



HAL
open science

Extrusion- spheronization of pharmaceutical products : system for the delivery of active ingredients which are poorly soluble by oral route

Thi Trinh Lan Nguyen

► **To cite this version:**

Thi Trinh Lan Nguyen. Extrusion- spheronization of pharmaceutical products : system for the delivery of active ingredients which are poorly soluble by oral route. Medicinal Chemistry. Université de Strasbourg, 2017. English. NNT : 2017STRAF047 . tel-01756974

HAL Id: tel-01756974

<https://theses.hal.science/tel-01756974>

Submitted on 3 Apr 2018

HAL is a multi-disciplinary open access archive for the deposit and dissemination of scientific research documents, whether they are published or not. The documents may come from teaching and research institutions in France or abroad, or from public or private research centers.

L'archive ouverte pluridisciplinaire **HAL**, est destinée au dépôt et à la diffusion de documents scientifiques de niveau recherche, publiés ou non, émanant des établissements d'enseignement et de recherche français ou étrangers, des laboratoires publics ou privés.



UNIVERSITÉ DE STRASBOURG

EDSC
École Doctorale des
Sciences Chimiques

ÉCOLE DOCTORALE DES SCIENCES CHIMIQUES

Laboratoire de Conception et Application de Molécules Bioactives (CAMB)

UMR 7199 CNRS Université de Strasbourg

THÈSE

présentée par :

Thi Trinh Lan NGUYEN

Soutenue le: **28/6/2017**

pour obtenir le grade de : **Docteur de l'université de Strasbourg**

Discipline/ Spécialité: Chimie

**Extrusion-sphéronisation de produits pharmaceutiques:
Système de délivrance des principes actifs peu solubles par voie orale**

THÈSE dirigée par :

VANDAMME Thierry

Professeur, université de Strasbourg

RAPPORTEURS :

Pr. LE Hau

Professeur,
université de pharmacie et médecine d'Hô-Chi-Minh-Ville, Vietnam

Pr. NGUYEN Ngoc Chien

Vietnam

Professeur, université de pharmacie de Hanoi,

AUTRES MEMBRES DU JURY :

ANTON Nicolas

HDR, université de Strasbourg

ACKNOWLEDGEMENTS

I would like to express my deepest thankfulness to all those who helped me during the work on my thesis at the University of Strasbourg.

This study was undertaken with financial support from the 911 programme and I want to thank to the People and the Government of Vietnam for scholarships and financial support.

First of all, I want to thank my supervisor **Prof. Dr. Thierry F. Vandamme** for giving me the opportunity to work and study in his research group, for his supervision, and scientific support.

I am deeply grateful to Dr. Nicolas Anton for proofreading parts of my thesis and for his valuable comments and suggestions.

I kindly thank Prof. Dr. Hau Le, Prof. Dr. Ngoc Chien Nguyen for their readiness to evaluate my thesis.

Special thanks also to Mr. Van Hai Ngo for his support, the motivating discussions and for his friendship.

Special thanks also to Mr. Jean-Serge Remy, Mrs. Véronique Bulach, Mrs. Nathalie Hammerschmitt, Mrs. Nathalie Kosman, Mrs. Isabelle Lapierre, Mrs. Nguyen Thi Ha Anh, Mrs. Ngo Thi Dieu Linh, Mr. Duong Viet Cuong, Mrs. Pham Thi Linh Giang, Mr. Ho Ngoc Dung and Mr. Dinh Xuan Tien for their support.

I thank my lab mates Li Xiang, Ding Shukai, Mohamed F. Attia, Justine Wallyn, Asad Ur Rehman, Bilal Mustafa, Salman Akram, Ali Imtiaz, Seralin Aidar, Mrs. Minjie Zhao and Mady Sy for the always friendly atmosphere in laboratory, for their support, the motivating discussions and for their friendship.

Furthermore, I thank all my colleagues of the Department of Pharmaceutical Industry of Hanoi University of Pharmacy.

Finally, I would like to express my deepest gratitude to my family and friends for their love and encouragement during this time and throughout my life.

Thi Trinh Lan Nguyen

TABLE OF CONTENTS

ACKNOWLEDGEMENTS	i
Table of contents	iii
Résumé.....	v
LIST OF TABLES	xvii
LIST OF FIGURES	xviii
LIST OF SYMBOLS AND ABBREVIATIONS	xxi
Chapter 1 : Introduction	1
1.1. Pellets	2
1.1.1. Introduction to pellet	2
1.1.2. General description of the extrusion spheronization process (wet mass extrusion)	6
1.1.3. Process and equipment.....	9
1.1.4. Formulation.....	15
1.1.5. Evaluation of Pellets.....	19
1.2. Nanoemulsions.....	20
1.2.1. Introduction	20
1.2.2. Method.....	22
1.2.3. Materials used in nanoemulsions production	25
1.3. Biopharmaceutical Classification System (BSC) and applications of pellet to improve dissolution rate of drugs in BCS class II	25
1.4. Coating	32
1.4.1. Introduction	32
1.4.2. Purpose of coating	32
1.4.3. Types of coating	33
1.4.4. Fluid bed coater	37
1.4.5. Enteric coating	41
Reference	44
Chapter 2 : Materials and methods	58
2.1. Materials and equipments	59
2.2. Methods	61
2.2.1. Characterization of folic acid	61
2.2.2. Characterization of ketoprofen.....	62

2.2.3. Preparation of emulsions	63
2.2.4. Preparation of pellets	63
2.2.5. Characterization of un-coated pellets	64
2.2.6. Preparation of coated pellets	68
2.2.7. Preparation of ketoprofen layered pellets	70
References	71
Chapter 3 : Influence of operational variables on properties of folic acid pellets prepared by extrusion-spheronization	72
3.1. Introduction	73
3.2. Physical characteristic of folic acid	74
3.2.1. Spectrophotometric analysis	74
3.2.2. Standard plot of folic acid	75
3.3. Preparation mixture Cremophor [®] ELP: Labrafil [®] M 1944 CS	76
3.4. Influence of operational variables on qualities of pellets prepared by extrusion-spheronization	77
3.4.1. Effect of type and screw speed of extruder	78
3.4.2. Effect of spheronization time	79
3.4.3. Survey the effect of drying techniques	80
3.5. Influence of formulation on properties of folic acid pellets prepared by extrusion-spheronization	82
3.5.1. Influence of oil and surfactants ratios on droplets size and size distribution of pellets	82
3.5.2. Influence of superdisintegrant, oil and surfactants ratios on disintegration time of pellets	84
3.5.3. In vitro drug release studies of folic acid pellets	85
3.5.4. Influence of oil and surfactants ratios on reconstitution of pellets	86
Conclusion	87
References	87
Chapter 4 : Development and characterization of enteric-coated immediate-release pellets of ketoprofen by extrusion-spheronization technique	89
4.1. Introduction	90
4.2. Physical characteristic of ketoprofen	92
4.2.1. Bulk density, tap density of ketoprofen	92
4.2.2. Spectrophotometric analysis	92

4.2.3.	Standard plot of ketoprofen	92
4.2.4.	Solubility study of ketoprofen in some solvents/surfactants	94
4.2.5.	Preformulation - compatibility studies between ketoprofen with excipients.....	94
4.3.	Survey effect of addition of different pelletizing agents and fillers.....	97
4.3.1.	Effect of addition of different pelletizing agents and fillers	98
4.3.2.	Effect of ratio of SOR 60.....	99
4.3.3.	Effect of the method combination SOR 60 in pellet	101
4.4.	Characteristics of the uncoated pellets	102
4.4.1.	Evaluation of pellets friability	102
4.4.2.	The physical characteristics of the uncoated pellets	102
4.5.	Enteric coating pellets.....	105
4.6.	Stability of enteric coated pellets	107
4.7.	Conclusion.....	110
	References.....	111
Chapter 5 : Influence of formulation and process variables on the quality of coated pellets prepared via Innojet Ventilus® V-2.5		
		113
5.1.	Introduction	114
5.2	Introduction of Innojet Ventilus® V-2.5, rotojet nozzle, type IRN 2.....	115
5.3.	Results and discussion.....	121
5.3.1.	The amount of liquid binder	121
5.3.2.	Batch size.....	122
5.3.3.	Characteristic of the coating layer pellets	124
5.3.4.	In-vitro drug release study	125
5.4.	Conclusion.....	126
	References.....	126
Chapter 6 : General discussion.....		
		127
Appendices.....		
		131

Résumé

1. Introduction

Les formes pharmaceutiques destinées à l'administration par voie orale et plus particulièrement les formes sèches (comprimés et gélules) jouent un rôle de tout premier plan dans la recherche et le développement industriel pharmaceutique. Elles représentent plus de 60% des médicaments produits dans le monde (Lindenberg *et al.*, 2004). D'administration très simple et très sûre, elles conduisent à des médicaments de stabilité très satisfaisante (par rapport aux formes liquides) avec des procédés industriels maîtrisés et économiquement intéressants.

40% des molécules actuellement en développement sont apolaires et donc peu solubles en milieu aqueux (Lipinski C.A. *et al.*, 2001, 2002; Lindenberg M. *et al.*, 2004).. Lorsqu'une administration par voie orale est recherchée pour obtenir une action systémique du principe actif (PA), une faible solubilité ainsi qu'une vitesse de dissolution lente dans les fluides digestifs, une possible dégradation dans le tractus gastro-intestinal (TGI), une faible perméabilité membranaire ou bien une élimination pré-systémique de ce dernier peuvent entraîner une biodisponibilité réduite (Aungst, 1993). Depuis de nombreuses années, l'amélioration de la solubilité des principes actifs peu solubles est devenue l'un des principaux enjeux de l'industrie pharmaceutique.

Le système de classification biopharmaceutique (SCB) est un outil d'orientation pour la prédiction de l'absorption d'un PA en fonction de sa solubilité dans les fluides digestifs et de sa perméabilité gastro-intestinale. Il est basé sur le fait que ces deux paramètres fondamentaux contrôlent à la fois la vitesse et la quantité de molécules absorbées. Les molécules de classe II sont connues pour leur biodisponibilité faible et variable, due essentiellement à une dissolution insuffisante et une solubilité limitée dans les fluides du TGI (Amidon *et al.*, 1995, Yu *et al.*, 2002).

Les nano-émulsions (NE) sont administrées par voie orale sous forme préformée (Tiwari and Amiji, 2006, Vyas *et al.*, 2008, Shen *et al.*, 2011) ou bien

sous forme de capsules molles contenant des systèmes auto-nano-émulsionnants (SNEDDS). Les capsules molles présentent certains inconvénients (équipement très spécial, risque important d'interactions contenu-contenant, migration du principe actif vers l'enveloppe et donc risque du piégeage du principe actif) (Gullapalli, 2010).

Une nanoémulsion et sa transformation physique ultérieure dans un système de forme solide offrent plusieurs avantages pour l'amélioration de la solubilité et de la dissolution des taux de médicaments solubles dans l'eau pour l'administration orale. Cette technologie pourrait également être développée pour surmonter la mauvaise absorption de certains ingrédients pharmaceutiques actifs.

Parmi les différentes techniques d'élaboration des formes divisées, le procédé d'extrusion-sphéronisation présente de nombreux avantages. Cette technologie permet notamment d'élaborer des minigranules fortement chargées en principe actif (taux dépassant les 50%) et permet d'éviter l'emploi de solvants organiques. Dans ce cas, l'extrusion-sphéronisation répond alors à la définition d'un « procédé vert », étant une méthode alternative aux procédés de montage en turbine ou en lit d'air fluidisé qui peuvent nécessiter l'emploi de solvants organiques. Les minigranules, encore appelées pellets sont une forme pharmaceutique sèche qui offre de nombreux avantages pour l'absorption de principes actifs administrés par voie orale. C'est une forme solide qui peut être pelliculée et qui peut se présenter dans son état d'origine, dans des gélules ou être sous forme de comprimés.

L'enrobage est une opération importante qui est très largement utilisée dans le domaine pharmaceutique, pour l'application d'enrobages non-fonctionnels ou fonctionnels (esthétiques, protecteurs ou films polymères contrôlant le taux) et pour le dépôt des ingrédients pharmaceutiques actifs (principes actifs) sur des non pareils (formes de dosage à particules multiples). Ils sont appliqués pour masquer le goût, modifier la couleur, protéger physiquement les comprimés et/ou créer une libération différente des médicaments lors de la production pharmaceutique.

Le but du travail de thèse est de décrire les propriétés et les procédés de fabrication de minigranules permettant d'augmenter la solubilité des principes actifs peu solubles dans l'eau et donc d'améliorer leur biodisponibilité lors de

l'administration par voie orale, pour deux modèles de molécules différentes qui sont l'acide folique (vitamine peu soluble dans l'eau) et le kétoprofène (anti-inflammatoire non stéroïdien qui présente une solubilité limitée dans les fluides gastriques à cause de la valeur de son pKa (classe II dans le système de classification biopharmaceutique – BCS, ayant une action anti-inflammatoire, antalgique et antipyrétique)). Chacune de ces minigranules comprend un cœur de principe actif peu soluble et une pellicule d'enrobage appliquée sur le cœur. Leurs diamètres moyens est inférieur à 1000 microns. La pellicule d'enrobage contient un polymère hydrosoluble pour la formulation contenant de l'acide folique et un polymère insoluble dans les liquides du tractus gastro-intestinal pour la formulation du kétoprofène.

Mots-clés:

Principe actif faiblement soluble, amélioration de la solubilité, extrusion-sphéronisation, minigranule, pellet, kétoprofène, acide folique, lit fluidisé.

2) Résultats et discussions

L'objectif du travail de recherche consiste à trouver la formulation la plus appropriée pour encapsuler de l'acide folique et du kétoprofène dans des minigranules pharmaceutiques et de permettre une libération rapide de ces principes actifs dans un système mimant le tractus gastro-intestinal.

La préformulation a été la première étape de cette étude. Des mélanges binaires ont été réalisés entre la sélection des excipients et celui des PA.

Les nanoémulsions contenant du kétoprofène et de l'acide folique ont été formulées avec un rapport Cremophor[®] ELP: Labrafil[®] M1944CS = 10: 5 à l'aide d'une technique d'émulsification à basse énergie.

Plusieurs paramètres de formulations (combinaison d'excipients et de PA) et de procédé d'extrusion-sphéronisation (mélange – extrusion – sphéronisation – séchage et tamisage) ont été modifiés durant la préparation des minigranules chargées en kétoprofène et en acide folique.

Les caractéristiques de l'extrudeur de laboratoire (Extrusion[®] Caleva 120, Royaume-Uni) qui a été utilisé dans les conditions de l'étude sont les suivantes: systèmes d'extrusion: radial, frontal; type de vis: mono-vis; vitesse de la vis (tpm): 20, 30, 40.

Pour produire les minigranules au cours de cette étude, nous nous sommes servis d'une extrudeuse à vis pour laboratoire de la marque Caleva. Cette extrudeuse de laboratoire est utilisée pour la recherche et le développement de procédés de fabrication sur des petits lots allant de 100 g à 1 kg.

Deux types de grilles d'extrusion existent pour cet appareil: matrice radiale et axiale. Les matrices radiales correspondent à une grille faisant le tour de la vis, les extrudats sont éjectés perpendiculairement aux mouvements de la vis. Cette matrice donne une plus grande capacité car le nombre d'orifices est plus important. Le diamètre des orifices peut aller de 0,5 mm à 2 mm de diamètre et de 0,5 mm à 4 mm de profondeur.

Les matrices axiales sont composées d'une grille plate disposée au bout de la vis : elles sont plus flexibles que les précédentes, la profondeur des orifices peut aller jusqu'à 8 mm. Le diamètre des orifices peut varier de 0,5 mm à 2 mm. Elle est la méthode de choix si une capacité suffisante peut être atteinte. Une matrice axiale est utilisée durant cette étude, le diamètre des orifices et la profondeur sont de 1 mm.

Le principe de l'extrusion est de produire des copeaux d'agglomérats appelés extrudats par une opération continue où une masse humide est transportée, comprimée et forcée à travers des orifices cylindriques par une vis sans fin. Les extrudats obtenus par cette méthode doivent présenter une cohésion suffisante pour garder leur forme et ne pas se désagréger en poudre lors de l'étape de sphéronisation.

Pour obtenir des sphéroïdes, ces extrudats doivent posséder une cohésion, une friabilité, une déformabilité et une plasticité suffisante.

Le sphéroniseur de laboratoire (Caleva[®] MBS 250, Caleva, Sturminster Newton, Dorset, Royaume-Uni) a été utilisé dans les conditions de l'étude suivante: charge du sphéroniseur (g): 50, 100, 200, 400; vitesse de sphéronisation (tpm): 600, 1100.

Le sphéroniseur MBS-250 Caleva permet d'obtenir à partir des extrudats, des sphéroïdes homogènes. Il est composé d'un tambour cylindrique fixe à parois lisses, il est ouvert sur sa partie supérieure pour introduire les extrudats humides. Un plateau mobile comprenant une surface crénelée composée de petites

pyramides est placé à sa base. Le sphéroniseur utilisé lors de cette étape peut contenir de 100 g à 1 kg de matière.

Pour obtenir des particules sphériques nous devons introduire les extrudats dans le tambour: ils seront entraînés par le plateau tournant à une vitesse définie. Les extrudats vont tourner dans le sens de rotation du plateau et seront projetés sur la paroi par force centrifuge. Ces collisions successives contre la paroi et le plateau vont provoquer une cassure des extrudats en cylindres plus petits qui vont progressivement s'arrondir en sphères par des forces de friction et de rotation engendrées par les collisions précédentes et des chocs interparticulaires.

Les minigranules seront ensuite placées à l'étuve une nuit pour être séchées et durcir.

Les systèmes obtenus ont été caractérisés par l'étude du profil de libération *in vitro* en milieu acide (pH 1,2 HCl 0,1M) et plus alcaline à pH 6,8 avec un tampon phosphate. Les libérations ont été volontairement réalisées en condition «non sink» afin d'évaluer le potentiel des formulations à produire des solutions sursaturées et la durée de ces dernières à libérer l'ensemble du principe actif (fig. 1).

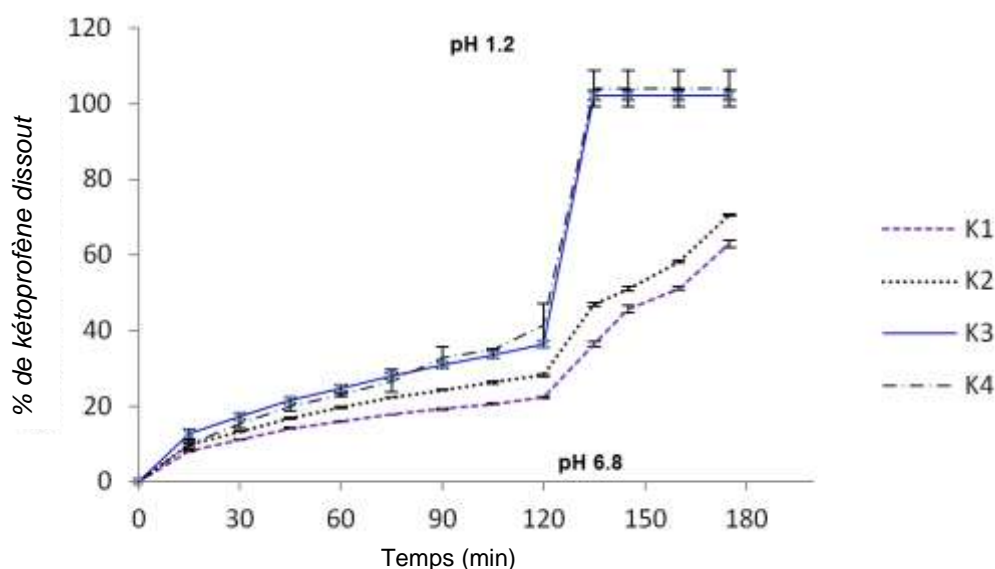

Figure 1. Etude de la dissolution de 4 formulations (K1-K4) de minigranules contenant du kétoprofène non-enrobées dans différents tampons (pH 1,2 et pH 6,8)

Les minigranules ont ensuite été analysées en fonction de cinq critères: la taille moyenne des minigranules, l'angle de repos, l'écoulement, le rapport d'Hausner et la friabilité. Leurs critères pour l'obtention d'un bon granulé sont : une distribution de taille étroite, un petit angle de repos, un écoulement rapide, et un rapport d'Hausner bas ($< 1,25$) ainsi qu'une faible friabilité ($< 0,5\%$).

La morphologie des minigranules a été évaluée par des observations à l'aide d'un microscope électronique à balayage (MEB) (JEOL 2600F) (fig. 2).

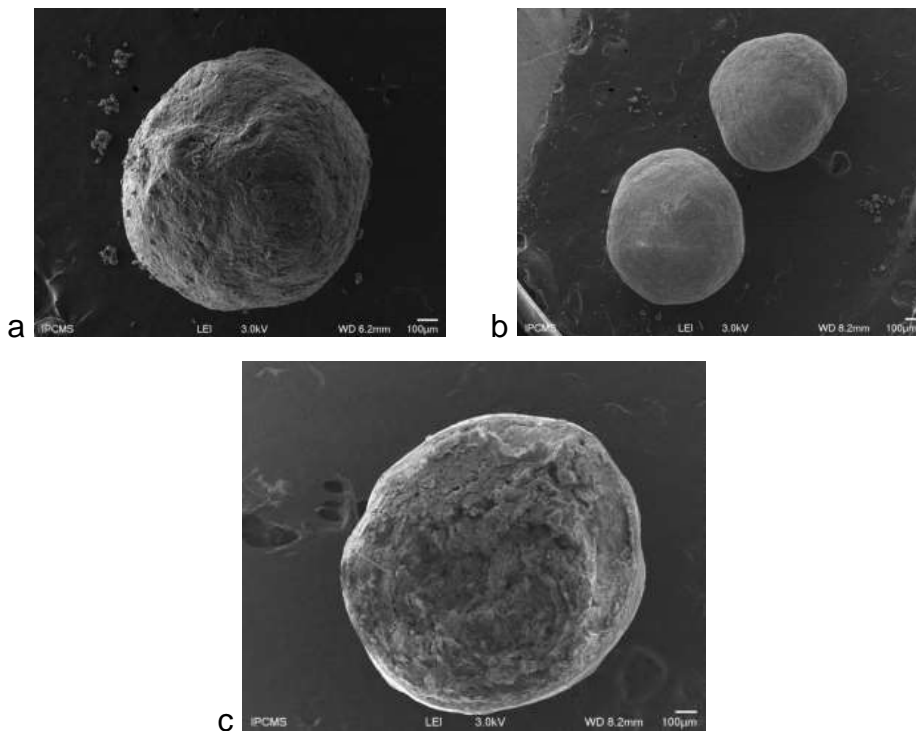

Figure 2. Morphologies de minigranules contenant du kétoprofène: a. minigranule non-enrobée; b. minigranules enrobées avec 15% Acryl-EZE[®] 93A92545 (surface); c. minigranule enrobée avec 15 % d'Acryl-EZE[®] 93A92545 (coupe transversale)

Les minigranule non enrobées (fig. 2a) ne présentent pas de pores en surface, même si les angles aigus sont très bien visibles. De plus, la surface des minigranules de kétoprofène enrobées Acryl EZE[®] 93A92545 était lisse (fig. 2b).

La formulation la plus efficace a été pelliculée pour protéger l'acide folique de la dégradation par les UV. Ce pelliculage est composé d'un mélange d'excipients contenant notamment de l'hydroxypropyl méthyl cellulose (HPMC) et du dioxyde de titane dispersés dans de l'eau (Advantia[®]Preferred HS/ immediate-

release coating). Les résultats de dissolution ont montré que le pourcentage d'acide folique avec le mélange Cremophor[®] ELP: Labrafil[®] M1944CS (formula F4) libérait plus rapidement en milieu acide que les minigranules ne contenant pas de Cremophor[®] ELP: Labrafil[®] M1944CS (fig. 3). Nous n'observons pas de différence entre les deux formulations F1 et F2 en ce qui concerne le profil de dissolution. Les minigranules non pelliculées libèrent le principe actif à environ 40% après 60 min.

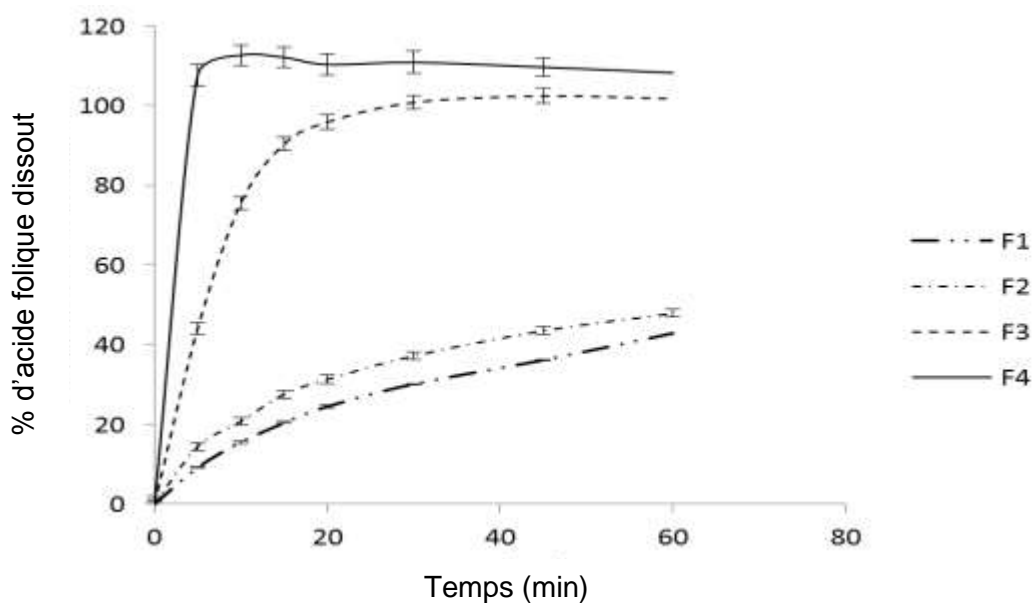

Figure 3. Etude de la libération du principe actif à partir des minigranules d'acide folique non-enrobées: (F1-F4).

Afin de protéger la muqueuse gastrique contre une irritation par le kétoprofène, les minigranules de kétoprofène à enrobage gastro-résistant sont contenues dans une capsule. Celle-ci se désagrège dans l'estomac, libérant les pellets qui sont transportés dans l'intestin, lieu d'absorption du principe actif. Ensuite, un film d'enrobage à base d'agents insolubles dans l'eau est nécessaire pour créer une barrière à la libération de la substance active. Le film peut être composé de polymère(s) contenu(s) dans une émulsion ou dans une dispersion aqueuse (Acryl – EZE[®] et Advantia[®] Performance/enteric-release coating).

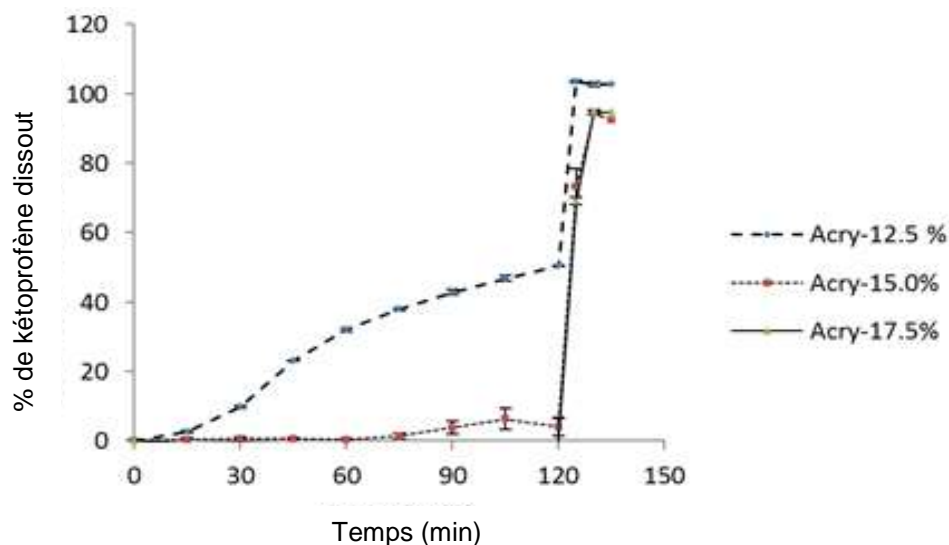

Figure 4. Etude de la libération du principe actif à partir de minigranules de kétoprofène enrobées par Acryl – EZE® 93A92545

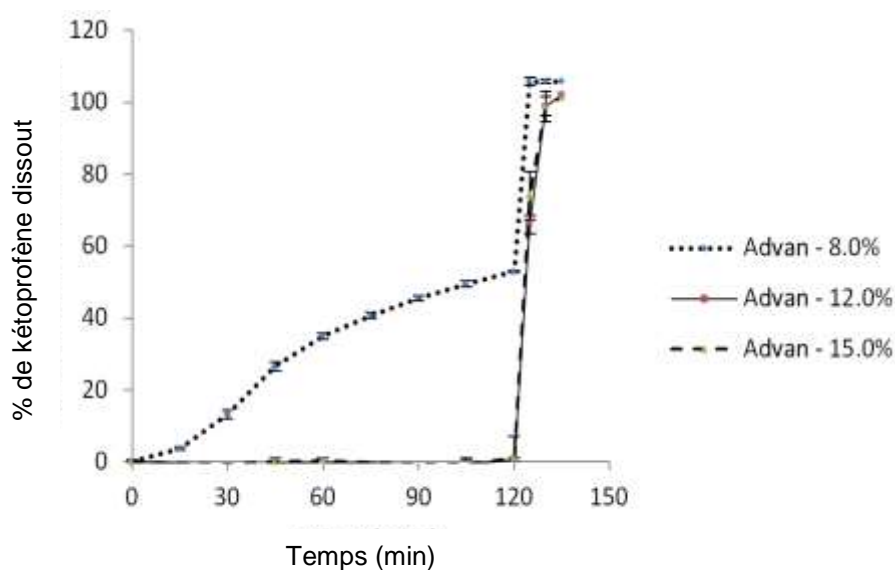

Figure 5. Etude de la libération du principe actif à partir de minigranules de kétoprofène enrobées par Advantia® Performance 190024HA49

Les minigranules pelliculées libèrent le principe actif à environ 80% après 10 min. Le maximum de libération est obtenu après 30 min à 90% pour la forme pelliculée. Le pelliculage choisi n'affecte pas la libération du principe actif car il est rapidement dissout dans le liquide à pH 1,2 et à pH 6,8. Ce pelliculage peut donc être utilisé pour protéger les pellets sans interférer sur le profil de dissolution de

l'acide folique et du kétoprofène (figure 4, 5). La taille des gouttelettes des émulsions est évaluée par diffraction laser avant extrusion-sphéronisation et suite à la libération du principe actif (< 150 nm).

Le gain des masses minimales nécessaires pour obtenir une libération entérique a également été déterminé: 15,0% Acryl-EZE[®] 93A92545 et 10,0% Advantia[®] Performance 190024HA49. Les résultats de dissolution ont montré que le pourcentage de médicament libéré dans l'environnement acide ne dépasse pas 3%. Après 10 minutes dans un tampon à pH 6,8, la libération totale est d'au moins 86%, ce qui est dans les limites fixées par la pharmacopée américaine pour la libération entérique (figure 4, 5).

Les enrobages sont utilisés pour les formulations solides pour des raisons décoratives, de protection ainsi que pour des raisons fonctionnelles. Ces enrobages sont généralement appliqués par un procédé de pulvérisation dans lequel le polymère est pulvérisé sur le substrat solide.

Les formes pharmaceutiques enrobées sont les plus représentées et proposent de nombreux avantages tels que la libération « temps-dépendante », le masquage de goût, la protection contre l'humidité, la libération site-spécifique pour cibler des portions du tube digestif, la facilité d'administration, une biodisponibilité accrue, une meilleure stabilité à long terme ainsi qu'une facilité d'identification du produit et l'amélioration de l'aspect esthétique. C'est pourquoi de nombreux produits médicamenteux sur le marché sont des formes pelliculées et les progrès dans la conception de formulation pharmaceutique, les techniques de fabrication et les méthodes de caractérisation ont une grande importance pratique.

Aujourd'hui, le lit fluidisé est largement mis à profit dans le domaine pharmaceutique, notamment pour des opérations de mélange, de granulation humide, de séchage, de pelletisation/sphéronisation ou d'enrobage. Les différents types de lits fluidisés utilisés pour l'enrobage pharmaceutique sont caractérisés par des éléments spécifiques dans leur conception et fonctionnement et par des domaines d'applications propres. Les systèmes d'enrobage à pulvérisation par le bas et à pulvérisation tangentielle conduisent à des enrobages de meilleure qualité que les systèmes à pulvérisation par le haut. Les récents progrès techniques des équipements et l'avancée des connaissances en formulation

galénique rendent possibles de nombreuses applications galéniques innovantes de l'enrobage en lit fluidisé. Le dépôt de l'agent d'enrobage sous forme liquide peut être remplacé par l'utilisation de poudres sèches ou par un procédé de fusion lipidique et ce, pour tous les systèmes de pulvérisation. Le microenrobage lipidique est préférentiellement réalisé en lit d'air fluidisé avec pulvérisation par le haut alors qu'une pulvérisation par le bas ou tangentielle est plutôt employée pour l'enrobage de pellets par des poudres sèches.

Diverses techniques d'enrobage existent telles que la pulvérisation, la double compression, l'immersion et la formation de couches de poudres qui sont utilisées selon le type de matières concernées et les caractéristiques souhaitées pour l'enrobage final.

Cependant, l'enrobage par pulvérisation, c'est-à-dire le processus par lequel un substrat solide est recouvert d'une mince couche de polymère déposé à partir d'une suspension ou d'une solution nébulisée reste la technique de référence, ceci en raison de son caractère avantageux en termes de temps, de coûts et d'évolutivité du processus, d'homogénéité de l'épaisseur, de la structure et de la surface de la couche, de la fine modulation du niveau d'enrobage et de la polyvalence en ce qui concerne le type et les dimensions des noyaux de départ. Différentes techniques de pulvérisation (pulvérisation inférieure, supérieure, de type Wurster ou de côté avec un anneau rotatif) existent et présentent chacune leurs avantages (poids limite de chargement de l'appareil ou homogénéité des formes solides à enrober et de l'enrobage). L'enrobage peut se faire par pulvérisation d'une solution contenant ou non du principe actif («drug coating») ou d'une poudre (pelliculage à sec).

Pour réaliser le pelliculage, nous avons employé un lit d'air fluidisé (Innojet VENTILUS® V-2.5 - Herbert Hüttlin). Avec cet appareil, nous pouvons réaliser de la granulation, de l'enrobage et du séchage.

Les paramètres restant fixes durant ce travail sont résumés dans la liste suivante:

- La position de la buse de pulvérisation: position supérieure.
- L'angle de dispersion de la buse de pulvérisation: dépendant de l'ajustement des deux parties de la buse bi-fluide (4,2 mm entre la buse et l'écrou).

- L'hygrométrie de l'air: précision selon le maniement du déshumidificateur.

Les paramètres du pelliculage ont également été étudiés, à savoir:

- Paramètres liés aux pellets: la distribution granulométrique: la taille des particules est comprise entre 1,0 mm et 1,4 mm, la hauteur du lit de pellets/quantité au moins de 50 % du volume de la chambre d'expansion.

- Paramètres d'entrée d'air de fluidisation (température, débit): température de l'air de fluidisation: la température optimale durant l'enrobage est de 60°C.

Débit de l'air de fluidisation: un débit trop important entraîne les minigranules vers les filtres et peut provoquer l'apparition de fines par attrition. Un débit trop faible provoque une fluidisation insuffisante.

- Paramètres d'entrée des suspensions aqueuses (concentration, quantité de solution pulvérisée).

- La pression de pulvérisation de l'air comprimé: 1,5 bar.

Ces essais ont été réalisés avec des pressions de 0,5 bar, 1,0 bar, 1,5 bar et 2,0 bar, le tout en gardant fixe la température d'air de fluidisation et le débit de la pompe. Il ressort que la pression de l'air de pulvérisation pour assurer une bonne répartition des minigranules, une bonne capacité au tassement ainsi qu'une bonne vitesse d'écoulement est la meilleure à 1,5 bar.

Les technologies d'enrobage en lit d'air fluidisé par pulvérisation d'une solution de nanoémulsion contenant du kétoprofène sur des microgranules inertes constituées d'un coeur solide (Cellets®) peut également être réalisée.

Les résultats expérimentaux permettent d'illustrer la performance d'un enrobage pour l'amélioration de la solubilité des principes actifs peu solubles.

Deux types d'études de stabilité des minigranules ont été réalisées: dégradation accélérée et en temps réel (température, humidité). Les méthodes générales d'analyse des études de stabilité comprenaient: un examen visuel, une identification, un essai d'uniformité de masse, un essai de désagrégation, et un essai de dissolution.

Les échantillons de minigranules présentés dans les bouteilles en verre ambré sont placés dans des humidificateurs contenant une solution saturée de NaCl et de NH_4NO_3 . Ces humidificateurs sont introduits dans des étuves maintenues à 25, 30 et 40°C pendant 3 ou 6 mois suivant la température choisie.

Tous les systèmes étudiés présentent un profil de libération du kétoprofène et de l'acide folique beaucoup plus rapide comparé à ceux des produits commerciaux (Profenid[®] 50 mg (kétoprofène) et de l'acide folique (complément alimentaire utilisé comme référence au Vietnam)) et à celui de la vitesse de solubilisation des principes actifs purs.

3) Conclusion générale

Cette étude nous a permis d'étudier la biodisponibilité de l'acide folique et du kétoprofène dans une forme sèche particulière: les minigranules. Nous avons défini une formulation efficace pour libérer la totalité du principe actif à partir des minigranules qui permet d'atteindre la vitesse de dissolution la plus rapide possible pour l'acide folique et pour le kétoprofène. Les techniques de préparation de ces systèmes sont relativement faciles à mettre en œuvre pour permettre d'assurer la reproductibilité et la qualité des formulations. Après reconstitution, ces formes se délitent et libèrent l'émulsion, ce qui permet de développer une grande surface d'échange avec les milieux digestifs et permet de la sorte une absorption rapide des principes actifs libérés.

4) Références

- Amidon G.L., Lennernas H., Shah V.P., Crison J.R., (1995). A theoretical basis for a biopharmaceutic drug classification: the correlation of in vitro drug product dissolution and in vivo bioavailability. *Pharm. Res.* 12, 413–420.
- Aungst B.J., (1993). Novel formulation strategies for improving oral bioavailability of drugs with poor membrane permeation or presystemic metabolism. *J Pharm Sci*, 82: 979-987.
- Gullapalli R.P., (2010). Soft gelatin capsules (softgels). *J Pharm Sci.*, 99(10): 4107-48.
- Lindenberg M., Kopp S., Dressman J. B., (2004). Classification of orally administered drugs on the World Health Organization Model list of Essential Medicines according to the biopharmaceutics classification system, *European Journal of Pharmaceutics and Biopharmaceutics*, 58 (2), 265–278.

- Lipinski C.A., (2002). Poor aqueous solubility: industry wide problem in drug discovery. *Am Pharmaceut Rev*, 5, 82–85.
- Lipinski C.A., Lombardo F., Dominy B.W., Feeney P.J., (2001). Experimental and computational approaches to estimate solubility and permeability in drug discovery and development settings. *Adv Drug Deliv Rev.*, 46 (1-3), 3-26.
- Shen Q., Wang Y. and Zhang Y., (2011). Improvement of colchicine oral bioavailability by incorporating eugenol in the nanoemulsion as an oil excipient and enhancer. *Int. J. Nanomedicine*, 6, 1237-1243.
- Tiwari S.B., Amiji M.M., (2006). Improved oral delivery of paclitaxel following administration in nanoemulsion formulations. *J. Nanosci. Nanotechnol* 6, 3215-3221.
- Vyas T. K., Shahiwala A. and Amiji M.M., (2008). Improved oral bioavailability and brain transport of Saquinavir upon administration in novel nanoemulsion formulations. *Int. J. Pharm.*, 347, 93-101.
- Yu L. X., Amidon G. L., Polli J. E., Zhao H., Mehta M. U., Conner D. P., Shah V. P., Lesko L. J., Chen, M. L., Lee V. H. and Hussain A. S., (2002). Biopharmaceutics classification system: the scientific basis for biowaiver extensions. *Pharm. Res.*, 19, 921-925.

LIST OF TABLES

Table 1.1. Examples of commonly used excipients	19
Table 1.2. List of different evaluation methods for determination of pellet properties	20
Table 1.3: Excipients used for formulation of o/w nanosized emulsions.....	25
Table 1.4. Options for formulation of poorly water-soluble drugs	27
Table 1.5: Enteric polymers and their threshold pH	42
Table 2.1. List of Materials	59
Table 2.2. List of equipments	60
Table 3.1. Absorbance and concentration of folic acid in stock solution and dilutions.....	75
Table 3.2. Droplet size and polydispersity Index (Pdl) measurement of mixture Cremophor [®] ELP: Labrafil [®] M 1944 CS	76
Table 3.3. Compositions of pellets contained folic acid.....	77
Table 3.4. Total output (gram) of the extrudate with two kinds of extruder.....	78
Table 3.5. The effect of ingredients, water, and spheronization time to qualities of pellets	79
Table 3.6. Some parameters of drying techniques	80
Table 3.7. Results of flow ability and friability of pellets	83
Table 3.8. Droplet size and polydispersity index measurement of nanoemulsion release from pellets after production and subjected to different storage after 3 months of storage at room temperature.....	86
Table 4.1. Absorbance and concentration of ketoprofen in stock solution and dilutions...	93
Table 4.2. The solubility of ketoprofen in various solvents	94
Table 4.3. Compositions of pellets batches	97
Table 4.4. Physical characteristics of the uncoated pellets	102
Table 4.5. Droplet size and polydispersity index (Pdl) measurement of nanoemulsion release from pellets after production	103
Table 4.6. Preparation of CKL3 pellets with different enteric coating	105
Table 5.1. Shows optimization of spray rate	122
Table 5.2. Composition of the batches and results of drug layering processes.....	124

LIST OF FIGURES

Figure 1.1. Schematic overview of the steps involved in an extrusion-spheronization process.....	6
Figure 1.2. The extrusion spheronization process (wet mass extrusion)	7
Figure 1.3: Critical factors in E-S (adapted from Ghebre-Sellassie and Knoch, 2002; Trivedi et al., 2007)	8
Figure 1.4. Schematic overview of the extruder types applied in extrusion-spheronization. Screw feed extruders with axial (a), dome (b) and radial (c) type, gravity feed extruders with cylinder (d), gear (e) and radial type (f) and piston feed ram extruders (g)	10
Figure 1.5. Photograph (plan view) of spheroniser plate in motion.	12
Figure 1.6. Friction plate design: (a) cross-hatch pattern; (b) radial pattern; (c) striated edge pattern, (d) cross-hatched friction plate (pyramidal elements on a square pattern, spacing 1.40 mm, height 0.86 mm and width at top 0.50 mm).....	12
Figure 1.7. Schematic presentation of the different pellet formation stages during spheronization according to Rowe (a), Baert and Remon (b) and Koester and Thommes (c).....	13
Figure 1.8. Coating powder adhesion process.....	37
Figure 1.9 (a-e). Diagrams showing the dynamics of a coating process.....	377
Figure 1.10. A schematic diagram of a top-spray fluidised bed coater.	39
Figure 1.11. A schematic diagram of a bottom-spray Wurster fluidised bed coater (Aerocoater).....	40
Figure 1.12. A schematic diagram of a rotary processor.....	41
Figure 3.1. Structural formula of folic acid.....	73
Figure 3.2. UV- Spectrum of folic acid in water.....	75
Figure 3.3. Standard calibration curve of folic acid in water.....	76
Figure 3.4. Light microscopy images of pellets with different spheronization times:	80
Figure 3.5. Drying times of fluid bed dryer and hot-air oven	81
Figure 3.6. Granulometric distributions of the pellets obtained in different formulations.	83
Figure 3.7. Disintegration time of various formulations	84

Figure 3.8. Effect of superdisintegrant sodium starch glycolate in different concentration (0 %- F1; 1%-F2; 2.5%-F3; 5%-F4) on in vitro release of folic acid (n=3, mean \pm SD).....	85
Figure 3.9. Percentage of folic acid released from pellet formulations prepared from mixtures of nanoemulsion (n=3, mean \pm SD).....	86
Figure 4.1. Ketoprofen structure formula.....	90
Figure 4.2. UV- Spectrum of ketoprofen in pH 1.2, λ_{\max} =258.4 nm (left) and in pH 6.8, λ_{\max} =260.0 nm (right)	92
Figure 4.3. Standard calibration curve of ketoprofen in pH 1.2, pH 6.8 phosphate buffer.....	93
Figure 4.4. Binary mixture ratio 1:1 of ketoprofen with HPMC (left) and ketoprofen with PVP (right) after 6 months were stored under accelerated stability test conditions.....	97
Figure 4.5. Release profile of uncoated pellets in pH 1.2 and then pH 6.8 phosphate buffer.	98
Figure 4.6. Release profile of uncoated pellets in pH 6.8 phosphate buffer	99
Figure 4.7. Release profile of uncoated pellets with different ratio SOR 60 in pH 1.2 and then pH 6.8 phosphate buffer.....	100
Figure 4.8. Release profile of uncoated pellets with different ratio SOR 60 in pH 6.8 phosphate buffer.	100
Figure 4.9. Release profile of uncoated pellets with SOR 60 was mixed directly with powder had KPF (KCL3); KPF was prepared by dissolution in SOR 60 (KCL3 a) in pH 1.2 and pH 6.8 phosphate buffer (pH 1.2 (0-2h) + pH 6.8 (2-3h)).....	101
Figure 4.10. Release profile of uncoated pellets with SOR 60 was mixed directly with powder had KPF (KCL3); KPF was prepared by dissolution in SOR 60 (KCL3a) in pH 6.8 phosphate buffer.....	102
Figure 4.11. Light microscopy images of KCL3 pellets	104
Figure 4.12. Light microscopy images of KCL4 particles	104
Figure 4.13. SEM images of KCL3 pellets	105
Figure 4.14. Dissolution profile of Acryl – EZE [®] 93A92545 coated pellets in fluid of pH 1.2 for first 2 h, and then continued in buffer of pH 6.8	106

Figure 4.15. Dissolution profile of Advantia® Performance 190024HA49 coated pellets in fluid of pH 1.2 for first 2 h, then continued in buffer of pH 6.8.....	106
Figure 4.16. SEM images of the pellets: a. Pellets coated with 15% Acryl-EZE® (Surface); b. Pellets coated with 15 % Acryl-EZE® 93A (Cross-section)	107
Figure 4.17. Loss on drying of ketoprofen enteric-coated pellets during stability study under three different conditions for a period of 6 months.	108
Figure 4.18. % drug released from ketoprofen enteric-coated pellets after 2h in pH 1.2 during stability study in three different conditions for a period of 6 months... ..	109
Figure 4.19. The drug remaining from coated pellets after being stored at 40°C/75% RH for 1, 2, 3 and 6 months.....	109
Figure 5.1. The Innojet Ventilus® V-2.5 laboratory scale was applied by Romaco Innojet GmbH.	116
Figure 5.2. Product container IPC1 (a) and IPC2.5 (b)	116
Figure 5.3. a and b. The design of the spray nozzle Rotojet type IRN 2.....	118
Figure 5.4. The design of the spray nozzle Rotojet type IRN 2.....	119
Figure 5.5. Functional principle of booster ORBITER and spray nozzle ROTOJET	120
Figure 5.6. Integrated hose pump.....	120
Figure 5.7. Relation between amount of liquid binder (water) when adjustment of spray rate and spray pressure was performed with spray rate 10 %, 15 % and 20%.....	121
Figure 5.8. Efficiency of coating calculates according to batch size	123
Figure 5.9. Depositing of coating material on the walls of the partition with three different inventories 15 % (a), 30% (b), 50% (c) of the maximum capacity in the product container IPC1.	123
Figure 5.10. Design of air grinding blades (a) and small pellets can “leak” and “were trapped” on the sieve of the product container (b)	125
Figure 5.11. Dissolution profile of layer coating pellets in different media.....	125

LIST OF SYMBOLS AND ABBREVIATIONS

°C	: Degree Celsius
µm	: Micrometer
API	: Active ingredient pharmaceutical
BCD	: Beta Cyclodextrin
BP	: British pharmacopoeia
CCS	: Croscarmellose sodium
dpm	: Dip per minute
DT	: Disintegration time
E-S	: Extrusion-spheronization
FA	: Folic acid
HPBCD	: Hydroxypropyl Beta Cyclodextrin
ICH	: International Conference on Harmonisation
IPEC	: International Pharmaceutical Excipients Council
KLHT	: Kollagen hydrolizate derivative
KPF	: Ketoprofen
MCC	: Microcrystalline cellulose
MDT	: Mean dissolution time
nm	: Nanometer
Ph. Eur.	: the European Pharmacopoeia
r^2	: Correlation coefficient
rpm	: Revolution per minute
SSG	: Sodium starch glycolate
USP	: The United States Pharmacopeia
UV	: Ultraviolet
v/w	: Volume by weight
w/w	: Weight by weight

Chapter 1 : Introduction

This chapter gives a brief overview of pellet technology, including its historical development and a classification of pharmaceutical pelletization processes, extrusion and spheronization equipment, film coating and fluid bed coater.

This chapter is mainly composed of the following accepted book chapters:

1. Thi Trinh Lan Nguyen, Nicolas Anton, Thierry F. Vandamme (2017); Chapter 9: “*Nutraceutical compounds encapsulated by extrusion-spheronization*”, in the book “New Polymers for Encapsulation of Nutraceutical Compounds”, Wiley, p. 195-230.
2. Thi Trinh Lan Nguyen, Nicolas Anton, Thierry F. Vandamme (2017); Chapter 8: “*Oral pellets loaded with nanoemulsions*”, in the book “Nanostructures for Oral Medicine”, Elsevier, p. 203 -230.

1.1. Pellets

1.1.1. Introduction to pellet

Historically, the term *pellet* has been used by a number of industries to describe a variety of agglomerates produced from diverse raw materials, using different pieces of manufacturing equipment. These agglomerates include fertilizers, animal feeds, iron ores, and pharmaceutical dosage units and thus do not only differ in composition but also encompass different sizes and shapes. In the pharmaceutical industry, pellets can be defined as spherical or nearly spherical, free flowing particles with a narrow size distribution, varying between 500 and 1500 μm manufactured by the agglomeration of fine powders or granules of drug substances and excipients using appropriate processing equipment (Ghebre-Sellassie I., 1989; Ghebre-Sellassie I. and Knoch A., 2007) and pellets are commonly filled into hard gelatine capsules but can also be compressed to tablets; furthermore, modified release dosage forms can be created (Conine and Hadley, 1970; Malinowski and Smith, 1975; Millili and Schwartz, 1990; Ghanam D. and Kleinebudde P., 2011; Mehta *et al.*, 2012; Hosseini *et al.*, 2013; Csobán Z. *et al.*, 2015; Xu M. *et al.*, 2015).

Pellets are spherical particles with a size normally between 100 and 1000 μm packed into capsules or compressed into tablets and taken orally. They are produced by an extrusion and spheronization process, by layering core pellets using drug dispersion, or by direct pelletization in a fluidized bed rotor chamber. Pellets are usually film-coated with one or more layers of polymer film that provide protection of the active ingredient or control the release of the drug (Fukumori and Ichikawa, 2006).

Pellets can be produced through different procedures. Variety of techniques is available for pellet manufacturing. In recent years extrusion-spheronization, cryopelletization, freeze pelletization and hot melt extrusion have been used to produce spherical pellets:

1. *Solution and suspension layering*: Coating processes are performed in either a rotated drum pan coater or fluidized bed with conventional top spray, bottom-spray (Wurster apparatus) (Sinhaipanid N. *et al.*, 2004; Priese F. *et al.*, 2013) and side

(tangential) spray to apply drug and/or binder solution or suspension to solid cores that can be inert materials (Suhrenbrock L., 2011; Lust A. *et al.*, 2013; Priese F., 2013) or granules of the same drug.

2. *Dry powder layering*: This involves the use of modified rotating pans, rotor-granulators/rotor tangential spray fluid-bed to deposit successive layers of dry powder (drug and excipients) on inert materials with the help of an adhesive solution/binding liquid (Nastruzzi C. *et al.*, 2000; Park H. J. *et al.*, 2016).

3. *Direct powder pelletization*: The technique uses high shear mixers (Schæfer T., 1996; Kristensen J. *et al.*, 2000 a, b; Hamdani J. *et al.*, 2002) and centrifugal fluid-bed or rotary fluid-bed granulators (Vilhelmsen T. *et al.*, 2004, Zema L. *et al.*, 2008; Pašić M. *et al.*, 2010) to apply agglomeration liquid direct to a powder mixture of a drug and excipients followed by pelletization by means of a rotating disc. A binder can be added as a liquid (wet pelletization) or added as a molten binder before or during the process (melt pelletization).

4. *Hot-melt extrusion*: the drugs substance and excipients (as polymers and waxes) are blended and extruded at a predetermined temperature. The extrusion temperature must be high enough to melt at least one or more of the formulation components. The molten extrudate is cut at the die-face pelletization into uniform cylindrical segments and/or not are spheronized in a jacketed spheronizer to generate uniformly size pellets (Follonier *et al.*, 1994, 1995; Young C. R. *et al.*, 2002; Radl S. *et al.*, 2010, Bialleck S. *et al.*, 2011; Yeung C.W. *et al.*, 2015).

5. *Cryopelletization*: pellets can be produced by allowing droplets of liquid formulation such as solution, suspension or emulsion to come in contact with liquid nitrogen at -160°C in which liquid nitrogen used as solidifying medium. The procedure permits instantaneous and even freezing of the material being processed due to the rapid heat transfer that occurs between the droplets and the liquid nitrogen. The required amount of liquid nitrogen for manufacturing a given quantity depends on the solids content and temperature of the solution or

suspension being processed. The pellets are dried in conventional freeze dryers to remove water or organic solvents (Erber M. and Lee G., 2015 a, b).

6. *Freeze pelletization*: a simple technique for producing spherical pellets for pharmaceutical use. In this technique, a molten-solid carrier/matrix is introduced as droplets into an inert column of liquid in which the molten solid is immiscible. The molten solid moves in the liquid column as droplets and solidifies into spherical pellets (Cheboyina S. *et al.*, 2004, 2008 a, 2008 b).

7. *Extrusion-Spheronization*: can be defined as the process of forcing a material through an orifice or die under controlled conditions thus forming cylinders or strands called extrudates. During spheronization, these extrudates are broken into small cylinders and consequently rounded into spheres (pellets). Hence, extrusion/spheronization is a multiple-step process capable of making uniformly sized spherical particles referred to as pellets and involving the following sequential steps: (1) dry blending, (2) wet granulation, (3) extrusion, (4) spheronization, (5) drying, and (6) optional screening (Erkoboni, 2003).

Compared with other drug-delivery systems, such as a single unit dosage form, pellets have several advantages:

- Pellets can improve the bioavailability, easier to administer, and provide for dose flexibility.
- The gastrointestinal transit time, especially the residence time in the stomach, is more uniform and less sensitive to food ingestion compared to single unit dosage forms because the small pellets can pass the pylorus even in the closed state. This leads to smaller intra and inter individual variations in the pharmacokinetic parameters.
- The local concentration of drug is relatively low because the particles are well dispersed after swallowing; irritation of the gastrointestinal mucosa is therefore minimized.
- Pellets with a coating for modified release have a lower risk of dose dumping than coated tablets.

- Pellets with different coatings can be mixed and filled into capsules to enable the desired dissolution profile to be achieved.
- Pellets containing different drugs can be filled into capsules without the risk of interaction of the substances during preparation and storage (Krämer J. and Blume H., 1994; Knop and Kleinebudde, 2005).
- Pellets offer greater flexibility in the design and development of active ingredient into oral dosage forms like tablets, capsules and suspensions with significant therapeutic advantages over single units (Bechgaard H. and Neilson G.H., 1978; Eskilson C., 1985) The functional coating usually being applied in a fluid bed coating process provides each subunit with the characteristic drug release properties.
- Controlled-release, gastro-resistant, sustained-release or site-specific drug delivery finds a greater advantage of drugs formulated as coated pellets that can be filled into capsules or compressed into tablets. They can be divided into desired dose strengths without formulation or process changes, and can also be blended to deliver even incompatible bioactive agents simultaneously or particles with different release profiles at the same site or at different sites within the gastrointestinal tract. The safety and efficacy of the formulation is higher than that of other dosage forms (Peck G.E. et al., 1989).

Disadvantages of pellets:

- The volume per dose is usually higher than for tablets because of the lower bulk densities of pellets compared to compressed tablets.
- Compared to larger single unit dosage forms, the specific surface area per dose is higher and more coating material is necessary to obtain coatings of the same thickness and the same functionality.
- The preparation of pellets and the subsequent filling into capsules and the compaction of pellet containing tablets are more complicated and time-consuming than the production of compressed tablets made from granules or powder mixtures (Knop and Kleinebudde, 2005).

A number of formulations in the form of pellets are available in the market, few of them are: Alventa[®] (Venlafaxine), Asasantin[®] (Dipyridamole and Aspirin), Astrix[®] (Aspirin), Bazetham[®] (Tamsulosini hydrochloridum), Bontril[®] SR

(Phendimetrazine), Brexin[®] LA (Chlorpheniramine, Pseudoephedrine), Compazine[®] (Prochlorperazine), Créon[®] (Pancreatine), Dilgard[®] (Diltiazem Hydrochloride), Doryx[®] (Doxycycline), Inderal[®] LA (Propranolol), Irfen[®] (Ibuprofen), Kadina[®] (Morphine sulphate), Minocin[®] (Minocycline Dihydrochloride), Nexium[®] (Esomeprazole), Olfen[®] (Diclofenac), Olicard[®] (isosorbid mononitrat), Omeprazole (Omeprazole), Ortanol[®] S (Omeprazole), Sopranox[®] (Itraconazole), Tanyz[®] (Tamsulosin), Teotard[®] (Theophylline), Testopel[®] (Testosterone), Videx[®] (Didanosine) ...

1.1.2. General description of the extrusion spheronization process (wet mass extrusion)

In 1970, Conine and Hadley were the first to describe the production of pellets via extrusion spheronization in the pharmaceutical industry, and Reynolds (Reynolds, 1970) elaborated this work through the further description of the equipment and process mechanisms. Extrusion spheronization is a multistep process consisting of the following consecutive stages (see *Figure 1.1*):

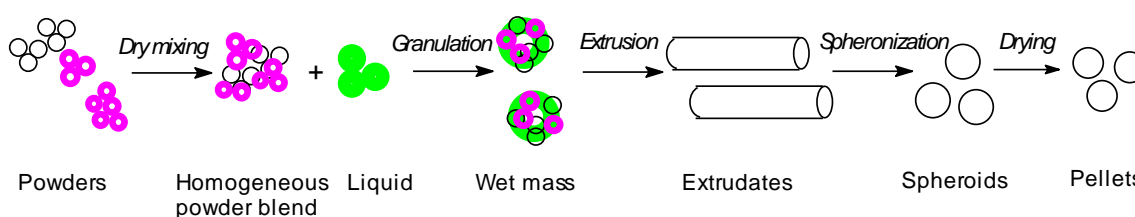

Figure 1.1. Schematic overview of the steps involved in an extrusion-spheronization process.

The extrusion-spheronization process typically involves a specific sequence of steps (see *Figure 1.2*). The characteristics and quality of the final pellets produced by the extrusion-spheronization process are dependent on the physicochemical properties of the active pharmaceutical ingredient (API) and excipients, and process variables. Specifically, the physicochemical properties of the API and excipients that affect the types of pellets produced by the process include particle size and surface area, moisture sorption capacity, polymorphism of the API, aqueous solubility, and density. The various process variables that affect the quality of the pellets include mixing time and speed, type and amount of binder/solvent added to wet the powder mixture, type of extruder, diameter of the

orifice and thickness of the die or screen, rate of extrusion, spheronization time, speed, load, and plate design, and drying time and rate (Hellén *et al.*, 1992; 1993a and b).

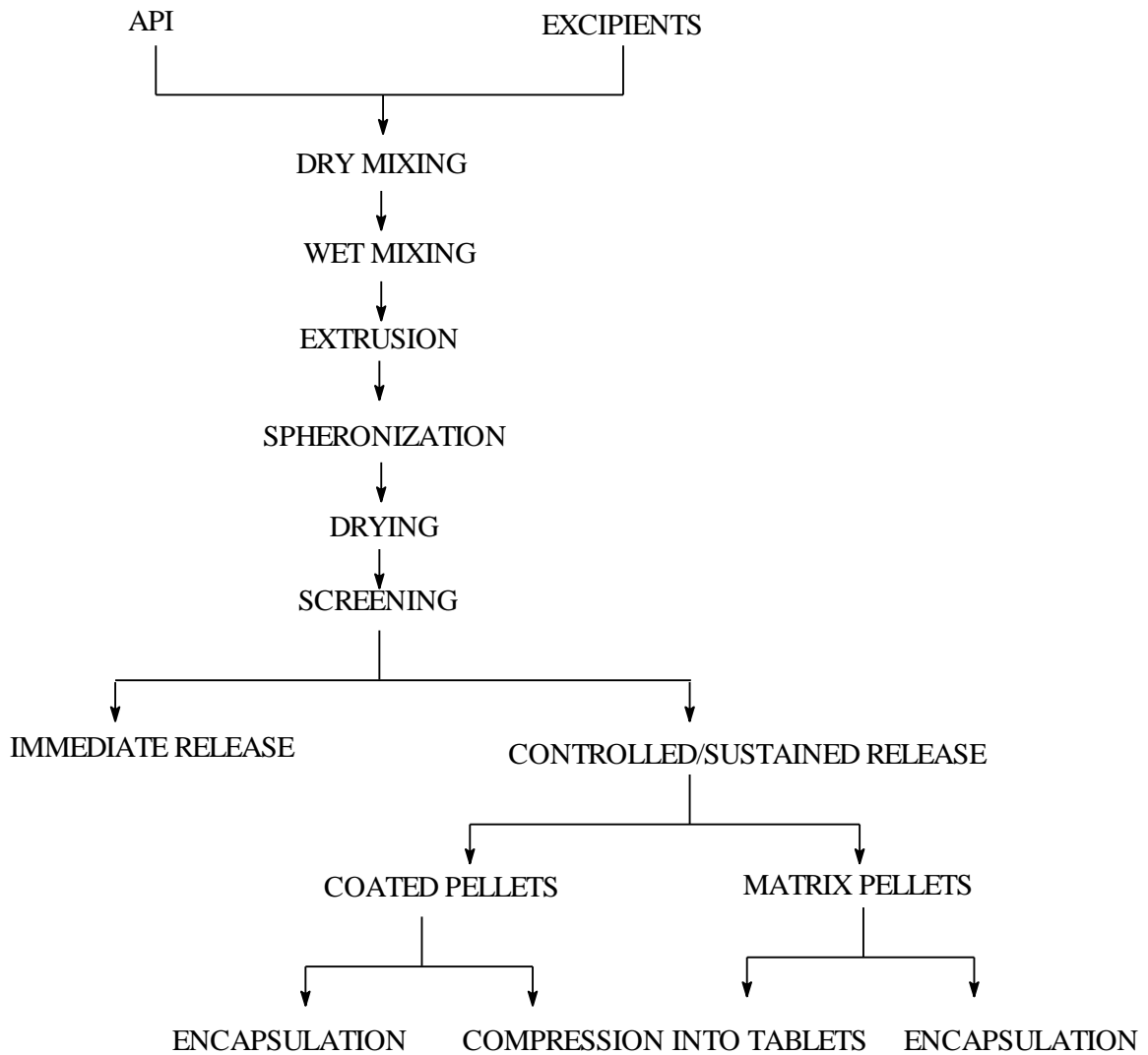

Figure 1.2. The extrusion spheronization process (wet mass extrusion)

The main steps of the process are:

1. *Dry mixing of ingredients to achieve homogeneous powder dispersion.*
2. *Wet massing to produce a sufficiently plastic wet mass.*
3. *Extrusion to form rod-shaped particles of uniform diameter.*
4. *Spheronization to round off these rods into spherical particles*

5. Drying to achieve the desired final moisture content
6. Screening (optional) to achieve the desired narrow size distribution.

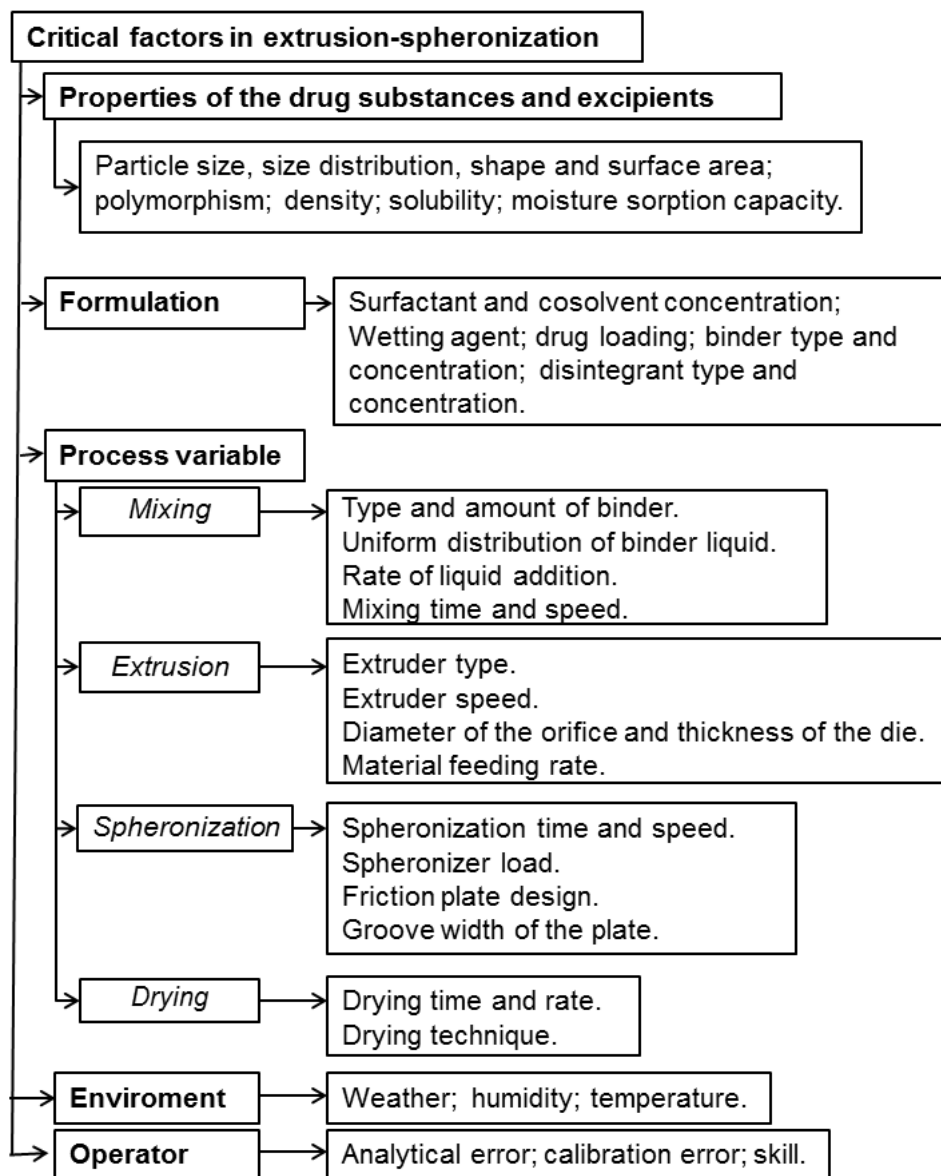

Figure 1.3: Critical factors in E-S (adapted from Ghebre-Sellassie and Knoch, 2002; Trivedi et al., 2007)

The disadvantages of the extrusion-spheronization process are that it is a multistep, labor intensive and time-consuming batch process. Each step in the process has its own variables that have major effects on the quality of the final product. Consequently, it is necessary to optimize the processing parameters for each formulation. Furthermore, the process requires the use of a relatively large of

water compared to the traditional granulation process, uniform distribution of the water in the wetted mass, and appropriate drying conditions, which may not be suitable for moisture and heat sensitive drugs (Trivedi *et al.*, 2007).

The characteristics and quality of the final pellets are dependent on the physicochemical properties of the active pharmaceutical ingredient, excipients and process variables which are shown in Figure 1.3 (Nakahara, 1964; Ghebre-Sellassie and Knoch, 2002; Trivedi *et al.*, 2007).

1.1.3. Process and equipment

1.1.3.1. Dry mixing and wet granulation

An uniform blend has to be obtained before wet granulation can take place, as it affects the pellets' content uniformity. An uneven distribution may also result into local over wetting during granulation, for materials with large differences in size and solubility properties (Dilip M. P., 2009). Dry mixing and wet granulation are usually carried out in the same equipment (*e.g.*, planetary mixer, high shear mixer, sigma blade mixer).

1.1.3.2. Extrusion

During extrusion, the plastic wet mass is forced through a die and shaped into cylindrical particles with a uniform diameter. The resultant extrudates diameter is determined by the diameter of the die, and its length depends upon the properties of the wet mass and the extruder type. A variety of extruder types has been developed, and can be divided into three classes based on their feed mechanism (*i.e.*, the way by which the wet mass is transported through the extrusion zone): screw feed extruders, gravity feed extruders, and piston feed extruders, shown in Figure 1.4.

According to Reynolds (1970) and Rowe (1985) an axial screw extruder produces a denser material than a radial screw extruder. The latter has a higher output but also produces but shows greater heat production during the processing. Pellet quality is dependent on the thickness of the screen and the diameter of the perforations (Hellén L. *et al.*, 1992). A thinner screen produced a rough and loosely bound extrudate, whereas a thicker screen forms smooth and well-bound extrudate because of the higher densification of the wet mass. Similarly, the

diameter of the perforations determines the size of the pellets: a larger diameter in the perforations will produce pellets with a larger diameter under similar processing conditions (Hellén L. *et al.*, 1993 a and b).

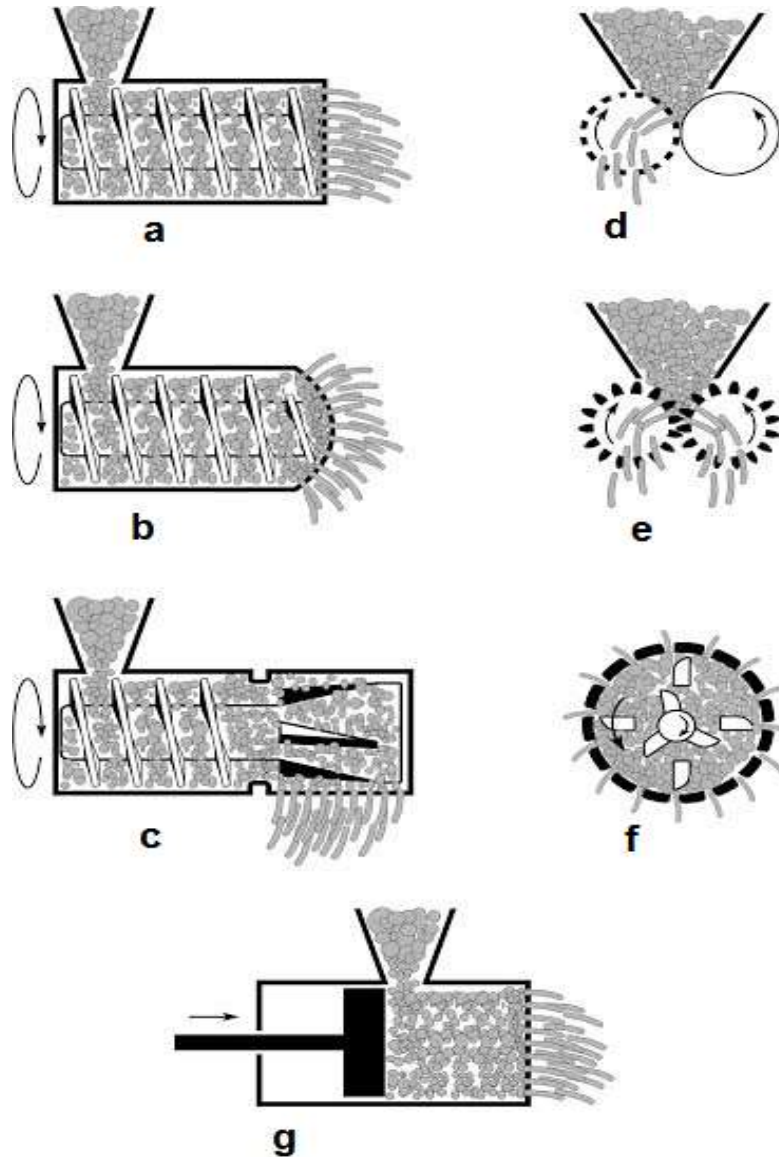

Figure 1.4. Schematic overview of the extruder types applied in extrusion-spheronization. Screw feed extruders with axial (a), dome (b) and radial (c) type, gravity feed extruders with cylinder (d), gear (e) and radial type (f) and piston feed ram extruders (g)

A number of studies for comparison of the extrusion and spheronization behavior of wet powder masses processed by a ram extruder and a cylinder extruder (Fielden *et al.*, 1992 b), comparison between the extrusion forces and sphere quality of a gravity feed extruder and a ram extruder (Baert *et al.*, 1992),

comparison between a gravity feed extruder and a twin screw extruder and a ram extruder (Baert *et al.*, 1993 b, c), comparison between a twin-screw extruder and a rotary ring die press (Schmidt C., *et al.*, 1997, 1998). Vervaet *et al.*, (1994) reported on the monitoring of the extrusion process using a basket extruder and on the influence of the extrusion screen specifications on the pellet quality.

1.1.3.3. Spheronization

A spheronizer consists of a bowl with fixed sidewalls and a bottom plate or disk that rotates at a high speed (see figure 1.5). The spheronizer is filled with extrudates, and due to frictional forces generated by particle-particle and particle-equipment interaction, the extrudates are initially broken into smaller cylinders and then rounded into spheres. To enhance the forces generated as particles move across its surface, the bottom plate generally exhibits a grooved surface (cross-hatched pattern or radial pattern).

Different manufacturers produce different types of plates. Most spheronizer plates have grooved surfaces, which are designed to increase the frictional forces (Vervaet *et al.*, 1995).

Pellet quality is also dependent on spheronizer load which affects the particle size distribution, bulk and tap density of the final pellets. The increase in the spheronizer speed and a low spheronizer load will result in wider particle size distribution with less yield of pellets, whereas it increases with extended spheronization time at a higher spheronizer load. Hellén *et al.* (1992) reported that the bulk and tap density increased and the size of the pellets decreased with an increasing spheronizer load.



Figure 1.5. Photograph (plan view) of spheroniser plate in motion.

Four different spheronizer friction plate patterns (*i.e.* cross-hatch, radial, striated edge pattern) have been used (*Figure 1.6. a, b, c, d*) (Michie *et al.*, 2012; Podczec and Newton, 2014; Caleva[®]).

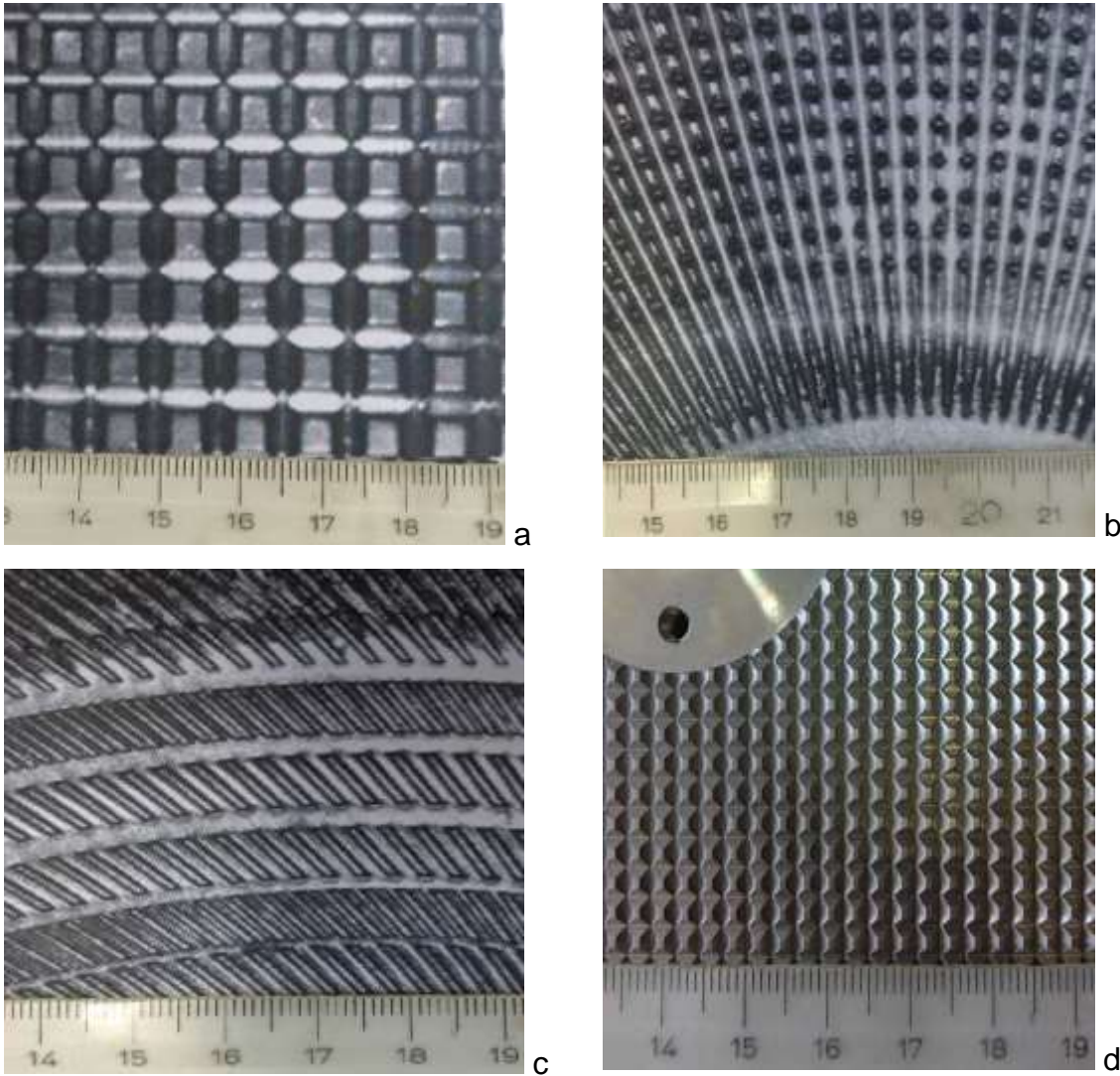

Figure 1.6. Friction plate design: (a) cross-hatch pattern; (b) radial pattern; (c) striated edge pattern, (d) cross-hatched friction plate (pyramidal elements on a square pattern, spacing 1.40 mm, height 0.86 mm and width at top 0.50 mm).

The transformation from a cylindrical extrudate in a spherical particle occurs in various stages, and two models have been proposed to describe this process (*Figure 1.6 a and b*). According to Rowe (1985) (*Figure 1.7 a*), the cylinders are rounded off at the edges, followed by the formation of dumbbell-shaped particles,

ellipsoids and finally spheres. The model proposed by Baert *et al.* (1993 c) (Figure 1.7 b) suggests that the cylinders are rounded off at the edges, but are additionally bent resulting in the formation of a rope-shaped particle. Next, a dumbbell with a twisted middle is formed, initiating particle breakage into two spherical particles with a cavity on their flat side. Further rounding in the spheronizer creates completely spherical articles. Recently, Koester and Thommes (2010) reported that these generally adopted pelletization mechanisms need to be extended, to account for the material transfer between pellet particles (Figure 1.7c). In addition to plastic deformation, the authors also observed a material transfer between pellet particles for different formulations. Herewith, regional distinctions in the amount of mass transfer and an influence of the water content were observed.

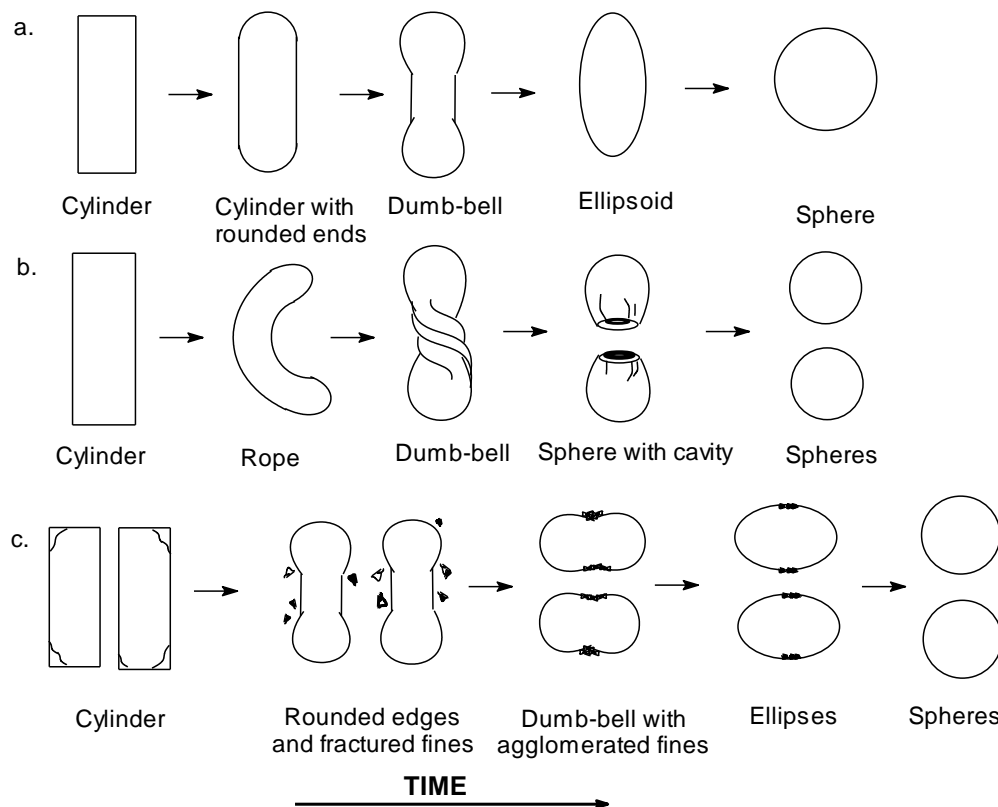

Figure 1.7. Schematic presentation of the different pellet formation stages during spheronization according to Rowe (a), Baert and Remon (b) and Koester and Thommes (c).

The duration of spheronization is usually 2-10 min (Gamlen M.J., 1985) and a rotational speed between 200-400 rpm of the friction plate is optimum to obtain a highly spherical pellet (West A.J. and Row R.C., 1988).

1.1.3.4. Drying

Drying is the final step of extrusion-spheronization process. The spherical particles are then dried at room temperature or at an elevated temperature (in an oven, a fluidized bed or microwave oven) until the desired residual moisture level is achieved. As the different process steps are influenced by a number of interrelated process and formulation variables, the extrusion-spheronization process requires the necessary control to obtain the required pellet quality.

Wet pellets are mostly dried in an oven or fluid-bed, although micro-wave and freeze drying have been also used to study the influence of drying method on pellet properties. The main differences between oven and fluid-bed drying are the rate of granulation liquid evaporation and the way how the material is handled during drying: during oven drying in a static bed liquid evaporates from the material over longer period of time, while during fluid-bed drying the turbulent motion of dried material in a heated air stream promotes significantly faster drying (Lieberman and Rankell, 1970). Several authors studied the influence of different drying techniques on pellet characteristics (Bataille *et al.*, 1993; Baert *et al.*, 1993a; Kleinebudde, 1994; Sousa *et al.*, 2002; Airaksinen *et al.*, 2004; Bashaiwoldu *et al.*, 2004; Römer M., *et al.*, 2007; Wlosnewski *et al.*, 2010). It was shown that the drying conditions have an impact of the physico-mechanical properties of pellets, but they did not lead to disintegration of the pellets.

1.1.3.5. Screening

Screening may be necessary to achieve the desired size distribution, and for this purpose sieves are used. In case of pellets prepared by extrusion-spheronization, screening is essentially required after manufacture, in order to avoid pellets having high size distribution (Koo. O.M.Y and Heng. P.W.S, 2001).

1.1.4. Formulation

Selection of suitable excipients for any formulation is one of the major tasks during formulation development. In a multistep process, the quality of the final product depends on the quality of intermediate products obtained at the end of each step, and that depends significantly on the type of the excipients used. The formulation must have certain qualities in order to produce extrudates that can be spheronized into appropriate particle-size pellets with desired surface characteristics. The following section describes various excipients that have been used to prepare pellets using the extrusion-spheronization process (Trivedi *et al.*, 2007).

1.1.4.1. Microcrystalline cellulose as spheronization aid

In 1962, Battista O.A. and Smith P.A. reported the preparation by the American Viscose Company of microcrystalline cellulose from cellulose, hence the origin of the product name “Avicel”. The “PH” designation indicates that the product is suitable for pharmaceutical use.

A comparison of Avicel[®] PH Microcrystalline Cellulose types and their uses: (George E. Reier, 2000):

PH-101 — Most widely used for direct compression tableting, wet granulation and spheronization; also used in capsule filling processes, especially those employing tamping or other means of consolidation as part of the process.

PH-102 — Used as above but larger particle size improves flow of fine powders.

PH-103 — Same particle size as PH-101; reduced moisture content (3%); used where moisture sensitive pharmaceutical active ingredients are present.

PH-105 — Smallest particle size; most compressible of the PH products; useful in direct compression of coarse, granular, or crystalline materials; can be mixed with PH-101 or PH-102 to achieve specific flow and compression characteristics; has applications in roller compaction; poorly flowable by itself – cannot determine neat compressibility.

PH-112 — Same particle size as PH-102; much reduced moisture content (1.5%); used where very moisture sensitive pharmaceutical active ingredients are present.

PH-113 — Same particle size as PH-101; much reduced moisture content (1.5%); used where very moisture sensitive pharmaceutical active ingredients are present.

PH-200 — Large particle size with increased flowability; used to reduce weight variation and to improve content uniformity in direct compression formulations and (as a final mix additive) in wet granulation formulations.

PH-301 — Same particle size as PH-101 but more dense providing increased flowability, greater tablet weight uniformity, the potential for making smaller tablets, and improved mixability; useful as a capsule filling excipient.

PH-302 — Same particle size as PH-102 but more dense providing increased flowability, greater tablet weight uniformity, the potential for making smaller tablets, and improved mixability; useful as a capsule filling excipient.

Microcrystalline cellulose (MCC) is the most commonly used spheronizing aid in a formulation undergoing extrusion-spheronization. It is available in different grades and particle sizes. Of all the different brands and grades of MCC, Avicel[®] PH 101 or Emcocel[®] 50 has been the most widely used. MCC helps in the formation of spheres because of its unique properties. Like other cellulosic materials, MCC is a filamentous material with a large surface area, high internal porosity, and high moisture retaining property (Shah R.D. *et al.*, 1995).

MCC is the golden standard as extrusion–spheronization aid based on its good binding properties that provide cohesiveness to a wetted mass containing MCC. Furthermore, it is able to absorb and retain a large quantity of water due to its large surface area and high internal porosity (Sonaglio *et al.*, 1995), thus facilitating extrusion, improving wetted mass plasticity and enhancing spheronization. Moreover, by controlling the movement of water through the plastic mass, it prevents phase separation during extrusion or spheronization. Due to these properties MCC-based pellets produced via extrusion spheronization have a good sphericity, low friability, high density and smooth surface properties. Its capacity to retain very large quantities of water internally means that wet masses made with MCCs have rheological properties that are very suitable for extrusion spheronization (Fielden K.E. *et al.*, 1992 a, 1995).

As noted, the mass to be extruded must be cohesive, yet deformable enough to flow through the die without sticking and able to retain its shape after

extrusion. It must be plastic so that it can be rolled into spheres in the spheronizer but non-cohesive so that each sphere remains discrete. To accomplish this, an extrusion-spheronization aid is necessary.

Such substances confer not only the required plasticity of the mass but add the binding properties that are necessary for pellet strength and integrity. During spheronization, extrudates that are rigid but lacking in plasticity, form dumbbell shaped pellets and/or a high percentage of fines relative to spherical pellets. Extrudates that are plastic, but without rigidity, tend to agglomerate into very large spherical balls. Microcrystalline cellulose has been studied extensively as an extrusion-spheronization aid. Avicel PH-101 has come to be regarded as an essential formulation component for successful extrusion-spheronization. It is thought that it acts as a molecular sponge for the water added to the formulation, altering the rheological properties of the wet mass. It has also been proposed that microcrystalline cellulose adds to the tensile strength of the wet mass through autoadhesion (the interdiffusion of free cellulose polymer chains). It is autoadhesion that makes pellets composed of neat microcrystalline cellulose that have been extruded and spheronized, hard, non-compressible and non-disintegrating. When mixtures of drug and microcrystalline cellulose are extruded and spheronized, the microcrystalline cellulose acts as a matrix from which the drug can slowly dissolve. Coating the pellets, or by using other ingredients in the pellet formulation, or both, can further control drug release (George E. Reier, 2000).

1.1.4.2. Alternative excipients for microcrystalline cellulose

Till date, microcrystalline cellulose (MCC) was considered as a golden standard for extrusion spheronization. However, the use of MCC has some disadvantages. Because MCC is water insoluble, pellets made with MCC take a long time to disintegrate and, therefore, release of drug from the pellets is not immediate.

However, several investigators have attempted to replace microcrystalline cellulose as a spheronizing agent, but with limited success. For example, Agrawal *et al.* (2004) studied the effect of formulation and process variables on the physical

properties of the pellets prepared with varying concentrations of chitosan, ethyl cellulose, and hydroxypropyl methylcellulose (HPMC), without using MCC. Results of the study indicated that process variables such as spheronizer and extruder speed, and formulation variables such as chitosan, HPMC, and water content significantly affected the physical properties of the pellets. Pellet size decreased with an increase in chitosan content. Glyceryl monostearate has also been used as an appropriate replacement for MCC for producing spherical pellets, using the extrusion spheronization process in two studies (Basit A. W. *et al.*, 1999; Newton J.M., 2001). Other excipients that have been used to prepare spherical pellets include: hydroxypropyl cellulose (Kleinebudde, 1994), HPMC, and hydroxyl ethyl cellulose (HEC) (with isopropanol as a solvent) (Chatlapalli R. and Rohera B.D., 1998), pectinic acid (Tho I. *et al.*, 2002), powdered cellulose (Alvarez L. *et al.*, 2003), starch-dextrin (Prieto S. M. *et al.*, 2005), cross-linked polyvinylpyrrolidone (Liew C.V. *et al.*, 2005) K-carrageenan (Thommes and Kleinebudde, 2006; Koester and Thommes, 2010; Ghanam and Kleinebudde, 2011), modified microcrystalline cellulose (Podczeck F. *et al.*, 2008 a and b), and isomalt (Antal *et al.*, 2013).

1.1.4.3. Use of Other Excipients in the Extrusion-Spheronization Process

Other excipients, such as water soluble/swellable polymers (*e.g.*, polyvinylpyrrolidone, hydroxypropyl methylcellulose, polyethylene oxide), ionic polymers (*e.g.*, carboxypolymethylene, chitosan, Eudragit[®]), hydrophobic/ water insoluble polymer (*e.g.*, ethylcellulose), waxes (*e.g.*, glyceryl monostearate, carnuba wax), disintegrants (*e.g.*, croscarmellose sodium, sodium starch glycolate, crospovidone), and polysaccharides (*e.g.*, starch, dextrin), are also added to the formulations containing MCC in order to attain the desired drug release characteristics from the pellets (Trivedi *et al.*, 2007).

Some of excipients used in combination with microcrystalline cellulose (MCC) to improve pellet disintegration and/or drug release from MCC-based pellets:

Surface active agents: surfactants are added to the liquid to improve wettability by lowering the interfacial tension between the liquid and drug particles.

Example: sodium lauryl sulphate, polyethylene glycol, polysorbate 80, glyceryl and sorbitan mono-oleate, sorbitan mono-palmitate, glycerol monostearate, self-emulsifying drug delivery systems (SEDDS) (Dukić R. *et al.*, 2009).

The types and concentrations of specific excipients incorporated in the formulations depend on the specific need and the desired drug-release rates from the pellets. For example, in spite of the large surface area of pellets which provides faster absorption from this dosage form, poorly soluble drugs might require super disintegrants to compensate for the delay in drug dissolution due to the high density of pellets (Souto C. *et al.*, 2005).

Table 1.1. Examples of commonly used excipients

Filler	MCC, starch and derivatives, sucrose, lactose, mannitol, Dicalcium diphosphate, β -Cyclodextrine, glucose
Binder	Gelatin, HPC, HPMC, MC, PVP, sucrose, starch, water
Lubricant	Calcium stearate, glycerin, PEG, magnesium stearate
Separating agent	Kaolin, talc, silicon dioxide
Disintegrant	Alginates, croscarmellose sodium, sodium starch glycolate
pH adjuster	Citrate, phosphate
Surfactant	Polysorbate 80, Sodium lauryl sulphate, polyethylene glycol, glyceryl and sorbitan mono-oleate, sorbitan mono-palmitate, glycerol monostearate, self-emulsifying systems
Spheronization enhancer	MCC, sodium carboxymethyl cellulose
Glidant	Talc, starch, magnesium stearate
Release modifier	Ethyl cellulose, carnauba wax, shellac

1.1.5. Evaluation of Pellets

A number of techniques are used to evaluate the physical properties of pellets prepared by the extrusion-spheronization process (Table 1.2) (Eriksson *et al.*, 1997; Podczeck *et al.*, 1999; Knop and Kleinebudde, 2005, Trivedi *et al.*, 2007, Michael E. Aulton and Kevin M.G. Taylor, 2013).

Table 1.2. List of different evaluation methods for determination of pellet properties

Properties	Requirement	Evaluation methods
Particle shape, sphericity or roundness	Uniform spherical shape	Two-dimensional methods: Image analysis (aspect ratio) OPCS (one-plane critical stability) Shape factor (e_R) Three-dimensional methods Heywood's shape coefficient Permeametry shape factor
Particle-size distribution	Narrow, uniform size	Image analysis
Mean particle size	Between 0.5 mm and 1.5 mm	Sieve or image analysis
Density	High	Bulk density Tapped density
Flow property	Very good	Angle of repose Dynamic flow Carr's index Hausner's ratio
Porosity	Low	Surface-area analysis Porosimetry True and bulk densities
Surface roughness	Smooth	Microscopic method (SEM-scanning electron microscopy)
Strength of pellets	High	Friability Crushing strength
Drug content	From very low to more than 95 %	Assay
Drug release	Have desired drug release characteristics	Dissolution

1.2. Nanoemulsions

1.2.1. Introduction

Nanoemulsions are defined as the structures having typically 20-200 nm droplet diameters (Solans *et al.*, 2005). Nanoemulsion term has been first used by Nakajima *et al.* (1993) or "ultrafine emulsion" (Nakajima, 1997), "submicron emulsion" (Amselem and Friedman, 1998) and called by different terms like "mini-emulsion" (El-Aasser and Sudol, 2004). Until today, it is recommended by Solans *et al.* (2005) to use the term "nanoemulsion" among the other terms, since

it clearly describes that droplets are at nano-level and it differs completely from the term of microemulsion or conventional emulsions (of micrometric size). Nanoemulsions are particular type of emulsions since they can have a transparent and semi-translucent appearance, they have very small droplet size, they are stable against sedimentation creaming and they tend to increase bioavailability (Shakeel *et al.*, 2008; Solans and Solé, 2012). In addition to their high colloidal stability, nanoemulsions need less than 10% surface-active agent in preparation stages (while this rate is 20% or higher in microemulsions). Furthermore, since nanoemulsions provide a wide surface area, they lead active components to be penetrated quickly (Laouini *et al.*, 2012). Due to their long-term stability over storage and an improve high bioavailability, they have attained particular interest as delivery systems for bioactive substances, such as carotenoids, phytostetol, polyunsaturated fatty acids, g-oryzanol, lipophilic vitamins, and numerous other compounds. Contrary to thermodynamically stable microemulsions, nanoemulsions are unstable systems and can be exposed to environmental degradation (Solans and Solé, 2012). The formation and manufacturing control of nanoemulsions require high shear force application in order to cope with surface tension of droplets (Mason *et al.*, 2006). In general, high-energy methods are used for preparation of nanoemulsions (high pressure homogenizers (Solans *et al.*, 2005; Sanguansri and Augustin, 2006; Laura L. *et al.*, 2014), microfluidizers (Swientek, 1990; Dalgleish *et al.*, 1997; Guraya and James, 2002; Kwon *et al.*, 2002; Thompson and Singh, 2006; Jafari *et al.*, 2006, 2007; Saeed S. G. *et al.*, 2015; Long B. and McClements D. J., (2016) Xiang L. *et al.*, 2017); ultrasonic generators (Xia *et al.*, 2001; Sanguansri and Augustin, 2006; Li and Chiang, 2012; Chandrapala *et al.*, 2012; Ghosh *et al.*, 2013; Gharibzahedi S. M. T., 2017; Sandra E. *et al.*, 2017); rotor–stator high speed stirring (Patrik S. and Cornelia M. K., 2015), and premix membrane emulsification (Sandra G. and Heike B., (2016)). There are also a number of studies applying low-energy methods for production of nanoemulsions, by using the chemical potential of the components under special conditions (Acosta, 2009; Rao and McClements, 2010; Calderó, *et al.*, 2011; Solans and Solé, 2012).

In general, oil-in-water (O/W) nanoemulsions have started to be investigated for a while ago and their role in such polymerization reactions as nanoreactors has been searched (Solans *et al.*, 2005). In previous studies, O/W nanoemulsion systems have been used as a carrier and combiner in food in order to encapsulate ω -3 fatty acids in yoghurt (Chee *et al.*, 2005) and ice cream (Chee *et al.*, 2007), nutraceutical as curcumin (Jinglei L. *et al.*, 2016; Raffaele V. *et al.*, 2016), drug as tocotrienols and simvastatin (Alaadin Y. A. *et al.*, 2013); vitamin E (Jacqueline M. M. and Diane J. B. 2014), spironolactone (François H. *et al.*, 2015); amphotericin B (Leila R. C. *et al.*, 2015); vitamin K1 (Virginia C. *et al.*, 2016); dexamethasone (Calderó G. *et al.*, 2016) parenteral nutrition (Dušica M. *et al.*, 2017); pyridoclox (Groo A. C. *et al.*, 2017).

Therefore, it could be concluded that O/W nanoemulsions offer a good potential in drug applications especially for encapsulation of lipophilic compounds.

1.2.2. Method

1.2.2.1. High-energy emulsification methods

The formation of nanoemulsions by high-energy methods is governed by the selected composition (*i.e.*, surfactants and functional compounds) and by the quantity of energy applied. Therefore, nanoemulsions produced through high energy methods present a natural predisposition to preserve the nanoemulsions formation against formulation modification *e.g.*, addition of monomer, surfactant, co-surfactant, etc. (Anton *et al.*, 2008).

The mechanical processes generating nanoemulsions can be divided into three major groups based on the used devices (Sanguansri and Augustin 2006; Anton *et al.*, 2008) that are presented below:

- High-pressure homogenization in high-pressure homogenization, the mixture is subject to very high pressures and is pumped through a restrictive valve. The very high shear stress causes the formation of very fine emulsion droplets (Sanguansri and Augustin, 2006; Quintanilla-Carvajal *et al.*, 2010).
- Ultrasound: when two immiscible liquids are submitted to high-frequency sound waves in the presence of a surfactant, emulsion droplets are formed by cavitation. This causes intense shock waves in the surrounding liquid and the formation of

liquid jets at high speed is responsible for the formation of emulsion droplets. However, this technology has not yet been proved as efficient for industrial-scale applications (Sanguansri and Augustin, 2006; Anton *et al.*, 2008; Quintanilla-Carvajal *et al.*, 2010).

- High-speed devices rotor/stator devices (such as Ultra-Turrax) when compared with the other high energy approaches do not provide a good dispersion in terms of droplet sizes. With the energy provided mostly being dissipated, generating heat (Walstra, 1993; Anton *et al.*, 2008).

Regarding the formation of nanoemulsions by high energy approaches, most of the energy provided is dissipated in the form of heat. Though this idea is generalized, only very few authors report energy calculations in their publications.

1.2.2.2. Low-energy emulsification methods

In low-energy approaches, nanoemulsions are obtained as a result of phase transitions produced during the emulsification process which is carried out, generally, at constant composition and changing the temperature (Izquierdo *et al.*, 2001; Morales *et al.*, 2003) or at constant temperature and changing the composition (Usón *et al.*, 2004)

The methods used more often are presented below:

- Membrane emulsification: it is a low-energy process that requires less surfactant (when compared with high energy methods) and produces emulsions with a narrow size distribution range. This method involves formation of a dispersed phase (droplets) through a membrane into a continuous phase. Nevertheless, this method has as limitation the low flux of the dispersed phase through the membrane, this being an issue during scale-up (Sanguansri and Augustin, 2006);

- Spontaneous emulsification: this mechanism occurs when an organic phase and an aqueous phase are mixed, with the organic phase being a homogeneous solution of oil, lipophilic surfactant and water-miscible solvent, and the aqueous phase consisting of water and hydrophilic surfactant (Bouchemal *et al.*, 2004). The spontaneous features of this method result of the initial non-equilibrium states of two bulks liquids when they are brought into contact without stirring. It is only under specific conditions that spontaneous emulsification occurs. Spontaneous

emulsification is produced by different mechanisms (e.g., diffusion of solutes between two phases, interfacial turbulence, surface tension gradient, dispersion mechanism, condensation mechanism) which seem to be affected by the systems' compositions and their physicochemical characteristics like the physical properties of the oily phase and nature of the surfactants (Bouchemal *et al.*, 2004). This process itself increases entropy and thus decreases the Gibbs free energy of the system (Anton *et al.*, 2008);

- Solvent displacement: this method consists of mixing a water-miscible organic solvent containing lipophilic functional compounds in an aqueous phase containing an emulsifier. The rapid diffusion of the organic solvent in the aqueous phase promotes the formation of nanoemulsions enabling their preparation in one step at low-energy input with high yield of encapsulation. Finally, the organic solvent is removed from the nanodispersion under reduced pressure. Nevertheless, the use of this technique is limited to water-miscible solvents (Chu *et al.*, 2007; Yin *et al.*, 2009);

- Emulsion inversion point: this method consists in varying the composition of the system at a constant temperature. The structures are formed through a progressive dilution with water or oil in order to create kinetically stable nanoemulsions (Anton *et al.*, 2008; Sadtler *et al.*, 2010);

- Phase inversion point: this method uses the specific ability of surfactants (non-ionic) to alter their affinities to water and oil in function of temperature at a fixed composition (Shinoda and Saito, 1968, 1969). It consists in suddenly breaking-up the microemulsions maintained at the phase inversion point by a rapid cooling (Izquierdo *et al.*, 2001, 2004; Sadurní *et al.*, 2005) or by a dilution in water or oil (Anton *et al.*, 2007, 2008). The nanoemulsions immediately formed are kinetically stable and can be considered as irreversible.

This process is relatively simple, prevents the encapsulated drug being degraded during processing, consumes low amounts of energy and allows an easy industrial scale-up (Anton *et al.*, 2008; Anton and Vandamme, 2009).

1.2.3. Materials used in nanoemulsions production

In general, the o/w nanosized emulsion should be formulated with compatible vehicles and additives. The components of internal and external phases of nanosized emulsion should be chosen to confer enhanced solubility and stability to the incorporated lipophilic drug. In addition, the selected excipients should also preferably be chosen to favorably influence the bio fate or therapeutic index of the incorporated drug following administration via parenteral, ocular, percutaneous, and nasal routes. This section is a comprehensive presentation of the general considerations concerning excipient selection and their optimum concentrations. Common excipients used for formulation of o/w nanosized emulsions are summarized in Table 1.3 (Tamilvanan S., 2010).

Table 1.3: Excipients used for formulation of o/w nanosized emulsions

Oils	Sesame oil, Castor oil, Soyabean oil, Paraffin oil, Paraffin light, Lanolin, Vaseline, Corn oil, Glycerin monostearate, Medium-chain monoglycerides, Medium-chain triglycerides, Squalen
Emulsifiers	Cholesterol, Phospholipids (Lipoid), Polysorbate 80 and 20 (Tween [®] 80 and 20), Transcutol [®] P, Cremophor [®] RH, Poloxamer [®] 407, Poloxamer [®] 188, Miranol [®] C ₂ M and MHT, Tyloxapol [®] (α -tocopheryl polyethylene glycol succinate)
Cationic lipids and polysaccharide	Stearylamine, Oleylamine, Chitosan
Miscellaneous	α - Tocopherol, Glycerin, Xylitol, Sorbitol, Thiomersal, ethylenediamine tetraacetic acid, Methyl paraben, Propyl paraben

1.3. Biopharmaceutical Classification System (BCS) and applications of pellet to improve dissolution rate of drugs in BCS class II

Biopharmaceutical classification system (BCS) divides all active pharmaceutical ingredients (API) into four classes based on drug dissolution rate and gastrointestinal permeability. BCS class II is defined by drugs of high permeability and low solubility (Amidon *et al.*, 1995).

The poor solubility of drug is a major problem which limits the development of highly potent pharmaceuticals. The drugs with low solubility lead to low oral bioavailability and erratic absorption which is particularly pertinent to drugs within class II of the Biopharmaceutical Classification System (BCS).

Examples of such Class II drugs include glibenclamide, phenytoin, danazol, ketoconazole, mefenamic acid, nifedipine, rifampicin, ethambutol, pyrazinamide, isoniazid, quinidine, chloroquine, mebendazole, niclosamide, prasiquantel, atenolol, piroxicam and amitriptyline ... (Amidon *et al.*, 1995; Takagi T. *et al.*, 2006; Dahan A. *et al.*, 2009).

Various strategies have been widely investigated to enhance the bioavailability of poorly absorbed drugs in order to increase their clinical efficacy when administered orally. It is estimated that between 40% and 70% of all new chemical entities identified in drug discovery programs are insufficiently soluble in aqueous media (Lipinski C.A. *et al.*, 2001, 2002; Lindenberg M. *et al.*, 2004).

Generally, the rate-limiting step for absorption of the drugs in this class is the dissolution velocity arising from low solubility. Although the drugs have a high permeability, the poor solubility results in a low concentration gradient between gut and blood vessel consequent to a limitation of drug transport and oral absorption. International Union of Pure and Applied Chemistry (IUPAC) have defined solubilisation of a drug molecule as a process by which an agent increases the solubility or the rate of dissolution of a solid or liquid solute (Gamsjäger H. *et al.*, 2008). The solubility of drug molecules is an important factor to take into account during the development and design of new drug products.

Nowadays, 40% of drug compounds in drug development have a poor aqueous solubility. Therefore, one of the most challenging tasks in drug development is to improve the drug solubility in order to enhance the bioavailability of these drugs. Several strategies have been employed to overcome these limitations. The approaches to increase the solubility and the available surface area for dissolution are classified as physical and chemical modifications. For the physical modification, the techniques include decreasing particle size (micronization, nanonization), formation of polymorphs/pseudo-polymorphs (including solvates), complexation/ solubilization (by means of using surfactants or cyclodextrins, conjugation to dendrimers, and an addition of co-solvents) and preparation of drug dispersions in carriers (eutectic mixtures, non-molecular solid dispersions, solid solutions). Pouton (2006) provides a brief indication of the main

formulation options and advantages and disadvantages of some approaches (Table 1.4).

Table 1.4. Options for formulation of poorly water-soluble drugs

Technology	Potential advantage	Potential disadvantage
Conventional micronization	Known technology, freedom to operate, solid dosage form	Insufficient improvement in dissolution rate
Nanocrystals obtained by ball-milling	Established products on the market, experienced technology provider (Elan), solid dosage form possible	Available only under license, secondary process required to avoid aggregation of nanocrystals
Nanocrystals obtained by dense gas technology	Alternative nanocrystal processing method, still room to develop new IP	Unproven technology, secondary process required to avoid aggregation of nanocrystals
'Solid solutions'—drug immobilized in polymer	Freedom to operate, new extrusion technology offers solvent-free continuous process	Physical stability of product questionable—drug or polymer may crystallize
Self-dispersing 'solid solutions' with surfactants	Steric hindrance to aggregation built into product, amenable to extrusion	Physical stability of product questionable—drug or polymer may crystallize
Lipid solutions (LFCS Type I lipid systems)	Freedom to operate, safe and effective for lipophilic actives, drug is presented in solution avoiding the dissolution step	Limited to highly lipophilic or very potent drugs, requires encapsulation
Self-emulsifying drug delivery systems (SEDDS) and SMEDDS (LCFS Type II or Type III lipid systems)	Prior art available, dispersion leads to rapid absorption and reduced variability, absorption not dependent on digestion	Surfactant may be poorly tolerated in chronic use, soft gel or hard gel capsule can be used in principle but seal must be effective
Solid or semi-solid SEDDS	Could be prepared as a free flowing powder or compressed into tablet form	Surfactant may be poorly tolerated in chronic use, reduced problem of capsule leakage, physical stability of product questionable—drug or polymer may crystallize
Surfactant-cosolvent systems (LFCS Type IV 'lipid' systems)	Relatively high solvent capacity for typical APIs	Surfactant may be poorly tolerated in chronic use, significant threat of drug precipitation on dilution

Particle size reduction has been a much smarter approach that can be applied to nonspecific formulation for many years. The micronization of drug leads to an increase in their surface area which proportionally increases in rate of dissolution and rate of diffusion (absorption). However, for very low solubility compounds, the micronization fails to improve the saturation solubility and increase the bioavailability of the drug. Therefore, the further step to reduce the particle dimension to nanometer size range has been invented. Recently, particle diminution to the sub-micron range has emerged to be a powerful formulation approach that can increase the dissolution rate and the saturation solubility, subsequently improve the bioavailability of poorly water-soluble drugs and may also decrease systemic side effects. For the chemical modification, the used technique is the synthesis of soluble prodrugs and salts (Magdalene R., 2001; Möschwitzer J. and Müller R.H., 2007; Gao L., 2008; Junghanns and Müller, 2008; Chen H. *et al.*, 2011).

Over the last decade, drug nanocrystals are considered as a novel approach to improve the solubility of hydrophobic drugs since the technique is simple and effective which can quickly launch product to the market. The nanocrystals were invented at the beginning of the 1990s and the first products appeared very fast on the market from the year 2000 onwards. Additionally, drug nanocrystals are an universal approach generally applied to all poorly soluble drugs for the reason that all drugs can be disintegrated into nanometer-sized particles (Müller R.H. *et al.*, 2011).

To date only few data are available on the incorporation of drug nanocrystals into solid dosage forms, although one multiparticulate dosage form containing drug nanocrystals has already entered the market (Emend[®] by Merck, pellets containing aprepitant approved by the FDA and introduced to the market in 2003). Emend[®] capsules contain spray-coated pellets with the nanocrystalline aprepitant, sucrose, microcrystalline cellulose, hypromellose and sodium dodecylsulfate (Merck, Drug Information Emend, 2004).

The formulation of ternary solid dispersions of ketoprofen with macrogol and kollagen hydrolizate derivative (KLHT) as carriers was elaborated on the basis of the results of the experiments in which different methods of solid dispersion

preparation (melting, solvent method, different cooling), different concentrations of drug/carriers and molecular weight of macrogol were tested. The best solid dispersion consisted of: ketoprofen - macrogol 6000 - KLHT: 1- 8.9 - 0.1. The increase in the amount of released ketoprofen from solid dispersion pellets was 3.8 times greater than from the pellets containing the drug alone (Jachowicz R. *et al.*, 2000).

The self-emulsifying (SE) pellets combine both advantages of self-emulsifying drug delivery systems (SEDDS) and pellets, and the extrusion/spheronization technique has been firstly introduced to prepare the SE pellets by Newton *et al.* (2001, 2007). In addition, Tuleu *et al.* (2004) has made a comparative bioavailability study of progesterone self-emulsifying formulations presented in a pellet and liquid form in dogs and the bioavailability of the two dosage forms was equivalent.

Dukić-Ott A. *et al.*, (2007) evaluated modified starch (high-amylose, crystalline and resistant starch) as the main excipient for immediate-release pellets containing poorly soluble drugs (hydrochlorothiazide and piroxicam) and prepared via extrusion-spheronization.

Möschwitzer J. and Müller R.H., (2006), used a mucoadhesive nanosuspension of poorly soluble hydrocortisone acetate produced by high pressure homogenization as layering dispersion in a fluidized bed process, followed by the application of an enteric coating to achieve a controlled drug release.

Abdalla A. *et al.* (2008) investigated the influence of physiological dilution media and enzymatic digestion on the solubilization capacity of the formulation for the model drug progesterone from self-emulsifying pellet and used Solutol® HS 15 and medium chain glycerides as lipid mixtures.

Iosio T. *et al.*, (2008) produced by co-extrusion-spheronization pellets with two cohesive layers, one of them containing a self-emulsifying system for vinpocetine, a poorly water soluble model drug.

Wang Z. *et al.* (2010) demonstrated that the self-emulsifying nitrendipine pellets with 30% of the liquid SEDDS were successfully developed by the use of

extrusion-spheronization technique and the SE pellets could improve oral absorption of poorly soluble drug such as nitrendipine.

Lei Y. *et al.*, (2011) studied solid self-nanoemulsifying cyclosporin A pellets prepared by fluid-bed coating.

Franceschinis E. *et al.* (2011) prepared solid self-emulsifying drug delivery systems (solid-SEDDS) by means of a wet granulation process which was optimized in a lab-scale by using a high shear mixer in order to improve the dissolution rate of piroxicam, a poorly water-soluble model drug. With this aim, the classic liquid granulation binder was replaced with an oil-in-water microemulsion, loaded with the drug.

Wang Z. *et al.* (2012) were increasing the oral bioavailability of poorly water-soluble carbamazepine using immediate-release pellets supported on SBA-15 mesoporous silica. The aim of this study was to develop an immediate-release pellet formulation with improved drug dissolution and adsorption. Carbamazepine (CBZ), a poorly water-soluble drug, was adsorbed into mesoporous silica (SBA-15) via a wetness impregnation method and then processed by extrusion-spheronization into pellets. Flowability and wettability of the drug-loaded silica powder were evaluated by bulk and tapped density and by the angle of repose and contact angle, respectively. The drug-loaded silica powder was formulated into pellets to improve flowability. With maximum drug loading in SBA-15 matrices determined to be 20% wt., *in vitro* release studies demonstrated that the carbamazepine dissolution rate was notably improved from both the SBA-15 powder and the corresponding pellets as compared with the bulk drug. Correspondingly, the oral bioavailability of SBA-15-CBZ pellets was increased considerably by 1.57-fold in dogs ($P < 0.05$) compared with fast-release commercial carbamazepine tablets.

Vaassen J. (2012) studies lipid based pellets of the poorly soluble drug NXP 1210. Pellets were successfully produced by the solid lipid extrusion/spheronization at room temperature. The dissolution profiles depicted a short lag time (about 2 min) and then fast and complete dissolution of NXP 1210 by increasing the amount of croscopvidone. The initial release was more delayed with an increased amount of PVA-PEG-graft copolymer. Dissolution rate could

also be influenced by changing the lipid binder from pure hard fat into a mixture of hard fat, glycerol distearate and glycerol trimyristate. The formulations are feasible for taste-masked granules or pellets containing poorly soluble drugs.

Cao Q.R. *et al.*, (2012) developed novel mucoadhesive pellets containing valsartan with enhanced oral bioavailability. Two types of valsartan loaded core pellets were prepared by an extrusion-spheronization method, and further dry-coated with a mixture of hydroxypropyl methylcellulose and carbomer at different ratios. The core pellets containing poloxamer 188 as a solubilizer and NaOH as a pH modulator showed significantly higher drug release rate than common pellets or drug powder *in vitro*.

Tian Z. *et al.*, (2013) studied nanostructured lipid carriers to improve the oral bioavailability of fenofibrate from pellet.

Lust A. *et al.*, (2013) studied drug-layer coated pellets of piroxicam. These ones exhibited improved dissolution rate compared to the powder forms of piroxicam. The presence of hydrophilic HPMC plays a major role in improving the dissolution characteristics of piroxicam solid-state forms in drug-layer coated pellets.

Recently, much attention has been paid to lipid-based formulations, especially self-emulsifying and self-nanoemulsifying drug delivery systems (SNEDDSs). In general, SNEDDS is an isotropic mixture of drug, oil, surfactants, and cosurfactants, which forms an oil-in-water nanoemulsion upon contact with aqueous medium under gentle agitation (Pouton and Porter, 2008; Zvonar A. *et al.*, 2010). SNEDDSs are commonly formulated in a liquid state and further encapsulated into soft gelatine capsules before use. However, the soft capsule formulations have some disadvantages, including low drug compatibility, poor stability, drug leakage and precipitation, capsule aging, and high production costs. Therefore, it is desirable to formulate SNEDDSs into solid dosage forms.

Fluid-bed coating technique is a process to prepare pellet-based solid SNEDDS formulations (Tian Z. *et al.*, 2013), such as solid dispersion and cyclodextrin inclusion complexes, from liquids or solidify Nanostructured lipid carriers onto pellets (Lei Y. *et al.*, 2011). This technique is based on removal of the

solvent from the bulk liquid, while the solid precipitates and deposits on the surface of non-poreil cores simultaneously.

Up until now, melt extrusion/spheronization has been employed as the only technique to prepare SNEDDS pellets. The formulation process depends highly on liquid SNEDDSs as moistening agents or adhesives to prepare paste for extrusion, which makes formulation development less flexible.

1.4. Coating

1.4.1. Introduction

Coating is an important process in the pharmaceutical and food industries (Hogan, 1990; Dewettinck K. and Huyghebaert A., 1999).

Fluidised bed technology is commonly employed in the film coating of pellets (Cole *et al.*, 1995; Christensen and Bertelsen, 1997). The coating suspension is sprayed as atomised droplets onto the fluidised pellets. A film coat is formed around the pellet with successive deposition of spray droplets accompanied by solvent evaporation due to the heat supplied by the fluidising air. A complete coat over the pellet is formed after several passes through the spray zone. In the preparation of controlled release dosage forms, the film coats formed should be homogeneous and of uniform thickness.

Regarding the spraying of coating agent, three elementary configurations are commonly used. Those are top-spray, bottom-spray (appropriate for Wurster apparatus) and side spray, see for instance Salman *et al.* (2007). The Wurster apparatus is seen to be the most suitable apparatus for film coating of small particles (Wurster, 1966, KuShaari *et al.*, 2006).

It had been reported in many studies of the great difficulties encountered in pellet coating due to problem of sticking, especially when aqueous coating solution was used (Fukumori *et al.*, 1992, 1993; Kokubo *et al.*, 1998).

1.4.2. Purpose of coating

There are many important reasons for coating pharmaceutical dosage forms. Some of these reasons are to:

- Protect the active ingredients against degradation caused by moisture, air and light (Nyqvist *et al.*, 1982),

- Mask unpleasant tastes or odours,
- Modify the drug release profile with the development of rapid release, controlled release or sustained release dosage forms (Mehta *et al.*, 1986; Govender *et al.*, 1995; Ho *et al.*, 1996; Bodmeier, 1997),
- Protect the active ingredients from the attack by gastric fluid via the application of enteric coat (Baudoux *et al.*, 1990; Guo *et al.*, 2002),
- Protect the stomach from the irritant effects of certain drugs,
- Prevent chemical interactions of active ingredients within a dosage form,
- Increase the mechanical strength of the dosage forms so that they can withstand stresses during manufacture, packaging, shipment and transport,
- Improve identification of the dosage form by manufacturers, healthcare professionals and consumers (Jones, 1993),
- Improve the aesthetic appearance through the addition of colour or shine to dosage forms (Jones, 1993),
- Facilitate absorption of a drug preferentially in specific areas in the alimentary system, colon (Leopold, 1999; Marvola *et al.*, 1999).

1.4.3. Types of coating

A coat on pharmaceutical dosage forms can be applied using different types of coating methods. The type of coating is selected depending on the desired function of the coat, the type of pharmaceutical dosage form and the equipment available. Four types of coating methods are described below:

1.4.3.1. Sugar coating

Sugar coating developed originally from the use of sugar to mask the taste and provide an attractive appearance to at the core. Sugar coating is an older coating technique adopted from the confectionery industry. The pharmaceutical industry refined the technique over the years and sugar coating has still reasonable following as it can provide a pleasant taste and attractive appearance to tablets and, less often, to pellets especially when dosage forms contain unpleasant tasting drugs. Sugar coating is still a multistep process, time-consuming and highly dependent on skilled technicians to conduct the process.

The process of sugar coating consists of several steps, which are described below:

- Sealing: A seal coat is applied over the tablet to prevent moisture penetration into the tablet core. Shellac was previously used as a sealant. But due to polymerization problems, it was replaced by zein (a corn protein derivative).

- Sub coating: This step is done to round the edges and increase the tablet weight.

- Syrup Coating: The imperfections in tablet surface are covered up and the predetermined size is achieved. This step requires the maximum skill.

- Coloring: Gives the tablet its final color.

- Polishing: Powdered wax (beeswax or carnauba) is applied to provide a desired luster.

Coating pans are the preferred type of the equipment, belt coaters being the exception (Lieberman *et al.*, 1990; Hogan, 1995 c).

1.4.3.2. Hot melt coating

Hot-melt coating with materials such as thermoplastic resins, waxes, polyoxyethylene glycols or mixtures thereof began in the textile and paper industries in the 1940s (Rothrock and Cheetham, 1942). Coating on particles can also be applied in the form of hot melts (Jozwiakowski *et al.*, 1990; Gren *et al.*, 1991). However, the technique was used to coat large materials (paper, foil, textiles, *etc.*) and not discrete particles or dosage forms. During the 1980s the pharmaceutical industry was looking for new coating technologies that were simple, effective, and affordable and hot melt coating appeared to be the answer (Dredán *et al.*, 1999). Since the coating material is applied on the substrate in a molten state no solvent is required. Despite hot melt coating being adopted and used at an industrial scale in the pharmaceutical industry for the past 30 years today, the technique is not focused extensively in literature.

Hot-melt coating offers many advantages in comparison to conventional coating techniques.

Principally the technique does not require the use of solvents (aqueous or organic) and consequently: (i) cost intensive solvent treatment can be avoided; (ii)

processing times reduced (as hot-melt coating allows higher and uniform application rates of coating agent and there is no solvent to evaporate); and (iii) the risk of microbial contamination is reduced due to a water-free process.

Coating pans are usually used in hot melt coating. However, in recent years, tumbling fluidised bed coaters are increasingly popular. Furthermore, this technique works with conventional coating systems such as fluid bed coaters that can be modified for this approach (Jannin V. and Cuppok Y., 2013; Haack D. and M. Koeberle M., 2014; Becker K. *et al.*, 2015, Lopes D.G. *et al.*, 2016).

1.4.3.3. *Film coating*

As the sugar coating process is very time consuming and is dependent on the skills of the coating operator, this technique has been replaced by film coating technology. Film coating has several advantages over sugar coating: requires a shorter processing time, less coating material and easy on operator skill, thus achieving greater overall process efficiency.

The process involves spraying of a solution of polymer, pigments and plasticizer onto a rotating tablet bed to form a thin, uniform film on the tablet surface. The choice of polymer mainly depends on the desired site of drug release (stomach/ intestine), or on the desired release rate. Some of the non-enteric coating polymers are: Hydroxypropyl methyl cellulose (HPMC), Methyl hydroxyethyl cellulose, Ethylcellulose, *etc*, while the commonly used enteric coating polymers are Cellulose acetate phthalate, Acrylate polymers (Eudragit L& Eudragit S), HPMC phthalate, *etc* (Bauer *et al.*, 1998 a-b; Guo *et al.*, 2002). An ideal film coating material should possess the following characteristics (Lachman L. *et al.*, 1991):

- It should be soluble in a solvent of choice.
- It must produce an elegant coat.
- It should be stable in presence of heat, light or moisture.
- It should not possess disagreeable color, taste or odor.
- It should be non-toxic and pharmacologically inert.
- It should be compatible with coating additives.

Film coating may be carried out using non-aqueous or aqueous polymer solutions or suspensions. In 1950-1970's, organic solvents were employed to improve polymer solubility, ease of coat application, shorter drying times and consequently shorter and trouble-free operation. In one study, sustained release aspirin crystals were obtained by film coating with different amounts of ethylcellulose and methylcellulose in a Wurster fluidised bed coater (Coletta *et al.*, 1964). However, the need to recover organic solvent due to its higher cost and potential pollution hazard as well as the need for a safe explosion-proof facility with certain regulatory restrictions made the use of organic solvents less attractive today. Possible explosion hazards with organic solvents also necessitate the use of more expensive flameproof equipment (Simon, 1978). The above disadvantages using organic solvents contributed to the rising popularity of aqueous film coating (Pondell, 1984; Hogan, 1995 a). However, problems such as picking, peeling, bridging, over wetting and sticking can occur in aqueous film coating due to slower vaporization of water compared to organic solvents (Porter, 1979; Mathur *et al.*, 1984). Thus, the introduction of coaters with greater evaporative efficiency and low viscosity aqueous coating systems made aqueous film coating very popular (Kokubo *et al.*, 1998).

1.4.3.4. Compression coating

Compression coating can be described as a technique of dry coating. It is applicable to tablets but not small particles or pellets.

Compression coating is not widely used, but it has advantages in some cases in which the tablet core cannot tolerate organic solvents or water and yet needs to be coated for taste masking, or to provide delayed or enteric properties to the product. In addition incompatible ingredients can be conveniently separated by process. This type of coating requires a specialized tablet machine e.g. Press coater, Dry Cota[®] (Lachman L. *et al.*, 1991).

1.4.3.5. Electrostatic coating

It is an effective way of applying a coat on conductive substances. A strong electrostatic charge is applied to the substrate. The coating material consisting of conductive ionic species of opposite charge is sprayed on the charged substrate.

A complete and uniform coating of corners on the substrate is achieved (Figure 1.8).

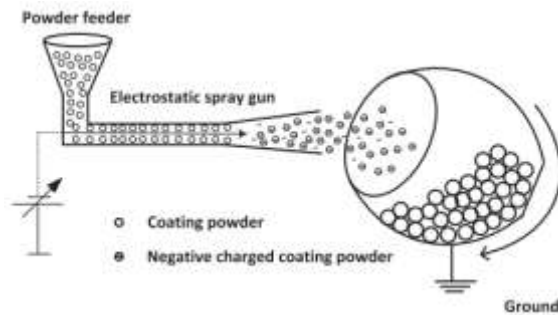

Figure 1.8. Coating powder adhesion process.

1.4.4. Fluid bed coater

The film coating process of pellets in a fluidised bed system can be divided into three phases: start-up, coating and drying (Christensen and Bertelsen, 1997).

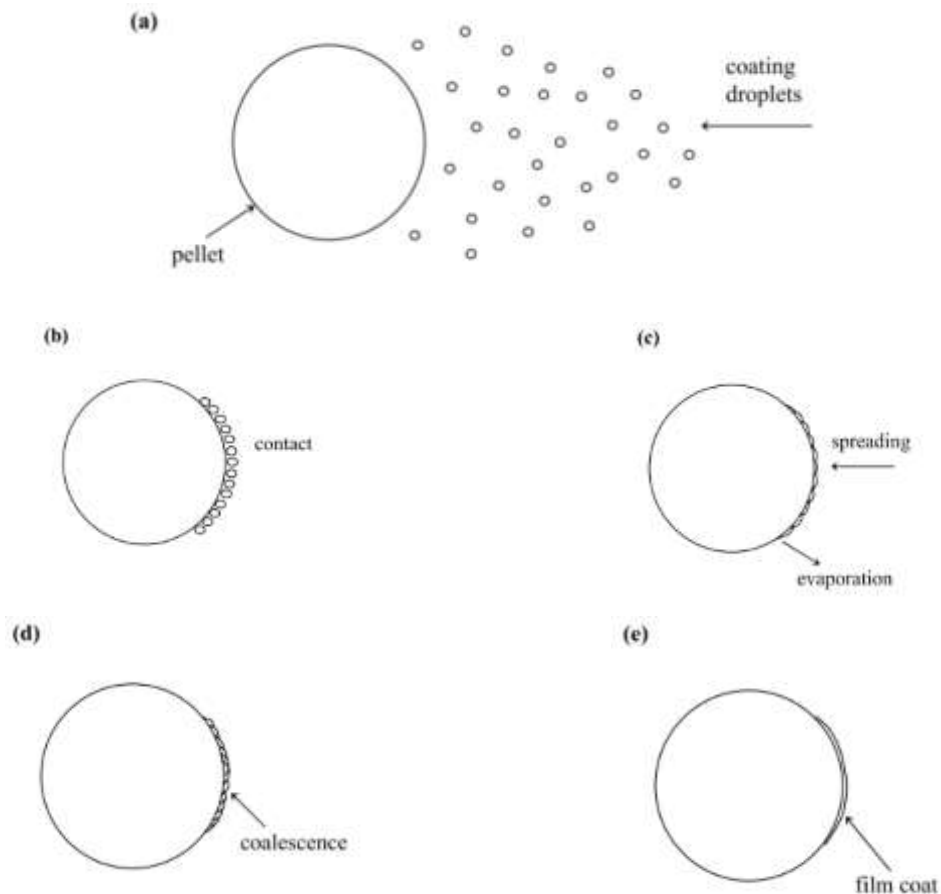

Figure 1.9 (a-e). Diagrams showing the dynamics of a coating process.

Preheating the equipment and core pellets makes up the start-up phase. Over wetting of the pellets during the initial application of the coating solution or suspension can be prevented as heating increases the rate of evaporation of the solvent. During the coating phase, the coating solution or suspension is atomised into droplets by a spray nozzle and distributed onto the surface of the pellets. These droplets, upon contact on the pellet surfaces, spread themselves and coalesce to form a film. The drying phase represents the solvent evaporative phase, where the solvent evaporates from the droplets in the spray mist, as well as from the droplets adhered on the pellet surfaces. Droplet formation, contact, spreading, coalescence and evaporation, as illustrated in Figure 1.9, occur simultaneously during the coating process. An uniform layer of coat does not occur with a single pass through the spray mist but requires many such passes to produce a complete coverage of the surface.

1.4.4.1. Top-spray fluidised bed coater

The top-spray fluidised bed coater (Figure 1.10) has a coating vessel with an expansion chamber. The spray nozzle is located in the upper part of the vessel and the coating solution or suspension is sprayed down (counter-current) onto the ascending fluidised pellets.

Even though the top-spray configuration has been successfully introduced in the food industry, the occurrence of side effects including the premature spray-drying of the droplets containing the dissolved coating material and agglomeration (i.e. sticking or clumping together of wetted particles) could result in poor product quality and product losses (Nakano *et al.*, 1999; Yuasa *et al.*, 1999; Dewettinck and Huyghebaert, 1999; Werner *et al.*, 2007). However, this disadvantage of agglomeration is useful when the top-spray fluidised bed is employed in the manufacture of granules (Aulton *et al.*, 1978; Biñ *et al.*, 1985; Banks *et al.*, 1991; Link *et al.*, 1997, Duangkhamchana W. *et al.*, 2015).

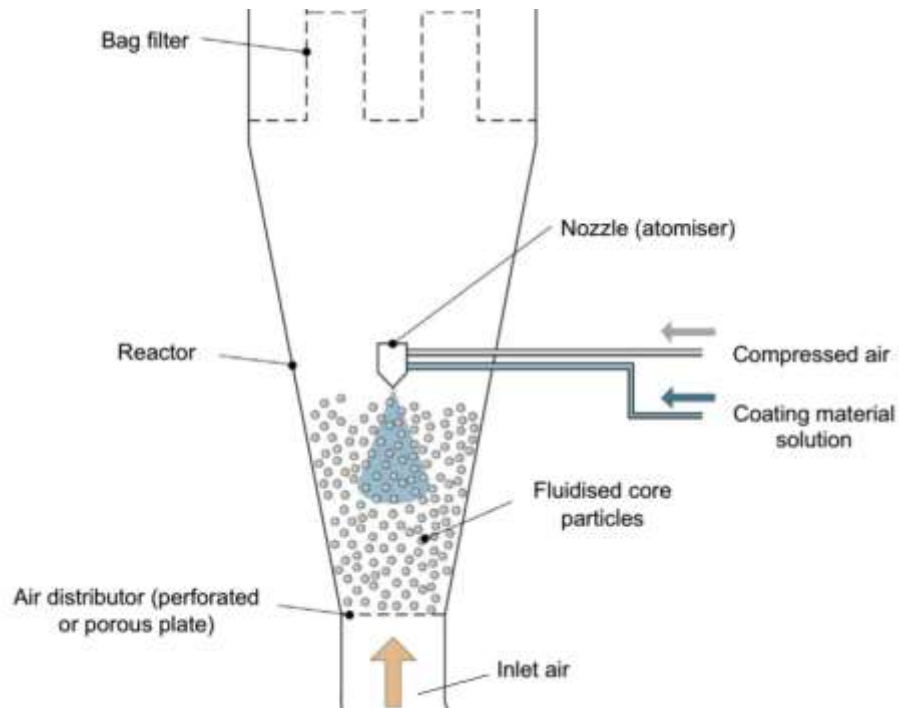

Figure 1.10. A schematic diagram of a top-spray fluidised bed coater.

1.4.4.2. Bottom-spray fluidised bed coater

The Wurster coating system was developed by Dale Wurster in 1959. The equipment consists of a coating vessel, a central Wurster partition column and a perforated base plate coupled with a fine sieve (Figure 1.11).

Particle concentration in a coating zone of fluid bed coater is important to ensure appropriate coating uniformity and process yield. Particle volume fraction in the coating zone is a transient parameter that depends on various process parameters, most characteristically on air volume flow rate and draft tube gap and has a big influence on both coating uniformity and process yield (Cheng and Turton, 2000; Šibanca *et al.*, 2016).

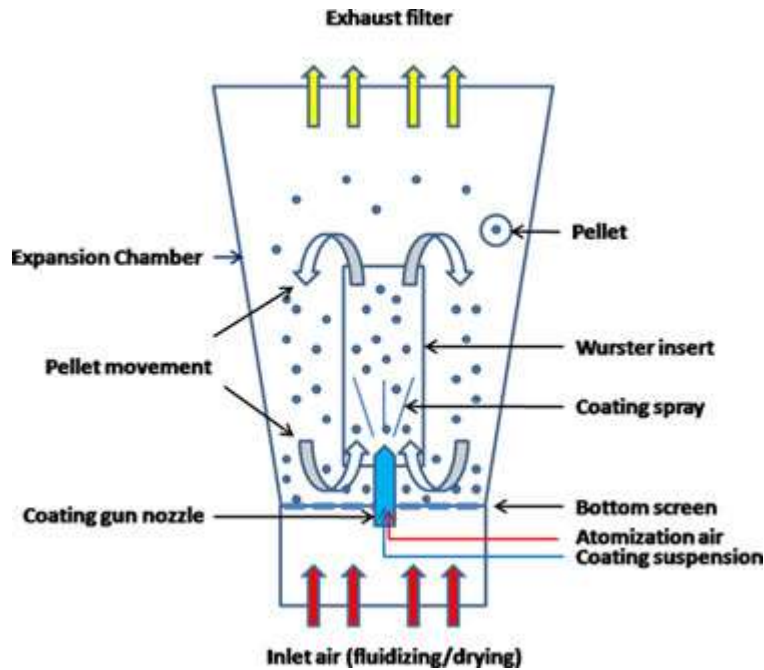

Figure 1.11. A schematic diagram of a bottom-spray Wurster fluidised bed coater (Aerocoater).

The distance travelled by the pellets above the partition column should be small so as to minimise attrition. With good process control, pellets with uniform film coats are produced (Jones, 1985; Olsen *et al.*, 1985; Parikh, 1991).

1.4.4.3. Tangential spray coater

The rotary processor (Figure 1.12) is a type of tangential spray coater with a rotating disc to provide centrifugal force to spin and mix the pellets for uniform coating by droplets sprayed from a tangential nozzle (Wigmore, 1989; Vecchio *et al.*, 1998).

This technique was originally developed for production of high-density granules and pellets by moistening powders using a tangential spray nozzle (Holm, 1996 a and b; Holm *et al.*, 1996). The primary advantage of rotary processor is the one-step technique of pelletization and coating, thus reducing processing time. The disadvantage is that products are subjected to a high level of mechanical stress and cannot be used for brittle materials. Moreover, the products are more susceptible to adhesion to the upper walls of the chamber resulting in lower yield (Wigmore, 1989; Vecchio *et al.*, 1998).

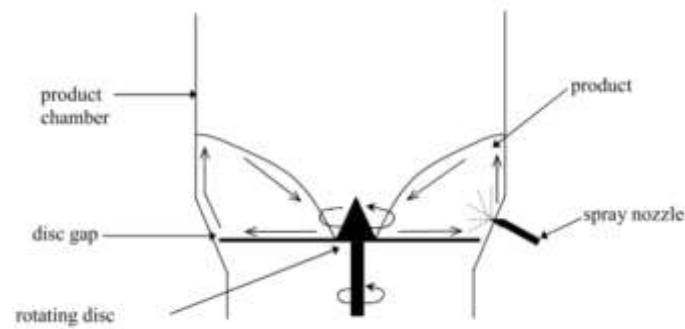

Figure 1.12. A schematic diagram of a rotary processor.

1.4.5. Enteric coating

The purpose of enteric film coating of an oral solid dosage form is to impart delayed drug release (Porter S.C. and Bruno C.H., 1989). Delayed release dosage forms are defined as the one 'that releases a drug (or drugs) at a time other than promptly after administration' (FDA, 2009). The enteric film coating is designed to resist the acidic environment of the stomach and starts to dissolve, leading to dosage form disintegration or drug release, in the higher pH environment of intestinal fluids.

Therefore, the main reasons for using enteric coating on oral solid dosages are the following:

1. To protect the drug content of a pharmaceutical dosage form from the acidic environment of the gastric media, hence, improving the stability and bioavailability of the active ingredient (e.g. enzymes and certain antibiotics);
2. To minimize bleeding or nausea by protecting the gastric mucosa from the irritating effects of some drugs such as nonsteroidal anti-inflammatory drug or sodium salicylate (Wagner J.G., 1971; Guo H.X., 2002).
3. To deliver the drug to the lower segment of the intestine for site-specific drug delivery or local action. For example, enteric coated mesalamine tablets exert topical anti-inflammatory action in the distal intestine and the colon (Physician's Desk Reference (PDR). (60 ed.) (2006)).
4. Required for minimizing first pass metabolism of drugs. (Kumar Vinay *et al.*, 2011)

Enteric coatings are prepared from gastric resistant polymers. The coatings prepared from such polymers remain intact in acidic environment, but dissolve readily at the elevated pH of the small intestine. This property is related to the chemical structure of the applied polymer. The most effective enteric polymers contain many carboxylic acid groups with a pKa of 3-5 (Lehmann, 1994; Porter, 1990). Therefore they will dissociate and dissolve only when the pH rises above this value. Before the synthetic polymers were introduced to the market, shellac, a natural polymer, was one of the main polymers used for this purpose (Hogan, 1995 b).

Table 1.5: Enteric polymers and their threshold pH

Class	Enteric polymer	Threshold pH
Cellulosics	Cellulose acetate phthalate (CAP)	6.0
	Cellulose acetate trimellitate (CAT)	4.8
	Hydroxypropylmethylcellulose acetate succinate (HPMCAS)	5.5–6.8
	Hydroxypropylmethylcellulose phthalate (HPMCP)	5.0–5.5
Vinyls	Polyvinylacetate phthalate (PVAP)	5.0
Acrylics	Methacrylic acid copolymer, Type A, NF	6.0
	Methacrylic acid: methylmethacrylate (1:1)	
	Methacrylic acid copolymer, Type C, NF	5.5
	Methacrylic acid: ethylacrylate (1:1)	
	Methacrylic acid copolymer, Type B, NF	7.0
	Methacrylic acid: methylmethacrylate (1:2)	
Polymethylacrylate: polymethyl methacrylate: polymethacrylic acid) (7:3:1)	7.0	
Natural polymers	Shellac (esters of aleuritic acid)	7.2
	Rosin	6.0

An enteric coating is a barrier that controls the location of oral medication in the digestive system where it is absorbed. The word “enteric” indicates small intestine; therefore enteric coatings prevent release of medication before it reaches the small intestine. The enteric coated polymers remain unionise at low pH, and therefore remain insoluble. But as the pH increases in the GIT, the acidic functional groups are capable of ionisation, and the polymer swells or becomes soluble in the intestinal fluid. Materials used for enteric coatings include CAP, CAT, PVAP and HPMCP, fatty acids, waxes, shellac, plastics and plant fibers.

Cellulose acetate phthalate (CAP) was the first synthetic polymer described in 1937, which gained soon high popularity as a gastric resistant polymer (Malm and Waring, 1937). Later polyvinyl acetate phthalate (PVAP) and hydroxypropyl methylcellulose phthalate (HPMCP) were preferred, due to their lower permeability in the gastric fluid and improved stability against hydrolysis (Porter, 1990). Today the methacrylate copolymers Eudragit[®] L and S are two of the most widely used polymers for this purpose.

Table 1.5 shows a list of enteric polymers and their respective threshold pH at which they start to dissolve (Chourasia M.K. and Jain S.K., 2003; Missaghi S., 2006).

The choice of the polymer and the thickness of the coated layer are critical to control the pH solubility profile of the enteric coated dosage form.

* Important factors that may influence the behavior of enteric coated dosage forms (Ozturk *et al.*, 1988) include the following:

1. type of the enteric polymer used and its threshold pH;
2. enteric coating composition (polymer, plasticizer and pigments);
3. core formulation, its swelling and disintegrant properties, and the nature of the drug in the dosage form;
4. presence of imperfections in the coating, such as fissures that can result in loss of integrity of the coating;
5. thickness of the film layers applied to the dosage form;
6. in vitro testing conditions, such as the composition, pH, ionic strength of dissolution media, and agitation intensity within the media; and
7. fed and fasted gastric conditions.

* Ideal properties of enteric coating material

- Resistance to gastric fluids.
- Susceptible/permeable to intestinal fluid.
- Compatibility with most coating solution components and the drug substrate.
- Formation of continuous film.
- Nontoxic, cheap and ease of application

(Aulton M. E, 2002; Ansel *et al.*, 2004)

Reference

- Abdalla A., Klein S., Mäder K., (2008). A new self-emulsifying drug delivery system (SEDDS) for poorly soluble drugs: characterization, dissolution, *in vitro* digestion and incorporation into solid pellets. *Eur J Pharm Sci.*, 35 (5):457-64.
- Acosta E., (2009). Bioavailability of nanoparticles in nutrient and nutraceutical delivery. *Curr Opin Colloid Interface Sci.*, 14, 3–15.
- Agrawal A.M., Howard M.A., Neau S.H., (2004). Extruded and spheronized beads containing no microcrystalline cellulose: influence of formulation and process variables. *Pharm. Dev. Tech*, 9,197-217.
- Airaksinen S., Karjalainen M., Räsänen E., Rantanen J., Yliruusi J., (2004). Comparison of the effects of two drying methods on polymorphism of theophylline. *Int. J. Pharm.*, 276, 129-141.
- Alaadin Y. A., John F. A., Seetharama D. S., Paul W. S., Sami N., (2013). Concurrent delivery of tocotrienols and simvastatin by lipid nanoemulsions potentiates their antitumor activity against human mammary adenocarcinoma cells, *European Journal of Pharmaceutical Sciences*, 48 (3), p. 385–392.
- Alvarez L., Concheiro A., Gomez-Amoza J.L., Souto C., Martinez-Pacheco R., (2003). Powdered cellulose as excipient for extrusion-spheronization pellets of a cohesive hydrophobic drug. *Eur. J. Pharm. Biopharm*, 55, 291-295.
- Amidon G.L., Lennernas H., Shah V.P., Crison J.R., (1995). A theoretical basis for a biopharmaceutic drug classification: the correlation of *in vitro* drug product dissolution and *in vivo* bioavailability. *Pharm. Res.* 12, 413–420.
- Amselem S., Friedman D., (1998). Submicron emulsions as drug carriers for topical administration. In: Benita S. *Submicron Emulsions in Drug Targeting and Delivery*. 9 th Edition. London: Harwood Academic Publishers, 153-173.
- Ansel H.C., Allen L. Jr., Popovich N. G., (2004). *Ansel’s Pharmaceutical Dosage Forms and Drug Delivery Systems*; Eighth Edition: 227-259.
- Antal I., Kállai N., Luhn O., Bernard J., Nagy Z. K., Szabó B., Klebovich I., Zelkó R., (2013). Supramolecular elucidation of the quality attributes of microcrystalline cellulose and isomalt composite pellet cores. *Journal of Pharmaceutical and Biomedical Analysis*, 84, 124–128.
- Anton N., Benoit J.P., Saulnier P., (2008). Design and production of nanoparticles formulated from nano-emulsion templates—A review. *Journal of Controlled Release*, 128 (3), 185–199.
- Anton N., Gayet P., Benoit J.-P., Saulnier P., (2007). Nanoemulsions and nanocapsules by the PIT method: An investigation on the role of the temperature cycling on the emulsion phase inversion. *International Journal of Pharmaceutics*, 344 (1–2), 44–52.
- Anton N., Vandamme T.F., (2009). The universality of low-energy nano-emulsification, *International Journal of Pharmaceutics*, 377 (1-2), 142-147.
- Aulton M. E., (2002). *Pharmaceutics: The Science of Dosage Form Design*. 2nd Edition: 304-321, 347-668.
- Aulton M. E., Banks, M., (1978). The factors affecting fluidised bed granulation, *Mfg. Chem. Aerosol News*, 49, 50 & 55-56.
- Baert L., Remon J.P., (1993 a). Influence of amount of granulation liquid on the drug release rate from pellets made by extrusion spheronisation. *International Journal of Pharmaceutics*, 95, 135–141.
- Baert L., Remon J.P., Elbers J.A.C., Van Bommel E.M.G., (1993 b). Comparison between a gravity feed extruder and a twin screw extruder. *Int. J. Pharm*, 99, 7- 12.

- Baert L., Remon J.P., Knight P., Newton J.M., (1992). A comparison between the extrusion forces and sphere quality of a gravity feed extruder and a ram extruder. *Int. J. Pharm*, 86, 187-192.
- Baert L., Vermeersch H., Remon J.P., Smeyers- Verbeke J., Massart D.L., (1993 c). Study of parameters important in the Spheronization process. *Int. J. Pharm*, 96, 225-229.
- Banks M., Aulton M. E., (1991). Fluidised-bed granulation: A chronology, *Drug Dev. Ind. Pharm.*, 17 (11), 1437-1463.
- Bashaiwoldu A.B.B., Podczec F., Newton M., (2004). A study on the effect of drying techniques on the mechanical properties of pellets and compacted pellets. *Eur. J. Pharm. Sci.* 21, 119-129.
- Basit A.W., Newton J.M., Lacey L.F., (1999). Formulation of ranitidine pellets by extrusion spheronization with little or no microcrystalline cellulose. *Pharm. Dev. Tech*, 4, 499-505.
- Bataille B., Ligarski K., Jacob M., Thomas C., Duru C., (1993). Study of the influence of spheronization and drying conditions on the physico-mechanical properties of neutral spheroids containing Avicel PH 101 and lactose. *Drug Det.Ind. Pharm*, 19, 653-671.
- Battista O. A., Smith P.A. (1962), Microcrystalline cellulose, *Ind. Eng. Chem.*, 54 (9), pp 20–29.
- Baudoux M., Dechesne J.-P., Delattre L., (1990). Film coating with enteric polymers from aqueous dispersions, *Pharm. Technol. Int.*, 2, 18 & 20-26.
- Bauer K. H., Lehmann K., Osterwald H. P., Rothgang G., (1998 a). Coated Pharmaceutical Dosage Forms – Fundamentals, Manufacturing Techniques, Biopharmaceutical Aspects, Test Methods and Raw Materials, 1.1. History of Coated Pharmaceutical Dosage Forms, Medpharm, Germany, pp. 13-17.
- Bauer K. H., Lehmann K., Osterwald H. P., Rothgang G., (1998 b). Coated Pharmaceutical Dosage Forms – Fundamentals, Manufacturing Techniques, Biopharmaceutical Aspects, Test Methods and Raw Materials, 4. Film Coating, Medpharm, Germany, pp. 64-119.
- Bechgaard H. and Neilson G.H., (1978). Controlled release multiple units and single-unit doses. *Drug Development and Industrial Pharmac*; 4: 53-67.
- Becker K., Salar-Behzadi S., Zimmer A., (2015). Solvent-Free Melting Techniques for the Preparation of Lipid-Based Solid Oral Formulations, *Pharm. Res.* 32, 1519-1545.
- Bialleck S., Rein H., (2011). Preparation of starch-based pellets by hot-melt extrusion. *Eur J Pharm Biopharm.* 79 (2), 440-8.
- Biń A., Warych J., Komorowski R., (1985). The batch granulation process in a fluidised bed, *Powder Technol.*, 41, 1-11.
- Bodmeier R., (1997). Tableting coated pellets, *Eur J. Pharm. Biopharm.*, 43 (1), 1-8.
- Bouchemal K., Briançon S., Perrier E., Fessi H., (2004). Nanoemulsion formulation using spontaneous emulsification: Solvent, oil and surfactant optimisation. *International Journal of Pharmaceutics*, 280(1–2), 241–251.
- Calderó G., García-Celma M.J., Solans C., (2011). Formation of polymeric nano-emulsions by a low-energy method and their use for nanoparticle preparation. *Journal of Colloid and Interface Science*, 353: 406-411.
- Calderó G., Montes R., Llinàs M., García-Celma M.J., Porrás M., Solans C. (2016). Studies on the formation of polymeric nano-emulsions obtained via low-energy emulsification and their use as templates for drug delivery nanoparticle dispersions. *Colloids and Surfaces B: Biointerfaces*, 145:922-31.
- Cao Q.R., Liu Y., Xu W.J., Lee B.J., Yang M., Cui J.H., (2012). Enhanced oral bioavailability of novel mucoadhesive pellets containing valsartan prepared by a dry powder-coating technique. *Int J Pharm.*; 434 (1-2), 325-33.

- Chandrapala J., Oliver C., Kentish S., Ashokkumar M., (2012). Ultrasonics in food processing. *Ultrasonics Sonochemistry*, 19: 975-983.
- Chatlapalli R., Rohera B.D., (1998). Physical characterization of HPMC and HEC and investigation of their use as pelletization aids. *Int. J. Pharm*, 161, 179–193.
- Cheboyina S., Chambliss W.G., Wyandt C.M., (2004). A novel freeze pelletization technique for preparing matrix pellets. *Pharm Techv.*, 28, 98-108.
- Cheboyina S., Wyandt C.M., (2008 a). Wax-based sustained release matrix pellets prepared by a novel freeze pelletization technique I. Formulation and process variables affecting pellet characteristics. *Int J Pharm.*, 359 (1-2), 158-66.
- Cheboyina S., Wyandt C.M., (2008 b). Wax-based sustained release matrix pellets prepared by a novel freeze pelletization technique II. In vitro drug release studies and release mechanisms. *Int J Pharm.*, 359 (1-2), 167-73.
- Chee C.P., Djordjevic D., Faraji H., Decker E.A., Hollender R., McClements D.J., Peterson D.G. (2007). Sensory properties of vanilla and strawberry flavored ice cream supplemented with omega-3 fatty acids. *Milchwissenschaft*. 62, 66-69.
- Chee C.P., Gallaher J.J., Djordjevic D., Faraji H., McClements D.J., Decker E.A., Hollender R., Peterson D.G., Roberts R.F., Coupland J.N. (2005). Chemical and sensory analysis of strawberry flavored yogurt supplemented with an algae oil emulsion. *J. Dairy. Res.* 72, 311-316.
- Chen H., Khemtong C., Yang X., *et al.*, (2011). Nanonization strategies for poorly water-soluble drugs. *Drug Discov Today*, 16(7/ 8), 354-360.
- Cheng X.X. , Turton R. (2000). The prediction of variability occurring in fluidized bed coating equipment. II. The role of nonuniform particle coverage as particles pass through the spray zone, *Pharm. Dev. Technol.*, 5 pp. 323–332.
- Chourasia M.K., Jain S.K., (2003). Pharmaceutical approaches to colon targeted drug delivery systems. *J. Pharm Pharm Sci.*, 6(1):33–66.
- Christensen F. N., Bertelsen P., (1997). Qualitative description of the Wurster-based fluid-bed coating process, *Drug Dev. Ind. Pharm.*, 23 (5), 451-463.
- Chu B.-S., Ichikawa S., Kanafusa S., Nakajima M., (2007). Preparation of protein-stabilized β -carotene nanodispersions by emulsification–evaporation method. *Journal of the American Oil Chemists' Society*, 84(11), 1053–1062.
- Cole G., Hogan J., Aulton M., (1995). Pharmaceutical coating technology. In: Cole, G. (Ed.), *Coating Pans and Coating Columns*. Taylor and Francis, London, pp. 203– 232.
- Coletta V., Rubin H., (1964). Wurster coated aspirin I Film-coating techniques, *J. Pharm. Sci.*, 53 (8), 953-955.
- Conine J.W., Hadley H.R., (1970). Preparation of small solid pharmaceutical spheres. *Drug Cosmet. Ind.* 106, 38–41.
- Csobán Z., Kállai-Szabó B., Kállai-Szabó N., Sebe I., Gordon P., Antal I., (2015). Improvement of mechanical properties of pellet containing tablets by thermal treatment. *Int J Pharm.*, 496 (2), 489–496.
- Dahan A., Miller J.M., Amidon G.L. (2009). Prediction of solubility and permeability class membership: provisional BCS classification of the world's top oral drugs. *AAPS J.*, 11(4):740-6.
- Dagleish D.G., West S.J., Hallett F.R., (1997). The characterization of small emulsion droplets made from milk proteins and triglyceride oil. *Colloids and Surfaces A: Physicochemical and Engineering Aspects*, 123: 145-53.
- Dewettinck K., Huyghebaert A., (1999). Fluidised bed coating in food technology. *Trends Food Sci. Technol.* 10, 163–168.

- Dilip M. Parikh, (2009). Handbook of Pharmaceutical Granulation Technology, Drugs and the Pharmaceutical Sciences. Informa Healthcare.
- Dredán J., Antal I., R. Zekó R., Rác I. (1999). Modification of drug release with application of pharmaceutical technological methods, *Acta Pharm. Hung.*, 69, pp. 176–180.
- Duangkhamchana W., Ronsseb F. , Siriamornpuna S., Pietersb J.G. (2015). Numerical study of air humidity and temperature distribution in a top-spray fluidised bed coating process, *Journal of Food Engineering*, 146, 81–91.
- Dukić R., Mens A., Adriaensens P., Foreman P., Gelan J.P., Remon J. and Vervaet C., (2009). Production of pellets via extrusion–spheronization without the incorporation of microcrystalline cellulose: A critical review. *Eur J Pharm Biopharm.* (71) 38-46.
- Dukić-Ott A., Remon J.P., Foreman P., Vervaet C., (2007). Immediate release of poorly soluble drugs from starch-based pellets prepared via extrusion/ spheronization, *European Journal of Pharmaceutics and Biopharmaceutics*, 67 (3), 715–724.
- Dušica M., Svetlana I., Bojana B., Željko K., Branko B., (2017). Evaluation of the impact of critical quality attributes and critical process parameters on quality and stability of parenteral nutrition nanoemulsions. *Journal of Drug Delivery Science and Technology*, 39, 341-347.
- Erber M., Lee G., (2015 a). Cryopellets based on amorphous organic calcium salts: Production, characterization and their usage in coagulation diagnostics, *Powder Technology*, 280, 10–17.
- Erber M., Lee G., (2015 b). Development of cryopelletization and formulation measures to improve stability of Echinococcus carinatus venom protein for use in diagnostic rotational thromboelastometry. *Int J Pharm.*, 495 (2), 692-700.
- Eriksson M., Alderborn G., Nyström C., Podczeczek F., Newton J.M., (1997). Comparison between and evaluation of some methods for the assessment of the sphericity of pellets. *International Journal of Pharmaceutics*, 148 (2), 149–154.
- Erkoboni D.F., (2003). Extrusion/spheronization. In: Ghebre-Sellassie I., Martin C., editors. *Pharmaceutical extrusion technology*. Vol. 133. New York: Marcel Dekker; p. 277–322.
- Eskilson C., (1985). Controlled release by microencapsulation. *Manufacturing Chemist* 1985; 56: 33–39.
- Fielden K.E., Newton J.M. and Rowe R.C., (1995). The influence of lactose particle size on spheronization of extrudate processed by a ram extruder. *Int. J. Pharm.*, 81, 1992, 205–224.
- Fielden K.E., Newton J.M., Rowe R.C., (1992 a). The influence of lactose particle size on spheronization of extrudate processed by a ram extruder. *Int. J. Pharm*, 81, 205-12.
- Fielden K.E., Newton J.M., Rowe R.C., (1992 b). A comparison of the extrusion and spheronization behaviour of wet powder masses processed by a ram extruder and a cylinder extruder. *Int. J. Pharm*, 81, 225- 233.
- Flaviana R. F., Daniel F. C., Frédéric F., Luís C. C. A., Lucas A. M. F., (2015), Nanoemulsions loaded with amphotericin B: A new approach for the treatment of leishmaniasis. *European Journal of Pharmaceutical Sciences*, 70, p. 125–131.
- Follonier N., Doelker E., Cole E.T., (1995). Various ways of modulating the release of diltiazem hydrochloride from hot-melt extruded sustained-release pellets prepared using polymeric materials, *Journal of Controlled Release*, 36, 243–250.
- Follonier N., E. Doelker E., Cole E.T., (1994). Evaluation of hot-melt extrusion as a new technique for the production of polymer-based pellets for sustained-release capsules containing high loadings of freely soluble drugs, *Drug Development and Industrial Pharmacy*, 20, 1323–1339.
- Food and Drug Administration. (2009). *Drugs, Dosage Form*.

- Franceschinis E., Bortoletto C., Perissutti B., Dal Zotto M., Voinovich D., Realdon N., (2011). Self-emulsifying pellets in a lab-scale high shear mixer: Formulation and production design, *Powder Technology*, 207, (1–3), 113–118.
- François H., Gilles D., Nolwenn B., Fabien G., Pascal L. C., (2015). Preparation and characterization of spironolactone-loaded nano-emulsions for extemporaneous applications. *International Journal of Pharmaceutics*, 478 (1): 193–201.
- Fukumori Y., Ichikawa H., (2006). Fluid bed processes for forming functional particles, *Encyclopedia of Pharmaceutical Technology*, third edition (J. Swarbrick (Ed.)), Informa Healthcare, New York (2006), pp. 1773-1778
- Fukumori Y., Ichikawa H., Jono K., Fukuda T., Osako Y., (1993). Effect of additives on agglomeration in aqueous coating with hydroxypropyl cellulose, *Chem. Pharm. Bull.*, 41 (4), 725-730.
- Fukumori Y., Ichikawa H., Jono K., Takeuchi Y., Fukuda T., (1992). Computer simulation of agglomeration in the Wurster process, *Chem. Pharm. Bull.*, 40 (8), 2159-2163.
- Gamlen M.J., (1985). Pellet manufacture for controlled release. *Manuf Chem*, 56, 55-59.
- Gamsjäger H., Lorimer J.W., Scharlin P., Shaw D.G., (2008). Glossary of terms related to solubility, *IUPAC-Pure and applied chemistry* 80, 233-276.
- Gao L., Zhang D., Chen M., (2008). Drug nanocrystals for the formulation of poorly soluble drugs and its application as a potential drug delivery system. *J Nanopart Res*, 10, 845-862.
- George E. Reier (2000). Avicel® PH Microcrystalline Cellulose, NF, Ph Eur., JP, BP. FMC.
- Ghanam D., Kleinebudde P., (2011). Suitability of κ -carrageenan pellets for the formulation of multiparticulate tablets with modified release. *International Journal of Pharmaceutics*, 409 (1–2), 9–18.
- Gharibzahedi S. M. T. (2017), Ultrasound-mediated nettle oil nanoemulsions stabilized by purified jujube polysaccharide: Process optimization, microbial evaluation and physicochemical storage stability. *Journal of Molecular Liquids*, 234, p. 240-248.
- Ghebre-Sellassie I., (1989). Pellets: A general overview. In: *Pharmaceutical Pelletization Technology*, Marcel Dekker Inc., New York and Basel: 1-13.
- Ghebre-Sellassie I., Knoch A., (2007). Pelletization Techniques, In: James Swarbrick editor. *Encyclopedia of Pharmaceutical Technology*, 3rd ed.; Informa healthcare: New York; p. 2651-2663.
- Ghosh V., Mukherjee A., Chandrasekaran N., (2013). Ultrasonic emulsification of food-grade nanoemulsion formulation and evaluation of its bactericidal activity. *Ultrasonics Sonochemistry*, 20: 338-344.
- Govender T., Dangor C.M., Chetty D.J., (1995). Drug release and surface morphology studies on salbutamol controlled release pellets, *Drug Dev. Ind. Pharm.*, 21 (11), 1303-1322.
- Gren T., Nystrom C., (1991). Characterization of surface coverage of coarse particles coated with stearic acid, *Int. J. Pharm.*, 74, 49-58.
- Groo A. C., Pascale M., Voisin-Chiret A.S., Corvaisier S., Since M., Malzert-Fréon A., (2017). Comparison of 2 strategies to enhance pyridoclox solubility: Nanoemulsion delivery system versus salt synthesis. *European Journal of Pharmaceutical Sciences*, 97, p. 218-226.
- Guo H.X. (2002). Compression behaviour and enteric film coating properties of cellulose esters. Academic dissertation, University of Helsinki, Helsinki, Finland.
- Guo H.X., Heinämäki J., Karjalainen M., Juhanoja J., Khriachtchev L., Yliruusi J., (2002). Compatibility of aqueous enteric film coating with pellets containing waxy maize starch and lactose, *STP Pharma Sci.*, 12 (3), 198-200.

- Guraya H.S., James C., (2002). Deagglomeration of rice starch-protein aggregates by high pressure homogenization. *Starch*, 54 (3-4), 108-116.
- Haack D. and M. Koeberle M., (2014). Hot Melt Coating for Controlling the Stability, Release Properties and Taste of Solid Oral Dosage Forms, *TechnoPharm* 4, Nr. 5, 258-263.
- Hamdani J., Moës A. J., Amighi K., (2002). Development and evaluation of prolonged release pellets obtained by the melt pelletization process. *Int J Pharm.* 245 (1-2), 167-77.
- Hellén L., Ritala M., Yliruusi J., Palmroos P, Kristoffersson E., (1992). Process variables of the radial screen extruder. Part II. Size and distribution of pellets; *Pharm. Tech. Int. Biophys*; 4, 50-7.
- Hellén L., Yliruusi J., Kristoffersson E. (1993 b). Process variables of instant granulator and spheroniser: II. Size and size distributions of pellets. *Int. J. Pharm*, 96, 205-216.
- Hellén L., Yliruusi J., Merkkü P., Kristoffersson E., (1993 a). Process variables of instant granulator and spheroniser: I. Physical properties of granules, extrudate and pellets, *Int. J. Pharm.*, 96, 197-204.
- Ho H. -O., Su H. -L., Tsai T., Sheu M. -T., (1996). The preparation and characterization of solid dispersions on pellets using a fluidized-bed system, *Int. J. Pharm.*, 139, 223-229.
- Hogan J. E, (1995 c). *Pharmaceutical Coating Technology*, In: 3. Sugar coating, Cole, G. C., Hogan, J. E., Aulton, M. E. (Ed.), Taylor and Francis, UK, pp.53-63.
- Hogan J. E., (1990). *Pharmaceutics The Science of Dosage Form Design*, In: 40. Tablet coating, Aulton M. E. (Ed), Churchill Livingstone, UK, pp 669-677.
- Hogan J.E. (1995 a) Film-coating materials and their properties. In *Pharmaceutical coating technology*, G. Cole, J. Hogan and M. Aulton; Taylor & Francis Ltd., London, 6-52.
- Hogan J.E. (1995 b) Modified release coatings. In *Pharmaceutical coating technology*, G. Cole, J. Hogan and M. Aulton; Taylor&Francis, London, 409-438.
- Holm P., (1996 a). Pelletization by granulation in a Roto-Processor RP-2. Part II: Effects of process and product variables on agglomerates' shape and porosity, *Pharm. Technol. Eur.*, 8, 38-45.
- Holm P., (1996 b). Pelletization by granulation in a Roto-Processor RP-2. Part III: Methods of process control and the effect of microcrystalline cellulose on wet granulation, *Pharm. Technol. Eur.*, 8 (10), 36-46.
- Hosseini A., Körber M., Bodmeier R., (2013). Direct compression of cushion-layered ethyl cellulose-coated extended release pellets into rapidly disintegrating tablets without changes in the release profile. *Int. J. Pharm.* 457, 503-509.
- <http://www.fda.gov/Drugs/DevelopmentApprovalProcess/FormsSubmissionRequirements/ElectronicSubmissions/DataStandardsManualmonographs/ucm071666.htm> [accessed July 6, 2009].
- Iosio T., Voinovich D., Grassi M., Pinto J.F., Perissutti B., Zacchigna M., Quintavalle U, Serdoz F., (2008). Bi-layered self-emulsifying pellets prepared by co-extrusion and spheronization: influence of formulation variables and preliminary study on the in vivo absorption. *Eur J Pharm Biopharm.*; 69 (2): 686-97.
- Izquierdo P., Esquena J., Tadros T. F., Dederen C., Garcia M. J., Azemar N., (2001). Formation and stability of nanoemulsions prepared using the phase inversion temperature method. *Langmuir*, 18(1), 26-30.
- Izquierdo P., Esquena J., Tadros T. F., Dederen J. C., Feng J., Garcia-Celma M. J., (2004). Phase behavior and nanoemulsion formation by the phase inversion temperature method. *Langmuir*, 20(16), 6594-98.
- Jachowicz R., Nürnberg E., Pieszczyk B., Kluczykowska B., Maciejewska A., (2000). Solid dispersion of ketoprofen in pellets. *Int J Pharm.*; 206 (1-2), 13-21.

- Jacqueline M. M., Diane J. B. (2014), In vitro release testing methods for vitamin E nanoemulsions. *International Journal of Pharmaceutics*, 475 (1-2), p. 393–400.
- Jafari S.M., He Y, Bhandari B., (2006). Nano-emulsion production by sonication and microfluidization-a comparison. *International Journal of Food Properties*, 9: 475-485.
- Jafari S.M., He Y, Bhandari B., (2007). Optimization of nano- emulsions production by microfluidization. *Eur Food Res Technol*, 225: 773-741.
- Jannin V., Cuppok Y., (2013). Hot-melt coating with lipid excipients, *International Journal of Pharmaceutics*, 457 (2), pp 480–487.
- Jinglei L., In-Cheon H., Xiguang C., Hyun J. P., (2016). Effects of chitosan coating on curcumin loaded nano-emulsion: Study on stability and in vitro digestibility. *Food Hydrocolloids*, 60, p. 138–147.
- Jones B. E., (1993). Colours for pharmaceutical products, *Pharm. Technol. Int.*, 17 (4), 14-20.
- Jones D. M., (1985). Factors to consider in fluid-bed processing, *Pharm. Technol.*, 9 (4), 50-62.
- Jozwiakowski M. J., Jones D. M., Franz R. M., (1990). Characterization of a hot melt fluid bed coating process for fine granules, *Pharm. Res.*, 7 (11), 1119-1126.
- Junghanns J.U.A.H, Müller R.H., (2008). Nanocrystal technology, drug delivery and clinical applications. *Int J Nanomedicine*, 3 (3), 295-309.
- Kleinebudde P., (1994). Shrinking and swelling properties of pellets containing microcrystalline cellulose and low substituted hydroxypropyl cellulose: I. Shrinking properties. *Int J Pharm.*; 109(3):209–19.
- Knop K.; and Kleinebudde P., (2005). Pharmaceutical pellets, definition, properties, production. *ExAct Excipients and Actives for Pharma*, 15: 2-5.
- Koester M., Thommes M., (2010). New insights into the pelletization mechanism by extrusion/spheronization. *AAPS Pharm. Sci. Technol.* 11, 1549-1551.
- Kokubo H., Obara S., Nishiyama Y., (1998). Application of extremely low viscosity methylcellulose (MC) for pellet film coating, *Chem. Pharm. Bull.*, 46 (11), 1803-1806.
- Koo. O.M.Y, Heng. P.W.S. (2001). The influence of microcrystalline cellulose grade on shape and shape distributions of pellets produced by extrusion-spheronization; *Chem. Pharm. Bull.*; 49, 1383-7.
- Krämer J., Blume H., (1994). Biopharmaceutical aspects of multiparticulates, in: J. Swarbrick (Ed.), *Multiparticulate Oral Drug Delivery*, first ed., Marcel Dekker, New York, 1994, pp. 307–332.
- Kristensen J., Schæfer T., Kleinebudde P., (2000 a). Direct pelletization in a rotary processor controlled by torque measurements. I. Influence of process variables. *Pharm. Dev. Technol.* 5, 247–256.
- Kristensen J., Schæfer T., Kleinebudde P., (2000 b). Direct pelletization in a rotary processor controlled by torque measurements. II: Effects of changes in the content of microcrystalline cellulose. *AAPS PharmSci.* 2, Article 24.
- Kumar Vinay K.V., Sivakumar T. and Tamizhmani T., (2011). Colon targeting drug delivery system: A review on recent approaches, *International Journal of Pharmaceutical and Biomedical Science*, 2, 11-19.
- KuShaari K., Pandey P. , Turton Y. (2006), Monte Carlo simulations to determine coating uniformity in a Wurster fluidized bed coating process *Powder Technol.*, 166 , pp. 81–90
- Kwon S.S., Nam Y.S., Lee J.S., Ku B.S., Han S.H., Lee J.Y., Chang I.S., (2002). Preparation and characterization of coenzyme Q10-loaded PMMA nanoparticles by a new emulsification process based on microfluidization. *Colloids and Surfaces A: Physicochemical and Engineering Aspects*, 210: 95-104.

- Lachman L., *et al.*, (1991), The Theory and Practice of Industrial Pharmacy. Second edition, Fourth Indian Reprint, Published by Varghese Publishing house, Bombay. 1991: 346-372.
- Laouini A., Fessi H., Charcosset C., (2012). Membrane emulsification: A promising alternative for vitamin E encapsulation within nano-emulsion. *Journal of Membrane Science*, 423-424: 85-96.
- Laura L., Robin H., Ian N., Ian T. N. (2014). Production of water-in-oil nanoemulsions using high pressure homogenisation: A study on droplet break-up. *Journal of Food Engineering*, 131, p. 33-37.
- Lehmann K., (1994). Coating of multiparticulates using polymeric solutions: formulation and process considerations. In *Multiparticulate oral drug delivery*, 1st Edition, I. Ghebresellassie; Marcel Dekker, Inc., New York, 51-78.
- Lei Y., Lu Y., Qi J., Nie S., Hu F., Pan W., Wu W., (2011). Solid self-nanoemulsifying cyclosporin A pellets prepared by fluid-bed coating: preparation, characterization and *in vitro* redispersibility. *Int J Nanomedicine*. 6, 795-805.
- Leopold C. S., (1999). Coated dosage forms for colon-specific drug delivery, *Pharm. Sci. Technol. Today*, 2 (5), 197-204.
- Li P., Chiang B., (2012). Process optimization and stability of D- limonene-in-water nanoemulsions prepared by ultrasonic emulsification using response surface methodology. *Ultrasonics Sonochemistry*, 19: 192-197.
- Lieberman H. H., Lachman, L. and Schwartz J. B. (1990). *Pharmaceutical Dosage Forms: Tablet Volume 3*, 2 nd Ed. Marcel Dekker Inc, New York, Basel.
- Lieberman Herbert A. and Albert Rankell, (1970). "Drying" In the *Theory and Practice of Industrial Pharmacy*, edited by Leon Lachman, Herbert A. Lieberman and Joshep L. Kanig, 22-48. Philadelphia: Lea & Febiger.
- Liew C.V., Gu L., Soh J.L., Heng P.W., (2005). Functionality of cross-linked polyvinylpyrrolidone as a spheronization aid: a promising alternative to microcrystalline cellulose, *Pharm Res.*, 22 (8), 1387-98.
- Lindenberg M., Kopp S., Dressman J. B., (2004). Classification of orally administered drugs on the World Health Organization Model list of Essential Medicines according to the biopharmaceutics classification system, *European Journal of Pharmaceutics and Biopharmaceutics*, 58 (2), 265–278.
- Link K.C., Schlunder E., (1997). Fluidized bed spray granulation Investigation of the coating process on a single sphere, *Chem Eng. Process.*, 36, 443-457.
- Lipinski C.A., (2002). Poor aqueous solubility: industry wide problem in drug discovery. *Am Pharmaceut Rev*, 5, 82–85.
- Lipinski C.A., Lombardo F., Dominy B.W., Feeney P.J., (2001). Experimental and computational approaches to estimate solubility and permeability in drug discovery and development settings. *Adv Drug Deliv Rev.*, 46 (1-3), 3-26.
- Long B., McClements D. J., (2016). Development of microfluidization methods for efficient production of concentrated nanoemulsions: Comparison of single- and dual-channel microfluidizers. *Journal of Colloid and Interface Science*, 466, p. 206–212.
- Lopes D.G., Garsuch V., Becker K., Paudel A., Stehr M., Zimmer A., Salar-Behzadi S., (2016). Improving the granule strength of roller-compacted ibuprofen sodium for hot-melt coating processing. *Int J Pharm.*, 510 (1), 285-95.
- Lust A., Lakio S., Vintsevits J., Kozlova J., Veski P., Heinämäki J., Kogermann K., (2013). Water-mediated solid-state transformation of a polymorphic drug during aqueous-based drug-layer coating of pellets. *Int J Pharm.*; 456 (1), 41-8.

- Magdalene R., (2001). Pure drug nanoparticles for the formulation of poorly soluble drugs. *NewDrugs*, 3, 62-68.
- Malinowski H.J., Smith W.E., (1975). Use of factorial design to evaluate granulations prepared by spheronization. *J. Pharm. Sci*, 64, 1688-1692.
- Malm C.J. and Waring C.E., (1937). Cellulose esters containing dicarboxylic acid groups and process of making the same, US-patent no: 2093462.
- Marvola M., Nykänen P., Rautio S., Isonen N., Autere A. -M., (1999). Enteric polymers and coating materials in multiple-unit site-specific drug delivery systems, *Eur. J. Pharm. Biopharm.*, 7 (3), 259-267.
- Mason T., Wilking J., Meleson K., Chang C., Graves S., (2006). Nanoemulsions: formation, structure, and physical properties. *Journal of Physics-Condensed Matter*, 18: 635-666.
- Mathur L.K., Forbes S.J., Yelvig M., (1984). Characterization techniques for the aqueous film coating process, *Pharm. Technol.*, 8 (10), 42-56.
- Mehta A.M., (1986). Factors in the Development of Oral Controlled-Release Dosage Forms, *Pharm. Mfg.*, 3 (1), 23-29.
- Mehta A.M., Valazza M. J., Abele S. E., (1986). Evaluation of fluid-bed processes for enteric coating systems, *Pharm. Technol.*, 10 (4), 46-56.
- Mehta S., De Beer T., Remona J. P., Vervaet C., (2012). Effect of disintegrants on the properties of multiparticulate tablets comprising starch pellets and excipient granules. *International Journal of Pharmaceutics*, 422, 310–317.
- Michael E. Aulton, Kevin M.G. Taylor, (2013). *Aulton's Pharmaceutics: The Design and Manufacture of Medicines*, 4th edition, Churchill Livingstone. Chapter 28, page 481.
- Michie H., Podczec F., Newton J.M., (2012). The influence of plate design on the properties of pellets produced by extrusion and spheronization. *Int J Pharm.*; 434 (1-2), 175-82.
- Millili G.P., Schwartz B., (1990). The strength of microcrystalline cellulose pellets: The effect of granulating with water-ethanol mixtures. *Drug Dev.Ind. Pharm*, 16, 1411-1426.
- Missaghi S., (2006). Formulation design and fabrication of acidlabile compounds employing enteric coating technique using omeprazole as a model drug. Ph.D. Dissertation, Temple University School of Pharmacy, Philadelphia.
- Morales D., Gutiérrez J.M., García-Celma M.J., Solans Y.C., (2003). A study of the relation between bicontinuous micro- emulsions and oil/water nano-emulsion formation. *Langmuir*, 19 (18), 7196–7200.
- Möschwitzer J., Müller R.H., (2006). Spray coated pellets as carrier system for mucoadhesive drug nanocrystals. *Eur J Pharm Biopharm.* 62 (3), 282-7.
- Möschwitzer J., Müller R.H., (2007). Drug nanocrystals - the universal formulation approach for poorly soluble drugs. In: Thassu D, Deleers M, Pathak Y, editors. *Nanoparticulate drug delivery systems*. New York: Informa Healthcare; 71-88.
- Müller R.H., Gohla S., Keck C.M., (2011). State of the art of nanocrystals e special features, production, nanotoxicology aspects and intracellular delivery. *Eur J Pharm Biopharm*; 78, 1-9.
- Nakahara N., (1964). Method and apparatus for making spherical granules, US patent 3 277 520.
- Nakajima H., (1997). Microemulsions in cosmetics. In: Solans C, Kunieda H. *Industrial Applications of Microemulsions*. New York: Marcel Dekker. 175-197.
- Nakajima H., Tomomasa S., Okabe M., (1993). Preparation of nanoemulsions. *Proceedings First World Congress on Emulsions*, 19-22 October, 1993, Paris, France.
- Nakano T., Yuasa H., Kanaya Y., (1999). Suppression of agglomeration in fluidized bed coating. III. Hofmeister series in suppression of particle agglomeration, *Pharm. Res.*, 16 (10), 1616-1620.

- Nastruzzi C., Cortesi R., Esposito E., Genovesi A., Spadoni A., Vecchio C., Menegatti E., (2000). Influence of formulation and process parameters on pellet production by powder layering technique. *AAPS PharmSciTech.*, 1 (2), E9.
- Newton J.M., Petersson J., Podczec F., Clarke A., Booth S., (2001). The influence of formulation variables on the properties of pellets containing a self-emulsifying mixture. *J. Pharm. Sci.* 90, 987–995.
- Newton J.M., Pinto M.R., Podczec F., (2007). The preparation of pellets containing a surfactant or a mixture of mono- and di-glycerides by extrusion/spheronization. *Eur. J. Pharm. Sci.* 30, 333–342.
- Nyqvist H., Nicklasson M., Lundgren, P., (1982). Studies on the physical properties of tablets and tablet excipients. V. Film coating for protection of a light-sensitive tablet-formulation, *Acta Pharm. Suec.*, 19, 223-228.
- Olsen K. W., Mehta A. M., (1985). Fluid bed agglomerating and coating technology - state of the art, *Drug, Int. J. Pharm. Technol. Prod. Manuf.*, 6 (4), 18-24.
- Ozturk S.S., Palsson B.O., Donhoe B., Dressman J., (1988). Kinetics of release from enteric coated tablets. *Pharm Res*, 5(9):550–6.
- Parikh D. M., (1991). Airflow in Batch Fluid-Bed Processing, *Pharm. Technol.*, 15 (3), 100-110.
- Park H.J., Lee G. H., Jun J.H., Son M., Choi Y.S., Choi M. K., Kang M.J., (2016). Formulation and *in vivo* evaluation of probiotics-encapsulated pellets with hydroxypropyl methylcellulose acetate succinate (HPMCAS). *Carbohydrate Polymers*, 136, 692-9.
- Pašić M., G. Betz G., Hadžidedić Š., Kocova El-Arini S., Leuenberger H., (2010). Investigation and development of robust process for direct pelletization of lansoprazole in fluidized bed rotary processor using experimental design, *Journal of Drug Delivery Science and Technology*, 20 (5), 367–376.
- Patrik S., Cornelia M. K., (2015), Nanoemulsions produced by rotor–stator high speed stirring, *International Journal of Pharmaceutics*, 482 (1-2), p. 110–117.
- Peck G.E., Baley G.J., McCurdy V.E. and Banker G.S., (1989). Tablet Formulation Design. In: Schwartz, B.J. (ed.) *Pharmaceutical Dosage Forms: Tablets*. Marcel Decker, New York, p. 75-130.
- Physician’s Desk Reference (PDR). (60^{ed}) (2006). Montvale: Thomson PDR.
- Podczec F., (2008 a). A novel aid for the preparation of pellets by extrusion/ spheronization. *Pharmaceutical Technology Europe*, 20, 26–31.
- Podczec F., Knight P.E., Newton J.M., (2008 b). The evaluation of modified microcrystalline cellulose for the preparation of pellets with high drug loading by extrusion/spheronization. *Int J Pharm.* 350 (1-2), 145-54.
- Podczec F., Newton J.M., (2014). Influence of the standing time of the extrudate and speed of rotation of the spheroniser plate on the properties of pellets produced by extrusion and spheronization. *Advanced Powder Technology*, 25, 659–665.
- Podczec F., Rahman S.R., Newton J.M., (1999). Evaluation of a standardised procedure to assess the shape of pellets using image analysis. *International Journal of Pharmaceutics* 192, 123–138.
- Pondell R.E., (1984). From solvent to aqueous coatings, *Drug Dev. Ind. Pharm.*, 10 (2), 191-202.
- Porter S.C., (1979). Aqueous film coating: an overview, *Pharm. Technol.*, 3 (9), 55.
- Porter S.C., (1990). Coating of pharmaceutical dosage forms. In Remington’s *Pharmaceutical Sciences*, 18th Edition, A.R. Gennaro; Mack Publishing Company, Easton, Pennsylvania, 1667-1675.

- Porter S.C., Bruno C.H., (1989). Coating of pharmaceutical solid dosage forms. In: Lieberman HA, Lachman L, Schwartz J, eds. *Pharmaceutical dosage forms: Tablets*. New York: Marcel Dekker, 77–151.
- Pouton C.W., (2006). Formulation of poorly water-soluble drugs for oral administration: physicochemical and physiological issues and the lipid formulation classification system. *Eur J Pharm Sci.*, 29 (3-4), 278-87.
- Pouton C.W., Porter C.J.H., (2008). Formulation of lipid-based delivery systems for oral administration: Materials, methods and strategies. *Adv Drug Deliv Rev.*, 60, 625–637.
- Priese F., Wolf B., (2013). Development of high drug loaded pellets by Design of Experiment and population balance model calculation, *Powder Technology*, 241, 149–157.
- Prieto S.M., Mendez J.B., Oreto Espinar F.J., (2005). Starch-dextrin mixtures as base excipients for extrusion spherulization pellets. *Eur. J. Pharm. Biopharm*, 59, 511-521.
- Quintanilla-Carvajal M., Camacho-Díaz B., Meraz-Torres L., Chanona-Pérez J., Alamilla-Beltrán L., Jiménez-Aparicio A., (2010). Nanoencapsulation: A new trend in food engineering processing. *Food Engineering Reviews*, 2(1), 39–50.
- Radl S., Tritthart T., Johannes G. Khinast J.G., (2010). A novel design for hot-melt extrusion pelletizers, *Chemical Engineering Science*, 65 (6), 1976–1988.
- Raffaele V., Vincenzo Q., Dominic C., Vincenzo C., Elisa D. L., Rosario V. I., Paolo A. N., (2016). Curcumin bioavailability from oil in water nano-emulsions: In vitro and in vivo study on the dimensional, compositional and interactional dependence. *Journal of Controlled Release*, 233 : 88–100.
- Rao J.J., McClements D.J., (2010). Stabilization of phase inversion temperature nanoemulsions by surfactant displacement. *J Agric Food Chem*, 58: 7059-7066.
- Reynolds A.D., (1970). A new technique for the production of spherical particles. *Manuf. Chem. Aer. News*, 44, 40–44.
- Römer M., Heinämäki J., Miroshnyk I., Sandler N., Rantanen J., Yliruusi J., (2007). Phase transformations of erythromycin A dihydrate during pelletisation and drying. *Eur. J. Pharm. Biopharm*, 67, 246-252.
- Rothrock D.A., Cheetham, H.C., (1942). Hot melt coating. US patent, 2,285,095, pp. 1–3.
- Rowe R.C., (1985). Spherulization: a novel pill-making process? *Pharm. Int.* 6, 119-123.
- Sadtler V., Rondon-Gonzalez M., Acrement A., Choplin L., Marie, E., (2010). PEO-covered nanoparticles by emulsion inversion point (eip) method. *Macromolecular Rapid Communications*, 31(11), 998–1002.
- Sadurní N., Solans C., Azemar N., García-Celma M. J., (2005). Studies on the formation of O/W nano-emulsions, by low-energy emulsification methods, suitable for pharmaceutical applications. *European Journal of Pharmaceutical Sciences*, 26(5), 438–445.
- Saeed S. G., Bahram D., Mehdi Z., (2015). An innovative numerical approach for simulation of emulsion formation in a Microfluidizer. *Colloids and Surfaces A: Physicochemical and Engineering Aspects*, 487, p. 169–179.
- Salman A., Hounslow M., Seville J. (2007), *Granulation Handbook of Powder Technology*, 11, Elsevier, Amsterdam.
- Sandra E., Charmaine K.W.K., Jochen W., McClements D. J. (2017). Continuous production of core-shell protein nanoparticles by antisolvent precipitation using dual-channel microfluidization: Caseinate-coated zein nanoparticles, *Food Research International*, 92, p. 48-55.
- Sandra G., Heike B., (2016). Preparation of lipid nanoemulsions by premix membrane emulsification with disposable materials, *International Journal of Pharmaceutics*, 511 (2), p. 741–744.

- Sanguansri P., Augustin M.A., (2006). Nanoscale materials development - food industry perspective. *Trends in Food Science and Technology*, 17: 547-556.
- Schæfer T., (1996). Melt pelletization in a high shear mixer. X. Agglomeration of binary mixtures. *Int. J. Pharm.* 139, 149– 159.
- Schmidt C., Kleinebudde P., (1998). Comparison between a twin-screw extruder and a rotary ring die press. Part II: influence of process variables, *European Journal of Pharmaceutics and Biopharmaceutics*, 45 (2), 173–179.
- Schmidt C., Lindner H., Kleinebudde P., (1997). Comparison between a twin-screw extruder and a rotary ring die press. Part I. Influence of formulation variables, *European Journal of Pharmaceutics and Biopharmaceutics*, 44, 169-176.
- Shah R.D., Kabadi M., Pope D.G., Augsburg L.L., (1995). Physico-mechanical characterization of the extrusion-spheronization process. Part II: Rheological determinants for successful extrusion and spheronization. *Pharm Res.*; 12(4): 496–507.
- Shakeel F., Baboota S., Ahuja A., Ali J., Shafiq S., (2008). Accelerated stability testing of celecoxib nanoemulsion containing cremophor-EL. *African Journal of Pharmacy and Pharmacology*, 2: 179-183.
- Shinoda K., Saito H., (1968). The effect of temperature on the phase equilibria and the types of dispersions of the ternary system composed of water, cyclohexane, and nonionic surfactant. *Journal of Colloid and Interface Science*, 26(1), 70–74.
- Shinoda K., Saito H., (1969). The stability of o/w type emulsions as a function of temperature and the hlb of emulsifiers: the emulsification by pit-method. *Journal of Colloid and Interface Science*, 30(1), 258–263.
- Šibanca R., Žunb I., Dreua R., (2016). Measurement of particle concentration in a Wurster coater draft tube using light attenuation, *Chemical Engineering Research and Design*, 110, p. 20–31.
- Simon E., (1978). Containment of hazards in fluid-bed technology, *Mfg. Chem. Aerosol News*, 49, 23-32.
- Sinchaipanid N., Chitropas P., Mitrevej A., (2004). Influences of layering on theophylline pellet characteristics. *Pharm. Dev. Technol.*, 9, pp. 163–170.
- Solans C., Izquierdo P., Nolla J., Azemar N., Garcia-Celma M.J., (2005). Nanoemulsions. *Curr Opin Coll Interface Sci* 10:102–110.
- Solans C., Solé I., (2012). Nano-emulsions: formation by low-energy methods. *Current Opinion in Colloid and Interface Science*, 17: 246-254.
- Sonaglio D., Bataille B., Ortigosa C. and Jacob M., (1995). Factorial design in the feasibility of producing Microcel MC 101 pellets by extrusion/spheronisation. *Int. J. Pharm.*, 115, 53–60.
- Sousa J.J., Sousa A., Podczec F., Newton J.M., (1992). Influence of process conditions on drug release from pellets. *Int. J. Pharm*, 144, 159-169.
- Sousa J.J., Sousa A., Podczec F., Newton J.M., (2002). Factors influencing the physical characteristics of pellets obtained by extrusion-spheronization. *International Journal of Pharmaceutics*, 232, 91–106.
- Souto C., Rodriguez A., Parajes S., Martinez-Pacheco R., (2005). A comparative study of the utility of two superdisintegrants in microcrystalline cellulose pellets prepared by extrusion-spheronization. *Eur J Pharm Biopharm*; 61(1–2):94–9.
- Suhrenbrock L., Radtke G., Knop K., Kleinebudde P., (2011). Suspension pellet layering using PVA-PEG graft copolymer as a new binder. *Int J Pharm.*, 412 (1-2), 28-36.
- Swientek R.J., (1990). Microfluidizing technology enhances emulsion stability. *Food Processing*, 152-153.

- Takagi T., Ramachandran C., Bermejo M., Yamashita S., Yu L.X., Amidon G.L., (2006). A provisional biopharmaceutical classification of the top 200 oral drug products in the United States, Great Britain, Spain, and Japan, *Mol Pharmaceutics*, 3, 631–43.
- Tamilvanan S., Senthilkumar R.S., Baskar R., Sekharan T.R., (2010). Manufacturing techniques and excipients used during the formulation of oil-in-water type nanosized emulsions for medical applications. *J. Excipients and Food Chem.* (1) 11-29.
- Tho I., Sande S.A., Kleinebudde P., (2002). Pectinic acid, a novel excipient for production of pellets by extrusion/spheronization: preliminary studies, *Eur J Pharm Biopharm.*, 54, 95–9.
- Thommes M., Kleinebudde P., (2006). Use of κ -carrageenan as alternative pelletization aid to microcrystalline cellulose in extrusion/spheronization. I. Influence of type and fraction of filler. *Eur J Pharm Biopharm.*, 63, 59–67.
- Thompson A.K., Singh H., (2006). Preparation of liposomes from milk fat globule membrane phospholipids using a microfluidizer. *J Dairy Sci*, 89: 410-419.
- Tian Z., Yi Y., Yuan H., Han Y., Zhang X., Xie Y., Lu Y., Qi J., Wu W., (2013). Solidification of nanostructured lipid carriers (NLCs) onto pellets by fluid-bed coating: Preparation, in vitro characterization and bioavailability in dogs. *Powder Technology* 247 (2013) 120–127.
- Trivedi N.R., Rajan M.G., Johnson J.R. and Shukla A.J., (2007). Pharmaceutical approaches to preparing pelletized dosage forms using the extrusion–spheronisation process. *Critical Reviews in Therapeutic Drug Carrier Systems*, 24, 1–40.
- Tuleu, C., Newton, M., Rose, J., Euler, D., Saklatvala, R., Clarke, A., Booth, S., (2004). Comparative bioavailability study in dogs of a self-emulsifying formulation of Progesterone presented in a pellet and liquid form compared with an aqueous suspension of Progesterone. *J. Pharm. Sci.* 93, 1495–1502.
- Usón N., Garcia M.J., Solans C., (2004). Formation of water-in-oil (W/O) nano-emulsions in a water/mixed non-ionic surfactant/ oil systems prepared by a low-energy emulsification method. *Colloids and Surfaces A: Physicochemical and Engineering Aspects*, 250(1–3), 415–421.
- Vaassen J., Bartscher K., Breitzkreutz J., (2012). Taste masked lipid pellets with enhanced release of hydrophobic active ingredient. *International Journal of Pharmaceutics* (429), p. 99–103.
- Vecchio C., Fabiani, F., Sangalli, M. E., Zerna, L., Gazzaniga, A., (1998). Rotary tangential spray technique for aqueous film coating of indobufen pellets, *Drug Dev. Ind. Pharm.*, 24 (3), 269-274.
- Vervaet C., Baert L., Remon J.P., (1995). Extrusion-spheronisation: A literature review. *International Journal of Pharmaceutics* 116, 131–146.
- Vervaet C., Baert L., Risha P.A., Remon J.P., (1994). The influence of the extrusion screen on pellet quality using an instrumented basket extruder, *International Journal of Pharmaceutics*, 107, 29-39.
- Vilhelmsen T., Kristensen J., Schaefer T., (2004). Melt pelletization with polyethylene glycol in a rotary processor. *Int J Pharm.*, 275 (1-2), 141-53.
- Virginia C., Marco B., Laura M., Francesco C., Michele P., Giuseppe D.R. (2016), Development of nanoemulsions for topical delivery of vitamin K1, *International Journal of Pharmaceutics*, 511 (1), p. 170-177.
- Wagner J.G., (1971). Enteric coatings. In: Wagner JG, ed. *Biopharmaceutics and relevant pharmacokinetics*. Hamilton: Drug Intelligence Publications, 158–65.
- Walstra P., (1993). Principles of emulsion formation. *Chemical Engineering Science*, 48(2), 333–349.

- Wang Z., Chen B., Quan G., Li F., Wu Q, Dian L, Dong Y, Li G, Wu C., (2012). Increasing the oral bioavailability of poorly water-soluble carbamazepine using immediate-release pellets supported on SBA-15 mesoporous silica. *Int J Nanomedicine*. 7, 5807-18.
- Wang Z., Sun J., Wang Y., Liu X., Liu Y., Fu Q., Meng P., He Z., (2010). Solid self-emulsifying nitrendipine pellets: preparation and in vitro/in vivo evaluation. *Int J Pharm.*; 383(1-2):1-6.
- Werner S.R.L., Jones J.R., Paterson A.H.J., Archer R.H., Pearce D.L., (2007). Air suspension particle coating in the food industry: part II – micro-level process approach. *Powder Technol.* 171, 34–45.
- West A.J., Rowe R.C., (1988). Production spheronisers ten years on. *Manuf. Chem*, 59, 79-80.
- Wigmore T., (1989). Film coaters for the future, *Mfg Chem.*, 60 (12), 33 & 36.
- Wlosnewski J.C., Kumpugdee-Vollrath M., Sriamornsak P., (2010). Effect of drying technique and disintegrant on physical properties and drug release behaviour of microcrystalline cellulose-based pellets prepared by extrusion/spheronization. *Chemical Engineering Research and Design*, 88, 100-108.
- Wurster D.E., (1966). Particle Coating Process. US Patent No. 3,253,944, Wisconsin Alumni Research Foundation.
- Xia H., Zhang C., Wang Q., (2001). Study on ultrasonic induced encapsulating emulsion polymerization in the presence of nanoparticles. *Journal of Applied Polymer Science*, 80, 1130-1139.
- Xiang L., Yanyan Z., Long B., Fuguo L., Ruojie Z., Zipei Z., Bingjing Z., Yihui D., David J. M., (2017). Production of highly concentrated oil-in-water emulsions using dual-channel microfluidization: Use of individual and mixed natural emulsifiers (saponin and lecithin). *Food Research International*, 96: 103–112.
- Xu M., Liew C.V., Heng P.W.S., (2015). Evaluation of the coat quality of sustained release pellets by individual pellet dissolution methodology. *International Journal of Pharmaceutics*, 478, 318–327.
- Yeung C.W., Rein H., (2015). Hot-melt extrusion of sugar-starch-pellets. *Int J Pharm.* 493 (1-2), 390-403.
- Yin L-J., Chu B-S., Kobayashi I., Nakajima M., (2009). Performance of selected emulsifiers and their combinations in the preparation of β -carotene nanodispersions. *Food Hydrocolloids*. 23 (6), 1617-1622.
- Young C.R., John J Koleng J.J., McGinity J.W., (2002). Production of spherical pellets by a hot-melt extrusion and spheronization process, *International Journal of Pharmaceutics*, 242 (1-2), 87-92.
- Yuasa H., Nakano T., Kanaya Y., (1999). Suppression of agglomeration in fluidized bed coating. II. Measurement of mist size in a fluidized bed chamber and effect of sodium chloride addition on mist size, *Int. J. Pharm.*, 178, 1-10.
- Zema L., Palugan L., Maroni A., Foppoli A, Sangalli M. E., Gazzaniga A., (2008). The Use of β -Cyclodextrin in the Manufacturing of Disintegrating Pellets with Improved Dissolution Performances, *AAPS PharmSciTech.*; 9 (2): 708–717.
- Zvonar A., Berginc K., Kristl A., *et al.*, (2010). Microencapsulation of self- microemulsifying system: Improving solubility and permeability of furosemide. *Int J Pharm.*, 388,151–158.

Chapter 2 : Materials and methods

This chapter deals with all the materials, fabrication methods, procedures and techniques used to develop and characterize of the different pellets that will be discussed in the following chapters.

2.1. Materials and equipments

The lists of materials and equipments that were used in this study are listed in tables 2.1 and 2.2, respectively.

Table 2.1. List of Materials

Materials	Companies	Lots
Acryl – EZE [®] 93A92545 yellow	Colorcon (England)	DT592801
Advantia [®] Performance 190024HA49	ISP Technologies INC (USA)	ER800201420
Advantia [®] Preferred HS 290008CR01	ISP Technologies INC (USA)	ER100265771
Cellets [®] 1000 – Microcrystalline cellulose- neutral pellets	Pharmatrans-Sanaq AG, Basel, Switzerland	13I056
Cellets [®] 710 – Microcrystalline cellulose- neutral pellets	Pharmatrans-Sanaq AG, Basel, Switzerland	13G027
Cremophor [®] ELP (polyoxyethylated-35 castor oil, hydrophilic–lipophilic balance approximately 12–14)	BASF SE (Ludwigshafen, Germany)	63928956P0
Explocel [®] (croscarmellose sodium)	Blanver (Brazil)	17862X
Folic acid (purity>97%, molecular weight 441.4)	Sigma-Aldrich Co. (St. Louis, MO)	GH0207634
Empty hard gelatin capsules: size 1, ivory color	Qualicaps [®] , Co., LTD. (Japan)	SB42ZB
Ketoprofen	S.I.M.S (Italy).	93.604
Kaolin beads, molecular sieves	Fisher Scientific (China)	111231B
Plasdone [®] K25	ISP (Germany)	05700174879
Labrafil [®] M 1944 CS (Oleoyl macrogol-6 glycerides)	Fagron Ibérica	L16010070- OF-208712
Mannitol 35	Roquette (France)	720501
Microcrystalline cellulose PH 101	Fagron (France)	14K18-B01-

Materials	Companies	Lots
		301059
Pharmacoat [®] 606 (Hydroxypropyl Methylcellulose: HPMC)	Seppic (France)	7068037
Potassium chloride	Fisher Scientific (UK)	0619403
Potassium dihydrogen orthophosphate	Fisher Scientific (UK)	0614164
Primojel [®] (Sodium starch glycolate)	Avebe (Holland)	10550645
Sodium hydroxide	Carlo Erba reagents (France)	2B076292C
Talc	Cooper (France)	010300005/B
Ultrapure water	PURELAB [®] Ultra filtration system	
VP AEROPERL [®] 300 Pharma	Evonik (France)	9123072

Table 2.2. List of equipments

Equipments	Models and Manufacturers
Air compressor	SM9 Aircenter Kaeser, Sigma, Germany
Analytical balance	Voyageur [®] Ohaus Corp., Switzerland
Balance	Navigator [®] Ohaus, Switzerland
Disintegration apparatus	Sotax DT2, Switzerland
Dissolution testing station	Bio-Dis RRT9, G.B. Caleva, UK
DLS/ Malvern Nano ZS [®] instrument	Malvern, Orsay, France
Drying oven (25 ⁰ C)	Memmert, GmbH+ Co.KG, Germany
Drying oven (30 ⁰ C)	73 7F; Fisher Scientific, Pittsburgh, PA
Drying oven (40 ⁰ C)	Heraeus Ger0000287

Equipments	Models and Manufacturers
Drying balance	Sartorius MA100 Infrared Moisture Analyser
Extruder	Variable Density Extrusion [®] Caleva 120 (UK)
Filter paper	Whatman (Cat No 1001 090)
Fluid-bed	Innojet VENTILUS [®] V-2.5, Germany
Friability tester	PTFE, Pharmatest, Hainburg, Germany
Lyophilisateur	Christ Alpha 2-4 LD plus, Martin Christ, Germany
Microscope	Nikon Eclipse E600 Pol.; Nikon Instech Co., Japan
Mixer	Stephan mixer (type UMC 5, Stephan und Söhne GmbH and Co., Hameln, Germany)
pH meter	CyberScan500
SEM	Jeol, JSM-1600, Tokyo, Japan
Sieve shaker	Retsch [®] type AS200, F. Kurt Retsch GmbH, Germany
Sonicator	DVE GS 88155, Geprüfte Sicherheit
Spheroniser	With a “cross-hatched” friction plate (Caleva Model 15, Caleva, Sturminster Newton, Dorset, UK).
Standard sieves	DIN/ISO3310-1, Retch, Germany
Tapping machine	ERWEKA, Germany
UV spectrophotometer	UV2401PC, SHIMADZU, Kyoto, Japan

2.2. Methods

2.2.1. Characterization of folic acid

Spectrophotometric analysis

Scanning to obtain wavelength of maximum absorption was done between 200 – 400 nm in artificial gastric and intestinal fluids. Standard curve was prepared by serially diluting a stock solution of the drug in water, artificial gastric fluid (pH 1.2) and artificial intestinal fluid (pH 6.8). Analysis was carried out on triplicate samples. Method described in USP XXXII was followed.

2.2.2. Characterization of ketoprofen

Samples of ketoprofen were characterized as received by using different instruments and measurement techniques that will be described in the following.

Compatibility studies between ketoprofen with binder excipients

Binary mixtures of 1:1 (w/w) ketoprofen/binder excipient (PVP or HPMC) contained in glass test tube and cover all tubes with one sheet of Parafilm[®] M. Samples were stored under accelerated stability test conditions (40 °C at 75% relative humidity) in 3 months.

Spectrophotometric analysis

Scanning to obtain wavelength of maximum absorption was done between 200 – 400 nm in artificial gastric and intestinal fluids. Standard curve was prepared by serially diluting a stock solution of the drug in water, artificial gastric fluid (pH 1.2) and artificial intestinal fluid (pH6.8). Analysis was carried out on triplicate samples. Method described in USP XXXII was followed. Absorption was measured in a standard 10 mm quartz cuvette.

Saturation solubility study of ketoprofen in some solvents/surfactants

The solubility of ketoprofen in various oils, surfactants, and co-surfactants was determined. 2 ml of each of the selected vehicles was added to each cap vial containing an excess of ketoprofen. After sealing, the mixture was heated at 40 °C in a water bath and treated with ultrasonic (the frequency of ultrasonic was 35 kHz) for 5 min to facilitate solubilisation. These mixtures were shaken at 25 °C for 72 h. After reaching equilibrium, each vial was centrifuged at 10,000 rpm for 10 min (25 °C). The supernatant was filtered through a 0.45 µm syringe filter membrane and the filtrate was diluted with ethanol. The concentration of

ketoprofen was measured after appropriate dilution by spectrophotometric 5UV_2101 PC Shimadzu analysis at 260 nm.

Prepare of blank samples: Blank samples with Cremophor and Labrafil (without ketoprofen) was used as the blank for auto zero the spectrometer at 260 nm.

Three determinations were carried out for each sample to calculate the solubility of ketoprofen in each vehicle and percent weight of ketoprofen in its saturated solution with the solvent under investigation was calculated.

2.2.3. Preparation of emulsions

The blend was prepared by mixing Cremophor[®] ELP hydrophilic surfactant and Labrafil[®] M 1944 CS as oily phase in different formulations of nanoemulsions with optimized proportions. Nano-emulsions were formed by spontaneous emulsification according to a method described in the reference “The universality of low-energy nano-emulsification” (Anton N. and Vandamme T.F., 2009). In brief, oil phase is mixed with surfactants at a given ratio, and heated up to 40°C. Oil / surfactant ratio and temperature are the main parameters impacting on the nano-emulsification process. Then, aqueous phase is added to homogeneous mixture, and stable oil-in-water nano-emulsions are immediately generated.

To observe the droplets size and size distribution, 250 µl of an emulsion was added to 300 ml of distilled water in a 500 ml beaker. A glass rod was used to induce gentle agitation in the mixture. The droplets size and size distribution of resultant emulsion were examined using a Malvern Nano ZS[®] instrument (Malvern, Orsay, France). A helium neon laser (4 mW) was operated at 633 nm with the scatter angle fixed at 173°, and the temperature was maintained at 25°C. The polydispersity index is a measure of the broadness of the size distribution derived from the cumulative analysis of dynamic light scattering.

2.2.4. Preparation of pellets

Pellets were produced by extrusion-spheronisation. Dry mixing was performed in a mixer (Stephan UMC5 Electronic, France) which was fitted with knife blade impellers of 14 cm in diameter. Mixing rate was 3000 rpm. Mixing time was set to 10 min. Further addition of water/emulsions/binder solution was added

until a mass suitable for extrusion was obtained and then the plastic mass was being mixed for a further 3 min. During wet massing, the material was repeatedly scraped from the mixing bowl walls, to ensure uniform water distribution.

The wet mass incubated for 1h and was extruded at an extrusion speed of 20 rpm using a single screw extruder (Variable Density Extrusion[®] Caleva 120 (UK) for the laboratory) equipped with an axial extrusion in a single bench-top unit (extrusion screen: thickness: 1.2 mm, perforation diameter: 1 mm). The extrudates were spheronised for 6 min at 1200 rpm in a spheroniser with a “cross-hatched” friction plate (Caleva Model 15, Caleva, Sturminster Newton, Dorset, UK). The pellets were dried in the ventilated oven Memmert (Germany) at 40 °C for 24 h or for 20 min at 50 °C in a fluid-bed (Innojet VENTILUS[®] V-2.5, Germany). Finally the pellets of size fraction 710-1400 µm were separated using a sieve shaker (Retsch, Haan, Germany). The pellets were stored in sealed bags. Equilibrated at 25°C/50%RH in a temperature and humidity controlled room before testing or coating.

2.2.5. Characterization of un-coated pellets

Morphological analysis

The morphological characteristics of particles were observed by scanning electron microscopy (SEM). The samples were sputter-coated with a thin gold palladium layer under an argon atmosphere using a gold sputter module in a high-vacuum evaporator. The coated samples were then scanned and photomicrographs were taken with a SEM (Jeol, JSM-1600, Tokyo, Japan).

Yield of micro particulates

The yield of the spheroids was taken as a percentage of the ratio of the final weight obtained after the production processes and the initial weight of the powder blend before final sizing.

Loss on drying of pellets

The pellets were milled before analysing in mortar. The loss on drying (LOD) was measured by heating about 3 g accurately weighed samples at 105°C, on a Sartorius MA100 Infrared Moisture Analyser.. The weight was monitored

every 30 s and measurement was stopped when the weight loss between two successive measurements was <0.01 g.

Size distribution

Size distribution of pellets was vibrated by a set of standard sieves (DIN/ISO3310-1, Retch, Germany) of 0.5, 0.71, 1.0, 1.4 and 2.0 mm aperture, for determination of size distribution. Fraction of the sieve was calculated taking into account the percentage of pellets, remaining on each sieve. The subsequent tests were carried out on the modal size fraction (710-1400 μm).

Pellet bulk and tapped density

The bulk (ρ_b) and tapped density (ρ_t) of pellets and granules were determined using a tapping machine (ERWEKA, Germany) (n=3). A 100 ml measuring cylinder was filled with the sample up to the mark. The volumes at the beginning (bulk volume, V_0) and after 1000 taps (tapped volume, V_{1000}) were recorded. The bulk density was calculated as the ratio of mass and initial volume V_0 , while the tapped density was calculated as the ratio of mass and tapped volume V_{1000} . The Hausner ratio (HR) was calculated according to the following equation:

$$\text{Hausner ratio (HR)} = \rho_t / \rho_b$$

Pellet friability

The friability was determined (n=3) using a friabilator (PTFE, Pharmatest, Hainburg, Germany). Pellets and granules ($I_{wt}=10$ g) were placed in an abrasion wheel together with 200 kaolin beads (diameter: 4 mm) and the sample was subjected to falling shocks for 10 min at a rotational speed of 25 rpm. Afterwards the fines were removed by sieving through a 250 μm mesh for 5 min (2 mm amplitude). The fraction above 250 μm (F_{wt}) was used to calculate the friability of pellets according to the following equation:

$$\text{Friability (\%)} = [(I_{wt} - F_{wt}) / I_{wt}] * 100$$

Each batch was analyzed in triplicate.

Disintegration

The disintegration time for uncoated and coated loaded pellets was measured in a disintegrator (Sotax DT2, Switzerland) using a method modified from the Eur. Ph. 8th edition monograph for tablet disintegration. Using a 500 µm mesh placed at the bottom of each tube (6 tubes) and discs to increase the mechanical stress on the pellets, 100 mg of uncoated pellets and enteric coated pellets were dispersed in each tube separately and immersed in a beaker containing 600 ml of demineralized water for uncoated pellets and phosphate buffer (pH 6.8) for enteric coated pellets respectively as disintegration media (both preheated to 37°C ±0.5°C), and cylinder dip rate of 30 dpm. Results represent the average of three determinations.

Ketoprofen content analysis

An amount of physical mixture and powder of pellet equivalent to a theoretical ketoprofen content of 25.00 mg was weighed accurately and allowed to disintegrate completely in 100 ml of absolute alcohol. Then suitable dilution in pH 6.8 phosphate buffer, after filtration through a 0.45 µm membrane filter, the absorbance of the above solution was measured at 260 nm using pH 6.8 phosphate buffer as blank solution. The drug content of ketoprofen was calculated using calibration curve.

Folic acid content analysis

The pellets were grinded finely powdered in a porcelain mortar. A portion of this powder, equivalent to 25.00 mg of folic acid was accurately weighed and dissolved in 80 ml of 0.10 mol/L phosphate buffer at pH 7.5 and shaken for 20 minutes in a mechanical stirrer. The solution was filtered through a membrane filter with a filter pore size of 0.45 mm and then suitable dilution in pH 7.5 phosphate buffer, the absorbance of the above solution was measured at 279 nm using pH 7.5 phosphate buffer as blank solution. The amount of folic acid was calculated from the calibration curve.

Reconstitution study

Uncoated pellets and enteric coated pellets (100 mg) were dispersed in 10 mL of deionized water and pH 6.8 phosphate buffer, respectively, by shaking for about 20 minutes.

The samples were filtered through filter paper Whatman (Cat No 1001 090) and solution were continuously filtered through a 0.45 μm membrane filter. After filtration, one millilitre of the resulting solution was placed in a test tube and allowed to stand for a few minutes and characterized for mean particle size and distribution by dynamic laser scattering.

Dissolution tests

Folic acid pellet: The dissolution studies were carried out according to the USP 32 using reciprocating-cylinder method (USP apparatus 3) at 15 dpm in 230 mL of water without enzyme were used as dissolution media at $37\pm 0.5^\circ\text{C}$.

Ketoprofen pellet:

The dissolution studies were carried out according to the USP 32 using reciprocating-cylinder method (USP apparatus 3) at 15 dpm in 230 mL of dissolution media at $37\pm 0.5^\circ\text{C}$.

Uncoated pellets equivalent to 25 mg ketoprofen were subjected to the dissolution studies in 230 ml 0.1 N HCl or pH 6.8 phosphate buffer, respectively.

For the drug release studies of the enteric-coated pellets, 0.1 N HCl (230 ml) was used as a dissolution medium for the first 2 h and then pH 6.8 phosphate buffer (230 ml).

Samples (5 mL) were withdrawn at regular time intervals (5, 10, 20, 30, 45, 60 min) and filtered using a Whatman filter paper (Cat No 1001 090). An equal volume of the respective dissolution medium was added to maintain the volume constant. Acid folic/Ketoprofen content of the samples was analyzed by UV spectrophotometer (UV2401PC, SHIMADZU, Kyoto, Japan) at suitable wavelength. All measurements were performed in triplicate from three independent samples.

According to the requirements from USP 32, an enteric coat was successfully applied if less than 10% of drug had been released after 2 h of

dissolution in acid dissolution medium (0.1 N HCl), not less than 75% of the amount of drug is dissolved in 45 min in buffer pH 6.8.

2.2.6. Preparation of coated pellets

Coating

Pellet coating was performed with a lab-scale airflow technology coater Innojet[®] Laboratory System Ventilus[®] V-2.5 (INNOJET Herbert Hüttlin) with the assembled product bowl IPC 1 and the Innojet Rotojet spraying Nozzle (IRN) 2 were used. The product was transported on a cushion of air flowing in an orbital spiral and circular fashion to the cylindrical container wall. Coating occurred in the centre of the product container, where the spray nozzle was located. The temperature of the coating material at the spraying nozzle is approximately 60° C.

As the goal was to prevent the release of drug in the stomach, the pellets were enteric-coated using Acryl – EZE[®] 93A92545 or Advantia[®] Performance 190024HA49. The coating suspension was prepared by dispersed powders (10% w/v) in water for 1h.

The suspension was then filtered through 90 µm sieve and agitated continuously throughout the coating process. The weighed quantity of pellets was charged into the glass coating chamber. The processing conditions of coating are mentioned in the Table 2.1.

Table 2.1. Operating conditions for the coating experiments

Operating condition	Enteric coating with Acryl – EZE [®] 93A and Advantia [®] Performance 190024HA49	Layered coating with Advantia [®] Preferred HS 290008CR01
Batch size (g)	150	150
Before coating preheating to (°C)	-	-
Spraying rate (g min ⁻¹)	1	3
Inlet air temperature (°C)	60	60
Air flow rate (m ³ /h)	60	60
Atomizing air pressure (bar)	1.5	1.5
Final drying (°C)	40	40

At the end of each coating process, the coated pellets were dried at the same product temperature for 15 min. Pellets were coated until 8%, 12.0%, 12.5%, 15%, 17% and 17.5% of dry polymer weight gain were obtained.

The coated pellets were stored in sealed bags.

Determination of yield

The yield (Y_d) was calculated as the ratio of mass increases during film coating procedure (m_I) and the dry mass of substances, dispersed in a coating solution applied to the initial pellet cores (m_D), using equation:

$$Y_d = \frac{m_I}{m_D} \times 100$$

The difference in moisture content between initial pellet cores and coated particles was taken into account. Moisture content was assessed by loss on drying (105°C, 15 min) using analytical balance equipped with a drying unit (Sartorius MA100 Infrared Moisture Analyser).

And at the end of the coating process Y_d values calculated based on the drug content in pellet before and after coating process.

Determination of degree of agglomeration

After coating, pellets from the 0.71–1.00 mm, 1.00–1.40 mm and 1.40–2.00 mm size fractions were passed through sieves of aperture sizes 0.71 mm, 1.0 mm and 1.4 mm, respectively. The oversized fractions of coated pellets were classified as agglomerates and weighed to calculate the degree of agglomeration (Agg) according to the following equation:

$$\text{Agg}(\%) = \frac{\text{Weight of pellets retained on the sieve}}{\text{Total weight of pellets collected after coating}} \times 100$$

Stability studies

All the formulations of ketoprofen enteric coated pellets were filled into hard gelatin capsules size 1. Samples of ketoprofen enteric coated pellets were packed in amber-colored 100 mL glass containers with polypropylene closures. Containers simulated actual packaging and the closures were secured tightly on the containers. Each container consisted of 100 ketoprofen delayed release capsules. They were stored in incubators maintained at 40°C (accelerated stability studies), 40±2°C and 75±5% RH, 30±2°C and 60±5% RH, 25±2°C and 60±5% RH (ICH guidelines). Appropriate salts were used to provide humidity in desiccators. At each time point, one container was take out from the respective storage condition

and subjected to content, dissolution, and thermal analysis. Ketoprofen delayed release capsules were analysed periodically for 6 months in the case of ICH guidelines and for 6 months in the case of accelerated stability studies.

2.2.7. Preparation of ketoprofen layered pellets

The model drug (Ketoprofen) was layered onto microcrystalline cellulose cores (Cellets[®] 1000). Ketoprofen layered pellets were manufactured in a fluid-bed (Innojet VENTILUS[®] V-2.5, Germany) to achieve 2%, 5%, 10% weight gain (based on initial weight of cores). Microcrystalline cellulose spheres were fluidized and sprayed with an aqueous suspension containing the ketoprofen, hypromellose, and water followed by spraying another aqueous solution containing hypromellose (seal coat). Optionally, an additional Advantia[®] Preferred HS 290008CR01 seal coat was sprayed onto the pellets from an aqueous solution of Advantia[®] Preferred HS 290008CR01. All coating solutions were prepared by mixing the appropriate amount of excipient in water for 1 h. When preparing the drug suspension, the suspension was further homogenized for 10 min with an IKA50 homogenizer and mixed continually while spraying. After application of the coating materials, the pellets were dried with fluidizing air until the pellet water content was less than 1%. The pellet water content was determined by placing approximately 3–4 g of pellets in a loss on drying balance (Sartorius MA100 Infrared Moisture Analyser).

Ketoprofen completely dissolved in ethanol (formulation L1) and Cremophor[®] ELP and Labrafil[®] M1944CS (formulations L2, L3, L4) and the polymer (HPMC E6/Advantia[®] Preferred HS 290008CR01) was dispersed in purified water at a temperature of 60°C under stirring (stirrer IKA Labortechnik, Staufen, Germany, speed 250 rpm). Talcum was dispersed in the solution; the suspension was homogenized with an Ultra-Turrax[®] T25 for 3 min (IKA, Staufen, Germany, speed 1000 rpm) and finally cooled to ambient temperature. During the coating process, the suspension was stirred to prevent solid particles sedimentation in the supply beaker. At the end of the experiment, the bed material was discharged and the total mass was measured.

References

- Anton N., Vandamme T.F. (2009). The universality of low-energy nano-emulsification. *Int J Pharm.*; 377(1-2):142-7.
- Disintegration and dissolution of dietary supplements. In: USP 38/NF 33, Supplement 9. The United States pharmacopeial convention, Rockville, MD; 2016. p. 4007-4009.
- Pharmacopée Européenne 8th edition, 2014.

**Chapter 3 : Influence of operational variables on
properties of folic acid pellets prepared by extrusion-
spheronization**

3.1. Introduction

Folic acid (FA) or pteroyl-L-glutamic acid, chemically known as N-[4- [[(2-amino-1,4-dihydro-4-oxo-6-pteridiny)methyl]amino]benzoyl]- L-glutamic acid (Figure 3.1), is a water-soluble B vitamin that helps build healthy cells, is essential to numerous bodily functions, and indispensable in cases of pregnancy (Lucock, 2000).

FA is tasteless, odourless and displays a yellow-orange crystalline appearance in the solid state. Despite being considered a hydrosoluble vitamin, its solubility in water is only 1.6 mg L⁻¹, increasing its solubility in weak acid and alkaline solutions. It is insoluble in alcohol, acetone, ether and chloroform. FA is a photosensitive compound that is degraded in aqueous solution by sunlight, ultraviolet and visible light (Akhtar *et al.*, 2003).

FA is sensitive to physical factors such as low pH, temperature, pressure, and light (Nguyen *et al.*, 2003; Yakubu & Muazu, 2010).

Folic acid's molecular structure (Figure 3.1) can be divided into three parts: a glutamic acid (Glu) moiety, a p-aminobenzoic acid (PABA) moiety and a pterin moiety. The pterin moiety is linked to PABA by a methylene bridge and in turn PABA is connected by a peptidic bond to Glu to form folic acid (Vora *et al.*, 2002)

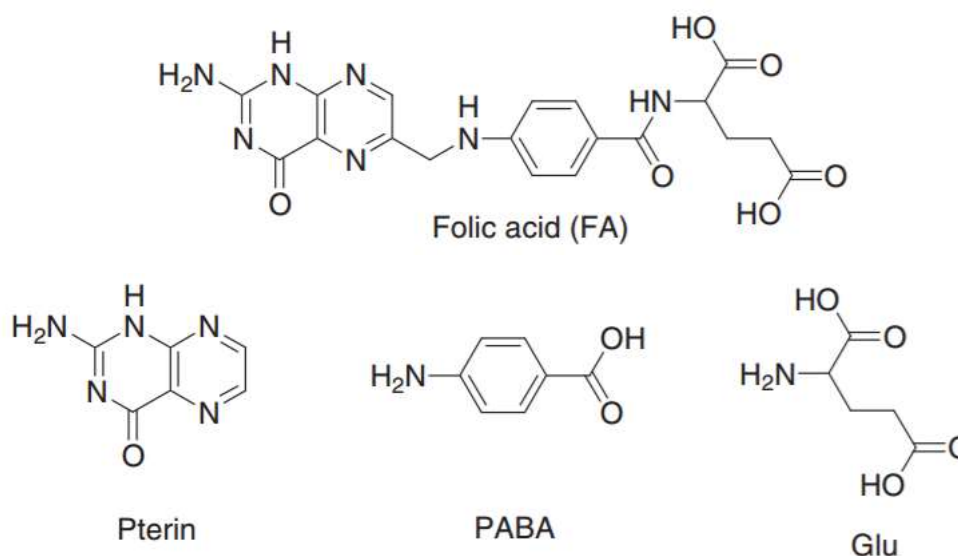

Figure 3.1. Structural formula of folic acid.

Many studies showed the failure of marketed folic acid supplements to meet the USP/BP disintegration and dissolution specifications for folic acid (Stout *et al.*, 1996; Hoag *et al.*, 1997; Giebe and Counts, 2000; Sculthorpe *et al.*, 2001; Islam R. Y. *et al.*, 2009; Pérez-Masiá R. *et al.*, 2015). These results highlight the problems of dose uniformity and the potential health risks of slow dissolution and under-dosing in commercially available folic acid dosage forms.

To date, those tests serve as the only tool to assess the quality of commercially available folic acid products. One can speculate that poor disintegration and/or dissolution may affect absorption and hence bioavailability; however, the *in vivo* bioavailability of folic acid from commercial products has not been reported in the literature yet nor have studies comparing these products *in vitro*, *in vivo* performance. However, the most striking finding in some results was the failure of all tested products to release more than 75% of their label claim when tested in water in 60 min.

Aim of this study:

- The objective of this study was to prepare pellets using extrusion-spheronization with Avicel PH 101 and to study the influence of operational variables like drying conditions, spheronization time, and spheronization speed on various pellet properties such as size and size distribution, shape, densities, flow properties, friability, and enhancing the bioavailability of folic acid from pellet.

3.2. Physical characteristic of folic acid

3.2.1. Spectrophotometric analysis

Spectrophotometric analysis in the Figure 3.2 showed that the folic acid concentration in solution can be determined by using UV Spectrophotometer at $\lambda = 279.0$ nm in distilled water (pH 5-6).

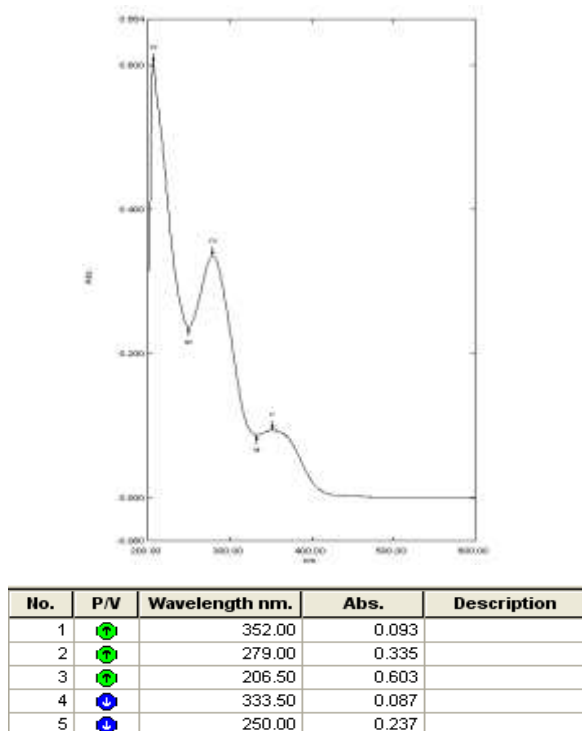

Figure 3.2. UV- Spectrum of folic acid in distilled water

3.2.2. Standard plot of folic acid

Stock solution: Stock solution (1000 µg/ml) was prepared by dissolving 100 mg of folic acid in 100 ml of pH 7.5 phosphate buffer. Solution was used for further studies.

From the above stock solution, aliquots of 1, 2, 4, 6, 8, 10, 12, 15 and 20 ml were transferred to 100 ml volumetric flasks and diluted with water (table 3.1). The absorption of solutions was measured at 279.0 nm. The calibration curve of folic acid in water is shown in Figure 3.3.

Table 3.1. Absorbance and concentration of folic acid in stock solution and dilutions.

Concentration (mg/ml)	0.00324	0.0081	0.00972	0.01296	0.0162	0.01944
Absorbance	0.186	0.467	0.55	0.728	0.899	1.064

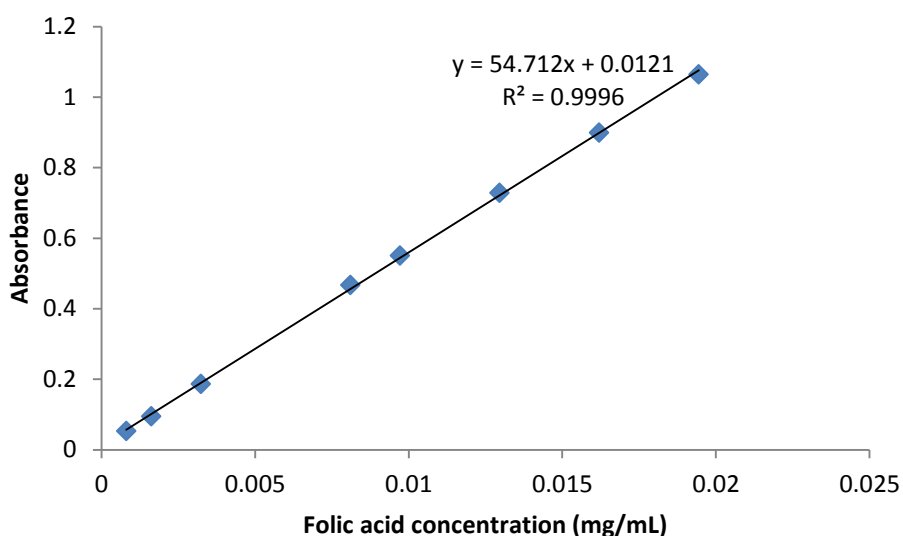

Figure 3.3. Standard calibration curve of folic acid in distilled water

A linear analytical method indicates that it has the ability to demonstrate experimentally that the results obtained are directly proportional to the concentration of analyte in the sample within a specified range (FDA, 1997). The standard curve (figure 3.3) showed an excellent correlation in the concentration range of 0.0005-0.02 mg/mL solutions.

3.3. Preparation mixture Cremophor[®] ELP: Labrafil[®] M 1944 CS

The droplet sizes of the mixture Cremophor[®] ELP and Labrafil[®] M 1944 CS were measured and showed on the Table 3.2.

Table 3.2. Droplet size and polydispersity Index (PDI) measurement of mixture Cremophor[®] ELP: Labrafil[®] M 1944 CS

Cremophor ELP (g)	Labrafil M1944CS (g)	SOR	Droplet size (nm)	PDI
2	8	20	109.2±2.1	0.057±0.02
2	3	40	55.1±6.6	0.148±0.02
2	1.33	60	23.8±3.2	0.043±0.02

$$\text{SOR} = 100 \times W_{\text{surfactant}} / (W_{\text{surfactant}} + W_{\text{oil}})$$

Surfactant = Cremophor[®] ELP

Oil = Labrafil[®] M1944CS

3.4. Influence of operational variables on qualities of pellets prepared by extrusion-spheronization

The pellet properties can be affected by many operational variables during the extrusion stage, the spheronization stage, or the drying stage. Both drying technique and drying temperature have a considerable effect on the pellet structure and properties. The variables that affect the final pellet qualities are screen pressure (Boutell S. *et al*, 2002); screen hole diameter (Dupont G. *et al*, 2002); extruder type and speed (Kleinebudde P. *et al*, 1993); type of friction plate; and spheronization time (Heng P.W.S. *et al*, 2002) speed, and load (Newton J.M. *et al*, 1995).

In the current study, the different process variables used for the preparation of pellets were drying method, drying temperature, spheronization time, and spheronization speed. Pellets were prepared using Avicel PH 101. The amount of water used in all the formulations was kept constant at 75% wt/wt on a dry basis. The drug (folic acid) concentration in the pellets was also kept constant at 0.4% of the total pellet weight (table 3.3).

Table 3.3. Compositions of pellets contained folic acid

No	Ingredient (g)	F0	F1	F2	F3	F4	F5	F6
1	Folic acid	-	0.4	0.4	0.4	0.4	0.4	0.4
2	MCC PH 101	70	70	70	70	70	70	70
3	Lactose	18	17.6	16.6	15.1	14.6	19.6	19.6
4	PVP K25	10	10	10	10	10	10	10
5	Talc	2	2	2	2	2	-	-
6	Sodium starch glycolate	-	-	1	2.5	5	-	-
7	Cremophor [®] ELP	-	-	-	-	-	3.6	18
8	Labrafil [®] M1944 CS	-	-	-	-	-	2.4	12
9	Water	80	80	82	87	89	72	52

The batches F0 were prepared using Avicel PH 101, the amount of water used change and pellets were prepared at a medium spheronization speed with 2, 6, 10 minutes of spheronization time and were subjected to different drying conditions, that is to say, at room temperature in a desiccator (with calcium dioxide were dried in hot air dryer at 70°C/24h); 37°C, 50°C, 60°C in a tray dryer fitted with fan (Mettmert, GmbH+ Co.KG, Germany); -20°C in a freeze dryer (Christ Alpha 2-

4 LD plus, Martin Christ, Germany) for 24 hours; and 50°C in fluid-bed dryer (Innojet Ventilus® 2.5).

3.4.1. Effect of type and screw speed of extruder

The total output of the extrudate is mainly governed by the extruder type and extrusion speed. The output should be as high as possible for economic reasons and an increase in extrusion speed influenced the final pellet quality (Vervaet C. *et al.*, 1995).

Exactly 200 g of the wet mass of batch F0 was extruded through a Caleva® extruder 25 (Caleva, Dorset, England) with two kinds of extruder (axial extruder and radical extruder) and subsequently spheronized (Caleva spheronizer 120) and total output of the extrudate showed in table 3.4.

Table 3.4. Total output (gram) of the extrudate with two kinds of extruder

Time (second)	Axial extruder			Radical extruder 20 rpm
	10 rpm	20 rpm	40 rpm	
30		12	40.1	
60	34.6	46	113.4	25.1
90		80	149.1	
120	84.1	111	-	109.8
150		127	-	132.6
180	156.3	134	-	
Weight of wet mass resident in extruder (waste)	24.5	25.2	26.2	50.6

According to Reynolds (1970) and Rowe (1985), an axial screw extruder produced a more dense material compared to a radial screw extruder which had a higher output but also a greater temperature rise of the mass during processing.

Axial extruder and 20 rpm of extruder speed was chosen for continuously studies because of the weight of wet mass resident after extruder almost of a half radical extruder with the same speed.

The batches F0 were prepared using 2.5 % of talcum for reduce the friction at the die wall of the extrusion screen was lowered. Mesiha and Valltés (1993) evaluated fourteen different substances for their usefulness in reducing surface

defects, heat due to friction and energy consumption in an instrumented extruder. The materials include several common lubricants and glidants, surface active agents, humectants, polyethylene glycol and a binder in a simple binary system with high drug loading. High HLB surfactants, particularly sodium lauryl sulphate, performed best at levels as low as 0.125%, keeping heat and amperage draw to a minimum and greatly reducing surface defects. This was correlated with reduced power consumption during extrusion as the friction at the die wall of the extrusion screen was lowered.

3.4.2. Effect of spheronization time

The levels of other ingredients, water, and spheronization time were identified from experiments. Spheronization time has a significant influence on the quality of the spheres (Bölskei É. *et al.*, 2012). Initial trials F0 were conducted with different ratios of water add to powder blends to evaluate the feasibility of pellets formation. An amount of the water was added and blended properly for 10 min using a pestle to obtain a soft cohesive mass. The wet mass was introduced into the extruder at the assigned extruder speed (20 rpm). Extrudates were spheronized at 600 rpm and at different spheronization times (Table 3.5). Various responses: disintegration time (DT), yield, sphericity and friability were identified and were selected for the study.

Table 3.5. The effect of ingredients, water, and spheronization time to qualities of pellets

Formula code	Water (%)	Spheronization time (min)	Yield (%)	Pelletization	Friability (%)	DT (min)
F01	40	2	NE	-	NE	NE
F02	50	2	NE	-	NE	NE
F03	75	2	NE	-++	NE	NE
		6	73	-+	0.75	ND
		10	89	+	0.86	ND
F04	85	2	NE	- +	NE	NE
		6	NE	-++	NE	NE
		10	NE	+ - +	NE	NE

Key: – pellets not obtained; + acceptable pellets obtained; - + dumbbells present; -++ non-uniform pellets; + - + large sized pellets; ND—no disintegration; NE—not evaluated;

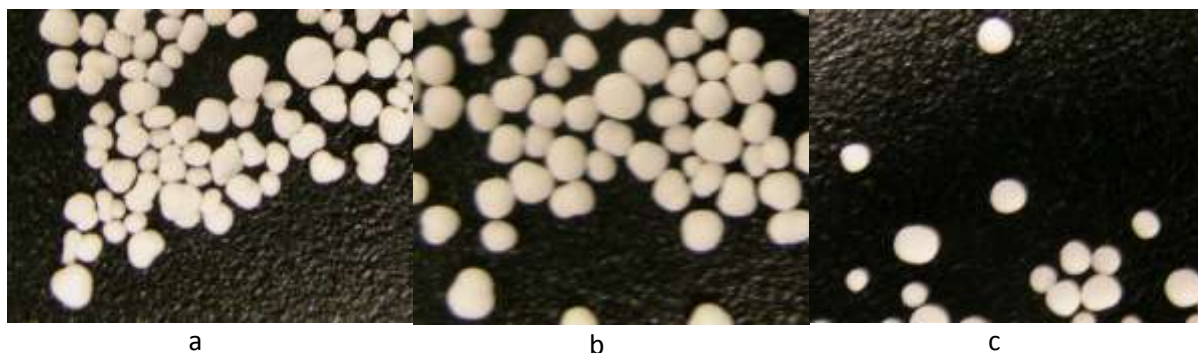

*Figure 3.4. Light microscopy images of pellets with different spheronization times:
a. 2 minutes, b. 6 minutes, c. 10 minutes*

The spheronisation of a product usually takes 6-10 min (Gamlen, 1985). A rotational speed of the friction plate in the range between 400 and 600 rpm would be satisfactory to obtain a highly spherical pellet according to West and Rowe (1988) and the results showed an influence of spheronization times, at least after 10 minutes, the pellets were nearby spheres (Figure 3.4.c).

3.4.3. Effect of drying techniques

Pellets were dried by four different techniques (to less than 5% (w/w) water content) with some parameters in table 3.6 and drying times are showed in figure 3.5, namely:

- fluid-bed drying,
- hot air oven,
- freeze drying,
- and desiccation with calcium dioxide were dried in hot air dryer at 70°C/24h.

Table 3.6. Some parameters of drying techniques

Machines	Temperature (°C)	Time (h)	Amount of pellet per batch
Desiccation	25	14 days	50 g
Lyophilization (Christ [®])	-196	2 days for pre-freezing, 1h for freeze dry	20 - 30 g
Fluid-bed drying (Innojet Ventilus [®] 2.5), air: 50 m ³ /h	50	15 min	200 g
Hot-air oven (Memmert [®]), fresh air: 10	50	5 h - 12h	>1-2kg

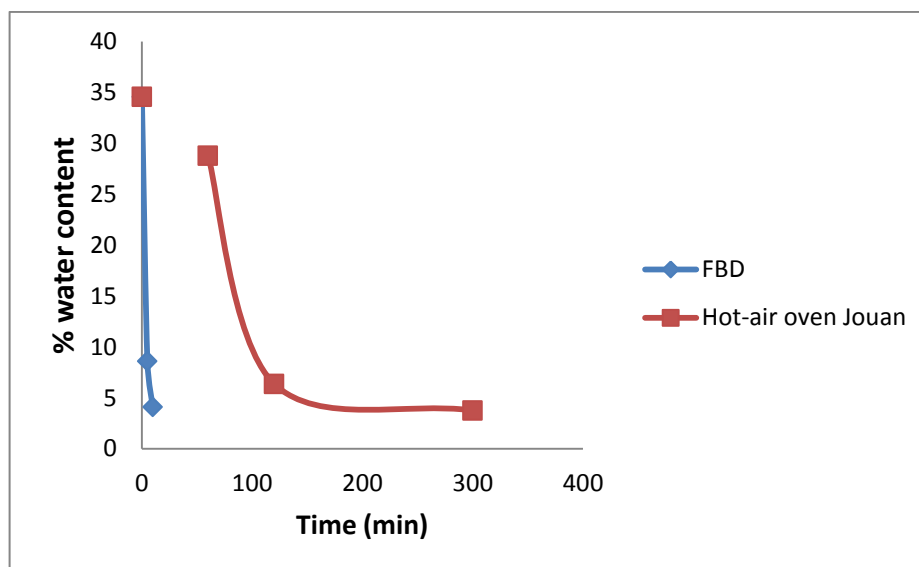

Figure 3.5. Drying times of fluid bed dryer and hot-air oven

The drying technique has great influence on the pellet quality. Bashaiwoldu *et al.* (2004) have done the comparison between freeze drying, fluid-bed drying, hot air oven drying and desiccation with silica-gel to less than 5% (w/w) water content. They found that freeze-drying is more porous, with most of the pores open to the atmosphere and having a higher surface area than pellets dried by the other methods. Pellets dried by desiccation contained the highest proportion of closed pores. The drying techniques, which produced porous, deformable and weak pellets, produced stronger tablets. Murray *et al.* (2007) observed that when oven and freeze-drying is compared the granule yield point (GYP) is significantly lower for the freeze-dried granular material. Granules with a lower GYP produced tablets of increased strength. Dissolution profiles are similar for both the oven and freeze dried samples. Song *et al.* (2007) have reported that freeze-drying retained the shape and size of the granules, whereas oven drying produced roughened granules due to the uneven shrinkage of the wet powders. According to Berggren *et al.* (2001 a), the difference in drying behavior of pellets can be explained by a liquid related change in both contractions driving force and contraction counteracting force or by a different contraction mechanism. The difference in final pellet porosity between the two types was caused by a difference in densification

during drying rather than a different degree of densification during the pelletization procedure. Berggren *et al.* (2001 b) has done their work on the effect of drying rate on pellets quality. In their study, they found that drying of the pellets occurred at a falling rate and the reduction in liquid content with time obeyed a first order type of relationship. An increased drying rate did not affect the shape and surface texture of the dried pellets and did not cause them to fracture, drying conditions did affect pellet porosity, with an increased drying rate resulting in more porous pellets, the drying rate also affected the deformability of the pellets (as assessed from Kawakita 1/b values) and their ability to form tablets, marked changes in tablet tensile strength with variations in drying rate may be obtained.

With hot-air oven amount of pellet per batch of drying can obtain 1-10 kg per batch compared with freeze drying or desiccation was so small (about 10 -50 g per batch).

3.5. Influence of formulation on properties of folic acid pellets prepared by extrusion-spheronization

3.5.1. Influence of oil and surfactants ratios on droplets size and size distribution of pellets

Mix of Cremophor[®] ELP + Labrafil M 1944 CS[®] was prepared with a ratio 2:1.33 (SOR 60) and amount of acid folic in solution buffer pH 7.5 was added little by little until the droplet size of emulsion reaches a diameter < 250 nm.

Depend on recommended daily intakes of each vitamin can determine optimum quantity of oil and surfactant for preparing nanoemulsion for produce a batch of pellets.

Effect of oil, surfactant and co-surfactant concentrations on the extrusion – spheronization process was important because they were used as wetting liquids for the preparation of experimental pellet batches. The relative quantities of oil/surfactant and water had an effect on the amount of liquid and oil/surfactant that could be incorporated into the powder, extrusion force, median diameter, size spread, disintegration time, tensile strength, and surface roughness.

The maximum quantity of the oil/surfactant combination studied that can be incorporated was 30% of the dry pellet weight (formulation F6).

The size and weight distribution of sieved pellets (100g) are presented in figure 3.6, indicating that a pellet yield (710-1400 μm fraction) of higher than 90% could be obtained. This shows that the addition of a binder Kollidon[®] 25 was necessary to obtain an acceptable yield since the binder increased the mechanical strength of wet extrudates and consequently fewer fines were formed during spheronization.

Table 3.7. Results of flow ability and friability of pellets

	Flow ability of pellets			Friability (%)
	D tapped (g/cm^3)	D bulk (g/cm^3)	Hausner ratio	
F1	0.78	0.76	1.03	0.01
F2	0.77	0.74	1.04	0.02
F3	0.68	0.66	1.03	0.03
F4	0.64	0.63	1.02	0.02
F5	0.63	0.62	1.02	0.03
F6	0.63	0.61	1.03	0.01

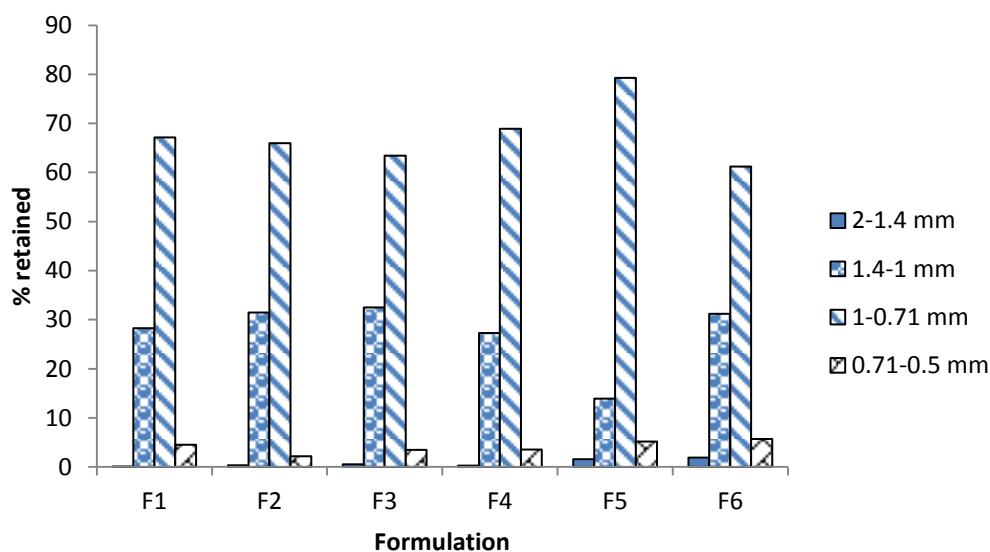

Figure 3.6. Granulometric distributions of the pellets obtained in different formulations.

Study of particle size distribution data (figure 3.6) reveals that the size distribution becomes narrow. This might be due to the uniformity in the length of extrudates that were formed when compositions containing oil and surfactant were extruded. This size distribution was not affected significantly by the addition of oil and surfactant.

Results of the investigation of flow properties indicate that all the formulations possess good flow properties (Table 3.7). The pellets from all the batches are not friable at all.

3.5.2. Influence of superdisintegrant, oil and surfactants ratios on disintegration time of pellets

The time taken for complete disintegration of pellets prepared with 5% superdisintegrant and oil and surfactant was 5 -10 minutes (F4, F6) and pellets prepared without superdisintegrant or oil and surfactant (formulation F1) were more than 35 min in water, respectively.

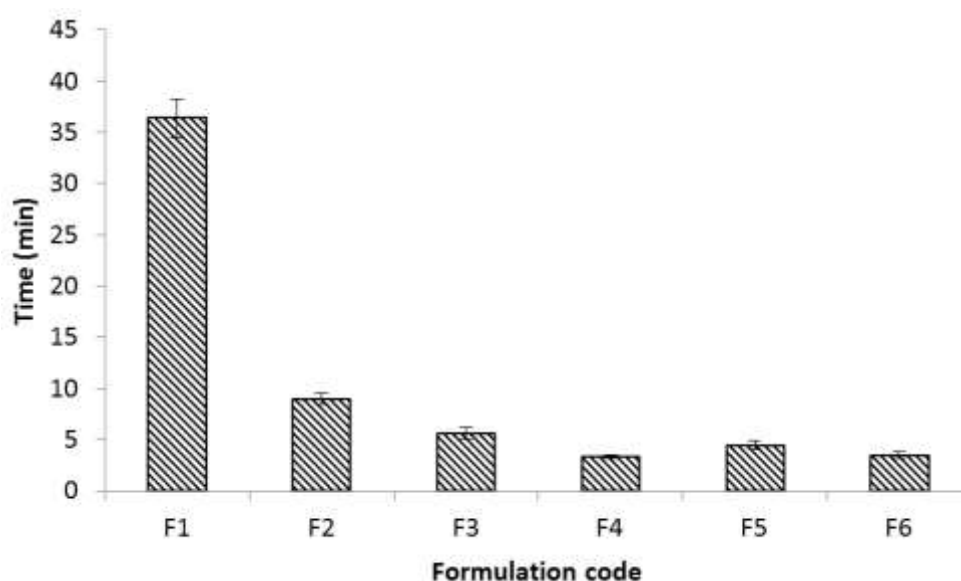

Figure 3.7. Disintegration time of various formulations

Pellets containing the surfactant and oil were observed to disintegrate during the dissolution test, whereas those without surfactant did not (F1, F2) or disintegrated to aggregates/gross particles (F3 with 2.5% SSG).

As expected, disintegration time increases as the concentration of oil and surfactant was reduced.

The data obtained for the disintegration times possibly explain the drug release profiles observed.

3.5.3. In vitro drug release studies of folic acid pellets

Drug release of F1-F4 batch containing superdisintegrant in different concentration of 0-5% w/w was compared, it was found that F4 batch containing 5% SSG releases drug more promptly and completely within 10 min (figure 3.8).

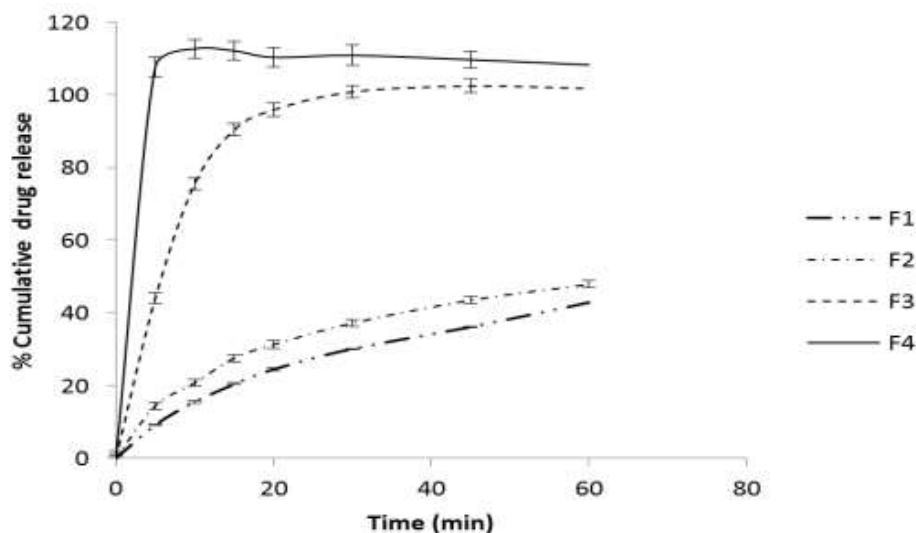

Figure 3.8. Effect of superdisintegrant sodium starch glycolate in different concentration (0 %- F1; 1%-F2; 2.5%-F3; 5%-F4) on in vitro release of folic acid (n=3, mean \pm SD)

The effect of addition of oil and surfactant on the improvement of dissolution rate of folic acid is illustrated in fig. 3.9. Formulations F6 showed significant increase in the dissolution rate of the drug, about 90% of folic acid was released within 10 min and 100% of folic acid was released after 15 min, whereas F5 showed 80% release within 60 min. The results showed that nano-emulsion content showed significant influence on dissolution rate. An increase in nano-emulsion content results in faster dissolution rate of API.

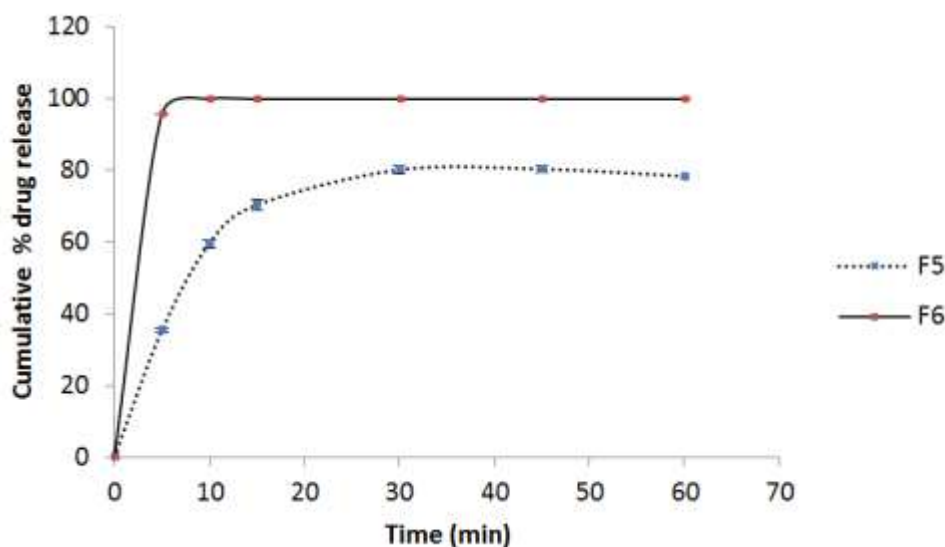

Figure 3.9. Percentage of folic acid released from pellet formulations prepared from mixtures of nanoemulsion ($n=3$, mean \pm SD).

3.5.4. Influence of oil and surfactants ratios on reconstitution of pellets

The results of reconstitution studies of different formulations of nanoemulsion pellets are presented in table 3.8, measured by Malvern Zetasizer to determine their droplets size, polydispersity index (PDI). Overall, all formulations showed small mean droplets size between 50 nm to 100 nm, also it was observed from the table that the droplets size were decreased with an increase in the oil concentration. Also all the formulations showed low PDI in a range between 0.19 to 0.47.

Table 3.8. Droplet size and polydispersity index measurement of nanoemulsion release from pellets after production and subjected to different storage after 3 months of storage at room temperature.

	After production		3 months	
	Mean size (nm)	PDI	Mean size (nm)	PDI
F1	-	-	-	-
F2	-	-	-	-
F3	-	-	-	-
F4	-	-	-	-
F5	91.9 \pm 7.3	0.465 \pm 0.04	57.8 \pm 5.1	0.199 \pm 0.03
F6	76.0 \pm 4.1	0.385 \pm 0.01	68.1 \pm 3.0	0.378 \pm 0.05

There weren't a slightly significant increase in the droplets size of nano-emulsion after 3 months of storage at room temperature.

One brands of dietary supplement “Folic acid” 800 µg in Vietnam was collected and studied. The results were conducted that 90 per cent drug release in the first hour of dissolution testing (Appendix A2).

Conclusion

The results have established that it is possible to prepare pellets by extrusion/spheronization from the individual nutraceutical as folic acid (pellets F6). Pellets containing at least 30 % of mixture of oil and surfactant for assurance the size droplet of nanoemulsion <150 nm.

Thus, the work demonstrates that the choice of type and quantity of the surfactant used in the formulation of nanoemulsions containing in pellets has an important influence on their production and performance.

References

- Akhtar M. J., Khan M. A., Ahmad I., (2003). Identification of photoproducts of folic acid and its degradation pathways in aqueous solution. *Journal of pharmaceutical and biomedical analysis*, 31(3), 579-588.
- Bashaiwoldu A.B., Podczeczek F., Newton J.M., (2004). A study on the effect of drying techniques on the mechanical properties of pellets, and compacted pellets. *Eur J Pharm Sci*; 21:119–129.
- Berggren J., Alderborn G. (2001 a). Drying behaviour of two sets of microcrystalline cellulose pellets. *Int J Pharm*; 219:113–126.
- Berggren J., Alderborn G. (2001 b). Effect of drying rate on porosity and tableting behaviour of cellulose pellets. *Int J Pharm*; 227:81–96.
- Bölcseki É., Regdon G., Sovány T., *et al.*, (2012). Optimization of preparation of matrix pellets containing Eudragit® NE 30D. *Chem Eng Res Des*; 90:651–657.
- Boutell S., Newton J.M., Bloor J.R., Hayes G., (2002). The influence of liquid binder on the liquid mobility and preparation of spherical granules by the process of extrusion/spheronization. *Int J Pharm.*; 238:61-76.
- Chariot M., FrancBs J., Lewis G.A., *et al.*, (1987). A factorial approach to process variables of extrusion–spheronisation of wet powder masses. *Drug Dev Ind Pharm*; 13:1639–1649.
- Dupont G., Flament M.P., Leterme P., Farah N., Gayot A., (2002). Developing a study method for producing 400 micron spheroids. *Int J Pharm.*; 247:159- 165.
- Gamlen M.J., (1985), Pellet manufacture for controlled release, *Manuf. Chem.*, 56, pp. 55–59
- Giebe K., Counts C., (2000). Comparison of Prenate Advance with other prescription prenatal vitamins: a folic acid dissolution study, *Adv. Ther.*, 17, pp. 179–183.
- Heng P.W.S., Liew C.V., Gu L., (2002). Influence of tear drop studs on rotating frictional base plate on spheroid quality in rotary spheronization. *Int J Pharm.*; 241:173-184.
- Hoag S.W., Ramachandruni H., Shangraw R.F., (1997). Failure of prescription prenatal vitamin products to meet USP standards for folic acid dissolution, *J. Am. Pharm. Assoc. (Wash.)*, NS37, pp. 397–400.

- Islam R. Y., Mary K. S, Patrick S.C., Paula Jo. M. S, (2009). Influence of pH on the dissolution of folic acid supplements, *International Journal of Pharmaceutics* 367, 97–102.
- Kleinebudde P., Lindner H., (1993). Experiments with an instrumented twin-screw extruder using a single-step granulation/extrusion process. *Int J Pharm.*; 94:49-58.
- Lucock M., (2000). Folic Acid: Nutritional Biochemistry, Molecular Biology, And Role In Disease Processes. *Molecular Genetics and Metabolism*, 71(1-2), 121–138.
- Matias R., Ribeiro P. R. S., Sarraguçaa M. C., Lopes J. A. (2014). A UV spectrophotometric method for the determination of folic acid in pharmaceutical tablets and dissolution tests, *Anal. Methods*, 6, 3065 -3071.
- Mesiha M., Valltés J., (1993). A screening study of lubricants in wet powder masses suitable for extrusion–spheronization. *Drug Dev Ind Pharm*; 19:943–959
- Murray T., Rough S.L., Wilson D.I., (2007). The effect of drying technique on tablets formed from extrusion–spheronization granules. *Chem Eng Res Des*; 85:996–1004.
- Newton J.M., Chapman S.R., Rowe R.C., (1995). The assessment of the scale-up performance of the extrusion/spheronization process. *Int J Pharm.*; 120:95-99.
- Newton J.M., Chapman S.R., Rowe R.C., (1995). The influence of process variables on the preparation and properties of spherical granules by the process of extrusion and spheronisation. *Int J Pharm*; 120:101–109.
- Nguyen M.T., Oey I., Verlinde P., van Loey A., Hendrickx M., (2003). Model Studies On The Stability Of Folic Acid And 5-Methyltetrahydrofolic Acid Degradation During Thermal Treatment In Combination With High Hydrostatic Pressure. *Journal of Agricultural and Food Chemistry*, 51(11), 3352–3357.
- Pérez-Masiá R., López-Nicolás R., Periago M.J., Ros G., Lagaron J.M., López-Rubio A., (2015). Encapsulation of folic acid in food hydrocolloids through nanospray drying and electrospraying for nutraceutical applications. *Food Chem.*, 1; 168:124-33
- Sculthorpe N.F., Davies B., Ashton T., Allison S., McGuire D.N., Malhi J.S., (2001). Commercially available folic acid supplements and their compliance with the British Pharmacopoeia test for dissolution, *J. Public Health Med.*, 23, pp. 195–197.
- Song B., Rough S.L., Wilson D.I., (2007). Effects of drying technique on extrusion–spheronisation granules and tablet properties. *Int J Pharm*; 332:38–44.
- Stout P.J., Brun J., Kesner J., Glover D., Stamatakis M., (1996). Performance assessment of vitamin supplements: efficacy issues, *Pharm. Res.*, 13, p. S-71.
- Vervaet C., Baert L., Remon J.P., (1995). Extrusion–spheronisation a literature review. *Int J Pharm*; 116:131–146.
- Vora A., Riga A., Dollimore D., Alexander K.S., (2002). Thermal stability of folic acid. *Thermochim. Acta* 392, 209–220.
- West A.J., Rowe R.C., (1988). Production spheronisers ten years on, *Manuf. Chem.*, 59 (1988), pp. 79–80
- Yakubu S., Muazu J., (2010). Effects of variables on degradation of folic acid. *Der Pharmacia Sinica*, 1(3), 55–58.

Chapter 4 : Development and characterization of enteric-coated immediate-release pellets of ketoprofen by extrusion-spheronization technique

4.1 Introduction

Ketoprofen (figure 4.1), chemically [2-(3-benzoylphenyl) propionic acid], a weak acid ($pK_a = 4.6$), poorly water-soluble type drug, is one type of “profen” class of non-steroid anti-inflammatory drug (NSAID) mainly used in osteoarthritis, rheumatoid arthritis, ankylosing spondylitis, acute articular and periarticular disorders (Parfitt K., 1999). As with most NSAIDs, irritation of the gastrointestinal (GI) tract is one of the major side effects reported after oral administration of ketoprofen. Ketoprofen is available for oral administration as regular – release capsules (Orudis[®] 50 mg, Profénid[®] 50 mg), enteric coated tablet (Ketron[®] 50 mg).

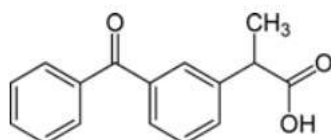

Figure 4.1. Ketoprofen structure formula

According to the Biopharmaceutical Classification System, ketoprofen is regarded as a class II compound characterized by low water solubility and high permeability so that it can cause problems in formulating and limiting the bioavailability. Thus, low water solubility is another major problem with this potentially useful drug candidate. For class II drugs, bioavailability is limited by their dissolution rate. Bioavailability can be increased by improving dissolution rate, and dissolution rate can be increased by achieving faster disintegration.

Literature reports various ways to overcome both these problems of ketoprofen. The acute local contact of ketoprofen has been avoided by formulating a combination of extended-release NSAID and immediate-release prostaglandins, dual-release compositions of Cox-2 inhibitors. Improvement in the water solubility and hence bioavailability of ketoprofen has been achieved by formulation using natural bile salts, solid dispersion method (Mura P., 2005). Kheradmandnia *et al.* (2010) evaluated the preparation and characterization of ketoprofen-loaded solid lipid nanoparticles (SLNs) made from beeswax and carnauba wax and found that the the mean particle size of drug loaded SLNs decreased upon mixing with Tween 80 and egg lecithin as well as upon increasing total surfactant

concentration. High drug entrapment efficiency of 97% revealed the ability of SLNs to incorporate a poorly water-soluble drug such as ketoprofen. Differential scanning calorimetry thermograms and high-performance liquid chromatographic analysis indicated the stability of nanoparticles with negligible drug leakage after 45 days of storage. It was also found that nanoparticles with more beeswax content in their core exhibited faster drug release as compared with those containing more carnauba wax in their structure.

Microcrystalline cellulose (MCC) is the most widely used pelletization aid. But MCC is known to interfere with the release of poorly soluble drugs (O'Connor R.E., Schwartz J.B. 1985).

Enteric coating of these pellets will prevent the drug to come into contact with ulcer prone area of gastrointestinal lining and hence will avoid gastrointestinal toxicity. Besides, pellets are easy to coat and have good flow properties.

Previous research for ketoprofen solid dispersions and inclusion complexes has covered a number of methods including incorporation of ketoprofen into PVP and β -CD. These include freeze drying to produce a solid dispersion (Takayama T. *et al.*, 1982; Tayade P. T. and Vavia P. R., 2006), spray drying (Ahn H.J. *et al.* 1997), kneading and co-evaporation (Maestrelli F. *et al.*, 2008). However, little has been published on the use of the melt method for the formulation of this drug with the chosen excipients other than two papers published in 2009 by Maestrelli F. and Cirri M. *et al.* In both the published papers ketoprofen was tumble mixed with β -cyclodextrin, methyl- β -cyclodextrin and egg phosphatidylcholine in various ratios. Each different mixture was then subjected to microwave heating for varying amounts of time and power. It was seen in all cases that an improvement for the dissolution of the drug occurred. However despite another method of microwave heating illustrating the potential, these methods still illustrated drawbacks which have previously been discussed and seem to be taken into consideration in the current project. Another novel aspect of this research is the incorporation of ketoprofen into PVP and 2HPBCD using the melt method.

Aim of this study:

- Enhancing the bioavailability of poorly water-soluble compounds (Ketoprofen) from pellet were produced through an extrusion-spheronization process and

subsequently coated with two commercial aqueous enteric polymer suspensions, Acryl-Eze[®] 93A92545 and Advantia[®] Performance 190024HA49 in fluidized bed coater.

4.2. Physical characteristic of ketoprofen

4.2.1. Bulk density, tap density of ketoprofen

Bulk density of ketoprofen powder was found to be 0.236 g/ml.

Tap density of ketoprofen powder was found to be 0.317 g/ml.

Ketoprofen is a cohesive powder. An Hausner ratio was found to be 0.63.

4.2.2. Spectrophotometric analysis

Spectrophotometric analysis in the figure 4.2 showed that the ketoprofen concentration in solution can be determined by using UV Spectrophotometer at $\lambda = 258.4$ nm in pH 1.2 and $\lambda = 260.0$ nm in pH 6.8.

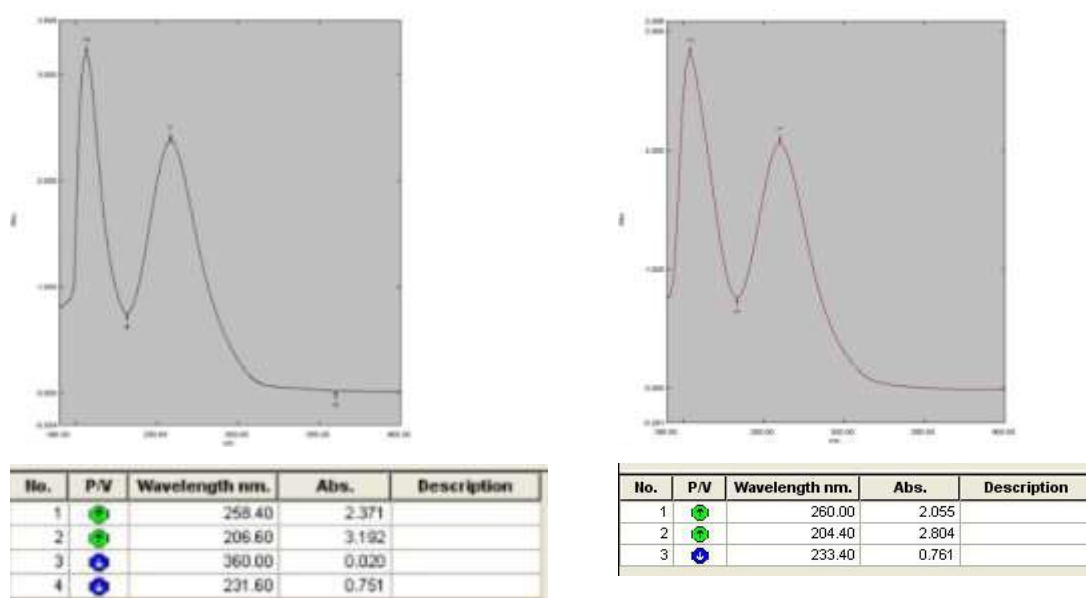

Figure 4.2. UV- Spectrum of ketoprofen in pH 1.2, $\lambda_{max} = 258.4$ nm (left) and in pH 6.8, $\lambda_{max} = 260.0$ nm (right)

4.2.3. Standard plot of ketoprofen

Stock solution: Stock solution was prepared by dissolving 100 mg of pure ketoprofen in 100 ml of pH 6.8 phosphate buffer. Solution was used for further studies.

From the above stock solution, aliquots of 1, 2, 4, 6, 8, 10, 12, 15 and 20 ml were transferred to 100 ml volumetric flasks and diluted with pH 1.2, pH 6.8 phosphate buffer (Table 4.1). The absorption of solutions was measured at either 258.4 nm or 260 nm. The calibration curve of ketoprofen in pH 1.2, pH 6.8 phosphate buffer is shown in Figure 4.3. Standard calibration curve of ketoprofen in pH 1.2, pH 6.8 phosphate buffer

Table 4.1. Absorbance and concentration of ketoprofen in stock solution and dilutions.

Concentration in $\mu\text{g/ml}$	Absorbance					
	4.128	6.192	8.256	10.32	12.384	20.64
pH 1.2	0.112	0.169	0.246	0.315	0.354	0.546
pH 6.8	0.110	0.165	0.226	0.321	0.356	0.543

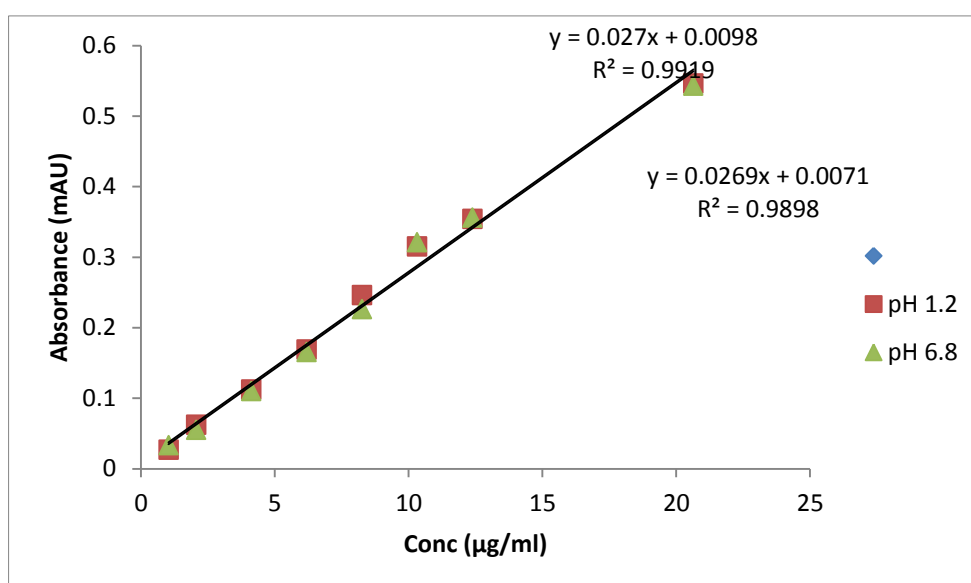

Figure 4.3. Standard calibration curve of ketoprofen in pH 1.2, pH 6.8 phosphate buffer

A linear analytical method indicates that it has the ability to demonstrate experimentally that the results obtained are directly proportional to the concentration of analyte in the sample within a specified range (FDA, 1997). The standard curve (figure 4.3) showed an excellent correlation in the concentration range of 1- 20 $\mu\text{g/ml}$ solutions.

4.2.4. Solubility study of ketoprofen in some solvents/surfactants

The solubility of ketoprofen in various solvents (Table 4.2) show that the solubility of ketoprofen is considerably increased in presence of Cremophor[®] ELP and Labrafil[®] M 1944 CS.

The increase in the solubility of ketoprofen at 25°C in Cremophor[®] ELP and Labrafil[®] M 1944 CS was about 26.9 and 19.8 fold respectively compared to pure ketoprofen at pH 6.8.

Table 4.2. The solubility of ketoprofen in various solvents

Solvent	Solubility (mg/g)
Cremophor [®] ELP	276.8±3.5
Labrafil [®] M 1944 CS	119.8±4.9
Cremophor [®] ELP: Labrafil [®] M 1944 CS = 2: 1.33 (SOR 60)	336.3±5.6
pH 1.2	0.0216±0.0021
pH 6.8	12.66±2.5

4.2.5. Preformulation - compatibility studies between ketoprofen with excipients

Preformulation is the first step in the rational formulation of an active pharmaceutical ingredient (API). It is an investigation of the physical-chemical properties of the drug substance, alone and in combination with excipients.

Studies of active drug/excipient compatibility represent an important phase in the preformulation stage of the development of all dosage forms. The potential physical and chemical interactions between drugs and excipients can affect the chemical nature, the stability and bioavailability of drugs and, consequently, their therapeutic efficacy and safety.

Assessment of possible incompatibilities between the drug and different excipients is an important part of preformulation. The formulation of a drug substance frequently involves it being blended with different excipients to improve manufacturability, and to maximize the product's ability to administer the drug dose effectively. Excipients are known to facilitate administration and modulate

release of the active component. They can also stabilize it against degradation from the environment.

Most excipients have no direct pharmacological action but they can impart useful properties to the formulation. However, they can also give rise to inadvertent and/or unintended effects such as increased degradation of the drug. Physical and chemical interactions between drugs and excipients can affect the chemical nature, the stability and bioavailability of drug products, and consequently, their therapeutic efficacy and safety (Rowe R. C *et al.*, 2009).

There have been several approaches proposed that satisfy the requirements of a drug-excipient chemical compatibility screen. The most resource sparing of these approaches is computational, where drug-excipient chemical compatibility can be predicted. This requires a comprehensive database of reactive functional groups for both drugs and excipients, combined with an in-depth knowledge of excipients and their potential impurities. Such an approach provides a rapid analysis and requires no bulk substance. However, there are inherent risks with using this computational approach as the sole source of information.

Binary mixture compatibility testing is another commonly used method. In this approach, binary (1:1 or customized) mixtures of the drug and excipient, with or without, added water and sometimes compacted or prepared as slurries, are stored under stressed conditions (also known as isothermal stress testing (IST)) and analyzed using a stability-indicating method, e.g. high performance liquid chromatography (HPLC). The water slurry approach allows the pH of the drug-excipient blend and the role of moisture to be investigated. Alternatively, binary mixtures can be screened using other thermal methods, such as differential scanning calorimetry (DSC) (Giron D., 1998; Clas S.D. *et al.*, 1999). DSC is currently the leading technique in this field (Sims J.L. *et al.*, 2003). The main benefit of DSC, rather than stressed storage methods, is its ability to quickly screen potential excipients for incompatibilities derived from the appearance, shifts or disappearances of peaks and/or variations in the corresponding ΔH (enthalpy of transition) (Vueba M.L. *et al.*, 2005).

Chemical interaction between the drug and excipients may lead to increased decomposition.

Mura P., *et al.* (1995) utilised differential scanning calorimetry as a screening technique to determine the compatibility of ketoprofen with excipients and compatibility of ketoprofen with the subsequently tested excipients, glucose, lactose, mannitol, sorbitol, cellulose derivatives, clays derivatives, arabic gum and corn starch can certainly be expected, since the thermal features of the drug in the mixed systems remained more or less constant. Some drug-excipient interaction was found with stearates, and eutectic formation was demonstrated with magnesium stearate. A strong interaction occurred with PEG 6000, polyvinyl polypyrrolidone and particularly polyvinyl pyrrolidone K30.

Differential scanning calorimetry was used to investigate the interactions between the drug ketoprofen and a number of commonly used tablet excipients. Ketoprofen was found to interact with Precirol[®] Ato 5 (Glycerol distearate), magnesium stearate, Emcompress[®] (Calcium Hydrogen Phosphate Dihydrate), PVP, cross-linked PVP, lactose and palmitic acid (Both S. A. et Lötter A. P., 1989; Batista de Carvalho LAEB *et al.* 2006, Bharate *et al.*, 2010)

Thermogravimetry/derivative thermogravimetry (TG/DTG) and differential scanning calorimetry (DSC) techniques were used for assessing the compatibility between ketoprofen (KT) and several excipients as: corn starch, microcrystalline cellulose (PH 101 and PH 102), colloidal silicon dioxide, lactose (monohydrate and anhydrous), polyvinylpyrrolidone K30, magnesium stearate and talc. On the basis of thermal results, was found a possible interaction between the KT with polyvinylpyrrolidone K30 and magnesium stearate (Tița B. *et al.*, 2011).



Figure 4.4. Binary mixture ratio 1:1 of ketoprofen with HPMC (left) and ketoprofen with PVP (right) after 6 months were stored under accelerated stability test conditions

The results indicate that ketoprofen is incompatible with PVP. The binary mixtures of 1:1 (w/w) ketoprofen + PVP (figure 4.4- test tube on the right) showed a slight yellow color and clotted at the bottom can be observed. However, the binary mixtures of 1:1 (w/w) ketoprofen + HPMC show no change (figure 4.4 - test tube on the left).

HPMC was chosen in the subsequent experiments.

4.3. Survey effect of addition of different pelletizing agents and fillers

Table 4.3. Compositions of pellets batches

Ingredients (mg)	Batches code								
	K1	K2	K3	K4	KCL1	KCL2	KCL3	KCL3a	KCL4
KPF (g)	10	10	10	10	10	10	10	10	10
MCC PH 101 (g)	60	60	60	60	60	60	60	60	60
Mannitol (g)	0	20	15	15	20	20	19	19	19
HPMC 6cP (g)	10	10	10	10	10	10	10	10	10
SSG (g)	0	0	5	0	0	0	1	1	1
CCS (g)	0	0	0	5	0	0	0	0	0
SOR 60 (g)	0	0	0	0	10	20	30	30	40
Water (ml)	90	90	95	98	80	70	52	64	48

The present study of ketoprofen (KPF) immediate release pellets were developed with a view to deliver the drug immediately. The formulation development work was initiated with extrusion spheronization method and a total of 8 formulations were made (Table 4.3). The formulated pellets were evaluated for various parameters like surface morphology, bulk density, tap density, Hausner's ratio, friability, particle size distribution, yield of pellets disintegration test, and *in vitro* release studies.

4.3.1. Effect of addition of different pelletizing agents and fillers

The effect of addition of different pelletizing agents and fillers on the improvement of dissolution rate of KPF is illustrated in figure 4.5 and figure 4.6.

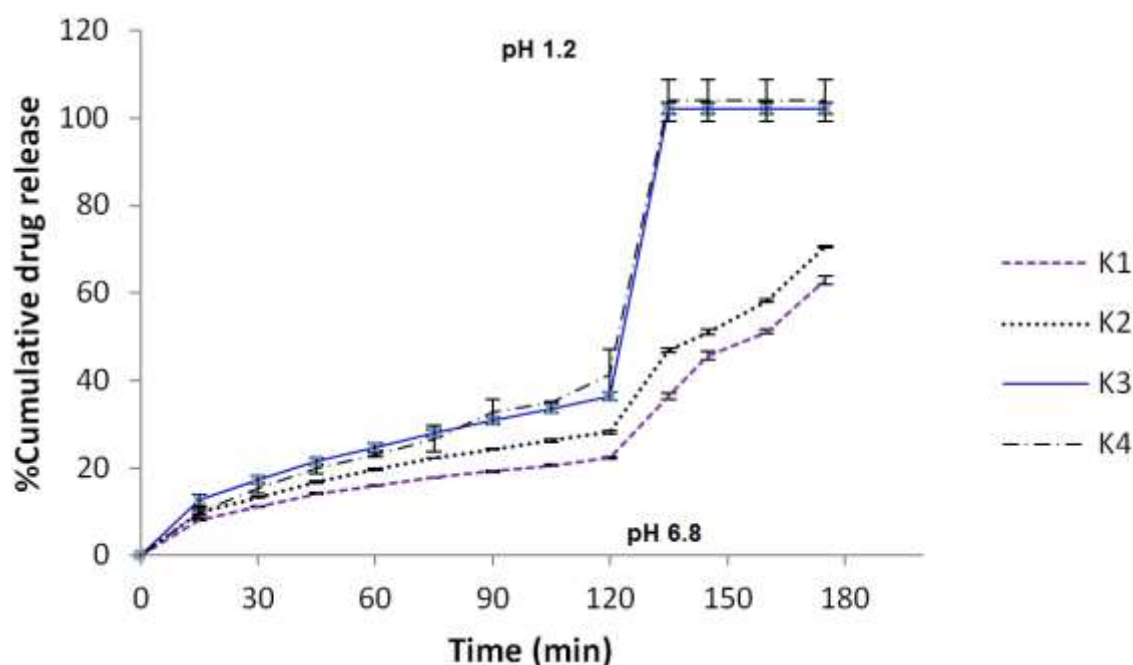

Figure 4.5. Release profile of uncoated pellets in pH 1.2 and then pH 6.8 phosphate buffer.

In vitro drug release profile of formulations K1, K2, K3 and K4 in 0.1 HCl and pH 6.8 phosphate buffer showed that not more than 40 % KPF was released in pH 1.2 in 2 h for all formulations without oil and surfactant; while MCC-based pellet release less than 65 % KPF after 3 h. Because MCC is known to interfere with the release of poorly soluble drugs (O'Connor R.E., Schwartz J.B. 1985).

Drug release was slightly faster for formulation containing mannitol (K2) and two types of disintegrants (formulation K3 added SSG and K4 added CCS), about 100 % KPF was released within 15 min at the intestinal pH when added disintegrants.

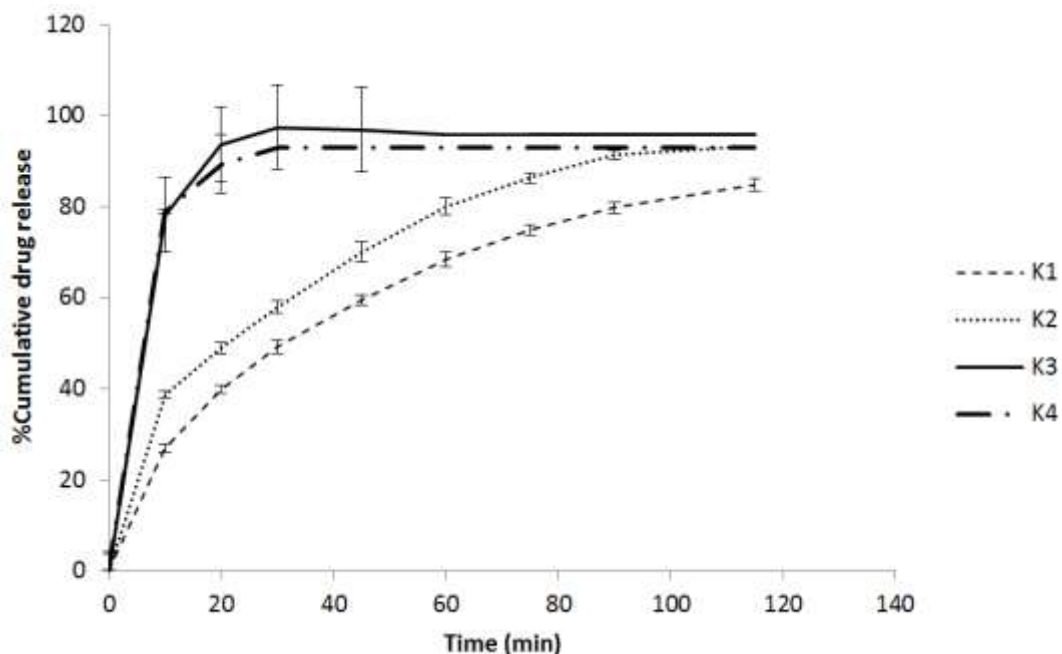

Figure 4.6. Release profile of uncoated pellets in pH 6.8 phosphate buffer

Figure 4.6 depicts the influence of the addition of disintegrants to the chosen formulation K3 and K4 on the dissolution rate of KPF from pellets in pH 6.8 phosphate buffer. Addition of disintegrants in formulation K3 and K4 indeed were found to improve the dissolution rates substantially. In the first 10 min, the percent dissolution was improved from 40 (formulation K2 added mannitol without disintegrants) to 80% (formulation K3 added 5% SSG and K4 added CCS).

4.3.2. Effect of ratio of SOR 60

The combination of Cremophor[®] ELP, Labrafil[®] MS 1944 with 30% w/w of pellets (KCL3) and 1% SSG led to cumulative drug dissolution of $83.5 \pm 2.6\%$ in 15 min in pH 1.2, meanwhile the formulation containing nanoemulsion with 10%, 20% w/w of pellets had only 20%, 30% of its total drug content dissolved in pH 1.2, respectively (figure 4.7).

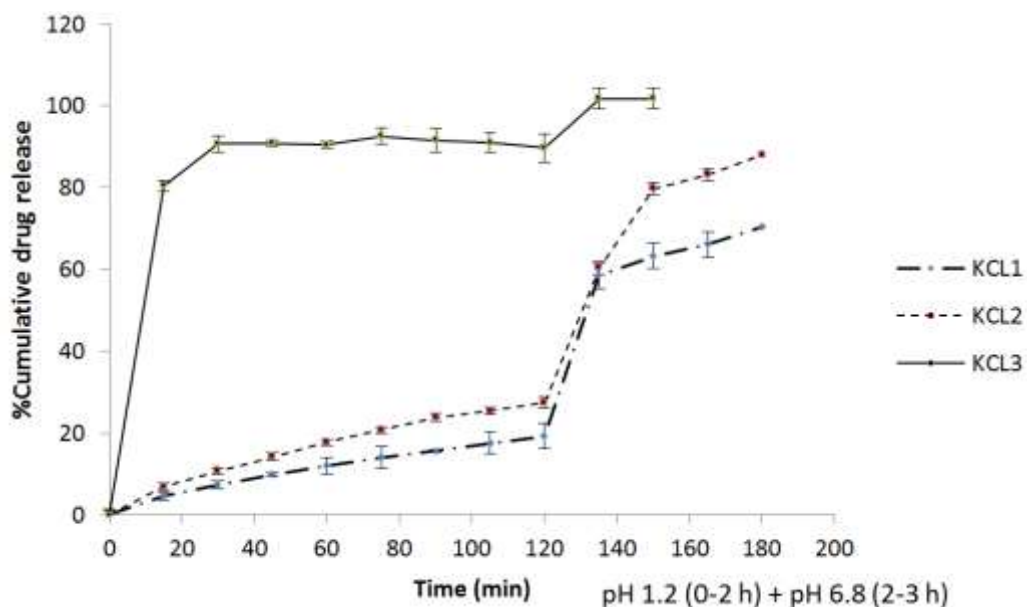

Figure 4.7. Release profile of uncoated pellets with different ratio SOR 60 in pH 1.2 and then pH 6.8 phosphate buffer.

The drug release from KCL3 after 10 min in basic media was ~86 % when compared to ~ 30 %, ~ 52 % from KCL1 and KCL2, respectively (figure 4.8).

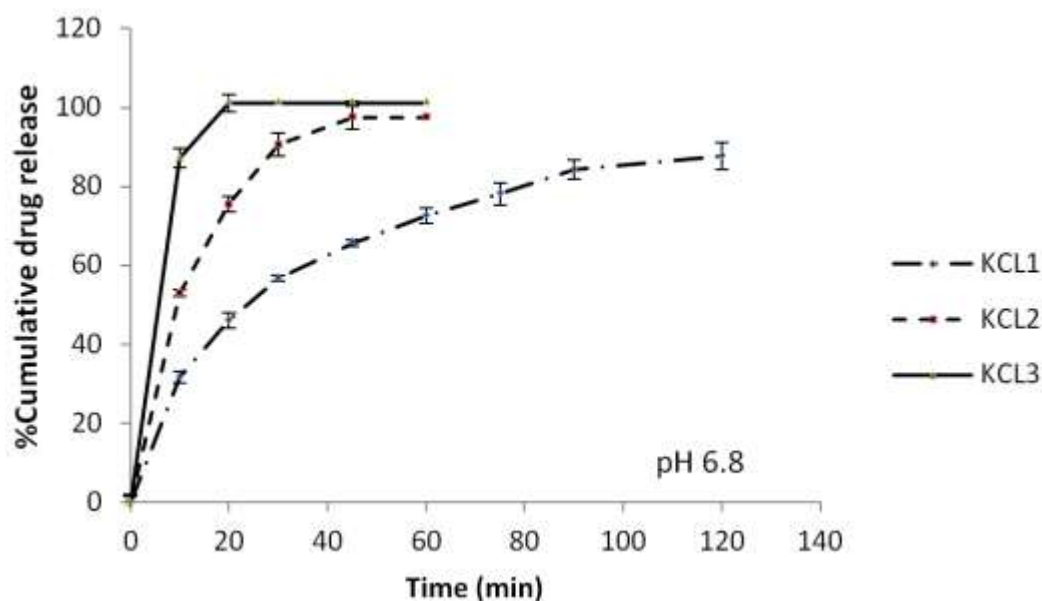

Figure 4.8. Release profile of uncoated pellets with different ratio SOR 60 in pH 6.8 phosphate buffer.

4.3.3. Effect of the method combination SOR 60 in pellet

Figure 4.9 and figure 4.10 show the ketoprofen release profile of the same formulation KCL3 but the way to combine SOR 60 in powder before extrusion is different:

- KCL3: ketoprofen and other powder excipients were mixed together.
- KCL3a: ketoprofen was dissolved in the mixture of Cremophor and Labrafil.

The method to combination SOR 60 in powder had a slightly significant to release KPF from uncoated pellets KCL3 in 0.1 HCl and pH 6.8 phosphate buffer. KCL3, 80 % KPF was released after 15 min in pH 1.2 and in pH 6.8 phosphate buffer 100 % after 15 min. Whereas, KCL3a could release 90 % after 15 min and 100 % after 30 min in pH 1.2.

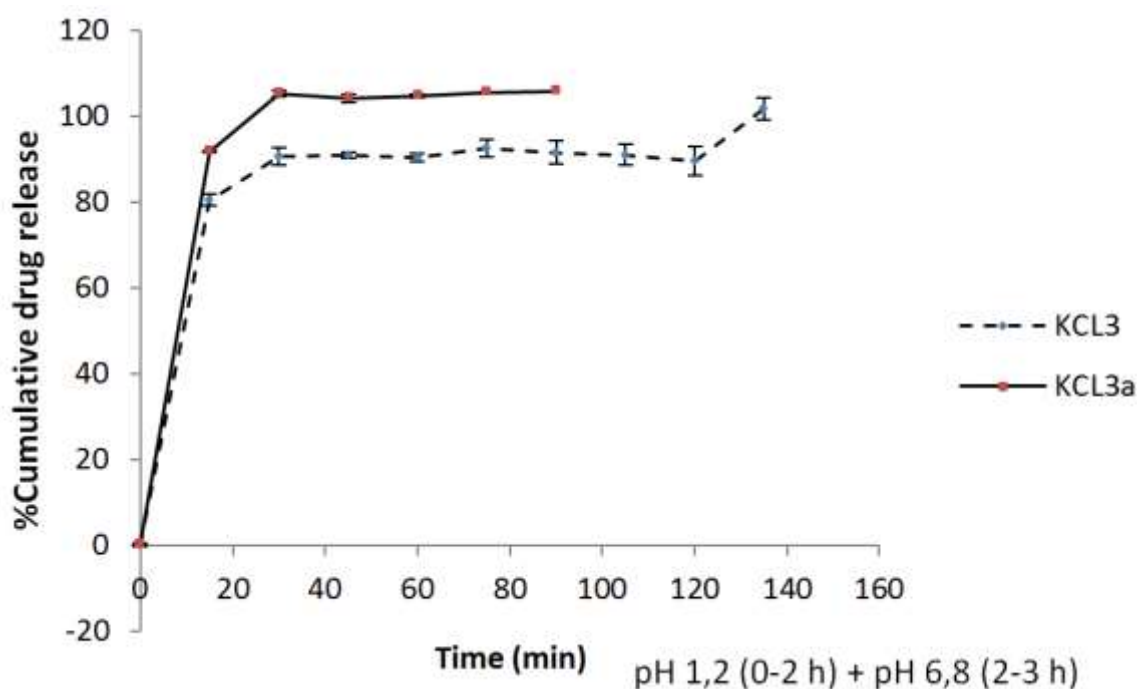

Figure 4.9. Release profile of uncoated pellets with SOR 60 was mixed directly with powder had KPF (KCL3); KPF was prepared by dissolution in SOR 60 (KCL3 a) in pH 1.2 and pH 6.8 phosphate buffer (pH 1.2 (0-2h) + pH 6.8 (2-3h)).

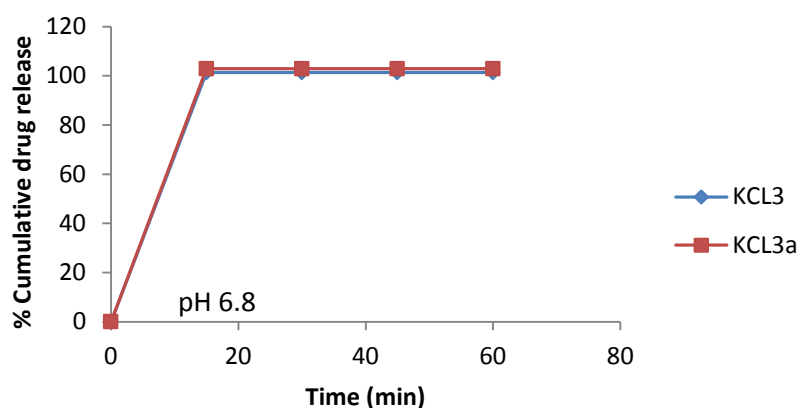

Figure 4.10. Release profile of uncoated pellets with SOR 60 was mixed directly with powder had KPF (KCL3); KPF was prepared by dissolution in SOR 60 (KCL3a) in pH 6.8 phosphate buffer.

Release profile of uncoated pellets with SOR 60 was mixed directly with powder had KPF (KCL3); KPF was prepared by dissolution in SOR 60 (KCL3a) in pH 6.8 phosphate buffer showed that two ways combination of SOR 60 was the same for release KPF from pellet.

4.4. Characteristics of the uncoated pellets

4.4.1. Evaluation of pellets friability

Pellets had a high mechanical strength, since friability values of less than 0.01% were obtained. A low friability indicates the pellets ability to withstand the shear forces during fluid bed coating. Evaluation of pellets friability

4.4.2. The physical characteristics of the uncoated pellets

The physical characteristics of the uncoated pellets are shown in Table 4.4, Table 4.5, figure 4.11, figure 4.12 and figure 4.13.

Table 4.4. Physical characteristics of the uncoated pellets

Parameters	Batches									
	K1	K2	K3	K4	KCL1	KCL2	KCL3	KCL3a	KCL4	
Apperance	Spherical white, with a slightly rough surface				Spherical white, smooth surface				Dum bell	
Hausner ratio	1.0	1.1	1.2	1.0	1.1	1.1	1.1	1.0	-	
Yield of pellets (%)	80.6	90.2	92.0	80.6	85.6	85.2	90.6	95.6	10.5	
Loss on drying (%)	1.23	1.56	2.19	2.68	2.96	2.41	2.59	2.64	3.59	
Disintegration test (min)	>60	>60	45	40	15	12	8	10	-	

Pellet disintegration test: The time taken for complete disintegration of uncoated pellets was 8-10 minutes with the pellets containing Cremophor[®] ELP: Labrafil[®] M1944CS and more than 45 minutes for the other pellets in water and pellets without disintegrants seem not disintegrate after 1 h.

Droplet size and polydispersity index (PDI) measurement of nanoemulsion release from pellets after production are shown in Table 4.5. The size of droplets is smaller than 120 nm.

Table 4.5. Droplet size and polydispersity index (PDI) measurement of nanoemulsion release from pellets after production

Batches	Mean size (nm)	PDI
KCL1	137±9.6	0.257
KCL2	118±5.5	0.348
KCL3	57±5.9	0.199
KCL3 a	73±5.1	0.462

The shapes of the pellets were very different for the different samples (Table 4.4, figure 4.11 and figure 4.12). Better results nearly spherical products, were observed for the particles prepared with ratio: Cremophor[®] ELP: Labrafil[®] M1944CS: ketoprofen = 10: 5: 5 (KCL3).



Figure 4.11. Light microscopy images of KCL3 pellets



Figure 4.12. Light microscopy images of KCL4 particles

Scanning electron micrographs of KCL3 pellets are displayed in figure 4.13 show that the pellet had quite smooth surfaces. The prepared pellets were rounded and intact in shape, except those prepared from very high level of Cremophor[®] ELP: Labrafil[®] M1944CS, which were not completely spherical, even dumbbell (figure 4.12- KCL4 pellets).

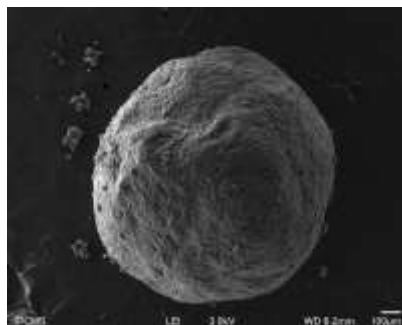

Figure 4.13. SEM images of KCL3 pellets

In conclusion, extrusion-spheronization is a suitable process to produce solid self-emulsifying pellets with up to 30% load of oil and surfactant mixture. The liquid of oil and surfactant mixture was successfully transformed into solid pellets by means of extrusion-spheronization with a maximum load of 30%. The pellets had a uniform size, a spherical shape and a low friability.

4.5. Enteric coating pellets

As regards the final dosage form, the pellets containing ketoprofen should be coated with intestine-soluble polymer. In accordance with the morphological observation and the friability of pellets, the dissolution results indicated that the KCL3 pellets had the best composition, suitable for the development of the final dosage form. Two commercial aqueous enteric polymer suspensions, Advantia[®] Performance 190024HA49 and Acryl-Eze[®] 93A92545 yellow were used for enteric coating of pellets in fluidized bed coater.

Table 4.6. Preparation of CKL3 pellets with different enteric coating

Coating (%w/w)	
Acryl – EZE [®] 93A92545 yellow	Advantia [®] Performance 190024HA49
12.5	8.0
15.0	12.0
17.5	15.0

The drug release studies of pellets were coated with 12.5 % w/w of Acryl – EZE[®] 93A92545 and with 8.0% w/w of Advantia[®] Performance 190024HA49. The release kinetic revealed that ketoprofen was still released for 2 h in pH 1.2 (Figure 4.14 and figure 4.15). When the release of drug in pH 1.2 increases >10%, the

amount of polymer necessary to surround the pellets in the dry film should be increases. Consequently, the minimum masses gain needed to achieve enteric release were also determined: Acryl-Eze[®] 93A92545: 15.0 % and Advantia[®] Performance 190024HA49: 12.0%.

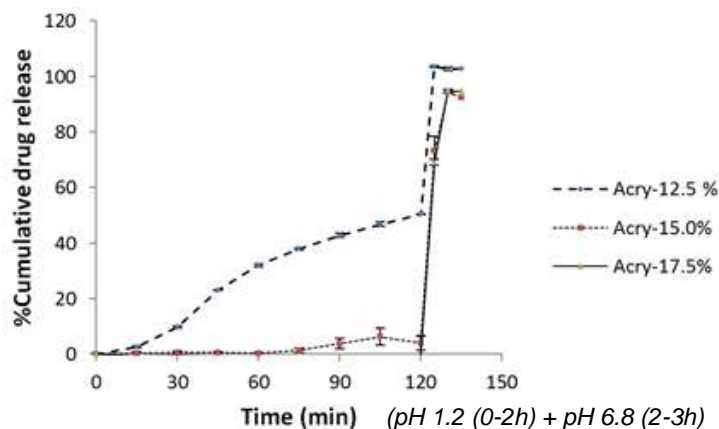

Figure 4.14. Dissolution profile of Acryl – EZE[®] 93A92545 coated pellets in fluid of pH 1.2 for first 2 h, and then continued in buffer of pH 6.8

Nearly 90% of the drug was released after 15 minutes in buffer of pH 6.8 in all coated pellets.

The average droplet size of the nano-emulsion formed from enteric-coated pellets was 121 ± 12 nm with narrow distributions.

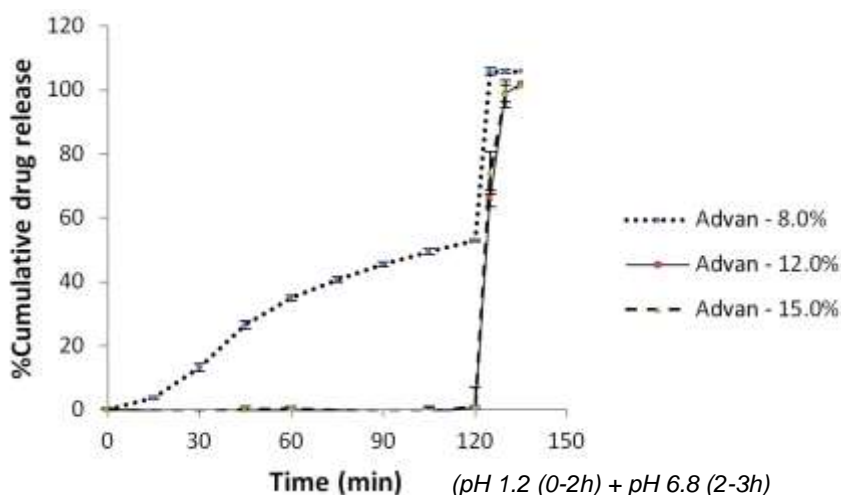

Figure 4.15. Dissolution profile of Advantia[®] Performance 190024HA49 coated pellets in fluid of pH 1.2 for first 2 h, then continued in buffer of pH 6.8

Figure 4.16 a and b show the SEM images obtained from coated pellets. SEM micrographs of coated pellets do not show any pores on the surfaces of the

film coated pellets; however, the surface of the Acryl EZE[®] 93A92545 coated pellets was not smooth, even if sharp corners are very well visible.

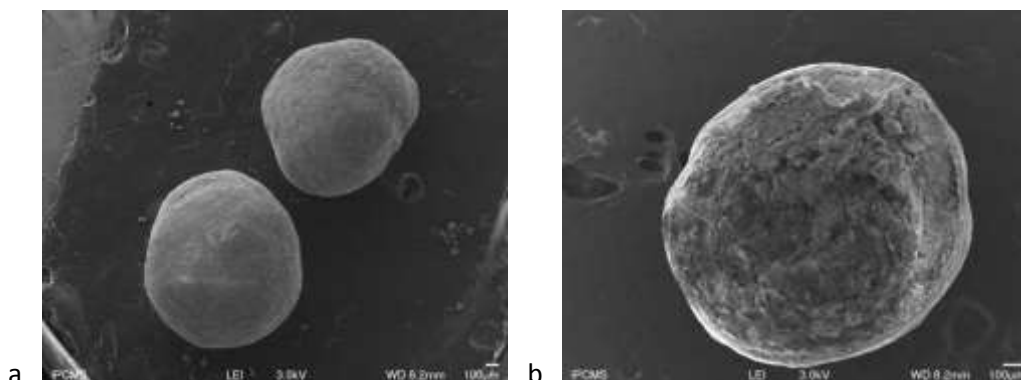

Figure 4.16. SEM images of the pellets: a. Pellets coated with 15% Acryl-EZE[®] (Surface); b. Pellets coated with 15 % Acryl-EZE[®] 93A (Cross-section)

The present study was to examine one of brands of ketoprofen (50 mg), available commercially in France, for compliance with the USP test for dissolution. Six capsules from Profénid[®] 50 mg were tested using dissolution apparatus compliant with USP requirements, using pH 1.2 as the dissolution medium. The results indicated that more than 90 per cent of the nominal drug content in 45 minutes of test and thus comply with the test (Appendix A1).

4.6. Stability of enteric coated pellets

Four batches of enteric coated pellets were chosen 15.0%, 17.5% w/w Acryl – EZE[®] 93A92545 and 12.0, 15.0% w/w with Advantia[®] Performance 190024HA49 for test stability and the results are mentioned in the figure 4.17, figure 4.18 and figure 4.19.

When coated pellets are stored at normal or accelerate conditions, after three months, the drug released in pH 1.2 during 2h was not increased about to the initial value that demonstrates the layer of enteric coat is quite stable after 3 months.

After three months the colour of the pellets stored in three conditions remained as initial and no agglomeration or stickiness among the pellets or pellets with the capsule was observed during the stability period.

After storage for 6 months at 40°C/75% RH, the drug released in pH 1.2 during 2h from pellets coated 15.0% Acryl- EZE[®] 93A92545 was increased more

than 20 % and pellets were agglomerated together, that prove the weight of enteric coated film should be more than 15 % if use Acryl- EZE[®] 93A92545 as material enteric coating (figure 4.18 a).

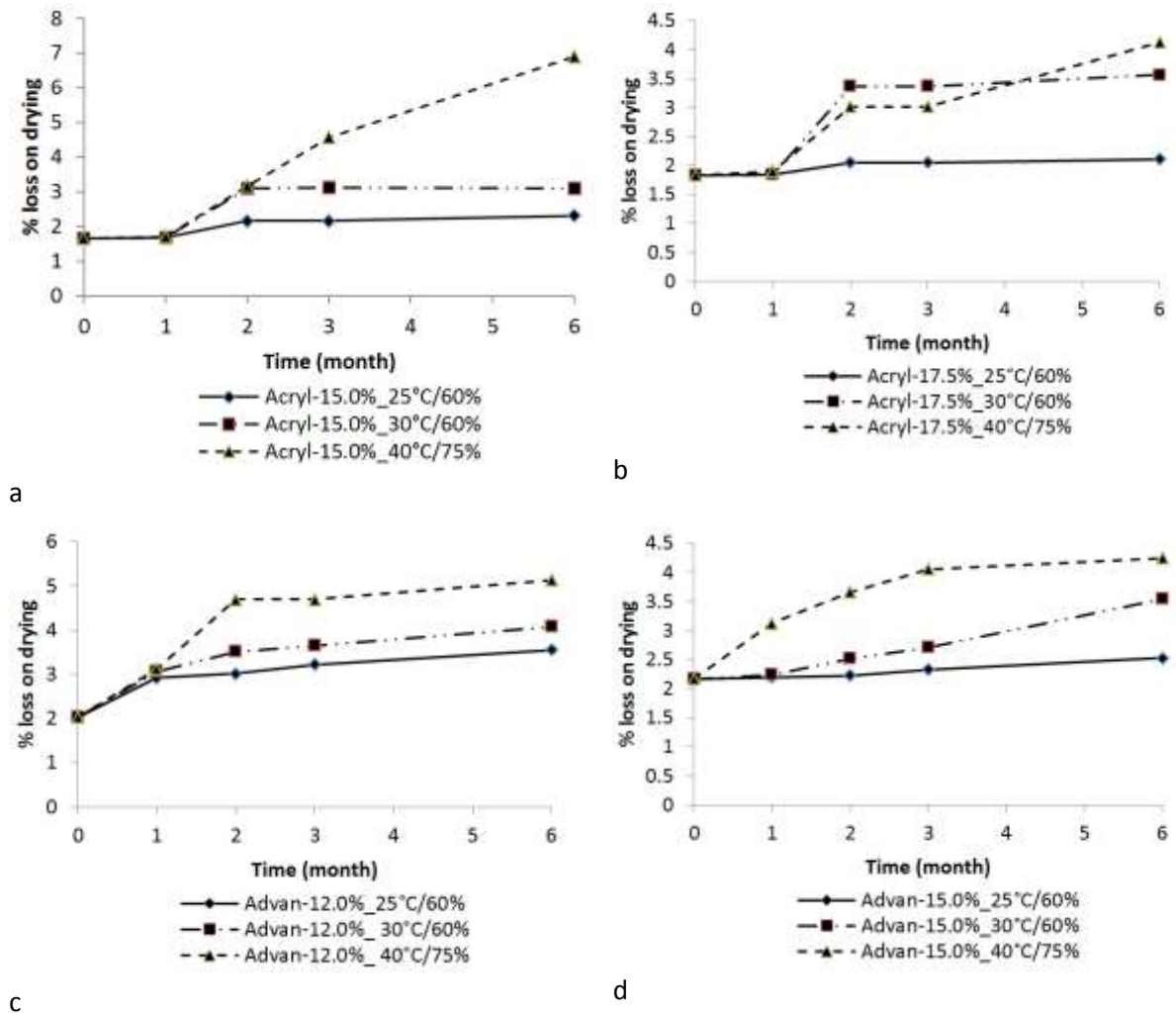

Figure 4.17. Loss on drying of ketoprofen enteric-coated pellets during stability study under three different conditions for a period of 6 months.

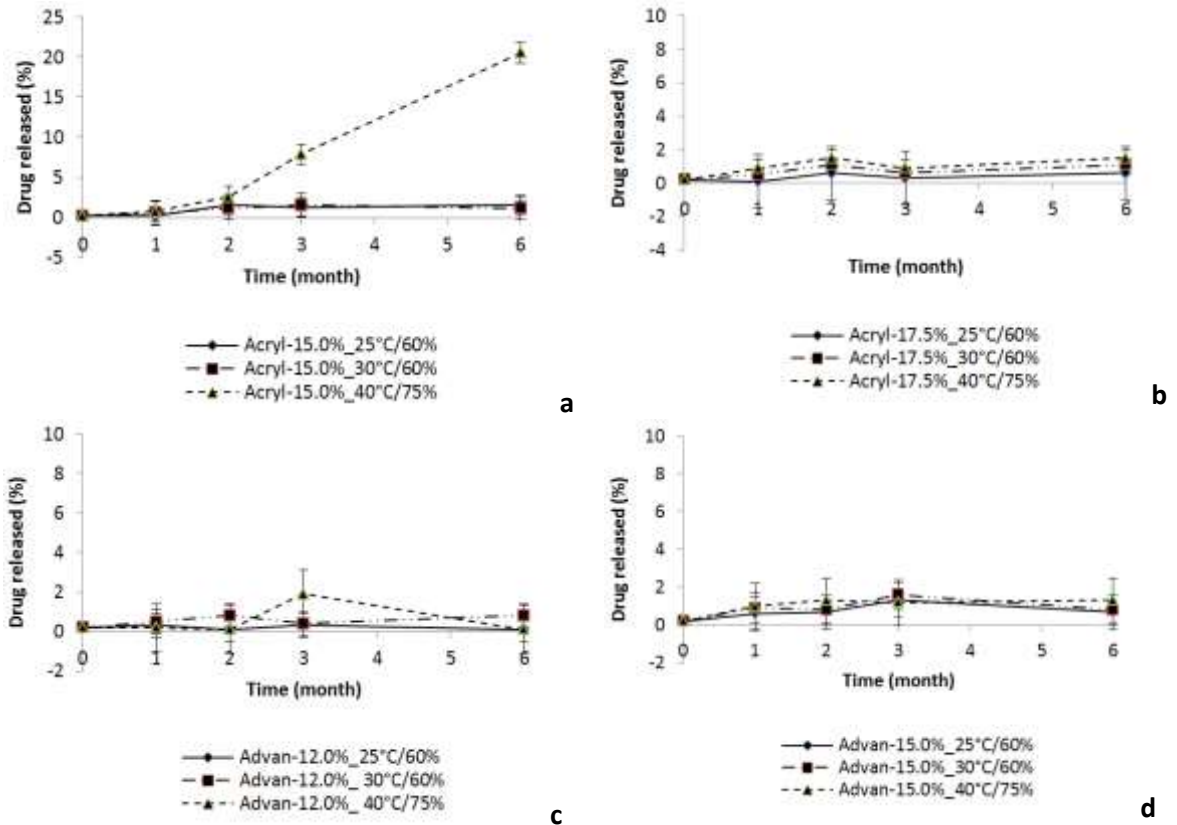

Figure 4.18. % drug released from ketoprofen enteric-coated pellets after 2h in pH 1.2 during stability study in three different conditions for a period of 6 months.

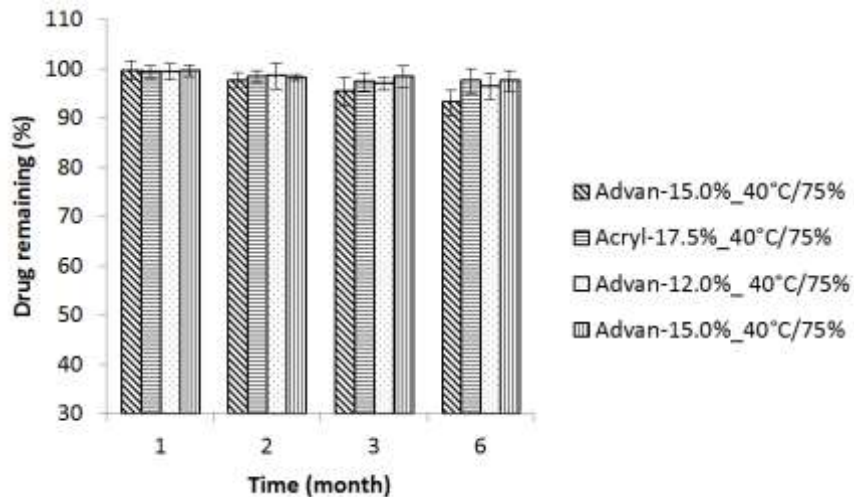

Figure 4.19. The drug remaining from coated pellets after being stored at 40°C/75% RH for 1, 2, 3 and 6 months.

After storage for 6 months at 40°C/75% RH, the remaining drug of enteric coated pellets was 95 – 99 % and assay results were within acceptable limits (figure 4.19).

Results of stability test were satisfactory showing no significant change in the colour, appearance and drug released of coated pellet with the samples as Acryl-17.5%, Advan-12% and Advan-15% and drug release met the criteria outlined in this study *i.e.* not less than 75% dissolved after 45 min in buffer pH 6.8. The enteric coated pellets were subjected to both disintegration and dissolution test. Results showed that there were no signs of cracking, peeling or disintegration in 0.1 N HCl however the coated pellets were completely disintegrated in 7–10 min in pH 6.8 phosphate buffer media. Pellet dissolution and assay results were within acceptable limits.

4.7. Conclusion

Based on the results of the experiments described in this chapter can be concluded that: pellet formation is strongly dependent on the pellet composition and the order of processing. MCC is essential as a spheronization aid in pellet production, therefore a compromise between the least amount of MCC that can produce pellets with good physical characteristics and the amount of lipid, drug containing phase, has to be achieved.

The main aim of this work was the formulation of matrix pellets containing ketoprofen by means of extrusion-spheronization with a view to increasing its bioavailability.

The current results demonstrate the possibility of using extrusion-spheronization to develop an oil and surfactant combinations pellet formulation with 30% of the oil and surfactant combinations mixture. The pellets have a spherical shape, small size distribution, and low friability.

The coated pellets were tested for drug content, dissolution and stability. Neither the drug content nor the release profiles were significantly affected by storage for 6 months stability study as per ICH guidelines.

The increase in dissolution rate could enhance the absorption of ketoprofen in human body. This work could possibly be extended to other application, particularly for poor water soluble drugs.

References

- Ahn H.J., Kim K.M., Choi J.S., Kim C.K., (1997). Effects of cyclodextrin derivatives on bioavailability of ketoprofen, *Drug Development and Industrial Pharmacy*, 4, Vol 23, 397-401.
- Batista de Carvalho L.A., Marques M.P., Tomkinson J., (2006). Drug-excipient interactions in ketoprofen: a vibrational spectroscopy study. *Biopolymers*. 82, 4, 420-4.
- Bharate S.S., Bharate S.B., Bajaj A.N., (2010). Interactions and incompatibilities of pharmaceutical excipients with active pharmaceutical ingredients: a comprehensive review. *J. Excipients and Food Chem.* 1 (3): 3-26.
- Both S.A., Lötter A.P., (1989). Compatibility Study Between Ketoprofen and Tablet Excipients Using Differential Scanning Calorimetry. *Drug Development and Industrial Pharmacy*. 15 (3).
- Cirri M., Maestrelli F., Mennini N., Mura P., (2009). Influence of the preparation method on the physical-chemical properties of ketoprofen-cyclodextrin-phosphatidylcholine ternary systems, *Journal of Pharmaceutical and Biomedical Analysis*, Vol 50, 690-694.
- Clas S.D., Dalton C.R., Hancock B.C., (1999). Differential scanning calorimetry: applications in drug development. *Pharm. Sci. Technol. Today* 2, 311320.
- De Carvalho L.A.E.B., Marques M.P.M., Tomkinson J., (2006). Drug-excipient interactions in Ketoprofen: A vibrational spectroscopy study. *Biopolymers* 82, 420-424.
- Giron D., (1998). Contribution of thermal methods and related techniques to the rational development of pharmaceuticals—Part 2. *Pharm. Sci. Technol.*
- Kheradmandnia S., Farahani V.E., Nosrati M., Atyabi F., (2010). Preparation and characterization of ketoprofen loaded solid lipid nanoparticles made from beeswax and carnauba wax. *Nano: Nano. Bio Med.*; 6:753–759.
- Maestrelli F., Zerrouk N., Cirri M., Mennini N., Mura P., (2008). Microspheres for colonic delivery of ketoprofen-hydroxypropyl- β -cyclodextrin complex, *European Journal of Pharmaceutical Sciences*, Vol 34, 1-11.
- Maestrelli F., Zerrouk N., Cirri M., Mennini N., Mura P., (2009). Physical-chemical characterisation of binary and ternary systems of ketoprofen with cyclodextrins and phospholipids, *Journal of Pharmaceutical and Biomedical Analysis*, Vol 50, 683-689.
- Mura P., Manderioli A., Bramanti G., Furlanetto S., Pinzauti S., (1995). Utilization of differential scanning calorimetry as a screening technique to determine the compatibility of ketoprofen with excipients. *Int. J. Pharm.* 119, 71-79.
- Mura P., (2005). Characterization and Dissolution Properties of Ketoprofen in Binary and ternary Solid Dispersions with Polyethylene Glycol and Surfactants, *Drug Dev. and Ind. Pharm.*, 30, 425–434
- O'Connor R.E., Schwartz J.B., (1985). Spheronization II: drug release from drug-diluent mixtures. *Drug Dev Ind Pharm.* 1985; 11: 1837–57.
- Parfitt K., (1999). Analgesic anti inflammatory and antipyretic. In: Reynolds JEF, editor. *Martindale: The complete drug reference*. 32nd ed. Taunton: Pharmaceutical Press, p. 2–12.
- Rowe R.C., Sheskey P.J., Quinn M.E., (2009). *Handbook of Pharmaceutical Excipients*. 6th Edition ed.; Pharmaceutical Press: London.

- Sims J.L., Carreira J.A., Carrier D.J., Crabtree S.R., Easton L., Hancock S.A., Simcox C.E., (2003). A New approach to accelerated drug-excipient compatibility testing. *Pharm. Dev. Technol.* 8, 119-126.
- Takayama T., Nambu N., Nagai T., (1982). Factors affecting the dissolution of ketoprofen from solid dispersions in various water-soluble polymers, *Chemical pharmaceutical Bulletin*, 8, Vol 30, 3013-3016.
- Tayade P.T., Vavia P.R., (2006). Inclusion complexes of ketoprofen with β -cyclodextrins: Oral pharmacokinetics of ketoprofen in humans, *Indian Journal of Pharmaceutical Sciences*, 2, Vol 68, 164-170.
- Tita B., Fulias A., Bandur G., Marianc E., Tit D., (2011). Compatibility study between ketoprofen and pharmaceutical excipients used in solid dosage forms. *Journal of Pharmaceutical and Biomedical Analysis*, 56, 221–227.
- Vueba M.L., Veiga F., Sousa J.J., Pina M.E., (2005). Compatibility studies between ibuprofen or ketoprofen with cellulose ether polymer mixtures using thermal analysis. *Drug Dev. Ind. Pharm.*, 31, 943-949.

Chapter 5 : Influence of formulation and process variables on the quality of coated pellets prepared via Innojet Ventilus[®] V-2.5

5.1. Introduction

Pellet coating processes are realized in industrial scale for the production of drugs, detergent, fertilizers of foods. The demand for coated granular materials is continuously growing in the field of pharmaceuticals and fertilizers. Moreover, multilayer coating is gaining importance since numerous functional properties can be achieved. In case of pharmaceutical products, the release of active pharmaceutical ingredients can be manipulated.

Fluidized beds are widely applied in industry for the coating of solid particles such as pellets, granules or particles (Dewettinck K. and Huyghebaert A., 1999). The initial carrier particles are fluidized by hot air, the liquid evaporates and the solid forms a shell enclosing the kernel material.

Technology based on fluidization technique, where solid particles are suspended by an up-flowing air is extensively used for coating of small particles or tablets, especially to assure resistance to acid, provide sustained release, extended release, colon specific delivery, to mask the taste of unpalatable substances and to control attrition of the product and powdered layering (pelletizing) application.

Regarding the spraying of coating agent, three elementary configurations are commonly used. Those are top-spray, bottom-spray (appropriate for Wurster apparatus) and side (tangential) spray (Salman A. *et al.*, 2007).

Different parameters influence the fluidization characteristics and they can be classified into two major groups comprised of independent variables and dependent variables. Independent variables include fluid properties (e.g., density, viscosity, relative humidity), particle characteristics (e.g., density, size, shape, distribution, surface roughness, and porosity) and equipment related such as direction of fluid flow, distributor plate design, vessel geometry, operating velocity, centrifugal force, temperature, pressure, type of nozzle, *etc.* The dependent variables are basically capillary forces, minimum fluidization velocity, electrostatic forces, bed voltage, van der Waals forces, *etc* (Dixit R. and Puthli S. 2009).

The aim of research was: to evaluate layering technique of loading a model drug (ketoprofen) onto inactive pellets using a binder-polymer suspension

containing the nanoemulsion ketoprofen is performed in Innojet Ventilus® V-2.5 laboratory scale systems equipped with ROTOJET spray nozzle systems. The product was transported on a cushion of air flowing in an orbital spiral and circular fashion to the cylindrical container wall. Coating occurred in the center of the product container, where the spray nozzle was located.

5.2 Introduction of Innojet Ventilus® V-2.5, rotojet nozzle, type IRN 2

Innojet Ventilus® V-2.5 (Figure 5.1) is based on the air flow bed method originally developed by Dr. Herbert Hüttlin. This laboratory-scale machine processes particles from 10 µm to 30 mm in diameter, such as powders, granulates, pellets, tablets, capsules and numerous other free-flowing bulk materials. A proven all-rounder, it is the perfect granulation and coating system for pharmaceutical, chemical and food products. The enhanced processing efficiency permits up to 25% shorter batch times. The homogeneous flow conditions inside the cylindrical product container enable extremely gentle intermixing of the batch. The process air is controlled by the ORBITER booster, an ingenious container bottom consisting of overlapping circular plates. Together with the ROTOJET, the central bottom spray nozzle, the booster forms an innovative functional unit that meets all the requirements for linear scale-ups. The air flow bed technology ensures accurate control of the product movement and equally precise application of the spray liquids. The resulting formulations achieve the required release profile with between 10 and 15 percent less spray liquid.



Figure 5.1. The Innojet Ventilus® V-2.5 laboratory scale was applied by Romaco Innojet GmbH.

Product container: cylindrical product container with 2 types of volume: IPC1 (1 litre- Figure 5.2 a) and IPC2.5 (2.5 litres - Figure 5.2 b).



a



b

Figure 5.2. Product container IPC1 (a) and IPC2.5 (b)

Process unit

The process air tangentially enters the product container above and subsequently flows through the INNOJET Booster Orbiter (type: IBO 100). The booster is composed of concentric air guide rings which deflect the process air radially, tangentially in the direction of the container wall.

The product follows this movement rising upwards at the container wall and then flowing back into the centre of the product container to be sprayed there by the centrally arranged IRN 2 spraying nozzle.

Inlet air area

The process air required for product movement and drying is treated in the inlet air area. The flowing air components have been integrated into a housing system in a compact manner:

- Inlet air filter with filter class F6.
- Inlet air ventilation to convey the process air through the facility
- Electric air heater
- Subsequently, the process air flows back into the product container in which the process takes place

Outlet air area

The outlet air area has the task of treating the “spent” process air in such a way that it may be released into the environment.

The outlet air is already filtered directly above the process by the INNOJET Sepajet Filter ISF 150 which is used with its dynamic cleaning function particularly in fine particles, powder and granulation. A screen insert may be installed instead. At the back of the process column, a two – stage static outlet air filter column has been arranged which is equipped with two filter cartridges of filter classes F6 and F9.

The outlet air ventilator is arranged downstream of the filter and “pulls” the process air through the facility. The inlet air and outlet air ventilators are always adjusted in such a way that a vacuum is generated in the facility which ensures that an active agent cannot escape and harm the operator in case of a leak.

Spraying system

The spraying system used in INNOJET® facilities is the Rotojet spray nozzle (IRN) (Figure 5.3 and Figure 5.4), mostly with an integrated liquid pump. It consists of an INNOJET Rotojet spray nozzle type and works according to the Rotojet principle. The IRN 2 sprays from the centre position of the facility and booster orbiter in a circumferential, horizontal manner into the product and also supports the product movement.

The sectional drawings show the Innojet Rotojet spraying nozzle, type IRN2.

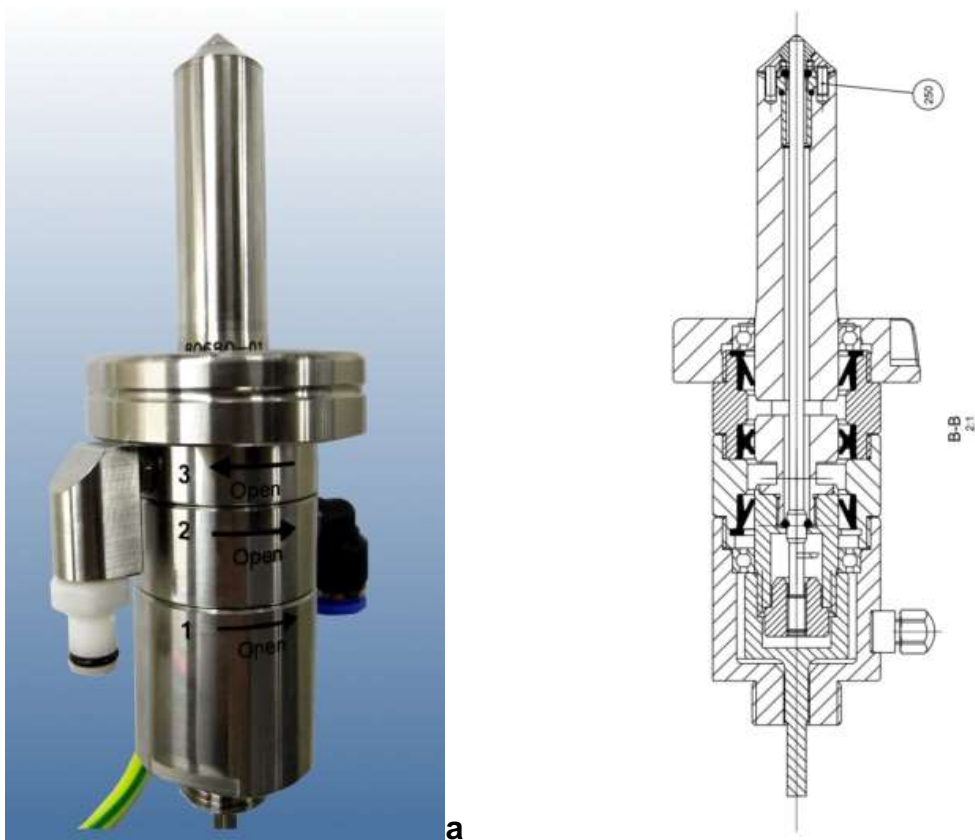

Figure 5.3. a and b. The design of the spray nozzle Rotojet type IRN 2

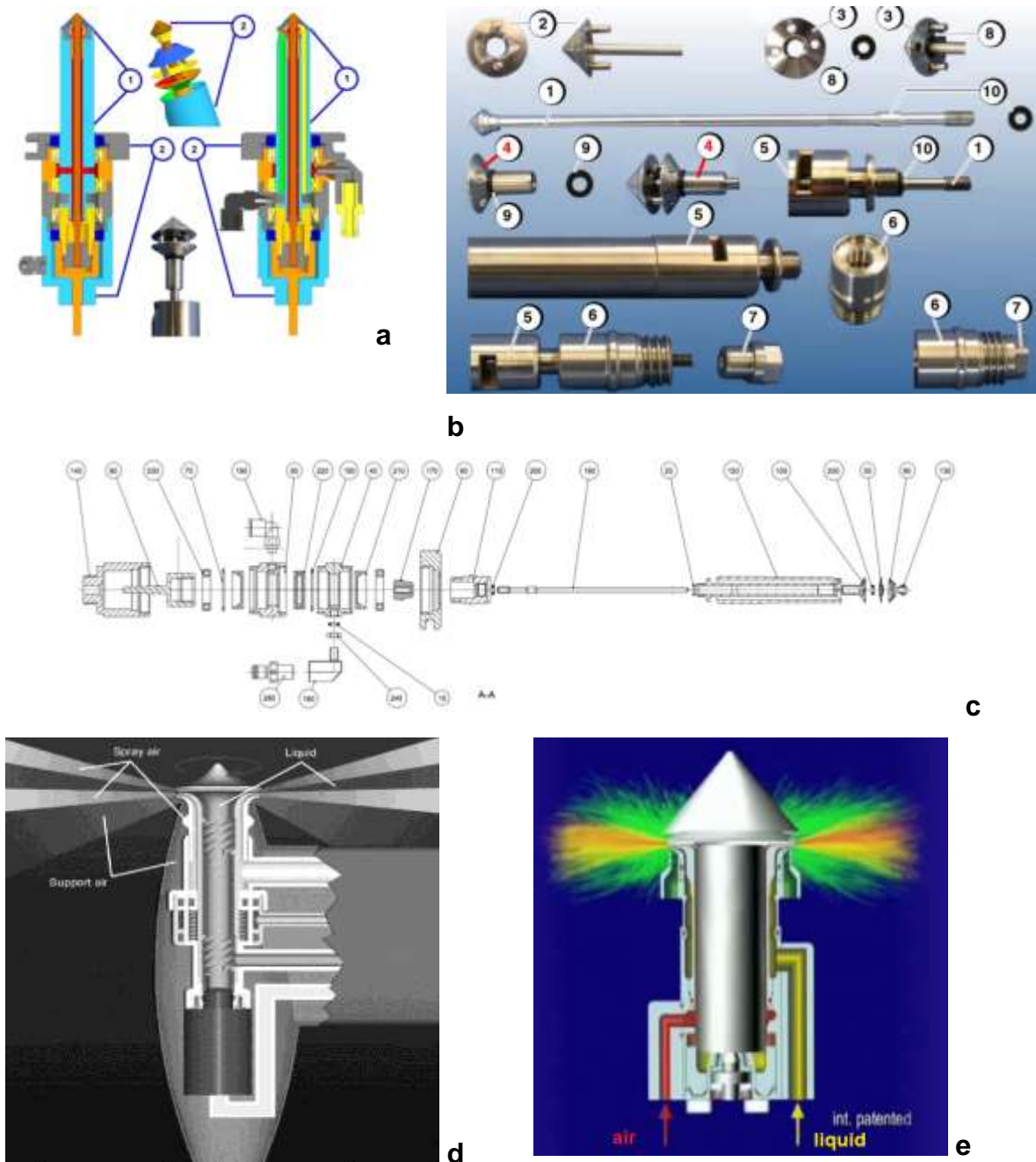

Figure 5.4. The design of the spray nozzle Rotojet type IRN 2.

- a.** The design of the spray nozzle Rotojet type IRN 2 is equipped with a dynamic spraying air gap (1). The spray air atomises a fine liquid film into a fine spray fog. The top of the spraying air gap is rotating (1) and the part underneath (2) is static;
- b and c.** Spraying liquid tube part: 1. Pull rod with Nozzle hat; 2. Nozzle cap 1; 3. Nozzle cap 2; 4. Nozzle cap 3; 5. Nozzle tube –upper part (spraying air and liquid); 6. Nozzle tube –lower part (spraying air and liquid); 7. Nozzle pull – screw; 8. O-ring for nozzle cap 2; 9. O-ring for nozzle cap 3; 10. O-ring for to mount on the Pull rod –bigger “swelling –place”.
- d. and e.** Support of spray air and liquid.

Functional principle of booster ORBITER and spray nozzle ROTOJET:

Product movement and nozzle spray work into the same direction, spraying and moving from the center make the particles disperse; very high spray rates are possible (Figure 5.5).

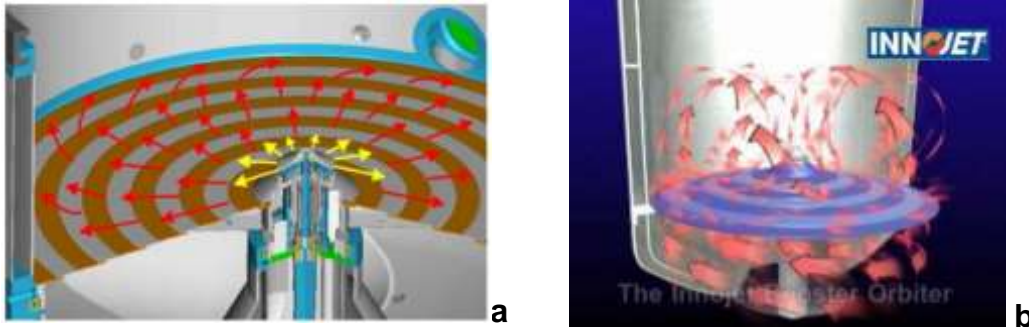

Figure 5.5. Functional principle of booster ORBITER and spray nozzle ROTOJET

a. Product movement (red arrows) and nozzle spray (yellow arrows) work into the same direction

b. Products movement (red arrows)

Integrated hose pump

Spray rate control via the control display (figure 5.6).



Figure 5.6. Integrated hose pump

5.3. Results and discussion

5.3.1. The amount of liquid binder

In coating process, the amount of liquid binder is also important, in the drop controlled region, powder particles are immersed in a droplet, which forms the primary nucleus. The optimization of amount of liquid binder depends on the temperature and the size of the pellets.

Position of nozzle with respect to material height is important suitably for better contact of binder with the powder to be granulated (Dixit R. and Puthli S. 2009).

With the design of the spray nozzle Rotojet type IRN 2, position of nozzle is fixed, rotor turns 14 rpm. So that, adjustment of spray rate of peristaltic pump and spray pressure of binder is important to avoid over wetting and agglomeration phenomena.

Survey the amount of liquid binder (water) when adjustment of spray rate and spray pressure was performed with spray rate at 10 %, 15 % and 20% (% spray rate control via the control display of integrated hose pump, size tube in the pump was 2 mm). The results was performed in Figure 5.7 show that, the amount of liquid binder increase when spray rate increase but not change when spray pressure from 1-2 bar.

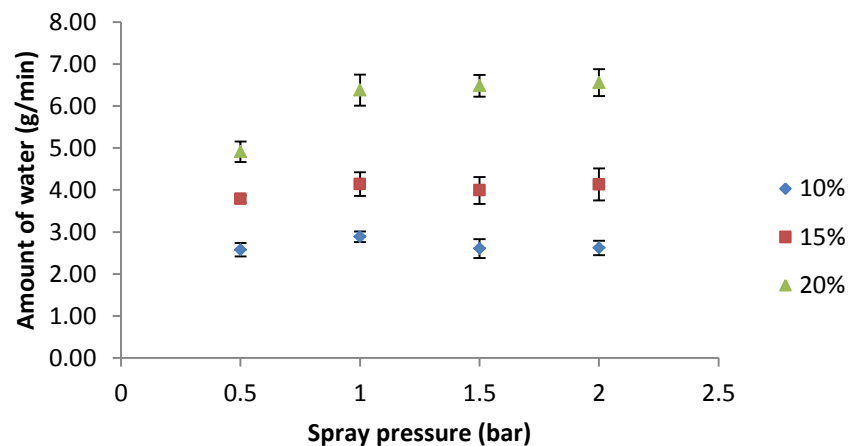

Figure 5.7. Relation between amount of liquid binder (water) when adjustment of spray rate and spray pressure was performed with spray rate 10 %, 15 % and 20%.

Optimization of Spray Rate

When an atomized coating solution successfully collides with pellets, it wets their surfaces. Depending on the conditions inside the bed, wetted particles may collide and form liquid bridges between them or they can be dried resulting in a layered growth. If there is excessive wetting, many pellets will form bridges between them, thus joining together to form large wet clumps which will lead to the defluidization of the bed in a phenomenon known as wet quenching. In the case of moderately wetted particles, a number of pellets will remain joined together when their liquid bridges are dried. Spray rate was determined by the drying capacity of the equipment which is directly proportional to cross sectional area of the air distribution plate rather than by the increase in batch size. At a given atomization pressure and air flow volume, change in liquid spray rate directly affects droplet size which in turn impacts particle agglomeration and may cause lumping. Pellets were fluidized and allowed to coat at different spray rate (rpm) and results were monitored (Namrata G. and Trivedi P., 2012).

Table 5.1. Shows optimization of spray rate

Parameters	Trial 1	Trial 2	Trial 3	Trial 4	Trial 5	Trial 6
Air flow rate (m ³ /h)	45	45	45	60	60	60
Inlet air temperature (°C)	50	50	50	60	60	60
Atomization pressure (bar)	0.5	1.0	0.5	1.0	1.5	2.0
Spray rate of coating solution (%)	20	15	10	15	10	10
Observation	Pellets adhere to the wall of FBP	Pellets adhere to the wall of FBP	Pellets adhere to the wall of FBP	Pellets adhere to the wall of FBP	Ideal for coating	Ideal for coating

5.3.2. Batch size

Fluidization is affected by the quantity of particles which are introduced onto the coating chamber: at least 50% of volume external to coating partition must be occupied by the particles to be coated. This makes it possible to have sufficient quantity of particles inside the partition to accumulate the maximum coating

solution droplets and to avoid premature drying, or depositing on the walls of the partition. In the Wurster coating process, to calculate load of particles to be introduced following formula can be used:

$$M = (r_1^2 - r_2^2)\pi L\rho_p$$

Where r_1 and r_2 are respectively chamber radius and partition radius, L is the length of the partition; ρ_p is bulk density of particles (Jones D. M., 1988)

In the case of a multi – partition process, the volume of partition must be multiplied by the number of partitions. The Figure 5.8 represents the calculated efficiency of coating of Cellets® 1000 with three different inventories 15 %, 30%, 50% of the maximum capacity in the product container IPC1.

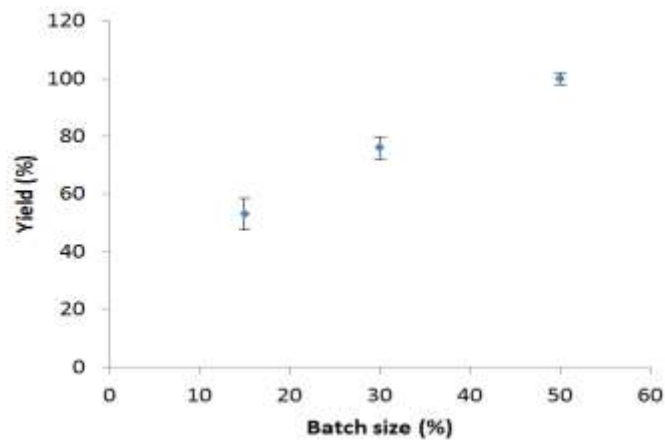

Figure 5.8. Efficiency of coating calculates according to batch size



Figure 5.9. Depositing of coating material on the walls of the partition with three different inventories 15 % (a), 30% (b), 50% (c) of the maximum capacity in the product container IPC1.

At least half of this capacity will be enough to ensure that there is sufficient material in the up bed region (insert) to accumulate all or most of the coating material being sprayed (Figure 5.9). If the product in the annulus “down bed” and its depth is insufficient, the up bed will be sparse, favouring spray drying or coating of the inner wall of the insert, which is the source of the poor efficiency.

5.3.3. Characteristic of the coating layer pellets

Four batches of pellets were produced to investigate the effects of varying coating material, drug layer uniformity and drug release from immediate release pellets.

Details of the pellet design specifications for each of the batches are summarized in Table 5.2. Cellets® starter cores were coated with aqueous mixture of ketoprofen (1% (w/w) suspension) and polymers (10% (w/w) solution) until a material of coating loading of 10% ((w/w) based on the core weight) was achieved. The process parameters were as follows: air flow rate: 60 m³/h, inlet air temperature: 60°C, atomization pressure: 1.5 bar, spray rate of coating solution: 10 %.

Table 5.2. Composition of the batches and results of drug layering processes.

Process related parameters	Batches			
	L1	L2	L3	L4
Binder solution	HPMC E6 (5%)	Advantia Preferred HS 290008CR01 (10% w/w in water)		
Weight of Cellets® 700	-	-	-	15
Weight of Cellets® 1000	100	100	150	135
Yield (%)	53	76	90	90
Friability (%)	0.1	0.1		
Reconstitution study	NA	Size: 182±23.6 nm PDI: 0.407±0.068		

The coating thickness and its uniformity are two important parameters even when layer coating is applied. More uniform coating results in lower quantities of coating material applied to achieve a desired result, shorter process time and lower power consumption during coating process.

Because of the design of air grinding blades has distance of about 1 mm, some small pellets can “leak” and “were trapped” on the sieve of the product

container (Figure 5.10 b) and couldn't involve in the coating process and effect to the uniformity of the coating layer. Particle size of pellets should be ideal for fluidization and coating. The very small or too large of particle size of pellets makes disorganized fluidizing. If too small, twinning and agglomeration of multiparticulates may occur (Barletta M. *et al.*, 2008)

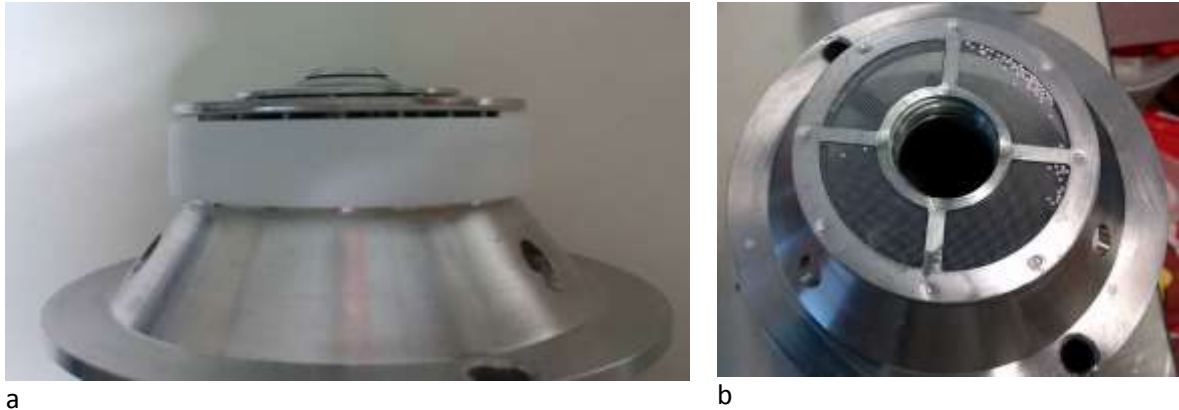

Figure 5.10. Design of air grinding blades (a) and small pellets can “leak” and “were trapped” on the sieve of the product container (b)

5.3.4. In-vitro drug release study

The effect of addition of oil and surfactant on the improvement of dissolution rate of ketoprofen is illustrated in figure 5.11. Formulations L3 showed significant increase in the dissolution rate of the drug, more than 95% of ketoprofen was released within 5 min and 100% of ketoprofen was released after 10 min in pH 1.2, whereas L1 showed maximum 90% of ketoprofen release within 30 min in pH 1.2.

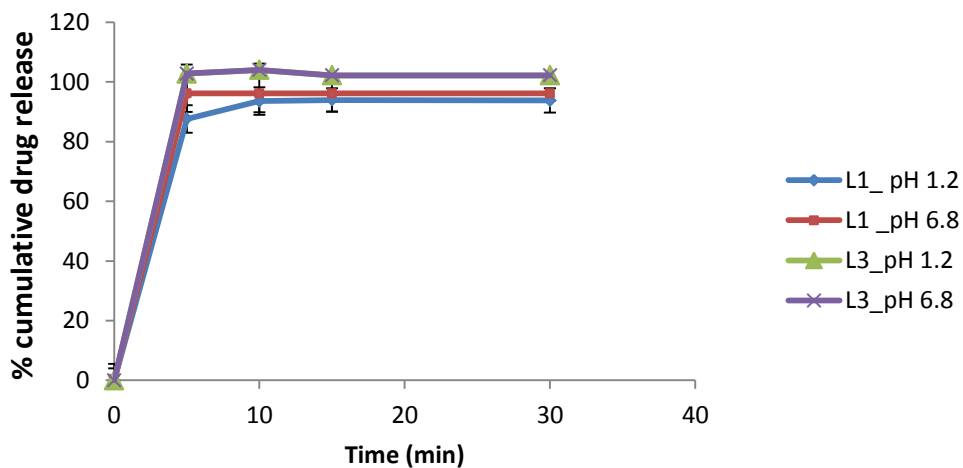

Figure 5.11. Dissolution profile of layer coating pellets in different media

5.4. Conclusion

Fluid bed processor offer unique opportunity to develop and produce coated controlled release products. However, various process parameters easily can alter the performance of a product and hence should be examined thoroughly. The interactions of various process parameters presents a great challenge in optimizing the coating process, hence it is important to investigate and understand these variables to ensure a reproducible performance of controlled release products.

The loss of coating material, presumably, due to drying of sprayed droplets before hitting the pellets surface, deposition to the walls of draft tube or attrition because of inter-particle collisions or collisions with the walls of the process chamber are the most important factors affecting the total process yield.

References

- Barletta M., Gisario A., Guarino S., Tagliaferri V., (2008). Fluidized bed coating of metal substrates by using high performance thermoplastic powders: Statistical approach and neural network modelling. *Engineering Applications of Artificial Intelligence*; 21: 1130-43.
- Chen W., Chang S.Y., Kiang S., Marchut A., Lyngberg O., Wang J., Rao W., Desai D., Stamato H., Early W., (2010). Modelling of pan coating processes: prediction of tablet content uniformity and determination of critical process parameters, *J. Pharm. Sci.* 99 (7) 3213–3225.
- Dixit R., Puthli S., (2009). Fluidization technologies: Aerodynamic principles and process engineering. *J Pharm Sci.*; 98(11): 3933-60.
- Jones D.M., (1988). Air suspension coating; *Pharmaceutical technology Encyclopedia*, 189-216.
- Dewettinck K., Huyghebaert A., (1999). Fluidized bed coating in food technology, *Trends in Food Science & Technology*, 10 (1999), pp. 163-168.
- Katori N., Aoyagi N., S. Kojima S., (2002). Mass variation tests for coating tablets and hard capsules: rational application of mass variation tests, *Chem. Pharm. Bull.* 50 (9) 1176–1180.
- Mafadi S., Hayert M., Poncelet D., (2003). Fluidization control in the wurster coating process. *Chem.Ind.*; 57(12): 641-644.
- Namrata G., Trivedi P., (2012). Formulation and development of pellets of Tolterodine Tartarate : A Qualitative study on Wurster Based Fluidized Bed Coating Technology, *Journal of Drug Delivery & Therapeutics*; 2(4), 90-96.
- Salman A., Hounslow M., Seville J., (2007). Granulation, *Handbook of Powder Technology*, 11, Elsevier, Amsterdam.

Chapter 6 : General discussion

Improvement in dissolution of poorly soluble drugs has many challenges.

In this thesis, an extrusion-spheronization process was thoroughly studied for improving dissolubility of drugs with nano-emulsions formulations.

The influence of each process parameter on quality of pellets by extrusion-spheronization only few set of experiments was studied.

Extrusion-spheronization process is a multistage process for obtaining pellets with uniform size from wet granulates. The success of these methods depends on the complex relations between the equipment, the formulation and process variables and even it is very much dependent on domain knowledge and practice of researchers.

The results showed that the chosen formula imparts a spherical shape, strength and integrity to the pellets and excellent flow characteristics, thus they have adequate properties for an uniform filling of the capsules.

Folic acid (FA) is the synthetic form of B9, found in supplements and fortified foods, while folate occurs naturally in foods. All the B vitamins are water-soluble, meaning the body does not store them and is regularly removed from the body through urine. Folic acid is crucial for proper brain function and plays an important role in mental and emotional health. FA is an essential vitamin for numerous bodily functions and is especially indispensable in pregnancy. Although there is irrefutable evidence for the benefits of FA supplementation, recent studies have suggested that massive exposure to high bioavailable FA is a double-edged sword. Thus controlling FA dosage and modulation of FA bioavailability (e.g. by adjusting its bio accessibility along the gastrointestinal tract) are apparently vital for maintaining positive effects of fortification, while avoiding massive exposure-related problems.

The results in chapter 3 showed that nano-emulsion content showed significant influence on dissolution rate. An increase in nano-emulsion content results in faster dissolution rate of folic acid.

Fluidized bed coaters are used widely for coating of powders, granules, tablets, pellets, beads held in suspension by column of air. The three types (top spray, bottom spray, tangential spray) are mainly used for aqueous or organic solvent-based polymer film coatings. Top-spray fluidized bed coating is used for

taste masking, enteric release and barrier films on particles/tablets. Bottom spray coating is used for sustained release and enteric release and tangential spray coating is used for sustained release and enteric coating products.

Delayed release and taste masking on oral dosage forms contribute significantly to the therapeutic effect of pharmaceutical and nutraceutical formulations either by ensuring patient compliance or by providing stability through shelf life in order to provide the desired efficacy to the end user.

Chapter 4 describes the preparation by extrusion-spheronization, characterisation and *in vitro* dissolution study of ketoprofen pellets coated with two commercial polymers used for enteric coating in a fluid-bed minicoater. The results of the tests showed the feasibility of the preparation of enteric-coated pellets containing a NSAID and that by coating the multiparticulate system with either 17.5% Acryl-EZE[®] 93A92545 or with 12.0% Advantia[®] Performance 190024HA49 weight gain, an enteric release of the drug from the pellets can be obtained. The results of dissolution testing indicated that in acidic medium, film coating resulted in a delay in the release of the drug, while no delay was observed in pH 6.8 buffer media.

To conclude the chapter 5, formulation of product and production process parameters for all coating experiments presented in this work were set on account of preliminary experiments which were carried out with the basic principles of pellet layering in mind, that is to minimize agglomeration of pellets during production process and to minimize use of excipients to shorten time of production. Pellets of microcrystalline cellulose were coated with a model drug substance and excipients in different concentrations by use of a fluidized bed technique in laboratory scale. Pellet coating was performed with a lab-scale air flow technology coater (Innojet VENTILUS[®] V-2.5).

Film coating processes are used for various purposes, such as detecting appearance changes, taste masking, and improving stability or drug delivery behaviour in the pharmaceutical industry. The performance of end products put through a coating process is greatly dependent upon the film coating thickness, its uniformity and morphology. For instance, coatings that are too thin would not meet the anticipated protection for sustained release, whereas coatings that are too

thick could result in delayed disintegration or dissolution, as well as poor efficiency in terms of coating time and materials consumed.

Film coating can be achieved through the use of water-soluble, cationic, anionic or neutral insoluble polymers from different chemical structures. Non-aqueous coatings are largely discouraged due to the hazards associated with the environment and solvent handling. Use of water-soluble polymers often results in a compromise of the delay or taste masking ability of the film. Aqueous coating process are normally associated with longer drying time.

Fluid bed processor offer unique opportunity to develop and produce coated controlled release products. However, various process parameters easily can alter the performance of a product and hence should be examined thoroughly. The interactions of various process parameters presents a great challenge in optimizing the coating process, hence it is important to investigate and understand these variables to ensure a reproducible performance of controlled release products.

Perspectives

In future there is need to focus on several issues related to the extrusion-spheronization production of pellets with high drug loading of water-insoluble model drugs, high nano-emulsion loading.

Appendices

Poster communications

1. Thi Trinh Lan Nguyen, Nicolas Anton, Thierry F. Vandamme, *Extrusion-spheronization for ketoprofen microencapsulation*, 24th International Conference on Bioencapsulation (Bioencapsulation Research Group) in Lisbon, Portugal – September, 21st – 23rd, 2016.

Book chapter

1. Thierry F. Vandamme, Gildas K. Gbassi, Thi Trinh Lan Nguyen, and Xiang Li; “*Microencapsulating Bioactives for Food*”, In the book “Beneficial Microbes in Fermented and Functional Foods”, by CRC Press, 2015, p. 255-271.
2. Thierry F. Vandamme, Gildas K. Gbassi, Thi Trinh Lan Nguyen, Xiang Li; “*Microencapsulation of probiotics*”, in the book “Encapsulation and Controlled Release Technologies in Food Systems”, by John Wiley & Sons, 2016, p. 97-128.
3. Thi Trinh Lan Nguyen, Nicolas Anton, Thierry F. Vandamme (2017); Chapter 9: “*Nutraceutical compounds encapsulated by extrusion-spheronization*”, in the book “New Polymers for Encapsulation of Nutraceutical Compounds”, by Wiley, p. 195-230.
4. Thi Trinh Lan Nguyen, Nicolas Anton, Thierry F. Vandamme (2017); Chapter 8: “*Oral pellets loaded with nanoemulsions*”, in the book “Nanostructures for Oral Medicine”, by Elsevier, p. 203 -230.

Appendix A1: Analytical profiles of Profénid® 50 mg

Product	: Profénid® 50 mg
Composition	: ketoprofen, lactose, magnesium stearate, yellow iron oxide (E 172), titane dioxide (E 171) gelatine.
Origin	: Sanofi Aventis
Lot number	: 14N0061
Expiry date	: 10/2017
Where collected sample	: France
Description	: two piece gelatine capsules containing yellow colored powder. Capsule size: "2"
Packaging	: 12 Capsules x 2 Blisters
Average weight of capsule	: 196.25 ± 12.39 mg
Average weight of powder in capsule	: 147.98 ± 12.49 mg
Loss on drying of powder	: 2.54 %
Disintegration	: < 45 min.
Dissolution in pH 1.2	: > 90 % in 45 minutes.

Appendix A2: Analytical profiles of Dietary supplement "Folic acid" 800 µg

Product	: Folic acid 800 mcg, Dietary Supplement
Composition	: folic acid 800 mcg, dicalci phosphate, cellulose (plant origin), maltodextrine, croscarmellose, vegetable stearic acid, magnesium stearate, silica.
Origin	: uBb®
Lot number	: SFA50727A
Manufactory date	: 180315
Expiry date	: 170318
Where collected sample	: a pharmacy in Hanoi, Vietnam
Description	: Yellow, circular, flat, bevelled-edge, 7 mm diameter, uncoated tablets
Packaging	: 100 tablets in HDPE white bottles
Average weight of capsule	: 201.13 ±1.55 mg
Loss on drying of powder	: 3.91 %

Hardness testing	:	75 ± 2.76 N
Friability	:	<1%
Disintegration	:	2 minutes
Dissolution in pH 1.2	:	>90 % in 60 minutes

Appendix A3: Analytical profiles of Cellets[®] 700 and 1000

Product	:	Cellets [®] 700	Cellets [®] 1000
Composition	:	100 % MCC 102	
Origin	:	Pharmatrans-Sanaq AG, Basel, Switzerland	
Lot number	:	13G027	13I056
Description	:	White or nearly white, hard and almost spherical particles	
Odor	:	Odorless	
Loss on drying (%)	:	2.70 %	2.92 %
Particle size distribution	:	97.3 % between 710-1000 µm	98.8 % between 1000-1400 µm
Friability	:	<0.1%	<0.1%
Bulk density (g/ml)	:	0.893±0.007	0.903±0.01
Tap density (g/ml)	:	0.944±0.003	0.925±0.009
Disintegration in pH 1.2	:	Non	Non

**Système de délivrance des principes actifs peu
solubles par voie orale**

Résumé

L'amélioration de la dissolution des médicaments peu solubles présente de nombreux défis.

Dans cette thèse, un procédé d'extrusion-sphéronisation a été étudié en profondeur pour améliorer la dissolubilité du médicament avec une formulation de nano-émulsion.

Le but du travail de thèse est de décrire les propriétés et les procédés de fabrication de minigranules permettant d'augmenter la solubilité des principes actifs peu solubles dans l'eau et donc d'améliorer leur biodisponibilité lors de l'administration par voie orale, pour deux modèles de molécules différentes qui sont l'acide folique (vitamine peu soluble dans l'eau) et le kétoprofène (anti-inflammatoire non stéroïdien qui présente une solubilité limitée dans les fluides gastriques à cause de son pKa (classe II dans le système de classification biopharmaceutique – BCS, ayant une action anti-inflammatoire, antalgique et antipyrétique)).

Cette étude décrit la préparation par extrusion-sphéronisation, caractérisation et étude de dissolution *in vitro* d'acide folique et de pastilles de kétoprofène revêtues de Acryl-EZE[®], Advantia[®] Performance dans un minicoatère à lit fluidisé. Les résultats des essais ont montré la faisabilité de la préparation de pastilles enrobées entériques contenant un AINS et que, en revêtant le système multiparticulaire avec Acryl-EZE[®] 93A92545 et Advantia[®] Performance 190024HA49 à un gain pondéral de 17,5%, 12,0%, respectivement, du médicament à partir des pastilles peuvent être obtenus. Les résultats des essais de dissolution ont indiqué que dans un milieu acide, le revêtement de film a entraîné un retard dans la libération du médicament, alors qu'aucun retard n'a été observé dans un milieu tampon à pH 6,8.

Mots-clés:

Principe actif faiblement soluble, amélioration de la solubilité, extrusion-sphéronisation, minigranule, pellet, kétoprofène, acide folique, lit fluidisé.

Summary

Improvement in dissolution of poorly soluble drugs has many challenges.

In this thesis, an extrusion-spheronization process was thoroughly studied for improving dissolubility of drug with nano-emulsion formulation.

The aim of the thesis work is to describe the properties and manufacturing processes of pellets to increase the solubility of poorly soluble active ingredients in water and thus improve their bioavailability when administered orally: folic acid (water-insoluble vitamin) and ketoprofen (Non-steroidal anti-inflammatory, having anti-inflammatory, analgesic and antipyretic action, class II in the Biopharmaceutical Classification System).

This study describes the preparation by extrusion-spheronization, characterisation and *in vitro* dissolution study of folic acid and ketoprofen pellets. Ketoprofen pellets coated with Acryl-EZE[®], Advantia[®] Performance in a fluid-bed minicoater. The results of the tests showed the feasibility of the preparation of enteric-coated pellets containing a NSAID and that by coating the multiparticulate system with either 17.5% Acryl-EZE[®] 93A92545 or with 12% Advantia[®] Performance 190024HA49 weight gain, an enteric release of the drug from the pellets can be obtained. The results of dissolution testing indicated that in acidic media, enteric film coating resulted in a delay in the release of the drug, while no delay was observed in pH 6.8 buffer media.

Keywords:

Water-insoluble drug, improved solubility, extrusion-spheronization, pellet, ketoprofen, folic acid, fluid bed coater.