



HAL
open science

Epidemiology and dynamic of dengue and chikungunya in several provinces in Vietnam

Kim Lien Pham Thi

► **To cite this version:**

Kim Lien Pham Thi. Epidemiology and dynamic of dengue and chikungunya in several provinces in Vietnam. Microbiology and Parasitology. Université Montpellier; National Institute of Hygiene and Epidemiology (Hanoi, Viet Nam), 2015. English. NNT : 2015MONT095 . tel-01763165

HAL Id: tel-01763165

<https://theses.hal.science/tel-01763165>

Submitted on 10 Apr 2018

HAL is a multi-disciplinary open access archive for the deposit and dissemination of scientific research documents, whether they are published or not. The documents may come from teaching and research institutions in France or abroad, or from public or private research centers.

L'archive ouverte pluridisciplinaire **HAL**, est destinée au dépôt et à la diffusion de documents scientifiques de niveau recherche, publiés ou non, émanant des établissements d'enseignement et de recherche français ou étrangers, des laboratoires publics ou privés.

THÈSE

Pour obtenir le grade de
Docteur

Délivré par Université de Montpellier

Préparée au sein de l'école doctorale GAIA -ED 584

Et de l'unité de recherche Intertryp

Spécialité : Biologie des Interactions

Présentée par Pham Thi Kim Lien

*Epidemiology and dynamic of dengue and
chikungunya in several provinces in Vietnam*

Soutenue le 15 Décembre 2015 devant le jury composé de

<i>Mme Sofia MUBARIKA, Prof, Universitas Gadjah Mada</i>	<i>Rapporteur</i>
<i>M Toan NGO VAN, Prof, Hanoi Medical University</i>	<i>Rapporteur</i>
<i>M Christian DEVAUX, DR, CNRS</i>	<i>Rapporteur</i>
<i>Mme Laurence BRIANT, CNRS</i>	<i>Examineur</i>
<i>Mme Nga PHAN THI, Prof, NIHE</i>	<i>Examineur</i>
<i>M Duong TRAN NHU, Prof, NIHE</i>	<i>Directeur</i>
<i>M Roger FRUTOS, DR, CIRAD</i>	<i>Directeur</i>



TABLE OF CONTENTS

ACKNOWLEDGEMENTS

LIST OF ABBREVIATIONS

LIST OF FIGURES AND TABLES

GENERAL INTRODUCTION 1

PART I. LITERATURE REVIEW 5

1. Arboviruses 5

2. Different of Arbovirus families..... 6

2.1. Family Flaviviridae 6

 2.1.1. Classification 6

 2.1.2 Genome structure 9

 2.1.3 Vector..... 11

 2.1.4 Flavivirus replication cycle..... 16

 2.1.5 Main disease 17

2.2. Family Togaviridae (genus Alphavirus) 20

 2.2.1. Classification 20

 2.2.2. Genome structure 21

 2.2.3. Vector..... 22

 2.2.4. Togaviridae replication cycle 22

 2.2.5. Main diseases 24

2.3. Family Bunyaviridae 27

 2.3.1. Classification 27

 2.3.2. Genome structure 27

 2.3.3. Bunyaviridae replication cycle 28

 2.3.4. Vector..... 29

 2.3.5. Main disease 30

3. Flavivirus and Dengue 32

3.1. Classification..... 32

3.2. Genetic evolution	33
3.3. Vectors	34
3.1.1 <i>Aedes aegypti</i> and <i>Aedes albopictus</i>	34
3.1.2 Transmission cycle	35
3.4. Dengue epidemiology	37
3.4.1. History and origin of Dengue	37
3.4.2. Global burden	38
3.5. Diagnosis	52
3.5.1. Clasification in clinical	52
3.5.2. Disease course.....	54
3.5.3. Laboratory diagnosis.....	56
3.5.4. Treatment and prevention	60
3.5.5. DHF immunopathogenesis	63
4. Alphaviruses and Chikungunya virus	70
4.1. Classification.....	70
4.2. Genetic evolution	71
4.3. Replication cycle	73
4.4. Vector	73
4.5. Chikungunya Epidemiology	75
4.5.1. History and origin of chikungunya.....	75
4.5.2. Global burden	76
4.5.3. Epidemiology trend in several regions of the world	78
4.5.4. Diagnosis.....	83
4.5.5. Treatment and prevention	86
4.5.6. Chikungunya immunopathogenesis.....	88
5. Combinated arboviral infections	89
5.1. Combinated Flavivirus infections	89
5.2. Combinated Dengue and Chikunguni viruses in the world	90

PART II. DENGUE AND CHIKUNGUNYA IN VIETNAM.....	93
CHAPTER 1. ROLE OF AEDES SPECIES IN THE TRANSLISSION OF DENGUE IN URBAN AREAS IN NORTH VIETNAM.....	94
1.1. Context of study.....	94
1.2. Objective.....	95
1.3. Discussion and conclusions	96
CHAPTER 2. SURVEILLANCE OF DENGUE AND CHIKUNGUNYA VIRUS INFECTION IN DONG THAP	98
2.1. Context of the study.....	98
2.2. Objective.....	99
2.3. Discussion and conclusions	99
CHAPTER 3. DENGUE VIRUS, CHIKUNGUNYA VIRUS AND RISK FACTORS IN SEVERALS PROVINCES OF VIETNAM.	101
3.1. Context of study.....	101
3.2. Objective.....	103
3.3. Discussion and conclusions	103
GENERATION CONCLUSSION AND PERSPECTIVES	107
REFERENCES	110

ACKNOWLEDGEMENTS

To write this thesis, I am greatly indebted to program, institutes and many people for their support and encouragements.

First of all, I would like to my thanks to the **Eramus Mundus program**, granted me the scholarship to pursue this doctoral program; To **Ecole doctorale Sibaghe, Montpellier 2 University**, French. To **Centre d'études d'agents Pathogènes et Biotechnologies pour la Santé, center National de la recherche scientifique (CPBS, CNRS)**, Montpellier, France, and **National Institute of Hygiene and Epidemiology**, Ha Noi, Vietnam for giving me an opportunity to follow this academic program and for equipping me with such an updated knowledge to make this thesis possible.

I want to express my deep gratitude to **Dr Christian Devaux (IRD)**, **Professor Sofia Mubarika (U. Gadjah Mada)** and **Professor Ngo Van Toan (Hanoi Medical University)** for having accepting and making me the honor to review this PhD work.

My deep gratitude goes to **Professor Roger Frutos**, from French Agricultural Research center, and **Centre d'études d'agents Pathogènes et Biotechnologies pour la Santé, center National de la recherche scientifique (CPBS, CNRS)**, Montpellier, France for accepting to be my supervisor, for his great support, effort and help in articles and thesis writing, for making several round trips between France and Vietnam.

My special thanks goes to my cosupervisor, **Associate Professor Tran Nhu Duong**, deputy of National Institute of Hygiene and Epidemiology, Ha noi Viet Nam for firstly allowing me to work as part of his project, for his great support, encouragement to complete the PhD program.

My huge thanks and appreciation to my cosupervisor, **Dr. Laurence Briant**, Head of Virus host cell interactions Laboratory, **Centre d'études d'agents Pathogènes et Biotechnologies pour la Santé, center National de la recherche scientifique (CPBS, CNRS)**, Montpellier, France accepting me to her laboratory, for transferring her expertise in biomolecular necessary for the accomplishment of the work in this thesis.

My special thanks to my cosupervisor, **Prof. Phan Thi Nga**, former Head of Training and Science Management Department, National Institute of Hygiene and Epidemiology, Ha Noi Viet Nam for her support and allowing me to work as part of her team and help me in her laboratory.

I would like to thank to **Dr Laurent Gavotte**, teacher of Montpellier 2 University (UM 2) for allowed me to his lab in Parasitology, Evolutionary Biology, Ecology Department, UM 2, French for the accomplishment of the work, for his help and support in an article.

My thanks to **Dr Pierrick Labbé**, teacher of Evolution, Vector, Adaptation in Symbioses Department, Montpellier 2 University, French for generously accepting me to his laboratory at Montpellier 2 University for sharing his precious expertise in DNA mosquitoes extraction, for his kindness.

I would like to express my sincere gratitude and appreciation to **Dr Babatunde Olowokure**, Director of Surveillance, Disease Prevention and Control, Caribbean Public Health Agency for his patient and encouragement to improve myself, valuable comments enabling me to attend and complete the PhD program.

I would like to thank the medical doctor and nursing staff of the **General Hospital in Dong Thap** for their care of patients, supported, and their cooperation for this research.

My grateful to the **Preventive Medicine Centers** in three regions in the North, Center, South were Ha Noi, Ha Tinh, Quang Tri, Thua Thien Hue, Dak nong and Long An, Vietnam for their cooperation during conducted of this study.

My thanks to **Arbovirus laboratory**, Virological Department National Institute of Hygiene and Epidemiology, Hanoi, Vietnam for allowed me to work as part of their team, and for their help.

I would like to thank the following Professors, friends and colleagues:

To my colleagues at Entomology Department, National Institute of Hygiene and Epidemiology, Hanoi, Viet Nam thanks to **Le Thi Yen, Tran Chi Cuong, Dang Duc Dong, Nguyen Van Soai** for their help collected vector and serum samples, shared to me the hard trips and very interested in provinces of three regions in Vietnam, for their generosity and for being so helpful in all the works in order to generate data used in this thesis.

My thanks to **Eric Bernard, Patriet Eldin, Nathalie Chazal, Eymeric Neyret, Simon Fontanel, Roy Matkovic** in the Virus host cell interactions Laboratory, Centre d'études d'agents Pathogènes et Biotechnologies pour la Santé, center National de la recherche scientifique, Montpellier, France allowed me to work as part of their team, and for their help in Montpellier, France.

Special many thanks mention to **Marco Perriat Sanguinet**, Evolutionary Biology, Ecology Department, Montpellier 2 University, France for his help during the time in France.

To **Dr. Emmanuel Cornillot**, CPBS, CNRS for talking interest in this work.

To **Dr. Vu Trong Duoc**, Vice head of Entomology department, National Institute of Hygiene and Epidemiology, Hanoi, Vietnam for his support and help on data analysis.

To **Dr. Truong Ba Tang**, General Dong Thap hospital for his cooperation to collected sample in General Dong Thap hospital.

All teachers, friends and colleagues for their help during the course.

Last but not a least, my heartfelt thanks and love to **my parents, my daughter, my young brother, my niece, and sister** who have helped me in every possible way to my completion of this Doctor of physiology study.

LIST OF ABBREVIATIONS

AIDSt	Acquired immune deficiency syndrome
Ae	Aedes
APCs	Antigen presenting cells
BALB/c	An Albino, laboratory-bred strain of the House Mouse
CCD	Charge couple device
CCHFV	Crimean- Congo Hemorrhagic fever virus
cDNA	Complementary Deoxyribonucleic acid
CDC	Centers for Disease Control and Prevention
CHIKV	Chikungunya virus
CPBS	Center Agents Pathogens and Biotechnology for Health study
CNRS	The French National Centre for Scientific Research
CNS	Central nervous system
CTF	Colorado tick fever
CTL	Cytotoxic T-Lymphocyte
CTLA 4	Cytotoxic T-Lymphocyte associated protein 4
DC-SIGN	Dendritic Cell-Specific Intercellular adhesion molecule-3-Grabbing Non-integrin
DENV	Dengue virus
DF	Dengue fever
DHF	Dengue hemorrhage fever
DSS	Dengue shock syndrome
E	Envelope protein
EEE	Eastern Equine Encephalitis
ER	Endoplasmic reticulum
GAC	IgG antibody capture
G6PD	Glucose 6-phosphate dehydrogenase
HI	Hemagglutination Inhibition assay
HLA	Human leucocyte antigen
HTNV	Hanta virus

ICTV	International Committee on Taxonomy of Virus
IgG	Immunoglobulin G
IgM	Immunoglobulin M
IHC	Immunohistochemical
IVM	Intergrate vetor management
JE	Japanise Encephalitis
KUN	Kunjin virus
LACV5	La crosse virus
MAC-ELISA	M antibody- capture Enzyme Link Immuosorbent Assay
MBL2	Mannose- binding lectin 2
MRC	Medical Research Council
MVE	Murray Valley Encephalitis virus
NHEK	Normal Human Epidermal Keratinocytes
NS	Nontructural protein
NSS	Non-structural protein NS-S
NIHE	National Institute of Hygien and Epidemiology
OD	Optical Density
ORF	Openreading frame
RNA	Ribonucleic Acid
RT- PCR	Reverse Transcriptase Polymerase Chain Reaction
RVFV	Rift Valley fever virus
SDS-PAGE	Sodium dodecyl sulfate polyacrylamide gel electrophoresis
SEA	Southeast Asia
SLE	St. Louis Encephalitis
SNV	Sin Nombre virus
SSRNA	Single Stranded ribnucleic Acid
TBE	Tick born encephalitis
TDR	Tropical disease research
TNF	Tumor necrosis factor
TGF	Transforming growth factor
TV	Tetravalent vaccine
UTR	Untranslate region

US	United state
VCAM-1	Vascular cell adhesion molercular -1
WEE	Western Enquin Encephalitis
WHO	World Health Organizaion
WNV	West Nile Virus
YFV	Yellow fever virus

LIST OF FIGURES AND TABLES

Figure 1: Three genera of the <i>Flaviviridae</i> family in the Phylogenetic tree.....	7
Figure 2: Devided from the GenBank library, phylogenetic tree of the flaviviruses derived from partial Non-structural protein NS-S sequences.	8
Figure 3: Schematic structure of flavivirus virion	9
Figure 4: The single open reading frame is depicted with the structural and non structural protein coding region (colored is blue and green repectively).	10
Figure 5: The detail of cleavage sites for cellular proteases, NS2B/ NS3 and unknown protease are indicated	10
Figure 6: Transmission cycle for tick-born encephalistic virus.	11
Figure 7: Life cycle of <i>Culex</i> mosquito	13
Figure 8: Depicting the hypothetical evolutionary history of endemic or epidemic DENV emergence from zoonotic transmission cycles	16
Figure 10: Genome structure of Togaviruse	21
Figure 14: Endemic or potentially endemic to 144 countries of Dengue transmission, 2015 ..	38
Figure 15: Worldwide. Dengue, cases.....	39
Figure 16: Average annual number of DF/DHF case reported to WHO, and average of countries reporting dengue, 1955-2007	40
Figure 17: The change in distribution of dengue serotype. The figure shows the distribution in 1970 (A) and 2004(B)	41
Figure 18: Western Pacific region. Dengue cases (A), deaths (B).....	43
Figure 19: Southeast Asian region. Dengue, cases (A) deaths (B).	45
Figure 20: Vietnam map.	46
Figure 21: Distribution of DF/DHF in Vietnam in 2009.....	47
Figure 22: Vietnam. Dengue / DHF, cases (A) and death (B)	48
Despite the existence of a National dengue control Program since 1998, dengue remains a major health problem in Vietnam. Over the past 15 years, the number of DENV cases has been increasing.....	48

Figure 23: European Union, Dengue cases.....	49
Figure 24: Americas region. DHF, cases (A) and deaths (B).	51
Figure 25: Dengue case classification and levels of severity	53
Figure 26: The Course of Dengue disease	54
Figure 27: Comparison of diagnostic tests according to their accessibility and confidence.....	57
Figure 28: Dengue research and training supported and encouraged by the UNICEF-UNDP-World Bank-WHO.	61
Figure 29: Model of antibodies- dependent enhancement	68
Figure 30: Chikungunya virus Genetic and Physical Structure	71
Figure 31: Chikungunya virus and dispersal and evolution.....	72
Figure 32: Origin, spread, and distribution of chikungunya virus and its vector.	74
Figure 33: Predicted dispersal pattern of Chikungunya virus from Africa to the Indian Ocean and Europe during the past 20 to 50 years	76
Figure 34: Chikungunya active transmission regions established from published data illustrate geographic and temporal knowledge of previous outbreaks.	77
Figure 35: Endemic or potentially endemic to 96 countries.	78
Figure 36: Map showing the distribution of chikungunya virus enzootic strains in Africa and the emergence and spread of the Asian lineage (red arrows and dots) and the Indian Ocean lineage (yellow arrows and dots) from Africa.....	79
Figure 37: Outbreak of Chikungunia, 2004-2007	81
Figure 38: European Union, chikungunya, case.	82
Figure 39: Introduction of chikungunya to the Caribbean by epidemiological week first reported in December 2013 to August 2014.	83
Figure 40: Timeline of Infection, Symptom, and Biomarkers.....	84
Figure 41: Distribution of Dengue, Yellow Fever, and their principal vector, the <i>Aedes aegypti</i> mosquito.	90
Figure 43: Location of the eight selected study districts in Hanoi, Vietnam.....	94
Figure 42: Location of the five selected study provinces in the north, center, south of Vietnam.	101

Table 1: The geographic distribution of spatially unique occurrence for the Americas, Europe/ Africa, and Asia/ Oceania	14
Table 2: Summarize of current dengue vaccines	63

TÓM TẮT

Sốt xuất huyết Dengue (SXHD) là bệnh truyền nhiễm cấp tính, gây dịch do vi rút Dengue gây nên. Dịch bệnh Sốt xuất huyết đã và đang là một đại dịch nguy hiểm, đe dọa đến sức khỏe và tính mạng của hàng triệu người dân trên toàn Thế giới. Bệnh sốt xuất huyết lưu hành chủ yếu ở vùng nhiệt đới và cận nhiệt đới. Hơn 50 năm qua, sốt xuất huyết dengue lan truyền với tốc độ rất nhanh, từ 9 nước báo cáo dịch bệnh vào năm 1970, cho đến nay vi rút dengue lan rộng tới 144 nước. Theo ước tính của WHO, hàng năm có khoảng 50 đến 100 triệu người nhiễm virus Dengue, trong đó có hơn 500.000 người phải nhập viện.

Chikungunya bệnh lần đầu tiên được phát hiện vào năm 1952 ở châu Phi tại cao nguyên Makonde. Đây là một khu vực biên giới giữa Tanzania và Mozambique. Bệnh cảnh lâm sàng của bệnh sốt Chikungunya có dấu hiệu gần giống với bệnh sốt xuất huyết, vì vậy nó có thể khó chẩn đoán ở những nơi có bệnh sốt xuất huyết lưu hành phổ biến. Cũng như bệnh sốt xuất huyết, bệnh sốt do vi rút Chikungunya chưa có vaccine phòng bệnh và thuốc điều trị đặc hiệu. Khi bị mắc bệnh, biện pháp điều trị chỉ tập trung vào việc giải quyết triệu chứng và biến chứng. Ở những nơi điều kiện thuận lợi, muỗi truyền bệnh *Aedes aegypti* và *Aedes albopictus* và có tập tính sống gần gũi với người là yếu tố nguy cơ quan trọng cho bệnh sốt Chikungunya và dengue lưu hành, phát triển và gây bệnh. Bệnh xảy ra ở châu Phi, châu Á và tiểu lục địa Ấn Độ. Trong nhiều thập kỷ gần đây, muỗi truyền bệnh sốt chikungunya đã có cơ hội lây lan sang cả châu Âu và châu Mỹ. Trong năm 2007, sự lây truyền bệnh này đã được thông báo phát hiện lần đầu tiên tại châu Âu trong một ổ dịch nội địa ở phía đông bắc nước Italia. Năm 2013, 2014 những vụ dịch lớn xảy ra của vi rút chikungunya tại American và Caribbean.

Mặc dù chương trình phòng chống sốt xuất huyết quốc gia ở Vietnam đã được thực hiện từ năm 1999, tuy nhiên sốt xuất huyết ở Việt Nam được coi là vùng dịch lưu hành địa phương, chủ yếu ở các tỉnh miền Nam và Nam Trung Bộ. Thống kê của Bộ Y tế Việt Nam cho thấy, hiện nay sốt xuất huyết Dengue đứng thứ 7 trong số 10 nguyên nhân nhập viện hàng đầu. Còn chikungunya vi rút được phát hiện ở Việt nam từ 10 người lính Mỹ vào năm 1967, nhưng cho tới nay, bệnh sốt xuất huyết do vi rút chikungunya tại Việt nam vẫn còn là một vấn đề cần được quan tâm. Ở Việt nam, tập quán trữ nước trong các dụng cụ chứa nước sinh hoạt để đối phó với thời tiết khô của người dân cũng là yếu tố làm gia tăng quần thể muỗi truyền bệnh và gia tăng nguy cơ xảy ra dịch lớn, đặc biệt là tại Miền Nam. Việc

sử dụng các hoá chất diệt côn trùng không được kiểm soát làm giảm tính kháng của vector truyền bệnh. Sự gia tăng các hoạt động giao lưu, buôn bán và du lịch giữa các vùng miền trong nước, ngoài nước như Cambodia và Lào góp phần làm tăng nguy cơ lan truyền SXH trong cộng đồng.

Mục tiêu nghiên cứu của luận văn này nhằm hiểu rõ hơn về bệnh sốt xuất huyết và tình hình vi rút chikungunya ở một số tỉnh tại Việt Nam, đặc biệt ở một số tỉnh có chung đường biên giới với Lào và Campuchia, nghiên cứu chi số *Stegomyia* của hai véc tơ truyền bệnh sốt xuất huyết *Ae. aegypti* và *Ae. Albopictus*, với những tác động của véc tơ sốt xuất huyết dengue và chikungunya khác nhau tại năm huyện tại miền Bắc, miền Trung và miền Nam, Việt Nam. Ngoài ra nghiên cứu cũng mô tả vai trò của bệnh sốt xuất huyết ở những bệnh nhân thu thập được ở bệnh viện Đồng Tháp, Việt Nam. Mặt khác, để hiểu rõ hơn về sự tương quan giữa mật độ của *Ae. aegypti* và *Ae. Albopictus* gây sốt xuất huyết Dengue bùng phát tại thủ đô Hà Nội, Việt Nam. Bên cạnh đó, phân tích kiểu gen của quần thể muỗi được thực hiện để cung cấp thông tin rõ ràng về khả năng lan truyền của muỗi với xuất huyết dengue và chikungunya ở Việt Nam. Kết quả cho thấy rằng sự phát hiện vi rút chikungunya ở muỗi *Ae. aegypti* nên được coi là cảnh báo vi rút chikungunya xuất hiện tại Việt Nam và có thể lưu hành cùng với bốn týp huyết thanh khác nhau là một vấn đề của sức khỏe cộng đồng và xã hội.

Résumé étendu en français

Depuis la seconde moitié du 20^{ème} Siècle, avec les progrès de la médecine, en particulier dans le domaine de la vaccination, des antibiotiques, et avec l'amélioration des conditions de vie, la disparition des maladies infectieuses était espérée. Il n'en est toutefois rien. Dans les pays développés les efforts se sont concentrés sur les maladies non infectieuses, délaissant les maladies infectieuses. Ces maladies infectieuses, paludisme, SIDA, tuberculose, dengue, chikungunya, ont continué à s'étendre dans les pays en développement mais émergent aussi en zone tempérée, et en particulier en Europe, à la faveur des changements environnementaux et d'une société globalisée.

Parmi ces maladies, la dengue est l'une des plus dynamiques en termes de propagation. Elle est particulièrement présente en Asie du Sud Est qui est sa zone d'origine. Elle est transmise par des moustiques du genre *Aedes* particulièrement adaptés à un environnement anthropisé. La dengue demeure un problème majeur de santé publique malgré des efforts de lutte antivectorielle et cela pour plusieurs raisons : 1) Il n'y a actuellement aucun traitement ni aucun vaccin connu, 2) Son incidence annuelle globale est estimée à 50 millions de cas entraînant plusieurs dizaines de milliers de morts, 3) Plus de 2.5 milliards de personnes sont à risque, 4) La maladie existe également sous deux formes sévères, la dengue hémorragique (DHF) qui peut évoluer en syndrome de choc (DSS) dont l'issue peut être mortelle, 5) Depuis les années 1950, l'incidence des formes graves (DHF/DSS) a été multipliée par 30, 6) L'infection est souvent asymptomatique, ce qui conduit à de mauvais diagnostics et une sous-estimation du nombre de cas. La dengue est causée par 4 virus ou sérotypes distincts, DENV1, DENV2, DENV3 et DENV4. Un cinquième serotype, DENV5, a récemment été isolé. Un patient infecté par un sérotype devient résistant à ce sérotype (immunité homologue) mais redevient sensible aux autres sérotypes après un délai d'environ 12 semaines et présente alors un risque accru de développer une forme sévère suite à une seconde infection.

Le chikungunya est une autre maladie arbovirale transmise par les mêmes vecteurs que la dengue. Le chikungunya et la dengue sont également très similaires du point de vue

des symptômes (en particulier les symptômes précoces), de la période d'incubation et de la zone géographique. Le terme « chikungunya », utilisé à la fois pour le virus et la maladie, signifie « marcher avec le dos courbé » en Swahili et Makonde, et fait référence à l'effet incapacitant des arthralgies. Ce virus a été isolé pour la première fois en 1952 en Tanzanie. Des épidémies de chikungunya ont été décrites en Birmanie, Thaïlande, Cambodge, Vietnam, Inde, Sri Lanka, et Philippines. Les épidémies récentes causées par un virus variant ont causé plusieurs millions de cas dans l'Océan Indien et en Inde. La forme réémergente s'est étendue en Thaïlande et au Cambodge et plus récemment dans les Caraïbes, le Pacifique et l'Europe où plusieurs cas autochtones ont été observés à Montpellier en 2014.

La dengue et le chikungunya sont parmi les maladies les plus difficiles à distinguer, en particulier en phase précoce, du fait de symptômes similaires, de co-infections et de la transmission par les mêmes moustiques péri-domestiques du genre *Aedes*. *Aedes aegypti* est considéré comme le vecteur principal en zone urbaine avec *Aedes albopictus* et d'autres moustiques anthropophiles du genre *Aedes* comme vecteurs secondaires.

Le Vietnam est en Asie du Sud Est situé entre le Golfe du Tonkin et le Golfe de Thaïlande et est limitrophe de la Chine, de Laos et du Cambodge. Le climat est tropical au sud et sous régime de mousson au nord avec quatre saisons marquées. Cette distribution climatique affecte l'apparition des épidémies de dengue. La dengue a pour la première fois été décrite au Vietnam en 1958 dans le nord puis à partir de 1960. En raison de la différence climatique, la dengue est présente toute l'année dans le sud alors qu'elle est liée à la saison des pluies dans les autres régions. Le chikungunya a lui été détecté pour la première fois en 1967 chez des soldats américains durant la guerre du Vietnam. Le chikungunya a cependant été détecté dans certaines études chez des patients présentant des symptômes de dengue.

La dynamique de ces deux maladies n'est toutefois pas claire et de nombreuses informations manquent encore sur les facteurs d'influence et les mécanismes. Ces connaissances sont essentielles pour comprendre les dynamiques en jeu et améliorer les capacités de gestion et maîtrise de ces maladies. Si la dengue est depuis longtemps

hyperendémique au Vietnam, ce n'est pas encore le cas du chikungunya qui est très présent au Cambodge et au Laos et présente donc un risque d'émergence. Les échanges très importants entre le Vietnam, le Cambodge et le Laos, tant au niveau des biens que des personnes, constituent donc une voie d'entrée très plausible.

L'objectif de ce travail de thèse était donc de conduire un travail de détection et de surveillance de la dengue et du chikungunya à la fois au niveau clinique chez des patients hospitalisés avec des symptômes fébriles aigus. Ces études se sont concentrées à la frontière avec le Cambodge et le Laos. Ce travail a été réalisé en partie au Vietnam dans le cadre du NIHE et en partie en France au CPBS (UMR 5236 UM-CNRS).

Les objectifs étaient les suivants :

1. Etablir une surveillance et une étude épidémiologique et entomologiques dans des zones frontalières avec le Laos et le Cambodge.
2. Mieux comprendre la dynamique de circulation de la dengue au Vietnam et identifier les serotypes en cause.
3. Evaluer la présence et la dynamique de circulation du chikungunya au Vietnam
4. Comparer les incidences et dynamiques entre les diverses régions du Vietnam.
5. Etudier le rôle des diverses populations de moustiques dans la transmission de la dengue et du chikungunya en période d'épidémie et hors période d'épidémie.
6. Etudier la dynamique de transmission lors de l'épidémie de Hanoi en 2011.
7. Evaluer le système hospitalier de surveillance
8. Analyser la structure génétique de populations de moustiques potentiellement vectrices.

Cette thèse est donc présentée sous forme d'articles organisés en chapitres. Ces chapitres et articles sont les suivants :

Partie 1: Etude bibliographique

Pham Thi Kim Lien, Roger Frutos. Joint arboviral infections: risk and prospective. (Article en préparation)

Partie 2 : Etudes de terrain et de laboratoire

Chapitre 1 - Role of *Aedes* species in the transmission of dengue in urban areas in North Vietnam

Pham Thi Kim Lien, Vu Trong Duoc, Laurent Gavotte, Emmanuel Cornillot, Phan Thi Nga, Laurence Briant, Roger Frutos, Tran Nhu Duong. Role of *Aedes aegypti* and *Aedes albopictus* during the 2011 dengue fever outbreaks in Hanoi, Vietnam. *Asian Pacific Journal of Tropical Medicine*, 2015; 8 (7); 543-548.

L'objectif de ce travail était d'évaluer les corrélations entre les cas de dengue et les densités de population de moustiques du genre *Aedes* durant l'épidémie de dengue de Hanoi en 2011. 24 foyers épidémiques ont été analysés sur 8 districts entre Août et Décembre 2011. 140 patients ont été hospitalisés suite à un diagnostic de dengue avec une prédominance masculine (59.3%) et une classe d'âge comprise entre 15 et 34 ans. Seuls DENV1 (11.27%) et DENV2 (88.79%) ont été détectés à partir des échantillons cliniques. L'échantillonnage des moustiques conduit dans et autour des habitations des patients a montré la prédominance d'*A. aegypti* (95.15%) par rapport à *A. albopictus* (4.85%). En

conclusion, il y a une corrélation positive entre les densités de population d'*A. aegypti*, le nombre de cas humains et la durée des épidémies. Ceci n'a pas été observé avec *A. albopictus*. Trois lots d'*A. aegypti* ont été trouvés positifs à la dengue. Deux avec DENV1 et un avec DENV2.

Chapitre 2 – Surveillance of dengue and chikungunya virus infection in Dong Thap

Pham Thi Kim Lien, Laurence Briant, Truong Ba Tang, Bui Minh Trang, Laurent Gavotte, Emmanuel Cornillot, Tran Nhu Duong, Roger Frutos, Phan Thi Nga. Virologic and serologic surveillance of arbovirus infection in Dong Thap, Vietnam with special reference to dengue and chikungunya viruses: a 13 months study. Asian Pacific Journal of Tropical Medicine, *In Press*.

Cette étude visait à établir une surveillance dans la province de Dong Thap, qui est frontalière avec le Cambodge, afin d'évaluer la présence de virus de la dengue et du chikungunya parmi les patients hospitalisés à l'hôpital général de Dong Thap. Une analyse descriptive a été conduite sur 131 patients hospitalisés avec une fièvre aiguë et des symptômes compatibles avec la dengue et le chikungunya. L'étude a été conduite de Janvier 2012 à Février 2013. Le tableau clinique complet a été établi, ainsi que la détection sérologique et moléculaire. L'analyse sérologique a été conduite de façon séquentielle sur des échantillons de sang collectés à l'admission et sept jours après admission. Les virus de la dengue et du chikungunya ont été recherchés par ELISA et PCR. 101 patients sur 131 (77%) ont été confirmés positifs pour la dengue. Les quatre sérotypes ont été détectés avec une prédominance de DENV2 et DENV4. Aucun virus du chikungunya n'a été détecté. Un différentiel d'efficacité a été observé. L'efficacité de détection sérologique sur les mêmes patients était de 29% à l'admission et de 53% après 7 jours. 30 patients sur 131 (23%) étaient négatifs pour la dengue et le chikungunya. En conclusion, la dengue est à

risque de sous-estimation et le chikungunya n'est pas systématiquement détecté. Des changements devraient être opérés dans les procédures de surveillance afin de permettre un meilleur suivi de ces maladies.

Chapitre 3 - Dengue virus, chikungunya virus and risk factors in several provinces of Vietnam

Pham Thi Kim Lien, Laurence Briant, Laurent Gavotte, Pierrick Labbe, Marco Perriat-Sanguinet, Laurent Gavotte, Emmanuel Cornillot, Vu Trong Duoc, Nguyen Thi Yen, Tran Vu Phong, Nguyen Van Soai, Tran Duc Dong, Tran Chi Cuong, Phan Thi Nga, Tran Nhu Duong, Roger Frutos. *Aedes* mosquitoes mobility, diversity and risk factors for the diffusion of dengue and chikungunya in Vietnam. In preparation for submission to Emerging Infectious Diseases

Une surveillance active a été conduite au Vietnam pour évaluer la présence de la dengue et du chikungunya chez des patients hospitalisés avec une fièvre aiguë dans cinq provinces frontalières avec le Laos et el Cambodge. Ce travail, conduit de 2012 à 2014, a été complété par une évaluation des populations de moustiques collectées dans la même zone. Un total de 558 sérums humains a été prélevé ainsi que 1104 moustiques adultes (991 *A. aegypti* et 113 *A. albopictus*) et 10995 larves (8542 *A. aegypti* et 2453 *A. albopictus*) collectés à partir de 2250 foyers. Le virus de la dengue a été trouvé sur 17 (3%) serums humains. Le virus du chikungunya n'a pas été détecté dans les échantillons humains. Des densités de population variables ont été trouvées, la plus élevée étant dans la province sud de Long An frontière avec le Cambodge. Le virus de la dengue a été détecté essentiellement chez *A. albopictus*. Le virus du chikungunya a été détecté chez *A. aegypti*. L'analyse phylogénétique des moustiques adultes collectés a montré une large diversité de génotypes, tous ayant été décrits dans d'autres parties du globe. De nouveaux haplotypes ont été détectés. Un moustique de l'espèce *Culex vishnui* a été trouvé positif pour la dengue, faisant de cette espèce un vecteur potentiel.

Ce travail sur la surveillance et la dynamique de la dengue et du chikungunya au Vietnam apporte un regard nouveau sur la situation actuelle et sur un certain nombre d'idées préconçues. En premier lieu cette étude est à notre connaissance la première analyse comparative à être conduite à une telle échelle sur le pays. Toutes les études précédentes concernaient des événements et épidémies à l'échelle locale et bien que correctes les conclusions ne reflètent qu'une vision locale et partielle de la dynamique. Une vision plus large est nécessaire pour mieux comprendre la dynamique de ces maladies.

La première conclusion de ce travail est qu'il est très difficile de tirer des conclusions sur le principal vecteur de la dengue. Dans ce travail, deux conclusions opposées ont été exprimées en fonction du lieu et peut être de la période. Durant l'épidémie de dengue de Hanoi en 2011, *A. aegypti* a été clairement identifié comme responsable de la propagation de la maladie. Une corrélation a été établie entre les densités de population locales d'*A. aegypti* et le nombre de cas cliniques. *A. albopictus* ne jouait aucun rôle. Quand une analyse globale a été réalisée dans plusieurs provinces du Nord, Centre et Sud Vietnam, le vecteur principal est apparu être *A. albopictus*. Encore plus important, les haplotypes impliqués ont été décrits dans d'autres parties du monde et un haplotype en particulier a été décrit récemment comme une population invasive en Europe. Plusieurs hypothèses peuvent émerger de cette apparente contradiction. La différence pourrait s'expliquer par la situation spécifique de Hanoi qui est une métropole urbaine à forte densité de population, un environnement favorable à *A. aegypti* par rapport à *A. albopictus*. *A. aegypti* est en effet plus anthropophile qu'*A. albopictus* et il est logiquement plus attendu dans une zone urbaine intense comme la capitale. L'étude conduite au sein de plusieurs provinces a montré à l'inverse qu'*A. albopictus* était le vecteur principal mais cette étude a été conduite en zone rurale où ce dernier est plus compétitif. Une autre explication pourrait être liée à la date des études. L'étude sur l'épidémie d'Hanoi a été conduite en 2011 alors que celle sur les diverses provinces a été réalisée entre 2012 et 2014. Il n'est donc pas possible d'exclure un remplacement d'espèce dominante. Toutefois, cette hypothèse n'apparaît pas très solide étant donné que dans l'étude sur plusieurs provinces, *A. aegypti* était très largement l'espèce dominante. Une dernière explication pourrait être trouvée dans la manière dont ces analyses ont été construites, ce qui représente aussi une forme d'autocritique. La conclusion issue de l'étude sur Hanoi était basée essentiellement

sur une corrélation entre densité et période de pic des populations de moustiques et le nombre de cas cliniques. Cette étude était basée sur un nombre d'échantillon faible. Dans l'étude sur plusieurs provinces, un plus grand nombre d'échantillons a été analysé et *A. albopictus* a été identifié comme le vecteur principal alors que sa densité de population était nettement plus faible que celle d'*A. aegypti*. Ceci est particulièrement vrai dans la province de Long An où *A. albopictus* représentait 0.9 % des captures et 50% des moustiques infectés. Avec un plus faible échantillon, cette étude aurait pu conduire à la conclusion d'un rôle prédominant d'*A. aegypti*.

Ce travail de thèse montre le besoin d'une approche globale et coordonnée lors de l'analyse de la dynamique de la dengue et du chikungunya. De telles études ne peuvent pas être conduites à partir d'événements ponctuels et localisés du fait que la somme d'études ponctuelles ne conduit pas nécessairement une vision globale exacte. Les études de surveillance devraient être conçues au niveau national et basée sur un plan maître incluant à la fois des études cliniques et entomologiques avec détection de virus dans tous les échantillons. Le génotypage des populations de moustiques devrait être conduit de façon obligatoire ainsi que le génotypage des virus isolés d'échantillons humains et entomologiques afin de conduire les analyses de dynamique au niveau des lignées virales. La lignée est le véritable niveau de granulométrie à considérer. L'espèce et le sérotype ne sont pas suffisamment précis pour permettre une analyse de la circulation et une cartographie d'association. Une première recommandation issue de ce travail serait donc de développer une telle approche intégrée et de la proposer au NIHE ainsi qu'au niveau national. Ceci doit inclure une base de données et un système de gestion des bases de données homogènes et intégrés permettant une analyse spatio-temporelle.

Ceci est particulièrement pertinent si l'on considère une autre conclusion de ce travail de thèse, à savoir que les moustiques impliqués dans la vection ne sont pas des populations locales mais des populations circulant à l'échelon du globe. Une analyse de la dynamique ne doit donc pas se concentrer sur les populations locales de moustiques, bien qu'elles puissent néanmoins jouer un rôle, mais plutôt sur le monitoring régulier des populations de moustiques et en particulier aux points d'entrée comme les ports. De telles procédures devraient aussi être développées et cela pourrait être une autre perspective de

ce travail. Génomique, bases de données adaptées et analyses comparative des séquences de moustiques et de virus devront être développées ainsi que des analyses géographiques et des mouvements commerciaux internationaux.

Un dernier aspect mis en évidence par ce travail est l'adaptation limitée des procédures actuelles de surveillance et de dépistage mises en œuvre à l'hôpital et dans les services de santé publique. Comme cela a été montré dans le cas de l'hôpital de Dong Thap, les tests sérologiques réalisés à l'admission sous-estiment le nombre de patients positifs pour la dengue. De plus, ils ne permettent pas l'identification des lignées virales. Le chikungunya n'est en outre pas dépisté du tout. Il serait trop onéreux et difficilement réalisable de mettre en place un test sérologique multi-étapes avec au final des résultats peu satisfaisants. La dernière recommandation et perspective issues de ce travail seraient donc la mise en place d'un test PCR multiplex pouvant détecter les quatre sérotypes de dengue ainsi que les deux variants, ancien et réémergent du chikungunya. Ce test devrait être associé au séquençage des échantillons positifs. Le cout de la PCR et du séquençage est désormais très compétitif et le bénéfice attendu pour la santé publique compense très largement l'investissement en surveillance. Ceci devrait être lié au même système intégré de bases de données dynamiques que pour la surveillance des moustiques. Un projet devra être soumis en ce sens au NIHE et aux instances nationales.

En conclusion, ce travail de thèse a mis en évidence des points important à aborder de façon coordonnée afin de développer un système de surveillance efficace pour la dengue et le chikungunya au Vietnam. Développer ces systèmes et outils représentera un défi stimulant à relever et une valorisation intéressante de ce travail.

SUMMARY

Arthropod-borne viral infections (or arboviral infections) are common causes of fever syndromes worldwide, more than 130 arboviruses are known to cause disease in humans. Dengue fever (DF) caused by *Flavivirus* belong to the family *Flaviviridae*, and chikungunya is caused by an *Alphavirus* in the family *Togaviridae*. Both dengue and chikungunya diseases are transmitted by mosquitoes mainly *Aedes aegypti* (*Ae. aegypti*) and *Aedes albopictus* (*Ae. albopictus*) and can cause potentially severe and or debilitating chronic disease. Over the past 50 years, dengue has spread inexorably, with nine countries reporting dengue transmission prior to 1970 compared to over 144 now, and incidence having increased 30 fold. While dengue is the commonest and the most rapidly spreading mosquito - borne viral disease in the world, chikungunya (CHIK) has recently re - emerged after an interval of several decades to affect and place at risk millions of people in the Indian Ocean areas, Africa, Southeast Asia and more recently has spread to the Caribbean region. There are evidence countries in Asia, Africa and the Pacific of patients exhibiting co - infection with dengue and chikungunya simultaneously. Without a licensed vaccine, therapeutic drugs and effective of vector transmission, the increasing number of case dengue virus (DENV), chikungunya virus (CHIKV) is associated with expanding geographyphic rage and increasing intensity of transmission in affected areas.

Vietnam is one of five countries in the Southeast Asia with the highest dengue burden. Cambodia and Laos countries share a long and extensive border with Vietnam that have endemic for dengue, reported increasing chikungunya activity in Laos and Cambodian provinces bordering Vietnam. Dengue is highly endemics in tropical southern Vietnam, while increasing larger seasonal epidemics have occurred in northern Vietnam over the last decade. Biomolecular level used to describes DENV serotypes. We have revealed that DENV serotypes circulating in Vietnam are similar to those observed in neighboring countries - in particular Cambodia and China. All four dengue virus serotypes founded circulating in Vietnam with dominant one varying through in southern and northern.

Although CHIKV affected areas often overlap with DENV - endemic areas, however, simultaneous outbreaks are rare. So far, no case of chikungunya in human reported in Vietnam, excepted 10 cases in 1967 of American soldiers in Vietnam. This

study is the first to prospective investigate the circulation of the CHIKV and detected two *Ae. Aegypti* mosquitoes infected with CHIKV in the south of Vietnam.

This thesis manuscript reports data obtained by multidisciplinary and integrative approaches aiming to better understand dengue and chikungunya virus situation in several provinces shares the border with Laos and Cambodia, and found that the proportion of *Stegomyia* index of two vectors *Ae. aegypti* and *Ae. albopictus*, with the potential effects of DENV and CHIKV vector differed at the communes belong five districts in the north, center and south of Vietnam. Additionally, we described that a significant the role of DENV as cause of febrile illness in human, and also identified high proportion of dengue infection among patients in Dong Thap hospital, in south of Vietnam. On the other hand, to better understand on the positive correlation between the population density of *Ae. aegypti* and the number of DENV human cases of outbreaks in Hanoi capital, north of Vietnam. Beside, an integrative analysis encompassing the genetic study of viral lineages on human patents and in mosquitoes along with the genotyping of mosquito population should be undertaken to provide clear information on the dynamic of dengue and chikungunya in Vietnam. Our result suggested that the detected CHIKV in *Ae. aegypti* mosquito should be considered as warned of CHIKV appear in Vietnam and may be with DENV consists of four distinct serotypes combination remains a major public health problem.

GENERAL INTRODUCTION

From the second half of the 20th century, with achievements of medical research in terms of vaccination, antibiotics and improvement of life and health conditions of mankind, it was expected that infectious diseases were going to disappear. However, in developed countries the efforts have been concentrated on illnesses as cancer. Consequently, at the dawn of the new century, infectious diseases are still causing suffering and mortality in developing countries. With the disease as Malaria, AIDS, *Mycobacteria tuberculosis* and other diseases will have marked the memory of humanity forever.

Among these diseases, dengue fever, especially known in Southeast Asia, are hitting countries with tropical and warm climates. It is transmitted to the man by the mosquito of the genus *Aedes* (*Ae.*) is the principal vector of dengue and adapted extremely well to the urban environment. Dengue remains a major public health problem in tropical and subtropical countries despite lots of effort to control the mosquito vector (1) with an estimated global annual incidence of 50 million cases leading to ten of thousands of deaths (2) and more than 2.5 billion people being at risk of infection. Since the 1950s, the incidence of DHF/DSS has increased over 30 fold (3), with more than countries affected by outbreaks of dengue (4) Infection with any of DENV serotype may be asymptomatic in the majority of case or may result in a wide spectrum of clinical symptom (5). Dengue fever exists in two forms: the classic dengue or Dengue Fever (DF) and the Dengue Hemorrhagic Fever (DHF) which may evolve toward a severe form known as Dengue Shock Syndrome (DSS). The major problem with dengue is the fact that the disease is caused by five distinct serotypes known as DEN1, DEN2, DEN3, DEN4 (6) and new DENV5 was detected in Thailand in 2013 (7). A person infected by one of the five serotypes will never be infected again by the same serotype (homologus immunity), but loses immunity to the three other serotypes (heterologus immunity) in about 12 weeks and then becomes more susceptible to developing dengue hemorrhagic fever.

The latter distinguishes chikungunya virus (CHIKV) from dengue fever, which otherwise shares the same vectors, incubation period, clinical course, symptoms, and geographical distribution. The word chikungunya, which is used for both the virus and the disease, means “to walk bent over” in African dialect Swahili or Makonde, and refers to

the effect of the incapacitating arthralgia. The virus was first isolated in 1952 in Tanzania (8). Human chikungunya virus infection has been documented in Burma, Thailand, Cambodia, Viet Nam, India, Sri Lanka, and the Philippines (9). Recent chikungunya outbreaks caused several million clinical cases in the Indian Ocean Islands and India. Neither Europe nor the Americas have had outbreaks of chikungunya virus so far (9) (10) and more recently has spread to the Caribbean region (11).

Dengue and Chikungunia are among the most difficult diseases to distinguish, especially because simultaneous co - infection can occur (12)(13)(14)(15)(16)(17). Chikungunya and dengue viruses are frequently transmitted to humans by peridomestic *Aedes* mosquitoes. *Ae. aegypti* has been considered to be the principal vector in the urban transmission cycle, with *Ae. albopictus* and other anthropophilic *Aedes* spp. serving as secondary vectors (18)(19).

Vietnam is located in South Eastern Asia, bordering the Gulf of Thailand, Gulf of Tonkin, and shares the border with South China Sea, China, Laos, and Cambodia. The climate is tropical in south; monsoonal in north with 4 seasons are spring, summer, autumn and winter. Vietnam faced with many health problems including fever/ dengue haemorrhagic fever (DF/DHF). In 1958, dengue was first detected in the North, and in 1960 was described in the South of Vietnam (20). Case occur year round in the South, and during the rainy season elsewhere. The incidence of DHF has increased from the first recorded outbreak in 1963, major epidemic occurred in 1969, 1983, and 1987 with a widespread epidemic in 1998 affecting 42 out of 61 provinces and resulting in 232,793 cases and 447 deaths (21). An estimated average reported morbidity and mortality between 1996 and 2005 was 75,407 cases and 145 deaths per year (22). In 2009, 27,000 cases (26 fatal), and in 2012 have 18,052 cases, 9 fatal, were reported during January to June (23). The outbreaks in 2013 were reported 25,300 cases and 16 fatal in August. (23)

Since 1975, chikungunya virus is first detected in Vietnam according WHO reported (24), To date, no cases of chikungunya have been reported in Vietnam, since 1967 when 10 cases were reported in American soldiers in Vietnam (25) and other study of anti - chikungunya antibodies in Vietnamese children in the South of Viet nam (26). In other research on anti - chikungunya antibodies in the North, Viet Nam show that, 60 percent of patients with classic dengue symptoms have tested negative for dengue virus. according to Vu Sinh Nam, Preventive Health and Environment Department, Ministry of health, and 4

of 17 provinces: Ha Noi, Nghe An, Ha Nam, Nam Dinh were positive to chikungunya virus with proportion 15/324 patients who have had classic dengue symptoms. Detected of chikungunya virus during dengue outbreak in the north, Viet Nam (27) .

To find out suitability for surveillance chikungunya and dengue viruses infection in Viet Nam, the knowledge about mechanism of Chikungunya and Dengue virus interaction has essential activities that can help in the prevention of vector - born disease to improve the management, surveillance, control of dengue and chikungunya virus infection in Vietnam. On the other hand, the current knowledge on early events of chikungunya and dengue transmission from mosquitoes to human is limited. Besides, there are several reasons to believe that dengue and chikungunya may be co circulating in Vietnam as cases of CHIKV have been reported in neighbouring human populations. Cambodia reported the re - emergence of CHIKV in 2011 with 24 patients identified when samples were tested for Flaviviruses and Alphaviruses (28). In 2012, chikungunya outbreaks were reported in Laos with 197 cases in Moonlpamok and Khong Districts of Chamasak province (29). Vietnam shares borders with Cambodia and Laos, its therefore possible that cross - border transmission into Vietnam may occur as result of travel and traffic between the neighbouring countries from infected people or mosquitoes.

Our aim is therefore to perform an epidemiological survey of dengue and chikungunya in several provinces in Vietnam shares the border to Cambodia and Laos during the 2011 - 2014 periods. We will also investigate the interaction of mosquito to human transmission and the risk factors transmission dengue and chikungunya viruses. This part of the study is coordinated with the Center of National Research Scientific (CNRS), and Montpellier University 2, Montpellier, France.

The specific objective of the research aims:

9. To describe the surveillance data of chikungunya virus from several provinces presence in the north, center and south in Vietnam shares border with Laos and Cambodia.
10. To better understand the monitor Dengue and identify the virus strains circulating in Vietnam.
11. To obtain and analysis, of some dengue strains circulating in the North, with dengue viruses isolated in other regions in Vietnam.

12. To describes the spread of chikungunya and dengue viruses with the role of mosquitoes transmission in Ha noi, Vietnam.
13. To identify the molecular epidemiology of vector transmission chikungunya and dengue viruses in Viet Nam.

The outline will be displayed in form of chapters with results presented as a form of published, submitted or in preparation articles. The articles included in this thesis are listed below:

FIRST PART

Pham Thi Kim Lien, Roger Frutos. Joint arboviral infections: risk and prospective. (in preparation)

SECOND PART

CHAPTER 1

Pham Thi Kim Lien, Vu Trong Duoc, Laurent Gavotte, Emmanuel Cornillot, Phan Thi Nga, Laurence Briant, Roger Frutos, Tran Nhu Duong. Role of *Aedes aegypti* and *Aedes albopictus* during the 2011 dengue fever outbreaks in Hanoi, Vietnam. Asian Pacific Journal of Tropical Medicine, 2015; 8 (7); 543-548.

CHAPTER 2

Pham Thi Kim Lien, Laurence Briant, Truong Ba Tang, Bui Minh Trang, Laurent Gavotte, Emmanuel Cornillot, Tran Nhu Duong, Roger Frutos, Phan Thi Nga. Virologic and serologic surveillance of arbovirus infection in Dong Thap, Vietnam with special reference to dengue and chikungunya viruses: a 13 months study. Asian Pacific Journal of Tropical Medicine, *In Press*.

CHAPTER 3

Pham Thi Kim Lien, Laurence Briant, Laurent Gavotte, Pierrick Labbe, Marco Perriat-Sanguinet, Laurent Gavotte, Emmanuel Cornillot, Vu Trong Duoc, Nguyen Thi Yen, Tran Vu Phong, Nguyen Van Soai, Tran Duc Dong, Tran Chi Cuong, Phan Thi Nga, Tran Nhu Duong, Roger Frutos. *Aedes* mosquitoes mobility, diversity and risk factors for the diffusion of dengue and chikungunya in Vietnam. In preparation for submission to Emerging Infectious Diseases

PART I

LITERATURE REVIEW

1. Arboviruses

Arthropod-borne viruses (arboviruses) are viruses that can be transmitted to human by arthropod vectors. The WHO definition is as follows: “Viruses maintained in nature principally, or to an important extent, through biological transmission between susceptible vertebrate hosts by haematophagous arthropods or through transovarian and possibly venereal transmission in arthropods.” (30).

Arboviruses that cause human encephalitis/animal or zoonotic disease have been identified, are members of four virus families: the *Togaviridae* (genus *Alphavirus*), *Flaviviridae*, *Bunyaviridae* and *Reoviridae*, contain most of the arbovirus that cause human/animal disease (31)(32)(33). The term of arboviruses is not taxonomic indicator, it describes their requirement for vector in their transmission cycle (34)(33). According to International catalogue of Arbovirus, 1992, 535 species belonging to 14 virus families were registered (33). More than 130 arboviruses are known to cause human disease.

Human and animals infected by arboviruses, may suffer diseases ranging from sub-clinical or mild through febrile to encephalitic or hemorrhagic with a significant proportion of fatalities. Arboviruses infections can cause four types of illness: 1) Illnesses of the central nervous system, ranging in seriousness from mild viral meningitis to encephalitis (inflammation of the brain), with coma, paralysis, and death; 2) Mild fever illnesses with or without rash; 3) Hemorrhagic fevers that can be serious and life - threatening; 4) Arthritis and rash, with or without fever (35)(36).

Three of a large number of neglected human pathogenic arthropod-borne viruses are chikungunya virus (CHIKV), dengue virus (DENV), and West Nile virus (WNV) whose combined figures for morbidity and mortality far exceed those for Ebola, severe acute respiratory syndrome and Middle East respiratory syndrome viruses (36).

Approximately 300 types of mosquitoes could transmit arbovirus, species *Aedes* and *Culex* mosquitoes are the species most frequently associated with arbovirus transmission, respectively more than 105 - 115 types of arbovirus (37) (33). Ticks are also prevalent vectors, 116 different species are currently known to transmit arboviruses, in addition 25 mite species mainly 24 types of *Culicoides* and *Lasiohelea*. Sandflies, blackflies,

stinkbugs, lice, mites, gadfly, and bedbugs can also transmit arboviruses (38). This diversity of species and the wide distribution of these transmission vectors explain why arboviruses are so successful in dispersing globally via the mechanisms highlighted earlier (39)(33). A high proportion of Arbovirus associated with human and animal disease circulate in tropical and subtropical regions, where mosquitoes, and other flying insects, tend to be abundant. Also, many arboviruses circulate among wildlife species in temperate regions of the world. They have evolved a wide variety of strategies to ensure their long term success, dispersal and survival. Arbovirus adapt readily to new susceptible hosts by alteration of receptor specificity, transmission efficiency, antigenicity, ecological and environmental conditions. Changing anthropological behaviour, climate change and high mutation frequency are important determinants of arbovirus emergence (36).

Up to date, in the 21st century, develop vaccine and antiviral drugs to prevent or treat humans against infection by pathogenic arboviruses will resolve the challenge associated with emerging arboviruses.

2. Different of Arbovirus families

2.1. Family Flaviviridae

2.1.1. Classification

The International Committee on Taxonomy of Viruses (ICTV) began to devise and implement rules for the naming and classification of viruses early in the 1970s, an effort that continues to the present day. According to the ICTV of virus *Flaviviruses* consist of three genera within the virus family *Flaviviridae*, and others two are the genera Pestivirus from Latin pestis is “Plague” and Hepacivirus from Greek hepatos is “liver”. The family *Flaviviridae* contains 58 species within three genera to include Flavivirus (53 species), Hepacivirus (1 species), and Pestivirus (4 species). Fourteen species within the genus Flavivirus and all species within the Hepacivirus and Pestivirus genera are not known to be transmitted by arthropod vectors. (Beth K. Schweitzer, 2009) (40).

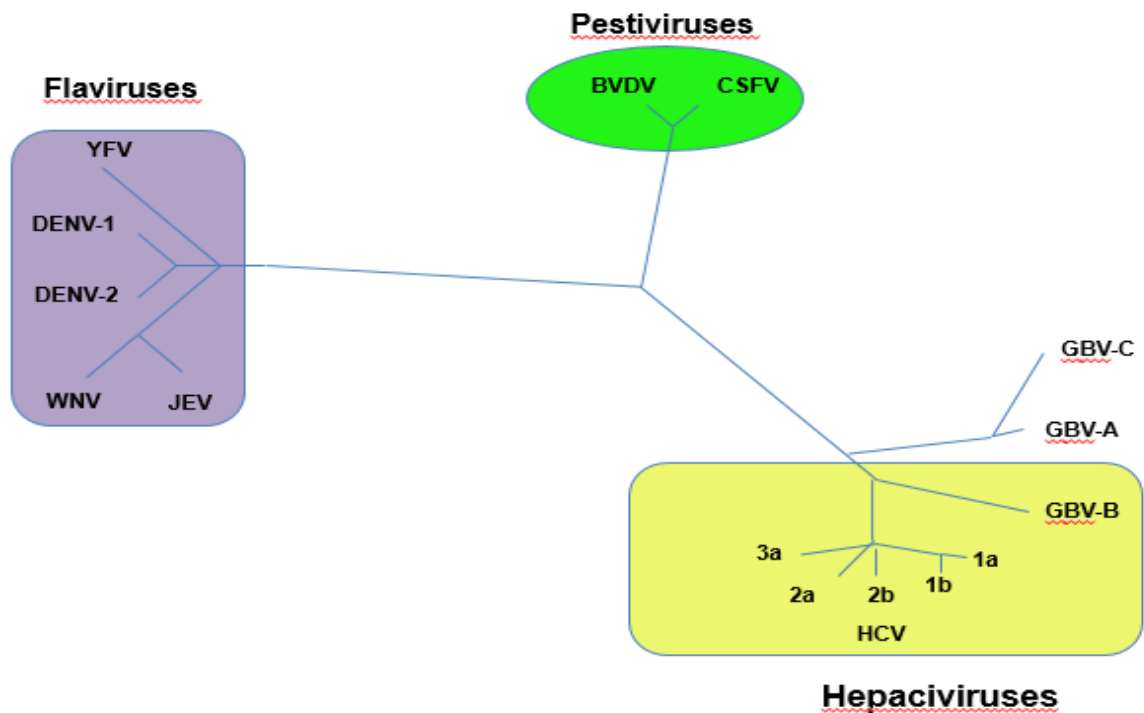

Figure 1: Three genera of the *Flaviviridae* family in the Phylogenetic tree.

The Flaviviruses are primarily transmitted by arthropods and consist of more than 73 viruses include yellow fever virus, Japanese encephalitis virus, Dengue virus, West Nile virus, tick borne encephalitis, (41)(42). The first identified human virus in the flavivirus prototype is Yellow fever virus (YFV), this is name derived from Latin word “flavus”, meaning yellow, evoking the jaundice caused by YFV (43).

In the genus *Flavivirus*, viruses share complex antigenic inter relationships, they can separate into four ecologicals or phylogenetic group with regard to their vector association: mosquito - borne group, a tick - borne group, and non- vectored viruses. (See figure 2) Subtypes are written in parentheses after virus names. New world viruses are printed in bold and underlined (43).

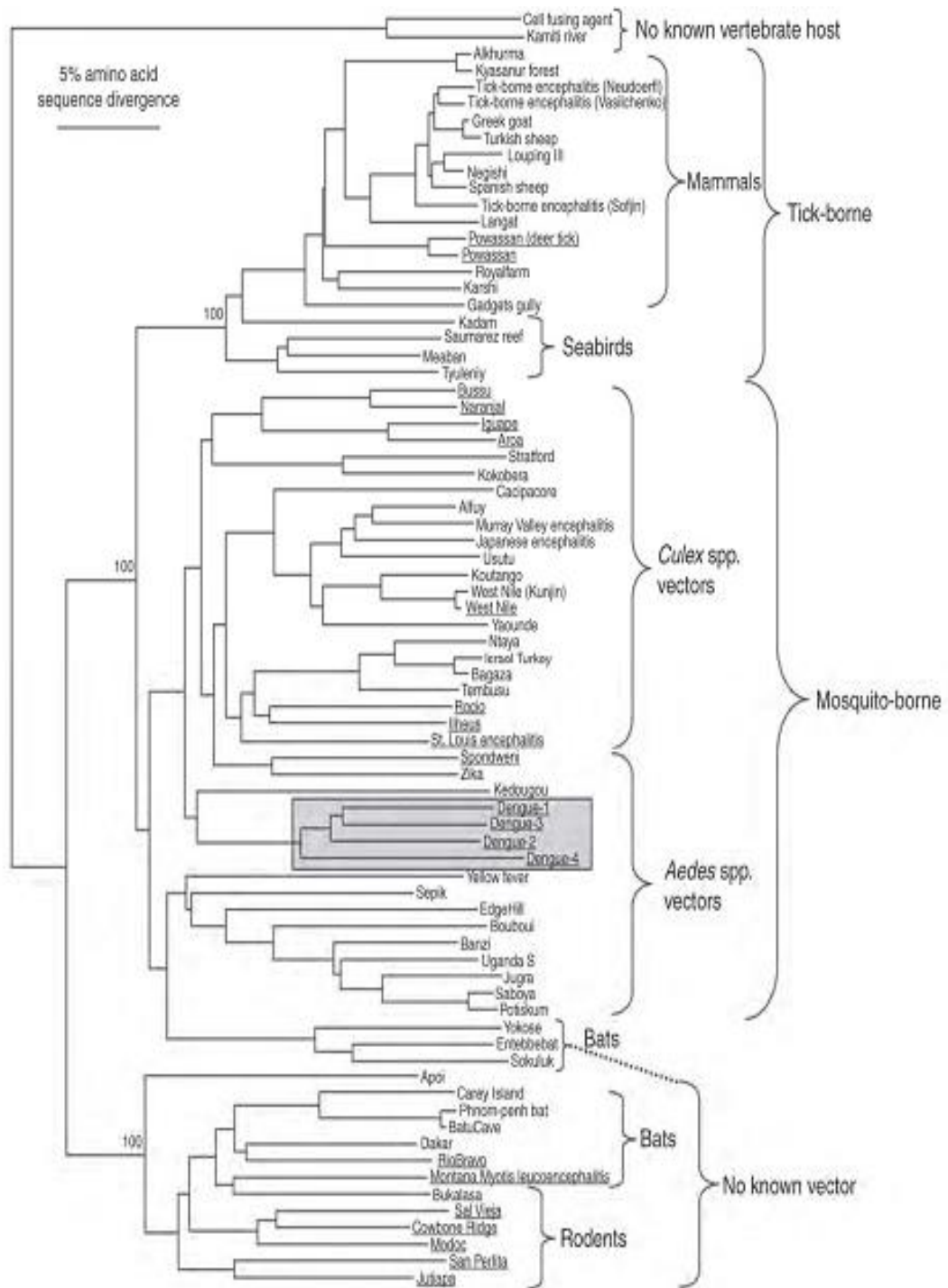
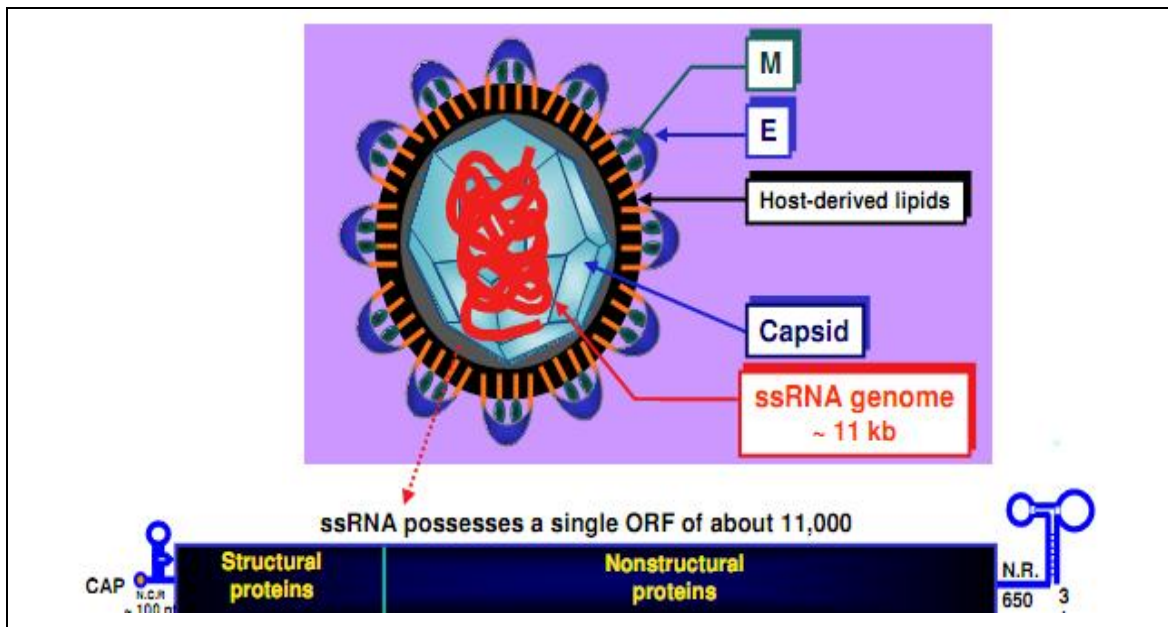

Figure 2: Derived from the GenBank library, phylogenetic tree of the flaviviruses derived from partial Non-structural protein NS-S (NSS) sequences.

2.1.2 Genome structure

The *Flaviviridae* genome contains a single, consists of a linear, positive-sense RNA molecule of about 10.8 kb in size, and the genome is not segmented. The complete genome is 9500 - 12500 nucleotides long, Flavivirus virion are 50nm in diameter, spherical, and enveloped (44). The genome has a 5'- end carries a methylated nucleotide cap or genome - linked protein. It also has a 3' polyadenylated tail, polyprotein from genomic RNA cleaved, three structural proteins and some non-structural proteins. The genome undergoes cytoplasmic replication (45). The translation initiation is cap - dependent in *Flaviviruses* (44).



Note: M is protein, E is protein envelope, ORF is openreading frame, ssRNA is Singgle Stranded Ribonucleic Acid.

Figure 3: Schematic structure of flavivirus virion (Philippe Buchy).

As study of Cleaves in 1981, the flavivirus genome has one open reading frame encoding a single polyprotein at the origin of structural and non structural proteins (45).

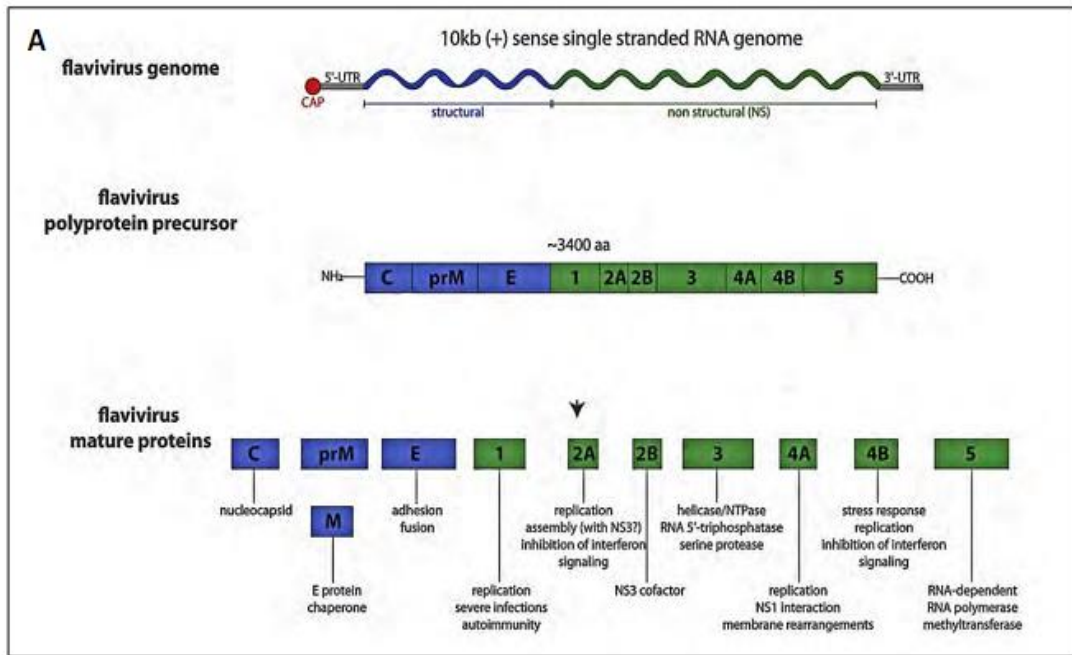

Figure 4: The single open reading frame is depicted with the structural and non structural protein coding region (colored is blue and green respectively). The 5' cap and the 5' and 3' untranslated region (UTR). The single open reading frame encodes an immature polyprotein precursor that is co and post translationally cleaved in to three structural proteins (in blue) and seven nonstructural proteins (in green) (46).

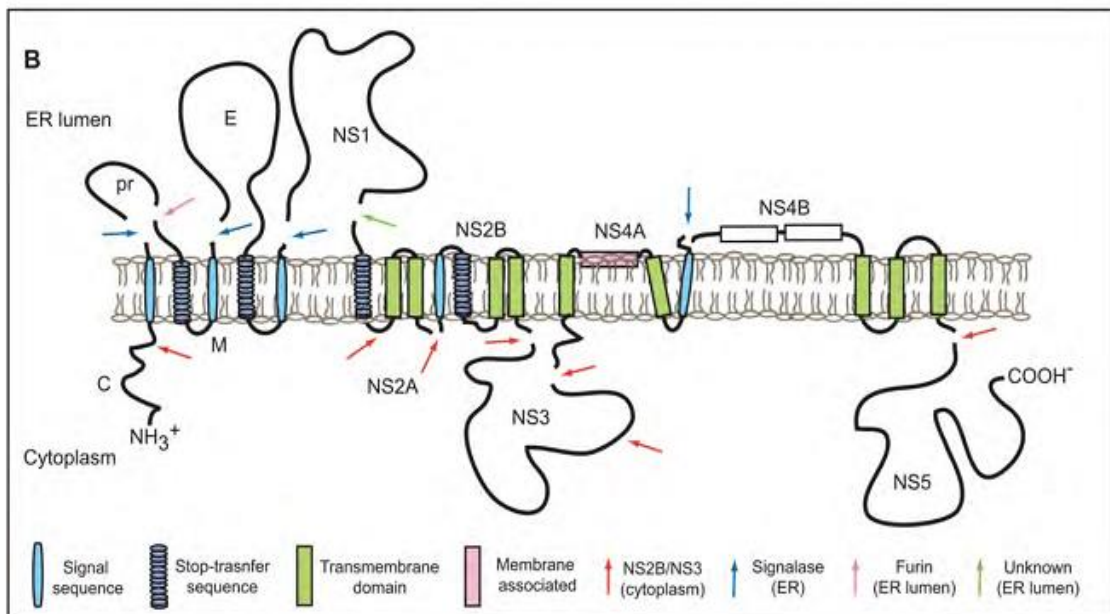

Figure 5: The detail of cleavage sites for cellular proteases, NS2B/ NS3 and unknown protease are indicated (47).

2.1.3 Vector

Ticks and mosquitoes are two major groups of arthropod vectors of Flaviviruses, of the known Flaviviruses, approximately 50% are recognized human pathogens causing fever, encephalitis, or hemorrhagic disease, however, for many of others, the pathogenic potential has not been well studied (Gubler Dj, Kuno G, 2007)(48) (49). Important mosquito-borne Flaviviruses include dengue virus serotypes 1 - 4, Yellow fever virus (YFV), West Nile virus (WNV), Japanese encephalitis virus (JEV) and St. Louis encephalitis virus (SLEV). The mosquito-borne flaviviruses comprise two distinct epidemiology groups: neurotropic viruses, often associated with encephalitic disease in human or livestock, *Culex* spp. Mosquito vectors, and bird reservoirs, and non-neurotropic viruses are associated with hemorrhagic disease in humans, *Aedes* spp. mosquito vector, and primate host (50).

Ticks

In nature, tick-borne flaviviruses are maintained through a transmission cycle involving an ixodid tick vector and a vertebrate host (51). Tick-transmitted flaviviruses comprise two distinct groups: mammalian and seabird virus groups. It is transmitted by the bite of several species of infected ticks, including *Ixodes scapularis*, *Ixodes ricinus* and *Ixodes persulcatus* (52) or very rarely through the non-pasteurized milk of infected cows.

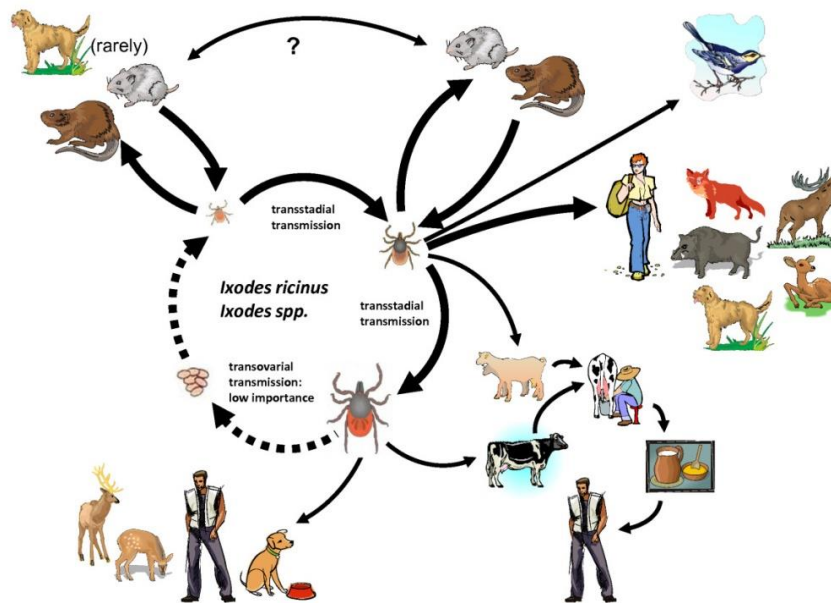

Figure 6: Transmission cycle for tick-borne encephalitic virus.

Tick - borne encephalitis virus (TBEV), which includes three subtypes, European, Far Eastern, and Siberian, was the most important role in human epidemiology, particularly in the old “Eastern bloc” countries, producing a wide range of diseases including subclinical infections, biphasic fever, encephalitis, and chronic disease. The vector of TBEV in European is *Ixodes ricinus*, and *I persulcatus* for the other two subtypes (53) (54)(55) (56)(57) (58) (59) (60). *I ricinus* is detected in the most of Europe, and the distribution extends to Turkey, Northern Iran, and in the Southeast of Caucasus (61). *I persulcatus* was found in the belt extending from Eastern Europe to China and Japan. Both tick species cocirculate in a restricted area in northeastern Europe, Russian Karelia, St Petersburg, and eastern Estonia and Latvia. An ectopic focus of TBE-Sib carried by *I persulcatus* has been discovered in western Finland. (62) (63)(64).

The seabird tick - borne virus group has not been shown to induce disease in humans or in seabirds and the reasons why these relatively closely related viruses differ so significantly in this particular characteristic have not been investigated. However, human contact with seabirds is limited (65).

Mosquitoes

Culex

The most dangerous and most widely distributed mosquito in the world is *Culex* mosquitoes, *Culex* mosquito feeding normally happens at night. After feeding, the *Culex* mosquito will find somewhere cold and damp to rest and digest. Digestion of a meal can take 2 to 7 days with 1 to 3 meals needed to produce a clutch of eggs. The female mosquitoes prefer to lay their eggs in standing water that contains plenty of organic matter (66).

The most importance of *Culex* vectors are member of *Culex pipiens* complex, known as the northern house mosquito. Normally, *Culex pipiens* is considered to be a bird feeder but some urban strains have a predilection for mammalian hosts and feed readily on humans. According to a classification system for Northeastern mosquito, the life cycle of *Culex pipiens* represents a variation of the *multivoltine* life cycle: non - desiccation resistant eggs laid directly on water, larvae develop in polluted water habitats, multiple generations each year; overwinters as a mated female.

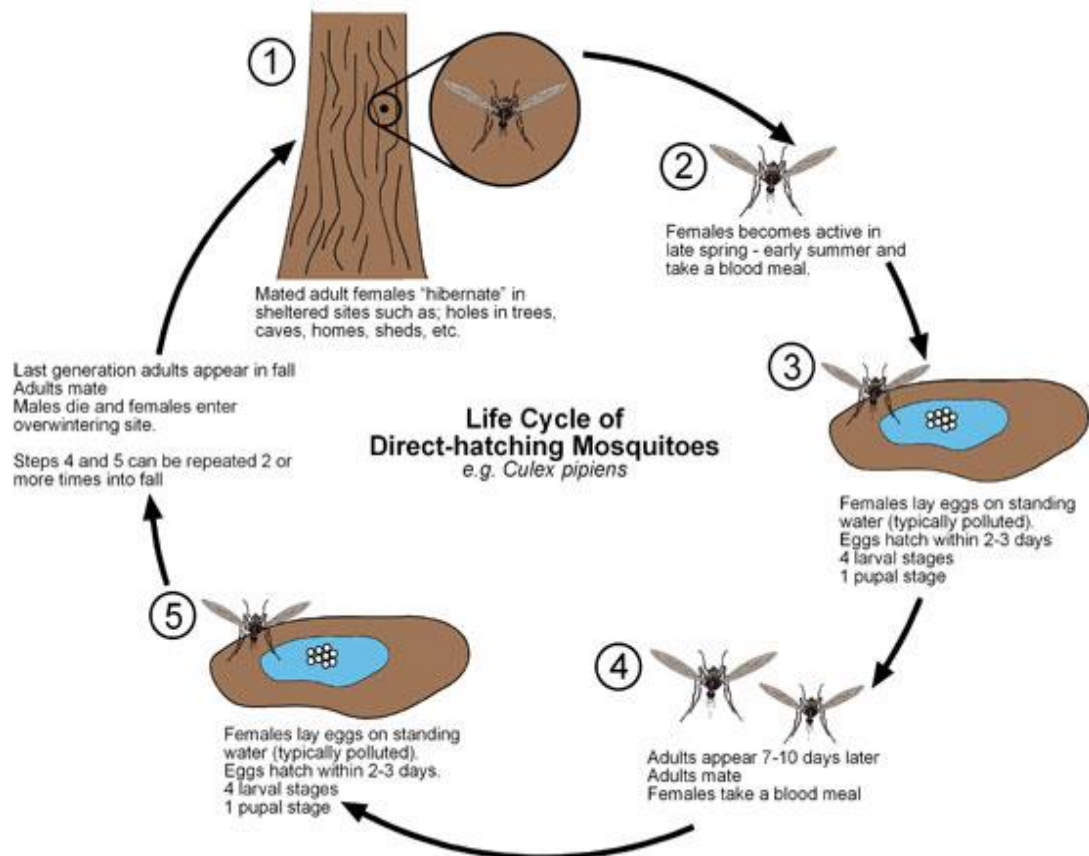

Figure 7: Life cycle of *Culex* mosquito

The second of *Culex* vectors are *C. australicus*, *C. triaeniorhynchus*, *C. salinatus*, *C. tarsalis*, *C. quinquefasciatus*, *C. nigripalpus*, *C. annulirostris*. The major Asian vector of Japanese encephalitis (JE) is *Culex triaeniorhynchus* (67). In Australia, the main vector transmission to human of Murray Valeley (MVE) and Kunjin (KUN) viruses is *Culex annulirostris* (68)(69).

Transmission cycles

In Human, cycle of *Culex* mosquito is multipliers of the virus, and serving as a source of the virus for uninfected mosquitoes. Most female mosquitoes have to feed on human or an animal and get a sufficient blood meal before she can develop eggs, and *Culex* mosquito usually lay their eggs at night.

Aedes aegypti and *Aedes Albopictus*

Aedes aegypti

Ae. aegypti is believed to have originated in the jungle of Africa where a sylvatic, where ancestral from (4)(70), and *Ae. aegypti formosus* is East and Central Africa (71). The domestic form of *Ae. aegypti* was most likely spread throughout the rest of the world via slave and

trading ships during the seventeenth to nineteenth centuries (72). After that, *Ae. aegypti* could be found in the tropical and subtropical regions of the world. According to Moritz UG Kraemer, 2015 prediction the distribution of the top ten countries in terms of occurrence records for each continent for *Ae. aegypti* and *Ae. albopictus* (73) are shown in table 1.

Table 1: The geographic distribution of spatially unique occurrence for the Americas, Europe/ Africa, and Asia/ Oceania (source: Moritz UG Kraemer, 2015) (73)

Americas		Europe/Africa		Asia/Oceania	
<i>Ae. aegypti</i>					
Brazil	5,044	Senegal	112	Taiwan	9,490
USA	436	Cameroon	55	Indonesia	603
Mexico	411	Kenya	52	Thailand	495
Cuba	177	United Republic of Tanzania	44	India	423
Argentina	170	Côte d'Ivoire	40	Australia	282
Trinidad & Tobago	152	Nigeria	35	Viet Nam	223
Venezuela	130	Madagascar	28	Malaysia	112
Colombia	128	Gabon	27	Singapore	44
Puerto Rico	120	Mayotte	20	Philippines	36
Peru	89	Sierra Leone	20	Cambodia	29
<i>Ae. albopictus</i>					
Brazil	3,441	Italy	203	Taiwan	15,339
USA	1,594	Madagascar	58	Malaysia	186
Mexico	50	Cameroon	42	Indonesia	161
Cayman Islands	15	France	37	India	150
Haiti	13	Gabon	27	Japan	97
Guatemala	12	Albania	22	Thailand	82
Venezuela	7	Mayotte	21	Singapore	44
Colombia	3	Greece	18	Laos	26
Cuba	3	Israel	17	Philippines	22
Puerto Rico	3	Lebanon	15	Viet Nam	18

Currently, *Ae. aegypti* is presented and frequently abundant in most tropical and subtropical countries of the world (73). It seems probable that the geographical distribution of *Ae. aegypti* will continue to expand, with incursion in previously uncolonised areas resulting in risk of vector born disease transmission to previously unaffected population (74).

Ae. albopictus

Ae. albopictus is believed to have originated in South - East Asia, islands of the Western Pacific and Indian Ocean, has spread during recent decades to Africa, the mid - east, Europe and the Americas (75).

Prior to 1979, *Ae. albopictus* was present from China, northern Japan to tropical Asia and in the Western Pacific, but it has spread to much of the rest of the world in recent decades, in 1983 *Ae. albopictus* was found in Memphis, Tennessee, United States, and in 1995, confirmed with its discovery in Houston, Texas, United States. (76) (77).

Ae. albopictus has been one of the fastest spreading animal species over the past two decades in central and South America (4). In addition to the ecological problems inherent in rapid spread of any species of particular importance are the serious public health risks posed by the introduction and establishment of an aggressive pest and efficient disease vector (78).

Transmission cycles

Infected humans are the main carriers and multipliers of the virus, and serving as a source of the virus for uninfected mosquitoes. The virus circulates in the blood of infected humans for two to seven days, at approximately the same time that they have a fever. *Aedes* mosquitoes may acquire the virus when they feed on an individual during this period. The transmission cycle may also involve jungle primates that act as a reservoir for the virus in parts of South East Asia and Africa (79)(80).

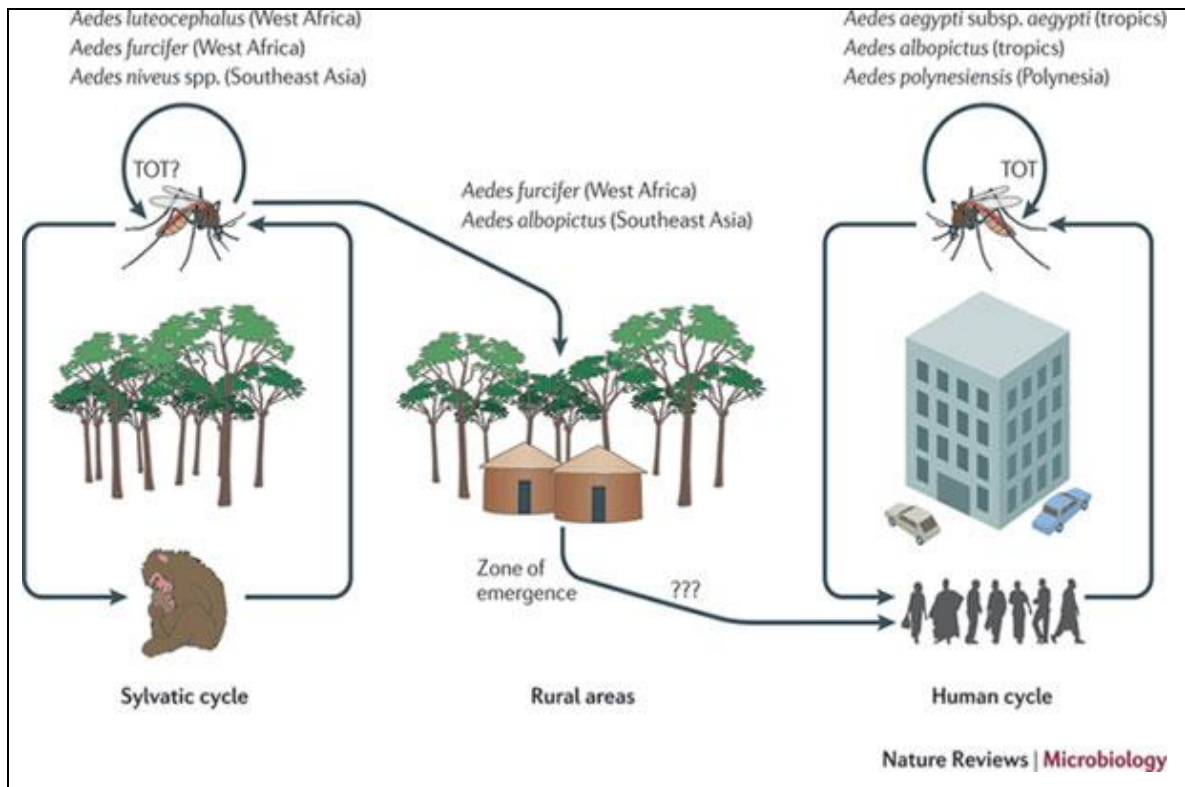

Figure 8: Depicting the hypothetical evolutionary history of endemic or epidemic DENV emergence from zoonotic transmission cycles (81).

2.1.4 Flavivirus replication cycle

In the host cell, Flavivirus enter by receptor - mediated endocytosis (82). In human target cell have two types of cell receptor appear to be involved in facilitating entry of Dengue virus depending on the cell (83). The first type corresponds to several primary receptors of low affinity and specificity including aminoglycan - type adhesion molecules such as heparin sulfate that are expressed in many cell types (84) (85). The second type corresponds to lectin - type receptors such as the Dendric cell - specific intercellular adhesion molecule 3 - grabbing non - antigen (DC-SIGN) expressed in some antigen - presenting cells such as immature dendritic cell (82).

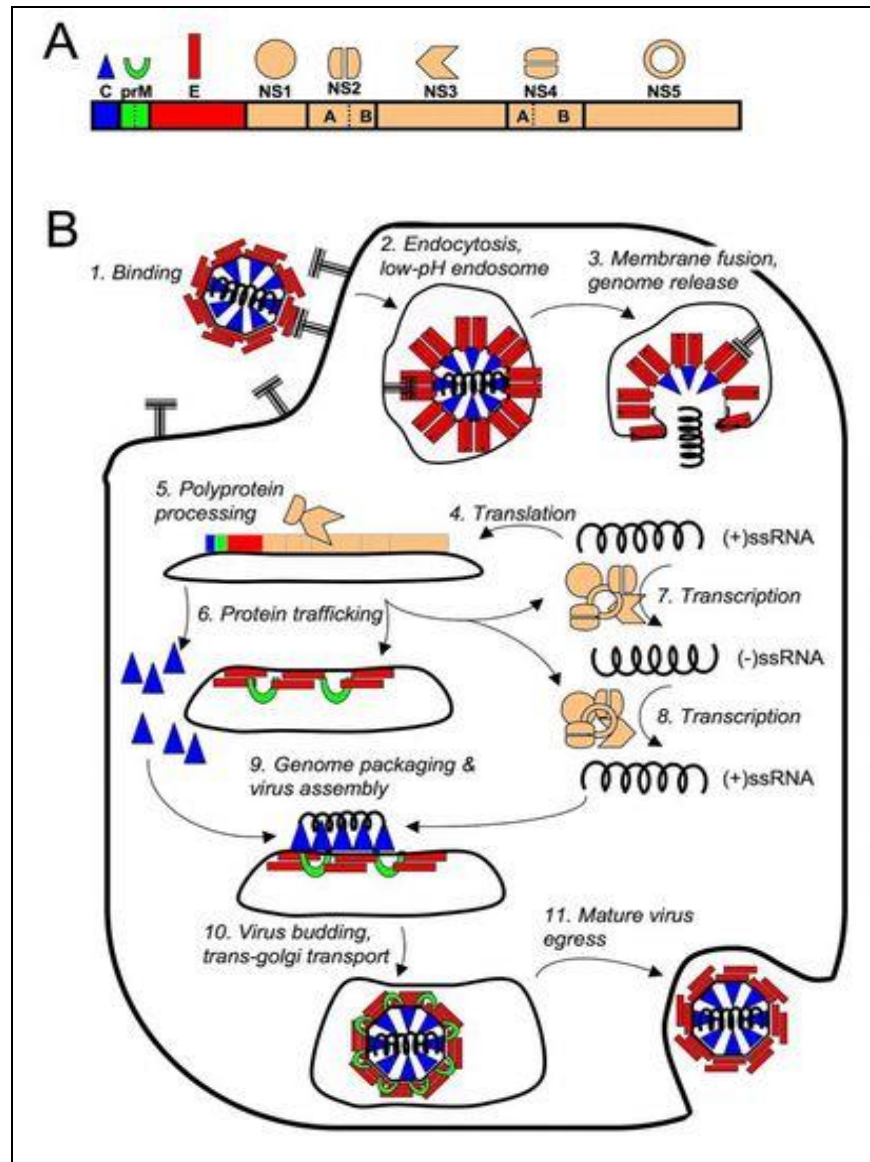

Figure 9: Schematic of viral replication within host cell of a Flavivirus. (Tomlinson et al, 2009) (86).

2.1.5 Main disease

Yellow fever

Yellow fever (YF) is an acute viral haemorrhagic disease transmitted by infected *Ae. aegypti* (87), and other species mosquitoes (88). YF was found in tropical and subtropical areas in South America and Africa, but not in Asia (89). The origin of the disease is most likely to be Africa, from where it was introduced to South America through

the slave trade in the 16th century. Since the 17th century, several major epidemics of the disease recorded in the Americas, Africa and Europe. In the 19th century, YF was deemed one of the most dangerous infectious diseases (90). According to the World Health Organization (WHO) estimates, there are approximately 200,000 cases of YF worldwide each year, and 30,000 deaths. About 90% of all cases occur in Africa. The virus is endemic in tropical areas of Africa and Latin America, with a combined population of over 900 million people (91).

The "yellow" in the name refers to the jaundice that affects some patient. The signs and YF symptoms in some people have no symptom but in the more severe case is fever, nausea, vomiting, neck and back pain and it generally subsides after several days.

There is no cure for yellow fever. Up to 50% of severely affected persons without treatment will die from yellow fever. Treatment is symptomatic, aimed at reducing the symptoms for the comfort of the patient (WHO).

In the middle of the 20th century a safe and effective live, and attenuated vaccine was created (92). However, since the 1980s the number of YF cases has increased, making it a reemerging disease. Besides vaccination, control of the YF mosquito *Ae. aegypti* and other species mosquitoes is of major importance in prevention YF virus (WHO).

St. Louis encephalitis

St. Louis Encephalitis (SLE) is a disease transmitted caused by the *Culex* mosquito. In 1993, SLE virus was first isolated from a brain suspension obtained from a case of acute encephalitis during a large urban outbreak of the disease in St Louis, Missouri, and the neighboring St. Louis County, the epidemics have occurred sporadically and unpredictably in the subsequent decades. Prior to the introduction of West Nile Virus to the United States in 1999, SLE was the most common mosquito transmitted pathogen in the United State, major SLE epidemics occurred in Florida in 1959, 1961, 1962, 1977 and 1990. A large outbreak occurred in the Ohio - Mississippi River Basin in 1975, a year when close to 2000 cases were reported nationwide. Occasional cases have been reported from Canada and Mexico. SLE virus is an emerging arbovirus in South America, with febrile illness and encephalitis cases reported in Argentina in 2002 and 2005, and in Brazil in 2004 and 2006 (93)(94).

In general people who are infected with SLE have very mild illness or may never become sick, mild infection are characterized by fever and headache, without other

apparent symptoms, but the symptoms of severe disease can include: headache, nausea, high fever, neck stiffness, confusion, coma, shaking, seizures and/or paralysis (95).

There is no effective antiviral medication for the treatment of SLE. Treatment for SLE is largely supportive and includes rest and medications to control vomiting (96).

Prevention to SLE virus infection is the easiest and best way to avoid mosquito bites. There is no commercially available human vaccine for SLE (97)(98).

Japanese encephalitis

Japanese encephalitis (JE) virus disease transmitted cause by the mosquito *Culex tritaeniorhynchus*, It was first recognised in Japan in the late 1800s (99), represents the most significant etiology of arboviral encephalitis worldwide, JE is a neurologic infection closely related to St. Louis encephalitis and West Nile encephalitis. JE disease is most prevalent in Southeast Asia, the Far East and the Pacific islands (100). Intensification and expansion of irrigated rice production systems in South and South East Asia over the past 20 years have had an important impact on the disease burden. According to the World Health Organization, at least 30,000 - 50,000 people in Asia develop visible symptoms of Japanese encephalitis each year. Around 1 in 200 people develop more serious symptom, which can lead to permanent brain damage or death. It occurs from the islands of the Western Pacific in the east to the Pakistani border in the west, and from Korea in the north to Papua New Guinea in the south. Countries which have had major epidemics in the past, but which have controlled the disease primarily by vaccination, include China, Korea, Japan, Taiwan and Thailand. Other countries that still have periodic epidemics include Viet Nam, Cambodia, Myanmar, India, Nepal, and Malaysia.

Infected mosquitoes then transmit the Japanese encephalitis virus to humans and animals during the feeding process. Mild infections occur without apparent symptoms other than fever with headache. More severe infection marked by quick onset, headache, high fever, neck stiffness, stupor, disorientation, coma, tremors, occasional convulsions (especially in infants) and spastic (but rarely flaccid) paralysis. Most infections are asymptomatic, but when encephalitis develops, the case - fatality rate can be as high as 30%. Neuropsychiatric sequelae reported in 50% of survivors.

In May 2009 and 2011 a new an effective inactivated vaccine is available for Japanese encephalitis, but it is expensive and requires one primary vaccination followed by two boosters.(101)(102)(103). According to WHO, in 2014 there are three types of

inactivated vaccines and one type of live attenuated vaccine currently used in the world: 1) mouse brain - derived, purified vaccine, which is based on either the Nakayama - NIH or Beijing -1 [P-1] strains; 2) primary hamster kidney (PHK) cell - derived, purified vaccine, based on the Beijing-3 [P-3] strain; 3) Vero - cell derived purified vaccine based on the P-1, P-3 or SA14-14-2 strains as virus seeds; and 4) PHK cell derived live attenuated vaccine based on the SA14-14-2 strain of the JE virus.

Dengue

Dengue viruses transmitted principally in a cycle involving humans and mosquito vectors, the *Ae. aegypti* or more rarely the *Ae. albopictus* mosquito. The first case was reported the existence of dengue - like disease in 1779 but it was most likely present long before in first appeared in literature. Dengue virus is major threat to health in tropical and sub - tropical countries, mostly found at Africa, Asia, Caribbean countries, Central and South America, Mexico, The Pacific. Severe dengue, previously known as Dengue Haemorrhagic Fever (DHF) was first recognized in the 1950s during dengue epidemics in the Philippines and Thailand. Before 1970, only nine countries had experienced severe dengue epidemics. The disease is now endemic in 144 countries in Africa, the Americas, the Eastern Mediterranean, South - East Asia and the Western Pacific. South - East Asia and the Western Pacific regions are the most seriously affected (3).

Dengue fever is a severe, flu - like illness that affects infants, young children and adults, but seldom causes death. For severe dengue, medical care by physicians and nurses experienced with the effects and progression of the disease can save lives. At present, the only method to control or prevent the transmission of dengue virus is avoid mosquito bites. Developing a vaccine against dengue or severe dengue has been challenging although there has been recent progress in vaccine development. To date, there is no vaccine to protect against dengue.

2.2. Family Togaviridae (genus Alphavirus)

2.2.1. Classification

The Togaviruses was originally classified together with several groups of viruses predominantly transmitted by insect, more recent analyses in Taxonomic structure of the

family have defined them into a distinct family with two genera: the alphaviruses and the rubiviruses (104). The alphaviruses has been classified into seven antigenically related complexes (105), this genera with about 40 recognized members, while the Rubivirus genus is composed of a single member is rubella virus.

2.2.2. Genome structure

Virions contain one molecular of linear positive-sense single stranded RNA. Total genome length is 9700 - 11800 nt. The RNA of the virus is pure stranded and capped at its 5' end as well as having a polyadenylene 3' tail. The virus is enveloped and forms spherical particles from 65 - 70 nm diameter, the capsid within is icosahedral, constructed of 240 monomers. This structure allows the virus to act as mRNA within the host cell and easy to replicate. Genome first translated into four non - structural proteins (nsP1- nsP2- nsP3- nsP4) and structural proteins (E1- E2 - E3) (106) (107).

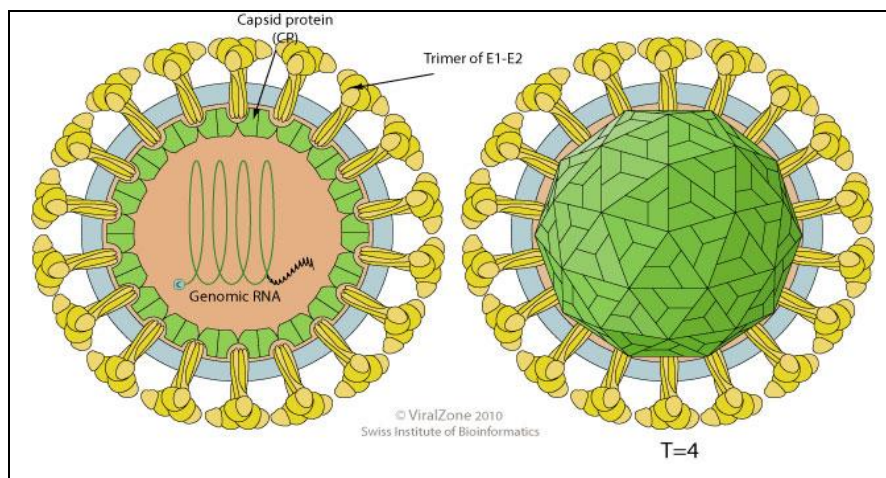

Figure 10: Genome structure of Togaviruse (Source NCBI) (108)

Togaviruses have an icosahedral capsid and have a surrounding envelope composed of two glycoproteins. These glycoproteins can be used to distinguish between species of the virus. It has been theorized that one of these proteins has a role in binding the virus to the host cell, allowing it to gain entry through receptors mediated endocytosis.

2.2.3. Vector

The most common is transmitted by arthropod vectors, most usually is *Ae. aegypti* and *Ae. albopictus* mosquitoes, vertebrate host is birds, rodents, rabbit. The mosquitoes was first found in the New World in 1985 when it was isolated in Houston, Texas. It probably traveled there from northern Asia in ships carrying scrap tires. To further complicate matters, not only is *Ae. albopictus* now a good host for chikungunya virus, but also the mosquito is spreading across the globe from eastern Asia to Europe and the United States (109) (110). The cycles of wild bird and mosquito interactions and infectivity allow the virus to remain endemic. No cases of bird transmission of the disease have been reported, making mosquitoes the primary vector and birds simply reservoirs (111).

2.2.4. Togaviridae replication cycle

In the host, the most important feature of togavirus replication is that it has a dicistronic genome. Two mRNAs are used, one to produce non-structural proteins and another to produce structural proteins. In fact, there is 4 times as much subgenomic RNA as genomic RNA in cells infected with togavirus. Two classes of proteins are synthesized from different mRNAs, which allows temporal regulation and qualitative replication. Genomic RNA can do first is make non-structural proteins (such as replicase) by synthesizing the minus strand, second is make structural proteins through synthesis of subgenomic RNA and synthesize positive strand RNA (112).

The virion has glycoproteins: Envelop 1 (E1) and envelop 2 (E2) that recognize and bind to the host cell membrane. The virion binds and is completely released inside of the host cell through endocytosis. The virion is taken in and binds to an endosome. The endosome has an ATP dependent H⁺ pumps that use ATP to pump into the endosome hydrogen ions, which decreases the pH and degrades the outer layer thus exposing and releasing the viral genome to the cytoplasm. The first process that the genome does is to translate the nonstructural proteins. This is possible because the genome is already in a positive-sense single stranded RNA, therefore the genome uses the host's ribosomes and tRNA to produce the nonstructural proteins. These proteins are produced as a single polypeptide that was then cleaved into four nonstructural proteins. These proteins are

important in forming a complex that was involved in transcribing the viral RNA into a complementary negative - sense single stranded RNA template. The negative - sense RNA template is used to replicate into positive - sense single stranded RNA. Also, from the 3' end (of the positive-sense RNA) to approximately the 1/3 mark on the genome was used to produce structural proteins that encodes: capsid proteins, E1's, and E2's. These structural proteins and +ssRNA are transported to the endoplasmis reticulum (ER) where they are modified, and bud from the ER to go to the golgi apparatus were they are packaged into virions. The virion is then released from the golgi apparatus to leave the cell, and in doing so it acquires its lipid membrane from budding from the host cell (113).

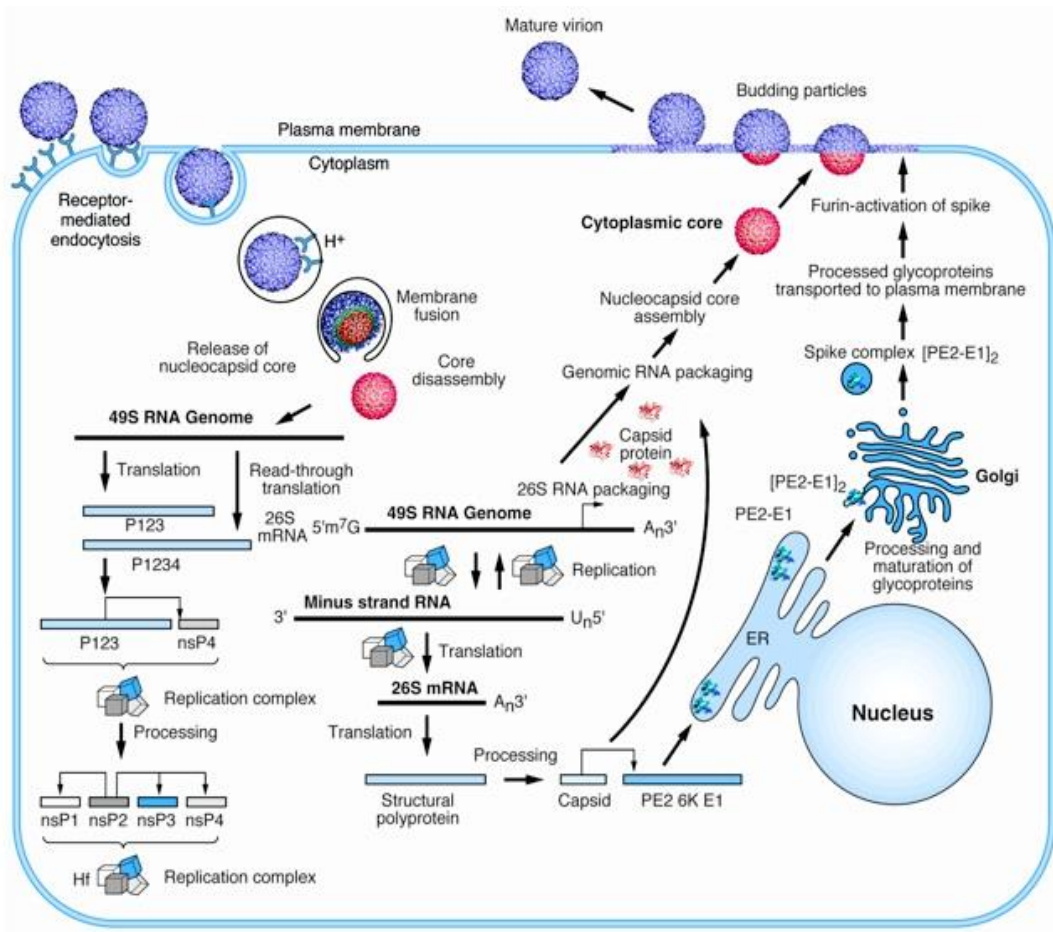

Figure 11: Replication cycle of Togaviridae (114)

2.2.5. Main diseases

Chikungunya

Chikungunya virus was first isolated from the blood of a febrile patient in Tanzania in 1952 (115), and there have been recent outbreaks of chikungunya in Africa, Asia and the Indian subcontinent. In recent decades mosquito vectors of chikungunya have spread to Europe and the Americas. Between 1960 and 1982, outbreaks of chikungunya fever was reported from Africa and Asia. In Asia, virus strains have been isolated in Bangkok in 1960s; various parts of India including Vellore, Calcutta and Maharashtra in 1964; in Sri Lanka in 1969; Vietnam in 1975; Myanmar in 1975 and Indonesia in 1982. In 2007, disease transmission was reported for the first time in Europe. Prior to 2013, chikungunya virus outbreak had been identified in countries in Africa Asia Europe, and the Indian and Pacific Oceans. In late 2013, the first local transmission of CHIKV in the Americas was identified in Caribbean countries and territories. Since then, location transmission has been identified in 44 countries (116).

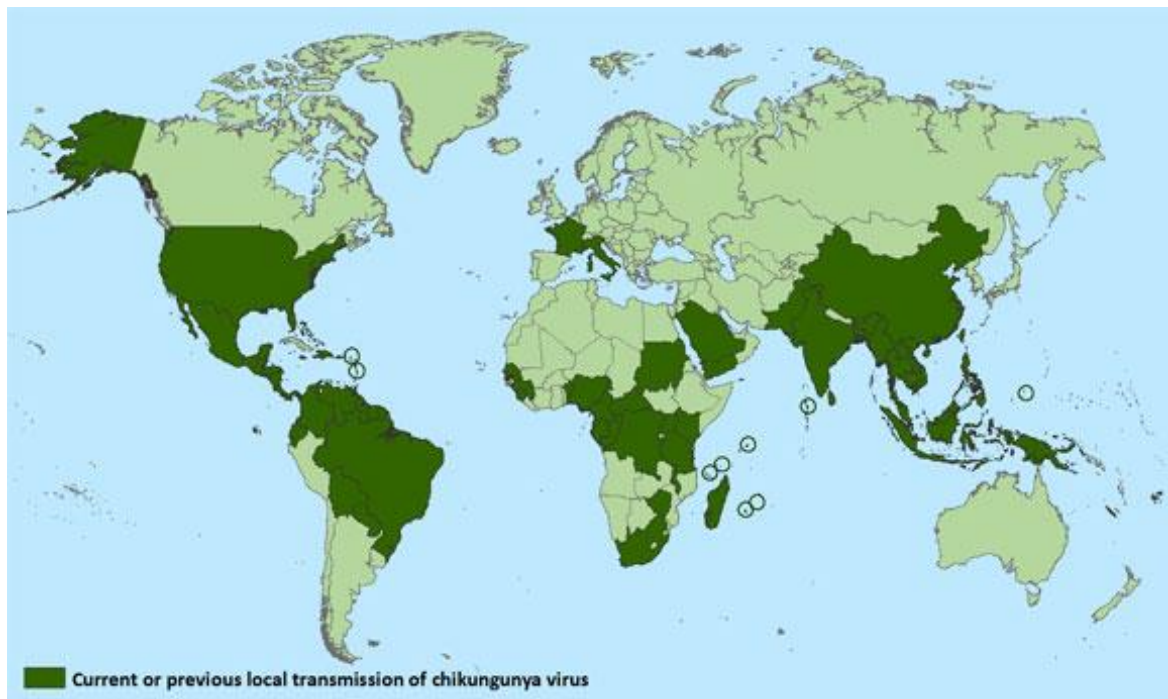

Figure 12: Countries and territories where chikungunya cases reported (116)

The disease resembles dengue fever, and is characterized by severe, sometimes persistent, joint pain (arthritis), as well as fever and rash. It is rarely life - threatening. Nevertheless, widespread occurrence of diseases causes substantial morbidity and economic loss.

There is no cure for the disease. Treatment is focused on relieving the symptoms. No vaccine is available against this virus infection. Prevention is entirely dependent upon taking steps to avoid mosquito bites and elimination of mosquito breeding sites (3).

Eastern Equine encephalitis

Since 1830's, Eastern Equine Encephalitis (EEE) is thought to have been the cause of virus in North American horses. EEE virus not received its name until a major outbreak occurred in horses in coastal areas of Delaware, Maryland, New Jersey, and Virginia in 1933. (The U.S. Department of Agriculture, 2008). So, the virus may have been present in its endemic form long time before, it is maintained in nature through a bird - mosquito cycle, there are two mosquito species primarily involved in this portion of the cycle, they are *Culiseta melanura* and *Cs. morsitans* and *Coquillettidia perturbans*, *Ochlerotatus canadensis*, *Oc.sollicitans*... (117). In 1934, mosquito species of *Aedes* and *Culex* could become infected with and transmit EEE virus from one vertebrate to another.

Most people bitten by an infected mosquito will not develop any symptoms. Severe cases of EEE virus infection, involving encephalitis (an inflammation of the brain) begin with the sudden onset of headache, high fever, chills, and vomiting. The illness may then progress into disorientation, seizures and coma. Approximately a third of patients who develop EEE die, and many of those who survive have mild to severe brain damage (118)(119).

There is no vaccine or drug against Eastern equine encephalitis virus (EEEV) for humans. Reducing exposure to mosquitoes is the best defense against infection with EEEV and other mosquito - borne viruses (120)(121).

Western Equine encephalitis

The western equine encephalitis (WEE) was first isolated in California in 1930 from the brain of a horse with encephalitis, and remains an important cause of encephalitis in horses and humans in North America, but most cases have been reported from the plains regions of the western and central United States since 1964 and in Canada (122). The main mosquito is transmission is *Cx. tarsalis*, and WEE virus are still present over a widespread

geographic range, has a complex life cycle involving birds and *Culex tarsalis* mosquito. *Cx tarsalis* is a mosquito that often found on the West Coast of the United States and that prefers warm, moist environments. Other mosquitoes eg, *Aedes* species and, occasionally, small, wild mammals also have been known to spread the virus (123).

Infection can cause a range of illnesses, from no symptoms to fatal disease. People with mild often have only a headache or sometimes have a fever. People with more severe WEE can have sudden high fever, headache, drowsiness, irritability, nausea, and vomiting, followed by confusion, weakness, and coma. Young infants often have seizures symptom (124).

Nowadays, a vaccine is available for horses but not for humans (125). While there is no specific treatment for WEE, prevention involves controlling mosquitoes and avoiding mosquito bites (124).

Venezuelan equine encephalitis

Venezuelan equine encephalitis (VEE) virus was first identified in horses in 1935 after outbreaks in Columbia, Venezuela and Trinidad, and isolated in 1938 (126)(127)(128). The outbreaks usually occur after a season of heavy rains, due to increases in the mosquito population (72) (129)(126)(130). In the 1960's and 1995 some outbreak were occurred Colombia and in Venezuela and Mexico. The epizootic and enzootic strains of the VEE virus range from northern Argentina to Florida and parts of the Rocky Mountains; however, it is most prevalent in northern South America (126) (127).

The VEE virus is typically spread by mosquitoes, although certain types of ticks and mites can spread the virus as well. The *Culex (Melanoconion)* mosquito is normally responsible for the dispersal of the enzootic strain of the VEE virus (126)(128), and transmission by *Ochlerotatus taeniorhynchus*, *Psorophora confinnis*, *Psorophora columbiae*, *Ochleratus sollicitans*, *Mansonia titillans* and *Anophilis aquasalis* are some of the species of mosquitoes known to carry the epizootic varieties of the VEE virus (126) (131)(130).

The most common symptoms are confusion, there is a sudden onset of flu - like symptoms including a severe headache, chills, fever, retro - orbital pain (pain behind the eyes), congestion, nausea and vomiting. In severe case the virus invades the central nervous system leading to encephalitis disorientation, convulsions, paralysis and coma. Adults are relatively resistant to the disease with <10% dying, but 20-30% of children

affected may die (International Classification of Disease Codes for Venezuelan Equine Encephalitis, 1999) (132).

There is no specific drug for treatment of VEEV infection. Currently, there is a vaccine available for both humans and horses. The live attenuated vaccine known as TC-83 is a strain of VEEV that was pass 83 times in guinea pig heart cells (126)(133).

2.3. Family Bunyaviridae

2.3.1. Classification

Formally, the family *Bunyaviridae* was established in 1975 and now contains four genera of animal-infecting viruses are Orthobunyavirus, Phlebovirus, Nairovirus, and Hantavirus genera and one genus of plant-infecting viruses is Tospovirus (134) (135). The *Bunyaviridae* family of segmented negative strand RNA viruses (136). The family includes a number of significant human pathogens such as La Crosse virus (LACV), Hantaan virus (HTNV), Sin Nombre virus (SNV), Rift Valley fever virus (RVFV), and Crimean - Congo hemorrhagic fever virus (CCHFV) (137)(138) (139).

Several members of the *Bunyaviridae* family also transmitted by mosquitoes, such as the Rift Valley fever virus and the California encephalitis virus, while in the others, such as the Crimean - Congo hemorrhagic fever (CCHF) virus, they are transmitted by ticks. Several of these viruses are the agents of viral haemorrhagic fevers.

2.3.2. Genome structure

According to the International Committee on Taxonomy of Virus, the Bunyavirus genome is monomeric and consists of three segments. These segments are labeled large (L), medium (M) and small (S) RNA segment (140). These RNA segments are single - stranded, and exist in a helical formation within the virion. On the other hand, they exhibit a pseudo - circular structure due to each segment's complementary ends. The L segment is 6300 - 12000 nucleotides long and encodes the viral RNA polymerase. Dependent RNA - polymerase, necessary for viral RNA replication and mRNA synthesis. The M segment is 3500 - 6000 nucleotides long and encodes two glycoproteins as a single gene product that is usually co - translationally cleaved. The L and M segment are negative sense. The S

segment is 1000 - 2200 nucleotides long and encodes the nucleocapsid protein. Total genome size is around from 10500 - 22700 nucleotides long. For the Genera of *Phlebovirus* and *Tospovirus*, the S segment is ambisense, that are some of the genes on the RNA strand are negative sense and others are positive sense. The S segment codes for the viral nucleoprotein in the negative sense and a nonstructural protein in ambisense. The terminal sequences of each segment are base paired. Because of the RNAs form non-covalently closed circles (141).

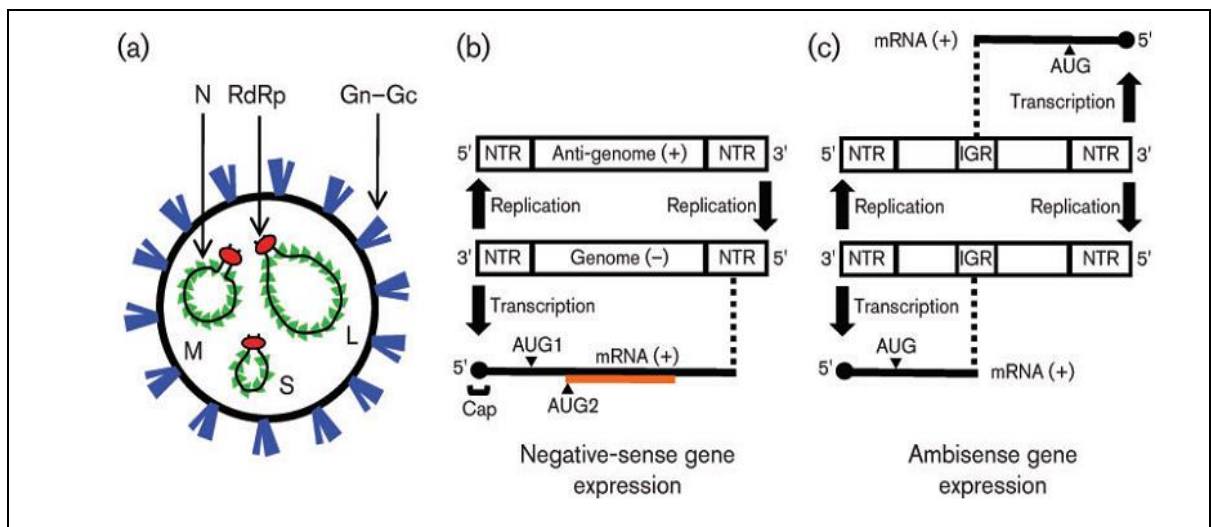

Figure 13: Schematic representation of a generic bunyavirus virion, and negative-sense or ambisense gene expression strategies (142).

Each Bunyavirus genome segment directs two RNA synthetic activities: the first is transcription of a single mRNA, and second is replication to generate an antigenome which acts as an intermediate for synthesis of further genomic strands. The nucleotide sequences at the 3'- terminus and the 5'- terminus are complimentary, forming panhandle structures. The 5'- terminus is not capped (143)(144)(145).

2.3.3. Bunyaviridae replication cycle

Replication begins with the attachment of viral proteins to host receptors and entry of virus by endocytosis. In the cell surfaces, viral proteins are used to bind to receptors. They are transit through the endoplasmic reticulum (ER), and Golgi apparatus, mature

virions bud from the Golgi apparatus into vesicles which are transported to the cell surface, while Bunyavirus RNA replicates in the cytoplasm via RNA and dependent RNA polymerase, transcription occurs in the cytoplasm of the cell rather than in the nucleus. As a result, it is hypothesized that caps are stolen from mRNAs that are derived from host messages within the cytoplasm. Secondary transcription, three mRNA species are transcribed from the three segments, which occurs after replication, increases the amount of L, S and M mRNA segments. Most of the segments found in the cell due to secondary transcription are S. The least amount of segments was M, with an intermediate amount of L segments formed. The L and S segments of the genome translated by free ribosomes. M segments translated by membrane bound ribosomes. The L, S, and M segments are responsible for different structural and non-structural proteins. The viral progeny assembled within the Golgi apparatus of the cell. All of the viruses given glycoproteins and undergo terminal glycolysation. In addition, the viral progeny adopt pieces of host membrane to form the envelope (146).

2.3.4. Vector

The *Bunyaviridae* are a large group of viruses that infect a diversity of arthropod vectors and animal hosts, virus is transmission through mosquito, ticks, sandflies and midgus (Chin J, 2000; Plyusnin, 2011) (147) (148) (149).

Mosquitoes

Ae. Triseriatus and Ae. Trivittatus

Ae. Triseriatus is commonly called the tree holes mosquito, or eastern tree holes mosquito, is a species of mosquito found in the western hemisphere in wooded regions of eastern and central North America. It is quite prevalent, ranging from New Brunswick to the Florida Keys and stretching as far west as central Texas (150) (151). Female *Ae. triseriatus* only mate once, and sperm are transferred into a structure known as the spermathecae. The female mosquito lays her eggs slightly above the water level, if water is present in the hole. Females require a blood by biting human for each batch of eggs produced, and can produce eggs throughout their lives (152) (153)(154). *Ae. triseriatus* has been identified as a vector of Eastern Equine Encephalitis and linked to the spread of La Crosse Encephalitis (155)(156).

Ae. Trivittatus is the inland floodwater mosquito has been recorded in Canada from Ontario (157) and Nova Scotia (158). In 1971, the female mosquito was take in North - East of Pinawa, larvae was found in floodwater pool in meadows, swamps, and woodlands. *Ae. trivittatus* is the most widely distributed in the United States, it occurs Southern Canada and generally over the Eastern half of the United States and as far west as Montana and Colorado (159). To most people who encounter *Ae. trivittatus*, the bite is much more painful and irritating than other mosquitoes encountered. *Ae. trivittatus* are persistent aggressive biters often attacking the human in a swarm - like manner (160).

Ticks

Ixodid (hard) ticks, especially those of the genus, are both a reservoir and a vector for the Bunyavirus virus. Numerous wild and domestic animals, such as cattle, goats, sheep and hares, serve as amplifying hosts for the virus. Transmission to humans occurs through contact with infected animal blood or ticks, virus can be transmitted from one infected human to another by contact with infectious blood or body fluids (Tick-borne bunyavirus fever). *I uriae* are thought to replicate in the arthropod vector and be transmitted to the vertebrate host (seabird) when the ticks feed on susceptible hosts. The virus then replicates in the seabird producing viraemia, infecting more ticks will also feed human. (161) (162)(163).

2.3.5. Main disease

La Crosse encephalitis

La Crosse encephalitis (LAC) was discovered in La Crosse, Wisconsin in 1963. Since then, the virus has been identified in several Midwestern and Mid - Atlantic states. In 1964, LAC reported in US and India (164). Different mosquitoes can carry the virus including *Aedes*, *Culex*, and *Culiseta* but common in nature is virus vertical transmission by *Ae. trivittatus* mosquitoes (149).

Although the vast majority of cases are not serious, LAC can cause severe illness, especially in children under age 16 (165). Similar to SLE virus, LAC virus does not cause disease in horses (166).

Many people infected with LACV have no apparent symptoms. Among people who become ill, initial symptoms include fever, headache, nausea, vomiting, and tiredness.

Some of those who become ill develop severe neuroinvasive disease (disease that affects the nervous system). Severe LACV disease often involves encephalitis (an inflammation of the brain) and can include seizures, coma, and paralysis. Severe disease occurs most often in children under the age of 16. In rare cases, long - term disability or death can result from LAC. There is no specific treatment for LACV infection - care is based on symptoms (167). The best way to reduce your risk of infection with LACV or other mosquito - borne viruses is to prevent mosquito bites (168).

Reoviruses

Reoviruses, which also called orthoreoviruses to avoid confusion with the family Reoviridae. In 1959, Sabin proposed the name reovirus to reflect the fact that viruses of this group had been isolated from the respiratory and enteric tracts and was orphan (reo) viruses without known associated disease. According from Intestinal Health Center for Poultry, Reovirus was first isolated from chickens in the 1950s. In human orthoreovirus was isolated in 1953, Reovirus infections occur frequently, but most are mild or subclinical. The role of these viruses in human disease is not clear, but they are not consider important agents of human disease, however, during the last two decades, few cases of human disease have been report. These viruses also have been evaluate extensively in studies involving laboratory animals (35).

No specific treatment or prevention measures have recommended for reovirus infections in humans because of the lack of definitive association with disease.

Colorado tick fever

Colorado tick fever (CTF) virus, also known as Mountain tick fever or American mountain fever, is a viral disease caused by infection with the CTF virus. CTF is transmitte to humans most commonly by the bite of an infected adult wood tick, *Dermacentor andersoni*, CTF occurs primarily in the Rocky Mountain region of the western United States as well as the Canadian provinces of British Columbia and Alberta, in 1930. More than 90% of all CTF cases in the United States are reported from Colorado, Utah and Montana (169) .

The initial symptoms of the disease often include fever, chills, headache, muscular, skeletal pain, and malaise. Other symptoms may include nausea, vomiting, stomach pain, light sensitivity and sore throat. In rare cases, patients experience illnesses of the central nervous system (CNS) ranging from mild to encephalitis with coma and death. CNS

illnesses commonly characterized by severe headache, sensory impairment, neck stiffness and light sensitivity.

No specific treatment for CTF is available. Management of CTF includes treatment of fever and pain with analgesics and acetaminophen, along with standard infection control procedures. Patients infected with CTF should advise blood collection agencies of their illness prior to donation, due to the risk of transmitting CTF through blood transfusion (57).

3. Flavivirus and Dengue

3.1. Classification

Dengue fever is caused by five closely related virus serotypes of the genus *Flavivirus*, family *Flaviviridae*; however, the differences between each serotype are sufficient to prevent epidemics of multiple serotypes (DENV1, 2, 3, 4, 5). *Flaviviridae* have single-stranded RNA of 9.6 - 12.3 kilobase in length with positive polarity that are monopartite and linear and a methylated nucleotide cap on the 5' end. The virus particles have spherical envelopes of about 40-60 nm in diameter (170). As with other viruses, the evidence for strain differences among DENVs was first detected serologically using antibodies made by inoculating laboratory animals (171). Later, nucleic acid sequencing allowed for the classification of DENV into genetically distinct groups or genotypes within each serotype (172). Various phylogenetic analyses based on complete E nucleotide or partial E/NS1 (173)(174) indicated that DENV-1 are grouped in four genotypes: 1) genotype 1, representing strains from Southeast Asia, China, and East Africa; 2) genotype 2, representing strains from Thailand collected in the 1950s and 1960s; 3) genotype 3, representing sylvatic strains collected in Malaysia; 4) genotype 4, representing strains from the West Pacific islands and Australia, and representing all strains collected in the Americas, West Africa and Asia (175)(176).

Second, in DENV - 2, based on E nucleotide sequences of phylogenetic analysis, DENV - 2 comprises five genotypes: 1) the Asia genotype included are genotype 1 representing strains from Vietnam, Thailand, Malaysia, Cambodia, and genotype 2 representing strains from Vietnam, China, Taiwan, Sri Lanka and the Philippines; 2) the cosmopolitan genotype, representing strains in Australia, East and West Africa, the Pacific

and India ocean islands, the Indian Subcontinent and Middle East; 3) the American geotype is presenting strains from Latin American and older strain from Caribbean, the India subcontinent and Pacific Islands in the 1950s and 1960s; 4) the Southeast Asia and America genotype, representing strains from Thailand, Cambodia and Vietnam and strains collected in the Americas over last 30 years; and 5) the sylvatic genotype, representing strains collected from humans, mosquitoes in forest or sentinel monkey in West Africa and Southeast Asia (177).

Isolated DENV-3 based on prM/E nucleotide and then complete genome sequences (178) in to four genotypes are 1) genotype 1 is presenting from Indonesia, Malaysia, Philippines and recent isolates from South Pacific Islands; 2) genotype 2, from Vietnam, Cambodia, Thailand and Bangladesh; 3) genotype 3, from India, Sri Lanka, Africa and Samoa, however, the complete genome phylogenetic analysis within this genotype includes the 1962 strains from Thailand (179); and 4) Genotype 4, from Puerto Rico, Latin and Central America. Sylvatic strains of DENV-3 are believed to exist in Malaysia based on the seroconversion of sentinel monkeys (176).

DENV- 4 strains exhibited greater sequence conservation than the other DENV serotypes (92%) and 96 -100% conservation in E protein amino acids. Currently, DENV-4 phylogenies complete E gene sequences delineate four genotypes base on the E gene or complete genome sequence (180)(181) (182)(183)(184) are: 1) genotype 1, representing strains from Thailand, Cambodia, the Philippines, Sri Lanka, and Japan; 2) genotype 2, from Indonesia, Malaysia, Tahiti, the Caribbean and the Americas; 3) genotype 3, representing recently sampled Thailand strains, that are distinct from other Thailand strains (181); and 4) genotype 4 representing the sylvatic strains of DENV - 4 from Malaysia.

The fifth and latest addition to the existing serotypes of dengue viruses is DENV - 5 which has been announced in Thailand, October, 2013 (185), is sylvatic strains. Phylogenetic evaluation revealed that DENV - 5 is genetically similar to other four serotypes, thereby hinting to a common ancestral origin (186).

3.2. Genetic evolution

In DENV, genetic variability most obviously manifest in the existence of four (or five) antigenically distinct serotypes. The introduction of comparative gene sequence

analysis, it has been possible to dissect the genetic structure of DENV populations and to reveal the processes governing viral evolution (81)(187)(188).

3.3. Vectors

3.1.1 *Aedes aegypti* and *Aedes albopictus*

The various serotype of the dengue virus transmitted to human through the bites of infected *Aedes* mosquitoes. The principal vector of DENV is the *Ae. aegypti* mosquito, an anthropophilic species that has adapted extremely well to the urban environment and is found both indoors and outdoors in close proximity to human dwelling and can complete their whole cycle life here, they prefer to feed during the day (189). *Ae. aegypti* is an efficient vector of DENV because of its preference for laying its eggs in artificial, rather natural container, biting human, and remaining indoors, where it has access to its favorite host (190).

The Asian tiger mosquito, *Ae. albopictus* is a secondary of DENV in SEA, the Western Pacific, and increasing in Central and South America (76), the *Ae. albopictus* mosquito appears to be following the same adaptation pattern as *Ae. aegypti* in becoming an increasing urban species. Compared to *Ae. aegypti*, which is the most important vector of Dengue, *Ae. albopictus* is a less competent vector of arboviruses, and the epidemics it causes are milder. However, *Ae. albopictus* is becoming an increasingly important vector because of its rapidly changing global distribution (191). Before 1979, *Ae. albopictus* was found only in Asia and in the Western Pacific, but it has spread to much of the rest of the world in recent decades (76), spreading through the United States in 198 (192)(193)(194). A mutation increasing the fitness in *Ae. albopictus* was identified for another mosquito-borne virus, the Chikungunya virus, during an epidemic on La Réunion in 2005; a virus strain with the same mutation also caused an outbreak in north-eastern Italy (195) (191) and recently in Caribbean (196)(197)(198).

3.1.2 Transmission cycle

Sylvatic DENV cycle

DENV exist in two separate cycles in nature, circulating in either non-human primates or humans. The endemic in humans today most likely evolved from non - human primate dengue viruses a few hundred years ago and have since established themselves as four distinct serotypes in human populations, causing periodic epidemics and severe disease (199) and principle on *Aedes spp.* as vector. The ancestral forms of DENV are believed to be viruses that circulate in forest habitats, presumably among nonhuman primates (173). There DENV sylvatic cycle have been demonstrated in Asia, where serological evidence as well as virus isolation suggest transmission of sylvatic strains of DEN-1, DEN-2, DEN-4 among Macaca and Presbytis monkeys vectored by *Aedes niveus* ((200)(201). The Sylvatic DEN-2 in West Africa shown to circulate regularly between *Erythrocebus* monkeys and various sylvatic *Aedes spp.*, such as *Ae. taylori*, *Ae. fuscifer*, *Ae. vitattus* and *Ae. luteocephalus* (202) Rodhain, 1991 (203) and was isolated from 5 humans in Eastern Senegal (Saluzzo et al., 1986; Zeller et al., 1992)(204) (205). All sylvatic isolates are generally distinct from all endemic isolates and are isolated evolutionarily (172)(206)(207).

Endemic/epidemic DENV cycles

Endemic / epidemic DENV circulated in both a sylvatic (enzootic) cycle involving non - human primates with various species of *Aedes* mosquitoes including *Ae. fuscifer*, *Ae. luteocephalus* and *Ae. taylori*, in a human cycle principally vectored by *Ae. aegypti* and *Ae. albopictus* (208) (209). The efficiency of the endemic cycle is now completely independent both evolutionarily and ecologically from the ancestral, sylvatic cycles (210). Time estimates for evolution of the endemic/ epidemic forms ranged from 100 to 1,500 years ago.

When a female *Aedes* bites a human for food, she injects saliva into wound where the anti - coagulants contained in her saliva facilitate feeding. The adult mosquitoes prefer to feed on human daylight hours (211), they prefer to stay indoors, do not travel great distance by themselves less than 200 meters. The peak of biting activity: early morning for 2-3 hours after daybreak and in the afternoon for several hours before dark (190). Female mosquitoes have habit disrupting the feeding process at the slightest movement and tend to

feed multiple times, she can feed on several person during a single blood meal and may transmission DENV to multiple person in a short time (212). After a person has bitten by an infective mosquito, the virus suffer an incubation average period of 4 - 7 days (or maybe 3 to 14 days), after which the person onset of fever accompanied by a variety of nonspecific signs and symptoms and DENV may circulate in the peripheral blood for as long as 10 days. If other *Ae. aegypti* mosquitoes bite the patient during this febrile viraemic stage, those mosquitoes may become infected and subsequently transmit the virus to other uninfected persons, after an extrinsic incubation period of 4 to 12 days (213)(214).

Maintenance of DENV and vertical transmission of DENV in mosquitoes

Several factors can influence the dynamic of virus transmission, including environmental and climate factors, host - pathogen interactions and population immunological factor. In the most countries, dengue displays a seasonal pattern related to temperature and rainfall (215). Climate directly influences the biology of the vectors and thereby their abundance and distribution, this has rise the question of how the virus overwinters, or persist during dry and cold seasons. One possibility is that a population of infected mosquitoes could survive throughout the interim and introduce the virus during the next season. *Aedes* mosquitoes remain DENV infected and the longest lifespan recorded to date is 174 days, although a more typical survival rete is 1 - 2 weeks (72) (216). A second possibility is passge of the virus the next generation of the mosquitoes via survival in an infected egg. Vertical transmission (transovarial transmission) has been demonstrated in the laboratory and in the wild (217). The significance of vertical transmission for maintenance of the virus is not well understood (218) (219). Some evidence shows that *Ae. albopictus* mosquitoes are more efficient at vertical transmission than *Ae. aegypti*, which would make them a candidate for maintaining DENV during interepidemic period (220). Thus, vertical transmission of DENV in mosquitoes is possible, where or not the mechanism is truly transovarial or mediated by infection of the mature egg at the time of oviposition (72)(216). Several research show that the asymptomatic case of dengue may be is silent transmission in humans by the reduced number of vectors maintains DENV circulation between epidemic season (221) (222)(223).

3.4. Dengue epidemiology

3.4.1. History and origin of Dengue

The origins of the word dengue are not clear, but one theory is that it is derived from the Swahili phrase "Ka-dinga pepo", meaning "cramp-like seizure caused by an evil spirit". The Swahili word "dinga" may possibly have its origin in the Spanish word "dengue" meaning fastidious or careful, which would describe the gait of a person suffering the bone pain of dengue fever. The earliest known clinical descriptions of a dengue like illness are from Chinese encyclopedias written during the Chin Dynasty. [Common Era (CE) 265– 420 AD], Tang Dynasty (CE 610) and Northern Sung Dynasty (CE 992) (190). These reports described a disease called "water poison" caused by its association with water - associated with flying insects. The next report of a similar appearance almost seven centuries later, describing an acute illness with prolonged convalescence in the French West Indies and Panama during 1635 and 1699 respectively (173). A century later, 1779 - 1788 the first reports of a possible dengue pandemic were described in Batavia (nowadays is Jakarta) (224), Cairo (225), Philadelphia (174), and Cadiz and Seville, Spain (225).

The viral etiology and the transmission by mosquitoes deciphered in the 20th century. The role of *Ae. aegypti* in transmission of dengue was confirmed in 1926 by the extensive and well - controlled experiments of Siler (226), followed by the incrimination of *Ae. albopictus* in 1931 (227). In 1943, the scientists of Japan isolated dengue serotype 1 in Nagasaki, it is Mochizuki strain as well as other DENV-1 strain from affected patients in Japan (228). Then, Sabin isolated both DENV-1 (Hawaii strain) and DENV- 2 (New Guinea C strain) from US Soldiers in 1944 (229) (230). The first well documented outbreak of dengue haemorrhagic fever took place in Manila in 1953/1954 (231), and was followed by a larger outbreak in Bangkok in 1958 (232). The viruses isolated from patients during the 1956 in Philippines epidemic were members of the DENV-3 (H87 strain) and DENV-4 (H241 strain) (232). Since that time, DHF/DSS have become endemic in all countries in Southeast Asia with dramatic increase in case number and DENV considered an 'emerging' disease. At the same time the geographic range of DHF/DSS has expanded considerably, and since 1950s, the incidence of DHF/DSS has increased over 30 fold (219) (3). Nowadays, dengue spread to more than 140 countries in

Asia, the Pacific, the Americas, Africa, and the Caribbean. Estimated that there are 390 million dengue infections per year, of which 96 million manifest apparently with any level of disease severity by using cartographic approaches (6).

Until now, it is not clear where dengue originated from region. Gaunt et al, 2001 suggested an African origin, principally because many of the most divergent mosquitoes - born flaviviruses circulate exclusively in Africa and often infect primates, implying that DENV has an origin in Africa. To go further, *Ae. aegypti* is believed to have originated in Africa, although this species is only likely to have been adopted as a vector for human transmission in the relatively recent past. Conversely, ecological and phylogenetic evidence argues for an Asian origin of Dengue (233)(234) (235)(236) (210) (237)(238).

3.4.2. Global burden

Dengue is the most rapidly spreading mosquito - borne viral disease in the world. In the last 50 years, incidence has increased 30 fold with increasing geographic expansion to new countries and, in the present decade, from urban to rural settings in tropical and subtropical countries in Southeast Asia, the Pacific, the Americas, Africa, European and the Caribbean. (Figure 14)

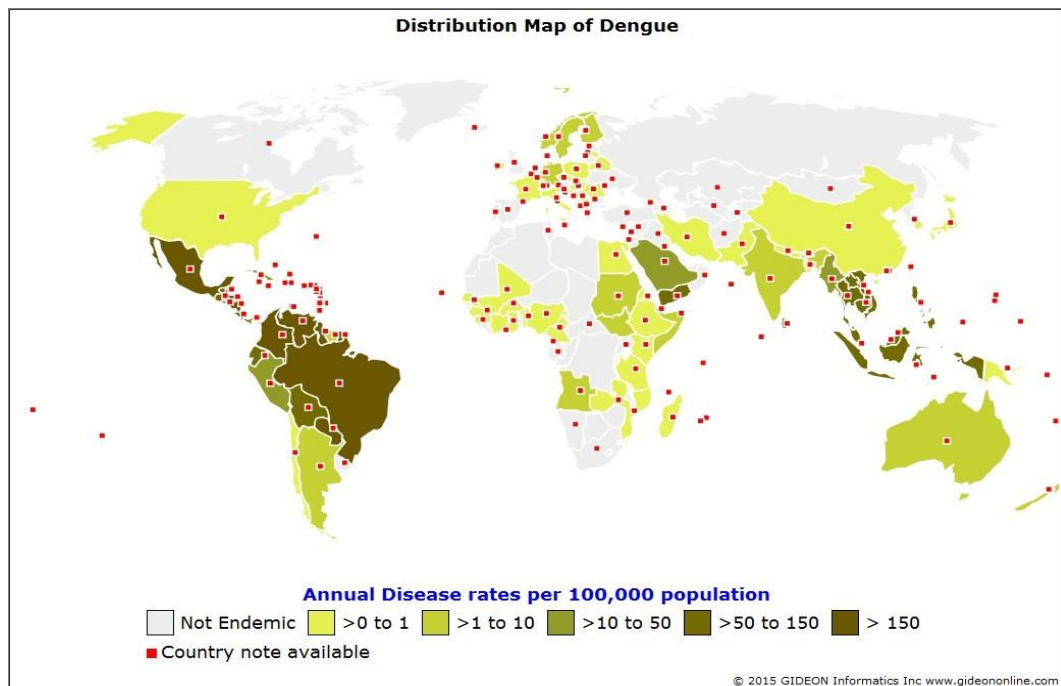

Figure 14: Endemic or potentially endemic to 144 countries of Dengue transmission, 2015 (23)

Worldwide, approximately 2.5 billion people live in dengue endemic countries and annually, an estimated 50 million dengue infections occur, up to 500,000 case of the life-threatening dengue DHF/DSS, mainly among children, with the case fatality rate exceeding 5% in some area (219) (239). The average number of DF/DHF cases reported to the WHO has increased dramatically (240). For the period 2000 - 2004, the annual average was 923,896 cases, almost double the figure of 429,848 cases that reported for the period 1990 - 1999. Cases across the Americas, South-east Asia and Western Pacific have exceeded 1.2 million cases in 2008 and over 2.2 million in 2010 (based on official data submitted by Member States). Recently the number of reported cases has continued to increase (240). (See figure 15).

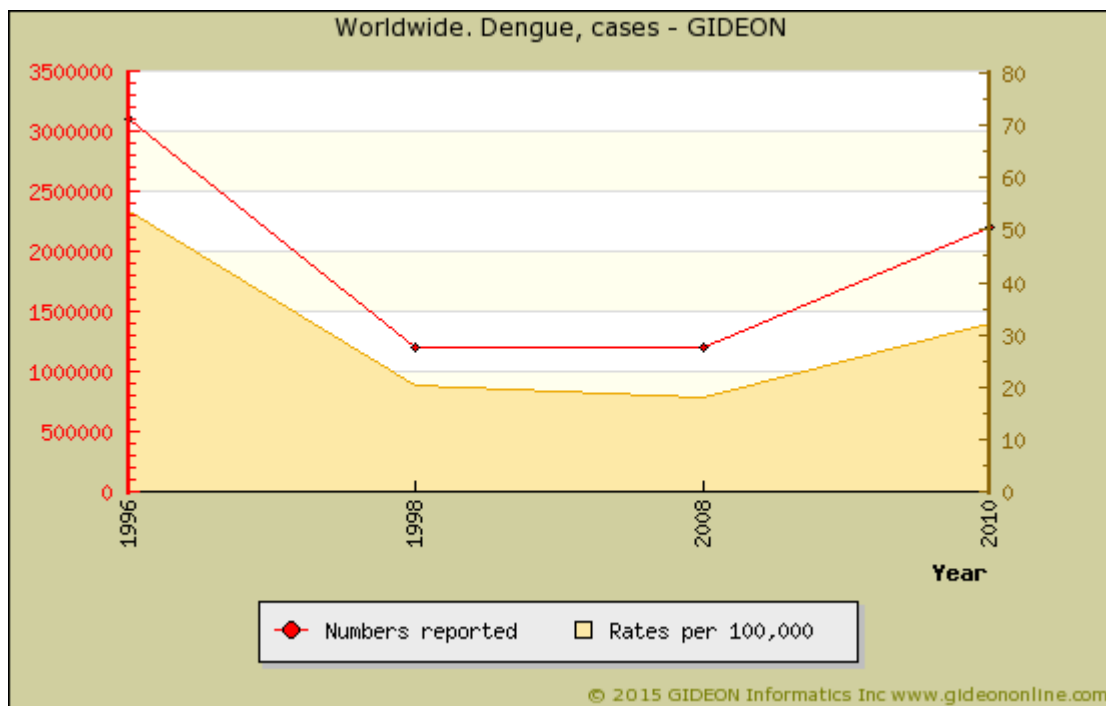

Figure 15: Worldwide. Dengue, cases.

In 2010, 1.6 million cases of dengue were reported in the Americas alone, of which 49 000 cases were severe dengue (241).

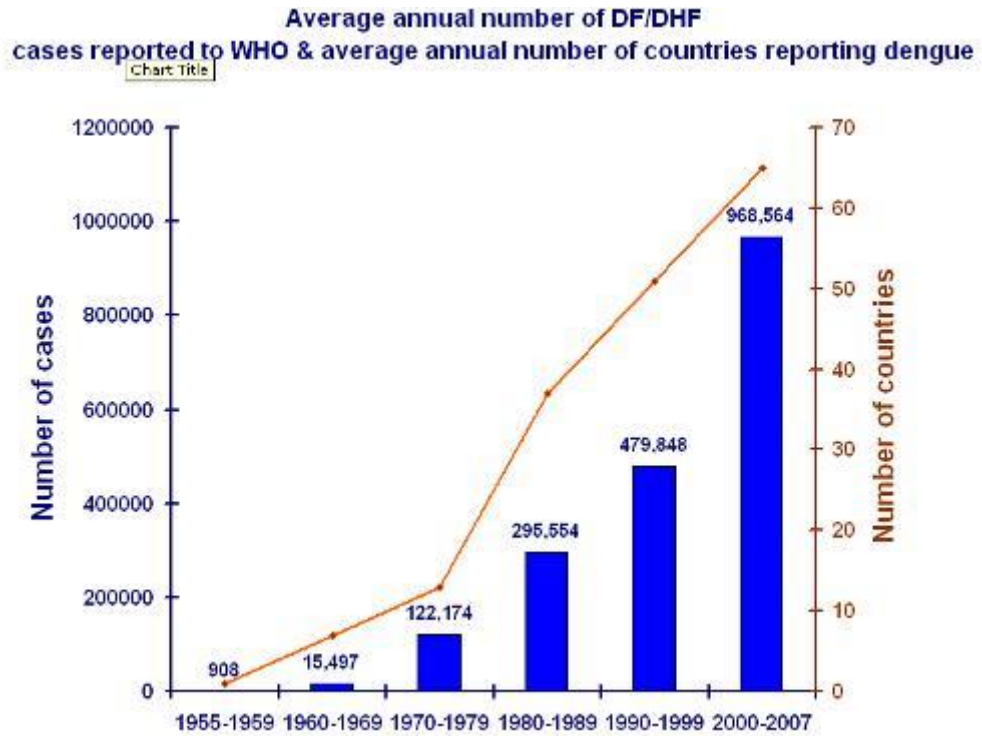

Figure 16: Average annual number of DF/DHF case reported to WHO, and average of countries reporting dengue, 1955-2007 (218) (3) .

Before 1970, only nine countries had experienced severe dengue epidemics. In 2001, a record 69 countries reported dengue activity to WHO (1). The disease is now endemic in countries of Africa, the Americas, the Eastern Mediterranean, South East Asia and the Western Pacific. South East Asia and the Western Pacific regions are the most seriously affected (241).

A



B

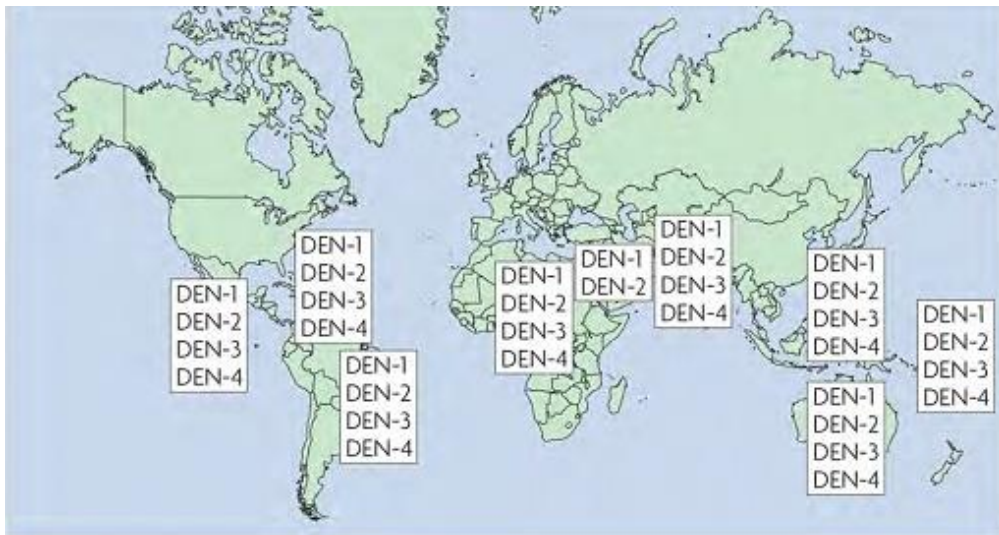

Figure 17: The change in distribution of dengue serotype. The figure shows the distribution in 1970 (A) and 2004(B) (240).

All four DENV serotypes are now circulating in Asia, Africa and the Americas, a dramatically different scenario from that which prevailed 20 - 30 years ago (Figure 17), only DENV 5 was in Thailand. By the 1980s, the American region was experiencing major epidemics of dengue in countries that have been free of the disease for 35 to 130 years (190). New DENV strains and serotypes were introduced: DENV-1 in 1977, a new strain of DENV-2 in 1981, DENV-4 in 1981, and a new strain of DENV-3 in 1994. Moreover, many countries of the region evolved from nonendemicity or hypodemicity (one

serotype present) to hyperendemicity (multiple serotype present), and epidemic DHF emerged, much as it had in Southeast Asia 25 years earlier (190).

Epidemiology trend in several regions of the world

Epidemiology trend in the Pacific region

Dengue has been described in the Pacific region for over 100 years (242). Over the past three decades, dengue fever has affected more and more countries in Pacific region (65) (243). In the World War II, dengue virus was introduced throughout Southeast Asia and Pacific Islands, Japan (244). During the 1990s, more than 1 million cases of dengue reported in weastern Pacific region. The Philippines, Malaysia, Cook Islands, French Polynesia, New Guinea, and Australia (72) (190) all reported cases early in the decade. In 1998 and 1999, there were 356,554 and 64,066 case of DF/ DHF with 1470 and 112 deaths (245). Dengue virus continues to circulate throughout the Pacific region and incidence of DHF may increase despite many of the inlands'geographic isolation, due to the ease international travel and global communities'desire for access to tropical settings.

A

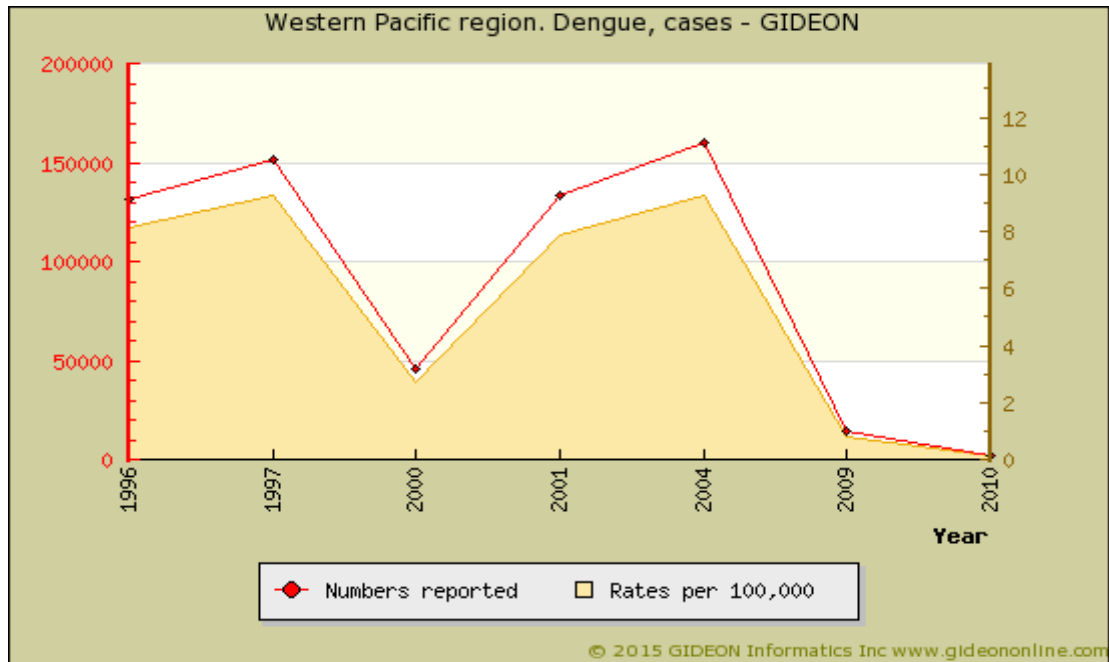

B

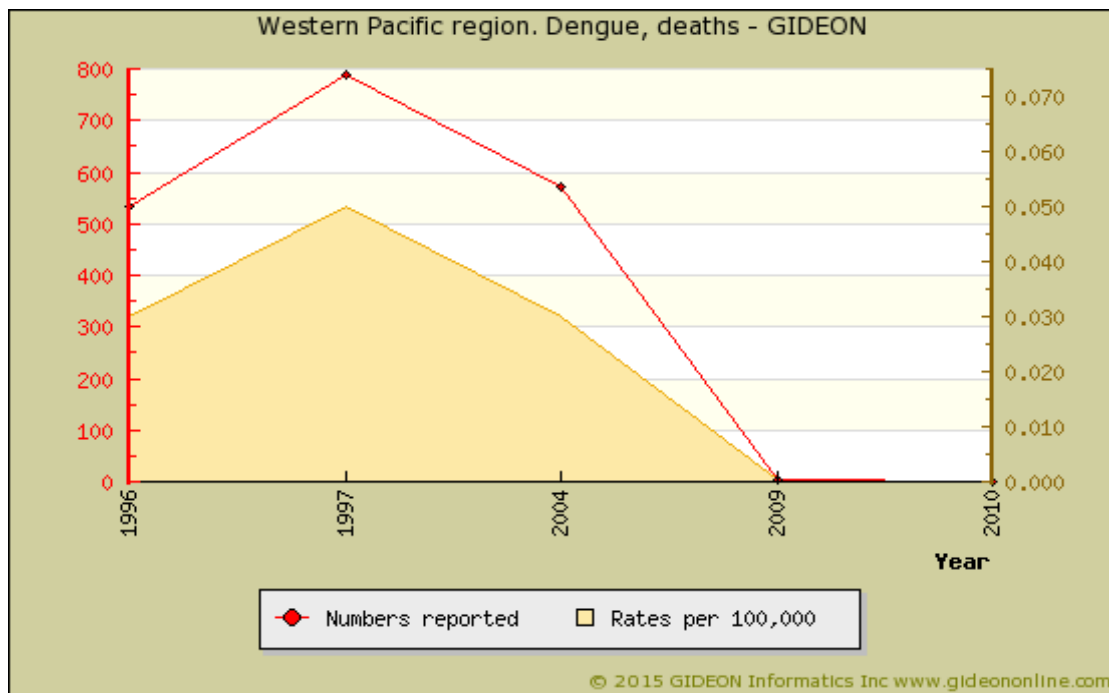
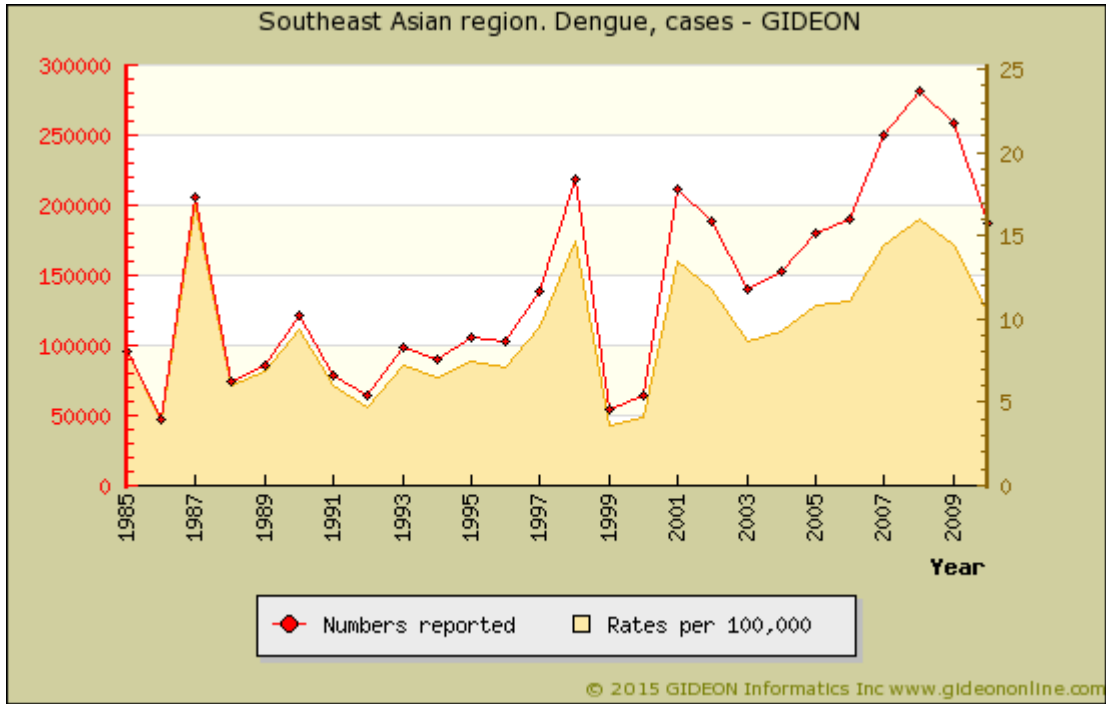

Figure 18: Western Pacific region. Dengue cases (A), deaths (B).

Epidemiology trend in Southeast Asia

Dengue haemorrhagic fever (DHF), a potentially lethal complication of dengue fever, first recognized in the 1950s during dengue epidemics in the Philippines and Thailand. Today DHF affects most Asian countries and has become a leading cause of hospitalization and death among children in the region. In 1998, worldwide dengue epidemics accounted for 1.3 million cases of DF and DHF with 3442 deaths and Southeast Asia reported 218,859 dengue cases and 2075 deaths (65). Since 2000, epidemic dengue has spread to new areas and has increased in the already affected areas of the region. The main reason is by the rapid demographic increase, migration, anarchic urbanization, transportation, etc. The endemic transmission cycle of Dengue in SEA differs from that American and characterized by transmission activity all year around with peak during rainy season. Although all five serotypes are now found in circulation in Asia and four serotypes in Americas, the severe form of dengue is more than 17 fold higher in Asia. The most affected are group is between 5 to 9 years. However, in Singapore and Thailand, adult are affected with moderate clinical symptoms. Between 2001 and 2008, 1020333 cases were reported in Cambodia, Philippines, Vietnam and Malaysia with the high numbers of deaths (246) (3)

A



B

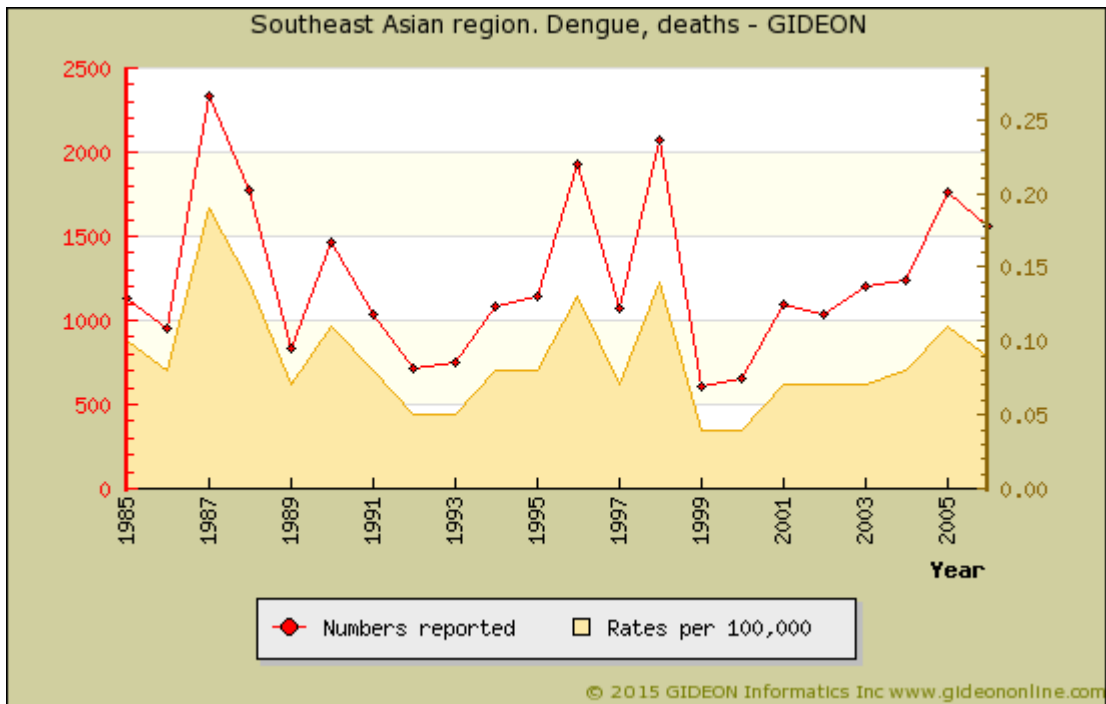
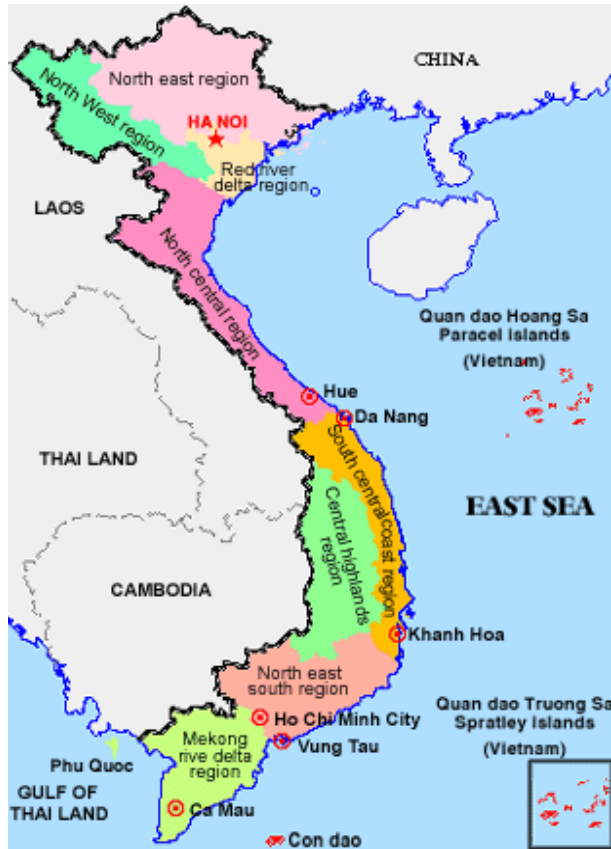

Figure 19: Southeast Asian region. Dengue, cases (A) deaths (B).

Vietnam



<http://www.unicef.org/infobycountry/vietnam.html>

Vietnam is located in South-Eastern Asia, bordering the Gulf of Thailand, Gulf of Tonkin, and South China Sea, China, Laos, and Cambodia. The climate is tropical in south; monsoonal in north with 4 seasons are spring, summer, autumn and winter. The environment: Slash-and-burn agricultural practices contribute to deforestation and soil degradation. Water pollution and over fishing threaten marine life. Groundwater contamination limits potable water supply. Growing industrialization (and population migration) is rapidly in Hanoi and Ho Chi Minh City. The population growth rate is estimated 1.077% and the age structure is 25.2% 0-14 years; 69.3% 15-64 years; 5.5% 65 years and over. The Vietnamese population estimated 93.386.630 as of July 1, 2015 (247).

Figure 20: Vietnam map.

In Viet Nam, historical evidence suggests that outbreaks of dengue with four fatal case occurred during 1895 to 1909. Dengue was the first recorded case occurring in 1959 in the North (Ha noi and Hai phong), and first reported in 1960 in the South (approximately 50 fatal cases of DHF reported from Cai Be). Since then, dengue has become an endemics, the rate of morbidity per 100,000 populations has been increasing steadily from 32 in the year 2000 to 120 in 2009, with 105,370 cases reported in the whole country. In the southern regional morbidity is as high as 214.5 cases per 100,000

populations. July and October are peak months of dengue activity. In 2009, over 70% of all dengue cases and 85% of all deaths due to dengue in this period occurred in the southern provinces, 80% of all dengue deaths occurred in children under the age of 15 years (248).

Distribution of DF/DHF in Viet nam in 2009

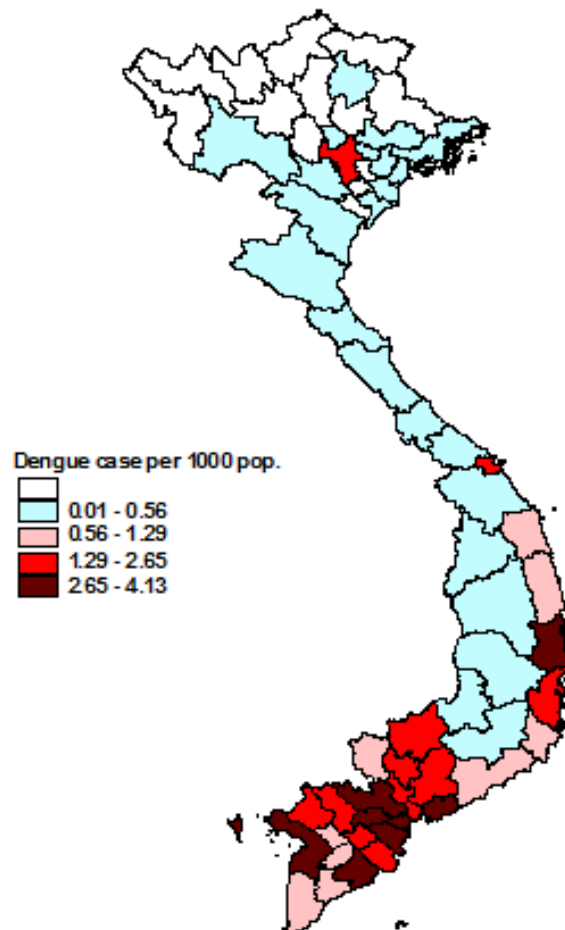
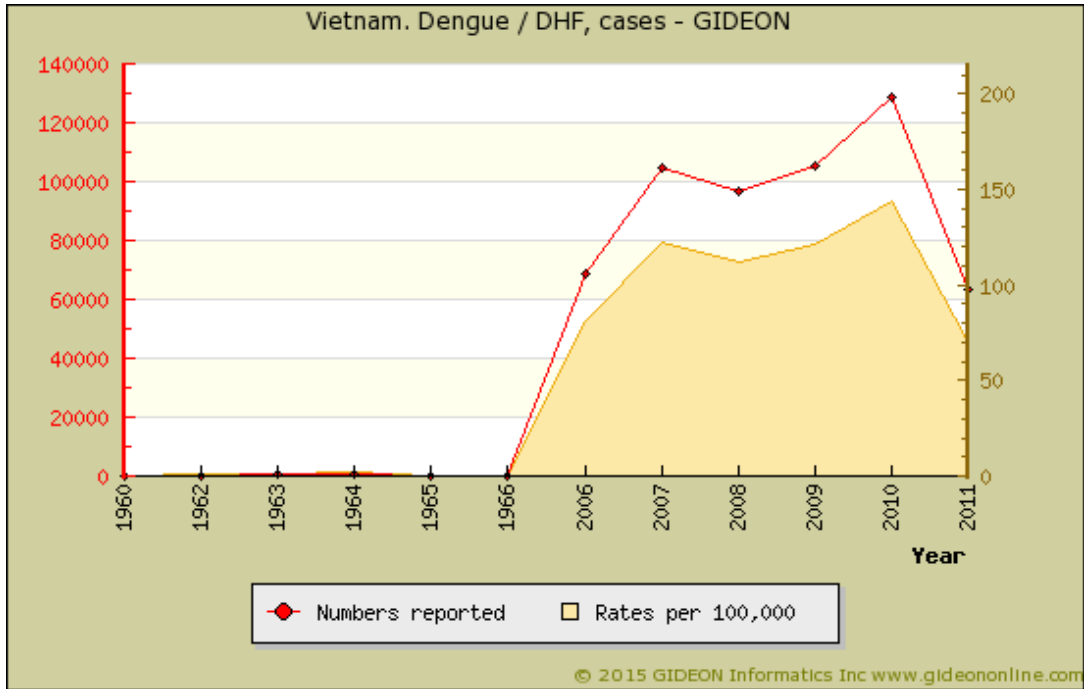

Figure 21: Distribution of DF/DHF in Vietnam in 2009.

From 1 Jan - 19 Jun 2011, Vietnam reported 18 432 cases with 15 deaths, CFR 0.08%, 13 898 cases with 17 deaths in 2010 for the same period. High activity reported in the southern areas of Vietnam. During 5 months from Jan - May 2011, of the 15 634 cases with 12 deaths, 13 999 cases with 11 deaths occurred in the 20 provinces of southern of Vietnam (248). Up to November 2011, Vietnam was reported outbreaks occur with 49,011 cases, 46 fatal. Outbreaks to September in 2012 were reported 51,000 cases, 42 fatal, in 2013 outbreaks to August reported 25, 300 cases, 16 fatal (249).

A



B

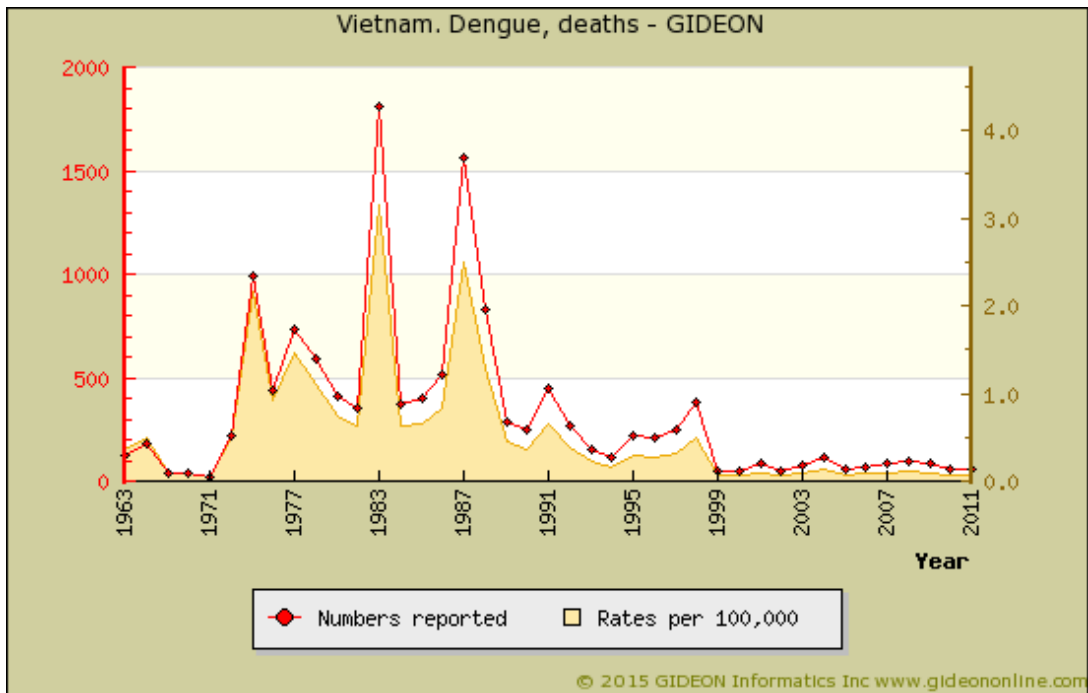

Figure 22: Vietnam. Dengue / DHF, cases (A) and death (B)

Despite the existence of a National dengue control Program since 1998, dengue remains a major health problem in Vietnam. Over the past 15 years, the number of DENV cases has been increasing.

Epidemiology trend Europe, Mediterranean, and the Middle East

Between 1784 and 1788, in Cadiz and Seville, Spain, dengue was described in clinical illnesses. Disease occurred throughout the 1980s in the Middle East regions of the Suez in 1824, the Arabian coast in 1835, in Yemen from 1870 - 1873, and in Israel 1889 - 1990 (250). From 1927 - 1928, an extensive dengue outbreak occurred in Greece with more than one million case (251) (252) Retrospective serology investigations clearly implicate DENV-1 and possibly DENV-2 as causative agents (253) (254).

Every year, numerous dengue cases are imported by travelers and expatriates, almost infection are acquired in the hyperendemic areas of Latin America and Southeast Asia (255). In 2008, 116 cases were reported, mostly in European travelers, 43% had travelled to Europe from South East Asia, 14% from Latin America, 12 % from the Indian subcontinent, 11 % from the Caribbean and 4% from Africa, reflecting worldwide dengue activity and travel preferences (256). Recently, first autochthonic DENV infections have been describe in France (257) and in Croatia (258).

In 2009 and the first half of 2010, outbreaks of Dengue fever and haemorrhagic fever were reported from Saudi Arabia, Sudan and Yemen. So far outbreaks concentrated in the cities and urban areas along the Red Sea and Arabian Sea coasts and Pakistan (259).

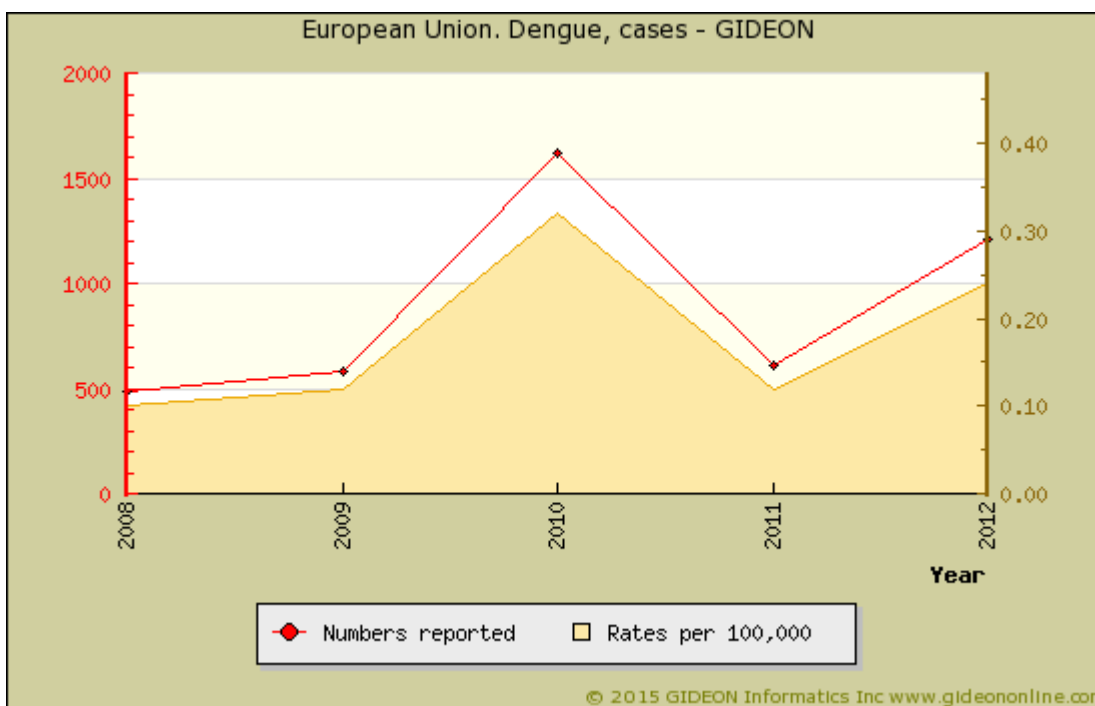
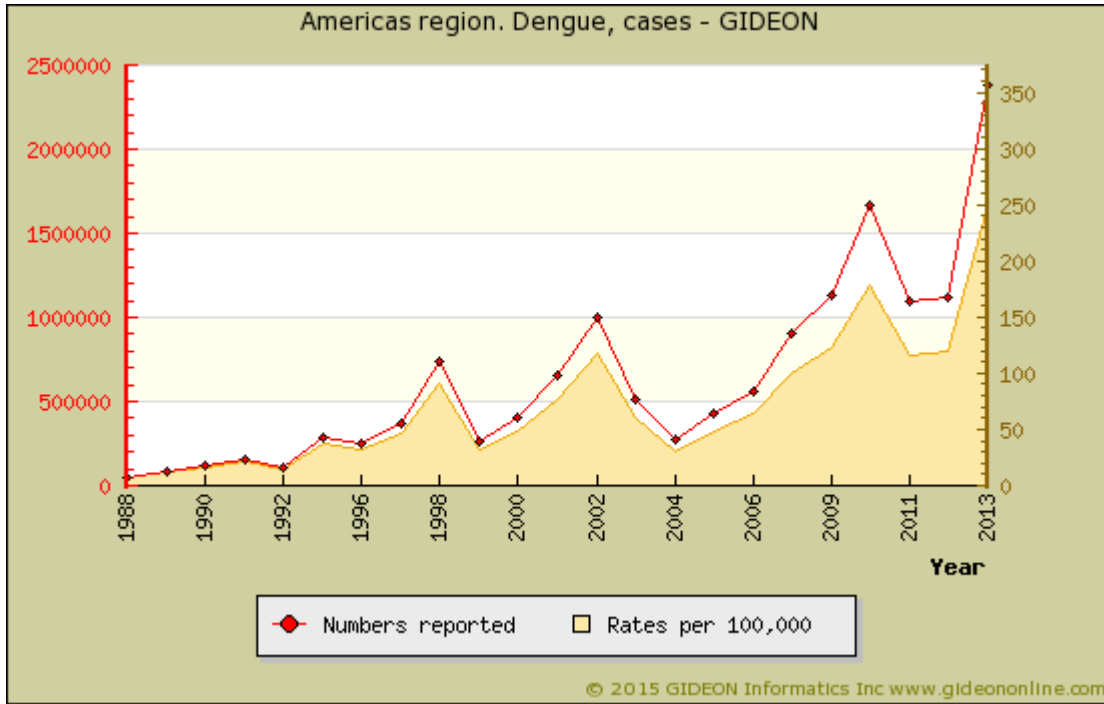

Figure 23: European Union, Dengue cases

Epidemiology trend in the Americas

Mainly during the 1960s and early 1970s in American, dengue epidemics was characterized by the circulation of single serotype at any given time within a region. From 1977 - 1978 in Cuba occurred major epidemic of dengue fever caused by the DENV-1 serotype. This trend was changed following the introduction of Southeast Asia strain of DENV-2 into Cuba, probably from Vietnam in 1981 (260) (261), followed by an increase in the severity, during Cuban epidemic in 1981 (262) (263), 98% - 99% of the case infections. In 1989, an epidemic of DHF occurred in Venezuela, followed by a epidemic in Cuba in 1997 and both epidemic caused by the DENV-2 serotype (264). In 2007, according to Emerging and Reemerging Infectious Diseases Region of the Americas, in the period from 2001 - 2006 have 3,419,999 cases of dengue were reported in Americas, including 79,664 cases of dengue hemorrhagic and 982 deaths, with a case fatality rate of 1.2%, and the circulation of all four serotypes (DENV1, 2, 3, 4) which increase the risk for the appearance of the most serious forms of the disease (265)(266).

A



B

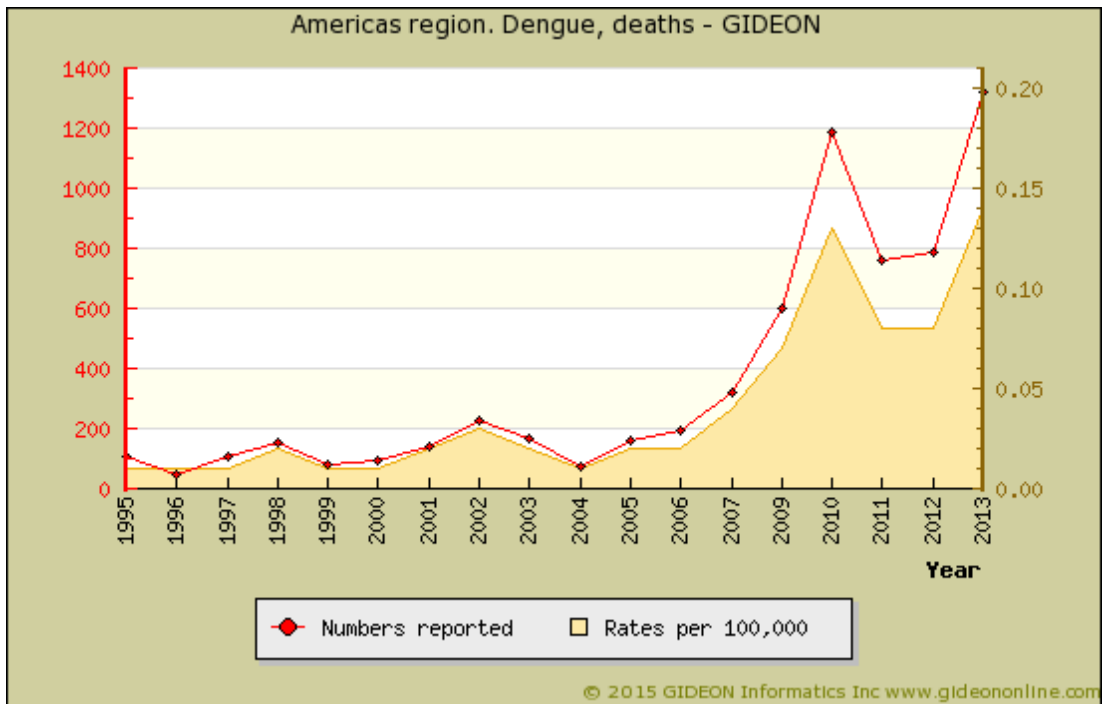

Figure 24: Americas region. DHF, cases (A) and deaths (B).

Epidemiology trend in Africa

Although the history of dengue in Africa is poorly documented, it is known that dengue has been on the continent since the start of the 20th century. During the surveillance program started in 1964, DENV - 1 and DENV- 2 were isolated at the Virus Research Laboratory at the University of Ibadan, Nigeria. DENV-1, DENV-2, are outbreaks in Comoros in various years in 1948, 1984, and 1993 (267). In 1983, the first evidence of autochthonous DENV - 4 transmission in Senegal was detected (268), and DENV - 3 transmission was identified in Mozambique in 1984 (269) (270)(271).

Despite poor surveillance for dengue in Africa, it is clear that epidemic dengue fever caused by all four dengue serotypes has increased dramatically since 1980, with most epidemics occurring in eastern Africa, and smaller extent in western Africa, though this situation may be changing in 2008 (218).

3.5. Diagnosis

Dengue has a wide spectrum of clinical presentations, often unpredictable clinical evolution and outcome (3). In clinical spectrum ranges from unapparent, may be mild febrile illness, non - severe to severe and fatal haemorrhagic diseases or vascular shock. Following WHO "Dengue Guideline for Diagnosis, Treatment, prevention and Control publish", in 2009 while most patients recover following a self limiting non severe clinical course, estimated 1% proportion progress to severe disease, mostly characterized by plasma leakage with or without haemorrhagic.

3.5.1. Classification in clinical

In 1999, according to the WHO guideline dengue manifest in three forms are DF, DHF and undifferentiated fever, with plasma leakage that may lead to hypovolemic shock, DSS. This classification was repeatedly evaluated and could mistakenly classify dengue cases because it was often found inappropriate for clinical management of dengue (272). In 2008, a WHO expert group was organized and proposed a new classification range based on dengue disease entity which manifest in a broad spectrum of symptoms and often with unpredictable evolution and outcome. The important of this classification is early

recognition and understanding of the clinical problem during the different phases of the disease, leading to a rational to case management and a good clinical outcome. In 2009, a new classification of dengue proposed by WHO Tropical Disease Research (TDR) was classified dengue into dengue, dengue with warning signs (DW) and severe dengue (SD). For practical reasons, the group of non - severe dengue divided in two subgroups: patients with warning signs and those without (see figure 25).

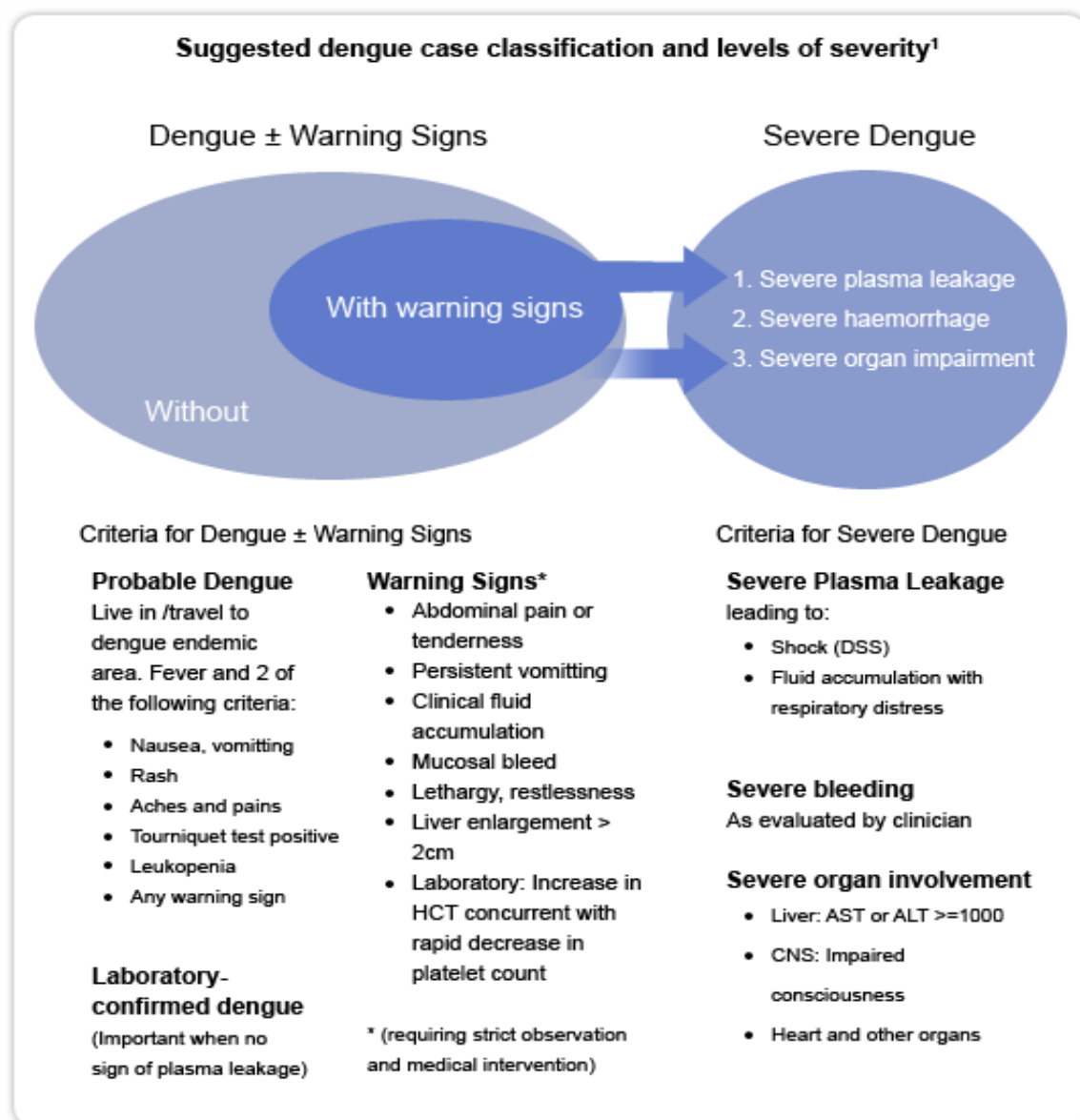

Figure 25: Dengue case classification and levels of severity (219)

Current WHO classification is recommended for continuing use because the newly suggested TDR classification creates about 2 times the work - load to health care

personnel. More than 90% of DHF defined by WHO case definition are dengue confirmed. However, current WHO classification needs to be modified for more simple and friendly use. The suggested modification is to address plasma leakage as the major criteria. Unusual dengue is proposed to be added to the current WHO classification to cover those patients who do not fit with the current WHO classification (273).

3.5.2. Disease course

Dengue infection is a systemic and dynamic disease. It has a wide clinical spectrum that includes severe, non - severe clinical manifestation. After the incubation period, the illness begins abruptly and followed by the three phases: febrile, critical, and recovery (3). (Figure 26).

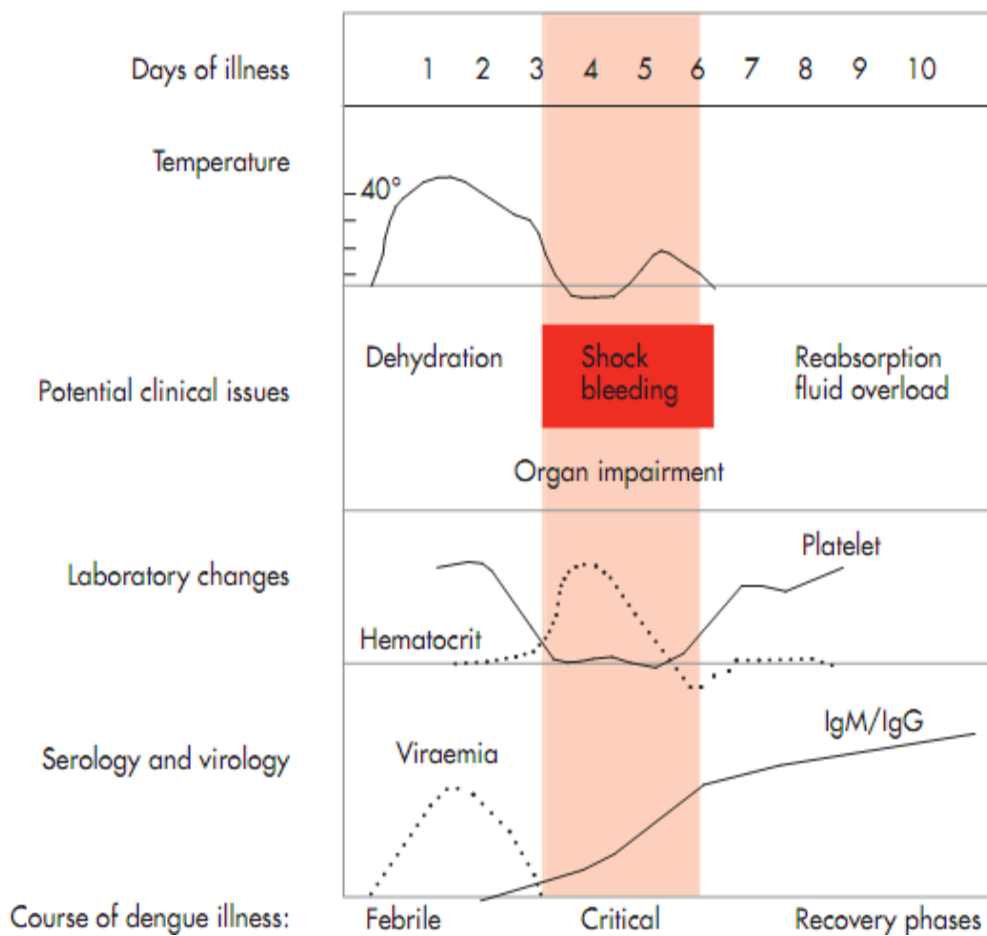

Figure 26: The Course of Dengue disease (WHO, 2009)

Febrile phase

Patients typically develop high-grade fever suddenly. This acute febrile phase usually lasts 2 - 7 days and is often accompanied by facial flushing, skin erythema, generalized body ache, myalgia, arthralgia and headache (274). Some patients may have sore throat, injected pharynx and conjunctival injection. Anorexia, nausea and vomiting are common. It can be difficult to distinguish dengue clinically from non-dengue febrile diseases in the early febrile phase. A positive tourniquet test in this phase increases the probability of dengue (275) (276). In addition, these clinical features are indistinguishable between severe and non severe dengue cases. Therefore monitoring for warning signs and other clinical parameters is crucial to recognizing progression to the critical phase.

Mild haemorrhagic manifestations like petechiae and mucosal membrane bleeding (e.g. nose and gums) may be seen (277) (276). Massive vaginal bleeding in women of childbearing age and gastrointestinal bleeding may occur during this phase but is not common (278). The liver is often enlarged and tender after a few days of fever (276). The earliest abnormality in the full blood count is a progressive decrease in total white cell count, which should alert the physician to a high probability of dengue.

Critical phase

Around the time of defervescence, usually on days 3 - 7 of illness, the temperature drops to 37.5 - 38⁰ C or less, an increase in capillary permeability in parallel with increasing haematocrit levels may occur (279) (280). This is the beginning of the critical phase. The period of clinically significant plasma leakage usually lasts 24 - 48 hours.

Progressive leukopenia followed by a rapid decrease in platelet count usually precedes plasma leakage (276). At this point patients without an increase in capillary permeability will improve, while those with increased capillary permeability may become worse as a result of lost plasma volume. The degree of plasma leakage varies. Pleural effusion and ascites may be clinically detectable depending on the degree of plasma leakage and the volume of fluid therapy. Hence, chest x-ray and abdominal ultrasound can be useful tools for diagnosis. The degree of increase above the baseline haematocrit often reflects the severity of plasma leakage.

Shock occurs when a critical volume of plasma is lost through leakage. It is often preceded by warning signs. The body temperature may be subnormal when shock occurs.

Recovery phase

In critical phase, if the patient can survive the 24 - 48 hours, a gradual reabsorption of extravascular compartment fluid takes place in the following 48 - 72 hours. General well being improves, appetite returns, gastrointestinal symptoms abate, haemodynamic status stabilizes and diuresis ensues. Some patients may have a rash of “isles of white in the sea of red” (281). May be some patient have experience generalized pruritus, bradycardia and electrocardiographic changes.

Due to the dilutional effect of reabsorbed fluid the haematocrit stabilizes or may be lower. White blood cell count usually starts to rise soon after defervescence but the recovery of platelet count is typically later than that of white blood cell count.

Severe dengue

Severe dengue is defined by one or more of the following this symptom: plasma leakage that may lead to shock (dengue shock) and/or fluid accumulation, with or without respiratory distress, and/or severe bleeding, and/or severe organ impairment.

The patient is considered to have shock if the pulse pressure (i.e. the difference between the systolic and diastolic pressures) is ≤ 20 mm Hg in children or has signs of poor capillary perfusion (cold extremities, delayed capillary refill, or rapid pulse rate).

Hypotension is usually associated with prolonged shock which is often complicated by major bleeding, severe organ impairment such as severe hepatitis, encephalitis or myocarditis, metabolic acidosis and disseminated intravascular coagulations, this in turn leads to severe haemorrhage causing the haemocrit to decrease in severe shock (3).

3.5.3. Laboratory diagnosis

Efficient and accurate diagnosis of dengue is of primary importance for clinical care. Laboratory diagnostic method has been developed to support patient management and disease control. The purpose of diagnosis method depends for choice of which the testing is done (i.e. surveillance activities, clinical trials, vaccine development, outbreak control, pathogenesis). Laboratory diagnosis methods for confirming dengue infection may involve detection of the virus, antigens or antibodies, viral nucleic acid, or a combination of these techniques. (Figure 27).

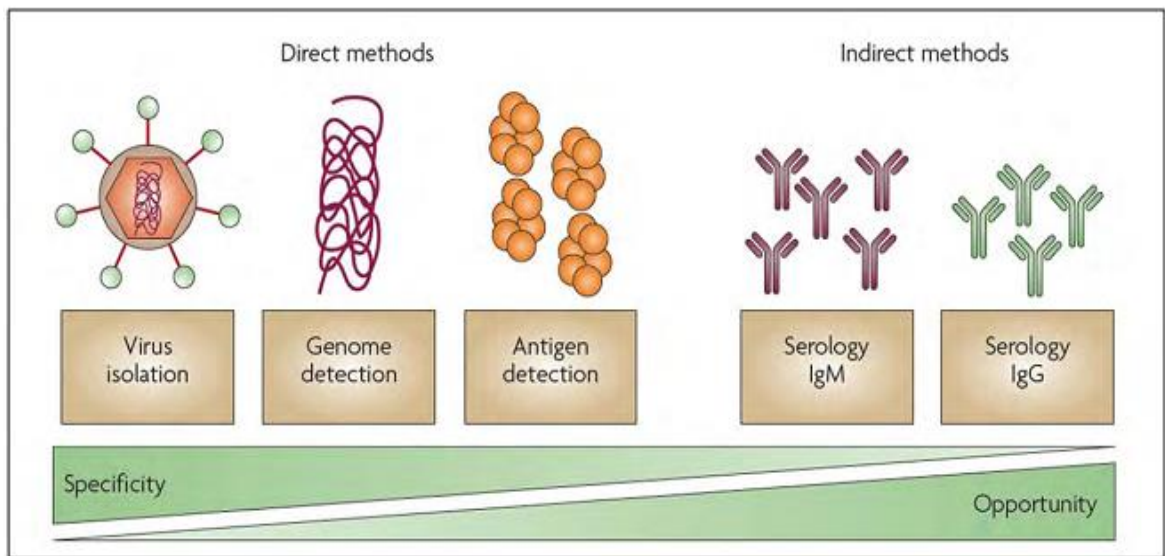

Figure 27: Comparison of diagnostic tests according to their accessibility and confidence (282).

Direct diagnosis methods

After the onset of illness, 4 - 5 days during the febrile period, dengue infection maybe diagnosed by virus isolation in cell culture, by detection of viral RNA by nucleic acid amplification tests, by detection of viral antigens by ELISA or rapid tests.

Virus detection

Dengue virus can be isolated by the inoculation of a clinical specimen such as serum, plasma or cerebro - spinal fluid, for virus isolation in cell culture, it is important to keep blood samples cooled or frozen to preserve the viability of the virus during transport from the patient to the laboratory. In the cell culture in to mosquitoes are using mosquito cell lines such as C6/36 colonized from *Aedes albopitus* or mammalian cell lines such as Vero and NHEK cells or intracerebral inoculation of suckling mice. For virus identification carried out the immunofluoresen assay using flavivirus group - reactive and serotype specific monoclonal antibodies (mAbs). The isolation and identification of dengue in cell cultures usually takes 1 - 2 weeks.

Viral antigen detection

Enzyme like linked immunosorbent assay (ELISA) and rapid immunochromographic assays that target NS1 protein have show that antigen can be detected in patients with dengue infection up to 9 days after the onset of illness. Many

studies investigated utility of NS1 detection as a diagnostic tool during acute phase of a dengue infection and showed a good sensitivity (63-94%), and excellent specificity (98.4-100%) (283)(284)(285). The rapid dengue antigen detection test can be used in field settings (i.e point of care diagnostic test) and provide results in less than one hour (286)(287)(288).

Viral RNA detection

Nucleic acid detection assays with excellent performance characteristics identify dengue RNA. Since the 1990s, several reverse transcriptase polymerase chain reaction (RT-PCR) assays have been developed. They offer better sensitivity compared to virus isolation with a much more rapid turnaround time. In situ RT-PCR offers the ability to detect dengue RNA in paraffin - embedded tissues. The utilize a nested RT-PCR assay, using universal dengue primers targeting the C/prM region of the genome for an initial reverse transcription and amplification step, followed by a nested PCR amplification that is serotype -specific.

Up to date, the real time RT - PCR assay is a one step assay system used to quantitative viral RNA and using prime pairs (289), and probes that are specific to each dengue serotype, use of a fluorescent probe enables the detection of the reaction products in real time.

These methods demonstrate a high specificity and sensitivity, it reduces the possibility of cross - contamination, allow the determination of viral load and gives result within 24h.

Indirect diagnosis methods

After 3 - 5 days onset of illness, Dengue and antigens disappear from the blood coincidentally immune host produces a primary response of antibody. Dengue infection in a non-previously immune host produces a primary response of antibodies characterized by a slow and low titer antibody response.

IgM ELISA

The IgM antibody - capture enzyme linked immunosorbent assay (MAC-ELISA) based on detecting IgM in serum using anti - human IgM that is bound to the solid phase. IgM detection is not useful for dengue serotype determination due to the cross - reactivity of the antibody observed even during primary infection, and is not specific in countries

with circulation of other flaviviruses as JEV or YFV in most case due to the presence of cross - reactive antigen shared by flaviviruses.

The detection of dengue - specific IgM is useful diagnostic and surveillance tool. The sensitivity and specificity of IgM based assay are strongly influenced by the quality of the antigen used is virus - infected cell culture supernatants or suckling mouse brain preparations (282) (290).

IgG ELISA

The IgG ELISA is used for the detection of recent or past dengue infections (if paired sera are collected within the correct time frame). This assay uses the same antigen E/M - specific capture (GAC) as the MAC - ELISA allows detection of IgG antibodies over a period of 10 months after the infection. IgG antibodies are life long as measured by E/M antigen coated in direct IgG ELISA. In general, IgG ELISA lacks of specificity within the flavivirus serocomplex groups. Following viral infections, newly produced antibodies are less avid than antibodies produced months or years after infection.

IgM/ IgG ratio

A dengue virus E/M protein - specific IgM/IgG ratio used to distinguish primary from secondary dengue virus infections. IgM capture and IgG capture ELISAs are the most common assays for this purpose. In some laboratories, dengue infection is defined as primary if the IgM/IgG OD ratio is greater than 1.2 (using patient's sera at 1/100 dilution) or 1.4 (using patient's sera at 1/20 dilutions). The infection is secondary if the ratio is less than 1.2 or 1.4. This algorithm also been adopted by some commercial vendors. However, ratios may vary between laboratories, thus indicating the need for better standardization of test performance (291)(292).

Western- Blot

Western blot is the most widely used technique for detecting specific proteins in complex samples like cell lysates, cell culture supernatants or body fluids. By offering a unique combination of specific immunodetection and size based separation, western blotting gives reliable, convenient, high - quality data, with a specific primary antibody. The relative amounts of the protein present in different samples, including: 1) Samples are prepared from tissues or cells that are homogenized in a buffer that protects the protein of interest from degradation; 2) The sample is separated using SDS-PAGE and then transferred to a nitrocellulose membrane for detection; 3) The membrane is incubated with

a generic protein (such as milk proteins) to bind to any remaining sticky places on the membrane. A primary antibody is then added to the solution which is able to bind to its specific protein; 4) A secondary antibody - enzyme conjugate, which recognizes the primary antibody is added to find locations where the primary antibody bound. Detect by enhanced chemiluminescent, the light is then detected by photographic film, and more recently by charge couple device (CCD) cameras which captures a digital image of the western blot.

3.5.4. Treatment and prevention

Treatment

At present, there is no specific treatment for dengue fever. For DHF, medical care by physicians and nurses experienced with the effects and progression of the complicating haemorrhagic fever can frequently save lives - decreasing mortality rates from more than 20% to less than 1%. Maintenance of the patient's circulating fluid volume is the central feature of DHF care. At present, the only method of controlling or preventing dengue virus transmission is to combat the vector mosquitoes (293).

Prevention

Preventing or reducing dengue virus transmission depends entirely on control of the mosquito vectors or interruption of human - vector contact. Activities to prevent transmission should target the main vector is *Ae. aegypti* and *Ae. albopictus* mosquito. Integrate vector management (IVM) is the strategic approach to vector control promoted by WHO, 1991. Defined as "a rational decision - making process for the optimal use of resources for vector control" five keys of IVM considers in the management process are: 1) The promotion development policies, establishment legislative controls for public health; and the empowerment of communities; 2) The collaboration within the health sector and with other sectors in the programme managers the control of vector-borne diseases; 3) An integrated approach to disease control of non - chemical and chemical vector control methods; and integration with other disease control measures; 4) Routine monitoring and evaluation based on adaptation of strategies and interventions to local vector ecology, epidemiology and resources, research; 5) IVM capacity building include infrastructure, financial and human.

Historically, efforts to control dengue vectors in the WHO Region of the Americas resulted in the elimination of *Aedes* populations from much of the neotropics by the 1970s. However, reintroduction followed, leading to the re - establishment of vector populations. Today, the main target of the most programmes is to reduce the densities of vector populations as much as possible and maintain them at low levels. Where feasible, efforts may also be made to reduce the longevity of adult mosquito by the use of insecticidal methods in order to lessen the risk of virus transmission.

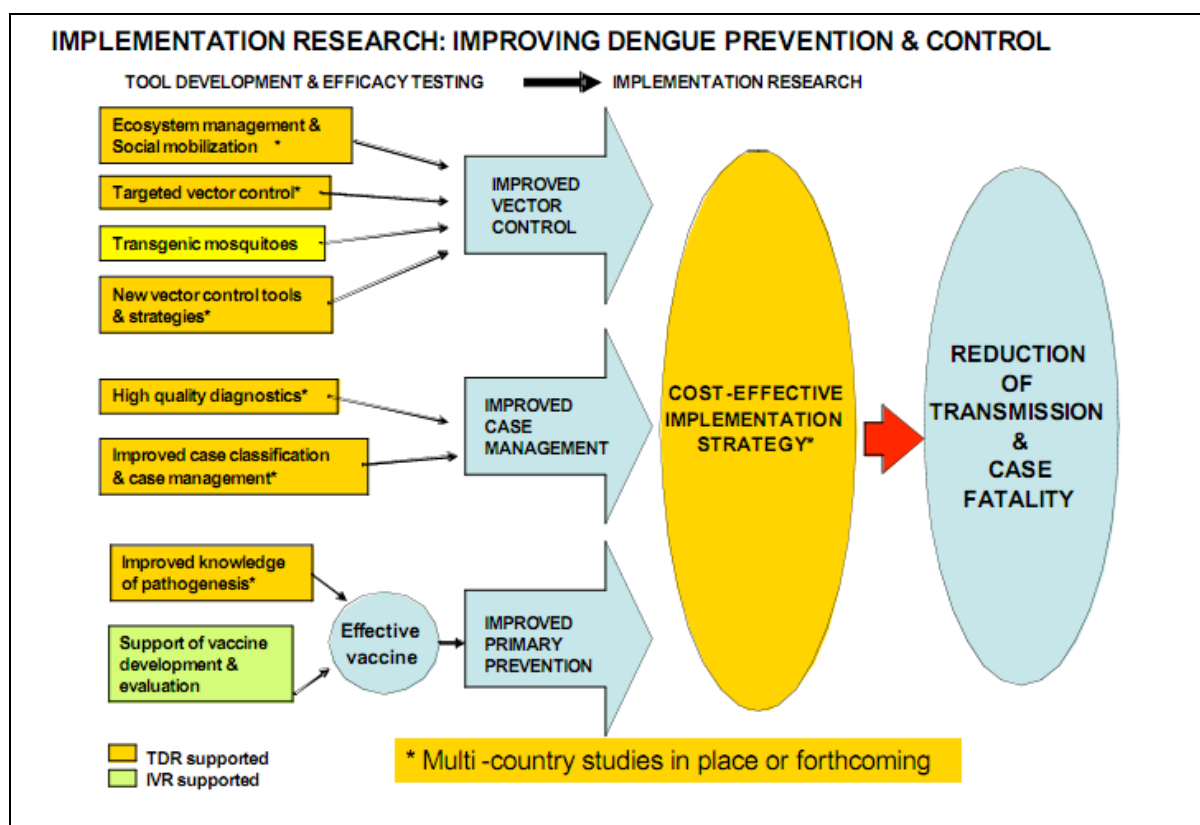

Figure 28: Dengue research and training supported and encouraged by the UNICEF-UNDP-World Bank-WHO. Special Programme for Research and Training in Tropical Diseases or the Initiative for Vaccine Research.

Vaccines

Because dengue virus is caused by five serologically related but distinct viruses, an effective dengue vaccine needs to induce a protective immune response against all four viruses simultaneously. Unlike other flaviviruses such as JEV, YFV and tick - born encephalitis virus, vaccine for dengue is no licensed exists. To the development of a

successful DENV vaccine is difficulties cause by reasons: 1) The need to develop a separate vaccine for each DENV serotype; 2) The risk of inducing enhanced disease upon subsequent natural infection if antibody to one or more serotype (294); 3) the lack of suitable animal model that reproduce human disease and can be used to evaluate candidate vaccines; and 4) is not fully understood about the lack of validated correlate of protection since the mechanism of protective immunity against DENV infection (3). Therefore, in the development of a dengue vaccine, an effective vaccine must induce long lasting and protective immunity against all four DENV serotypes (295). Despite these many above mentioned challenges, DENV vaccine development have made great strides in recent decades.

Nowadays, the clinical evaluation of candidate vaccines for dengue has several unique aspects, some of which related to the obstacles. The candidate vaccines that have been most extensively evaluated and are most advanced in development are live attenuated DENV vaccines from Sanofi Pasteur. The tetravalent dengue vaccine (TV) candidate utilizes the YFV (17) backbone with DENV prM and E genes from each DENV type replacing those of YFV. Pre - clinical studies demonstrated genetic and phenotypic stability, no hepatotropism, less neurovirulence than YF 17D, and failure to infect orally fed mosquitoes (296)(297)(298).

Table 2: Summarize of current dengue vaccines (299) (300).

Institution/commercial partner	Vaccine Approach	Development stage	Reference
Carolina Vaccine Institute	Viral replication: Venezuelan equine encephalitis virus replicon expressing DENV E prot.	Pre-clinical: successful monovalent DENV3Es-VRP. Tetravalent planned.	(White et al., 2007)
GenPhar Inc.	Viral replication: non-replicating adenovirus-5 construct with prM and E DENV proteins	Pre-clinical: bivalent candidate (CAcVax-Den1,2 + CAcVax-Den3,4)	(Holman et al., 2007; Raja et al., 2007)
Pedro Kouri Tropical Medicine Institute, Havana, Cuba	Recombinant: Fusion EDIII of DENV-1 and DENV-2 into P64K protein of <i>N. meningitidis</i>	Pre-clinical: monovalent DENV-1 or DENV-2 + Freund's adjuvant.	(Bernardo et al., 2008)
WRAIR/GSK	Inactivated: Purified inactivated virus (PIV) produced in VERO cells inactivated by formalin	Pre-clinical; Phase 1: planning.	(Eckels and Putnak, 2003)
Inviragen Inc.	Replicating: DENV-DENV chimeria (DENV-2 PDK-53backbone; DENVax)	Pre-clinical; Phase 1: Tetravalent phase 1 Studies planned (U.S. and Columbia).	(Huang et al., 2003; Osorio et al., 2011)
Hawaii Biotech /Merck & Co.	Recombinant: Truncated recombinant E protein (DEN-80E) expressed in <i>Drosophila</i> S2	Phase 1: DENV-1 monovalent trial completed; Tetravalent phase 1 planned.	(Clements et al., 2010)
U.S. National Institutes of Health	Replicating: Recombinant live attenuated; Directed mutagenesis and DENV-DENV chimeras (DENV-4 backbone; TetraVax-DV)	Phase 1: 15 phase 1 studies of monovalent Vaccines completed; one tetravalent phase 1 study completed.	(Durbin et al., 2001; Durbin et al., 2006)
Naval Medical Research Center	DNA: prM and E DENV 1, CMV promoter (D1ME-VRP)	Phase 1: DENV-1 phase 1 completed; future testing unsure.	(Beckett et al., 2011)
WRAIR/GSK	Replicating: Live attenuated virus (LAV) (PDK passage)	Phase 2: Completed in U.S., Puerto Rico, Thailand, further Development in question (manufacturing complexities)	(Simasathien et al., 2008)
Sanofi Pasteur	Replicating: Chimera Yellow fever 17D-DENV (CYD)	Completing phase 2b. Phase 3: in Australia 2010, program expansion expected.	(Guy, 2009; Guy et al., 2011)

*Note: WRAI is Walter Reed Army Institute of Reseache
GSK is GlaxoSmith- Kline*

3.5.5. DHF immunopathogenesis

3.5.5.1. Dengue pathogenesis

The understood about mechanisms leading to the severe manifestation of DENV infections are still not completely clear, however they are likely to be multifactorial (5), because no other animals develop symptoms of disease, and research, therefore, has been

limited to studies involving patients (301). The genetic back ground of the human host or other underlying diseases have been hypothesized to increase disease pathogenesis (302)(303)(304). Upon inoculation of DENV in the dermis, Langerhans cells and keratinocytes will primarily be infected. DENV subsequently spreads via the blood (primary viraemia) and infects tissue macrophages in few organs, especially the macrophages in the spleen. The replication efficiency of DENV in dendritic cells, monocytes, and macrophages (305)(306), as well as its tropism for and replication efficiency in endothelial cell, bone marrow stromal cells and liver cells, collectively determine the viral load measured in blood. This viral load represents an important risk factor for development of severe disease. Infected cells die predominantly through apoptosis and to lesser extent through necrosis. Necrosis results in release of toxic products, which activate the coagulation and fibrinolytic systems. Depending on the extent of infection of bone marrow stromal cells and the levels of IL-6, IL-10, and IL-18, haematopoiesis is suppressed, resulting in thrombocytopenia. Platelets interact closely with endothelial cells, and a normal number of functioning platelets is necessary to maintain vascular stability. A high viral load in blood and possibly viral tropism for endothelial cells, severe thrombocytopenia, and platelet dysfunction may result increased capillary fragility, clinically manifested as bleeding symptoms which is characteristic of DHF (307). The infection stimulates development of specific antibody and cellular immune response to DENV at the same time. When IgM antibodies that cross-react with endothelial cells, platelets, and plasmin are produced, resulting in increased vascular permeability and coagulopathy is amplified. Beside, enhancing IgG antibodies bind heterologous virus during secondary infection and enhance infection of antigen presenting cells (APCs) and thereby contribute to the increased viral load that is seen during secondary viraemia in some patients. Furthermore, a high viral load over stimulates both low and high activity cross - reactive T cells. In the context of certain HLA haplotypes, cross - reactive T cells produce high levels of proinflammatory cytokines and other mediators. Ultimately, these high levels of soluble factors, many of which still remain to be identified, induce changes in endothelial cells leading to the coagulopathy and plasma leakage characteristic of Dengue shock syndrome.

3.5.5.2 Dengue risk factor

DENV tropism

Animal models of DENV disease have been very difficult to develop because of the virus's specificity for infection and replication in certain human cells. Cell and tissue tropism of DENV may have a major impact on the outcome of DENV infections. In vitro data and autopsy studies suggest that three organ systems play an important role in the pathogenesis of DHF/ DSS: 1) the cell of immune system such as immature Langerhans cells, keratinocytes in epidermis and dermis (308), and in Lymph nodes such as monocytes and macrophages; 2) the liver (hepatocytes and Kupffer cells) resulting in viral induced apoptosis and necrosis (5) and 3) endothelial cell specifically the microvessel in dermal papillae (309). The tropism of DENV for cells of these systems and the corresponding pathological effects of DENV infection of these systems contribute to the pathogenesis of DHF.

Virulence

According to the virus virulence hypothesis, certain DENV strains are responsible for more severe disease. DENV serotypes can be further classified into different genotypes on the basis of nucleotide variations. Viral genetic differences have been associated with differences in virulence (310) (311)(312) (313).

The most important evidence of DENV virulence was observed in the Americas during the first outbreak of DHF occurred in 1981 after the introduction of the possibly more virulent DENV-2 Southeast Asian genotype, as the original American genotype already present was only associated with DF (314) (315). Although DHF occurs more frequently in secondary infection than in primary infection, however DHF also occurs in primary. This suggests that virulence of virus strains may contribute to the development of DHF (316)(311) (317). A study of Tuiskunen et al., 2011a showed that DENV isolation from patient with different degrees of severity could be characterized phenotypically and genetically in cell culture and in BALB/c mice (318) (107) (317). The result revealed that a virus isolated from a DSS patient showed unique features characterized by a lower level of replication in mammalian cells and extensive apoptosis in mosquito cells compared to those isolated from DHF patients (318) (319), while in mice, a virus isolate derived from a DSS patient persisted longer in vivo with extensive neuroinvasion in contrast to other

DENV-1 isolates that originated from milder human cases (317), genomic characterization of the three clinical isolates identified six amino acid substitutions unique for the DSS isolates that were located both in structural genes (M and E) and non structural genes (NS1, NS3 and NS5).

It has also been proposed that intra epidemic evolution of the circulating DENV might be responsible for increased severity of disease and more severe of disease manifestation and case fatality rates were observed toward the end of epidemic (320)(321). This phenomenon suggested that circulating DENV might have become more virulent through passage in hosts during the epidemic. In addition, epidemic with high incidence of DHF have been link to primary infection with DENV-1 followed by infection with DENV-2 or DENV-3 (322) (323). Therefore, in studying DENV virulence, both host and viral factors should be considered.

Activation of complement system

The complement system is one of the main humoral components of the innate immunity and interacts closely with the hemostatic system to provide the first line of defense against pathogens (5). Activation of complement is another important in the clinical manifestation in DHF, it was reported that the level of capsid protein (C3a and C5a), complement activation products, are correlated with the severity of DHF. When plasma leakage becomes most apparent and decreased in patients with DSS due to an accelerated consumption the level of C3a and C5a reached the peak at the time of defervescence (324) (325). The pre - existing cross reactive antibody, high levels of secreted NS, immune complexes were implied in mediating complement activation through classical and alternative pathways (324) (326).

Transient autoimmunity

The presence of serum antibodies specific to NS1 also has been to correlate with disease severity (327)(328). Antibodies produced during a DENV infection have been shown to cross - react with some self - antigens, so it is not clear if production of these antibodies is associated with secondary DENV infection (329). Cross- reaction of anti NS1 with cell of the liver, EC, and platelets have been observed (330) (331) (332). Anti - NS1 antibodies specific to cross-react with human and mouse platelets leading to transient thrombocytopenia and hemorrhage in mice (333) and with EC causing cells apoptosis (330). It is not clear yet why the autoimmune phenomenon observed in some DENV

infected patients does not persist, though it is likely that the cross reactive antibodies to self - antigens are of the short - lived IgM isotype (334) (335).

Host Genetic factors

Differences in DENV disease severity can be seen at both the individual and population levels. Several human HLA class I and II alleles are associated with development of DHF (336) (337) (338) (339). Some epidemiological studies indicated that genetic factors constitute important components in disease susceptibility. Polymorphism in the tumor necrosis factor alpha (TNF - α), Fc γ receptor, vitaminD receptor, CTLA - 4, and transforming growth factor β (TGF - β) genes has been associated with development of DHF/DSS (336) (340). However, certain host factors, such as glucose 6 - phosphate dehydrogenase (G6PD) deficiency may also contribute to increased replication of DENV in monocytes. Polymorphism in transporters associated with antigen presentation and human platelet antigen, additionally, polymorphism in the mannose - binding lectin 2 (MBL2) gene were shown to be associated with thrombocytopenia and an increased risk for developing DHF (341).

The risk to develop DHF and DSS following infection with DENV is likely to be determined by a combination of multiple common genetic traits, each with mild to moderate effects, predisposing to moderate effects, predisposing to a more severe form of disease.

Anti-Dependent Enhancement

Studies in epidemiological have shown an increased risk of developing DHF/DSS after a secondary DENV infection (342) (343) (344) (345). Halsted and colleagues observed the incidence of DHF and DSS peaked divided in two groups of young children, the first group in infants from 6 to 9 months infected with different DENV serotype that infected from their mother, cross- reactive antibodies that lack neutralizing activity are induced in the primary infection. In the second group was observed in children older than 1 year and in secondary infection. DENV and non-neutralizing antibodies from virus - antibody complexes (See figure 29).

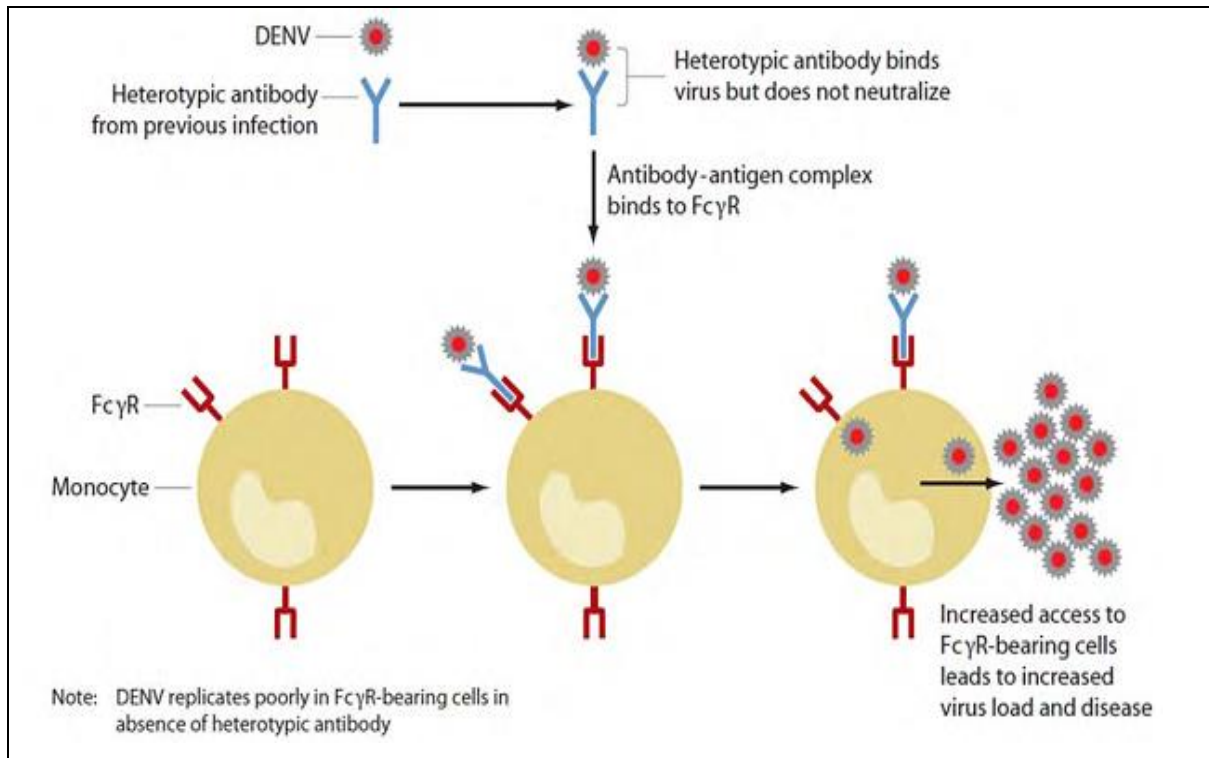

Figure 29: Model of antibodies- dependent enhancement (346)

This non neutralizing cross - reactive antibodies form virus - antibodies complexes bind to Fcγ receptors on target cell and result in enhancement of DENV infection leading to high viral load and to DHF (347). In the most acute virus infection models, the presence of antibodies, both neutralizing and non neutralizing, correlates with control, elimination and eventually protection. However, a possible detrimental role of virus- specific antibodies has been described for several viruses as measured by in vitro enhancement of infection of cells (348) (349) (350) (351) (352) (353) (354). Although, some studies have shown a correlation between enhancing activity of serum, high levels of viraemia, and an increased risk for DHF/DSS, not all cases of severe disease are associated with antibody - dependent enhancement or preceded infection with a heterologous serotype or by high viral loads (355) (356). In some cases, when DHF/DSS is seen, the presence of viral RNA became undetectable (328).

Cros reactive T-cell response

Although memory T cell cross - reactive with a heterologous virus can provide partial protective immunity, they can also cause substantial immunopathology (357). Human infected with DENV result in the development of dengue - specific CD4+ and

CD8⁺ T cell responses with epitopes in multiple DENV antigens, primarily nonstructural proteins, being recognized by these T cells (358). However, this T cell responses cross-reactivity with heterologous virus can provide partial protective immunity as well as play a role in dengue pathogenesis.

T cell responses pattern is similar to the antibody response, T cells responses are characterized by higher homotypic than heterotypic responses (359). During the acute phase of a secondary of human infection with heterologous DENV, highly cross-reactive CD8⁺T cells with high avidity for the infecting virus are preferentially activated (360) (361). The majority of these cross-active T cells produce high concentrations of pro - and anti - inflammatory cytokines such as IFN- γ , TNF- α and IL-13, IL-6 but somewhat lower levels of IL-10. The phenomenon where cross-reactive memory T cells for primary infecting virus are more efficiently activated, due to the increased frequency and higher activation state of memory cells, this phenomenon referred to as “original antigenic sin”. However, in accordance to what has been described for several other systems, it is possible that during a heterologous DENV infection, only small subset of cross - reactive memory cells will be stimulated to expand because of a narrowing TCR repertoire with unique specificity within individual has a unique T cell receptor specific (362) (363).

Soluble factors

Several studies analyzed sample from infants, children and adult infected with different DENV serotypes have shown it is highly believed dengue pathogenesis to a “storm” of inflammatory cytokines and other mediators that lead to the increased plasma leakage in DHF/DSS. Higher plasma level of IL-1 β , IL-2, IL-4, IL-6, IL-7, IL-8, IL-10, IL-13, IL-18, TGF-1 β , TNF- α and IFN- β have been found in patients with severe DENV infection, in particular in Patient with DSS (355) (364) (365)(366)(366). It is reasonable to assume that synergistic interaction between these cytokines will occur. It is more likely that multiple cytokines contribute simultaneously in a complex way to the development of DHF/DSS. Actually, DSS patients recover extremely rapidly after appropriate fluid therapy suggests that cytokines do not cause tissue destruction like in many immunopathology models but rather cause a reversible EC dysfunction. Other mediators and soluble factors found to be increased in severe disease include: vascular endothelial growth factor, granulocyte-macrophage colony - stimulating factor, monocyte chemoattractant protein 1, macrophage migration inhibitory factor, thrombopoietin, soluble

vascular cell adhesion molecule 1 (VCAM-1), soluble ICAM-1, von Willebrand factor antigen, thrombomodulin, E-selectin, tissue factor, plasminogen activator inhibitor 1, and tissue plasminogen activator (364)(367) (368)(369)(370)(371)(372). Apart from any other considerations, it is reasonable to assume that cytokines and other soluble mediators of the functional, and to a lesser degree the morphological, pathology characteristic of DHF/DSS are also essential for efficient viral clearance.

4. Alphaviruses and Chikungunya virus

4.1. Classification

Chikungunya virus (CHIKV) is a member of the *Alphavirus* genus in the family *Togaviridae*. *Alphavirus* can be divided into New World and Old World viruses. These two groups have evolved distinct ways of interacting with their respective hosts, and differ in for instance their pathogenicity, and tropism. Chikungunya virus is part of Semliki Forest (SF) group of Old World *Alphaviruses*. Predominantly New World viruses are associated with encephalitis, whereas poly-arthritis and rash is predominantly associated with Old World *Alphaviruses*. There are 29 different types of alphaviruses that cause diseases in human and other mammals.

Genome structure

CHIKV is a small, about 60-70 nm diameter, enveloped, a positive single - strand RNA virus (Figure 30). In early 2006, according to NCBI/ GenBank accession no.DQ443544.1, the complete sequence of a chikungunya isolate from Reunion Island was made, the virion consists of an envelope and a nucleocapsid. The chikungunya virus genome is 11,805 nucleotides long encodes for two polyproteins: 1) the nonstructural polyprotein consisting of four proteins from nsP1-4; 2) and the structural polyprotein consisting of five proteins as capsid, E1-3, 6K. The 5' end of RNA molecule is capped with a 7-methylguanosine while the 3' end is poly-adenylated (373)

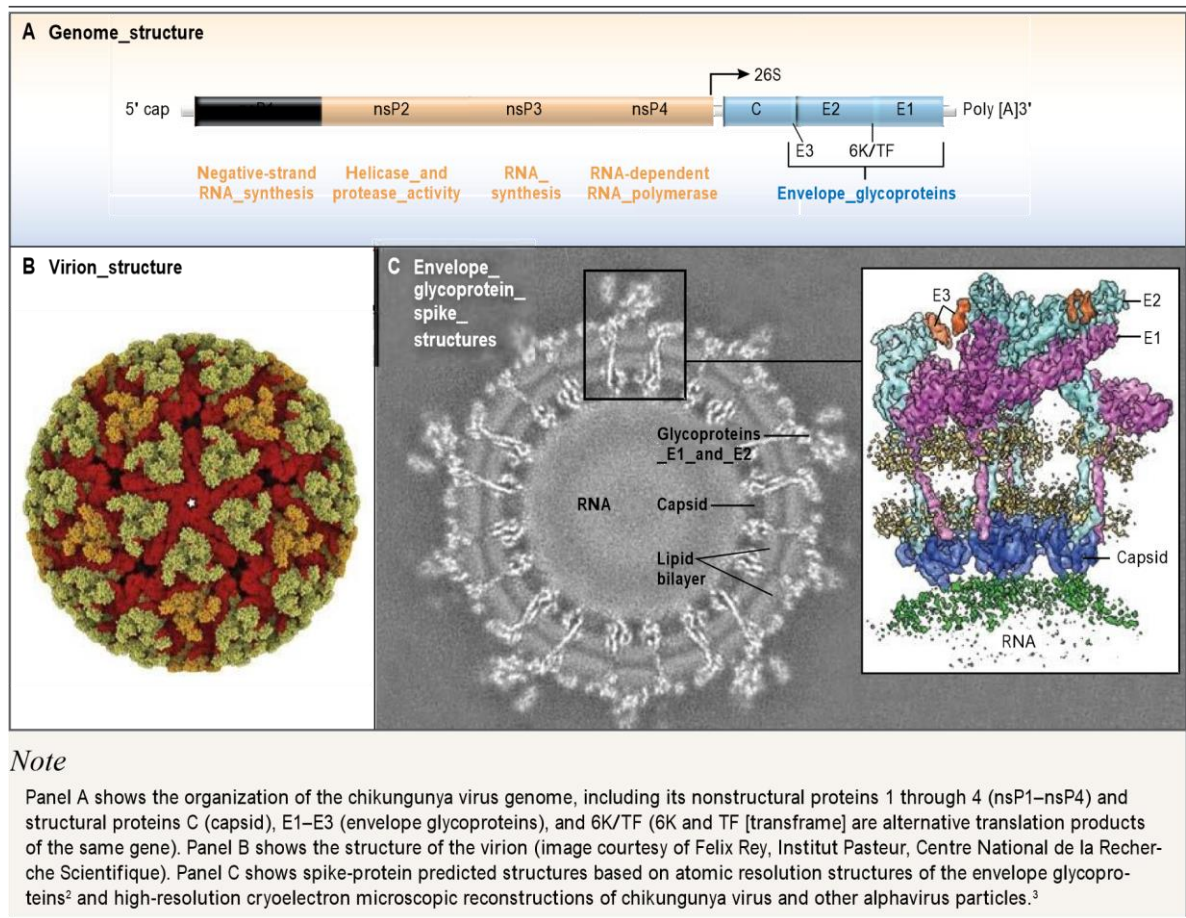

Figure 30: Chikungunya virus Genetic and Physical Structure (373)

4.2. Genetic evolution

Chikungunya fever swept across many South and South East Asia countries, following extensive outbreak in the India Ocean Island in 2005. However, molecular epidemiology data explain the recent spread and evolution of CHIKV in the Asian region are limited.

Many studies conducted so far to understand the origin and evolution of CHIKV have focused on full genome and E1 gene sequences of the virus (374) (195) (375) (376). Phylogenetic analyses of the CHIKV genome have shown three genetic lineages: Asian, West African, and East, Central and South African (ECSA) (374). It is now clear that the emergence of CHIKV in the Indian Ocean Islands in early 2005 was due to a newer strain of the ECSA lineage (195). Current epidemiological evidence suggests that this strain

could have moved to the Indian Ocean Islands following CHIKV outbreaks in Kenya in 2004 (377). Although the molecular epidemiology of CHIKV in India has been thoroughly described (378) (375), similar data to explain the evolutionary relationships of CHIKV that spread in the rest of the Asian region after 2005 are still limited. In the study of H.C. Hapuarachchi et al., 2010 (379), they sought to analyse the evolutionary relationships of CHIKV in South and South-east Asian regions after 2005, in order to understand the possible routes of spread of the virus to Sri Lanka, Singapore, Malaysia and the Maldives. Moreover, a hypothetical evolutionary pathway for CHIKV strains that emerged in the Indian Ocean Islands and Asian region after 2005. (See figure 31). The later is circulating in the Caribbean and South America.

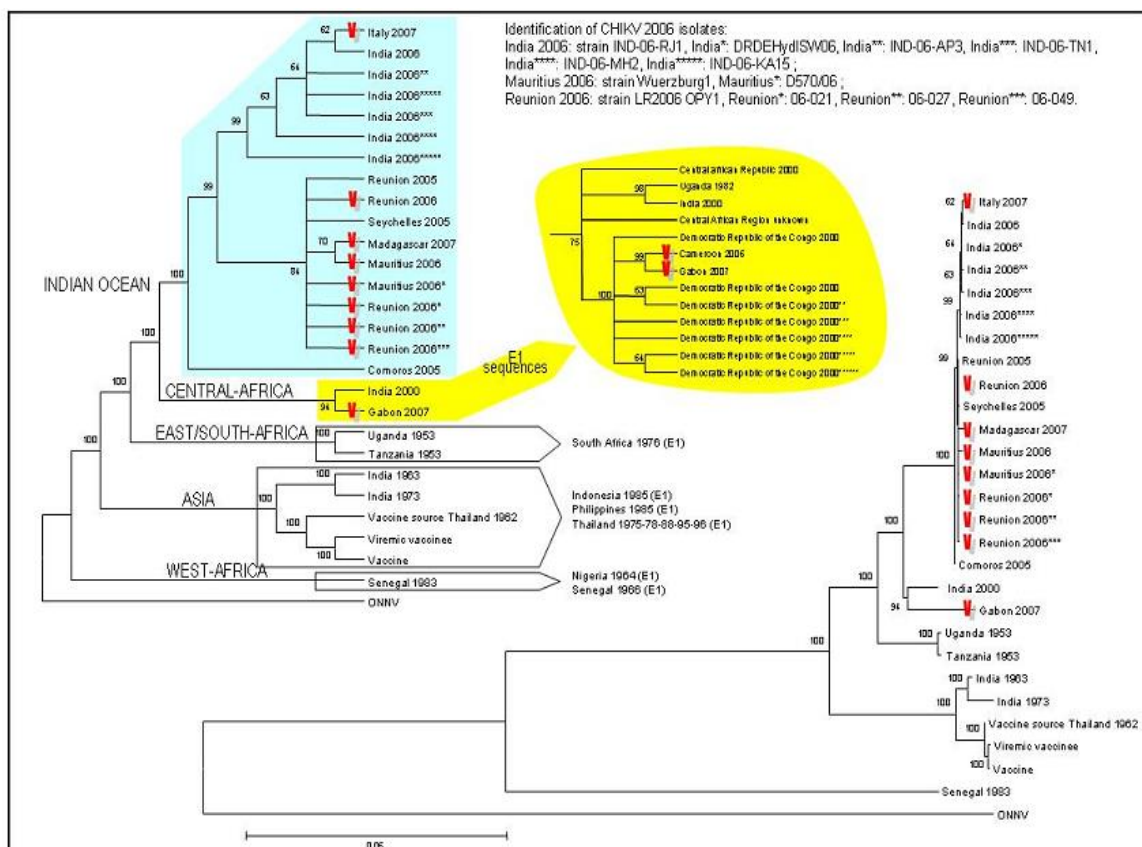

Figure 31: Chikungunya virus and dispersal and evolution.

To date, the difference genotype of ECSA CHIKV have been identified. The acquisition of A226 mutation in the envelope protein E1 of the ECSA genotype, as observed in La Reunion in 2005, has increased the transmissibility of the CHIKV through

the widely distributed *Ae. albopictus* mosquitoes (380). This mutated virus spread from the Indian Ocean to East Africa and Asia such as India, Sri Lanka, Singapore, Malaysia and China, and caused the chikungunya outbreak in Italy. In 2010, CHIKV strain responsible for autochthonous cases in France belong to the ECSA genotype but without the mutation at position 226 (381) (382).

4.3. Replication cycle

Following transmission, CHIKV replicates in the skin and then disseminates to the liver and joints, presumably through the blood. Unlike typical encephalogenic alphaviruses, which infect neurons, CHIKV seems to infect the stromal cell of central nervous system and in particular, the lining of the choroid plexus (383). CHIKV replication has been extensively studied in mammalian and insect cell culture system (384). The replication and propagation of viruses is dependent on entry into permissive cells. Biological samples from acutely and chronically infected humans have been analysed and, together with the development of animal models, have provided invaluable tools for studying the physiopathology of infection. CHIKV share many characteristics with other Old world alphavirus but also displays unique and previous unexpected properties (385) (386) (383).

4.4. Vector

Aedes mosquitoes

Historical data report the first detection of chikungunya in 1952 in the Makonde Plateau in Africa (387)(388) where the virus is known to be maintained in the sylvatic cycle of wild primates and mosquitoes such as *Ae. taylori* (389) (390). Later in 1958 it was detected in urban Asia such as Thailand mainly transmitted by *Ae. aegypti* (391). In India, CHIKV was first detected in 1963 in West Bengal, where *Ae. aegypti* and *Ae. albopictus* were known to exist and are widely prevalent during the post monsoon season (391). From 1972 to 1986, CHIKV was observed in Kedougou, Senegal from forest mosquitoes, with most of them isolated from *Ae. fuscifemur - taylori*, *Ae. luteocephalus* and *Ae. dalzieli* (390), so the most recent one occurred in 1996 in Kaffrine where CHIKV

isolated from *Ae. aegypti* (390). In Europe, *Ae. albopictus* (Asian Tiger mosquito) has also recently emerged as an important vector to transmission CHIKV in temperate country (392) (393).

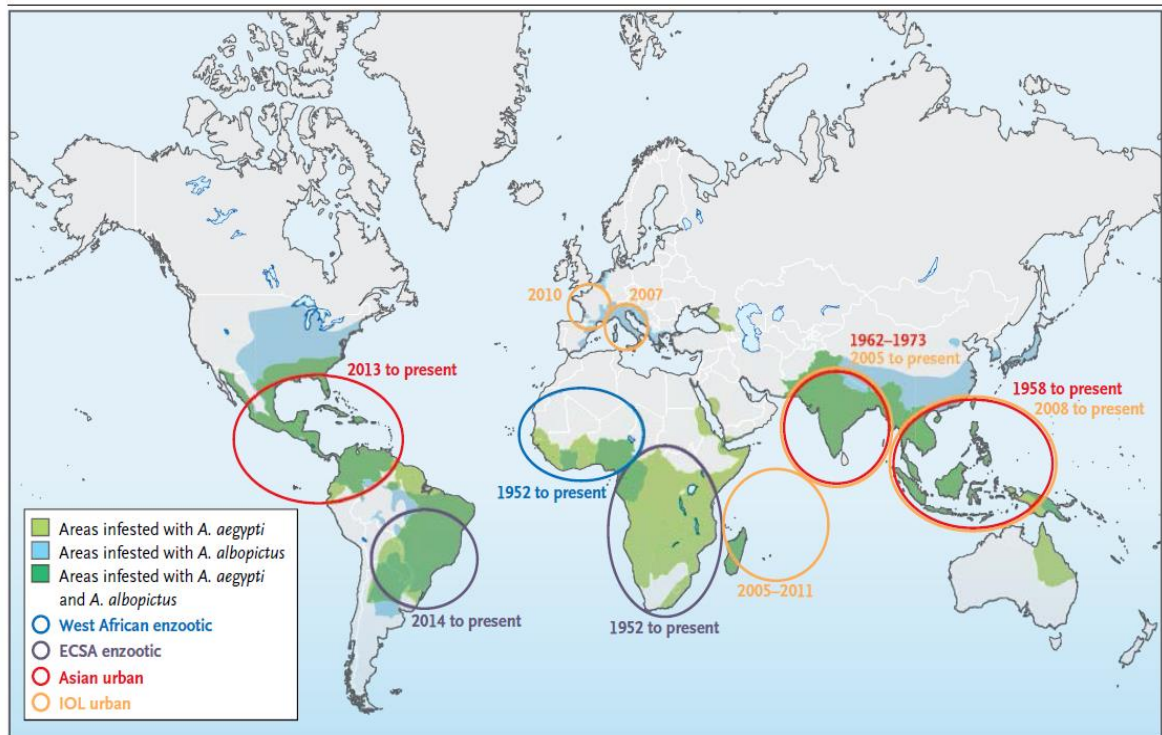

Note: ECSA denotes eastern, central, and southern Africa.

Figure 32: Origin, spread, and distribution of chikungunya virus and its vector.

The map shows the African origin of enzootic chikungunya virus strains and the patterns of emergence and spread of the Asian lineage and Indian Ocean lineage (IOL) of the virus during epidemics since 1950s, based phylogenetic studies (394) (374). The distribution of the peridomestic vectors, *Ae. aegypti* and *Ae. albopictus*, are also shown (373).

Transmission cycle

Sylvatic Chikungunya cycle

In Africa, CHIK virus appears to be maintained in a sylvatic cycle involving wild primates and forest-dwelling *Aedes spp.* mosquitoes. Serological studies have repeatedly demonstrated the presence of antibodies in humans and wild primates throughout the moist forests and semi - arid savannas of Africa (395) (396) (397)(398). To date, a vertebrate reservoir or sylvan transmission cycle has not been identified outside Africa, supporting

the historical evidence (399) that CHIK virus originated in Africa and was subsequently introduced into Asia, where it is now typically associated with *Ae. aegypti* mosquitoes. The strains from Africa and Asia are reported to differ biologically, indicating that distinct lineages may exist (400).

Urban chikungunya cycle

In Europe where sylvatic cycles are absent, vertical transmission may participate in the maintenance and/or cyclic re-emergences of CHIKV. This critical issue remains to be investigated in diapausing temperate populations of *Ae. albopictus* that may have more efficient vertical transmission than mosquito populations in eastern Italy and tropical regions (401) (402).

4.5. Chikungunya Epidemiology

4.5.1. History and origin of chikungunya

The Alphavirus genus, that include the group of viruses to which chikungunya virus belongs, originated around 2000 to 3000 years ago (403). The name “Chikungunya” was derived from a word in the Makonde language (spoken by a population living in the Mozambique region) that means “that which bends up” (404). These instances of emergence and spread beyond Africa may have begun as early as the 18th century, when sailing ships carried chikungunya virus along with human and *Ae. aegypti* (399). In 1824, epidemics of fever, rash, and arthritis were cited in India and elsewhere. But until 1952, the clinical features of chikungunya virus were first described during an outbreak in villages on the Makonde Plateau in the southern province of Tanganyika, Africa (405) (387) (406). The virus was isolated one year later during an epidemic in Tanzania using human sera and mosquitoes (406) (401). In 1955, the disease was reported to be similar to a “Dengue-like fever” (387) (388). Since 1955, most cases of CHIKV infection have been described in Africa and India, during the last 60 years, the epidemic outbreak of CHIKV infection has been reported in India, and in several countries in Africa, in the Indian Ocean region, and Southeast Asia. The first emergence of the virus into the urban cycle during the modern scientific era occurred between 1897 and 1956, when a member of Eastern, Central, and Southern Africa (ECSA) (373). Another ECSA lineage progenitor began in coastal Kenya

outbreak in 2004 (407) explosive epidemics of millions people before spreading to Indian Ocean islands and India (408) and South East Asia, reaching Myanmar in 2010. The Indian Ocean lineage (IOL) CHIKV strains transmission in the Americas during the peak of 2006 - 2009 outbreaks (409). However, an Asian lineage CHIKV strain was introduced into the island of St. Martin in October 2013 (410) and subsequently spread throughout the Caribbean (11) and Central America as into northern South America and Florida. It seems likely that there will be further spread throughout the Americas where CHIKV vectors are widespread, as well as epidemics in Polynesia (410)(11) (373).

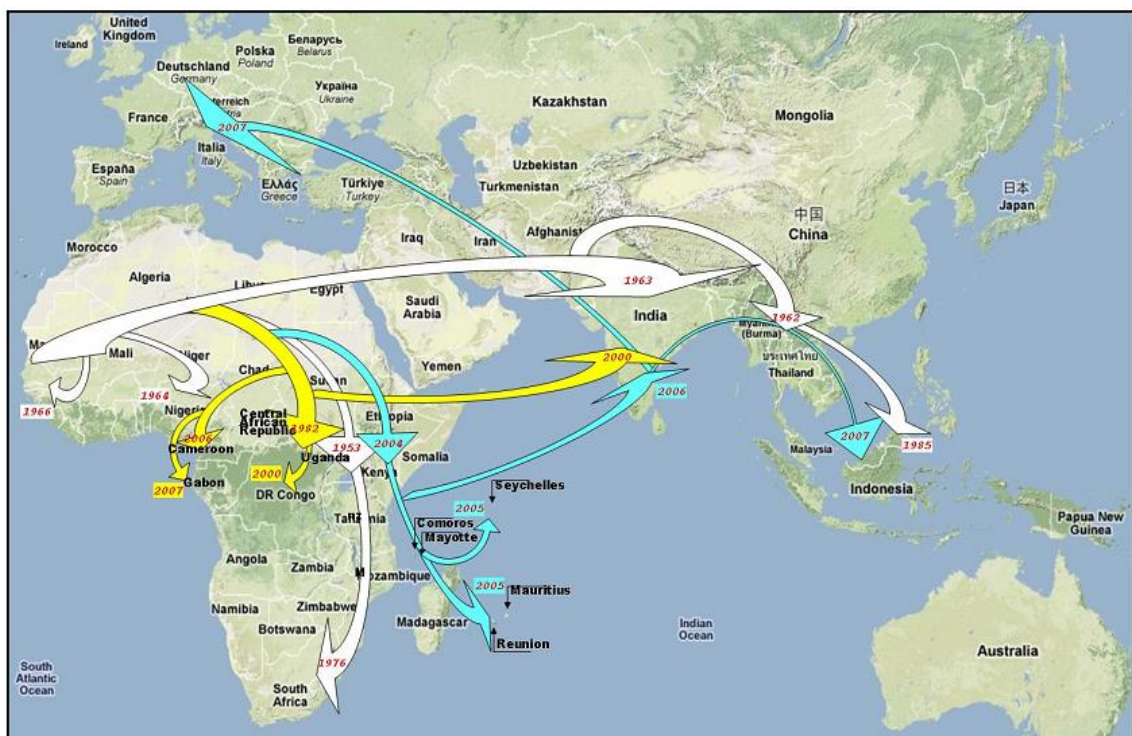

Figure 33: Predicted dispersal pattern of Chikungunya virus from Africa to the Indian Ocean and Europe during the past 20 to 50 years (411).

4.5.2. Global burden

In the last 60 years, outbreaks of CHIKV infection reported for the first time in East Africa in 1952 - 1953, incidence has increasing geographic expansion to new countries and, in the present decade, from urban to rural settings in tropical and subtropical countries in Africa, India, the Indian Ocean region, and Southeast Asia (392). More

recently, the CHIKV diffusion area moved to European as Italy, French or North America countries as Canada, USA. (392) (412) (413)

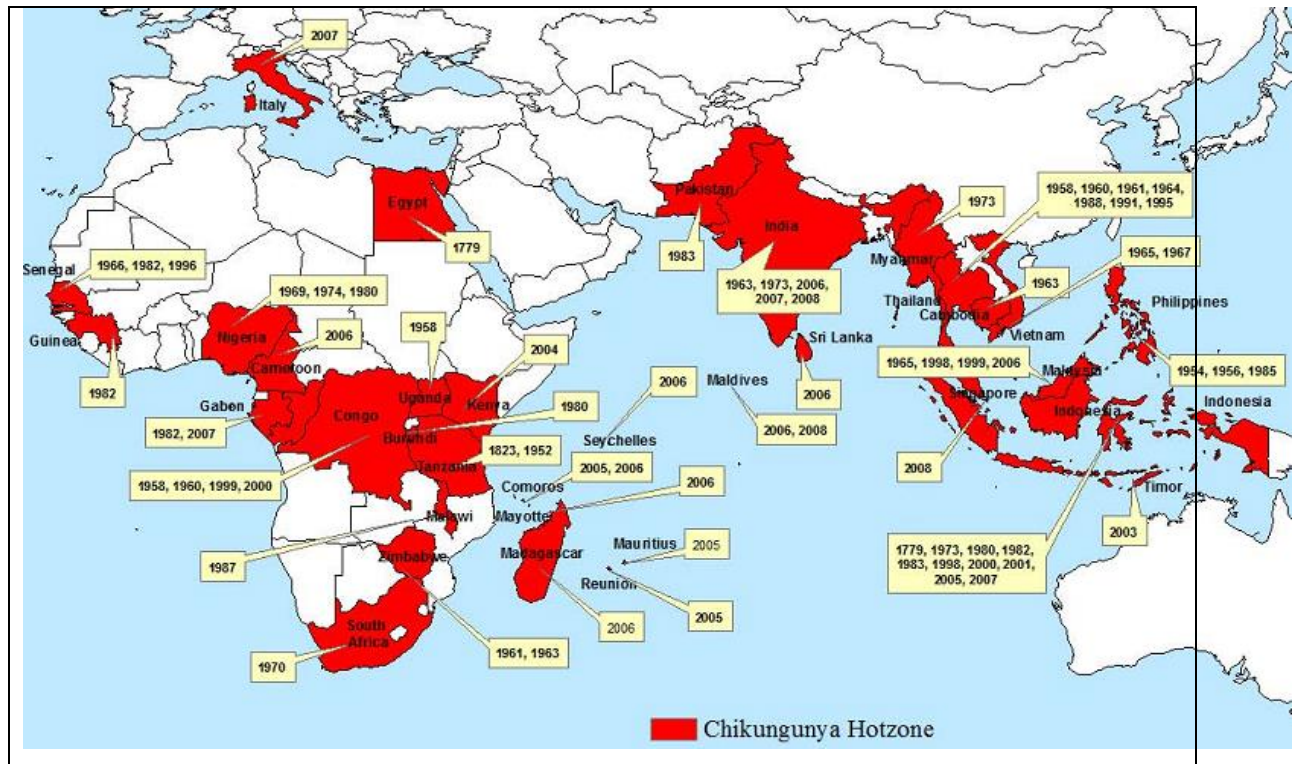

Figure 34: Chikungunya active transmission regions established from published data illustrate geographic and temporal knowledge of previous outbreaks.

In 2001, CHIKV was first documented in Indonesia, and by 2007, more than 15,000 cases had occurred there. The year 2004 witnessed an outbreak of CHIKV in Kenya followed by another massive outbreak on the French island of La Réunion in 2005 (401). By this point in time, an estimated 266,000 people had developed chikungunya virus (attack rate, 35%) (414). In 2006, a CHIKV epidemic reached Sri Lanka, and through 2007, WHO reported more than 37,000 Sri Lankans were affected by the disease. In 2006, more than 1.3 million cases of CHIKV were reported in India with attack rates as high as 45% in some areas. In 2007, more than 17,000 were infected in Gabon, Africa. Around the same time in 2007, CHIKV first introduced to Europe during the aforementioned outbreak in Italy. However, the attack rate measured only 5.4% in Castiglioni Cervia and 2.5% in Castiglione di Ravenna, a much smaller figure than in other countries (401) and more recently has spread to the Caribbean region (11).

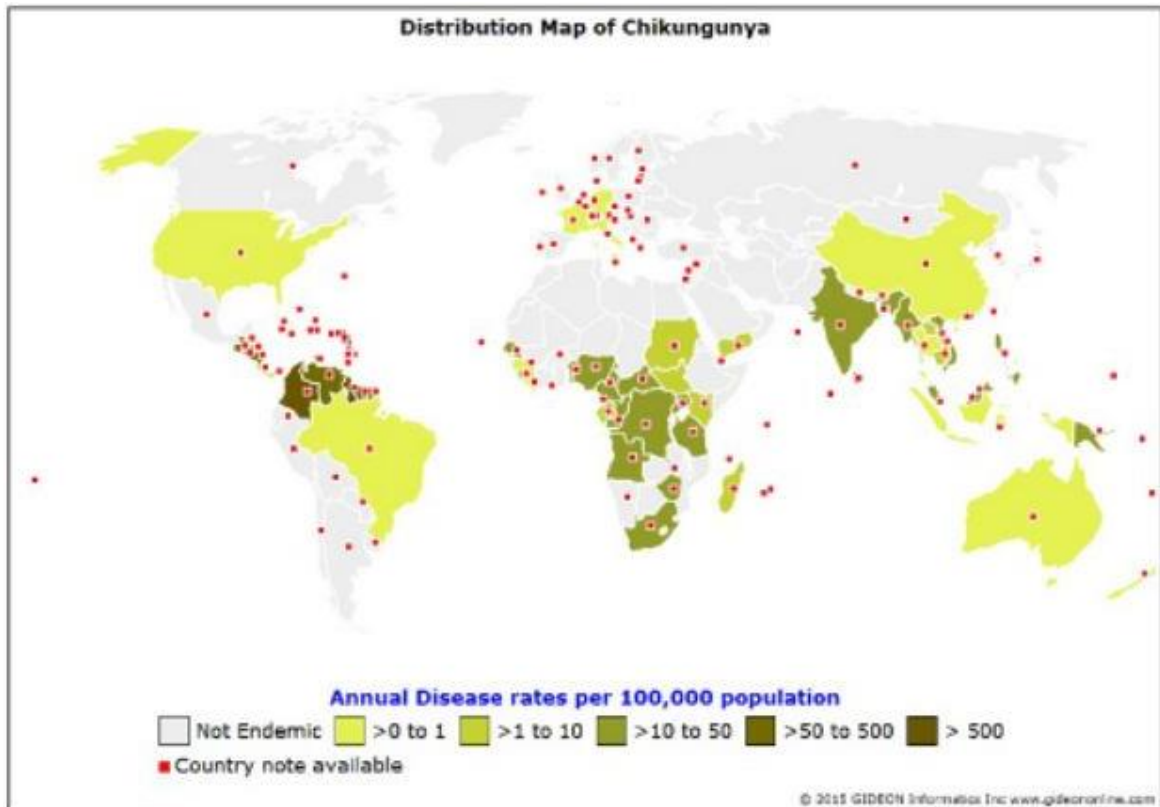

Figure 35: Endemic or potentially endemic to 96 countries.

4.5.3. Epidemiology trend in several regions of the world

4.5.3.1. Epidemiology trend in Africa

Since the first report in 1952, most cases of CHIKV infection have been in described in Africa and India. However, during the last 60 years, isolated cases or epidemic outbreaks of CHIKV infection have reported in several countries in Africa, more specifically West Africa from Senegal to Cameroon, Central and East Africa including Central African Republic, Angola, Democratic Republic of Congo, Zambia, Zimbabwe, Tanzania, Malawi, Mozambique, eastern Botswana, and north eastern parts of South Africa, there is also evidence of viral presence in parts of Ethiopia and Sudan (Health Protection Agency reported, 2011). Human infections in Africa have been at relatively low levels for a number of years, but in 1999 - 2000, there was a large outbreak in the Democratic Republic of the Congo, and in 2007 there was an outbreak in Gabon. (415) (416).

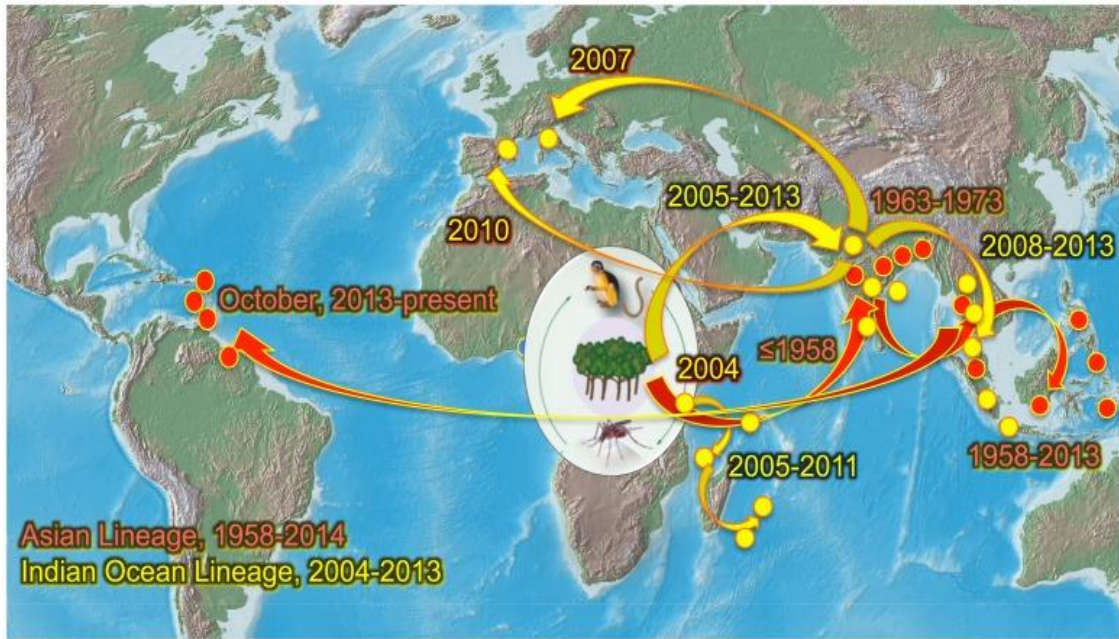

Figure 36: Map showing the distribution of chikungunya virus enzootic strains in Africa and the emergence and spread of the Asian lineage (red arrows and dots) and the Indian Ocean lineage (yellow arrows and dots) from Africa (404).

4.5.3.2 Epidemiology trend in Southeast Asia

In recent years, large scales epidemics of CHIKV with considerable morbidity and suffering in their wake have occurred in a number of Member countries of WHO South East Asia Region. In Asia, CHIKV strains were isolated in Bangkok in the 1960s, Sri Lanka in 1969, Vietnam in 1975, Myanmar in 1975 and Indonesia in 1982. Outbreaks were reported from Indonesia (1979, 1985, 2001 and 2003-2007), Myanmar (1975 and 1984), Maldives (2006-2007), Sri Lanka (1965 and 2006) and Thailand (1960, 1978, 1988 and 1995- 1996). The outbreaks in Region prior to 2000 were due to Asian strain. In Indonesia, CHIKV occurred sporadically until 1985 after which there were no reports of the disease till a series of outbreaks between 2001 and 2007. The reported 15207 cases from seven provinces with the peak observed in 2003, over 1200 suspected cases of CHIK were reported from 23 sub - districts in 2007, and most of the reported cases were from the province of Java (219).

4.5.3.3. Epidemiology trend in India and India Ocean region

Since CHIKV identification, the first outbreaks of CHIKV in India was documented of the Calcutta in 1963 (417). Afterwards shortly time, several outbreaks of Chikungunya occurred throughout the country until 1973 (418). A gap of several years ensued, during which viral activity in human was thought to have disappeared or to lost its pathogenic potential (419). However, the virus re-emerging in India in 2005 and the country has so far seen more than 1.3 million suspected case of CHIK infection (418) (419). In Southern of India in 2006, an outbreak of CHIK began in Kerala, has so far affected nearly 70,000 people from 14 districts (420) and continues today, in the years of 2009, more than 11,000 suspected cases of CHIK have been reported from Kerala state. The abundance of *Ae. Albopictus* mosquito in the region and molecular evolution by mutation in the glycoprotein envelope gene of CHIK virus may be contributing to the renewed outbreaks.

Starting from the emergence of CHIKV in Kenya in 2004 (421) (422), after that the outbreaks spread to Comoros and Seychelles in early 2005, followed by Mauritius (423) (424) (425). Later the outbreak were reported to have spread to other islands in the Indian Ocean, including La Reunion Islands which is apart of France in 2005, 2006 (195) (426) (427). An causing major outbreaks in there regions (428).

4.5.3.4. Epidemiology trend in European and Americans

Between 2005- 2007, epidemic CHIKV occurred in many European countries (429), CHIKV infection was diagnosed in travelers coming from epidemic areas (a person traveling from India). During the summer 2007, and for the first time in a temperate country, an epidemic of this tropical disease occurred in Italy (430), in Castiglione di Cervia and Castiglione di Ravenna (Emilia Romagna, Northern Italy), which together form a single urban area, the mosquito was detected in local is *Ae. albopictus*. Erosurvaeillance report *Ae. albopictus* is found in several other European countries, including Albania, France, Belgium, Montenegro, Switzerland, Greece, Spain, Croatia, German, the Netherlands, Slovenia, Bosnia, Herzegovina, and possibly more, suggesting a potential for further spread of the disease (431).

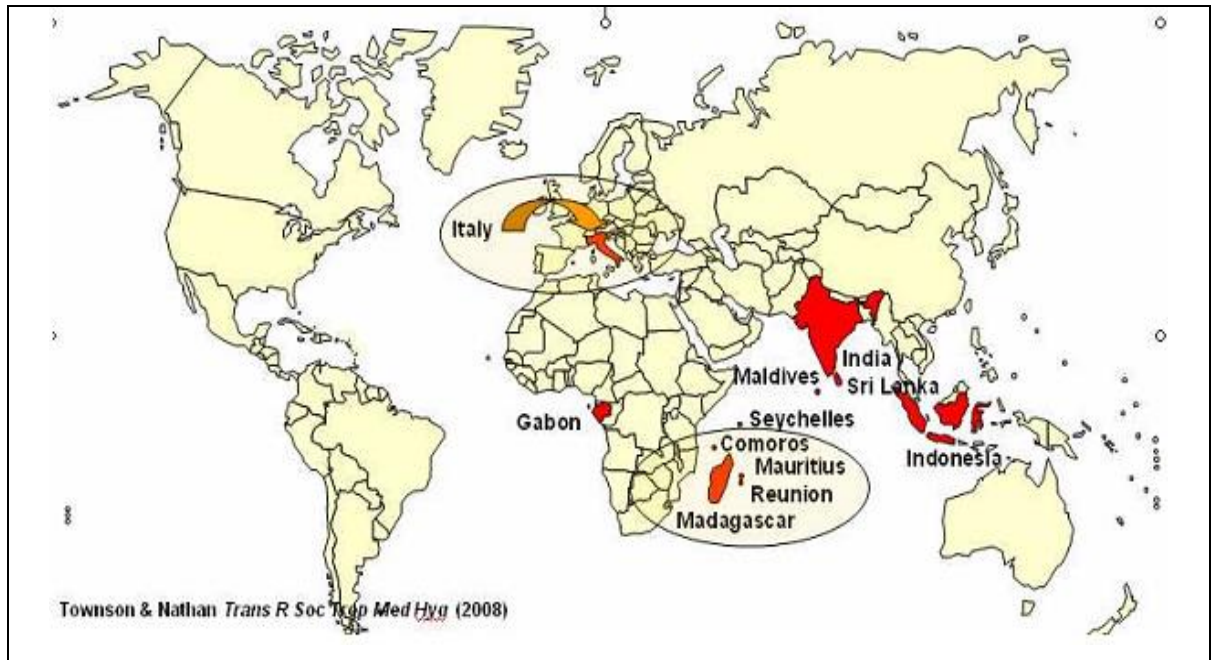

Figure 37: Outbreak of Chikungunya, 2004-2007

In German describes the first isolation and molecular characterization of CHIKV in 2009. The virus contained the E1 A226V mutation, shown to be responsible for an adaptation to the Asian tiger mosquito *Ae. albopictus*. The E1 coding sequence was identical to chikungunya virus isolates from Sri Lanka and showed three nt-mismatches to the only available E1nt sequence from the Maldives (425). One year later, in 2010, autochthonous transmission of chikungunya virus was recorded in Southeastern France (335), and in Montpellier, southern of France, 2014 (382).

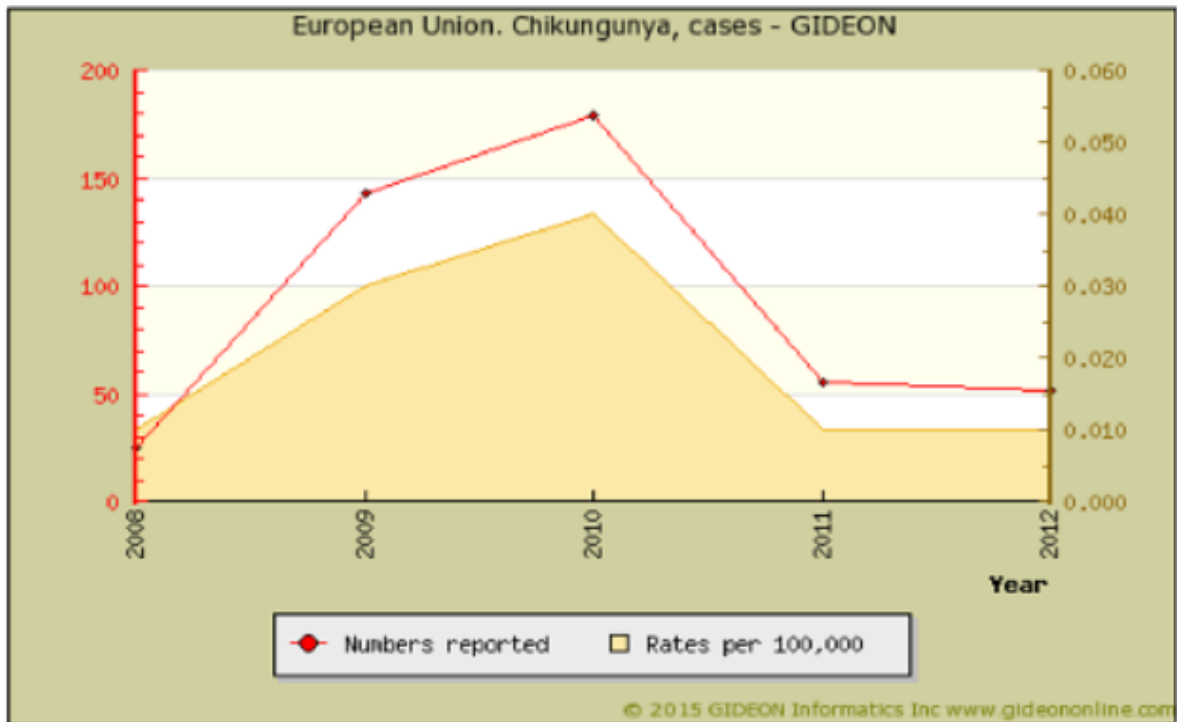

Figure 38: European Union, chikungunya, case.

During the past four weeks in 2014, numerous imported cases reported from the Americas and Europe among travellers return from the Caribbean regions, in particular from Haiti or Dominican Republic. Such as USA in the North America; Panama, Suttiname, Cuba, Barbados, and Bonaire island in Central America and Caribbean; Venezuela, braazil, Peru, Chile in South America; France, Italy, Netherlands, and Spain in Europe (432).

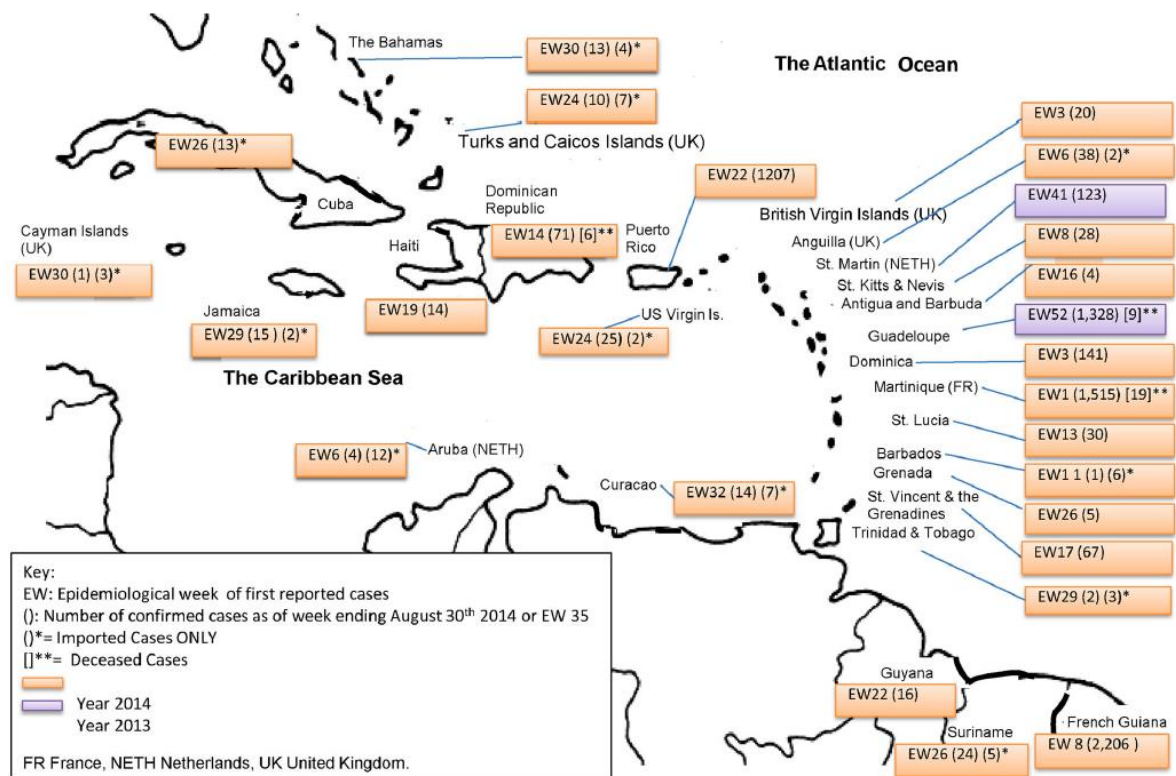

Figure 39: Introduction of chikungunya to the Caribbean by epidemiological week first reported in December 2013 to August 2014. Data from PAHO/WHO statistics (433)

4.5.4. Diagnosis

Classification in clinical

In the clinical, serological and molecular diagnosis of CHIKV fever patients and its comparison with dengue viral fever. Classical clinical features of CHIKV infected patients were recorded to differentiate chikungunya from dengue, which were fever, arthralgia, myalgia and rash (434).

Approximately, 3% - 8% of patient infected with CHIKV will remain asymptomatic. For people who develop symptomatic illness, the incubation period is typically 3-7 days (range 2-12 days) with the fever is usually of short duration (435). In some patients, a biphasic pattern of fever has been described with a febrile episode of 4 to 6 days, followed by fever-free period of a few days followed by recurrence of fever (usually 101- 102⁰ F) that may last a few days.

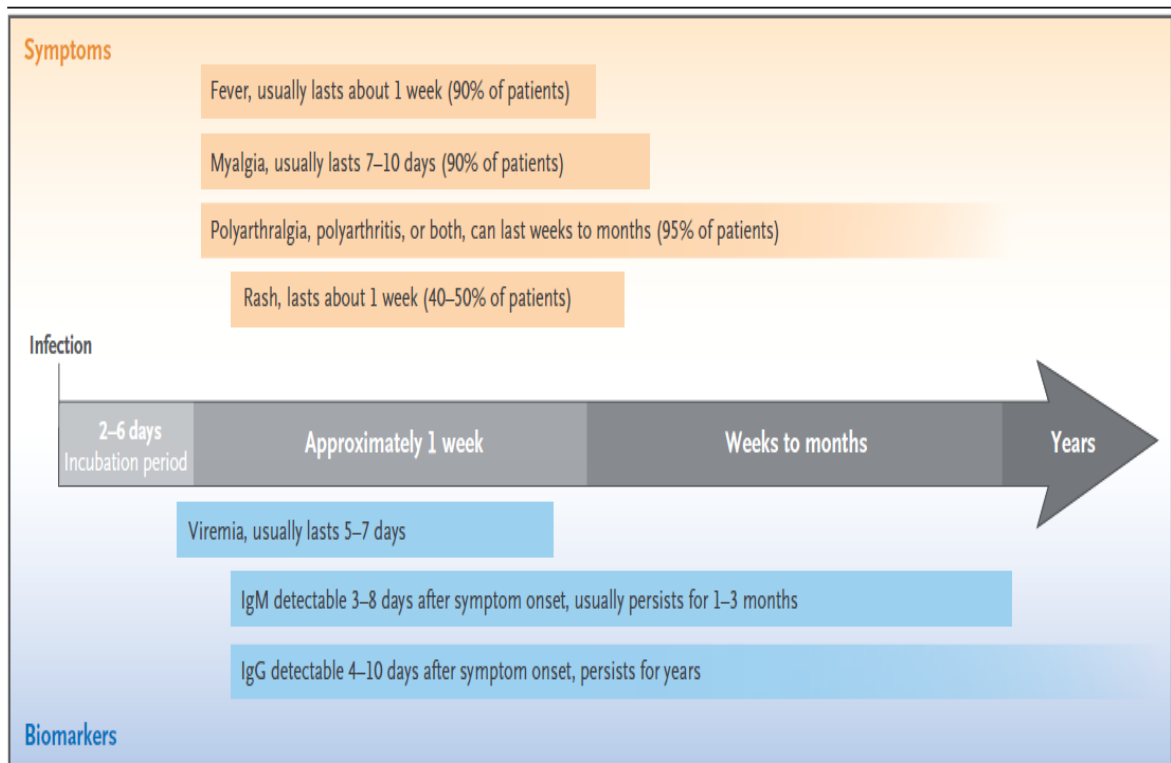

Note: The chronology of viral replication in relation to the clinical and biologic signs of disease, including the biomarkers used diagnostic assays to detect chikungunya virus infection (Suhriebier et al, 2012)(436)

Figure 40: Timeline of Infection, Symptom, and Biomarkers

Soon after the onset of fever, severe myalgias and arthralgias occur, 80% of patients. The joint pain is usually symmetric and localized in both arms and legs, estimated in 90% of patients, the large joints are almost invariably symptomatic, as are to a lesser extent, the small joints and the vertebral column (437). Rash occurs in 20-80% of cases, less common, nonspecific signs and symptoms include lymphadenopathy, pruritus, and digestive abnormalities, more common after viremia has resolved. In acute phase, feelings of faintness, fainting, confusion and attention - deficit disorders (373). Rare complications can occur including conjunctivitis, uveitis, iridocyclitis and retinitis, which typically resolve (438). Manifest in severe chikungunya fever as encephalopathy and encephalitis, myocarditis, hepatitis, and multiorgan failure. These rare forms can be fatal and typically arise in patients with underlying medical conditions. Hemorrhagic complications are rare and consideration of alternative if coinfection with dengue virus or coexisting conditions such as chronic hepatopathy. In infant group, neonates at risk for severe infection

associated with neurologic signs, the rare extremely, 50% of neonates born of infection to viremic mother, and exposed to the virus during birth, leading to severe disease and encephalopathy in half and resulting in long term neurology sequelae (439).

Disease course

After the incubation period, the illness begins abruptly and is followed by three phases: Acute phase, onset phase and chronic phase.

Acute phase

CHIK fever affects all age groups, and both genders are equally affected. The incubation period ranges from 2 to 12 days (usually 3-7 days) (440) (441) (405) (442) (422) (443). In susceptible populations, the attack rates can be as high as 40-85 %.

Onset phase

Prodromal symptoms are very rare. In the acute stage, the onset is usually abrupt and sudden with high - grade fever, severe arthralgias, myalgias, and skin rash (440) (441) (405) (442) (422) (443). Headache, throat discomfort, abdominal pain, and constipation may also be evident. Conjunctival suffusion, persistent conjunctivitis, cervical, or sometime generalized lymphadenopathy may be present.

Chronic phase

In a majority of the patients, the joint pains resolve in 1 to 3 weeks. In a majority of the patients, the joint pains resolve in 1 to 3 weeks. However, the arthritis can persist in about 33% of patients for 4 months, 15% for 20 months, and in 12% for 3-5 years (422) (444)(444) (445). The chronic stage is characterized by unpredictable relapses that include sensation of fever, asthenia, and exacerbation of arthralgias and stiffness. Affected patients may manifest inflammatory polyarthritis, severe subacute tenosynovitis/bursitis (consequently nerve tunnel syndromes) in hands, wrists, and exacerbation of pain on movement in previously injured joints (441)(446). Older individuals and those with underlying rheumatic and traumatic joint disorders seem to be more vulnerable to develop the chronic stage (441) (405) (442) (422) (443). Rarely, rheumatic manifestations resulting in joint destruction before resolution after 15 years have been reported (447). Some studies have documented occurrence of rheumatoid arthritis following chikungunya fever, suggesting that the viral infection may have a role in the initiation or unmasking of rheumatoid arthritis (448)(449).

Laboratory diagnosis

Laboratory diagnosis depends on antibody-capture IgM ELISA and plaque-reduction neutralization tests of serum. Comparative serologic tests for closely related alphaviruses (e.g., o'nyong-nyong and Sindbis viruses) should be conducted as geographically appropriate, and tests for dengue usually are indicated. Virus isolation attempts and PCR assays are performed selectively. Serologic tests should be performed on both acute and convalescent phase serum specimens collected at least 2 weeks apart, but clinicians should not delay submission of acute phase samples pending collection of convalescent phase samples (CDC). There is no specific assay for assessing chronic signs and symptoms associated with chikungunya fever, although elevated levels of C - reactive protein and proinflammatory cytokines correlate with disease activity as do IgG and IgM (450) (436).

4.5.5. Treatment and prevention

Treatment

There is currently no effective antiviral treatment for chikungunya. Treatment is therefore purely symptomatic and based on non - salicylate analgesics and non-steroidal anti-inflammatory drugs. Synergistic efficacy was reported between interferon - α and ribavirin on chikungunya virus in vitro (451)(452) and other antiviral compounds are under investigation (453). Analgesic drugs often combined with nonsteroid antiinflammatory drug (454). Although morphine effective during the initial phase but seldom used (387). In the incapacitating form, corticosteroids was sometime prescribed to treat (454). Chloroquine used treating in certain forms of chronic arthralgia (455), and there was no justification for treat acute infection (456).

Vaccines

Chikungunya fever represents a simple vaccine target than DF, There is currently no commercial vaccine for chikungunya virus, although some candidate vaccines have been tested in human beings (457) (458). Since the 1970, CHIK vaccine approaches have been pursued using mainly formalin killed and live approaches (VADIP). In the trials conducted by the US Army Medical Research Institute, very satisfactory seroconversion rates (98% on day 28) and neutralising antibody titres were obtained, persisting in 85% of

cases at 1 year, but these American vaccine trials were interrupted in 2003. On 6 September, 2006, the US Army Medical Research and Materiel Command signed a Material Transfer Agreement with the French National Institute of Health and Medical Research focusing on the records of previous clinical studies. Have tested a live vaccine (TSI-GSD-218) in Phase I and II where the vaccine was shown to be safe and immunogenic in 88 volunteers, although some vaccines experienced transient arthralgia (457). A phase III trial of the US Army candidate vaccine is in preparation (US Embassy in France; press release, Sept 14, 2006). The candidate vaccine is a live vaccine (TSI-GSD-218) based on chikungunya virus strain 15561 and 1962 isolated from a patient in Thailand and attenuated by serial passage in MRC-5 cells (458) (459). The status of TSI-GSD-218 is currently unclear although the US government allowed French authorities to collaborate based on the situation in La Reunion. In 2008 new vaccine candidates were proposed (460) (461). In 2009, a formalin inactivated vaccine candidate prepared used Indian strain implicated in epidemic in 2006 (462). This vaccine candidate has very good immunogenic potential to neutralize the virus infectivity.

Prevention and control

The immediate prospects for the control of chikungunya fever are poor. There are no specific therapeutic agent to treat patients and no licensed vaccine to prevent CHIKV. Pending vaccine development, the only effective preventive measures consist of individual protection against mosquito bites and vector control. Control of both adult and larval mosquito populations uses the same model as for dengue and has been relatively effective in many countries and settings. Mosquito control is the best available method for preventing chikungunya, as reduce the vector and limit the contact between human and *Ae. aegypti* and *Ae. albopictus* mosquito (463), including wearing protective clothing, bednet or curtains with insecticides impregnated. The focus on reduce or treat water containers or wet discard products where eggs are laid and larvae develop. Mosquito population is reduce through traditional larvicide and adulticide applications penetrate the house and premises where mosquito rest and feed. Another reduce transmission is use of Wolbachia bacteria (464)(465) and a novel strategies for vector control include the release of transgenic *Ae. aegypti* engineered to carry a late-acting lethal genetic system (466).

4.5.6. Chikungunya immunopathogenesis

4.5.6.1. CHIK pathogenesis

The pathogenesis of chikungunya in human and the mechanism by which it causes arthritic disease is poorly understood (467). Apart from the clinical manifestation of CHIK infection, the information about the pathogenesis of the virus in human is little document. Some study in clinical of CHIK patients reported the occurrence of rhabdomyolysis with elevated creatine phosphokinase levels. To determine whether pathogenesis of CHIK is based on studied of the arthritogenic alphaviruses in vitro, and a mouse model of virus - induced arthritic/arthritis has been used to study the pathology and immunology (468), infection results in severe inflammation and necrosis of skeletal muscle. The histopathological and immunohistochemical (IHC) finding in human are similar in the CHIKV - infected mice (467).

4.5.6.2 Risk factors

The many experts in the field of infectious diseases, epidemiology, entomology, and risk assessment were to assess the short - term risk of Chikungunya virus in Europe. An artificial distinction was made between the risks of establishment of CHIKV transmission in Europe related to the three key determinants: 1) Risk related to the introduction of the virus, considering the highest likelihood for virus introduction comes from viraemic persons. That is the high frequency of travel between high incidence areas in the Indian Ocean and Europe, limited likelihood for introduction through blood transfusion from a viraemic donor; 2) Risk related to the presence and characteristics of the vector were the spread of *Ae. albopictus* in Europe has been documented, but the map would need to be update, such as taking in to account ecological and climatic information, and considering a more detailed administrative level, the vectorial capacity (host preference, longevity density) and competence (Susceptibility of local strain) for transmitting CHIKV in Europe, needs to further investigation particular in highly infested areas; 3) Risk related to interaction with the host was factors influencing the host and

related risk include the likelihood of being bitten, immunological susceptibility, duration and level of viraemia, proportion of asymptomatic case and capability to detect a case.

5. Combined arboviral infections

5.1. Combined Flavivirus infections

Dengue and encephalitis

Although both dengue and Japanese encephalitis virus (JEV- is one of the most important cause of viral encephalitis worldwide) belong to the genus Flaviviridae, however, the biological characteristics of these two viruses are somewhat different. JEV is mainly transmitted by mosquitoes of the genus *Culex* (469), isolated of this virus are also reported from Anophelinae mosquitoes (470).

The investigation on the activity of two DENV and JFV were conducted in and around Malina, Philippines, and Luzon islands, they could not demonstrate the DENV and JFV combination (470). But encephalopathy has been well reported and has classically been thought to result from the multisystem derangement that occurs in severe dengue infection with liver failure, shock, and coagulopathy causing cerebral insult, there is increasing evidence for DENV neurotropism, these may be an element of direct viral encephalitis (471). DENV infections represent a significant burden of disease in the tropics, and neurologic manifestations are increasingly recognized, but remain relatively poorly understood.

Dengue and Yellow fever

Dengue and Yellow fever viruses are single - stranded RNA viruses in the Flaviridae, they are endemic to and epidemic in tropical and subtropical regions (472). In their original habitat, both are Zoonotic infection transmitted by forest-dwelling mosquitoes, *Aedes*. There is little doubt that the yellow fever virus (YFV) originated in Africa, and that viruses circulating in the New World are of African origin (473). Curiously, YFV never been recorded in Asia, although *Ae. aegypti* is widespread there (473) (See figure 41).

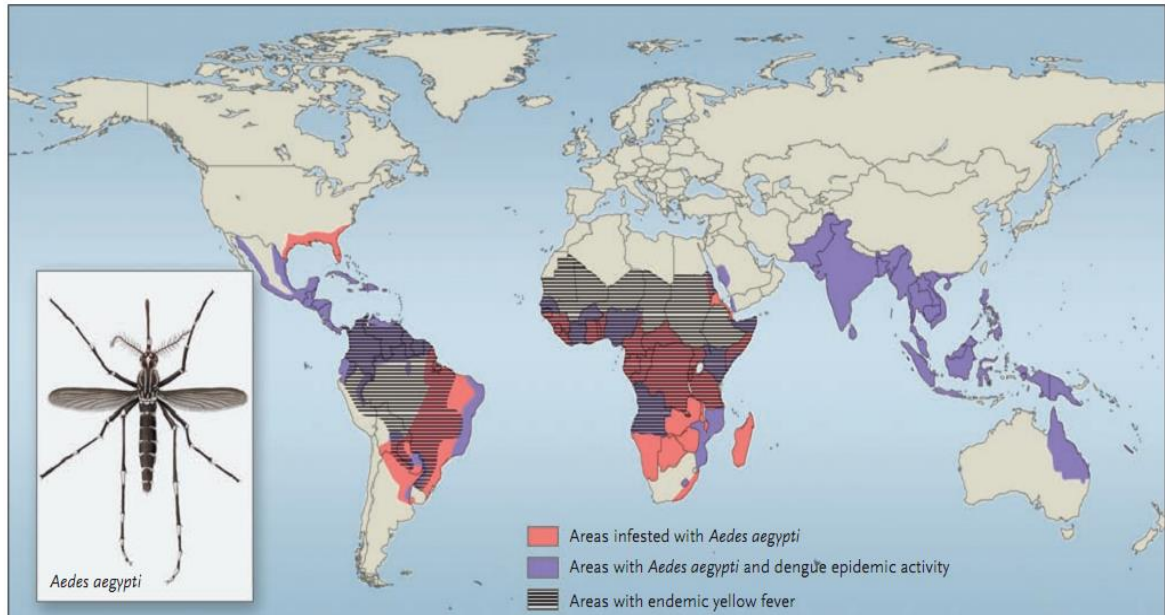

Figure 41: Distribution of Dengue, Yellow Fever, and their principal vector, the *Aedes aegypti* mosquito.

Although YFV is now largely controlled by vaccination and successful mosquitoes eradication campaign, many regions are susceptible to a reemergence if the movement of infected person (472), and both of viruses continually rising (474) (475). The large urban outbreaks of yellow fever were common until the early 20th century remain a real and constant danger in enzootic countries that do not enforce routine vaccination. However, it is reasonable to assume areas were prone to dengue transmission was equally prone to YFV, so areas without history of the latter, including those in South East Asia, may well be at risk (473).

5.2. Combined Dengue and Chikunguni viruses in the world

Dengue and Chikungunya co-infection

Co - infection by DENV and CHIKV in patient has been known for along time. The first described in patients, and reports of co - infections with DENV and CHIKV in 1964 in South India (476), a co - infection in human can occur following the bite of two main mosquitoes infected with one virus or to the bite of a mosquito infected with two viruses. In the some outbreaks, CHIKV affected areas overlap with dengue fever - endemic areas and provide opportunities for mosquitoes to become infected with both the viruses, and co

- infection are increasing, particularly after the emergence of CHIK in the India Ocean in 2005 - 2006 due to a new variant highly transmitted by *Ae. albopictus*, a dengue outbreak in the same geographic area transmitted by *Ae. albopictus* was shortly before the emergence of chikungunya, and co - infections (476). In Asia, the first case report of CHIKV and DENV co-infection confirm by molecular methods was from Sri Lanka (477) and the CHIKV affected areas overlap with DENV in endemic areas (478). In 1967, co - infections with DENV and CHIKV reported in Calcutta, India. Subsequent serologic investigation in Southern India indicated that the two viruses can co-exist in the same host (418).

In clinical, the common symptom of both disease included fever, joint and bone pain, nausea, vomiting, headache, and fatigue. Therefore, while screening considering both dengue and chikungunya infection is necessary because though the clinical features are similar, the outcomes maybe different, chikungunya is nonfatal while dengue may lead to severe health complication and including death (479). A study from Department of Microbiology, Sri Venkateswara Institute of Medical Sciences, Tirupati, India showed that the co - infection with dengue and chikungunya fever was found in 2.7% of the cases in India (479).

Dynamic Dengue and Chikungunya co-infection

In the past years, DENV and CHIKV have caused large and geographically wide ranging epidemics (6)(480) (481). The actual situation of co - infection is much more complex. First, *Ae. albopictus* was repeatedly show to be highly competent vector of CHIKV during the recent outbreak in the Indian Ocean and Italy (482). Second, the overall distribution of *Aedes* mosquitoes is rapidly changing. Specifically, *Ae. albopictus* has dispersed globally in to new territories previously occupied by *Ae. aegypti*. As a consequence, the characteristics of DENV and CHIKV circulation and their outbreak dynamics are likely to be modified (483). The CHIKV affected areas overlap with DENV endemic areas and provide opportunities for mosquitoes to become infected with both viruses (484). Co - infection with DENV- 1 and DENV- 2 was reported in Puerto Rico in 1982 (485). Since then, many cases of concurrent infections with multiple DENV serotypes have been reported in many countries, such as co - infections with more than two DENV serotypes in India in 1967 and 2006. The co - infection with DENV and CHIKV in Calcutta, India show that subsequent serologic investigation the two viruses can coexist in the same host (486) (418).

Seasonal trend observed with both the fevers with rise of the cases during the post monsoon period. *Ae. aegypti* is sensitive to changes in temperature and available moisture, they decrease in number in dry and cool seasons, and increase when temperatures increase and when the wet season begins (487) (488).

Beside, in the some countries setting, overcrowding, low socioeconomic conditions, and poor sanitary conditions, mixed population of mosquitoes thriving together cannot be excluded is reason to make dynamic of CHIKV and DENV co - infection.

Mechanisms of Dengue and Chikungunya co-infection

The exact mechanisms of the DENV and CHIKV co - infection still remain a mystery. Despite the threat of this virus to public health and its importance to research on viral hemorrhagic fevers our understanding of the virulence, pathogenesis, and mechanisms of re - emergence of the dengue virus is limited. Unlike dengue, chikungunya typically consists of a self - limiting and nonfatal acute illness characterised by fever, rash and incapacitating arthralgia. Several mechanisms including a complex interaction between various factors such as the susceptibility of humans and the mosquito vectors to the virus, conditions facilitating mosquito breeding resulting in a high vector density, ability of the vector to efficiently transmit the both of virus are all thought to play a role.

PART II
DENGUE AND CHIKUNGUNYA IN VIETNAM

CHAPTER 1

ROLE OF AEDES SPECIES IN THE TRANSLISSION OF DENGUE IN URBAN AREAS IN NORTH VIETNAM

1.1. Context of study

Hanoi, capital of Vietnam, is an urban center located in the northern part of the country. It is a large city with a population estimated at 2.6 million for the urban districts and 6.5 million for the metropolitan jurisdiction (489) (490).

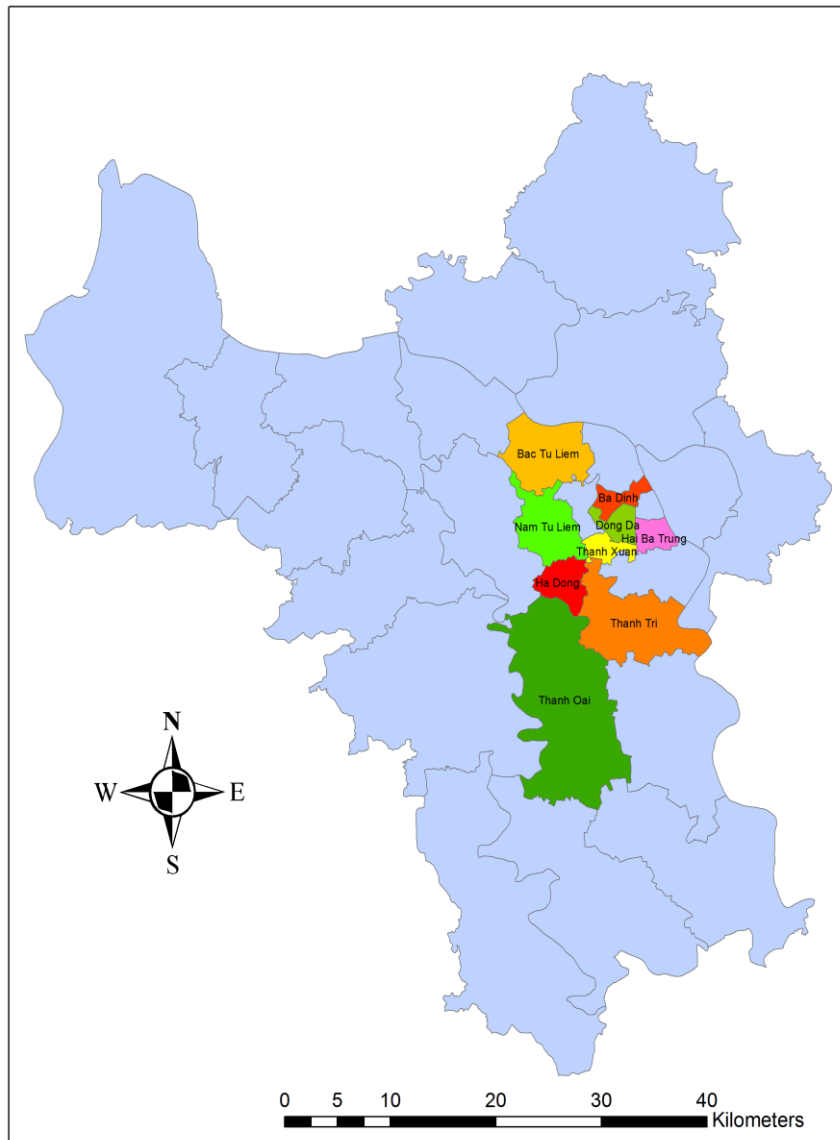

Figure 43: Location of the eight selected study districts in Hanoi, Vietnam

Hanoi is known as a low-transmission area for DF (491), but recently DF appeared to be emerging (492). Public health authorities in Vietnam are now considering dengue as an emerging health problem in Hanoi. The climate is contrasted with hot and humid summers and a rainy season from May to September with temperatures from 38 - 40⁰ C. Winters are relatively dry and cool from November to March with temperatures as low as 6⁰ C. Spring is marked by light rains. The period from June to September is suitable for the development of mosquito vectors (493). Besides, Hanoi experiences annual seasonal dengue outbreaks with the peaks of epidemics usually falling in September/October and ending in November/December. There are only few studies published on the epidemiology of dengue in Hanoi all based on public surveillance data routinely collected by the Ministry of Health (494). DF was first described in northern Vietnam in 1958, where DHF was first reported (495) (496), and later expanded to the southern area where it was described in 1960 (497). During the first 1958 DHF outbreak in Hanoi, 68 patients with identical clinical symptoms were hospitalized with a mortality rate of 7% (19). Dengue infections have been regularly reported since then, but during the 1998-2009 decade, two large outbreaks occurred in the central urban area of Hanoi, which resulted in a total 25983 cases mostly among young adults (494) (498). Incidence rates of DF have increased significantly during the last few years in many province and cities, especially Hanoi.

The invasion of *Aedes* mosquito is assumed to be high in tropical, dengue endemic, countries like Vietnam. *A. aegypti* is considered the most important vector of DENV while *A. albopictus* is generally believed to be a less competent vector resulting in milder epidemics (18). However, dengue outbreaks have been attributed to both *A. aegypti* and *A. albopictus* in different regions of the world including Asia (499) (495) (18) (500). Each species displays a specific ecology, behavior and geographical distribution. *A. aegypti* prefers urban habitats, whereas *A. albopictus* is primarily a forest species that has become adapted to rural, suburban and urban human environments (18) (501) (502). Owing to this co-circulation of both mosquito species in Vietnam (503) (504), and although Hanoi has a cool winters (505), both species are found in Hanoi (506).

1.2. Objective

To assess the spread of dengue virus and the risk factors for this virus, we conducted a surveillance of mosquitoes and blood samples from hospitalized patients

collected during outbreaks from August 2011 to December 2011 in eight districts of Hanoi as Ba Dinh, Hai Ba Trung, Dong Da, Ha Dong, Thanh Xuan, Thanh Oai, Thanh Tri, and Tu Liem. This study was conceived to investigate the respective role of *A. aegypti* and *A. albopictus* in DENV transmission and correlation between mosquito abundance and size and duration of outbreaks in Ha Noi, Vietnam.

1.3. Discussion and conclusions

This study conducted in Hanoi, Vietnam, reported 140 confirmed cases of DF in 24 outbreaks over eight districts. The patients were mainly males older than 15 with the highest number of dengue cases found in the 15-34 years age class. Only 10% of patients were under 15 years old. The age distribution reported in this study differs from other works which reported dengue mainly in children (507) (508) (509) (510) (511) (512) (513) (514). However, our results are supported by reports from both Latin America and Southeast Asia where increasing dengue incidence has been found among older age groups (515) (516) (517) (518). During the study period, we also found proportionately more males affected than females. Others have reported similar findings in Vietnam, China and Nepal (519) (520) (507). There is no clear explanation for this bias which might be associated to an occupational factor.

The presence of only DENV 1 and DENV 2 along with the predominance of DENV 2 reported in this work are in agreement with previous reports on from Hanoi in recent years (494) (519). This suggests that DENV 1 and DENV 2 were already co-circulating during previous outbreaks in the same area and most likely maintained over time through transmission in mosquito populations. This importance of mosquito populations in the maintenance and development of outbreaks is clearly highlighted in this work with the widespread distribution of *A. aegypti* together with high local densities during the outbreak period in Dong Da, Hai Ba Trung, Ba Dinh, Ha Dong and to a lesser extent in other districts. *Ae. aegypti* was also the single vector in simultaneous outbreaks of dengue fever in Hanoi. Furthermore, high population densities of *A. aegypti* were correlated with the number of human cases reported in outbreaks. The number of *A. aegypti* individuals collected in the early period of outbreaks was higher than the number collected towards the end of the outbreaks. However, due to the small size of mosquito samples

collected in Thanh Tri, Thanh Oai and Tu Liem districts, we cannot exclude that this result was biased as mosquitoes may have been collected under different meteorological conditions or time periods. Nevertheless, altogether these results provide evidence that *A. aegypti* populations from eight districts were involved in dengue virus transmission, and probably played a pivotal role during the 2011 dengue outbreaks and before as a maintenance host.

Despite the fact that it is considered to be a less efficient vector, *Ae. albopictus* is adapted to urban domestic environments and was described as vector in DENV outbreaks in different regions including China, Gabon or Madagascar (521) (18) (522). However, in this work, DENV were not detected in *Ae. albopictus* and no correlation was found between *Ae. albopictus* populations and increase in number of human cases. These data corroborate other reports suggesting that *Ae. albopictus* is not an important vector in urban environment when compared to *Ae. aegypti* (523) (502) (524) (525)(526).

The importance of mosquito population densities in the dynamic of dengue fever highlighted by this work might however be underestimated. Indeed, a limitation to this study is that it only covered the latter part of the rainy season, considered an ideal time for dengue transmission. Additionally, no information was available for artificial containers that might have acted as breeding habitats for *Aedes* mosquitoes. There may also have been case ascertainment biases as we relied on patients presenting themselves to health services, thus milder and asymptomatic cases may not have been identified. Nevertheless, this work strongly supports the need of further investigation in other geographic areas and environment, i.e. suburban and rural, to determine the distribution and relative role of *Ae. aegypti* and *Ae. albopictus* in the transmission of DF and DHF in Vietnam. This work also underline the need of a better understanding of the dynamics of mosquito populations to implement efficient and adapted mosquito population monitoring and mosquito control strategies, which is at the moment the best way of controlling dengue and other mosquito-borne diseases.

The results of this work are summarized in the article entitled “Role of *Aedes aegypti* and *Aedes albopictus* during the 2011 dengue fever epidemics in Hanoi, Vietnam”. This article published in “Asian Pacific Journal of Tropical Medicine” is presented thereafter.

HOSTED BY



ELSEVIER

Contents lists available at ScienceDirect

Asian Pacific Journal of Tropical Medicine

journal homepage: <http://ees.elsevier.com/apjtm>Original research <http://dx.doi.org/10.1016/j.apjtm.2015.06.009>Role of *Aedes aegypti* and *Aedes albopictus* during the 2011 dengue fever epidemics in Hanoi, VietnamPham Thi Kim Lien^{1,2}, Vu Trong Duoc^{1*}, Laurent Gavotte³, Emmanuel Cornillot³, Phan Thi Nga¹, Laurence Briant², Roger Frutos^{2,4}, Tran Nhu Duong^{1*}¹National Institute of Hygiene and Epidemiology, 1 Yersin Street, 10000 Hanoi, Viet Nam²CPBS, UMR 5536, CNRS-UM1-UM2, 1919, route de Mende 34293 Montpellier Cedex 5, France³ISEM, UMR 5554, CNRS-UM2-IRD, Université Montpellier 2 CC065, Place E. Bataillon, 34095 Montpellier Cedex 5, France⁴Intertryp, UMR 17, Cirad-IRD, Campus International de Baillarguet, 34398 Montpellier Cedex 5, France

ARTICLE INFO

Article history:

Received 15 Apr 2015

Received in revised form 20 May 2015

Accepted 15 Jun 2015

Available online xxx

Keywords:

*Aedes aegypti**Aedes albopictus*

Dengue

Vector density

ABSTRACT

Objective: To record the human cases of dengue fever (DF) and investigate the *Aedes* mosquito species circulating during the Hanoi 2011 DF epidemics.**Methods:** 24 different outbreak points were recorded in 8 districts between August and December 2011.**Results:** 140 patients were hospitalized following dengue diagnostic with a predominance of males (59.3%) and the 15–34 age class. Only DENV-1 (11.27%) and DENV-2 (88.73%) serotypes were detected in human samples. Mosquito sampling performed in and around patients households revealed the predominance of *Aedes aegypti* (*A. aegypti*) (95.15%) versus *Aedes albopictus* (4.85%).**Conclusions:** There is a positive correlation between the population density of *A. aegypti* and the number of human cases and duration of outbreaks. This was not observed for *Aedes albopictus*. Three pools of *A. aegypti* were positive with dengue virus, two with DENV-1 and one with DENV-2.

1. Introduction

Four distinct DENV serotypes are currently described which cause dengue fever in humans resulting in a range of clinical symptoms including fever, headache, muscle, joint pains, and a characteristic skin rash similar to measles [1–4]. Dengue fever (DF) can also evolve into severe forms such as dengue hemorrhagic fever (DHF) or dengue shock syndrome (DSS), which could result in death [5]. An estimated 390 million dengue infections occur every year, of which 96 million are asymptomatic [6], which could make the burden of dengue three times higher than considered [7,8]. More than 100 countries are affected by outbreaks of dengue and more than 60 have reported the occurrence of DHF [9]. Southeast Asia is among the regions most affected by dengue and Vietnam is

one of the five countries in this region with the highest burden [10]. DF was first described in northern Vietnam in 1958 and expanded to the southern area in the 1960s [11–13]. DHF was first described in Hanoi during the rainy season of 1958 [14,11] with a mortality rate of 7% [15]. During the 1998–2009 decade, two large outbreaks occurred in the central urban area of Hanoi, which resulted in a total of 25983 cases mostly among young adults [16,17].

Dengue virus (DENV) is transmitted to humans by two mosquito species, *Aedes aegypti* (*A. aegypti*) and *Aedes albopictus* (*A. albopictus*). *A. aegypti* is considered the most important vector of DENV while *A. albopictus* is generally believed to be a less competent vector resulting in milder epidemics [18]. However, dengue outbreaks have been attributed to both *A. aegypti* and *A. albopictus* in different regions of the world including Asia [1,11,18,19]. Each species displays a specific ecology, behaviour and geographical distribution. *A. aegypti* prefers urban habitats, whereas *A. albopictus* is primarily a forest species that has become adapted to rural, suburban and urban human environments [18,20,21]. Owing to the increasing presence of *A. albopictus* and the co-circulation of both mosquito species in

*Corresponding author: Vu Van Duoc, National Institute of Hygiene and Epidemiology, 1 Yersin Street, 10000 Hanoi, Viet Nam.

Tran Nhu Duong, Intertryp, UMR 17, Cirad-IRD, Campus International de Baillarguet, 34398 Montpellier Cedex 5, France.

E-mails: roger.frutos@univ-montp2.fr, frutosmt@gmail.com

Peer review under responsibility of Hainan Medical University.

Vietnam [22,23], this study was undertaken to investigate their respective potential role in DENV transmission in the recent epidemics and correlation between mosquito abundance and size and duration of outbreaks.

2. Materials and methods

2.1. Ethics and enrolment of patients

The study protocol was cleared and approved by the Scientific and Ethical Committee of the National Institute of Hygiene and Epidemiology, Vietnam. The study was conducted as part of the Vietnamese National Dengue Prevention and Control Program. All patients considered in the analysis gave a written informed consent of participation to the study.

2.2. Location of sampling

Mosquitoes and blood samples from hospitalized patients were collected during outbreaks from August 2011 to December 2011 in eight districts of Hanoi: Ba Dinh, Hai Ba Trung, Dong Da, Ha Dong, Thanh Xuan, Thanh Oai, Thanh Tri, and Tu Liem (Figure 1). The population of the Northern city of Hanoi was estimated in 2009 to be 2.6 million for urban districts, and 6.5 million for the metropolitan jurisdiction [24]. Climate is contrasted with hot and humid summers, a rainy season from May to September with temperatures from 38 °C to 40 °C. Winters are relatively dry and cool from November to March with temperatures as low as 6 °C. Spring is marked by light rain. The period from June to September is suitable for the development of the mosquitoes [25]. The DF outbreak areas were defined according to Ministry of Health guidelines as geographic areas (town/village/hamlet, population groups or equivalent) where patients were tested positive for DENV and simultaneous detection of mosquitoes was confirmed [26]. Small outbreaks were defined as occurrences with less than 20 positive patients, medium outbreaks comprised 21 to 100 positive patients and large outbreaks were considered as involving more than 100 patients. Outbreaks were considered terminated when no case was reported for at least 14 days.

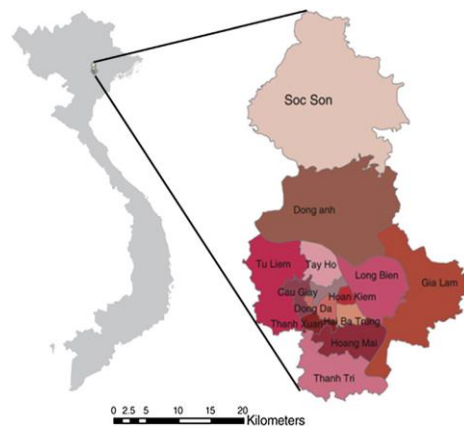

Figure 1. Map of sampling locations.

2.3. Case definition and sampling

Patients admitted to the National Hospital for Tropical Diseases in Hanoi between August 1, 2011 and December 21, 2011 were considered in the study when presenting dengue symptoms as defined both by WHO and Vietnamese Ministry of Health guidelines on surveillance, diagnosis, treatment of dengue. These symptoms were a continuous fever for 2–7 days in an individual from an endemic area and displaying two or more of the following clinical manifestations of DF: nausea, vomiting, rash, aches and pains; positive tourniquet test, leukopenia and any warning sign [7,27]. Blood samples were systematically collected from patients corresponding to the above-mentioned criteria. Acute phase serum sample was collected after fever onset from day 1 to 7 and a follow-up 3–5 ml serum sample was taken, stored at 4 °C until being sent each day to arbovirus laboratory, NIHE for RNA extraction then stored at –80 °C. Description of cases included the onset date and place, age and gender of patients with notified cases of DF infection. The serum obtained was subjected to serological and molecular testing to determine the presence of dengue virus and identify the serotype. With the patient's consent, the following data were collected: full name, residence address, gender, time of onset and intensity, and location of symptoms. After data collection, contacts were taken with Preventive Medicine Centres in each district to implement captures of mosquitoes in patient's house and households.

2.4. Mosquito collection and identification

Adult mosquitoes were collected from patient's house, and 15 households around the patient's household located within a radius of approximately 20–50 m using a backpack aspirator. For each outbreak area, 50–100 households were randomly selected for daily collection. For each household, sampling was performed indoor and outdoor for approximately 15 min during the day. Mosquito collection were carried out by 4 groups volunteer with 2 sessions per day between 5–10 AM and 4–8 PM. Collected mosquitoes were stored in RNA later solution (Qiagen) and kept refrigerated at 2 °C–8 °C. Identification of *A. aegypti* and *A. albopictus* was performed according to morphological criteria following binocular examination. Mosquito samples were sorted according to species, gender, date of collection, geographical coordinates and number of mosquitoes for each location, and then stored at –80 °C in RNA later solution until further use.

2.5. RNA extraction and RT-PCR amplification

Viral RNA was extracted from 140 µL patient blood serum and from 970 mosquitoes (923 *A. aegypti* and 47 *A. albopictus* individuals) by pools of up to 10 mosquitoes depending upon sample size. Males and females were pooled separately. Viral RNA was extracted using QIAamp viral RNA Mini kit (Qiagen) according to the supplier and stored at –80 °C until further use. DENV RNA was detected and typed using a single tube multiplex RT-PCR according to an experimental protocol adapted from previously published procedures [28,29]. Both reverse transcription and PCR were conducted using the Access Quick RT-PCR kit (Promega). Reverse transcription was conducted at 45 °C for 30 min using random primers

(Invitrogen). PCR was then performed in a 50 μ L reaction volume using a set of five primers (25 pmol each) comprising a dengue virus consensus reverse primer and four serotype-specific forward primers (Table 1). PCR was conducted for 35 cycles under the following conditions: denaturation at 94 °C for 2 min, annealing at 55 °C annealing for 45 s and extension at 72 °C for 90 s followed by a final extension for 10 min at 72 °C. PCR products were analysed in a 2% agarose gel electrophoresis using 10% SYBR safe DNA dye (Invitrogen) in 1% TAE buffer. The expected size of the amplicons was 492 bp, 119 bp, 290 bp and 392 bp for DENV-1, DENV-2, DENV-3 and DENV-4, respectively.

2.6. Data analysis

Data were analyzed using STATA 10.0. Spearman's Rank correlation coefficient analysis was used to investigate the association between the density of *Aedes* mosquitoes, number of confirmed dengue cases and duration of outbreaks.

3. Results

3.1. Outbreaks location, size and duration

During the study period, a total of 24 infectious foci were detected within the eight districts in Hanoi, all of them being small or medium outbreaks (Figure 1). The mean duration of an individual outbreak was 69.3 days, ranging from 17 to 123 days (median duration 76 days). Samples were collected from a total of 140 hospitalized patients confirmed with dengue by serology. The number of confirmed cases in each district varied from 2 to 42 (mean = 16, and median = 23) (Table 2). No shock or haemorrhage characteristic of severe dengue was reported among cases included in the study. Men (59.3%) were more affected than women (40.7%) (Table 3). The youngest patient was 3 years old and the oldest was 88 (mean age = 33 years, median = 29 years) (Table 3).

3.2. Collection of mosquitoes in and around patients' households

A total of 1200 households were sampled during the study and 970 mosquitoes were collected (Table 2). All mosquitoes collected belonged to the genus *Aedes*. 923 (95%) belonged to the *A. Aegypti* species whereas 47 (5%) were *A. albopictus*. For each district, the total number of *Aedes* collected ranged from 5 to 322. *A. aegypti* largely predominated in each district with the exception of Thanh Oai and Thanh Tri where the number of *A. albopictus* was higher. Hai Ba Trung district recorded the highest number of captured *A. albopictus* (17/47 or 36%). The

Table 2

Mosquito and human samples collected from outbreaks in Hanoi, 2011.

District	Case	<i>A. aegypti</i>	<i>A. albopictus</i>	Time outbreaks (day/month/year)	Duration of outbreak in days
Ba Dinh	23	180	0	1/8–13/10/2011	74
Hai Ba Trung	31	204	17	12/8–13/12/2011	123
Dong Da	42	313	9	18/8–30/11/2011	104
Thanh Xuan	6	68	4	11/9–28/11/2011	78
Thanh Oai	6	1	4	1/10–25/10/2011	25
Thanh Tri	2	1	5	12/10–28/10/2011	17
Tu Liem	2	13	0	1/9–30/9/2011	20
Ha Dong	28	143	8	12/8–3/12/2011	113
Total	140	923	47	1/8–13/12/2011	564

observed density of *Aedes* mosquitoes was higher during outbreaks. However, due to the small size of mosquito samples collected in Thanh Tri, Thanh Oai and Tu Liem districts, we cannot exclude that this result was biased as mosquitoes may have been collected under different meteorological conditions or time periods.

3.3. Detection and identification of dengue virus

Out of the 140 dengue serology-positive blood samples, 71 were tested by PCR. Only DENV-1 and DENV-2 serotypes were detected. Only 8 patients (11.27%) distributed over four districts, i.e. Ba Dinh, Hai Ba Trung, Dong Da, and Thanh Tri, tested positive for DENV-1 (Table 3). 63 patients (88.73%) tested positive for DENV-2 which was present in all the districts investigated with the exception of Thanh Tri. In three districts, i.e. Dong Da, Hai Ba Trung and Ba Dinh, the presence of both DENV-1 and DENV-2 was recorded.

3.4. Correlation between *Aedes* population size and outbreak intensity

A positive correlation was observed between the population density of *A. aegypti* and the number of human cases recorded during an outbreak ($R = 0.57$, $P = 0.003$). A similarly positive association was observed between the number of *A. aegypti* mosquitoes collected at outbreak sites and the duration of outbreaks. *A. aegypti* population density was found higher when outbreak was longer ($R = 0.57$, $P = 0.003$). The number of *A. aegypti* individuals collected in the early period of outbreaks was higher than the number collected towards the end of the outbreaks. Conversely, no correlation was found between the number *A. albopictus* collected in outbreak areas and the number of confirmed dengue cases in the same areas ($R = -0.62$) or with

Table 1

Oligonucleotide primers used to amplify and type dengue viruses.

Primer	Sequence	Genome position	Size, in bp, of amplified DNA product (primers)
D1	5'-TCAATATGCTGAAACGCGGAGAA ACCG-3'	616–644	511
TS1	5'-CGTCTCAGTGATCCG GGGG-3'	568–586	492 (D1 and TS 1)
TS2	5'-CGC CAC AAG GGC CAT GAA CAG-3'	232–252	119 (D1 and TS 2)
TS3	5'-TAA CAT CATCAT GAG ACA GAGC-3'	400–421	290 (D1 and TS 3)
TS4	5'-CTCTGTGTCTTAAACAA GAGA-3'	506–527	392 (D1 and TS 4)

Note: D1 is reverse primer, and forward primers are TS1 (DENV1), TS2 (DENV2), TS (DENV3) and TS 4 (DENV4).

Table 3

Distribution of gender and age in dengue case.

Gender	Dengue case (%)	Age of dengue case (%)				Rate ratio
		<15	15–34	35–44	>45	
Male	83 (59.3)	9 (10.8)	47 (56.6)	10 (12.0)	16 (19.3)	1.46
Female	57 (40.7)	5 (8.7)	27 (47.4)	10 (17.5)	16 (28.0)	1.00
Total	140 (100%)	14 (10%)	74 (52.9%)	20 (14.3%)	32 (22.9%)	

the duration of outbreaks ($R = -0.67$). All *A. albopictus* samples were negative for dengue virus (Table 4). Only *A. aegypti* female mosquitoes collected in the districts of Ba Dinh, Hai Ba Trung and Dong Da were positive for DENV-1 and DENV-2 (Table 5).

4. Discussion

This study conducted in Hanoi, Vietnam, reported 140 confirmed cases of DF in 24 outbreaks over eight districts. The patients were mainly males over 15 with the highest number of dengue cases found in the 15–34 years age class. Only 10% of patients were under 15. The age distribution reported in this study differs from other works which reported dengue mainly in children [30–37]. However, increasing dengue incidence in older age groups was also reported in Latin America and Southeast Asia [38–41]. During the study period, we also found that more males were affected than females. Others have reported similar findings in Vietnam, China and Nepal [30,42,43]. There is no clear explanation for this bias which might be associated to an occupational factor.

Table 4

Distribution of serotypes among confirmed dengue positive patients.

District	Case	DENV serotype in patient			
		DENV-1	DENV-2	DENV-3	DENV-4
Ba Dinh	23	1	11	0	0
Hai Ba Trung	31	5	9	0	0
Dong Da	42	1	24	0	0
Thanh Xuan	6	0	1	0	0
Thanh Oai	6	0	3	0	0
Thanh Tri	2	1	0	0	0
Tu Liem	2	0	1	0	0
Ha Dong	28	0	14	0	0
Total	140	8	63	0	0

Table 5Dengue virus serotypes detected in *Aedes* mosquitoes collected in outbreaks areas.

District	No. of mosquito pools		No. of positive pools		% Positive pools	
	<i>A. aegypti</i>	<i>A. albopictus</i>	<i>A. aegypti</i>	<i>A. albopictus</i>	<i>A. aegypti</i>	<i>A. albopictus</i>
Ba Dinh	18	0	1 (D1)	0	5.53%	0.00%
Hai Ba Trung	21	3	1 (D1)	0	5.90%	0.00%
Dong Da	32	4	1 (D2)	0	3.10%	0.00%
Thanh Xuan	7	2	0	0	0.00%	0.00%
Thanh Oai	1	1	0	0	0.00%	0.00%
Thanh Tri	1	1	0	0	0.00%	0.00%

The detection of only DENV-1 and DENV-2 in mosquitoes along with the predominance of DENV-2 reported in this work is in agreement with previous reports on from Hanoi in recent years [16,42]. This suggests that DENV-1 and DENV-2 were already co-circulating during previous outbreaks in the same area and probably maintained over time through vertical transmission in mosquito populations. The overwhelming presence of *A. aegypti* in the captured mosquitoes, its widespread distribution and the positive correlation of higher local density with the number of human cases reported in outbreaks, altogether strongly suggest that *A. aegypti* is involved in dengue virus transmission in Hanoi, with a pivotal role during the 2011 dengue outbreaks and before as a maintenance host.

Despite the fact that it is considered to be a less efficient vector, *A. albopictus* is adapted to urban domestic environments and was described as a vector in DENV outbreaks in different regions including China, Gabon or Madagascar [44–46]. However, in this work, DENV were not detected in *A. albopictus* and no correlation was found between the number of *A. albopictus* captured and the number of human cases. These data corroborate reports suggesting that *A. albopictus* is not an important vector in urban environment when compared to *A. aegypti* [21,47–50]. Despite its growing importance and presence it remains a secondary dengue vector, indicating that control actions must remain directed towards *A. aegypti* habitats.

The importance of mosquito population densities in the dynamic of dengue fever highlighted by this work might, however, be underestimated. Indeed, a limitation to this study is that it only covered the latter part of the rainy season, considered an ideal time for dengue transmission. Additionally, no information was available for artificial containers that might have acted as breeding habitats for *Aedes* mosquitoes. There may also have been case ascertainment biases as we relied on patients presenting themselves to health services, thus milder and asymptomatic cases may not have been identified. Nevertheless, this work strongly supports the need of further investigation in other geographic areas and environment, i.e. suburban and rural, to determine the distribution and relative role of *A. aegypti* and *A. albopictus* in the transmission of DF and DHF in Vietnam and a potential evolution linked to the spread of *A. albopictus*. This work also underlines the need of a better understanding of the dynamics of mosquito populations to implement efficient and adapted mosquito population monitoring and mosquito control strategies, which is at the moment the best way of controlling dengue and other mosquito-borne diseases.

Conflict of interest statement

We declare that we have no conflicts of interest.

Acknowledgements

PTKL was supported in part by the Erasmus Mundus project MAHEVA and by the CNRS-UM1-UM2 PEPS project

MoDyCA. The study was supported by the Entomology Department, National Institute of Hygiene and Epidemiology, Hanoi, Vietnam.

The authors are grateful to leaders and medical staff of the National Hospital for Tropical Diseases, the Center for Preventive Medicine in Hanoi, the District Health Centre and commune healthcentre/wards in Hanoi city for their enthusiastic support, active participation and close collaboration. The authors are very grateful to Dr Babatunde Olowokure, WHO Vietnam, for his support and fruitful comments on the manuscript.

References

- [1] Kyle JL, Harris E. Global spread and persistence of dengue. *Annu Rev Microbiol* 2008; **62**(1): 71-92.
- [2] Dietz VJ, Nieburg P, Gubler DJ, Gomez I. Diagnosis of measles by clinical case definition in dengue-endemic areas: implications for measles surveillance and control. *Bull World Health Organ* 1992; **70**(6): 745-750.
- [3] López-Vélez R, Pérez-Casas C, Vorndam AV, Rigau J. Dengue in Spanish travelers returning from the tropics. *Eur J Clin Microbiol Infect Dis* 1996; **15**(10): 823-826.
- [4] Pull L, Briclher S, Bouchaud O, Siriez J-Y. Differential diagnosis of dengue fever: beware of measles! *J Travel Med* 2012; **19**(4): 268-271.
- [5] Martina BEE, Koraka P, Osterhaus ADME. Dengue virus pathogenesis: an integrated view. *Clin Microbiol Rev* 2009; **22**(4): 564-581.
- [6] Bhatt S, Gething PW, Brady OJ, Messina JP, Farlow AW, Moyes CL, et al. The global distribution and burden of dengue. *Nature* 2013; **496**(7446): 504-507.
- [7] WHO. Dengue guidelines for diagnosis, treatment, prevention and control: new edition. Available from: <http://www.who.int/rpc/guidelines/9789241547871/en/>.
- [8] WHO. *Dengue guidelines for diagnosis, treatment, prevention and control*. 2009.
- [9] Kyle JL, Hariss E. Dengue fever in a warming world. Global spread and persistence of dengue. *Annu Rev Microbiol* 2008; **62**: 71-92.
- [10] Shepard DS, Undurraga EA, Halasa YA. Economic and disease burden of dengue in southeast Asia. *PLoS Negl Trop Dis* 2013; **7**(2): e2055.
- [11] Karine, Le Loan Luu, Hoang Tran Huu, Tien Tran Khanh, Rodhain Francois, Failloux Anna-Bella. *Aedes aegypti* in South Vietnam: ecology, genetic structure, vectorial competence and resistance to insecticides. *Southeast Asian J Trop Med Public Health* 2003; **34**(1): 81-86.
- [12] Tran KT, Vazeille-Falcoz M, Mousson L, Tran HH, Rodhain F, Ngugen TH, et al. *Aedes aegypti* in Ho Chi Minh City (Viet Nam): susceptibility to dengue 2 virus and genetic differentiation. *Trans R Soc Trop Med Hyg* 1999; **93**(6): 581-586.
- [13] Do QH, Nguyen TKT, Vu TQH, Huynh TKL, Cao MT. Dengue epidemic in southern Vietnam, 1998. *Emerg Infect Dis* 2000; **6**(4): 422-425.
- [14] Mihov C, Tuong CV, Tuong HP. A propos d'une épidémie du type des fièvres hémorragiques à Hanoi. *Folia Med* 1959; **1**: 169-173.
- [15] Halstead SB. Mosquito-borne haemorrhagic fevers of South and South-East Asia. *Bull World Health Organ* 1966; **35**(1): 3-15.
- [16] Toan DTT, Hu W, Thai PQ, Hoat LN, Wright P, Martens P. Hot spot detection and spatio-temporal dispersion of dengue fever in Hanoi, Vietnam. *Glob Health Action*. [Online] Available from: <http://www.ncbi.nlm.nih.gov/pmc/articles/PMC3556563/>
- [17] Cuong HQ, Hien NT, Duong TN, Phong TV, Cam NN, Farrar J, et al. Quantifying the emergence of dengue in Hanoi, Vietnam: 1998-2009. *PLoS Negl Trop Dis* 2011; **5**(9): e1322.
- [18] Rezza Giovanni. *Aedes albopictus* and the reemergence of dengue. *BMC Public Health* 2012; **12**(1): 72.
- [19] Brathwaite Dick O, San Martín JL, Montoya RH, del Diego J, Zambrano B, Dayan GH. The history of dengue outbreaks in the Americas. *Am J Trop Med Hyg* 2012; **87**(4): 584-593.
- [20] Paupy C, Ollomo B, Kamgang B, Moutailler S, Rousset D, Demanou M, et al. Comparative role of *Aedes albopictus* and *Aedes aegypti* in the emergence of dengue and chikungunya in central Africa. *Vector Borne Zoonotic Dis Larchmt N* 2010; **10**(3): 259-266.
- [21] WHO. The mosquito. [Online] Available from: <http://www.who.int/denguecontrol/mosquito/en/> [Accessed on 30th October, 2013]
- [22] Kay BH, Tuyet Hanh TT, Le NH, Quy TM, Nam VS, Hang PVD, et al. Sustainability and cost of a community-based strategy against *Aedes aegypti* in northern and central Vietnam. *Am J Trop Med Hyg* 2010; **82**(5): 822-830.
- [23] Higa Y, Thi Yen N, Kawada H, Hai Son T, Thuy Hoa N, Takagi M. Geographic distribution of *Aedes aegypti* and *Aedes albopictus* collected from used tires in Vietnam. *J Am Mosq Control Assoc* 2010; **26**(1): 1-9.
- [24] The Vietnam Population and Housing census. *Ministry of planning and investment*. General Statistics Office; 2009.
- [25] Toan D, Hu W, Thai P, Hoat L, Wright P, Martens P. Hot spot detection and spatio-temporal dispersion of dengue fever in Hanoi, Vietnam. *Glob Health Action* 2013; **6**: 7-15.
- [26] MOH, Vietnam. Decided of MOH, no 1499/QĐ-BYT, date 17/5/2011.
- [27] MOH, Vietnam. *Guidelines on the surveillance, diagnosis, and treatment of dengue hemorrhagic fever*. Medical Publishing House.
- [28] Saxena P, Dash PK, Santhosh SR, Shrivastava A, Parida M, Rao PL. Development and evaluation of one step single tube multiplex RT-PCR for rapid detection and typing of dengue viruses. *Virol J* 2008; **5**(1): 20.
- [29] Harris E, Roberts TG, Smith L, Selle J, Kramer LD, Valle S, et al. Typing of dengue viruses in clinical specimens and mosquitoes by single-tube multiplex reverse transcriptase PCR. *J Clin Microbiol* 1998; **36**(9): 2634-2639.
- [30] Luo L, Liang H, Hu Y, Liu W, Wang Y, Jing Q, et al. Epidemiological, virological, and entomological characteristics of dengue from 1978 to 2009 in Guangzhou, China. *J Vector Ecol J Soc Vector Ecol* 2012; **37**(1): 230-240.
- [31] Halstead SB. More dengue, more questions. *Emerg Infect Dis* 2005; **11**(5): 740-741.
- [32] Halstead SB, Scanlon JE, Umpaivit P, Udomsakdi S. Dengue and chikungunya virus infection in man in Thailand, 1962-1964. IV. Epidemiologic studies in the Bangkok metropolitan area. *Am J Trop Med Hyg* 1969; **18**(6): 997-1021.
- [33] Huy R, Buchy P, Conan A, Ngan C, Ong S, Ali R, et al. National dengue surveillance in Cambodia 1980-2008: epidemiological and virological trends and the impact of vector control. *Bull World Health Organ* 2010; **88**(9): 650-657.
- [34] Kongsomboon K, Singhasivanon P, Kaewkungwal J, Nimmannitya S, Mammen MP Jr, Nisalak A, et al. Temporal trends of dengue fever/dengue hemorrhagic fever in Bangkok, Thailand from 1981 to 2000: an age-period-cohort analysis. *Southeast Asian J Trop Med Public Health* 2004; **35**(4): 913-917.
- [35] Thai KTD, Nagelkerke N, Phuong HL, Nga TTT, Giao PT, Hung LQ, et al. Geographical heterogeneity of dengue transmission in two villages in southern Vietnam. *Epidemiol Infect* 2010; **138**(4): 585-591.
- [36] Teixeira MG, Costa MCN, Coelho G, Barreto ML. Recent shift in age pattern of dengue hemorrhagic fever. *Braz Emerg Infect Dis* 2008; **14**(10): 1663-1663.
- [37] Phuong HL, de Vries PJ, Nga TT, Giao PT, Hung LQ, Binh TQ, et al. Dengue as a cause of acute undifferentiated fever in Vietnam. *BMC Infect Dis* 2006; **6**(1): 123.
- [38] Teng AK, Singh S. *Epidemiology and new initiatives in the prevention and control of dengue in Malaysia*. 2001 Dec [Online] Available from: <http://repository.searo.who.int/handle/123456789/15837> [Accessed on 2nd November, 2013]
- [39] Guzmán MG, Kouri GP, Bravo J, Soler M, Vazquez S, Morier L. Dengue hemorrhagic fever in Cuba, 1981: a retrospective sero-epidemiologic study. *Am J Trop Med Hyg* 1990; **42**(2): 179-184.
- [40] Ooi E-E, Goh K-T, Gubler DJ. Dengue prevention and 35 years of vector control in Singapore. *Emerg Infect Dis* 2006; **12**(6): 887-893.

- [41] Rigau-Pérez JG, Vorndam AV, Clark GG. The dengue and dengue hemorrhagic fever epidemic in Puerto Rico, 1994-1995. *Am J Trop Med Hyg* 2001; **64**(1-2): 67-74.
- [42] Fox A, Hoa LNM, Simmons CP, Wolbers M, Wertheim HFL, Khuong PT, et al. Immunological and viral determinants of dengue severity in hospitalized adults in Ha Noi, Viet Nam. In: Rico-Hesse R, editor. *PLoS Negl Trop Dis*, **5**(3); 2011, e967.
- [43] Gupta G, Shah Y, Poudel A, Pun R, Pant K, Kshetri R, et al. Serological and molecular study of dengue viruses in different hospitals of Nepal. *Nepal J Med Sci* 2013; **2**(1): 20-25.
- [44] Guozhang Xu HD. An outbreak of dengue virus serotype 1 infection in Cixi, Ningbo, People's Republic of China, 2004, associated with a traveler from Thailand and high density of *Aedes albopictus*. *Am J Trop Med Hyg* 2007; **76**(6): 1182-1188.
- [45] Leroy EM, Nkoghe D, Ollomo B, Nze-Nkoghe C, Becquart P, Grand G, et al. Concurrent chikungunya and dengue virus infections during simultaneous outbreaks, Gabon, 2007. *Emerg Infect Dis* 2009; **15**(4): 591-593.
- [46] Ratsitorahina M, Harisoa J, Ratovonjato J, Biacabe S, Reynes J-M, Zeller H, et al. Outbreak of dengue and chikungunya fevers, Toamasina, Madagascar, 2006. *Emerg Infect Dis* 2008; **14**(7): 1135-1137.
- [47] Lozano-Fuentes S, Hayden MH, Welsh-Rodriguez C, Ochoa-Martinez C, Tapia-Santos B, Kobylinski KC, et al. The dengue virus mosquito vector *Aedes aegypti* at high elevation in Mexico. *Am J Trop Med Hyg* 2012; **87**(5): 902-909.
- [48] Romero-Vivas, Leake, Falconar. Determination of dengue virus serotypes in individual *Aedes aegypti* mosquitoes in Colombia. *Med Vet Entomol* 1998; **12**(3): 284-288.
- [49] Gratz NG. Critical review of the vector status of *Aedes albopictus*. *Med Vet Entomol* 2004; **18**(3): 215-227.
- [50] Richards SL, Anderson SL, Alto BW. Vector competence of *Aedes aegypti* and *Aedes albopictus* (Diptera: Culicidae) for dengue virus in the Florida Keys. *J Med Entomol* 2012; **49**(4): 942-946.

CHAPTER 2

SURVEILLANCE OF DENGUE AND CHIKUNGUNYA VIRUS INFECTION IN DONG THAP

2.1. Context of the study

Dengue is endemic throughout Vietnam, but transmission is highest in the South where very large epidemics occur regularly (527). Dengue occurs year-round, but a marked seasonal peak occurs during the rainy season from June to December. Since 1960, DF epidemics tend to spread widely with a continuous increase in number of patient and deaths (528)(529)(527). 1,518,808 DHF cases and 14,133 deaths were reported between 1963 and 1995 (530). The dengue surveillance program in Southern Vietnam shows epidemic peaks of increasing magnitude occurring approximately every 5 years between 1975 and 1987, with a longer period of 11 years preceding a large epidemic of 119,429 DHF cases and 342 fatalities in 1998 (531). All four DENV serotypes were found to circulate in Southern Vietnam (532). Over the past 15 years, the number of DENV cases has been increasing (529).

Although chikungunya was first described in Vietnam in the 1960s (533), national serological evidence of its activity in Vietnam remains sparse and mainly historical. In 1966, ten American soldiers were identified (534), and serological surveys among children identified antibodies to CHIKV in 1967 (535). A number of review articles have also shown that Vietnam is one of several Asian countries to have reported chikungunya. (536)(537)(538)(539)(540).

Dong Thap general hospital located in Dong thap province in the Mekong Delta region of southern Vietnam. Dong Thap is 165 km away from Ho Chi Minh city, shares a 48-km border with the Preay Veng province of Cambodia. In recent years, Cambodia, already endemic for dengue, declared chikungunya infection in provinces bordering Vietnam (541). The disease can easily be imported by travellers and spread rapidly resulting social, economic and healthcare system impacts. This is currently threatening Vietnam and may happen in the coming year.

2.2. Objective

Vietnam being at risk of joint DENV and CHIKV infections, characterized by overlapping clinical manifestations and differences in clinical management, clinicians should be aware of the need to include CHIK in the differential diagnosis of DF. This work was conducted to evaluate the real burden of dengue infection in the general population and to identify the presence of CHIKV in Dong Thap. Another objective was to determine whether underdiagnosis of CHIKV was occurring through prospective screening of sera from patients admitted with an acute febrile episode in one hospital in southern Vietnam. In addition, the study also examined DENV serotypes in the same cohort of patients, and whether there was co-infection with CHIKV.

2.3. Discussion and conclusions

The initial objective of this work was to assess within 13 months the occurrence of dengue and chikungunya among patients from Dong Thap general hospital admitted for acute fever and dengue/chikungunya-related symptoms. The most common symptoms on the day of admission were headache, fever, myalgia, arthralgia, and a positive tourniquet test. Although the majority of clinical manifestations were similar between adult and pediatric patients, adults were significantly more affected by arthralgia than pediatric patients. More males were found to be affected than females. The most affected age class was the 5-14 year class which in agreement with other studies which have reported dengue mainly in children.

The co-circulation of four serotypes of DENV is in agreement with the status of region of hyperendemicity of both southern Vietnam and Cambodia with a predominance of DENV2 and DENV4. Reports from Cambodia have stressed the predominance of DENV2 and DENV3. Although, the 13-months surveillance described in this work did not show any presence of CHIKV, the risk is still present and this surveillance should be maintained.

An important outcome from this work is the differential efficiency of detection of dengue through serology. DENV infection was hardly detected in acute phase through serological tests with only 29% of plasma and 14% of sera to be positive. Conversely,

DENV infection was detected at 53% in clinical samples obtained during the convalescence phase and up to 74% when using PCR. Time of seroconversion should be taken into account when implementing detection procedures. Indeed there is no control on the time between onset and admission and this time might varies greatly from one patient to another. Time for seroconversion should be taken into account when implementing detection procedures. However, for practical reasons, admission is the only time when blood samples can be taken since patients can hardly be followed up after leaving the hospital. The best solution would be therefore to implement multiplex PCR detection on blood sample taken at admission. Cost of PCR is nowadays not higher than that of serological tests and the possibility to combine several detection tests, i.e. dengue and chikungunya, at the same time in a one-step single tube procedure as well as the higher efficiency of PCR make it a highly cost-effective option. A recommendation from this work would therefore be to replace current procedures for serological detection of dengue by a standard operating procedure for DENV-CHIKV multiplex single step PCR.

26% of patients hospitalized with acute fever symptoms were negative for both DENV and CHIKV. This unknown etiology may need further work to identify what the causative pathogens involved. Other limitations of this study is the limited number of patients enrolled and therefore of samples available. Owing to the dynamics of both chikungunya and dengue and the potential of emergence for chikungunya in Vietnam it is of importance to implement a larger surveillance system which will provide valuable information on the prevalence and incidence of DENV infection and CHIKV circulation which are essential for planning an appropriate public health strategy.

This work is presented in an article currently in press at Asian-Pacific Journal of Tropical Medicine (Elsevier) and entitled “Surveillance of dengue and chikungunya infection in Dong Thap, Vietnam: A 13-months study ». The corrected proof version of the article is presented there after.



Contents lists available at ScienceDirect IF: 1.062

Asian Pacific Journal of Tropical Medicine

journal homepage: www.elsevier.com/locate/apjtm



Document heading doi:

Surveillance of dengue and chikungunya infection in Dong Thap, Vietnam: A 13-month study

Pham Thi Kim Lien^{1,2}, Laurence Briant², Truong Ba Tang³, Bui Minh Trang¹, Laurent Gavotte⁴, Emmanuel Cornillot², Vu Trong Duoc¹, Tran Nhu Duong¹, Roger Frutos^{2,5*}, Phan Thi Nga¹

¹National Institute of Hygiene and Epidemiology, 1 Yersin Street, 10000 Hanoi, Vietnam

²University of Montpellier, CEMIPAI-CPBS, UMR 5236, 1919, route de Mende, 34293 Montpellier Cedex 5, France

³Department of Biology, Dong Thap General Hospital, 144, Mai Van Khai, My Xuan, 870000 Cao Lanh, Dong Thap, Vietnam

⁴University of Montpellier, ISEM, CC063, Place E. Bataillon, 34095 Montpellier Cedex 5, France

⁵Cirad, TA-A17/G, Campus International de Baillarguet, 34398 Montpellier Cedex 5, France

ARTICLE INFO

Article history:

Received
Received in revised form
Accepted
Available online

Keywords:

Dengue
Chikungunya
Arbovirus
Dong Thap Vietnam

ABSTRACT

Objective: To establish a surveillance in Dong Thap, at the border with Cambodia by assessing the presence of DENV serotypes and CHIKV among patients hospitalized at Dong Thap general hospital. **Methods:** Cross-sectional descriptive analysis was conducted on a cohort of 131 patients hospitalized with acute fever and symptoms compatible with dengue or chikungunya. The study was conducted from January 2012 to February 2013. The full clinical picture was established as well as serological and molecular detection. Serological analysis was sequentially performed on blood samples collected on admission and an average of seven days after admission. The detection of IgM antibody to DENV was performed by IgM capture ELISA and the detection of DENV and CHIKV RNA was done by reverse-transcription multiplex PCR. **Results:** 101 patients out of 131 (77%) were confirmed with dengue. All four dengue serotypes were detected with a predominance of DENV2 and DENV4. No chikungunya infection was detected although reported in neighboring Cambodia. A differential efficiency of serological dengue detection was observed. Efficiency was 29% upon admission and 53% after seven days on the same patients. 30 patients out of 131 (23%) were negative with both DENV and CHIKV. **Conclusions:** Dengue is at risk of being underestimated and chikungunya is not systematically detected. Changes in detection and surveillance procedures are therefore discussed to increase efficiency of dengue detection and continue the monitoring the emergence of CHIKV in Dong Thap province and in Vietnam.

1. Introduction

Arthropod-borne viral infections (or arboviral infections) are common causes of fever syndromes worldwide and more than 100 kinds of arboviruses are known to cause disease in humans [1–3]. Dengue fever (DF) is caused by a flavivirus belonging to the family of Flaviviridae [4] while the chikungunya virus (CHIKV) is

an alphavirus from the family Togaviridae [5–7]. Both dengue and chikungunya diseases are transmitted by *Aedes aegypti* (*Ae. aegypti*) and *Aedes albopictus* (*Ae. albopictus*) [6,8] and can cause potentially severe and/or debilitating chronic disease [9]. While dengue has been recorded as the most rapidly spreading mosquito-borne viral disease in the world [10,11], chikungunya has recently re-emerged after an interval of several decades. It represents a risk for millions of people in the Indian Ocean areas, Africa, Southeast Asia and more recently has spread to the Caribbean, Pacific and Europe [12–14]. Coinfection with DENV and CHIKV has been reported on patients from Asian, African and Pacific countries [15–19].

Vietnam is a hyperendemicity country with all four serotypes being present all year long throughout the country [20], but affecting

*Corresponding author: Roger Frutos, Institut de Recherche en Cancérologie de Montpellier (U1194), Campus Val d'Aurelle, 34298 Montpellier Cedex 5, France.

E-mail: roger.frutos@univ-montp2.fr; frutosmt@gmail.com

mostly the southern part with major seasonal outbreaks during the rainy season from June to December [21]. Since 1960, dengue fever (DF) epidemics have become more frequent and widespread with an increasing number of cases and deaths over the past 15 year [21,22]. From 1963 to 1995, 1 518 808 DHF cases and 14 133 deaths were reported [22,23]. The dengue surveillance program in the Southern Vietnam has demonstrated the occurrence of epidemic peaks of higher magnitude approximately every 5 years from 1975 to 1987 [24]. Following an 11-year gap a major outbreak of 119 429 DHF cases and 342 fatalities occurred in 1998 [24], 592 938 dengue cases were reported during the 2001-2010 decade in 19 southern Vietnam provinces, which corresponds to a median annual incidence of 232 cases per 100 000 [20].

DENV and CHIKV are both transmitted by the same mosquito species, *Ae. aegypti* and *Ae. albopictus*. Although chikungunya was first described in Vietnam in the 1960's [25], serological evidence of its presence remain scarce and is mainly associated to the Vietnam War era. In 1966, ten American soldiers were identified to be infected with CHIKV [26] and serological surveys among children have detected anti-CHIKV antibodies as early as 1967 [27]. Cambodia which has a long and extensive border with Vietnam, is not only endemic for dengue, but also for chikungunya which has developed recently [28]. Both diseases can easily be imported by travelers, spread rapidly through common vectors and result in social, economic and healthcare system impacts.

Vietnam is at risk to be like Cambodia affected both by dengue and chikungunya and be an overlapping area of distribution for both viruses. Furthermore, owing to the similarity in clinical manifestations and differences in clinical management, clinicians should be aware of the need to include CHIKV in the differential diagnosis of DF. The aim of the study was therefore to assess, through a dual screening of clinical samples of acute febrile episode patients in Dong Thap general hospital in Southern Vietnam, the respective prevalence of dengue and chikungunya.

2. Material and methods

2.1. Cohort design and ethical clearance

The study was approved by the Institutional Review Board of National Institute of Hygiene and Epidemiology (NIHE), Hanoi, Vietnam (No: 14IRB July 23, 2012) in charge of ethical clearance. Patients were eligible for recruitment if they were admitted to the infectious diseases department of Dong Thap general hospital between January 1, 2012 and February 28, 2013. All hospitalized patients with suspected arbovirus infection were eligible for participating in this study provided they displayed acute fever in addition to two of any of the following symptoms: headache, rash, myalgia, joint pain and arthralgia.

2.2. Study setting

Dong Thap general hospital is located in Cao Lanh city, Dong Thap province. The province is located in the Mekong delta region in

southern Vietnam, and bordered with Cambodia to the north (Figure 1). Dong Thap is characterized by a typical tropical climate with two distinctive seasons: The rainy season from May to November and the dry season from December to April. The annual average temperature is around 26 °C. Dong Thap is one of the provinces of southern Vietnam with people movement from Cambodia and display a high rate of dengue infection.



Figure 1. Location and map of the Dong Thap province

2.3. Patient enrollment, clinical sample and data management

After obtaining informed consent from patients, a total of 131 paired blood samples were collected from January 2012 to February 2013 from acute fever cases suspected to be infected by dengue within 1-14 days from the day onset of illness according to WHO guidelines [2,29]. The collection of clinical samples was performed twice and 3 mL or 5 mL of blood were collected each phase: (1) In acute phase, blood samples were collected <7 days from onset of illness and then divided into two tubes: One tube for serum analysis and the other one for plasma analysis; (2) Ten to fifteen days later, in convalescent phase, a second blood sample was collected from the same patients. Samples were kept at -20 °C and kept at -80 °C for virological diagnosis by ELISA and PCR. For each patient, the collected information included a unique identification number and demographic data such as full name, age, gender, residential address, day of onset, date of first and second sample collection. Signs and symptoms were recorded on the day of admission. Samples were coded prior to laboratory analysis.

2.4. RNA Extraction and cDNA synthesis

The viral RNA was extracted from 140 µL of sample using the QIAamp viral RNA Mini kit (QIAGEN, Hilden, Germany). Elution was performed in 60 µL according to the supplier and RNA stored at -80 °C until further use. RNA was reverse transcribed into cDNA using Super transcript III reverse transcriptase (RT- Invitrogen). RNA template was mixed with DNase, incubated at 37 °C for 30 minutes and then 75 °C for 15 minutes, reverse transcription mix was then added and incubated at 65 °C for 5 minutes and then transferred in ice immediately. To prepare double-stranded cDNA, annealing was performed at 25 °C for 5 minutes, followed by extension at 42 °C for

60 minutes, and inactivation by holding the mixture at 75 °C for 15 minutes.

2.5. Laboratory confirmation of dengue and chikungunya

Detection of DENV and CHIKV was conducted both by a Dengue IgM capture ELISA in first samples (plasma and serum) and second samples (serum) and by a multiplex PCR amplification for both first and second samples. IgM antibody-capture Enzyme Linked Immunosorbent Assay (MAC-ELISA) was conducted using the Capture DxSelect™ kit made in CDC Fort Collins, United States according to the supplier. PCR detection of DENV and CHIKV was conducted in a one-step, single tube serotype specific assay using double-stranded cDNA templates as previously described[30,31]. The amplification was carried out in 50 µL reaction volume with DENV a group-specific consensus forward primer and four serotype-specific reverse primers. Nonstructural protein 2 (nsP2) primers were used for the detection of CHIKV. All relevant aspects of the PCR reaction (Master Mix, Primer, Tag polymerase, number of cycles and annealing temperature) were initially optimized using a quantitated purified DENV ds-cDNA to achieve a maximum level of sensitivity. Target RNA was amplified in 50 µL volume containing 5 µL of DNA was combined with 10 pmol of each specific primer DENV 1- 4. PCR was conducted with 35 cycles under the following conditions: denaturation at 94 °C for 2 minutes, annealing at 57 °C for 45 seconds and extension at 72 °C for 1.30 minutes with a final extension at 72 °C for 10 minutes. PCR products were analyzed by Agarose gel electrophoresis in Tris- acetate- EDTA (TAE) buffer.

The expected size of amplicons were 492 bp (DENV1), 119 bp (DENV2), 290 bp (DENV3), 392 bp (DENV4) ad 120 bp (CHIKV).

2.6. Data analysis

All the results were summarized in terms of medians and ranges for continuous data, odds ratio (OR), Chi square and Fishers exact tests were used as appropriate. Data for study clinical symptom of patients was compared, which includes age, gender, province and district.

3. Results

3.1. Clinical features

A total of 131 eligible DHF suspected cases were enrolled at Dong Thap general hospital over 13 months starting in January 2012. 114 patients were from 11 districts in the Dong Thap province, 16 patients from neighboring provinces such as An Giang and 1 case from Ho Chi Minh City. The cohort comprised 62 females and 69 males, ranging in age from 5 months to 49 years with a median age of 15 years . The mean body temperature of patients on the day of admission was 39 °C, and fever was observed from 37.5 °C - 40.5 °C of patients. The most common clinical features observed were: headache (88.5%), myalgia (72.0%), arthralgia (40.5%), rash (12.2%) a positive tourniquet test (16.8%), and nausea/vomiting (3.8%) The mean length of time to admission was 4 days after

Table 1
Frequency of symptoms on admission to Dong Thap general hospital (n=131).

Signs and symptoms	Value	Odds ratio (OR)	<18 years(n = 98)	>18 years(n = 33)	P-value
Headache	88.5%	12.10	84.7	97.0%	0.0625
Myalgia	72.0%	2.54	75.5	60.6%	0.0900
Arthralgia	40.5%	0.70	31.6	66.6%	0.0039
Rash	12.2%	0.14	10.0	18.0%	0.2200
Petechiae	19.0%	0.20	20.4	15.0%	0.5000
Nausea/Vomit	3.8%	0.03	3.0	6.0%	0.4300
Positive Tourniquet test	16.8%	0.25	14.3	24.2%	0.1800

Note: Value are the mean (range) or number (%). P calculated by Chi square test and fisher test.

Table 2
Results of diagnostic tests for suspected dengue patients in Dong Thap, Vietnam.

Diagnostic test	Phase	Type of sample	No. of samples tested	No. of positive samples	% positive cases
IgM capture ELISA	Acute	Plasma	131	38	29
		Serum	131	18	14
	Convalescent	Serum	131	70	53
Multiplex PCR	Acute	Plasma	131	97	74
		Serum	131	95	73

Table 3
Distribution of dengue serotypes among positive patients in Dong Thap hospital, Vietnam.

Age	No.of DENV patients	No. Male	No. Female	Dengue serotypes			
				DENV1	DENV2	DENV3	DENV4
0-4	8	3	5	0	3	5	0
5-14	55	25	30	7	20	11	17
15-24	19	8	11	1	6	2	10
25-34	14	8	6	2	6	0	6
>35	5	2	3	1	1	1	2
Total	101	46	55	11	36	19	35

reported onset of fever ranging from 1-7 days. The first blood sample occurred in a median time of 4 days (1 to 7 days) after onset (time of admission) while the second blood sample was taken at median time of 7 days (admission (7 to 14 days).

3.2. Prevalence of dengue and chikungunya in Dong Thap hospital

Among the 131 acute fever patients enrolled in the cohort, none of them were found to have been infected with chikungunya. All CHIKV PCR tests proved to be negative. However, results were totally different with respect to dengue and were dependent upon the detection method implemented and on the time of blood sampling when using serology. Out of the 131 paired serum/plasma samples collected on the day of admission (first sample collection) during the acute phase, 38 patients (29%) were dengue-positive when analyzing sera samples whereas 18 (14%) patients only were positive when using the plasma fraction (Table 2). When analyzing sera from convalescent patients, i.e. second collection time, the number of IgM positive samples rose to 70 (53%) (Table 2).

3.3. Distribution of dengue serotypes in Dong Thap positive dengue cases

101 samples (77%) out of 131 collected were positive for dengue. All four dengue serotypes were identified and the respective number of positive was 11 (11%) for DENV1, 36 (36%) for DENV2, 19 (19%) for DENV3, and 35 (35%) for DENV4 (Table 3). Males were more affected than females (Table 3). Age was another discriminative criterion with the 5-14 year class comprising 54.5% of all cases (55 out of 101) (Table 3).

4. Discussion

The initial objective of this work was to assess within 13 months the occurrence of dengue and chikungunya among patients from Dong Thap general hospital admitted for acute fever and dengue/chikungunya-related symptoms. The most common symptoms on the day of admission were headache, fever, myalgia, arthralgia, and a positive tourniquet test. Although the majority of clinical manifestations were similar between adult and pediatric patients, adults were significantly more affected by arthralgia than pediatric patients. More males were found to be affected than females which corresponds to other reports from Nepal, China and Vietnam [32-34]. The most affected age class was the 5-14 year class which in agreement with other studies which have reported dengue mainly in children [33-39].

The co-circulation of four serotypes of DENV is in agreement with the status of region of hyperendemicity of both southern Vietnam and Cambodia [38,40,41]. However, if the overall predominance recorded in this work is for DENV2 and DENV4, reports from Cambodia have stressed the predominance of DENV2 and DENV3 with a rotation and regular replacement of serotypes [40,41]. Dong Thap is located along the Mekong River at the Cambodian border where cases of chikungunya have been described along the major northwest

to southwest routes and in provinces bordering Vietnam [28]. This dynamic of expansion might lead to emergence in neighboring Vietnam provided that the Cambodian-Vietnamese border in Dong Thap is a highly active zone of transboundary movements. Although, the 13-months surveillance described in this work did not show any presence of CHIKV, but the risk is still present and this surveillance should be maintained.

An important outcome from this work is the differential efficiency of detection of dengue through serology. DENV infection was hardly detected in acute phase through serological tests with only 29% of plasma and 14% of sera to be positive. Conversely, DENV infection was detected at 53% in clinical samples obtained during the convalescence phase and up to 74% when using PCR. Time of seroconversion should be taken into account when implementing detection procedures. Indeed there is no control on the time between onset and admission and this time might vary greatly from one patient to another. Time for seroconversion should be taken into account when implementing detection procedures. However, for practical reasons, admission is the only time when blood samples can be taken since patients can hardly be followed up after leaving the hospital. The best solution would be therefore to implement multiplex PCR detection on blood sample taken at admission. Cost of PCR is nowadays not higher than that of serological tests and the possibility to combine several detection tests, i.e. dengue and chikungunya, at the same time in a one-step single tube procedure as well as the higher efficiency of PCR make it a highly cost-effective option. A recommendation from this work would therefore be to replace current procedures for serological detection of dengue by a standard operating procedure for DENV-CHIKV multiplex single step PCR.

26% of patients hospitalized with acute fever symptoms were negative for both DENV and CHIKV. This unknown etiology may need further work to identify what the causative pathogens involved. Other limitations of this study is the limited number of patients enrolled and therefore of samples available. Owing to the dynamics of both chikungunya and dengue and the potential of emergence for chikungunya in Vietnam it is of importance to implement a larger surveillance system which will provide valuable information on the prevalence and incidence of DENV infection and CHIKV circulation which are essential for planning an appropriate public health strategy.

Declare of interest statement

We declare that we have no conflict of interest.

References

- [1] Gubler DJ. The global emergence/resurgence of arboviral diseases as public health problems. *Arch Med Res* 2002; **33**(4): 330-342.
- [2] WHO Regional Office for South-East Asia. *Comprehensive guideline for prevention and control of dengue and dengue haemorrhagic fever*. Geneva: WHO;2011,p.196.
- [3] Powers AM. Overview of Emerging arboviruses. *Future Virol* 2009; **4**:

- 391-401.
- [4] Anez G, Chancey C, Grinev A, Rios M. Dengue virus and other arboviruses: a global view of risks. *ISBT Sci Ser* 2012; **7**(1):274–282.
- [5] Pialoux G, Gauzere BA, Jaureguierry S, Strobel M. Chikungunya, an epidemic arbovirosis. *Lancet Infect Dis* 2007; **7**: 319-327.
- [6] Sudeep AB, Parashar D. Chikungunya: an overview. *J Biosciences* **33**(4): 443–449.
- [7] Chhabra M, Mittal V, Bhattacharya D, Rana UVS, Lal S. Chikungunya Fever: A Re-Emerging Viral Infection. *Indian J Med Microbiol* 2008; **26**(1):5–12.
- [8] Weaver SC, Reisen WK. Present and future arboviral threats. *Antiviral Res* 2010; **85**(2): 328-345.
- [9] Sam IC, Kümmerer BM, Chan YF, Roques P, Drosten C, AbuBakar S. Updates on chikungunya epidemiology, clinical disease, and diagnostics. *Vector Borne Zoonotic Dis* 2015; **15**(4): 223-230.
- [10] Gubler DJ. Dengue, urbanization and globalization: The unholy trinity of the 21(st) century. *Trop Med Health* 2011; **39**(4 Suppl): 3–11.
- [11] Ross TM. Dengue virus. *Clin Lab Med* 2010; **30**(1): 149-160.
- [12] Lahariya C, Pradhan SK. Emergence of chikungunya virus in Indian subcontinent after 32 years: A review. *J Vector Borne Dis* 2006; **43**(4): 151–160.
- [13] Van Boxtel W, Dorleans F, Rosine J, Blateau A, Rousset D, Matheus S, et al. Chikungunya outbreak in the Caribbean region, December 2013 to March 2014, and the significance for Europe. *Euro Surveill Bull Eur Sur Mal Transm Eur Commun Dis Bull* 2014; **19**(13): 1-11.
- [14] Nhan TX, Musso D. The burden of chikungunya in the Pacific. *Clin Microbiol Infect* 2015; doi: 10.1016/j.cmi.2015.02.018.
- [15] Chahar HS, Bharaj P, Dar L, Guleria R, Kabra SK, Broor S. Co-infections with chikungunya virus and dengue virus in Delhi, India. *Emerg Infect Dis* 2009; **15**(7):1077–1080.
- [16] Leroy EM, Nkoghe D, Ollomo B, Nze-Nkoghe C, Becquart P, Grard G, et al. Concurrent Chikungunya and Dengue Virus Infections during Simultaneous Outbreaks, Gabon, 2007. *Emerg Infect Dis* 2009; **15**(4): 591–593.
- [17] Laoprasopwattana K, Kaewjungwad L, Jarumanokul R, Geater A. Differential diagnosis of Chikungunya, dengue viral infection and other acute febrile illnesses in children. *Pediatr Infect Dis J* 2012; **31**(5): 459–463.
- [18] Derraik JGB, Slaney D, Nye ER, Weinstein P. Chikungunya virus: a novel and potentially serious threat to New Zealand and the South Pacific islands. *Am J Trop Med Hyg* 2010; **83**(4): 755–759.
- [19] Dupont-Rouzeyrol M, Caro V, Guillaumot L, Vazeille M, D'Ortenzio E, Thiberge J, et al. Chikungunya Virus and the Mosquito Vector *Aedes aegypti* in New Caledonia (South Pacific Region). *Vector-Borne Zoonotic Dis* 2012; **12**(12): 1036–1041.
- [20] Cuong HQ, Vu NT, Cazelles B, Boni MF, Thai KTD, Rabaa MA, et al. Spatiotemporal Dynamics of Dengue Epidemics, Southern Vietnam. *Emerg Infect Dis* 2013; **19**(6): 945–953.
- [21] Do QH, Vu TQH, Huynh TKL, Dinh QT, Deubel V. Epidemic of dengue haemorrhagic fever in South Vietnam: Epidemiological and virological studies. *Trop Med* 1995; **36**(4): 187–201.
- [22] Anders KL, Nguyet NM, Chau NVV, Hung NT, Thuy TT, Lien LB, et al. Epidemiological factors associated with dengue shock syndrome and mortality in hospitalized dengue patients in Ho Chi Minh City, Vietnam. *Am J Trop Med Hyg* 2011; **84**(1):127–134.
- [23] Coudeville L, Garnett GP. Transmission dynamics of the four dengue serotypes in southern vietnam and the potential impact of vaccination. *PLoS ONE* 2012; **7**(12): e51244.
- [24] Gubler DJ. Dengue and dengue hemorrhagic fever. *Clin Microbiol Rev* 1998; **11**(3): 480–496.
- [25] Vu QD, Nguyen TKT, Ly QB. Study of anti-Chikungunya antibodies in Vietnamese children in Saigon. *Bull Société Pathol Exot Ses Fil* 1967a; **60**(14): 353-359.
- [26] Deller JJ Jr, Russell PK. An analysis of fevers of unknown origin in American soldiers in Vietnam. *Ann Intern Med* 1967; **6**(6): 1129–1143.
- [27] Vu QD, Nguyen TKT. Hemorrhagic fever in Vietnam in 1964-1965. Serologic study with a brief clinical and epidemiologic note. *Bull Société Pathol Exot Ses Fil* 1967b; **60**(1): 21-33.
- [28] Duong V, Andries AC, Ngan C, Sok T, Richner B, Asgari-Jirhandeh N, et al. Reemergence of Chikungunya Virus in Cambodia. *Emerg Infect Dis* 2012; **18**(12): 2066–2069.
- [29] WHO. *Dengue: guidelines for diagnosis, treatment, prevention and control*. New edition. Geneva: WHO press;2009.
- [30] Harris E, Roberts TG, Smith L, Selle J, Kramer LD, Valle S, et al. Typing of dengue viruses in clinical specimens and mosquitoes by single-tube multiplex reverse transcriptase PCR. *J Clin Microbiol* 1998; **36**(9): 2634-2639.
- [31] Saxena P, Dash PK, Santhosh SR, Shrivastava A, Parida M, Rao PL. Development and evaluation of one step single tube multiplex RT-PCR for rapid detection and typing of dengue viruses. *Viro J* 2008; **5**(1): 20.
- [32] Fox A, Hoa LNM, Simmons CP, Wolbers M, Wertheim HFL, Khuong PT, et al. Immunological and Viral Determinants of Dengue Severity in Hospitalized Adults in Ha Noi, Viet Nam. *PLoS Negl Trop Dis* 2011; **5**(3): e967.
- [33] Luo L, Liang H, Hu Y, Liu W, Wang Y, Jing Q, et al. Epidemiological, virological, and entomological characteristics of dengue from 1978 to 2009 in Guangzhou, China. *J Vector Ecol* 2012; **37**(1): 230–240.
- [34] Gupta G, Shah Y, Poudel A, Pun R, Pant K, Kshetri R, et al. Serological and Molecular Study of Dengue Viruses in Different Hospitals of Nepal. *Nepal J Med Sci* 2013; **2**(1): 20-25.
- [35] Phuong HL, Vries PJ de, Nga TT, Giao PT, Hung LQ, Binh TQ, et al. Dengue as a cause of acute undifferentiated fever in Vietnam. *BMC Infect Dis* 2006; **6**(1): 123.
- [36] Teixeira MG, Costa MCN, Coelho G, Barreto ML. Recent shift in age pattern of dengue hemorrhagic fever, Brazil. *Emerg Infect Dis* 2008; **14**(10): 1663.
- [37] Halstead SB. More dengue, more questions. *Emerg Infect Dis* 2005; **11**(5): 740-741.
- [38] Thai KTD, Phuong HL, Thanh Nga TT, Giao PT, Hung LQ, Van Nam N, et al. Clinical, epidemiological and virological features of dengue virus infections in Vietnamese patients presenting to primary care facilities with acute undifferentiated fever. *J Infect* 2010; **60**(3-2): 229–237.
- [39] Huy R, Buchy P, Conan A, Ngan C, Ong S, Ali R, et al. National dengue surveillance in Cambodia 1980-2008: epidemiological and virological trends and the impact of vector control. *Bull World Health Organ* 2010; **88**(9): 650–657.
- [40] Duong V, Simmons C, Gavotte L, Viari A, Ong S, Chantha N, et al. Genetic diversity and lineage dynamic of dengue virus serotype 1 (DENV-1) in Cambodia. *Infect Genet Evol* 2013a; **15**: 59-68.
- [41] Duong V, Henn MR, Simmons C, Ngan CYB, Gavotte L, Viari A, et al. Complex dynamic of dengue virus serotypes 2 and 3 in Cambodia following series of climate disasters. *Infect Genet Evol* 2013b; **15**: 77-86.

CHAPTER 3
DENGUE VIRUS, CHIKUNGUNYA VIRUS AND RISK FACTORS IN SEVERALS
PROVINCES OF VIETNAM.

3.1. Context of study

With an estimated 93 Million people, Vietnam undergoes a rapid urban population growth due to the influx of workers and students from rural areas (247). Vietnam is a country with poor health and economic indicators. The S-shaped country shares borders with China, Laos and Cambodia.

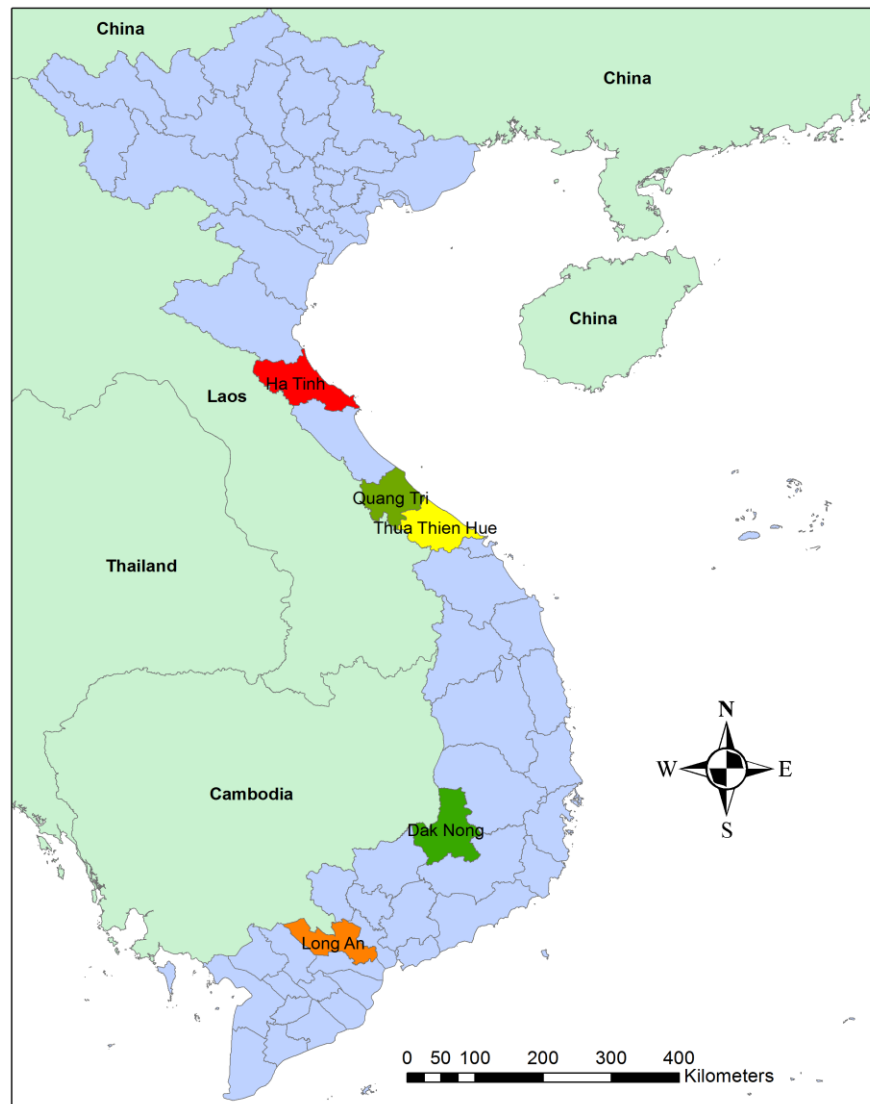

Figure 42: Location of the five selected study provinces in the north, center, south of Vietnam.

Vietnam is recognized as one of five countries in Southeast Asia with the highest dengue burden (542). Dengue fever (DF) was first described in northern Vietnam in 1958 and expanded to the southern area in 1960 (543). Despite the existence of a National Dengue Control Program since 1998, Dengue remains a major health problem in Vietnam. Over the past 15 years, the number of DENV cases has been increasing (529), DF and DHF are leading causes of hospitalization, period 1991 - 2004 accounting for 1.000.866 case reported in Vietnam, and increasing year to year in the high urban central areas of Hanoi (544). Dengue is highly endemic in tropical southern Vietnam, while increasing larger seasonal epidemics have occurred in northern Vietnam over the last decade (545). All four dengue virus serotypes have been found circulating in Vietnam with the dominant one varying over time (546). The predominant circulating viruses have DENV 1 and DENV 2, but until the late 1990s, DENV 3 emerged and was responsible for the large outbreak of 1998, whereas DENV 4 was also detected between 1999 and 2003 (547). Dengue transmission occurs throughout the year in Vietnam, with peaks in the number of cases (72% of total cases) reported between June and November. In the Northern and Central Highland regions, dengue notifications are low during the winter time from December to March (548) (549). In the South, dengue transmission is higher in the rainy season from July to September, specially transmission is highest in the South where very large epidemics occur regularly (550), *Aedes* mosquitoes, which are the vectors of dengue and chikungunya, are widely prevalent in the region (551).

Chikungunya virus (CHIKV) was first isolated in Tanzania in 1953 (552) and was until 2004 known to cause debilitating rheumatologic disease in many parts of Sub-Saharan Africa and Asia (553). The symptoms of CHIKV infection are quite similar to those caused by many other infectious agents in the endemic areas. One particular difficulty in identifying CHIKV infection is its overlapping distribution with dengue viruses. It has been postulated that many cases of dengue virus infection were misdiagnosed. In many endemic areas of Asia, CHIKV overlaps with DENV, providing thus opportunities for *Aedes* mosquitoes to be coinfecting by both viruses. Co-circulation of CHIKV and DENV is not uncommon in South - East Asia (14). Although CHIKV affected areas often overlap with DENV - endemic areas (554), however, simultaneous outbreak are rare. So far, no case of chikungunya has been reported in Vietnam, excepted in 1966 with 10 infected American soldiers (555) and and a study on IgM in children between 2 and 14

years in Tien Giang general hospital (556). There is currently a lack of information on CHIKV in Vietnam.

There is in Vietnam the simultaneous presence of the primary vector of dengue and chikungunya, i.e. *A. aegypti* in Vietnam and of the considered secondary vector, *A. albopictus*. Besides, weather conditions and local Vietnamese habit of storing water in containers at their house favor the development of mosquitoes. Identification of vectors and potential vectors of CHIKV and DENV in a given geographical areas has therefore important implications with respect to outbreak control.

There are many reasons to believe that dengue and chikungunya are expanding and cocirculating in Vietnam. Movement of human populations from neighboring countries is considered a cause of expansion. Chikungunya infection was recently identified as a problem in Cambodia. During this reemergence of CHIKV in 2011, 24 patients was detected positive with CHIKV, during tests for Flaviviruses and Alphaviruses (557), with two chikungunya cases in two provinces border with Vietnam. In 2012, chikungunya outbreaks were reported in Laos with 197 cases in the Moonlpamok and Khong Districts of the Chamasak province (29). Vietnam shares borders with Cambodia and Laos and people mobility and trade between the neighboring countries may be a cause of transmission to Vietnam.

3.2. Objective

The objective of this part of the PhD was to understand the potential role of CHIKV and DENV as a cause of febrile illnesses in five provinces border with Laos and Cambodia in three regions of north, center and south of Vietnam during a non-epidemic period. In this section we investigated the incidence and clinical features of dengue and chikungunya infections. We also surveyed the populations of mosquitoes collected in the five provinces in order to identify circulating viruses. In addition, a phylogenetic analysis of the collected adult mosquitoes was conducted to characterize the potential vectors.

3.3. Discussion and conclusions

To monitor the dissemination of the dengue and chikungunya viruses in Vietnam, we conducted active surveillance of acute febrile syndromes suspect DENV and CHIKV

throughout Vietnam from 2012 - 2014. To our knowledge, this study is the first to prospectively investigate the circulation of DENV and CHIKV, and the risk factors i.e. mosquitoes and water containers in three different regions, north, centre and south of Vietnam. Mosquito samples were collected in five provinces sharing borders with Cambodia and Laos. DENV is still a high burden in Vietnam but the presence of chikungunya is still unclear, for part because of lack of proper laboratory diagnosis capacity in patients samples. Although, both CHIKV and DENV have been detected in Cambodia and Laos, no CHIKV was detected among the hospitalized patients in Vietnam. However, CHIKV was detected in adult *A. aegypti* mosquitoes.

The number of symptoms in patients under 18 was higher than in the older group. The most common symptoms on admission were myalgia, headache, fever, rash, petechia, and arthralgia. The dominant symptoms were myalgia and headache. From the clinical survey presented in this work, the only similar symptom between adult and pediatric patients was rash. Several symptoms, i.e. myalgia, fever, petechia and arthralgia ($p < 001$), were shown to be significantly different between adult and pediatric patients. More males were found affected than females, in agreement with other reports in Nepal, China and Vietnam (558) (559) (560). There is no clear explanation for this bias which might be associated to occupational factors. Although all four DENV serotypes were circulating in three regions throughout the study period, the predominant serotype was DENV-1, circulating in both human and mosquito samples. The presence of the co-circulating four serotypes of DENV along with predominance of DENV- 1 reported in this work was similar to the result of previous research on DENV in Vietnam (561) and Cambodia (562).

Entomological investigations conducted in this work provided an interesting insight on the potential dynamic of infection over the two years of the study. With the exception of Hue, where *A. albopictus* were as numerous as *A. aegypti*, the latter was overwhelming present in households in all other provinces. The most important ratio in favor of *A. aegypti* was found in Long An. These results match those from a previous survey conducted in 2010 where *A. aegypti* dominated in the south and *A. albopictus* was more present in the cool mountainous areas. This work provides however an insight on dengue dynamic different from what was expected. First, although *A. aegypti* is the most represented species most of the dengue-infected mosquitoes captured were *A. albopictus*. This species thus appears to be the main vector in Vietnam. This situation is particularly

sticking in the Southern province of Long An, neighbour of both Cambodia and Ho Chi Minh City and where the main tranboundary road system is located. In addition, Long An is the province where the highest number of mosquitoes have been captured with *A. albopictus* making less than 1% of the mosquitoes. Nevertheless, although *A. albopictus* represents 0.9% of the sampled population, it represents 50% of the infected mosquitoes in Long An. Another important conclusion from this work is that if there is indeed a regular introduction of dengue virus to Vietnam, the suspected introductions from Cambodia or Laos might represent only a small part of the process. As shown by phylogenetic data, there is no single local endemic population of mosquitoes but rather the cocirculation of several distinct populations countrywide. With the exception of QT_LB_albo_55M1 which belonged to the haplotype alb9 described in Thailand, all the other dengue-infected *A. albopictus* individuals belonged to the same population, with no haplotype name, characterized in Romania and described as an invasive population in Europe. The alb9 dengue-infected-mosquito was a male indicating thus the presence of vertical transmission, a trait already known in dengue. The last dengue-infected mosquito was found not to be *A. albopictus* but instead *Culex vishnui*. This is to our knowledge the first time, *C. vishnui*, known for transmitting Japanese encephalitis, is found infected with dengue.

Further indication of involvement of exogenous mosquitoes is also provided by the *A. aegypti* individuals. The dengue-infected *A. aegypti* mosquitoes were found to be associated to haplotypes described in Tamil Nadu, India (i.e. BUZOO-M-Aa), in the Martinique Island in the French West Indies (i.e. Martinique1) and in Thailand (i.e. aeg7). Interestingly, other individuals from the same haplotypes described in India and Martinique Island, i.e. BUZOO_M_Aa and Martinique 1, were found to be infected by CHIKV. Tamil Nadu and Martinique Island have been heavily infected by chikungunya (563) (564) (565) and the similarity of haplotypes also suggests that the chikungunya dynamic, like that of dengue, might be significantly supported by long distance-travelling mosquitoes rather than local populations.

It seems important to decipher the movement of mosquitoes but not only at the Lao PDR and Cambodian borders as previously considered but rather through routes of international trade. This work is stressing the need to establish a genotype-based survey of circulating mosquitoes in Vietnam, not based as currently done on the species but instead on the population at the infra-species level. An integrative analysis encompassing the

genetic study of viral lineages on human patients and in mosquitoes along with the genotyping of mosquito population should be undertaken to provide clear information on the dynamic of dengue and chikungunya. Although no clinical chikungunya case was declared and no CHIKV was found on human samples in this work, the detection of CHIKV in mosquito haplotypes bound to worldwide movements and to areas with major chikungunya outbreaks indicate that the threat should be taken seriously and a dedicated surveillance programme should be implemented. From this work, dengue and chikungunya, appear as global threats that should not be addressed at a national or even regional scale but rather at a global, worldwide dimension of permanent exchanges and movements.

This part of the PhD is presented in Manuscript under final stage of preparation for submission to Emerging Infectious Diseases. The manuscript, entitled “*Aedes* mosquitoes mobility, diversity and risk factors for the diffusion of dengue and chikungunya in Vietnam” is presented thereafter.

**For *Emerging Infectious Diseases*
Corresponding author**

Tran Nhu Duong

National Institute of Hygiene and Epidemiology
1 Yersin Street
10000 Hanoi
Vietnam

Roger Frutos

UMR 17, Intertryp
TAA 17/G
Campus International de Baillarguet
CIRAD
34398 Montpellier Cedex 5
France

***Aedes* mosquitoes mobility, diversity and risk factors for the diffusion of dengue and
chikungunya in Vietnam**

Pham Thi Kim Lien^{1,2,3}, Laurence Briant², Laurent Gavotte⁴, Pierrick Labbe⁴, Marco Perriat-Sanguinet⁴, Laurent Gavotte⁴, Emmanuel Cornillot², Vu Trong Duoc¹, Nguyen Thi Yen¹, Tran Vu Phong¹, Nguyen Van Soai¹, Tran Duc Dong¹, Tran Chi Cuong¹, Phan Thi Nga¹, Tran Nhu Duong^{1*}, Roger Frutos^{2,3*}

- 1) National Institute of Hygiene and Epidemiology, 1 Yersin Street, 10000 Hanoi, Vietnam
- 2) CPBS, UMR 5236, 1919, route de Mende, 34293 Montpellier Cedex 5, France
- 3) Cirad, TA-A17/G, Campus International de Baillarguet, 34398 Montpellier Cedex 5, France
- 4) University of Montpellier, ISEM, CC063, Place E. Bataillon, 34095 Montpellier Cedex 5, France

+ : Current address: Institut de Recherche en Cancérologie de Montpellier (U1194), Campus Val d'Aurelle, 34298 Montpellier Cedex 5, France

*: Corresponding authors

Running title: *Aedes*, dengue and chikungunya in Vietnam

Keywords: Dengue, Chikungunya, Vietnam, *Aedes aegypti*, *Aedes albopictus*

Abstract

An active surveillance was conducted in Vietnam to assess the presence of dengue and chikungunya virus in patients hospitalized with acute fever in five Vietnam provinces neighbouring Lao PDR and Cambodia. This work conducted from 2012 to 2014 was completed by a survey of the mosquitoes found in the same areas. A total 558 human serums were collected along with 1104 adult mosquitoes (991 *A. aegypti* and 113 *A. albopictus*) and 10995 larvae (8542 *A. aegypti* and 2453 *A. albopictus*) from 2250 households. Dengue virus was found in 17 (3%) human serum samples. No chikungunya virus was detected in human. Differing densities of mosquito populations were found with the highest one being in the Long An province border with Cambodia. Dengue viruses were detected mostly in *A. albopictus*. But CHIKV was also detected in *A. aegypti*. The phylogenetic analysis of the collected mosquitoes showed a large diversity of genotypes, all of them having been described in other parts of the world. New haplotypes were found, a *Culex vishnui* mosquito was found positive for dengue, making this species a potential vector.

Introduction

In the current absence of vaccines and efficient therapeutic drugs, both dengue and chikungunya are expanding. There is an estimated number of 390 million dengue infections per year, out of which 96 million are asymptomatic (1). Over the past 50 years dengue has spread inexorably from 9 countries reporting dengue transmission prior to 1970 to over 124 today (2). Incidence has also increased 30 fold (2). Vietnam is one of five countries in the Southeast Asia with the highest dengue burden (3). Dengue fever was first described in northern Vietnam in 1958 and expanded to the southern area in 1960 (4). Despite the existence of a National Dengue Control Program since 1998, Dengue remains a major health problem in Vietnam and the number of cases has increased over the last past 15 years (5). Dengue Fever (DF) and Dengue Haemorrhagic Fever (DHF) were leading causes of hospitalization from 1991 to 2004, accounting for 1,000,866 case over the whole country (6). It also increased every year in the urban central areas of Hanoi (7), while seasonal outbreaks have occurred in northern Vietnam over the last decade (8). Vietnam is a hyperendemicity country with all four dengue virus serotypes circulating, the dominant one varying over time (9). DENV 1 and DENV 2 are the most predominant serotypes, however DENV 3 emerged in the late 1990s and was responsible for the large outbreak of 1998 whereas DENV 4 was also detected between 1999 and 2003 (10). Dengue transmission occurs throughout the year in Vietnam, with peaks (72% of total cases) reported between June and November, in especially in the southern part of the country during the rainy season from July to September (11). In the Northern and Central highland regions, dengue notifications are low during the winter time from December to March (12, 13).

Chikungunya, a disease caused by an alphavirus, was isolated in Tanzania in 1953 (13), but has been present in Asia where a specific genotype circulates since the 1960s and was described in Vietnam in 1967 with 10 cases of American soldiers (14). In 2004, a new variant of CHIKV emerged in East Africa which quickly spread and generated major outbreaks over the Indian Ocean, India and Thailand (15, 16, 17, 18). This East-African reemerging CHIKV has been described in Cambodia in 2011 and in 2012, chikungunya outbreaks were reported in Laos with 197 cases in the Moonlpamok and Khong districts of the Chamasak province. However until now no clinical case of chikungunya has been described in Vietnam. Vietnam shares a border with Cambodia and Laos and there is thus

the possibility that CHIKV might circulate already in Vietnam but without being detected. Dengue and chikungunya symptoms are very similar, in particular in the early stage (19) making thus easy to confuse both diseases and underestimate the burden of chikungunya. Surveillance studies in Vietnam focus on dengue and detection of chikungunya is not considered. There are many reasons to suspect that chikungunya might have already expanded to Vietnam and might cocirculate with dengue. Long distance migration of DENV and CHIKV in Asia as well as transboundary movements of human populations can contribute to it. Furthermore, the same *Aedes* mosquito species are vectoring both viruses and are widely prevalent in the region (20). Co-circulation of CHIKV and DENV have already been reported, however, simultaneous outbreaks are rare.

This work was therefore undertaken in connection with the National Vietnamese programs dengue surveillance to investigate a potential co-circulation of DENV and CHIKV and assess their respective role in febrile illnesses in several provinces in three regions of North, Central and South Vietnam having borders with Laos and Cambodia. This survey was conducted over two years to assess the prevalence of both viruses in patients hospitalized with acute fever and in mosquito populations present around the patient's households.

Material and Methods

Ethics. The study was approved by the Scientific and Ethical Committee of the National Institute of Hygiene and Epidemiology (NIHE), Hanoi, Vietnam, under supervision by the Ministry of Health. The study was conducted jointly with the Provincial Preventive Medicine Offices and the study received clearance and approval from the regional health directors.

Location of sampling. Active surveillance of acute febrile syndromes was and collection of human blood samples were conducted from September 2012 to September 2014 in five preventive medicine centres in Ha Tinh, Thua Thien Hue, Quang Tri, Dac Nong and Long An (Figure 1). Mosquitoes were collected from districts of Huong Khe, Ha Tinh, A Luoi, Huong Hoa, Dac min, Moc Hoa belonging to the Ha Tinh, Hue, Quang Tri, Dac Nong and Long An provinces, respectively. All collection points were recorded by GPS. All selected provinces have borders with either Laos or Cambodia.

Case definition and sampling. Acute phase blood samples were collected from patients admitted with high fever ($\geq 38.5^{\circ}\text{C}$) and at least two of the following symptom: rash, myalgia, joint pain, swelling of joints, nausea/vomiting, and headache. Sera of acute febrile cases were obtained within 7 days after the onset of disease. Informed consent was obtained from the patient or from the parent or legal guardians of minors before the collection of sample. The information collected for each patient included a unique identification number and demographic data such as full name, age, gender, residential address, date of symptom onset or diagnosis, date of the first and second sample collection. Samples were coded and sent to the virology laboratory, National Institute of Hygiene and Epidemiology (NIHE), Hanoi, Vietnam. Acute phase serum samples was collected follow up serum sample taken from 3 to 5 ml, stored at 4°C or in ice dry during the time for transferring in the day to preventive medicine centers of provinces in -20°C until being transfer to NIHE for RNA extraction and stored at -80°C .

Mosquito collection. Collection of larvae, pupae and adult mosquitoes were conducted four times, i.e. in rainy and dry seasons, over two years from September 2012 to

September 2014. For each province, collections were conducted in four communes of a district border with either Laos or Cambodia. Each selected commune was geo-referenced using a portable global positioning system (GPS). Door to door entomological survey was also conducted. However, procedures were slightly different for adult collection and for larvae and pupae collections. Adult mosquitoes were collected in and around households. A household was defined as single residential building, including any storage building, kitchen, latrine huts and garden as well as the outside areas up to the fenced partition separating a house from its neighbour. Household selection was performed in a systematic random manner. If it was not possible to include a house chosen in the study due to the absence of the owner, the closest neighbouring household was chosen instead. Mosquitoes were captured outdoor and indoor during day time day from 5 to 10 AM and 4 to 8 PM using a backpack aspirator. A total of 30 households were investigated in each commune. Collected mosquitoes were stored in RNAlater (Qiagen) and kept refrigerated at 4⁰C prior to identification. Only *A. aegypti* and *A. albopictus* were retained and identification was performed according to morphological criteria following binocular examination. Mosquito samples were sorted according to species, sex, date of collection, geographical coordinates and number of mosquitoes for each location, and then stored at -80⁰C in RNA later solution until further use. For the collection of larvae and pupae, all accessible artificial larval developmental sites such as discarded tires, water containers, fish water pot, flower pot, water jar/ pot, water tank, vase, wet container, etc., were searched for potential larval habitats in indoor and outdoor. Developmental sites were inspected using dippers, as previously described (21, 22). The equipment used for collection consisted of a standard mosquito dipper with extendable handle, pipette, spoon and torchlight. All of the potential developmental sites were examined using a flashlight. All collected mosquitoes were placed into plastic vials and labelled according to the date, location and container type. Identification was performed using morphological taxonomic keys. Only *A. aegypti* and *A. albopictus* were retained.

DNA, RNA extraction and cDNA synthesis. Viral RNA was extracted from the human serum samples, and mosquito's abdomens, DNA was extracted from the heads of mosquito samples using the QIAamp viral RNA Mini kit and QIAamp® DNA Micro Kit procedure (QIAGEN, Hilden, Germany). Elution was performed in 60 µl according to the supplier

and DNA, RNA stored at - 80°C until further use. Purified RNA templates were transcribed into cDNA using Super transcript III reverse transcriptase (RT- Invitrogen). RNA templates were mixed with RNase-free DNase and incubated at 37°C for 30 minutes and then 75°C for 15 minutes. Annealing was performed at 25°C for 5 minutes, followed by extension at 42°C for 60 minutes and reaction was terminated by holding the mixture at 70°C for 15 minutes.

PCR detection of DENV, CHIKV and COI gene. Multiplex PCR amplification was performed for dengue virus detection whereas Real Time PCR was implemented for chikungunya virus. For DENV, a one-step single tube serotype specific multiplex PCR was adapted from previously reports of Lanciotti et al. Amplification was carried out in 50µl with a dengue-virus group specific consensus forward primer and four serotype-specific reverse primers. Nonstructural protein 2 (nsP2) primers were used for CHIKV and COI primers for genome of mosquitoes (Table 1). PCR products were analyzed in a 2% (W/V) agarose gel containing 10% SYBR safe DNA gestain (Invitogen, S33102) in Tris- acetate-EDTA (TAE) buffer 1%. A 100-bp ladder was used as a molecular weight marker. The expected size of amplicons was 492 bp, 119 bp, 290 bp and 392 bp for DENV1, DENV2, DENV3 and DENV4, respectively. Chikugunya virus was detected by using quantitative Real-Time PCR. The non-structural protein 2 of CHIKV was used as template and amplified using light cycler 480 Syber Green I master enzyme (Roche). RT-PCR was run in a final volume of 50 µl. The standard cycling conditions were incubation at 95°C for 10 min, followed by 40 cycles of denaturation at 95°C for 15 sec, annealing at 56°C for 30 sec, extension at 72°C for 30 sec, and to monitor potential non-specific amplification, one cycle of 95°C for 15 sec, 60°C for 1 min, and 95°C for 15 sec. Data collection occurred during the 72°C extension step. Amplification was done using a Rotor-gene RG3000 (Corbett Research).

Entomological data analysis. All statistical analysis were done using R. All results were summarized in terms of medians and ranges for continuous data, odds ratio (OR), Chi square and Fisher exact tests were used as appropriate. Abundance was defined as the number of individuals of a species per container and used rainy and dry season relative as variables. The presence or absence of larvae of *A. aegypti* and/or *A. albopictus* or both

species co-occurrence were treated as binary dependent variables. Predictor variables were season collection, physiographic, container type and their possible two-way interactions. Entomological indices were defined as follows: House Index (HI), which is the percentage of houses infested with larvae and/or pupae. Container Index (CI), which is the percentage of positive containers (i.e. infested with larvae and /or pupae). Breteau Index (BI), which is the number of positive containers per 100 households. The 95% confidence interval was calculated for using an exact binomial test.

Phylogeny analysis. Multiple sequence alignment was conducted using the MUSCLE program (23) available in the Seaview 4.5.1 package (24, 25). To determine the best fit model of nucleotide substitution, we used the MODELTEST program (26). Phylogenetic analysis was performed using maximum likelihood (ML) approach available within the PHYML package (27) and incorporating the GTR+ Γ_4 model of nucleotide substitution. A bootstrap resampling process (1,000 replications) was performed to assess the robustness of individual nodes on each phylogeny utilizing the ML substitution model.

Results

General description of the study patient population. A total of 558 serum samples were collected from patients admitted in the 2012-2014 period in the five preventive medicine centres with acute fever and symptoms compatible to DENV- CHIKV infection. The patient cohort consisted of 253 females and 305 males, ranging from 4 months to 74 years with a median age of 24 years, and a mean age of 26 years (Table 2). No significant difference was recorded with respect to age with 269 patients below 18 (from 0.4 to 18) and 289 patients above 18 (from 19 to 74). The sex ratio was slightly biased towards males with 305 males patients out of 558 (54.6%) for 259 females patients out of 558 (45.4%). The most frequent symptom was myalgia (59%), followed by headaches (41%) and arthralgia (21%) (Table 2). All symptoms were significantly more represented in the population over 18 with the exception of rash which was similarly represented in both populations and nausea/vomiting which was more frequent for patients under 18 (Table 2).

Frequency of DENV and CHIKV in the human cohort. 100, 91, 97, 142 and 128 serum samples were collected from Ha Tinh, Hue, Quang Tri, Long An and Dac Nong, respectively (Table 3). Out of these 558 acute-phase serum samples collected, 17 (3.05 %) were positive for dengue (Table 3). Dengue-positive samples were detected in all five provinces. The percentage of positive samples ranged from 2.06% to 5.47%. The highest rate was found in the southern province of Dac Nong. Rates of positive DENV samples were 2.06%, 2.11%, 3.00%, 3.30% and 5.47% for Quang Tri, Long An, Ha Tinh, Hue and Dac Nong, respectively (Table 3). The four serotypes were simultaneously found only in Dac Nong. The combination of DENV1 and DENV2 was found only in Hue and Long An whereas the combination of DENV1 and DENV3 was found in Ha Tinh and Quang Tri (Table 3). Altogether, the most frequent serotype was DENV1 (1.25 %), followed by DENV2 (0.90 %); DENV3 (0.72 %) and DENV4 (0.18 %). No positive CHIKV sample was identified.

Frequency of DENV and CHIKV in adult mosquitoes. A total of 1104 adult *Aedes* mosquitoes have been captured from an overall 2268 households. *A. aegypti* made up 89.8 % (991 individuals) of the captures while *A. albopictus* represented only 10.2 % (113

individuals) (Table 4). When considering the breakdown per province, the two southernmost provinces displayed a far higher density of adult mosquitoes in the vicinity of households with 285 and 580 individuals captured in Dac Nong and Long An, respectively whereas in Ha Tinh, Hue and Quang Tri, the number of adults captured was 74, 92 and 70, respectively (Table 4). This Southern / Central-North Central difference was also observed in the *A. aegypti* / *A. albopictus* ratio (Table 4). Out of 580 individuals captured in Long An, no *A. albopictus* was identified and in Dac Nong only 3 *A. albopictus* were present for 285 *A. aegypti*. In Ha Tinh the rate of *A. albopictus* was 25.7 % (19 out of 74) and in Quang Tri 9.35 % were *A. albopictus* (6 out of 64). In Hue the ratio was reversed with a strong predominance of *A. albopictus* (92.4 % or 85 out of 92 individuals) (Table 4). Out of the 1104 adults *Aedes* mosquitoes collected, 9 (0.8%) were infected with dengue. 4 positive samples were found in Long An, 3 bearing a DENV2 virus and 1 bearing a DENV4 strain. 2 dengue-positive mosquitoes were found in Dac Nong, each one bearing a different DENV serotype (DENV1 and DENV4). Two infected mosquitoes were also found in Quang Tri, both with a DENV1 virus and only one DENV1-infected mosquito in Ha Tinh. No infected mosquito was found in Hue. With respect to species distribution, only *A. aegypti* were infected in the two southern provinces whereas only *A. albopictus* individuals were found infected in the central/north central provinces (Table 4). Two mosquitoes were found to be infected by CHIKV, both in the southern province of Long An, and both in *A. aegypti* which was the only species captured in this province (Table 4).

Distribution of mosquito populations. A total 8269 water containers coming from 2698 households were sampled from September 2012 to September 2014. A total of 12041 larvae were collected from the five provinces. 9588 larvae (80%) were identified as *A. aegypti* whereas 2453 (20 %) were *A. albopictus* individuals (20%) (Table 5). When considering the provincial breakdown, the ratio between *A. aegypti* and *A. albopictus* was 1046/551, 1147/423, 1147/1022, 760/411 and 5126/46 for Ha Tinh, Quang Tri, Hue, Dac Nong and Long An, respectively (Table 5). Entomological indexes indicated some disparities between the provinces and no correlation between the number of infected houses, number of containers and mosquito density (Table 5). In Long An, while about five more times open water containers were present, only 19.2% of the containers were

positive for mosquito larvae and only 3 % of the houses were infected. The Breteau Index (205) was highest of all the provinces analysed while the House Index (3.02) was the lowest. Conversely, in Dac Nong the Breteau Index (35.71) was 6 times lower than in Long An and the number of larvae 10 times lower (1693 vs. 16480) while the House Index (9.21) was three times higher (Table 5).

Vectoring capacity and genetic structure of mosquito populations. DENV- positive adult mosquitoes were found in four out of the five provinces studied (Table 4). In Dac Nong, two adult females were found positive, an *A. albopictus* individual infected with DENV4 and an *A. aegypti* mosquito infected with DENV1. In Long An four infected mosquitoes were identified, an *A. albopictus* female harbouring DENV4 and three other individuals, one *A. albopictus* and two *A. aegypti*, all infected with DENV2. In Ha Tinh, one infected mosquito was captured, an *A. albopictus* female carrying DENV2. In Quang Tri, two *A. albopictus* individuals infected with DENV2 were found, one of those being a male which indicates the occurrence of vertical transmission. No infected mosquito was found in Hue. With respect to CHIKV, two infected *A. aegypti* mosquitoes were found, one in the province of Long An and the second one in the province of Dac Nong (Table 4).

The COI phylogenetic analysis of the captured mosquitoes revealed the simultaneous presence in all sites of genetically diverse populations (Figure 2). Two main groups were found which corresponded to the main vectoring species, i.e. *A. aegypti* and *A. albopictus*. Each group was divided into several clusters of identical or nearly identical sequences (Figure 2). No geographic discrimination was found. Several mosquito individuals did not fall within any of the clusters and when analysing their sequence on BLAST, they were found to correspond either to unknown haplotypes, to known haplotypes described in other countries (i.e. Colombia, or to different mosquito species mistakenly identified as *A. albopictus* when sampling, i.e. *Aedes w-albus*, *Aedes mcintoshii*, *Aedes cogilli*, *Culex vishnui* and *Ochlerotatus flavescens*. One of these misidentified mosquito, i.e. *Culex vishnui*, was found to harbor the dengue virus DENV4 (Table 6). Interestingly, the COI mosquito haplotypes found in the five provinces covered by the study and distributed over the 10 clusters identified (Figure 2; Table 6) have been described in other parts of the world (Table 6).

Discussion

To our knowledge, this study is the first to investigate vectors distribution, DENV and CHIKV circulation and occurrence in patients hospitalized with acute febrile symptoms, in a comparative way over several provinces throughout Vietnam. Results coming from this active surveillance conducted over two years in five provinces neighbours with Lao PDR where dengue is present and Cambodia where both dengue and chikungunya are present bring a new perspective on the dynamic of these diseases.

The average rate of dengue among acute fever patients was about 3% and ranged from 2.06 % to 5.7% depending on the province. This is 10- to 5-times less than previously reported incidence rates among acute fever inpatients (28, 29). This lower incidence could be related to an improved primary dengue diagnostic, the current study being more recent. It could also be a consequence of the focus of this study on regional health centres while suspected dengue cases might be directed to major hospitals. The presence of all four serotypes of dengue is in accordance with the hyper-endemic status of Vietnam (30, 8).

The main result of this work is the lack of correlation observed between the incidence rates, the mosquito population density and the data on their genetic diversity which could shed a new light on the complex dynamic of dengue in Vietnam. Dengue virus was shown to undergo a complex dynamic involving both serotype and lineage replacements (31, 32, 33, 34, 35). Although many parameters could be involved in this mechanism, replacement was thought to be more stochastic than selective (32, 36). Raghwani et al. (36) reported the occurrence of differential dynamics depending upon rural or urban areas in South Vietnam. They demonstrated that infections were moving from urban to rural populations, which in turn could explain, at least in part, the lower incidence rate observed in this work, with Ho Chi Minh City playing a major role as an infection foci. The transmission gradient was linked to the human population density and the low rate of virus dispersal, i.e. 20km/year, associated to mosquito-mediate dispersal (36). Although in full agreement with these conclusions, the data reported here lead to a slightly different insight on the dynamic of dengue in Vietnam.

Dengue is considered being regularly introduced to Vietnam from Cambodia, mostly through people mobility (36). South-Vietnam and the Mekong River delta represent therefore regions at risk for high incidence. The data reported here provide a slightly different picture. The province of Long An, neighbour to Cambodia on one side and to Ho Chi Minh City on the other did not display the higher rate of incidence as expected but instead one of the lowest despite a very high Breteau Index indicative of a bad mosquito management system, proximity to high human population density and presence of the main cross border road system. The province with the highest incidence rate was the southern province Dac Nong. However, the province was also the one with the lowest population density of mosquitoes, i.e. Long An 10-times less than the other provinces. The Breteau and Container Indexes were the second lowest ones whereas the House Index was the highest one, in agreement with the observed incidence rate. This suggest that it is not the overall *Aedes* density that should be considered but rather some specific populations, perhaps less numerous but more actively involved in the effective transmission of the virus.

Another set of data from this work could bring together these conclusions and those from Raghwani et al., 2011 (36). The phylogeny and genetic diversity of the adult mosquitoes captured near the health centres investigated shed a new light on the mechanisms involved in the dynamic of dengue. The captured mosquitoes corresponded to COI haplotypes described in other parts of the world. Furthermore, unknown haplotypes were sequences along with other species mistakenly identified as *A. albopictus*. The high genetic diversity observed combined with clearly delineated cluster gathering mosquitoes from the different provinces indicated the absence of geographic discrimination. The sampled mosquito haplotypes are present all over the country but also in other countries and continents. It is not possible to say whether these mosquito populations originated in Vietnam and were moved to other places or conversely were moved to Vietnam from other parts of the world. Nevertheless, this worldwide description of the same haplotypes indicates a very large mobility of mosquitoes, most likely due to international trade, and therefore of viruses. This could participate to the explanation for regular virus replacement (31, 32,33, 34, 35), for the stochastic determinism of these replacements (32, 35), and for the higher presence in urban areas more prone to international trade exposure (36). It

seems that if there is indeed a regular introduction of dengue virus to Vietnam, the suspected introductions from Cambodia might represent only part of the process. As shown by phylogenetic data, there is no single local endemic population of mosquitoes but rather the cocirculation of several distinct populations countrywide. This conclusion is reinforced by the presence of unknown haplotypes among the samples. Two interesting facts also emerged from the study. The first one is that although *A. aegypti* outnumbered *A. albopictus*, the latter appeared to be more present among the infected individuals. This is particularly true for the southern province of Long An where *A. albopictus* made 50 % of the infected mosquitoes while they only represented 0.9% of the sampled mosquitoes. In the Northern/Central provinces of Ha Tinh and Quang Tri, where *A. albopictus* made up to 27-28% of the sampled mosquitoes, this species was the only one to harbour dengue viruses. Interestingly, in Hue where *A. albopictus* represented 47% of the captured mosquitoes, no infected individual was found. The other interesting fact relates to the haplotype of the dengue-infected *A. albopictus* mosquitoes. With the exception of QT_LB_albo_55M1 which belonged to the haplotype alb9 described in Thailand, all the other dengue-infected *A. albopictus* individuals belonged to the same population, with no haplotype name, characterized in Romania and described as an invasive population in Europe (37). The alb9 dengue-infected-mosquito was a male indicating thus the presence of vertical transmission, a trait already known in dengue (38, 39, 40). The last dengue-infected mosquito was found not to be *A. albopictus* but instead *Culex vishnui*. This is to our knowledge the first time, *C. vishnui*, known for transmitting Japanese encephalitis, is found infected with dengue. There is no evidence from the data reported here that *C. vishnui* can efficiently transmit dengue to human through a blood meal. However, there is at least the demonstration that *C. vishnui* can take the dengue virus and therefore be considered a potential vector. Further research should be considered to investigate the occurrence of efficient transmission of dengue in this already medically-important mosquito group.

Further indication of involvement of exogenous mosquitoes is also provided by the *A. aegypti* individuals. The dengue-infected *A. aegypti* mosquitoes were found to be associated to haplotypes described in Tamil Nadu, India (i.e. BUZOO-M-Aa), in the Martinique Island in the French West Indies (i.e. Martinique1) and in Thailand (i.e. aeg7).

Interestingly, other individuals from the same haplotypes described in India and Martinique Island, i.e. BUZOO_M_Aa and Martinique 1, were found to be infected by CHIKV. Tamil Nadu and Martinique Island have been heavily infected by chikungunya (18, 41, 42) and the similarity of haplotypes also suggest that the chikungunya dynamic, like dengue, might be significantly supported by long distance-travelling mosquitoes rather than local populations.

It seems important to decipher the movement of mosquitoes but not only at the Lao PDR and Cambodian borders as previously considered but rather through routes of international trade. High human population density foci are thus important to target as proposed by Raghwani et al. 2011 (35), but perhaps more because of their exposure to international exchanges than purely because of population density.

This work is stressing the need to establish a genotype-based survey of circulating mosquitoes in Vietnam, not based as currently done on the species but instead on the population at the infra-species level. An integrative analysis encompassing the genetic study of viral lineages on human patients and in mosquitoes along with the genotyping of mosquito population should be undertaken to provide clear information on the dynamic of dengue and chikungunya. Although no clinical chikungunya case was declared and no CHIKV was found on human samples in this work, the detection of CHIKV in mosquito haplotypes bound to worldwide movements and to areas with major chikungunya outbreaks indicate that the threat should be taken seriously and a dedicated surveillance programme should be implemented. From this work, dengue and chikungunya, appear as global threats that should not be addressed at a national or even regional scale but rather at a global, worldwide dimension of permanent exchanges and movements.

References

1. Bhatt S, Gething PW, Brady OJ, Messina JP, Farlow AW, Moyes CL, et al. The global distribution and burden of dengue. *Nature*. 2013 Apr 25;496(7446):504–7.
2. Kroeger A, Nathan MB. Dengue: setting the global research agenda. *The Lancet*. 2006 Dec;368(9554):2193–5.
3. Shepard DS, Undurraga EA, Halasa YA. Economic and disease burden of dengue in Southeast Asia. *PLoS Negl Trop Dis*. 2013;7(2):e2055.
4. Huber K, Le Loan L, Hoang TH, Tien TK, Rodhain F, Failloux A-B. *Aedes aegypti* in south Vietnam: ecology, genetic structure, vectorial competence and resistance to insecticides. *Southeast Asian J Trop Med Public Health*. 2003 Mar;34(1):81–6.
5. Anders KL, Nguyet NM, Van Vinh Chau N, Hung NT, Thuy TT, Lien LB, et al. Epidemiological Factors Associated with Dengue Shock Syndrome and Mortality in Hospitalized Dengue Patients in Ho Chi Minh City, Vietnam. *Am J Trop Med Hyg*. 2011 Jan 5;84(1):127–34.
6. WHO. Dengue and dengue haemorrhagic fever. *Health in Asia and the Pacific* 2008.
7. Cuong HQ, Hien NT, Duong TN, Phong TV, Cam NN, Farrar J, et al. Quantifying the Emergence of Dengue in Hanoi, Vietnam: 1998–2009. *PLoS Negl Trop Dis*. 2011 Sep 27;5(9):e1322.
8. Rabaa MA, Simmons CP, Fox A, Le MQ, Nguyen TTT, Le HY, et al. Dengue Virus in Sub-tropical Northern and Central Viet Nam: Population Immunity and Climate Shape Patterns of Viral Invasion and Maintenance. *PLoS Negl Trop Dis* [Internet]. 2013 Dec 5 [cited 2015 Oct 30];7(12). Available from: <http://www.ncbi.nlm.nih.gov/pmc/articles/PMC3854975/>
9. Do TTT, Martens P, Luu NH, Wright P, Choisy M. Climatic-driven seasonality of emerging dengue fever in Hanoi, Vietnam. *BMC Public Health*. 2014;14:1078.
10. NIHE: Final Report on evaluation of communicable diseases surveillance system in Vietnam 2008. Hanoi: National Institute of Hygiene and Epidemiology.
11. Phuong HL, Vries PJ de, Nga TT, Giao PT, Hung LQ, Binh TQ, et al. Dengue as a cause of acute undifferentiated fever in Vietnam. *BMC Infect Dis*. 2006 Jul 25;6(1):123.

12. Pham HV, Doan HTM, Phan TTT, Minh NNT. Ecological factors associated with dengue fever in a Central Highlands province, Vietnam. *BMC Infect Dis.* 2011;11:172.
13. Ross RW. The Newala epidemic. III. The virus: isolation, pathogenic properties and relationship to the epidemic. *J Hyg (Lond).* 1956 Jun;54(2):177–91.
14. Deller JJ, Russell PK. An analysis of fevers of unknown origin in American soldiers in Vietnam. *Ann Intern Med.* 1967 Jun;66(6):1129–43.
15. Morrison TE. Reemergence of chikungunya virus. *J Virol.* 2014 Oct;88(20):11644–7.
16. Schuffenecker I, Itean I, Michault A, Murri S, Frangeul L, Vaney M-C, et al. Genome microevolution of chikungunya viruses causing the Indian Ocean outbreak. *PLoS Med.* 2006 Jul;3(7):e263.
17. Chusri S, Siripaitoon P, Silpapojakul K, Hortiwakul T, Charernmak B, Chinnawirotpisan P, et al. Kinetics of chikungunya infections during an outbreak in Southern Thailand, 2008-2009. *Am J Trop Med Hyg.* 2014 Mar;90(3):410–7.
18. Kaur P, Ponniah M, Murhekar MV, Ramachandran V, Ramachandran R, Raju HK, et al. Chikungunya outbreak, South India, 2006. *Emerg Infect Dis.* 2008 Oct;14(10):1623–5.
19. Tyler M. Sharp. Differentiating Chikungunya From Dengue: A Clinical Challenge [Internet]. Medscape. 2014 [cited 2015 Nov 2]. Available from: <http://www.medscape.com/viewarticle/831523>
20. Pham HV, Doan HTM, Phan TTT, Minh NNT. Ecological factors associated with dengue fever in a Central Highlands province, Vietnam. *BMC Infect Dis.* 2011;11:172.
21. Gautam I, Dhimal MN, Shrestha SR, Tamrakar AS. First Record of *Aedes aegypti* (L.) Vector of Dengue Virus from Kathmandu, Nepal. *J Nat Hist Mus.* 2009 Oct 9;24(1):156.
22. Ishan Gautam AK. Container preference of the Asian tiger mosquito (*Aedes albopictus*) in Kathmandu and Lalitpur districts of Nepal. *J Nat Hist Mus.* 2012;26:181–93.
23. Edgar RC. MUSCLE: multiple sequence alignment with high accuracy and high throughput. *Nucleic Acids Res.* 2004;32(5):1792–7.
24. Galtier N, Gouy M, Gautier C. SEAVIEW and PHYLO_WIN: two graphic tools for sequence alignment and molecular phylogeny. *Comput Appl Biosci CABIOS.* 1996 Dec;12(6):543–8.

25. Gouy M, Guindon S, Gascuel O. SeaView version 4: A multiplatform graphical user interface for sequence alignment and phylogenetic tree building. *Mol Biol Evol.* 2010 Feb;27(2):221–4.
26. Posada D, Crandall KA. MODELTEST: testing the model of DNA substitution. *Bioinforma Oxf Engl.* 1998;14(9):817–8.
27. Guindon S, Gascuel O. A simple, fast, and accurate algorithm to estimate large phylogenies by maximum likelihood. *Syst Biol.* 2003 Oct;52(5):696–704.
28. Capeding MR, Chua MN, Hadinegoro SR, Hussain IIHM, Nallusamy R, Pitisuttithum P, et al. Dengue and other common causes of acute febrile illness in Asia: an active surveillance study in children. *PLoS Negl Trop Dis.* 2013;7(7):e2331.
29. Thai KTD, Cazelles B, Nguyen NV, Vo LT, Boni MF, Farrar J, et al. Dengue Dynamics in Binh Thuan Province, Southern Vietnam: Periodicity, Synchronicity and Climate Variability. *PLoS Negl Trop Dis.* 2010 Jul 13;4(7):e747.
30. Bartley LM, Carabin H, Vinh Chau N, Ho V, Luxemburger C, Hien TT, et al. Assessment of the factors associated with flavivirus seroprevalence in a population in Southern Vietnam. *Epidemiol Infect.* 2002 Apr;128(2):213–20.
31. Duong V, Simmons C, Gavotte L, Viari A, Ong S, Chantha N, Lennon NJ, Birren BW, Vong S, Farrar JJ, Henn MR, Deubel V, Frutos R, Buchy P. 2013. Genetic diversity and lineage dynamic of dengue virus serotype 1 (DENV-1) in Cambodia. *Infect. Genet. Evol.* 15: 59-68.
32. Duong V, Henn MR, Simmons C, Ngan C, Y B, Gavotte L, Viari A, Ong S, Huy R, Lennon NJ, Ly S, Vong S, Birren BW, Farrar JJ, Deubel V, Frutos R, Buchy P. 2013. Complex dynamic of dengue virus serotypes 2 and 3 in Cambodia following series of climate disasters. *Infect Genet Evol.* 15: 77-86.
33. Ty Hang VT, Holmes EC, Duong V., Quy NT, Tinh Hien T, Quail M, et al. Emergence of the Asian 1 Genotype of Dengue Virus Serotype 2 in Viet Nam: In Vivo Fitness Advantage and Lineage Replacement in South-East Asia. *PLoS Negl Trop Dis.* 2010 Jul 20;4(7):e757.
34. Rabaa MA, Ty Hang VT, Wills B, Farrar J, Simmons CP, Holmes EC. Phylogeography of recently emerged DENV-2 in southern Viet Nam. *PLoS Negl Trop Dis.* 2010;4(7):e766.

35. Myat Thu H, Lowry K, Jiang L, Hlaing T, Holmes EC, Aaskov J. Lineage extinction and replacement in dengue type 1 virus populations are due to stochastic events rather than to natural selection. *Virology*. 2005 Jun 5;336(2):163–72.
36. Raghwani J, Rambaut A, Holmes EC, Hang VT, Hien TT, Farrar J, et al. Endemic dengue associated with the co-circulation of multiple viral lineages and localized density-dependent transmission. *PLoS Pathog*. 2011 Jun;7(6):e1002064.
37. Prioteasa LF, Dinu S, Fălcută E, Ceianu CS. Established Population of the Invasive Mosquito Species *Aedes albopictus* in Romania, 2012-14. *J Am Mosq Control Assoc*. 2015 Jun;31(2):177–81.
38. Buckner EA, Alto BW, Lounibos LP. Larval Temperature–Food Effects on Adult Mosquito Infection and Vertical Transmission of Dengue-1 Virus. *J Med Entomol*. 2015 Oct 20;tjv145.
39. Cecílio SG, Júnior WFS, Tótola AH, de Brito Magalhães CL, Ferreira JMS, de Magalhães JC. Dengue virus detection in *Aedes aegypti* larvae from southeastern Brazil. *J Vector Ecol J Soc Vector Ecol*. 2015 Jun;40(1):71–4.
40. Tri Baskoro Tunggul Satoto, Siti Rahmah Umniyati, Fardhiasih Dwi Astuti, Nastiti Wijayanti, Laurent Gavotte, Christian Devaux, et al. Assessment of vertical dengue virus transmission in *Aedes aegypti* and serotype prevalence in Bantul, Indonesia. *Asian Pac J Trop Dis*. 2014;4:S563–8.
41. Vega-Rúa A, Lourenço-de-Oliveira R, Mousson L, Vazeille M, Fuchs S, Yébakima A, et al. Chikungunya virus transmission potential by local *Aedes* mosquitoes in the Americas and Europe. *PLoS Negl Trop Dis*. 2015 May;9(5):e0003780.
42. Vega-Rúa A, Zouache K, Girod R, Failloux A-B, Lourenço-de-Oliveira R. High level of vector competence of *Aedes aegypti* and *Aedes albopictus* from ten American countries as a crucial factor in the spread of Chikungunya virus. *J Virol*. 2014 Jun;88(11):6294–306.

Acknowledgements

Pham This Kim Lien was supported in part by the ADB funded, Erasmus Mundus project MAHEVA and by the CNRS - Virus host cell interactions Laboratory; and Montpellier University, France. The study was supported by the Entomology department, Arbo Virus laboratory in National Institute of Hygiene and Epidemiology, Hanoi, Vietnam. To the Parasitology, Evolutionary Biology, Ecology Department; and Evolution, Vector, Adaptation in Symbioses Department in Montpellier University, France for their help and supported. The authors are grateful to leaders and medical staff of the the Center for Preventive Medicine in Ha Tinh, Thua Thien Hue, Quang Tri, Dac Nong, Long An, the District Health Centre and commune health centre/wards in their provinces for their enthusiastic support, active participation and close collaboration. The authors are very grateful to Dr Babatunde Olowokure, Disease Prevention and Control, Caribbean Public Health Agency, for his support and fruitful comments on the manuscript.

Table 1: Oligonucleotide primers used to amplify and type dengue, chikungunya viruses and COI gene

	Primer	Sequence	Position ¹	Size
DENV	D1	5'-TCAATATGCTGAAACGCGCGAGAA ACCG-3'	616-644	511
	TS1	5'-CGTCTCAGTGATCCG GGGG-3'	568-586	482 (D1 and TS 1)
	TS2	5'-CGC CAC AAG GGC CAT GAA CAG-3'	232-252	119 (D1 and TS 2)
	TS3	5'-TAA CAT CAT CAT GAG ACA GAGC-3'	400-421	290 (D1 and TS 3)
	TS4	5'-TGTTGTCTTAAACAAGAGAGGTC-3'	506-527	392 (D1 and TS 4)
CHIKV	NSP2-F	5'-GGCACTGGTCCCAGATAATTCAAG-3'	3181-3241	120
	NSP2-R	5'- GCTGTCTAGTACCACCCCATACATG-3'		
COI gene	COI F	5'- TATCGCCTAAACTTCAGCC -3'		1651
	COI R	5'- CCTAAATTTGCTCATGTTGCC -3'		

Table 2: Frequency of symptoms upon admission

Patient (n = 558)		Value	Odds ratio (OR)	<18 years n = 269	>18 years n = 289	P-value
Age (years);(mean, range)		26 (0.4-74)		(0.4-18)	(19-74)	
Sex (M/F) (%)		305/253(54.6%/45.4%)	1.2			
Duration of febrile (mean, range)		3.6 (1-7 days)				
Signs and symptoms	Temperature on admission (°C) (range)	38.8 (38-40 °C)				
	Headache	248 (44%)	0.8	36.4%	51.9%	0.0003
	Myalgia	328 (59%)	1.4	30.8%	64.8%	0.0001
	Arthralgia	117 (21%)	0.3	10.0%	31.1%	0.0001
	Rash	189 (16%)	0.5	35.3%	32.5%	0.5311
	Petechia	156 (10%)	0.4	15.6%	38.8%	0.0001
	Nausea/ Vomiting	68 (3.2%)	0.13	13.7%	1.04%	0.0001
	Positive Tourniquet test	53 (9.5%)	0.1	4.5%	14.2%	0.0001
Warning sign	Back pain	56 (10%)	0.11	1.85%	17.7%	0.0001
	Bleeding gums	18 (3.2%)	0.03	0.74%	5.54%	0.0001
	Abdominal pain	38 (6.8%)	0.07	3.34%	10.03%	0.001

Note: Value are the mean (range) or number (%)

Table 3 : Frequency of DENV and CHIKV in the human serum.

Province	Nb patients	Dengue serotype				Chikungunya
		D1	D2	D3	D4	
Ha Tinh	100	1	0	1	0	0
Hue	91	1	2	0	0	0
Quang Tri	97	1	0	1	0	0
Dac Nong	128	2	2	2	1	0
Long An	142	2	1	0	0	0
Total	558	7	5	4	1	0

Table 4: Incidence of dengue and chikungunya virus in collected adult mosquitoes

Province	Number of mosquito		Dengue-positive		Chikungunya-positive	
	<i>A. aegypti</i>	<i>A.albopictus</i>	<i>A. aegypti</i>	<i>A. albopictus</i>	<i>A. aegypti</i>	<i>A. albopictus</i>
Ha Tinh	55 (5.55%)	19 (16.81%)		1 x DENV 1	0	0
Hue	7 (0.7%)	85 (75.2 %)			0	0
Quang Tri	64 (6.46%)	6 (5.3%)		2 x DENV 1	0	0
Dac Nong	285 (28.8%)	3 (2.65%)	1 x DENV 1	1 x DENV 4	1	0
Long An	580 (58.5%)	0 (0%)	2 x DENV 2	1x DENV 2 1 x DENV 4	1	0
	991 (100%)	113 (100%)	3	6	2	0

Table 5. Distribution of *Aedes* larvae and entomological indexes

Province	N° Houses	N° Positive	N° Containers	N° Positive	<i>A. aegypti</i>	<i>A. albopictus</i>	BI	CI	HI
	Explored	Houses	Explored	Containers	Larvae	Larvae			
Ha Tinh	450	41 (8.1%)	936	79 (8.4%)	1046				
	551	17.56	8.44	8.12					
Quang Tri	420	24 (4.9%)	778	170 (21.9%)	1147	423	40.48	21.85	4.82
Hue	480	40 (6.8%)	730	202 (27.7%)	1147	1022	42.08	27.67	6.77
Dac Nong	420	47 (9.2%)	807	150 (18.6%)	760	411	35.71	18.59	9.21
Long An	480	18 (3.0%)	5128	984 (19.2%)	5126	46		205	19.19 3.02
Total	2250	170 (7.5%)	8549	1585 (18.5%)	8542	2453			

BI: Breteau Index = Nb Positive Containers / Nb Houses Explored x 100

CI: Container Index = Nb Positive Containers / Nb Containers Explored x 100

HI: House Index = Nb Positive Houses / Number Houses Explored x 100

Table 6. Distribution of haplotypes among captured adult mosquitoes

Strain	Cluster	Species	Haplotype	Country	Accession number
19M22	Individual	<i>Aedes aegypti</i>	Unknown	Unknown	NA
19M32	Individual	<i>Aedes aegypti</i>	Unknown	Unknown	NA
22F4	Individual	<i>Aedes aegypti</i>	Unknown	Unknown	NA
19M34	Individual	<i>Aedes aegypti</i>	Haplotype 68	Colombia	KM203207
19M25	Individual	<i>Aedes aegypti</i>	Haplotype 80	Colombia	KM203219
22F7	Individual	<i>Aedes aegypti</i>	Haplotype 14	Colombia	KM203153
39F2	Individual	<i>Aedes aegypti</i>	Unknown	Unknown	NA
49F7	Individual	<i>Aedes aegypti</i>	Unknown	Unknown	NA
20M3	Individual	<i>Aedes aegypti</i>	Unknown	Unknown	NA
19M24	Individual	<i>Aedes aegypti</i>	Unknown	Unknown	NA
19M20	root individual	<i>Aedes aegypti</i>	CDC11	Colombia	KM452747
19M29	Individual/C1	<i>Aedes aegypti</i>	Guinea 1	Guinea	JQ926700
19M33	Individual/C1	<i>Aedes aegypti</i>	BUZOO-M-Aa	India	KR817731
34M14	Cluster 1	<i>Aedes aegypti</i>	Haplotype 70	Colombia	KM203209
24F1	Cluster 1	<i>Aedes aegypti</i>	BUZOO-M-Aa	India	KR817731
26F3	Cluster 1	<i>Aedes aegypti</i>	BUZOO-M-Aa	India	KR817731
19M23	Root Cluster 2	<i>Aedes aegypti</i>	Haplotype 37	Colombia	KM203176
34M7	Root Cluster 2	<i>Aedes aegypti</i>	BUZOO-M-Aa	India	KR817731
9M5	Root Cluster 2	<i>Aedes aegypti</i>	None	India	KJ680548
19M10	Cluster 2	<i>Aedes aegypti</i>	aeg7	Thailand	KP843388
30F5	Cluster 2	<i>Aedes aegypti</i>	aeg7	Thailand	KP843388
19M21	Cluster 2	<i>Aedes aegypti</i>	aeg7	Thailand	KP843388
28F5	Cluster 2	<i>Aedes aegypti</i>	aeg7	Thailand	KP843388
06F3	Root Cluster 3	<i>Aedes aegypti</i>	Isolate 4	Brazil	JX456414
19M5	Cluster 3	<i>Aedes aegypti</i>	Martinique 1	Martinique (French Caribbean)	JQ926696
06F2	Cluster 3	<i>Aedes aegypti</i>	Martinique 1	Martinique (French Caribbean)	JQ926696
01F4	Cluster 3	<i>Aedes aegypti</i>	Martinique 1	Martinique (French Caribbean)	JQ926696
47F2	Cluster 3	<i>Aedes aegypti</i>	Isolate 2	Brazil	JX456412
29F3	Cluster 4	<i>Aedes aegypti</i>	BUZOO-M-Aa	India	KR817731
01F10	Cluster 4	<i>Aedes aegypti</i>	Vietnam 5	Vietnam	JQ926687
59F3	Cluster 5	<i>Aedes aegypti</i>	BUZOO-M-Aa	India	KR817731
20M1	Cluster 5	<i>Aedes aegypti</i>	Haplotype 94	Colombia	KM203233
72F1	Cluster 6	<i>Aedes albopictus</i>	AB7	Thailand	KM613099
7M6	Cluster 6	<i>Aedes albopictus</i>	alb9	Thailand	KP843400
49f13	Cluster 6	<i>Aedes albopictus</i>	alb9	Thailand	KP843400
49f11	Cluster 6	<i>Aedes albopictus</i>	AB7	Thailand	KM613099
49f3	Cluster 6	<i>Aedes albopictus</i>	None	Romania	HF536717
22F5	Cluster 6	<i>Aedes albopictus</i>	None	Romania	HF536717
37F2	Cluster 6	<i>Aedes albopictus</i>	None	Romania	HF536717
45m4	Cluster 6	<i>Aedes albopictus</i>	alb9	Thailand	KP843400

46F4	Cluster 7	<i>Aedes albopictus</i>	None	Romania	HF536717
50m4	Cluster 7	<i>Aedes albopictus</i>	None	Romania	HF536717
19m13	Cluster 7	<i>Aedes albopictus</i>	None	Romania	HF536717
55M1	Cluster 7	<i>Aedes albopictus</i>	alb9	Thailand	KP843400
50M1	Cluster 8	<i>Aedes albopictus</i>	alb9	Thailand	KP843400
50M14	Cluster 8	<i>Aedes albopictus</i>	alb9	Thailand	KP843400
49F10	Cluster 9	<i>Aedes albopictus</i>	alb9	Thailand	KP843400
56F1	Root C10	<i>Aedes albopictus</i>	None	Romania	HF536717
17F6	Cluster 10	<i>Aedes albopictus</i>	None	Romania	HF536717
72F7	Cluster 10	<i>Aedes albopictus</i>	None	Romania	HF536717
36F3	Cluster 10	<i>Aedes albopictus</i>	alb9	Thailand	KP843400
19m26	Individual (72%)	<i>Aedes aegypti</i>	BUZOO-M-Aa	India	KR817731
44f6	Individual	<i>Aedes w-albus</i>	NIBGE MOS-00132	Pakistan	KF406649
63f1	Individual	<i>Aedes mcintoshi</i>	SEN5	Senegal	KJ940759
50m8	Individual	<i>Aedes albopictus</i>	H_5	Vietnam	LM999976
64F2	Individual	<i>Ochlerotatus flavescens</i>	NHM014_5	UK	KC602635
01F8	Individual	<i>Culex vishnui</i>	564IRI2008	Unknown	AB738195
39F1	Individual	<i>Aedes cogilli</i>	NIBGE MOS-01588	Pakistan	KF406621
39F3	Individual	<i>Aedes cogilli</i>	NIBGE MOS-01588	Pakistan	KF406621
38M2	Individual	<i>Aedes cogilli</i>	NIBGE MOS-01588	Pakistan	KF406621
38M3	Individual	<i>Aedes cogilli</i>	NIBGE MOS-01588	Pakistan	KF406621

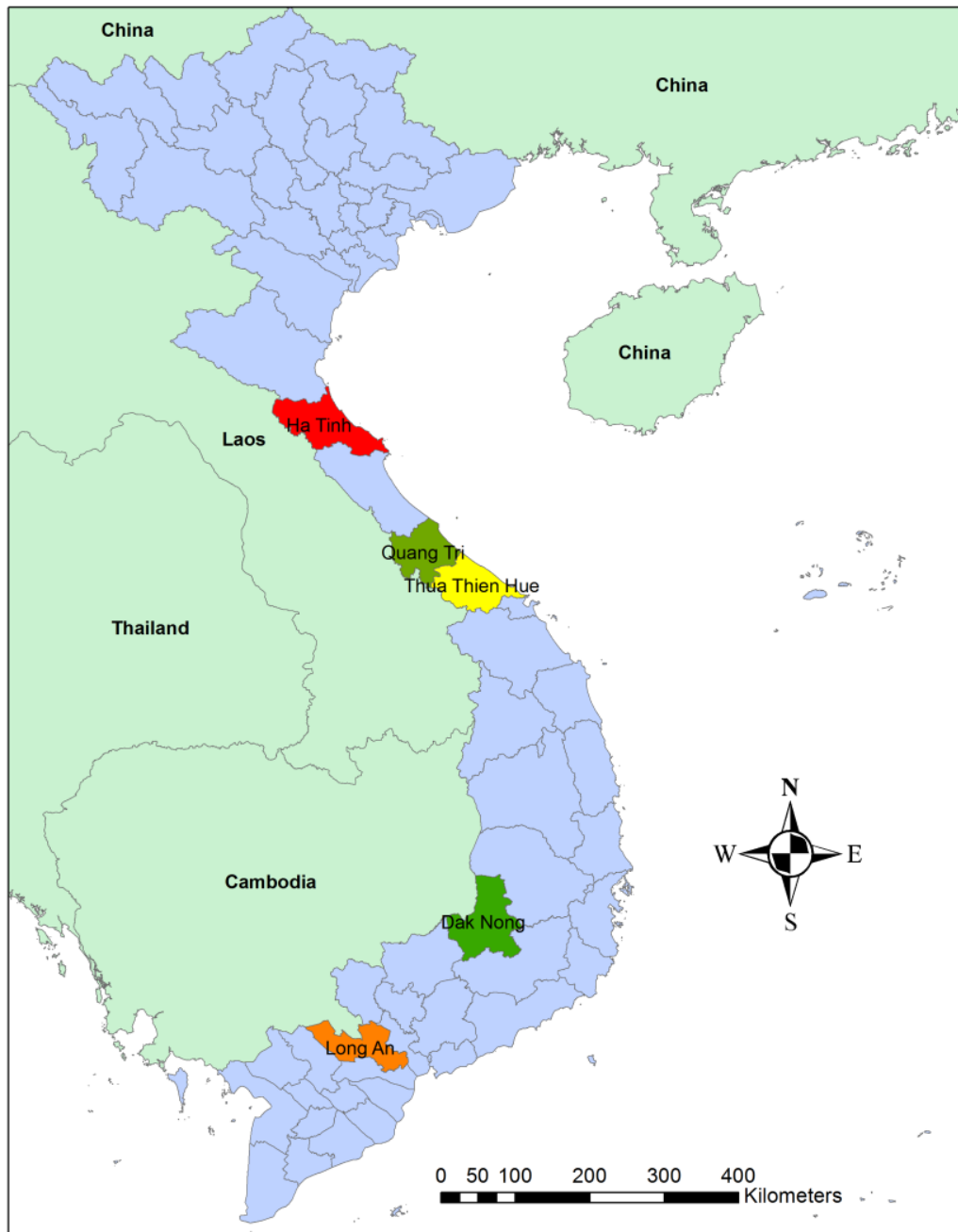

Figure 1: Viet Nam map and sampling sites

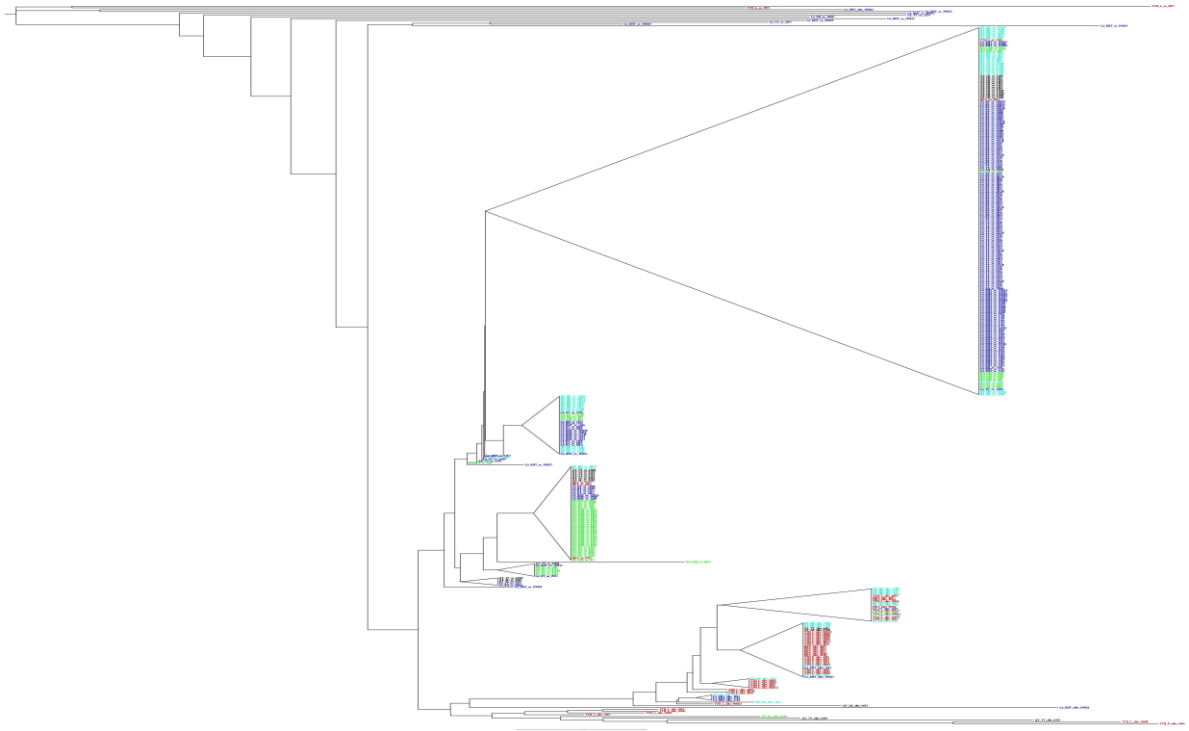

Figure 2: The genetically diverse populations of mosquitoes

GENERATION CONCLUSION AND PERSPECTIVES

This work on the surveillance and dynamic of dengue and chikungunya in Vietnam has brought a new insight and raised questions upon situations, which happened to be preconceived ideas. First of all this work is to our knowledge the first one to have been conducted in a comparative way at such a scale over the whole country. All previous reports have described local events and outbreaks and although rightful conclusions have been drawn, they reflected the local dynamic. A broader view was needed to understand the dynamic of these diseases.

The first conclusion is that it very difficult to draw general conclusions on the main vector of dengue. In this work, two opposite conclusions were reached depending on location and perhaps time. In the dengue outbreak in Hanoi in 2011, *A. aegypti* was clearly shown to be the vector responsible for the diffusion dengue. A clear correlation was observed between the density of local populations of *A. aegypti* and clinical cases of dengue. *A. albopictus* did not play any role. When the global analysis was conducted in several provinces from North, Central and South Vietnam, the main vector was clearly *A. albopictus* and even more importantly haplotypes described in other parts of the world, including the haplotype recently described as invasive in Europe. Several hypotheses could be drawn to explain this apparent discrepancy. This difference could be explained by a specific situation in Hanoi, which is a highly densely populated urban area where *A. aegypti* might be more prevalent owing to its adaptation to the urban environment when compared to *A. albopictus*. *A. aegypti* is indeed far more anthropophilic than *A. albopictus* and then might be logically more important in high urban areas like the capital city. The survey conducted within this PhD work on the several provinces where *A. albopictus* was found to be the most important vector was conducted on rural areas where *A. albopictus* might be more competitive than *A. aegypti*. Another explanation might be found in the fact that the Hanoi analysis was conducted in 2011 whereas the several provinces analysis was conducted in 2012-2014. It is not possible to exclude a replacement of mosquito populations in the meantime. This hypothesis is however not very strong since in the several provinces study, *A. aegypti* was clearly the dominant species. A last explanation

might be found in the way the analysis was designed, which could be also a self-criticism of this work. The conclusions from the Hanoi study were based essentially on the correlation between the density and time of occurrence of mosquito populations and the number of clinical cases. However the ample size was limited. In the several provinces analysis, *A. albopictus* was shown to be the main vector for dengue although population density of *A. aegypti* was higher. This is particularly true for the Long An province where *A. albopictus* made 0.9% of the mosquitoes captured and 50% of the dengue-infected individuals. However, if the number of clinical cases in Long An had been correlated to the population density of mosquitoes using a smaller sample, the study might have instead concluded in the overwhelming role of *A. aegypti*.

This PhD work demonstrates the need of a comprehensive and coordinated approach when analyzing the dynamic of dengue, and chikungunya. Such studies should not be conducted on isolated outbreaks as the sum of individual studies does not necessarily give a true vision of the whole context. Instead, surveillance studies should be designed at the national level and based on the same master plan including both clinical and entomological studies with virus detection in all samples. Genotyping of mosquito populations should be mandatorily performed but also virus genotyping, from both human and insect samples, in order to be able to conduct the analysis of the dynamic of the disease at the level of the viral lineage. The viral lineage is the true level at which virus circulation should be considered, just like populations, i.e. infra specific, for the mosquitoes. The species and serotype levels are not accurate enough to allow for a precise analysis of circulation and association mapping. A first recommendation and perspective from this work would be therefore to develop such an integrated analysis framework and propose it to NIHE and at the national level. This should also include an homogeneous and integrated database and database management system compatible with spatio-temporal analysis.

This is particularly relevant when considering, another major conclusion from this PhD work, that mosquito populations involved are not local populations but instead populations circulating worldwide. The analysis should therefore not concentrate on local populations of mosquito, although they can play a role, but instead on the regular monitoring of mosquito populations, and in particular at the points of entry like seaports.

Such procedures should also be developed, and this could be another perspective from this work. Genotyping, suitable databases and comparative analysis of worldwide mosquito and virus sequences must be developed but also geographic analysis and international trade movements.

A last aspect unveiled by this work is the limited adaptation of the current surveillance and monitoring procedures implemented at hospitals and public health centers. As shown in the Dong Thap surveillance work, serological tests done upon admission are underestimating the number of dengue-positive patients. In addition, it does not allow for lineage identification. Chikungunya is not tested at all. It would be too expensive and practically difficult to implement a multi-step serological test and still the results would not be fully satisfactory. We therefore propose as a final recommendation and perspective from this PhD work to implement a multiplex-PCR test detecting at once the four types of dengue virus and the old and reemerging chikungunya viruses associated with the sequencing of the positive samples. The cost of PCR and sequencing is now very low and the public health benefits largely compensate the cost of the surveillance. This should be linked to the same integrated system of dynamic databases as for mosquito surveillance. A proposal should be made at NIHE and at the national level for such a procedure.

As a final word, this PhD work has underlined some key issues to be addressed in a coordinated way in order to help developing an efficient surveillance and monitoring system for both dengue and chikungunya in Vietnam. Developing these systems and tools will thus be both a challenge and an exciting outcome of this work.

REFERENCES

1. Guzman MG, Halstead SB, Artsob H, Buchy P, Farrar J, Gubler DJ, et al. Dengue: a continuing global threat. *Nat Rev Microbiol*. 2010 Dec 1;8:S7–16.
2. WHO | Dengue guidelines for diagnosis, treatment, prevention and control: new edition [Internet]. WHO. [cited 2014 Dec 5]. Available from: <zotero://attachment/1174/>
3. WHO. DENGUE: Guidline for diagnosis, treatment, prevention and control. 2009.
4. Kyle JL, Harris E. Global spread and persistence of dengue. *Annu Rev Microbiol*. 2008;62:71–92.
5. Martina BEE, Koraka P, Osterhaus ADME. Dengue Virus Pathogenesis: an Integrated View. *Clin Microbiol Rev*. 2009 Oct;22(4):564–81.
6. Bhatt S, Gething PW, Brady OJ, Messina JP, Farlow AW, Moyes CL, et al. The global distribution and burden of dengue. *Nature*. 2013 Apr 25;496(7446):504–7.
7. M. S. Mustafa VR. Discovery of fifth serotype of dengue virus (DENV-5): A new public health dilemma in dengue control. *Med J Armed Forces India*. 2014;
8. MacFadden DR, Bogoch II. Pan American Health Organization/World Health Organization (AHO/WHO). Number of Reported Cases of Chikungunya Fever in the Americas, by Country or Territory 2013–2014, *Epidemiological Week/EW 35* Available from: http://www.paho.org/hq/index.php?option=com_topics&view=rdrmore&tt=PAHO%2FWHO%20Data%20Maps%20and%20Statistics&id=5927&tp. *CMAJ Can Med Assoc J J Assoc Medicale Can*. 2014 Jul 8;186(10):775–775.
9. Weaver SC. Arrival of Chikungunya Virus in the New World: Prospects for Spread and Impact on Public Health. *PLoS Neglected Tropical Diseases*. 2014 Jun;1.
10. Fischer M, Staples JE. Notes from the field: chikungunya virus spreads in the Americas - Caribbean and South America, 2013-2014. *MMWR Morb Mortal Wkly Rep*. 2014 Jun 6;63(22):500–1.
11. Van Bortel W, Dorleans F, Rosine J, Bateau A, Rousset D, Matheus S, et al. Chikungunya outbreak in the Caribbean region, December 2013 to March 2014, and the significance for Europe. *Euro Surveill Bull Eur Sur Mal Transm Eur Commun Dis Bull*. 2014;19(13).

12. Caron M, Paupy C, Grard G, Becquart P, Mombo I, Nso BBB, et al. Recent introduction and rapid dissemination of Chikungunya virus and Dengue virus serotype 2 associated with human and mosquito coinfections in Gabon, central Africa. *Clin Infect Dis Off Publ Infect Dis Soc Am.* 2012 Sep;55(6):e45–53.
13. Chikungunya Confused With Dengue In Malaysia :Clinical, Serological And Molecular Perspective. *Internet J Microbiol [Internet].* 2011 [cited 2013 Oct 19];9(2). Available from: <http://www.ispub.com/doi/10.5580/647>
14. Chahar HS, Bharaj P, Dar L, Guleria R, Kabra SK, Broor S. Co-infections with Chikungunya Virus and Dengue Virus in Delhi, India. *Emerg Infect Dis.* 2009 Jul;15(7):1077–80.
15. Kumar KJ, Manjunath VG, Shailashree M, Girish GN. Coinfection with dengue and chikungunya--a case report. *J Indian Med Assoc.* 2012 Oct;110(10):749, 752.
16. Nayar SK, Noridah O, Paranthaman V, Ranjit K, Norizah I, Chem YK, et al. Co-infection of dengue virus and chikungunya virus in two patients with acute febrile illness. *Med J Malaysia.* 2007 Oct;62(4):335–6.
17. Leroy EM, Nkoghe D, Ollomo B, Nze-Nkogue C, Becquart P, Grard G, et al. Concurrent Chikungunya and Dengue Virus Infections during Simultaneous Outbreaks, Gabon, 2007. *Emerg Infect Dis.* 2009 Apr;15(4):591–3.
18. Giovanni Rezza. *Aedes albopictus* and the reemergence of Dengue. *BMC Public Health.* 2012 Jan 24;12(1):72.
19. Halstead SB. Mosquito-borne haemorrhagic fevers of South and South-East Asia. *Bull World Health Organ.* 1966;35(1):3–15.
20. Quang Ha Do TQHV. Dengue Haemorrhagic Fever in the South of Vietnam during 1975-1992 and Its Control Strategy.
21. Thi Kim Tien N, Ha DQ, Tien TK, Quang LC. Predictive Indicators for Forecasting Epidemic of Dengue/Dengue Haemorrhagic Fever Through Epidemiological, Virological and Entomological Surveillance. 1999 Dec [cited 2014 Dec 5]; Available from: <http://repository.searo.who.int/handle/123456789/15794>
22. The National Dengue Control Program in NIHE of Vietnam. Reported from period time 1998-2008.

23. Stephen Berger. Dengue: Global Status 2015 | HESP News Briefing – RSS feeds [Internet]. [cited 2015 Aug 25]. Available from: <http://hesp-news.org/2015/03/11/dengue-global-status-2015/>
24. WHO | Chikungunya [Internet]. WHO. [cited 2014 Dec 5]. Available from: http://www.who.int/denguecontrol/arbo-viral/other_arboviral_chikungunya/en/
25. Deller JJ Jr, Russell PK. An analysis of fevers of unknown origin in American soldiers in Vietnam. *Ann Intern Med.* 1967 Jun;66(6):1129–43.
26. Vu-Quy-Dai null, Nguyen-Thi Kim-Thoa null, Ly-Quoc-Bang null. [Study of anti-Chikungunya antibodies in Vietnamese children in Saigon]. *Bull Société Pathol Exot Ses Fil.* 1967 Aug;60(14):353–9.
27. Duc HM, Takagi M, Tnusoda T, Hien NT, Duong TN and Thuy NTT. Detected of Chikungunya virus during Dengue outbreak in the Northern Vietnam. The 4th Nagasaki symposium on tropical and emerging diseases. November 26th-28th, 2009. Ryojun-Hall and Pompe Hall, Nagasaki University, Japan); 2009.
28. Duong V, Andries A-C, Ngan C, Sok T, Richner B, Asgari-Jirhandeh N, et al. Reemergence of Chikungunya Virus in Cambodia. *Emerg Infect Dis.* 2012 Dec;18(12):2066–9.
29. Inc GI, Berger DS. *Infectious Diseases of Laos.* GIDEON Informatics Inc; 2014. 405 p.
30. WHO. Arboviruses and human disease. Report of a WHO Scientific Group; 1967.
31. Hernandez R, Brown DT, Paredes A. Structural Differences Observed in Arboviruses of the Alphavirus and Flavivirus Genera. *Adv Virol.* 2014 Sep 16;2014:e259382.
32. Overturf GD. World arboviruses: the Bunyaviridae. *Pediatr Infect Dis J.* 2009 Nov;28(11):1014–5.
33. Karabatsos edited by N. International catalogue of arboviruses, including certain other viruses of vertebrates [Internet]. 3rd ed. San Antonio, Texas: American Society of Tropical Medicine and Hygiene for The Subcommittee on Information Exchange of the American Committee on Arthropod-borne Viruses; 1985. Available from: https://catalyst.library.jhu.edu/catalog/bib_66192
34. Andrew MQ King, Elliot Lefkowitz, Michael J. Adms, Eric B. Carstens. *Virus Taxonomy: Ninth Report of the International Committee on Taxonomy of Viruses:* 9780123846846: Medicine & Health Science Books @ Amazon.com.

35. Strauss EG, Strauss JH. *Viruses and Human Disease*. Academic Press; 2007. 477 p.
36. Liang G, Gao X, Gould EA. Factors responsible for the emergence of arboviruses; strategies, challenges and limitations for their control. *Emerg Microbes Infect*. 2015 Mar 25;4(3):e18.
37. Berge TO. *International Catalogue of Arboviruses: Including Certain Other Viruses of Vertebrates*. Public Health Service; 1975. 816 p.
38. Adelman ZN, Miller DM, Myles KM. Bed Bugs and Infectious Disease: A Case for the Arboviruses. *PLoS Pathog*. 2013 Aug;9(8):1–4.
39. Weaver SC, Reisen WK. Present and future arboviral threats. *Antiviral Res*. 2010 Feb;85(2):328–45.
40. Schweitzer BK, Chapman NM, Iwen PC. Overview of the Flaviviridae With an Emphasis on the Japanese Encephalitis Group Viruses. *Lab Med*. 2009 Aug 1;40(8):493–9.
41. Kalitzky M, Borowski P. *Molecular Biology of the Flavivirus*. Horizon Scientific Press; 2006. 397 p.
42. John H.O. Pettersson. *The Origin of the Flavivirus and the Ecology of Tick-Borne Pathogen*. 2013.
43. Vasilakis N, Tesh RB, Weaver SC. Sylvatic Dengue Virus Type 2 Activity in Humans, Nigeria, 1966. *Emerg Infect Dis*. 2008 Mar;14(3):502–4.
44. Calisher CH, Gould EA. Taxonomy of the virus family Flaviviridae. *Adv Virus Res*. 2003;59:1–19.
45. Lindenbach BD, Rice CM. Molecular biology of flaviviruses. *Adv Virus Res*. 2003;59:23–61.
46. Pastorino B, Nougairède A, Wurtz N, Gould E, de Lamballerie X. Review: Role of host cell factors in flavivirus infection: Implications for pathogenesis and development of antiviral drugs. *Antiviral Res*. 2010 Jan 1;87:281–94.
47. Perera R, Kuhn RJ. Structural proteomics of dengue virus. *Curr Opin Microbiol*. 2008 Aug;11(4):369–77.
48. Gubler DJ. The Continuing Spread of West Nile Virus in the Western Hemisphere. *Clin Infect Dis*. 2007 Oct 15;45(8):1039–46.
49. Kuno G, Chang GJ. Full-length sequencing and genomic characterization of Bagaza, Kedougou, and Zika viruses. *Arch Virol*. 2007;152:687–96.

50. Brown JE, McBride CS, Johnson P, Ritchie S, Paupy C, Bossin H, et al. Worldwide patterns of genetic differentiation imply multiple “domestications” of *Aedes aegypti*, a major vector of human diseases. *Proc R Soc B Biol Sci.* 2011 Aug 22;278(1717):2446–54.
51. Gritsun TS, Nuttall PA, Gould EA. Tick-borne flaviviruses. *Adv Virus Res.* 2003;61:317–71.
52. Dumpis U, Crook D, Oksi J. Tick-borne encephalitis. *Clin Infect Dis Off Publ Infect Dis Soc Am.* 1999 Apr;28(4):882–90.
53. Suss, J. Epidemiology and ecology of TBE relevant to the production of effective vaccines. *Vaccine Suppl.* 2003;21:19–35.
54. Gritsun TS, Lashkevich VA, Gould EA. Tick-borne encephalitis. *Antiviral Res.* 2003 Jan;57(1-2):129–46.
55. Gaunt MW, Sall AA, de Lamballerie X, Falconar AK, Dzhibanlian TI, Gould EA. Phylogenetic relationships of flaviviruses correlate with their epidemiology, disease association and biogeography. *J Gen Virol.* 2001 Aug;82(Pt 8):1867–76.
56. Jääskeläinen AE, Sironen T, Murueva GB, Subbotina N, Alekseev AN, Castrén J, et al. Tick-borne encephalitis virus in ticks in Finland, Russian Karelia and Buryatia. *J Gen Virol.* 2010 Nov;91(Pt 11):2706–12.
57. Salman MD, Tarrés-Call J, Estrada-Peña A. *Ticks and Tick-borne Diseases: Geographical Distribution and Control Strategies in the Euro-Asia Region.* CABI; 2013. 320 p.
58. Lvov DK, Shchelkanov MY, Alkhovsky SV, Deryabin PG. *Zoonotic Viruses of Northern Eurasia: Taxonomy and Ecology.* Academic Press; 2015. 453 p.
59. Hayasaka D, Goto A, Yoshii K, Mizutani T, Kariwa H, Takashima I. Evaluation of European tick-borne encephalitis virus vaccine against recent Siberian and far-eastern subtype strains. *Vaccine.* 2001 Sep 14;19(32):4774–9.
60. Golovljova. Characterization of tick-borne encephalitis virus from Estonia. *J Med Virol.* 2004;74:580.
61. Jaenson TG, Jaenson DG, Eisen L, Petersson E, Lindgren E. Changes in the geographical distribution and abundance of the tick *Ixodes ricinus* during the past 30 years in Sweden. *Parasit Vectors.* 2012 Jan 10;5:8.

62. Jääskeläinen AE, Tikkakoski T, Uzcátegui NY, Alekseev AN, Vaheri A, Vapalahti O. Siberian Subtype Tickborne Encephalitis Virus, Finland. *Emerg Infect Dis.* 2006 Oct;12(10):1568–71.
63. Jääskeläinen AE, Tonteri E, Sironen T, Pakarinen L, Vaheri A, Vapalahti O. European Subtype Tick-borne Encephalitis Virus in *Ixodes persulcatus* Ticks. *Emerg Infect Dis.* 2011 Feb;17(2):323–5.
64. Sergey Bugmyrin, Timo J. Hokkanen, Lidiya Romanova, Lubov’Bespyatova, Fyodor Fyodorov, Ludmila Burenkova, et al. *Ixodespersulcatus* [Schulze 1930](Acari: Ixodidae) in eastern finand. *Entomol Fenn.* 2012 Mar 13;22:268–73.
65. The Flaviviruses: Detection, Diagnosis and Vaccine Development: Detection, Diagnosis and Vaccine Development. Academic Press; 2003. 608 p.
66. Low VL, Chen CD, Lee HL, Lim PE, Leong CS, Sofian-Azirun M. Nationwide Distribution of *Culex* Mosquitoes and Associated Habitat Characteristics at Residential Areas in Malaysia. *J Am Mosq Control Assoc.* 2012 Sep 1;28(3):160–9.
67. L Rosen JCL. Experimental vertical transmission of Japanese encephalitis virus by *Culex tritaeniorhynchus* and other mosquitoes. *Am J Trop Med Hyg.* 1989;40(5):548–56.
68. Mc Donald G, McLaren IW, Shelden GP, Smith IR. The effect of temperature on the population growth potential of *Culex annulirostris* Skuse (Diptera: Culicidae). *Aust J Ecol.* 1980;5(4):379–84.
69. Dhileepan K. Mosquito seasonality and arboviral disease incidence in Murray Valley, southeast Australia. *Med Vet Entomol.* 1996;10(4):375–84.
70. Important Helminth Infections in Southeast Asia: Diversity and Potential for Control and Elimination. Academic Press; 2011. 488 p.
71. Halstead SB. Dengue virus-mosquito interactions. *Annu Rev Entomol.* 2008;53:273–91.
72. Gubler, D.J. Dengue and dengue hemorrhagic fever: Its history and resurgence as a global public health problem. In DJ Gubler, G Kuno (eds), *Dengue and Dengue Hemorrhagic Fever.* CAB Int Wallingford UK. 1997;1–22.
73. Kraemer MU, Sinka ME, Duda KA, Mylne AQ, Shearer FM, Barker CM, et al. The global distribution of the arbovirus vectors *Aedes aegypti* and *Ae. albopictus*. *eLife.* 2015;4.

74. Lambrechts L, Scott TW, Gubler DJ. Consequences of the Expanding Global Distribution of *Aedes albopictus* for Dengue Virus Transmission. *PLoS Negl Trop Dis*. 2010 May 25;4(5):e646.
75. Benedict MQ, Levine RS, Hawley WA, Lounibos LP. Spread of the Tiger: Global Risk of Invasion by the Mosquito *Aedes albopictus*. *Vector Borne Zoonotic Dis Larchmt N*. 2007;7(1):76–85.
76. Gratz NG. Critical review of the vector status of *Aedes albopictus*. *Med Vet Entomol*. 2004 Sep;18(3):215–27.
77. Reiter P. West Nile virus in Europe: understanding the present to gauge the future. *Euro Surveill Bull Eur Sur Mal Transm Eur Commun Dis Bull*. 2010 Mar 11;15(10):19508.
78. Benedict MQ, Levine RS, Hawley WA, Lounibos LP. Spread of the tiger: global risk of invasion by the mosquito *Aedes albopictus*. *Vector Borne Zoonotic Dis Larchmt N*. 2007;7(1):76–85.
79. Vasilakis N, Weaver SC. The history and evolution of human dengue emergence. *Adv Virus Res*. 2008;72:1–76.
80. Mehlhorn H. *Arthropods as Vectors of Emerging Diseases*. Springer Science & Business Media; 2012. 398 p.
81. Weaver SC, Vasilakis N. Molecular evolution of dengue viruses: contributions of phylogenetics to understanding the history and epidemiology of the preeminent arboviral disease. *Infect Genet Evol J Mol Epidemiol Evol Genet Infect Dis*. 2009 Jul;9(4):523–40.
82. Lozach P-Y, Burleigh L, Staropoli I, Navarro-Sanchez E, Harriague J, Virelizier J-L, et al. Dendritic cell-specific intercellular adhesion molecule 3-grabbing non-integrin (DC-SIGN)-mediated enhancement of dengue virus infection is independent of DC-SIGN internalization signals. *J Biol Chem*. 2005 Jun 24;280(25):23698–708.
83. Huerta V, China G, Fleitas N, Sarría M, Sánchez J, Toledo P, et al. Characterization of the interaction of domain III of the envelope protein of dengue virus with putative receptors from CHO cells. *Virus Res*. 2008 Nov;137(2):225–34.
84. Mukhopadhyay S, Kuhn RJ, Rossmann MG. A structural perspective of the flavivirus life cycle. *Nat Rev Microbiol*. 2005 Jan;3(1):13–22.

85. Germe R, Crance J-M, Garin D, Guimet J, Lortat-Jacob H, Ruigrok RWH, et al. Heparan sulfate-mediated binding of infectious dengue virus type 2 and yellow fever virus. *Virology*. 2002 Jan 5;292(1):162–8.
86. Tomlinson SM, Malmstrom RD, Watowich SJ. New approaches to structure-based discovery of dengue protease inhibitors. *Infect Disord Drug Targets*. 2009 Jun;9(3):327–43.
87. Mutebi J-P, Gianella A, Travassos da Rosa A, Tesh RB, Barrett ADT, Higgs S. Yellow Fever Virus Infectivity for Bolivian *Aedes aegypti* Mosquitoes. *Emerg Infect Dis*. 2004 Sep;10(9):1657–60.
88. Schmaljohn AL, McClain D. Alphaviruses (Togaviridae) and Flaviviruses (Flaviviridae). In: Baron S, editor. *Medical Microbiology* [Internet]. 4th ed. Galveston (TX): University of Texas Medical Branch at Galveston; 1996 [cited 2014 Dec 11]. Available from: <http://www.ncbi.nlm.nih.gov/books/NBK7633/>
89. Yellow Fever - Chapter 3 - 2014 Yellow Book | Travelers' Health | CDC [Internet]. [cited 2014 Dec 11]. Available from: <http://wwwnc.cdc.gov/travel/yellowbook/2014/chapter-3-infectious-diseases-related-to-travel/yellow-fever>
90. Michael B.A. Oldstone. *Viruses, plagues, and history. Past, Present, and Future*. 2010.
91. Tolle MA. Mosquito-borne diseases. *Curr Probl Pediatr Adolesc Health Care*. 2009 Apr;39(4):97–140.
92. WHO | Yellow fever [Internet]. WHO. [cited 2015 Aug 24]. Available from: <http://www.who.int/ith/vaccines/yf/en/>
93. Mondini A, Bronzoni RV de M, Cardeal ILS, Santos TMIL dos, Lázaro E, Nunes SHP, et al. Simultaneous infection by DENV-3 and SLEV in Brazil. *J Clin Virol*. 2007 Sep;40(1):84–6.
94. Rocco IM, Santos CLS, Bisordi I, Petrella SMCN, Pereira LE, Souza RP, et al. St. Louis encephalitis virus: first isolation from a human in São Paulo state, Brasil. *Rev Inst Med Trop São Paulo*. 2005 Oct;47(5):281–5.
95. Reisen WK. Epidemiology of St. Louis encephalitis virus. *Adv Virus Res*. 2003;61:139–83.
96. Maguire JH, Strickland GT, Ryan ET, Solomon T, Hill DR. *Hunter's Tropical Medicine and Emerging Infectious Disease, Expert Consult - Online and Print*, 9:

- Hunter's Tropical Medicine and Emerging Infectious Disease. Elsevier Health Sciences; 2012. 1215 p.
97. Blaney JE, Speicher J, Hanson CT, Sathe NS, Whitehead SS, Murphy BR, et al. Evaluation of St. Louis encephalitis virus/dengue virus type 4 antigenic chimeric viruses in mice and rhesus monkeys. *Vaccine*. 2008 Aug 5;26(33):4150–9.
 98. Gould EA, Solomon T. Pathogenic flaviviruses. *Lancet Lond Engl*. 2008 Feb 9;371(9611):500–9.
 99. Erlanger TE, Weiss S, Keiser J, Utzinger J, Wiedenmayer K. Past, Present, and Future of Japanese Encephalitis. *Emerg Infect Dis*. 2009 Jan;15(1):1–7.
 100. Campbell G, Hills S, Fischer M, Jacobson J, Hoke C, Hombach J, et al. Estimated global incidence of Japanese encephalitis: *Bull World Health Organ*. 2011 Oct 1;89(10):766–74.
 101. Japanese Encephalitis Vaccines: WHO position paper – February 2015: dans tout BiblioVie : des articles, des livres... [Internet]. [cited 2015 Aug 17]. Available from: <http://eds.a.ebscohost.com.gate1.inist.fr/eds/detail/detail?vid=3&sid=dbe76bc8-e44d-4c51-9fd1-5e3b13a5a298%40sessionmgr4004&hid=4105&bdata=Jmxhbmc9ZnImc2l0ZT1lZHMtbGl2ZQ%3d%3d>
 102. Yun KW, Lee HJ, Kang JH, Eun BW, Kim Y-J, Kim K-H, et al. Safety and immunogenicity of a freeze-dried, Vero cell culture-derived, inactivated Japanese encephalitis vaccine (KD-287, ENCEVAC®) versus a mouse brain-derived inactivated Japanese encephalitis vaccine in children: a phase III, multicenter, double-blinded, randomized trial. *BMC Infect Dis*. 2015 Jan 8;15:7–7.
 103. Halstead SB, Thomas SJ. New Japanese encephalitis vaccines: alternatives to production in mouse brain. *Expert Rev Vaccines*. 2011 Mar;10(3):355–64.
 104. Matthews REF, editor. *Classification and Nomenclature of Viruses*. Basel: S Karger Pub; 1982. 200 p.
 105. Powers AM, Brault AC, Shirako Y, Strauss EG, Kang W, Strauss JH, et al. Evolutionary Relationships and Systematics of the Alphaviruses. *J Virol*. 2001 Nov 1;75(21):10118–31.

106. Jimit S Pate, Charoo S Garg, Kiran M Patel, Rinku K Patel, Ravi S Patel and Dhruvo Jyoti Sen. Catastrophic effect of *Aedes aegypti*: an insect borne virus from togaviride family. *Phamacie Glob IJCP*. 2011;2(2).
107. Fauquet CM, Martelli GP. *Viral Classification and Nomenclature*. In: John Wiley & Sons, Ltd, editor. eLS [Internet]. Chichester, UK: John Wiley & Sons, Ltd; 2013 [cited 2014 Dec 15]. Available from: <http://www.els.net/WileyCDA/ElsArticle/refId-a0000440.html>
108. ViralZone: *Togaviridae* [Internet]. [cited 2015 Aug 12]. Available from: http://viralzone.expasy.org/all_by_species/3.html
109. Enserink M. Infectious diseases. Chikungunya: no longer a third world disease. *Science*. 2007 Dec 21;318(5858):1860–1.
110. Bueno-Marí R. Global change and human vulnerability to vector-borne diseases. *Frontiers E-books*; 183 p.
111. Calisher CH. *Arthropod-borne Viruses*. In: John Wiley & Sons Ltd, editor. eLS [Internet]. Chichester, UK: John Wiley & Sons, Ltd; 2007 [cited 2014 Dec 16]. Available from: <zotero://attachment/962/>
112. Schlesinger MJ. The Replication of *Togaviridae* and *Flaviviridae* at the Molecular Level. In: Bercoff RP, editor. *The Molecular Basis of Viral Replication* [Internet]. Springer US; 1987 [cited 2014 Dec 16]. p. 217–37. Available from: http://link.springer.com/chapter/10.1007/978-1-4684-5350-8_9
113. Schmaljohn AL, McClain D. *Alphaviruses (Togaviridae) and Flaviviruses (Flaviviridae)*. In: Baron S, editor. *Medical Microbiology* [Internet]. 4th ed. Galveston (TX): University of Texas Medical Branch at Galveston; 1996 [cited 2015 Jun 3]. Available from: <http://www.ncbi.nlm.nih.gov/books/NBK7633/>
114. Jose J, Snyder JE, Kuhn RJ. A structural and functional perspective of alphavirus replication and assembly. *Future Microbiol*. 2009 Sep;4:837–56.
115. Ananthanarayan. *Introduction to Medical Microbiology*. Orient Blackswan; 1990. 194 p.
116. Centers for Disease Control and Prevention. *Geographic Distribution | Chikungunya virus | CDC* [Internet]. 2015 [cited 2015 Aug 6]. Available from: <http://www.cdc.gov/chikungunya/geo/>

117. Armstrong PM, Andreadis TG. Eastern Equine Encephalitis Virus in Mosquitoes and Their Role as Bridge Vectors. *Emerg Infect Dis.* 2010 Dec;16(12):1869–74.
118. Stresing D, Horn DL M.D., FACP. Eastern equine encephalitis. *Salem Press Encycl Health.* 2011;
119. CDC - Eastern Equine Encephalitis [Internet]. 2010 [cited 2015 Sep 9]. Available from: <http://www.cdc.gov/EasternEquineEncephalitis/>
120. Long MT. West nile virus and equine encephalitis viruses: new perspectives. *Vet Clin North Am Equine Pract.* 2014 Dec;30(3):523–42.
121. Reed DS, Glass PJ, Bakken RR, Barth JF, Lind CM, da Silva L, et al. Combined alphavirus replicon particle vaccine induces durable and cross-protective immune responses against equine encephalitis viruses. *J Virol.* 2014 Oct;88(20):12077–86.
122. Novaes Oliveira R, Iamamoto K, Silva MLCR, Achkar SM, Castilho JG, Ono ED, et al. Eastern equine encephalitis cases among horses in Brazil between 2005 and 2009. *Arch Virol.* 2014;(10):2615.
123. Mohan Nandalur. Western Equine Encephalitis. 2013 Jul 19 [cited 2014 Dec 18]; Available from: <http://emedicine.medscape.com/article/233568-overview>
124. Greenlee JE. The equine encephalitides. *Handb Clin Neurol.* 2014;123:417–32.
125. Carossino M, Thiry E, de la Grandière A, Barrandeguy ME. Novel vaccination approaches against equine alphavirus encephalitides. *Vaccine.* 2014 Jan 9;32(3):311–9.
126. Weaver SC, Anishchenko M, Bowen R, Brault AC, Estrada-Franco JG, Fernandez Z, et al. Genetic determinants of Venezuelan equine encephalitis emergence. *Arch Virol Suppl.* 2004;(18):43–64.
127. De la Monte S, Castro F, Bonilla NJ, Gaskin de Urdaneta A, Hutchins GM. The systemic pathology of Venezuelan equine encephalitis virus infection in humans. *Am J Trop Med Hyg.* 1985 Jan;34(1):194–202.
128. Zacks MA, Paessler S. Encephalitic alphaviruses. *Vet Microbiol.* 2010 Jan 27;140(3-4):281–6.
129. Taylor KG, Paessler S. Pathogenesis of Venezuelan equine encephalitis. *Vet Microbiol.* 2013 Nov 29;167:145–50.
130. Knipe DM, Howley, PM (eds). *Fields virology.* 4th Edn Lippincott Williams Wilkins Phila. 2001;

131. Sidwell RW, Gebhardt LP, Thorpe BD. Epidemiological Aspects of Venezuelan Equine Encephalitis Virus Infections. *Bacteriol Rev.* 1967 Mar;31(1):65–81.
132. Weaver SC, Ferro C, Barrera R, Boshell J, Navarro J-C. Venezuelan Equine Encephalitis*. *Annu Rev Entomol.* 2004;49(1):141–74.
133. Paessler S [b1] (analytic), Weaver SC [b1] (analytic). Vaccines for Venezuelan equine encephalitis (English). *Vaccine Suppl.* 2009 Jan 1;27(4).
134. Eifan S, Schnettler E, Dietrich I, Kohl A, Blomström A-L. Non-Structural Proteins of Arthropod-Borne Bunyaviruses: Roles and Functions. *Viruses.* 2013 Oct 4;5(10):2447–68.
135. Nichol ST. Genetic analysis of Hantaviruses and their host relationships. Elsevier Publishers, Paris; 1999. 99-109 p.
136. Walter CT, Barr JN. Bunyamwera virus can repair both insertions and deletions during RNA replication. *RNA.* 2010 Jun;16(6):1138–45.
137. Lukashev AN. Evidence for recombination in Crimean-Congo hemorrhagic fever virus. *J Gen Virol.* 2005 Aug 1;86(8):2333–8.
138. Ergonul O, Whitehouse CA. Crimean-Congo Hemorrhagic Fever: A Global Perspective. Springer Science & Business Media; 2007. 334 p.
139. Plyusnin A, Elliott RM. Bunyaviridae: Molecular and Cellular Biology. Horizon Scientific Press; 2011. 226 p.
140. Barr JN, Rodgers JW, Wertz GW. Identification of the Bunyamwera bunyavirus transcription termination signal. *J Gen Virol.* 2006 Jan 1;87(1):189–98.
141. Shope RE. Bunyaviruses. In: Baron S, editor. *Medical Microbiology* [Internet]. 4th ed. Galveston (TX): University of Texas Medical Branch at Galveston; 1996 [cited 2014 Dec 19]. Available from: <http://www.ncbi.nlm.nih.gov/books/NBK8004/>
142. Walter CT, Barr JN. Recent advances in the molecular and cellular biology of bunyaviruses. *J Gen Virol.* 2011 Nov 1;92(11):2467–84.
143. Barr JN. Bunyavirus mRNA synthesis is coupled to translation to prevent premature transcription termination. *RNA.* 2007 May;13(5):731–6.
144. Barr JN, Elliott RM, Dunn EF, Wertz GW. Segment-specific terminal sequences of Bunyamwera bunyavirus regulate genome replication. *Virology.* 2003 Jul 5;311(2):326–38.

145. John N Barr JWR. Identification of the Bunyamwera bunyavirus transcription termination signal. *J Gen Virol.* 2006;87(Pt 1):189–98.
146. Klemm C, Reguera J, Cusack S, Zielecki F, Kochs G, Weber F. Systems To Establish Bunyavirus Genome Replication in the Absence of Transcription. *J Virol.* 2013 Jul;87(14):8205–12.
147. Chin, J. Control of communicable diseases manual. Am Public Helth Assoc WashingtonDC US Army FM 8-83 US Navy P-5038.
148. Alexander Plyusnin, Richard M.Elliott. *Bunyaviridae: Molercular and Cellular Biology.* 2011.
149. Alatoon A, Payne D. An Overview of Arboviruses and Bunyaviruses. *Lab Med.* 2009 Apr 1;40(4):237–40.
150. Horsfall, WR. *Mosquitoes: their bionomics and relation to disease.* Halner Publ Co N Y Hulme M Ed. 1996;
151. Crans, WJ. A classification system for mosquito life cy- cles: life cycle types for mosquitoes of the northeastern United States. *J Vector Ecol.* 2004;29:1–10.
152. Horsfall, W.R. *Mosquitoes. Their Bionomics and relation to Disease.* Ronald Press, New York; 1955.
153. Matheson R. *A handbook of the mosquitoes of North America.* Springfield, II: Thomas Books. 1929.
154. Marquardt WH. *Biology of Disease Vectors.* Academic Press; 2004. 811 p.
155. Stasio BT. *Diapause in Aquatic Invertebrates: Theory and Human Use.* Springer Science & Business Media; 2007. 266 p.
156. JACKSON BT, BREWSTER CC, PAULSON SL. La Crosse Virus Infection Alters Blood Feeding Behavior in *Aedes triseriatus* and *Aedes albopictus* (Diptera: Culicidae). *J Med Entomol.* 2012 Nov;49(6):1424–9.
157. steward,C.C, J.W. McWade. *The mosquitoes of Oritrario (Diptera: culicidae with keys to the species and notes an distribuion).* 1961. 91:121–88.
158. Twinn, C.R. *Mosquito and Mosquito Control in Northern Canada.* Mosquitoes News. 9:35–41.
159. Carpenter, S.J, Middlekauff, W.W., Chmberlain, R.W. *The Mosquitoes of the Southern United States east of Oklahoma and Texas.* Am Midl Nat Monogr. 1946;No3.Ed.Just., T.University of Notre Dame, Notre Dame, Ind.

160. Duryea, R. D. *Aedes trivittatus* in New Jersey. ProcNJ Mosquito Control Assoc. 1990;73–8.
161. Nuttall, G.H.F. & Warburton, C. Ticks, a monograph of the Ixodoidea. Part II The Ixodidae. Section II genus I. *Ixodes* Latreille 1975. Camb Univ Press Lond. 1911;133–293.
162. Guglielmone AA, Robbins RG, Apanaskevich DA, Petney TN, Estrada-Peña A, Horak IG. The Hard Ticks of the World: (Acari: Ixodida: Ixodidae). Springer Science & Business Media; 2013. 730 p.
163. Mahl, R, Traavik. The tick *Ixodes uriae* (Acari, Ixodidae) in seabird colonies in Norway. Faun Norvegica Series B. 1983. 94-107 p.
164. McJunkin JE, Khan RR, Tsai TF. California-La Crosse encephalitis. Infect Dis Clin North Am. 1998 Mar;12(1):83–93.
165. Centers for Disease Control and Prevention (CDC). La Crosse virus neuroinvasive disease - Missouri, 2009. MMWR Morb Mortal Wkly Rep. 2010 Jul 23;59(28):869–71.
166. Trout Fryxell RT, Freyman K, Ulloa A, Hendricks B, Paulsen D, Odoi A, et al. Cemeteries Are Effective Sites For Monitoring La Crosse Virus (LACv) and these Environments May Play a Role in LACv Infection. PloS One. 2015;10(4):e0122895.
167. CDC - La Crosse Encephalitis | Symptoms & Treatment [Internet]. [cited 2015 Sep 16]. Available from: <http://www.cdc.gov/lac/tech/symptoms.html>
168. Rey JR. La Crosse Encephalitis [Internet]. 2012 [cited 2014 Dec 23]. Available from: <http://edis.ifas.ufl.edu/in420>
169. Yendell SJ, Fischer M, Staples JE. Colorado tick fever in the United States, 2002–2012. Vector Borne Zoonotic Dis Larchmt N. 2015 May;15(5):311–6.
170. Dengue and dengue haemorrhagic fever. factsheet No 117, revised May 2008. Geneva, World Health Organization, 2008.
171. Sabin AB. Research on dengue during World War II. Am J Trop Med Hyg. 1952 Jan;1(1):30–50.
172. Rico-Hesse R. Molecular evolution and distribution of dengue viruses type 1 and 2 in nature. Virology. 1990 Feb;174(2):479–93.
173. Vasilakis N, Weaver SC. Chapter 1 The History and Evolution of Human Dengue Emergence. In: Karl Maramorosch AJS and FAM, editor. Advances in Virus Research

- [Internet]. Academic Press; 2008 [cited 2015 Jun 2]. p. 1–76. Available from: <http://www.sciencedirect.com/science/article/pii/S0065352708004016>
174. Weaver SC, Vasilakis N. Molecular evolution of dengue viruses: Contributions of phylogenetics to understanding the history and epidemiology of the preeminent arboviral disease. *Infect Genet Evol.* 2009 Jul;9(4):523–40.
175. Fahri S, Yohan B, Trimarsanto H, Sayono S, Hadisaputro S, Dharmana E, et al. Molecular Surveillance of Dengue in Semarang, Indonesia Revealed the Circulation of an Old Genotype of Dengue Virus Serotype-1. *PLoS Negl Trop Dis* [Internet]. 2013 Aug 8 [cited 2014 Dec 24];7(8). Available from: <http://www.ncbi.nlm.nih.gov/pmc/articles/PMC3738473/>
176. Day- Yu Chao. Inter- and Intra- Host Evolution of dengue Viruses and the Inference to the pathogenesis. 2012.
177. Zhang C, Mammen MP, Chinnawirotpisan P, Klungthong C, Rodpradit P, Nisalak A, et al. Structure and age of genetic diversity of dengue virus type 2 in Thailand. *J Gen Virol.* 2006 Apr 1;87(4):873–83.
178. Thaisonthi S, Rababert J, Yoksan S. Comparison of full-length genomics sequences between dengue virus serotype 3, parental strain, and its derivatives, and B-cell epitopes prediction from envelope region. *Bioinformatics.* 2013 Jul 12;9(12):622–8.
179. Chao D-Y, King C-C, Wang W-K, Chen W-J, Wu H-L, Chang G-JJ. Strategically examining the full-genome of dengue virus type 3 in clinical isolates reveals its mutation spectra. *Virol J.* 2005 Aug 24;2(1):72.
180. Lanciotti, R.S, Gubler DJ, Trent DW. Molecular evolution and phylogeny of dengue 4 virus. *JGenVirol.* 1997;78:2279–86.
181. Klungthong C, Zhang C, Mammen MP, Ubol S, Holmes EC. The molecular epidemiology of dengue virus serotype 4 in Bangkok, Thailand. *Virology.* 2004 Nov 10;329(1):168–79.
182. AbuBakar S, Wong P-F, Chan Y-F. Emergence of dengue virus type 4 genotype IIA in Malaysia. *J Gen Virol.* 2002 Oct;83(Pt 10):2437–42.
183. Chonticha Klungthong CZ. The molecular epidemiology of dengue virus serotype 4 in Bangkok, Thailand. *Virology.* 2004;329(1):168–79.

184. Foster, J.E, Bennett, S.N, Vaughan, H, Vorndam, V., McMillan, W.O, Carrington, C.V.F. Molecular evolution and phylogeny of dengue type 4 virus in the Caribbean. *Virology*. 2003;306:126–34.
185. Dengue Fever type 5 is discovered in a tropical country - SBMT [Internet]. [cited 2015 Aug 7]. Available from: <http://sbmt.org.br/portal/noticias-2557/?lang=en>
186. Mustafa MS, Rasotgi V, Jain S, Gupta V. Discovery of fifth serotype of dengue virus (DENV-5): A new public health dilemma in dengue control. *Med J Armed Forces India*. 2015 Jan 1;71(1):67–70.
187. Rico-Hesse R. Microevolution and virulence of dengue viruses. *Adv Virus Res*. 2003;59:315–41.
188. Holmes EC, Twiddy SS. The origin, emergence and evolutionary genetics of dengue virus. *Infect Genet Evol J Mol Epidemiol Evol Genet Infect Dis*. 2003 May;3(1):19–28.
189. Threats F on M, Health B on G, Medicine I of. *Vector-Borne Diseases:: Understanding the Environmental, Human Health, and Ecological Connections, Workshop Summary (Forum on Microbial Threats)*. National Academies Press; 2008. 350 p.
190. Gubler DJ. Dengue and Dengue Hemorrhagic Fever. *Clin Microbiol Rev*. 1998 Jul 1;11(3):480–96.
191. Rezza G. *Aedes albopictus* and the reemergence of Dengue. *BMC Public Health*. 2012;
192. Moore C. *Aedes albopictus* in the United States: Ten-Year Presence and Public Health Implications. *Emerg Infect Dis*. 1997 Sep;3(3):329–34.
193. Usinger RL. Entomological phases of the recent dengue epidemic in Honolulu. *Public Health Rep*. 1994;59:423–30.
194. Moore CG, Francy DB, Eliason DA, Monath TP. *Aedes albopictus* in the United States: rapid spread of a potential disease vector. *J Am Mosq Control Assoc*. 1988 Sep;4(3):356–61.
195. Schuffenecker I, Iteman I, Michault A, Murri S, Frangeul L, Vaney M-C, et al. Genome Microevolution of Chikungunya Viruses Causing the Indian Ocean Outbreak. *PLoS Med* [Internet]. 2006 Jul [cited 2015 Feb 26];3(7). Available from: <http://www.ncbi.nlm.nih.gov/pmc/articles/PMC1463904/>

196. Magurano F, Zammarchi L, Baggieri M, Fortuna C, Farese A, Benedetti E, et al. Chikungunya from the Caribbean: the importance of appropriate laboratory tests to confirm the diagnosis. *Vector Borne Zoonotic Dis* Larchmt N. 2015 Apr;15(4):258–60.
197. Mowatt L, Jackson ST. Chikungunya in the Caribbean: An Epidemic in the Making. *Infect Dis Ther*. 2014 Sep 23;3(2):63–8.
198. Mansuy J-M, Grouteau E, Mengelle C, Claudet I, Izopet J. Chikungunya in the Caribbean - Threat for Europe. *Emerg Infect Dis*. 2014 Aug;20(8):1423–5.
199. Cardoso J, Ooi MH, Tio PH, Perera D, Holmes EC, Bibi K, et al. Dengue Virus Serotype 2 from a Sylvatic Lineage Isolated from a Patient with Dengue Hemorrhagic Fever. *PLoS Negl Trop Dis*. 2009 Apr 28;3(4):e423.
200. Peiris JS, Amerasinghe FP. Japanese encephalitis in Srilanka: comparison of vector and virus ecology in different agro- climatic areas. *Trans R Soc Trop Med Hyg*. 1993;87 (5):514-48.
201. Justin R. anderson, rebecca rico-hesse. aedes aegypti vectorial capacity is determined by the infecting genotype of dengue virus. *Am J Trop Med Hyg*. 2006 Nov;75(5):886–92.
202. Diallo M, Ba Y, Sall AA, Diop OM, Ndione JA, Mondo M, et al. Amplification of the Sylvatic Cycle of Dengue Virus Type 2, Senegal, 1999-2000: Entomologic Findings and Epidemiologic Considerations. *Emerg Infect Dis*. 2003 Mar;9(3):362-7.
203. Rodhain F. The role of the monkey in the biology of dengue and yellow fever. *Comp Immun Microbiol Infect Dis*. 1991;14:9–19.
204. Saluzzo, J.F., cornet, M., Adam, C., Eyraud, M., Digoutte, J.P. Dengue 2 in eastern Senegal: serologic survey in simian and human populations 1974-85. *Bull Soc Pathol Exot Fil*. 1986 a;79:313–22.
205. Zeller, H.G, Traore-Lamizana, M., Monlun, E., Hervy, J.P, Mondo, M., Digoutte, J.P. Dengue-2 virus isolation from humans during an epizootic in southeastern Senegal in November, 1990. *Res Virol*. 1992;143(2):101–2.
206. Cardoso J, Ooi MH, Tio PH, Perera D, Holmes EC, Bibi K, et al. Dengue Virus Serotype 2 from a Sylvatic Lineage Isolated from a Patient with Dengue Hemorrhagic Fever. *PLoS Negl Trop Dis*. 2009 Apr 28;3(4):e423.
207. Wang J, Rossow WB, Zhang Y. Cloud Vertical Structure and Its Variations from a 20-Yr Global Rawinsonde Dataset. *J Clim*. 2000 Sep;13(17):3041–56.

208. Vasilakis N, Cardoso J, Hanley KA, Holmes EC, Weaver SC. Fever from the forest: prospects for the continued emergence of sylvatic dengue virus and its impact on public health. *Nat Rev Microbiol*. 2011 Jul;9(7):532–41.
209. Wolfe ND, Kilbourn AM, Karesh WB, Rahman HA, Bosi EJ, Cropp BC, et al. Sylvatic transmission of arboviruses among Bornean orangutans. *Am J Trop Med Hyg*. 2001 Jun;64(5-6):310–6.
210. Wang E, Ni H, Xu R, Barrett ADT, Watowich SJ, Gubler DJ, et al. Evolutionary Relationships of Endemic/Epidemic and Sylvatic Dengue Viruses. *J Virol*. 2000 Apr;74(7):3227–34.
211. Ordóñez-González J, Mercado-Hernández R, Flores-Suárez A, Fernández-Salas I. The use of sticky ovitraps to estimate dispersal of *Aedes aegypti* in northeastern Mexico. *J Am Mosq CONTROL Assoc*. 2001 Jun;17(2):93–7.
212. Platt EJ, Madani N, Kozak SL, Kabat D. Infectious properties of human immunodeficiency virus type 1 mutants with distinct affinities for the CD4 receptor. *J Virol*. 1997 Feb;71(2):883–90.
213. Rosen L, Rozeboom LE, Reeves WC, Saugrain J, Gubler DJ. A field trial of competitive displacement of *Aedes polynesiensis* by *Aedes albopictus* on a Pacific atoll. *Am J Trop Med Hyg*. 1976 Nov;25(6):906–13.
214. Gubler DJ, Rosen L. Variation among geographic strains of *Aedes albopictus* in susceptibility to infection with dengue viruses. *Am J Trop Med Hyg*. 1976 Mar;25(2):318–25.
215. Halstead SB. Dengue Virus–Mosquito Interactions. *Annu Rev Entomol*. 2008;53(1):273–91.
216. Gubler DJ, Ooi EE, Vasudevan S, Farrar J. *Dengue and Dengue Hemorrhagic Fever*, 2nd Edition. CABI; 2014. 626 p.
217. Günther J, Martínez-Muñoz JP, Pérez-Ishiwara DG, Salas-Benito J. Evidence of vertical transmission of dengue virus in two endemic localities in the state of Oaxaca, Mexico. *Intervirology*. 2007;50(5):347–52.
218. WHO | Dengue/dengue haemorrhagic fever [Internet]. WHO. [cited 2014 Dec 5]. Available from: <http://www.who.int/csr/disease/dengue/en/>

219. WHO | Dengue guidelines for diagnosis, treatment, prevention and control: new edition [Internet]. WHO. [cited 2014 Dec 19]. Available from: <zotero://attachment/1276/>
220. Lequime S, Lambrechts L. Vertical transmission of arboviruses in mosquitoes: A historical perspective. *Infect Genet Evol.* 2014 Dec;28:681–90.
221. Balmaseda A, Hammond SN, Pérez L, Tellez Y, Saborío SI, Mercado JC, et al. Serotype-specific differences in clinical manifestations of dengue. *Am J Trop Med Hyg.* 2006 Mar;74(3):449–56.
222. Chastel C. Eventual Role of Asymptomatic Cases of Dengue for the Introduction and Spread of Dengue Viruses in Non-Endemic Regions. *Front Physiol* [Internet]. 2012 Mar 30 [cited 2015 Jun 2];3. Available from: <http://www.ncbi.nlm.nih.gov/pmc/articles/PMC3315825/>
223. Endy TP, Chunsuttiwat S, Nisalak A, Libraty DH, Green S, Rothman AL, et al. Epidemiology of inapparent and symptomatic acute dengue virus infection: a prospective study of primary school children in Kamphaeng Phet, Thailand. *Am J Epidemiol.* 2002 Jul 1;156(1):40–51.
224. Pepper OHP, Daid Bylon. A note on David Bylon and dengue. 1941.
225. Christie. On epidemics of dengue fever: Their diffusion and etiology. *Glasg Med J.* 1881;16:161–76.
226. Siller, J.F, Hall, M.W., Hitchens, A.P. Dengue: its history, epidemiology, mechanism of transmission, etiology, clinical manifestations, immunity, and prevention. *Philipp JSci.* 29:1–304.
227. Simmons, J.S., St John, J.H., Reynolds, F.H.K. Experimental studies of Dengue. *Philipp JSci.* 1931;44:1–252.
228. Hotta S. Experimental studies on dengue: Isolation, identification and modification of the virus. *J Infect Dis.* 1952;90:1–9.
229. Barrett ADT, Stanberry LR. Vaccines for Biodefense and Emerging and Neglected Diseases. Academic Press; 2009. 1519 p.
230. Sabin AB, Schlesinger, R.W. Production of immunity to dengue with virus modified by propagation in mice. *Science.* 1945;101:640–2.
231. Quintos FN et al. Hemorrhagic fever observed among children in the Philippines. *Philipp J Pediatr.* 1954;3:1–19.

232. Hammon, W.M, Rudnick, A, Sther, G.E. Viruses associated with epidemic hemorrhagic fevers of the Philippines and Thailand. *Science*. 1960;131:1102–3.
233. Cordeliier, R., Bouchite, B., Roche, J.C., Moneny, N., Diaco, B, Akoliba, P. Circulation selvatique du virus Dengue 2. *Med Parasitol*. 1983;21:165–79.
234. Rudnick, A, Lim, T.W. Dengue fever studies in Malaysia. 1986;23:51–152.
235. Twiddy, S., C. Phylogentic evidence for adptative evolution of degue viruses in nature. *JGenVirol*. 2002;83:1679–89.
236. Service SW. *Mosquito Ecology: Field sampling methods*. Springer Science & Business Media; 2013. 999 p.
237. Holmes EC. The Evolution and Epidemiology of Dengue Virus. *Salud Pública México*. 2007 Mar 2;49:E296.
238. Twiddy, S.S., Farrar, J., J, Chau, N.V., Wills, B., Gould, E.A., Gritsun.T., Gritsun, T., et al. Phylogenetic relationships and differential selection pressures among genotypes of dengue -2 virus. *Virol J*. 298:63–72.
239. Ferreira GLC. Global dengue epidemiology trends. *Rev Inst Med Trop São Paulo*. 2012 Oct;54:5–6.
240. Guzman MG, Halstead SB, Artsob H, Buchy P, Farrar J, Gubler DJ, et al. Dengue: a continuing global threat. *Nat Rev Microbiol*. 2010 Dec 1;8:S7–16.
241. WHO | Handbook for clinical management of dengue [Internet]. WHO. [cited 2015 Jun 6]. Available from: <http://www.who.int/denguecontrol/9789241504713/en/>
242. Halstead SB. Dengue haemorrhagic fever--a public health problem and a field for research. *Bull World Health Organ*. 1980;58(1):1–21.
243. Pinheiro FP, Corber SJ. Global situation of dengue and dengue haemorrhagic fever, and its emergence in the Americas. *World Health Stat Q Rapp Trimest Stat Sanit Mond*. 1997;50(3-4):161–9.
244. Thomas SJ, Strickman D, Vaughn DW. Dengue Epidemiology: Virus Epidemiology, Ecology, And Emergence. In: Research B-A in V, editor. Academic Press; 2003 [cited 2015 Jun 6]. p. 235–89. Available from: <http://www.sciencedirect.com/science/article/pii/S0065352703610067>
245. WHO | 1998 - Dengue [Internet]. WHO. [cited 2015 Jun 6]. Available from: http://www.who.int/csr/don/1998_06_08e/en/

246. Organization WH. Dengue: Guidelines for Diagnosis, Treatment, Prevention and Control. World Health Organization; 2009. 159 p.
247. Population of Vietnam (2015) - Worldometers [Internet]. [cited 2015 Jul 14]. Available from: <http://www.worldometers.info/world-population/vietnam-population/>
248. WHO. Dengue and severe dengue. 2015.
249. Inc GI, Berger DS. Chikungunya and Zika: Global Status. GIDEON Informatics Inc; 2015. 80 p.
250. Gubler MC1, Dahmane F, Dommergues M, Narcy F. Prenatal diagnosis of renal malformations and diseases. *Ann Pathol.* 1997;17(4):240–50.
251. Sabin, A. B. Dengue. in *Viral and Rickettsial Infections of Man*, 3rd ed. Philadelphia: Lippincott. 1959;361–73.
252. Schlesinger RW. *Dengue Viruses*. Springer Science & Business Media; 2012. 140 p.
253. Villabona-Arenas CJ, Zanotto PM de A. Worldwide Spread of Dengue Virus Type 1. *PLoS ONE* [Internet]. 2013 May 13 [cited 2015 Jun 8];8(5). Available from: <http://www.ncbi.nlm.nih.gov/pmc/articles/PMC3652851/>
254. Theiler M, Casals J, Moutousses C. Etiology of the 1927-28 epidemic of dengue in Greece. *Proc Soc Exp Biol Med Soc Exp Biol Med N Y N.* 1960 Jan;103:244–6.
255. Janisch, T., Preiser, W., Berger, A. et al. Emerging viral pathogens in long-term expatriates (II): dengue virus. *Trop Med Int Health.* 1997;2:934–40.
256. Guzman A, Istúriz RE. Update on the global spread of dengue. *Int J Antimicrob Agents.* 2010 Nov;36 Suppl 1:S40–2.
257. La Ruche G, Souarès Y, Armengaud A, Peloux-Petiot F, Delaunay P, Desprès P, et al. First two autochthonous dengue virus infections in metropolitan France, September 2010. *Euro Surveill Bull Eur Sur Mal Transm Eur Commun Dis Bull.* 2010 Sep 30;15(39):19676.
258. Gjenero-Margan I, Aleraj B, Krajcar D, Lesnikar V, Klobučar A, Pem-Novosel I, et al. Autochthonous dengue fever in Croatia, August-September 2010. *Euro Surveill Bull Eur Sur Mal Transm Eur Commun Dis Bull.* 2011;16(9).
259. WHO. *Comprehensive Guidelines for Prevention and Control of Dengue and Dengue Haemorrhagic Fever*. 2011.

260. Kourí G, Más P, Guzmán MG, Soler M, Goyenechea A, Morier L. Dengue hemorrhagic fever in Cuba, 1981: rapid diagnosis of the etiologic agent. *Bull Pan Am Health Organ.* 1983;17(2):126–32.
261. María G. G. Thirty years after the cuban hemorrhagic dengue epidemic of 1981. *MEDICC Rev.* 2012;(2):46.
262. Aquino VH, Amarilla AA, Alfonso HL, Batista WC, Figueiredo LTM. New Genotype of Dengue Type 3 Virus Circulating in Brazil and Colombia Showed a Close Relationship to Old Asian Viruses. *PLoS ONE.* 2009 Oct 13;4(10):e7299.
263. Kouri GP, Guzmán MG, Bravo JR, Triana C. Dengue haemorrhagic fever/dengue shock syndrome: lessons from the Cuban epidemic, 1981. *Bull World Health Organ.* 1989;67(4):375–80.
264. Uzcategui NY, Camacho D, Comach G, Cuello de Uzcategui R, Holmes EC, Gould EA. Molecular epidemiology of dengue type 2 virus in Venezuela: evidence for in situ virus evolution and recombination. *J Gen Virol.* 2001 Dec;82(Pt 12):2945–53.
265. Brathwaite Dick O, San Martín JL, Montoya RH, del Diego J, Zambrano B, Dayan GH. The History of Dengue Outbreaks in the Americas. *Am J Trop Med Hyg.* 2012 Oct 3;87(4):584–93.
266. San Martín JL, Brathwaite O, Zambrano B, Solórzano JO, Bouckennooghe A, Dayan GH, et al. The epidemiology of dengue in the americas over the last three decades: a worrisome reality. *Am J Trop Med Hyg.* 2010 Jan;82(1):128–35.
267. Boisier P et al.,. Dengue 1 epidemic in the Grand comoro Island (Federal Islamic Republic of the Comores). *Ann Soc Belge Med Trop.* 1993;74:217–29.
268. Saluzzo J.F. et al. Isolation of dengue 2 and dengue 4 viruses from patientd in Senegal. *Trans R Soc Trop Med Hyg.* 1986;(80):5.
269. Gubler DJ. Dengue 3 Virus trnsmissiom in Africa. *Am J Trop Med Hyg.* 1986;35(6):1280–4.
270. Were F. The dengue situation in Africa. *Paediatr Int Child Health.* 2012 May;32 Suppl 1:18–21.
271. Amarasinghe A. Dengue Virus Infection in Africa. *Emerg Infect Dis* [Internet]. 2011 Aug [cited 2015 Jun 7]; Available from: http://wwwnc.cdc.gov/eid/article/17/8/10-1515_article.htm
272. Rothman AL. *Dengue Virus.* Springer Science & Business Media; 2009. 173 p.

273. Setiati TE, Mairuhu AT, Koraka P, Supriatna M, Mac Gillavry MR, Brandjes DP, et al. Dengue disease severity in Indonesian children: an evaluation of the World Health Organization classification system. *BMC Infect Dis.* 2007;7(1):22.
274. Rigau-Pérez JG, Clark GG, Gubler DJ, Reiter P, Sanders EJ, Vance Vorndam A. Dengue and dengue haemorrhagic fever. *The Lancet.* 1998 Sep;352(9132):971–7.
275. Cao XT et al. Evaluation of the World Health Organization standard touniquet test in the diagnosis of dengue infection in Vietnam. *Trop Med Int Health.* 7(2):125–32.
276. Kalayanarooj S, Vaughn DW, Nimmannitya S, Green S, Suntayakorn S, Kunentrasai N, et al. Early Clinical and Laboratory Indicators of Acute Dengue Illness. *J Infect Dis.* 1997 Aug;176(2):313–21.
277. Hammon SN, Balmadede A, Perez L, Tellez Y, Harris et al E. Differences in dengue severity in infants, children, adults in a 3 years hospital based study in Nicaragua. *Am J Trop Med Hyg.* 73:1063–70.
278. Balmaseda A, Hammond SN, Pérez MA, Cuadra R, Solano S, Rocha J, et al. Assessment of the World Health Organization Scheme for Classification of Dengue Severity in Nicaragua. *Am J Trop Med Hyg.* 2005 Dec 1;73(6):1059–62.
279. Srikiatkachorn A, Krautrachue A, Ratanaprakarn W, Wongtapradit L, Nithipanya N, Kalayanarooj S, et al. Natural history of plasma leakage in dengue hemorrhagic fever: a serial ultrasonographic study. *Pediatr Infect Dis J.* 2007 Apr;26(4):283–90; discussion 291–2.
280. Nimmannitya S, Halstead SB, Cohen SN, Margiotta MR. Dengue and chikungunya virus infection in man in Thailand, 1962-1964. I. Observations on hospitalized patients with hemorrhagic fever. *Am J Trop Med Hyg.* 1969 Nov;18(6):954–71.
281. Nimmannitya S, Thisyakorn U, Hemsrichart V. Dengue haemorrhagic fever with unusual manifestations. *Southeast Asian J Trop Med Public Health.* 1987 Sep;18(3):398–406.
282. Peeling RW, Artsob H, Pelegrino JL, Buchy P, Cardoso MJ, Devi S, et al. Evaluation of diagnostic tests: dengue. *Nat Rev Microbiol.* 2010 Dec;8(12 Suppl):S30–8.
283. Chuansumrit A, Chaiyaratana W, Pongthanapisith V, Tangnararatchakit K, Lertwongrath S, Yoksan S. The use of dengue nonstructural protein 1 antigen for the

- early diagnosis during the febrile stage in patients with dengue infection. *Pediatr Infect Dis J*. 2008 Jan;27(1):43–8.
284. Dussart P, Labeau B, Lagathu G, Louis P, Nunes MRT, Rodrigues SG, et al. Evaluation of an enzyme immunoassay for detection of dengue virus NS1 antigen in human serum. *Clin Vaccine Immunol CVI*. 2006 Nov;13(11):1185–9.
285. Guzman MG, Vazquez S. The complexity of antibody-dependent enhancement of dengue virus infection. *Viruses*. 2010 Dec;2(12):2649–62.
286. Tricou V, Vu HTT, Quynh NVN, Nguyen CVV, Tran HT, Farrar J, et al. Comparison of two dengue NS1 rapid tests for sensitivity, specificity and relationship to viraemia and antibody responses. *BMC Infect Dis*. 2010;10:142.
287. Wang SM, Sekaran SD. Early diagnosis of Dengue infection using a commercial Dengue Duo rapid test kit for the detection of NS1, IGM, and IGG. *Am J Trop Med Hyg*. 2010 Sep;83(3):690–5.
288. Wang SM, Sekaran SD. Evaluation of a commercial SD dengue virus NS1 antigen capture enzyme-linked immunosorbent assay kit for early diagnosis of dengue virus infection. *J Clin Microbiol*. 2010 Aug;48(8):2793–7.
289. Lanciotti RS, Calisher CH, Gubler DJ, Chang GJ, Vorndam AV. Rapid detection and typing of dengue viruses from clinical samples by using reverse transcriptase-polymerase chain reaction. *J Clin Microbiol*. 1992 Mar;30(3):545–51.
290. Porter KR, Widjaja S, Darmawan H, Lohita, Hadiwijaya SH, Maroef CN, et al. Evaluation of a Commercially Available Immunoglobulin M Capture Enzyme-Linked Immunosorbent Assay Kit for Diagnosing Acute Dengue Infections. *Clin Diagn Lab Immunol*. 1999 Sep;6(5):741–4.
291. Dittmar D, Cleary TJ, Castro A. Immunoglobulin G- and M-specific enzyme-linked immunosorbent assay for detection of dengue antibodies. *J Clin Microbiol*. 1979 Apr;9(4):498–502.
292. Vazquez S, Hafner G, Ruiz D, Calzada N, Guzman MG. Evaluation of immunoglobulin M and G capture enzyme-linked immunosorbent assay Panbio kits for diagnostic dengue infections. *J Clin Virol Off Publ Pan Am Soc Clin Virol*. 2007 Jul;39(3):194–8.
293. Beesetti H, Khanna N, Swaminathan S. Drugs for dengue: a patent review (2010 – 2014). *Expert Opin Ther Pat*. 2014 Oct 6;24(11):1171–84.

294. Durbin AP, Whitehead SS. Dengue vaccine candidates in development. *Curr Top Microbiol Immunol.* 2010;338:129–43.
295. Whitehead SS, Blaney JE, Durbin AP, Murphy BR. Prospects for a dengue virus vaccine. *Nat Rev Microbiol.* 2007 Jul;5(7):518–28.
296. Barban V, Munoz-Jordan JL, Santiago GA, Mantel N, Girerd Y, Gulia S, et al. Broad neutralization of wild-type dengue virus isolates following immunization in monkeys with a tetravalent dengue vaccine based on chimeric yellow fever 17D/dengue viruses. *Virology.* 2012 Aug 1;429(2):91–8.
297. Guirakhoo F, Zhang Z, Myers G, Johnson BW, Pugachev K, Nichols R, et al. A single amino acid substitution in the envelope protein of chimeric yellow fever-dengue 1 vaccine virus reduces neurovirulence for suckling mice and viremia/viscerotropism for monkeys. *J Virol.* 2004 Sep;78(18):9998–10008.
298. Guirakhoo F, Pugachev K, Zhang Z, Myers G, Levenbook I, Draper K, et al. Safety and efficacy of chimeric yellow Fever-dengue virus tetravalent vaccine formulations in nonhuman primates. *J Virol.* 2004 May;78(9):4761–75.
299. Thomas SJ, Endy TP. Critical issues in dengue vaccine development. *Curr Opin Infect Dis.* 2011 Oct;24(5):442–50.
300. Thomas SJ, Endy TP. Vaccines for the prevention of dengue: development update. *Hum Vaccin.* 2011 Jun;7(6):674–84.
301. Rebeca Rico-Hesse. Dengue Virus Evolution and Virulence Models. *Clin Infect Dis.* 2007 Jun 1;44(11):1462–6.
302. Sierra B, Kourí G, Guzmán MG. Race: a risk factor for dengue hemorrhagic fever. *Arch Virol.* 2007;152(3):533–42.
303. Tibayrenc M. *Genetics and Evolution of Infectious Diseases.* Elsevier; 2011. 773 p.
304. González D, Castro OE, Kourí G, Perez J, Martinez E, Vazquez S, et al. Classical dengue hemorrhagic fever resulting from two dengue infections spaced 20 years or more apart: Havana, Dengue 3 epidemic, 2001-2002. *Int J Infect Dis IJID Off Publ Int Soc Infect Dis.* 2005 Sep;9(5):280–5.
305. Marovich M, Grouard-Vogel G, Louder M, Eller M, Sun M, Wu SJ, Putvatava R, et al. Human dendritic cells as targets of dengue virus. *J Invest Dermatol Symp Proc.* 2001;6:219–24.

306. Wu SJ, Grouard-Vogel G, Sun W, Mascola JR, Brachtel E, Putvatana R, et al. Human skin Langerhans cells are targets of dengue virus infection. *Nat Med*. 2000 Jul;6(7):816–20.
307. Nachman RL, Rafii S. Platelets, petechiae, and preservation of the vascular wall. *N Engl J Med*. 2008 Sep 18;359(12):1261–70.
308. Limon-Flores AY, Perez-Tapia M, Estrada-Garcia I, Vaughan G, Escobar-Gutierrez A, Calderon-Amador J, et al. Dengue virus inoculation to human skin explants: an effective approach to assess in situ the early infection and the effects on cutaneous dendritic cells. *Int J Exp Pathol*. 2005 Oct;86(5):323–34.
309. Boonpucknavig S, Boonpucknavig V, Bhamarapravati N, Nimmannitya S. Immunofluorescence study of skin rash in patients with dengue hemorrhagic fever. *Arch Pathol Lab Med*. 1979 Aug;103(9):463–6.
310. Rico-Hesse R. Dengue Virus Virulence and Transmission Determinants. *Curr Top Microbiol Immunol*. 2010;338:45–55.
311. Leitmeyer KC, Vaughn DW, Watts DM, Salas R, Villalobos I, de Chacon null, et al. Dengue virus structural differences that correlate with pathogenesis. *J Virol*. 1999 Jun;73(6):4738–47.
312. Ubol S, Chareonsirisuthigul T, Kasisith J, Klungthong C. Clinical isolates of dengue virus with distinctive susceptibility to nitric oxide radical induce differential gene responses in THP-1 cells. *Virology*. 2008 Jul 5;376(2):290–6.
313. Cologna R, Rico-Hesse R. American genotype structures decrease dengue virus output from human monocytes and dendritic cells. *J Virol*. 2003 Apr;77(7):3929–38.
314. Guzmán MG, Pelegrino JL, Pumariega T, Vázquez S, González L, Kourí G, et al. [Quality control of the serological diagnosis of dengue in laboratories throughout the Americas, 1996-2001]. *Rev Panam Salud Pública Pan Am J Public Health*. 2003 Dec;14(6):371–6.
315. Kouri GP, Guzmán MG, Bravo JR, Triana C. Dengue haemorrhagic fever/dengue shock syndrome: lessons from the Cuban epidemic, 1981. *Bull World Health Organ*. 1989;67(4):375–80.
316. Kurane. Dengue hemorrhagic fever with special emphasis on immunopathogenesis. *Comp Immunol Microbiol Infect Dis*. 2007 Sep;30(5-6):329–40.

317. Tuiskunen A, Wahlström M, Bergström J, Buchy P, Leparç-Goffart I, Lundkvist Å. Phenotypic characterization of patient dengue virus isolates in BALB/c mice differentiates dengue fever and dengue hemorrhagic fever from dengue shock syndrome. *Virology*. 2011 Aug 11;8(1):398.
318. Tuiskunen A, Monteil V, Plumet S, Boubis L, Wahlström M, Duong V, et al. Phenotypic and genotypic characterization of dengue virus isolates differentiates dengue fever and dengue hemorrhagic fever from dengue shock syndrome. *Arch Virol*. 2011 Nov;156(11):2023–32.
319. Halstead SB. Antibodies determine virulence in dengue. *Ann N Y Acad Sci*. 2009 Sep;1171 Suppl 1:E48–56.
320. Kouri GP, Guzmán MG, Bravo JR. Why dengue haemorrhagic fever in Cuba? 2. An integral analysis. *Trans R Soc Trop Med Hyg*. 1987;81(5):821–3.
321. Kouri GP, Guzmán MG, Bravo JR, Triana C. Dengue haemorrhagic fever/dengue shock syndrome: lessons from the Cuban epidemic, 1981. *Bull World Health Organ*. 1989;67(4):375–80.
322. Guzman MG, Kouri G. Dengue and dengue hemorrhagic fever in the Americas: lessons and challenges. *J Clin Virol Off Publ Pan Am Soc Clin Virol*. 2003 May;27(1):1–13.
323. Halstead SB. Dengue. *Lancet*. 2007 Nov 10;370(9599):1644–52.
324. Malasit P. Complement and dengue haemorrhagic fever/shock syndrome. *Southeast Asian J Trop Med Public Health*. 1987 Sep;18(3):316–20.
325. Nishioka K. Serum complement level in dengue hemorrhagic fever. *Allerg Immunol (Leipz)*. 1974 1975;20-21(4):385–92.
326. Avirutnan P, Punyadee N, Noisakran S, Komoltri C, Thiemmecca S, Auethavornanan K, et al. Vascular leakage in severe dengue virus infections: a potential role for the nonstructural viral protein NS1 and complement. *J Infect Dis*. 2006 Apr 15;193(8):1078–88.
327. Shu PY, Chen LK, Chang SF, Yueh YY, Chow L, Chien LJ, et al. Dengue NS1-specific antibody responses: isotype distribution and serotyping in patients with Dengue fever and Dengue hemorrhagic fever. *J Med Virol*. 2000 Oct;62(2):224–32.
328. Libraty DH, Young PR, Pickering D, Endy TP, Kalayanarooj S, Green S, et al. High circulating levels of the dengue virus nonstructural protein NS1 early in dengue

- illness correlate with the development of dengue hemorrhagic fever. *J Infect Dis.* 2002 Oct 15;186(8):1165–8.
329. Lin C-F, Wan S-W, Cheng H-J, Lei H-Y, Lin Y-S. Autoimmune pathogenesis in dengue virus infection. *Viral Immunol.* 2006;19(2):127–32.
330. Lin C-F, Lei H-Y, Shiau A-L, Liu C-C, Liu H-S, Yeh T-M, et al. Antibodies from dengue patient sera cross-react with endothelial cells and induce damage. *J Med Virol.* 2003 Jan;69(1):82–90.
331. Oishi K, Inoue S, Cinco MTDD, Dimaano EM, Alera MTP, Alfon JAR, et al. Correlation between increased platelet-associated IgG and thrombocytopenia in secondary dengue virus infections. *J Med Virol.* 2003 Oct;71(2):259–64.
332. Sun D-S, King C-C, Huang H-S, Shih Y-L, Lee C-C, Tsai W-J, et al. Antiplatelet autoantibodies elicited by dengue virus non-structural protein 1 cause thrombocytopenia and mortality in mice. *J Thromb Haemost JTH.* 2007 Nov;5(11):2291–9.
333. Lin C-F, Wan S-W, Chen M-C, Lin S-C, Cheng C-C, Chiu S-C, et al. Liver injury caused by antibodies against dengue virus nonstructural protein 1 in a murine model. *Lab Investig J Tech Methods Pathol.* 2008 Oct;88(10):1079–89.
334. Saito M, Oishi K, Inoue S, Dimaano EM, Alera MTP, Robles AMP, et al. Association of increased platelet-associated immunoglobulins with thrombocytopenia and the severity of disease in secondary dengue virus infections. *Clin Exp Immunol.* 2004 Nov;138(2):299–303.
335. Lin CF, Lei HY, Liu CC, Liu HS, Yeh TM, Wang ST, et al. Generation of IgM anti-platelet autoantibody in dengue patients. *J Med Virol.* 2001 Feb;63(2):143–9.
336. Ritesh Panchal, S. Mukerjee, Abay Chowdhar. Influence of Human Leucocyte Antigens of Altered Immunopathology of Dengue Virus. *Int J Hum Genet.* 2012;12(1):1–9.
337. Stephens H a. F, Klaythong R, Sirikong M, Vaughn DW, Green S, Kalayanaroj S, et al. HLA-A and -B allele associations with secondary dengue virus infections correlate with disease severity and the infecting viral serotype in ethnic Thais. *Tissue Antigens.* 2002 Oct;60(4):309–18.

338. Appanna R, Ponnampalavanar S, Lum Chai See L, Sekaran SD. Susceptible and protective HLA class I alleles against dengue fever and dengue hemorrhagic fever patients in a Malaysian population. *PloS One*. 2010;5(9).
339. Malavige GN, Rostron T, Rohanachandra LT, Jayaratne SD, Fernando N, De Silva AD, et al. HLA class I and class II associations in dengue viral infections in a Sri Lankan population. *PloS One*. 2011;6(6):e20581.
340. Rothman AL. Immunology and immunopathogenesis of dengue disease. *Adv Virus Res*. 2003;60:397–419.
341. Soundravally R, Hoti SL. Immunopathogenesis of dengue hemorrhagic fever and shock syndrome: role of TAP and HPA gene polymorphism. *Hum Immunol*. 2007 Dec;68(12):973–9.
342. Thomas L, Verlaeten O, Cabié A, Kaidomar S, Moravie V, Martial J, et al. Influence of the dengue serotype, previous dengue infection, and plasma viral load on clinical presentation and outcome during a dengue-2 and dengue-4 co-epidemic. *Am J Trop Med Hyg*. 2008 Jun;78(6):990–8.
343. Graham RR, Juffrie M, Tan R, Hayes CG, Laksono I, Ma'roef C, et al. A prospective seroepidemiologic study on dengue in children four to nine years of age in Yogyakarta, Indonesia I. studies in 1995-1996. *Am J Trop Med Hyg*. 1999 Sep;61(3):412–9.
344. Kliks SC, Nisalak A, Brandt WE, Wahl L, Burke DS. Antibody-dependent enhancement of dengue virus growth in human monocytes as a risk factor for dengue hemorrhagic fever. *Am J Trop Med Hyg*. 1989 Apr;40(4):444–51.
345. Sangkawibha N, Rojanasuphot S, Ahandrik S, Viriyapongse S, Jatanasen S, Salitul V, et al. Risk factors in dengue shock syndrome: a prospective epidemiologic study in Rayong, Thailand. I. The 1980 outbreak. *Am J Epidemiol*. 1984 Nov;120(5):653–69.
346. Murphy BR, Whitehead SS. Immune response to dengue virus and prospects for a vaccine. *Annu Rev Immunol*. 2011;29:587–619.
347. Halstead SB, Simasthien P, H Dippe. Observations related to the pathogenesis of dengue hemorrhagic fever. II. Antigenic and biologic properties of dengue viruses and their association with disease response in the host. *Yale J Biol Med*. 1970 Apr;42(5):276–92.

348. Ghiasi H, Cai S, Perng GC, Nesburn AB, Wechsler SL. The role of natural killer cells in protection of mice against death and corneal scarring following ocular HSV-1 infection. *Antiviral Res.* 2000 Jan;45(1):33–45.
349. Hober D, Chehadeh W, Bouzidi A, Wattré P. Antibody-dependent enhancement of coxsackievirus B4 infectivity of human peripheral blood mononuclear cells results in increased interferon-alpha synthesis. *J Infect Dis.* 2001 Nov 1;184(9):1098–108.
350. Iankov ID, Pandey M, Harvey M, Griesmann GE, Federspiel MJ, Russell SJ. Immunoglobulin G antibody-mediated enhancement of measles virus infection can bypass the protective antiviral immune response. *J Virol.* 2006 Sep;80(17):8530–40.
351. Ponnuraj EM, Springer J, Hayward AR, Wilson H, Simoes EAF. Antibody-dependent enhancement, a possible mechanism in augmented pulmonary disease of respiratory syncytial virus in the Bonnet monkey model. *J Infect Dis.* 2003 Apr 15;187(8):1257–63.
352. Subbramanian RA, Xu J, Toma E, Morisset R, Cohen EA, Menezes J, et al. Comparison of human immunodeficiency virus (HIV)-specific infection-enhancing and -inhibiting antibodies in AIDS patients. *J Clin Microbiol.* 2002 Jun;40(6):2141–6.
353. Takada A, Feldmann H, Ksiazek TG, Kawaoka Y. Antibody-dependent enhancement of Ebola virus infection. *J Virol.* 2003 Jul;77(13):7539–44.
354. Wallace MJ, Smith DW, Broom AK, Mackenzie JS, Hall RA, Shellam GR, et al. Antibody-dependent enhancement of Murray Valley encephalitis virus virulence in mice. *J Gen Virol.* 2003 Jul;84(Pt 7):1723–8.
355. Martina BEE, Koraka P, Osterhaus ADME. Dengue virus pathogenesis: an integrated view. *Clin Microbiol Rev.* 2009 Oct;22(4):564–81.
356. Chau TNB, Quyen NTH, Thuy TT, Tuan NM, Hoang DM, Dung NTP, et al. Dengue in Vietnamese infants--results of infection-enhancement assays correlate with age-related disease epidemiology, and cellular immune responses correlate with disease severity. *J Infect Dis.* 2008 Aug 15;198(4):516–24.
357. Selin LK, Welsh RM. Plasticity of T cell memory responses to viruses. *Immunity.* 2004 Jan;20(1):5–16.
358. Mathew A, Rothman AL. Understanding the contribution of cellular immunity to dengue disease pathogenesis. *Immunol Rev.* 2008 Oct;225:300–13.

359. Bashyam HS, Green S, Rothman AL. Dengue virus-reactive CD8⁺ T cells display quantitative and qualitative differences in their response to variant epitopes of heterologous viral serotypes. *J Immunol Baltim Md 1950*. 2006 Mar 1;176(5):2817–24.
360. Dong Y, Chen Y, Wang Z, Naito J, Chen J-L. Role of sympathetic nerves on early embryonic development and immune modulation of uterus in pregnant mice. *Auton Neurosci Basic Clin*. 2007 Jan 30;131(1-2):87–93.
361. Imrie A, Meeks J, Gurary A, Sukhbaatar M, Truong TT, Cropp CB, et al. Antibody to dengue 1 detected more than 60 years after infection. *Viral Immunol*. 2007 Dec;20(4):672–5.
362. Cornberg M, Chen AT, Wilkinson LA, Brehm MA, Kim S-K, Calcagno C, et al. Narrowed TCR repertoire and viral escape as a consequence of heterologous immunity. *J Clin Invest*. 2006 May;116(5):1443–56.
363. Kim EY, Juvet SC, Zhang L. Regulatory CD4(-)CD8(-) double negative T cells. *Methods Mol Biol Clifton NJ*. 2011;677:85–98.
364. Bozza FA, Cruz OG, Zagne SMO, Azeredo EL, Nogueira RMR, Assis EF, et al. Multiplex cytokine profile from dengue patients: MIP-1beta and IFN-gamma as predictive factors for severity. *BMC Infect Dis*. 2008;8:86.
365. Juffrie M, Meer GM, Hack CE, Haasnoot K, Sutaryo null, Veerman AJ, et al. Inflammatory mediators in dengue virus infection in children: interleukin-6 and its relation to C-reactive protein and secretory phospholipase A2. *Am J Trop Med Hyg*. 2001 Jul;65(1):70–5.
366. Mustafa AS, Elbishbishi EA, Agarwal R, Chaturvedi UC. Elevated levels of interleukin-13 and IL-18 in patients with dengue hemorrhagic fever. *FEMS Immunol Med Microbiol*. 2001 Apr;30(3):229–33.
367. Butthep P, Chunhakan S, Tangnararatchakit K, Yoksan S, Pattanapanyasat K, Chuansumrit A. Elevated soluble thrombomodulin in the febrile stage related to patients at risk for dengue shock syndrome. *Pediatr Infect Dis J*. 2006 Oct;25(10):894–7.
368. Cardier JE, Balogh V, Perez-Silva C, Romano E, Rivas B, Bosch N, et al. Relationship of thrombopoietin and interleukin-11 levels to thrombocytopenia associated with dengue disease. *Cytokine*. 2006 May;34(3-4):155–60.

369. Koraka P, Murgue B, Deparis X, Van Gorp ECM, Setiati TE, Osterhaus ADME, et al. Elevation of soluble VCAM-1 plasma levels in children with acute dengue virus infection of varying severity. *J Med Virol.* 2004 Mar;72(3):445–50.
370. Mairuhu ATA, Peri G, Setiati TE, Hack CE, Koraka P, Soemantri A, et al. Elevated plasma levels of the long pentraxin, pentraxin 3, in severe dengue virus infections. *J Med Virol.* 2005 Aug;76(4):547–52.
371. Sosothikul D, Seksarn P, Pongsewalak S, Thisyakorn U, Lusher J. Activation of endothelial cells, coagulation and fibrinolysis in children with Dengue virus infection. *Thromb Haemost.* 2007 Apr;97(4):627–34.
372. Srikiatkachorn A, Ajariyakhajorn C, Endy TP, Kalayanarooj S, Libraty DH, Green S, et al. Virus-induced decline in soluble vascular endothelial growth receptor 2 is associated with plasma leakage in dengue hemorrhagic Fever. *J Virol.* 2007 Feb;81(4):1592–600.
373. Weaver SC, Lecuit M. Chikungunya Virus and the Global Spread of a Mosquito-Borne Disease. *N Engl J Med.* 2015 Mar 26;372(13):1231–9.
374. Powers AM, Brault AC, Tesh RB, Weaver SC. Re-emergence of Chikungunya and O'nyong-nyong viruses: evidence for distinct geographical lineages and distant evolutionary relationships. *J Gen Virol.* 2000 Feb;81(Pt 2):471–9.
375. Arankalle VA, Shrivastava S, Cherian S, Gunjekar RS, Walimbe AM, Jadhav SM, et al. Genetic divergence of Chikungunya viruses in India (1963-2006) with special reference to the 2005-2006 explosive epidemic. *J Gen Virol.* 2007 Jul;88(Pt 7):1967–76.
376. Kumar CJ, Baboo CA, Krishnan BU, Kumar A, Joy S, Jose T, et al. The socioeconomic impact of the chikungunya viral epidemic in India. *Open Med Peer-Rev Indep Open-Access J.* 2007;1(3):e150–2.
377. Kariuki Njenga M, Nderitu L, Ledermann JP, Ndirangu A, Logue CH, Kelly CHL, et al. Tracking epidemic Chikungunya virus into the Indian Ocean from East Africa. *J Gen Virol.* 2008 Nov;89(Pt 11):2754–60.
378. Yergolkar PN, Tandale BV, Arankalle VA, Sathe PS, Sudeep AB, Gandhe SS, et al. Chikungunya outbreaks caused by African genotype, India. *Emerg Infect Dis.* 2006 Oct;12(10):1580–3.

379. Hapuarachchi HC, Bandara KB a. T, Sumanadasa SDM, Hapugoda MD, Lai Y-L, Lee K-S, et al. Re-emergence of Chikungunya virus in South-east Asia: virological evidence from Sri Lanka and Singapore. *J Gen Virol*. 2010 Apr;91(Pt 4):1067–76.
380. Vazeille M, Moutailler S, Coudrier D, Rousseaux C, Khun H, Huerre M, et al. Two Chikungunya Isolates from the Outbreak of La Reunion (Indian Ocean) Exhibit Different Patterns of Infection in the Mosquito, *Aedes albopictus*. *PLoS ONE*. 2007 Nov 14;2(11):e1168.
381. Grandadam M, Caro V, Plumet S, Thiberge JM, Souarès Y, Failloux A-B, et al. Chikungunya virus, southeastern France. *Emerg Infect Dis*. 2011 May;17(5):910–3.
382. Delisle E, Rousseau C, Broche B, Leparc-Goffart I, L'Ambert G, Cochet A, et al. Chikungunya outbreak in Montpellier, France, September to October 2014. *Euro Surveill Bull Eur Sur Mal Transm Eur Commun Dis Bull*. 2015;20(17).
383. Olivier Schwartz MLA. Biology and pathogenesis of Chikungunya virus. *Nat Rev Microbiol* 8:491-500. *Nat Rev Microbiol*. 2010;8(7):491–500.
384. Gérardin P, Barau G, Michault A, Bintner M, Randrianaivo H, Choker G, et al. Multidisciplinary Prospective Study of Mother-to-Child Chikungunya Virus Infections on the Island of La Réunion. *PLoS Med* [Internet]. 2008 Mar [cited 2015 Nov 8];5(3). Available from: <http://www.ncbi.nlm.nih.gov/pmc/articles/PMC2267812/>
385. Leung JY-S, Ng MM-L, Chu JJH, Leung JY-S, Ng MM-L, Chu JJH. Replication of Alphaviruses: A Review on the Entry Process of Alphaviruses into Cells, Replication of Alphaviruses: A Review on the Entry Process of Alphaviruses into Cells. *Adv Virol Adv Virol*. 2011 Jul 2;2011, 2011:e249640.
386. Solignat M, Gay B, Higgs S, Briant L, Devaux C. Replication cycle of chikungunya: A re-emerging arbovirus. *Virology*. 2009 Oct 25;393(2):183–97.
387. Robinson MC. An epidemic of virus disease in Southern Province, Tanganyika Territory, in 1952-53. I. Clinical features. *Trans R Soc Trop Med Hyg*. 1955 Jan;49(1):28–32.
388. Lumsden WH. An epidemic of virus disease in Southern Province, Tanganyika Territory, in 1952-53. II. General description and epidemiology. *Trans R Soc Trop Med Hyg*. 1955 Jan;49(1):33–57.

389. Jupp PG, McIntosh BM. *Aedes furcifer* and other mosquitoes as vectors of chikungunya virus at Mica, northeastern Transvaal, South Africa. *J Am Mosq Control Assoc.* 1990 Sep;6(3):415–20.
390. Diallo M, Thonnon J, Traore-Lamizana M, Fontenille D. Vectors of Chikungunya virus in Senegal: current data and transmission cycles. *Am J Trop Med Hyg.* 1999 Feb;60(2):281–6.
391. Shah KV, Gilotra SK, Gibbs CJ, Rozeboom LE. Laboratory studies of transmission of chikungunya virus by mosquitoes: A preliminary report. *Indian J Med Res.* 1964 Jul;52:703–9.
392. Francesca Cavrini, Anna Maria Pierro, Giada Rossini, Maria Paola Landini, Vittorio Sambri. Chikungunya: an emerging and spreading arthropod-borne viral disease. *J Infect Dev Ctries.* 2009;3(10):744–52.
393. Vega-Rua A, Zouache K, Caro V, Diancourt L, Delaunay P, Grandadam M, et al. High Efficiency of Temperate *Aedes albopictus* to Transmit Chikungunya and Dengue Viruses in the Southeast of France. *PLoS ONE.* 2013 Mar 18;8(3):e59716.
394. Volk SM, Chen R, Tsetsarkin KA, Adams AP, Garcia TI, Sall AA, et al. Genome-scale phylogenetic analyses of chikungunya virus reveal independent emergences of recent epidemics and various evolutionary rates. *J Virol.* 2010 Jul;84(13):6497–504.
395. Adesina OA, Odelola HA. Ecological distribution of Chikungunya haemagglutination inhibition antibodies in human and domestic animals in Nigeria. *Trop Geogr Med.* 1991 Jul;43(3):271–5.
396. Gargan TP, Jupp PG, Novak RJ. Panveld oviposition sites of floodwater *Aedes* mosquitoes and attempts to detect transovarial transmission of Rift Valley fever virus in South Africa. *Med Vet Entomol.* 1988 Jul;2(3):231–6.
397. Rodhain F. [Vector-borne transmission]. *Bull Société Pathol Exot Ses Fil.* 1989;82(2):167–72.
398. Karabatsos N. Antigenic relationships of group A arboviruses by plaque reduction neutralization testing. *Am J Trop Med Hyg.* 1975 May;24(3):527–32.
399. Carey DE. Chikungunya and dengue: a case of mistaken identity? *J Hist Med Allied Sci.* 1971 Jul;26(3):243–62.
400. Jupp PG, McIntosh BM. Chikungunya virus disease. In: Monath TP, ed. *The arboviruses: epidemiology and ecology.* Boca Raton Fla CRC Press. 1988;2:137–57.

401. Rezza G, Nicoletti L, Angelini R, Romi R, Finarelli AC, Panning M, et al. Infection with chikungunya virus in Italy: an outbreak in a temperate region. *Lancet*. 2007 Dec 1;370(9602):1840–6.
402. Vazeille M, Mousson L, Failloux A-B. Failure to demonstrate experimental vertical transmission of the epidemic strain of Chikungunya virus in *Aedes albopictus* from La Réunion Island, Indian Ocean. *Mem Inst Oswaldo Cruz*. 2009 Jul;104(4):632–5.
403. Weaver SC, Hagenbaugh A, Bellew LA, Netesov SV, Volchkov VE, Chang GJ, et al. A comparison of the nucleotide sequences of eastern and western equine encephalomyelitis viruses with those of other alphaviruses and related RNA viruses. *Virology*. 1993 Nov;197(1):375–90.
404. Weaver SC. Arrival of Chikungunya Virus in the New World: Prospects for Spread and Impact on Public Health. *PLoS Negl Trop Dis* [Internet]. 2014 Jun 26 [cited 2015 Jun 11];8(6). Available from: <http://www.ncbi.nlm.nih.gov/pmc/articles/PMC4072586/>
405. Sudeep AB, Parashar D. Chikungunya: an overview. *J Biosci*. 2008 Nov;33(4):443–9.
406. Ross RW. The Newala epidemic. III. The virus: isolation, pathogenic properties and relationship to the epidemic. *J Hyg (Lond)*. 1956 Jun;54(2):177–91.
407. Chretien J-P, Anyamba A, Bedno SA, Breiman RF, Sang R, Sergon K, et al. Drought-associated chikungunya emergence along coastal East Africa. *Am J Trop Med Hyg*. 2007 Mar;76(3):405–7.
408. Weaver SC, Osorio JE, Livengood JA, Chen R, Stinchcomb DT. Chikungunya virus and prospects for a vaccine. *Expert Rev Vaccines*. 2012 Sep;11(9):1087–101.
409. Lanciotti RS, Kosoy OL, Laven JJ, Panella AJ, Velez JO, Lambert AJ, et al. Chikungunya virus in US travelers returning from India, 2006. *Emerg Infect Dis*. 2007 May;13(5):764–7.
410. Leparç-Goffart I, Nougairède A, Cassadou S, Prat C, de Lamballerie X. Chikungunya in the Americas. *Lancet Lond Engl*. 2014 Feb 8;383(9916):514.
411. Gérardin P, Guernier V, Perrau J, Fianu A, Le Roux K, Grivard P, et al. Estimating Chikungunya prevalence in La Réunion Island outbreak by serosurveys: two methods for two critical times of the epidemic. *BMC Infect Dis*. 2008;8:99.
412. Grandadam M, Caro V, Plumet S, Thiberge JM, Souarès Y, Failloux A-B, et al. Chikungunya virus, southeastern France. *Emerg Infect Dis*. 2011 May;17(5):910–3.

413. Roiz D, Boussès P, Simard F, Paupy C, Fontenille D. Autochthonous Chikungunya Transmission and Extreme Climate Events in Southern France. *PLoS Negl Trop Dis*. 2015 Jun 16;9(6):e0003854.
414. Renault P, Solet J-L, Sissoko D, Balleydier E, Larrieu S, Filleul L, et al. A major epidemic of chikungunya virus infection on Reunion Island, France, 2005-2006. *Am J Trop Med Hyg*. 2007 Oct;77(4):727–31.
415. Weaver SC, Forrester NL. Chikungunya: Evolutionary history and recent epidemic spread. *Antiviral Res*. 2015 Aug 1;120:32–9.
416. Desdouits M, Kamgang B, Berthet N, Tricou V, Ngoagouni C, Gessain A, et al. Genetic characterization of Chikungunya virus in the Central African Republic. *Infect Genet Evol J Mol Epidemiol Evol Genet Infect Dis*. 2015 Jul;33:25–31.
417. Shah KV, Gibbs CJ, Banerjee G. Virological investigation of the epidemic of haemorrhagic fever in Calcutta: isolation of three strains of chikungunya virus. *Indian J Med Res*. 1964 Jul;52:676–83.
418. Yergolkar PN, Tandale BV, Arankalle VA, Sathe PS, Gandhe SS, Gokhle MD, et al. Chikungunya Outbreaks Caused by African Genotype, India. *Emerg Infect Dis*. 2006 Oct;12(10):1580–3.
419. Pavri K. Disappearance of Chikungunya virus from India and South East Asia. *Trans R Soc Trop Med Hyg*. 1986;80(3):491.
420. National Vector-Borne Disease Control Programme. Chikungunya fever situation in the country during 2006. Delhi: NVBDCP. 2009.
421. Chretien J-P, Anyamba A, Bedno SA, Breiman RF, Sang R, Sergon K, et al. Drought-associated chikungunya emergence along coastal East Africa. *Am J Trop Med Hyg*. 2007 Mar;76(3):405–7.
422. Pialoux G, Gaüzère B-A, Jauréguiberry S, Strobel M. Chikungunya, an epidemic arbovirosis. *Lancet Infect Dis*. 2007 May;7(5):319–27.
423. Vourc'h G, Halos L, Desvars A, Boué F, Pascal M, Lecollinet S, et al. Chikungunya antibodies detected in non-human primates and rats in three Indian Ocean islands after the 2006 ChikV outbreak. *Vet Res*. 2014;45:52.
424. Renault P, Josseran L, Pierre V. Chikungunya-related fatality rates, Mauritius, India, and Reunion Island. *Emerg Infect Dis*. 2008 Aug;14(8):1327.

425. Kowalzik S, Xuan NV, Weissbrich B, Scheiner B, Schied T, Drosten C, et al. Characterisation of a chikungunya virus from a German patient returning from Mauritius and development of a serological test. *Med Microbiol Immunol (Berl)*. 2008 Dec;197(4):381–6.
426. Bonn D. How did chikungunya reach the Indian Ocean? *Lancet Infect Dis*. 2006 Sep;6(9):543.
427. Lahariya C, Pradhan SK. Chikungunya virus returns to Indian Ocean. *J Indian Med Assoc*. 2006 Nov;104(11):618.
428. Renault P, Solet J-L, Sissoko D, Balleydier E, Larrieu S, Filleul L, et al. A major epidemic of chikungunya virus infection on Reunion Island, France, 2005-2006. *Am J Trop Med Hyg*. 2007 Oct;77(4):727–31.
429. Beltrame A, Angheben A, Bisoffi Z, Monteiro G, Marocco S, Calleri G, et al. Imported Chikungunya Infection, Italy. *Emerg Infect Dis*. 2007 Aug;13(8):1264–6.
430. Bonilauri P, Bellini R, Calzolari M, Angelini R, Venturi L, Fallacara F, et al. Chikungunya virus in *Aedes albopictus*, Italy. *Emerg Infect Dis*. 2008 May;14(5):852–4.
431. Roos R, 18 LS| SW| CN| J, 2014. Reports profile Caribbean chikungunya threat to Europe [Internet]. CIDRAP. [cited 2015 Jul 10]. Available from: <http://www.cidrap.umn.edu/news-perspective/2014/07/reports-profile-caribbean-chikungunya-threat-europe>
432. 16-06-2014-RRA-Chikungunya-Caribbean, European Union/European Economic Area - chikungunya-caribbean-june-2014-risk-assessment.pdf [Internet]. [cited 2015 Aug 31]. Available from: <http://ecdc.europa.eu/en/publications/Publications/chikungunya-caribbean-june-2014-risk-assessment.pdf>
433. Pan American Health Organization/World Health Organization (AHO/WHO). Number of Reported Cases of Chikungunya Fever in the Americas, by Country or Territory 2013–2014. 2014.
434. Ali U, Isahak I, Rahman MM. A Case Report of Classical Chikungunya Fever. *Int J Virol*. 2011 Jan 1;7(1):39–41.

435. Gibney KB, Fischer M, Prince HE, Kramer LD, St George K, Kosoy OL, et al. Chikungunya fever in the United States: a fifteen year review of cases. *Clin Infect Dis Off Publ Infect Dis Soc Am*. 2011 Mar 1;52(5):e121–6.
436. Andreas Suhrbier, Marie-Christine Jaffar-Bandjee, Philippe Gasque. Arthritogenic alphaviruses—an overview. *Nat Rev Rheumatol*. 2012;8:420–9.
437. Staikowsky F, Talarmin F, Grivard P, Souab A, Schuffenecker I, Le Roux K, et al. Prospective Study of Chikungunya Virus Acute Infection in the Island of La Réunion during the 2005–2006 Outbreak. *PLoS ONE*. 2009 Oct 28;4(10):e7603.
438. Javelle E, Tiong TH, Leparc-Goffart I, Savini H, Simon F. Inflammation of the external ear in acute chikungunya infection: Experience from the outbreak in Johor Bahru, Malaysia, 2008. *J Clin Virol Off Publ Pan Am Soc Clin Virol*. 2014 Apr;59(4):270–3.
439. Gérardin P, Barau G, Michault A, Bintner M, Randrianaivo H, Choker G, et al. Multidisciplinary Prospective Study of Mother-to-Child Chikungunya Virus Infections on the Island of La Réunion. *PLoS Med*. 2008 Mar 18;5(3):e60.
440. Mohan A. Chikungunya fever: clinical manifestations & management. *Indian J Med Res*. 2006 Nov;124(5):471–4.
441. Simon F, Savini H, Parola P. Chikungunya: a paradigm of emergence and globalization of vector-borne diseases. *Med Clin North Am*. 2008 Nov;92(6):1323–43, ix.
442. Chevillon C, Briant L, Renaud F, Devaux C. The Chikungunya threat: an ecological and evolutionary perspective. *Trends Microbiol*. 2008 Feb;16(2):80–8.
443. Powers AM, Logue CH. Changing patterns of chikungunya virus: re-emergence of a zoonotic arbovirus. *J Gen Virol*. 2007 Sep;88(Pt 9):2363–77.
444. Fourie ED, Morrison JG. Rheumatoid arthritic syndrome after chikungunya fever. *South Afr Med J Suid-Afr Tydskr Vir Geneesk*. 1979 Jul 28;56(4):130–2.
445. Brighton SW, Prozesky OW, de la Harpe AL. Chikungunya virus infection. A retrospective study of 107 cases. *South Afr Med J Suid-Afr Tydskr Vir Geneesk*. 1983 Feb 26;63(9):313–5.
446. Simon F, Parola P, Grandadam M, Fourcade S, Oliver M, Brouqui P, et al. Chikungunya infection: an emerging rheumatism among travelers returned from Indian Ocean islands. Report of 47 cases. *Medicine (Baltimore)*. 2007 May;86(3):123–37.

447. Brighton SW, Simson IW. A destructive arthropathy following Chikungunya virus arthritis--a possible association. *Clin Rheumatol*. 1984 Jun;3(2):253–8.
448. Bouquillard E, Combe B. Rheumatoid arthritis after Chikungunya fever: a prospective follow-up study of 21 cases. *Ann Rheum Dis*. 2009 Sep;68(9):1505–6.
449. Bouquillard E, Combe B. A report of 21 cases of rheumatoid arthritis following Chikungunya fever. A mean follow-up of two years. *Jt Bone Spine Rev Rhum*. 2009 Dec;76(6):654–7.
450. Schilte C, Staikowsky F, Staikovskiy F, Couderc T, Madec Y, Carpentier F, et al. Chikungunya virus-associated long-term arthralgia: a 36-month prospective longitudinal study. *PLoS Negl Trop Dis*. 2013;7(3):e2137.
451. Briolant S, Parola P, Fusai T, Madamet-Torrentino M, Baret E, Mosnier J, et al. Influence of oxygen on asexual blood cycle and susceptibility of *Plasmodium falciparum* to chloroquine: requirement of a standardized in vitro assay. *Malar J*. 2007;6:44.
452. Briolant S, Garin D, Scaramozzino N, Jouan A, Crance JM. In vitro inhibition of Chikungunya and Semliki Forest viruses replication by antiviral compounds: synergistic effect of interferon-alpha and ribavirin combination. *Antiviral Res*. 2004 Feb;61(2):111–7.
453. de Lamballerie X, Ninove L, Charrel RN. Antiviral treatment of chikungunya virus infection. *Infect Disord Drug Targets*. 2009 Apr;9(2):101–4.
454. STAIKOWSKY F, Le ROUX K, SCHUFFENECKER I, LAURENT P, GRIVARD P, DEVELAY A, et al. Retrospective survey of Chikungunya disease in Réunion Island hospital staff. *Epidemiol Infect*. 2008 Feb;136(2):196–206.
455. Brighton SW. Chloroquine phosphate treatment of chronic Chikungunya arthritis. An open pilot study. *South Afr Med J Suid-Afr Tydskr Vir Geneesk*. 1984 Aug 11;66(6):217–8.
456. De Lamballerie X, Boisson V, Reynier J-C, Enault S, Charrel RN, Flahault A, et al. On chikungunya acute infection and chloroquine treatment. *Vector Borne Zoonotic Dis Larchmt N*. 2008 Dec;8(6):837–9.
457. Edelman R, Tacket CO, Wasserman SS, Bodison SA, Perry JG, Mangiafico JA. Phase II safety and immunogenicity study of live chikungunya virus vaccine TSI-GSD-218. *Am J Trop Med Hyg*. 2000 Jun;62(6):681–5.

458. Levitt NH, Ramsburg HH, Hasty SE, Repik PM, Cole FE, Lupton HW. Development of an attenuated strain of chikungunya virus for use in vaccine production. *Vaccine*. 1986 Sep;4(3):157–62.
459. Edelman R, Tacket CO, Wasserman SS, Bodison SA, Perry JG, Mangiafico JA. Phase II safety and immunogenicity study of live chikungunya virus vaccine TSI-GSD-218. *Am J Trop Med Hyg*. 2000 Jun;62(6):681–5.
460. Wang E, Volkova E, Adams AP, Forrester N, Xiao S-Y, Frolov I, et al. Chimeric alphavirus vaccine candidates for chikungunya. *Vaccine*. 2008 Sep 15;26(39):5030–9.
461. Muthumani K, Lankaraman KM, Laddy DJ, Sundaram SG, Chung CW, Sako E, et al. Immunogenicity of novel consensus-based DNA vaccines against Chikungunya virus. *Vaccine*. 2008 Sep 19;26(40):5128–34.
462. Tiwari M, Parida M, Santhosh SR, Khan M, Dash PK, Rao PVL. Assessment of immunogenic potential of Vero adapted formalin inactivated vaccine derived from novel ECSA genotype of Chikungunya virus. *Vaccine*. 2009 Apr 21;27(18):2513–22.
463. Eisen L, Beaty BJ, Morrison AC, Scott TW. Proactive Vector control strategies and improved monitoring and evaluation practices for dengue prevention. *J Med Entomol*. 2009 Nov;46(6):1245–55.
464. Moreira LA, Iturbe-Ormaetxe I, Jeffery JA, Lu G, Pyke AT, Hedges LM, et al. A Wolbachia Symbiont in *Aedes aegypti* Limits Infection with Dengue, Chikungunya, and Plasmodium. *Cell*. 2009 Dec 24;139(7):1268–78.
465. van den Hurk AF, Hall-Mendelin S, Pyke AT, Frentiu FD, McElroy K, Day A, et al. Impact of Wolbachia on Infection with Chikungunya and Yellow Fever Viruses in the Mosquito Vector *Aedes aegypti*. *PLoS Negl Trop Dis*. 2012 Nov 1;6(11):e1892.
466. Phuc HK, Andreasen MH, Burton RS, Vass C, Epton MJ, Pape G, et al. Late-acting dominant lethal genetic systems and mosquito control. *BMC Biol*. 2007 Mar 20;5(1):11.
467. Ziegler SA, Lu L, da Rosa APAT, Xiao S-Y, Tesh RB. An animal model for studying the pathogenesis of chikungunya virus infection. *Am J Trop Med Hyg*. 2008 Jul;79(1):133–9.
468. Morrison TE, Fraser RJ, Smith PN, Mahalingam S, Heise MT. Complement contributes to inflammatory tissue destruction in a mouse model of Ross River virus-induced disease. *J Virol*. 2007 May;81(10):5132–43.

469. Mathenge EGM, Parquet M del C, Funakoshi Y, Houhara S, Wong PF, Ichinose A, et al. Fusion PCR generated Japanese encephalitis virus/dengue 4 virus chimera exhibits lack of neuroinvasiveness, attenuated neurovirulence, and a dual-flavi immune response in mice. *J Gen Virol*. 2004 Sep;85(Pt 9):2503–13.
470. Radda A, Escalona T, H Dippe. Occurrence of dengue and Japanese Encephalitis viruses in Oriental Mindoro, Philippines. *Parasitol J*. 1993;15:179–82.
471. Varatharaj A. Encephalitis in the clinical spectrum of dengue infection. *Neurol India*. 2010 Aug;58(4):585–91.
472. Monath TP. Dengue and yellow fever--challenges for the development and use of vaccines. *N Engl J Med*. 2007 Nov 29;357(22):2222–5.
473. Reiter P. Yellow fever and dengue: a threat to Europe? *Euro Surveill Bull Eur Sur Mal Transm Eur Commun Dis Bull*. 2010 Mar 11;15(10):19509.
474. Wichmann O, Gascon J, Schunk M, Puente S, Siikamaki H, Gjørup I, et al. Severe dengue virus infection in travelers: risk factors and laboratory indicators. *J Infect Dis*. 2007 Apr 15;195(8):1089–96.
475. Wilder-Smith A, Schwartz E. Dengue in travelers. *N Engl J Med*. 2005 Sep 1;353(9):924–32.
476. Vazeille M, Mousson L, Martin E, Failloux A-B. Orally co-Infected *Aedes albopictus* from La Reunion Island, Indian Ocean, can deliver both dengue and chikungunya infectious viral particles in their saliva. *PLoS Negl Trop Dis*. 2010;4(6):e706.
477. Hapuarachchi H a. C, Bandara KB a. T, Hapugoda MD, Williams S, Abeyewickreme W. Laboratory confirmation of dengue and chikungunya co-infection. *Ceylon Med J*. 2008 Sep;53(3):104–5.
478. Mackenzie JS, Chua KB, Daniels PW, Eaton BT, Field HE, Hall RA, et al. Emerging viral diseases of Southeast Asia and the Western Pacific. *Emerg Infect Dis*. 2001;7(3 Suppl):497–504.
479. Kalawat U, Sharma KK, Reddy SG. Prevalence of dengue and chickungunya fever and their co-infection. *Indian J Pathol Microbiol*. 2011 Dec;54(4):844–6.
480. Gubler DJ. The global emergence/resurgence of arboviral diseases as public health problems. *Arch Med Res*. 2002 Aug;33(4):330–42.

481. Charrel RN, de Lamballerie X, Raoult D. Chikungunya outbreaks--the globalization of vectorborne diseases. *N Engl J Med*. 2007 Feb 22;356(8):769–71.
482. Tsetsarkin KA, Vanlandingham DL, McGee CE, Higgs S. A single mutation in chikungunya virus affects vector specificity and epidemic potential. *PLoS Pathog*. 2007 Dec;3(12):e201.
483. Leroy EM, Nkoghe D, Ollomo B, Nze-Nkoghe C, Becquart P, Grard G, et al. Concurrent chikungunya and dengue virus infections during simultaneous outbreaks, Gabon, 2007. *Emerg Infect Dis*. 2009 Apr;15(4):591–3.
484. Capinera JL. *Encyclopedia of Entomology*. Springer Science & Business Media; 2008. 4411 p.
485. Gubler DJ, Kuno G, Sather GE, Waterman SH. A case of natural concurrent human infection with two dengue viruses. *Am J Trop Med Hyg*. 1985 Jan;34(1):170–3.
486. Myers RM, Carey DE. Concurrent isolation from patient of two arboviruses, Chikungunya and dengue type 2. *Science*. 1967 Sep 15;157(3794):1307–8.
487. Schultz GW. Seasonal abundance of dengue vectors in Manila, Republic of the Philippines. *Southeast Asian J Trop Med Public Health*. 1993 Jun;24(2):369–75.
488. Change IP on C. *Climate Change 2014 – Impacts, Adaptation and Vulnerability: Regional Aspects*. Cambridge University Press; 2014. 695 p.
489. Ishan Gautam AK. Container preference of the Asian tiger mosquito (*Aedes albopictus*) in Kathmandu and Lalitpur districts of Nepal. *J Nat Hist Mus*. 2012;26:181–93.
490. The Vietnam Population and Housing census 2009. Ministry of planning and investment. General statistics office.
491. Do Quang Ha, Truong Uyen Ninh. Virological Surveillance of Dengue Haemorrhagic Fever in Viet Nam, 1987-1999. *Dengue Bull*. 2000;Vol 24.
492. Cuong HQ, Hien NT, Duong TN, Phong TV, Cam NN, Farrar J, et al. Quantifying the Emergence of Dengue in Hanoi, Vietnam: 1998–2009. *PLoS Negl Trop Dis*. 2011 Sep 27;5(9):e1322.
493. Toan D, Hu W, Thai P, Hoat L, Wright P, Martens P. Hot spot detection and spatio-temporal dispersion of dengue fever in Hanoi, Vietnam. *Glob Health ACTION*. 2013;6:7–15.

494. Toan DTT, Hu W, Thai PQ, Hoat LN, Wright P, Martens P. Hot spot detection and spatio-temporal dispersion of dengue fever in Hanoi, Vietnam. *Glob Health Action* [Internet]. 2013 Jan 24 [cited 2013 Oct 18];6. Available from: <http://www.ncbi.nlm.nih.gov/pmc/articles/PMC3556563/>
495. Karine, Luu Le Loan, Tran Huu Hoang, Tran Khanh Tien, Francois, Rodhain, Anna-Bella Failloux. *Aedes Aegypti* in South Vietnam: Ecology, genetic structure, vectorial competence and resistance to insecticides. *Southeast Asian J Trop Med Public Health*. 2003;34(No 1):81–6.
496. Mihov C, Tuong CV, Tuong HP. A propos d'une épidémie du type des fièvres hémorragiques à Hanoi. *Folia Med*. 1959;1:169–73.
497. Tran KT, Vazeille-Falcoz M, Mousson L, Tran HH, Rodhain F, Ngugen TH, et al. *Aedes aegypti* in Ho Chi Minh City (Viet Nam): susceptibility to dengue 2 virus and genetic differentiation. *Trans R Soc Trop Med Hyg*. 1999 Dec;93(6):581–6.
498. Cuong HQ, Hien NT, Duong TN, Phong TV, Cam NN, Farrar J, et al. Quantifying the Emergence of Dengue in Hanoi, Vietnam: 1998–2009. *PLoS Negl Trop Dis*. 2011 Sep 27;5(9):e1322.
499. Brathwaite Dick O, San Martín JL, Montoya RH, del Diego J, Zambrano B, Dayan GH. The history of dengue outbreaks in the Americas. *Am J Trop Med Hyg*. 2012 Oct;87(4):584–93.
500. Kyle JL, Harris E. Global Spread and Persistence of Dengue. *Annu Rev Microbiol*. 2008;62(1):71–92.
501. Paupy C, Ollomo B, Kamgang B, Moutailler S, Rousset D, Demanou M, et al. Comparative role of *Aedes albopictus* and *Aedes aegypti* in the emergence of Dengue and Chikungunya in central Africa. *Vector Borne Zoonotic Dis* Larchmt N. 2010 Apr;10(3):259–66.
502. WHO | The mosquito [Internet]. WHO. [cited 2013 Oct 30]. Available from: <http://www.who.int/denguecontrol/mosquito/en/>
503. Kay BH, Tuyet Hanh TT, Le NH, Quy TM, Nam VS, Hang PVD, et al. Sustainability and cost of a community-based strategy against *Aedes aegypti* in northern and central Vietnam. *Am J Trop Med Hyg*. 2010 May;82(5):822–30.

504. Higa Y, Thi Yen N, Kawada H, Hai Son T, Thuy Hoa N, Takagi M. Geographic Distribution of *Aedes aegypti* and *Aedes albopictus* Collected from Used Tires in Vietnam. *J Am Mosq Control Assoc.* 2010 Mar 1;26(1):1–9.
505. Weatherbase, Hanoi, Vietnam Travel Weather Averages (Weatherbase). Canty and Associates LLC. 2012.
506. Cuong HQ, Hien NT, Duong TN, Phong TV, Cam NN, Farrar J, et al. Quantifying the Emergence of Dengue in Hanoi, Vietnam: 1998–2009. *PLoS Negl Trop Dis.* 2011 Sep 27;5(9):e1322.
507. Luo L, Liang H, Hu Y, Liu W, Wang Y, Jing Q, et al. Epidemiological, virological, and entomological characteristics of dengue from 1978 to 2009 in Guangzhou, China. *J Vector Ecol J Soc Vector Ecol.* 2012 Jun;37(1):230–40.
508. Halstead SB. More Dengue, More Questions. *Emerg Infect Dis.* 2005 May;11(5):740–1.
509. Halstead SB, Scanlon JE, Umpaivit P, Udomsakdi S. Dengue and chikungunya virus infection in man in Thailand, 1962-1964. IV. Epidemiologic studies in the Bangkok metropolitan area. *Am J Trop Med Hyg.* 1969 Nov;18(6):997–1021.
510. Huy R, Buchy P, Conan A, Ngan C, Ong S, Ali R, et al. National dengue surveillance in Cambodia 1980-2008: epidemiological and virological trends and the impact of vector control. *Bull World Health Organ.* 2010 Sep 1;88(9):650–7.
511. Thai KTD, Nagelkerke N, Phuong HL, Nga TTT, Giao PT, Hung LQ, et al. Geographical heterogeneity of dengue transmission in two villages in southern Vietnam. *Epidemiol Infect.* 2010 Apr;138(4):585–91.
512. Kongsomboon K, Singhasivanon P, Kaewkungwal J, Nimmannitya S, Mammen MP Jr, Nisalak A, et al. Temporal trends of dengue fever/dengue hemorrhagic fever in Bangkok, Thailand from 1981 to 2000: an age-period-cohort analysis. *Southeast Asian J Trop Med Public Health.* 2004 Dec;35(4):913–7.
513. Teixeira MG, Costa MCN, Coelho G, Barreto ML. Recent Shift in Age Pattern of Dengue Hemorrhagic Fever, Brazil. *Emerg Infect Dis.* 2008 Oct;14(10):1663–1663.
514. Phuong HL, Vries PJ de, Nga TT, Giao PT, Hung LQ, Binh TQ, et al. Dengue as a cause of acute undifferentiated fever in Vietnam. *BMC Infect Dis.* 2006 Jul 25;6(1):123.

515. Teng AK, Singh S. Epidemiology and New Initiatives in the Prevention and Control of Dengue in Malaysia. 2001 Dec [cited 2013 Nov 2]; Available from: <http://repository.searo.who.int/handle/123456789/15837>
516. Guzmán MG, Kouri GP, Bravo J, Soler M, Vazquez S, Morier L. Dengue hemorrhagic fever in Cuba, 1981: a retrospective seroepidemiologic study. *Am J Trop Med Hyg.* 1990 Feb;42(2):179–84.
517. Ooi E-E, Goh K-T, Gubler DJ. Dengue prevention and 35 years of vector control in Singapore. *Emerg Infect Dis.* 2006 Jun;12(6):887–93.
518. Rigau-Pérez JG, Vorndam AV, Clark GG. The dengue and dengue hemorrhagic fever epidemic in Puerto Rico, 1994-1995. *Am J Trop Med Hyg.* 2001 Feb;64(1-2):67–74.
519. Fox A, Hoa LNM, Simmons CP, Wolbers M, Wertheim HFL, Khuong PT, et al. Immunological and Viral Determinants of Dengue Severity in Hospitalized Adults in Ha Noi, Viet Nam. Rico-Hesse R, editor. *PLoS Negl Trop Dis.* 2011 Mar 1;5(3):e967.
520. Gupta G, Shah Y, Poudel A, Pun R, Pant K, Kshetri R, et al. Serological and Molecular Study of Dengue Viruses in Different Hospitals of Nepal. *Nepal J Med Sci* [Internet]. 2013 Feb 21 [cited 2013 Nov 13];2(1). Available from: <http://nepjol.info/index.php/NJMS/article/view/7646>
521. Guozhang Xu HD. An outbreak of dengue virus serotype 1 infection in Cixi, Ningbo, People's Republic of China, 2004, associated with a traveler from Thailand and high density of *Aedes albopictus*. *Am J Trop Med Hyg.* 2007;76(6):1182–8.
522. Ratsitorahina M, Harisoa J, Ratovonjato J, Biacabe S, Reynes J-M, Zeller H, et al. Outbreak of Dengue and Chikungunya Fevers, Toamasina, Madagascar, 2006. *Emerg Infect Dis.* 2008 Jul;14(7):1135–7.
523. Lozano-Fuentes S, Hayden MH, Welsh-Rodriguez C, Ochoa-Martinez C, Tapia-Santos B, Kobylinski KC, et al. The dengue virus mosquito vector *Aedes aegypti* at high elevation in Mexico. *Am J Trop Med Hyg.* 2012 Nov;87(5):902–9.
524. Romero-Vivas, Leake, Falconar. Determination of dengue virus serotypes in individual *Aedes aegypti* mosquitoes in Colombia. *Med Vet Entomol.* 1998;12(3):284–8.

525. Gratz NG. Critical review of the vector status of *Aedes albopictus*. *Med Vet Entomol*. 2004 Sep;18(3):215–27.
526. Richards SL, Anderson SL, Alto BW. Vector competence of *Aedes aegypti* and *Aedes albopictus* (Diptera: Culicidae) for dengue virus in the Florida Keys. *J Med Entomol*. 2012 Jul;49(4):942–6.
527. Do, Quang Ha, Vu, Thi Que Huong, Huynh, Thi Kim Loan, Dinh, Quoc Thong, Deubel, Vincent. Epidemic of dengue haemorrhagic fever in South Vietnam: Epidemiological and virological studies. *Trop Med*. 1995;36 (4):187–201.
528. Do Quang Ha, Nguyen Kim Tien, et al. Epidemic of dengue haemorrhagic fever in South Vietnam: Epidemiological and virological studies, 1987. *Dengue News Lett*. 1989 February;14:46–59.
529. Anders KL, Nguyet NM, Chau NVV, Hung NT, Thuy TT, Lien LB, et al. Epidemiological factors associated with dengue shock syndrome and mortality in hospitalized dengue patients in Ho Chi Minh City, Vietnam. *Am J Trop Med Hyg*. 2011 Jan;84(1):127–34.
530. Gubler DJ. Dengue and dengue hemorrhagic fever. *Clin Microbiol Rev*. 1998 Jul;11(3):480–96.
531. D Q Ha NTT. Dengue epidemic in southern Vietnam, 1998. *Emerg Infect Dis*. 2000;6(4):422–5.
532. Coudeville L, Garnett GP. Transmission Dynamics of the Four Dengue Serotypes in Southern Vietnam and the Potential Impact of Vaccination. *PLoS ONE*. 2012 Dec 10;7(12):e51244.
533. Vu-Quy-Dai, Nguyen-Thi Kim-Thoa. [Hemorrhagic fever in Vietnam in 1964-1965. Serologic study with a brief clinica and epidemiologic note]. *Bull Société Pathol Exot Ses Fil*. 1967 Feb;60(1):21–33.
534. Deller JJJ, Russell PK. An analysis of fevers of unknown origin in American soldiers in Vietnam. *Ann Intern Med*. 1967 Jun;66(6):1129–43.
535. Vu-Quy-Dai, Nguyen-Thi Kim-Thoa, Ly-Quoc-Bang. [Study of anti-Chikungunya antibodies in Vietnamese children in Saigon]. *Bull Société Pathol Exot Ses Fil*. 1967 Aug;60(14):353–9.

536. Cavrini F, Gaibani P, Pierro AM, Rossini G, Landini MP, Sambri V. Chikungunya: an emerging and spreading arthropod-borne viral disease. *J Infect Dev Ctries.* 2009;3(10):744–52.
537. Alladi Morhan. Chikungunya fever: clinical manifestation and management. editorial. *Indian J Med Res* 124,; 2006. 471-474 p.
538. Seneviratne SL, Gurugama P, Perera J. Chikungunya Viral Infections: An Emerging Problem. *J Travel Med.* 2007 Oct 9;14(5):320–5.
539. MACASAET FF. Further observations on chikungunya fever. *J Philipp Isl Med Assoc.* 1970;46(5):235–42.
540. WHO. History of Chikungunya. Available in website: (<http://www.chikungunya.in/history-of-chikungunya-disease.shtml>).
541. Duong V, Andries A-C, Ngan C, Sok T, Richner B, Asgari-Jirhandeh N, et al. Reemergence of Chikungunya Virus in Cambodia. *Emerg Infect Dis.* 2012 Dec;18(12):2066–9.
542. Shepard DS, Undurraga EA, Halasa YA. Economic and Disease Burden of Dengue in Southeast Asia. *PLoS Negl Trop Dis.* 2013 Feb 21;7(2):e2055.
543. Huber K, Le Loan L, Hoang TH, Tien TK, Rodhain F, Failloux A-B. *Aedes aegypti* in south Vietnam: ecology, genetic structure, vectorial competence and resistance to insecticides. *Southeast Asian J Trop Med Public Health.* 2003 Mar;34(1):81–6.
544. Cuong HQ, Hien NT, Duong TN, Phong TV, Cam NN, Farrar J, et al. Quantifying the Emergence of Dengue in Hanoi, Vietnam: 1998–2009. *PLoS Negl Trop Dis.* 2011 Sep 27;5(9):e1322.
545. Rabaa MA, Simmons CP, Fox A, Le MQ, Nguyen TTT, Le HY, et al. Dengue Virus in Sub-tropical Northern and Central Viet Nam: Population Immunity and Climate Shape Patterns of Viral Invasion and Maintenance. *PLoS Negl Trop Dis.* 2013 Dec 5;7(12):e2581.
546. Do TTT, Martens P, Luu NH, Wright P, Choisy M. Climatic-driven seasonality of emerging dengue fever in Hanoi, Vietnam. *BMC Public Health.* 2014 Oct 16;14(1):1078.
547. NIHE: Final Report on evaluation of communicable diseases surveillance system in Vietnam 2008. Hanoi: National Institute of Hygiene and Epidemiology.

548. Pham HV, Doan HT, Phan TT, Minh NNT. Ecological factors associated with dengue fever in a central highlands Province, Vietnam. *BMC Infect Dis.* 2011 Jun 16;11(1):172.
549. Rabaa MA, Simmons CP, Fox A, Le MQ, Nguyen TTT, Le HY, et al. Dengue Virus in Sub-tropical Northern and Central Viet Nam: Population Immunity and Climate Shape Patterns of Viral Invasion and Maintenance. Morrison AC, editor. *PLoS Negl Trop Dis.* 2013 Dec 5;7(12):e2581.
550. Phuong HL, de Vries PJ, Nga TTT, Giao PT, Hung LQ, Binh TQ, et al. Dengue as a cause of acute undifferentiated fever in Vietnam. *BMC Infect Dis.* 2006 Jul 25;6:123–123.
551. Pham HV, Doan HT, Phan TTT, Minh NNT. Ecological factors associated with dengue fever in a Central Highlands province, Vietnam. *BMC Infect Dis.* 2011;11:172.
552. Ross RW. The Newala epidemic. *J Hyg (Lond).* 1956 Jun;54(2):177–91.
553. Changing patterns of chikungunya virus: re-emergence of a zoonotic arbovirus [Internet]. [cited 2015 Mar 4]. Available from: http://vir.sgmjournals.org/content/88/9/2363.full?ijkey=3deea1c17dff4bb7821b6d33a06bcc2d6859008&keytype=tf_ipsecsha
554. Mackenzie JS, Chua KB, Daniels PW, Eaton BT, Field HE, Hall RA, et al. Emerging viral diseases of Southeast Asia and the Western Pacific. *Emerg Infect Dis.* 2001;7(3 Suppl):497–504.
555. Deller JJJ, Russell PK. An analysis of fevers of unknown origin in American soldiers in Vietnam. *Ann Intern Med.* 1967 Jun;66(6):1129–43.
556. Capeding MR, Chua MN, Hadinegoro SR, Hussain IIM, Nallusamy R, Pitisuttithum P, et al. Dengue and Other Common Causes of Acute Febrile Illness in Asia: An Active Surveillance Study in Children. *PLoS Negl Trop Dis.* 2013 Jul 25;7(7):e2331.
557. Duong V, Andries A-C, Ngan C, Sok T, Richner B, Asgari-Jirhandeh N, et al. Reemergence of Chikungunya Virus in Cambodia. *Emerg Infect Dis.* 2012 Dec;18(12):2066–9.
558. Gupta G, Shah Y, Poudel A, Pun R, Pant K, Kshetri R, et al. Serological and Molecular Study of Dengue Viruses in Different Hospitals of Nepal. *Nepal J Med Sci*

- [Internet]. 2013 Feb 21 [cited 2015 Sep 20];2(1). Available from: <http://nepjol.info/index.php/NJMS/article/view/7646>
559. Fox A, Le Nguyen Minh Hoa, Simmons CP, Wolbers M, Wertheim HFL, Pham Thi Khuong, et al. Immunological and Viral Determinants of Dengue Severity in Hospitalized Adults in Ha Noi, Viet Nam. *PLoS Negl Trop Dis*. 2011 Mar;5(3):1–8.
560. Luo L, Liang H, Hu Y, Liu W, Wang Y, Jing Q, et al. Epidemiological, virological, and entomological characteristics of dengue from 1978 to 2009 in Guangzhou, China. *J Vector Ecol J Soc Vector Ecol*. 2012 Jun;37(1):230–40.
561. Thai KTD, Phuong HL, Thanh Nga TT, Giao PT, Hung LQ, Van Nam N, et al. Clinical, epidemiological and virological features of Dengue virus infections in Vietnamese patients presenting to primary care facilities with acute undifferentiated fever. *J Infect*. 2010 Mar;60(3):229–37.
562. Rekol Huy, Buchy P, Conan A, Chantha Ngan, Sivuth Ong, Rabia Ali, et al. National dengue surveillance in Cambodia 1980--2008: epidemiological and virological trends and the impact of vector control. *Vigil Nac Dengue En Camboya Entre 1980 2008 Tend Epidemiológicas Viroológicas E Impacto Control Vector*. 2010 Sep;88(9):650–7.
563. Vega-Rúa A, Lourenço-de-Oliveira R, Mousson L, Vazeille M, Fuchs S, Yébakima A, et al. Chikungunya virus transmission potential by local *Aedes* mosquitoes in the Americas and Europe. *PLoS Negl Trop Dis*. 2015 May;9(5):e0003780.
564. Kaur P, Ponniah M, Murhekar MV, Ramachandran V, Ramachandran R, Raju HK, et al. Chikungunya outbreak, South India, 2006. *Emerg Infect Dis*. 2008 Oct;14(10):1623–5.
565. Vega-Rúa A, Zouache K, Girod R, Failloux A-B, Lourenço-de-Oliveira R. High level of vector competence of *Aedes aegypti* and *Aedes albopictus* from ten American countries as a crucial factor in the spread of Chikungunya virus. *J Virol*. 2014 Jun;88(11):6294–306.

Summary

Dengue and chikungunya are both transmitted by *Aedes aegypti* and *Aedes albopictus* and can cause potentially severe and or debilitating chronic disease. They are the fastest spreading diseases, in part because of the climate change. Vietnam is a hyperendemicity country for dengue and is at risk to be like neighboring Cambodia affected both by dengue and chikungunya and be an overlapping area of distribution for both viruses. The aim of this PhD work was therefore to assess the status of single and dual infections all over the country, investigate the presence of chikungunya, assess the efficiency of the surveillance procedures routinely established and assess the diversity of mosquito populations and their potential respective role. A first part of the PhD dissertation is devoted to a bibliographic review. The second part comprises three chapters associated to three different publications. The first chapter is devoted to a surveillance study in the general hospital of the Southern Province of Dong Thap. A cohort of 131 patients with acute fever symptoms was investigated for the presence of dengue and chikungunya. 101 patients out of 131 were confirmed with dengue. All four dengue serotypes were detected with a predominance of DENV2 and DENV4. No chikungunya infection was detected although reported in neighboring Cambodia. A differential efficiency of serological dengue detection was observed. Efficiency was 29% upon admission and 53% after seven days on the same patients. There is thus a clear risk of dengue being underestimated while chikungunya is not systematically detected. Changes in detection and surveillance procedures are therefore proposed to increase the efficiency of dengue detection and continue the monitoring the emergence of CHIKV. The second Chapter is dedicated to the respective role of *A. aegypti* and *A. albopictus* in the 2011 outbreak in the Northern capital city of Hanoi. Only DENV-1 and DENV-2 serotypes were detected from the 140 patients hospitalized. A positive correlation was found between the population density of *A. aegypti* and the number of human cases and duration of outbreaks. This was not observed for *A. albopictus*. Three pools of *A. aegypti* were positive with dengue virus, two with DENV-1 and one with DENV-2. This work indicate clearly the role of *A. aegypti* in the 2011 Hanoi epidemics. The last chapter of the PhD is devoted to a crosscutting country wide survey in five provinces border with Lao PDR and Cambodia. In this work, a total of 558 serum samples were collected from patients admitted in the 2012-2014 period in five provincial preventive

medicine centers with acute fever and symptoms compatible to DENV-CHIKV infection. All four dengue serotypes were found altogether but not in the same province. Only two serotypes were found at the maximum in a single province. No CHIKV was detected. A total of 1104 adult mosquitoes were collected inside and outside houses at the same place. Mosquito population density and vector indexes were assessed following capture of larvae. Differing densities of mosquito populations were found with the highest one being in the Long An province border with Cambodia. Dengue viruses were detected mostly in *A. albopictus*. CHIKV was also detected in *A. albopictus* mosquitoes. The phylogenetic analysis of the collected mosquitoes showed a large diversity of genotypes, all of them having been described in other parts of the world. This part of the PhD work underline the dual role of *A. aegypti* and *A. albopictus*, the increasing role of the latter and the high level of man-related very long distance mobility of mosquitoes. This work underlines the need of novel approaches for surveillance both at the clinical and at the entomological level to efficiently tackle the risk of dengue and chikungunya outbreaks.

Résumé

La dengue et le chikungunya sont des maladies transmises par *Aedes aegypti* et *Aedes albopictus* pouvant causer des pathologies sévères et des atteintes incapacitantes chroniques. Ce sont aussi les maladies qui se diffusent le plus rapidement, en partie à cause du changement climatique. Le Vietnam est une zone d'hyperendémicité pour la dengue et à risque pour le chikungunya comme le Cambodge voisin qui est atteint par les deux maladies, et représente une source de diffusion. L'objectif de cette thèse est d'évaluer le statut de ces deux maladies et la présence du chikungunya, d'évaluer l'efficacité du système de surveillance et d'évaluer la diversité des populations de moustiques vecteurs et leurs rôles respectifs dans la transmission. Une première partie de la thèse est dévolue à une revue bibliographique. La seconde partie comprend trois chapitres associés à trois publications. Le premier chapitre est consacré à une étude de la surveillance à l'hôpital général de la province sud de Dong Thap. Une cohorte de 131 patients avec une fièvre aiguë a été étudiée pour tester la présence de dengue et de chikungunya. 101 patients sur 131 ont été positifs pour la dengue et les quatre sérotypes ont été détectés avec une prédominance de DENV1 et DENV4. Aucun cas de chikungunya n'a été détecté. Une variation d'efficacité dans la détection sérologique de la dengue a été observée avec un passage de 29% lors de l'admission à 53% sept jours après admission. Il y a donc clairement un risque de sous-estimation de la dengue alors que le chikungunya, n'est pas du tout testé. Des changements dans la procédure de détection et de surveillance sont proposés pour améliorer l'efficacité de la surveillance et surveiller l'émergence du chikungunya. Le deuxième chapitre est consacré à l'étude du rôle respectif d'*A. aegypti* et *A. albopictus* dans l'épidémie de Dengue de 2011 à Hanoi. Seuls DENV1 et DENV2 ont été détectés chez les 140 patients étudiés. Une corrélation positive a été observée entre la densité de population d'*A. aegypti* et le nombre de cas humains et la durée des épidémies. Ceci n'a pas été observé chez *A. albopictus*. Trois lots d'*A. aegypti* se sont révélés positifs pour la dengue, deux pour DENV1 et un pour DENV2. Cette étude montre clairement le rôle d'*A. aegypti* dans l'épidémie de 2011 à Hanoi. Le dernier chapitre est consacré à une analyse transversale sur 5 provinces frontalières du Laos et du Cambodge. 558 sérums collectés chez des patients admis pour fièvre aiguë et de symptômes compatibles avec la dengue et chikungunya entre 2012 et 2014 dans des centres de médecine préventive. Les

quatre sérotypes ont été détectés mais pas tous dans la même province. Seulement deux sérotypes ont été détectés au maximum dans une même province. Le chikungunya n'a pas été détecté. Un total de 1104 moustiques adultes a été prélevé dans les mêmes zones à l'intérieur et à l'extérieur des habitations. La densité de population de moustiques et les indices entomologiques ont été évalués suite à la capture de larves. Des densités très différentes ont été observées et la densité la plus importante a été obtenue dans la province de Long An, voisine du Cambodge. Le virus de la dengue a été détecté principalement chez *A. albopictus*. Le virus du chikungunya a également été détecté chez *A. albopictus*. L'analyse phylogénétique des moustiques collectés a montré une grande diversité génétique avec des génotypes décrits sur d'autres continents. Cette partie de la thèse met en évidence le rôle différentiel d'*A. aegypti* et *A. albopictus*, le rôle croissant de ce dernier et le transport anthropique des moustiques sur de grandes distances. Ce travail souligne le besoin de nouvelles approches de surveillance, au niveau clinique et au niveau entomologique, pour s'attaquer de façon efficace au risque épidémique de dengue et de chikungunya.