



HAL
open science

3D modeling of city building and lifecycle simulation

Wenhua Zhu

► **To cite this version:**

Wenhua Zhu. 3D modeling of city building and lifecycle simulation. Mechanics [physics.med-ph]. Université de Technologie de Compiègne, 2017. English. NNT : 2017COMP2344 . tel-01768997

HAL Id: tel-01768997

<https://theses.hal.science/tel-01768997>

Submitted on 17 Apr 2018

HAL is a multi-disciplinary open access archive for the deposit and dissemination of scientific research documents, whether they are published or not. The documents may come from teaching and research institutions in France or abroad, or from public or private research centers.

L'archive ouverte pluridisciplinaire **HAL**, est destinée au dépôt et à la diffusion de documents scientifiques de niveau recherche, publiés ou non, émanant des établissements d'enseignement et de recherche français ou étrangers, des laboratoires publics ou privés.

Par **Wenhua ZHU**

3D modeling of city building and lifecycle simulation

Thèse présentée
 pour l'obtention du grade
 de Docteur de l'UTC

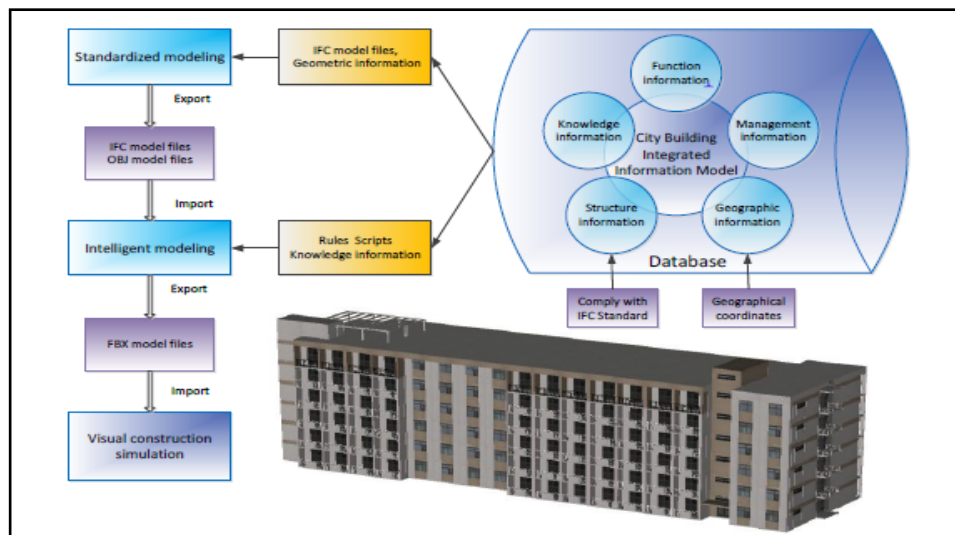

Soutenue le 28 mars 2017

Spécialité : Mécanique Avancée : Unité de recherche en Mécanique - Laboratoire Roberval (UMR-7337)

D2344

Ecole doctorale n°71: Science pour l'Ingénieur

THÈSE DE DOCTORAT

pour obtenir le grade de docteur délivré par

L'UNIVERSITE DE TECHNOLOGIE DE COMPIEGNE

Spécialité : Mécanique Avancée

Présentée et soutenue publiquement par

Wenhua ZHU

le 28 Mars 2017

3D modeling of city building and lifecycle simulation

Membres du jury :

DENEUX Dominique, Professeur des Universités, Université de Valenciennes et du Hainaut-Cambrésis, **rapporteur**

ROUCOULES Lionel, Professeur des Universités, Ecole Nationale Supérieure d'Arts et Métiers, LSIS, Aix-en-Provence, **rapporteur**

ANTALUCA Eduard, Enseignant Chercheur, Université de Technologie de Compiègne, **examineur**

BATOZ Jean-Louis, Professeur émérite, Université de Technologie de Compiègne, **examineur**

BRICOGNE Matthieu, Enseignant Chercheur, Université de Technologie de Compiègne, **examineur**

EYNARD Benoît, Enseignant Chercheur HDR, Université de Technologie de Compiègne, *directeur de thèse*

REMY Sébastien, Maître Chercheur HDR, Université de Technologie de Troyes, *co-directeur de thèse*

ZOLGHADRI Marc, Professeur des Universités, Supméca, Laboratoire QUARTZ, **examineur**

Modélisation 3D du bâtiment urbain et simulation du cycle de vie

Soutenue le 28 mars 2017 devant le jury composé de :

- M. J-L. BATOZ (Président)
- M. B. EYNARD (Directeur de thèse)
- M. S. RÉMY (Directeur de thèse)
- M. D. DENEUX (Rapporteur)
- M. L. ROUCOULES (Rapporteur)
- M. E. ANTALUCA
- M. M. BRICOGNE-CUIGNIÈRES
- M. M. ZOLGHADRI

Acknowledgements

I believe that last three and a half years were a very valuable time in my life. What I learned is not only an advanced academic knowledge on research but also many different attitudes and methods in solving practical problems. At the end of the thesis, I would like to extend my sincere thanks to all the teachers and friends who have helped me.

Firstly I would like to acknowledge my doctoral advisor, Professor Benoit EYNARD, for his patient support, invaluable guidance and constructive advice for my research. Most of all, his endless encouragements were the most powerful source that makes the thesis succeed.

I would like to acknowledge my co-advisors, Professor Sebastien REMY and Matthieu BRICOGNE, for their support, guidance and encouragement.

I would also like to express my gratitude to Professor Mon Zen TZEN, Fabien PFAENDER and Professor Wanggen WAN for all their supports and helps. In particular, I wish to thank the sino-french joint ComplexCity Lab for the project.

Moreover, I would like to thank the Laboratory Roberval and Department of Mechanical Systems Engineering in University of Technology of Compiègne for providing me with a good learning environment and research conditions. I would also like to thank the leaders and colleagues of Shanghai University and Shanghai Polytechnic University for sharing their ideas and time with me. Especially, I would like to thank the President of Shanghai Polytechnic University, Professor Tao YU, for his strong support of this thesis.

In addition, I am grateful to thank my colleagues and friends in Compiègne for their support and time. They are Julien Le DUIGOU, Magali BOSCH-MAUCHAND, Alexandre DURUPT, Chen ZHENG, Jinhua XIAO, et al. and I am grateful to thank the support from the Embassy of France in China and the Embassy of China in France.

This thesis could have never been completed without the love, support and patience of my family. I am deeply indebted to them for their understanding and encouraging for my research.

Lastly, I would like to thank the experts, the judges of the review of this thesis for their valuable advice. Many thanks for your attentions!

Abstract

With the construction and development of the smart city, how to construct the realistic 3D model of the large-scale city buildings quickly and efficiently which becomes the research hotspot. In this thesis, a novel 3D modeling approach is proposed to quickly and efficiently build 3D model of large-scale city buildings based on shape grammar and facade rule modeling. Building Information Model(BIM) is an important technical means to enhance the construction industry, for the city building design and construction, how to better research and application of BIM technology which is the key, in this thesis City Building Integrated Information Model (CBIIM) is specified to manage the information of building lifecycle effectively and realize the information sharing and exchanging.

This thesis has studied the acquisition and processing of the modeling data. Google Earth and ArcGIS software are mainly used to acquire and process image-maps data and elevation-maps data of the target area, these two kinds of data match and overlay, which can generate 3D city terrain data with geographic location information. Then OpenStreetMap is used to acquire road data of the target area, and it can be optimal processed to the necessary road network by JOSM software. 3D laser scanning technology is used to collect building surface texture images and create the point clouds model of the target architecture modeling so as to get the modeling dimensions by measurement. On this basis, this thesis mainly has studied the principle and the process of CGA rule to create building models, and studied the method that can separate architectural elements using image segmentation to generate CGA rule automatically and to create building model furtherly. Thus 3D building models have been established in the CityEngine software using CGA rules and facade modeling technology.

This thesis has specified the City Building Integrated Information Model (CBIIM) based on BIM. The city building information are classified and integrated, and the building and component was described with the IFC standard, in order to manage the informations of building lifecycle effectively. This thesis studies the integrated information association model technology, that it can realize standardized component design with associated features and intelligent building design with associated parameters in knowledge rules combined with IFC. The construction simulation technology is studied. The knowledge rules in the integrated information model provide a reliable reference for the construction simulation, and the simulation scene is created through the invoking the integrated information model, thus the construction simulation process is

completed by the program.

Taking Baoshan Campus of Shanghai University as an example, the modeling process of the whole scene is illustrated, and the modeling steps of all kinds of 3D objects are described in detail to solve the specific problems in the actual modeling process. Thus the feasibility and validity of the procedural intelligent modeling approach are verified. Taking the dormitory of Shanghai University as an example, a simulation scene and the simulation model were created by the integrated informations, combined with the relevant construction information the construction simulation was completed by the program. Thus the feasibility and validity of the CBIIM are verified.

Key Words: Procedural Intelligent Modeling, Integrated Information Model, CGA Modeling, Façade Modeling, Construction Simulation

Table of Contents

Acknowledgements	I
Abstract.....	II
Table of Contents	IV
List of Figures.....	V
List of Acronyms.....	VIII
Chapter 1. Introduction.....	1
1.1. Research background	1
1.2. Research significance and characteristics.....	4
1.3. The topic source and the main content	6
1.4. Structure of the thesis	7
1.5. Chapter summary	9
Chapter 2. Literatures Reviews	10
2.1. State of the art of 3D city building modeling methods.....	10
2.2. State of the art of building information integration and construction simulation	15
2.3. Chapter summary	20
Chapter 3. Research on Acquiring Modeling Data Methods	21
3.1 Study on the method of constructing geographical data	21
3.2 3D spatial data acquisition method	28
3.3 Texture data acquisition method	32
3.4 Chapter summary	34
Chapter 4. Research on Procedural Intelligent Modeling Approach of City Buildings	35
4.1 Rule modeling technology	35
4.2 Façade rule modeling technology with laser scanning.....	41
4.3 The application example of the novel approach.....	47
4.4 Chapter summary	63
Chapter 5. City Building Integrated Information Model.....	65
5.1. Building information integration analysis	65
5.2. Construction of City Building Integrated Information Model (CBIIM)	66
5.3. IFC-based building information description	73
5.4. Chapter Summary	79
Chapter 6. Integrated Information Associated Model Technology.....	80
6.1. Integrated information associated model technology analysis.....	80
6.2. Building components standardization associated model technology.....	88
6.3. Rule-based intelligent modeling technology	94
6.4. Chapter summary	115
Chapter 7. Building Construction Simulation Technology	116
7.1. Analysis of visual construction simulation Technology.....	116
7.2. Simulation model processing and collision detection technology	120
7.3. Visual construction process planning.....	125
7.4. An application example for building construction simulation	129
7.5. Chapter summary	135
Chapter 8. Conclusion and Future Work	136
8.1. Conclusion	136
8.2. Discussion.....	138
8.3. Future work.....	139
References.....	141
Publications	150
Résumé.....	151

List of Figures

Figure 3. 1 Image of Baoshan Campus of Shanghai University	23
Figure 3. 2 The location of the four key points in the image	25
Figure 3. 3 Baoshan Campus of Shanghai University contour map	27
Figure 3. 4 Baoshan Campus of Shanghai University Digital Elevation Map.....	28
Figure 3. 5 Basic terrain data of Baoshan Campus.....	28
Figure 3. 6 FARO Focuse3D laser scanner	29
Figure 3. 7 Scanner station design	30
Figure 3. 8 Pretreatment of point cloud	30
Figure 3. 9 Generated point cloud model	31
Figure 3. 10 FARO Focuse3D Principle of measuring building height	32
Figure 3. 11 The collected texture image.....	33
Figure 4. 1 Example of shape grammar	35
Figure 4. 2 CGA Rule Subdivision Process	37
Figure 4. 3 CGA rule modeling process	38
Figure 4. 4 Generating a variety of models with the same rule.....	38
Figure 4. 5 Cost comparisons between manual modeling and rule modeling.....	39
Figure 4. 6 OBJ models of railing and goal	41
Figure 4. 7 Building facade image vanishing point.....	42
Figure 4. 8 Change of the Façade and parallel lines after correction.....	43
Figure 4. 9 Building facade segmentation.....	45
Figure 4. 10 3D building components added to the building model	46
Figure 4. 11 Completing rule substitution with symmetry	46
Figure 4. 12 Attribute information edition.....	48
Figure 4. 13 Statistical report forms.....	48
Figure 4. 14 File format supported by CityEngine	49
Figure 4. 15 Classification of objects in Baoshan campus of Shanghai University	49
Figure 4. 16 Workflow of the novel modeling approach for campus	50
Figure 4. 17 The overall flow chart for the dormitory #1 with CGA rules.....	52
Figure 4. 18 Preparation of CGA rules for the front façade of dormitory # 1	55
Figure 4. 19 The 3D model of dormitory.....	56
Figure 4. 20 Before and after processing by Crop Image tool.....	56
Figure 4. 21 Teaching building E model creation process	57
Figure 4. 22 Road template style in CityEngine	58
Figure 4. 23 The road network obtained in OpenStreetMap.....	59
Figure 4. 24 JOSM modification interface and modified OSM file.....	59
Figure 4. 25 Road network width and curvature before and after editing	60
Figure 4. 26 Road network width and curvature before and after editing	60
Figure 4. 27 Final optimized road network	60
Figure 4. 28 Road division.....	61
Figure 4. 29 Road CGA application principle.....	61
Figure 4. 30 Road surface part of the texture material.....	62
Figure 4. 31 The OBJ model of some road facilities	62
Figure 4. 32 The created road model	62
Figure 4. 33 Effect diagram of Lawn, water, trees, street lighting.....	63
Figure 4. 34 The whole model scene at Baoshan Campus of Shanghai University.....	64
Figure 5. 1 Classification of Integrated Information.....	68
Figure 5. 2 Structure composition of Integrated Information Model.....	71
Figure 5. 3 System process framework of CBIIM	73
Figure 5. 4 IFC model information architecture.....	75
Figure 5. 5 Primary derived relationship of IfcRoot	76
Figure 5. 6 Building components based on IFC standards	77

Figure 5. 7 Example of integrated information representation of components	78
Figure 5. 8 Integration of building components and integrated information model	79
Figure 6. 1 Integrated information association model technology	80
Figure 6. 2 Standardized modeling design	81
Figure 6. 3 Information-driven modeling.....	84
Figure 6. 4 Intelligent modeling design.....	85
Figure 6. 5 Variant definitions in Inspector model options.....	88
Figure 6. 6 The python script console	88
Figure 6. 7 Simplified model for T-pillars	90
Figure 6. 8 Data exchange based on IFC.....	91
Figure 6. 9 Relationship between standardized modeling and database	94
Figure 6. 10 Building component definition method.....	95
Figure 6. 11 Parameter Variable Code	97
Figure 6. 12 Parameter variable controls.....	98
Figure 6. 13 Building outline creation process.....	99
Figure 6. 14 Floor and Tile corresponding to the index.....	99
Figure 6. 15 The building is stretched and layered in the Y direction.....	100
Figure 6. 16 Hierarchy diagram	100
Figure 6. 17 Floor (split.index) Split the effect comparison and hierarchical	101
Figure 6. 18 Tile (floorIndex, tileIndex) and its derivatives.....	102
Figure 6. 19 Tile (floorIndex, tileIndex) Comp (f) split effect comparison and its hierarchical graph....	103
Figure 6. 20 Corresponding code	103
Figure 6. 21 Corresponding flow chart	104
Figure 6. 22 FrontFacade (floorIndex, tileIndex) before and after the comparison.....	104
Figure 6. 23 Outline of the building	105
Figure 6. 24 Bottom Façade corresponding area	106
Figure 6. 25 BottomFacade (floorIndex, tileIndex) extends the Y direction split.....	106
Figure 6. 26 Flow chart of BedRoomFront	107
Figure 6. 27 BedRoomFront effect changes and hierarchical relationship diagram	108
Figure 6. 28 Flow chart of BedRoomFront_TopFacade	109
Figure 6. 29 BedRoomFront_TopFacade effect changes and hierarchical relationship diagram	110
Figure 6. 30 Flow chart of BedRoomFront_RightFacade.....	111
Figure 6. 31 BedRoomFront_RightFacade effect changes and hierarchical relationship diagram.....	112
Figure 6. 32 Flow chart of BedRoomFront_21	112
Figure 6. 33 BedRoomFront_21 effect changes and hierarchical relationship diagram	113
Figure 6. 34 Flow chart of LCorridor_21_LeftFacade.....	114
Figure 6. 35 LCorridor_21_LeftFacade effect change and hierarchy diagram	114
Figure 6. 36 Flow chart of StairCase	115
Figure 6. 37 Effect of comparison chart with stairs.....	115
Figure 7. 1 Visual construction simulation and information integration	116
Figure 7. 2 Building lifecycle simulation types	117
Figure 7. 3 Visual Construction Simulation Technology.....	120
Figure 7. 4 Simulation Model and Lightweight technology	121
Figure 7. 5 Collider classification	123
Figure 7. 6 Adding a Box Collider to the Wall.....	124
Figure 7. 7 Character Add Capsule Collider.....	124
Figure 7. 8 Construction process planning content	125
Figure 7. 9 System-level construction simulation steps.....	127
Figure 7. 10 Component Level Construction Process Planning.....	128
Figure 7. 11 Scene preparation process.....	130
Figure 7. 12 Obtain the simulation scene terrain image.....	130
Figure 7. 13 3D model of building components OBJ.....	131
Figure 7. 14 Dormitory model by rule modeling	131
Figure 7. 15 Unity Simulation Scene	132

Figure 7. 16 Construction simulation flow.....	133
Figure 7. 17 Simulaiton information C# program.....	134
Figure 7. 18 Construciton path planning.....	134

List of Acronyms

3D	Three Dimension
CAD	Computer Aided Design
GIS	Geographic Information System
DEM	Digital Elevation Model
CGA	Computer Generate Architecture
SG	Shape Grammar
OSM	Open Street Map
UTM	The Universal Transverse Mercator
LiDAR	Light Detection And Ranging
ICT	Information and Commucation Technology
IoT	Internet of Things
BIM	Building Imformation Model
CBIIM	City Building Integrated Information Model
BLM	Building Lifecycle Management
IFC	Industry Foundation Classes
STEP	STandard for the Exchange of Product
OBJ	File format, a geometry definition file for building component
FBX	File format, for buildings and scence
VR	Virtual Reality

Chapter 1. Introduction

1.1. Research background

With the rapid development of industrialization, China is experiencing the world's largest urbanization process. According to the data released by Chinese National Bureau of Statistics, the urbanization rate has risen sharply from 17.92% in 1978, China's urbanization rate in 2012 is more than half, has reached 51.27%, it is the first time that urban population exceeds the rural population. Chinese social structure has undergone a historic change, which is from the era of rural society as the main body into the era of urban society as the main body [1]. By end of 2015 Chinese urbanization rate reached 56.1% [2], the urban resident population reached 770 million. In the "City Blue Book: Development Report of Chinese City No.8" pointed out, it is expected that Chinese urbanization rate will reach about 60% in 2020, Chinese urban population is expected to nearly 1 billion. In order to accommodate these new urban populations, it is necessary to build up to 40 billion square meters of living space in the city. Although urbanization promotes socio-economic development, it brings unsustainable problems to the city. It brings great challenges to city planning and operation, which makes the city bear the population, resources, environment, all aspects of the enormous social pressure, seriously restricting the development of modern cities. From the history of city development, any city has the process of its occurrence, development, prosperity and final decline. Of course, the development of the city is not linear, the cycle of prosperity and recession will bring the oscillation of city development. To study the life cycle of the city is one of the main problems to keep the city healthy development, which can prevent the city decline and maintain the long-term prosperity.

The smart city is a city form under the knowledge society innovation environment supported by the new generation of information technology, which is the advanced developed city form of information technology after the digital city. With the rapid development of advanced information and communication technology (ICT), Internet of Things, cloud computing and Big data etc., IBM company has put forward the concept of "smart earth" in the speech "Smart Earth: The Agenda of the Next Generation", it focused on the smart city. Information port is the city of information technology 1.0, digital city

is the city of information technology 2.0, and the smart city is the city of information technology 3.0. Smart city is based on the digital city which takes the Internet of Things (IoT) as the fifth infrastructure, it takes advantage and integrates more advanced technology to promote the interaction ability between peoples to improve the city's intelligence [3]. Therefore, the smart city is a high-end infrastructure, efficient management services, vibrant industry, friendly environment and a new city form with the future characteristics.

City built on the basis of the building, building depends on the city. Impression of a city is mainly high-rise buildings and structures, and then is roads, transport, greening and facilities, which are constrained by the building. Thus, the building is the main part of a city, is a symbol of the city, and is an appearance of the city. All walks of life in city are inseparable from the building. From residential to commercial buildings, from office buildings to hotels, from pavilions to green squares, from ancient buildings to public facilities, all these are buildings. Therefore, the building is the soul of the city, is the backbone of the city, and is the monument of the city.

As the carrier of the smart city, the city 3D building model is the foundation of the study of the smart city, is t an important part of the construction of the smart city. With the continuous development of smart city, the demand of 3D model of city building is also increasing. At present, 3D modeling methods of city building include the following: a) CAD-based 3D modeling method of city building; b) 3D modeling method of city building based on 2D GIS; c) Image-based 3D modeling method of city building [4]. The 3D modeling method of city building based on CAD is to build the 3D CAD model by using the traditional 3D modeling software such as SketchUp and 3D MAX, usually a 3D CAD model is composed of one or more mesh models, so it can express the detailed geometric characteristics of the building, however the CAD modeling process includes complex human-computer interaction process and a large number of manual operations, and the data volume of model is large, it is difficult to adapt to large-scale rapid modeling needs [5]. Although 3D modeling method of city building based on 2D GIS can quickly build large-scale 3D model of city buildings, but the bigger drawback is that it can only express a relatively simple and regular buildings, complex shape of the 3D model of city building is difficult to create, at the same time, the lack of accurate 3D data and texture information, the building model is lack of realism [6]. Image-based 3D modeling method of city building takes advantage of image data and digital photogrammetry to establish digital

terrain model, and then create a 3D model of the building by texture mapping. But the 3D building model based on image can not describe all the details and characteristics of the buildings, it is difficult to meet the needs of close observation and indoor roaming [7]. Therefore, focusing on the construction and development of smart city, how to build a realistic 3D model of large-scale city building quickly and efficiently becomes the research hotspot.

With the development of the smart city, construction industry which is committed to infrastructure construction has got a new round of development opportunities. From 2009 to 2020, Asia-Pacific region's emerging construction market is expected to increase of 125%. In 2020 China will become the largest global market of construction, the market value is expected to be \$ 2.4 trillion. The development of the construction market is not consistent with the continuous reduction of Chinese labor, the traditional construction industry which relies heavily on labor resources has faced the problem of enormous labor shortages. According to statistics, in 2014, economic growth is declined, at the same time the proportion of working-age population has also declined, from 16 to 59-year-old working age population in 2014 decreased by 371 million, the demise of the demographic dividend has also become one of the new normal appearances of Chinese economy [8]. Therefore, the traditional construction industry which heavily relies on resource consumption and large quantities of cheap labor resources can no longer meet the requirements of the new times. The construction industry needs to deepen the informatization construction in order to steadily improve the competitiveness of Chinese construction engineering enterprises.

Construction of informatization in the construction industry is to combine the advanced information technology with building lifecycle, it takes advantage of computer, communication, control, network, system integration and information security technology to transform and upgrade the design, construction, management and service levels in the construction industry. After several decades of development, information technology in Chinese construction industry has rapidly developed. In engineering design, computer-aided design (CAD) technology is more popular [9], which improve the design efficiency. However, application of informatization technology in most of the projects is still confined to some processes [10]. Information technology has played an important role in architectural design, but at present it still can not realize to manage the information in the whole building lifecycle, and due to the lack of unified information standards,

effective integration, sharing of information can not be achieved between different systems of building application [11]. Computer systems used in various stages of construction are isolated and self-contained, resulting in information occlusion, which makes it impossible to share information, thus forming an "information island" phenomenon [12]. In the whole building lifecycle, including the design, construction, use and maintenance phases will generate a series of information of building and components, how to effectively store, use and share these informations, it appears very significant. But currently due to degree of informatization in the construction industry is not high, the standards of building design, construction are not uniform, information sharing is not smooth, and the lack of a unified information management, all these will bring difficulties to achieve the construction industry informatization. Therefore, focusing on the construction industry information, how to build an integrated information model to effectively manage the informations of building lifecycle, to achieve building information sharing and exchange, to improve the construction quality and efficiency by the construction process simulation. It will play an important role to the actual implementation of the construction engineering.

1.2. Research significance and characteristics

The research on the 3D modeling method of city building has great practical significance and application value, which is mainly reflected in the following aspects:

(1) The city administrative department can take advantage of the 3D model of city building intuitive understanding of city development, and then for the city's planning, construction and improvement to provide support. For example, 3D model of city building can be used to analysis the traffic situation to improve the traffic environment.

(2) With the rapid development of film and television entertainment industry, experts can use the 3D model of city building to produce the film with surreal effects, to develop the interactive virtual reality game with the visual impact, to improve the level of film and game production, to promote the development of film and television entertainment industry.

(3) Google, Baidu and other network technology companies are competing to launch the city electronic map which is based on 3D model of building with a 3D roaming effect. In order to meet the diverse information needs of city residents, they provide more efficient, fast and convenient geographic information inquiry service combined with GIS function.

The main purpose of this thesis is to study the 3D procedural intelligent modeling method of city building, to further improve the speed of modeling and expand modeling range. In this thesis CGA rules, facade images and 3D laser scanning technology are adopted to achieve fast and efficient, large-scale 3D modeling of city building, then a realistic large-scale 3D virtual scene is established, it can greatly reduce the labor costs and improve the modeling efficiency and model quality, and provide technical support for the smart city construction. In this thesis the 3D modeling technology of city buildings is characterized by the following aspects:

(1) This procedural intelligent 3D modeling method can take advantage of the 3D laser scanning technology to obtain various modeling data, which can save a lot of time and improve the modeling speed.

(2) The model established by this procedural intelligent 3D modeling method and the whole scene have real geographical position information and terrain elevation information.

(3) This procedural intelligent 3D modeling method realizes the parametric modeling of city buildings through the compilation of CGA rules.

(4) This procedural intelligent 3D modeling method combine CGA rules with image segmentation modeling technology, which enriches the modeling approach and improves the modeling efficiency.

(5) This procedural intelligent 3D modeling method is suitable for large-scale modeling of complex scenes, the modeling cost is greatly reduced, the modeling efficiency is improved and the modeling quality is improved.

Currently, the level of informatization in Chinese construction industry has been unable to meet the needs of the status. The gap of information has resulted in occlusion of information, which hinder the sharing of information and limit the development of information technology. The level of industrialization in Chinese construction industry is still at a very low degree, which is the work of construction standardization lags behind and the new building structural system is still in the exploratory stage. City Building Integrated Information Model is specified to manage the informations in building lifecycle effectively and to realize the information sharing and exchange, which can solve the problem of information fault and provides a powerful tool for the informatization construction in construction industry. At a higher level to explore the potential value of information is the current trend of information technology development, to promote Chinese construction industry from the "the times of number" to "the times of quality"

[13]. The significance and characteristics of this subject are mainly reflected in the following aspects:

(1) Focusing on the informatization of construction industry, City Building Integrated Information Model is put forward to manage the informations in building lifecycle effectively and to achieve building information sharing and exchange.

(2) Integrated information association model combines with the international foundation standards to drive the standardization modeling of building and its components, and to drive the intelligent modeling of buildings rapidly with the knowledge rule informations.

(3) Integrated information model are used to drive the construction process simulation to enhance the efficiency and quality of construction, which play an important role for the actual implementation of the construction project.

1.3. The topic source and the main content

The subject of the thesis comes from Sino-French cooperation project "3D modeling of city building and lifecycle simulation", which is the sub-project of "Urban metabolism and sustainable development". Its main research content is: focusing on the construction and development of smart city, the digital technology and virtual simulation technology are put into the city building research, which can get the integration innovation in the city building 3D modeling and lifecycle simulation technology, and provide support technology for the smart city construction to reduce the cost of digital city, thus it can improve the construction efficiency and quality of city buildings and enhance the research and development capabilities in smart city construction..

Currently, with the construction and development of smart city, 3D modeling technology and informatization of city building is in a stage of rapid development. Based on the summary and analysis of the relevant research, this thesis studies the key technologies of procedural intelligent modeling and building informatization. The main contents of the study include the following aspects:

(1) This thesis summarizes the development and research state of art of the key technologies of 3D modeling of city buildings, and analyzes the shortcomings and limitations of the existing 3D modeling techniques of city buildings. This thesis analyzes the demand of building informatization, and explores the integrated information

association model technology.

(2) The methods to acquire and process the various modeling data for modeling necessary are studied, these modeling data include geography topographic data, 3D spatial data and texture data. Then the methods to create 3D terrain with geographic location information and elevation model are studied.

(3) A procedural intelligent 3D modeling approach is proposed in this thesis, which is introduced in detail to combine the CGA rule modeling technology with the façade modeling technology. Then the modeling idea how to create the entire scene is analyzed feasibly, and the method how to quickly obtain the road network with geographical position information and elevation information are studied to match the terrain image map.

(4) This thesis specifies the City Building Integrated Information Model (CBIIM). The demand for building information integration is analyzed, and then the contents of CBIIM are described, IFC Standard is introduced to describe the building components.

(5) Integrated information association model technology is studied to design the building and its components. Combined with the IFC standard and related information in CBIIM, building model is driven by a variety of associated information.

(6) The visual construction simulation of city building is illustrated. The system structure of visual construction simulation is analyzed, the simulation scene and simulation model is designed with the integrated informations, and the building construction process is completed by the program.

1.4. Structure of the thesis

This thesis is divided into eight chapters, the arrangement of each chapter and research contents are as follows:

Chapter 1 Introduction

This chapter introduces the research background, research significance and characteristics, the source of the topic and the main research content, the structure of the thesis.

Chapter 2 Literature review

This chapter summarizes the development and research status of 3D modeling technology of city buildings, and summarizes the development and research status of building information model and construction simulation technology.

Chapter 3 The methods to acquire and process the modeling data

This chapter mainly introduces the method how to acquire and process the modeling data, these data includes geographic terrain data, 3D spatial data and texture data. Then the methods how to create 3D terrain with geographic location information and elevation model are studied. Moreover the model required sizes are obtained by 3D laser scanning measurement.

Chapter 4 Research on procedural intelligent 3D modeling approach of city building

This chapter introduces the rule modeling based on shape grammar and image based façade modeling. The procedural intelligent 3D modeling approach is proposed to combine CGA modeling with façade modeling. Taking Baoshan Campus of Shanghai University as an example, Thus the feasibility and validity of the procedural intelligent 3D modeling method are verified.

Chapter 5 City Building Integrated Information Model

This chapter mainly constructs the City Building Integrated Information Model(CBIIM). The demand for building information integration is analyzed, and then the contents of CBIIM are described, IFC Standard is introduced to describe the building components.

Chapter 6 Integrated information associated model technology

This chapter studies integrated information association model technology, which is used to design the building and its components. Combined with the IFC standard and related information in CBIIM, building model is driven by a variety of associated information.

Chapter 7 Building Construction Simulation Technology

This chapter mainly studies the building visual construction simulation technology. The visual construction simulation of city building is illustrated. The system structure of visual construction simulation is analyzed, the simulation scene and simulation model is designed with the integrated informations, and the building construction process is completed by the program.

Chapter 8 Conclusion and future work

This chapter mainly summarizes and discusses the main work and research results of the thesis. According to the current research situation, further research work is prospected

1.5. Chapter summary

This chapter introduces the research background, research significance and characteristics, the source of the topic and the main research content, the structure of the thesis.

Chapter 2. Literatures Reviews

2.1. State of the art of 3D city building modeling methods

2.1.1 CAD-based interactive modeling method

CAD-based interactive modeling method mainly refers to the use of a number of software tools for the platform through the interactive operation. Geometry elements are edited to generate the final goal. The first company SDRC has released 3D solid modeling software I-DEAS [14]. Modeling modeling software has been rapid development during last 30 years, such as general business modeling software Max, Maya; AnchiCAD for building construction, SolidEdge, Pro/E and SolidWorks for machine building.

With the development of professional modeling software, there are many professional softwares for modeling of 3D city buildings, such as SketchUp, Skyline, 3ds MAX, AutoCAD, Multigen, Maya, etc.[15] These 3D CAD models have been built by one or more Polygonal model (or mesh model), which is capable of expressing the detailed geometrical features of modeling building.[14]

In the CAD system, 3D model information of an object is realized by drawing and calculating various design parameters. CAD technology has a unique technique advantage in graphics processing and true 3D modeling, and it is a realistic 3D solid modeling method.

CAD-based models not only express the appearance of object, but also describe its complex structure. And the process of CAD 3D model contains complicated human-computer interaction process and large amount of manual operation. It is difficult to adjust the large-scale model and visualization requirements. For a single city building structure, the model has many advantages on reasonability, fine texture and visual effects. However, for the large data applications, a large number of 3D animation engineers need be arranged to carry out the model so that the workload is huge.

2.1.2 Based on 3D laser scanning modeling method

The 3D laser scanning model is a kind of laser scanning instrument which is used to

obtain high-volume and high-precision 3D point cloud data. There exist many steps: denoising, hole filling, registration, surface reconstruction and texture mapping. In 2004, Hofmann et al. built a Delaunay Triangulation based on LIDAR irregular point cloud and extracted the roof plane to reconstruct the building [17]. In 2006, Briese et al. studied ground-based laser scanning data to extract the structural lines of buildings and then to reconstruct buildings [18]. In 2007, Rottensteiner et al. proposed a building detection method that integrates airborne laser scanning data and multi-band data. It was found that adding multispectral data to the classification model would significantly improve the accuracy of residential building extraction [19]. In the same year, Sohn and Dowman used IKONOS panchromatic wave band and airborne laser scanning data as experimental data, the first time extracted the pixels on the building by the height of laser spot and NDVI index, and then got the line segment on the building outline. The bifurcation space tree is used to obtain the building area (primitive), and the accuracy of the recognition is 90.1% and the total accuracy is 80.5% [20]. In 2009, Zeng Qihong proposed a building extraction and 3D reconstruction method based on LIDAR point cloud. This method firstly filtered out the building point cloud from the LIDAR, and then fitted the roof plane by clustering roof points. In order to determine the outer boundary of the roof and the boundaries of the plane, the roof of the 3D coordinates reconstruct the 3D model of the building [21]. The method can reconstruct buildings not only with simple rules, but also with complex roof structures and irregular structures. In 2011, Wen Shu proposed a 3D reconstruction technique of regional buildings based on radar data and aerial images [22]. Firstly, an elevation gray image was created based on the radar data. Then the building edge was extracted from the radar data and the texture was extracted from the aerial image. Finally, the 3D model was generated. In 2012, Wang et al. proposed a 3D reconstruction algorithm for building facades based on image matching to achieve point cloud fusion, reducing the reconstruction time and improving the reconstruction accuracy [23]. In the same year, Sahin et al. established the 3D city model by combining photogrammetry and laser scanning data [24], and then achieved good results.

The advantage of this method is that the accuracy of point cloud data is very high and the performance of architectural in detail is good. It is especially suitable for the protection of ancient buildings and digital heritage. The disadvantage is the need of professional equipment support. The larger amount of artificial interaction and the higher cost make it difficult obtain the large-scale regional point cloud data, popularize and apply it.

2.1.3 Image-based modeling method

Image-Based Modeling (IBM) is an image-based modeling method that extracts basic building data from a single image or a number of images or generates a 3D model directly from a specific algorithm. Images include ground and aerial photographs. The aerial photographs provide precise information about the location, height and top of the building. The photogrammetry provides accurate information about the building's topography and elevation, but not the top information. In 1999, F. A. Van.den Heuvel et al. Realized 3D reconstruction of buildings based on single scene image by detecting horizontal and vertical edges and vanishing points in building images [25]. In 2004, Xue Qiang et al. Proposed a method based on image modeling using computer vision [26]. This method first reconstructs the building and then uses the surface features of the building to complete the Euclidean reconstruction. The results were optimized. The advantage of this method is that the accuracy of point cloud data is very high and the performance of architectural details is in place. It is especially suitable for the protection of ancient buildings and digital heritage. The disadvantage is the need of professional equipment support. The larger the amount of artificial interaction, the higher the cost of obtaining the large-scale regional point cloud data, the longer the production cycle, and it is difficult to popularize and apply it. In 2007, L. Wang et al. used aerial photographs to delineate the boundaries of building roofs and elevate them. Using the ground images to compose panoramas and to detect line segments, the algorithm automatically matches the edges of the roof boundary on the panorama map and calibrates the camera. And then the user amend the matching results, and finally generate a 3D model of the building [27]. In the same year, Zhang proposed a new method of 3D surface modeling using digital photorealistic stereo vision, and realized complex morphological modeling based on digital close-up stereo photography [28]. In 2008, Lafarge et al. extracted the approximate building profiles from the DEM data, which were fitted by multiple rectangular mosaics, connected to adjacent rectangles, optimized to obtain a complex building profile, and extracted elevation information to complete the city three-dimensional modeling [29]. The method has a good effect on the reconstruction of complex buildings. In 2011, Tan obtained the better model result through the steps of regional growth segmentation, object classification, regularization of building objects, and so on. For the IKONOS image which integrated the elevation information [30]. In the same year, Wang et al. explored a method of building 3D city building models using oblique

photography [31]. The advantage of this method is that it can easily and inexpensively obtain the building outline or 3D model for the image through the computer algorithm. The disadvantage of this method is that the method is designed independently for a specific target with lacking unified framework guidance. However, efficiency needs to be improved.

2.1.4 Grammar-based procedural modeling method

Procedural modeling techniques describe the structure and evolution of modeling objects by a set of string re-writing rules to describe the entity including its geometric shape, texture, or action, and then generate various models by adjusting the parameters and greatly improving the efficiency of modeling.

Procedural modeling technology has been successfully applied in the field of computer graphics since the 1980s, when it was mainly applied to texture generation. The grammar-based procedural modeling technology that we now know is evolved from the concept of the L system introduced by Hungarian biologist Aristid Lindenmayer in his modeling of multicellular organisms [32]. This becomes an important technology in modeling field. L system, namely the Lyndon Meyer system, is essentially a rewriting system. It performs a finite iteration on the evolutionary process of plant object growth through empirical generalization and abstraction. Initial state and description rules generate not only character development sequences to represent plants of the topological structure, but also a string of geometric interpretation and complex fractal graphics. In 1996, Przemyslaw Prusinkiewicz et al. have made further improvements and extensions to the original L system, allowing the system to interact with the environment. This system design L grammar and a variety of extended grammar used in constructing realistic plant model, simulation of plant growth and environmental interaction process [33].

However, the L system itself is not suitable for building modeling, because the design of plants and roads are actually in an open space to simulate the growth process, while the modeling of buildings is a spatial combination process under strict spatial constraints. Inspired by the L system, Parish and Muller proposed a process modeling method based on the L system in 2001 [34]. Using terrain boundary maps and population density maps to generate high-speed roads and streets, the terrain is divided into blocks, and then build the building. L system in the generated street map considers global and local constraints and

reduces the complexity of generating rules based on texture elements and process-based methods. In 2006, Muller et al. extended the split grammar to propose a kind of new shape grammar, namely CGA shape grammar [35]. The grammar is capable of producing architectural models with high-quality geometrical details. And context-related shape rules allow the user to interact with shapes. The volume shape of the orientation can be modeled by continuous blocks. In 2007, Muller proposed a 3D model algorithm that derives high visual quality from elevation images of buildings of arbitrary resolution [36]. This algorithm combines the procedural modeling flow of shape grammar with building facade analysis to derive a meaningful facade segmentation with layer. In 2008, Watson et al. gave a comprehensive review of the application of procedural modeling in film games [37]. That is to say, CityEngine is a procedural modeling tool that uses the most important grammatical rules of the tool. By setting model rules, random parameters can generate a variety of random models, and then generate large-scale city model. In 2009, Whiting et al. proposed a process-oriented modeling approach to be structurally stable masonry [38], which plays an important role in the analysis of historic buildings. In 2010, Vanegas et al. proposed a passive computer vision method using existing maps and aerial data to automatically generate 3D building models. By using multiple calibrated aerial images, a single coherent complete building geometry model is generated [39]. In 2011, Jerry et al. proposed a control-based and process-based modeling algorithm. The building is generated by optimizing the possible building space [40]. The algorithm has been used to generate process models such as trees, cities, and buildings. In 2012, Su et al. studied city process modeling, interactive process street modeling, and large-scale city environment modeling based on building footprints in a procedural modeling approach. The study provides a new direction [41]. In 2013, Xie et al. introduced the method of 3D modeling based on rules in the CityEngine platform [42] using existing GIS data for rapid and automatic modeling. The method can improve the efficiency of 3D modeling. In 2014, S. Lienhard et al. proposed a kind of system which generates automatically, aggregates, arranges and selects a series of representative thumbnail images from a set of rules [43]. Procedural modeling allows the generation of infinitely variable models from parametric, conditional, or stochastic rule sets. The system uses a set of view attributes to measure the suitability of an image and then to represent a model. And it allows comparison of different models derived from the same set of rules so that the best view of the process model can be found. For any mesh topology, it is good.

The biggest problem is that the grammar-based modeling method is not intuitive. It is difficult to formalize the description of the modeling objects and to extract the rule generation set. Due to the limited nature of pre-set rules, extensions are limited and the modeling lacks practical flexibility. Although the shape of the building structure and texture is difficult to close to the reality of standards, it can be used as a special virtual city modeling tool or game player environment editor. The latest research is to overcome the user difficult to manipulate the grammar, user-oriented interactive control, and achieve visual editing, design grammar, real-time operation building modeling.

2.1.5 Summary

For large-scale 3D modeling of city buildings, using CAD-based interactive modeling method will consume too much manpower and time. The modeling method based on 3D laser scanning needs the support of professional equipment. The process of point cloud data processing is complex and the amount of artificial interaction is large. The cost of obtaining cloud data in a large area is relatively high, and the production cycle is long and difficult to popularize. Furthermore, semi-automatic image-based modeling method is mainly designed for a specific target. The lack of a unified framework for guidance, modeling accuracy and efficiency are to be improved. From the actual demand, large-scale city building modeling using grammar-based process modeling method to improve the modeling speed and model quality is of great significance. Therefore, the main purpose of this thesis is to study the 3D modeling methods of city building based on the existing procedural modeling methods, i.e.: the rules modeling based on shape grammar and the facade modeling method based on image. Through using CAD technology to create model for the specific building and this will enrich the modeling method of the city building, 3D building model can be generated quickly in order to meet the needs of large-scale city 3D modeling needs.

2.2. State of the art of building information integration and construction simulation

2.2.1 Research on building information integration

The concept of building information model theory dates back to the early 1970s. Charles Eastman in the field of architectural design based on CAD system proposed Building Description System concept [44]. This is the prototype of Building Information Model (BIM). Eastman is also known as the father of BIM. BIM is the construction of the project related to the information and data as the basis for the building model through the digital information simulation building [45]. In the application has shown the following aspects of the characteristics: (1) The model contains information about the entire project lifecycle; (2) To support the project coordination construction; (3) The information involved is computable and emphasizing the full digitization of the information; (4) The performance of the information in the building information model can be achieved by graphical and non-graphical means [46].

Based on the "Building Description System" proposed by Professor Eastman, Coyne et al. from Edinburgh University in the UK proposed and developed the "knowledge-based design system" in 1990 [47]. Based on the purpose of knowledge is to integrate the original scattered information into the structure of the integrated state, and then guide the building life cycle of the various processes. Javier Monedero of Catalonia Polytechnic University in Spain [48] summarizes and looks forward to the application and evolution of parametric design techniques in building simulation modeling technology. Lee Ghang from the Georgia Institute of Technology in the United States has embedded design and engineering knowledge into BIM applications [49] and developed a fast-to-use protocol for the sharing of architectural design, validation and parametric design intent. James D. Goedert et al. [50] of the University of Nebraska in the United States have analyzed the application of BIM in the current housing construction field throughout the construction project cycle. They pointed out that today's BIM technology and tools can not be implemented into a complete process. And information interaction and collaboration can not be perfect to achieve. Bilal Succar of the University of Newcastle, Australia, [51] gave an introduction to the BIM framework and explored the underlying technologies needed for enterprise implementation. Some examples of BIM applications are provided to illustrate the application areas, levels, and steps of BIM. Y. Arayici et al. [52] from the University of Salford in the UK explains the efficiency gains and implications of BIM's integrated system implementation and its application to lean construction practices, and provides guidance for the implementation of the enterprise. In 2012, Li LI et al. of Tongji University studied the preliminary development and research of building information platform based

on BIM technology, and put forward the basic construction of building information collaboration platform based on BIM technology [53]. In addition, IFC standards-based BIM database construction of input, output, query, etc. for multiple project models were studied in 2013 [54]. It was proposed that a BIM-based architecture collaboration platform should be constructed.

As the whole, with the development of building information, the design and construction of city building have entered into the era of research and application of BIM, but the application and implementation of BIM still have some difficulties in the whole city construction industry, the main reasons are the shortcomings of geographic information, data standards on the application and the integrated information. If we can combine the integrated information with the geographic information and international standards, and utilize the stored information to create a building components associated model, it would make the lifecycle of city buildings to effectively manage and improve the sharing of information and exchange of data.

2.2.2 Research on construction simulation technology

Vineet R. Kamat et al. [55] at the Virginia Polytechnic Institute in the United States of America developed a general-purpose simulation system --- a dynamic construction virtualizer. The construction simulation model and operation have time and space, including the height of the accurate description. Julio C. Martinez et al. [56] used the modeling tools CYCLONE and STROBO SCOPE to simulate and analyze the characteristics of the standard discrete event system from multi-angle, model paradigm and flexibility. Iris D. Tommelein of the University of California at Berkeley [57] studied lean construction simulation techniques and applied them to the simulation and optimization of certain installation operations during the construction process by reducing the stock of construction materials and speeding up construction progress. Dany Hajjar et al. [58] of the University of Alberta in Canada have discussed the use of a new unified modeling approach for simulation techniques used in the construction industry. Mohamed Al-Hussein et al. [59] also from the University of Alberta, presented a practical method for simulating the production operations of tower cranes in the construction site and validated them in a 3D MAX Studio environment. Ali Jaafari et al. [60] of the University of Sydney,

Australia, presented a dynamic simulation model system (DSMS) that was used to evaluate the management and functionality of the entire project cycle and to validate the case. Heng Li et al. Of the Hong Kong Polytechnic University of Hong Kong, China, investigated the use of virtual prototyping techniques to optimize the construction plan [61] and analyzed and optimized a 6-day construction project by analyzing the resource layout, construction model and site layout. Tsinghua University's H.J. Wang et al. [62] constructed a 4D construction planning and resource utilization management model system to simulate the operation and management of the construction site. In the industrial manufacturing process of building construction, the assembly and assembly process occupy the main process content in this research. The United States National Institute of Standards and Technology (NIST) have developed a virtual assembly simulation design environment, namely Virtual Assembly Design Environment (VADE) [63][64] While the modeling of buildings is a spatial combination process under strict spatial constraints. This project analyzes the application prospect of virtual reality technology in industrial assembly field, studies the virtual assembly environment, assembly planning and evaluation, etc. and establishes a virtual environment. The purpose is that designers can access the product assembly process and equipment, virtual product assembly simulation evaluation, automatic assembly planning, manufacturing simulation evaluation. B.Jung of Bielefeld University in Germany [65] combined the virtual reality interaction technology and artificial intelligence technology, built a virtual assembly simulation system CODY based on the concept of Construction Kits, and studied the intelligent matching technology of components in the virtual assembly process. Leu et al. [66] of the University of Missouri studied the techniques of assembling simulation models, capturing motion in human-computer interaction, and explored the application of virtual assembly technology in assembly planning and training skills. Zhang Yi's research and application of HLA-based and Unity3D-based visual simulation technology in 2014 [67] studied HLA distributed simulation technology and visual simulation technology framework. And he investigated various visual simulation tools, successfully distributed VR-Link Tools and Unity3D visual simulation tools together. In 2016, Min Fang studied 3D visualization and simulation based on OpenGL [68].

In general, the progress of research on building simulation can be divided into two levels: one is the visualization of the construction process and interference checking tools. Visual display of the product during the installation of the movement of parts and spatial

position of the relationship between motion and provide interference in the process of inspection and alarm. The second is based on virtual reality (VR, Virtual Reality) technology to construct a virtual construction environment. Operators have an immersive feel, and through the visual, auditory and tactile sense of the construction process and results. The research on the application of visual simulation technology mainly focuses on the design and planning of products such as automobiles, aircrafts and ships. There are few researches on the simulation of city buildings. The construction simulation has important effect on the construction efficiency and quality.

2.2.3 Summary

With the construction of smart city, construction industry has got a new opportunity to develop. Building Information Model is an important technical means to enhance the construction industry. With the development of building information, the design and construction of city building has entered into the era of research and application of BIM. But at present the application and implementation of BIM in the whole city construction industry has certain difficulty: which are the lack of geographic information and the application of data standards, and insufficient information integration on the model. This thesis proposes to combine geographic information with international standards, so that the association informations can store in the integrated information model which are used to create building and component model. The result will make the lifecycle of city buildings to effectively manage and improve the sharing of information and exchange of data.

Building lifecycle simulation is the technology to apply visual simulation technology to a series of activities of lifecycle, such as the building design, construction and maintenance, etc. Due to the complexity and industrialization of building construction, building lifecycle simulation is particularly important. The research of construction simulation can be divided into two levels: one is the visualization method and the interference check tool. Product visual display during the installation of the movement of parts and spatial position of the relationship provides interference in the process of inspection and alarm. The second is based on VR technology to construct a virtual construction environment. Operators have an immersive feel through the visual, auditory and tactile sense of the construction process and results. The research of visual simulation technology is mainly used in the design and planning of automobile, aircraft, ship and so

on. There are few researches on the simulation of building construction. The simulation of construction has important effect on the construction efficiency.

2.3. Chapter summary

This chapter summarizes the development and research status of 3D modeling technology of city buildings, and summarizes the development and research status of building information model and construction simulation technology.

Chapter 3. Research on Acquiring Modeling Data

Methods

During the 3D modeling of city buildings, we firstly need to obtain all kinds of data which building model required and processing the corresponding data. On this basis, we then study the rapid modeling approach of city buildings. The data required for building modeling mainly refers to geographic terrain data, three-dimensional spatial data of buildings and texture data. In the process of constructing virtual scene, obtaining real and detailed geographic terrain data is a prerequisite to study the city building model. The geographic data used in constructing the virtual scene mainly include: terrain image map, geographic location information and elevation map. Terrain image map is the base map of the modeling. All the processes are based on the base map. Geographic location information is one of the characteristics of this thesis in city building modeling. All objects are modeled with its actual location coordinates by adding geographic location information. Digital elevation model (DEM), which is a grayscale map between the black and white, each point of the image is stored in the point's altitude, which resulting in the ups and downs of the terrain. The 3D spatial data of building mainly refers to the exterior profile of each building, height of the building and other data. Firstly, all kinds of data are classified in this chapter. Then we focus on the study of the obtaining and processing geographic terrain data, which lays a foundation for the follow-up modeling method.

3.1 Study on the method of constructing geographical data

Geo-topographic data is a collection of spatial location features and attributes, which is the foundation of constructing virtual scenes. From a mathematical point of view, it can be described as an area elevation Z which is on the plane coordinates X, Y two discrete variables function [69].

The function form is:

$$V_i = (X_i, Y_i, Z_i)(i = 1, 2, 3, \dots, n) \quad (3.1)$$

Where, X_i, Y_i is the plane coordinates, Z_i is (X_i, Y_i) corresponding elevation.

The geographical data mentioned in this section mainly refers to terrain image map, geographical location information, terrain digital elevation map and other data. The terrain

image map depicts the distribution of various buildings, roads and vegetation in the real scene. Geographic location information gives the true geo-location coordinates of each modeling object. Altitude chart shows the ups and downs of the terrain. The superposition of the three forms the base map data of the building model, which is the basis of the whole modeling process.

3.1.1 Acquiring and processing of terrain image

Terrain image is a map with ground remote sensing images. Terrain image use of aerial photographs or satellite remote sensing images directly reflect the geographical features and spatial distribution of the map through the geometric correction, projection transformation, scale of normalization and use of certain map symbols, annotation, mapping objects. Early image data are obtained by purchasing to the commercial satellite company and the government surveying and mapping departments, which to be paid per square kilometer fees. That is expensive. The image accuracy and resolution are not high, because of technical means and security issues, which is fail to meet the most basic requirements. Nowadays, due to the continuous development and extensive application of satellite remote sensing, Global Positioning System (GPS) positioning, aerial photography, digital imaging, information visualization and Geographic Information System (GIS), it has been possible able to provide true, high precision and high resolution image map data, comprehensive, intuitive digital image geospatial.

The acquisition of topographic maps is usually done in Google Earth. Google Earth is the software developed by Google Company. Google Earth is provided to the user an accurate positioning of the virtual Earth. The surface model of the Earth's high-definition images are processed through the elevation. The image data can be obtained by plug-in. Its satellite imagery comes from Digital Globe's Quick Bird commercial satellites and Earth Sat. The aerial part comes from Blue Sky and Sanborn [70]. We obtain the image file methods in Google Earth are: direct save method, the same name of the center overlay with CorelDraw software, automatically stitching by Photoshop software. GetScreen software screenshot method through the two-point positioning or input starting point coordinates to intercept the image. By Google Satellite Maps Retriever software to capture the regional image method is firstly entering the regional diagonal latitude and longitude and then creating more than a small picture, finally Map Combiner splicing generated JPG format

images. But these methods are still not free to download high-definition image map, how to get high-definition image map is still a question which is worthy of study.

This thesis presents a method of obtaining HD image based on GogoMap plug-ins of Google Earth. GogoMap is the geographic information system plug-ins based on internet free resource development. It can be used in academic research, engineering surveying, planning and display, hiking and other fields [71]. GogoMap plug-ins supports multi-layer overlay display, download, puzzle screenshot, which facilitate the latter part of the selected area elevation map access. GogoMap plug-ins also supports a variety of download levels to control the image resolution. GogoMap use 1~26 levels to distinguish different map resolution. The higher the number is the higher the resolution. For foreign image map, Google, Microsoft and other high-level map display the image more clearly. For the Chinese map, such as Map world, Baidu map also have a good display effects. The resolution is not the same in different regions and layers. For the target area of the image map we can choose several layers to compare and select the favorite layer for the screenshot operation. In this thesis, we take Baoshan campus of Shanghai University as an example. We cut the corresponding area and set the zoom level of 16-19 in the ArcGIS map. As we can see in the figure, the buildings, roads, rivers and trees in the selected area are clearly visible enough to satisfy the image map requirements in this thesis.



Figure 3. 1 Image of Baoshan Campus of Shanghai University

3.1.2 Geographic location information adding

Since the image is manually intercepted, the deformation is inevitable. In addition to the remote sensing image there is a certain geometric deformation itself. So in order to improve data quality, the interception of the image must be geometric corrected. The affine transformation is a kind of first-order polynomial transformation method, which usually used for geometric image correction. The algorithm can make the image different scales scaling, rotation and translation at the same time in the X-axis and Y-axis direction. The characteristics of the affine transformation is that line after the linear transformation is still straight and parallel lines after transformation is still parallel, the length ratio changed in different directions. The coordinate transformation formula is:

$$\left. \begin{aligned} X &= A_0 + A_1x + A_2y \\ Y &= B_0 + B_1x + B_2y \end{aligned} \right\} \quad (3.2)$$

Where, x 、 y are the digitizer coordinates. X , Y are the actual coordinates. A_0 , A_1 , A_2 , B_0 , B_1 , B_2 are six unknown coefficients. When the number of control points more than the number of basic solutions it can be used the least squares method to calculate the six unknown number, 即, namely

$$\left. \begin{aligned} Q_X &= U_i - (A_0 + A_1x_i + A_2y_i) \\ Q_Y &= V_i - (B_0 + B_1x_i + B_2y_i) \end{aligned} \right\} \quad (3.3)$$

Where, x_i 、 y_i for the i -th control point of the digitizer coordinates, U_i 、 V_i corresponding to the measured coordinates, A_0 、 A_1 、 A_2 、 B_0 、 B_1 、 B_2 can be solved by minimum $\sum(Q_X)^2$ and $\sum(Q_Y)^2$. So the deformation correction of the sheet can be achieved [72].

The image map does not have the appropriate spatial reference information and the location accuracy is often relatively low. Therefore, it is necessary to map the terrain image to a specified geographic coordinate system by adding multiple control points with high position accuracy and add the corresponding geographical position information to the image map. There are many ways to match. The simplest way is to establish the mathematical function connecting the position of each control point in the image map with the position of the known geographic coordinate point in the standard spatial reference. In this way, the geographic coordinates of any point in the image can be determined. The whole process of geographic alignment requires multiple operations such as selecting the coordinate system, adding control points, checking residuals, selecting geographic

alignment methods, performing geographic alignment etc..

In order to make the image map have the corresponding spatial reference coordinates, it is necessary to select at least four control points for the captured image in the corresponding map software and record the corresponding common horizontal Mercator projection coordinate values of the selected control points. Universal Transverse Mercator (UTM) projection is an isometric angle horizontal axis cutting cylindrical projection. The cylindrical cuts the earth at two latitude circle which are 80 and 84 degrees latitude. Many countries serve this as the mathematical basis for topographic maps [73]. This thesis takes the Baoshan campus of Shanghai University as an example, selecting four control points to realize the image location information adding.

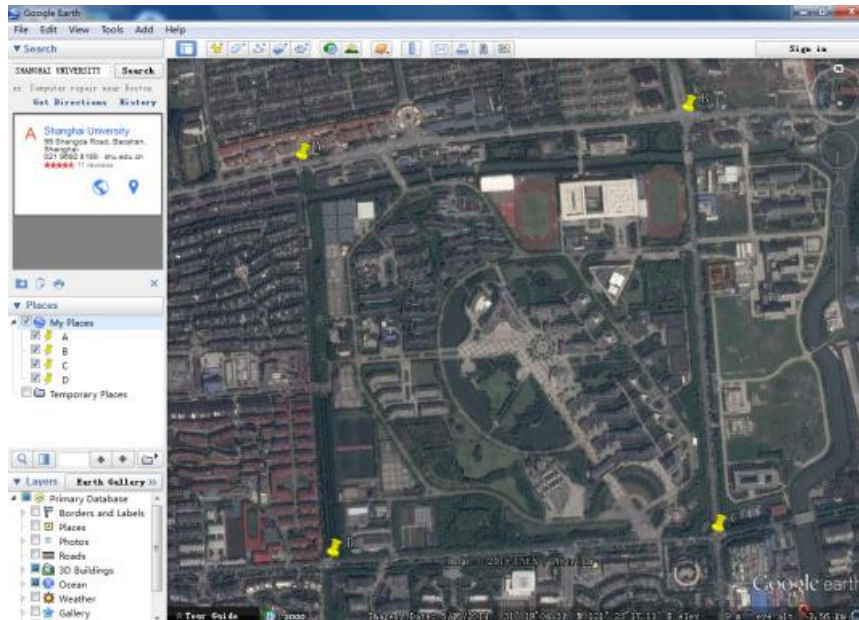

Figure 3. 2 The location of the four key points in the image

Table 3.1 Common Transverse Mercator Projection Coordinates for Four Control Points

name	A (Northwest corner)	B (Northeast corner)	C (Southeast corner)	D (Southwest corner)
Zone	51 R	51 R	51 R	51 R
Easting	346064.11 m	347058.08 m	347111.88 m	346127.99 m
Northing	3466319.63 m	3466524.51 m	3465459.98 m	3465408.36 m

In order to get the position in intercepted image map, we input the four control point with the appropriate position to correct the image map and select the world-class geographic coordinate system World Geodetic System 1984. The coordinates of the main parameters are the earth latitude and longitude. Coordinate system projection Earth is

divided into 60 longitude belt. Shanghai belongs to 51 longitude belt, which is the northern hemisphere, so we need to choose 51N. Checking the residual and RMS values after the application, where the residual value is the difference between the position of the starting point and the actual position and RMS is the root mean square of the residuals for all control points, which is called the total error. If the residual value or the RMS value is too large, reselecting the control points and repeating the operation until the residual value of each control point or the RMS total error is less than 1. Finally, the image is corrected and resampled to generate a new raster file. Typically, the types of resample include nearest neighbor interpolation, bilinear interpolation, and Bi-cubic convolution interpolation. The nearest neighbor interpolation is to assign the nearest pixel value to the new pixel. The bilinear interpolation uses the pixel value of the adjacent four points to linearly interpolate according to different weights. Bi-cubic convolution interpolation uses the 16-pixel value around the inner-difference point, interpolating with the cubic convolution function. The gray value which obtained by nearest neighbor interpolation method has obvious discontinuity. The double cubic convolution interpolation overcomes the shortcoming of gray discontinuity in the nearest neighbor interpolation method but the computational complexity increases [74]. So the bilinear interpolation is selected as resampling type (continuous data).

The exported image map is generated to tiff file, which is the terrain image map with geo-location information this thesis needed in. It will be imported into the modeling software and added terrain digital elevation map to show the ups and downs of the terrain. It can be used as a base map of city construction modeling data.

3.1.3 Acquiring and processing of terrain elevation map

Digital elevation map is a gray-scale image in which each pixel has different grayscale values that represent different heights of the terrain's corresponding position. The higher the gray value of the pixel, the higher the corresponding height; the smaller the gray value of the pixel, the lower the corresponding height. Digital elevation map is usually 8-bit grayscale. Its height value range is between 0 ~ 255, where 0 represents the minimum height of the terrain, 255 represents the maximum height of the terrain. In order to obtain the digital elevation map of the selected area, we need to intercept the same area in the map software and extract the elevation point data. And then automatically generate txt file. The

sampling spacing is needed to set when collecting elevation point data. The greater the distance is the smaller the number of elevation points. The transition between the vertices will become steep. The smaller the pitch, the more the number of elevation points. The transition between the vertices becomes smooth. The sampling interval is set according to the size of the terrain changes. The greater the terrain changes, the smaller the sampling spacing settings. The smaller terrain changes, the greater the sampling spacing settings. In this thesis, the terrain of the selected area changes little, so we set the sampling interval is small. The height data generated (.txt file) requires contour lines to be generated in the third-party software. In this thesis, we selected Surfer software, which is a software developed by Golden Software Company. The software has powerful interpolating and drawing capabilities, which make it the preferred software for processing XYZ data. The software is the essential professional mapping software for geologists [75]. Figure 3.3 is a contour map generated in the Surfer software, where the relatively dense contour lines represent the higher the altitude. The GRD file generated by Surfer software is made in ArcMap in 8-bit gray scale with height value ranging from 0 to 255. The digital elevation map of this thesis is chosen as tiff format. Figure 3.4 is a digital elevation map generated in ArcMap, where the lighter the color, the higher the altitude. The darker the color is the lower the altitude.

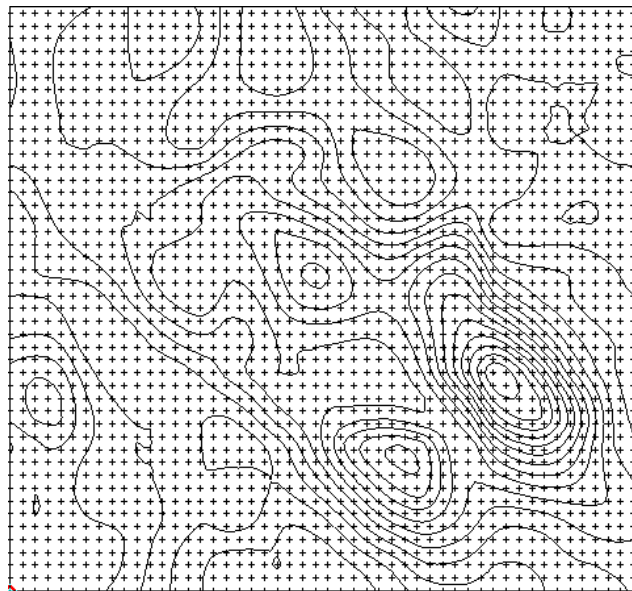

Figure 3. 3 Baoshan Campus of Shanghai University contour map

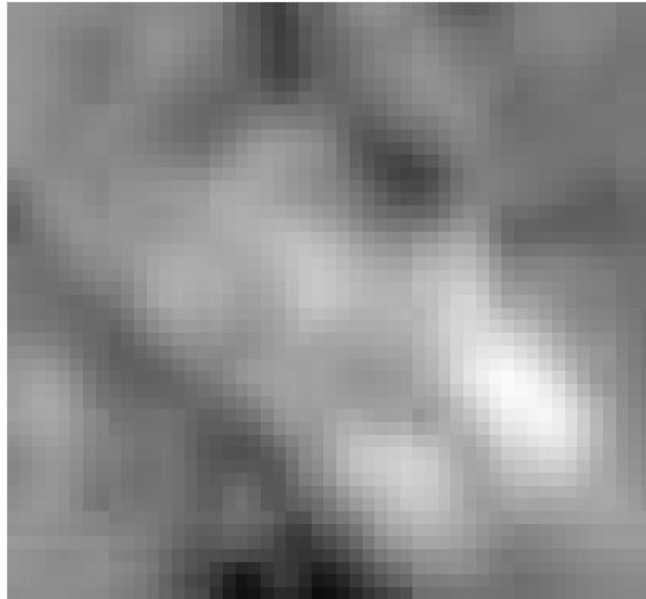

Figure 3. 4 Baoshan Campus of Shanghai University Digital Elevation Map

Image and digital elevation map data to generate the basic terrain data, which lays a foundation for the city architecture three-dimensional modeling. The generated terrain data not only has the geographical coordinates but also has the elevation information, which realizes the true reproduction of the terrain in the modeling scene. Figure 3.5 shows the basic terrain data. In order to facilitate the display terrain ups and downs of the visual effects, we set 2.0 as the elevation of its exaggeration coefficient.



Figure 3. 5 Basic terrain data of Baoshan Campus

3.2 3D spatial data acquisition method

3.2.1 3D laser scanning technology

Three-dimensional laser scanning technology is a high-tech which appears in the

1980's. The method can acquire data by high-speed laser scanning on the surface of the measured object. After alignment, stitching and simplification, then form a point cloud with multi-space coordinates (x, y, z) to reshape sampling results of the scanned object. In the real world, the shape of city building is usually complex and its size data are difficult to be realized directly by measurement method. The dimension data of building target surface can be acquired automatically and conveniently by directly fitting the point cloud data obtained by laser scanning. [76]. Compared with other traditional measurement methods, 3D laser scanning has the characteristics of real-time data acquisition, all-weather work, high precision and all-digital acquisition, etc. This technology has been widely used in digital city, digital preservation of cultural relics, terrain visualization, civil engineering and other fields.

In this thesis, FARO Focus3D method is used to acquire the point cloud by scanning the building with 3D laser scanner and the data are measured. The FARO Focus3D Laser Scanner is a high-speed 3D scanner for complex measurement and archiving, which uses laser technology to generate detailed 3D point cloud images of complex environments and geometries in just a few minutes. It can measure and obtain the modeling data.



Figure 3. 6 FARO Focus3D laser scanner

This thesis takes Shuixiu restaurant in Baoshan campus of Shanghai University as an example and briefly describes the operation process of FARO Focus3D method such as 3D laser scanner. According to the characteristics of Shuixiu restaurant, the location of the scanner and the number of the stations were determined by field investigation. Laser scanning measurement to scan from different angles and stitching to form a complete physical digital model. In this measurement process, a total of 12 stations (S1, S2, S3, S4,

S5, S6, S7, S8, S9, S10, S11 and S12) are set up, they are S1, S2, S3, S4, S5, S6, S7, S8, S9, S10, S11, S12 respectively. 12 stations are shown in figure 3.7, where the triangle is the scanner station location and the round is blue and white sphere target location.

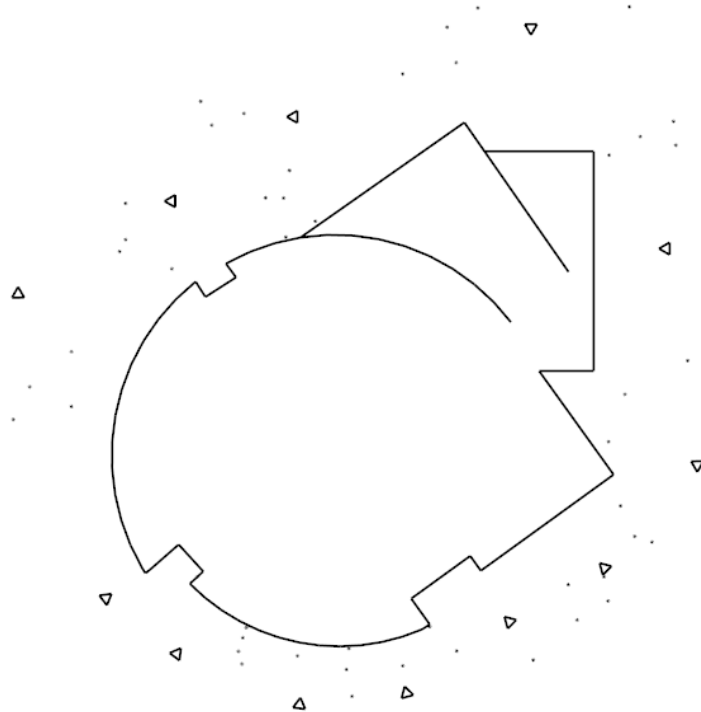

Figure 3. 7 Scanner station design

3.2.2 Modeling data measurement based on point cloud

In order to obtain the modeling data by measurement, it is necessary to preprocess the point cloud data directly obtained by the 3D laser scanner. The pretreatment mainly includes point cloud splicing, filtering and simplification.

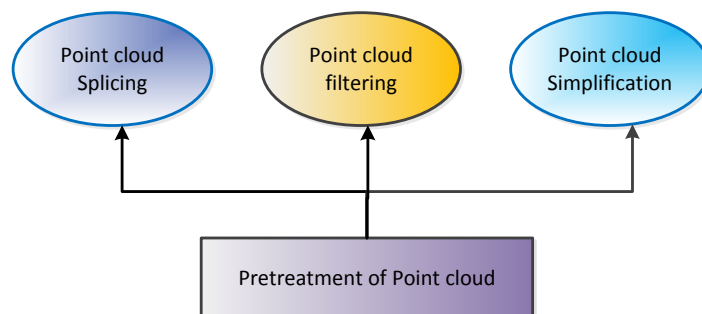

Figure 3. 8 Pretreatment of point cloud

In order to obtain the modeling data by measurement, it is necessary to preprocess the

point cloud data directly obtained by the 3D laser scanner. The pretreatment mainly includes point cloud splicing, filtering and simplification. Point cloud splicing is based on the control points or target points set in the scanning area to make the adjacent area of the scanning point cloud map has more than 3 of the same name control points or control targets. Through the control point of the mandatory attachment, the adjacent scanning point cloud diagram is unified to the same coordinate system. But when the same name point cannot be found, we must use the manual stitching method that is manually selected control point for mandatory splicing. The noise point always in the point cloud data acquired by the 3D laser scanner, such as the noise point caused by the occlusion of the scanning target caused by the external environment and other factors. At this time, point cloud should be filtered, and be eliminated the unstable point, error point and redundant point, in order to reduce the noise point and improve the quality of point cloud. Because the laser scanning speed is very fast, the point cloud data itself will be very large and a number of point cloud data stitching, which will result in a large number of point cloud data redundancy. These points are arranged in a small space, which is unbeneficial to the later measurement of point cloud model. Moreover, a large number of redundant point clouds will also affect the processing speed and processing efficiency. Therefore, the point cloud data must be simplified. The redundant point clouds should be deleted in the case of not affect cloud boundary feature points. The point cloud model is generated automatically after the pretreatment of the point cloud data. The more accurate parametric modeling information can be obtained by measuring the point cloud model, thus laying the data foundation for the following three-dimensional modeling of city buildings.



Figure 3. 9 Generated point cloud model

3.2.3 Building height data acquisition

Building height data is an important parameter in 3D modeling of city buildings. There are many means to obtain building height data, which can be summarized as optical remote sensing images, Synthetic Aperture Radar (SAR) images and fusion of optical and SAR images [77]. By comparing the various methods of data acquisition difficulty degree, time cost, price cost, difficulty degree of data processing and so on. In this thesis, we choose FARO Focuse3D method, such as three-dimensional laser scanner measurement method, because the method is relatively simple and high precision. The data of the height of the building can be obtained by the simple calculation of the trigonometric function through the measured inclination angle α , the inclination angle β and the flat distance L .

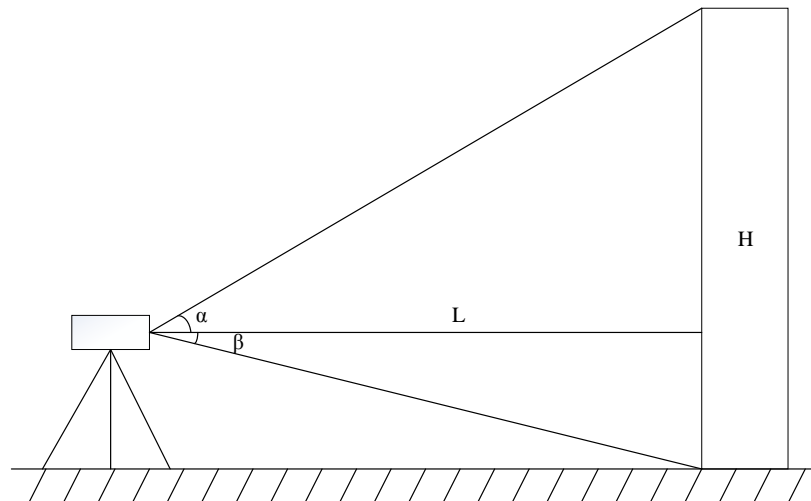

Figure 3. 10 FARO Focuse3D Principle of measuring building height

The building and the scanner between the horizontal distance and tilt angle are measured by three-dimensional laser scanner. The height of the building data can be got by the mathematical formula:

$$H = L \times (\tan\alpha + \tan\beta) \quad (3.4)$$

H-height, L-distance, α -tilt angle, β -tilt angle

3.3 Texture data acquisition method

The texture images of three-dimensional architectural model are acquainted basically by a comprehensive picture of the building collection using FARO Focuse3D

three-dimensional laser scanner. We choose 18 million pixels Canon digital camera with anti-shake effect to get some of the building facade pictures. As the quality of the photo directly affect the entire building model of realistic degree, a high-quality pictures have high requirements of the shooting time, lighting conditions, location and tilt angle, and shooting means. In order to obtain high-quality clear picture, we select the sunny morning and evening or cloudy no rain weather to scan or shoot, because in this weather collecting photos can ensure the clarity of the photo because of not subject to strong light interference. In addition, in order to reduce the burden of the latter image processing part, scanning or shooting should pay attention to the scanner or the camera as far as possible to maintain parallel but not tilt with the building. The texture data at the top of the building can be obtained by aerial or remote sensing images, such as the Google Earth can be successfully obtained. Figure 3.11 (b) shows the stadium roof texture picture we got in Google Earth.

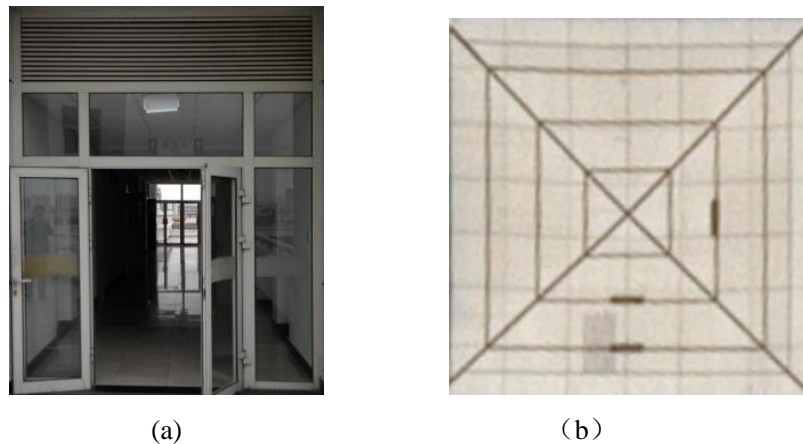

Figure 3. 11 The collected texture image

In order to improve the picture quality and make the model has a better visual effect, we need to deal with the resulting picture. The processing of photos mainly includes adjusting the resolution and size of the picture, converting the picture format, ortho-rectification, picture stitching, landscaping and other operations. This thesis selects Adobe Photoshop CS3 Extended software to complete the photo-related processing. Adobe Photoshop is recognized as the best general graphic art design software. Its user interface is simple and image enhancement is very powerful which widely used in game art, advertising photography and so on. Adobe Photoshop not only can be performed orthophoto correction, part of the interception, including stretching, rotation, cutting and other operations, but also can adjust the picture color, brightness, contrast, etc. to improve picture quality, image format conversion, adjust the image size, remove and Modify the

image of the damage, spots, copy, repair and other related operations, sufficient to meet the high-quality picture needs.

3.4 Chapter summary

The methods of acquiring and processing the geographic terrain data are mainly introduced in this chapter. The methods how to modify, superposition and construct the basic terrain data that needed to generate the three-dimensional modeling of city buildings in CityEngine software are also discussed in this chapter. After we analyze the methods to acquire various data, a series of optimization methods are introduced which are used in this thesis and are proven the feasibility by using examples. The high resolution image data of the specific area is obtained by Google Earth software, which is processed in the ArcGIS software and added the geographical information of the corresponding area acquired in Google Earth. The Google Earth software was used to obtain the altitude information of the selected area. The contour map was generated by Surfer software. Then the gray map was generated by ArcGIS software to represent the terrain elevation, and was imported to CityEngine software to further optimize until the modeling needs are satisfied. Finally, the topographic map, digital elevation map and road data are imported into the CityEngine software, all these overlay to construct the basic terrain required for 3D modeling of city buildings. In this chapter, we also use the 3D laser scanning technology to obtain the surface texture image of the building and create the point clouds model of the target building to measure the relevant modeling dimensions, which lays a solid data foundation for the 3D modeling of city buildings.

Chapter 4. Research on Procedural Intelligent Modeling Approach of City Buildings

4.1 Rule modeling technology

Rule modeling can be understood as procedural modeling or parametric modeling. Rules define a series of geometric and texture features to determine how the model is generated. The idea of rule-based modeling is to define the rules, and constantly optimize the design to create more model details.

4.1.1 Shape grammar

The shape grammar was proposed in 1972 by George Stiny, who is the professor of architecture from the United States. It gradually became a powerful design and analysis tool for building shape [78]. Shape Grammar (SG) is a method of design reasoning that uses grammatical structure analysis and produces new shapes which takes symbol shape as the basic element. Shape grammar contains some shape rules and an initial state, by constantly applying the rule to the initial state or the current shape to generate new shape, and finally get new design results. The core of shape grammar is using graphics replacement, so that graphics generate automatically from scratch and from simple to complex. The shape grammar $SG = (S, L, R, I)$ defines four parts: the shape part S is an arrangement of straight lines or curves; the letter part L is the sign and the number of the restriction rule application; The rule part R is a requirement to change the shape; the interchange part I is the shape translation, rotation and scaling operations; In SG, a design is described as a result of a series of rule applications. All possible designs are referred as design space of SG, also referred as defined language of SG.

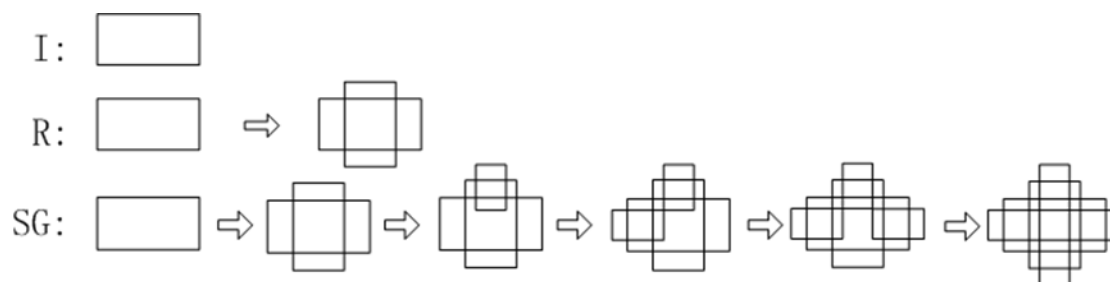

Figure 4. 1 Example of shape grammar

In 2003, Wonka proposed a new design grammar based on shape grammar: Split Grammar [79]. Split grammar is defined as a splitting or splitting of a basic shape into a combination of several shapes in a set of shapes, and the whole splitting process meets the requirements of splitting and transformation rules. Split rule is to do a split on the basic shape of the operation. The transformation rule is a rule that transforms one shape into another shape. It is necessary to ensure that the transformed shape and volume are smaller than those before the transformation. Although split grammar describes the splitting rules for spatial shapes, it can only be edited manually in the database.

4.1.2 Computer Generated Architecture rule

Although the application of shape grammar is very extensive, but its basic concept is abstract, and shape change is too rich, resulting in architectural design applications difficult to be standardized by the computer program operation. The splitting grammar makes a detailed definition of the basic shape, which makes the rule of shape change on the specific "skin" of the building, which not only ensures the logic of split grammar, but also makes it applicable to the calculation of computer programs. But at the same time, this has led to the split in the conceptual design phase grammar cannot handle the key architectural space problem, but also in the conceptual design of excessive automation also affected the freedom of design [80]. It can be seen shape grammar and split grammar has a big shortage in the application of specific conceptual design.

In order to cope with the defects of shape and split grammars, Pascal Muller proposed a context-sensitive set grammar in 2006 by extending the split grammar which is Computer Generated Architecture (CGA) rule grammar [81]. CGA rules grammar is a semantic modeling language, contains a series of rules to determine how the model is generated. CGA mainly by describing the layout of the building, and set the layout of the iterative description, making the building can be established, and also can continue to refine. The typical appearance of the process is to decompose the surface into floors firstly, and then break down the floor for the tiles; finally, the block is decomposed into a wall, a window, or a door. This process of segmentation in CGA feature grammar is shown in Figure 4.2.

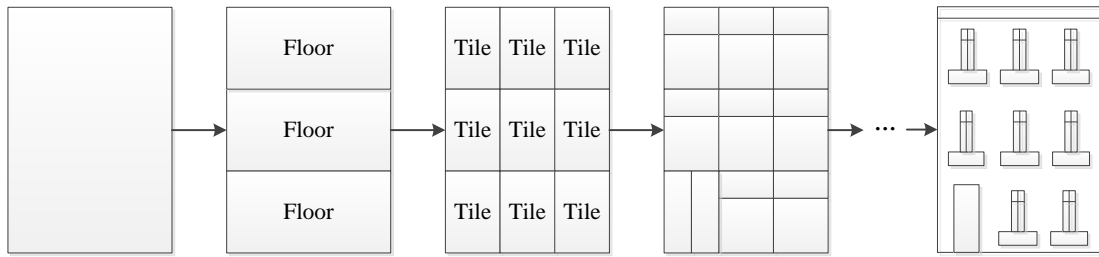
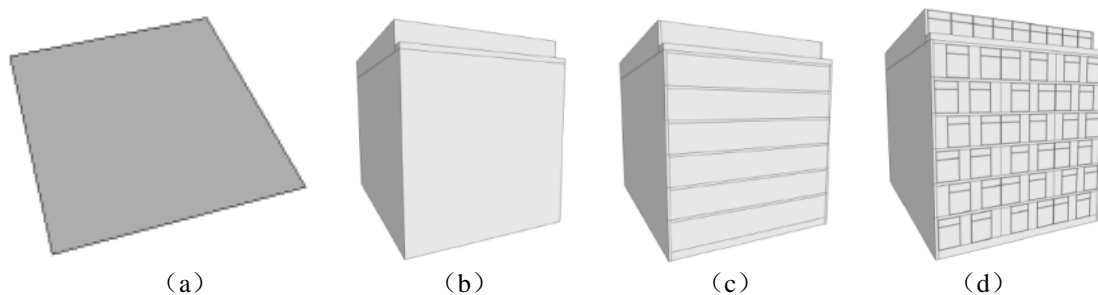

Figure 4. 2 CGA Rule Subdivision Process

The basic idea of a CGA rule is to replace a specific model with a new model. The basic form is as follows: PredecessorShape \rightarrow Successor. PredecessorShape is the rule name, which represents the model object before execution; \rightarrow indicates execution; Successor is the shape operation and model identification. Such as $A \rightarrow B$. The modeling process begins with arbitrary shape A and ends at B, and A execution is no longer performed, followed by A cannot appear with the same name rules; the model represented by A is called the branch model, after the execution of death, B model does not match the new rules, known as leaf model. CGA production process can generally start from any shape; the general process is as follows:

- (1) In the initial shape set, the shape is selected based on a certain symbol.
- (2) Getting the selected shape of a certain production rules, to be based on the rules generated under the new shape, the new shape can be called New Object.
- (3) Marking the New Object as invalid, put it in the production cycle, repeat step (1), until the end of the production process symbol, the production process will be terminated.

The following rule inference diagram shows the generation of CGA rule modeling, in which the left side shows the Lot shape and the rightmost side shows the final model generated by the CGA rule driver:



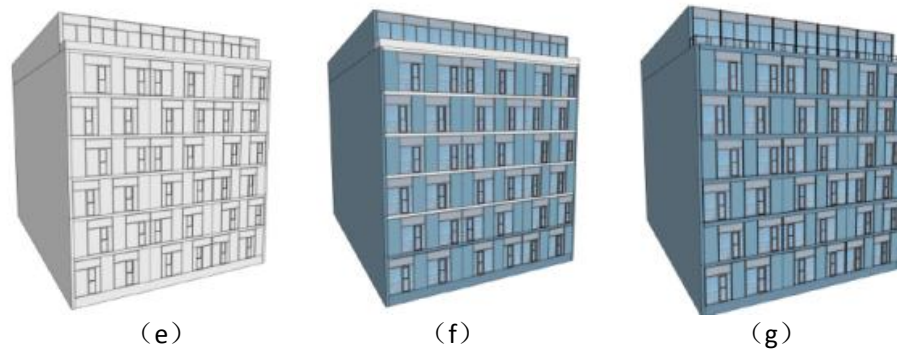

Figure 4.3 CGA rule modeling process

A generic rule can be written for similar buildings, which can be generated using the same CGA rule, through binding associating property information to the rule script as a parameter, we can use the same CGA rules to generate a variety of styles of the model. As shown in Figure 4.4.

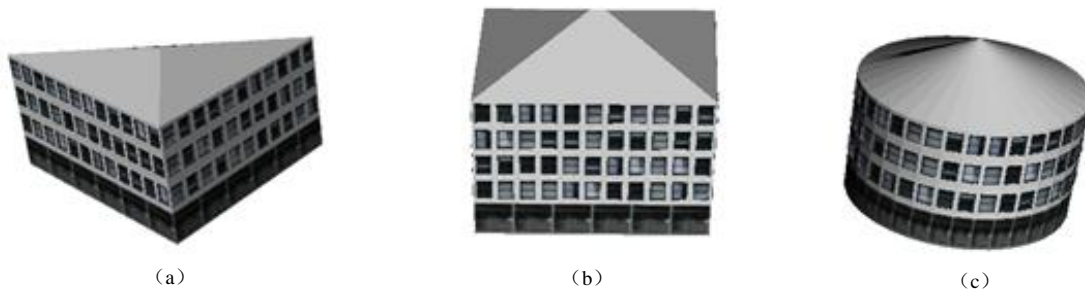

Figure 4.4 Generating a variety of models with the same rule

The modeling method of "grammar" or "procedural" based on shape grammar has a wide range of applications, in most cases it is applied to a large number of design interactions or build a large number of objects which must follow a standard rule, the purpose is to achieve the modeling automation, and integrated quality of grammatical scripts is reflected in the production model quality and detail quantity. Of course, the preparatory work to set the rules will bring some workload in the early stage, but after the establishment of the rule base, through the constant expansion and accumulation of the rule base, the latter part of the modeling only need to add and modify some rules, we can quickly invoke the rules of existing rules in the rule base for bulk modeling, reducing the cost of modeling. In addition, compared with the traditional manual modeling, the model itself only takes a very short time, after this time, the rule-based modeling will be much more efficient than the traditional manual modeling. The following diagram compares the two modeling methods of rule modeling and manual modeling. It is obvious that rule

modeling technology based on shape grammar is more advantage for large-scale building model.

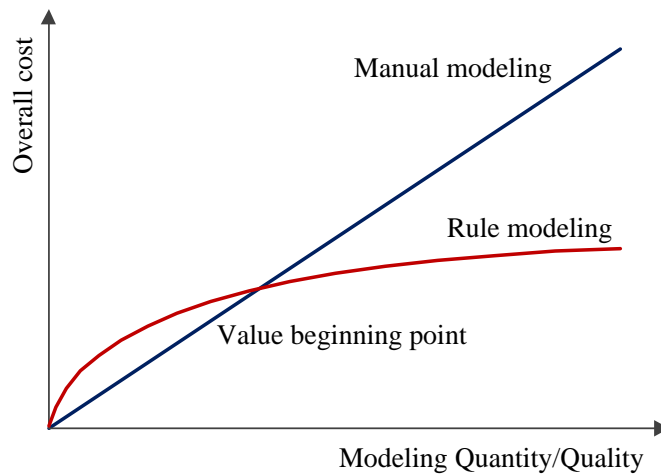

Figure 4. 5 Cost comparisons between manual modeling and rule modeling

The advantages of rule-based modeling techniques based on shape grammar are as follows: first, bulk modeling is fast and convenient; second, the low cost of bulk modeling, input-output ratio is relatively high; Third, the resulting model with geographic coordinates, which is placed into the scene easily and quickly; Fourth, after the establishment of basic rules, the modeling cycle is short, high efficiency, moderate labor costs; Fifth, compatibility with other modeling methods is good, can complement each other; Sixth, it can make full use of the detailed geometry of the building information, create a higher degree of fine model.

4.1.3 Function library of CGA rules and commonly used functions

The CGA rules library includes Shape Operations, Shape Attributes, Built-in Functions, CGA Utility Library, and other keywords. The main part of the model operation is to change the shape of the model, including Geometry Creation, Geometry Subdivision, Transformations, Geometry Manipulation, and Texture. The model attribute is the attribute information included after the model is created, such as the length of the scope of the model on each axis (scope. {Sx | sy | sz}). Built-in functions include math functions, string functions, and so on.

Parameterized modeling commonly used functions are: Extrude function (axisWorld, height), function is to squeeze a height, the model from the surface into a block, the default

along the model Y-axis stretch, axisWorld representatives Set the stretching axis, it can stretch the object have a common direction, the use of the world coordinate system axis as the stretching axis, the optional parameters for world.x / world.y / world.z; Split function comp(compSelector) { selector operator operations | selector operator operations ... } is to separate from the model to meet certain conditions, compSelector(keyword) refers to the type of component to be split, its optional value f on behalf of the surface, e on behalf of edge, v on behalf of the point, selector (keyword) front, back, left, right, Top, bottom around the up and down (model axis), commonly used as vertical, horizontal, aslant, side, all; Cutting function(splitAxis) { size1 : operations1 | size2 : operations2 | ... | sizen-1 : operationsn-1 } is to cut the model along a certain direction into different layers, splitAxis represents the value {X | Y | Z}, the axis of the model for the shaft system, sizen refers to the width of the partition; The coloring function color (r, g, b) refers to the different colors of the model, where r, g, b (float, float, float) represents the floating point type color values, each value in the 0 to 1.0 between; Texture (string texturePath) is given to the surface to give different texture mapping, texturePath that the map image storage path; The replacement function i (geometryPath) refers to replacing the current model with an existing model or model part, where geometryPath refers to the path of the model or model part; Roof function roof, mainly refers to the slope roof, including single-slope roofShed (angle), double slope (roofGable), four-slope (roofHip) and the pyramid roof (roofPyramid); In addition to the translation function f (tx, ty, tz), the rotation function r (rx, ry, rz), scaling function s (sx, sy, sz) and centering function center (x | y | z | xy | xz | Yz | xyz).

CGA rule grammar includes standard rules, with parameter rules, random rules, conditional rules, recursive rules [82]. The standard rule is expressed as PredecessorShape -> Successor, and its characteristics are similar to the no-argument function. The result is returned to the model identifier. With the rules of expression in the form of Predecessor Shape (Parameters) -> Successor, arguments can be of type bool, float, and string, and can be expressions that have characteristics similar to those that have arguments, passing information about the appearance of the inherited model as needed. The random rule is expressed as PredecessorShape -> percentage: Successor1, percentage%: Successor2... else: SuccessorN, the main role is to randomly generate different appearance of the model. The conditional rule is expressed as Predecessor Shape -> case condition1: Successor 1, case condition2: Successor2... else: SuccessorN, it is similar to the conditional statement in the

function, but the keyword of the conditional rule is case, else, and the models with different appearance are generated according to different conditions. The recursive rule is expressed as Predecessor Shape -> case condition1: Operations PredecessorShape, case condition2: Successor2... else: SuccessorN, similar to the loop statement in a function, it is useful for repeating the same operation when certain conditions are met.

4.1.4 Instantiation of static model or component

A static model or component is a three-dimensional model created by third-party software, primarily to better represent landmark models or to re-use complex details such as landmark buildings, doors, windows, cars, and trees. In the written CGA rules, the function `i` is an insert function to insert the OBJ file. On the one hand instantiation of static model or component can make up for the lack of fineness of the model by the CGA rules, on the other hand it make the CGA rule model is more realistic and perfect expression. Because the traditional three-dimensional modeling software has great advantages in making the city complex or fine model, this thesis proposes to use the traditional three-dimensional modeling software to make the corresponding three-dimensional model of the OBJ format. These models are invoked by the CGA rules, as a separate entity, the vertex of the model cannot be edited, the texture cannot be modified, and the rules cannot be used for secondary drive, only the placement, size and rotation angle can be edited.

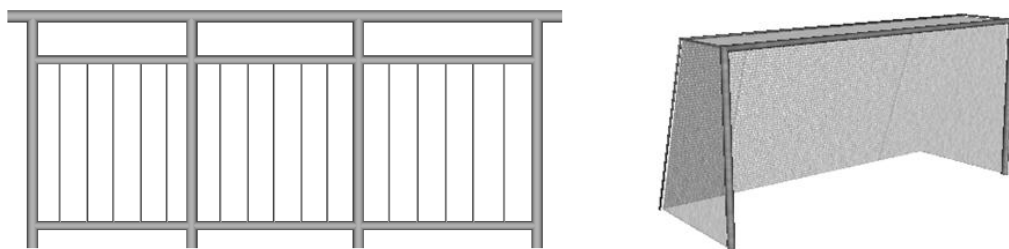

Figure 4. 6 OBJ models of railing and goal

4.2 Façade rule modeling technology with laser scanning

Image or video-based modeling technique is to reconstruct the 3D geometric model by capturing the image or video sequence of the physical model and using the computer vision method to reconstruct the 3D geometric model by the spatial composition information such as layout, position, scale and texture in the image [82]. Creating complex

CGA rule templates using the segmentation of building Façade image, the biggest advantage is that the code could be generated automatically without manual writing, structure complex can also generate a simple and efficient, and can be reused. In this section, we focus on how CGA rules and images combined with facade rule modeling techniques can quickly generate city building models in large-scale scene.

4.2.1 Image ortho-rectification

The image ortho-rectification is due to the projection distortion of the Façade with respect to the true facade, i.e., the Façade position has an inclination with respect to the camera plane.

The effect of facade rectification is through a single facade pixel correction to keep the same vertical direction of the pixel texture with the façade, and subjectively observe the texture without perspective distortion. This thesis directly uses the texture or imaging information existing in the image to adjust and correct the perspective distortion according to the image information, such as using visual judgment by artificial or drawing tools directly stretch and twist the Façade or using image vanishing point adjustment to complete the correction and etc.. A vanishing point is a point at which the parallel lines of the three-dimensional space are mapped to the point on the image plane that intersects in the perspective environment [84]. This point contains the direction information of the straight line, and the edge and corner. For example, in Fig. 4.7, the dividing line of each layer on the building side belongs to the same direction. In the image two-dimensional plane, they converge to the same point that is the vanishing point of the direction.

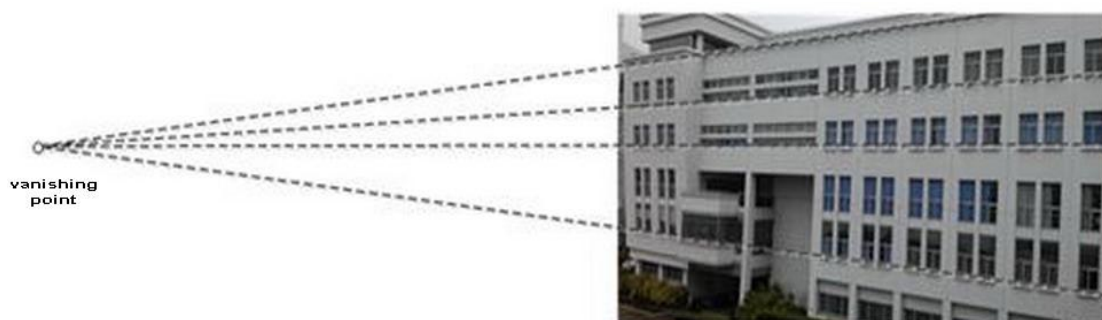

Figure 4. 7 Building facade image vanishing point

The use of image vanishing point adjustment to complete the correction method is based on space in the parallel line segment in the correction of the facade which is also

maintained parallel to this rule, firstly, the straight line of the image is detected and the vanishing point is calculated. Then, the two-dimensional Façade image is corrected to the front view texture by the vanishing point adjustment. Since Hough transform has good anti-noise and is not sensitive to partial occlusion, it is widely used to detect straight lines in images [85]. In this thesis, the Hough transform is used to detect several line segments on the Façade image, then the vanishing point in the horizontal direction is calculated by using the same direction line segment, and then the horizontal parallel line cluster is selected according to whether it belongs to the similar vanishing point and slope judgment. For a parallel line cluster belonging to horizontal vanishing point, the non-uniform stretching of the whole pixel of the opposite plane is achieved by converting the vanishing point to the infinity point so as to achieve a linear ortho-metric height in the horizontal direction, completing the ortho-rectification of the Façade image Correction.

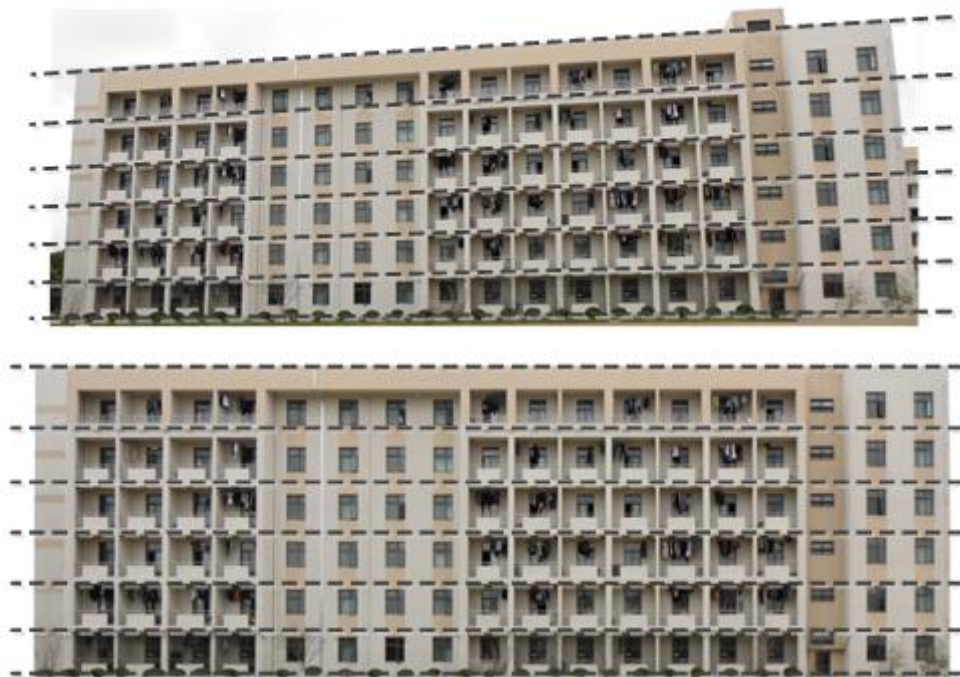

Figure 4. 8 Change of the Façade and parallel lines after correction

4.2.2 Image façade segmentation

Image-based facade modeling requires obtaining each facade of the building firstly and then each facade is divided from top to bottom, floors, tiles, doors, windows, balconies, eaves and other hierarchical structure. The so-called top-down, from the entire building facade, follow the order of Façade , floors, tiles, doors, windows, walls, roof frame,

through horizontal and vertical segmentation, gradually segmentation of architectural elements minimum units, namely from the root node of the tree to the leaf node by segmentation. The tiles in the modeling process mainly refer to a kind of architectural elements in the process of segmentation, similar to the concept of regional block.

In order to segment the image, the horizontal dividing line and the vertical dividing line must be determined. The horizontal dividing line usually exists between the floor and the floor. The presence of a flag level or edge is obtained by the following two functions:

$$\text{hor}(x,y) = \max\left\{\left(\frac{\partial I}{\partial y}\right)^2 - \alpha|\nabla I|^2, 0\right\} = \max\left\{(1 - \alpha)\left(\frac{\partial I}{\partial y}\right)^2 - \alpha\left(\frac{\partial I}{\partial x}\right)^2, 0\right\} \quad (4.1)$$

$$\text{ver}(x,y) = \max\left\{\left(\frac{\partial I}{\partial x}\right)^2 - \alpha|\nabla I|^2, 0\right\} = \max\left\{(1 - \alpha)\left(\frac{\partial I}{\partial x}\right)^2 - \alpha\left(\frac{\partial I}{\partial y}\right)^2, 0\right\} \quad (4.2)$$

Where I is the intensity of the image, $\frac{\partial I}{\partial}$ is the partial differential operator, $\nabla I = \left(\frac{\partial I}{\partial x}, \frac{\partial I}{\partial y}\right)$ is gradient operator, usually $\alpha = 0.9$. In the position y for the horizontal split line or at the location x for the vertical split line depends on the following two interest function values:

$$\text{Ver}(y) = (\sum_x \text{ver}(x, y)) * g_\sigma(y) - \beta(\sum_x \text{hor}(x, y)) * g_\sigma(y) \quad (4.3)$$

$$\text{Hor}(x) = (\sum_y \text{hor}(x, y)) * g_\sigma(x) - \beta(\sum_y \text{ver}(x, y)) * g_\sigma(x) \quad (4.4)$$

Where $g_\sigma(\cdot) = \frac{1}{2\pi\sigma^2} e^{-\frac{|\cdot|^2}{2\sigma^2}}$ is the Gaussian kernel, $*$ is the convolution operation, and β is a constant value of 0.1. A higher value of Ver (Hor) will accumulate the vertical (horizontal) edge. Based on this function of interest, a set of potential locations $\{y_i\}$ or $\{x_i\}$ can be extracted at local minima, where splitting lines are generated.

If a horizontal split line is generated, Ver (y) reaches a local minimum at position y , and the presence of the vertical split line is reduced. Finally, the optimal set of these potential locations $\{Y_i\} \subset \{y_i\}$ is exhaustively searched by the prior condition of floor height (3m ~ 5m):

$$\{Y_i\} = \arg \min_{\{\hat{y}_i\}} \frac{\sum_i \text{Ver}(\hat{y}_i)}{\|\{\hat{y}_i\}\|}, 3 < \nabla \hat{y}_i < 5, \{\hat{y}_i\} \subset \{y_i\} \quad (4.5)$$

Where $\|\cdot\|$ denotes the number of elements in the set, $\nabla \hat{y}_i = \hat{y}_{i+1} - \hat{y}_i$, and similarly, the vertical partition line satisfies the following optimal set:

$$\{X_i\} = \arg \min_{\{\hat{x}_i\}} \frac{\sum_i \text{Hor}(\hat{x}_i)}{\|\{\hat{x}_i\}\|}, 0.2 < \nabla \hat{x}_i < 8, \{\hat{x}_i\} \subset \{x_i\} \quad (4.6)$$

Based on the above functions, you can determine the location of the optimal horizontal or vertical segmentation line. Simple buildings are usually composed of floors,

the floor above the windows, doors and other architectural elements, so the specific building facade image segmentation method is as follows:

(1) The original image is cut to obtain the ortho-photo image to obtain the building facade;

(2) Vertical segmentation, access to floors (Floors), the composition of the floor group;

(3) For each floor group split horizontally, access to tiles, the composition of tile groups;

(4) For each tile group vertical and horizontal segmentation, access to windows, doors and other architectural elements.

In the segmentation process, not necessarily in strict accordance with such a segmentation step, if the building does not need to go through tile subdivision can get the final architectural elements.



Figure 4. 9 Building facade segmentation

In the segmentation operation, you can set the floor height value as absolute value or relative value according to the needs of the building structure. If the building has multiple floors, and each floor height is the same, then you can use the relative value of the partition, so that can ensure that the generated floor height consistent. For other divisions, absolute or relative values can also be set as desired. In addition, the size of the Z-axis direction can be modified to adjust the unevenness of each divided portion. For example, if the window is recessed relative to the wall, the dimension in the Z-axis direction can be modified to correspond to the wall.

4.2.3 Rules generation and optimization

After the facade is divided, the build rules of the building will be generated automatically. In order to highlight the visualization of the 3D model, it is necessary to add

some 3D building components, modify the generated rules to add the 3D model to the building, such as eaves, ledges, doors and windows.



Figure 4.10 3D building components added to the building model

For noisy images, image segmentation can be accomplished by symmetry of the image. In Figure 4.11, we can see that the right facade of the building is not ideal, and can use its symmetry with the left side, with the rules generated on the left instead of the rules on the right to complete the overall rules of production, applying the rules to the target area, you can generate the corresponding building model, building height or width of the model can be changed according to demand.

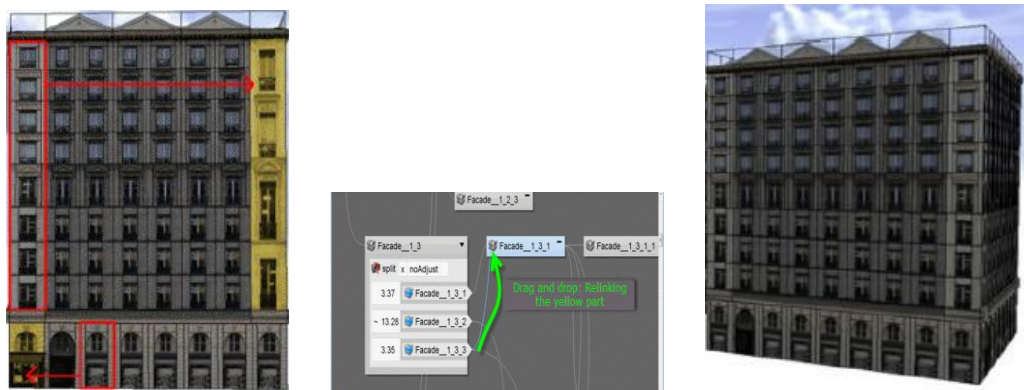

Figure 4.11 Completing rule substitution with symmetry

4.3 The application example of the novel approach

4.3.1 Procedural intelligent modeling software analysis

In simple terms, Esri CityEngine is a software of three-dimensional city modeling and planning design. Esri CityEngine is based on city building of parametric modeling technology, which is a batch creation city model software mainly focus on large-scale three-dimensional city, and mainly used in geographic information, city planning, rail transportation, cultural heritage, simulation, game development, film entertainment and other fields. CityEngine software can import map data and generate real road network. It invokes CGA rule files to generate buildings and match the map, which easy to generate real large-scale city. Moreover CityEngine software can support ArcGIS software perfectly, which can realize the three-dimensional modeling without changing the existing basic GIS data, thus it can reduce the cost of the system and shorten the construction period of 3D GIS system. In addition, CityEngine software can also generate a good model to import to the other three-dimensional software, such as ArcGIS, 3D Max, Maya, Google Earth, Unity3D or Unreal. [86].

The main idea of the CityEngine software is to implement fast and efficient modeling through programs, including 3D models and textures. By applying a rule file made up of several codes, a geometric model is created during the execution of the code and a rule program can generate many 3D models. City environment modeling with CityEngine typically begins with the creation of a street network, which subdivides the lots several times in specified way until the streets and lots meet the requirements. After selecting all or part of the lots, CityEngine can generate the road and building model as instructed by the rule code. By changing the parameters or grammar rules, city model can be re-adjusted and designed. The more parameters, the more accurate model generated.

There are four key benefits of Esri CityEngine software in three-dimensional modeling of city buildings:

(1) GIS data can be used as the basis of modeling to ensure the consistency of the spatial location, accuracy of the created model and the attachment of corresponding attribute information. For example, the rules can be bound to the relevant attribute

information in the GIS data when modeling with CityEngine rules, such as the width of the road, the name of the building, the number of floors, the height of the building, the texture path of the window and so on. So we need to add attribute information to vectored two-dimensional GIS data, as shown in figure 4.12. Such as the height of the building, the number of floors, height, roof style, exterior style, etc.; public facilities, property, size, spacing, functions, etc.; the application of road bridge, size, material, etc. can be real-time adjustment, modification and shown immediately.

FID	Shape *	FMFC	Floors	Height	Comment	C_Height	U_Height	U_Floors	C_WT
3	Polygon	(新4)信息电气工程学	5	16		3	12	4	textures/20.jpg
23	Polygon	香5	6	18.8		3	15	5	textures/16.jpg
16	Polygon	香1楼	6	18.8		3	15	5	textures/14.jpg
6	Polygon	深部岩土力学与地下工	2	6.4		3.2	3.2	1	textures/12.jpg
34	Polygon	学4	6	19.2		3.2	16	3	textures/06.jpg
32	Polygon	学2	6	19.2		3.2	16	5	textures/01.jpg
33	Polygon	学1	6	19.2		3.2	16	5	textures/01.jpg
35	Polygon	学3	6	19.2		3.2	16	5	textures/01.jpg

Figure 4. 12 Attribute information edition

(2) Create three-dimensional model by rule-driven. The modeling law are described by rules, which realized the terrain-based modeling of batch, automation and parameterization requirements.

(3) Dynamic intelligent editing and layout. Adjusting model appearance according to the attribute, we can realize the road and plot linkage edition. We can also count the building covers the area, the total construction area, the volume rate and so on.

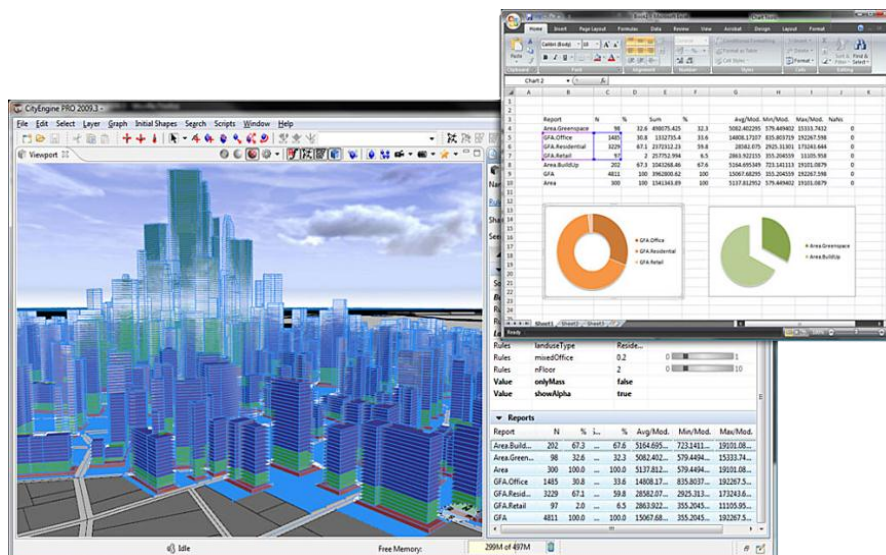

Figure 4. 13 Statistical report forms

(4) Input and output in standard industry 3D format. CityEngine software can support

most industry-standard 3D formats, including FBX, OBJ, 3DS and DAE etc..

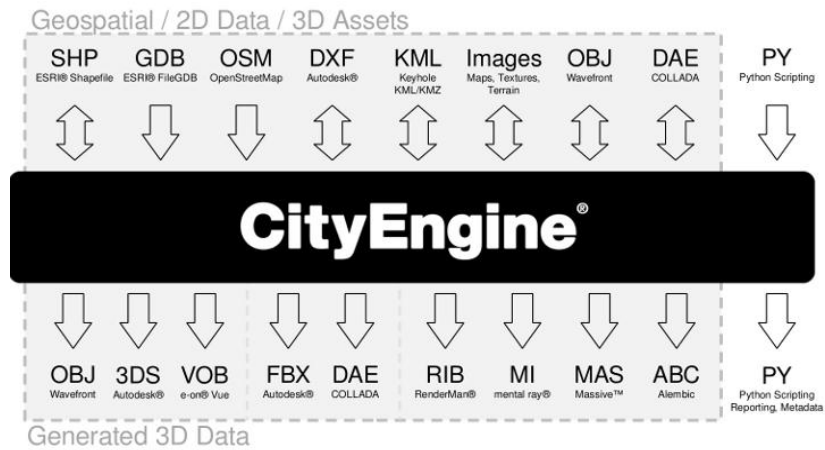

Figure 4. 14 File format supported by CityEngine

CityEngine provides an excellent tool platform and support environment for city building designers and government decision-makers. With the support of GIS data and domain model rules, we create more models or different design schemes by changing model parameters. The "WYSIWYG"(What You See Is What You Get) approach enables decision makers to quantitatively compare and choose for a variety of planning ideas. Planners' ideas and assumptions can be evaluated and responded in a timely manner, which ultimately enabling the planner to design a blueprint for the future.

4.3.2 The novel modeling approach workflow

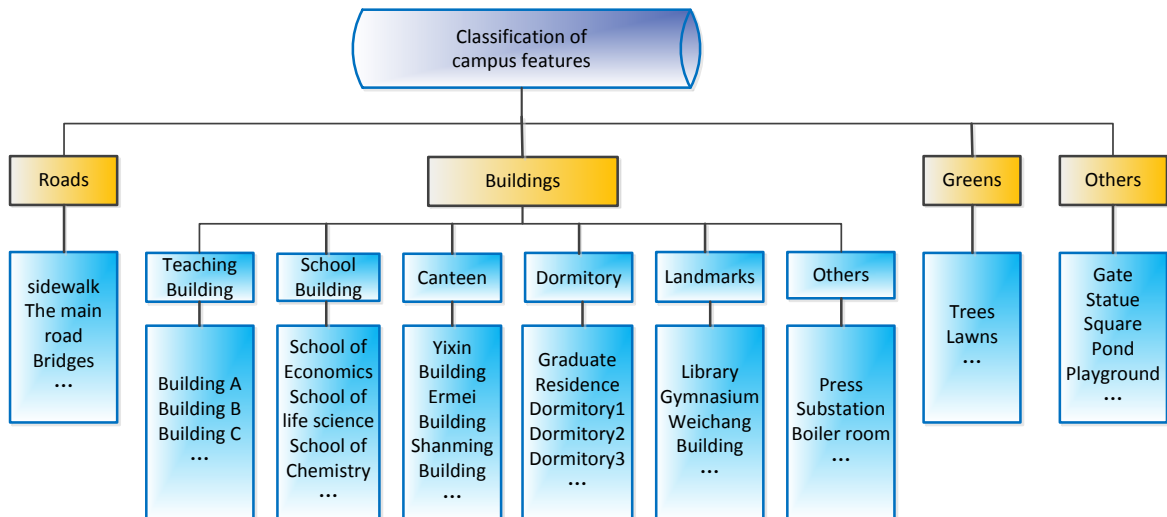

Figure 4. 15 Classification of objects in Baoshan campus of Shanghai University

This thesis chooses Baoshan Campus of Shanghai University as an example to show

the application process of the novel 3D modeling approach and the final scene effect. Baoshan campus of Shanghai University is mainly composed of buildings, roads, stadiums, trees, lawns, rivers and other components, which covering the majority of the city's main elements, has a certain significance. The campus features were classified in order to make the modeling process more clear. It mainly divided into four categories such as roads, buildings, trees, lawn and the other. Roads which include all the roads in the campus such as street, pedestrian road and so on. Buildings mainly include teaching buildings, dormitories, landmarks, canteens, boiler rooms and the other buildings. Greening including the campus of the trees, lawns, flower beds and so on. The other is all the other things, such as stadiums, squares, statues, rivers, watersides and so on.

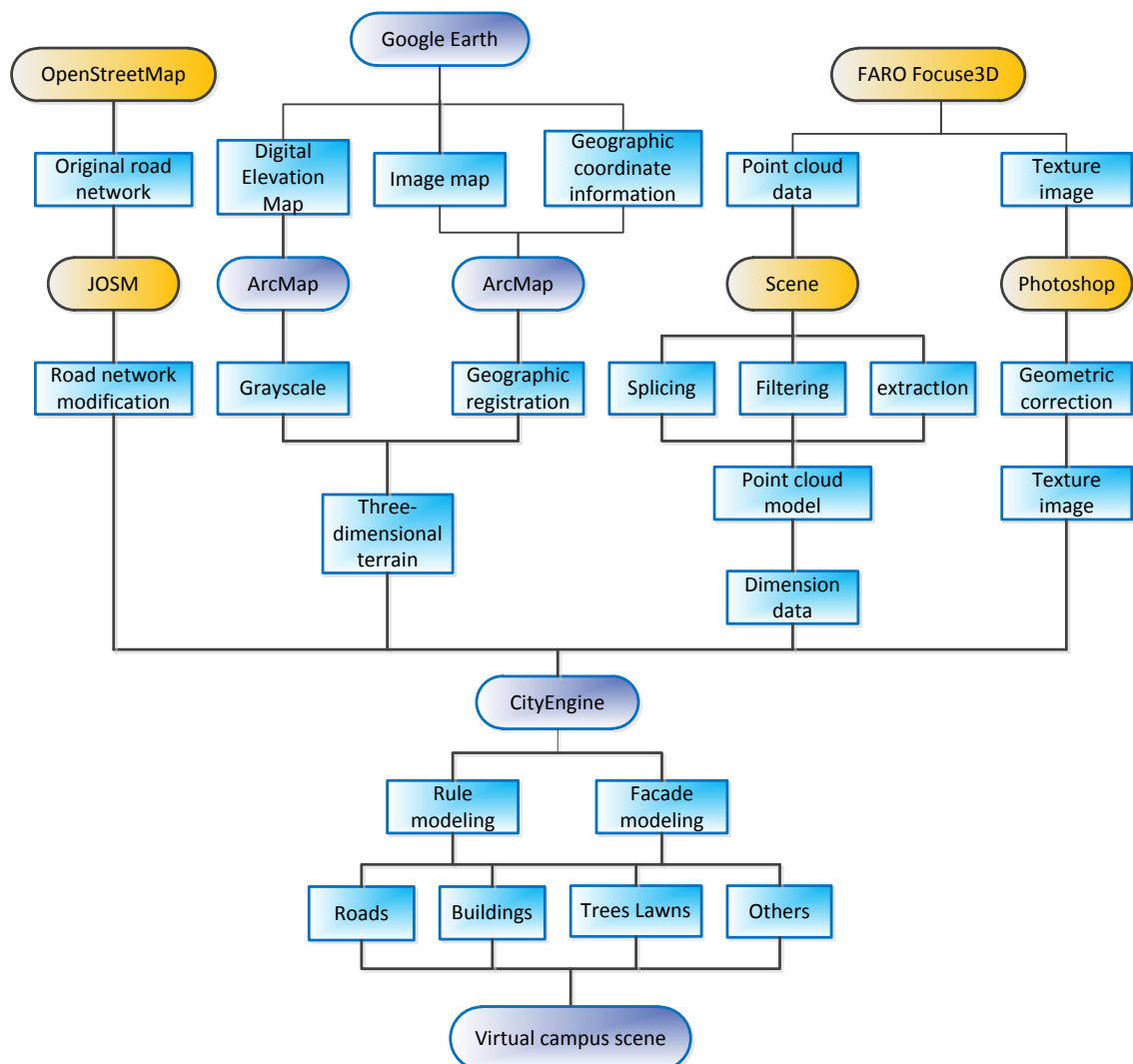

Figure 4. 16 Workflow of the novel modeling approach for campus

The whole process of modeling in Baoshan campus of Shanghai University: First of

all, according to the terrain data acquisition and processing methods described in Chapter 3. We using Google Earth and ArcGIS software to obtain and process the target area of the image map and height map data and add geographic information. In the CityEngine software platform, we superpose image map, height map and location information to complete the city three-dimensional basic terrain construction. And then, we use the open source map OpenStreetMap to obtain the target area of road data and to deal with the optimization of the road data in the JOSM software. We import it to CityEngine software platform to match 3D terrain. We scan the buildings on the campus to get their point cloud data and texture picture by using FARO Focuse3D laser scanner. The building of various modeling dimensions are measured after stitching, filtering and extraction of point cloud model generated by the pretreatment in the Scene software. In Photoshop, the resolution and the size of the picture are adjusted, the image format conversion, ortho-rectification, picture stitching, beautifying and other operations to get high-quality map images and complete the data preparation before modeling. Then in the CityEngine software platform the rule-based modeling technique based on shape grammar and image-based facade rule modeling are used to create the model of each object. Thus the whole scene model of the Baoshan campus of Shanghai University is completed.

4.3.3 Creation of building model

4.3.3.1 Creation of model building based on CGA rules

The core of rule-based modeling techniques based on shape grammar is to write CGA rule scripts. Take the dormitory #1 as an application case, a brief description of the corresponding rules to the preparation process was introduced.

In the modeling of the dormitory, the first thing is to use extrude function stretch the building along the Y-axis and generates white mold according to the actual height. Then we use the comp (comp Selector) {selector} function to split the building into front, back, left, right, top, bottom and other parts. And then split the building into more finely divided windows such as windows, doors, walls and so on by using segmentation function split (splitAxis){size1:operations1|size2:operations2| · · · }. Finally, texture mapping is constructed for each detail object. Texture rules are used to map. For details such as windows, doors and railings, the object can be replaced with the pre-created OBJ

components. Then the 3D model can be created.

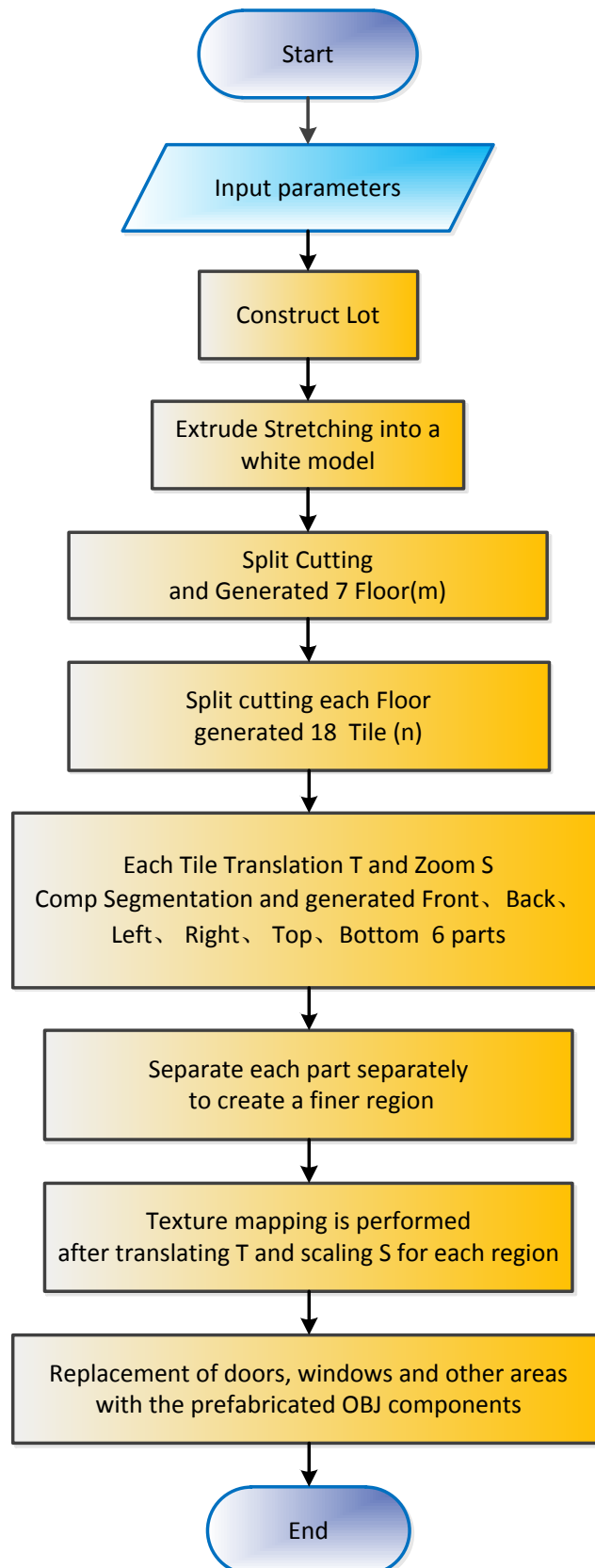

Figure 4. 17 The overall flow chart for the dormitory #1 with CGA rules

This thesis chooses the front façade of the dormitory for more meticulous decomposition and explains how the CGA rules create the characteristics of the various parts of the building model in detail in order to explain write process of the rule. According to the previously defined floor number m and area Tile number n , each building feature the blocks generated is accurately specified. And then in accordance with the corresponding size translation and scale settings were conducted on each block. Finally, the texture mapping and component call are respectively performed to complete the model creation of the front façade of dormitory #1.

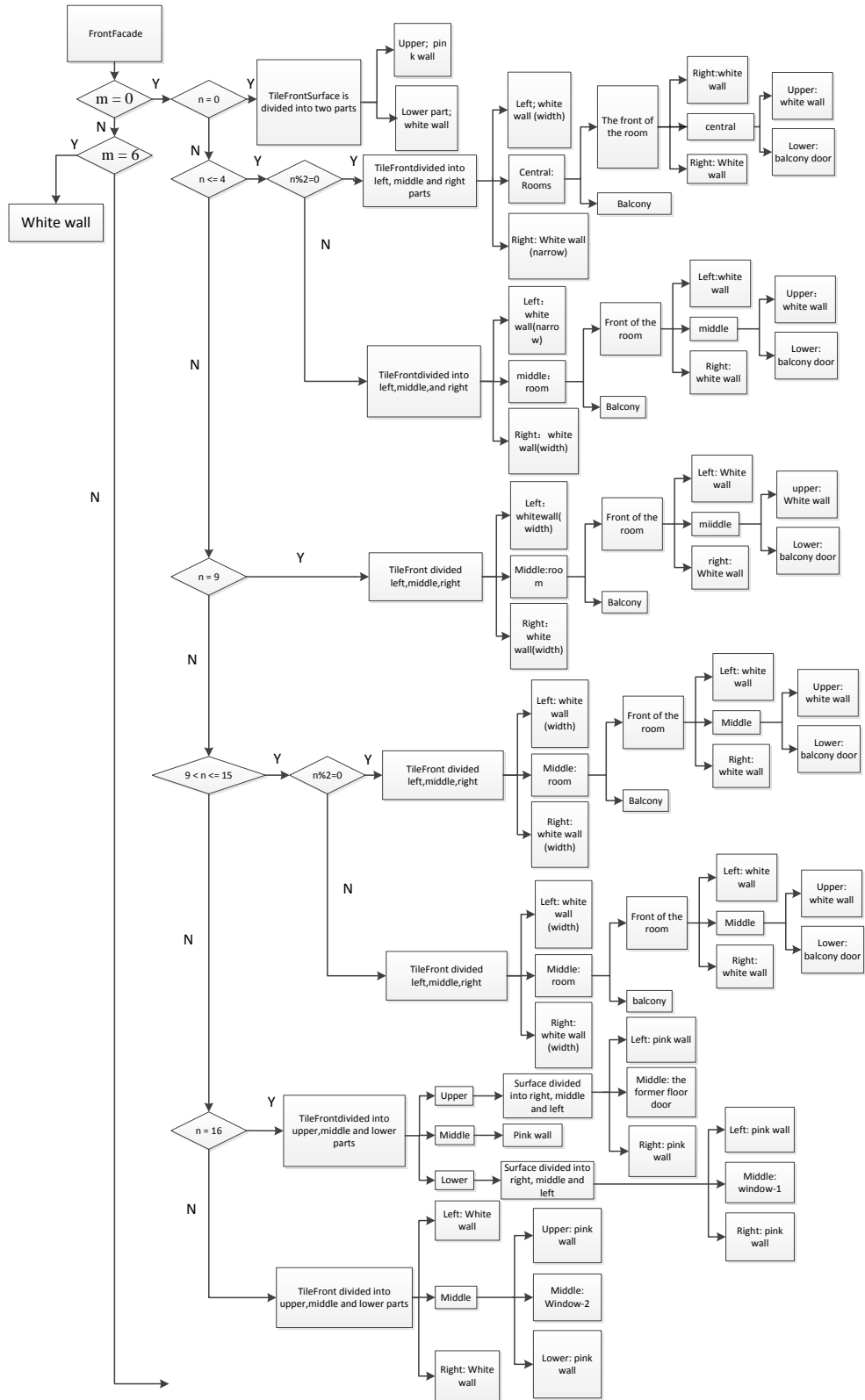



Figure 4. 19 The 3D model of dormitory

4.3.3.2 Building model creation based on image façade segmentation

In order to facilitate the application of façade modeling technology, CityEngine provides a Crop Image tool for image processing. On the left of the picture window in the Crop Image tool, we change the output of the picture by adjusting the location of the red yellow box, in which the yellow part can adjust the location of the corner and the red part can adjust the location of the side. In order to accurately control the corrected picture, we can control the size of the original picture by mouse wheel and we can also use Alt + middle mouse button to shift the original picture. The area within the box will be cut out from the original image and cut out of the picture is ortho-rectified. The building façade ortho-rectification images can be obtained by this tool.

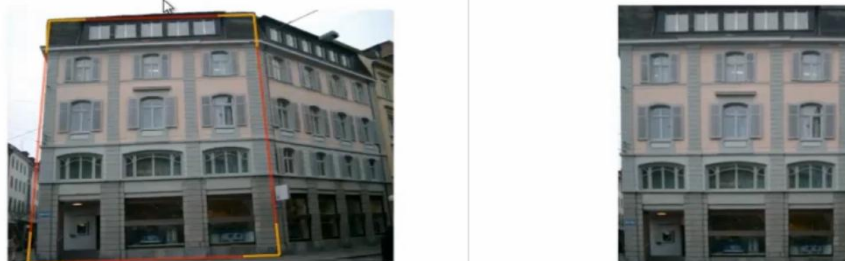

Figure 4. 20 Before and after processing by Crop Image tool

The Façade Wizard provided in the CityEngine is an interactive tool for quickly creating a 3D elevation. The result of the tool outputs is a CGA code (rule file). Image segmentation is the core of the image-based façade rule modeling technology, which gradually segmented until the most basic building elements through the X-cut and Y-cut image. CGA rules will automatically complete write when image segmentation is complete. Then, the CGA rules are modified and optimized combined with the CGA rules function. Finally, the CGA rules are integrated and finally the 3D model of the building is generated. The following is an example of building E in Baoshan campus of Shanghai University, which shows the whole process of building 3D model based on image-based façade rule modeling technology.

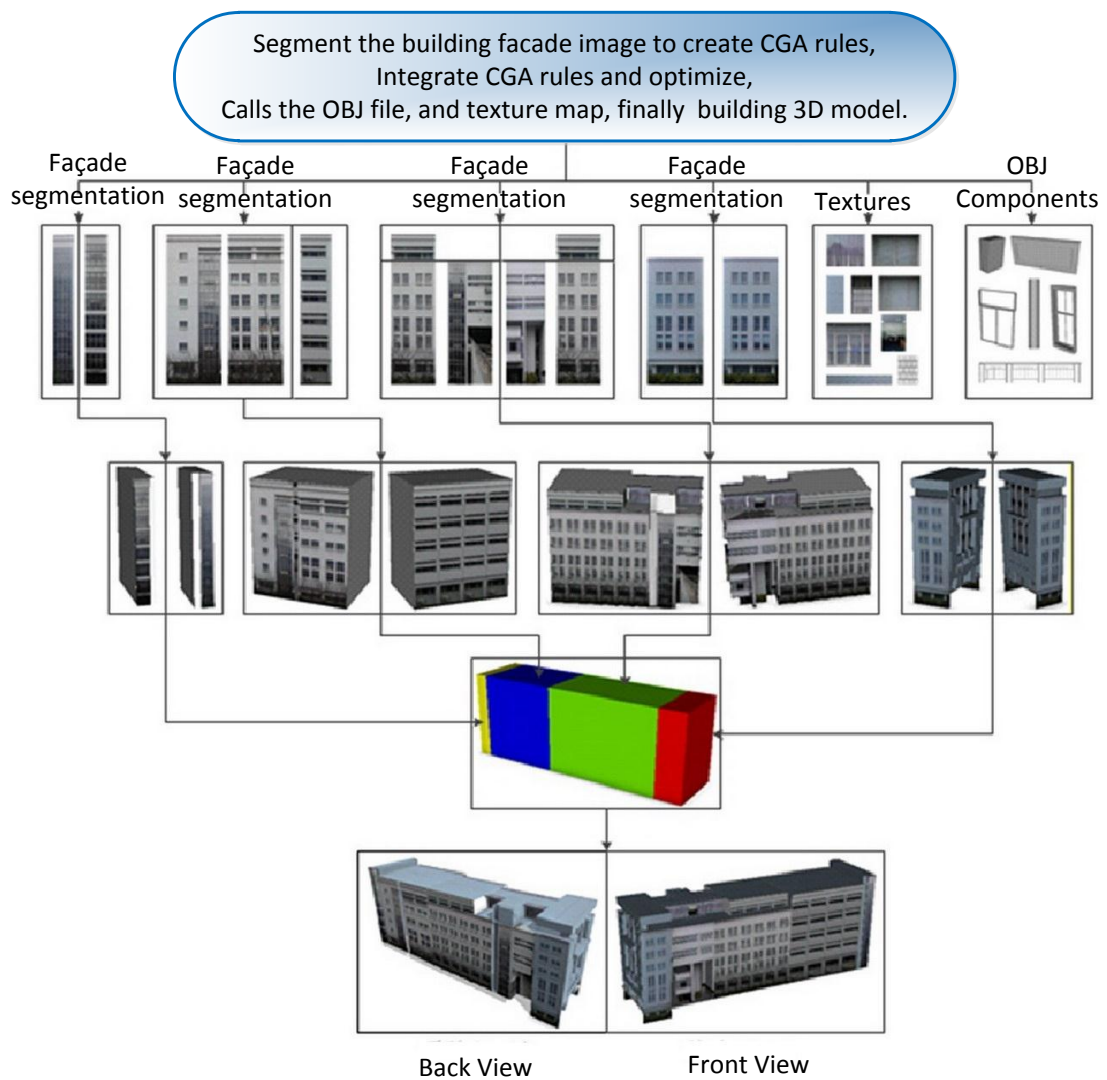

Figure 4. 21 Teaching building E model creation process

4.3.4 Road model creation

4.3.4.1 Road data acquisition and pretreatment

Urban roads bear the city's traffic, which are the important part of the city. Once the formation of road network, it basically identified the layout of land usage and land use profile. In the three-dimensional modeling of city buildings, urban roads determine the formation of blocks and the distribution of roads. Whether the city road layout is reasonable determines the 3D model of the city building is true. So to create urban roads correctly and reasonable are the premise of 3D city building modeling. The CityEngine road network is a graph with properties consisting of a graph node (intersection) and a graph edge (street segment). Roads can be created either inside the CityEngine based on the road generation feature, or import through an external file, for example, OSM road data in OpenStreetMap, DXF road data in CAD software and GDB road data in ArcGIS software.

The road template style in CityEngine is relatively simple, mainly including free style, grid type and radiation, as shown in Figure 4.22.

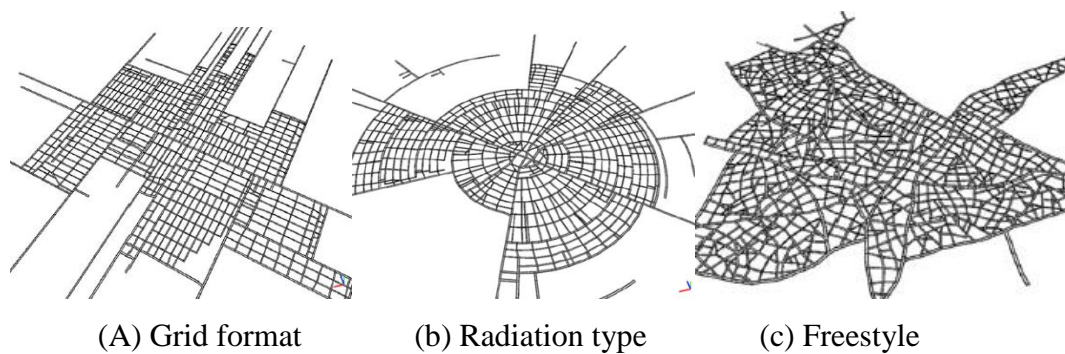

Figure 4. 22 Road template style in CityEngine

This thesis chooses OpenStreetMap to get the road data, because OpenStreetMap's biggest characteristic and advantage are the openness compares to other spatial geography data [87]. It is an XML-based format used to describe the vector data in the map. There are three basic types to describe all the other elements of the road, such as the definition of nodes, roads and the closed way. OSM documents include a variety of road data, such as a road, two roads, three roads, rail traffic roads, rivers, lakes and building bottom shape. Figure 4.23 shows the road network at Baoshan campus of Shanghai University in

OpenStreetMap.

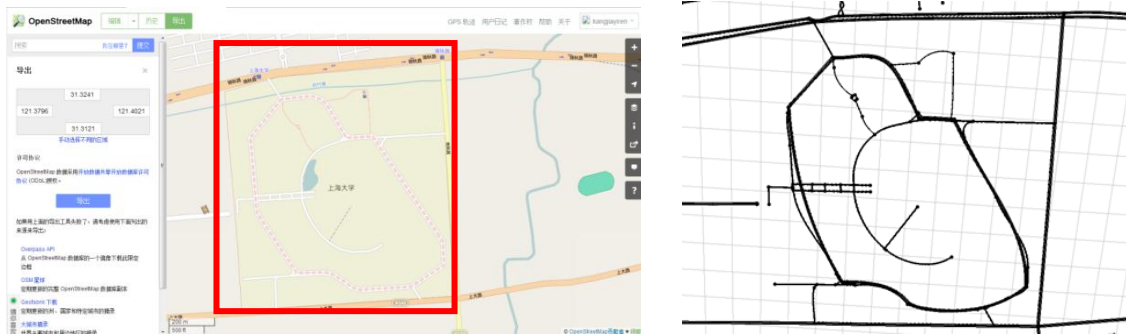

Figure 4.23 The road network obtained in OpenStreetMap

As the Shanghai University area is small, the road data is not detailed enough. There are noise data during the OSM road network data construction and conversion process. So the OSM files need to be further modified, such as correct unreasonable road location, delete unnecessary roads and add missing roads. We choose to modify OSM road data in JOSM software.

JOSM is a OpenStreetMap editor using Java language [88]. It provides a good interface to facilitate the user to the specified area for data download, rendering and visual processing. After import the downloaded EXCEL file, the image layer is added and the road information is modified according to the image layer. And then the new OSM data file is optimized.

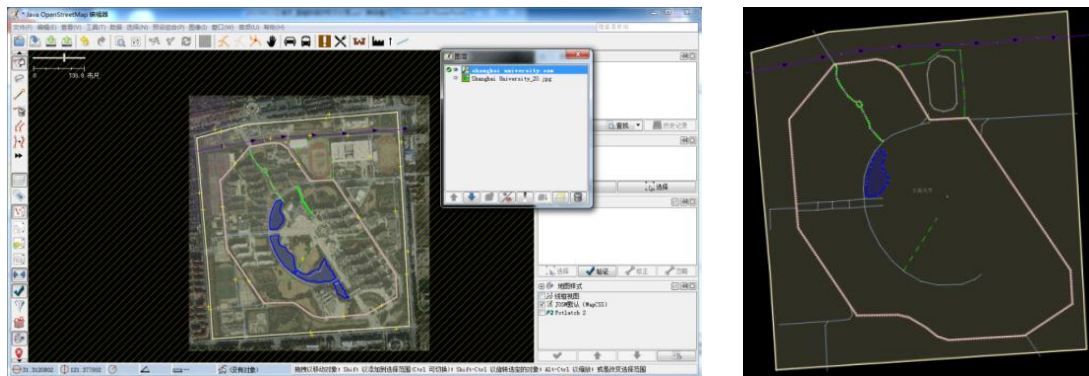

Figure 4.24 JOSM modification interface and modified OSM file

4.3.4.2 Road data modification and optimization

We import the newly generated OSM data into the CityEngine and add the coordinate system, create the road network layer properties, define the OSM road width type. By setting a new road width parameter value manually modify the width of the road or through the toolbar editing tools to manually modify the parameters of the road and the

degree of fit with the terrain until the road modeling to meet the demand. It can be used as the basic road data needed for city building modeling.

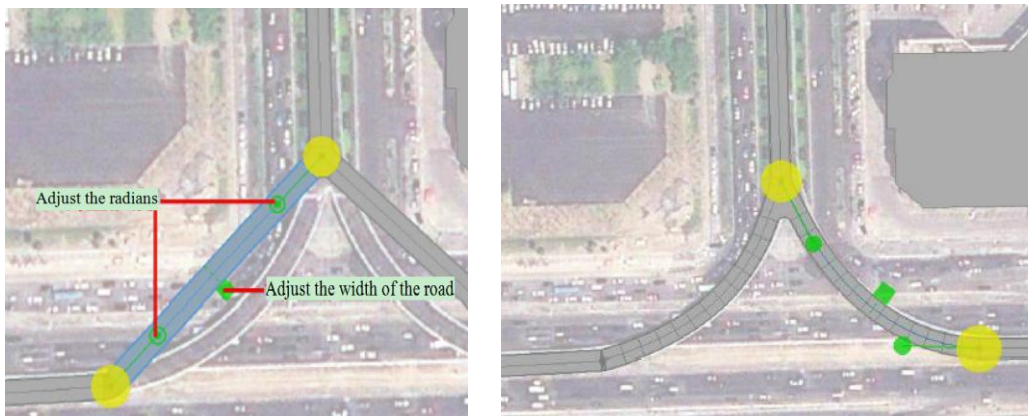

Figure 4. 25 Road network width and curvature before and after editing

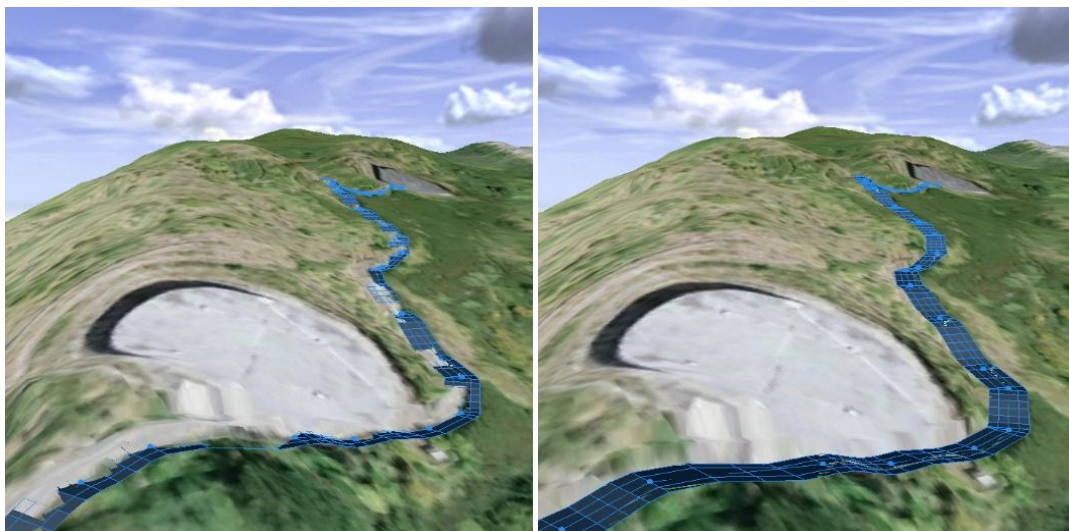

Figure 4. 26 Road network width and curvature before and after editing



Figure 4. 27 Final optimized road network

4.3.4.3 Road model creation

Road will be split into the previous five parts during CityEngine road modeling process. Street, Sidewalk, Crossing, Junction, JunctionEntry. Parametric modeling of the street is the preparation of different rules for each part. Different parts apply different parameter settings. We achieve fast and convenient road design and modification by adjusting the parameter values.

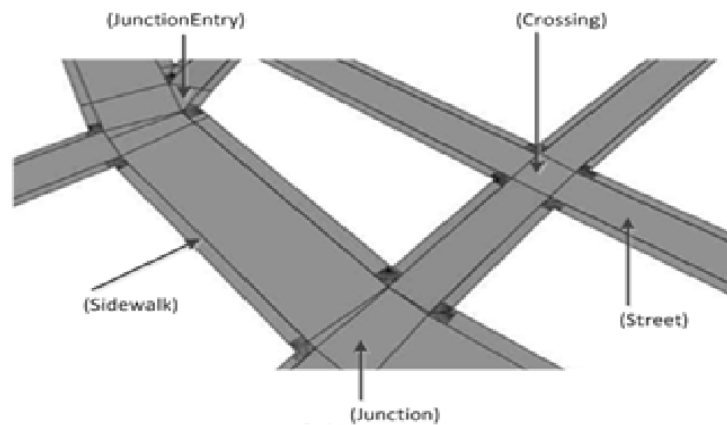

Figure 4. 28 Road division

Street determines the road center line direction and cross-sectional configuration. We model the crosswalk, isolation belt, motorway, non-motorized belt and other rules. We stretch the sidewalk at high degree, apply sidewalk texture and distribute of street facilities through the rules. Such as street lamps, street trees, etc.; Crossing, Junction, JunctionEntry, apply the actual texture and determine the turning radius.

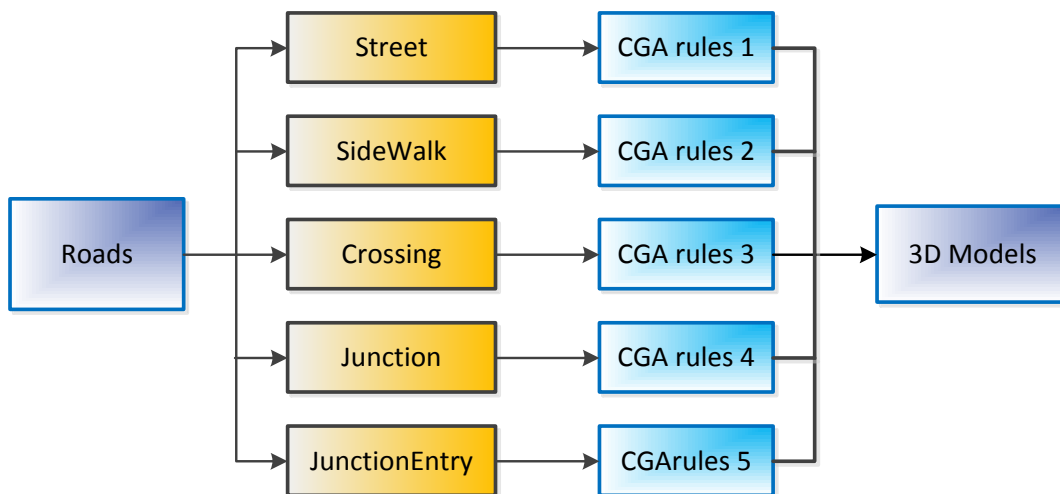

Figure 4. 29 Road CGA application principle

Because the road is divided into four basic forms [89], single road, double road, three road, and four roadways, the different rules and different textures are applied to different types of roads.

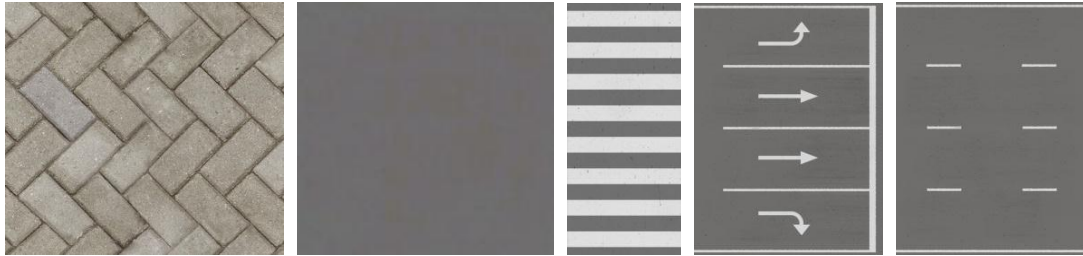

Figure 4.30 Road surface part of the texture material



Figure 4.31 The OBJ model of some road facilities

We add lights, motor vehicles, green belts and other prefabricated models for the road to make the road closer to the real effect.



Figure 4.32 The created road model

4.3.5 The creation of other models

The other model creation mainly refers to the creation of trees, lawns, street lights and river surface models in the scene. For the creation of lawn and river surface, we use texture mapping to complete. Firstly, we outline the contour of the lawn or water to form a closed area and make it fit with the terrain, and then create texture mapping. In order to achieve a more realistic effect, we use the different layers to setup Projection to map. We can use the external reference to complete the creation of the street lights, cars, trash and other models. We mainly use the alternative function i call prefabricated model of the material OBJ, and then to meet the needs by adjusting the model scale and angle. For trees and other models, because of its many branches and leaves, creating solid model is more difficult. Therefore, we use Bill Board technology [90] to create trees by decomposing trees into crisscrossing fa çades and then performing texture mapping for each facet to model the trees.

Table 4.1 six texture layers to setup Projection

uv-set	Texture Layer
0	Colormap
1	Bumpmap
2	Dirtmap
3	Specularmap
4	Opacitymap
5	Normalmap

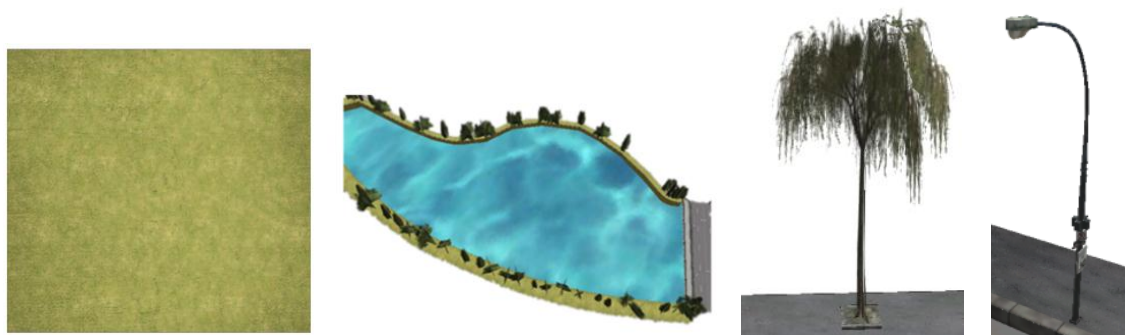

Figure 4. 33 Effect diagram of Lawn, water, trees, street lighting

4.4 Chapter summary

The 3D modeling of city building is the main content of the construction and

development of smart city. Its model quality directly affects the overall effect of 3D visualization. The speed of modeling affects the process of smart city indirectly, so the studies on 3D modeling technology of city building have a practical significance to smart city construction. This thesis demonstrate the rule modeling technology based on the shape grammar, this technology can achieve the automation of building modeling. First, the rule base must be established, moreover, through the constant expansion and accumulation of the rule base, then later modeling only need to add some new rules and modify some rules, finally we can quickly invoke the rules of existing rules in the rule base to the bulk of modeling, this will reduce the modeling time and decrease the cost of investment. Based on image-based facade modeling, CGA rules are combined with image segmentation, which enables the automatic generation of rule codes without the need of hand-coding. The complex structure can also be generated easily and efficiently, and the generated rules can be reused.

We generate the entire model scene of Baoshan campus of Shanghai University by the novel approach of 3D modeling in the CityEngine software platform. It can be automatically rendered and has its own spatial location information, attribute information after the completion of each model, which has user-friendly query and good browsing experience.



Figure 4. 34 The whole model scene at Baoshan Campus of Shanghai University

Chapter 5. City Building Integrated Information Model

5.1. Building information integration analysis

5.1.1 Requirements of building information integration

With the development of the smart city, construction industry which is committed to infrastructure construction has got a new round of development opportunities. The traditional construction industry which heavily relies on resource consumption and large quantities of cheap labor resources can no longer meet the requirements of the new times. The construction industry needs to deepen the informatization construction in order to steadily improve the competitiveness of Chinese construction engineering enterprises.

There will inevitably be a lot of information about the building life cycle during the design, construction and maintenance of buildings. If the information can't be effectively managed and shared, there will be "information island" phenomenon. It cannot make the information effective sharing and reuse, which will result in inefficient use of information and information blocking. Use the concept of integration of the building lifecycle to manage a series of information, through the construction of city building integrated information model. It is of great practical significance to realize the information sharing and exchange.

Building information technology refers to the use of information technology, especially computer, network, communication, system integration and information security technology to improve the design, construction, management and service level of the construction industry, improve the construction enterprise management level and core competitiveness, which makes the rapid development of the construction industry. The effective way to realize the informatization of building is to create integrated information model and database platform to manage the information generated in the construction lifecycle so that the information can be reused in the next process.

5.1.2 Building information integration features

The information integration refers to the use of effective information as the starting point and the end point in the construction and operation of information systems. The organization mobilizes all technical means for the effective use of information services. Information integration is the system engineering. It is the computer technology, network technology and communication technology integrated application: real-time process information integration is the core of real-time database technology. The basis of information integration is data integration, which is the characteristic of data.

Since the structures of the different systems are divided according to their functions, the different parts of the system are assigned different functions and use different information systems to complete the prescribed functions, which results in a large number of information being confined in independent systems, this is called "Information Island". The value and necessity of application integration are beginning to be reflected in how many "islands of information" are linked, so that the interaction between different systems is presented as a business need.

In the enterprise information processing, the realization of information integration can eliminate the information island, so the entire computer system to play the overall effectiveness. In particular, information integration has the following advantages:

- 1) Reduce data duplication, enhance information sharing, share the same information within the database, and keep data consistency.
- 2) To facilitate the rational planning and distribution of data. And information integration in the environment to maintain a unified plan, unified management, thereby improving the efficiency of data storage and retrieval, further improve the operational efficiency and level.
- 3) Facilitate the coordination between different users. Integrated information can be the user to easily query with the power of information, which to facilitate enterprise management.

5.2. Construction of City Building Integrated Information Model (CBIIM)

5.2.1 Structure composition of integrated information model

The integration of building information plays an important role in the effective management of information in the whole building lifecycle. Integration of building information is good for construction of standardization and normalization process, and it can enhance the level of building informatization. The requirements of informatization are increasing for city construction, in order to build information of city construction. City Building Integrated Information Model (CBIIM) is constructed based on the building information model (BIM). It absorbs the building information expressed in BIM with building and building components as the core. And according to the needs of information integration, the geography information and IFC standard are added references, CBIIM can describe the entire building and a building complex, which making CBIIM to include the building lifecycle of some of the necessary information. By using the concept of information integration, this information is effectively managed and stored. The effective method is to specify the city building integrated information model. The Building Information Model (BIM) is an intelligent 3D building model [91]. CBIIM is the inheritance and development of Building Information Model (BIM). CBIIM is in the information level not only for a building, and can be extended to the city within the concept of buildings, and then all related building information is integrated. Compared with BIM, CBIIM is similar to BIM, and CBIIM has its own specialties. CBIIM inherits the BIM definition of building component level information, but compared with BIM, CBIIM has a better flexibility and breadth. CBIIM can either retrieve the corresponding information in BIM according to the actual needs, and all these informations are expressed with the form of integrated information model. CBIIM can integrate some information which has not been defined in BIM according to the demand, for example geographic information. As a whole, CBIIM pay more attention to the effective integration of building information and management, it is based on BIM to integrate unique geographical information and IFC standard information for building components, building and building complex.

CBIIM is more focused on the modeling, construction, maintenance and other building lifecycle process, and integrates the information in the form of CBIIM. CBIIM has several advantages:

- a) Since the information architecture of CBIIM is mainly based on BIM architecture,

the information of building components is inherited the BIM, and comply with IFC standards. CBIIM is advantage to information sharing and exchange.

- b) CBIIM information obtain the required information definition according to the need to in BIM, thus CBIIM can avoid the phenomenon of information redundancy, and ensure the efficiency of the use of information. CBIIM shows a better flexibility and personalization.
- c) CBIIM adopt the special information integration, the information is classified into several types to manage. CBIIM can effectively comprehensive management of building lifecycle information.
- d) CBIIM contains geographic information which is not included in the BIM, which can meet information management requirements of the city building complex.

Compared with the traditional integrated model and the feature model, CBIIM integrates the information of related architecture, include the overall construction, geometric, technical and management information etc.. Moreover it contains the geographical information that not included in the BIM, etc., which to meet the information needs of the relevant content of the city and building. The architecture of CBIIM can be summarized as follows: structure information, function information, management information, knowledge information and geographic information. As shown in Figure 5.1

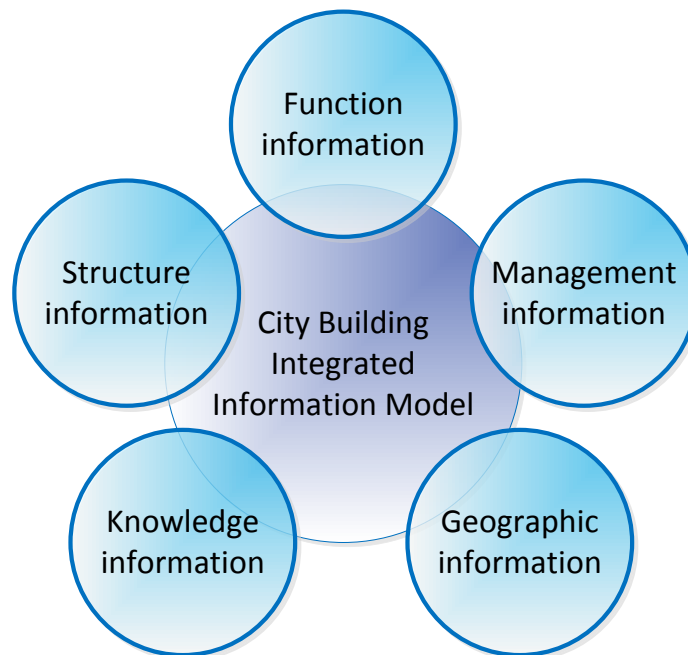

Figure 5. 1 Classification of Integrated Information

Management information mainly refers to: basic management information, construction management information, maintenance management information, etc.. Knowledge information mainly refers to: design experience and formula, knowledge and rules; geographic information mainly refers to GIS-related information; functional information is mainly on its function and technical performance description. The concept of CBIIM will undoubtedly provide an appropriate development path for the information integration in cities and buildings. It will promote the standardization of modeling, design, construction and maintenance of city buildings, so it has extremely important realistic and economic benefits.

The structure of the City Building Integrated Information Model includes five kinds of information as following:

(1) Structural information

Structural information mainly refers to the geometric information and the constraints between the components of information and ancillary information. The geometric information of the model is a set of data that expresses the shape of building components, and is the main object and information of component design modeling. The geometric information of the model can be divided into two-dimensional model information (such as two-dimensional plan of components) and three-dimensional model information (such as component 3D model information) from the spatial dimension. Geometric information is not only used to express the building components of the length, width, height, coordinates and a series of component parameters. It has components of the 2D plan or 3D geometric model.

Component constraint information is a description of the relationship between building components and components. This description contains the location relations, construction rules and construction order of the components. Constraints between components are the important information for virtual construction. The positioning of building components is achieved through constraints.

The use of structural information is throughout the building design, construction, maintenance of the building lifecycle, which is the main object of information transmission. The structural information not only includes basic geometric elements such as points, lines, and planes, but also architectural objects such as walls, windows, columns, beams, but also the scale and function information of all the buildings, structures and other components, which can be analyzed and observation from different angles, to make the building design

and structure of the mutual information complete. Additional information includes color, density, material, acoustic properties, optical properties, part code, component type, manufacturer, cost, etc.

(2) Management information

Management information mainly refers to the construction of the entire life cycle in a series of management information. According to the information at different stages to distinguish, it can be broadly divided into: basic management information, construction management information, maintenance management information.

Basic management information refers to the entire life cycle of basic information resources and basic information activities management. Such as component manufacturers, component cost price, fire information. Construction management information and maintenance management information refer to the management information generated during construction and maintenance, respectively.

(3) Knowledge and information

Knowledge information mainly refers to: design experience and formula, knowledge rules. The design experience, formulas, and knowledge rules generated during the lifecycle are preserved for reuse. Knowledge information includes modeling knowledge rules, building knowledge and rules, building order information, and so on. Modeling knowledge mainly includes the design manual, modeling norms, physical characteristics, construction features, as well as the design of two-dimensional, three-dimensional drawings, design formulas and other design process knowledge. Construction rules refer to the rules and standards that can be followed during the installation, maintenance, and dismantling of a building component product.

(4) Geographic information

Geographic information mainly refers to GIS-related information, such as geographic coordinates of latitude and longitude of the building and image data, topographic maps, digital elevation models and other geographic data information.

(5) Function information

Function information is mainly refers to the description of its function and technical performance.

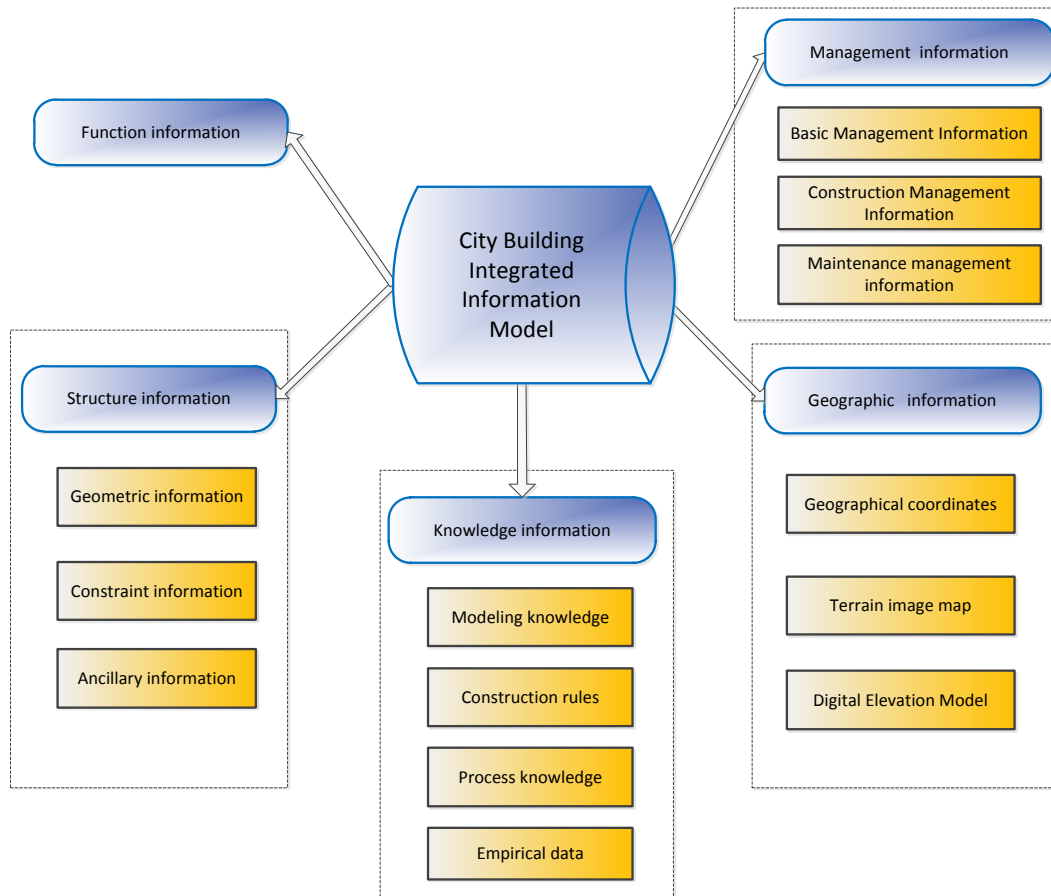

Figure 5. 2 Structure composition of Integrated Information Model

5.2.2 Creation of CBIIM

City building integrated information model is designed to facilitate the process of modeling and construction of the building to achieve the effective information preservation and utilization of a series of information process. The creating process of building integrated information model is inseparable from processes of creation and using various informations. The creation of information can promote modeling design and construction of simulation process. And the information created in the process of modeling design and construction simulation can reversely enrich the information within the integrated information model. Moreover, the information created and used is not one-way and constant, which will be repeated according to the actual needs of the call. The information can also be cross-transmission. CBIIM model is closely related to the building 3D modeling and construction simulation process. The information generated during the 3D

model creation and visual simulation process can be used to enrich the information capacity of the CBIIM model. In turn, the information in the CBIIM model can inversely generate the 3D model of building components and specify the specific simulation behavior of the visual construction simulation. Figure 5.3 shows the system process framework of City Building Integrated Information Model.

CBIIM model can cover the building design modeling and simulation process involved in a series of related information. The geometrical information in structural information is mainly used for the standardized modeling design of building components, standardized modeling of building components with certain modeling knowledge and norms. In addition to the standardized modeling of the components, the structural information and knowledge information created in the standardized modeling can be added to the CBIIM model and stored in the database. The model files generated after the standardized modeling are saved to the database in the form of certain file formats, which can make the model formats such as IFC and Obj. Intelligent modeling utilizes standardized part of the model data according to the knowledge rule in the integrated information model. Through intelligent modeling can be efficient, rapid and large-scale construction of building components, and ultimately form the whole building. The general process of intelligent modeling is to call the corresponding knowledge rules in the database. Then apply the rules of knowledge to the building, call the database to create the preservation of the building component model data. And to Obj model format into the scene of intelligent modeling, and according to the actual situation of a certain parameter correction in order to achieve the desired results.

Construction simulation is based on the knowledge of the construction rules, geographic information and a series of rules for visual construction simulation. Visualization general process of building simulation is to import the models generated by the intelligent modeling into FBX file format into the visual construction simulation scene, which to make the construction simulation with the construction rules and flow.

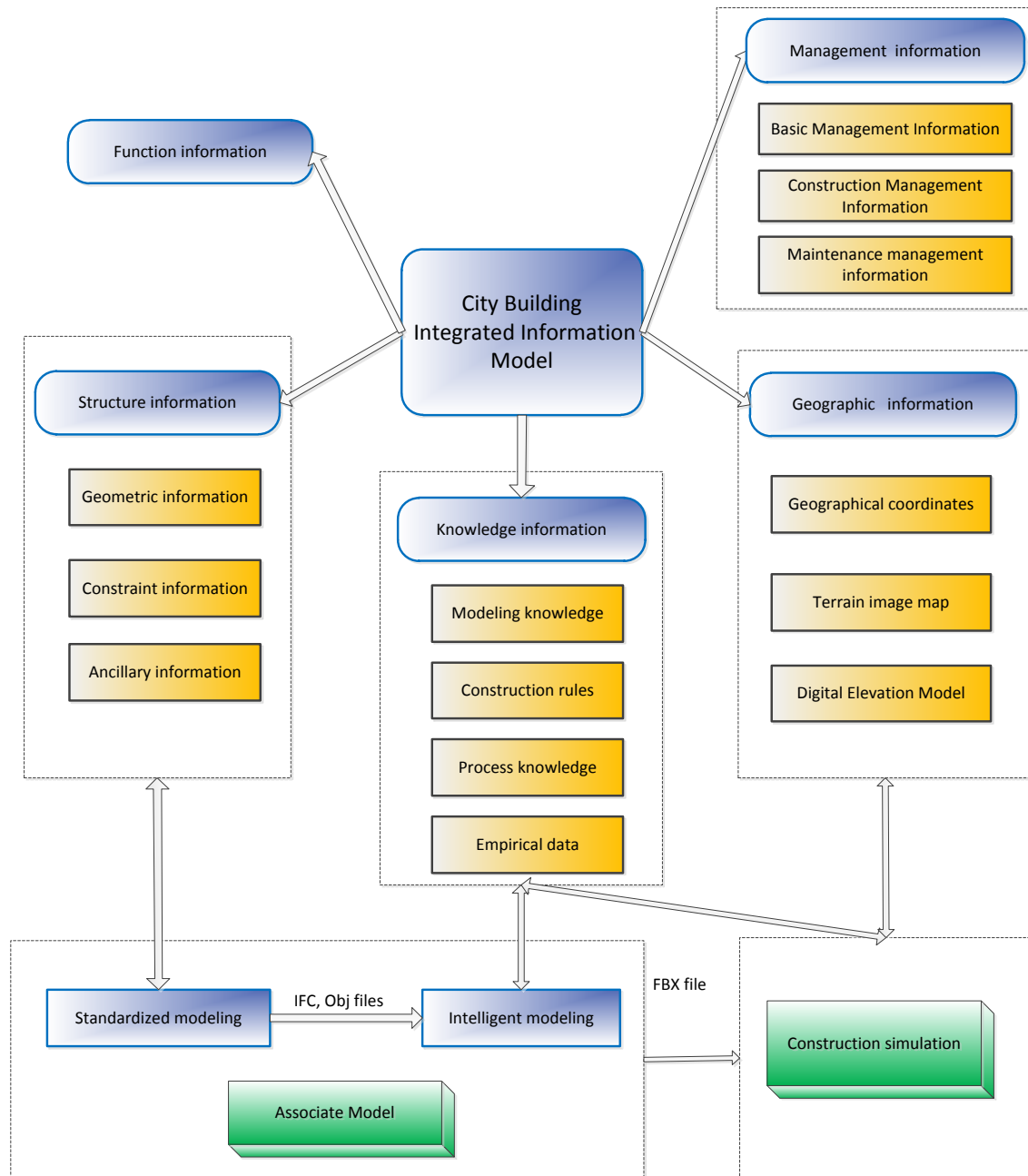

Figure 5. 3 System process framework of CBIIM

5.3. IFC-based building information description

Component is the most basic building units and elements, building components at the beginning of the design had to consider versatility problem to other building software, three-dimensional modeling data. 3D modeling data has good versatility, which will greatly enhance the building components in different building modeling software data sharing. It can be seen that, in view of the fact that IFC is a comprehensive international

standard for the exchange and sharing of building information. It is considerable practical value to construct IFC-compliant building components.

Building components is the most basic and important structural information of the building components. The structural information determines the final shape, property and function of the building components. It is of practical significance to realize the standardization of building components, the convenience of exchange and sharing by building structural information of IFC-compliant building components.

5.3.1 IFC standards and their hierarchical architecture

IFC is an acronym for Industry Foundation Classes. It is a comprehensive international standard for the exchange and sharing of building information. The IFC standard was created by the International Alliance for Interoperability (IAI). BuildingSMART is a commitment to the adoption of a common data model and a unified data standard. The standard specification for collaborative processes in the construction and facilities management industry is promoted to promote a smarter approach to information sharing and collaboration across different software platform building models around the world. IFC is the industry standard for the construction industry launched by the International Collaborative Alliance, which is designed to describe data for the construction and construction industry [92].

The IFC standard references some of STEP's standards and extends the lifecycle concept of the STEP standard. To the building's life cycle as the main line to design the building's information model, covering architectural design, structural design and other fields.

IFC Schema provides the construction industry with specifications for the different types of information description and definition involved in construction works. IFC Schema consists of four layers: Resource layer, Core layer, Interoperability layer and Domain layer, as shown in Figure 5.4 IFC model information architecture. Each level has a different role in the model [93].

It is important to note that the Interoperability layer defines the main building blocks in the Shared Building Elements Schema that define the beams, columns, doors, windows, walls, etc. This is also the primary operational object for which we define building construction.

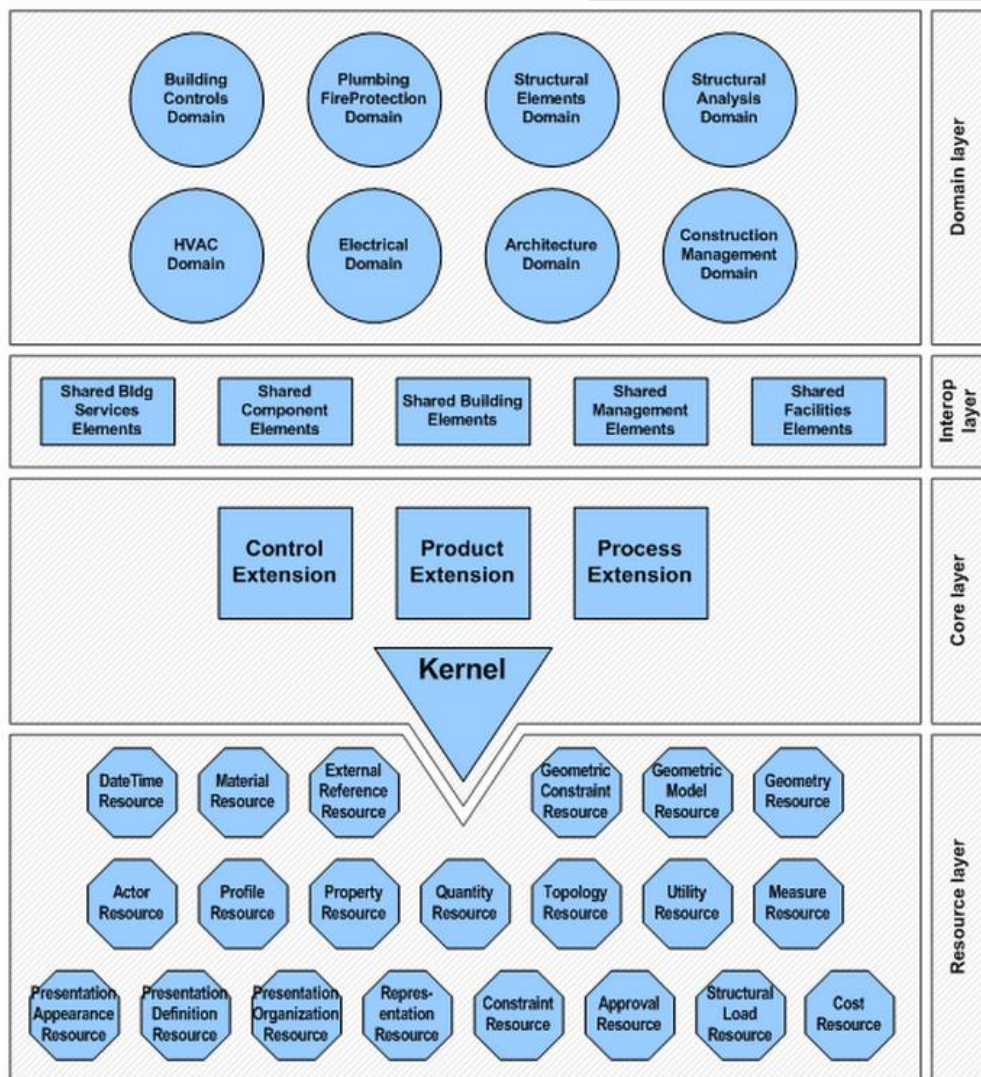

Figure 5. 4 IFC model information architecture

5.3.2 Description of the CBIIM information based on the IFC standard

In order to solve the sharing problems between different discipline and different software, 3D building information model need to be that software developers approved, the neutral, unified expression of building information, standardization of building information, which is to solve different discipline and software collaboration between the basis of the problem.

IfcRoot is not only the abstract base type of all the core layers, but also the abstract base type of all the IFC object models in its upper layer. Therefore, all IFC entities except

the Resource layer IfcRoot directly or indirectly. From the IFC architecture, IfcRoot is the parent of IfcObjectDefinition and IfcObjectDefinition is the parent of IfcObject. IfcObject can not only represent all the actual things (such as walls, columns, doors, windows, beams), physical (such as space) and conceptual (such as virtual boundaries, mesh) things also represent the process. IfcObject derived IfcProduct six entities, the corresponding type of objective world that the objective things respectively. These six types and their derived types form the core of the IFC model information exchange.

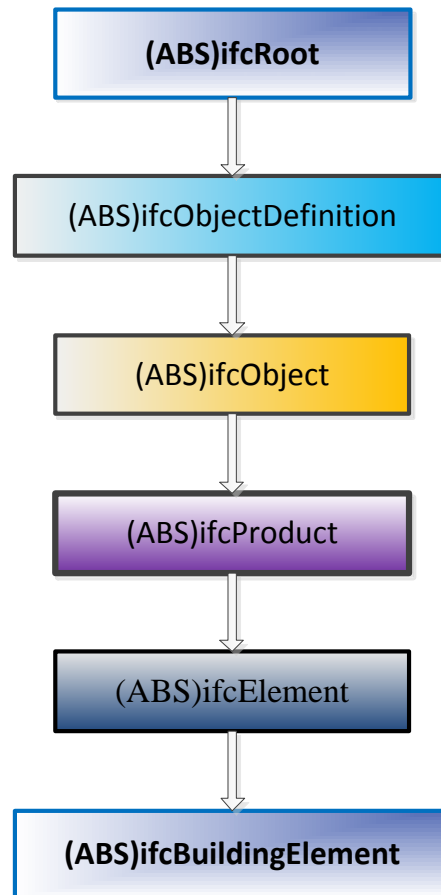

Figure 5. 5 Primary derived relationship of IfcRoot

IfcProduct and its derived entities can represent objects related to geometric or spatial environments. IfcElement is an IfcProduct subclass and IfcElement represents all the concrete physical solid components that make up the building. IfcElement not only contains the physical entity component but also contains some building elements whose entities do not exist, such as holes; not only permanent building components, but also temporary components. Of course, IfcElement can be on-site building components and can also be prefabricated building components. IfcElement Contains IfcBuildingElement,

IfcDistributionElement, IfcFurnishingElement, IfcGeographicElement, IfcTransportElement, IfcElementAssembly, IfcFeatureElement and IfcVirtualElement. Figure 5.5 shows the main derivation of IfcRoot.

5.3.3 Description of building components

IfcBuildingElement is a subclass of IfcElement. IfcBuildingElement continues to derive more concrete building components such as beams (IfcBeam), columns (IfcColumn), walls (IfcWall), doors (IfcDoor), windows (IfcWindow), etc. in the Interoperability layer. As shown in Figure 5.6.

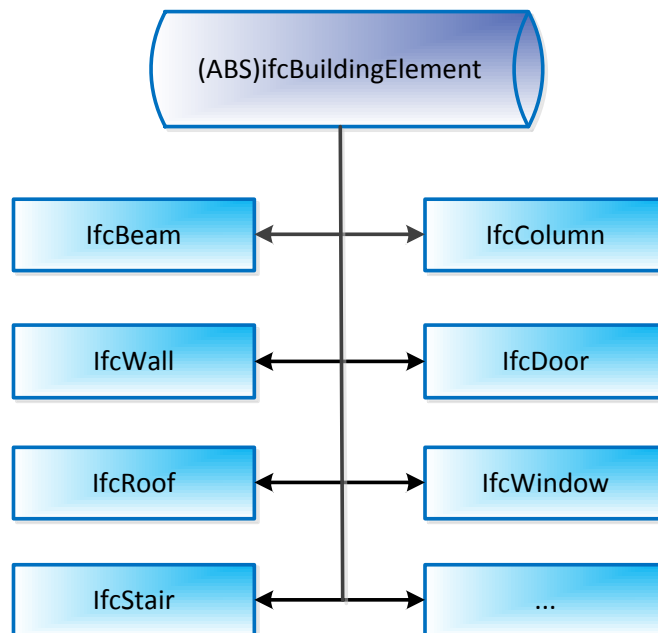

Figure 5.6 Building components based on IFC standards

Based on the IFC standard, the information description of the building components is constructed so that all the components of the building can be expressed by the IFC standard. The information of all the building components is then placed in the CBIIM model. We take IFCColumn as an example to illustrate, IFCColumn have multiple examples as shown in Figure 5.7. The instance ID number is IFCColumn *, each instance corresponds to the corresponding information and based on the form of IFC standards stored in the database. Other building elements such as beams, columns, walls, windows and so on are expressed in this manner correspondingly.

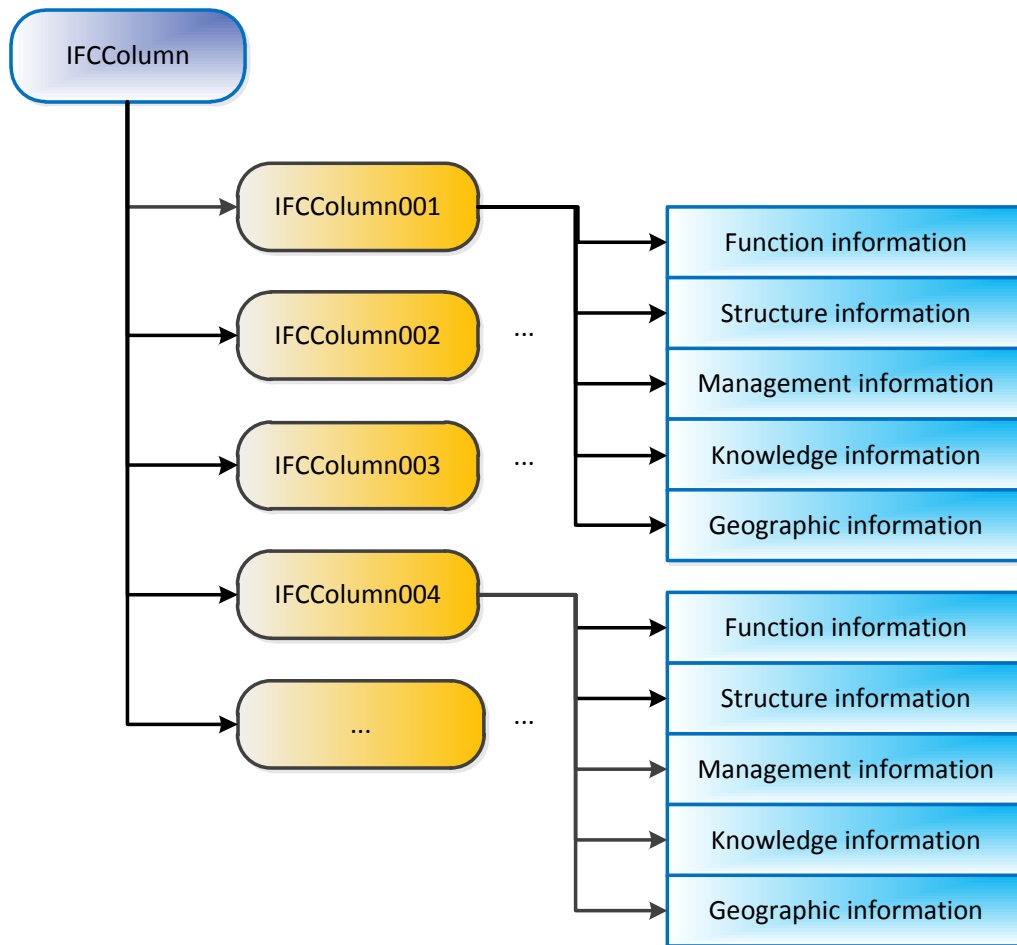

Figure 5. 7 Example of integrated information representation of components

After the city building integrated information model associated with the various components of the building, a relation between them is created. The information in the integrated information model can not only create various components of the building, but also express the building components through the information in the CBIIM model. Figure 5.8 shows the integration of building components and CBIIM model.

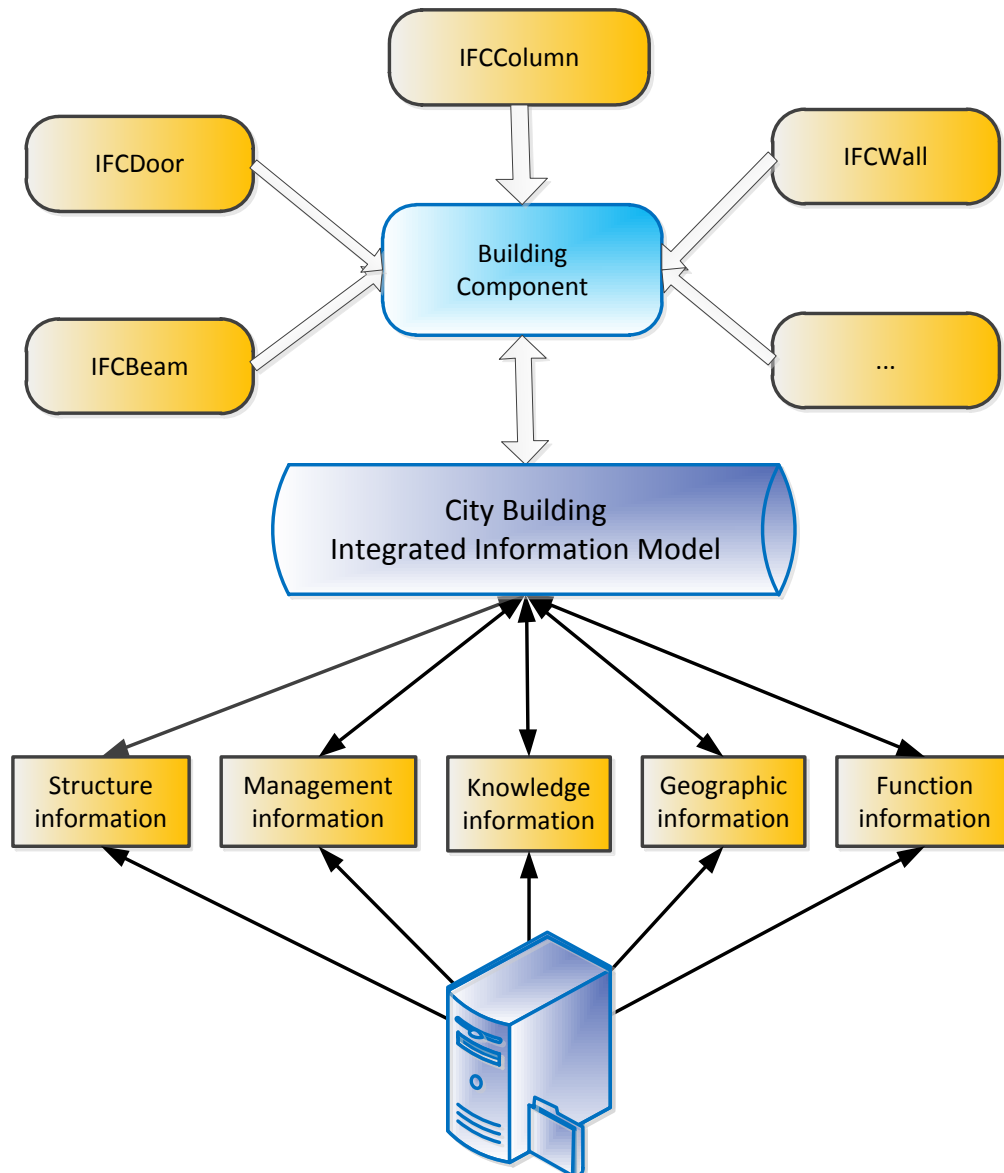

Figure 5. 8 Integration of building components and CBIIM model

5.4. Chapter Summary

This chapter mainly studies the City Building Integrated Information Model(CBIIM). Firstly, the concept of city building integrated information model is specified according to the demand of information integration in the current construction industry. We explain the information composition of the CBIIM model and analyze the information construction mode of the CBIIM model. In addition, IFC standards are proposed to construct the CBIIM model, which can ensure the standardization of the CBIIM model and strengthen the exchange of information between different systems.

Chapter 6. Integrated Information Associated Model Technology

6.1. Integrated information associated model technology analysis

Integrated information association model technology which is required to make full use of the knowledge, information, rules and model files, and drive the 3D geometric modeling process with information during the process of 3D geometric modeling. Figure 6.1 shows the basic information flow and model reuse process based on CBIIM 3D geometry modeling techniques.

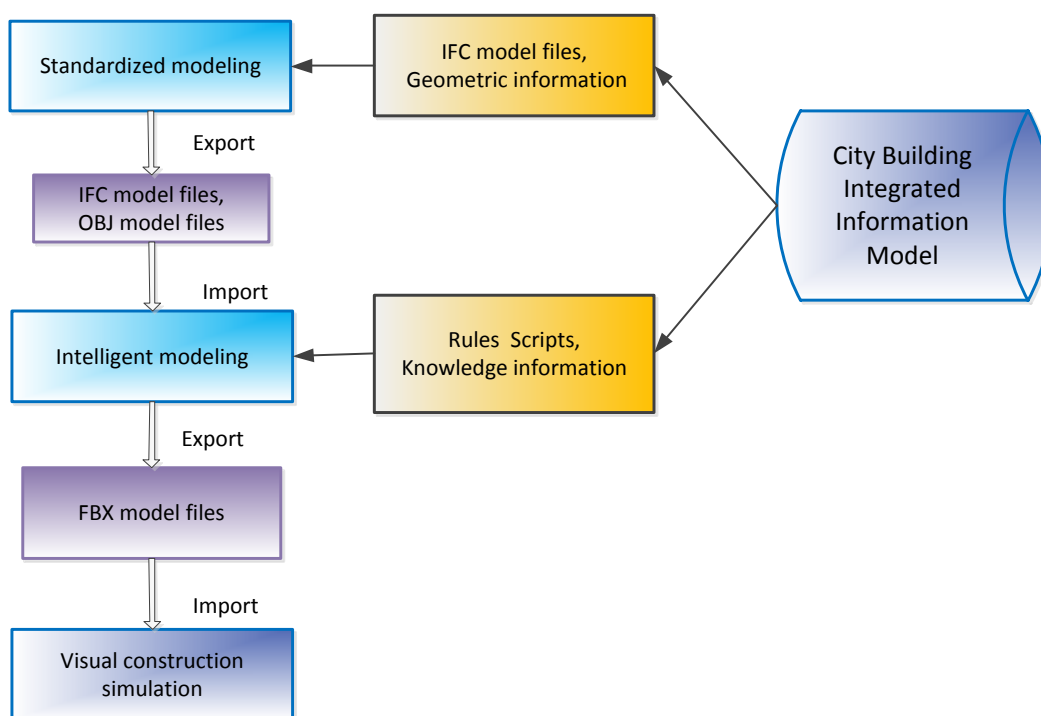

Figure 6. 1 Integrated information association model technology

Through invoking the CBIIM model database in the IFC format files can be quickly rebuilt the standard building components, combined with the corresponding geometry of the information for the next standardized model, and the data between the standardized modeling and the CBIIM model are two-way inter-communication, that is, the relevant model and information in the CBIIM model can drive the standardized modeling process,

and in turn, the standardization modeling can enrich the relevant information in the CBIIM model, which is convenient for future uses. The model data generated by the standardized modeling can not only export the neutral IFC format files, but also can export certain format files such as OBJ format, and then it can be imported the intelligent modeling process, intelligent modeling also invokes for rapid and efficient intelligent modeling of information, rules, scripts, and model files in the CBIIM model, and the knowledge, rules, and scripts generated during the corresponding intelligent modeling process, the model file information can also be reversed to enrich the CBIIM model within the relevant information.

6.1.1 Standardized associated model design

Standardized design of buildings refer to the design and modeling of building components in accordance with unified specifications when the components are designed and modeled, which makes the design of building components have good general purpose and interchangeability, and can adapt to large-scale industrial production. Standardization of building component design relies on the development of information technology, and the development of information technology can support the standardization of building component design and implementation, which can be diversified design sequence, such as the use of bottom-up design patterns can be used, standardization of building component design is mainly embodied in the standardization, good sharing and interchangeability and building standard parts library design these aspects, as shown in Figure 6.2.

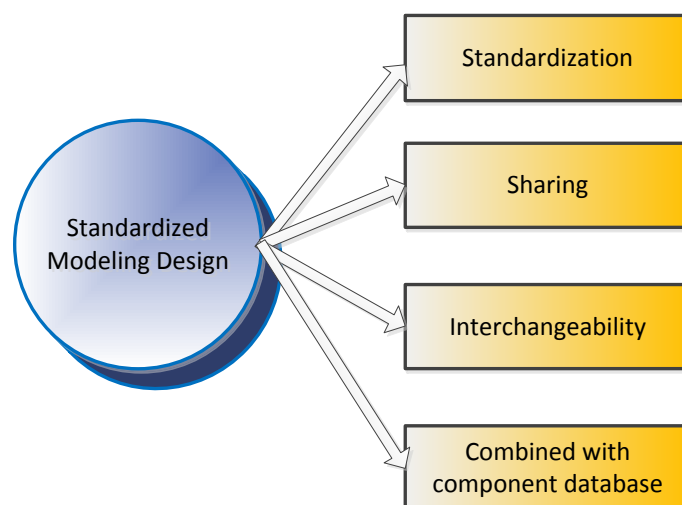

Figure 6. 2 Standardized modeling design

1) Comply with the standard

First of all, building components should be considered at the beginning of the design of standardized, that is, in the design of building components, we should make the design of building components in line with existing building design specifications, all designed building components are in line with standardized needs, moreover, in the design of building components of the specific details of structural features, should also take full account of the requirements of standardization. That is to say, the design of building components should not only accord with the current national standards of architectural design, but also give full consideration to the norms such as firefighting, waterproofing, sound insulation, earthquake resistance and safety precautions. Fully with the concept of structural design, at the beginning of the design through a number of design tools so that the building to achieve the physical, structural and other properties.

2) Good sharing:

Good sharing is an important part of the standardization of building components, good sharing makes our design of building components not only in their own systems for sharing, but also with other software tools to share building components, providing a shared interface will greatly enhance the building components can be shared, thereby enhancing the degree of standardization of building components. Building components to achieve the sharing of information technology cannot be separated from the development. The approach we adopted was to make the building components we created conform to the IFC standard and to export the .IFC format file. This greatly improves the sharing of information with other 3D building software tools, improves the reusability of building components, and greatly improves the standardization process of the designed building components, and the building components. IFC format files can be placed in the database, thereby enhancing the building components in a wider range of sharing.

3) Good interchangeability:

The design of building components should be suitable for large-scale industrial production mode, which requires us to design at the beginning of the need to design with the same structural features of the building components to improve the building components in the construction of interchangeability. Improving the interchangeability of building components plays an important role in the design of building components and the construction of final buildings. One of the measures to improve building interchangeability is to achieve modular design of building components, where the basic modulus of the

numerical value of 100mm, with the symbol M to represent, and its conversion relationship is 1M equal to the value of 100mm, the entire building components should be an integral multiple of the basic modulus. At the beginning of the design of building components, using the same structure features can reduce the difficulty of modeling, shorten the design time and improve the design efficiency. The components with the same structural characteristics have similar and even same processing technics when the building components are produced, which reduces the difficulty of the mechanics to produce the building components, at the same time, due to the same structural features, the required fixing and operating equipment will be similar, thus reducing the fixed investment in equipment and fixtures, bringing more production benefits.

During the construction phase, building elements with higher interchangeability showed greater advantages, with higher interchangeability of the building elements due to the same construction method, which reduces the difficulty of constructing the building, the construction efficiency, but also improve the reliability of the construction.

4) Combined with database technology

The building component library is also an important part of the building component library is the role of the design of the building components through the database technology stored in the database, in the next use of the building components, you can once again from the database in the building components extracted to achieve the purpose of reuse of building components, and thus reflect the standardization of building components design ideas.

In addition, when building components standardized design, we sometimes need to start from scratch to re-design a building component, this time can also be combined with the database for the next design modeling. In the database to read the relevant structural components of the building information, including geometric information and a series of modeling design information, combined with the preservation of the database components of the two-dimensional drawing data or three-dimensional model data, through the information to build the next mode.

During the process of modeling, some structural information, knowledge information and other information about this building component can be created and newly generated. Such information can be updated by the database technology to update the relevant information content in the database.

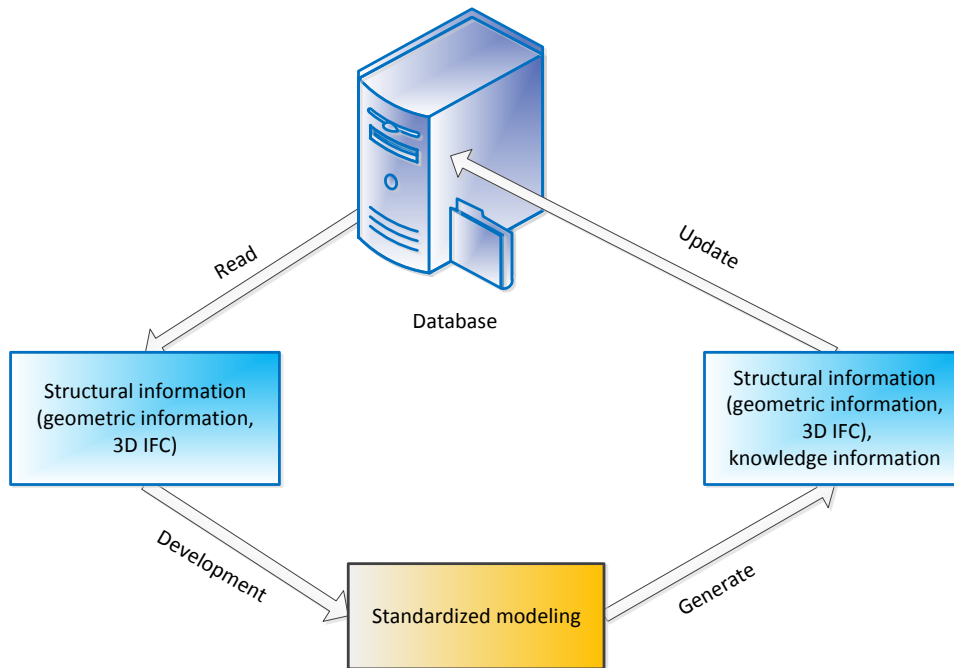

Figure 6. 3 Information-driven modeling

6.1.2 Intelligent associated model design

Intelligent modeling and design is relatively biased in favor of the manual operation of the interactive model in terms of contrast, intelligent modeling design is not dependent on the main features of the manual creation of model entities and modify the parameters, but through a certain knowledge , Rules and control parameters in conjunction with the defined variables. Compared with manual modeling with low efficiency, the intelligent modeling based on knowledge and rules has higher modeling efficiency. The overall efficiency of manual modeling is higher than that of regular modeling, but as the knowledge and rules are improved, the intelligent modeling based on knowledge and rules will be more effective than manual construction at a certain point in time. The gap between manual modeling and intelligent modeling will be increasing.

Building intelligent modeling is mainly based on knowledge rules, parameter control and script control of these three aspects, as shown in Figure 6.4.

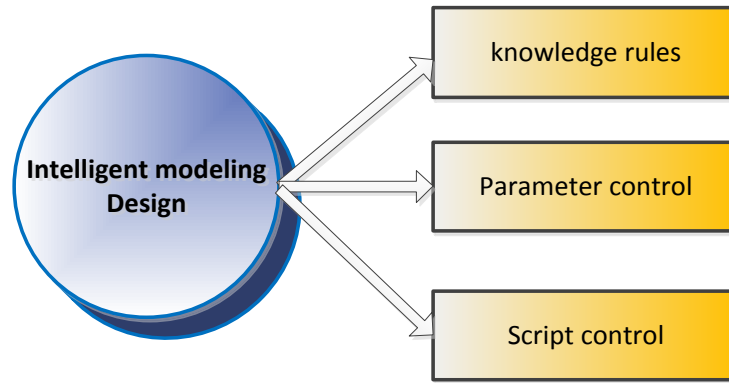

Figure 6. 4 Intelligent modeling design

The following three aspects were discussed:

1) Rule-based modeling

The rule-based modeling method is a modeling method based on the process modeling technique. The process modeling technology is widely used in computer graphics and computer vision. The core idea of the process modeling approach is to use grammar rules to iterate, manipulate, and optimize the basic geometry to produce the desired 3D geometry.

With the further development of the process modeling method, a set grammar based on the definition of context-related grammar, namely, Computer Generated Architecture (CGA) grammar, is gradually formed. The CGA grammar defines the basic concepts of shape grammar in a way that is different from the previous split grammar. The CGA grammar supports many rules, such as rotation, segmentation, duplication, substitution, etc., to produce the vast majority of buildings and their components. CGA grammar is characterized by the original three-dimensional building model mesh is divided into a collection of 2D surface, and then separately on the division of each 2D surface modeling, and ultimately generate the ideal building 3D model. The model of CityEngine (CGA Shape Grammar Reference), also known as the CityEngine function library, is used as an example to further explain the object. The main functions of the CityEngine library are six parts: Shape Operations, Shape Attributes, Builtin Functions, CGA Utility Function Library, Misc Information, and CGA Utility Function Library, Other Keywords.

The Shape Operations section mainly deals with the shape of a model. Geometry Creation, Geometry Subdivision, Transformations, Geometry Manipulation, and Texture are the most common operations.) and so on;

Geometry creation

The substitution function (i)

The function of the replacement function (i) is to replace the current model with the model of the .OBJ format which has been modeled by the standardized design, and then to generate the complex set model with fewer rules and to standardize the building components. The specific use of the form is: i (geometryPath), which geometryPath:. OBJ format file model or model part of the specific storage path.

Stretching function

Stretching is used to extrude a shape. The extrude (height) expression can be used to represent the distance to the height or to extrude (axisWorld, height) on the specified axis axisWorld, where axisWorld can be replaced by world. X world.y or world.z.

Geometric transformation

CityEngine commonly used geometric transformation function of the main geometry of the translation function (t), rotation function (r) and scaling function (s), etc.

The translation function (t)

The translation function (t) is used to implement the translation operation and the vector increment in a vector is achieved by the parameters in (tx, ty, tz). And the translation is translated with respect to the scope axis, and the translation is relative to the current object. When the offset is not prefixed with "", the offset is the value in (tx, ty, tz). When the prefix "" is used, the amount is tx * scope.sx.

Scaling function (s)

The scaling function (s) is used to implement scaling of the model. Its specific use of the form of s (float xSize, float ySize, float zSize), xSize, ySize and zSize, respectively, corresponding to the length of the axial scope. And zoom to the scope of the direction of the pivot point direction. When the zoom value is not preceded by the " ", its value is the length of the corresponding scope axis. When the prefix is ' ', the length of the X axis is XSize * scope.sx.

Model refinement function

Subdivision of the geometry is in the already created geometry on the basis of this model for further refinement operation. Including split function (comp), cutting function (split) and so on.

Split function (comp)

Split function (comp) role in the model in this split a certain model. The general use

of the split function (comp) is comp (compSelector) {selector operator operations | selector operator operations ...}, where compSelector is used to specify the object to split, such as f for face and e for edge. Selector used to select the characteristics of the generated split, such as a commonly used form: front, back, left, right, top, bottom.

Cutting function

The cutting function divides the axes along the specified axis in a Cartesian coordinate system. The splitAxis in split (splitAxis) can be x, y, or z.

2) Parameter control

Parameter control technology refers to the set of parameters, variables and the association between the shape of the set, by adjusting the parameters, variables, numerical control geometry to achieve the purpose and size. The parameter control method is applied to the modeling. After the parameters and variables in the model are parameterized, the optimal solution can be obtained by changing the parameters and variables in the process of modeling and optimization. In the rule modeling, we can set the actual needs of the control model parameters of the variables. These variables work throughout the program life cycle. For example, the following variables are defined:

```
Attr wallThickness = 0.2 # wall thickness
```

```
Attr floorHeight = 3.5 # floor height
```

```
Attr doorWidth = 1 # door width
```

```
Attr TPillarWidth = 0.1 # T column width
```

From the above code, we initially set the variable wallThickness value to 0.2 meters, so we use the variable wallThickness on behalf of the use of its representative value of 0.2 meters, so when we need to change the thickness of the wall, just variable definition the numerical value becomes the ideal value. In addition, we define the variables can be viewed in the Inspector, Inspector is used to view and modify the object parameters, variable values of an important way, depending on the selected object, Inspector can provide access to object properties corresponding to the complete interface. Figure 6.5:

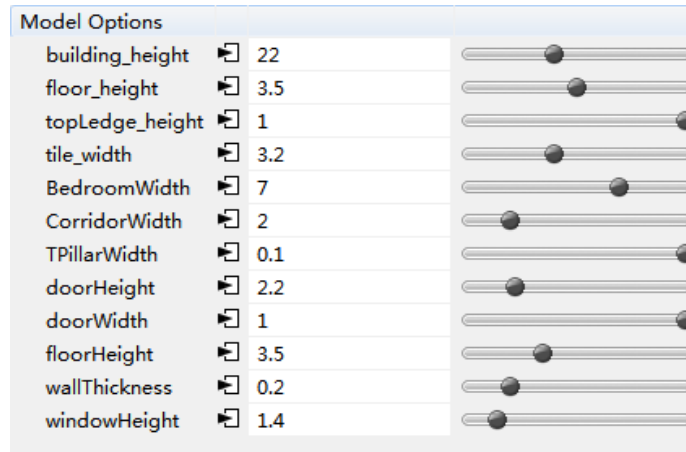

Figure 6. 5 Variant definitions in Inspector model options

3) Script control

As the CityEngine integrated Python script, so you can also write Python script to complete some of the workflow, as shown in Figure 6.6, such as batch import model, export File GDB, Web Scene, OBJ and other format files. In addition, due to the Python script has a strong scalability; it can be according to their own needs to carry out some necessary secondary development.

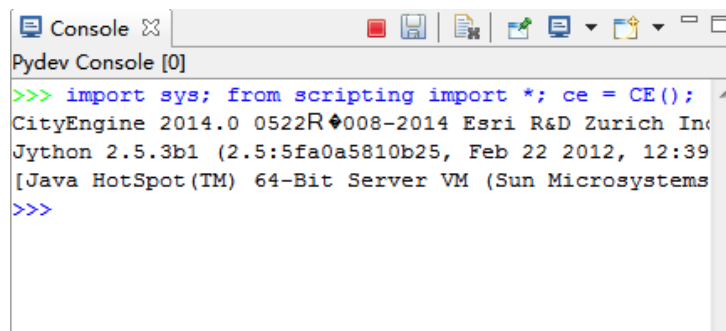

Figure 6. 6 The python script console

6.2. Building components standardization associated model technology

Standardized modeling technology of building components based on the characteristics of standardized modeling and design to ensure that the standardization of building component modeling, combined with IFC standard modeling to facilitate the reuse of the model between different systems, in addition, standardized modeling technology of building components is inseparable from the support of database technology.

Compared with the complex large-scale machinery industry components, building components because of its relatively simple structure and rules, so the standardized modeling process of building components is also relatively simple, many modeling tools are competent in many cases.

6.2.1 Feature-based standardized model design

Based on the characteristics of building components standardized modeling and design refers to the building components of the original abstract and have different types of features in a good interchangeability, sharing the form of expression, specifically for its high reusable characteristics, and then reflect the standardization of modeling design ideas. There are two distinguishing features in the standardization modeling of building components based on features: First, the design conforms to the standardization, that is, the shape and size of building components are standardized design. Once the design is finalized, it cannot be modified at will, and in a unified and integrated way Stored in the component database. Second, the design characteristics of a high degree of interchangeability, that is, in the design of building components, building components should be considered to design a similar structural characteristics, to enhance the interchangeability between building components. In addition, building component database technology, in the architectural design and construction, according to the actual need to call the building in accordance with the norms of building components to improve the reuse and interchangeability of building components, and then reaction in the standardization of building components.

Taking the T - shaped column of building as an example, the thesis describes the main process of building modeling based on feature. Figure 6.7 shows a simplified T-shaped column for the purpose of emphasizing the design process of the T-pillar, neglecting the construction features of the T-pillar, such as the characteristics of the bolted hole. The T-shaped column is characterized by the fact that the T-shaped extension is made with the wall by reliable construction, and the thickness of the T-shaped extension is consistent with the thickness of the wall, the height of which is determined by the height of the design building.

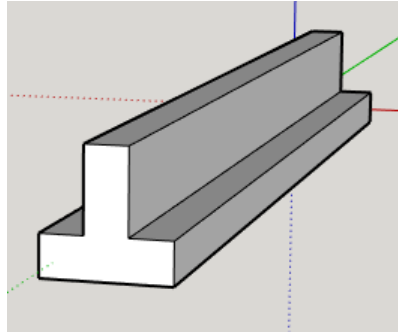

Figure 6. 7 Simplified model for T-pillars

6.2.2 Associated model design combined with IFC standards

In order to improve the sharing of building components and the exchangeability of model information, a common format file is needed in order to exchange model information among various modeling tools. Building information models require a neutral, unified approach to building information that is endorsed by different software developers, and standardization of building information is the basis for resolving synergies between different disciplines and different software. Therefore, the IFC standard as an international building standard for solving the problem of sharing between different professional and different software has a very significant role in the standardization of building components design [94]. So in the standardization of building components, the modeling tool is required to generate IFC-compliant .ifc files to share model information among various IFC-compliant design tools, as shown in Figure 6.8.

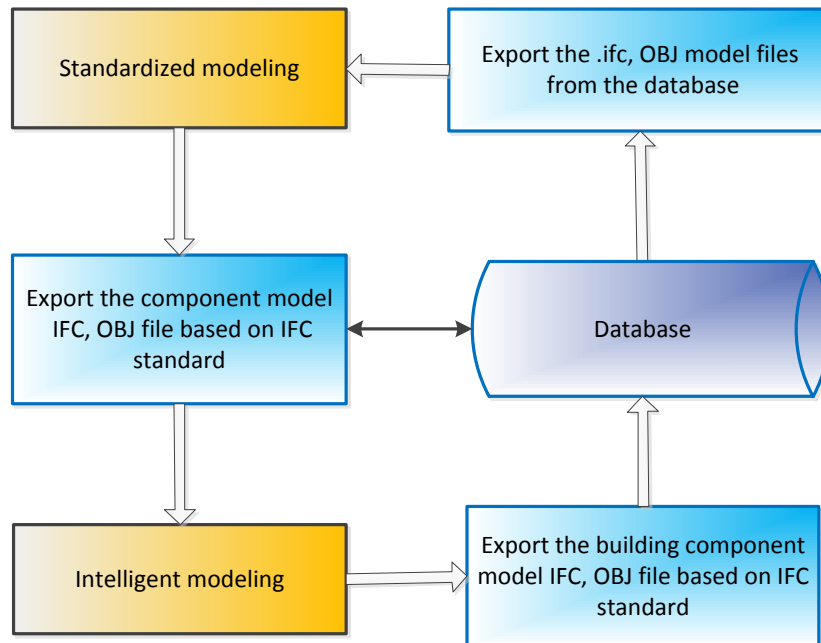

Figure 6. 8 Data exchange based on IFC

The modeling design tool exports formatted files with the suffix .ifc. This ifc file contains the building information for the building we are designing. This is the next ifc format file resolution. For example, we export from a tool ifc format as an example to illustrate. This tool already has the ability to export IFC2X3 format files, IFC file using EditPlus3 open, open, then displays the following information:

```

ISO-10303-21;          // IFC file start statement
HEADER;              // Header section begins
FILE_DESCRIPTION (('ViewDefinition [CoordinationView]', '2;1');
FILE_NAME ('', '2016-02-23T22:44:55', ('), ('), '', 'SketchUp Pro 2015',
");
FILE_SCHEMA (('IFC2X3'));          // IFC mode description
ENDSEC;                      // Header end
DATA;                          // Data Section Start the

```

following is the data portion

```

#1 = IFCPROJECT('0$QSS98Oz60PqieYQEaGK7', #2, 'Default Project',
'Description of Default Project', $, $, $, (#20), #7);
#2 = IFCOWNERHISTORY(#3, #6, $, .ADDED., $, $, $, 1456238695);
#3 = IFCPERSONANDORGANIZATION(#4, #5, $);

```

```

#4 = IFCPERSON($, "", "", $, $, $, $, $);
#5 = IFCORGANIZATION($, 'SketchUp', "", $, $);
#6 = IFCAPPLICATION(#5, '2015', 'SketchUp Pro 2015', '2015');
#7 = IFCUNITASSIGNMENT((#8, #9, #10, #11, #15, #16, #17, #18,
#19));
#8 = IFCSIUNIT(*, .LENGTHUNIT., .MILLI., .METRE.);
#9 = IFCSIUNIT(*, .AREAUNIT., $, .SQUARE_METRE.);
#10 = IFCSIUNIT(*, .VOLUMEUNIT., $, .CUBIC_METRE.);
#11 = IFCCONVERSIONBASEDUNIT(#12, .PLANEANGLEUNIT., 'DEGREE',
#13);
#12 = IFCDIMENSIONALEXPONENTS(0, 0, 0, 0, 0, 0, 0);
#13 = IFCMEASUREWITHUNIT(IFCPLANEANGLEMEASURE(1.745E-2) ,
#14);
...
#104 = IFCPRESENTATIONSTYLEASSIGNMENT((#105));
#105 = IFCSURFACESTYLE($, .POSITIVE., (#106));
#106 = IFCSURFACESTYLESHADING(#107);
#107 = IFCCOLOURRRGB($, 1., 1., 1.);
ENDSEC; // the data
segment ends
END-ISO-10303-21;

```

The IFC file is now parsed, and for each IFC file there is only one pair of ISO-10303-21 and END-ISO-10303-21 statements, which represent the beginning and end of the IFC format file, respectively. The part between the ISO-10303-21 and END-ISO-10303-21 statements is called the HEADER header file section and the DATA data section, and both the header file section and the data section end with ENDSEC. The header and data portions can appear only once in an IFC file, and they follow a strict order of precedence. The HEADER header file section contains information about the entire IFC swap file. The HEADER header file section consists of three parts, which must be in the strict order of FILE_DESCRIPTION, FILE_NAME, and FILE_SCHEMA. FILE_NAME contains the IFC file name, file generation time, author, organization and other information,

this information is mainly used for mutual communication between the front and rear processors, such as the IFC file generation date: '2016-02-23T22: 44: 55', This IFC file generation software tool: 'SketchUp Pro 2015', this IFC file version: 'IFC2X3' and other information. The DATA data part contains the exchange information of the building component. The DATA part is also the main part of the IFC file. It is composed of a plurality of pieces of record data, and is represented in the above IFC file as a part between # 1 line and # 107 lines.

The content of the record data is the entity instance of the building component created and its attribute set. IFC model definition and attributes of the specific data types need to be consistent: Numeric types are generally more direct form of some, but it is required to retain the decimal point. Aggregate types such as LIST.SET are represented by nested parentheses. The string type is enclosed in single quotation marks, and the enumeration type is enclosed in periods, such as .NOTDEFINED. Boolean type between .T. And .F. Values, the logic type in the Boolean type based on the increase. UNKNOWN. Range of values. When an attribute type is a reference to another instance, it is represented by the ID of the referenced instance. The OPTIONAL attribute is indicated in the model definition, and its value can be null, denoted by the \$ sign. In addition, the first instance of the entity IFCSIUNIT may also be empty, denoted by the * symbol, which is a special case. It is important to note that all derived attributes (attributes computed from other attributes, such as area), reverse attributes, constraints between attributes, and methods (behavior) of the entity are ignored in the IFC model definition, and do not participate in data exchange. The three-dimensional solid building component requires that the IFC format file can be exported to communicate with other software supporting the IFC format, thus ensuring the interoperability of the model. Save this IFC file in the SQL database to facilitate the storage and viewing of model files, or to carry out the next model changes and other operations. Save this IFC file in the SQL database to facilitate the storage and viewing of model files, or to carry out the next model changes and other operations.

In order to ensure the high sharing and reusability of the building components, the designed building components can be stored in the database after the modeling design of the building components. In the similar design or construction, the design of the building components can be realized by calling the database Stored components for reuse, thus ensuring the standardization of the design of the building. For non-local users, you can also remote access to the database through the network, and then call the required building

components in the database, and then standardized modeling, as shown in Figure 6.9.

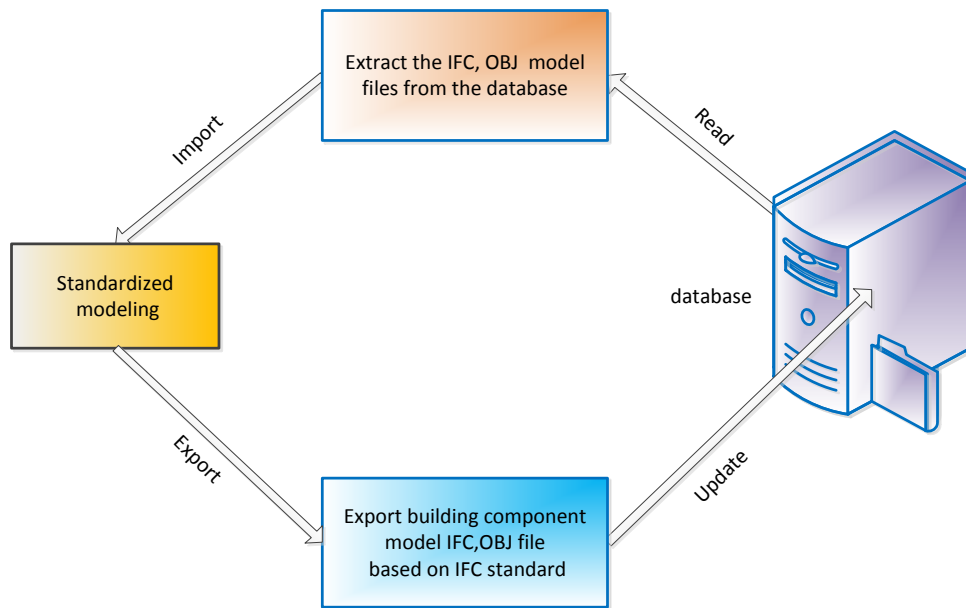

Figure 6. 9 Relationship between standardized modeling and database

6.3. Rule-based intelligent modeling technology

In the building, the same type of building components, components are highly reusable, that is the same category of building components, components in many of the time only some parameters are different, and most of the shape and parameters with Greater similarity. However, the three-dimensional modeling tool we use today is mainly based on interactive manual modeling, which greatly increases the workload and makes the modeling efficiency extremely low. Therefore, at this stage, we need a more convenient tool, so to greatly improve our modeling efficiency, and the advantages of process modeling techniques widely used in computer graphics and computer vision fields are highlighted.

George Stiny and James Gips first introduced shape grammar in 1972 to represent procedural modeling [95]. Shape grammar is mainly composed of four parts, namely: the collection of shapes, symbols set, and shape rule sets, and shape of the mark. 2003 Peter Wonka for the shape of grammar and put forward the concept of grammar set. And thus avoid the matching process, just shape and shape to match the left can be. Pascal Muller extended the split grammar in 2006 to define a set of context-sensitive grammar: CGA (Computer Generated Architecture) grammar.

The basic rules of CGA grammar are defined as follows:

id : predecessor :→ cond successor : prob

The id is the unique identifier of the rule. Predecessor is a symbol used to identify the shape. It is replaced by a successor, which represents a logical expression whose purpose is to enable the rule to be used correctly, where prob is used to set the probability that the rule is selected. The CGA grammar defines the basic concepts of shape grammar in more detail, and it supports rules such as scaling, segmentation, and repetition to generate architectural features. The essence of building process modeling method is to adopt certain grammar rules, iterate to optimize the basic geometric shape, and finally generate the ideal 3D geometric model.

6.3.1 Rule definition and associated parameter control

1) Rule-based component definition

Component is the most basic component of building components, building components, there are two sources of creation, the first is completely generated by the CGA rules, the second is by calling the other tools have been created in the completed OBJ file, as shown in Figure 6.10.

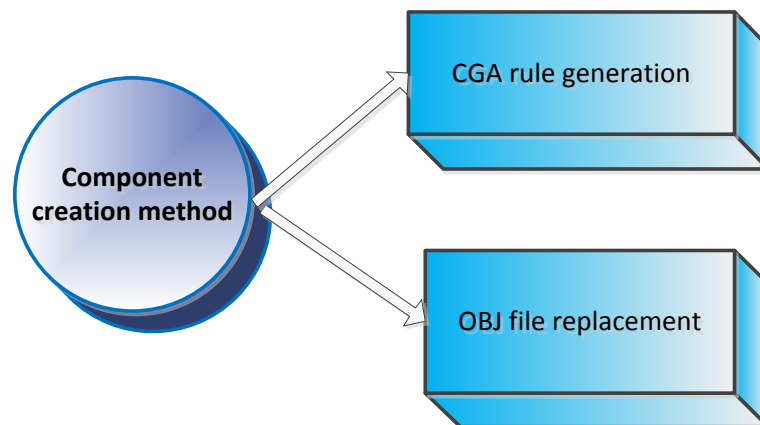

Figure 6. 10 Building component definition method

(1) CGA rule generation

We first introduce the first kind: Generated by CGA rules. Take WallBrick as an example. As you can see from the code, we define WallBrick, and it has properties that are determined by the definition part after the iteration symbol. It is thus known that the value of WallBrick in the Z direction is set to wallThickness (i.e., thickness of the wall) by the size s operation command. And the shift operation of this instance is realized by

transforming the t operation command. That is to say, some building components can be created by directly writing CGA rules, and the creation process of this method is realized only by executing the CGA code rules. It is not directly related to any external model. It is a more direct and simple and effective method. For some relatively simple building components such as floor and wall, the more regular building components can give priority to using CGA rule generation method to generate component entity features. Specific code is as follows:

WallBrick-->

```
alignScopeToGeometry(zUp, any, world.lowest)
```

```
s('1, '1, wallThickness)
```

```
t(0, 0, -wallThickness)
```

```
i("builtin:cube")
```

FloorFacade -->

```
s('1, '1, 0.2)
```

```
t(0, 0, 0)
```

```
i("builtin:cube")
```

(2) OBJ files replacement

The second is by calling OBJ files that have been created in other software as well: Unlike the first method, the OBJ file replacement method requires that you first create the OBJ file for the required entity outside of the tool, the method of replacing the OBJ file with the original location entity by the i substitution operation command is used to generate the required entity feature. From this we can see that OBJ files have been created by calling: doors, windows and T-column entities, and thus quickly generate complex physical characteristics.

It can be seen that OBJ file replacement method can make up for the shortcomings of CGA rules in creating complex entity features, and create complex building components through external tools and replace them with i commands in CGA rules. , Thus shortening the modeling time, thus greatly improving the modeling efficiency. Specific code is as follows:

DoorCube -->

```
i("assets/AOBJ/Door.obj")
```

WindowCube -->

```
i("assets/elem.window.frame.obj")
```

TPillar-->

```
i("assets/AOBJ/Piliar.obj")
```

2) Parameter variable control

In the beginning of modeling, some variables should be defined to facilitate the preparation of rules to call this variable, and in accordance with the actual situation of timely modification of the value of the variable parameters, you can easily change the model parameter values, generate new 3D model [96], so as to achieve the purpose of changing the model. As shown in Figure 6.11:

```
@Group("Model Options",0) @Order(1) @Range(20,25)
attr building_height = 22
@Group("Model Options",0) @Order(2) @Range(3,4)
attr floor_height = 3.5
@Group("Model Options",0) @Order(3) @Range(0.5,1)
attr topLedge_height = 1
@Group("Model Options",0) @Order(4) @Range(3,3.5)
attr tile_width = 3.2

attr BedroomWidth=7
attr CorridorWidth=2
attr wallThickness=.2#墙厚度
attr floorHeight = 3.5#楼层高度
attr doorWidth = 1#门宽度
attr windowHeight = 1.4#窗户高度
attr doorHeight = 0.8 + windowHeight #门的高度
const zFightDelta = 0.1#是误差额常量
attr TPillarWidth = 0.1#T型柱宽度
```

Figure 6. 11 Parameter Variable Code

@Group, @ Order, and @Range are annotations in CGA rules. Such as @ Group said the subordinate property building_height placed in the Model Options group. @Order (1) indicates that the variable building height is in the first order in the group of Model Options. @Range (20, 25) indicates that the variable building_height has a range of (20,25). Attr is the keyword used to define the variable. Specifically, as shown in Figure 6.12,

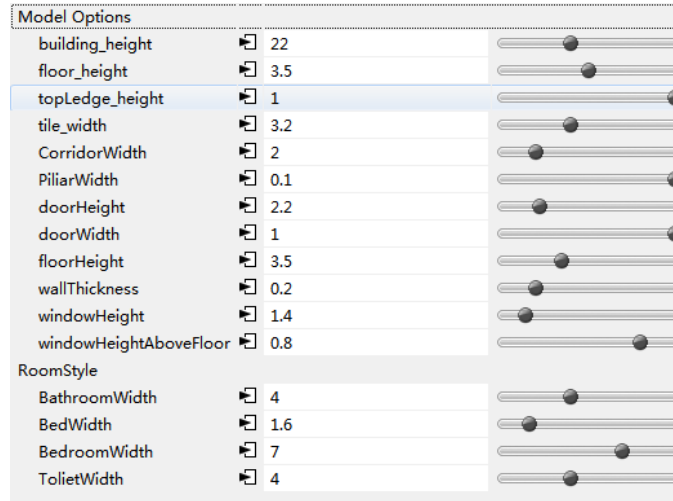

Figure 6.12 Parameter variable controls

By adjusting the size of each variable, you can achieve the purpose of controlling the value of the corresponding variables in order to achieve the purpose of rapid changes in the model for the creation of large buildings with large buildings; this advantage will become more apparent. The characteristic of parameter variable control brings great convenience to the change and diversification of building model, so that the modeler will devote more energy to conceiving the building itself rather than the code. And give full play to the parameterization of ideas, in the preparation of CGA rules as far as possible the use of variable parameter control with the form of the model in order to facilitate future revision and implementation of model serialization, the creation of component families to bring enough convenience.

6.3.2 Outline modeling of buildings

The CGA rule grammar shows its power when building a building. Building modeling is mainly divided into two parts: three-dimensional modeling and texture modeling. Three-dimensional modeling of exterior contours of buildings can be achieved by using CGA grammar to create building features such as exterior walls, different styles of roofs, and more. Texture modeling is based on the construction of the actual object and then to obtain its surface characteristics, and then its surface texture processing, texture image acquisition methods, such as field photography, photogrammetry and digital panoramic photography and so on [97]. Through the use of texture mapping method, you can make the virtual three-dimensional model can be more realistic, rich, so as to achieve the purpose

of the real scene more realistic. Unlike traditional manual modeling, the use of rule-based modeling methods makes modeling extremely easy. Figure 6.13 shows the outline creation process for the building.

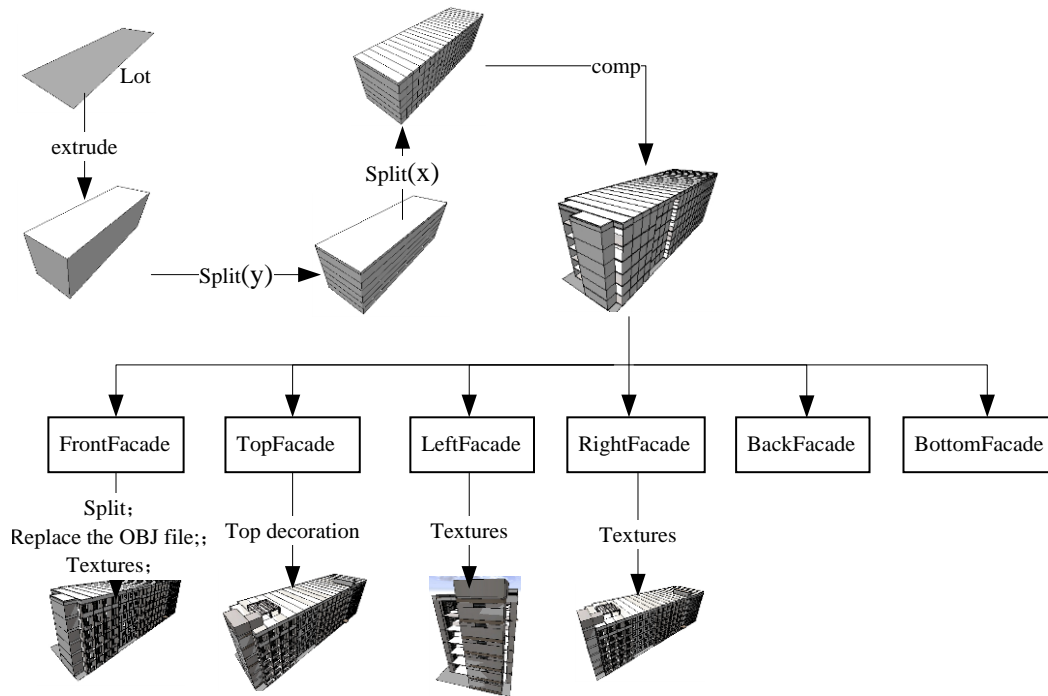

Figure 6. 13 Building outline creation process

Before modeling, first of all clear the concept of the index, that is, different Tile and the floor of the index corresponds to a different block, the specific division in Figure 6.14 Floor and Tile corresponding to the index.



Figure 6. 14 Floor and Tile corresponding to the index

1) The building is stretched and layered

For any Lot, first extrude the building to the height of the building_height using the extrude operation command and split the building along the vertical Y direction using the split command to layer the building so that the building has a floor. Index). See Figure 6.15.

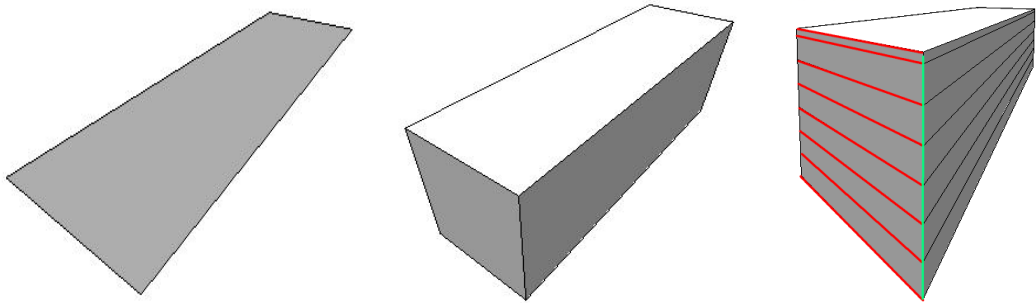
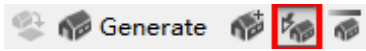

Figure 6. 15 The building is stretched and layered in the Y direction

To better understand the model-level relationships that are modeled, we will show the logical hierarchical relationships that are created in the next modeling. We can open the Model Hierarchy approach to view. To open the Model Hierarchy: From the menu bar, click windows and select Show Model Hierarchy. Then select the model in the viewport view.

3) Select Inspect Model from the menu bar , As shown in Figure 6.16. From the hierarchy of inheritance, we can see that the building is now divided into seven-story structure of the building.

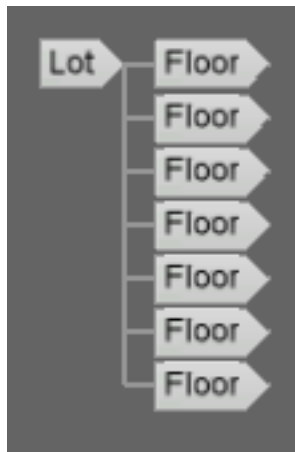

Figure 6. 16 Hierarchy diagram

The corresponding implementation code is:

Lot -->

```

extrude(building_height)
split(y){ {~floor_height : Floor(split.index)}* |
~topLedge_height : Floor(split.index) }

```

2) X direction of the Tile (floorIndex, tileIndex)

After layering in the Y direction, it is necessary to split Floor (split.index) in the direction of X in order to split into smaller cells (floorIndex, tileIndex) Space of the original room pattern, correspondingly in the Model Hierarchy, we can see that we have created, including Tile, including model hierarchy. The corresponding graphical changes and inheritance relationships are shown in Figure 6.17.

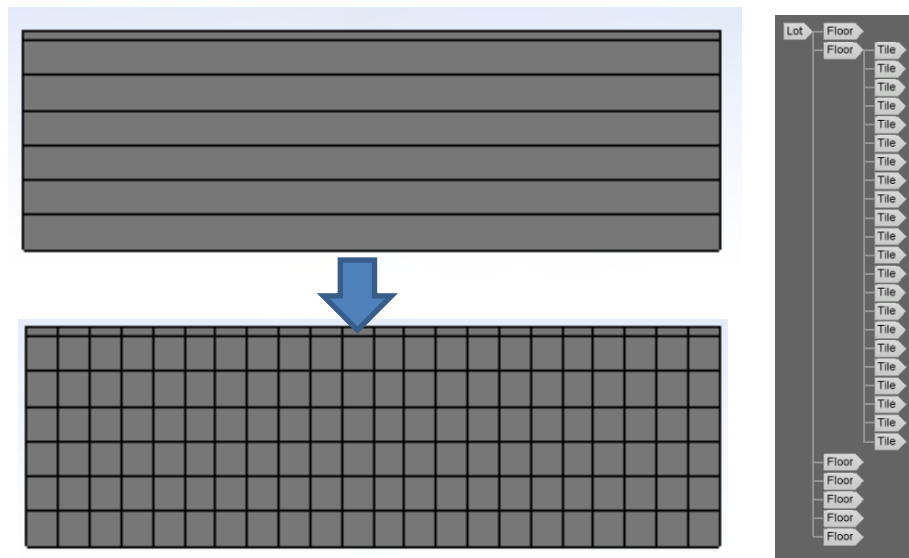

Figure 6. 17 Floor (split.index) Split the effect comparison and hierarchical

relationship along the X direction

The corresponding implementation code is:

```

Floor(floorIndex) -->
split(x){ ~tile_width : Tile(floorIndex, split.index)}* i("builtin:cube")

```

3) Tile(floorIndex, tileIndex)

3) Tile (floorIndex, tileIndex) Derived features

For buildings with different shapes, it can be easily implemented by writing rules. For indoor rooms with different functions and layouts, you can generate indoor rooms with different architectural patterns and their necessary building elements by different values or ranges of floorIndex, tileIndex pointed to in Tile (floorIndex, tileIndex). Use the case statement to control the floorIndex, tileIndex point to the different parameter values or a certain range. In general, Tile (floorIndex, tileIndex) will generate the front, back, left, top

and bottom of the corresponding: FrontFacade, BackFacade, LeftFacade, RightFacade, TopFacade and BottomFacade all or part of it, this needs according to the actual situation , As shown in Figure 6.18.

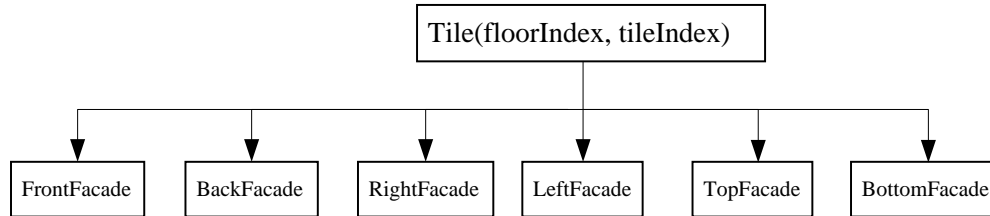

Figure 6. 18 Tile (floorIndex, tileIndex) and its derivatives

The corresponding implementation code is:

```

case floorIndex == 6 &&tileIndex == 0:
s( '1,' 1, scope.sz-12) t(0, 0, 10)
comp(f){
front : FrontFacade(floorIndex,  tileIndex)  |
back : BackFacade(floorIndex,  tileIndex)  |
left :  LeftFacade (floorIndex,  tileIndex)  |
top :  TopFacade(floorIndex,  tileIndex)  |
bottom :  BottomFacade(floorIndex,  tileIndex) }
  
```

S ('1,' 1, scope.sz-12) s is an operation command identifier for the size range change. '1 is equivalent to the scope.sx * 1 function, The z-coordinate of scope.sz-12 specifies that the z-direction is set to scope.sz-12. T is the vector translation operation command identifier, and the translation: t (tx, ty, tz) refers to the translation of the length of tx, ty and tz along the positive x, y and z axes, respectively. Comp (f) is the split component operation command identifier, use this operation command can be easily separated from the room structure.

The above code is interpreted as dividing this room into rooms with: front, back, left, top, and bottom. FrontFacade (floorIndex, tileIndex) in the front: FrontFacade (floorIndex, tileIndex) represents the distinguished name that has been added to this construct to facilitate future operations after partitioning. The code used is shown below, and features such as those shown in Figure 6.19 can be formed by code such as this.

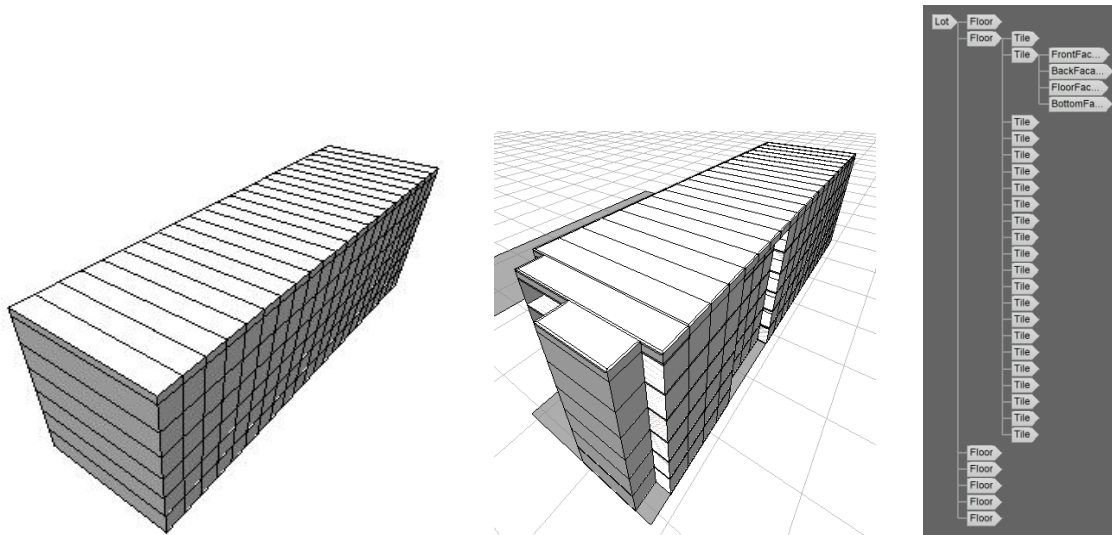

Figure 6.19 Tile (floorIndex, tileIndex) Comp (f) split effect comparison and its hierarchical graph

4) FrontFacade (floorIndex, tileIndex) modeling

Buildings After comp (f) splitting components, the building can be divided into rooms with features such as: front, back, left, right, top, bottom. Then you can the front of the corresponding FrontFacade (floorIndex, tileIndex) for further refinement modeling. For example, for $\text{tileIndex} \geq 17 \ \&\& \ \text{tileIndex} \leq 21$, by first enclosing WallWhite on both sides of the X direction and 1.5m in the middle, then divide the window into Y-oriented Wall_Pinks (floorIndex, TileIndex) and the middle TileWindow_not16 section. The required code is shown in Figure 6.20. Figure 6.21 for the corresponding process, Figure 6.22 for the formation of the structure and its hierarchical relationship.

```

split(x){ ~1 :WallBrick WallWhite |
  1.5 : split(y){~1 :WallBrick Wall_Pink(floorIndex, tileIndex) |
    1.5 : TileWindow_not16 |
    ~1 :WallBrick Wall_Pink(floorIndex, tileIndex) } |
  ~1 :WallBrick WallWhite }

```

Figure 6.20 Corresponding code

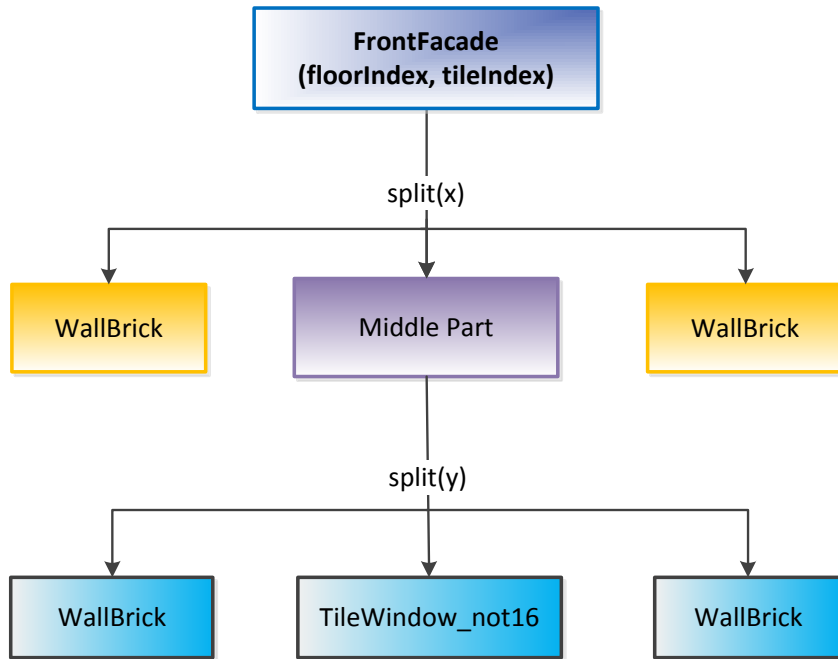

Figure 6. 21 Corresponding flow chart

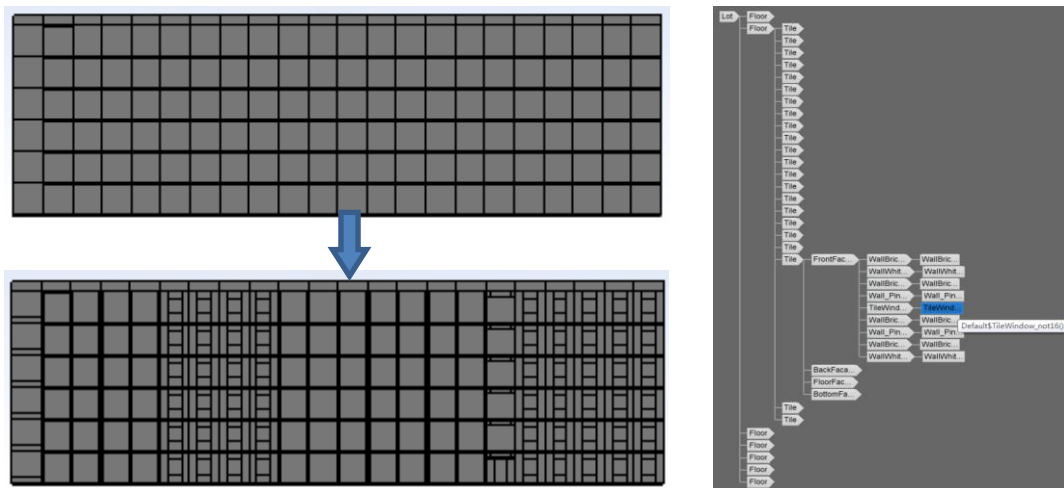

Figure 6. 22 FrontFacade (floorIndex, tileIndex) before and after the comparison

5) Window thinning modeling

Next, the `TileWindow_not16` is modeled in detail. The `setupProjection` is used to set the texture size and the texture coordinate system layer corresponding to the texture. `I` is the replacement operation command identifier. `I ("assets / AOBJ / window.obj")` Use the `window.obj` file in the `assets / AOBJ` directory to replace the entity part of `TileWindow_not16`. The purpose of `projectUV (0)` is to select the application layer: 0 represents the color map, 1 represents the bump map, 2 represent the selection Textures. Specific code is as follows, generating effect diagram shown in Figure 6.23.

```

TileWindow_not16 -->
setupProjection(0, scope.xy, '1, '1)
i ("assets/AOBJ/window.obj")
projectUV(0)
t(0, 0, -0.2)

```

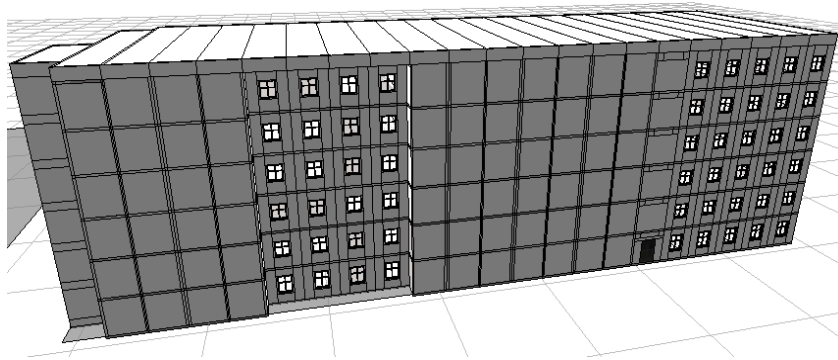

Figure 6. 23 Outline of the building

It can be seen, we know that by writing the appropriate code, we can generate the corresponding characteristics of building components, you can also replace the operation command by `i`, in other software to create three-dimensional model file by exporting the appropriate file formats: such as OBJ format File, and then come in to achieve the standard components, components, efficient re-use.

6.3.3 Building interior fine modeling

Buildings are assembled from a series of building components and components in a construction relationship. The use of CGA rules can not only modeling the shape of the building, but also through the preparation of the rules of the building components and components of the room to model. After the preparation of the corresponding code, the final building can generate internal and external features. Next, the building interior is modeled according to the characteristics of building components.

1) BottomFacade to split

For building in-house modeling, the action object used is BottomFacade (floorIndex, tileIndex). BottomFacade (floorIndex, tileIndex) in the building represents the bottom of the building, which is the main object of the next operation. Figure 6.24 in the red box for BottomFacade the corresponding area.

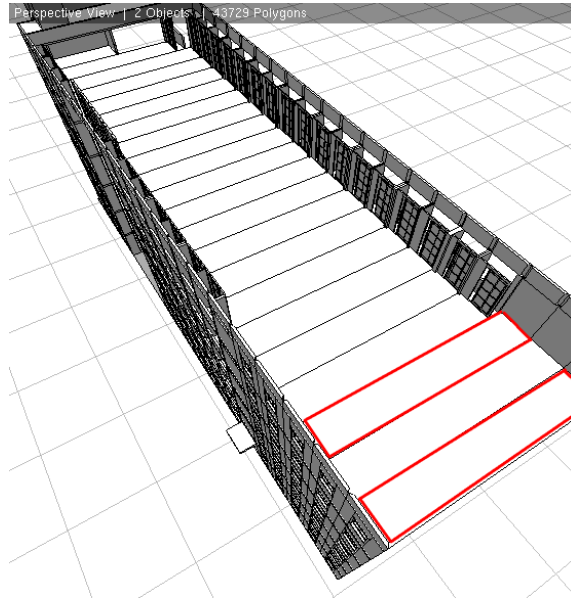

Figure 6. 24 Bottom Façade corresponding area

First, the BottomFacade (floorIndex, tileIndex) in the Y direction is divided into the front part of the building, the corridor part and the rear part, according to the role of the room were named, for example, quarters part of the room were named: BedRoomFront (floorIndex, TileIndex), LCorridor (floorIndex, tileIndex), and BedRoomBack (floorIndex, tileIndex). For other rooms and buildings, they can be named according to their functions. For example, StairCase (floorIndex, tileIndex), WashRoomFront (floorIndex, tileIndex), TolietFront (floorIndex, tileIndex) , As shown in Figure 6.25.

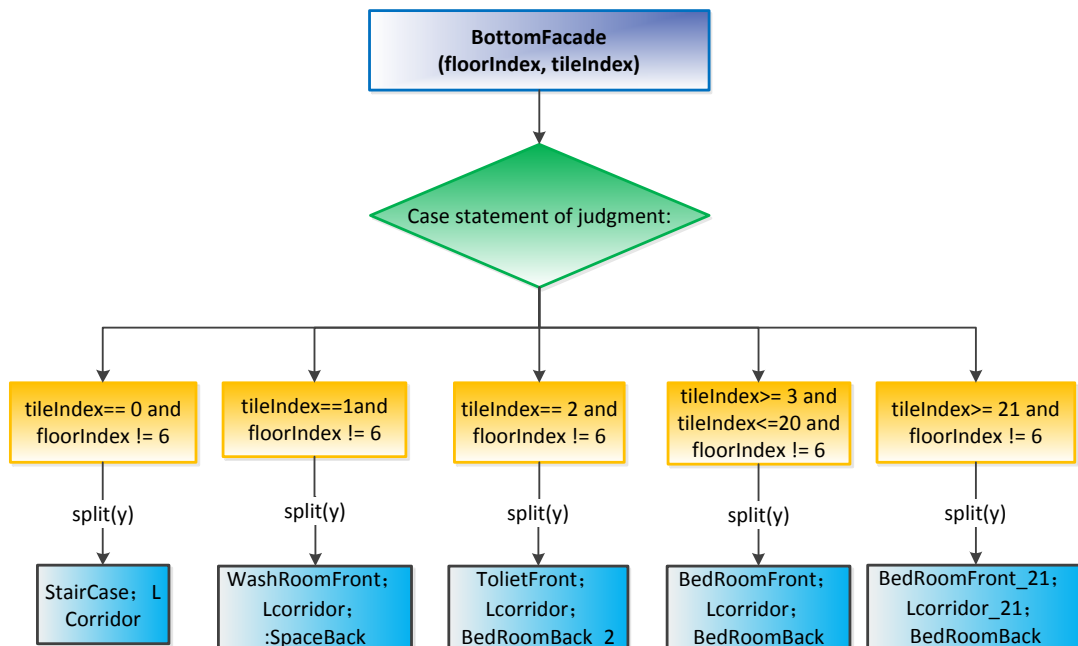

Figure 6. 25 BottomFacade (floorIndex, tileIndex) extends the Y direction split

Part of the code is as follows:

```
BottomFacade(floorIndex, tileIndex) -->
...
case tileIndex >= 3 && tileIndex <= 20 && floorIndex != 6:
split(y){8.5 :BedRoomFront(floorIndex, tileIndex) |
1.5:LCorridor(floorIndex, tileIndex) |
8.5 :BedRoomBack(floorIndex, tileIndex) }...
```

2) BedRoomFront split

For a room designed as a dormitory, we should model the area defined by BedRoomFront (floorIndex, tileIndex) and BedRoomBack (floorIndex, tileIndex). The corresponding StairCase (floorIndex, tileIndex), WashRoomFront (floorIndex, tileIndex) and TolietFront (floorIndex, tileIndex) define the corresponding area. We use BedRoomFront (floorIndex, tileIndex) as an example to illustrate the building room internal structural components and other specific modeling methods. BedRoomFront (floorIndex, tileIndex) is first split into the BedRoomFront_RightFacade (floorIndex, tileIndex) and BedRoomFront_TopFacade (floorIndex, tileIndex) near the corridor via the comp (f) split component command.

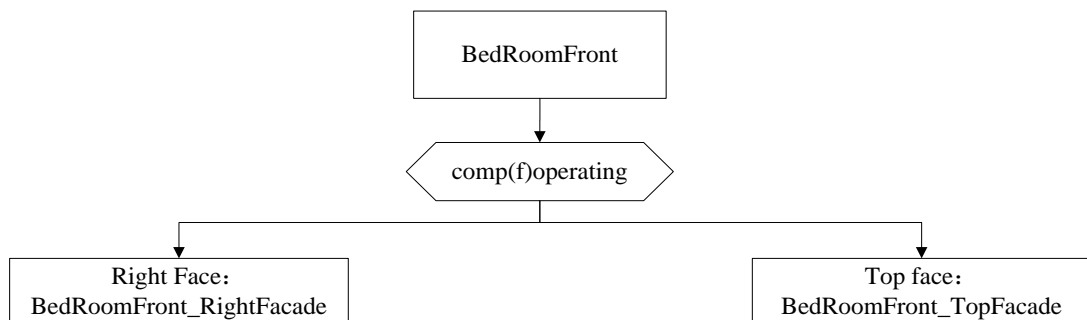

Figure 6. 26 Flow chart of BedRoomFront

The alignScopeToGeometry (zUp, any, world.lowest) command is used to change the coordinate system: zUp refers to the z-axis upward, any represents the face with the extremum selected, and world.lowest represents the edge with the smallest Y world coordinate.

Specific code is as follows, Figure 6.27 for BedRoomFront effect changes and hierarchical relationship diagram:

```

BedRoomFront(floorIndex, tileIndex) -->
  s(1, '1, 0.1) i("builtin:cube") WallCubeBright
  comp(f){right : alignScopeToGeometry(zUp, any, world.lowest) i("builtin:cube")
BedRoomFront_RightFacade(floorIndex, tileIndex) |
  top : alignScopeToGeometry(zUp, any, world.lowest)
i("builtin:cube") BedRoomFront_TopFacade(floorIndex, tileIndex) }

```

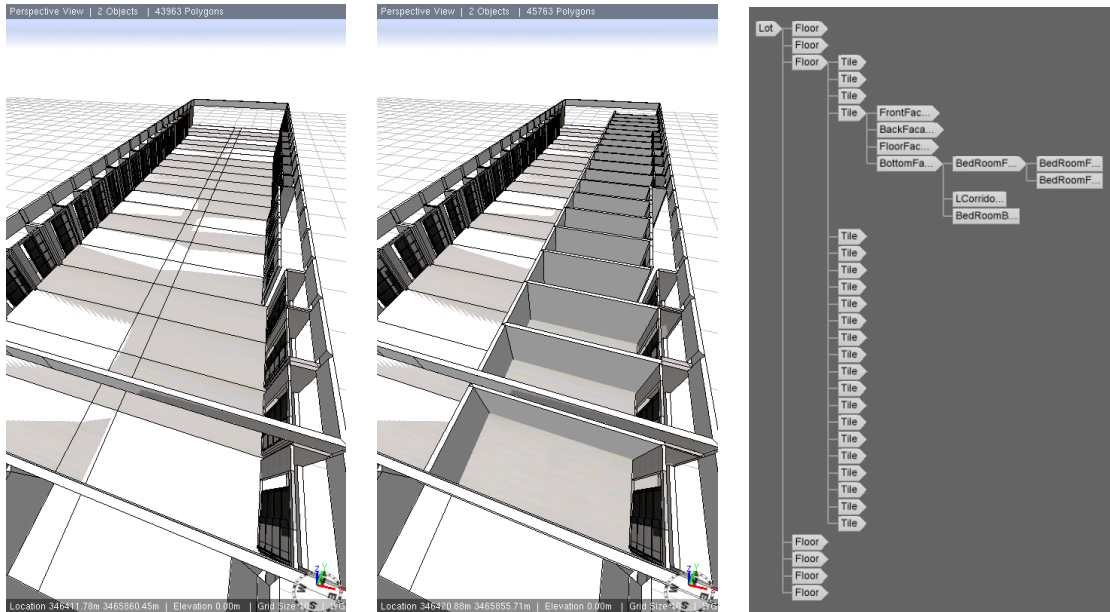

Figure 6.27 BedRoomFront effect changes and hierarchical relationship diagram

3) BedRoomFront_TopFacade Fine modeling

The BedRoomFront_TopFacade (floorIndex, tileIndex) is then defined to generate the DoorCube near the beam and corridor, the WindowCube on the door, and the WallCubeDark on both sides. The BedRoomFront_TopFacade (floorIndex, tileIndex) is then defined to generate the DoorCube near the beam and corridor, the WindowCube on the door, and the WallCubeDark on both sides. Then, the door and window portion having the doorWidth width in the middle continues to be divided into the door DoorCube having the doorHeight height and the WindowCube having the remaining height in the Y direction. Figure 6.28 is the flow chart.

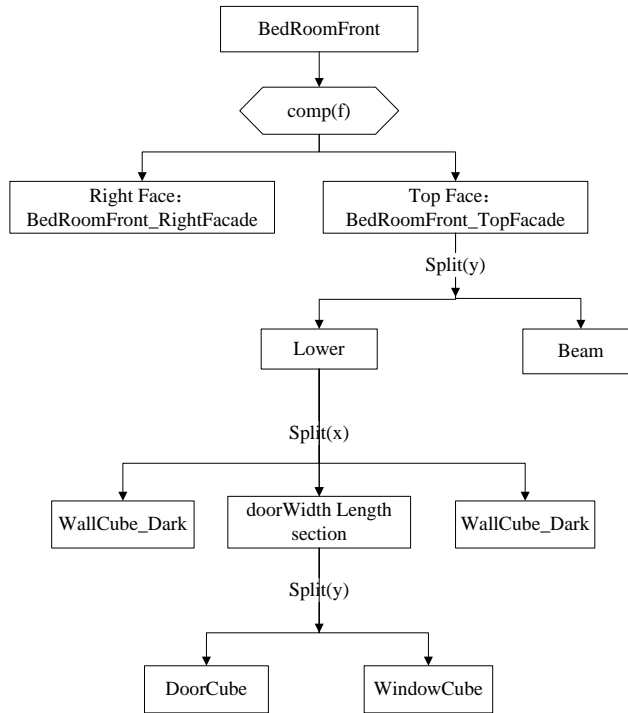

Figure 6. 28 Flow chart of BedRoomFront_TopFacade

The specific code is as follows, the model will be generated as shown in the changes, and its corresponding hierarchical relationship shown in Figure 6.29.

BedRoomFront_TopFacade(floorIndex, tileIndex)-->

```

split(y){~1 :
    split(x){~1 : WallCubeDark |
doorWidth: split(y){doorHeight : DoorCube | ~1: WindowCube }|
~1: WallCubeDark }
|.3:
    Beam
}
  
```

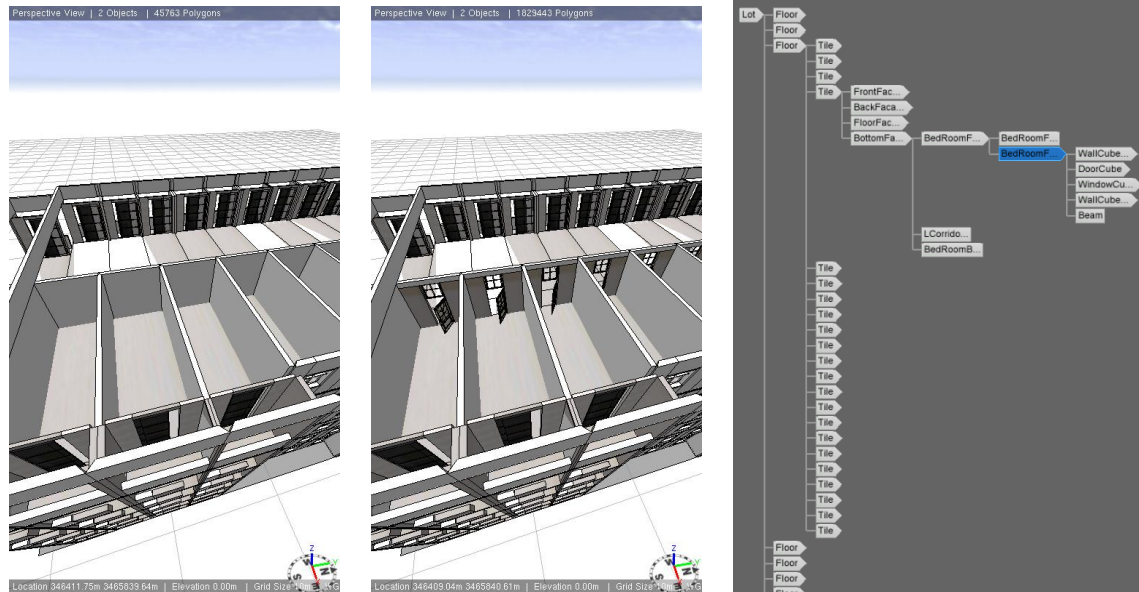

Figure 6.29 BedRoomFront_TopFacade effect changes and hierarchical relationship diagram

4) BedRoomFront_RightFacade fine modeling

Next, the BedRoomFront_RightFacade (floorIndex, tileIndex) is modeled to create a Piliar and middle section with PiliarWidth width on both sides. The middle part is subdivided into a wall wall and Beam_H for generating a beam part.

First BedRoomFront_RightFacade (floorIndex, tileIndex) along the X direction to generate both sides of the PiliarWidth width of the column Piliar and the middle part of the middle part of the fine to continue to split the fixed height of the value of the upper part of the beam and the lower wall. The upper beam continues to split the wall wall and the beam Beam_H, each of which is generated in an X direction. The flow chart is shown in Figure 6.30.

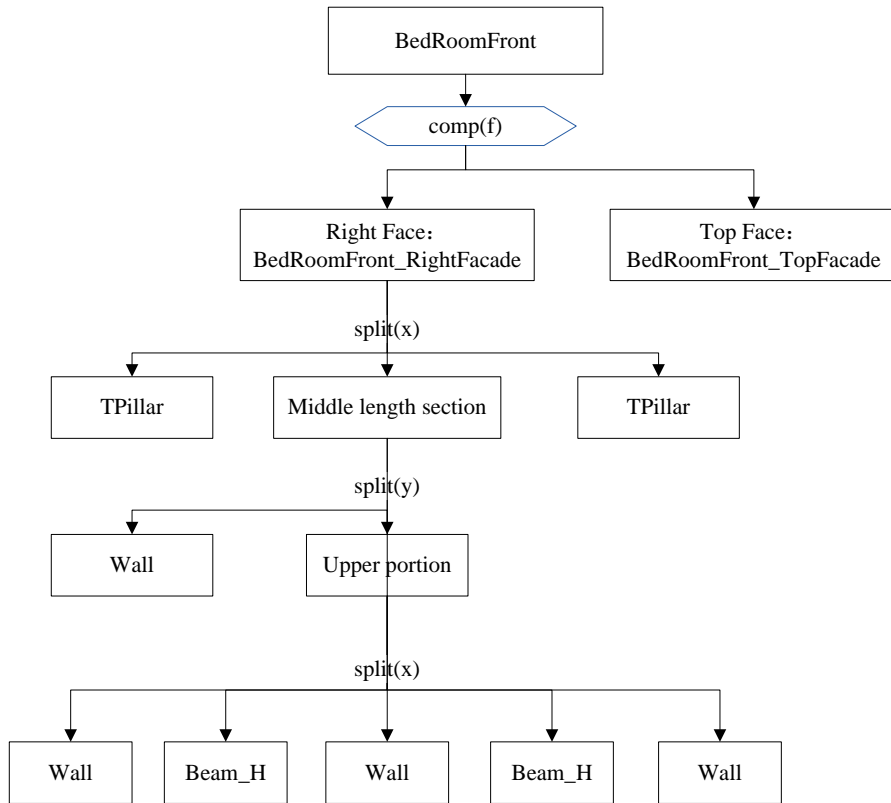

Figure 6. 30 Flow chart of BedRoomFront_RightFacade

The specific code is as follows, the model will be generated as shown in the changes, the corresponding hierarchical relationship shown in Figure 6.31.

BedRoomFront_RightFacade(floorIndex, tileIndex)--># Used to generate columns

```

split(x){~PiliarWidth : Piliar |
    ~1:split(y){~1 :Wall |
        0.3:split(x){3 :Wall |
            0.2: Beam_H |# Used
            to generate beams
            ~2.5:Wall |
            0.2: Beam_H |
            #~1 :Wall |
            ~1 :Wall }
        } |
    ~PiliarWidth: Piliar
}
  
```

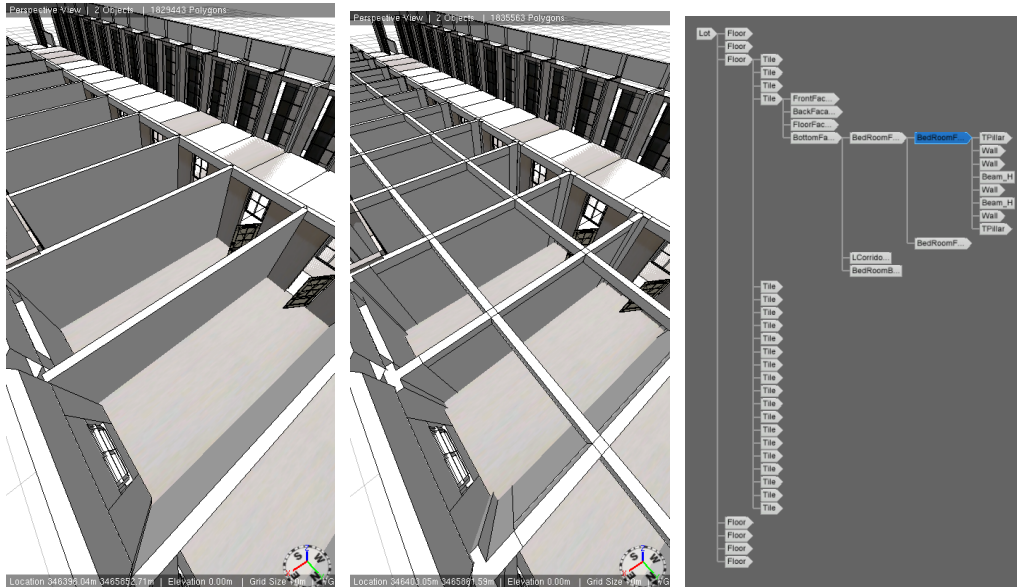

Figure 6.31 BedRoomFront_RightFacade effect changes and hierarchical relationship diagram

5) BedRoomFront_21 fine modeling

BedRoomFront_21 (floorIndex, tileIndex) and BedRoomFront (floorIndex, tileIndex) the top surface: BedRoomFront_TopFacade and Right: BedRoomFront_RightFacade is the same, and therefore have the same definition. The special thing about BedRoomFront_21 is that it generates the left face: BedRoomFront_LeftFacade21. Figure 6.32 for the flow chart, Figure 6.33 BedRoomFront_21 effect changes and hierarchical relationship diagram.

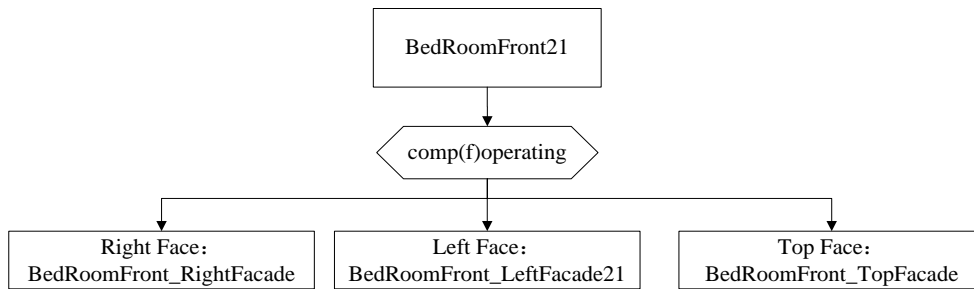

Figure 6.32 Flow chart of BedRoomFront_21

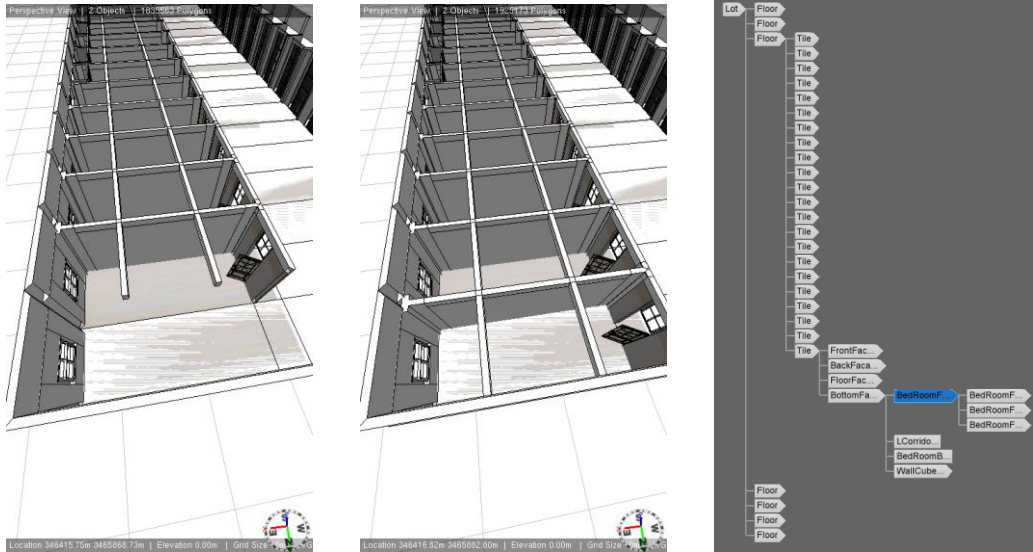

Figure 6.33 BedRoomFront_21 effect changes and hierarchical relationship diagram

6) LCorridor_21_LeftFacade fine modeling

LCorridor_21_LeftFacade the first floor to generate the door DoorCube and the window on the window WindowCube_tile1 and the window beam: AboveWindowBeam, the second and above to generate the window WindowCube_tile1 and the upper and lower windows of a wall wall WallCube_Dark. Figure 6.34 for the flow chart, Figure 6.35 LCorridor_21_LeftFacade effect changes and hierarchical relationship diagram.

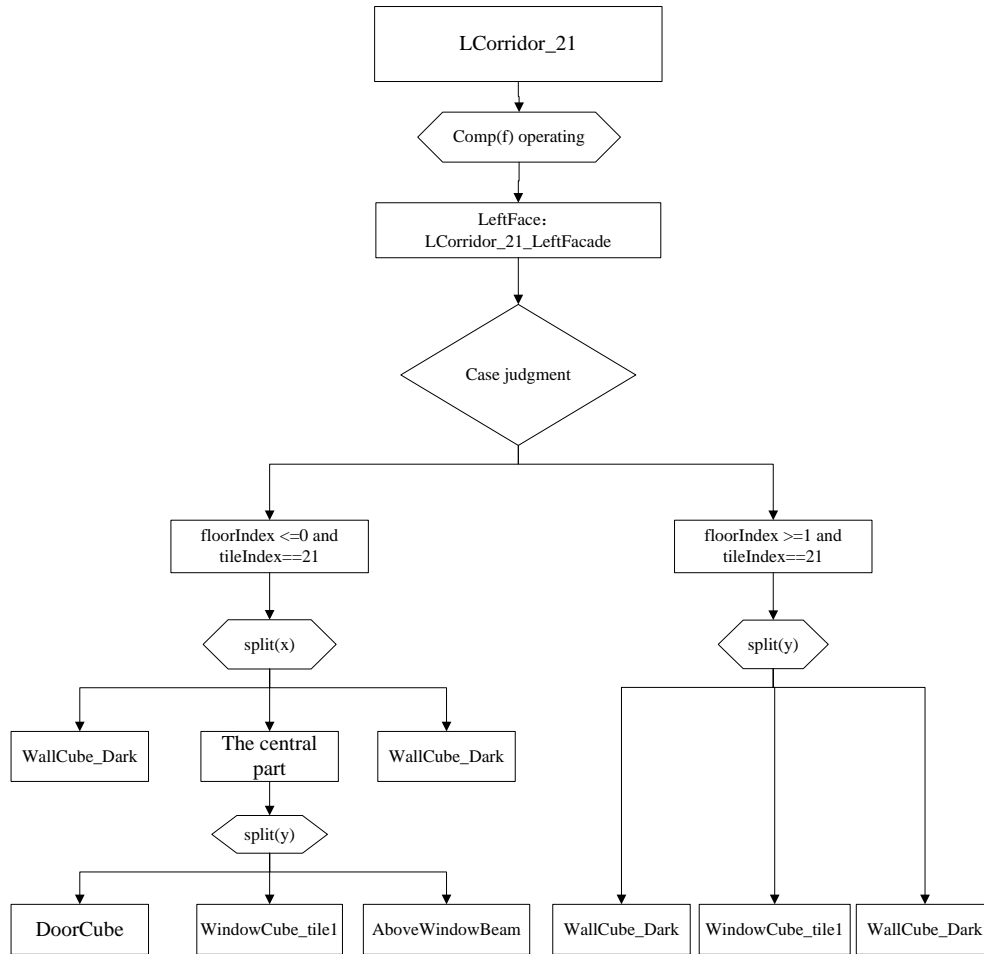

Figure 6. 34 Flow chart of LCorridor_21_LeftFacade

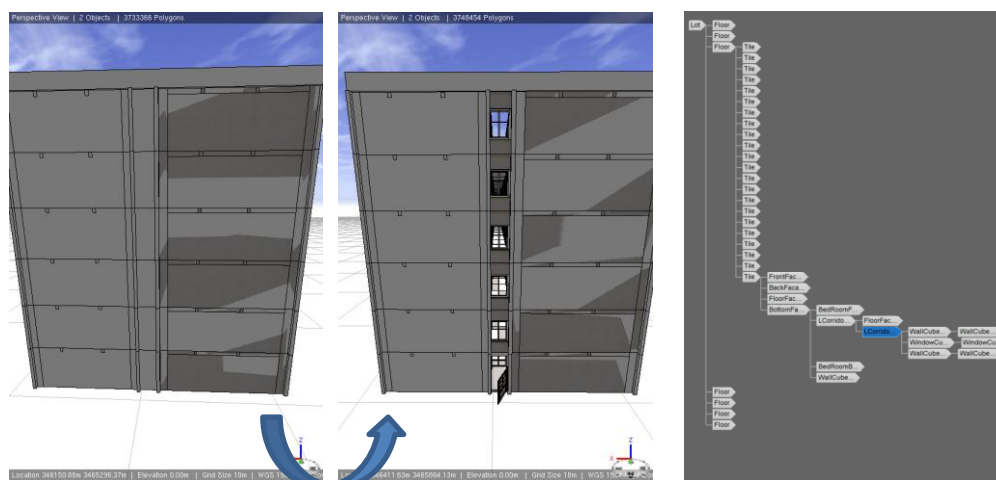

Figure 6. 35 LCorridor_21_LeftFacade effect change and hierarchy diagram

7) StairCase fine modeling

StairCase in the back direction is divided into the name of the part called Stairs. Stairs will then be replaced by OBJ files. Figure 6.36 for the flow chart, Figure 6.37 for the effect

of comparison chart.

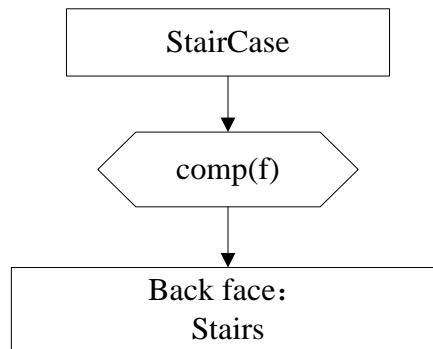

Figure 6.36 Flow chart of StairCase

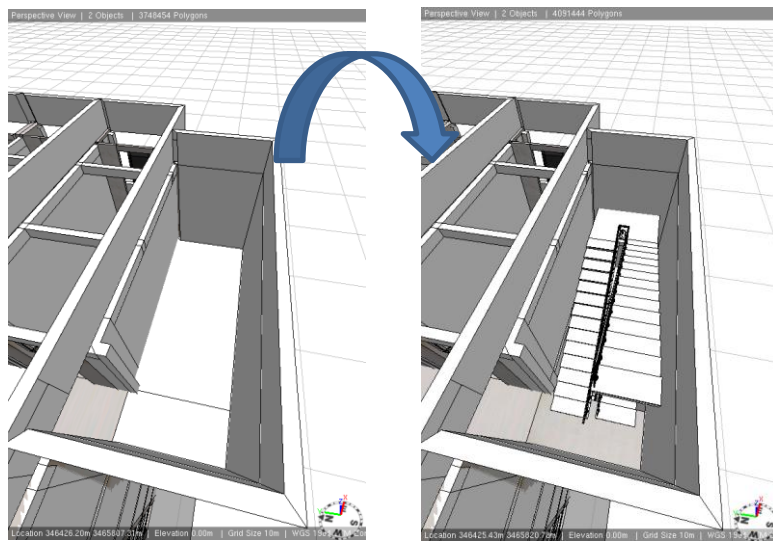

Figure 6.37 Effect of comparison chart with stairs

6.4. Chapter summary

This chapter studies the integrated information associated model technology based on the CBIIM (City Building Integrated Information Model). The technical methods of 3D geometric modeling are demonstrated, and the methods are analyzed technically and summarized as standardization and intelligent design. Standardized design based on model features, which must be comply with IFC standards and combined with database technology. Intelligent design is based on knowledge, rules and information driven to generate the corresponding model features, and can achieve parameterized control and script control.

Chapter 7. Building Construction Simulation Technology

Building lifecycle simulation is the application of visual simulation technology to building design, construction and maintenance etc., which are a series of activities in building lifecycle. Visual simulation (VS) technology is a new simulation technology which is formed after the combination of computer visualization technique and system modeling technology. Its technical principle is by means of graphics to track, control and process results in the process of computer, and use the visual software interface, Therefore has the characteristics of rapid, efficient and image and so on [98].

7.1. Analysis of visual construction simulation Technology

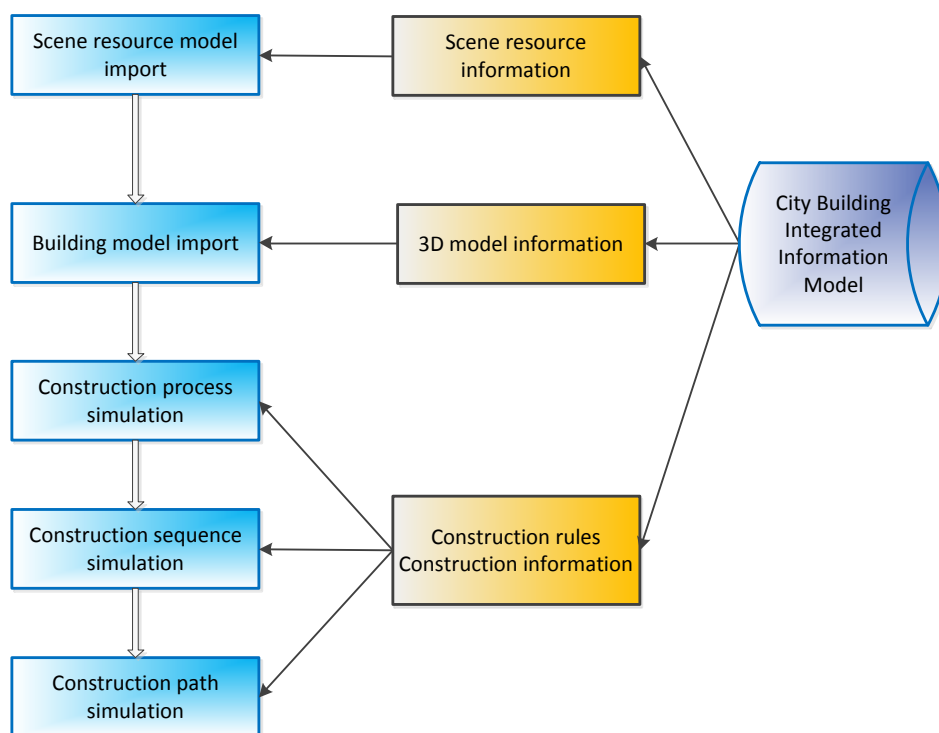

Figure 7. 1 Visual construction simulation and information integration

Visual simulation has two important elements: model, scene creation and motion simulation. Among them, the building model and scene model is the basis of simulation, usually modeling time accounts for 45% of the whole simulation project cycle [98]. Visual simulation is to achieve visual analog reproduction of the objective world. So the

simulation of the geometric model and three-dimensional scenes need to be objective and true, the models and scenes created include: light source, location and other information. Motion simulation is the most important content of visualization, the movement of the created model should be consistent with the objective reality, which can to show its original movement process truly. This thesis mainly focuses on visual construction simulation, figure 7.1 shows the visual construction simulation and CBIIM.

7.1.1 Classification of Visual Simulation Technology

In accordance with the visual simulation of the role and purpose of the different simulation, at present, the building lifecycle simulation can be divided into three categories: building design-centric simulation, building construction-centric simulation, and building maintenance-centric simulation.

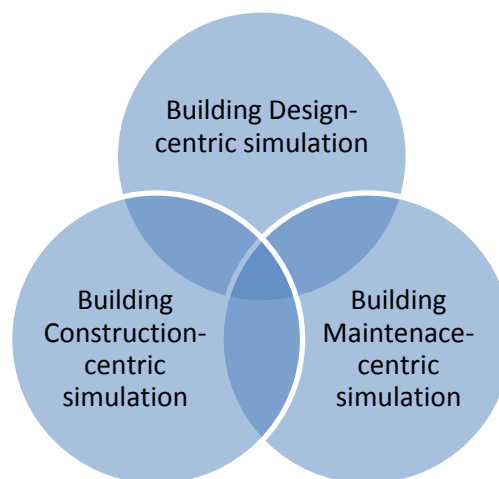

Figure 7. 2 Building lifecycle simulation types

Following are the main contents of these three types of simulation are briefly introduced:

a) Building design-centric simulation

Building design-centric simulation requires in the building and component design process to analyze the building design model with construction technology. This can provide a theoretical basis for building and component design. Building design-centric simulation can consider the construction at the beginning of the building and component design, in order to improve the construction of the building. Combined with the theory of construction design methods, through the simulation the design defects can be found

earlier which can be improved timely, and the technical rationality and feasibility of building components can be ensured.

b) Building construction-centric simulation

In the process of building construction design and process planning process, the computer simulation technology was used to simulate the construction process, in order to obtain feasible and the better construction process plan to direct the actual construction production. Construction planning refers to the construction operation and process planning, including construction sequence planning, construction path planning, Operation space interference verification and process routing etc. Through a highly realistic build operation simulation, the real construction process is presented intuitively and vividly, which can provide reference for the feasibility and scientificity of process planning, and provide guidance for actual building operations.

c) Building maintenance-centric simulation

Building maintenance-centric simulation requires consider maintainability at the beginning of building and component design, in order to improve the maintainability of the building. Through the simulation the deformation and destruction of buildings and components can be found, which can be replaced or repaired to ensure the reliability of buildings and components. Based on the integrated information model, combined with the building maintenance simulation to realize building management and integrated information data integration. If the corresponding building operating health indicators are established, we can easily guide, record, remind the property operation and maintenance plan implementation to achieve the transformation of the building (I-beam reinforcement, etc.), expansion, demolition of the whole management. Building components which can meet the requirements of city building reliability can be reused. This will reduce the consumption of materials and energy to meet the needs of sustainable development.

7.1.2 Visual construction simulation technology

Modern building construction is often industrialized production, in the construction process a number of large-scale construction machinery and equipment is usually used. Construction is a very important part in the building lifecycle, so the construction simulation plays a very important role in the building lifecycle simulation. This thesis mainly focuses on the building construction-centric simulation, building visual

construction simulation technology mainly consists of the following components:

1) Creating simulation model and its processing

Visual construction simulation process is carried out in a simulated real environment, so it is necessary to import the corresponding data model before simulation. Scene model can be exported in the format of FBX after creation in CityEngine, to be able to display the terrain, you should select the option to export terrain when exporting.

The construction process of building requires a lot of construction information, which contains the location information of the various building components and the mutual construction relationship between them and the construction sequence information. The visual construction simulation model is the link between the visual construction process and the information data base for obtaining the simulation results. On the basis of existing models to do the lightweight processing, it can not only effectively improve the efficiency of all aspects of visual construction simulation, but also hide the key confidential design information, to achieve the purpose of intellectual property protection.

2) Building constructive analysis method

Constructability is an important performance index for describing construction performance, Visual construction simulation constructive analysis method provides an auxiliary analysis tool for building visual simulation. Building visual construction simulation system is based on virtual system to present the building construction in the way of visual simulation, and analyze the construction performance by collision detection.

3) Process planning methodology of building construction

There are two types of building construction process planning methods: System level construction process planning method and component level construction process planning method. The method of building system level construction process planning is the method of system planning operation for the whole construction scene, mainly have logistics placement layout of building components, arrangement of all kinds of hoisting and transportation equipment, allocation of various auxiliary equipment resources and so on. Construction component-level construction process is a planning which is specific to the most basic elements of a component, specifically included construction sequence of building components, construction path planning, construction process development and the other process planning methodology, which related to the building component level.

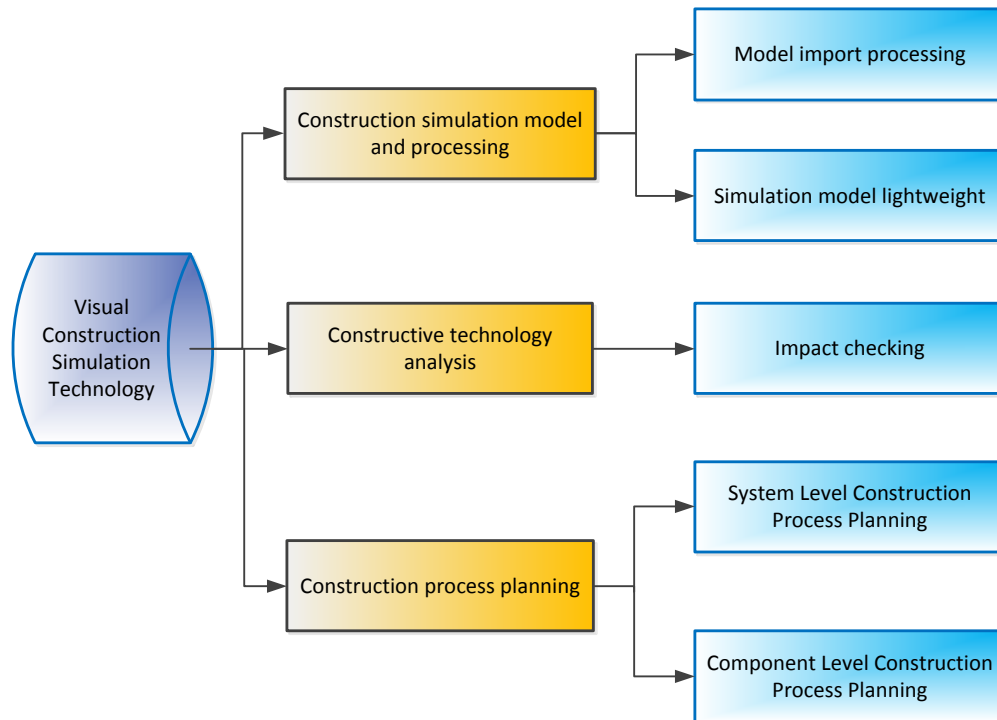

Figure 7. 3 Visual Construction Simulation Technology

7.2. Simulation model processing and collision detection technology

Virtual simulation environment is based on the creation of 3D model in the scene, the quality of the model is directly related to the realistic degree of the simulation scene, Therefore, in order to better simulate the building construction process, need to create high-quality three-dimensional model, and import it into the simulation scene in the required file format. The simulation technology mainly includes simulation environment creating and simulation driven, this section focuses on the simulation environment.

7.2.1 Simulation model and lightweight technology

According to the different characteristics of models in the simulation scene, we use different modeling methods to try to play the modeling features of different modeling tools, Strive for maxing modeling efficiency. For the creation of scene terrain, In order to display the geographical topography and topographical features simulation terrain and geomorphic features in simulation scenes as realistic as possible, we used the actual image map which

obtained in Google Maps, and do matching in the map process through the CityEngine, Combined with the actual situation such as building, decoration to create model, Then generate preliminary modeling and simulation scenarios. 3D modeling tools such as Sketch up [100], 3D Max and so on are used to select as the modeling tool according to the modeling precision and modeling difficulty of building components 3D model. Building body model through the intelligent modeling technology can quickly achieve three-dimensional modeling of the building body, and the code of the intelligent process of modeling can be modified according to the actual needs, then it can easily achieve the purpose of modeling diversification. Finally, the scene and the 3D model are imported into the simulation scene by exporting the FBX file format to realize the import of scene model and 3D model.

The lightweight of simulation model can solve the problem of large amount of data in the process of building visual simulation, ensure the visual construction simulation process can be carried out smoothly, so it is necessary to deal with the model of building visual simulation using the lightweight technology.

The model data involved in the visual construction simulation of the building need to participate in the next construction process after the lightweight processing, therefore, the lightweight model involved in building visual simulation is not a simple model simplification, Lightweight building simulation model need to consider the role of multiple factors. Lightweight technology of simulation model, mainly have the following several,

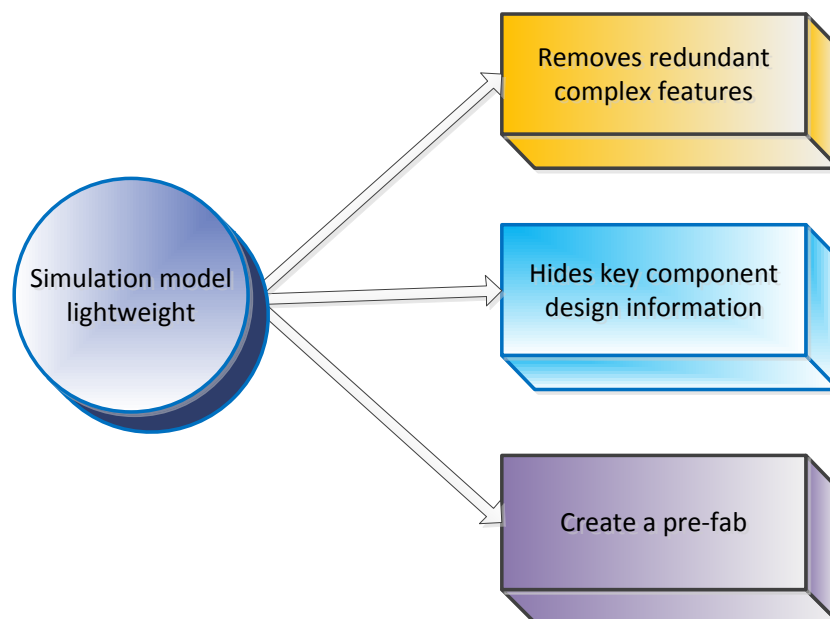

Figure 7. 4 Simulation Model and Lightweight technology

1) Removing redundant complex features not involved in construction

In the process of lightweight simulation model, First of all, should ensure that the model involved in the construction of the construction surface shape and location should remain unchanged, According to the actual situation, we can remove redundant features which are not involved in construction, Such as decorative parts and auxiliary parts, Of the building components with special complex feature without affecting its construction, can consider removing redundant features that are not involved in construction, This has a significant effect on reducing the amount of data involved in the visual simulation process.

2) Hide key component design information

In the process of building visual simulation, inevitably requires the use of company-designed and confidential key building components, these building components are part of the company's competitiveness, Its confidential core will not and should not be exposed, So in the process of building visual simulation, Necessary fuzzification and lightweight process of core building components, Protection of independent intellectual property rights, Thus protecting the interests of the Company.

3) Create a prefab in the simulation scene

In a project development process, we need to create several identical objects in the same scene at the same time. If you create a single object for each object, it will not only waste time but also slow down the processing speed of the computer, moreover it will increase the difficulty to the object management. And in many cases, the workload is not just a simple manual can be completed, in order to solve this real problem, and then to achieve light weight of the model and the scene, we use the way to create presets to solve.

For example, the traditional method we add some specific attributes or mount the script to the object is to add various game objects manually. It is extremely inconvenient. Therefore, using pre-set way, we only need to carry out related operations on the presets. It can be created by instantiating objects so that objects have the same attributes and scripting.

A building element can be set as a pre-set building component. Once we set as it a pre-set, the pre-set can be used repeatedly in the visual simulation of the scene and do not limit the number of uses. And it avoids the need to add building component entities to the visual simulation scene. All the entities which are loaded into the simulation scene by prefabrication are only clones of the source entity. When this preform is modified, all

corresponding preformed clones in the scene will be changed accordingly. This not only ensures the uniformity of building components, but also does not add an additional operating burden for the simulation scene. Preset can be placed in the same simulation scene or in the different simulation scenarios.

7.2.2 Collision detection technology

Interference checking and collision detection in construction simulation are important indicators to verify the construction performance. The principle of this test is detecting the presence of rigid or violent contact between components or with other builders during the construction process. And then the feasibility of building is verified by the performance analysis of building components.

We set the object involved in collision detection as rigid, so the object has the physical properties that assigned by the Unity physics engine. So that even in the absence of external code-driven circumstances, rigid objects will have a gravity characteristic. When colliding with an object with a collider, it will make the appropriate physical response. There are six types of colliders built in Unity: Box Collider, Ball Collider, Capsule Collider, Mesh Collider, Wheel Collider and Terrain Collider.

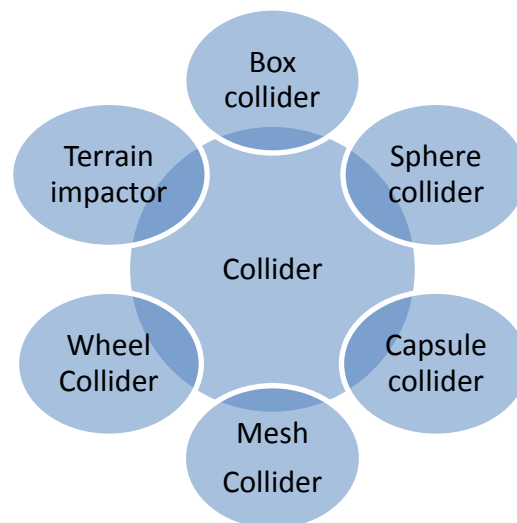

Figure 7.5 Collider classification

Box collider is a basic square for the collision prototype and can adjust the size of the actual situation in the simulation scene, which can be applied to the door, wall, floor and flat roof etc..

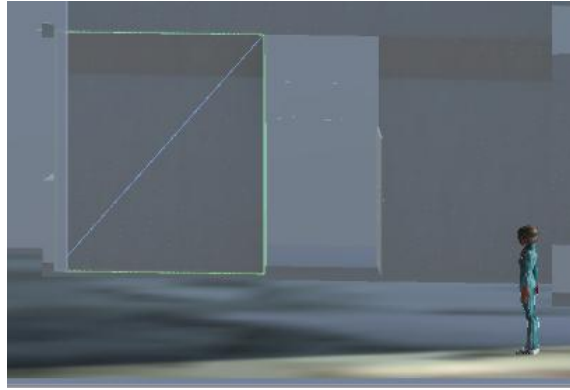

Figure 7. 6 Adding a Box Collider to the Wall

Sphere collider is a basic spherical collision prototype and can adjust the size of the three-dimensional range at the same time. It can't adjust in only one dimension and used just for the sphere object.

Capsule collider consists of a cylinder connected with two hemispheres. It is a capsule-shaped collision prototype. The radius and height of the capsule colliders can be adjusted individually. In the simulation scenario, we can be used for character control or some capsule-like objects.

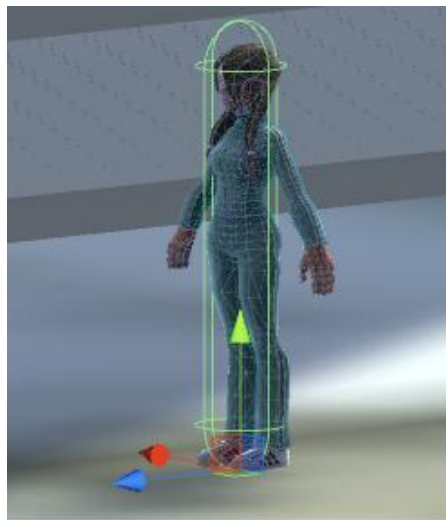

Figure 7. 7 Character Add Capsule Collider

The mesh collider utilizes a mesh resource and constructs a collider on it. For collision detection on complex mesh models, it is much more accurate than a device, which constructs a collision effect by a mesh attached to the game object.

The Wheel Collider is a special ground vehicle collider with built-in collision detection, a wheel physics engine and a sliding tire-based friction model.

The terrain collider acts primarily on collisions between the terrain and the objects. We add a collider to the terrain which can effectively prevent the infinite drop of an object that the rigid body attribute is added.

In the simulation scenario, the main control variables used for collision detection are interference control such as collisionDetectionMode (collision detection mode for selecting a rigid body), detectCollisions (selection of collision detection should be enabled), velocity (velocity vector of rigid body) Collision Detection Control Variables.

7.3. Visual construction process planning

In order to improve the scientific nature of the construction simulation and the characteristics of the concrete reality, according to the construction of a series of simulation steps, we make scientific and rational process planning for the construction process. According to the difference of planning content level, we divided the construction process planning into two levels. One is the system level process planning based on the entire simulation scene and the other is the component level process planning for the operation object. System-level process planning mainly lay out for the entire construction scene, and allocates the resources and facilities for planning. Component-level process planning is mainly used to set the construction order of components and construction path, as shown in Figure 7.8.

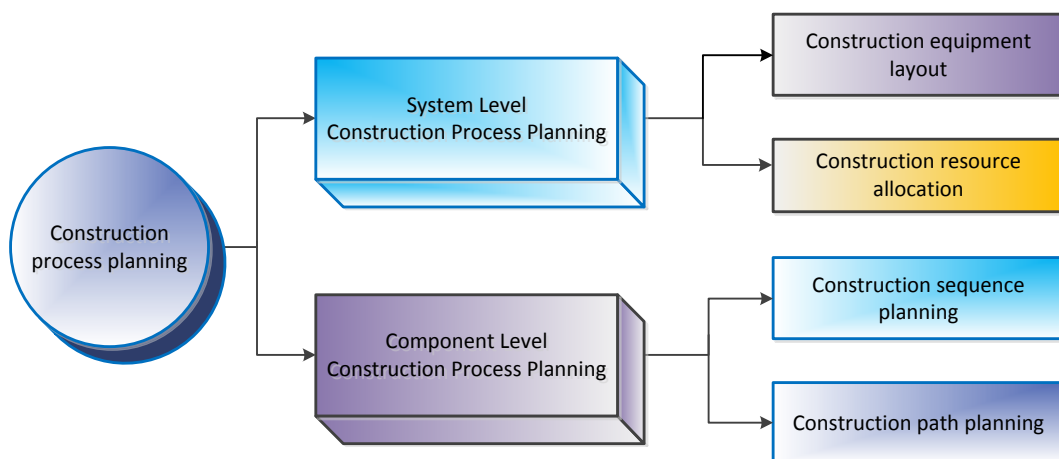

Figure 7.8 Construction process planning content

7.3.1 System-level construction planning

System-level construction planning is to design feasible and reliable construction plan by

arranging all kinds of equipment, materials and resources in the simulation scene and analyzing the whole simulation scene. System-level construction simulation can show the overall layout of the entire construction scene. So that through the system-level construction planning will be able to timely discover the overall layout of the simulation scene and can interfere with the collision which can be effectively validated. Figure 7.15 shows the layout of the scene.

According to the construction method of the building, we analyze and formulate the reasonable construction plan, select the appropriate hoisting equipment, rational layout of the site hoisting, construction, transportation equipment and operating position. The traditional layout planning is often to stay in the two-dimensional plan for the main show. This approach is not intuitive and clear, the reference for decision-makers of the three-dimensional stereoscopic map is not strong and is also likely to cause misunderstanding in a certain case. Making the decision-makers can not personally feel the design of the station and location in the construction site is out of enough space or the logistics path is reasonable and some factors are not clear enough. Therefore, it is necessary and urgent to construct visual simulation.

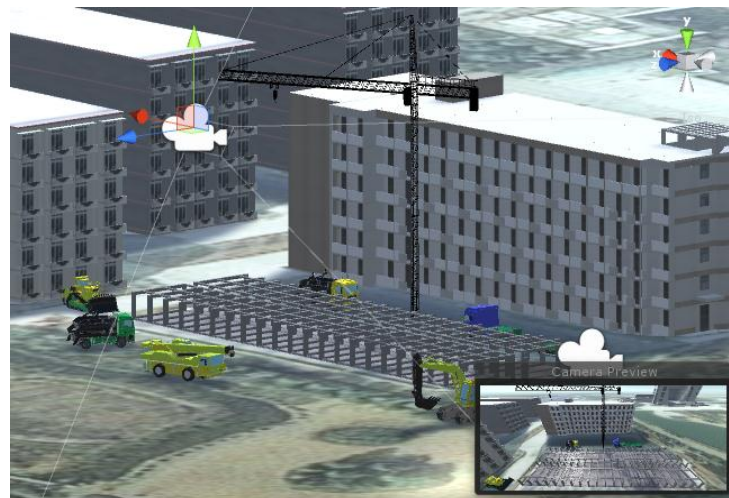

Figure 7.15 Build the scene layout

Construction technology and a variety of construction equipment position can be vividly displayed through the visual simulation. We can not only realistic display the scene of the construction, but also to present logistics, storage, inventory, a series of building materials, components and other factors. After run the initial simulation, we can optimize the existing construction methods through the simulation results. The system-level construction simulation steps involved are illustrated in Figure 7.9.

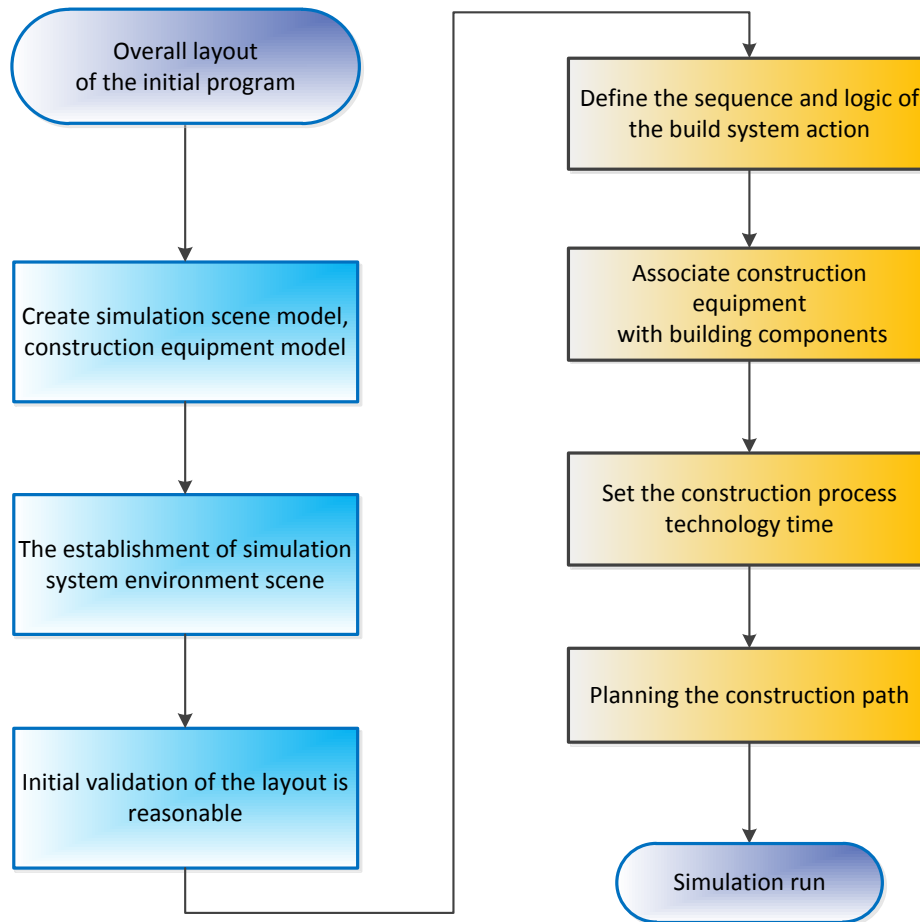

Figure 7. 9 System-level construction simulation steps

Through the visual simulation in the construction of the system-level layout planning, we can find the entire simulation scene layout or collision interference situation. We can directly observe the utilization rate of construction equipment in the field, optimize the logistics path of the hoisting equipment according to the simulation results, improve the hoisting equipment construction methods.

7.3.2 Component-level construction process planning

Component-level construction process planning involves the planning of specific components, which has been refined to a specific component. Therefore, it is necessary to plan the construction method of building components. Component-level construction process is driven by the integrated informations, construction knowledge rules are used to regulate the construction sequence planning, construction path information is used to provide guidance for the construction path planning.

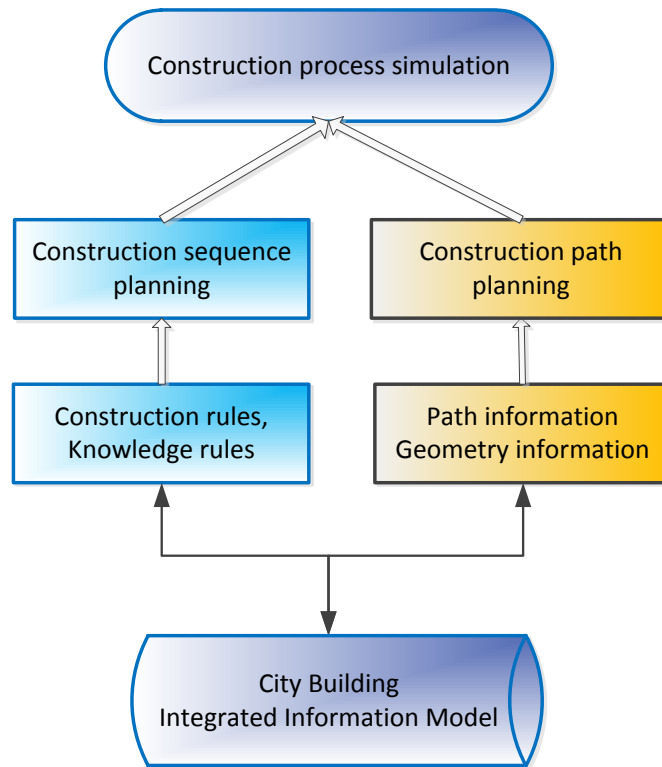

Figure 7. 10 Component Level Construction Process Planning

7) Construction sequence planning

The order in constructing buildings is generally determined by factors such as building performance and process priority. Building construction performance refers to reasonably achieve on-site construction on the condition of meeting the existing practical experience and the construction principles. Building construction performance is an important indicator to describe the construction performance of the building. It is of great significance to the concrete result of this construction. It generally follow the principle of the first after the outside, the first after the next, the first difficult after the easy.

8) Construction path planning

Construction sequence planning determines the order of construction between building components. We need the construction path planning after completion of the construction sequence planning. Construction path planning is used to determine the entire process from the placement to the final location of the building element. Construction path planning requires components and equipment in the entire process from the placement to the final construction position can't occur the collision or interference between other equipment and components and to ensure the reliability of the premise shall not occur Collision or interference between components. Therefore, when planning the construction

path, we should fully consider the actual situation of the construction site and plan the construction path rationally so as to find the optimal route plan.

7.4. An application example for building construction simulation

In this thesis taking the dormitory in Baoshan campus of Shanghai University as an example, the validity and feasibility of CBIIM and construction simulation are verified.

7.4.1 Creation of an integrated information simulation scene

Integrated information associated model technology is required in the 3D geometric modeling to make full use of integrated information related to the IFC standard model and knowledge rules. Information-driven 3D geometric modeling process makes model associated with information. For the creation of scene terrain, in order to display the simulation terrain and geomorphic features in simulation scenes as realistic as possible, we used the actual image map which obtained in Google Earth, and do matching in the map process through the CityEngine, combined with the actual situation such as building, decoration to create model, and generate preliminary modeling and simulation scene. Simulation model is generated by integrated information association model technology, and in accordance with the actual needs the code of intelligent process can be modified, you can easily achieve a variety of different design simulation. The initial simulation scene and the 3D simulation model are imported into the simulation scene by exporting the FBX file format, thus achieve the scene model and the import of 3D model.

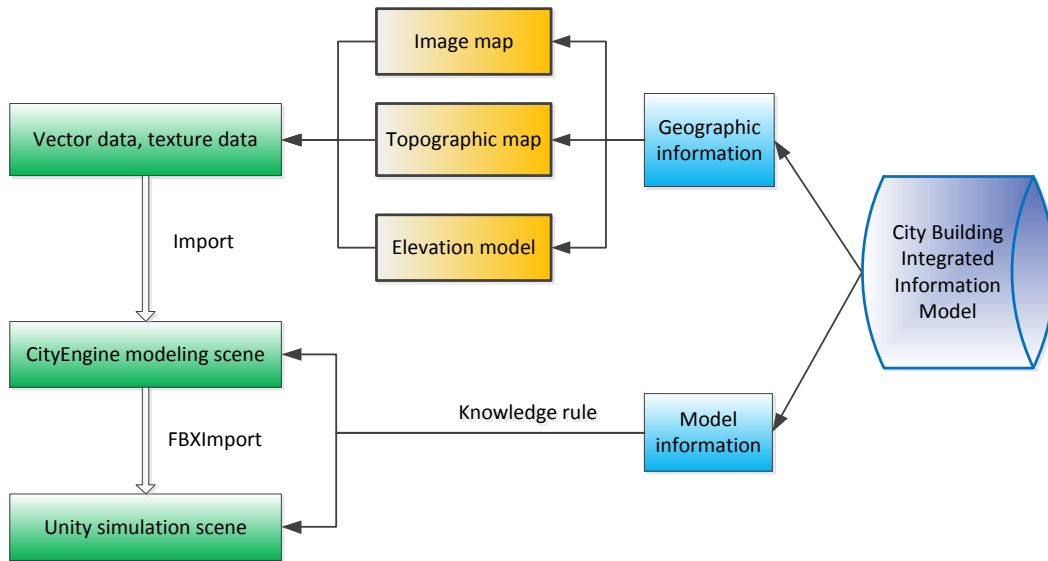

Figure 7. 11 Scene preparation process

1) The stage of scene preparation

The acquisition and processing of geographic terrain scene data in the process of Modeling and simulation including images obtained in Google maps, topographic map and digital elevation model, and matching these image data in CityEngine. These images are preserved in the geographic information of the building CBIIM model,



Figure 7. 12 Obtain the simulation scene terrain image

2) The construction of 3D simulation model

The simulation model provides the necessary model data preparation for the simulation process. In the integrated information model we instantiate the standard building components, such as doors, windows and staircases, which are stored in OBJ format after standardized modeling by 3D modeling tools such as Sketchup. As shown in

3) Scene modeling by using Unity

Before the scene modeling, firstly, terrain scene and building model are derived from CityEngine, Which is derived in FBX format, and then import it into the Assets directory in the Unity scene. Then do some adjustments and processing for the scene, which need to import the tower crane, crane and other engineering equipment vehicles applied in building simulation process.



Figure 7. 15 Unity Simulation Scene

7.4.2 An example for construction simulation

The city building lifecycle simulation has gone through the whole process of design, construction and maintenance. As a virtual simulation environment to design, analyze and construct provides a high-level, physics-based 3D environment. It can accurately represent the real system with the relevant geometric data and motion. In the virtual environment for the construction of a variety of real-time analysis, such as interference analysis, construction process analysis etc.. And then quickly modify the appearance of the building, structure, process, etc., effectively improve the quality and efficiency of building construction. The construction process is as follows:

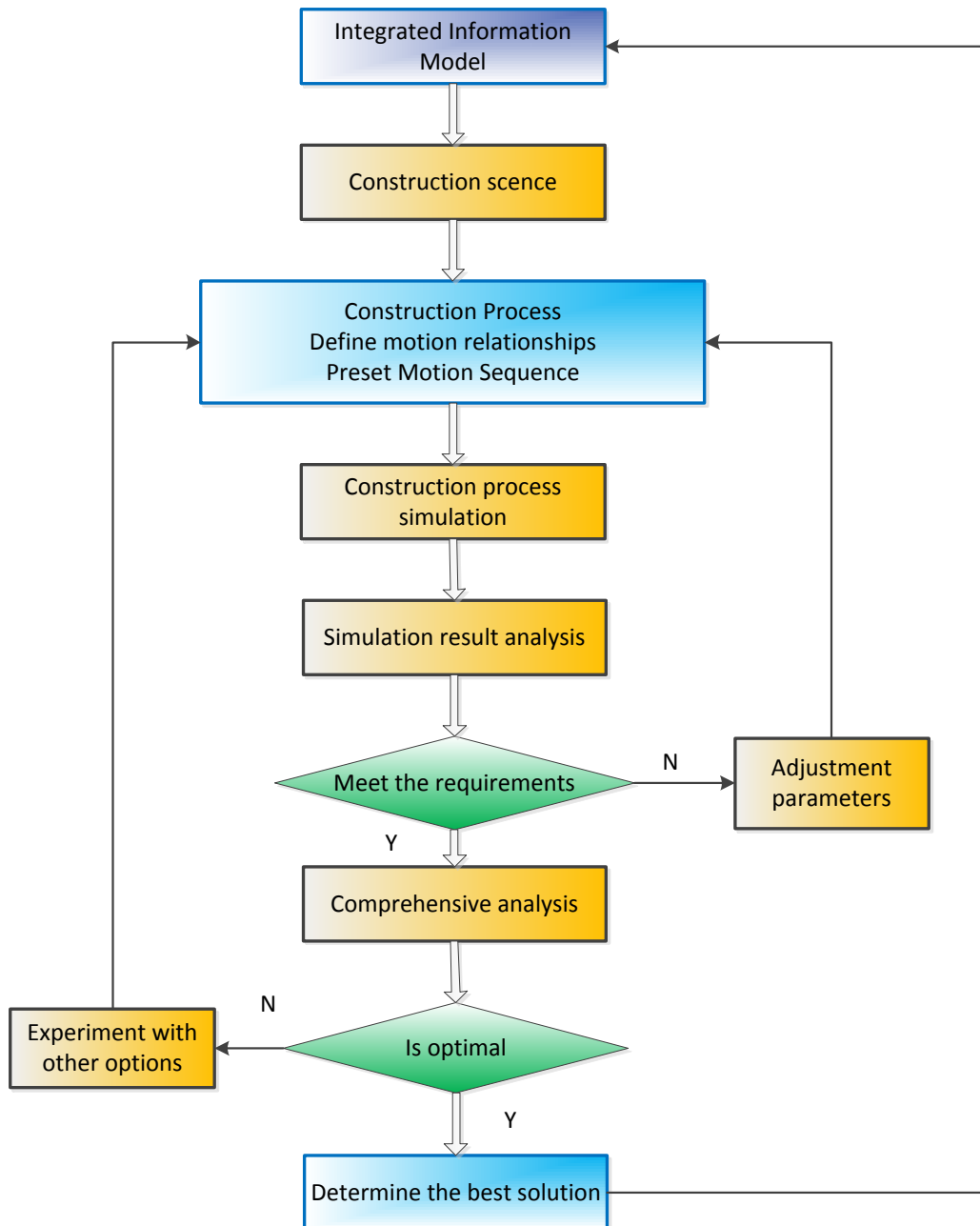

Figure 7. 16 Construction simulation flow

The purpose of the construction process principle is to improve the quality and efficiency of construction, at same time to reduce the difficulty of on-site operation. Using the simulation information of integrated information, C # program is taken advantage to drive the construction of the simulation process. As shown in the Figure 7.17, construction sequences are preset in the C # program and determine the order of construction of main components. The main building components order of the dormitory is floor, beams, walls, doors, windows, balconies and stairs. After completing the

construction sequence planning, the construction path is planned.

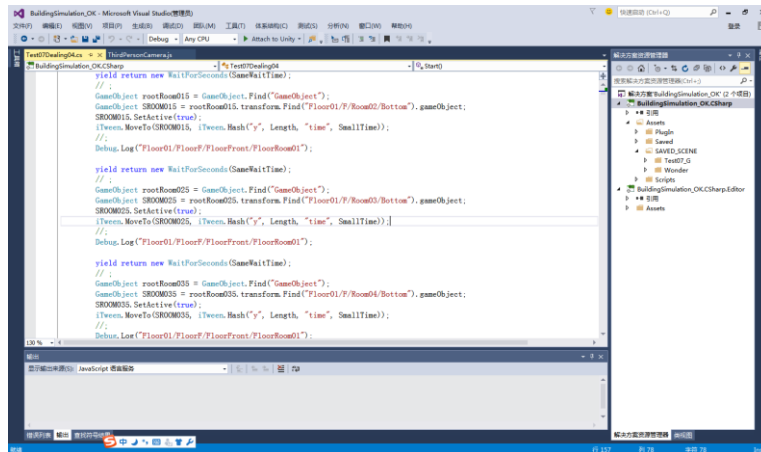

Figure 7. 17 Simalaiton information C# program

The construction path planning is used to determine the whole process of the building component from the placement to the final position. Construction path planning in the construction process can not occur collision or interference between the components or other equipment, and to ensure the construction of accessibility between the components. So when we plan the construction path, we need to consider the actual situation of construction site, to plan the construction path reasonable, to strive to find the optimal path. As shown Figure 7.18 Construction path planning.

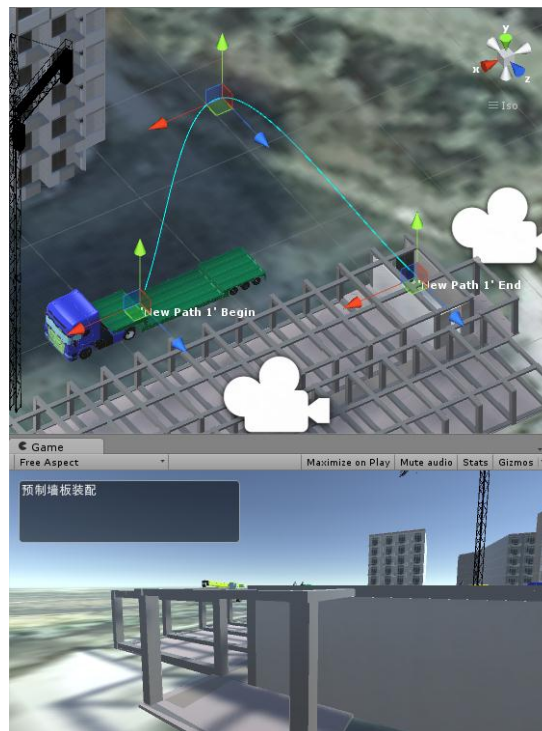

Figure 7. 18 Constructon path planning

7.5. Chapter summary

In this chapter, the visual simulation of building is discussed and the simulation of building construction is studied in detail. First of all, this chapter introduces the classification of building lifecycle simulation technology research. Then according to the construction requirements of the building, we analyzed the techniques of visual construction simulation based on simulation models and scene. Taking the dormitory of Shanghai University as an example, the simulation scene and simulation model is created with the integrated informations, and the building construction process is completed by the program. Thus the feasibility and validity of the CBIIM and construction simulation are verified.

Chapter 8. Conclusion and Future Work

8.1. Conclusion

With the rapid development of industrialization, China is experiencing the world's largest urbanization process. The smart city becomes the inevitable trend of city development. Focusing on the construction and development of the smart city, how to build a realistic 3D model of large-scale city building quickly and efficiently becomes the research hotspot. This thesis analyzes the state of the art of 3D modeling, a Procedural intelligent 3D modeling approach of city buildings is proposed. This thesis focuses on how to use the rule modeling technology and the facade modeling technology to construct the realistic large-scale 3D building model quickly and efficiently. The feasibility and validity of the 3D modeling approach are verified by an example.

With the development of the smart city, construction industry has gotten a new round of development opportunities. Building informatization technology is an important technical means to enhance the construction industry. Focusing on the building informatization, how to study and apply the BIM technology is the key to the design and construction city buildings. This thesis analyzes the state of art of building informatization, City Building Integrated Information Model (CBIIM) is proposed to the insufficiency of BIM for the city buildings, which can manage the informations in the building lifecycle effectively. The integrated information association model technology is studied for standardized design and intelligent design combined with IFC. The visual construction simulation technology is analyzed, based on the CBIIM model, simulation model and scene are designed and the construction simulation processes are completed.

The main work of the thesis is summarized as follows:

- 1) The thesis analyzes the development and research state of art of 3D modeling technology of city buildings, and analyzes the development and research state of art of building information model and construction simulation technology.
- 2) A novel 3D modeling approach of city building is proposed to combine the rule-based modeling technique of shape grammar with image-based facade rule modeling technique, which can further improve the speed of city building modeling and expand the scope of modeling.

- 3) The methods how to acquire and process the modeling data are studied, Google Earth and ArcGIS software are mainly used to acquire and process image-maps data and elevation-maps data of the target area, these two kind of data match and overlay, which can generate 3D city terrain data with geographic location information. 3D laser scanning technology is used to collect building surface texture images and create the point clouds model of the target architecture modeling so as to get the modeling dimensions by measurement.
- 4) The rule modeling based on shape grammar and image based façade modeling are studied to create the building model. The principles and steps of CGA rules are illustrated, the method which can separate architectural elements using image segmentation is studied to generate CGA rule automatically and to create building model furtherly. Thus 3D building models have been established in the CityEngine software using CGA rules and facade segmentation technology, which lay a theoretical foundation for the application of 3D modeling approach in city buildings.
- 5) Taking Baoshan Campus of Shanghai University as an example, the modeling process of the whole scene is illustrated, and the modeling steps of all kinds of 3D objects are described in detail to solve the specific problems in the actual modeling process. Thus the feasibility and validity of the Procedural intelligent 3D modeling approach are verified.
- 6) The City Building Integrated Information Model (CBIIM) is constructed based on BIM. The city building information is classified and integrated, and the building and component was described with the IFC standard, in order to manage the informations of building lifecycle effectively.
- 7) The integrated information association model technology is studied, that it can realize standardized component design with associated features and intelligent building design with associated parameters in knowledge rules. Combined with the IFC building model is driven by a variety of associated information.
- 8) The visual construction simulation technology is studied, and the system structure of visual construction simulation is analyzed. Taking the dormitory of Shanghai University as an example, the simulation scene and simulation model is created with the integrated informations, and the building construction process is completed by the program. Thus the feasibility and validity of the CBIIM

are verified.

8.2. Discussion

In this section we will compare our approach with the previous work, and determine the advantages and characteristics of our procedural intelligent 3D modeling approach.

a) Combine with the geographic information

General building modeling methods often only focus on the architectural outline of the buildings, which neglect the geographic data information of the real buildings, such as geographic spatial coordinate and terrain elevation information. In this thesis we proposed the procedural modeling approach that combined with Google Earth to acquire kinds of geographic data information, and processed the data information in ArcGIS. The perfect combination of Geographic data information and building models in CityEngine effectively guarantee the authenticity of building models.

b) Intelligent facade modeling based on images

For large-scale three-dimensional city building modeling, the traditional CAD modeling techniques (Maya, AutoCAD, 3DS Max) will cost too much manpower and time. The procedural modeling method in this thesis, with the help of intelligent facade modeling based on images, improve modeling efficiency and model quality, and reduce the cost of modeling.

c) Useful for large-scale buildings modeling tasks

There are many 3D modeling software for buildings, such as Sketchup, 3DS MAX, AutoCAD, Maya, etc., the software have a comparative advantage for a single building, but for large-scale complex city buildings, such problems as low efficiency, insufficient data update will appear. So the procedural modeling approach is proposed in this thesis. Through repeated use of CGA rules and structural parts (such as door, window and ledge), the approach can effectively implement the rapid modeling of large-scale city buildings, and can guarantee the quality of building models.

Taking a 3D virtual campus as an application example to validate the approach of procedural modeling, it shows the approach can take good advantage of existing GIS data, can rapidly modeling based on CGA rule for the large-scale campus, and can facade modeling to create complex building. The characteristics of the procedural approach are high modeling efficiency, high degree of intelligence and good quality of modeling.

This thesis specifies the CBIIM based on BIM, which focuses on the building lifecycle process, compared with the previous work it has several advantages as follows:

a) Comply with IFC standards

Since the CBIIM informations are mainly based on BIM architecture, and comply with IFC standards. It is beneficial to information sharing and exchanging, and can effectively comprehensive manage the information of building lifecycle.

Integrated information association model with IFC standard, which can drive the standardization design of building components, and drive the rapid intelligent design of building combined with the rules of information.

b) Classification contain geographic information

CBIIM adopt the special information integration, the information is classified into several types to manage. Geographic information is contained, which can meet information management requirements of the city building complex.

CBIIM information obtain the required information definition according to the need to in BIM, thus CBIIM can avoid the phenomenon of information redundancy, and ensure the efficiency of the use of information. CBIIM shows a better flexibility and personalization.

Taking the dormitory of Shanghai University as an example, a simulation scene and the simulation model were created by the integrated informations, combined with the relevant construction information the construction simulation was completed by the program. Thus the feasibility and validity of the CBIIM are verified.

8.3. Future work

In this thesis, a novel 3D modeling approach of city building and city building integrated information model (CBIIM) are studied and discussed, and the subject covers a wide range of knowledge. Due to limited time and knowledge, there are still some shortcomings, the author thinks that the following aspects can be improved in the future research work:

- a) In this thesis image segmentation is manual to generate rules automatically in the process of facade modeling technology. The author thinks the relevant algorithm can be used to realize the automatic image recognition and segmentation, and then automatically generate rules to better achieve the 3D modeling of city building

automation.

b) In this thesis 3D laser scanning technology is used to acquire the building surface data and to generate the point cloud to measure the size of building. The author thinks the full application of point cloud data combined with CGA rules, which have yet to be further studied and explored.

c) With the development of intelligent design technology, the methods of standardized design of component and intelligent design of building in integrated information association model technology need to be further expanded. The author thinks building visual simulation technology to further enhance the integration, and applied to the building maintenance simulation.

References

- [1] Zheng, Yongnian. Zhao, Litao. & Tong, Sarah. Y. (Eds.). (2016). *China's Great Urbanization*. Routledge.
- [2] <http://finance.sina.com.cn/roll/2016-02-29/doc-ifxpvtuf3673189.shtml>
- [3] Nam, T., & Pardo, T. A. (2011). Smart city as urban innovation: Focusing on management, policy, and context. In *Proceedings of the 5th international conference on theory and practice of electronic governance* (pp. 185-194). ACM.
- [4] Guidi, G., Russo, M., Ercoli, S., Remondino, F., Rizzi, A., & Menna, F. (2009). A multi-resolution methodology for the 3D modeling of large and complex archeological areas. *International Journal of Architectural Computing*, 7(1), 39-55.
- [5] Zhou Ling. (2013). *Based on the parametric technology of digital city three-dimensional modeling method* (Doctoral dissertation, Zhejiang University). (in Chinese)
- [6] Cornelis, N., Cornelis, K., & Van Gool, L. (2006). Fast compact city modeling for navigation pre-visualization. In *Computer Vision and Pattern Recognition, 2006 IEEE Computer Society Conference on* (Vol. 2, pp. 1339-1344). IEEE.
- [7] Shashi, M., & Jain, K. (2007). Use of photogrammetry in 3D modeling and visualization of buildings. *ARPN Journal of Engineering and Applied Sciences*, 2(2), 37-40.
- [8] Xu, H. (2016). The time use pattern and labour supply of the left behind spouse and children in rural China. *China Economic Review*.
- [9] Veeramani, D., Tserng, H. P., & Russell, J. S. (1998). Computer-integrated collaborative design and operation in the construction industry. *Automation in Construction*, 7(6), 485-492.
- [10] Chen Xun. (2006). *Research on the Thought and Application of Life-cycle Information Management (BLM) in Construction Engineering* (Tongji University). (in Chinese)
- [11] Wedding, J., & Probert, D. (2008). *Mastering AutoCAD Civil 3D 2009*. John Wiley & Sons.
- [12] Xie Yanqing (2006). *Research on Key Technology of Information Sharing and Exchange Platform in Logistics Enterprises* (Beijing Jiaotong University). (in

Chinese)

- [13] Finkel, G. (2015). The economics of the construction industry. Routledge.
- [14] Fu Yuchen (2003). Computer Graphics: Principles, Methods and Applications. Huazhong University of Science and Technology Press. (in Chinese)
- [15] Xu H, Badawi R, Fan X, et al. Research for 3D visualization of Digital City based on SketchUp and ArcGIS[C]. International Symposium on Spatial Analysis, Spatial-temporal Data Modeling, and Data Mining. International Society for Optics and Photonics, 74920Z-74920Z-6 (2009).
- [16] Lorenz W.E. Estimating the Fractal Dimension of Architecture: Using two Measurement Methods implemented in AutoCAD by VBA. Proceedings of the 30th eCAADe Conference, 9:505--513 (2012).
- [17] Hofmann, A. D. (2004). Analysis of TIN-structure parameter spaces in airborne laser scanner data for 3-D building model generation. International Archives of Photogrammetry, Remote Sensing and Spatial Information Sciences, 35(B3), 302-307.
- [18] Briese, C. (2006). Structure line modelling based on terrestrial laserscanner data. In ISPRS Symposium, Dresden, Commission V-Image Engineering and Vision Metrology.
- [19] Rottensteiner, F., Trinder, J., Clode, S., & Kubik, K. (2007). Building detection by fusion of airborne laser scanner data and multi-spectral images: Performance evaluation and sensitivity analysis. ISPRS Journal of Photogrammetry and Remote Sensing, 62(2), 135-149.
- [20] Sohn, G., & Dowman, I. (2007). Data fusion of high-resolution satellite imagery and LiDAR data for automatic building extraction. ISPRS Journal of Photogrammetry and Remote Sensing, 62(1), 43-63.
- [21] Zeng Qihong. (2009). Airborne lidar point cloud data processing and building three-dimensional reconstruction. Shanghai: Shanghai University. (in Chinese)
- [22] WENG Shu. (2011). 3D Reconstruction Technology and Implementation of Regional Buildings (Doctoral dissertation, Huazhong Normal University). (in Chinese)
- [23] WANG Jun, ZHU Li, WANG Jun, ZHU Li. 3D Reconstruction of Facade of Building Based on Image Matching and Point Cloud Fusion. Chinese Journal of Computers, 35 (10), 2072-2079. (in Chinese)

- [24] Sahin, C., Alkis, A., Ergun, B., Kulur, S., Batuk, F., & Kilic, A. (2012). Producing 3D city model with the combined photogrammetric and laser scanner data in the example of Taksim Cumhuriyet square. *Optics and Lasers in Engineering*, 50(12), 1844-1853.
- [25] Van den Heuvel, F. A. (1998, December). Line-photogrammetric mathematical model for the reconstruction of polyhedral objects. In *Electronic Imaging'99* (pp. 60-71). International Society for Optics and Photonics.
- [26] Xue Qiang, Zhang Zhiqiang, & Sun Jizhou. (2004). A method for building scene reconstruction. *Computer Engineering*, 30 (6), 179-181. (in Chinese)
- [27] Wang, L., You, S., & Neumann, U. (2007, October). Semiautomatic registration between ground-level panoramas and an orthorectified aerial image for building modeling. In *2007 IEEE 11th International Conference on Computer Vision* (pp. 1-8). IEEE.
- [28] Zhang Ka, Sheng Yehua, Li Yongqiang, Han Bing, & Liang Cheng. (2007). Construction of 3D Surface Model Based on Digital Close-up Stereo Photogrammetry. *Data Acquisition and Processing*, 22 (3), 309-314. (in Chinese)
- [29] Lafarge, F., Descombes, X., Zerubia, J., & Pierrot-Deseilligny, M. (2008, June). Building reconstruction from a single DEM. In *Computer Vision and Pattern Recognition, 2008. CVPR 2008. IEEE Conference on* (pp. 1-8). IEEE.
- [30] TAN Qu-lin, & WANG Jin-fei. (2011). Combined with high-resolution multi-spectral image and lidar data to extract urban buildings. *Journal of Applied Basic and Engineering Science*, 19 (5), 741-748. (in Chinese)
- [31] WANG Wei, HUANG Wen-wen, HUANG Wen-wen, ZHEN Jiao. (2011). Tiltometry of Pictometry and its application in 3-D city modeling. *Surveying and Geo-spatial Information*, 34 (3), 181-183. (in Chinese)
- [32] Lindenmayer, A. (1975). Developmental algorithms for multicellular organisms: A survey of L-systems. *Journal of Theoretical Biology*, 54(1), 3-22.
- [33] Prusinkiewicz, P., Hammel, M., Hanan, J., & Mech, R. (1996, February). L-systems: from the theory to visual models of plants. In *Proceedings of the 2nd CSIRO Symposium on Computational Challenges in Life Sciences* (Vol. 3, pp. 1-32).
- [34] Müller, P., & Parish, Y. (2001). Procedural modeling of cities. In *Proceedings of the International Conference on Computer Graphics and Interactive Techniques* (pp. 301-308).

- [35] Müller, P., Wonka, P., Haegler, S., Ulmer, A., & Van Gool, L. (2006, July). Procedural modeling of buildings. In *Acm Transactions On Graphics (Tog)* (Vol. 25, No. 3, pp. 614-623). ACM.
- [36] Müller, P., Zeng, G., Wonka, P., & Van Gool, L. (2007). Image-based procedural modeling of facades. *ACM Transactions on Graphics (TOG)*, 26(3), 85.
- [37] Watson, B., Müller, P., Veryovka, O., Fuller, A., Wonka, P., & Sexton, C. (2008). Procedural Urban Modeling in Practice. *IEEE Computer Graphics and Applications*, 28(3), 18-26.
- [38] Whiting, E., Ochsendorf, J., & Durand, F. (2009, December). Procedural modeling of structurally-sound masonry buildings. In *ACM Transactions on Graphics (TOG)* (Vol. 28, No. 5, p. 112). ACM.
- [39] Vanegas, C. A., Aliaga, D. G., Wonka, P., Müller, P., Waddell, P., & Watson, B. (2010). Modelling the appearance and behaviour of urban spaces. In *Computer Graphics Forum* (Vol. 29, No. 1, pp. 25-42). Blackwell Publishing Ltd
- [40] Talton, J. O., Lou, Y., Lesser, S., Duke, J., Měch, R., & Koltun, V. (2011). Metropolis procedural modeling. *ACM Transactions on Graphics (TOG)*, 30(2), 11.
- [41] Su, P., & Xiong, L. (2012). Procedural modeling technology in Urban design. In *Advanced Materials Research* (Vol. 482, pp. 2481-2484). Trans Tech Publications.
- [42] XIE Nian, XIANG Yu, XU Bo-wei (2013). Research on Rule-based Rapid 3D Modeling Technology. *City Survey* (4), 5-8. (in Chinese)
- [43] Lienhard, S., Specht, M., Neubert, B., Pauly, M., & Müller, P. (2014). Thumbnail galleries for procedural models. In *Computer Graphics Forum* (Vol. 33, No. 2, pp. 361-370).
- [44] Eastman, C., Fisher, D., Lafue, G., Lividini, J., Stoker, D., & Yessios, C. (1974). An outline of the building description system. *Research Rep*, 50.
- [45] United States(2007) National Building Information Modeling Standard, Version 1, 2007:49.
- [46] Eastman, C. M., Teicholz, P., Sacks, R., Liston, K., (2008). *Handbook, BIM. A Guide to Building Information Modeling for Owners, Managers, Architects, Engineers, Contractors, and Fabricators*. New Jersey: John Wiley& Sons, Inc.
- [47] Coyne, R. D., Rosenman, M. A., & Radford, A. D. (1990). Knowledge based design systems.
- [48] Monedero, J. (2000). Parametric design: a review and some experiences.

- Automation in Construction, 9(4), 369-377.
- [49] Lee, G., Sacks, R., & Eastman, C. M. (2006). Specifying parametric building object behavior (BOB) for a building information modeling system. *Automation in construction*, 15(6), 758-776.
- [50] Goedert, J. D., & Meadati, P. (2008). Integrating construction process documentation into building information modeling. *Journal of construction engineering and management*, 134(7), 509-516.
- [51] Succar, B. (2009). Building information modelling framework: A research and delivery foundation for industry stakeholders. *Automation in construction*, 18(3), 357-375.
- [52] Arayici, Y., Coates, P., Koskela, L., Kagioglou, M., Usher, C., & O'reilly, K. (2011). Technology adoption in the BIM implementation for lean architectural practice. *Automation in Construction*, 20(2), 189-195.
- [53] Li Li, & Deng Xueyuan. (2012) .BIM technology based on the construction of building information platform. *Civil Engineering Information Technology* (2), 25-29. (in Chinese)
- [54] Li Li, & Deng Xueyuan. (2013). Construction and Application of BIM Database Based on IFC Standard. *Sichuan Architecture Science Research*, 39 (3), 296-301. (in Chinese)
- [55] Kamat, V. R., & Martinez, J. C. (2001). Visualizing simulated construction operations in 3D. *Journal of computing in civil engineering*, 15(4), 329-337.
- [56] Martinez, J. C., & Ioannou, P. G. (1999). General-purpose systems for effective construction simulation. *Journal of construction engineering and management*, 125(4), 265-276.
- [57] Tommelein, I. D. (1998). Pull-driven scheduling for pipe-spool installation: Simulation of lean construction technique. *Journal of construction engineering and management*, 124(4), 279-288.
- [58] Hajjar, D., & AbouRizk, S. M. (2002). Unified modeling methodology for construction simulation. *Journal of Construction Engineering and Management*, 128(2), 174-185.
- [59] Al-Hussein, M., Niaz, M. A., Yu, H., & Kim, H. (2006). Integrating 3D visualization and simulation for tower crane operations on construction sites. *Automation in Construction*, 15(5), 554-562.

- [60] Jaafari, A., & Kumar Doloi, H. (2002). A simulation model for life cycle project management. *Computer - Aided Civil and Infrastructure Engineering*, 17(3), 162-174
- [61] Li, H., Chan, N., Huang, T., Guo, H. L., Lu, W., & Skitmore, M. (2009). Optimizing construction planning schedules by virtual prototyping enabled resource analysis. *Automation in construction*, 18(7), 912-918.
- [62] Wang, H. J., Zhang, J. P., Chau, K. W., & Anson, M. (2004). 4D dynamic management for construction planning and resource utilization. *Automation in Construction*, 13(5), 575-589.
- [63] Jayaram, S., Jayaram, U., Wang, Y., Tirumali, H., Lyons, K., & Hart, P. (1999). VADE: a virtual assembly design environment. *IEEE Computer Graphics and Applications*, 19(6), 44-50.
- [64] Jayaram, S., Connacher, H. I., & Lyons, K. W. (1997). Virtual assembly using virtual reality techniques. *Computer-Aided Design*, 29(8), 575-584.
- [65] Leu, M. C., ElMaraghy, H. A., Nee, A. Y., Ong, S. K., Lanzetta, M., Putz, M., ... & Bernard, A. (2013). CAD model based virtual assembly simulation, planning and training. *CIRP Annals-Manufacturing Technology*, 62(2), 799-822
- [66] Jung, B., Latoschik, M., & Wachsmuth, I. (1998). Knowledge-based assembly simulation for virtual prototype modeling. In *Industrial Electronics Society, 1998. IECON'98. Proceedings of the 24th Annual Conference of the IEEE (Vol. 4, pp. 2152-2157)*. IEEE.
- [67] Zhang Y. (2014). Research and application of visual simulation technology based on HLA and Unity3D. (Xidian University, Xi'an, China). (in Chinese)
- [68] Min Fang, Zhang Zhixian, & Yang Gongting. (2016). Research and simulation of 3D building visualization based on opengl. *Modern Electronic Technology*, v.39; No.457 (2), 78-81. (in Chinese)
- [69] Ke Dong (2006) Research on virtual reality geographic information system VRGIS (Wuhan University of Technology). (in Chinese)
- [70] Yamagishi, Y., Yanaka, H., Suzuki, K., Tsuboi, S., Isse, T., Obayashi, M., ... & Nagao, H. (2010). Visualization of geoscience data on Google Earth: Development of a data converter system for seismic tomographic models. *Computers & Geosciences*, 36(3), 373-382.

- [71] GogoMap [DB/O] http://blog.sina.com.cn/s/blog_e4fa60710101e5sv.html.
- [72] Kennedy, M. D. (2013). *Introducing geographic information systems with ARCGIS: a workbook approach to learning GIS*. John Wiley & Sons.
- [73] LI Chao. (2006). *Based on the control point of the database images distance detection image geometric correction and semi-automatic recording*. (Doctoral Thesis, University of Zhejiang). (in Chinese)
- [74] https://www.giassa.net/?page_id=207
- [75] <http://www.goldensoftware.com/products/surfer>
- [76] Elmqvist, M., Jungert, E., Lantz, F., Persson, A., & Soderman, U. (2001). Terrain modelling and analysis using laser scanner data. *International Archives of Photogrammetry Remote Sensing and Spatial Information Sciences*, 34(3/W4), 219-226.
- [77] Lee, T., & Kim, T. (2013). Automatic building height extraction by volumetric shadow analysis of monoscopic imagery. *International journal of remote sensing*, 34(16), 5834-5850.
- [78] Yavuz, A. Ö., & Sağıroğlu, Ö. (2016). Reviewing the Bricks Used in The Traditional Architecture with The Shape Grammar Method. *GAZI UNIVERSITY JOURNAL OF SCIENCE*, 29(4), 741-749.
- [79] Skillen, K. L., Chen, L., Nugent, C. D., Donnelly, M. P., Burns, W., & Solheim, I. (2014). Ontological user modelling and semantic rule-based reasoning for personalisation of Help-On-Demand services in pervasive environments. *Future Generation Computer Systems*, 34, 97-109.
- [80] Li, J., Zhang, Y., & Kong, D. (2012). Rule-based procedural modeling of buildings. In *Computer Science and Automation Engineering (CSAE), 2012 IEEE International Conference on* (Vol. 2, pp. 450-454). IEEE.
- [81] <http://cehelp.esri.com/help/index.jsp?topic=/com.procedural.cityengine.help/html/manual/cga/toc.html>
- [82] Soltana, G., Fournieret, E., Adedjouma, M., Sabetzadeh, M., & Briand, L. (2014, September). Using UML for modeling procedural legal rules: Approach and a study of Luxembourg's Tax Law. In *International Conference on Model Driven Engineering Languages and Systems* (pp. 450-466). Springer International Publishing.
- [83] Xiao, J., Fang, T., Tan, P., Zhao, P., Ofek, E., & Quan, L. (2008). Image-based

- façade modeling. In *ACM transactions on graphics (TOG)* (Vol. 27, No. 5, p. 161). ACM.
- [84] Le Tran, H. N., Sornum, K., Seah, H. S., Cai, W., Low, M. Y. H., Zhou, S., & Lees, M. (2010). A systematic approach for rapid 3D reconstruction from photosets. In *Control Automation Robotics & Vision (ICARCV), 2010 11th International Conference on* (pp. 1167-1174). IEEE.
- [85] Li, J., Han, J. Y., & Hao, L. J. (2013). The Discussion of Applying Parametric 3D Modeling in Urban Design Based on Cityengine. In *Advanced Materials Research* (Vol. 774, pp. 1734-1737). Trans Tech Publications.
- [86] Esri CityEngine <https://en.wikipedia.org/wiki/CityEngine>
- [87] Barron, C., Neis, P., & Zipf, A. (2014). A comprehensive framework for intrinsic OpenStreetMap quality analysis. *Transactions in GIS*, 18(6), 877-895.
- [88] Brinkhoff, T. (2016). Open Street Map Data as Source for Built-Up and Urban Areas on Global Scale. *ISPRS-International Archives of the Photogrammetry, Remote Sensing and Spatial Information Sciences*, 557-564.
- [89] Sun, J., Yu, X., Baci, G., & Green, M. (2002, November). Template-based generation of road networks for virtual city modeling. In *Proceedings of the ACM symposium on Virtual reality software and technology* (pp. 33-40). ACM.
- [90] Neubert, B., Franken, T., & Deussen, O. (2007, August). Approximate image-based tree-modeling using particle flows. In *ACM Transactions on Graphics (TOG)* (Vol. 26, No. 3, p. 88). ACM.
- [91] Xu, Z., Zhang, Y., & Xu, X. (2016). 3D visualization for building information models based upon IFC and WebGL integration. *Multimedia Tools and applications*, 75(24), 17421-17441.
- [92] Laakso, M., & Kiviniemi, A. O. (2012). The IFC standard: A review of history, development, and standardization, information technology. *ITcon*, 17(9), 134-161.
- [93] ZHANG, J., GUO, J., WANG, S., & XU, Z. (2008). Intelligent facilities management system based on IFC standard and building equipment integration [J]. *Journal of Tsinghua University (Science and Technology)*, 6, 009.
- [94] Plume, J., & Mitchell, J. (2007). Collaborative design using a shared IFC building model—Learning from experience. *Automation in Construction*, 16(1), 28-36.
- [95] Stiny, G., & Gips, J. (1971, August). Shape Grammars and the Generative Specification of Painting and Sculpture. In *IFIP Congress (2)* (Vol. 2, No. 3).

- [96] Yeh, T. P., & Vance, J. M. (1998). Applying virtual reality techniques to sensitivity-based structural shape design. *Journal of Mechanical Design*, 120(4), 612-619.
- [97] Měch, R., & Prusinkiewicz, P. (1996, August). Visual models of plants interacting with their environment. In *Proceedings of the 23rd annual conference on Computer graphics and interactive techniques* (pp. 397-410). ACM.
- [98] Robinson, S. (2014). *Simulation: the practice of model development and use*. Palgrave Macmillan.
- [99] Mackulak, G. T., Lawrence, F. P., & Colvin, T. (1998, December). Effective simulation model reuse: a case study for AMHS modeling. In *Proceedings of the 30th conference on Winter simulation* (pp. 979-984). IEEE Computer Society Press.
- [100] Wu, Q., Xu, H., & Zou, X. (2005). An effective method for 3D geological modeling with multi-source data integration. *Computers & Geosciences*, 31(1), 35-43.

Publications

- [1] Procedural Approach for 3D Modeling of City Buildings, Wenhua Zhu, Dexian Wang, Benoit Eynard, Matthieu Bricogne, Sebastien Remy, Product Lifecycle Management in the Era of Internet of Things 12th IFIP WG 5.1 International Conference, PLM 2015 Springer March 2016
- [2] Framework for Information Modeling of an Integrated Building, Wenhua Zhu, Benoit Eynard, Matthieu Bricogne, Sebastien Remy, Wanggen Wan Proceedings of 2015 International Conference on Smart and Sustainable City, p139-144, ICSSC 2015 July 26-27, 2015, Shanghai, China
- [3] Toward Sustainable Manufacturing through PLM, GIS and LCA interaction Kiyan Vadoudi Nadège Troussier Toney Wenhua Zhu. International Conference on Engineering, Technology and Innovation (ICE), Bergamo, Italy June 23-25 2014 EI:20143618125083
- [4] Research on the Reconstruction of City Building with 3D Laser Scanner, Xuqian Zhang, Wenhua Zhu, Xiang Feng, Fabien PFAENDER, Proceedings of 2013 International Conference on Smart and Sustainable City, p32-35, ICSSC 2013 August 19-20, 2013, Shanghai, China EI:20141117440871

Résumé

Avec la construction et le développement de la ville intelligente, la façon de construire le modèle 3D réaliste des grands bâtiments de la ville rapidement et efficacement devient le hotspot de recherche. Dans cette thèse, une méthode procédurale de modélisation intelligente est proposée pour construire rapidement et efficacement un modèle de construction de ville 3D à grande échelle basé sur la modélisation de la forme de la facade et de la grammaire de forme. La technologie de l'information du bâtiment (BIM) est un moyen technique important pour améliorer l'industrie de la construction, pour la conception du bâtiment de la ville et la construction de la meilleure recherche et l'application de la technologie BIM est la clé, De gérer efficacement les informations du cycle de vie du bâtiment et de réaliser le partage et l'échange.

Cette thèse a étudié l'acquisition et le traitement des données de modélisation. Google Earth et le logiciel ArcGIS sont principalement utilisés pour acquérir et traiter des données d'images-cartes et des données de cartes d'élévation de la zone cible, ces deux types de correspondance et de superposition de données, qui peuvent générer des données de terrain urbain 3D avec des informations de localisation géographique. Ensuite OpenStreetMap est utilisé pour acquérir les données routières de la zone cible, et il peut être optimisé pour le réseau routier nécessaire par le logiciel JOSM. La technologie de balayage laser 3D est utilisée pour collecter des images de texture de surface de bâtiment et pour créer le modèle de nuages de points de la modélisation d'architecture cible afin d'obtenir les dimensions de modélisation par mesure. Sur cette base, cette thèse a principalement étudié le principe et le processus de la règle CGA pour créer des modèles de construction, et étudié la méthode qui peut séparer les éléments architecturaux en utilisant la segmentation d'image pour générer automatiquement la règle CGA et de créer ensuite le modèle de construction. Ainsi, des modèles de construction 3D ont été établis dans le logiciel CityEngine en utilisant les règles CGA et la technologie de segmentation des façades.

Cette thèse a construit le modèle d'information intégré au bâtiment urbain (CBIIM) basé sur BIM. L'information sur la construction de la ville est classée et intégrée, et le bâtiment et la composante ont été décrits avec la norme IFC, afin de gérer efficacement les informations du cycle de vie du bâtiment. Cette thèse étudie la technologie du modèle d'association d'information intégrée, qui permet de réaliser une conception standardisée des composants avec des caractéristiques associées et une conception intelligente des bâtiments avec des paramètres associés dans les règles de connaissances combinées avec l'IFC. La technologie de simulation de la construction de visualisation est étudiée. Les règles de connaissance dans le modèle d'information intégré fournissent une référence fiable pour la simulation de construction, et la scène de simulation est créée en invoquant le modèle d'information intégré, ainsi le processus de simulation est terminé.

En prenant le campus Baoshan de l'Université de Shanghai comme exemple, le processus de modélisation de la scène entière est illustré, et les étapes de modélisation de toutes sortes d'objets 3D sont décrites en détail pour résoudre les problèmes spécifiques dans le processus de modélisation réelle. Ainsi, la faisabilité et la validité de la méthode de modélisation intelligente procédurale sont vérifiées. Prenant comme exemple le dortoir de l'Université de Shanghai, une simulation et le modèle de simulation ont été créés par les informations intégrées, combinées aux informations de construction pertinentes, la simulation de construction a été complétée par le programme. Ainsi, la faisabilité et la validité du CBIIM sont vérifiées.

Mots-clés: Modélisation intelligente procédurale, Modèle d'information intégré, Modélisation CGA, Modélisation de façades, Simulation de construction