



**IMT Atlantique**  
Bretagne-Pays de la Loire  
École Mines-Télécom

**UNIVERSITE  
BRETAGNE  
LOIRE**

## **THÈSE / IMT Atlantique**

*sous le sceau de l'Université Bretagne Loire*

pour obtenir le grade de

**DOCTEUR D'IMT Atlantique**

*Spécialité : Informatique*

**École Doctorale Mathématiques et STIC**

Présentée par

**Dareen Shehadeh**

Préparée dans le département Systèmes réseaux,  
cybersécurité & droit du numérique

Laboratoire Irisa

# **Dynamic Network Adaptation for Energy Saving**

**Thèse soutenue le 04 décembre 2017**

devant le jury composé de :

**Nathalie Mitton**

Directrice de recherche, Inria Lille-Nord Europe / rapporteur & présidente

**Marcelo Dias de Amorin**

Directeur de recherche, UPMC - Jussieu / rapporteur

**Alberto Blanc**

Maître de conférences, IMT Atlantique / examinateur

**Nicolas Montavont**

Professeur, IMT Atlantique / directeur de thèse



# Acknowledgement

Writing these lines is the finishing touch to my thesis and to this phase in my life. This work would not have been possible without the invaluable help of the many people I had the privilege to encounter during this thesis.

First, and foremost, I would like to express my sincere gratitude to my thesis director Prof. Nicolas Montavont who inspired and motivated me to continue my studies. Thank you for giving me this opportunity. Your passion to research, vision, and immense knowledge, helped achieve my goal. And with your guidance, commitment, patience and unlimited support all along my PhD, I could not have imagined having a better supervisor and mentor. Thank you for helping me give the best of me and make it to this point.

I would also thank my supervisor Dr. Alberto Blanc for his accompaniment, and availability. His valuable advice, helped me enlarge my vision of the research topic, and enabled me to advance and enhance my work.

I would like to thank all professors and members of the jury, for having accepted being part of my thesis committee.

I would like to thank the CominLabs excellence laboratory for supporting and financing the research presented in this thesis.

I would also like to thank all the professors and colleagues in IMT Atlantique that I met during all these years. I want to especially thank Tanguy and Laudin from the RSCD Department, for the collaboration, discussion, contributions, critics and comments they gave me during these years.

A very special thank to my friends with whom I shared moments of joy and unforgettable memories that I will keep with me all my life.

I would like to thank my most loved ones, Maher and Gabrielle.

Maher, you have been an unlimited source of support and encouragement during this challenge. Words can not express how much I am grateful for the devotion and sacrifice you made. Thanks for sticking by me in the difficult moments. Without you none of this would have happened. Thank you for being who you are.

Gabrielle, I am truly blessed for having you in my life. Thank you for the patience, understanding and harmony you granted to me. Your unconditional love kept me from falling apart. You are the reason I live for.

I am most grateful for all my friends that made my stay in France easier and enjoyable. Thanks for supporting me spiritually, emotionally and practically throughout all this journey.

Last but not least, I want to thank my family who have always loved me. Mom, this PhD is a proof to your unlimited faith in me. I hope I have made you proud. Nisreen, Roula and Michel, you were not that far from me. Thanks for all those years of support in spite of the distance.

# List of Publications

## CONFERENCES

- D. Shehadeh, N. Montavont, T. Kerdoncuff, and A. Blanc, “Minimal access point set in urban area wifi networks,” in *Modeling and Optimization in Mobile, Ad Hoc, and Wireless Networks (WiOpt), 2015 13th International Symposium on*. IEEE, 2015, pp. 221–228
- D. Shehadeh, T. Kerdoncuff, A. Blanc, and N. Montavont, “How to wake up an access point?” in *2016 Wireless Days (WD)*. IEEE, 2016, pp. 1–6
- N. Montavont, D. Shehadeh, J. Palicot, X. Lagrange, A. Blanc, R. Gribonval, P. Mary, J.-Y. Baudais, J.-F. H elard, M. Cruss iere *et al.*, “Toward energy proportional networks,” in *Journ ees scientifiques, URSI 2016*, 2016

## JOURNALS

- L. Molina, T. Kerdoncuff, D. Shehadeh, N. Montavont, and A. Blanc, “WMSP: Bringing the wisdom of the crowd to wifi networks,” *Transactions on Mobile Computing*, 2017



# Abstract

WiFi is probably the most popular short-range wireless access technology with an exponential increase of access point deployments for the past few years [5]. In order to support high connectivity and reduce latency of services, a large number of WLAN have been widely deployed. They are being deployed in companies, schools, public and private areas; resulting in a high APs density and overlapping coverage areas. The density of access points is over-provisioned in order to provide enough capacity to meet the demands of peak hours. Tsui et al. [6] detected over 103000 access points in the city of Taipei through war-walking, while Achtzehn et al. [7] estimated the density of access points deployed in different cities in Germany to vary between 488 access points per km<sup>2</sup> in industrial areas, and 6103 access points per km<sup>2</sup> in urban residential areas. However, during the off-peak period, the capacity demand declines sharply, and many access points become idle or in low utilisation. Even though, all access points are kept switched on all the time, even when the number of users served by the wireless access network is very low, resulting in a high and partially wasteful energy consumption. Even though a single access point consumes only few watts, the total energy consumed could reach hundreds of watts in large deployments. For example, according to [8] the ADSL boxes (which are usually access points too) in France consume 5TWh per year. Faced by access point proliferation and with the goal of reducing the energy consumption, recent research efforts have proposed algorithms to dynamically switch on and off a set of access points depending on the traffic load. In continuity with these efforts, this thesis aims to design an Energy Proportional Networks by taking intelligent decisions into the network such as switching on and off network components in order to adapt the energy consumption to the user needs [9]. Our work mainly focuses on reducing the energy consumption by adapting the number of access points that are operating to the actual user need.

## Keywords

Sleeping Mode, Green wireless networks, power consumption, Energy efficiency, WLAN, IEEE 802.11, Traffic measurements





# Résumé en Français

## CONTEXTE ET MOTIVATIONS DU TRAVAIL

Les réseaux et services mobiles sans fil ont connu ces dernières années une expansion considérable. Les dernières estimations indiquent un nombre total de plus de 4 milliards d'abonnements mobiles dans le monde et prévoient une augmentation continue du taux de pénétration du mobile qui devrait atteindre 100% à l'horizon de 2020 [10]. Suivant cette même tendance, le trafic global de données mobiles dans le monde a augmenté de 63% en 2016 pour atteindre 7,2 exaoctets par mois [10]. Nous observons également l'émergence et le développement de nouveaux services et applications nécessitant une connectivité omniprésente et un débit important de données. Les exemples de tels services sont nombreux : les villes intelligentes, l'Internet des objets (IoT), communications entre véhicules (V2V), etc

Accompagnant ces évolutions, les nouveaux smartphones et autres appareils portables intègrent des technologies sans fil telles que le WiFi et le Bluetooth afin de fournir une connectivité continue à l'utilisateur. Ceci a permis aux opérateurs de téléphonie mobile de transférer une partie importante du trafic utilisant originellement les réseaux cellulaires vers les réseaux WiFi [11–13]. Ce transfert est appelé *offloading* et consiste à déplacer certains utilisateurs sur des réseaux alternatifs pour équilibrer la charge sur le réseau. Il peut être implémenté de différentes manières, avec différents niveaux d'intégration dans le réseau, ou même grâce à des décisions sur le mobile.

Ainsi, afin de répondre aux besoins croissants et diversifiés et satisfaire une préférence des utilisateurs pour ce type de connectivité [10], les réseaux locaux sans fil (WLAN) ont connu une grande expansion. Actuellement, il n'est pas difficile de constater l'énorme prolifération des points d'accès (APs) et leur omniprésence dans les maisons, les entreprises, les usines, les lieux publics tels que les cafés, les aéroports, les librairies et même dans les rues. Des études récentes montrent que la densité de WiFi dans les zones urbaines a été multiplié par 14 sur les dix dernières années [7], et que le nombre total de réseaux WiFi avoisinait 300 millions au début de 2017 [14].

Cette formidable expansion des réseaux WiFi ne va pas sans conséquences négative sur l'environnement en raison notamment de la quantité d'énergie nécessaire à leur fonctionnement. Ainsi, motivé par le désir de limiter l'effet néfaste des réseaux WiFi, un courant de recherche s'est développé ces dernières années ayant pour ob-

jectif de réduire la consommation d'énergie par ces réseaux. Parmi les approches utilisées à cette fin, le Sleeping Mode est basée sur la désactivation de certains composants dans l'architecture du réseau pendant les heures de faible trafic. L'idée est d'adapter le nombre de composants actifs (points d'accès et stations de base) en fonction du volume de trafic dans le réseau. Ainsi, suivant cette approche, un certain nombre des composants du réseau pourront être éteints lorsqu'un nombre réduit d'utilisateurs du réseau le permet. En effet, les réseaux sans fil étant conçu avec une capacité suffisante pour un trafic de pointe d'un certain niveau, une partie du réseau peut à tout moment être redondante. Cette partie pourrait donc être désactivée sans affecter la qualité de service. Par exemple, le réseau WiFi est conçu de façon à permettre un volume conséquent de trafic de données pendant les horaires de travail, alors qu'une grande partie de ce réseau reste inutilisée et pourrait donc être désactivée pendant la nuit. En milieu urbain, aujourd'hui chacun déploie son propre réseau sans fil, et cela donner des densités de points d'accès très importantes. Par exemple, Arcia et al. [15] ont détecté jusqu'à 70 points d'accès par point de mesure, c'est-à-dire par localisation dans la ville. Non seulement cette forte densité a un impact négatif sur les communications en générant de nombreuses interférences, mais ces points d'accès consomment une énergie considérable. Alors que finalement seulement quelques uns suffiraient certainement pour couvrir les besoins des utilisateurs. C'est là l'objectif de ce thèse : préciser ces "quelques uns" et déterminer comment il est possible de les éteindre et de les allumer quand il est nécessaire.

## CONTRIBUTIONS

Notre travail s'inscrit dans le cadre des recherches sur le Sleeping mode. Notre contribution est structurée principalement autour deux axes : l'étude et l'évaluation de la performance des processus de mise en veille/réveil des points d'accès et la sélection du nombre minimal des points d'accès dans un milieu urbain dense.

- Etude et évaluation de la performance des processus de mise en veille/réveil des points d'accès.

Nous étudions les processus de mise en veille/réveil des points d'accès dans un scenario classique de réseau domestique. Ce scenario suppose que le point d'accès mis en veille doit détecter la présence d'un utilisateur potentiel dans sa zone de couverture et réagir par conséquence d'une façon autonome pour se mettre en état de fonctionnement normal. Une revue de la littérature sur ce sujet nous a permis d'identifier et de choisir quatre processus de réveil du point d'accès dans ce contexte afin de les étudier. Notre choix comportait trois processus basés sur la mise en place d'une interface sans fil supplémentaire entre l'appareil mobile de l'utilisateur et le point d'accès qui prendra en charge la mise en veille et le réveil du point d'accès. Ces interfaces utilise les technologies suivantes: Bluetooth, IEEE 802.15.4 et une interface WiFi basse

consommation. Le quatrième processus consiste à utiliser une prise intelligente (*SmartPlug*) pour diriger la signalisation vers un appareil externe chargé de contrôler l'électricité fournie au point d'accès.

Nous avons ensuite étudié chacun de ces processus, et proposé un protocole de communication qui permette à un utilisateur d'envoyer l'ordre au point d'accès de s'éteindre. Lorsque cela était possible, nous avons utilisé le protocole COAP qui est prévu pour établir des sessions de commande pour l'Internet des Objets. Nous avons ensuite mesuré les performances du point de vue de l'économie d'énergie qu'il permet de réaliser et du délai entre le moment où un utilisateur potentiel est détecté et le moment où le point d'accès devient opérationnel.

Nos expérimentations montrent que l'économie d'énergie réalisée en utilisant une interface Bluetooth, IEEE 802.15.4 ou WiFi est moins importante que celle réalisée lors de l'utilisation de la SmartPlug. Ceci peut être expliqué par le fait que dans le cas où l'une des interfaces Bluetooth, IEEE 802.15.4 ou WiFi est utilisée, seule l'interface WiFi principale est éteinte tandis que l'utilisation du SmartPlug permet d'éteindre le point d'accès entièrement. Nous constatons également que les technologies Bluetooth et IEEE 802.15.4 permettent une économie d'énergie plus importante que la technologie WiFi.

Contrastant avec leurs performances relatives en ce qui concerne l'économie d'énergie, les niveaux de performance des interfaces Bluetooth et IEEE 802.15.4 sont inférieurs à celui de l'interface WiFi et le SmartPlug en se concerne le délai. Nous avons donc mis en évidence qu'il y a un compromis entre le niveau d'endormissement du point d'accès et le délai de réveil. Avec la SmartPlug, le point d'accès est complètement éteint (la prise coupe le courant). Ceci permet d'économiser fortement l'énergie, sachant que seule la SmartPlug consomme pendant ce temps, environ 1W. Par contre, quand la SmartPlug reçoit un ordre de réveil, elle alimente à nouveau le point d'accès, qui re-démarre. Ce processus est bien plus long (plusieurs secondes) que le réveil du point d'accès lorsqu'il est en état de veille (autour d'une seconde). Mais l'économie d'énergie pendant l'état de veille n'est pas importante, car seul l'interface radio est coupée, ce qui généralement consomme quelques watts seulement.

Ce travail a permis de mettre en évidence ce compromis entre l'état de veille, l'économie d'énergie réalisé, et le temps de latence pour réveiller un module endormi. Grâce à des techniques de mise en veille plus adapté, et peut-être en anticipant les besoins des utilisateurs grâce par exemple à la maison connecté et l'Internet des Objets, la mise en veille du point d'accès pourraient être mieux intégrer dans les maisons intelligentes du futur.

- Sélection du nombre minimal des points d'accès dans un milieu urbain dense. Nous avons étudié un réseau dense dans un milieu urbain (le centre ville de

Rennes) où la zone de couverture d'un point d'accès pouvait être partiellement ou totalement couverte par d'autres points d'accès. Pour évaluer la redondance dans le réseau, nous avons collecté des informations réelles sur les points d'accès en utilisant l'application Wi2Me développée spécialement à cette fin. [16]. Le traitement de ces informations nous a permis d'identifier les points d'accès existants dans la zone étudiée et leurs zones de couverture respectives démontrant ainsi la superposition de ces zones de couverture et le potentiel d'élimination d'un certain nombre de points d'accès sans affecter la couverture globale.

Nous avons alors proposé un système centralisé qui collecte les données de couverture des points d'accès observée par les utilisateur. En utilisant son téléphone mobile, ou alors même en l'ayant dans sa poche, les utilisateurs répertorie les réseaux sans fil disponibles. Nous avons donc utilisé ce simple fait pour centraliser la vue du réseau de plusieurs utilisateurs, ce qui permet d'avoir une vue assez précise de la disponibilité des points d'accès dans une zone géographique (les données sont estampillées avec les coordonnées GPS). Nous avons alors proposé une représentation de ces données de couverture à travers des matrices qui traitent les différentes erreurs de capture (coordonnées GPS non précises, ré-utilisation des noms de réseaux, etc).

Enfin, nous avons ensuite proposé deux algorithmes permettant de sélectionner l'ensemble minimal des points d'accès requis fournissant une couverture identique à celle d'origine. L'un de ces algorithmes choisit le point d'accès ayant la plus grande couverture, et boucle sur ce choix tant qu'un grand pourcentage (par exemple 99% de la zone étudiée) n'est pas couverte. Le second algorithme simule en quelque sorte le mouvement d'un utilisateur : on fixe un point de départ et un trajet, et on sélectionne le meilleur point d'accès. On déplace cet utilisateur fictif, et lorsqu'il sort de la zone de couverture du point d'accès choisi, on choisit le nouveau meilleur point d'accès. Ce deuxième algorithme permet de corriger le billet du premier algorithme qui choisit beaucoup de points d'accès dans les dernières itérations pour combler des "petits" trous de couverture. L'application de ces deux algorithmes sur les différents ensembles des données collectées nous a permis de montrer qu'en moyenne seulement 6,5% des points d'accès existants dans le milieu étudié fournissent la même couverture que l'ensemble des points d'accès. Ainsi, le potentiel d'économie d'énergie obtenu en désactivant les points d'accès non sélectionnés pourrait atteindre 95%. Les résultats montrent également que l'ensemble des points d'accès sélectionnés fournit un chevauchement d'au moins deux points d'accès sur plus de 60% de la zone étudiée.

## ORGANISATION DU TRAVAIL

Cette thèse est structurée de la façon suivante. Dans le chapitre 1 nous exposons la problématique et les motivations du travail. Dans le chapitre 2 nous présentons l'état de l'art de l'approche Sleeping Mode dans les réseaux sans fil. Nous présentons ensuite dans le chapitre 3 les technologies de l'IEEE que nous avons utilisées tout au long de la thèse. Le chapitre 4 décrit l'étude des processus de mise en veille / réveil des points d'accès et relate les résultats obtenus. Le chapitre 5 est consacré au problème de sélection de l'ensemble des points d'accès minimal dans un environnement urbain. Les conclusions finales de cette thèse et les perspectives de développements futurs sont présentées dans le chapitre 6.

### Mots-clés

Réseaux d'accès sans-fil, réseaux locaux sans-fil, consommation d'énergie, IEEE 802.11, efficacité énergétique.



# Contents

<b>1</b>	<b>Introduction</b>	<b>1</b>
1.1	Evolution of Wireless Communications . . . . .	1
1.2	Energy Efficiency in Wireless Networks . . . . .	2
1.2.1	Motivations for energy-efficient wireless networks . . . . .	3
1.2.2	Existing Solutions for energy efficiency . . . . .	3
1.3	Contributions . . . . .	4
1.4	Organisation of work . . . . .	5
<b>2</b>	<b>Greening Wireless Networks: The sleeping Technique</b>	<b>7</b>
2.1	Introduction . . . . .	7
2.2	Energy Consumption in Wireless Local Networks . . . . .	12
2.2.1	IEEE 802.11 Access Point breakdown . . . . .	14
2.3	Switching ON/OFF approaches: From The Network Perspective . . . . .	14
2.3.1	Network Architecture and Technology . . . . .	15
2.3.2	Network Density . . . . .	17
2.4	Management and Control of Switching ON/OFF approaches . . . . .	18
2.4.1	Who decides . . . . .	18
2.4.2	When to decide . . . . .	20
2.4.3	Waking-up the AP . . . . .	22
2.5	Energy Efficiency Metrics on BS Sleep Mode Techniques . . . . .	23
2.5.1	Evaluation Methods . . . . .	23
2.5.2	Evaluation Metrics . . . . .	24
2.6	WLAN vs. Cellular . . . . .	27
2.7	Conclusion . . . . .	27
<b>3</b>	<b>WLAN: Architecture, Standards and Discovery</b>	<b>31</b>
3.1	Introduction . . . . .	31
3.2	IEEE 802.11 Networks . . . . .	32
3.2.1	Deployment and Architecture . . . . .	32
3.2.2	Scanning process . . . . .	33
3.3	WLAN Standards . . . . .	34
3.3.1	WLAN standard evolution . . . . .	34
3.3.2	Quick overview of some Amendments . . . . .	34
3.3.3	Radio Resource Measurement RRM (802.11k) . . . . .	35
3.3.4	Fast BSS Transition (802.11r) . . . . .	37
3.3.5	Wireless Network Management (802.11v) . . . . .	38
3.4	WiFi Discovery in 3GPP Standards . . . . .	38
3.4.1	Access Network Discovery and Selection Function ANDSF . . . . .	39

3.5	Conclusion . . . . .	39
<b>4</b>	<b>Wake up Process for Sleeping Approach</b>	<b>41</b>
4.1	Introduction . . . . .	41
4.2	Wake up on demand . . . . .	43
4.2.1	Set up 1: Using a Bluetooth interface . . . . .	44
4.2.2	Set up 2: Using a 802.15.4 interface . . . . .	45
4.2.3	Set up 3: Using a smart plug . . . . .	46
4.2.4	Set up 4: Using an additional Wireless Fidelity (WiFi) interface	47
4.3	The Evaluation Platform and Experiment Setups . . . . .	48
4.3.1	The Monitored AP . . . . .	49
4.3.2	The Measurement Unit (MU) . . . . .	50
4.3.3	The analysing Tools . . . . .	50
4.3.4	The smart plug . . . . .	51
4.3.5	The Raspberry Pi . . . . .	51
4.4	Experimental Results . . . . .	51
4.4.1	AP Power Consumption . . . . .	52
4.4.2	AP Wake-Up Time . . . . .	55
4.5	Conclusion . . . . .	57
<b>5</b>	<b>A Collaborative Framework For Energy Saving in WLAN</b>	<b>59</b>
5.1	Introduction . . . . .	60
5.2	System overview . . . . .	60
5.3	Data collection . . . . .	61
5.3.1	Wi2Me description . . . . .	62
5.3.2	Data set . . . . .	63
5.4	Processing the data sets . . . . .	65
5.4.1	The Coverage Matrix . . . . .	66
5.4.2	Detecting Physical Access Points (APs) . . . . .	67
5.4.3	Coverage Gaps . . . . .	67
5.4.4	Medium Access Control (MAC) Address Re-use . . . . .	68
5.4.5	Merging Traces . . . . .	70
5.5	Computing the minimal AP set . . . . .	71
5.5.1	The Greedy Algorithm . . . . .	71
5.5.2	The Continuous Algorithm . . . . .	72
5.6	Empirical Evaluation of the MIN AP Set . . . . .	73
5.6.1	Evaluation of coverage . . . . .	73
5.6.2	AP Redundancy . . . . .	73
5.6.3	Marginal AP Coverage Contribution . . . . .	75
5.6.4	Comparing the two Algorithms . . . . .	76
5.6.5	Merged Traces . . . . .	76
5.7	conclusion . . . . .	78



<b>6</b>	<b>Conclusions</b>	<b>79</b>
6.1	Thesis outcome . . . . .	79
6.2	Future work . . . . .	81
6.3	Perspectives . . . . .	81
	<b>List of Tables</b>	<b>83</b>
	<b>List of Figures</b>	<b>85</b>
	<b>Acronyms</b>	<b>87</b>
	<b>Bibliography</b>	<b>90</b>







# Introduction

## Contents

---

<b>1.1</b>	<b>Evolution of Wireless Communications . . . . .</b>	<b>1</b>
<b>1.2</b>	<b>Energy Efficiency in Wireless Networks . . . . .</b>	<b>2</b>
1.2.1	Motivations for energy-efficient wireless networks . . . . .	3
1.2.2	Existing Solutions for energy efficiency . . . . .	3
<b>1.3</b>	<b>Contributions . . . . .</b>	<b>4</b>
<b>1.4</b>	<b>Organisation of work . . . . .</b>	<b>5</b>

---

## 1.1 EVOLUTION OF WIRELESS COMMUNICATIONS

Today's world is more mobile than it has ever been before. Mobile wireless networks and services have witnessed a tremendous evolution since the introduction of Global System for Mobile Communications (GSM) in the 90's. Nowadays, with more than 4 billion mobile subscriptions in the world, the mobile penetration rate worldwide is expected to reach 100% by the year 2020 [10]. The overall mobile data traffic around the globe grew 63% in 2016. It increased from 4.4 exabytes per month at the end of 2015 reaching 7.2 exabytes per month at the end of 2016 [10]. This evolution of mobile communications did not only reflect the enormous number of various types of connected devices but it also boosted the development of new services and applications in various domains. New applications emerge every day such as those used for smart cities, Internet of Things (IoT) applications, and vehicle to vehicle (V2V) communications and they became very important in daily life. This requires pervasive connectivity and variable data rate depending on the specific application.

Another trend that is currently observed in Wireless Networks (WNs) is the adoption in portable devices of multiple wireless technologies. Beside cellular connectivity, almost all new smartphones and other portable devices embed other wireless technologies such WiFi and Bluetooth in order to provide continuous connectivity to the user. However, mobile operators profited from this multi-technology environment



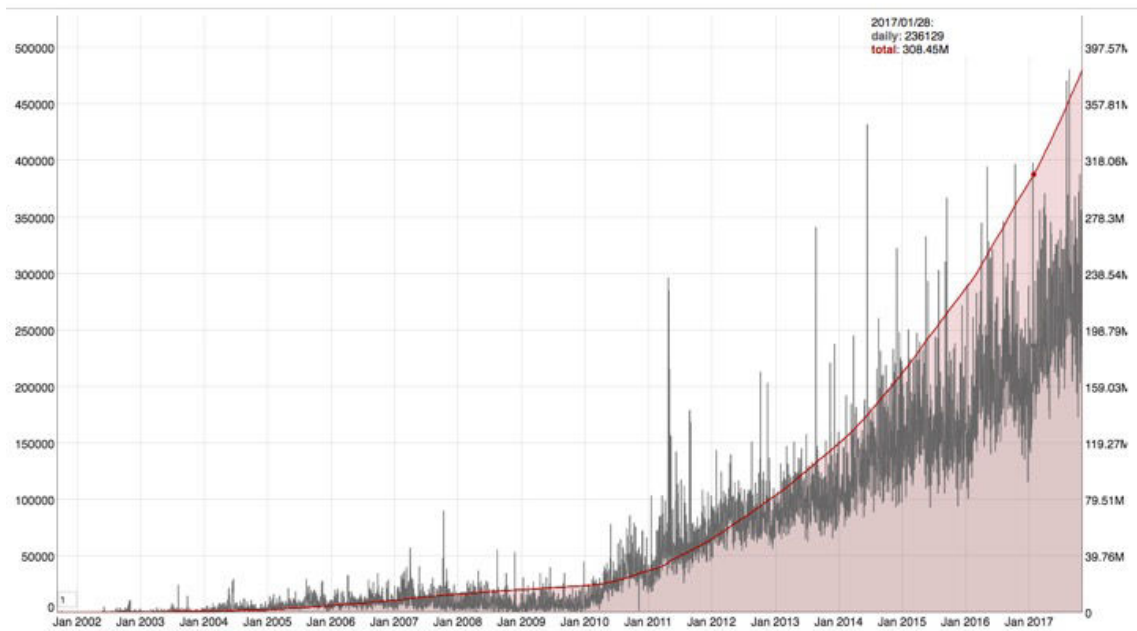

Figure 1.1: Number of WiFi networks over time [14].

in order to reduce the charge of their overloaded cellular networks by significantly offloading data to WiFi networks [11–13]. In fact, WiFi networks are expected to carry up to 60% of global mobile data by 2019 [17]. Nevertheless, recent survey show that mobile users (and in particular those who use it for work purposes) favour WiFi to cellular connection [10]. These users are mainly attracted by WiFi’s lower cost and higher speed. So it is not surprising to see the tremendous expansion in Wireless Local Area Network (WLAN) deployment in order to fulfil the increased demand for Internet connectivity. APs are being installed everywhere: at homes, enterprises, factories, public places such as coffee shops, airports, book stores, and even in streets. Studies show an increase in WiFi density in urban areas of over 14 times since the last decade [7]. According to [18] more than 250 million WiFi hotspots are deployed world wide. Similarly, Fig 1.1 shows the increase in global WiFi deployment. The total number of WiFi networks was about 300 millions in the beginning of 2017.

## 1.2 ENERGY EFFICIENCY IN WIRELESS NETWORKS

As pointed in the previous section, we are witnessing a tremendous growth in WNs deployment, which leads to a tremendous energy consumption as well. Conscious of the consequences on the environment and on global warming, researchers have focused their efforts to find ways to reduce energy consumption. Many studies investigate energy efficient protocols, power management schemes and energy oriented

architectures, in order to reduce the existent energy consumption. In the following sections we first highlight the main motivations that drive Energy Efficiency (EE) in the Information and Communication Technology (ICT) sector. Then we present some of the proposed solutions for EE.

### 1.2.1 Motivations for energy-efficient wireless networks

There are two main motivations that drive the quest for green ICT. The first one is the environmental concern related to the reduction of wastes and CO<sub>2</sub> emission impact on the planet. In 2015, the UN Climate Change Conference (COP21) was held in Paris. It came out with a set of mandatory climate protection goals to which almost all countries in the world announced their commitment to. The aim is keeping global warming below 2°C. This pushed ICT actors such as network operators and products owners more toward a low-carbon, sustainable Innovation practices.

The second motivation is an economical one. It aims to reduce the operating costs Operating Expenditures (OPEX) of ICT services for network operators.

### 1.2.2 Existing Solutions for energy efficiency

Research work to enhance the EE in WNs covers almost all aspects of the network. Some studies focus on the user side to minimize the energy consumption of mobile device batteries [19,20]. However, since the largest part of the energy consumption is in the wireless access part of the WNs [21], this area generates more active research to make the WN energy efficient. They provide solutions for energy efficiency network from different points of view.

Some work focused on the physical layer in order to improve the performance of the network. For example, redesigning some hardware components in the WN which consumes much power, such as the power amplifier [22]. An other example is enhancing the radio transmission process. This includes introducing advanced techniques, such as the MIMO technique [23], cognitive radio transmission, and Peak-to-average Power Ratio (PAPR) [24].

Other approaches focus on the network level. They investigate the potential benefit of planning and deploying low-power small cells in the cellular network in eares of high traffic [25].

An important category of research focus on turning off some components in the network architecture during low traffic hours [26–28]. The idea is to adapt the number of operating components according to the traffic load in the network. This technique was already introduced on the user side through applying Power Save

Mode (PSM) to the Mobile Terminal (MT) [29, 30]. This mode allows the MT to switch off its network interface when there is no traffic. This results in minimizing battery usage and extending battery life of the MT. As for the network side, this technique, known as the *Sleeping Approach*, selectively turns off some resources (APs and Base Stations (BSs)) in the existing network architecture when no or few users are present and can be served by the rest of the network.

## 1.3 CONTRIBUTIONS

The main goal of the thesis is to design an Energy Proportional Network by taking intelligent decisions into the network such as switching on and off network components in order to adapt the energy consumption to the user needs [9]. Our work mainly focuses on reducing the energy consumption by adapting the number of APs that are operating to the actual user need.

In fact, traffic load varies a lot during the day. Traffic is high in urban areas and low in the suburb during day work hours, while it is the opposite at night. Often, peak loads during rush hours are lower than capacities of the networks. Thus they remain lightly utilized for long periods of time. Thus keeping all APs active all the time even when the traffic is low causes a huge waste of energy.

Our goal is to benefit from low traffic periods by automatically switch off redundant cells, taking into consideration the actual number of users, their traffic and the bandwidth requested to serve them. Ideally we wish to do so while maintaining reliable service coverage; i.e we would like the network to continue to operate and guarantee the quality of service for existing and new coming users.

The contributions of this thesis is two-folded:

- **Studying the Sleep/Wake-up process of an AP in a home networking scenario.**

Here we consider a home networking scenario. In this case only one AP covers a given area. So when this AP is switched off (when no users are present), there will be no other AP to fill the gap of coverage. Moreover, upon the arrival of new users, no controller or other mechanism exists to wake up the AP. Consequently, new arriving users would not be served and would remain out of coverage. The study of the state of the art allowed us to have a clear overview of the existing approaches in this context. As a result, we designed a platform to investigate different methods to wake up an AP using different technologies. We measure two metrics to evaluate the Switching ON/OFF process for the different methods. The first is the energy consumed by the AP during the three phases it goes through. The second is the delay of time for the AP to wake up and be operational to serve the new users.

- **Select the minimal AP set in a dense urban environment.**

In this case we consider a dense network such as the ones found in urban cities, where the coverage area of an AP is also covered by several other APs [15,31]. In other words, the gap resulting from switching off one or several APs can be covered by other neighbouring ones. Thus the first thing to do was to evaluate the potential of switching off APs using real measurements taken in a dense urban area. Based on this collected information, we evaluate how many APs can be switched off while maintaining the same coverage. To this end, we propose two algorithms that select the minimum set of APs needed to provide full coverage. We compute several performance parameters, and evaluate the proposed algorithms in terms of the number of selected APs, and the coverage they provide.

## 1.4 ORGANISATION OF WORK

The thesis is structured as follows.

We start in Chapter 2 by reviewing the state of the art of sleeping approaches in WN. We focus in particular on the Switching ON/OFF techniques in WLANs. We discuss and classify the approaches and solutions of the sleeping mode presented in the literature. We provide more details on the implementation requirements, assumptions made on the system, and constraints taken into consideration. We point out the importance of the system metrics that are defined when designing the sleeping algorithm on the overall evaluation of the results. In addition we present a taxonomy of the reviewed schemes to identify which solution is addressing which problem and by which approach. In addition we show where and how our proposal fits in this classification.

The aim of Chapter 3 is to present the technologies we used throughout the thesis. We begin by introducing the architecture of WLANs that constitutes the environment of our work. In particular, the centralized infrastructure mode. Then we give a general overview of the IEEE 802.11 standard, its different versions, how it evolved over the years, in addition to some amendments related to our work. We focus on the ones used for information exchange between different elements in our system. We also shade the light on a specific 3rd Generation Partnership Project (3GPP) standard that can be useful in WiFi discovery, the Access Network Discovery and Selection Function (ANDSF).

Chapter 4 depicts our first contribution: studying the Sleep/Wake-up process of an AP. We present the experimental platform that we designed and developed to experiment switching on and off APs in urban environments. This platform can automatically send repeated sleep/wake up request to an AP. We measure the energy it consumes in each state (ON, OFF, and Switching On). We also measure the time

taken by the AP to exit the sleeping state and get ready to serve users. We define and conduct several experiments to evaluate four different techniques to control and manage the sleep/wake up procedure of an AP. We compare their performance in terms of the time needed to complete the wake up, the energy consumed, and the changes, if any, needed in the mobile terminals.

Chapter 5 is dedicated to our second contribution: how to select the minimal AP set in an urban environment that guarantee a functioning network. In this chapter we provide a study of potential energy savings in urban environment. We propose a framework to discover the network and gather information in real time. We use this information to compute the smallest number of APs that should be kept on to provide the same coverage area than all existing APs. We begin by describing the overall central system and its components. Then we explain our data collection and processing tools. Finally, we present two algorithms to compute the minimal AP set and evaluate and compare their performances.

The final conclusions of this thesis are presented in Chapter 6. We summarize the thesis outcome and present some perspectives and future work directions.



# 2

## Greening Wireless Networks: The sleeping Technique

### Contents

---

<b>2.1</b>	<b>Introduction</b>	<b>7</b>
<b>2.2</b>	<b>Energy Consumption in Wireless Local Networks</b>	<b>12</b>
2.2.1	IEEE 802.11 Access Point breakdown	14
<b>2.3</b>	<b>Switching ON/OFF approaches: From The Network Perspective</b>	<b>14</b>
2.3.1	Network Architecture and Technology	15
2.3.2	Network Density	17
<b>2.4</b>	<b>Management and Control of Switching ON/OFF approaches</b>	<b>18</b>
2.4.1	Who decides	18
2.4.2	When to decide	20
2.4.3	Waking-up the AP	22
<b>2.5</b>	<b>Energy Efficiency Metrics on BS Sleep Mode Techniques</b>	<b>23</b>
2.5.1	Evaluation Methods	23
2.5.2	Evaluation Metrics	24
<b>2.6</b>	<b>WLAN vs. Cellular</b>	<b>27</b>
<b>2.7</b>	<b>Conclusion</b>	<b>27</b>

---

## 2.1 INTRODUCTION

The last decade has witnessed a tremendous expansion in WNs deployment to support the exponentially increasing number of mobile users and subsequently the data traffic. With more than half a billion new mobile devices and connections in 2015, the global mobile data traffic grew 74% in just one year [32]. Aware of the consequences on the environment and especially on global warming, researchers have

been keen to find ways to reduce energy consumption. Studies on EE improvements in wireless communications span very diverse aspects and domains.

Early research focused on the user side to minimize the energy consumption and produce long-life batteries for the MTs [19, 20, 33, 34]. However, the largest part of energy consumption is at the network side WNs [21], and more specifically in the wireless access part WN. It is estimated that it consumes about 60% of the total amount of the consumed energy [22]. Thus research activities are also focusing on improving the EE in the wireless access part, since it has a strong potential for energy savings.

Various approaches were developed to reduce energy consumption in order to make WNs greener. Several survey papers have been published for reviewing existing work on the entire field of green technologies, see for example WNs [35–38]. These surveys show the increased interest of the research community to achieve better energy efficiency.

Wu et al. [37] summarize these approaches into five categories. The first category covers the work on reducing energy consumption of some hardware components in the WN, such as the power amplifier. The power amplifier is the largest consumer of energy in a BS [22, 39]. The second category proposes turning off some components in the network architecture during low traffic hours [40, 41]. The third category focuses on radio transmission EE using new advanced techniques such as Multiple Input Multiple Output (MIMO) technology, cognitive radio, channel coding and resource allocation [23, 42]. Another category includes planning and deploying low-power small cells (micro, pico and femto cells), in the cellular network in areas of high traffic [25, 43]. The last category aims at integrating renewable energy resources in WNs [44, 45].

While all the aforementioned techniques introduce energy savings, it is not so evident that they all could be adopted and deployed for several reasons. For example, replacing old equipments with new enhanced ones might be very costly and operators would think twice before moving into action. On the contrary, approaches based on the current network architecture are more likely to cost less and thus they are more likely to be implemented.

One of these approaches presented above is turning off some network components. This approach consists in putting some components into sleep for some period of time, usually when there is no or at least less traffic. We distinguish two implementations of this approach;

**At the MAC level**, several authors proposed enhancements for the IEEE 802.11 MAC layer, in particular the PSM. Banerjee et al. [47] propose a cooperative system (NetCoop) that monitors the occupancy of the channel in order to optimize the energy consumption of the whole network when applying the PSM. Similarly, Jang et al. [30] propose the *Snooze* protocol: an energy management technique that applies

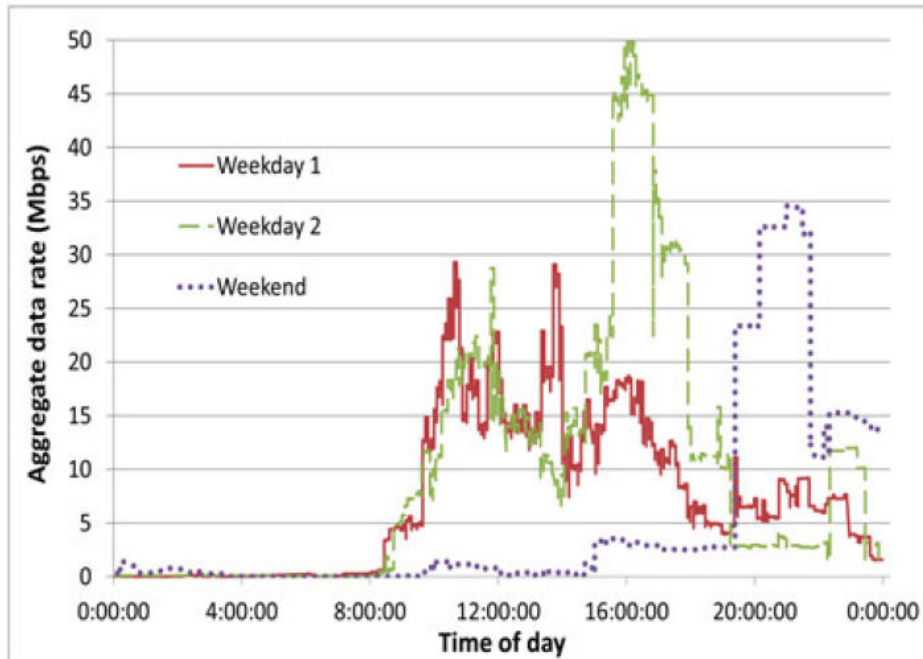

Figure 2.1: Statistics of WiFi networks in a building hosting 30 APs for two weekdays and one weekend: Aggregate data rate of clients over a 24-hour period [46].

micro-sleep scheduling in order to achieve energy saving in 802.11n networks. These proposals are very specific and only allow limited energy saving compared to system wide sleeping techniques.

**At the Network level**, instead of focusing on saving energy in individual APs, some research works focused on minimizing the global energy consumption of a group of APs using a collaboration framework. These strategies might be particularly interesting in urban environments, where we observe a large density of home APs (6103 AP per km<sup>2</sup> in urban residential areas according to [7]). The principle is simple: currently deployed WNs were originally planned on peak traffic load basis. However, APs/BSs are very underutilized during low traffic periods which leads to a significant energy waste. Moreover, even in peak hours, 90% of the data traffic is carried out only by 40% of the cells [48]. Thus, it would be feasible to achieve considerable energy savings by switching off some of these APs/BSs.

This approach makes use of the significant spatial and temporal fluctuations of traffic load in WNs. Fig. 2.1 shows the aggregated data rate measured in one residential building containing 30 APs over several days [46]. It illustrates the vast variation of traffic along one day, and between week days and the week-end. These fluctuations are due to several reasons. The main one is user mobility and daily/weekly life patterns. For example users go to work during the day, return back home in the

evening and go to sleep at night. Another influential factor is the bursty nature of some mobile application data. Of course, energy savings should not be achieved at the expense of the overall coverage in the network, nor the Quality of Service (QoS) offered to users.

In this chapter we focus on the Switching ON/OFF techniques in WNs in general and WLANs in particular. In order to study and analyse the techniques presented in the literature, we propose the taxonomy shown in Fig. 2.2. We discuss and classify the approaches and solutions of the sleeping mode and provide more details on the implementation requirements, assumptions made, and constraints taken into consideration.

As shown in Fig. 2.2, we classify the sleeping approaches in 4 main categories:

- according to the network and its architecture,
- from the management and control of the sleeping algorithms point of view,
- based on the characteristics and properties of the sleeping strategy itself,
- according to the evaluation method that was used.

Each of these categories is presented in a different color and further detailed into subcategories will be thoroughly discussed in later sections.

The remainder of this chapter continues as follows. Next section is dedicated to understanding power model for APs, measuring the AP power consumption and evaluating its impact on designing an energy saving algorithm. Handling and controlling the sleeping process from the network management point of view is presented in section 2.4. Section 2.5 summarizes the metrics and platforms used in the literature to evaluate the sleeping approaches. Finally in section 2.6 we indicate the main difference between cellular and WLAN networks when implementing a sleeping algorithm.

In this chapter and for the sake of simplicity, we are going to use the term AP to refer to AP/BS unless otherwise mentioned.

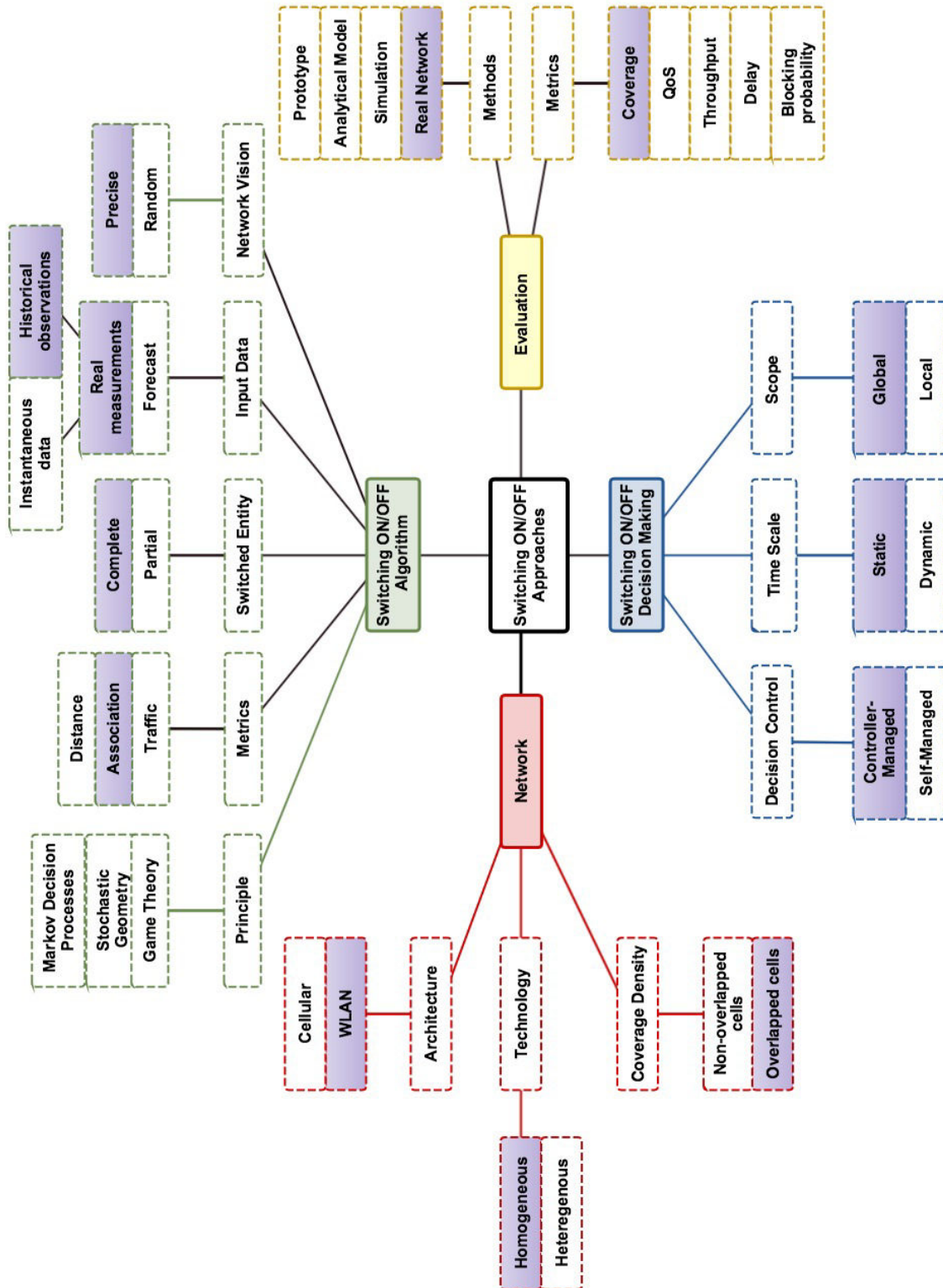

Figure 2.2: Taxonomy for Classification of Switching ON/OFF Approaches. Approaches are categorised into four main domains and are further detailed into several categories. Violet Boxes represent how our proposal in the thesis fits in this taxonomy.

## 2.2 ENERGY CONSUMPTION IN WIRELESS LOCAL NETWORKS

In a typical WLAN, APs operate with different values for transmitted power level, data rate, packet length and many other parameters. The combination of all these parameters highly affects the traffic and processing loads on the AP and hence the power consumption of different parts of the AP. Understanding where and how power is consumed in APs, and where it is wasted is necessary to identify the possible means to reduce the energy consumption. Unfortunately, sleeping algorithms are often designed without taking into consideration the power model of the AP. This might affect the performance of the algorithm or yields to inaccurate results. So in order to have an effective algorithm, it is important to first define an appropriate power model of the AP.

Numerous research studies have analysed in detail the power consumption of an AP, presenting various power consumption models [49–53]. Most typically, these models consist of two elements:

1. The baseline power consumption of the base components, showing the power consumed by the processing and cooling circuits when the AP is idle (67% of the total power consumption in WLAN [54])
2. The power consumption of the transceiver or the radio interfaces during communication (about 33% of the total power consumption in WLAN [54])

In a recent study on the energy consumption of the WN of one of China's largest university campuses [55], the authors measure and analyse the real power consumption of APs under different settings (number of radio interfaces, antenna mode and traffic load). They found that APs are the main consumers of energy with 67% of the total energy consumption of the campus network (including Power over Ethernet (PoE) switches and controllers). However, out of the total AP power consumption, only 10.9% is due to the radio part when no load is present on the AP. This ratio rises to 25% under heavy load. Assuming that network capacity can be dynamically adjusted by changing the number of radio, the antenna mode and the number of active APs, the authors estimate the ideal power consumption of the network in the campus to be 37.4% of the current power consumption.

Consistent results are presented in [53]. An AP mainly consumes its energy in idle state due to Ethernet and WLAN radio interfaces.

Garroppo et al. [52] build a general model of the WLAN and derive 4 power consumption models of the AP in order to study the impact of the various elements. These models consist of four elements: the baseline, the radio, the airtime, and the traffic processing. They assess the performance of the power consumption models over homogeneous and heterogeneous networks under various operational scenarios.



They found that the power consumption due to the traffic processing operation is negligible. In addition, an AP typically adopts the highest power level when more than one are available even under low traffic conditions. They conclude that by applying a simple on/off power model good results could be achieved. Nevertheless, more complex models offer further energy gain, but they are much more complex in computation time.

A thorough study by Chiaravalloti et al. [56] provides a comprehensive database for the power consumption of different types of APs by various manufacturers. The measurements were conducted during different operation modes: transmitting, receiving and idle. Results show that APs supporting MIMO techniques consume more power than other types of APs supporting dual-band (i.e., 2.4 GHz and 5 GHz) operation. The main conclusion drawn from this study is that a considerable amount of power can be saved by switching off the transceivers of APs operating in the idle mode.

Gomez et al. [57] conduct experiments to measure and analyse the power consumption of WLANs devices. They use a plugin called *Watts Up?* [58] to take the measurements for different traffic rates and network settings. They characterize the power consumption in terms of traffic, modulation and coding, and the size of session level data units. Results show that traffic size significantly impacts power consumption pattern of wireless devices. APs consume more power when receiving than when sending. Also the higher the traffic rate, the more power consumed and the bigger packet size, the lower power consumption.

Demir et al. [59] characterize the energy consumption of APs supporting IEEE 802.11ac. They measure the instantaneous power consumption of the AP and the data rate for different transmit power, bandwidth, and packet size configurations. Then the EE is calculated to find the most efficient configuration according to the user traffic demand. The results show that it is more efficient for the AP to transmit longer packets at high data rates and the small packets at low data rates.

Thus, understanding how energy is consumed in the WN and in which parts of the system is crucial to figure out how, where and how much energy consumption can be reduced. In order to design an energy saving algorithm, it is fundamental to first define a power model of the AP. Producing a realistic energy consumption model enables developing EE mechanisms such as the Switching ON/OFF, for energy-aware networks deployments. The assumptions on the AP power model has a non-negligible impact on accuracy of the results, since they depend on the features of the model itself.

## 2.3. SWITCHING ON/OFF APPROACHES: FROM THE NETWORK PERSPECTIVE

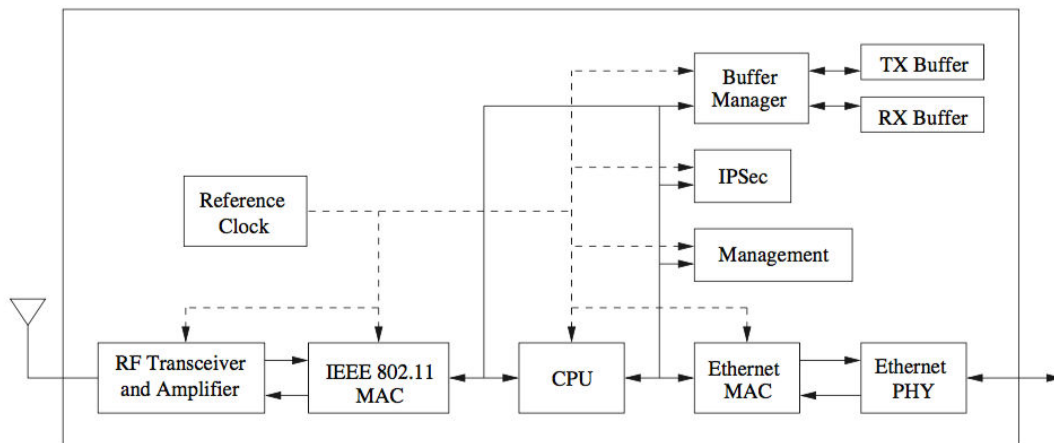

Figure 2.3: A simplified block diagram of an IEEE 802.11 access point [60] .

2

### 2.2.1 IEEE 802.11 Access Point breakdown

A simplified block diagram of an IEEE 802.11 access point based on [60–62] is shown in Figure 2.3.

Sikdar et al. [60] measurements show that the current drawn from the power supply was constant at 150.25 mA at all loads and the supply voltage was 14.78 V. Considering a power supply efficiency of 80% (Switching Power Supply Design), the per day energy consumption of the access point is 66.62 W h, assuming a typical usage scenario where the access point always stays powered on (e.g. in academic institutions and many residences). Thus the total power intensity of the access point is 24.316 30 kWh, 48.632 60 kWh and for 72.948 90 kWh usage lifetimes of one, two and three years, respectively.

## 2.3 SWITCHING ON/OFF APPROACHES: FROM THE NETWORK PERSPECTIVE

Investigating the potentials of the Sleeping Approach to save energy in WNs have been extensively considered in the literature. Research mostly focused on Cellular Networks [26, 40, 41, 63–80]. Recently, more efforts have been dedicated to WLANs [81–103]. In this section we review the basic characteristics of the Switching ON/OFF approaches from the network’s architecture point of view.



## 2.3.1 Network Architecture and Technology

In this section, Switching ON/OFF approaches are classified according to the network architecture and the technologies used to implement the Switching ON/OFF technique. Budzisz et al. [35] classify Switching ON/OFF approaches in WLANs in two main categories: homogeneous and heterogeneous. Due to the distinctive nature in network architecture between WLANs and cellular ones, this categorisation can only be applied on WLANs. As for cellular networks, the homogeneity and heterogeneity rather refer to the type of the network architecture.

### 2.3.1.1 Homogeneous Approaches

These approaches rely entirely on the 802.11 technology. This means that the whole switching on/off process only depends on the components of the WLAN network and its technology and protocols. The advantage of such approaches is the low complexity and ease of implementation since no additional technologies are required on both the client and the network sides.

One solution presented in several research papers [81–83] consists of forming clusters of adjacent APs with one of them as the head. The head of the cluster AP is kept activated while the others are switched off. The head AP is responsible of providing the coverage and the required capacity for the entire cluster. When the number of users exceeds the designated threshold of the cluster, the head AP sends an activation message to a controller or directly to another (asleep) APs in its cluster.

Another solution is to use an additional 802.11 interface with minimal transmission power [104]. This solution is designed for isolated APs which does not rely on dense environment where several APs are deployed. The low powered wireless interface is only used to detect incoming users; it has the same Basic Service Set Identifier (BSSID) and MAC address as the primary interface, and upon a new user arrival, it can start the primary interface. The advantage of this approach is that it requires no changes to the Station (STA).

### 2.3.1.2 Heterogeneous Approaches

In these approaches, an additional out-of-band radio support from other technologies is used, such as cellular, 802.15.4 or bluetooth technologies. The idea is to make use of the multiple radio access technologies (which are now already implemented in most user terminals) to compensate the absence of the WiFi radio interface that has been switched off. As it is known, the switched off AP loses the ability to operate since the AP can not send or receive management frames to handle new users. Thus

### 2.3. SWITCHING ON/OFF APPROACHES: FROM THE NETWORK PERSPECTIVE

it is necessary to find a way to switch the AP on when new users arrive, or to estimate user's demand in order to activate the switched off APs automatically.

The additional technology maintains coverage to the whole network (or area under consideration) all the time but most importantly during AP sleeping periods. It also provides a way of communication with the turned off AP to alert it of the presence of new users and eventually turn it on. This kind of approaches does not require a pre knowledge of user demand or position.

Haratcherev et al. [21] propose to turn off only the Wi-Fi radio part which consumes most of the energy supplied to the AP. A low power radio module is added to both AP and terminal to carry out-of-band control information when the WiFi radio interface is turned off. So user's requests for a connection are handled by this low-power radio link which maintains connectivity and wakes up the APs when necessary. They designate this control information as "Reverse beacons" transmitted periodically only from the terminal to the AP to initiate connection and wake up the AP radio interface. In order to evaluate their proposal they have set-up a prototype with a popular WiFi AP and integrated the low-power radio module. They measured the electrical consumption gain and wake-up delay. They show that the theoretical maximum reduction in the power consumption that can be achieved is 28.57 %. In our measurements, we achieve a power saving of 22.9 % and the average wake-up delay is around 10 seconds.

Jin et al. [105] use a secondary out-of-band low power radio to activate the AP. They introduce Wizi-Cloud system in which APs and laptops are equipped with a secondary 802.15.4 interface to interact while the primary WiFi interface of the AP is off. Another example of an out-of-band radio technology can be found in [106] and [107]. They propose to use the WiFi interface for high speed traffic while keeping a bluetooth interface for low speed traffic such as the wake up signals. Alternatively, Agarwal et al. [108] propose to wake up the AP using an external Ethernet module connected to it via a USB port.

Yomo et al. [109–111] use such a low capacity interface to detect and decode some specific signals which can be identified from the length of the packets in order to send a wake up signal to the AP.

In the same spirit, other studies take advantage of the fact that 802.11 and 802.15.4 networks operate on the same frequency bands. Thus it is possible to use the client's WiFi interface to interact with 802.15.4 low-power interface of the AP in Sleep Mode (SM). For example, Mishra et al. [112] use this property to wake up long range WiFi interfaces. They use the 802.15.4 interface to detect the power level and the WiFi interface to detect the traffic. The author improved their work in [113]. Instead of observing the power level, they proposed S-WOW. In this system, the presence or absence of traffic on the frequency band is identified by a specific binary pattern. The recognition of this pattern triggers the wake up signal of the AP.

### 2.3.1.3 As for the cellular Networks

As mentioned above, in Cellular Networks, homogeneity has a different interpretation than the one it stands for WNs. It rather refers to the type of the network architecture itself. Homogeneous Switching ON/OFF approaches target cellular networks consisting of only one type of cells, i.e with macro cells only. Heterogeneous approaches target mixed network deployments including micro, pico and femto cells.

## 2.3.2 Network Density

We distinguish two different types of WNs depending on the density of the deployed architecture:

### 2.3.2.1 Dense Network architecture

In dense networks the deployed cells overlap over each other, i.e the coverage areas of cells intersects with each other. In cellular networks this type of architecture usually falls in the category of heterogeneous ones where macro cells guarantee the coverage and small cells ensures the capacity [26, 74, 114]. In WLANs it is the typical case of a dense environment where many APs are deployed in the same place to increase capacity of the network [91, 94, 115, 116]. Since cells are overlapping, then turning off some APs would not cause a coverage gap, and would not require extra measures (compared to the non-overlapping case discussed below).

High-density wireless networks are topologies where the number of wireless devices and required wireless throughput exceeds the capacity of the network design and the Access Point. With this issue a high Receiving Signal Strength Indicator (RSSI) and/or a good Signal-to-Noise Ratio (SNR) is insufficient to provide a good performing wireless connectivity for wireless devices. A used solution for this is implementing more Access Points and avoid interference by using techniques such as different channels for the wireless signals

### 2.3.2.2 Non-overlapping Network architecture

In a non-overlapping network architecture, cell coverage areas do not intersect with each other. Applying a switching ON/OFF strategy is achieved by defining the cell to be switched off, and requires the remaining cells to compensate the coverage gap caused by the absence of the switched-off cell. There are several solutions to this issue. One is *cell zooming* which can be defined as the reduction or increment of the cell size depending on the traffic condition in a cell and its neighbours, along

with the increment or reduction of the transmit power. Niu et al. [117] control the cell size according to the traffic load. When there is low traffic some cells zoom in to reduce their cell sizes, while neighbouring cells should increase the cell size and zoom out to avoid any possible coverage hole. If traffic load of the cell is very low, cells can go into SM which means zooming in to a size of 0.

## 2.4 MANAGEMENT AND CONTROL OF SWITCHING ON/OFF APPROACHES

In this section we present AP Switching ON/OFF approaches according to the manner in which the process is handled and controlled from a network management point of view. We classify the Switching ON/OFF approaches based on three criteria: first, depending on how the switching off process is controlled and who makes the decision about the state of the APs. Second, from the time scale of the Switching ON/OFF procedure perspective. Finally, from the network vision point of view.

2

### 2.4.1 Who decides

Switching ON/OFF approaches are broadly classified into two categories: centralised and distributed approach.

#### 2.4.1.1 Self-Managed Approaches

Also known as auto-configured, self adaptive or distributed, these approaches allow the APs themselves to decide independently when to switch between sleep and wake-up modes according to their own local information, measurements or calculations [71, 83, 118]. In other words, sleeping decision is taken locally by the AP. The information used to take the decision may be the number of associated users, the traffic load, the signal strength from the users and other APs, and the quality of the connection (e.g., the number of dropped/lost packets). The AP is responsible of all the management and control exchanges in the network in order to apply the Sleeping mode. It is also possible for the APs to cooperate with each other and exchange information to form a better vision of the network.

Ganji et al. [94] make use of the high density of APs in enterprise WLAN to save energy consumption while providing coverage over the entire target area and maintaining a specific bit-rate. Their approach is to switch off the maximum number of APs during low traffic periods and only keep a skeleton of APs to maintain the AP coverage. This reduced set of APs is selected according to their detection coverage area in which users are detectable even though connection establishment is

not possible. Thus this set is used to discover new users, and upon new user arrival, additional AP are turned on in a controlled delay. The bounded connection latency ensures that the permitted waiting time for a user connection establishment is not exceeded. Evaluating the performance of their proposed strategy in Matlab for both IEEE 802.11g and IEEE 802.11b networks, they show that the achievable power saving in dense WLANs is in the range of 98% of total consumed power, where the number of APs needed to provide coverage for the considered area is about 1% of the total number of APs.

Rossi et al. [97] propose a cooperative energy management method to schedule wireless resources among gateways through monitoring. They implemented it within a federated WiFi network through a fully distributed protocol. Nevertheless, the energy consumption and user Quality Of Experience (QoE) were not considered in resource scheduling and user offloading of those methods.

Kumazoe et al. [102] implement a distributed system in which neighbouring APs coordinate and collaborate to handle user demands. APs periodically monitor and share the information about their own utilization and the utilization of the channel, in addition to their status information. If all users associated to an under-utilized AP could be served by neighbour APs then the AP forces its associated users to perform a handover to neighboring cells, and it goes to sleep.

#### 2.4.1.2 Controller-Managed Approaches

These approaches are a more common solution than the distributed ones. In these approaches a central controller or a central node is in charge of the whole Switching ON/OFF procedure. The central controller is responsible of identifying and controlling the other nodes (APs). In order to achieve that, this controller has to have a global view and knowledge about the state of the network. This might be achieved by demanding the AP to report to the controller via a separate protocol or method (as it will be described later in Chapter 3) information or measurements about the used channel, the number of associated users, and the traffic handled by the APs. The central controller decides what is the appropriate network configuration according to these reports, i.e. which APs to turn off, which to keep active and which to switch on.

It should be noted that in a centralized system, APs only handle management frames for the mobile stations, while all control (for reporting requests and switching commands) are handled by the central controller. Although this implies more complexity for the controller, it guarantees a more reliable QoS.

One way to implement such a centralized system is by using *Clustering*, an emerging technique for deploying scalable and easy manageable networks. To form clusters, several APs are grouped together and one of them is designated as the cluster head.

Usually the selection of the APs forming the cluster may be based on their adjacency to each other, and in the case of dense networks, APs are chosen close enough to each other so a single AP from each group is able to provide basic coverage to users in the cluster.

Jardosh et al. [81,82] proposed a Resource-On-Demand (RoD) strategy called SEAR to dynamically switch on and off APs in dense WLAN. The algorithms operate as follows. The first step is "green-clustering", it groups close APs into "clusters". In the second step, a user demand estimation is done based on the information collected in the clustering stage using the channel utilization, i.e channel busy time. Afterwards, it is time for the topology management phase. This phase studies the topology of the clusters and takes decision about powering on and off secondary APs in each cluster according to the user demand estimation done in the previous phase. Finally user association management handles the handover and re-association of users resulting from powering on and off decisions taken in the previous phase. Evaluation of this proposal is done through experimental set-up deployments to study three metrics: coverage, client performance, and client re-associations. Their results show that energy saving up to 53% can be achieved during the intervals of low load by powering off APs, while it is only 16% when powering APs on during heavy load based on the location and volume of user demand without much impact on the end user performance of the network.

Marsan et al. [115] consider the same context as Jardosh et al. [82] of dense centralized WLAN. They proposed an analytical model of the behaviour of an AP cluster. The cluster model is based on a continuous time Markov chain model where users associate according to a time varying Poisson process and leave according to an exponential distribution. Two policies for switching on/off the appropriate number of APs are presented: association-based policy where the number of powered on APs depends on the number of associated users in a cluster, and traffic-based policy where APs are switched on and off based on the amount of traffic that is carried out by the cluster. Through simulations, they evaluate the performance of these two policies under different conditions of traffic load during 1-day period. Not only that they evaluate the effectiveness of their proposal by studying the EE, but also by taking into consideration the quality of service. Their results show the possibility to save up to 87% of the power requested to operate the WLAN APs.

### 2.4.2 When to decide

In the literature, we can find two different approaches for the temporality of the switching ON/OFF decision. On the one hand, there are the static approaches which use pre-defined schedule. On the other hand, there are the dynamic approaches which follow the network demand in real time and adapt to it. These two approaches are further presented below.

### 2.4.2.1 Static Approaches

The static approaches, also referred to as off-line or scheduling-based approaches, depend on a predefined schedule that specifies which radio resources need to be turned on and off during a certain period of time. The schedule is obtained either analytically from a traffic prediction model or an energy model of the network, or through processing previously measured and collected information. These approaches are generally centralized since the schedule is usually calculated by a central algorithm. In such algorithm, APs are switched off according to a predefined pattern by network controller during a predefined time period when low traffic is expected. The static algorithms have the advantage of low complexity and low processing time since the calculations are made a limited number of times. But this is at the cost of accuracy in estimating the user demand in real conditions. Another advantage for these approaches is their flexibility since they give the possibility to program different sleeping algorithms and schedules for different parts of the network depending on the user behaviour in these parts. For example, in a university campus, user patterns differ significantly between the restaurant, the reading room, and class rooms.

One disadvantage of these pre-scheduled approaches is that they are not reactive to network changes in the user demand. They depend more on the long-term changes and estimations are based on average traffic measurements. Thus they might over or under estimate the real traffic demand, especially in cases such as for sudden or unusual changes of the network traffic.

### 2.4.2.2 Dynamic Approaches

The dynamic approaches, or on-line / reactive approaches, calculate the user demand based on real measurements collected in real time. They are more accurate in estimating the real needs of the network, and are better in handling unexpected changes in user patterns. They however require continuous measurements of the surrounding environment and thus more processing and communication between the different parts of the system. These approaches are also qualified as reactive, as they respond rapidly to network changes in the user demand, allowing quick modification of the network configuration to cope with the actual situation. But at the same time this means more processing, computations and latency.

Convention centres give a good example of the importance of dynamic algorithms. In a such place the use of the WN varies from one event to another, according to the timetable and organisation of the day. The load on the APs of the WLAN depends on their location. People connects to the APs situated in the conference room during talk time; while during coffee-breaks they connect to APs that are near the area where the coffee-break takes place.



### 2.4.3 Waking-up the AP

An equally important issue to how to switch off an AP, is how to wake it up. Different SMs with different levels of functionalities are possible for an AP. They vary from *light* to *deep* sleep to complete shutdown of the AP and its components. Each sleep mode requires a wake-up time, defined as the time needed to restore the normal functionality and connectivity.

It is worth mentioning here that energy consumption of a SM depends on how deep the SM is (as it is shown in Chapter 3). The deeper the SMs is, the lower power consumption is. Nevertheless, this gain in power consumption is at the expense of reduced functionality and wake-up latency. For example, wake-up time of small cells are in the order of seconds [119].

Another important aspect of being able to wake-up an AP is how to signal a given AP to wake up. In the case of a shared core network, APs can communicate together with another interface, which is usually not a wireless interface. For example, in [82, 83], the central controller can send control information while the radio interface of the target AP is off. If such a core network is not available, or if APs are in a deeper sleep mode, some kind of control channel needs to be set up to detect new users [21, 104–107].

Kumazoe et al. [103] propose radio-on-demand technology. In radio-on-demand, APs are equipped with wake-up receivers that change their status to sleep or active mode based on the network traffic distribution. APs with radio-on-demand capabilities automatically switch off when they detect no activity in the network for a predefined period of time in order to reduce the number of active APs. Thus users are associated to another active AP depending on the APs utilization. In order to prevent excessive aggregations of users on an AP, a control mechanism is applied. This requires a periodical exchange of channel utilization information of each AP among all of them. The authors proposed 3 schemes for implementing their algorithm:

1. The default operating mode of radio-on-demand: where APs switch off when no traffic passes through them over a predefined period of time
2. UT: The selection of new APs to re-associate users is based on the current utilization of active APs.
3. EUT: The selection of new APs to re-associate users is based on expected utilization according to updated channel utilization.

Through simulation, authors show that a reduction in power consumption by 40 % for a WLAN and by 20 % for the radio-on-demand default case is possible. Simulations also reveal the high variance in channel utilization for UT, whereas it is low for EUT. Another aspect that was studied is the STAs re-associate with new APs in a cluster which is the case for UT, whereas they are distributed to multiple



APs by adopting EUT, EUT can realize good load balancing in WLANs.

## 2.5 ENERGY EFFICIENCY METRICS ON BS SLEEP MODE TECHNIQUES

EE measurement is not straight forward. The authors in [120] survey the different EE metrics proposed in the literature and show that the performance evaluations may substantially depend on the chosen metrics. Measurement of legacy equipment is challenging as the equipments are not designed to allow measurements and invasive approaches would require lot of work and may cause interruptions in service in operating networks. The current literature proposes many heterogeneous metrics to qualify and quantify the energy savings.

2

### 2.5.1 Evaluation Methods

Studies give significantly different energy savings, they vary from 16% to 98%. This can be explained by the different scenarios considered in each study. Some studies are based on simulations, others on real measurements, but the most important factor is whether they consider a dense environment or not. Obviously there is a bigger opportunity for EE in over-dimensioned networks, specially when traffic is low. Before listing the most used metrics, let us review the different evaluation methods that we reviewed in the literature.

#### Analytical Approaches

Through developing mathematical formulas to represent the system under study, numerical analysis is used to calculate the number of active radio resources needed to provide the coverage or the QoS for the required users and traffic in the network, depending on different parameters [26, 93, 98]. This type of approaches can provide the number of radio resources to operate a network under certain conditions, and thus is interesting because it can give the optimal network configuration. These approaches are the baseline before going into the implementation of a solution, in order to fix the objectives of a new algorithm.

#### Simulation Evaluation

Most common simulators such as NS3, OMNet++ and OPNET provide a very realistic and detailed network, channel, mobility and energy models. Simulation is simple to use and implement the sleeping algorithms and the results of this method are considered close to reality. Simulations can give quick results on a new algorithm

or protocols, however the evaluation of the energy consumption and saving can be less accurate. It is considered as a first step in the protocol evaluation.

### Prototype Evaluation

Evaluation in this category is done over a specific platform developed precisely for the sleeping algorithm [66, 121–123]. The advantage of this method is that experimentations are undergone in a completely controlled environment, it permits the testing of different aspects and functionalities through repeating the experiments as much as needed. The results though might not always be realistic or valid since the test bed does not always represent the real network conditions.

### Real Network Evaluation

This is the case mainly in WiFi networks studies, because it is extremely difficult to implement the algorithms in cellular networks [90, 91, 124]. Thus it might be limited somehow especially since the algorithms are applied to uncontrolled environment; but results from these approaches are usually realistic and reflect the effects of real external conditions in the network.

2

## 2.5.2 Evaluation Metrics

The various solutions developed to improve the WN EE use different strategies. They propose metrics to evaluate their energy saving techniques and their performance in the systems. Metrics are normally used to study the effect of the use of SMs on the performance of the network; They are used to compare the energy consumption performance of different components and systems. Some of the factors taken into consideration to evaluate the performance of the proposed methods are the following:

- QoS: Evaluate whether remaining active radios resources provide the minimum requirements for QoS. The QoS requirements greatly depend on the type of traffic. For example for applications such as Voice Over IP (VoIP) it is essential to maintain a high level of QoS (e.g., end-to-end latency and jitter) for the user.

Elayoubi et al. [126] try to achieve a compromise between EE and QoS for Third Generation (3G) networks. They studied the effects of practical implementation on the QoS and system stability. In particular, the authors studied the time necessary to re-activate sleeping stations and the possible throughput degradation and the appearance of a Ping-Pong effect.

- Throughput: Evaluate user throughput which is in direct correlation with interference and collision. When the number of serving APs is reduced for energy saving purposes, users might experience a lower throughput.

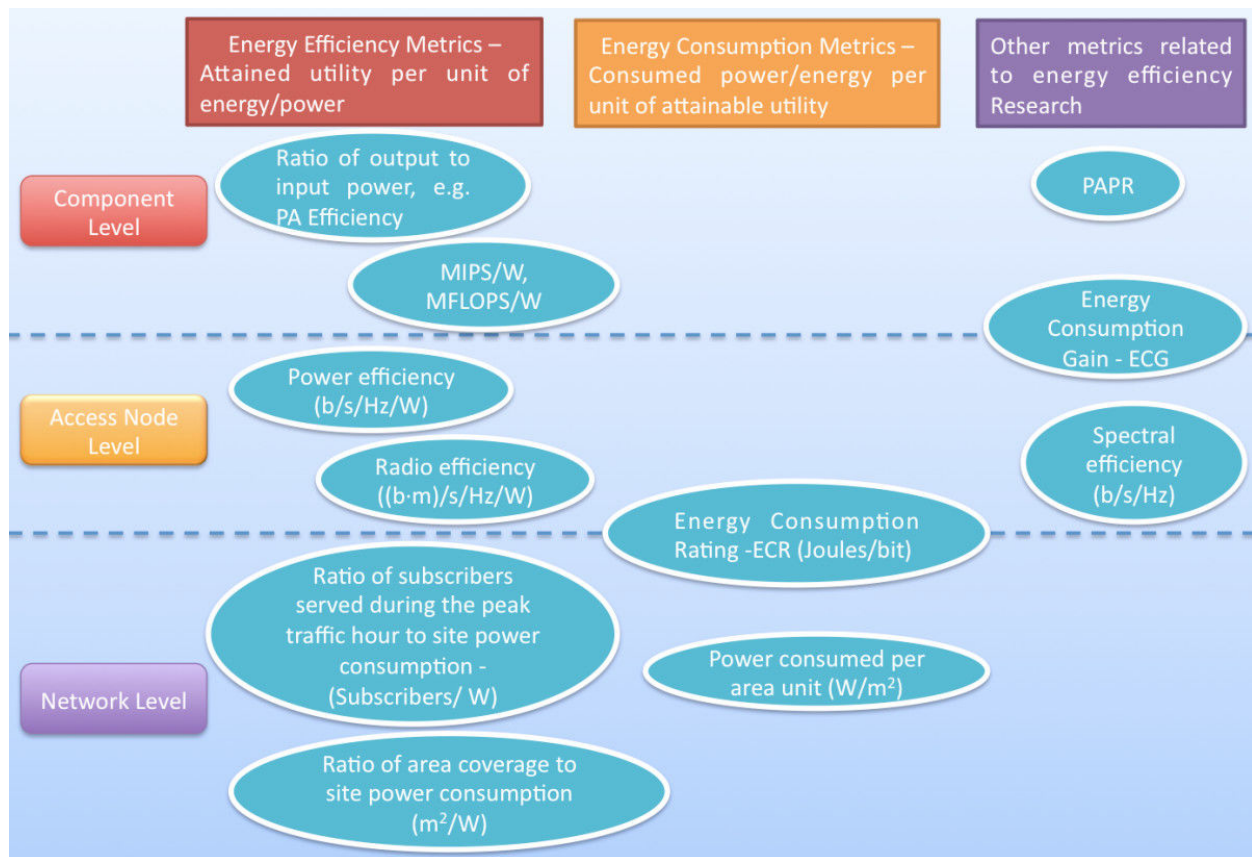

Figure 2.4: Classification of metrics used in energy efficiency for wireless networks [125].

## 2.5. ENERGY EFFICIENCY METRICS ON BS SLEEP MODE TECHNIQUES

- **User Demand:** This factor can be measured or estimated based on the observation, number of users associated or the total traffic generated by all active users.

Micallef et al. [127] present a solution to select the cells to switch off based on the threshold of average load. A comparison of the activity levels of cells allows to detect if some cells can be switched off after transferring the remaining traffic to neighboring cells. The threshold value determines the trade off between saving energy and network performance. With a high threshold, a large number of cells may be put to sleep, which affects the capacity and network performance. On the other hand, with a low threshold, the cell number in the SMs is low, which would limit the expected energy savings. Determining this threshold is thus critical, and the choice may depend on the specific scenario of application.

- **Delay:** Evaluate the delay in communication between end users or between users and APs. Study the delay introduced and caused by reducing the number of active APs and the effect on the time required for a user to send packets to a certain destination over the network. Two different delays may be measured: the end-to-end delay per packet that is observed by users, which may depend on the number of active cells, and the delay involved when switching back on a sleeping AP, or when a user needs to handover to a new cell if its current AP is going into SM.
- **Blocking probability** Gong et al. [128] proposed a dynamic switch on/off algorithm based on blocking probabilities. The BSs are switched off according to the traffic variation with respect to the blocking probability.
- **Network Coverage:** In order to avoid cases where a user experiences a bad signal quality due to switching off the radio resource to which he was associated; coverage over the entire network area should remain guaranteed. Power saving approaches should either calculate or estimate the coverage provided by the rest ON radio resources in order to avoid cases like this.
- **Admission control:** Or in other words the blocking probability, i.e. the probability that a flow that requires a certain amount of (dedicated) bandwidth, is blocked due to the lack of the available resources. When switching off radio resources, the sleeping algorithm should guarantee that the remaining resources are sufficient to handle existing and new users according to the admission control value defined for the network.

## 2.6 WLAN VS. CELLULAR

Throughout the literature addressing the problem of energy saving using the sleeping approach in both WLAN and Cellular Networks, we find some differences between these two types of networks.

First of all and most important is the sleeping operation itself. In cellular networks the sleeping mode might be applied to some parts of the BS or the entire BS might be switched off. So the wake up time needed to reactivate a cell varies from tens of seconds to a couple of minutes for small cells, and up to 10-15 minutes for macro BSs [38]. In WLAN, the entire AP might be turned off or only the radio interface, and in both cases the wake up time is of the order of seconds. This means that this transient period has much more impact in cellular networks rather than in WLAN. Another aspect of the sleeping operation is the frequency of applying it. Usually it is once a day or a couple of times per day in cellular networks, while it is dynamic in WLAN depending on the real time traffic measurements.

A very important issue is the administrative rights of the handover process for users in the cells to be turned off. In cellular networks it is entirely up to the mobile operator to decide to which cell it will redirect users, while in WLAN it might be managed by the users who can choose the new AP to connect to.

In terms of QoS provided to users, compensation mechanisms should be introduced in cellular networks such as cell zooming and increasing the transmit power and reduction of the antenna tilt. On the other hand, in WLAN this is usually done by adapting the authorized modulation in the cell, which changes the transmission rate and the coverage.

Another key aspect concerns the limitations and constraints like interference and coverage for users. While it is necessary to find a mechanism to overcome coverage holes caused by a sleeping BS, this is not an issue in WLAN since APs are usually densely deployed and overlapped in urban areas for example. In WLAN, sleeping techniques may actually reduce interferences since putting some APs into SM may decrease the number of APs operating in the same or adjacent channel(s). On the contrary, this might be a real issue in cellular networks since compensation mechanism like power increase yields to potentially increase the interference.

## 2.7 CONCLUSION

In this chapter, we reviewed the state of the art on sleeping methods for WN. We presented in fig 2.2 a taxonomy to identify which solution is addressing which problem and by which approach. Diverse crossovers are possible depending on the type of network (homogeneous versus heterogeneous, dense or sparse environment), the type of decision (centred versus distributed, real time versus long term prediction),

the required changes on the devices (network versus end terminal) or the type of the proposal (mathematical model versus a deployed protocol and algorithm). Throughout this chapter, we also reveal the importance of the metrics that are taken into consideration, as well as for the decision making and for the evaluation. We identified that there is a clear trade-off between the level of QoS and the energy saving that can be achieved through SM techniques. The first reason that leads to this compromise is the simple fact that by switching off resources in the network, the network capacity decreases, and thus may be perceived as a lower level of QoS for the users. But there are two other parameters that affect the QoS.

As mentioned earlier, there are different levels of SM, which lead to different amount of energy savings and wake up times [38]. Applying the SM to a radio resource varies between turning off only one radio transceiver of a radio interface for a short time, switching off the radio resource, or putting the whole AP in deep SM. Depending on the sleep level, a non negligible time to switch the radio resource back on may be observed, from a couple of seconds to few minutes [119].

The time interval between the sleep and active modes is also an important factor for the efficiency of the system. Depending on the chosen parameters, APs and users may suffer from the ping pong effect, i.e repeated ON/OFF decision of a radio resource in short time periods. When a decision has been taken for the network configuration (switching on or off some APs), users need to change its point of attachment. For example, if the AP to which a client is connected needs to turn off, the client will need to perform a handover to another AP to ensure service continuity. These transitions between APs have a cost in terms of signalling and delay that can degrade the overall QoS. Thus, changing too often the network topology may greatly affect the network stability. Adequate thresholds need to be found for each use case, and the dynamicity of the whole system needs to be well tuned. As we saw, several works consider long term prediction and real time network measurement to take a decision [119, 129, 130].

Throughout the chapter, we also noticed that most of the proposed sleeping techniques focus on maintaining an equivalent coverage area with a lower number of operating APs than when all APs are turned on [94]. Other parameters can be taken into account as well, such as the traffic load including user arrival/departure, signal-to-noise ratio, path loss or fading, or the maximum power transmitted along with energy consumption. In any case, what we will call later the minimal AP set - the set of APs that can provide the same coverage area as if all APs were turned on - needs a way to detect changes in the user demand, and be able to communicate with sleeping APs to request them to turn on. This is yet another object of research itself. As we saw, this communication first depends on the particular solution (centered versus distributed) since it dictates which entity needs to talk to which other one. In the related work, we found that APs may communicate directly with each other through an alternative interface [82, 83], or by using an alternative wireless

interface with users, such as a low powered and low capacity WiFi interface, or a dedicated technology such as 802.15.4 or Bluetooth [21, 104–107]. This is actually the focus of the remaining part of this thesis. In the next section, we will review more specifically IEEE 802.11 and its satellite protocols to see what protocols are today already available for the purpose of setting up energy saving algorithm. In the following chapters, we will study the waking up performance of an AP using an alternative 802.15.4 interface before studying a more global energy saving solution for urban areas.





# 3

## WLAN: Architecture, Standards and Discovery

### Contents

---

<b>3.1</b>	<b>Introduction</b>	<b>31</b>
<b>3.2</b>	<b>IEEE 802.11 Networks</b>	<b>32</b>
3.2.1	Deployment and Architecture	32
3.2.2	Scanning process	33
<b>3.3</b>	<b>WLAN Standards</b>	<b>34</b>
3.3.1	WLAN standard evolution	34
3.3.2	Quick overview of some Amendments	34
3.3.3	Radio Resource Measurement RRM (802.11k)	35
3.3.4	Fast BSS Transition (802.11r)	37
3.3.5	Wireless Network Management (802.11v)	38
<b>3.4</b>	<b>WiFi Discovery in 3GPP Standards</b>	<b>38</b>
3.4.1	Access Network Discovery and Selection Function ANDSF	39
<b>3.5</b>	<b>Conclusion</b>	<b>39</b>

---

### 3.1 INTRODUCTION

As mentioned earlier, this thesis tackles the issue of greening WiFi networks. In order to facilitate the understanding of some concepts in later chapters, we present a general overview of the technologies we used throughout our work. We begin by introducing the architecture of WLANs that constitutes the environment of our work. In particular, the centralized infrastructure mode. Then we present the different IEEE 802.11 standards and focus on the ones used for information exchange between different elements in our system. We also shade the light on a specific 3GPP standard that can be useful in WiFi discovery, the ANDSF.

## 3.2 IEEE 802.11 NETWORKS

### 3.2.1 Deployment and Architecture

WiFi networks exist in three modes on which the functionality and management of the whole network depends. These modes are:

- Infrastructure mode: In this mode the network is controlled by an AP that generates the signals for the individual stations that need to be connected to the AP in order to communicate with other stations.
- Ad hoc mode: It is referred to as wireless peer-to-peer network, in which all stations are linked together and they communicate with each other directly without the need to pass through an AP.
- Mixed or Hybrid mode: in which both infrastructure and ad hoc network modes coexist. In Hybrid mode, the AP does not have to handle all traffic between stations, thus maximizing the bandwidth of the WN.

The main difference between the infrastructure and ad hoc modes is the management and control of wireless network. The two main architectures used in the WLAN environment mainly differ regarding the AP's autonomy, security, and operation.

The choice of an enterprise of which type for wireless network architecture to deploy in its campus depends in the first place on the approach it adopts to manage the network. Other factors to take into consideration are costs, security, scalability etc.

The architecture of the networks can be either *centralized* or *distributed*.

#### 3.2.1.1 Centralized architecture

The *centralized architecture* is a hierarchical architecture that involves a WLAN controller that is responsible for configuration, control, and management of several APs. The WLAN controller is also known as the Access Controller (AC). In a *centralized architecture*, one or more servers or special purpose switches (Mobility controller) can be deployed jointly with APs to manage and control traffic. The number of controllers required is defined by the number of APs and Autonomous System (AS) they form.

The primary advantage of the centralized architecture is that it provides network administrators with a structured and hierarchical mode for controlling multiple APs in the enterprise. APs have limited functionality, with most of the wireless intelligence residing at a central controlling device. APs are easily configured and managed by the controller. APs have visibility and awareness of the neighbouring APs.

### 3.2.1.2 Distributed architecture

The other approach is the *Distributed architecture*, in which autonomous APs are used and do not require a wireless controller. APs support all necessary switching, security, and advanced networking functions necessary to route wireless traffic. APs require individual management. Any configuration changes must be made on the entire WLAN components one by one. APs usually have no visibility of other neighbouring APs.

## 3.2.2 Scanning process

The WiFi scanning process is one of most important functionalities of WLAN. It is the mechanism which allows a mobile device to discover the APs that are available in their range. It also provides the scanning device with information about the signal strength, the channel, the security policy of the discovered networks. Then the mobile device uses this information to choose and decide which network they can roam to. There are two methods to perform WiFi scanning: *active* and *passive*.

### Passive scanning

In the passive scanning process, the mobile device listens to each channel for a given period of time in order to detect the presence of beacons transmitted by the APs. Beacons are periodic messages broadcast by the WiFi network, to announce its presence. These messages contain information about the network such as the timestamp, the interval time between two beacons, the possible bit rates supported by the AP, the identification information of the network (Service Set Identifier (SSID), BSSID) and the modulation parameters. In the infrastructure mode, these beacons are sent periodically by the AP. The interval between two consequent beacons is usually set to 100ms. Note that using this method only may lead to large scanning latencies, as each channel needs to be listened for at least 100ms. However this methods is non intrusive and does not require the mobile device to send any frames, which can be convenient in some cases.

### Active scanning

During the active scanning process, the mobile device searches for the available APs by sending probe requests and waiting for their responses. The mobile device scans the channels one by one, sending a probe request in each of them, and waiting for the response for a predefined period of time. Upon receiving a probe request, all APs working on a specific channel respond with a probe response. Probe responses contain the same information about the network configurations and capabilities as the beacons.

## 3.3 WLAN STANDARDS

### 3.3.1 WLAN standard evolution

The IEEE 802.11 is a widely deployed and though continuously evolving technology. The IEEE 802.11 standard has gradually progressed over the years, aiming to adapt its specification to the evolution of wireless networking and traffic characteristics.

IEEE 802.11 is a set of standards supporting WLAN access in the 2.4 GHz and 5 GHz frequency bands. According to the IEEE Standards Association, a standard is denoted by “IEEE 802.11” followed by its date of publishing.

The original or basic version of the standard is *IEEE 802.11-1997*. In 2007, the first update of the standard *IEEE 802.11-2007* was published merging eight amendments (802.11a, b, d, e, g, h, i, j).

The latest version of the standard and currently in use is *IEEE 802.11-2012* [131], and as its name indicates it was published in 2012 with the merge of another set of recent amendments (802.11k, r, y, n, w, p, z, v, u, s). IEEE 802.11-2012 provides optimizations for fast BSS transitions (802.11r), operations for interworking with external networks (802.11u).

### 3.3.2 Quick overview of some Amendments

- IEEE 802.11F-2003: Inter-Access Point Protocol (Withdrawn in February 2006). It was supposed to provide wireless AP communications among different AP systems from various vendors.
- IEEE 802.11k-2008: Radio Resource Measurement enhancements [132] (see Section 3.3.3).
- IEEE 802.11r-2008: Fast BSS transition (FT) [133] (see Section 3.3.4).
- IEEE 802.11u-2011: Interworking with External Networks. The standard introduces improvements related to HotSpots and 3rd-party authorization of clients, e.g., cellular network offload [134].
- IEEE 802.11v-2011: Wireless network management: It allows client devices to exchange information about the network topology, including information about the RF environment, making each client network aware, facilitating overall improvement of the wireless network.
- IEEE 802.11w-2009: Protected Management Frames
- IEEE 802.11T: Wireless Performance Prediction (WPP). Regrouped recommendations and practices to test and measure performance in wireless net-

Table 3.1: Some radio resource measurements defined in 802.11k.

Measurement	Reporting scheme	Information reported
Beacon report	Request/Report	List of APs the STA can receive from in the specified channels
Channel load	Request/Report	Channel utilization
Noise histogram	Request/Report	Power histogram of non-IEEE 802.11 noise power
Neighbor report	Request/Report	Known neighboring APs
Link measurement	Request/Report	Instantaneous quality of a link

works. **cancelled**

- IEEE 802.21-2008: Media Independent Handoff [135], enabling seamless handover between networks of the same type as well as handover between different network types. Different scenarios are described for different entities to decide the handover procedure, handover messages.

In the next sections we will focus on amendments 802.11k and 802.11r because they are more related to our work and can be used to characterize the wireless deployment by reporting user measurements.

### 3.3.3 Radio Resource Measurement RRM (802.11k)

The aim of this amendment is to provide measurements to improve performance and reliability of the WN. The standard should be supported by both STAs and APs in order to work [132]. They can perform their own measurements or request them from other STAs. This requires some modifications to the body of management frames. On the one hand, modifications are needed to announce Radio Resource Measurement (RRM) capabilities of STAs. On the other hand, other modifications are needed to enable the exchange of the measurements among the STAs. Thus the standard defines the frame formats for RRM through which the measurement requests and results are communicated among stations. It also specifies several types of radio resource information measurements. For each of them, it associates a request/report messaging mechanism between the communicating entities. Some types of measurements are report-only or request-only messages.

Table 3.1 shows some of the measurements and the information provided.

#### 3.3.3.1 Characteristics

The main characteristics of this amendment can be summarized by the following points:

- Provides knowledge about the radio environment to improve performance and

reliability.

- Provides information to discover the best available AP.
- Enables seamless Basic Service Set (BSS) transitions in the WLAN environment
- Manages the air interface between several APs.
- Enabling automatic frequency planning.
- Enhances network performance like the overall throughput and efficiency of the network through redistributing the traffic in it.
- Enables new services for applications like VoIPs, video over IP, location based applications.
- Diagnoses interference from other sources (802.11 and non 802.11) and other APs in the same or in different Extended Service Set (ESS).

3

### 3.3.3.2 measurement requests and reports

The standard defines a set of requests and reports for data measurement upon the request of APs or STAs.

Here are some examples of the use of 802.11k measurements:

- **Roaming decisions:** Using the *site report*. This type for measurements is used when a STA is about to perform a handover. It uses a list of available APs in the network that helps STAs to choose the new AP. To obtain this list the AP sends a beacon request to the STA asking it to go to a specific channel and report all the AP beacons it receives on that channel.

There are two scenarios in which this site report can be used. The first is when the STA is moving out of the coverage area of its own AP and needs to connect to another one, thus it requests a *site report* from the AP. The second, is when the AP becomes very loaded and decides that a STA has to go to another AP. In both cases, the AP gives the user terminal a list (within a site report) of other available APs in the neighbourhood. This list is ordered from best to worst according to their QoS. Now the STA selects an AP based on its utilization (number of active users) and overall traffic, rather than the one having the strongest signal that might have too much load.

- **Channel load :** for measuring the channel busy fraction. It is the fraction of time when wireless channel is sensed busy due to its own or neighbouring activities. It helps to distinguish between bit error related losses and losses due to collisions for example. IEEE 802.11k defines the channel load based on

the channel busy fraction as in the following equation:

$$Channel\_Load = Integer * \left( \frac{Channel\_Busy\_Fraction}{Measurement\_Duration} \right) \quad (3.1)$$

- **RF channel knowledge:** Using *medium sensing histogram report*. This measurement allows APs to gather information about channels from the STA, and thus estimate channel utilization in order to regulate access to channels. The AP asks the mobile device to build a "noise histogram" for a certain channel displaying all non-802.11 energy on that channel. In addition, it uses the interference or traffic on a channel to use it
- **Beacon Report :** contains Beacon Measurement Reports for all observed BSSs matching the BSSID and SSID in the Beacon Measurement Request.
- **Hidden nodes:** A STA reports the identity and frame statistics of hidden nodes detected during the measurement period.
- **Link statistics:** An AP can ask the mobile device for reports of its own statistics regarding throughput and network performance; for example Data rate, modulation of last received and transmitted packets, RSSI, number of received and (re)transmitted packets.
- **Transmit Power Control Transmit Power Control (TCP)** To reduce interference and power consumption. Extended from IEEE 802.11h.

### 3.3.4 Fast BSS Transition (802.11r)

This amendment addresses the movement of a STA from one BSS to another within the same ESS. The main purpose behind introducing it is to provide continuous connectivity to wireless devices in motion. Without the features of 802.11r, a moving device may lose connectivity while searching for a new AP, before finally re-associating to a new AP. Thus the mobile device's traffic, such as voice calls, is interrupted during the time these management messages are being exchanged. One of the major advantages of 802.11r, is that STAs have the possibility to register in advance with neighboring APs. This way, security and QoS-related issues are negotiated before STA handovers to a new AP. Thus saving time and minimizing the duration of the handover process, and consequently reducing connectivity loss time. This is done by modifying the mobile device transition process between APs through redefining the security key negotiation protocol permitting negotiations and requests for wireless resources to occur in parallel.

Basically, the handover procedure remains the same as in 802.11 networks that are not applying 802.11r. i.e, the mobile device decides when to handover and to which

AP. What is different is the messages exchanged.

The non-802.11r BSS transition goes through the following steps:

- Scanning (active or passive) for other APs in the neighbourhood.
- Exchanging 802.11 authentication messages with the new AP.
- Exchanging reassociation messages and establishing connection with the new AP.

At this point, in an 802.1X BSS, the AP and the STA still have to perform pairwise master key (PMK) negotiation which is a time consuming process.

A fast BSS transition performs the same steps except for the 802.1X negotiations. It allows caching the key derived from the authentication server in the wireless network, so that future connections can be based on the cached key, avoiding the 802.1X process.

3

#### 3.3.5 Wireless Network Management (802.11v)

The IEEE 802.11v amendment introduces new power savings features to WLANs. These features include a **Wireless Network Management Sleep Mode**, an extension to the power savings mode in the 802.11 standard. It comprises a set of network infrastructure assisted power saving features that allows 802.11 radios to be powered off for longer times while still performing essential functions. It also gives network managers much more control and a detailed view of network performance through the station management functionality, such as the "Wake on WLAN" capabilities that permits waking up wireless devices. The location features provides more accuracy for services like RFID. However, these power saving features are primarily designed for mobile devices and not for APs.

## 3.4 WIFI DISCOVERY IN 3GPP STANDARDS

The increasing deployment of WiFi networks and the continuous development of its technology and standardizations by IEEE encouraged mobile operators to study the potential integration of WiFi as an alternate radio access method to the core network and services. Several authors proposed what they called offloading techniques that go in this direction as well [11–13]. Mobile operators investigated various use cases and defined different levels of interworking between the WiFi and cellular networks. Interworking between 3GPP and WiFi networks essentially consists of mobility of IP-Flows between the 3GPP and WiFi networks. To achieve this, the framework of ANDSF was standardized, in order to store the operator's policies regarding discovery and selection of WiFi access.



### 3.4.1 Access Network Discovery and Selection Function ANDSF

ANDSF [136] is a framework that specifies and provides access network selection to mobile devices. It has been defined by the 3GPP to assist User Equipment (UE) to discover non-3GPP access networks, such as WiFi or Worldwide Interoperability for Microwave Access (WiMAX) networks. A case scenario for example occurs when a certain geographic area is covered by both Long Term Evolution (LTE) cells, and several WLAN APs. Without ANDSF, most mobile devices choose WiFi networks based on explicit user preferences or preconfigured preferences, already stored in the UE. But in this case of using ANDSF, UEs in this area regularly perform network scanning in order to detect the presence of available APs in the neighbourhood. Then the UE performs some measurements reports to the ANDSF server. The ANDSF server is deployed in the core network, and acts as a central database to record the network context and thus provides network information to the UE, in order to enhance the network discovery and selection process. Thus as the UE moves, it sends queries to the ANDSF demanding network information. The ANDSF checks the network context and respond to the UE's query with a list of the available networks in the UE's coverage area.

Based on the operator's configuration, ANDSF can be used to exchange the following information with the UE:

- Network context information. The UE sends its current location to the ANDSF server. The UE's location information can be based on geographical coordinates, a cellular cell identifier, or a WLAN location (SSID, BSSID). The ANDSF server sends to the UE the discovery information (depending on the operators' configuration)
- Access network discovery information. ANDSF provides a list of available networks in the neighbourhood of the UE and relevant information assisting the UE to discover and connect to these networks. It gives the type of the access technology, such as WiFi or WiMAX and the radio access network identifier, such as SSID of WLANs.

## 3.5 CONCLUSION

As we briefly saw, the IEEE 802.11 has always evolved, and this is probably one of the reason why it is so popular today. Apart from the physical and MAC layer amendments that we did not present in this thesis, we saw that many protocols were defined to provide a communication framework with different purposes, mostly to better manage a set of APs managed by a given entity. The most interesting amendments regarding our research topic are probably the ones that allow to better know the wireless environment: which are the neighboring APs, considering homo-

geneous and heterogeneous technologies, what are the performance of the APs and what are their load? While some of these amendments were not meant to be used for sleeping techniques but rather for network optimization and higher performance, they can be very attractive for managing sleeping APs.

We identified two features that could be very interesting for our work. The first one is the handover management. As we have shown, in IEEE 802.11 STAs are managing their mobility; they decide when to de-associate from an AP and perform scanning, authentication and association. When applying sleeping techniques in a dense network, users attached to an AP that is going to sleep need to handover to another awake AP. Optimized handover such as the one proposed in 802.11r or 802.21 can be very useful to minimize the impact of the handover operation on the application traffic of mobile user, and 802.11k / ANDSF can help in better choosing the target AP.

3 The second highly important feature is the radio measurement reports provided by 802.11k or ANDSF. As we will see in Chapter 5, choosing which APs to keep online and those to switch off in a dense and large network is not an easy task. In order to select the APs, an operator or a central controller need to know which APs are redundant, which are the AP coverage area, what performance each AP is providing and what is the load of each of them (in terms of number of users and traffic load). And it is important to note that APs only can not report all network metrics, since a large part of the network performance is observed on the user side. So standards like 802.11k and ANDSF can be very useful in providing the communication protocol to report radio and performance measurement, in order to make the network breath by selecting wisely which AP is better to sleep and which one is better to stay wake up.

# 4

## Wake up Process for Sleeping Approach

### Contents

---

<b>4.1</b>	<b>Introduction</b>	<b>41</b>
<b>4.2</b>	<b>Wake up on demand</b>	<b>43</b>
4.2.1	Set up 1: Using a Bluetooth interface	44
4.2.2	Set up 2: Using a 802.15.4 interface	45
4.2.3	Set up 3: Using a smart plug	46
4.2.4	Set up 4: Using an additional WiFi interface	47
<b>4.3</b>	<b>The Evaluation Platform and Experiment Setups</b>	<b>48</b>
4.3.1	The Monitored AP	49
4.3.2	The Measurement Unit (MU)	50
4.3.3	The analysing Tools	50
4.3.4	The smart plug	51
4.3.5	The Raspberry Pi	51
<b>4.4</b>	<b>Experimental Results</b>	<b>51</b>
4.4.1	AP Power Consumption	52
4.4.2	AP Wake-Up Time	55
<b>4.5</b>	<b>Conclusion</b>	<b>57</b>

---

### 4.1 INTRODUCTION

As shown by several studies, the number of deployed APs and mobile traffic is exploding worldwide [5, 7, 32, 137]. As presented by Castignani et al. [138], WiFi deployment does not follow a structured deployment strategy as it can be observed for cellular networks, but is rather chaotic. Anyone can deploy an AP for its specific use, and in dense areas, it results in a large number of unsynchronized and overlapping APs. This use of the technology leads to large energy consumption [56].

Although a single AP consumes a few watts, it is the large number of APs that makes the total energy consumption raises serious concerns. For example, according to [8] the ADSL boxes (which are usually APs too) in France consume 5 TWh per year.

As we discussed in Chapter 2, a promising approach to save the energy is to put the APs into sleep mode when there is low or even no activity on the channel, and to wake them up again when needed. We are talking about long period of sleep, in opposition to short interleaved sleep periods between packet emission and reception. Long period of sleeps offer great energy savings, and are convenient to the considered scenario: assume a home AP, a family is only using its AP for some hours while it is running for 24/7. However, using sleep modes pose several challenges. The major issue about this approach is the lack of synchronization between the STAs and the APs during the sleep phase. When using the sleep mode technique, it should not degrade the QoS expected from users. So sleeping APs should wake up as soon as they are needed. In Chapter 2 we reviewed centralized systems where a controller can activate or put to sleep APs. But what about the individual AP that are not part of a global managed infrastructure?

We propose in this chapter to consider the case of isolated APs, such as home APs, or APs that are deployed in a way that only one AP provides coverage to a given physical location. In this case, an AP can not rely on another device to wake it up, or to provide network connectivity on its behalf. In this case, the AP is only able to go to sleep when there is no more user to serve (no traffic) and should come back online as soon as one user is requesting connectivity. Detecting when there is no more activity is an easy task, but detecting a new user while sleeping is not trivial. One naive approach that is used in sensor networks would be to use periodic wake up to check whether there is a client or not. But this solution is not suitable since a user will not wait long before considering that his/her network is done if its AP appears offline. So in this Chapter, we consider a kind of a control channel in which the AP and a STA can communication together somehow. This control channel should be low power, and have a very reduced semantic, i.e., just the command to wake up.

Thus we propose four methods to establish a sort of a communication between an asleep AP and an incoming users. We are proposing to use alternative and low power wireless technologies (Bluetooth, IEEE 802.15.4), or an external WiFi module, or a separate hardware to control the electricity supply of the AP. For each method, we indicate in which sleep state the AP can be, and how long the AP takes to be back online for serving the user.

The rest of this chapter is organised as follows: in the next Section, we describe the four approaches to wake-up an AP. In Section 4.3 we present our platform and in Section 4.4 we discuss the obtained results. Finally, conclusions and future work are presented in Section 4.5.

## 4.2 WAKE UP ON DEMAND

Alternating between sleep and active periods require to define a trigger to change the state of the device. Considering an AP, one event should trigger an active AP to go to sleep and another event should trigger an asleep AP to go back on. In the case of an independent AP, such as a home AP that is provided with an Internet box, there is not other AP that can provide the coverage when the AP goes to sleep. So the asleep AP should be able to detect when it needs to wake up again to serve users.

The triggers in a home scenario are trivial: when there is no more traffic from the current users, or when the last connected STA de-associates from the AP, the AP can go to sleep. There is no need for any communication protocol for this case. When a STA is getting back and looking for a connection to start a new session, the AP should wake up. So while asleep, there must be a communication between a new user and the AP to indicate the AP to wake up.

In this chapter, we study four different technologies that can be used between a STA and an asleep AP to let a STA wakes up the AP (see Table 4.1). Three of the chosen solutions are based on adding an extra wireless interface between the STA and the AP. These interfaces will be responsible of the sleep/wake-up procedure, to let the AP detect a new user, and awake to operate its main WiFi interface. As alternative technology, we propose to use Bluetooth, IEEE 802.15.4 and a low powered WiFi interface. All of them present different advantages and drawbacks. Bluetooth is very common and can be found on many devices, including smart phones and personal computers, which is very valuable to deploy such a solution. The IEEE 802.15.4 is one of the standard the most used in the Internet of Things, and so its distribution may increase in the next years. It will probably be well integrated in the smart homes. These two methods offer to transport the wake up signal on an alternative channel, however they require the AP to only put its main WiFi interface to sleep, while the rest of the system should be online to wait for an incoming user. So the gain in energy is only the energy consumption difference between the WiFi and the Bluetooth / IEEE 802.15.4 interface. The third proposed technology is an external WiFi module that is embedded on an external system (USB key or Ethernet module). This proposal has two strong advantages: no changes are required on the user terminal (not even the use of an alternate technology to wake up the AP), and the AP can be put in deep sleep mode.

The last method we propose here is to deport the signalling on an external device to control the electricity provided to the AP. In this case, we are using a smart plug that communicates with the users via IEEE 802.15.4 and switch on and off the current that supplies the AP. In that way, the AP is completely shutdown instead of being asleep. In the following subsections, we detail each of these set ups.

Table 4.1: Devices and technologies used for the four setups

Setup	Technology	Sleep mode	Receiver module (Wake up device on the AP)	Power consumption (W) ON / OFF / Receiver
1	Bluetooth	Turn off 802.11 interface	Bluetooth Dongle	13.7 / 12.4 / 0.4
2	802.15.4	Turn off 802.11 interface	TMote Sky	13.35 / 12.05 / 0.05
3	SmartPlug	Complete shutdown of AP	SmartPlug	14.3 / 1 / 1.00
4	External 802.11 module	AP Sleep mode (Suspension to RAM)	Raspberry Pi + 802.11 interface in promiscuous mode	18.3 / 11 / 5

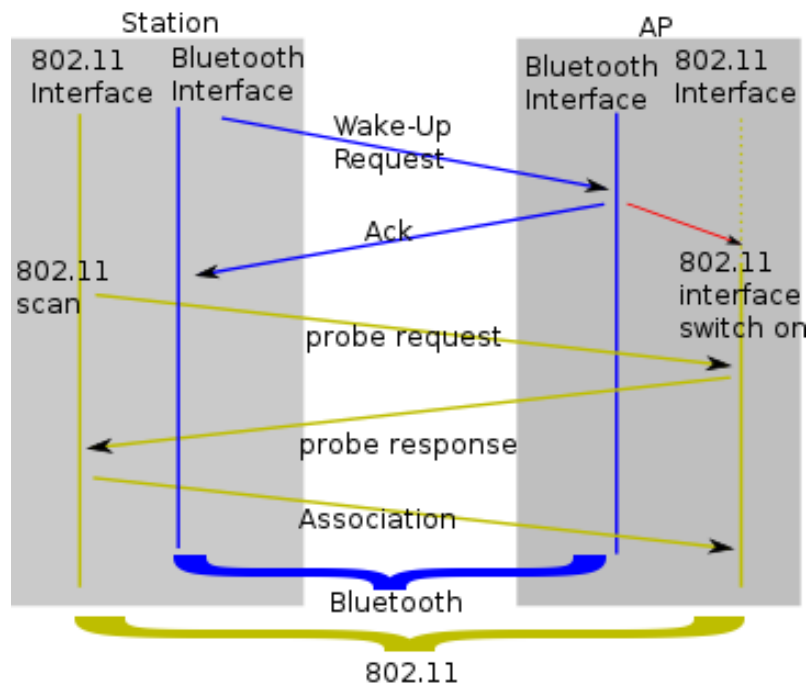

Figure 4.1: Wake up sequence diagram when using the secondary Bluetooth interface (setup 1). AP wake-up phase is assured through Bluetooth interface to start up the WiFi interface.

### 4.2.1 Set up 1: Using a Bluetooth interface

The first chosen technology is Bluetooth, which is a widespread wireless standard for communication over short ranges within Wireless Personal Area Networks (WPANs). Nowadays, the Bluetooth technology is embedded in almost every new device such as computers, laptops, cell phones, Global Positioning Systems (GPSs), etc. Bluetooth defines eight different operational states, 3 of which are dedicated to low power operations for an extended battery life. It operates in the same unlicensed band as WiFi devices, the 2.4GHz band.

In this setup, both the AP and the STA should be equipped with a Bluetooth interface in addition to their integrated WiFi interfaces. When the AP goes to

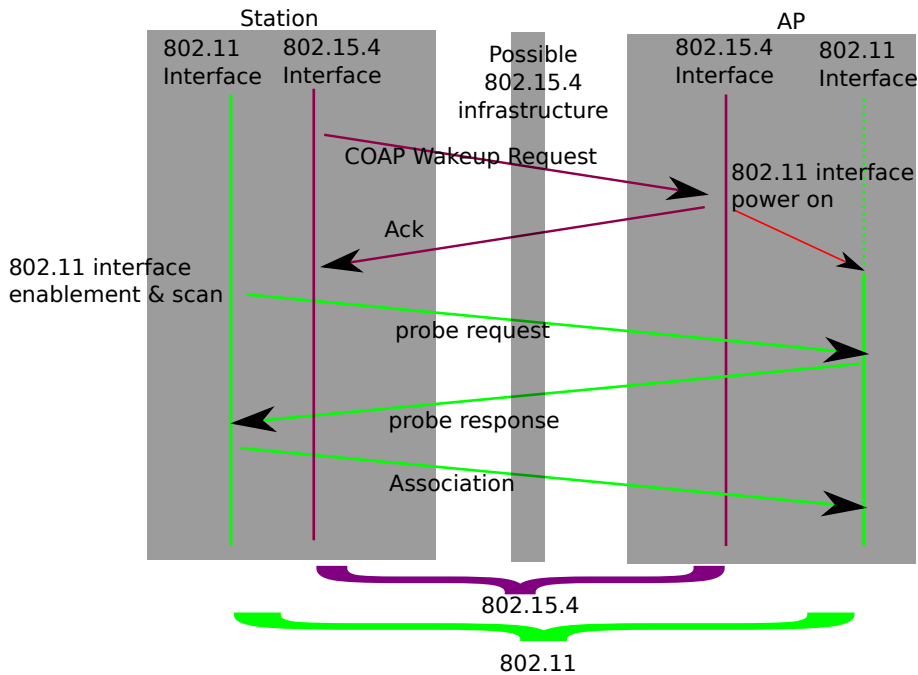

Figure 4.2: Wake up sequence diagram when using the secondary IEEE 802.15.4 interface (setup 2). AP wake-up phase is assured through an 802.15.4 interface to start up the WiFi interface.

sleep, it shuts down its WiFi interface but keep the Bluetooth interface on in order to receive wake-up signals. The wake-up procedure is done in two consecutive phases. In the first phase, the AP is waiting a wake-up message from the STA via the Bluetooth interface to request the wake up. Once this message is received, the AP responds with an acknowledgement and switches its WiFi interface on, and then enters phase 2. Upon receiving the acknowledgement, the STA can start the WiFi scanning.

The second phase is the WiFi connection establishment (i.e., the association) and data communication. The STA starts the scanning process and associates to the AP over the WiFi interface. Once associated, the STA can send its data toward the AP.

### 4.2.2 Set up 2: Using a 802.15.4 interface

The second proposed solution is to use IEEE 802.15.4 as the alternative technology to enable a control channel between the asleep AP and the STA. IEEE 802.15.4 is the most widely used short range radio communication technology for Wireless Sensor Networks (WSNs) operating in the 2.4GHz band. It provides low data rate, low power communication and short range for the Internet of Things. Its low power

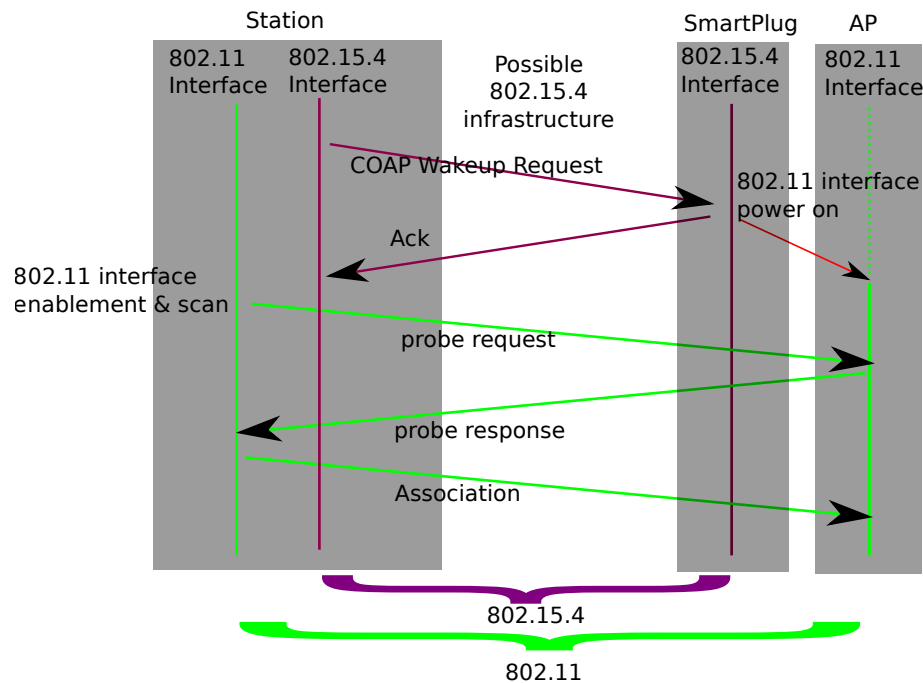

**Figure 4.3:** Wake up sequence diagram when using an IEEE 802.15.4 Smart Plug (setup 3). The STA communicates in 802.15.4 with the smart plug to request to power on the AP. The smart plug then switches on the AP by providing electricity.

feature is mainly due to duty cycles between peers; devices can periodically sleep between their communication opportunities. These duty cycles require a synchronization between the devices to make sure the receiver is awake when the transmitter is sending. 802.15.4 requires the adaptation of the IPv6 stack, mainly because the payload size is small. So compression mechanisms are required, and they are provided by 6lowpan. A routing protocol (such as Routing Protocol for Low-Power and Lossy Networks (RPL) or LOAD) can also be used to extend communication beyond one node radio range.

The sequence diagram of the wake up procedure is given in Figure 4.2. In this set up, only the WiFi interface is turned off during the sleep periods, while the AP is listening on the IEEE 802.15.4 interface for incoming users. The only difference with the previous set up is the type of wake up messages which are Constrained Application Protocol (CoAP) and are routed over the 802.15.4 network through the RPL protocol.

### 4.2.3 Set up 3: Using a smart plug

Staying in the world of the Internet of Things, we propose here to add a so-called smart plug between the AP and the electricity plug. This smart plug embeds an



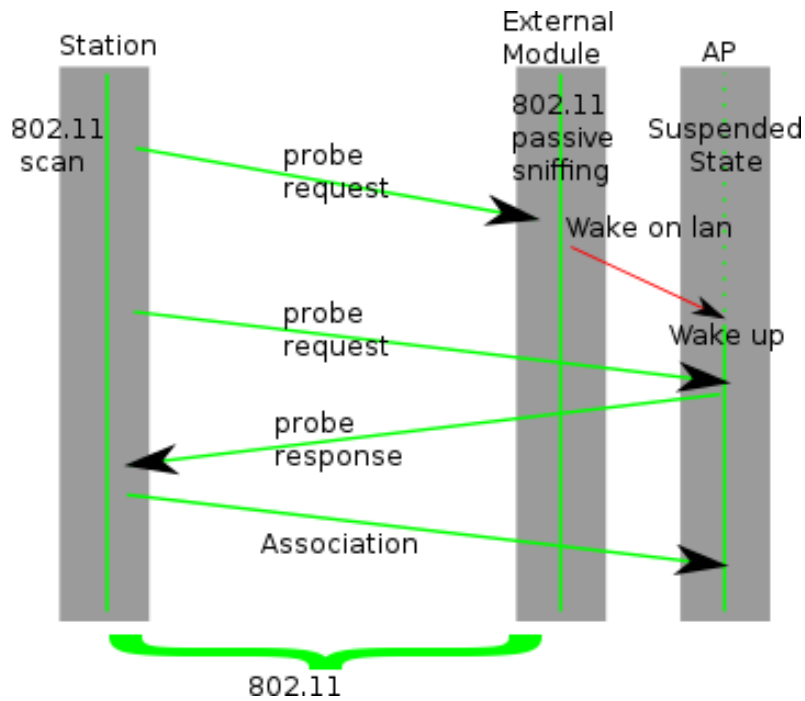

Figure 4.4: Wake up Sequence diagram when using an external 802.11 module (setup 3). AP wake-up phase is assured through the external WiFi interface, while Connection establishment phase through WiFi interface.

IEEE 802.15.4 communication stack and thus is able to respond to COAP requests. As we will see later, this smart plug can monitor and report the electricity consumed by the device that is connected to it. In addition, the Smart Plug can also activate or de-activate the plug. Upon a request from the 802.15.4 network, the Smart Plug can cut off or power on the device that is using it.

So in this third set up, we propose to connect the AP to this smart plug, which is then plugged in the power supply. A new incoming user will request the Smart Plug to turn on the AP through the IEEE 802.15.4 interface. The sequence diagram for this case is given in Figure 4.3.

#### 4.2.4 Set up 4: Using an additional WiFi interface

The fourth proposed method to wake-up the AP is to use an additional (and low power) WiFi interface on the AP. We connected an external module equipped with an 802.11 interface to wake up the AP. When the AP is in SM, it is suspended to RAM and only the Ethernet interface connected to the external interface is active. The additional WiFi interface is in promiscuous mode, i.e., it tries to decode and handle all the frames sent on the channel on which it is operating (the same one as

### 4.3. THE EVALUATION PLATFORM AND EXPERIMENT SETUPS

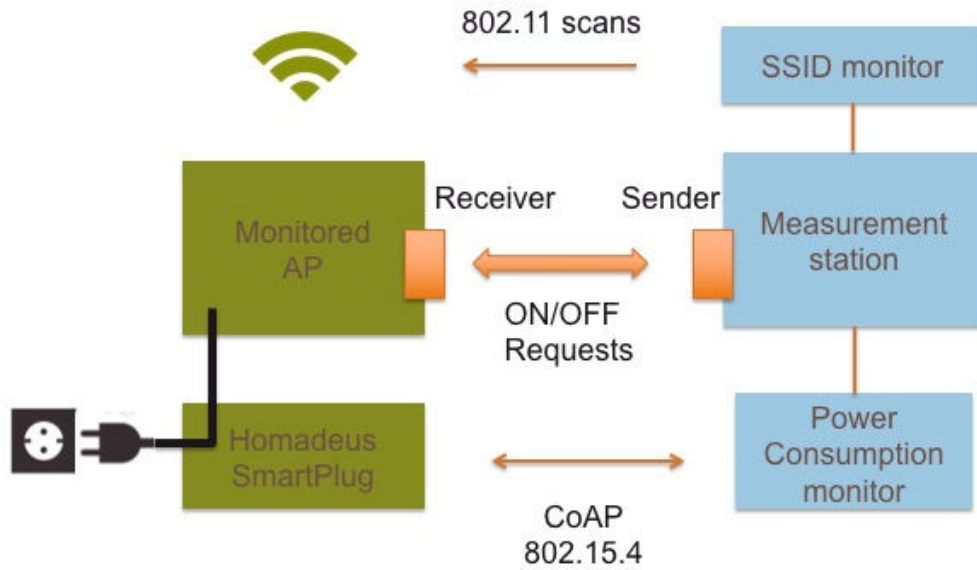

**4** Figure 4.5: The Experimental Platform implemented to evaluate and compare the different wake-up methods

the AP), regardless of the destination MAC address. This way it can detect probe requests addressed to the AP.

The sequence diagram for this case is presented in Fig 4.4. When the STA wants to connect to the AP, it initiates a usual scanning process to discover the available APs and their SSIDs by sending probe request on all frequencies. Normally APs respond by probe responses, but our AP receives this probe request through its external WiFi interface which is in a passive sniffing mode. When this interface recognizes the STA as one of the allowed stations to connect to the AP, it sends a *WakeOnLan* wake up message to the main WiFi interface. Usually the wake up process is fast enough to allow the AP to get back on-line in time to receive and respond to the scanning performed by the STA.

## 4.3 THE EVALUATION PLATFORM AND EXPERIMENT SETUPS

In order to evaluate and compare the different wake-up methods, we designed and implemented the platform presented in Fig 4.5. It includes the AP under study, which is put in and out of SM and the Measurement Unit (MU) that sends the wake up requests, collects measurement data, and embeds the monitoring and analysis tools. It is also in charge to monitor the SSID advertised by the AP under study to check when it is asleep and when the network is available again. Each of the elements is described in the following subsections.



Figure 4.6: The hardware Components used to implement the experimental platform

### 4.3.1 The Monitored AP

The main element in our study is the AP which is turned on and off. The studied AP has the usual functionalities present on a WiFi AP, enabling it to announce a network SSID through beacons, respond to probe requests from a STA, authenticate it and handle its traffic. We have also equipped it with software allowing it to take into account a request to suspend or wake up the AP, through different modules, represented by the "receivers" in Figure 4.5. In addition, the AP is not directly connected to the electrical outlet, but to an intermediate equipment providing information of the energy consumption of the AP: an IEEE 802.15.4 smart plug.

In order to select a suitable hardware for all four experiments, we looked at the possible devices (options) that can be used as an AP and evaluated the pros and cons regarding each experiment configuration. Although our control system is not dependent on a specific platform and can be used on different linux systems, our choice has been imposed by hardware limitations due to our experiments. The candidate devices that we considered are shown in Table 4.2.

As shown in this table, only the Dell laptop allows us to carry out the four experiments. However, this is a full operational personal computer and has a very high power consumption compared to the other devices. In order to use a device closer to a stock AP, we chose to use the APU 1d4, using a Compex WLE200NX 802.11

Table 4.2: Choices for the Access points under evaluation

Device	ALIX	RaspberryPi	APU 1d4	Dell Latitude
Consumption (W)	6.5	7.84	13.54	20.69
1	OK	OK	OK	OK
2	OK	OK	OK	OK
3	Long starting time	OK	OK	OK
4	ACPI not supported	WakeOnLan not supported	ACPI not supported	OK

interface. As we will see, only in the fourth set up the lack of ACPI will be penalizing the latency to wake up. In this specific case, we will also show the latency for Dell laptop implementing ACPI to show what performance can be reached.

### 4.3.2 The Measurement Unit (MU)

The MU is a Dell Latitude E6230 with Debian operating system. The MU is the equipment responsible for coordinating measurements and experiments. On one hand, it is equipped with "triggers" that communicate with the "receivers" of the AP. These software modules with the appropriate hardware are used by the MU to automatically generate a large number of alarm clocks and standby. In parallel with these automatic actions, the measuring station also has "Monitors", modules for collecting information about the current experiment. For the moment, only two monitors have been implemented:

- The power consumption monitor polls the smart plug to which the AP is being connected in order to obtain the studied AP's power consumption link its consumption with the requests for change of state that have been made.
- The SSID monitor watches the announcement of the WiFi network of the studied AP to validate the standby or wake-up commands addressed to it. The commands transmitted via the triggers and the data of the monitors are then stored in a file for analysis.

### 4.3.3 The analysing Tools

All measurement data of the various experiments that are collected by the MU are stored in one common file in a text format. We have developed tools based on the matplotlib library to visualize these data.



Figure 4.7: The smart plug from Homadeous (a company developing embedded systems).

### 4.3.4 The smart plug

The smart plug represented in Figure 4.7 is used to monitor the power consumption of the AP as well as to control the electricity plug of the AP in the third set up. This equipment is the result of a collaboration between IMT Atlantique and a company resulting from its business incubator: Homadeus. Connected to an electrical outlet upstream of the studied AP, the smart plug provides information about the current flowing through it. Via the 802.15.4 network deployed by the platform, we regularly inspect the smart plug to qualify the consumption of our AP during its wakefulness and activity states.

### 4.3.5 The Raspberry Pi

In the 4<sup>th</sup> setup, we added a Raspberry Pi model B, powered through a USB port connected to the AP and using Ethernet to send wake up signals to the AP. The Raspberry is equipped with a TP-Link TL-WN721N 802.11 interface configured in monitor mode.

## 4.4 EXPERIMENTAL RESULTS

For each setup, we measured the AP power at the smart plug during the ON and OFF states, and also during the time the AP is switching back ON from the OFF state. We also measured the time between the wake up request sent by the MU and the moment when the SSID Monitor module detects the announcement of the AP SSID. Each setup has been tested 100 times.

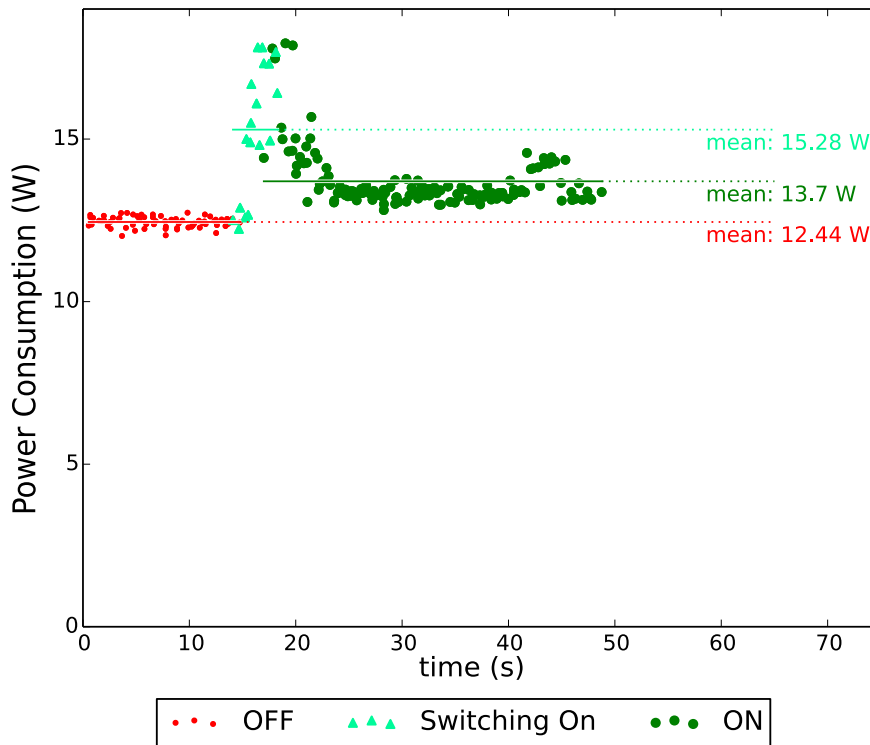

Figure 4.8: Power consumption for Set up 1: Using secondary Bluetooth interface

#### 4.4.1 AP Power Consumption

According to the specification sheet, the APU 1d4 consumes between 6 W and 12 W depending on the load on the CPU. We measured the APU consumption between 13.35W and 13.7W with the WiFi interface on and around 12W when the WiFi interface is in stand-by mode. In the last two experiments, we need to take into account the additional hardware that are used, and the total power consumption goes up to 14.3 in the third set up and 18.3 with the RaspberryPi. These baseline consumptions are given in Table 4.3.

Fig 4.8 and 4.9 show a limited gain in power saving between the ON and OFF states for the 1<sup>st</sup> and 2<sup>nd</sup> setups (1.26 W and 1.19 W respectively). This is due to the fact that only the main WiFi interface is switched off in the OFF state, which does not allow to save significant power. We also notice that the switching on phase introduces some additional power consumption of the order of 2 W due to turning on the WiFi interface.

On the contrary, Fig 4.10 shows a very good power saving of 11.4 W in the 3<sup>rd</sup> setup. This is due to the very low power consumption in the OFF state since the whole AP is turned off and only the smart plug is operating and consuming 1.14 W. Also, the power consumption during the ON state is slightly less than it is in the first two

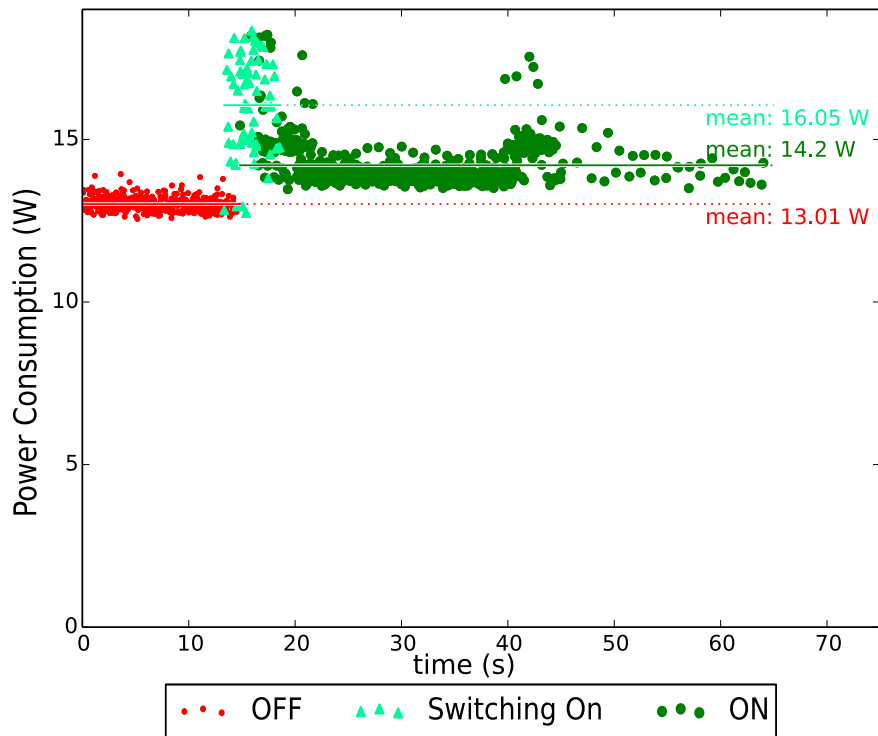

Figure 4.9: Power consumption for Set up 2: Using secondary 802.15.4 interface

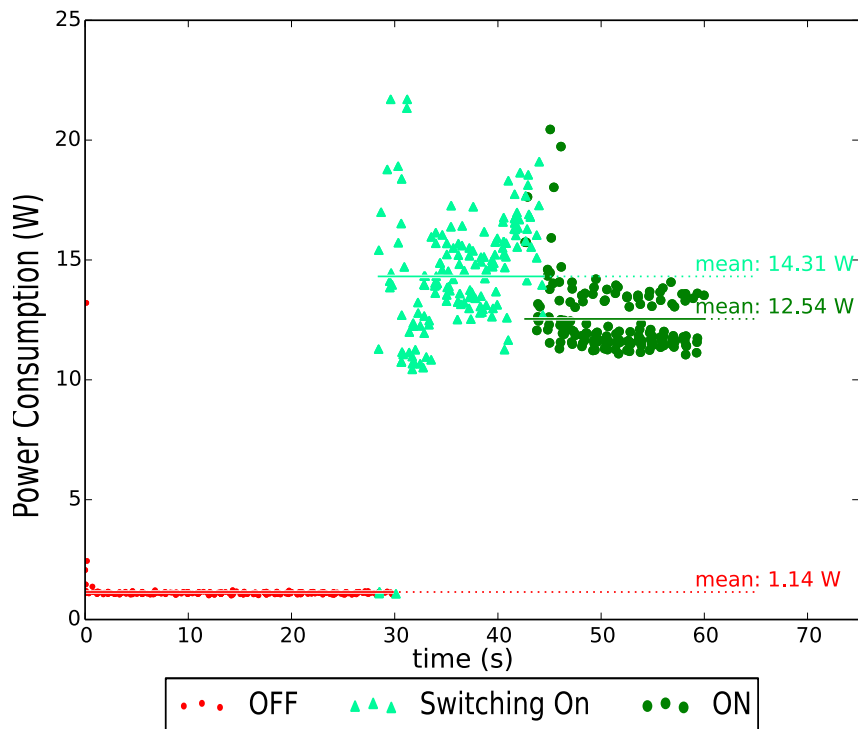

Figure 4.10: Power consumption for Set up 3: Using a Smart Plug

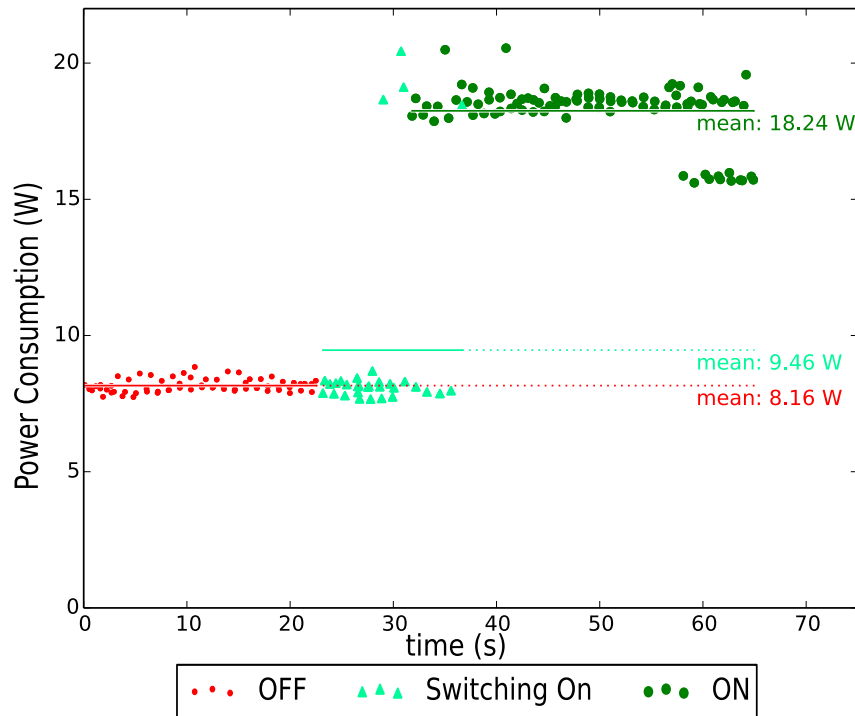

Figure 4.11: Power consumption for Set up 4: Using External 802.11 module

Table 4.3: Power measurements for the four set ups

Setup	Average Power (watt)			Gain (ON-OFF)
	OFF state	ON state	switching state	
1	12.44	13.7	15.28	1.26
2	13.01	14.2	16.05	1.19
3	1.14	12.54	14.31	11.4
4	8.16	18.24	9.46	9

setups because the smart plug is consuming less power than the secondary interface used to wake up the AP.

Fig 4.11 shows the performance of the 4<sup>th</sup> setup, which is similar to the 3<sup>rd</sup> setup in terms of the power saving (about 9 W). The advantage of this setup is the low power consumption needed when switching back on the AP. However, the power consumption in the ON state is the highest measured among all setups. This is due to the two active systems, i.e., the AP and the external module (the RaspberryPi). Thus, it may look uninteresting but this setup is easy to implement, uses common technology and could be much improved if the external module was replaced by a low-power (WiFi) interface.



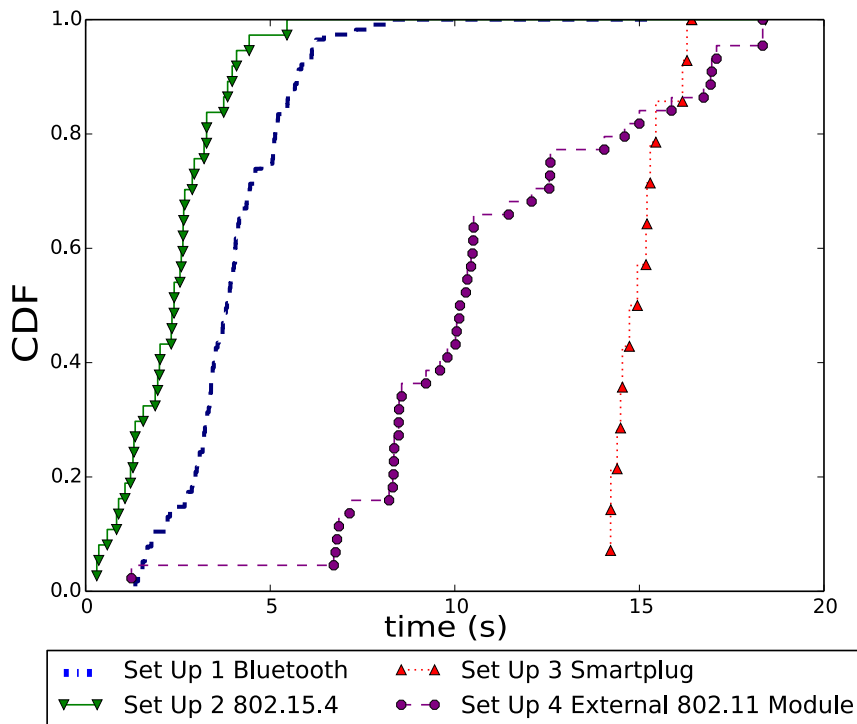

Figure 4.12: Wake up time for the four setups

## 4.4.2 AP Wake-Up Time

In this section, we study the latency to put back on the AP. Note that this latency must be minimized, as a client is already there waiting for establishing the WiFi connection.

Fig. 4.12 shows the time taken by each setup to activate the AP and gets it back in function. The 1<sup>st</sup> setup has an acceptable wake up delay between 4 and 6 seconds while the 2<sup>nd</sup> setup has a much better delay of less than 2 seconds. In the 3<sup>rd</sup> setup, the AP takes much more time to be ready to communicate with clients, as the AP is completely switched off during the OFF state. Note that the time to wake up varies a lot from one AP to another depending on the hardware and software, and new technologies and hardware may drastically reduce this time.

Considering that suspending a device to RAM should enable a swift restoration of its state, the results of the 4<sup>th</sup> setup appear disappointing. This is due to the implementation of the suspension to RAM in the APU. To further investigate this behaviour, we repeated this setup using a Dell laptop running Debian, providing the suspension to RAM feature through the well known ACPI interface. A comparison of both implementation's performances is presented in Fig. 4.13. We measured that it takes less than 4 seconds to re-activate the AP, which is far more interesting than

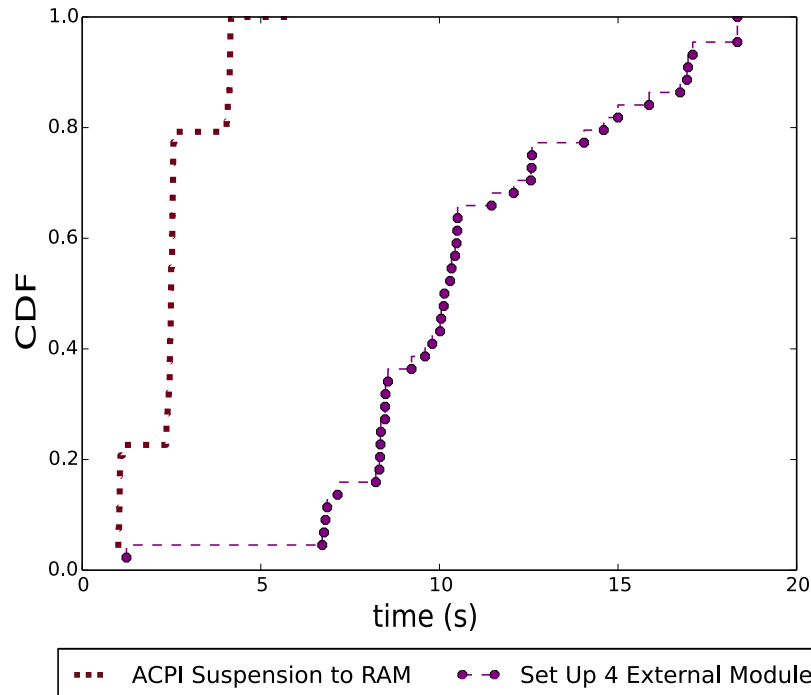

Figure 4.13: Wake up time for different suspension to RAM implementations (4<sup>th</sup> setup)

what we obtained with the APU. We conclude that this 4<sup>th</sup> setup is a good candidate to implement a sleep mode on AP, but some work is needed on the AP hardware and software to enable efficient suspension to RAM, which is usually not the case as most APs are ON all the time.

In conclusion, we notice that the 1<sup>st</sup> and 2<sup>nd</sup> setups show good wake up times but they do not offer much gain in power consumption. The 3<sup>rd</sup> and 4<sup>th</sup> setups take a long time somehow to switch the AP back on, however, and more importantly, they offer a good power saving in the OFF mode, especially the 3<sup>rd</sup>. The choice between these two setups depends on the technology integration. If an 802.15.4 sensor network is already deployed, the integration of the smart plug in such an environment will be straightforward. Existing sensors could even detect the user presence to activate the AP, such as a presence detector or a light sensor. The 4<sup>th</sup> setup seems more appropriate today, as only an external module (implementing WiFi) needs to be added to existing APs. Only the suspension to RAM and the interaction between the external module and the AP need to be optimized to make this solution more efficient. In Table 4.4, we summarize the main strengths and weaknesses of each method.

Table 4.4: A summary of the strengths and weaknesses of the four setups

Setup	Strengths	Weaknesses
1	Widespread technology Very low wake up module consumption	No service announcement Low gain of power saving
2	Routed and auto-configured network Promising technology	Technology not widely deployed Low gain of power saving
3	High power saving Independent from the MS	Long AP activation time
4	High power consumption gain Independent from the MS	High consumption of the wake-up module Long AP activation time (can be improved though)

## 4.5 CONCLUSION

In this chapter we designed and implemented a measurement platform which can automatically send repeated sleep/wake up request to an AP, and measure the energy it consumes in each state. We define and conduct several experiments to evaluate four different techniques to control and manage the sleep/wake up procedure of an AP. We compare their performance in terms of the time needed to complete the wake up, the energy consumed, and the changes, if any, needed in the mobile terminals.

We found that the AP needs a deep sleep mode to really save power consumption, such as suspension to RAM or to completely turn it off rather than only turning the WiFi interface off. However there is a trade-off that needs to be found between the power saving and the time the AP needs to be available again. While optimization can still be made on the wake up time, we found that using an 802.15.4 smart plug offers an interesting solution, especially if the environment is already provided with an 802.15.4 network. Using an external WiFi enabled device seems to be a viable solution too, where there is no changes required on the mobile terminals.

In the next chapter, we will consider a completely different scenario to study how to select a subset of APs that are enough to provide coverage in dense environment.



# 5

## A Collaborative Framework For Energy Saving in WLAN

### Contents

---

<b>5.1</b>	<b>Introduction</b>	<b>60</b>
<b>5.2</b>	<b>System overview</b>	<b>60</b>
<b>5.3</b>	<b>Data collection</b>	<b>61</b>
5.3.1	Wi2Me description	62
5.3.2	Data set	63
<b>5.4</b>	<b>Processing the data sets</b>	<b>65</b>
5.4.1	The Coverage Matrix	66
5.4.2	Detecting Physical APs	67
5.4.3	Coverage Gaps	67
5.4.4	MAC Address Re-use	68
5.4.5	Merging Traces	70
<b>5.5</b>	<b>Computing the minimal AP set</b>	<b>71</b>
5.5.1	The Greedy Algorithm	71
5.5.2	The Continuous Algorithm	72
<b>5.6</b>	<b>Empirical Evaluation of the MIN AP Set</b>	<b>73</b>
5.6.1	Evaluation of coverage	73
5.6.2	AP Redundancy	73
5.6.3	Marginal AP Coverage Contribution	75
5.6.4	Comparing the two Algorithms	76
5.6.5	Merged Traces	76
<b>5.7</b>	<b>conclusion</b>	<b>78</b>

---

## 5.1 INTRODUCTION

In this chapter, we provide a study of potential energy savings in urban environment. We propose a framework to discover the network in real time and use this information to compute the smallest number of APs that should be kept online to provide the same coverage area than all existing APs.

We chose urban areas as our playground for two reasons. The first one is that it is a real environment that is easily accessible. It is simple to perform studies by just going out there and walking in the streets. The second reason is that urban areas show a high density of WLAN deployment, with thousands of APs deployed [7, 31, 138]. Following the concept of the sleep mode presented in Chapter 2, this gives high potential for energy saving; in low traffic periods, an operator could only keep a set of APs up, providing network coverage and switch off the rest of them. Thus we propose to characterize and analyze real urban environment in terms of number of APs deployed, their density and their coverage areas. We want to evaluate the AP redundancy and identify how much the AP density can be reduced while still providing connectivity for mobile users. We provide a methodology and a set of tools to measure this density. Using the Android application *Wi2Me* [16] to perform network scanning, we gather real data about APs through war-walking in the centre of Rennes - France. After processing these data with various filters, we apply two different selection algorithms to select a minimal set of APs that are enough to provide the same coverage, assuming that the non-selected APs could be switched off.

The remainder of this chapter is as follows. The next section describes the overall central system with all the components. Section 5.3 explains our tool to monitor the network deployment and the data set we collected. In Section 5.4 we explain how we do merge several traces and smooth the data. Finally in Section 5.5 we propose two algorithms to compute the minimal AP set which is evaluated in Section 5.6. Section 5.7 concludes this chapter.

## 5.2 SYSTEM OVERVIEW

The proposed framework is presented in Figure 5.1 with four main components. It provides a loop in which a deployed network is characterized in real time with mobile user measurements, and a back end system is able to run diverse algorithms on these data to set up a new network environment. A communication framework is provided between the mobile user and the back-end to gather the data, and another communication framework enables the instantiation of the new network configuration.

We apply this system in our case of energy saving. We assume a central network

controller, which is responsible for identifying which APs are actually needed to maintain coverage, while others could be switched off. This vision corresponds to the one proposed by Ganji et al. [94] reviewed in Chapter 2 where a skeleton of APs is defined to provide the network coverage in low traffic period. In the same spirit, we define as minimal AP set the smallest number of APs that are providing the same coverage as all deployed APs. The proposed framework allows us to implement the AP selection.

The first component of the system is the mobile users themselves. By using the network, they are able to gather meaningful information about the current deployment: which AP covers which part of the target area, what is the performance of the network access and so on. Note that APs can gather information as well about connected users, but the mobile user vision of the network is quite interesting, since it better indicates the coverage area of an AP in terms of detecting capacity, and throughput.

The second component of the system is the front-end, which is the interface to gather mobile user measurements. A single user can only see part of the network, and its observation is very specific to the particular user. So many parameters influence its view: its mobility pattern, its device type, where the device is held, what applications the user is running. However, gathering several traces from different users may give a realistic view of the network. So this front-end should be scalable to allow multiple users to report their measurements.

The third component is the back-end, the intelligent engine. It makes use of the data to compute various optimization of the network. The one we are focusing on is the computation of the minimal AP set. By merging all user traces, it can run algorithms to define the minimal AP set.

The fourth and last component is the application of the result of the algorithm. In our case, it can be the instructions to each AP to turn on or off. In this thesis, we developed part of this system in a real environment, i.e. in existing urban areas. As we will see, we developed an Android application for mobile user to gather data. Then we used these data to compute the minimal AP set and perform an evaluation of these sets according to various parameters. Because we used real-world network in urban areas, we were not able to actually apply these minimal AP sets (i.e., switching on and off the APs), but we were still able to emulate the network coverage provided by this set.

### 5.3 DATA COLLECTION

As said before, the proposed system relies on measurements gathered by mobile users. These measurements could be the smartphone logs concerning the network, i.e. the list of discovered networks, and the list of selected APs during user sessions.

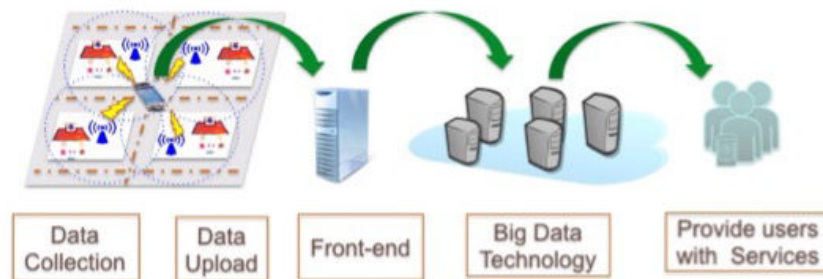

Figure 5.1: System Architecture and Components

However, gathering such information from many users would have taken too much time and effort for this thesis. Instead, we rely on a tool called Wi2Me developed in our lab [16]. In the following we briefly describe Wi2Me before explaining the traces we will use in the following sections.

### 5.3.1 Wi2Me description

Wi2Me performs network discovery through scanning, automatic connection and data traffic generation using the 802.11 and 3G interfaces of Android smartphones. The mobile terminal performs periodic scanning in all channels [15]. In each scanning cycle, the mobile terminal starts from channel number 1, sends two probe requests, waits for responses from APs, then moves on to the next channel and repeats the process until reaching channel number 13. The time for which a mobile terminal waits on each channel is device dependent, and for the devices we used in our measurements, this time was between 80 ms and 130 ms per channel resulting in about 1.70 s for all the channels. Having finished a scanning process, the mobile terminal waits for some time before re-initiating a new one. This waiting time is preconfigured in the devices and it was set to 3 s. This value was chosen based on previous studies in order to avoid receiving responses from a previous scanning cycle during the current one. The mobile terminals were scanning during the entire measurement campaign, i.e., they never tried to associate with an AP.

During each scanning phase, information about available APs are collected and



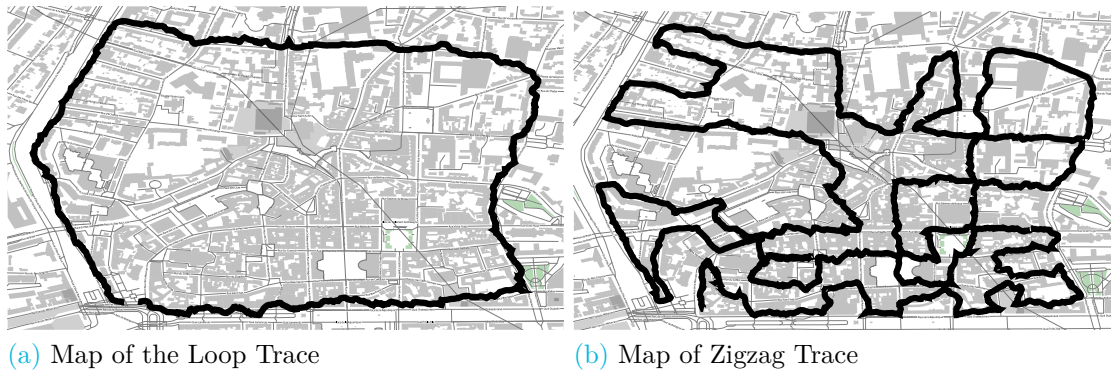

Figure 5.2: The war-walking paths in Down town Rennes - France

stored as a *scanning event* in a database called *Wi2me Trace*. A scanning event includes information about each detected AP such as BSSID, SSID, channel number, signal level, supported security protocols, link data-rate, GPS coordinates of the mobile terminal and a timestamp.

### 5.3.2 Data set

We walked for more than 20 hours in the center of Rennes (France) carrying smartphones running the *Wi2Me* application (“war-walking”).

We chose two different paths in downtown Rennes. The first path is a 3.7 km *Loop* on major streets (see Fig. 5.2a). The second path is a 10 km *Zigzag* path (see Fig. 5.2b). In the first path, we wanted to avoid as much as possible detecting the same AP twice, hence we followed a roughly rectangular path. On the contrary, in the Zigzag path we took a winding route through smaller streets, and thus we were able to detect the same APs from different places. The idea behind this was to get two different sets of data representing two radically different real life itineraries of a mobile user and then apply our AP selection algorithms to both cases.

We covered each path four times, using two mobile terminals running Wi2Me. The first terminal is a Samsung Nexus S to which we attached an external antenna of 3 dBi gain. The second terminal is a Samsung Nexus 5. The war-walking was done at an almost constant speed of 1 m/s.

Data Set	Mobile Terminal	Path	Duration (h)	Distance (km)	N. of Scans /min	N. of BSSIDs	Aver. BSSID / scan
NS-L1	Nexus S	Loop	1:32	4.311	15.71	1750	14.20
NS-L2	Nexus S	Loop	1:3	3.885	14.48	1811	16.8
N5-L1	Nexus 5	Loop	1:28	3.764	12.65	2252	20.36
N5-L2	Nexus 5	Loop	1:3	3.700	12.56	2223	20.50
NS-Z1	Nexus S	Zigzag	3:35	10.777	14.23	4303	14.46
NS-Z2	Nexus S	Zigzag	3:7	11.271	16.27	4985	17.51
N5-Z1	Nexus 5	Zigzag	3:34	11.244	12.83	5835	21.97
N5-Z2	Nexus 5	Zigzag	3:6	10.142	12.53	5854	21.01

Table 5.1: Wi2me Traces and Measurements.

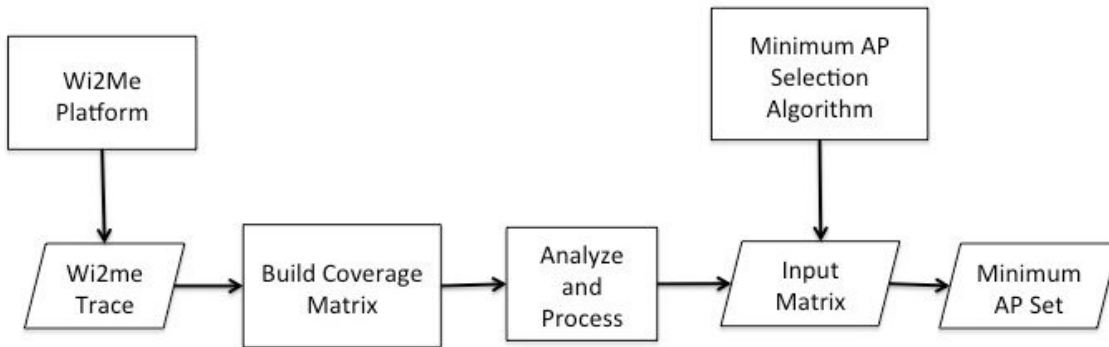

Figure 5.3: Methodology diagram

Table 5.1 contains some of the results that we obtained. As we compute the total distance covered based on the GPS coordinates, results show different lengths for each traces due to the cumulative GPS errors. The results also show different numbers of scans and discovered APs for each path and trace. This is due, on the one hand, to the random variability of the link quality between the APs and the terminals; and on the other hand, to the device characteristics and the actual scanning duration. In particular, we notice that the Nexus 5 has a better wireless performance than the Nexus S for the number of APs detected and the average number of APs per scan. The results also show that around 2000 different BSSIDs were discovered in the Loop Traces, and up to 5854 APs in the Zigzag path. The average scanning rate is about 15 scans per minute for Nexus S and the average number of detected APs per scan is 14, while the scanning rate in the Nexus 5 is about 12 scans per minute with an average number of APs detected per scan of 20. These results are consistent with our observations in previous studies [15] and with the results of [31].

## 5.4 PROCESSING THE DATA SETS

Once a mobile user trace is gathered and uploaded on the back-end, we process the data and perform various operations to concatenate them and extract an AP selection as presented in Figure 5.3. We use matrices to represent the AP coverage area; We process one or more Wi2Me these traces to produce a *Coverage Matrix*, summarizing the APs observed. The *Coverage Matrix* is converted to an *Input Matrix*, which is finally used as the input of different algorithms that select the *Minimal AP Set*, that is a significantly smaller set of APs providing almost the same coverage as all the APs detected. In this section we explain this process more in details.

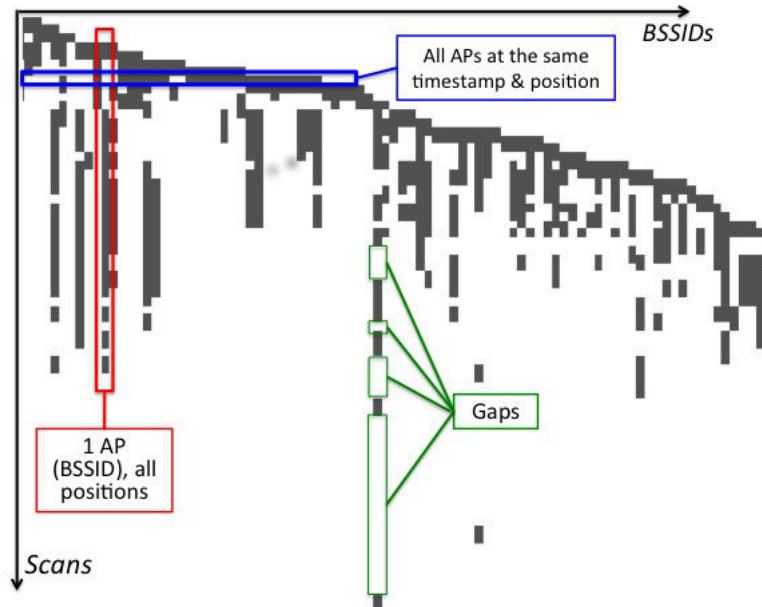

Figure 5.4: APs' Coverage Matrix

### 5.4.1 The Coverage Matrix

In order to represent the coverage of each AP, we build a Coverage Matrix, where each line corresponds to a scanning event and each column to an AP. If a given AP was detected during a scanning event, the corresponding element in the matrix is one, and zero otherwise. Thus the ones in a given line represent all the APs detected in the corresponding scanning event (i.e., AP from which the mobile terminal received either a probe response or a beacon). The ones in a given column indicate all the *scanning events* where a given AP was discovered. Thus the coverage of an AP can be defined as the set of ones in the corresponding column.

Fig. 5.4 shows an example of the Coverage Matrix. We call *Continuous Coverage* of an AP, the parts of the column in the Coverage Matrix where there are successive ones and no zeros in between. While *Total Coverage* of an AP is the total of all scanning events where it was discovered, i.e., the set of all ones in the column representing the AP in the Coverage Matrix.

In the rest of the section we describe how the data of the Coverage Matrix is analysed and processed in order to build the Input Matrix, used by the selection algorithms.

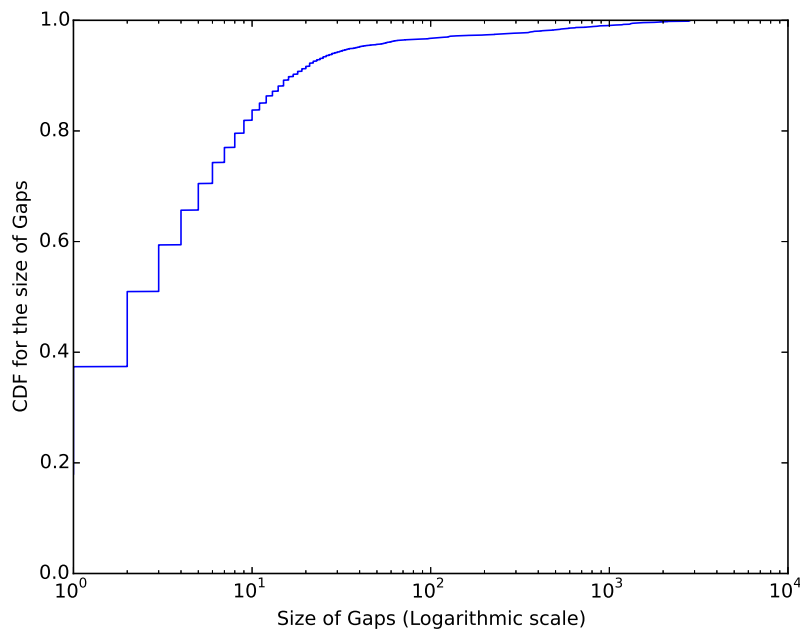

Figure 5.5: AP coverage gap size distribution

## 5.4.2 Detecting Physical APs

It is often the case that a large number of APs announce multiple networks. Each of these networks is assigned a different SSID and BSSID. Usually, these BSSIDs are all derived from the MAC address of the AP. Analysing the Wi2Me Traces, we noticed that some co-located BSSIDs have MAC addresses very similar to each other and they only differ in the value of the last byte or first byte (depending on the operator). Since we are only interested in the coverage that a physical AP provides, and not in the different networks it advertises, we group these BSSIDs and treat them as one physical AP in the Input Matrix. This is done by combining all the columns of similar BSSIDs in one column. By doing so we obtain a number of physical APs corresponding to roughly 70% of the total number of BSSIDs for each trace.

## 5.4.3 Coverage Gaps

Especially in the Loop path, we would expect a continuous coverage of each AP. Recall that each row in the matrix corresponds to a scanning event, which in turn corresponds to a given location and timestamp. Therefore we would expect the columns of the Coverage Matrix to have long runs of consecutive ones, as each column corresponds to a single AP. But this is not the case for all the APs. Analyzing

the Coverage Matrix, we find gaps of different sizes in the coverage of APs, i.e., we find zeros between runs of ones, as highlighted in Fig. 5.4. Fig. 5.5 shows the cumulative distribution of the size of the gaps for one of the Loop traces. It shows that the size of the gaps varies from 0 (corresponding to no gap in the coverage) to 3000. About 80% of them are of a size smaller than 10. Such a small size for the vast majority of the gaps seems to indicate that they were caused by the terminal not being able to exchange messages with the AP for a few scanning events, for instance because of random channel fluctuation. This is consistent with what we have observed in a previous study [15]: occasionally probe requests, probe responses or beacon messages can be lost during the scanning procedure, even if the terminal is within the coverage area of the AP. Applying the Selection Algorithm on the raw data, including these spurious coverage gaps, would lead to an overly pessimistic coverage set, as the algorithm would need to include in the minimal AP set a number of APs to cover these spurious gaps. This is reinforced by the fact that these data belong to a single trace. As we discuss in Section 5.4.5, we addressed this problem by merging multiple traces for the same path: if a certain point is indeed within the coverage area of an AP we expect to be able to detect at least once during our measurements.

Some of the gaps could indeed correspond to actual coverage gaps, for instance because of an obstacle (building, tree, etc.). In the case of the Zigzag path, this could also be caused by the user starting to move away from the AP only to move closer shortly thereafter because of the shape of the path. The Loop path should not have such a problem as it is a straight line most except for the four turns, as mentioned in Section 5.3.1. These gaps are handled by the Selection Algorithm that is going to select another AP to compensate for the absence of coverage (see in Section 5.5).

Another possible explanation for some of the gaps is the re-use of MAC address, i.e., two (or more) different physical APs, located in different places, using the same BSSID. This is most likely the case for the larger gaps. We have confirmed this by plotting the positions of some of these BSSIDs on a map, which showed that the positions are grouped in two or more different locations and could not possibly belong to the same AP. The following section addresses this problem in more details.

#### 5.4.4 MAC Address Re-use

In order to separate the APs that share the same MAC address, we developed a technique depending on the SSID information available in the Wi2Me Traces. As it is known, an AP can advertise several SSIDs each with a different MAC address. Many of the announced SSIDs of an AP are commonly used among different APs of the same operator. Only the SSID of the private network that belongs to the owner of the AP is different. Thus it is possible to separate the different APs that

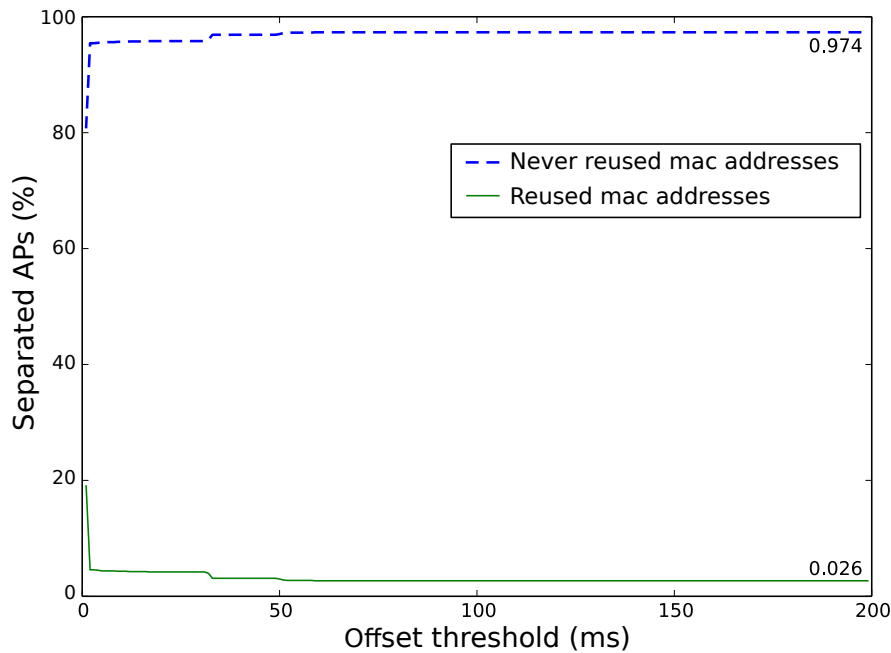

Figure 5.6: AP separation depending on the offset threshold

are using the same MAC address depending on the SSIDs of the private network. First, for each column in the Coverage Matrix we filter the SSIDs depending on the private ones. Then we separate them creating a new column for each private SSID. Applying this technique, we find that 1% of the APs share the same MAC Address.

The drawback of this method is that we do not always receive all the SSIDs broadcasted by an AP, and thus we might miss the private network SSID (failing to detect MAC address re-use). To address this problem, we covered the same paths using a Dell Latitude E4300 laptop running Linux. The advantage of these traces is that they contain the uptime of the AP included in the TSF field used for clock synchronisation and included in the beacons and probe responses. We compared the uptime value of the AP to the clock of the laptop, and we calculated the offset, i.e., the difference between these two values. As long as this offset is below a certain threshold, we conclude that the message was sent by the same AP. On the contrary, if the offset is above the threshold, we conclude that two different APs are using the same MAC address.

Fig. 5.6 shows the percentage of MAC addresses that are never reused (top curve) and those that are reused at least once (bottom curve), as a function of the threshold. It is easy to see that both curves stabilize quickly after roughly 75 ms. Using a 100 ms threshold for the *Loop* traces, we find that 2.6% of the detected APs reuse MAC addresses.

Comparing these two techniques, we found that the SSID method detected only

41.22% of the MAC address re-use detected by the time offset method. We examine the APs undetected by the SSID method to see if they introduce any anomaly when applying the selection algorithms. We found that these undetected MAC reuse cases belong to APs with minimal coverage. This makes sense because APs coverage correlates to detectability of the private SSID.

For these reasons, and because of the small subset of APs it concerns (around 2% of APs re-use MAC addresses), we consider that the SSID technique is sufficient to provide reliable android data to our algorithms.

### 5.4.5 Merging Traces

As mentioned above, some of the AP coverage gaps, detected in a single trace, can be caused by random fluctuations in the radio link quality. It is possible to address this problem by combining different traces covering the same path. This is possible thanks to the GPS coordinates associated to each scanning event. As different traces never have exactly the same coordinates, we operated as follows: using data from *Open Street Map*, we divided each path into 1 m segments, then the location of each scanning event is projected orthogonally to the closest street in the path. In the case of merged traces, the rows of the Input Matrix correspond to the 1 m segments and not to the scanning events. If the AP is detected in two successive scannings in the Coverage Matrix, we consider that it is present in all the segments between the projection points of these two scannings in the Input Matrix and thus the lines of the corresponding column are filled with ones. It is worth underlining that these ones are added only if the AP was detected in two *consecutive* scanning events in the Coverage Matrix; in other words, all the coverage gaps present in the Coverage Matrix are preserved.

Once we have converted the Coverage Matrices to Input Matrices with rows corresponding to the 1-meter segments, we can combine them using the following two steps, the first determines the column of the merged matrix and the second determines the one and the zeros:

#### 5.4.5.1 Identifying APs

Some APs are present in only one of the traces, typically because their messages were received with low power. As such, they are poor candidates for the minimal AP set. Therefore, in the merged matrix, we keep only the APs that have been detected in each trace. This corresponds to a logical AND between the columns of the Input Matrices of each trace.



### 5.4.5.2 Filling the Input Matrix

We use logical OR between the rows of the Input Matrices. Thus an AP is considered present at a given geographical position if there was at least a one at this position in any of the matrices being merged. As we have previously mentioned, this is done because, due to the random fluctuations of the radio channel, it can happen that an AP was not detected at a given point even though that point is well within the coverage area of the AP.

## 5.5 COMPUTING THE MINIMAL AP SET

As we expected and as it has been shown by several studies [7, 31], the Coverage Matrices of the two paths show that there is a large number of APs with overlapping coverage. Finding the smallest set of APs to cover the whole path is an instance of the set cover problem [139, 140], one of the classical examples of NP-Complete problems.

To find a minimal number of APs that guarantees a continuous coverage along a path, we propose two algorithms that, when applied on the Input Matrix of a trace, they return a skeleton of APs which provides almost the same coverage but with a very low number of APs. The first one is the well known *Greedy Algorithm* [139] which, in principle, selects APs with largest coverage. However, as we will see in the next section, the existence of holes alters (perturbs) the performance of this algorithm because additional APs are selected only to cover these holes. In the context of a WLAN, this is not necessarily the ideal solution as the APs used to fill these gaps can have a fairly small coverage area, causing mobile users to have more handovers and to be associated for a short period of time to these APs. To take the problem of holes into consideration and to resemble the way the moving mobile terminal selects APs, we developed *The Continuous Algorithm* which selects the APs according to their continuous coverage.

The main principle of the continuous algorithm is to start at some point on the path, select the AP with the longest coverage from the current position, then move to the end of the coverage area of the selected AP and repeat the process until the whole path has been covered. These two algorithms are more formally given in the next subsections.

### 5.5.1 The Greedy Algorithm

The greedy algorithm is represented in Fig. 5.7, and follows these steps:

*Step 1:* Calculate the *total coverage* value for the APs, i.e., the sum of all the *ones*

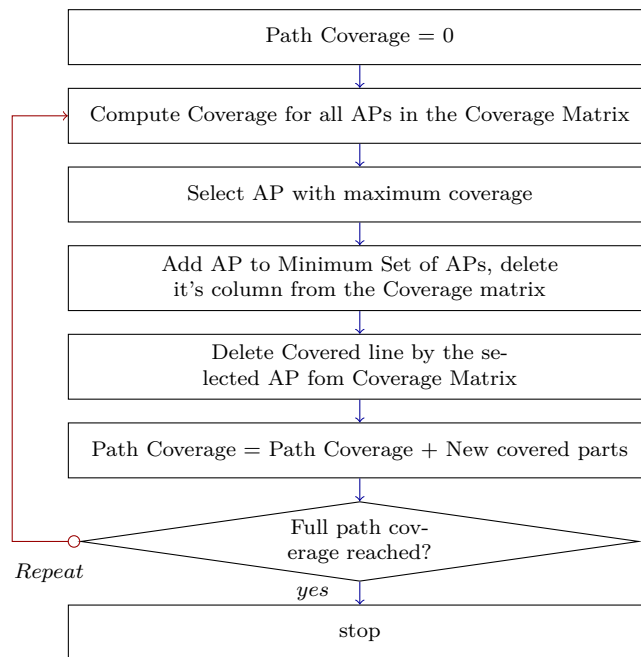

Figure 5.7: Flow chart of the Greedy algorithm.

in the corresponding column of the *Input Matrix*.

*Step 2:* Select the AP with the largest *total coverage* value and add it to the *Minimum APs Set*.

*Step 3:* Delete the lines where there is a *one* in the column of the selected AP from the *Input Matrix*.

*Step 4:* Delete the column of the selected AP from the *Input Matrix*.

*Step 5:* Go to *Step 1* and repeat until all the lines are deleted.

### 5.5.2 The Continuous Algorithm

The continuous algorithm (see fig. 5.8) uses a local optimization criteria that consists of selecting the AP with the longest continuous coverage for the next part of the path, and works as follows:

*Step 1:* Starting from the beginning of the path, i.e., the first line of the *Input Matrix*, identify the available APs (the columns where there are ones in this line).

*Step 2:* Calculate for each of these APs the continuous coverage (sum of successive *ones* starting from the current position until the first *zero*).

*Step 3:* Choose the AP with the longest continuous coverage and add it to the

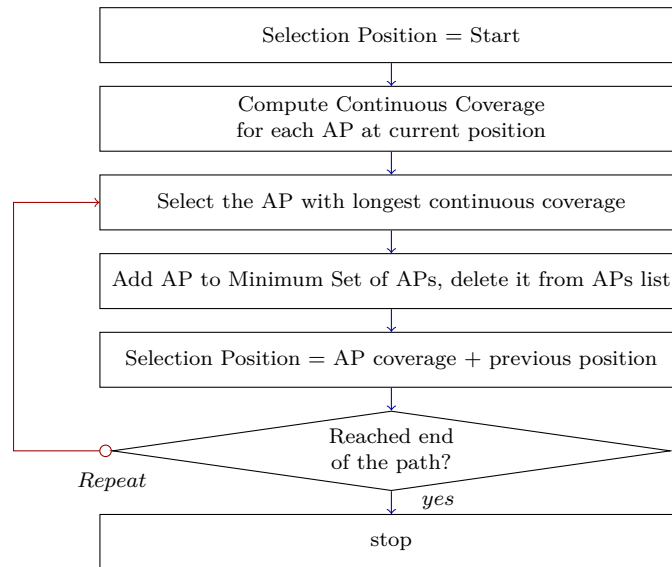

Figure 5.8: Flow chart of the Continuous Algorithm.

*Minimum APs Set.*

*Step 4:* Go to the last line of the continuous coverage of the selected AP.

*Step 5:* Repeat steps 2 to 4 until the end of the matrix i.e end of the path.

## 5.6 EMPIRICAL EVALUATION OF THE MIN AP SET

### 5.6.1 Evaluation of coverage

We applied the two algorithms presented in the previous section to the dataset presented in Section 5.3.1. For each trace, we build an input matrix by grouping BSSIDs, identifying MAC address re-use, and correcting the GPS coordinates as explained in Section 5.4. We also merged the traces as discussed in Section 5.4.5 and applied the algorithms to the resulting input matrices. Table 5.2 summarizes some of the results for each algorithm, including the number of selected APs and the number of handovers, i.e., the number of handovers that a user would have to make if she followed the same path and only the selected APs were active.

### 5.6.2 AP Redundancy

As mentioned earlier, our main objective in this study is to evaluate the redundancy of APs in a dense urban deployment, and see by how much the number of operating AP can be reduced, while maintaining the same coverage. The results in Table 5.2

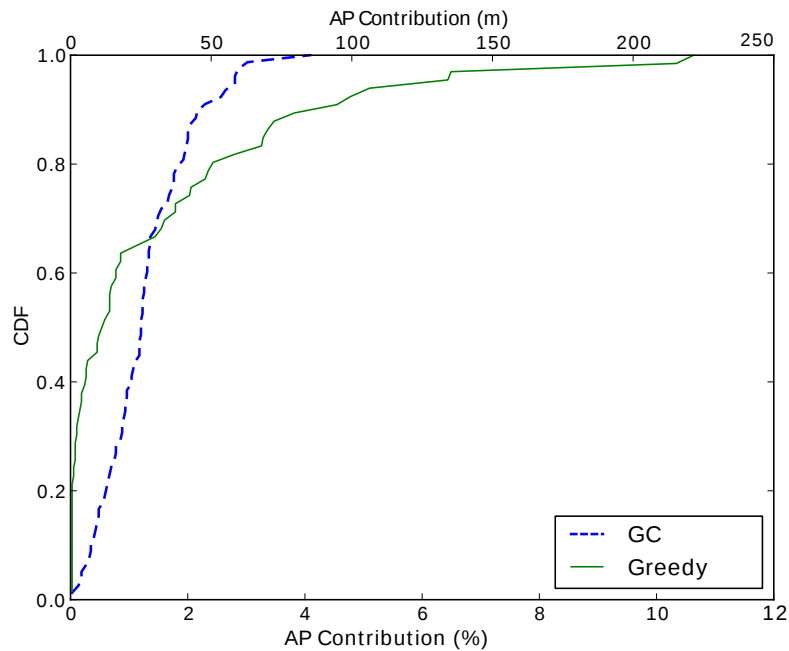

Figure 5.9: CDF of APs Contribution to Coverage

show that, on average, around 6.5% of the detected APs are sufficient to provide full coverage of the path. This percentage varies from 4.25% to 10.91% depending on the dataset, the phone, and the AP selection algorithm. In other words, we can maintain the coverage of a path while switching off at least 89% of the existing APs. This means that the potential of energy saving obtained by switching off the non selected APs is about 89% too. We estimated the energy consumed by the selected APs using the results of [57], which reported that the average consumption of a single AP is about 6 W. Results show that the selected APs consume around 540 W in average for the Loop path and 1215 W for the Zigzag path. This reflects a significant reduction in energy consumption when compared to the initial estimated consumption of 7200 W and 19 323 W for the two paths respectively.

Results also show that the minimal AP set offers a good overlapping. The number of APs seen at any position of the path varies between 1 and 6, with a mean of approximately 2, and an overlapping of two or more APs along more than 60% of the path. Compared to the initial situation where we had an average of 17 APs present at each position of the path (see Table 5.1), this represents a large reduction in overlapping. The overlapping in the minimal set is useful to insure smoother handovers.

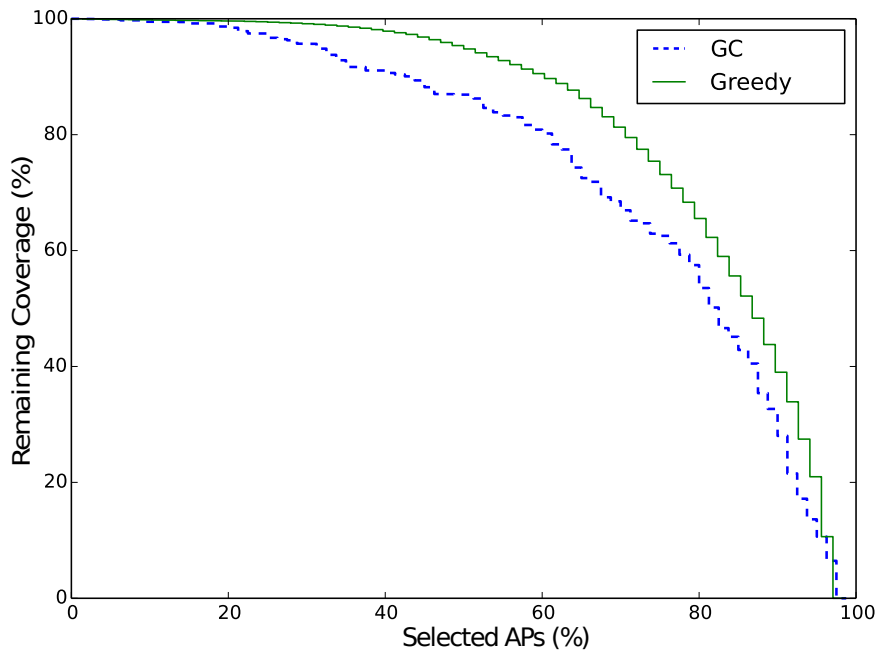

Figure 5.10: Trade off between N. of selected APs and Coverage

### 5.6.3 Marginal AP Coverage Contribution

In the minimal AP set, not all APs contribute evenly to the path coverage. This is particularly true for the results of the greedy algorithm since some APs are only selected to cover a small gap and thus provides minimal additional coverage. Fig. 5.9 illustrates this, by showing the percentage of marginal contribution to the coverage of each AP (i.e., the *additional* (marginal) coverage contributed by each AP and not already covered by the previously selected APs). About 75% of the selected APs contribute to less than 2% of the total coverage of a path each. It also shows that for the greedy algorithm only 5% of the selected APs contribute to more than 6% of the coverage each, while for the GC algorithm the APs contribute more evenly to coverage.

When measuring the APs' marginal contribution in meters (shown on top of the figure), one can notice that, for both algorithms, around 75% of the selected APs cover less than 40 m each. Only 5% of the APs cover more than 140 m each for the Greedy Algorithm, while this is not the case for the Continuous Algorithm.

Fig. 5.10 shows the remaining coverage of a path when successively eliminating low coverage APs out of the minimal AP set. Consistently with the above results, this figure shows that we can maintain about 98% of the coverage even when eliminating 40% and 22% out of the selected APs for the greedy algorithm and the GC algorithm respectively.

### 5.6.4 Comparing the two Algorithms

The results show that, for any trace, the number of APs selected by the greedy algorithm is smaller than the number of APs selected by the GC algorithm. These results are consistent with the APs' selection criteria used by each algorithm. The greedy algorithm selects AP with the large coverage areas first, so that it needs fewer APs to cover a path compared to the GC algorithm.

But if we look at the number of handovers required by a potential user that would move along this path using this minimal AP set, we see that the GC algorithm requires fewer handovers. This is because the greedy algorithm selects APs based only on the size of the coverage area and not the location of each AP, while the GC algorithm takes location into account. The AP coverage overlap provided by the two algorithms is similar (almost equivalent) with the GC algorithm being slightly better since it selects more APs. To summarise, the greedy algorithm is more efficient in terms of energy consumption since it selects fewer APs, while the GC algorithm provides better overall coverage (fewer handover and bigger overlap).

## 5

### 5.6.5 Merged Traces

Applying the merging technique, as described in Section 5.4.5, decreases the number of APs in the Input Matrix between 20% and 30%. This is because the Input Matrix contains only the APs that have been detected in all the traces. Recall that this is to eliminate APs that have been usually detected in only one trace and with a low signal strength, making them bad candidates for the minimal set. Therefore such reduction in the number of APs should not affect the minimal set.

When applying the two algorithms on the merged traces, we find that the number of APs in the minimal set has decreased for both algorithms between 25% and 40%. This is a direct result of the second step of the merging technique that handles the cases where a mobile station misses an available AP due to low channel quality in one trace by finding a match in the other trace. Thus it tends to decrease the size of the gaps and increases the continuity of coverage of the APs (selected in the first step) by accepting that the AP be present in one of the traces. Consequently, this improves the performance of the two algorithms in terms of the number of required handovers and the number of the available APs present at each position by 10% to 30%.

Data Set	N. of APs	Selected APs						APs' Estimated energy (W)		Avg. N. of available APs		N. of Handover/100 m	
		Continuous			Greedy			Continuous	Greedy	Continuous	Greedy	Continuous	Greedy
		N. of APs	%	m/AP	N. of APs	%	m/AP						
NS-L1	1081	118	10.91	44.60	107	9.90	49.18	708	642	1.94	1.75	2.22	2.76
NS-L2	1123	90	8.01	53.20	77	6.86	62.18	540	462	2.00	1.60	1.86	2.26
N5-L1	1280	95	7.42	48.86	82	6.41	56.61	570	492	2.28	1.99	2.02	2.87
N5-L2	1316	82	6.23	55.48	70	5.32	64.99	492	420	1.83	1.59	1.78	2.15
NS-Z1	2718	176	6.48	75.95	153	5.63	87.37	1056	918	1.81	1.43	1.31	1.47
NS-Z2	3180	222	6.99	62.50	208	6.54	66.71	1332	1248	1.80	1.50	1.59	1.84
N5-Z1	3450	221	6.40	62.11	192	5.57	71.49	1326	1152	1.92	1.74	1.60	1.92
N5-Z2	3534	238	6.73	52.32	210	5.94	59.29	1428	1260	1.92	1.66	1.90	2.29
NS-L1,2	823	79	9.60	66.61	69	8.38	76.26	474	414	2.38	2.04	1.48	2.22
N5-L1,2	949	62	6.53	74.88	51	5.38	91.02	372	306	2.36	2.09	1.31	2.07
NS-Z1,2	2400	128	5.33	108.40	105	4.38	132.14	768	630	2.49	1.78	0.92	1.25
N5-Z1,2	2848	184	6.46	74.60	121	4.25	113.44	1104	726	3.18	2.11	1.33	1.90

Table 5.2: Results of Minimal AP Set Algorithms and Different Metrics.

## 5.7 CONCLUSION

We addressed the feasibility of reducing the number of active APs in an urban setting. We presented two algorithms to compute the minimal AP set and compared their performance using traces collected in the center of Rennes (France). The results show that it is possible to use only around 6.5% of the existing APs in order to provide the same coverage. The exact number of the selected APs depends on the dataset, the algorithm used, and the platform that is used to perform the measurements. Results vary from around 4.25% to 10.91%. Thus the potential of energy saving obtained by switching off the non selected APs could reach 95%. Results also show that the selected AP set provides an overlapping of a minimum of two APs along more than 60% of the path. The greedy algorithm is more efficient in terms of energy consumption since it selects fewer APs, while the GC algorithm provides better coverage since it requires fewer handovers.

As mentioned earlier, our algorithms only guarantee that users in a path are covered by at least one AP. Further investigations are required to evaluate how many users the minimal AP set can support, the traffic rate it can provide for them, and the tradeoff between the number of active APs and the resulting QoS. Another possibility is to enhance the proposed algorithms in order to take into account constraints such as the minimum average APs present at each position and the maximum number of handovers allowed. Finally, it could also be possible to investigate how to assign the selected APs to the different WiFi channel in order to minimize the interference among them.



# 6

## Conclusions

### 6.1 THESIS OUTCOME

In this thesis, we have investigated how to improve energy efficiency of wireless networks. It is well known now that most of the wireless network energy consumption comes from the radio access part [22], in which APs are responsible for a large proportion of this consumption. Among all the techniques to save energy at the APs, we chose to work on the sleeping techniques in which AP go to sleep when there is no traffic to handle, or when the load can be handled by other APs. This is a very efficient method to save energy which comes from a simple principle: turn off a resource if it is not needed. However, even if the principle is simple, networks have not been designed to handle such switching, because the energy consumption was not an issue few dozen years back. What matters was the QoS and the coverage. We ended up with dense deployment, over-dimensionned network to provide the best possible QoS in peak hours, i.e., the time of the day when we observed more traffic. However, at the other times of the day, the network is under-utilized.

The sleeping techniques emerge from this observation that the traffic demand is highly fluctuating in time and space. For example, during a special event such as a soccer game, or a concert, for few hours there is plenty of people connecting in the same area. When the event is over, folk density significantly decreases. Or assume people working in offices. Only during the day time, they are using their office wireless network and during the evening their home access. What if the network could adapt to these fluctuating traffic demand? The sleeping techniques are part of the answer: the network breathes according to user demand. The wireless network is still provisionned to manage the peak hours, but during the other hours, the resources are switched on and off according to the real time user demand.

In Chapter 2 we reviewed a rich state of the art regarding sleeping techniques. As we saw, there are many proposals that tackle several issues raised when implementing sleeping techniques. For example, we saw that authors propose cooperation among APs serving a specific area [81–83]: while some APs are put to sleep, the others adapt their parameters to handle the remaining users, e.g., change their transmission power to cover the area usually handled by the sleeping APs.

In this chapter, we highlighted two challenges on which we build our work. We actually identified two very different use cases, that depend on the deployment. One of them is the home networking, or let us say non-dense deployment such as a campus network. When there is a single AP covering an area, there is no other AP that can handle the area of a sleeping AP. So a sleeping AP needs to detect new user arrival to wake up and serve him / her. In chapter 4 we investigated different methods to wake up an AP, using different technologies. We proposed four methods, using Bluetooth or IEEE 802.15.4 as alternative technology to provide the control channel to send wake up requests, using a smart plug, a communicating plug that is able to switch on and off the electricity supplying the AP, and the use of an alternative 802.11 interface to manage new user detection only. By implementing these methods in a real experimentation, we found that the energy saving is greatly depending on the sleep level. In WiFi, only switching off the network interface does not allow great energy saving, only few watts are saved. So the use of the smart plug which completely switch off the AP, or the use of a low power WiFi interface that allow the AP to go into a deep sleep seem better candidate. However, we also highlighted that the latency to wake up the AP can be significantly high, up to several seconds. The other conclusion that we draw is that all technologies are not always available on smart phone or personal computer. For example, IEEE 802.15.4, a technology dedicated to the Internet of Things is very attractive because it provides exactly the kind of control channel to exchange the wake up signal, but it is not well deployed on existing "Internet" devices. This is obviously another parameter to take into account to deploy a solution.

The other challenge that we identified follows some preliminary ideas suggested by Ganji et al. [94] for example, when considering a total different scenario, i.e., the case of dense wireless network. Contrary to the previous case, we consider here that the coverage area of a sleeping AP can be handled by another AP. So many APs are deployed to provide capacity, or in the specific case of WiFi, it might only be because the deployment is uncontrolled (we observed in urban areas very high density of APs [137, 138]). So we were interested in providing a study of the AP density and evaluate how many could be switched off while still maintaining the coverage. This number obviously depends on the way the APs are selected. So we proposed a global system where clients performs radio measurements, and provide these partial vision of the network to a central controller. Gathering multiple partial visions allow the controller to have a good estimate of the network coverage and the AP topology. We reviewed in Chapter 3 some recent IEEE 802.11 standards that could be used for this exchange of radio measurements, such as IEEE 802.11k. In order to implement this system, we used the Wi2Me application [16] to emulate several mobile client traces, and we did several computations to merge our traces together into what we called input matrices. After applying two different algorithm for AP selection, we found that only 10% or less APs are needed to provide the coverage of all the APs.

## 6.2 FUTURE WORK

The work provided in this thesis can be extended at different levels.

Regarding the last chapter, we provided a framework to compute a minimal AP set that is made of the smallest number of AP to provide the same coverage as all the deployed APs. However, this minimal set also reduces the capacity of the network to provide resources to many users. One interesting follow up of this work would be to study how to find intermediate sets that allow to handle different traffic loads. Finding the right number of APs to address both energy efficiency and QoS.

Another continuation of this work would be to better test the computed set of APs and evaluate our methods in different environments. While the real experiments in urban centers are interesting, simulation tools could also help in evaluating different topologies and use cases. The ns-3 simulator seems to provide a good framework to implement wireless network in urban environment. In that way the full framework including the communication protocol could be implemented, and the APs selected to sleep could actually be set to sleep. Then we could evaluate the impact on the QoS experienced by users.

It would also be interesting to work out these approaches with an operator, and evaluate the gain that one operator could have with these methods. In our work, we considered all APs that can be found in the urban areas, however they belong to different operators. So working with an operator could lead to two studies. We could restraint this study to the APs belonging to this operator only and evaluate the gain and the selection process with a smaller set of APs. On the other hand, we could evaluate what could be the gain of establishing a cooperation agreement between different operators to share the access network.

Another study that could be interesting is to investigate the connectivity inside buildings. Our contribution focus on outside connectivity, when users are walking in the street. However, switching off APs will also have an impact for indoor users, and it would be very interesting to merge indoor user measurement into our system.

## 6.3 PERSPECTIVES

There are many perspectives to this work, and to energy saving in wireless network in general. As we tried to show, we believe that sleeping techniques are an evidence for wireless networks.

One interesting lead would be to consider renewable energy sources to supply the APs. Renewable energy causes lot of challenges, including the intermittent production. The energy may not be available when needed. If we consider this source of energy, more synchronization may be needed between the end terminal and the

infrastructure to exchange data at the best time regarding the overall network capacity and the electricity production. If we follow up on our idea to select a minimal AP set, the energy source can be another factor to take into account.

The future network infrastructure could also be thought with the sleeping feature in mind. As we said, the sleeping techniques emerged from the current state of the network and the will to start saving energy. However, with that feature in mind, network deployment could be better optimized to allow an easier implementation of the sleep mode. Introducing redundancy and overlapping area on purposes to address the trade-off between capacity and energy saving.

The ANDSF [136], IEEE 802.21 [135] or IEEE 802.11k/r [132,133] are also promising standard to set up energy efficient network. First they address the heterogeneity of the network. Using heterogeneous technologies is probably the future of the wireless access, because it allows to address all use cases, including machine to machine communication for example. However having a performant heterogeneous network requires cooperation between the technology, to address capacity and energy saving. If operator can better now the real time network QoS experienced by users, they would be able to better control their resources and switch on and off their resources, and move the users to the best point of attachment.

# List of Tables

3.1	Some radio resource measurements defined in 802.11k. . . . .	35
4.1	Devices and technologies used for the four setups . . . . .	44
4.2	Choices for the Access points under evaluation . . . . .	50
4.3	Power measurements for the four set ups . . . . .	54
4.4	A summary of the strengths and weaknesses of the four setups . . . .	57
5.1	Wi2me Traces and Measurements. . . . .	64
5.2	Results of Minimal AP Set Algorithms and Different Metrics. . . . .	77

## LIST OF TABLES

# List of Figures

1.1	Number of WiFi networks over time [14]. . . . .	2
2.1	Statistics of WiFi networks in a building hosting 30 APs for two weekdays and one weekend: Aggregate data rate of clients over a 24-hour period [46]. . . . .	9
2.2	Taxonomy for Classification of Switching ON/OFF Approaches. Approaches are categorised into four main domains and are further detailed into several categories. Violet Boxes represent how our proposal in the thesis fits in this taxonomy. . . . .	11
2.3	A simplified block diagram of an IEEE 802.11 access point [60] . . . .	14
2.4	Classification of metrics used in energy efficiency for wireless networks [125]. . . . .	25
4.1	Wake up sequence diagram when using the secondary Bluetooth interface (setup 1). AP wake-up phase is assured through Bluetooth interface to start up the WiFi interface. . . . .	44
4.2	Wake up sequence diagram when using the secondary IEEE 802.15.4 interface (setup 2). AP wake-up phase is assured through an 802.15.4 interface to start up the WiFi interface. . . . .	45
4.3	Wake up sequence diagram when using an IEEE 802.15.4 Smart Plug (setup 3). The STA communicates in 802.15.4 with the smart plug to request to power on the AP. The smart plug then switches on the AP by providing electricity. . . . .	46
4.4	Wake up Sequence diagram when using an external 802.11 module (setup 3). AP wake-up phase is assured through the external WiFi interface, while Connection establishment phase through WiFi interface. . . . .	47
4.5	The Experimental Platform implemented to evaluate and compare the different wake-up methods . . . . .	48
4.6	The hardware Components used to implement the experimental platform . . . . .	49
4.7	The smart plug from Homadeous (a company developing embedded systems). . . . .	51
4.8	Power consumption for Set up 1: Using secondary Bluetooth interface	52
4.9	Power consumption for Set up 2: Using secondary 802.15.4 interface .	53
4.10	Power consumption for Set up 3: Using a Smart Plug . . . . .	53
4.11	Power consumption for Set up 4: Using External 802.11 module . . .	54
4.12	Wake up time for the four setups . . . . .	55



## LIST OF FIGURES

4.13	Wake up time for different suspension to RAM implementations (4 <sup>th</sup> setup) . . . . .	56
5.1	System Architecture and Components . . . . .	62
5.2	The war-walking paths in Down town Rennes - France . . . . .	63
5.3	Methodology diagram . . . . .	65
5.4	APs' Coverage Matrix . . . . .	66
5.5	AP coverage gap size distribution . . . . .	67
5.6	AP separation depending on the offset threshold . . . . .	69
5.7	Flow chart of the Greedy algorithm. . . . .	72
5.8	Flow chart of the Continuous Algorithm. . . . .	73
5.9	CDF of APs Contribution to Coverage . . . . .	74
5.10	Trade off between N. of selected APs and Coverage . . . . .	75



# Acronyms

3G	Third Generation. 26
3GPP	3rd Generation Partnership Project. 5, 31, 38, 39
AC	Access Controller. 32
ANDSF	Access Network Discovery and Selection Function. 5, 31, 38–40
AP	Access Point. xiv, 2, 4–6, 9, 10, 12, 13, 15–23, 26–28, 32–52, 54–57, 59–63, 65–76, 78–82, 85, 86
AS	Autonomous System. 32
BS	Base Station. 4, 9, 10, 27
BSS	Basic Service Set. 36–38
BSSID	Basic Service Set Identifier. 15, 33, 37, 39, 65, 67, 68, 73
CoAP	Constrained Application Protocol. 46
EE	Energy Efficiency. 3, 8, 13, 20, 23, 24, 26
ESS	Extended Service Set. 36, 37
GPS	Global Positioning System. 44, 63, 65, 73
GSM	Global System for Mobile Communications. 1
ICT	Information and Communication Technology. 3
IoT	Internet of Things. 1
LTE	Long Term Evolution. 39
MAC	Medium Access Control. xiv, 8, 15, 48, 59, 67–70, 73
MIMO	Multiple Input Multiple Output. 8, 13



MT	Mobile Terminal. 4, 8
MU	Measurement Unit. 48, 50, 51
OPEX	Operating Expenditures. 3
PAPR	Peak-to-average Power Ratio. 3
PMK	pairwise master key. 38
PoE	Power over Ethernet. 12
PSM	Power Save Mode. 3, 8
QoE	Quality Of Experience. 19
QoS	Quality of Service. 10, 23, 24, 26–28, 36, 42, 79, 81, 82
RoD	Resource-On-Demand. 20
RPL	Routing Protocol for Low-Power and Lossy Networks. 46
RRM	Radio Resource Measurement. 35
RSSI	Receiving Signal Strength Indicator. 17, 37
SM	Sleep Mode. 16, 18, 22, 24, 26–28, 47, 48
SNR	Signal-to-Noise Ratio. 17
SSID	Service Set Identifier. 33, 37, 39, 48–51
STA	Station. 15, 35–38, 40, 42–46, 48, 49, 85
TCP	Transmit Power Control. 37
UE	User Equipment. 39
V2V	vehicle to vehicle. 1
VoIP	Voice Over IP. 24, 36
WiFi	Wireless Fidelity. xiv, 1, 2, 5, 9, 15, 16, 24, 31–33, 38, 39, 41–50, 52, 54–57, 78, 80, 85
WiMAX	Worldwide Interoperability for Microwave Access. 39

## ACRONYMS

WLAN	Wireless Local Area Network. 2, 5, 10, 12–15, 17–23, 26, 27, 31–34, 36, 38, 39, 60, 71
WN	Wireless Network. 1–3, 5, 7–10, 12–14, 17, 21, 24, 27, 32, 35
WPAN	Wireless Personal Area Network. 44
WSN	Wireless Sensor Network. 45



## ACRONYMS

# Bibliography

- [1] D. Shehadeh, N. Montavont, T. Kerdoncuff, and A. Blanc, “Minimal access point set in urban area wifi networks,” in *Modeling and Optimization in Mobile, Ad Hoc, and Wireless Networks (WiOpt), 2015 13th International Symposium on*. IEEE, 2015, pp. 221–228.
- [2] D. Shehadeh, T. Kerdoncuff, A. Blanc, and N. Montavont, “How to wake up an access point?” in *2016 Wireless Days (WD)*. IEEE, 2016, pp. 1–6.
- [3] N. Montavont, D. Shehadeh, J. Palicot, X. Lagrange, A. Blanc, R. Gribonval, P. Mary, J.-Y. Baudais, J.-F. Hélard, M. Crusière *et al.*, “Toward energy proportional networks,” in *Journées scientifiques, URSI 2016*, 2016.
- [4] L. Molina, T. Kerdoncuff, D. Shehadeh, N. Montavont, and A. Blanc, “WMSP: Bringing the wisdom of the crowd to wifi networks,” *Transactions on Mobile Computing*, 2017.
- [5] “Dartmouth collegewlan, <http://crowdad.cs.dartmouth.edu>.”
- [6] A. W. Tsui, W.-C. Lin, W.-J. Chen, P. Huang, and H.-H. Chu, “Accuracy Performance Analysis between War Driving and War Walking in Metropolitan Wi-Fi Localization,” *IEEE Transactions on Mobile Computing*, vol. 9, no. 11, pp. 1551–1562, Nov. 2010.
- [7] A. Achtzehn, L. Simic, P. Gronerth, and P. Mahonen, “Survey of iee 802.11 wi-fi deployments for deriving the spatial structure of opportunistic networks,” in *Personal Indoor and Mobile Radio Communications (PIMRC), 2013 IEEE 24th International Symposium on*. IEEE, 2013.
- [8] O. Philippot, “Les box adsl vont gaspiller 3 twh en 2012,” Feb. 28



- 2011, <http://www.greenit.fr>.
- [9] “Toward Energy Proportional Networks,” CominLabs Laboratoire d’Excellence, <http://www.tepn.cominlabs.ueb.eu/>.
- [10] C. V. Mobile, “Cisco visual networking index: global mobile data traffic forecast update, 2016–2021,” *San Jose, CA*, vol. 1, 2016.
- [11] K. Lee, J. Lee, Y. Yi, I. Rhee, and S. Chong, “Mobile data offloading: How much can wifi deliver?” *Networking, IEEE/ACM Transactions on*, vol. 21, no. 2, pp. 536–550, April 2013.
- [12] B. Han, P. Hui, V. Kumar, M. Marathe, J. Shao, and A. Srinivasan, “Mobile data offloading through opportunistic communications and social participation,” *Mobile Computing, IEEE Transactions on*, vol. 11, no. 5, pp. 821–834, May 2012.
- [13] A. Y. Ding, Y. Liu, S. Tarkoma, H. Flinck, H. Schulzrinne, and J. Crowcroft, “Vision: Augmenting WiFi Offloading with An Open-source Collaborative Platform,” in *6th International Workshop on Mobile Cloud Computing and Services*, ser. MCS ’15. New York, NY, USA: ACM, 2015, pp. 44–48.
- [14] “Number of wifi networks over time, <https://wicle.net/stats>.”
- [15] A. Arcia-Moret, L. Molina, N. Montavont, G. Castignani, and A. Blanc, “Access point discovery in 802.11 networks,” in *2014 IFIP Wireless Days (WD)*. IEEE, 2014, pp. 1–6.
- [16] G. Castignani, A. Lampropulos, A. Blanc, and N. Montavont, “Wi2me: a mobile sensing platform for wireless heterogeneous networks,” in *2012 32nd International Conference on Distributed Computing Systems Workshops*. IEEE, 2012, pp. 108–113.
- [17] Z. Vukanović, *Foreign Direct Investment Inflows Into the South East European Media Market: Towards a Hybrid Business Model*. Springer, 2016.
- [18] “Wifi growth map, <https://www.ipass.com/wifi-growth-map>.”
- [19] N.-H. Lee and S. Bahk, “Mac sleep mode control considering

## BIBLIOGRAPHY

- downlink traffic pattern and mobility,” in *2005 IEEE 61st Vehicular Technology Conference*, vol. 3. IEEE, 2005, pp. 2076–2080.
- [20] S. Alanara, J. Ranta, H. Pirila, and H. Jokinen, “Mobile station having enhanced standby mode,” May 23 2000, uS Patent 6,067,460.
- [21] I. Haratcherev, M. Fiorito, and C. Balageas, “Low-power sleep mode and out-of-band wake-up for indoor access points,” in *GLOBECOM Workshops*, 2009, pp. 1–6.
- [22] G. Auer, V. Giannini, C. Desset, I. Godor, P. Skillermark, M. Olsson, M. A. Imran, D. Sabella, M. J. Gonzalez, O. Blume *et al.*, “How much energy is needed to run a wireless network?” *Wireless Communications, IEEE*, vol. 18, no. 5, pp. 40–49, 2011.
- [23] C. Xiong, G. Y. Li, S. Zhang, Y. Chen, and S. Xu, “Energy-efficient resource allocation in ofdma networks,” *IEEE Transactions on Communications*, vol. 60, no. 12, pp. 3767–3778, 2012.
- [24] M. Chaffi, J. Palicot, and R. Gribonval, “Closed-form approximations of the peak-to-average power ratio distribution for multi-carrier modulation and their applications,” *EURASIP Journal on Advances in Signal Processing*, vol. 2014, no. 1, p. 121, 2014.
- [25] E. Björnson, L. Sanguinetti, and M. Kountouris, “Deploying dense networks for maximal energy efficiency: Small cells meet massive mimo,” *IEEE Journal on Selected Areas in Communications*, vol. 34, no. 4, pp. 832–847, 2016.
- [26] L. Suárez, L. Nuaymi, and J.-M. Bonnin, “Energy-efficient bs switching-off and cell topology management for macro/femto environments,” *Computer Networks*, vol. 78, pp. 182–201, 2015.
- [27] A. Bousia, E. Kartsakli, L. Alonso, and C. Verikoukis, “Dynamic energy efficient distance-aware base station switch on/off scheme for lte-advanced,” in *Global Communications Conference*

- (*GLOBECOM*), *2012 IEEE*. IEEE, 2012, pp. 1532–1537.
- [28] J. Rubio, A. Pascual-Iserte, J. del Olmo Alos, and J. Vidal, “Dynamic base station switch on/off strategies for sustainable wireless networks,” in *Signal Processing Advances in Wireless Communications (SPAWC), 2014 IEEE 15th International Workshop on*. IEEE, 2014, pp. 289–293.
- [29] A. J. Pyles, X. Qi, G. Zhou, M. Keally, and X. Liu, “Sapsm: Smart adaptive 802.11 psm for smartphones,” in *Proceedings of the 2012 ACM conference on ubiquitous computing*. ACM, 2012, pp. 11–20.
- [30] K.-Y. Jang, S. Hao, A. Sheth, and R. Govindan, “Snooze: Energy Management in 802.11n WLANs,” in *Proceedings of the Seventh Conference on Emerging Networking EXperiments and Technologies*, ser. CoNEXT. ACM, 2011.
- [31] A. W. T. Tsui, W.-C. Lin, W.-J. Chen, P. Huang, and H.-H. Chu, “Accuracy performance analysis between war driving and war walking in metropolitan wi-fi localization,” *IEEE Transactions on Mobile Computing*, vol. 9, no. 11, pp. 1551–1562, 2010.
- [32] C. V. Mobile, “Cisco visual networking index: global mobile data traffic forecast update, 2015–2020,” *San Jose, CA*, vol. 1, 2016.
- [33] P. Willars, “Variable sleep mode for mobile stations in a mobile communications,” Nov. 12 2002, uS Patent 6,480,476.
- [34] J. Lindskog, G. Malmgren, L. Almhag, F. Wenger, J. Ebenhard, and U. Hansson, “Method to put a mobile terminal into sleep when a frame control channel containing a location of slow broadcast channel does not include wakeup information,” Sep. 16 2003, uS Patent 6,622,251.
- [35] L. Budzisz, F. Ganji, G. Rizzo, M. A. Marsan, M. Meo, Y. Zhang, G. Koutitas, L. Tassiulas, S. Lambert, B. Lannoo *et al.*, “Dynamic resource provisioning for energy efficiency in wireless access networks: A survey and an outlook,” *Communi-*



## BIBLIOGRAPHY

- cations Surveys & Tutorials, IEEE*, vol. 16, no. 4, pp. 2259–2285, 2014.
- [36] A. De Domenico, E. C. Strinati, and A. Capone, “Enabling green cellular networks: A survey and outlook,” *Computer Communications*, vol. 37, pp. 5–24, 2014.
- [37] J. Wu, Y. Zhang, M. Zukerman, and E. K.-N. Yung, “Energy-efficient base-stations sleep-mode techniques in green cellular networks: A survey,” *Communications Surveys & Tutorials, IEEE*, vol. 17, no. 2, pp. 803–826, 2015.
- [38] Y. Zhang, L. Budzisz, M. Meo, A. Conte, I. Haratcherev, G. Koutitas, L. Tassiulas, M. A. Marsan, and S. Lambert, “An overview of energy-efficient base station management techniques,” in *Digital Communications-Green ICT (TIWDC), 2013 24th Tyrrhenian International Workshop on*. IEEE, 2013, pp. 1–6.
- [39] O. Arnold, F. Richter, G. Fettweis, and O. Blume, “Power consumption modeling of different base station types in heterogeneous cellular networks,” in *2010 Future Network & Mobile Summit*. IEEE, 2010, pp. 1–8.
- [40] J. Wu, S. Zhou, and Z. Niu, “Traffic-aware base station sleeping control and power matching for energy-delay tradeoffs in green cellular networks,” *IEEE Transactions on Wireless Communications*, vol. 12, no. 8, pp. 4196–4209, 2013.
- [41] B. Rengarajan, G. Rizzo, and M. A. Marsan, “Energy-optimal base station density in cellular access networks with sleep modes,” *Computer Networks*, vol. 78, pp. 152–163, 2015.
- [42] M. Li, P. Li, X. Huang, Y. Fang, and S. Glisic, “Energy consumption optimization for multihop cognitive cellular networks,” *IEEE Transactions on Mobile Computing*, vol. 14, no. 2, pp. 358–372, 2015.
- [43] A. Mukherjee, S. Bhattacharjee, S. Pal, and D. De, “Femtocell

- based green power consumption methods for mobile network,” *Computer Networks*, vol. 57, no. 1, pp. 162–178, 2013.
- [44] H. A. H. Hassan, A. Ali, L. Nuaymi, and S. E. Elayoubi, “Renewable energy usage in the context of energy-efficient mobile network,” in *2015 IEEE 81st Vehicular Technology Conference (VTC Spring)*. IEEE, 2015, pp. 1–7.
- [45] A. M. Aris and B. Shabani, “Sustainable power supply solutions for off-grid base stations,” *Energies*, vol. 8, no. 10, pp. 10 904–10 941, 2015.
- [46] V. Sivaraman, J. Matthews, C. Russell, S. T. Ali, and A. Vishwanath, “Greening residential wi-fi networks under centralized control,” *Mobile Computing, IEEE Transactions on*, vol. 14, no. 3, pp. 552–564, 2015.
- [47] A. Banerjee, C. H. Foh, C. K. Yeo, and B. S. Lee, “A network lifetime aware cooperative MAC scheme for 802.11b wireless networks,” in *Consumer Communications and Networking Conference (CCNC)*. IEEE, 2010.
- [48] H. Holma and A. Toskala, *LTE for UMTS-OFDMA and SC-FDMA based radio access*. John Wiley & Sons, 2009.
- [49] V. Baiamonte and C.-F. Chiasserini, “Saving energy during channel contention in 802.11 wlans,” *Mobile Networks and Applications*, vol. 11, no. 2, pp. 287–296, 2006.
- [50] M. Ergen and P. Varaiya, “Decomposition of energy consumption in ieee 802.11,” in *2007 IEEE International Conference on Communications*. IEEE, 2007, pp. 403–408.
- [51] M. M. Carvalho, C. B. Margi, K. Obraczka, and J. Garcia-Luna-Aceves, “Modeling energy consumption in single-hop ieee 802.11 ad hoc networks,” in *Computer Communications and Networks, 2004. ICCCN 2004. Proceedings. 13th International Conference on*. IEEE, 2004, pp. 367–372.
- [52] R. G. Garroppo, G. Nencioni, G. Procissi, and L. Tavanti, “The

## BIBLIOGRAPHY

- impact of the access point power model on the energy-efficient management of infrastructured wireless lans,” *Computer Networks*, 2015.
- [53] G. Palem and S. Tozlu, “On energy consumption of wi-fi access points,” in *2012 IEEE Consumer Communications and Networking Conference (CCNC)*. IEEE, 2012, pp. 434–438.
- [54] A. Murabito, “A comparison of efficiency, throughput, and energy requirements of wireless access points,” University of New Hampshire, InterOperability Laboratory, Tech. Rep., 2009.
- [55] W. Sun, H. Li, and J. Wu, “Study on real energy consumption of large-scale campus wireless network,” in *Computing, Networking and Communications (ICNC), 2013 International Conference on*. IEEE, 2013, pp. 605–609.
- [56] S. Chiaravalloti, F. Idzikowski, and L. Budzisz, “Power consumption of wlan network elements,” *Tech. Univ. Berlin, Tech. Rep. TKN-11-002*, 2011.
- [57] K. Gomez, R. Riggio, T. Rasheed, and F. Granelli, “Analysing the energy consumption behaviour of wifi networks,” in *Online Conference on Green Communications (GreenCom), 2011 IEEE*. IEEE, 2011, pp. 98–104.
- [58] “Watts Up? Plug Load Meters,” [www.wattsupmeters.com](http://www.wattsupmeters.com).
- [59] M. Ö. Demir, G. K. Kurt, and M. Karaca, “An energy consumption model for 802.11 ac access points,” in *Software, Telecommunications and Computer Networks (SoftCOM), 2014 22nd International Conference on*. IEEE, 2014, pp. 67–71.
- [60] B. Sikdar, “Environmental impact of ieee 802.11 access points: A case study,” *ACM SIGMETRICS Performance Evaluation Review*, vol. 38, no. 3, pp. 66–70, 2011.
- [61] B. Ogilvie, “Clock solutions for wifi (ieee 802.11),” *Saronix (tm) application note*, 2003.
- [62] J. Trachewsky, A. Rofougaran, A. Behzad, T. Robinson, and

- E. Frank, "Broadcom wlan chipset for 802.11 a/b/g," *Broadcom Corporation, CA, USA*, 2003.
- [63] C. Liu, Y. Wan, L. Tian, Y. Zhou, and J. Shi, "Base station sleeping control with energy-stability tradeoff in centralized radio access networks," in *2015 IEEE Global Communications Conference (GLOBECOM)*. IEEE, 2015, pp. 1–6.
- [64] G. Li, S. Jin, F. Zheng, X. Gao, and X. Wang, "Dynamic base station sleeping scheme for potential super density networks," in *Wireless Communications & Signal Processing (WCSP), 2013 International Conference on*. IEEE, 2013, pp. 1–5.
- [65] G. Wu, G. Feng, and S. Qin, "Cooperative sleep-mode and performance modeling for heterogeneous mobile network," in *Wireless Communications and Networking Conference Workshops (WCNCW), 2013 IEEE*. IEEE, 2013, pp. 6–11.
- [66] J. Wu, S. Jin, L. Jiang, and G. Wang, "Dynamic switching off algorithms for pico base stations in heterogeneous cellular networks," *EURASIP Journal on Wireless Communications and Networking*, vol. 2015, no. 1, pp. 1–18, 2015.
- [67] A. Bousia, A. Antonopoulos, L. Alonso, and C. Verikoukis, "green" distance-aware base station sleeping algorithm in lte-advanced," in *Communications (ICC), 2012 IEEE International Conference on*. IEEE, 2012, pp. 1347–1351.
- [68] M. A. Yigitel, O. D. Incel, and C. Ersoy, "Qos vs. energy: A traffic-aware topology management scheme for green heterogeneous networks," *Computer Networks*, vol. 78, pp. 130–139, 2015.
- [69] M. H. Alsharif, R. Nordin, and M. Ismail, "Cooperation management among base stations based on cells switch-off for a green lte cellular network," *Wireless Personal Communications*, vol. 81, no. 1, pp. 303–318, 2015.
- [70] E. Oh and B. Krishnamachari, "Energy savings through dynamic

## BIBLIOGRAPHY

- base station switching in cellular wireless access networks,” in *Global Telecommunications Conference (GLOBECOM 2010), 2010 IEEE*. IEEE, 2010, pp. 1–5.
- [71] S. Samarakoon, M. Bennis, W. Saad, and M. Latva-aho, “Dynamic clustering and on/off strategies for wireless small cell networks,” *IEEE Transactions on Wireless Communications*, vol. 15, no. 3, pp. 2164–2178, 2016.
- [72] L. Al-Kanj, W. El-Beaino, A. M. El-Hajj, and Z. Dawy, “Optimized joint cell planning and bs on/off switching for lte networks,” *Wireless Communications and Mobile Computing*, 2015.
- [73] A. S. Alam, L. S. Dooley, and A. S. Poulton, “Traffic-and-interference aware base station switching for green cellular networks,” in *Computer Aided Modeling and Design of Communication Links and Networks (CAMAD), 2013 IEEE 18th International Workshop on*. IEEE, 2013, pp. 63–67.
- [74] M. M. Raikar, P. Doddagoudar, and M. S. Maralapannavar, “An algorithmic perspective of base station switching in dense cellular networks,” in *Eco-friendly Computing and Communication Systems (ICECCS), 2014 3rd International Conference on*. IEEE, 2014, pp. 177–182.
- [75] R. Wang, J. S. Thompson, H. Haas, and P. M. Grant, “Sleep mode design for green base stations,” *Communications, IET*, vol. 5, no. 18, pp. 2606–2616, 2011.
- [76] J. Zheng, Y. Cai, X. Chen, R. Li, and H. Zhang, “Optimal base station sleeping in green cellular networks: A distributed cooperative framework based on game theory,” *Wireless Communications, IEEE Transactions on*, vol. 14, no. 8, pp. 4391–4406, 2015.
- [77] M. Oikonomakou, A. Antonopoulos, L. Alonso, and C. Verikoukis, “Cooperative base station switching off in multi-operator shared heterogeneous network,” in *2015 IEEE Global Communications Conference (GLOBECOM)*. IEEE, 2015, pp. 1–6.

- [78] Q. Wang and J. Zheng, “A distributed base station on/off control mechanism for energy efficiency of small cell networks,” in *2015 IEEE International Conference on Communications (ICC)*. IEEE, 2015, pp. 3317–3322.
- [79] J. Yang, X. Zhang, and W. Wang, “Two-stage base station sleeping scheme for green cellular networks,” *Journal of Communications and Networks*, vol. 18, no. 4, pp. 600–609, 2016.
- [80] X. Guo, Z. Niu, S. Zhou, and P. Kumar, “Delay-constrained energy-optimal base station sleeping control,” *IEEE Journal on Selected Areas in Communications*, vol. 34, no. 5, pp. 1073–1085, 2016.
- [81] A. P. Jardosh, G. Iannaccone, K. Papagiannaki, and B. Vinnakota, “Towards an energy-star wlan infrastructure,” in *Mobile Computing Systems and Applications, 2007. HotMobile 2007. Eighth IEEE Workshop on*. IEEE, 2007, pp. 85–90.
- [82] A. P. Jardosh, K. Papagiannaki, E. M. Belding, K. C. Almeroth, G. Iannaccone, and B. Vinnakota, “Green w lans: on-demand wlan infrastructures,” *Mobile Networks and Applications*, vol. 14, no. 6, pp. 798–814, 2009.
- [83] Y. Lu, X. Tan, Y. Mo, and L. Ma, “A new green clustering algorithm for energy efficiency in high-density w lans,” *KSII Transactions on Internet and Information Systems (TIIS)*, vol. 8, no. 2, pp. 326–354, 2014.
- [84] ———, “Green clustering implementation based on dps-mopso,” *Mathematical Problems in Engineering*, vol. 2014, 2014.
- [85] R. Nagareda, A. Hasegawa, T. Shibata, and S. Obana, “A proposal of power saving scheme for wireless access networks with access point sharing,” in *Computing, Networking and Communications (ICNC), 2012 International Conference on*. IEEE, 2012, pp. 1128–1132.
- [86] J. Lorincz, A. Capone, and M. Bogarelli, “Energy savings in

## BIBLIOGRAPHY

- wireless access networks through optimized network management,” in *Wireless Pervasive Computing (ISWPC), 2010 5th IEEE International Symposium on*. IEEE, 2010, pp. 449–454.
- [87] J. Lorincz, A. Capone, and D. Begušić, “Optimized network management for energy savings of wireless access networks,” *Computer Networks*, vol. 55, no. 3, pp. 514–540, 2011.
- [88] T. Tanaka, K. Abe, S. Aust, T. Ito, H. Yomo, and S. Sakata, “Automatic and cooperative sleep control strategies for power-saving in radio-on-demand wlans,” in *Green Technologies Conference, 2013 IEEE*. IEEE, 2013, pp. 293–300.
- [89] X. Gong, J. Trogh, Q. Braet, E. Tanghe, P. Singh, D. Plets, J. Hoebeke, D. Deschrijver, T. Dhaene, L. Martens *et al.*, “Measurement-based wireless network planning, monitoring, and reconfiguration solution for robust radio communications in indoor factories,” *IET Science, Measurement & Technology*, 2016.
- [90] F. G. Debele, N. Li, M. Meo, M. Ricca, and Y. Zhang, “Experimenting resourceon-demand strategies for green wlans,” *ACM SIGMETRICS Performance Evaluation Review*, vol. 42, no. 3, pp. 61–66, 2014.
- [91] F. G. Debele, M. Meo, D. Renga, M. Ricca, and Y. Zhang, “Designing resource-on-demand strategies for dense wlans,” *Selected Areas in Communications, IEEE Journal on*, vol. 33, no. 12, pp. 2494–2509, 2015.
- [92] M. A. Marsan and M. Meo, “Queueing systems to study the energy consumption of a campus wlan,” *Computer Networks*, vol. 66, pp. 82–93, 2014.
- [93] C. Donato, “Analysis and implementation of an infrastructure-on-demand scheme for 802.11 wlans,” Ph.D. dissertation, Universidad Carlos III de Madrid, 2015.
- [94] F. Ganji, L. Budzisz, and A. Wolisz, “Assessment of the power saving potential in dense enterprise wlans,” in *Personal Indoor*



- and Mobile Radio Communications (PIMRC), 2013 IEEE 24th International Symposium on.* IEEE, 2013, pp. 2835–2840.
- [95] F. Ganji, Ł. Budzisz, F. G. Debele, N. Li, M. Meo, M. Ricca, Y. Zhang, and A. Wolisz, “Greening campus wlans: Energy-relevant usage and mobility patterns,” *Computer Networks*, vol. 78, pp. 164–181, 2015.
- [96] I. Foche-Pérez, J. Simó-Reigadas, I. Prieto-Egido, E. Morgado, and A. Martínez-Fernández, “A dual ieee 802.11 and ieee 802.15–4 network architecture for energy-efficient communications with low-demanding applications,” *Ad Hoc Networks*, vol. 37, pp. 337–353, 2016.
- [97] C. Rossi, C. Casetti, C.-F. Chiasserini, and C. Borgiattino, “Cooperative energy-efficient management of federated wifi networks,” *Mobile Computing, IEEE Transactions on*, vol. 14, no. 11, pp. 2201–2215, 2015.
- [98] B. Balaji, B. R. Tamma, and B. Manoj, “A novel power saving strategy for greening ieee 802.11 based wireless networks,” in *Global Telecommunications Conference (GLOBECOM 2010), 2010 IEEE*. IEEE, 2010, pp. 1–5.
- [99] A. P. C. Da Silva, M. Meo, and M. A. Marsan, “Energy-performance trade-off in dense wlans: A queuing study,” *Computer Networks*, vol. 56, no. 10, pp. 2522–2537, 2012.
- [100] M. E. Islam, N. Funabiki, and T. Nakanishi, “Extensions of access-point aggregation algorithm for large-scale wireless local area networks,” *International Journal of Networking and Computing*, vol. 5, no. 1, pp. 200–222, 2015.
- [101] M. Lin, Z. Xiuming, Q. Danyang, and L. Yang, “Green ap dynamic and adaptive control algorithm,” in *Instrumentation and Measurement, Computer, Communication and Control (IMCCC), 2014 Fourth International Conference on.* IEEE, 2014, pp. 299–305.



## BIBLIOGRAPHY

- [102] K. Kumazoe, D. Nobayashi, Y. Fukuda, and T. Ikenaga, “Station aggregation scheme considering channel interference for radio on demand networks,” in *Communications, Computers and Signal Processing (PACRIM), 2013 IEEE Pacific Rim Conference on*. IEEE, 2013, pp. 265–270.
- [103] K. Kumazoe, D. Nobayashi, Y. Fukuda, T. Ikenaga, and K. Abe, “Multiple station aggregation procedure for radio-on-demand wlans,” in *Broadband, Wireless Computing, Communication and Applications (BWCCA), 2012 Seventh International Conference on*. IEEE, 2012, pp. 156–161.
- [104] F. Hutu, A. Khoumeri, G. Villemaud, and J.-M. Gorce, “Wake-up radio architecture for home wireless networks,” in *Radio and Wireless Symposium (RWS)*. IEEE, 2014.
- [105] T. Jin, G. Noubir, and B. Sheng, “WiZi-Cloud: Application-transparent dual ZigBee-WiFi radios for low power internet access,” in *INFOCOM*. IEEE, 2011.
- [106] Y. Agarwal, T. Pering, R. Want, and R. Gupta, “Switchr: Reducing system power consumption in a multi-client, multi-radio environment,” in *Wearable Computers, 2008. ISWC 2008. 12th IEEE International Symposium on*. IEEE, 2008.
- [107] T. Pering, Y. Agarwal, R. Gupta, and R. Want, “Coolspots: reducing the power consumption of wireless mobile devices with multiple radio interfaces,” in *Proceedings of the 4th international conference on Mobile systems, applications and services*. ACM, 2006.
- [108] Y. Agarwal, S. Hodges, R. Chandra, J. Scott, P. Bahl, and R. Gupta, “Somniloquy: Augmenting network interfaces to reduce pc energy usage.” in *NSDI*, vol. 9, 2009.
- [109] F. Saito, H. Yomo, K.-i. Abe, and A. Hasegawa, “A probability-based wake-up mechanism for radio-on-demand wireless lan,” in *Personal Indoor and Mobile Radio Communications (PIMRC), 2013 IEEE 24th International Symposium on*. IEEE, 2013, pp.

- 2120–2124.
- [110] H. Yomo, Y. Kondo, N. Miyamoto, S. Tang, M. Iwai, and T. Ito, “Receiver design for realizing on-demand wifi wake-up using wlan signals,” in *Global Communications Conference (GLOBECOM)*. IEEE, 2012.
  - [111] H. Yomo, Y. Kondo, K. Namba, S. Tang, T. Kimura, and T. Ito, “Wake-up id and protocol design for radio-on-demand wireless lan,” in *Personal Indoor and Mobile Radio Communications (PIMRC), 2012 IEEE 23rd International Symposium on*. IEEE, 2012, pp. 419–424.
  - [112] N. Mishra, K. Chebrolu, B. Raman, and A. Pathak, “Wake-on-wlan,” in *Proceedings of the 15th international conference on World Wide Web*. ACM, 2006, pp. 761–769.
  - [113] N. Mishra, D. Golcha, A. Bhadauria, B. Raman, and K. Chebrolu, “S-wow: Signature based wake-on-wlan,” in *Communication Systems Software and Middleware, 2007. COMSWARE 2007. 2nd International Conference on*, Jan 2007.
  - [114] A. Dudnikova, P. Dini, L. Giupponi, and D. Panno, “Multi-criteria decision for small cell switch off in ultra-dense lte networks,” in *Telecommunications (ConTEL), 2015 13th International Conference on*. IEEE, 2015, pp. 1–8.
  - [115] M. A. Marsan, L. Chiaraviglio, D. Ciullo, and M. Meo, “A simple analytical model for the energy-efficient activation of access points in dense wlans,” in *Proceedings of the 1st International Conference on Energy-Efficient Computing and Networking*. ACM, 2010, pp. 159–168.
  - [116] V. S. Kumar and K. R. Kumar, “Greening resource provisioning and role of communication systems in wi-fi networks,” *International Journal of Emerging Trends in Science and Technology*, vol. 2, no. 03, 2015.
  - [117] Z. Niu, Y. Wu, J. Gong, and Z. Yang, “Cell zooming for cost-

## BIBLIOGRAPHY

- efficient green cellular networks,” *Communications Magazine, IEEE*, vol. 48, no. 11, pp. 74–79, 2010.
- [118] J.-W. Yoo and K. H. Park, “A cooperative clustering protocol for energy saving of mobile devices with wlan and bluetooth interfaces,” *Mobile Computing, IEEE Transactions on*, vol. 10, no. 4, pp. 491–504, 2011.
- [119] W. Vereecken, I. Haratcherev, M. Deruyck, W. Joseph, M. Pickavet, L. Martens, and P. Demeester, “The effect of variable wake up time on the utilization of sleep modes in femtocell mobile access networks,” in *2012 9th Annual Conference on Wireless On-Demand Network Systems and Services (WONS)*, Jan 2012, pp. 63–66.
- [120] A. P. Bianzino, A. K. Raju, and D. Rossi, “Apples-to-apples: a framework analysis for energy-efficiency in networks,” *ACM SIGMETRICS Performance Evaluation Review*, vol. 38, no. 3, pp. 81–85, 2011.
- [121] R. Combes, S. E. Elayoubi, A. Ali, L. Saker, and T. Chahed, “Optimal online control for sleep mode in green base stations,” *Computer Networks*, vol. 78, pp. 140–151, 2015.
- [122] M. Andriani, M. Irhamsyah *et al.*, “Analysis of energy efficiency for wi-fi 802.11 b multi-hop networks,” in *Communication, Networks and Satellite (COMNETSAT), 2013 IEEE International Conference on*. IEEE, 2013, pp. 64–68.
- [123] B. Bellalta, L. Bononi, R. Bruno, and A. Kassler, “Next generation ieee 802.11 wireless local area networks: Current status, future directions and open challenges,” *Computer Communications*, 2015.
- [124] M. Meo, E. Le Rouzic, R. Cuevas, and C. Guerrero, “Research challenges on energy-efficient networking design,” *Computer Communications*, vol. 50, pp. 187–195, 2014.
- [125] L. Suárez, L. Nuaymi, and J.-M. Bonnin, “An overview and

- classification of research approaches in green wireless networks,” *Eurasip journal on wireless communications and networking*, vol. 2012, no. 1, p. 142, 2012.
- [126] S.-E. Elayoubi, L. Saker, and T. Chahed, “Optimal control for base station sleep mode in energy efficient radio access networks,” in *INFOCOM, 2011 Proceedings IEEE*. IEEE, 2011, pp. 106–110.
- [127] G. Micallef, P. Mogensen, and H.-O. Scheck, “Cell size breathing and possibilities to introduce cell sleep mode,” in *Wireless Conference (EW), 2010 European*. IEEE, 2010, pp. 111–115.
- [128] J. Gong, S. Zhou, Z. Niu, and P. Yang, “Traffic-aware base station sleeping in dense cellular networks,” in *Quality of Service (IWQoS), 2010 18th International Workshop on*. IEEE, 2010, pp. 1–2.
- [129] L. Saker and S. E. Elayoubi, “Sleep mode implementation issues in green base stations,” in *21st Annual IEEE International Symposium on Personal, Indoor and Mobile Radio Communications*, Sept 2010, pp. 1683–1688.
- [130] S. Dawoud, A. Uzun, S. Göndör, and A. Küpper, “Optimizing the power consumption of mobile networks based on traffic prediction,” in *2014 IEEE 38th Annual Computer Software and Applications Conference*, July 2014, pp. 279–288.
- [131] I. S. Association *et al.*, “802.11-2012-IEEE Standard for Information technology. Telecommunications and information exchange between systems, Local and metropolitan area networks, Specific requirements. Part 11: Wireless LAN Medium Access Control (MAC) and Physical Layer (PHY) Specifications,” *IEEE Std 802.11<sup>TM</sup>-2012*, pp. 1–2793, March 2012.
- [132] ———, “IEEE Standard for Information technology. Local and metropolitan area networks, Specific requirements, Part 11: Wireless LAN Medium Access Control (MAC) and Physical Layer (PHY) Specifications. Amendment 1: Radio Resource

## BIBLIOGRAPHY

- Measurement of Wireless LANs,” *IEEE Std 802.11k<sup>TM</sup>-2008 (Amendment to IEEE Std 802.11-2007)*, pp. 1–244, June 2008.
- [133] —, “IEEE Standard for Information Technology, Telecommunications and Information Exchange Between Systems, Local and Metropolitan Area Networks, Specific Requirements. Part 11: Wireless LAN Medium Access Control (MAC) and Physical Layer (PHY) Specifications. Amendment 2: Fast Bss Transition,” *IEEE Std 802.11r<sup>TM</sup>-2008 (Amendment to IEEE Std 802.11-2007)*, Jan. 2008.
- [134] —, “IEEE Standard for Information Technology, Telecommunications and information exchange between systems, Local and Metropolitan networks, Specific requirements; Part II: Wireless LAN Medium Access Control (MAC) and Physical Layer (PHY) specifications. Amendment 9: Interworking with External Networks,” *IEEE Std 802.11u<sup>TM</sup>-2011 (Amendment to IEEE Std 802.11-2007)*, pp. 1–208, Feb.
- [135] —, *IEEE Std 802.21-2017 (Revision of IEEE Std 802.21-2008 as amended by IEEE Std 802.21a-2012, IEEE Std 802.21b-2012, IEEE Std 802.21c-2014, and IEEE Std 802.21d-2015) - Redline, title=IEEE Standard for Local and metropolitan area networks—Part 21: Media Independent Services Framework*, pp. 1–747, April 2017.
- [136] “3GPP TS 24.312, 3rd Generation Partnership Project ; Access Network Discovery and Selection Function (ANDSF) Management Object (MO),” Tech. Rep., Sep. 2016, Release 13, V13.4.0.
- [137] A. Achtzehn, L. Simic, M. Petrova, and P. Mahonen, “Ieee 802.11 wi-fi access point density estimation with capture-recapture models,” in *Computing, Networking and Communications (ICNC), 2015 International Conference on*. IEEE, 2015, pp. 153–159.
- [138] G. Castignani, A. Blanc, A. Lampropulos, and N. Montavont, “Urban 802.11 community networks for mobile users: Current

## BIBLIOGRAPHY

- deployments and prospectives,” *Mobile networks and applications*, vol. 17, no. 6, pp. 796–807, 2012.
- [139] T. H. Cormen, *Introduction to algorithms*. MIT press, 2009.
- [140] G. Brassard and P. Bratley, *Fundamentals of algorithmics*. Prentice-Hall, Inc., 1996.



Notre travail s'inscrit dans le cadre des recherches sur le Sleeping mode. Notre contribution est structurée principalement autour deux axes : l'étude et l'évaluation de la performance des processus de mise en veille/réveil des points d'accès et la sélection du nombre minimal des points d'accès dans un milieu urbain dense. Dans un premier temps, nous étudions les processus de mise en veille/réveil des points d'accès dans un scénario classique de réseau domestique. Ce scénario suppose que le point d'accès mis en veille doit détecter la présence d'un utilisateur potentiel dans sa zone de couverture et réagir par conséquent d'une façon autonome pour se mettre en état de fonctionnement normal. Nous avons choisi quatre processus de réveil du point d'accès, et nous avons ensuite étudié chacun de ces processus, et proposé un protocole de communication qui permette à un utilisateur d'envoyer l'ordre au point d'accès de s'éteindre. Lorsque cela était possible, nous avons utilisé le protocole COAP qui est prévu pour établir des sessions de commande pour l'Internet des Objets. Nous avons ensuite mesuré les performances du point de vue de l'économie d'énergie qu'il permet de réaliser et du délai entre le moment où un utilisateur potentiel est détecté et le moment où le point d'accès devient opérationnel.

Nous avons aussi étudié un réseau dense dans un milieu urbain (le centre ville de Rennes) où la zone de couverture d'un point d'accès pouvait être partiellement ou totalement couverte par d'autres points d'accès. Pour évaluer la redondance dans le réseau, nous avons collecté des informations réelles sur les points d'accès en utilisant l'application Wi2Me. Le traitement de ces informations nous a permis d'identifier les points d'accès existants dans la zone étudiée et leurs zones de couverture respectives démontrant ainsi la superposition de ces zones de couverture et le potentiel d'élimination d'un certain nombre de points d'accès sans affecter la couverture globale. Nous avons alors proposé un système centralisé qui collecte les données de couverture des points d'accès observée par les utilisateurs. Nous avons donc utilisé ce simple fait pour centraliser la vue du réseau de plusieurs utilisateurs, ce qui permet d'avoir une vue assez précise de la disponibilité des points d'accès dans une zone géographique. Nous avons alors proposé une représentation de ces données de couverture à travers des matrices qui traitent les différentes erreurs de capture (coordonnées GPS non précises, réutilisation des noms de réseaux, etc).

Enfin, nous avons ensuite proposé deux algorithmes permettant de sélectionner l'ensemble minimal des points d'accès requis fournissant une couverture identique à celle d'origine..

**Mots clefs :** Réseaux d'accès sans-fil, Réseaux locaux sans-fil, Consommation d'énergie, IEEE 802.11, Efficacité énergétique

The main goal of the thesis is to design an Energy Proportional Network by taking intelligent decisions into the network such as switching on and off network components in order to adapt the energy consumption to the user needs. Our work mainly focuses on reducing the energy consumption by adapting the number of APs that are operating to the actual user need. In fact, traffic load varies a lot during the day. Traffic is high in urban areas and low in the suburb during day work hours, while it is the opposite at night. Often, peak loads during rush hours are lower than capacities of the networks. Thus they remain lightly utilized for long periods of time. Thus keeping all APs active all the time even when the traffic is low causes a huge waste of energy. Our goal is to benefit from low traffic periods by automatically switch off redundant cells, taking into consideration the actual number of users, their traffic and the bandwidth requested to serve them. Ideally we wish to do so while maintaining reliable service coverage for existing and new coming users.

First we consider a home networking scenario. In this case only one AP covers a given area. So when this AP is switched off (when no users are present), there will be no other AP to fill the gap of coverage. Moreover, upon the arrival of new users, no controller or other mechanism exists to wake up the AP. Consequently, new arriving users would not be served and would remain out of coverage. The study of the state of the art allowed us to have a clear overview of the existing approaches in this context. As a result, we designed a platform to investigate different methods to wake up an AP using different technologies. We measure two metrics to evaluate the Switching ON/OFF process for the different methods. The first is the energy consumed by the AP during the three phases it goes through. The second is the delay of time for the AP to wake up and be operational to serve the new users.

In the second case we consider a dense network such as the ones found in urban cities, where the coverage area of an AP is also covered by several other APs. In other words, the gap resulting from switching off one or several APs can be covered by other neighbouring ones. Thus the first thing to do was to evaluate the potential of switching off APs using real measurements taken in a dense urban area. Based on this collected information, we evaluate how many APs can be switched off while maintaining the same coverage. To this end, we propose two algorithms that select the minimum set of APs needed to provide full coverage. We compute several performance parameters, and evaluate the proposed algorithms in terms of the number of selected APs, and the coverage they provide.

**Keywords:** Sleeping Mode, Green wireless networks, power consumption, Energy efficiency, WLAN, IEEE 802.11, Traffic measurements