



HAL
open science

Intersection theory of spaces of holomorphic and meromorphic differentials

Adrien Sauvaget

► **To cite this version:**

Adrien Sauvaget. Intersection theory of spaces of holomorphic and meromorphic differentials. Functional Analysis [math.FA]. Université Pierre et Marie Curie - Paris VI, 2017. English. NNT: 2017PA066460 . tel-01795154

HAL Id: tel-01795154

<https://theses.hal.science/tel-01795154>

Submitted on 18 May 2018

HAL is a multi-disciplinary open access archive for the deposit and dissemination of scientific research documents, whether they are published or not. The documents may come from teaching and research institutions in France or abroad, or from public or private research centers.

L'archive ouverte pluridisciplinaire **HAL**, est destinée au dépôt et à la diffusion de documents scientifiques de niveau recherche, publiés ou non, émanant des établissements d'enseignement et de recherche français ou étrangers, des laboratoires publics ou privés.

Université Pierre et Marie Curie



École doctorale de sciences mathématiques de Paris centre

THÈSE DE DOCTORAT

Discipline : Mathématiques

présentée par

Adrien SAUVAGET

Théorie de l'intersection sur les espaces de différentielles holomorphes et méromorphes

dirigée par Alessandro CHIODO et Dimitri ZVONKINE

Soutenue le 30 novembre 2017 devant le jury composé de :

M. Alessandro CHIODO	Institut de mathématiques de Jussieu	directeur
M. Gavril FARKAS	Humboldt-Universität zu Berlin	examinateur
M. Erwan LANNEAU	Institut Fourier - Université de Grenoble I	examinateur
Mme. Ariane MÉZARD	Institut de mathématiques de Jussieu	examinatrice
M. Alexander POLISHCHUK	University of Oregon	rapporteur
M. Dimitri ZVONKINE	Institut de mathématiques de Jussieu	directeur

Au vu des rapports de :

M. Rahul PANDHARIPANDE ETH Zürich
M. Alexander POLISHCHUK University of Oregon

Institut de mathématiques de
Jussieu-Paris Rive gauche. UMR
7586.
Boîte courrier 247
4 place Jussieu
75 252 Paris Cedex 05

Université Pierre et Marie Curie.
École doctorale de sciences
mathématiques de Paris centre.
Boîte courrier 290
4 place Jussieu
75 252 Paris Cedex 05

*C'est notre attention qui place les objets dans une chambre et l'habitude qui les
en retire pour nous y faire de la place.*

Marcel Proust, *A l'ombre des jeunes filles en fleurs*.

Remerciements

Tout d'abord je tiens à remercier Dimtri Zvonkine pour m'avoir proposé la problématique de départ de cette thèse. Il a consacré un temps considérable à m'écouter, à m'indiquer des pistes de recherche et à mettre à l'épreuve mes travaux afin d'en tirer le meilleur. Je remercie Alessandro Chiodo pour avoir accepté de co-encadrer cette thèse et pour les conseils et discussions que nous eues.

Rahul Pandharipande et Anton Zorich ont été deux des premières personnes à suivre avec attention la progression de mes recherches. Cela a joué un rôle important pour le développement de cette thèse et a très certainement aiguisé mon appétit pour la recherche.

Par ailleurs je tiens à remercier Rahul Pandharipande et Alexander Polishchuk pour leur travail de rapporteur du manuscrit ainsi que Gavril Farkas, Erwan Lanneau et Ariane Mézard pour avoir accepté de faire partie du jury.

Plusieurs personnes ont été des interlocuteurs précieux et disponibles pour comprendre, approfondir ou découvrir de nouveaux aspects de la géométrie des espaces des modules. Quelques noms me viennent à l'esprit dans le désordre mais j'ai bien peur d'en oublier : Felix Janda, Dawei Chen, Martin Moëller, Samuel Grushevsky, Peter Zograf, Dmitri Korotkin, Hsueh-Yung Lin, Etienne Mann, Paolo Rossi, Jérémy Guéré, Qile Chen, Yongbin Ruan, Pierrick Bousseau, Omid Amini, Charles Fougeron, Pascal Hubert.

J'aimerais remercier les doctorants de Jussieu (et de la région parisienne) que j'ai eu la chance de côtoyer au quotidien durant ces années de thèse et qui ont créé un environnement convivial et agréable. Plus généralement, l'IMJ (ou plutôt les personnes qui le constituent) a été un cadre idéal pour le développement de mes recherches.

Enfin merci à mes proches pour avoir été des soutiens inébranlables. Et surtout, merci à Virginie pour avoir été à mes côtés depuis le début.

Contents

Chapter 1. Introduction	7
1.1. Les surfaces de translation	7
1.2. Espaces des modules de courbes	8
1.3. Anneaux tautologiques	11
1.4. Stratification des espaces des modules de courbes stables	13
1.5. Stratification des espaces de différentielles	15
1.6. Différentielles d'ordres supérieurs et classes de Prym-Tyurin	18
1.7. Nombres d'Hurwitz	19
1.8. Cycles de double ramification	21
Chapter 2. Cohomology classes of strata of differentials	23
2.1. Different formulations of the problem	23
2.2. Stable differentials	29
2.3. The induction formula	54
2.4. Examples of computation	74
2.5. Relations in the Picard group of the strata	75
Chapter 3. Prym-Tyurin classes and loci of degenerate differentials	83
3.1. Prym-Tyurin classes	83
3.2. Space of admissible n -differentials	89
3.3. Bergman tau function and Hodge class on $P\overline{\mathcal{M}}_g^{(n)}$	94
3.4. An alternative computation of δ_{deg}	101
3.5. Prym-Tyurin differentials on \widehat{C} and holomorphic n -differentials on C	104
Chapter 4. Hurwitz numbers and intersection in spaces of differentials	111
4.1. Some families of Hurwitz numbers	111
4.2. From stable differentials to stable maps	114
4.3. End of the proof of Theorem 4.1.8	118
4.4. Completed cycles	120
Chapter 5. Double ramification cycles and strata of differentials	127
5.1. Moduli space of r -spin structures	127
5.2. Double Ramification cycles	129
5.3. Twisted canonical divisors	130
Appendix A. Algebraic Stacks	135
A.1. Sites and sheaves	135
A.2. Stacks	136
A.3. Moduli spaces of curves	138

Bibliography

139

CHAPTER 1

Introduction

1.1. Les surfaces de translation

Avant de formuler nos problématiques dans un langage plus algébrique, nous commençons par donner une première approche “visuelle” des strates de différentielles holomorphes. Ce point de vue des surfaces de translation est notamment celui qui permet de munir chaque strate de différentielles d’une structure de système dynamique (voir [83] pour une introduction plus ample aux surfaces de translations).

Definition 1.1.1. Une *surface de translation* est la donnée d’un polygone P du plan euclidien satisfaisant les propriétés suivantes:

- P a un nombre pair d’arêtes;
- les arêtes de P sont regroupées par paires;
- les deux arêtes d’une paire représentent le même vecteur de \mathbb{R}^2 .

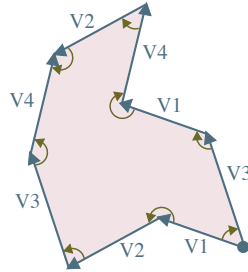

FIGURE 1. Surface de translation de type (2).

On note C la surface obtenue en identifiant les arêtes de P par paires. C est une surface compacte et orientée sans bord. On note g son genre (son nombre de “trous”) et $\{x_1, x_2, \dots, x_n\} \subset C$ l’ensemble des images de sommets. Pour chaque x_i on définit l’angle de x_i comme la somme des angles des sommets de P envoyés sur x_i . Cet angle est un réel de la forme $2(k_i + 1)\pi$ avec $k_i \in \mathbb{N}$. On appellera la liste $\mu = (k_1, \dots, k_n)$ le type de la surface de translation.

La surface $C \setminus \{x_1, x_2, \dots, x_n\}$ possède une structure de surface de Riemann naturelle. Celle-ci est obtenue en identifiant le plan euclidien à \mathbb{C} , cela permet de déduire simplement la structure complexe en dehors des arêtes. La structure complexe au voisinage des arêtes est obtenue en identifiant un voisinage d’un point d’une arête avec le voisinage de son translaté sur l’arête jumelle. La surface C possède également une forme différentielle holomorphe naturelle α définie en dehors des x_i : si on note z la coordonnée du plan complexe, celle-ci est donnée par $\alpha = dz$.

La structure de surface de Riemann et la forme différentielle s'étendent de manière unique à toute la surface C . Pour tout $1 \leq i \leq n$, la forme α ainsi construite a un zéro d'ordre k_i en x_i . La formule de Gauss-Bonnet (ou de Riemann-Roch) implique donc que $2g - 2 = \sum_{i=1}^n k_i$.

On peut vérifier cette égalité sur l'exemple de la figure 2 obtenue par recollement du polygone de la figure 1: $2g - 2 = 2 \times 2 - 2 = 2$.

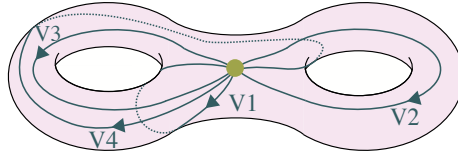

FIGURE 2. Surface obtenue par recollement du polygone de la figure 1.

A partir de la donnée d'une surface de translation P on a construit une surface de Riemann avec une forme différentielle holomorphe. Réciproquement, soit C une surface de Riemann munie d'une différentielle holomorphe α avec des zéros $\{x_1, \dots, x_n\}$. Si on se donne des cycles formant une base de l'homologie relative $H_1(C, \{x_1, \dots, x_n\}, \mathbb{Z})$ on peut reconstituer le polygone par intégration de la forme différentielle α .

Surfaces de translation équivalentes. On dira que deux surfaces de translation P et P' sont isomorphes si les couples (C, α) et (C, α') sont isomorphes (voir Section 1.5). Une interprétation graphique de cette équivalence est la suivante.

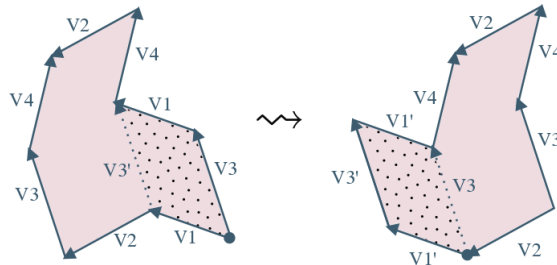

FIGURE 3. Deux surfaces de translation équivalentes.

Sur la figure 3 on a représenté deux surfaces équivalentes: on passe d'un polygone à l'autre en découpant un sous-polygone et en recollant les deux morceaux le long d'une paire d'arêtes jumelles. Deux surfaces de translation sont isomorphes s'il existe une série de découpages et recollements permettant de passer de l'une à l'autre.

1.2. Espaces des modules de courbes

1.2.1. Qu'est-ce qu'un espace des modules? Un espace des modules est un espace dont les points représentent les classes d'isomorphisme d'objets géométriques d'un type fixé (les connexions d'un fibré vectoriel, les structures presque complexes d'une variété différentielle, les hypersurfaces d'un espace projectif d'un degré fixé,...). L'espace des modules est en général lui-même muni d'une structure

géométrique (variété analytique réelle ou complexe, schéma,...) déterminée par la théorie des déformations des objets paramétrés.

Exemple 1.2.1. Un des premiers exemples d'espace des modules est l'*espace projectif* de dimension $n > 0$. En tant qu'ensemble, l'espace projectif est défini comme le quotient $\mathbb{C}P^n = (\mathbb{C}^{n+1} \setminus \{0\})/\mathbb{C}^*$, où l'action de \mathbb{C}^* est donnée par la multiplication des vecteurs de \mathbb{C}^{n+1} par un scalaire. Les points de $\mathbb{C}P^n$ sont en bijection avec les droites de \mathbb{C}^{n+1} passant par l'origine. L'espace projectif possède une structure naturelle de variété analytique complexe ou de variété algébrique complexe.

Exemple 1.2.2. Une généralisation de l'exemple précédent est donnée par les *grassmanniennes*. Fixons un espace vectoriel complexe de dimension finie V et un entier positif r . La grassmannienne $\text{Gr}(V, r)$ est l'espace paramétrant les sous-espaces vectorielles de V de dimension r .

Exemple 1.2.3. Fixons une variété complexe (algébrique ou analytique) X . Le *groupe de Picard* de X est défini comme l'ensemble des classes d'équivalence de fibré en droites holomorphe sur X . Comme son nom l'indique il s'agit également d'un groupe que l'on note $\text{Pic}(X)$.

1.2.2. Espace des modules de courbes. Les espaces des modules de courbes complexes seront le dénominateur commun des objets introduits dans cette thèse. Nous avons choisi de donner ici une approche "intuitive" des espaces des modules. Nous renvoyons le lecteur à l'Appendice A pour une introduction aux champs de Deligne-Mumford et à la définition des espaces des modules des courbes dans ce formalisme.

Considérons des surfaces compactes orientées et sans bord. Il est connu depuis le XIX^{ème} siècle que deux telles surfaces Σ et Σ' sont isomorphes si et seulement si elles ont la même caractéristique d'Euler ou le même genre (nombre de trous).

Maintenant considérons deux surfaces de Riemann C and C' d'un genre fixé. Ces deux surfaces sont isomorphes en tant que variétés différentielles mais elles ne sont pas nécessairement isomorphes en tant que surfaces de Riemann. En d'autres termes, un isomorphisme réel ne respecte pas la structure complexe en général. Cela nous conduit à définir M_g comme l'ensemble des surfaces de Riemann de genre g à biholomorphisme près.

En général, fixons g et n deux entiers positifs. Une *surface de Riemann marquée* est la donnée de (C, x_1, \dots, x_n) où C est une surface de Riemann et les x_i sont des points deux à deux de C . Deux surfaces marquées (C, x_1, \dots, x_n) et (C', x'_1, \dots, x'_n) sont isomorphes si il existe un biholomorphisme $\phi : C \rightarrow C'$ tel que $\phi(x_i) = x'_i$ pour tout $1 \leq i \leq n$. On définit $M_{g,n}$ comme l'ensemble des surfaces de Riemann de genre g à n points marqués à isomorphismes près.

L'ensemble $M_{g,n}$ peut être équipé d'une structure de variété algébrique complexe singulière mais pour des raisons techniques ce n'est pas la plus naturelle. Nous avons le résultat important suivant.

Proposition 1.2.4. *Supposons que g et n vérifient la condition $2g - 2 + n > 0$ (condition de stabilité). Alors, il existe un champ algébrique lisse de Deligne-Mumford*

$\mathcal{M}_{g,n}$ dont les points géométriques sont les classes d'équivalence de surfaces de Riemann de genre g à n points marqués.

Les champs algébriques de Deligne-Mumford sont une généralisation de la notion de schémas qui permet de prendre en compte les automorphismes des objets classifiés. C'est ce champ que nous appellerons *l'espace des modules de surfaces de Riemann de genre g à n points marqués*.

Remarque 1.2.5. La condition de stabilité n'exclut que quatre cas: $(g, n) = (0, 0)$, $(0, 1)$, $(0, 2)$ et $(1, 0)$.

Remarque 1.2.6. Toute surface de Riemann compacte peut être réalisée comme une courbe algébrique projective lisse. C'est pourquoi nous parlerons dans cette thèse plutôt d'espaces des modules de courbes complexes lisses (ou courbes lisses marquées) plutôt que de surfaces de Riemann.

Mentionnons tout de suite quelques propriétés des espaces des modules de courbes lisses.

Proposition 1.2.7. *L'espace $\mathcal{M}_{g,n}$ est lisse, irréductible et de dimension (complexe) $3g - 3 + n$.*

Une autre propriété importante est l'existence de courbes universelles (voir figure 8).

Proposition 1.2.8. *Soit g, n tels que $2g - 2 + n > 0$. Il existe un champ algébrique de Deligne-Mumford $\mathcal{C}_{g,n}$ lisse et de dimension $3g - 2 + n$ tel que:*

- *il existe un morphisme plat $\pi : \mathcal{C}_{g,n} \rightarrow \mathcal{M}_{g,n}$;*
- *la fibre de π au-dessus d'un point géométrique est une courbe dans la classe d'isomorphisme représentée par ce point.*

Exemple 1.2.9 ($\mathcal{M}_{0,3}$ et $\mathcal{M}_{0,4}$). Le théorème d'uniformisation de Riemann implique toute surface de Riemann compacte de genre 0 est isomorphe à $\mathbb{C}P^1$. De plus un automorphisme de $\mathbb{C}P^1$ est complètement déterminé par l'image de 3 points. Nous en déduisons que $\mathcal{M}_{0,3}$ est un point : toute surface de genre 0 à 3 points marqués est isomorphe à $(\mathbb{C}P^1, 0, 1, \infty)$.

Maintenant tout point de $\mathcal{M}_{0,4}$ sera donné par $(\mathbb{C}P^1, 0, 1, \infty, t)$ où t est un point de $\mathbb{C}P^1$ différent de 0, 1 et ∞ . On conclut donc que $\mathcal{M}_{0,4} \simeq \mathbb{C}P^1 \setminus \{0, 1, \infty\}$.

Exemple 1.2.10 ($\mathcal{M}_{1,1}$). On va noter \mathbb{H} le demi-plan supérieur de \mathbb{C} . Une courbe pointée de genre 1 est toujours isomorphe au quotient $\mathbb{T}_\tau = \mathbb{C}/(\mathbb{Z} \oplus \tau\mathbb{Z})$ pour un certain τ dans \mathbb{H} . De plus deux tores \mathbb{T}_τ et $\mathbb{T}_{\tau'}$ sont isomorphes si et seulement si $\tau' = \gamma \cdot \tau$ pour une certaine matrice γ dans $\mathrm{PSL}(2, \mathbb{Z})$ (voir figure 1, (a)). Donc l'espace des modules $\mathcal{M}_{1,1}$ est isomorphe au quotient $\mathbb{H}/\mathrm{PSL}(2, \mathbb{Z})$ (voir figure 1, (b)).

1.2.3. Compactification de l'espace des modules de courbes. L'espace $\mathcal{M}_{g,n}$ n'est en général pas compact. D'une part, deux points marqués ne peuvent pas se rencontrer par définition de $\mathcal{M}_{g,n}$. D'autre part, un cycle d'une surface de Riemann peut être rendu aussi court que l'on veut mais on ne peut pas le contracter (voir figure 1). La non-compacité est un problème si l'on veut utiliser des outils de théorie

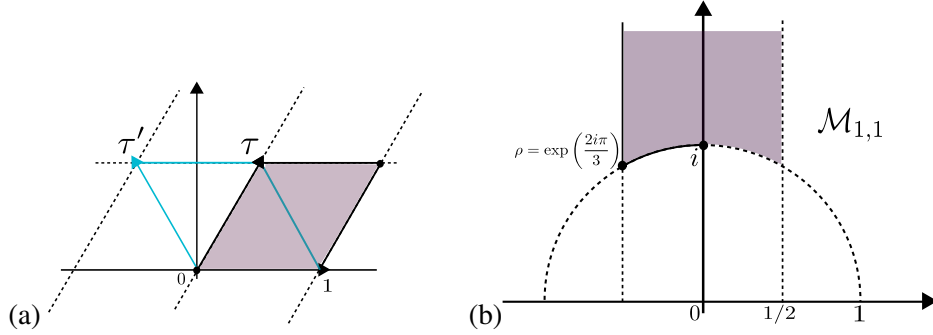

FIGURE 4. (a) Les tores \mathbb{T}_τ et $\mathbb{T}_{\tau'}$ sont isomorphes. (b) Domaine fondamental du quotient $\mathbb{H}/\mathrm{PSL}(2, \mathbb{Z}) \simeq \mathcal{M}_{1,1}$.

de l'intersection ou la dualité de Poincaré. Ce problème est résolu en autorisant une classe de courbes légèrement plus large.

Une *courbe complexe nodale* est une courbe singulière dont les singularités sont localement données par l'équation $\{(x, y) \in \mathbb{C}^2 / xy = 0\}$. Une courbe nodale de genre g à n points marqués est une courbe nodale avec n points 2 à 2 distincts dans le lieu lisse. Une courbe nodale marquée sera dite *stable* si elle possède un nombre fini d'automorphismes. On peut remarquer que cette définition de stabilité est équivalente à celle de la section précédente pour les courbes lisses. On notera $\overline{\mathcal{M}}_{g,n}$ l'espace des modules de courbes stables de genre g à n points marqués.

Proposition 1.2.11. *L'espace $\overline{\mathcal{M}}_{g,n}$ est un champ de Deligne-Mumford lisse, propre et irréductible de dimension $3g-3+n$. De plus $\mathcal{M}_{g,n}$ est un sous-champ ouvert et dense de $\overline{\mathcal{M}}_{g,n}$.*

Par ailleurs, il existe une courbe universelle $\pi : \overline{\mathcal{C}}_{g,n} \rightarrow \overline{\mathcal{M}}_{g,n}$ vérifiant les mêmes propriétés que $\mathcal{C}_{g,n}$.

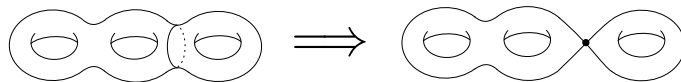

FIGURE 5. Exemple de dégénérescence: si l'on contracte un 1-cycle d'une surface de genre 3 on obtient une courbe nodale de même genre arithmétique.

1.3. Anneaux tautologiques

L'homologie et la cohomologie (singulière ou par résolution des faisceaux localement triviaux) des champs de DM peut être définie pour n'importe quel anneau de coefficients, mais cette définition est relativement technique. Nous n'utiliserons dans cette thèse que des groupes de cohomologie et de Chow à coefficients dans \mathbb{Q} (voir [78] pour la définition des anneaux de Chow des champs algébriques). Dans ce cas l'anneau de cohomologie du champ est l'anneau de cohomologie de l'espace topologique sous-jacent. De plus on dispose dans ce cas de la dualité de Poincaré pour les champs de DM lisses.

Exemple 1.3.1. La cohomologie du champ $\{\text{pt}\}/(\mathbb{Z}/2\mathbb{Z})$ est la cohomologie de l'espace classifiant de $\mathbb{Z}/2\mathbb{Z}$, i.e. l'espace projectif réel infini. On a alors $H^{2i}(\{\text{pt}\}/(\mathbb{Z}/2\mathbb{Z}), \mathbb{Z}) \simeq \mathbb{Z}/2\mathbb{Z} \neq H^{2i}(\{\text{pt}\}, \mathbb{Z})$ pour $i > 0$.

Mumford a introduit l'idée de ne considérer qu'une partie des anneaux de cohomologie (ou de Chow) des espaces des modules que l'on appellera anneaux tautologiques (voir [62]).

Définition 1.3.2. Il existe 3 types d'applications naturelles entre espaces des modules de courbes:

- L'application d'oubli, $\pi : \overline{\mathcal{M}}_{g,n+1} \rightarrow \overline{\mathcal{M}}_{g,n}$ envoie une courbe à $(n+1)$ points marqués sur la stabilisation de la courbe sans le $n+1$ -ème point. Cette application est équivalente à la courbe universelle.
- Le morphisme de recollement de type arbre, $j_{\text{tree}} : \overline{\mathcal{M}}_{g_1, n_1+1} \times \overline{\mathcal{M}}_{g_2, n_2+1} \rightarrow \overline{\mathcal{M}}_{g,n}$ est le morphisme qui "attache" 2 courbes par leur dernier point marqué formant ainsi un nœud.
- Le morphisme de recollement de type boucle, $j_{\text{loop}} : \overline{\mathcal{M}}_{g-1, n+2} \rightarrow \overline{\mathcal{M}}_{g,n}$ est le morphisme qui attache deux points d'une courbe formant une auto-intersection nodale (voir la figure 7).

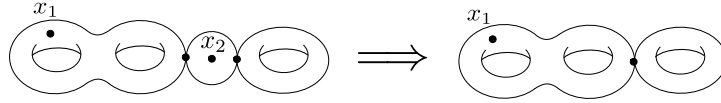

FIGURE 6. Un exemple pour l'application d'oubli. On oublie le point x_2 et on contracte la composante rationnelle qui ne vérifie plus la condition de stabilité.

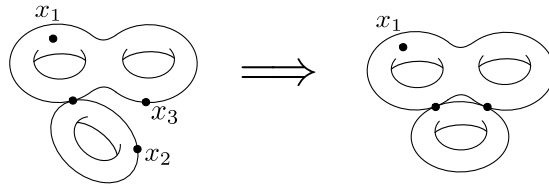

FIGURE 7. Un exemple pour le morphisme de recollement de type boucle. Ici on représente l'application $j_{\text{loop}} : \overline{\mathcal{M}}_{3,3} \rightarrow \overline{\mathcal{M}}_{4,1}$. Les points 2 et 3 sont identifiés pour créer un nœud.

Définition 1.3.3. La famille minimale de sous-anneaux $RH^*(\overline{\mathcal{M}}_{g,n}) \subset H^*(\overline{\mathcal{M}}_{g,n}, \mathbb{Q})$ contenant 1 et stable par les poussés-en-avant des applications d'oubli et de recollement est appelée famille des *anneaux tautologiques* des espaces des modules de courbes stables. De la même manière on définit les anneaux de Chow tautologiques $R^*(\overline{\mathcal{M}}_{g,n}) \subset A^*(\overline{\mathcal{M}}_{g,n}, \mathbb{Q})$.

Il y a deux familles importantes de classes tautologiques: les *classes* ψ et les *classes* κ .

Définition 1.3.4. Soient g, n tels que $2g - 2 + n > 0$ et soit $i \in \llbracket 1, n \rrbracket$. Le fibré en droite $\mathcal{L}_i \rightarrow \overline{\mathcal{M}}_{g,n}$ est défini comme le fibré cotangent relatif au i -ème point marqué (voir figure 8). La classe $\psi_i \in H^2(\overline{\mathcal{M}}_{g,n}, \mathbb{Q})$ est la classe de Chern de \mathcal{L}_i .

La classe $\kappa_m \in H^{2m}(\overline{\mathcal{M}}_{g,n}, \mathbb{Q})$ est définie comme $\pi_*(\psi_{n+1}^{m+1})$ où $\pi : \overline{\mathcal{M}}_{g,n+1} \rightarrow \overline{\mathcal{M}}_{g,n}$ est l'application d'oubli du $(n+1)$ -ème point marqué.

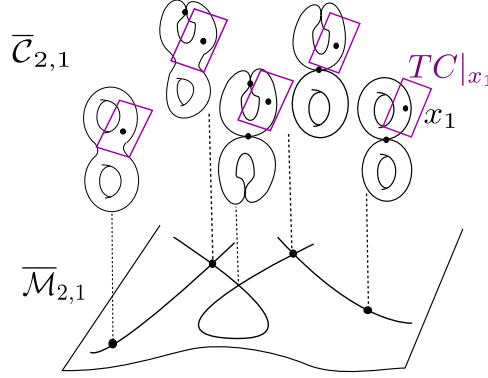

FIGURE 8. Le fibré $\mathcal{L}_1^V \rightarrow \overline{\mathcal{M}}_{2,1}$. Sa fibre au point (C, x_1) est l'espace tangent à C au point x_1 .

Remarque 1.3.5. Les anneaux tautologiques sont en général strictement plus petits que les anneaux de cohomologie complets. Cependant c'est un problème difficile d'exhiber des classes non-tautologiques (voir [35] ou [65] par exemple). Les anneaux tautologiques ont été largement étudiés pour plusieurs raisons:

- On a plusieurs résultats caractérisant la structure de ces anneaux. Les deux plus importants étant d'une part le théorème de Witten-Kontsevich permettant de calculer les nombres d'intersections de classes tautologiques (voir [79] et [54]) et d'autre part les relations de Pixton-Faber-Zagier décrivant partiellement la structure des anneaux tautologiques en tout degré (voir [64]).
- Les anneaux tautologiques recèlent une combinatoire et une algèbre riche. Celle-ci est généralement étudiée grâce au formalisme de Givental des variétés de Frobenius, des théories cohomologiques des champs et des opérades (voir [32], [33], ou [60]). L'un des résultats importants étant le théorème de reconstruction de Teleman pour les théories cohomologiques des champs semi-simples (voir [75]).
- Enfin, et c'est ce qui va nous intéresser dans cette thèse, "beaucoup" de sous-lieux de $\overline{\mathcal{M}}_{g,n}$ définissables géométriquement ont une classe de cohomologie Poincaré-duale dans $RH^*(\overline{\mathcal{M}}_{g,n}, \mathbb{Q})$.

1.4. Stratification des espaces des modules de courbes stables

1.4.1. Stratification. Soit X un champ de DM. Une *stratification* de X est une famille $(Y_i)_{i \in I}$ de sous-espaces lisses telle que

- X est l'union disjointe des Y_i ;

- la clôture de chaque Y_i dans X est une union disjointe de $(Y_j)_{j \in J}$ avec $J \subset I$.

Si Y_j est dans la clôture Y_i , on dit que Y_j est une *strate de bord* de Y_i .

Remarque 1.4.1. Si X est irréductible alors l'un des Y_i vérifiera $X = \bar{Y}_i$.

Exemple 1.4.2. Voici une stratification de la sphère. Les flèches représentent la relation “être dans le bord de”.

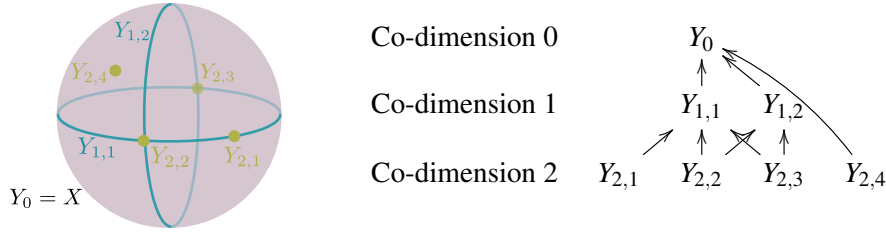

FIGURE 9. Exemple de stratification.

1.4.2. Graphes stables. Les espaces des modules de courbes stables admettent une stratification naturelle.

Définition 1.4.3. Un *graphe stable* est la donnée de

$$\Gamma = (V, H, g : V \rightarrow \mathbb{N}, a : H \rightarrow V, i : H \rightarrow H, E, L)$$

satisfaisant les propriétés suivantes

- V est un ensemble de sommets muni d'une fonction de genre g ;
- H est un ensemble de demi-arêtes muni d'une fonction d'attribution de sommet a et d'une involution i ;
- E , l'ensemble des arêtes est défini comme l'ensemble des orbites de longueur 2 de i dans H ;
- (V, E) définit un graphe connexe;
- L est l'ensemble des points fixes par i en bijection avec $\{1, \dots, n\}$ appelés des pattes;
- pour chaque sommet v , la condition de stabilité suivante $2g(v) - 2 + n(v) > 0$ est satisfaite, où $n(v)$ est la valence de Γ en v .

Notation 1.4.4. Le genre de Γ est défini par $g(\Gamma) = \sum_{v \in V} g(v) + \#(E) - \#(V) + 1$. Notons $v(\Gamma)$, $e(\Gamma)$, et $n(\Gamma)$ les cardinaux de V , E , et L , respectivement. On note $\mathbf{G}_{g,n}$ l'ensemble des graphes stables de genre g à n pattes.

Soit Γ un graphe stable. On définit l'espace des modules

$$\overline{\mathcal{M}}_{\Gamma} = \prod_{v \in V} \overline{\mathcal{M}}_{g(v), n(v)},$$

et $\zeta_{\Gamma} : \overline{\mathcal{M}}_{\Gamma} \rightarrow \overline{\mathcal{M}}_{g,n}$ le morphisme naturel défini par une succession de morphismes de recollement. L'image de $\overline{\mathcal{M}}_{\Gamma}$ est un sous-champ de $\overline{\mathcal{M}}_{g,n}$ qui est isomorphe à $\overline{\mathcal{M}}_{\Gamma}/\text{Aut}(\Gamma)$. Si une courbe est dans l'image de $\overline{\mathcal{M}}_{\Gamma}$ on dit que Γ est son *graphe dual*. La famille des sous-champs $(\overline{\mathcal{M}}_{\Gamma}/\text{Aut}(\Gamma))_{\Gamma \in \mathbf{G}_{g,n}}$ fournit une stratification de

$\overline{\mathcal{M}}_{g,n}$ indexée par les graphes stables. Les strates sont irréductibles. La codimension d'une strate est donnée par $\#(E)$.

1.4.3. Algèbre des strates. La stratification de l'espace des modules de courbes stables permet de décrire une famille génératrice des anneaux tautologiques.

Définition 1.4.5. Un *graphe stable décoré* est la donnée d'un graphe stable Γ et de classes $P_v \in A^*(\overline{\mathcal{M}}_{g(v),n(v)})$ pour chaque sommet v de Γ telles que P_v est un produit en classes κ et ψ .

Un graphe décoré détermine une classe

$$\zeta_{\Gamma*} \left(\prod_{v \in V} P_v \right) \in R^*(\overline{\mathcal{M}}_{g,n}).$$

Notation 1.4.6. On note $\mathcal{S}_{g,n}$ le \mathbb{Q} -espace vectoriel engendré par les classes des graphes décorés. On a une application linéaire naturelle: $\mathcal{S}_{g,n} \rightarrow R^*(\overline{\mathcal{M}}_{g,n})$. On appelle l'espace $\mathcal{S}_{g,n}$ l'algèbre des strates (cf Remarque 1.4.8).

Proposition 1.4.7. *L'anneau tautologique $R^*(\overline{\mathcal{M}}_{g,n})$ est linéairement engendré par les classes des graphes décorés, i.e. $\text{Im}(\mathcal{S}_{g,n}) = R^*(\overline{\mathcal{M}}_{g,n})$.*

Remarque 1.4.8. On se réfère à [35] pour une preuve de la Proposition 1.4.7. La famille des espaces vectoriels $\mathcal{S}_{g,n}$ est clairement stable pour les poussés-en-avant des applications d'oubli de points marqués et les morphismes de recollements. Pour montrer la Proposition 1.4.7, il suffit de montrer que cet espace vectoriel est une algèbre. Cela revient à exprimer le produit d'intersection de graphes décorés en fonctions de graphes décorés.

1.5. Stratification des espaces de différentielles

Ici nous introduisons les espaces de différentielles ainsi que leur stratification. Notre résultat principal est l'expression des classes Poincaré-duales des strates de différentielles en termes de classes tautologiques.

1.5.1. Définition algébrique. Soient g, n tels que $2g - 2 + n > 0$. Le *fibré de Hodge* $p: \mathcal{H}_{g,n} \rightarrow \mathcal{M}_{g,n}$ est le fibré vectoriel dont la fibre au dessus de (C, x_1, \dots, x_n) est donnée par $H^0(C, \omega_C)$ où ω_C est le fibré cotangent à C . Par la formule de Riemann-Roch, il s'agit d'un fibré vectoriel de rang g .

Définition 1.5.1. Soit $Z = (k_1, \dots, k_n)$ une liste d'entiers positifs. La strate des différentielles de types Z est le lieu $A_{g,Z} \subset \mathcal{H}_g$ des éléments $(C, \alpha, x_1, \dots, x_n)$ tels que x_i soit un zéro d'ordre k_i de α pour tout $1 \leq i \leq n$.

Le lieu $A_{g,Z}$ est bien un sous-champ de DM de $\mathcal{H}_{g,n}$. En effet on verra plus loin qu'il peut être défini comme le lieu d'annulation d'une section d'un fibré vectoriel.

Remarque 1.5.2. On ne suppose pas dans la Définition 1.5.1 ci-dessus que la somme des k_i soit $2g - 2$.

Le lieu $A_{g,Z}$ est invariant sous l'action de \mathbb{C}^* . On notera $\mathbb{P}A_{g,Z} \subset \mathbb{P}\mathcal{H}_{g,n}$ sa projectivisation. Par ailleurs, le fibré de Hodge possède une extension naturelle

à l'espace des courbes stables. Cette extension $\overline{\mathcal{H}}_{g,n} \rightarrow \overline{\mathcal{M}}_{g,n}$ est définie en remplaçant la notion de différentielle holomorphe par celle de différentielle abélienne (voir chapitre 2 pour une description des différentielles abéliennes sur les courbes nodales). L'espace total du projectivisé $\mathbb{P}\overline{\mathcal{H}}_{g,n}$ est donc compact. On va noter $\overline{A}_{g,Z}$ et $\mathbb{P}\overline{A}_{g,Z}$ les clôtures de $A_{g,Z}$ et $\mathbb{P}A_{g,Z}$ dans $\overline{\mathcal{H}}_{g,n}$ et $\mathbb{P}\overline{\mathcal{H}}_{g,n}$.

1.5.2. Retour sur les surfaces de translation. Supposons que Z est une partition de $2g-2$. La correspondance exposée dans la section 1.1 entre surfaces de translation et surfaces de Riemann munies d'une différentielle holomorphe nous permet de définir $A_{g,Z}$ comme l'espace des modules de surface translations avec singularités marquées. En utilisant ce point de vue on déduit deux propriétés importantes des surfaces de translation:

- Une paramétrisation locale de $A_{g,Z}$ est donnée par $H^1(C, \{x_1, \dots, x_n\}, \mathbb{C})^\vee$. Graphiquement, on se donne simplement un nombre complexe par paire d'arêtes correspondant au choix d'un vecteur. On obtient alors que $A_{g,Z}$ est lisse et de dimension $2g-1+n$ (sur l'exemple 1 on a bien $2 \times 2 - 1 + 1 = 4$ dimensions).
- Le groupe $\mathrm{PSL}(2, \mathbb{R})$ agit sur les vecteurs de \mathbb{R}^2 et donc sur les surfaces de translation en agissant sur les polygones. On obtient ainsi une action du groupe $\mathrm{PSL}(2, \mathbb{R})$ sur l'espace $A_{g,Z}$. Cette action induit une structure de système dynamique en restreignant l'action au groupe diagonal

$$\left\{ \begin{pmatrix} e^t & 0 \\ 0 & e^{-t} \end{pmatrix}, t \in \mathbb{R} \right\} \subset \mathrm{PSL}(2, \mathbb{R}).$$

Mentionons deux problèmes importants qui ont motivé (et continuent de motiver) les géomètres et dynamiciens qui étudient les surfaces de translation.

- Le premier problème important est de classifier les sous-variétés analytiques fermées sous l'action de $\mathrm{PSL}(2, \mathbb{R})$. Un des résultats les plus importants affirme que toutes ces sous-variétés sont algébriques et définissables sur $\overline{\mathbb{Q}}$ (voir [24] et [30]).
- Le second problème consiste à déterminer les invariants dynamiques de l'action du groupe diagonal (exposants de Lyapounov). Ces invariants sont reliés à des calculs de nombres d'intersection algébriques (voir [53]) ou à des asymptotiques de nombres de revêtements ramifiés du tore standard (voir [25], [12] ou [11]). Des inégalités sur les exposants de Lyapounov ou leur somme ont été prouvées récemment par des considérations sur les fibrés stables et en exhibant des suites de Harder-Narasimhan du fibré de Hodge au dessus de courbes de Teichmüller (voir [81] ou [22]).

Au travers de ces deux problématiques on voit se tisser des liens forts et encore peu compris entre les propriétés dynamiques et algébriques des strates de différentielles.

1.5.3. Classes des strates. Nous pouvons maintenant énoncer notre problème principal.

Problème 1.5.3. Comment exprimer les classes de cohomologie Poincaré-duales des strates $\mathbb{P}\overline{A}_{g,Z}$ dans $H^*(\mathbb{P}\overline{\mathcal{H}}_{g,n}, \mathbb{Q})$?

Soit \mathcal{L} le dual du fibré tautologique $\mathcal{O}(1) \rightarrow \mathbb{P}H_{g,n}$. Soit ξ la première classe de Chern de \mathcal{L} . L'un des théorèmes principaux de cette thèse est le suivant.

Théorème 1.5.4. *Soit $RH^*(\overline{\mathcal{H}}_{g,n}, \mathbb{Q})$ le sous-anneau de $H^*(\overline{\mathcal{H}}_{g,n}, \mathbb{Q})$ engendré par les tirés-en-arrière de classes tautologiques de $\overline{\mathcal{M}}_{g,n}$ et la classe ξ . Pour tout Z , la classe de cohomologie Poincaré-duale de $\mathbb{P}\overline{\mathcal{A}}_{g,Z}$ appartient à $RH^*(\overline{\mathcal{H}}_{g,n}, \mathbb{Q})$ et est explicitement calculable.*

La preuve de ce théorème est un algorithme. On décrit un ensemble de techniques permettant de calculer les classes des $\mathbb{P}\overline{\mathcal{A}}_{g,Z}$ et nous prouvons qu'à chaque étape les classes que nous obtenons sont des combinaisons de classes tautologiques et de puissances de ξ (voir chapitre 2).

1.5.4. Variations autour du théorème 1.5.4. Il existe plusieurs questions analogues au Problème 1.5.3.

1.5.4.1. *Strates non marquées.* Soit μ une partition de $2g-2$. On définit par $\overline{\mathcal{H}}_{g,\mu} \subset \overline{\mathcal{H}}_g$ le lieu des différentielles avec un ensemble d'ordres de zéros donnée par μ . Dans ces strates de différentielles les zéros sont donc non-marqués. Pour calculer les classes de cohomologie des strates de différentielles non marquées, on calcule l'expression des strates pour les différentielles avec singularités marquées et on utilise l'application d'oubli des points marqués. En utilisant la formule de projection et le fait que le fibré $\overline{\mathcal{H}}_{g,n} \rightarrow \overline{\mathcal{M}}_{g,n}$ est le tiré-en-arrière de $\overline{\mathcal{H}}_g \rightarrow \mathcal{M}_g$ par l'application d'oubli des points marqués on déduira le théorème suivant.

Théorème 1.5.5. *Soit $RH^*(\overline{\mathcal{H}}_g, \mathbb{Q})$ le sous-anneau de $H^*(\overline{\mathcal{H}}_g, \mathbb{Q})$ engendré par les tirés-en-arrière des classes tautologiques de $\overline{\mathcal{M}}_g$ et la classe ξ . Pour toute partition μ de $2g-2$, la classe de cohomologie Poincaré-duale de $\mathbb{P}\overline{\mathcal{H}}_{g,\mu}$ appartient à $RH^*(\overline{\mathcal{H}}_g, \mathbb{Q})$ et est explicitement calculable.*

1.5.4.2. *Différentielles méromorphes.* Nous allons introduire l'espace de différentielles stables (voir Définition 2.1.3). Cet espace paramètre les différentielles méromorphes avec des pôles d'ordres fixés. De même que le fibré du Hodge, les espaces de différentielles stables sont stratifiés en fonction des ordres des zéros de la différentielle. On va prouver au chapitre 2 que la conclusion des théorèmes 1.5.4 ou 1.5.5 est également valide pour les espaces de différentielles stables.

Remarque 1.5.6. Dans le chapitre 2 nous travaillons simultanément avec des différentielles méromorphes et holomorphes. De fait notre démonstration par récurrence nous y oblige, car même si l'on commence par une strate holomorphe la récurrence peut faire appel à une strate méromorphe.

1.5.4.3. *Différentielles d'ordres supérieurs.* Soit $k > 1$. On considère le fibré vectoriel

$$\Omega_{g,n}^{(k)} \rightarrow \overline{\mathcal{M}}_{g,n} = \pi_* \omega_{\overline{\mathcal{C}}_{g,n}/\overline{\mathcal{M}}_{g,n}}^{\otimes k}.$$

Les points de $\Omega_{g,n}^{(k)}$ sont des courbes stables munies d'une différentielle abélienne d'ordre k . Ce fibré est stratifié de la même manière que le fibré de Hodge en fonction des zéros de la k -différentielle. Peut-on généraliser les théorèmes 1.5.4 et 1.5.5 aux différentielles d'ordre k ? Pour l'instant la réponse est inconnue. La difficulté provient du fait que les strates de différentielles d'ordre supérieur ne sont

pas de dimension pure: en effet, les k -différentielles qui sont des puissances k -ièmes de différentielles abéliennes forment un lieu de dimension plus grande que les autres. Ceci empêche d'appliquer directement les techniques du chapitre 2.

1.5.4.4. *Expression des classes dans $H^*(\overline{\mathcal{M}}_{g,n}, \mathbb{Q})$.* On considère le morphisme d'oubli $p : \mathbb{P}\overline{\mathcal{H}}_{g,n} \rightarrow \overline{\mathcal{M}}_{g,n}$. On s'intéresse aux poussés-en-avant des classes $[\mathbb{P}\overline{A}_{g,Z}]$ par le morphisme p . On prouve que ces classes de cohomologie dans $H^*(\overline{\mathcal{M}}_{g,n}, \mathbb{Q})$ sont encore des classes tautologiques.

1.6. Différentielles d'ordres supérieurs et classes de Prym-Tyurin

Soient $g > 1$ et $k > 1$. Nous allons considérer le projectivisé de l'espace des k -différentielles $\mathbb{P}\Omega_g^{(k)} \rightarrow \overline{\mathcal{M}}_g$. L'espace $\mathbb{P}\Omega_g^{(k)}$ contient un ouvert dense U des différentielles aux zéros simples définies sur des courbes lisses. Soit (C, w) un élément de U . On peut associer à (C, w) un revêtement cyclique $f : \widehat{C} \rightarrow C$ de degré k , où

$$\widehat{C} = \{(x, v) | x \in C, v \in T_x^*C, v^k = w\}.$$

Ce revêtement est totalement ramifié au dessus des zéros simples de w . La courbe \widehat{C} est lisse de genre $\widehat{g} = k^2(g-1) + 1$. L'action de $\mathbb{Z}/k\mathbb{Z}$ sur le revêtement est donnée par $\rho^j : (x, v) \mapsto (x, \rho^j v)$, où $\rho = e^{\frac{2i\pi}{k}}$. On note $\sigma : \widehat{C} \rightarrow \widehat{C}$ l'automorphisme \widehat{C} correspondant à $j = 1$. L'existence du revêtement $\widehat{C} \rightarrow C$ permet de définir une application

$$\begin{aligned} \hat{v} : U &\rightarrow \mathcal{M}_{\widehat{g}}, \\ (C, w) &\mapsto \widehat{C}. \end{aligned}$$

On considère le tiré-en-arrière du fibré de Hodge $\overline{\mathcal{H}}_{\widehat{g}}$ par l'application \hat{v} . L'automorphisme σ induit un endomorphisme σ^* du fibré vectoriel $\hat{v}^*\overline{\mathcal{H}}_{\widehat{g}}$ donné par $u \mapsto \sigma^*u$, où u est un élément de $H^0(\widehat{C}, \omega_{\widehat{C}})$. L'endomorphisme σ^* vérifie $(\sigma^*)^k = \text{Id}$. D'où la décomposition

$$\hat{v}^*\overline{\mathcal{H}}_{\widehat{g}} = \bigoplus_{j=0}^{k-1} \Lambda^{(j)},$$

où $\Lambda^{(j)}$ est le fibré propre de $\hat{v}^*\overline{\mathcal{H}}_{\widehat{g}}$ correspondant à la valeur propre $\rho^j = e^{\frac{2i\pi j}{k}}$.

Définition 1.6.1. Les fibrés vectoriels $\Lambda^{(j)}$ sont appelés *fibré vectoriels de Prym-Tyurin*. La *classe de Prym-Tyurin* $\lambda_{PT}^{(j)}$ est la première classe de Chern de $\Lambda^{(j)}$ dans le groupe de Picard rationnel de U .

Dans le chapitre 3 nous allons construire une extension de la classe de Prym-Tyurin à l'espace $\mathbb{P}\Omega_g^{(k)}$ tout entier et l'exprimer dans une base standard du groupe de cet espace.

Proposition 1.6.2. *Une base standard du groupe de Picard $\mathbb{P}\Omega_g^{(k)}$ est donnée par $(\xi, \lambda, \delta_0, \delta_1, \dots, \delta_{\lfloor g/2 \rfloor})$ où :*

- la classe ξ est la première classe de Chern du fibré tautologique $\mathcal{O}(1) \rightarrow \mathbb{P}\Omega_g^{(k)}$;
- la classe λ est la première classe de Chern de $\overline{\mathcal{H}}_g$;

- pour $1 \leq i \leq \lfloor g/2 \rfloor$, la classe δ_i est la classe du diviseur de bord dont le point générique est une courbe à un noeud séparant des composantes de genre i et $g-i$;
- la classe δ_0 est la classe du diviseur des courbes possédant un noeud non séparant.

(par abus de notation, on utilise les mêmes notations δ_i et λ pour les classes dans le groupe de picard de $\overline{\mathcal{M}}_g$ et leur tirés-en-arrière dans le groupe de Picard de $\mathbb{P}\Omega_g^{(k)}$).

Pour formuler les résultats nous introduisons également la classe δ_{deg} : il s'agit de la classe Poincaré-duale du lieu des k -différentielles avec au moins un zéro multiple.

Théorème 1.6.3. *On a les égalités suivantes dans le groupe de Picard de $\mathbb{P}\Omega_g^{(k)}$*

$$\delta_{\text{deg}} = 12k(k+1)\lambda + 2(g-1)(2k+1)\xi - k(k+1)\sum_{i=0}^{\lfloor g/2 \rfloor} \delta_i$$

$$\lambda_{pT}^{(k-j)} = (6j^2 + 6j + 13)\lambda + \frac{g-1}{k}j(2j+1)\xi - j(j+1)\sum_{i=0}^{\lfloor g/2 \rfloor} \delta_i + a_j \delta_{\text{deg}}$$

où

$$a_j = \begin{cases} \frac{2j-k}{2k} & \text{si } (k-1)/2 < j < k, \\ 0 & \text{sinon.} \end{cases}$$

1.7. Nombres d'Hurwitz

Au chapitre 4, nous exposerons des relations entre les espaces de différentielles et la géométrie énumérative. La théorie de Hurwitz s'intéresse aux nombres de revêtements de courbes lisses avec singularités fixés. Nous verrons que l'on peut exprimer certains nombres de Hurwitz comme des nombres d'intersection dans les espaces de modules de différentielles stables.

1.7.1. Définition générale. Soit X une courbe lisse avec l points marqués (x_1, \dots, x_l) . Soit d un entier positif et soit $\Lambda = (\mu_1, \dots, \mu_l)$ une liste de l partitions de d . Un revêtement de X de type Λ est une paire $(C, f : C \rightarrow X)$ où:

- la courbe C est lisse;
- l'application f est de degré d et ramifiée uniquement au dessus des x_i . De plus au dessus de x_i le profil de ramification est donné par μ_i .

Deux revêtement ramifiés (C, f) et (C', f') sont isomorphes si il existe $\phi : C \xrightarrow{\sim} C'$ tel que $f \circ \phi = f'$. Le nombre de Hurwitz $H_d^X(\mu_1, \dots, \mu_n)$ est le nombre de classes d'équivalence de revêtements ramifiés à de type Λ comptés avec des poids $1/|\text{Aut}(C, f)|$.

Remarque 1.7.1. Nous avons choisi ici de mettre une structure complexe sur la surface cible X mais les nombres de Hurwitz ne dépendent pas de celle-ci. Ils ont une nature purement topologique.

1.7.2. Nombres de Hurwitz simples. D’abord, on considère une famille plus restreinte de nombres de Hurwitz que l’on appelle *nombres de Hurwitz simples*. Soit g et n des entiers positifs tels que $2g - 2 + n > 0$ et $d \leq 0$. La courbe cible est \mathbb{P}^1 , la courbe source est de genre g et on ne spécifie qu’un seul profil de ramification $\mu = (k_1, \dots, k_n)$ (au dessus de l’infini par exemple) et tous les autres profils de ramification sont simples. Autrement dit, les nombres de Hurwitz simples sont les nombres

$$h_{g,d}(k_1, \dots, k_n) = H_d^{\mathbb{P}^1} \left(\mu, \underbrace{(2, 1, 1 \dots), \dots, (2, 1, 1 \dots)}_K \right),$$

où K est déterminé par la formule de Riemann-Hurwitz $K = 2g - 2 + d + n$.

La formule ELSV est une égalité entre les nombres d’Hurwitz simples et des nombres d’intersection dans l’espace des modules de courbes stables. On note λ_i la i -ème classe de Chern du fibré de Hodge.

Theorem 1.7.2. *On a l’égalité suivante*

$$h_{g,d}(k_1, \dots, k_n) = \frac{2g - 2 + d + n}{|\text{Aut}(k_1, \dots, k_n)|} \prod_{i=1}^n \frac{k_i^{k_i}}{k_i!} \int_{\mathcal{M}_{g,n}} \frac{1 - \lambda_1 + \dots + (-1)^g \lambda_g}{\prod_{i=1}^n (1 - k_i \psi_i)}.$$

Ce théorème a d’abord été prouvé dans [20] puis dans [36] par des techniques de localisation.

1.7.3. Généralisations de ELSV. A partir de la formule ELSV plusieurs résultats importants ont été établis et des généralisations ont été prouvées (ou conjecturées).

- Dans [46], Maxim Kazarian a utilisé la formule ELSV pour montrer que les intégrales de Hodge vérifient la hiérarchie KP. Il en déduit la première preuve algébrique du théorème de Kontsevich-Witten.
- Dans [63], Okounkov et Pandharipande ont donné une expression des invariants de Gromov-Witten stationnaires de n’importe quelle courbe algébrique en fonction de nombres d’Hurwitz. Ce résultat est connu comme la correspondance Gromov-Witten/Hurwitz au travers de la formule de cycles complétés.
- Dans [34], Goulden, Jackson et Vakil ont conjecturé une formule à la formule ELSV dans le cas des nombres d’Hurwitz doubles totalement ramifiés au dessus de 0 (profils de ramification spécifiés au dessus de 0 et ∞). Ils ont conjecturé que ces nombres de Hurwitz doubles devraient être exprimés comme des nombres d’intersections dans un “groupe de Picard universel” au-dessus de l’espace des modules de courbes. Plusieurs propriétés combinatoires de la conjecture GJV ont été mises en lumière (voir [74] ou [9]).
- La formule r -ELSV est une formule conjecturale qui relie des nombres d’Hurwitz avec cycles complétés de longueur $r + 1$ et des nombres d’intersection dans les espaces de structures r -spin (voir chapitre 5 pour la définition des espaces de structures spin et [73] pour une présentation détaillée de la conjecture).

1.7.4. Nombres d’Hurwitz et intersection dans les espaces de différentielles. Nous verrons au chapitre 4 une modification de la preuve de la formule ELSV utilisant des nombres d’intersection dans les espaces des modules de différentielles stables introduits au chapitre 2. Cette preuve est proche de la preuve originale mais elle peut être adaptée pour prouver la conjecture GJV en genre 0. La conjecture GJV en genre 0 était déjà connue mais aucune preuve géométrique n’existait. La preuve que l’on en donne s’appuie sur une généralisation de la formule des cycles complétés en genre 0 déjà observée dans [47].

1.8. Cycles de double ramification

Soit g et n tels que $2g-2+n > 0$. Soit $k \in \mathbb{N}$ et $\mu = (k_1, \dots, k_n)$ une liste d’entiers (positifs ou négatifs) telle que la somme des k_i soit égale à $2k(g-1)$. Nous allons nous intéresser au lieu $\mathcal{H}_g^k(\mu) \subset \mathcal{M}_{g,n}$ défini par

$$\left\{ (C, x_1, \dots, x_n) \in \mathcal{M}_{g,n} \mid \omega_C^{\otimes k} \simeq \mathcal{O}\left(\sum_{i=1}^n k_i \cdot x_i\right) \right\}.$$

On notera $\overline{\mathcal{H}}_g^k(\mu)$ la clôture de $\mathcal{H}_g^k(\mu)$ dans $\overline{\mathcal{M}}_{g,n}$. Nous allons étudier les classes $[\overline{\mathcal{H}}_g^k(\mu)] \in A^*(\overline{\mathcal{M}}_{g,n})$ ou $H^*(\overline{\mathcal{M}}_{g,n})$. Pour $k=0$, Faber et Pandhariapande ont prouvé que les classes $[\mathcal{H}_g^0(\mu)]$ sont tautologiques (voir [26]). Pour $k=1$ nous verrons que ces classes sont également tautologiques (et calculables) d’après le théorème du chapitre 2. Pour $k > 1$ le problème est ouvert.

Un problème important est de savoir s’il existe une expression fermée des classes $[\overline{\mathcal{H}}_g^k(\mu)]$. En effet, ni les méthodes développées dans [26] ni celles développées dans cette thèse ne permettent de donner une expression simple des classes $[\overline{\mathcal{H}}_g^k(\mu)]$. Il est donc difficile pour l’instant de dégager une structure générale de l’expression de ces classes.

Applications élastiques. On suppose ici que $k=0$. Il existe une compactification alternative des espaces de diviseurs principaux $\mathcal{H}_g^0(\mu)$. Ce sont les espaces d’applications élastiques $\overline{\mathcal{M}}_{g,n}^{\sim}(\mathbb{P}^1, \mu)$ (voir chapitre 5 pour les définitions). Ces espaces possèdent une théorie de l’obstruction parfaite et un cycle fondamental virtuel $[\overline{\mathcal{M}}_{g,n}^{\sim}(\mathbb{P}^1, \mu)]^{\text{vir}}$ de dimension virtuelle $2g-3+n$ (au sens de Behrend et Fantechi, voir [5]). De plus les espaces d’applications élastiques ont un morphisme d’oubli $p : \overline{\mathcal{M}}_{g,n}^{\sim}(\mathbb{P}^1, \mu) \rightarrow \overline{\mathcal{M}}_{g,n}$. Le cycle de double ramification est la classe

$$\text{DR}_g^0(\mu) = p_*[\overline{\mathcal{M}}_{g,n}^{\sim}(\mathbb{P}^1, \mu)]^{\text{vir}} \in A^g(\overline{\mathcal{M}}_{g,n}).$$

La différence entre $\text{DR}_g^0(\mu)$ et $[\overline{\mathcal{H}}_g^0(\mu)]$ est supportée $\overline{\mathcal{M}}_{g,n} \setminus \mathcal{M}_{g,n}$ puisqu’il s’agit de deux compactifications de $\mathcal{H}_g^0(\mu)$. L’expression des cycles de Double Ramification a été donnée dans [42]. Cette expression permet notamment de prouver que ces classes dépendent polynomialement des k_i et pourrait avoir des applications en théorie symplectique des champs (voir [21] et [39]).

Cycles de double ramification pour $k > 0$. Des généralisations des cycles de double ramification ont été définis pour des valeurs de k strictement positives (voir [28], [38], ou [72]). Par ailleurs un ensemble de conjectures donnent des

expressions des cycles de double ramification généralisés similaires à celle des cycles $DR_g^0(\mu)$ prouvé dans [42] et les reliant aux classes de strates des différentielles et des différentielles d'ordre supérieur. Nous exposerons précisément au dernier chapitre le contenu de ces conjectures.

Pour $k = 1$, les techniques développée au chapitre 2 permettent de tester la validité de ces conjectures cas par cas.

Cohomology classes of strata of differentials

We introduce a space of stable meromorphic differentials with poles of prescribed orders and define its tautological cohomology ring. This space, just as the space of holomorphic differentials, is stratified according to the set of multiplicities of zeros of the differential. The main goal of this chapter is to compute the Poincaré-dual cohomology classes of all strata. We prove that all these classes are tautological and give an algorithm to compute them.

In a second part of the last section of the chapter we study the Picard group of the strata. We use the tools introduced in the first part to deduce several relations in these Picard groups.

This chapter is mostly based on the paper [71].

2.1. Different formulations of the problem

2.1.1. Stratification of the Hodge Bundle. Let $g \geq 1$. Let \mathcal{M}_g be the space of smooth curves of genus g . The *Hodge bundle*,

$$\mathcal{H}_g \rightarrow \mathcal{M}_g$$

is the vector bundle whose fiber over a point $[C]$ of \mathcal{M}_g is the space of holomorphic differentials on C . A point of \mathcal{H}_g is then a pair $([C], \alpha)$, where C is a curve and α a differential on C . We will denote by $\mathbb{P}\mathcal{H}_g \rightarrow \mathcal{M}_g$ the projectivization of the Hodge bundle.

Notation 2.1.1. Let Z (for zeros) be a vector (k_1, k_2, \dots, k_n) of positive integers satisfying

$$\sum_{i=1}^n k_i = 2g - 2.$$

We will denote by $\mathbb{P}\mathcal{H}_g(Z)$ the subspace of $\mathbb{P}\mathcal{H}_g$ composed of pairs $([C], \alpha)$ such that α is a differential (defined up to a multiplicative constant) with zeros of orders k_1, \dots, k_n .

The locus $\mathbb{P}\mathcal{H}_g(Z)$ is a smooth orbifold (or a Deligne-Mumford stack), see for instance, [67]. However, neither $\mathbb{P}\mathcal{H}_g$, nor the strata $\mathbb{P}\mathcal{H}_g(Z)$ are compact.

The Hodge bundle has a natural extension to the space of stable curves:

$$\overline{\mathcal{H}}_g \rightarrow \overline{\mathcal{M}}_g.$$

We recall that abelian differentials over a nodal curve are allowed to have simple poles at the nodes with opposite residues on the two branches.

The space $\overline{\mathbb{P}\mathcal{H}}_g$ is compact and smooth, and we can consider the closures $\overline{\mathbb{P}\mathcal{H}}_g(Z)$ of the strata inside this space. Computing the Poincaré-dual cohomology classes of these strata is our motivating problem. In the present Chapter we solve

this problem and present a more general computation in the case of meromorphic differentials.

2.1.2. Stable differentials. On a fixed smooth curve C with one marked point x consider a family of meromorphic differentials with one pole of order p at x , such that the leading coefficient of the differential at the pole tends to 0. In order to construct a compact moduli space of meromorphic differentials we need to decide what the limit of a family like that should be. One natural idea is to include differentials with poles of orders less than p in the moduli space. It turns out, however, that a more convenient way to represent the limit is to allow the underlying curve to bubble at x ; in other words, to allow differentials defined on semi-stable curves.

A *semi-stable curve* is a nodal curve with smooth marked points such that every genus 0 component of its normalization contains at least two marked points and preimages of nodes (instead of at least three for stable curves). In the example above, the limit of the family would be a meromorphic differential defined on a semi-stable curve with one unstable component and on marked point x on it. The curve maps to C under the contraction of the unstable component. The meromorphic differential still has a pole of order exactly p at x .

Definition 2.1.2. Let $n, m \in \mathbb{N}$ and let P (for poles) be a vector (p_1, p_2, \dots, p_m) of positive integers. A *stable differential* of type (g, n, P) is a tuple $(C, x_1, \dots, x_{n+m}, \alpha)$ where (C, x_1, \dots, x_{n+m}) is a semi-stable curve with $n+m$ marked points and α is a meromorphic differential on C , such that

- the differential α has no poles outside the m last marked points and nodes;
- the poles at the nodes are at most simple and have opposite residues on the two branches;
- if $p_i > 1$ then the pole at the marked point x_{n+i} is of order exactly p_i ; if $p_i = 1$ then x_i can be a simple pole, a regular point, or a zero of any order;
- the group of isomorphisms of C preserving α and the marked points is finite.

Definition 2.1.3. A *family of stable differentials* is a tuple $(C \rightarrow B, \sigma_1, \dots, \sigma_n, \alpha)$ where $(C \rightarrow B, \sigma_1, \dots, \sigma_n)$ is a family of marked semi-stable curves and α is a meromorphic section of the relative dualizing line bundle $\omega_{C/B}$ such that for each geometric point b of B , the tuple $(C_b, \sigma_1(b), \dots, \sigma_n(b), \alpha|_{C_b})$ is a stable differential.

The *stack $\overline{\mathfrak{H}}_{g,n,P}$ of stable differentials* of type (g, n, P) is the category of families of stable differentials of type (g, n, P) , fibered over the category of \mathbb{C} -schemes.

Proposition 2.1.4. *The moduli space $\overline{\mathfrak{H}}_{g,n,P}$ is a smooth Deligne-Mumford (DM) stack. It is of dimension $4g-4+\sum p_i$ if P is non-empty and $4g-3$ otherwise.*

The space $\overline{\mathfrak{H}}_{g,n,P}$ carries a natural \mathbb{C}^* -action given by the multiplication of the differential by non-zero scalars. Besides, there exists a forgetful map $\overline{\mathfrak{H}}_{g,n,P} \rightarrow \overline{\mathcal{M}}_{g,n+m}$ that maps a family stable differentials to the stabilization of its underlying family of semi-stable curves. However, the space $\overline{\mathfrak{H}}_{g,n,P}$ does not have a natural vector bundle structure because there is no natural definition of the sum of two differentials with fixed orders of poles.

We will construct a partial coarsification of $\overline{\mathfrak{H}}_{g,n,P}$ that has the structure of an orbifold cone over $\overline{\mathcal{M}}_{g,n+m}$.

Proposition 2.1.5. *There exists a unique DM stack $\overline{\mathcal{H}}_{g,n,P}$ fitting in the following commutative triangle*

$$\begin{array}{ccc} \overline{\mathfrak{H}}_{g,n,P} & \longrightarrow & \overline{\mathcal{H}}_{g,n,P} \\ & \searrow & \downarrow \pi \\ & & \overline{\mathcal{M}}_{g,n+m} \end{array}$$

and satisfying

- the morphism π is schematic, i.e. for any \mathbb{C} -scheme U with a morphism $U \rightarrow \overline{\mathcal{M}}_{g,n+m}$, the pull-back $\overline{\mathcal{H}}_{g,n,P} \times_{\overline{\mathcal{M}}_{g,n+m}} U$ is representable by a \mathbb{C} -scheme;
- for any such $U \rightarrow \overline{\mathcal{M}}_{g,n+m}$, the scheme $\overline{\mathcal{H}}_{g,n,P} \times_{\overline{\mathcal{M}}_{g,n+m}} U$ is the coarse space of $\overline{\mathfrak{H}}_{g,n,P} \times_{\overline{\mathcal{M}}_{g,n+m}} U$.

Definition 2.1.6. The space $\overline{\mathcal{H}}_{g,n,P}$ is called the *space of stable differentials*.

Proposition 2.1.7. *The space of stable differentials is an orbifold cone over $\overline{\mathcal{M}}_{g,n+m}$. Besides the space $\overline{\mathcal{H}}_{g,n,P}$ and its projectivization are normal.*

We prove these propositions in Section 2.2, where we will also give a definition of an orbifold cone. At present it suffices to note that the cone structure on $\overline{\mathcal{H}}_{g,n,P}$ allows one to define a projectivization $\mathbb{P}\overline{\mathcal{H}}_{g,n,P}$, a tautological line bundle over the projectivization, and the Segre class. Besides, the morphism $\overline{\mathfrak{H}}_{g,n,P} \rightarrow \overline{\mathcal{H}}_{g,n,P}$ is \mathbb{C}^* -equivariant.

Remark 2.1.8. The stack $\overline{\mathfrak{H}}_{g,n,P}$ can be endowed with the structure of an orbifold cone over a different moduli space $\overline{\mathcal{M}}_{g,n,P}$. The space $\overline{\mathcal{M}}_{g,n,P}$ is a $\left(\prod_{i=1}^m \mathbb{Z}/(p_i-1)\mathbb{Z}\right)$ -gerb over $\overline{\mathcal{M}}_{g,n+m}$. The fibers of $\overline{\mathfrak{H}}_{g,n,P} \rightarrow \overline{\mathcal{M}}_{g,n,P}$ are vector spaces, but the \mathbb{C}^* -action on these spaces has nontrivial weights.

One can define the projectivization of $\overline{\mathfrak{H}}_{g,n,P}$ and the tautological line bundle over this projectivization. Then we have a map $\mathbb{P}\overline{\mathfrak{H}}_{g,n,P} \rightarrow \mathbb{P}\overline{\mathcal{H}}_{g,n,P}$ which is a bijection between the geometric points of these two stacks.

Therefore we have natural isomorphisms $H^*(\mathbb{P}\overline{\mathfrak{H}}_{g,n,P}, \mathbb{Q}) \simeq H^*(\mathbb{P}\overline{\mathcal{H}}_{g,n,P}, \mathbb{Q})$ and $A^*(\mathbb{P}\overline{\mathfrak{H}}_{g,n,P}, \mathbb{Q}) \simeq A^*(\mathbb{P}\overline{\mathcal{H}}_{g,n,P}, \mathbb{Q})$. Thus, all the results of this text are valid for both spaces.

While the space $\overline{\mathfrak{H}}_{g,n,P}$ is the more natural choice for the moduli space of differentials, in the present Chapter we prefer to work with $\overline{\mathcal{H}}_{g,n,P}$ in order to have $\overline{\mathcal{M}}_{g,n+m}$ as the base of our cone.

Notation 2.1.9. Let $P = (p_1, \dots, p_m)$ be a vector of positive integers and $Z = (k_1, \dots, k_n)$ a vector of nonnegative integers. We denote by $A_{g,Z,P} \subset \overline{\mathcal{H}}_{g,n,P}$, the locus of stable differentials $(C, x_1, \dots, x_{n+m}, \alpha)$ such that C is smooth and α has zeros exactly of orders prescribed by Z at the first n marked points. The locus $A_{g,Z,P}$ is invariant under the \mathbb{C}^* -action. We denote by $\mathbb{P}A_{g,Z,P}$ the projectivization of $A_{g,Z,P}$.

Moreover, we denote by $\overline{A}_{g,Z,P}$ (respectively $\mathbb{P}\overline{A}_{g,Z,P}$) the closures of $A_{g,Z,P}$ (resp. $\mathbb{P}A_{g,Z,P}$) in the space $\overline{\mathcal{H}}_{g,n,P}$ (respectively in $\mathbb{P}\overline{\mathcal{H}}_{g,n,P}$).

2.1.3. The tautological ring of $\mathbb{P}\overline{\mathcal{H}}_{g,n,P}$. Let P be a vector of positive integers. From now on, unless specified otherwise, we will denote by $\pi : \overline{\mathcal{M}}_{g,n+1} \rightarrow \overline{\mathcal{M}}_{g,n}$ the forgetful map and by $p : \overline{\mathcal{H}}_{g,n,P} \rightarrow \overline{\mathcal{M}}_{g,n+m}$ the projection from the space of stable differentials to $\overline{\mathcal{M}}_{g,n+m}$. Moreover we use the same notation $p : \mathbb{P}\overline{\mathcal{H}}_{g,n,P} \rightarrow \overline{\mathcal{M}}_{g,n+m}$ for the projectivized cone. Let

$$\mathcal{L} = \mathcal{O}(1) \rightarrow \mathbb{P}\overline{\mathcal{H}}_{g,n,P}$$

be the dual of the tautological line bundle of $\mathbb{P}\overline{\mathcal{H}}_{g,n,P}$, and let $\xi = c_1(\mathcal{L})$.

Definition 2.1.10. The *tautological ring* of $\mathbb{P}\overline{\mathcal{H}}_{g,n,P}$ is the subring of the cohomology ring $H^*(\mathbb{P}\overline{\mathcal{H}}_{g,n,P}, \mathbb{Q})$ generated by ξ and the pull-back of $RH^*(\overline{\mathcal{M}}_{g,n+m})$ under p . We denote it by $RH^*(\mathbb{P}\overline{\mathcal{H}}_{g,n,P})$.

Remark 2.1.11. We have $\xi^d = 0$ for $d > \dim(\mathbb{P}\overline{\mathcal{H}}_{g,n,P})$. Therefore the tautological ring of $\mathbb{P}\overline{\mathcal{H}}_{g,n,P}$ is a finite extension of the tautological ring of $\overline{\mathcal{M}}_{g,n+m}$.

Example 2.1.12. In absence of poles, the Hodge bundle is a vector bundle and we have

$$RH^*(\mathbb{P}\overline{\mathcal{H}}_{g,n}) = RH^*(\overline{\mathcal{M}}_{g,n})[\xi]/(\xi^g + \lambda_1 \xi^{g-1} + \dots + \lambda_g).$$

Proposition 2.1.13. *The Segre class of the cone $\overline{\mathcal{H}}_{g,n,P} \rightarrow \overline{\mathcal{M}}_{g,n+m}$ equals*

$$\prod_{i=1}^m \frac{(p_i - 1)^{p_i - 1}}{(p_i - 1)!} \cdot \frac{1 - \lambda_1 + \dots + (-1)^g \lambda_g}{\prod_{i=1}^m (1 - (p_i - 1)\psi_i)}.$$

This proposition will be proved in Section 2. An important corollary of this proposition is that the push-forward of a tautological class from $\mathbb{P}\overline{\mathcal{H}}_{g,n,P}$ to $\overline{\mathcal{M}}_{g,n+m}$ is tautological.

2.1.4. Statement of the results. Now, we have all elements to state the main theorems of the present Chapter.

Theorem 2.1.14. *For any vectors Z and P , the class $[\mathbb{P}\overline{A}_{g,Z,P}]$ introduced in Notation 2.1.9, lies in the tautological ring of $\mathbb{P}\overline{\mathcal{H}}_{g,n,P}$ and is explicitly computable.*

The main ingredient to prove this theorem will be the induction formula of Theorem 2.3.41.

Definition 2.1.15. Let V be a vector with integral coefficients, in the present Chapter we will denote by $|V|$ the sum of elements of V and by $\ell(V)$ the length of V .

Given g and P , we will say that Z is *complete* if it satisfies $|Z| - |P| = 2g - 2$. If Z is complete, we denote by $Z - P$ the vector $(k_1, \dots, k_n, -p_1, \dots, -p_m)$ (in particular if P is empty, then we only impose $|Z| = 2g - 2$).

Restricting ourselves to the holomorphic case and applying the forgetful map of the marked points we obtain the following corollary.

Theorem 2.1.16. *For any complete vector Z , the class $[\mathbb{P}\overline{\mathcal{H}}_g(Z)]$ introduced in Notation 2.1.1 lies in the tautological ring of $\mathbb{P}\overline{\mathcal{H}}_g$ and is explicitly computable.*

Remark 2.1.17. As a guideline for the reader, it will be important to understand that the holomorphic case in Theorem 2.1.14 cannot be proved without using strictly meromorphic differentials. Thus Theorem 2.1.16 is a consequence of a specific case of Theorem 2.1.14 but one cannot avoid to prove Theorem 2.1.14 in its full generality.

The second important corollary is obtained by forgetting the differential instead of the marked points. Let $P = (p_1, \dots, p_m)$ be a vector of poles and $Z = (k_1, \dots, k_n)$ be a complete vector of zeros. We define $\mathcal{H}_g(Z-P) \subset \mathcal{M}_{g,n+m}$ as the locus of points (C, x_1, \dots, x_n) that satisfy

$$\omega_C \left(- \sum_{i=1}^n k_i x_i + \sum_{j=1}^m p_j x_{n+j} \right) \simeq \mathcal{O}_C.$$

We denote by $\overline{\mathcal{H}}_g(Z-P)$ the closure of $\mathcal{H}_g(Z-P)$ in $\overline{\mathcal{M}}_{g,n+m}$.

Theorem 2.1.18. *For any vectors Z and P , the class $[\overline{\mathcal{H}}_g(Z-P)]$ lies in the tautological ring of $\overline{\mathcal{M}}_{g,n+m}$ and is explicitly computable.*

Remark 2.1.19. Theorems 2.1.14, 2.1.16 and 2.1.18 are stated for the Poincaré-dual rational cohomology classes. However, all identities of the present Chapter are valid in the Chow groups.

In a second part of the text (Section 2.5) we will consider the rational Picard group of the space $\overline{\mathcal{H}}_g(Z-P)$. We will define several natural classes in this Picard group and apply the tools developed in the first part of the Curve to deduce a series of relations between these classes (see Theorem 2.5.5).

2.1.5. An example. Here we illustrate the general method used in the present Chapter by computing the class of differentials with a double zero $[\mathbb{P}\overline{\mathcal{H}}_g(2, 1, \dots, 1)]$. This computation was carried out by D. Zvonkine in an unpublished note [84] and was the starting point of the present work.

We begin by marking a point, i.e. we study the space $\mathbb{P}\overline{\mathcal{H}}_{g,1}$ of triples $(C, x_1, [\alpha])$ composed of a stable curve C with one marked point x_1 and an abelian differential α modulo a multiplicative constant. Recall that $\mathbb{P}\overline{\mathcal{A}}_{g,(2)} \subset \mathbb{P}\overline{\mathcal{H}}_{g,1}$ is the closure of the locus of smooth curves with a double zero at the marked point. In order to compute $[\mathbb{P}\overline{\mathcal{A}}_{g,(2)}]$, we consider the line bundle

$$\mathcal{L} \otimes \mathcal{L}_1 \simeq \text{Hom}(\mathcal{L}^\vee, \mathcal{L}_1)$$

over $\mathbb{P}\overline{\mathcal{H}}_{g,1}$. (Recall that \mathcal{L}^\vee is the tautological line bundle of the projectivization $\mathbb{P}\overline{\mathcal{H}}_{g,1}$ and \mathcal{L}_1 is the cotangent line bundle at the marked point x_1 .) We construct a natural section s_1 of this line bundle,

$$\begin{aligned} s_1 : \mathcal{L}^\vee &\rightarrow \mathcal{L}_1 \\ \alpha &\mapsto \alpha(x_1). \end{aligned}$$

Namely, an element of \mathcal{L}^\vee is an abelian differential on C , and we take its restriction to the marked point.

The section s_1 vanishes if and only if the marked point is a zero of the abelian differential. Thus we have the following identity in $H^2(\mathbb{P}\overline{\mathcal{H}}_{g,1})$:

$$[\mathbb{P}\overline{A}_{g,(1)}] = [\{s_1 = 0\}] = c_1(\mathcal{L} \otimes \mathcal{L}_1) = \xi + \psi_1.$$

Now we restrict ourselves to the locus $\{s_1 = 0\}$ and consider the line bundle

$$\mathcal{L} \otimes \mathcal{L}_1^{\otimes 2}.$$

We build a section s_2 of this new line bundle. An element of $\mathcal{L}_{\{s_1=0\}}^\vee$ is an abelian differential with at least a simple zero at the marked point x_1 . Its first derivative at x_1 is then an element of $\mathcal{L}_1^{\otimes 2}$ (we can verify this assertion using a local coordinate at x_1).

As before, s_2 is equal to zero if and only if the marked point is at least a double zero of the abelian differential. However, $\{s_2 = 0\}$ is composed of three components:

- $\mathbb{P}\overline{A}_{g,(2)}$;
- the locus a_e where the marked point lies on an elliptic component attached to the rest of the stable curve at exactly one point and the abelian differential vanishes identically on the elliptic component;
- the locus a_r where the marked point lies on a “rational bridge”, that is, a rational component attached to two components of the stable curve that are not connected except by this rational component (in this case the abelian differential automatically vanishes on the rational bridge).

We deduce the following formula for $[\mathbb{P}\overline{A}_{g,(2)}]$:

$$\begin{aligned} [\mathbb{P}\overline{A}_{g,(2)}] &= [\{s_2 = 0\}] - [a_e] - [a_r] \\ &= (\xi + \psi_1)(\xi + 2\psi_1) - [a_e] - [a_r] \\ &= \xi^2 + 3\psi_1\xi + 2\psi_1^2 - [a_e] - [a_r]. \end{aligned}$$

Remark 2.1.20. We make a series of remarks on this result.

- To transform the above considerations into an actual proof we need to check that the vanishing multiplicity of s_2 along all three components equals 1. We will prove this assertion and its generalization in Section 3.
- Denote by $\pi : \mathbb{P}\overline{\mathcal{H}}_{g,1} \rightarrow \mathbb{P}\overline{\mathcal{H}}_g$ the forgetful map, by δ_{sep} the boundary divisor of composed of curves with a separating node, and δ_{nonsep} the boundary divisor of curves with a nonseparating node. Let us apply the push-forward by π to the above expression of $[\mathbb{P}\overline{A}_{g,(2)}]$.
 - The term $\pi_*(\xi^2)$ vanishes by the projection formula, since it’s a push-forward of a pull-back.
 - The term $\pi_*(3\xi\psi_1)$ gives $3\kappa_0\xi = (6g-6)\xi$ by the projection formula.
 - The term $\pi_*(2\psi_1^2)$ gives $2\kappa_1$.
 - The term $\pi_*([a_e])$ vanishes, because the geometric image of a_e is of codimension 2 in $\mathbb{P}\overline{\mathcal{H}}_g$.
 - The term $\pi_*([a_r])$ gives δ_{sep} since π induces a degree one map from a_r onto δ_{sep} .

Thus we get

$$[\mathbb{P}\overline{\mathcal{H}}(2, 1, \dots, 1)] = \pi_*[\mathbb{P}\overline{A}_{g,(2)}] = (6g-6)\xi + 2\kappa_1 - \delta_{\text{sep}}.$$

Using the relation $\kappa_1 = 12\lambda_1 - \delta_{\text{sep}} - \delta_{\text{nonsep}}$ on $\overline{\mathcal{M}}_g$ (see, for example, [1], chapter 17), we have

$$[\mathbb{P}\overline{\mathcal{H}}(2, 1, \dots, 1)] = (6g - 6)\xi + 24\lambda_1 - 3\delta_{\text{sep}} - 2\delta_{\text{nonsep}}.$$

This formula was first proved by Korotkin and Zograf in 2011 using an analysis of the Bergman tau function [57]. Dawei Chen gave another proof of this result in 2013 using test curves [13].

- In general, to prove Theorem 2.1.14 we will work by induction. Let $Z = (k_1, k_2, \dots, k_n)$ and P be vectors of positive integers. Let $Z' = (k_1, \dots, k_i + 1, \dots, k_n)$. Then we will show that

$$[\mathbb{P}\overline{A}_{g,Z',P}] = (\xi + (k_i + 1)\psi_i) [\mathbb{P}\overline{A}_{g,Z,P}] - \text{boundary terms}.$$

The computation of these boundary terms is the crucial part of the proof.

2.2. Stable differentials

In this section, we study the space of stable differentials. We construct the space of stable differentials and compute its Segre class. We also define stable differentials on disconnected curves.

2.2.1. The cone of generalized principal parts.

2.2.1.1. *Orbifold cones.* We follow here the approach of [20]. Let X be a projective DM stack.

Definition 2.2.1. An *orbifold cone* is a finitely generated sheaf of graded \mathcal{O}_X -algebras $S = S^0 \oplus S^1 \oplus S^2 \oplus \dots$ such that $S^0 = \mathcal{O}_X$.

Remark 2.2.2. This definition of cone is weaker than the classical definition of Fulton (see [31]) because we do not ask that S be generated by S^1 . In the classical definition, a cone is a subvariety of a vector bundle (the dual of S^1) given by homogeneous equations. Its projectivization is a subvariety of a bundle of projective spaces. In the orbifold case, the cone is, again, a suborbifold of a vector bundle, but is now given by quasi-homogeneous equations. Its projectivization is a suborbifold of the corresponding bundle of weighted projective spaces, which carries a tautological line bundle in the orbifold sense. Thus the projectivization $\mathbb{P}\mathcal{C}$ of a cone is an orbifold and carries a natural orbifold line bundle $\mathcal{O}(1)$, the dual of the tautological line bundle. We denote $p : \mathbb{P}\mathcal{C} = \text{Proj}(S) \rightarrow X$ and $\xi = c_1(\mathcal{O}(1))$. Let $\mathcal{C} \rightarrow X$ be a pure-dimensional cone and r the rank of the cone defined as $\dim(\mathcal{C}) - \dim(X)$. The i -th Segre class of \mathcal{C} is defined as

$$s_i = p_*(\xi^{r+i-1}) \in H^{2i}(X, \mathbb{Q}).$$

Example 2.2.3. Let us consider the graded algebra $\mathbb{C}[x, y, z]$ such that x is an element of weight 2, y is an element of weight 3 and z is an element of weight 1. This graded algebra is not generated by its degree 1 elements. The associated projectivized cone over a point is the weighted projective space $\mathbb{P}(2, 3)$ which is the quotient of $(\mathbb{C}^3)^*$ by \mathbb{C}^* with the action:

$$\lambda \cdot (x, y, z) = (\lambda^2 x, \lambda^3 y, \lambda z).$$

Example 2.2.4. More generally, consider a sheaf of algebras of the form $\mathcal{O}_X \otimes_{\mathbb{C}} S$, where S is a graded algebra over \mathbb{C} . The projective spectrum of this sheaf is a direct product of X with $\text{Proj}(S)$. We call this a *trivial orbifold cone*.

2.2.1.2. Cone of generalized principal parts.

Definition 2.2.5. Let p be an integer greater than 1. A *principal part* of order p at a smooth point of a curve is an equivalence class of germs of meromorphic differentials with a pole of order p ; two germs f_1, f_2 are equivalent if $f_1 - f_2$ is a meromorphic differential with at most a simple pole.

First, we parametrize the space of principal parts at a point. Let z be a local coordinate at $0 \in \mathbb{C}$. A principal part at 0 of order p is given by:

$$\left[\left(\frac{u}{z} \right)^{p-1} + a_1 \left(\frac{u}{z} \right)^{p-2} + \dots + a_{p-2} \left(\frac{u}{z} \right) \right] \frac{dz}{z}$$

with $u \neq 0$. However, given a principal part, the choice of (u, a_1, \dots, a_{p-2}) is not unique. Indeed there are $p-1$ choices for u given by the $\zeta^\ell \cdot u$ (with $\zeta^\ell = \exp(\frac{2i\pi \cdot \ell}{p-1})$, for $0 \leq \ell \leq p-1$) and, once the value of u is chosen, the a_i 's are determined uniquely. Therefore the coordinates (u, a_1, \dots, a_{p-2}) parametrize a degree $p-1$ covering of the space of principal parts. This motivates the following definition.

Definition 2.2.6. Assign to u the weight $1/(p-1)$ and to a_j the weight $j/(p-1)$. The graded algebra $S \subset \mathbb{C}[u, a_1, \dots, a_{p-2}]$ spanned by the monomials of integral weights is called the *algebra of generalized principal parts* and $\mathcal{P} = \text{Spec}(S)$ is the *space of generalized principal parts*.

The space \mathcal{P} is the quotient of \mathbb{C}^{p-1} by the group $\mathbb{Z}/(p-1)\mathbb{Z}$, which, from now on, we will denote by \mathbb{Z}_{p-1} for shortness. An element $\zeta \in \mathbb{Z}_{p-1}$ acts by

$$\zeta \cdot (u, a_1, \dots, a_{p-2}) = (\zeta u, \zeta a_1, \dots, \zeta^{p-2} a_{p-2}).$$

Moreover, the natural action of \mathbb{C}^* on \mathcal{P} is given by

$$\lambda \cdot (u, a_1, \dots, a_{p-2}) = (\lambda^{\frac{1}{p-1}} u, \lambda^{\frac{1}{p-1}} a_1, \dots, \lambda^{\frac{p-2}{p-1}} a_{p-2}).$$

Note that this action is not well-defined on the covering space \mathbb{C}^{p-1} , but is well defined on its \mathbb{Z}_{p-1} quotient \mathcal{P} .

Notation 2.2.7. Denote by $I_u \subset S$ the ideal of polynomials divisible by u . Denote by $\mathcal{A} \subset \mathcal{P}$ the suborbifold defined by I_u .

The suborbifold $\mathcal{A} \subset \mathcal{P}$ is the Weil divisor obtained as the image of the Cartier divisor $\{u = 0\} \subset \mathbb{C}^{p-1}$ under the quotient of \mathbb{C}^{p-1} by the action of \mathbb{Z}_{p-1} . The divisor $(p-1)\mathcal{A}$ is the Cartier divisor given by the equation $u^{p-1} = 0$. (Note that u^{p-1} lies in S while u does not.) The space of principal parts embeds into \mathcal{P} as the complement of \mathcal{A} .

Lemma 2.2.8. A change of local coordinate z induces an isomorphism of S that preserves the grading and acts trivially on the quotient algebra S/I_u .

PROOF. Let $z = f(w) = \alpha_1 w + \alpha_2 w^2 + \dots$ be a local coordinates change. We denote by $(u', a'_1, \dots, a'_{p-2})$ the parameters of the presentation of principal parts in

coordinate w . We have the transformation:

$$\begin{aligned} u &\mapsto \alpha_1 u \\ a_1 &\mapsto a_1 + \gamma_{1,1} u \\ a_2 &\mapsto a_2 + \gamma_{2,1} u a_1 + \gamma_{2,2} u^2 \\ &\dots \end{aligned}$$

where the $\gamma_{i,j}$ are polynomials in $\alpha_1, \alpha_2, \dots$ depending only on the order of the principal part. By taking u to be 0, we see that the coordinates (a_1, \dots, a_{p-2}) of \mathcal{A} are independent of the choice of local coordinate. \square

Remark 2.2.9. In Section 2.2.2 we will see that the locus \mathcal{A} corresponds to the appearance of a semi-stable bubble of the underlying curve C at the i th marked point. The coordinate on the bubble is $w = u/z$.

Remark 2.2.10. The cone of principal parts of differentials differs from the cone of principal parts of functions of [20] only by the coefficients $\gamma_{i,j}$.

Now, let g, n be nonnegative integers such that $2g - 2 + n > 0$. Let $i \in \llbracket 1, n \rrbracket$ and $p_i \geq 2$. We denote by \mathbb{P}_i the following sheaf of graded algebras over $\overline{\mathcal{M}}_{g,n}$.

Pick an open chart $U \subset \overline{\mathcal{M}}_{g,n}$ together with a trivialization of a tubular neighborhood of the i th section σ_i of the universal curve over U . In other words, denoting by Δ the unit disc, we choose an embedding

$$U \times \Delta \hookrightarrow \overline{\mathcal{C}}_{g,n}$$

commuting with $U \hookrightarrow \overline{\mathcal{M}}_{g,n}$ and such that $U \times \{0\}$ is the i -th section of the universal curve. The sheaf \mathbb{P}_i over U is given by $\mathbb{P}_i(U) = \mathcal{O}_U \otimes S$.

Now, given two overlapping charts U and V we need to define the gluing map between the sheaves on their intersection. To do that, denote by z the coordinate on Δ in the product $U \times \Delta$ and by w the coordinate on Δ in the product $V \times \Delta$. Over the intersection $U \cap V$ we get a change of local coordinates $z(w)$. We use this change of local coordinate and the constants $\gamma_{i,j}$ from Lemma 2.2.8 to construct an identification between the two algebras $\mathbb{P}_i(U)|_{U \cap V}$ and $\mathbb{P}_i(V)|_{U \cap V}$.

Note that the sheaf of ideals I_u is well-defined and the quotients S/I_u are identified with each other in a canonical way that does not depend on the local coordinates z and w .

We denote by $\mathcal{P}^i = \text{Spec}(\mathbb{P}_i)$ the spectrum of \mathbb{P}_i and by $\mathcal{A}^i = \text{Spec}(\mathbb{P}_i/I_u)$ the spectrum of the quotient. The latter is a trivial cone over $\overline{\mathcal{M}}_{g,n}$.

Proposition 2.2.11. *The cone \mathcal{P}^i and its projectivization are normal.*

PROOF. Indeed the space $\overline{\mathcal{M}}_{g,n}$ is smooth and the sheaf of fractions of the algebra \mathbb{P}_i is the same as the sheaf of fractions of \mathbb{P}_i^1 , thus for all $U \rightarrow \overline{\mathcal{M}}_{g,n}$ affine chart of $\overline{\mathcal{M}}_{g,n}$, the domain $B = \mathcal{O}_U \otimes \mathbb{P}_i$ is an integrally closed domain. Indeed suppose that f is a fraction of B such that a polynomial with coefficient in B satisfies $Q(B) = 0$. Then for an element $a \in B^1$, we have that aQ is polynomial with coefficient in B^1 (because every element of B is a fraction of elements of B^1) and $aQ(f) = 0$ with f a fraction of B^1 . Therefore f is an element of B^1 , thus of B . \square

Lemma 2.2.12. *The cone \mathcal{A}^i is the product of $\overline{\mathcal{M}}_{g,n}$ with the weighted projective space with weights $(\frac{1}{p_i-1}, \dots, \frac{p_i-2}{p_i-1})$ quotiented by the action of \mathbb{Z}_{p_i-1} . Moreover the Segre classes of \mathcal{A}^i and \mathcal{P}^i are given by*

$$\begin{aligned} s(\mathcal{A}^i) &= \frac{(p_i-1)^{p_i-2}}{(p_i-1)!} \\ s(\mathcal{P}^i) &= \frac{(p_i-1)^{p_i-1}}{(p_i-1)!} \cdot \frac{1}{1-(p_i-1)\psi_i}. \end{aligned}$$

PROOF. The proof is based on the same arguments as for the cone of principal parts of functions. The section u^{p_i-1} is a section of the line bundle $\mathcal{L}_i^{-\otimes(p_i-1)}$ which vanishes with multiplicity p_i-1 along \mathcal{A}^i . \square

2.2.1.3. *Stack of generalized principal parts.* In the above paragraph we have defined the cone of generalized principal parts which is a normal scheme over $\overline{\mathcal{M}}_{g,n}$. We introduce here another approach to the quotient by the \mathbb{Z}_{p_i-1} -action. Let $\tilde{\mathbb{P}}_i$ be the sheaf of algebra defined locally by

$$\tilde{\mathbb{P}}_i(U) = \mathcal{O}_U[u, a_1, \dots, a_{p_i-2}]$$

where U is a chart with a trivialization of a tubular neighborhood of the i -th section of the universal curve and the coordinates $(u, a_1, \dots, a_{p_i-2})$ are defined as above.

Definition 2.2.13. The stack of generalized principal parts \mathfrak{P}_i is the stack quotient

$$\mathrm{Spec}(\tilde{\mathbb{P}}_i) / \mathbb{Z}_{p_i-1}.$$

By construction we have the following proposition.

Proposition 2.2.14. *For all schemes U with a map $U \rightarrow \overline{\mathcal{M}}_{g,n}$, the scheme $U \times_{\overline{\mathcal{M}}_{g,n}} \mathfrak{P}_i$ is the coarse space of $U \times_{\overline{\mathcal{M}}_{g,n}} \tilde{\mathfrak{P}}_i$.*

Proposition 2.2.15. *The stack of generalized principal parts is a smooth DM stack.*

PROOF. The space $\overline{\mathcal{M}}_{g,n}$ is a smooth DM stack and \mathfrak{P}_i is locally the quotient of an affine smooth scheme over $\overline{\mathcal{M}}_{g,n}$ by a finite group. \square

2.2.1.4. *Cones of generalized principal parts and jet bundles.* From now on in the text, unless otherwise mentioned, for any family of semi-stable curves $C \rightarrow S$ we denote by ω the relative dualizing sheaf $\omega_{C/S}$.

Definition 2.2.16. Let $\pi : \overline{\mathcal{C}}_{g,n} \rightarrow \overline{\mathcal{M}}_{g,n}$ be the universal curve and $(\sigma_i)_{1 \leq i \leq n} : \overline{\mathcal{M}}_{g,n} \rightarrow \overline{\mathcal{C}}_{g,n}$ the global sections of marked points. Let $1 \leq i \leq n$ and $p_i \geq 1$. The vector bundle $J^i \rightarrow \overline{\mathcal{M}}_{g,n}$ of polar jets of order p_i at the i -th marked point is defined as the quotient

$$J^i = R^0 \pi_* (\omega(p_i \sigma_i)) / R^0 \pi_* (\omega(\sigma_i)).$$

We fix $1 \leq i \leq n$ and $p_i > 0$. The bundle of polar jet of order p_i is a vector bundle of rank p_i-1 . As before, we consider an open chart U of $\overline{\mathcal{M}}_{g,n}$ with a trivialization z_i of a tubular neighborhood of the section σ_i . Over the chart U the

jet bundle is trivial. Indeed an element of J^i over U is given by

$$\left[\frac{b_0}{z_i^{p_i-1}} + \dots + \frac{b_{p_i-2}}{z_i^{p_i-2}} \right] \frac{dz_i}{z_i}.$$

Thus, the jet bundle J^i restricted to U is given by $\text{Spec}(\mathcal{O}_U[b_0^i, \dots, b_{p_i-2}^i])$. Recall that, using the trivialization z_i we have defined coordinates u, a_1, \dots, a_{p_i-2} such that $\mathbb{P}^i(U)$ is the sub-algebra of

$$\mathcal{O}_U[u, a_1, \dots, a_{p_i-2}]$$

generated by monomials with integral weights. We define the following morphism of graded algebras over \mathcal{O}_U

$$\begin{aligned} \phi_i(U) : \text{Sym}^*(J^i \vee)(U) &\rightarrow \mathbb{P}^i(U) \\ b_0 &\mapsto u^{p_i-1}, \\ b_j &\mapsto u^{p_i-1-j} a_j \quad (\text{for } 1 \leq j \leq p_i-2). \end{aligned}$$

The morphism $\phi_i(U)$ is defined for a chart U with a choice of trivialization z_i . We can easily check that the $\phi_i(U)$ can be glued into a morphism of sheaves of graded algebras. Thus we have constructed a morphism of cones

$$\phi_i : \mathcal{P}^i \rightarrow J^i.$$

It is important to remark that for $p_i \geq 3$ the morphism ϕ_i is neither surjective nor injective.

Lemma 2.2.17. *We define the following two spaces*

$$\begin{aligned} \mathcal{P}^i \supset \tilde{\mathcal{P}}^i &= (\mathcal{P}^i \setminus \mathcal{A}^i) \cup \text{the zero section}, \\ J^i \supset \tilde{J}^i &= (J^i \setminus \{b_0 = 0\}) \cup \text{the zero section}. \end{aligned}$$

The image of the morphism ϕ_i is the space \tilde{J}^i . Moreover, the morphism ϕ_i restricted to $\tilde{\mathcal{P}}^i$ induces an isomorphism from $\tilde{\mathcal{P}}^i$ to \tilde{J}^i .

The proof is a simple check.

Remark 2.2.18. Note in particular that the morphisms ϕ_i do not define a morphism of projectivized cones. Indeed, certain points outside of the zero section of \mathcal{P}^i are mapped to zero section of J^i .

2.2.2. The space of stable differentials. Let g, n , and m be nonnegative integers satisfying $2g - 2 + n + m > 0$. Let $P = (p_1, p_2, \dots, p_m)$ be a vector of positive integers. For all $1 \leq i \leq m$, we denote by \mathcal{P}^{n+i} (respectively \mathfrak{P}^{n+i} and J^{n+i}) the cone of principal parts (respectively the stack of principal parts and the vector bundle of polar jets) of order p_i at the $(n+i)$ -th marked point. Let $p : \bar{\mathfrak{H}}_{g,n,P} \rightarrow \bar{\mathcal{M}}_{g,n+m}$ be the space of stable differentials of Definition 2.1.2 together with the forgetful map.

We recall that $\pi : \bar{\mathcal{C}}_{g,n+m} \rightarrow \bar{\mathcal{M}}_{g,n+m}$ is the universal curve and the $(\sigma_i)_{1 \leq i \leq n+m} : \bar{\mathcal{M}}_{g,n+m} \rightarrow \bar{\mathcal{C}}_{g,n+m}$ are the global sections corresponding to marked points.

Notation 2.2.19. Let $K\bar{\mathcal{M}}_{g,n}(P) \rightarrow \bar{\mathcal{M}}_{g,n+m}$ be the vector bundle

$$R^0 \pi_* \left(\omega \left(\sum_{i=1}^m p_i \sigma_{n+i} \right) \right) \rightarrow \bar{\mathcal{M}}_{g,n+m}.$$

It is a vector bundle of rank $g-1 + \sum p_i$ if P is not empty.

We have the following exact sequence of vector bundles over $\overline{\mathcal{M}}_{g,n+m}$

$$(2.2.1) \quad 0 \rightarrow R^0 \pi_* \left(\omega \left(\sum_{i=1}^m \sigma_{n+i} \right) \right) \rightarrow K\overline{\mathcal{M}}_{g,n}(P) \rightarrow \bigoplus_{i=1}^m J^{n+i} \rightarrow 0,$$

This exact sequence is simply the long exact sequence obtained from the residue exact sequence.

Proposition 2.2.20. *The stack $\overline{\mathfrak{H}}_{g,n,P}$ is isomorphic to the fiber product of $K\overline{\mathcal{M}}_{g,n}(P)$ and $\bigoplus_{i=1}^m \mathfrak{P}^{n+i}$ over $\bigoplus_{i=1}^m J^{n+i}$ where the map $\mathfrak{P}^{n+i} \rightarrow J^{n+i}$ is the composition of maps $\mathfrak{P}^{n+i} \rightarrow \mathcal{P}^{n+i} \xrightarrow{\phi_i} J^{n+i}$.*

PROOF. We denote by $\widetilde{\mathcal{H}}_{g,n,P}$ the fiber product

$$(2.2.2) \quad \begin{array}{ccc} \widetilde{\mathcal{H}}_{g,n,P} & \longrightarrow & \bigoplus_{i=1}^m \mathfrak{P}^{n+i} \\ \downarrow & & \downarrow \\ K\overline{\mathcal{M}}_{g,n}(P) & \longrightarrow & \bigoplus_{i=1}^m J^{n+i}. \end{array}$$

We construct the two directions of the isomorphism $\widetilde{\mathcal{H}}_{g,n,P} \simeq \overline{\mathfrak{H}}_{g,n,P}$ separately.

From $\overline{\mathfrak{H}}_{g,n,P}$ to $\widetilde{\mathcal{H}}_{g,n,P}$. To construct a morphism $F_1 : \overline{\mathfrak{H}}_{g,n,P} \rightarrow \widetilde{\mathcal{H}}_{g,n,P}$ we define morphisms $\Phi_i : \overline{\mathfrak{H}}_{g,n,P} \rightarrow \mathfrak{P}^{n+i}$ for all $1 \leq i \leq m$ and $\chi : \overline{\mathfrak{H}}_{g,n,P} \rightarrow K\overline{\mathcal{M}}_{g,n}(P)$ fitting in the diagram (2.2.2).

Let $(C \rightarrow S, \sigma_1, \dots, \sigma_{n+m}, \alpha)$ be a family of stable differentials. Let $s \rightarrow S$ be a geometric point of S and $(C_s, x_1, \dots, x_{n+m}, \alpha_s)$ be the stable differential determined by s . The element $\Phi_i(\alpha_s)$ is determined as follows

- If x_{n+i} does not belong to a rational component then $\Phi_i(s)$ is the principal part at the marked point. It belongs to $\mathfrak{P}^{n+i} \setminus \{u=0\}$.
- If x_{n+i} belongs to an unstable rational component, let w_{n+i} be a global coordinate of the rational component such that: x_{n+i} is at infinity, the node is at 0 and the term of α in front of $w_{n+i}^{p_i-2} dw_{n+i}$ is -1 . Then α_s is of the form

$$-\left(w_{n+i}^{p_i-1} + a_1 w_{n+i}^{p_i-2} + \dots + a_{p_i-2} w_{n+i} + \text{res}_{\sigma_{n+i}}(\alpha) \right) \frac{dw_{n+i}}{w_{n+i}}$$

and we set $\Phi_i(s) = (0, a_1, \dots, a_{p_i-2})$. Indeed the substack $\{u=0\}$ is the quotient of a trivial vector bundle by \mathbb{Z}_{p_i-1} and the a_i 's are the global coordinates of this vector bundle.

We will prove that the map Φ_i depends holomorphically on s . If s is a point of the first type this is an obvious statement. If s is a point of the second type, let U be a chart of $\overline{\mathcal{M}}_{g,n+m}$ with a trivialization z_{n+i} of a tubular neighborhood of σ_{n+i} in the universal curve (see the previous section). Let w_{n+i} be the coordinate of the rational component. The node between the rational component and the rest of the curve is parametrized by $w_{n+i} z_{n+i} = u$. The differential α is given by

$$(2.2.3) \quad \alpha = - \left(w_{n+i}^{p_i-1} + a_1 w_{n+i}^{p_i-2} + \dots + a_{p_i-2} w_{n+i} + \text{res}_{\sigma_{n+i}}(\alpha) + \underset{u \rightarrow 0}{O(u)} \right) \frac{dw_{n+i}}{w_{n+i}}$$

in coordinate w_{n+i} and by

$$(2.2.4) \quad \alpha = \left(\left(\frac{u}{z_{n+i}} \right)^{p_i-1} + \dots + a_{p_i-2}^i \frac{u}{z_{n+i}} + \text{res}_{\sigma_{n+i}}(\alpha) + \mathcal{O}_{z_{n+i} \rightarrow 0}(z_{n+i}) \right) \frac{dz_{n+i}}{z_{n+i}}$$

In coordinate z_{n+i} . Therefore the map Φ_i depends holomorphically on s .

Now, we construct the map $\chi: \overline{\mathfrak{H}}_{g,n,P} \rightarrow K\overline{\mathcal{M}}_{g,n}(P)$. Let $(C \rightarrow S, \sigma_1, \dots, \sigma_{n+m}, \alpha)$ be a family of stable differentials. We denote by $\tilde{C} \rightarrow S$ the stabilization of C and by $\tilde{\alpha} = \alpha|_{\tilde{C}}$. The family $(\tilde{C} \rightarrow S, \sigma_1, \dots, \sigma_{n+m}, \tilde{\alpha})$ is a section of $\omega_{C/S}(\sum p_i \sigma_{n+i})$, thus a map $S \rightarrow K\overline{\mathcal{M}}_{g,n}(P)$. By construction, the morphisms χ and the $(\Phi_i)_{i=1, \dots, m}$ fit in diagram (2.2.2).

From $\tilde{\mathcal{H}}_{g,n,P}$ to $\overline{\mathfrak{H}}_{g,n,P}$. Let S be a \mathbb{C} -scheme and let $S \rightarrow \tilde{\mathcal{H}}_{g,n,P}$ be a morphism. By composition with the morphism $\tilde{\mathcal{H}}_{g,n,P} \rightarrow K\overline{\mathcal{M}}_{g,n}(P)$, we get a family of stable curves $C \rightarrow S$ with $n+m$ sections σ_i and a section α of $\omega_{C/S}(\sum p_i \sigma_{n+i})$. The family $S \rightarrow \tilde{\mathcal{H}}_{g,n,P}$ determines also families of generalized principal parts. From the family of meromorphic differentials α and the principal parts we will construct a family of stable differentials.

Let z_{n+i} be local trivializations of the tubular neighborhoods of the sections σ_{n+i} of the curve C/S for $1 \leq i \leq m$. Let w_{n+i} be global coordinates of the complex plane. We denote by $(u^i, a_1^i, \dots, a_{p_i-2}^i)$ the standard coordinates of the principal parts \mathfrak{P}^{n+i} obtained from the trivializations z_{n+i} . We construct a family of semi-stable curves $\tilde{C} \rightarrow S$ defined by the equation $z_{n+i} w_{n+i} = u^i$. On the curve \tilde{C} we construct a differential $\tilde{\alpha}$. This differential is given by the expression (2.2.3) in coordinate w_{n+i} and by the expression (2.2.4) in coordinate z_{n+i} . The tuple $(\tilde{C}, \sigma_1, \dots, \sigma_{n+m}, \tilde{\alpha})$ is a family of stable differentials over S .

Therefore we have determined a morphism $F_2: \tilde{\mathcal{H}}_{g,n,P} \rightarrow \overline{\mathfrak{H}}_{g,n,P}$. By construction it is the inverse of F_1 previously defined. \square

The following proposition finishes the proof of Proposition 2.1.4 and thus complete Definition 2.1.3.

Proposition 2.2.21. *We denote by $\overline{\mathcal{H}}_{g,n,P}$ the following fiber product (in the category of cones over $\overline{\mathcal{M}}_{g,n+m}$ or in the category of DM-stacks)*

$$(2.2.5) \quad \begin{array}{ccc} \overline{\mathcal{H}}_{g,n,P} & \longrightarrow & \bigoplus_{i=1}^m \mathcal{P}^{n+i} \\ \downarrow & & \downarrow \oplus \phi_i \\ K\overline{\mathcal{M}}_{g,n}(P) & \longrightarrow & \bigoplus_{i=1}^m \mathcal{J}^{n+i}. \end{array}$$

Then space $\overline{\mathcal{H}}_{g,n,P}$ is the unique space that satisfies the properties of Proposition 2.1.4.

PROOF. The fact that $\overline{\mathcal{H}}_{g,n,P}$ satisfies the properties of Proposition 2.1.4 is a direct consequence of Propositions 2.2.14, 2.2.20. The uniqueness of this stack follows from the uniqueness of coarse spaces. \square

From now on we will denote by $\text{stab}: \overline{\mathcal{H}}_{g,n,P} \rightarrow K\overline{\mathcal{M}}_{g,n}(P)$ the vertical projection in diagram (2.2.5).

2.2.3. Properties of spaces of stable differentials. We keep the notation g, n, m , and P of the previous sections. We state here several general properties of $\overline{\mathfrak{H}}_{g,n,P}$ and $\overline{\mathcal{H}}_{g,n,P}$ that will be needed further in the text.

Proposition 2.2.22. *Suppose that P is not empty. Then the spaces $\overline{\mathfrak{H}}_{g,n,P}$ $\overline{\mathcal{H}}_{g,n,P}$ are irreducible DM stacks of pure dimension $4g-4+\sum p_i$ and $\mathbb{P}\overline{\mathcal{H}}_{g,n,P}$ is a proper DM stack (of dimension one less). The space $\overline{\mathcal{H}}_{g,n,P}$ and its projectivization are normal. The space $\overline{\mathfrak{H}}_{g,n,P}$ is a smooth DM stack.*

If P is empty then both $\overline{\mathfrak{H}}_{g,n,P}$ and $\overline{\mathcal{H}}_{g,n,P}$ are isomorphic to the Hodge bundle, which is a smooth DM stack of dimension $4g-3$.

PROOF. The first part of the proposition follows from Propositions 2.2.15, 2.2.20, and 2.2.11. The second part is straightforward. \square

We consider the following two maps: on the one hand the inclusion of vector bundles $R^0\pi_*(\omega(\sum_{i=1}^m \sigma_{n+i})) \rightarrow K\overline{\mathcal{M}}_{g,n}(P)$, and on the other hand the zero map $R^0\pi_*(\omega(\sum_{i=1}^m \sigma_{n+i})) \rightarrow \bigoplus \mathbb{P}^{n+i}$. Then we get an embedding $R^0\pi_*(\omega(\sum_{i=1}^m \sigma_{n+i})) \rightarrow \overline{\mathcal{H}}_{g,n,P}$ by the universal property of the cartesian diagram (2.2.5).

Proposition 2.2.23. *For all g, n , and P , we have the following exact sequence of cones (in the sense of [31] Proposition 4.1.6)*

$$0 \rightarrow R^0\pi_*(\omega(\sum_{i=1}^m \sigma_{n+i})) \rightarrow \overline{\mathcal{H}}_{g,n,P} \rightarrow \bigoplus_{i=1}^m \mathbb{P}^{n+i} \rightarrow 0.$$

PROOF. By construction, the sheaf of algebra defining $\overline{\mathcal{H}}_{g,n,P}$ is locally the tensor product of the sheaves of algebras $\text{Sym}^\vee\left(R^0\pi_*(\omega(\sum_{i=1}^m \sigma_{n+i}))\right)$ and the \mathbb{P}^{n+i} . \square

The action of \mathbb{C}^* on the space $\overline{\mathcal{H}}_{g,n,P}$ is determined by multiplication of the differential by a scalar. Let us give a description of the \mathbb{C}^* -fixed locus, i.e. the locus of points that are invariant under the action of \mathbb{C}^* .

Let (C, x_1, \dots, x_{n+m}) be a curve in $\overline{\mathcal{M}}_{g,n+m}$. We denote by m' the number of entries of P greater than 1. From C we construct a semi-stable curve \tilde{C} as follows. The curve \tilde{C} has $m'+1$ irreducible component: one main component isomorphic to C and m' rational components attached to C at the marked points corresponding to poles of order greater than 1. We mark points (x'_1, \dots, x'_{n+m}) on \tilde{C} . The first n marked points and the points corresponding to poles of order at most 1 are on the main component and satisfy $x_i = x'_i$. The poles of orders greater than one are carried by the rational components.

Now we define a meromorphic differential α on \tilde{C} by

- the differential α vanishes identically on the main component;
- on an exterior rational component, if we assume that the marked point is at 0 and the node at ∞ then α is given by dz/z^{p_i} .

The tuple $(\tilde{C}, x'_1, \dots, x'_{n+m}, \alpha)$ is a stable differential invariant under the action of \mathbb{C}^* . Indeed, let λ be a scalar in \mathbb{C}^* , the differential $\lambda\alpha$ vanishes on the main component and $\lambda dz/z^{p_i}$ is equal to $d w/w^{p_i}$ if we use the change of coordinate $z = w/\lambda^{1/p_i}$ for any p_i -th root of λ .

Conversely any \mathbb{C}^* -invariant point of $\overline{\mathcal{H}}_{g,n,P}$ is of this type. Indeed $\overline{\mathcal{H}}_{g,n,P}$ is a cone thus the locus of \mathbb{C}^* -invariant points is a section of this cone and we have constructed this section here.

2.2.4. Residues. Let g, n, m and P be as in the previous sections.

Definition 2.2.24. Let \mathcal{R} be the vector subspace of \mathbb{C}^m defined by

$$\mathcal{R} = \{(r_1, r_2, \dots, r_m) / r_1 + r_2 + \dots + r_m = 0\}.$$

The vector space \mathcal{R} will be called the *space of residues*. The *residue map* is the following map of cones over $\overline{\mathcal{M}}_{g,n+m}$

$$\begin{aligned} \text{res} : \overline{\mathcal{H}}_{g,n,P} &\rightarrow \mathcal{R} \\ \alpha &\mapsto (\text{res}_{x_{n+1}}(\alpha), \text{res}_{x_{n+2}}(\alpha), \dots, \text{res}_{x_{n+m}}(\alpha)) \end{aligned}$$

where \mathcal{R} stands for the trivial cone. We use the same notation for the residue map $\text{res} : K\overline{\mathcal{M}}_{g,n}(P) \rightarrow \mathcal{R}$. In this case it is a morphism of vector bundles.

These two residue maps fit in the following commutative triangle

$$(2.2.6) \quad \begin{array}{ccc} \overline{\mathcal{H}}_{g,n,P} & \xrightarrow{\text{stab}} & K\overline{\mathcal{M}}_{g,n}(P) \\ & \searrow \text{res} & \downarrow \text{res} \\ & & \mathcal{R}. \end{array}$$

Let $\overline{\mathcal{H}}_{g,n,P}^0 \subset \overline{\mathcal{H}}_{g,n,P}$ (respectively $K\overline{\mathcal{M}}_{g,n}^0(P) \subset K\overline{\mathcal{M}}_{g,n}(P)$) be the sub-cone (resp. sub vector bundle) of differentials without residues.

We recall that the Hodge bundle is by definition equal to $\overline{\mathcal{H}}_{g,n+m} = R^0\pi_*\omega$. The following sequence of vector bundles over $\overline{\mathcal{M}}_{g,n+m}$ is exact

$$(2.2.7) \quad 0 \rightarrow \overline{\mathcal{H}}_{g,n+m} \rightarrow R^0\pi_*(\omega(\sum_{i=1}^m \sigma_{n+i})) \xrightarrow{\text{res}} \mathcal{R} \rightarrow 0$$

(this is the exact sequence obtained from the residue exact sequence $0 \rightarrow \omega_C(\sum x_i) \rightarrow \omega_C \rightarrow \mathbb{C} \rightarrow 0$). The vector bundle $K\overline{\mathcal{M}}_{g,n}^0(P)$ fits into the following commutative diagram of vector bundles over $\overline{\mathcal{M}}_{g,n+m}$:

$$(2.2.8) \quad \begin{array}{ccccccc} 0 & \longrightarrow & K\overline{\mathcal{M}}_{g,n}^0(P) & \longrightarrow & K\overline{\mathcal{M}}_{g,n}(P) & \xrightarrow{\text{res}} & \mathcal{R} \longrightarrow 0 \\ & & \uparrow & & \uparrow & \nearrow & \\ \overline{\mathcal{H}}_{g,n+m} & \longrightarrow & R^0\pi_*(\omega(\sum_{i=1}^m \sigma_{n+i})) & & & & \end{array}$$

where the central square is cartesian. The first line of diagram (2.2.8) is exact by exactness of the sequence (2.2.7). Therefore, the cone structure of $\overline{\mathcal{H}}_{g,n,P}^0$ can be defined equivalently from the cone structure of $\overline{\mathcal{H}}_{g,n,P}$ or by saying that $\overline{\mathcal{H}}_{g,n,P}^0$ is

the fiber product

$$\begin{array}{ccc} \overline{\mathcal{H}}_{g,n,P}^0 & \longrightarrow & \bigoplus \mathcal{P}^{n+i} \\ \downarrow & & \downarrow \\ K\overline{\mathcal{M}}_{g,n}^0(P) & \longrightarrow & \bigoplus \mathcal{J}^{n+i}. \end{array}$$

We have the following exact sequence of cones

$$0 \rightarrow \overline{\mathcal{H}}_{g,n+m} \rightarrow \overline{\mathcal{H}}_{g,n,P}^0 \rightarrow \bigoplus \mathcal{P}^{n+i} \rightarrow 0.$$

Remark 2.2.25. Note that we cannot say that sequence

$$0 \rightarrow \overline{\mathcal{H}}_{g,n,P}^0 \rightarrow \overline{\mathcal{H}}_{g,n,P} \rightarrow \mathcal{R} \rightarrow 0$$

is exact because exactness for morphism of cones is ill-defined if the first term is not a vector bundle.

More generally we define the following.

Definition 2.2.26. Let R be a vector subspace of \mathcal{R} . $\overline{\mathcal{H}}_{g,n,P}^R \subset \overline{\mathcal{H}}_{g,n,P}$ (respectively $K\overline{\mathcal{M}}_{g,n}^R(P) \subset K\overline{\mathcal{M}}_{g,n}(P)$) to be the sub-cone (resp. sub vector bundle) of differentials with a vector of residues lying in R . We will call R a *space of residue conditions*.

Lemma 2.2.27. Let $R \subset \mathcal{R}$ be a vector subspace.

- The space $\overline{\mathcal{H}}_{g,n,P}^R$ is a closed subcone of $\overline{\mathcal{H}}_{g,n,P}$ of codimension $\dim(\mathcal{R}/R)$ (where we set $\dim(\mathcal{R}/R) = 0$ if P is empty)
- The Segre classes of $\overline{\mathcal{H}}_{g,n,P}^R$ and $\overline{\mathcal{H}}_{g,n,P}$ are equal.
- The Poincaré-dual class of $\mathbb{P}\overline{\mathcal{H}}_{g,n,P}^R$ in $H^*(\mathbb{P}\overline{\mathcal{H}}_{g,n,P}, \mathbb{Q})$ is given by

$$\left[\mathbb{P}\overline{\mathcal{H}}_{g,n,P}^R \right] = \xi^{\dim(\mathcal{R}/R)}.$$

PROOF. Let us denote by res_R the composition of morphisms $\overline{\mathcal{H}}_{g,n,P} \rightarrow \mathcal{R} \rightarrow \mathcal{R}/R$ (we use the same notation for its alter ego for $K\overline{\mathcal{M}}_{g,n}(P)$). We denote by $\overline{\mathcal{H}}_{g,n+m}^R$ the kernel of the morphism

$$R^0 \pi_* (\omega(\sum_{i=1}^m \sigma_{n+i})) \xrightarrow{\text{res}_R} \mathcal{R}/R \rightarrow 0.$$

It is a vector bundle of rank $g + \dim(R)$. By repeating the above argument, we have the following exact sequence of cones:

$$0 \rightarrow \overline{\mathcal{H}}_{g,n+m}^R \rightarrow \overline{\mathcal{H}}_{g,n,P}^R \rightarrow \mathcal{R}/R.$$

We deduce from this exact sequence that:

- the co-dimension of $\overline{\mathcal{H}}_{g,n,P}^R$ in $\overline{\mathcal{H}}_{g,n,P}$ is $\dim(\mathcal{R}/R)$;
- the Segre class of $\overline{\mathcal{H}}_{g,n,P}^R$ is given by

$$c_* \left(\overline{\mathcal{H}}_{g,n+m}^R \right) \cdot s_* \left(\bigoplus \mathcal{P}^{n+i} \right)$$

(see [31] Proposition 4.1.6).

Besides, the vector bundle \mathcal{R}/R is trivial thus

$$c_* \left(\overline{\mathcal{H}}_{g,n+m}^R \right) = c_* \left(R^0 \pi_* \left(\omega \left(\sum_{i=1}^m \sigma_{n+i} \right) \right) \right)$$

and the Segre class of $\overline{\mathcal{H}}_{g,n,P}^R$ does not depend on the choice of R .

To prove the last statement, we study the vector bundle $\mathcal{O}(1) \otimes p^*(\mathcal{R}/R) \rightarrow \mathbb{P}\overline{\mathcal{H}}_{g,n,P}$, where we recall that $p: \mathbb{P}\overline{\mathcal{H}}_{g,n,P} \rightarrow \overline{\mathcal{M}}_{g,n+m}$ is the forgetful map. We have $\mathcal{O}(1) \otimes p^*(\mathcal{R}/R) \simeq \text{Hom}(\mathcal{O}(-1), p^*(\mathcal{R}/R))$. A section of this vector bundle is given by:

$$s: \alpha \mapsto \text{res}_R(\alpha).$$

The vanishing locus of s is $\mathbb{P}\overline{\mathcal{H}}_{g,n,P}^R$ which is of codimension $\dim(\mathcal{R}/R)$. Thus the Poincaré-dual class of $\mathbb{P}\overline{\mathcal{H}}_{g,n,P}^R$ in $H^*(\mathbb{P}\overline{\mathcal{H}}_{g,n,P}, \mathbb{Q})$ is given by

$$d \cdot c_{\text{top}}(\mathcal{O}(1) \otimes p^*(\mathcal{R}/R)) = d \cdot \xi^{\dim(\mathcal{R}/R)}$$

where d is a rational number. Besides the cones $\overline{\mathcal{H}}_{g,n,P}^R$ and $\overline{\mathcal{H}}_{g,n,P}$ have the same Segre class thus

$$s_0 = p_* \left(\xi^{\text{rk}(\overline{\mathcal{H}}_{g,n,P})-1} \right) = p_* \left([\mathbb{P}\overline{\mathcal{H}}_{g,n,P}^R] \xi^{\text{rk}(\overline{\mathcal{H}}_{g,n,P})-1} \right) = ds_0,$$

and the coefficient d is equal to 1. \square

Proposition 2.2.28. *The Segre class of $\overline{\mathcal{H}}_{g,n,P}$ is given by*

$$\prod_{i=1}^m \frac{(p_i - 1)^{p_i - 1}}{(p_i - 1)!} \cdot \frac{1 - \lambda_1 + \dots + (-1)^g \lambda_g}{\prod_{i=1}^m (1 - (p_i - 1)\psi_i)}.$$

PROOF. From the above lemma, we have

$$\begin{aligned} s_*(\overline{\mathcal{H}}_{g,n,P}) &= s_*(\overline{\mathcal{H}}_{g,n,P}^0) \\ &= c_*(\overline{\mathcal{H}}_{g,n+m})^{-1} \cdot s_* \left(\bigoplus_{i=n+1}^m \mathcal{P}^{n+i} \right) \\ &= c_*(\overline{\mathcal{H}}_{g,n+m}^\vee) \cdot s_* \left(\bigoplus_{i=n+1}^m \mathcal{P}^{n+i} \right) \\ &= \prod_{i=1}^m \frac{(p_i - 1)^{p_i - 1}}{(p_i - 1)!} \cdot \frac{1 - \lambda_1 + \dots + (-1)^g \lambda_g}{\prod_{i=1}^m (1 - (p_i - 1)\psi_i)}. \end{aligned}$$

From the third line to the fourth we have used the fact that $c(\overline{\mathcal{H}}_g)^{-1} = c(\overline{\mathcal{H}}_g^\vee)$ (see [62]). \square

2.2.5. Standard coordinates. In this section we describe how to parametrize differentials with prescribed singularities. We use the notation $\Delta_\rho = \{z \in \mathbb{C} : |z| < \rho\}$ for the disks of radius $\rho \in \mathbb{R}^+$ and $A_{\rho_1, \rho_2} = \{z \in \mathbb{C} : \rho_1 < |z| < \rho_2\}$ for the annulus of parameters $0 < \rho_1 < \rho_2$.

Let α be a meromorphic differential on a small disk $\Delta_\rho \subset \mathbb{C}$. We denote by r the residue of α at 0. Then, there exists a conformal map $\varphi: \Delta_{\rho'} \rightarrow \Delta_\rho$ for ρ'

small enough, such that: $\varphi(0) = 0$ and

$$\varphi^*(\alpha) = \begin{cases} d(z^k) & \text{if } 0 \text{ is a zero of order } k-1; \\ r \frac{dz}{z} & \text{if } 0 \text{ is a pole of order } 1; \\ d\left(\frac{1}{z^k}\right) + r \frac{dz}{z} & \text{if } 0 \text{ is a pole of order } k+1. \end{cases}$$

The map φ is unique up to multiplication of the coordinate z by a k -th root of unity when 0 is a zero of order $k-1$ or a pole of order $k+1$. The coordinate z will be called the *standard coordinate*.

More generally, if U is an open neighborhood of 0 in \mathbb{C}^n and α_u is a holomorphic family of differentials on Δ_ρ such that the order of α_u at 0 is constant, then there exists an holomorphic map $\varphi : \tilde{U} \times \Delta_{\rho'} \rightarrow \Delta_\rho$ such that $\varphi(u, \cdot)^*(\alpha_u)$ is in the standard form for some neighborhood of $0, \tilde{U}$. Once again the map φ is unique up to multiplication of the standard coordinate by a root of unity.

Now the following classical lemma describes the deformations of $d(z^k)$ (see [55] for a proof):

Lemma 2.2.29. *Let $\rho > 0$ and $U \subset \mathbb{C}^n$ be a domain containing 0 . Let α_u be a family of holomorphic differentials on Δ_ρ such that α_0 has a zero of order $k-1$ at the origin. Then, there exists $\rho' > 0$, a neighborhood of 0 in \mathbb{C}^{k-2} , \mathcal{Z} and a conformal map*

$$\varphi : U \times \Delta_{\rho'} \rightarrow \Delta_\rho \times \mathcal{Z}$$

such that that $\varphi(u, \cdot)^(\alpha_u) = d(z^k + a_{k-2}z^{k-2} \dots + a_1z)$. The map φ is unique up to multiplication of z by a k -th root of unity.*

The locus $z = 0$ determines a section of the projection $U \times \Delta_\rho$ that does not depend on the choice of k -th root of unity. This section is called the *local center of mass of zeros*.

Now we would like to generalize the above lemma to deformations of poles of order 1.

Definition 2.2.30. Let $\rho > 0$ and $U \subset \mathbb{C}^n$ be a domain containing 0 . Let α be a differential on Δ_ρ in the standard form $d(z^k)$. A *standard deformation* of α is defined by a holomorphic function $\beta : U \times \Delta_\rho \rightarrow \mathbb{C}$ satisfying $\beta(0, z) = 0$. A standard deformation associated to β is the family of differentials on Δ_ρ parametrized by U

$$\alpha_u = d(z^k) + \frac{\beta(u, z)}{z} dz.$$

In general, there exists no standard coordinate for a standard deformation. However, the following proposition has been proved in [3] (see Theorem 4.3).

Proposition 2.2.31. *We consider the annulus A_{ρ_1, ρ_2} for any choice of $0 < \rho_1 < \rho_2 < \rho$.*

Chose a point $p \in A_{\rho_1, \rho_2}$ and $\zeta^\ell = \exp(\frac{2i\pi\ell}{k})$ a k -th root of unity. Chose a map $\sigma : U \rightarrow \Delta_\rho$ such that $\sigma(0) = \zeta^\ell p$. Then there exists a neighborhood \tilde{U} of 0 in U and a holomorphic map $\varphi : \tilde{U} \times A_{\rho_1, \rho_2} \rightarrow \Delta_R$ such that

$$\varphi_u^*(\alpha_u) = d(z^k) + \frac{\beta(u, 0)}{z} dz,$$

and $\varphi(0, z) = \zeta^\ell z$ and $\varphi(u, p) = \sigma(u)$ for all $u \in \tilde{U}$ and $z \in A_{\rho_1, \rho_2}$. For \tilde{U} small enough, the map φ is unique.

Let g, n and m be positive integers such that $2g - 2 + n + m > 0$. Let P be a vector of m positive integers and let $R \subset \mathcal{R}$ be a vector subspace. We have described the local parametrization of families of differentials, we will use it to describe how to parametrize the strata $A_{g, Z, P}^R$ and their neighborhood in $\mathbb{P}\overline{\mathcal{H}}_{g, n, P}$.

Lemma 2.2.32. *There exists a neighborhood V of $A_{g, Z, P}$ in $\mathcal{H}_{g, n, P}$ and a holomorphic retraction $\eta : V \rightarrow A_{g, Z, P}$ such that η preserves the residues at the poles.*

PROOF. We suppose in first place that Z is complete for g and P . Let $y_0 = (C, x_1, \dots, x_{n+m}, \alpha)$ be a point in $A_{g, Z, P}$. Let $U \hookrightarrow A_{g, Z, P}$ be an open orbifold chart containing y_0 and let $W \hookrightarrow \mathcal{H}_{g, n, P}$ be an open orbifold chart containing U . We consider the following relative homology group

$$H = H_1(C \setminus \{x_{n+1}, \dots, x_{n+m}\}, \{x_1, \dots, x_n\}; \mathbb{Z}).$$

Let $\gamma_1, \dots, \gamma_m \in H$ be the simple loops around the marked points corresponding to poles. These cycles are independent and can be completed into a basis $(\gamma_1, \dots, \gamma_{2g-2+n+m})$ of H . We fix such choice of basis. Up to a choice of smaller U and W , we will construct the following map

$$\Phi : W \rightarrow (H^\vee \otimes \mathbb{C}) \times \prod_{i=1}^n \mathcal{Z}_i,$$

where \mathcal{Z}_i is an open neighborhood of 0 in \mathbb{C}^{k_i} .

We denote by $C_W \rightarrow W$ the universal curve. To construct the map $\Phi_W^1 : W \rightarrow H^\vee \otimes \mathbb{C}$ we chose a C^∞ -trivialization (given by Ehresmann's Theorem) $C_W \xrightarrow{\sim} W \times C$. This trivialization allows one to identify $H_1(C_s \setminus \{x_{n+1}, \dots, x_{n+m}\}, \{x_1, \dots, x_n\}; \mathbb{Z})$ with H for all points s of W . Thus we define

$$\begin{aligned} \Phi_W^1 : W &\rightarrow H^\vee \otimes \mathbb{C} \\ (C_s, x_1, \dots, x_{n+m}, \alpha_s) &\mapsto (\gamma \mapsto \int_\gamma \alpha_s). \end{aligned}$$

The restriction of the map Φ_W^1 to U is a local isomorphism (see [55]).

Now the map $\Phi_W^2 : W \rightarrow \prod_{i=1}^n \mathcal{Z}_i$ is defined by a modification of Lemma 2.2.29 for marked differentials. For all $1 \leq i \leq n$, we consider a tubular neighborhood $W \times \Delta_\rho \rightarrow C_W$ around the i -th section of the universal curve. There exists a $\rho' > 0$ and a neighborhood \mathcal{Z}_i of $0 \in \mathbb{C}^{k_i}$ with coordinates $(a_{i,1}, \dots, a_{i,k_i})$ and a map $\varphi : W \times \Delta_\rho \rightarrow \Delta_{\rho'} \times \mathcal{Z}_i$ such that the marked point is at $z_i = 0$ and

$$\alpha_s = d(z_i^{k_i+1} + a_{i,k_i} z_i^{k_i} + \dots + a_{i,1} z_i)$$

for each point s of W . The map φ is unique up to a multiplication of z_i by a $(k_i + 1)$ -st root of unity. Thus we have defined a map from W to \mathcal{Z}_i given by $\alpha_s \mapsto (a_{i,1}, \dots, a_{i,k_i})$. The map Φ_W is a local isomorphism (see [55]).

The map Φ_W^1 restricted to U being a local isomorphism, we can define locally the map $\eta_W : W \rightarrow U$ as the composition $(\Phi_W^1|_U)^{-1} \circ \Phi_W^1$. This map obviously preserves the residues at the nodes. Besides, this map is independant of the choices of

$(k_i + 1)$ -st roots defining the maps $W \rightarrow \mathcal{Z}_i$ for all $1 \leq i \leq n$ and of the trivialization of the universal curve.

Therefore we define globally the neighborhood V of $A_{g,Z,P}$ and the retraction η as the union of neighborhoods W defined as above. The retraction $\eta : V \rightarrow A_{g,Z,P}$ is defined by gluing the η_W (the local retractions η_W being compatible as explained above).

We no longer suppose that the vector Z is complete. Let $y_0 = (C, x_1, \dots, x_{n+m}, \alpha)$ be a point of $A_{g,Z,P}$ and let $(\tilde{k}_1, \dots, \tilde{k}_{n'})$ be the orders of zeros of α outside the marked points. Let U and W be defined as in the complete case. We denote by $(\tilde{x}_i)_{1 \leq i \leq n'}$ be the non-marked zeros of α . We consider the relative homology group $H = H_1(C \setminus \{x_{n+1}, \dots, x_{n+m}\}, \{x_1, \dots, x_n, \tilde{x}_1, \dots, \tilde{x}_{n'}\}; \mathbb{Z})$. Then there exists a map

$$\Phi_W : W \rightarrow (H^\vee \otimes \mathbb{C}) \times \left(\prod_{i=1}^n \mathcal{Z}_i \right) \times \left(\prod_{i=1}^{n'} \tilde{\mathcal{Z}}_i \right)$$

where $\tilde{\mathcal{Z}}_i$ is a neighborhood of 0 in $\mathbb{C}^{\tilde{k}_i - 1}$ for all $1 \leq i \leq n'$. The maps from W to \mathcal{Z}_i are defined as in the complete case. For all $1 \leq i \leq n'$, the map $W \rightarrow \tilde{\mathcal{Z}}_i$ is determined by Lemma 2.2.29.

To define the map $W \rightarrow H^\vee \otimes \mathbb{C}$ we use once again Lemma 2.2.29. For all $1 \leq i \leq n'$ we have a section $\tilde{\sigma}_i : W \rightarrow C_W$ given by the local center of mass of zeros. Thus, up to a choice of smaller W , for all s in W , Ehresmann's Theorem allows us to identify $H_1(C_s \setminus \{x_n, \dots, x_{n+m}\}, \{x_1, \dots, x_n, \tilde{\sigma}_1(s), \dots, \tilde{\sigma}_{n'}(s)\}; \mathbb{Z})$ with H . The map $W \rightarrow H^\vee \otimes \mathbb{C}$ maps $(C_s, x_1, \dots, x_{n+m}, \alpha_s)$ to $(\gamma \mapsto \int_\gamma \alpha_s)$. The map Φ_W is a local isomorphism (see [55]).

We denote by Φ_W^1 the composition of Φ_W with the projection onto $(H^\vee \otimes \mathbb{C}) \times \prod_{i=1}^{n'} \tilde{\mathcal{Z}}_i$. Then the restriction of Φ_W^1 to U is a local isomorphism by [55]. The retraction $\eta_W : W \rightarrow U$ is defined as $(\Phi_W^1|_U)^{-1} \circ \Phi_W^1$. It does not depend on the choice of base of the H nor on the choice of roots of unity defining the maps from W to the \mathcal{Z}_i and $\tilde{\mathcal{Z}}_i$. Thus this determines a global retraction of a neighborhood of $A_{g,Z,P}$ in $\mathcal{H}_{g,n,P}$ that preserves the residues at the poles. \square

Corollary 2.2.33. *The residue map restricted to $A_{g,Z,P}$ is a submersion. More generally, if $R \subset \mathcal{R}$ is any vector subspace, the residue map $A_{g,Z,P}^R \rightarrow R$ is a submersion.*

PROOF. Let $(C, x_1, \dots, x_{n+m}, \alpha)$ be a point of $A_{g,Z,P}$. Let $\mathbf{r} = (r_1, \dots, r_m)$ be a vector in \mathcal{R} . There exists a meromorphic differential φ on C with at most simple poles at the m last marked points with residues prescribed by \mathbf{r} . Let Δ be a disk of \mathbb{C} centered at 0 and parametrized by ϵ . Let η be the retraction map of Lemma 2.2.32. The residues of $\eta(\alpha + \epsilon\varphi)$ at the poles are given by

$$\text{res}_{x_{n+i}}(\alpha) + \epsilon r_i.$$

Thus the vector \mathbf{r} belongs to the image of the tangent space of $A_{g,Z,P}$ under the differential of the map res . The same result stands if we restrict the tangent direction to a vector subspace R . \square

Remark 2.2.34. Recently Gendron and Tahar studied the surjectivity of the residue maps for open strata in the space of meromorphic differentials (and also of higher

order differentials – see [70]). Our statement that the residue map is a submersion does not imply surjectivity. However, the image of an algebraic submersion is always a Zarisky open set. Thus we can claim that the residue map is surjective on the *closure* of every nonempty stratum.

Now let $g, n, n', m \geq 0$ such that $2g - 2 + n + n' + m \geq 0$. Let $P = (p_1, \dots, p_m)$ be a vector of positive integer. Let $Z = (k_1, \dots, k_n, k_{n+1}, \dots, k_{n+n'})$ be a vector of nonnegative integers of length $n + n'$. We denote by $P' = (p_1, \dots, p_m, 1, \dots, 1)$ the vector obtained from p by adding n' times 1 and by $Z' = (k_1, \dots, k_n)$ the vector obtained by erasing the last n' entries of Z . The space $\overline{\mathcal{H}}_{g, n+n', P}$ is naturally a closed subspace of $\overline{\mathcal{H}}_{g, n, P'}$. We denote by \mathcal{R} and \mathcal{R}' the vector spaces of residues of $\overline{\mathcal{H}}_{g, n+n', P}$ and $\overline{\mathcal{H}}_{g, n, P'}$. Let R' be a vector subspace of \mathcal{R}' . The vector space \mathcal{R} is a vector subspace of \mathcal{R}' , we will denote by $R = \mathcal{R} \cap R'$. Now we have the natural closed inclusions

$$A_{g, Z, P}^R \subset A_{g, Z', P}^R \subset A_{g, Z', P'}^{R'}.$$

Proposition 2.2.35. *Let y_0 be a point in $A_{g, Z, P}^R$. Let U be neighborhood of y_0 in $A_{g, Z, P}^R$. There exists a neighborhood V of y_0 in $A_{g, Z', P'}^{R'}$ and a map*

$$\phi : V \xrightarrow{\sim} U \times \left(\prod_{i=1}^{n'} \mathcal{Z}_i \right) \times \mathcal{Z}$$

where:

- \mathcal{Z}_i is a neighborhood of 0 in $\mathbb{C}^{k_{n+i}}$ for all $1 \leq i \leq n'$ and \mathcal{Z} is a neighborhood of 0 in R'/R ;
- if Δ_ρ is a disk and $s : U \times \Delta_\rho \rightarrow (\prod \mathcal{Z}_i) \times \mathcal{Z}$ is a holomorphic map such that $s(u, 0) = 0$ then the family of differentials

$$\begin{aligned} \tilde{s} : U \times \Delta_\rho &\rightarrow V \\ (u, \epsilon) &\mapsto \phi^{-1}(u, s(u, \epsilon)) \end{aligned}$$

is a standard deformation of $d(z^{k_{n+i}+1})$ for all $1 \leq i \leq n'$.

PROOF. We have seen that a neighborhood of U in $A_{g, Z', P}^R$ is isomorphic to $U \times \prod_{i=1}^{n+n'} \mathcal{Z}_i$. For all $1 \leq i \leq n'$, the differential at the marked point x_{n+i} is given by $d(z^{k_{n+i}} + a_1 z^{k_{n+i}+1} + \dots)$ (Lemma 2.2.29).

Now, we chose a set of meromorphic differentials φ_i with simple poles at the marked points such that the vectors of residues \mathbf{r}_i of φ_i form a basis of R'/R . The residue map $A_{g, Z', P'}^{R'} \rightarrow R'$ is a submersion (Corollary 2.2.33). Thus a neighborhood of $U \times \prod \mathcal{Z}_i$ in $A_{g, Z', P'}^{R'}$ is naturally identified with a $U \times (\prod \mathcal{Z}_i) \times \mathcal{Z}$ with \mathcal{Z} neighborhood of 0 in R'/R , the identification being given by adding a linear combination of the φ_i 's.

Both the deformations of U into $U \times \prod \mathcal{Z}_i$ and the deformations of $U \times \prod \mathcal{Z}_i$ into $U \times (\prod \mathcal{Z}_i) \times \mathcal{Z}$ are standard deformations at the marked point x_{n+i} for $1 \leq i \leq n'$. \square

The isomorphism ϕ is not unique. It depends of the choice of a standard coordinates at the x_{n+i} for $1 \leq i \leq n'$ and of the choice of the differentials φ_i with simple poles.

Proposition 2.2.36. *Given such a choice of ϕ , Proposition 2.2.35 defines a local retraction $\eta : V \rightarrow U$ such that $\eta \circ \tilde{s} = \text{Id}_U$ for any holomorphic section $s : U \times \Delta_\rho \rightarrow (\prod \mathcal{Z}_i) \times \mathcal{Z}$.*

2.2.6. Dimension of the strata. Let g, n, m be positive integer such that $2g - 2 + n + m > 0$, P a vector of m positive integers, and R a vector subspace of \mathcal{R} . Let Z be a vector of n nonnegative integers. If the context is clear, we will denote by the same letter the map $p : \overline{\mathcal{H}}_{g,n,P} \rightarrow \overline{\mathcal{M}}_{g,n}$ and its restriction to $p : A_{g,Z,P}^R \rightarrow \overline{\mathcal{M}}_{g,n+m}$. We denote by $\text{Im}(p)$ the image of $A_{g,Z,P}^R$ by p in $\overline{\mathcal{M}}_{g,n+m}$.

Lemma 2.2.37. *If the vector Z is complete for g and P , then the map $p : A_{g,Z,P}^R \rightarrow \text{Im}(p)$ is a line bundle minus the zero section. In particular $\mathbb{P}A_{g,Z,P}^R$ is isomorphic to its image.*

PROOF. Let (C, x_1, \dots, x_{n+m}) be a point of $\text{Im}(p)$. The curve C is smooth and the divisor $\omega_C - \sum_{i=1}^n k_i(x_i) + \sum_{j=1}^m p_j(x_{n+j})$ is a principal divisor of degree 0. Therefore the fiber of p over (C, x_1, \dots, x_{n+m}) is given by the nonzero multiples of one differential with fixed orders of zeros and poles. \square

Definition 2.2.38. Let $Z = (k_1, \dots, k_n)$ be a vector of nonnegative integer which is not necessarily complete for g and P . A *completion* of Z is a vector $Z' = (k'_1, \dots, k'_{n'})$ such that $n' \geq n$ and for all $1 \leq i \leq n$ we have $k'_i \geq k_i$. We will say that the completion Z' is *exterior* if for all $1 \leq i \leq n$ we have $k'_i = k_i$. Finally we will denote by Z_m the *maximal completion*, i.e. the exterior completion of Z that satisfies $k'_i = 1$ for all $n+1 \leq i \leq n'$.

Lemma 2.2.39. *We have*

$$A_{g,Z,P}^R = \bigcup_{Z'} \pi(A_{g,Z',P}^R),$$

where the union is over all exterior completions of Z and π is the forgetful map of the zeros that are not accounted for by Z .

PROOF. Let $(C, x_1, \dots, x_{n+m}, \alpha)$ be a point of $A_{g,Z,P}^R$. The differential α has zeros exactly of order k_i at the first n marked points, thus the point lies in the image of $A_{g,Z',P}^R$ for an exterior completion. \square

Proposition 2.2.40. *Let Z be a vector of nonnegative integers and R a vector subspace of \mathcal{R} . The locus $A_{g,Z,P}^R$ is empty or of codimension exactly $|Z| + \dim(\mathcal{R}/R)$ in $\overline{\mathcal{H}}_{g,n,P}$.*

PROOF. First we assume that Z is complete. The dimension of $\mathbb{P}A_{g,Z,P}$ is equal to the dimension of its image in the moduli space of curves. We suppose that $R = \mathcal{R}$ (no residue condition). Then the image of $\mathbb{P}A_{g,Z,P}$ is of dimension $2g - 2 + n$ if P is empty (see [67]) and $2g - 3 + n + m$ otherwise (see [28]). By a simple count of dimension we can check that the proposition is valid in this specific case.

We still assume that Z is complete, however we no longer assume that $R = \mathcal{R}$. We have seen that the residue map $A_{g,Z,P}^R \rightarrow R$ is a submersion, therefore the dimension of $A_{g,Z,P}^R$ is equal to the dimension of R plus the dimension of the fiber of the residue map at any point. If we choose $R = \mathcal{R}$, we get that the fiber at any

point is given by $\dim A_{g,Z,P} - \dim \mathcal{R}$. Therefore the dimension of $A_{g,Z,P}^R$ is equal to $\dim A_{g,Z,P} - (m-1) + \dim(R)$. Thus the proposition is valid for all choices of R .

Now, let Z be any vector. Let $Z' = (k_1, \dots, k_n, \tilde{k}_{n+1}, \dots, \tilde{k}_{n'})$ be an exterior completion of Z . The map $\pi : A_{g,Z',P}^R \rightarrow A_{g,Z,P}^R$ is quasi-finite. Indeed the preimage of a point $(C, x_1, \dots, x_{n+m}, \alpha)$ is finite of cardinality

$$\#\text{Aut}(\tilde{k}_{n+1}, \dots, \tilde{k}_{n'}),$$

(here $\#\text{Aut}(a_1, \dots, a_n)$ stands for the set of permutations σ of $[1, n]$ such that $a_i = a_{\sigma(i)}$). Indeed, the points in the preimage correspond to the different orderings of the zeros that are not accounted for by Z . The proof of Lemma 2.2.32 implies that if $A_{g,Z',P}$ is not empty for some exterior completion then $A_{g,Z_m,P}$ is not empty: indeed we can always perturbate a differential to “break up” a zero of order greater than 1. By counting the dimensions, we have $\dim(A_{g,Z_m,P}^R) > \dim(A_{g,Z',P}^R)$ for all exterior completions $Z' \neq Z_m$. Therefore $\dim(A_{g,Z_m,P}^R) = \dim(A_{g,Z,P}^R)$ and the proposition is proved. \square

Proposition 2.2.41. *Let Z be a vector of nonnegative integers. The following statements are equivalent:*

- (1) *there exists a dense open set $U \subset \text{Im}(p)$ such that the fiber of p over any point of U is of dimension 1;*
- (2) *the dimension of $\mathbb{P}A_{g,Z,P}^R$ is less than or equal to the dimension of $\overline{\mathcal{M}}_{g,n+m}$.*

PROOF. First, we assume that the dimension of $\mathbb{P}A_{g,Z,P}^R$ is less than or equal to the dimension of $\overline{\mathcal{M}}_{g,n+m}$. Let Z_m be the maximal completion of Z . We have seen that the image of $A_{g,Z_m,P}^R$ is dense in $A_{g,Z,P}$. Therefore the image of $\text{Im}(p_m)$ is dense in $\text{Im}(p)$:

$$\begin{array}{ccc} A_{g,Z_m,P}^R & \longrightarrow & A_{g,Z,P}^R \\ p_m \downarrow & & \downarrow p \\ \text{Im}(p_m) & \longrightarrow & \text{Im}(p). \end{array}$$

In order to prove that the fiber of p over a generic point of $\text{Im}(p)$ is of dimension 1, we only need to prove that $\dim(\text{Im}(p)) = \dim(\mathbb{P}A_{g,Z,P}^R)$. We obviously have $\dim(\mathbb{P}A_{g,Z,P}^R) \geq \dim(\text{Im}(p))$. Now we will prove that $\dim(\mathbb{P}A_{g,Z,P}^R) \leq \dim(\text{Im}(p))$.

We consider the two following two vector bundles over the moduli space of curves $\mathcal{M}_{g,n+m}$

$$\begin{aligned} \overline{K\mathcal{M}}_{g,n}(P) &= R^0 \pi_* (\omega_C (\sum_{i=1}^m p_i \sigma_{n+i})), \\ E &= \mathcal{R}/R \oplus \left(\bigoplus_{i=1}^n J_{i,k_i}^{\text{hol}} \right), \end{aligned}$$

where J_{i,k_i} is the vector space of holomorphic jets of order k_i at the marked point x_i , i.e.

$$J_{i,k_i}^{\text{hol}} = R^0 \pi_* (\omega(-k_i x_i)/\omega).$$

(beware the vector space of jets here is not the vector space of polar jets used in Section 2.2.2). We have a well defined map $e : \overline{K\mathcal{M}}_{g,n}(P) \rightarrow E$. The rank of

$K\overline{\mathcal{M}}_{g,n}(P)$ is $r_1 = g - 1 + \sum p_i$ if P is not empty and $r_1 = g$ otherwise. The rank of E is $r_2 = \dim(\mathcal{R}/R) + \sum k_i$. By assumption, we have

$$\dim(\mathbb{P}A_{g,Z,P}^R) = \dim(\overline{\mathcal{M}}_{g,n+m}) + r_1 - r_2 - 1 < \dim(\overline{\mathcal{M}}_{g,n+m}).$$

Let $\mathcal{E} \subset \mathcal{M}_{g,n+m}$ be the locus where e is not injective. We have $r_1 < r_2$, thus the locus \mathcal{E} is of codimension at least $r_2 - r_1 + 1$ because it is the vanishing locus of $r_2 - r_1 + 1$ minors of the map e . Therefore the locus \mathcal{E} is of dimension greater than or equal to $\dim(\mathbb{P}A_{g,Z,P}^R)$.

Now we need to prove that $\text{Im}(p)$ is open and dense in \mathcal{E} . Let P' be a vector of m positive integers such that $P' \leq P$. Let Z' be a vector of n nonnegative integers such that $Z' \geq Z$. The image of $\mathbb{P}A_{g,Z',P'}^R$ lies in \mathcal{E} . Conversely, the locus \mathcal{E} is the union of all the $\text{Im}(p')$ where p' is the map from $\mathbb{P}A_{g,Z',P'}^R$ to $\mathcal{M}_{g,n+m}$ for $P' \leq P$ and $Z' \geq Z$. We have $\dim(\mathbb{P}A_{g,Z',P'}^R) < \dim(\mathbb{P}A_{g,Z,P}^R) \leq \dim(\mathcal{E})$ if $P' < P$ or $Z' > Z$. Therefore $\text{Im}(p)$ is open and dense in the locus \mathcal{E} and $\dim(\text{Im}(p)) = \dim(\mathbb{P}A_{g,Z,P}^R)$.

Now to prove the converse implication we assume that the dimension of $\mathbb{P}A_{g,Z,P}^R$ is greater than than the dimension of $\overline{\mathcal{M}}_{g,n+m}$. We denote by $d = \dim(\mathbb{P}A_{g,Z,P}^R) - \dim(\overline{\mathcal{M}}_{g,n+m})$. We consider the vector Z_d which is obtained from Z by adding d times 1. We denote $p_d : \mathbb{P}A_{g,Z_d,P}^R \rightarrow \overline{\mathcal{M}}_{g,n+m+d}$ the forgetful map. We have $\dim(\mathbb{P}A_{g,Z_d,P}^R) = \dim(\overline{\mathcal{M}}_{g,n+m+d})$ thus the map p_d is quasi-finite over a dense open set of $\overline{\mathcal{M}}_{g,n+m+d}$. Therefore on a dense open subset of $\overline{\mathcal{M}}_{g,n+m}$ the fiber of p contains at least one contracted curve obtained by forgetting the last d marked points. \square

2.2.7. Stable differentials on disconnected curves. In order to prove the main theorem, we will need a generalization of the notion of stable differentials to the case of disconnected curves. Let q be a positive integer, and

$$\begin{aligned} \mathbf{g} &= (g_1, g_2, \dots, g_q), \\ \mathbf{n} &= (n_1, n_2, \dots, n_q), \\ \mathbf{m} &= (m_1, m_2, \dots, m_q) \end{aligned}$$

be lists of nonnegative integers satisfying $2g_j - 2 + m_j + n_j > 0$. Let

$$\mathbf{P} = (P_j)_{\leq j \leq q} = (p_{j,i})_{\leq j \leq q, 1 \leq i \leq m_j}$$

be a list of vectors of positive integers of length m_j .

Definition 2.2.42. The space of stable differentials of type \mathbf{P} is

$$\overline{\mathcal{H}}_{\mathbf{g},\mathbf{n},\mathbf{P}} = \prod_{i=1}^q \overline{\mathcal{H}}_{g_i, n_i, P_i}.$$

Proposition 2.2.43. *The space of stable differentials of type \mathbf{P} is a cone over $\overline{\mathcal{M}}_{\mathbf{g},\mathbf{n},\mathbf{m}} \stackrel{\text{def}}{=} \prod_{j=1}^q \overline{\mathcal{M}}_{g_j, n_j + m_j}$. Its Segre class is given by*

$$s(\overline{\mathcal{H}}_{\mathbf{g},\mathbf{n},\mathbf{P}}) = \prod_{j=1}^q s(\overline{\mathcal{H}}_{g_j, n_j + m_j, P_j}),$$

where $s(\overline{\mathcal{H}}_{g_j, n_j, P_j})$ is the pull-back of the Segre class of $\overline{\mathcal{H}}_{g_j, n_j, P_j}$ to the product $\prod_{j=1}^q \overline{\mathcal{M}}_{g_j, n_j + m_j}$ under the j^{th} projection.

PROOF. The proof is straightforward because the space $\overline{\mathcal{H}}_{\mathbf{g}, \mathbf{n}, \mathbf{P}}$ is a product of cones. \square

To handle the residues, we extend the definition of the space of residues \mathcal{R} :

$$\mathcal{R} = \bigoplus_{j=1}^q \mathcal{R}_j = \{(r_{j,i})_{j,i} \text{ such that } \sum_{i=1}^{m_j} r_{j,i} = 0, \forall j \in [1, q]\} \subset \mathbb{C}^{m_1 + \dots + m_q}.$$

Definition 2.2.44. Let R be a vector subspace of \mathcal{R} . The space $\overline{\mathcal{H}}_{\mathbf{g}, \mathbf{n}, \mathbf{P}}^R$ is the space of stable differentials with residues lying in R .

Remark 2.2.45. The linear relations that define the space R can involve residues at poles of different connected components.

Notation 2.2.46. Let $1 \leq j \leq q$. We will denote by $\text{pr}_j : \mathcal{R} \rightarrow \mathcal{R}_j$ the projection onto \mathcal{R}_j along $\bigoplus_{j' \neq j} \mathcal{R}_{j'}$. We will denote by R_j the space $\text{pr}_j(R)$. The previous remark implies that in general $R \cap \mathcal{R}_j \subsetneq R_j$.

Notation 2.2.47. Let $\mathbf{Z} = (Z_j)_{j=1 \dots q} = ((k_{1,1}, \dots, k_{1,n_1}), \dots, (k_{q,1}, \dots, k_{q,n_q}))$ be a list of vectors of nonnegative integers of length n_j . We define

$$A_{\mathbf{g}, \mathbf{Z}, \mathbf{P}}^R \subset \overline{\mathcal{H}}_{\mathbf{g}, \mathbf{n}, \mathbf{P}}^R$$

as the locus of points $(C, (x_{j,i})_{1 \leq j \leq q, 1 \leq i \leq n_j + m_j}, \alpha) \in \overline{\mathcal{H}}_{\mathbf{g}, \mathbf{n}, \mathbf{P}}^R$ such that C is smooth and α which is nonzero on each connected component and with zeros of orders exactly $k_{j,i}$ at the n_j first marked points of each connected component. If there is no condition on the residues we will simply denote it by $A_{\mathbf{g}, \mathbf{Z}, \mathbf{P}}$. We will call \mathbf{Z} *complete* if all the Z_j are complete.

Lemma 2.2.48. Let R be a linear subspace of \mathcal{R} . The space $\overline{\mathcal{H}}_{\mathbf{g}, \mathbf{n}, \mathbf{P}}^R$ is a subcone of $\overline{\mathcal{H}}_{\mathbf{g}, \mathbf{n}, \mathbf{P}}^R$ of codimension $\dim(\mathcal{R}) - \dim(R)$ and we have:

- the cones $\overline{\mathcal{H}}_{\mathbf{g}, \mathbf{n}, \mathbf{P}}$ and $\overline{\mathcal{H}}_{\mathbf{g}, \mathbf{n}, \mathbf{P}}^R$ have the same Segre class;
- the Poincaré-dual class of $[\mathbb{P}\overline{\mathcal{H}}_{\mathbf{g}, \mathbf{n}, \mathbf{P}}^R]$ in $H^*(\mathbb{P}\overline{\mathcal{H}}_{\mathbf{g}, \mathbf{n}, \mathbf{P}}, \mathbb{Q})$ is given by

$$\xi^{\dim(\mathcal{R}) - \dim(R)},$$

- let \mathbf{Z} be a list of vectors which is complete for \mathbf{g} and \mathbf{P} , then the map $p : A_{\mathbf{g}, \mathbf{Z}, \mathbf{P}}^R \rightarrow R$ is a submersion;
- let \mathbf{Z} be a list of vectors of nonnegative integer. The locus $A_{\mathbf{g}, \mathbf{Z}, \mathbf{P}}^R$ is empty or of codimension $\sum_{k \in \mathbf{Z}} k + \dim(\mathcal{R}) - \dim(R)$ in $\overline{\mathcal{H}}_{\mathbf{g}, \mathbf{n}, \mathbf{P}}$.

PROOF. All proofs of Section 2.2.4 and 2.2.6 can be adapted immediately to the disconnected case. \square

2.2.8. Fibers of the map $p : A_{\mathbf{g}, \mathbf{Z}, \mathbf{P}}^R \rightarrow \overline{\mathcal{M}}_{\mathbf{g}, \mathbf{Z}, \mathbf{P}}$. Let $q \geq 1$. Let $\mathbf{g}, \mathbf{n}, \mathbf{m}, \mathbf{Z}$, and \mathbf{P} be lists of integers and vectors of integers of length q as in the previous section. Let \mathcal{R} be the vector space of residues and $R \subset \mathcal{R}$ a vector subspace.

If the context is clear, we will denote by the same letter the map $p : \overline{\mathcal{H}}_{\mathbf{g}, \mathbf{n}, \mathbf{P}} \rightarrow \overline{\mathcal{M}}_{\mathbf{g}, \mathbf{n}, \mathbf{m}}$ and its restriction $p : A_{\mathbf{g}, \mathbf{Z}, \mathbf{P}}^R \rightarrow p(A_{\mathbf{g}, \mathbf{Z}, \mathbf{P}}^R)$. We will denote by $\text{Im}(p) = p(A_{\mathbf{g}, \mathbf{Z}, \mathbf{P}}^R) \subset \overline{\mathcal{M}}_{\mathbf{g}, \mathbf{Z}, \mathbf{P}}$ its image. In this section we will state some conditions to determine if the fiber of p over a general point of $\text{Im}(p)$ is of dimension 1 or not. This will be important to describe the boundary divisors of the the stratum $A_{\mathbf{g}, \mathbf{Z}, \mathbf{P}}^R$.

Let $1 \leq j \leq q$. We denote by p_j the map from $A_{g_j, Z_j, P_j}^{R_j}$ to $\overline{\mathcal{M}}_{g_j, n_j + m_j}$. Finally we denote by $\text{Im}(p_j)$ the image of p_j . We have a natural inclusion of $A_{\mathbf{g}, \mathbf{Z}, \mathbf{P}}^R$ into $\prod_{j=1}^q A_{g_j, Z_j, P_j}^{R_j}$ and of $\text{Im}(p)$ into $\prod_{i=1}^n \text{Im}(p_j)$.

Assume that \mathbf{Z} is complete. We recall that $A_{g_j, Z_j, P_j}^{R_j} \rightarrow \text{Im}(p_j)$ is a line bundle minus the zero section. We will denote by L_j the pull-back of this line bundle to $\text{Im}(p)$.

We recall that \mathcal{R}_j is the space of residues at the j^{th} component and that we have $\mathcal{R} = \bigoplus_{i=1}^q \mathcal{R}_i$. We define the j -th evaluation map of residues $\text{ev}_j : L_j \rightarrow \mathcal{R}_j$ as the morphism of vector bundles over $\text{Im}(p)$ given by the evaluation of the residues at the i -th connected component. We define the evaluation of residues as the morphism of vector bundles: $\text{ev} = (\bigoplus_{j=1}^q \text{ev}_j) : \bigoplus_{j=1}^q L_j \rightarrow \mathcal{R}$.

Remark 2.2.49. The evaluation map (ev) and the residue map (res) are not defined on the same spaces. The first one is a morphism of vector bundles on the space $\text{Im}(p)$ while the second one is defined as a morphism of vector bundles over $\mathbb{P}A_{\mathbf{g}, \mathbf{Z}, \mathbf{P}}^R$. If $q = 1$, then $\mathbb{P}A_{\mathbf{g}, \mathbf{Z}, \mathbf{P}}^R$ is isomorphic to its image and the two maps correspond.

Proposition 2.2.50. *Suppose that \mathbf{Z} is complete. Then the families*

$$p : A_{\mathbf{g}, \mathbf{Z}, \mathbf{P}}^R \rightarrow \text{Im}(p)$$

and

$$\tilde{p} : \text{ev}^{-1}(R) \cap \left(\prod_{j=1}^q L_j^* \right) \rightarrow \text{Im}(p)$$

are isomorphic. If $q \geq 2$, the fiber of p over a point is of dimension 1 if and only if ev is injective and $R \cap \text{ev}(\bigoplus_j L_j)$ is of dimension 1.

PROOF. For a point $x \in \text{Im}(p)$, the fiber of p can be described as follows: it is the choice of a nonzero differential for each connected component such that the residues at the poles define a vector in R . Therefore the fiber over x is the subset of points of $\prod L_j^*$ with residues in R . This fiber is given by $\text{ev}^{-1}(R) \cap \prod_{j=1}^q L_j^*$.

The fiber of $\text{ev}^{-1}(R) \cap \prod_{j=1}^q L_j^*$ over $x \in \text{Im}(p)$ is not empty. Indeed, suppose that for some $1 \leq j \leq q$ the space $\text{ev}^{-1}(R)$ is contained in $\{0\} \oplus_{j' \neq j} L_{j'}$, then the residue condition R imposes that the differential on one of the component is zero. In which case, x is not a point of $\text{Im}(p)$. Therefore the dimension of $\text{ev}^{-1}(R) \cap \prod_{j=1}^q L_j^*$ is the same as the dimension of $\text{ev}^{-1}(R) \cap \bigoplus_{j=1}^q L_j$.

The only point that remains to prove is: if the map ev is not injective then the fiber of p is of dimension greater than 1. We assume that the map ev is not

injective, then one of the L_j 's is mapped to zero for some $1 \leq j \leq q$. Thus we have:

$$\mathrm{ev}^{-1}(R) \cap \bigoplus_{j=1}^q L_j = L_j \oplus \left(\mathrm{ev}^{-1}(R) \cap \bigoplus_{j' \neq j} L_{j'} \right).$$

We have seen that $\mathrm{ev}^{-1}(R)$ cannot be contained in $L_j \times \{0\}$, thus the second summand is of positive dimension and $\mathrm{ev}^{-1}(R) \cap \bigoplus_{j=1}^q L_j$ is of dimension greater than 1. \square

Let Σ be the union of the vector subspaces $R \cap \ker(\mathrm{pr}_j)$ for $1 \leq i \leq q$. If R is of positive dimension, we denote by $\mathbb{P}\Sigma$ the image of Σ in $\mathbb{P}R$. This is the locus of vectors of residues that vanish on at least one connected component. Suppose that all R_j are of positive dimension, then $\Sigma \subsetneq R$ and there is a natural map $\rho : \mathbb{P}R \setminus \mathbb{P}\Sigma \rightarrow \prod_{j=1}^q \mathbb{P}R_j$ defined as the projection on each factor.

Notation 2.2.51. We will say that the residue vector spaces $(\mathcal{R}, R, (\mathcal{R}_j)_{1 \leq i \leq q})$ satisfy the condition (\star) if

- the space R and the R_j 's are of positive dimension;
- the map ρ from $\mathbb{P}R \setminus \mathbb{P}\Sigma$ to $\prod_{i=1}^q \mathbb{P}R_j$ is finite over a dense open subset of $\mathbb{P}R \setminus \mathbb{P}\Sigma$.

Proposition 2.2.52. *Suppose that \mathbf{Z} is complete and that q is at least 2. Then the fiber of p over a generic point of $\mathrm{Im}(p)$ is of dimension 1 if and only if the triple $(\mathcal{R}, R, (\mathcal{R}_j)_{1 \leq j \leq q})$ satisfies the condition (\star) .*

PROOF. We have already seen that if R_j is reduced to the trivial space, then the map $\mathrm{ev} : \bigcup_{j=1}^q L_j \rightarrow \mathcal{R}$ is not injective and the fibers of p are all of dimension greater than 1 (see the proof of Proposition 2.2.50). We assume that all R_j are non trivial. For all j , we denote by $A_j^0 \subset A_{\mathbf{g}, \mathbf{Z}, \mathbf{P}}^R$ to be the locus of differentials with zero residues on the j^{th} component. The image of A_j^0 by the residue map lies in $R \cap \ker(\mathrm{pr}_j)$ which is of positive codimension in R . Besides the residue map is a submersion, thus $\dim(A_j^0) < \dim(A_{\mathbf{g}, \mathbf{Z}, \mathbf{P}}^R)$. We will denote

$$A' = A_{\mathbf{g}, \mathbf{Z}, \mathbf{P}}^R \setminus \bigcup_{j=1}^q A_j^0.$$

The locus A' is dense in $A_{\mathbf{g}, \mathbf{Z}, \mathbf{P}}^R$. If we assume that the fibers of p are generically of dimension 1, then $p(A')$ is also dense in $\mathrm{Im}(p)$. Therefore we only need to prove that a generic point of $p(A')$ has fibers of dimension 1 if and only if condition (\star) is satisfied.

It is easy to check that the residue map sends A' to $R \setminus \Sigma$. Therefore the locus $p(A')$ is the locus of points such that the map ev defined in the proof of Proposition 2.2.50 is injective. Thus a point of $p(A')$ has fibers of dimension 1 by p if and only if $R \cap \mathrm{ev}(\bigoplus_j L_j)$ is of dimension 1. Now, $R \cap \mathrm{ev}(\bigoplus_j L_j)$ is of dimension 1 if and only if the preimage under ρ of the point $(L_1, \dots, L_q) \in \prod_{j=1}^q \mathbb{P}R_j$ is composed of a unique point.

Now the residue map is a submersion from $A_{\mathbf{g}, \mathbf{Z}, \mathbf{P}}^R$ to R . Therefore, the map ρ is finite on a dense open subset of $\mathbb{P}R \setminus \mathbb{P}\Sigma$ if and only if the fiber of p is of dimension 1 on a dense open set of $\text{Im}(p)$. \square

Now no longer assume that \mathbf{Z} is complete for \mathbf{g} and \mathbf{P} .

Notation 2.2.53. We will say that $(\mathbf{g}, \mathbf{Z}, \mathbf{P}, R)$ satisfies condition $(\star\star)$ if and only if either $q = 1$ or the following two following conditions are satisfied

- the vector spaces $(\mathcal{R}, R, (\mathcal{R}_j)_{1 \leq j \leq q})$ satisfy the condition (\star) ;
- for all $1 \leq j \leq q$, we have $\dim(A_{g_j, Z_j, P_j}^{R_j}) - 1 \leq \dim(\overline{\mathcal{M}}_{g_j, n_j + m_j})$.

Proposition 2.2.54. *The fiber of p over a generic point of $\text{Im}(p)$ is of dimension 1 if and only if $(\mathbf{g}, \mathbf{Z}, \mathbf{P}, R)$ satisfies condition $(\star\star)$.*

PROOF. Let \mathbf{Z}_m be the maximal completion of \mathbf{Z} . We denote by $Z_{j,m}$ the maximal completion of Z_j . We recall that

$$\dim(A_{\mathbf{g}, \mathbf{Z}_m, \mathbf{P}}^R) = \dim(A_{\mathbf{g}, \mathbf{Z}, \mathbf{P}}^R).$$

If $(R, \mathcal{R}, (\mathcal{R}_j)_{1 \leq j \leq q})$ does not satisfy the condition (\star) , then the dimension of $A_{\mathbf{g}, \mathbf{Z}_m, \mathbf{P}}^R$ is greater than the dimension of its image in the moduli space of curves and the general fiber of p is of dimension greater than 1. From now on, we assume that $(R, \mathcal{R}, (\mathcal{R}_j)_{1 \leq j \leq q})$ satisfies the condition (\star) .

First, we suppose that $\dim(A_{g_j, Z_j, P_j}^{R_j}) - 1 > \dim(\overline{\mathcal{M}}_{g_j, n_j + m_j})$ for some $j \in \llbracket 1, q \rrbracket$. The preimage of a point in $\text{Im}(p_j)$ under p_j has fibers of dimension greater than 1. Let y be a point in $A_{\mathbf{g}, \mathbf{Z}, \mathbf{P}}^R$. The point y determines point $y_{j'}$ in $A_{g_{j'}, Z_{j'}, P_{j'}}^{R_{j'}}$ for $j' \neq j$ and a point y_j in $A_{g_j, Z_j, P_j}^{R_j}$. We denote by E_j the locus of points in $y'_j \in p_j^{-1}(\{p_j(y_j)\})$ such that the residues of y'_j and y_j are equal. By hypothesis, the locus E_j is of dimension at least 1. Now the preimage of $p(y)$ under p contains the points $(y_1, \dots, y'_j, \dots, y_q)$ for all $y'_j \in E_j$. Therefore the dimension of the fiber of $p(y)$ under p is greater than 1.

Now, we assume that $\dim(A_{g_j, Z_j, P_j}^{R_j}) - 1 \leq \dim(\overline{\mathcal{M}}_{g_j, n_j + m_j})$ for all $1 \leq j \leq q$. We already know that $\dim(\text{Im}(p)) \leq \dim(A_{\mathbf{g}, \mathbf{Z}, \mathbf{P}}^R)$. To prove that $\dim(\text{Im}(p)) \geq \dim(A_{\mathbf{g}, \mathbf{Z}, \mathbf{P}}^R)$, we study the two vector bundles over $\overline{\mathcal{M}}_{\mathbf{g}, \mathbf{n}, \mathbf{m}}$ defined as:

$$\begin{aligned} E_1 &= \bigoplus_{j=1}^q K \overline{\mathcal{M}}_{g_j, n_j}(P_j) = \bigoplus_{j=1}^q R^0 \pi_* (\omega_j (\sum_{i=1}^{m_j} p_i x_{n_j+i})), \\ E_2 &= \mathcal{R}/R \oplus \left(\bigoplus_{j=1}^q \bigoplus_{i=1}^{n_q} J_{j,i,k_i}^{\text{hol}} \right), \end{aligned}$$

where the notation ω_j stands for the dualizing sheaf of the j -th component of the universal curve and J_{j,i,k_i} is the space of jets of holomorphic jets order k_i at the i th marked point of the j th component (see the proof of Proposition 2.2.41 for definition). There is a natural morphism of vector bundles $e : E_1 \rightarrow E_2$. As in the proof of Proposition 2.2.41, $\text{Im}(p)$ is dense in the locus where e is not injective and we conclude that $\dim(A_{g_j, Z_j, P_j}^{R_j}) - 1 = \dim(\overline{\mathcal{M}}_{g_j, n_j + m_j})$. \square

2.2.9. Unstable base. Here we extend the definition of the spaces of stable differentials to the case of an unstable base. Two kinds of spaces $\overline{\mathcal{H}}_{g,n,P}$ with unstable base appear as degenerations of the spaces with stable base:

- The genus g is equal to 0, $n = m = 1$ and $P = (p)$ with $p > 1$ (stability condition).
- The genus g is equal to 0, $n = 0, m = 2$ and $P = (1, p)$ with $p > 1$ (stability condition).

These two spaces do not come with a natural structure of cones because the moduli space $\overline{\mathcal{M}}_{0,2}$ is empty. However we can still define these moduli spaces and the \mathbb{C}^* -action.

The space $\overline{\mathcal{H}}_{0,1+1,(p)}$ is defined as complementary of $\{u = 0\}$ in the space of generalized principal parts defined in Section 2.2.1. In other words $\overline{\mathcal{H}}_{0,1+1,(p)}$ is the spectrum of the graded subalgebra of $\mathbb{C}[a_1, \dots, a_{p-2}]$ generated by monomials with integral weights (where the weight of a_j is $j/(p-1)$).

Similarly the space $\overline{\mathcal{H}}_{0,2,(1,p)}$ is the spectrum of the graded subalgebra of the algebra $\mathbb{C}[a_1, \dots, a_{p-2}, r]$ generated by monomials with integral weights where r (for residue) has weight 1.

Definition 2.2.55. A triple (g, n, P) composed of a nonnegative integers g and n and a vector P of positive integers is *semi-stable* if $2g - 2 + n + \ell(P) > 0$ or $g = 0, n = 1$ and $P = (p)$ with $p > 1$ or $g = 0, n = 0, P = (1, p)$ with $p > 1$.

If Z is vector of nonnegative integers, then the triple (g, Z, P) is *semi-stable* if $(g, \ell(Z), P)$ is semi-stable.

Consider two lists \mathbf{g} and \mathbf{n} of q nonnegative integers and a list \mathbf{P} of q vectors. The triple $(\mathbf{g}, \mathbf{n}, \mathbf{P})$ is *semi-stable* if all (g_j, n_j, P_j) are semi-stable. If \mathbf{Z} is a list of vectors then $(\mathbf{g}, \mathbf{Z}, \mathbf{P})$ is *semi-stable* if all (g_j, Z_j, P_j) are semi-stable.

Definition 2.2.56. Let $\mathbf{g}, \mathbf{n}, \mathbf{m}, \mathbf{P}$ be lists of genera, numbers of marked points without poles, numbers of marked poles and vectors of positive integers indexed by $j \in \llbracket 1, q \rrbracket$. We suppose that $(\mathbf{g}, \mathbf{n}, \mathbf{P})$ is a semi-stable triplet. We define $\overline{\mathcal{H}}_{\mathbf{g}, \mathbf{n}, \mathbf{P}} = \prod_{j=1}^q \overline{\mathcal{H}}_{g_j, n_j, P_j}$. If at least one of the $j \in \llbracket 1, q \rrbracket$ satisfies $2g_j - 2 + n_j + m_j > 0$, then $\overline{\mathcal{H}}_{\mathbf{g}, \mathbf{n}, \mathbf{P}}$ is a cone over the following base

$$\overline{\mathcal{M}}_{\mathbf{g}, \mathbf{n}, \mathbf{m}}^{\text{red}} = \prod_{j: 2g_j - 2 + n_j + m_j > 0} \overline{\mathcal{M}}_{g_j, n_j + m_j}.$$

We will call this space, the *reduced base*.

Now we can extend the definition of the previous sections to semi-stable triples.

Notation 2.2.57. Let \mathbf{Z} be a list of vectors such that the triple $(\mathbf{g}, \mathbf{Z}, \mathbf{P})$ is semi-simple. Let $R \subset \mathcal{R}$ a vector subspace. We still denote by $A_{\mathbf{g}, \mathbf{Z}, \mathbf{P}}^R \subset \overline{\mathcal{H}}_{\mathbf{g}, \mathbf{n}, \mathbf{P}}$ the locus of differentials with residues lying in R and zeros of order prescribed by \mathbf{Z} (see Notation 2.2.47).

We also define the tautological ring.

Definition 2.2.58. Let $p : \overline{\mathcal{H}}_{\mathbf{g}, \mathbf{n}, \mathbf{P}} \rightarrow \overline{\mathcal{M}}_{\mathbf{g}, \mathbf{n}, \mathbf{m}}^{\text{red}}$ be the projection to the base. The *tautological ring* $RH^*(\mathbb{P}\overline{\mathcal{H}}_{\mathbf{g}, \mathbf{n}, \mathbf{P}})$ is the ring generated by $\xi = c_1(\mathcal{O}(1))$ and pull-backs by p of tautological classes from the base $\overline{\mathcal{M}}_{\mathbf{g}, \mathbf{n}, \mathbf{m}}^{\text{red}}$.

We generalize Theorem 2.1.14.

Theorem 2.2.59. *For all $\mathbf{g}, \mathbf{Z}, \mathbf{P}$ (list of integers and vectors of integers) and R a subspace of \mathcal{R} , the Poincaré-dual class of $\mathbb{P}\overline{A}_{\mathbf{g}, \mathbf{Z}, \mathbf{P}}^R$ in $H^*(\mathbb{P}\overline{\mathcal{H}}_{\mathbf{g}, \mathbf{Z}, \mathbf{P}}, \mathbb{Q})$ is tautological and can be explicitly computed.*

2.2.10. Semi-stable graphs. Let $\mathbf{g}, \mathbf{n}, \mathbf{m}, \mathbf{P}$ be lists of genera, numbers of marked points without poles, numbers of marked poles and vectors of positive integers indexed by $j \in \llbracket 1, q \rrbracket$ as in the previous Section. The space $\overline{\mathcal{H}}_{\mathbf{g}, \mathbf{n}, \mathbf{P}}$ has a natural stratification whose strata are described by semi-stable graphs that we define here.

Definition 2.2.60. A semi-stable graph of type $(\mathbf{g}, \mathbf{n}, \mathbf{P})$ is given by the data

$$\Gamma = (V, H, g : V \rightarrow \mathbb{N}, a : H \rightarrow V, i : H \rightarrow H, E),$$

satisfying the following properties:

- V is a vertex set with a genus function g .
- H is a half-edge set equipped with a vertex assignment a and an involution i ;
- the edge set E is defined as the set of length 2 orbits of i in H (self-edges at vertices are permitted);
- (V, E) has q connected components;
- for all $1 \leq j \leq q$, the genus of the connected component labeled by j is defined by $\sum g(v) + \#(E_j) - \#(V_j) + 1$ and is equal to g_j ;
- L is the set of fixed points of i called *legs*;
- for all $1 \leq j \leq q$, there are $n_j + m_j$ legs on the j^{th} connected component;
- for each vertex v in V ,
 - let $n(v)$ be the number of legs of v corresponding to marked points without poles;
 - let $m(v)$ be the number of legs of v corresponding to marked points with poles plus the number of half-edges adjacent to v which correspond to edges;
 - let $P(v)$ be the vector of orders of poles at marked points adjacent to v , to which we add poles of order one for the half-edges;
- for each vertex v , the triple $(g(v), n(v), P(v))$ is semi-stable.

We define the following lists indexed by the vertices of Γ :

$$\begin{aligned} \mathbf{g}_\Gamma &= (g(v))_{v \in V} & , & & \mathbf{n}_\Gamma &= (n(v))_{v \in V}, \\ \mathbf{m}_\Gamma &= (m(v))_{v \in V} & , & & \mathbf{P}_\Gamma &= (P(v))_{v \in V}. \end{aligned}$$

The triple $(\mathbf{g}_\Gamma, \mathbf{n}_\Gamma, \mathbf{P}_\Gamma)$ by definition of a semi-stable graph. We will consider the space $\overline{\mathcal{H}}_{\mathbf{g}_\Gamma, \mathbf{n}_\Gamma, \mathbf{P}_\Gamma}$. We denote by \mathcal{R}_Γ the space of residues of $\overline{\mathcal{H}}_{\mathbf{g}_\Gamma, \mathbf{n}_\Gamma, \mathbf{P}_\Gamma}$. We define $R_\Gamma \subset \mathcal{R}$ as the vector subspace of residues satisfying that the sum of residues at two half edges of an edge is zero.

Notation 2.2.61. Let Γ be a semi-stable graph we denote by $\overline{\mathcal{H}}_\Gamma$ the moduli space $\overline{\mathcal{H}}_{\mathbf{g}_\Gamma, \mathbf{n}_\Gamma, \mathbf{P}_\Gamma}^{R_\Gamma}$ and by

$$\zeta_\Gamma^\# : \overline{\mathcal{H}}_\Gamma \rightarrow \overline{\mathcal{H}}_{\mathbf{g}, \mathbf{n}, \mathbf{P}}$$

the natural closed immersion.

Thus boundary strata of $\overline{\mathcal{H}}_{\mathbf{g},\mathbf{n},\mathbf{P}}$ are described by semi-stable graphs.

The space $\mathbb{P}\overline{\mathcal{H}}_\Gamma$ comes with a tautological line bundle. This line bundle is the pullback by $\zeta_\Gamma^\#$ of the tautological line bundle of $\mathbb{P}\overline{\mathcal{H}}_{\mathbf{g},\mathbf{n},\mathbf{P}}$. By abuse of notation we will write ξ for the first Chern class of the dual of the tautological line bundle for both spaces. We have the following important proposition.

Proposition 2.2.62. *Let Γ be semi-stable graph. The morphism $\zeta_{\Gamma^*}^\# : H^*(\mathbb{P}\overline{\mathcal{H}}_\Gamma, \mathbb{Q}) \rightarrow H^*(\mathbb{P}\overline{\mathcal{H}}_{\mathbf{g},\mathbf{n},\mathbf{P}}, \mathbb{Q})$ maps tautological classes to tautological classes.*

PROOF. Let Γ be a semi-stable graph. Let $k \geq 0$ and $\beta \in \overline{\mathcal{M}}_\Gamma^{\text{red}}$. We need to prove that the class $\zeta_{\Gamma^*}^\#(\xi^k p^*(\beta))$ is tautological. We will prove this statement in three steps.

Stable graphs. We suppose first that Γ is a stable graph. We recall that in this case we have defined a map $\zeta_\Gamma : \overline{\mathcal{M}}_\Gamma \rightarrow \overline{\mathcal{M}}_{\mathbf{g},\mathbf{n},\mathbf{m}}$. Then $\overline{\mathcal{H}}_\Gamma$ is the fiber product

$$\begin{array}{ccc} \overline{\mathcal{H}}_\Gamma & \xrightarrow{\zeta_\Gamma^\#} & \overline{\mathcal{H}}_{\mathbf{g},\mathbf{n},\mathbf{P}} \\ p_\Gamma \downarrow & & \downarrow p \\ \overline{\mathcal{M}}_\Gamma & \xrightarrow{\zeta_\Gamma} & \overline{\mathcal{M}}_{\mathbf{g},\mathbf{n},\mathbf{m}} \end{array}$$

Let β be a cohomology class in $H^*(\overline{\mathcal{M}}_\Gamma, \mathbb{Q})$. We use the projection formula and the fact that $\overline{\mathcal{H}}_\Gamma$ is a fiber product to get $\zeta_{\Gamma^*}^\#(\xi^k \cdot p_\Gamma^*(\beta)) = \xi^k p^*(\zeta_{\Gamma^*}(\beta))$. Therefore, if the class β belongs to the tautological ring $RH^*(\overline{\mathcal{M}}_\Gamma, \mathbb{Q})$, then the class $\zeta_{\Gamma^*}^\#(\xi^k \cdot p_\Gamma^*(\beta))$ belongs to the tautological ring of $\overline{\mathcal{H}}_{\mathbf{g},\mathbf{n},\mathbf{P}}$.

Graph with one main vertex. Now we no longer assume that Γ is stable. Let $1 \leq j \leq q$ and $1 \leq i \leq m_j$. Let p_i be the i^{th} entry of P_j . Assume that Γ is the following graph

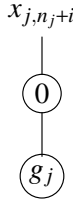

(we take the trivial graph for all the other connected components). We will prove that the class $\zeta_{\Gamma^*}^\#(1)$ lies in $RH^*(\mathbb{P}\overline{\mathcal{H}}_{\mathbf{g},\mathbf{n},\mathbf{P}})$. We use the parametrization of the cone of principal parts at x

$$\left[\left(\frac{u}{z} \right)^{p_i-1} + a_1 \left(\frac{u}{z} \right)^{p_i-2} + \dots + a_{p_i-2} \left(\frac{u}{z} \right) \right] \frac{dz}{z}.$$

The stratum defined by Γ is the vanishing locus of u . We have seen that u^{p_i-1} is a section of the line bundle $\text{Hom}(\mathcal{O}(-1), \mathcal{L}_i^{p_i-1})$. Therefore the vanishing locus of u has Poincaré-dual class given by

$$[u = 0] = \frac{1}{p_i-1} \xi - \psi_i.$$

By the same argument, if Γ is the graph

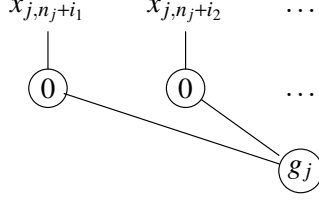

where the set $\{i_k\}$ is a set of indices in $\llbracket 1, m_j \rrbracket$. Then we have

$$\zeta_{\Gamma_*}^{\#}(1) = \prod_k \left(\frac{1}{p_{i_k} - 1} \xi - \psi_{i_k} \right).$$

And more generally, for a class β in $RH^*(\overline{\mathcal{M}}_{\mathbf{g},\mathbf{n},\mathbf{m},\mathbf{P}}^{\text{red}})$ and $k \in \mathbb{N}$, we have

$$\zeta_{\Gamma_*}^{\#}(\xi^k \beta) = \xi^k \beta \cdot \prod_k \left(\frac{1}{p_{i_k} - 1} \xi - \psi_{i_k} \right) \in RH^*(\overline{\mathcal{H}}_{\mathbf{g},\mathbf{n},\mathbf{m},\mathbf{P}}).$$

General unstable graph. We combine the two previous arguments. Let Γ be a general semi-stable graph. Let $\widehat{\Gamma}$ be the graph obtained by contracting all edges between stable vertices. We have $\overline{\mathcal{M}}_{\mathbf{g},\mathbf{n},\mathbf{m}}^{\text{red}} = \overline{\mathcal{M}}_{\widehat{\Gamma}}^{\text{red}}$. The space $\overline{\mathcal{H}}_{\Gamma}$ is the fiber product

$$\begin{array}{ccccc} \overline{\mathcal{H}}_{\Gamma} & \longrightarrow & \overline{\mathcal{H}}_{\widehat{\Gamma}}^{\text{red}} & \xrightarrow{\zeta_{\widehat{\Gamma}}^{\#}} & \overline{\mathcal{H}}_{\mathbf{g},\mathbf{n},\mathbf{m}} \\ p_{\Gamma} \downarrow & & \downarrow p_{\widehat{\Gamma}} & & \\ \overline{\mathcal{M}}_{\Gamma} & \xrightarrow{\zeta_{\Gamma}} & \overline{\mathcal{M}}_{\mathbf{g},\mathbf{n},\mathbf{m}}^{\text{red}} & & \end{array}$$

Thus $\zeta_{\Gamma_*}^{\#}(\xi^k p_{\Gamma}^* \beta) = \zeta_{\widehat{\Gamma}}^{\#}(\xi^k p_{\widehat{\Gamma}}^*(\zeta_{\Gamma_*} \beta))$. Now $\widehat{\Gamma}$ has one stable vertex, and $\zeta_{\widehat{\Gamma}} \beta \in RH^*(\overline{\mathcal{M}}_{\mathbf{g},\mathbf{n},\mathbf{m}}^{\text{red}})$ thus the class $\zeta_{\Gamma_*}^{\#}(\xi^k p_{\Gamma}^* \beta)$ is tautological. \square

2.3. The induction formula

The aim of this section is to prove Theorem 2.2.59 stating that the cohomology classes $[\mathbb{P}\overline{A}_{\mathbf{g},\mathbf{Z},\mathbf{P}}^R] \in H^*(\mathbb{P}\overline{\mathcal{H}}_{\mathbf{g},\mathbf{n},\mathbf{P}}, \mathbb{Q})$ are tautological. For this purpose we will state and prove the most technical and important result: the induction formula for the classes $[\mathbb{P}\overline{A}_{\mathbf{g},\mathbf{Z},\mathbf{P}}^R]$. Before doing this, we need to understand the closure of $A_{\mathbf{g},\mathbf{Z},\mathbf{P}}^R$ in $\overline{\mathcal{H}}_{\mathbf{g},\mathbf{n},\mathbf{P}}$. We will describe this closure using graphs with twists and level structures following [3] and [28]. However our space $\overline{\mathcal{H}}_{\mathbf{g},\mathbf{n},\mathbf{P}}$ is different from the spaces used in [3] and [28] so that we have to modify their definitions. That is why we will introduce \mathbf{P} -admissible graphs.

2.3.1. Twisted graphs with level structures. Let $\mathbf{g}, \mathbf{n}, \mathbf{m}, \mathbf{P}$ be lists of genera, numbers of marked points without poles, numbers of marked poles and vectors of positive integers indexed by $j \in \llbracket 1, q \rrbracket$. We suppose that the triplet $(\mathbf{g}, \mathbf{n}, \mathbf{P})$ is semi-stable. Let \mathbf{Z} be a list of q vectors of nonnegative integers of lengths prescribed by \mathbf{n} . Let R be a vector subspace of the space of residues \mathcal{R} . We introduce a stratification of $\overline{A}_{\mathbf{g},\mathbf{Z},\mathbf{P}}^R$. Strata will be described by combinatorial objects called \mathbf{P} -admissible graphs. We introduce these graphs here and explain how they correspond to strata of $\overline{A}_{\mathbf{g},\mathbf{Z},\mathbf{P}}^R$ in section 2.3.2.

Let Γ be a semi-stable graph of type $(\mathbf{g}, \mathbf{n}, \mathbf{m}, \mathbf{P})$. We denote by H_e the set of half-edges of Γ which are not legs.

Definition 2.3.1. A *twist* on Γ is a function

$$I : H_e \rightarrow \mathbb{Z}$$

Satisfying the following conditions.

- If h and h' form an edge, then $I(h) + I(h') = 0$.
- Let v and v' be two vertices, and $\{(h_1, h'_1), \dots, (h_n, h'_n)\}$ be the set of edges from v to v' . Then either $I(h_j) = 0$ for all $1 \leq j \leq n$, or $I(h_j) > 0$ for all $1 \leq j \leq n$, or $I(h_j) < 0$ for all $1 \leq j \leq n$. We say that $v = v'$, or $v > v'$, or $v < v'$, depending on the above inequalities.
- The relation \leq thus defined on vertices is transitive.

For shortness, a semi-stable graph endowed with a twist function will be called a *twisted graph*. If (Γ, I) is a twisted graph, the above conditions define a partial order on the set of its vertices of Γ .

Definition 2.3.2. A *level structure* on a twisted graph is a function:

$$l : \text{Vertices} \rightarrow \mathbb{Z}^-,$$

compatible with the partial order induced by the twist, i.e., for all vertices v and v' ,

$$v = v' \Rightarrow l(v) = l(v'), \quad v < v' \Rightarrow l(v) < l(v').$$

We impose that the image of l is an interval containing all integers from 0 to $-d$ and we call d the *depth* of the twisted graph. We will denote by V^i the set of vertices of level i .

Definition 2.3.3. A twisted graph with level structure is called **P-admissible** if all marked poles of order at least 2 belong to vertices of level 0. For shortness we will call such graphs *admissible graphs*.

Example 2.3.4. We represent in Figure 1 an example of admissible graphs. Each vertex v is represented by a circle containing the integer g_v . The marked poles and zeros are represented by legs. A leg corresponding to a pole (respectively a zero) of order k is marked by $-k$ (respectively $+k$). The twists are indicated on each edge.

Definition 2.3.5. An edge between vertices of the same level will be called an *horizontal edge*.

2.3.2. Boundary strata associated to admissible graphs. Let $\mathbf{g}, \mathbf{n}, \mathbf{m}, \mathbf{P}, \mathbf{Z}$ and R be as in the previous section. Let (Γ, I, l) be an admissible graph. In this subsection, we assign to this admissible graph a stratum of abelian differentials $A_{\Gamma, I, l} \subset \overline{\mathcal{H}}_{\mathbf{g}, \mathbf{n}, \mathbf{P}}$ that lies in the closure of $A_{\mathbf{g}, \mathbf{Z}, \mathbf{P}}^R$. We build this stratum level by level.

To every level 0 vertex we will assign a cycle in the corresponding space of differentials. To every vertex of negative levels we will assign a cycle in the corresponding moduli space of curves. The product of these cycles will give us a cycle

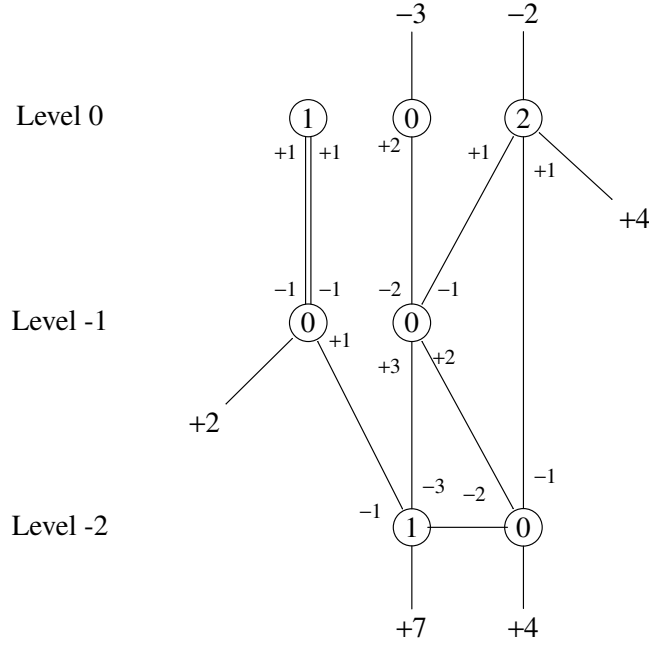

FIGURE 1. An example of admissible graph of genus 7 for the vectors $Z = (2, 4, 4, 7)$ and $P = (-3, -2)$.

in the space $\overline{\mathcal{H}}_\Gamma$ by putting an identically vanishing differential on every component of the curve of negative level. Thus our input is (Z, R) and an admissible graph (Γ, I, l) of type $\mathbf{g}, \mathbf{n}, \mathbf{P}$; our output is a collection of cycles in the spaces of differentials (for level 0 vertices) and in the spaces of curves (for vertices of negative levels).

Level 0. Suppose there are q_0 level 0 vertices. Their genera, half-edges and twists determine lists $\mathbf{g}_0, \mathbf{n}_0, \mathbf{m}_0, \mathbf{P}_0, \mathbf{Z}_0$ of length q_0 as in Section 2.2.7: half-edges h to deeper levels are listed as zeros of orders $I(h) - 1$.

Now we define a space of residues. Residues are assigned to legs that correspond to marked poles and to horizontal edges. These residues should satisfy three conditions:

- the residues on the two half-edges of a horizontal edge are opposite;
- the sum of residues at each vertex vanishes;
- the vector of residues on the marked poles belongs to the space R .

These conditions define a vector space denoted by R^0 . With these data, we define the level 0 stratum $A_{\Gamma, I, l}^0 = A_{\mathbf{g}_0, \mathbf{P}_0, \mathbf{Z}_0}^{R^0}$.

Level -1. Suppose there are q_1 level -1 vertices. Their genera, half-edges and twists determine lists $\mathbf{g}_1, \mathbf{n}_1, \mathbf{m}_1, \mathbf{P}_1, \mathbf{Z}_1$ of length q_1 as in Section 2.2.7: half-edges to level 0 are listed as poles of order $-I(h) + 1$ and half-edges to deeper levels as zeros of order $I(h) - 1$.

To define the space of residue R^1 we need a little more notation than for the level 0. We define a first space of residues $\widetilde{\mathcal{R}}$: residues are assigned to legs that correspond to marked poles on components of level 0 or -1 and to half-edges of

edges between components of level 0 or -1 . The space $\tilde{\mathcal{R}}$ is the direct sum of \mathcal{R}^0 and \mathcal{R}^1 corresponding respectively to residues assigned to half-edges of level 0 and -1 . Let pr be the projection from $\tilde{\mathcal{R}}$ to \mathcal{R}^1 along \mathcal{R}^0 . Let $\tilde{\mathcal{R}}^1 \subset \tilde{\mathcal{R}}$ be the vector subspace defined by the linear conditions:

- the residues on the two half-edges of a horizontal edge are opposite;
- the sum of residues at each vertex vanishes;
- the vector of residues on the marked poles on components of level 0 belongs to the space R .

The vector space R^1 is defined as $\text{pr}(\tilde{\mathcal{R}}^1)$.

Example 2.3.6. To illustrate the definition of R^1 , we compute all vector spaces for the following two graphs

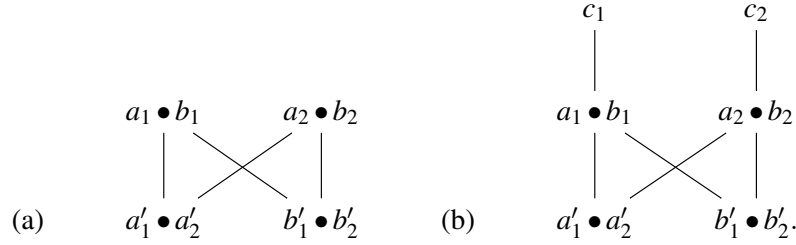

On these two examples we have not represented the genera of the vertices and we have only represented the legs with poles (thus at level 0). In the first case $R = \mathcal{R} = \{0\}$ (there are no poles). In the second case we assume that $R = \mathcal{R} \simeq \mathbb{C}$ (we impose no condition on the residues). All letters stand for the value of the residue, i.e. for a coordinate in $\tilde{\mathcal{R}}$ corresponding either to a half-edge or to a marked pole. In the following table we give the dimensions and equations of all sub-vector spaces of $\tilde{\mathcal{R}}$ and a presentation of $\tilde{\mathcal{R}}^1$ and R^1 .

Vector space	Example (a)	Example (b)
$\tilde{\mathcal{R}}$	\mathbb{C}^8	\mathbb{C}^{10}
\mathcal{R}^1	$\mathbb{C}^4 \{a_1 = a_2 = b_1 = b_2 = 0\}$	$\mathbb{C}^4 \{a_1 = a_2 = b_1 = b_2 = c_1 = c_2 = 0\}$
\mathcal{R}^0	$\mathbb{C}^4 \{a'_1 = a'_2 = b'_1 = b'_2 = 0\}$	$\mathbb{C}^6 \{a'_1 = a'_2 = b'_1 = b'_2 = 0\}$
Relations from edges	$\{a_1 + a'_1 = a_2 + a'_2 = b_1 + b'_1 = b_2 + b'_2 = 0\}$	$\{a_1 + a'_1, a_2 + a'_2, b_1 + b'_1 = b_2 + b'_2 = 0\}$
Relations from vertices	$\{a_1 + b_1 = b_1 + b_2 = a'_1 + a'_2 = b'_1 + b'_2 = 0\}$	$\{a_1 + b_1 + c_1 = b_1 + b_2 + c_2 = a'_1 + a'_2 = b'_1 + b'_2 = 0\}$
Relations from R	$\{0\}$	$\{c_1 + c_2 = 0\}$
$\tilde{\mathcal{R}}^1$	$\{(a_1 = \epsilon, a'_1 = -\epsilon, a_2 = -\epsilon, a'_2 = \epsilon, b_1 = -\epsilon, b'_1 = \epsilon, b_2 = \epsilon, b'_2 = -\epsilon), \epsilon \in \mathbb{C}\}$	$\{(a_1 = \epsilon_1, a'_1 = -\epsilon_1, a_2 = -\epsilon_1, a'_2 = \epsilon_1, b_1 = -\epsilon_2, b'_1 = \epsilon_2, b_2 = \epsilon_2, b'_2 = -\epsilon_2, c_1 = -\epsilon_1 + \epsilon_2, c_2 = +\epsilon_1 - \epsilon_2), (\epsilon_1, \epsilon_2) \in \mathbb{C}^2\}$
R^1	$\{(a'_1 = -\epsilon, a'_2 = \epsilon, b'_1 = \epsilon, b'_2 = -\epsilon), \epsilon \in \mathbb{C}\}$	$\{(a'_1 = -\epsilon_1, a'_2 = \epsilon_1, b'_1 = \epsilon_2, b'_2 = -\epsilon_2), (\epsilon_1, \epsilon_2) \in \mathbb{C}^2\}$

Now we define

$$A_{\Gamma, I, l}^1 = p(A_{\mathbf{g}_1, \mathbf{Z}_1, \mathbf{P}_1}^{R^1}) \subset \overline{\mathcal{M}}_{\mathbf{g}_1, \mathbf{n}_1, \mathbf{m}_1} = \prod_{v \in V^1} \overline{\mathcal{M}}_{g_v, n_v + m_v},$$

where $p : \overline{\mathcal{H}}_{\mathbf{g}_1, \mathbf{n}_1, \mathbf{P}_1} \rightarrow \overline{\mathcal{M}}_{\mathbf{g}_1, \mathbf{n}_1, \mathbf{m}_1}$ is the forgetful map.

Level $-\ell$. Let Γ' be the graph obtained from Γ by contracting edges between vertices of levels 0 through $-\ell + 1$. The twist on Γ restricts to Γ' and the level structure is shifted. Vertices of levels 0 to $-\ell + 1$ merge to level 0, level $-\ell$ vertices become level -1 vertices and so on. Therefore we have the natural identification

$$\prod_{\substack{v \in V(\Gamma), \\ \ell(v) = -\ell}} \overline{\mathcal{M}}_{g(v), n(v)} = \prod_{\substack{v \in V(\Gamma'), \\ \ell(v) = -1}} \overline{\mathcal{M}}_{g(v), n(v)}$$

and we define $A_{\Gamma, I, l}^\ell$ as $A_{\Gamma', I, l}^1$.

Example 2.3.7. The contraction of level 0 and -1 of the admissible graph of Figure 1 gives the following admissible graph with two levels

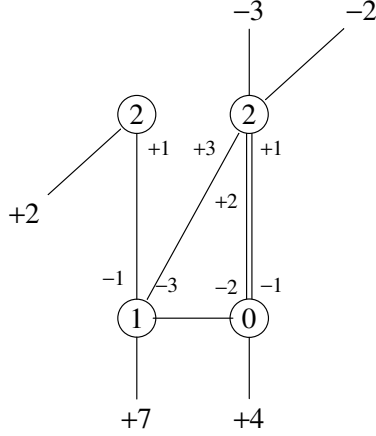

If we assume that we have $R = \mathcal{R} \simeq \mathbb{C}$ then here we have $R^0 = \{0\}$ while $R^{0'} = R$.

Notation 2.3.8. Now that we have defined the $A_{\Gamma, I, l}^\ell$ for all levels, we denote

$$A_{\Gamma, I, l} = \prod_{\ell \in \mathbb{Z}^-} A_{\Gamma, I, l}^\ell.$$

We have a natural inclusion of $A_{\Gamma, I, l} \hookrightarrow \overline{\mathcal{H}}_{\mathbf{g}, \mathbf{n}, \mathbf{P}}$: the differential is nonzero only on the level 0 vertices and vanishes identically everywhere else. We will call $A_{\Gamma, I, l}$ the *boundary stratum of type $(\mathbf{g}, \mathbf{Z}, \mathbf{P}, R)$ associated to (Γ, I, l)* .

Remark 2.3.9. Note that the stratum $A_{\Gamma, I, l}$ is constructed from an admissible graph (Γ, I, l) of type $(\mathbf{g}, \mathbf{n}, \mathbf{P})$, a space of residues $R \subset \mathcal{R}$ and q vectors of zeros \mathbf{Z} . However, for simplicity, R and \mathbf{Z} do not explicitly appear in the notation.

Remark 2.3.10. If $R = \mathcal{R}$, then the construction of the space of residues is the translation of the global residue condition of [3]. For every level $-\ell$ and every vertex v of level greater than $-\ell$ that does not contain a pole the following conditions holds. Let h_1, \dots, h_k denote the half-edges adjacent to v and part of an edge to a

vertex of level $-\ell$. Then the sum of residues assigned to this set of half-edges is zero.

Our definition of the R^i is more complicated to state because we need to take into account any vector subspace R of \mathcal{R} .

2.3.3. Stratification of $\bar{A}_{\mathbf{g}, \mathbf{Z}, \mathbf{P}}^R$. Let $q, \mathbf{g}, \mathbf{n}, \mathbf{m}, \mathbf{Z} = (k_{j,i})_{\substack{1 \leq j \leq q \\ 1 \leq i \leq n_j}}, \mathbf{P} = (p_{j,i})_{\substack{1 \leq j \leq q \\ 1 \leq i \leq m_j}}$,

and R be as in the previous section.

Lemma 2.3.11. *Let (Γ, I, l) be an admissible graph of type $(\mathbf{g}, \mathbf{Z}, \mathbf{P}, R)$. The locus $A_{\Gamma, I, l}$ lies in the closure of $A_{\mathbf{g}, \mathbf{Z}, \mathbf{P}}^R$. Conversely if y is a point of $\bar{A}_{\mathbf{g}, \mathbf{Z}, \mathbf{P}}^R$ then there exists an exterior completion \mathbf{Z}' of \mathbf{Z} and an admissible graph (Γ, I, l) of type $(\mathbf{g}, \mathbf{Z}', \mathbf{P}, R)$ such that y lies in $\pi(A_{\Gamma, I, l})$, where $\pi : A_{\mathbf{g}, \mathbf{Z}', \mathbf{P}}^R \rightarrow A_{\mathbf{g}, \mathbf{Z}, \mathbf{P}}^R$ is the forgetful map of the marked zeros that are not accounted for by \mathbf{Z} .*

Before proving it we will introduce the incidence variety compactification of [3].

Notation 2.3.12. We suppose that $2g_j - 2 + n_j + m_j > 0$ for all $1 \leq j \leq q$. Then we denote by $K\bar{\mathcal{M}}_{\mathbf{g}, \mathbf{n}}(\mathbf{P})$ the vector bundle

$$R^0 \pi_* \left(\omega \left(\sum_{j=1}^q \sum_{i=1}^{m_j} p_{j,i} \sigma_{j, n_j + i} \right) \right),$$

where $\pi : \bar{\mathcal{C}}_{\mathbf{g}, \mathbf{n}, \mathbf{m}} \rightarrow \bar{\mathcal{M}}_{\mathbf{g}, \mathbf{n}, \mathbf{m}}$ is the forgetful map, ω is the relative dualizing sheaf and the $\sigma_{j,i}$'s are the sections of the universal curve (this generalizes the notation 2.2.19 to the disconnected case).

As in Section 2.2, there exists a natural morphism of cones

$$\text{stab} : \bar{\mathcal{H}}_{\mathbf{g}, \mathbf{n}, \mathbf{P}} \rightarrow K\bar{\mathcal{M}}_{\mathbf{g}, \mathbf{n}}(\mathbf{P}).$$

2.3.3.1. *The image of $\bar{A}_{\mathbf{g}, \mathbf{n}, \mathbf{P}}^R$ under the morphism stab .*

Definition 2.3.13. We denote by $\Omega\mathcal{M}_{\mathbf{g}}^{\text{inc}}(\mathbf{Z}, \mathbf{P})^R \subset K\bar{\mathcal{M}}_{\mathbf{g}, \mathbf{n}}(\mathbf{P})$ the image of $A_{\mathbf{g}, \mathbf{n}, \mathbf{P}}^R$ under the morphism stab . The *incidence variety* for the tuple $(\mathbf{g}, \mathbf{Z}, \mathbf{P}, R)$ is the closure of $\Omega\mathcal{M}_{\mathbf{g}}^{\text{inc}}(\mathbf{Z}, \mathbf{P})^R$ in $K\bar{\mathcal{M}}_{\mathbf{g}, \mathbf{n}}(\mathbf{P})$.

The morphism stab induces a map from $A_{\mathbf{g}, \mathbf{n}, \mathbf{P}}^R$ to $\Omega\mathcal{M}_{\mathbf{g}}^{\text{inc}}(\mathbf{Z}, \mathbf{P})^R$. We will use the same notation for the morphism stab and its restriction

$$\text{stab} : \bar{A}_{\mathbf{g}, \mathbf{n}, \mathbf{P}}^R \rightarrow \bar{\Omega}\mathcal{M}_{\mathbf{g}}^{\text{inc}}(\mathbf{Z}, \mathbf{P})^R.$$

Proposition 2.3.14. *We suppose that \mathbf{Z} is complete. The map $\text{stab} : \bar{A}_{\mathbf{g}, \mathbf{n}, \mathbf{P}}^R \rightarrow \bar{\Omega}\mathcal{M}_{\mathbf{g}}^{\text{inc}}(\mathbf{Z}, \mathbf{P})^R$ is an isomorphism.*

Remark 2.3.15. Beware that this statement is valid only under the hypothesis that \mathbf{Z} is complete. Otherwise the map stab may have fibers of positive dimension and/or not be surjective.

PROOF. In Section 2.2 we proved that the following square is cartesian

$$\begin{array}{ccc} \overline{\mathcal{H}}_{\mathbf{g},\mathbf{n},\mathbf{P}} & \xrightarrow{\Phi_{j,i}} & \bigoplus_{\substack{1 \leq j \leq q \\ 1 \leq i \leq m_j}} \mathcal{P}^{j,n_j+i} \\ \downarrow & & \downarrow \\ K\overline{\mathcal{M}}_{\mathbf{g},\mathbf{n}}(\mathbf{P}) & \xrightarrow{\text{proj}_{j,i}} & \bigoplus_{\substack{1 \leq j \leq q \\ 1 \leq i \leq m_j}} J^{j,n_j+i}, \end{array}$$

where \mathcal{P}^{j,n_j+i} is the cone of principal parts of order $p_{j,i}$ at the i -th marked point of j -th connected component and J^{j,n_j+i} the bundle of polar jets of order $p_{j,i}$. We recall that we have defined the spaces

$$\begin{aligned} \tilde{\mathcal{P}}^{n_j+i} &= (\mathcal{P}^{n_j+i} \setminus \mathcal{A}^{n_j+i}) \cup \text{the zero section} \\ \tilde{J}^{n_j+i} &= (J^{n_j+i} \setminus \{\text{leading term} = 0\}) \cup \text{the zero section.} \end{aligned}$$

We have seen that the map $\phi_{i,j}$ maps \mathcal{P}^{n_j+i} to \tilde{J}^{n_j+i} and that the restriction of $\phi_{i,j}$ to $\tilde{\mathcal{P}}^{j,n_j+i} \rightarrow \tilde{J}^{j,n_j+i}$ is an isomorphism (see Lemma 2.2.17). Therefore, we need to prove that the image of $\overline{A}_{\mathbf{g},\mathbf{n},\mathbf{P}}^R$ (respectively $\overline{\Omega}\mathcal{M}_{\mathbf{g}}^{\text{inc}}(\mathbf{Z},\mathbf{P})^R$) under $\Phi_{i,j}$ (respectively $\text{proj}_{j,i}$) is included in $\tilde{\mathcal{P}}^{j,n_j+i}$ (respectively \tilde{J}^{j,n_j+i}).

Let us consider a differential in $\overline{A}_{\mathbf{g},\mathbf{n},\mathbf{P}}^R$ and one of the marked points x_{j,n_j+i} corresponding to a pole. There are two possibilities.

- The point x_{j,n_j+i} belongs to a stable irreducible component of level 0. In which case the principal part belongs to $\mathcal{P}^{n_j+i} \setminus \mathcal{A}^{n_j+i}$;
- The point x_{j,n_j+i} belongs to an unstable rational component. In this case the differential restricted to this rational component is necessarily given by $dw/w^{p_{j,i}}$ (the marked point is at 0 and the node at ∞). Indeed we have supposed that \mathbf{Z} is complete thus the differential has no unmarked on this rational component. The principal part is 0.

Therefore the image of $\overline{A}_{\mathbf{g},\mathbf{n},\mathbf{P}}^R$ under $\Phi_{j,i}$ is included in $\tilde{\mathcal{P}}^{j,n_j+i}$. Now, let us consider a differential in $\overline{\Omega}\mathcal{M}_{\mathbf{g}}^{\text{inc}}(\mathbf{Z},\mathbf{P})^R$, and one of the marked points x_{j,n_j+i} corresponding to a pole. Once again, there are two possibilities.

- The point x_{j,n_j+i} belongs to an irreducible component of level 0. In which case the differential has a pole of order exactly $p_{j,i}$ at this marked point and the jet at x_{j,n_j+i} is in \tilde{J}^{j,n_j+i} ;
- The point x_{j,n_j+i} belongs to an irreducible component of level $-\ell < 0$. Then the differential vanishes identically on this component and the jet at x_{j,n_j+i} is 0.

Therefore the image of $\overline{\Omega}\mathcal{M}_{\mathbf{g}}^{\text{inc}}(\mathbf{Z},\mathbf{P})^R$ under $\text{proj}_{j,i}$ is included in \tilde{J}^{j,n_j+i} . This completes the proof. \square

2.3.3.2. *The image of the $A_{\Gamma,I,l}$ under the morphism stab .* To complete the description of the map stab we describe the image of the strata defined by admissible graphs.

Definition 2.3.16. Let (Γ, I, l) be a semi-stable graph with a twist and a level structure. We say that (Γ, I, l) is *twisted stable graph* if Γ is a stable graph (in the sense of Definition 1.4.3).

Remark 2.3.17. For any choice of \mathbf{Z} , the set of admissible and realizable graphs is finite. Besides, if (Γ, I, l) is an admissible graph, then the locus $A_{\Gamma, I, l}$ is empty if (Γ, I, l) is not realizable. Thus Lemma 2.3.11 asserts that $\overline{A}_{\mathbf{g}, \mathbf{Z}, \mathbf{P}}^R$ is stratified by finitely many strata corresponding to admissible graphs.

Definition 2.3.18. Let (Γ, I, l) be a semi-stable graph with a twist and a level structure. We say that (Γ, I, l) is *realizable* if for all vertices v of Γ we have

$$\sum_{(j,i) \mapsto v} k_{j,i} - \sum_{(j,n_j+i) \mapsto v} p_{j,i} + \sum_{h \mapsto v} I(h) - 1 \leq 2g(v) - 2$$

where the sums are respectively over marked points corresponding to zeros, marked points corresponding to poles and half-edges adjacent to v .

Lemma 2.3.19. *If \mathbf{Z} is complete, then there exists a bijection between the set of realizable and admissible graphs and the set of realizable and twisted stable graphs.*

PROOF. To an admissible graph we assign its stabilization. The twists and levels on this graph are obtained by restriction of the former twists and level functions.

From a twisted stable graph, we construct an admissible graph by adding an unstable vertex for each marked point corresponding to a pole of order p greater than 1 and adjacent to a vertex of level < 0 . This new vertex is of level 0 and the new edge between this vertex and the rest of the curve has twists given by $+p-1$ and $-p+1$. \square

Notation 2.3.20. Suppose that \mathbf{Z} is complete and (Γ, I, l) is a realizable stable twisted graph. Let (Γ', I', l') be the corresponding admissible graph. We denote by $\Omega\mathcal{M}_{\Gamma, I, l}^{\text{inc}}$ the locus $\text{stab}(A_{\Gamma, I, l}) \subset K\overline{\mathcal{M}}_{\mathbf{g}, \mathbf{n}}(\mathbf{P})$.

Example 2.3.21. On Figure 2 we have represented the stabilization of the admissible graph of Figure 1.

2.3.3.3. *Stratification of $\overline{\Omega}\mathcal{M}_{\mathbf{g}}^{\text{inc}}(\mathbf{Z}, \mathbf{P})^R$.* Recall the main result of [3].

Lemma 2.3.22. *(Theorem 1.3 of [3]) Suppose that \mathbf{Z} is complete and that the triple (g_j, n_j, P_j) is stable for all $1 \leq j \leq q$. Let (Γ, I, l) be a stable graph. The locus $\Omega\mathcal{M}_{\Gamma, I, l}^{\text{inc}}$ lies in the closure of $\Omega\mathcal{M}_{\mathbf{g}}^{\text{inc}}(\mathbf{Z}, \mathbf{P})^R$. Conversely the space $\overline{\Omega}\mathcal{M}_{\mathbf{g}}^{\text{inc}}(\mathbf{Z}, \mathbf{P})^R$ is the union of the $\Omega\mathcal{M}_{\Gamma, I, l}^{\text{inc}}$ for all stable graphs (Γ, I, l) .*

Remark 2.3.23. The statement here is slightly more general than Theorem 1.3 of [3]. Indeed it takes into account possible disconnected basis and general choices of vector subspace $R \subset \mathcal{R}$. However all arguments in the proof of [3] can be adapted *mutatis mutandis* to get the general statement above.

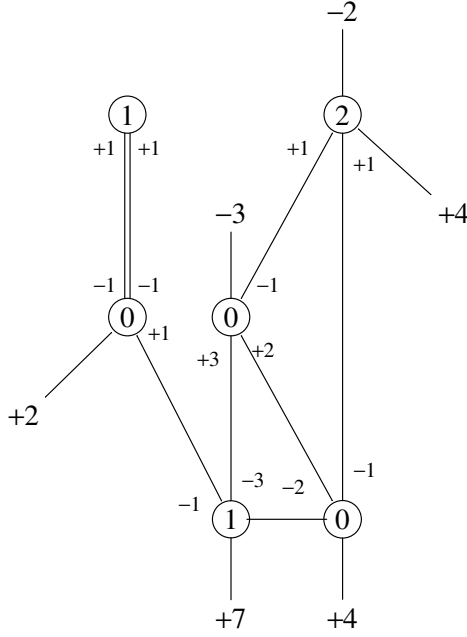

FIGURE 2. Stable twisted graph of genus 7.

PROOF OF LEMMA 2.3.11. Suppose that \mathbf{Z} is complete and that the triple (g_j, n_j, P_j) is stable for all $1 \leq j \leq q$. Then, using Lemma 2.3.22 and Proposition 2.3.14 we automatically get

$$\bar{A}_{\mathbf{g}, \mathbf{Z}, \mathbf{P}}^R = \bigcup A_{\Gamma, l, l}$$

where the union is taken over all admissible graphs. Therefore we only need to prove that the statement of Lemma 2.3.11 is still valid if we allow unstable base curves and non complete lists of vectors \mathbf{Z} .

Unstable basis. We assume that \mathbf{Z} is complete but we no longer impose that the base curves are stable. Then on a rational component with two point the only possible configuration is $P = (p)$ and $Z = (p-2)$. This is a closed point in $\bar{\mathcal{H}}_{0,1,(p)}$. Thus the statement of Lemma 2.3.11 is still valid if we consider unstable basis.

Non complete \mathbf{Z} . We no longer impose that \mathbf{Z} is complete. The space $A_{\mathbf{g}, \mathbf{Z}, \mathbf{P}}^R$ is the union of the $\pi(A_{\mathbf{g}, \mathbf{Z}', \mathbf{P}}^R)$ for all exterior completion \mathbf{Z}' of \mathbf{Z} (π being the forgetful map of the zeros which or accounted for by \mathbf{Z}). Therefore we have

$$\bar{A}_{\mathbf{g}, \mathbf{Z}, \mathbf{P}}^R = \bigcup \pi(\bar{A}_{\mathbf{g}, \mathbf{Z}', \mathbf{P}}^R) = \bigcup \pi(A_{\Gamma, l, l}),$$

where the last union is over all possible completions and admissible graphs. \square

2.3.4. Description of boundary divisors. Let $\mathbf{g}, \mathbf{Z}, \mathbf{P}$ and R be as in the previous sections. In the proof of the main theorem, we will be interested in the vanishing loci of sections of certain line bundles over $\bar{A}_{\mathbf{g}, \mathbf{Z}, \mathbf{P}}^R$. That is why we need

to understand the boundary divisors of $\overline{A}_{\mathbf{g}, \mathbf{Z}, \mathbf{P}}^R$. The purpose of this section is to determine the set of admissible graphs which are associated to strata of codimension 1, that is to divisors.

Lemma 2.3.24. *Let (Γ, I, l) be an admissible graph. The codimension of $\overline{A}_{\Gamma, I, l}$ in $\overline{A}_{\mathbf{g}, \mathbf{Z}, \mathbf{P}}^R$ is greater than or equal to the depth of the level structure l .*

PROOF. Let Γ, I, l be an admissible graph of depth d . Let (Γ', I', l') be the admissible graph obtained by merging the levels 0 and -1 . The locus $A_{\Gamma, I, l}$ lies in the closure of $A_{\Gamma', I', l'}$. Indeed this follows from Lemma 2.3.11 applied to the stratum $A_{\Gamma', I', l'}^0$: the sub-graph of (Γ, I, l) obtained by keeping only vertices of level 0 and -1 determines a boundary stratum of $A_{\Gamma', I', l'}^0$. Thus $A_{\Gamma, I, l}$ is of dimension at most $\dim(A_{\Gamma', I', l'}) - 1$. Therefore, every time we merge two levels we decrease the codimension at least by 1. \square

Lemma 2.3.25. *Let (Γ, I, l) be an admissible graph of depth 1. The codimension of $\overline{A}_{\Gamma, I, l}$ in $\overline{A}_{\mathbf{g}, \mathbf{Z}, \mathbf{P}}^R$ is greater than the number of horizontal edges.*

PROOF. We can independently merge vertices along horizontal edges (See ‘‘classical plumbing’’ in [3]). At every merging, we decrease the codimension by at least 1. \square

It follows from Lemmas 2.3.24 and 2.3.25 that a nontrivial admissible graph corresponding to a divisor of $A_{\mathbf{g}, \mathbf{Z}, \mathbf{P}}^R$ is necessarily of depth 1 and has no horizontal edges.

Notation 2.3.26. We denote by $\text{Bic}(\mathbf{g}, \mathbf{Z}, \mathbf{P}, R)$ the set of graphs with two levels and possessing no horizontal edges. We will call such graphs *bi-colored graphs*.

Remark 2.3.27. Elements of $\text{Bic}(\mathbf{g}, \mathbf{Z}, \mathbf{P}, R)$ are twisted graphs with level structures. However, the level structure of a bi-colored graph is completely determined by the twists. This is why we will denote (Γ, I) the elements of $\text{Bic}(\mathbf{g}, \mathbf{Z}, \mathbf{P}, R)$.

We recall from Section 2.3.2 that the boundary strata associated to a graph of depth 1 is equal to $p(A_{\mathbf{g}_1, \mathbf{Z}_1, \mathbf{P}_1}^{R^1}) \times A_{\mathbf{g}_0, \mathbf{Z}_0, \mathbf{P}_0}^{R^0}$, where p is the map from $A_{\mathbf{g}_1, \mathbf{Z}_1, \mathbf{P}_1}^{R^1}$ to the moduli space of curves $\overline{\mathcal{M}}_{\mathbf{g}_1, \mathbf{n}_1, \mathbf{m}_1}$.

Proposition 2.3.28. *Let (Γ, I) be a bi-colored graph. We assume that $A_{\Gamma, I, l}$ is nonempty. Then $\overline{A}_{\Gamma, I, l}$ is a divisor of $\overline{A}_{\mathbf{g}, \mathbf{Z}, \mathbf{P}}^R$ if and only if $(\mathbf{g}_1, \mathbf{Z}_1, \mathbf{P}_1, R^1)$ satisfies the condition $(\star\star)$. In which case we will say that the (Γ, I) satisfies condition $(\star\star)$.*

PROOF. We have the equality

$$\dim(\overline{A}_{\mathbf{g}, \mathbf{Z}, \mathbf{P}}^R) = \dim(\overline{A}_{\Gamma, I, l}) + \dim(A_{\mathbf{g}_1, \mathbf{Z}_1, \mathbf{P}_1}^{R^1}) - \dim(p(A_{\mathbf{g}_1, \mathbf{Z}_1, \mathbf{P}_1}^{R^1})).$$

Therefore the stratum $\overline{A}_{\mathbf{g}, \mathbf{Z}, \mathbf{P}}^R$ is a divisor if and only if the fibers of p are of dimension 1. Thus the proposition is a direct consequence of Proposition 2.2.54. \square

Notation 2.3.29. We denote by $\text{Div}(\mathbf{g}, \mathbf{Z}, \mathbf{P}, R)$ the set of bi-colored graphs (Γ, I) which satisfies condition $(\star\star)$. For short we will call these elements *admissible divisor graphs*.

Notation 2.3.30. Let $1 \leq j \leq q$ and $1 \leq i \leq \ell(Z_j)$. We denote by $\mathbf{Z}_{j,i}$ the list of vectors obtained from \mathbf{Z} by increasing the i^{th} coordinate of Z_j by one.

Proposition 2.3.31. Let \mathbf{Z}' be a completion of \mathbf{Z} and let (Γ, I, l) be an admissible graph such that $D = \pi(\overline{A}_{\Gamma, I})$ is a divisor of $\overline{A}_{\mathbf{g}, \mathbf{Z}, \mathbf{P}}^R$ (where π is the forgetful map of the points), then D is necessarily of one of the four kinds:

- (1) the stratum $\overline{A}_{\Gamma, I}$ for $(\Gamma, I) \in \text{Div}(\mathbf{g}, \mathbf{Z}, \mathbf{P}, R)$;
- (2) the locus $\overline{A}_{\mathbf{g}, \mathbf{Z}_{j,i}, \mathbf{P}}^R$ for some label (j, i) corresponding to a marked point which is not a pole;
- (3) the locus $\overline{A}_{\Gamma, I, l}$ for a \mathbf{P} -admissible graph of depth 0 with a unique horizontal edge;
- (4) the locus $\overline{A}_{\mathbf{g}, \mathbf{Z}, \mathbf{P}}^{R'}$ for the vector subspace $R' \subset R$ defined by the condition: $\text{res}_{x_{j,n_j+i}} = 0$ for a choice of j and i such the point x_{j,n_j+i} corresponds to a pole of order at most -1 .

PROOF. Let \mathbf{Z}' be a completion of \mathbf{Z} . If \mathbf{Z}' is not the maximal completion then $\dim(A_{\mathbf{g}, \mathbf{Z}', \mathbf{P}}^R) < \dim(A_{\mathbf{g}, \mathbf{Z}, \mathbf{P}}^R)$. The only possible admissible graph is the trivial and we obtain a divisor of type 2.

We suppose now that $\mathbf{Z}' = \mathbf{Z}_m$, then (Γ, I, l) is of depth less than 1. If (Γ, I, l) is of depth 0 then (Γ, I, l) has at most one horizontal edge (type 3). If (Γ, I, l) is of depth 1 then either all or none of the edges of (Γ, I, l) are contracted under the forgetful map of the marked points which are not accounted for by \mathbf{Z} (otherwise this graph does not satisfy condition $(\star\star)$). If none of the edges are contracted, then D is a divisor of type 1. If all edges are contracted then we get a divisor of type 2 or 4 (depending on whether there are legs corresponding to poles of order 1 on level -1 vertices or not). \square

Proposition 2.3.32. Let D_1 and D_2 be two divisors obtained from an admissible graph as in Proposition 2.3.31. Then D_1 and D_2 have no common irreducible components.

PROOF. The divisors D_1 and D_2 can be of one of the four types described in Proposition 2.3.31. We will prove this proposition by considering every possible cases.

Type 1/type 1. Let (Γ, I) and (Γ', I') in $\text{Div}(\mathbf{g}, \mathbf{Z}, \mathbf{P}, R)$ such that $A_{\Gamma, I}$ and $A_{\Gamma', I'}$ have a common irreducible component D . The component D determines a semi-stable graph by taking the dual graph of a any point of $D \cap A_{\Gamma, I}$, therefore $\Gamma = \Gamma'$. Moreover, the vertices of Γ with identically zero differentials are the vertices of level -1 . Therefore the level structure (or more precisely the signs of the twists) are the same for (Γ, I) and (Γ', I') . Now the twist at an edge is determined by the vanishing order of the differential at the corresponding node on the component of level 0 for any point in $D \cap A_{\Gamma, I}$. Therefore $(\Gamma, I) = (\Gamma', I')$. Thus divisors of type 1 have no common irreducible components.

Types 2 and 4. The underlying generic curve of the divisors of type 2 or 4 is a curve without singularities, therefore divisors of type 2 or 4 do not intersect divisors of type 1 or type 3. Now the differentials of the generic differentials of two divisors of type 2 have different vanishing order at two of the marked points (either a marked zero or a marked pole of order -1).

Type 3. Two divisors of type 3 are distinguished by the topological types of a generic curve. Besides, a divisor of type 3 is distinguished from a divisor of type 1 because none of the components carries a vanishing differential in a divisor of type 3. \square

Locus of generic points. Let $(\Gamma, I) \in \text{Div}(\mathbf{g}, \mathbf{Z}, \mathbf{P}, R)$. We recall that

$$A_{\Gamma, I} = p(A_{\mathbf{g}_1, \mathbf{Z}_1, \mathbf{P}_1}^{R^1}) \times A_{\mathbf{g}_0, \mathbf{Z}_0, \mathbf{P}_0}^{R^0},$$

where $p : A_{\mathbf{g}_1, \mathbf{Z}_1, \mathbf{P}_1}^{R^1} \rightarrow \overline{\mathcal{M}}_{\mathbf{g}_1, \mathbf{n}_1, \mathbf{m}_1}$ is the forgetful map. The condition $(\star\star)$ ensures that there exists an open dense locus $A_1^{\text{gen}} \subset A_{\mathbf{g}_1, \mathbf{Z}_1, \mathbf{P}_1}^{R^1}$ such that the map $p : A_1^{\text{gen}} \rightarrow p(A_1^{\text{gen}})$ has fibers of dimension 1 (see Proposition 2.2.54). Then we set

$$A_{\Gamma, I}^{\text{gen}} = A_1^{\text{gen}} \times A_{\mathbf{g}_0, \mathbf{Z}_0, \mathbf{P}_0}^{R^0}.$$

This open locus of generic points will be important for us because the map

$$p : A_1^{\text{gen}} \times A_{\mathbf{g}_0, \mathbf{Z}_0, \mathbf{P}_0}^{R^0} \rightarrow A_{\Gamma, I}^{\text{gen}} = p(A_1^{\text{gen}}) \times A_{\mathbf{g}_0, \mathbf{Z}_0, \mathbf{P}_0}^{R^0}$$

is a line bundle minus the zero section.

Notation 2.3.33. We denote by $p : \mathcal{N}_{\Gamma, I} \rightarrow A_{\Gamma, I}^{\text{gen}}$ this line bundle.

2.3.5. Class and multiplicity of a boundary divisor. Let $\mathbf{g}, \mathbf{Z}, \mathbf{P}$ and R be as in the previous sections. We want to compute the Poincaré-dual class of the divisor associated to an element of $\text{Div}(\mathbf{g}, \mathbf{P}, \mathbf{Z}, R)$.

Let (Γ, I) be an admissible graph in $\text{Bic}(\mathbf{g}, \mathbf{P}, \mathbf{Z}, R)$ (this graph is a divisor or not). We recall that

$$A_{\Gamma, I} \simeq p(A_{\mathbf{g}_1, \mathbf{Z}_1, \mathbf{P}_1}^{R^1}) \times A_{\mathbf{g}_0, \mathbf{Z}_0, \mathbf{P}_0}^{R^0} \subset \overline{\mathcal{M}}_{\mathbf{g}_1, \mathbf{n}_1, \mathbf{m}_1} \times \overline{\mathcal{H}}_{\mathbf{g}_0, \mathbf{n}_0, \mathbf{P}_0}.$$

Now, we recall that the semi-stable graph Γ determines a stratum

$$\zeta_{\Gamma}^{\#} : \overline{\mathcal{H}}_{\Gamma} = \overline{\mathcal{H}}_{\mathbf{g}_{\Gamma}, \mathbf{n}_{\Gamma}, \mathbf{P}_{\Gamma}}^{R_{\Gamma}} \rightarrow \overline{\mathcal{H}}_{\mathbf{g}, \mathbf{n}, \mathbf{P}}$$

(see Section 2.2.10). We define the linear subspace $\overline{R}_{\Gamma} \subset R_{\Gamma}$, as the space of vectors of residues such that the residues at poles on components of level -1 (including the edges) are equal to zero. Moreover, we denote by

$$d_{\Gamma} = \dim(R_{\Gamma}) - \dim(\overline{R}_{\Gamma}).$$

The Poincaré-dual cohomology class of $\mathbb{P}\overline{\mathcal{H}}_{\mathbf{g}_{\Gamma}, \mathbf{n}_{\Gamma}, \mathbf{P}_{\Gamma}}^{\overline{R}_{\Gamma}}$ in $H^*(\mathbb{P}\overline{\mathcal{H}}_{\Gamma}, \mathbb{Q})$ is equal to $\xi^{d_{\Gamma}}$ (see Lemma 2.2.27). Moreover we have

$$\overline{\mathcal{H}}_{\mathbf{g}_{\Gamma}, \mathbf{n}_{\Gamma}, \mathbf{m}_{\Gamma}, \mathbf{P}_{\Gamma}}^{\overline{R}_{\Gamma}} \simeq \overline{\mathcal{H}}_{\mathbf{g}_0, \mathbf{n}_0, \mathbf{P}_0} \times \left(\prod_{v \in V^1} \overline{\mathcal{H}}_{g_v, n_v + m_v} \right),$$

where the poles at vertices of level 0 are the marked poles of $\overline{\mathcal{H}}_{\mathbf{g}, \mathbf{n}, \mathbf{P}}$ restricted to each vertex and the half-edges are counted as marked points without poles; the spaces at the vertices of level -1 are the spaces of *holomorphic* differentials. We consider the projection

$$\begin{array}{ccc}
\mathcal{O}(-1) & \longrightarrow & \prod_{v \in V_1} p_v^*(\overline{\mathcal{H}}_{g_v, n_v + m_v}) \\
\downarrow & & \swarrow \\
\mathbb{P}\overline{\mathcal{H}}_{\mathbf{g}, \mathbf{n}, \mathbf{m}, \mathbf{P}}^{\overline{R}} & &
\end{array}$$

where p_v is the forgetful map from $\overline{\mathcal{H}}_{g_v, n_v + m_v}$ to $\overline{\mathcal{M}}_{g_v, n_v + m_v}$. Therefore the Poincaré-dual class of the locus of differentials with vanishing differential on the level -1 in $H^*(\mathbb{P}\overline{\mathcal{H}}_{\Gamma}, \mathbb{Q})$ is given by

$$\xi^{d_{\Gamma}} \cdot \prod_{v \in V_1} (\xi^{g_v} + \lambda_1 \xi^{g_v - 1} + \dots + \lambda_{g_v}).$$

We denote this locus by $\mathbb{P}\tilde{A}_{\Gamma, I} \subset \mathbb{P}\overline{\mathcal{H}}_{\Gamma}$. We have a natural identification:

$$\mathbb{P}\tilde{A}_{\Gamma, I} \simeq \mathbb{P}\overline{\mathcal{H}}_{\mathbf{g}_0, \mathbf{n}_0, \mathbf{P}_0} \times \overline{\mathcal{M}}_{\mathbf{g}_1, \mathbf{n}_1, \mathbf{P}_1}.$$

We denote by Φ_0 and Φ_1 the projections on both factors.

Definition 2.3.34. The class $a_{\Gamma, I} \in H^*(\mathbb{P}\overline{\mathcal{H}}_{\mathbf{g}, \mathbf{n}, \mathbf{P}}, \mathbb{Q})$ is given by

$$\zeta_{\Gamma}^{\#} \left(\xi^{d_{\Gamma}} \cdot \Phi_1^*(p_*[\mathbb{P}\overline{A}_{\mathbf{g}_1, \mathbf{Z}_1, \mathbf{P}_1}^{R^1}]) \cdot \Phi_0^*[\mathbb{P}\overline{A}_{\mathbf{g}_0, \mathbf{Z}_0, \mathbf{P}_0}^{R^0}] \prod_{v \in V^1} (\xi^{g_v} + \lambda_1 \xi^{g_v - 1} + \dots + \lambda_{g_v}) \right).$$

Proposition 2.3.35. Let $(\Gamma, I) \in \text{Bic}(\mathbf{g}, \mathbf{P}, \mathbf{Z}, R)$. We have:

- (1) if (Γ, I) is divisor graph then $a_{\Gamma, I} = [\mathbb{P}\overline{A}_{\Gamma, I}]$;
- (2) if (Γ, I) is not a divisor graph then $a_{\Gamma, I} = 0$;
- (3) if $[\mathbb{P}\overline{A}_{\mathbf{g}_0, \mathbf{Z}_0, \mathbf{P}_0}^{R^0}]$ and $[\mathbb{P}\overline{A}_{\mathbf{g}_1, \mathbf{Z}_1, \mathbf{P}_1}^{R^1}]$ are tautological and can be explicitly computed then so is $a_{\Gamma, I}$.

PROOF OF THE FIRST AND SECOND POINTS. If (Γ, I) is a divisor graph then $p : A_{\mathbf{g}_1, \mathbf{Z}_1, \mathbf{P}_1}^{R^1} \rightarrow \text{Im}(p)$ is of degree 1, thus $p_*[A_{\mathbf{g}_1, \mathbf{Z}_1, \mathbf{P}_1}^{R^1}] = [p(A_{\mathbf{g}_1, \mathbf{Z}_1, \mathbf{P}_1}^{R^1})]$. Therefore, by construction $a_{\Gamma, I}$ is the Poincaré-dual class of $\mathbb{P}\overline{A}_{\Gamma, I}$.

If (Γ, I) belongs to $\text{Bic}(\mathbf{g}, \mathbf{P}, \mathbf{Z}, R) \setminus \text{Div}(\mathbf{g}, \mathbf{P}, \mathbf{Z}, R)$ then the fibers of the map $p : \mathbb{P}A_{\mathbf{g}_1, \mathbf{Z}_1, \mathbf{P}_1}^{R^1} \rightarrow \text{Im}(p)$ are of positive dimension and $p_*[\mathbb{P}\overline{A}_{\mathbf{g}_1, \mathbf{Z}_1, \mathbf{P}_1}^{R^1}] = 0$. \square

PROOF OF THE THIRD POINT. We assume that $[\mathbb{P}\overline{A}_{\mathbf{g}_0, \mathbf{Z}_0, \mathbf{P}_0}^{R^0}]$ and $[\mathbb{P}\overline{A}_{\mathbf{g}_1, \mathbf{Z}_1, \mathbf{P}_1}^{R^1}]$ are tautological and can be explicitly computed.

The projections Φ_1 is equal to the composition of the forgetful map from $\overline{\mathcal{H}}_{\Gamma}$ to $\overline{\mathcal{M}}_{\Gamma}^{\text{red}}$ with the projection to the vertices of level -1 . Thus by definition, if β is a tautological class of $\overline{\mathcal{M}}_{\mathbf{g}_1, \mathbf{Z}_1, \mathbf{m}_1}$ then $\Phi_1^* \beta$ is a tautological class of $H^*(\mathbb{P}\overline{\mathcal{H}}_{\mathbf{g}, \mathbf{Z}, \mathbf{P}}, \mathbb{Q})$. Besides, if $[\mathbb{P}\overline{A}_{\mathbf{g}_1, \mathbf{Z}_1, \mathbf{P}_1}^{R^1}]$ is tautological and be explicitly computed then so is the class $p_*[\mathbb{P}\overline{A}_{\mathbf{g}_1, \mathbf{Z}_1, \mathbf{P}_1}^{R^1}]$: indeed the Segre class of $\overline{\mathcal{H}}_{\mathbf{g}_1, \mathbf{n}_1, \mathbf{P}_1}$ is a tautological class of $\overline{\mathcal{M}}_{\mathbf{g}_1, \mathbf{m}_1, \mathbf{P}_1}$.

The map Φ_1 is equivariant with respect to the \mathbb{C}^* -action, thus we have $\Phi_1^{-1}(c_1(\mathcal{O}(1))) = c_1(\mathcal{O}(1))$. Besides the following diagram commutes:

$$\begin{array}{ccc} \mathbb{P}\tilde{\mathcal{A}}_{\Gamma, I} & \xrightarrow{\Phi_0} & \mathbb{P}\bar{\mathcal{A}}_{\mathbf{g}_0, \mathbf{n}_0, \mathbf{P}_0} \\ \downarrow & & \downarrow p \\ \overline{\mathcal{M}}_{\Gamma}^{\text{red}} & \longrightarrow & \overline{\mathcal{M}}_{\mathbf{g}_0, \mathbf{n}_0, \mathbf{m}_0}^{\text{red}} \end{array}$$

Thus, if β is a tautological class of $\overline{\mathcal{M}}_{\mathbf{g}_0, \mathbf{n}_0, \mathbf{m}_0}^{\text{red}}$, then the class $\Phi_0^*(p^*(\beta))$ is a tautological class of $\mathbb{P}\tilde{\mathcal{H}}_{\Gamma}$ and thus a tautological class of $H^*(\mathbb{P}\tilde{\mathcal{H}}_{\mathbf{g}, \mathbf{n}, \mathbf{P}}, \mathbb{Q})$. \square

Definition 2.3.36. Let $(\Gamma, I) \in \text{Bic}(\mathbf{g}, \mathbf{P}, \mathbf{Z}, R)$. The *multiplicity* of (Γ, I)

$$m(I) = \prod_{h \rightarrow V^0} I(h),$$

where the product runs over the half-edges which are not legs, pointing to vertices of level 0. The *least commune multiple* and the *group of roots* of the twist are

$$\begin{aligned} L(I) &= \text{LCM}(\{I(h)\}_{h \rightarrow V^0}), \\ G_I &= \left(\prod_{h \rightarrow V^0} \mathbb{Z}_{I(h)} \right) / \mathbb{Z}_{L(I)}. \end{aligned}$$

Let $1 \leq j \leq q$ and $1 \leq i \leq n_j$. Let $k_{j,i}$ be the i^{th} entry of Z_j . We consider the line bundle:

$$\mathcal{O}(-1) \otimes \mathcal{L}_{j,i}^{k_{j,i}+1} \Big|_{A_{\mathbf{g}, \mathbf{P}, \mathbf{Z}}^R} \simeq \text{Hom} \left(\mathcal{O}(-1), \mathcal{L}_{j,i}^{k_{j,i}+1} \right) \Big|_{A_{\mathbf{g}, \mathbf{P}, \mathbf{Z}}^R},$$

where $\mathcal{L}_{j,i}$ is the cotangent line bundle to the i -th marked point of j -th connected component. Let $s_{j,i}$ be the natural section of the line bundle $\text{Hom}(\mathcal{O}(-1), \mathcal{L}_{j,i}^{k_{j,i}+1})|_{A_{\mathbf{g}, \mathbf{P}, \mathbf{Z}}^R}$ which maps a differential to its $(k_{j,i} + 1)^{\text{st}}$ -order term at the i^{th} marked point of the j^{th} connected component.

Lemma 2.3.37. *Then the section $s_{j,i}$ vanishes with multiplicity 1 along $\mathbb{P}A_{\mathbf{g}, \mathbf{Z}_{j,i}, \mathbf{P}}^R$.*

PROOF. Let y_0 be a point of $\mathbb{P}A_{\mathbf{g}, \mathbf{Z}_{j,i}, \mathbf{P}}^R$. We have seen in the proof of Lemma 2.2.32 that a neighborhood U of y_0 in $\mathbb{P}A_{\mathbf{g}, \mathbf{Z}_{j,i}, \mathbf{P}}^R$ is parametrized by the relative cohomology group $H^1(\Sigma \setminus \{x_{n+1}, \dots, x_{n+m}\}, \{x_1, \dots, x_n\}; \mathbb{C})$ and that a neighborhood of y_0 in $\mathbb{P}\tilde{\mathcal{H}}_{\mathbf{n}, \mathbf{m}, \mathbf{P}}$ is parametrized by $H \times \prod_{i=1}^n \mathcal{Z}_{j,i}$ where $\mathcal{Z}_{j,i}$ is an open neighborhood of 0 in $\mathbb{C}^{k_{j,i}-1}$.

Thus a neighborhood of U in $\mathbb{P}A_{\mathbf{g}, \mathbf{Z}, \mathbf{P}}^R$ is parametrized by $U \times \Delta$ where Δ is an open disk of \mathbb{C} with parameter ϵ . Indeed a deformation of an element of $\mathbb{P}A_{\mathbf{g}, \mathbf{Z}_{j,i}, \mathbf{P}}^R$ will determine a coordinate z and a complex number ϵ such that the differential is given by $d(z^{k_{j,i}+1}(z + \epsilon))$ in a neighborhood of $x_{j,i}$. This choice is unique up to multiplication of z by a $(k_{j,i} + 2)^{\text{nd}}$ -root of unity. Fix a choice for the coordinate z then we have $s_{j,i}(u, \epsilon) = \epsilon$. Thus the vanishing multiplicity of $s_{j,i}$ along $\mathbb{P}A_{\mathbf{g}, \mathbf{Z}_{j,i}, \mathbf{P}}^R$ is equal to 1. \square

Notation 2.3.38. We denote by $\text{Bic}(\mathbf{g}, \mathbf{P}, \mathbf{Z}, R)_{j,i} \subset \text{Bic}(\mathbf{g}, \mathbf{P}, \mathbf{Z}, R)$ the subset of bi-colored graphs such that the i^{th} marked point of the j^{th} connected component belongs to a level -1 vertex and we will denote by

$$\text{Div}(\mathbf{g}, \mathbf{P}, \mathbf{Z}, R)_{j,i} = \text{Bic}(\mathbf{g}, \mathbf{P}, \mathbf{Z}, R)_{j,i} \cap \text{Div}(\mathbf{g}, \mathbf{P}, \mathbf{Z}, R).$$

Lemma 2.3.39. *The divisors contained in the vanishing locus of $s_{j,i}$ are exactly the divisors corresponding to admissible graphs in $\text{Div}(\mathbf{g}, \mathbf{P}, \mathbf{Z}, R)_{j,i}$ and the divisor $\mathbb{P}\bar{A}_{\mathbf{g}, \mathbf{Z}_{j,i}, \mathbf{P}}^R$. No two of these divisors have a common irreducible component.*

PROOF. It is a consequence of Propositions 2.3.31 and 2.3.32. \square

The first Chern class of $\mathcal{O}(-1) \otimes \mathcal{L}_{j,i}^{k_{j,i}+1}$ is equal to $\xi + (k_{j,i} + 1)\psi_{j,i}$ therefore we deduce from Lemmas 2.3.37 and 2.3.39 that

$$(\xi + (k_{j,i} + 1)\psi_{j,i}) \cdot [\mathbb{P}\bar{A}_{\mathbf{g}, \mathbf{Z}, \mathbf{P}}^R] = [\mathbb{P}\bar{A}_{\mathbf{g}, \mathbf{Z}_{j,i}, \mathbf{P}}^R] + \mathbb{Z},$$

where \mathbb{Z} is a cycle supported on the union of $\mathbb{P}\bar{A}_{\Gamma, I}$ for $(\Gamma, I) \in \text{Div}(\mathbf{g}, \mathbf{P}, \mathbf{Z}, R)_{j,i}$. In the next section, we will prove that $\mathbb{Z} = \sum_{(\Gamma, I) \in \text{Div}(\mathbf{g}, \mathbf{P}, \mathbf{Z}, R)_{j,i}} m(I) a_{\Gamma, I}$ where the sums runs over all (Γ, I) in $\text{Div}(\mathbf{g}, \mathbf{P}, \mathbf{Z}, R)_{j,i}$. We can already remark that Proposition 2.3.35 implies the following

Corollary 2.3.40. *The following equality holds:*

$$\sum_{(\Gamma, I) \in \text{Bic}(\mathbf{g}, \mathbf{P}, \mathbf{Z}, R)_{j,i}} m(I) a_{\Gamma, I} = \sum_{(\Gamma, I) \in \text{Div}(\mathbf{g}, \mathbf{P}, \mathbf{Z}, R)_{j,i}} m(I) a_{\Gamma, I}.$$

PROOF. It follows from the fact that if $(\Gamma, I) \in \text{Bic}(\mathbf{g}, \mathbf{P}, \mathbf{Z}, R)_{j,i} \setminus \text{Div}(\mathbf{g}, \mathbf{P}, \mathbf{Z}, R)_{j,i}$ then $a_{\Gamma, I} = 0$. \square

2.3.6. Induction formula. With the above notation, we state the main theorem of the present Chapter.

Let $\mathbf{g} = (g_1, \dots, g_q)$, $\mathbf{Z} = (Z_1, \dots, Z_q)$, $\mathbf{P} = (P_1, \dots, P_q)$ be lists of nonnegative integers (genera), vectors of nonnegative integers (orders of zeros), and vectors of positive integers (orders of poles), respectively. Let \mathbf{n} and \mathbf{m} be two lists of q nonnegative integers given by $n_j = \text{length}(Z_j)$, $m_j = \text{length}(P_j)$. Let $R \subset \mathcal{R}$ be a space of residue conditions. We assume that $(\mathbf{g}, \mathbf{Z}, \mathbf{P})$ satisfy the semi-stability condition of Definition 2.2.55.

Let $1 \leq j \leq q$ and let $1 \leq i \leq n_j$. Let $k_{j,i}$ be the i th element of Z_j . Denote by $\mathbf{Z}_{j,i}$ the list of vectors obtained from \mathbf{Z} by increasing k_i by 1. Denote by $\psi_{j,i} \in H^2(\mathbb{P}\bar{\mathcal{H}}_{\mathbf{g}, \mathbf{n}, \mathbf{P}}, \mathbb{Q})$ the ψ -class corresponding to the i th marked point on the j th connected component of the curve.

Recall that to each bi-colored graph $(\Gamma, I) \in \text{Bic}(\mathbf{g}, \mathbf{P}, \mathbf{Z}, R)_{j,i}$ we have assigned a cohomology class $\alpha_{\Gamma, I} \in H^*(\mathbb{P}\bar{\mathcal{H}}_{\mathbf{g}, \mathbf{n}, \mathbf{P}}, \mathbb{Q})$ and a positive integer $m(I)$ (see Section 2.3.5).

Theorem 2.3.41. *In $H^*(\mathbb{P}\bar{\mathcal{H}}_{\mathbf{g}, \mathbf{n}, \mathbf{P}}, \mathbb{Q})$ we have*

$$(2.3.1) \quad [\mathbb{P}\bar{A}_{\mathbf{g}, \mathbf{Z}_{j,i}, \mathbf{P}}^R] = (\xi + (k_{j,i} + 1)\psi_{j,i}) \cdot [\mathbb{P}\bar{A}_{\mathbf{g}, \mathbf{Z}, \mathbf{P}}^R] - \sum_{(\Gamma, I) \in \text{Bic}(\mathbf{g}, \mathbf{P}, \mathbf{Z}, R)_{j,i}} m(I) a_{\Gamma, I}$$

if $2g_j - 2 + n_j + m_j > 0$, or

$$(2.3.2) \quad [\mathbb{P}\bar{A}_{\mathbf{g}, \mathbf{Z}, \mathbf{P}}^R] = \frac{p-k-2}{p-1} \xi \cdot [\mathbb{P}\bar{A}_{\mathbf{g}, \mathbf{Z}, \mathbf{P}}^R]$$

if $g_j = 0$, $Z_j = (k)$, $P_j = (p)$.

PROOF OF (2.3.1). First of all, by Corollary 2.3.40 we replace the sum over bi-colored graphs in Equation (2.3.1) by a sum over divisor graphs, i.e. elements of $\text{Div}(\mathbf{g}, \mathbf{Z}, \mathbf{P}, R)_{j,i}$. We will prove the equality in this form.

As in Section 2.3.5 consider the line bundle $\text{Hom}(\mathcal{O}(-1), \mathcal{L}_{j,i}^{k_{j,i}+1}) \rightarrow \mathbb{P}\bar{A}_{\mathbf{g}, \mathbf{Z}, \mathbf{P}}^R$. Its first Chern class equals $\xi + (k_{j,i} + 1)\psi_{j,i}$. Moreover, it has a natural section $s_{j,i}$ which maps a differential to its $(k_{j,i} + 1)^{\text{st}}$ -order term at the marked point (j, i) .

Lemma 2.3.11 states that the locus $\mathbb{P}A_{\Gamma, I}$ lies in the closure of $\mathbb{P}A_{\mathbf{g}, \mathbf{Z}, \mathbf{P}}^R$. In Lemma 2.3.37 we showed that $s_{j,i}$ vanishes along $\mathbb{P}\bar{A}_{\mathbf{g}, \mathbf{Z}, \mathbf{P}}^R$ with multiplicity 1. In Lemma 2.3.39 we showed that the remaining vanishing loci of $s_{j,i}$ are supported on the $\mathbb{P}\bar{A}_{\Gamma, I}$ for (Γ, I) of $\text{Div}(\mathbf{g}, \mathbf{Z}, \mathbf{P}, R)_{j,i}$. Now we claim that the vanishing order of $s_{j,i}$ along the locus $\mathbb{P}A_{\Gamma, I}$ is equal to $m(I)$ (see Definition 2.3.36). Lemma 2.3.42 below implies this statement and thus Equation (2.3.1). \square

We recall that for a divisor graph $(\Gamma, I) \in \text{Div}(\mathbf{g}, \mathbf{Z}, \mathbf{P}, R)_{j,i}$ we have (see Section 2.3.2)

$$A_{\Gamma, I} = p(A_{\mathbf{g}_1, \mathbf{Z}_1, \mathbf{P}_1}^{R^1}) \times A_{\mathbf{g}_0, \mathbf{Z}_0, \mathbf{P}_0}^{R^0},$$

where

$$p : A_{\mathbf{g}_1, \mathbf{Z}_1, \mathbf{P}_1}^{R^1} \rightarrow \overline{\mathcal{M}}_{\mathbf{g}_1, \mathbf{n}_1, \mathbf{m}_1}$$

is the forgetful map (see Section 2.3.4). Moreover we have defined an open dense subset of generic points $A_1^{\text{gen}} \subset A_{\mathbf{g}_1, \mathbf{Z}_1, \mathbf{P}_1}^{R^1}$ such that $p(A_1^{\text{gen}})$ is dense and open in $p(A_{\mathbf{g}_1, \mathbf{Z}_1, \mathbf{P}_1}^{R^1})$ and the map $p : A_1^{\text{gen}} \rightarrow p(A_1^{\text{gen}})$ is a line bundle minus the zero section. We denote by

$$p : \mathcal{N}_{\Gamma, I} \rightarrow A_{\Gamma, I}^{\text{gen}}$$

the pull-back of this line bundle to $A_{\Gamma, I}^{\text{gen}} = p(A_1^{\text{gen}}) \times A_{\mathbf{g}_0, \mathbf{Z}_0, \mathbf{P}_0}^{R^0}$.

Also recall the group G_I and the least common multiple $L(I)$ assigned to the set of twists in Section 2.3.5.

Lemma 2.3.42. *Let (Γ, I) be a divisor graph in $\text{Div}(\mathbf{g}, \mathbf{Z}, \mathbf{P}, R)_{j,i}$. Let $y_0 \in \mathbb{P}A_{\Gamma, I}^{\text{gen}}$. Let Δ be an open disk in \mathbb{C} containing 0 and parametrized by ϵ . There exists an open neighborhood U of y_0 in $\mathbb{P}A_{\Gamma, I}^{\text{gen}}$ together with a map $\iota : U \times \Delta \times G_I \rightarrow \mathbb{P}\overline{\mathcal{H}}_{\mathbf{g}, \mathbf{n}, \mathbf{m}, \mathbf{P}}$ satisfying:*

- the restriction $\iota|_{U \times 0 \times g}$ is the identity on U for all $g \in G_I$;
- the image of the restriction $\iota|_{\epsilon \neq 0}$ lies in the open stratum $\mathbb{P}A_{\mathbf{g}, \mathbf{Z}, \mathbf{P}}^R$;
- for all $g \in G_I$, the section $s_{j,i}$ restricted to $\iota(U \times \Delta \times g)$ vanishes along $\iota(U \times 0 \times g)$ with multiplicity $L(I)$;
- the map $\iota : U \times \Delta \times G_I \rightarrow \mathbb{P}\bar{A}_{\mathbf{g}, \mathbf{Z}, \mathbf{P}}^R$ is a degree 1 parametrization of a neighborhood of U in $\mathbb{P}\bar{A}_{\mathbf{g}, \mathbf{Z}, \mathbf{P}}^R$.

The proof of Theorem 2.3.41 immediately follows from Lemma 2.3.42 because the vanishing order of $s_{j,i}$ along $\mathbb{P}\bar{A}_{\Gamma,I}$ is equal to

$$L(I) \cdot \text{Card}(G_I) = m(I).$$

PROOF OF LEMMA 2.3.42. We prove the lemma in two steps: first we will prove the first three points of the lemma and then we will prove that ι is a parametrization of degree 1 of a neighborhood of U in $A_{\mathbf{g},\mathbf{Z},\mathbf{P}}^R$.

Proof of the first three points. For the sake of clarity we will successively prove the first three points at three levels of generality: first for a divisor graph with one edge, then for divisor graph with $R^1 = \{0\}$ and finally in full generality.

Divisor graph with one edge. For the moment we place ourselves in the simplest case: (Γ, I) is an admissible graph with two vertices, one at level 0 and one at level -1 . We suppose that there is only one edge with a twist given by $k > 0$. Let y_0 be a point of $\mathbb{P}A_{\Gamma,I}^{\text{gen}}$. Let U be an open neighborhood of y_0 in $\mathbb{P}A_{\Gamma,I}^{\text{gen}}$. A point y of U is given by

$$([C^0], [C^1], \bar{x}^0, \bar{x}^1, [\alpha^0]),$$

where C^0 and C^1 are the curves corresponding to the two vertices of the graph; \bar{x}^0 and \bar{x}^1 are their marked point sets; α^0 is a differential on the curve C^0 and $[\alpha^0]$ its equivalence class under the \mathbb{C}^* -action. More precisely, we denote by $\alpha^0(y)$ a nonvanishing section of the line bundle $\mathcal{O}(-1)$ over U . (Also recall that on C^1 the differential vanishes identically.)

The condition that $y \in A_{\Gamma,I}^{\text{gen}}$ implies that the curve C^1 carries a *unique* meromorphic differential α^1 with zeros and poles of prescribed multiplicities at the marked points, up to a scalar factor. Let $\alpha^1(y)$ be a nonvanishing section of the line bundle $\mathcal{N}_{\Gamma,I}$, i.e., a choice of the scalar factor for each point y .

At the neighborhood of the node the curves C^1 and C^0 have standard coordinates z and w such that $\alpha^0 = d(z^k)$ and $\alpha^1 = d(\frac{1}{w^k})$. The local coordinates z and w are unique up to the multiplication by a k^{th} root of unity. We fix one such choice in a uniform way over U . We define a family of curves $C(y, \epsilon)$ over $U \times \Delta$ by smoothing the node between C^0 and C^1 via the equation $zw = \epsilon$, where ϵ is the coordinate on the disc Δ and z, w are as above. The differentials α^0 and $\epsilon^k \alpha^1$ automatically glue together into a differential on $C(y, \epsilon)$.

The deformation that we have constructed does not depend on the choice of standard coordinates z and w . For instance, if we multiply z by a k^{th} root of unity ζ , the equation of the deformation becomes $zw = \zeta \epsilon$, which is isomorphic to the original deformation under a rotation of the disc Δ .

The section $s_{j,i}$ vanishes with multiplicity k along U : indeed we have explicitly

$$s_{j,i}(y, \epsilon) = \epsilon^k \cdot \alpha_1(y).$$

Divisor graph (Γ, I) with $R^1 = \{0\}$. We suppose now that the space R^1 is trivial (residues at the nodes between vertices of level 0 and -1 are equal to 0). A point y in U still determines

$$([C^0], [C^1], \bar{x}^0, \bar{x}^1, [\alpha^0], [\alpha^1])$$

where α^0 and α^1 are sections of $\mathcal{O}(-1)$ and $\mathcal{N}_{\Gamma,I}$ as in the previous paragraph.

Let e be an edge of Γ . We denote by k_e the positive integer equal to $|I(h)|$ for any of the two half-edges of e . Let z_e and w_e be a choice of standard coordinates in

a neighborhood of the node corresponding to e : i.e. $\alpha^0 = d(z_e^{k_e})$ and $\alpha^1 = d(1/w_e^{k_e})$. This choice of standard coordinates being fixed for all edges, we choose, on top of that, ζ_e a k_e -th root of unity for each edge e .

We define a family of curves $C(y, \epsilon)$ over $U \times \Delta$ by smoothing the node corresponding to an edge e of Γ via the equation $z_e w_e = (\zeta_e \epsilon)^{L(I)/k_e}$ where ϵ is the coordinate on the disc Δ . The differentials defined by α^0 and by $\epsilon^{L(I)} \alpha_1$ automatically glue together into a differential on $C(y, \epsilon)$.

A multiplication of ϵ by a $L(I)$ -th root of unity ζ gives an isomorphic deformation. Thus two choices of roots $(\zeta_e)_{e \in \text{Edges}}$ and $(\zeta'_e)_{e \in \text{Edges}}$ gives isomorphic deformation if $\zeta'_e = \zeta^{L(I)/k_e} \zeta_e$ for all edges. Once again we get that the vanishing multiplicity of $s_{j,i}$ along U is $L(I)$.

General divisor graph (Γ, I) . We no longer impose restrictions on R^1 . We still define

$$([C^0], [C^1], \bar{x}^0, \bar{x}^1, \alpha^0, \alpha^1),$$

as above. Moreover we define the section r

$$r(y) = (r_e(y))_{e \in \text{Edges}},$$

where $r_e(y)$ is the residue of α_1 at the node of C^1 corresponding to the edge e . For every edge e , we fix a choice of standard coordinates of z_e and w_e in a neighborhood of the node corresponding to e , i.e., coordinates satisfying $\alpha^0 = d(z_e^{k_e})$ and $\alpha^1 = d(1/w_e^{k_e}) + \frac{r_e(y)dw_e}{w_e}$.

Using Proposition 2.2.35, we get a family of differentials $(\tilde{C}^0, \tilde{x}^0, \tilde{\alpha}^0)$ parametrized by $U \times \Delta$ such that:

- when $\epsilon = 0$, we have $(C^0, \bar{x}^0, \alpha^0) = (\tilde{C}^0, \tilde{x}^0, \tilde{\alpha}^0)$;
- the zeros of the differential which are not at the marked points corresponding to nodes are of fixed orders;
- the differential $\tilde{\alpha}^0$ has at most simple poles at the nodes of \tilde{C}^0 and the residue at the node corresponding to the edge e equals $-\epsilon^{L(I)} r_e(y)$;
- the vector of residues at the poles of $\tilde{\alpha}^0$ lies in R ;
- for each node corresponding to an edge e with a twist k_e , the family of differentials defined by $U \times \Delta$ is a standard deformation of $d(z_e^{k_e})$ (see Definition 2.2.30).

We use the fact that the family parametrized by $U \times \Delta$ is a standard deformation of $d(z_e^{k_e})$ to apply Proposition 2.2.31. At each node e the differential $\tilde{\alpha}_0$ can be written in the form $d(z_e^{k_e}) - \epsilon^{L(I)} r(u) \frac{dz_e}{z_e}$ in any annulus contained in a neighborhood of the node. Therefore we can still glue the two components together along this annulus with the identification $z_e w_e = \zeta_e \epsilon^{L(I)/k_e}$ for any choice of the k_e -th root of unity ζ_e . The end of the proof is the same as for divisor graphs with trivial residue conditions.

Proof of the fourth point. Now we will prove that the map $\iota : U \times \Delta \times G_I \rightarrow \mathbb{P}\bar{A}_{\mathbf{g}, \mathbf{Z}, \mathbf{P}}^R$ is a degree 1 parametrization of a neighborhood of U in $\mathbb{P}\bar{A}_{\mathbf{g}, \mathbf{Z}, \mathbf{P}}^R$.

First we prove that the image $\iota(U \times \Delta \times G_I)$ covers *entirely* a neighborhood of U in $A_{\mathbf{g}, \mathbf{Z}, \mathbf{P}}^R$. Let $y_0 = (C = C_0 \cup C_1, \bar{x}_0, \bar{x}_1, \alpha_0)$ be a point in $A_{\Gamma, I}^{\text{gen}}$. Let $\tilde{\iota} : \Delta \rightarrow \bar{A}_{\mathbf{g}, \mathbf{Z}, \mathbf{P}}$ be a family of differentials such that $\tilde{\iota}(0) = y_0$ and $\tilde{\iota}(\epsilon) \in A_{\mathbf{g}, \mathbf{Z}, \mathbf{P}}^R$ for $\epsilon \neq 0$. We denote by

$\pi : \mathcal{C} \rightarrow \Delta$ the induced family of curves and by α the induced family of differentials on the fibers of $\mathcal{C} \rightarrow \Delta$.

Let e be a node of \mathcal{C} with a twist of order k_e . Let γ_e be a simple loop in the curve C_0 around the node e . Let W_e be a neighborhood of γ_e in \mathcal{C} such that $W_e \cap \pi^{-1}(\epsilon)$ is an annulus for any ϵ small enough. Now, the differential α_0 is given by $d(z_e^{k_e})$ in a standard coordinate. Thus the differential $\alpha|_{\pi^{-1}(\epsilon)}$ is given by $d(z_e^{k_e}) + \phi(\epsilon, z_e)dz_e$ and we denote by $r_e(\epsilon)$ the integral of $\phi(\epsilon, z_e)dz_e$ along γ_e . We consider the differential $\alpha_e(\epsilon) = dz_e + \phi(\epsilon, z_e)dz_e - r_e(\epsilon)\frac{dz_e}{z_e}$. We fix a point p in the annulus $W_e \cap \pi^{-1}(\epsilon)$, the function $f : z \mapsto (\int_p^z \alpha_e)^{1/k_e}$ is uniquely determined for small values of ϵ . This determines a coordinate (that we will still denote z_e) such that $\alpha_0 = z_e^{k_e}dz_e - \varphi(\epsilon, z_e)\frac{dz_e}{z_e}$ with φ holomorphic and thus a standard deformation of α^0 . Proposition 2.2.31 implies that there exists a coordinate z_e on this annulus such that $\alpha|_{\pi^{-1}(\epsilon)} = d(z_e^{k_e}) + r_e(\epsilon)\frac{dz_e}{z_e}$.

We fix ϵ small enough so that the coordinates z_e are defined for all edges e . We cut the curve $\pi^{-1}(\epsilon)$ along simple loops contained in W_e . This gives two (possibly disconnected) curves with boundary C_0^{open} and C_1^{open} . We “plug” the holes of C_0^{open} with disks parametrized by the coordinate z_e and the holes of C_1^{open} with disks with coordinate $1/z_e$. This determines two curves $C_0(\epsilon)$ and $C_1(\epsilon)$. On both C_0 and C_1 , the local chart used to “plug” the holes allow us to define differentials $\alpha_0(\epsilon)$ and $\alpha_1(\epsilon)$.

The differential $\alpha_1(\epsilon)$ has a pole of order $k_e + 1$ at $w_e = 0$; thus $(C_1, \bar{x}_1, \alpha_1)(\epsilon)$ is an element of $A_{\mathbf{g}_1, \mathbf{Z}_1, \mathbf{P}_1}^{R^1}$. Now, at the level 0, we use Proposition 2.2.36: in a neighborhood of y_0 we can apply the retraction η . The point $\eta((C_0, \bar{x}_0, \alpha_0)(\epsilon))$ is a point of $A_{\mathbf{g}_0, \mathbf{Z}_0, \mathbf{P}_0}^{R^0}$. Therefore we define

$$y(\epsilon) = (\eta(C_0, \bar{x}_0, \alpha_0), (C_1, \bar{x}_1, \alpha_1))(\epsilon) \in A_{\Gamma, I}^{\text{gen}}.$$

For all ϵ in a neighborhood of 0, the point $\tilde{y}(\epsilon)$ lies in the deformation of $y(\epsilon)$ by the family ι restricted to $y(\epsilon) \times \Delta \times g$ for some $g \in G_I$ (in fact here $g = 1$ because of the choices of the parameters around y_0 that we have fixed).

To finish the proof of the fourth point, we need to prove that the parametrization is of degree 1. For this, we once again use the retraction η defined in Proposition 2.2.36. We have $\eta \circ \iota = \text{Id}_U$, thus we only need to prove that for all $y \in U$, the family ι restricted to $y \times \Delta \times G_I$ is of degree 1. We consider this family in the moduli space of curves, i.e let

$$\begin{aligned} \iota' : \Delta \times G_I &\rightarrow \overline{\mathcal{M}}_{\mathbf{g}, \mathbf{n}, \mathbf{m}} \\ \epsilon \times g &\mapsto p(\iota(y, \epsilon, G_I)). \end{aligned}$$

This family is of degree one. Indeed the stack $\overline{\mathcal{M}}_{\Gamma}$ is regularly imbedded in $\overline{\mathcal{M}}_{\mathbf{g}, \mathbf{n}, \mathbf{m}}$ and its normal bundle is the direct sum of the $T_h \otimes T_{h'}$ for all edges $e = (h, h')$ of Γ . Thus the family ι' is given by the family:

$$\begin{aligned} \iota' : \Delta \times G_I &\rightarrow \bigoplus_{(h, h') \in \text{Edges}} T_h \otimes T_{h'} \\ (\epsilon, (\zeta_e)_{e \in \text{Edges}}) &\mapsto \left(\zeta_e \epsilon^{L(I)/k_e} \right)_{e \in \text{Edges}}, \end{aligned}$$

which is of degree 1. □

PROOF OF FORMULA (2.3.2). We have seen that the space of differentials on an unstable component is a weighted projective space parametrized by

$$\left[w^{p-1} + a_1 w^{p-2} + \dots + a_{p-2} w \right] \frac{dw}{w},$$

where the weight of a_j is $\frac{j}{p-1}$. The fact that the order of the point x is $k_{j,i}$ is equivalent to the vanishing of the terms $a_{p-2}, \dots, a_{p-k_{j,i}-3}$. Therefore, the class of $[\mathbb{P}\bar{A}_{\mathbf{g}, \mathbf{Z}, i, \mathbf{P}}^R]$ is the closure of the vanishing locus $a_{p-k_{j,i}-2}$. Moreover we can easily check that $a_{p-k_{j,i}+1}^{p-1}$ is a global section of $\mathcal{O}(-1)^{p-k_{j,i}+1}$. \square

2.3.7. Proof of Theorems 2.1.14, 2.1.16, and 2.1.18. We now have all ingredients to prove Theorem 2.2.59: for all $\mathbf{g}, \mathbf{Z}, \mathbf{P}$ (list of integers and vectors of integers) and R vector subspace of \mathcal{R} , the Poincaré-dual class of $[\mathbb{P}\bar{A}_{\mathbf{g}, \mathbf{Z}, \mathbf{P}}^R]$ in $H^*(\mathbb{P}\bar{\mathcal{H}}_{\mathbf{g}, \mathbf{Z}, \mathbf{P}}, \mathbb{Q})$ can be explicitly computed and is tautological (see Section 2.2.9).

PROOF OF THEOREM 2.2.59. We prove Theorem 2.2.59 by induction on $|\mathbf{Z}| = \sum_{k \in \mathbf{Z}} k$.

Base of the induction: $|\mathbf{Z}| = 0$. If \mathbf{Z} is trivial then $A_{\mathbf{g}, \mathbf{Z}, \mathbf{P}}^R$ is dense in $\bar{\mathcal{H}}_{\mathbf{g}, \mathbf{Z}, \mathbf{P}}$. Therefore

$$[\mathbb{P}A_{\mathbf{g}, \mathbf{Z}, \mathbf{P}}^R] = [\mathbb{P}\bar{\mathcal{H}}_{\mathbf{g}, \mathbf{Z}, \mathbf{P}}^R] = \xi^{\dim(\mathcal{R}) - \dim(R)},$$

by Lemma 2.2.27.

Induction. Now we assume that $|\mathbf{Z}| > 0$. The induction Formulas (2.3.1) and (2.3.2) of Theorems 2.3.41 express the class $[\mathbb{P}\bar{A}_{\mathbf{g}, \mathbf{Z}, \mathbf{P}}^R]$ in terms of classes with smaller sum of the order of zeros. We only need to prove that the class $a_{\Gamma, I}$ is tautological for any $(\Gamma, I) \in \text{Div}(\mathbf{g}, \mathbf{Z}, \mathbf{P}, R)$.

The vectors of zeros \mathbf{Z}_0 and \mathbf{Z}_1 of the levels 0 and -1 satisfy $|\mathbf{Z}_i| < |\mathbf{Z}|$. Therefore the classes $[\mathbb{P}\bar{A}_{\mathbf{g}_1, \mathbf{Z}_1, \mathbf{P}_1}^{R^1}]$ and $[\mathbb{P}\bar{A}_{\mathbf{g}_0, \mathbf{Z}_0, \mathbf{P}_0}^{R^0}]$ can be computed and are tautological. Using Proposition 2.3.35, this implies that the class $a_{\Gamma, I}$ is tautological and can be computed. \square

Theorems 2.1.14, 2.1.16, and 2.1.18 stated in Section 2.1.4 are straightforward corollaries of Theorem 2.2.59.

PROOF OF THEOREMS 2.1.14, 2.1.16, AND 2.1.18. Theorem 2.1.14 is the special case of Theorem 2.2.59 for a connected and stable curves. Theorem 2.1.18 is a consequence of 2.1.14 and Proposition 2.1.4 (the Segre class of the spaces of stable differential is tautological).

To prove Theorem 2.1.16, we recall that we denote by $\tilde{\pi}_n : \mathbb{P}\bar{\mathcal{M}}_{g,n} \rightarrow \mathbb{P}\bar{\mathcal{M}}_g$, the forgetful map of points. The bundle $\bar{\mathcal{H}}_{g,n}$ is the pull-back of $\bar{\mathcal{H}}_g$ by π_n , then $\xi \in H^*(\mathbb{P}\bar{\mathcal{H}}_{g,n}, \mathbb{Q})$ is the pull-back of $\xi \in H^*(\mathbb{P}\bar{\mathcal{H}}_g, \mathbb{Q})$. Therefore the push-forward of a tautological class of $RH^*(\mathbb{P}\bar{\mathcal{H}}_{g,n}, \mathbb{Q})$ by π_n is in $RH^*(\mathbb{P}\bar{\mathcal{H}}_g, \mathbb{Q})$ and can be explicitly computed.

If $Z = (k_1, \dots, k_n)$ is complete, the map $\tilde{\pi}_n$ restricted to $\mathbb{P}A_{g,Z}$ is finite of degree $\text{Aut}(Z)$ onto $\mathbb{P}\mathcal{H}[Z]$. We have

$$[\mathbb{P}\bar{\mathcal{H}}[Z]] = \frac{1}{\text{Aut}(Z)} \cdot \tilde{\pi}_{n*} [\mathbb{P}\bar{A}_{g,Z}],$$

and the class $[\mathbb{P}\overline{\mathcal{H}}[Z]]$ is tautological and can be computed. \square

2.4. Examples of computation

We give two examples of computation: the first one is a computation in the projectivized Hodge bundle (we forget the marked points), the second is a computation in the moduli space of curves (we forget the differential).

2.4.1. The class $[\mathbb{P}\overline{\mathcal{H}}_g(3)]$. We consider here $g > 2$ and $Z = (3, 1, \dots, 1)$. We have seen in the introduction the computation of $[\mathbb{P}A_{g,(2)}]$. Therefore, in order to compute $[\mathbb{P}A_{g,(3)}]$ we need to list the divisor graphs contributing to $[\mathbb{P}\overline{A}_{g,(3)}] - (\xi + 3\psi_1)[\mathbb{P}\overline{A}_{g,(2)}]$.

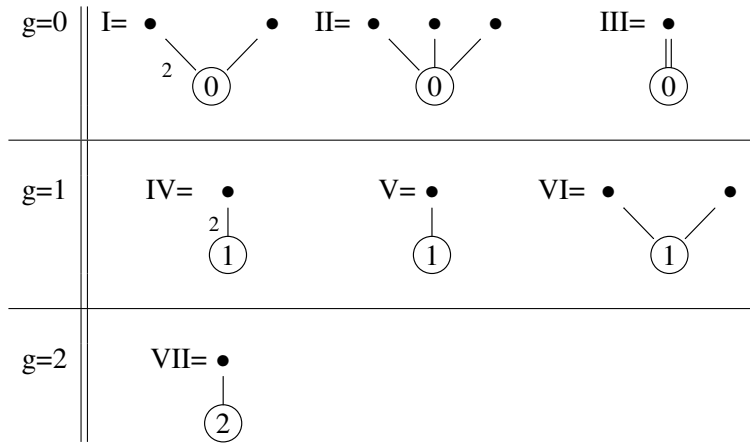

FIGURE 3. List of boundary terms in $[\mathbb{P}\overline{A}_{g,(3)}] - (\xi + 3\psi_1)[\mathbb{P}\overline{A}_{g,(2)}]$.

We have represented vertices of level -1 with their genera and the vertices of level 0 by bullets (the sum will run over all possible distribution of the genera of vertices of level 0). The marked point always belong to the unique vertex of level -1. The twists are represented by one number because the level structure already implies the sign of the twist on each half-edge. Finally we only represented the twists of absolute value greater than 1.

After push-forward by the forgetful map of the marked point, we get the following formula for the class $[\mathbb{P}\overline{\mathcal{H}}(3, 1, \dots, 1)] \in H^*(\mathbb{P}\overline{\mathcal{H}}_g, \mathbb{Q})$:

$$[\mathbb{P}\overline{\mathcal{H}}(3, 1, \dots, 1)] = (12g - 12) \xi^2 + (11\kappa_1 - \delta - \delta_{sep} - 5 \textcircled{1} - \bullet) \xi + (6\kappa_2 - \bullet^{\psi_e} - \bullet - 1/12 \textcircled{\textcircled{0}} - \bullet).$$

We explain the notation of the above expression. If the graph is not decorated, then the notation stands for the push forward of the fundamental class of $\overline{\mathcal{M}}_\Gamma$ under ζ_γ . If a graph is decorated with classes P_v in $\overline{\mathcal{M}}_{g(v),n(v)}$ for each vertex then the notation stands for $\zeta_{\gamma*}(\prod P_v)$. These classes are either ψ_i for a marked point, ψ_e for an half-edge or λ_i and κ_i for a vertex. In the above expression there is only one decoration ψ_e on a half-edge.

Remark 2.4.1. For $g = 3$, we can compute $p_*[\mathbb{P}\overline{A}_{3,(3)}] \in H^0(\overline{\mathcal{M}}_3, \mathbb{Q}) \simeq \mathbb{Q}$, where p is the forgetful map of the differential. We get $p_*[\mathbb{P}\overline{A}_{3,(3)}] = 24$, the number of

ordinary double points of a general quartic plane curve. In genus 3, we can also compute $p_*(\pi_*[\mathbb{P}\overline{A}_{3,(2,2)}]) = 2 \times 28$, i.e. two times the number of bitangents to a general quartic plane curve.

2.4.2. The class of $\overline{\mathcal{H}}_3(4)$. Here $g = 3$ and $\mu = 4$. We will compute the class $\overline{\mathcal{H}}_3(4) = \pi_*[\mathbb{P}\overline{A}_{3,(4)}] \in H^4(\overline{\mathcal{M}}_{3,1})$. We will not give the details of the computation however we have

$$\begin{aligned} [\overline{\mathcal{H}}_3(4)] &= \lambda_2 - 10\psi_1\lambda_1 + 35\psi_1^2 - 5 \begin{array}{c} \textcircled{0} \\ | \\ \textcircled{2} \end{array} - \begin{array}{c} \textcircled{1} \\ | \\ \textcircled{1} \end{array} + 6 \begin{array}{c} \textcircled{1} \\ | \\ \textcircled{1} \end{array} - \begin{array}{c} \textcircled{1} \\ | \\ \textcircled{1} \end{array} \\ &+ \begin{array}{c} \textcircled{1} \\ | \\ \textcircled{1} \end{array} - \begin{array}{c} \textcircled{1} \\ | \\ \textcircled{1} \end{array} + 6 \begin{array}{c} \textcircled{1} \\ | \\ \textcircled{2} \end{array} - 34 \begin{array}{c} \textcircled{1} \\ | \\ \textcircled{2} \end{array} - 11 \begin{array}{c} \textcircled{1} \\ | \\ \textcircled{2} \end{array} \begin{array}{c} \psi_e \\ | \\ \textcircled{2} \end{array} \\ &+ \begin{array}{c} \textcircled{1} \\ | \\ \textcircled{2} \end{array} - 10 \begin{array}{c} \textcircled{1} \\ | \\ \textcircled{2} \end{array} - \begin{array}{c} \textcircled{1} \\ | \\ \textcircled{2} \end{array} \begin{array}{c} \psi_e \\ | \\ \textcircled{2} \end{array} \\ &\quad \lambda_1 \quad \psi_1 \quad \psi_1 \quad \psi_e \end{aligned}$$

We explain the notation of the above expression. The legs on the graphs stands for the only marked point. We have decorated graph with classes P_v in $\overline{\mathcal{M}}_{g(v),n(v)}$ for each vertex. These classes are either ψ_1 (for the marked point), ψ_e for an half-edge or λ_1 for a vertex.

We recall that $\mathcal{H}_3(4)$ has two connected components (hyperelliptic and odd). In this case one can compute $[\overline{\mathcal{H}}_3(4)^{\text{hyp}}]$ by using the work of Faber and Pandharipande (see [26]). This way one can also compute $[\overline{\mathcal{H}}_3(4)^{\text{odd}}] = [\overline{\mathcal{H}}_3(4)] - [\overline{\mathcal{H}}_3(4)^{\text{hyp}}]$. In general, it is possible to compute the class of the hyperelliptic component but we do not know how to compute separately the classes of odd and even components for $g \geq 4$.

Felix Janda has compared this expression with the expression of Conjecture B. The two expressions agree modulo tautological relations (see Chapter 5 for presentation of the conjecture).

If we forget the marked point, then we get a class in $\text{Pic}(\overline{\mathcal{M}}_g) \otimes \mathbb{Q}$. Using the string and dilaton equations and Mumford's formula for κ_1 we get

$$\begin{aligned} \pi_*[\overline{\mathcal{H}}_3(4)] &= 0 - 10 \times 4 \lambda_1 + 35 \kappa_1 - 5 \delta_{\text{nonsep}} - 0 + 6 \cdot 0 \\ &+ 0 + 6 \cdot 0 - 34 \delta_{\text{sep}} - 11 \delta_{\text{sep}} \\ &+ 0 - 10 \times 3 \delta_{\text{sep}} - \delta_{\text{sep}} \\ &= 380 \lambda_1 - 40 \delta_{\text{nonsep}} - 100 \delta_{\text{sep}}. \end{aligned}$$

The expression agrees with the formula of Scott Mullane (see [61]).

2.5. Relations in the Picard group of the strata

We fix the notation for all the section. Let $g, n, m \geq 0$ such that $2g - 2 + n + m > 0$. Let $Z = (k_1, \dots, k_n)$ and $P = (p_1, \dots, p_n)$ be vectors of positive integers such that $|Z| - |P| = 2g - 2$. In this section we consider the space $\overline{\mathcal{H}}_g(Z - P) \subset \overline{\mathcal{M}}_{g,n+m}$ (see Section 2.1.4 for definitions). The purpose is to define several natural classes in $\text{Pic}(\overline{\mathcal{H}}_g(Z - P)) \otimes \mathbb{Q}$ and compute relations between these elements. Namely there are two types of classes which arise naturally:

- Divisors associated to admissible graphs (see Sections 2.3.2 and 2.3.4);
- Intersections of $\overline{\mathcal{H}}_g(Z-P)$ with the tautological classes of $A_1(\overline{\mathcal{M}}_{g,n})$.

2.5.1. Classes defined by admissible graphs. We consider the moduli space of stable differentials $\overline{\mathcal{H}}_{g,n,P}$ and the locus $\overline{A}_{g,Z,P} \subset \overline{\mathcal{H}}_{g,n,P}$. We have seen that $\overline{A}_{g,Z,P}$ admits a stratification indexed by admissible graphs (see Lemma 2.3.11). In this section, we describe the set of admissible graphs (Γ, I, l) such that $p(\overline{A}_{\Gamma, I, l})$ is a divisor in $\overline{\mathcal{H}}_g(Z-P) = p(\overline{A}_{g,Z,P})$, where we recall that $p : \overline{\mathcal{H}}_{g,n,P} \rightarrow \overline{\mathcal{M}}_{g,n+m}$ is the forgetful map.

The map $p : \mathbb{P}A_{g,Z,P} \rightarrow \mathcal{H}_g(Z-P)$ is an isomorphism (see Lemma 2.2.37). Therefore an admissible graph (Γ, I, l) which determines a divisor in $\overline{\mathcal{H}}_g(Z-P)$ needs to correspond to a divisor in $\overline{A}_{g,Z,P}$. We have seen that an admissible graph (Γ, I, l) corresponds to a divisor of $\overline{A}_{g,Z,P}$ if and only if it is of one of the three following types (see Section 2.3.4):

- (1) the admissible graph of depth 0 with one vertex and one edge;
- (2) an admissible graph of depth 0 with two vertices and one edge;
- (3) a bicolored graph that satisfies the condition $(\star\star)$.

Proposition 2.5.1. *Let (Γ, I, l) be an admissible graph. The locus $p(\mathbb{P}\overline{A}_{\Gamma, I, l})$ is a divisor of $\overline{\mathcal{H}}_g(Z-P)$ if and only if:*

- or (Γ, I, l) is of the type 1 above ;
- or (Γ, I, l) is a bicolored graph with one vertex of level -1 , one stable vertex of level 0 and possibly other semi-stable vertices of level 0.

We call *irreducible divisor* the divisor of $\overline{\mathcal{H}}(Z-P)$ of the first type. We denote this divisor by D_0 (with reduced structure) and by δ_0 its class in $\text{Pic}(\overline{\mathcal{H}}_g(Z-P)) \otimes \mathbb{Q}$.

In the second case, the stabilization of the graph Γ determines a unique stable twisted graph of depth 1, (Γ', I') (we no longer write the level structure which is uniquely determined by I). Conversely, a twisted stable graph of depth 1 with two vertices, we can uniquely determine an admissible graph satisfying the condition of Proposition 2.5.1 by putting all the poles on the component of level -1 on unstable rational components of level 0 (see Lemma 2.3.19 and Example 2.5.3 below).

Definition 2.5.2. A *simple bicolored graph* is a twisted stable graphs of depth 1 with two vertices. We denote by $\text{SB}(Z, P)$ the set of simple bicolored graphs. If (Γ, I) is a simple bicolored graph, we denote by $D_{\Gamma, I}$ the corresponding divisor in $\overline{\mathcal{H}}_g(Z, P)$ (with the reduced structure) and by $a_{\Gamma, I}$ its class in $\text{Pic}(\overline{\mathcal{H}}_g(Z-P)) \otimes \mathbb{Q}$.

The class $i_* a_{\Gamma, I}$ (where i is the closed immersion of $p(\overline{A}_{\Gamma, I})$ in $\overline{\mathcal{M}}_{g,n+m}$) in the moduli space of curves is simply given by:

$$\zeta_{\Gamma*}([\overline{\mathcal{H}}_{g_0}(Z_0 - P_0)], [\overline{\mathcal{H}}_{g_1}(Z_1 - P_1)]),$$

where g_0 and g_1 are the genera of the vertices of level 0 and -1 and the vectors Z_0, P_0, Z_1 and P_1 are the vectors encoding the orders of zeros and poles at the marked points and half-edges induced by Z, P and the twist I .

Example 2.5.3. We illustrate this correspondence between simple bicolored graphs and boundary divisors. We consider $g = 3$, $Z = (2, 6)$ and $P = (-2, -2)$ and the admissible graph (on this example we take the twists equal to 1 on all edges). On this

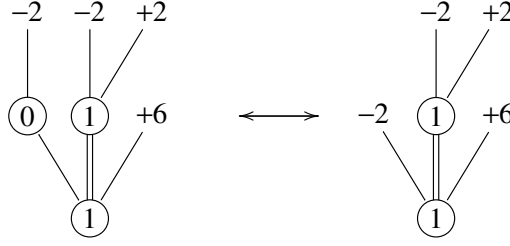

FIGURE 4. Example of the correspondance between admissible and stable graphs.

example, the class $i_*a_{\Gamma,I}$ in the moduli space of curves will be given by

$$\zeta_{\Gamma^*}([\overline{\mathcal{H}}_1(+2,+0,+0,-2)], [\overline{\mathcal{H}}_1(+6,-2,-2,-2)]).$$

PROOF OF PROPOSITION 2.5.1. Let (Γ, I) be an amissible graph of depth at most 1 with several stable components of level 0. Then the fiber of p over a generic point of $p(A_{g,Z,P})$ is of dimension greater than one. That is why divisors of type 2 are not mapped to divisors while the map p restricted to D_0 is indeed of degree one onto its image.

Now we consider an admissible graph of depth 1 with one stable vertex of level 0. Then the graph satisfies condition $(\star\star)$ if and only it has one vertex of level -1 .

Finally, we consider an admissible graph (Γ, I, l) of depth 1 and with no stable vertex of level 0. The projectivized stratum $\mathbb{P}A_{\Gamma,I,l} \subset \mathbb{P}\overline{\mathcal{H}}_{g,n,P}$ is empty. Indeed, Z is complete for g and P thus the differential on each unstable component with a marked pole of order p is given by dz/z^p . Therefore $A_{\Gamma,I,l}$ is a substack of the zero section of the cone $\overline{\mathcal{H}}_{g,n,P} \rightarrow \overline{\mathcal{M}}_{g,n+m}$ (see Section 2.2.3 for the description of the zero section). \square

2.5.2. Class defined by residue conditions. We recall that \mathcal{R} is the vector space of residues, i.e. the subspace of \mathbb{C}^m defined by $\{(r_1, \dots, r_m)/r_1 + \dots + r_m = 0\}$. Let $R \subset \mathcal{R}$ be vector subspace of codimension 1. We define the following class in the rational Picard group of $\overline{\mathcal{H}}_g(Z-P)$:

$$\delta_R^{\text{res}} = p_*(\mathbb{P}\overline{A}_{g,Z,P}^R).$$

Notation 2.5.4. Let $1 \leq i < j \leq n+m$. We denote $\text{SB}(Z, P)_i$ (respectively $\text{SB}(Z, P)^i$) the set of simple bicolored graphs such that the leg corresponding to i is adjacent to the vertex of level -1 (respectively to the vertex of level 0). We denote $\text{SB}(Z, P)_i^j = \text{SB}(Z, P)_i \cap \text{SB}(Z, P)^j$.

If $R \subset \mathcal{R}$ is a vector subspace, we denote by $\text{SB}(Z, P)_R$ the set simple bicolored graphs satisfying: the space R contains the vector space $R^0 \subset \mathcal{R}$ defined by the linear conditions $\{r_i = 0\}$ for all $1 \leq i \leq m$ such that the leg of index $n+i$ is at level -1 .

2.5.3. Classes defined by intersection. Let β be a tautological class in the rational Picard group of $\overline{\mathcal{M}}_{g,n+m}$. The class β determines a class in $\text{Pic}(\overline{\mathcal{H}}_g(Z-P)) \otimes \mathbb{Q}$ by taking $i^*\beta$ where i is the closed immersion of $\overline{\mathcal{H}}_g(Z-P)$ into $\overline{\mathcal{M}}_{g,n+m}$.

If β is either λ_1, κ_1 or a ψ -class then we will denote by the same letter its pull-back to $\text{Pic}(\overline{\mathcal{H}}_g(Z-P)) \otimes \mathbb{Q}$ if the context is clear.

The last class that we will consider is the push-forward of the ξ -class that we denote:

$$\overline{\xi} = p_*(\xi \cdot [\mathbb{P}\overline{A}_{g,Z,P}]).$$

Theorem 2.5.5. *The following relations holds in $\text{Pic}(\overline{\mathcal{H}}_g(Z-P)) \otimes \mathbb{Q}$:*

(1) for all $1 \leq i \leq n$:

$$\overline{\xi} + (k_i + 1)\psi_1 = \sum_{(\Gamma, I) \in \text{SB}(Z, P)_i} m(I)a_{\Gamma, I};$$

(2) for all $1 \leq i, j \leq n$:

$$(k_i + 1)\psi_i - (k_j + 1)\psi_j = \sum_{(\Gamma, I) \in \text{SB}(Z, P)_i^j} m(I)a_{\Gamma, I} - \sum_{(\Gamma, I) \in \text{SB}(Z, P)_j^i} m(I)a_{\Gamma, I};$$

(3) for all $R \subset \mathcal{R}$ vector subspace of codimension 1:

$$\overline{\xi} = \delta_R^{\text{res}} + \sum_{(\Gamma, I) \in \text{SB}(Z, P)_R} m(I)a_{\Gamma, I};$$

(4) if $m = 0$ then

$$\lambda_1 + \kappa_\mu \overline{\xi} = \frac{1}{12} \delta + \sum_{(\Gamma, I) \in \text{SB}(Z, P)} 2\overline{m}(I, \Gamma)a_{\Gamma, I},$$

where δ is boundary divisor of $\overline{\mathcal{M}}_{g,n}$,

$$\kappa_\mu = \frac{1}{12} \sum_{i=1}^n \frac{k_i(k_i + 2)}{k_i + 1}$$

$$\text{and } \overline{m}(I, \Gamma) = \frac{m(I)}{12} \left(-m(I) + \sum_{i \rightarrow v^1} \frac{k_i(k_i + 2)}{k_i + 1} \right).$$

the second sums goes over all legs adjacent to the vertex of level -1 .

2.5.3.1. Relations (1) and (2) and Double Ramification cycles. The second relation of Theorem 2.5.5 is a direct consequence of the first one: we write $(k_i + 1)\psi_i - (k_j + 1)\psi_j = (\overline{\xi} + (k_i + 1)\psi_i) - (\overline{\xi} + (k_j + 1)\psi_j)$. However, we have chosed to write this relation in this form for two reasons:

- first because it involves only classes defined directly in the moduli space of curves;
- the second motivation is related to the Conjectures A and B. Indeed the classes $[\overline{\mathcal{H}}_g(\mu)]$ (see Chapter 5 for definitions) are supposed to be generalizations of the so-called Double Ramification cycles. In [8], the authors proved several identities between intersection of ψ -classes with the Double Ramification cycles. These relations are important for example to construct the Double Ramification hierarchies. One consequence of the relations proven in [8] is the existence a universal ψ -class over the Double Ramification Cycles (independent of the choice of a marked point). For strata of differentials the following corollary gives a candidate for this ψ -class.

Corollary 2.5.6. *The following class in $\text{Pic}(\overline{\mathcal{H}}_g(Z-P)) \otimes \mathbb{Q}$*

$$(k_i + 1) \psi_i - \sum_{(\Gamma, I) \in \text{SB}(Z, P)_i} m(I) a_{\Gamma, I}$$

is independent of the choice of $1 \leq i \leq n$.

PROOF OF RELATION (1). It is a direct consequence of the induction formula (see Theorem 2.3.41). We consider Z_i , the vector obtained from Z by increasing the i -th entry by 1 and $R = \mathcal{R}$ (no residue condition), then we get:

$$(\xi + (k_i + 1) \psi_i) \cdot [\mathbb{P}\overline{A}_{g, Z, P}] = [\mathbb{P}\overline{A}_{g, Z_i, P}] + \sum_{(\Gamma, I) \in \text{Bic}(g, Z, P)_i} m(I) a_{\Gamma, I}.$$

We remark that $|Z_j| - |P| > 2g - 2$ thus $[\mathbb{P}\overline{A}_{g, Z_i, P}] = 0$. Now we apply the push forward by p to this expression. In the sum of the right-hand side only the simple bicolored graphs will contribute and we indeed get

$$\overline{\xi} + (k_i + 1) \psi_1 = \sum_{(\Gamma, I) \in \text{SB}(Z, P)_i} m(I) a_{\Gamma, I}$$

□

2.5.3.2. *Relation (3).* To prove the third relation, we need a generalization of the induction formula:

Proposition 2.5.7. *The following equality holds in $H^*(\mathbb{P}\overline{\mathcal{H}}_{g, n, P}; \mathbb{Q})$*

$$[\mathbb{P}\overline{A}_{g, Z, P}^R] = \xi [\mathbb{P}\overline{A}_{g, Z, P}] - \sum_{(\Gamma, I) \in \text{Bic}(g, Z, P)_R} m(I) a_{\Gamma, I}.$$

Remark 2.5.8. We could have stated this proposition in a larger generality (unstable disconnected base) but it will not be useful here.

PROOF. The proof is the same as the proof of Theorem 2.3.41. We consider the line bundle $\mathcal{O}(1) \simeq \mathcal{O}(-1)^\vee$ restricted to $\mathbb{P}\overline{A}_{g, Z, P}$ with its section

$$\begin{aligned} s : \mathcal{O}(-1) &\rightarrow \mathbb{C} \\ \alpha &\mapsto \mathcal{R}/R \end{aligned}$$

defined as the composition of the residue map $\mathcal{O}(-1) \rightarrow \mathcal{R}$ and the projection $\mathcal{R} \rightarrow \mathcal{R}/R$. The vanishing locus of the section s is the union of $\mathbb{P}\overline{A}_{g, Z, P}^R$ and of the divisors $\mathbb{P}\overline{A}_{\Gamma, I}$ for all $(\Gamma, I) \in \text{Bic}(g, Z, P)_R$.

Now the vanishing order of s along $\mathbb{P}\overline{A}_{g, Z, P}^R$ is 1 because the residue map is a submersion. The vanishing order of s along $\mathbb{P}\overline{A}_{\Gamma, I}$ is 1 because Lemma 2.3.42 remains valid if we replace the section $s_{i, j}$ by the section s and the set of graphs $\text{Div}(\mathbf{g}, \mathbf{Z}, \mathbf{P}, R)_{ij}$ by the set of graphs $\text{Div}(g, Z, P)_R$. □

PROOF OF RELATION (3). Relation (3) is a direct consequence of Proposition 2.5.7. It suffices to use apply the push-forward by the forgetful map p . □

2.5.3.3. *Relation (4) and the work of Kontsevich and Zorich.*

Let $g \geq 2$. Let $Z = (k_1, k_2, \dots, k_n)$ be a partition of $2g - 2$. Let $\mathcal{M}(Z)$ be a connected component of $\mathbb{P}\overline{\mathcal{H}}_g(Z)$. There is a natural action of $PSL(2, \mathbb{R})$ on $\mathcal{H}_g(Z)$ and $\mathcal{M}(Z)$ is invariant under this action. Now we can consider the dynamic on

$\mathcal{M}(Z)$ defined by the action of the diagonal $(e^{-t}, e^t)_{t \in \mathbb{R}}$. This allows to define a constant associated to this action: the sum of the Lyapunov exponents. Another invariant of the connected component c_Z is the Siegel-Veech constant c_Z (see [23]). The two constants are related by the relation

$$(2.5.1) \quad \mathcal{L}_Z = K_Z + c_Z,$$

where $K_Z = \frac{1}{12} \sum \frac{k_i(k_i+2)}{k_i+1}$.

Kontsevich proved the existence of a closed real 2-form β on $\mathcal{M}(Z)$, such that,

$$\mathcal{L}_Z = - \frac{\int_{\overline{\mathcal{M}(Z)}} \beta \wedge \lambda_1}{\int_{\overline{\mathcal{M}(Z)}} \beta \wedge \xi}.$$

Here λ_1 and ξ are considered as elements in $H^2(\mathbb{P}\overline{\mathcal{H}}_g(Z), \mathbb{R})$. Relation (2.5.1) comes from the following equality in $H^2(\mathbb{P}\overline{\mathcal{H}}_g(Z), \mathbb{R})$:

$$\lambda_1 = K_Z(-\xi) + \delta,$$

and from:

$$c_Z = - \frac{\int_{\overline{\mathcal{M}(Z)}} \beta \wedge \delta}{\int_{\overline{\mathcal{M}(Z)}} \beta \wedge \xi}.$$

The class δ lies in the boundary of $\mathbb{P}\overline{\mathcal{H}}_g(Z)$. The fourth relation of Theorem 2.5.5 is the explicit computation of the boundary class in $\text{Pic}(\overline{\mathcal{H}}_g(Z)) \otimes \mathbb{Q}$.

Remark 2.5.9. Here we compute the boundary terms in the compactification of the strata inside the moduli space of curves. Another formula can be obtained in the Hodge bundle. The two are very similar but we prefer to state the formula in this form to complete our study of the Picard group of $\overline{\mathcal{H}}_g(Z)$.

PROOF OF RELATION (4). We consider $g > 0$, $P = 0$ and $Z = (k_1, \dots, k_n)$ a partition of $2g-2$. Let Z' be the vector equal to $(k_1, \dots, k_n, 0)$. If $\pi: \overline{\mathcal{M}}_{g,n+1} \rightarrow \overline{\mathcal{M}}_{g,n}$ is the forgetful map of the last marked point, then we have $\overline{A}_{g,Z'} = \pi^{-1}(\overline{A}_{g,Z})$. We use the induction formula to obtain the relation:

$$(\xi + \psi_{n+1})[\mathbb{P}A_{g,Z'}] = 0 + \sum_{\text{Bic}(g,Z)_{n+1}} m(I) a_{\gamma,I}$$

We multiply this formula by ψ_{n+1} to get

$$(2.5.2) \quad \xi \psi_{n+1}[\mathbb{P}A_{g,Z'}] + \psi_{n+1}^2[\mathbb{P}A_{g,Z'}] = \sum_{\text{Bic}(g,Z')_{n+1}} m(I) \psi_{n+1} a_{\Gamma,I}.$$

Now we apply $(p_*) \circ (\pi_*)$ to this formula (we forget the last point and then the differential). We study each term separately.

Contribution of $\xi \psi_{n+1}[\mathbb{P}A_{g,Z'}]$. The classes ξ and $[\mathbb{P}A_{g,Z'}]$ are pull back by π thus

$$\begin{aligned} p_* (\pi_*(\psi_{n+1} \xi [\mathbb{P}A_{g,Z'}])) &= p_* (\pi_*(\psi_{n+1}) \xi [\mathbb{P}A_{g,Z}]) \\ &= \kappa_0 p_*(\xi [\mathbb{P}A_{g,Z}]) \\ &= (2g-2+n) \bar{\xi} \end{aligned}$$

by the projection formula.

Contribution of $\psi_{n+1}^2[\mathbb{P}A_{g,Z'}]$. Still by the projection formula we have:

$$\begin{aligned} p_* (\pi_*(\psi_{n+1}^2[\mathbb{P}A_{g,Z'}])) &= p_* (\pi_*(\psi_{n+1}^2)[\mathbb{P}A_{g,Z}]) \\ &= \kappa_1 \\ &= 12\lambda_1 - \delta + \sum_{i=1}^n \psi_i. \end{aligned}$$

Now we use the first relation to write:

$$\sum_{i=1}^n \psi_i = - \left(\sum_{i=1}^n \frac{1}{k_i + 1} \right) \bar{\xi} + \sum_{i=1}^n \left(\sum_{(\Gamma, I) \in \text{BS}(g, Z)_i} \frac{m(I)}{k_i + 1} a_{\Gamma, I} \right).$$

Contribution of $\sum_{\text{Bic}(g, Z')_{n+1}} m(I) \psi_{n+1} a_{\Gamma, I}$. Let (Γ, I) be a bicolored graph in $\text{Bic}(g, Z')_{n+1}$. There are two possible configurations:

- the point $n+1$ belongs to a rational components with 3 special points. In which case $\psi_{n+1} a_{\Gamma, I} = 0$;
- the point $n+1$ is carried by general vertex of level -1 which is not contracted after the forgetful map.

In the second case, we denote by (Γ', I') the twisted graph obtained after forgetting the marked point. We get:

$$\pi_*(\psi_{n+1} a_{\Gamma, I}) = (2g_{\Gamma', I', 1} - 2 + n_{\Gamma', I', 1}) a_{\Gamma', I'},$$

where $g_{\Gamma, 1}$ and $n_{\Gamma, 1}$ denote the genus and valency of the vertex of level -1 . Thus

$$(p_* \circ \pi_*) \sum_{\text{Bic}(g, Z')_{n+1}} m(I) \psi_{n+1} a_{\Gamma, I} = \sum_{(\Gamma, I) \in \text{BS}(g, Z)} m(I) (2g_{\Gamma', I', 1} - 2 + n_{\Gamma', I', 1}) a_{\Gamma, I}.$$

We obtain Relation (4) by replacing all the terms in Equation (2.5.2) by their expressions in terms of simple bicolored graphs. \square

Prym-Tyurin classes and loci of degenerate differentials

In the present chapter, we study the rational Picard group of the projectivized moduli space $P\overline{\mathcal{M}}_g^{(n)}$ of abelian n -differentials on complex genus g stable curves. We define $n-1$ natural classes in this Picard group that we call *Prym-Tyurin* classes. We express these classes as linear combinations of boundary divisors and the divisor of n -differentials with a double zero. We give two different proofs of this result, using two alternative approaches: an analytic approach that involves the Bergman tau function and its vanishing divisor and an algebro-geometric approach that involves cohomological computations on the universal curve.

The present chapter is mostly based on the article [56]

3.1. Prym-Tyurin classes

Remark 3.1.1. The article [56] has been written in cooperation with Dimitri Krotkin and Peter Zograf. Several pieces of notation in this chapter are different from the chapter introduction. This is due to the fact that we have tried to stay coherent in the introduction with the notation of the other chapters.

3.1.1. Moduli space of n -differentials. Let g and n be positive integers with $g \geq 2$. Let \mathcal{M}_g (respectively $\overline{\mathcal{M}}_g$) be the moduli space of smooth (respectively stable nodal) complex curves. Denote by $D_0 \subset \overline{\mathcal{M}}_g$ the closure of the locus of stable curves with one nonseparating node. Further, denote by $D_i \subset \overline{\mathcal{M}}_g$, $1 \leq i \leq [g/2]$, the closure of the locus of curves with a separating node and two irreducible components of genera i and $g-i$. Finally, denote by $\pi : \mathcal{C}_g \rightarrow \mathcal{M}_g$ or $\pi : \overline{\mathcal{C}}_g \rightarrow \overline{\mathcal{M}}_g$ the universal curve and by $\omega = \omega_{\overline{\mathcal{C}}_g/\overline{\mathcal{M}}_g}$ the relative dualizing sheaf.

Let

$$\Omega_g^{(n)} = R^0 \pi_* \omega^{\otimes n}$$

be the direct image of the n th tensor power of ω . Using the Riemann-Roch formula and Serre's duality, one can easily check that $h^1(C, \omega_C^{\otimes n}) = 0$ if $n \geq 2$ and $h^1(C, \omega_C) = 1$ for any stable curve C . Thus $\Omega_g^{(n)}$ is a vector bundle for any $n \geq 1$. For $n = 1$ we write Ω_g instead of $\Omega_g^{(1)}$ and call it the *Hodge bundle*. The Riemann-Roch formula implies:

$$\mathrm{rk} \Omega_g^{(n)} = \begin{cases} g & \text{if } n = 1; \\ (2n-1)(g-1) & \text{otherwise.} \end{cases}$$

We define the following elements in the rational Picard group of $\overline{\mathcal{M}}_g$:

- the Chern class $\lambda_n \in \mathrm{Pic}(\overline{\mathcal{M}}_g)$ of the determinant line bundle of $\Omega_g^{(n)}$;
- the Poincaré dual classes $\delta_0, \dots, \delta_{[g/2]} \in \mathrm{Pic}(\overline{\mathcal{M}}_g)$ of the boundary divisors $D_0, D_1, \dots, D_{[g/2]} \subset \overline{\mathcal{M}}_g$.

For $k = 1$ we write λ instead of λ_1 and call this class the *Hodge class*.

Definition 3.1.2. The total space of the vector bundle $\Omega_g^{(n)}$ is denoted by $\overline{\mathfrak{M}}_g^{(n)}$ and is called the *space of n -differentials*.

The points of $\overline{\mathfrak{M}}_g^{(n)}$ correspond to equivalence classes of pairs (C, w) , where C is a stable genus g algebraic curve, and w is an n -differential on C . We recall that an n -differential w on C is a meromorphic n -differential on each irreducible component of the normalization of C such that

- w can only have poles at the preimages of the nodes;
- these poles are of order at most n ;
- at every node the n -residues of w at the poles satisfy

$$\operatorname{res}_{p_1}(w) = (-1)^n \operatorname{res}_{p_2}(w)$$

where p_1 and p_2 are the two preimages of the node.

We denote by $\nu : \overline{\mathfrak{M}}_g^{(n)} \rightarrow \overline{\mathcal{M}}_g$ the forgetful map and we will use the same notation for its restriction $\nu : \mathfrak{M}_g^{(n)} \rightarrow \mathcal{M}_g$ to the locus of smooth curves. We also denote by $\tilde{\nu} : P\overline{\mathfrak{M}}_g^{(n)} \rightarrow \overline{\mathcal{M}}_g$ the projectivized space of n -differentials.

In the present Chapter, we study the Picard group of $P\overline{\mathfrak{M}}_g^{(n)}$. We will work over rational numbers, so that Pic will always denote the *rational* Picard group.

By abuse of notation we will denote by λ , λ_n and δ_i both the elements of $\operatorname{Pic}(\overline{\mathcal{M}}_g)$ and their pull-backs in $\operatorname{Pic}(P\overline{\mathfrak{M}}_g^{(n)})$. In addition, we introduce the first Chern class $\psi \in \operatorname{Pic}(P\overline{\mathfrak{M}}_g^{(n)})$ of the tautological line bundle $L \rightarrow P\overline{\mathfrak{M}}_g^{(n)}$.

The following lemma is standard (cf., e.g. [57], Lemma 1).

Lemma 3.1.3. *The classes $\lambda, \psi, \delta_0, \dots, \delta_{\lfloor g/2 \rfloor}$ form a basis of $\operatorname{Pic}(P\overline{\mathfrak{M}}_g^{(n)})$.*

The goal of the present Chapter is to define the Prym-Tyurin classes in $\operatorname{Pic}(P\overline{\mathfrak{M}}_g^{(n)})$ and express them in the above basis.

3.1.2. Stratification of $P\overline{\mathfrak{M}}_g^{(n)}$. The space of n -differentials is naturally stratified according to the multiplicities of the differential's zeros.

Let $\mathbf{k} = (k_1, \dots, k_m)$ be a partition of $n(2g-2)$. We denote by $\mathfrak{M}_g^{(n)}[\mathbf{k}] \subset \mathfrak{M}_g^{(n)}$ the locus of pairs (C, w) such that the n -differential w has m pairwise distinct zeros of orders exactly k_i . This locus is \mathbb{C}^* -invariant, thus we can also define its projectivization $P\mathfrak{M}_g^{(n)}[\mathbf{k}] \subset P\mathfrak{M}_g^{(n)}$. The space $P\mathfrak{M}_g^{(n)}$ is the disjoint union of the strata $P\mathfrak{M}_g^{(n)}[\mathbf{k}]$ for all partitions \mathbf{k} of $n(2g-2)$. The following properties of the strata were proved in [59] and [72].

- Each stratum $P\mathfrak{M}_g^{(n)}[\mathbf{k}]$ is smooth.
- If at least one k_i is not divisible by n then either $P\mathfrak{M}_g^{(n)}[\mathbf{k}]$ is empty or it has pure dimension $2g-3+m$.
- If all k_i 's are divisible by n then $P\mathfrak{M}_g^{(n)}[\mathbf{k}]$ has at least one irreducible component of dimension $2g-2+m$. A differential (C, w) lies in a component like that if and only if w is the n th power of a holomorphic differential. The stratum $P\mathfrak{M}_g^{(n)}[\mathbf{k}]$ may also have irreducible components of dimension $2g-3+m$ composed of n -differentials that are not n th powers.

We denote by $P\overline{\mathfrak{M}}_g^{(n)}[\mathbf{k}]$ the closure of $P\mathfrak{M}_g^{(n)}[\mathbf{k}]$ in $P\overline{\mathfrak{M}}_g^{(n)}$. In particular we have $P\overline{\mathfrak{M}}_g^{(n)}[\mathbf{1}] = P\overline{\mathfrak{M}}_g^{(n)}$, where $\mathbf{1}$ stands for the partition $(1, 1, \dots, 1)$.

Definition 3.1.4. Let $g, n \geq 2$. The *divisor of degenerate n -differentials* is defined as

$$D_{\text{deg}} = \begin{cases} P\overline{\mathcal{M}}_g^{(n)}[2, 1, \dots, 1], & \text{if } (g, n) \neq (2, 2), \\ P\overline{\mathcal{M}}_g^{(n)}[2, 1, 1] + 2 \cdot P\overline{\mathcal{M}}_g^{(n)}[2, 2], & \text{if } g = n = 2. \end{cases}$$

We denote by δ_{deg} the cohomology class that is Poincaré dual of D_{deg} .

Remark 3.1.5. Heuristically, D_{deg} is the divisor of n -differentials with a double zero, and for $(g, n) \neq (2, 2)$ it is just the closure of $P\overline{\mathcal{M}}_g^{(n)}[2, 1, \dots, 1]$ in $P\overline{\mathcal{M}}_g^{(n)}$. In the case $g = n = 2$, however, D_{deg} has a special component consisting of squares of holomorphic differentials. This is because in genus 2 each quadratic differential is invariant with respect to the hyperelliptic involution. The four simple zeroes of w are pairwise equivalent under the hyperelliptic involution, and when two non-equivalent zeroes coalesce, the other two ones also coalesce, giving a differential with two double zeroes. Since every such differential has two square roots that differ by a sign, the divisor $P\overline{\mathcal{M}}_g^{(n)}[2, 2]$ comes with a factor of 2. (Note that when two equivalent zeroes coalesce, the differential in the limit has one double zero at a Weierstrass point and two simple zeroes.)

3.1.3. First definition of Prym-Tyurin classes. Let (C, w) be a point in the projectivized moduli space $P\overline{\mathcal{M}}_g^{(n)}[\mathbf{1}]$. One can define a canonical cyclic ramified covering $f: \widehat{C} \rightarrow C$ of degree n , where

$$\widehat{C} = \{(x, v) | x \in C, v \in T_x^*C, v^n = w\}.$$

This covering is completely ramified over the zeros of w . The curve \widehat{C} is smooth of genus $\widehat{g} = n^2(g-1) + 1$. It comes with a *canonical holomorphic differential* v given by $v(x, v) = v$. This differential v on \widehat{C} satisfies $v^n = f^*w$.

The action of $\mathbb{Z}/n\mathbb{Z}$ on the covering is given by $\rho^k: (x, v) \mapsto (x, \rho^k v)$, where $\rho = e^{\frac{2\pi\sqrt{-1}}{n}}$. We denote by $\sigma: \widehat{C} \rightarrow \widehat{C}$ the automorphism of \widehat{C} corresponding to $k = 1$. Now consider the natural map

$$\begin{aligned} \widehat{v}: P\overline{\mathcal{M}}_g^{(n)}[\mathbf{1}] &\rightarrow \mathcal{M}_{\widehat{g}}, \\ (C, w) &\mapsto \widehat{C} \end{aligned}$$

(\widehat{C} remains the same when we multiply w by a non-zero constant). We consider the pull-back of the Hodge bundle $\Omega_{\widehat{g}}$ by the map \widehat{v} . The automorphism σ induces an endomorphism σ^* of the vector bundle $\widehat{v}^*\Omega_{\widehat{g}}$ given by: $((C, w), u) \mapsto ((C, w), \sigma^*u)$, where u is an element of $H^0(\widehat{C}, \omega_{\widehat{C}})$. The endomorphism σ^* satisfies $(\sigma^*)^n = \text{Id}$. Hence we have a decomposition

$$(3.1.1) \quad \widehat{v}^*\Omega_{\widehat{g}} = \bigoplus_{k=0}^{n-1} \Lambda^{(k)},$$

where $\Lambda^{(k)}$ is the eigenbundle of $\widehat{v}^*\Omega_{\widehat{g}}$ corresponding to the eigenvalue $\rho^k = e^{\frac{2\pi\sqrt{-1}k}{n}}$.

Remark 3.1.6. The space $\Lambda^{(k)}$ is a vector bundle because the dimension of the fiber of $\Lambda^{(k)}$ is upper-continuous for all k and $\widehat{v}^*\Omega_{\widehat{g}}$ is a vector bundle thus the rank of each $\Lambda^{(k)}$ is constant.

Definition 3.1.7. The vector bundles $\Lambda^{(k)}$ are called the *Prym-Tyurin vector bundles*. The *Prym-Tyurin class* $\lambda_{PT}^{(k)}$ is the first Chern class $c_1(\Lambda^{(k)}) \in \text{Pic}(P\mathfrak{M}_g^{(n)}[\mathbf{1}])$.

For $n = 2$ the study of vector bundles of this type was initiated by Prym [69] and for $n > 2$ by A. N. Tyurin [7].

Remark 3.1.8. By abuse of notation we denote in the same way the *determinant line bundle* $\lambda_{PT}^{(k)} = \det \Lambda^{(k)}$ and its class in the Picard group.

We will see in Section 3.5 that the map $\hat{\nu} : \mathfrak{M}_g^{(n)} \rightarrow \mathcal{M}_{\hat{g}}$, used to define the Prym-Tyurin vector bundles, admits no natural extension to $P\overline{\mathfrak{M}}_g^{(n)}$. Nonetheless, in the next section we extend the definition of the Prym-Tyurin class to $P\overline{\mathfrak{M}}_g^{(n)}$ by a construction involving the space of admissible covers and an intermediate bigger stack.

3.1.4. Admissible coverings and Prym-Tyurin bundles. Let $N = 2n(g-1)$ be the degree of $\omega^{\otimes n}$. We denote by Hur_g^n the moduli space whose geometric points are isomorphism classes of pairs $(f : \hat{C} \rightarrow C, \sigma)$ where:

- C and \hat{C} are smooth curves;
- f is a cyclic ramified covering of degree n which is totally ramified over N distinct points of C ;
- σ is an automorphism of \hat{C} that commutes with f .

We denote by $\overline{\text{Hur}}_g^n$ the compactification of this space by admissible coverings (see [40]). The space of admissible coverings has two forgetful maps (source and target of the covering):

$$\begin{array}{ccc} & \overline{\text{Hur}}_g^n & \\ \text{target} \swarrow & & \searrow \text{source} \\ \overline{\mathcal{M}}_{g,N}/S_N & & \overline{\mathcal{M}}_{\hat{g}} \end{array}$$

We consider the pull-back $\text{source}^* \Omega_{\hat{g}}$ of the Hodge bundle under the source map. This vector bundle is endowed with the automorphism

$$\sigma^* : \left((\hat{C} \rightarrow C, \sigma), u \right) \mapsto \left((\hat{C} \rightarrow C, \sigma), \sigma^* u \right).$$

Thus, as in (3.1.1), we have the decomposition

$$(3.1.2) \quad \text{source}^* \Omega_{\hat{g}} = \bigoplus_{k=0}^{n-1} \Lambda^{(k)},$$

where $\Lambda^{(k)}$ is the eigenbundle corresponding to the eigenvalue $\rho^k = e^{\frac{2\pi\sqrt{-1}k}{n}}$.

In the previous section we have constructed an embedding $i : P\mathfrak{M}_g^{(n)}[\mathbf{1}] \hookrightarrow \overline{\text{Hur}}_g^n$ and, by construction, the pull-back $i^* \Lambda^{(k)}$ is, indeed, isomorphic to the Prym-Tyurin bundle $\Lambda^{(k)}$ over $P\mathfrak{M}_g^{(n)}[\mathbf{1}]$ as defined in the previous section.

We see that the Prym-Tyurin vector bundles, and therefore the Prym-Tyurin classes, have a natural extension to the compactification of $P\mathfrak{M}_g^{(n)}[\mathbf{1}]$ by admissible covers. We would like, however, to extend the Prym-Tyurin classes to a different compactification of $P\mathfrak{M}_g^{(n)}[\mathbf{1}]$, namely, to $P\overline{\mathfrak{M}}_g^{(n)}$. To do that we will construct a

bigger space with a projection to both $\overline{\text{Hur}}_g^n$ and $P\overline{\mathfrak{M}}_g^{(n)}$ and use the push-forward of a pull-back.

3.1.5. Space of admissible differentials.

Definition 3.1.9. Let

$$I : \mathfrak{M}_g^{(n)}[\mathbf{1}] \hookrightarrow \overline{\mathfrak{M}}_g^{(n)} \times_{\overline{\mathcal{M}}_g} \overline{\text{Hur}}_g^n$$

be the product of the two natural embeddings. The *moduli space of admissible n differentials* $X(g, n)$, is the Zariski closure of the image of I in $\overline{\mathfrak{M}}_g^{(n)} \times \overline{\text{Hur}}_g^n$.

Remark 3.1.10. The space of admissible n -differentials is a compactification of the stratum $\mathfrak{M}_g^{(n)}[\mathbf{1}]$. In [4], the authors introduced and described another compactification, the *incidence variety compactification*. The incidence variety is obtained by replacing the space $\overline{\text{Hur}}_g^n$ by the space $\overline{\mathcal{M}}_{g,N}/S_N$ in Definition 3.1.9. We denote the incidence variety by $X_{g,n}^{\text{inc}}$.

There is a birational and finite map from $X_{g,n}$ to $X_{g,n}^{\text{inc}}$, however this map is not an isomorphism (see Example 4.3 of [4]). We will make use of $X_{g,n}^{\text{inc}}$ once in this text (proof of Lemma 3.2.3).

The space $X(g, n)$ has two natural morphisms: $\text{adm} : X(g, n) \rightarrow \overline{\text{Hur}}_g^n$ and $\text{diff} : X(g, n) \rightarrow P\overline{\mathfrak{M}}_g^{(n)}$. We summarize the notation on the following diagram.

$$\begin{array}{ccccc} & & \bigoplus \Lambda^{(k)} & \xrightarrow{\text{source}^*} & \Omega_{\widehat{g}} \\ & & \downarrow & & \downarrow \\ X(g, n) & \xrightarrow{\text{adm}} & \overline{\text{Hur}}_g^n & \xrightarrow{\text{source}} & \overline{\mathcal{M}}_{\widehat{g}} \\ \downarrow \text{diff} & & & & \\ & & P\overline{\mathfrak{M}}_g^{(n)} & & \end{array}$$

By construction the forgetful map $\text{diff} : X(g, n) \rightarrow P\overline{\mathfrak{M}}_g^{(n)}$ is birational and its restriction to $P\overline{\mathfrak{M}}_g^{(n)}[\mathbf{1}]$ is an isomorphism onto its image. In general the space $X(g, n)$ is not normal; thus the push-forward of classes in the Picard group under diff is ill-defined. However we will prove the following proposition in Section 3.2.

Proposition 3.1.11. *There exist two smooth open-dense substacks $j : V \hookrightarrow X(g, n)$ and $j' : U \hookrightarrow P\overline{\mathfrak{M}}_g^{(n)}$ fitting into the commutative diagram*

$$\begin{array}{ccc} V & \xrightarrow{j} & X(g, n) \\ \downarrow & & \downarrow \text{diff} \\ U & \xrightarrow{j'} & P\overline{\mathfrak{M}}_g^{(n)} \end{array}$$

such that

- the map $V \rightarrow U$ is an isomorphism on the underlying coarse spaces;
- the complement of U is of codimension at least 2 in $P\overline{\mathfrak{M}}_g^{(n)}$.

The existence of U and V as above allows one to define the induced push-forward diff_* in the Picard groups. Indeed, the first property ensures that $\text{Pic}(U)$ and $\text{Pic}(V)$ are isomorphic. Similarly, the second property ensures that j' induces an isomorphism between $\text{Pic}(U)$ and $\text{Pic}(\overline{\mathcal{M}}_g^{(n)})$. Thus, given an element in $\text{Pic}(X_{g,n})$, one defines its push-forward to $\text{Pic}(\overline{\mathcal{M}}_g^{(n)})$ by first taking its pull-back by j , then the push-forward from V to U , and finally the push-forward by j' .

Definition 3.1.12. The Prym-Tyurin class $\lambda_{PT}^{(k)}$ on $\overline{\mathcal{M}}_g^{(n)}$ is defined by the formula $\lambda_{PT}^{(k)} = \text{diff}_* c_1(\Lambda^{(k)})$.

3.1.6. Statement of the results. The main result obtained in the present Chapter is the expression for the Prym-Tyurin classes and the class δ_{deg} of Definition 3.1.4 in the $(\lambda, \psi, \delta_i)$ basis.

Theorem 3.1.13. In the rational Picard group of $\overline{\mathcal{M}}_g^{(n)}$ we have

$$(3.1.3) \quad \delta_{\text{deg}} = 12n(n+1)\lambda - 2(g-1)(2n+1)\psi - n(n+1) \sum_{i=0}^{\lfloor g/2 \rfloor} \delta_i;$$

$$(3.1.4) \quad \lambda_{PT}^{(n-k)} = (6k^2 + 6k + 1)\lambda - \frac{g-1}{n}k(2k+1)\psi - \frac{1}{2}k(k+1) \sum_{i=0}^{\lfloor g/2 \rfloor} \delta_i + c_k \delta_{\text{deg}},$$

where

$$(3.1.5) \quad c_k = \begin{cases} \frac{2k-n}{2n}, & \text{if } (n-1)/2 < k < n, \\ 0, & \text{otherwise.} \end{cases}$$

3.1.7. Strategy of the proof. Formula (3.1.3) of Theorem 3.1.13 is proved in two distinct ways.

- In Section 3.3 we introduce the Bergman tau function on the moduli space $\mathcal{M}_g^{(n)}$. We study its transformation property and its asymptotic behavior at the boundary divisors D_{deg} and D_i , $0 \leq i \leq \lfloor g/2 \rfloor$. We explicitly compute the vanishing order of the Bergmann tau function along these divisors. We use these results to express the divisor δ_{deg} in the $(\lambda, \delta_i, \psi)$ basis of the Picard group. This first proof is a further development of the ideas introduced in [57] and [58].
- In Section 3.4 we give an alternative proof of Formula (3.1.3) based on algebro-geometric computations as introduced in [71] and [84] in the context of abelian differentials. We consider the moduli space of n -differentials on genus g curves with one marked point. This space carries a vector bundle of 2-jets of an n -differential at the marked point. The Euler class of this vector bundle has a natural expression involving the locus A_2 of n -differentials with a double zero at the marked point. The locus A_2 pushes forward to D_{deg} under the forgetful map that forgets the marked point. This allows one to compute the cohomology class δ_{deg} that is Poincaré dual to the divisor class of D_{deg} .

To prove Formulas (3.1.4) and (3.1.5) we combine (3.1.3) with the following two facts.

- First, the well-known Mumford formula [62] expressing the first Chern class of the vector bundle of k -differentials on $\overline{\mathcal{M}}_g$ via the Hodge class:

$$(3.1.6) \quad \lambda_k = (6k^2 - 6k + 1)\lambda - \frac{k(k-1)}{2} \sum_{i=0}^{\lfloor g/2 \rfloor} \delta_i .$$

- Second, the fact that the morphism

$$(3.1.7) \quad \begin{array}{ccc} \Phi_k : \Lambda^{(k)} \otimes T^{\otimes n-k} & \rightarrow & H^0(C, \omega_C^{n-k+1}) \\ (q, v^{n-k}) & \mapsto & qv^{n-k} \end{array}$$

is actually an isomorphism of vector bundles outside D_{deg} .

The second fact allows one to compute the rank of the Prym-Tyurin vector bundle $\Lambda^{(k)}$:

$$(3.1.8) \quad \text{rk } \Lambda^{(k)} = \text{rk } \Omega^{(n-k+1)} = (2n - 2k + 1)(g - 1), \quad k = 1, \dots, n - 1 .$$

It also implies that

$$(3.1.9) \quad \lambda_{PT}^{(k)} = \lambda_{n-k+1} - \frac{g-1}{n} (n-k)(2n-2k+1)\psi + \text{const} \cdot \delta_{\text{deg}} .$$

In Section 3.5, we study the asymptotic of the determinant of Φ_k along the divisor D_{deg} to obtain Expressions (3.1.4) and (3.1.5).

Remark 3.1.14. Presence of an additional contribution proportional to δ_{deg} in (3.1.4) for $k > (n-1)/2$ was first suggested by the third author in [82] using an idea of [84].

Plan of the present Chapter. In Section 3.2 we prove Proposition 3.1.11 and thus complete the definition of the Prym-Tyurin classes. In Sections 3.3 and 3.4 we prove Formula (3.1.3) of Theorem 3.1.13 using the two different approaches described above. In Section 3.5 we discuss the relationship between Prym-Tyurin vector bundles and vector bundles of k -differentials and derive a relationship between corresponding determinant line bundles. This allows us to express the Prym-Tyurin classes in the $(\lambda, \delta_i, \psi)$ basis of the Picard group and complete the proof of Theorem 3.1.13.

3.2. Space of admissible n -differentials

In this Section we justify the definition of the Prym-Tyurin classes by proving the following extended version of Proposition 3.1.11.

Proposition 3.2.1. *There exist two smooth open-dense substacks $j : V \hookrightarrow X(g, n)$ and $j' : U \hookrightarrow \overline{\mathcal{PM}}_g^{(n)}$ fitting into the commutative diagram*

$$\begin{array}{ccc} V & \xrightarrow{j} & X(g, n) \\ \downarrow & & \downarrow \text{diff} \\ U & \xrightarrow{j'} & \overline{\mathcal{PM}}_g^{(n)} \end{array}$$

such that

- V and U contain the image of $P\mathfrak{M}_g^{(n)}[\mathbf{1}]$ under the embeddings into $X(g, n)$ and $\overline{P\mathfrak{M}}_g^{(n)}$;
- the complement of U is of codimension at least 2 in $\overline{P\mathfrak{M}}_g^{(n)}$;
- the map $V \rightarrow U$ is an isomorphism on the underlying coarse spaces;
- there exists a line bundle $T \rightarrow V$ such that T is a sub-vector bundle of $\Lambda^{(1)}$, $T^{\otimes n} \simeq L$ and the restriction of T to $P\mathfrak{M}_g^{(n)}[\mathbf{1}]$ coincides with the sub-vector bundle of $\hat{v}^*\Omega_{\hat{g}}$ spanned by v .

3.2.1. Distinguished local coordinates on a cyclic covering. Consider a curve C endowed with an n -differential w with simple zeros. Let $f: \hat{C} \rightarrow C$ be the associated covering and $v = w^{1/n}$ be the canonical abelian differential on \hat{C} . Denote by $x_i \in C$, $i = 1, \dots, N = 2n(g-1)$, the branch points of $\hat{C} \rightarrow C$, which coincide with the zeros of w . Denote by \hat{x}_i the unique preimage of x_i in \hat{C} . Here we describe a specific parametrization of the covering curve \hat{C} near the branching points of $f: \hat{C} \rightarrow C$. It is easy to see that all zeros of the holomorphic 1-form v are situated at the ramification points \hat{x}_i and have multiplicity n . In other words,

$$(3.2.1) \quad (v) = n\hat{x}_1 + \dots + n\hat{x}_N.$$

Introduce a local parameter ζ_i in a neighborhood of $x_i \in C$ and a local parameter ξ_i in a neighborhood of $\hat{x}_i \in \hat{C}$ such that

$$(3.2.2) \quad w = \zeta_i (d\zeta_i)^n, \quad \xi_i(\hat{x})^{n+1} = \int_{\hat{x}_i}^{\hat{x}} v.$$

Both parameters are defined up to an $(n+1)$ st root of unity and we make one choice in such a way that

$$\zeta_i = \left(\frac{n+1}{n} \right)^{n/(n+1)} \xi_i^n.$$

The local parameters ξ_i on \hat{C} and ζ_i on C given by (3.2.2) are called *distinguished*.

Since $f^*v = \rho v$, the local parameter $\xi_i(x)$ transforms under the action of f as $\xi_i(f(x)) = \rho \xi_i(x)$.

3.2.2. Extension of the Prym-Tyurin bundles to codimension 1 loci. By construction, $P\mathfrak{M}_g^{(n)}[\mathbf{1}]$ is an open dense substack of $X(g, n)$. Thus $\text{diff}: X(g, n) \rightarrow \overline{P\mathfrak{M}}_g^{(n)}$ is birational and its restriction to $P\mathfrak{M}_g^{(n)}[\mathbf{1}]$ is an isomorphism onto its image.

By abuse of notation we denote by D_i , $0 \leq i \leq [g/2]$, the preimage in $\overline{P\mathfrak{M}}_g^{(n)}$ of the boundary divisor $D_i \subset \overline{\mathcal{M}}_g$. Then the complement of $P\mathfrak{M}_g^{(n)}[\mathbf{1}]$ in $\overline{P\mathfrak{M}}_g^{(n)}$ is the union of the divisors D_i and D_{deg} .

For each of these divisors we define a dense open locus $\tilde{D} \subset D$ as follows.

- \tilde{D}_0 is the locus of (C, w) such that the curve C has exactly one non-separating node and the differential w has poles of order n at the node and N simple zeros;
- \tilde{D}_i for $i \geq 1$ is the locus of (C, w) such that the curve C has exactly one separating node and the differential w has poles of order n at the node and N simple zeros.

- \tilde{D}_{deg} if $(g, n) \neq (2, 2)$ is the locus of (C, w) such that the curve C is a smooth curve and the differential w has one zero of order exactly 2 and its other zeros are simple;
- \tilde{D}_{deg} if $(g, n) = (2, 2)$ is the disjoint union of the locus $\tilde{D}_{\text{deg}}(2, 1, 1)$ described above and of the locus $\tilde{D}_{\text{deg}}(2, 2)$ of pairs (C, w) where C is smooth and w is a square of a holomorphic differential with simple zeros.

We define U as the union of $P\overline{\mathcal{M}}_g^{(n)}[\mathbf{1}] \cup \tilde{D}_{\text{deg}} \cup_i \tilde{D}_i \subset P\overline{\mathcal{M}}_g^{(n)}$. We define V as $\text{diff}^{-1}(U) \subset X(g, n)$. We will prove that U and V satisfy the properties of Proposition 3.2.1.

Property 1 is satisfied by construction.

Lemma 3.2.2 (Property 2). *The stack U is an open substack of $P\overline{\mathcal{M}}_g^{(n)}$ and its complement is of codimension at least 2.*

PROOF. The complement of U is a union of closed substacks: the strata of curves with at least two nodes and the strata $P\overline{\mathcal{M}}_g^{(n)}[\mathbf{k}]$ for all \mathbf{k} except $(1, \dots, 1)$ and $(2, 1, \dots, 1)$. Thus U is an open substack in $P\overline{\mathcal{M}}_g^{(n)}$ and by dimension count its complement is of codimension at least 2. \square

Lemma 3.2.3 (Property 3). *The restriction of $\text{diff} : V \rightarrow U$ induces an isomorphism on the underlying schemes. Moreover the map of stacks $\text{diff} : V \rightarrow U$ is of degree one over $U \setminus D_{\text{deg}}$ and of degree $1/2$ over D_{deg} .*

PROOF. The underlying scheme of U is smooth and the map $\text{diff} : V \rightarrow U$ is birational. Thus the map diff of schemes is an isomorphism if and only if it is finite. We consider the incidence variety $X_{g,n}^{\text{inc}}$ compactification defined in Remark 3.1.10. We have two birational map: $\text{diff}' : X_{g,n}^{\text{inc}} \rightarrow X_{g,n}$ and $\epsilon : X_{g,n}^{\text{inc}} \rightarrow \overline{\mathcal{M}}_g^{(n)}$ such that $\text{diff} = \text{diff}' \circ \epsilon$. The map diff' is obtained by forgetting the admissible covering (but not the markings) and ϵ is obtained by forgetting the markings. As we have already stated in Remark 3.1.10, the map diff' is finite because $\overline{\text{Hur}}_{g,n} \rightarrow \overline{\mathcal{M}}_{g,N}/S_N$ is finite. Therefore we need to check that the map ϵ restricted to $\epsilon^{-1}(U)$ is finite.

The restriction $\epsilon : \epsilon^{-1}(U) \rightarrow U$ is a bijection. Indeed, if (C, w) be a n -differential in $U \setminus D_{\text{deg}}$, then the preimage of (C, w) under ϵ is the n -differential w with the marked simple zeros. Now if (C, w) is a n -differential in \tilde{D}_{deg} then the preimage of (C, w) is the point (C', w', x_i) where C' is the curve with two components: one component isomorphic to C and one rational component attached to C at the double zero; the differential w' is then given by w on the main component and vanishes identically on the rational component; finally the marked points are the simple zeros on the main component and two marked points on the rational component.

Therefore $\epsilon : \epsilon^{-1}(U) \rightarrow U$ is finite and $\text{diff} : V \rightarrow U$ is birational and finite thus an isomorphism of the underlying schemes. Moreover the restriction of the map ϵ to $U \setminus D_{\text{deg}}$ is obviously an isomorphism of stacks. The degree of diff along D_{deg} will be computed in the next paragraphs. \square

Lemma 3.2.4 (Property 4). *There exists a line bundle $T \rightarrow V$ such that $T^{\otimes n} \simeq L$, T is a sub-vector bundle of $\Lambda^{(1)}$, and the restriction of T to $P\overline{\mathcal{M}}_g^{(n)}[\mathbf{1}]$ coincides with the sub-vector bundle of $\hat{v}^*\Omega_{\hat{g}}$ spanned by v .*

The proof requires a detailed analysis of the inverse morphism $\text{diff}^{-1} : U \rightarrow V$ and is contained in the next two subsections.

3.2.2.1. *Nodal curves.* Let $0 \leq i \leq [g/2]$ and let (C, w) be a point in \tilde{D}_i . The n -fold covering associated to (C, w) is given by $\hat{C} = \{(x, v) \in T_C^* / v^n = w\}$ and the canonical differential v is still defined by $v(x, v) = v$. We can describe the topology of \hat{C} and the singularities (zeros and poles) of v :

- If $i = 0$, then the curve \hat{C} is an irreducible curve with n self-intersections. The differential v has zeros of order n at the marked points and poles of order 1 at the nodes.
- If $i \geq 1$ then the \hat{C} has two irreducible components intersecting at n distinct nodes. The differential v has also zeros of order n at the marked points and poles of 1 at the nodes.

The canonical differential v is well-defined on $U \setminus D_{\text{deg}}$, thus the line bundle T can be extended to $\text{diff}^{-1}(U \setminus D_{\text{deg}})$.

3.2.2.2. *Degenerate differentials.* Here we describe the local structure of the stacks $X(g, n)$ and $\overline{\mathfrak{M}}_g^{(n)}$ close to D_{deg} . This allows us to explicit the isomorphism of Lemma 3.2.3 and to describe the fiber of the canonical line bundle along \tilde{D}_{deg} . Let (C_0, w_0) be a point in \tilde{D}_{deg} and let W be a neighborhood of (C_0, w_0) in D_{deg} . We will give a local parametrization of $X(g, n)$ and $\overline{\mathfrak{M}}_g^{(n)}$ around the point (C_0, w_0) .

- *Parameters of $\overline{\mathfrak{M}}_g^{(n)}$.* A neighborhood of (C_0, w_0) is given by $W \times \Delta$ where Δ is a disk of \mathbb{C} centered at zero. A point (u, a) in $W \times \Delta$ parametrizes an n -differentials (C, w) such that

$$w = (\zeta^2 + a)d\zeta^n.$$

where the parameter ζ of the curve C is uniquely determined by the choice of a . The parameter a is a transverse local parameter of D_{deg} in $\overline{\mathfrak{M}}_g^{(n)}$.

- *Parameters of $X(g, n)$.* A neighborhood of (C_0, w_0) in $X_{g, n}$ is parametrized by $W \times \Delta' / (\mathbb{Z}/2\mathbb{Z})$ where Δ' is a disk of \mathbb{C} centered at zero. Indeed, suppose first that the two colliding zeros of a differential (C, w) are labeled x_1 and x_2 . Let ζ be a local parameter of C such that the positions of x_1 and x_2 are given by ζ_1 and ζ_2 , respectively. To fix ζ uniquely we can define it by exact relation:

$$w(x) = (\zeta(x) - \zeta_1)(\zeta(x) - \zeta_2)(d\zeta(x))^n, \quad x \in C.$$

The parameter $(\zeta_1 - \zeta_2) / \{\pm 1\}$ is a local transverse parameter to D_{deg} in $X(g, n)$ (See Lemma 3.3.6 for a proof).

With these two local parametrizations, the map $\text{diff} : X(g, n) \rightarrow \overline{\mathfrak{M}}_g^{(n)}$ is given by

$$\begin{aligned} W \times \Delta' / (\mathbb{Z}/2\mathbb{Z}) &\rightarrow W \times \Delta \\ (u, \zeta_1 - \zeta_2) &\mapsto (u, (\zeta_1 - \zeta_2)^2). \end{aligned}$$

This map is indeed an isomorphism of the underlying schemes. However it is of degree 1/2 along $D_{\text{deg}} \subset X(g, n)$ once we consider the stack structures of $X(g, n)$ and $\overline{\mathfrak{M}}_g^{(n)}$. This finishes the proof of Lemma 3.2.3.

Finally we describe the extension of the canonical line bundle T to D_{deg} . Let (C, w) be a family of differentials with simple zeros which tends to $(C_0, w_0) \in D_{\text{deg}} \subset X(g, n)$. Once again we label the two coalescing zeros x_1 and x_2 and we use the local parameter of the curve ζ with $\zeta(x_i) = \zeta_i$ and $w(x) = (\zeta(x) - \zeta_1)(\zeta(x) - \zeta_2)(d\zeta(x))^n$

As (C, w) tends to a pair (C_0, w_0) the zeros x_1 and x_2 tend to the double zero x_0 of w_0 . The limit curve C_0 is a nodal curve with two components: a Riemann sphere C_1 which gets naturally equipped with the *meromorphic* n -differential $w_1(\zeta)$ given by the formula

$$(3.2.3) \quad w_1(\zeta) = (\zeta - \zeta_1)(\zeta - \zeta_2)(d\zeta)^n, \quad \zeta \in C_1,$$

which is holomorphic outside of $\zeta = \infty$ and has two simple zeros at ζ_1 and ζ_2 . The Riemann surface C_2 is equipped with the holomorphic n -differential w_0 . The nodal point on C_0 is formed by identifying the point $\zeta = \infty$ on C_1 with the point x_0 on C_2 .

The limit n -differential (C_0, w_0) determines a canonical n -sheeted covering $\widehat{C}_0 \rightarrow C_0$. The curve \widehat{C}_0 consists of two components \widehat{C}_1 and \widehat{C}_2 . The canonical covering \widehat{C}_1 of C_1 is given by equation

$$(3.2.4) \quad v_1^n = w_1(\zeta)$$

which, if we write $v_1 = yd\zeta$, is the curve

$$(3.2.5) \quad y^n = (\zeta - \zeta_1)(\zeta - \zeta_2)$$

of genus $\widehat{g}_1 = [(n-1)/2]$. The canonical covering \widehat{C}_2 of C_2 is defined by the equation

$$(3.2.6) \quad v_2^n = w_2;$$

its genus equals $\widehat{g}_2 = \widehat{g} - [n/2]$. Therefore, for odd n we have $\widehat{g} = \widehat{g}_1 + \widehat{g}_2$ while for even n we have $\widehat{g} = \widehat{g}_1 + \widehat{g}_2 + 1$.

The difference between the case of even n and the case of odd n is due to the fact that for odd n the coverings \widehat{C}_1 and \widehat{C}_2 intersect at only one nodal point while for even n the nodal point on C_0 has two pre-images on \widehat{C}_0 i.e. for even n \widehat{C}_1 and \widehat{C}_2 intersect at two nodal points, $x_0^{(1)}$ and $x_0^{(2)}$ (see Figure 1 below).

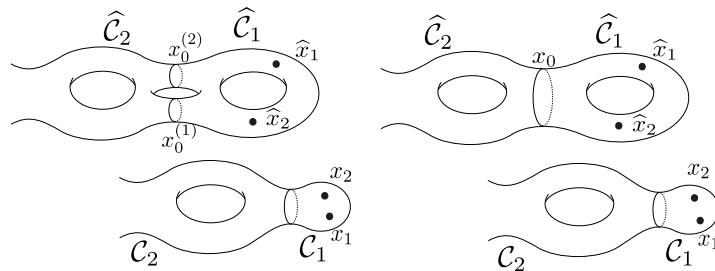

FIGURE 1. Examples of degeneracy of canonical n -coverings (before colliding the zeros): on the left $n = 4$ and on the right $n = 3$.

With this description of the limit covering, we define the limit canonical differential v_0 as follows: it is given by $v_0 = v_2$ on the component \widehat{C}_2 and vanishes

identically on the rational component \widehat{C}_1 . It satisfies $v_0^n = f^* w_0$. Thus the canonical line bundle T can be extended to the open set V . This completes the proof of Lemma 3.2.4.

3.3. Bergman tau function and Hodge class on $P\overline{\mathcal{M}}_g^{(n)}$

Tau functions play an important role in the theory of integrable systems providing canonical generators for commuting flows on the phase space [2]. In some cases tau functions carry interesting algebro-geometric information, like the isomonodromic tau function of the Riemann-Hilbert problem that is relevant in the theory of Frobenius manifolds [18].

The Bergman tau function introduced in [51] allowed to express the Hodge class on the space of admissible covers of the projective line as an explicit linear combination of the boundary divisors [52]. Then in [77] this result was proven by pure algebro-geometric methods (namely, by means of the Grothendieck-Riemann-Roch theorem) and later in [76] used to answer a question of Harris-Mumford [40] about the classes of Hurwitz divisors in the moduli space $\overline{\mathcal{M}}_g$ of stable complex algebraic curves of even genus g .

A version of the Bergman tau function for the moduli space of holomorphic abelian differentials on algebraic curves [52] allowed to get new relations in the rational Picard group of this space and was applied to the Kontsevich-Zorich theory of Teichmüller flow [57], see also [23]. In [58], the Bergman tau function was used to express the Prym class on the moduli space of holomorphic quadratic differentials in terms of the standard generators. Here we continue with developing these ideas further for the moduli space of holomorphic n -differentials.

3.3.1. Bergman tau function on strata of n -differentials. We begin with defining the Bergman tau function for each stratum $\mathcal{M}_g^{(n)}[\mathbf{k}]$ where $\mathbf{k} = (k_1, \dots, k_m)$ is a partition of $N = 2n(g-1)$. We introduce the following notation (see [29] for precise definitions):

- v_1, \dots, v_g – the normalized basis of holomorphic abelian differentials with respect to a given Torelli marking (or cut system) on C ;
- Ω – the corresponding period matrix;
- $\Theta(z, \Omega)$ – the theta function associated with Ω ;
- $W(x)$ – the Wronskian determinant of differentials v_1, \dots, v_g ;
- \tilde{C} – the fundamental polygon corresponding to the chosen cut system on C ;
- $E(x, y)$ – the prime form on $C \times C$;
- \mathcal{A}_x – the Abel map corresponding to the initial point x ;
- K^x – the vector of Riemann constants.

The distinguished local parameters on C in a neighborhood of the points x_i (zeroes of the n -differential w) are given by

$$(3.3.1) \quad \zeta_i(x) = \left(\int_{x_i}^x v \right)^{n/(k_i+n)}$$

where k_i is the order of x_i (in terms of these parameters $w \sim \zeta_i^{k_i} (d\zeta_i)^n$ near $x_i \in C$, and $v = w^{1/n} \sim \zeta_i^{k_i/n} d\zeta_i$ near $\hat{x}_i = f^{-1}(x_i) \in \widehat{C}$). Then for the prime form $E(x, y)$ on

$C \times C$ we have

$$E(x, y) = \frac{E(\zeta(x), \zeta(y))}{\sqrt{d\bar{\zeta}(x)}\sqrt{d\bar{\zeta}(y)}},$$

and we put

$$\begin{aligned} E(\zeta, x_k) &= \lim_{y \rightarrow x_k} E(\zeta(x), \zeta(y)) \sqrt{\frac{d\zeta_k}{d\zeta}(y)}, \\ E(x_k, x_l) &= \lim_{\substack{x \rightarrow x_k \\ y \rightarrow x_l}} E(\zeta(x), \zeta(y)) \sqrt{\frac{d\zeta_k}{d\zeta}(x)} \sqrt{\frac{d\zeta_l}{d\zeta}(y)}. \end{aligned}$$

We define two vectors $Z, Z' \in \frac{1}{n}\mathbb{Z}^g$ by the condition

$$(3.3.2) \quad \frac{1}{n}\mathcal{A}_x((w)) + 2K^x = \Omega Z + Z'.$$

Definition 3.3.1. The Bergman tau function on the space $\mathfrak{M}_g^{(n)}[\mathbf{k}]$ is given by

$$(3.3.3) \quad \tau(C, w) = c(x)^{2/3} e^{-\frac{\pi}{6}\langle \Omega Z, Z \rangle - \frac{2\pi\sqrt{-1}}{3}\langle Z, K^x \rangle} \left(\frac{w(x)}{\prod_{i=1}^m E^{k_i}(x, x_i)} \right)^{(g-1)/3n} \prod_{i < j} E(x_i, x_j)^{\frac{k_i k_j}{6n^2}},$$

where

$$c(x) = \frac{1}{W(x)} \left(\sum_{i=1}^g v_i(x) \frac{\partial}{\partial z_i} \right)^g \theta(z; \Omega) \Big|_{z=K^x}$$

Proposition 3.3.2. Under the change of Torelli marking on C

$$\begin{pmatrix} \tilde{b} \\ \tilde{a} \end{pmatrix} = \begin{pmatrix} A & B \\ C & D \end{pmatrix} \begin{pmatrix} b \\ a \end{pmatrix}, \quad \begin{pmatrix} A & B \\ C & D \end{pmatrix} \in Sp(2g, \mathbb{Z}),$$

the tau function (3.3.3) transforms as follows:

$$(3.3.4) \quad \frac{\tau(C, w, \{\tilde{a}_i, \tilde{b}_i\})}{\tau(C, w, \{a_i, b_i\})} = \epsilon \det(C\Omega + D)$$

where ϵ is a root of unity of degree $48d$ with $d = \text{l.c.m.}(k_1 + n, \dots, k_m + n)$.

The proof can be obtained by using standard transformation properties of all factors in (3.3.3) under the change of Torelli cut system on C (cf. [29]). The root of unity appears due to an ambiguity in the definition of the distinguished local parameters (3.3.1), which translates into an ambiguity in the definition of $E(x, x_i)$ and $E(x_i, x_j)$. The appearance of the term $\det(C\Omega + D)$ can also be seen from variational formulas for $\tau(C, w)$ discussed below, similarly to [52, 57, 58].

Proposition 3.3.3. The tau function has the following quasi-homogeneity property:

$$(3.3.5) \quad \tau(C, \delta w) = \delta^\kappa \tau(C, w)$$

with

$$(3.3.6) \quad \kappa = \frac{1}{12n^2} \sum_{i=1}^m \frac{k_i(k_i + 2n)}{k_i + n}.$$

This proposition follows from the explicit formula (3.3.3), but can also be derived by applying the Riemann bilinear identity to variational formulas for τ as in was done in [52] in the context of Hurwitz spaces.

Combining Propositions 3.3.2 and 3.3.3, we arrive at the following

Theorem 3.3.4. *On the stratum $\mathfrak{M}_g^{(n)}[\mathbf{1}] \subset \overline{\mathfrak{M}}_g^{(n)}$ of n -differentials with simple zeroes, the power $\tau^{48n(n+1)}$ of the tau function $\tau = \tau(C, w)$ is a nowhere vanishing holomorphic section of the line bundle $\lambda^{48n(n+1)} \otimes L^{-8(g-1)(2n+1)} \rightarrow \mathfrak{M}_g^{(n)}[\mathbf{1}]$.*

In order to find the divisor of the section $\tau^{48n(n+1)}$ on $\overline{\mathfrak{M}}_g^{(n)}$, we will compute the asymptotics of τ at the boundary divisors D_{deg} and D_j , $j = 0, 1, \dots, [g/2]$. For that we need to study the tau function more carefully.

3.3.2. Homological coordinates and variational formulas for the tau function. The tau function $\tau(C, w)$ satisfies a system of linear differential equations on the space $\mathfrak{M}_g^{(n)}$ similar to the tau functions on Hurwitz spaces, or spaces of abelian or quadratic differentials [52, 51, 57, 58]. Here we assume that all zeros of w are simple i.e. that all $k_i = 1$ in (3.3.3).

The homology group $H_1(\widehat{C}, \mathbb{C})$ can be decomposed into the eigenspaces of the automorphism σ_* :

$$H_1(\widehat{C}, \mathbb{C}) = \bigoplus_{i=0}^{n-1} \mathcal{H}_k,$$

where $\dim \mathcal{H}_0 = 2g$ and in the case of simple zeros the dimensions of \mathcal{H}_k for $k = 1, \dots, n-1$ are independent of k and

$$(3.3.7) \quad \dim \mathcal{H}_k = (2n+2)(g-1), \quad k = 1, \dots, n-1$$

The dimensions (3.3.7) can be computed as the dimensions of the dual spaces \mathcal{H}^k in cohomology of \widehat{C} , where \mathcal{H}^k is the subspace of $H^1(\widehat{C}, \mathbb{R})$ corresponding to eigenvalue ρ^k . The space \mathcal{H}^k can be decomposed as $\Omega^{(k)} \oplus \overline{\Omega}^{(n-k)}$ (since $\rho^k = \overline{\rho}^{n-k}$) and, using (3.1.8), we get $\dim \mathcal{H}^k = (2n+2)(g-1)$.

For any two classes $s_1 \in \mathcal{H}_l$ and $s_2 \in \mathcal{H}_k$ we have $s_1 \circ s_2 = 0$ unless $k+l = n$. The spaces \mathcal{H}_k and \mathcal{H}_{n-k} are, therefore, dual to each other with respect to the standard intersection pairing (the space \mathcal{H}_0 can be identified with $H_1(C)$, and, therefore, it is self-dual). On the other hand, for any $q \in \Omega^{(k)}$ and $s \in \mathcal{H}_l$ we have $\int_s q = 0$ unless $k = l$. In particular, since $v = w^{1/n} \in \Omega^{(1)}$, it can have non-trivial periods only over the cycles representing homology classes in \mathcal{H}_1 . Actually, \mathcal{H}_1 can be naturally identified with the tangent space to the moduli space $\mathfrak{M}_g^{(n)}$. Choosing a basis $\{s_i\}_{i=1}^{(2n+2)(g-1)}$ in \mathcal{H}_1 we introduce *homological coordinates* \mathcal{P}_i on $\mathfrak{M}_g^{(n)}$ by the formula

$$(3.3.8) \quad \mathcal{P}_i = \int_{s_i} v$$

(see also Corollary 2.3 of [4]).

Choose a Torelli marking on C and define the associated canonical bimeromorphic differential $B(x, y) = d_x d_y \log E(x, y)$ on C (here $E(x, y)$ is the prime form). The bidifferential B is symmetric with a second order pole with biresidue 1 on the diagonal $x = y$ and vanishing a -periods with respect to both arguments.

The bidifferential $B(x, y)$ has the following local behaviour near the diagonal $x = y$:

$$(3.3.9) \quad B(x, y) = \left(\frac{1}{(\zeta(x) - \zeta(y))^2} + \frac{1}{6} S_B(\zeta(x)) + \dots \right) d\zeta(x) d\zeta(y);$$

here $\zeta(x)$ is a local parameter, and $S_B(x)$ is the so-called Bergman projective connection.

To study the tau function on $\overline{\mathfrak{M}}_g^{(n)}$ we will need some variational formulas for $B(x, y)$. For a basis $\{s_i\}_{i=1}^{(2n+2)(g-1)}$ in \mathcal{H}_1 consider the dual basis $\{s_j^*\}_{j=1}^{(2n+2)(g-1)}$ in \mathcal{H}_{n-1} , so that $s_j^* \circ s_i = \delta_{ij}$.

Consider a fundamental polygon \tilde{C} of C (that is, dissect C along the cuts representing the Torelli marking). Choose a system Γ of non-intersecting cuts that lie within \tilde{C} and connect the first zero x_1 with other zeros of w . Pick a connected component of $f^{-1}(\tilde{C} \setminus \Gamma) \subset \hat{C}$ and identify it with $\tilde{C} \setminus \Gamma$. On $\tilde{C} \setminus \Gamma$ introduce the coordinate

$$(3.3.10) \quad z(x) = \int_{x_1}^x v,$$

where the path connecting x with x_1 entirely lies in $\tilde{C} \setminus \Gamma$.

Theorem 3.3.5. *The following variational formula holds for $i = 1, \dots, (2n+2)(g-1)$:*

$$(3.3.11) \quad \frac{\partial}{\partial \mathcal{P}_i} B(z(x), z(y)) = \frac{1}{2\pi\sqrt{-1}n} \int_{s_i^*} \frac{B(z(x), \cdot) B(\cdot, z(y))}{v}$$

Formula (3.3.11) can be derived from the variational formulas for the stratum $\mathcal{H}_{\hat{g}}(n, \dots, n)$ of the moduli space of holomorphic 1-differentials of genus $\hat{g} = n^2(g-1) + 1$, see Theorem 3 of [52], in a way similar to Lemma 5 of [58] and Proposition 3.2 of [6].

Consider the differential operator $S_v = \frac{v''}{v} - \frac{3}{2} \left(\frac{v'}{v} \right)^2$ (that is, the Schwarzian derivative of the abelian integral $\int^x v$ with respect to the coordinate z on C). For the holomorphic 1-differential v , S_v is a meromorphic projective connection on C , so that the difference $S_B - S_v$ is a meromorphic quadratic differential.

The tau function $\tau = \tau(C, w)$ satisfies the following system of differential equations with respect to the homological coordinates \mathcal{P}_i on $P\overline{\mathfrak{M}}_g^{(n)}$:

$$(3.3.12) \quad \frac{d}{d\mathcal{P}_i} \log \tau = -\frac{1}{12\pi\sqrt{-1}n} \int_{s_i^*} \frac{S_B - S_v}{v}$$

(notice that the differential $(S_B - S_v)/v$ gets multiplied by ρ^{-1} under the action of f^* ; thus its integral over $s_i^* \in \mathcal{H}_{n-1}$ is non-trivial). The compatibility of the system (3.3.12) follows from the symmetry of the expression

$$\frac{\partial}{\partial \mathcal{P}_j} \int_{s_i^*} \frac{S_B - S_v}{v} = \frac{1}{12\pi\sqrt{-1}n} \int_{s_i^*} \int_{s_j^*} \frac{B(z(x), z(y)) B(z(y), z(x))}{v(z(x))v(z(y))}$$

under the interchange of i and j .

3.3.3. Asymptotics of tau function near the boundary of $\overline{\mathfrak{M}}_g^{(n)}$. Here we compute the asymptotics of τ near the boundary $\overline{\mathfrak{M}}_g^{(n)} \setminus \mathfrak{M}_g^{(n)}[1]$ of $\overline{\mathfrak{M}}_g^{(n)}$ that consist of the following divisors:

- D_{deg} , the divisor of n -differentials with multiple zeroes,
- D_0 , the divisor of n -differentials on irreducible nodal curves, and
- D_j , $j = 1, \dots, [g/2]$, the divisors of n -differentials on reducible nodal curves.

3.3.3.1. *Coalescing simple zeros of w : divisor D_{deg} .*

Lemma 3.3.6. *Let x_1 and x_2 be two zeros of w coalescing at D_{deg} . Then a transversal local coordinate on $\overline{\mathfrak{M}}_g^{(n)}$ in a tubular neighbourhood of D_{deg} is given by*

$$(3.3.13) \quad t_{\text{deg}} = \left(\int_{x_1}^{x_2} v \right)^{2n/(n+2)}.$$

PROOF. It is parallel to the proof of Lemma 8 of [58]. Denote by ζ a local coordinate in a small disk U containing the coalescing zeros $x_{1,2}$ and no other zeros. Then we can write in U

$$(3.3.14) \quad w(\zeta) = (\zeta - \zeta(x_1))(\zeta - \zeta(x_2))(d\zeta)^n,$$

so that

$$\int_{x_1}^{x_2} v = \int_{\zeta(x_1)}^{\zeta(x_2)} ((\zeta - \zeta(x_1))(\zeta - \zeta(x_2)))^{1/n} d\zeta = \text{const} \cdot (\zeta(x_1) - \zeta(x_2))^{(n+2)/n}.$$

and the parameter t_{deg} defined by (3.3.13) looks like Since $(\zeta(x_1) - \zeta(x_2))^2$ is independent of labeling of zeroes, t_{deg} is a coordinate transversal to D_{deg} . \square

Lemma 3.3.7. *The tau function $\tau(C, w)$ has the following asymptotics near D_{deg} :*

$$(3.3.15) \quad \tau(C, w) = t_{\text{deg}}^{\frac{1}{12n(n+1)}} \tau(C_0, w_0)(1 + o(1))$$

where $(C_0, w_0) \in D_{\text{deg}}$.

PROOF. The asymptotics (3.3.15) can be derived by computing the asymptotics of all factors in the explicit formula (3.3.3). Alternatively, using the system of equations (3.3.12) we see that in the limit $t_{\text{deg}} \rightarrow 0$ the tau function $\tau(C, w)$ behaves like $t_{\text{deg}}^p \tau(C_0, w_0)$ for some power p , where w_0 is a differential with one zero of order two and all other zeroes simple. To find p explicitly, we look at the transformation properties of τ , τ_0 and t_{deg} under the rescaling $w \mapsto \delta w$. The homogeneity degrees κ of τ and κ_0 of τ_0 are given by the formula (3.3.6), so that

$$\kappa - \kappa_0 = \frac{1}{6n(n+1)(n+2)}$$

On the other hand, the local parameter t_{deg} has homogeneity degree $2/(n+2)$, which gives $p = \frac{1}{12n(n+1)}$. \square

3.3.3.2. *Asymptotics of τ near D_0 .* Take two loops a and b on C intersecting transversally at one point; their homology class we will also denote by $a, b \in H_1(C, \mathbb{Z})$. Let us pinch a to a point, then C degenerates to a nodal curve C_0 that we represent by a smooth curve of genus $g-1$ with two points (say, x_0 and y_0)

identified (we assume that all zeros of w remain far from the node). The holomorphic n -differential w on C degenerates to a meromorphic n -differential w_0 on C_0 with poles of degree n at x_0 and y_0 such that the corresponding n -residues differ by $(-1)^n$.

The canonical covering \widehat{C} of C degenerates to a nodal curve \widehat{C}_0 with n nodes that can be thought of as n pairs of points $x_0^{(m)} = \sigma^m(x_0)$ and $y_0^{(m)} = \sigma^m(y_0)$, $m = 0, \dots, n-1$, on the normalization of \widehat{C}_0 that are pairwise identified (here σ is the covering automorphism of \widehat{C}_0). The differential v on \widehat{C} degenerates to a meromorphic differential v_0 on \widehat{C}_0 with simple poles at the preimages of nodal points with residues at $x_0^{(m)}$ and $y_0^{(m)}$ that differ by a sign.

Choose one of n simple loops on in the preimage $f^{-1}(a) \subset \widehat{C}$. Let us assume that this loop pinches to the first node on \widehat{C}_0 .

Consider the classes $\alpha, \beta \in \mathcal{H}_1$ given by

$$(3.3.16) \quad \alpha = \sum_{m=0}^{n-1} \rho^{-m} \sigma_*^{-m} a, \quad \beta = \sum_{m=0}^{n-1} \rho^{-m} \sigma_*^{-m} b$$

(where σ is the covering automorphism of \widehat{C}), and introduce the homological coordinates $\mathcal{P}_\alpha = \int_\alpha v$ and $\mathcal{P}_\beta = \int_\beta v$ associated with α and β .

A local coordinate on $\mathfrak{M}_g^{(n)}$ transversal to D_0 in a tubular neighborhood can be chosen as

$$t_0 = e^{2\pi i \mathcal{P}_\beta / \mathcal{P}_\alpha}$$

(notice that $\text{Im}(\mathcal{P}_\beta / \mathcal{P}_\alpha) > 0$ near D_0).

We may assume that \mathcal{P}_α remains constant under the degeneration of C to C_0 . Let $\omega_{x,y}$ be the abelian differential of the 3rd kind on \widehat{C}_0 with simple poles at points x and y of residues $+1$ and -1 respectively, normalized with respect to some canonical basis (a_i, b_i) in $H_1(\widehat{C}_0, \mathbb{Z})$. Since $v_0 \in \mathcal{H}^1$, it can be written as

$$v_0 = \frac{\mathcal{P}_\alpha}{2\pi\sqrt{-1}} \sum_{j=0}^{n-1} \rho^j \omega_{\sigma^j(x_0), \sigma^j(y_0)} + \text{holomorphic terms}.$$

In the limit $t_0 \rightarrow 0$ the bidifferential $B(x, y)$ on $C \times C$ tends to the meromorphic bidifferential $B_0(x, y)$ on $C_0 \times C_0$ with the same properties.

To find the asymptotics of the tau function τ as $t_0 \rightarrow 0$ (i.e. $\mathcal{P}_\beta \rightarrow \infty$), consider the equation

$$(3.3.17) \quad \frac{\partial \log \tau}{\partial \mathcal{P}_\beta} = -\frac{1}{12\pi\sqrt{-1}n} \int_{\beta^*} \frac{S_B - S_v}{v} \xrightarrow{t_0 \rightarrow 0} -\frac{1}{6n} \text{res}_{x_0} \frac{S_{B_0} - S_{v_0}}{v_0},$$

where $\beta^* = \frac{1}{n} \sum_{m=0}^{n-1} \rho^m \sigma_*^m a \in \mathcal{H}_{n-1}$ is the class dual to $\beta \in \mathcal{H}_1$.

To compute the residue, choose a local coordinate ζ near x_0 on C_0 such that $S_{B_0} = 0$. Then we have $v_0 = \frac{\mathcal{P}_\alpha}{2\pi\sqrt{-1}n} \frac{d\zeta}{\zeta} + O(1)$ and

$$\left\{ \int v_0, \zeta \right\} = \left(\frac{v'_0}{v_0} \right)' - \frac{1}{2} \left(\frac{v'_0}{v_0} \right)^2 = \frac{1}{2\zeta^2} + O(1)$$

as $t_0 \rightarrow 0$, so that $S_{v_0}/v_0 = \frac{\pi\sqrt{-1}n}{\mathcal{P}_\alpha} \frac{d\zeta}{\zeta} + O(1)$. Therefore, (3.3.17) implies

$$(3.3.18) \quad \frac{\partial \log \tau}{\partial \mathcal{P}_\beta} \Big|_{t_0=0} = \frac{\pi\sqrt{-1}}{6\mathcal{P}_\alpha}$$

and $\tau \sim e^{\pi\sqrt{-1}\mathcal{P}_\beta/6\mathcal{P}_\alpha}$, i.e.

$$(3.3.19) \quad \tau = t_0^{1/12}(\text{const} + o(1))$$

as $t \rightarrow 0$.

3.3.3.3. *Asymptotics of τ near D_j .* Contracting a homologically trivial simple loop γ on C we get a reducible nodal curve C_0 that splits into two irreducible components C_1 and C_2 of genera $g_1 = j$ and $g_2 = g - j$ respectively, $j = 1, \dots, [g/2]$. Denote by $x_0 \in C_1$ and $y_0 \in C_2$ the intersection point of C_1 and C_2 (the node of C_0). The holomorphic n -differential w on C degenerates to a pair of meromorphic n -differentials w_1 and w_2 on C_1 and C_2 respectively, with poles of order n at $x_0 \in C_1$ and $y_0 \in C_2$ whose n -residues differ by $(-1)^n$ (we assume that under generation the zeroes of w stay away from the vanishing cycle γ).

Denote by $f_i: \widehat{C}_i \rightarrow C_i$ the canonical n -fold covering ($i = 1, 2$), and let $x_0^{(1)}, \dots, x_0^{(n-1)}$ (resp. $y_0^{(1)}, \dots, y_0^{(n-1)}$) denote the preimages of the node in \widehat{C}_1 (resp. \widehat{C}_2) that are cyclically ordered relative to the covering maps $\sigma_i: \widehat{C}_i \rightarrow \widehat{C}_i$. The canonical cover \widehat{C}_0 of the nodal curve C_0 is obtained from \widehat{C}_1 and \widehat{C}_2 by identifying $x_0^{(m)}$ with $y_0^{(m)}$ for each $m = 0, \dots, n-1$.

Define the 1-form v_i on \widehat{C}_i by $v_i^n = f_i^* w_i$, ($i = 1, 2$). The (meromorphic) 1-forms v_1 and v_2 have first order poles at the n preimages of the node whose residues differ by a sign, i. e. $\text{res}_{x_0^{(m)}} v_1 = -\text{res}_{y_0^{(m)}} v_2$. Moreover, applying m times the covering map σ_0 , we see that $\text{res}_{x_0^{(m)}} v_1 = \rho^{-m} \text{res}_{x_0^{(0)}} v_1$ (resp. $\text{res}_{y_0^{(m)}} v_2 = \rho^{-m} \text{res}_{y_0^{(0)}} v_2$).

The preimage $f^{-1}(\gamma) \subset \widehat{C}$ of the loop γ on C is the disjoint union of n loops γ_m , $m = 0, \dots, n-1$ (we enumerate them in such a way that $\gamma_{m+1} = \sigma(\gamma_m)$, assuming that $\gamma_n = \gamma_0$). Note that the union of γ_m , $m = 0, \dots, n-1$, is homologically trivial on \widehat{C} . Consider also a simple loop η_0 on \widehat{C} such that $\gamma_0 \circ \eta_0 = 1$, $\gamma_1 \circ \eta_0 = -1$, and $\gamma_k \circ \eta_0 = 0$ for $k = 2, \dots, n-1$, where \circ denotes the intersection pairing of 1-cycles on \widehat{C} .

Introduce the loops $\eta_m = \sigma^m(\eta_0)$, $m = 1, \dots, n-1$, and consider the cycles

$$(3.3.20) \quad \alpha = \sum_{m=1}^{n-1} (\rho^{-m} - 1) \gamma_m, \quad \beta = \frac{1}{\rho - 1} \sum_{m=1}^{n-1} (1 - \rho^{-m}) \eta_m$$

(for homology classes in $H_1(\widehat{C}, \mathbb{Z})$ represented by γ_m and η_m we use the same notation); clearly, $\alpha, \beta \in \mathcal{H}_1$. The class $\beta^* \in \mathcal{H}_{n-1}$ dual to β is given by

$$(3.3.21) \quad \tilde{\alpha} = \frac{1}{n} \sum_{m=1}^{n-1} (\rho^m - 1) \gamma_m.$$

Introduce the following homological coordinates:

$$(3.3.22) \quad \mathcal{P}_\alpha = \int_\alpha v = n \int_{\gamma_0} v, \quad \mathcal{P}_\beta = \int_\beta v = \frac{n}{1 - \rho} \int_{\eta_0} v.$$

Without loss of generality we may assume that while C degenerates to C_0 all homological coordinates except \mathcal{P}_β remain finite.

Lemma 3.3.8. *A local parameter transversal to $D_j \subset \overline{\mathfrak{M}}_g^{(n)}$ can be chosen as*

$$(3.3.23) \quad t_j = e^{2\pi\sqrt{-1}\mathcal{P}_\beta/\mathcal{P}_\alpha}.$$

PROOF. We can realize the loops γ_m and η_m by simple closed geodesics in hyperbolic metric on \widehat{C} . Denote by T_i the maximal hyperbolic cylinder with waist γ_i (the collar of γ_i). Put $\eta_0^{(i)} = \eta_0 \cap T_i$, $i = 0, 1$. Then $\frac{1}{n}\mathcal{P}_\beta = \frac{1}{1-\rho} \int_{\eta_0} v \sim \int_{\eta_0^{(0)}} v$ when C approaches C_0 is the ‘‘complex heght’’ of the cylinder T_0 while $\frac{1}{n}\mathcal{P}_\alpha = \int_{\gamma_0} v$ is its ‘‘complex waist’’. Therefore, (3.3.23) gives a local coordinate transversal to D_j . \square

To find the asymptotics of τ when $t_j \rightarrow 0$, consider

$$(3.3.24) \quad \begin{aligned} \frac{\partial \log \tau}{\partial \mathcal{P}_\beta} &= -\frac{1}{12\pi\sqrt{-1}n} \int_{\beta^*} \frac{S_B - S_v}{v} \\ &= -\frac{1}{12\pi\sqrt{-1}n} \int_{\gamma_0} \frac{S_B - S_v}{v} \rightarrow -\frac{1}{6n} \text{res}_{x_0^{(0)}} \frac{S_{B_0} - S_{v_0}}{v_0}. \end{aligned}$$

Pick a coordinate ζ near $x_0^{(0)}$ such that $S_{B_0} = 0$, then $v_0 = \frac{\mathcal{P}_\alpha}{2\pi\sqrt{-1}n} \frac{d\zeta}{\zeta} + O(1)$ and $\frac{S_{v_0}}{v_0} = \frac{\pi\sqrt{-1}n}{\mathcal{P}_\alpha} \frac{d\zeta}{\zeta} + O(1)$ as $t_j \rightarrow 0$. Therefore, (3.3.24) implies

$$\left. \frac{\partial \log \tau}{\partial \mathcal{P}_\beta} \right|_{t_j=0} = \frac{\pi\sqrt{-1}}{6\mathcal{P}_\alpha}.$$

Thus, $\tau \sim e^{\pi\sqrt{-1}\mathcal{P}_\beta/6\mathcal{P}_\alpha}$ as $t_j \rightarrow 0$, and

$$(3.3.25) \quad \tau = t_j^{1/12} (\text{const} + o(1)).$$

3.3.4. Hodge class on $P\overline{\mathfrak{M}}_g^{(n)}$. A straightforward combination of Theorem 3.3.4 with asymptotic formulas (3.3.15), (3.3.19) and (3.3.25) yields

Theorem 3.3.9. (Formula (3.1.3) of Theorem 3.1.13) *The Hodge class λ on $\overline{\mathfrak{M}}_g^{(n)}$ is a linear combination of the tautological class ψ and the classes of boundary divisors D_{deg} and D_j , $j = 0, 1, \dots, [g/2]$, as follows:*

$$(3.3.26) \quad \lambda = \frac{(g-1)(2n+1)}{6n(n+1)} \psi + \frac{1}{12n(n+1)} \delta_{\text{deg}} + \frac{1}{12} \sum_{j=0}^{[g/2]} \delta_j.$$

3.4. An alternative computation of δ_{deg}

An alternative proof of Theorem 3.3.9 was given in [82] using an approach proposed by D. Zvonkine [84] and developed in [71].

Let $g, n \geq 2$. In order to compute the class δ_{deg} in $\text{Pic}(P\overline{\mathfrak{M}}_g^{(n)})$ we begin with marking one point on C , i.e. we study the space $P\overline{\mathfrak{M}}_{g,1}^{(n)}$. In $P\overline{\mathfrak{M}}_{g,1}^{(n)}$ we define the loci

$$Z_i = \{(C, x_1, w) \mid C \text{ is smooth and } x_1 \text{ is a zero of } w \text{ of order at least } i\}.$$

We denote by \bar{Z}_i the closure of Z_i . This is a closed substack of $P\overline{\mathcal{M}}_{g,1}^{(n)}$ of pure codimension i for $1 < i < N = (2g-2)n$, while for $i = N$ it has two components of codimensions $N-1$ and N respectively, cf Section 3.1.2.

Let $\pi : P\overline{\mathcal{M}}_{g,1}^{(n)} \rightarrow P\overline{\mathcal{M}}_g^{(n)}$ be the forgetful map of the marked point. Then it is easy to see that the image of \bar{Z}_2 under π is the divisor D_{deg} . This statement takes into account the multiplicities of the components of D_{deg} . Indeed, if $(g, n) \neq (2, 2)$ then the restriction of π to Z_2 is of degree 1 and if $(g, n) = (2, 2)$ then π is of degree one onto $P\overline{\mathcal{M}}_g^{(n)}(2, 1, 1)$ and two onto $P\overline{\mathcal{M}}_g^{(n)}(2, 2)$. Therefore $\pi_*[\bar{Z}_2] = \delta_{\text{deg}}$. Thus to find an expression of δ_{deg} it suffices to compute the class $[\bar{Z}_2] \in A^2(P\overline{\mathcal{M}}_{g,1}^{(n)})$.

Computation of $[\bar{Z}_2]$. Let $\mathcal{L}_1 \rightarrow \overline{\mathcal{M}}_{g,1}$ be the line bundle whose fiber is the cotangent line to the curve C at x_1 , and put $\psi_1 = c_1(\mathcal{L}_1)$. Consider the following line bundle over $P\overline{\mathcal{M}}_{g,1}^{(n)}$:

$$\mathcal{O}(1) \otimes \mathcal{L}_1^{\otimes n} \simeq \text{Hom}(L, \mathcal{L}_1^{\otimes n}).$$

This line bundle has a natural section

$$s_1 : (C, w) \mapsto w(x_1).$$

In other words, s_1 is the evaluation of w at the marked point. The class of the vanishing locus of s_1 is given by the first Chern class of the line bundle:

$$\{s_1 = 0\} = c_1(\mathcal{O}(1) \otimes \mathcal{L}_1^{\otimes n}) = -\psi + n\psi_1.$$

It is easy to see that \bar{Z}_1 is a component of the vanishing locus $\{s_1 = 0\}$. In the next section we will show that the vanishing locus has no other components and that the vanishing order of s_1 along \bar{Z}_1 is equal to 1. Thus we have $[\bar{Z}_1] = -\psi + n\psi_1$.

Now we restrict to \bar{Z}_1 and study the line bundle $\mathcal{O}(1) \otimes \mathcal{L}_1^{\otimes n+1}$. This line bundle has a natural section

$$s_2 : (C, w) \mapsto w'(x_1).$$

In other words, assuming that w vanishes at x_1 , the section s_2 assigns to w its derivative at x_1 . It is easy to see that \bar{Z}_2 is a component of the vanishing locus $\{s_2 = 0\}$. In the next section we will show that the vanishing locus has no other components and that the vanishing order of s_2 along \bar{Z}_2 is equal to 1. Thus we have

$$[\bar{Z}_2] = (-\psi + (n+1)\psi_1)[\bar{Z}_1] = (-\psi + n\psi_1)(-\psi + (n+1)\psi_1).$$

Recall that δ_{deg} is the push-forward by π of this expression. To compute this push-forward we use

- ψ is a pull-back under π ;
- $\pi_*\psi_1 = 2g-2$;
- $\pi_*\psi_1^2 = \kappa_1 = 12\lambda_1 - \sum_{i=1}^{\lfloor g/2 \rfloor} \delta_i$.

The last equality is the well-known Mumford's formula.

Applying these equalities we get

$$\begin{aligned} \delta_{\text{deg}} &= \pi_*((-\psi + n\psi_1)(-\psi + (n+1)\psi_1)) \\ &= n(n+1)\pi_*(\psi_1^2) - (2n+1)\pi_*(\psi_1)\psi \\ &= 12n(n+1)\lambda_1 - n(n+1) \sum_{i=1}^{\lfloor g/2 \rfloor} \delta_i - (2n+1)(2g-2)\psi. \end{aligned}$$

This coincides with the expression of Theorem 3.3.9.

In order to complete the proof of Theorem 3.3.9, it remains to prove that the vanishing locus of s_1 (respectively s_2) is exactly \bar{Z}_1 (respectively \bar{Z}_2) and that the vanishing order of s_1 and s_2 is 1.

Vanishing loci of s_1 and s_2 . Let W be an irreducible divisor of $P\overline{\mathcal{M}}_{g,1}^{(n)}$ in the vanishing locus of s_1 . Let k be the number of nodes of the curve represented by a generic point of W . The vanishing locus of s_1 is of codimension 1 in $P\overline{\mathcal{M}}_{g,1}^{(n)}$ thus $k = 0$ or 1. We investigate both cases.

- Let $k = 0$. Then a dense subset of W is contained in Z_1 and thus W is a component of \bar{Z}_1 .
- Let $k = 1$. Then the divisor W is contained in $\tilde{\nu}^{-1}(D)$ for some irreducible boundary divisor D of the moduli space of stable curves with one marked point (we recall that $\tilde{\nu} : P\overline{\mathcal{M}}_{g,1}^{(n)} \rightarrow \overline{\mathcal{M}}_{g,1}$ is the forgetful map). Since the D is irreducible, and $\tilde{\nu}$ is the projectivization of a vector bundle, we necessarily have $W = \tilde{\nu}^{-1}(D)$. However there exists an n -differential in $\tilde{\nu}^{-1}(D)$ which is not identically zero on the component of marked point. Therefore, there exists a point in $\tilde{\nu}^{-1}(D)$ which is not in the vanishing locus of s_1 . Thus the case $k = 1$ does not occur.

To study the vanishing locus of s_2 we follow the same strategy. First we can check by dimension count that no irreducible component of Z_1 is in the zero locus of s_2 . Now let W be an irreducible divisor in the vanishing locus of s_2 and let k be the number of nodes of the curve represented by a generic point of W . We have now 3 cases to study: $k = 0, 1$ and 2.

- Let $k = 0$. Then a dense subset of W is contained in Z_2 and thus W is a component of \bar{Z}_2 .
- Let $k = 2$. Then $W = \tilde{\nu}^{-1}(D)$ where D is a codimension 2 boundary stratum of $\overline{\mathcal{M}}_{g,1}$. As above $\tilde{\nu}^{-1}(D)$ is not contained in the vanishing locus of s_2 . Thus the case $k = 2$ cannot occur.
- Let $k = 1$. Then W is a co-dimension 1 locus inside $\tilde{\nu}^{-1}(D)$ for a boundary divisor D of $\overline{\mathcal{M}}_{g,1}$. The generic curve has two components of genera g' and $g - g'$ with $1 \leq g' \leq g - 1$. We assume that the marked point is carried by the component of genus g' . The rank of the bundle of n -differentials with a pole of order at most n at the node is $n(2g' - 2 + 1) > 1$. Thus the divisor D is not contained in the locus of differentials that vanish identically on this component. Thus D is not contained in the vanishing locus of s_2 .

We conclude that $\{s_i = 0\} = \bar{Z}_i$ for $i = 1$ and 2.

Vanishing order of s_1 . Let $y_0 = (C_0, w_0, x_0)$ be a point in Z_1 . We recall that $P\overline{\mathcal{M}}_{g,1}^{(n)} \rightarrow P\overline{\mathcal{M}}_g^{(n)}$ is isomorphic the universal curve. Thus a neighborhood of y_0 in Z_1 is given by $U \times \Delta$ where U is a neighborhood of (C_0, w_0) in $P\overline{\mathcal{M}}_g^{(n)}[\mathbf{1}]$ and $\zeta \in \Delta$ is the distinguished parameter around x_0 in C_0 (cf Section 3.2.1). Let (C, w, x) be an n -differential in $U \times \Delta$. In coordinates $(u, \zeta) \in U \times \Delta$, the differential w is

given by $w = \zeta d\zeta^n$, the locus Z_1 is $\{\zeta = 0\}$ and the section s_1 is given by $s_1(u, \zeta) = \zeta$. Therefore the vanishing order of s_1 along Z_1 is 1.

Vanishing order of s_2 . Let $y_0 = (C_0, w_0, x_0)$ be a point in Z_2 . A neighborhood of y_0 in $\overline{\mathcal{PM}}_{g,1}^{(n)}$ is now given by $U \times \Delta \times \Delta'$ where U is a neighborhood of y_0 in Z_2 and Δ and Δ' are disks of the complex plane centered at 0 and parametrized by ζ and a such that:

$$w = (\zeta^2 + a)d\zeta^n.$$

With the parameters $(u, \zeta, a) \in U \times \Delta \times \Delta'$, the locus Z_1 is defined by $\zeta^2 + a = 0$. Moreover with these parameters, the section s_2 is given by $s_2(u, \zeta, a) = a$. Thus the vanishing order of s_2 along Z_2 is again 1.

3.5. Prym-Tyurin differentials on \widehat{C} and holomorphic n -differentials on C

Here we relate Prym-Tyurin vector bundles to vector bundles of holomorphic k -differentials on the base Riemann surface C . We use this relation to finish the proof of Theorem 3.1.13.

We also prove that the Prym-Tyurin bundle is not a pullback from $\overline{\mathcal{PM}}_g^{(n)}$ in general.

3.5.1. Prym-Tyurin bundles and n -differentials. Consider two vector bundles $\Lambda^{(k)}$ and $\tilde{\nu}^*\Omega_g^{(n-k+1)}$ over $X(g, n)$. The fiber of $\Lambda^{(k)}$ is the k th eigenspace in the space of abelian differentials on \widehat{C} . The fiber of Ω_{n-k+1} is the space of $(n-k+1)$ -differentials on C . There are natural morphisms:

$$(3.5.1) \quad \begin{aligned} \Phi_0 : \Lambda^{(0)} &\rightarrow \tilde{\nu}^*\Omega_g, \\ \Phi_k : \Lambda^{(k)} \otimes T^{\otimes(n-k)} &\rightarrow \tilde{\nu}^*\Omega_g^{(n-k+1)} \quad \text{for } 1 \leq k \leq n. \end{aligned}$$

Indeed, let (C, w) be a point in $U \setminus D_{\text{deg}}$ and let q be a differential in the fiber of $\Lambda^{(k)}$. The $n-k+1$ differential qv^{n-k} is invariant under the action of the automorphism group of the covering, thus qv^{n-k} is the pull-back of $n-k+1$ differential on C . For $k=0$ the differential q is already invariant under the action of the automorphism group of the covering, so there is no need to multiply it by a power of v .

Lemma 3.5.1. *The map Φ_k is an isomorphism over $V \setminus D_{\text{deg}}$.*

PROOF. The maps Φ_k for $0 \leq k \leq n-1$ are injective because v does not vanish identically on any component of the nodal curve \widehat{C} . They are bijective because the sum of ranks of the Prym-Tyurin bundles $\Lambda^{(k)}$ for $0 \leq k \leq n-1$ is equal to the sum of ranks of the vector bundles Ω_{n-k+1} . Indeed,

$$\sum_{k=0}^{n-1} \text{rk} \Lambda^{(k)} = \text{rk} \Omega_{\widehat{C}} = n^2(g-1) + 1$$

and

$$\text{rk} \Omega_g + \sum_{k=1}^{n-1} \text{rk} \Omega_g^{(n-k+1)} = g + \sum_{k=1}^{n-1} (2n-2k+1)(g-1) = n^2(g-1) + 1.$$

□

Corollary 3.5.2. *The rank of the Prym-Tyurin bundle is g for $k = 0$ and $(2n - 2k + 1)(g - 1)$ for $1 \leq k \leq n - 1$.*

Corollary 3.5.3. *In $\text{Pic}(P\overline{\mathcal{M}}_g^{(n)} \setminus D_{\text{deg}})$ we have*

$$(3.5.2) \quad \lambda_{PT}^{(k)} = \lambda_{n-k+1} - \frac{g-1}{n}(n-k)(2n-2k+1)\psi$$

for $1 \leq k \leq n - 1$.

PROOF. On the locus where Φ_k is an isomorphism we have

$$\begin{aligned} \lambda_{PT}^{(k)} &= c_1(\Lambda^{(k)}) \\ &= c_1(\tilde{\nu}^* \Omega_k \otimes T^{\otimes -(n-k)}) \\ &= \lambda_{n-k+1} - (g-1)(n-k)(2n-2k+1)c_1(T) \\ &= \lambda_{n-k+1} - \frac{g-1}{n}(n-k)(2n-2k+1)\psi, \end{aligned}$$

where the last equality is due to $T^{\otimes n} = L$.

The locus where Φ_k is an isomorphism coincides with $P\overline{\mathcal{M}}_g^{(n)} \setminus D_{\text{deg}}$ up to codimension 2 substacks that are immaterial for the first Chern class computations. \square

To study the extension of the formula (3.5.2) to $P\overline{\mathcal{M}}_g^{(n)}$ we need to study the behavior of Φ_k along the boundary divisor D_{deg} . The determinant of Φ_k is a global section of

$$\det(\Lambda^{(k)} \otimes T^{n-k})^{-1} \otimes \det(\tilde{\nu}^* \Omega_g^{(n-k+1)}).$$

Thus the difference between $\lambda_{PT}^{(k)}$ and $\lambda_{n-k+1} - \frac{g-1}{n}(n-k)(2n-2k+1)\psi$ is an effective divisor defined as the vanishing locus of $\det \Phi_k$.

In Section 3.2.2, we have described a parametrization of the cyclic coverings along D_{deg} . We use here this parametrization to prove the following Lemma.

Lemma 3.5.4. *If $[(n-1)/2] + 1 \leq k \leq n-1$ or $k = 0$, then the morphism Φ_k is an isomorphism of vector bundles over $V \subset X(g, n)$. Otherwise, $\det(\Phi_k)$ vanishes along D_{deg} with order $(1 - \frac{2k}{n})$.*

This lemma implies the following

Corollary 3.5.5. *The following relations between Prym-Tyurin class $\lambda_{PT}^{(k)}$, the class $\psi = c_1(L)$ and the pullback of class λ_{n-k+1} from $\overline{\mathcal{M}}_g$ to $P\overline{\mathcal{M}}_g^{(n)}$ holds:*

$$(3.5.3) \quad \lambda_{PT}^{(k)} = \lambda_{n-k+1} - \frac{g-1}{n}(n-k)(2n-2k+1)\psi + \left(\frac{1}{2} - \frac{k}{n}\right) \delta_{\text{deg}},$$

$$1 \leq k \leq [(n-1)/2],$$

$$(3.5.4) \quad \lambda_{PT}^{(k)} = \lambda_{n-k+1} - \frac{g-1}{n}(n-k)(2n-2k+1)\psi,$$

$$[(n-1)/2] + 1 \leq k \leq n - 1.$$

This corollary together with Theorem 3.3.9 and Formula (3.1.6) completes the proof of Theorem 3.1.13.

Remark 3.5.6. Note the difference of a factor 2 between the vanishing order of $\det \Phi_k$ and the contribution of δ_{deg} in $\lambda_{PT}^{(k)}$. This is due to the fact that $V \rightarrow U$ is of degree $1/2$ along D_{deg} .

The proof of Lemma 3.5.4 will occupy the two following sections. We consider separately the cases of even n and odd n .

3.5.2. Odd $n = 2m + 1$.

3.5.2.1. *Kernel and cokernel of Φ_k .* Let (C_0, w_0) be a point in D_{deg} and $f : \widehat{C}_0 \rightarrow C_0$ be the associated admissible covering. We recall that \widehat{C}_0 is a curve with two components intersecting in one point. The two components \widehat{C}_1 and \widehat{C}_2 are of genera $\widehat{g}_1 = m$ and $\widehat{g}_2 = \widehat{g} - m$ (see Section 3.2.1). We have denoted by w_1 the meromorphic n -differential on C_1 given by $(\zeta - \zeta_1)(\zeta - \zeta_2)d\zeta^n$. The curve \widehat{C}_1 is parametrized by $y^n = (\zeta - \zeta_1)(\zeta - \zeta_2)$ and the n th root of f^*w_1 is given by $v_1 = yd\zeta$. The covering $\widehat{C}_2 \rightarrow C_2$ is defined by $v_2^{\otimes n} = w_0$. Finally, let v be the canonical differential satisfying $v^{\otimes n} = f^*w_0$: it is determined by $v = v_2$ on the component \widehat{C}_2 and vanishes identically on the component \widehat{C}_1 .

Denote the fiber of k th Prym-Tyurin vector bundle $\mathcal{L}^{(k)}$ over the point $(C_0, w_0) \in D_{\text{deg}}$ by $\Omega_0^{(k)}$. We can decompose

$$\Omega_0^{(k)} = \Omega_1^{(k)} \oplus \Omega_2^{(k)}$$

where $\Omega_1^{(k)}$ is the space of holomorphic differentials on \widehat{C}_1 which get multiplied by ρ^k under the action of the automorphism $(y, \zeta) \rightarrow (\rho^k y, \zeta)$; the space $\Omega_2^{(k)}$ is the analogous space of holomorphic differentials on \widehat{C}_2 .

The canonical differential v vanishes identically on \widehat{C}_1 . Thus the kernel of Φ_k contains space $\Omega_1^{(k)} \otimes T^{\otimes n-k}$. On another hand, the restriction of the morphism Φ_k to the linear subspace $\Omega_2^{(k)} \otimes T^{\otimes n-k}$ is injective. Indeed the differential v does not vanish identically on \widehat{C}_2 . Thus

$$\ker \Phi_k \simeq \Omega_1^{(k)} \otimes T^{(n-k)}.$$

over a generic locus of D_{deg} .

We have $\dim \Omega_1^{(k)} = 1$ for $k = 1, \dots, m$. These one-dimensional spaces are generated by the holomorphic differentials on \widehat{C}_1 given by $q_1^{(k)} = \frac{d\zeta}{y^{2m+1-k}}$. For $k = m+1 \dots 2m+1$ the eigenspaces $\Omega_1^{(k)}$ are trivial. Therefore,

$$\dim \Omega_2^{(k)} = \dim \Omega_0^{(k)} - 1, \quad k = 1, \dots, m;$$

$$\dim \Omega_2^{(k)} = \dim \Omega_0^{(k)}, \quad k = m+1, \dots, 2m.$$

We can also describe the images of Φ_k . For $k = m+1, \dots, 2m$, the morphism Φ_k is an isomorphism from $\Omega_2^{(k)} \otimes T^{\otimes n-k}$ to $H^0(C_0, \omega_{C_0}^{n+k-1})$. However, for $k = 1, \dots, m$ the image of $\Omega_2^{(k)} \otimes T^{\otimes n-k}$ is the space of holomorphic $n-k+1$ differentials vanishing at x_0 .

We have proved the following

Lemma 3.5.7. *The kernel of Φ_k over D_{deg} is the vector bundle $\Omega_1^{(k)} \otimes T^{\otimes n-k}$. This kernel is trivial for $k > m$ and $k = 0$. If $1 \leq k \leq m$, the image of Φ_k is the vector*

bundle whose fibers are the $H^0(C, \omega^{n+k-1}(-x_0))$ where x_0 is the unique zero of order 2.

Therefore the first part of Lemma 3.5.4 and Formula (3.5.4) are valid for odd n .

3.5.2.2. *Study of Φ_k for $k = 1 \dots m$.* We fix $1 \leq k \leq m$. We have seen that the kernel and cokernel of Φ_k are of dimension 1. Let (C_0, w_0) be a generic point in D_{deg} . Let W be an open neighborhood of (C_0, w_0) in $X(g, n)$ with a non-vanishing section $q_0^{(k)}$ of $\Lambda^{(k)}|_W$ such that $q_0^{(k)}|_{D_{\text{deg}}}$ spans $\ker \Phi_k|_{W \cap D_{\text{deg}}}$. The section Φ_k is of co-rank 1 along D_{deg} , thus the vanishing order of $\det \Phi_k$ is equal to the vanishing order of $\Phi_k(q_0^{(k)} \otimes v^{\otimes n-k})$ along D_{deg} . Therefore, we will construct such a local section $q_0^{(k)}$ of $\Lambda^{(k)}$ and study the asymptotic behavior of $q_0^{(k)} \otimes v^{\otimes n-k}$ along D_{deg} .

Let $\tilde{q}_0^{(k)}$ be a non-vanishing section of $\tilde{\nu}^*(\Omega^{(n-k+1)})$ over W such that: for all $(C, w) \in D_{\text{deg}}$, $q_0^{(k)}(C, w)$ is a differential that does not vanish at the double zero of w . Up to a choice of a smaller W , such a section exists. We label the coalescing zeros by x_1 and x_2 . We chose the parameter of the curve ζ such that position of x_1 and x_2 are ζ_1 and ζ_2 and $w = (\zeta - \zeta_1)(\zeta - \zeta_2)(d\zeta)^n$ (see Section 3.2.2). We define

$$q_0^{(k)} = (\zeta_1 - \zeta_2)^{-1+2k/n} \cdot \frac{f^*(\tilde{q}_0^{(k)})}{v^k}.$$

We recall that root $(\zeta_1 - \zeta_2)^{2/n}$ is well defined, it is the integral of v between \hat{x}_1 and \hat{x}_2 (see Lemma 3.3.6).

Over $W \setminus D_{\text{deg}}$, the differential $q_0^{(k)}$ is obviously a non-vanishing section of $\hat{\nu}^*(\Lambda^{(k)})$. Beside, along D_{deg} the differential $q_0^{(k)}$ vanishes identically on \widehat{C}_2 because of the factor $(\zeta_1 - \zeta_2)^{-1+2k/n}$. To compute the limit of $q_0^{(k)}$ on \widehat{C}_1 , we remark that $q_0^{(k)}$ is equivalent to

$$(3.5.5) \quad (\zeta_1 - \zeta_2)^{1-2k/n} [(\zeta(x) - \zeta_1)(\zeta(x) - \zeta_2)]^{k/n-1} d\zeta.$$

in coordinate ζ . The differential (3.5.5) is invariant under simultaneous rescaling $\zeta \rightarrow \epsilon\zeta$, $\zeta_i \rightarrow \epsilon\zeta_i$, $i = 1, 2$. Therefore, as $x_{1,2} \rightarrow x_0$, the differential $q_0^{(k)}$ tends to the holomorphic differential

$$q_1^{(k)} = y^{-n+k} dx = (\zeta_1 - \zeta_2)^{1-2k/n} [(\zeta(x) - \zeta_1)(\zeta(x) - \zeta_2)]^{k/n-1} d\zeta$$

on the curve \widehat{C}_1 (the generator of $\Omega_1^{(k)}$).

The image of $q_0^{(k)} \otimes v^{\otimes n-k}$ under Φ_k is $(\zeta_1 - \zeta_2)^{1-2k/n} \tilde{q}_0^{(k)}$ by construction. Thus the determinant of Φ_k is equivalent to a constant times $(\zeta_1 - \zeta_2)^{1-2k/n}$. The parameter $(\zeta_1 - \zeta_2)^2$ being a transverse parameter to D_{deg} , we conclude that the vanishing order of Φ_k along D_{deg} is $1 - \frac{2k}{n}$. This finishes the proof of Lemma 3.5.4 for odd n . \square

3.5.3. Even $n = 2m$. The proof of Lemma 3.5.4 is essentially identical to the odd case. Let (C_0, w_0) be a generic point in D_{deg} . Now we have $\widehat{g}_1 = m - 1$ and $\widehat{g}_2 = \widehat{g} - m$ and the two components intersect in two points. Let Ω_0^k be the PT bundle over (C_0, w_0) and let $\Omega_i^{(k)}$ be the subspace of Ω_0^k of holomorphic differentials supported on \widehat{C}_i . We still have the decomposition:

$$\Omega_0^{(k)} = \Omega_1^{(k)} \oplus \Omega_2^{(k)}$$

except for $k = m$. The kernel Φ_k is $\Omega_1^{(k)} \otimes T^{\otimes n-k}$. This kernel is trivial for $k = m+1, \dots, 2m-1$. For $k = 1, \dots, m-1$, the map Φ_k has co-rank one and the generator of $\Omega_1^{(k)}$ is the differential $q_1^{(k)} = y^{k-2m} d\zeta$ on the canonical covering \widehat{C}_1 $y^{2m} = (\zeta - \zeta_1)(\zeta - \zeta_2)$ (see Section 3.2.2 for definition of the parameters).

For $k = m$, the space $\Omega_0^{(k)}$ contains a 1-dimension subspace of differentials of a third kind. These are differentials with simple poles at the nodal points $x_0^{(1)}$ and $x_0^{(2)}$ (both on \widehat{C}_1 and \widehat{C}_2) and opposite residues. The image of such differential under Φ_m is a holomorphic m -differential. Beside $\Omega_1^{(m)}$ is trivial. Therefore the morphism Φ_k is also bijective for $k = m$.

Similarly to the case of odd n , for $k = 1, \dots, m-1$, let $\tilde{q}_0^{(k)}$ be a section of $\tilde{\nu}^*(\Omega^{(n-k+1)})$ over a neighborhood of (C_0, w_0) that does not vanish at the double zero of w_0 . We define $q_0^{(k)} = (\zeta_1 - \zeta_2)^{-1+2k/n} \cdot \frac{f^*(\tilde{q}_0^{(k)})}{y^k}$. and we study the asymptotic behavior of $\Phi_k(q_0^{(k)} \otimes \nu^{n-k})$ along D_{deg} .

As in the odd case, the differential $q_0^{(k)}$ is a non vanishing section of $\Lambda^{(k)}$ and $\Phi_k(q_0^{(k)} \otimes \nu^{n-k}) = (\zeta_1 - \zeta_2)^{-1+2k/n} \cdot \tilde{q}_0^{(k)}$ by construction. Therefore the vanishing order of $\det(\Phi_k)$ is given by $1 - \frac{2k}{n}$ for $k = 1, \dots, m-1$. \square

3.5.4. Obstruction to the extension of the Prym bundles to $\overline{\mathfrak{M}}_g^{(n)}$. In order to define the Prym-Tyurin classes we have constructed the space of admissible differentials $X(g, n)$ (see 3.1.5). Indeed, the Prym-Tyurin bundles are naturally defined over $X(g, n)$. The following theorem explains the necessity of the introduction of the space $X(g, n)$.

Theorem 3.5.8. *Let $g > 2$ and $k > 0$. There exists no vector bundle $\tilde{\Lambda} \rightarrow P\overline{\mathfrak{M}}_g^{(n)}$ such that $\Lambda^{(k)} = \text{diff}^* \tilde{\Lambda}^{(k)}$, where $\text{diff} : X(g, n) \rightarrow P\overline{\mathfrak{M}}_g^{(n)}$ is the forgetful map.*

PROOF. Suppose that there exists $\tilde{\Lambda} \rightarrow P\overline{\mathfrak{M}}_g^{(n)}$ such that $\Lambda^{(k)} = \text{diff}^* \tilde{\Lambda}^{(k)}$. Then in particular $\lambda_{PT}^k = c_1(\tilde{\Lambda}^{(k)})$ and thus $c_1(\Lambda^k) = \text{diff}^* \lambda_{PT}^k$. We will prove that this equality does not hold for $g > 2$ and $k > 0$.

Let $m > 2$ and μ be the partition of $n(2g-2)$ given by $(m, 1, \dots, 1)$. We denote by $\mathfrak{M}_g^{(n)}[m]$ the locus $\mathfrak{M}_g^{(n)}[\mu] \subset \overline{\mathfrak{M}}_g^{(n)}$. We suppose that $\gcd(m, n) = 1$. We denote by D_m the preimage of $\mathfrak{M}_g^{(n)}[m]$ in $X(g, n)$ under diff . The locus D_m is a divisor whose generic points are elements $(C, w, x_i, f : \widehat{C} \rightarrow C) \in X(g, n)$ such that:

- the curve C is a nodal curve with two components: C_2 isomorphic to C with $n(2g-2) - m$ marked points attached in one node to a rational component C_1 at the zero of order m ;
- the n -differential w is identically zero on C_1 and has profile μ on C_1 ;
- the covering curve $\widehat{C} \rightarrow C$ has two component \widehat{C}_2 and \widehat{C}_1 . The component \widehat{C}_2 determined by the w as in Section 3.2.2 and $\widehat{C}_1 \rightarrow C_1$ is the unique n -sheeted ramified covering maximally ramified at the marked points and the node.

Moreover the canonical root ν of f^*w vanishes identically on \widehat{C}_1 and has a zero of order $m+n-1$ at the preimage of the zero of order m . Thus the morphism

$\Phi_k : \Lambda^{(k)} \otimes T^{\otimes(n-k)} \rightarrow \tilde{\nu}^* \Omega_g^{(n-k+1)}$ has a non-empty co-kernel along D_m for m large enough. Therefore the line bundle

$$\det(\Lambda^{(k)}) \otimes \text{diff}^* (\det \tilde{\Lambda}^{(k)\vee})$$

has a global section which vanishes along divisors contained in $X(g, n) \setminus V$. Thus $\Lambda^{(k)} \neq \text{diff}^* \tilde{\Lambda}^{(k)}$. \square

Hurwitz numbers and intersection in spaces of differentials

In this chapter, we introduce new methods to compute Hurwitz in terms of Hodge integrals in moduli spaces of curves. We express the number of ramified coverings of \mathbb{P}^1 as intersection numbers in the moduli space of stable differentials introduced in Chapter 2. Using this idea, we produce alternative proofs of the ELSV formula (see [20]) and of the Goulden-Jackson-Vakil formula in genus 0 (see [34]).

4.1. Some families of Hurwitz numbers

4.1.1. Simple Hurwitz numbers. Let g, n be nonnegative integers such that $2g - 2 + n > 0$ and let d be a positive integer. Let $\mu = (k_1, k_2, \dots, k_n)$ be a partition of d . A *simple ramified covering* of \mathbb{P}^1 of type μ is a pair (C, f) where C is a smooth connected complex algebraic curve of genus g and $f : C \rightarrow \mathbb{P}^1$ is a map of degree d with ramifications orders k_1, \dots, k_n over ∞ and $K = d + n + 2g - 2$ other simple ramification points (beware, our notation is slightly different from the one of [20]). A morphism between two coverings (C, f) and (C', f') is given by a map $\phi : C \rightarrow C'$ such that the following diagram commutes

$$\begin{array}{ccc} C & \xrightarrow{\phi} & C' \\ & \searrow f & \swarrow f' \\ & \mathbb{P}^1 & \end{array}$$

Definition 4.1.1. The *simple Hurwitz number* $h_{g,\mu}$ is the number of equivalence classes of simple ramified coverings of type μ counted with weight $1/|\text{Aut}(C, f)|$.

If $2g - 2 + n > 0$, we denote by $\overline{\mathcal{M}}_{g,n}$ the moduli space of stable nodal curves. We will need two types of cohomology classes in this space:

- For $i \in [1, n]$, let \mathcal{L}_i be the line bundle on $\overline{\mathcal{M}}_{g,n}$ whose fiber at (C, x_1, \dots, x_n) is the cotangent line at x_i . We set $\psi_i = c_1(\mathcal{L}_i)$.
- We denote by $\overline{\mathcal{H}}_{g,n} \rightarrow \overline{\mathcal{M}}_{g,n}$ the *Hodge bundle*. For $0 \leq i \leq g$, we set $\lambda_i = c_i(\overline{\mathcal{H}}_{g,n})$.

The celebrated ELSV formula is the following theorem

Theorem 4.1.2. *For all genus g and profile of ramification μ such that $2g - 2 + n > 0$, we have*

$$(4.1.1) \quad h_{g,\mu} = (2g - 2 + d + n)! \left(\prod_{i=1}^n \frac{k_i^{k_i}}{k_i!} \right) \cdot \int_{\overline{\mathcal{M}}_{g,n}} \frac{1 - \lambda_1 + \dots + (-1)^g \lambda_g}{\prod_{i=1}^n (1 - k_i \psi_i)}.$$

There are already two different proofs of this theorem. The first proof was obtained by studying a cone over $\overline{\mathcal{M}}_{g,n}$ whose fibers are germs of meromorphic functions at the marked points (see [20]). The second proof uses the localization formula in the space of relative stable maps (see [27] and [36]). Our proof will be close to the original one. Indeed, the cone of stable differentials is a modification of the cone of principal parts of [20].

Remark 4.1.3. Our formulation of the ELSV formula differs from the original one by a factor $\#\text{Aut}(k_1, \dots, k_n)$. This depends on the convention that we chose: here we count ramified of \mathbb{P}^1 with labeled preimages of ∞ . This formulation can be found for example in [34].

Let g, n, m be nonnegative integers such that $2g - 2 + n + m > 0$. Let d be a positive integer and let $\mu = (k_1, \dots, k_n)$ be a partition of d . We recall that the stack of stable differentials $\overline{\mathfrak{H}}_{g,n+m,\mu}$ is the moduli space whose points are given by the datum of $(C, \alpha, x_1, \dots, x_{n+m})$ where C is a pre-stable curve with $n+m$ marked points and α is a meromorphic differential such that:

- The differential α has poles only at the nodes and at the first n marked points.
- Poles at the nodes are of order at most one and poles at the first n marked points are of order exactly $k_i + 1$.
- There are finitely many automorphisms of (C, x_1, \dots, x_n) that preserve α (stability condition).

The space of stable differentials $\overline{\mathcal{H}}_{g,n+m,\mu}$ is the partial coarsification of $\overline{\mathfrak{H}}_{g,n+m,\mu}$ as in Chapter 2.

Remark 4.1.4. Beware, the space of stable differentials here is essentially the same space as in Chapter 2 but the poles are at the first marked points and the poles are of order $k_i + 1$ (in particular we will not consider poles of order 1).

There is a natural map $p : \overline{\mathcal{H}}_{g,n+m,\mu} \rightarrow \overline{\mathcal{M}}_{g,n+m}$ obtained by forgetting the differential and stabilizing the curve C . With this map, $\overline{\mathcal{H}}_{g,n+m,\mu}$ is a cone of rank $d + n + g - 1$ over $\overline{\mathcal{M}}_{g,n+m}$. The Segre class of $\overline{\mathcal{H}}_{g,n+m,\mu}$ is given by

$$(4.1.2) \quad \xi = \left(\prod_{i=1}^n \frac{k_i^{k_i}}{k_i!} \right) \cdot \frac{1 - \lambda_1 + \dots + (-1)^g \lambda_g}{\prod_{i=1}^n (1 - k_i \psi_i)}.$$

Let $\xi = c_1(\mathcal{O}(1)) \in H^2(\mathbb{P}\overline{\mathcal{H}}_{g,n+m,\mu}, \mathbb{Q})$ where $\mathcal{O}(1)$ is the dual of the tautological line bundle. In order to prove the ELSV formula, we will prove that

$$(4.1.3) \quad h_{g,\mu} = (2g - 2 + d + n)! \int_{\mathbb{P}\overline{\mathcal{H}}_{g,n,\mu}} \xi^{4g-5+d+2n}.$$

Remark 4.1.5. The space of stable differentials is a modification of the cone of generalized principal parts used in [20]. We will see that the benefit of the cone of stable differentials is that we dispose of several techniques to consider maps with more general types of ramifications.

4.1.2. Simple Hurwitz numbers with cycles. Let g, n, m and d be as in the previous Section. Let $\mu = (k_1, \dots, k_n)$ be a partition of d and let $\nu = (k'_1, \dots, k'_m)$ be a partition of $2g - 2 + d + n + m$.

Definition 4.1.6. A *simple cyclic covering* of type (μ, ν) is a pair $(C, f : C \rightarrow \mathbb{P}^1)$ where f is ramified with orders (k_1, \dots, k_n) at ∞ and with orders $(k'_1, 1, \dots, 1)$ at m other marked points. The *simple Hurwitz numbers with cycles* is the number of classes of simple cyclic coverings of type (μ, ν) counted with weight $1/|\text{Aut}(C, f)|$. We denote this number by $h_g^{\text{cyc}}(\mu, \nu)$.

Notation 4.1.7. Let $A_{g, \mu, \nu}$ be the locus of $\overline{\mathcal{H}}_{g, n+m, \mu}$ of elements $(C, x_1, \dots, x_{n+m}, \alpha)$ such that:

- the curve C is smooth,
- the residues of α at the marked poles are equal to zero,
- the differential α has zeros exactly of order $k'_i - 1$ at x_{n+i} .

We have seen that the locus $A_{g, \mu, \nu}$ is a locus of codimension $2g - 3 + d + 2n$ in $\overline{\mathcal{H}}_{g, n+m, \nu}$. The locus $A_{g, \mu, \nu}$ is \mathbb{C}^* -invariant and we denote $\mathbb{P}A_{g, \mu, \nu} \subset \mathbb{P}\overline{\mathcal{H}}_{g, n+m, \mu}$ the projectivization of $A_{g, \mu, \nu}$. We denote by $\overline{A}_{g, \mu, \nu}$ and $\mathbb{P}\overline{A}_{g, \mu, \nu}$ the closures of $A_{g, \mu, \nu}$ and $\mathbb{P}A_{g, \mu, \nu}$. We will denote by $a_{g, \mu, \nu} \in H^*(\mathbb{P}\overline{\mathcal{H}}_{g, n+m, \nu}, \mathbb{Q})$ the Poincaré-dual cohomology class of the closure of $\mathbb{P}\overline{A}_{g, \mu, \nu}$. We proved at Chapter 2 that $a_{g, \mu, \nu}$ can be computed explicitly in terms of tautological classes. We will prove

Theorem 4.1.8. *The following equality holds*

$$h_0^{\text{cyc}}(\mu, \nu) = \int_{\mathbb{P}\overline{\mathcal{H}}_{0, n+m, \mu}} a_{0, \mu, \nu} \cdot \xi^{m-2}.$$

In general, we have

$$\int_{\mathbb{P}\overline{\mathcal{H}}_{g, n+m, \mu}} a_{g, \mu, \nu} \cdot \xi^{m-2} = h_g^{\text{cyc}}(\mu, \nu) + \text{boundary contributions},$$

where the boundary terms are Hurwitz numbers of lower genera. We will compute explicitly these boundary terms on some examples in genus 1.

4.1.3. Double Hurwitz numbers. Let g, n, m and d be as in the previous section. Let $\mu = (k_1, \dots, k_n)$ and $\nu = (k'_1, \dots, k'_m)$ be two partitions of d .

Definition 4.1.9. The *double Hurwitz number* $h_g^{\text{d}}(\mu, \nu)$ is the number of ramified coverings of \mathbb{P}^1 with ramification profile over ∞ specified by μ and ramification profile over zero specified by ν .

Cavalieri, Johnson and Markwig conjectured the existence of a moduli space $\mathcal{P}_{g, n+m}$ of dimension $4g - 3 + n + m$ with a map to $\overline{\mathcal{M}}_{g, n+m}$ such that there exists classes Λ_{2i} in $A_{2i}(\mathcal{P}_{g, n+m})$ for $i = 1, \dots, g$ such that

$$h_g^{\text{d}}(\mu, \nu) = \int_{\mathcal{P}_{g, n+m}} \frac{1 - \Lambda_2 + \dots + (-1)^g \Lambda_{2g}}{\left(\prod_{i=1}^n 1 - k_i \psi_i\right) \cdot \left(\prod_{i=1}^m 1 + k'_i \psi_{m+i}\right)}.$$

In fact, the space $\mathcal{P}_{g, n+m}$ should depend on μ and ν but be constant in some chambers of the parameters (see [9]). This conjecture is a generalization of the conjecture of Goulden, Jackson and Vakil:

Conjecture 4.1.10. (GJV) If $\nu = (d)$, then there exists $\mathcal{P}_{g,n}$ and $\Lambda_{2i} \in A_{2i}(\mathcal{P}_{g,n})$ such that:

$$h_g^d(\mu, (d)) = K! d \int_{\mathcal{P}_{g,n}} \frac{1 - \Lambda_2 + \dots + (-1)^g \Lambda_{2g}}{\prod_{i=1}^n (1 - k_i \psi_i)},$$

where K is the number of simple branch points.

In this context we can see that $h_g^d(\mu, (d)) = h_g^{\text{cyc}}(\mu, (d))$. We will prove the following:

Theorem 4.1.11. In genus 0, we have

$$h_0^d(\mu, (d)) = K! d \int_{\mathcal{M}_{0,n}} \frac{1}{\prod_{i=1}^n (1 - k_i \psi_i)}.$$

for all μ .

Remark 4.1.12. These two cases of the conjecture were already known. However the proof that we give is geometric while the original one was a combinatorial identity. We will see that another interest of this proof is to use the generalization of completed cycles in genus 0 introduced by Kazarian, Lando and Zvonkine in [47]. We will see the importance of the “hidden” terms of the completed cycles formula of Okounkov and Pandharipande (see [63]).

4.2. From stable differentials to stable maps

4.2.1. Stable maps. Let g, n, d be non negative integers. The space of stable maps to \mathbb{P}^1 of degree d is the moduli space whose points correspond to classes of tuples

$$(C, x_1, \dots, x_n, f : C \rightarrow \mathbb{P}^1),$$

where

- (C, x_1, \dots, x_n) is a nodal curve of genus g with n marked points;
- f is a map of degree d ;
- there are finitely many automorphisms of f .

We denote this space by $\overline{\mathcal{M}}_{g,n}(\mathbb{P}^1, d)$. This space is endowed with a perfect obstruction theory defined by Behrend and Fantechi (see [5]) and thus carry a virtual fundamental class.

Definition 4.2.1. Let $\mu = (k_1, \dots, k_n)$ be a partition of d . We define the *Hurwitz space* $\text{Hur}_{g,\mu}$ as the sub-space of $\overline{\mathcal{M}}_{g,n}(\mathbb{P}^1, d)$ of stable maps (C, x_1, \dots, x_n, f) such that

- there is no contracted component over ∞ ;
- the point x_i is mapped to ∞ by f with order k_i for all $1 \leq i \leq n$.

This space is not compact but it has structure of cone over $\overline{\mathcal{M}}_{g,n}$ and we denote by $\mathbb{P}\text{Hur}_{g,\mu}$ its projectivization which is compact. The space $\text{Hur}_{g,\mu}$ is endowed with a perfect obstruction theory (and a virtual fundamental cycle) that we recall now.

The space $\text{Hur}_{g,\mu}$ has a forgetful map $p : \text{Hur}_{g,\mu} \rightarrow \mathfrak{M}_{g,n}$ the Artin stack of pre-stable curves. There is a relative perfect obstruction theory defined as follows

at a point (C, f, x_i)

$$\begin{aligned} \text{Def}_{\text{Hur}_{g,m,\mu}/\mathfrak{M}_{g,n}} &= H^0\left(C, f^*T\mathbb{P}^1(-\sum k_i x_i)\right), \\ \text{Ob}_{\text{Hur}_{g,m,\mu}/\mathfrak{M}_{g,n}} &= H^1\left(C, f^*T\mathbb{P}^1(-\sum k_i x_i)\right). \end{aligned}$$

The global obstruction theory of $\text{Hur}_{g,\mu}$ is defined as for the space of stable maps (see [5]).

Remark 4.2.2. The perfect obstruction theory of $\text{Hur}_{g,\mu}$ is not induced by the perfect obstruction theory of $\overline{\mathcal{M}}_{g,n}(\mathbb{P}^1, d)$ but rather by the obstruction theory of the space of relative stable maps that we introduce in the next Chapter. Indeed the space $\text{Hur}_{g,\mu}$ is an open subspace of the space of relative stable maps.

4.2.2. Lyashko-Looijenga mapping. We denote by $V = \mathbb{C}^K/S_K$ where we recall that K is the number of simple branch points. Let (C, f, x_1, \dots, x_n) be a point in $\text{Hur}_{g,\mu}$. The branch locus of f is the point of V whose entries are the following values:

- if C_v is an irreducible component of C where f is not constant then we take the set of critical values (repeated with the multiplicity of the critical point if it is not simple);
- if C_v is an irreducible component of C where f is constant, the value of f on this component repeated with multiplicity $2g_v - 2$;
- if x is a node of C , $f(x)$.

Definition 4.2.3. The *Lyashko-Looijenga mapping* is the map

$$\begin{aligned} \mathcal{LL} : \text{Hur}_{g,\mu} &\rightarrow V \\ f &\mapsto \text{branch locus of } f. \end{aligned}$$

We define the map $\text{br} : \text{Hur}_{g,\mu} \rightarrow \mathbb{C}$ which maps a point to the sum of values of its branch locus.

4.2.3. Integration of differentials. The space $\text{Hur}_{g,\mu}$ is endowed with a map $\text{diff} : \text{Hur}_{g,\mu} \rightarrow \overline{\mathcal{H}}_{g,\mu}$ which maps a stable maps to its differential. Beside, we have seen it has a map $\text{br} : \text{Hur}_{g,\mu} \rightarrow \mathbb{C}$ which maps a stable map in $\text{Hur}_{g,\mu}$ to the sum of its branch points. These two maps together define a map of cones over $\overline{\mathcal{M}}_{g,n}$

$$i : \text{Hur}_{g,\mu} \rightarrow \mathbb{C} \oplus \overline{\mathcal{H}}_{g,\mu}.$$

This map is closed embedding. We will prove that $\mathbb{P}\text{Hur}_{g,\mu}$ is obtained as the vanishing locus of a global section of a vector bundle. We first consider the space of stable differentials $\mathbb{P}\overline{\mathcal{H}}_{g,\mu}$.

4.2.3.1. *Residues.* Let \mathcal{R} be the linear subspace of \mathbb{C}^n defined as

$$\mathcal{R} = \{(r_1, \dots, r_n), r_1 + \dots + r_n = 0\}.$$

The residue map is the section of $\mathcal{O}(1) \otimes \mathcal{R}$ defined by

$$\begin{aligned} \text{Res} : \mathcal{O}(-1) &\rightarrow \mathcal{R} \\ \alpha &\mapsto (\text{res}_{x_1}(\alpha), \dots, \text{res}_{x_n}(\alpha)). \end{aligned}$$

The zero locus of this map is the sub-locus $\mathbb{P}(\overline{\mathcal{H}}_{g,\mu}^0)$ of differentials with zero residues.

4.2.3.2. *Closed differentials.* Let $i \in [1, n]$ and $k_i > 0$. Let C be a curve with markings. A principal part of order k_i at x_i is a class of equivalence of germ of meromorphic function with a pole of order k_i where the equivalence is given by $f \sim g$ if and only if $f - g$ has no pole at x_i . We denote by $\mathcal{P}_{i,k_i} \rightarrow \overline{\mathcal{M}}_{g,n}$ the *cone of generalized principal parts* of order k_i at x_i defined in [20]. It is a compactification of the space of principal parts. Moreover we denote

$$\mathcal{P} = \bigoplus_{i=1}^n \mathcal{P}_{i,k_i}.$$

We define the morphisms int and ϕ_1 on the diagram below

$$(4.2.1) \quad \begin{array}{ccc} \mathcal{O}(-1) & \xrightarrow{\text{int}} & p^*\mathcal{P} & \xrightarrow{\phi_1} & p^*(\overline{\mathcal{H}}_{g,n}^\vee) \\ & \searrow & \downarrow & \swarrow & \\ & & \mathbb{P}\overline{\mathcal{H}}_{g,\mu} & & \end{array}$$

The map $\text{int}_i : \mathcal{O}(-1) \rightarrow p^*\mathcal{P}_i$ maps a meromorphic differentials to the germ of meromorphic function at x_i obtained by integration:

$$\left(\left(\frac{u}{z} \right)^{k_i} + a_1 \left(\frac{u}{z} \right)^{k_i-1} + \dots + a_{k_i-1} \frac{u}{z} \right) \frac{dz}{z} \mapsto \frac{1}{k_i} \left(\frac{u}{z} \right)^{k_i} + \frac{a_1}{k_i-1} \left(\frac{u}{z} \right)^{k_i-1} + \dots + a_{k_i-1} \frac{u}{z}.$$

The map int_i is equivariant with respect to the action of $\mathbb{Z}/k_i\mathbb{Z}$ defined by multiplication of the local coordinate z by k_i^{th} -roots of unity. The map int is defined as $\bigoplus_{i=1}^n \text{int}_i$. The map ϕ_1 is defined as in [20]:

$$\begin{aligned} \phi_1 : p^*\mathcal{P} &\rightarrow p^*(\overline{\mathcal{H}}_{g,n}^\vee) \\ (p_1, \dots, p_n) &\mapsto \left(\omega \mapsto \sum_{i=1}^n \text{res}_{x_i}(p_i \cdot \omega) \right). \end{aligned}$$

We set $\Phi_1 = \phi_1 \circ \text{int}$. The map Φ_1 defines a section of the bundle $\mathcal{O}(1) \otimes p^*(\overline{\mathcal{H}}_{g,n}^\vee)$.

Proposition 4.2.4. *The vanishing locus of Φ_1 is the locus of points $(C, \alpha, x_1, \dots, x_n)$ such that the primitives of the germs of poles of α at the x_i 's can be extended into a unique (up to an additive constant) global meromorphic function f on the curve C . We denote by $\mathbb{P}\mathcal{Z}_1$ the vanishing locus of Φ_1 .*

PROOF. This proposition is a direct consequence of the Mittag-Leffler theorem. \square

4.2.3.3. *Exact differentials.* We complete the diagram 4.2.1 and we will define the map Φ

$$(4.2.2) \quad \begin{array}{ccc} i_1^*\mathcal{O}(-1) & \xrightarrow{\Phi} & i_1^*(p^*(\overline{\mathcal{H}}_{g,n}^\vee)) \\ & \searrow & \downarrow \\ & & \mathbb{P}\mathcal{Z}_1 \hookrightarrow \mathbb{P}\overline{\mathcal{H}}_{g,n,\mu} \end{array}$$

where $i_1 : \mathbb{P}\mathcal{Z}_1 \rightarrow \mathbb{P}\overline{\mathcal{H}}_{g,n,\mu}$ is the embedding morphism. The map Φ maps a point $(C, \alpha, x_1, \dots, x_n)$ to $df - \alpha$ where f is the unique function (up to an additive constant) defined by the germs of poles of α and by the Mittag-Leffler theorem. Thus Φ defines a section of the bundle $i_1^* \mathcal{O}(-1) \otimes i_1^*(p^*(\overline{\mathcal{H}}_{g,n}))$.

Proposition 4.2.5. *The vanishing locus of Φ is the locus of exact differentials i.e. the locus of differential α such that there exists a meromorphic function f such that $df = \alpha$. We denote this locus by $\mathbb{P}\mathcal{Z}$.*

PROOF. The proof is straightforward. A point in the vanishing locus of Φ is a point $(C, \alpha, x_1, \dots, x_{n+m})$ of $\mathbb{P}\mathcal{Z}_1$ such that the unique meromorphic function f defined by the germs of poles of α satisfies $df - \alpha = 0$. \square

Following the same construction we obtain $\mathbb{P}(\mathbb{C} \oplus \mathcal{Z})$ as the vanishing locus of global sections of vector bundles over $\mathbb{P}(\mathbb{C} \oplus \overline{\mathcal{H}}_{g,\mu})$. We obviously have the isomorphism $\mathbb{P}(\mathbb{C} \oplus \mathcal{Z}) \simeq \mathbb{P}\text{Hur}_{g,\mu}$.

4.2.4. Comparison of the perfect obstruction theories. We have already defined a perfect obstruction theory on $\mathbb{P}\text{Hur}_{g,\mu}$. We will prove here

Proposition 4.2.6. *Let $i : \mathbb{P}\text{Hur}_{g,\mu} \hookrightarrow \mathbb{P}(\mathbb{C} \oplus \overline{\mathcal{H}}_{g,\mu})$ be the above embedding. We have the following equality in $H^*(\mathbb{P}(\mathbb{C} \oplus \overline{\mathcal{H}}_{g,\mu}), \mathbb{Q})$:*

$$i_*[\mathbb{P}\text{Hur}_{g,\mu}]^{\text{vir}} = \xi^{2g+m-1}.$$

PROOF. First we note that:

$$\begin{aligned} c_{\text{top}}(\mathcal{O}(1) \otimes (\mathcal{R} \oplus \overline{\mathcal{H}}_{g,n} \oplus \overline{\mathcal{H}}_{g,n}^\vee)) &= \xi^{m-1} \cdot c_{\text{top}}(\mathcal{O}(1) \otimes \overline{\mathcal{H}}_{g,n}) \cdot \\ &\quad c_{\text{top}}(\mathcal{O}(1) \otimes \overline{\mathcal{H}}_{g,n}^\vee) \\ &= \xi^{m-1} \cdot (\xi^g + \lambda_1 \xi^{g-1} + \dots) \cdot \\ &\quad (\xi^g - \lambda_1 \xi^{g-1} + \dots) \\ &= \xi^{2g+m-1}. \end{aligned}$$

Thus in order to prove the proposition we only need to prove that the virtual cycle obtained from the theory of spaces of maps and the cycle obtained from vanishing of the global section of $\mathcal{R} \oplus \overline{\mathcal{H}}_{g,n} \oplus \overline{\mathcal{H}}_{g,n}^\vee$ are the same. To achieve this we work in relatively to $\mathfrak{M}_{g,n}$. We fix a pre-stable curve C . We have the two exact sequences of sheaves

$$\begin{aligned} 0 \rightarrow \mathcal{O}_C \rightarrow \mathcal{O}_C(\sum k_i x_i) \rightarrow \mathcal{O}_C|_{\sum k_i x_i} \rightarrow 0, \\ 0 \rightarrow \omega_C(+\sum x_i) \rightarrow \omega_C(\sum (k_i+1)x_i) \rightarrow \\ \omega_C(\sum (k_i+1)x_i) / \omega_C(+\sum x_i) \omega_C \rightarrow 0. \end{aligned}$$

The last terms of the two sequences are isomorphic via local integration. A germ of meromorphic differentials with a pole of order k_i+1 is the same as equivalent to a germs of meromorphic function with a pole of order k_i . Thus we get two long exact sequence with a common term:

$$\begin{aligned} 0 \rightarrow H^0(\mathcal{O}_C) \rightarrow H^0(\mathcal{O}_C(\sum k_i x_i)) \rightarrow H^0(\mathcal{O}_C|_{\sum k_i x_i}) \\ \rightarrow H^1(\mathcal{O}_C) \rightarrow H^1(\mathcal{O}_C(\sum k_i x_i)) \rightarrow 0, \end{aligned}$$

$$0 \rightarrow H^0(\omega_C(\sum x_i)) \rightarrow H^0(\omega_C(\sum(k_i+1)x_i)) \rightarrow H^0(\mathcal{O}_C|_{\sum k_i x_i}) \rightarrow 0.$$

We have $f^*T\mathbb{P}^1(-\sum k_i x_i) \simeq \mathcal{O}_C(\sum k_i x_i)$. Thus, in the first exact sequence we recognize the deformation and obstruction terms of the obstruction theory of $\text{Hur}_{g,\mu}$ relative to $\mathfrak{M}_{g,n}$. Beside the tangent space of $\mathbb{C} \oplus \overline{\mathcal{H}}_{g,\mu}$ is $H^0(\mathbb{C}) \oplus H^0(\omega_C(\sum k_i + 1)x_i)$. Thus in the Grothendieck group of $\mathfrak{M}_{g,n}$ we get

$$[\text{Def}_{\text{Hur}/\mathfrak{M}_{g,n}} - \text{Ob}_{\text{Hur}/\mathfrak{M}_{g,n}}] = [T_{(\mathbb{C} \oplus \overline{\mathcal{H}}_{g,\mu})/\mathfrak{M}_{g,n}} - H^0(\omega_C(\sum k_i x_i) - H^0(\omega_C)^\vee)].$$

Finally we remark that $H^0(\omega_C(\sum k_i x_i))$ splits into $H^0(\omega_C) \oplus \mathcal{R}$ to finish the proof. \square

4.3. End of the proof of Theorem 4.1.8

The end of our proof of the ELSV formula is the same as the original one. We recall it here and adapt it to genus 0 cyclic coverings.

4.3.1. End of the proof of ELSV formula. Recall that $V = \mathbb{C}^K/S_K$ and that the map $\mathcal{L}\mathcal{L} : \text{Hur}_{g,\mu}(\simeq \mathcal{Z}) \rightarrow V$ is the Lyashko-Looijenga mapping. The torus \mathbb{C}^* acts on V and the $\mathcal{L}\mathcal{L}$ mapping is \mathbb{C}^* -equivariant. We will use the same letter for the *projectivized Lyashko-Looijenga mapping*:

$$\mathcal{L}\mathcal{L} : \mathbb{P}\mathcal{Z} \rightarrow \mathbb{P}V.$$

Let $\mathcal{Z}_s \subset \text{Hur}_{g,\mu}$ be the locus of elements $(C, x_1, \dots, x_n, f : C \rightarrow \mathbb{P}^1)$ such that C is smooth. The Lyashko-Looijenga mapping restricted to \mathcal{Z}_s is étale (see [20] Proposition A.3) and we have the following equality:

$$h_{g,\mu} = \deg(\mathcal{L}\mathcal{L}|_{\overline{\mathcal{Z}}_s}) = \deg(\mathcal{L}\mathcal{L}|_{\mathbb{P}\mathcal{Z}_s}).$$

Indeed, given a topological ramified covering $(f : C \rightarrow \mathbb{P}^1)$, for any complex structure on \mathbb{P}^1 , there exists a unique complex structure on C and a unique function f with the given topological type. We will prove:

Lemma 4.3.1. *The simple Hurwitz numbers are given by:*

$$h_{g,\mu} = \int_{\mathbb{P}\overline{\mathcal{Z}}_s} \xi^{K-2}.$$

PROOF. We denote by $\mathcal{O}(1)_V$ the dual of the tautological line bundle of $\mathbb{P}V$ (to keep the notation $\mathcal{O}(1)$ for the dual of the tautological line bundle of $\mathbb{P}(\mathbb{C} \oplus \overline{\mathcal{H}}_{g,\mu})$). The class of a point in $\mathbb{P}V$ is given by $c_1(\mathcal{O}(1)_V)^{K-1}$ therefore the degree of $\mathcal{L}\mathcal{L}|_{\mathbb{P}\mathcal{Z}_s}$ is equal to $\deg(\mathcal{L}\mathcal{L}|_{\mathbb{P}\mathcal{Z}_s}^* c_1(\mathcal{O}(1)_V)^{K-1})$. The map $\mathcal{L}\mathcal{L} : \mathcal{O}(-1) \rightarrow V$ is equivariant with respect to the \mathbb{C}^* action. Thus we have $\mathcal{L}\mathcal{L}^*(\mathcal{O}(1)_V) = \mathcal{O}(1)$ and we get

$$\deg(\mathcal{L}\mathcal{L}|_{\mathcal{Z}_s}) = \int_{\mathbb{P}\overline{\mathcal{Z}}_s} \xi^{K-1}.$$

\square

Lemma 4.3.2. *For all irreducible components W of $\mathbb{P}\text{Hur}_{g,\mu} \setminus \overline{\mathbb{P}\mathcal{Z}}_s$, we have $\deg(c_1(\mathcal{O}(1)|_W)^{K-1}) = 0$.*

PROOF. Let $x_0 = (C_1, x_1, \dots, x_n, \alpha)$ be a point of $\mathbb{P}\text{Hur}_{g,\mu} \setminus \overline{\mathbb{P}\mathcal{Z}}_s$. The curve C has several irreducible components and the differential α vanishes identically on

at least one of these components. In which case, there exists a component \tilde{C} of C which satisfies:

- the differential α vanishes on \tilde{C}
- at least 2 of the marked zeros are carried by \tilde{C} .

To prove that \tilde{C} exists, it is enough to take a component with maximal depth in the level structure to which the differential α belongs (see [3]). Thus the image of x_0 by $\mathcal{L}\mathcal{L}$ lies in Σ . The boundary components of \mathcal{Z} are mapped to an hypersurface of V , therefore $\deg(c_1(\mathcal{O}(1)|_W)^{K-1}) = 0$. \square

Now the ELSV formula is a direct consequence of the following proposition:

Proposition 4.3.3. *The following equality holds*

$$[\mathbb{P}\overline{\mathcal{Z}}_s] \cdot \xi^{K-1} = \xi^{4g-4+d+2n}.$$

where $[\mathbb{P}\overline{\mathcal{Z}}_s]$ stands for the Poincaré-dual class of $\mathbb{P}\overline{\mathcal{Z}}_s$ in $\mathbb{P}\overline{\mathcal{H}}_{g,\mu}$.

PROOF. We have seen that the virtual fundamental class of $\mathbb{P}\text{Hur}_{g,\mu}$ is given by $\xi^{2g-2+n-1}$, thus

$$[\mathbb{P}\text{Hur}_{g,\mu}]^{\text{vir}} \cdot \xi^{K-1} = \xi^{4g-4+d+2n}.$$

The proposition follows from the fact (that we will not prove here) that the sections Φ_1 and Φ are transverse to $\overline{\mathbb{P}\mathcal{Z}}_s$. Thus $[\mathbb{P}\text{Hur}_{g,\mu}]^{\text{vir}} = [\mathbb{P}\overline{\mathcal{Z}}_s] + \beta$ where β is a class supported on $\mathbb{P}\text{Hur}_{g,\mu} \setminus \overline{\mathbb{P}\mathcal{Z}}_s$. It follows from Lemma 4.3.2 that $\beta \cdot \xi^{K-1} = 0$. \square

4.3.2. Simple Hurwitz numbers with cycles. The proof of Theorem 4.1.8 is simpler than the proof of the ELSV formula. We fix μ and ν as in Section 4.1.2. We consider the locus $A_{0,\mu,\nu} \subset \overline{\mathcal{H}}_{0,m,\mu}$ of differentials over smooth curves, with no residues and zeros of orders prescribed by ν .

In genus 0 the datum of a differential with prescribed zeros is equivalent to the datum of a meromorphic function with fixed ramification orders modulo additive constant. Indeed all meromorphic differentials without residues can be integrated. The obstructions coming from the Hodge bundle and its dual are trivial.

Therefore we can define the LL-mapping as follows:

$$\begin{aligned} \mathcal{L}\mathcal{L} : \overline{A}_{0,\mu,\nu} \oplus \mathbb{C} &\rightarrow V \\ f &\mapsto (f(x_{n+1}), \dots, f(x_{n+m})). \end{aligned}$$

We also denote the projectivization of the Lyashko-Looijenga mapping by $\mathcal{L}\mathcal{L}$. We have

$$h_0^{\text{cyc}}(\mu, \nu) = \deg(\mathcal{L}\mathcal{L}|_{\overline{A}_{0,\mu,\nu} \oplus \mathbb{C}})$$

Therefore as for the ELSV formula we have

$$h_0^{\text{cyc}}(\mu, \nu) = \int_{\mathbb{P}(\overline{A}_{0,\mu,\nu} \oplus \mathbb{C})} \xi^{K-1} = \int_{\mathbb{P}\overline{A}_{0,\mu,\nu}} \xi^{K-2}.$$

The proof is much simpler because there are no boundary components to take into account.

4.4. Completed cycles

4.4.1. Shifted symmetric functions. Let N be a positive integer. The symmetric group $S(N)$ acts on the algebra $\mathbb{Q}[\lambda_1, \dots, \lambda_N]$, for a permutation σ the action is defined by

$$\sigma \cdot f(\lambda_1 - 1, \dots, \lambda_N - N) = f(\lambda_{\sigma(1)} - \sigma(1), \dots, \lambda_{\sigma(N)} - \sigma(N)).$$

We denote by $\mathbb{Q}[\lambda_1, \dots, \lambda_N]^{S(N)}$ the algebra of polynomials invariant under the action of $S(N)$. This algebra has a natural filtration by the degree. Moreover we have a natural arrow

$$\mathbb{Q}[\lambda_1, \dots, \lambda_{N+1}]^{S(N+1)} \rightarrow \mathbb{Q}[\lambda_1, \dots, \lambda_N]^{S(N)}$$

sending λ_{N+1} to 0. Thus we can define

Definition 4.4.1. The algebra of shifted symmetric functions Λ^* is defined as the projective limit of the $\mathbb{Q}[\lambda_1, \dots, \lambda_N]^{S(N)}$.

Concretely an element \mathbf{f} of Λ^* is a sequence $\{f_N\}$ satisfying:

- the sequence of degrees is bounded;
- $f_N = f_{N+1}|_{\lambda_{N+1}=0}$.

We are going to build two different basis of this space. The completed-cycle formula gives the coefficients allowing to go from one basis to the other.

4.4.2. Partition functions. Let $\mathcal{P}(N)$ be the set of partitions of N . The set $\mathcal{P}(N)$ indexes the irreducible representations of $S(N)$ (or conjugacy classes of $S(N)$). For partitions λ and μ , we denote by $\dim(\lambda)$ the dimension of the representation associated to λ , $|C_\mu|$ the cardinal of the conjugacy class of μ and χ_μ^λ the evaluation of the character of the representation defined by λ at the conjugacy class C_μ . The Fourier transform gives an isomorphism between the algebra of functions invariant by conjugacy and the algebra of functions on $\mathcal{P}(N)$

$$\begin{aligned} \phi_N : \mathcal{Z}(N) &\rightarrow \mathbb{Q}^{\mathcal{P}(N)} \\ C_\mu &\mapsto \left(\mathbf{f}_\mu : \lambda \mapsto |C_\mu| \frac{\chi_\mu^\lambda}{\dim(\lambda)} \right). \end{aligned}$$

If we define \mathcal{P} as the set of all partitions, we can define an extended Fourier transform

$$\phi : \bigoplus_{d=0}^{\infty} \mathcal{Z}(N) \rightarrow \mathbb{Q}^{\mathcal{P}}.$$

This morphism is no longer an isomorphism however it is injective and the image is the algebra of shifted symmetric functions. Indeed, let $\mathbf{f} \in \Lambda^*$, for a finite sequence (x_1, x_2, x_3, \dots) (i.e. non-zero on a finite set), the evaluation of $\mathbf{f}(x_1, x_2, \dots)$ is well-defined. For a partition $\lambda = (\lambda_1, \lambda_2, \dots, \lambda_l)$, we can evaluate \mathbf{f} by completing by a sequence of zeros. Therefore \mathbf{f} defines an element of $\mathbb{Q}^{\mathcal{P}}$. The element \mathbf{f} is in fact uniquely determined by the evaluation on the partitions, thus Λ^* as a subalgebra of $\mathbb{Q}^{\mathcal{P}}$.

A non-trivial result of Kerov and Olshanski (see [49]), states that the $(\mathbf{f}_\mu)_{\mu \in \mathcal{P}}$ are shifted symmetric and generate all Λ^* , therefore these functions provide a first basis of Λ^* .

4.4.3. Shifted symmetric power sums. Let k be a positive integer and λ be partition. We define $\mathbf{p}_k \in \Lambda^*$ by:

$$\mathbf{p}_k(\lambda) = \sum_{i=1}^{\infty} \left[(\lambda_i - i - \frac{1}{2})^k - (-i + \frac{1}{2})^k \right].$$

For all positive integers n , the restriction to the algebra of polynomials in N variables is of degree k , hence \mathbf{p}_k is a well-defined element of Λ^* . For a partition μ , we define $\mathbf{p}^\mu = \prod \mathbf{p}_{\mu_i}$. Vershik and Kerov (see [48]) proved that:

$$\mathbf{f}_\mu = \frac{1}{\prod \mu_i} \mathbf{p}^\mu + \dots,$$

the other terms being associated to partitions of size strictly lower than $|\mu|$. Thus (\mathbf{p}_μ) and \mathbf{f}_μ are related by an infinite dimensional triangular matrix. We will denote by

$$\overline{C}_\mu = \frac{1}{\prod \mu_i} \phi^{-1}(\mathbf{p}_\mu) \in \bigoplus_{d=0}^{\infty} \mathcal{Z}(N),$$

the *completed conjugacy classes*. For any positive integer k , we denote by $\overline{(k)}$ the *completed cycle*. We denote by

$$\mathcal{S}(z) = \frac{\sinh(z/2)}{z/2},$$

and define the numbers $\rho_{k,\mu}$ as the coefficients in the expansion of

$$\frac{\prod \mu_i}{|\mu|!} \mathcal{S}(z) \prod S(\mu_i z) = \sum_{k \geq |\mu| + l(\mu) - 1} \frac{\rho_{k,\mu}}{(k-1)!} z^{k+1-|\mu|-l(\mu)}.$$

Proposition 4.4.2. (*Completed cycles formula*) We have

$$\overline{(k)} = \sum_{\mu} \rho_{k,\mu} \cdot (\mu).$$

We give the expression of the first completed cycles:

$$\begin{aligned} 0! \cdot \overline{(1)} &= (1) \\ 1! \cdot \overline{(2)} &= (2) \\ 2! \cdot \overline{(3)} &= (3) + \boxed{(1,1)} + \frac{1}{12} \cdot (1) \\ 3! \cdot \overline{(4)} &= (3) + \boxed{2 \cdot (2,1)} + \frac{5}{4} \cdot (2) \\ 4! \cdot \overline{(5)} &= (5) + \boxed{3 \cdot (3,1)} + \boxed{4 \cdot (2,2)} + \frac{11}{2} \cdot (3) \\ &\quad + \boxed{4 \cdot (1,1,1)} + \frac{3}{2} \cdot (1,1) + \frac{1}{80} \cdot (1) \end{aligned}$$

In these expression we have boxed the boundary terms corresponding to genus 0 contributions.

4.4.4. Gromov-Witten/Hurwitz correspondence. The correspondence between Gromov-Witten theory and Hurwitz theory is based on the completed cycle formula. We present this correspondence for \mathbb{P}^1 here but it holds for any smooth algebraic curve X .

Let g, n, d be non negative integers. We consider the moduli space of stable maps to \mathbb{P}^1 of degree d denoted by $\overline{\mathcal{M}}_{g,n}(\mathbb{P}^1, d)$. We recall that this space is endowed with a forgetful map $\text{st} : \overline{\mathcal{M}}_{g,n}(\mathbb{P}^1, d) \rightarrow \overline{\mathcal{M}}_{g,n}$ and the evaluation map $\text{ev}_i : \overline{\mathcal{M}}_{g,n}(\mathbb{P}^1, d) \rightarrow \mathbb{P}^1$ of the i -th marked point for all $1 \leq i \leq n$. We denote by pt the class of point in $H^2(\mathbb{P}^1, \mathbb{Q})$. We are interested in the numbers

$$\langle \tau_{k_1} \tau_{k_2} \dots \tau_{k_n} \rangle = \int_{[\overline{\mathcal{M}}_{g,n}(\mathbb{P}^1, d)]^{\text{vir}}} \prod_{i=1}^n \text{st}^*(\psi_i^{k_i}) \text{ev}_i^*(\text{pt}).$$

On another side if we give ourselves n partitions of d , (μ_1, \dots, μ_n) , we will denote by $H_{d,g}(\mu_1, \dots, \mu_n)$ the Hurwitz number for connected coverings with n prescribed profiles of ramification (and possibly other simple ramification point). We generalize this notation. If μ is a partition of $d' \leq d$, then we denote by $\tilde{\mu}$ the partition obtained by completing μ with ones. We define in this case

$$H_{d,g}(\mu_1, \dots, \mu_n) = H_{d,g}(\tilde{\mu}_1, \dots, \mu_n) \cdot \prod_{i=1}^n \binom{m_1(\tilde{\mu}_i)}{m_1(\mu_i)},$$

where $m_1(\mu)$ stands for the number of 1 in the partition μ .

Proposition 4.4.3. (GW/H correspondence) *We have the following equality*

$$\langle \tau_{k_1} \tau_{k_2} \dots \tau_{k_n} \rangle = H_{d,g}(\overline{(k_1)}, \dots, \overline{(k_n)}),$$

where the right hand-side is defined by linear expansion of the completed cycles in ordinary partitions.

4.4.5. Completed cycles formula for classes. We have seen at Chapter 2 how to compute the $a_{g,\mu,\nu}$ in general. We will restrict ourselves here the genus 0 case with one marked zero. In particular we will reformulate induction formula 2.3.41 in this restricted context.

Let d be positive integer and let μ be a partition of d . Let k be a positive integer. We denote by $A_{0,\mu,k} \subset \overline{\mathcal{H}}_{g,n+1,\mu}$ the locus of differentials with zero residues and with a zero exactly of order $k-1$ at the last marked point. Note that once again we do not assume here that $k-1 = 2g-2 + \sum k_i + n$, i.e. the differential can have unmarked zeros. Then we have:

$$(\xi + k\psi_{n+1})a_{0,\mu,k} = a_{0,\mu,k+1} + \text{boundary terms.}$$

Now we will describe the boundary terms.

A twist $I = (I_1, \dots, I_m)$ is a partition of k of length greater than 1. Let (μ_1, \dots, μ_m) be a partition of the set of values μ such that non of the μ_i 's is empty. The datum of I and the $(\mu_i)_{i=1, \dots, m}$ will be called a *twisted graph*. We represent graphically this

datum below:

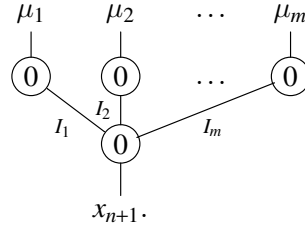

We define a locus $A_{I,(\mu_i)} \subset \overline{\mathcal{H}}_{0,n+1,\mu}$ associated to the twisted graph $(I, (\mu_i))$. A point $(C, x_1, \dots, x_{n+1}, \alpha)$ in $A_{I,(\mu_i)}$ is a curve together with a differential such that:

- the curve C is composed of $m+1$ components: m components attached to a main component;
- the point x_{n+1} belongs to the central components and the set of marked points on the i^{th} exterior component is determined by μ_i ;
- the differential α_i on the i^{th} exterior component has poles without residues at the marked points and a zero of order $I_i - 1$ at the node;
- the differential vanishes on the main component.

Remark 4.4.4. Twisted graphs represent boundaries of $A_{0,\mu,k}$. The above conditions are determined to ensure that the point $(C, x_1, \dots, x_{n+1}, \alpha)$ is in the closure of $A_{0,\mu,k}$.

Let $I = (I_1, \dots, I_m)$ be a twist, we define the class of a twist as

$$i_I = \sum_{(\mu_i)_i} [\mathbb{P}\overline{A}_{I,(\mu_i)}],$$

where the sum is over all possible twisted graphs with twist I and $[\mathbb{P}\overline{A}_{I,(\mu_i)}]$ is the Poincaré-dual class of $\mathbb{P}\overline{A}_{I,(\mu_i)}$ in $H^*(\mathbb{P}\overline{\mathcal{H}}_{0,n+1,\mu}, \mathbb{Q})$. We define the multiplicity of a twist as $m(I) = \prod_{j=1}^m I_j$. Then we have

$$(4.4.1) \quad (\xi + k\psi_{n+1})a_{0,\mu,k} = a_{0,\mu,k+1} + \sum_I \frac{m(I)}{|\text{Aut}(I_1, \dots, I_m)|} i_I.$$

Remark 4.4.5. This formula is only the reformulation of the general induction formula of Theorem 2.3.41.

We get the following expressions for the class $\psi = \psi_{n+1}$:

$$\begin{aligned} 1! \psi &= a_{\mu,2} + O(\xi) \\ 2! \psi^2 &= a_{\mu,3} + \frac{1}{2}i_{1,1} + O(\xi) \\ 3! \psi^3 &= a_{\mu,4} + 2i_{1,2} + \boxed{\frac{1}{6}i_{1,1,1}} + O(\xi) \\ 4! \psi^4 &= a_{\mu,5} + 3i_{1,3} + 2i_{2,2} + \boxed{2i_{1,1,2}} + \boxed{\frac{1}{24}i_{1,1,1,1}} + \frac{2}{3}\psi i_{1,1,1} + O(\xi) \end{aligned}$$

In these expressions, we have not represented the terms of higher degrees in ξ . The boxed terms are the terms which are not present in the completed-cycles formula of Okounkov and Pandharipande. For example, we can see that the term $i_{1,1,1}$

contributes in the expression of ψ^4 once multiplied by ψ . We will see that these terms are used in the computation of double Hurwitz numbers. The expressions above have already been obtained for universal cohomology classes of singularities in families of stable maps (see [47]).

In genus 0 and $n = 1$. If $g = 0$ and $n = 1$, then the stability condition $2g - 1 + n > 0$ is no longer satisfied. Thus the moduli space of curves $\overline{\mathcal{M}}_{0,1+1}$ is ill-defined. However, the moduli space of $\mathbb{P}\overline{\mathcal{H}}_{0,1+1,(d)}$ is well-defined and so are the loci $a_{0,(d),k}$. In which case, we have a simpler formula relating $a_{0,(d),k}$ and $a_{0,(d),k}$

$$(4.4.2) \quad \frac{d-k}{d} \xi a_{0,\mu,k} = a_{0,\mu,k+1}.$$

4.4.6. GJV formula in the genus 0. Let n, m be positive integers such that $n + m > 2$. Let d be a positive integer and let μ be a partition of length n of d and ν be a partition of $n+m+d-2$ of length m . We proved that $h_0^{\text{cyc}}(\mu, \nu) = \int_{\mathbb{P}\overline{\mathcal{H}}_{0,n+m,\mu}} \xi^{n-3} a_{0,\mu,\nu}$. We take $\nu = (d, 2, \dots, 2)$. The forgetful map $\pi : \mathbb{P}\overline{\mathcal{H}}_{0,n+m,\mu} \rightarrow \mathbb{P}\overline{\mathcal{H}}_{0,n+1,\mu}$ maps the locus $A_{0,\mu,\nu}$ to the locus $A_{0,\mu,d}$. The map $\pi|_{A_{0,\mu,\nu}}$ is of degree $K!$. Thus:

$$\begin{aligned} h_0^d(\mu, (d)) = h_0^{\text{cyc}}(\mu, \nu) &= \int_{\mathbb{P}\overline{\mathcal{H}}_{0,n+m,\mu}} \xi^{n-3} a_{0,\mu,\nu} \\ &= K! \int_{\mathbb{P}\overline{\mathcal{H}}_{0,n+1,\mu}} \xi^{n-3} a_{0,\mu,d}. \end{aligned}$$

Thus, in order to prove Theorem 4.1.11, we have to prove that:

$$\begin{aligned} \int_{\mathbb{P}\overline{\mathcal{H}}_{0,n+1,\mu}} \xi^{n-3} a_{0,\mu,d} &= d \int_{\mathcal{M}_{0,n}} \frac{1}{\prod_{i=1}^n (1 - k_i \psi_i)} \\ &= \int_{\mathcal{M}_{0,n+1}} \frac{1}{\prod_{i=1}^n (1 - k_i \psi_i)}. \end{aligned}$$

This equality is a special case of the following more general proposition:

Proposition 4.4.6. *For all profiles μ of length greater than 1 and all $\mu \geq 1$, we have:*

$$\int_{\mathbb{P}\overline{\mathcal{H}}_{0,1+n,\mu}} \xi^{n-3-k} \psi_{n+1}^k a_{0,\mu,d} = \int_{\mathcal{M}_{0,n+1}} \frac{\psi_{n+1}^k}{\prod_{i=1}^n (1 - k_i \psi_i)}$$

PROOF. We prove this proposition by induction on the length of μ . The base of the induction is at $n = 2$. In which case we can already see that for $k > 1$ we have $\psi_{n+1}^k = 0$, thus we only have to check the above proposition for $k = 0$. Besides, we have already proved in [71] that

$$\int_{\mathbb{P}\overline{\mathcal{H}}_{0,3,(k_1,k_2)}} a_{0,(k_1,k_2),(d)} = 1.$$

Now we assume that n is greater than 2. Let μ be a profile of length n . We write Formula (4.4.1) for $k = d$, we get:

$$(\xi + d\psi_{n+1})a_{0,\mu,(d)} = a_{0,\mu,(d+1)} + \sum_I m(I) \frac{i_I}{|\text{Aut}(I_1, \dots, I_m)|}.$$

The class $a_{0,\mu,(d+1)}$ is equal to zero: indeed an element of $A_{0,\mu,(d+1)}$ gives a meromorphic function of degree d with a zero of order $d + 1$ at the last marked point.

This is not possible, thus $A_{0,\mu,(d+1)}$ is empty. Then we have

$$\int_{\mathbb{P}\overline{\mathcal{H}}_{0,1+n,\mu}} \xi^{n-k-4} \psi_{n+1}^k (\xi + d\psi_{n+1}) a_{0,\mu,(d)} = \sum_I \frac{m(I)}{|\text{Aut}(I_1, \dots, I_m)|} \int_{\mathbb{P}\overline{\mathcal{H}}_{0,1+n,\mu}} \xi^{n-k-4} \psi_{n+1}^k i_I,$$

Now we compute the left-hand side of this equality. Let I be a twist. The class is $\psi_{n+1}^k i_I$ is equal to 0 if k is greater than $\text{length}(I) - 2$. If k is inferior to $\text{length}(I) - 2$ then we have $\int_{\overline{\mathcal{M}}_{0,\text{length}(I)-2}} \psi_{n+1}^k = 0$. Now if $k = \text{length}(I) - 2$, then $\int_{\overline{\mathcal{M}}_{0,\text{length}(I)-2}} \psi_{n+1}^k = 1$. Let I be a twist of length $k+2$. Let $(I, (\mu_i)_{i=1, \dots, k-2})$ be a twisted graph. We denote by $a_{I,(\mu_i)}$ the Poincaré-dual class of $A_{I,(\mu_i)}$. We have

$$\begin{aligned} \int_{\mathbb{P}\overline{\mathcal{H}}_{0,1+n,\mu}} \xi^{n-3-k} \psi_{n+1}^k a_{I,(\mu_i)} &= m(I) \prod_{i=1}^m h_0^d(\mu_i, (I_i)) \\ &= \prod_{i=1}^m I_i^{\text{length}(\mu_i)-1}, \end{aligned}$$

where we have used the induction hypothesis from the first line to the second: $h_0^d(\mu_i, (I_i)) = I_i^{\text{length}(\mu_i)-2}$. Therefore we have:

$$\begin{aligned} \left(\int_{\mathbb{P}\overline{\mathcal{H}}_{0,1+n,\mu}} \xi^{n-k-3} \psi_{n+1}^k a_{0,\mu,(d)} \right) + d \left(\int_{\mathbb{P}\overline{\mathcal{H}}_{0,1+n,\mu}} \xi^{n-k-4} \psi_{n+1}^{k+1} a_{0,\mu,(d)} \right) \\ = \frac{1}{(k+1)!} \sum_{(\mu_i)_{i=1 \dots k+2}} \left(\prod_{i=1}^m |\mu_i|^{\text{length}(\mu_i)-1} \right) \end{aligned}$$

where the sum goes over all partitions of μ into $k+2$ sets and $|\mu_i| = \sum_{k_j \in \mu_i} k_j$. Now using string and dilaton relations we can check that:

$$\begin{aligned} \int_{\overline{\mathcal{M}}_{0,n+1}} \frac{\psi_{n+1}^k}{\prod_{i=1}^n (1 - k_i \psi_i)} + d \int_{\overline{\mathcal{M}}_{0,n+1}} \frac{\psi_{n+1}^{k+1}}{\prod_{i=1}^n (1 - k_i \psi_i)} \\ = \frac{1}{(k+1)!} \sum_{(\mu_i)_{i=1 \dots k+2}} \left(\prod_{i=1}^m |\mu_i|^{\text{length}(\mu_i)-1} \right). \end{aligned}$$

Moreover, for $k > n-2$ we have $\psi_{n+1}^k = 0$. Therefore we get

$$\begin{aligned} \int_{\overline{\mathcal{M}}_{0,n+1}} \frac{\psi_{n+1}^k}{\prod_{i=1}^n (1 - k_i \psi_i)} + d \int_{\overline{\mathcal{M}}_{0,n+1}} \frac{\psi_{n+1}^{k+1}}{\prod_{i=1}^n (1 - k_i \psi_i)} \\ = \left(\int_{\mathbb{P}\overline{\mathcal{H}}_{0,1+n,\mu}} \xi^{n-k-3} \psi_{n+1}^k a_{0,\mu,(d)} \right) + d \left(\int_{\mathbb{P}\overline{\mathcal{H}}_{0,1+n,\mu}} \xi^{n-k-4} \psi_{n+1}^{k+1} a_{0,\mu,(d)} \right), \end{aligned}$$

and

$$\int_{\overline{\mathcal{M}}_{0,n+1}} \frac{\psi_{n+1}^k}{\prod_{i=1}^n (1 - k_i \psi_i)} = \left(\int_{\mathbb{P}\overline{\mathcal{H}}_{0,1+n,\mu}} \xi^{n-3-k} \psi_{n+1}^j a_{0,\mu,(d)} \right) = 0$$

for $k > n-2$. Therefore, for all $k \geq 0$, we have:

$$\int_{\overline{\mathcal{M}}_{0,n+1}} \frac{\psi_{n+1}^k}{\prod_{i=1}^n (1 - k_i \psi_i)} = \int_{\mathbb{P}\overline{\mathcal{H}}_{0,1+n,\mu}} \xi^{n-k-3} \psi_{n+1}^k a_{0,\mu,(d)}.$$

□

Double ramification cycles and strata of differentials

This chapter is an overview of a series of conjectural relations between classes of strata differentials, moduli spaces of r -spin structures and Double Ramification cycles.

5.1. Moduli space of r -spin structures

We define here moduli spaces of roots of line bundles and a series of tautological classes associated to them.

5.1.1. Spaces of roots. Let r be a positive integer and let k be a nonnegative integer. Let $A = (a_1, \dots, a_n)$ be a list of integers in $\{0, \dots, r-1\}$ such that r divides $k(2g-2) - \sum m_i$. Let (C, x_1, \dots, x_n) be a smooth curve with n marked points. A r -th root of type (k, A) on C is a line bundle $L \rightarrow C$ which satisfies

$$L^{\otimes r} \simeq \omega_C^k - \sum_{i=1}^n a_i(x_i).$$

(if $k = 1$, we speak of r -spin structure).

Definition 5.1.1. The *space of r -th roots* of type (k, A) is the moduli space whose points represent classes of smooth curves with n markings and a r th root of type (k, A) . We denote this moduli space by $\mathcal{M}_{g,A}^{k, \frac{1}{r}}$

There is a natural map $\epsilon : \mathcal{M}_{g,A}^{k, \frac{1}{r}} \rightarrow \mathcal{M}_{g,n}$ obtained by forgetting the r -th root L . The map ϵ is étale of degree r^{2g-1} .

The moduli space $\mathcal{M}_{g,A}^{k, \frac{1}{r}}$ admits a smooth compactification $\overline{\mathcal{M}}_{g,A}^{k, \frac{1}{r}}$ (see [43] and [44]). It is endowed with a universal curve $\pi : \overline{\mathcal{C}}_{g,A}^{k, \frac{1}{r}} \rightarrow \overline{\mathcal{M}}_{g,A}^{k, \frac{1}{r}}$ such that the fiber of a point (C, L, x_1, \dots, x_n) is isomorphic to C . Moreover there is a *tautological line bundle* $\mathcal{L} \rightarrow \overline{\mathcal{C}}_{g,n}^{1/r,A}$ such that the restriction of \mathcal{L} to the fiber of (C, L, x_1, \dots, x_n) by π is isomorphic to the line bundle $L \rightarrow C$. Finally the map $\epsilon : \overline{\mathcal{M}}_{g,A}^{k, \frac{1}{r}}$ extends to finite map.

5.1.2. Pixton's class. We will denote by $R^* \pi_* \mathcal{L} = [R^0 \pi_* \mathcal{L} \rightarrow R^1 \pi_* \mathcal{L}]$ in the derived category of $\overline{\mathcal{M}}_{g,n}^{1/r,A}$. We summarize the notation on the following diagram

$$\begin{array}{ccc}
 \mathcal{L} & & \\
 \downarrow & \searrow & \\
 R^* \pi_* \mathcal{L} & & \overline{\mathcal{C}}_{g,n}^{1/r,A} \\
 & & \downarrow \pi \\
 & & \overline{\mathcal{M}}_{g,n}^{1/r,A} \\
 & & \downarrow \epsilon \\
 & & \overline{\mathcal{M}}_{g,n}.
 \end{array}$$

We are interested in the Chern classes of $R^* \pi_*(\mathcal{L})$. In [16], Chiodo gave an expression of these classes in term of tautological classes using the Grothendieck-Riemann-Roch formula. We denote by $c_i(g, r, k, A)$ the i -th Chern class of $R^* \pi_*(\mathcal{L})$.

If $\mu = (k_1, \dots, k_n)$ be a list of and integers such that $k(2g-2) = \sum k_i$. We denote by $\mu[r]$ the list of integers $a_i \in \{0, \dots, r-1\}$ such that $a_i \equiv k_i[r]$ (the reduction modulo r of μ).

Proposition 5.1.2. (see [66] or [42]). We consider the function:

$$\begin{aligned}
 \tilde{P}_{g,\mu}^k : \mathbb{N}^* &\rightarrow A^g(\overline{\mathcal{M}}_{g,n}) \\
 r &\mapsto r \epsilon_*(c_g(g, r, k, \mu[r])).
 \end{aligned}$$

The function $\tilde{P}_{g,\mu}^k$ is a polynomial. We denote this polynomial by $\overline{P}_{g,\mu}^k$.

Definition 5.1.3. Pixton's class is defined as

$$P_{g,\mu}^k = \overline{P}_{g,\mu}^k(0).$$

5.1.3. Witten's top Chern class. We suppose here that $k = 1$ and that μ has only postive entries.

In [80] Witten has also introduced a notion of top Chern class that we denote by $c_{r,A}^W$. This class is supposed to behave as a "top Chern class of $R^1 \pi_* \mathcal{L}$ ". This class is ill defined a priori. However in [45], the others defined a series of axioms that Witten's class should satisfy. Several equivalent constructions of the $c_{r,A}^W$ have been proposed based on these axioms: the first two constructions and [68], [15] and recently Chang, Li and Li gave a construction based on the formalism of localization by cosection (see [10] and [50]). This last approach seems now to be the most natural.

The degree of Witten's top Chern class is:

$$\deg(c_{r,A}^W) = \frac{(r-2)(g-1) + \sum a_i}{r}.$$

Now for r large enough we have $\mu[r] = \mu$ and we have imposed that the sum of the entries of μ is $2g-2$. Thus

$$\deg(c_{r,\mu[r]}^W) = g-1,$$

for r large enough. Pixton proved

Proposition 5.1.4. (see [64]). We consider the function:

$$\begin{aligned} \widehat{P}_{g,\mu}^W : \mathbb{N}^* &\rightarrow A^{g-1}(\overline{\mathcal{M}}_{g,n}) \\ r &\mapsto r^{g-1} \epsilon_* (c_{r,\mu[r]}^W). \end{aligned}$$

The function $\widehat{P}_{g,\mu}^W$ is a polynomial. We denote this polynomial by $\overline{P}_{g,\mu}^W$.

Definition 5.1.5. We define Pixton-Witten's class as

$$P_{g,\mu}^W = \overline{P}_{g,\mu}^W(0).$$

5.2. Double Ramification cycles

In this section we recall the construction of Double Ramification cycles for maps to \mathbb{P}^1 .

5.2.1. Relative stable maps. Let $d \geq 0$. We denote by $\overline{\mathcal{M}}_{g,n}(\mathbb{P}^1, d)$ the moduli space of stable maps to \mathbb{P}^1 of degree d . In Chapter 4 we have introduced a subspace of $\overline{\mathcal{M}}_{g,n}(\mathbb{P}^1, d)$, namely the Hurwitz space. Its points are stable maps with fixed ramification profile at infinity. A construction exists for fixed ramification profiles at both 0 and infinity. The Hurwitz spaces are not well-behaved. In particular these are not proper. We will describe here a compactification of Hurwitz spaces by the so-called *relative stable maps*. This compactification was introduced by Ionel and Parker in a symplectic context [41] and by Jun Li in the algebraic set-up.

We fix a \mathbb{P}^1 curve with its two special points 0 and ∞ . Let k_0 and k_∞ be two non negative integers. We denote by $\mathbb{P}^1[k_0, k_\infty]$ the nodal curve obtained by attaching a chain of k_0 (resp. k_∞) rational curves at 0 (resp. at ∞). We suppose that the chains of \mathbb{P}^1 are obtained by attaching the 0 of a \mathbb{P}^1 to the ∞ of the next one. Thus the torus $(C^*)^{k_0+k_\infty+1}$ acts on $\mathbb{P}^1[k_0, k_\infty]$ by multiplication on each component. Finally, his curve has two special points x_0 and x_∞ which are supported on the extreme rational component of both chains (see Figure 1 below).

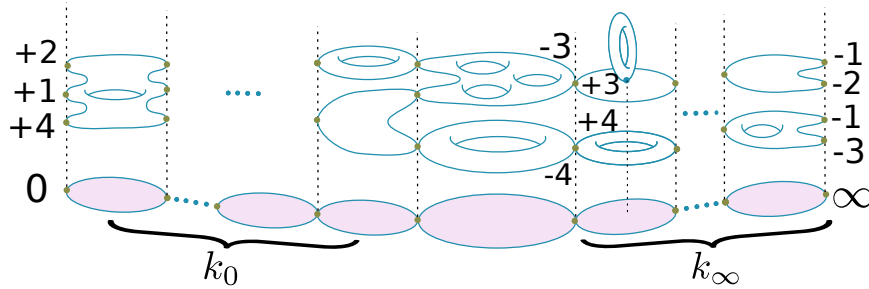

FIGURE 1. Example of relative stable map.

A *pre-deformable map* to $\mathbb{P}^1[k_0, k_\infty]$ is a stable map $f : C \rightarrow \mathbb{P}^1[k_0, k_\infty]$ such that:

- the preimage of a node of $\mathbb{P}^1[k_0, k_\infty]$ is a set of nodes of C ;
- there are no contracted components over the nodes of x_0 and x_∞ ;
- if a node of C is mapped to a node of $\mathbb{P}^1[k_0, k_\infty]$, the ramification orders of f at the branches of C are the same (kissing condition);

- the action of the torus \mathbb{C}^* on a rational components of the attached chains cannot leave the curve C invariant.

Definition 5.2.1. We denote by $\mathcal{M}_{g,n}(\mathbb{P}^1, \mu, k_0, k_\infty)$ the space of pre-deformable maps to \mathbb{P}^1 such that the ramification order at the marked points 0 and ∞ are prescribed by μ . The torus $(\mathbb{C}^*)^{k_0+k_\infty+1}$ acts $\mathbb{P}^1[k_0, k_\infty]$ and thus on $\mathcal{M}_{g,n}(\mathbb{P}^1, \mu, k_0, k_\infty)$.

The space of relative stable maps $\overline{\mathcal{M}}_{g,n}(\mathbb{P}^1, \mu)$ is the disjoint union of all spaces $\mathcal{M}_{g,n}(\mathbb{P}^1, \mu, k_0, k_\infty)/(\mathbb{C}^*)^{k_0+k_\infty+1}$ for k_0 and $k_\infty \geq 0$.

Here the union is disjoint, however Jun Li described the local structure of the space of relative stable maps. In particular it is connected. One important feature of the space of relative stable maps is

Proposition 5.2.2. *The space of relative stable maps is a DM stack with a perfect obstruction theory and a virtual fundamental cycle. The virtual dimension of $\mathcal{M}_{g,n}(\mathbb{P}^1, \mu)$ is $2g-3+n$.*

5.2.2. Rubber maps. Jun Li also introduced a slightly different space of “rubber” maps (sometimes also called the un-parametrized relative stable maps).

Definition 5.2.3. The space of rubber maps is the closed substack of $\overline{\mathcal{M}}_{g,n}(\mathbb{P}^1, \mu)$ of maps $f : C \rightarrow \mathbb{P}^1[k_0, k_\infty]$ such that:

- $k_\infty = 0$ and $k_0 \geq 1$;
- the curve above the main \mathbb{P}^1 is a disjoint union of rational curves C_i with a node and a marked point x_i with $k_i < 0$; the map $f : C_i \rightarrow \mathbb{P}^1$ is given by $z \mapsto z^{k_i}$.

We denote by $\mathcal{M}^\sim(\mathbb{P}^1, \mu)$ the space of rubber maps.

Proposition 5.2.4. *The space of rubber maps is a DM stack with a perfect obstruction theory and a virtual fundamental cycle of virtual dimension $2g-3+n$.*

5.2.3. Double Ramification cycles. Both spaces $\overline{\mathcal{M}}_{g,n}(\mathbb{P}^1, \mu)$ and $\mathcal{M}^\sim_{g,n}(\mathbb{P}^1, \mu)$ have a forgetful map p to $\overline{\mathcal{M}}_{g,n}$ obtained by forgetting the map to \mathbb{P}^1 . The double ramification cycle $\text{DR}_g^0(\mu)$ is the class

$$p_* [\mathcal{M}^\sim_{g,n}(\mathbb{P}^1, \mu)]^{\text{vir}} \in A^g(\overline{\mathcal{M}}_{g,n}).$$

This was a long-standing problem to compute this cycle (see [39]). This problem was solved by Janda, Pandharipande, Pixton and Zvonkine

Proposition 5.2.5. (see [42]) *The following equality holds in $A^g(\overline{\mathcal{M}}_{g,n})$:*

$$\text{DR}_g^0(\mu) = P_{g,\mu}^0.$$

The open problem now is to find a geometric interpretation of the classes $P_{g,\mu}^0$ for $k \geq 1$ and $P_{g,\mu}^W$.

5.3. Twisted canonical divisors

In [28], Farkas and Pandharipande proposed a compactification of strata of differentials different from the one we use in Chapter 2 (in spaces of stable differentials). The construction of Farkas and Pandharipande has been generalized

to differentials of superior order by Johannes Schmitt. We will recall here their definitions.

5.3.1. Space of twisted canonical divisors. We fix g, n such that $2g - 2 + n > 0$ and $k > 0$. Let $\mu = (k_1, \dots, k_n)$ be a list of intergers such that the sum of the k_i 's is $k(2g - 2)$. We denote by $\mathcal{H}_g^k(\mu) \subset \mathcal{M}_{g,n}$ the locus of smooth curves such that

$$\omega_C^{\otimes k} \simeq \sum_{i=1}^n k_i(x_i)$$

and we denote by $\overline{\mathcal{H}}_g(\mu)$ its closure in $\overline{\mathcal{M}}_{g,n}$. In this section we will call the locus $\mathcal{H}_g^k(\mu)$ the *space of k -canonical divisors*.

Let Γ be a stable graph (see definition 1.4.3). We recall that a twist on Γ is the datum of a function $I : \text{Half-edges}(\Gamma) \rightarrow \mathbb{Z}$ such that:

- If h and h' form an edge, then $I(h) + I(h') = 0$.
- Let v and v' be two vertices, and $\{(h_1, h'_1), \dots, (h_n, h'_n)\}$ be the set of edges from v to v' . Then either $I(h_j) = 0$ for all $1 \leq j \leq n$, or $I(h_j) > 0$ for all $1 \leq j \leq n$, or $I(h_j) < 0$ for all $1 \leq j \leq n$. We say that $v = v'$, or $v > v'$, or $v < v'$, depending on the above inequalities.
- The relation \leq thus defined on vertices is transitive.

A pair (Γ, I) of a stable graph Γ and a twit I on Γ is called a *twisted graph*.

Definition 5.3.1. A *twisted canonical divisor* of type μ is a marked curve (C, x_1, \dots, x_n) in $\overline{\mathcal{M}}_{g,n}$ such that

- there exists a twist I on the dual graph of C ;
- for each irreducible component C_v of C we have:

$$\omega_{C_v}^{\otimes k} \simeq \sum_{i \rightarrow C_v} k_i(x_i) + \sum_{h \rightarrow C_v} (I(h) - k)x_h$$

where $i \rightarrow C_v$ stands for the marked points lying on C_v and $h \rightarrow C_v$ stands for the branches of nodes lying on C_v .

We will denote by $\widetilde{\mathcal{H}}_g^k(\mu) \subset \overline{\mathcal{M}}_{g,n}$ the *moduli space of k -twisted canonical divisors*.

The space of k -twisted canonical divisors is singular and it is not even reduced in general. It has the following properties:

Proposition 5.3.2. *The space $\widetilde{\mathcal{H}}_g^k(\mu)$ is proper. If all k_i are positive and $k|k_i$ for all $1 \leq i \leq n$ then the space $\widetilde{\mathcal{H}}_g^k(\mu)$ is not of pure dimension, it has components of dimension $2g - 2 + n$ and $2g - 3 + n$. Otherwise it is of pure dimension $2g - 3 + n$.*

Morover irreducible components of $\overline{\mathcal{H}}_g^k(\mu)$ are irreducible components of $\widetilde{\mathcal{H}}_g^k(\mu)$. In the case first (positive k_i 's divisible by k) the components of dimension $2g - 2 + n$ corresponds to components of $\overline{\mathcal{H}}_g^1(\frac{\mu}{k})$ where $\frac{\mu}{k}$ is the list of integers $(\frac{k_1}{k}, \dots, \frac{k_n}{k})$.

Thus the spaces $\widetilde{\mathcal{H}}_g^k(\mu)$ are compactifications of $\mathcal{H}_g^k(\mu)$ with extra components but we will see that the classes of the $\widetilde{\mathcal{H}}_g^k(\mu)$ are (conjecturally) much better-behaved than the classes of $\overline{\mathcal{H}}_g^k(\mu)$.

5.3.2. Components of $\tilde{\mathcal{H}}_g^k(\mu)$. We fix, g, n, k , and μ as the previous Section. We have seen that the components of $\overline{\mathcal{H}}_g^k(\mu)$ are irreducible components of $\tilde{\mathcal{H}}_g^k(\mu)$. We give here an explicit classification of the extra component.

A twisted stable graph (Γ, I) is called *simple-star* for the profile μ if:

- there exists a unique vertex v_0 of Γ and a non empty set of outlying vertices v_1, \dots, v_r ;
- all edges of Γ connect the central vertex to an outlying vertex;
- the values of k_i for legs adjacent to outlying vertices have weights divisible by k ;
- the twists at half-edges of the central vertex is strictly negative.

We denote by $S_{g,\mu}^k$ the set of simple star graphs. If (I, Γ) is simple-star, we denote by μ_0 the list whose entries are the k_i 's for the legs i adjacent to v_0 and $I(h) - k$ for the half-edges adjacent to v_0 . Moreover, if v_r is an outlying vertex, we denote by μ_r the list of k_i 's and $I(h) + k$ for legs and half-edges adjacent to v_r .

Proposition 5.3.3. *Let W be an irreducible component of $\tilde{\mathcal{H}}_g^k(\mu) \setminus \overline{\mathcal{H}}_g^k(\mu)$. There exists a simple-star twisted graph (Γ, I) such that W is an irreducible component of the stack:*

$$\zeta_\Gamma \left(\overline{\mathcal{H}}_{g_0}^k(\mu_0) \times \prod_{v_r \in V^{\text{out}}(\Gamma)} \overline{\mathcal{H}}_g^1\left(\frac{\mu_r}{r}\right) \right)$$

5.3.3. Fundamental class of $\tilde{\mathcal{H}}_g^k(\mu)$. We have now all elements to define the Double Ramification cycle for higher values of k . We define this cycle as a weighted sum over the irreducible components of $A_{2g-3+n}(\tilde{\mathcal{H}}_g^k(\mu))$.

Let (Γ, I) be a simple-star graph as above. We define the multiplicity of (Γ, I) as

$$m_{\Gamma, I} = \frac{\prod_{h \rightarrow v_0} -I(h)}{|\text{Aut}(\Gamma)| \cdot k^{|V(\Gamma)|-1}}$$

where the product is over all half edges adjacent to the central vertex.

Definition 5.3.4. We suppose that μ is not divisible by k or contains at least on positive value, then we set

$$\text{DR}_g^k(\mu) = [\overline{\mathcal{H}}_g^k(\mu)] + \sum_{(\Gamma, I) \in S_{g,\mu}^k} m_{\Gamma, I} \cdot \zeta_{\Gamma*} \left(\left[\overline{\mathcal{H}}_{g_0}^k(\mu_0) \right] \cdot \prod_{v_r \in V^{\text{out}}(\Gamma)} \left[\overline{\mathcal{H}}_g^1\left(\frac{\mu_r}{r}\right) \right] \right).$$

This is a class in $A^g(\overline{\mathcal{M}}_{g,n})$.

Remark 5.3.5. This definition of the Double Ramification cycles may seem arbitrary at first sight. However, in [38], Jérémy Guéré used log-geometry to define a moduli space $\mathcal{D}(\mu)$ of “rubber” differentials. Based on the ideas developed in [14] and [37], he managed to prove that this space is a DM stack with a perfect obstruction theory and construct its virtual fundamental cycle. Besides there exists a forgetful map $p : \mathcal{D}(\mu) \rightarrow \overline{\mathcal{M}}_{g,n}$. He proved that $\text{DR}_g^k(\mu) = p_*[\mathcal{D}(\mu)]^{\text{vir}}$.

Conjecture 5.3.6. *If μ is not divisible by k or contains at least one positive value, then following equality holds in $A^g(\overline{\mathcal{M}}_{g,n})$:*

$$\mathrm{DR}_g^k(\mu) = P_{g,\mu}^k.$$

Remark 5.3.7. As a consequence of Theorem 2.1.18 we can already prove that the class $\mathrm{DR}_g^k(\mu)$ is tautological for $k = 1$.

Remark 5.3.8. A complementary conjecture has been proposed for the value of $P_{g,\mu}^k$ in the case of μ positive and divisible by k (see [72]).

A second conjecture for the specific case $k = 1$ and μ positive has been proposed in [64].

Conjecture 5.3.9. *For all partition μ of $2g - 2$ the following equality holds in $A^{g-1}(\overline{\mathcal{M}}_{g,n})$*

$$[\overline{\mathcal{H}}_g(\mu)] = (-1)^g P_{g,\mu}^W.$$

This conjecture is easier to state but somewhat more difficult to handle because the construction of Witten's is more technical than the $c_i(R\pi_*\mathcal{L})$. The proof will most likely use the localization by cosection of Kiem and Li.

Algebraic Stacks

We give here the basic definitions of the theory of algebraic stacks. Then we give the definition of the moduli spaces of curves in this language and state their main properties.

This presentation essentially follows the notes of Edidin [19] and the original paper of Deligne and Mumford [17].

A.1. Sites and sheaves

First, we recall the definition of Grothendieck topologies and of sheaves on sites. Let \mathcal{C} be a category such that the fiber product exists.

Definition A.1.1. Let $c \in \mathcal{C}$ be an object. A *sieve* on c is a subfunctor of $\text{Hom}(-, c)$. If c and c' are objects of \mathcal{C} , $f : c \rightarrow c'$ is a morphism and s is a sieve on c' then we denote by f^*s the *pull-back* of s by f i.e. the functor: $s \times_{\text{Hom}(-, c')} \text{Hom}(-, c)$ with its embedding in $\text{Hom}(-, c)$.

Definition A.1.2. A *Grothendieck topology* on \mathcal{C} is a collection of Sieves $\text{Cov}(c)$ (covering sieves) for each object c of \mathcal{C} satisfying the axioms:

- (1) if $f : c \rightarrow c'$ is a morphism and $s \in \text{Cov}(c')$ then $f^*s \in \text{Cov}(c)$;
- (2) let c be an object of \mathcal{C} , s be a covering sieve of c and t be any sieve of c . If for all object c' in \mathcal{C} and for all $f \in s(c', c)$ the sieve f^*t is a covering sieve then t is a covering sieve.
- (3) the sieve $\text{Hom}(-, c)$ is a covering sieve for all objects c of \mathcal{C} .

Definition A.1.3. A *site* is a category \mathcal{C} with a Grothendieck topology.

Example A.1.4. If X is a topological space then one can naturally construct a site. We consider the category of open sets of X and the morphisms are the inclusions of open sets. Given an open set U of X , the collection of covering sieves will be given by all possible families of coverings of U by open sets $(U_i)_{i \in I}$ (in which case the sieve is the subfunctor of $\text{Hom}(-, c)$ selecting the $i \in I$).

Example A.1.5. The main example that we will consider and which is not based on the previous example is the étale topology.

Let S be a scheme. We consider the category Sch_S of schemes over S . The morphisms are given by étale maps $X' \rightarrow X$ over S . The covering sieves over X are the families of étale morphisms which are surjective finite families of étale maps $(X_i \rightarrow X)_{i \in I}$ (this is the so-called *big étale site*).

Here we use the fact that we will use the fact that we have fiber products to define sheaves.

Definition A.1.6. A sheaf over a site $(\mathcal{C}, \text{Cov})$ is a contravariant functor $F : \mathcal{C} \rightarrow \text{Set}$ (or to any classical category) such that: for all $c \in \mathcal{C}$ and $c_{ii \in I}$ in $\text{Cov}(c)$ the diagram

$$F(c) \rightarrow \prod_{i \in I} F(c_i) \rightrightarrows \prod_{i, j \in I^2} F(c_i \times_c c_j)$$

is an equalizer.

A.2. Stacks

A.2.1. Groupoids. Let S be scheme. We denote by Sch_S the category of schemes over S .

Definition A.2.1. A category over S is a category F with a contravariant functor $p_F : F \rightarrow \text{Sch}_S$.

Let (F, p_F) be a category over S . We say that (F, p_F) is a *groupoid over S* if:

- if $f : B' \rightarrow B$ is a morphism in Sch_S . If X is an object lying over B then there exists a unique object f^*X over B' and a unique morphism $\phi : f^*(X) \rightarrow X$ such that $p_F(\phi) = f$;
- if X, X' and X'' are objects of F lying over B, B' and B'' respectively and $\phi' : X' \rightarrow X$, $\phi'' : X'' \rightarrow X$ and $f : B' \rightarrow B''$ are morphism satisfying $p_F(\phi'') \circ f = f \circ p_F(\phi')$ then there exists a unique $\phi : X' \rightarrow X''$ such that $f = p_F(\phi)$.

Remark A.2.2. In particular, if F is a groupoid over S and B is an S -scheme, then we can define $F(B)$ the subcategory of F of objects lying over B with morphism ϕ such that $p_F(\phi) = \text{Id}$. The category F_B is a groupoid.

Definition A.2.3. Let (F_1, p_{F_1}) and (F_2, p_{F_2}) be two groupoids over S . A *morphism of groupoids* is a functor $p : F_1 \rightarrow F_2$ such that $p_{F_2} \circ p = p_{F_1}$. Let p, q be two morphisms from F_1 to F_2 , a 2-isomorphism is a transformation of functors from f to g . We denote by $\text{Hom}(F_1, F_2)$ the category of morphism from F_1 to F_2 .

A morphism of groupoids is an isomorphism if it is an equivalence of category.

Remark A.2.4. An isomorphism $p : F_1 \rightarrow F_2$ need not to have an inverse. However it has a quasi-inverse, i.e. an isomorphism $q : F_2 \rightarrow F_1$ such that pq is isomorphic to the functor Id_{F_2} and qp isomorphic to Id_{F_1} .

Example A.2.5. Let X be a scheme over S then the category of X -schemes is a groupoid over S . In particular if X and Y are two S -schemes, then $X \simeq Y$ as S -scheme if and only if X and Y are isomorphic as groupoids over S .

Example A.2.6. Let X/S be a scheme and G/S a group scheme of finite type acting on the left on X . We construct the category $[X/G]$ whose objects are $E \rightarrow B$ with B an X scheme and E is G -bundle. The morphisms are G equivariant morphism $[E' \rightarrow B'] \rightarrow [E \rightarrow B]$ over X .

Let F, G and H be groupoids over S and $f : F \rightarrow G$ and $h : H \rightarrow G$ be morphisms of groupoids. The fiber product $F \times_G H$ is the groupoid whose objects are triples (x, y, ψ) where $(x, y) \in F(B) \times H(B)$ for a S -scheme B and $\psi : f(x) \rightarrow h(y)$ is an isomorphism in $G(B)$. A morphism of triples $(x, y, \psi) \rightarrow (x', y', \psi')$ is given by morphism $\alpha : x \rightarrow x'$ and $\beta : y \rightarrow y'$ satisfying $\psi' \circ f(\alpha) = h(\beta) \circ \psi$.

Remark A.2.7. We have natural projections $p_F : F \times_G H \rightarrow F$ (same for H). However note that the diagram

$$\begin{array}{ccc} F \times_G H & \xrightarrow{p_H} & H \\ p_F \downarrow & & \downarrow h \\ F & \xrightarrow{f} & G \end{array}$$

is not necessarily commutative but there exists a natural transformation from $f p_F$ to $h p_H$.

A.2.2. Stacks. Let F be a groupoid over S . Let B be an S -scheme and X and Y be objects in $F(B)$. We define the contravariant functor $\text{Iso}_B(X, Y) : \text{Sch}_B \rightarrow \text{Sets}$ which to a scheme $f : B' \rightarrow B$ associates the set of isomorphism from f^*X to f^*Y .

Definition A.2.8. A *stack* is a groupoid over S such that

- the functor $\text{Iso}_B(X, Y)$ is a sheaf over Sch_B for the étale topology for all objects B, X and Y .
- If $\{B_i \rightarrow B\}_{i \in I}$ is a covering family and $X_{i \in I}$ is a collection of objects of $F(B_i)$ with choices of isomorphisms $\phi_{ij} : X_i \times_B B_j \rightarrow B_i \times_B X_j$ satisfying cocycles relations then there exists X in $F(B)$ such that $X_i = X \times_B B_i$ and inducing the ϕ_{ij} .

Definition A.2.9. Let F and G be stacks over S and $f : F \rightarrow G$ be a morphism. We say that f is representable if for any map $B \rightarrow G$ where B is an S -scheme, the stack $B \times_G F$ is isomorphic to the stack of a scheme.

A.2.3. Deligne-Mumford stacks. In particular this definition allows to characterize morphism of stacks.

Definition A.2.10. Let (P) be a property of maps of schemes stable under base change (smooth, flat, étale, proper, separated, surjective...). We say that a representable map of stack $f : F \rightarrow G$ satisfies property (P) if for any scheme B , the map $B \times_G F \rightarrow B$ satisfies the property (P) .

Definition A.2.11. A stack F is said of *Artin* (respectively of *Deligne-Mumford*) if:

- the diagonal $F \rightarrow F \times F$ is representable and separated;
- there exists a scheme U and a smooth surjective (respectively étale surjective) morphism $U \rightarrow F$.

The scheme U will be called an atlas for F .

Remark A.2.12. In particular one can see that the number of automorphism of an object in a DM stack is finite while the automorphism group of an object in an Artin stack can be a scheme.

Remark A.2.13. Let F be a Deligne-Mumford stack. Since there exists an étale surjective map $U \rightarrow F$ with U a scheme, we can define the étale site of X as the category $X_{\text{ét}}$ of schemes together with étale morphisms to X . Using $X_{\text{ét}}$, we can generalise many concepts from scheme theory (such as quasi-coherent sheaves, vector bundles, cotangent sheaves, cotangent complexes, etc.) to Deligne-Mumford

stacks. Artin stacks do not in general have a well-behaved étale site. The étale site is replaced by the so-called lisse-étale site.

A.3. Moduli spaces of curves

Let g, n be integers such that $2g - 2 + n > 0$. Let $\mathcal{M}_{g,n}$ (respectively $\overline{\mathcal{M}}_{g,n}$ and $\mathfrak{M}_{g,n}$) be the category of objects:

$$(\pi : C \rightarrow B, \{\sigma_i : B \rightarrow C\}_{i \leq n})$$

where B is a scheme over \mathbb{C} and π is a flat family of smooth (respectively stable and pre-stable) curves of genus g and the σ_i are sections in the smooth locus of C and that do not intersect. Then the functor $F : \mathcal{M}_{g,n} \rightarrow \text{Sch}_{\mathbb{C}}$ which maps a family to its base makes $\mathcal{M}_{g,n}$ into a groupoid over \mathbb{C} .

Proposition A.3.1. *The groupoids $\mathcal{M}_{g,n}$ and $\overline{\mathcal{M}}_{g,n}$ are smooth DM stacks. The groupoid $\mathfrak{M}_{g,n}$ is a smooth Artin stack. All three stacks are of pure dimension $3g - 3 + n$.*

Remark A.3.2. The dimension of a DM stack is defined as the dimension of its atlas while the dimension of an Artin stack is the dimension of its atlas minus the relative dimension of the map.

Proposition A.3.3. *The stack \mathcal{M}_g is irreducible for $g \geq 2$.*

To prove this statement, Deligne and Mumford used the fact that every curve of genus g is a ramified covering of $\mathbb{C}P^1$ of degree $k > 0$ with simple branch points for large values of k . Thus for k large enough, we have a surjective map from a dense open subset of $\text{Sym}^b(\mathbb{C}P^1)$ to \mathcal{M}_g . The space $\text{Sym}^b(\mathbb{C}P^1)$ is irreducible and thus so is \mathcal{M}_g .

Proposition A.3.4. *The stack $\overline{\mathcal{M}}_{g,n}$ is proper. The complement $\overline{\mathcal{M}}_{g,n} \setminus \mathcal{M}_{g,n}$ is a normal crossing divisor.*

Remark A.3.5. The properness of $\overline{\mathcal{M}}_{g,n}$ is proved by using the valuative criterion. Let $C \rightarrow B$ be a family of curves over a smooth B and with singular fibers over a locus of codimension 1 in B . Then C admits a model over B with stable fibers.

Bibliography

- [1] Enrico Arbarello, Maurizio Cornalba, and Phillip A. Griffiths. *Geometry of algebraic curves. Volume II*, volume 268 of *Grundlehren der Mathematischen Wissenschaften [Fundamental Principles of Mathematical Sciences]*. Springer, Heidelberg, 2011. With a contribution by Joseph Daniel Harris.
- [2] Olivier Babelon, Denis Bernard, and Michel Talon. *Introduction to classical integrable systems*. Cambridge Monographs on Mathematical Physics. Cambridge University Press, Cambridge, 2003.
- [3] M. Bainbridge, D. Chen, Q. Gendron, S. Grushevsky, and M. Moller. Compactification of strata of abelian differentials. 2016, arXiv:1604.08834.
- [4] M. Bainbridge, D. Chen, Q. Gendron, S. Grushevsky, and M. Moller. Compactification of strata of k -differentials. 2016, arXiv:1610.09238.
- [5] K. Behrend and B. Fantechi. The intrinsic normal cone. *Invent. Math.*, 128(1):45–88, 1997.
- [6] M. Bertola, D. Korotkin, and C. Norton. Symplectic geometry of the moduli space of projective structures in homological coordinates. 2015, arXiv:1506.07918.
- [7] F. A. Bogomolov, A. L. Gorodentsev, V. A. Iskovskikh, and et al. Andreĭ Nikolaevich Tyurin. *Uspekhi Mat. Nauk*, 58(3(351)):176–182, 2003.
- [8] A. Buryak, S. Shadrin, L. Spitz, and D. Zvonkine. Integrals of ψ -classes over double ramification cycles. *Amer. J. Math.*, 137(3):699–737, 2015.
- [9] Renzo Cavalieri, Paul Johnson, and Hannah Markwig. Wall crossings for double Hurwitz numbers. *Adv. Math.*, 228(4):1894–1937, 2011.
- [10] Huai-Liang Chang, Jun Li, and Wei-Ping Li. Witten’s top Chern class via cosection localization. *Invent. Math.*, 200(3):1015–1063, 2015.
- [11] D. Chen, , M. Moller, and Don Zagier. Quasimodularity and large genus limits of siegel-veech constantss. 2016, arXiv:1606.04065.
- [12] Dawei Chen. Square-tiled surfaces and rigid curves on moduli spaces. *Adv. Math.*, 228(2):1135–1162, 2011.
- [13] Dawei Chen. Strata of abelian differentials and the Teichmüller dynamics. *J. Mod. Dyn.*, 7(1):135–152, 2013.
- [14] Qile Chen. Stable logarithmic maps to Deligne-Faltings pairs I. *Ann. of Math. (2)*, 180(2):455–521, 2014.
- [15] Alessandro Chiodo. A construction of Witten’s top Chern class in K -theory. In *Gromov-Witten theory of spin curves and orbifolds*, volume 403 of *Contemp. Math.*, pages 21–29. Amer. Math. Soc., Providence, RI, 2006.
- [16] Alessandro Chiodo. Towards an enumerative geometry of the moduli space of twisted curves and r th roots. *Compos. Math.*, 144(6):1461–1496, 2008.
- [17] P. Deligne and D. Mumford. The irreducibility of the space of curves of given genus. *Inst. Hautes Études Sci. Publ. Math.*, (36):75–109, 1969.
- [18] Boris Dubrovin. Geometry of 2D topological field theories. In *Integrable systems and quantum groups (Montecatini Terme, 1993)*, volume 1620 of *Lecture Notes in Math.*, pages 120–348. Springer, Berlin, 1996.
- [19] Dan Edidin. Notes on the construction of the moduli space of curves. In *Recent progress in intersection theory (Bologna, 1997)*, Trends Math., pages 85–113. Birkhäuser Boston, Boston, MA, 2000.
- [20] Torsten Ekedahl, Sergei Lando, Michael Shapiro, and Alek Vainshtein. Hurwitz numbers and intersections on moduli spaces of curves. *Invent. Math.*, 146(2):297–327, 2001.

- [21] Y. Eliashberg, A. Givental, and H. Hofer. Introduction to symplectic field theory. *Geom. Funct. Anal.*, (Special Volume, Part II):560–673, 2000. GAFA 2000 (Tel Aviv, 1999).
- [22] Alex Eskin, Maxim Kontsevich, Martin Moeller, and Anton Zorich. Lower bounds for Lyapunov exponents of flat bundles on curves. 2016, arXiv:1609.01170.
- [23] Alex Eskin, Maxim Kontsevich, and Anton Zorich. Sum of Lyapunov exponents of the Hodge bundle with respect to the Teichmüller geodesic flow. *Publ. Math. Inst. Hautes Études Sci.*, 120:207–333, 2014.
- [24] Alex Eskin, Maryam Mirzakhani, and Amir Mohammadi. Isolation, equidistribution, and orbit closures for the $SL(2, \mathbb{R})$ action on moduli space. *Ann. of Math. (2)*, 182(2):673–721, 2015.
- [25] Alex Eskin and Andrei Okounkov. Asymptotics of numbers of branched coverings of a torus and volumes of moduli spaces of holomorphic differentials. *Invent. Math.*, 145(1):59–103, 2001.
- [26] C. Faber and R. Pandharipande. Relative maps and tautological classes. *J. Eur. Math. Soc. (JEMS)*, 7(1):13–49, 2005.
- [27] B. Fantechi and R. Pandharipande. Stable maps and branch divisors. *Compositio Math.*, 130(3):345–364, 2002.
- [28] Gavril Farkas and Rahul Pandharipande. The moduli space of twisted canonical divisors. 2015, arXiv:1508.07940.
- [29] John Fay. Kernel functions, analytic torsion, and moduli spaces. *Mem. Amer. Math. Soc.*, 96(464):vi+123, 1992.
- [30] Simion Filip. Splitting mixed Hodge structures over affine invariant manifolds. *Ann. of Math. (2)*, 183(2):681–713, 2016.
- [31] William Fulton. *Intersection theory*, volume 2 of *Ergebnisse der Mathematik und ihrer Grenzgebiete. 3. Folge. A Series of Modern Surveys in Mathematics [Results in Mathematics and Related Areas. 3rd Series. A Series of Modern Surveys in Mathematics]*. Springer-Verlag, Berlin, second edition, 1998.
- [32] Alexander B. Givental. Gromov-Witten invariants and quantization of quadratic Hamiltonians. *Mosc. Math. J.*, 1(4):551–568, 645, 2001. Dedicated to the memory of I. G. Petrovskii on the occasion of his 100th anniversary.
- [33] Alexander B. Givental. Symplectic geometry of Frobenius structures. In *Frobenius manifolds*, Aspects Math., E36, pages 91–112. Friedr. Vieweg, Wiesbaden, 2004.
- [34] I. P. Goulden, D. M. Jackson, and R. Vakil. Towards the geometry of double Hurwitz numbers. *Adv. Math.*, 198(1):43–92, 2005.
- [35] T. Graber and R. Pandharipande. Constructions of nontautological classes on moduli spaces of curves. *Michigan Math. J.*, 51(1):93–109, 2003.
- [36] Tom Graber and Ravi Vakil. Hodge integrals and Hurwitz numbers via virtual localization. *Compositio Math.*, 135(1):25–36, 2003.
- [37] Mark Gross and Bernd Siebert. Logarithmic Gromov-Witten invariants. *J. Amer. Math. Soc.*, 26(2):451–510, 2013.
- [38] Jérémy Guéré. A generalization of the double ramification cycle via log-geometry. 2016, arXiv:1603.09213.
- [39] Richard Hain. Normal functions and the geometry of moduli spaces of curves. In *Handbook of moduli. Vol. I*, volume 24 of *Adv. Lect. Math. (ALM)*, pages 527–578. Int. Press, Somerville, MA, 2013.
- [40] Joe Harris and David Mumford. On the Kodaira dimension of the moduli space of curves. *Invent. Math.*, 67(1):23–88, 1982. With an appendix by William Fulton.
- [41] Eleny-Nicoleta Ionel and Thomas H. Parker. Relative Gromov-Witten invariants. *Ann. of Math. (2)*, 157(1):45–96, 2003.
- [42] F. Janda, R. Pandharipande, A. Pixton, and D. Zvonkine. Double ramification cycles on the moduli spaces of curves. 2016, arXiv:1602.04705.
- [43] T. J. Jarvis. Torsion-free sheaves and moduli of generalized spin curves. *Compositio Math.*, 110(3):291–333, 1998.
- [44] Tyler J. Jarvis. Geometry of the moduli of higher spin curves. *Internat. J. Math.*, 11(5):637–663, 2000.

- [45] Tyler J. Jarvis, Takashi Kimura, and Arkady Vaintrob. Moduli spaces of higher spin curves and integrable hierarchies. *Compositio Math.*, 126(2):157–212, 2001.
- [46] M. Kazarian. KP hierarchy for Hodge integrals. *Adv. Math.*, 221(1):1–21, 2009.
- [47] Maxim Kazarian, Sergey Lando, and Dimitri Zvonkine. Universal cohomological expressions for singularities in families of genus 0 stable maps. 2016, arXiv:1512.03285v1.
- [48] S. V. Kerov and A. M. Vershik. Asymptotic theory of the characters of a symmetric group. *Funktsional. Anal. i Prilozhen.*, 15(4):15–27, 96, 1981.
- [49] Serguei Kerov and Grigori Olshanski. Polynomial functions on the set of Young diagrams. *C. R. Acad. Sci. Paris Sér. I Math.*, 319(2):121–126, 1994.
- [50] Young-Hoon Kiem and Jun Li. Localizing virtual cycles by cosections. *J. Amer. Math. Soc.*, 26(4):1025–1050, 2013.
- [51] A. Kokotov and D. Korotkin. Isomonodromic tau-function of Hurwitz Frobenius manifolds and its applications. *Int. Math. Res. Not.*, pages Art. ID 18746, 34, 2006.
- [52] Aleksey Kokotov and Dmitry Korotkin. Tau-functions on spaces of abelian differentials and higher genus generalizations of Ray-Singer formula. *J. Differential Geom.*, 82(1):35–100, 2009.
- [53] M. Kontsevich. Lyapunov exponents and Hodge theory. In *The mathematical beauty of physics (Saclay, 1996)*, volume 24 of *Adv. Ser. Math. Phys.*, pages 318–332. World Sci. Publ., River Edge, NJ, 1997.
- [54] Maxim Kontsevich. Intersection theory on the moduli space of curves and the matrix Airy function. *Comm. Math. Phys.*, 147(1):1–23, 1992.
- [55] Maxim Kontsevich and Anton Zorich. Connected components of the moduli spaces of Abelian differentials with prescribed singularities. *Invent. Math.*, 153(3):631–678, 2003.
- [56] D. Korotkin, A. Sauvaget, and P. Zograf. Tau functions, prym-tyurin classes and loci of degenerate differentials. 2017, arXiv:.
- [57] D. Korotkin and P. Zograf. Tau function and moduli of differentials. *Math. Res. Lett.*, 18(3):447–458, 2011.
- [58] D. Korotkin and P. Zograf. Tau function and the Prym class. In *Algebraic and geometric aspects of integrable systems and random matrices*, volume 593 of *Contemp. Math.*, pages 241–261. Amer. Math. Soc., Providence, RI, 2013.
- [59] Erwan Lanneau. Connected components of the strata of the moduli spaces of quadratic differentials. *Ann. Sci. Éc. Norm. Supér. (4)*, 41(1):1–56, 2008.
- [60] E. Mann and M. Robalo. Brane actions, categorification of gromov-witten theory and quantum k-theory. 2015, arXiv:1505.02964.
- [61] Scott Mullane. Divisor strata of abelian differentials. 2015, arXiv:1509.03648.
- [62] David Mumford. Towards an enumerative geometry of the moduli space of curves. In *Arithmetic and geometry, Vol. II*, volume 36 of *Progr. Math.*, pages 271–328. Birkhäuser Boston, Boston, MA, 1983.
- [63] A. Okounkov and R. Pandharipande. Gromov-Witten theory, Hurwitz theory, and completed cycles. *Ann. of Math. (2)*, 163(2):517–560, 2006.
- [64] Rahul Pandharipande, Aaron Pixton, and Dimitri Zvonkine. Relations on mg,n via 3-spin structures. *J. Amer. Math. Soc.*, 28(1):279–309, 2015.
- [65] Dan Petersen and Orsola Tommasi. The Gorenstein conjecture fails for the tautological ring of $\overline{\mathcal{M}}_{2,n}$. *Invent. Math.*, 196(1):139–161, 2014.
- [66] Aaron Pixton. Double ramification cycles and tautological relations on mg,n . 2014, unpublished.
- [67] A. Polishchuk. Moduli spaces of curves with effective r -spin structures. In *Gromov-Witten theory of spin curves and orbifolds*, volume 403 of *Contemp. Math.*, pages 1–20. Amer. Math. Soc., Providence, RI, 2006.
- [68] Alexander Polishchuk and Arkady Vaintrob. Algebraic construction of Witten’s top Chern class. In *Advances in algebraic geometry motivated by physics (Lowell, MA, 2000)*, volume 276 of *Contemp. Math.*, pages 229–249. Amer. Math. Soc., Providence, RI, 2001.
- [69] F. Prym. Ableitung. *Acta Math.*, 3(1):216–239, 1883. Einer allgemeinen Thetaformel.
- [70] Gendron Q. and GI Tahar. Différentielles à singularités prescrites. 2017, arXiv:1705.03240.
- [71] Adrien Sauvaget. Cohomology classes of strata of abelian differentials. arXiv:1701.07867.

- [72] Johannes Schmitt. Dimension theory of the moduli space of twisted k -differentials. 2016, arXiv:1607.08429.
- [73] S. Shadrin, L. Spitz, and D. Zvonkine. Equivalence of ELSV and Bouchard-Mariño conjectures for r -spin Hurwitz numbers. *Math. Ann.*, 361(3-4):611–645, 2015.
- [74] Sergey Shadrin and Dimitri Zvonkine. Changes of variables in ELSV-type formulas. *Michigan Math. J.*, 55(1):209–228, 2007.
- [75] Constantin Teleman. The structure of 2D semi-simple field theories. *Invent. Math.*, 188(3):525–588, 2012.
- [76] Gerard van der Geer and Alexis Kouvidakis. The Hodge bundle on Hurwitz spaces. *Pure Appl. Math. Q.*, 7(4, Special Issue: In memory of Eckart Viehweg):1297–1307, 2011.
- [77] Gerard van der Geer and Alexis Kouvidakis. The class of a Hurwitz divisor on the moduli of curves of even genus. *Asian J. Math.*, 16(4):787–805, 2012.
- [78] Angelo Vistoli. Intersection theory on algebraic stacks and on their moduli spaces. *Invent. Math.*, 97(3):613–670, 1989.
- [79] Edward Witten. Two-dimensional gravity and intersection theory on moduli space. In *Surveys in differential geometry (Cambridge, MA, 1990)*, pages 243–310. Lehigh Univ., Bethlehem, PA, 1991.
- [80] Edward Witten. Algebraic geometry associated with matrix models of two-dimensional gravity. In *Topological methods in modern mathematics (Stony Brook, NY, 1991)*, pages 235–269. Publish or Perish, Houston, TX, 1993.
- [81] Fei Yu and Kang Zuo. Weierstrass filtration on Teichmüller curves and Lyapunov exponents. *J. Mod. Dyn.*, 7(2):209–237, 2013.
- [82] Peter Zograf. Moduli of differentials and prym-tyurin classes. *personal communication*, 2013.
- [83] Anton Zorich. Flat surfaces. In *Frontiers in number theory, physics, and geometry. I*, pages 437–583. Springer, Berlin, 2006.
- [84] Dimitri Zvonkine. Strata in the projectivization of the hodge bundle. *personal communication*, 2012.

Résumé. Nous construisons l'espace des différentielles stables : un espace des modules de différentielles méromorphes avec des pôles d'ordres fixés. Cet espace est un cône au dessus de l'espace $\overline{\mathcal{M}}_{g,n}$ des courbes stables. Si l'ensemble de poles est vide, il s'agit du fibré de Hodge. Nous introduisons l'anneau tautologique du projectivisé de l'espace des différentielles stables par analogie avec $\overline{\mathcal{M}}_{g,n}$.

L'espace des différentielles stables est stratifié en fonction des ordres des zéros de la différentielle. Nous montrons que la classe de cohomologie Poincaré-duale de chaque strate est tautologique et peut être calculée explicitement, ce qui constitue le résultat principal de la thèse. Nous appliquons ces résultats pour calculer des nombres de Hurwitz et pour prouver plusieurs identités dans le groupe de Picard des strates.

Ensuite, nous nous intéressons aux espaces des modules des différentielles d'ordre supérieur. Une courbe munie d'une k -différentielle holomorphe possède un revêtement naturel de groupe de Galois $\mathbb{Z}/k\mathbb{Z}$. Le fibré de Hodge sur la courbe revêtante se décompose en une somme directe de sous-fibrés en fonction du caractère de $\mathbb{Z}/k\mathbb{Z}$. Nous calculons la première classe de Chern de chacun de ces sous-fibrés.

Un dernier chapitre sera consacré à l'exposé des liens conjecturaux entre les classes des strates de différentielles, les espaces de courbes r -spin et les cycles de double ramification.

Abstract. We construct the *space of stable differentials*: a moduli space of meromorphic differentials with poles of fixed order. This space is a cone over the moduli space $\overline{\mathcal{M}}_{g,n}$ of stable curves. If the set of poles is empty, then this cone is the Hodge bundle. We introduce the tautological ring of the projectivized space of stable differentials by analogy with $\overline{\mathcal{M}}_{g,n}$.

The space of stable differentials is stratified according to the orders of zeros of the differential. We show that the Poincaré-dual cohomology classes of these strata are tautological and can be explicitly computed, this constitutes the main result of this thesis. We apply this result to compute Hurwitz numbers and to show several identities in the Picard group of the strata.

Then, we interest ourselves to moduli spaces of differentials of superior order. A curve endowed with a k -differential carry a natural ramified covering of Galois group $\mathbb{Z}/k\mathbb{Z}$. The Hodge bundle over the covering curve is decomposed into a direct sum of sub-vector bundles according to the character of $\mathbb{Z}/k\mathbb{Z}$. We compute the first Chern class of each of these sub-bundles.

A last chapter will be dedicated to the presentation of conjectural relations between classes of strata of differentials, moduli of r -spin structures and double ramification cycles.