



HAL
open science

Experimental evaluation of stent retrievers's mechanical properties and thrombi removal effectiveness

Paolo Machi

► **To cite this version:**

Paolo Machi. Experimental evaluation of stent retrievers's mechanical properties and thrombi removal effectiveness. Biomechanics [physics.med-ph]. Université Montpellier, 2016. English. NNT : 2016MONTT263 . tel-01809007

HAL Id: tel-01809007

<https://theses.hal.science/tel-01809007>

Submitted on 6 Jun 2018

HAL is a multi-disciplinary open access archive for the deposit and dissemination of scientific research documents, whether they are published or not. The documents may come from teaching and research institutions in France or abroad, or from public or private research centers.

L'archive ouverte pluridisciplinaire **HAL**, est destinée au dépôt et à la diffusion de documents scientifiques de niveau recherche, publiés ou non, émanant des établissements d'enseignement et de recherche français ou étrangers, des laboratoires publics ou privés.

THÈSE

Pour obtenir le grade de Docteur

Délivré par Université de Montpellier

Préparée au sein de l'école doctorale
Information Structures Systèmes (I2S)
Et de l'unité de recherche UMR 5508 - LMGC

Spécialité : Mécanique et Génie Civil

Présentée par Paolo Machi

**Evaluation expérimentale des propriétés
mécaniques et de l'efficacité d'enlèvement des
thrombus des stent retrievers**

Soutenue le 22 novembre 2016 devant le jury composé de

Mr Denis FAVIER, Professeur
Université de Grenoble

Rapporteur

Mr ZSOLT KULCSAR, Professeur
HUG, Université de Genève

Rapporteur

Mr Fabrice BONNEVILLE, Professeur
CHU, Université de Toulouse

Examineur

Mr Franck JOURDAN Professeur,
Université de Montpellier

Directeur de
Thèse

Mr Vincent COSTALAT, Professeur,
CHU, Université de Montpellier

Co-Directeur de
Thèse



UNIVERSITY OF MONTPELLIER

MECHANICAL AND CIVIL ENGINEERING LABORATORY

PhD. THESIS

Presented for the degree of Doctor of the

University of Montpellier

by

Paolo Machi

Experimental Evaluation of Stent Retrievers's Mechanical Properties and Thrombi Removal Effectiveness

Mr. Franck Jourdan	University of Montpellier – LMG	(Supervisor)
Mr. Vincent Costalat	University of Montpellier – CHU	(Co-Supervisor)
Mr. Fabrice Bonneville	University of Toulouse- CHU	(President of jury)
Mr. Zsolt Kulcsar	University of Geneve	(Reviewer)
Mr. Denis Favier	University of Grenoble	(Reviewer)

Résumé

Evaluation expérimentale des propriétés mécaniques et de l'efficacité d'enlèvement des thrombus des stent retrievers

L'accident vasculaire cérébral ischémique (AVC) est dû à un thrombus qui obstrue une artère cérébrale et cause l'interruption brutale de l'irrigation sanguine du cerveau. L'AVC est la première cause de handicap chez l'adulte et la deuxième cause de mortalité. La fibrinolyse intraveineuse (rt-PA) a été depuis 1990 le traitement de référence pour l'AVC ischémique aigu. Néanmoins, une limitation principale d'un tel traitement est sa faible efficacité. Afin d'améliorer l'efficacité du traitement de l'AVC la thrombectomie mécanique a été proposée. Cette procédure consiste en l'enlèvement mécanique du thrombus qui occlut l'artère cérébrale.

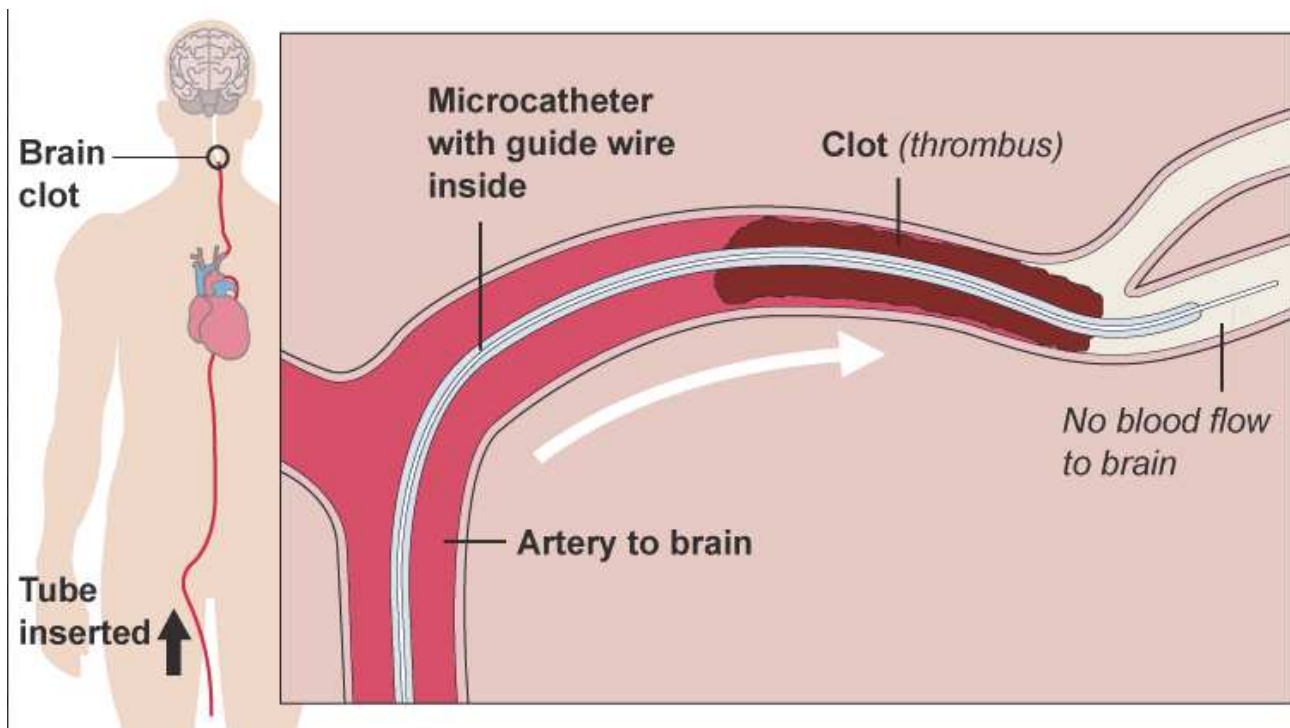

Fig. 1 La vascularisation cerebral est atteinte via l'artere femorale ; un microcatheter est acheminé sur une micro guide au-delà du caillot occlusif placé au niveau de l'artere cerebrale moyenne gauche.

Un certain nombre d'essais cliniques contrôlés, randomisés et publiés récemment dans la littérature a démontré que la thrombectomie mécanique, offerte aux patients présentant un AVC ischémique aigu, permettait une recanalisation plus fréquente et rapide de l'artère occluse en comparaison au traitement standard de fibrinolyse intraveineuse, ce qui est en corrélation avec de meilleurs résultats cliniques.

Les stents retriever ont été reconnus dans ces essais comme les dispositifs les plus efficaces pour la thrombectomie intracrânienne. Ces dispositifs sont déployés sur le thrombus, les filaments qui forme le dispositif même, fournissent la force nécessaire pour la pénétration et l'engagement du caillot qui est récupéré avec le stent. L'efficacité du retrait du caillot est le résultat de l'interaction entre le dispositif et le thrombus.

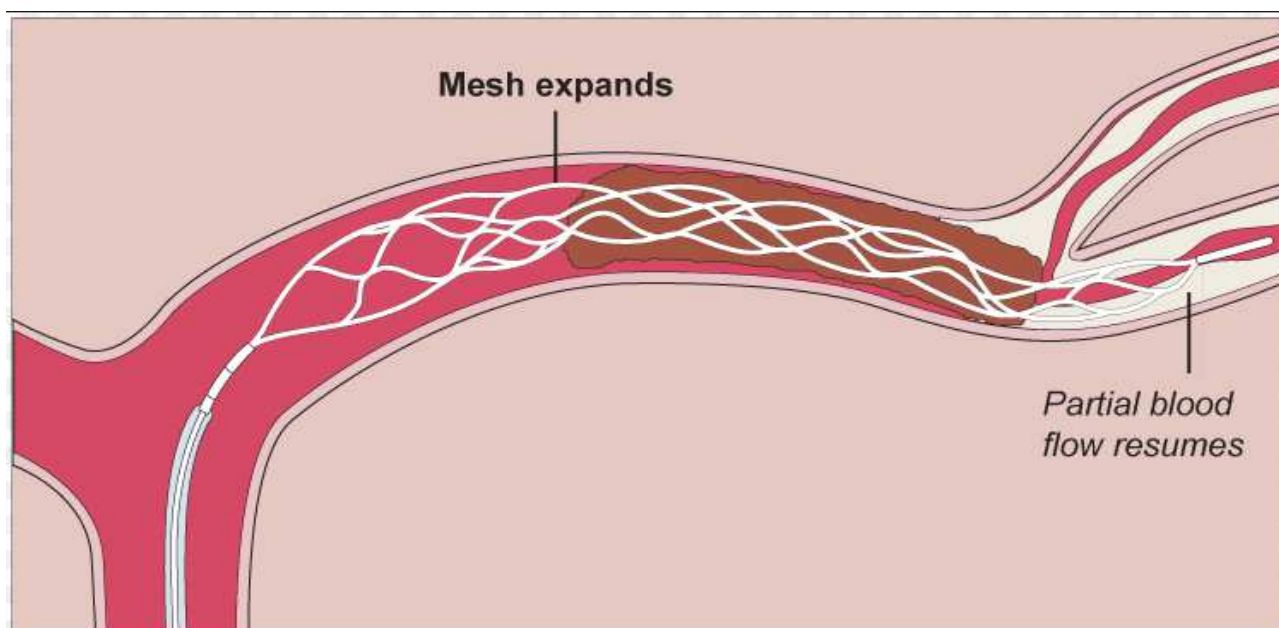

Fig. 2 Le stent retriever est complètement déployé sur le thrombus.

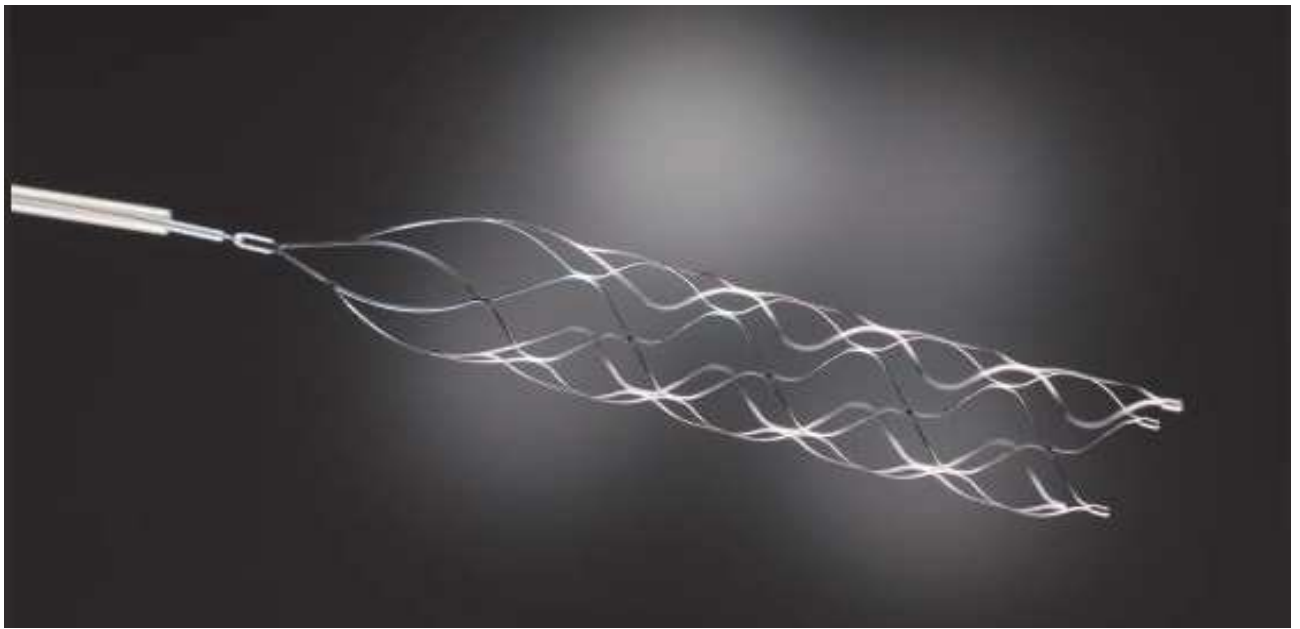

Fig. 3 Un exemple de stent retriever : *SOLITAIRE* (Photo Covidien)

Actuellement, toutes les industries produisant des dispositifs neuro-interventionnels lancent sur le marché un nombre croissant de stents retriever. Chaque nouveau dispositif proposé est censé avoir une particularité permettant de meilleures performances par rapport aux dispositifs déjà disponibles sur le marché. Néanmoins, aucune étude clinique n'a démontré, jusqu'à présent, la supériorité en termes de résultats anatomiques et cliniques d'un stent retriever donné. En outre, le mécanisme d'interaction entre les stents retrievers et le thrombus n'a pas été évalué jusqu'ici de façon exhaustive. Dans la présente étude, nous avons analysé expérimentalement les performances de tous les stents retriever disponibles sur le marché français jusqu'à juin 2015.

Device	Size*
Trevo Provue (Stryker, Kalamazoo, Michigan, USA)†	4–20/3–20
Catch (Balt, Montmorency, France)‡	3–15/4–20/6–30
Eric (Microvention, Aliso Viejo, California, USA)†	3–20/4–24/6–44
Preset (Phenox, Bochum, Germany)‡	4–20/6–30
Preset LT (Phenox, Bochum, Germany)‡	3–20/4–20
Embotrap (Nauravi, Galway, Ireland)†	5–21
Separator 3D (Penumbra Inc, Alameda, California, USA)†	4.5–26
Revive (Codman, Raynham, Massachusetts, USA)†	4.5–22
Mindframe (Medtronic, Irvine, California, USA)†	3–23
Solitaire FR (Medtronic, Irvine, California, USA)‡	4–20/6–30

*For each device, the first value refers to the nominal diameter, the second value refers to the length expressed in mm.
†Complete axial section device.
‡Incomplete axial section device.

Tab. 1 Liste des dispositifs évalués dans l'étude.

Le but de cette étude était d'identifier toutes les caractéristiques des dispositifs fonctionnels à la capture du thrombus.

Chaque dispositif a été évalué par des tests mécaniques et fonctionnels : les tests mécaniques ont été effectués afin d'étudier la force radiale des dispositifs. L'objectif était d'évaluer la force radiale exercée par le stent dans deux conditions spécifiques : lors du déploiement et pendant le retrait. Dans un premier temps, nous avons caractérisé la force radiale de chaque stent en utilisant un test de compression, classiquement utilisé pour ce genre de dispositif. Cependant, ce type de tests mécanique ne permet pas une caractérisation satisfaisante au regard des conditions réelles d'utilisation des stents. Nous avons alors développé un nouveau test mécanique adapté aux conditions fonctionnelles des stents retraits. Il s'agit d'un dispositif permettant de déterminer la pression radiale exercée par un stent déployé dans un tube de silicone (fig. 4). C'est un dispositif relativement simple à mettre en œuvre qui donne une valeur relative de pression radiale et permet de comparer chaque stent par rapport aux autres.

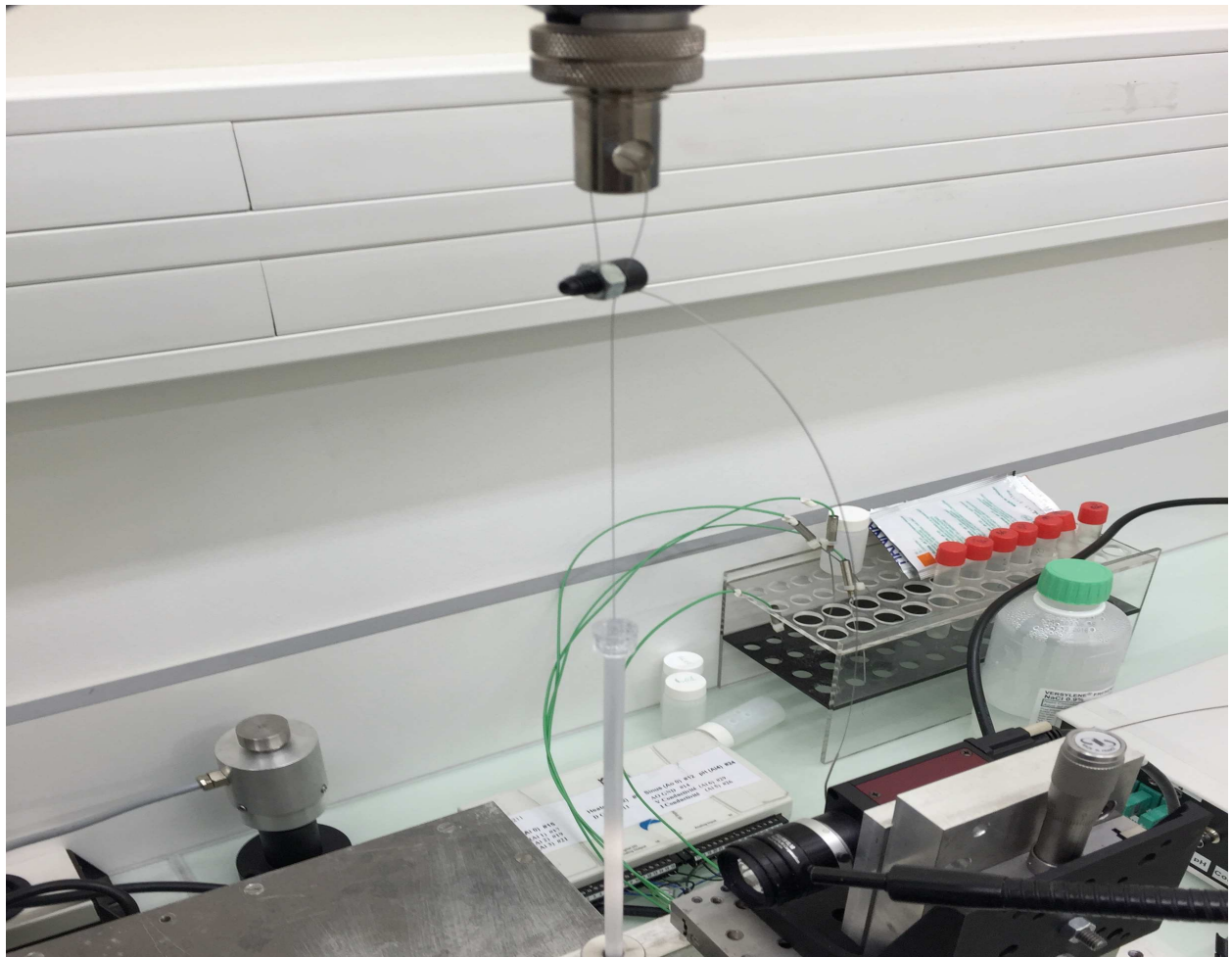

Fig. 4 Un stent retriever est déployé dans un tube en silicone fixé à l'intérieur d'un support cylindric rigide. Le poussoir du stent est attaché au bras de traction pour réaliser un "Pull up traction test".

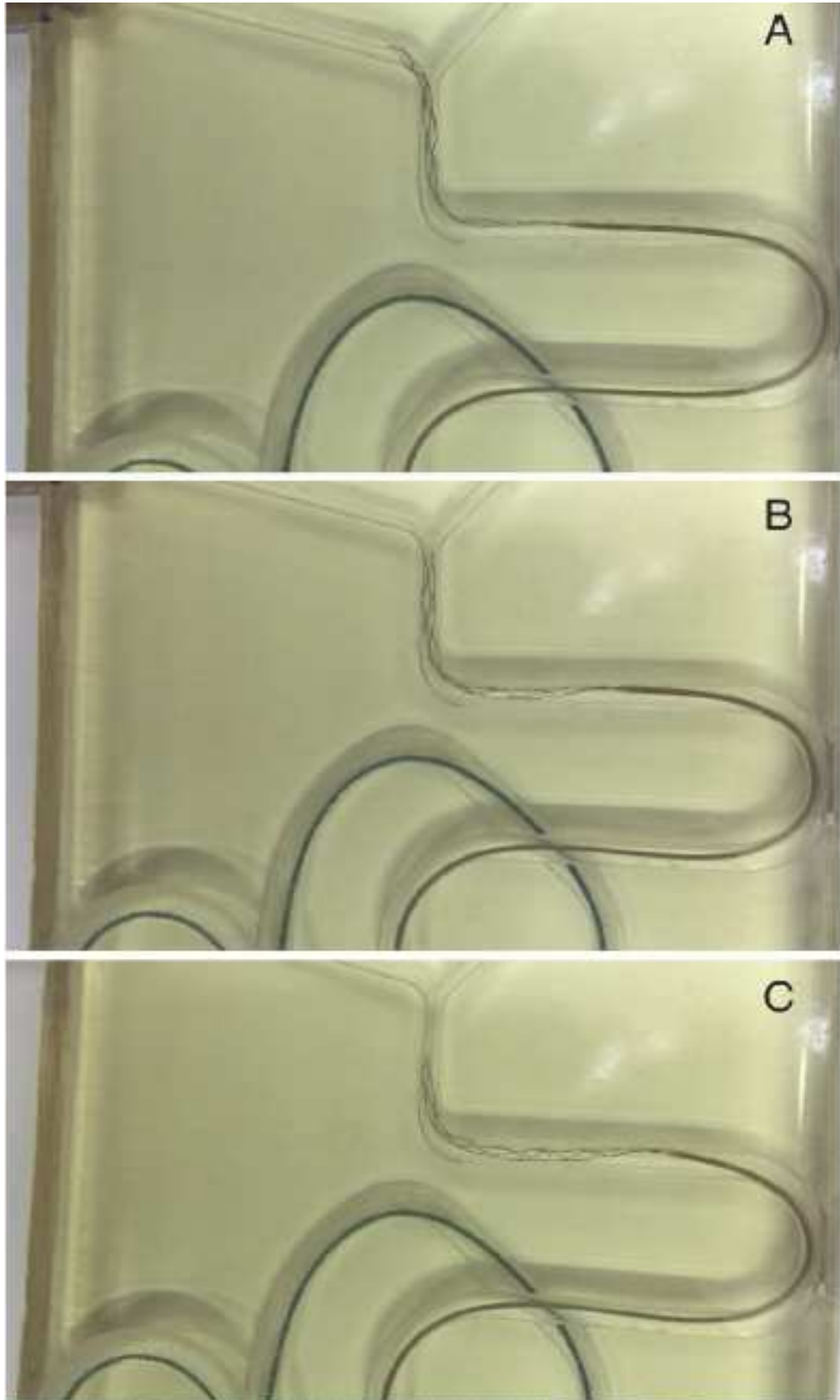

Fig. 5 Certains dispositifs montrent une élongation importante sur les angles aigues : interaction du tiers proximal, moyenne et distal du Solitaire 4-20 (A-C).

Les tests fonctionnels ont visé à évaluer visuellement la capacité du stent à rester en apposition sur la paroi des vaisseaux et à maintenir le thrombus à l'intérieur de ses grilles durant le retrait.

Nous avons évalué l'interaction des dispositifs avec des thrombus de taille et de caractéristiques différentes que nous avons générés en utilisant du sang humain afin d'obtenir deux types de caillot : un souple « de type rouge » composé par tous les éléments du sang et un dur « de type blanc » qui a été principalement composé de plasma riche en plaquettes.

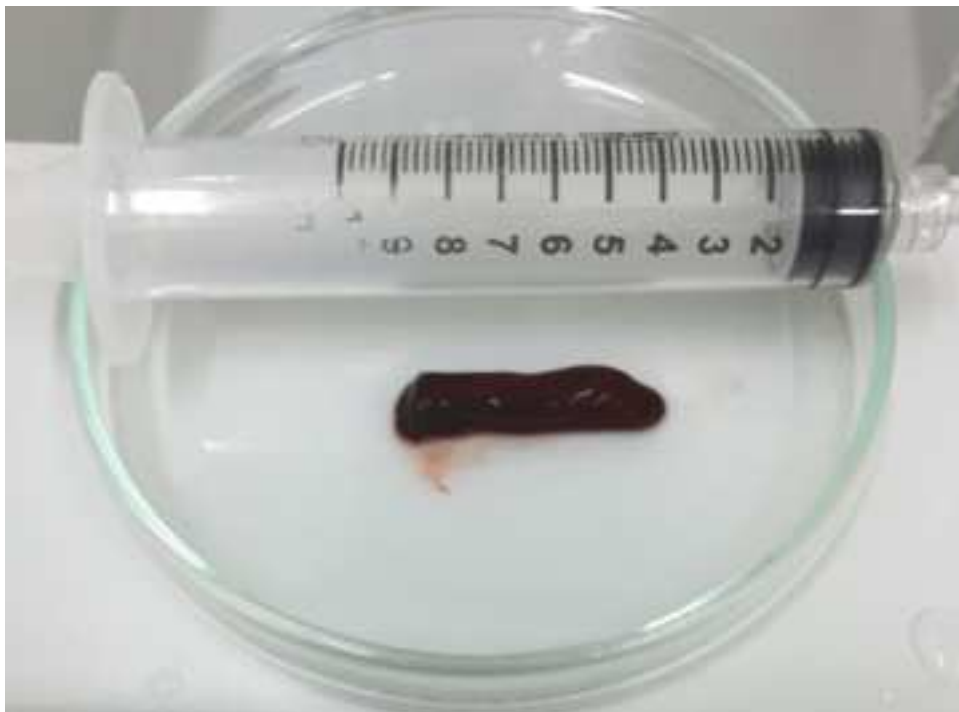

Fig. 6 *Thrombus rouge "souple" formé avec du sang complet*



Fig. 7 *Thrombus blanc “rigide” formé avec du plasma riche en plaquettes.*

Ces essais ont été effectués en utilisant un modèle vasculaire rigide reproduisant la circulation cérébrale antérieure. Deux neuro-interventionnels ayant une expérience dans les procédures de thrombectomie ont effectué les tests fonctionnels. Chaque expérience a été filmée et deux autres collaborateurs, par la suite, ont effectué une analyse visuelle des résultats.

Size	<i>Flat plate tests</i> Radial force density N/mm	<i>Pull up traction tests</i> Radial pressure Pa (N/m ²) (1.5 mm tube)	<i>Pull up traction tests</i> Radial pressure Pa (N/m ²) (3.5 mm tube)
Trevo PV			
4-20	0.01480	920	50* (p=0.050)
3-20	0.00600	300	60* (p=0.030)
Eric			
3-20	0.01100	220	–
4-24	0.01850	1540	340* (p=0.008)
6-44	0.01304	770	400* (p=0.010)
Embotrap			
5-21	0.00642	1430	770* (p=0.014)
Separator 3D			
4.5-26	0.00791	1360	400* (p=0.006)
Revive			
4.5-22	0.01269	1360	850* (p=0.021)
Mindframe			
3-23	0.00451	1250	330* (p=0.034)
Solitaire FR			
4-20	0.00448	1110	530* (p=0.014)
6-30	0.00351	1060	580* (p=0.020)
Preset			
4-20	0.00521	1090	730* (p=0.018)
6-30	0.00368	630	600* (p=0.25)
Preset LT			
3-20	0.00320	1060	160* (p=0.03)
4-20	0.00370	460	480* (p=0.77)
Catch			
3-15	0.00350	840	220* (p=0.049)
4-20	0.00444	1810	360* (p=0.010)
6-30	0.00368	1870	900* (p=0.030)

*p Value for the comparison between force exerted in tubes of 1.5 and 3.5 mm inner diameter during *Pull up traction tests*. Note results obtained with Preset 6-30 and Preset LT 4-20 for which there is not significant shift of the radial pressure when retrieved in tubes of different diameter; p=0.25 and p=0.77, respectively.

Tab. 2 *Resultats de Flat plates et Pull Up Traction Tests*

En conclusion, les essais mécaniques ont montré un comportement différent en termes de variation de pression radiale au cours du retrait pour chaque stent. Une pression radiale constante pendant le retrait est liée à une cohésion constante sur la paroi artérielle pendant le retrait, avec un taux plus important de retrait du caillot. Par ailleurs, tous les stents retriever glissent sur les caillots blancs de grande taille (diamètre > 6 mm), donnant un taux très bas d'efficacité en termes de retrait de thrombus.

Contents

Introduction

CHAPTER 1: Acute Ischemic Stroke

1.1 Intravenous Thrombolysis

1.1.1 Recombinant Tissue Plasminogen Activator (rt-PA)

1.1.2 Tenecteplase

1.1.3 Desmoteplase

1.1.4 Ancrod

1.1.5 Glycoprotein IIb/IIIa Antagonist

1.1.6 Argetroban

1.2 Factors Affecting Outcome of Thrombolysis

1.3 Other treatments

1.3.1 Sonothrombolysis

1.4 Mechanical Treatment of Acute Ischemic Stroke

1.4.1 The Beginning of Mechanical Treatment

1.4.2 Multi Merci Trial

1.4.3 Aspiration Thrombectomy

1.4.4 Penumbra Pivotal Stroke Trial

1.4.5 Stent Retriever Devices

1.4.6 Description of the Thrombectomy Procedure using Stent Retrievers

1.4.7 Early Inconclusive Mechanical Thrombectomy Trials

1.4.8 Early and rapid Reperfusion are Critical for Good Clinical Outcome

1.5 Stroke Trials of the “New Era”

1.5.1 Multicenter Randomized Clinical Trial of Endovascular Treatment for Acute Ischemic Stroke in the Netherlands (Mr Clean)

1.5.2 Endovascular Treatment for Small Core and Proximal Occlusion Ischemic Stroke ESCAPE Trial

1.5.3 Extending the Time for Thrombolysis in Emergency Neurological Deficits Intra-Arterial EXTENDED IA Trial

1.5.4 Solitaire With the Intention for Thrombectomy as Primary Endovascular Treatment for Acute Ischemic Stroke Trial

1.6 Patient Selection for Endovascular Treatment

CHAPTER 2: The Plan of the Thesis

2.1 Purpose

2.2 Mechanical Tests

2.2.1 Flat Plate Compression Test

2.2.2 Pull Up Traction Test

2.3 Functional Tests

2.3.1 3D Printed Vascular Model

2.3.2 Retrieving Test

2.3.3 In Vitro Thrombectomies

2.3.4 Thrombi Preparation

2.3.5 White "Stiff" Thrombi

2.3.6 Red "Soft" Thrombi

2.3.7 Thrombi Flat Plate Compression Test

2.4 Statistics

2.5 Results

2.5.1 Mechanical Tests

2.5.2 Functional Tests

2.6 Discussion

Conclusions and perspective

Introduction

Stroke is one major public health issues worldwide and the third most costly health condition in developed countries [1]. Approximately 800,000 strokes are reported in the United States every year leading to 200,000 deaths, almost 1 out of every 16 deaths [2, 3]. For patients who survive, stroke is the most common cause of adult disability in the occidental world and it is associated with long-term rehabilitation care [2, 4–6]. Costs are estimated over 60 billion dollars per year in the United States alone [2, 4, 7]. More than 80% of stroke victims suffer from a disease ischemic in nature related to a thrombus (or thromboembolism), with the remainder hemorrhagic [2].

During the acute ischemic stroke (up to 6 hours after the stroke onset), a “core area” of tissue due to inadequate perfusion quickly dies while a surrounding area of hypo-perfused brain (penumbra zone) fed by collateral vessels remains salvageable if promptly reperfused [8]. Consequently, the target of treatment is the prompt reperfusion of the occluded vessel and the ischemic tissue, the reperfusion of is related to better clinical outcome and decreased mortality at 90 days after the stroke [9-10].

Recombinant tissue plasminogen activator rt-PA has been the therapy of reference for intravenous thrombolysis since FDA approval in 1996 [14]. Nevertheless, the limited efficacy for recanalization of large vessel occlusion (<35%) and the associated risk of intracranial bleeding along with the short therapeutic window (up to 4.5 hours after stroke onset) has motivated the development of endovascular approaches [11-12-13].

Since the early 1990s endovascular approaches have been performed as a compassionate treatment in cases in which the standard care was not effective or contraindicated. At the time, thrombectomies were performed with not adequate or “adapted” devices and results of interventions were consequently not always optimal or reproducible. Only in the last ten years, starting in 2006 with the launch in Europe of the MERCI retriever device and the Penumbra Thrombectomy System, dedicated thrombectomy devices become available. A couple of years

later, a new heartbreaking technology were added to neurointerventional armamentarium: the stent retrievers. Such tools tremendously improved the effectiveness of mechanical thrombectomy and allowed for technical success reproducibility. Since the availability of the first stent retriever device (Solitaire) clinical outcome of stroke patients who benefited of mechanical treatment have dramatically improved and such improvement has been also confirmed in clinical trials aimed to validate their use.

Since the beginning of 2015, for the first time in the history of the acute ischemic stroke therapy, the mechanical approach was definitely validated as treatment of reference, beside the intravenous fibrinolysis, by several clinical trials. Since that time a multitude of stent retriever devices, with different design features, have been proposed by the most part of the companies producing devices for neurovascular interventions. In spite of the large availability of stent retriever of different designs none comparative study evaluating difference in terms of recanalization effectiveness was so far present in literature. Consequently our study was conceived and conducted to evaluate such differences. With this aim we evaluated in vitro the interaction between all stent retriever models available in France up to June 2015 and thrombi of different consistencies. Furthermore, we analyzed in an experimental setting mechanical properties of all devices in order to investigate their interaction with the clot and their behavior during the retrieval. The aim of this study was to identify any mechanical device properties that correlate with a higher rate of thrombus removal.

In the first chapter we report about advantages and disadvantages of historical treatments for acute ischemic stroke. The second chapter is the core of the thesis and it is devoted to the experimental study, we report in detail about experimental tests on stent retrievers and results.

CHAPTER 1: Acute Ischemic Stroke: The Medical Therapy

1.1 Intravenous Thrombolysis

Up to January 2015 intravenous rt-PA (Fig. 1) has been the only approved treatment for acute ischemic stroke, in the following paragraph we briefly report about trials that demonstrated the efficacy and the safety of such treatment.



Fig. 1: Intravenous rt-PA is administered at a dose of 0.9 mg/kg, with a maximum dose of 90 mg. Ten percent of the medication is given as a bolus and the remainder is infused over 60 minutes (Photo Boehringer Ingelheim).

1.1.1 Recombinant Tissue Plasminogen Activator (rt-PA)

Intravenous rt-PA therapy in the first 3 hours after stroke onset was demonstrated to be beneficial in the NINDS (National Institute of Neurological Disorders and Stroke) trial, which reported a significantly greater proportion of patients having a normal or near normal outcome compared to placebo (38% vs. 21%, $p=0.001$) [16].

In 2009, the ECASS 3 (European Cooperative Acute Stroke Study 3) found that patients treated with rt-PA within the 3–4.5 hours window showed improved outcome in comparison to placebo (mRS 0-1 in 52% vs. 45% of the patients, $p=0.04$) with no increase in mortality [17]. Accordingly, the American Heart Association guidelines for intravenous rt-PA administration extended the window of treatment from 3 to 4.5 [1, 34, 36].

IST-3 trial evaluated safety and efficacy of intravenous rt-PA administered between 4.5 and 6 hours after stroke onset but results were disappointing. The study, which enrolled 3035 patients within 6 hours from stroke onset, showed a high rate of symptomatic intracranial bleeding and mortality, with not significant trend towards favorable clinical outcome at 6 months in the intervention group in comparison to the control group (37% vs. 35 %, $p=0.181$) [18]. Nevertheless, the large Ischemic Stroke Recorded in the Safe Implementation (SITS-IST) registry on 29.619 patients did not found worse clinical outcome in patients treated between 4.5 to 6 hours in comparison to patients treated between 3 and 4.5 hours [19].

The efficacy of the combination of intravenous rt-PA with heparin or antiplatelet to prevent re-occlusion of vessels has been also investigated. Even if not statistically significant, a trend towards more favorable outcome was shown in patients treated with intravenous rt-PA in combination with low molecular weight heparin although this was associated with a small increased risk of symptomatic intracranial bleeding [37, 38].

The Antiplatelet Therapy in Combination with Recombinant rt-PA Thrombolysis in Ischemic Stroke Study (ARTIS) showed that the use of 300 mg of intravenous acetyl salicylic acid within 1.5 hours of rt-PA did not improve outcome at 3 months but increased the rate of symptomatic bleeding [20, 37, 39]. According to the current guidelines, no evidence supports the initiation of the antiplatelet therapy within the first 24 hours after rt-PA administration.

Common thrombolytic agents like rt-PA (alteplase) and prourokinase act by converting plasminogen into active plasmin [2, 17, 40, 41]. Even if rt-PA is so far the only FDA approved medical treatment for acute ischemic stroke, other agents are now being produced and

investigated with the goal of improving the efficacy and the safety of the intravenous thrombolysis. There are also concerns that rt-PA may have negative effects on the ischemic brain, including cytotoxicity and increased permeability of the blood-brain-barrier facilitating cerebral edema [42]. Efficacy of new agents like tenecteplase, reteplase, plasmin, microplasmin, and desmoteplase and their combination therapy is now being investigated [2, 36, 37, 43].

1.1.2 Tenecteplase

Tenecteplase is a structurally modified rt-PA, which presents increased half-life and fibrin affinity [37, 39, 44]. Parsons et al. (2012) randomized 75 patients to receive alteplase (0.9 mg/kg of body weight) or tenecteplase (two groups received tenecteplase: 0.1 mg/kg or 0.25 mg/kg) and found that the two tenecteplase groups had greater reperfusion compared to alteplase and the high dose tenecteplase group was superior to the lower dose group in all outcome measures [21].

Smadja et al. evaluated the efficacy of 0.1 mg per kg intravenous bolus of tenecteplase as a rescue therapy in middle cerebral artery occlusions (M1) not responsive to rt-PA. All 13 patients treated had favorable recanalization rate (TIMI 2/3) and a modified Rankin Scale (mRS) of 0 or 1 was achieved in 69% of the patients at 90 days [45].

Other similar studies are ongoing, for instance The Norwegian Tenecteplase Stroke Trial (NOR-TEST is a trial evaluating the efficacy and the safety of tenecteplase in comparison to alteplase for stroke patients presenting within 4.5 hours of stroke onset [46].

1.1.3 Desmoteplase

Desmoteplase is a plasminogen activator obtained from the vampire bat saliva, it presents higher fibrin affinity and longer half-life in comparison to rt-PA. Desmoteplase in Acute Stroke Study (DIAS) evaluated safety and efficacy of intravenous desmoteplase (with different dosages) in patients presenting with a perfusion/diffusion MRI mismatch within 3 hours from stroke onset. The first part of this study was stopped prematurely due to the excessive rates of symptomatic intracranial hemorrhage (up to 30%) but the part two of the study, in which patients received a lower weight adjusted desmoteplase dose, showed higher reperfusion rate and better clinical outcomes for patients who received desmoteplase in comparison to the placebo group [22,37].

Followed the phase II placebo-controlled Dose Escalation of Desmoteplase for Acute Ischemic Stroke Study (DEDAS), which showed safety and efficacy of 125µg/Kg dose of intravenous desmoteplase in acute ischemic stroke, nevertheless only 25 patients were assigned to the treatment arm [14, 37].

Later on, the phase III study, DIAS-2, failed in demonstrating the superiority of desmoteplase over placebo. Such result was probably related to different factor including the lower stroke severity of patients in the study, smaller infarct core. Furthermore, only 30% of patients in the study presented a proximal vessel occlusion [4, 37]. Currently, phase III DIAS-3 and DIAS-4 trials are ongoing to investigate safety and efficacy of 90µg/kg bolus administered within 3 and 9 hours after stroke onset [47].

1.1.4 Ancrod

Ancrod is a serine protease, derivate from the Malayan pit viper's venom. Administered intravenously, it reduces blood fibrinogen levels and the viscosity of the blood; hence it leads to anticoagulation [48, 23, 37, 49]. The Stroke Treatment with Ancrod Trial (STAT) included 500 patients admitted within 3 hours from stroke onset randomized to receive an infusion of ancrod or placebo over 72 hours and 1-hour infusions at 96 and 120 hours. Better clinical outcome was recorded in the treatment group, 42.2% vs. 34.4%, (p=0.04). Nevertheless, symptomatic

intracranial hemorrhage rate was higher in the treatment group, 5.2% vs. 2% ($p=0.06$, not significant) [23]. Further trials evaluating the treatment up to 6 hours from stroke onset failed in demonstrating significant difference in clinical outcome [37, 49–51].

1.1.5 Glycoprotein IIb/IIIa Antagonists

Glycoprotein IIb/IIIa inhibitors act preventing platelet activation facilitating thrombus breakdown [52]. They have been shown as an adjuvant to improve coronary recanalization in acute myocardial infarction with more TIMI 3 reperfusion in phase II studies but no significant final outcome improvement in the phase III study [37, 53,54].

Tirofiban in Acute Ischemic Stroke (SaTIS) was a phase II placebo-controlled trial on mono-therapy with intravenous tirofiban in patients presenting up to 22 hours after stroke onset. The study demonstrated the safety of tirofiban; nevertheless no neurological benefit was found in comparison with the placebo group at 5 months except for lower mortality shown in the treatment group [24, 37].

Successively, the Abciximab in Emergency Treatment of Stroke Trial (AbESTT-II), a phase III study on GP IIb/IIIa inhibitor, was stopped prematurely because of an unfavorable risk-benefit profile. A significant increase in symptomatic intracranial hemorrhage was found in the intervention group. In the conclusion section, authors stated that abciximab has not to be administered to treat acute ischemic stroke patients [25, 37, 55].

The Combined Approach to Lysis Utilizing Eptifibatide and Recombinant Tissue Plasminogen Activator in Acute Ischemic Stroke Enhanced Regimen stroke trial (CLEAR-ER) evaluated efficacy and safety of combined Eptifibatide and rt-PA vs. rt-PA alone. The combined treatment group showed a lower symptomatic intracranial hemorrhage rate (2%) and a trend to better outcome (49.5% mRS 0-1 vs. 36% in the control group) [26].

1.1.6 Argatroban

Argatroban is a thrombin inhibitor that was evaluated in the Argatroban Anticoagulation in

Patients with Acute Ischemic Stroke (ARGIS-I) trial. Patients were treated with a high or low intravenous dose of argatroban or placebo within 12 hours from symptoms onset. The argatroban groups did not show any benefit in functional outcome compared to placebo.

1.2 Factors Affecting Outcome of Thrombolysis

As already mentioned, cerebral blood flow restoration to the ischemic brain tissue is the immediate aim of the intravenous thrombolysis. A meta-analysis on 2006 patients showed that recanalization compared to no recanalization was associated with good functional outcome (OR 4.43, 95% CI 3.32–5.91) and reduced mortality (OR 0.24, 95% CI 0.16–0.35) at 3 months [9]. The outcome of treated ischemic stroke patients depends on multiple factors including: location, extent and type of thrombus, presence and efficacy of a collateral circulation, presence of comorbidities, age of the patient, delay from symptoms onset and target artery recanalization [2].

Studies on thrombolysis have largely demonstrated that large diameter proximal vessels are unlikely to be recanalized by intravenous thrombolysis alone [37, 61, 62]. Trans-cranial ultrasound studies showed an intravenous thrombolysis recanalization rate of 44.2% for distal middle cerebral branches (M2) occlusion, 30% and 6% for proximal MCA (M1) and distal ICA, respectively [37, 62, 63]. Furthermore, studies have found that the likelihood of recanalization is also related to the thrombus burden, with clot less than 8 mm in length having a higher likelihood of achieving recanalization [2, 64].

Thrombus composition and mechanical characteristics may also determine effectiveness of thrombolysis or mechanical thrombectomy. A study demonstrated that cardio-embolic thrombus achieved faster and more frequent recanalization with rt-PA in comparison with large vessel atherosclerotic lesions [63, 65].

MRI/CT perfusion imaging studies in acute stroke are providing nowadays a basis to select patients with salvageable brain tissue. Such selection is effective not only for patients admitted within the traditional 3-4.5 hours window from stroke onset but also for patients who present beyond this window or victims of wake-up strokes. Imaging guided patient selection aimed two studies: the

Diffusion and Perfusion Imaging Evaluation for Understanding Stroke Evaluation (DEFUSE) study and MRI Profile and Response to Endovascular Reperfusion after Stroke (DEFUSE-2) study. Those studies found that when a favorable perfusion/diffusion mismatch was present patients who had early reperfusion after rt-PA and/or endovascular treatment had more favorable outcomes and attenuation of infarct growth. Studies also highlighted a subset of patients with a “malignant mismatch” characterized by large DWI extent (≥ 100 mL) that was more likely to have symptomatic intracranial hemorrhage and poor outcome after reperfusion [29, 30].

The effects of alteplase beyond 3 hours after stroke in the Echoplanar Imaging Thrombolytic Evaluation Trial (EPITHET) was a trial evaluating effectiveness of intravenous rt-PA in comparison to placebo in patients presenting a perfusion mismatch between 3 and 6 hours after symptoms onset. In comparison to placebo, rt-PA was not significantly associated with better clinical outcome at 90 days but with higher rates of reperfusion, 56% versus 26% ($p=0.01$). Also such trial found a significant association between reperfusion and better clinical outcome and less infarct growth [31]. Further trials are currently underway to evaluate if patients with penumbra mismatch would benefit from rt-PA between 3 and 9 hours from stroke onset [66]. For instances, WAKE-UP is an ongoing trial that uses DWI-FLAIR mismatch to identify patients for intravenous thrombolysis with rt-PA amongst patients who wake up with stroke symptoms [67].

1.3 Other Treatments

1.3.1 Sonothrombolysis

The Combined Lysis Of Thrombus in Brain Ischemia Using Transcranial Ultrasound and Systemic rt-PA (CLOTBUST) study demonstrated that thrombolytic efficacy of intravenous rt-PA can be increased due to the separating effect of the energy delivered by sound waves on fibrin within the thrombus [32, 37, 68].

Although this study was not powered for clinical outcome, it showed that trans-cranial emission of a 2 MHz sound beam for 2 hours targeted towards the thrombus significantly increased the rate of complete recanalization with rt-PA compared with placebo (38% vs. 13%) with no increase in hemorrhagic transformation risk [32, 37, 68]. Studies performed with lower frequency beams for thrombus disruption were shown to be unsafe [37, 69, 70].

Ultrasound contrast agents have shown that further energy can be delivered to the tissue when oscillating micro-bubbles cavitate, facilitating thrombus degradation and likely promoting recanalization [37]. The Transcranial Ultra Sound in Clinical SoNo-Thrombolysis (TUSCAN) study looked into the safety and efficacy of ultrasound assisted rt-PA thrombolysis, using escalating doses of lipid-based micro-bubbles (Microsphere), which are resistant to trans-pulmonary passage. The study demonstrated 67% complete recanalisation following the first dose [33, 37]. However, the study was terminated prematurely due to significantly increased risk of intracranial hemorrhage after the second dose [33,37].

In another study, three different groups of stroke patients within 3 hours received rt-PA alone, rt-PA plus ultrasound, or combined rt-PA, ultrasound, and micro-bubbles. The final comparison demonstrated safety of the micro-bubbles with no increased treatment complications and significantly higher recanalization rate [37], warranting further comprehensive studies into efficacy of sono-thrombolysis [17, 69].

1.4 Mechanical treatment of Acute Ischemic Stroke

1.4.1 The Beginning of the Mechanical Treatment

Mechanical thrombectomy devices for stroke treatment have been developed since the early 1990s. Such tools have been ideated to mechanically engage and remove the clot in order to reestablish the normal blood flow through the occluded artery. Mechanical approaches were supported by a number of theoretical advantages, including more frequent and rapid recanalization, longer treatment time window, revascularization of large proximal vessels refractory to standard care therapy.. Current thrombectomy tools act through engagement and retrieval or direct aspiration of the occluding clot. Clinical studies evaluating performances of mechanical thrombectomy devices have mainly been aimed to show safety of use for the purpose of the regulatory approval.

In the following paragraphs we briefly report an historical overview of clinical trials evaluating the safety and the efficacy of the first available dedicated intracranial thrombectomy devices.

1.4.2 Multi Merci trial

By 2004, the first FDA-approved product specifically intended for thrombectomy in acute stroke patients was launched, called the Merci Retriever (Concentric Medical; successively acquired by Stryker Neurovascular). The first generation devices resembled a wire with the shape of a corkscrew, which was placed beyond the clot in an effort to engage it and retrieve out of the body. A balloon-tipped guide catheter would be delivered in the proximal internal carotid and inflated prior to fully withdrawing the Merci under “flow arrest” conditions (Fig.2). Aspiration was applied on the balloon guide to arrest the anterograde blood-flow and capture residual emboli not collected by the Merci device. Later generations, including the “L” and “K-mini” devices, modified the configuration of the grabber wire, some adding suture strands to assist in retaining the thrombus. The Merci device was only moderately successful in the clinic practice, astonishingly, in the Multi MERCI trial, the study done to evaluate the safety and efficacy of the Merci Retriever device, the mortality rate at 90 days was 34% [71].

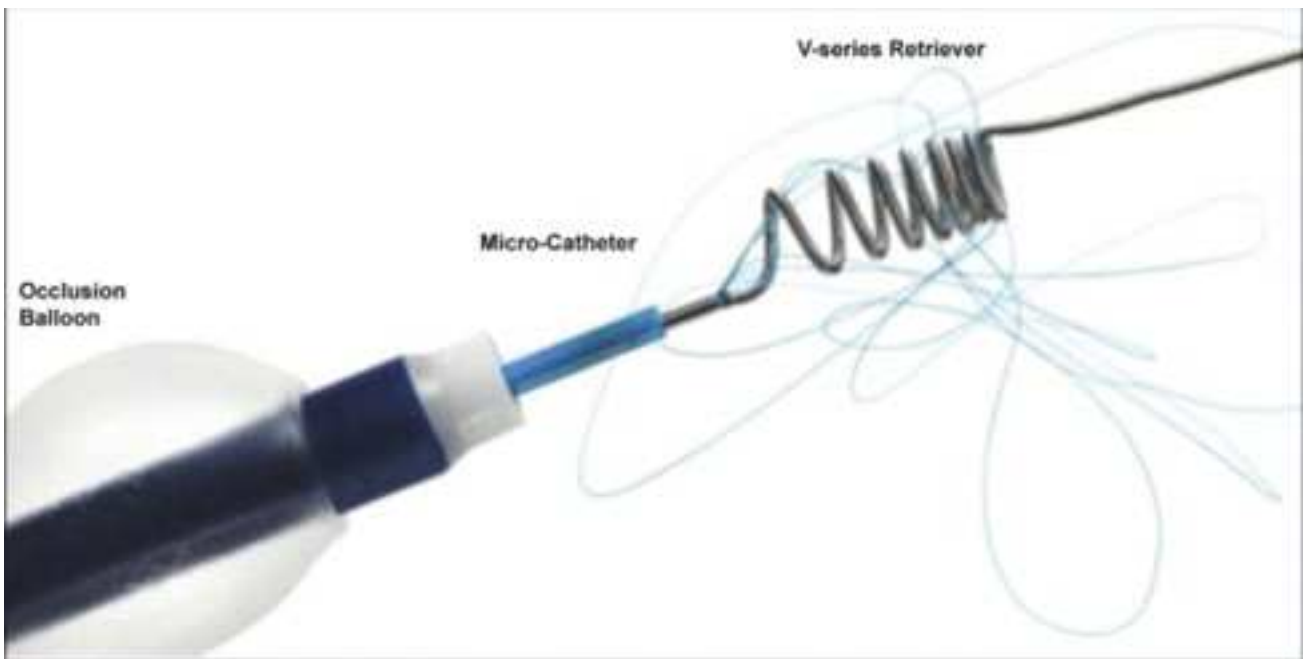

Fig. 2 *The Merci thrombectomy system; the device itself consisted in a corkscrew shaped wire. The guiding catheter originally recommended in this setting presents a distal tip balloon, which is inflated to arrest the anterograde flow and to allow concomitant aspiration during the retrieval of the thrombectomy device. Such type of guiding catheter is nowadays used in association with new generation thrombectomy devices. (Photo Concentric-Stryker)*

1.4.3 Aspiration Thrombectomy

In December 2007, the Penumbra System (Penumbra, Inc.) gained approval in the United States for use in revascularization of acute stroke patients. The Penumbra System used aspiration as its primary method of action. A large bore micro-catheter was deployed to the site of occlusion and aspiration applied directly on the lesion itself. However, the early Penumbra System catheters, the largest of which was 0.041" in internal diameter, were not wide enough to avoid becoming obstructed by the thrombus and so another component, Separator device, was introduced to clear the catheter lumen and to continually break up the thrombus ingested under aspiration. Without a Separator, the early micro-catheters could clog necessitating removal and re-access, prolonging procedural times. Thus by using a Separator, direct aspiration and clot capture were combined to facilitate continuous thrombectomy (Fig. 3).

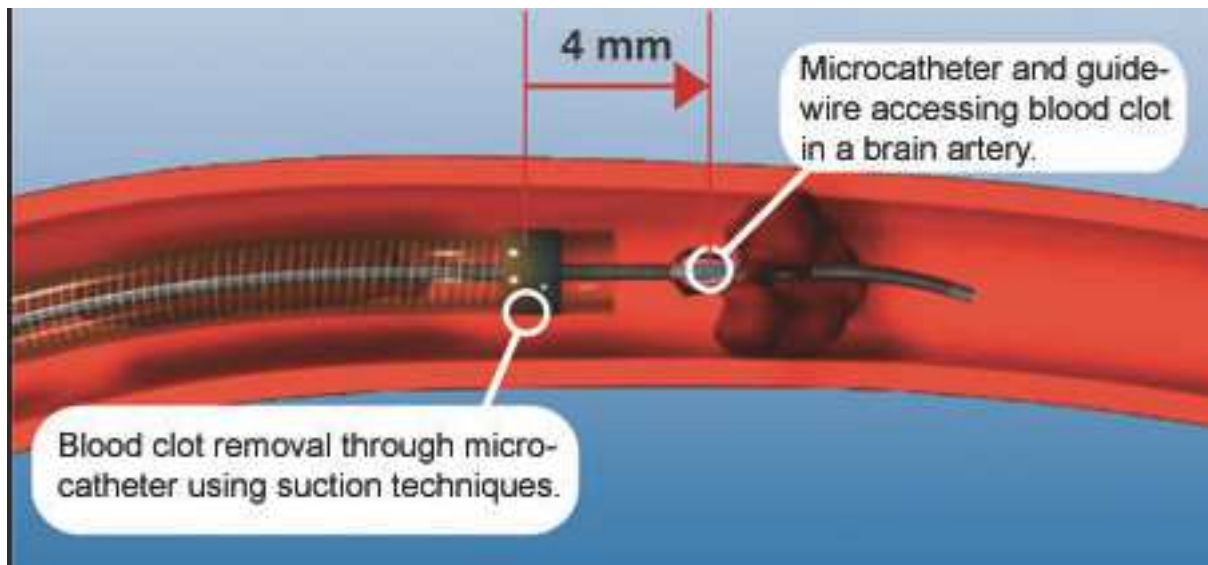

Fig. 3 The figure represent the first version of the Penumbra System; a large bore aspiration catheter was navigated up to 4 mm to the clot, then a separator device was employed to fragment the clot while an aspiration pump was used to aspirate clot fragments. (Photo Penumbra Inc.)

The Penumbra System increased the rate of successful reperfusion to 82% in the Pivotal trial for FDA approval, and improving further to 87% in the real-world POST study. A three-dimensional (3D) nitinol stent retriever device known as the Separator 3D (evaluated in our study) was launched in Europe in January 2012 as an additional component of this system.. Currently, Penumbra Inc. produces large bore catheters with an internal diameter up to 0.054 inches; in addition the power of the aspirating pump has been improved. Such improvements have definitely increased the rate of target vessel recanalization of the Penumbra thrombectomy system.

1.4.4 Penumbra Pivotal Stroke Trial

The Penumbra Pivotal Stroke Trial evaluated the efficacy and the safety of the Penumbra system for the treatment of large intracranial arteries in patients with AIS up to 8 hours from symptom onset [72] This trial showed a 90 days mortality rate of 32.8%, which was comparable to the mortality rate reported for Multi MERCI trial; the rate of the patients achieving a favorable clinical outcome in this study (mRS \leq 2) was 25%. The study concluded that Penumbra system was safe and effective for mechanical revascularization.

1.4.5 Stent Retriever Devices

Stent retrievers are derived from self-expanding intracranial stents; they are made of nitinol, which is a metal alloy of nickel and titanium. The proximal extremity of the stent-retriever is fixed on a delivery wire; such wire allows for advancement and positioning of the device and also for removal after complete deployment. Such feature is the base of the use of stents for mechanical thrombectomy (Fig. 4). The aim of the stent retriever thrombectomy is to deploy the device across the occluding thrombus (see below). The meshes of the device penetrate the thrombus over the next few minutes after delivering. The efficacy of the clot retrieval is due to the interaction between the device and the thrombus. Such interaction is influenced by stent's properties such as design, mechanical characteristics, and behavior during retrieval and thrombus properties such as biomechanical behavior.

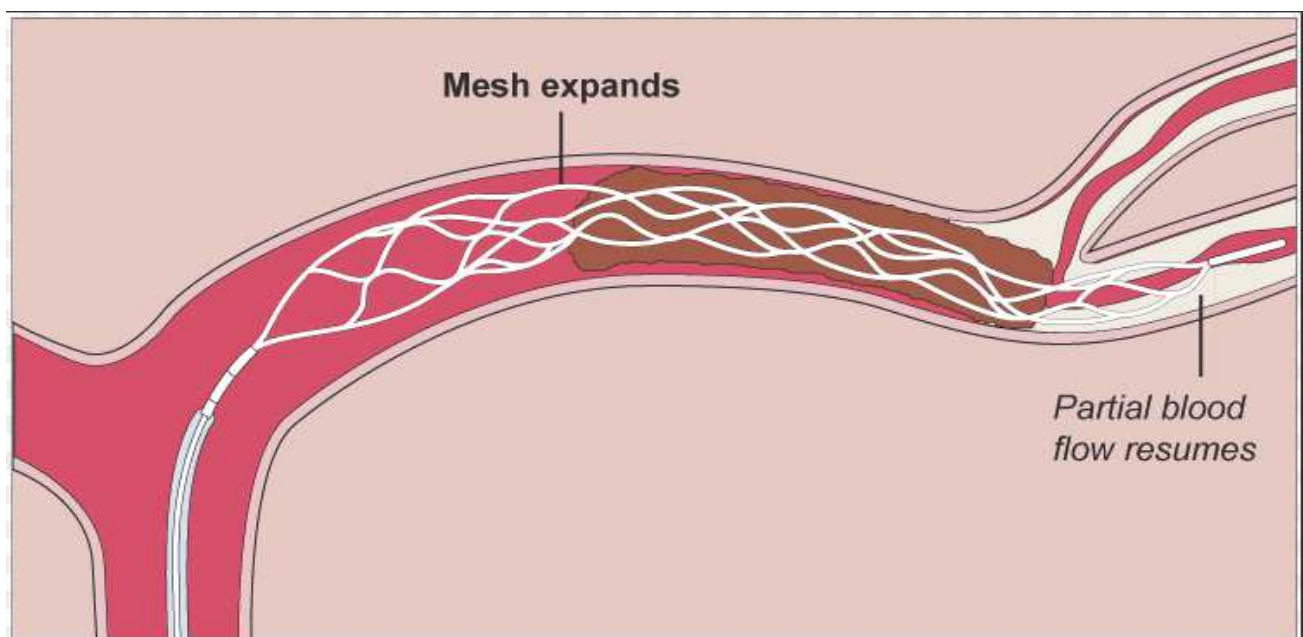

Fig. 4 A stent retriever completely deployed through an occluding thrombus, although the stent is completely delivered the push-wire remains attached to its proximal end and allows for retrieving and removal. The stent compresses the clot against the vessel wall and allows for some blood flow restoration (by pass effect).

1.4.6 Description of Thrombectomy Procedure with Stent Retrievers

Mechanical thrombectomy are performed via a common femoral artery approach with the patient under general anesthesia or conscious sedation. A guide catheter is placed in the concerned carotid or vertebral artery. Thus, a micro-catheter is navigated across the occluding clot over a micro-wire; the micro-wire is after exchanged with the stent retriever and deployed across the thrombus (Fig. 5-8).

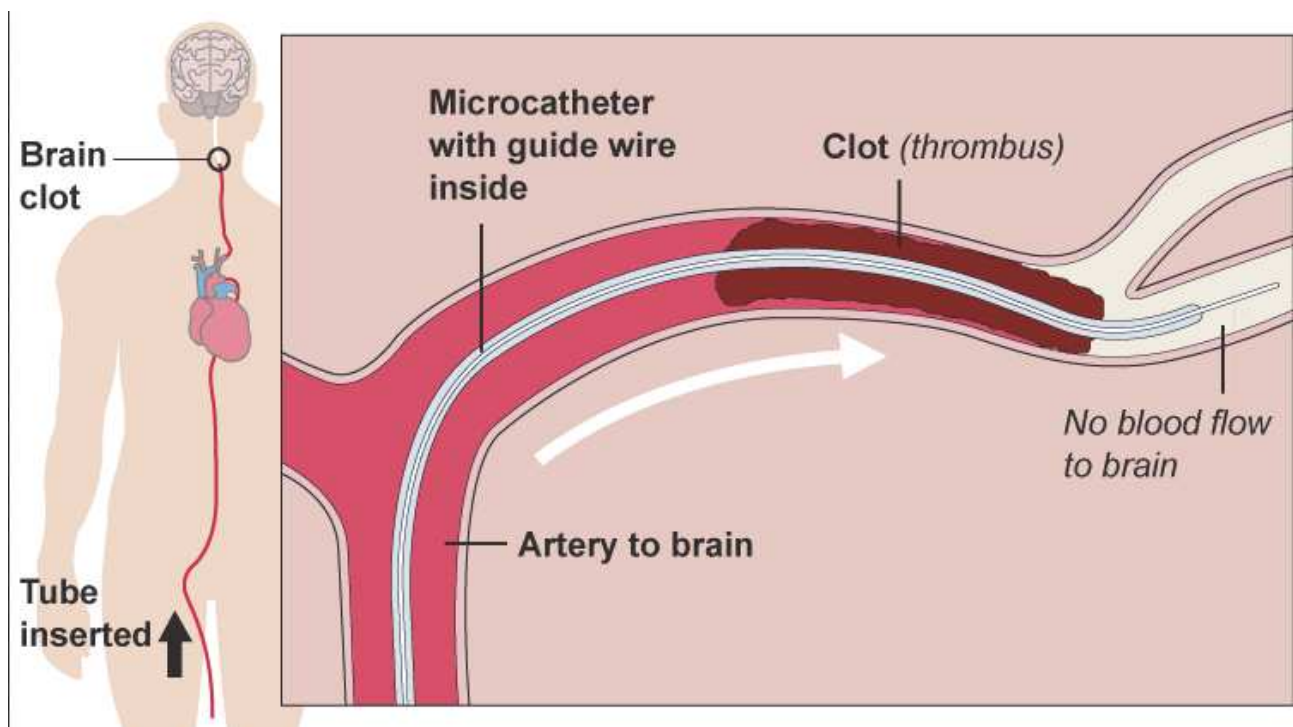

Fig. 5 The brain vasculature is reached via a femoral artery approach; a micro-catheter is navigated over a micro-guide wire beyond an occluding clot placed at the level of the left middle cerebral artery.

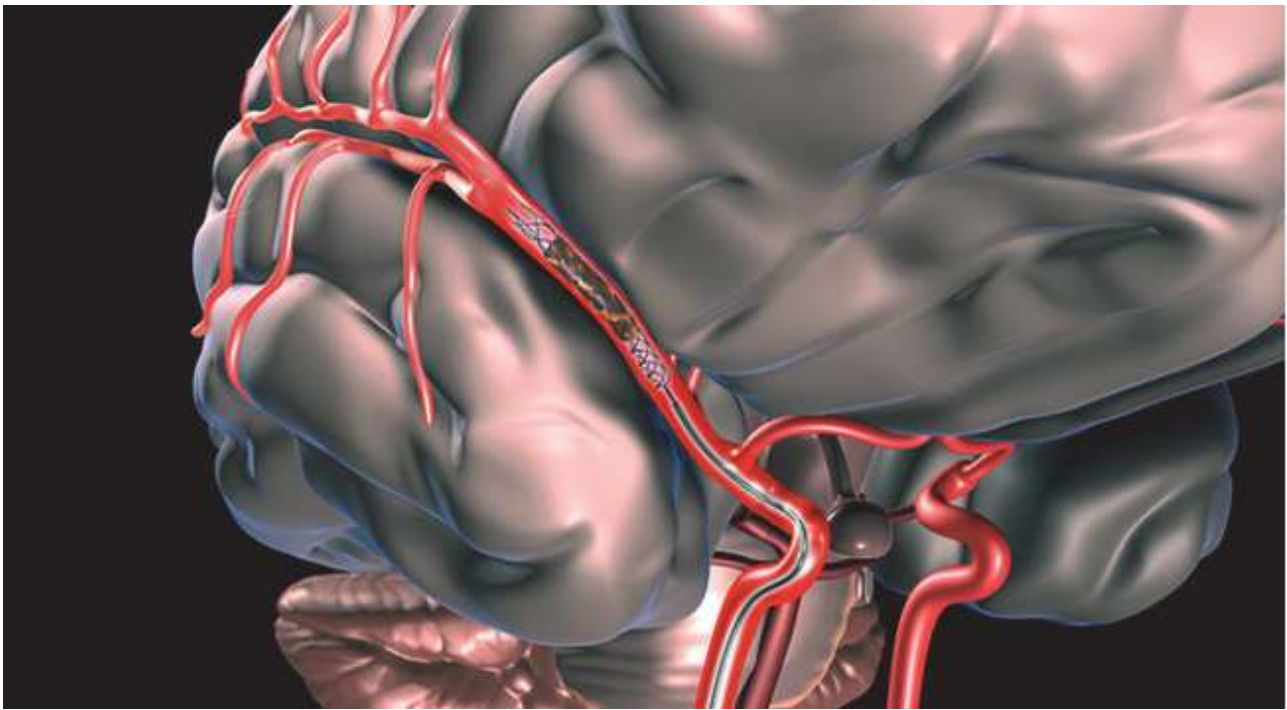

Fig. 6 *A stent retriever deployed through a clot located at the right middle cerebral artery*

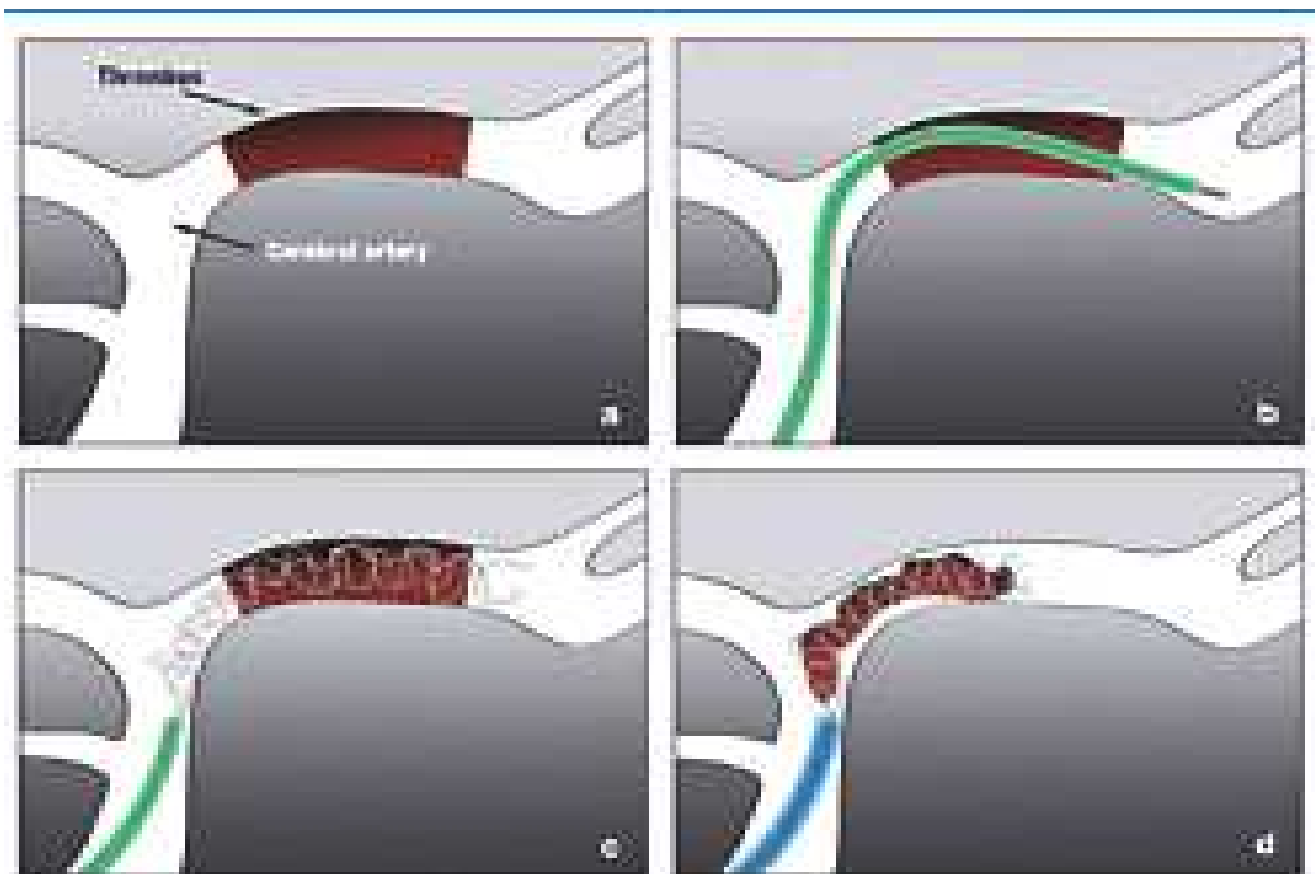

Fig. 7. *a: A clot is located at the level of the left middle cerebral artery (M1). b: A micro-catheter is navigated over a guide-wire beyond the thrombus. c: A stent retriever is exchanged with the guide-wire and deployed through the thrombus. d: The stent retriever and the thrombus are retrieved as a unit.*

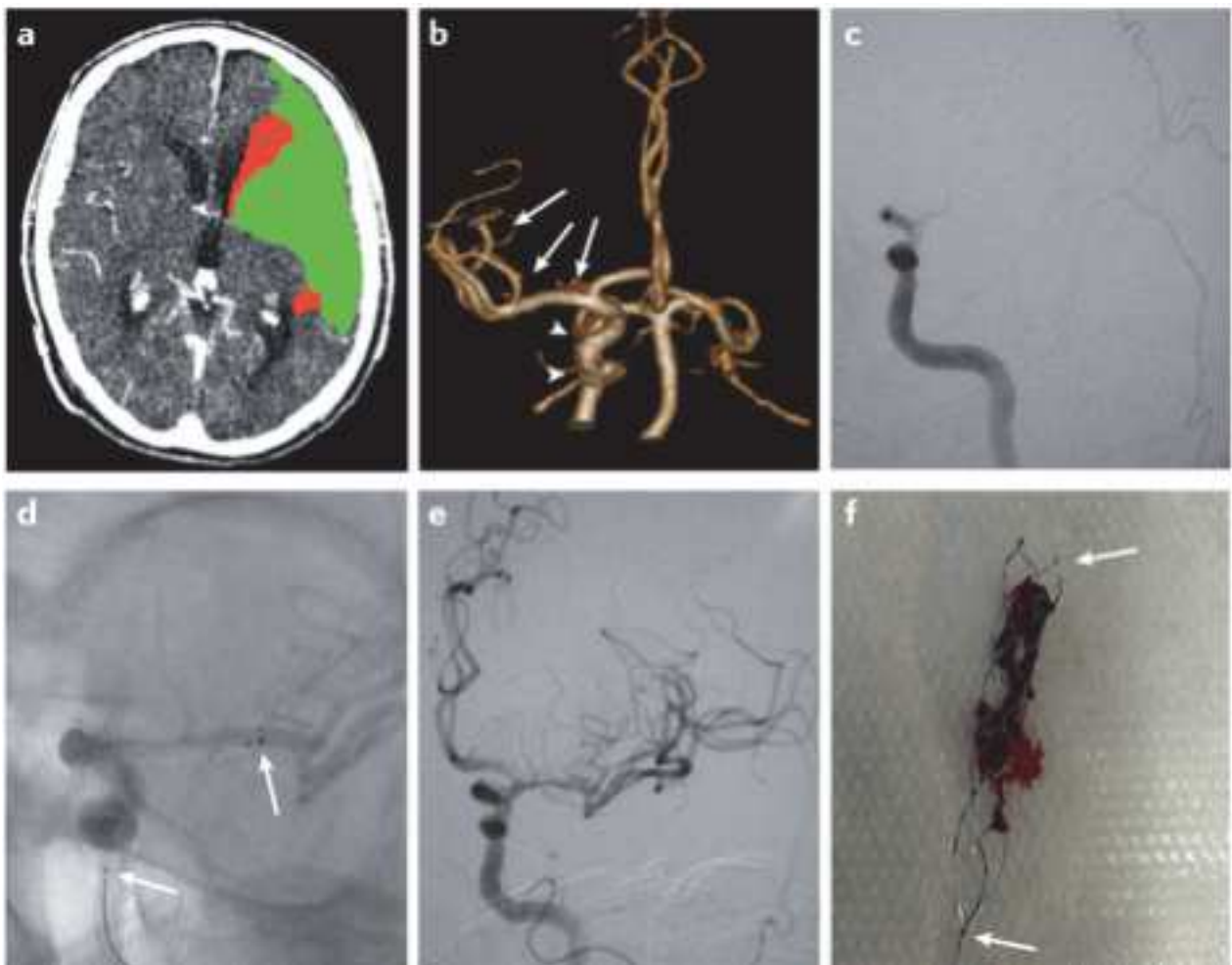

Fig. 8 This is the case of a real patient presenting with an acute middle cerebral artery stroke. *a*: an extensive penumbral mismatch is demonstrated by CT perfusion maps. *b*: CT Angiography (tridimensional reconstruction) shows the occlusion of the left internal carotid. *c*: digital subtracted angiography confirms the occlusion of the left terminal carotid. *d*: a stent retriever is deployed through the clot in the middle cerebral artery (Arrows indicate the proximal (one) and the distal (four) radiopaque markers of the device. See also fig. *f*). *e*: the angiographic control performed after stent retrieval shows complete recanalization of the middle cerebral artery. *f*: the clot has been completely engaged by the stent retriever struts.

Upon deployment, stent retrievers have to be maintained in place for a few minutes (embedding time), this because at the body temperature the best expansion of the nitinol filaments is obtained about five minutes after delivering. Afterwards, the device is gently retrieved from the brain vasculature into the guide catheter. During the retrieving, concomitant aspiration is performed through the guiding catheter in order to reduce the risk of clot fragments embolization. In case of vessel tortuosity, a lower profile distal access catheter can be navigated through the first guide catheter (co-axially) in order to give more stability to the micro-catheter, which is advanced beyond the clot. A co-axial catheter is also usually employed in case of tandem occlusion, in such instance a large profile guide catheter is placed in the common carotid artery below the level of the proximal internal carotid occlusion, while a second low profile distal access catheter is advanced through the proximal occlusion to the intracranial carotid. Through this second low profile catheter the thrombectomy is performed.

The first stent retrievers that have been evaluated in a prospective trial were Trevo and Solitaire. Both devices were compared to the Merci retriever device in non-inferiority randomized controlled trials published in 2012. The Trevo 2 trial compared performances of Trevo with Merci retriever in 178 patients presenting within 8 hours of stroke onset and ineligible for IV rt-PA or failing to respond to it [73]. Trevo showed significantly higher rates of recanalization in comparison to Merci (86% vs. 60%; $p < .0001$) with no difference for safety end points. SWIFT trial compared performance of Solitaire and Merci retriever, with similar design to Trevo 2 trial [74]. Similarly, SWIFT trial demonstrated the superiority of Solitaire over Merci retriever device with higher rates of recanalization in the Solitaire group (61% vs. 24%; $p < .0001$) as well as lower 90 days mortality rate.

Recently, results of the American post-marketing retrospective multicenter registry examining the real-world clinical outcome and reperfusion using Solitaire device (NASA), showed a rate of $mRS \leq 2$ at 90 days of 42% compared to 37% in SWIFT and 40% in TREVO 2 [75].

1.4.7 Early Inconclusive Mechanical Thrombectomy Trials

Three trials published simultaneously in *New England Journal of Medicine* in 2013, IMS III, SYNTHESIS Expansion, and MR RESCUE were the first to compare results of endovascular therapy associated with rt-PA to rt-PA alone and reported similar findings of safety and functional outcome for both treatments [76, 77, 78]. Most neuro-interventionalists would agree that endovascular treatment would not be expected to benefit patients lacking a large vessel occlusion. In addition to a lack of requirement for angiographically confirmed large vessel occlusion as an inclusion criterion for patient selection (IMS III, SYNTHESIS), other contributing factors to the finding of neutrality included the predominant use of older thrombectomy devices such as the Merci retriever instead of contemporary methodology such as stent retrievers and delay in initiation of endovascular treatment after symptom onset. In IMS III, pre-specified subgroup analysis of subjects with large vessel occlusion documented at baseline CT angiography, however, found a highly significant benefit with the combination of endovascular therapy and IV rt-PA over standard IV rt-PA alone. Terminal and tandem occlusions of the internal carotid artery (ICA) and M1 MCA segment demonstrated a trend towards better 90 days outcomes after combined treatment.

1.4.8 Early and Rapid Reperfusion are Critical for Good Clinical Outcomes

Revascularization is associated with better clinical outcomes and decreased mortality as numerous publications support the hypothesis that removal of the occlusion and achieving reperfusion of the target vessel is a strong predictor of improved 90 days good outcomes in ischemic stroke patients. In the IMS III trial, for example, 90 days good outcome was 18% when TICI 0-1, and 42% when TICI 2A-3 was achieved [76]. In Nourollahzadeh's meta-analysis of 140 studies published from 1985 to 2011, subjects with successful revascularization had a five-fold higher likelihood of being functionally independent at 90 days [79]. Furthermore, mortality rate was three times higher in patients with closed vs. open vessels. In Rha and Saver's meta-analysis, 90-day good outcome was 25% at TIMI 0-1 and 58% when TIMI 2-3 or TICI 2-5 was achieved [80]. Likewise, mortality was

42% when vessels were closed and 14% when open. In addition, shorter time to angiographic reperfusion has been shown to be the key for better clinical outcomes in the IMS pilot trials, the RECANALISE registry [81] and, most recently, the IMS III trial. In a post-hoc analysis of pooled data from the IMS pilot trials (IMS I and II), longer time to angiographic reperfusion after IV-IA rt-PA therapy was associated with a lower likelihood of mRS score ≤ 2 at 90 days [82]. In fact, the probability of functional independence decreased by 20% for each 30-min delay in reperfusion. MCA and distal internal carotid artery (ICA-T) occlusions with successful reperfusion to TIC1 2–3 were included in their analysis. Similarly, the RECANALISE prospective registry study reported that a 30-min decrease in time to reperfusion after IV-IA rt-PA treatment and, if required, thrombectomy, significantly increased the probability of 90-day good clinical outcome after adjustment for admission NIHSS and age. Further, an analysis of pooled data from IMS I and II plus five prospective observational studies reported favorable clinical outcomes decreased with each 30-min delay in reperfusion after IV-IA therapy. In a preplanned analysis of data from the IMS III trial, delays in time to reperfusion were also found to be associated with a reduced likelihood of good clinical outcome in patients after moderate to severe stroke [83]. Thus, a number of publications suggest that rapid treatment should be emphasized regardless of the reperfusion modality chosen.

1.5 Stroke Trials of the “New Era”

Until the beginning of 2015, a crucial question left unanswered by clinical trials was whether or not endovascular treatment alone or in combination with IV thrombolysis can result in superior outcomes when compared to IV thrombolysis alone. The newly published results of the MR CLEAN trial as well as ESCAPE, EXTEND-IA, and SWIFT PRIME have shed some light on this subject and result in a dramatic change in acute stroke management [84-87]. In the following paragraphs we report on such “new era” trials.

1.5.1 Multicenter Randomized Clinical Trial of Endovascular Treatment for Acute Ischemic Stroke in the Netherlands (MR CLEAN)

MR CLEAN was a phase III, multicenter randomized controlled trial with open-label treatment and blinded end point evaluation enrolling 500 patients between December 2010 and March 2014 from 16 centers in the Netherlands [84]. This trial compared IA treatment (IA thrombolysis, mechanical thrombectomy, or both) plus usual care (IV rt-PA) to usual care alone (control group) in patients with acute ischemic stroke and a proximal intracranial arterial occlusion of the anterior circulation confirmed on vessel imaging. Patients included in the study were 18 years of age or older with no upper age limit; had an occlusion of the distal intracranial carotid artery, MCA (M1- M2), or anterior cerebral artery (A1-A2) confirmed by CTA, MRA, or digital-subtraction angiography (DSA); and an NIHSS of 2 or higher, with patients having additional extra-cranial internal carotid artery occlusion or dissection included at the discretion of the treating physician. All IA treatment had to be initiated within 6 hours of stroke onset. The primary outcome measured was the mRS score at 90 days. Secondary outcomes included the NIHSS score at 24 hours and at 5 to 7 days or discharge, activities of daily living as measured by the Barthel index, and health-related quality of life measured by the EuroQol Group 5-Dimension Self-Report Questionnaire (EQ-5D) at 90 days. Safety outcomes included progression of ischemic stroke, new ischemic stroke into a different vascular territory, hemorrhagic complications, and death.

Five hundred study participants were included in the final analysis with a mean age of 65 years (range 23-96), 58.4% being men, and 89.0% treated with IV rt-PA before randomization. A total of 233 (46.6%) patients were assigned to the intervention group, while 267 (53.4%) patients were assigned to the control group, with risk factors for poor outcome as well as vascular risk factors evenly distributed between the 2 groups. The median time from stroke onset to start of IV rt-PA was 85 minutes in the intervention group and 87 minutes in the control group, with the median time from start of IV rt-PA to randomization 204 and 196

minutes, respectively. Intra-arterial treatment (with or without mechanical thrombectomy) was provided to 84.1% of patients in the intervention group, with stent retrievers used in 81.5%. The median time from stroke onset to groin puncture in the intervention group was 260 minutes. All data on primary outcome measures were complete, with an adjusted common odds ratio (OR) of 1.67 (95% confidence interval [CI], 1.21-2.30). There was an absolute difference of 13.5 percentage points (95% CI, 5.9-21.2) in the rate of functional independence (mRS 0-2) in favor of intervention (32.6% vs. 19.1%) with an adjusted OR of 2.16 (95% CI, 1.39-3.38). All secondary outcomes also favored intervention, with the NIHSS score after 5 to 7 days being on average 2.9 points lower in the intervention group (95% CI, 1.5-4.3) and absence of residual occlusion at the target site being more common in the intervention group compared to the control group on CT Angiography at 24 hours (75.4% vs. 32.9%). Although data on infarct volume were available for only 298 of the 500 enrolled patients, such data also favored the intervention group with the between-group difference in volume of 19 mL (95% CI, 3-34). There was no significant difference in mortality or the occurrence of sICH. However, 5.6% of patients in the intervention group had clinical signs of a new ischemic stroke in a different vascular territory within 90 days compared to 0.4% in the control group.

The results of the MR CLEAN trial demonstrate that IA treatment administered within 6 hours of stroke onset to patients with acute ischemic stroke caused by a proximal intracranial occlusion of the anterior circulation in the context of systemic rt-PA is safe and effective. Investigators showed that this intervention led to a clinically significant increase in functional status and independence at 90 days without increasing mortality.

1.5.2 Endovascular Treatment for Small Core and Proximal Occlusion Ischemic Stroke ESCAPE Trial

ESCAPE was a Canadian, phase III, randomized controlled trial with open-label treatment and blinded end point evaluation. The trial began enrollment in January 2013 [85]. The primary objective of this study was to demonstrate that prompt endovascular mechanical treatment in patients with acute ischemic stroke and proximal intracranial artery occlusion results in improved outcomes when compared to usual care. This trial compared IA treatment (IA thrombolysis, mechanical intervention, or both) plus usual care (which included IV rt-PA within 4.5 hours) to usual care alone (control group) in patients with acute ischemic stroke and a proximal intracranial arterial occlusion of the anterior circulation confirmed on vessel imaging. Patients eligible for the study were 18 years of age or older, with a disabling stroke defined as a baseline NIHSS >5, having a pre-stroke modified Barthel Index score >90, and a confirmed symptomatic intracranial occlusion based on CT Angiography at one or more of the following locations: carotid T/L, M1 MCA, or M1-MCA equivalent (2 or more M2-MCAs). Additionally, eligible participants had to have symptom onset within 12 hours prior to randomization and endovascular treatment (groin puncture) within 60 minutes of baseline non contrast CT. Participants had a small infarct core on baseline non contrast CT, defined as an Alberta Stroke Program Early Computed Tomography Score (ASPECTS) of 6 to 10. The primary outcome measure was the shift in mRS score at 90 days, defined by a proportional odds model. Secondary outcomes included the proportion of patients achieving an NIHSS score of 0 to 2, the proportion of patients who achieved a mRS of 0 to 2, and the proportion of patients who achieved a Barthel Index >90.

The ESCAPE trial was halted early due to efficacy after enrollment of 316 of the anticipated 500 study participants, 238 of who received IV rt-PA (120 in the intervention group and 118 in the control group). The median time from stroke onset to first reperfusion was 241 minutes in

the intervention group, with stent retriever devices used in 86.1% of the participants. The primary end point favored intervention with a common OR (odds of improvement of 1 point on the mRS) of 2.6 (95% CI, 1.7-3.8), a median 90-day mRS score of 2 in the intervention group compared to 4 in the control group ($P < .001$) and a higher rate of functional independence (90-day mRS score 0-2) in the intervention group: 53.0% versus 29.3%. Additionally, the mortality rate at 90 days was lower in the intervention group compared to control group (10.4% vs. 19.0%, $P = .04$), and there was no significant difference in the occurrence of sICH between the 2 groups. All secondary outcomes also favored intervention with a higher rate of patients in the intervention group having a Barthel Index of 95 to 100 at 90 days (57.7% vs. 33.6%), an NIHSS score of 0 to 2 at 90 days (51.6% vs. 23.1%), and higher 90-day scores on the EQ-5D, indicating better quality of life. Although this trial allowed enrollment of patients up to 12 hours after symptom onset, only 15.5% of participants underwent randomization 6 or more hours after symptom onset, and thus the study was not adequately powered to assess endovascular therapy among patients presenting in the 6 to 12 hour window.

The ESCAPE trial confirms the benefit of rapid endovascular therapy in improving functional outcomes and reducing mortality in patients with acute ischemic stroke with proximal vessel occlusion and small infarct core. Like MR CLEAN, there were clear benefits and low rates of complications with endovascular mechanical intervention, with both trials predominantly using stent retrievers. ESCAPE achieved shorter interval times than prior trials, with a median time from baseline CT head to first reperfusion of 84 minutes. This rapid treatment time was achieved due to parallel decision making, with patients in the intervention group undergoing groin puncture while the rt-PA was still being infused and in some cases achieving reperfusion before the rt-PA infusion was even complete.

1.5.3 Extending the Time for Thrombolysis in Emergency Neurological Deficits Intra-Arterial EXTEND IA Trial

EXTEND-IA was a multicenter, randomized controlled trial with open-label treatment and blinded end point evaluation, which planned on enrolling 100 patients with ischemic stroke receiving IV rt-PA within 4.5 hours of stroke onset in Australia and New Zealand [86]. This trial compared IV rt-PA plus endovascular thrombectomy with Solitaire Flow Restoration (FR) stent retriever to IV rt-PA alone in patients with an anterior circulation acute stroke and proximal intracranial arterial occlusion with evidence of salvageable brain tissue on CT perfusion imaging. Patients included in the study were of all ages with no age restrictions, were eligible to receive IV rt-PA within 4.5 hours, had an occlusion of the internal carotid artery or MCA (M1 or M2) on CT angiography, had evidence of salvageable brain on CT perfusion with an ischemic core of less than 70 mL, and had undergone endovascular therapy (groin puncture) within 6 hours of stroke onset. Although there were no restrictions on the clinical severity of the stroke, with all NIHSS scores included, participants had to have functional independence at baseline with a baseline mRS score of less than 2. The co-primary outcomes measured were early neurologic improvement and reperfusion at 24 hours. Early neurologic improvement was defined as a reduction of 8 or more points on NIHSS or a score of 0 or 1 at 3 days and reperfusion as the percentage reduction in the perfusion-lesion volume between baseline imaging and imaging at 24 hours. Secondary outcomes included the mRS at 90 days, death from any cause, and sICH.

The EXTEND-IA trial was also stopped early in October 2014 due to efficacy, after randomization of 70 patients (35 in each group). The median time from stroke onset to endovascular intervention (groin puncture) was 210 minutes. Both primary outcomes favored the endovascular therapy group with increased reperfusion at 24 hours ($P < .001$) and a probability of reperfusion that was greater than 90% without sICH when compared to the IV

rt-PA only group (89% vs. 34%; $P < .001$). Endovascular therapy resulted in greater early neurological recovery at 3 days when compared to the control group (80% vs. 37%, $P = .002$) and improved functional outcome at 90 days, with a greater number of patients in the endovascular group achieving functional independence as measured by an mRS score of 0 to 2 (71% vs. 40%; $P = .01$). There was no significant difference in mortality or the occurrence of sICH between the 2 groups. Six percent of patients in the endovascular group had embolization into a different vascular territory, but this did not result in clinical symptoms.

EXTEND-IA confirms the results of both MR CLEAN and ESCAPE and emphasizes the benefit of early mechanical thrombectomy with a Solitaire FR stent retriever after the administration of IV rt-PA in achieving more complete reperfusion and greater functional recovery when compared to the use of alteplase alone. A unique feature of the EXTEND-IA trial was the use of CT perfusion imaging in all patients, with the goal of selecting patients with the greatest potential to benefit from rapid endovascular intervention and exclude patients with large ischemic cores, who are at greater risk of sICH and malignant edema and have a lower chance of good outcomes.

1.5.4 Solitaire With the Intention for Thrombectomy as Primary Endovascular Treatment for Acute Ischemic Stroke Trial

SWIFT PRIME was a multicenter, two-arm, randomized controlled trial with open-label treatment and blinded end point evaluation, which began enrollment in November 2012 [87]. The purpose of the study was to demonstrate that patients with an anterior circulation acute ischemic stroke and proximal arterial occlusion treated with IV rt-PA and endovascular intervention (Solitaire FR) have less disability 3 months post stroke. This trial compared IV rt-PA plus endovascular thrombectomy with Solitaire FR to IV rt-PA alone. Eligible patients were between the ages of 18 and 80, with an acute anterior circulation ischemic stroke and proximal intracranial arterial occlusion (intracranial ICA, carotid T, and MCA segment of M1) confirmed on CT- or MR- Angiography, had a baseline NIHSS ≥ 8 and < 30 , had a pre stroke mRS of ≤ 1 , and

received IV rt-PA within 4.5 hours of stroke onset. Additionally, study participants had to be treated with endovascular therapy within 6 hours of stroke onset and have groin puncture within 90 minutes of CT- or MR- Angiography. The primary outcome was the degree of disability at 90 days post stroke as measured by the mRS. Secondary outcomes included mortality at 90 days, functional independence (mRS ≤ 2) at 90 days, the change in NIHSS at 27 hours post randomization, infarct volume at 27 hours post randomization, reperfusion at 27 hours post randomization, and arterial revascularization measured by TIC1 2b or 3 following the intervention. Safety outcomes evaluated in the study were all serious adverse events and sICH at 27 hours post- randomization.

SWIFT PRIME was halted in January 2015 due to efficacy of endovascular treatment after enrollment of 196 of the anticipated 833 study participants. There was a similar pattern of downshift in disability and favorable 90-day outcomes in the endovascular intervention group with 60.2% having an mRS ≤ 2 compared to 35.5% in the IV rt-PA only group ($p = .0002$). There were also excellent reperfusion rates as well as significant improvement in NIHSS at 72 hours, with minimal complications and no difference in sICH between groups. Thus, SWIFT PRIME confirmed that endovascular intervention with Solitaire stent retriever was not only safe and technically successful but also significantly reduced disability at 90 days.

Thus far there we have not clear evidence that the association of IV rt-PA to mechanical thrombectomy improve or worsen the efficacy or the safety of such technique. Further clinical trials comparing stand-alone thrombectomy vs. thrombectomy plus IV-rt-PA will hopefully clarify such issue.

1.6 Patients Selection for Endovascular Treatment

Results of mentioned clinical trials helped clinicians in outlining criteria to select patients who could benefit of endovascular recanalization. Independently of the delay between symptoms onset and admission to the treating hospital and in some instances even independently of patient clinical status (in MR CLEAN study even patient presenting with an NIHSS of 2 were included), a good candidate for mechanical revascularization is a patient presenting with a large intracranial vessel occlusion for which multiparametric imaging (MRI or CT scan) demonstrates a limited ischemic core extension along with the presence of a large salvageable penumbra zone (Fig. 9-10).

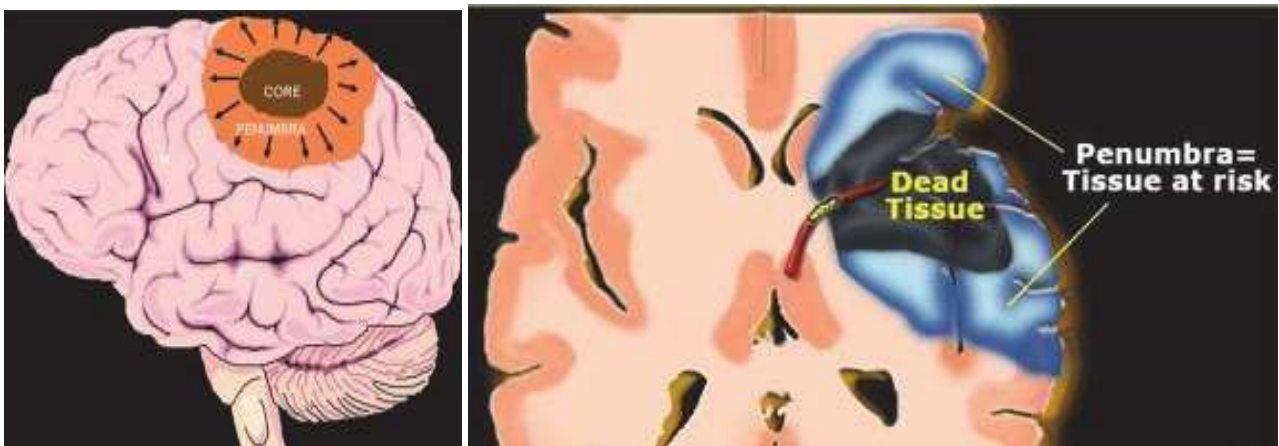

Fig. 9 The figure represents the core of the ischemic lesion, which is a brain area already infarcted, and the surrounding penumbra zone, an area, which is “suffering”, but not already infarcted, such area represents the penumbral mismatch. The goal of the therapy is the reperfusion of this salvageable area.

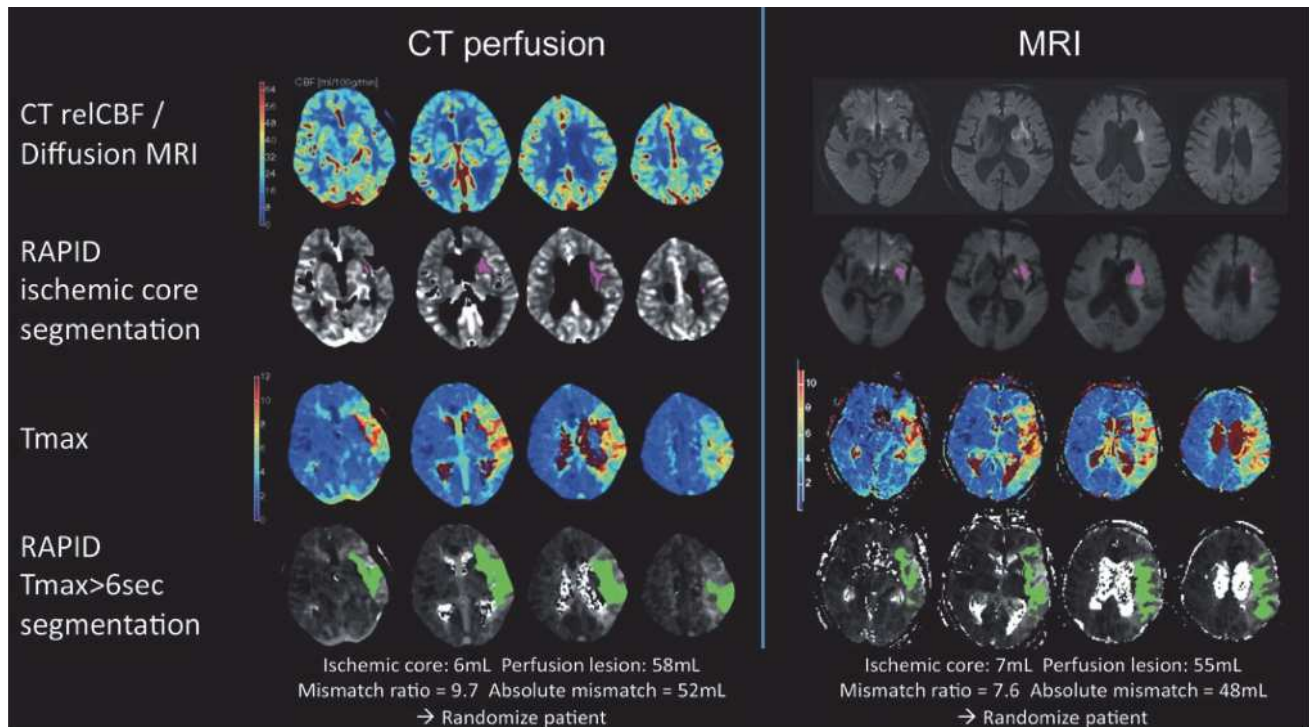

Fig. 10 In this figure are reported CT and MRI perfusion maps obtained from the same patient by an automated processing software (RAPID) used to calculate the penumbral mismatch. Both techniques concord in showing a moderately large area of hypoperfusion in the MCA territory and a small ischemic core; a large penumbral mismatch, in such case the patient is a good candidate for mechanical thrombectomy.

CHAPTER 2: The Plan of the Thesis

2.1 Purposes

As largely discussed in the previous chapter, early mechanical thrombectomy offered to patients presenting with acute ischemic stroke due to a large vessel occlusion is related to improved functional outcome and reduced mortality as compared with standard of care rt-PA alone. Stent-retrievers were the thrombectomy device mainly used in these trials and they are consequently recognized as the most effective devices for intracranial thrombectomy. As already described, the stent retriever is inserted into the patient body via a femoral artery sheath and navigated via a micro-catheter to be deployed within the occluding thrombus. Subsequently, the deployed stent retriever along with the delivery micro-catheter is gently retrieved as a single unit from the patient's body. The key-point for the capture of the clot is the interaction between the device and the clot itself. Such interaction is influenced in one hand by features of the device such as: device design, device mechanical characteristics and behavior during the retrieval and in the other hand to own features of the clot such as clot biomechanics and consistencies.

Different types of stent retrievers are currently available in Europe, and even if they seem similar because all "stent based devices" they differ for design and mechanical behavior (Fig. 11-19). So far, comparative studies demonstrating the superiority in terms of efficacy of clot removal of a given stent retriever in comparison to the others available on the market are lacking.

In the present study we analyzed in an experimental setting mechanical properties of all stent retriever models available in France in order to investigate their interaction with the clot and their behavior during the retrieval. Furthermore, we evaluated the interaction between different type of stent retrievers and thrombi of different consistencies. The aim of this study was to identify any

mechanical device properties that correlate with effective thrombus removal.

Material and Methods

All stent retrievers available in France up to June 2015 were evaluated in the present study (Tab. 1). Two types of tests were performed to evaluate each single device: mechanical and functional tests.

Device	Size*
Trevo Provue (Stryker, Kalamazoo, Michigan, USA)†	4–20/3–20
Catch (Balt, Montmorency, France)‡	3–15/4–20/6–30
Eric (Microvention, Aliso Viejo, California, USA)†	3–20/4–24/6–44
Preset (Phenox, Bochum, Germany)‡	4–20/6–30
Preset LT (Phenox, Bochum, Germany)‡	3–20/4–20
Embotrap (Nauravi, Galway, Ireland)†	5–21
Separator 3D (Penumbra Inc, Alameda, California, USA)†	4.5–26
Revive (Codman, Raynham, Massachusetts, USA)†	4.5–22
Mindframe (Medtronic, Irvine, California, USA)†	3–23
Solitaire FR (Medtronic, Irvine, California, USA)‡	4–20/6–30

*For each device, the first value refers to the nominal diameter, the second value refers to the length expressed in mm.
†Complete axial section device.
‡Incomplete axial section device.

Tab. 1 List of devices evaluated in the present study. For each device we have analyzed all available sizes.

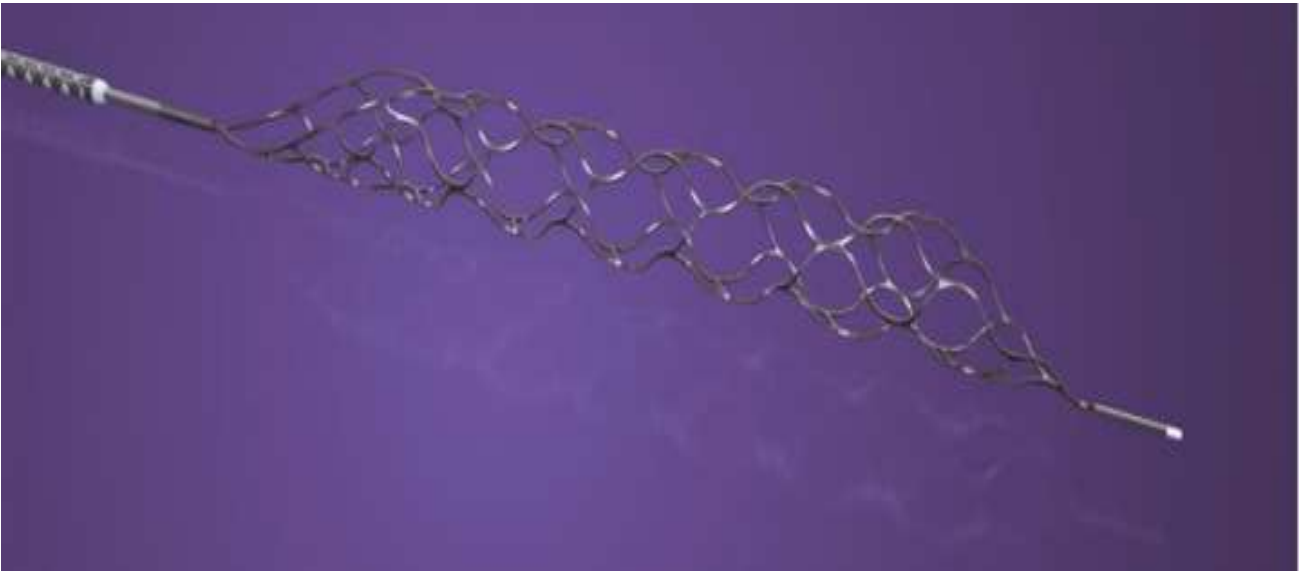

Fig. 11 *TREVO. (Photo Stryker)*

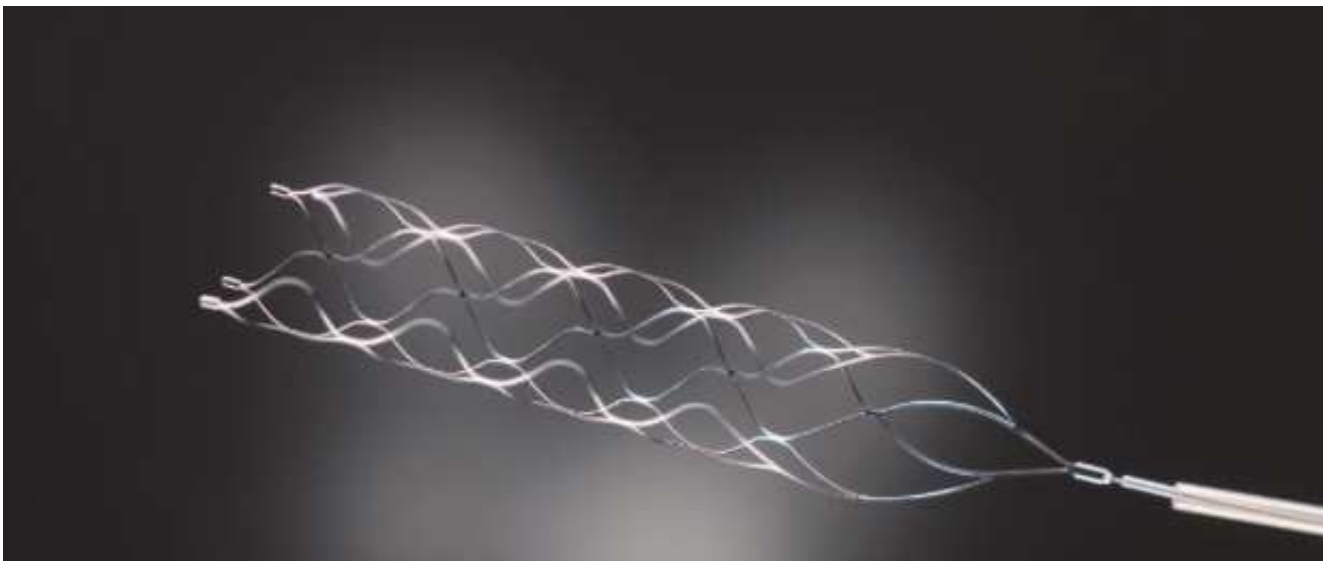

Fig. 12 *CATCH (Photo Balt)*

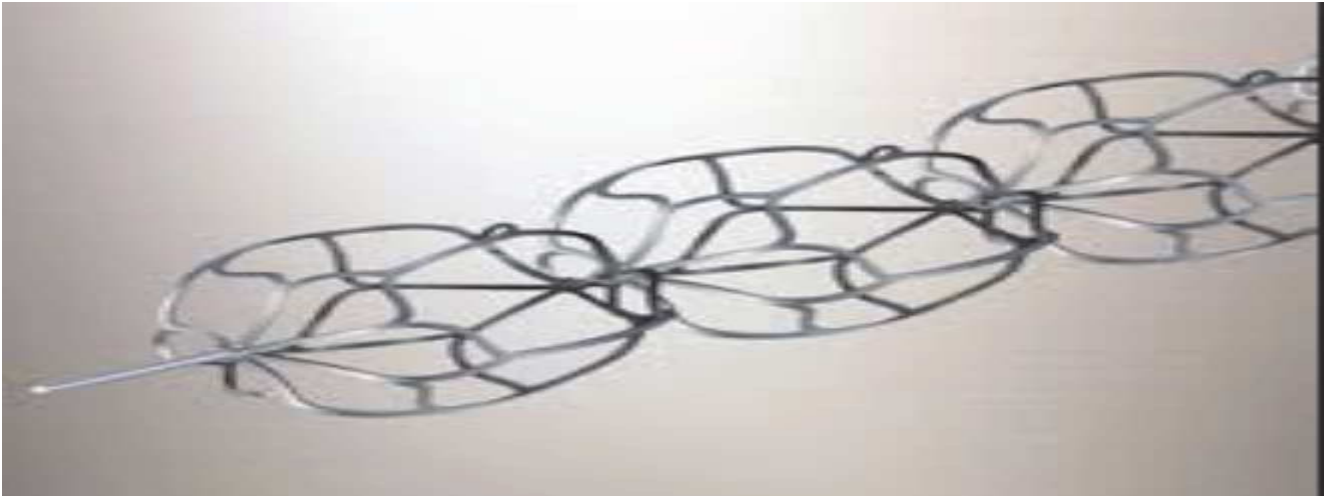

Fig. 13 ERIC (*Photo MicroVention*)



Fig. 14 PRESET (*Photo Phenox*)



Fig. 15 *EMBOTRAP* (Photo Neuravi)

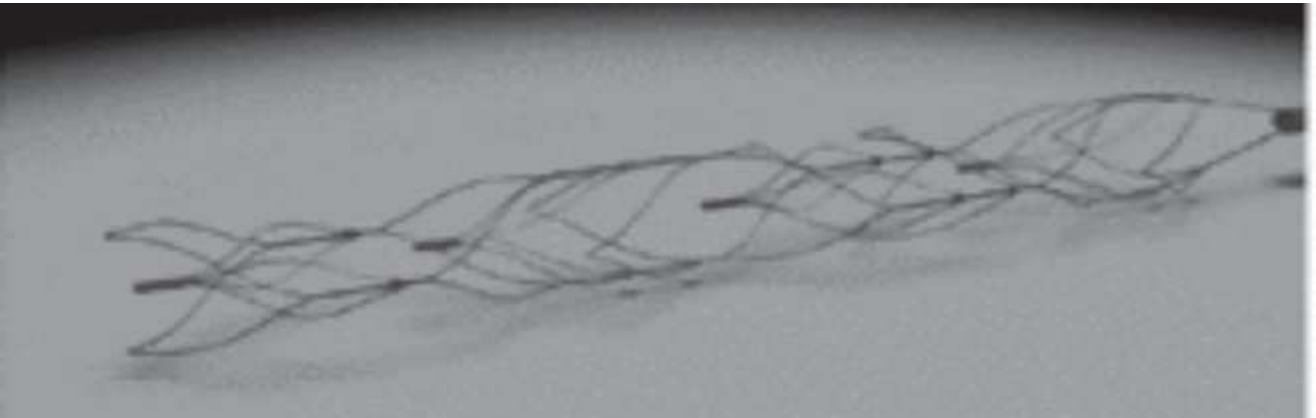

Fig. 16 *SEPARATOR 3D* (Photo Penumbra)



Fig. 17 *REVIVE* (Photo Codman)

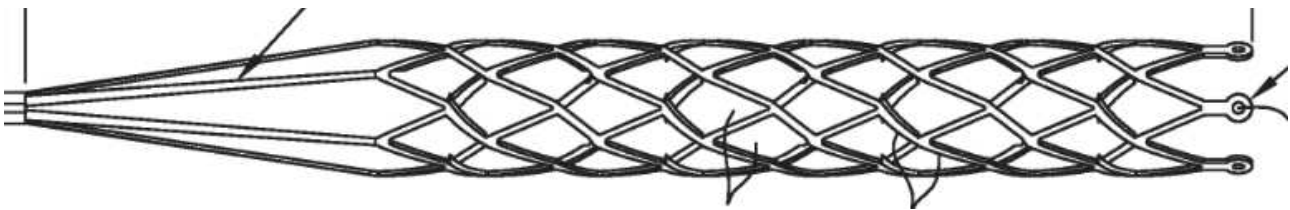

Fig. 18 *MINDFRAME* (Photo Covidien)

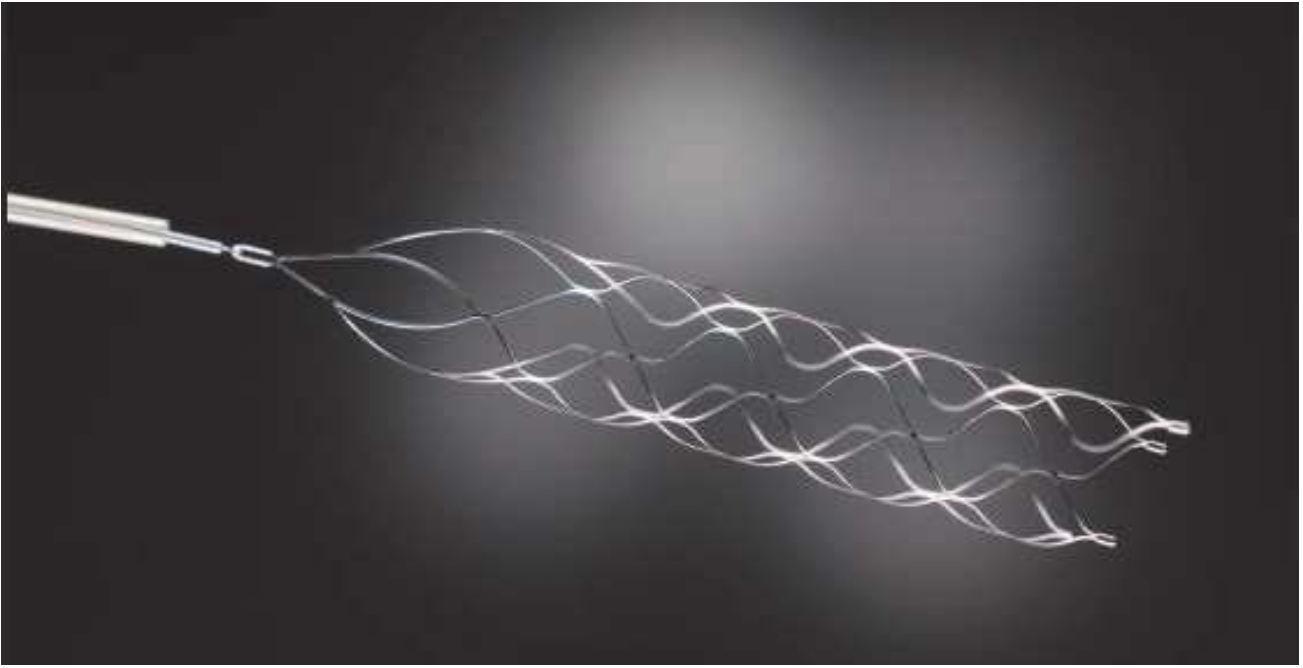

Fig. 19 *SOLITAIRE* (Photo Covidien)

2.2 Mechanical Tests

Mechanical tests were aimed to measure the radial force exerted by the stent retriever in two specific conditions: upon deployment and during the retrieval. The aim of these tests was to measure the value of the radial force exerted by the device at the moment of the deployment over the clot and during the retrieving. Our idea was to investigate how the radial force exerted by the device varied from the moment of the deployment and during the retrieving through the cerebral vasculature. This because in clinical practice we had the perception that two of the main factors crucial for a successful clot removal were: the initial interaction of the stent retriever with the clot upon deployment, in this phase the stent should penetrate and capture the clot, and the capability of the stent of maintaining constant cohesion to the vessel wall along the retrieval, during the retrieval the device should be able in not loosing the captured clot. Another well-known factor crucial for the interaction between the stent retriever and the clot and a successful clot removal is clot consistency. For such reason we have produced an experimental setting in which we were able to evaluate interaction of stent retrievers with two type of experimental clots: red clots, reproducing a soft red cells rich clot which is considered in the clinical practice easy to capture and remove and white fibrin rich clot, which instead represent a clot arduous to be penetrated and captured.

2.2.1 Flat Plate Compression Test

This test measured the stent retriever outward radial force density [88]; it corresponds to the force exerted by the device against a flat surface during compression. Tests were performed on a Texture Analyzer (TA-XT2, Stable Microsystems, UK) with a 50 N load cell and an optical microscope (ZEISS) equipped with a digital video camera to control stent retriever deformations. Each stent retriever was placed between two flat plate transducers and the radial force was measured while the two plates compressed the device (Fig. 20).

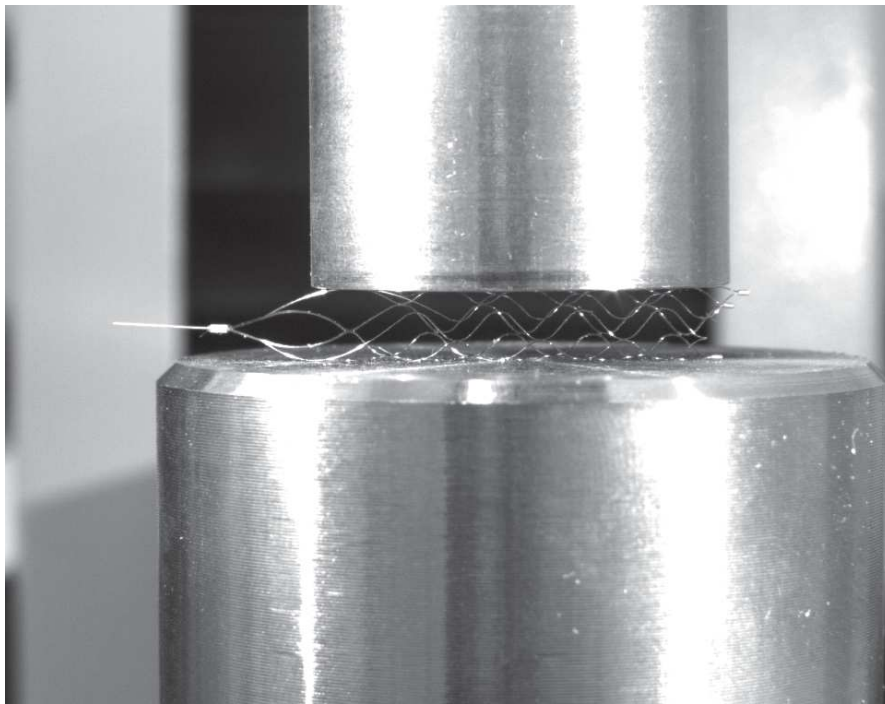
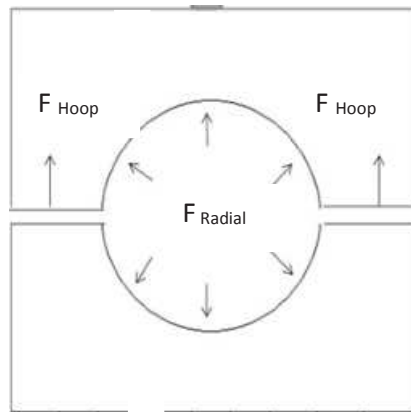

Fig. 20 *The texture analyzer machine (TA-XT2, Stable Microsystems, UK) used for the compression and traction tests.*

For the purposes of this study, the radial force was recorded while the stent retrievers were compressed to 50% of their labeled diameter. Compression tests consisted in five consecutive cycling compressions and were repeated three times for each device. The mean value of the force exerted by the machine to compress the stent at each cycle was used to calculate the radial force per unit length expressed in N/mm as follows: F (average)/ L (after compression).

As largely reported in literature, this test is commonly used to measure stent's radial force. Nevertheless it does not consider the realistic eccentric expansion of stents within the vessels. Some research team designed more adapted mechanical tests aimed to evaluate stent's radial force. (Scheme 1 and figure 21), Nevertheless, no data on such radial force tests have been published so far.

For the purpose of this study we developed a new radial force test, presented in the following paragraph.



Scheme 1: Realistic distribution of stent radial force during eccentric expansion (Property of Neuravi)



Fig: 21 This machine is able to measure the radial fore produced during the eccentric expansion of the stent (Photo MSI Company)

2.2.2 Pull Up Traction Test

We conceived such test for the aim of this study in order to evaluate how the outward radial pressure exerted by the stent retrievers varied during retrieval along vessels (tubes) of different diameters; we have reported for the first time in literature about methodology and results of this test [89]. Tests were performed using the same tensile test machine used for compression tests but in this case the machine was regulated for traction; the device was deployed within a silicone tube that was placed into a rigid scaffold while the delivery wire of the stent was tied to the traction transducer arm (Fig. 22).

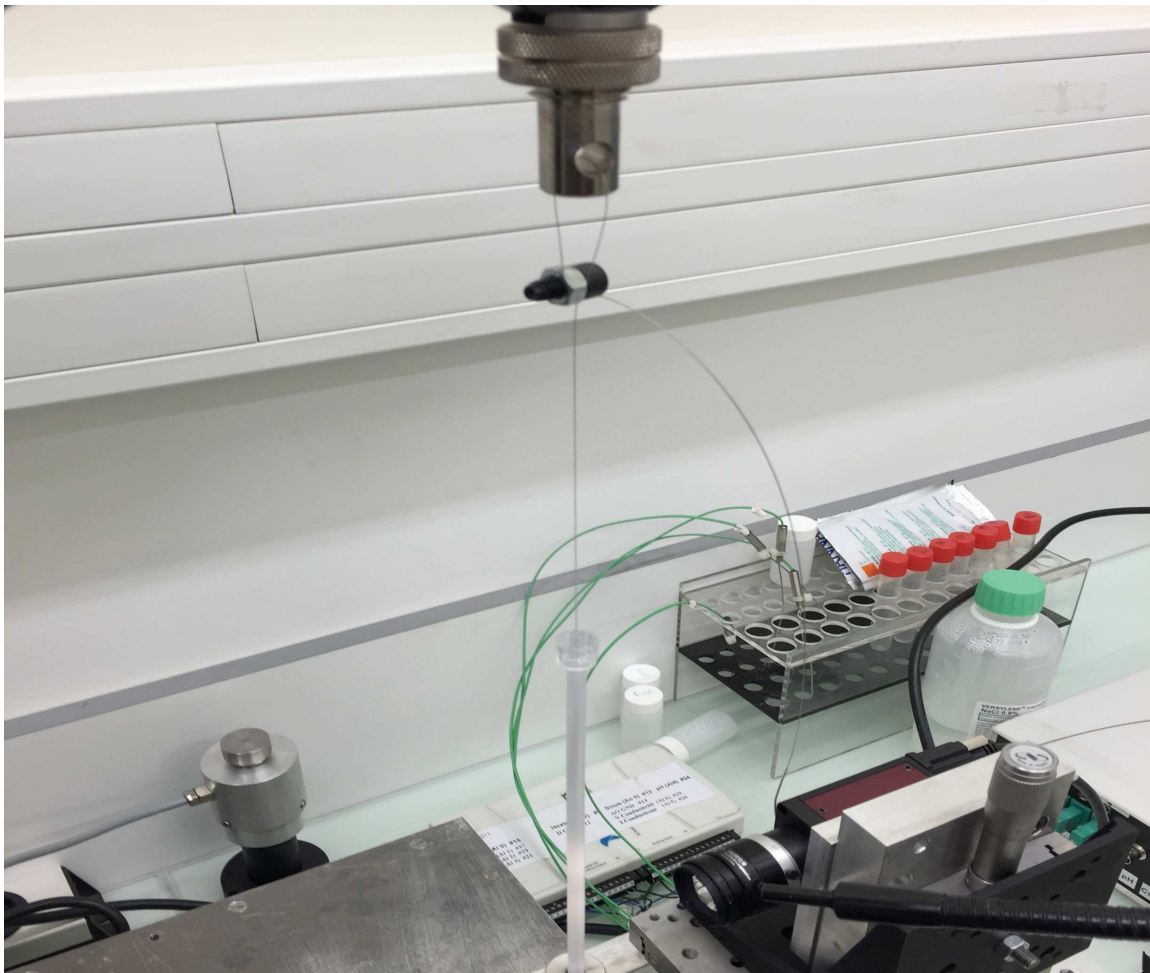

Fig. 22 A stent retriever is deployed within a silicone tube previously placed into a rigid scaffold, the delivery wire of the stent is tied to the traction transducer arm to perform a “Pull up traction tests”.

In order to obtain the best expansion of the nitinol, the silicon tubes were filled with saline solution heated at 37°. The transducer arm retrieved the devices from the silicon tube with a velocity of 2

mm by second for a distance of 5 cm. The force F exerted by the arm during the retrieval was measured in Newton. Therefore, the average of these values (obtained after 10 tractions) were used to estimate the radial pressure R_N exerted by the stent toward the vessel wall. This test was conducted using tubes of 1.5 and 3.5 mm inner diameter and was repeated 10 times for each stent retriever. The radial pressure exerted by the stent on the silicone pipe was calculated considering the contact pressure. Due to the friction, this contact pressure was not only normal to the internal surface of the silicone pipe but had also a tangential component R_T . The total force F measured by the tensile test machine was the sum of tangential contact pressures R_T over the entire internal surface of the silicone pipe. Assuming a uniform contact pressure, it comes

$$F=2prLR_T$$

where r is the internal radius of the silicone pipe and L the length of the deployed stent.

According to the Coulomb friction law, there is a relationship between R_N and R_T when the stent is sliding: $R_T =mR_N$, which depends on the friction coefficient m . Finally, the radial pressure R_N is obtained as follows

$$R_N=F/(2prLm)$$

It is expressed in Pascal (N/m^2). For our calculations, the friction coefficient has not been measured; it has been chosen equals to 0.4 according to values given in [90].

2.3 Functional tests

Functional tests were two distinct tests aimed to visually evaluate the ability of the stent retrievers in remaining in close apposition to the vessels wall (*“Retrieving tests”*) and to maintain the thrombus engaged within its struts during the retrieval (*“In vitro thrombectomy”*).

2.3.1 3D Printed Vascular Model

Functional tests were performed using a rigid 3D printed vascular model reproducing the brain anterior circulation (Fig. 23). We used special translucent photosensible resins (UV resin) for stereolithography's 3D printing process. Artificial vessels were produced with realistic dimensions but magnified tortuosity in order to evaluate the apposition of the device in unfavorable conditions; the diameter of the middle cerebral artery of the model measured 2.5 mm, the terminal carotid 3 mm, from the carotid syphon to the cervical carotid segment the diameter increased from 4 to 6 mm (fig. 24).

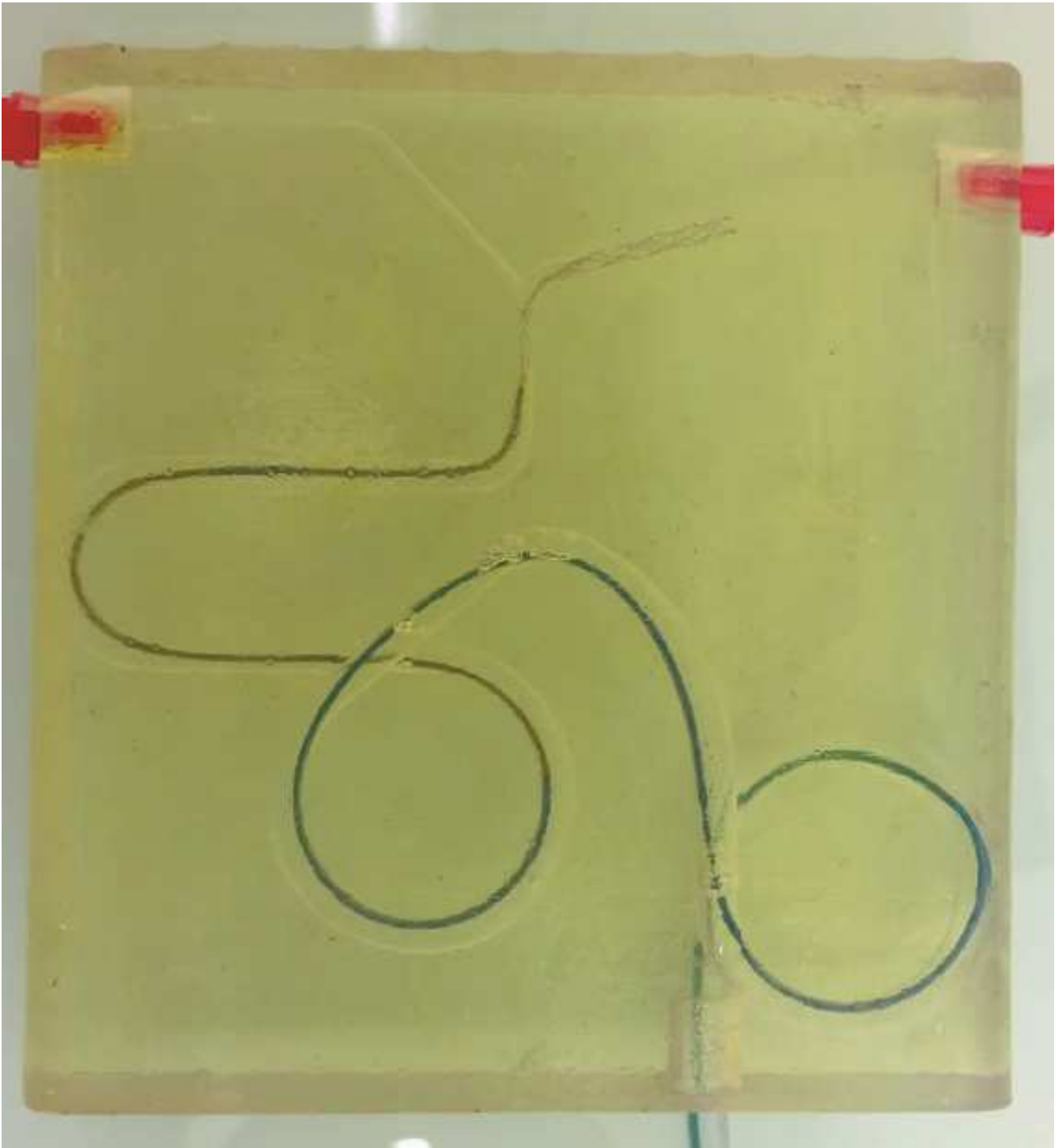

Fig. 23 *The 3D printed vascular model reproducing the brain anterior circulation used for “Retrieving tests” and “In Vitro Thrombectomies”.*

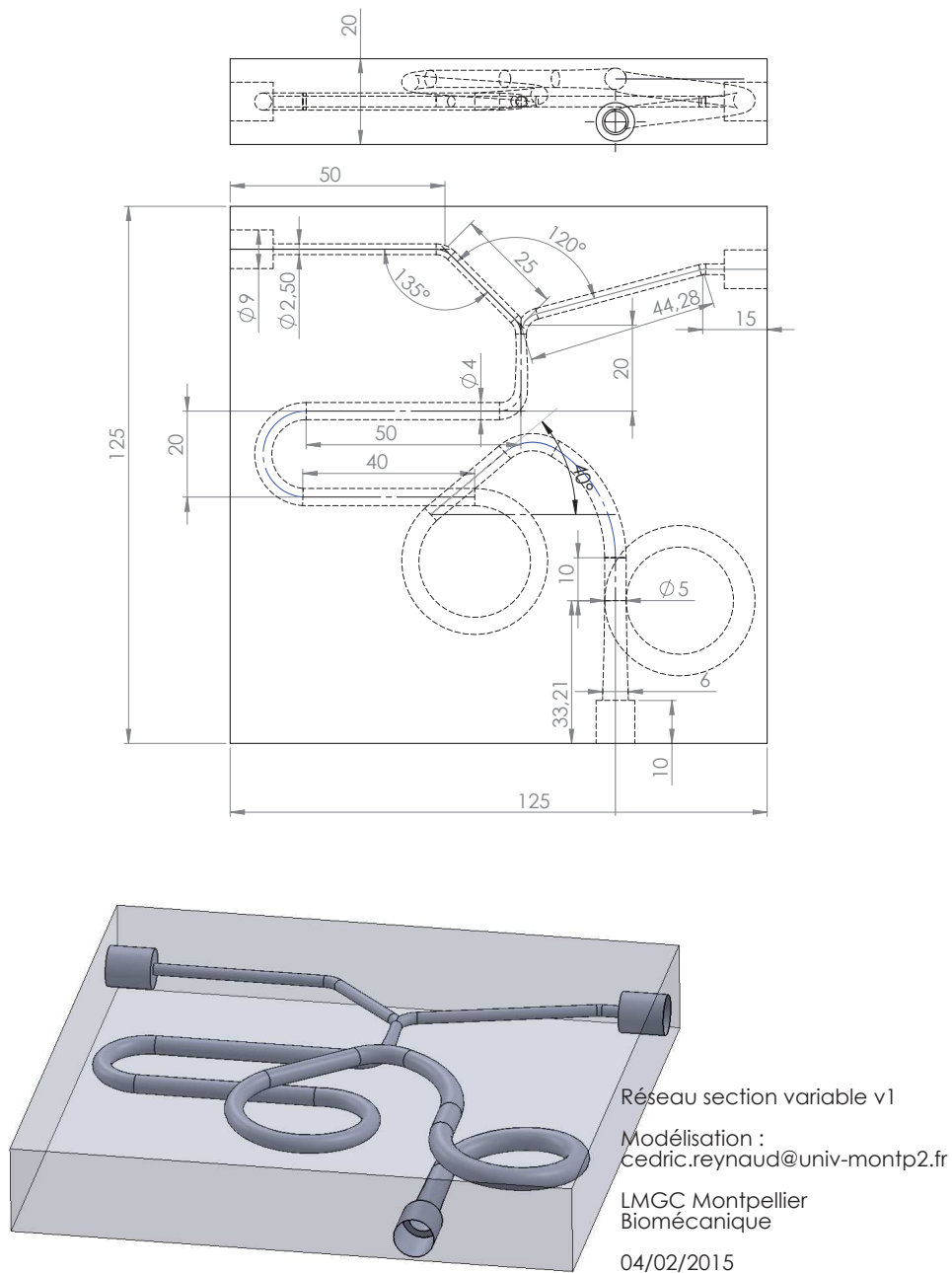

Fig. 24 *The scheme of the rigid 3D printed vascular model.*

During the experiments the model was continuously flushed with saline solution previously heated at 37° in order to allow the optimal expansion of devices made of nitinol alloy.

Two neuroradiologists with experience in thrombectomy procedures (P.M. and V.C.) performed functional tests, each experiment was filmed and two other collaborators (F.J. and D.A.) also visually analyzed the results.

2.3.2 Retrieving Test

This test was conceived to visual evaluate the ability of the stent retriever in remaining in close apposition to the vessels wall during the retrieval. The rational behind such test is that any loss of contact with the vessel wall during the retrieval, being the clot entrapped within the device and vessel wall, is a potential cause of clot disengaging and thrombectomy failure.

Stent retrievers were navigated and released at the level of the middle cerebral artery of the phantom; hence few minutes after deployment, allowing for their complete expansion, devices were gently retrieved along the vascular model into the guiding catheter connected to the model (Fig. 25).



Fig 25. *In this figure a stent retriever is placed at the level of the middle cerebral artery of the phantom to perform a “Retrieving test”.*

Two operators with experience in mechanical thrombectomy performed retrieving tests with the aim of reproducing a realistic stent retrieving. This experiment was repeated ten times for each

type of stent.

2.3.3 In Vitro Thrombectomies

This test was aimed to visually evaluate the interaction between the stent retriever and the clot and also the ability of the stent retriever in maintaining the thrombus engaged within its struts during the retrieval. In order to evaluate how the devices interacted with thrombi of different consistencies, for this test were employed red “soft” and white “stiff” artificial thrombi. Neither proximal flow arrest nor manual aspiration was performed during retrievals in order to ensure that thrombus removal was uniquely due to the device [91]. Artificial thrombi were placed within the middle cerebral artery or terminal carotid artery of the phantom (Fig. 26).



Fig. 26 *An experimental white “stiff” clot was released in the left middle cerebral artery of the phantom. A standard micro-catheter previously navigated upon the clot is used to deploy the stent retriever for “in vitro thrombectomy test”.*

A standard micro-catheter was navigated over a micro guide-wire beyond the artificial clot; afterward the stent retrievers were exchanged with the micro-wire and delivered across the thrombus. The distal extremity of the devices was delivered approximately one cm distally to the thrombus in order to ensure that the clot interacted at least with the two distal thirds of the device during the retrieval. After the deployment, stents were left in place for 5 minutes in order to allow their best expansion and penetration into the clot; this delay is named embedding time.

Afterward, the devices were gently retrieved along the phantom vessels into the guiding catheter.

In order to investigate interaction between stent retrievers and clot of different size and consistency *In vitro thrombectomies* were conducted with red and white artificial thrombi of three diameters: small (2mm), middle (4mm) and large (6mm). Devices were tested five times for each thrombus type; each retrieving was filmed and reviewed to analyze the interaction. The rate of successful clot removal was calculated singularly for each clot type and as a whole for “red” or “white” clots.

2.3.4 Thrombi Preparation

Thrombi were generated using human blood obtained from ten healthy volunteers without history of anti-platelet medications or other medications that might interfere with normal coagulation. Each volunteer provided written informed consent prior to obtaining blood samples.

2.3.5 White “Stiff” Thrombi

Blood samples were collected into tubes containing 3.2% sodium citrate solution (1:9 in volume) used for blood anti-coagulation. In order to obtain platelet-rich plasma [92], tubes containing whole blood were centrifuged at 350g for 10 minutes at 22°C (Fig. 27). After centrifugation, the plasma layer was extracted for thrombus making while the erythrocyte layer was discarded. CaCl_2 was added to platelet rich plasma in a ratio of 100 μL : 1000 μL to reverse the effect of the sodium citrate. The re-calcified plasma was then incubated at 37°C for 1 hour. Finally, white thrombi formed from platelet-rich plasma were extracted (Fig. 28).



Fig. 27 *The centrifuge machine used in our experiments to produce white stiff clot from platelet rich plasma. Tubes containing whole blood were centrifuged at 350g for 10 minutes at 22°C.*



Fig. 28 *An experimental white clot formed by platelet rich plasma.*

2.3.6 Red “Soft” Thrombi

Whole blood samples were collected in standard tubes without sodium citrate solution. After collection, tubes were stored at 37°C for 24 hours. Subsequently, red thrombi formed from the whole blood were extracted [93] (Fig. 29).

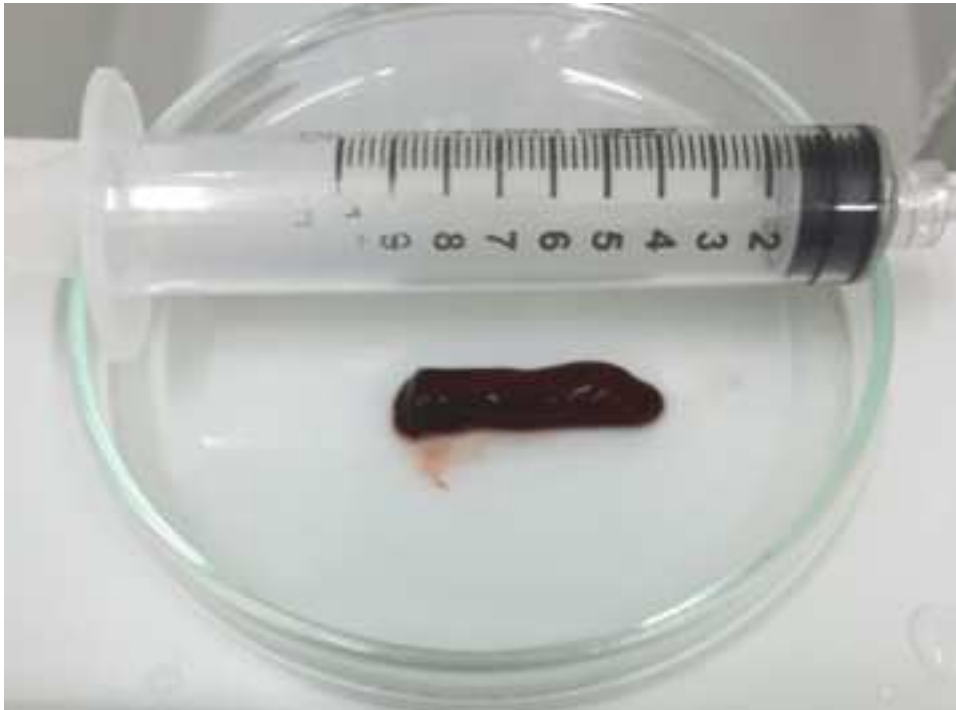

Fig. 29 *An experimental red “soft” clot formed from the whole blood.*

2.3.7 Thrombi Flat Plate Compression Test

Our aim was to produce clots of different stiffness; for such reason we produced white stiff fibrin rich clots and soft red cells rich clots. Thereafter, we verified whether there was a real difference in terms of stiffness between artificial red and white clots. Similarly to flat plate tests performed for the stent retrievers, thrombi of identical cylindrical shape (4 mm for the radius and 5 mm length) (Fig. 30), were placed between two flat plate transducers and the force needed to compress the clots to 50% of their height was measured. Tests consisted in five not consecutive compression

cycles; the mean value of the force exerted by the machine to compress the clot at each cycle was used to calculate the compression stress expressed in mN/mm^2 (Fig. 31).

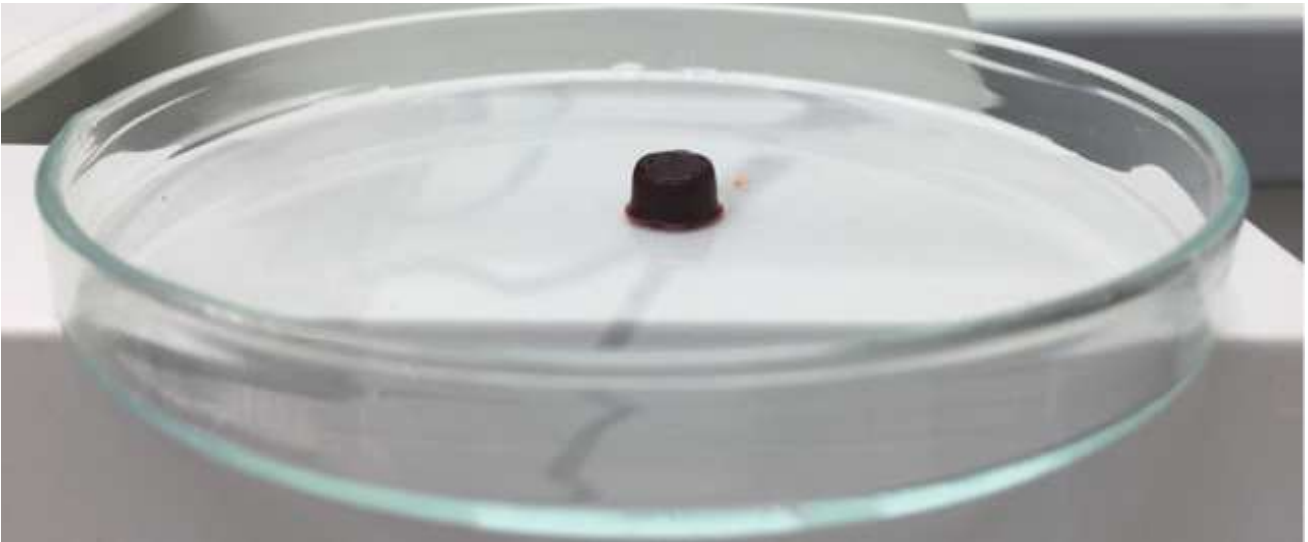

Fig. 30 *Thrombi of cylindrical shape were produced to perform flat plates tests.*

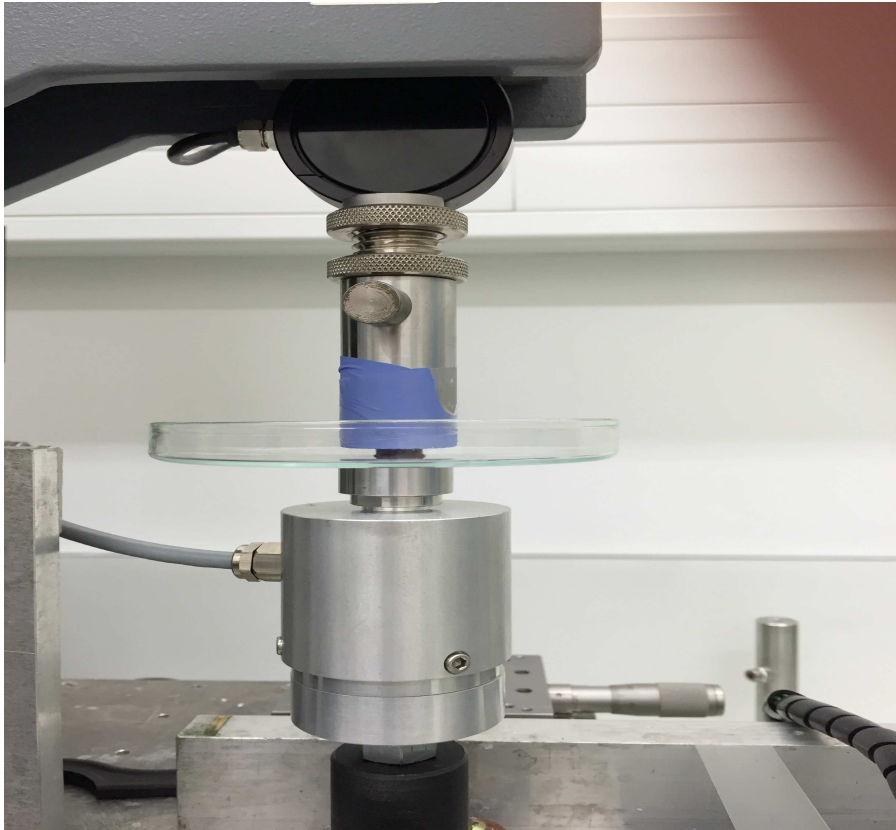

Fig. 31 A compression test performed with an experimental red “soft” clot.

2.4 Statistics

In order to investigate whether the variations of the radial pressure exerted by the devices within tube of diameter of 1.5mm and 3.5mm recorded in *Pull up traction tests* were statistically significant the Mann-Whitney test was employed.

The rate of successful clot removal recorded for *In vitro thrombectomies* using different devices for red and white clots were compared with the Mc Nemar test. Differences were considered statistically significant when $p < 0.05$.

2.5 Results

2.5.1 Mechanical Tests

The results of *Flat plate compression tests* and *Pull up traction tests* are reported in Tab. 2.

In figure 31 is given an example of Stretch/Force curves obtained during a flat plate compression test. As expected, curves are not linear. This is due to large displacements and structural effects.

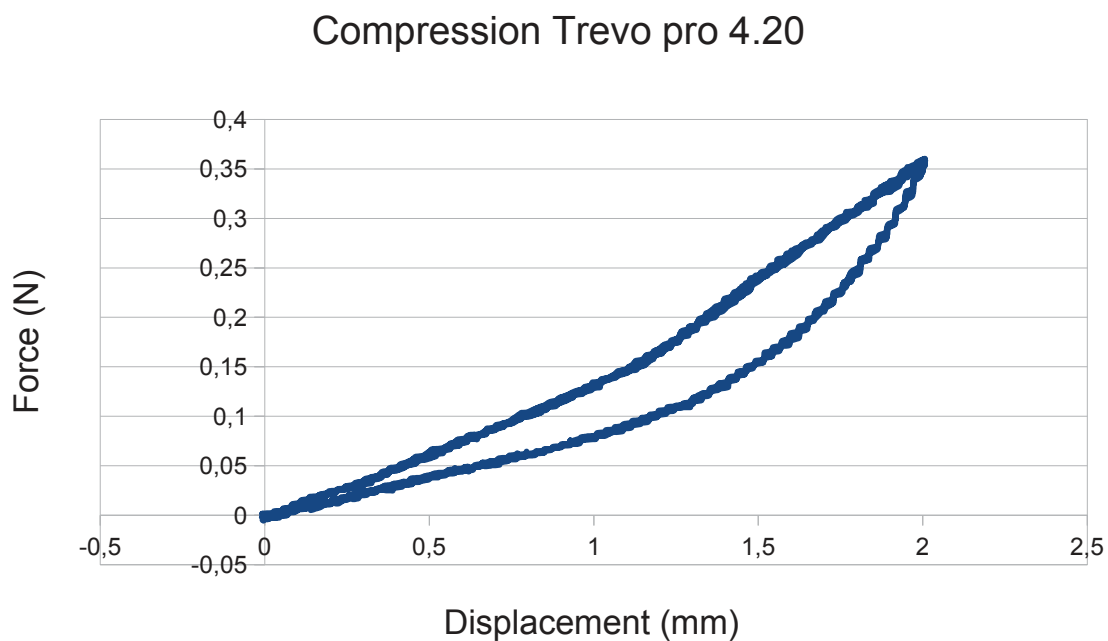
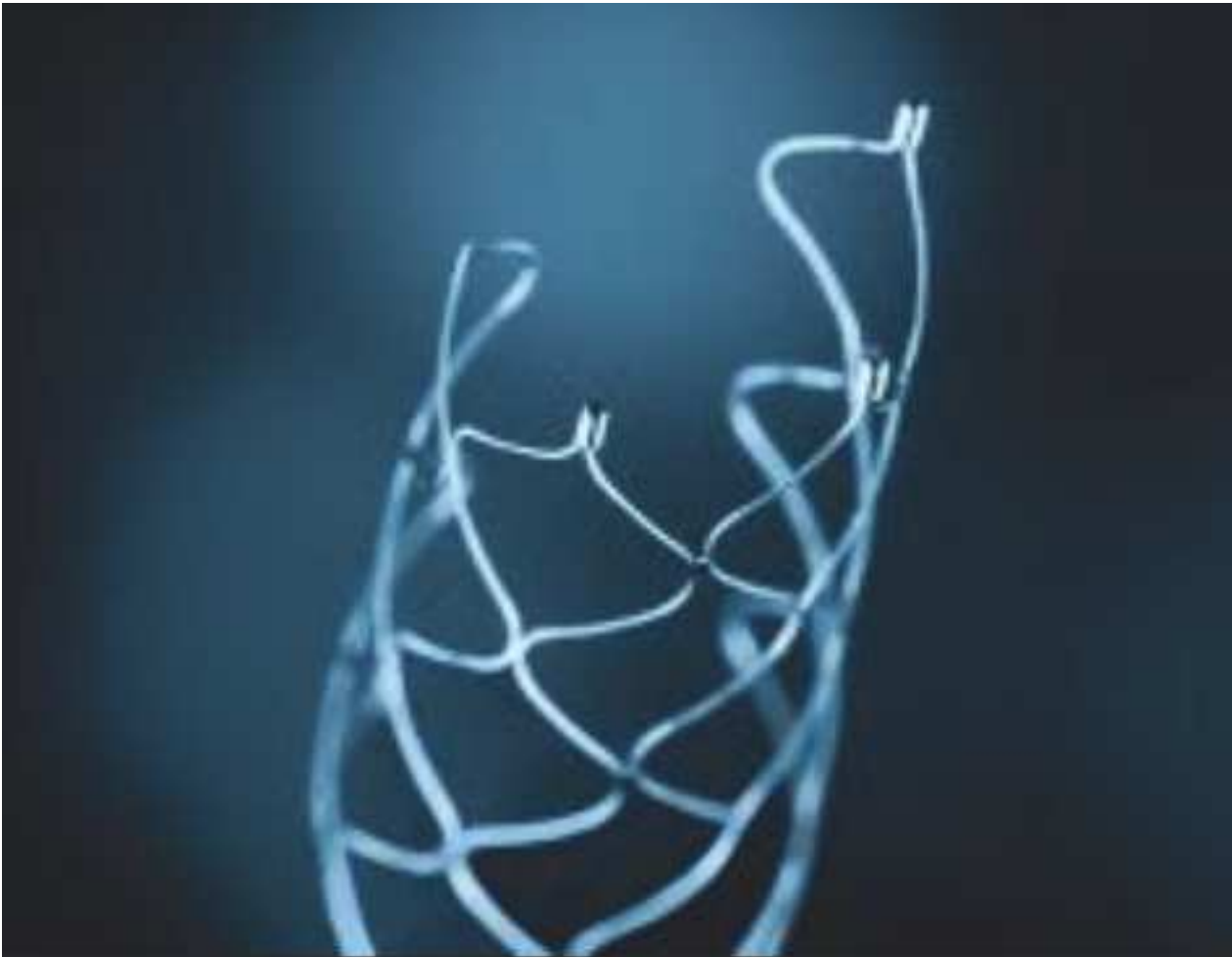

Fig. 32 An example of Stretch/Force curves obtained during a flat plate compression test of a stent Trevo PV 4-20.

During *Flat plate compression* the devices tended to ovalize hence discharging radial force toward the axis orthogonal to the plates. This phenomenon was more emphasized for the incomplete section devices (Solitaire, Catch and Preset, Fig. 33-34) since the free edges of the stent circumferentially overlapped under compression.



Figures 33 and 34 *An example of incomplete section device: Solitaire (Photo Covidien)*

Consequently, this test was not reliable comparator for all devices in this study; nevertheless it allowed a separate comparison for complete and incomplete section devices. Among complete

section devices, comparing stents of similar diameter, Eric 4-24 had the highest radial force density followed by Trevo PV 4-20, Revive 4.5-22, Separator 3D 4.5-26 and Embotrap 5-21 (these last two device showed similar radial force). Among incomplete section devices (Solitaire 4-20, Catch 4-20 and Preset 4-20) the value of the radial force density was comparable and it was inferior to the lowest value recorded for complete section devices.

The Pull up traction tests permitted the evaluation of the radial pressure variation when the stents were retrieved along tubes of increasing diameter. A typical curve of the force versus the vertical displacement of the upper arm of the machine is given in the following figure. We observe a first phase where the force is increasing and then is stabilizing.

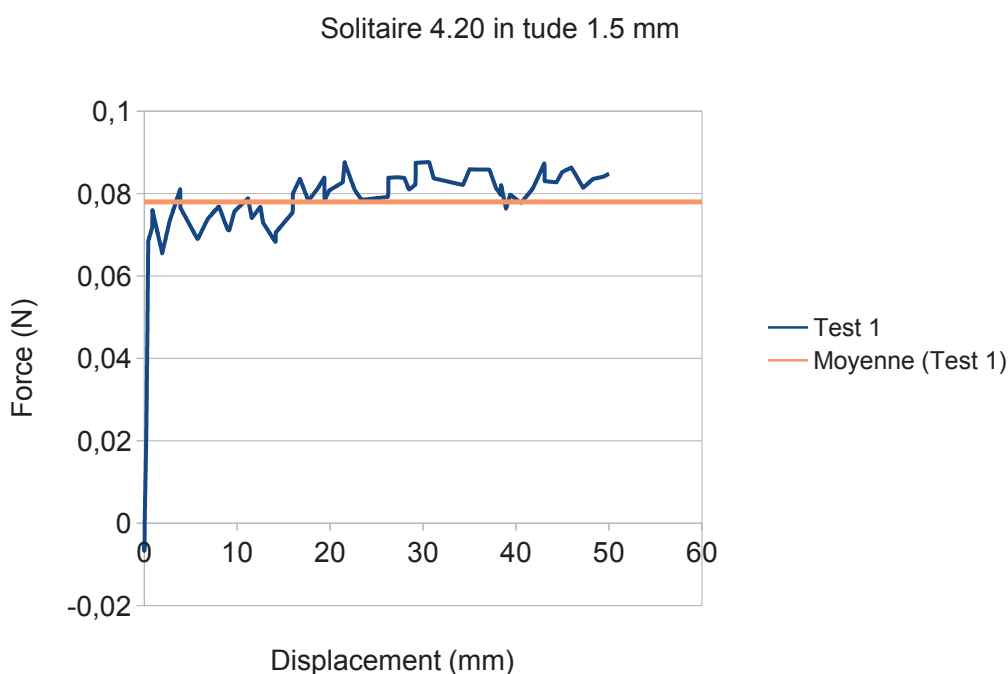

Fig. 35 A typical curve of the force versus the vertical displacement of the upper arm of the machine. We observed a first phase in which the force increases, then a second phase in which the force is stabilized.

For each stent retriever/Tube couple, we performed five tests (Fig. 35) and computed the average value.

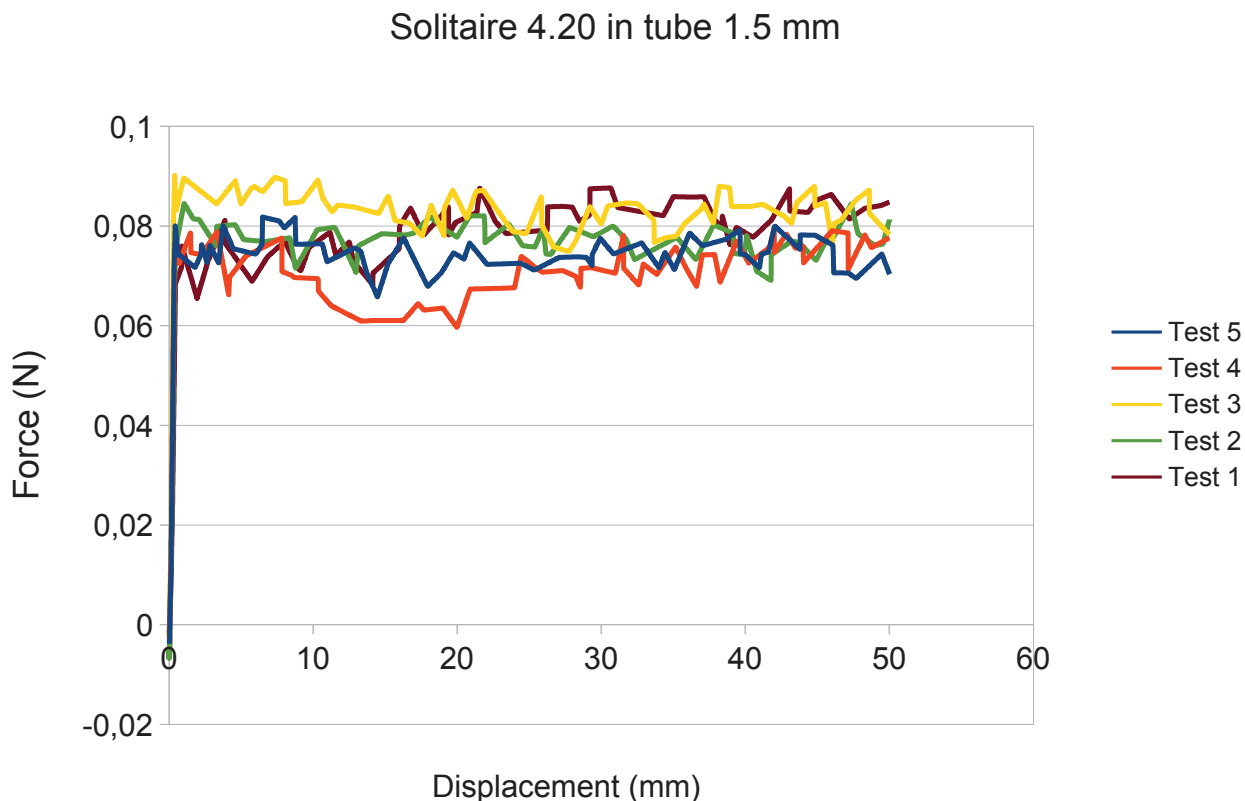
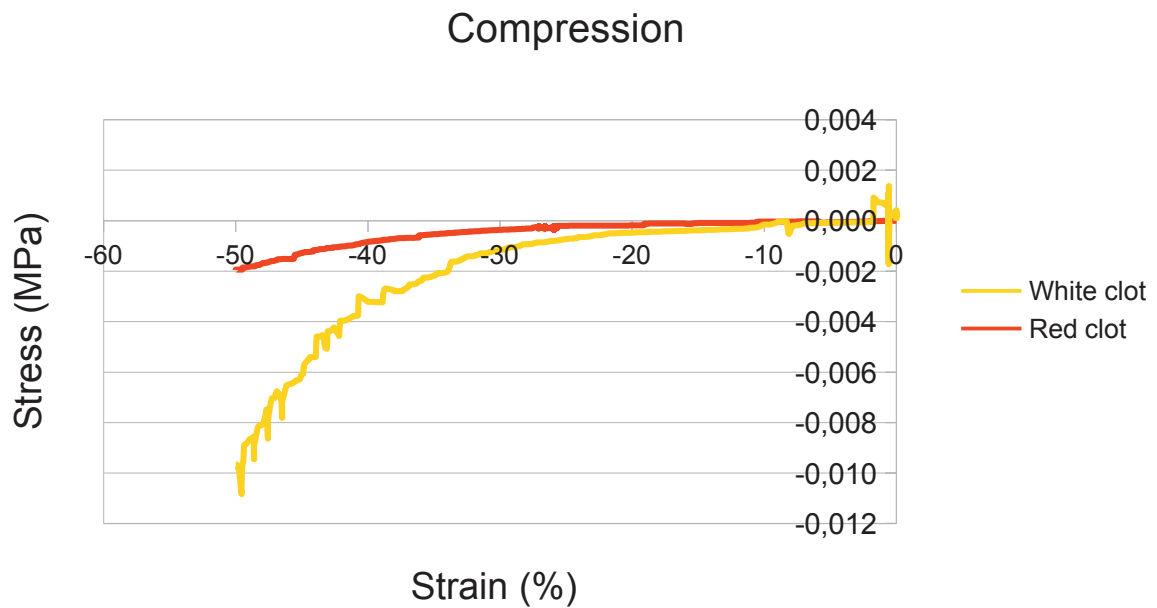

Fig. 36 For each stent retriever, five “Pull up retrieving” tests were performed with tubes of 1.5 and 3.5 mm.

These stabilized force values were collected and used to estimate the radial pressure. Among the complete section devices, Eric 4-24/3-20, Trevo PV 4-20/3-20, Mindframe 3-23 and Separator 3D 4.5-26 showed significant reduction of the radial pressure when retrieved within tubes of 3.5 mm in comparison to the pressure recorded in tubes of 1.5 mm inner diameter. Similar behavior was recorded for the Catch 3-15/4-20 and Preset 3-20 LT, among incomplete section devices (Tab. 2). Only Preset 4-20 LT and Preset 6-30 showed not significant difference in terms of radial pressure shift when retrieved in tubes of 1.5 and 3.5 inner diameter; $p=0.77$ and $p=0.25$ respectively.

Thrombi Flat Plate Compression Tests:

In the following figure (Fig. 37) there is an example of the mechanical response for a white clot and a red one. Stress is expressed in MPa and is the force divided by the initial surface of the sample, also called “true stress”. Strain is expressed in percent and is the “engineering strain”, defined as the lengthening divided by the initial length.



The difference is significant. White clot resulted nearly five times stiffer than white clots; the pressure needed to compress white clot was five times greater than for red clots.

Size	Flat plate tests Radial force density N/mm	Pull up traction tests Radial pressure Pa (N/m ²) (1.5 mm tube)	Pull up traction tests Radial pressure Pa (N/m ²) (3.5 mm tube)
Trevo PV			
4-20	0.01480	920	50* (p=0.050)
3-20	0.00600	300	60* (p=0.030)
Eric			
3-20	0.01100	220	–
4-24	0.01850	1540	340* (p=0.008)
6-44	0.01304	770	400* (p=0.010)
Embotrap			
5-21	0.00642	1430	770* (p=0.014)
Separator 3D			
4.5-26	0.00791	1360	400* (p=0.006)
Revive			
4.5-22	0.01269	1360	850* (p=0.021)
Mindframe			
3-23	0.00451	1250	330* (p=0.034)
Solitaire FR			
4-20	0.00448	1110	530* (p=0.014)
6-30	0.00351	1060	580* (p=0.020)
Preset			
4-20	0.00521	1090	730* (p=0.018)
6-30	0.00368	630	600* (p=0.25)
Preset LT			
3-20	0.00320	1060	160* (p=0.03)
4-20	0.00370	460	480* (p=0.77)
Catch			
3-15	0.00350	840	220* (p=0.049)
4-20	0.00444	1810	360* (p=0.010)
6-30	0.00368	1870	900* (p=0.030)

* p Value for the comparison between force exerted in tubes of 1.5 and 3.5 mm inner diameter during Pull up traction tests. Note results obtained with Preset 6-30 and Preset LT 4-20 for which there is not significant shift of the radial pressure when retrieved in tubes of different diameter; p=0.25 and p=0.77, respectively.

Tab. 2 Results of Flat plates and Pull Up Traction Tests

2.5.2 Functional Tests

The retrieving tests allowed evaluation of stent retriever's ability in remaining in close apposition to the vessels wall during the retrieval (Tab.3). For the purpose of this test, devices were subdivided in: 1) devices that remained in close apposition to the vessel wall during the entire retrieval. 2) Devices that remained in apposition to the vessel wall but showed a degree of elongation around acute vessel angles (Fig. 38). 3) Devices that completely lost contact to the vessel wall during the retrieval. The following devices remained in close apposition to the vessel wall during the entire retrieval: Preset 4-20 (Standard/LT), Preset 6-30, Catch 6-30 and Solitaire 4-20/6-30. The following devices remained in apposition to the vessel wall but demonstrated elongation when retrieved across acute angles: Embotrap 5-21, Separator 3D, Revive 4.5-22, Eric 4-24/6-44.

The following devices completely lost apposition to the vessel wall during the retrieval: Trevo PV 4-20/3-20, Catch 4-20/3-20, Preset 3-20, Eric 3-20, Mindframe 3-23.

Device	Size	Close apposition	Elongation	Loss of contact
Trevo PV	4-20		+	
	3-20			+
Eric	3-20			+
	4-24		+	
	6-44		+	
Embotrap	5-21		+	
Separator 3D	4.5-26		+	
Revive	4.5-22		+	
Mindframe	3-23			+
Solitaire FR	4-20	+		
	6-30	+		
Preset	4-20	+		
	6-30	+		
Preset LT	3-20			+
	4-20		+	
Catch	3-15			+
	4-20		+	
	6-30	+		

Tab 3 Results of "Retrieving Tests"

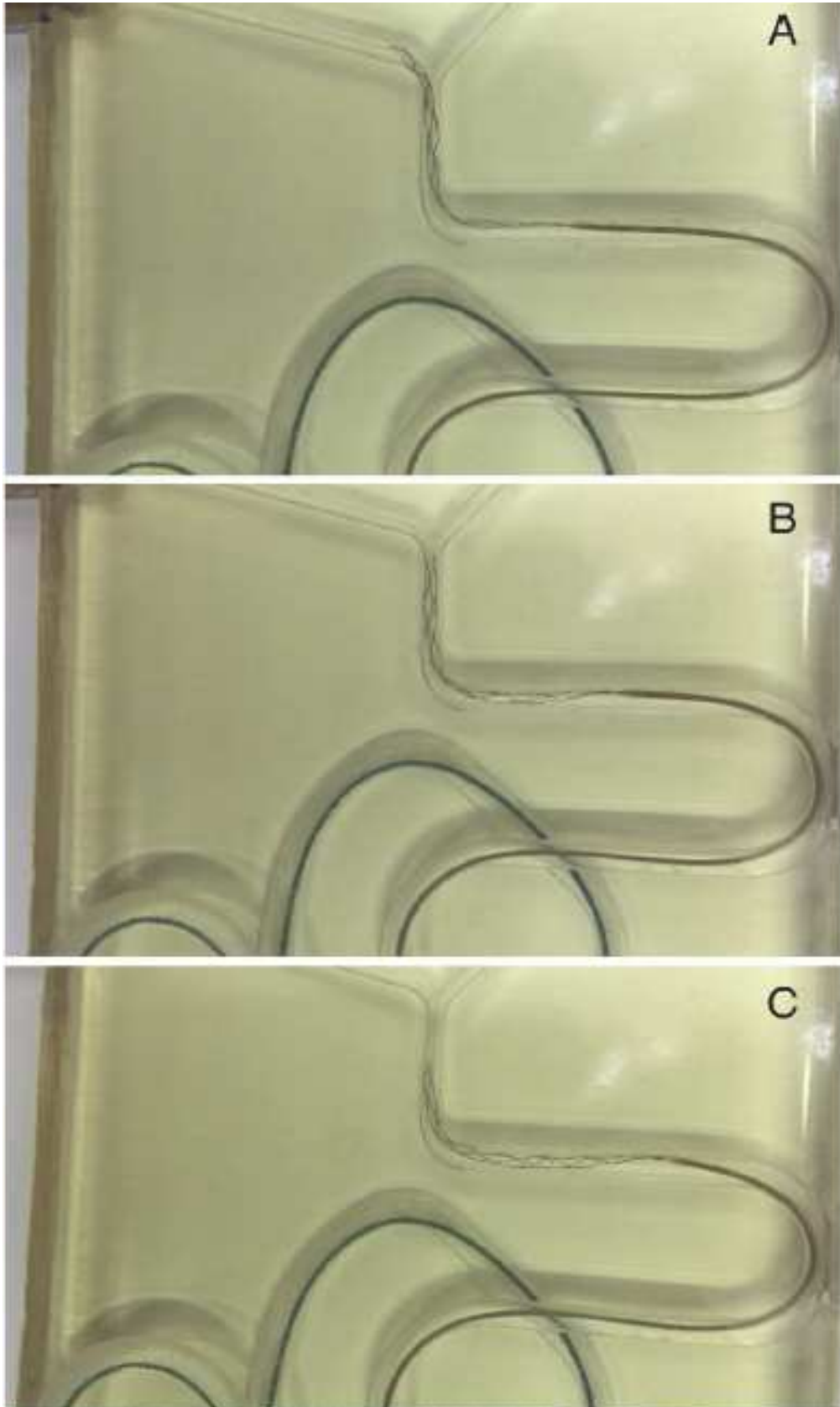

Fig. 38 Some device showed a greater degree of elongation around acute vessel angles: interaction of the proximal, middle and distal third of Solitaire 4-20 (A-C).

In vitro thrombectomies allowed an appreciation of the interaction between devices and thrombi of different consistency (red or white) and sizes (small, moderate or large), (Tab.4).

With large white thrombi (6 mm), the delivery catheter navigated across the clot by passing between the clot and the vessel wall and not within the clot as expected. Once delivered, stent retrievers remained constrained between the clot and the vessel wall in place of expanding and penetrating the clot (Fig. 39). Thereafter, during the retrieval the devices remained constrained and slid between the thrombus and the vessel wall without any removal effect, only in a few cases was the device effective in a minimal clot displacement. Interacting with a small or moderate size white thrombus (2-4 mm), stents partially expanded after deployment. Nevertheless, similarly to what noted with the larger white thrombi, the clot was not penetrated by the stent struts but remained on the side of the devices compressed against the vessel wall. Contrarily to larger thrombi, small and middle thrombi were partially engaged by the stent struts and displaced during the retrieval. Nevertheless, we noted a curious mechanism with which the clot was displaced by the stent: the clots did not remain engaged during the entire retrieval but intermittently rolled between the stent and the vessel wall toward the tip of the device. The effectiveness of the removal was secondary to the clot being maintained by the stent struts and the clot rolled between the stent and the vessel wall.

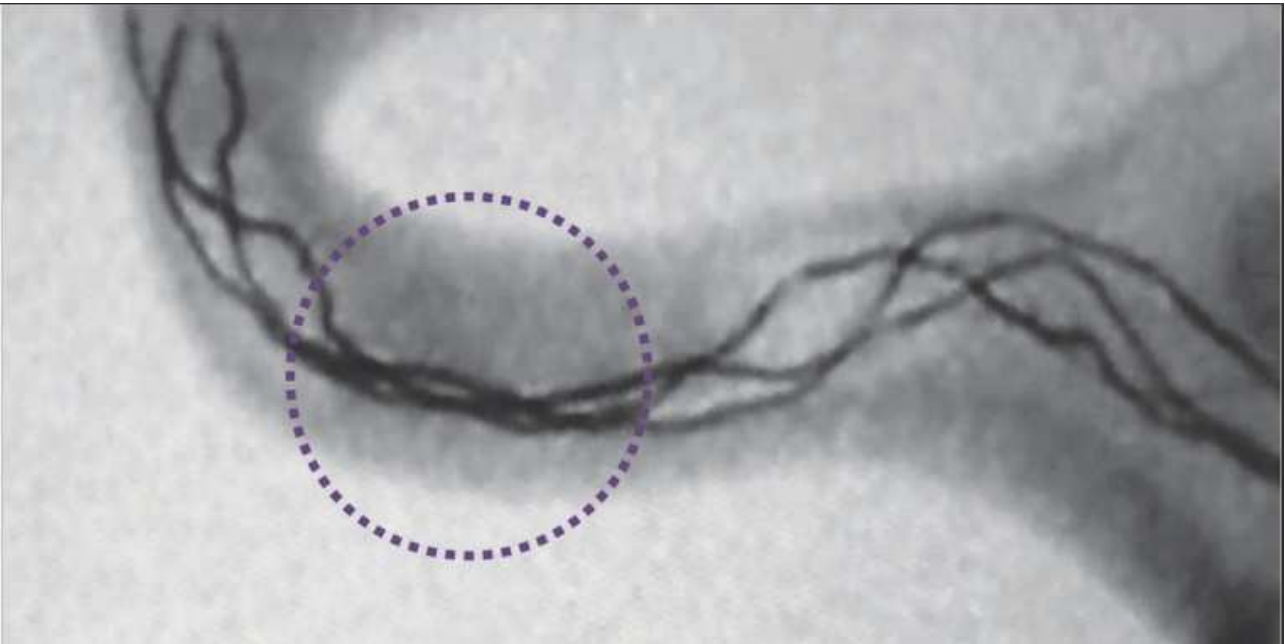

Fig. 39 When interact with large stiff white clots stent retrievers remain constrained between the clot and the vessel wall without penetrating the thrombus. During the retrieval the device slide over the clot without any removal effect.

Looking at results of *In vitro thrombectomies* performed using white thrombi we found significant difference when comparing performances of Preset 6-30 with those of Catch 3-15, Preset LT 3-20, Eric 3-20 and Trevo 3-20 (60% vs. 20%; $p=0.031$). These differences are explained by the fact that the interaction within the clot and the vessel wall is constantly maintained during the entire retrieval by Preset 6-30 while smaller devices tend to lose the contact with the clot and the vessel wall when retrieved into vessels of increasing diameters.

Device	Size	Large white clot	Medium white clot	Small white clot	%	Large red clot	Medium red clot	Small red dot	%
Trepo PV	4-20	0/5	2/5	3/5	33	3/5	4/5	5/5	80
	3-20	0/5	1/5	2/5	20	3/5	3/5	3/5	60
Eric	3-20	0/5	1/5	2/5	20	3/5	3/5	2/5	53
	4-24	0/5	2/5	3/5	33	2/5	3/5	4/5	60
	6-44	0/5	3/5	3/5	40	2/5	5/5	4/5	73
Embotrap	5-21	1/5*	2/5	3/5	40	3/5	5/5	4/5	80
Separator 3D	4.5-26	0/5	2/5	2/5	26	2/5	2/5	3/5	46
Revive	4.5-22	1/5*	2/5	3/5	40	3/5	5/5	4/5	80
Mindframe	3-23	0/5	2/5	2/5	26	3/5	4/5	3/5	66
Solitaire FR	4-20	0/5	3/5	3/5	40	4/5	5/5	5/5	93‡
	6-30	1/5*	3/5	4/5	53	4/5	5/5	5/5	93‡
Preset	4-20	0/5	3/5	4/5	46	4/5	5/5	5/5	93‡
	6-30	2/5*	3/5	4/5	60†	5/5	5/5	5/5	100§
Preset LT	3-20	0/5	1/5	2/5	20	3/5	2/5	3/5	53
	4-20	0/5	2/5	2/5	26	3/5	3/5	3/5	60
Catch	3-15	0/5	1/5	2/5	20	2/5	3/5	3/5	53
	4-20	1/5*	1/5	2/5	26	3/5	3/5	3/5	60
	6-30	1/5*	3/5	4/5	53	5/5	5/5	4/5	93‡

*Minimal clot displacement.
†The rate of white clot removal found for Preset 6-30 was significantly higher than the rates for Catch 3-15, Preset LT 3-20, Eric 3-20, and Trevo 3-20 (60% vs 20%; p=0.031).
‡The rate of red clot removal found for Solitaire 4-20/6-30, Preset 4-20, and Catch 6-30 was significantly higher than the rates for Separator 3D, Eric 3-20, Preset LT 3-20, and Catch 3-15 (93% vs 46%; p=0.016 or 93% vs 53%; p=0.031).
§The rate of red clot removal found for Preset 6-30 was significantly higher than the rates for Separator 3D (100% vs 46%; p=0.008), Eric 3-20, Preset LT 3-20, Catch 3-15 (100% vs 53%; p=0.016), Trevo 3-20, and Eric 4-24 (100% vs 60%; p=0.031).

Tab. 4 Results of “In vitro thrombectomy” Test

We noted a totally different behavior when we evaluated the interaction of the stents with the red soft thrombi. In contrast to white thrombi, the delivery micro-catheter would navigate through (within) the clot and not beside it. Furthermore, once deployed, all stents penetrated the thrombus with their struts and very easily the clot entered within their lumen. Red clots mostly remained engaged inside the devices during retrieval with a higher rate of complete clot removal in comparison to what recorded for white thrombi. Nevertheless, we noted some substantial differences in terms of clot fragmentation and embolic complications. Such behavior was due to the fact that red thrombi had a tendency to fragmentize when interacted with the stents upon deployment and during the retrievals. Preset 6-30 the most effective device in red clot removal; it was able to completely retrieve the clot in 100% of the tests, such rate was significantly higher in comparison to the rates obtained with Separator 3D (100% vs. 46%; p=0.008), Eric 3-20, Preset LT 3-20, Catch 3-15 (100% vs. 53%; p=0.016), Trevo 3-20 and Eric 4-24 (100% vs. 60%; p=0.031).

Solitaire 4-20 and 6-30, Preset 4-20 and Catch 6-30 were effective in red clot removal in 93% of the tests and such rate was significantly higher in comparison to the rates of Separator 3D, Eric 3-20, Preset LT 3-20 and Catch 3-15 (93% vs. 46%; $p=0.016$ or 93% vs. 53%; $p=0.031$).

2.6 Discussion

Our study allowed the evaluation of mechanical characteristics of different stent retrievers and permitted a better understanding of how they interact with different types of thrombi.

To date there are not in literature studies evaluating the mechanical features of thrombectomy devices and there are only very few experimental studies investigating their interaction with artificial thrombi [94-98]. Nevertheless, such studies are more focused on a comparative evaluation of clot removal efficacy of different thrombectomy devices. In contrast to our study, none among the previous studies evaluated the stent retriever's radial pressure variation during retrieval. Furthermore, these studies predominantly limited their evaluation to the interaction of devices with only one type of thrombus.

Wenger et al. [95] evaluated the interaction of four devices (Solitaire, Aperio [Acandis, Pforzheim, Germany], Merci X6, Merci L5 [Concentric medical, Mountain View, CA, USA] with experimental clots. The authors found that the migration of the stent struts into the clot is promoted by a strong radial force of the device and by large gaps in between filaments. Nevertheless, in our study we found that when delivered within small vessels, across large white clots, devices remain constrained and gaps between filaments do not open. In other words, instead of its own radial force, none of the tested device opened when tested in such extreme conditions. Moreover, devices presenting large gaps between filaments, especially open-cell devices were more prone to lose contact to the vessel wall when retrieved along sharp angles disengaging the clot. For example Embotrap showed a quite constant radial pressure during retrieval as recorded during *pull up traction tests*, nevertheless *retrieving tests* showed that when retrieved along sharp angles, the outer stent forming the device (with an open cell design so large gaps between filaments) lost the contact with the vessel wall and this was related, as also demonstrated in *In vitro thrombectomy* with clot disengagement,

especially for white clots. Authors found that the use of longer stents improved stable clot engagement. Our results confirm this finding with the bigger devices showing a higher rate of complete clot removal in our experiments. We believe that such better performances are due to the larger surface of interaction, which is offered by bigger devices to the clot along with their ability in maintaining a more constant pressure over the clot along the retrieval.

Madjidyar et al. [97] experimentally evaluated device-clot interaction and the influence of distal aspiration on performances of four thrombectomy devices: Solitaire FR, Trevo, Separator 3D and Aperio. The authors performed experimental thrombectomies using an artificial vascular model reproducing the human brain anterior circulation with and without additional distal aspiration. Distal aspiration was performed during retrievals through an intermediate distal access catheter placed at the origin of the middle cerebral artery. Authors reported that during the stent deployment, the artificial thrombus was pushed against the opposite vessel wall and no integration of the clot into the inner lumen of the device could be observed in any device. Furthermore, during the pulling back of the stent the clot was rolling between the device and the vessel wall wandering toward the tip of the device. These findings correspond to what we observed in our experiments analyzing the interaction between devices and thrombi of small and moderate size. Interestingly, authors observed that when distal aspiration was added to the retrieval process, clot removal efficacy was comparable for all devices. Such results correlate with observations in our study. In *pull up traction tests* conducted in 1.5 mm inner diameter tubes we have found comparable radial pressure (>900 Pa) for the majority of the 4 mm diameter devices. Hence, it can be reasoned that all devices have equal performances in terms of clot engagement in the early phase of the retrieval. This could explain why no differences in terms of clot removal efficacy were found when distal aspiration was associated to experimental thrombectomies. On the contrary, we observed that when thrombectomies are performed without any additional aspiration, each device has different performances, which are related to its own mechanical characteristics. And this is related to the behavior of the device along the entire retrieval. Mechanical tests gave an overview of each STRs radial pressure. It should be pointed out that the radial pressure calculation depends on the friction

coefficient between STRs and silicon tubes and has been chosen equal to 0.4, which is probably not the real experimental value. But actually we focused on a comparative evaluation and in this case the absolute value of the radial pressure is not necessary to be accurately estimated. *Pull up traction tests* performed in tubes of 1.5 mm inner diameter found similar radial pressure for devices of similar diameter (4-4.5 mm). Results of tests performed in tubes of 3.5 mm inner diameter revealed different behavior for each device, in this instance, most of the tested devices showed an undeniable decrease of the radial pressure in comparison to values recorded in tubes of 1.5 mm. On the contrary, some incomplete section devices showed constant radial pressure in both 1.5 mm and 3.5 mm inner diameter tubes (Preset 4-20 LT and 6-30, $P=0.77$ and $P=0.25$ respectively in Tab. 2). Interestingly, the *Retrieving tests* did not show any loss of apposition to the vessel wall during retrieval for such devices. Moreover, a relatively high rate of contact loss was recorded for those devices for which *Pull up traction tests* have shown a sharp decrease of the radial pressure when tested in 3.5 mm inner diameter tubes.

Analyzing results of *In vitro thrombectomies* we noted that devices did not expand when interacted with large white clots (6 mm) but remained constrained between the clot and the vessel wall, then during the retrieval, devices slide over the clot without capturing it. None among the devices tested in our study was able to penetrate and remove large white thrombi (6 mm). Nevertheless, devices could expand and penetrate white thrombi of smaller sizes (2-4 mm). During the retrieval, the contact with these clots was not homogenous but there was a succession of phases in which the clot was engaged by the stent struts and phases in which the clot was disengaged and rolled between the device and the vessel wall.

A completely different interaction was appreciated when devices were tested with red thrombi; in this instance all thrombectomy devices could easily penetrate and incorporate the clot inside their lumen. During the retrieval red clots showed a tendency to fragmentation and this was related to a higher rate of distal fragments embolization occurrence.

Investigating the interaction devices and thrombi we found that removal efficacy was related to the

device's ability to maintain a constant radial pressure and hence allowing for gradual expansion and constant apposition during retrieval (i.e. Preset 6-30). This reduced the occurrence of distal fragment embolization during the interaction with both white and red thrombi. Such effective behavior was not recorded for devices for which the radial force sharply reduced along retrieval.

Retrieving tests showed that overall devices flattened when facing sharp vessel angles (90° in our model) (Fig. 37). Devices that after interaction with sharp angles presented a prompt and complete reopening of their proximal and middle thirds showed better cohesion to the vessel wall and stability during the retrieval. Such favorable behavior was mainly recorded for incomplete section devices and in particular for devices of larger diameters: Preset 6-30, Solitaire 6-30 and Catch 6-30. In the other hand, devices that did not promptly re-expand after interaction with sharp angles lost contact to the vessel wall and abruptly jumped toward the downstream vessels. This behavior, mainly recorded for complete section device, was in our experiments related to whole clot disengagement and fragment embolization.

Our study presents some limitations. Firstly, we used a rigid plastic model and hence during retrievals across the model's curves and tortuosity, the vasculature did not straighten. Nevertheless, we planned to employ a rigid model in order to exacerbate device performances and to assure identical conditions for all devices. Moreover, the thrombus interaction with the inner surface of the plastic vessel is not comparable with the interaction with the human endothelium, consequently the resistance recorded in our experiments during retrieval was lower than in real vessels. In addition, despite of our best efforts in producing clot of similar features, thrombi slightly varied in size or texture.

Finally, the values of radial pressure are related to the friction coefficient. However, we attributed a constant value to this coefficient in order to allow comparison between devices of different design.

Conclusions and Perspectives

Our results add some innovative information to the current understanding of mechanical thrombectomy. We found and reported for the first time in literature the mechanism of thrombus removal failure; namely all stent retrievers slide over large white thrombi with the clot failing to be captured. Again for the first time we found and reported that constant radial pressure during retrieval allows constant apposition to the vessel wall and pressure over the clot. Such features allow for a higher rate of clot removal efficacy. We also reported that white small and medium thrombi are not permanently engaged by the stent struts but roll between it and the vessel wall during retrieval, while red thrombi are easily caught by device but have a tendency to fragment. Furthermore, our experiments showed that bigger size devices (6 mm in diameter) have better clot removal performance because bigger device sizes increase the probability of capturing the clot. The results of our study should be compared with further clinical investigations. Nevertheless, clinical trials comparing efficacy of “new generation” thrombectomy devices are lacking and comparative experiences are limited to in-vitro evaluations. Based on our results we can speculate that one given device would be effective in specific clinical circumstances and not in others. In example a small diameter low radial force open cells device (such as Catch 3-15 or Preset LT 3-20) could be used to retrieve a little diameter clot occluding a distal middle cerebral artery branch (M2); while a large diameter open cell device (such as Preset 6-30 or Solitaire 6-30) could be employed to retrieve a large clot occluding a proximal middle cerebral artery (M1) segment or a carotid termination. Furthermore, an high radial force device (such as Trevo PV 4-20 or a Revive 4.5-22) could be useful in cases in which a “low” radial force device failed in retrieving the clot especially when the occlusion is due to a stiff clot for which higher friction between the device and the clot is needed especially when a large bore intermediate catheter used for concomitant distal aspiration.

Our study focused on the evaluation of the only thrombectomy procedure and related devices for which clinical trials have demonstrated the efficacy; nevertheless, an alternative thrombectomy

procedure is currently gaining popularity in the neuro-interventional world. Such procedure consists in the direct aspiration of the clot via a distal access large bore catheter placed to the proximal aspect of the clot. Such procedure, as reported by the current literature, is highly effective and it is an additional, promising technique to treat acute ischemic stroke. Based on recent publications, the rate of complete vessel recanalization obtained with direct clot aspiration ranges between 50% and 70%; hence in a number of cases a standard stent retriever thrombectomy has to be performed as a rescue therapy. In such cases, the operator could use the stent retriever to move the clot close the distal edge of the aspiration catheter. Also in this circumstance the knowledge of the behavior of each stent retriever could help the operator in selecting the most appropriate device for a given clinical condition in order to obtain the most effective interaction between the clot, the stent and the aspiration catheter. With this aim, the future evolution of our research will be the experimental evaluation of the efficacy of different stent retrievers used in combination with different types of large bore aspiration catheter to perform experimental thrombectomy. Of course, another potential evolution of our research will be the evaluation of the efficacy of the direct clot aspiration technique performed with different large bore aspiration catheter using clot of different stiffness as we have done with stent retrievers.

References

- [1] A. S. Ferrell and G. W. Britz, "Developments on the horizon in the treatment of neurovascular problems," *Surgical Neurology International*, vol. 4, supplement 1, pp. S31–S37, 2013.
- [2] K. A. Blackham, P.M.Meyers, T. A. Abruzzo et al., "Endovascular therapy of acute ischemic stroke: report of the standards of practice committee of the society of neuroInterventional surgery," *Journal of NeuroInterventional Surgery*, vol. 4, no. 2, pp. 87–93, 2012.
- [3] D. Lloyd-Jones, R. Adams, M. Carnethon et al., "Heart disease and stroke statistics—2009 update: a report from the American heart association statistics committee and stroke statistics subcommittee," *Circulation*, vol. 119, no. 3, pp. 480–486, 2009.
- [4] W. Hacke, A. J. Furlan, Y. Al-Rawi et al., "Intravenous desmoteplase in patients with acute ischaemic stroke selected by MRI perfusion-diffusion weighted imaging or perfusion CT (DIAS-2): a prospective, randomised, double-blind, placebo-controlled study," *The Lancet Neurology*, vol. 8, no. 2, pp. 141–150, 2009.
- [5] S. M. Adelman, "The national survey of stroke. Economic impact," *Stroke*, vol. 12, supplement 1, no. 2, pp. I-69–I-87, 1981.
- [6] T. N. Taylor, P.H.Davis, J.C.Torner, J. Holmes, J.W.Meyer, and M. F. Jacobson, "Lifetime cost of stroke in the United States," *Stroke*, vol. 27, no. 9, pp. 1459–1466, 1996.
- [7] W. Rosamond, K. Flegal, G. Friday et al., "Heart disease and stroke statistics—2007 update: a report from the American Heart Association Statistics Committee and Stroke Statistics Subcommittee," *Circulation*, vol. 115, no. 5, pp. e69–e171, 2007.

- [8] R. G. González, W. A. Copen, P. W. Schaefer et al., "The Massachusetts General Hospital acute stroke imaging algorithm: an experience and evidence based approach," *Journal of NeuroInterventional Surgery*, vol. 5, supplement 1, pp. i7–i12, 2013.
- [9] J.-H. Rha and J. L. Saver, "The impact of recanalization on ischemic stroke outcome: a meta-analysis," *Stroke*, vol. 38, no. 3, pp. 967–973, 2007.
- [10] A. Meretoja, M. Keshtkaran, J. L. Saver et al., "Stroke thrombolysis: save a minute, save a day," *Stroke*, vol. 45, no. 4, pp. 1053–1058, 2014.
- [11] A. Eissa, I. Krass, C. Levi, J. Sturm, R. Ibrahim, and B. Bajorek, "Understanding the reasons behind the low utilisation of thrombolysis in stroke," *Australasian Medical Journal*, vol. 6, no. 3, pp. 152–163, 2013.
- [12] K. R. Lees, E. Bluhmki, R. von Kummer et al., "Time to treatment with intravenous alteplase and outcome in stroke: an updated pooled analysis of ECASS, ATLANTIS, NINDS, and EPITHET trials," *The Lancet*, vol. 375, no. 9727, pp. 1695–1703, 2010.
- [13] M. Ebinger, B. Winter, M. Wendt et al., "Effect of the use of ambulance-based thrombolysis on time to thrombolysis in acute ischemic stroke: a randomized clinical trial," *Journal of the American Medical Association*, vol. 311, no. 16, pp. 1622–1631, 2014.

[14] A. J. Furlan, D. Eyding, G. W. Albers et al., "Dose escalation of Desmoteplase for Acute Ischemic Stroke (DEDAS): evidence of safety and efficacy 3 to 9 hours after stroke onset," *Stroke*, vol. 37, no. 5, pp. 1227–1231, 2006.

[15] H. P. Adams Jr., G. del Zoppo, M. J. Alberts et al., "Guidelines for the early management of adults with ischemic stroke: a guideline from the American Heart Association/American Stroke Association Stroke Council, Clinical Cardiology Council, Cardiovascular Radiology and Intervention Council, and the atherosclerotic peripheral vascular disease and quality of care outcomes in research interdisciplinary working groups: the American Academy of Neurology affirms the value of this guideline as an educational tool for neurologists," *Circulation*, vol. 115, no. 20, pp. e478–534, 2007.

[16] "Tissue plasminogen activator for acute ischemic stroke," *New England Journal of Medicine*, vol. 333, no. 24, pp. 1581–1587, 1995.

[17] W. Hacke, M. Kaste, E. Bluhmki et al., "Thrombolysis with alteplase 3 to 4.5 hours after acute ischemic stroke," *The New England Journal of Medicine*, vol. 359, no. 13, pp. 1317–1329, 2008.

[18] P. Sandercock, J. M. Wardlaw, R. I. Lindley et al., "The benefits and harms of intravenous thrombolysis with recombinant tissue plasminogen activator within 6 h of acute ischaemic stroke (the third international stroke trial [IST-3]): a randomised controlled trial," *The Lancet*, vol. 379, no. 9834, pp. 2352–2363, 2012.

[19] N. Ahmed, L. Kellert, K. R. Lees, R. Mikulik, T. Tatlisumak, and D. Toni, "Results of intravenous thrombolysis within 4.5 to 6 hours and updated results within 3 to 4.5 hours of onset of acute ischemic stroke recorded in the safe implementation of treatment in stroke international stroke thrombolysis register (SITS-ISTR): an observational study," *JAMA Neurology*, vol. 70,

no. 7, pp. 837–844, 2013.

[20] S. M. Zinkstok and Y. B. Roos, “Early administration of aspirin in patients treated with alteplase for acute ischaemic stroke: a randomised controlled trial,” *The Lancet*, vol. 380, no. 9843, pp. 731–737, 2012.

[21] M. Parsons, N. Spratt, A. Bivard et al., “A randomized trial of tenecteplase versus alteplase for acute ischemic stroke,” *The New England Journal of Medicine*, vol. 366, no. 12, pp. 1099–1107, 2012

[22] W. Hacke, G. Albers, Y. Al-Rawi et al., “The Desmoteplase in Acute Ischemic Stroke Trial (DIAS): a phase II MRI-based 9- hour window acute stroke thrombolysis trial with intravenous desmoteplase,” *Stroke*, vol. 36, no. 1, pp. 66–73, 2005.

[23] D. G. Sherman, R. P. Atkinson, T. Chippendale et al., “Intravenous ancrod for treatment of acute ischemic stroke. the STAT study: a randomized controlled trial,” *Journal of the American Medical Association*, vol. 283, no. 18, pp. 2395–2403, 2000

[24] M. Siebler, M. G. Hennerici, D. Schneider et al., “Safety of tirofiban in acute ischemic stroke: the SaTIS trial,” *Stroke*, vol. 42, no. 9, pp. 2388–2392, 2011.

[25] H. P. Adams Jr., M. B. Effron, J. Torner et al., “Emergency administration of abciximab for treatment of patients with acute ischemic stroke: results of an international phase III trial: Abciximab in Emergency Treatment of Stroke Trial (AbESTTII),” *Stroke*, vol. 39, no. 1, pp. 87–99, 2008.

[26] A. M. Pancioli, O. Adeoye, P. A. Schmit et al., "Combined approach to lysis utilizing eptifibatide and recombinant tissue plasminogen activator in acute ischemic stroke-enhanced regimen stroke trial," *Stroke*, vol. 44, no. 9, pp. 2381–2387, 2013.

[27] M. P. La Monte, M. L. Nash, D. Z. Wang et al., "Argatroban anticoagulation in patients with acute ischemic stroke (ARGIS-1): a randomized, placebo-controlled safety study," *Stroke*, vol.35, no. 7, pp. 1677–1682, 2004.

[28] A.D. Barreto, A. V. Alexandrov, P. Lyden et al., "The Argatroban and tissue-type plasminogen activator stroke study: final results of a pilot safety study," *Stroke*, vol. 43, no. 3, pp. 770–775, 2012.

[29] M. G. Lansberg, M. Straka, S. Kemp et al., "MRI profile and response to endovascular reperfusion after stroke (DEFUSE 2): a prospective cohort study," *The Lancet Neurology*, vol. 11, no. 10, pp. 860–867, 2012.

[30] G.W. Albers, V.N.Thijs, L.Wechsler et al., "Magnetic resonance imaging profiles predict clinical response to early reperfusion: the diffusion and perfusion imaging evaluation for understanding stroke evolution (DEFUSE) study," *Annals of Neurology*, vol. 60, no. 5, pp. 508–517, 2006.

[31] S. M. Davis, G. A. Donnan, M. W. Parsons et al., "Effects of alteplase beyond 3 h after stroke in the echoplanar imaging thrombolytic evaluation trial (EPITHET): a placebo-controlled randomised trial," *The Lancet Neurology*, vol. 7, no. 4, pp. 299– 309, 2008.

[32] A. V. Alexandrov, C. A.Molina, J. C. Grotta et al., "Ultrasoundenhanced systemic thrombolysis for acute ischemic stroke," *The New England Journal of Medicine*, vol. 351, no. 21, pp. 2170–2178, 2004.

[33] C. A. Molina, A. D. Barreto, G. Tsivgoulis et al., "Transcranial ultrasound in clinical

sonothrombolysis (TUCSON) trial,” *Annals of Neurology*, vol. 66, no. 1, pp. 28–38, 2009.

[34] G. J. del Zoppo, J. L. Saver, E. C. Jauch, and H. P. Adams Jr., “Expansion of the time window for treatment of acute ischemic stroke with intravenous tissue plasminogen activator: a science advisory from the American heart association/american stroke association,” *Stroke*, vol. 40, no. 8, pp. 2945–2948, 2009.

[35] G. W. Albers, P. Amarenco, J. D. Easton, R. L. Sacco, and P. Teal, “Antithrombotic and thrombolytic therapy for ischemic stroke: the Seventh ACCP Conference on Antithrombotic and Thrombolytic Therapy,” *Chest*, vol. 126, supplement 3, pp. 483S–512S, 2004.

[36] C. A. Molina and J. L. Saver, “Extending reperfusion therapy for acute ischemic stroke: emerging pharmacological, mechanical, and imaging strategies,” *Stroke*, vol. 36, no. 10, pp. 2311–2320, 2005.

[37] A. D. Barreto and A. V. Alexandrov, “Adjunctive and alternative approaches to current reperfusion therapy,” *Stroke*, vol. 43, no. 2, pp. 591–598, 2012.

[38] R. Mikulík, M. Dufek, D. Goldemund, and M. Reif, “A pilot study on systemic thrombolysis followed by low molecular weight heparin in ischemic stroke,” *European Journal of Neurology*, vol. 13, no. 10, pp. 1106–1111, 2006.

[39] S. M. Zinkstok, M. Vermeulen, J. Stam, R. J. de Haan, and Y. B. Roos, "A randomised controlled trial of antiplatelet therapy in combination with Rt-PA thrombolysis in ischemic stroke: rationale and design of the ARTIS-Trial," *Trials*, vol. 11, article 51, 2010.

[40] G. J. del Zoppo, R. T. Higashida, A. J. Furlan, M. S. Pessin, H. A. Rowley, and M. Gent, "PROACT: a phase II randomized trial of recombinant pro-urokinase by direct arterial delivery in acute middle cerebral artery stroke," *Stroke*, vol. 29, no. 1, pp. 4–11, 1998.

[41] A. Furlan, R. Higashida, L. Wechsler et al., "Intra-arterial prourokinase for acute ischemic stroke. The PROACT II study: a randomized controlled trial," *Journal of the American Medical Association*, vol. 282, no. 21, pp. 2003–2011, 1999.

[42] M. Yepes, B. D. Roussel, C. Ali, and D. Vivien, "Tissue-type plasminogen activator in the ischemic brain: more than a thrombolytic," *Trends in Neurosciences*, vol. 32, no. 1, pp. 48–55, 2009.

[43] E. C. Haley, J. L. P. Thompson, J. C. Grotta et al., "Phase IIB/III trial of tenecteplase in acute ischemic stroke: results of a prematurely terminated randomized clinical trial," *Stroke*, vol. 41, no. 4, pp. 707–711, 2010.

[44] E.C.Haley Jr., P. D. Lyden, K. C. Johnston, and T. M. Hemmen, "A pilot dose-escalation safety study of tenecteplase in acute ischemic stroke," *Stroke*, vol. 36, no. 3, pp. 607–612, 2005.

[45] D. Smadja, N. Chausson, J. Joux et al., "A new therapeutic strategy for acute ischemic stroke: sequential combined intravenous tpa-tenecteplase for proximal middle cerebral artery occlusion based on first results in 13 consecutive patients," *Stroke*, vol. 42, no. 6, pp. 1644–1647, 2011.

[46] N. Logallo, C. E. Kvistad, A. Nacu et al., "The Norwegian tenecteplase stroke trial (NOR-TEST): randomised controlled trial of tenecteplase vs. alteplase in acute ischaemic stroke," *BMC Neurology*, vol. 14, no. 1, article 106, 2014.

[47] R. von Kummer, G.W. Albers, E.Mori et al., "The desmoteplase in acute ischemic stroke (DIAS) clinical trial program," *International Journal of Stroke*, vol. 7, no. 7, pp. 589–596, 2012.

[48] J. F. Kirmani, A. Alkawi, S. Panezai, and M. Gizzi, "Advances in thrombolytics for treatment of acute ischemic stroke," *Neurology*, vol. 79, no. 13, supplement 1, pp. S119–S125, 2012.

[49] D. E. Levy, G. J. Del Zoppo, B. M. Demaerschalk et al., "Ancrod in acute ischemic stroke: results of 500 subjects beginning treatment within 6 hours of stroke onset in the ancrod stroke program," *Stroke*, vol. 40, no. 12, pp. 3796–3803, 2009.

[50] M. G. Hennerici, R. Kay, J. Bogousslavsky, G. L. Lenzi, M. Verstraete, and J. M. Orgogozo, "Intravenous ancrod for acute ischaemic stroke in the European stroke treatment with ancrod trial: a randomised controlled trial," *The Lancet*, vol. 368, no. 9550, pp. 1871–1878, 2006.

[51] M. G. Hennerici, R. Kay, J. Bogousslavsky, G. L. Lenzi, M. Verstraete, and J. M. Orgogozo, "Intravenous ancrod for acute ischaemic stroke in the European Stroke Treatment with Ancrod Trial: a randomised controlled trial," *The Lancet*, vol. 368, no. 9550, pp. 1871–1878, 2006.

[52] P. R. Eisenberg, B. E. Sobel, and A. S. Jaffe, "Activation of prothrombin accompanying thrombolysis with recombinant tissue-type plasminogen activator," *Journal of the American College of Cardiology*, vol. 19, no. 5, pp. 1065–1069, 1992.

[53] H. Pereira, "Reperfusion therapy for acute myocardial infarction with fibrinolytic therapy or combination reduced fibrinolytic therapy and platelet glycoprotein IIb/IIIa inhibition: the GUSTO V randomised trial," *Revista Portuguesa de Cardiologia*, vol. 20, no. 6, pp. 687–688, 2001.

[54] E. M. Ohman, N. S. Kleiman, G. Gacioch et al., "Combined accelerated tissue-plasminogen activator and platelet glycoprotein IIb/IIIa integrin receptor blockade with integrilin in acute myocardial infarction: results of a randomized, placebocontrolled, dose- ranging trial," *Circulation*, vol. 95, no. 4, pp. 846–854, 1997.

[55] G. Torgano, B. Zecca, V. Monzani et al., "Effect of intravenous tirofiban and aspirin in reducing short-term and long-term neurologic deficit in patients with ischemic stroke: a doubleblind randomized trial," *Cerebrovascular Diseases*, vol. 29, no. 3, pp. 275–281, 2010.

[56] I.K. Jang, D. F. M. Brown, R. P. Giugliano et al., "A multicenter, randomized study of argatroban versus heparin as adjunct to tissue plasminogen activator (TPA) in acute myocardial infarction: myocardial infarction with novastan and TPA (MINT) study," *Journal of the American College of Cardiology*, vol. 33, no. 7, pp. 1879–1885, 1999.

[57] H. Kawai, K. Umemura, and M. Nakashima, "Effect of argatroban on microthrombi formation and brain damage in the rat middle cerebral artery thrombosis model," *Japanese Journal of Pharmacology*, vol. 69, no. 2, pp. 143–148, 1995.

[58] D. C. Morris, L. Zhang, Z. G. Zhang et al., "Extension of the therapeutic window for recombinant tissue plasminogen activator with argatroban in a rat model of embolic stroke," *Stroke*, vol. 32,

no. 11, pp. 2635–2640, 2001.

[59] R.M. Sugg, J. K. Pary, K.Uchino et al., “Argatroban tPA stroke study: study design and results in the first treated cohort,” *Archives of Neurology*, vol. 63, no. 8, pp. 1057–1062, 2006.

[60] A. D. Barreto, “Randomized controlled trial of argatroban with tPA for acute stroke (ARTSS-2),” in *ClinicalTrials.gov*, National Library of Medicine (US), Bethesda, Md, USA, 2011, <https://clinicaltrials.gov/show/NCT01464788>.

[61] G. J. del Zoppo, K. Poeck, M. S. Pessin et al., “Recombinant tissue plasminogen activator in acute thrombotic and embolic stroke,” *Annals of Neurology*, vol. 32, no. 1, pp. 78–86, 1992.

[62] M. Saqqur, K. Uchino, A. M. Demchuk et al., “Site of arterial occlusion identified by transcranial Doppler predicts the response to intravenous thrombolysis for stroke,” *Stroke*, vol. 38, no. 3, pp. 948–954, 2007.

[63] C. A.Molina, J. Montaner, J. F. Arenillas, M. Ribo, M. Rubiera, and J.Alvarez-Sab´ın, “Differential pattern of tissue plasminogen activator-induced proximal middle cerebral artery recanalization among stroke subtypes,” *Stroke*, vol. 35, no. 2, pp. 486–490, 2004.

[64] C. H. Riedel, P. Zimmermann, U. Jensen-Kondering, R. Stingele, G. Deuschl, and O. Jansen, “The importance of size: successful recanalization by intravenous thrombolysis in acute anterior stroke depends on thrombus length,” *Stroke*, vol. 42, no. 6, pp. 1775–1777, 2011.

[65] M. Rubiera, J. Alvarez-Sabín, M. Ribo et al., “Predictors of early arterial reocclusion after tissue plasminogen activator-induced recanalization in acute ischemic stroke,” *Stroke*, vol. 36, no. 7, pp. 1452–1456, 2005.

[66] H. Ma, M. W. Parsons, S. Christensen et al., “A multicentre, randomized, double-blinded, placebo-controlled Phase III study to investigate EXtending the time for Thrombolysis in Emergency Neurological Deficits (EXTEND),” *International Journal of Stroke*, vol. 7, no. 1, pp. 74–80, 2012.

[67] G. Thomalla, “Efficacy and safety of MRI-based thrombolysis in wake-up stroke (WAKE-UP),” in *ClinicalTrials.gov* [Internet], National Library of Medicine (US), Bethesda, Md, USA, 2014, NLM Identifier: NCT01525290, <http://clinicaltrials.gov/show/NCT01525290>.

[68] J. A. Álvarez-Fernández, “Ultrasound-enhanced systemic thrombolysis. An effective and underutilized treatment for acute ischemic stroke,” *Medicina Intensiva*, vol. 35, no. 2, pp. 134–135, 2011.

[69] M. Daffertshofer, A. Gass, P. Ringleb et al., “Transcranial low-frequency ultrasound-mediated thrombolysis in brain ischemia: Increased risk of hemorrhage with combined ultrasound and tissue plasminogen activator: results of a phase II clinical trial,” *Stroke*, vol. 36, no. 7, pp. 1441–1446, 2005.

[70] “Cerevast. Phase 3, randomized, placebo-controlled, doubleblinded trial of the combined lysis of thrombus with ultrasound and systemic tissue plasminogen activator (tPA) for emergentrevascularization in acute ischemic stroke (CLOTBUSTER),” in *ClinicalTrials.gov*, National Library of Medicine (US), Bethesda, Md, USA, 2014, <http://clinicaltrials.gov/show/NCT01098981>.

- [71] Smith WS, Sung G, Saver J, et al. Mechanical thrombectomy for acute ischemic stroke: final results of the Multi MERCI trial. *Stroke* 2008;39:1205-12.
- [72] Penumbra Pivotal Stroke Trial Investigators. The Penumbra Pivotal Stroke trial: safety and effectiveness of a new generation of mechanical devices for clot removal in intracranial large vessel occlusive disease. *Stroke* 2009;40:2761-8.
- [73] Noguera R, Lutsep H, Gupta R, Trevo versus Merci retrievers for thrombectomy revascularisation of large vessel occlusions in acute ischaemic stroke (TREVO 2): a randomised trial. *The Lancet* 2012 doi.org/10.1016/S0140-6736(12)61299-9
- [74] Saver J, Jahan R, Levy L, Solitaire flow restoration device versus the Merci Retriever in patients with acute ischaemic stroke (SWIFT): a randomised, parallel-group, non-inferiority trial. *The Lancet* 2012 doi.org/10.1016/S0140-6736(12)61384-1
- [75] Linfante I, Walker JR, Castonguay AC, Predictors of Mortality in Acute Ischemic Stroke Intervention: Analysis of the North American Solitaire Acute Stroke Registry *Stroke*. 2015 Aug;46(8):2305-8. doi: 10.1161/STROKEAHA.115.009530. Epub 2015 Jul 9
- [76] Broderick J, Palesch Y, Demchuk A, et al. Endovascular therapy after intravenous t-PA versus t-PA alone for Stroke. *N Engl J Med* 2013;368:893-903
- [77] Ciccone A, Valvassori L, Nichelatti M, et al. Endovascular treatment for acute ischemic stroke *N Engl J Med* 2013;368:904-13.
- [78] Kidwell C, Jahan R, Gornbein J, et al. A trial of imaging selection and endovascular treatment for ischemic stroke. *N Engl J Med* 2013; 368:914-23

- [79] Nourollahazdeh E, Kass-Hout O, Mokin M Correlation between recanalization rate and good clinical outcome in acute ischemic stroke, a meta-analysis J NeuroIntervent Surg 2012;4:A44
doi:10.1136/neurintsurg-2012-010455b.46
- [80] Rha JH, Saver JL The impact of recanalization on ischemic stroke outcome: a meta-analysis Stroke. 2007 Mar;38(3):967-73
- [81] Mazighi M, Serfaty JM, Labreuche J, et al. Comparison of intravenous alteplase with a combined intravenous –endovascular approach in patients with stroke and confirmed arterial occlusion (RECANALISE study): a prospective cohort study. Lancet Neurol 2009;8: 802-9.
- [82] The IMS II Trial Investigators. The Interventional Management of Stroke (IMS) II study. Stroke 2007;38:2127-35.
- [83] Broderick J, Palech Y, Demchuk A, Endovascular Therapy after Intravenous t-PA versus t-PA Alone for Stroke. N Engl J Med 2013; 368:893-903
- [84] Berkhemer OA, Fransen PSS, Beumer D, et al. A randomized trial of intraarterial treatment for acute ischemic stroke. N Engl J Med 2015; 372:11-20 - DOI: 10.1056/NEJMoa1411587.
- [85] Goyal M, Demchuk AM, Menon M, et al. Randomized assessment of rapid endovascular treatment of ischemic stroke. N Engl J Med 2015; 372:1019-1030. DOI: 10.1056/NEJMoa1414905
- [86] Campbell BCV, Mitchell TJ, Kleinig HM, et al. Endovascular therapy for ischemic stroke with perfusion imaging selection. N Engl J Med 2015; 372: 1009-1018. DOI: 10.1056/NEJMoa1414792
- [87] Saver JL, Goyal M, Bonafé A, et al. Stent retriever thrombectomy after intravenous t-PA vs. t-PA alone in stroke. N Engl J Med 2015. DOI: 10.1056/NEJMoa1415061

[88] Krische K O, Miloslavski E, Fischer S, et al. A comparison of functional and physical properties of self-expanding intracranial stents (Neuroform 3, Wingspan, Solitaire, Leo+, Enterprise). *Minim Invas Neurosurg* 2011; 54:21-28

[89] Machi P, Jourdan F, Ambard D, Experimental evaluation of stent retrievers' mechanical properties and effectiveness. *J NeuroIntervent Surg* 2016;0:1-7.

[90] Ranc H, Servais C., Chauvy P-F, Debaud S, Mischler S, et al. Effect of surface structure on frictional behaviour of a tongue/palate tribological system: *Tribology International* 39 (2006) 1518-1526

[91] Boeckh-Behrenc T, Schubert M, Forschler A, et al. The impact of histological Clot Composition In Embolic Stroke. *Clin Neuroradiol* 2014. DOI 10.1007/s00062-014-0347-x

[92] Turk AS, Frei D, Fiorella D, et al. ADAPT FAST Study: a direct aspiration first pass technique for acute stroke thrombectomy. *J Neurointerv Surg* 2104; 6: 260-264

[93] Katori N, Tanaka KA, Szlam F, et al. The effect of platelet count on clot retraction and tissue-plasminogen activator-induced fibrinolysis on thrombelastography. *Anesth Analg.* 2005; 100: 1781-1785

[94] Ogata J, Yutani C, Otsubo R, et al. Heart and vessel pathology underlying brain infarction in 142 stroke patients. *Ann Neurol* 2008; 63: 770-781

[95] Wenger KJ, Berkefeld J, Wagner M, et al. Flat panel detector computed tomography for the interaction between contrast-enhanced thrombi and stent retrievers in stroke therapy: a pilot study. *Clin Neuroradiol.* 2014; 24:251-254

[96] Wenger KJ, Nagle F, Wagner M, et al. Improvement of stent retriever design and efficacy of mechanical thrombectomy in a flow model. *Cardiovasc Intervent Radiol* 2013; 36:192-197

[97] Madjidyar J, Hermes J, Freitag-Wolf S, et al. Stent-thrombus interaction and the influence of the aspiration on mechanical thrombectomy: evaluation of different stent retrievers in a circulation model *Neuroradiology* DOI 10.1007/s00234-015-1526-4

[98] Mordasini P, Brekenfeld C, Byrne J, et al. Experimental evaluation of immediate recanalization effect and recanalization efficacy of a new thrombus retriever for acute stroke treatment in vivo. *AJNR A J Neuroradiol* 2013; 34:153-58

Résumé

L'AVC est la première cause de handicap acquis de l'adulte et la deuxième cause de mort

La fibrinolyse intraveineuse (rt-PA) a été, depuis 1990, le traitement de référence pour l'AVC ischémique aigu. Néanmoins, une limitation principale d'un tel traitement est la faible efficacité.

Afin d'améliorer l'efficacité du traitement de l'AVC la thrombectomie mécanique a été proposée.

La thrombectomie mécanique permet une recanalisation plus fréquente et rapide de l'artère occluse, ce qui est en corrélation avec de meilleurs résultats cliniques.

Les stents retriever sont reconnus comme des dispositifs plus efficaces pour la thrombectomie. Les stents retriever sont déployés sur le thrombus. Ses filaments fournissent la force pour la pénétration et l'engagement du caillot qui peut être récupéré avec le stent. L'efficacité du retrait du caillot est le résultat de l'interaction entre le dispositif et le thrombus.

Dans notre étude, nous avons évalué expérimentalement les propriétés mécaniques, le comportement au cours du retrait et l'interaction avec différents types de thrombus pour tous les stents retriever disponibles en France jusqu'à juin 2015. Le but de cette étude était d'identifier toutes les caractéristiques du dispositif qui étaient fonctionnelles à la capture du thrombus.

Abstract

Stroke is the second most leading cause of death and the first most frequent cause of burden of disease worldwide.

Intra-venous fibrinolysis (rt-PA) has been since 1990 the therapy of reference for acute ischemic stroke, nevertheless such treatment offers a low rate of efficacy.

In order to improve efficacy of stroke treatment, the endovascular thrombectomy has been proposed. Such approach allows more frequent and rapid recanalization of the occluded artery and is associated with better clinical outcomes .

Stent retrievers are recognized as the most effective devices for endovascular thrombectomy. Such device are deployed across the thrombus. Expansion forces of the stent provide penetration and engagement of the clot that can be retrieved together with the stent.

The efficacy of clot retrieval is the result of the interaction between the device and the clot. In the present study we experimentally evaluated mechanical properties, behavior during retrieval and interaction with thrombi of different features of all stent retrievers available in France up to June 2015. The aim of this study was to identify any device feature that was functional to the thrombus removal.