



HAL
open science

Development of optimal energy management in Galapagos Islands towards Smart Grid

Diego Morales Jadan

► **To cite this version:**

Diego Morales Jadan. Development of optimal energy management in Galapagos Islands towards Smart Grid. Electric power. Université Grenoble Alpes, 2017. English. NNT : 2017GREAT106 . tel-01813158

HAL Id: tel-01813158

<https://theses.hal.science/tel-01813158v1>

Submitted on 12 Jun 2018

HAL is a multi-disciplinary open access archive for the deposit and dissemination of scientific research documents, whether they are published or not. The documents may come from teaching and research institutions in France or abroad, or from public or private research centers.

L'archive ouverte pluridisciplinaire **HAL**, est destinée au dépôt et à la diffusion de documents scientifiques de niveau recherche, publiés ou non, émanant des établissements d'enseignement et de recherche français ou étrangers, des laboratoires publics ou privés.

THÈSE

Pour obtenir le grade de

DOCTEUR DE LA

COMMUNAUTÉ UNIVERSITÉ GRENOBLE ALPES

Spécialité : **GENIE ELECTRIQUE**

Arrêté ministériel : 25 mai 2016

Présentée par

Diego Xavier MORALES JADAN

Thèse dirigée par **Yvon Bésanger**

préparée au sein du **Laboratoire de Génie Electrique -G2ELab**
dans l'**École Doctorale Electronique, Electrotechnique,**
Automatique, Traitement du Signal (EEATS)

Développement de la gestion optimale de l'énergie électrique dans les îles Galápagos vers les Réseaux Intelligents

Development of optimal energy management in Galapagos Islands towards Smart Grid

Thèse soutenue publiquement le **18 décembre 2017**
devant le jury composé de :

M. Xavier GUILLAUD

Président du jury, Professeur Adjoint, Université de Lille, Rapporteur

M. Mircea EREMIA

Rapporteur, Professeur, Université Polytechnique de Bucarest

M. Marc PETIT

Examineur, Professeur, CentraleSupélec

M. Yvon BESANGER

Directeur de thèse, Professeur, Institut Polytechnique de Grenoble

M. Ricardo MEDINA

Ingénieur de Recherche, Smart Grid Group, Catholic University of Cuenca



“Insanity: doing the same thing over and over again and expecting different results.”

-Albert Einstein

ACKNOWLEDGEMENTS

First of all, I want to thank God, who gave me all the things needed to achieve this success. He gifts me health, love and a beautiful family. After that, I would like to express all my love to my wife Angela, who is my best friend, lover and soul mate. “Osita” all your patient and support were the key factors behind it goal. Sebis during these three years you were my inspiration for never to give up, I really sorry all the time that I could not spend with you, I promise you, it will be rewarded. *“Le pido a Dios que me alcance la vida y me dé tiempo para regresar aunque sea tan solo un poco de lo mucho que me dan.”*

Yvon thanks a million for your tremendous help in every detail, in each review; your comments always are used to improve any research. Your effort to review my thesis it is appreciated, your understanding of the different issues during this thesis was incredible. You are an excellent example of the French people; practices, with clear objectives and an extraordinary gift of people. Without you, this dream would never have been possible. Aurélien, I would like to say thanks a million for all your help during the master and the Ph.D., I considered you an excellent friend and professional. Also, big thanks to you Cedric for your enormous effort to deploy the Simulator in the virtual machine, you are an excellent professional. Kevin and Karla thanks a million for all your support.

During all my life, I received the unconditional support of my family, especially of my Mother “Maria,” thanks mom for absolutely everything. Thanks, Dad, Tania, Diana, Edu, and Jimmy, you are the best family ever. I will be ungrateful if I do not tell you thanks, Ms. Blanquita and Mr. Bolivar.

I want to express my sincere thanks to the Eng. Patricio Erazo for being a continuous support during this dream; I hope someday to reach your level and have your professional vision. Thanks, group “SIGDE” for your support. Also a big thanks to ELECGALAPAGOS for the information provided.

How to forget the research group “Smart Power Grid” founded in the UPS with Ricardo (diablo robot) and Marco, and now strengthened with Javier and Santiago in the UCACUE. Thanks to everyone for your tremendous support and your friendship.

Finalement, “Merci Beaucoup, George le pance” pour tout, c’est la vie.

Table of Contents

Chapter 1: General Introduction: Needs and Challenges for Smart Grid in Galapagos Islands..... - 8 -

| | | |
|-------|--|--------|
| 1.1. | Introduction | - 9 - |
| 1.1.1 | EcoSmart Project..... | - 10 - |
| 1.1.2 | SIGDE Project..... | - 12 - |
| 1.2. | Thesis Challenges | - 13 - |
| 1.3. | Thesis justification and objectives..... | - 14 - |
| 1.4. | Scope | - 15 - |
| 1.5. | Chapters introduction | - 15 - |

Chapter 2: Traditional Network vs Smart Grids: State of the Art - 1 -

| | | |
|-------|--|--------|
| 2.1 | Generation, Transmission, Distribution and End User..... | - 2 - |
| 2.1.1 | Generation..... | - 3 - |
| 2.1.2 | Distribution | - 6 - |
| 2.1.3 | End-user | - 8 - |
| 2.2 | Regulations | - 10 - |
| 2.2.1 | Colombia..... | - 10 - |
| 2.2.2 | Spain | - 10 - |
| 2.2.3 | United States | - 11 - |
| 2.2.4 | United Kingdom..... | - 14 - |
| 2.2.5 | France..... | - 16 - |
| 2.2.6 | Comparative Analysis | - 18 - |
| 2.3 | DG Connection..... | - 20 - |
| 2.4 | Smart Grids..... | - 23 - |
| 2.4.1 | Smart Grids Components | - 24 - |
| 2.4.2 | Innovations around the world..... | - 27 - |
| 2.4.3 | Smart Grids in Ecuador..... | - 30 - |
| 2.5 | Conclusion..... | - 32 - |

Chapter 3: Impact Assessment of New Services in the Galapagos Low Voltage Network - 33 -

| | | |
|-------|---|--------|
| 3.1 | Modeling..... | - 34 - |
| 3.1.1 | Transformers | - 34 - |
| 3.1.2 | Load..... | - 36 - |
| 3.1.3 | Unconventional electrical elements..... | - 36 - |
| 3.2 | Interface GIS-MATLAB | - 37 - |

| | | |
|-----|--|--------|
| 3.3 | Active and Reactive scenario -PQ..... | - 40 - |
| 3.4 | Induction Cooker (IC) scenario –PQ+IC..... | - 43 - |
| 3.5 | Electric Motorbike scenario –PQ+IC+EM..... | - 45 - |
| 3.6 | Photovoltaic scenario -PQ+IC+EM+G+PV | - 48 - |
| 3.7 | Conclusion..... | - 51 - |

Chapter 4 Advanced Distribution Automation –ADA- functions in the Medium and Low voltage network from Galapagos - 52 -

| | | |
|------|--|--------|
| 4.1 | Low Voltage – Simulink | - 53 - |
| | 4.1.1 Smart Demand Side Management..... | - 53 - |
| | 4.1.2 Battery Energy Storage System -BESS..... | - 67 - |
| | 4.1.3 Automatic Phase Switching System..... | - 80 - |
| 4.2. | Medium Voltage – CYMDIST | - 87 - |
| | 4.2.1 Reclosers deployment for improving reliability | - 87 - |
| | 4.2.2 Network reconfiguration | - 95 - |
| | 4.2.3 Volt/Var Optimization -VVO..... | - 97 - |
| 4.3. | Conclusion..... | - 98 - |

Chapter 5 Analysis of medium and low voltage networks on a large scale - 100 -

| | | |
|-----|---|---------|
| 5.1 | Strong Integration of DGs | - 102 - |
| 5.2 | Upgraded management of energy in Galapagos..... | - 111 - |
| 5.3 | Galapagos such as a Smart Island..... | - 115 - |
| 5.4 | Conclusion..... | - 119 - |

Chapter 6 Communications Architecture for a Smart Grid in Galapagos - 120 -

| | | |
|------|---|---------|
| 6.1. | Introduction | - 121 - |
| | 6.1.1 Current Situation in Ecuador..... | - 121 - |
| 6.2 | ADMS | - 124 - |
| 6.3 | AMI | - 128 - |
| | 6.3.1 Power Line Communication | - 130 - |
| | 6.3.2 Radio Frequency- Mesh..... | - 132 - |
| | 6.3.3 FAN/NAN architecture proposal | - 133 - |
| | 6.3.4 HAN..... | - 135 - |
| 6.4 | Conclusion..... | - 140 - |

Chapter 7 Conclusions and PerspectivesAnalysis - 141 -

Scientific publications - 146 -

| | |
|--|----------------|
| Scientific Papers..... | - 146 - |
| Book Chapter | - 147 - |
| Annexes | - 148 - |
| Annex 1: Library Created with blocks for LV loads..... | - 148 - |
| Annex 2: LV network within Simulink..... | - 148 - |
| Annex 3: List of overloaded transformers at Future Scenario | - 149 - |
| Annex 4: List of overloaded transformers at Future Scenario with DG at 100%..... | - 151 - |
| Bibliography | - 154 - |
| ABSTRACT | - 164 - |
| RÉSUMÉ..... | - 165 - |
| Résumé français..... | - 166 - |

List of Figures

| | |
|---|--------|
| Fig. 1.1 Satellite View [2] | - 9 - |
| Fig. 1.2. EcoSmart axes..... | - 11 - |
| Fig. 1.3. Functional axes considered within the SIGDE project | - 13 - |
| Fig. 2.1. (a) Shows the traditional vertically integrated utility (b) Shows a fully unbundled utility where each function (except the local distribution company) is subject to competition.[7] | - 2 - |
| Fig. 2.2. Interconnection between Baltra and Santa Cruz | - 3 - |
| Fig. 2.3. Santa Cruz and Baltra Islands | - 4 - |
| Fig. 2.4. Solar resource (measurements 2007 - 2009)..... | - 5 - |
| Fig. 2.5. a) Maximum daily profile (March) and b) Minimum daily profile (July) | - 5 - |
| Fig. 2.6. a) Wind speed in Baltra, measurements in 2012..... | - 5 - |
| Fig. 2.7. a) Minimum daily profile (February) and b) Maximum daily profile (July) in kW. | - 6 - |
| Fig. 2.8. PV plant and batteries coupled with the wind power plant at Baltra, [11]..... | - 6 - |
| Fig. 2.9. Feeders spatial Distribution..... | - 8 - |
| Fig. 2.10. Consumer Composition..... | - 8 - |
| Fig. 2.11. Clients Spatial Distribution. | - 9 - |
| Fig. 2.12. ISO/RTO in the United States, [20]. | - 12 - |
| Fig. 2.13. Markets in the United States,[17]..... | - 12 - |
| Fig. 2.14. DSM integration in all the markets in France, based on [42]. | - 17 - |
| Fig. 2.15. Organization chart of the Ecuadorian electric sector, [43]..... | - 18 - |
| Fig. 2.16. New Conceptual model with generation at any level.[48]..... | - 21 - |
| Fig. 2.17. DGs number in Ecuador..... | - 22 - |
| Fig. 2.18. DG composition – Total=116 units..... | - 23 - |
| Fig. 2.19. Installed capacity by an energy source. Total=365MW..... | - 23 - |
| Fig. 2.20. Top-6 Ranked Motivating Drivers [51] | - 24 - |
| Fig. 2.21. Example of a communication structure of an Automated Substation [56] | - 26 - |
| Fig. 2.22. Distribution domain, where it is possible to identify DA,[48]..... | - 27 - |
| Fig. 2.23. ANM as a new layer in distribution grid management. | - 28 - |
| Fig. 2.24. IDE4L automation solution [63] | - 29 - |
| Fig. 2.25. CLASS: five steps involved in the voltage-led load management scheme [64] | - 29 - |
| Fig. 2.26. Microgrid diagram [65]..... | - 30 - |
| Fig. 2.27. Top-10 Ranked motivating drivers in Ecuador,[66] | - 31 - |
| Fig. 3.1. Equivalent circuit for centre tapped transformer..... | - 35 - |
| Fig. 3.2. a) Equivalent circuit based on the secondary side, b) Simulink block, c) CYMDIST block [72] | - 35 - |
| Fig. 3.3. Model of the Line, [73] [74] | - 36 - |
| Fig. 3.4. Load modeled into Simulink and CYMDIST [76] | - 36 - |
| Fig. 3.5. Interface between ArcMap and Matlab/Simulink | - 37 - |
| Fig. 3.6. Connectivity diagram created into GIS | - 38 - |
| Fig. 3.7. Consumers classified by rated power of MV/LV transformers | - 38 - |
| Fig. 3.8. Frequency distribution of connected clients at 50 kVA transformers..... | - 39 - |

| | |
|---|--------|
| Fig. 3.9. LV Network modeled into Simulink..... | - 40 - |
| Fig. 3.10. P curves database with 40 curves..... | - 41 - |
| Fig. 3.11. Q curves database with 40 curves..... | - 41 - |
| Fig. 3.12. Blocks created automatically for feeding loads..... | - 42 - |
| Fig. 3.13. Scenario PQ..... | - 42 - |
| Fig. 3.14. Induction Cooker profiles..... | - 43 - |
| Fig. 3.15. Blocks created automatically considering active and reactive curves for IC..... | - 44 - |
| Fig. 3.16. Scenario PQ+IC..... | - 44 - |
| Fig. 3.17. Vehicle types within Santa Cruz..... | - 45 - |
| Fig. 3.18. Average Profile for Electric Motorbike..... | - 47 - |
| Fig. 3.19. Scenario PQ+IC+EM..... | - 47 - |
| Fig. 3.20. Simulink Model considering all the new services..... | - 48 - |
| Fig. 3.21. PV profiles..... | - 49 - |
| Fig. 3.22. Scenario PQ+IC+EM+G+PV..... | - 50 - |
| Fig. 3.23. Comparative Analysis..... | - 50 - |
| Fig. 4.1. DSM Categories [100]..... | - 55 - |
| Fig. 4.2. DSM Categories with and w/o rebound [100], Energy Efficiency in green..... | - 56 - |
| Fig. 4.3. DR using Appliance controller device [108]..... | - 56 - |
| Fig. 4.4. Weighting function for performing TOU considering the guidelines given by ARCONEL- | 58 |
| - | |
| Fig. 4.5. Comparative curves of residential profile vs. residential profile with TOU..... | - 58 - |
| Fig. 4.6. Results after applying DSM using ARCONEL curve..... | - 59 - |
| Fig. 4.7. Method for getting the power delivered to the end users..... | - 59 - |
| Fig. 4.8. TOU defined by real measurements.[116]..... | - 60 - |
| Fig. 4.9. Weighting function for performing TOU considering the guidelines given by the study conducted to deploy Smart Grids in Ecuador -UPV-..... | - 61 - |
| Fig. 4.10. Comparative curves of residential profile vs. residential profile with TOU defined by regions..... | - 61 - |
| Fig. 4.11. Results after applying DSM using UPV curve..... | - 62 - |
| Fig. 4.12. Smart function for performing DSM..... | - 63 - |
| Fig. 4.13. Comparative curves of residential profile vs. residential profile with smart function..... | - 63 - |
| Fig. 4.14. Flowchart of the DSM programs executed..... | - 64 - |
| Fig. 4.15. Results after applying intelligent DSM..... | - 65 - |
| Fig. 4.16. Comparative Analysis: Power at Transformer..... | - 66 - |
| Fig. 4.17. Comparative Analysis: Voltage at secondary phase L1-to-neutral..... | - 66 - |
| Fig. 4.18. System in study..... | - 71 - |
| Fig. 4.19 TOU scheme..... | - 73 - |
| Fig. 4.20 Load in each phase in the presence of PV generation..... | - 73 - |
| Fig. 4.21 Total Cost for different batteries' sizes..... | - 76 - |
| Fig. 4.22 Total Cost for different batteries' sizes considering different TOU for batteries..... | - 76 - |
| Fig. 4.23 Simulink Model based in [135]..... | - 77 - |
| Fig. 4.24 Total Load (Phase1 + Phase 2)..... | - 78 - |

| | |
|---|---------|
| Fig. 4.25 Power at transformer (Phase1 + Phase 2) | - 78 - |
| Fig. 4.26 Power Battery connected at 240V, Exchanged battery energy | - 79 - |
| Fig. 4.27 SOC, one cycle per day | - 79 - |
| Fig. 4.28 Whole system behavior | - 79 - |
| Fig. 4.29. CAP System [41] | - 81 - |
| Fig. 4.30. Tailored CAP system for Galapagos | - 81 - |
| Fig. 4.31. Topology for testing CAP System | - 82 - |
| Fig. 4.32. Voltage profiles before installing CAP system | - 83 - |
| Fig. 4.33. Closest Node | - 84 - |
| Fig. 4.34. Middle Node | - 85 - |
| Fig. 4.35. Lowest voltages during the switching | - 86 - |
| Fig. 4.36. Farthest Node | - 86 - |
| Fig. 4.37. Calibration Flow Chart | - 91 - |
| Fig. 4.38. Base Scenario in Feeder 1 | - 93 - |
| Fig. 4.39. Scenario with reclosers in Feeder 1 | - 94 - |
| Fig. 4.40. Initial Topology: Feeder 1 and 2 | - 95 - |
| Fig. 4.41. Final Topology after reconfiguration: Feeder 1 and 2 | - 96 - |
| Fig. 4.42. Voltage Profile | - 98 - |
| Fig. 5.1. CYMDIST Model | - 101 - |
| Fig. 5.2. Load Profiles in the feeder Header | - 102 - |
| Fig. 5.3. Examples of $CPro_i$ for different clients. | - 103 - |
| Fig. 5.4. Methodology applied on a large scale | - 104 - |
| Fig. 5.5. Average Profile of ICs | - 104 - |
| Fig. 5.6. Profile for Street Lighting | - 106 - |
| Fig. 5.7. Examples of $NrCPro_i$ and $NcCPro_i$ | - 107 - |
| Fig. 5.8. The base scenario 9 years later (with IC and EM and without DSM and DG) | - 108 - |
| Fig. 5.9. Analysis of Under Voltages in Santa Cruz | - 109 - |
| Fig. 5.10. The scenario at 9 years with TOU and DG | - 110 - |
| Fig. 5.11. Analysis of under voltages in Santa Cruz in the presence of DSM and DG | - 110 - |
| Fig. 5.12. EMS architecture proposal for Galapagos. | - 111 - |
| Fig. 5.13. Scenario at 9 years (DG at 100% and 3 weighting functions) | - 112 - |
| Fig. 5.14. Loadability Map | - 113 - |
| Fig. 5.15. Feeders 1, 2 with transformers overloaded in yellow. | - 113 - |
| Fig. 5.16. Energy Management on a large scale | - 114 - |
| Fig. 6.1. WAN for supporting the Smart Grid in Ecuador | - 122 - |
| Fig. 6.2. Interoperability scheme in Ecuador | - 123 - |
| Fig. 6.3. Global Architecture for ADMS based on [174] | - 124 - |
| Fig. 6.4. Substation architecture | - 126 - |
| Fig. 6.5. Wireless Network for Galapagos | - 127 - |
| Fig. 6.6. Proposed architecture communications for ADMS in Galapagos | - 128 - |
| Fig. 6.7. Proposed AMI architecture based on [185, 186] | - 129 - |
| Fig. 6.8. Model of a PLC diagram system | - 130 - |

Fig. 6.9. Smart meter communications through different mediums..... - 132 -
 Fig. 6.10. Wireless Meshed Network Architecture, [196]..... - 133 -
 Fig. 6.11. FAN/NAN architecture proposal - 134 -
 Fig. 6.12. SEP 2.0 layers - 136 -
 Fig. 6.13. OpenADR nodes,[203]..... - 137 -
 Fig. 6.14. OpenADR architectures - 138 -
 Fig. 6.15. Communication architecture proposal for HAN considering DSM..... - 140 -

List of Tables

TABLE I GENERATION THERMAL UNITS..... - 4 -
 TABLE II FEEDERS - 7 -
 TABLE III DEMAND IN 2016..... - 9 -
 TABLE IV MARKETS - 19 -
 TABLE V DEMAND SIDE MANAGEMENT - 20 -
 TABLE VI DECALOGUE FOR SMART GRID DEVELOPMENT - 31 -
 TABLE VII DESCRIPTION OF THE SELECTED LV NETWORK..... - 39 -
 TABLE VIII RECHARGE TYPES - 46 -
 TABLE IX DAILY CHARGERS..... - 46 -
 TABLE X TARIFF FOR EV - 57 -
 TABLE XI BATTERY SIZE TESTED - 74 -
 TABLE XII COST DETERMINATION FOR LOADS WITH PV - 75 -
 TABLE XIII BATTERY CHARGING PERIODS..... - 75 -
 TABLE XIV BATTERY DISCHARGING PERIODS - 75 -
 TABLE XV FMIK-TTIK - 88 -
 TABLE XVI TARGET VALUES..... - 90 -
 TABLE XVII RATES FOR SCZ01 FEEDER - 92 -
 TABLE XVIII RELIABILITY SCZ01 FEEDER - 93 -
 TABLE XIX RELIABILITY SCZ01 FEEDER..... - 94 -
 TABLE XX FINAL RELIABILITY ON SCZ01 FEEDER..... - 95 -
 TABLE XXI INITIAL AND FINAL CASES - 97 -
 TABLE XXII VALUES FOR ASSESSING INTEGRATION OF NEW SERVICES..... - 107 -
 TABLE XXIII STAKEHOLDERS: LEADING ACTORS - 118 -
 TABLE XXIV STAKEHOLDERS: STRATEGIC ACTORS..... - 118 -

Chapter 1:

General Introduction: Needs and Challenges for Smart Grid in Galapagos Islands

1.1. Introduction

The Galápagos Islands are an archipelago of volcanic islands located in the Pacific Ocean, 926 km west of continental Ecuador, of which they are a part. The Galápagos Islands together with their surrounding waters form an Ecuadorian province, a national park, and a biological marine reserve. The official language on the islands is Spanish, although the English each time is more common due to tourists coming from the entire world. The islands are famous for their vast number of endemic species and because the scientist Charles Darwin studied them. His observations and collections contributed to the inception of Darwin's theory of evolution by natural selection. Since 1978, Galapagos Islands are accepted as Heritage World [1], and in 1998, the Organic Law of Special Regime for the Conservation and Sustainable Development of the Province of Galápagos has been approved. Since this date, the Galapagos Marine Reserve of 138,000 km² is established.



Fig. 1.1 Satellite View [2]

Due to the growth of the population, there are several social, economic and environmental problems, which endanger the environment conservation of the Islands. According to the census made on 2010 by the “Instituto Nacional de Estadística y Censo” –INEC-, on the Galapagos province, there are 25.224 people [3], of which 15.393 live at Santa Cruz Island, 7.475 at San Cristobal Island, 2.256 at Isabela Island and 100 at Floreana Island.

The Ecuadorian government desires to preserve its ecological heritage. Hence, with the participation of several stakeholders such as the Ministry of Energy and Renewable Energy –MEER-, Galapagos Government Council, among others, is releasing a lot of initiatives. In order to improve the

general services that are provided in the islands either to the population or to the 180.000 people who visit Galapagos every year.

Nowadays, there are so many activities ongoing; international and national organisms perform these ones, all this to achieve the Island's sustainability and to reduce the environmental impact. One of these initiatives is the EcoSmart Project [4], managed by the Ecuadorean government, which is looking to improve the preservation of the Galapagos Islands and reduce the environmental footprint, becoming a world reference in optimal management of the energy and sustainability. This goal will be achieved by means of reducing fossil fuel consumption and therefore CO2 emissions, improving service quality and working together with the different utility companies, public agencies, local and national governments, and Galapagos Island's residents and visitors. Various strategies such as increasing the use of renewable energies, balancing the generation and consumption, aiming for a rational use of energy and energy efficiency, and reducing the environmental footprint on this unique treasure must be implemented.

1.1.1 EcoSmart Project

MEER released EcoSmart Project through the project "Redes Inteligentes Ecuador" – *REDIE*- in 2014, the project has three objectives:

1. The main goal of the project is to improve the preservation of the Galapagos Islands and reduced the environmental footprint, becoming a world reference in the management of the energy and sustainability.
2. Promote the social, economic and cultural progress upon respect sustainable and respectful development.
3. Finally, as derived objective, all the generated knowledge during the implementation phase will be used to extrapolate the best practices and models to the rest of provinces of Ecuador efficiently.

1.1.1.1 EcoSmart Scope

The fields of energy, mobility, water and solid waste are the main sectors in which it is suggested to work to achieve the objectives aforementioned. Within those areas described above, it is possible to identify the following axes:

1. Power generation
2. Mobility
3. Electricity network modernization
4. Efficient consumption
5. Efficiency in Public Lighting
6. Integrated water cycle management
7. Solid waste treatment
8. Governance
9. Smart Health

In the next figure, it is possible to see the relationships among all the axes and their relation with transversals axes (general support) such as Geographic Information System –GIS-, Data Centers –DC- and Enterprise Service Bus –ESB-.

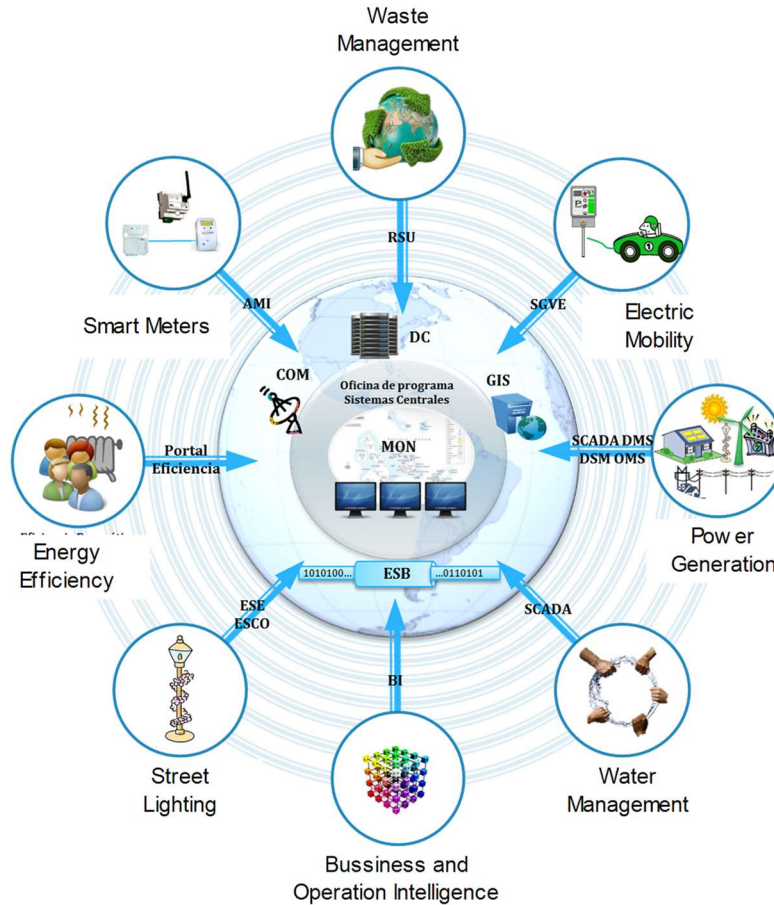

Fig. 1.2. EcoSmart axes

The Figure 1.2 illustrates the global objective of EcoSmart; foster the implementation of integrated and efficient services for social, economic development without affecting the environment, using technological enablers based on the availability and advances in information technology.

1.1.1.2 Electrical Network Modernization

Within this axis, its main objective is creating mechanisms to automate the low voltage network, to facilitate integrated management of the same, facilitating operation and maintenance tasks, and providing remote control. One of the objectives in this area of work includes installing smart meters as well as the Advanced Metering Infrastructure –AMI- system, defining power control models and establishing hourly tariffs.

The benefits originated by the installation of Smart meters are the following:

1. Improved control of consumption.
2. Increase energy efficiency, to have more information about where or how energy is consumed.
3. Improve the management of networks, introducing mechanisms to encourage energy consumption at valley moments
4. Improved reliability of supply, because it sets limits on the maximum power supplies, improving conditions for network stability.

Another important objective is deploying an Advanced Distribution Management System, to facilitate the maintenance through prevention systems and fault detection, have a better robustness, improve processes network operation, contribution rates and avoid a reduction in the service quality.

The EcoSmart project takes benefits from a national Ecuadorian project called “SIGDE”, which aim is to modernize and optimize the distribution system.

1.1.2 SIGDE Project

The electric distribution companies of Ecuador signed an agreement of institutional cooperation for the strengthening of the sector of the electrical distribution with the aim of achieving a paradigm shift toward an adequate and modern distribution service, working in a united and homogeneous way. In order to achieve this, the Integrated System for the Management of Electrical Distribution project - SIGDE- was created [5]. This project intends to improve the business management of the electricity distribution sector of the country, understanding how to improve administration in aspects of the better use of company resources, optimization of processes, technology and infrastructure, human resources and information management.

The SIGDE project was conceived and designed with a reference framework consisting of globally recognized standards such as i) IEC 61968, ii) IEC 61970, and iii) the NIST framework and roadmap for Smart Grid interoperability standards. The project is also perfectly aligned with the Constitution, the National Plan for Good Living, and with MEER strategic plan [6].

The program is based on six strategic axes, each of which is composed of a series of projects; these axes are i) Network Operation, ii) Business Management, iii) Enterprise Resources, iv) Strategic Management, v) Network Georeferencing and vi) Technology Management.



Fig. 1.3. Functional axes considered within the SIGDE project

The objective is to improve the management of Utilities, by means of standardizing and homologation of

- i) Processes,
- ii) Procedures,
- iii) Semantics,
- iv) Intelligent devices,
- v) Adoption of a common information model –CIM-,
- vi) Definition and implementation of mission critical systems,
- vii) Standardization of information and communication technology,
- viii) Establishment of unique data centers.

1.2. Thesis Challenges

Considering that, the Distributed Generation –DG- penetration increases significantly because of governments led targets and incentives. In parallel, electric vehicles are being developed, and the need for energy efficiency has resulted in the development of smart buildings. It is worth to evaluate the challenges originated on the traditional operation and planning of distribution networks, bringing the concept of Smart Grid –SG-. Thus, future network will have to be controlled through Advanced Distribution Automation –ADA- functions such as Voltage VAR Control –VVC- or grid reconfiguration (self-healing, minimization of losses), or soft load shedding.

For many years, research has been focusing on Medium Voltage network, since its instrumentation and monitoring are more economically attractive. Now, the current deployment of smart meters and the availability of the corresponding data have drawn attention to the ADA functions for Low Voltage.

Another key aspect is the study of the impact of massive insertion of Renewable Energy Sources –RES-, Electric Vehicle –EV- and induction cookers –IC- on the Galapagos grid. Indeed, in EcoSmart Project, RES, EV, and IC have been identified to replace all the fuel and gas devices with a zero fossil energy objective. Also, the inclusion of storage systems is highly suggested. These impacts could be linked to different phenomena such as short-circuits, voltage drops, protection, detection and localization of faults, an increase of losses, voltage variations, and congestions. In order to achieve that, an "exhaustive" collect of detailed data of the Galapagos power system will have to be carried out.

Another significant challenge: the optimal management of electricity of isolated grid with zero fossil energy.

1.3. Thesis justification and objectives

Taking into account that i) Galapagos Islands are a unique world treasure and ii) according to [3], Galapagos still have issues on topics such as electric service, waste management, and sewerage coverage, this thesis will deal with the electrical area. An important objective is to analyze the impact of new services on the grid such as the mandatory replacement of conventional vehicles and cookers for efficient ones, the massive deployment of renewable energies sources –RES-, and to propose solutions for reducing negative issues on the network originated by these new services.

Innovative proposals have to be implemented within Galapagos for improving the electrical service without affecting the environment and conserving this world heritage. Therefore, several analysis and studies have to be performed in Galapagos Grid, in order to carry Galapagos towards a Smart Grid. Due to the demographic characteristics and the logistic existent, the analysis will be focused on the island with the largest population, i.e., Santa Cruz (61%), although, some measures could also be implemented at San Cristobal and Isabela. Thus, the primary objectives of this thesis are:

1. Assess the impact of new services such as EV, IC, DG, Demand Side Management –DSM- into the MV and LV network.
2. Proposes a communication architecture for deploying a Smart Grid within Galapagos.
3. Test ADA functions on the distribution grid at Medium Voltage –MV- and Low Voltage –LV- level.
4. Develop an adapted solution for reducing unbalance in low voltage.
5. Define the Advanced Distribution Management System structure for Galapagos, capable of dealing with the optimal management of electricity.

In addition, this thesis is the first step towards an on-site implementation of Smart Grids in Galapagos, strongly desired by Ecuadorian Government, and thus, to reach this goal, various domains are addressed like power system, technical-economic concerns, reliability, communication and supervision systems.

1.4. Scope

For this project, the assumption is that the Galapagos MV grid is already designed. It means that the works will focus on the LV network and the most important points to study are the RES optimal location and size, the impact of massive insertion of RES, EV, and IC on the grid and the optimal energy management of electricity.

The second step will consist of modeling the actual and planned Galapagos power system in the tools which will be used (Matlab-Simulink, CYMDIST, and RT Lab). These tools are parts of a powerful real-time simulation environment, which will allow to study, develop, test and validate algorithms and scenarios. An important point to keep in mind is that the modeling will have to take care of the mandatory replacement of fuel vehicles by electric vehicles and gas cookers by induction ones. Thus, adequate models have to be taken into account.

The thesis is framed in the context of the EcoSmart and SIGDE projects describes above.

1.5. Chapters introduction

The first chapter has described concretely the research done during this Ph.D., including the thesis challenges, the objectives, scope and the two most important projects released in Ecuador in order to reach a Smart Grid deployment.

The second chapter presents the State of the Art of traditional networks regarding the main topics such as generation, transmission, and distribution. Also, several regulations are reviewed about various subjects such as markets, system operators, tariffs, and regulations. In addition, the DG deployment in Ecuador is presented. The central concepts of Smart Grids are also introduced.

The third chapter provides an interface between Geographical System and Matlab/Simulink to create LV networks automatically, the suitable way of modeling PV panels, IC, electric motorbikes and DG is addressed as well. The impact in a typical LV system is assessed.

The fourth chapter describes the analysis done at MV and LV levels to implement ADA functions. On Medium Voltage grid, we have considered Optimal Placement of Reclosers, Volt-Var Optimization and Network Reconfiguration. In low voltage network, an intelligent DSM method is proposed as well as the inclusion of storage in MV/LV transformers.

The fifth chapter deals with the whole simulation of the distribution system (MV and LV network) at 1:1 scale in order to assess a high integration of PV panels. An optimal energy management system is proposed as well as the next steps for transforming Galapagos towards a Smart Island.

The sixth chapter presents a proposal for the communication architecture needed for deploying a Smart Grid within Galapagos since AMI and SCADA systems surely will need an adequate infrastructure. The protocols SEP 2.0 and OpenADR, as a solution for Smart Grid, are considered; in addition, a proposal

for a communication architecture at different levels is presented. In a Research & Development context, this chapter addresses more the development part since it presents a new communication architecture for Galapagos based on protocols already tested commercially.

The final chapter summarizes the main conclusions of the research done during the Ph.D. and presents in a general manner the future works to implement within Galapagos.

Chapter 2:

Traditional Network vs. Smart Grids: State of the Art

In this chapter, a bibliographical review of the state of the art of traditional networks as well as Smart Grids is carried out. The purpose has a two-fold objective; on the one hand, to identify the latest advances around the world in the domain of SG and, on the other hand, to have a clear vision of the main weaknesses of Ecuadorian regulation, in order to identify barriers to the deployment of smart grids. In the same way, the key features of the Galapagos power system are presented.

2.1 Generation, Transmission, Distribution and End User

Historically, the electricity became a necessity due to the advent of broadcast radio in the 1920s. Since the radio served as a powerful tool for quickly send information to citizens, and it was, therefore, desirable to electrify as many homes as possible. A decade after, the electricity was considered as a public service, which had the exclusive right to provide electricity to customers within a concession area. In exchange for price regulation, utilities were operated such a monopoly to generate, transmit, and distribute electricity [7].

The term ‘electrical system’ is often used to define the whole chain of power supply from the generators usually located far away to consumption centers, including electrical transmission and distribution systems [8]. The two paradigms governing around the world the electrical system are:

- 1.1 The historical one based on a vertical organization where a single company owns generation, transmission, distribution, and energy services;
- 1.2 The new one, which considers the liberalization of energy markets, within a competing framework.

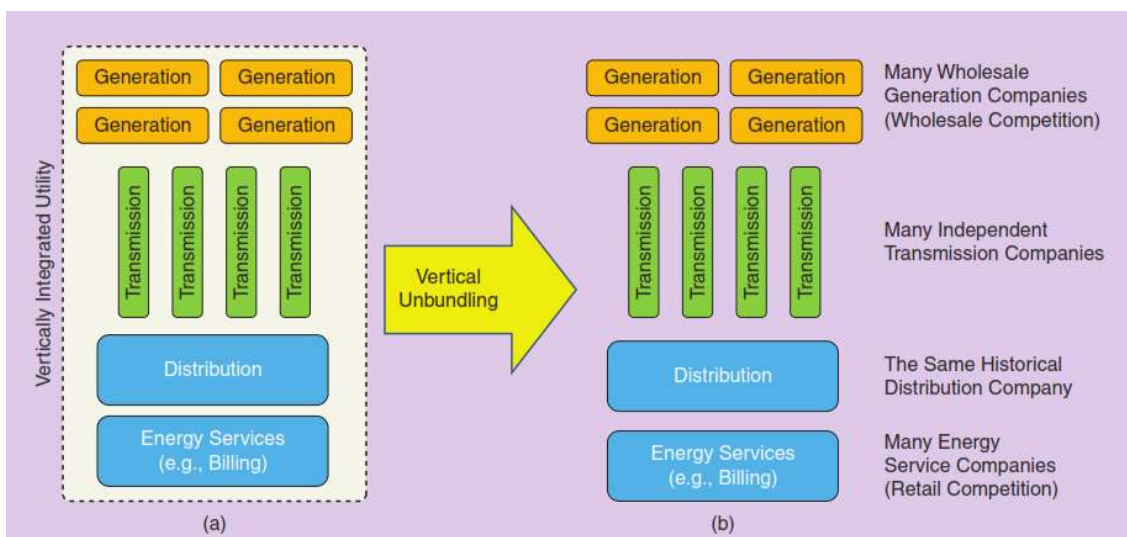

Fig. 2.1. (a) Shows the traditional vertically integrated utility (b) Shows a fully unbundled utility where each function (except the local distribution company) is subject to competition.[7]

This paradigm change, known as the liberalization of the energy markets, started in certain countries as Chile and the United Kingdom as early as 1980.

2.1.1 Generation

The first generators built were designed for operating in direct current, but quickly the impossibility of transmitting the energy in the presence of large distances led to the development of alternating current (War of currents). Indeed, the transformer allows transmitting power at high voltage levels, in consequence, to limit losses during the transmission stage, since losses are inversely proportional to the square of the voltage. Traditionally, the construction of large hydraulic and thermal power stations is made on sites in which primary energy is readily available, it means near to i) rivers, ii) coal mines, iii) refineries and so on. As it is well known, the main drawback of the electrical energy it is the difficulty of storing significant amounts of energy. Thus the mean of avoiding this insufficiency is to keep the balance between generation and consumption at any time using transmission and distribution lines. The next paragraphs in a brief way describe the current situation in Santa Cruz according to [9] and [10].

First, the next figure shows a simplified scheme of Santa Cruz power system indicating the location of generation units. The generation systems of Santa Cruz and Baltra islands are interconnected, through a 34,5 kV line, as shown in the single-line diagram of Figure 2.2. Santa Cruz Substation has an installed capacity of 8,75 MVA; the voltages are 480V/13,8 kV for distribution.

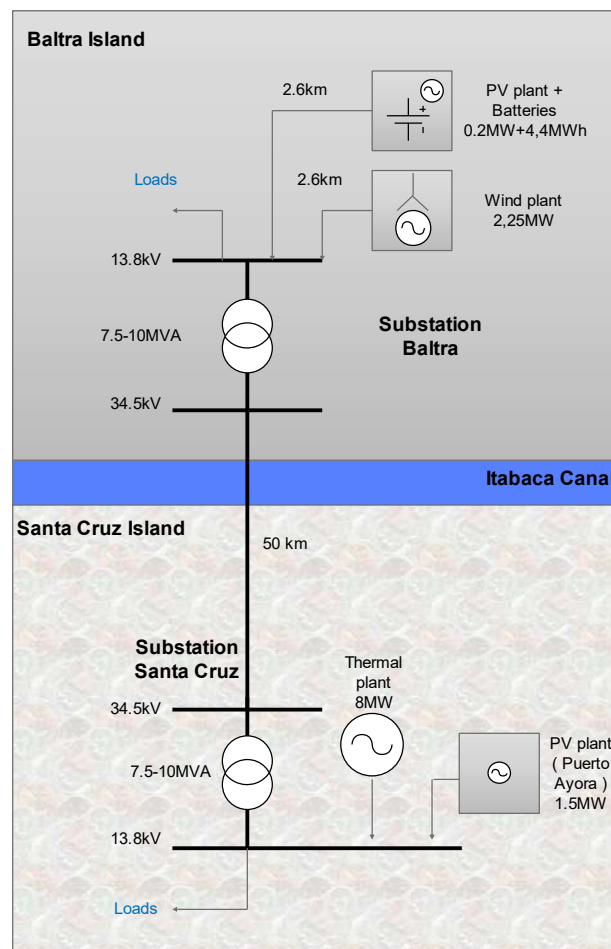

Fig. 2.2. Interconnection between Baltra and Santa Cruz

The next figure shows on a single map the location of Puerto Ayora and Baltra

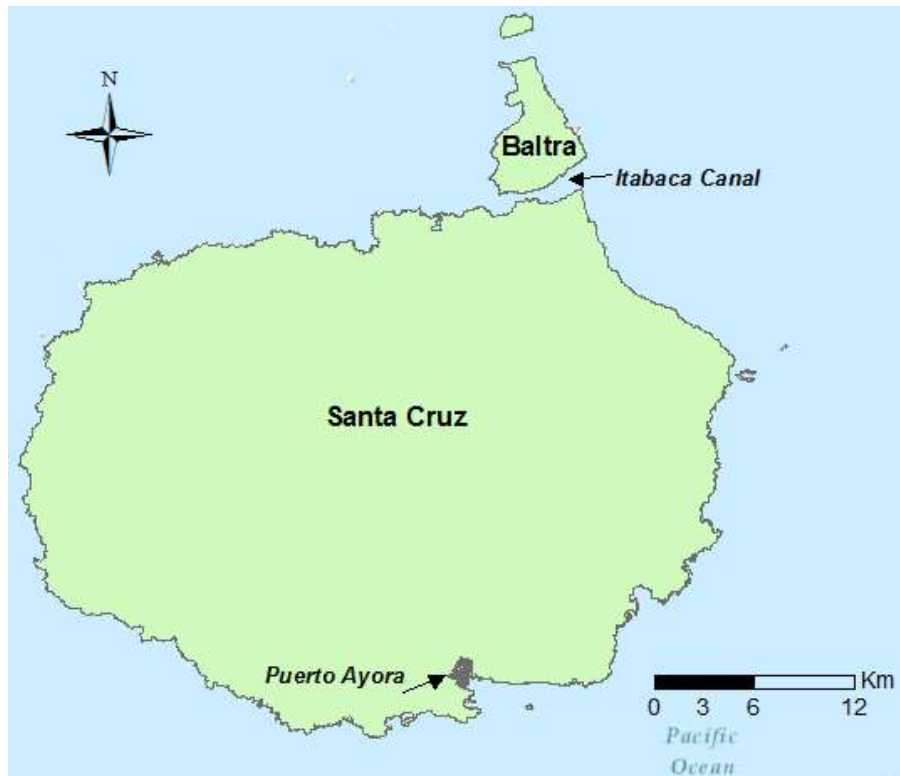

Fig. 2.3. Santa Cruz and Baltra Islands

Thermal Power Plant: Puerto Ayora

The system is composed of eight units; the installed capacity is 8,01 MW, and the primary energy source is diesel. Table I presents the details.

TABLE I GENERATION THERMAL UNITS

| <i>Number</i> | <i>Model</i> | <i>Manufacturing year</i> | <i>Rated power (kW)</i> | <i>Effective Power (kW)</i> | <i>Comments</i> |
|---------------|--------------|---------------------------|-------------------------|-----------------------------|-----------------|
| 1 | Caterpillar | 1990 | 650 | 520 | Operative |
| 3 | Caterpillar | 1990 | 650 | 520 | Operative |
| 4 | Caterpillar | 1990 | 650 | 520 | Operative |
| 5 | Caterpillar | 2007 | 1.100 | 880 | Operative |
| 6 | Caterpillar | 1990 | 650 | 520 | Operative |
| 7 | Caterpillar | 2008 | 910 | 800 | Injured |
| 8 | Hyundai | 2011 | 1.700 | 1.450 | Operative |
| 9 | Hyundai | 2011 | 1.700 | 1.450 | Operative |

Photovoltaic Plant: Puerto Ayora

The records of the solar resource indicate May, June, and July, as the months of the lesser presence of the resource, and March and October as the maximum radiation, see Figures 2.4 and 2.5.

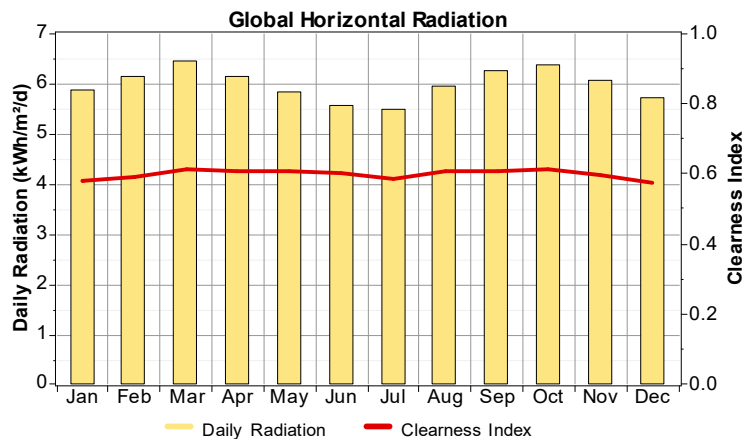

Fig. 2.4. Solar resource (measurements 2007 - 2009)

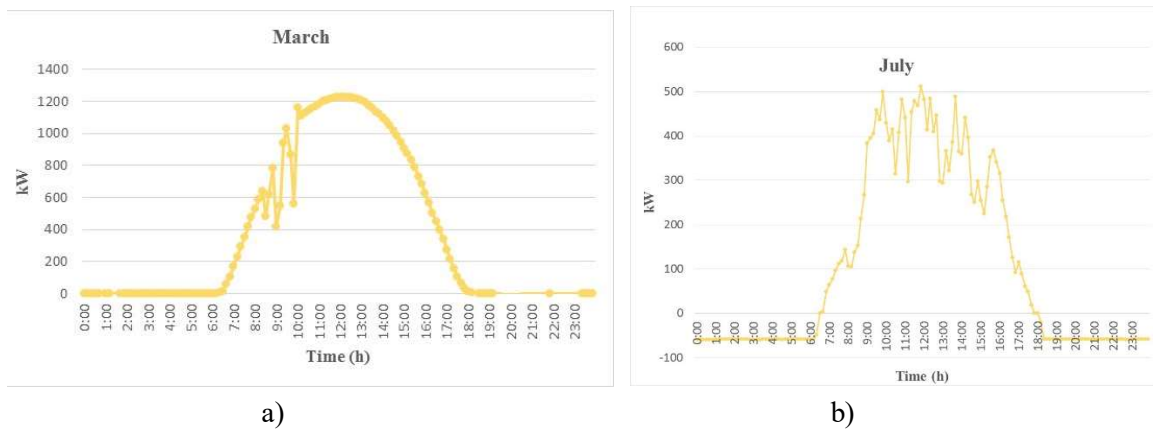

Fig. 2.5. a) Maximum daily profile (March) and b) Minimum daily profile (July)

The 1.500 kWp power plant started its operation in May 2014; the energy contribution in 2015 was about 6%.

Wind Power Plant: Baltra

The Baltra wind farm is made up of three 750 kW wind turbines (2,25 MW installed capacity); this park became operational in December 2014. Historical wind records indicate that in the warm season (December to May) where the demand is maximum, there is minimal presence of the resource and in the cold season (June to November), the opposite happens: maximum wind generation and minimum demand, see Figures 2.6 and 2.7.

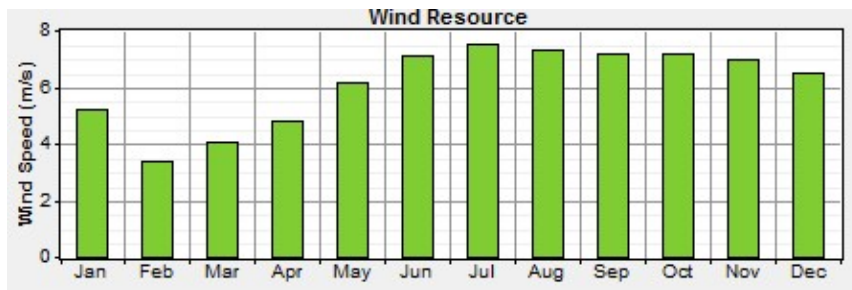

Fig. 2.6. a) Wind speed in Baltra, measurements in 2012.

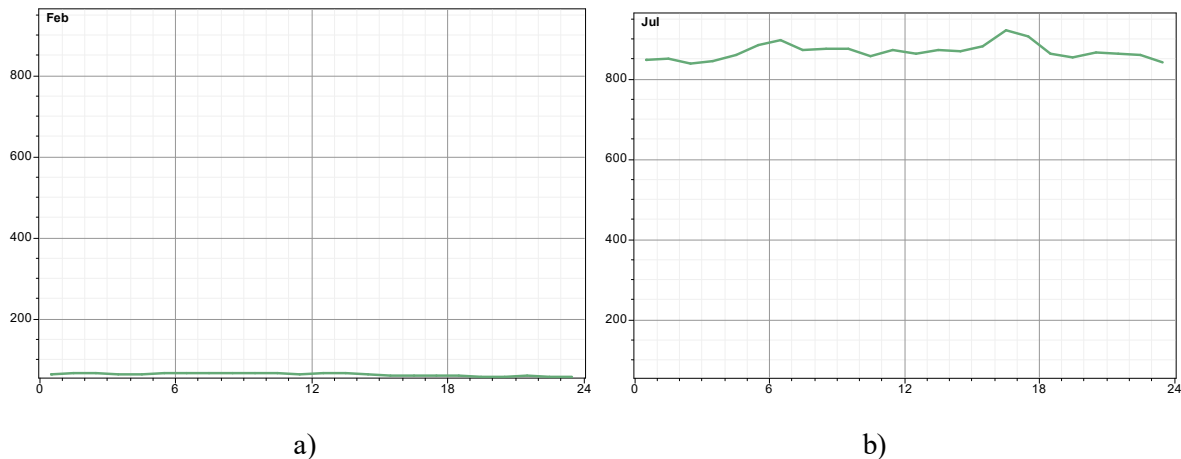

Fig. 2.7. a) Minimum daily profile (February) and b) Maximum daily profile (July) in kW.

The variation of the wind resource requires thermal backup in order to take their load, mainly in the warm season. The energy contribution of the Baltra wind farm in 2015 was about 7%. In 2016, it was around 13%. In order to perform peak load shifting and stabilizing power fluctuation of wind generation, a battery system was installed in 2016 at Baltra; an additional PV power plant was commissioned as well, see Figure 2.8.

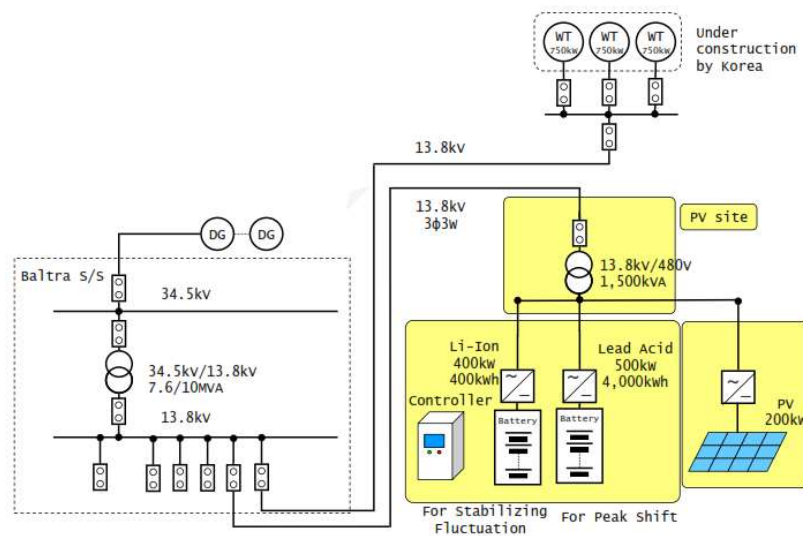

Fig. 2.8. PV plant and batteries coupled with the wind power plant at Baltra, [11]

2.1.2 Distribution

In a power system, the electrical network is composed of three levels, with different functions for each one.

1. The first level is the transmission system, which is responsible for delivering electricity from power plants to consumer centers.
2. The second one is the sub-transmission system, which is in charge of distributing the electricity to different places of the consuming centers.
3. Finally, the distribution system is responsible for feeding consumers in MV and LV.

The transmission networks work in mesh form, the sub-transmission works in light mesh form (loops) and/or antenna form, whereas distribution systems although are designed such a mesh network, but they always operate radially, except in high urban areas where they can work with loops. The distribution grid is composed of both overhead lines and underground cables, and its primary objective is feeding all customers who request electrical service.

Obviously, in Galapagos Islands, there are no transmission lines, the most nearly is the line of 34,5 kV (In continental Ecuador, this level is used for distribution) and 50 km interconnecting the substations of Baltra and Santa Cruz. Within Galapagos, there are 12 feeders spread over the inhabited islands (see Table II for details).

TABLE II FEEDERS

| <i>Island</i> | <i>Name</i> | <i>Voltage (kV)</i> | <i>Consumers</i> | <i>Installed Capacity (kVA)</i> |
|----------------------|-------------------------|---------------------|------------------|---------------------------------|
| <i>Baltra</i> | <i>ALIM.-19BAL40T01</i> | <i>13,8</i> | <i>2</i> | <i>62,5</i> |
| | <i>ALIM.-19BAL40T02</i> | <i>13,8</i> | <i>1</i> | <i>300</i> |
| | <i>ALIM.-19BAL40T03</i> | <i>13,8</i> | <i>2</i> | <i>200</i> |
| <i>Floreana</i> | <i>ALIM-19FLO40T01</i> | <i>13,2</i> | <i>71</i> | <i>90</i> |
| <i>Isabela</i> | <i>ALIM-19ISB30T01</i> | <i>13,8</i> | <i>976</i> | <i>2027,5</i> |
| | <i>ALIM-19ISB30T02</i> | <i>13,8</i> | <i>169</i> | <i>605</i> |
| <i>San Cristobal</i> | <i>ALIM-19SCB10T01</i> | <i>13,2</i> | <i>1635</i> | <i>3090</i> |
| | <i>ALIM-19SCB10T02</i> | <i>13,2</i> | <i>1151</i> | <i>3315</i> |
| | <i>ALIM-19SCB10T03</i> | <i>13,2</i> | <i>426</i> | <i>1345</i> |
| <i>Santa Cruz</i> | <i>ALIM-19SCZ20T01</i> | <i>13,8</i> | <i>1534</i> | <i>5005</i> |
| | <i>ALIM-19SCZ20T02</i> | <i>13,8</i> | <i>3578</i> | <i>5112,5</i> |
| | <i>ALIM-19SCZ20T03</i> | <i>13,8</i> | <i>1513</i> | <i>3815</i> |

The next figure depicts the spatial distribution of feeders within Santa Cruz and Baltra. We can see that feeders 1 and 2 in Santa Cruz are urban (blue and green) and feeder 3 is rural (red) and extremely dispersed. Another important point to note is that the area not occupied by people in both Island Santa Cruz and Baltra is considerable since those areas are national parks or ecological reserves. In Baltra, only four clients exist; one of them is the airport.

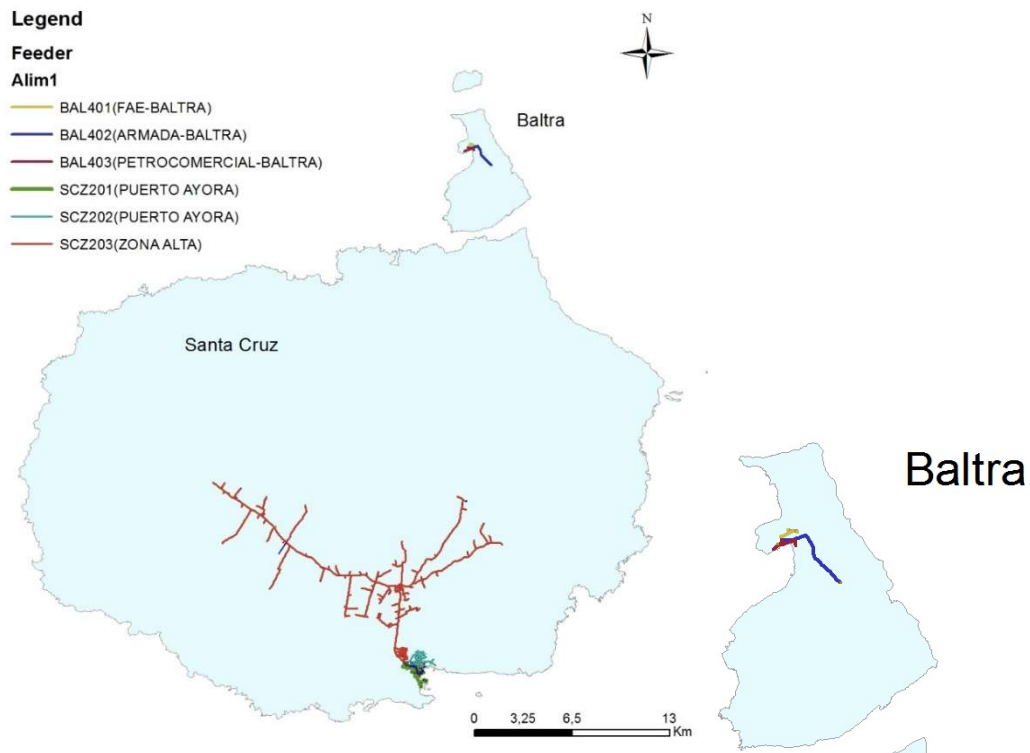

Fig. 2.9. Feeders spatial Distribution.

2.1.3 End-user

The energy consumption location has a well-marked characteristic, i.e., its dispersion over a given territory, see Figure 2.11. The client classification defines the next types i) residential, ii) commercial, iii) industrial, and iv) other uses (public services, pumps, etc.), see Figure 2.10.

The predominant client is the residential type (80,99% located in urban areas). Hence, the geographical distribution of power consumption will be concentrated in the urban center.

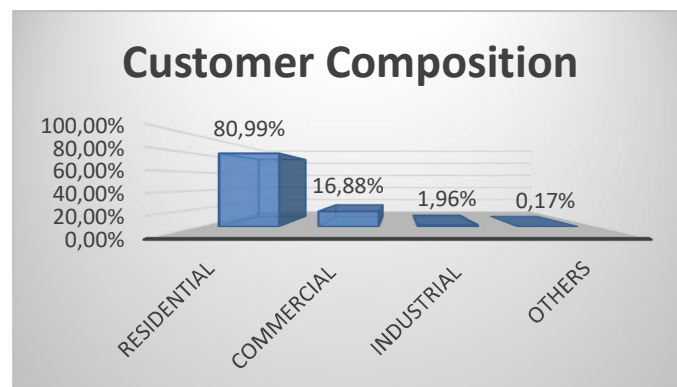

Fig. 2.10. Consumer Composition

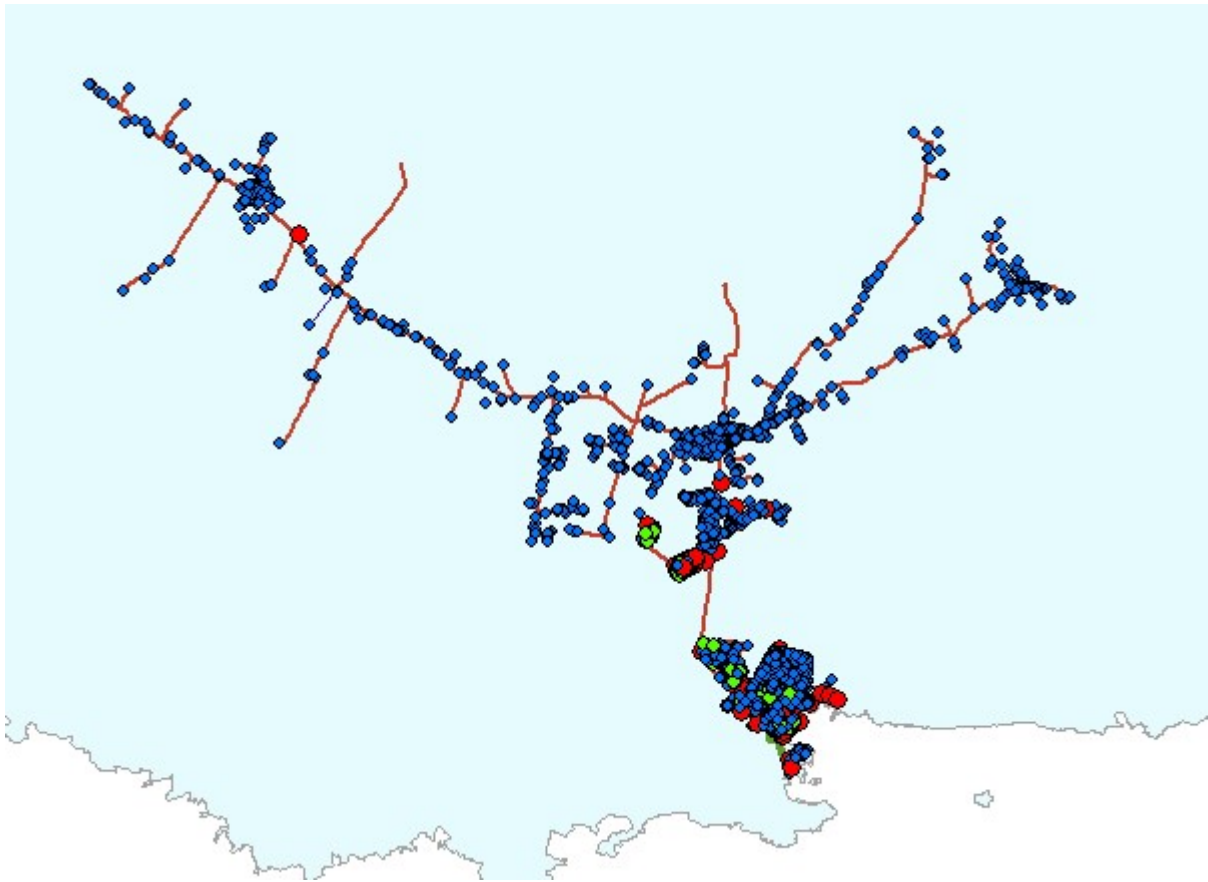

Fig. 2.11. Clients Spatial Distribution.

Blue: Single Phase, Green: Two-Phase and Red: Three-Phase

Table III depicts the number of users of each island, the energy generated and billed and the annual growth rate. For the next analysis and simulations, the Santa Cruz values are chosen, it means 7,85% of increase in energy and 6,02% in users.

TABLE III DEMAND IN 2016

| Island | Users | Net energy GWh-year | Billed Energy GWh-year | Annual Growth Rate | | |
|---------------|--------|------------------------|---------------------------|--------------------|-----------------|--------------------|
| | | | | Users % | Net energy % | Billed Energy % |
| San Cristobal | 3292 | 14,6 | 14,41 | 4,43 | 8,33 | 9,50 |
| Santa Cruz | 6642 | 31,9 | 27,86 | 6,02 | 7,85 | 7 |
| Isabela | 1224 | 5 | 4,55 | 5,34 | 11,64 | 10,92 |
| Floreana | 76 | 0,26 | 0,19 | 6,53 | 25,55 | 28,51 |
| Total | 11.234 | 51,76 | 47,01 | | | |

SOURCE, [10]

So far, the characteristics of Galapagos with an emphasis in Santa Cruz concerning generation, distribution network, and clients have been presented. The next section shows the key features of the regulations of different countries. A review of countries operating in an entirely integrated way, others under the liberalized scheme, and some in transition is performed.

2.2 Regulations

The regulation must cover different topics such as i) Structure of the electrical sector, ii) Markets and tariffs, iii) Service quality, iv) Renewable Energy Sources and v) EV and DSM. Around the world, the management and operation of the electrical sector can change dramatically, thus, to have a general idea of different models and schemes, a review of Colombia, Spain, United States, United Kingdom and France regulations is done. The idea is to study a similar country (Colombia), another one more developed (Spain) than Ecuador, another one working with different models within the same country (United States), one unliberalized (United Kingdom) and France as a reference in Smart Grid projects. After that, a comparative analysis with Ecuadorian regulations is performed in order to identify strengths and weaknesses in the current regulation, since it might be necessary to change the regulatory framework to enable the deployment of smart grids.

2.2.1 Colombia

The governing body of the Colombian electrical system is the Ministry of Mines and Energy – MINMINAS- [12], Energy and Gas Regulatory Commission –CREG- is responsible for regulating the activity of the sector. The company XM manages the transactions in the wholesale electrical market, which is competitive with the participation of generators, transmitters, distributors, retailers and large consumers.

The Colombian sector considers the retail market; for regulated clients, a tariff defined by CREG exists, and for large consumers, the prices are accorded freely. The energy cost is composed of the whole chain since generation to retail commercialization. There are six strata in the tariff scheme; the three first have a subsidy, the next three categories pay the complete cost.

Regarding quality service, it is evaluated each three months and considers mainly indexes for assessing the Energy Not Supplied – ENS- and unavailability [13]. Mainly, flicker, swell, sag, and harmonics are regulated. In [14], the topics related to distributed generation-connected to a distribution system, efficient energy management, demand response to price signals or incentives and connection criteria are addressed. The normative for cogeneration is presented in [15].

2.2.2 Spain

Law 54/1997 established the normative principles of liberalization of the sector. The new model creates an electricity market, where prices are based on the decisions made by agents. In July 2007, the Iberian (Portugal – Spain) electricity market started, reaching around 30 million customers and an annual

consumption of around 300 TWh (10% of European energy consumption). There are two operators to manage the electrical sector for the Market and System [16]. In Spain, the system operator also operates the transmission network.

The planning and regulation of the electricity sector are elaborated by the Ministry of Industry, Energy, and Tourism. Regarding the market, there is spot market (daily and intraday), forward market and bilateral contracting.

There are currently around 560 companies dedicated to the commercialization of electricity. These companies establish agreements with final customers where both parties negotiate the final price of energy. These agreements set energy prices and conditions of payment. Although, there is an exception for consumers with a contracted power of less than 10 kW, who could apply for subsidies on the tariff in certain cases. Access tariffs are classified according to the voltage level and discrimination hour, dividing into one, two or three periods in low voltage and three and six periods in medium/high voltage [17].

It exists ancillary services for frequency regulation; primary regulation is mandatory, whereas secondary and tertiary include a payment based on capacity and energy. The service quality consider the follows aspects, i) product quality relies on the Standard UNE-EN 50160 (voltage and frequency variations, flicker, swag, and harmonics) [18], ii) supply continuity (TIEPI and NIEPI indexes) and iii) Consumer attention (individual and zone indexes).

The topic related to Renewable Energy and Cogeneration is addressed in [19], the technical criteria for connecting renewable energy are defined in Royal Decree 1955/2000 and Royal Decree 1699/2011. The Spanish government, in order to foster EV change, has implemented economic incentives for buying EV (€ 2.700 to € 5.500). Also, super valley tariffs try to support the EV charging. Most companies have three time zones along of the day: the most economical is the “super valley” rate. The other two are the "valley," cheaper than a standard tariff, and the "peak" with surcharge.

- Super Valley period: from 01:00 to 07:00 in the morning.
- Valley period: from 07:00 to 13:00 in the afternoon and from 23:00 to 01:00 in the early morning.
- Peak period: from 13:00 to 23:00.

The interruptible service in Spain is a mechanism that allows making the operation of the electrical system more flexible from the demand side. It is destined to a reduced group of 145 large consumers; they can offer packets of reduction either of 5 MW or 90 MW; customers receive discounts on their bills in exchange for reducing their electricity consumption. In this way, participants receive a payment, even if no interruption is required. On the other hand, sanctions apply if customers do not reduce their power by the agreed amount.

2.2.3 United States

In the United States, there are two large regional markets, i) markets where there is an independent electricity system operator that coordinates the different players under its control area, and ii) vertically integrated markets.

Markets with Independent System Operator

A system operator operating in a single state is called the Independent System Operator –ISO-; while when a system operator works in more than one state, it is known as the Regional Transmission Organizations –RTO-. See the next figure for identifying ISO and RTO within the United States.

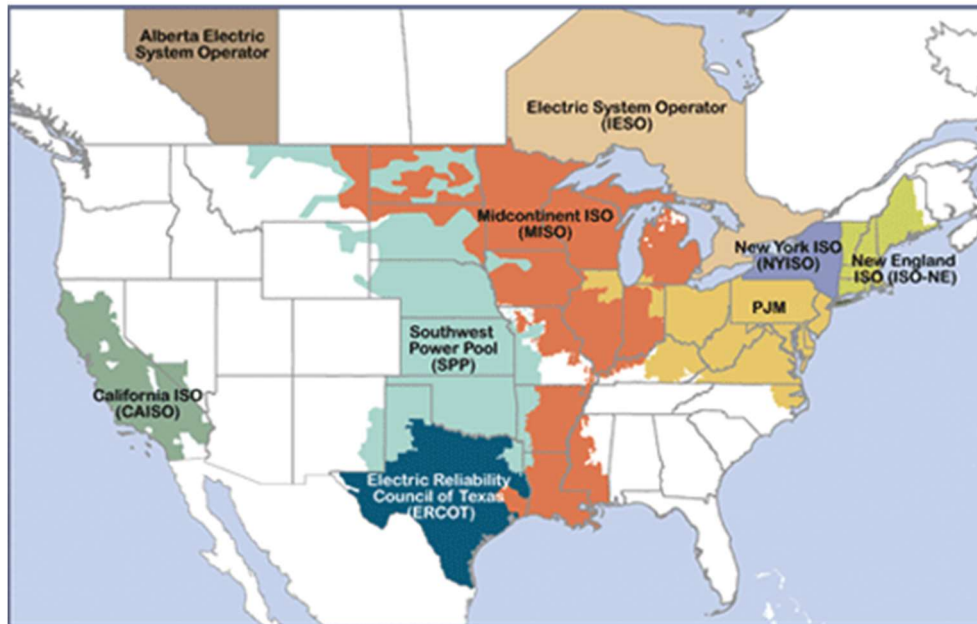

Fig. 2.12. ISO/RTO in the United States, [20].

Vertically integrated markets

There are three other markets in regions; these areas are Northwest, Southeast, and Southwest. See Figure 2.13

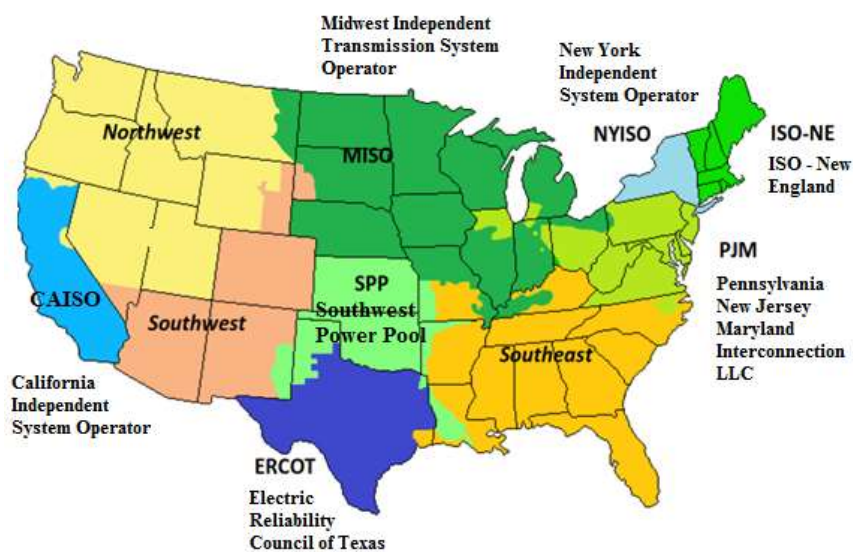

Fig. 2.13. Markets in the United States,[17].

At present, some states maintain the liberalization of their retail market and others have not even activated it. On the contrary, some states like California have suspended the liberalization of the retail market and have resumed the previous model of regulated supply.

The California and New York markets in the next paragraphs will be discussed with particular attention in order to show different approaches within the United States.

California – CAISO

CAISO also has the responsibility of managing the wholesale electricity market under the direct jurisdiction of the Federal Energy Regulatory Commission –FERC-. The electric system has four distribution utilities.

The electrical system in California is a mix of regulated and liberalized markets. The wholesale market (day ahead and real-time) is liberalized, and large supply companies carry out transactions through an auction process managed by the operator CAISO [21]. By contrast, the retail market is regulated, so that utilities sell electricity to end-users at regulated prices set by the California Public Utilities Commission –CPUC-

The retail market is heavily regulated, and the liberalization process is suspended. Consumers are not free to choose; the CPUC regulates their supplier and prices. This entity sets electricity prices for residential, commercial and industrial consumers. Several subsidy programs are available in California to reduce the tariff [22].

In [23] and [24], the renewable energy sources (RES) integrated into California are detailed, also the incentives for commissioning of new power plants, also the cogeneration is addressed. Regarding, the recharge of electric vehicles can be done at home, or public or commercial places enabled for it. For this, those who perform the recharging of electric vehicles have at their disposal special rates with reduced prices during the load. The recharging of the vehicle can be done at three voltage levels i) 120v – 17h, ii) 240v – 7h, iii) 400v – 45min.

Pacific Gas and Electricity company –PG&E- offers several Demand Response Programs within California, among them could be mentioned [25]:

1. Peak Day Pricing
2. Base Interruptible Program
3. Scheduled Load Reduction Program
4. Optional Binding Mandatory Curtailment Plan
5. Capacity Bidding Program, which is a program that works with aggregated loads.

New York – NYISO

There is a liberalized wholesale market where large blocks of electricity are exchanged between generators and traders and large consumers. NYISO operates the market through a mechanism known as market clearing auction (day ahead and real-time); it also exits the virtual trading [26].

Unlike California, there is a liberalized retail market where consumers can freely choose their supplier company. There are about 75 retailers in the state of New York, with about seven different suppliers in

each area. There is also the possibility of establishing bilateral contracts between generators and consumers, subject to the terms agreed by both parties. Ancillary services exist such as frequency control, spinning and non-spinning reserves, voltage control and black start [27].

In New York State, the consumers are grouped into service classes, which help determine which rate fits needs best. Not all supplier companies have defined rates for each of the service classes; also, the retailer has social tariffs for consumers with low incomes that meet certain conditions.

In addition to the programs offered by the system operator and retailers, New York State Energy Research and Development Authority, NYSERDA, provides grants to help to finance the cost of equipments needed to train consumers to participate in demand response programs [28]. For the deployment of renewable energy, several programs have been launched, for instance, Green Power, Solar market acceleration, Small wind turbine programs.

New York State, through NYSERDA, began in 2013 the ChargeNY program which aims to reach 3.000 charging stations for electric vehicles by 2018. This program will involve service to an estimated 40.000 electric vehicles throughout the state. Almost 500 recharging stations have already been installed. Five stations recharge types exist, i) AC, ii) DC, iii) Wireless, iv) Fast chargers in DC, v) Tesla Supercharger. The incentive for buying an electric car is of \$7.500 [29].

The Quality Service, in the United States, is based on IEEE and ANSI standards. There are also safety standards, such as the National Electrical Code. The North American Electric Reliability Corporation – NERC- is responsible for ensuring the reliability of electricity supply in North America. The NERC is an international non-profit regulator whose principal duties are the development of standards, annual and seasonal assessments of long-term system reliability, monitoring the reliability parameters of the North American power system. The momentary interruptions are those higher than 1 min; IEEE addresses the power quality in *Recommended Practice for Monitoring Power Quality* and ANSI C84.1.

In California, consumers and generators can participate together in DSM programs to support the system operator to manage the network. To do this, participants in these programs must have installed the control and telemetry equipment required for each of them. There are three programs with different requirements for participants i) Participating Load program, ii) Proxy Demand Resources program and iii) Reliability Demand Response Product [30].

The NYISO offers four demand response programs: Emergency Demand Response Program –EDRP-, Installed Capacity Special Case Resource Program –SCR-, Day-Ahead Demand Response Program –DADRP- and Demand Side Ancillary Services Program –DSASP- [31].

2.2.4 United Kingdom

Although Chile was the pioneer in market liberalization, the reforms in the British sector were more radical. Since the evolution of the British electricity market refers to the change of competition and regulation in the electricity industry rather than technical development [32]. The transport system operator is the NATIONAL GRID company. In Britain, there is a wholesale market where large energy packages (mainly through bilateral transactions) are exchanged and a retail market through which

retailers sell electricity to small consumers. There are six utilities and 22 retailers; the national operator is National Grid Electricity Transmission –NGET-.

The operator of the Market of Balances and Liquidations of the British market is Elexon, a subsidiary company of National Grid. Its mission is to manage this market of economic form, effective and efficient, for the benefit of the consumers [33].

The regulator is the Office of Gas and Electricity Markets –OFGEM-. It is a non-ministerial governmental entity headed by a committee of experts called GEMA (Gas and Electricity Markets Authority), appointed by the Secretary of State of the Ministry of Energy and Climate Change. Its role is to protect the interests of consumers by promoting competition to the extent possible. The British wholesale market can be divided into four blocks i) Long-term market, ii) Short-term market, iii) Balance market and iv) Settlement of deviations [34].

In the UK retail market, retailers compete on price and service with each other to get more consumers. The prices include the costs they incur and add a profit margin. The only part of the electricity bill that is regulated corresponds to the expenses of managing the transmission network. Regarding ancillary services, three types are defined in the UK system; the first one is mandatory and includes reactive power supply and frequency control. The second category is optional and includes black start and frequency control with fast generators. The last type, known as commercial ancillary services, proposes optional services related with standby reserve.

The only regulated part of the price paid by consumers corresponds to the tolls for the use of transport and distribution networks, in addition to taxes. The cost of the transmission network accounts for about 4% of the total bill for consumers, while the cost of the distribution network amounts to 16% of the invoice. The tariff is composed of three terms i) contracted power, ii) a fixed value and iii) penalty for reactive energy (if any). It exists different prices in function of voltage level and day period (peak, valley, and semi-peak).

In [35] is set the Regulation for Service Quality; the voltage regulation and frequency variations are considered for product quality, in continuity the interruptions are considered momentary when the interrupted time is lower than 3 minutes and the interrupted power is at least 20 MW. Another case is when the disconnected power is higher than 5 MW or when 5000 clients are involved; in this case, the time is 1 hour.

Nowadays, the rate of renewable within the UK is about 7% composed of the wind, biomass, hydraulic and photovoltaic plants. There are several incentives for fostering RES deployment (Renewable

Obligation and Feed in tariff). Some retailers are offering special tariffs for charging EV in super valley periods.

Several demand response programs, including various hourly discrimination and interruption programs, have been available for some time. About time discrimination rates, the Economy 7 and Economy 10 rates allow consumers to have a lower price for 7 or 10 hours per day, respectively, so that they can adapt their consumption curves to take advantage of these prices during the valley hours. Also, other programs exist such as Short-term Operating reserve, Fast Reserve, Firm Frequency response, Frequency control by demand management and DSM balancing reserve.

2.2.5 France

In France, until the year 2000, the supply of electricity was regulated such a monopoly provided by EDF (Electricité de France) and in some localities or local areas by local distribution companies. The laws No. 2000-108 and No. 2004-803 initiated the market liberalization. This liberalization was gradual, starting in 1999 by companies consuming more than 100 GWh/year and progressively opening up to all professional customers and then, to domestic customers in 2007. On 1 July 2007, the entire electricity supply market became open to competition [36].

In France, the Transmission System Operator –TSO- is Réseau de Transport d'Electricité –RTE-, which is a subsidiary of EDF. Its mission is to ensure, in real time, a balance between supply and demand for electricity, building on the capacities and needs of electricity producers, traders, distributors, industrial consumers and railway companies. The regulation function is done by the Commission de Régulation de l'Énergie -CRE-. Its primary objectives are to guarantee the system operator independence, establish harmonized rules for the operation of networks and markets, develop competition between energy suppliers, ensure the best service and a fair price [37].

In France, electricity distribution is a public service, the local authorities are the owners of the distribution network, but they entrust the management to ENEDIS company (95% of the distribution system), as part of a public service delegation, or to local distribution companies (5% of the distribution system). Through this delegation, ENEDIS fulfills the public service tasks related to the distribution of electricity in the topics of continuity and quality of service, nondiscriminatory access to the network, maintain the high level of safety and reliability, promote and to deploy the Linky smart meter along France [38]. ENEDIS is also a subsidiary of EDF.

The first producer of energy in France is EDF Production company. Its primary energy source is nuclear (78%) followed by hydropower, combined cycle gas, cogeneration, coal, and renewables. Regarding EV, different incentives exist for fostering EV deployment, for instance for a vehicle emitting between

21 and 60g CO₂/km, the bonus amount is € 1'000, and for a vehicle 20g CO₂/km or less, the bonus amount is € 6'300 [39].

The service quality is addressed in the standard NF EN 50 160 [40], where the main features of supply are described; the voltage level, voltage deviation and unbalance, harmonics, among others. According to the French regulation, it is possible to connect DGs at low voltage network and to inject energy into the grid, the respective standards are [41]:

1. NF C 15 100 « Installation électrique à basse tension »
2. UTE C15-712 « Installations photovoltaïques »
3. UTE C15-400 « Raccordement des générateurs d'énergie électrique dans les installations alimentées par un réseau public de distribution » Décret 2008-386 du 23 Avril 2008.

According [42], France was initially a country with significant Demand response –DR- participation, but since market opening, a gradual decrease in DR capacities occurred due to lack of incentives in the regulatory framework and technical difficulties like no smart meters. After a strong commitment and technical involvement, the DSM participation in the markets was authorized in 2010. DSM has already become a new market, where independent new entrants compete with incumbent suppliers, and DSM operator manages the activity (achieved in 2014). In Europe, France is the only country to allow DSM players to participate directly in D-1 markets as a resource (direct participation), see next figure.

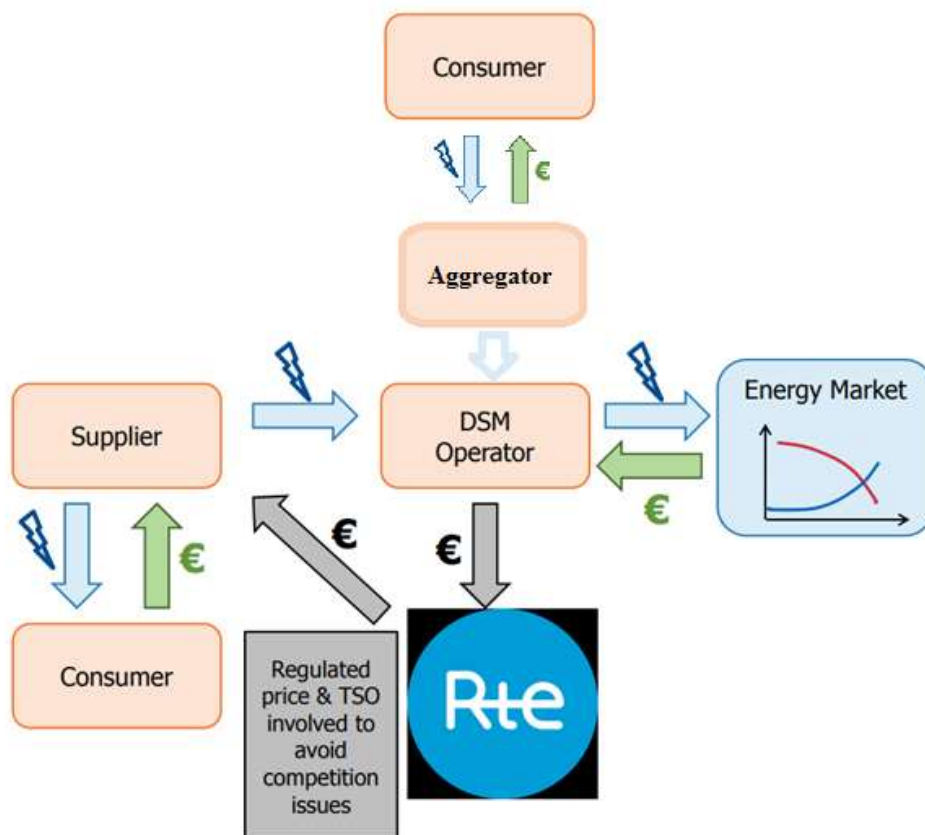

Fig. 2.14. DSM integration in all the markets in France, based on [42].

2.2.6 Comparative Analysis

This section compares the Ecuadorian electrical sector with those of the countries previously reviewed. In Ecuador, the MEER is responsible of the whole electrical sector and the planning activity. The Agency for Electricity Regulation and Control –ARCONEL- is in charge of regulating and controlling the activities related to the public electric power service and the general public lighting service, taking care of the interests of the consumers. The National Center for Energy Control –CENACE- is responsible for the functions of operation coordination of the National Interconnected System –SNI- and the administration of the technical and financial transactions of the Wholesale Electricity Market –MEM-, as well as the electrical interconnections with Colombia and Peru. The Electric Corporation of the Ecuador –CELEC- with its different subsidiaries is responsible for the generation and transmission of energy. TRANSELECTRIC, subsidiary of CELEC, carry out the function of Transmission System Operator –TSO-, the National Corporation of electricity –CNEL- is a public company, which distributes and sells the energy, since in Ecuador a retailer market does not exist (see next figure). Figure 2.15 depicts the different agents and it is worth noting that TRANSELECTRIC is within CELEC EP block.

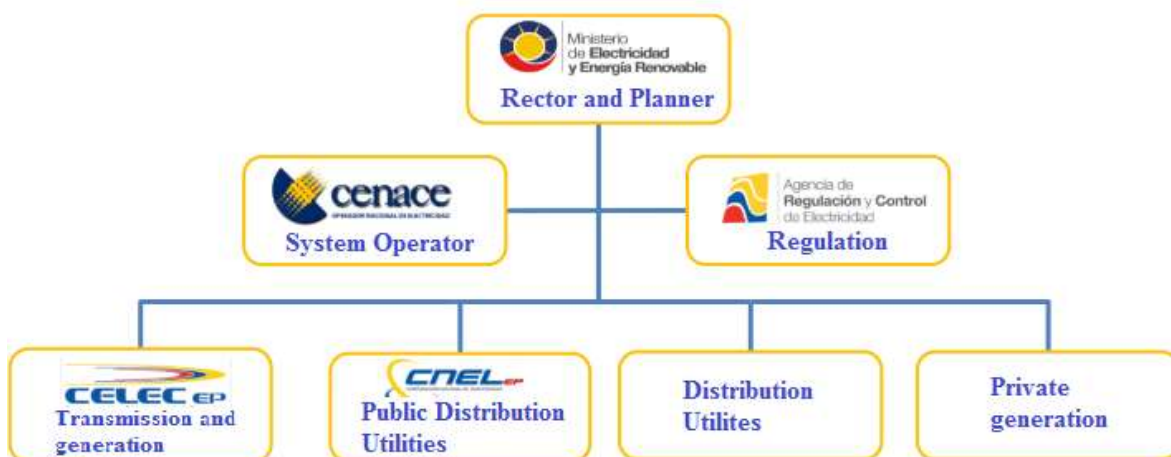

Fig. 2.15. Organization chart of the Ecuadorian electric sector, [43].

In Ecuador, the average price for the final customers of the distributors is 9,2 USDc/kWh. The average price per type of regulated customers is 7,15 USDc/kWh for industrial and other groups, 8,9 USDc/kWh for commercial group, 10 USDc/kWh for residential and finally 12,7 USDc/kWh for public lighting. There are three subsidies; the first is aimed for low consumptions; 4 USDc/kWh for consumption less than 110 kWh/month in the Sierra region, and 130 kWh/month for Coast and Island region. The second is a cross subsidy and a special tariff for the third age. The regulation 004/01 [44] addresses the aspect of service quality in three main axes i) Quality product, ii) Quality of technical service and iii) commercial service quality.

The regulation on the criteria and requirements related to the connection of non-conventional renewable generators to transmission and distribution networks is under review and based on the standards IEC 61400-12, IEC 62116 and IEEE1547. On the other hand, an incentive exists to promote the RES deployment; it is a special period of 15 years for mandatory dispatching [45].

In order to support EV, the Coordinating Ministry of Employment and Competitiveness Production – MCPEC- established the framework for the commercialization of batteries and electric vehicles, and the tariffs for importing finished EV and taxes for domestic manufacture were eliminated. In Ecuador, only Time Of Use –TOU- programs exist for large industrial consumers.

Table IV summarizes the type of contracts that exist in each country within the wholesale market, and if there is also a retail market, and the concerned participants. In addition, a summary of the tariff components, the incentives for RES, and the EV programs is given.

TABLE IV MARKETS

| Country | Wholesale | | | Retail Market | Tariff components | Incentives for RES | EV |
|----------------|---------------------------|-------------------|---------------------|---|-------------------|--|--|
| | Short-term | Long Term | Bilateral Contracts | | | | |
| Colombia | Daily market | - | Unregulated | The retail market only for large consumers. | Energy | | Considered in Smart Grids roadmap |
| Spain | Daily and intraday market | Yes | Unregulated | The retail market for all the consumers. If $P < 10kW$, it is possible to choose a regulated tariff | Energy and Power | Priority in daily market Prime for operation and installed capacity | Super valley periods Bonus for buying |
| United States | Daily Market | - | Unregulated* | Retail market in New York Regulated rates in California | Energy and Power | Tax reduction | Taxes reduction Program for installing recharge points. |
| United Kingdom | Daily Market | Exchange Platform | Unregulated | Retail Market | Energy and Power | Prime for operation Requirement of renewable rate to generators | Super valley periods Discounts for charging |
| France | Daily and intraday market | Exchange Platform | Unregulated | Retail Market | Energy | Taxes Incentives | Bonus |
| Ecuador | Economic Dispatch | - | Unregulated | Regulated rates for all customers | Energy | Preferential period for 15 years | Taxes reduction |

* CAISO has no Bilateral Contracts

In Table V, a summary of the Demand Side Management program within each country is presented as well as the participants, the minimum power for participating (if any) and if the aggregator figure is considered.

TABLE V DEMAND SIDE MANAGEMENT

| <i>Country</i> | <i>Program Type</i> | <i>Participant</i> | <i>Power</i> | <i>Aggregator</i> |
|-----------------------|------------------------|---|--------------------------------|-------------------|
| <i>Colombia</i> | - | - | - | - |
| <i>Spain</i> | <i>TOU</i> | <i>Residential ,Commercial , Industrial</i> | - | <i>No</i> |
| | <i>Demand response</i> | <i>Large consumers</i> | <i>5 and 90MW</i> | <i>No</i> |
| <i>United States</i> | <i>TOU</i> | <i>All consumers</i> | <i>P>10kW in California</i> | <i>Yes</i> |
| | <i>Demand response</i> | | <i>P>100kW in New York</i> | |
| <i>United Kingdom</i> | <i>TOU</i> | <i>Residential, Commercial, Industrial</i> | - | <i>No</i> |
| | <i>Demand response</i> | <i>Large consumers</i> | <i>P>3MW</i> | <i>Yes</i> |
| <i>France</i> | <i>TOU</i> | <i>All consumers</i> | - | <i>Yes</i> |
| | <i>Demand response</i> | | | |
| <i>Ecuador</i> | <i>TOU</i> | <i>Industrial</i> | - | <i>NO</i> |

Once reviewed eight regulations with different approaches and designed for various kind of markets, it is possible to conclude that Ecuador presents substantial regulatory barriers for SG deployment, for instance, the DSM is not considered at the residential level. The next section presents a review of current state of DGs in Ecuador.

2.3 DG Connection

In [46] and [47] are addressed the standard definitions for Distributed Generation, considering that around the world there is still no agreement on this concept. Indeed, some authors define DG in function of voltage, power, technology, placement of installation, control mode, among others. [47] introduces the following definition:

“An electric power generation source that is connected directly to the distribution network or on the customer side of the meter.”

and [46] defines DG such as:

“Distributed generation is a generating plant serving a client on-site or providing support to a distribution network, connected to the grid at distribution-level voltages. The technologies include engines, small (and micro) turbines, fuel cells, and photovoltaic systems. It excludes wind power since that is mostly produced on wind farms rather than for on-site power requirements.”

Wind farms are commonly included in Dispersed Generation definition. In the particular case of France, the DG (Distributed Generation) would not have to be higher than 12 MW. For the Ecuadorian case, the limit power in distribution is 30 MW [45], and the next energy sources are considered:

1. Biomass power plant: generates electricity using as primary energy i) forest residues, ii) agro-industrial waste and livestock and iii) urban waste.
2. Biogas power plant generates electricity using as primary energy the biogas obtained in a digester as a product of the anaerobic degradation of organic waste.
3. Conventional power plant: generates electricity using primary energy sources of energy that have already had a long history of exploitation and commercialization worldwide, such as water, coal, fossil fuels, petroleum products, natural gas and radioactive materials.
4. Non-conventional power plant: uses energy resources capable of renewing unlimitedly such as sun (photovoltaic and solar thermal), wind, water, (small, micro and pico hydroelectric power stations), geothermal, biomass, biogas, waves, tides, hot rocks and dried.

In the world, there have mainly been three great motivators for the increase of the distributed generation.

- i) Liberalization of markets
- ii) Governments incentives to achieve reductions in CO₂ emissions
- iii) Technological advances, especially the performance of photovoltaic and wind power generators have increased and their investment costs, on the other hand, have been reduced.

In [46], it is stated that, with DG, it is possible to reduce up to 30% the total cost of the electricity, due to a reduction in investments in transmission and distribution networks. However, all is not right with DG. For instance, the intermittency of the solar and wind resources causes a vital necessity of new methods for forecasting. Also, if the DGs are not well located, the losses could increase, and with the injection of energy in the network, the traditional protection schemes must be updated to consider at least bi-directional energy flows. Thus, DG will lead to a new conceptual mode for operating electrical systems; this is depicted in the Figure 2.16.

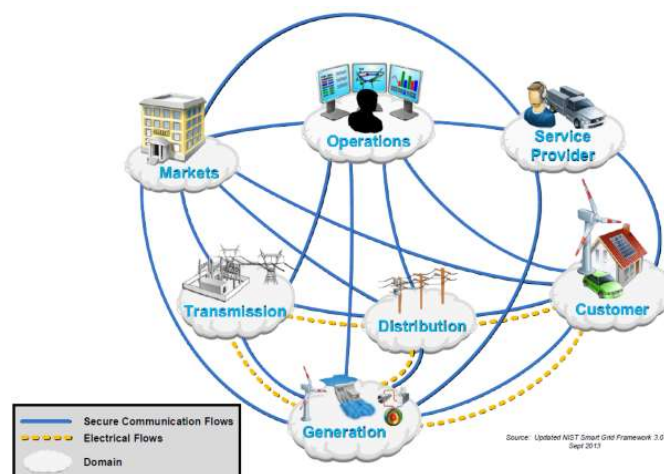

Fig. 2.16. New Conceptual model with generation at any level.[48]

In Ecuador, there are 21 distribution utilities, 11 of them are within the same enterprise (CNEL). Once reviewed the DG in the country, only 18 utilities have DG connected at distribution level either along the feeders or in distribution substations.

The energy sources currently present in Ecuador are:

- i) Biomass: 8 units, 58 MW
- ii) Wind : 3 units, 2,25 MW
- iii) Photovoltaic: 14 units, 12 MW
- iv) Hydraulic: 59 units, 94 MW
- v) Thermal: 31 units, 197 MW

The next figure depicts the number of DGs per utility; Emelnorte is the utility with the most amount of DGs (23; 16 hydraulic and 7 thermal).

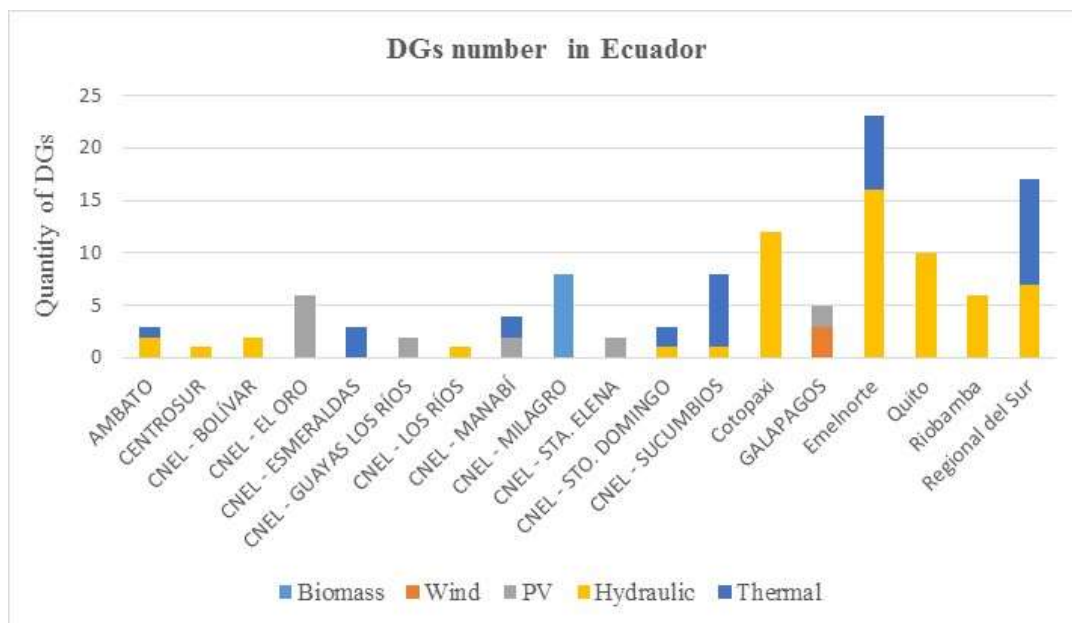

Fig. 2.17. DGs number in Ecuador.

Figure 2.18 shows the composition of the DG in Ecuador, the number of hydraulic units represents 51% of the existent park, whereas the number of wind units represents only 3%.

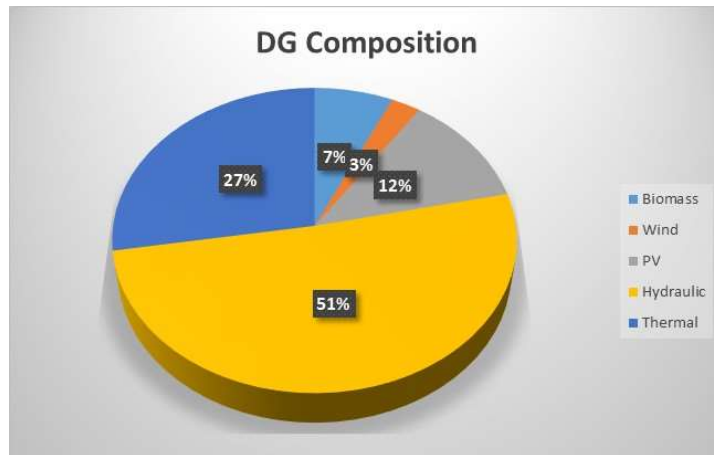

Fig. 2.18. DG composition – Total=116 units.

Although the hydraulic type has numerous units (51%), the installed power represents only 26%, whereas the thermal units reach the 54%; it means the thermal units have a higher installed capacity per unit, see Figure 2.19

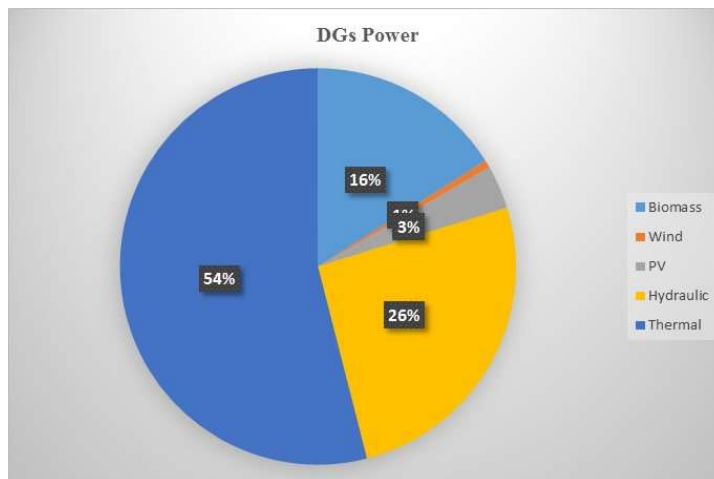

Fig. 2.19. Installed capacity by an energy source. Total=365MW

This section has allowed determining that the DG in Ecuador has not yet been implemented in a great way. The following section outlines the fundamentals of smart grids and the steps to follow for implementation in Ecuador.

2.4 Smart Grids

The current electricity grid is a system created at the end of the 19th century that has to meet the needs of the 21st century. Furthermore, the traditional network nowadays has to deal with aging infrastructure, non-technical losses, renewable integration, electrification of megacities, distributed generation and EV integration. All these challenges have forced the traditional electricity network to evolve towards a more

intelligent grid that keeps at least the same levels of reliability, sustainability and environmentally friendly. This new network concept is known as Smart Grid, according to [49]:

“A smart grid is an electricity network that uses digital and other advanced technologies to monitor and manage the transport of electricity from all generation sources to meet the varying electricity demands of end-users. Smart grids coordinate the needs and capabilities of all generators, grid operators, end-users, and electricity market stakeholders to operate all parts of the system as efficiently as possible, minimizing costs and environmental impacts while maximizing system reliability, resilience, and stability.”

According [50]:

“A Smart Grid is one that incorporates information and communications technology into every aspect of electricity generation, delivery and consumption in order to minimize environmental impact, enhance markets, improve reliability and service, and reduce costs and improve efficiency.”

In [51], an exhaustive analysis is done around the world in order to determine the primary motivating drivers and technology priorities to deploy Smart Grids, the report present results by continent (Asia, Australia, Europe, and North America). The main result depicts that the most important driver among the 21 participating countries is energy efficiency improvements (see Figure 2.20).

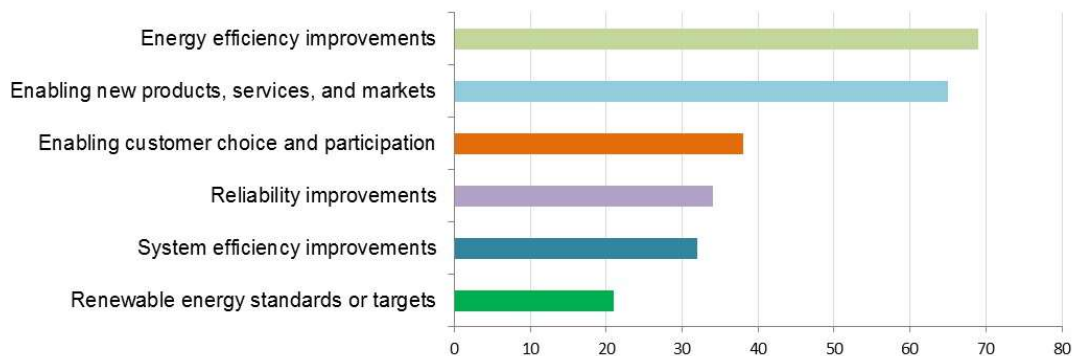

Fig. 2.20. Top-6 Ranked Motivating Drivers [51]

See participant list in <http://www.iea-isan.org/>

2.4.1 Smart Grids Components

The main components inside a Smart Grid are still in discussion. Some authors consider AMI as the key factor to deploy a Smart Grid, whereas other authors define the Distribution Automation –DA- as the pillar for it. In [52], a comprehensive analysis is presented including the different components inside a Smart Grid.

Intelligent appliances

They are appliances within the households with the ability for measuring power consumption and turn on and off themselves based on time-based pricing periods. Also, they can decide when to consume

power based on pre-set customer preferences or even based on the owner style and preferences using machine-learning algorithms [53]. In order to achieve the skills above, it needs to enable appliances to monitor their consumption and to support remote management. Smart grids projects have shown that consumers can save up to 25% on their consumption by providing them information about their consumption and tools to manage it.

Smart power meters

A meter, to be considered “Smart,” must comply at least with the task of data processing and storage for several purposes such as [54]:

1. Monitoring of proper installation and working.
2. Update of the meter software remotely.
3. Calculating and monitoring power quality.
4. Billing and settlement.
5. Analysis of energy end use.
6. Provide real-time data.
7. Management of tariffs.
8. Demand Response using device controllers.
9. Detect outages and dispatch repair crews to the correct location faster.

In order to roll-out smart metering projects, the project scope, operational expenses, and average meter life must be appropriately determined, since, according to [55], smart metering projects are not self-financing from a DSO perspective.

Smart substations

These substations have a Substation Automation System –SAS-, like the one proposed in [56] :

1. Using novel communication technologies and Intelligent Electronic Devices – IEDs-
2. Control and monitoring facilities for auxiliary power systems.
3. Integrate the standard IEC 61850 – Communication networks and systems for power utility automation – in order to perform control, monitoring, automation, metering and protection functions of critical and non-critical operational data such as power factor performance, breaker, transformer and battery status, security, etc.

Within the SAS system, it could be built interlocking logics, switching sequences, and load management substation level. The next figure depicts the communication structure of an automated substation.

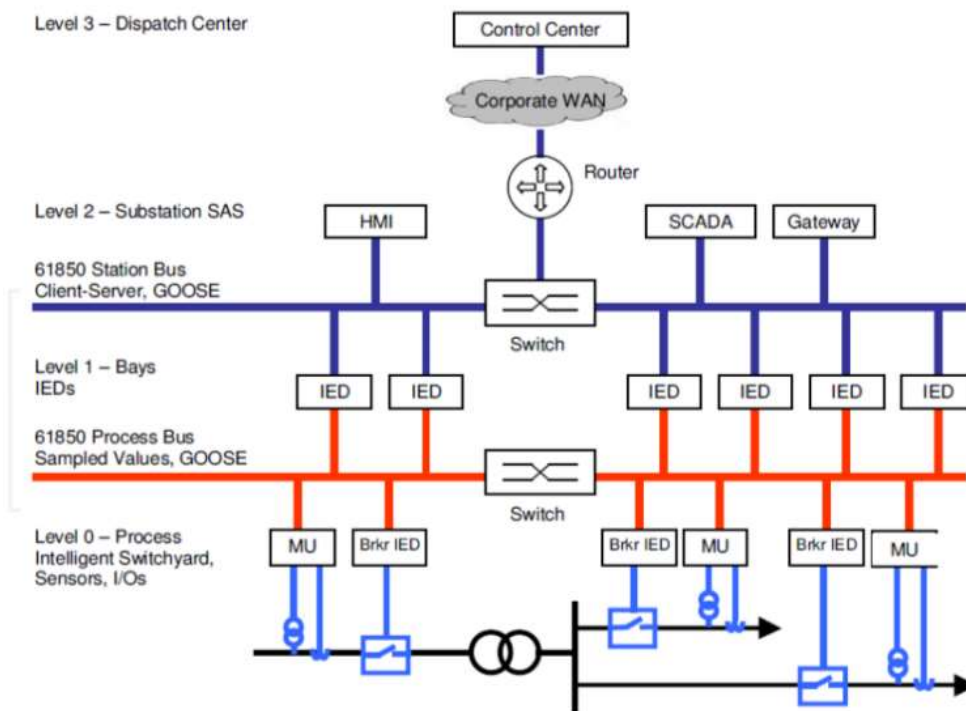

Fig. 2.21. Example of a communication structure of an Automated Substation [56]

Distribution Automation

According [57], Distribution Automation –DA- is the set of sensors, IEDs, communications equipment, protocols, reclosers, switches, and disconnectors integrated either in a local architecture of automation or a centralized one. It means that those elements along the distribution network can be operated remotely. Using DA deployment could achieve around 15 Advanced Distribution Automation functions. They could be divided into three groups according to their action:

1. Observe: sensors that collect accurate real-time information, i.e. DG monitoring for example.
2. Analyze/Decide: methods to transform the massive data in information in order to improve awareness situational, i.e., Optimal Power Flow, for instance.
3. Execute: electrical devices respond to control signals coming through either SCADA, IEDs or SAS systems, i.e., Fault Location Isolation Supply Restoration – FLISR-, for example.

One of the new functions that the last years have taken off significantly is the FLISR function. FLISR could be executed in a centralized or local architecture. For instance, Schneider Electric has developed this feature embedded in a SCADA system [58]. It is worth noting that the Volt Var Control function, which aims maintain acceptable voltage along feeders under different loading conditions [59], is also implemented by Schneider Electric. Even it is possible that both VVC and FLISR closed loop control are active at the same time on the same feeder.

The FLISR included the next steps:

1. Fault Localization: this step consists in locating the faulted section. The fault location could be estimated by means of equipment in the distribution system as fault locators or by advanced methods based on fault currents.
2. Fault Isolation: this step through of opening equipment controlled remotely isolates the fault.
3. Service Restoration: once the fault is located, by means of remote control signals to devices such switches, the major quantity of sections are re-energized.
4. Return to Normal State: once the fault is solved, the devices come back to their normal position in order to return the network to the regular state.

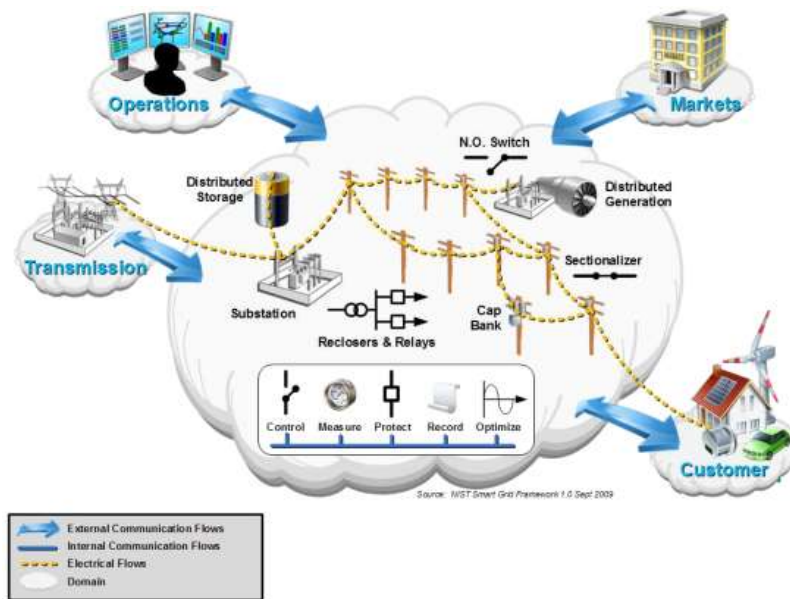

Fig. 2.22. Distribution domain, where it is possible to identify DA,[48]

Smart generation

It is capable of optimizing energy production, and automatically maintaining voltage, frequency, power factor within the allowed ranges delivering stability to the grid regardless of the complexity of the system. The smart generation manages advanced methods and techniques for forecasting and data analytics in order to deal with DG integration and energy storage solutions.

2.4.2 Innovations around the world

This section summarizes the most innovative projects around the world according to IEEE Power and Energy Magazine. The main purpose is to determine the latest research and development topics around the world, as well as its results. These experiences could be considered the moment of the deployment of Smart Grids in Ecuador.

AVANGRID

The project is being implemented in New York; the primary objective is to provide an active network management –ANM- to the network. ANM is looking for management and control of DGs in order to

increase DG hosting capacity and managing operational constraints on the existing distribution system. The impact of ANM occurs throughout the life of DG assets, from planning and operation to market participation [60].

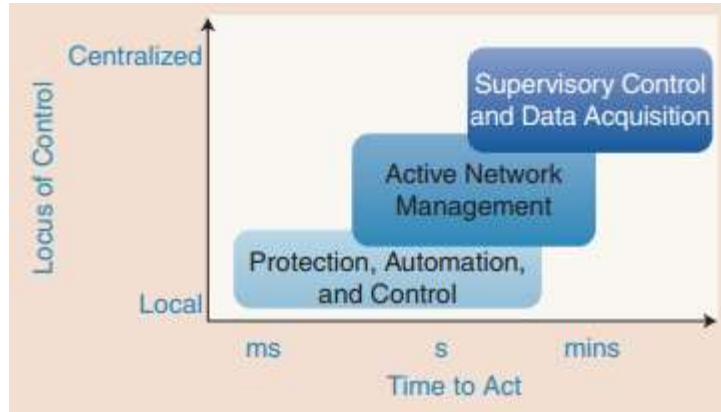

Fig. 2.23. ANM as a new layer in distribution grid management.

IGREENGRID

The objective of this project, Integrating Renewables in the EuropeAN electricity Grid (IGREENGrid), was to evaluate and select the most promising research and development for the integration of Distributed Renewable Energy Sources –DRESS-. The project concludes that a centralized solution using in a coordinated way the OLTC and DRESSs reach the highest amounts of hosting capacity. It is worth mentioning that in [61], an optimal control for DGs based on a decoupled Mixed Optimization algorithm is presented in order to keep a set point of reactive power or voltage at the connection point, and the same conclusion is obtained. Another important conclusion was that DSO must have advanced planning tools and an excellent asset management system. [62].

ID4L

The main objective of this project tested in Bornholm Island (Denmark) was to define, design, and demonstrate the ideal grid for all, with an active distribution network, which integrates RES with new loads.

The project was focused in to propose innovative solutions for i) hierarchical control architecture ii) Aggregator implementation for virtualization of DGs and iii) large-scale integration of DGs in network management

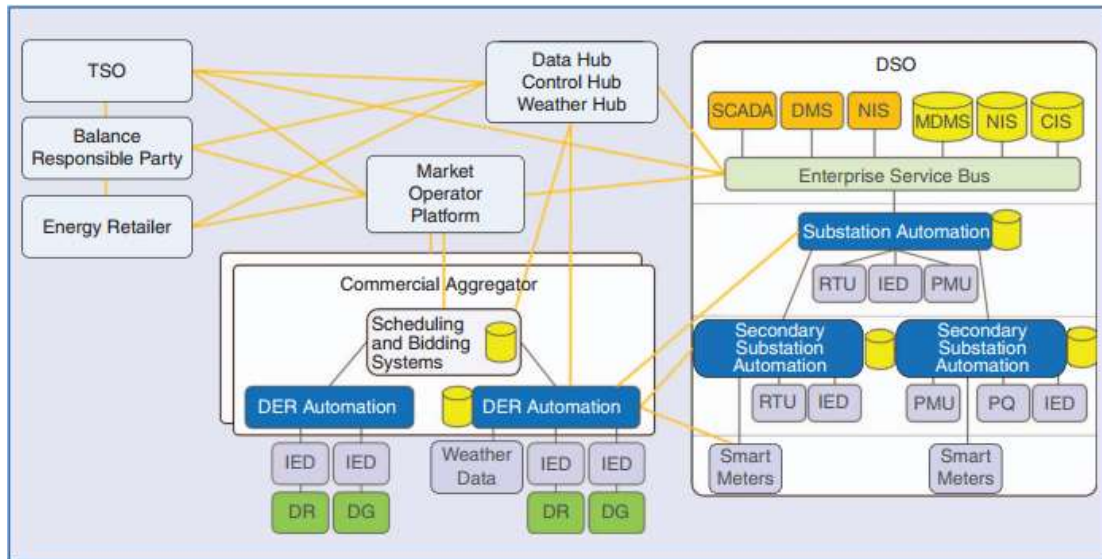

Fig. 2.24. IDE4L automation solution [63]

CLASS

The project Customer Load Active System Services –CLASS- operated by the U.K. DNO Electricity North West Limited (ENWL) from 2014 to 2016 proposed and implemented an innovative voltage-led load management program that was demonstrated to be both practical and scalable.

The CLASS Project managed demand instead customers, based on the Conservation Voltage reduction –CVR –. An innovative scheme, which controls the supplied voltage by means of primary substation transformers OLTC, can reduce customer demand for short periods (e.g., 15, 30, or 60 min) when the TSO requires this action in balancing operations.

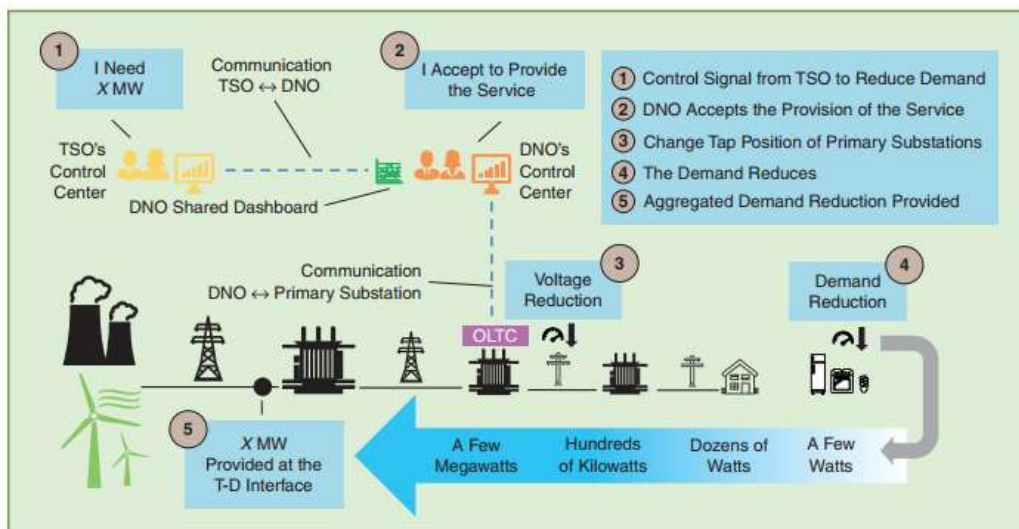

Fig. 2.25. CLASS: five steps involved in the voltage-led load management scheme [64]

Isolated Community Microgrids

Here, three isolated microgrid projects are presented i) Huatacondo, Chile, ii) Ollagüe, Chile and iii) Puertecitos, Mexico. All of them were developed in the last few years with the support of the University of Chile.

The main conclusions are i) the dependency of a single energy source easily could be avoided if the microgrid is properly designed, ii) microgrids incorporate interesting security characteristics that facilitate a quick and robust response to specific disturbances, iii) the experience provided by microgrid pilot projects can be converted into a learning platform for future resilient distribution systems.

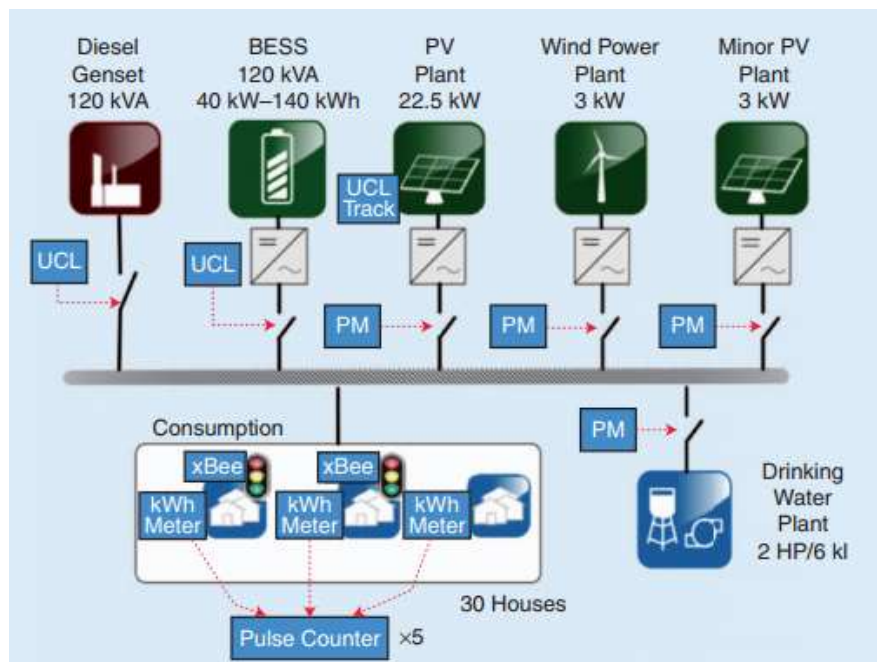

Fig. 2.26. Microgrid diagram [65]

2.4.3 Smart Grids in Ecuador

The first pillar for developing Smart Grids in Ecuador was the SIGDE project that started in 2009. After that, in 2013, the MEER signed a cooperation agreement for implementing Smart Grids in Ecuador, and a roadmap with a time horizon till 2030 was done.

In 2015, the MEER with the support of the “Universidad Politécnica de Valencia” –UPV- carried out an analysis to deploy Smart Grids in five pilot areas including Galapagos. In this framework, a survey study was done to determine the primary drivers to implement SG in Ecuador; the participants were MEER (5), ARCONEL (2), CENACE (2), CELEC (1) and distribution utilities (7) resulting in 17 surveys. The results are presented in the next figure.

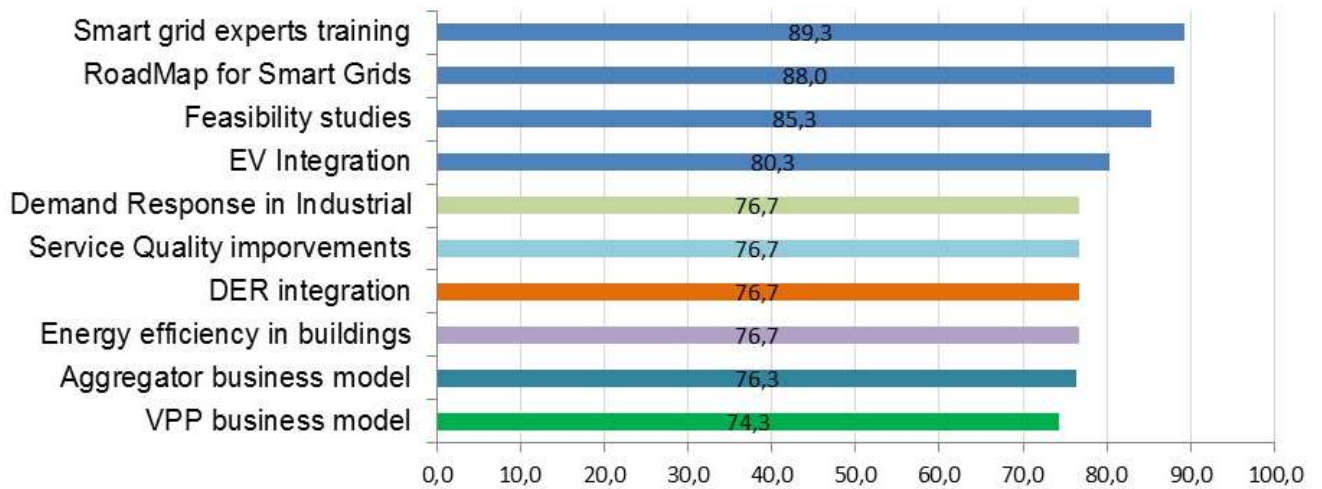

Fig. 2.27. Top-10 Ranked motivating drivers in Ecuador,[66]

The philosophy to deploy SG in Ecuador is based on [67], where ten minimal actions must be done in order to have a successful transition towards Smart Grids.

TABLE VI DECALOGUE FOR SMART GRID DEVELOPMENT

| <i>Item</i> | <i>Action</i> | <i>Responsible Project/Entity</i> |
|---|--|---|
| <i>Develop Regional and national roadmaps for smart grids</i> | <i>National roadmap defined in 2013, under updating with the "Agence Francaise de Developpement" –AFD- support.</i> | <i>REDIE</i> |
| <i>Develop a policy framework to promote smart grids</i> | <i>Several Meetings with ARCONEL and stakeholders.</i> | <i>MEER</i> |
| <i>Adapt the energy regulation to promote smart grids</i> | <i>Some regulations adopted and other in developing stage.</i> | <i>ARCONEL</i> |
| <i>Create, collect and disseminate business cases</i> | <i>Losses reduction program Funding from International Development Bank, AFD, Government</i> | <i>MEER + Utilities</i> |
| <i>Develop and demonstrate smart grids technologies</i> | <i>Advanced Distribution Management System deployed in all the country Commercial Information system ongoing</i> | <i>SIGDE + Utilities</i> |
| <i>Demonstrate distribution automation and smart meters</i> | <i>20.000 smart meters in Guayaquil city DA projects in 5 cities</i> | <i>MEER+ Utilities</i> |
| <i>Share best practices and knowhow</i> | <i>IEEE ISGT Latin America conference in Quito, 2017 IEE and IEC standard such fundamentals Smart Grid Interoperability panel member</i> | <i>MEER IEEE Ecuador CENACE</i> |
| <i>Promote standardization</i> | <i>Materials and Processes unified Technical systems unique</i> | <i>SIGDE+ Utilities</i> |

| | | |
|---|---|---|
| <i>Engage public awareness</i> | <i>Energy efficiency program Galapagos free of CO2 project Induction Cooker project</i> | <i>MEER + ARCONEL + Local Governments</i> |
| <i>Build up on regional skills and excellence</i> | <i>Cooperation with other countries and foreign agencies Smart Grid master in Ecuador</i> | <i>MEER + Universities</i> |

The country is working hard to build in the long term a Smart Grid, although several projects are ongoing, a lack of developing in the regulation subject is identified. In addition, Research & Development programs must support skills, excellence, know-how and best practices. In this framework, this Ph.D. will contribute to increase the level and develop of the items above usually not encouraged within Ecuador.

2.5 Conclusion

A detailed description of the Santa Cruz network was carried out in this chapter; it was possible to identify the installed power about thermal and renewable generation. There was also a survey of the number of customers and their type, as well as the number of feeders with their installed capacity.

The regulatory analysis revealed that in Ecuador today there are substantial regulatory barriers to the implementation of SG, the main ones refer to the lack of a regulatory framework for the execution of DSM, and there is no retail market. The incentives for DG deployment are only applicable at MV / HV level, and TOUs are available only at the level of industrial users. Thus, a long way in the regulatory aspect must be pursued.

Concerning DG deployed in Ecuador, the integration rate yet is small, and a strong incentive to install renewable energies is required. The major capacity power installed is coming from thermal sources, if we remember that an incentive to deploy DG is the CO₂ emission reduction, the concept in Ecuador is not well managed.

The Smart Grid concepts and the different projects around the world were studied. It was identified that Ecuador needs to define a roadmap to deploy new technologies, and the international experience and the most recent advances in research fields have to be considered in order to improve the projects.

The next chapter deals with the assessment of integrating new loads in the low voltage network, such as electrical motorbikes, induction cookers and PV panels.

Chapter 3:

Impact Assessment of New Services in the Galapagos Low Voltage Network

Traditionally, strong investments have been made on the transmission network, since a fault in this level may cause severe issues such as thousands of clients with an outage, acting of frequency protections and even a blackout. Furthermore, the transmission system is designed with the N-1 criteria, which means that the system must be able to keep working properly even in a scenario with a faulted major element, i.e., generator, transformer or line. Unlike transmission system, the distribution grid historically has not had the deserved attention; it has changed with the advent of SG since now the attention is focused mainly on the distribution and end-user segments.

End users have patterns unpredictable and non-scheduled consumption, with the arrival of SG, these users are enabled for managing their consumption, based on hourly tariffs interacting with utilities, through devices that can measure and control the loads, as well as, increase the visibility for DSO or agents as the aggregator or the Virtual Power Plant –VPP-. Thereby, consumers will now become prosumers (producer + consumer) [68]. Also, the prosumer is defined like a pro-active consumer since in the case it is possible, they can sell energy to the utility.

DGs, control equipment, EV, storage, smart appliances among other new services, are connected in low voltage networks. Thus, it is necessary to address the modeling of the low voltage system appropriately, in order to have an accurate model in which to test the SG concepts. All this must be made through several realistic simulations to identifying the impacts on the grid of i) high penetration of DG which may cause bi-directional flows [69], ii) EV and iii) IC.

Therefore, the ability to model the distribution network including all aforementioned new services would provide a clear and accurate perspective of the future impacts into the low voltage network. Thus, this chapter will assess the impact of induction cookers, electric motorbikes, and distributed generation (PV panels) on the Galapagos LV network. A powerful interface to extract information from Geographical Information System – GIS- and then import it into Matlab/Simulink is proposed as well.

3.1 Modeling

An important step previous to execute analysis, simulations and to create scenarios, consists in modeling the different electrical devices of the distribution network. Those elements are lines, cables, transformers, loads [70] and unconventional elements, e.g., PV panels, smart buildings, EV, microgrid controllers, batteries, and DGs. In order to consider the mutual effects between wires, it is essential to model the distribution network in MV and LV phase by phase, considering the neutral; thus, the traditional models used in simplified calculus are not an option anymore. Furthermore, for the modeling purpose, Matlab-Simulink ® and CYMDIST® software are good options for modeling due to their programming/calculation capability and versatility [71].

3.1.1 Transformers

Distribution transformers are the key element in distribution networks since they have the function of connecting end-users with medium voltage levels. In addition, in the distribution system, there are several existing wiring architectures. For instance, in Ecuador, it is possible to find single-phase, two-

phase, three-phase, overhead and underground configurations. The most typical configuration in low voltage is 1P3W; a single-phase transformer at MV side with a central tap at the low voltage side in order to obtain 240/120 V, i.e., two-phase + neutral (see Figure 3.1).

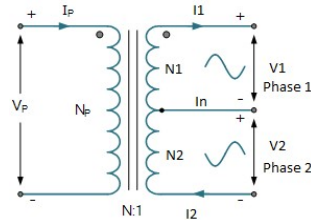

Fig. 3.1. Equivalent circuit for centre tapped transformer

Most of the transformers are single-phase-overhead with power around 5 to 75 kVA. For this reason, the 12 terminals Simulink block is suitable, since, allow connecting transformers in different ways. For modeling, required parameters are:

- R_m : Resistance of iron losses
- X_m : magnetizing inductance
- R_p : primary winding resistance
- L_p : primary leakage inductance
- R_s : secondary winding resistance
- L_s : secondary leakage inductance
- a : transformer ratio

Parameters above are calculated using information coming from open and short circuit tests. Figure 3.2 shows equivalent circuit and the blocks employed in Simulink and CYMDIST

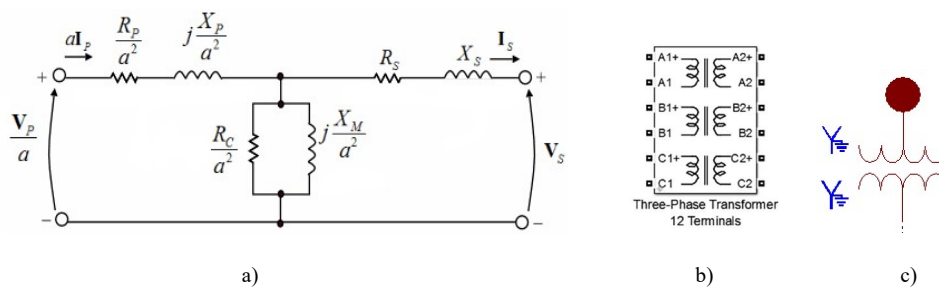

Fig. 3.2. a) Equivalent circuit based on the secondary side, b) Simulink block, c) CYMDIST block [72]

Distribution lines in medium voltage carry power to distribution transformers usually located close to the customers. In Ecuador, the typical configuration is 3P4W (3-phases, 4-wires), and most of the lines are overhead. For modeling, the nominal PI model, which does not take into account propagation effects, is used.

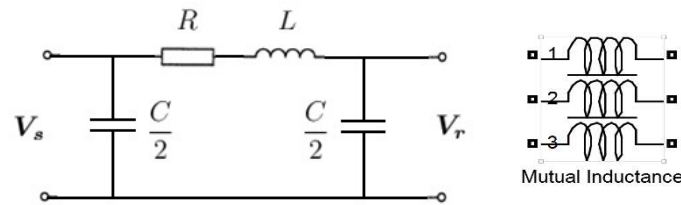

Fig. 3.3. Model of the Line, [73] [74]

It implies the necessity of the calculus of inductance and capacitance for each configuration. According to [75], recommended Simulink block is "Mutual inductance" set as Generalized Mutual Inductance, in order to have more accurate and reliable results. Within CYMDIST, the unbalanced line must be selected.

3.1.2 Load

The load is a circuit that consumes electric power; for modeling, three models could be chosen i) constant impedance, ii) constant current and iii) constant power, even in order to be more accurate, a combination of the three (ZIP model) is sometimes used. Nevertheless, it is worth noting that end users are classified typically such as residential, commercial and industrial. Thus, each client has a characteristic load profile. This profile could be specified with more precision taking into account another factor such season, the day of the week (weekend or holiday) or geographical regions. Hence, if the utility has real load profiles, those must be included in the simulation in order to improve the results. In Matlab, it is done using the "Three Phase Dynamic Load" block; this block is fed with active and reactive curves [76]. In addition, this block enables load modeling using any model. In CYMDIST the Energy Profiles Manager module, allow using different load curves.

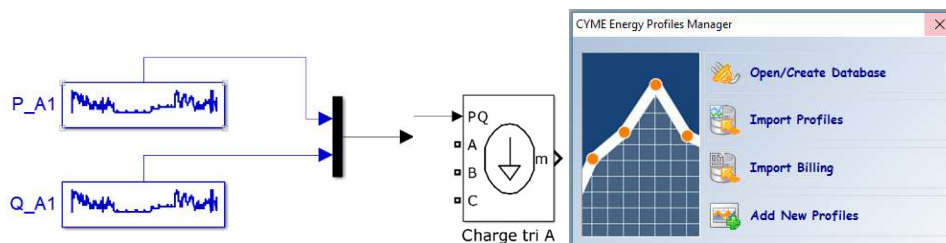

Fig. 3.4. Load modeled into Simulink and CYMDIST [76]

3.1.3 Unconventional electrical elements

PV sources could be modeled as a negative load, whereas EV and smart buildings, could be represented by equivalent blocks [74]. On one side, EV is modeled through a particular profile, which absorbs power. On the other hand, the smart building is modeled with a residential or a commercial profile. Load shedding process could be tested distinguishing appliances, using real load profiles disaggregated in end-uses of energy such as heating, hot water, lighting and so on [77].

3.2 Interface GIS-MATLAB

The SIGDE project described in Chapter 1 has as one of its axes on Network Georeferencing, this axis has been under deployment since 2009. Nowadays, the whole country has a GIS and the data model in the same way. The chosen software was ArcGIS®, which provides contextual tools for mapping and spatial reasoning, so the user can explore data and share location-based insights [78]. ArcGIS Desktop, the family of desktop GIS applications, is one of the most widely used, including in its latest editions the tools ArcReader, ArcMap, ArcCatalog, ArcToolbox, ArcScene, and ArcGlobe. All the distribution network, including MV and LV, is geo-referenced in ArcMap as well as loads, meters, substations, transformers, reclosers, switches, and all the electric devices in general. Thus, the power network topology needed for the modeling must be built in function of GIS system.

The conventional process consists in transfer manually the characteristics of the GIS system to Matlab-Simulink topologically speaking. However, this process could take several weeks or even months; thus, it was decided to invest time in developing an interface to create the Simulink blocks automatically based on GIS information. Also, the interface must have the ability to fill the electric characteristics of the each device, in other words, to query a database with electric parameters. The next figure depicts the process performed by the interface; first, the information of the GIS system necessarily has to be represented such a connectivity diagram, it is done using the extension ArcGIS Schematics (see Figures 3.5-3.6).

The second phase is to read the connectivity diagram (tables with source and terminal nodes) in Matlab. Thus, the tables are imported, and by means of code, the different elements are created within Simulink. Once created, those elements need to be connected (join command) according to the connectivity imported from GIS. In addition, two databases with information of i) electric parameters and ii) load curves are considered in order to complete all the information requested by Simulink. The final model within Simulink platform now is ready to be executed.

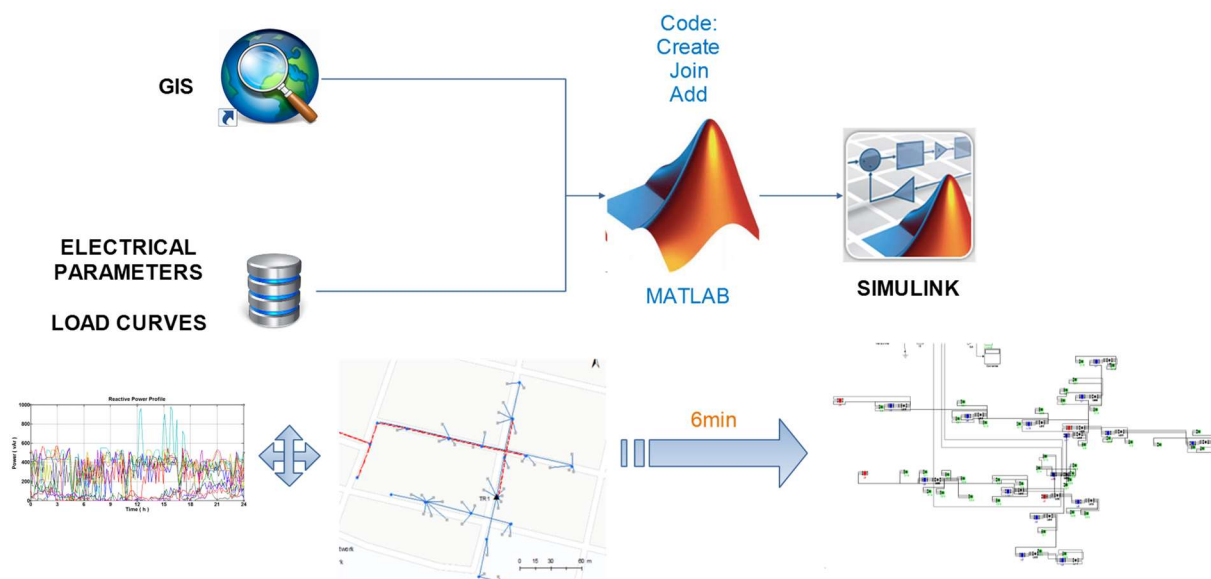

Fig. 3.5. Interface between ArcMap and Matlab/Simulink

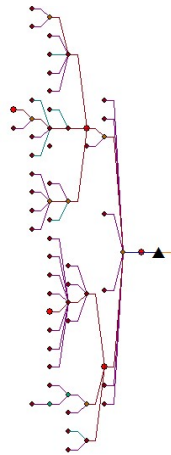

Fig. 3.6. Connectivity diagram created into GIS

As was previously described in Table II, Santa Cruz island has three MV feeders of 13.8 kV, the backbone network is three-phase, whereas the branches are composed of single-phase sections. This chapter deals with the impact assessment of new services connected at low voltage system. Therefore, a representative MV/LV transformer with its LV network must be selected to perform the simulations; in this selected system, all the new services would be integrated and must enable extrapolation of results in most cases. The next paragraphs describe the process to choose this representative transformer.

In Chapter II, Feeder 1 and Feeder 2 are classified as urban and Feeder 3 as rural. In addition, Feeder 1 has residential characteristics. Thus, the selection should be focused in Feeder 1. In order to select a representative LV network, a statistical analysis is necessary since there are 123 MV/LV transformers with their LV networks within Feeder 1. Through the GIS own tools, the summary about the rated power of the transformers is performed. The next figure depicts that the minimum installed power is 10 kVA and the maximum is 150 kVA. The values in the diagram parts represent the number and percentage (referring to total number of clients) of connected clients for each type of transformer, and the legend on the right gives the rated power of transformers in kVA. According to this figure, the largest number of users (510) is connected to 50 kVA transformers. Thus, this power value is the first parameter defined to select the transformer for simulations.

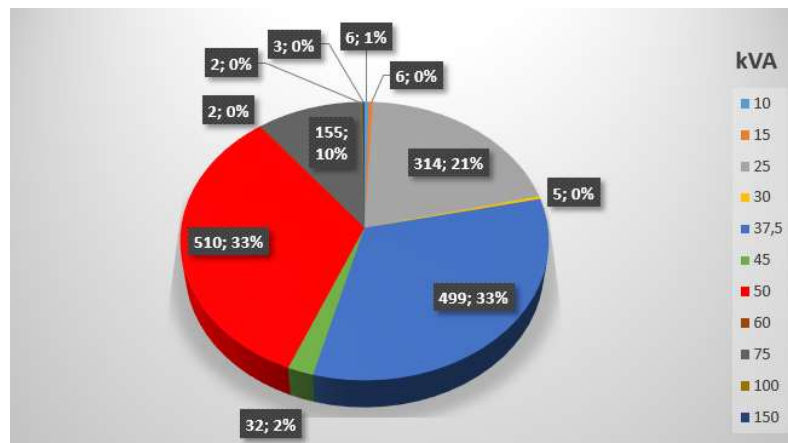

Fig. 3.7. Consumers classified by rated power of MV/LV transformers

Once established the representative rated power, it is time to determine the typical number of clients in a transformer of 50 kVA. The range of connected clients goes from 1 to 70 (see Figure 3.8).

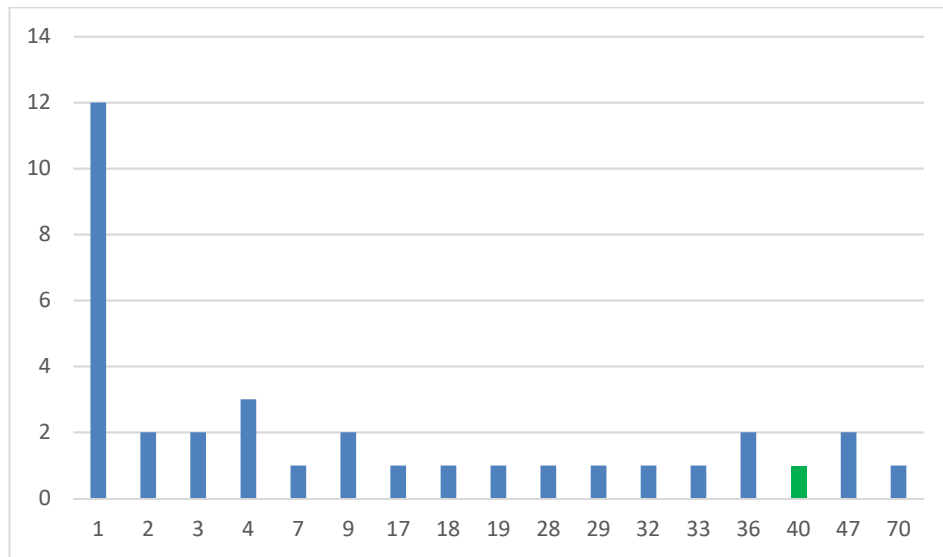

Fig. 3.8. Frequency distribution of connected clients at 50 kVA transformers.

One client per transformer commonly refers to a commercial/industrial use. According to Galapagos Electric Distribution Utility -ELECGALAPAGOS-, the peak of an average residential client is 1,55 kVA. Hence, any transformer of 50 kVA with less than 10 clients would have as maximum 30% of relative load. In this manner, we must select a transformer with at least 30 customers in order to have a “fully” loaded transformer with clients close to the “average client” to see the effect of strong integration of IC, EV, and DGs over the loadability. Therefore, the results are valid for other residential LV networks; the significant change would be established in the base scenario of each transformer. For commercial/industrial networks, a similar statistical analysis must be carried out.

Then, Table VII shows the main characteristics of the defined LV network, which is shown in Figure 3.9

TABLE VII DESCRIPTION OF THE SELECTED LV NETWORK

| <i>Substation</i> | <i>Feeder</i> | <i>Transformer</i> | <i>Power (KVA)</i> | <i>Customers</i> | <i>Nodes</i> |
|-------------------|---------------|--------------------|--------------------|------------------|--------------|
| <i>Santa Cruz</i> | <i>1</i> | <i>TR1</i> | <i>50</i> | <i>40</i> | <i>15</i> |

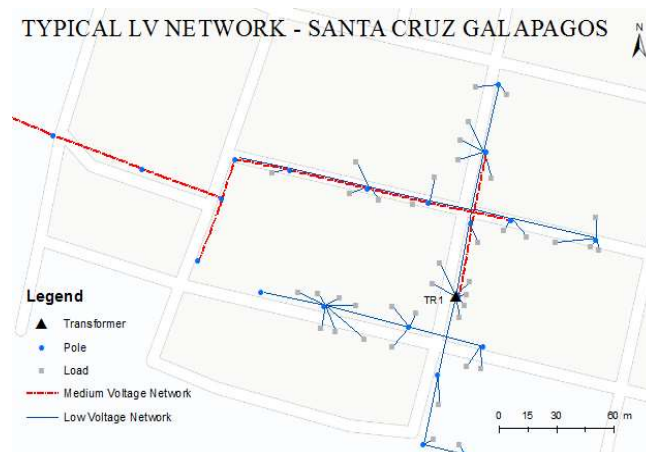

Fig. 3.9. LV Network modeled into Simulink

Once defined the LV network, the logical step for starting the simulations is creating the base scenario, in terms of load curves.

3.3 Active and Reactive scenario -PQ

The base scenario represents the current situation of the transformer. This first scenario is named PQ since it integrates real load curves for both active power (P) and reactive power (Q). For each scenario, the voltages, power, and currents are analyzed.

Within Simulink, several blocks have to be filled in order to feed the load with real load curves, for instance, a block for the P curve, another for Q curve, one more to join P and Q, and so on. To avoid excessive time in building the model necessary for feeding the load in Simulink manually, another script was developed to execute the entire process. In GIS system, the number of clients per phase and per node, the client type, the last consumption, and an average of P and Q are clearly defined. With this information, a traditional study using coincidence factors could be done, and thus, the impact of new services can be estimated, but the result will be a simple value representing the power in the transformer.

In this chapter, the proposed methodology is based on using real load profiles for each client, and the reader can note that several curves are necessary. In Galapagos, different types of clients exist, most of them are of residential type; a typical residential client has various appliances such as refrigerator, television, washing machine, microwave, and lighting. The Galapagos utility makes regular measuring campaigns. Therefore, there are available real load curves concern both the active and reactive power with 10 minutes samples [79]. The database of real curves has to be filtered in order to use only curves from the month in analysis. For that, historically, the higher consumption in Galapagos is registered in April; it is associated directly with the temperature since more air conditioners and fans are used.

Most loads are connected to 120 V (phase-to-neutral), then, the script assigns randomly, load curves for each client in phase either 1 or 2. The next figures show the database of P and Q curves.

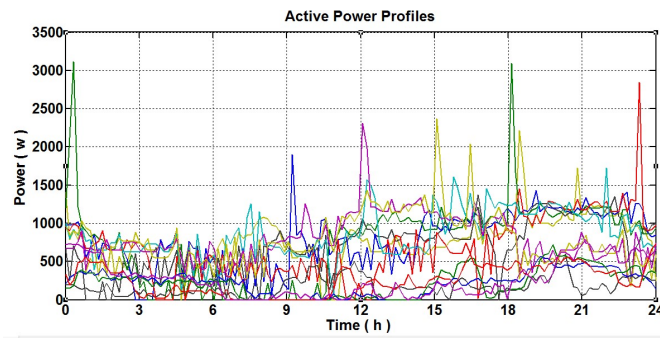

Fig. 3.10. P curves database with 40 curves

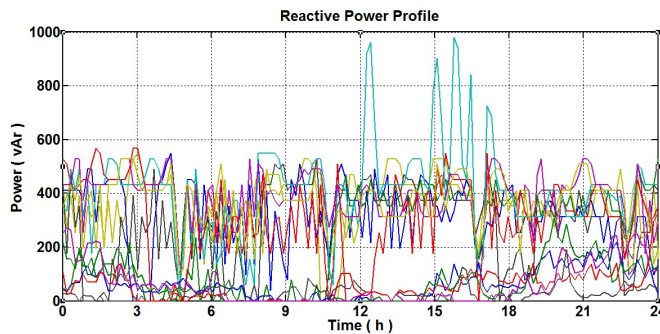

Fig. 3.11. Q curves database with 40 curves

The approach that considers real curves is much better than one which considers only an average curve [80]. Although obviously, it is more complex due to i) usually, the utilities have not real residential curves ii) It needs a higher computational effort.

In addition, the typical configuration in Galapagos LV network has to be modeled [81]. For that, a custom library [82] with blocks for representing single and two-phase loads has been created, see Annex 1. With the interface described in the Figure 35, which create/add/join/fill blocks called from the custom library, the electric model inside Simulink is created. Annex 2 depicts a portion of the LV network. The model includes the blocks for measuring voltage and current, as well as the tapped central transformer, and the plotter and scopes for viewing the results.

Regarding the load curves, the next figure depicts a portion of blocks created for feeding the single and two-phase loads; the disconnected pins are ready for the inclusion of EV, IC, and DGs.

Figure 3.13 presents the main results of the base case simulation, i.e., with only the loads; the maximum power occurs at 20:48 and its value is 36,96 kVA. Regarding the drop voltage standard (limits of +/- 5% of the nominal voltage) all the nodes are inside the margin. The maximum current through the transforms is 164,30 A in the phase L1, and the minimum voltage is 233,40 V (phase-to-phase). As expected, a current flowing through the neutral wire exists, the maximum value is 27,06 A. This confirms that the network is unbalanced.

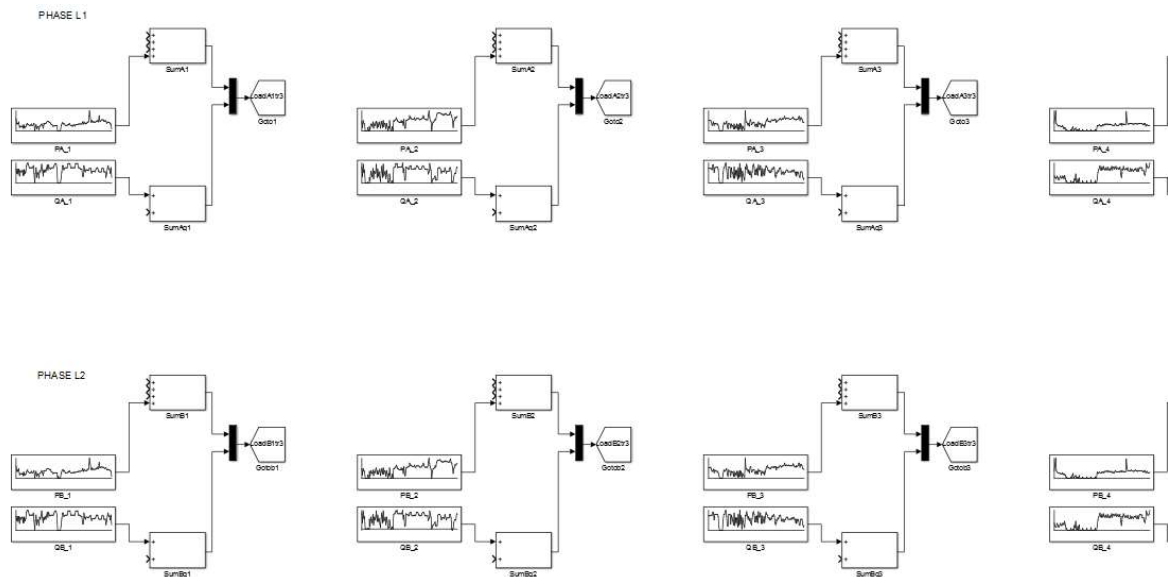

Fig. 3.12. Blocks created automatically for feeding loads.

The average power in the transformer is 24,40 kVA, and the factor of use is defined such as:

$$FU = \frac{\text{Maximum Demand}}{\text{Installed Capacity}} \quad (3.1)$$

Thus, the FU in this scenario is 73,9%

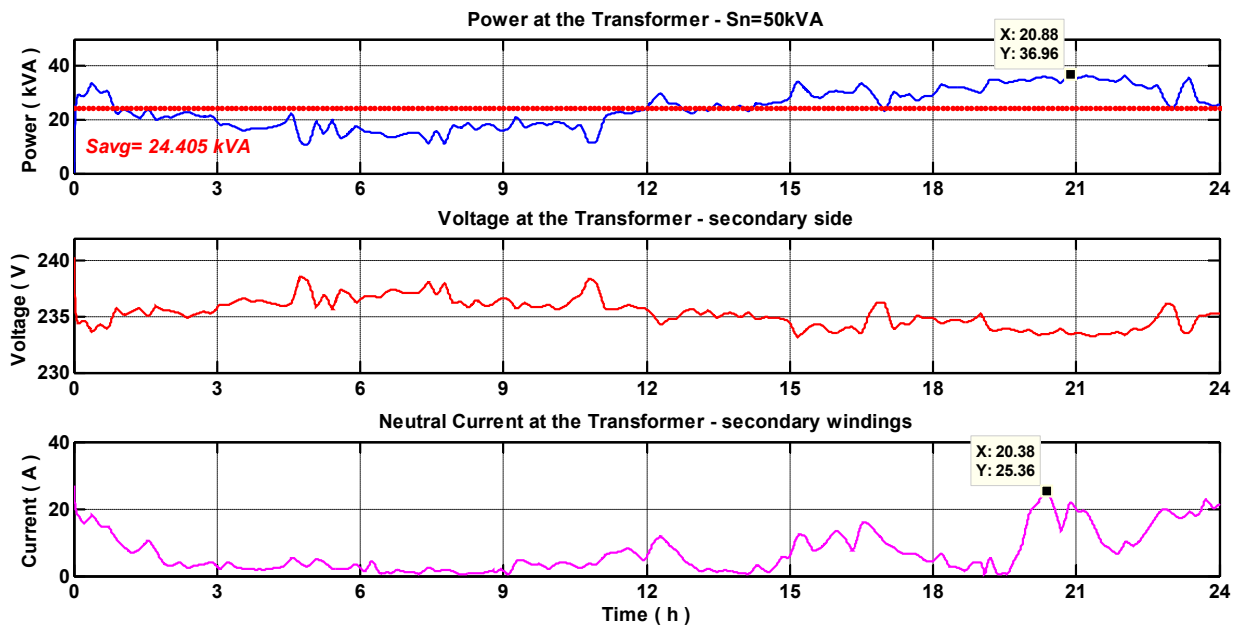

Fig. 3.13. Scenario PQ

Now, the base case scenario is entirely defined, thus, in the next sections, the scenarios including induction cookers, electric vehicles, and photovoltaic energy sources, and the results of their impact studies on the LV grid will be presented.

3.4 Induction Cooker (IC) scenario –PQ+IC

In Ecuador, especially in Galapagos, several policies foster the change of conventional stoves by induction ones. The IC is a particular new load in Ecuador, which has been recently deployed into the LV grid to replace gas stoves. There already have been deployed 187.280 induction cookers in Ecuador, and for the particular case of Galapagos Archipelago nowadays, there are 80 already connected, and 240 have been requested [83]. The induction cooker rated power is typically in the range 2500-7000 W and connection voltage level is 240 V.

In the case of IC, profile curves already exist since IC program has been deployed previously in the Continental Country and the Distribution Utilities installed exclusive meters for determining power and current in IC as well as habits in the cooking process. The database of IC measurements was taken from Quito city, where ICs are already installed. After the validation process, it remains 1442 daily use curves with a sample time of 10 min. Thus, real measurements are used to feed the block used for modeling induction cooker. The next figure shows 40 induction cooker profiles and depicts that the greater use occurs at 12:00 coinciding with the mealtime. Peaks are also appreciably higher at 7:00 a.m. and at 7:00 p.m., coinciding with breakfast and dinner, respectively.

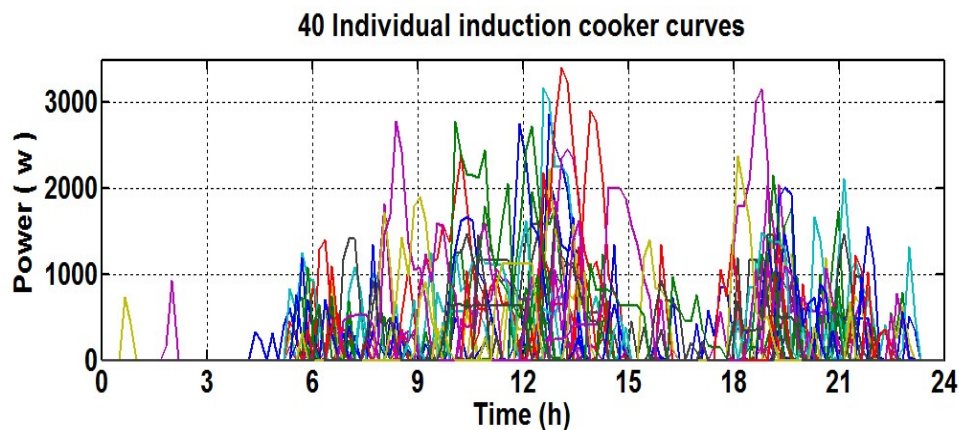

Fig. 3.14. Induction Cooker profiles

Upon the PQ scenario, an IC is implemented for each residential client; in order to assess the impact on the grid variables, for the case of analysis at the transformer level, it would be considered an integration ratio of 100%, since the changing is mandatory nowadays.

The next figure depicts the created blocks to consider IC; the real curves of active and reactive power are added to the P and Q curves.

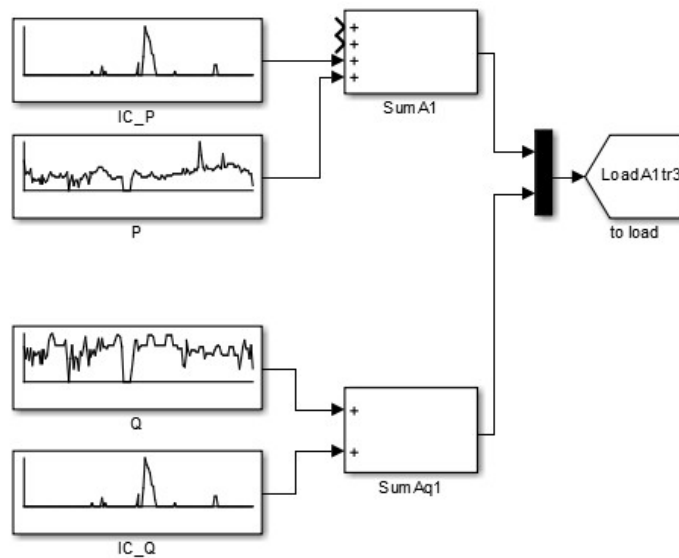

Fig. 3.15. Blocks created automatically considering active and reactive curves for IC.

The results of the second scenario (PQ + IC) show an increase of 5,73 kVA in the average power, see Figure 3.16. Now, the profile has two peaks during the day, the first one at 12:48 and the second one at 19:18. The peak in the night is higher and reaches a value of 56,05 kVA. The lowest voltage is 229,8V (phase-to-phase). This scenario highlights overloads during the night and noon. However, voltages are still within the standard limits. The maximum value of neutral current is 28,15 A.

The increase in the current flowing in phases 1 and 2 is approximately 50%. Thus the maximum current is 234,11A in the phase 2. The factor of use in the night is $FU=112\%$, which shows a small overload of the transformer, whereas the FU in the noon is $FU=102\%$.

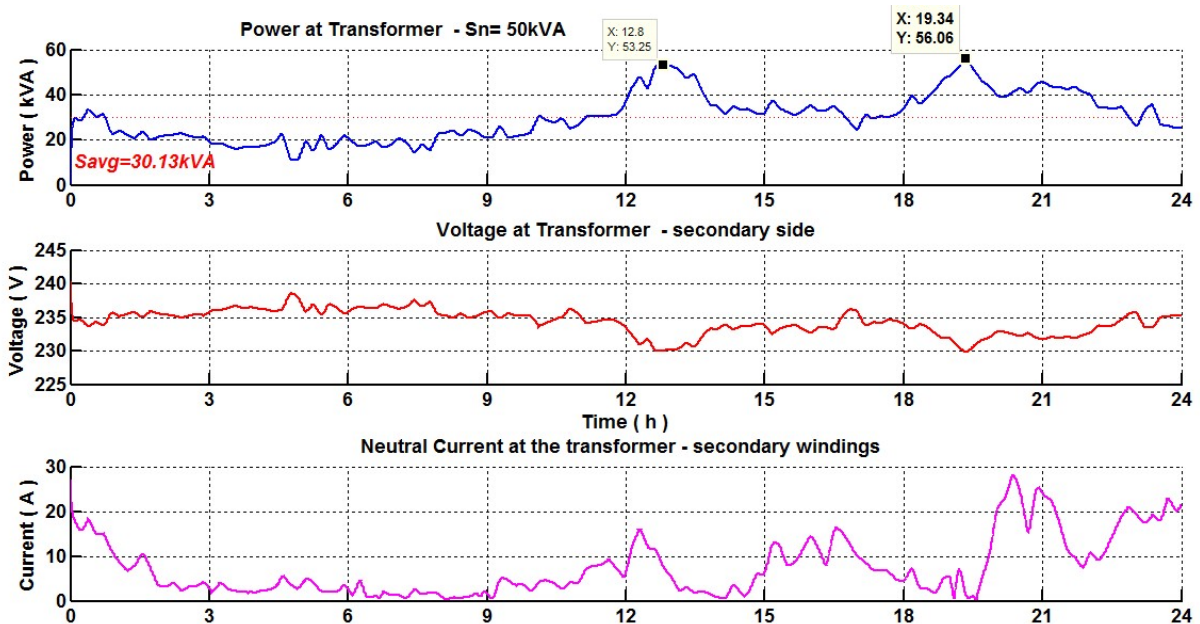

Fig. 3.16. Scenario PQ+IC

Once the impact of IC is assessed, the next step consists in integrating electric motorbike in each household.

3.5 Electric Motorbike scenario –PQ+IC+EM

The government of Ecuador has launched the initiative zero CO₂ emissions in order to support the nature preservation. Thus, electric vehicles must replace the conventional ones (fuel oil). Hence, the council of government of Galapagos –CGREG- has been released a law to promote the massive change towards electric vehicles. The regulation is in force since March 23, 2016.

According to CGREG, there are 1391 vehicles in Santa Cruz, of which motorbikes represent 48%, vans represent 34%, and cars represent only 5% (see next figure).

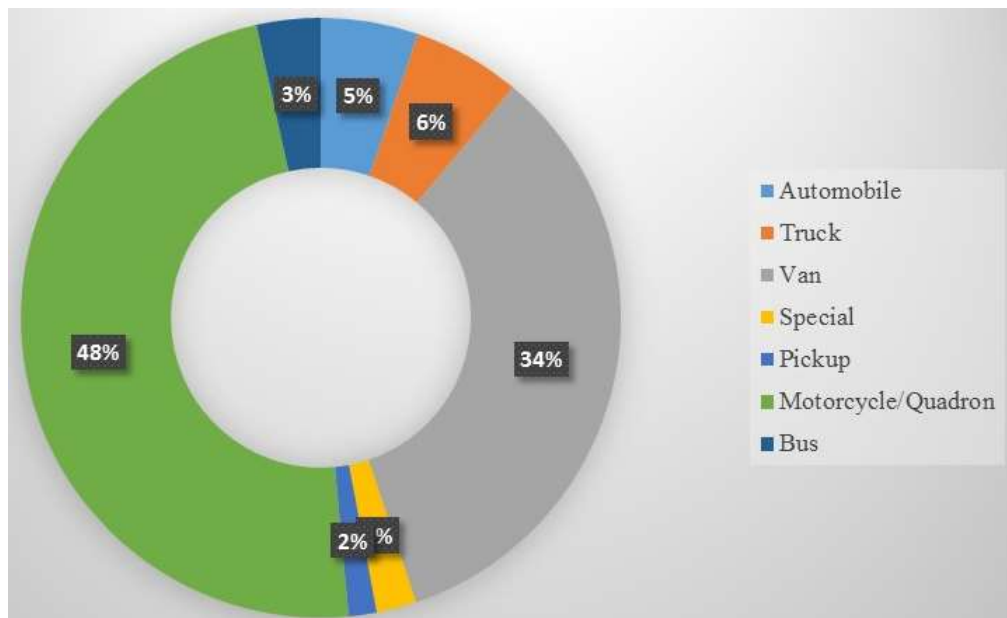

Fig. 3.17. Vehicle types within Santa Cruz

There are only 81 trucks, all of them with a commercial purpose. Thus, the study will be focused in the proper way of modeling the electric motorbikes –EM-. Due to the lack of information on the pattern of use of the new elements in analysis, specific studies should be carried out. Such studies must be based on surveys or comparisons with other similar studies based on the opinion of experts in sociology and electric demand.

A Monte Carlo simulation has been performed to estimate an average profile for EM; two types of motorbikes are considered based on CGREG guidelines. The first one is the ZX-220 model and the second one is the ZX-3M model, both of them from UNIDECO Company. Their power is 3000 W and 1500 W respectively. The autonomy for the ZX-220 is 70km with a charging time between 6h and 8h; the model ZX-3M has an autonomy of 60km with the same charging time. Next table depicts the hypotheses to build the model. Two recharge types are created; Type 1 is associated with ZX-3M model

and the Type 2 with ZX-220, also, two kinds of users are defined; the first one (User A) charges the battery only when it is completely discharged and the second one (User B) charges the battery every day.

TABLE VIII RECHARGE TYPES

| <i>Features</i> | <i>Type 1</i> | <i>Type 2</i> |
|------------------------|--------------------|--------------------|
| <i>Power –kW-</i> | <i>1,5</i> | <i>3</i> |
| <i>Charging period</i> | <i>16:30-20:30</i> | <i>16:30-20:30</i> |
| <i>Peak</i> | <i>18:30</i> | <i>18:30</i> |

Monte Carlo simulation obtains the average curve of 600 users in each iteration. Additionally, it is supposed that the user A represents 20% and the user B 80% of the users. Moreover, an amount of 25% of full daily charges is assumed. Thus, Table IX presents the percentage by users and recharge type.

TABLE IX DAILY CHARGERS

| | <i>Type 1</i> | <i>Type 2</i> |
|-------------------|--|--|
| | <i>50%</i> <i>300 users</i> | <i>50%</i> <i>300 users</i> |
| <i>User A</i> | <i>2,5%</i> <i>3h for charging</i> <i>and 30 min of deviation</i> <i>15 users</i> | <i>2,5%</i> <i>5h for charging</i> <i>and 1 h of deviation</i> <i>15 users</i> |
| <i>User B</i> | <i>40%</i> <i>30 min for charging</i> <i>and 10 min of deviation</i> <i>240 users</i> | <i>40%</i> <i>45 min for charging</i> <i>and 15 min of deviation</i> <i>240 users</i> |
| <i>W/O charge</i> | <i>15% - 90 users</i> | |

After executing the Monte Carlo model with 1.100 simulations, an average profile is determined, the maximum value is 630 W, see Figure 3.18.

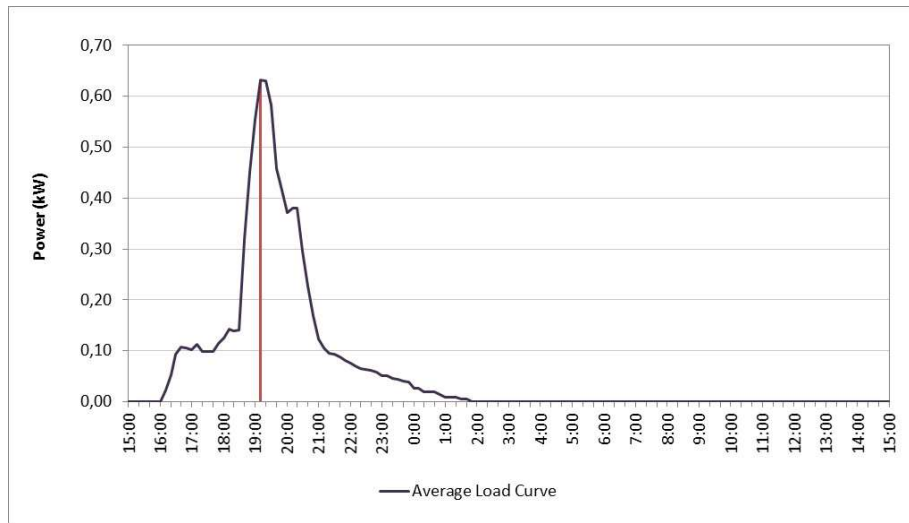

Fig. 3.18. Average Profile for Electric Motorbike

This average profile has been combined with a coincidence factor, which is a function of client's number [80]. The coincidence curve is defined in [84]. It is worth to mention that the electric motorbikes are modeled only with the active power, assuming that their interface converter can tune a power factor equal to 1.

This scenario shows an increase in the maximum power of 10,76 kVA, the second peak at night is 66,81 kVA at 19:18, the lowest voltage is 228,2 V (phase-to-phase) during a few minutes. The maximum value of neutral current is 30,09 A, which indicates that the imbalance is still equivalent to the scenario 1 and 2. However, the maximum current in the transformer is 279,94 A, i.e., almost twice than for PQ scenario. This scenario highlights voltages outside the standard limits and a significant overload in the transformer. During few minutes at night, the FU=134%, whereas FU in the noon still equal to previous scenario FU=106%

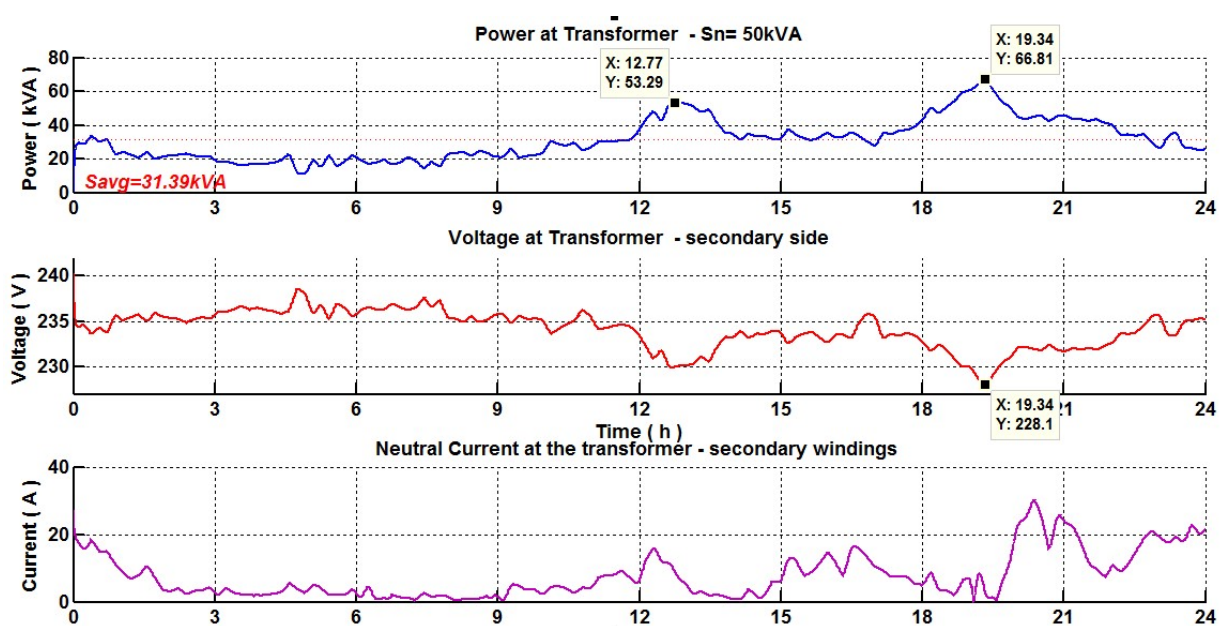

Fig. 3.19. Scenario PQ+IC+EM

The natural growth also must be considered in the scenarios. Hence, the next section presents a simulation that integrates the growth as well as PV panels installation in each household.

3.6 Photovoltaic scenario -PQ+IC+EM+G+PV

This scenario considers an annually growing (G) due to population increase rate leading to a 7,85% increase in the load [85]. This value is higher than growth population rate in other provinces because the population has grown haphazardly mainly for the tourist activities. This growth has forced to increase the generation capacity and to deploy energy efficiency programs. Also, encourage customers for generating their energy is an essential aspect considered within the new policies to convert Galapagos to an archipelago energetically self-sustaining.

In addition, assuming that the transformer will suffer overloads and take advantage of the existence of solar resources, an array of PV panels [84] is connected to each client house to 240 V. The next figure illustrates the scenario, where all the new services are connected. PV and EM are modeled only with active power, assuming that their interface converter can tune a power factor equal to 1.

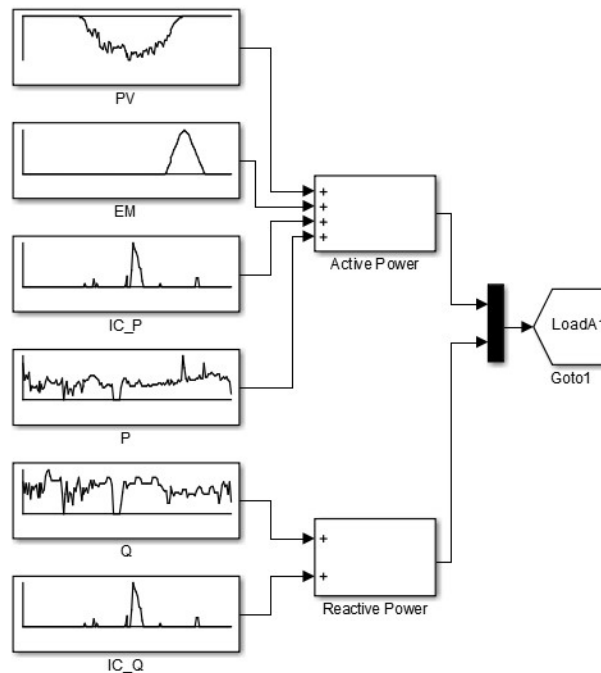

Fig. 3.20. Simulink Model considering all the new services

PV sources could be modeled taking into account different approaches; for instance, in [86] the PV model consider the single-diode five-parameters model. In [41], the block “three phase dynamic load ” fed with a negative profile is used. For our studies, this last approach has been selected since this chapter seeks to evaluate the PV impact on the network and several PV curves from real measurements are

available. The April active power measures of the existing PV power plant of 1500 kW installed on Santa Cruz Island are used in order to create 40 individual PV curves for the end-users. Hence, thirty curves are available (one per day from the main meter), the other ten are obtained from the backup meter of the PV power plant.

The existing curves were transformed to per unit system after that these were multiplied by the rated power desired. According to [84], the energy resources in Santa Cruz island are enough to satisfy the end-user's average consumption. These resources even could generate 25% of additional power. In order to achieve the above mentioned, it is necessary to install 2.150 Wp on the roof of each client's household. For reaching 2.150Wp, it is required to build a PV array composed of several PV panels. Thus, the new PV profiles are created based on Equation 3.2

$$New_PV_{profile} = \frac{PV_i}{1500kW} * 2,150kWp \quad (3.2)$$

The Figure 3.21 shows the different profiles obtained. As the reader can see, the resource is available between 06:00 AM and 06:00 PM.

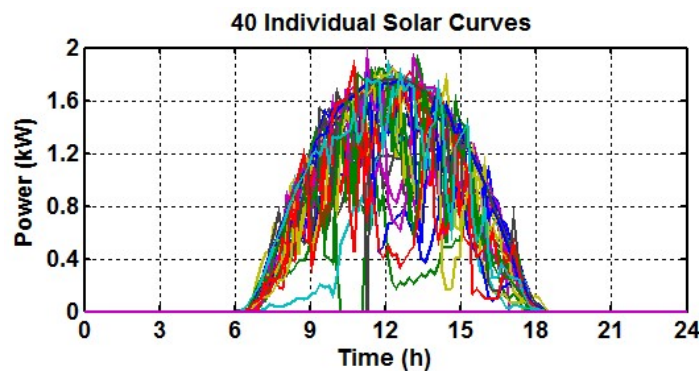

Fig. 3.21. PV profiles

The final scenario assesses the insertion of PV sources in the end-user's facilities plus natural growth. The installed PV panels are enough (in terms of produced power) to reverse the flow between 07:36 and 15:54. The average power in the transformer decreases considerably to 13,75 kVA. Despite the PV sources installation, we still have one overload period during the night for obvious reasons, since this scenario considers annual Growing -G-; now the power peak is greater reaching a value of 71,07 kVA and a FU=142%, and consequently, the voltage still crosses the lower limit during this peak. The maximum current flowing in the reverse sense is 122,44 A, the imbalance is higher than in the previous scenarios since the neutral current is 35,20A (see next figure).

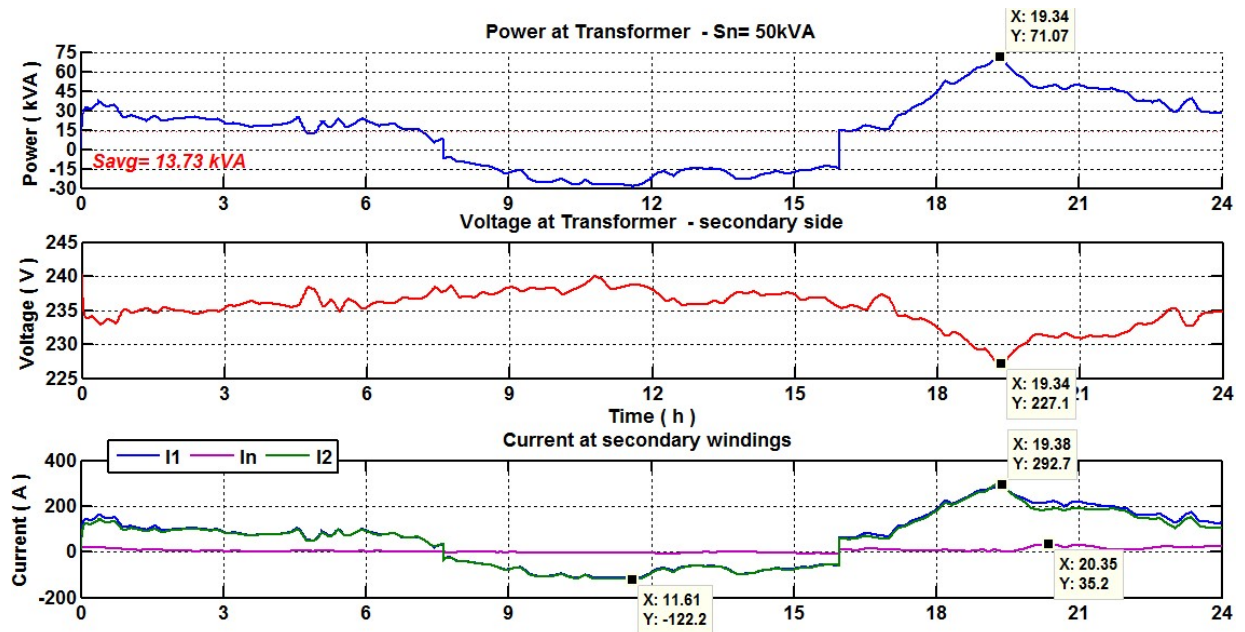

Fig. 3.22. Scenario PQ+IC+EM+G+PV

The Figure 3.23 shows in a single graph the four scenarios analyzed in low voltage, the scenarios with IC creates two peaks along the day; both of them are higher than rated power.

Similarly, the scenario with EM and G presents considerable peaks, the scenario with PV can delete the first peak at noon and even reverse the flow. However, the peak at night for obvious reasons is still present.

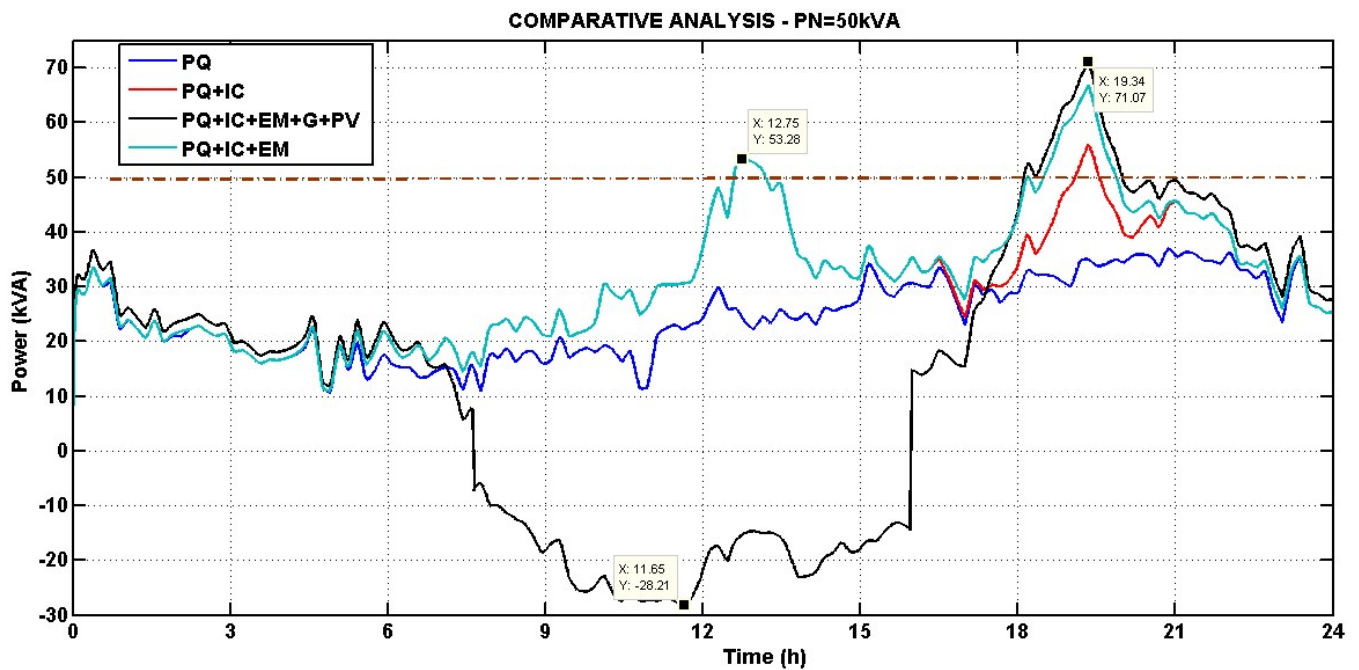

Fig. 3.23. Comparative Analysis

3.7 Conclusion

In this chapter, a study of the impact of new services which will be implemented soon in the Galapagos Islands has been carried out. Real data curves have been used such as residential load, PV production, and induction cookers, with a real part of LV Galapagos network, in order to make the simulations most realistic as possible. Normally, it is common to suppose that between midnight and 03:00 AM, the consumption is almost zero. However, as we can see in the results, it does not happen in Santa Cruz, and therefore, shift the EM load to this period is not convenient. On the other hand from 3:00 to 6:00 the consumption reaches its minimum, probably being a time to stimulate EM charging.

The EM and IC also could be connected at 120V. However, it will not be a good solution because high power loads must be connected to the highest voltage available and the load unbalance in the center tapped transformer is a strong reason for this. Thus, the idea is to take advantage of the changes that are suffering the clients to change their supply to 240V.

A powerful interface between GIS and Simulink has been developed to facilitate the carrying out of several analysis with different scenarios and topologies, and a Simulink library was created with new blocks for considering the Galapagos reality.

In the next chapter, smart strategies to avoid significant overloads in the MV/LV transformer and keeping the voltages within the normal operating range, as well as, a solution considering batteries in order to store the excess energy to be returned at night, are presented.

Chapter 4

Advanced Distribution Automation –ADA- functions in the Medium and Low voltage networks of Galapagos

The future network will have for sure to be controlled through Advanced Distribution Automation functions such as volt-var control, grid reconfiguration or soft load shedding, with the current deployment of smart meters, and the availability of the corresponding data have drawn particular attention to the ADA functions in Low Voltage. Thus, once determined the impact of new services, it is worth proposing smart strategies in order to deal with the load growth due to these services and to solve issues like voltage drops, power peaks, neutral current, etc., that have been highlighted in the last chapter. Therefore, this chapter proposes an adapted and intelligent method for performing Demand Side Management in the Galapagos low voltage network. The proposal executes Demand Response (DR) in the presence of Time Of Use (TOU) pricing. In addition, a solution based on electric batteries is analyzed at low voltage level; the primary objective is to shave the peak in the night. At last, an Automatic Phase Switching system to reduce unbalance in the Galapagos LV networks is presented.

After that, solutions at medium voltage network are analyzed; for instance, the deployment of reclosers to improve the reliability, as well as network reconfiguration techniques for reducing losses. Also, the Volt-Var Optimization strategy is analyzed as well.

4.1 Low Voltage – Simulink

So far, the impacts in the LV network due to new services such as EM, IC, and DGs has been determined. It was observed a considerable increase in the required power and adverse effects such significant overloads. For modeling, the Simulink platform was used, due to its ability to model the load fed by real load curves. Simulink models also can be easily tailored to run the model in a real-time simulation. The software RT-LAB is a Simulink fully integrated software, which was selected due to its flexibility and scalability allowing any simulation for the electrical network. Additionally, it exists the possibility to include real devices in simulations with low cost with automatic scripts to run 24h / 7d simulations [87]. RT-LAB enables Simulink models to interact with the real-world in real-time [88]. Although for this study was used just RT-LAB server in order to improve the simulations speed and to have a model ready to be integrated with real devices.

Innovative solutions must be proposed to address the negative issues generated by the inclusion of new services. Thus, the next section will present the first proposed solution for LV; it consists in perform DSM in LV.

4.1.1 Smart Demand Side Management

Once quantified the impacts of new equipment on the LV network, smart techniques have to be proposed in order to manage adverse effects and to keep the client's comfort. In [81] (author's paper), all the assessment of these policies is conducted in the particular case of Galapagos. In [89], a methodology to evaluate DSM in electric distribution systems, based on time of use pricing and elasticity concepts is presented, the evaluation is performed through an optimal power flow model considering linear constraints. Reference [90] shows a time-of-use-based bottom-up model of residential electricity consumption; the model deals with the presence of multiple individuals in a household, their behavior

and the related use of appliances. Reference [91] simulates domestic energy consumption and presents an algorithm which controls consumption during peak hours. The results indicate 40% reduction in peak time energy demand. In [92], two DR program options are analyzed for low voltage feeders, the first one based on the electricity price, and the second one based on the loading of the network, the benefits of these two DR programs are presented. In [93], the likely impacts of China's ongoing power sector reform on its DSM is conducted. The effects of the new reform are determined, among them i) grid companies may have more motivations for DSM investment, ii) electricity end-users' motivations for DSM may be both enhanced and dampened. [94] Affirms that the tariff programs commonly used do not achieve the desired results. Hence, the article includes an assessment of using a Decentralized Active Demand Response system for activities related to the reduction of peak loads.

Reference [95] proposes a stochastic programming approach model, which is developed with cloud computing scheme for effective DSM in the smart grid. In [96], the new proposal of the tariff structure of distribution companies in Brazil, which is looking for establishing a mechanism called Tariff Flags, which aims to foster a Demand Response Program in Brazil via an increase in the energy tariff, is analyzed. In [97], a two-stage stochastic problem for energy resource scheduling to address the challenge brought by the demand, renewable sources, electric vehicles, and market price uncertainty, is proposed. The proposed method minimizes the expected operational cost of the energy aggregator. Reference [98] develops an algorithm for automatically adjusts the power demand according to the output of the distributed renewable generation, mitigating disruptions due to variations of the DER output, as well as, adjusting the load demand dynamically according to the fluctuations of electricity price.

The literature review reveals a need for research in DR programs applied in the presence of TOU pricing, mainly in LV networks. Most of the research is focused on independent initiatives. Thus, this section proposes an innovative combined program DR+TOU in Galapagos Low Voltage network. Also, the current rate model of Ecuador is analyzed objectively.

The proposed DSM program meet some goals such as i) avoid peaks canceling the rebound effect, ii) keep the voltage profile within acceptable limits and iii) shift the energy during the whole day and not only after the peak period.

Figure 3.22 shows that the transformer is overloaded during almost 2 hours per day and thus, the need for performing additional techniques such as DSM to reduce the peak is highlighted. According to [99], an intelligent DSM provides an excellent approach to optimize the management of energy use by means of i) advanced communication device, ii) regulation methods and iii) appropriate economic incentives. DSM is seen in [100] as a good promoter of distributed generation: in order to avoid long-distance transport, locally generated energy could be consumed by local loads, immediately when it is available [101]. The main advantage of DSM, taking into account the economic point of view, is that it is a less expensive way to influence changes in the load than to build a bulk power plant. In [102], a multi-agent system for the coordination of active demand and plug-in EV is presented, the agents perform the optimization following the Nash's theory on games. Then, DSM can be classified as shown in Figure 4.1.

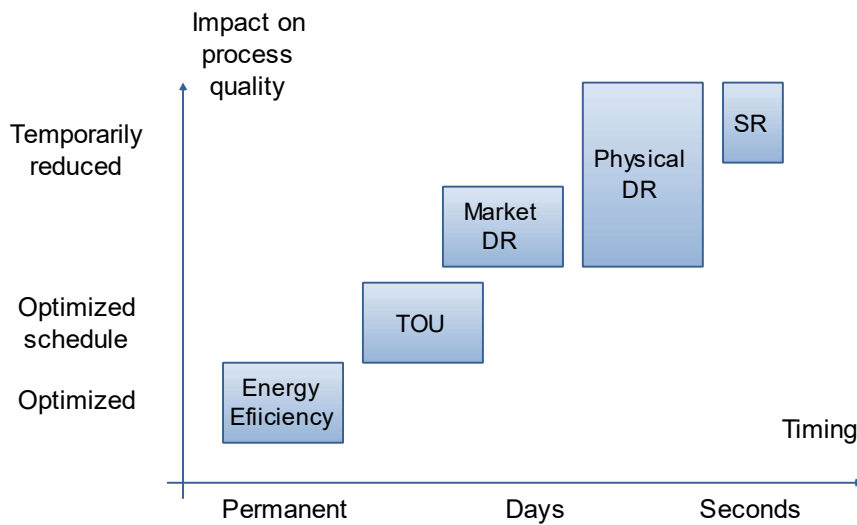

Fig. 4.1. DSM Categories [100]

a) *Energy Efficiency -EE*

b) *Time of Use -TOU-*

c) *Demand Response -DR-*

- Market DR
- Physical DR

d) *Spinning Reserve*

In [103] (author's paper), each category of DSM and the actions taken in Ecuador are explained, since the proposal considers DR+TOU. A brief explanation of these topics is given hereunder.

4.1.1.1 Time of Use -TOU-

The time of use is an array of static tariffs that penalize with a higher price specified periods of time, generally the peak hours, in order to motivate the customers to re-arrange their processes to minimize the energy cost. It does not mean that a consumption reduction exists in all the cases, but an expected change in the consumption patterns would be registered. In the worst scenario case, even if we have a reduction of the consumption in a first step, a period known as "rebound effect" (or payback) [104] appears. Thus, the expected energy saving is typically not carried out, and maybe even a new peak is generated [100] (see Figure 4.2).

Reference [105] presented the rebound effect and the energy shifted that is taking into account through a shedding vector. The peak could be moved before or after. However, it is better to move the peak before the shed time and be prepared. There are two additional options considered as Time-Based rates i) Critical peak pricing and ii) Real-time pricing [106].

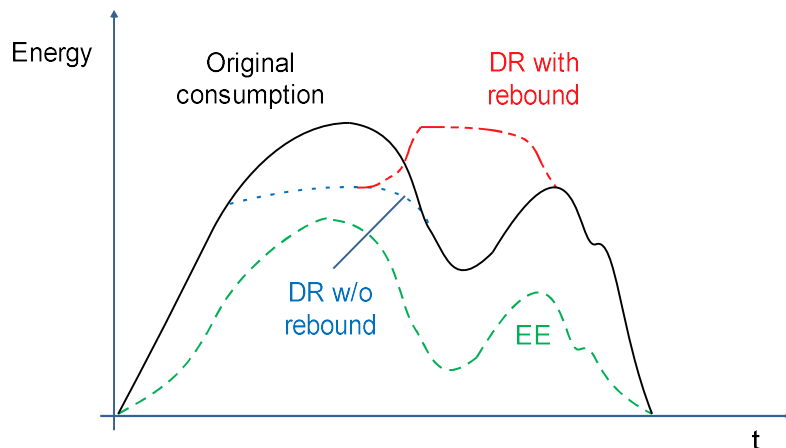

Fig. 4.2. DSM Categories with and w/o rebound [100], Energy Efficiency in green.

4.1.1.2 Demand Response –DR-

In this DSM, a signal coming from the DSO is broadcasted to the clients in order to get a much quicker response than TOU. Typically, this signal contains i) price of energy ii) command for load shedding or shifting. To perform DR efficiently, a “controller” is required (see Figure 4.3), which uses load models for taking good decisions. It can be done in an autonomous way or in a coordinated way. For the last case, a multi-agent controller with communications between distributed controllers should be considered. However, it implies a huge work. In order to execute automated demand response, a new protocol has been presented recently by OpenADR [107].

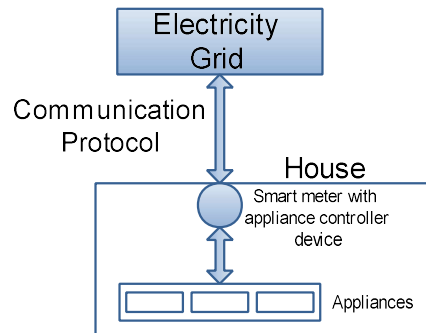

Fig. 4.3. DR using Appliance controller device [108]

4.1.1.3 Intelligent DSM for Galapagos

In this section, the current TOU in Ecuador, developed by ARCONEL, will be explained; then, an upgrading proposal prepared by UPV (Polytechnic University of Valence) for Ecuador is analyzed, and after that, a new intelligent method that combines DR + TOU is proposed.

Nowadays, considering all the policies launched by the Ecuadorean government, ARCONEL has updated the tariff schedule in order to include a new tariff for EV (up to 10kw) [109], see Table X.

The primary initiative is based on fostering the EV deployment, ought their efficiency and contribution to the environment. In addition, the power grid applications such as i) voltage control, ii) exchange reactive power for autonomous voltage support, iii) influencing the available active power for primary transportation function [110]. Unscheduled high penetration of EVs surely has adverse effects on power system performance when EVs are used widely. As a result, there is an exigent need to predict the EVs' consumption; [111] present a probabilistic modeling for EV charging demand, to avoid irreparable effects, in particular for the distribution network. In [112], a time series forecasting of EV charging demand for a stochastic power system is conducted.

TABLE X TARIFF FOR EV

| Days/Hour | Demand (USD/kw) | Energy (USD/kwh) | Commercialization (USD/consumer) |
|-----------------------|--------------------|---------------------|-------------------------------------|
| M-F 8h00 to 18h00 | 2,43 | 0,08 | 1,414 |
| M-S 18:00 to 22:00 | 4,050 | 0,10 | 1,414 |
| M-S 22h00 to 8h00 | 1,458 | 0,05 | 1,414 |
| S*-D 8:00 to 18:00 | 1,458 | 0,05 | 1,414 |

M= Monday, F= Friday, S=Sunday, S*= Saturday

The above table presents the tariff calculated by two variable components and by a fixed one. The variables components i) demand, and ii) energy, change according to the day and hour. For instance, the consumption in the national peak period (18:00 – 22:00) is the most expensive (demand 4,05 USD/kW and energy 0,10 USD/kWh). Assuming, that 15% of the loads are controllable [113] and that every household possesses at least one controllable device which participates in the load management process, a polynomial function is created in order to represent the effect of applying TOU according the Table X, and a 50% rebound is integrated into the simulation [114].

The weighting function implements the weekly tariff (Monday to Friday). The A region from 18:00 to 22:00 is shifted immediately after the most expensive period to the region B where we have the lowest price, this means from 22:00 to 08:00. However, the reader should take into account that the energy of 4 hours was shifted. Thus, energy now is consumed between 22:00 and 02:00. An essential premise, this kind of DSM keeps the consumption almost equal [115], see Equation 4.1.

$$\int_0^{24} RpbTOU \approx \int_0^{24} RpwTOU \quad (4.1)$$

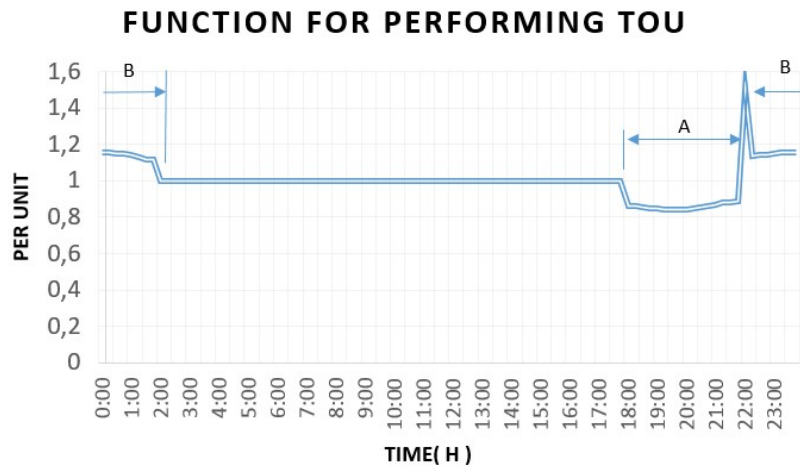

Fig. 4.4. Weighting function for performing TOU considering the guidelines given by ARCONEL

Where:

RpbTOU = Residential Profile before TOU

RpwTOU = Residential Profile with TOU

Figure 4.5 illustrates an example of changing caused over an average residential profile; this profile represents a typical shape, it was given by ELECGALAPAGOS utility. It is possible to identify the rebound and how the load is shifted to the night hours.

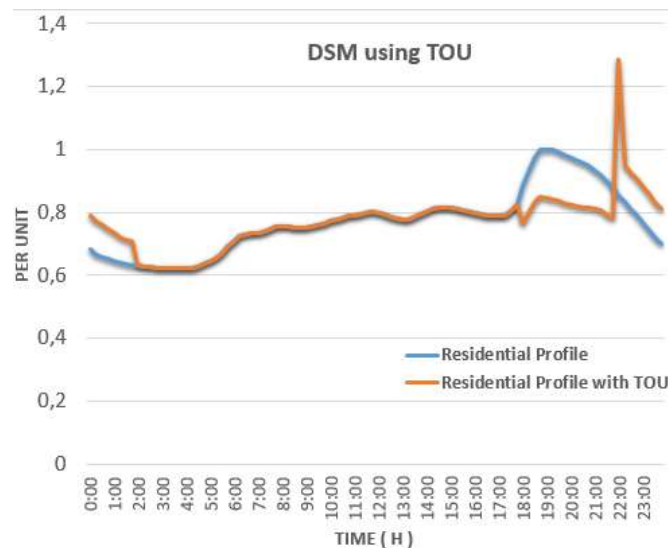

Fig. 4.5. Comparative curves of residential profile vs. residential profile with TOU

A modification in the model developed by [81] was executed in order to perform DSM. The changes consist in adjusting all the residential curves (40) by means of multiply the curve by the weighting function defined using the information of Table X.

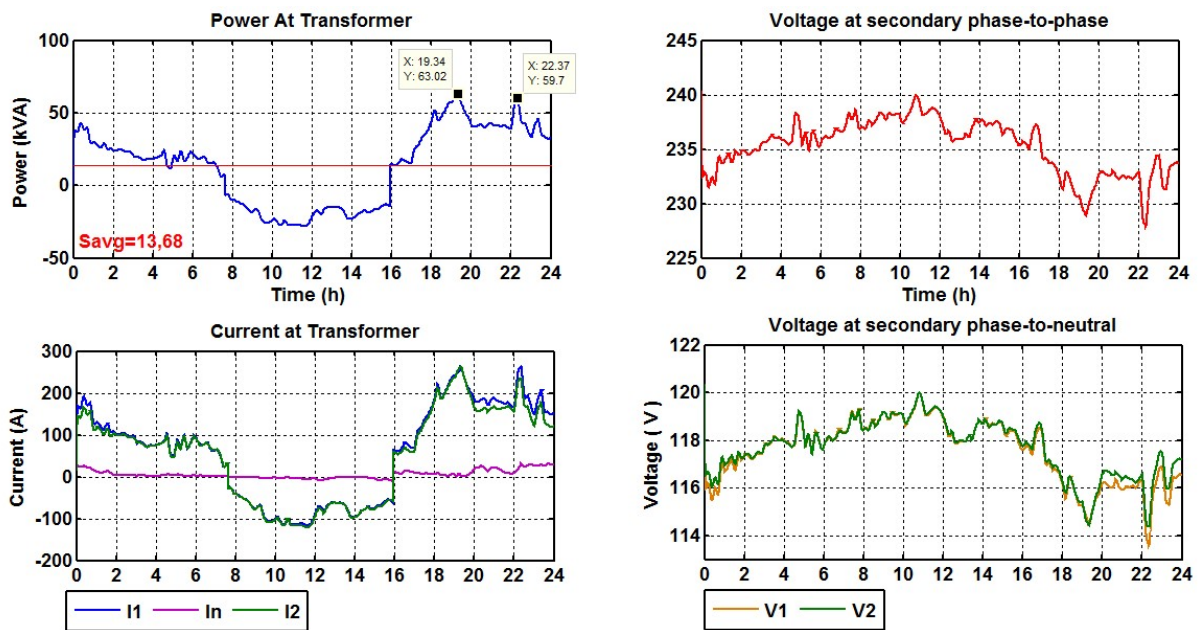

Fig. 4.6. Results after applying DSM using ARCONEL curve

As illustrated Figure 4.6, and compared to Figure 3.22, the power peak in the transformer at 19:18 has been decreased to 63,02 kVA, but a new peak at 22:18 is registered (59,7 kVA). The voltages are exceeding the limits required by the quality standard (minimum 114V). Additionally, the neutral current at 22:18 is higher than the original case. In summary, the rating scheme proposed by ARCONEL is not suitable.

Then, a first study carried out by UPV about the feasibility of deploying Smart Grids in Ecuador [116] suggests a better TOU schedule considering different profiles in the country since ARCONEL has been using only a national profile. This methodology is more consistent because it takes into account the real time measurements available at the interconnection points between transmission and distribution, the measurements were provided by CENACE. Figure 4.7 depicts the methodology for achieving the new profiles.

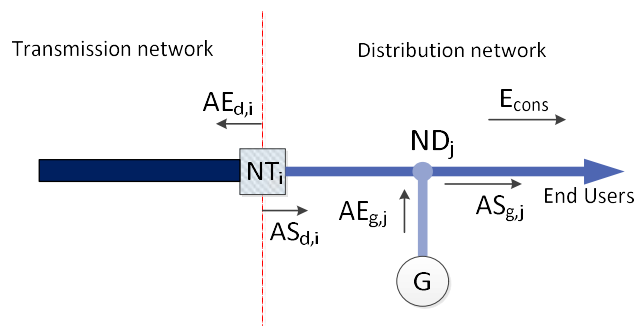

Fig. 4.7. Method for getting the power delivered to the end users

The equation 4.2 defines the total power delivered to the end users.

$$E_{cons} = \left(\sum_{i=1}^n AS_{d,i} + \sum_{j=1}^m AE_{g,j} \right) - \left(\sum_{i=1}^n AE_{d,i} + \sum_{j=1}^m AS_{g,j} \right) \quad (4.2)$$

Where:

E_{cons} = Total power delivered to the end users connected to the distribution network.

$AS_{d,i}$ = Power delivered coming from the transmission network to the distribution network at the node NTi

$AE_{d,i}$ = Power delivered coming from the distribution network to the transmission network at the node NTi

$AE_{g,j}$ = Power delivered to the distribution network by the generators connected to the node NDj

$AS_{g,j}$ = Demand of the elements connected to distribution network at the node NDj

n = Transmission nodes

m = Distribution nodes with a generator connected.

Once defined the methodology and the equation 4.2, different profiles are determined for 6 regions in Ecuador, i) Sea Coast, ii) Sierra, iii) Amazon, iv) Quito, v) Guayaquil and vi) Galapagos; those profiles are divided by weeks, weekends and holidays as well as seasons. For the study, only a typical profile is considered (weekly profile during summer). Then, a new TOU schedule is defined. Figure 4.8 depicts 3 periods within Galapagos, P1 is the on-peak, P2 the semi-peak, and P3 the off-peak.

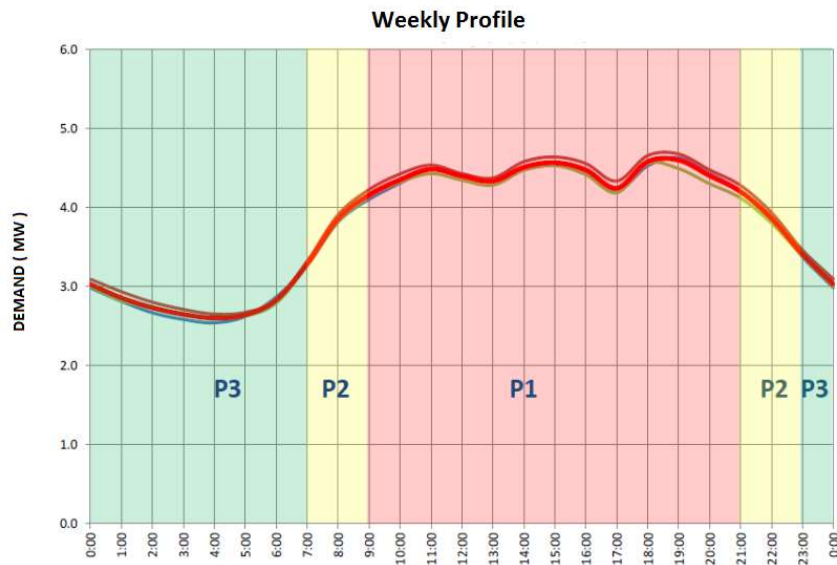

Fig. 4.8. TOU defined by real measurements.[116]

Reference [116] reported that after performing an in-depth analysis on the monotonic curve, three periods are identified and the peak period (P1) is located between 09:00 and 21:00. Then, a new simulation considering the described above is performed. The principal curves are depicted in the following figures.

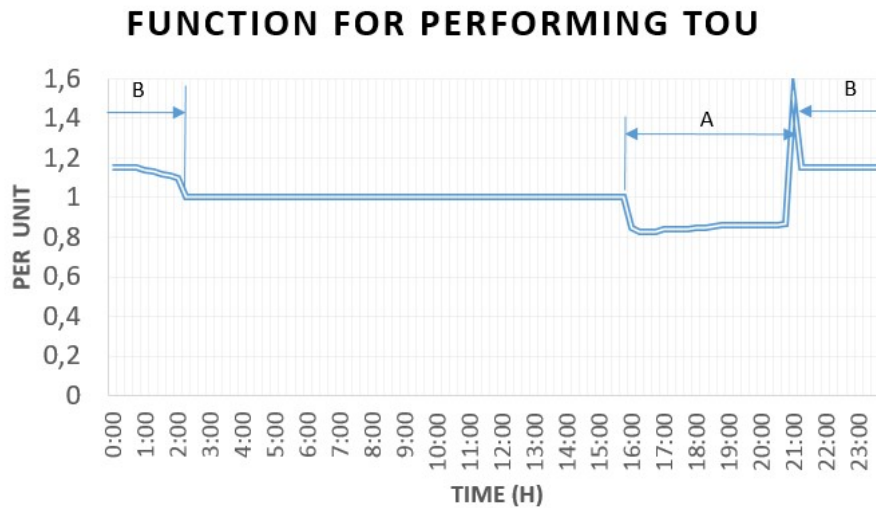

Fig. 4.9. Weighting function for performing TOU considering the guidelines given by the study conducted to deploy Smart Grids in Ecuador -UPV-

This function starts the shifting process in the region A (16:00 – 21:00) and shifts this reduction in the consumption to the region B (21:00 – 02:00). In addition, the rebound effect is taken into account. Figure 4.10 illustrates the changes caused over an average residential profile, and it is possible to identify the rebound and how the load is shifted.

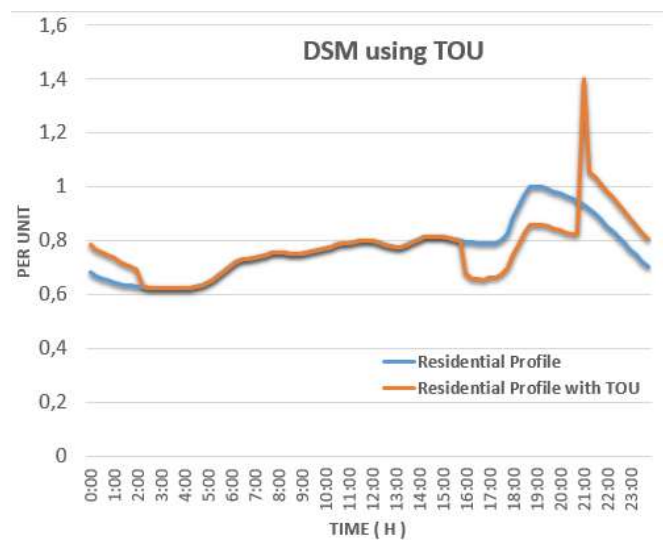

Fig. 4.10. Comparative curves of residential profile vs. residential profile with TOU defined by regions.

As we can see in figure 4.11, a higher peak (74, 31 kVA) at 21:00 is recorded. The voltages are worst, compared with the previous scenarios, and the limits accepted by the quality standard are violated (minimum 111.3V).

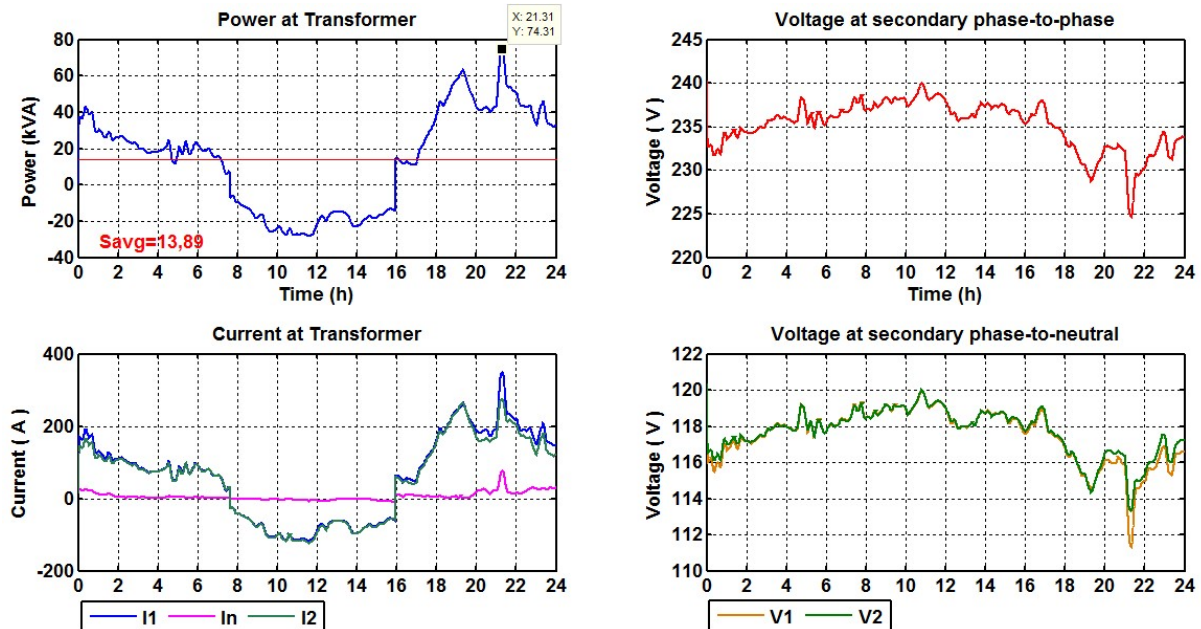

Fig. 4.11. Results after applying DSM using UPV curve

Obviously, the rebound added to the original power around 21:00 (higher than 22:00, see Figure 3.22) causes this increase in the peak. Hence, a smart strategy must be implemented in order to avoid the peak as well as to shift the energy during the whole day, and not only after the peak period. Therefore, the previous weighting function is modified until to reach a soft function, which has the same energy during the whole day with the difference that now, it will be considered an algorithm for the appliance controller device in each household, and the shifted energy will be consumed during the whole day. It is worthwhile to mention that there are two key technologies enabling demand side load optimization: i) Building automation and ii) Smart metering + Appliance controller.

Previously, it was defined a 15% of controllable loads; the loads are usually classified as:

- Baseline loads refer to those appliances that must be activated immediately at any time or maintained at 'Standby' mode. Their economic value does not allow any intelligence integration, and they are not controllable because they depend on consumer behavior and comfort. Lighting, TV, and computing are some examples.
- Regular loads are those corresponding to the appliances that are operated for extended time periods like fridge and water heater
- Burst loads concern the appliances that must work for a limited period within deadlines. This last type can be flexible and so, delayed to start operation in another moment, like washing machine, dryer dishwasher, air conditioning and EV

The peak load problem is mainly caused by regular and burst loads combination. In addition, DSM programs could be classified as traditional or as modern ones. Thus, the smart strategy will consider only actions over the burst loads and will use a modern DSM program (DR+TOU), with no more rebound. The proposed weighting smart function is shown in see Figure 4.12.

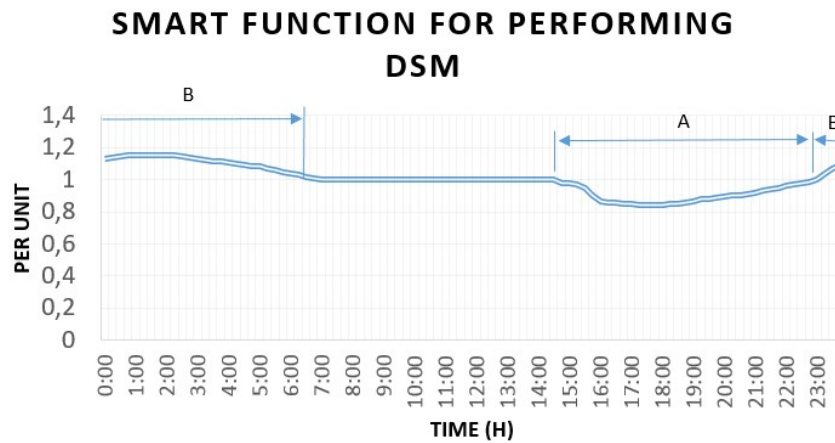

Fig. 4.12. Smart function for performing DSM

As depicted, the consumption of the region A is shifted to the Region B. The limit of the region B is 7:00 because after this time, the price is not the cheapest. Figure 4.13 illustrates the new residential profile obtained without peaks.

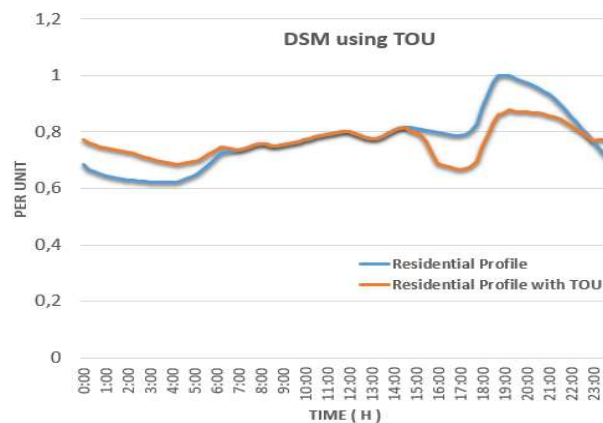

Fig. 4.13. Comparative curves of residential profile vs. residential profile with smart function.

In order to summarize the process, a flowchart of the developed methodology, with the main steps, is presented in Figure 4.14. The developed script offers the possibility to run the 3 options (ARCONEL, UPV, and Smart DSM) for comparative purposes.

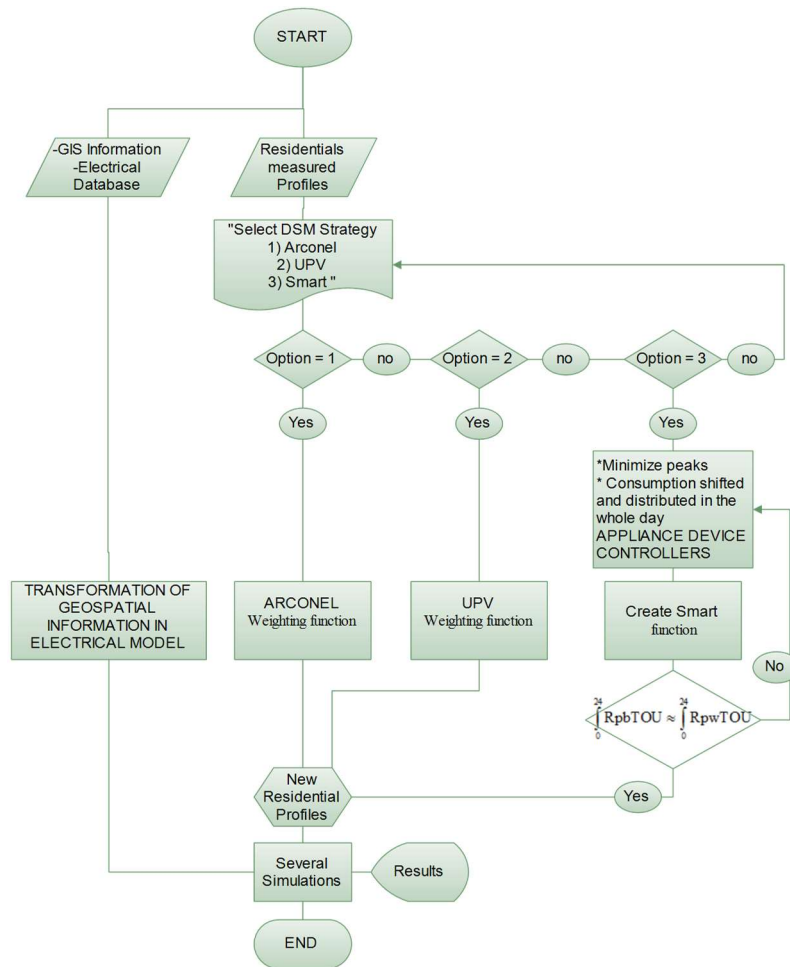

Fig. 4.14. Flowchart of the DSM programs executed.

This flowchart depicts the whole process for performing the DR+TOU program, as input information are defined i) 40 residential profiles, ii) topology information (GIS) and iii) electrical database. After, all this information are transformed into an electrical model. The program implements three options:

1. ARCONEL DSM, which uses the function defined in Figure 4.4
2. UPV DSM, which uses the function defined in Figure 4.9 and
3. SMART DSM, which considers the implementation of appliance device controllers, as well as, minimize the peaks originated by rebound effect through of shifting the consumption in the whole day and use the function of Figure 4.12. The program respects the equation 4.1 and creates modified profiles, which will be utilized for new simulations.

Using the profiles affected by the smart function, another simulation is performed.

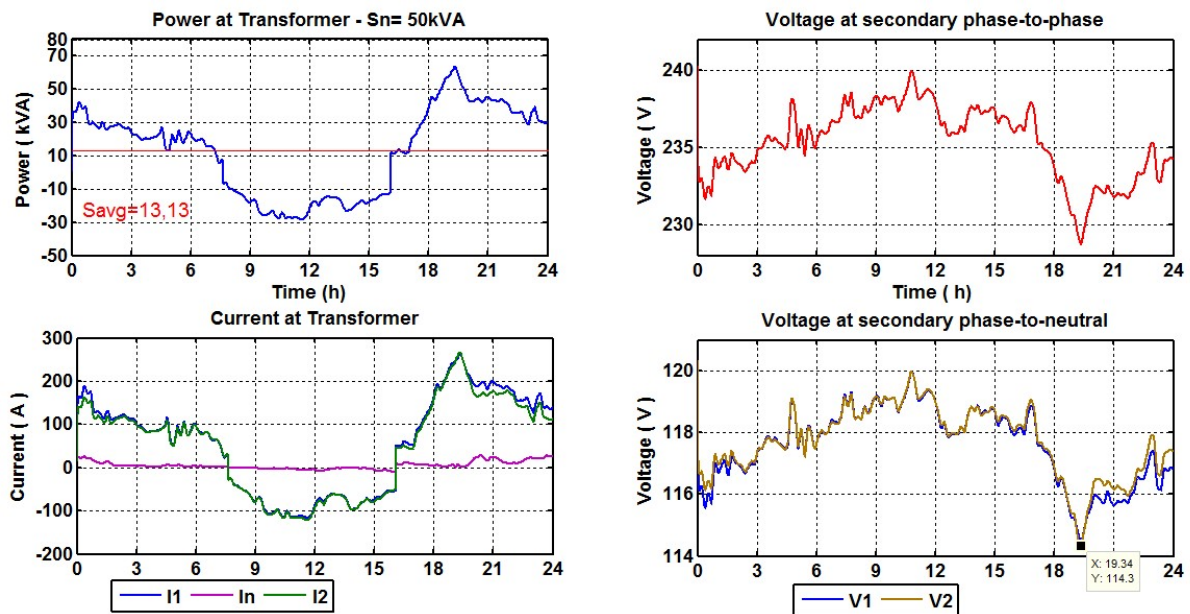

Fig. 4.15. Results after applying intelligent DSM.

Figure 4.15 shows the principal curves of active power and voltages. As we can see, the peak generated by the rebound in the previous scenarios is annulated due to the consideration of an installed controller at the households, and ought to a smart technique for DSM.

This scenario takes into account the implementation of an appliance device controller in each household. By means of the option 3) (Smart) of the flowchart illustrated in Figure 4.14, the residential profiles are modified in order to perform DSM program to decrease peaks through of consumption shifting of energy in expensive periods to cheapest periods along the day. The maximum FU is 128%, and the voltages in phases L1 and L2 respect the quality regulation (114,3 V minimum). The highest power during the day is 64,07 kVA, the reverse flow generated is 28,33 kVA and the average power is 13,13 kVA. Considering all these values, it is easy to conclude that this scenario is the better. The next figures show a comparative analysis of the DSM programs in reference to the active power and voltages.

The Figure 4.16 depicts the power along a typical day. As we can see, the first strategy (ARCONEL in blue) has a prominent peak around 22:00 and the second strategy (UPV in green) reaches the higher peak around 21:00. Whereas the Smart DSM strategy, in red, has the minimum peak and the shifted energy is allocated mainly in dawn hours. In addition, the peak created for the rebound effect is entirely annulated.

The Figure 4.17 depicts the voltage profile along the day. As it was expected, the minimum voltage value is reached when the load is highest. The ARCONEL strategy reached a minimum voltage of 113,58V; the average voltage is 117,55V. The UPV strategy reached the lowest voltage value of 111,3V, and its average voltage is 117,51V. The Smart strategy shows the best profile since no minimum peaks are disrespecting the quality regulation.

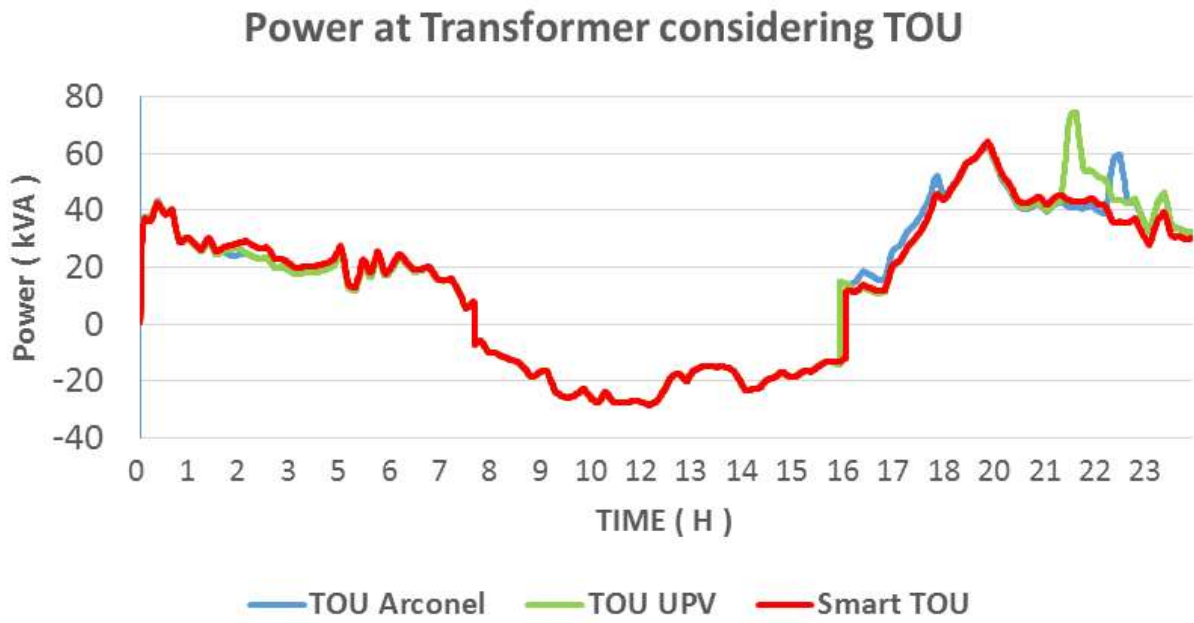

Fig. 4.16. Comparative Analysis: Power at Transformer

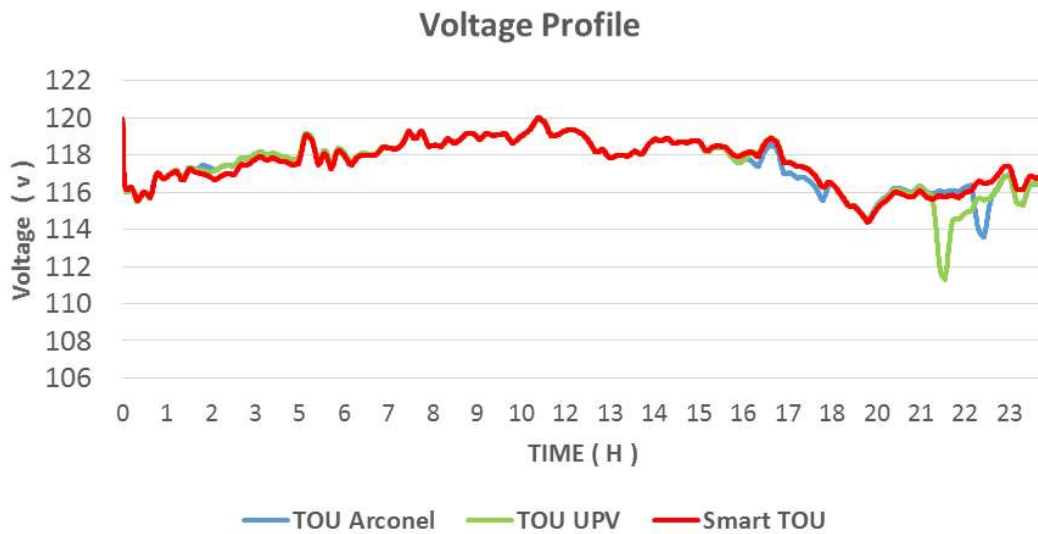

Fig. 4.17. Comparative Analysis: Voltage at secondary phase L1-to-neutral

Even if the proposed Smart DR+TOU has a better behavior than ARCONEL and UPV strategies, a power peak around 19:30 still exists, and during this peak, the MV/LV transformer is overloaded. To shave this peak and avoid this overload, a well-known mean is the use of storage. We propose then to implement a BESS and to develop an intelligent controller adapted to Galapagos's particular case.

4.1.2 Battery Energy Storage System -BESS

The BESS is a system based on electrical batteries that capture energy produced at one time for a later use [117]. With a proper management of a BESS, the excess generation originated by DG could be stored and used during peaks hours or the connection period of the new loads. This section presents a new intelligent controller capable of managing the additional energy generated by PV solar panels. It reduces the relative load on the distribution transformers. In addition, the total cost using PV solar panels and batteries is defined through an iterative process, and ideal size battery approach is calculated taking into account technical and economic constraints.

Several simulations showed that, during some hours, the PV generation is higher than the load. On the contrary, the peak in Galapagos occurs in the night where the PV resources are not enough to satisfy the power consumption; means of DSM methods reduce the peak during this time. However, it is quite clear that the PV energy surplus in the morning could be stored and used later in the peak hour through a BESS; this system must be able to perform peak shaving and store energy for nighttime use.

The design and implementation of an advanced Battery Management System –BMS- is conducted in [118], with continuous monitoring of voltage and current of each battery. The research presented in [119] assesses the storage aging of different types of batteries such Li-ion and Lead-acid for stand-alone systems, in order to have reliable lifetime estimation. It was stated in [120] that the energy storage technology would be the key to the future development of renewables. However, the limited practical applications of storage using batteries were linked to 1) typically, enough energy exists coming from generating sources whose generation could be easily varied to match the load in real time. In addition, a balance could be achieved using the interconnections between different zones. 2) there are no optimal tools available to manage i) operational cost's optimization and ii) assess benefits of long-term storage. Further to those above, it is quite complicated to justify the economic gains obtained by using storage systems.

A smart grid environment with a high penetration level of household's storage batteries is presented in [121], where the utilities influence family's consumption by means of electricity price structure, while the homes aim to reduce their bills using coordinate charging and discharging process. Also, it is assumed that the batteries will be charged only after the load has been satisfied. Through Nash equilibrium, the users are modeled as selfish but rational players.

Relationship curve of BESS capacity versus economic benefits is presented in [122], in order to seek the best solution for BESS capacity and power allocation with the maximum economic advantages. A mechanism for optimal power flow management in grid-connected PV systems was carried out in [123], the proposal consists in increasing the PV penetration level taking advantage of the peak shaving service at lowest cost achieved with batteries. Reference [124] proposed a comprehensive methodology to optimally control lead-acid batteries operating under dynamic pricing schemes in both independent and aggregated ways and taking into account the effects of the charge controller operation, as well as the variable efficiency of the power converter, and the maximum capacity of the electricity network. A genetic algorithm was used to solve the optimization problem in which the daily net cost is minimized.

In reference [125], a probabilistic approach was used for sizing battery in a scenario considering TOU pricing; the research takes into account the uncertainties such as load demand, energy prices, and economic factors. In addition, the customers were allowed to sell power back to the grid. On the other hand, in [126], an evaluation of tariffs in the scenario with self-generation using photovoltaic generation and battery storage was presented. A case study in low voltage with semi-urban topology was analyzed in detail. In [127], the evaluation of the contribution of DR and Electrical Energy Storage – EES- to adequacy the supply was modeled and analyzed using operational flexibility parameters and constraints.

Reference [128] covered comprehensively the individual, aggregated ESS applications and their corresponding benefits, compared the different technology selection methods and provided application-specific controls. In addition, the combination of ESSs coupled with application-specific control methods to achieve the interdependent objectives of Distribution System Operator – DSO-, electrical utilities, retailers, equipment sellers, the government and the electricity customers were also reviewed.

Reference [129] studied the placement of energy storage based on models of real LV distribution network, as well as the energy storage for peak power reduction. In addition, a comparative analysis of energy storage only versus energy storage with phase balancing and the additional benefits derived from voltage support and losses reduction was presented. In [130] and [131], real-time simulations have been conducted to analyze smart strategies with a high level of distributed generation in low voltage networks. Several uncertainties hinder the deployment of large-scale BESSs due to their relatively high capital costs, and to the difficulty to evaluate their performance, their lifetime and thereby, their potential financial benefits [132]. The main applications of the batteries in mid-term (min to hours < 5 h) for the utility surely would be: i) market unbalance, ii) arbitrage, iii) load balancing, iv) peak load shaving (2 and 4 h duration), v) improving reliability vi) support for transport and automobile feeding, and vii) deferment of new generation and transmission investments.

4.1.2.1 Cost Functions considering TOU tariffs

A detailed model for determining the possibilities of storage in a context with TOU tariffs was presented in [125], although the presented scenario does not consider the PV generation. About the case that the end user is not allowed to sell energy, the total cost of the system is given by:

$$C_T(x) = C_0 + Cen \quad (4.3)$$

C_0 is the capital cost including, purchase, installation, and maintenance (percentage of capital cost). The replacement cost is not included because the battery lifetime is not lower than the planning time, for our case (10 years) [133].

The energy cost C_{en} involves the expense of the load in the presence of PV generation C_{load_ppv} , the expense of charging the battery C_{ch} , and the savings originated for discharging the battery C_{dch} . The PV generation cost is considered as free [123].

$$C_{en} = C_{load_ppv} + C_{ch} - C_{dch} \quad (4.4)$$

The model presented in [125] is now adapted to take into account the PV generation and three price levels.

$$C_{load_ppv} = \sum_{n=1}^N \frac{1}{(1+\beta)^{n-1}} \left(\sum_{i=1}^{S_n} D(i) * [(E_{L_off}(n,i) - E_{ppv_off}(n,i)) * Pri_{off}(n,i) + (E_{L_med}(n,i) - E_{ppv_med}(n,i)) * Pri_{med}(n,i) + (E_{L_peak}(n,i) - E_{ppv_peak}(n,i)) * Pri_{peak}(n,i)] \right) \quad (4.5)$$

Where N is the number of years, β is the discount rate, S_n is the season numbers of each year (winter, summer, etc.). $D(i)$ is the number of days of the i th season.

E_{L_off} , E_{L_med} and E_{L_peak} are the total energy absorbed by the load during the off-peak, medium consumption and on the peak periods, respectively.

E_{ppv_off} , E_{ppv_med} and E_{ppv_peak} are the total energy generated by the PV panels during either off-peak or medium consumption or during peak periods.

Pri_{off} , Pri_{med} and Pri_{peak} are the energy prices of off-peak, medium consumption and on peak periods of the i th season of the n th year.

The energy required by the load during the off-peak, medium consumption and on-peak periods could be evaluated using the integral between the start time and end time of the load power profile P_L of each

period; using the trapezoidal rule $\int_a^b f(x)dx \approx \frac{(b-a)}{n} \left[\frac{f(a)+f(b)}{2} + \sum_{k=1}^{n-1} f(a+k*\frac{(b-a)}{n}) \right]$ as:

$$E_{L_off} \approx \frac{(Tb_{off} - Ta_{off})}{n_i} * \left[\frac{P_L(Tb_{off}) + P_L(Ta_{off})}{2} + \sum_{k=1}^{n_i-1} P_L \left(Ta_{off} + k * \frac{(Tb_{off} - Ta_{off})}{n_i} \right) \right] \quad (4.6)$$

$$E_{L_med} \approx \frac{(Tb_{med} - Ta_{med})}{n_i} * \left[\frac{P_L(Tb_{med}) + P_L(Ta_{med})}{2} + \sum_{k=1}^{n_i-1} P_L \left(Ta_{med} + k * \frac{(Tb_{med} - Ta_{med})}{n_i} \right) \right] \quad (4.7)$$

$$E_{L_peak} \approx \frac{(Tb_{peak} - Ta_{peak})}{n_i} * \left[\frac{P_L(Tb_{peak}) + P_L(Ta_{peak})}{2} + \sum_{k=1}^{n_i-1} P_L \left(Ta_{peak} + k * \frac{(Tb_{peak} - Ta_{peak})}{n_i} \right) \right] \quad (4.8)$$

Where n_i is the subintervals number of each period, T_{b_off} and T_{a_off} are the upper and lower limits of the off-peak period. T_{b_med} and T_{a_med} are the upper and lower limits of the medium consumption period, T_{b_peak} and T_{a_peak} are the upper and lower limits of the on-peak period.

In the same way, the energy generated by PV panels is

$$E_{ppv_off} \approx \frac{(T_{b_off} - T_{a_off})}{n_i} * \left[\frac{P_{pv}(T_{b_off}) + P_{pv}(T_{a_off})}{2} + \sum_{k=1}^{n_i-1} P_{pv} \left(T_{a_off} + k * \frac{(T_{b_off} - T_{a_off})}{n_i} \right) \right] \quad (4.9)$$

$$E_{ppv_med} \approx \frac{(T_{b_med} - T_{a_med})}{n_i} * \left[\frac{P_{pv}(T_{b_med}) + P_{pv}(T_{a_med})}{2} + \sum_{k=1}^{n_i-1} P_{pv} \left(T_{a_med} + k * \frac{(T_{b_med} - T_{a_med})}{n_i} \right) \right] \quad (4.10)$$

$$E_{ppv_peak} \approx \frac{(T_{b_peak} - T_{a_peak})}{n_i} * \left[\frac{P_{pv}(T_{b_peak}) + P_{pv}(T_{a_peak})}{2} + \sum_{k=1}^{n_i-1} P_{pv} \left(T_{a_peak} + k * \frac{(T_{b_peak} - T_{a_peak})}{n_i} \right) \right] \quad (4.11)$$

The charging and discharging cost could be defined as [125]:

$$C_{ch} = \sum_{n=1}^N \frac{1}{(1+\beta)^{n-1}} \left(\sum_{i=1}^{S_n} D(i) * \frac{1}{\eta_{ch}} * e(n,i) * \text{Pri}_{off}(n*i) \right) \quad (4.12)$$

$$C_{dch} = \sum_{n=1}^N \frac{1}{(1+\beta)^{n-1}} \left(\sum_{i=1}^{S_n} D(i) * \eta_{dch} * e(n,i) * \text{Pri}(n*i) \right) \quad (4.13)$$

Assuming a daily balance $e(n,i)$ is the energy charged and discharged in a typical day by the BESS. $\text{Pri}(n*i)$ could be either Pri_{med} or Pri_{peak} depending on which period is performed the discharge process.

$$\text{Let } \begin{aligned} & [(E_{L_off}(n,i) - E_{ppv_off}(n,i)) * \text{Pri}_{off}(n,i) + \\ & (E_{L_med}(n,i) - E_{ppv_med}(n,i)) * \text{Pri}_{med}(n,i) + \\ & (E_{L_peak}(n,i) - E_{ppv_peak}(n,i)) * \text{Pri}_{peak}(n,i)] = A \end{aligned}$$

Then, the cost is expressed as:

$$C_{en} = Co + \sum_{n=1}^N \frac{1}{(1+\beta)^{n-1}} \left(\sum_{i=1}^{Sn} D(i) \left[A + e(n,i) \left(\frac{\text{Pri}_{off}(n*i)}{\eta_{ch}} - \eta_{dch} * \text{Pri}(n*i) \right) \right] \right) \quad (4.14)$$

Considering that PV generation reduces the energy consumption from the electric grid, the minimum cost is reached when the charge/discharge energy is maximal.

4.1.2.2 Constraints

To encourage customers to generate their own energy is an essential aspect considered within the new policies to convert Galapagos to an archipelago energetically self-sustaining. Hence, in [103] (author's paper), the PV integration at low voltage level was analyzed. The next figure depicts the scheme.

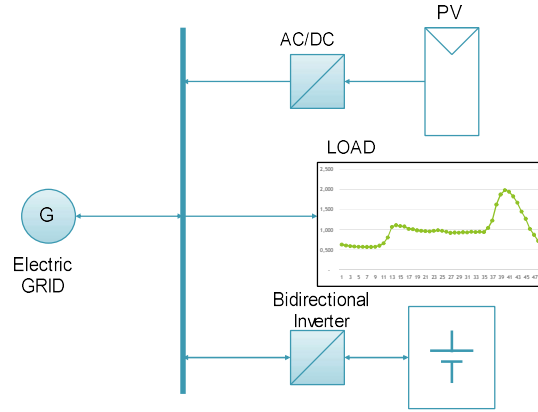

Fig. 4.18. System in study

The next equation represents the power balance in the system.

$$P_{EGRID}(t) = P_{PV}(t) + P_{BAT}(t) + P_{LOAD}(t) \quad (4.15)$$

The next constraints equations represent the batteries' degradation [123].

$$SOC^{\min} \leq SOC(t) \leq SOC^{\max} \quad (4.16)$$

$$P_{BAT}^{\min} \leq P_{BAT}(t) \leq P_{BAT}^{\max} \quad (4.17)$$

Where SOC is the State Of Charge of the battery, this value should be maintained between the levels suggested by the battery manufacturer. P_{BAT} is the power in the battery at any instant. Also, these levels must be kept in conscious levels. In order to consider the peak shaving function, the next constraint is imposed.

$$P_{EGRID}(t) \leq P_{GRID}^{\max} \quad ^1 \quad (4.18)$$

Where:

P_{GRID}^{\max} is the maximum value of power coming from the network.

In [134], the Equation 4.18 is restrictive since if this restriction is not respected, a penalty is assigned. However, [123] defines flexibility in it, for distribution transformers this consideration is suitable. In the proposed model, the preservation of the battery's lifetime is also considered as a constraint, which is in function of the number of cycles at a level of the depth of discharge defined by the manufacturer and the daily charging/discharging cycles - ν . In order to keep the lifetime equals to the value defined by the manufacturer, charging/discharging cycles must be:

$$\nu=1 \quad (4.19)$$

Based on the battery size, the maximum daily energy that can be exchanged is:

$$e_{\max} = size * \frac{\delta_{\max}}{100} \quad (4.20)$$

Where δ_{\max} is the value of the maximum depth of discharge of the battery [120]. The Equation 4.14 determines the total cost and must take into account the technical and contractual constraints described in equations (4.15) -(4.20). Finally, the revenue considering selling energy to the grid would be:

$$C_{en} = C_{load_ppv} + C_{ch} - R_{dch} \quad (4.21)$$

Where R_{dch} is the revenue for discharging the battery. For more details, the reader is encouraged to read [125], [124] and [135].

4.1.2.3 The system

In this section, we calculate the battery size, which minimizes the cost function defined in Equation 4.14

4.1.2.3.1 Setting

The government gives the TOU electricity tariffs, ARCONEL has updated the tariff schedule in order to include a new tariff for EV (up to 10kw) [109]

Pri_{off} , 0.05 ¢/kWh from 22 PM to 8 AM

Pri_{med} , 0.08 ¢/kWh from 8 AM to 18 PM

Pri_{peak} , 0.10 ¢/kWh from 18 PM to 22 PM

¹ The customer is not allowed to sell energy to utilities

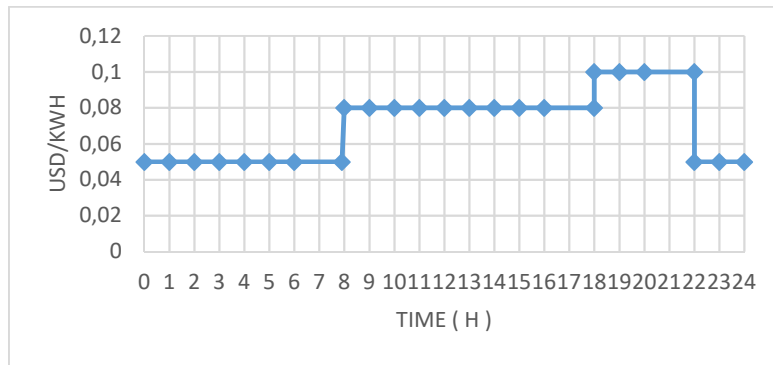

Fig. 4.19 TOU scheme

Figure 4.20 depicts the load in each phase after DSM strategy, which assumes that 15% of the loads are controllable [113] and that every household possesses at least one controllable device which participates in the load management process, with a 50% rebound integrated into the simulation [114].

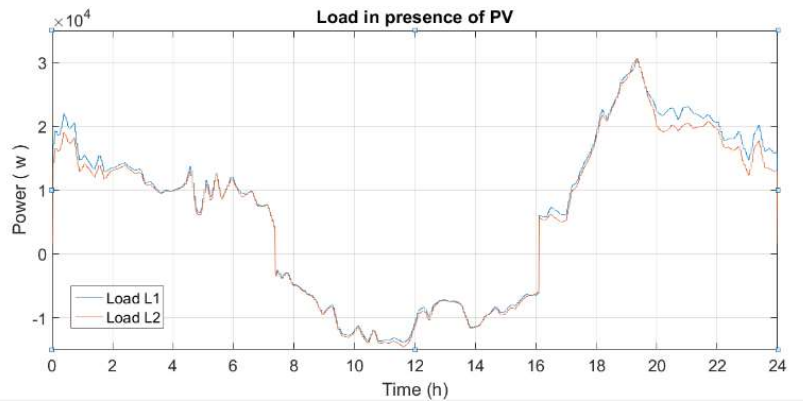

Fig. 4.20 Load in each phase in the presence of PV generation.

As we can see, due to PV generation, a reverse flow is originated between 7:23 and 16:06.

4.1.2.3.2 Battery

First, the proper battery must be selected. Nowadays, the two most developed types are *i)* Lead-acid and *ii)* Li-ion. A detailed battery type review is presented in [120] and [136]. The Li-ion battery possesses the greatest potential, a small size and low weight, higher energy density and efficiency near to 100%, life span (300 cycles at 80% of discharge), and self-discharge (1%/month). The main drawback is related to the investment cost (731-1045 USD/kWh). The lead acid (flooded type) battery has an efficiency $\eta = 72 - 78\%$, life span 200-300 cycles at 70% depth of discharge, self-discharge 2-5%/month. The cost is relatively cheap 52-157 USD/kWh.

A threshold value for assessing batteries in function of the prices, which takes into account the aging factor, is defined in [134]

$$K_{crit} \approx \frac{(\max_{tariff} - \min_{tariff}) * \eta_B}{Z} \quad (4.22)$$

Where K_{crit} is the maximum value for the unit cost for the admitted capacity loss, Z is the aging factor and η_B is the battery performance. According to the test made by [119], $Z = 3 * 10^{-4}$. Using the Galapagos data, K_{crit} value is:

$$K_{crit} \approx \frac{(10-5) * 10^{-5} * 0,9}{3 * 10^{-4}} \approx 0,15$$

Different values for K are presented in [137], for instance for Lead-acid batteries, for Li-ion $K = 1,33 \frac{USD}{Wh}$. According to K_{crit} and K values for these two batteries types; the Li-ion battery would not be selected because the huge investment is not justified. The Lead-acid battery is selected for the next simulations, although its K value is equal to the K_{crit} . Equation 4.14 requires an iterative process to evaluate different batteries capacity in order to determine the optimal battery size. To comply that, the next table is used.

TABLE XI BATTERY SIZE TESTED

| <i>Name</i> | <i>Size (kWh)</i> | <i>Cost (USD)</i> |
|-------------|-------------------|-------------------|
| <i>C1</i> | <i>1</i> | <i>100</i> |
| <i>C2</i> | <i>4</i> | <i>400</i> |
| <i>C3</i> | <i>8</i> | <i>800</i> |
| <i>C4</i> | <i>12</i> | <i>1200</i> |
| <i>C5</i> | <i>16</i> | <i>1600</i> |
| <i>C6</i> | <i>20</i> | <i>2000</i> |
| <i>C7</i> | <i>24</i> | <i>2400</i> |
| <i>C8</i> | <i>28</i> | <i>2800</i> |
| <i>C9</i> | <i>32</i> | <i>3200</i> |
| <i>C10</i> | <i>36</i> | <i>3600</i> |
| <i>C11</i> | <i>40</i> | <i>4000</i> |

The battery must be charged during the period when the PV generation exceeds the consumption. It means 0.6h with Pri_{off} and 8,1h with Pri_{med} . The discharge must be performed immediately after, in order to reduce the electric power coming from the grid. Using equations (4.6) to (4.11) and the TOU scheme, we can calculate C_{load_ppv} . In this case, $C_{load_ppv} = USD 20,33$

TABLE XII COST DETERMINATION FOR LOADS WITH PV

| <i>Period</i> | <i>Time</i> | <i>Energy</i> | | <i>TOU tariffs (USD/kWh)</i> | <i>Total Cost (\$)</i> |
|---------------|-------------|-----------------|-----------------|------------------------------|------------------------|
| | | <i>L1 (kWh)</i> | <i>L2 (kWh)</i> | | |
| 1 | 0:00-8:00 | 86,37 | 81,56 | 0,05 | 8,39 |
| 2 | 8:00-18:00 | -59,64 | -63,20 | 0,08 | -9,82 |
| 3 | 18:00-22:00 | 94,63 | 89,76 | 0,1 | 18,44 |
| 4 | 22:00-24:00 | 35,10 | 30,78 | 0,05 | 3,29 |

In the same way, the charging energy cost defined in Equation 4.12 would be calculated considering Table XI and XIII.

TABLE XIII BATTERY CHARGING PERIODS

| <i>Period</i> | <i>Time</i> | <i>TOU tariffs (USD/kWh)</i> |
|---------------|--------------|------------------------------|
| 1 | 07:23-08:00 | 0,05 |
| 2 | 08:00 -16:06 | 0,08 |

In order to maximize the discharging energy, the exchange energy needs to be equal to the charging energy. The **Assumption 1** is defined as the energy will be discharged at the same time that it was charged, thus in 8,711h. Therefore, the discharging process is performed between 16h06 and 00:00. With this assumption, three periods are defined for discharging energy.

TABLE XIV BATTERY DISCHARGING PERIODS

| <i>Period</i> | <i>Time</i> | <i>TOU tariffs (USD/kWh)</i> |
|---------------|--------------|------------------------------|
| 1 | 16:06-18:00 | 0,08 |
| 2 | 18:00 -22:00 | 0,10 |
| 3 | 22:00-00:00 | 0,05 |

Once executed the evaluation of Equation 4.14 using Table X – XIV, $\eta_{ch} = \eta_{dch} = 0,9$, a fixed discount rate $\beta = 1\%$, a fixed annual increment of 0%² of the tariff and a fixed annual increase of 5% of the load

² The tariff in Ecuador is subsidiary and does not reflect the real cost of energy.

[9]. The results show that there is no profitability during 10 years with the installation of batteries at low voltage level.

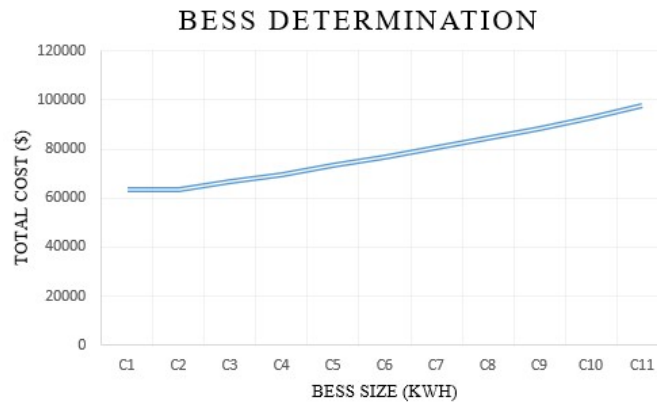

Fig. 4.21 Total Cost for different batteries’ sizes.

In Galapagos, when the peak is reached, it is necessary to start thermal generators. Normally, the payment for those is expensive, about 0,40 - 0,45 USD/kWh. Thus, a new regulation of ARCONEL defines 0,57 USD/kWh for PV generation in order to encourage changing the technology [138].

Based on those above, we define the **Assumption 2** for the batteries considered such as a distributed energy resource –DER-: the consumers using batteries to reduce the peak will be beneficiaries of a TOU of 0,33 USD/kWh. Also, a fixed annual increment of 3% is considered. The results are depicted in the next figure.

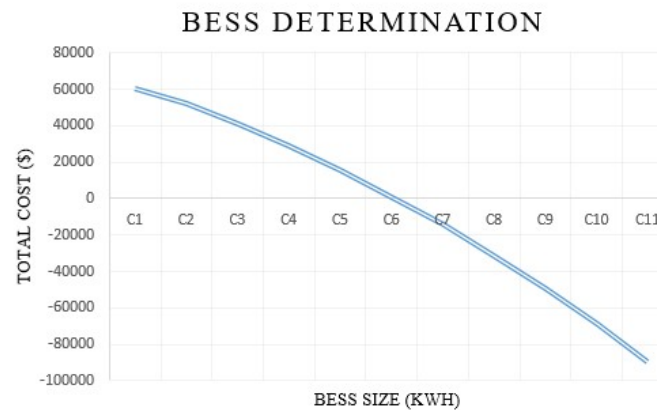

Fig. 4.22 Total Cost for different batteries’ sizes considering different TOU for batteries.

The value that reaches a cost near to zero is around C6 (size of 20 kWh, see Table XI); for the simulations, we chose 19,5 kWh.

4.1.2.4 Simulations

The system in this study is modeled in the Matlab/Simulink environment; the selected simulation method is the Phasor Mode, instead of Time Domain Mode, because we do not consider dynamic phenomena and with this model, the simulation/computing time is faster. Figure 4.23 depicts the model

built in, which is the network defined in Chapter 3. Since the battery is installed at transformer secondary bus bar, the 40 clients are grouped in 2 loads, one per phase.

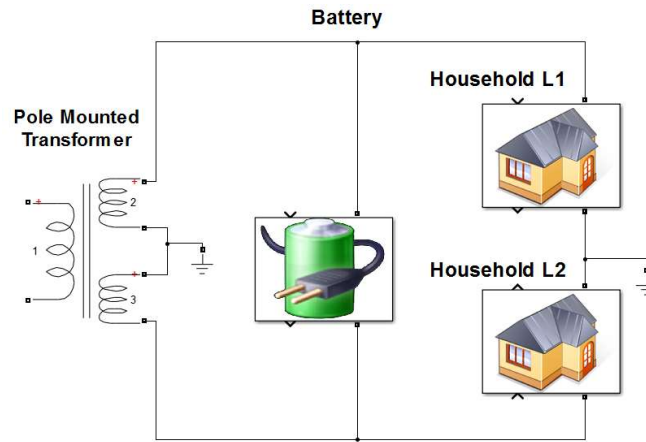

Fig. 4.23 Simulink Model based in [135]

A simple model for modeling the battery is built, which shows the electric discharge capacity [Ah] and SOC that have been taken from [135]. The advantage is that it is compatible with the Phasor Mode.

$$Capacity [Ah] = \frac{\int_0^t i(t) dt}{3600} \quad (4.23)$$

$$q(0) = \int_{-\infty}^0 i(t) dt \Big|_{t=0} \quad (4.24)$$

$$SOC [\%] = 100 * \left(1 - \frac{\int_0^t i(t) dt + q(0)}{Q * 3600} \right) \quad (4.25)$$

The battery is connected between L1 and L2, thus to 240V. This approach was chosen because it is too expensive to install a battery by phase. In addition, one of the primary objectives is to reduce the relative load in the transformer.

4.1.2.4.1 Controller

Once configured the model within Simulink, a controller for the respect of the constraints defined in Equations 4.16 – 4.20 is proposed and implemented. An admissible value for the depth of discharge is 50%

$$SOC^{\min} = 40\%$$

$$SOC^{\max} = 90\%$$

$$SOC(0) = 40\%$$

$$P_{BAT}^{\max} = -P_{BAT}^{\min} = 12\text{KW}$$

$$P_{EGRID}(t) \leq Pn_{Transformer} = 50\text{kVA}$$

$$U=1$$

4.1.2.5 Results

Figure 4.24 shows the total load, in other words, the load in phase 1 plus load in phase 2. The peak is reached at 19:21 with a value of 61,1 kVA. The section marked in red shows a negative power load, which is originated by the PV Generation.

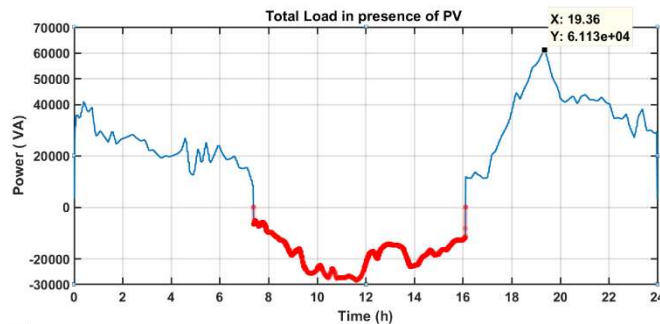

Fig. 4.24 Total Load (Phase1 + Phase 2)

The next figure shows the load seen at transformer secondary side. The maximum demand is now 49,1 kVA due to the battery action. The section marked in red show the reverse flow. As the reader can see, the constraint related to the assigned power of the transformer Pn (50kVA) is now respected.



Fig. 4.25 Power at transformer (Phase1 + Phase 2)

The FU is 98%; in [103], the minimum FU achieved with the proposed Smart Techniques is 128%. Hence, a considerable reduction has been reached. The next figure shows the power in the battery (receiver convention), the controller starts the charging process when the PV generation is higher than the load until the generation is equal to the load. After that, the discharge process begins. As the load during the discharge process is higher; the discharging energy is consumed in less time (6,91h) than the time used for charging. In figure 4.26, it is also depicted the charging energy E_{ch} and the discharging energy E_{dch} . By calculating the areas, we can say that $E_{ch} = E_{dch}$.

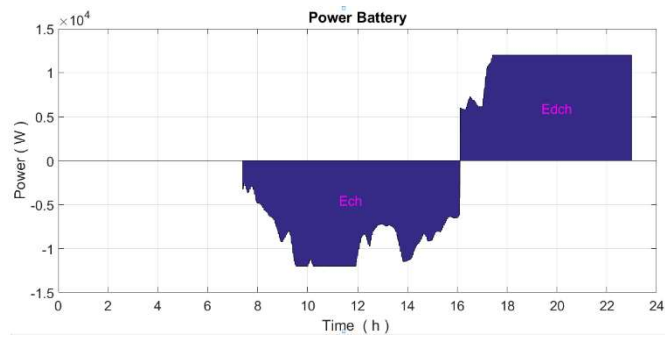

Fig. 4.26 Power Battery connected at 240V, Exchanged battery energy

In the next figure, we can see the SOC. The lower and upper levels are respected, as well as the constraint related to the number of cycles per day. In addition, the maximum allowed depth of discharge is respected as well.

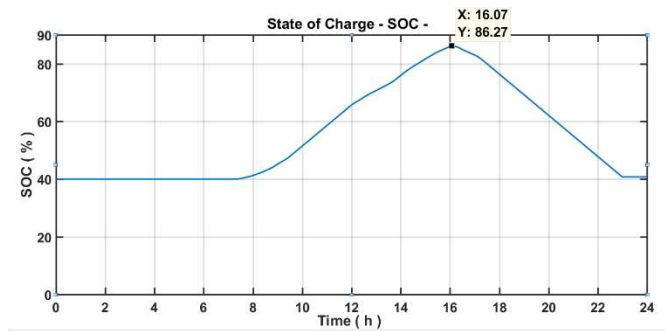

Fig. 4.27 SOC, one cycle per day

In order to better illustrate the behavior of the whole system, Figure 4.28 is presented. At point A, we see the beginning of the charging; the point B is the charging end point. The battery and the electric grid feed the load at point C (peak), respecting the power balance. Point D is the discharging end point.

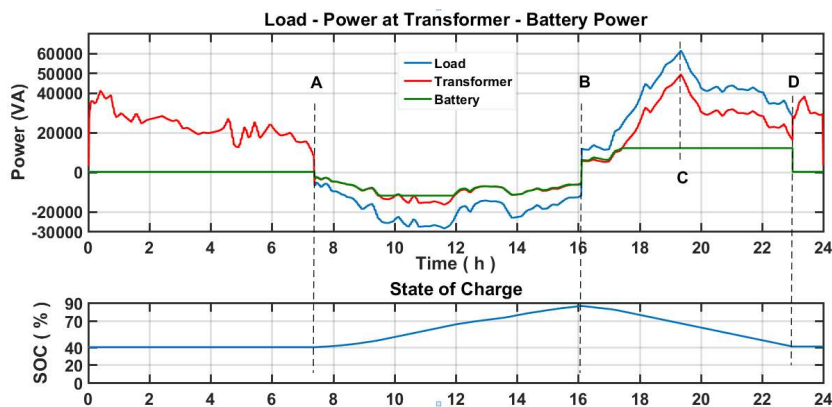

Fig. 4.28 Whole system behavior

4.1.2.6 Analysis and Discussion of the Results

According to the results, the controller suitably performs its function. It means that all constraints are respected. However, in Figure 4.25 and Figure 4.28, it is possible to see that the energy coming from

PV could be reversely injected in the transformer. Thus, it is used for charging the battery, because a maximum limit for P_{bat} is imposed. We could change this limit (it was calculated as $P_{load_{at_peak}} - P_{n_{transformer}}$), but it will not be used because this value is more than enough to reach a relative load under 100%. Another important case noted in the Figure 4.27 and Figure 4.28 is that the controller is more efficient than the Assumption 2, because, in function of the load, it decides how much energy to discharge. Hence, the discharging time is lower than the charging time.

Once executed the simulation and obtained this new time value, the calculus for cost discharging battery should be repeated to have more precise value for battery size. Finally, Equation 4.14 does not take into account the revenue generated by selling energy to the grid; therefore, Equation 4.21 must be evaluated, and surely, the battery size will change (lower size), and the benefits from the end user would improve.

An important topic identified during the previous simulations is the phase unbalance. The next section will present a proposal to reduce it in the presence of DGs.

4.1.3 Automatic Phase Switching System

With the advent of Smart Grids and the strong deployment of DGs, especially PV panels, nowadays the end-users are able to install local generation, generally single-phase because of low power levels (some kW). It means that now, the DSO has to deal with the effects derivate of DGs such as bi-directional flows or increase in the losses. The most common approach is connecting the single-phase PV system in the same phase of the load; however, it could generate unbalance increase and voltage problems. In [131], a methodology for analyzing the best phase for connection of single phase DGs is presented. Using weighting functions, each phase is classified; the phase with lower coefficients is chosen. Nevertheless, in the medium or long-term, the selected phase could not be the best option. In order to avoid having permanently the same phase and to enable to the PV for choosing the optimal phase based on network state, in [41], a system named “Commutation Automatique de phase – Automatic Phase Shifting” –CAP-APS has been patented.

The system is designed for working with configurations 3P4W; it means 3 phases - 4 wires (three phases+neutral) and then with single-phase PV. It could also work with other types of DG, interruptible loads, EV charging stations. The next figure illustrates the concept.

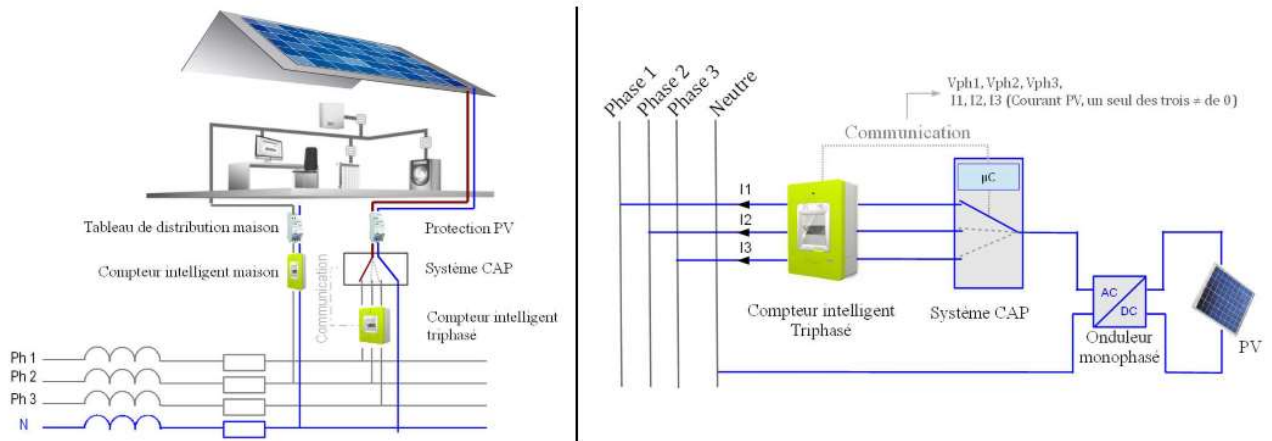

Fig. 4.29. CAP System [41]

The patent developed for CAP system must be tailored for working properly in other configurations; in the context of this thesis, the CAP system would be adapted for operating in the most typical configuration in Galapagos, in other words, 1P3W as is depicted in figure 3.1. It means that the system would choose between Phase L1 or Phase L2, see the next figure.

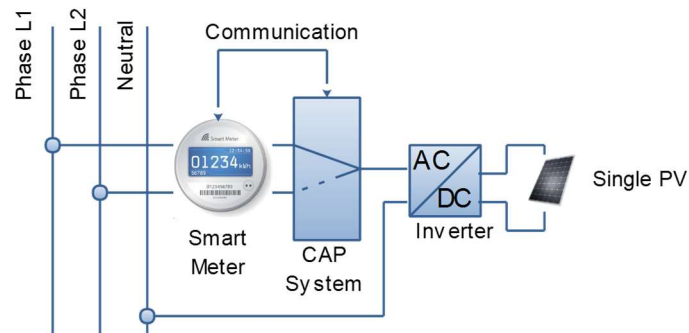

Fig. 4.30. Tailored CAP system for Galapagos

For testing purposes, the same LV network is chosen than previously, and three CAP systems are installed with different distances from the transformer; One at the secondary bus bar of the transformer, one at the end of a feeder, and one approximately in the middle of a feeder, see next figure.

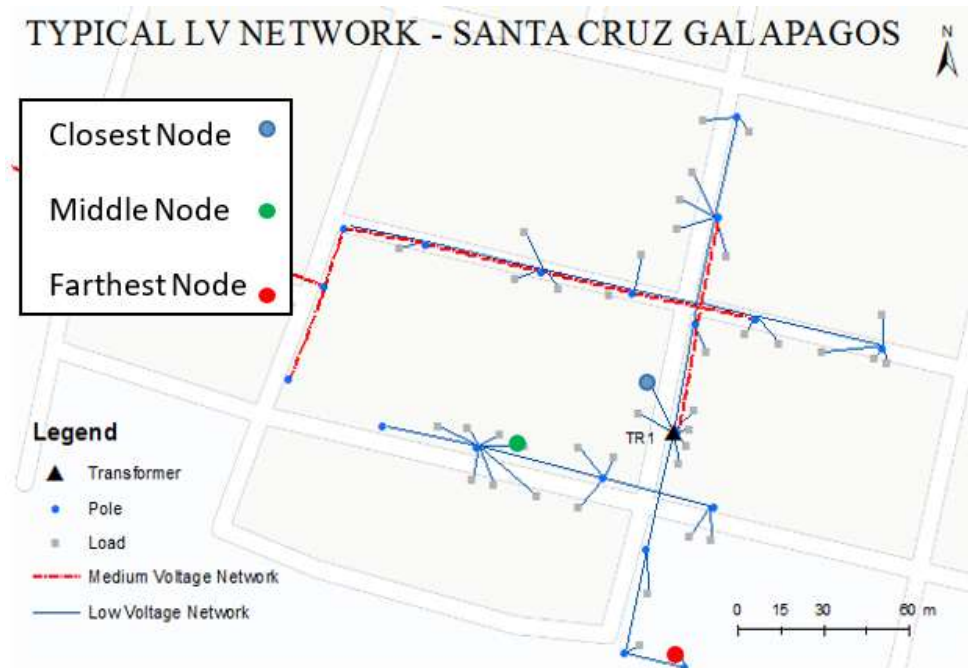

Fig. 4.31. Topology for testing CAP System

For this scenario, the PV systems installed in each household (2.150Wp) are removed, except those of the clients equipped with a CAP system. The deadband used for switching is 0,96. In other words, each time the voltage reaches this value will have the effect to switch to another phase.

4.1.3.1 Algorithm

At the initial state, the PV could be connected in any phase. Obviously, the voltage profiles in each node will depend on the initial phase chosen for PV connection. For instance, the Figure 4.32 shows the profiles in the closest node when the Phase 1 or 2 is selected.

The algorithm uses the local voltage measurements of the two phases and the current produced by the DG as input data. These quantities make it possible to perform an estimation of the impact of a switching on the phase voltages and give thus a switching validation if required.

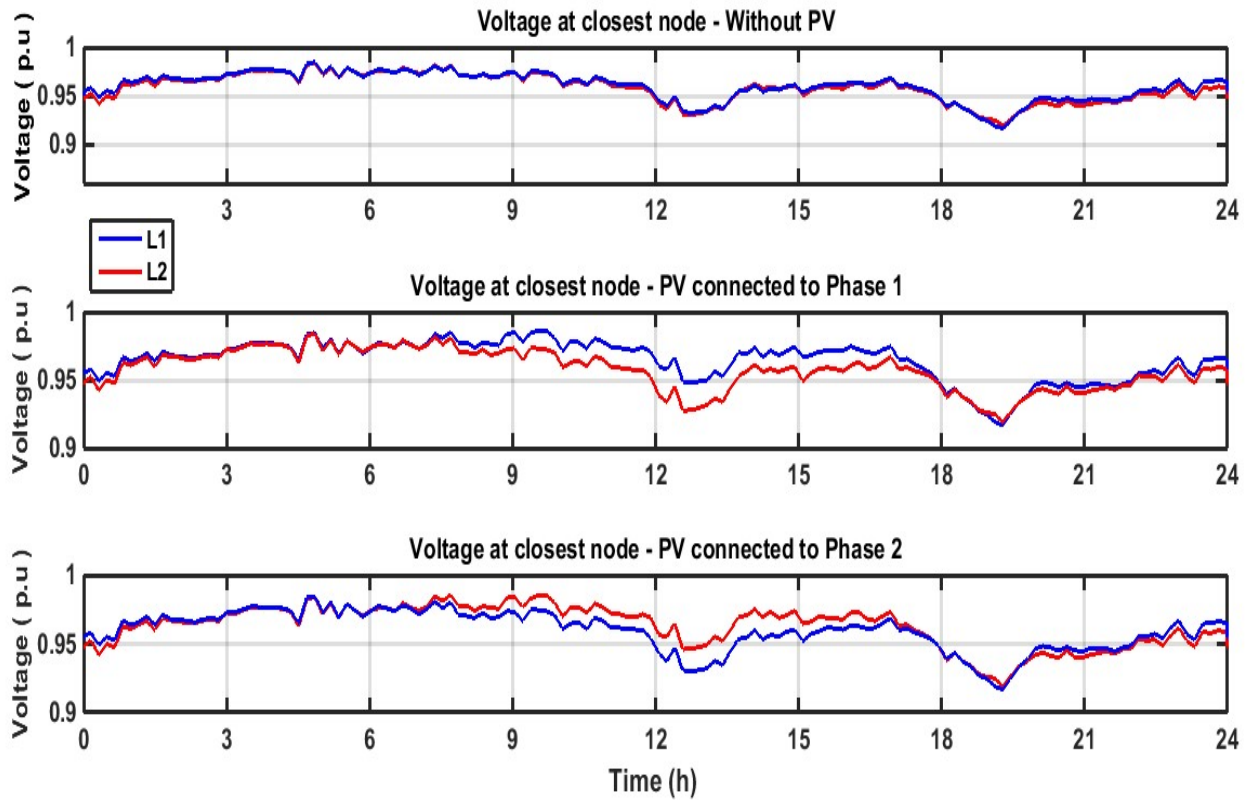

Fig. 4.32. Voltage profiles before installing CAP system

A phase change is allowed if the two inequalities remain valid for a minimum time.

$$(V_j + S_{pj(V/W)} * P_{DG}) * 0,96 < V_i \quad (4.26)$$

$$P_{DG} > 0,1 * (P_{\max DG}) \quad (4.27)$$

Where:

i the current phase

j the other phase

V_i Phase i amplitude

$S_{pj(V/W)}$ phase j sensibility at the moment of the active power insertion

P_{DG} power produced by DG

For validating Equation 4.26, the voltage in the phase i must be 4% higher than the estimated one of phase j after the switching. The phase j voltage is determined by means of $S_{pj(V/W)}$. Moreover, Equation

4.27 guarantees that the DG supply is at least 10% of its rated capacity, which means that the impact of a switching will not be negligible.

4.1.3.2 Implementation

The load curves, the LV network, the EM average profile and the IC curves are the same that those defined in Chapter III. At the beginning of the simulation, the Phase L1 is chosen arbitrarily for connecting the PV. Once connected the PV through the CAP system, the model is set to automatic to select the best phase option for the PV connection. The next curves show voltages of Phase 1 and 2 i) without PV, ii) with PV connected to Phase 1 without CAP system iii) with PV with CAP system.

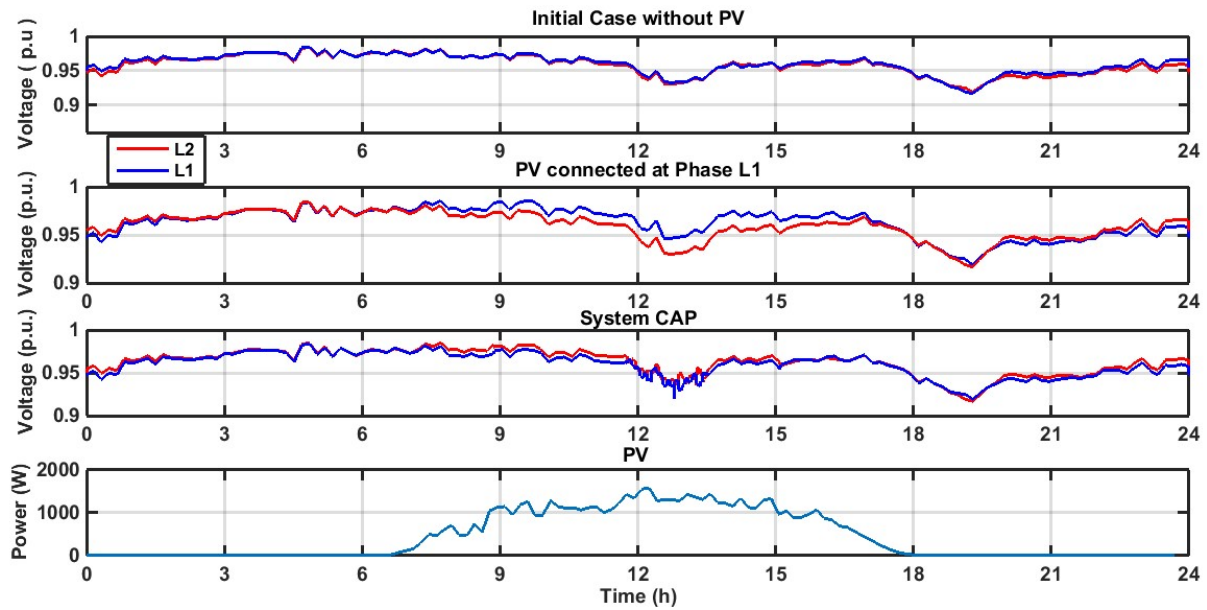

Fig. 4.33. Closest Node

The Figure 4.33 illustrates that installing PV at the closest node tends to increase the voltage of the connection phase when the PV produces power. The CAP system allows coming back to a similar situation of the one where there is no PV, i.e., the unbalance between phase voltages due to the insertion of PV is substantially reduced. We can also notice that the CAP system is not able to solve the problem of voltage drop at 19:30 since there is no PV production at this time. However, in the previous section, we observed that with the employment of BESS, the maximum peak, which is responsible for the voltage drop, is deleted. Therefore, the solution that considers the application of Smart DR+TOU, BESS and CAP system at the same time, will be able of shifting consumption along the whole day, shaving the maximum peak and reduce the unbalance.

In order to determine the improvements concerning to unbalance, the next equation is defined.

$$U_{1-2} = \sum_{i=1}^{24} |V1_i - V2_i| \quad (4.28)$$

Where:

U_{1-2} Voltage difference between phase 1 and 2 along the day

$V1_i$ Voltage in phase 1 in the i th hour

$V2_i$ Voltage in phase 2 in the i th hour

Thus, for the initial case without PV generation $U_{1-2}=4,74v$, when the PV panel is connected to the Phase 1, $U_{1-2}=16,07v$, and when the CAP system is installed in the closest node $U_{1-2}=7,82v$

Regarding the middle node, the effect of CAP system is similar, but a bit better $U_{1-2}=11,68v$. However, there are two negative commutations (red one around 12:48 and blue one around 13:16). See Figure 4.34

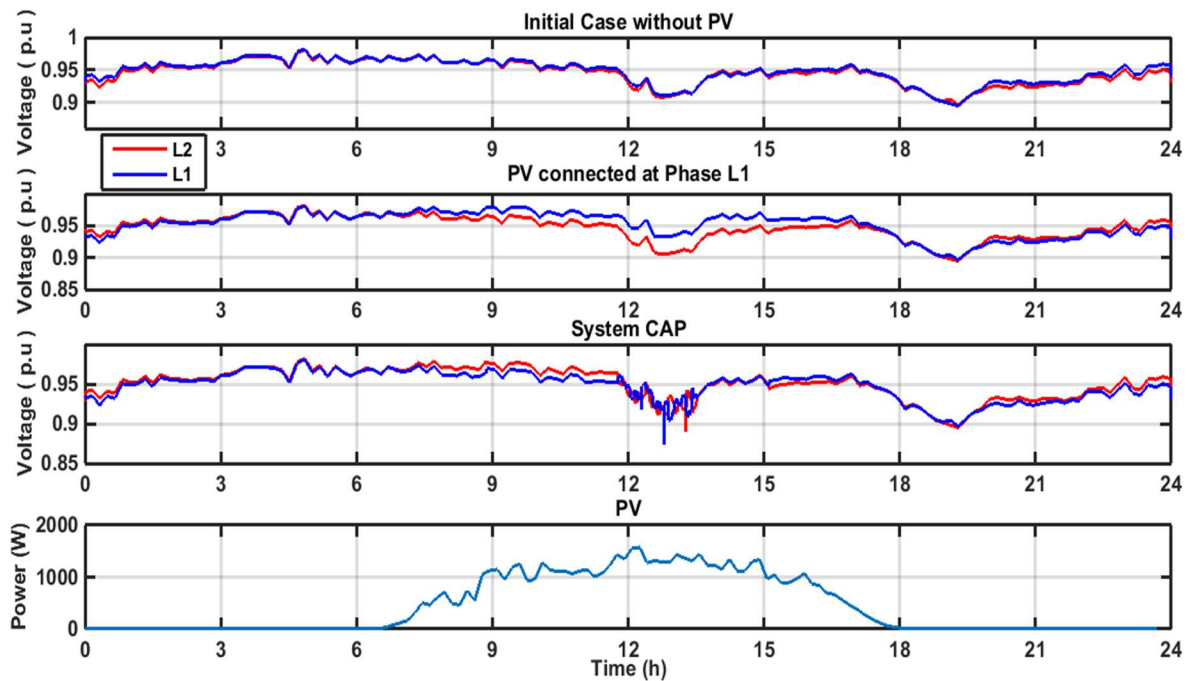

Fig. 4.34. Middle Node

The values reached are 0,88 p.u. at Phase L2 and 0,87 p.u. at Phase L1, nevertheless, those peaks last less than 2 min. Thus, the effect is negligible since the quality standard in Ecuador establishes a maximum duration of 10 min for a voltage drop under the standard limit [44].

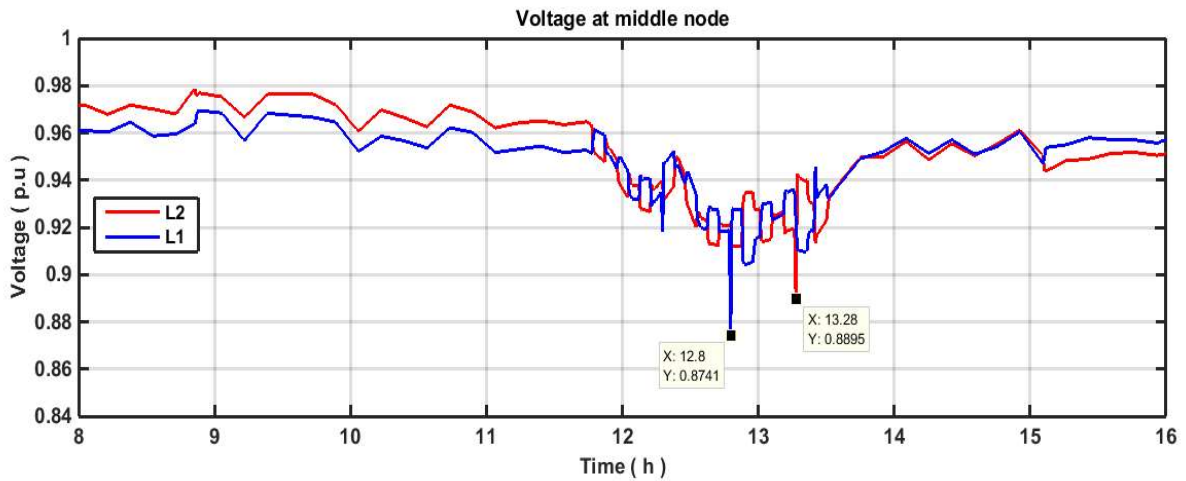

Fig. 4.35. Lowest voltages during the switching

Finally, the next figure shows the results for the farthest node, a slight improvement of the voltage profile is registered, $U_{1-2} = 10,83 \text{ V}$.

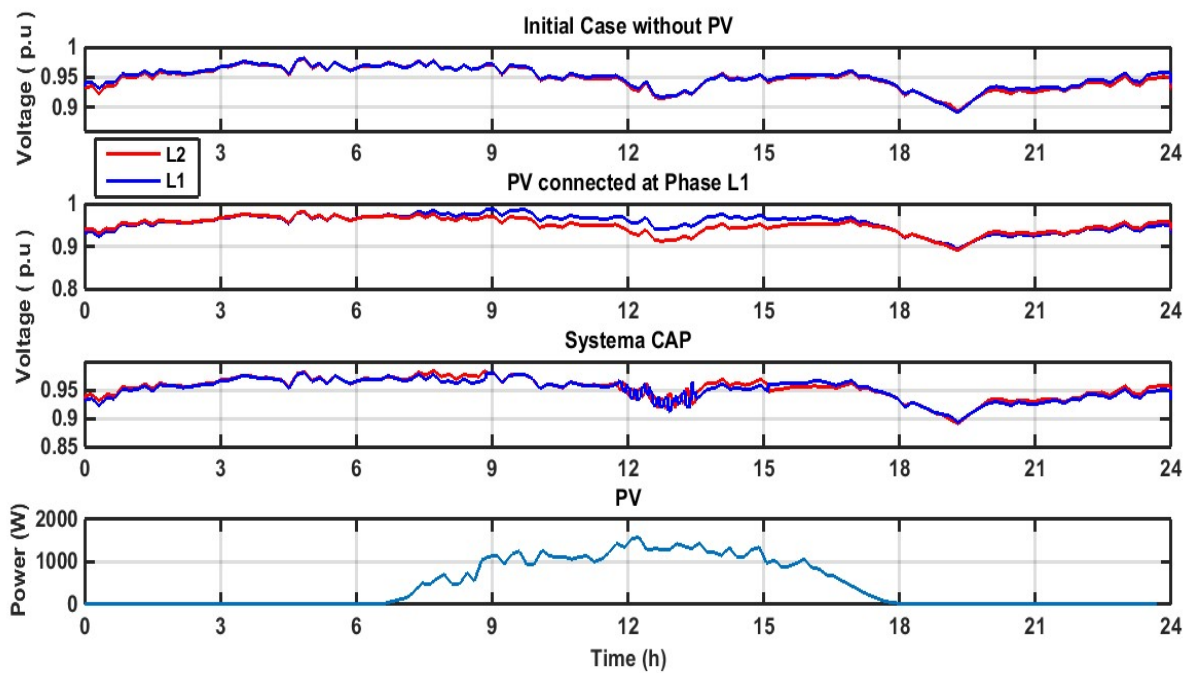

Fig. 4.36. Farthest Node

After several simulations and detailed analyses of all the curves, with the chosen conditions, the PV seems to have only a slight effect on the voltage profile of the phase where it is connected. However, the results are promising because along the day the U_{1-2} value improved considerably after CAP installation. In order to notice a better effect the follows actions could be taken into account:

1. The unbalance should be higher, this LV network has $U_{1-2}=4,74v$, but other LV networks surely would have different values.
2. The PV power must be increased, indeed, if the PV has a small effect on voltage, the CAP system is not useful.
3. More CAP systems could be deployed, as simulation considered 1 per node, it means in total 3.

It is important to mention that EM and IC do not generate an increase in the unbalance since they are connected to 240 V.

Once analyzed strategies in low voltage such as Intelligent DSM, BESS, and CAP system, it is worth to investigate the effect of ADA functions in Medium Voltage. This is the purpose of the next section.

4.2. Medium Voltage – CYMDIST

Once proposed different innovative solutions in low voltage, this section will address the implementation of ADA functions in Medium Voltage: the network reconfiguration, recloser deployment, and VV0 (Volt-Var Optimization) functions are chosen for the analysis because they have been widely studied in the literature these last years. These functions would improve reliability, reduce losses and keep voltages in regulated limits respectively, with small investments.

4.2.1 Reclosers deployment for improving reliability

In this section, we propose first to show the need of reliability improvement in the Galapagos network. We have thus developed a predictive reliability model. The objective of this model is to represent the average reliability of the area under study and, later, to estimate how it will be improved by the reclosers implementation [139].

In Ecuador, the reliability standard is defined in [44]. Reliability indices are based on frequency and duration of the interruption. There are two stages, the first one defines global indices at MV feeder and whole network level, and the second one defines individual indices at the client level. The interruptions that are taken into account in the indices calculation are those which last more than 3 min (momentary interruptions).

4.2.1.1 Indices

The indices are calculated for the whole network (Rd) and each MV feeder (Aj)

$$FMIK_{Rd} = \frac{\sum_i kVAfs_i}{kVA_{inst}} \quad (4.29)$$

$$FMIK_{Aj} = \frac{\sum_i kVAfs_{iAj}}{kVA_{instAj}} \quad (4.30)$$

$$TTIK_{Rd} = \frac{\sum_i kVAfs_i * Tfs_i}{kVA_{inst}} \quad (4.31)$$

$$TTIK_{Aj} = \frac{\sum_i^{Aj} kVAfs_{iAj} * Tfs_{iAj}}{kVA_{inst Aj}} \quad (4.32)$$

Where:

FMIK: Cumulated Average Interruption Frequency per rated kVA installed and per year, expressed in faults per kVA

TTIK: Total Interruption Time per rated kVA installed and per year, expressed in hours per kVA.

\sum_i : Sum of all interruptions of the service, i is an interruption with duration higher than three minutes

\sum_i^{Aj} : Sum of all service interruptions in the "Aj" feeder in the period under analysis.

kVAfs_i: kVA out of service at each of the i interruptions.

kVAinst: Rated kVA installed.

Tfs_i: Time out of service, for interruption i

Rd: Distribution Network

Aj: MV feeder j

The reliability indices are reported monthly to ARCONEL; the MEER is responsible for setting the limits of each index. For Galapagos case, the limit for FMIK is 8 and 15 for TTIK. Next Table shows the monthly value of the indices in 2016 for Feeder 1 of Santa Cruz island.

TABLE XV FMIK-TTIK

| <i>Period</i> | <i>FMIK</i> | <i>TTIK</i> |
|---------------|-----------------|-----------------|
| | <i>Feeder 1</i> | <i>Feeder 1</i> |
| | <i>SCZ01</i> | <i>SCZ01</i> |
| <i>Jan</i> | 1,51 | 6,79 |
| <i>Feb</i> | 1,48 | 1,66 |
| <i>Mar</i> | 2,01 | 6,51 |
| <i>Apr</i> | 1,03 | 4,05 |

| | | |
|--------------|--------------|--------------|
| May | 0,00 | 0,00 |
| Jun | 1,60 | 0,84 |
| Jul | - | - |
| Aug | 2,00 | 2,67 |
| Sep | 0,48 | 0,48 |
| Oct | 1,03 | 2,03 |
| Nov | 3,25 | 1,98 |
| Dec | 2,44 | 6,20 |
| Total | 16,83 | 33,21 |

As the reader can appreciate, the values for FMIK and TTIK in the year 2016 have exceeded the regulation limits in more than twice. Thus, an improvement of the network is urgent.

As was mentioned previously, the medium voltage network is modeled in CYMDIST. This software has a powerful module for assessing the reliability. However, CYMDIST complies with IEEE standards; it means that it works with well-known indices SAIFI, MAIFI, and SAIDI defined in [140].

$$SAIFI = \frac{\sum \text{Total Number of Customers Interrupted}}{\text{Total Number of Customers Served}} \quad (4.33)$$

$$MAIFI = \frac{\sum \text{Total Number of Customer Momentary Interruption}}{\text{Total Number of Customers Served}} \quad (4.34)$$

$$SAIDI = \frac{\sum \text{Customer Minutes of Interruption}}{\text{Total Number of Customers Served}} \quad (4.35)$$

Where:

SAIFI: System Average Interruption Frequency Index

MAIFI: Momentary Average Interruption Frequency Index

SAIDI: System Average Interruption Duration Index

Therefore, the assumption based on [139] is considered: *The index FMIK is equivalent to SAIFI, and the index TTIK is equal to SAIDI.* The main advantages of using these indices are.

1. It exists an extensive database prepared by the IEEE Distribution Reliability Working Group that allows comparing the reliability of any Utility with a wide range of North America utilities.
2. There is abundant specialized literature and reports of experiences and projects carried out by the industry with the aim of improving these reliability indices.

3. In addition, these indices are based on customers served by the utility, whereas the indices currently used in Ecuador estimate the average reliability per installed kVA. In this sense, using the SAIDI and SAIFI indices is considered as an intermediate step in the final long-term objective considered by MEER that is estimating the reliability at the individual customer level.

4.2.1.2 Predictive Model

The methodology described in [141] and [139] is implemented within CYMDIST in order to determine a predictive model. Using the Reliability Assessment Module –RAM-, the model aims to represent the baseline or initial reliability of the feeder, in other words, the current situation of the system before any implementation. In the predictive model, changes in the reliability parameters (failure rates and average repair times) produce modifications in the reliability indices such as SAIFI and SAIDI, as well as TTIK and FMIK.

In order to calibrate the model, an iterative process must be executed; the objective is to equal the reliability indices calculated by RAM with the target values, see Table XVI.

TABLE XVI TARGET VALUES

| <i>SAIFI</i> | <i>SAIDI</i> | <i>MAIFI</i> |
|--------------|--------------|--------------|
| <i>16,83</i> | <i>33,21</i> | <i>21,03</i> |

For establishing the MAIFI, according to the expert criterion of distribution technicians, the momentary interruptions are likely 25% more. Considering that these professionals know very well the network and work on it all the year, this value is accepted as a good approximation.

Unfortunately, ELECGALAPAGOS has no historical information of failure rates or average repair times. Hence, several simulations with RAM has to be carried out to determine the suitable values for reaching the target values of the initial situation defined in Table XVI. According to [142] and [143], the relationship between the permanent failure rate of overhead lines with SAIFI index is linear and the relation between average repair time of overhead lines with SAIDI index is approximately linear. The next figure depicts the process developed to calibrate the failure rate – FR- and the average repair time –RT-.

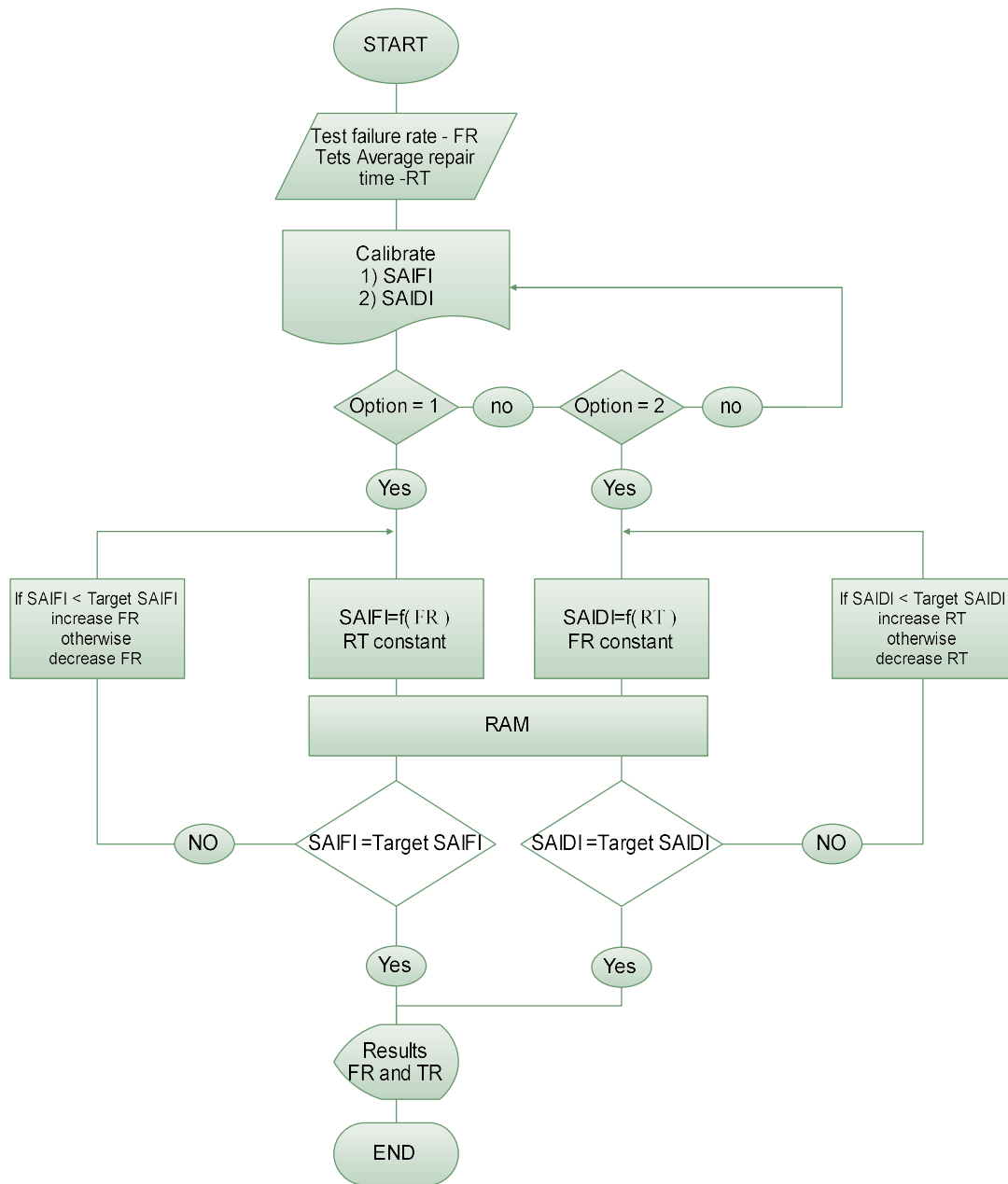

Fig. 4.37. Calibration Flow Chart

In addition, the next parameters are configured in the RAM

1. Fuse saving scheme
2. Reconnection and three-phase blocking
3. The permanent and momentary faults were classified according to the following percentages, 80% single-phase, 15% two-phase and 5% three-phase [144].
4. Momentary interruptions under 3 min.
5. Switching time of manual devices equal to 45 min.
6. Restoration downstream
7. Restoration upstream
8. Maximization of number of restored clients

Once executed the whole calibration process, the rates are obtained for reaching the target values. Next table shows the calibrated values.

TABLE XVII RATES FOR SCZ01 FEEDER

| <i>Type</i> | <i>Failure Rate (int/year/km)</i> | <i>Momentary Failure Rate (int/year/km)</i> | <i>Repairing Time (h/int)</i> |
|--------------------|---------------------------------------|---|-----------------------------------|
| <i>Overhead</i> | <i>4,26</i> | <i>0,091</i> | <i>0,05</i> |
| <i>Underground</i> | <i>1,28</i> | <i>0,013</i> | <i>17,20</i> |

With the values defined in Table XVII, the SAIFI, MAIFI, and SAIDI identified as targets are accomplished. Now, the improvements in the reliability due to reclosers deployment can be quantified.

4.2.1.3 Implementation

A recloser is defined in [145] such « A self-controlled device for automatically interrupting and reclosing an alternating-current circuit, with a predetermined sequence of opening and reclosing followed by resetting, hold-closed, or lockout operation »

CYMDIST has another module named “Optimum Recloser Placement,” which suggests optimal locations where reclosers could be installed, based on user-defined targets to improve network reliability [146]. Considering that Galapagos indices are upper the required limits, the objective function must consider the improvement of those indices. Let J denote the objective function

$$J = \min(SAIFI * k1 + SAIDI * k2) \quad (4.36)$$

Where k1 and k2 are the weighting values, in this case, 1 for both of them. It means that SAIDI and SAIFI would be minimized in the same proportion. The constraints are i) rated current of reclosers (150A), ii) ignore underground sections, iii) ignore bi-phase sections and iv) ignore the downstream sections of the fuses.

A sequential method for the optimization is chosen, due to its simplicity and its good results, even if this kind of method is sub-optimal; this approach places a first recloser at each location in the network and finds the best location before repeating the same process with the second. In addition, the maximum number of reclosers per feeder is set to four, because it is often complex to coordinate more than three reclosers in series. For instance, in [147], a scheme with two reclosers in series and one additional in open state for performing transfers between feeders is presented. Table XVIII show the base scenario of reliability in Santa Cruz on Feeder 1.

TABLE XVIII RELIABILITY SCZ01 FEEDER

| <i>SAIFI</i> | <i>MAIFI</i> | <i>SAIDI</i> | <i>ENS</i> |
|--------------------------|--------------------------|---------------------------|-----------------|
| <i>int/consumer-year</i> | <i>int/consumer-year</i> | <i>hour/consumer-year</i> | <i>kWh/year</i> |
| 16,79 | 21,49 | 33,22 | 74460,627 |

The ENS is calculated in CYMDIST as follows [148]:

$$ENS = \sum load * interruption\ duration \quad (4.37)$$

Where:

ENS: Energy not supplied during a year due to the interruptions in the period.

The base scenario is depicted in the next figure. Nowadays there are two reclosers, one of them in the feeder header and the other one downstream. The reclosers, named R1 and R2, are identified by means of a green circle, all the sections in blue are three-phase.

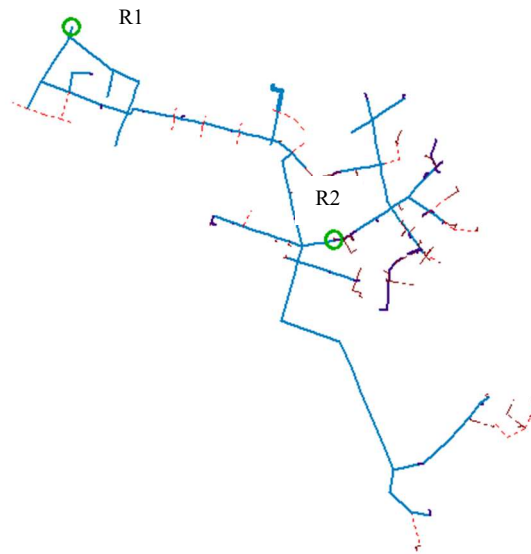

Fig. 4.38. Base Scenario in Feeder 1

Once executed the sequential analysis for optimal placement of reclosers, two additional reclosers are suggested, and their location is shown in figure 4.39. In addition, a fuse exists at the interconnection node between Feeder 1 and Feeder 2, which is replaced by a normally-open recloser (RI). Table XIX shows the improvements on the indices.

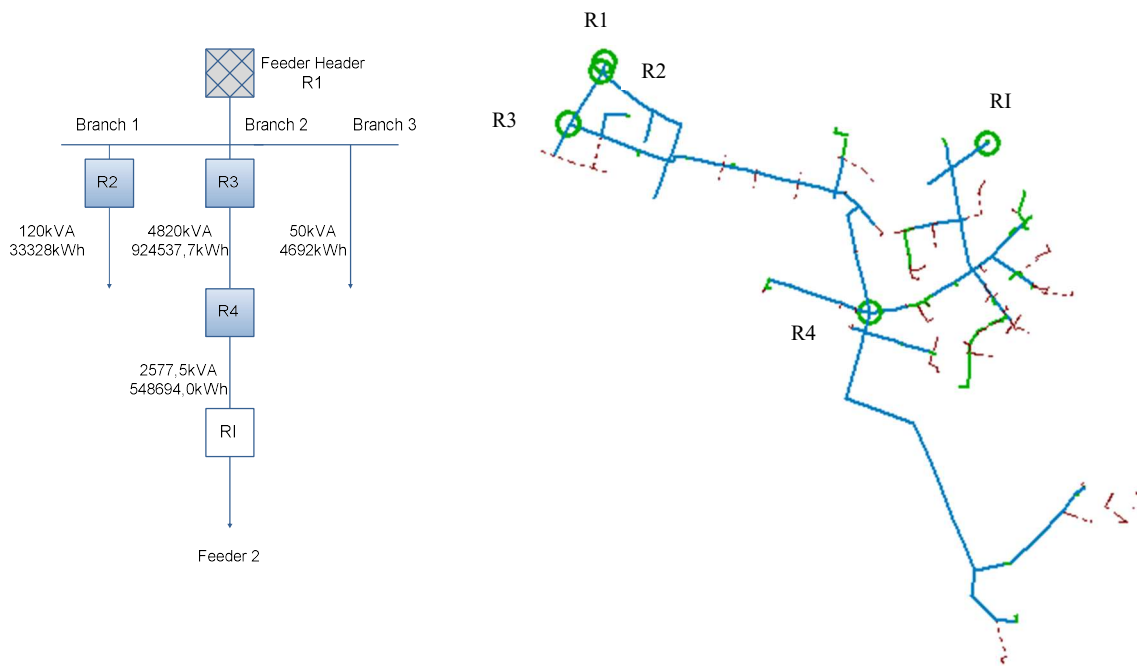

Fig. 4.39. Scenario with reclosers in Feeder 1

TABLE XIX RELIABILITY SCZ01 FEEDER

| # Reclosers | <i>SAIFI</i> <i>int/consumer-year</i> | <i>SAIDI</i> <i>hour/consumer-year</i> | <i>Objective Function</i> % | <i>Improvement</i> |
|-------------|--|---|--------------------------------|--------------------|
| <i>Base</i> | <i>16,79</i> | <i>33,22</i> | <i>100</i> | - |
| <i>1</i> | <i>14,60</i> | <i>30,19</i> | <i>88,95</i> | <i>11,1%</i> |
| <i>2</i> | <i>14,34</i> | <i>27,88</i> | <i>84,67</i> | <i>4,8%</i> |
| <i>3</i> | <i>14,27</i> | <i>25</i> | <i>78,5</i> | <i>7,2%</i> |

The results are promising; however, it is worth noting that the value of one recloser is about USD 20.000. The ENS in the scenario with four reclosers is 56.494,479 kWh/year. According to [149], the ENS cost is 1,53 USD/kWh. Thus, in a year, the savings would be approximately 27.488 USD; in consequence, the return on investment (ROI) will be achieved in 2,18 years, which is a very short period. It is also worth noting that the last generation reclosers have the options of single-phase trip and single-phase lock. Considering those options, the reduction in the indices is extremely effective, see next Table.

TABLE XX FINAL RELIABILITY ON SCZ01 FEEDER

| <i>SAIFI</i> | <i>MAIFI</i> | <i>SAIDI</i> | <i>ENS</i> |
|--------------------------|--------------------------|---------------------------|-----------------|
| <i>int/consumer-year</i> | <i>int/consumer-year</i> | <i>hour/consumer-year</i> | <i>kWh/year</i> |
| 8,21 | 12,03 | 14,65 | 38289,715 |

4.2.2 Network reconfiguration

The Galapagos distribution network, as it was mentioned, previously, has three feeders in Santa Cruz Island. Only one interconnection point exists, between Feeder 1 and Feeder 2. Feeder 3, classified as rural, does not have any interconnection point. In the interconnection point between Feeder 1 and Feeder 2, a normally-open fuse is installed. The previous section defined as a good strategy to replace it by a recloser to allow transferring load in case of contingencies. This change also enables the network to perform reconfiguration actions to reduce losses, which is the purpose of this section.

For this purpose, CYMDIST uses the Network Configuration Optimization module, which minimizes the losses or the voltage violations in the network by changing the network topology, while respecting voltage and loading limits [150]. The next figure shows the two feeders, the switch disconnecter in orange and the recloser in green, interconnection node is indicated.

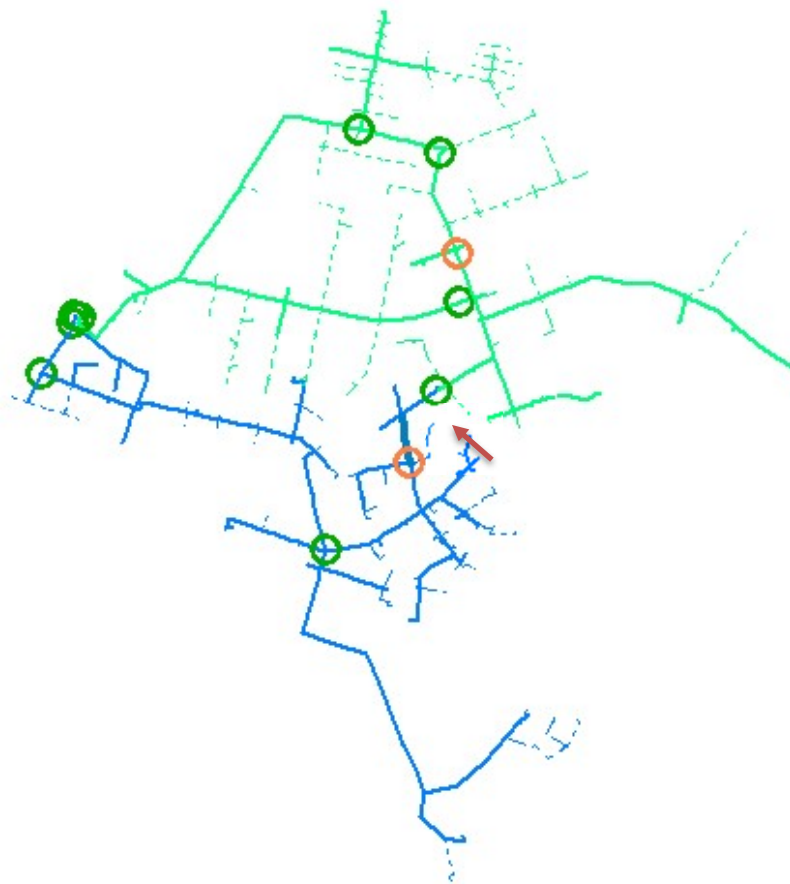

Fig. 4.40. Initial Topology: Feeder 1 and 2

4.2.2.1 Implementation

The analysis must be executed over the two feeders, the configuration parameters for the module as follows:

1. Allow initial overload conditions
2. Energy cost 0,09 USD/kWh
3. Overvoltage limit = 105%
4. Under voltage limit= 95%
5. All the switchgear devices are considered

The module can be configured to achieve different objective functions such as i) minimize overload, ii) minimize voltage violations, iii) balance feeders and, iv) minimize losses. For this study, the initial actuators are 2 switch disconnectors + 9 reclosers, the objective is the minimization of losses. The algorithm is sub-optimal since that choose the best solution for 1 switch, then the best solution for a second switch keeping the first one and so on, and then organize the results according to the input criteria and respecting the limitations imposed by the user. For instance, an option that allows adding new switch disconnectors is activated.

Thus, a new topology for Feeder 1 and 2 is configured; the change consists in transferring 365 kVA from Feeder 1 to Feeder 2. For achieving it, recloser R4 (Figure 4.41) is closed, and the switch S1 (added by the module) is opened, see next Figure 4.41.

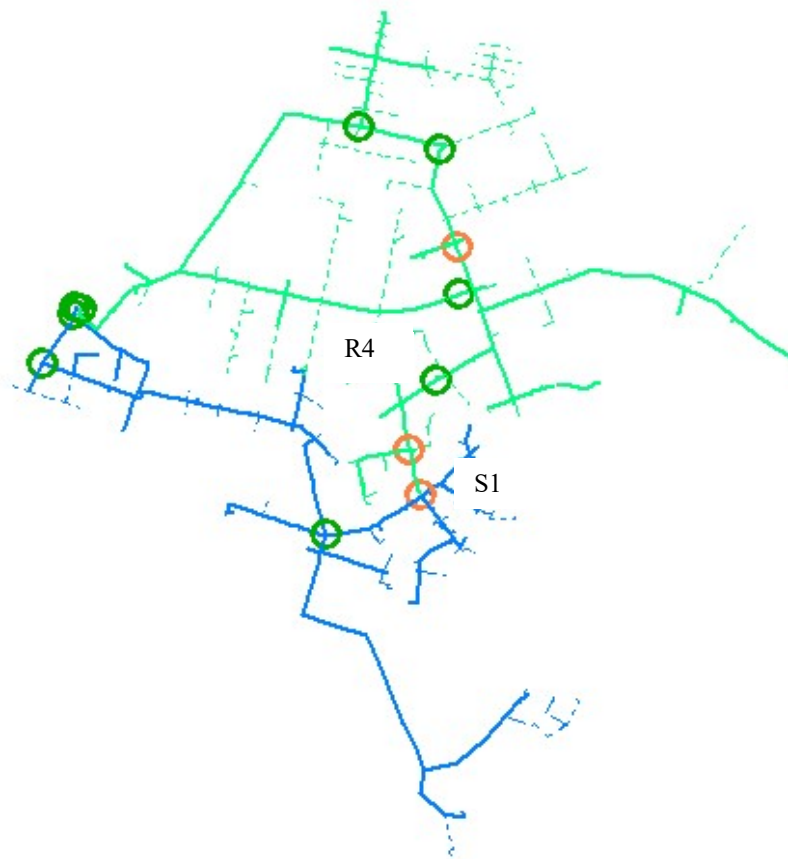

Fig. 4.41. Final Topology after reconfiguration: Feeder 1 and 2

With the actions of closing and opening an improvement in losses of 0,98 % is reached; naturally, we can conclude that this small value does not merit any real action. Better results are not evidenced since the network has not enough interconnection points and both feeders are radial. See next table for detailed results.

TABLE XXI INITIAL AND FINAL CASES

| <i>Feeder</i> | <i>Initial Load -kVA</i> | <i>Final Load -kVA</i> | <i>Initial Losses -kW</i> | <i>Final losses -kW</i> |
|---------------|--------------------------|------------------------|---------------------------|-------------------------|
| SCZ01 | 2450,4 | 2083,4 | 61,30 | 48,41 |
| SCZ02 | 2825,0 | 3190,7 | 62,36 | 74,04 |

4.2.3 Volt/Var Optimization -VVO

According to [151] a standard definition for Vol/Var optimization is as follows :

Volt/VAR optimization (VVO) is a process of optimally managing voltage levels and reactive power to achieve more efficient grid operation by reducing system losses, peak demand or energy consumption or a combination of the three.

The Volt/VAR regulation consists in supplying VARs to the network by means of different devices; for substations, capacitor banks, voltage regulators and power transformers with on-load tap changers – OLTC- are considered. On the other hand, along feeders, capacitor banks and regulators are considered. Experience has proven that overall costs and performance of operating a power system can be best managed if voltage control and reactive power control are well integrated [152]. One type of VVO solution is the strategy known as Conservation Voltage Reduction –CVR-, which is based on lowering the supply voltage to consumers to reduce the energy consumption while maintaining customer service voltage within statutory limits [153]. A significant benefit of CVR is to flatten voltage profile, doing this reduces overall system demand by a factor of 0,7-1% for every 1% reduction in voltage.

For performing the VVO analysis, the Volt/VAR Optimization module of CYMDIST is used. This module finds the best configuration of the installed capacitors, the inline regulators and the transformers with load tap changers in a distribution network [154] using sub-optimal algorithms. Some important details need to be considered i) there are neither regulator nor capacitors initially installed in the distribution network, ii) in the current situation, there are no violations of the voltage limits. Thus, there is no real voltage problem to solve. Figure 95 shows the voltage profile in phases A, B, and C along the feeder, the minimum voltage is 0,95 p.u.

The configuration of the module includes:

1. CVR method, it means minimizing the active power
2. The objective is to remove abnormal states as under voltages
3. Constraint of Power factor as minimum 0,95

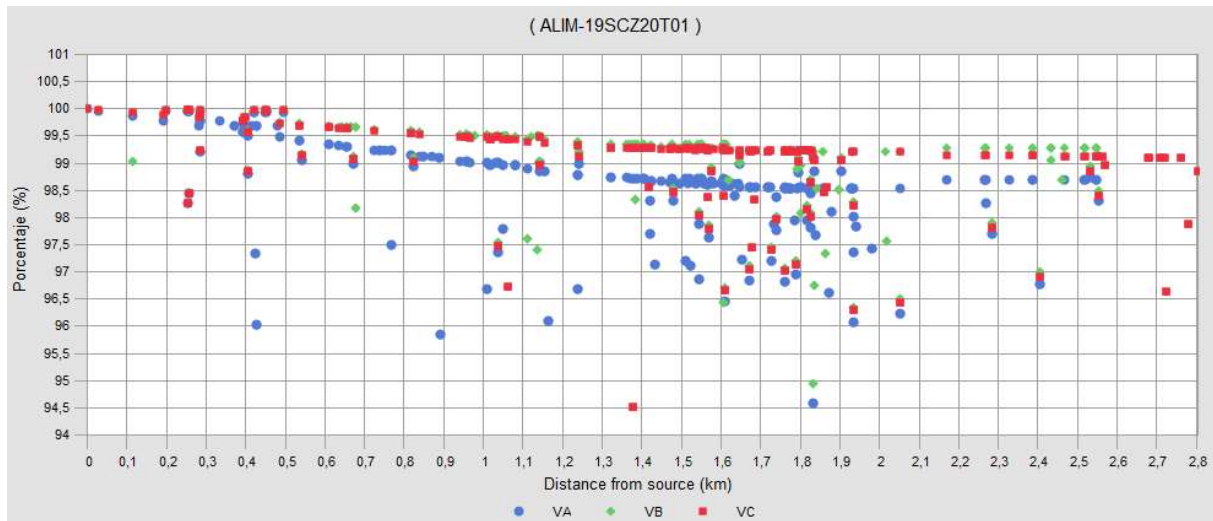

Fig. 4.42. Voltage Profile

As expected, since there were no violations in the voltage profile, the VVO module offers no solution. Additionally, implementing capacitor banks or regulators in the distribution network is not considered an alternative at least in the short-term, because the voltage levels are acceptable.

4.3. Conclusion

A Smart DSM program composed of DR+TOU has been developed and implemented. This program uses a practical and ingenious approach in order to modify the load curves and to create new ones, and these new curves consider peak reduction and shifted energy along the whole day. In addition, the developed algorithm takes into account an appliance controller in each house to neutralize the rebound effect and keep the load curve without new higher peaks.

Despite this new Smart DSM, overloads in the transformer still exist, so we investigated an analysis for decreasing the relative load in distribution transformers through BESS application. In order to define the battery size, a cost function minimization has been proposed. This function takes into account technical and contractual constraints. After the corresponding modeling and economic evaluation, it was determined that Li-ion batteries are not profitable at low voltage level, the lead-acid batteries are just on the border to be considered, a controller to manage the charging/discharging process is designed, implemented and tested. A new TOU scheme has to be implemented in Galapagos if the government wants to encourage end-users to install BESS system.

For managing unbalances and voltages induced by the connection of new single-phase devices to the grid, the automatic phase shifting (CAP) system offers interesting benefits such selecting the best phase for connecting DGs in this particular case, PV panels. Results of insertion of the CAP system in Galapagos LV network show new capabilities to reduce adverse impacts of connection of single-phase PV systems.

The reliability of the distribution network can be drastically improved by the installation of remote-controlled reclosers and activating the option of trip/lock single-phase, with a quick Return On Investment. Optimal reconfiguration of the network in the case of the feeder 1 is theoretically possible; however, its practical application is not viable for the Galapagos case since the feeders have not enough interconnection points. The VVO strategy for the particular case of the feeder 1 does not find any improvement proposal due mainly to the lack of elements for the reactive energy injection and to the fact that the current voltage magnitudes are in ranges that comply with the regulation.

The next present a methodology for analyzing the whole Santa Cruz electrical system in the presence of a strong integration of DGs, as well as the management of energy in the island, in order to move towards a Smart Island.

Chapter 5

Analysis of medium and low voltage networks on a large scale

This chapter deals with the results and their analysis of the simulation of the whole distribution network of Santa Cruz. In chapter four, a representative LV network has been selected in order to quantify the impact of new services. Some studies were carried out also on the MV network. However, it is an essential point to get a detailed vision of the changes that would suffer the whole distribution network, considering the strong aim of implementing smart grid facilities in the near future in Galapagos islands. Thus, an analysis considering all the clients and the three feeders must be accomplished. Santa Cruz network is composed as follows:

1. Three Medium Voltage feeders
2. 465 MV/LV Transformers
3. 6625 customers: 5364 residential, 1118 commercial, 130 industrial and 13 lighting streets

CYMDIST includes a powerful interface to create the electrical model [155], using the information coming from GIS and a database of electrical parameters.

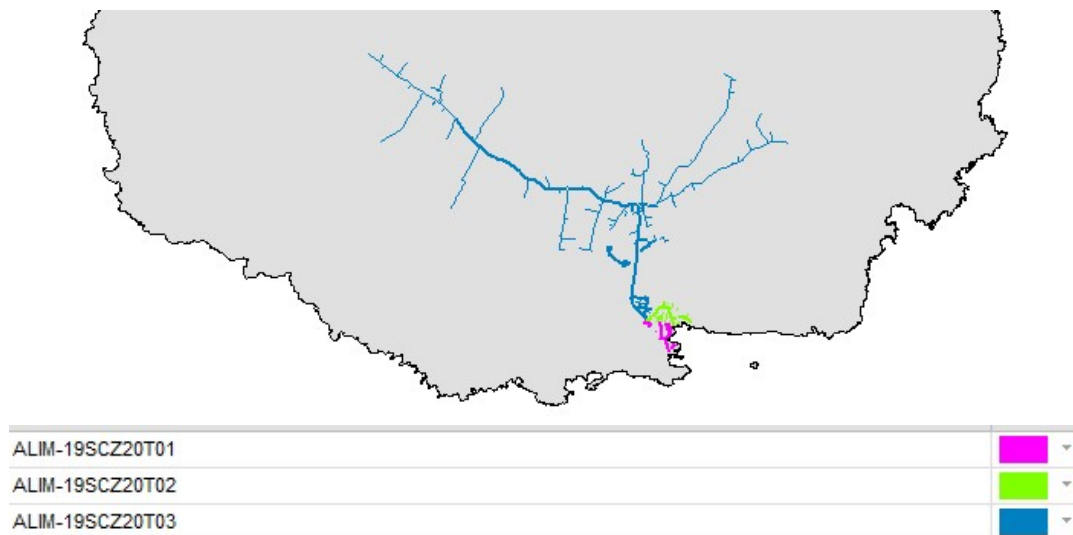

Fig. 5.1. CYMDIST Model

Thus, within CYMDIST, the author has modeled the whole network (see Figure 5.1). Hence, assessing the overall impact at the main MV substation when all the clients have IC, EM, and DG, is feasible. As the purpose of the analysis is focused at substation level, the simulation begins from feeder's real measurements to build end-users load curves, so that the 6625 clients are modeled. For the inclusion of new services, the analysis would consider coincidence criteria or use average profiles in order to reflect the impact at substation level.

5.1 Strong Integration of DGs

This section compares the base scenario, which considers just typical clients connected to the network, with a future scenario with new services. The percentage of integration of IC, EM, and DG are defined in function of sociological studies (carried out by UPV with the participation of the author during the whole process) based on several meetings with different sectors in Santa Cruz, by means of focus groups, the acceptance degree of new technologies was defined [156].

The information available for the analysis is composed of the Commercial Database with consumers consumption, Geodatabase with the geographical placement, CYME model with electrical topology and feeder load profiles, which have been measured by ELECGALAPAGOS in the MV substation. Starting from these real measurements, our first purpose is to propose a methodology to build end-consumers load profiles, which are not available, of course, as there are no measurement devices today at this level. These client load curves will then be included in the detailed network model in CYMDIST to carry out the simulations.

ELECGALAPAGOS has then daily load profiles at substation level; the maximum profile of April is selected since it represents the highest consumption during the year in Santa Cruz.

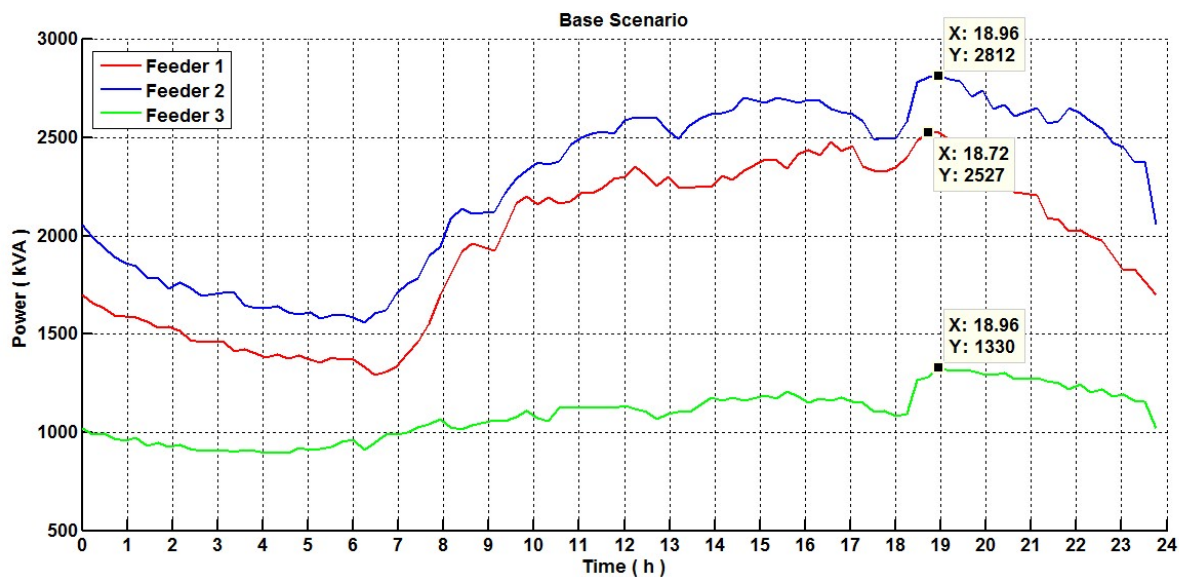

Fig. 5.2. Load Profiles in the feeder Header

The above figure depicts the three load profiles for the base scenario, the curves correspond to the day with the maximum load profile of April, and the maximum in each feeder is identified. We can see that the maximum power in Feeder 2 and 3 is reached at 19:00, whereas the peak in Feeder 1 occurs at 18:45. The maximum load at the Santa Cruz MV substation is 6.669,109 kVA (sum of the power peaks of the three feeders, which are coincident).

For determining the base load profiles at the consumer level, the next equation is applied in each feeder. Thus, all the clients have the same load profile shape, the difference will be the average values.

$$CPro_i = \frac{Cons_i * LP_{feeder}}{\sum_1^{clients} Cons_i} \quad (5.1)$$

Where:

$CPro_i$ Base Customer Profile.

$Cons_i$ Average Consumption of the i-th customer in kWh of the last 6 months.

LP_{feeder} Maximum Feeder Load Profile of April in kVA.

$\sum_1^{clients} Cons_i$ Sum of the total consumption in April of the Feeder in kWh.

The next figure shows some $CPro_i$ for different clients generated after applying Equation 5.1

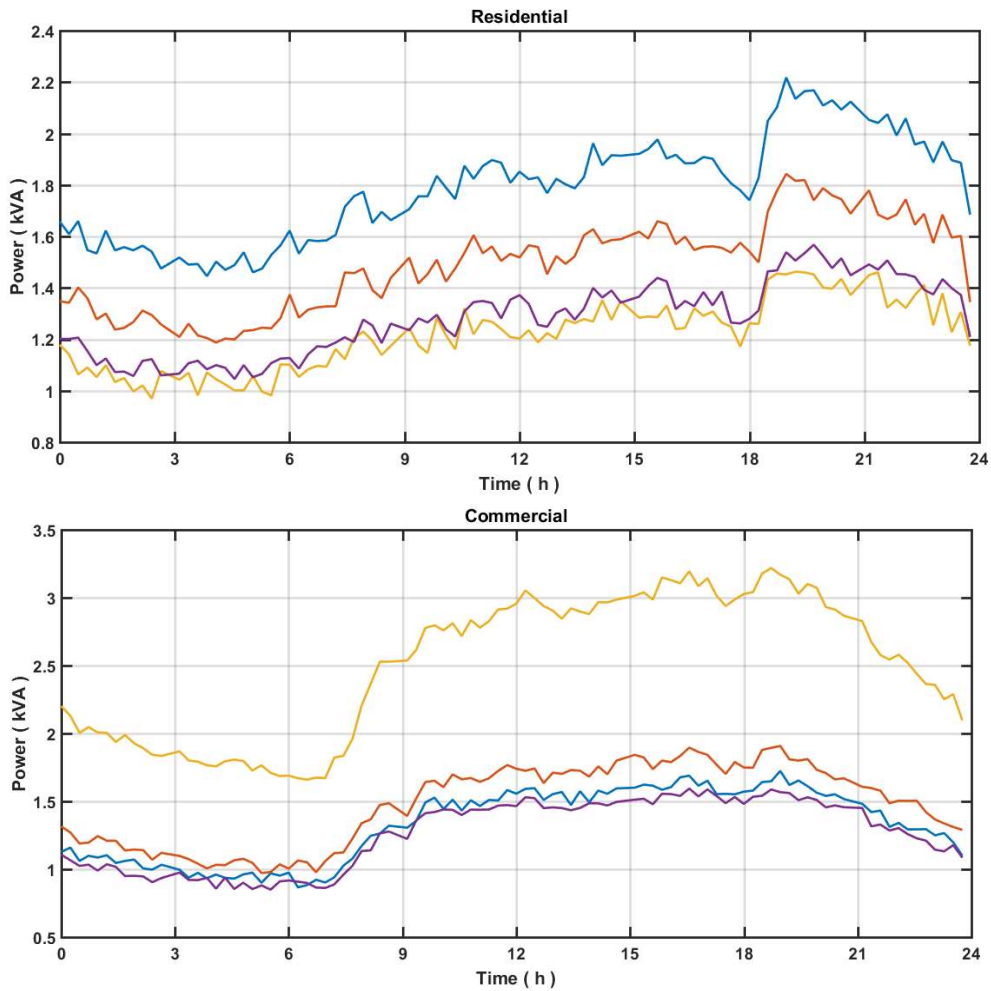

Fig. 5.3. Examples of $CPro_i$ for different clients.

To build the new “smart grid” load curves, IC, EM and DG profiles must be added to this base profile, as well as the natural growth of population and the DSM strategy. The next figure depicts briefly the

methodology followed in order to modify the consumer's profiles for considering the inclusion of DG, EM, DG, and DSM (DR+TOU).

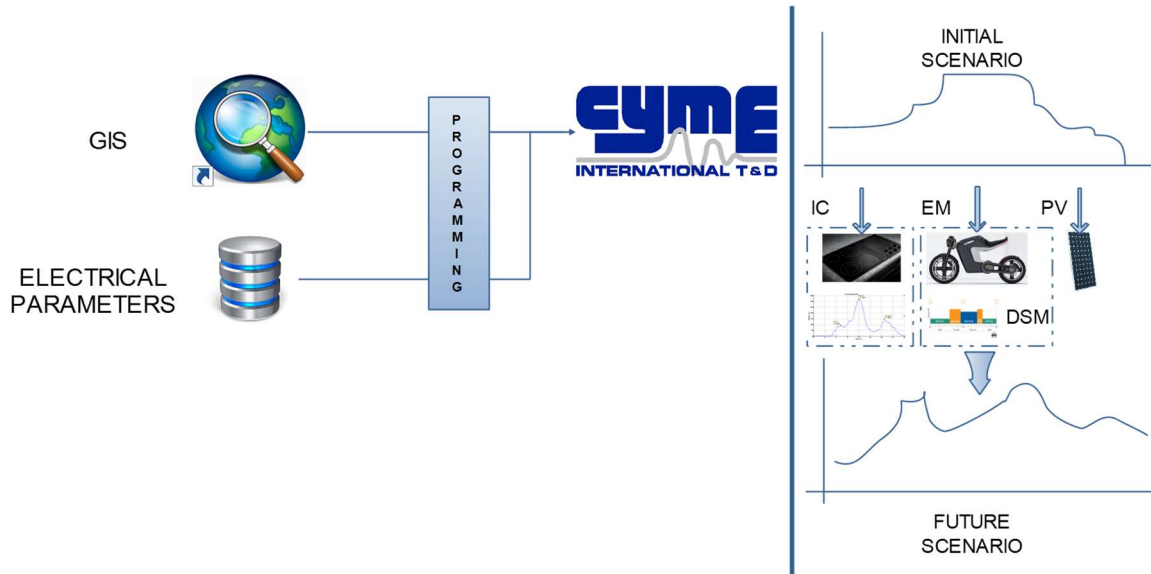

Fig. 5.4. Methodology applied on a large scale

For the IC integration, the next profile is considered since this represents an average profile of IC seen at substation level.

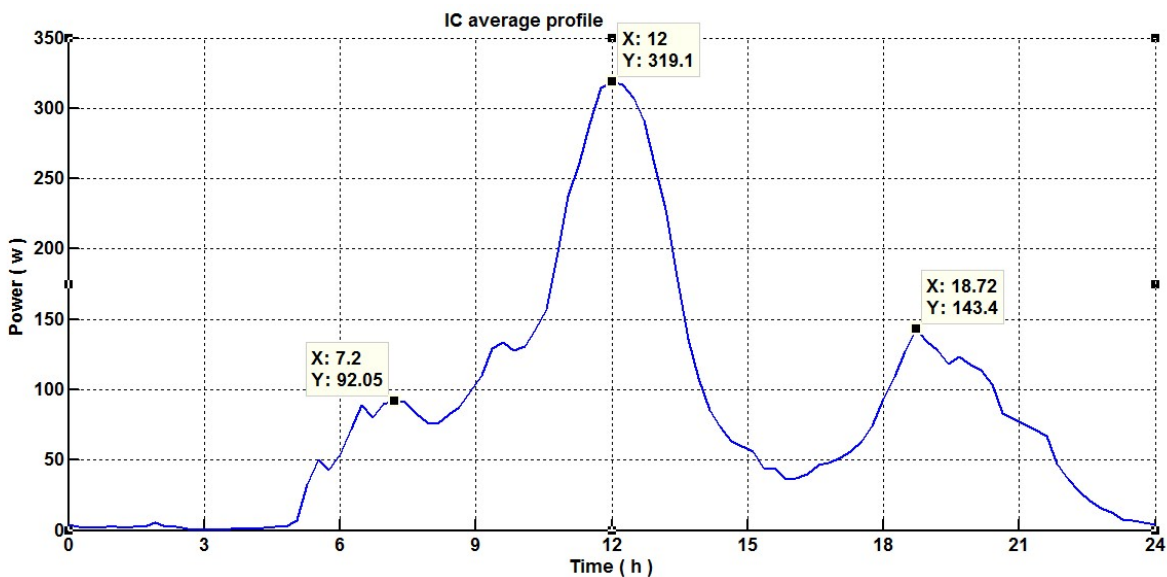

Fig. 5.5. Average Profile of ICs

Concerning EM, the average profile of EM defined in Figure 3.18 is considered. For the case of DG, in order to be conservative, the minimum curve of PV generation in p.u. is considered. If we remember, it is possible to install 2150Wp in the roofs of each client, therefore this factor also should be integrated. The DSM strategy defined in chapter 4 is considered in each client. As the reader can notice, in the base

customer profile, average profiles will be integrated for IC and EM; this consideration is valid since the analysis seek to determine the impact in the substation and at this level, the profiles are much more aggregated. Another important consideration is that the level of participation of residential clients in the DSM has to be determined previously as well as the penetration degree of DG. Thus, the next equation for considering new services integration is proposed:

$$NrCPro_i = \frac{Cons_i * LP_{feeder}}{\sum_1^{#clients} Cons_i} * \frac{(1 - \%DSM + \%DSM * DSM_{curve}) * (1 + \Delta_r)^{year}}{1 - losses_{LV}} + \frac{\%IC * IC_{curve}}{PF} + \frac{\%EM * n * EM_{curve} - \%DG * 2,15 * DG_{curve}}{\quad} \quad (5.2)$$

Where:

| | |
|---------------|---|
| $NrCPro_i$ | New Residential Customer Profile |
| $\%DSM$ | Participation degree of residential customers in DSM strategy |
| DSM_{curve} | Polynomial function for executing Smart DSM (DR+TOU) defined in the chapter 4, Figure 4.12 |
| Δ_r | Growth rate for residential customers |
| $\%IC$ | Insertion degree of Induction Cooker in the network |
| IC_{curve} | Average profile of IC seen at substation level, see Figure 5.5 |
| $\%EM$ | Insertion degree of Electric Motorbike in the network |
| n | Number of EM per house |
| EM_{curve} | Average profile of EM, see Figure 3.18 |
| $\%DG$ | Insertion degree of Distributed Generation in the network |
| DG_{curve} | Minimum curve of PV generation in p.u, see Figure 3.21 |
| PF | Power Factor of IC (typically 0,95) |
| $losses_{LV}$ | The losses in low voltage are composed of losses in the transformers, cables, meters and connections. The average value of these losses in Galapagos is 9%. According to [202], the part referring to meters (coil/sensors) is evaluated to 4% of the average value of losses. Thus in the modeling, an efficiency of 0.9964 (9% * 4%) is considered. |

In Equation 5.2, there are several terms; one of them is $(1 - \%DSM + \%DSM * DSM_{curve})$, which consider two component; first, the percentage without DSM ($1 - \%DSM$) and the second, the percentage with DSM ($\%DSM * DSM_{curve}$). The term $\frac{\%IC * IC_{curve}}{PF}$ represents the insertion degree of IC along the day; the term $\%EM * n * EM_{curve}$ represents the insertion degree of EM along the day considering the number of motorbikes per house. The last term, $-\%DG * 2,15 * DG_{curve}$ represents the insertion degree of DGs along the day, and it is negative since it is not a load. As it was mentioned in previous chapters,

the EM and DGs are modeled assuming that their interface converter can tune a power factor equal to 1, thus, the IC component must be divided by its PF in order to allow the sum of all the terms.

A similar analysis is done for commercial clients. At this point, it is important to note that for the commercial sector (greater subsidy), gas tanks different from those of the residential sector are used, besides the national plan of change towards induction cookers is designed only for residential customers. Thus, the next equation is applied and no EM nor IC are considered. As DG could have a considerable installed power on the roof of commercial buildings due to higher areas of installation, this service is considered.

$$NcCPro_i = \frac{Cons_i * LP_{feeder}}{\sum_1^{#clients} Cons_i} * \frac{(1+\Delta_c)^{year}}{1-losses_{LV}} - Power_{installed} * DG_{curve} \quad (5.3)$$

Where:

$NcCPro_i$ New Commercial Customer Profile

Δ_c Growth rate for commercial customers

For the case of street lighting, first, the monthly consumption has to be transformed to power, for doing that, a month of 30 days is considered and luminaires are turned on during 12 hours per day. Once done it, the value must be multiplied by the typical profile. Thus, the next equation is used.

$$SLPro_i = \frac{Consumption * SL_{curve}}{12 * 30 * (1-losses_{LV})} \quad (5.4)$$

Where:

SL_{curve} Profile of street lighting in p.u, see Figure 5.6

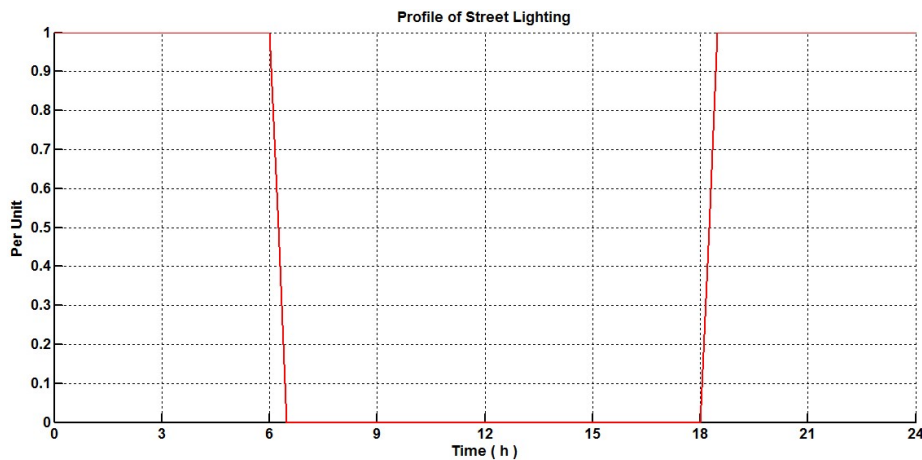

Fig. 5.6. Profile for Street Lighting

Once applied the Equations 5.2-5.3, new “smart grid” load curves are available, for illustrative purposes the next figure depicts some of them.

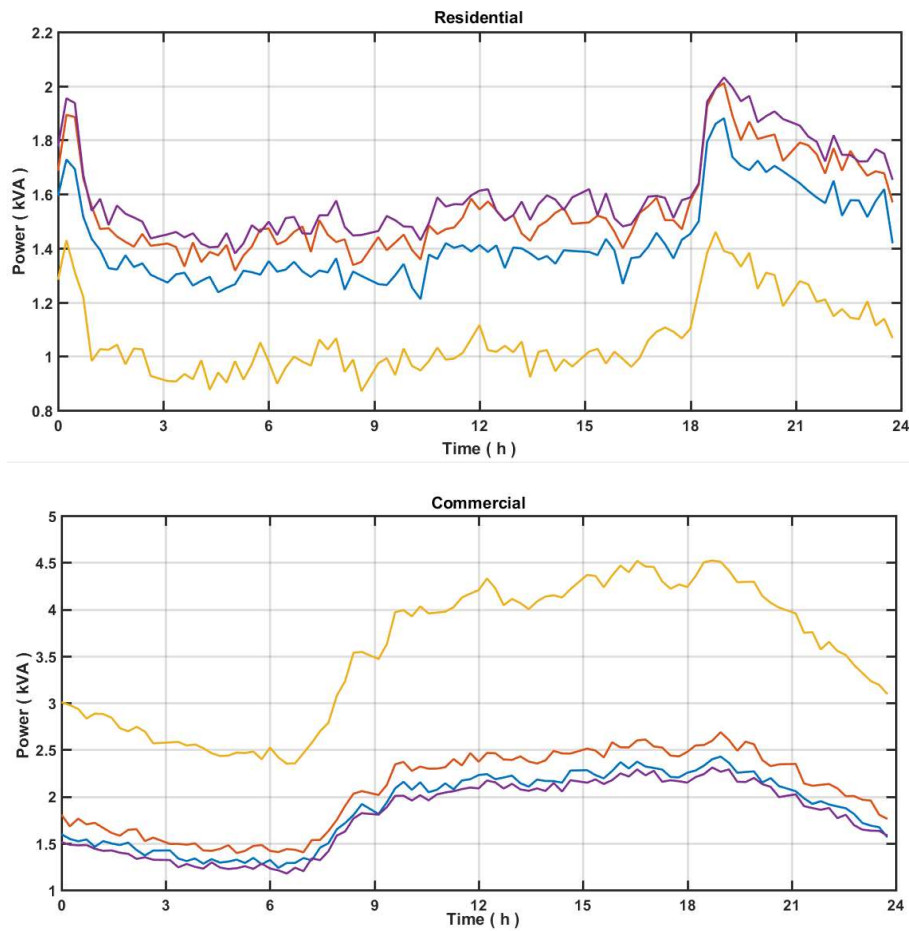

Fig. 5.7. Examples of $NrCPro_i$ and $NcCPro_i$

Once defined the base scenario and the consumer profiles, through the Equations 5.2-5.4, the new services can be integrated massively. In accordance with the sociological studies [195], the different values for the simulation are set. Thus, the next table illustrates the percentage of total users for each modeled element.

TABLE XXII VALUES FOR ASSESSING INTEGRATION OF NEW SERVICES

| Item | Value |
|--------------------------|-------|
| Year | 9 |
| IC insertion degree | 70% |
| EM insertion degree | 50% |
| DSM participation degree | 40% |
| DG residential | 40% |
| Δ_r | 2% |
| Δ_c | 4,02% |

Before performing the simulation with the values described in Table XXII, a previous simulation without any response of the people to neither TOU strategies nor DG deployment is executed, in other words, with %DSM and %DG equals to 0. The purpose of this simulation is clearly to show the benefits of the implementation of DSM and DG.

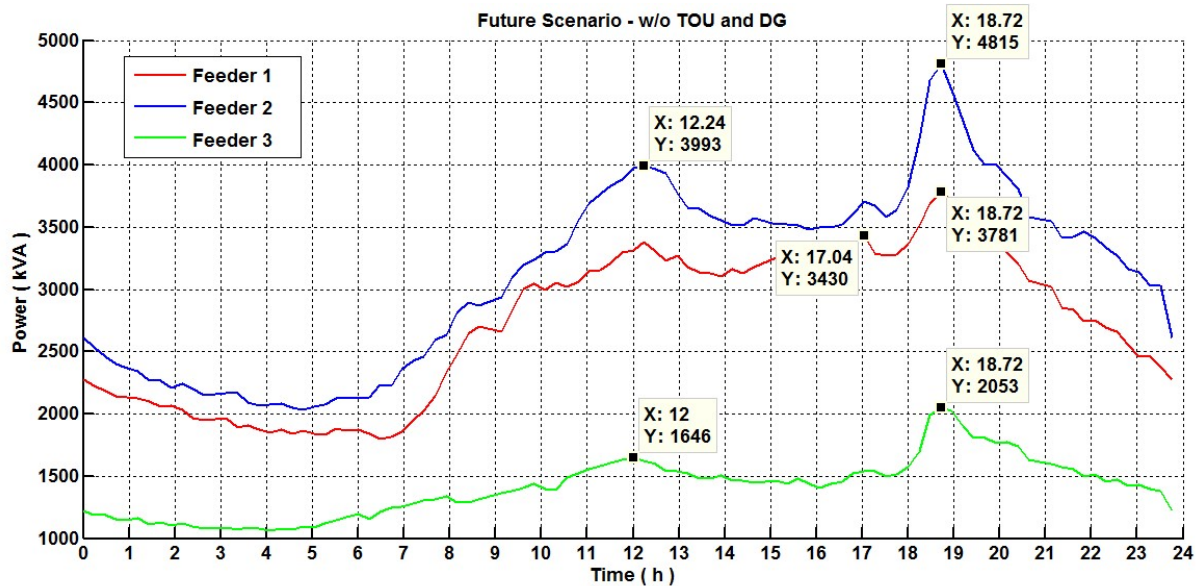

Fig. 5.8. The base scenario 9 years later (with IC and EM and without DSM and DG).

In this scenario, the maximum power is 10.648,56 kVA (sum of the power peaks of the three feeders); the peaks in the three feeders are coincident and are reached at 18:45. If we remember, the installed capacity in Santa Cruz is of 8,75 MVA. Hence, the consumption will exceed to the generation of 21% in 9 years if no DSM and DG are implemented.

The simulation within CYMDIST is performed considering the worst scenario, it means with the peak values. Thus, the next figure shows the whole network after the load flow analysis. The most affected feeder is the number 3, where a significant portion highlighted in red of the feeder is suffering under voltages (<95%).

Regarding MV/LV transformers overloads (most of them located in Puerto Ayora), the results are less encouraging since there are 110 of them with overloads that go from 100,1% until 466,7%. The transformers with overload with unthinkable levels have a rated power of 5 or 10 kVA, feeding a range of 5 to 40 clients. Obviously, this is a consequence of an unplanned growth. Therefore, the investment plan must include a reinforcement not only in generation but also in the replacement of lines and transformers on the distribution network.



Fig. 5.9. Analysis of Under Voltages in Santa Cruz

5.1.1 Load flow with DSM + DG

A new load flow analysis with the values set in Table XX is carried out; as it was expected, we can observe a reduction of 8,8% in the higher peak, that is now of 9.709,98 kVA (see Figure 5.10). This decrease is due to DSM strategy. Besides, a reduction in the noon peak is reached thanks to DG deployment. The decrease goes from 9.000 kVA to 8.451 kVA (6,1%). However, a new peak of 8.039 kVA appears near to midnight since the polynomial function shifts the energy to these hours. Although the existing generation could supply this value, it is dangerous because any failure in a generation unit would cause power outages, since there is not enough reserve at this point. The next figure depicts all the aforementioned.

Regarding transformers overloads, the number decreases to 94. However, the ranges are almost the same. It is because the main issues are originated for the same transformers with a small rate power that are feeding many clients. In Annex 3, the complete list is presented.

As we can see in Figure 5.11, the zone that suffered under voltages has been significantly improved; in this scenario, the main problems are located in transformers in both populated center and far places (red points in Figure 5.11 zooms on the top right and bottom right). To fix these issues, the next section proposes a better management of resources in Galapagos.

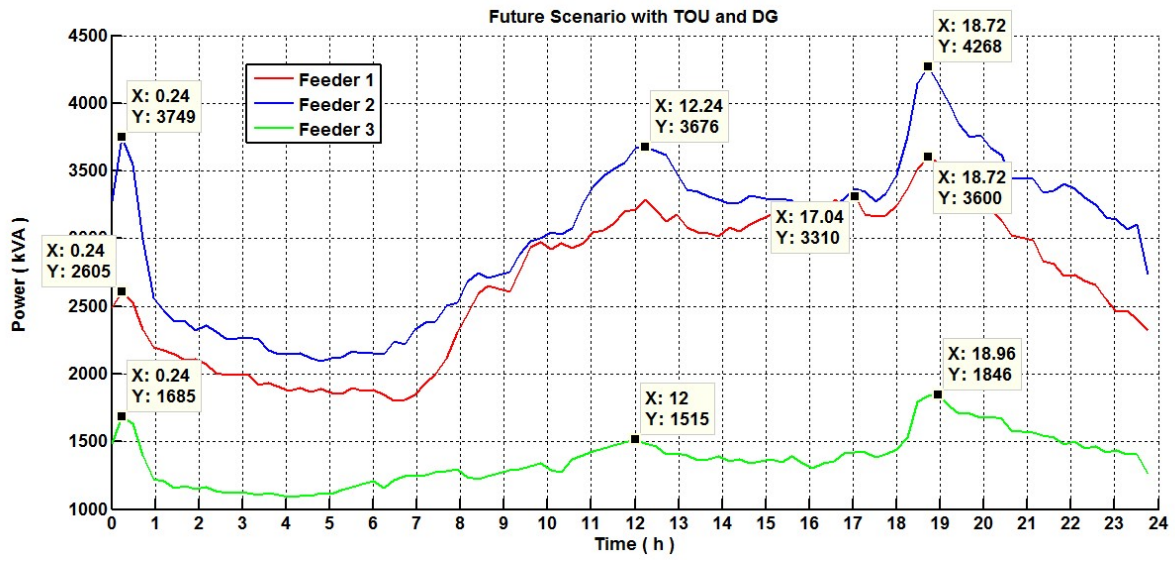

Fig. 5.10. The scenario at 9 years with TOU and DG.

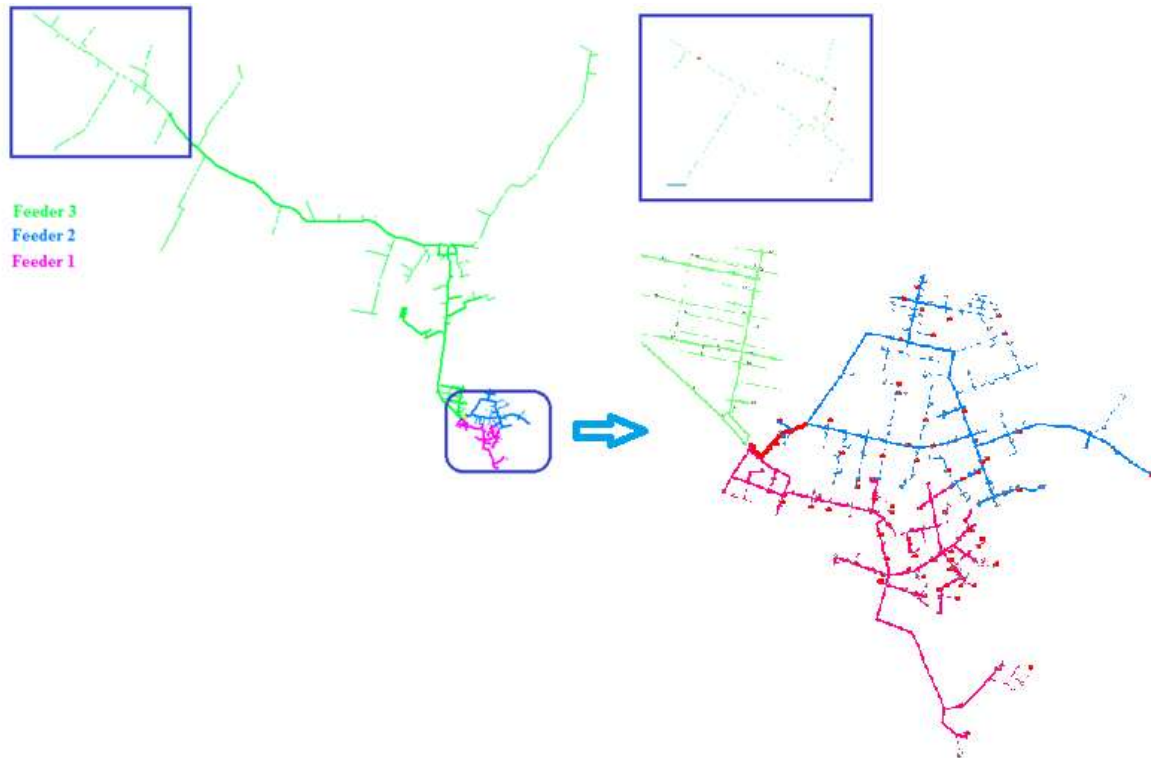

Fig. 5.11. Analysis of under voltages in Santa Cruz in the presence of DSM and DG.

5.2 Upgraded management of energy in Galapagos

In chapter four, a proposal for the management of the energy considering PV panels, loads and BESS at low voltage level was presented. The problem of energy management consisted in the storage of PV energy surplus in the noon to feed the loads with the BESS system in the peak hours. The previous section identified that it would be mandatory to launch an investment program that considers the commissioning of new power plants and to reinforce lines and MV/LV transformers as well since the maximum DG residential penetration rate in 9 years will achieve only 40% of the total users.

In [157], two approaches for EMS architectures are presented i) centralized EMS and ii) distributed EMS; the primary function of an EMS is to dispatch the resources optimally according to the selected objectives. For that, information referent to cost functions, technical characteristics, constraints [158], topology, network parameters, load as well as the forecasting of wind and solar resources must be considered, even the effect of the temperature in the load ought to be modeled [159]. For the Galapagos case, the centralized EMS architecture is the best solution since it will take advantage of the ADMS system as well as the communication architecture proposed in Chapter 5. Thus, the proposed EMS for Galapagos is depicted in the next figure.

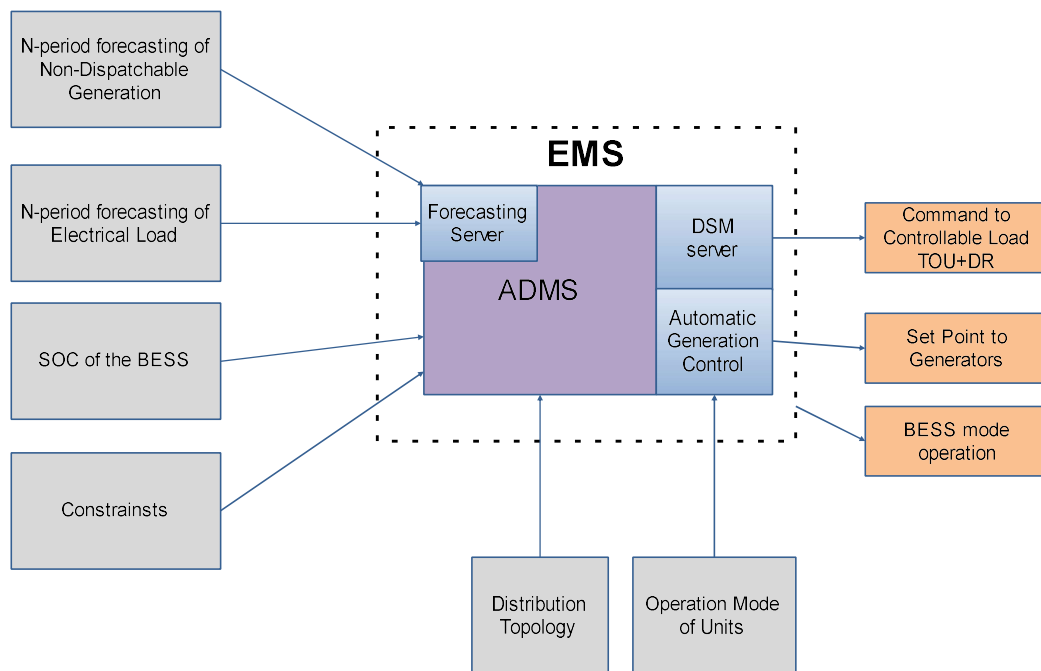

Fig. 5.12. EMS architecture proposal for Galapagos.

In order to test the EMS on a large scale, a penetration rate of PV of 100% of users is considered, this value pretends to show that if a strong PV penetration exists, the thermal generation investment could be deferred or even canceled. Indeed, if the regulatory barriers are addressed properly, it could be possible to reach this value in 9 years. If PV surplus exists in the noon, this energy could be stored and used in the peak hours in order to reduce the peak and likely to defer investments in bulk generation. For the simulations, the Eqs. 17-23 are considered and the model developed for the inclusion of BESS is tailored for working at substation level. In order to reduce the maximum load, the EMS must use three

weighting functions for DSM (based on Equation 4.1), the function for Feeder 1 is shifted forward 30 min, and the polynomial function for the feeder 3 is shifted backward 30min; the purpose of that is to cancel the coincidence between maximum peaks of feeders. Thus, the new maximum peak is 9.399,82 kVA at 18:45; the noon peak is 7.501,31 kVA at 12:45 and the peak at midnight is 7.465,9 kVA at 00:15. Although the load in the peak decrease of 3,2%, the generation is still insufficient. With this change, the noon peak reached a reduction of 12,66%, hence, theoretically, 785 kVA could be stored.

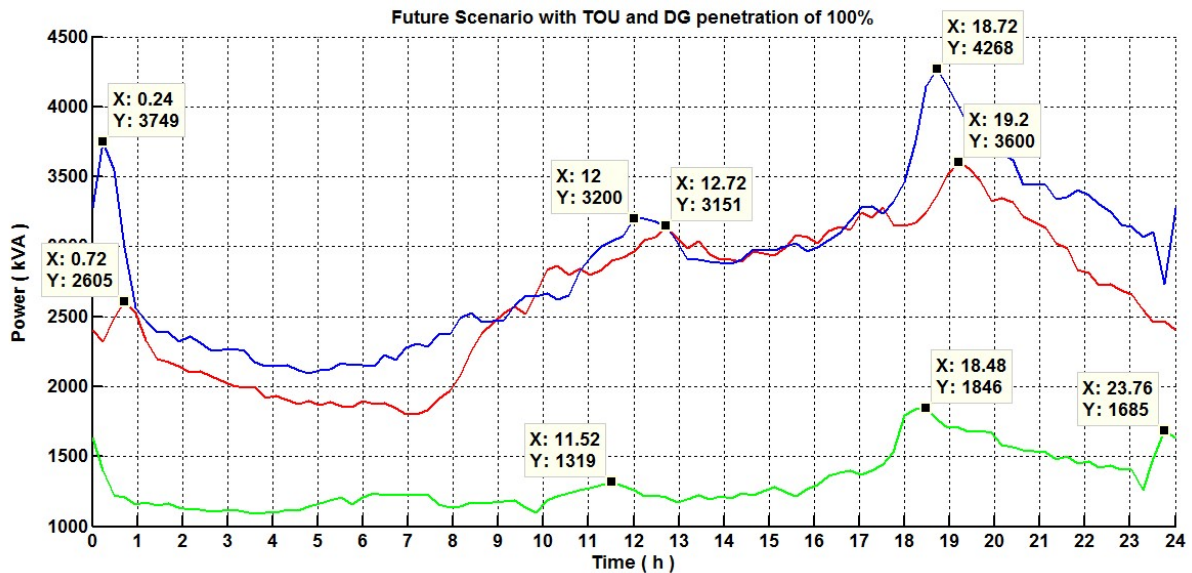

Fig. 5.13. Scenario at 9 years (DG at 100% and 3 weighting functions)

There are now 83 overloaded transformers; the maximum peak value is slightly reduced (see Annex 4 for the complete list). The next figure shows a thematic map, which depicts in detail the distribution network colored by loadability (load in transformers/rated power).

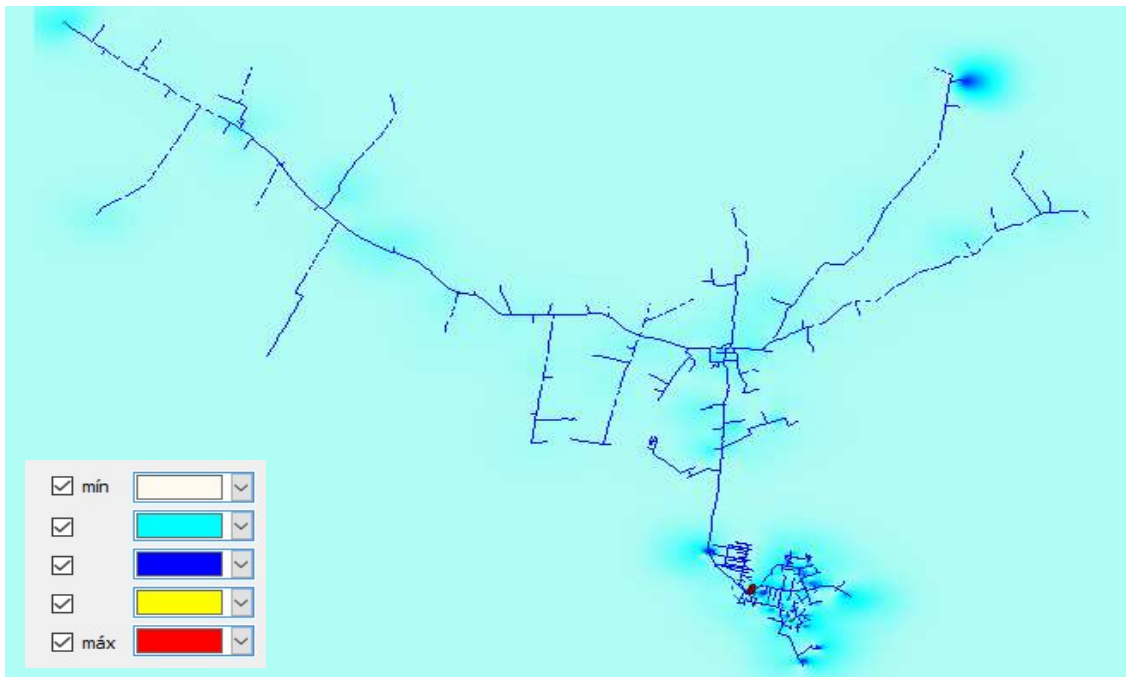

Fig. 5.14. Loadability Map

As we can see, the biggest problems will be located in the populated center. Therefore, a zoom into this area is done in order to see with more detail the different levels of loadability.

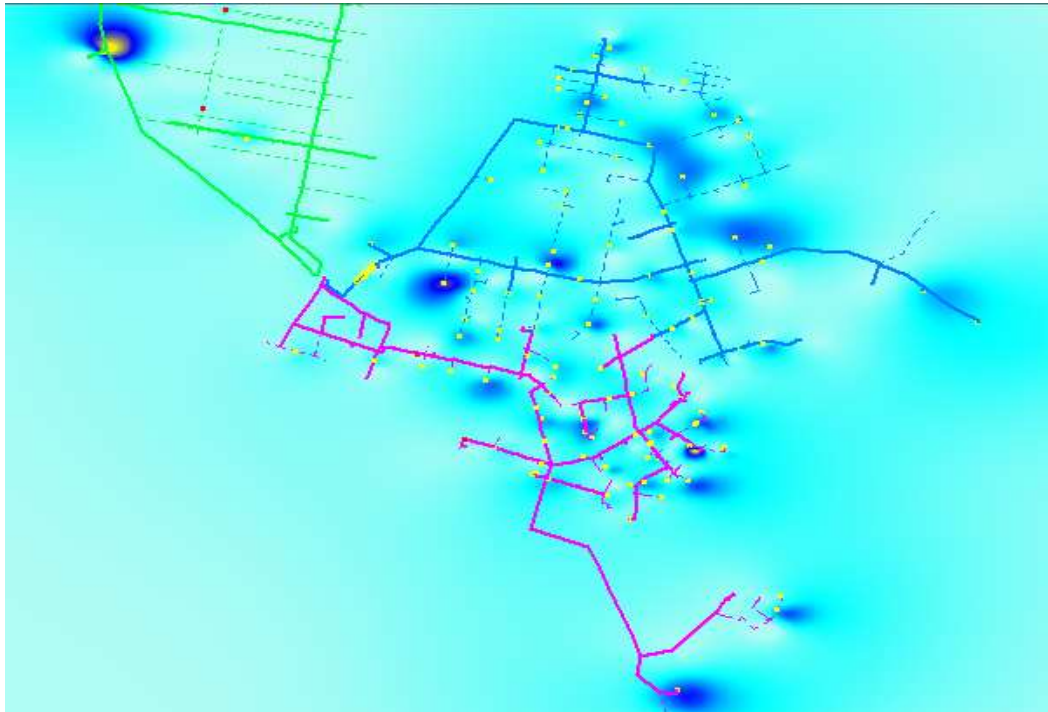

Fig. 5.15. Feeders 1, 2 with transformers overloaded in yellow.

The equations and constraints from Chapter 4 are used at this level for determining the optimal battery size at substation level. Thus, the value is 1194 kVA.

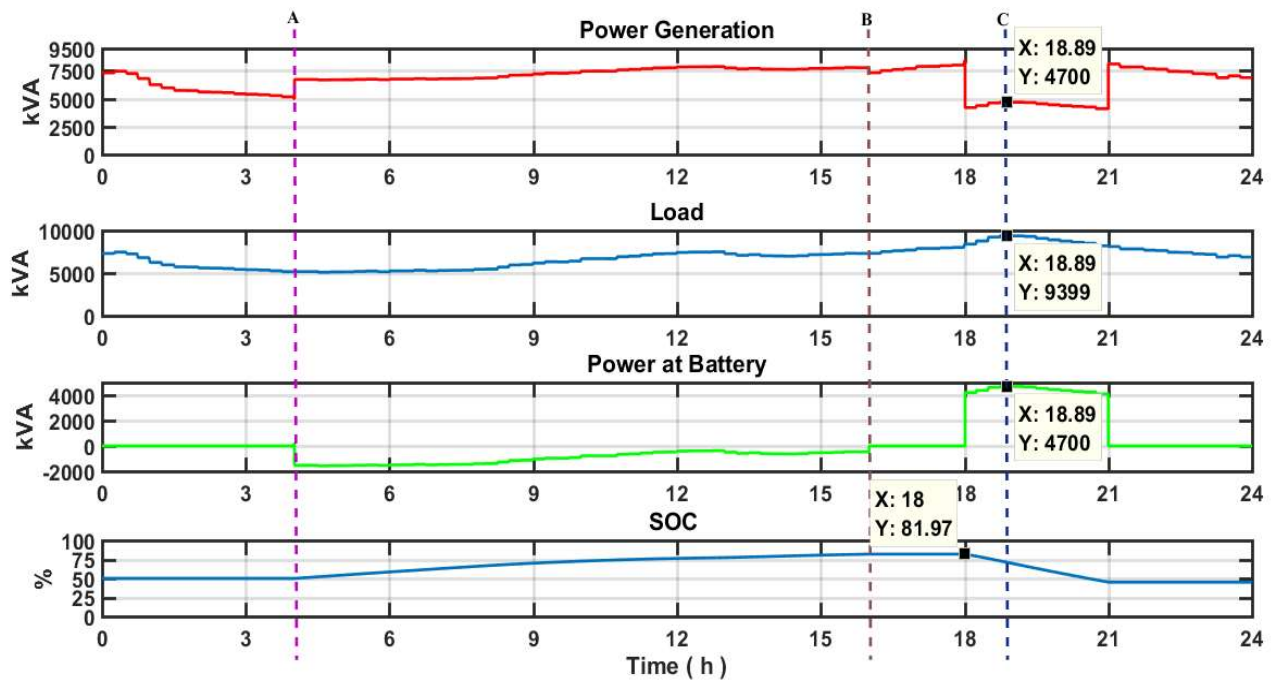

Fig. 5.16. Energy Management on a large scale.

The above figure shows interesting things; first, with the implementation of a BESS, it is possible to defer investments in the thermal generation since the previous figures showed that the main peak during the whole day occurs around 18:45-19:15. Thus, renewables energies are not available in this period. Second, to charge the BESS during the morning (4:00 – 16:00), the thermal resources are used. The load will be composed of the inherent load of the island, plus battery charging. Here, it is important to notice that the noon peak was reduced by the deployment of DG with 100% of integration. The top curve of Figure 5.16 shows clearly that the power generation curve has a smoothed shape with an exception from 18:00 to 21:00, where all the energy stored during the morning is used to supply the load. The charging beginning is depicted with the point A (4:00), and the charging end is noted with point B (16:00). At point C, the maximum peak is reached, however, due to BESS discharging, the generation at the substation is now sufficient. Even, a generation reserve is available. Another feature of the point C is that it depicts the balance between load (9.400 kVA), the generation (4.700 kVA) and the BESS (4.700 KVA). The bottom curve shows the SOC of the BEES, the initial/final value is 50%, whereas the maximum value reached in the charging is 81,97%.

Obviously, this scenario considers important assumptions like the 100% DG penetration rate. Nevertheless, it is a good example to show how the developed models could be tailored for different scales. ELECGALAPAGOS must take the final decision in the future, it is a choice between betting on new and friendly technologies with the environment, or continue to invest in traditional approaches like thermal generation.

The final section of this manuscript will present the next steps to be implemented in Galapagos in order to achieve smart islands in the long term.

5.3 Galapagos such as a Smart Island

According to [160], it is crucial nowadays to address topics such as i) energy efficiency, ii) sustainability, iii) waste and water management and iv) mobility. However, for the specific case of islands, it is even more important; it is a matter of survival. This topic is so important that the European Union has created the Smart Islands Initiative, an effort of European island authorities and communities for implementing real-life laboratories for technological, social, environmental, economic and political innovation within the islands due to their significant potential. Insularity implies today energy dependency on fossil fuels, high transportation costs, limited economic diversification and access to markets. Although there are not many pieces of evidence yet, it is likely that the synergy between innovative technologies and regulatory frameworks could reverse this trend within the islands [160].

Thus, the first step to become a smart island is carrying out a comprehensive plan that unifies and brings together all the efforts made by the different stakeholders. This plan would provide common objectives and a unified management through different working axes. The plan must involve all agencies with competence in the territory, both national and provincial, as well as international organizations that also works for the improvement and conservation of the islands. In addition, the leaders in the sectors of energy efficiency, water cycle management, waste treatment, mobility, and technology have to take action too, in order to find feasibility and effectiveness solutions.

In Galapagos the EcoSmart project, described in Chapter 1 page 11, it is a good first try for achieving this unified plan. The fields of energy, mobility, water, and waste have been identified as the main sectors, on which it is recommended to work urgently. Within these fields, the EcoSmart axes should be addressed in depth and can be completed as follows:

1. Power generation
2. Mobility
3. Electricity network modernization
4. Efficient consumption
5. Efficiency in Public Lighting
6. Integrated water cycle management
7. Solid waste treatment
8. Governance
9. Smart Health

The five first axes are totally related to the Smart Grid concept, and most of them have been addressed in this thesis. Power generation is studied in chapter 5, the mobility in chapter 3 and 4, the electricity network modernization is addressed in a certain way in chapter 5 with the communication proposal for substation and distribution network, the efficient consumption is explained in detail in chapter 4 previous to implement DSM strategies.

The points 5-9 must be studied in order to have a whole vision of the next steps for Galapagos.

5.3.1 Axes Description

The power generation is the most critical axe since, without enough energetic resources, preferably renewables, it is not possible to deploy the majority of projects, for instance, change of traditional vehicles by electric ones or the commissioning of a new plant for waste treatment. Hence, the forecasting must include all the new projects in order to define the future power generation needs accurately within the islands. The reality of islands is worrying as terrestrial and maritime mobility consume more than 75% of the fossil fuels that arrive in Galapagos. Therefore, the planning of traffic within the islands and the displacements between them of both public and private users should be improved. In addition, the new solutions must have an efficient use of resources, and a constant transition towards a 100% electric and emission-free mobility. According to Ecuador Oil Company, taxis, especially in the trips between Baltra Airport and Puerto Ayora town, consume 55% of the total daily fuel for land transportation in Santa Cruz. For this reason, a good option to be considered is the replacement of traditional gasoline buses by electric ones. For this purpose, additional studies for determining the necessary public recharging infrastructures should be carried out; two fast-charging stations at the beginning (Baltra) and at the end of the bus line (Puerto Ayora) likely are required. In mobility, there are significant advances, including that the Galapagos Governing Council establishes to buy only new electric vehicles, as well as ARCONEL defined the electrical characteristics of motorcycles, and the Ministry of Foreign Trade eliminated the taxes on the purchase of electric vehicles. On the other hand, the MEER is implementing thermal generation based on biofuels on Isabela island.

Concerning electricity network modernization, some innovative solutions have been proposed in this thesis, for instance, PV installation in LV grid, BESS deployment, reclosers installation, AMI, smart meters, communication architecture for Smart Grids among others. However, there are additional improvements to be considered. First, the connection of public lighting to a dedicated circuit since it is currently connected directly to the low voltage network, which makes it difficult to manage and prevents accurate data collection; second, the definition of new modalities to contract the power supply, considering power control mechanisms, such as maximum power or load shedding.

Efficiency plans implemented in Ecuador have already been described. To sum up, old refrigerators have been replaced with more efficient ones, incandescent bulbs with energy-saving bulbs and a plan to replace traditional cookers with induction ones are underway. To this, it is recommended to work on a regulation for the construction of efficient buildings in which to regulate aspects related to the thermal insulation and the water cycle. It is also advisable to have subsidies for water heaters and centralized air conditioning of energy category A. Concerning efficiency of public lighting, it is recommended to implement flow control systems for luminaires, lamp replacements, and programming on and off cycles to regulate power according to the needs of use.

The integrated water cycle management is vital in Galapagos since only one of the five inhabited islands of the archipelago has natural water sources. San Cristobal has abundant water in the highlands but it's

difficult to bring it to people and Floreana has depleted its springs [161]. In the other islands, the main sources are rainwater or salt water, the latter resulting from the mixing of rainwater with that of the sea. In addition, sewer coverage is the only service that has not increased its coverage in the last 10 years. It is necessary to implant the awareness that an efficient and quality water cycle represents energy saving. It is imperative to design a sewerage network and begin the construction, of water treatment plants in order to ensure the correct processing of the same and avoid the pollution problems that currently exist. In the long term, a SCADA system could be implemented for the automation of water supply and sewage management.

For performing solid waste treatment, first, it is recommended to carry out studies on the optimal waste treatment and its uses for energy use, such as biomass. Another recommendation is the implementation of a household trash characterization program.

The axes of Governance include the interaction of local and national authorities with citizens, with accountability and transparency. By means of social networks, the government can interact quickly with different users keeping client data secure. The first try of ELECGALAPAGOS is made with a Facebook account to inform of outages and scheduled maintenance; the Galapagos Governance Council must coordinate all these initiatives in order to offer unified applications, for instance, parking lots available, optimal bus routes, water and energy debts queries.

The last axe is Smart Health; this concept puts ICTs at the service of health, where sensors and information will improve the quality of life of people. In Galapagos, only one hospital exists, and it is located in Puerto Ayora town, in Santa Cruz. This shows that there is still a long way to go on this axis. Just as an example of an application for Smart Health, a mobile application exists which allows to geolocalize patients with various forms of cognitive impairment, such as Alzheimer's, detecting if these patients leave their routine or their usual spaces and automatically notify the responsible person.

As the reader may have noticed, for each of the axes, a communication network is necessary. Fortunately, according to [162-164], the Smart Grids support a subsequent deployment of a Smart City, thus, the communications architecture proposal for the NAN / FAN will play a fundamental role in transforming Galapagos towards a Smart Island, but all the presented axes have to be taken into account for its sizing.

5.3.2 Stakeholders

Two groups are identified: the leading actors and the strategic actors. Both are complementary and to reach the objectives, a good synergy is needed.

- Leading actors: they will be the project promoters, in charge of proposing the different solutions for improvement in each of the work axes. Their collaboration is essential for the successful completion of the project, facilitating institutional support, promoting regulatory changes, seeking funding, and providing a cross-cutting vision for solutions to ensure maximum synergies.

- Strategic actors: integrated by collaborators in the fields of consulting, technology and financial fields, which will contribute to the definition of business and exploitation models, providing experiences and technological solutions.

The next tables show the relation between leading actors and axes.

TABLE XXIII STAKEHOLDERS: LEADING ACTORS

| Name | Axes |
|------------------------------------|-----------------------|
| MEER | 1-5 |
| Ministry of Environment | 6-7 |
| ARCONEL | 2,4,5 |
| CENACE | 1 |
| CELEC | 1 |
| SIGDE | 1-5 |
| Galapagos Government Council | 8, Whole Coordination |
| ELECGALAPAGOS | 1-5 |
| United Nations Development Program | 1-8 |
| Ministry of Health | 6,7-9 |
| Ministry of Transport | 2 |

TABLE XXIV STAKEHOLDERS: STRATEGIC ACTORS

| Name | Axes |
|---|---------|
| Citizenship | 1-8 |
| Taxi Association | 2 |
| Commercial and hotel sector. | 2-4-6 |
| Ecuadorian Institute of Normalization | 2,3,4,5 |
| Internal transport companies in Galápagos. | 2 |
| Suppliers of renewable generation solutions. | 1 |
| Suppliers of smart metering solutions. | 3 |
| Providers of Smart Grid solutions. | 3 |
| Providers of effective solutions in homes and commercial. | 4 |
| Suppliers of effective solutions in public lighting. | 5 |
| Suppliers of electric mobility solutions. | 2 |
| Suppliers of recharge infrastructure solutions. | 2 |
| Providers of communications solutions. | 3 |
| Universities | 1-8 |
| Ecuador Oil Company | 2 |

At present, the current services are dispersed, not integrated and incomplete. Hence, there are particular solutions for each case. There is no unified, centralized and integrated control center for monitoring energy/water, although there are some regulations, those would need to be modified in order to integrate new concepts. An integrated and efficient solution must be implemented with a view to achieve social

and economic development without affecting the environment, with the use of technological enablers based on the availability and timeliness of the information.

5.4 Conclusion

A future scenario with penetration rates based on sociological studies has been analyzed. The results show that, in a future of 9 years, more thermal generation would be needed. However, through an EMS system based on the ADMS system proposed in chapter 5 and complemented with other systems such as the DSM server, it is possible to integrate a BESS to store energy during the morning and return this energy at night avoiding to exceed the maximum limit of available generation. The proposed solutions are feasible, and their implementation will depend on ELECGALAPAGOS efforts and its ability to promote the initiative to find investments sources. The government is fostering some projects inside Galapagos; however, they should have a unified vision to make Galapagos a self-sustaining island and energy management model.

Again, the need for a change in the regulatory framework is evident in order to allow the inclusion of BESS, which will contribute to maintaining the reliability of the system, as well as the domestic generation based on renewable energies, must be supported.

The lack of an integral vision on the different projects that have been implemented in recent years, and in some cases technical or economic incapacity, have caused that the projects have not generated the improvements that were expected, or have remained in a pilot phase that has not been further developed and extended.

It is necessary to carry out detailed studies of the socio-economic and socio-cultural aspects that the different projects can originate so that the citizens accept any implemented measures. Likewise, financing and sustainability studies are necessary. As a final conclusion, it is worth mentioning that a roadmap must be drawn up with input from all those involved in each of the axes. This roadmap is imperative to chart the way forward in order to achieve unified and optimal solutions as well as improving public services delivered to the interior of the islands.

The next chapter will present a proposal for the communication architecture needed for deploying a Smart Grid in Galapagos.

Chapter 6

Communications Architecture for a Smart Grid in Galapagos

6.1. Introduction

From the communications point of view, the smart grid definition is a concept quite difficult to capture with one single definition. The United States Energy Independence and Security Act of 2007, among the main characteristics that describe the evolving smart grid, mentions that a smart grid must include *Standards development to enable seamless communication and interoperability of equipments connected to the grid* [165]. The U.S. Department of Energy –DOE- establishes in [166] the communications requirements and recommendations of various components of the Smart Grid. The NIST in [48] has identified six key priority functionalities of the Smart Grid. The correct functioning of these features depends in large part on a robust and reliable communications system.

6. Advanced metering infrastructure
7. Demand Response
8. Electric vehicles
9. Wide-area situational awareness
10. Distributed energy resources and storage and,
11. Distribution grid management

In [167], a vision of the Smart Grid for the year 2030 from a communication perspective is presented. The main driver for improvements in communications is based on increasing the situation awareness of power grid operators, in order to avoid major power disturbances that could cascaded into large blackouts. However, it is worth noting that the integration and interoperability of the traditional grid with communication technologies would present significant constraints for the evolving towards a smart grid. The key role of the communications in the Smart Grids is clear. However, we must not forget that also the Smart Grid has to be interoperable, secure and cost effective [168].

In addition, the smart measurement that needs communications systems strongly would require such as sensors networks, and phasor measurement units –PMUs- [169]. This chapter will present the main advances in Ecuador regarding Wide Area Network –WAN- as well as a proposal for communications architecture for the specific case of Galapagos.

6.1.1 Current Situation in Ecuador

An important component of the SIGDE Project is the axis number 6 cited above, which is related to the Technology Management. Within this axis, the Information and Communications Technologies –ICTs- are considered.

The communications infrastructure must enable the Utilities to interact with devices on their electric grid as well as with end users. Thus, it has also to cover large geographical areas connecting a large set of communication nodes along the entire region. For this purpose, a WAN should be deployed [170].

Currently, a WAN exclusive for the distribution sector has been established. This network interconnects the different utilities, and there are three main nodes in Quito, Guayaquil, and Cuenca forming the backbone. The medium is optical fiber, and the transmission capacity is 10 Gbps. CELEC-Transelectric owns the network; the system uses the Dense Wavelength Division Multiplexing technology based on the variation of the wavelengths to diffuse several signals through the same physical medium. This bandwidth is also used for interconnecting the two existing data centers located in Quito and Guayaquil. In each main node, several Utilities are connected with a bandwidth of 1 Gbps. For instance, in the Cuenca node, the next Utilities are connected i) Loja, ii) Azogues, iii) Riobamba, and iv) Centrosur. The next figure depicts that Galapagos is connected to Centrosur by means of a satellite link.

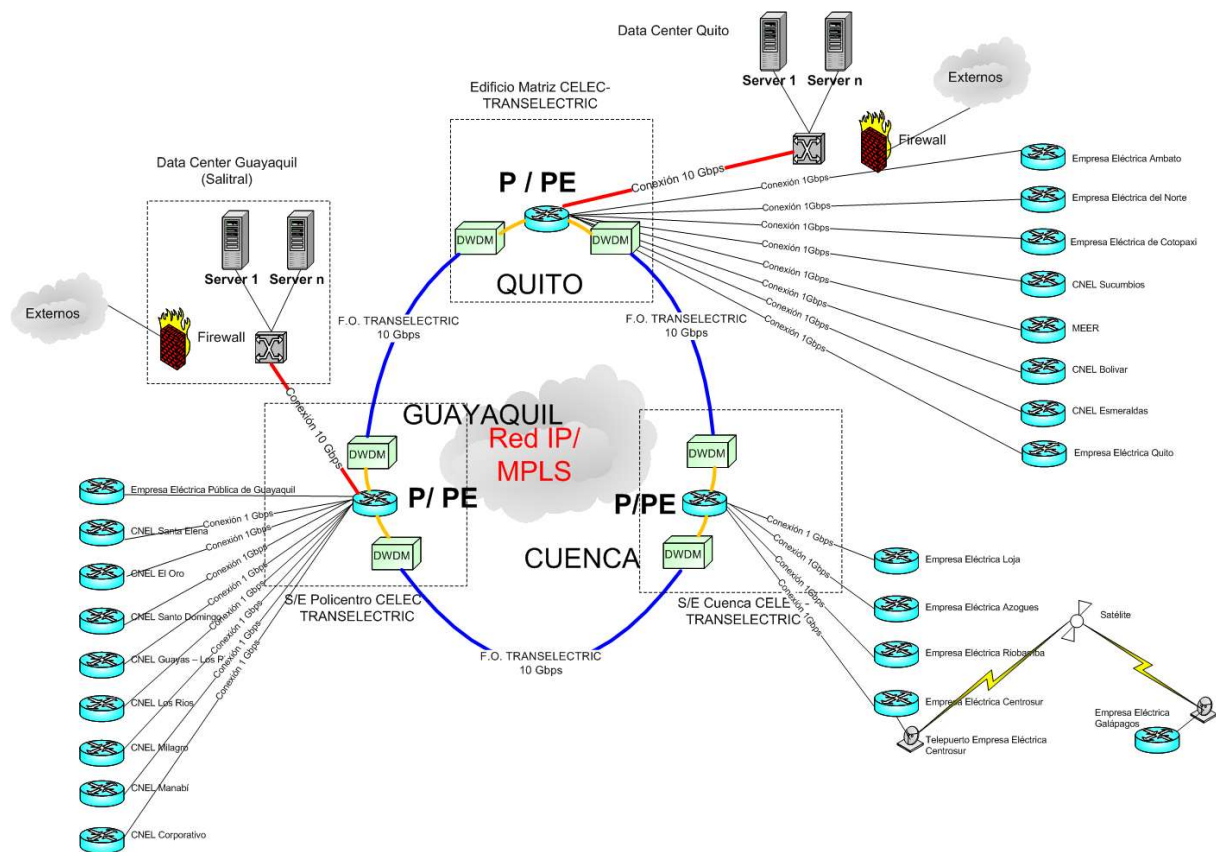

Fig. 6.1. WAN for supporting the Smart Grid in Ecuador

In order to separate logically the communication networks, a data transport mechanism called Multi-Protocol Label Switching –MPLS–, which supports the use of multiple protocols on the same physical network, is implemented. Additionally MPLS allows the creation of virtual private networks.

The interface architecture is based on [171], which established a Common Information Model for Utilities, the idea lies in the concept of an Enterprise Service Bus –ESB–. The ESB faces the interconnection between the different systems avoiding point-to-point connections.

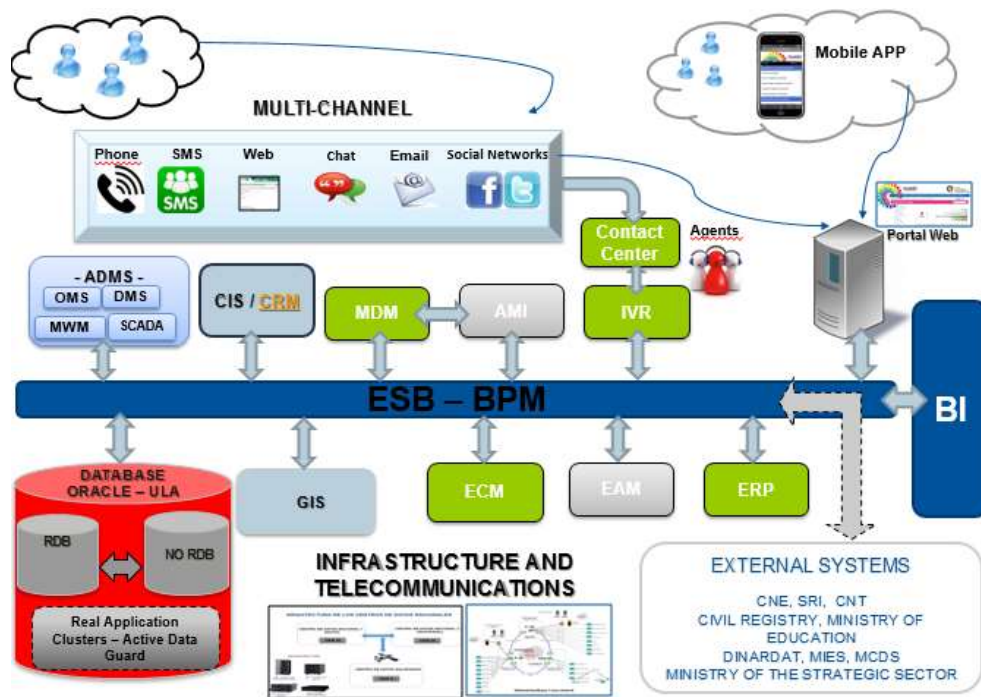

Fig. 6.2. Interoperability scheme in Ecuador

- BPM: Business Process Management
- ADMS: Advanced Distribution Management System
- OMS: Outage Management System
- DMS: Distribution Management System
- MWM: Mobile Workforce Management
- CRM: Custom Relationship Management
- MDM: Meter Data Management
- AMI: Advanced Metering Infrastructure
- IVR: Integrate Voice Response
- ECM: Enterprise Content Management
- EAM: Enterprise Asset Management
- ERP: Enterprise Resource Planning
- BI: Business Intelligence
- External System: Ministries, Agencies.

Once presented the developments reached in Ecuador concerning the WAN for Smart Grid, the need of addressing the communications at lower levels in order to arrive at the end-user level, more known as Home Area Network –HAN- [172], is evident. Thus, the next sections present a proposal for a communication architecture for AMI system as well as for the ADMS system.

6.2 ADMS

According to [173] an Advanced Distribution Management System is:

The software platform that supports the full suite of distribution management and optimization. An ADMS includes functions that automate outage restoration and optimize the performance of the distribution grid. ADMS features being developed for electric utilities include fault location, isolation and restoration; volt/volt-ampere reactive optimization; conservation through voltage reduction; peak demand management; and support for microgrids and electric vehicles.

Since 2011, the MEER have begun the design phase for the acquisition of an ADMS system for Ecuador. The design phase lasted about 2 years, thus in 2013, the implementation of the solution of Schneider Electric in the whole country started. The ADMS suite has embedded the SCADA, OMS, DMS and MWM systems. Taking into account the homologation objective of SIGDE project, the adopted solution is based on the concept server/clients, it means that the core application is installed in the National Data Centers (CDN1 and CDN2) and the clients (20 Utilities) will connect their operation consoles to the server using the WAN.

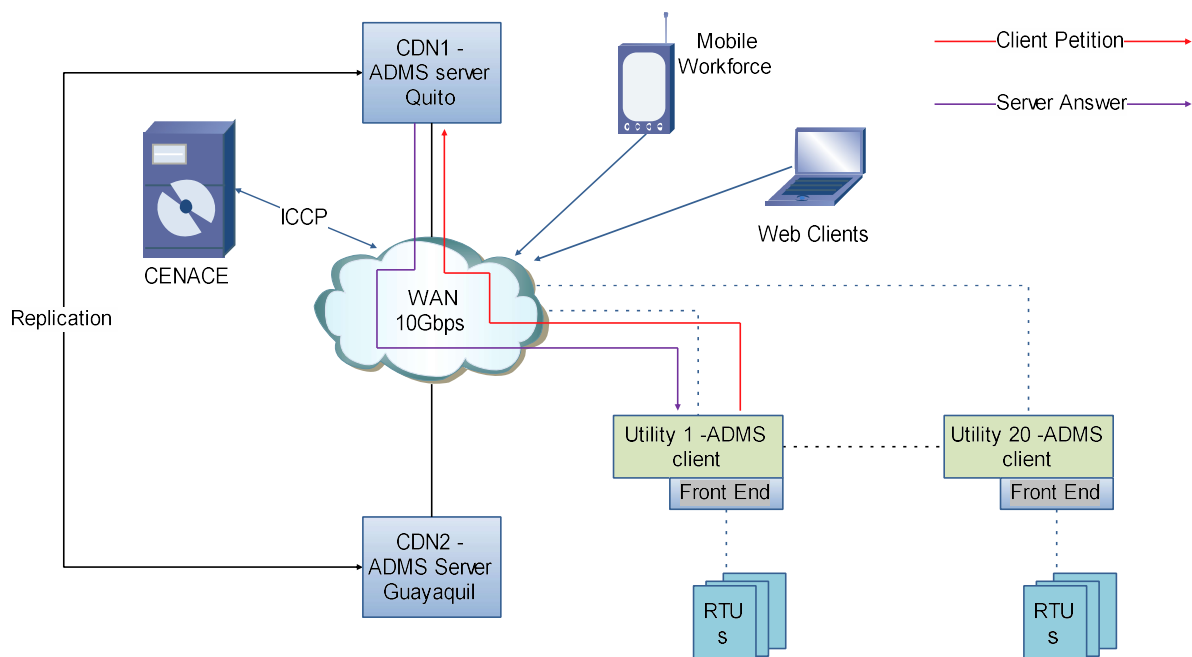

Fig. 6.3. Global Architecture for ADMS based on [174]

The above figure shows the replication process between ADMS servers, the access to the web or remote clients through the WAN, and the Utilities connected by means of a Front End, which is responsible for collecting the information coming from Remote Terminal Units –RTUs-, as well as being the bridge between the client application and the server.

Now, the communication for the segment between the RTU and the sensors or IEDs (Intelligent Electronic Devices) has to be defined. The new proposed architecture considers a RTU per substation, which must be able to receive information from different sources using different mediums. A typical substation in Ecuador has about 30 years aging; however, almost all of them have been strengthened. Thus, there are various devices installed.

1. IEDs recently installed: those are typically connected to the feeder header for performing control, protection and measurement actions. They are equipped with the last technology; hence, the medium is either copper or fiber using Ethernet protocols.
2. Meters: those have been installed since the operation beginning since it is always necessary to measure the energy. The meters can transmit information over serial protocols with RS232 and/or RS485 configurations.
3. Usually, open and closed contacts: any substation has contacts for indicating the status of devices such as breakers, reclosers or disconnectors. To integrate this information, the contacts have to be wired.
4. Coils: the operation devices have coils for receiving signals of opening or closing. For instance, a signal coming from the control center to close a breaker.

Therefore, the RTU for the substation must have the software and hardware enough to integrate IEDs, meters, and wired signals. For this purpose, a CPU to execute different control logics and processing information ought to be included, as well as a serial module (COM) and different cards, such as i) Digital Outputs –DO-, ii) Analog Outputs –AO-, iii) Digital Inputs –DI-, iv) Analog Inputs –AI-. [175]. It is common in a substation that there are several IEDs, so a Local Area Network –LAN- has to be deployed within the substation.

Regarding protocols, the most commons in the electrical industry are MODBUS, Profibus, DNP 3.0, [176], IEC 60870-5-104 [177] and IEC 61850 [178]. MODBUS can be implemented either serial or Ethernet, but its main drawback is that it has not stamp time. Profibus has been discontinued for the electrical sector, and nowadays, it is considered for industrial applications.

IEC-101 overcomes the deficiencies of MODBUS, but it works serially. IEC-104 works over Ethernet and currently is the most common protocol used to interconnect RTUs with SCADA systems. DNP 3.0 is very common in North America, whereas IEC 61850 is taking importance in Europe, both protocols converge in terms of capabilities. DNP 3.0 is designed for working on inexpensive endpoints and low-bandwidth communication channels while IEC 61850 is suitable for environments with high-bandwidth communication channels [179].

The next figure summarizes those above and presents the new substation architecture with details about protocols and physical mediums.

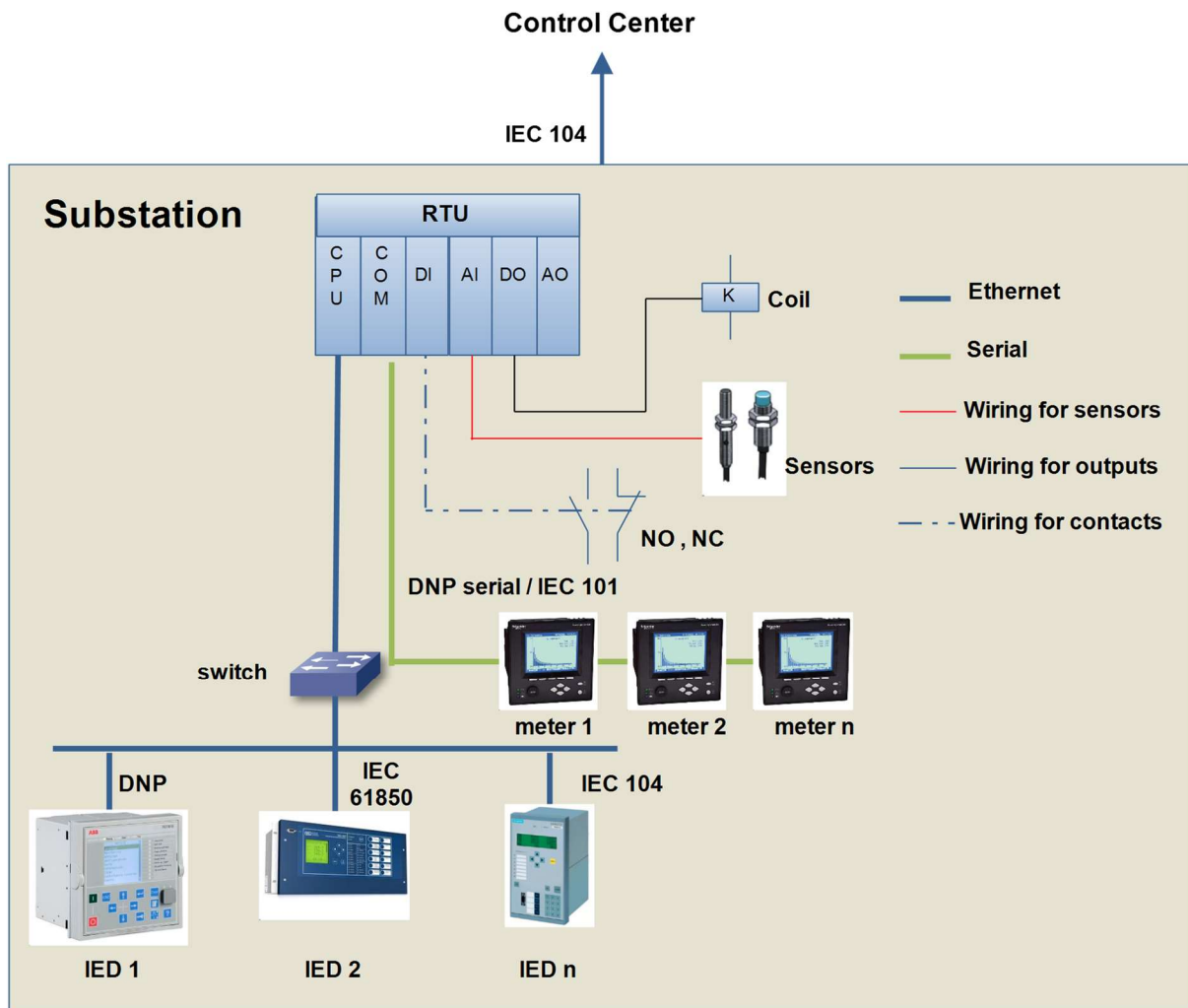

Fig. 6.4. Substation architecture

Within the archipelago, tens of kilometers separate the islands, thus interconnecting them by means of the optical fiber is not a viable solution due to some important considerations:

1. The implementation cost is still higher than the wireless solution.
2. According to [180], the wireless transmission capacity between the islands can reach up to 42 Mbps. This value is more than enough for control and monitoring applications.
3. The sea bottom of Galapagos makes challenging the fiber deployment.

Hence, a wireless communication has to be considered [181]. The network should interconnect the inhabited islands, except Floreana since the population there is too small and the investment will not be profitable. Thus, four links have to be established from the central node, which is located in Santa Cruz substation. The links characteristics are i) private channel and ii) Frequency of 7,2 GHz, see the next figure.

1. Santa Cruz – San Cristobal
2. Santa Cruz – Isabela

3. Santa Cruz – Baltra
4. Santa Cruz – Puerto Ayora



Fig. 6.5. Wireless Network for Galapagos

As it was mentioned in Chapter 1, Santa Cruz is the most populated island. As a consequence, this island has more power generation. For this reason, the main control center –MCC- should be installed there; the second island with most population is San Cristobal. Hence, this island would have a backup control center –BCC-. In the MCC, two servers (hot/standby configuration) per application are considered to guarantee a high availability in the servers. On the other hand, in the BCC, only one server is installed since the operation of the BCC will be rare, as BCC will operate only when the link Santa Cruz –San Cristobal will be down. It means that this control center is of emergency; in addition, BCC is able to operate only San Cristobal whereas MCC is able of controlling Baltra, Santa Cruz, and San Cristobal.

The ADMS system has different functionalities. Hence consoles for operation (user: distribution operator), simulation (user: planning analyst) and development (user: integration engineers) should be considered. In most cases, the connection with the ADMS servers is executed using IEC 104 protocol, although there is a particular case for the wind power plant from Baltra since the current SCADA is only able to transfer information using OPC protocol. It is worth noting that the PV power plant and the wind power plant from Baltra, as well as wind power plant from San Cristobal, have their own SCADA. The communication between the already installed SCADAs and the suite ADMS is carried out for the most part with IEC 104. Thus, the next figure shows the proposed communications architecture for Galapagos Islands.

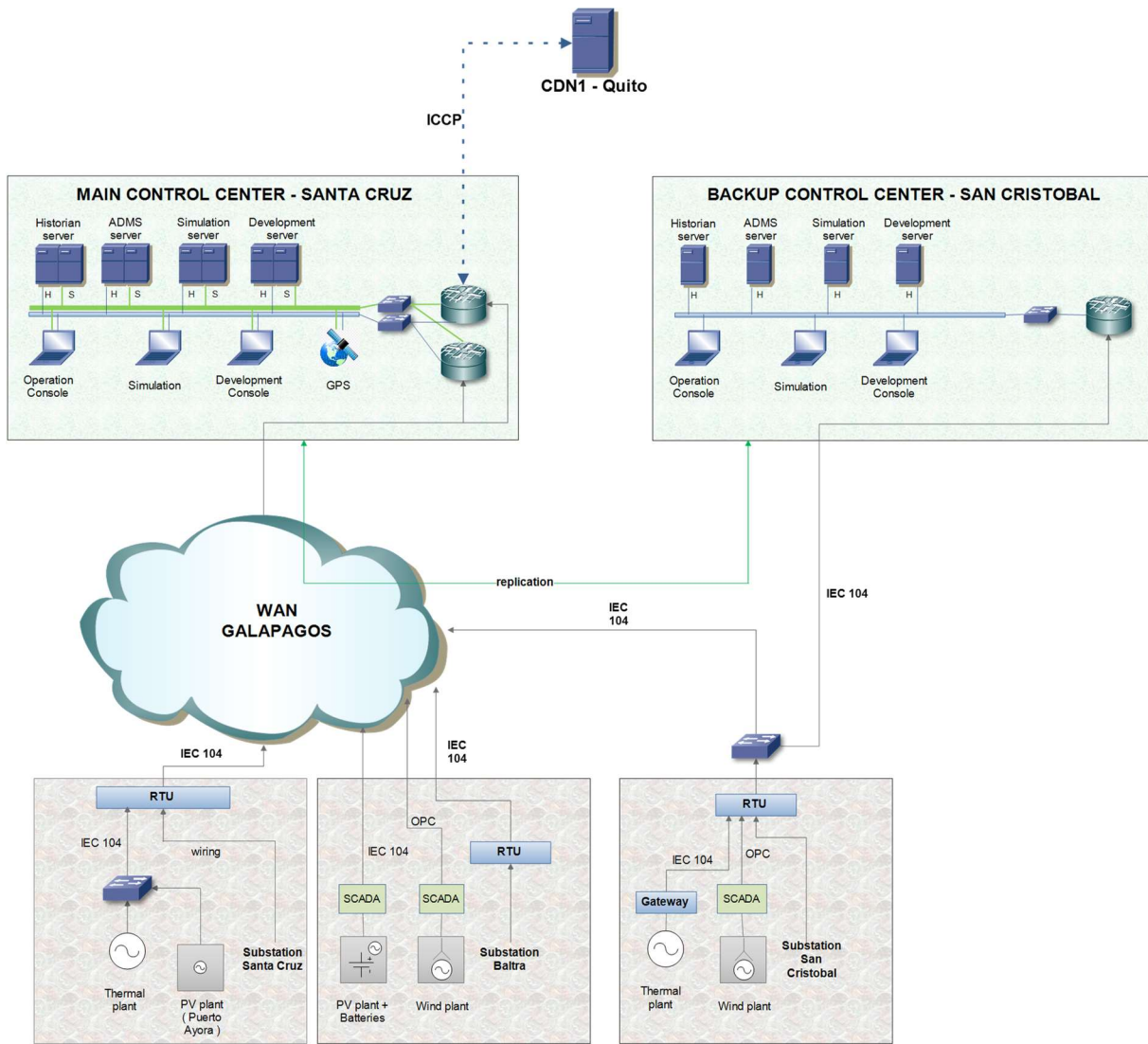

Fig. 6.6. Proposed architecture communications for ADMS in Galapagos

In order to interconnect Galapagos with CDN1, the new proposal considers the Inter-Control Centre Communications Protocol – ICCP- [182]. ICCP allows for data exchange over the WAN or LAN between a utility control center and other control centers, other utilities, power pools, regional control centers, and non-utility generators. Data exchange information consists of real-time and historical data, including measured values, scheduling data, energy accounting data, and operator messages. Nowadays, the ICCP is the most capable, widely adopted communication protocol available for interconnection control centers each other.

6.3 AMI

Taking into account that distribution networks will evolve towards Smart Grids and the most significant change would occur in the customer segment, an AMI system will able consumers to get more data in

order to make informed decisions in some cases, even in real time. According to [183] AMI is defined as

The communications hardware and software and associated system and data management software that creates a network between advanced meters and utility business systems and which allows collection and distribution of information to customers and other parties such as competitive retail providers, in addition to providing it to the Utility itself

The main smart meter characteristics, as well as its benefits, were defined in Chapter 2, the proposal presented in Chapter 4 concerning DSM considered a Smart Meter with an embedded device controller. Thus, in order to execute the intelligent DR+TOU, the existence of an AMI system is mandatory, which will be responsible for receiving signals from the Utility and, at the same time, sending customer information such as outages, consumption, among other electrical variables to the Utility. In addition, it is recommended to integrate the reclosers (suggested in the previous chapter in order to improve the FLISR function of the ADMS) into the control center.

In [184], a methodology for installing Fault Locators –FL- with communication in the Galapagos distribution network is presented. In addition, in a medium term, the MEER will finance distribution automation projects. Taking into account this background, the proposed infrastructure must be designed to support i) Smart meters, ii) Distribution Automation, iii) Electrical devices located on the distribution network (reclosers, FL, Voltage and current sensors, capacitor banks, regulators), iv) EV and v) DSM, see next figure.

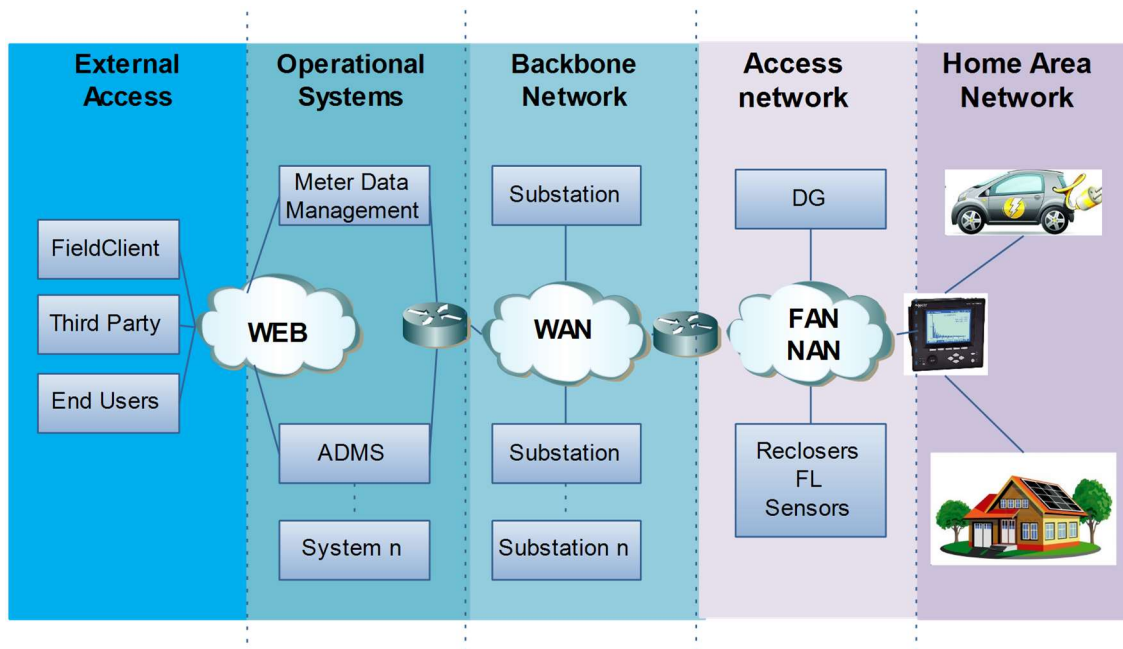

Fig. 6.7. Proposed AMI architecture based on [185, 186]

The segments External Access and Operational Systems are not the subjects of this AMI study. The backbone network, which includes the architecture for substation and the WAN, was presented in the previous section (Figure 6.6). Hence, the access network and home area network are segments which

will be addressed. Before proceeding with the proposal, the Power Line Communication – PLC- and RF – Radio Frequency- mesh technologies have to be presented.

6.3.1 Power Line Communication

PLC is a technology that provides interactive communication by embedding modulated carrier signals on already existing power lines. Thus, those signals must be embedded on the different frequency bands from the electric power system now in use. Since the power system is operated at typical frequencies of 50 or 60 Hz, the application of PLC can be limited at relatively higher frequency bands. The technology of PLC is based on digital communication. However, the power lines originally were designed to transfer electric power. Thus, it is not well protected from external noise. The next figure shows the simple diagram of PLC system.

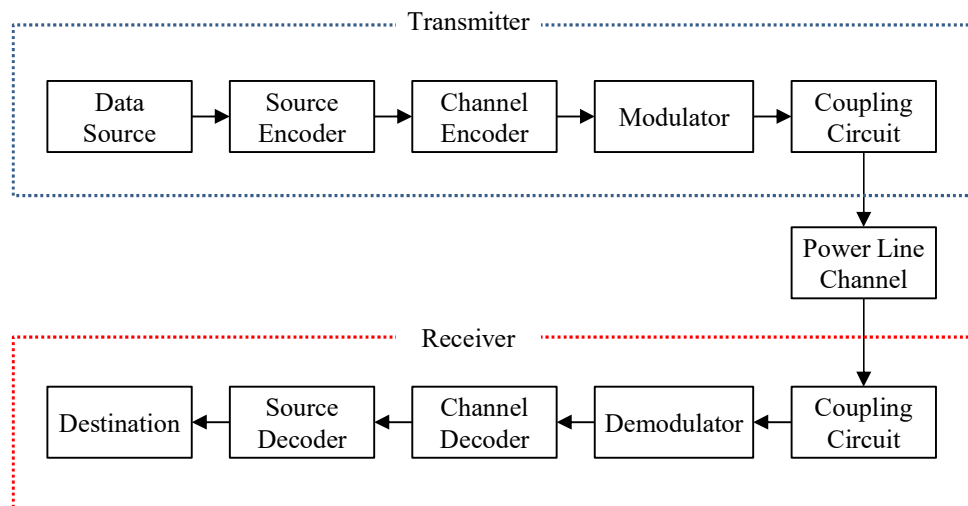

Fig. 6.8. Model of a PLC diagram system

A basic PLC transmitter/receiver consists of four subsets: data source/destination, encoder/decoder, a modulator/demodulator and coupling circuits. The function of the transmitter is to modulate the data signal using digital modulation techniques in order to overdrive it on the power signal. The method commonly used is known as spread frequency shift keying –SFSK-, and orthogonal frequency division multiplexing –OFDM-. It is important to mention that it exists two kinds of PLC very well proved [187].

1. Broadband: a technology that uses high and very high frequency (1,5-250 MHz) and reaches data rates of the order of hundreds of Mbps.
2. Low and High data rate (LDR & HDR) narrowband (NB): operating at very low, low and medium frequencies (3 kHz – 500 kHz), the LDR technology reaches some kbps, while HDR can reach until 500kbps.

At the medium voltage level, the Narrowband is preferred instead of Broadband PLC, since that the lines present lower attenuation at the lower frequencies, reducing the numbers of repeaters. Besides, the

transmitter power is lower, resulting in reduced electromagnetic interferences. The Narrowband PLC applications are best suitable for medium voltage networks [187] in comparison with the wireless solutions, especially for large scale systems, the narrowband is the best cost-effective technology, mainly for the complex extent of the network. Besides, it is worth remembering that PLC uses the existing infrastructure as a channel of communication.

As results of the increasing need for improving the control and management capabilities, several projects are using the PLC technology. Narrowband and Broadband provide a bi-directional communications platform able of delivering real-time data for some applications such as:

- Identify Failures,
- Monitoring and Control of distributed generation DG [188],
- Power Grid reconfiguration [189],
- AMI
- Real-time energy pricing, DSM
- Smart Home Networking [190],
- Street lighting control,
- Control of distributed energy storage, and
- Electric vehicles.

The figure below shows that PLC technology is used to acquire the data of smart meters through a data concentrator located in the transformer. Then, using GPRS or 3G technologies, the collected information is delivered to the control center. Although, it is also possible to create a direct physical channel between the smart meter and the control center using the MV/LV network via a bypass coupling [191]. One really interesting project [192] has been deployed at Europe-France by ERDF from 2001 to 2007; it consisted in the creation of a system with 300.000 meters and 5.000 concentrators. The system is based on PLC LAN and a GPRS WAN. Also, recently the project So-Grid launched in Toulouse in 2013 has completed its activities, among the main conclusions could be evidenced the real potential of the G3-PLC (last version of the protocol) communication technology in reference to performances, flows, latencies, robustness, and security [193].

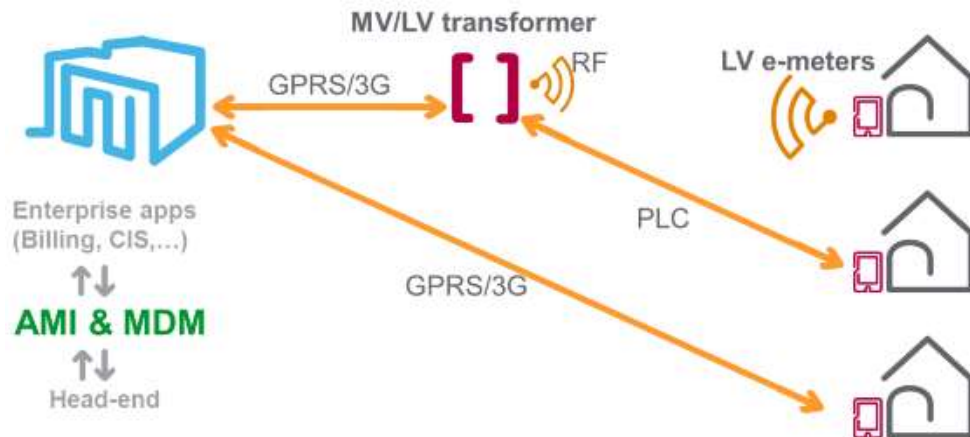

Fig. 6.9. Smart meter communications through different mediums.

6.3.2 Radio Frequency- Mesh

RF mesh technology is widely used today in the world for smart metering applications. The main purpose of an RF mesh is to perform automatic meter readings as well as to offer DR programs, which require reliable and robust two-way communication between the metering end-points and the Utility's head-end system. Over 10 million metering end points are managed today using RF mesh technology [194]. RF mesh technology is suitable for use in smart metering applications since this network is able of dynamically self-organize and self-configure itself and, with the nodes in the network, automatically establishing an ad hoc network and maintaining the mesh connectivity. In addition, the range is increased performing multiple hops between different nodes within the same neighborhood until to reach the final destination. Thus, RF mesh overcomes the main issue in the Neighborhood Area Network –NAN- that is related to propagation by finding alternative paths through the mesh. RF mesh operates predominantly in the unlicensed bands such as the 902- 928 MHz [195]. The next figure illustrates the conceptual architecture for Wireless Meshed Networks. We can identify mesh router, which has routing functions to support mesh networking and it is equipped with multiple wireless interfaces. In addition, a sub network labeled as Wireless Mesh clients is depicted. In this network, the mesh clients are able of working as a router for mesh networking purposes, but the mesh clients have only a single wireless interface.

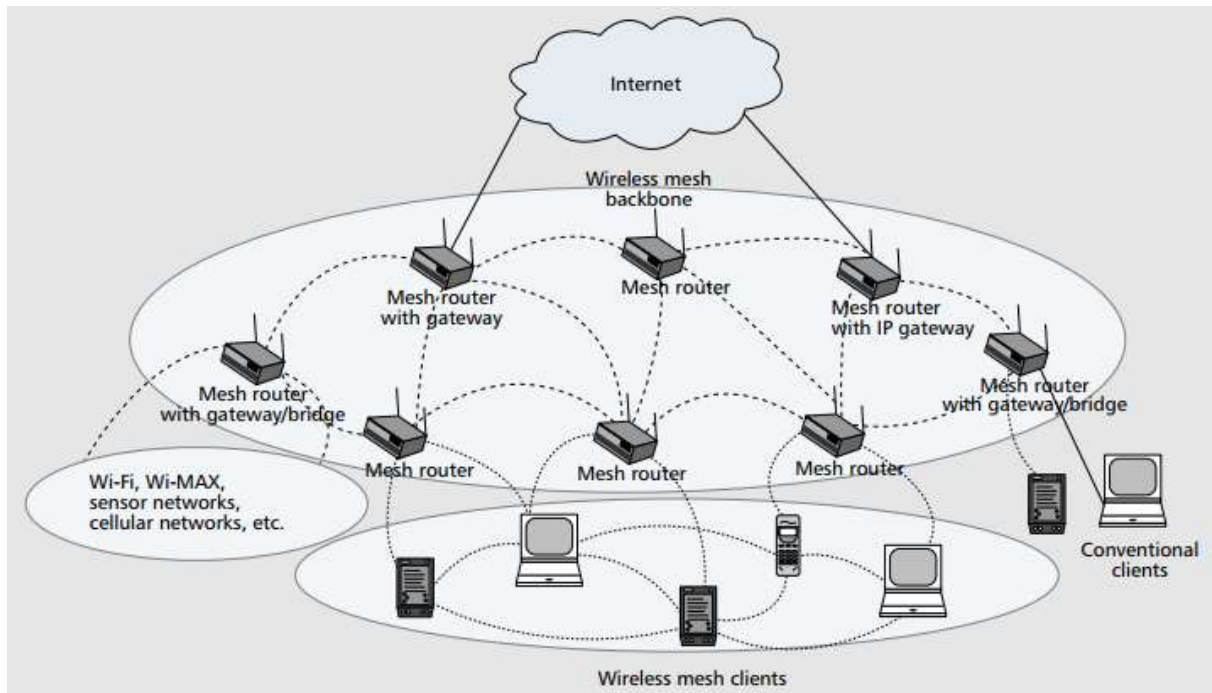

Fig. 6.10. Wireless Meshed Network Architecture, [196]

The main characteristics of a RF Mesh architecture are:

- Scalable
- Mesh connectivity guaranteed
- Broadband and Quality of Service available
- Secure
- Ease of use
- Compatible and Interoperable

The 802.15.4 standard [197] defines frequency, power, modulation, and other wireless conditions of the link as well as the format of the data handling.

6.3.3 FAN/NAN architecture proposal

According to [198], the Field Area Network is a *broadband wireless network providing essentially ubiquitous regional coverage*, whereas the NAN is responsible for providing coverage to a more little area, in this case, neighborhood. With the advent of the Smart Grids, the last-mile data communications networks referred as FAN have gained considerable importance since they have to support a variety of applications, such as DA (Distribution Automation), smart metering remote asset management, DG, EV, micro grids, and remote workforce automation [199]. Thus, the next figure depicts the proposal for FAN/NAN architecture communications. For the NAN, PLC and RF mesh technologies are combined. The reason is simple; due to the topology of the islands, it will be more rentable to deploy PLC between Meter-Meter and Meter-Data Concentrator –DC- than RF mesh in some places. Also, some unfavorable

conditions exist where RF mesh cannot be implemented due to lack of coverage in difficult access areas such as basements, high buildings, far points, among others.

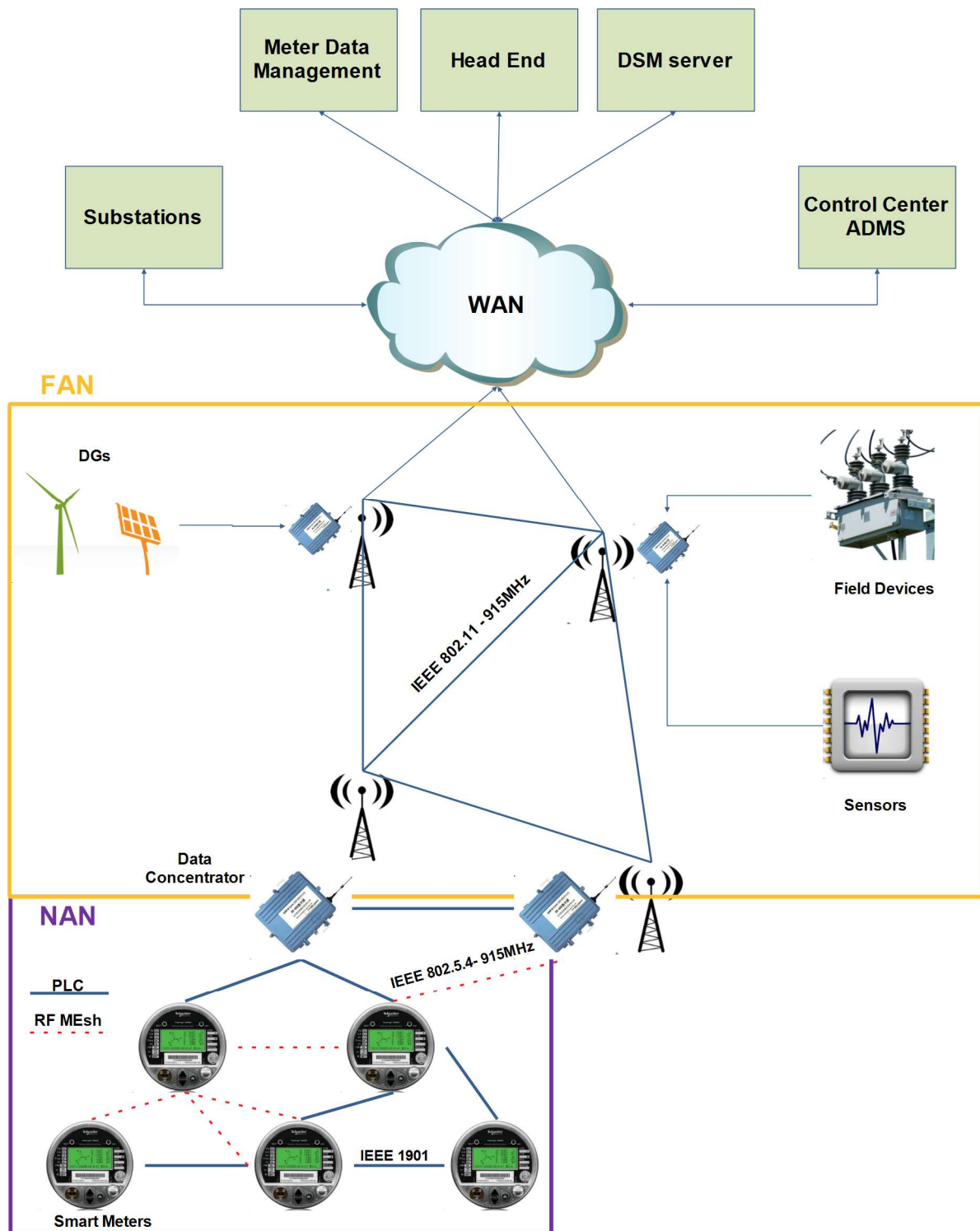

Fig. 6.11. FAN/NAN architecture proposal

The Data Concentrator –DC- is the bridge between the NAN and the FAN; it is equipped with different interfaces for wireless and wired communications. For the FAN area, IEEE 802.11 protocol is chosen

because it is a promising communication standard that provides improvements in i) scalability, ii) low energy consumption, and iii) coverage of large area. In addition, the standard performs better performance than the 802.15.4 regarding coverage range and association time [200]. The NAN is designed to integrate field devices like the reclosers proposed in the previous chapter or FLs, as well as, future sensors in the distribution networks. The DGs could also be integrated into the FAN easily through of a DC. Using radio links is the most economical solution since the distance between the field devices, sensors, and DG, with respect to Santa Cruz substation, is suitable for this kind of technology.

The FAN border is the link with the WAN, and operational systems are accessed through the WAN. The DSM server and the meter data management –MDM- system are also depicted in the previous figure. An MDM can store long-term data coming from the AMI and manages this information. It is worth noting that the volume of generated data is huge and consists primarily of usage data and events that are imported from Head-End. The MDM system collects the data, then validates, cleanses and processes it in order to have useful information for billing and data analytics.

On the other hand, Head-End system is able of scheduling, adding and setting rates locally or remotely, by customer group or individual. In addition, it must configure punctually or collectively the measurement devices as well as updating the firmware remotely. Other essential functions are i) sending commands of cut and reconnection (for safety, when a reconnection command is sent, the meter must verify that there is no voltage on the load side), ii) to manage demand profiles and iii) reporting and alarms.

In order to have a complete architecture for implementing Smart Grids in Galapagos islands, the last segment is known as Home Area Network –HAN- must be defined, the next section addresses this topic.

6.3.4 HAN

An HAN is a communication network within a household, which establishes communications between smart meter, Energy Management System, and other gateways or devices inside a home. This kind of network is relatively new, its proposal is i) to inform the consumer about energy usage and pricing and ii) to request actions to support to the grid for instance thermostat changes, plug-in electric vehicle charging among others. In other words, its goal is to reach an integration of the end-users into the smart grid (Smart Home or Smart Building concepts). Variety of architectures can be considered in-home only, via smart meter, via Internet, cloud-based or combinations.

The most popular protocols for HAN are i) Smart Energy Profile –SEP- and ii) OPENADR.

6.3.4.1 SEP

SEP 2.0 is the last edition of this protocol, and it is addressed in IEEE 2030.5-2013 [201]. The protocol is based on internetworking using routers in order to allow easily connect consumers' existing devices and to manage convergence and architecture changes easily. For instance, it allows smartphones (Wi-Fi) to speak directly with the smart meter (ZigBee), as well as a plug-in electric vehicle (HomePlug). One of the main advantages of this protocol is that it allows consumers to use existing

devices, has a rapid development and adoption since is sponsored by strong Alliances such Zigbee and HomePlug, and it is an already mature protocol. Besides, SEP2.0 is compatible with IEC 61850 and IEC 61968, for sending information over the internet uses Hypertext Transfer Protocol -HTTP-.

The protocol is divided into blocks of functionalities, any device can be a server and/or a client for a function set, and the servers provide the data whereas clients use the data. The main functionalities are:

- Price Communication: support time and consumption based tariffs.
- Demand Response and Load Control: events of request to shed a certain amount of Watts.
- Energy Usage Information: a variety of measurements near to real time.
- Service Provider messaging: billing messages, energy saving tips.
- Prepayment Metering: interface for privileged clients to view, update or act upon account balance information.
- Distributed Energy Resources: support for both generation and storage.
- Electric Vehicle: the ability to schedule charging times.
- Billing Communication: provides consumption or costs, estimates of future consumption, and/or historical consumption.
- File Download / Update: support secure, interoperable, remote software download to SEP 2.0 devices.

SEP 2.0 protocol has four layers; the physical layer supports 802.15.4 and PLC. The internet layer supports IPv4 and IPv6; the transport layer works with UDP and TCP, the application layer handles SEP, HTTP, and Efficient XML Interchange –EXI- protocols, see next figure.

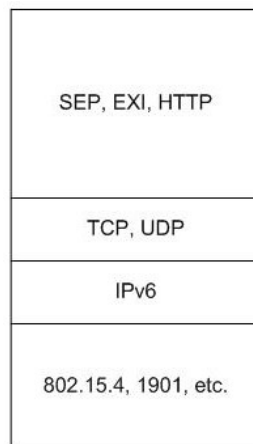

Fig. 6.12. SEP 2.0 layers

6.3.4.2 OpenADR

OpenADR 2.0 is the current edition of the original standard released in 2009. Nowadays, it is an internationally recognized standard for Automated Demand Response –ADR-. It defines the interaction between an ADR server and client, and its profile is defined in [202]. OpenADR improves the optimization between electric supply and consumption. The primary purpose of OpenADR is to manage

automated DR actions at the customer side, with no manual intervention either by means of load shedding or shifting. OpenADR is also able of providing a dynamic price in a range that goes since day-ahead until real time. There are two profiles:

- Profile A (OpenADR 2.0a): it is designed for low-end embedded devices to support basic demand response services and markets.
- Profile B (OpenADR 2.0b): it is designed for high-end embedded devices and includes consumer feedback of past, current, and future data events.

OpenADR 2.0 support two types of communication nodes: the Virtual Top Node –VTN-, which is typically considered as a server that transmits OpenADR signals to end devices or other intermediate servers, and the Virtual End Node –VEN- thought as a client or an Energy Management System –EMS-, or any device that accepts OpenADR signals from a server VTN. It is important to note that a node could be both a VTN and VEN at the same time, see next figure.

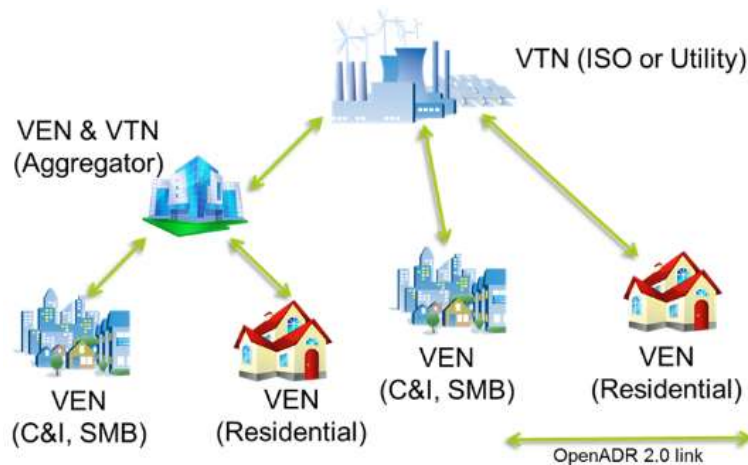

Fig. 6.13. OpenADR nodes,[203]

The available architectures for OpenADR [204] are i) single VTN communicating with one or multiple VENs, ii) XMPP -Extensible Messaging and Presence Protocol- server architecture, iii) three-level architecture, iv) hybrid device deployment architecture, v) vendor cloud, vi) vendor cloud per household, vii) VEN Application Server Architecture and viii) XMPP Server-to-Server Architecture.

XMPP is an open and extensible XML-based protocol originally designed for instant messaging. In the next figure, the acronym Rcrs represents a resource of demand within the household, for instance, a thermostat, a dryer or any smart appliance. For integrating EMS and aggregators in the ADR process, the architecture of three-level is chosen due to its flexibility and scalability since the same nodes act as VTN or VEN. In addition, it does not need an additional server (option ii, vii and viii), options v and vi require a cloud network, which is generally provided by a third party. The option iv is a good option as well. However, the need of a VTN server on the customer side will increase the cost of implementation. The next figure depicts the eight architectures with their main elements.

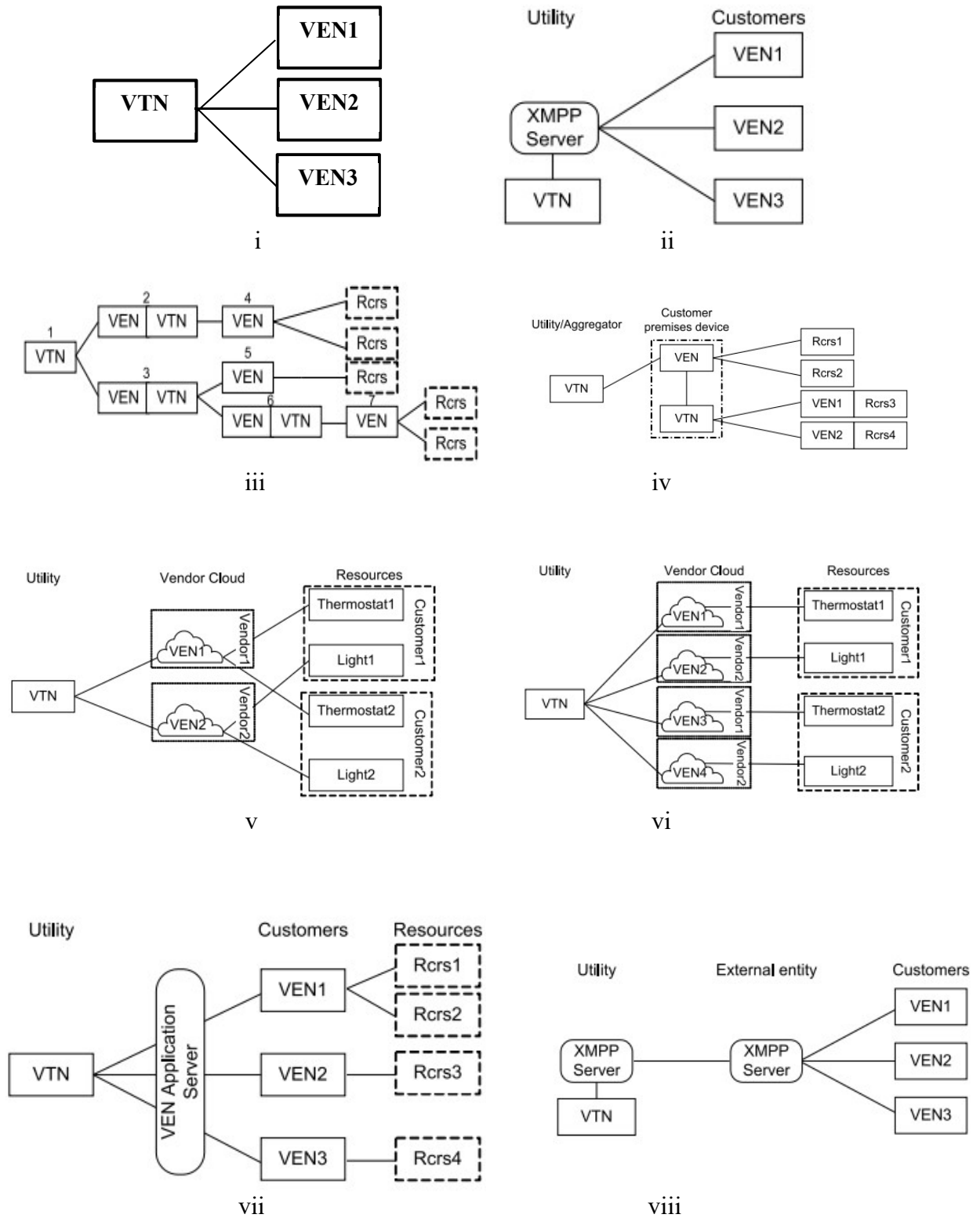

Fig. 6.14. OpenADR architectures

6.3.4.3 Proposal for HAN

Although theoretically SEP 2.0 is able to perform DSM and OpenADR, with some adaptations, it can support the HAN. One could think that both protocols are in competition, but OpenADR has traditionally focused on commercial and industrial customers, whereas SEP 2.0 has traditionally focused on residential customers. OpenADR has a more focused scope (DR) than SEP 2.0. However, the two standards can work together quite well, for example, using OpenADR to communicate from the utility to an Energy Service Interface –ESI-, and then use SEP 2.0 to communicate from the ESI into the home. According to [205], an ESI is a gateway placed at the boundary of the customer domain and exchange energy data between the client's domain and other external domains such as distribution, operation, and market.

Thus, for the HAN segment, the SEP 2.0 protocol is chosen for the features aforementioned. In addition, SEP 2.0 covers the Internet of Things concept completely. On the other hand, for the Intelligent DSM proposal presented in chapter 4, the OpenADR protocol is suitable. Generally, the EV is charged within the household by means of a slow charger. There are some important variables to monitor such as SOC and power consumed, even the EV could participate in DR programs due to its higher power. In order to perform ADR for EV charging, a communication protocol between EV and distribution network is required. Nowadays, for this purpose, SEP 2.0, OpenADR 2.0, the Society of Automotive Engineers –SAE-, ISO/IEC 15118 and the Open Charge Point Protocol –OPCC- have been developed. According to [206], SEP 2.0 and SAE protocols are good solutions when DR is applied to EV.

In [207], an exhaustive survey of Utilities is made, the principal interest was to know the real interest to perform DR with EV. The results show that 69% of the utilities in the United States of America are planning, researching, or considering DR programs that integrate EV managed charging, and just 20% have no interest. The report also summarizes the protocols incorporated into the Electric Vehicle Supply Equipment –EVSE- from different manufacturers. Nine of them were analyzed. According to five manufacturers, it is possible to use OCCP protocol. For three others, SEP 2.0 and OpenADR are available. It means that OCCP, SEP 2.0 and OpenADR are already commercial protocols.

Considering that SEP 2.0 is able to perform DR with EV, an unified solution for the HAN is evident; the HAN will be designed over SEP 2.0. In the previous sections, the protocol IEEE 802.15.4 and the protocol 802.11.4 were defined as best solutions for NAN and FAN respectively. Besides, taking into account that SEP 2.0 supports IEEE 802.15.4 (Figure 6.12), this protocol is selected in order to have a more unified solution for communication architecture for Smart Grids. The next figure depicts thus the proposal for HAN architecture.

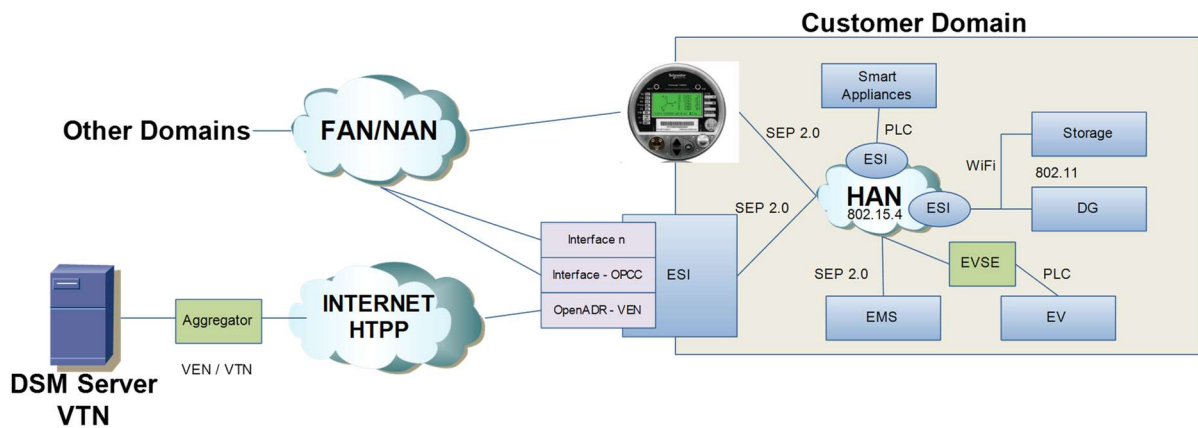

Fig. 6.15. Communication architecture proposal for HAN considering DSM

6.4 Conclusion

An architecture proposal has been presented for the adequate functioning of the ADMS of Galapagos islands. The architecture starts at the substation and ends at the Control Center / Data Center. Considering the substation, a key piece within the context of Smart Grids, the architecture to integrate measurement devices has also been presented in details, either by serial protocols, Ethernet or wiring.

Likewise, in order to deploy a real Smart Grid in Galapagos, the communication system is of course needed. This chapter defined the recommended communications architecture for three key segments:

- for the HAN network, the SEP 2.0 protocol is proposed
- for the NAN network, the suggested protocol is IEEE 802.15.4
- for the FAN network, the proposal has considered IEEE 802.11.4 for its best features in large areas.

The last chapter present the main conclusions reached during this thesis and the perspectives to continue working.

Chapter 7

Conclusions and Perspectives

The Galapagos Islands are a fragile ecosystem that must be preserved. For that, the Ecuadorian Government has initiated ambitious projects so that the islands are self-sustaining. An attractive solution analyzed during this Ph.D. is to transform Galapagos towards Smart Island, which is based on a Smart Grid capable of managing new renewable energy resources and the inclusion of new charges through the deployment of modern and intelligent systems.

First of all, a review of state of the art was done. This analysis revealed that in Ecuador nowadays substantial regulatory barriers exist to the SG implementation. The main ones refer to the lack of a regulatory framework for the execution of DSM, nor is there a retail market. The incentives for DG deployment are only applicable at MV / HV level, and TOU is available only for the industrial user. The reliability indices are not comparable with the international community since they are not following IEEE, ANSI or IEC standards; thus, the adoption of SAIDI and SAIFI indices is suggested. Also, a strong incentive to install renewable energies is required as well as it is needed to define a roadmap for the SG deployment in Galapagos. A long way in the regulatory aspect must be pursued.

The inclusion of new services in the low voltage network enabled by induction cookers, electric motorbike, and distributed generation has been assessed on a representative network to generalize the results later and have a clear idea of the impact generated in LV. These new services have a significant impact since cause overloads and drop voltages in the transformers. The approach that considers real data curves (IC, PV, loads) allow to make the simulations as most realistic as possible. The EM and IC must be connected to 240V for avoiding increasing unbalance. The developed interface between GIS and Simulink allow carrying out enough analysis with different scenarios and topologies.

Smart strategies to avoid significant overloads in the MV/LV transformer and keeping the voltages within the standard operating range are necessary. The Demand Side Management is the first strategy and a program composed of DR+TOU has shown outstanding results. The component corresponding to TOU must be designed based on measurements given by CENACE since the studies have reflected that before of establishing the TOU scheme, an in-depth analysis is needed because of the national load profile does not reflect the behavior of Galapagos. Also, for being more accurate, the rebound effect should be modeled. DR ought to use appliance controllers in each house in order to shift the energy during the whole day and in this way, the rebound is deleted.

The results show that either ARCONEL or UPV strategies are nor suitable since in some periods the voltages limits are violated, and the peaks created by rebound effect are important. Thus, the proposed Smart DSM program has the minimum peak, and the shifted energy is allocated mainly in dawn hours. Also, the best voltage profile is obtained since there are not minimum peaks disrespecting the quality regulation.

While overload in the transformer still exists, another smart solution has been applied: BESS connected at MV/LV transformer level. For determining the optimal battery size, the cost function has to be minimized; this function should take into account technical and contractual constraints such as daily charges, SOC, number of cycles, the maximum power of the network, among others. It was determined that Li-ion batteries are not profitable at low voltage level due to its high cost, the lead-acid batteries are just on the border to be considered, a controller to perform the charging/discharging process has to be installed to comply all the technical constraints. A new TOU scheme has to be implemented in

Galapagos if the government wants to encourage to end user for installing BESS system. Certainly, the regulations also have to be modified in order to allow the end user to become a “prosumer”; the BESS system should be recognized as RES and should be included in the regulation with a preferential price. According to the simulations, this price must be around 0,33USD/kWh for being profitable. The lead-acid battery has interesting characteristics for deploying grids projects. For instance, it could be mentioned a good depth of discharge rate and most important, the capital cost is cheaper.

For managing unbalances and voltages induced by the connection of new single-phase devices to the grid, the automatic phase shifting (CAP) system offers exceptional benefits such selecting the best phase for connecting DGs in this particular case, PV panels. Results of the connection CAP systems in Galapagos LV network have shown new capabilities to reduce adverse impacts of connection of single-phase PV systems, for instance, the unbalance is reduced considerably. It is worth noting that if the PV has a small effect on voltage, the CAP system is not useful.

The reliability of the distribution network can be drastically improved by the installation of remote-controlled reclosers and activating the option of trip/lock single-phase, with a quick Return On Investment. With the deployment of four reclosers, one in the header, two more downstream and the last one as interconnection point between feeders, a reduction of more than 50% on SAIFI, MAIFI, and SAIDI indices have been achieved

The optimal reconfiguration of the network is theoretically possible; however, its practical application is not viable for the Galapagos case since the feeders have not enough interconnection points. Similarly, the VVO strategy does not find any improvement proposal due mainly to the lack of elements for the reactive energy injection and to the fact that the current levels of voltage are in values that comply with the regulation.

The implementation of an Advanced Distribution Management System will bring technical benefits to the distribution network since will enable to the utility for controlling and monitoring the system in real time, other systems such as an OMS and MWM integrated into the platform allows improving the service quality. For the proper functioning of the ADMS, a communication architecture is essential; this architecture has to enable the communication between all the substations with the Control Center by means of a WAN. Also, the architecture must integrate the different IEDs by either serial protocols, Ethernet or wiring. The rolling out of AMI system is highly recommended. AMI system will allow collecting information in real time of different devices installed in the distribution networks such as i) smart meters, ii) fault locators, iii) reclosers, iv) DGs, v) current and voltage sensors, v) regulators, vi) capacitor banks and any intelligent device able of being integrated by means of a communication protocol.

For determining the degree of acceptance of EM, IC, DG and DSM sociological studies have been executed at Santa Cruz. The results of the simulation that considered these acceptance values show that, in a future of 9 years, more thermal generation would be needed. However, through an EMS system based on the ADMS system and complemented with DSM and forecasting servers, it is possible to integrate the BESS to store energy during the morning and return this energy at night avoiding exceeding the maximum limit of available generation. The solution is feasible and will prevent the installation of thermal generation in the future.

To make Galapagos a Smart Island, some mandatory fields must be addressed i) power generation, ii) mobility, iii) electricity network modernization, iv) efficient consumption, v) efficiency in public lighting, vi) integrated water cycle management, vii) solid waste treatment, viii) governance and ix) smart health. All these fields are related to each other in some way, for this reason, following projects should bring together all stakeholders for determining a common objective.

It is necessary to carry out detailed studies of the socio-economic and socio-cultural aspects that the different projects can originate so that the citizens accept/support the proposed improvements within the islands. Likewise, financing and sustainability studies are necessary. As an important conclusion, it is worth mentioning that a roadmap must be drawn up with input from all those involved in each of the axes. This roadmap is imperative to chart the way forward in order to achieve unified and optimal solutions as well as improving public services delivered to the interior of the islands.

After a detailed review of existing commercial protocols, the best options for the deployment of NAN, FAN, and HAN networks have been determined within the context of a Smart Grid. Thus, for the HAN network, the SEP 2.0 protocol is proposed due to its capacity to enable end user as an active element within a smart grid. For the NAN network, the selected protocol is IEEE 802.15.4 in combination with PLC (IEEE 1901) due to the topology of the islands; it will be more profitable to deploy PLC than RF mesh in some places due to lack of coverage in difficult access areas. For the FAN network, the proposal has considered IEEE 802.11.4 for its best features in large areas.

The interconnection between the HAN and the FAN/NAN segment is performed through the smart meter, to interconnect the DSM server, which manages OpenADR and the demand resources within the household an Energy Service Interface is required. The energy service interface can work with several protocols, for instance, OPCC. As last consideration, the EVSE is integrated using SEP 2.0 protocol.

As a final conclusion, we would like to mention that real-time simulations allow analyzing various scenarios with reduced optimizing costs time and effort; also offer the possibility of connecting real devices in the simulation. Using real-time simulation is possible to get accurate information such as voltage profiles, line current, power in peak hours, current in the power transformer and so on. All this information is necessary to understand the network state in both present and future scenarios. Hence, the simulations help us to build a new vision based on smart grids, which consider new services and effective strategies to face the challenges ahead for the distribution networks.

Some simulations have been tried using the RT-Lab real-time simulator during the Ph.D., because the Matlab/Simulink platform integrated with RT-Lab allows performing both medium and low voltage analysis. However, the large-scale implementation of the Galapagos electric model in RT-Lab is not feasible due to a large number of nodes and a lot of hardware resources needed at the time of the compilation. In this way, the CYMDIST platform was chosen for the large-scale analysis, for its flexibility and mainly for being the technical analysis software homologated in Ecuador.

Following the work carried out in this thesis, different perspectives for studies has been identified; this Ph.D. have explored several leads and, in further works, each item could be much more detailed and improved.

It is not trivial to install CAP system in a massive way within the whole LV network and to analyze the results at substation level. In addition, it would be interesting to simulate the communication of smart meters using IEC61850, as well as to implement a direct communication between the Virtual Power Plant and DGs to receive set points and make available ancillary services.

The typical philosophy of the protection scheme that considers that the flow of current is given in a single direction must be rethought to consider the bidirectional flows originated by the distributed generators. Also, it needs a detailed study for analyzing the benefits of integrating into the electrical sector new agents such as Aggregators, Retailers, Virtual Power Plants, and Energy Service Companies, the communication architecture to support the different interrelationships between each other should be analyzed as well.

ELECGALAPAGOS should choose the option of investing in innovative solutions such as EMS deployment, installation of reclosers of the last generation and roll out of smart meters with appliance controller instead of typical approach (reinforcement).

All new project for Galapagos should involve all stakeholders and are based on international standards and national policies. The results obtained during this Ph.D. must be extrapolated to the continental country with the particular considerations.

It is highly recommended to begin the modeling of the generation within CYMDIST. It will allow the model to executed dynamics analyses; it is important since the integration of renewables energies requires studies focused not only on the steady state. In addition, with the generators within CYMDIST, we can perform integral studies considering other phenomena such transients.

Some test were carried out between CYMDIST and RT-LAB ephasorsim in order to get the real-time component on the electrical models developed in CYMDIST, the results were promising, as a recommendation, this work should continue until full integration between the two platforms.

Finally, it is suggested to apply the Smart Grid Maturity model within Ecuador in order to assess the current situation and define the desired future of the electrical sector of the country.

Scientific publications

Scientific Papers

Assessment of the impact of intelligent DSM methods in the Galapagos Islands toward a Smart Grid

D.X. Morales, Y. Besanger, S. Sami, C. Alvarez Bel

Elsevier, Journal Electric Power System Research, Volume 146, May 2017, Pages 308–320

Intelligent energy management in the Galapagos Islands towards a smart grid

D. X. Morales, Y. Besanger, J.P. Erazo, R.D. Medina

Technical Sciences Academy of Romania, Journal of Engineering Sciences and Innovation (JESI), Journal - Volume 2, Issue 1/2017, Pages 63-82

Impact study of new loads and time of use schedule in the low voltage network

D. X. Morales; Y. Besanger; M. Toledo; R. D. Medina

2016 IEEE PES Innovative Smart Grid Technologies International Conference Europe (ISGT-Europe), Ljubljana-Slovenia, 9-12 Oct.

Impact assessment of new services in the Galapagos low voltage network

D. X. Morales; Y. Besanger; C. Alvarez Bel; R. D. Medina

2016 IEEE PES Transmission & Distribution International Conference and Exposition-Latin America (PES T&D-LA), Morelia-Mexico, 21-24 Sep.

Proposal and requirements for a real-time hybrid simulator of the distribution network

D. X. Morales; R. D. Medina; Y. Besanger

2015 IEEE CHILEAN International Conference on Electrical, Electronics Engineering, Information and Communication Technologies (CHILECON), Santiago-Chile, 28-30 Oct.

Real-Time Hybrid Simulator of the Distribution Network for Smart Grid Applications

Diego Morales, Ricardo Medina

VIII Simposio Internacional sobre la Calidad de la Energía Eléctrica – SICEL, Viña del Mar-Chile, 20-22 Nov, 2015

Enterprise Architecture for the Utility of the Future: Case Study Ecuador

Patricio Erazo, Diego Morales and Patricio Pesantez

2017 IEEE PES Innovative Smart Grid Technologies-Latin America Conference, Quito-Ecuador, 20-22 Sept.

Development of a spatial load-forecasting module for optimizing planning of electricity supply

Diego Morales, Yvon Besanger, Santiago Moscoso and Patricio Pesantez

2017 IEEE PES Innovative Smart Grid Technologies-Latin America Conference, Quito-Ecuador, 20-22 Sept.

Book Chapter

Complex networks: Case Study Galapagos Islands

Diego X. Morales, Yvon Besanger, Ricardo D. Medina

Accepted on 11/03/2017: chapter of the book entitled Sustainable Interdependent Networks: From Theory to Application”, Coordinator: M. Hadi Amini, Springer, to be published by March 2018

Annexes

Annex 1: Library Created with blocks for LV loads.

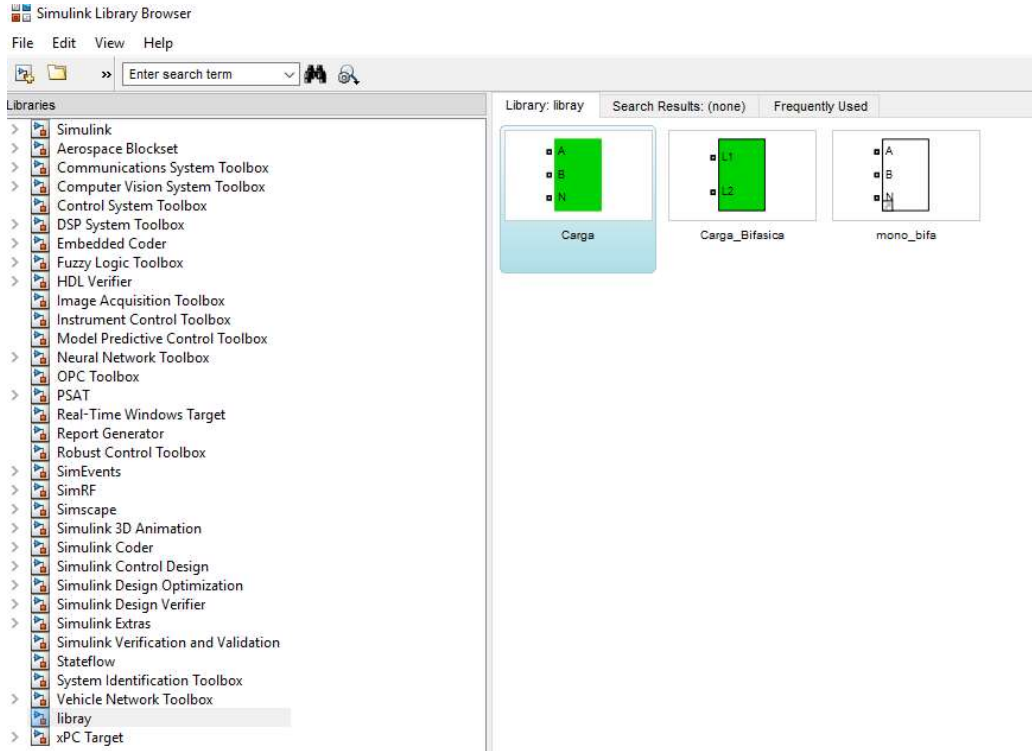

Annex 2: LV network within Simulink

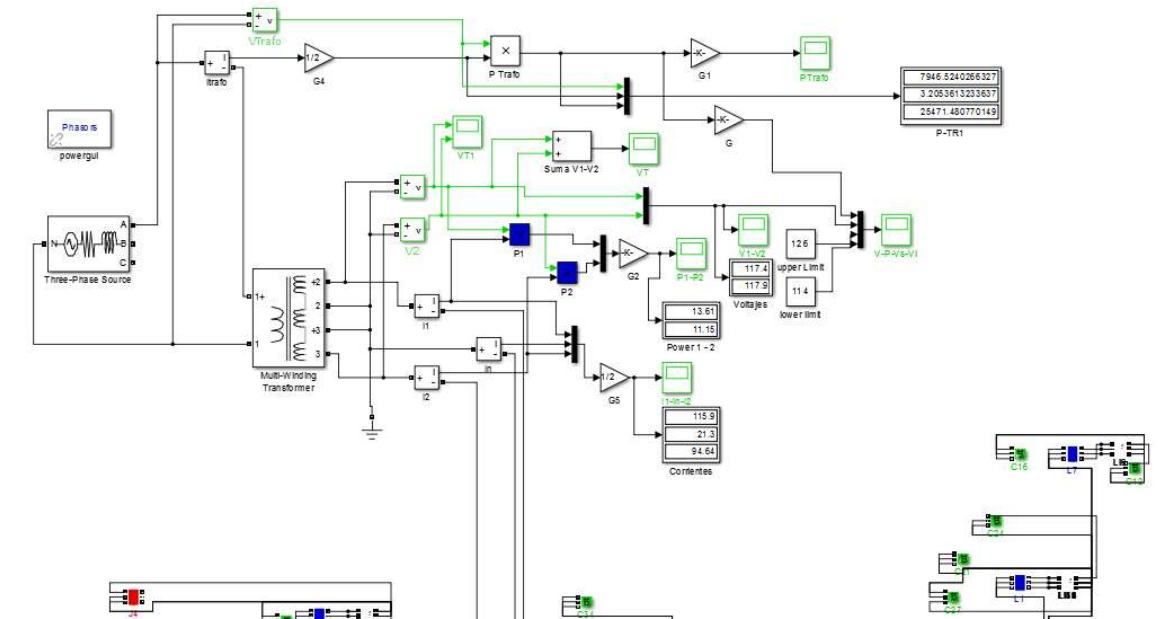

Annex 3: List of overloaded transformers at Future Scenario

| Equipment Number | Initial Node | Final Node | Load (%) |
|------------------|--------------|-------------|----------|
| 18153_MTA-1 | MTA_S_18153 | MTA_L_18153 | 100,1 |
| 13161_MTA-1 | MTA_L_13160 | MTA_L_13161 | 100,8 |
| 5650_MTA-1 | MTA_L_5649 | MTA_L_5650 | 100,9 |
| 11202_MTS-1 | MTS_S_11202 | MTS_L_11202 | 101,1 |
| 5479_MTA-1 | MTA_L_5478 | MTA_L_5479 | 101,2 |
| 5734_MTA-1 | MTA_S_5734 | MTA_L_5734 | 101,6 |
| 5439_MTA-1 | MTA_S_5439 | MTA_L_5439 | 102,7 |
| 16064_MTA-1 | MTA_S_16064 | MTA_L_16064 | 102,7 |
| 70971_MTA-1 | MTA_S_70971 | MTA_L_70971 | 104,8 |
| 17283_MTA-1 | MTA_L_17282 | MTA_L_17283 | 104,9 |
| 5736_MTA-1 | MTA_L_5735 | MTA_L_5736 | 105,9 |
| 2287_MTS-1 | MTS_S_2287 | MTS_L_2287 | 106,4 |
| 14722_MTA-1 | MTA_L_14721 | MTA_L_14722 | 107 |
| 5327_MTA-1 | MTA_S_5327 | MTA_L_5327 | 107 |
| 10896_MTS-1 | MTA_L_34292 | MTS_L_10896 | 107,4 |
| 2288_MTS-1 | MTA_L_5729 | MTS_L_2288 | 107,7 |
| 68666_MTA-1 | MTA_L_68665 | MTA_L_68666 | 108,2 |
| 11204_MTS-1 | MTS_S_11204 | MTS_L_11204 | 108,3 |
| 69953_MTA-1 | MTA_L_69952 | MTA_L_69953 | 108,3 |
| 5640_MTA-1 | MTA_S_5640 | MTA_L_5640 | 108,6 |
| 14728_MTA-1 | MTA_S_14728 | MTA_L_14728 | 109,6 |
| 7744_MTS-1 | MTS_S_7744 | MTS_L_7744 | 109,8 |
| 5670_MTA-1 | MTA_S_5670 | MTA_L_5670 | 110,3 |
| 5668_MTA-1 | MTA_L_5667 | MTA_L_5668 | 111,2 |
| 5484_MTA-1 | MTA_L_5483 | MTA_L_5484 | 111,6 |
| 63204_MTA-1 | MTA_L_63203 | MTA_L_63204 | 112,5 |
| 17968_MTA-1 | MTA_S_17968 | MTA_L_17968 | 112,9 |
| 5739_MTA-1 | MTA_S_5739 | MTA_L_5739 | 116,3 |
| 5357_MTA-1 | MTA_S_5357 | MTA_L_5357 | 116,8 |
| 15044_MTA-1 | MTA_S_15044 | MTA_L_15044 | 118 |
| 13140_MTA-1 | MTA_S_13140 | MTA_L_13140 | 120,1 |
| 5622_MTA-1 | MTA_L_5621 | MTA_L_5622 | 121,9 |
| 13471_MTA-1 | MTA_S_13471 | MTA_L_13471 | 122,3 |
| 5347_MTA-1 | MTA_L_5346 | MTA_L_5347 | 123,7 |
| 5656_MTA-1 | MTA_S_5656 | MTA_L_5656 | 124,1 |
| 5519_MTA-1 | MTA_L_5518 | MTA_L_5519 | 128,6 |
| 69951_MTA-1 | MTA_S_69951 | MTA_L_69951 | 129,8 |
| 14408_MTA-1 | MTA_S_14408 | MTA_L_14408 | 132,7 |
| 17640_MTA-1 | MTA_S_17640 | MTA_L_17640 | 133,4 |
| 68664_MTA-1 | MTA_L_68663 | MTA_L_68664 | 134,1 |

| | | | |
|-------------|-------------|-------------|-------|
| 11208_MTS-1 | MTA_L_5631 | MTS_L_11208 | 134,4 |
| 13165_MTA-1 | MTA_S_13165 | MTA_L_13165 | 135,3 |
| 5317_MTA-1 | MTA_S_5317 | MTA_L_5317 | 135,4 |
| 16114_MTA-1 | MTA_S_16114 | MTA_L_16114 | 135,6 |
| 63210_MTA-1 | MTA_L_63209 | MTA_L_63210 | 135,7 |
| 13761_MTA-1 | MTA_L_13472 | MTA_L_13761 | 136,3 |
| 5644_MTA-1 | MTA_S_5644 | MTA_L_5644 | 137,2 |
| 10894_MTS-1 | MTS_S_10894 | MTS_L_10894 | 137,3 |
| 5666_MTA-1 | MTA_S_5666 | MTA_L_5666 | 138,2 |
| 17988_MTA-1 | MTA_L_17987 | MTA_L_17988 | 138,3 |
| 69305_MTA-1 | MTA_S_69305 | MTA_L_69305 | 138,6 |
| 5468_MTA-1 | MTA_L_5467 | MTA_L_5468 | 139,7 |
| 13469_MTA-1 | MTA_S_13469 | MTA_L_13469 | 141,5 |
| 13466_MTA-1 | MTA_S_13466 | MTA_L_13466 | 142,3 |
| 5740_MTA-1 | MTA_S_5740 | MTA_L_5740 | 144,1 |
| 17623_MTA-1 | MTA_L_17622 | MTA_L_17623 | 144,9 |
| 5537_MTA-1 | MTA_L_5536 | MTA_L_5537 | 146,9 |
| 5540_MTA-1 | MTA_L_5539 | MTA_L_5540 | 148 |
| 72242_MTA-1 | MTA_L_72241 | MTA_L_72242 | 150 |
| 5646_MTA-1 | MTA_L_5645 | MTA_L_5646 | 150,4 |
| 2277_MTS-1 | MTS_S_2277 | MTS_L_2277 | 152,1 |
| 15050_MTA-1 | MTA_S_15050 | MTA_L_15050 | 157,7 |
| 13137_MTA-1 | MTA_L_13136 | MTA_L_13137 | 157,9 |
| 68658_MTA-1 | MTA_S_68658 | MTA_L_68658 | 161,6 |
| 2176_MTS-1 | MTS_S_2176 | MTS_L_2176 | 163,2 |
| 38135_MTA-1 | MTA_S_38135 | MTA_L_38135 | 163,5 |
| 14730_MTA-1 | MTA_S_14730 | MTA_L_14730 | 170,3 |
| 16099_MTA-1 | MTA_S_16099 | MTA_L_16099 | 170,7 |
| 5642_MTA-1 | MTA_S_5642 | MTA_L_5642 | 178,8 |
| 5495_MTA-1 | MTA_S_5495 | MTA_L_5495 | 180,3 |
| 13167_MTA-1 | MTA_L_13166 | MTA_L_13167 | 181,7 |
| 5365_MTA-1 | MTA_L_5364 | MTA_L_5365 | 182,9 |
| 5626_MTA-1 | MTA_S_5626 | MTA_L_5626 | 185,2 |
| 13446_MTA-1 | MTA_S_13446 | MTA_L_13446 | 188,9 |
| 5387_MTA-1 | MTA_L_5386 | MTA_L_5387 | 189 |
| 5359_MTA-1 | MTA_L_5358 | MTA_L_5359 | 197,6 |
| 5634_MTA-1 | MTA_L_5633 | MTA_L_5634 | 199,3 |
| 5477_MTA-1 | MTA_L_5476 | MTA_L_5477 | 199,4 |
| 5395_MTA-1 | MTA_S_5395 | MTA_L_5395 | 201,4 |
| 11207_MTS-1 | MTS_S_11207 | MTS_L_11207 | 210,6 |
| 13163_MTA-1 | MTA_L_13162 | MTA_L_13163 | 214,5 |
| 5376_MTA-1 | MTA_L_5375 | MTA_L_5376 | 216,7 |
| 5630_MTA-1 | MTA_S_5630 | MTA_L_5630 | 221,2 |

| | | | |
|-------------|-------------|-------------|-------|
| 5662_MTA-1 | MTA_S_5662 | MTA_L_5662 | 227,2 |
| 68980_MTA-1 | MTA_L_68979 | MTA_L_68980 | 230,8 |
| 6081_MTA-1 | MTA_L_5776 | MTA_L_6081 | 232,1 |
| 13153_MTA-1 | MTA_L_13152 | MTA_L_13153 | 236,4 |
| 5660_MTA-1 | MTA_L_5659 | MTA_L_5660 | 252,8 |
| 7698_MTS-1 | MTS_S_7739 | MTS_L_7698 | 257,1 |
| 14405_MTA-1 | MTA_L_14404 | MTA_L_14405 | 296,6 |
| 69298_MTA-1 | MTA_S_69298 | MTA_L_69298 | 339,9 |
| 69621_MTA-1 | MTA_L_69620 | MTA_L_69621 | 387,3 |
| 20017_MTS-1 | MTS_S_20018 | MTS_L_20017 | 467,5 |
| 5459_MTA-1 | MTA_L_5458 | MTA_L_5459 | 495,6 |

Annex 4: List of overloaded transformers at Future Scenario with DG at 100%

| Equipment Number | Initial Node | Final Node | Load (%) |
|------------------|--------------|-------------|----------|
| 70971_MTA-1 | MTA_S_70971 | MTA_L_70971 | 100,3 |
| 69953_MTA-1 | MTA_L_69952 | MTA_L_69953 | 101 |
| 5327_MTA-1 | MTA_S_5327 | MTA_L_5327 | 101,6 |
| 18153_MTA-1 | MTA_S_18153 | MTA_L_18153 | 102,6 |
| 63204_MTA-1 | MTA_L_63203 | MTA_L_63204 | 103,2 |
| 5484_MTA-1 | MTA_L_5483 | MTA_L_5484 | 103,3 |
| 5736_MTA-1 | MTA_L_5735 | MTA_L_5736 | 104 |
| 2287_MTS-1 | MTS_S_2287 | MTS_L_2287 | 104,8 |
| 5357_MTA-1 | MTA_S_5357 | MTA_L_5357 | 105,3 |
| 7744_MTS-1 | MTS_S_7744 | MTS_L_7744 | 105,7 |
| 2288_MTS-1 | MTA_L_5729 | MTS_L_2288 | 105,7 |
| 10896_MTS-1 | MTA_L_34292 | MTS_L_10896 | 105,8 |
| 5668_MTA-1 | MTA_L_5667 | MTA_L_5668 | 106,5 |
| 5670_MTA-1 | MTA_S_5670 | MTA_L_5670 | 106,7 |
| 11204_MTS-1 | MTS_S_11204 | MTS_L_11204 | 106,7 |
| 15044_MTA-1 | MTA_S_15044 | MTA_L_15044 | 107,5 |
| 13140_MTA-1 | MTA_S_13140 | MTA_L_13140 | 108,8 |
| 13471_MTA-1 | MTA_S_13471 | MTA_L_13471 | 109,3 |
| 17968_MTA-1 | MTA_S_17968 | MTA_L_17968 | 111 |
| 5347_MTA-1 | MTA_L_5346 | MTA_L_5347 | 114 |
| 5739_MTA-1 | MTA_S_5739 | MTA_L_5739 | 114,6 |
| 5622_MTA-1 | MTA_L_5621 | MTA_L_5622 | 114,9 |
| 5656_MTA-1 | MTA_S_5656 | MTA_L_5656 | 118,1 |
| 69951_MTA-1 | MTA_S_69951 | MTA_L_69951 | 119,9 |
| 17640_MTA-1 | MTA_S_17640 | MTA_L_17640 | 120,4 |
| 5519_MTA-1 | MTA_L_5518 | MTA_L_5519 | 120,8 |
| 17988_MTA-1 | MTA_L_17987 | MTA_L_17988 | 121 |

| | | | |
|-------------|-------------|-------------|-------|
| 13165_MTA-1 | MTA_S_13165 | MTA_L_13165 | 121,5 |
| 14408_MTA-1 | MTA_S_14408 | MTA_L_14408 | 121,6 |
| 13761_MTA-1 | MTA_L_13472 | MTA_L_13761 | 123,7 |
| 63210_MTA-1 | MTA_L_63209 | MTA_L_63210 | 123,9 |
| 68664_MTA-1 | MTA_L_68663 | MTA_L_68664 | 125,2 |
| 13469_MTA-1 | MTA_S_13469 | MTA_L_13469 | 126,2 |
| 69305_MTA-1 | MTA_S_69305 | MTA_L_69305 | 126,2 |
| 5317_MTA-1 | MTA_S_5317 | MTA_L_5317 | 127,2 |
| 13466_MTA-1 | MTA_S_13466 | MTA_L_13466 | 127,9 |
| 5468_MTA-1 | MTA_L_5467 | MTA_L_5468 | 128,5 |
| 16114_MTA-1 | MTA_S_16114 | MTA_L_16114 | 130,6 |
| 11208_MTS-1 | MTA_L_5631 | MTS_L_11208 | 130,7 |
| 5644_MTA-1 | MTA_S_5644 | MTA_L_5644 | 130,8 |
| 17623_MTA-1 | MTA_L_17622 | MTA_L_17623 | 132 |
| 5666_MTA-1 | MTA_S_5666 | MTA_L_5666 | 132,8 |
| 10894_MTS-1 | MTS_S_10894 | MTS_L_10894 | 135,2 |
| 5540_MTA-1 | MTA_L_5539 | MTA_L_5540 | 139,9 |
| 5740_MTA-1 | MTA_S_5740 | MTA_L_5740 | 141,9 |
| 5537_MTA-1 | MTA_L_5536 | MTA_L_5537 | 142,4 |
| 72242_MTA-1 | MTA_L_72241 | MTA_L_72242 | 142,5 |
| 15050_MTA-1 | MTA_S_15050 | MTA_L_15050 | 143,2 |
| 5646_MTA-1 | MTA_L_5645 | MTA_L_5646 | 146,7 |
| 13137_MTA-1 | MTA_L_13136 | MTA_L_13137 | 148,7 |
| 2277_MTS-1 | MTS_S_2277 | MTS_L_2277 | 149,8 |
| 68658_MTA-1 | MTA_S_68658 | MTA_L_68658 | 153,9 |
| 14730_MTA-1 | MTA_S_14730 | MTA_L_14730 | 157,4 |
| 16099_MTA-1 | MTA_S_16099 | MTA_L_16099 | 160 |
| 38135_MTA-1 | MTA_S_38135 | MTA_L_38135 | 160,2 |
| 2176_MTS-1 | MTS_S_2176 | MTS_L_2176 | 161,1 |
| 5495_MTA-1 | MTA_S_5495 | MTA_L_5495 | 163,8 |
| 13167_MTA-1 | MTA_L_13166 | MTA_L_13167 | 166,8 |
| 5642_MTA-1 | MTA_S_5642 | MTA_L_5642 | 166,9 |
| 13446_MTA-1 | MTA_S_13446 | MTA_L_13446 | 167,3 |
| 5365_MTA-1 | MTA_L_5364 | MTA_L_5365 | 170,4 |
| 5626_MTA-1 | MTA_S_5626 | MTA_L_5626 | 172,7 |
| 5387_MTA-1 | MTA_L_5386 | MTA_L_5387 | 179,5 |
| 5359_MTA-1 | MTA_L_5358 | MTA_L_5359 | 181,3 |
| 5395_MTA-1 | MTA_S_5395 | MTA_L_5395 | 188,6 |
| 5477_MTA-1 | MTA_L_5476 | MTA_L_5477 | 190,1 |
| 13163_MTA-1 | MTA_L_13162 | MTA_L_13163 | 195,3 |
| 5634_MTA-1 | MTA_L_5633 | MTA_L_5634 | 196,3 |
| 5376_MTA-1 | MTA_L_5375 | MTA_L_5376 | 204,4 |
| 11207_MTS-1 | MTS_S_11207 | MTS_L_11207 | 206,5 |

| | | | |
|-------------|-------------|-------------|-------|
| 5662_MTA-1 | MTA_S_5662 | MTA_L_5662 | 206,7 |
| 5630_MTA-1 | MTA_S_5630 | MTA_L_5630 | 211,6 |
| 6081_MTA-1 | MTA_L_5776 | MTA_L_6081 | 213,3 |
| 68980_MTA-1 | MTA_L_68979 | MTA_L_68980 | 217 |
| 13153_MTA-1 | MTA_L_13152 | MTA_L_13153 | 218,7 |
| 5660_MTA-1 | MTA_L_5659 | MTA_L_5660 | 240,3 |
| 7698_MTS-1 | MTS_S_7739 | MTS_L_7698 | 253,3 |
| 14405_MTA-1 | MTA_L_14404 | MTA_L_14405 | 268,1 |
| 69298_MTA-1 | MTA_S_69298 | MTA_L_69298 | 309,8 |
| 69621_MTA-1 | MTA_L_69620 | MTA_L_69621 | 361,9 |
| 5459_MTA-1 | MTA_L_5458 | MTA_L_5459 | 470,9 |
| 20017_MTS-1 | MTS_S_20018 | MTS_L_20017 | 475,1 |

Bibliography

- [1] Unesco. (2017, 14/07/2017). *Galápagos Islands*. Available: <http://whc.unesco.org/en/list/1>
- [2] G. Earth. (2017, 14/07/2017). *Satellite View*. Available: <https://www.google.com/maps/@-0.29579,-90.40367,637680m/data=!3m1!1e3>
- [3] INEC. (2017, 14/07/2017). *Fascículo Provincial Galápagos*. Available: <http://www.ecuadorencifras.gob.ec/wp-content/descargas/Manu-lateral/Resultados-provinciales/galapagos.pdf>
- [4] AYESA, "EcoSmart Galapagos , A sustainable city," Quito,Ecuador,2014.
- [5] Ministerio_de_Electricidad_y_Energia_Renovable, "Sistema Integrado para Mejorar la Gestión de la Distribución Eléctrica," Senplades, Quito,2010.
- [6] P. Erazo, D. X. Morales, and P. A. Pesántez, "Enterprise Architecture for the Utility of the Future: Case Study Ecuador," presented at the IEEE PES INNOVATIVE SMART GRID TECHNOLOGIES LATIN AMERICA (ISGT LATAM), Quito,Ecuador, 2017.
- [7] R. E. Brown, C. S. Wilson, and H. v. Nispen, "Becoming the Utility of the Future: Risks and Opportunities," *IEEE Power and Energy Magazine*, vol. 14, pp. 57-65, 2016.
- [8] N. Hadjsaid and J.-C. Sabonnadière, *Power Systems and Restructuring*. Great Britain: ISTE Ltd and John Wiley & Sons, Inc, 2009.
- [9] R. Chumbi and M. Salao, "Reforzamiento de la Generación en las Islas de Santa Cruz y Baltra, como actualización del "Recambio Tecnológico 2014" " ELECGALAPAGOS, Santa Cruz,Galapagos,2016.
- [10] MEER, "Plan Maestro de Electricidad 2016-2015," Quito,Ecuador,2017.
- [11] JICS, "Design Policy for the Battery System," Japan International Cooperation System Oriental Consultants Co., Ltd2013.
- [12] MINMINAS. (2017, 19/07/2017). *El Ministerio*. Available: <https://www.minminas.gov.co/ministerio1>
- [13] *RESOLUCIÓN 97* 2008.
- [14] *Ley 1715*, 2014.
- [15] *RESOLUCIÓN 05*, 2010.
- [16] *Ley 24/2013*, 2014.
- [17] UPV, "Anexo II. Marco regulatorio de España ", Quito,Ecuador,2015.
- [18] AENOR, "UNE-EN 50160:Características de la tensión suministrada por las redes generales de distribución.," ed. Madrid,España, 2011.
- [19] *Real Decreto 413/2014*, 2014.
- [20] FERC. (2017, 21/07/2017). *Regional Transmission Organizations (RTO)/Independent System Operators (ISO)*. Available: <https://www.ferc.gov/industries/electric/indus-act/rto.asp>
- [21] CAISO. (2017). *Market processes and products*. Available: <http://www.caiso.com/market/Pages/MarketProcesses.aspx>
- [22] G. R. Spotlight. (2017, 21/07/2017). *How Electricity Gets Bought and Sold in California*. Available: <https://www.greentechmedia.com/articles/read/How-Electricity-Gets-Bought-and-Sold-in-California>
- [23] CAISO, "Integration of Renewable Resources," California,2007.
- [24] CEC. (2017, 21/07/2017). *California Renewable Energy Overview and Programs*. Available: <http://www.energy.ca.gov/renewables/index.html>
- [25] PG&E. (2017, 21/07/2017). *Demand Response Program Options*. Available: https://www.pge.com/en_US/business/save-energy-money/energy-management-programs/demand-response-programs/demand-response-programs.page
- [26] NYISO. (2017, 21/07/2017). *New York's Marketplace for Wholesale Electricity*. Available: http://www.nyiso.com/public/webdocs/media_room/publications_presentations/Other_Reports/Other_Reports/NYISO%20Markets%20-%20New%20Yorks%20Marketplace%20for%20Wholesale%20Electricity.pdf

- [27] NYISO. (2017, 21/07/2017). *Ancillary Services*. Available: http://www.nyiso.com/public/markets_operations/market_data/ancillary/index.jsp
- [28] N. P. Authority. (2017, 21/07/2017). *Demand Response*. Available: <http://www.nypa.gov/services/customer-energy-solutions/demand-response>
- [29] O. o. E. E. R. Energy. (2017, 21/07/2017). *Electric Vehicles: Tax Credits and Other Incentives*. Available: <https://energy.gov/eere/electricvehicles/electric-vehicles-tax-credits-and-other-incentives>
- [30] *Order Conditionally Accepting Tariff Changes and Directing Compliance Filing*, 2010.
- [31] NYISO, "Day-Ahead Demand Response Program Manual " 2003.
- [32] X. Cui, "The UK Electricity Markets: Its Evolution, Wholesale Prices and Challenge of Wind Energy," PhD, Division of Economics Stirling Management School, University of Stirling, Stirling, Scotland, UK, 2010.
- [33] ELEXON, "The Balancing and Settlement Code (BSC) Arrangements " 2013.
- [34] N. Grid, "The Statement of Use of System Charges," 2017.
- [35] *The Electricity Safety, Quality and Continuity Regulations 2002*, 2002.
- [36] ENI. (2017, 21/07/2017). *The electricity market in France*. Available: https://www.eni.com/en_FR/products-services/electricity/electricity_market/electricity_market.shtml
- [37] CRE, "ACTIVITY REPORT 2015:15 years of regulation," France2015.
- [38] ENEDIS. (2017). *Missions de service public*. Available: <http://www.enedis.fr/missions-de-service-public>
- [39] European Automobile Manufacturers Association, "Overview of incentives for buying electric vehicles," 2017.
- [40] CENELEC, "Caractéristiques de la tension fournie par les réseaux publics de distribution," ed. Bruxelles, 2000, p. 24.
- [41] A. Mercier, "Pilotage de la production décentralisée et des charges non conventionnelles dans le contexte Smart Grid et simulation hybride temps réel," PhD, Université Grenoble Alpes Grenoble, France, 2015.
- [42] T. Veyrenc, "Market design for Demand Response: the French experience," RTE2014.
- [43] UPV, "Estudio comparativo del marco regulatorio de Ecuador : Conclusiones," Quito, Ecuador, 2015.
- [44] *CONELEC – 004/01: Calidad del Servicio Eléctrico de Distribución*, 2001.
- [45] *La participación de los generadores de energía eléctrica producida con Recursos Energéticos Renovables No Convencionales*, 2013.
- [46] INTERNATIONAL_ENERGY_AGENCY, "Distributed Generation in Liberalised Electricity Markets," Paris, France, 2002.
- [47] G. Pepermans, J. Driesen, D. Haeseldonckx, R. Belmans, and W. D'haeseleer, "Distributed generation: definition, benefits and issues," *Energy Policy*, vol. 33, pp. 787-798, 2005/04/01/ 2005.
- [48] NIST, "Framework and Roadmap for Smart Grid Interoperability Standards," 2014.
- [49] INTERNATIONAL_ENERGY_AGENCY, "Technology Roadmap: Smart Grids," Paris, France, 2011.
- [50] EPRI. (2017). *Smart Grid Resource Center*. Available: <http://smartgrid.epri.com/>
- [51] ISGAN, "Smart Grid Drivers and Technologies by Country, Economies, and Continent," 2012.
- [52] B. Hoang, "Smart Grids," IEEE, 2012.
- [53] D. Schweizer, M. Zehnder, H. Wache, H. F. Witschel, D. Zanatta, and M. Rodriguez, "Using Consumer Behavior Data to Reduce Energy Consumption in Smart Homes: Applying Machine Learning to Save Energy without Lowering Comfort of Inhabitants," in *2015 IEEE 14th International Conference on Machine Learning and Applications (ICMLA)*, 2015, pp. 1123-1129.

- [54] P. Koponen, L. D. Saco, N. Orchard, T. Vorisek, J. Parsons, C. Rochas, *et al.*, "Definition of Smart Metering and Applications and Identification of Benefits," Intelligent Energy Europe, Finland, 2008.
- [55] MeterOn, "Steering the implementation of smart metering solutions throughout Europe," 2014.
- [56] E. Chikuni, "Power System and Substation Automation," ed: InTech, 2012.
- [57] California_Energy_Commission, "The Value of the Distribution Automation," California, U.S., 2009.
- [58] S. Electric, "Advanced Distribution Management System," 2013.
- [59] EPRI, "Volt/VAR Control and Optimization Concepts and Issues," 2011.
- [60] B. Currie, C. Abbey, G. Ault, J. Ballard, B. Conroy, R. Sims, *et al.*, "Flexibility Is Key in New York: New Tools and Operational Solutions for Managing Distributed Energy Resources," *IEEE Power and Energy Magazine*, vol. 15, pp. 20-29, 2017.
- [61] B. Bersenef, "Régulation de la tension dans les réseaux de distribution du futur," Université de Grenoble, 2010.
- [62] J. Varela, N. Hatziargyriou, L. J. Puglisi, M. Rossi, A. Abart, and B. Bletterie, "The IGREENGrid Project: Increasing Hosting Capacity in Distribution Grids," *IEEE Power and Energy Magazine*, vol. 15, pp. 30-40, 2017.
- [63] S. Repo, F. Ponci, D. D. Giustina, A. Alvarez, C. C. Garcia, Z. Al-Jassim, *et al.*, "The IDE4L Project: Defining, Designing, and Demonstrating the Ideal Grid for All," *IEEE Power and Energy Magazine*, vol. 15, pp. 41-51, 2017.
- [64] A. Ballanti, L. N. Ochoa, K. Bailey, and S. Cox, "Unlocking New Sources of Flexibility: CLASS: The World's Largest Voltage-Led Load-Management Project," *IEEE Power and Energy Magazine*, vol. 15, pp. 52-63, 2017.
- [65] G. Jiménez-Estévez, A. Navarro-Espinosa, R. Palma-Behnke, L. Lanuzza, and N. Velázquez, "Achieving Resilience at Distribution Level: Learning from Isolated Community Microgrids," *IEEE Power and Energy Magazine*, vol. 15, pp. 64-73, 2017.
- [66] UPV, "Análisis Conceptual, Definición de Metas y Objetivos," Quito, Ecuador, 2015.
- [67] M. D. Nigris and M. F. Coviello, "Smart grids in Latin America and the Caribbean," Economic Commission for Latin America and the Caribbean, 2012.
- [68] A. J. D. Rathnayaka, V. M. Potdar, T. Dillon, O. Hussain, and S. Kuruppu, "Analysis of energy behaviour profiles of prosumers," in *Industrial Informatics (INDIN), 2012 10th IEEE International Conference on*, 2012, pp. 236-241.
- [69] P. Kotsampopoulos, V. Kleftakis, G. Messinis, and N. Hatziargyriou, "Design, development and operation of a PHIL environment for Distributed Energy Resources," in *IECON 2012 - 38th Annual Conference on IEEE Industrial Electronics Society*, 2012, pp. 4765-4770.
- [70] M. Kezunovic, "Teaching the smart grid fundamentals using modeling, simulation, and hands-on laboratory experiments," in *Power and Energy Society General Meeting, 2010 IEEE*, 2010, pp. 1-6.
- [71] D. X. Morales, R. D. Medina, and Y. Besanger, "Proposal and requirements for a real-time hybrid simulator of the distribution network," in *2015 CHILEAN Conference on Electrical, Electronics Engineering, Information and Communication Technologies (CHILECON)*, 2015, pp. 591-596.
- [72] J. Sanz Feito, "Máquinas eléctricas," Ed. Pearson Educación. Madrid, 2002.
- [73] (2014, 1.5.15). *Single-Phase Line Models*. Available: http://www.openelectrical.org/wiki/index.php?title=Single-Phase_Line_Models
- [74] A. Mercier, "Etude de l'insertion massive de production décentralisée et des charges non conventionnelles dans les réseaux urbains dans le contexte Smart Grid," Master, Institut Polytechnique de Grenoble, France, 2013.
- [75] J. Sifuentes, "Modélisation de réseaux de distribution dans un simulateur temps-réel pour des applications « Smart Grids », " PhD, STAGE PFE, Institut Polytechnique de Grenoble, 2013.
- [76] D. Morales, "Modeling of distribution networks in a Real-time simulator for 'smart grids' Applications," Master, Institut Polytechnique de Grenoble, France, 2014.

- [77] R. D. Medina Velecela, "Plan de gestión del consumo residencial en la Empresa Eléctrica Regional CENTROSUR CA," 2009.
- [78] ESRI. (2017, 29/07/2017). *About ArcGIS*. Available: <http://www.esri.com/arcgis/about-arcgis>
- [79] D. Morales, Medina, R., "Real-Time Hybrid Simulator of the Distribution Network for Smart Grid Applications," *SICEL 2015*, vol. 8, p. 4, November 20th, 2015.
- [80] W. H. Lee, *Power Distribution Planning Reference Book* vol. 2nd: Marcel Dekker, Inc., 2004.
- [81] D. X. Morales, Y. Besanger, C. A. Bel, and R. D. Medina, "Impact assessment of new services in the Galapagos low voltage network," in *2016 IEEE PES Transmission & Distribution Conference and Exposition-Latin America (PES T&D-LA)*, Morelia-Mexico, 2016, pp. 1-6.
- [82] Mathworks. (2017, 31/07/2017). *Create a Custom Library*. Available: <https://fr.mathworks.com/help/simulink/ug/creating-block-libraries.html>
- [83] MEER, "Dashboard Cocinas de Inducción," in *Ministry of Electricity and Renewable Energy of Ecuador*, M. o. E. a. R. E. o. Ecuador, Ed., ed. <http://gis-sigde.maps.arcgis.com/apps/dashboard/index.html#/a84655ed31fc407bb9afdfc0dae968c6>, 2015.
- [84] UPV, "Análisis para la Implementación de Redes Inteligentes en Ecuador," Insituto de Ingeniería Energética, Universidad Politécnica de Valencia, 2015.
- [85] ARCONEL. (2015). *Estadísticas del Sector Electrico - Demanda Anual*.
- [86] D. Sera, R. Teodorescu, and P. Rodriguez, "PV panel model based on datasheet values," in *Industrial Electronics, 2007. ISIE 2007. IEEE International Symposium on*, 2007, pp. 2392-2396.
- [87] O. RT, "Real-Time system fundamentals," 2010.
- [88] Mathworks. (2017, 05/08/2017). *RT-LAB*. Available: https://se.mathworks.com/products/connections/product_detail/product_35401.html
- [89] J. C. Galvis and A. Costa, "Demand Side Management Using Time of Use and Elasticity Price," *IEEE Latin America Transactions*, vol. 14, pp. 4267-4274, 2016.
- [90] F. Bizzozero, G. Gruosso, and N. Vezzini, "A time-of-use-based residential electricity demand model for smart grid applications," in *2016 IEEE 16th International Conference on Environment and Electrical Engineering (EEEIC)*, 2016, pp. 1-6.
- [91] L. Kaira, M. Nthontho, and S. Chowdhury, "Achieving demand side management with appliance controller devices," in *2014 49th International Universities Power Engineering Conference (UPEC)*, 2014, pp. 1-6.
- [92] M. Nijhuis, M. Babar, M. Gibescu, and S. Cobben, "Demand Response: Social Welfare Maximization in an Unbundled Energy Market Case Study for the Low-Voltage Networks of a Distribution Network Operator in The Netherlands," *IEEE Transactions on Industry Applications*, vol. 53, pp. 32-38, 2017.
- [93] S. Zhang, Y. Jiao, and W. Chen, "Demand-side management (DSM) in the context of China's on-going power sector reform," *Energy Policy*, vol. 100, pp. 1-8, 1// 2017.
- [94] S. Werminski, M. Jarnut, G. Benysek, and J. Bojarski, "Demand side management using DADR automation in the peak load reduction," *Renewable and Sustainable Energy Reviews*, vol. 67, pp. 998-1007, 1// 2017.
- [95] S. S. Reka and V. Ramesh, "Demand side management scheme in smart grid with cloud computing approach using stochastic dynamic programming," *Perspectives in Science*, vol. 8, pp. 169-171, 9// 2016.
- [96] D. A. Lima, R. C. Perez, and G. Clemente, "A comprehensive analysis of the Demand Response Program proposed in Brazil based on the Tariff Flags mechanism," *Electric Power Systems Research*, vol. 144, pp. 1-12, 3// 2017.
- [97] J. Soares, M. A. Fotouhi Ghazvini, N. Borges, and Z. Vale, "A stochastic model for energy resources management considering demand response in smart grids," *Electric Power Systems Research*, vol. 143, pp. 599-610, 2// 2017.
- [98] R. Tulabing, R. Yin, N. DeForest, Y. Li, K. Wang, T. Yong, *et al.*, "Modeling study on flexible load's demand response potentials for providing ancillary services at the substation level," *Electric Power Systems Research*, vol. 140, pp. 240-252, 11// 2016.

- [99] X.-t. Chen, Y.-h. Zhou, W. Duan, J.-b. Tang, and Y.-x. Guo, "Design of intelligent Demand Side Management system respond to varieties of factors," in *Electricity Distribution (CICED), 2010 China International Conference on*, 2010, pp. 1-5.
- [100] P. Palensky and D. Dietrich, "Demand Side Management: Demand Response, Intelligent Energy Systems, and Smart Loads," *IEEE Transactions on Industrial Informatics*, vol. 7, pp. 381-388, 2011.
- [101] K. G. Boroojeni, M. H. Amini, S. S. Iyengar, M. Rahmani, and P. M. Pardalos, "An economic dispatch algorithm for congestion management of smart power networks," *Energy Systems*, pp. 1-25, 2016.
- [102] S. Mocci, N. Natale, F. Pilo, and S. Ruggeri, "Demand side integration in LV smart grids with multi-agent control system," *Electric Power Systems Research*, vol. 125, pp. 23-33, 8// 2015.
- [103] D. Morales, Y. Besanger, S. Sami, and C. A. Bel, "Assessment of the impact of intelligent DSM methods in the Galapagos Islands toward a Smart Grid," *Electric Power Systems Research*, vol. 146, pp. 308-320, 2017.
- [104] V. Gouin, M. C. Alvarez-H, and B. Raison, "Operational vs. structural strategies for distribution grid planning in Smart Grids context," in *PowerTech, 2015 IEEE Eindhoven*, 2015, pp. 1-6.
- [105] V. Gouin, M. C. Alvarez-H, and B. Raison, "Benefits of load shedding for distribution grids investments planning," in *2015 IEEE Power & Energy Society General Meeting*, 2015, pp. 1-5.
- [106] A. H. Mohsenian-Rad and A. Leon-Garcia, "Optimal Residential Load Control With Price Prediction in Real-Time Electricity Pricing Environments," *IEEE Transactions on Smart Grid*, vol. 1, pp. 120-133, 2010.
- [107] M. A. Piette, "Automated Demand Response to Enable the Integration of Renewable Resources ", Cuenca,Ecuador,2015.
- [108] L. Kaira, M. Nthontho, and S. Chowdhury, "Achieving demand side management with appliance controller devices," in *Power Engineering Conference (UPEC), 2014 49th International Universities*, 2014, pp. 1-6.
- [109] *Esquema Tarifario para la Introducción de Vehículos Eléctricos en el Ecuador*, ARCONEL, 2015.
- [110] K. Knezović and M. Marinelli, "Phase-wise enhanced voltage support from electric vehicles in a Danish low-voltage distribution grid," *Electric Power Systems Research*, vol. 140, pp. 274-283, 11// 2016.
- [111] M. H. Amini and M. P. Moghaddam, "Probabilistic modelling of electric vehicles' parking lots charging demand," in *2013 21st Iranian Conference on Electrical Engineering (ICEE)*, 2013, pp. 1-4.
- [112] M. H. Amini, A. Kargarian, and O. Karabasoglu, "ARIMA-based decoupled time series forecasting of electric vehicle charging demand for stochastic power system operation," *Electric Power Systems Research*, vol. 140, pp. 378-390, 11// 2016.
- [113] UPV, "Análisis para la Implementación de Redes Inteligentes en Ecuador : Definición Cuantitativa " Instituto de Ingeniería Eléctrica, Quito,Ecuador,2015.
- [114] Greenlys_Project. (2015). *Un premier retour sur expérience* Available: <http://greenlys.fr/>
- [115] D. X. Morales, Y. Besanger, M. Toledo, and R. D. Medina, "Impact Study of New Loads and Time of Use Schedule in the Low Voltage Network," in *IEEE PES Innovative Smart Grid Technologies, Europe Ljubljana-Slovenia*, 2016.
- [116] UPV, "Modelo Conceptual para la Implementación de Redes Inteligentes en Ecuador: Aspectos Técnicos y Económicos " Instituto de Ingeniería Eléctrica, Quito,Ecuador,2015.
- [117] ABB. (2017, 07/08/2017). *Battery Energy Storage Systems (BESS)*. Available: <http://new.abb.com/smartgrids/smart-grid-technologies/energy-storage-solutions/battery-energy-storage-systems>
- [118] A. T. Elsayed, C. R. Lashway, and O. A. Mohammed, "Advanced Battery Management and Diagnostic System for Smart Grid Infrastructure," *IEEE Transactions on Smart Grid*, vol. 7, pp. 897-905, 2016.

- [119] E. Lemaire-Potteau, F. Mattera, A. Delaille, and P. Malbranche, "Assesment of Storage Ageing in Different Types of PV Systems: Technical and Economical Aspects," in *23rd European Photovoltaic Solar Energy Conference and Exhibition*, Valencia, Spain, 2008, pp. 2765-2769.
- [120] K. C. Divya and J. Østergaard, "Battery energy storage technology for power systems—An overview," *Electric Power Systems Research*, pp. 897-905, 2009.
- [121] C. O. Adika and L. Wang, "Non-Cooperative Decentralized Charging of Homogeneous Households' Batteries in a Smart Grid," *IEEE Transactions on Smart Grid*, vol. 5, pp. 1855-1863, 2014.
- [122] C. Jilin, X. Qingshan, Y. Jilei, X. Jinghua, and X. Xiaohui, "Optimal configuration of battery energy storage system considering comprehensive benefits in power systems," in *2016 IEEE 8th International Power Electronics and Motion Control Conference (IPEMC-ECCE Asia)*, 2016, pp. 2650-2653.
- [123] Y. Riffonneau, S. Bacha, F. Barruel, and S. Ploix, "Optimal Power Flow Management for Grid Connected PV Systems With Batteries," *IEEE Transactions on Sustainable Energy*, vol. 2, pp. 309-320, 2011.
- [124] J. Lujano-Rojas, R. Dufo-Lopez, J. Bernal-Agustin, and J. Catalao, "Optimizing Daily Operation of Battery Energy Storage Systems under Real-Time Pricing Schemes," *IEEE Transactions on Smart Grid*, vol. PP, pp. 1-1, 2016.
- [125] G. Carpinelli, F. Mottola, and D. Proto, "Probabilistic sizing of battery energy storage when time-of-use pricing is applied," *Electric Power Systems Research*, pp. 73-83, 2016.
- [126] J. Jargstorf, C. De Jonghe, and R. Belmans, "Assessing the reflectivity of residential grid tariffs for a user reaction through photovoltaics and battery storage," *Sustainable Energy, Grids and Networks*, vol. 1, pp. 85-98, 3// 2015.
- [127] Y. Zhou, P. Mancarella, and J. Mutale, "Modelling and assessment of the contribution of demand response and electrical energy storage to adequacy of supply," *Sustainable Energy, Grids and Networks*, vol. 3, pp. 12-23, 9// 2015.
- [128] M. Katsanevakis, R. A. Stewart, and J. Lu, "Aggregated applications and benefits of energy storage systems with application-specific control methods: A review," *Renewable and Sustainable Energy Reviews*.
- [129] T. Yunusov, D. Frame, W. Holderbaum, and B. Potter, "The impact of location and type on the performance of low-voltage network connected battery energy storage systems," *Applied Energy*, vol. 165, pp. 202-213, 3/1/ 2016.
- [130] A. Mercier, C. Benoit, Y. Besanger, A. Rumeau, and C. Boudinet, "Comparative study of solar panel decentralized controls in low voltage network with real time simulation," in *2015 IEEE Power & Energy Society General Meeting*, 2015, pp. 1-5.
- [131] A. Mercier, C. Benoit, and Y. Besanger, "Best phase connection for DGs using individual smart meter data," in *2014 IEEE PES General Meeting Conference & Exposition*, 2014, pp. 1-5.
- [132] F. Matthey, T. Kamijoh, K. Takeda, S. Ando, T. Nomura, T. Shibata, *et al.*, "Cost-benefit analysis tool and control strategy selection for lithium-ion battery energy storage system," in *2015 IEEE Power & Energy Society General Meeting*, 2015, pp. 1-5.
- [133] PowerThru. (2016, 29/12/2016). *LEAD ACID BATTERY working – LIFETIME STUDY*. Available: <http://www.power-thru.com/documents/The%20Truth%20About%20Batteries%20-%20POWERTHRU%20White%20Paper.pdf>
- [134] Y. Ru, J. Kleissl, and S. Martinez, "Storage Size Determination for Grid-Connected Photovoltaic Systems," *IEEE Transactions on Sustainable Energy*, vol. 4, pp. 68-81, 2013.
- [135] H. Mita, "Simulation of Small Scale micro Grid during 24 Hours by Phasor Method in Simulink " MathWorks Japan, 2016.
- [136] S. Faias, J. Sousa, and R. Castro, "Contribution of energy storage systems for power generation and demand balancing with increasing integration of renewable sources:

- application to the Portuguese power system," in *Power Electronics and Applications, 2007 European Conference on*, 2007, pp. 1-10.
- [137] Battery_University. (2016). *BU-403: Charging Lead Acid*. Available: http://batteryuniversity.com/learn/article/charging_the_lead_acid_battery
- [138] *Precios de la Energía Producida con Recursos Energéticos Renovables No Convencionales*, ARCONEL, 2006.
- [139] Quanta_Technology, "Distribution Automation Planning," Cuenca,Ecuador,2013.
- [140] IEEE, "IEEE Guide for Electric Power Distribution Reliability Indices," ed. New York, 2012, p. 43.
- [141] R. Brown, *Electric Power Distribution Reliability -Chapter 6*. United States of America: Marcel Dekker,Inc., 2002.
- [142] J. R. Aguero, R. E. Brown, J. Spare, E. Phillips, L. Xu, and J. Wang, "A reliability improvement roadmap based on a predictive model and extrapolation technique," in *2009 IEEE/PES Power Systems Conference and Exposition*, 2009, pp. 1-8.
- [143] R. E. Brown, *Electric Power Distribution Reliability*, Second ed.: CRC Press, 2008.
- [144] J. J. Burke and D. J. Lawrence, "Characteristics of Fault Currents on Distribution Systems," *IEEE Power Engineering Review*, vol. PER-4, pp. 26-26, 1984.
- [145] IEEE, "IEEE Standard Definitions for Power Switchgear," *IEEE Std C37.100-1992*, p. 0_1, 1992.
- [146] CYME, "Curso de capacitación en el uso de CYMDIST," First ed, 2016, pp. 164-166.
- [147] Quanta_Technology, "Lineamientos para la Automatización de la Distribución," 2013.
- [148] CYME, "RAM User Guide," ed. Canada: CYME International T&D Inc, 2017.
- [149] P. Vásquez and A. Vaca, "Methodology for Estimating the Cost of Energy not Supplied - Ecuadorian Case," in *2012 Sixth IEEE/PES Transmission and Distribution: Latin America Conference and Exposition (T&D-LA)*, 2012, pp. 1-9.
- [150] CYME, "Tutorial :Network Configuration Optimization," ed. Canada: CYME International T&D Inc, 2017.
- [151] J. Green, J. Roark, and J. Parks. (2015, 19/08/2017). *Determining the impacts of volt/VAR optimization: a tale of two approaches*. Available: http://www.elp.com/articles/powergrid_international/print/volume-20/issue-8/features/determining-the-impacts-of-volt-var-optimization-a-tale-of-two-approaches.html
- [152] NEMA, "Volt/VAR Optimization Improves Grid Efficiency,," 2015.
- [153] M. Castro, A. Moon, L. Elner, D. Roberts, and B. Marshall, "The value of conservation voltage reduction to electricity security of supply," *Electric Power Systems Research*, vol. 142, pp. 96-111, 2017/01/01/ 2017.
- [154] CYME, "Volt / Var Optimization Analysis," ed. Canada: CYME International T&D Inc, 2017.
- [155] CYME. (2017, 07-07-2017). *Análisis de Sistemas de Distribución*. Available: <http://www.cyme.com/es/software/cymdist/>
- [156] UPV, "Estudio sociológico para medida y mejora del grado de aceptación de los cambios identificado," Quito,Ecuador,2015.
- [157] D. E. Olivares, C. A. Cañizares, and M. Kazerani, "A centralized optimal energy management system for microgrids," in *2011 IEEE Power and Energy Society General Meeting*, 2011, pp. 1-6.
- [158] W. Shi, X. Xie, C. C. Chu, and R. Gadh, "Distributed Optimal Energy Management in Microgrids," *IEEE Transactions on Smart Grid*, vol. 6, pp. 1137-1146, 2015.
- [159] M. Choobineh, P. C. Tabares-Velasco, and S. Mohagheghi, "Optimal energy management of a distribution network during the course of a heat wave," *Electric Power Systems Research*, vol. 130, pp. 230-240, 2016.
- [160] Smartislandsinitiative. (2017, 05/09/2017). *The Initiative*. Available: <http://www.smartislandsinitiative.eu/en/about.php>
- [161] N. d'Ozouville. (2012, Fresh water: the reality of a critical resource 5. Available: <https://www.galapagos.org/wp-content/uploads/2012/04/biodiv10-fresh-water-reality.pdf>

- [162] M. Curiale, "From smart grids to smart city," in *2014 Saudi Arabia Smart Grid Conference (SASG)*, 2014, pp. 1-9.
- [163] M. Li, H. Xiao, W. Gao, and L. Li, "Smart grid supports the future intelligent city development," in *2016 Chinese Control and Decision Conference (CCDC)*, 2016, pp. 6128-6131.
- [164] J. Mandic-Lukic, B. Milinkovic, and N. Simic, "Communication solutions for smart grids, smart cities and smart buildings," in *Mediterranean Conference on Power Generation, Transmission, Distribution and Energy Conversion (MedPower 2016)*, 2016, pp. 1-7.
- [165] M. Emmanuel and R. Rayudu, "Communication technologies for smart grid applications: A survey," *Journal of Network and Computer Applications*, vol. 74, pp. 133-148, 2016.
- [166] Department_of_Energy, "Communcations Requirements of Smart Grid Technologies," EEUU,2010.
- [167] S. F. Bush, S. Goel, and G. Simard, "IEEE Vision for Smart Grid Communications: 2030 and Beyond Roadmap," *IEEE Vision for Smart Grid Communications: 2030 and Beyond Roadmap*, pp. 1-19, 2013.
- [168] J. Gao, Y. Xiao, J. Liu, W. Liang, and C. L. P. Chen, "A survey of communication/networking in Smart Grids," *Future Generation Computer Systems*, vol. 28, pp. 391-404, 2012.
- [169] Y. Kabalci, "A survey on smart metering and smart grid communication," *Renewable and Sustainable Energy Reviews*, vol. 57, pp. 302-318, 2016/05/01/ 2016.
- [170] A. Naamane and N. K. Msirdi, "Towards a Smart Grid Communication," *Energy Procedia*, vol. 83, pp. 428-433, 2015/12/01/ 2015.
- [171] IEEE, "Application integration at electric utilities –System interfaces for distribution management " in *Interface architecture and general requirements*, ed. Geneva,Switzerland, 2003, p. 68.
- [172] V. Namboodiri, V. Aravinthan, S. N. Mohapatra, B. Karimi, and W. Jewell, "Toward a Secure Wireless-Based Home Area Network for Metering in Smart Grids," *IEEE Systems Journal*, vol. 8, pp. 509-520, 2014.
- [173] Gartner. (2017, 24/08/2017). *Advanced Distribution Management Systems*. Available: <http://www.gartner.com/it-glossary/advanced-distribution-management-systems-adms>
- [174] Telvent, "Arquitectura y Configuración del Sistema," Quito,2013.
- [175] S. Electric. (2012, SCADA Systems. 13. Available: http://www.schneider-electric.com/solutions/ww/es/med/20340568/application/pdf/1485_se-whitepaper-letter-scadaoverview-v005.pdf
- [176] IEEE, "Telecontrol equipment and systems –," in *Transmission protocols –Companion standard for basic telecontrol tasks*, ed. Geneva, 2003, p. 157.
- [177] IEEE, "Telecontrol equipment and systems –," in *Transmission protocols – Network access for IEC 60870-5-101 using standard transport profiles*, ed. Geneva, 2006, p. 139.
- [178] IEEE, "Communication networks and systems for power utility automation," ed. Geneva, 2017.
- [179] E. Light&Power, "DNP vs. IEC," First ed, 2009.
- [180] C. Tapia and C. Yopez. (2010, Diseño e Implementación de una red para el transporte de datos, voz e internet para conexión de nodos de Fibra Optica de Telconet Galapagos entre las islas Santa Cruz y San Cristobal. Available: <https://www.dspace.espol.edu.ec/bitstream/123456789/13594/1/Dise%C3%B1o%20e%20implementacion%20de%20una%20red%20para%20el%20transporte%20de%20datos.pdf>
- [181] R. Lara-Cueva, G. Olmedo, M. Acosta, and J. Sandoval, "Performance evaluation of the new algorithm of the TCP protocol for a long distance wireless link in the Galapagos Islands," in *2016 IEEE International Engineering Summit, II Cumbre Internacional de las Ingenierias (IE-Summit)*, 2016, pp. 1-5.
- [182] IEEE, "Telecontrol protocols compatible with ISO standards and ITU-T recommendations – TASE.2 Services and protocol," ed. Geneva,Switzerland, 2002, p. 107.
- [183] AEIC, "SmartGrid/AEIC AMI Interoperability Standard Guidelines for ANSI C12.19 / IEEE 1377 / MC12.19," The Association of Edison Illuminating Companies,2012.

- [184] D. X. Morales, D. Icaza, P. Flores, F. Conce, G. Conce, R. D. Medina, *et al.*, "Enhanced placement of fault locators on overhead distribution networks," in *2016 IEEE International Conference on Automatica (ICA-ACCA)*, 2016, pp. 1-7.
- [185] K. Sharma and L. Mohan Saini, "Performance analysis of smart metering for smart grid: An overview," *Renewable and Sustainable Energy Reviews*, vol. 49, pp. 720-735, 2015/09/01/ 2015.
- [186] M. Kuzlu, M. Pipattanasomporn, and S. Rahman, "Communication network requirements for major smart grid applications in HAN, NAN and WAN," *Computer Networks*, vol. 67, pp. 74-88, 2014/07/04/ 2014.
- [187] T. A. Papadopoulos, C. G. Kaloudas, A. I. Chrysochos, and G. K. Papagiannis, "Application of Narrowband Power-Line Communication in Medium-Voltage Smart Distribution Grids," *IEEE Transactions on Power Delivery*, vol. 28, pp. 981-988, 2013.
- [188] R. Benato and R. Caldon, "Distribution Line Carrier: Analysis Procedure and Applications to DG," *IEEE Transactions on Power Delivery*, vol. 22, pp. 575-583, 2007.
- [189] S. Canale, A. D. Giorgio, A. Lanna, A. Mercurio, M. Panfili, and A. Pietrabissa, "Optimal Planning and Routing in Medium Voltage PowerLine Communications Networks," *IEEE Transactions on Smart Grid*, vol. 4, pp. 711-719, 2013.
- [190] C. Jin and T. Kunz, "Smart home networking: Combining wireless and powerline networking," in *2011 7th International Wireless Communications and Mobile Computing Conference*, 2011, pp. 1276-1281.
- [191] C. J. Kikkert, "MV to LV transformer PLC bypass coupling networks for a low cost Smart Grid rollout," in *2011 IEEE PES Innovative Smart Grid Technologies*, 2011, pp. 1-6.
- [192] EUROPEAN COMMISSION, "Smart Grids: From Innovation to Deployment," Brussels, 2011.
- [193] ENEDIS. (2017, 14/09/2017). *SO GRID: A project experiment with a PLC communication chain to control the distribution network*. Available: <http://www.enedis.fr/so-grid-0#onglet-main-results>
<http://www.enedis.fr/so-grid-0#onglet-main-results>
- [194] B. Lichtensteiger, B. Bjelajac, C. Mueller, and C. Wietfeld, "RF Mesh Systems for Smart Metering: System Architecture and Performance," in *2010 First IEEE International Conference on Smart Grid Communications*, 2010, pp. 379-384.
- [195] I. F. Akyildiz and W. Xudong, "A survey on wireless mesh networks," *IEEE Communications Magazine*, vol. 43, pp. S23-S30, 2005.
- [196] M. Eslami, O. Karimi, and T. Khodadadi, "A survey on wireless mesh networks: Architecture, specifications and challenges," in *2014 IEEE 5th Control and System Graduate Research Colloquium*, 2014, pp. 219-222.
- [197] "IEEE Standard for Local and metropolitan area networks--Part 15.4: Low-Rate Wireless Personal Area Networks (LR-WPANs) Amendment 3: Physical Layer (PHY) Specifications for Low-Data-Rate, Wireless, Smart Metering Utility Networks," *IEEE Std 802.15.4g-2012 (Amendment to IEEE Std 802.15.4-2011)*, pp. 1-252, 2012.
- [198] EPRI. (2011, 28/08/2017). *The Field Area Network FAN*. Available: https://web.stanford.edu/class/archive/ee/ee392n/ee392n.1116/Lectures/EE392n_Lecture4.pdf
- [199] CISCO, "Unified Field Area Network Architecture for Distribution Automation," 2014.
- [200] N. Ahmed, H. Rahman, and M. I. Hussain, "A comparison of 802.11ah and 802.15.4 for IoT," *ICT Express*, vol. 2, pp. 100-102, 2016/09/01/ 2016.
- [201] "IEEE Adoption of Smart Energy Profile 2.0 Application Protocol Standard," *IEEE Std 2030.5-2013*, pp. 1-348, 2013.
- [202] "IEC PAS 62746-10-1:2014 Systems interface between customer energy management system and the power management system - Part 10-1: Open Automated Demand Response (OpenADR 2.0b Profile Specification)," 2014, p. 101.
- [203] O. Alliance. (2017, 30/08/2017). *VTN&VEN*. Available: <http://www.openadr.org/faq#21>
- [204] U. Herberg, D. Mashima, J. G. Jetcheva, and S. Mirzazad-Barijough, "OpenADR 2.0 deployment architectures: Options and implications," in *2014 IEEE International Conference on Smart Grid Communications (SmartGridComm)*, 2014, pp. 782-787.

- [205] E. K. Lee, R. Gadh, and M. Gerla, "Energy Service Interface: Accessing to Customer Energy Resources for Smart Grid Interoperation," *IEEE Journal on Selected Areas in Communications*, vol. 31, pp. 1195-1204, 2013.
- [206] T. Shimizu, A. Yokoyama, K. Sato, and K. Kumita, "Smart charging system for PEV based on SEP 2.0 and SAE standards," in *2014 IEEE International Conference on Smart Grid Communications (SmartGridComm)*, 2014, pp. 692-697.
- [207] Smart_Electric_Power_Alliance, "Utilities and Electric Vehicles: The case for managed charging," 2017.

ABSTRACT

The Galápagos Islands are an archipelago of volcanic islands located in the Pacific Ocean, 926 km west of continental Ecuador, of which they are a part. Since 1978, Galapagos Islands are accepted as Heritage World. Due to the growth of the population, there are several social, economic and environmental problems, which endanger the environment conservation of the Islands.

In this context, the Ecuadorian government desires to preserve its ecological heritage. Hence, with the participation of several stakeholders, mainly the Ministry of Energy and Renewable Energy, it is releasing a lot of initiatives. In order to improve the general services that are provided in the islands, this goal will be achieved by means of reducing fossil fuel consumption and therefore CO₂ emissions. Thus, this thesis has analyzed the impact of new services on the grid such as the mandatory replacement of conventional vehicles and cookers for efficient ones and to propose solutions for reducing negative issues originated on the network. Also, a strong integration of distributed generation is considered in the analysis.

In addition, innovative solutions for both low and medium voltage have been designed and tested for improving the electrical service without affecting the environment and conserving this world heritage. For instance, a smart DSM program composed of Time Of Use scheme combined with Demand Response has shown interesting results, the installation of a Battery Energy Storage System has been studied as well; the results in Medium Voltage are promising. An Automatic Phase Switching system is adapted like a solution for reducing unbalance in low voltage with impressive results. The deployment of reclosers has demonstrated a considerable improvement in the reliability with a very short Return On Investment.

Considering the Information and Communication Technologies, a key piece to deploy Smart Grids, the communication architecture of the Neighbor, Field and Home Area Networks is addressed.

An important contribution is a methodology proposed to perform analysis on a large scale considering that all the clients connect to Santa Cruz distribution network. The percentage of integration of each new service is determined through sociological studies. As last, an Energy Management System for performing optimal energy management within Galapagos is designed. All these studies have a significant challenge: the optimal management of electricity of isolated grid with zero fossil energy.

RÉSUMÉ

Les îles Galápagos sont un archipel d'îles volcaniques situées dans l'océan Pacifique, à 926 km à l'ouest de l'Equateur continental, dont elles font partie. Depuis 1978, les îles Galápagos sont acceptées comme patrimoine mondial. En raison de la croissance de la population, il existe plusieurs problèmes sociaux, économiques et environnementaux qui mettent en péril la conservation de l'environnement des îles.

Dans ce contexte, le gouvernement équatorien veut préserver son patrimoine écologique. Par conséquent, avec la participation de plusieurs intervenants, principalement du ministère de l'Énergie et des Énergies renouvelables, beaucoup d'initiatives ont été lancées. Avec, l'amélioration des services généraux fournis dans les îles, cet objectif de préservation sera atteint grâce à la réduction de la consommation de combustibles fossiles et donc des émissions de CO₂. Ainsi, cette thèse a analysé l'impact des nouveaux services sur le réseau, par exemple le remplacement obligatoire des véhicules conventionnels et des cuisinières pour des solutions efficaces. Aussi, elle propose des solutions pour réduire les impacts négatifs sur le réseau et une forte intégration de la génération distribuée est considérée dans l'analyse.

De plus, des solutions innovantes à la fois en basse et moyenne tension ont été conçues et testées pour améliorer le service électrique sans affecter l'environnement et conserver ce patrimoine mondial. Par exemple, un programme intelligent DSM composé d'un schéma de temps d'utilisation (TOU) combiné à la réponse à la demande (DR) a montré des résultats intéressants, l'installation d'un système de stockage d'énergie de batterie a également été étudié; les résultats de moyenne tension sont prometteurs. Un système de commutation de phase automatique a été adapté comme une solution pour réduire le déséquilibre en basse tension avec de bons résultats. Le déploiement des réenclencheurs a démontré une amélioration considérable de la fiabilité avec un retour sur investissement très court.

Compte tenu des technologies de l'information et de la communication, une pièce clé pour déployer des Smart Grids, l'architecture de communication des réseaux de NAN/FAN/HAN est abordée.

Une contribution importante est une méthodologie proposée pour effectuer une analyse à grande échelle étant donné que tous les clients se connectent au réseau de distribution de Santa Cruz. Le pourcentage d'intégration de chaque nouveau service est déterminé par des études sociologiques. Enfin, un système de gestion de l'énergie pour la gestion optimale de l'énergie au sein des Galápagos est conçu. Toutes ces études ont un défi majeur : la gestion optimale de l'électricité d'un réseau isolé sans énergie fossile.

Résumé français

Les îles Galápagos sont un archipel d'îles volcaniques situées dans l'océan Pacifique, à 926 km à l'ouest de l'Équateur continental, dont elles font partie. Depuis 1978, les îles Galápagos sont acceptées comme patrimoine mondial, en raison de la croissance de la population, il existe plusieurs problèmes sociaux, économiques et environnementaux qui mettent en danger la conservation de l'environnement des îles.

Dans ce contexte, le gouvernement équatorien veut préserver son patrimoine écologique. Par conséquent, avec la participation de plusieurs parties prenantes, principalement le ministère de l'Énergie et des Énergies renouvelables, il publie de nombreuses initiatives. Afin d'améliorer les services généraux fournis dans les îles, cet objectif sera atteint grâce à la réduction de la consommation de combustibles fossiles et donc des émissions de CO₂. Ainsi, la première étape consistait à effectuer une revue bibliographique de l'état de l'art des réseaux traditionnels ainsi que des Réseaux Intelligents –SG-. Le but a deux fois pour objectif, d'une part, d'identifier les dernières avancées dans le monde dans le domaine de la SG et, au contraire, d'avoir une vision claire des principales faiblesses de la réglementation équatorienne. Les analyses ont révélé qu'en Équateur, il existe des obstacles réglementaires importants à la mise en œuvre de SG, principalement pour la perte d'un cadre réglementaire pour l'exécution de DSM, et il n'existe pas non plus de marché de détail. Les incitations au déploiement de la DG ne sont applicables qu'au niveau MV / HV, et le TOU sont disponibles uniquement au niveau des utilisateurs industriels.

Avec l'arrivée de Smart Grids, les consommateurs deviendront prosumers (producteur + consommateur). Étant donné que les DG, les équipements de contrôle, les EV, les appareils de stockage, les appareils intelligents, entre autres nouveaux services, sont connectés dans des réseaux basse tension, il est nécessaire d'aborder la modélisation du système basse tension de manière appropriée. Cette thèse a évalué l'impact sur le réseau basse tension des cuisinières à induction, des motos électriques et de la production distribuée (panneaux photovoltaïques) en utilisant une interface puissante pour extraire des informations du Système d'Information Géographique -GIS- puis l'importer dans Matlab / Simulink. Ainsi, un transformateur MV / LV représentatif avec son réseau LV a été sélectionné pour effectuer les simulations. Dans ce système sélectionné, tous les nouveaux services sont intégrés. Différents scénarios ont été créés pour quantifier l'impact de nouveaux services et les principaux résultats ont montré que les scénarios avec des cuisinières à induction produisent deux pics le long de la journée ; les deux sont supérieurs à la puissance nominale. De même, le scénario avec motos électriques et en croissance présente des pics considérables, le scénario avec PV peut supprimer le premier pic à midi et même inverser le flux. Cependant, le pic de nuit pour des raisons évidentes est toujours présent.

En outre, des solutions innovantes à la fois basse et moyenne tension ont été conçues et testées pour améliorer le service électrique sans affecter l'environnement et conserver ce patrimoine mondial. Une fois déterminé l'impact des nouveaux services, il vaut la peine de proposer des stratégies intelligentes pour faire face à la croissance de la charge due à ces services et résoudre des problèmes tels que les chutes de tension, les pics de puissance, le courant neutre, entre autres. Deux stratégies ont

été analysées, la première définie par ARCONEL et le second un schéma mis à jour effectué par UPV, les deux ne tiennent pas compte de l'effet de rebond et les limites pour les profils de tension ne sont pas respectées. Ainsi, une stratégie intelligente qui considère uniquement les actions sur les charges de rafale et utilise un programme DSM moderne (DR + TOU) pour supprimer le rebond a été développée, en utilisant une fonction de pondération intelligente, l'énergie est déplacée tout au long de la journée. Il a été possible d'identifier que, en utilisant ce programme DSM, le pic généré par le rebond dans les scénarios précédents est annulé en raison de la prise en compte d'un contrôleur installé chez les ménages puisque ce scénario prend en compte la mise en œuvre d'un contrôleur de périphérique d'appareil dans chaque ménage. La puissance la plus élevée pendant la journée est de 64,07 kVA, et les tensions des phases L1 et L2 respectent la régulation de la qualité (114,3 V minimum). Compte tenu de toutes ces valeurs, il est facile de conclure que ce scénario est le meilleur. Cependant, un pic de puissance vers 19h30 existe toujours, et pendant ce pic, le transformateur MV / LV est surchargé. Pour raser ce pic et éviter cette surcharge, un moyen bien connu est l'utilisation du stockage. Par conséquent, un système de stockage d'énergie de batterie est développé ainsi qu'un contrôleur adapté au cas particulier de Galápagos.

Un modèle détaillé pour déterminer les possibilités de stockage dans un contexte avec les tarifs TOU est présenté en tenant compte de la génération PV. Afin de dimensionner la batterie, certaines contraintes sont considérées comme i) balance de puissance dans le système, ii) dégradation des piles, iii) déglacage et iv) énergie de charge / décharge maximale. Ainsi, la batterie qui atteint un coût proche de zéro est de 19,5 KWh. Les simulations ont montré que la demande maximale est maintenant de 49,1 kVA en raison de l'action de la batterie. Par conséquent, une réduction considérable a été atteinte ; il convient de noter que le contrôleur démarre le processus de chargement lorsque la génération PV est supérieure à la charge jusqu'à ce que la production soit égale à la charge. Selon les résultats, le contrôleur effectue de manière appropriée sa fonction. Cela signifie que toutes les contraintes sont respectées. Afin que le déploiement des batteries soit bénéfique, les batteries doivent être considérées comme une ressource énergétique distribuée et les consommateurs qui utilisent des piles pour réduire le pic devraient être bénéficiaires d'une TOU de 0,33 USD / kWh.

En outre, un système de commutation automatique de phase -CAP- est adapté comme une solution pour réduire le déséquilibre en basse tension avec des résultats impressionnants; le système serait adapté pour fonctionner dans la configuration la plus typique de Galápagos, autrement dit 1P3W. Cela signifie que le système choisirait entre la phase L1 ou la phase L2. À des fins de test, le même réseau LV est sélectionné et trois systèmes CAP sont installés à différentes distances du transformateur; Un à la barre de bus secondaire du transformateur, un à la fin d'un alimentateur, et un au milieu d'un alimentateur. L'algorithme utilise comme données d'entrée les mesures de tension locales des deux phases et le courant produit par la DG. Ces quantités permettent d'effectuer une estimation de l'impact d'une commutation sur les tensions de phase et donner ainsi une validation de commutation si nécessaire. Afin de constater un meilleur effet, les actions suivantes pourraient être prises en compte :

1. Le déséquilibre devrait être plus élevé.
2. La puissance PV doit être augmentée, en effet, si le PV a un faible effet sur la tension, le système CAP n'est pas utile.

3. Plus de systèmes CAP pourraient être déployés, car la simulation est considérée comme 1 par nœud, c'est au total 3.

Il est important de mentionner qu'EM et IC ne génèrent pas une augmentation du déséquilibre puisqu'ils sont connectés à 240 V.

Une fois proposées différentes solutions innovantes en basse tension, on étudie la mise en œuvre des fonctions de Automatisation de distribution Avancée en moyenne tension ; la reconfiguration du réseau, le déploiement du réenclencheur et les fonctions VVO sont choisis pour l'analyse. Étant donné que ces fonctions amélioreront la fiabilité, réduiront les pertes et garderont les tensions dans les limites réglementées respectivement, avec de petits investissements

Le déploiement des réenclencheurs a démontré une amélioration considérable de la fiabilité avec un retour sur investissement très court. Afin de déterminer la fiabilité initiale, un modèle prédictif a été mis en œuvre au sein de CYMDIST, étant donné que les indices de Galápagos sont supérieurs aux limites requises, la fonction objective a considéré l'amélioration de SAIDI et de SAIFI. Une méthode séquentielle pour l'optimisation a été utilisée en raison de sa simplicité et de ses bons résultats; cette approche place le premier réenclencheur à chaque emplacement du réseau et trouve le meilleur endroit avant de répéter le même processus avec le second. Les résultats de l'installation de quatre réenclencheurs dans le chargeur sont prometteurs car le retour sur investissement sera réalisé dans 2,18 ans.

La reconfiguration optimale du réseau dans le cas de l'alimentateur 1 est théoriquement possible; cependant, son application pratique n'est pas viable pour l'affaire Galápagos puisque les alimentateurs n'ont pas suffisamment de points d'interconnexion. La stratégie VVO pour le cas particulier de l'alimentateur 1 ne trouve aucune proposition d'amélioration en raison principalement du manque d'éléments pour l'injection d'énergie réactive et du fait que les niveaux de tension actuels sont en valeurs conformes à la réglementation.

Actuellement, en Équateur, une WAN exclusive pour le secteur de la distribution a été établie. Ce réseau interconnecte les différents Entreprises Électriques, et il y a trois nœuds principaux à Quito, Guayaquil et Cuenca formant l'épine dorsale. Le support est une fibre optique et la capacité de transmission est de 10 Gbps. CELEC-Transelectric possède le réseau. Cependant, l'architecture pour les segments plus près de l'utilisateur final est nécessaire. ADMS est la plate-forme logicielle qui prend en charge la gestion complète de la gestion et de l'optimisation de la distribution, la nouvelle architecture proposée considère une RTU par poste de source qui doit pouvoir recevoir des informations provenant de différentes sources en utilisant différents supports. Compte tenu de l'objectif d'homologation du projet SIGDE, la solution adoptée est basée sur le concept serveur / clients ; Cela signifie que l'application principale est installée dans les National Data Centers (CDN1 et CDN2) et que les clients (20 Entreprises) connectent leurs consoles d'exploitation au serveur à l'aide du WAN.

Dans l'archipel, des dizaines de kilomètres séparent les îles, les interconnecter par la fibre optique n'est pas une solution viable en raison de certaines considérations importantes

1. Le coût d'implémentation est encore plus élevé que la solution sans fil.

2. La capacité de transmission sans fil entre les îles peut atteindre jusqu'à 42Mbps; sa valeur est plus que suffisante pour les applications de contrôle et de surveillance.

3. Le fond marin de Galápagos rend difficile le déploiement des fibres.

Par conséquent, une communication sans fil doit être considérée. Compte tenu des technologies de l'information et de la communication, une pièce clé pour déployer Smart Grids, l'architecture de communication des réseaux NAN/FAN/HAN est abordée. Pour le segment NAN, les technologies PLC et mesh RF sont combinées. La raison est simple; en raison de la topologie des îles, il sera plus rentable de déployer l'automate entre Meter-Meter et Meter-Data Concentrator -DC- que RF mesh dans certains endroits. En outre, des conditions défavorables existent, où le maillage RF ne peut pas être implémenté en raison du manque de couverture dans les zones d'accès difficiles telles que les sous-sols, les bâtiments élevés, les points lointains, entre autres. Le concentrateur de données est le pont entre la NAN et le FAN ; Il est équipé d'interfaces différentes pour les communications sans fil et câblées. Pour la zone FAN, le protocole IEEE 802.11 est choisi car il s'agit d'une norme de communication prometteuse qui permet d'améliorer i) l'évolutivité, ii) la faible consommation d'énergie, et iii) la couverture de grande surface.

En ce qui concerne le segment HAN, le protocole SEP 2.0 est choisi car couvre entièrement le concept Internet de choses. D'autre part, pour la proposition Intelligente DSM développée, le protocole OpenADR convient. L'EV est chargé dans le ménage à l'aide d'un chargeur lent. Il existe certaines variables importantes à surveiller, telles que le SOC et la puissance consommée, même si l'EV pourrait participer aux programmes DR en raison de sa puissance supérieure. Afin d'effectuer une réponse automatisée de la demande pour la charge EV, un protocole de communication entre EV et un réseau de distribution est requis, dans ce cas SEP 2.0 couvre également cette nécessité.

C'est un point essentiel pour obtenir une vision détaillée des changements qui pourraient subir tout le réseau de distribution, compte tenu de l'objectif ferme de la mise en place d'installations de réseaux intelligents sous peu dans les îles Galápagos. Ainsi, une analyse portant sur tous les clients et les trois alimentateurs a été réalisée. Le pourcentage d'intégration d'IC, EM et DG a été défini en fonction d'études sociologiques basées sur plusieurs rencontres avec différents secteurs à Santa Cruz, au moyen de groupes de discussion, le degré d'acceptation des nouvelles technologies a été défini. À partir de ces mesures réelles, l'objectif était de développer une méthodologie pour créer des profils de charge des consommateurs finaux, qui ne sont pas disponibles, bien sûr, car il n'existe actuellement aucun dispositif de mesure à ce niveau. Ces courbes de charge du client ont ensuite été incluses dans le modèle de réseau détaillé dans CYMDIST pour effectuer les simulations. La stratégie DSM est considérée dans chaque client. Dans le profil de base du client seront intégrés des profils moyens pour IC et EM; cette considération est valable car l'analyse cherche à déterminer l'impact dans la sous-station et, dans ce niveau, les profils sont beaucoup plus agrégés. Le scénario de base 9 ans plus tard (avec IC et EM et sans DSM et DG) a montré une puissance maximale de 10.648,56 kVA (somme des pics de puissance des trois alimentateurs); les pics dans les trois alimentateurs sont coïncidents et sont atteints à 18h45. Considérant que la capacité installée à Santa Cruz est de 8,75 MVA, la consommation dépassera la génération de 21% en 9 ans si aucun DSM et DG ne sont mis en œuvre.

Une nouvelle analyse du flux de charge prenant en considération la DG et le DSM a été effectuée; comme on pouvait s'y attendre, on observe une réduction de 8,8% dans le sommet supérieur,

soit maintenant de 9,709,98 kVA. Cette diminution est due à la stratégie DSM. En outre, une réduction du pic du midi est atteinte grâce au déploiement de la DG. La diminution va de 9.000kVA à 8.451kVA (6,1%). Cependant, un nouveau pic de 8,039 kVA apparaît près de minuit puisque la fonction de pondération déplace l'énergie à ces heures. Bien que la génération existante puisse fournir cette valeur, elle est dangereuse car toute défaillance dans une unité de génération entraînerait des pannes de courant, car il n'y a pas assez de réserve à ce stade.

La simulation finale considère qu'un EMS centralisé sera installé à Galápagos, l'EMS profitera du système ADMS ainsi que de l'architecture de communication proposée. Ainsi, avec la mise en œuvre d'un BESS, il est possible de différer les investissements dans la production thermique, car il a été démontré que le pic principal pendant toute la journée se produit vers 18:45-19:15. Ainsi, les énergies renouvelables ne sont pas disponibles dans cette période. Deuxièmement, pour charger le BESS pendant la matinée (4:00 - 16:00), la ressource thermique est utilisée. La charge sera composée de la charge inhérente de l'île, plus la charge de la batterie. Ici, il est important de noter que le pic du midi a été réduit par le déploiement de la DG avec 100% d'intégration (obtenue avec des incitations appropriées et un cadre réglementaire amélioré). Avec toutes ces mesures, la courbe de génération d'énergie a une forme lissée avec une exception de 18:00 à 21:00, où toute l'énergie stockée pendant la matinée est utilisée pour fournir la charge.

Pour pouvoir faire de Galápagos une île intelligente, certains champs obligatoires doivent être abordés: i) production d'électricité, ii) mobilité, iii) modernisation du réseau électrique, iv) consommation efficace, v) efficacité dans l'éclairage public, vi) gestion intégrée du cycle de l'eau, vii) solide traitement des déchets, viii) gouvernance et ix) santé intelligente. Tous ces domaines sont liés de quelque manière que ce soit, pour cette raison, les projets suivants devraient regrouper toutes les parties prenantes pour déterminer un objectif commun. À l'heure actuelle, les services actuels sont dispersés, non intégrés et incomplets. Par conséquent, il existe des solutions particulières pour chaque cas. Il n'y a pas de centre de contrôle unifié, centralisé et intégré pour surveiller l'énergie / l'eau, bien qu'il existe des règlements, ceux-ci devront être modifiés pour intégrer de nouveaux concepts. Une solution intégrée et efficace doit être mise en œuvre pour atteindre le développement social et économique sans affecter l'environnement, en utilisant les facilitateurs technologiques en fonction de la disponibilité et de la rapidité de l'information.

En conclusion, il convient de mentionner qu'une feuille de route doit être établie avec l'apport de tous ceux impliqués dans chacun des axes. Cette feuille de route est impérative pour tracer la voie à suivre pour parvenir à des solutions unifiées et optimales ainsi qu'à l'amélioration des services publics livrés à l'intérieur des îles. Tout cela avec un défi majeur: la gestion optimale de l'électricité de réseau isolée sans énergie fossile.

Quelques recommandations à considérer, les méthodologies développées au cours de ce doctorat pourraient être adaptées pour fonctionner correctement dans le pays continental avec des considérations particulières. Il est fortement recommandé de commencer la modélisation de la génération au sein de CYMDIST, il pourra analyser les analyses dynamiques du modèle ; il est important car l'intégration des énergies renouvelables nécessite des études axées non seulement sur l'état d'équilibre. De plus, avec les

générateurs de CYMDIST, nous pouvons effectuer des études intégrales en considérant d'autres phénomènes tels que transitoires.

Certains tests ont été effectués entre CYMDIST et RT-LAB ephasorsim pour obtenir la composante en temps réel sur les modèles électriques développés dans CYMDIST; les résultats étaient prometteurs, ce travail devrait se poursuivre jusqu'à une intégration complète entre les deux plateformes.

Enfin, il est suggéré d'appliquer le modèle Smart Grid Maturity au sein de l'Équateur afin d'évaluer la situation actuelle et de définir l'avenir désiré du secteur électrique.