



**HAL**  
open science

# Improving building operational performance with reactive management embedding diagnosis capabilities

Mahendra Singh

► **To cite this version:**

Mahendra Singh. Improving building operational performance with reactive management embedding diagnosis capabilities. Automatic. Université Grenoble Alpes, 2017. English. NNT: 2017GREAT107. tel-01814362

**HAL Id: tel-01814362**

**<https://theses.hal.science/tel-01814362>**

Submitted on 13 Jun 2018

**HAL** is a multi-disciplinary open access archive for the deposit and dissemination of scientific research documents, whether they are published or not. The documents may come from teaching and research institutions in France or abroad, or from public or private research centers.

L'archive ouverte pluridisciplinaire **HAL**, est destinée au dépôt et à la diffusion de documents scientifiques de niveau recherche, publiés ou non, émanant des établissements d'enseignement et de recherche français ou étrangers, des laboratoires publics ou privés.

## THÈSE

Pour obtenir le grade de

### **DOCTEUR DE LA COMMUNAUTÉ UNIVERSITÉ GRENOBLE ALPES**

Spécialité : AUTOMATIQUE - PRODUCTIQUE

Arrêté ministériel : 25 mai 2016

Présentée par

**Mahendra SINGH**

Thèse dirigée par **Frédéric WURTZ** et  
codirigée par **Stéphane PLOIX**

préparée au sein du **Laboratoire Laboratoire dSciences pour la  
Conception, l'Optimisation et la Production de Grenoble**  
dans l'**École Doctorale Electronique, Electrotechnique,  
Automatique, Traitement du Signal (EEATS)**

**Améliorer la performance opérationnelle du  
bâtiment avec intégration de la gestion  
réactive capacités de diagnostic**

**Improving building operational performance  
with reactive management embedding  
diagnosis capabilities**

Thèse soutenue publiquement le **11 décembre 2017**,  
devant le jury composé de :

**Monsieur Frédéric WURTZ**

Directeur de Recherche, CNRS Délégation Alpes, Directeur de thèse

**Monsieur Stéphane PLOIX**

Professeur, Grenoble INP, Co-directeur de thèse

**Monsieur Antoine CAUCHETEUX**

Ingénieur, CEREMA, Examineur

**Monsieur Cristian MURESAN**

Ingénieur, ENGIE, Examineur

**Monsieur Mohamed El Hachemi BENBOUZID**

Professeur, Université de Bretagne Occidentale, Rapporteur

**Monsieur Hervé GUEGUEN**

Professeur, Centrale Supélec, Président



*Dédié à mes parents, professeurs, et amis ...*

# *Acknowledgements*

Firstly, I would like to express my sincere gratitude to my advisers Prof. Stéphane Ploix and Dr. Frédéric Wurtz for their continuous support and providing me a pleasant working environment. I always enjoyed working with both of them. Their guidance and motivation helped me a lot in my research progress and writing of this manuscript. I highly appreciate their patience, immense knowledge of the subject and showing confidence in me.

Besides my advisers, I would like to thank the rest of my jury member: Prof. Hervé Guéguen, Prof. Mohamed Benbouzid, Dr. Cristian Muresan and Dr. Antoine Caucheteux for their insightful comments and critics, but also for questions which widen my research perspective. My sincere thank also goes to Dr. Kurt Roth who provided me an opportunity to join their team as a research fellow at Fraunhofer Center for Sustainable Energy Systems (CSE), USA. There are so many people, directly and indirectly, involved in my thesis development and difficult to mention everyone. However, I thank my fellow labmates, colleagues for the stimulating research discussions, and for all the fun we have had in the last four years. Also, I thank my friends in Grenoble particularly Dr. Preeti Sharma for making my life easy during thesis writing. In particular, I am grateful to Prof. Sukratu Barve, my cousin brother Dr. Rakesh Singh from the Florida State University (FSU) for enlightening me the first glance of research. In addition, I would like to thank my family: my late parents and to my brothers and sister for their blessing and unconditional support. Last but not the least, I would like to express my gratitude for European Commission Erasmus program and InnoEnergy for offering me a generous support.

## Resume

Currently, indoor discomfort in dwellings is one of the crucial issues along with the building energy consumption. Indeed, people spend 60-90% of their lives in buildings. Indoor comfort plays a vital role in occupants health, productivity, and well-being. However, various optimization and rule-based anticipative or predictive building strategies have been proposed to achieve the perceived comfort taking into account the energy consumption. However, in practice, anticipation or plans are far from the reality. Usually, anticipative plans are synchronized with one-hour anticipation period and do not consider the various sources of discrepancies as well as current envelope configurations. Unbeknownst to many, discrepancies from different sources could cause big penalty over cost and comfort. To tackle this issue, building management system needs to be designed as reactive or almost with no planning, so that it can respond to all discrepancies re-actively. To address this problem, a multi-scale Anticipative Reactive Diagnosing-Building Management System (ARD-BMS) is proposed in this dissertation. ARD-BMS is an internal management and performs three important actions i.e., *Discrepancy detection*, *Cause isolation*, and finally *Corrective actions*. ARD-BMS follow the short-time resolution i.e., 10-minutes to analyze the fault trends and current the building dynamics and take necessary corrective actions to maintain the desired level of comfort. This thesis proposes a fast dynamics simplified reactive model that can be used to estimate the current status of the building. Modern buildings are a sophisticated system with a large number of sensors, controllers, and HVACs. Most of the building facilities are using scheduled preventive maintenance services derived from periodic operations of the buildings. These preventive actions do not take into account the other inadmissible issues such as unplanned situations, weather prediction failures etc. These unplanned issues could cause unaccountable impacts over occupant's comfort during the 24-hour operation cycle. Diagnosability of short-term discomfort causes is still a challenging job at whole building operation level. Furthermore, to analyze this situation the thesis proposes a diagnostic methodology for detection and isolation of cause (faults) in buildings. The proposed methodology includes a rule-based HAZOP (Hazard and Operability analysis) and model-based approach. Further, in order to oversee unplanned discomforts, a short-term reactive optimization has been proposed.

## Résumé

Actuellement, l'inconfort intérieur dans les bâtiments est l'une des questions cruciales, ainsi que la consommation énergétique du bâtiment. En effet, les gens passent 60 à 90% de leur vie dans les bâtiments. Le confort intérieur sont indispensables pour bienfaits sur la santé, la productivité et le bien-être des occupants. Cependant, diverses stratégies d'optimisation et de fondée sur des règles, anticipatives ou prédictives ont été proposées pour atteindre le confort perçu en tenant compte de la consommation d'énergie. Dans la pratique, il existe un écart entre l'anticipation et la réalité. Habituellement, les plans anticipatifs sont synchronisés avec une période d'anticipation d'une heure et ne tiennent pas compte des différentes sources de contradiction ainsi que des configurations d'enveloppes actuelles. À l'insu de beaucoup, les divergences entre différentes sources pourraient entraîner une grande pénalité sur le coût et le confort. Pour résoudre ce problème, le système de gestion du bâtiment doit être conçu comme réactif ou presque sans planification, de sorte qu'il réponde à toutes les divergences de manière réactive. Pour remédier à la fin, un système multi-échelle d'analyse de diagnostic réactif anticipatif (ARD-BMS) est proposé dans cette dissertation. ARD-BMS est une gestion interne et effectue trois actions importantes, c'est-à-dire la détection de la discrétisation, l'isolation des causes et, enfin, les actions correctives. ARD-BMS à la résolution à court terme, à savoir 10 minutes pour analyser les tendances des défauts et l'actualité de la dynamique du bâtiment et prendre les mesures correctives nécessaires pour maintenir le niveau de confort désiré. Cette thèse propose un modèle réactif à dynamique rapide simplifié qui peut être utilisé pour estimer l'état actuel du bâtiment. Les bâtiments modernes sont un système très sophistiqué avec un grand nombre de capteurs, de contrôleurs et de CVC. La plupart des installations de construction utilisent des services prévus de maintenance préventive provenant des opérations périodiques des bâtiments. Ces problèmes imprévus puce causer des répercussions inexplicables sur le confort de l'occupant pendant le cycle de fonctionnement de 24 heures. Ces problèmes ne sont pas inadmissibles tels que les situations imprévues, les pannes de prévisions météorologiques. Le diagnostic des causes d'inconfort à court terme est encore un problème difficile au niveau de l'opération de construction intégrale. En outre, pour analyser cette situation, proposez une méthodologie diagnostique pour la détection et l'isolement des causes (fautes) dans les bâtiments. La méthodologie proposée comprend une HAZOP fondée sur les règles (analyse des risques et de l'optimisation) et une approche basée sur un modèle.

# Contents

<b>Acknowledgements</b>	<b>ii</b>
<b>List of Figures</b>	<b>ix</b>
<b>List of Tables</b>	<b>xi</b>
<b>Acronyms</b>	<b>xii</b>
<b>Notations</b>	<b>xiv</b>
<b>1 General Introduction</b>	<b>1</b>
1.1 Energy verses Buildings . . . . .	1
1.1.1 Indoor comfort issue in Buildings . . . . .	3
1.1.2 Indoor comfort and Energy saving . . . . .	4
1.2 Research objective . . . . .	4
1.3 Thesis outline . . . . .	6
<b>2 Problem statement and Research objective</b>	<b>9</b>
2.1 Introduction . . . . .	10
2.2 Platform Predis/Monitoring and Habitat Intelligent(MHI) . . . . .	12
2.2.1 Overview and Context . . . . .	12
2.2.2 Research objective with Predis/MHI . . . . .	13
2.2.3 Previous research and Collaborations . . . . .	13
2.2.4 Platform Description-Architectural and Technical perspectives . . . . .	14
2.2.5 Sensor Placement . . . . .	15
2.2.5.1 Ventilation system and Air quality control . . . . .	16
Air distribution network and fans: . . . . .	17
Heat exchanger: . . . . .	17
Dust filters: . . . . .	17
2.2.6 Control and Supervision . . . . .	18
2.2.7 Home abstraction Layer - HAL . . . . .	18
2.3 Problem statement . . . . .	20
2.4 Issue analysis . . . . .	21
2.4.1 Scenario 1: Unplanned situation . . . . .	21
2.4.2 Scenario 2: Reality vs Anticipation . . . . .	24
2.5 Diagnosis issue in Buildings . . . . .	25
2.6 Conclusion . . . . .	27

<b>3</b>	<b>Building Energy Management</b>	<b>28</b>
3.1	Introduction . . . . .	28
3.2	Existing Building Energy Management System-Context and Issue . . . . .	30
3.3	Proposition of Anticipative Reactive Diagnosing (ARD-BMS) . . . . .	37
3.3.1	Algorithms for Anticipative Reactive Diagnosing (ARD-BMS) . . . . .	40
3.4	Conclusion . . . . .	43
<b>4</b>	<b>Modeling for Reactive Diagnosing-BMS</b>	<b>44</b>
4.1	Introduction . . . . .	46
4.2	Need for a simplified reactive model . . . . .	47
4.2.1	Simplified Building Model; State-of-the-art . . . . .	48
	Contribution of present work: . . . . .	50
4.3	State-Space Modeling . . . . .	50
4.4	Fine Simulation Model-Predis/MHI . . . . .	50
4.4.1	Fine Simulation-Thermal model . . . . .	52
	Assumptions: for (3R-2C) thermal model . . . . .	53
	State-space representation: . . . . .	55
	Simulation result, Fine simulation thermal model: . . . . .	56
	Limitations of Fine Simulation Thermal model: . . . . .	57
4.4.2	Indoor Air Quality (IAQ) Model . . . . .	58
4.5	Anticipative Energy Management - Modeling Context . . . . .	59
4.5.1	Anticipative Thermal model . . . . .	60
4.5.2	Anticipative air quality model . . . . .	62
4.5.2.1	Air treatment unit . . . . .	62
4.5.2.2	CO2 concentration modeling . . . . .	62
4.5.3	Anticipative optimizer . . . . .	62
4.6	Reactive Building Model . . . . .	63
	Assumptions and Specifications for: reactive model . . . . .	64
4.6.1	Simplified reactive thermal model - Modeling perspective . . . . .	64
4.6.2	Canonical State-Space Representation for Simplified Model . . . . .	65
	Features of Simplified Thermal model: . . . . .	66
4.6.3	Qualitative Comparison between Simplified and Fine simulation model . . . . .	67
4.6.4	Indoor Air Quality Model for Reactive Management . . . . .	68
4.7	Reactive strategies in Building Management (10 minutes reactions) . . . . .	68
4.8	Conclusion . . . . .	69
<b>5</b>	<b>Building Maintenance strategy using Anticipative Reactive Diagnosing-BMS</b>	<b>71</b>
5.1	Introduction . . . . .	72
5.2	Buildings Maintenance and Planning . . . . .	73
5.3	Abnormal building system performance . . . . .	74
5.3.1	Actions: specific maintenance action . . . . .	74
5.3.2	Decision making . . . . .	75
5.4	Reactive strategies . . . . .	75
5.4.1	Abnormal building driving: misuse and behavioral context . . . . .	75
5.4.2	Feedback and appreciation . . . . .	76



5.4.3	Mirroring and visibility . . . . .	77
5.4.4	Illustration of abnormal building driving issue: Office H-358 . . . . .	77
5.5	Abnormal building system state . . . . .	79
5.5.1	corrective action: Online action, short-term optimization . . . . .	80
5.5.1.1	Formulation of short-term optimization . . . . .	80
5.5.2	Anticipative actions . . . . .	82
5.6	Conclusion . . . . .	84
<b>6</b>	<b>Fault Detection and Diagnosis in Building: issues and state-of-the-art</b>	<b>85</b>
6.1	Introduction . . . . .	86
	Why a Diagnosing-BMS? . . . . .	87
6.2	Diagnosability challenge in Buildings . . . . .	87
6.3	Terminology and Definition . . . . .	89
6.3.1	Fault Detection and Diagnosis (FDD) in Buildings . . . . .	90
6.4	The FDI approach . . . . .	92
6.4.1	Limitation of FDI . . . . .	96
6.5	The DX Approach . . . . .	97
6.5.1	Diagnosis with DX . . . . .	97
6.5.2	Concept of Hitting set and conflict . . . . .	102
6.5.3	Limitation of DX . . . . .	102
6.6	FDI and DX: A Bridge approach framework . . . . .	103
6.7	Conclusion . . . . .	106
<b>7</b>	<b>Proposed diagnosis approach for buildings</b>	<b>107</b>
7.1	Introduction . . . . .	108
7.2	New concept of validity for partial Test . . . . .	109
7.3	Proposed diagnosis methodology . . . . .	110
7.4	Generation of rule and range-based test using HAZOP . . . . .	111
7.4.1	Example of range-based test: Test1 (indoor temperature test leading to the set-point deviation) . . . . .	112
7.4.2	Example of rule-based test: Test2 (airflow) . . . . .	115
	Limitation of HAZOP based test . . . . .	117
7.5	Model-based test leading to zonal-test . . . . .	117
7.5.1	Example of Model-based: Test3 (zonal thermal test) . . . . .	117
7.6	Analyzing heterogeneous tests using Bridge approach . . . . .	119
7.7	Application of proposed approach . . . . .	120
	Result discussion . . . . .	122
7.8	Conclusion . . . . .	123
<b>8</b>	<b>Case study for the proposed diagnosis method</b>	<b>124</b>
8.1	Introduction . . . . .	125
8.2	Presentation of Predis/MHI platform . . . . .	125
8.2.1	HAZOP analysis for range and rule-based test of Predis/MHI system	125
8.2.2	Generation of rule, range model-based test using HAZOP . . . . .	126
8.2.3	Range-based test: Test4 (indoor CO2 concentration leading to air quality) . . . . .	127
8.2.4	Deduced signature table from heterogeneous test . . . . .	130
8.2.5	Diagnostic analysis . . . . .	132

8.2.5.1	Simulated fault scenario . . . . .	132
8.3	Presentation of the CECP/CEREMA building . . . . .	145
8.3.1	Tests analysis for CECP building . . . . .	147
8.3.2	Rule-based thermal test: Test1 . . . . .	147
8.3.3	Model-based zonal thermal test: Test3 . . . . .	147
8.3.4	Symptoms analysis for CECP/CEREMA building . . . . .	151
8.3.5	Diagnoses and comments . . . . .	152
8.4	Conclusion . . . . .	154
	<b>Conclusion and Future work</b>	<b>156</b>
	<b>A XML Implementation of HAZOP</b>	<b>160</b>
	<b>Bibliography</b>	<b>183</b>

# List of Figures

1.1	Percentage of people at risk of energy poverty in 2012 . . . . .	2
1.2	Energy consumption trends in buildings and GDP at EU level . . . . .	2
1.3	Reactive Building Management configurations . . . . .	7
2.1	EU-28 Total construction, buildings, and civil engineering, 2005-2016, monthly data, seasonally and working day adjusted (2010=100), Source: Eurostat . . . . .	11
2.2	Energy rating for French buildings (source:Energy efficiency action plan for France-2014) . . . . .	12
2.3	Research progress with Predis/MHI . . . . .	14
2.4	Predis-Shell . . . . .	15
2.5	Predis Exterior view and Plan . . . . .	15
2.6	Sensor configuration at Predis/MHI . . . . .	16
2.7	Ventilation system in Predis . . . . .	17
2.8	LEGACY supervision system: INTOUCH + automata (PLC) . . . . .	18
2.9	Home Abstraction layer (HAL) . . . . .	19
2.10	Occupation profile for winter . . . . .	22
2.11	Planned and simulated results for small variations in occupation . . . . .	22
2.12	Planned and simulated results for large variations in occupation . . . . .	23
2.13	Planned and simulated results for variation in weather . . . . .	23
2.14	Requested change in heating and ventilation . . . . .	24
3.1	A typical Smart Building . . . . .	30
3.2	Multi-layer BEMS . . . . .	31
3.3	Agent based Energy management . . . . .	33
3.4	Reactive control for power management [Klein et. al., (2010)] . . . . .	35
3.5	Reactive planning for laptop consumption [Abram et. al., (2014)] . . . . .	35
3.6	Proactive building management [Victor M. Zavala et. al., (2010)] . . . . .	36
3.7	Reactive Building Management configurations . . . . .	38
3.8	Reactive update . . . . .	39
3.9	Ventilation plan updation . . . . .	42
4.1	Planned and unplanned occupancy . . . . .	47
4.2	Simplified modeling approaches . . . . .	49
4.3	Fine simulation model . . . . .	51
4.4	Thermal discomfort in Winter [One weak simulation] . . . . .	51
4.5	Electricity tariff for a day . . . . .	52
4.6	Input output model . . . . .	53
4.7	Thermal model Equivalent R-C circuit . . . . .	54

4.8	Zoom of down slab . . . . .	55
4.9	Indoor temperature simulation . . . . .	57
4.10	Inputs for Fine simulation Thermal model . . . . .	57
4.11	Simulated CO2 Concentration . . . . .	59
4.12	Hourly weather prediction (Temperature): (a) Winter (b) Summer . . . . .	60
4.13	Occupancy plan- An example . . . . .	60
4.14	Anticipative thermal R-C model . . . . .	61
4.15	Anticipated total comfort [Anticipation period=1 hour] . . . . .	63
4.16	Anticipated day ahead cost in Euro . . . . .	64
4.17	Simplified 1R-1C thermal model . . . . .	65
4.18	Model comparison . . . . .	67
4.19	Reactive tuning of indoor temperature [sampling period =10 minutes] . . . . .	69
4.20	Illustration of Reactive action at the begining of Anticipative hour . . . . .	69
5.1	Possible corrective actions . . . . .	73
5.2	Office H-358 Felix viallet . . . . .	78
5.3	Occupany in office . . . . .	78
5.4	Comparison of diffirent opening in office H358 . . . . .	79
5.5	Indoor comfort recommendation for office H358 . . . . .	79
5.6	Thermal and Air quality comfort criteria . . . . .	80
5.7	Reactive update of CO2 and inddor temperature . . . . .	82
5.8	Example for Anticipative actions . . . . .	83
5.9	Comparision of total energy consumption with anticipated and re-computed plan . . . . .	83
6.1	Fault detection and isolation (FDI) . . . . .	93
6.2	Test and validity constraints representation . . . . .	101
6.3	Bridge approach of diagnosis . . . . .	104
7.1	Enumerated scheme with HAZOP and Diagnosis for buildings . . . . .	110
7.2	HAZOP process . . . . .	113
7.3	HS-tree . . . . .	121
8.1	System-level analysis of Predis/MHI . . . . .	126
8.2	Fault memory organization . . . . .	130
8.3	Different Tests for Predis/MHI . . . . .	132
8.4	3D view of CEPM Building . . . . .	146
8.5	Rule-based thermal test for thermal discomfort . . . . .	147
8.6	Zonal thermal test for thermal discomfort in office 009 . . . . .	147
8.7	TRNsys model . . . . .	149
8.8	Simulated fault scenario . . . . .	151

# List of Tables

2.1	Explanation of discrepancies with possible causes . . . . .	23
4.1	Comparison of Simplefied and Fine simulation thermal model . . . . .	68
6.1	Theoretical Signature table . . . . .	95
7.1	Ontology for HAZOP . . . . .	112
7.2	Heterogeneous test signature table . . . . .	119
8.1	Theoretical signature table . . . . .	130
8.2	Reduced signature table . . . . .	131
8.3	Simulated fault scenario . . . . .	133
8.4	Validity and Behavioral constraints for Tests . . . . .	135
8.5	Tests conclusion . . . . .	136
8.6	Observed Symptom table . . . . .	137
8.7	Simulated fault scenario . . . . .	150
8.8	Validity and Behavioral constraints for Tests . . . . .	152

# Acronyms

<b>ARD-BMS</b>	<b>A</b> nticipative <b>R</b> eactive <b>D</b> iagnosing - <b>B</b> uilding <b>M</b> anagement <b>S</b> ystem
<b>ASHRAE</b>	<b>A</b> merican <b>S</b> ociety of <b>H</b> eating and <b>R</b> efrigeration and <b>A</b> ir-conditioning <b>E</b> ngineers
<b>ABEMS</b>	<b>A</b> nticipative <b>B</b> uilding <b>E</b> nergy <b>M</b> anagement <b>S</b> ystem
<b>BMS</b>	<b>B</b> uilding <b>M</b> anagement <b>S</b> ystem
<b>BEMS</b>	<b>B</b> uilding <b>E</b> nergy <b>M</b> anagement <b>S</b> ystem
<b>BAC</b>	<b>B</b> uilding <b>A</b> utomation <b>C</b> ontrol
<b>DX</b>	<b>L</b> ogical <b>D</b> iagnosis
<b>EED</b>	<b>E</b> nergy <b>E</b> fficiency <b>D</b> irective
<b>EPBD</b>	<b>E</b> nergy <b>P</b> erformance of <b>B</b> uilding <b>D</b> irective
<b>EPC</b>	<b>E</b> nergy <b>P</b> erformance <b>C</b> ertification
<b>EMS</b>	<b>E</b> nergy <b>M</b> anagement <b>S</b> ystem
<b>FDI</b>	<b>F</b> ault <b>D</b> etection <b>I</b> solation
<b>FDD</b>	<b>F</b> ault <b>D</b> etection <b>D</b> iagnosis
<b>FSM</b>	<b>F</b> ault <b>S</b> ignature <b>M</b> atrix
<b>HS-Tree</b>	<b>H</b> itting <b>S</b> et <b>T</b> ree
<b>IEA</b>	<b>I</b> nternational <b>E</b> nergy <b>A</b> gency
<b>IAQ</b>	<b>I</b> ndoor <b>A</b> ir <b>Q</b> uality
<b>GDP</b>	<b>G</b> ross <b>D</b> omestic <b>P</b> roduct
<b>HAZOP</b>	<b>H</b> azard <b>A</b> nd <b>O</b> perability <b>A</b> nalysis
<b>OCED</b>	<b>O</b> rganization for <b>E</b> conomic <b>C</b> o-operation and <b>D</b> evelopment
<b>NZB</b>	<b>N</b> et <b>Z</b> ero <b>B</b> uilding
<b>HVAC</b>	<b>H</b> eating <b>V</b> entilation <b>A</b> nd air <b>C</b> onditioning
<b>MPC</b>	<b>M</b> odel <b>P</b> redictive <b>C</b> ontrol
<b>CFM</b>	<b>C</b> omplementary <b>F</b> ault <b>M</b> ode
<b>HEMS</b>	<b>H</b> ome <b>E</b> nergy <b>M</b> anagement <b>S</b> ystem

<b>SBS</b>	<b>Sick Building Syndrome</b>
<b>HAL</b>	<b>Home Abstraction Layer</b>
<b>ITC</b>	<b>Information Technology and Communication</b>
<b>MAS</b>	<b>Multi-Agent System</b>
<b>MET</b>	<b>Metabolic Equivalent</b>
<b>MILP</b>	<b>Mixed Integer Linear Programming</b>
<b>R-C</b>	<b>Resistance Capacitance</b>
<b>MBD</b>	<b>Model-Based Diagnosis</b>
<b>ARR</b>	<b>Analytical Redundancy Relation</b>
<b>BM</b>	<b>Behavioral Model</b>
<b>OM</b>	<b>Observation Model</b>
<b>SM</b>	<b>System Model</b>

# Notations

$\Delta_a$	Anticipative period
$\Delta_r$	Reactive period
$T_{in}$	Indoor temperature
$R$	Resistance
$C$	Capacitance
$T_{out}$	Outdoor temperature
$T_{space}$	Space temperature
$T_{office}$	Office temperature
$T_{corridor}$	Corridor temperature
$T_{down}$	Down temperature
$\phi_{in}$	Internal and solar heat gain
$\phi_{heat}$	Heat from heating system
$P_{heat}$	Heater power
$P_{vent}$	Ventilation power
$C_{air}$	Air capacitance
$T_s$	Sampling period
$T_{max}$	Maximum thermal comfort limit
$T_{min}$	Minimum thermal comfort limit
$CO2_{max}$	Maximum CO2 concentration limit in ppm
$Q_{air}$	Ventilation air flow rate
$\oplus$	XOR
$\neg$	Logical negation
$\subseteq$	Subset
$\cup$	Union
$\geq$	Greater or equal



$\leq$	Less or equal
$\pm$	Plus and minus
$\wedge$	Logical AND
$\vee$	Logical OR
$\in$	An element of
$\models$	Entails (semantic consequence)
$\perp$	Contradiction
$\forall$	For all
$\exists$	Exists
$\cap$	Intersection
$\neq$	Not equal
$\ $	Euclidean norm
$\Rightarrow$	Implies (if ... then)
$>$	Is less than
$<$	Is greater than
$d_H$	Hamming distance
$\mathbb{K}$	Predicate
$ $	Such that
$\rightarrow$	Implies
$J(V)$	Domain of behavioral constraints
$J'(V)$	Domain of validity constraints
$NA$	Not applicable
$obs$	Observed value

# Chapter 1

## General Introduction

### Contents

---

<b>1.1 Energy verses Buildings</b> . . . . .	<b>1</b>
1.1.1 Indoor comfort issue in Buildings . . . . .	3
1.1.2 Indoor comfort and Energy saving . . . . .	4
<b>1.2 Research objective</b> . . . . .	<b>4</b>
<b>1.3 Thesis outline</b> . . . . .	<b>6</b>

---

### 1.1 Energy verses Buildings

Over a prolonged period of time, energy has become the pivotal center of our society. Every civilization needs a significant amount of energy to drive its economy and to fulfill its fundamental needs. According to latest projection, world population is set to surge to 9 billion by 2040 and the gross domestic product (GDP) is projected to grow at an average annual rate of 3.5% over 2013-2040. Limited fossil fuels and intermittent energy sources are projected to lead to energy insecurity and fuel poverty problem in future. In the European context, fuel poverty is going to be one of the major problems. For instance, in 2012, 10.8% of the total population were unable to afford the proper indoor thermal comfort and this number could shoot up to 24%, be referring to low-income people (figure 1.1), it means one out of four people are on the verge of fuel poverty<sup>1</sup>.

---

<sup>1</sup>Source-Building performance institute Europe (BPIE) and Eurostate

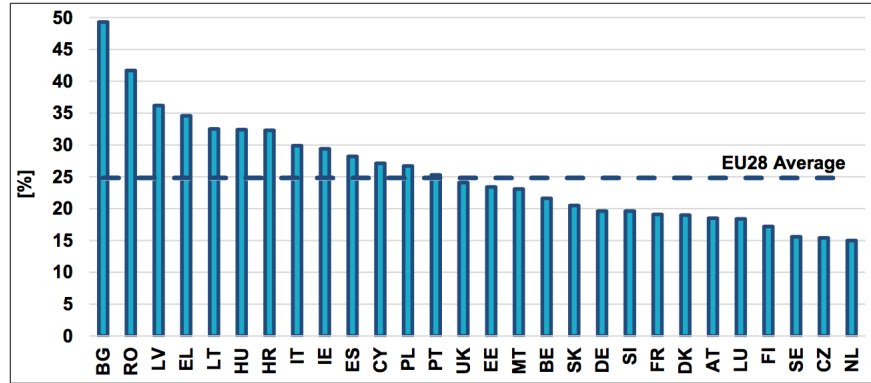


FIGURE 1.1: Percentage of people at risk of energy poverty in 2012

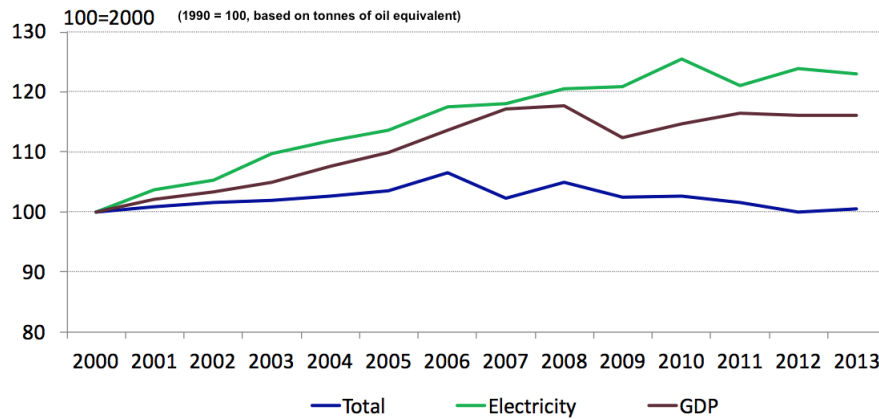


FIGURE 1.2: Energy consumption trends in buildings and GDP at EU level

Considering the above fact, it would be relevant to say energy is our key dependency and influence our everyday activity. In Europe, buildings are the core consumer of energy and represent a significant amount of CO<sub>2</sub> footprint. European Building accounts for 32% of total energy consumption. Nevertheless, in terms of primary energy consumption buildings represents 40% in most of the OCED<sup>2</sup> countries. Energy consumption in buildings also influences the aggregate European GDP due to the high import of energy, (figure 1.2)<sup>3</sup>. Energy in the household is mainly consumed by heating, cooling, hot water, and appliances. Achieving the energy saving in buildings is a complex process. European union (EU) demonstrated a strong ambition to reduce this energy consumption by enforcing various legislation, building regulations, and policies in line with EU 2050 roadmap. At the European ground, the main policy driver to the energy use in buildings is the Energy performance of building Directives (EPBD, 2002/91EC

<sup>2</sup>OCED-Organisation de Coopération et de Développement Économiques

<sup>3</sup>Source-Energy Efficiency Trends and Policies in the Household and Tertiary Sectors, Eurostate

amended as Directive 2010/31/EU) and Energy Efficiency Directive (EED, Directive 2012/27/EU). EPBD introduces Energy Performance Certification (EPC), instruction and renovation codes for member states while EED deals with the measure of energy efficiency in buildings<sup>4</sup>.

The primary objective set by EU-Commission are:

- All the new buildings must be nearly zero energy buildings (NZEB) by December 2020.
- All the member countries must set a minimum energy performance requirement for the new building for major renovation and for retrofitting of buildings elements.
- All member states must draw up long-term national building renovation strategies which can be included in their National Energy action plan.
- EU is committed to reducing Greenhouse gas (GHG) to 80-90% by 2050 as the part of its low carbon economy roadmap.

### 1.1.1 Indoor comfort issue in Buildings

Indoor comforts in buildings can profoundly affect the health, comfort, and work-efficiency of occupants. Various risk factors and serious diseases could take place due to poor indoor comfort. Especially, in offices and residential buildings with HVAC and Non-HVAC system, the primary concern is to achieve the desired comfort level. In various studies and publications, buildings with poor health consequences are referred as *Sick building syndrome* (SBS) (Molina et al., 1989). Several diseases such as “humidifier fever” and “Legionnaire’s diseases” reported epidemic due to SBS. Furthermore, other illness symptoms like nasal and cutaneous manifestations were also experienced due to inadequate indoor climate. Furthermore, indoor comfort can be account to three major key factors i.e., *Indoor thermal comfort (ITC)*, *Indoor air quality (IAQ)* and *Indoor lighting comfort (ILC)*.

ASHRAE<sup>5</sup> defined thermal comfort as *state of mind which expresses satisfaction with the thermal environment*<sup>6</sup> and directly linked to indoor air temperature, humidity and personal factors such as clothing level, metabolic conditions etc. IAQ refers to the

---

<sup>4</sup>Available at-<https://ec.europa.eu/energy/en/topics/energy-efficiency/buildings>

<sup>5</sup>ASHRAE-American Society of Heating, Refrigeration and Air-conditioning Engineers.

<sup>6</sup>ANSI/ASHRAE Standard 55-210, <http://comfort.cbe.berkeley.edu/>

indoor air quality inside the buildings and usually measured in term of CO<sub>2</sub> concentration. Akin to CO<sub>2</sub> concentration other pollutants emitted from different sources also accountable for poor IAQ. Finally, indoor lighting comfort addresses the significant level of illuminance inside the buildings. A good level of lighting is an integral part of indoor comfort. Indoor lighting comfort is considered as a combination of daylight and lights from lighting equipment. Nevertheless, it is really impossible to achieve the desired level of comfort according to each occupant because everyone has the different perception of comfort. For that matter, an existing anticipative building energy management system (ABEMS) can predict an optimum level of comfort compromising with optimal energy consumption. These plans and predictions are derived from historical performance and slow dynamics of the building model.

De-facto, anticipation does not follow the reality because of unexpected discrepancies from different unidentified sources such as unplanned occupancy or weather prediction failures etc. These uncertainties or failures cause inadequate indoor environment as well as high expenses due to demand of excess energy.

### **1.1.2 Indoor comfort and Energy saving**

Indoor comfort in buildings and energy saving are closely allied. At European level, the energy performance building directives (EPBD) clearly states minimum energy performance requirements “*Shall take the account of general indoor climate conditions in order to avoid possible negative effects such as inadequate ventilation*” (source-Article 4 of the EPBD, 2010/31/EU). However, there are no clear guidelines for how to accomplish the optimum energy saving with perceived comforts in buildings. Various malfunctions and unplanned events cause an unaccountable indoor comfort and increase the energy consumption.

## **1.2 Research objective**

In everyday operation, the building faces numerous ambiguous situation that can not be planned earlier. These vague faults causes divergence in anticipated building performance with inappropriate indoor discomfort. In spite of, advancement in building automation, it is difficult to achieve the anticipated comfort after post commissioning of

existing anticipative building energy management systems (ABEMS). The dissertation focuses on the development of a holistic methodology for multi-scale building management, a reactive building management has been proposed with the fault diagnosis and isolation capability.

A system is defined as '*reactive*' if it is able to adapt to any change that occurs in the real world, while the system is running. Thus far, a re-actively managed building can endure various unplanned situations in conjunction with indoor comfort. Presently, most of the building management systems rely on an expert system (ES) i.e., rule-based or knowledge-based, and predictive model-based optimization algorithm. Predictive optimization schemes like Model predictive control (MPC) is well-known and has been exercised by several building researchers. Though, MPC offers a relatively easy tuning and can deal with the multi-variable problem. Notably, the following concerns make MPC less reliable for practical implementation (Zong et al., 2015; Derouineau, 2013; Lefort et al., 2013).

- Model based control lacks in providing the guarantee for stability and robustness to modeling error.
- MPC needs an appropriate process/plant model that is the biggest challenge for MPC.
- MPC delivers a high performance for theoretical purpose but hard to apply for practical purpose due to model complexity.
- Sometimes calculation of control inputs becomes difficult while considering the constraints in control.
- Eventually, MPC is unable to diagnose the root cause of the issue that must be identified to take a corrective action.

On the other hand, heuristic or rule-based (if-then-else) building management can provide relatively easy to implement rule-based decision making. The dark side of this rule-based methods is that it requires detailed prior knowledge of building operations. These rule-based approaches, lead to huge complexity with a very large decision tree for decision making and makes inconsistent system. Using, only heuristic, it is cumbersome to cover all the possible reactive actions because rule driven decision making might involve conflicts with other decisions.

In order to develop the reactive building management, four key objectives are illustrated in this thesis:

1. Propose a reactive methodology for buildings management that can bridge the gap between anticipated building performance and reality.
2. Propose a nature of reactive model that can account fast dynamics and current situation of buildings.
3. Propose an approach to diagnose the major anomalies along with unplanned situations that may cause unaccountable impact over indoor comfort and operational cost.
4. Develop various reactive actions including reactive optimization to tackle the unplanned discrepancies and misuses.

### **1.3 Thesis outline**

The contribution of this dissertation is to develop a reactive building management algorithm that can co-operate with existing anticipative building management. The strength of the proposed methodology is not to look for only energy savings but also assure the indoor comfort to occupants and uninterrupted building operation. With this in mind, a fault diagnosis and detection technique has been proposed in the sense of whole building operation.

Chapter 2 discusses the pragmatic research question and objective. The main focus is given to validation of problem statement with real-time case studies. Nevertheless, the problem has been studied in more detail in consecutive chapters. Further, an advanced building management research platform known as Predis/MHI is described in detail. A validation of problem statement is presented considering Predis as a paradigm for smart building.

Further chapter 3 deals with existing building energy management issues. A state of the art is provided in beginning to understand the prevailing building energy management techniques, for example, Multi-scale Energy management and Model predictive control based BEMS. Further, major concerns with existing BEMS have been briefed.

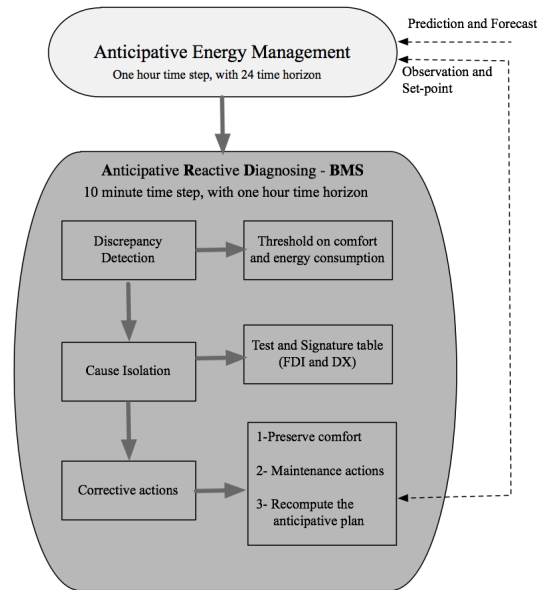


FIGURE 1.3: Reactive Building Management configurations

The final outcome of this chapter results in a proposition of an algorithm for reactive building energy management.

In respect to previous two chapters, it was realized that ARD-BMS (figure 1.3) requires a fast dynamics and easy to initialize the model. An anticipative energy management is used to anticipate the day ahead building performance. Anticipations are determined from pre-scheduled building parameters such as planned occupancy, hourly weather forecast, heating services etc. An encapsulated anticipative optimizer provides the hourly building performance in terms of energy and comfort prediction. Nevertheless, at various occasions building reality do not follow the anticipation and engender the poor indoor comfort or over energy consumption. A fine simulation model i.e. idealization of reality is used to simulate the real situation. Thereupon, reactive thermal and air quality model is developed in the context of reactive building management. Reactive models are responsible for adjusting the building heating and ventilation services depending on the different building situations. Comfort adjustment is an imperative objective for reactive models. However, the whole building energy performance is accomplished by Reactive building management. Further, Resistance and capacitance (R-C) modeling technique with parity relation is opted to model the reactive model in chapter 4.

The discrepancy in expected building operation could arise due to physical failure, abnormal driving or unplanned situations. Further, the corrective actions could be offline



maintenance, reactive update, anticipative, giving feedback or appreciation. A generic maintenance scheme with online and off-line corrective actions is described in chapter 5. An optimization problem is formulated to achieve the online reactive actions. The global objective for the optimization problem is to bring the discomfort situation in comfort zone, so that normal building operation could be achieved. Few examples are provided for the different type of corrective actions.

Fault diagnosis and detection is an integral part of reactive building management. Different conflicting situations arise during the building operation and it is difficult to decide how to react. Chapter 6 proposes various issues in existing building fault management. A succinct state-of-the-art is provided considering fault diagnosis in the building system. Furthermore, this chapter develops a theoretical background for existing fault diagnosis and isolation techniques. A concept of logical bridge diagnosis is explained in details.

In reference to the previous background, chapter 7 introduces a methodology for fault analysis in buildings. A new concept of *partial* test with behavioral and validity constraints is presented in detail. The bridge approach is developed between qualitative and quantitative model. Further, different heterogeneous tests are developed to test whole building system. These tests encompass rule, range, and model-based test. The bridge approach is developed between qualitative and quantitative model. This chapter points up one example of proposed diagnosis.

At the end chapter 8 illustrates the practical application of proposed diagnosis method. Two case studies are developed for different building. These buildings differ in operation and offer the different level of complexity. Three key performance indicators (KPIs) has been considered to testifying the performance of proposed diagnosis scheme, are:

- a-) Justification of validity and behavioral constraints based on heterogeneous tests
- b-) Diagnosability issue of multiple faults in buildings.
- c-) Fault explanation and minimum diagnosis.

## Chapter 2

# Problem statement and Research objective

### Contents

---

<b>2.1</b>	<b>Introduction</b>	<b>10</b>
<b>2.2</b>	<b>Platform Predis/Monitoring and Habitat Intelligent(MHI)</b>	<b>12</b>
2.2.1	Overview and Context	12
2.2.2	Research objective with Predis/MHI	13
2.2.3	Previous research and Collaborations	13
2.2.4	Platform Description-Architectural and Technical perspectives	14
2.2.5	Sensor Placement	15
2.2.6	Control and Supervision	18
2.2.7	Home abstraction Layer - HAL	18
<b>2.3</b>	<b>Problem statement</b>	<b>20</b>
<b>2.4</b>	<b>Issue analysis</b>	<b>21</b>
2.4.1	Scenario 1: Unplanned situation	21
2.4.2	Scenario 2: Reality vs Anticipation	24
<b>2.5</b>	<b>Diagnosis issue in Buildings</b>	<b>25</b>
<b>2.6</b>	<b>Conclusion</b>	<b>27</b>

---

*Abstract- People spend 70 to 80 percent of their life in dwellings. Indoor building climate influence occupants productivity and health. A poorly ventilated or managed building may cause a serious health issue to occupants. In recent years, several*

*tools have been developed to manage building performance. Present buildings energy management strategies rely on different control and optimization techniques, with the primary focus on energy saving. However, these management schemes do not currently include adequate fault diagnosis and isolation algorithms to detect problems that cannot be redressed by controllers. Due to uncertainty in building operation and higher user expectation, it is difficult to manage the building operation in a short interval. Unplanned events could raise discomfort and abate the potential energy saving. This chapter will provide a global discussion about different discrepancies in expected and predicted building performance with a case study.*

## 2.1 Introduction

Almost every developed OCED countries have the following challenges related to their energy spectrum and long-term sustainability goal:

- deep decarbonization of the energy infrastructure
- independent from fossil fuel import that majorly comes from politically unstable countries
- nationwide energy security
- development mitigation and adaptation strategies for climate change

Come to grip above challenges, European commission is committed taking actions and had shown global leadership on various occasions. In furtherance of research and innovation, EU and member states came up with the different proposal and prospective roadmap. For instance, Horizon 2020<sup>1</sup> is proposed as an instrument to act upon these serious issues. The objective of Horizon 2020 is to address the key issues such as energy, health, security, transport, etc., on European ground. In this context, building *construction production (volume)* accounted as a ***Principal European economic indicator (PEEI)*** for EU economic zone.

The building sector has been reported as a significant undershoot during the financial crises between 2008 to 2013. However, it is recovering since 2013 (figure 2.1).

---

<sup>1</sup>Horizon 2020-<http://www.horizon2020.gouv.fr/>

Further, construction sector contributes approximately to 5% of overall European GDP. The growing construction sector is alarming a significant rise in energy demand with

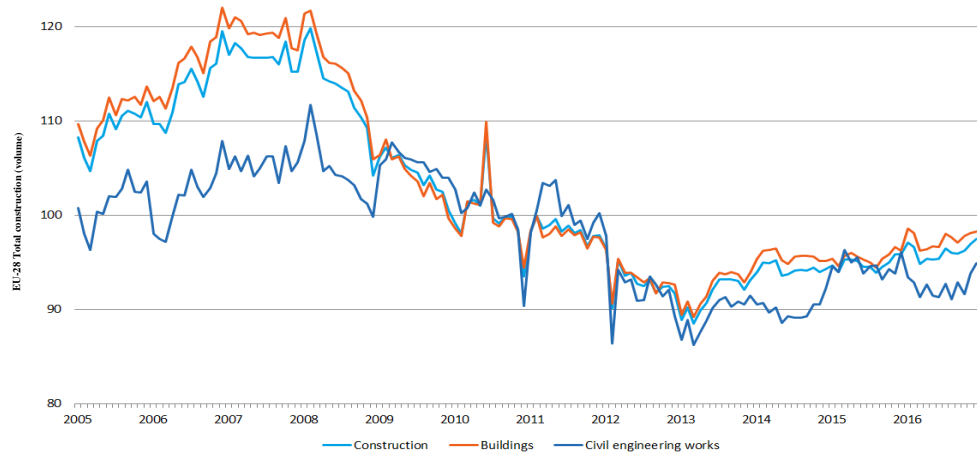


FIGURE 2.1: EU-28 Total construction, buildings, and civil engineering, 2005-2016, monthly data, seasonally and working day adjusted (2010=100), Source: Eurostat

anticipated CO2 emission. To meet European goal and desire, building either new or old must adopt an energy and comfort management schemes. So far, a parallel market is growing for smart home energy management systems (HEMS) and whole building management. Present global BEMS market worth about the \$3.6 Billion with 50% of European counterpart. A yearly growth of 10% has been noticed in European smart building management services.

The other important issue with the existing building is indoor discomfort. Due to peak oil crises and rising energy demand, a large group of building researchers has been promoted the energy saving concern in buildings. Nevertheless, later they had agreed upon that energy saving is important but not at the cost of health issues. Moreover, few studies had revealed that social costs of sick buildings are more than achieved energy savings. Indeed, in a study from World health organization (WHO) had clearly pointed out that *“Energy-efficient but sick buildings often costs society far more than it gains by energy savings”*

The objective of this chapter is to introduce the indoor discomfort issue because of existing building energy managements schemes. Of course, energy saving and efficiency research are likely to have no end but at the same time, building management system have to develop the enough confidence to win the emotional values of dwellers that can remove the social and technical barrier to adopting the smart building culture. Section

2.2 provides details about the experimental platform used for study and validate the building comfort-related problems. Later, section 2.3 and 2.4 deal with the problem and evidence analysis respectively.

## 2.2 Platform Predis/Monitoring and Habitat Intelligent(MHI)

### 2.2.1 Overview and Context

Over the course of years, buildings are the second largest energy consumers in France after transport and industry sector combinedly. The National government is enforcing different policies and regulations to meet promises with European commission. As the part of the commitment, the French government had expressed the desire to reduce the final energy consumption from 236.3 Mtep<sup>2</sup> to 131.4 Mtep till 2020. Unfortu-

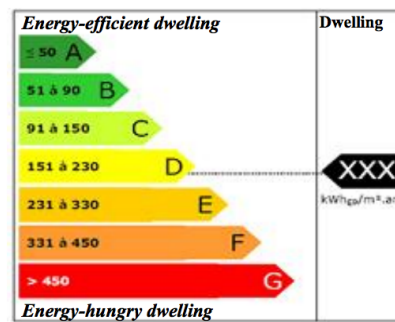


FIGURE 2.2: Energy rating for French buildings (source:Energy efficiency action plan for France-2014)

nately, the building sector is alone responsible for 68.7 Mtep. Since past few years, a nationwide building regulations such as *plan de rénovation énergétique de l'habitat (PREH)*<sup>3</sup> and standards, RT 2012 thermal regulations<sup>4</sup> have been constituted and deployed. In addition, various social benefits like the tax credit, an easy loan with emotional campaigning, for example, *économies d'énergie faisons vite, ça chauffe* also been practiced to involve people more effectively. Further, to support building related research several laboratories and the experimental platform has been set-up with the help of public and private funding.

With these in mind, Predis/MHI<sup>5</sup> is a platform dedicated to research in smart building energy management. It allows researchers to study several aspects of smart

<sup>2</sup>Mtep-Millions of Tonnes Equivalent to Petrol

<sup>3</sup>PREH-<http://www.logement.gouv.fr/le-plan-de-renovation-energetique-de-l-habitat>

<sup>4</sup><http://www.rt-batiment.fr/batiments-neufs/reglementation-thermique-2012/presentation.html>

<sup>5</sup><http://ense3.grenoble-inp.fr/predis/monitoring-et-habitat-intelligent-320962.kjsp>

home including the analysis of the difference between prediction and reality and interaction with the smart grid. Predis/MHI is equipped with numerous communication sensors to monitor the indoor comfort and energy consumption as well. It combines the study of the physical model and experimental measurements with virtual simulation and optimal control. Physically it was located at the ENSE3 school in Grenoble-INP campus but recently moved to the newly constructed smart building GREEN-ER. A group of researchers including professors, postdocs, PhDs and master students actively takes part in the various research capacity.

### **2.2.2 Research objective with Predis/MHI**

Predis platform offers a wide range of research interests with the focus on whole building management. However, a comprehensive list of key research objectives with Predis is given below:

- ✓ To measure all kinds of energy consumption with its related cost.
- ✓ To analyze the good and bad consequences of BEMS practices over the indoor comfort and energy saving.
- ✓ To study the social and behavioral context of people towards energy saving and monetary benefits.
- ✓ To analyze the faults and different failures with their root causes that may lead to an inadequate indoor environment.
- ✓ To understand the interaction of smart grid with buildings and demand response.
- ✓ To monitor the building performance and usage prediction.
- ✓ To simulate and measure the reality with discrepancy analysis from anticipative energy management.
- ✓ To follow the user's perception and adaptability towards the smart building.
- ✓ To analyze *Dweller's activity* with their *Energy impact*.

### **2.2.3 Previous research and Collaborations**

Over the years, several remarkable research achievements and collaborations have been developed in the framework of Predis/MHI. Though the platform is located inside the

ENSE3 but has other industrial and academic partners. Major industrial alliances are EDF, SNCF, Schneider electric, Vesta system, while having academic and research partnerships with CSTB, CNRS, G2Elab, INRIA, and G-SCOP. A couple of notable research

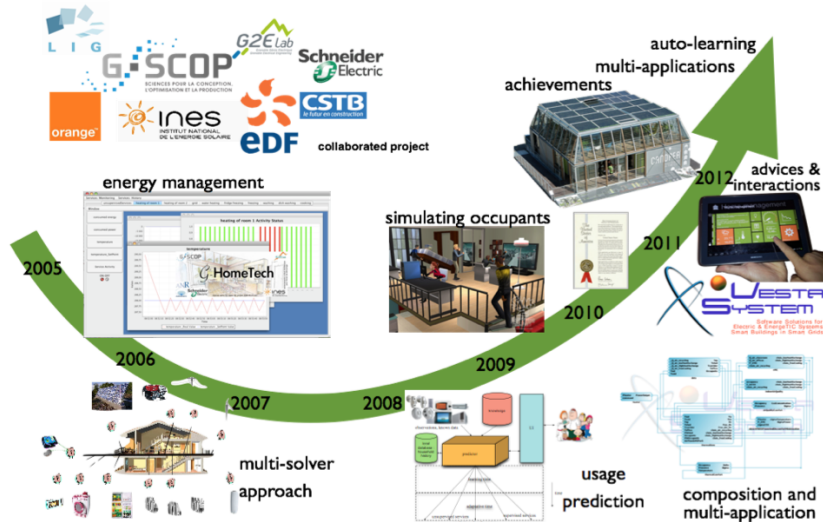


FIGURE 2.3: Research progress with Predis/MHI

accomplishments have been demonstrated by implementing the complex algorithm and building related tool (G-homeTech, MILP workshop, SML composer, Vesta Energy studio etc). A Canopea house project was developed under the lead of École nationale supérieure d’architecture de Grenoble with the help of the Vesta-system company in the context of solar decathlon Europe competition. This house represents a prototype of a smart building with higher energy efficiency, easy to integrate with smart-grid (Hadj-Said et al., 2013).

### 2.2.4 Platform Description-Architectural and Technical perspectives

Predis platform is partially isolated from the direct influence of external environment. It is completely inside surrounding facades. Indeed, it has been constructed like a building within a building (figure 2.4). The platform has two big rooms for users. One room is used as a lecture room for students whereas the other is an open space for building researchers (figure 2.5). Lecturer rooms equipped with 15 computers, are connected to the electrical grid and local electricity generation i.e. solar panels. Two other small rooms are connected to a building management system (local BEMS) and an air handling unit (ventilation system). A cellulose thermal insulation has been done to prevent any

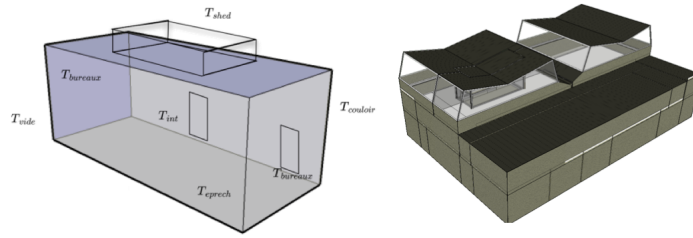


FIGURE 2.4: Predis-Shell

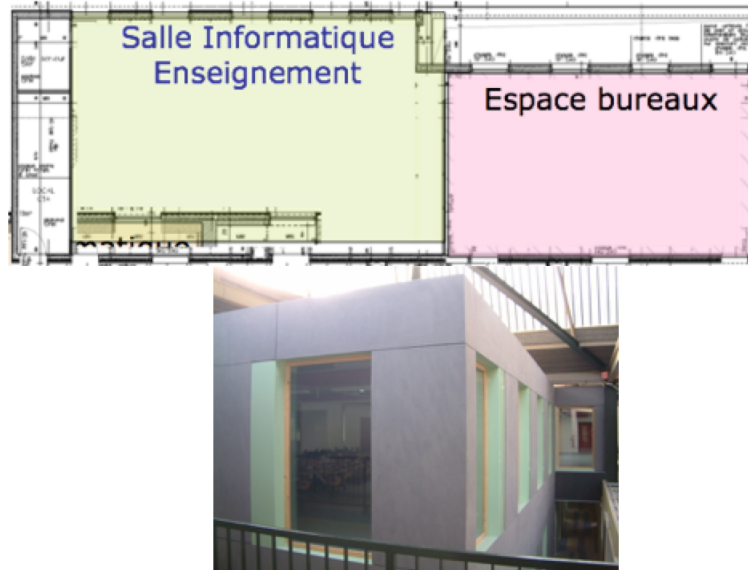


FIGURE 2.5: Predis Exterior view and Plan

kind of heat leakage. Proper insulation and appropriate strategies make Predis a lower consumption building with primary energy (PE) < 50 kWhEP (category B, RT2005 thermal regulation). However, insulation causes a thermal discomfort in summer due to internal and solar heat gains. So far, an air conditioning system and ventilation system have been used to get proper comfort. To take advantage of natural lighting, big windows are installed around the platform and at the ceiling of the computer room. In order to reduce the power consumption from the lighting equipment, light wells have also been placed at various locations.

### 2.2.5 Sensor Placement

More than 100 sensors have been installed in Predis to monitor the indoor thermal comfort, Indoor air quality (IAQ), humidity, energy consumption and occupant's presence as well. The sensor management is done in such way that it can record variations in temperature, CO<sub>2</sub>, humidity at the different part of the platform. Figure 2.6 shows the



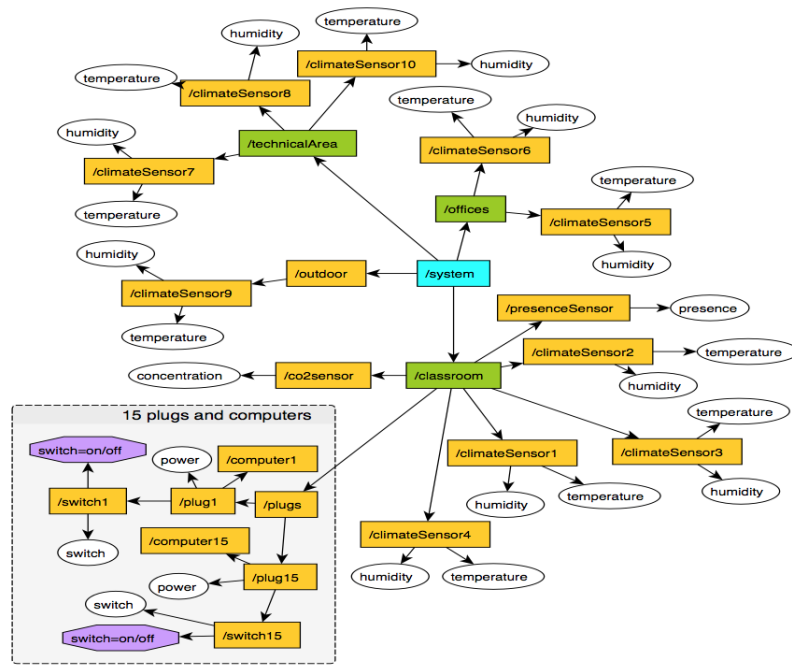


FIGURE 2.6: Sensor configuration at Predis/MHI

complete sensor configuration for Predis. A thermal model and an air quality model are validated with the help of sensor placement. Further, about 40 actuators are connected to sensors and controllers. They provide a safe operation by transforming sensor information for controllers. Using actuators, controllers are able to act on the environment. Besides natural lighting, an artificial lighting system is also used to regulate the brightness of the platform. The number and arrangement of the lamps are designed to ensure a certain homogeneity. To get the right energy management solution a lighting control system can be achieved by the combination of an occupancy detection sensor network and illuminance sensors. Motion detectors are able to detect occupants presence either by their motion or by skin detection. However, manual switches are also available to control lights in standby mode that turn off lights after 15 minutes of non-occupancy detection.

### 2.2.5.1 Ventilation system and Air quality control

A mechanically controlled double flow ventilation (VMC) system is installed inside the Predis/MHI platform to renew the air. The ventilation system ensures thermal comfort by exchanging the indoor heating from outside. VMC saves a portion of the heating or cooling power by heat exchange between the fresh air supply and exhaust. If the

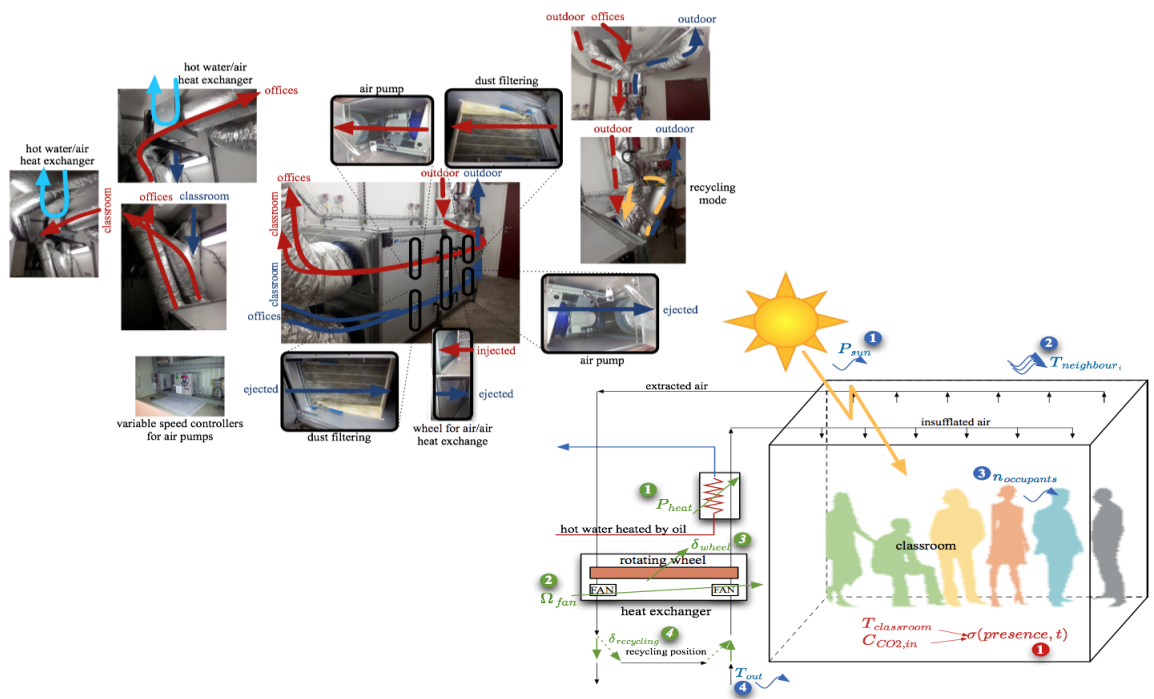


FIGURE 2.7: Ventilation system in Predis

exhaust air temperature is lower than the set temperature then hot water coil regulate the air temperature of the room by a heat exchange with the heated water system from a central boiler. VMC is consist of mainly four parts,

**Air distribution network and fans:** Ventilation system consists of an air distribution network that includes the duct and pipes to circulate the fresh air and remove stale air from inside. A supply fan with return fan used for mixing the hot air and cold air for heat exchange.

**Heat exchanger:** Predis ventilation system uses a rotatory heat exchanger and a part of the thermal energy is exchanged from the duct exhaust air to the fresh air duct. A small motor and drive controllers are associated with it. The minimum ventilation is set by the building code and for offices with normal activity, it is  $25m^3/h \setminus occupants$ . An effective heat exchange saves heating requirements in winter when ventilation is needed.

**Dust filters:** The role of dust filters to block contaminated air from outside. The indoor air quality depends on the concentration of unwanted particle. In this case, a viscous filter has been used. A clogged or blocked filter can cause serious air

quality problem. However, clogging can be measured by measuring the pressure drop in incoming and outgoing air-flux.

## 2.2.6 Control and Supervision

An InTouch SCADA system tracks all the measured information and control from local BMS. In figure 2.8, an operation of SCADA system is shown. An internal software management can display platform's state of operation according to the automatic or manual mode. Further, it can also display the real-time information from various sensors such as door opened or temperature. The SCADA server can define the occupied and unoccupied period. This is important for the automatic control of ventilation in order to approach optimal management.

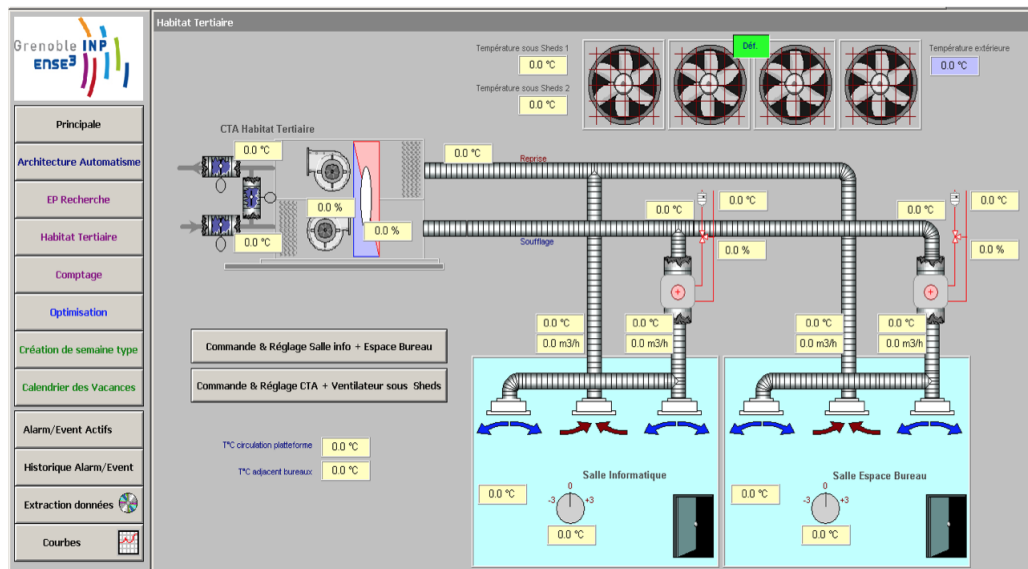


FIGURE 2.8: LEGACY supervision system: INTOUCH + automata (PLC)

## 2.2.7 Home abstraction Layer - HAL

A system called HAL (Home Abstraction Layer) has been added as a general interface to the control system and sensors/actuators. HAL allows an interface between drivers and different communication protocols relating to physical devices. The HAL system has been coded in Python language because most of the sensor drivers have been provided in this language. Figure 2.9 shows the HAL architecture. It encompasses different sensors like temperatures, CO<sub>2</sub>, humidity, door position, air flows, electric energy,

electric power, light, presence, etc, These sensors rely on many communication technologies: X10, Oregon Scientific, Zigbee, Philips Hue, HTTP GET and USB. Thanks to the Intouch SCADA system, which can be connected through an OPC (Open Platform Communications) interface linked with other protocols: Modbus, Lonworks, and Dali. HAL system expedites full functionality of Predis/MHI. If a driver linked to sensors

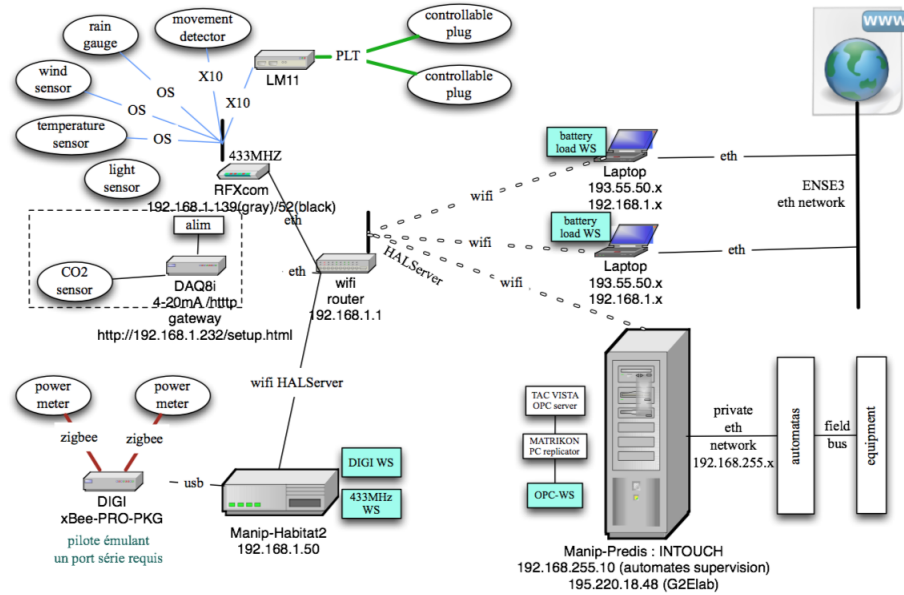


FIGURE 2.9: Home Abstraction layer (HAL)

or actuator fails, it affects the accompanying part or whole system while placement of new sensors/actuators will change the energy management policies. In the HAL system, the life cycle of each sensor, actuator, driver or control algorithm is managed by the developers. For example, each time, a new sensor is added to the system, the developer has to update the new configuration for the whole system, which takes some time as it implies to restart the system. The HAL system depends on the life cycle of sensors and the configurations defined by the developer. It has to manage the access to the functionality provided by each of its elements, but also the dynamism of the models representing the environment, which should be outside its scope. These two aspects of the system being particularly different. The implementation of the HAL system has become complex, leading to a number of malfunctions. Therefore, to give the specification-based substitutability, an **iPOPO** service inspired from a Java version of Pelix Remote Services has been integrated. iPOPO combines many advantages for instance: Simplicity, Performance improvement, Embedded HTTP server and provides a publish-subscribe service (Abrams et al., 2014).

## 2.3 Problem statement

The previous section has introduced a comprehensive detail about the advanced platform i.e. Predis/MHI for building energy management. The platform uses an anticipation based energy management with a Mixed Integer Linear Programming (MILP) optimizer and slow dynamics model to forecast the day-ahead cost (consumption) and comfort plan. Predis represents an advanced anticipative energy management paradigm for energy efficient buildings. Despite, having an efficient energy management scheme, at various occasions, occupants complain about the indoor discomfort and as consequence over consumption has been reported. Anticipative management is alone not sufficient to address this problem (Singh et al., 2014) and at the same time, it is difficult to diagnose the true causes behind the discomfort. Now fundamental research question is how to make building *alive* and *reactive* rather having a long hour plan. Nevertheless, anticipative plans determine the long-term objective and goals that give a future scenario about the energy and comfort management. In such situation, two solutions can be possible.

- ▷ First to recompute the plan for a shorter time period (eg., few minute). Though, changing the plan for every shorter time resolution may yield discomfort to occupants and plans no longer to be synchronized with one-hour available weather prediction. Re-computation of plans also requires a lot of computations because of the changing building configuration for every minute (Zong et al., 2015; Cigler et al., 2013; Singh et al., 2014)
- ▷ An alternative way is to update the next hour anticipative plan, but the question arises what to do in the current anticipative hour (Singh et al., 2015a).

There are few optimization control and rule-based approaches to bring down the problem. The model-based optimization schemes are challenged by the complex modeling issues. It is difficult to have an appropriate building model that can stand for complete building model dynamics. Further, the rule-based approach requires a complex decision making. Usually, rules are defined by expert knowledge and are not easy to modify. Moreover, introducing more and more rules or control actions make a tyranny over the building occupants. Undeniably, occupants do not want to loose their control over their

surrounding. Getting frequent alarms and new set-point configurations is also annoying for building users. In several talks and building conferences (IBPSA, ASHRAE), this issue had been discussed how to comply occupants with building management rather giving them the bunch of rules and pre-decided control actions. Future energy management schemes should have to respect the occupant's behavior and their freedom to take actions.

Actually, dwellers want a hassle free, easy to understand endorsement, and actions from the building management. In addition to above existing building management undergoes with following concerns:

- ▷ Available building management rarely includes the whole building operation, building current state and uncertainty in building operation.
- ▷ *Fault Detection* and *Diagnosability* is still a major issue at a short time interval.

However, these issues are detailed in subsequent sections 2.4 and 2.5 respectively. In the following section, an experimental validation for the problem has been discussed.

## 2.4 Issue analysis

In order to explain the problem at the practical ground, this section provides a detailed experimental analysis and corresponding validation. The considered platform for data collection and validation is Predis/MHI due to easy availability of measurement techniques and model validation. A significant time had been spent to develop the research background, that includes two master thesis and one industrial collaboration<sup>6</sup>. In the following sub-sections, two real-time observations have been illustrated to conclude the problem statement.

### 2.4.1 Scenario 1: Unplanned situation

This scenario presents a case study of the variation in simulated and observed reality. The objective of this study was to understand the fundamental reasons behind the discrepancy in simulated performance in the building, that could lead to indoor discomfort

---

<sup>6</sup>Vesta-Energy <http://www.vesta-system.fr/fr/produits/vestaenergy/nos-partenaires/>

or over expenses. However, the discussion was well studied and published in (Singh et al., 2014). A  $3R-2C$  model is used to simulate the real behavior of Predis/MHI (see chapter 4 for detail). Figures 2.10(a) and 2.10(b) show the large and small variation in planned occupancy profile. Results from figure 2.11 and 2.12 clearly explain the inconsistency in building comfort because of change in occupancy profile.

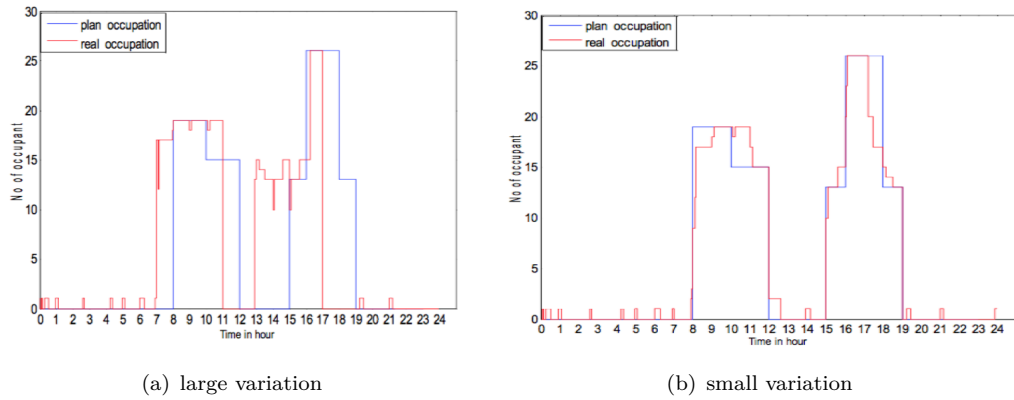


FIGURE 2.10: Occupation profile for winter

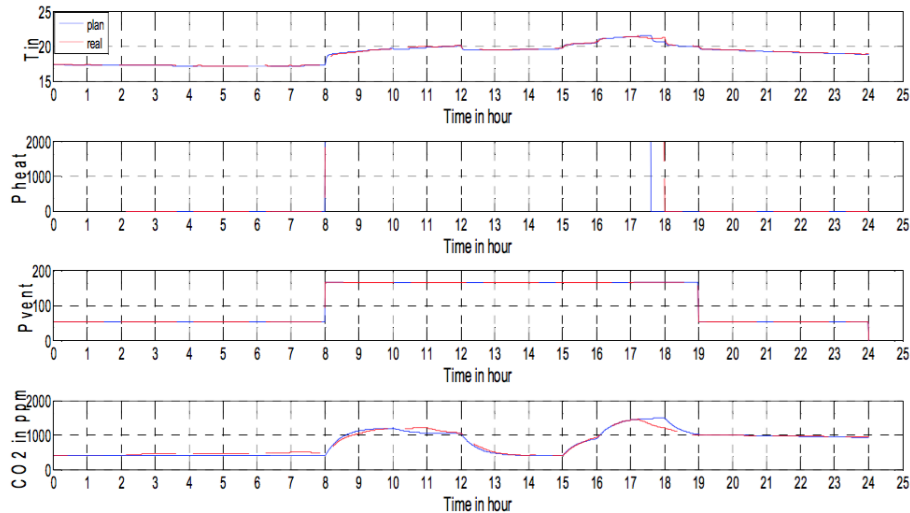


FIGURE 2.11: Planned and simulated results for small variations in occupation

Changes in outside weather also cause discrepancies. Anticipative energy management uses weather information from the weather prediction model and plans the use of heating appliances. The modified use of these appliances affects the energy cost. So discrepancies in weather require an updated energy consumption plan. Here only winter situation is considered. During winter, people may require extra heating appliances that were not planned in the anticipative energy management. The use of such kind of

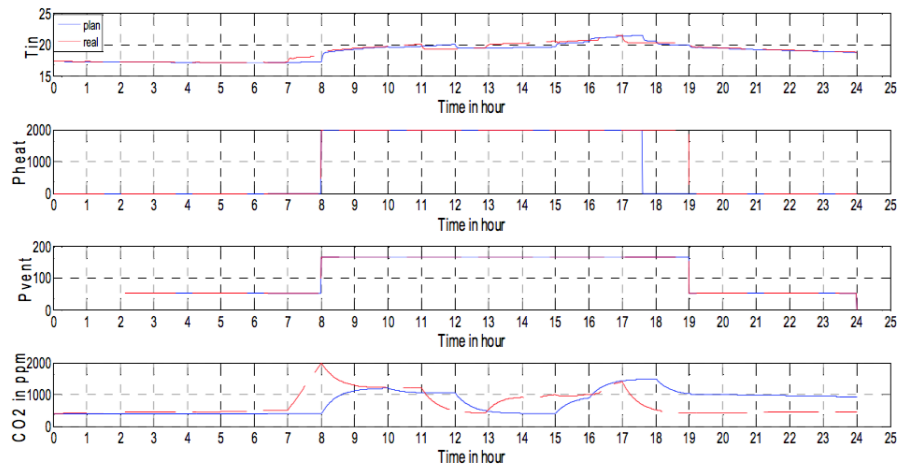


FIGURE 2.12: Planned and simulated results for large variations in occupation

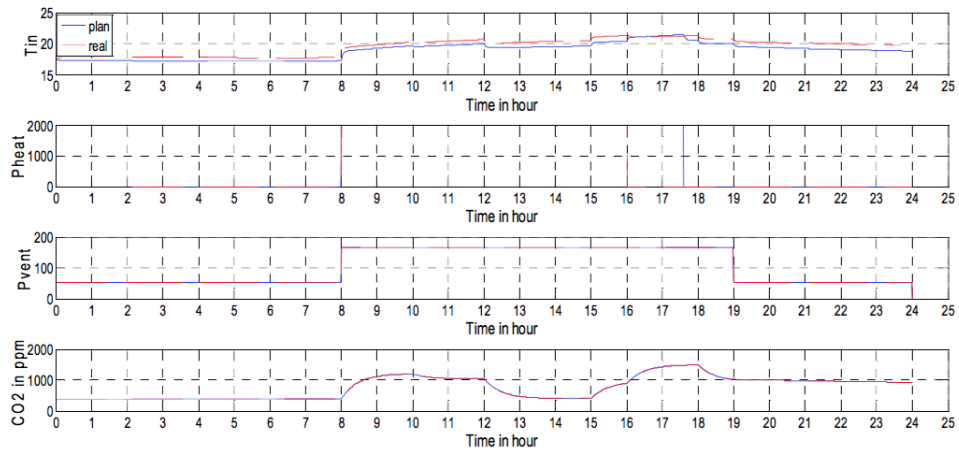


FIGURE 2.13: Planned and simulated results for variation in weather

TABLE 2.1: Explanation of discrepancies with possible causes

Possible causes	Possible discrepancy		
	CO2 Conc.	Energy cost	Indoor temp.
occupancy variation	+/-	+/-	+/-
weather change	No change	+/-	+/-
unplanned appliances	No change	+/-	+/-
open door or window	-	+	+/-

unplanned appliances will increase the energy consumption and cost as well. Simulation results in figure 2.13 explain how extra heating power appears because of unplanned heating appliances. It also represents the variations in indoor temperature. On the other hands, CO2 concentration, and ventilation power do not significantly change. Table 2.1 delineates the outcome of a study. It shows the underlying relation between causes and possible discrepancies. However, a detailed study at whole building level



including sub-system and nodes has been done in chapter 7.

### 2.4.2 Scenario 2: Reality vs Anticipation

A second study also has been done. The reactive mechanism with a period  $\Delta_r=5$  minutes has been examined. Considered method was inspired from *Run till hit* approach to achieve the minimum indoor comfort. A minimum air quality and the indoor temperature are requested to be maintained by considering the anticipated power available for future. Reactive actions are only able to reschedule the services or request for new services respecting the available power and desired comfort. Figures 2.14(a) and 2.14(b) depict the change in ventilation and heating system due to the discrepancy in anticipated and measured reality. Though, present approach follows the direct intervention of reactive changes without knowing the causes and consequence. Moreover, actions are limited to only two actions but in reality, actions could be more with conflicting interest. Using the above discussion and problem statement a reactive building management is

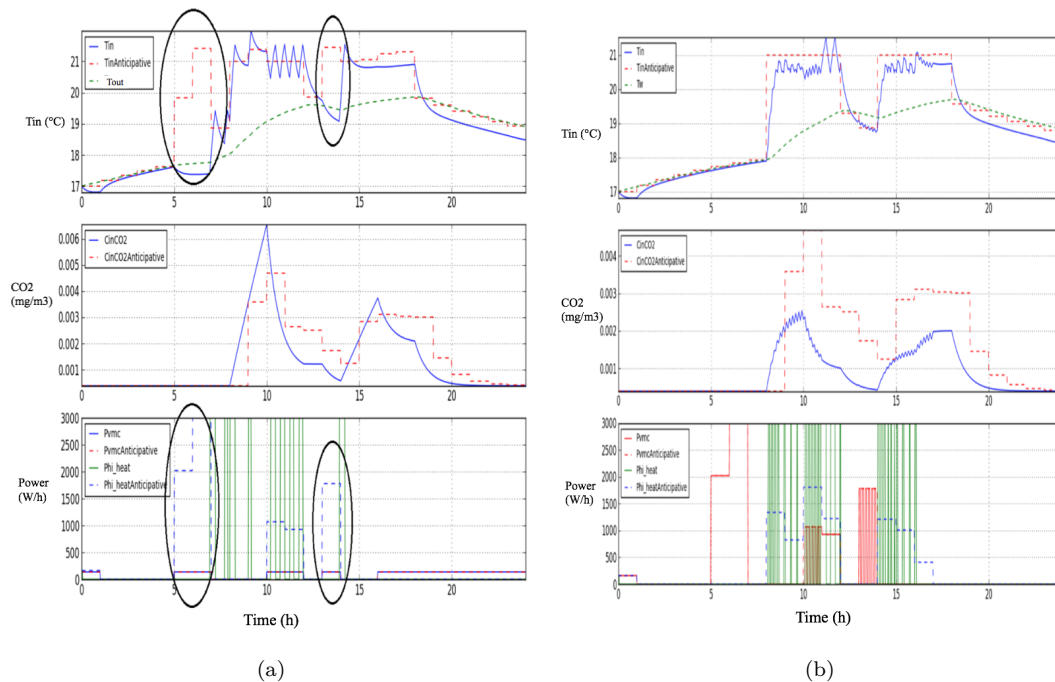


FIGURE 2.14: Requested change in heating and ventilation

proposed in future work. In the following chapters, the present problem is investigated in detail with the limitation of existing BEMS and fault diagnosis for reactive causes. A fast dynamics reactive model requirement is studied in detail in chapter 4. The building heating and ventilation services depending on the different building situations. Comfort adjustment is an imperative objective for reactive models. However, the whole building

energy performance is accomplished by Reactive building management. Further, Resistance and capacitance ( $R-C$ ) modeling technique with parity relation is opted to model the reactive model.

## 2.5 Diagnosis issue in Buildings

Smart buildings are complex systems with a large number of sensors, controllers, and HVACs. Fault diagnosis is a cumbersome process for building management system. Currently, most of the building facilities are using a scheduled preventive maintenance derived from periodic operations of the buildings. These preventive actions do not take into account the other inadmissible issues that can cause unaccountable impacts over occupant's comfort during the 24-hour operation cycle. A conventional building automation system (BAS) can raise discomfort or failure alarms, which identify some issues in buildings. Alarms are based on thresholds but do not locate the exact causes and their type. For example, an air quality alarm activates when actual measurements fall above the desired threshold. In practice, alarms should not necessarily belong to an operational failure. It could be from other sources, for instance, unplanned situations (eg. unplanned occupancy), change in forecasts, misusages or faults (eg. anticipative system is out of order). An alarm requires further analysis to identify the fault causes and their remedies to fix the problem. More importantly, BAS alarms consider only critical alarms that lead to discomfort or maintenance issues. Further, these explications escalate the following important concern for building research community.

- Is maintenance the only solution to avoid discomfort and over consumption?
- How to assure the minimum level of comfort during the failure or unplanned situations?
- How to analyze short-term and long-term effects of technical failures or anomalies? For example, a bias sensor cannot cause immediate discomfort and could be ignored while a misused heating system might raise discomfort and energy consumption issue.
- What is the origin of anomalies and how to investigate them with their consequences and their causes?

- How to react, if an issue is not a technical failure?
- What to do during the interruption of building services?
- How much time and money will be needed to restore the normal building operations?

Until this point, it is very obvious, only maintenance or anticipations are not enough to vouch for a good level of comfort or energy efficiency. Indeed, maintenance or refurbishment also require a financial support and planning, usually building owner dither to adopt these actions because of initial investment and return. To circumvent these situations, buildings operations need to be coupled with different intricate actions. From the experience, occupants complaints and feedback, it was found there are following primary reasons that cause discrepancy in anticipated building performance;

1. equipment failures in buildings including HVAC
2. unplanned situations
  - 2.a. unplanned environmental context
  - 2.b. misuse i.e. humans behavior and occupancy
3. abnormal building driving
4. abnormal building system state

Fault diagnosability is still a challenging task taking into account the whole building performance in a short-time period. Hence, there is a need for fault detection and diagnosing BEMS that consider the whole building system and diagnosis in a short interval. It should focus on all major anomalies including unplanned situations and able to provide corrective actions or recommendations to the building operator as well as users. In this thesis, a new Anticipative Reactive Diagnosing-building management system (ARD-BMS) is proposed. Present approach takes into account the relatively shorter time period i.e. reactive period, associated with the longer anticipative period. A detailed diagnosis methodology integrated with reactive building system is discussed in chapter 7.

## 2.6 Conclusion

Present discussion explores the detailed problem. An anticipated set-point is used to regulate the indoor comfort and associated cost. Often, discrepancies arise in reality and anticipation. For instance, indoor thermal discomfort causes an apprehensive situation for occupants. An anticipative energy management is not able to explain the faults or failures in building operation. Further, a conventional reactive building operation relying on *hit and run* and, not capable to analyse building interruptions. Predis/MHI is considered as an experimental platform to warrant the problem statement. A real-time problem is examined to expound the discrepancy in anticipative management. At the end, a simulated validation of the problem is studied.

## Chapter 3

# Building Energy Management

### Contents

---

<b>3.1 Introduction</b> . . . . .	<b>28</b>
<b>3.2 Existing Building Energy Management System-Context and Issue</b> . . . . .	<b>30</b>
<b>3.3 Proposition of Anticipative Reactive Diagnosing (ARD-BMS)</b>	<b>37</b>
3.3.1 Algorithms for Anticipative Reactive Diagnosing (ARD-BMS) .	40
<b>3.4 Conclusion</b> . . . . .	<b>43</b>

---

*Abstract- Energy management and efficiency became a perpetual research for building researchers. Managing the energy consumption along with operational cost and comfort is the primary objective for all building energy management system (BEMS). The Present chapter highlights the current building energy management paradigm and practices. An Anticipative Reactive Diagnosing (ARD-BMS) is proposed in amalgamation with previous research and application.*

### 3.1 Introduction

Human species is the most intelligent species on the planet and always intend to control their surrounding. The purpose of control actions is to achieve the desired merit whether it is monitory, comfort or time-saving. An evolution of control theory began

with the intention to define the set of rules to take control over the different circumstances. Buildings are constructed to achieve the greater comfort and well-being. They are complex in nature and consist of different zones. Each building has different constructional properties and is occupied by people with different comfort preferences and needs. Historically, buildings were accounted for shelter and architectural view. However, the modern definition of the building is changed, for instance, US Department of Energy (DOE) defines the building as:

- *A structure wholly or partially enclosed within exterior walls, or within exterior and party walls, and a roof providing services and affording shelter to persons, animals or property.*

While European building directive EPBD define building in-terms of energy use:

- *building means a roofed construction having walls, for which energy is used to condition the indoor climate.*

To satisfy the inhabitant's comfort needs and energy constraints, a new concept of building i.e. **energy smart building** has been emerged in recent few years. Energy smart building uses an energy management system (EMS) to monitor the energy consumption and respective cost. An EMS consists of controllers and building information models (BIMs) to establish communication between occupants perception and building dynamics. Building automation and control (BAC) is considered as a brain for building energy management system and it shapes the indoor comfort according to users demands. It controls the HVAC, lighting, and operational cost of the building. In general, BEMS were found in big official and a commercial building where comfort need to be monitored automatically. A widely accepted and very often used controller for building automation is rule-based. They are simple on-off controllers and offer an easy implementation to control the building environment. The recent development of ITC based technologies and improved controllers provide more advanced BEMS that can pledge greater comfort and cost saving. This chapter introduces the issues and limitations of current trends of BEMS. Section 3.2 describe the various strategies for existing BEMS with concise state of art. Further, a reactive building management is proposed in section 3.3.

Figure 3.1 shows the typical smart building system. It uses on-site and off-site electricity generation. In some cases, notably in Europe, gas based heating systems are

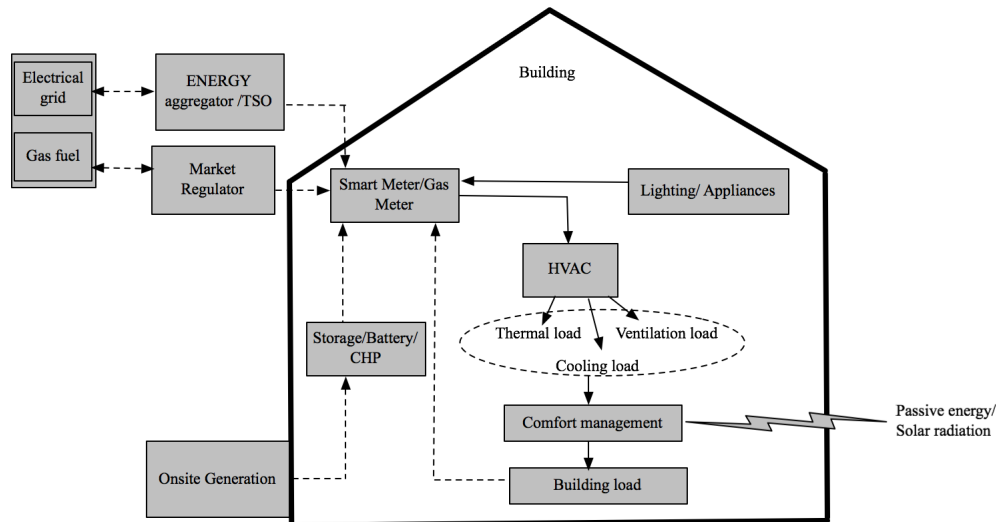


FIGURE 3.1: A typical Smart Building

widely used for heating purpose. The electricity and gas prices are decided by market regulators. A heating, cooling, and ventilation (HVAC) system improve the indoor thermal comfort with better indoor air quality (IAQ) services. A comfort management system uses the building information such as solar radiation, occupancy presence, internal gains, weather prediction to update the current building load.

### 3.2 Existing Building Energy Management System-Context and Issue

During 1987-1991, International energy agency (IEA) had set-up a consortium annex-16<sup>1</sup> with the countries Japan, Germany, Finland, United kingdom and Netherland. The aim was to examine the common practices of controllers and BEMS. The expected outcome was to establish a computerized control regulatory and monitoring system that can ensure:

1. Healthy and pleasant indoor comfort
2. Safety of users and owners
3. Economical operation of building

<sup>1</sup>Annex-16, <http://www.ecbcs.org/annexes/annex16.htm>

Moreover, in annex-16, IEA has adopted the following definition of a BEMS:

**Building Energy Management System**

An electrical control and monitoring system that has the ability to communicate data between control nodes (monitoring points) and an operator terminal. The system can have attribute from all facts of building control and management function such as HVAC, lighting, fire, security, maintenance management and energy management.

**-International Energy Agency (IEA)**

The performance of BEMS is inherently affected by the occupant’s behavior, weather condition, and building dynamics. In practice, BEMS acts like a coordinator, negotiator, and supervisor to achieve the optimal operational performance. An advance BEMS offers not only the energy saving and comfort but is also able to manage other requirements for example lighting, fire protection and blind control (Guillemin and Morel, 1999). The recent trends of BEMS utilize the modern optimization based *distributed* control with layer structure (Lefort et al., 2013; Ha et al., 2012). To exemplify, some building energy management scheme are discussed below.

The first very common approach is a multi-scale building energy management system (Ha et al., 2012). In this approach, energy managements system follow the

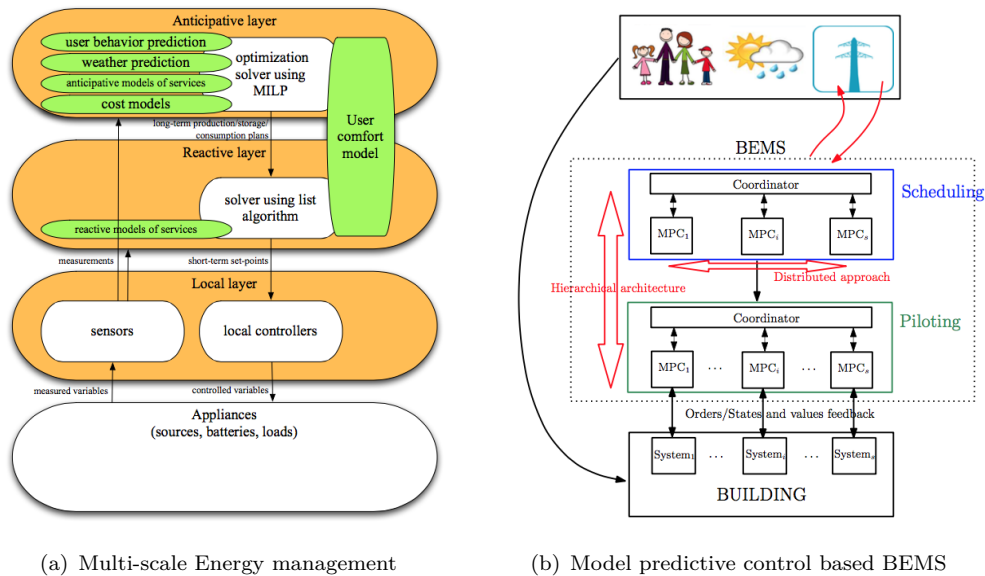


FIGURE 3.2: Multi-layer BEMS

multi-scale control hierarchy, in which energy management strategies were explained at



the higher level control and often referred as a *supervisory control*. However, middle and local layer are responsible for service model and local controllers. Higher level controllers use an optimizer that provides the better agreement between cost, comfort and controller actions. Indeed, supervisory control supervises the local controllers to achieve the desired building performance. In the present, multi-scale energy management figure 3.2(a), (Ha et al., 2012) followed the three layer architecture i.e. *anticipative*, *reactive*, and *local* layer to monitor the occupant's comfort and direct energy cost. The anticipative layer is responsible for scheduling the end user services and forecasts for the day-ahead cost, and comfort profile for occupants. These forecasts were derived from user behavior prediction, weather model, cost and service model. The middle layer i.e. reactive layer adjusts the energy assignment by delaying or unplugging the services for unpredictable events or perturbation and update the set-point determined by the upper layers according to users comfort.

Finally, the local layer consists in the local controllers at device level such as a thermostat, switches etc. It reschedules the local appliances according to upper layer requirement.

In the recent development, a model predictive controller (MPC) based BEMS has been proposed. In figure 3.2(b), author (Lefort, 2014) demonstrated a BEMS using MPC as a node at the different level. MPC is also known as Receding horizon optimization control (RHOC) and works with sliding time window. In this work, author proposed a hierarchical decentralized MPC scheme for BEMS. At each stage, MPC BEMS solves an optimization problem and decompose the global building optimization problem into local sub-problems. However, each MPC node requires a physical model to solve the optimization problem.

Though MPC offered a potential energy saving in a multi-variable environment at simulation ground but handling complexity with the model requirement, deployment, monitoring and intensive computation made it expensive for real practice. It is also difficult to deploy for medium size or small buildings. Despite, these issues few major projects i.e. OptiControl<sup>2</sup> in Switzerland and MIGER<sup>3</sup> funded by The French Energy Agency (ADEME) reported a successful implementation of MPC. Undoubtedly, MPC

---

<sup>2</sup>OptiControl-<http://www.opticontrol.ethz.ch/04E-Publications.html>

<sup>3</sup><http://www.tenerdis.fr/Efficacite-energetique-dans-le-batiment/migrer.html>

offers a significant energy saving and peak load reduction at experimental ground but still lacking to justify the whole building operation (WBO) (Cigler et al., 2013).

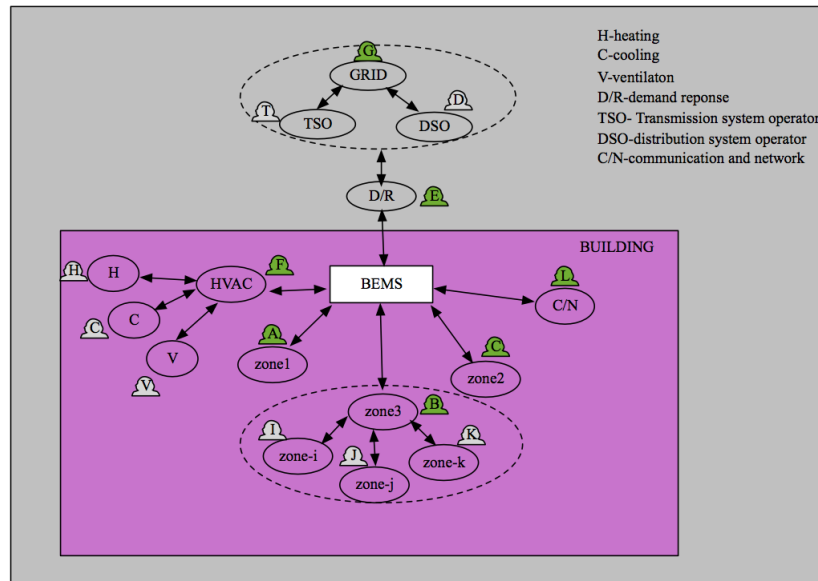


FIGURE 3.3: Agent based Energy management

Another popular approach of BEMS design is known as multi-agent based (MAS) (Wang et al., 2010; Joumaa et al., 2011) uses MAS structure with a central agent-controller and multiple local agent-controllers to achieve the maximum user comfort in two different operational modes. (Joumaa et al., 2011), proposed a MAS structure to track the electricity consumption and production flexibility, it considered different service model with reactive and anticipative actions respectively. Likewise, other interesting MAS structures were found in (Ramchurn et al., 2011). MAS uses the concept of the *agent*, that can be defined as: “*Independent software entity that can perform actions in a dedicated environment to achieve the goal*”. Agents are intelligent and coordinate with the surrounding environment and are able to react to any change in coupled environment. It works on the principle *sense*, *decide*, and *act*. The agents have three main properties i.e. *reactive*, *proactive*, and *social* (Gilbert, 2008). In the real world, most of the environments are dynamic and agents need to respond to changes in the environment. Thus far, agents are programmed as dynamic software with reactive capability. These reactive agents are able to maintain the interaction with changing environments and respond the ongoing changes. Despite reactive to change each agent has local goals to achieve that refer to protectiveness of agents. Agents make effort to achieve their own goals. Eventually, each agent has social attributes that allow him to communicate with

others. Some goals can be realized by interacting with other agents. In spite of above three, agents have some more properties such as *mobility, openness, learning, adaptation, rationality veracity* etc. (Gilbert, 2008).

Figure 3.3 illustrates a multi-agent based BEMS for a building with the multi-zone (Wang et al., 2010). Though this structure could be more complex but for the sake of simplicity, a more common structure is adopted for the present study. To deal with the building operational complexity, BEMS divides the building into different zones and sub-zones. These zones are used to be divided on the basis of the functional characteristic or zonal attribute such as: occupancy and comfort. BEMS assigns agents for each zone. Further, each agent has a special task to be performed, for instance, agent E and F are responsible for demand/response and HVAC operation. For building operation, each agent has two universal goals: maintaining the indoor comfort and minimizing the energy consumption (or cost).

In addition to above, other model-based controllers such as predictive (Chen, 2001; Gayeski et al., 2011), adaptive (Kontes et al., 2012; Nesler, 1986; Nicol and Humphreys, 2002) and optimal (Kang et al., 2014; Zaheer-Uddin and Zheng, 2000) controllers are available in the literature. However, they have appropriate model availability and implementation complexity.

### **Reactive approaches:**

In the previous reactive building approaches, most of the researchers practiced the direct definition of word “reactive” i.e. “ready for action”, without considering any integrated management. The reactive approaches were considered as only a control mechanism. For example, (Klein et al., 2010), compared reactive control techniques with the manual and proactive approach. An energy savings of 11.8%, was realized, compared to base-line consumption. Figure 3.4 illustrate the resultant saving. Such studies investigated that reactive building approaches are least performing in comparison to proactive or anticipative approaches. In few other studies, the reactive mechanism is applied with building management system and planning. Abras et al., 2014, verified the significant energy saving with the help of reactive planning algorithm for on-site solar electricity generation to control the laptop charging. The results (figure 3.4) shows the meaningful saving during the reactive period. The proposed reactive algorithm is given below. Likewise, a building energy management system (EMS) with reactive mechanism is proposed

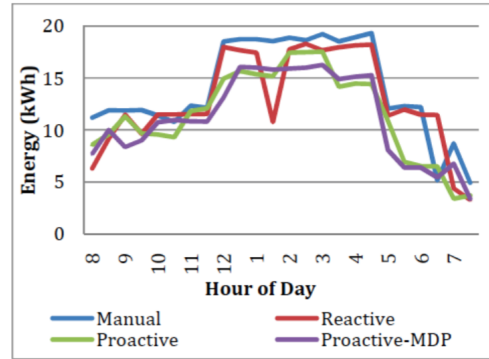


FIGURE 3.4: Reactive control for power management [Klein et. al., (2010)]

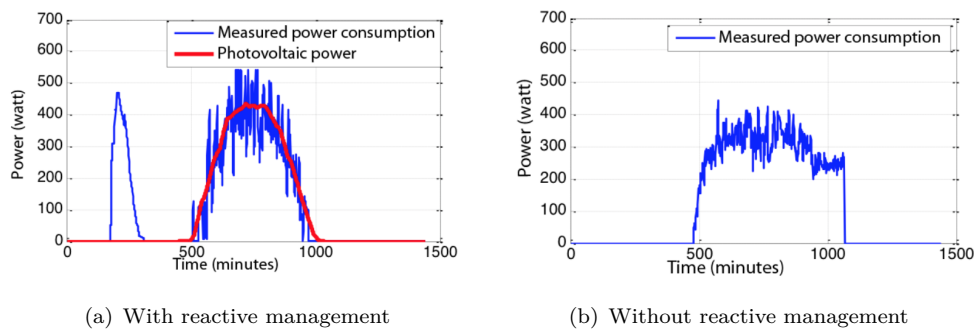


FIGURE 3.5: Reactive planning for laptop consumption [Abram et. al., (2014)]

by (Missaoui et al., 2011). The concerned work concludes the potential saving of PV integration with and without energy management system.

Victor M. Zavala presents a proactive optimization based energy management for next generation building system. The proposed framework integrates predictive building models with day-ahead forecast and disturbances (Zavala et al., 2010). The planning strategy is based on the on-line solution of mixed integer nonlinear programming (MINLP) problem. The major finding of this work is to evaluate the performance of building energy management under the various disturbances such as weather change, heat gain, and utility demand.

### Challenges:

Even though buildings have enough advancement in automation and communication technology, still, existing BEMS suffers from the following problems:

- *Uncertainty*- Most of the energy management schemes suffer from the uncertainty in building operation. The major uncertainties come from the non-measurable

```

Require : Emergency ← Emergency level for laptops;
For (period ∈ reactive periods) do
  sum = 0;
  Require : PV.production ← Real production for this period from Photovoltaic Panels;
  For ((PC ∈ List of laptops)) do
    Require : PC.SOC ← PC Info : State of charge;
    Require : PC.Set_Point ← Set point of PC from anticipative plan;
    If (PC.Set_Point = ON) then
      Switch PC ON;
      sum = sum + PC.consumption; [if PC.production ; sum : use PV ; else use grid]
    else
      If (PC.SOC < Emergency) then
        Switch PC ON;
        sum = sum + PC.consumption; [if PC.production ; sum : use PV ; else use grid]
      else
        Switch PC OFF;
      end If
    end If
  end For
end For

```

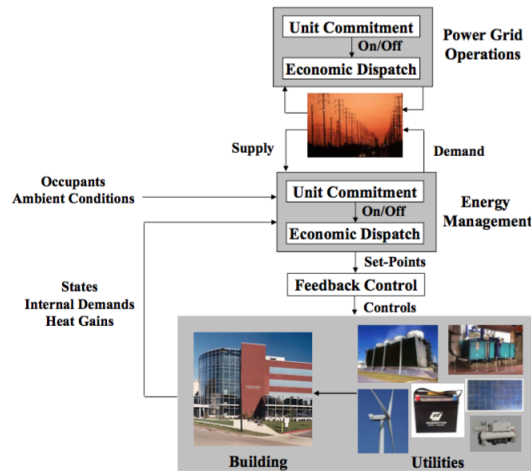


FIGURE 3.6: Proactive building management [Victor M. Zavala et. al., (2010)]

quantities like occupancy, lack of coherent weather prediction, unpredictable human behavior. The unavailability of the current state of buildings is also a hindrance for BEMS.

- **Whole building operation-** Determining the reactive strategies at whole building level is also a difficult task. A BEMS operation should cover all building elements such as HVAC, lighting, unplanned events. Current rule-based approaches or human operator supervision is not enough due to increasing building complexity and add-on services. Model-based building managements are challenged by the

availability of precise model and parameter estimation.

- **Performance monitoring and fault detection-** Future smart buildings are going to be more complex due to continuous integration of substantial amount of emerging technologies and higher user expectations. In this context, technical malfunctions or unplanned situations can cause a huge impact on building operation and occupant's comfort. To make a resilient building management system, it is important to identify the severity, cause, and type of each fault. An insignificant fault with less impact can be ignored deciding the maintenance strategies whereas faults that might lead to critical discomfort or excess energy consumption cannot be avoided by the building management.

### 3.3 Proposition of Anticipative Reactive Diagnosing (ARD-BMS)

As discussed before, existing BEMSs suffer from few major issues such as whole building operation, and performance monitoring. Anticipative building energy management provides the best cost (consumption) and comfort profile for day ahead operation (Missaoui et al., 2014). These anticipations are computed by predictive models and optimizer from the building performance history, planned occupancy and occupants preferences. The objective of an optimizer is to provide an optimized plan for 24-hour operation (Le et al., 2013). These plans are usually harmonized with one hour sampling period i.e. anticipative period ( $\Delta_a = 1hour$ ). By following the anticipated plan, buildings can get optimal performance along the day. However, these plans are influenced by contextual changes such that may cause discomfort and over expenses. To tackle these problems, an Anticipating Reactive Diagnosing-building management system (ARD-BMS) is proposed in this section (figure 3.7). Moreover, the proposed reactive building management address the following problem:

- **Building uncertainty-** Very often, unplanned occupants and their actions are responsible for uncertainty in building operation. Unplanned occupancy might raise thermal discomfort or poor air quality problem. Set-points or plan need to be adjusted according to current occupancy. ARD-BMS should diagnose the unplanned

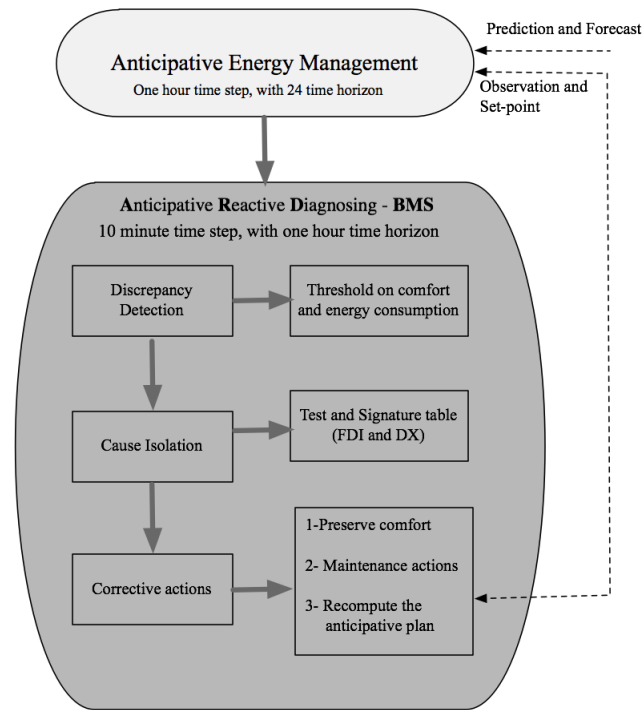


FIGURE 3.7: Reactive Building Management configurations

occupancy situation and its consequences. At the same time, it should recommend some actions such as open/close the door/window or update the current anticipative plan.

- **Whole building operation-** Various existing BEMS studies verified for a specific component of buildings. However, ARD-BMS should be able to tackle whole building operation as a system with human-in-loop. The whole building can be divided into various sub-systems and nodes followed by the component analysis. A sub-system can be added or removed depending upon building operation and occupancy. Each sub-system has linked with specific variable and deviation in these variables imply some issue in building operation. A more detailed with case study is discussed in chapter 7.
- **Building performance analysis-** Continuous monitoring of building performance is also an important tool to ensure the indoor comfort. Future building operation should not completely follow the plan irrespective of current building situation. Buildings have to operate with little planning but more re-activeness. In this capacity, ARD-BMS should analyze the building performance at every reactive period. ARD-BMS solely rely on anticipative energy management with

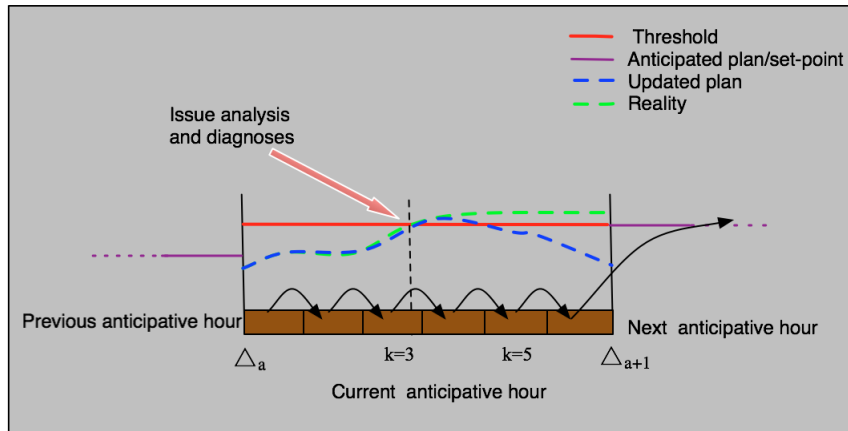


FIGURE 3.8: Reactive update

relatively shorter time resolution i.e. reactive period  $\Delta_r = 10 \text{ minutes}$ . An example for discomfort in anticipative period is illustrated in figure 3.8, where reality disobey ( $k = 3$ ) the comfort threshold. ARD-BMS analyzes the issue and finds the potential causes. Further, with the help of reactive optimization, it should update and predict when (eg.,  $k = 5$ ) the building will come back to its normal operation. However, complete failure and poor performance of equipment can be tracked by following the whole building operation.

An off-line hazard and operability (HAZOP) analysis give a bank of faults, causes, and consequences. Further, bridge approach for FDI and DX is used to detect and isolate the respective causes. Bridge provides a list of possible diagnostic to manage the reaction in this context. The next stage decides *what to do* and *how*. Actions could be reactive, maintenance or advice and anticipative. It is able to perform the fault detection and diagnoses to measure the discrepancy in building operation.



## 3.3.1 Algorithms for Anticipative Reactive Diagnosing (ARD-BMS)

```

Data: comfort boundary ( $c_b$ ), real measurements ( $r_m$ ), anticipative
        plan ( $p$ ), discrepancy test ( $d_t$ )
Result: updated comfort before next anticipative period
Initialization;
    anticipative period  $\Delta_a$ ;
    reactive period  $\Delta_r$ , with  $n\Delta_r = \Delta_a$ ,  $n \in \mathbb{N}$ ;
    time :  $t \in [j \Delta_r + i\Delta_a, (j + 1) \Delta_r + i\Delta_a]$ ,
         $i \in [0, 23]$  : index for anticipative period;
         $j \in [0, n - 1]$ , index for reactive period;
Require: comfort boundary( $c_b$ )  $\leftarrow$  discrepancy test ( $d_t$ )
while do
    | get  $r_m \forall t$ ;
    | if  $r_m$  violates  $c_b$  then
    | | perform detection and diagnosis;
    | | issue analysis;
    | | action;
    | |   update the comfort plan;
    | |   update the energy plan;
    | |   recommend to occupants;
    | | ENSURE comfort;
    | else
    | | follow anticipative plan( $p$ );
    | end
end

```

**Algorithm 1:** Reactive action, on-line update

*Remark 3.1.* The scope of *algorithm 1* runs within one anticipative period. If the indoor comfort measurements violate the comfort boundaries then ARD-BMS release the request for immediate update in ventilation and heating tuning or recommendations. Finally, it ensures the comfort by rechecking the comfort boundaries. However, in the case of normal comfort, it follows the anticipative plan.

```

Data: Comfort boundary ( $c_b$ ), real measurements ( $r_m$ ), anticipative
        plan ( $p$ ), discrepancy test ( $d_t$ )
Result: updated comfort and energy plan
Initialization;
Algorithm 1;
anticipative period  $\Delta_a = \Delta_a + 1$ (next anticipative period);
time :  $t \in [j \Delta_r + i \Delta_a + 1, (j + 1) \Delta_r + i \Delta_a + 1]$ ,
         $i \in [0, 23]$  : index for anticipative period;
         $j \in [0, n - 1]$ , index for reactive period;
Require: comfort boundary( $c_b$ )  $\leftarrow$  discrepancy test ( $d_t$ ) while
         $\Delta_a = \Delta_a + 1$ (next anticipative period) do
    | get  $r_m \forall t$ ;
    | if  $r_m$  violates  $c_k$  then
    | | perform detection and diagnosis;
    | | issue analysis;
    | | action;
    | |   request for new plan;
    | | ENSURE comfort;
    | else
    | | follow anticipative plan( $p$ );
    | end
end

```

**Algorithm 2:** Anticipative action, anticipative plan update

*Remark 3.2.* Algorithm 2 utilizes the result from algorithm 1 with the scope wider than one anticipative period. In the case, if immediate reactive action are not enough to resolve the discomfort issue and problem continue to next anticipative period or longer then ARD-BMS request for change or re-computation of anticipative set-points. It may require rescheduling of appliances or HVAC.

```

Data: off-line HAZOP building fault analysis in detail
Result: maintenance request
Initialization;
Algorithm 1;
Algorithm 2;
while BUILDING NOT in Normal operation do
    follow building fault analysis;
    action;
        request for maintenance call;
        wait for normal operation;
end

```

**Algorithm 3:** Maintenance action, off-line

*Remark 3.3.* Algorithm 3 launches an immediate maintenance request action when building management system is not able to retrieve the normal operation by applying the reactive or anticipative action. A waiting time is required to perform desired maintenance for getting normal operation.

A detailed description of diagnosis test, corrective action, and HAZOP process is given in chapter 7. An example of reactive update in ventilation is illustrated in figure 3.9. An air quality issue is raised during the 14-15 hour due to unplanned occupants. After analyzing the actual cause associated with the air quality problem ARD-BMS apply the ventilation tuning.

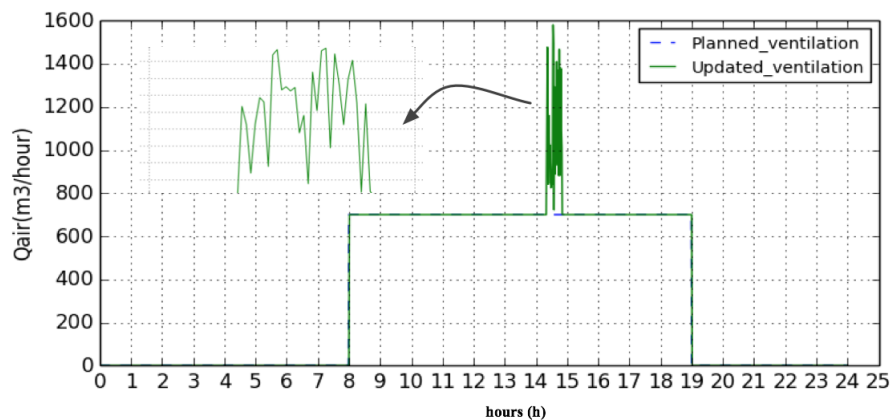


FIGURE 3.9: Ventilation plan update

### **3.4 Conclusion**

This chapter explores the different aspects of existing building energy management systems. The existing BEMS primarily emphasize the energy saving and is inadequate for reactive management. The most common structure for existing BEMS is multi-scale and rely on the predictive planning of indoor comfort. Nevertheless, plan is useful for energy saving and optimal building operation but the discrepancy in the plan may arise due to different unexpected or spontaneous changes in building operation. The other model-based approaches are challenged with modeling issues. To underline these issues in detail an Anticipative Reactive Diagnosing-BMS with the capability of whole building analysis and fault diagnoses discussed in the present chapter. ARD-BMS can delve into potential causes and consequences. Further, reactive, anticipative and maintenance actions make it competent to avoid unanticipated events.

# Chapter 4

## Modeling for Reactive Diagnosing-BMS

### Contents

---

<b>4.1</b>	<b>Introduction</b>	<b>46</b>
<b>4.2</b>	<b>Need for a simplified reactive model</b>	<b>47</b>
4.2.1	Simplified Building Model; State-of-the-art	48
<b>4.3</b>	<b>State-Space Modeling</b>	<b>50</b>
<b>4.4</b>	<b>Fine Simulation Model-Predis/MHI</b>	<b>50</b>
4.4.1	Fine Simulation-Thermal model	52
4.4.2	Indoor Air Quality (IAQ) Model	58
<b>4.5</b>	<b>Anticipative Energy Management - Modeling Context</b>	<b>59</b>
4.5.1	Anticipative Thermal model	60
4.5.2	Anticipative air quality model	62
4.5.3	Anticipative optimizer	62
<b>4.6</b>	<b>Reactive Building Model</b>	<b>63</b>
4.6.1	Simplified reactive thermal model - Modeling perspective	64
4.6.2	Canonical State-Space Representation for Simplified Model	65
4.6.3	Qualitative Comparison between Simplified and Fine simulation model	67
4.6.4	Indoor Air Quality Model for Reactive Management	68
<b>4.7</b>	<b>Reactive strategies in Building Management (10 minutes reactions)</b>	<b>68</b>

**4.8 Conclusion** . . . . . **69**

---

*Abstract- Indoor comforts in residential and office building highly depend on changing the environment and unplanned discrepancies. To act upon, discrepancies and changes a fast dynamic simplified model are one of the main prerequisite for Reactive Diagnosing-BMS. In fact, reactive strategies rely on the current state of building. This chapter emphasizes the development of low order, simplified resistance-capacitance (1R-1C) model with equivalent state-space representation. Simplified model with relatively easy initialization and able to capture the reactive behaviors of the building are crucial interest to handle abnormal situations. Parity relation method is used for modeling purpose. Further, an air quality model is discussed in the context of reactive management.*

## 4.1 Introduction

A re-actively managed building needs continuous performance monitoring of indoor comfort with the ability to respond to ambiguous situations during the daily building operation. Corrective actions based on building controller alarms are not enough to countermeasure the discrepancy due to lack of incorporation with current information (e.g., weather forecast or change in occupancy pattern) with building automation system (BAS). In addition, existing controller actions do not account for the current or new reality of buildings. For various buildings, the detailed thermal properties of construction material are not available and it is difficult to model properties of inner walls. Due to unavailability of required parameters, it is impossible to measure the interior wall temperature, whereas surface temperature is not adequate for corrective actions. In this context, a wrong action might lead to awful discomfort.

A simplified model with short sampling period is indispensable to compute the current state of the building. These models should be easy to initialize and useful for fault correction and set-point update. Discussion in this chapter is covered as follows: sections 4.2 describe the need of reactive model with simplified model literature review. Further, section 4.3 and 4.4 describes the state-space modeling approach and 3R-2C, the simulation model for the Predis/MHI. At the end, section 4.6 and 4.8 sums the chapter with reactive modeling and conclusion.

## 4.2 Need for a simplified reactive model

As explained before in chapter 3, ARD-BMS is synchronized with short-time reactive period and follow the anticipative plan. Meanwhile, it also looks after the occupant's comfort. In everyday building operation is sensitive to surrounding dynamics such as environmental changes or occupants behavior. An example of unplanned occupancy situation for Predis/MHI is illustrated in figure 4.1. So far, to capture the short-term inconsistency in building performance reactive management needs a fast dynamics reactive model. A simplified model provides the short-term control strategies and decides actual heating and ventilation load for current building operation. A detailed reactive

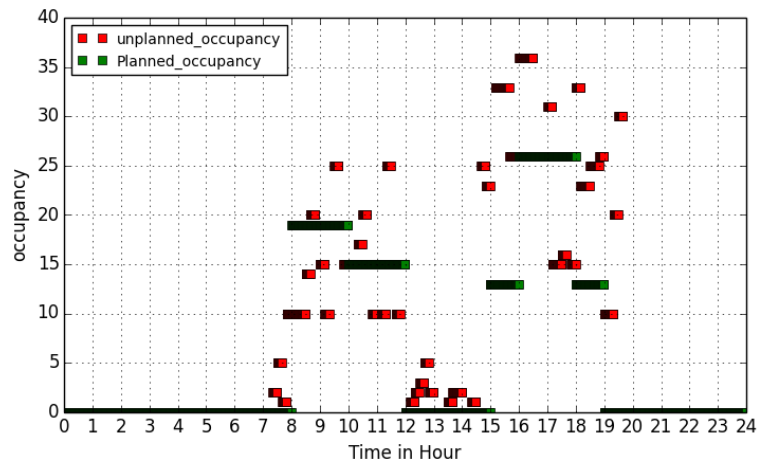


FIGURE 4.1: Planned and unplanned occupancy

modeling arguments has been discussed in section 4.6.

The other integral part of reactive building management is an indoor air quality (IAQ) model. This model is able to compute the CO<sub>2</sub> concentration for each reactive period. In the situation of poor air quality or when it goes above the threshold value, an air quality model updates the ventilation considering the current thermal comfort. Furthermore, the model takes into accounts the variation in occupancy, current ventilation rate and metabolic level of occupants. An optimizer is responsible for computing the appropriate ventilation rate with the help of air quality model.



### 4.2.1 Simplified Building Model; State-of-the-art

Various sources of heat gains or flows are impossible to model. Parameter estimation is also a critical challenge for both black-box (data-based) as well as gray-box (knowledge-based) models. Since last few years, various researchers have made an effort to develop an appropriate simplified or reduced order model with fewer parameters to estimate. Indeed, the major concern was given to predict the peak electrical load by computing control strategies (Braun and Chaturvedi, 2002; Braun, 1990; Candanedo et al., 2013; Fux, 2013) or used for diagnosis purpose<sup>1</sup> (Kramer et al., 2013). Moving forward, S. Wang, Xinhua Xu proposed a hybrid model for both diagnosis and control purpose (Xu et al., 2009). The primary methods have been used for developing the simplified model depicted in figure 4.2.

The neural network model and linear parametric models fall under the category of black box models. Neural network models are basically data driven and do not require any additional knowledge about the physical properties of the building, it is considered as a major advantage over other modeling techniques. In an interesting work, Mustafaraj (Mustafaraj et al., 2011) developed a neural network based on a nonlinear auto-regressive model with external inputs (NNARX) to predict the room temperature and relative humidity. Time resolution for this work was considered as 30 min to 3 hours ahead. Finding reveals, NNARX model have improved results over ARX. Further, more convincing results were published in subsequent reports (Patil et al., 2008; Tao Lu and Viljanen, 2009). Linear parametric models also rely on data based modeling without having any knowledge of physical parameter. Loveday and Craggs proposed stochastic model and Box-Jenkins time series is employed to describe the thermal behavior of a building, influenced by ventilation variation, external temperature variation and change in occupancy pattern (Loveday and Craggs, 1993). Again, Mustafaraj (Mustafaraj et al., 2010) introduces a temperature and relative humidity linear parametric model for an open office. In his findings, he explained several advantages of linear parametric modeling over other techniques. Few other works related to thermal modeling using linear parametric models are described in (Lowry and Lee, 2004; Mitalas and Stephenson, 1967).

---

<sup>1</sup>Whole Building Diagnostics (WBD) <http://poet.lbl.gov/diagworkshop/proceedings/claridge.htm>

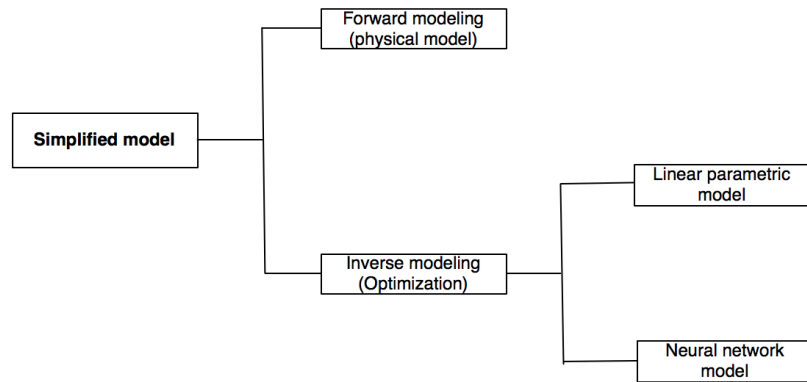


FIGURE 4.2: Simplified modeling approaches

Analogous to data based modeling approaches a group of researchers focused on the development of low order simplified model using electrical network analogy. These models are known as lumped capacitance model and use  $R$ - $C$  network to represent building elements. Mostly, works related to  $R$ - $C$  modeling only dealt with indoor temperature simulation (Kämpf and Robinson, 2007; Nielsen, T., 2005). A validation of these models was published by P . Kopecky (Kopecky, 2011). He experimentally validated a simplified model for a thermally insulated box. Each node in  $R$ - $C$  network represents a temperature and  $C$  represents the model order. A good number of arguments were also found in literature, discussing the required model order (Fraisie et al., 2002; Hudson and Underwood, 1999). In (Fraisie et al., 2002), author made the comparison of frequencies and time domain response of  $4R$ - $3C$  model with  $3R$ - $2C$  and  $1R$ - $2C$  model respectively.

An inverse modeling approach is often used to decide the modeling parameter. In this method model parameters are determined by comparing the reference output. An objective function is used to perform matching between reference and simplified model. For instance in (Mustafaraj et al., 2010; Wang and Xu, 2003) authors used root mean square error and multiple objective functions to formulate the optimization problem. However, due to the availability of a plenty of choices for optimization methods various researchers used different methods to solve optimization problems. These methods vary from classical optimization theory (Mustafaraj et al., 2011; Penman, 1990) to metaheuristic optimization method (Wang and Xu, 2003).

**Contribution of present work:** In present work, a simplified  $1R-1C$  thermal model is developed for reactive building management. This model is developed from complete  $3R-2C$  building model. In the rest of the chapter, a  $3R-2C$  model is referred as *Fine simulation* thermal model whereas the  $1R-1C$  model is referred as a *Simplified model*. **parity relation** (Ploix and Adrot, 2006; Singh et al., 2015b) is used to compare fine simulation ( $3R-2C$ ) model with a simplified model ( $1R-1C$ ) at every reactive period i.e., 10 minutes. A detailed modeling is discussed in section 4.6.

### 4.3 State-Space Modeling

To perform, an analytical study over any physical model the first requirement is to set up a mathematical model, describing the system parameter and their relations. In many cases, a differential equation serves for the modeling purpose. State-space models have certain privilege when the system is time varying and contains some non-linearities. An easy matrix notation and available numerical solutions are added advantage for state-space models. A detailed study of state-space modeling techniques is available in (Kaplan, 1964; Mortensen, 1975). State-space modeling techniques assume that properties of a physical system depend on certain variables. These variables represent the state of a system. Having the knowledge of states and their relation, it is easy to describe the complete system behavior.

### 4.4 Fine Simulation Model-Predis/MHI

In practice, it is impossible to get precise building's reality though measurements are the image of reality, measured at definite time samples. In the present study, a fine simulation model i.e. idealization of reality is used to simulate the building's reality. So far, it is very obvious that fine simulation model is **not reality** but the reflection of reality with sampling period as one minute. A fine simulation model for classroom zone of Predis/MHI (refer to chapter 2 for details) is shown in figure 4.3. This model simulates the closer reference of reality for experimental platform considering one-minute time resolution. Fine simulation model comprises an air quality model along with thermal

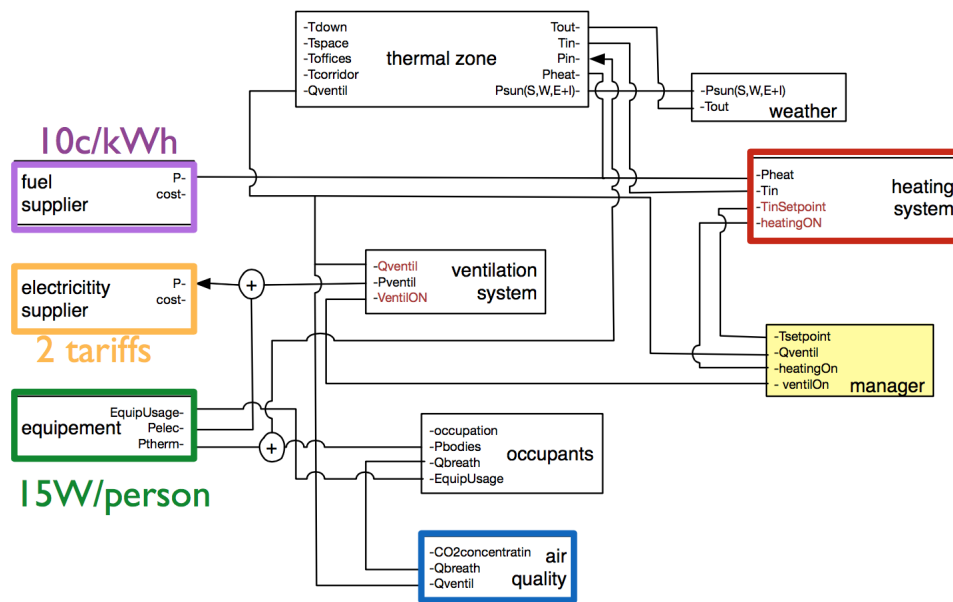


FIGURE 4.3: Fine simulation model

zone model. Thermal model, simulates the indoor temperature based on weather information and occupancy planning. A manager is dedicated to providing the anticipative set-points with heating and ventilation profiles.

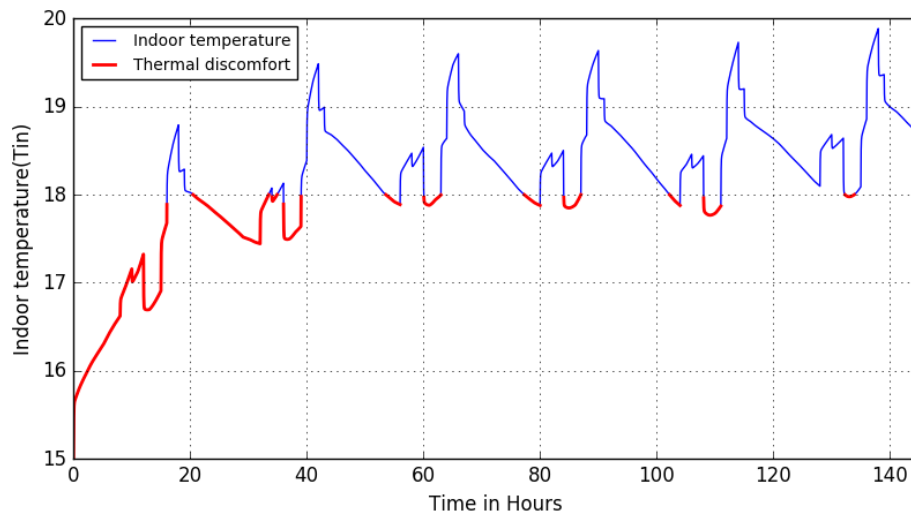


FIGURE 4.4: Thermal discomfort in Winter [One weak simulation]

There are two primary sources of available energy i.e. electricity and fuel. Electricity is used to run the electrical appliances like laptops, lighting, and other appliances. Depending on the consumption profile, an electricity supplier charges the electricity cost with varying tariff (figure 4.5). Every day hourly prices could be different and rely on

electricity generator and market regulator<sup>2</sup>. Additionally, a gas based heating system is used for indoor heating with flat heating tariff 0.1 €KWhr. An on-off controller with a precision of  $\pm 0.5^{\circ}C$  regulates the heating system according to current hour set-point. However, the controller may not be able to regulate the temperature beyond a certain limit and it might cause discomfort (figure 4.4). A short description of the controller is given below:

---

```

if Tin < Tsetpoint - 0.5 and (not isHeating and heater_switch == 1):
    isHeating = True
elif (Tin > Tsetpoint + 0.5) and isHeating:
    isHeating = False
if isHeating and heater_switch == 1:
    PhiHeat = heaterPower
else:
    PhiHeat = 0
heating_powers.append(PhiHeat)

```

---

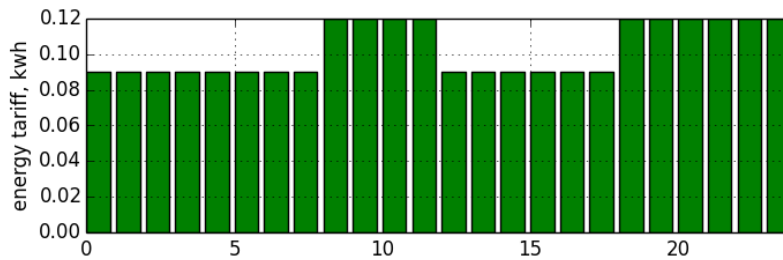


FIGURE 4.5: Electricity tariff for a day

Fine simulation model also implicates an indoor air quality model that simulates the indoor CO<sub>2</sub> concentration with the help of ventilation on-off scheme, occupants profile and their activity. Metabolic Equivalent (MET) values ( $\approx 80$  Watt for office work) are referred to measure the occupant's activity. For an average person working in office or classroom, this value is  $MET \leq 2$ . Further, both thermal model and air quality model are described in the next two sub-sections.

#### 4.4.1 Fine Simulation-Thermal model

Figure 4.6 illustrates the input-output relation for the fine simulation model. The description of model input and output is given below:

##### INPUT:

- $T_{office}$  : office temperature

---

<sup>2</sup>(Réseau de transport d'électricité-RTE) <http://www.rte-france.com/en/accueil>

- $T_{corridor}$  : corridor temperature
- $T_{down}$  : down slab temperature
- $T_{space}$  : space temperature
- $T_{out}$  : outdoor temperature
- $\phi_{heat}$  : heating system
- $\phi_{in}$  : internal heat and solar gain

**OUTPUT:**

- $T_{in}$  : indoor temperature

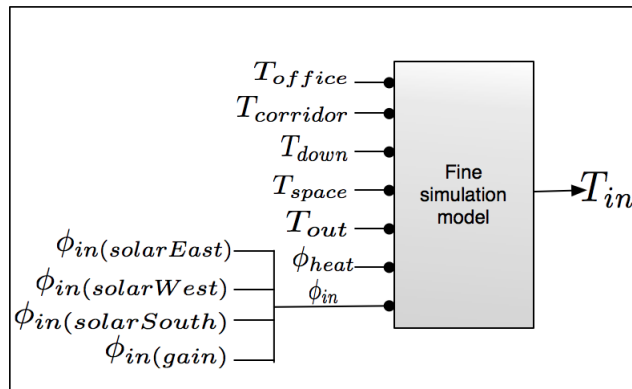


FIGURE 4.6: Input output model

A  $R-C$  equivalent of fine simulation thermal model is shown in figure 4.7. In various studies, it had been proved that, increasing the numbers of sub-layer beyond three sub-layers will increase the computation time significantly (Fraisie et al., 2002).

**Assumptions: for (3R-2C) thermal model**

- It is assumed that within the limit  $3R-2C$  model approaches the real behavior that can be learned for heat transfer and storage. Ngendakumana proved that following criteria need to be satisfied to achieve the better approximation of the number of layers ( $n$ ) inside the wall (Ngendakumana, 1988).

$$n^2 \geq \frac{4RC}{\pi\Delta t}$$

- Under the steady state condition model obeys:

$$R_{down} = (Rd0 + R) + (R_i + R_i) + (Rd1 + R)$$

- It is considered that the total capacity of the wall is

$$\frac{1}{C_{total}} = \frac{1}{C_{slab1}} + \frac{1}{C_{slab2}} \text{ with } C = C_{slab1} = C_{slab2}$$

However, it depends on the wall material and thickness, Here it is assumed that wall is constructed from the same material and have same thermal conductance.

The presented modeling approach is inspired from the Nielsen (Nielsen, T., 2005) afterward modifications done by the Jérôme and Darren (Kämpf and Robinson, 2007). To make model closer to reality the down layer is further discretized in two sub-layers; top slab and down slab. Each layer is assumed to be built by the same material with thermal capacity ( $C$ ). These two layers are connected by thermal conductance  $R_i = R$ . A zoomed image of the down layer is shown in figure 4.8. Let's consider the heat balance equation 4.1:

$$\phi_{in} = \phi_v + \phi_{space} + \phi_{office} + \phi_{corridor} + \phi_L + \phi_{slab} \quad (4.1)$$

here,  $\phi_L = C \frac{dT_{w'}}{dt} + C \frac{dT_w}{dt} + \phi_{slab}$  and  $\phi_{air} = C_{air} \frac{dT_{in}}{dt}$ . Further, applying the Kirchhoff's law of heat transfer, thermal node  $T_{in}$ ,  $T_{w'}$  and  $T_w$  gives the following set of first order differential equations. These equations explicitly express the heat flow dynamics at concerning temperature node.

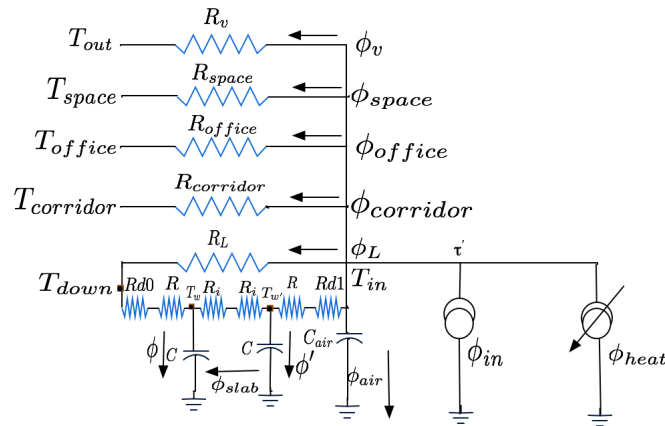


FIGURE 4.7: Thermal model Equivalent R-C circuit

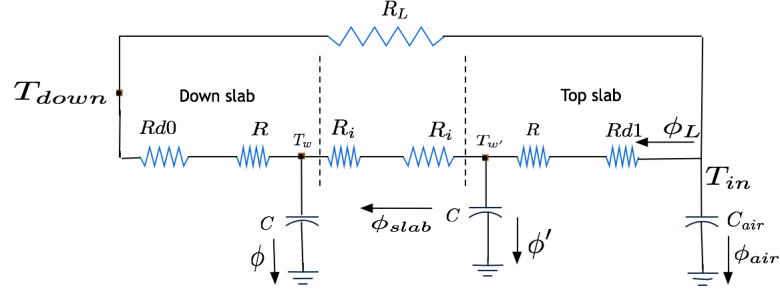


FIGURE 4.8: Zoom of down slab

$$\frac{dT_{in}}{dt} = - \left( \frac{1}{R_v} + \frac{1}{R_{space}} + \frac{1}{R_{office}} + \frac{1}{R_{corridor}} + \frac{1}{R_L} + \frac{1}{(R_{d1} + R)} \right) \frac{1}{C_{air}} + \frac{T_w}{C_{air}} \left( \frac{1}{R_{d1} + R} \right) \quad (4.2)$$

$$\frac{dT_{w'}}{dt} = - \frac{T_{w'}}{C} \left( \frac{1}{2R} + \frac{1}{R_{d0} + R} \right) + \frac{T_w}{2RC} + \frac{T_{down}}{(R_{d0} + R)C} \quad (4.3)$$

$$\frac{dT_w}{dt} = \frac{T_{in}}{(R_{d1} + R)C} + \frac{T_{w'}}{2RC} - \frac{T_w}{C} \left( \frac{1}{2R} + \frac{1}{R_{d1} + R} \right) \quad (4.4)$$

**State-space representation:** A state represents the internal dynamics of the model and simulates the system's behavior under the defined input. A set of differential equations 4.2, 4.3 and 4.4 refers the different states for fine simulation model. Notably, they are  $T_{in}$ ,  $T_{w'}$  and  $T_w$ . Further, Eq. 4.5 constitute a continuous time state-space model derived from set of first order differential equations:

$$\frac{d}{dt} \begin{bmatrix} T_{in} \\ T_{w'} \\ T_w \end{bmatrix} = A_F \mathbf{x}(\mathbf{t}) + B_F \mathbf{u}(\mathbf{t}) \quad (4.5)$$

with

$$A_F(\text{state-matrix}) = \begin{bmatrix} A_{11} & 0 & A_{13} \\ 0 & A_{22} & A_{23} \\ A_{31} & A_{32} & A_{33} \end{bmatrix} \quad (4.6)$$



Here the non-zero elements of matrix  $A_F$  are:

$$\begin{aligned}
 A_{11} &= -\left(\frac{1}{R_v} + \frac{1}{R_{space}} + \frac{1}{R_{office}} + \frac{1}{R_{corridor}} + \frac{1}{R_L} + \frac{1}{(Rd1 + R)}\right) \frac{1}{C_{air}} \\
 A_{13} &= \frac{1}{(Rd1 + R)C_{air}} \\
 A_{22} &= -\left(\frac{1}{2R} + \frac{1}{(Rd0 + R)}\right) \frac{1}{C} \\
 A_{23} &= \frac{1}{2RC} \\
 A_{31} &= \frac{1}{(Rd1 + R)C} \\
 A_{32} &= \frac{1}{2RC} \\
 A_{33} &= -\left(\frac{1}{2R} + \frac{1}{(Rd1 + R)}\right) \frac{1}{C}
 \end{aligned}$$

$$B_F(\text{control matrix}) = \begin{bmatrix} \frac{1}{C_{air}} & \frac{1}{R_v C_{air}} & \frac{1}{R_{space} C_{air}} & \frac{1}{R_{office} C_{air}} & \frac{1}{R_{corridor} C_{air}} & \frac{1}{R_L C_{air}} \\ 0 & 0 & 0 & 0 & 0 & \frac{1}{(Rd0+R)} \\ 0 & 0 & 0 & 0 & 0 & 0 \end{bmatrix} \quad (4.7)$$

$$\mathbf{u}(\text{input vector}) = \begin{bmatrix} \phi_{in} \\ T_{out} \\ T_{space} \\ T_{office} \\ T_{corridor} \\ T_{down} \end{bmatrix} \quad (4.8)$$

**Simulation result, Fine simulation thermal model:** So as to simulate the fine simulation thermal model, building operation is considered as sampled data system with sampling period  $T_s = 1$  minute. The matrix coefficient  $F$  and  $G$  for discrete sampled state-space are given below:

$$F = \exp(A_F T_s) \quad (4.9)$$

$$G = (\exp(A_F T_s) - I)A^{-1}B_F \quad (4.10)$$

The resulting solution simulates the indoor temperature  $T_{in}$ , shown in figure 4.9. Moreover, a set of inputs needed to simulate the indoor temperature are depicted in figure 4.10 (a, b, c, d, e, f) respectively, and g represents the total gain from the occupants, equipment as well as solar gains.

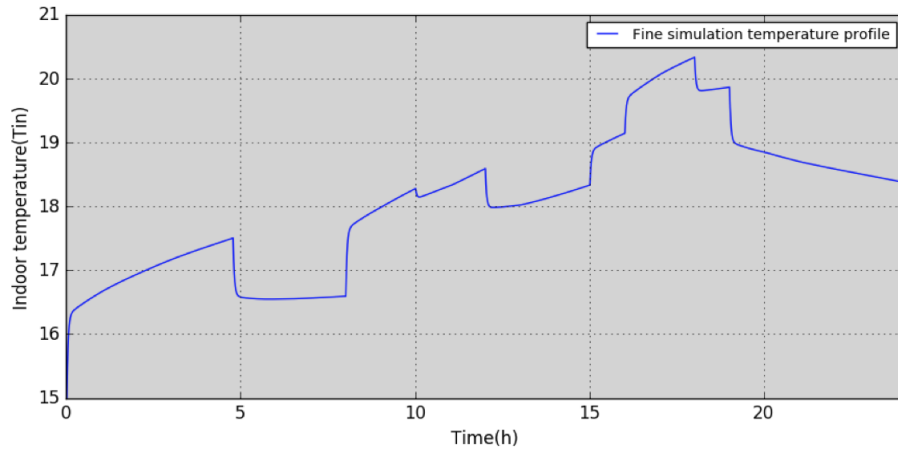


FIGURE 4.9: Indoor temperature simulation

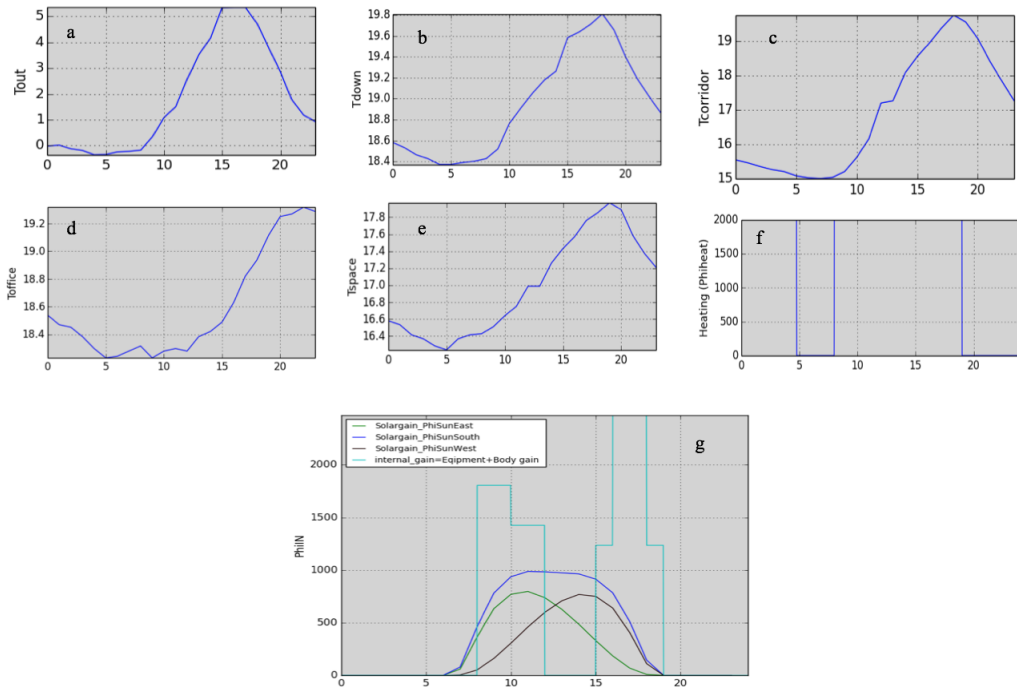


FIGURE 4.10: Inputs for Fine simulation Thermal model

**Limitations of Fine Simulation Thermal model:** Nevertheless, the fine simulation thermal model is an idealization of the reality for building operation (Predis/MHI). This model include a large number of parameters and difficult to measure

the state variables at every reactive period. In order to perform the reactive actions, it is difficult to initialize fine simulation model at every reactive sample because internal state variables (Eq.4.11) cannot be measured easily. Furthermore, it is also difficult to estimate the inner wall temperature at short reactive period.

$$\frac{d}{dt} \begin{bmatrix} T_{w'} \\ T_w \end{bmatrix} \rightarrow \text{Internal state variable} \quad (4.11)$$

Fine thermal model executes a **warm-up period** for numerical initialization also require previous thermal history from the building operation. In context with Predis/MHI, inner slab temperature  $T_{w'}$  and  $T_w$  are not possible to measure by using physical sensor at every reactive period. Thus, the 3R-2C thermal model starts with an initial environment available and assumes that it is not going to change at least for an anticipative period span. A conspicuous problem arises: how to deal with the initialization problem and impact on indoor comfort due to the instantaneous changes in the building operation. Further, it is impossible to measure this temperature at every reactive period. In order to tackle the long initialization issue of the 3R-2C model a simplified 1R-1C model is proposed in section 4.6. It provides a good approximation for fine simulation thermal model while dealing with initialization problem.

#### 4.4.2 Indoor Air Quality (IAQ) Model

CO2 concentration indicates the indoor air quality, also an important concern for occupants comfort. Fine simulation building model uses a CO2 simulation model to simulate the modeled reality of Predis/MHI. The air quality model is 1<sup>st</sup> order differential equation, which governs all sources of CO2 generation and air leak.

$$V_{in} \frac{dCO2_{in}}{dt} = -q_0 CO2_{out} + q_i CO2_{in} + nS \quad (4.12)$$

In the above equation,  $q_i$  = (air flow from ventilation),  $q_0$  = (ventilation leak from building envelope), and  $CO2_{in}$ ,  $CO2_{out}$  are indoor and outdoor CO2 concentration respectively. Further,  $S$  is CO2 generation rate from occupants and  $n$  is the number of occupants. In present model 4.12, internal state variable  $CO2_{in}$  is easy to measure using

available sensor technology and do not require any estimation and approximation.

$$S = \frac{MA_D R_Q D_{CO_2} V_{CO_2}}{352 M_{CO_2} (0.23 R_Q + 0.77)} \quad (4.13)$$

It depends on body area ( $A_D$ ) of person, activity level (MET values), and the ratio of CO<sub>2</sub> exhaled to O<sub>2</sub> inhaled i.e. respiratory quotient ( $R_Q$ ). For an average person, body area is  $1.8m^2$  and MET values ( $M$ ) varies in between 1 and 2 for a normal activity like office or classroom. Respiratory quotient depends on occupant diet, physical condition and physical activity of the person. For an average person  $R_Q = 0.83$  (Aglan, 2003; Persily, 1997).  $D_{CO_2}$  is carbon dioxide density in mg/l,  $M_{CO_2}$  is the molar mass of CO<sub>2</sub> in g/mol and  $V_{CO_2}$  is the molar volume of CO<sub>2</sub> in l/mol respectively. Figure 4.11 shows the simulated CO<sub>2</sub> concentration for a typical day operation. The illustrated simulation explains that CO<sub>2</sub> accumulation is higher near to occupied duration and start

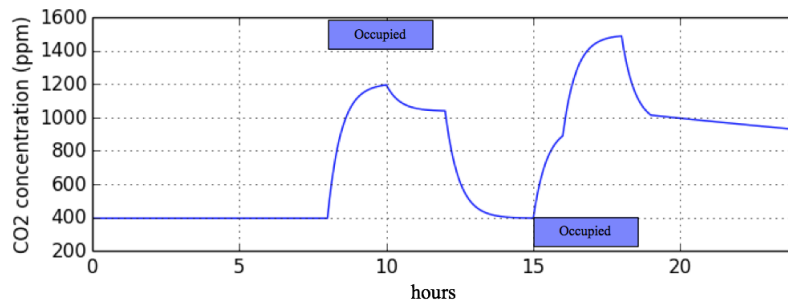


FIGURE 4.11: Simulated CO<sub>2</sub> Concentration

decaying in absence of occupancy. Though, CO<sub>2</sub> concentration respects the maximum allowable CO<sub>2</sub> concentration but an unplanned occupancy or poor ventilation could raise air quality problem. In chapter 6, this model has been used for reactive correction under the various unplanned scenarios.

## 4.5 Anticipative Energy Management - Modeling Context

This section refers to the modeling details for anticipative building management. Anticipative energy management requires a thermal model and air quality model with an optimizer to predict the cost and comfort plan for next 24 hour. The Plan is derived from pre-planned building configuration. This configuration may include the scheduled

occupancy, hourly weather prediction, planned ventilation, heating, available energy, and appliances. For example, an hourly weather prediction for a day in summer and winter is shown in figure 4.12 with planned occupancy in figure 4.13. In present discussion Predis/MHI platform referred to model the thermal equations. In the following sub-sections, anticipative thermal model is disused along with indoor air quality model.

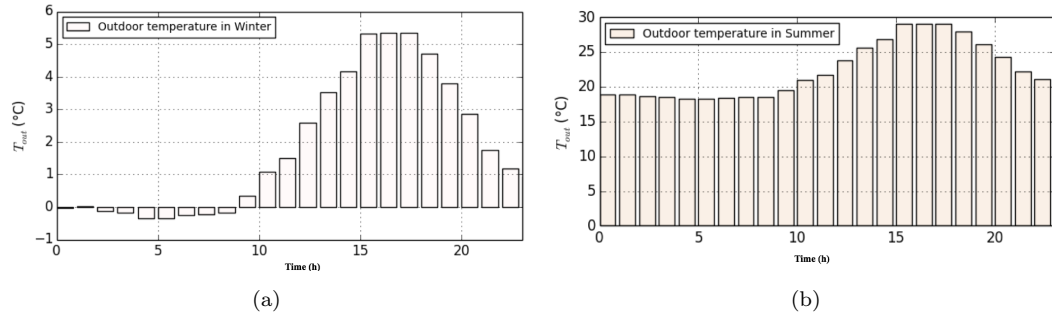


FIGURE 4.12: Hourly weather prediction (Temperature): (a) Winter (b) Summer

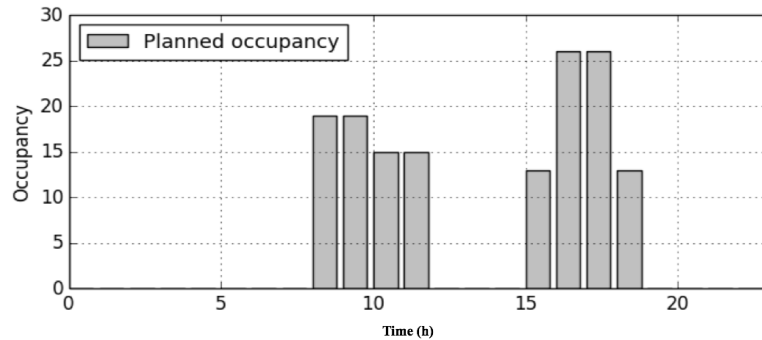


FIGURE 4.13: Occupancy plan- An example

#### 4.5.1 Anticipative Thermal model

Figure 4.14 represent the thermal  $R-C$  model for Predis/MHI. This model corresponds to a single zone model and does not use detailed knowledge of Predis/MHI. For the sake of simplicity, notations are similar to fine simulation model described above. The prerequisite for anticipative model is to provide the day-ahead optimized plan with all available information for the simulator. Heat balance equation for an anticipative thermal model (figure: 4.14) is given as:

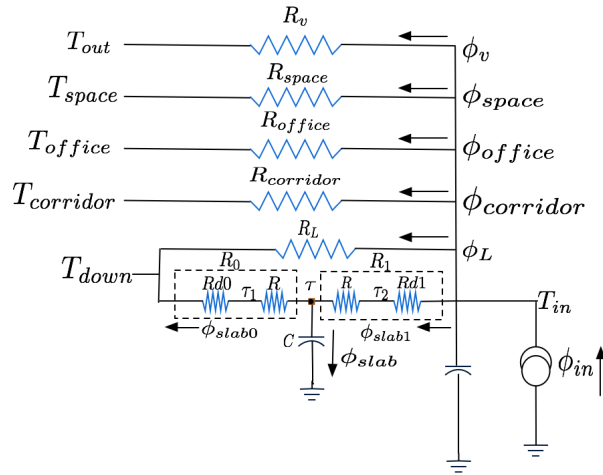


FIGURE 4.14: Anticipative thermal R-C model

$$\phi_{in} = \phi_v + \phi_{space} + \phi_{office} + \phi_{corridor} + \phi_L + \phi_{slab1} \quad (4.14)$$

After simple mathematical calculations the state-space representation anticipative model is given by:

$$\begin{aligned} [T_\tau(\text{state equation})] &= \left[ - \left( \frac{1}{R_0 C} + \frac{R_1 - R}{R_1^2 C} \right) \right] [T_\tau] \\ &+ \left[ \frac{R}{R_1 C} \quad \frac{R}{R_1 R_v C} \quad \frac{R}{R_1 R_{space} C} \quad \frac{R}{R_1 R_{corridor} C} \quad \left( \frac{R}{R_1 R_L C} + \frac{1}{R_0 C} \right) \right] \begin{bmatrix} \phi_{in} \\ T_{out} \\ T_{space} \\ T_{office} \\ T_{corridor} \\ T_{down} \end{bmatrix} \end{aligned} \quad (4.15)$$

$$T_{in}(\text{output equation}) = \left[ \frac{R}{R_1} \right] [T_\tau] + R \left[ 1 \quad \frac{1}{R_v} \quad \frac{1}{R_{space}} \quad \frac{1}{R_{office}} \quad \frac{1}{R_{corridor}} \quad \frac{1}{R_L} \right] \begin{bmatrix} \phi_{in} \\ T_{out} \\ T_{space} \\ T_{office} \\ T_{corridor} \\ T_{down} \end{bmatrix} \quad (4.16)$$

where;

$$\frac{1}{R} = \frac{1}{R_v} + \frac{1}{R_{space}} + \frac{1}{R_{office}} + \frac{1}{R_{corridor}} + \frac{1}{R_L} + \frac{1}{R_1}$$

## 4.5.2 Anticipative air quality model

### 4.5.2.1 Air treatment unit

Air treatment unit includes HVAC system with 4 possible ventilation modes. They are Low heat exchange, Medium heat exchange, High heat exchange and Free cooling respectively. They are numerically defined below. It is assumed that these modes cannot exist simultaneously.

$$Q_v(m^3/s) = (200/3600, 400/3600, 800/3600, 1600/3600)$$

The power consumed by the ventilation system is given by the following formula determined experimentally:

$$P_v = 2 \left( 8.64 \times 10^{-5} - \left( \frac{3600Q_v}{0.56} - 500 \right)^2 + 65 \right)$$

and the resulting ventilation resistance is given as  $R_v = \frac{1}{(1-\text{efficiency})\rho_{air}Cp_{air}0.61Q_v}$  with efficiency = 0.5,  $\rho_{air} = 1.184$ ,  $Cp_{air} = 1006$ . The ventilation system can provide heat only when  $Q_v \geq 400m^3/h$ . The maximum heating power ( $\phi_v$ ) is 3000W.

### 4.5.2.2 CO2 concentration modeling

CO2 concentration is modeled as first order differential equation and explained in subsection 4.4.2. Anticipated air quality primarily depends upon the planned occupancy and ventilation system performance. It changes for each day depending on scheduled occupancy. However, the initial concentration each day is considered as 395 ppm.

### 4.5.3 Anticipative optimizer

The anticipative optimizer uses two primary objective to predict the future plan. The first objective encompasses thermal comfort and air quality (Ha et al., 2000). Thermal comfort is applied only when someone is present but for in the absence of occupants,

the following constraint has to be satisfied.

$$T_{in} \geq 10^{\circ}C \text{ (minimum thermal comfort)}$$

Similarly, a maximum CO2 constraint  $C_{max}$  is used to model the CO2 concentration

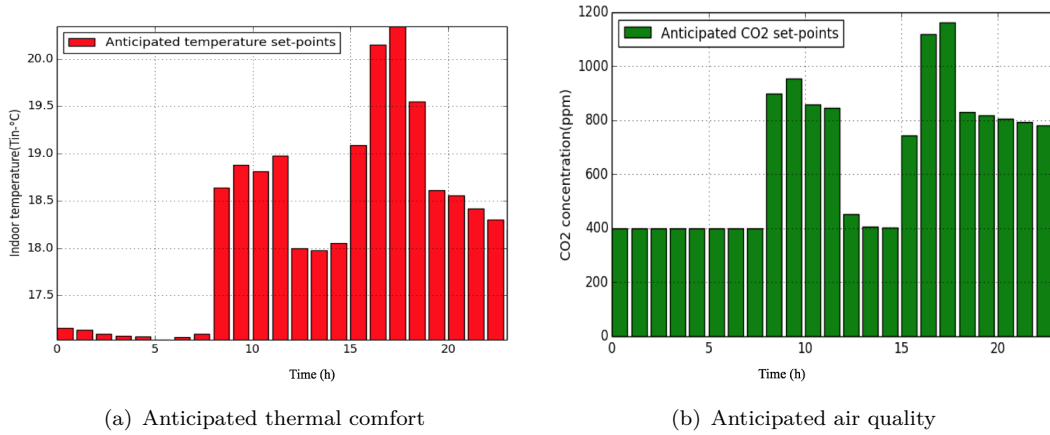


FIGURE 4.15: Anticipated total comfort [Anticipation period=1 hour]

and depend on the occupancy plan. An initial CO2 concentration 395 *ppm* is set to simulate the anticipative model. Now total comfort objective with weight  $w_1$  and  $w_2$  can be defined as:

$$\psi_{total} = w_1 \sum_i \psi_{thermal,i} + w_2 \sum_i \psi_{CO2,i} \quad (4.17)$$

Further, overall criteria for cost and comfort will be

$$J = \psi_{total} + 0.1cost \quad (4.18)$$

Above objective function gives an optimized comfort and cost plan, an example of the optimized comfort and cost plan is depicted in figure 4.15, 4.16.

## 4.6 Reactive Building Model

A reactive model comprises a simplified thermal R-C model and an air quality model to improve the overall occupants comfort respective to whole building operation. In this section, a reactive model aligns with the fine simulation model have been discussed. A



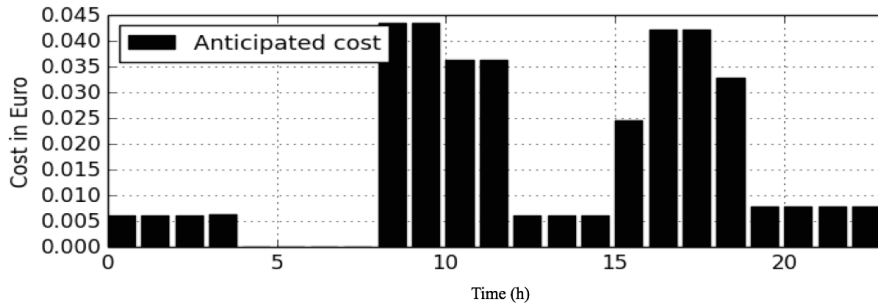


FIGURE 4.16: Anticipated day ahead cost in Euro

reactive model is vital to rectify the indoor discomfort situations in buildings. Further, it provides the current situations of the facade, requires to apply the modified HVAC planning. The underlying assumptions and specifications for the reactive model are given below:

#### Assumptions and Specifications for: reactive model

- The objective of reactive modeling is to develop a relatively fast dynamics model that can cope with the unambiguous short-term changes in building
- These models are easy to initialize and require less parameters to model
- It is assumed that reactive models ignores the slow dynamics or fewer important changes in the buildings
- Reactive model incorporates with building anticipation to set the reference point for cost and comfort
- Reactive thermal model is  $1R-1C$  model and temperature is estimated at every reactive sample

The following two subsections brief the simplified model transformation and an air quality model represents the reactive behavior of buildings. Moreover, a detailed comparison of simplified and fine simulation model is discussed in table 4.1.

#### 4.6.1 Simplified reactive thermal model - Modeling perspective

The simplified thermal model is derived from the  $3R-2C$  network. Short-term initialization problem of fine simulation model brings on a development of a simplified model. The simplified model facilitates easy initialization of model and allows to decide new

set-points in the case of thermal discomfort or discrepancy in the anticipative plan. A conversion of a 1R-1C simplified thermal model is shown in figure 4.17. In this transformation all the slow dynamics i.e. thermal conductance and capacity between the down slab is approximated as inner slab temperature  $T'$ . The simplified model represents the good approximation of fine simulation model and follows the modeled reality up to a certain extent. A clear demonstration of simulations is described in sub-section 4.6.3. In present work, a simplified reactive thermal model is used to correct the thermal

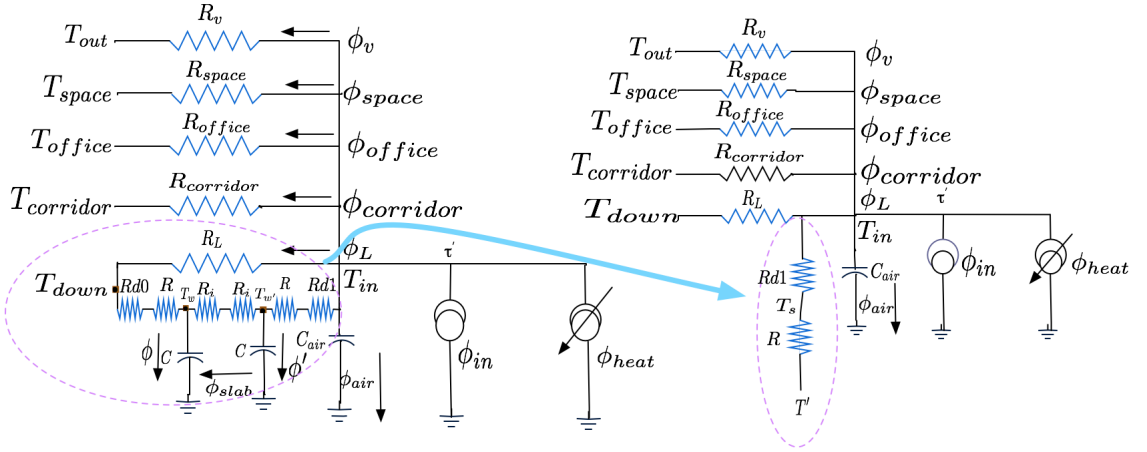


FIGURE 4.17: Simplified 1R-1C thermal model

discrepancy that occurs within an anticipative period.

#### 4.6.2 Canonical State-Space Representation for Simplified Model

A first order differential equation for simplified 1R-1C model, showing relation between indoor temperature ( $T_{in}$ ) and heat-flow ( $\phi_{in}$ ) is given by:

$$\begin{aligned} \frac{dT_{in}}{dt} = & -T_{in} \left[ \frac{1}{R_v} + \frac{1}{R_{space}} + \frac{1}{R_{office}} + \frac{1}{R} + \frac{1}{R_L} + \frac{1}{R + Rd1} \right] \frac{1}{C_{air}} + \frac{\phi_{in}}{C_{air}} \\ & + \left[ \frac{T_{out}}{R_v} + \frac{T_{space}}{R_{space}} + \frac{T_{office}}{R_{office}} + \frac{T_{corridor}}{R_{corridor}} + \frac{T_{down}}{R_L} + \frac{T'}{R + Rd1} \right] \frac{1}{C_{air}} \end{aligned} \quad (4.19)$$

From the above equation a state-space model equivalent matrix is given by:

$$A_{react} = - \left[ \frac{1}{R_v} + \frac{1}{R_{space}} + \frac{1}{R_{office}} + \frac{1}{R_{corridor}} + \frac{1}{R} + \frac{1}{R_L} + \frac{1}{R + Rd1} \right] \frac{1}{C_{air}} \quad (4.20)$$

$$B_{react} = \left[ \frac{1}{C_{air}} \quad \frac{1}{R_v C_{air}} \quad \frac{1}{R_{space} C_{air}} \quad \frac{1}{R_{office} C_{air}} \quad \frac{1}{R_{corridor} C_{air}} \quad \frac{1}{R_L C_{air}} \quad \frac{1}{(R + Rd1) C_{air}} \right] \quad (4.21)$$

Now a discrete state-space model with  $\Delta_r$  sampling period is modeled as

$$x(k+1) = F_{REACT}x(k) + G_{REACT}u(k) \quad (4.22)$$

with  $F_{REACT} = e^{(A_{REACT})\Delta_r}$  and  $G_{REACT} = (F_{REACT} - I) / A \times B$ . Simulation of the above model results in the reactive profile of temperature. This state-space model is a sampled data system with the sampling period  $\Delta_r$  i.e. reactive period, used to sample the input at reactive level. Further, it is assumed that  $T'$  do not vary during one reactive period. In order to estimate surface temperature an estimator is designed in the following manner:

Let's define a reduced order system as ( $T'$  invariant but not known)

$$\begin{aligned} \tau_{k+1} &= F\tau_k + Gu_k + K_1T' \\ T_{in,k+1} &= C\tau_k + Du_k + k_2T' \end{aligned} \quad (4.23)$$

Gathering two consecutive intervals,  $T'$  has then be calculated, gives:

$$\begin{bmatrix} T_{in,k+1} \\ T_{in,k} \end{bmatrix} = \begin{bmatrix} C \\ CF \end{bmatrix} \begin{bmatrix} \tau_k \end{bmatrix} + \begin{bmatrix} D & 0 \\ CG & D \end{bmatrix} \begin{bmatrix} u_{k-1} \\ u_k \end{bmatrix} + \begin{bmatrix} k_2 \\ CK_1 + K_2 \end{bmatrix} \begin{bmatrix} T' \end{bmatrix} \quad (4.24)$$

Let's  $H = \begin{bmatrix} h0 & h1 \end{bmatrix}$  be a matrix such as  $H \begin{bmatrix} C \\ CF \end{bmatrix} = 0$  finally create  $C$  is a scalar for H we can choose  $\begin{bmatrix} -F & 1 \end{bmatrix}$ . It comes out:

$$T' = \frac{T_{in,k} - FT_{in,k-1} + (FD - CG)u_{k-1} - Du_k}{(1 - F)K_2 + CK_1} \quad (4.25)$$

This estimated temperature  $T'$  is computed using ‘‘Parity Relation’’ method (Ploix and Adrot, 2006), (Singh et al., 2015b) which uses the two consecutive reactive temperatures as input for the estimator. This estimation does not change for a reactive period.

### Features of Simplified Thermal model:

- Simplified thermal model is easy to initialize or reset due to fewer parameters.
- It gets initialized with current hour temperature at the beginning of every anticipative hour. Further, in order to capture the reality, it is re-initialized at every

reactive period.

- The reactive model also facilitates the easy learning from measurement because of less number of measured variables.
- During the each reactive period it provides the reactive actions or corrections to meet the desired the thermal comfort.

### 4.6.3 Qualitative Comparison between Simplified and Fine simulation model

In subsections 4.4.1 and 4.6.1, a  $3R-2C$  fine simulation thermal model and  $1R-1C$  simplified model has been discussed in detail. Each has their own applications and limitations. Simplified model needed to manage if a discrepancies occur in building's reality. Moreover, in table 4.1 a comparison between  $3R-2C$  and  $1R-1C$  model is presented.

A resulting simulation comparison of simplified and fine simulation thermal model is depicted in figure 4.18. The simulation performed on a set of recorded data from Predis/MHI. The data set corresponds to winter and summer operation of Predis/MHI. A zoomed area in plot illustrates the thermal behavior of the the simplified model in an anticipative hour specifically 8 am to 9 am. Plots in yellow shows the maximum and minimum difference in both model output. The results interpret, the simplified model almost follows the  $3R-2C$  fine simulation thermal model i.e. modeled reality where zoom area of graph clarify that simplified model gets initialized at every reactive period  $\Delta_r$ .

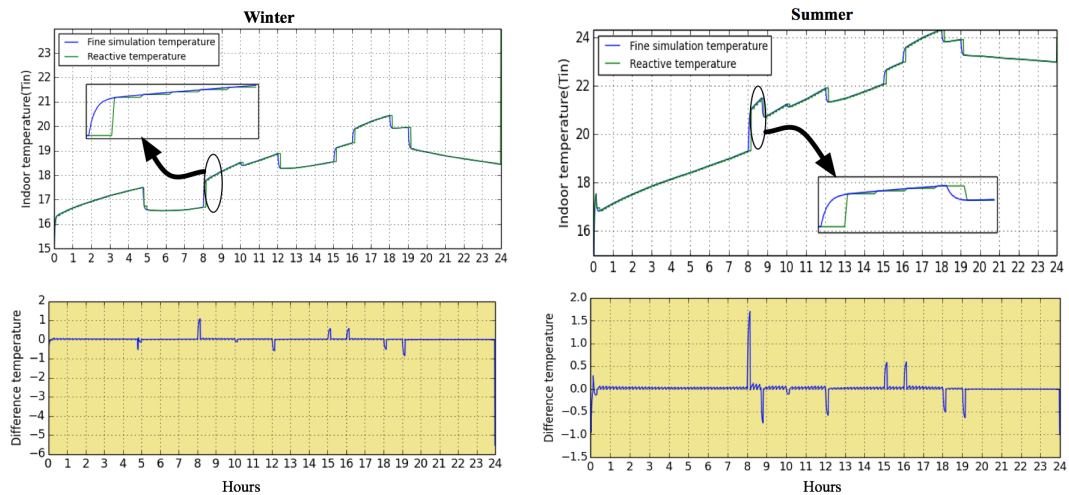


FIGURE 4.18: Model comparison

TABLE 4.1: Comparison of Simplified and Fine simulation thermal model

	3R-2C building model	1R-1C building model
Initialization	Long warm-up period (numerical initialization)	Short-time (2 samples)
Complexity	More complex, due to higher order	Less complex, Lower order
Modeling	Difficult to model, More knowledge required	Easy to model
Identification	Complex parameter estimation, large number of parameter	Easy estimation, less parameter
Computation	Intensive	Less computation

#### 4.6.4 Indoor Air Quality Model for Reactive Management

Anticipative Reactive Diagnosing-BMS uses direct sensor measurement to monitor the indoor CO<sub>2</sub> concentration. Further, a fault diagnosis mechanism analyzes measured value at every reactive period and determines whether it is above the desired comfort level or not (eg: 1700 ppm for school and medium office). During unplanned situations, an optimizer updates the ventilation level and brings building in comfort zone. It uses the alike model used for fine simulation model with current state of building (eg: occupancy).

### 4.7 Reactive strategies in Building Management (10 minutes reactions)

Reactive strategies correct the discomfort issues at the shorter time interval. On the other hand, reactive management also able to suggest the new plans or adjustments, to get the desired comfort and energy saving. An example of reactive tuning of indoor temperature is shown in figure 4.19. The indoor temperature occurs due to variation in heating power requirement. However, reactive tuning takes place only when indoor temperature violates the thermal comfort bounds and the building zone is occupied. Further, figure 4.20 illustrate another example for reactive mechanism that valid only for one-hour anticipative period. The objective of 10 minutes reactions to computing the new short-term planning that can bring building's operation in normal mode with the desired level of comfort. Nevertheless, these actions also require further analysis considering building's fault diagnosis and isolation. Depending on fault type and severity, corrective actions could be online and offline. Moreover, a detailed discussion of the

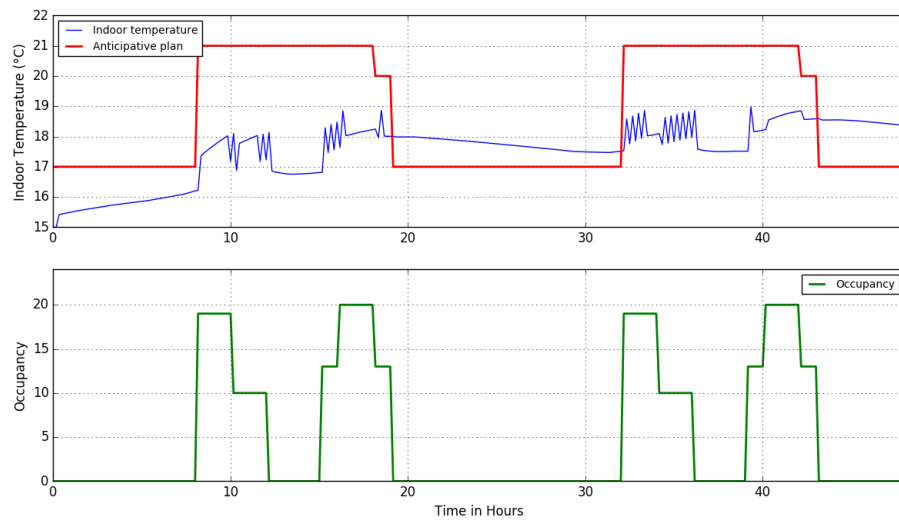


FIGURE 4.19: Reactive tuning of indoor temperature [sampling period =10 minutes]

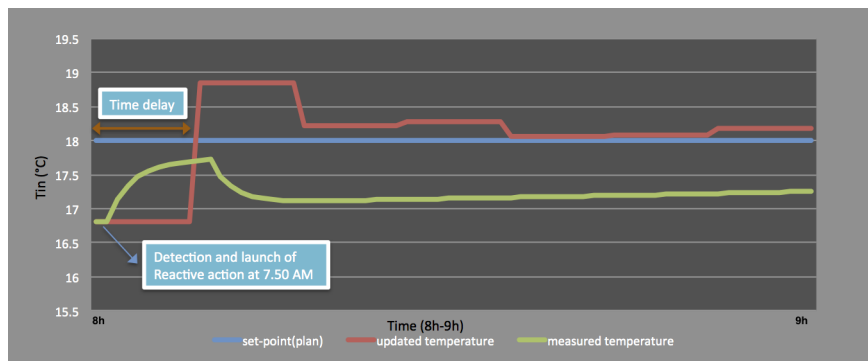


FIGURE 4.20: Illustration of Reactive action at the beginning of Anticipative hour

fault diagnosis and reactive strategies is provided in chapter 6, 7 and, 8 respectively.

## 4.8 Conclusion

This chapter introduces a reactive perspective of building modeling, focusing on fast dynamics and easy to initialize models. Present discussion validates the need of a reactive model to monitor the building operation in a continuous manner. A state-space modeling approach for fine simulation and reactive thermal model has been provided. The results explain, the simplified reactive  $1R-1C$  model is a good approximation of  $3R-2C$  fine model. A method to initialize simplified model is useful to decide the building strategy under the variations from different sources. An indoor air quality model is presented to simulate the CO<sub>2</sub> build up and decay rate. Further, this work is in line with the

corrective actions in the following chapter.

## Chapter 5

# Building Maintenance strategy using Anticipative Reactive Diagnosing-BMS

### Contents

---

<b>5.1</b>	<b>Introduction</b>	<b>72</b>
<b>5.2</b>	<b>Buildings Maintenance and Planning</b>	<b>73</b>
<b>5.3</b>	<b>Abnormal building system performance</b>	<b>74</b>
5.3.1	Actions: specific maintenance action	74
5.3.2	Decision making	75
<b>5.4</b>	<b>Reactive strategies</b>	<b>75</b>
5.4.1	Abnormal building driving: misuse and behavioral context	75
5.4.2	Feedback and appreciation	76
5.4.3	Mirroring and visibility	77
5.4.4	Illustration of abnormal building driving issue: Office H-358	77
<b>5.5</b>	<b>Abnormal building system state</b>	<b>79</b>
5.5.1	corrective action: Online action, short-term optimization	80
5.5.2	Anticipative actions	82
<b>5.6</b>	<b>Conclusion</b>	<b>84</b>

---



*Abstract-Building's operation is a highly dynamic and complex process and often, it is difficult to decide the right actions in the case of anomalies. In order to improve the energy and comfort footprint of existing building, a generalized maintenance approach is required that it could cover all major building abnormality. Building's planning and maintenance should involve all the stakeholders, responsible for long and short-term anomalies. The human involvement cannot be ignored during the planning and executing maintenance strategies. This chapter concludes with a global discussion about the various corrective actions derived from reactive building management.*

## 5.1 Introduction

Buildings are complex systems, faults or failures could occur during the occupancy. Occupants are highly relied on indoor climate and building operation. Cole (Cole and Brown, 2009) analyzed the *Human Intelligence* and *Interactive Adaptability* with the degree of involvement of occupants to building management. Occupants explicitly desire to be involved in building control and operations. Proper strategies for facility maintenance is vital for building management.

In most of the cases, only equipment failures are considered as faults and preventive actions are recommended by the responsible stewardship. However, few building management use the predictive maintenance, derived from the regular monitoring. Nevertheless, in everyday operation building's enters into the various ambiguous situation that cannot be planned or predicted based on historical building performance. Indeed, short-term building discrepancies are often overlooked. A right mix of the maintenance plan and building strategies could improve building performance and are able to offer a pleasant living and working conditions.

The objective of this chapter is to explain different corrective actions that will require to manage the building reactively. Furthermore, the proposed methodology counts on underlying ideology of reactive diagnosing BMS proposed in the chapter 3. Present chapter is organized as follows: Section 5.2 discusses the different actions including maintenance. Further, in section 5.3 and 5.4 different corrective actions are discussed in the detail. Formulation of optimization problem followed by an example is presented in

the subsection 5.5.1.1.

## 5.2 Buildings Maintenance and Planning

Corrective actions are important features of reactive building management system. Taking into account the maintenance actions, the major faults in the building operation come from the following two primary reasons (figure 5.1):

- abnormal building system performance
- abnormal building system state

However, corrective actions could be off-line maintenance, short-term online corrective actions, finally human acknowledgment or recognition. Maintenance or off-line actions required during the complete failure of appliances or interruption in the building services.

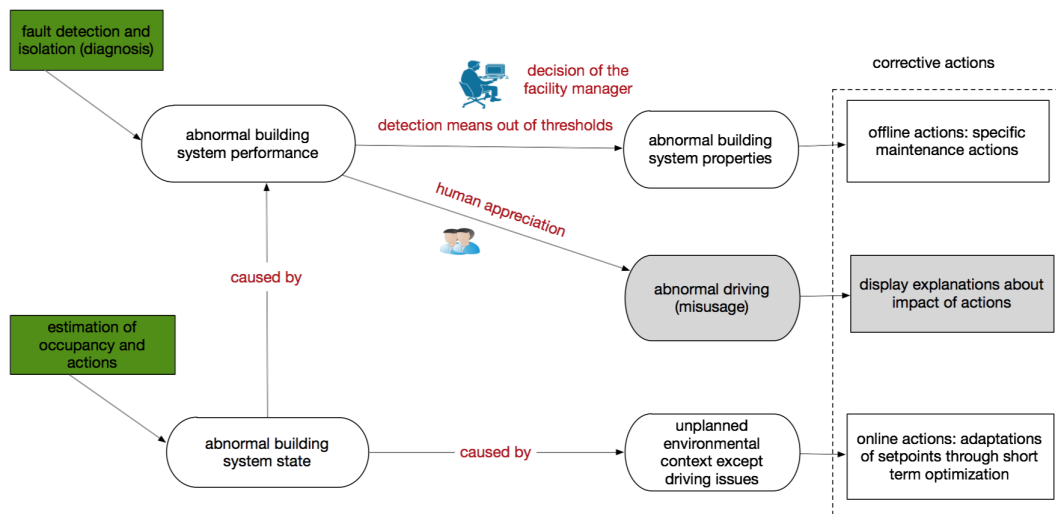


FIGURE 5.1: Possible corrective actions

An online or live corrective action is only possible for automated building that allows remote access to appliances and HVAC. The other possible corrective action could be changing the long-term building operational strategies i.e. changing the anticipative building plan. Anticipative actions only possible for buildings that use the day-ahead planning. Finally, maintenance actions required during the complete failure of appliances

or interruption in building services. In following sub-sections, a detailed analysis is presented including various building driving issues.

### **5.3 Abnormal building system performance**

The whole building system consists of different complex building sub-system. Each sub-system individually responsible for appropriate building performance. A failure or abnormal performance could degrade the whole building performance.

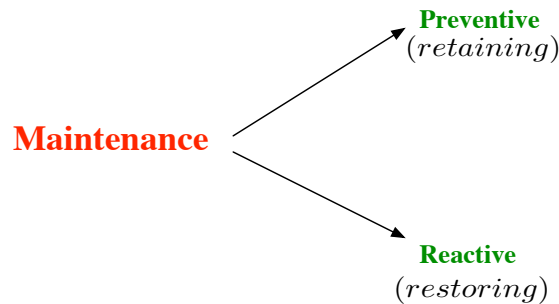
#### **5.3.1 Actions: specific maintenance action**

The objective of specific maintenance actions are:

- pin-pointing the failure and faulty system using the fault diagnosis techniques
- prioritizing the faults according to their severity
- developing a strategic maintenance plan
- allocating the available resources and specify the type of maintenance
- carrying out the necessary maintenance services required to maintain the building services
- ensuring the building is ready for use
- achieving a satisfactory level of indoor comfort with the optimum operational cost

Two major maintenance techniques are adopted in building maintenance i.e. preventive (retaining) and reactive (restoring). Preventive maintenance techniques are inspired from the building performance analysis and rely on early detection whereas, reactive maintenance services guide the immediate or urgent maintenance requirements. However, reactive actions might involve following crucial steps:

- tolerate i.e. wait for the appropriate comfort
- repair as soon as possible (reactive maintenance)
- set-point tuning and adopt control



### 5.3.2 Decision making

The process of decision making completely banks on human intervention. The corrective action might require a maintenance expert depending on the facility manager decision. The decision making decides **how** and **when** to react or interact with the building system. Considering the knowledge from fault evaluation facility manager decide what kind of maintenance action will require addressing the fault or failures. Under the normal circumstances, fault tolerance could be a possibility to maintain the current building operation. For example, a broken window positioning sensor might not require an immediate action and could be planned for scheduled maintenance.

On the other hand, a serious fault related to comfort and safety consequences must be resolved as soon as possible under the reactive maintenance category. In the case of serious fault related to safety issue building, the building operator could recommend stopping the building operation.

## 5.4 Reactive strategies

### 5.4.1 Abnormal building driving: misuse and behavioral context

Undoubtedly, building's performance is highly sensitive to occupants behavior, nevertheless, driving issue in the building also significantly affects the building performance. Often, occupants behavior and building operation strategies are overlooked by the building energy management vendors. Thus far, there is always a gap associated with the designed and actual performance, because of occupant's behavior and building driving issues (Turner and Frankel, 2008). A perfect behavior does not imply that building is

driven correctly. In a recent work, Janda (Janda, 2014) found that the *social issue* of energy efficiency at the workplace is equally important as the *technical potential* and have a similar impact as other operational discrepancies. Behavior includes the *pattern of actions* and how people interact with the building system. In the other words, behavior complies the decision making and how people decide to make their choices under the different conditions. However, behavior changes refer to change in the pattern of actions and choices. For instance, continuous plug-load and unplanned opening in buildings cause a significant loss in energy and comfort. In many cases, there is a lack of information to building users about the consequences of inappropriate building driving. Occupants are obliged to respond internal and external stimuli under different situations. For example, feeling warm might lead to opening a window or door. In this example, users are unable to anticipate the other consequences such as *what if* it left opened for a longer time.

Particularly, in the small office and non-ventilated houses, it has been seen that building users do not have visibility and explanation for different consequences that could arrive from the abnormal driving issues. Usually, building operational performance is measured in the terms of comfort, system efficiency, productivity, environmental quality, and functionality.

Buildings are highly user driven. The way how building space getting used and equipment performance affect the building performance. Occupants are intended to save energy and aspect a better comfort, however, he does not aware of the unpredictable consequences. In this context, the primary concern is how to engage the human component with the building management system? However, in order to tackle human involvement problem, there are following methods have been discussed in present work.

#### **5.4.2 Feedback and appreciation**

Human are very sensitive to their social reputation and always would like to involve with their surroundings. Feedback techniques provide information how well an individual or group of dwellers are using the building space. Indeed, the desired target is set by in the terms of anticipation or standard recommendation. Feedback techniques illustrate how occupants are behaving or should behave to achieve the desired goal. Depending on buildings and available techniques, the feedback could be long-term and short-term.

Furthermore, nowadays, a real-time feedback or feed-forward suggestions are very important in the context of building management.

In a study by Foster and Mazur-Stommen (Foster and Mazur-Stommen, 2012) concluded that household receiving continuous feedback reduced their consumption in comparison to household getting monthly feedback. The important consideration with the feedback techniques is that often they are not combined with the actions and occupants are unable to discover how they can respond to given explanation. For instance, getting feedback about the over energy consumption might require an action that could find misuse or unplanned appliances in buildings and recommend them to switch off. Froehlich (2009) described this as an *invisibility issue*. Because of this, it is difficult to motivate building users to change their behavior or adopt new driving strategies for the building operation. Further, several factors are interlinked to each other and hard to describe how occupants can make a trade-off between the inter-connected variables.

### **5.4.3 Mirroring and visibility**

Mirroring is an important phenomenon that could improve the building performance dramatically. In this context, thanks to available technology that can create and display a dashboard for users. Using available dashboard facility manager or occupants can analyze and track how particular appliances have been performing. In many cases data does not represent the real values of actions. Moreover, there are several factors are linked to each other and occupants are unable to choose right actions. For example, closing a window might improve the indoor thermal comfort but the same time it might reduce the air quality level. Similarly, heating or cooling load is very sensitive to outdoor temperature and often it is not connected to future energy consumption load.

### **5.4.4 Illustration of abnormal building driving issue: Office H-358**

The present example provides a case study that shows how recommendation or human appreciation based actions improves the overall indoor comfort for office (H-358), (figure 5.2). The office is located at Grenoble-INP, GSCOP Lab. It is non-ventilated, with two windows, one door and often occupied by four people. In this situation, occupants have only door or window opening/closing as a preferred alternative to improve the air quality and thermal comfort. In fact, it is the most common scenario for typical small office and residence. In various cases, occupants do not aware how to manage building settings in

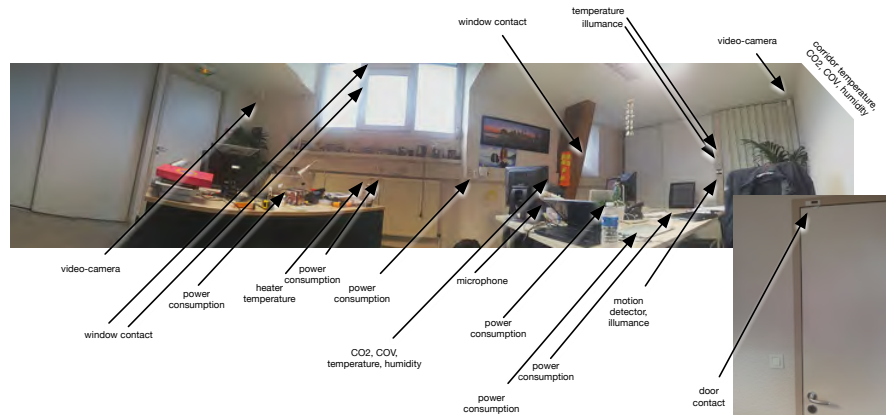


FIGURE 5.2: Office H-358 Felix viallet

order to have a right balance of comfort. Figure 5.3 shows occupancy pattern for the day

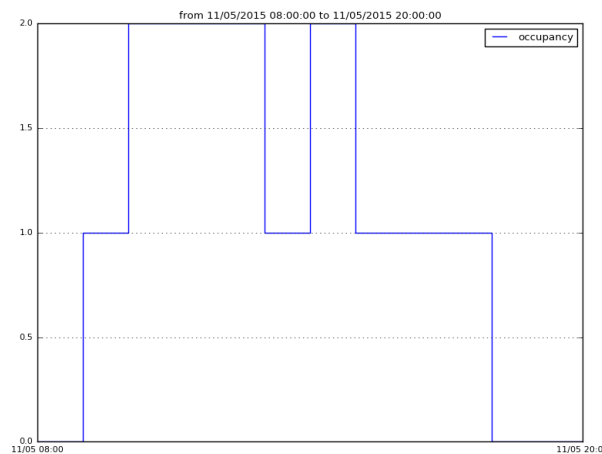


FIGURE 5.3: Occupancy in office

11/05/2015. The maximum occupancy during that particular day is 2. However, figures 5.4(a) and 5.4(b) shows the best and user drove window and door opening strategies. However, the best strategies are decided according to the indoor thermal comfort and air quality. Often, users are not aware with a such strategies and drive building in an abnormal way.

Figure 5.5(a) illustrates the measured CO2 concentration along with the best CO2 concentration and optimal. During the several hours, best CO2 do not follow the measured CO2, due to the abnormal driving. In order to have best indoor air quality users are encouraged to follow the recommend door and window opening.

Similarly, figure 5.5(b) shows a comparison between reference and best office temperature considering to recommended door and window position. The simulation

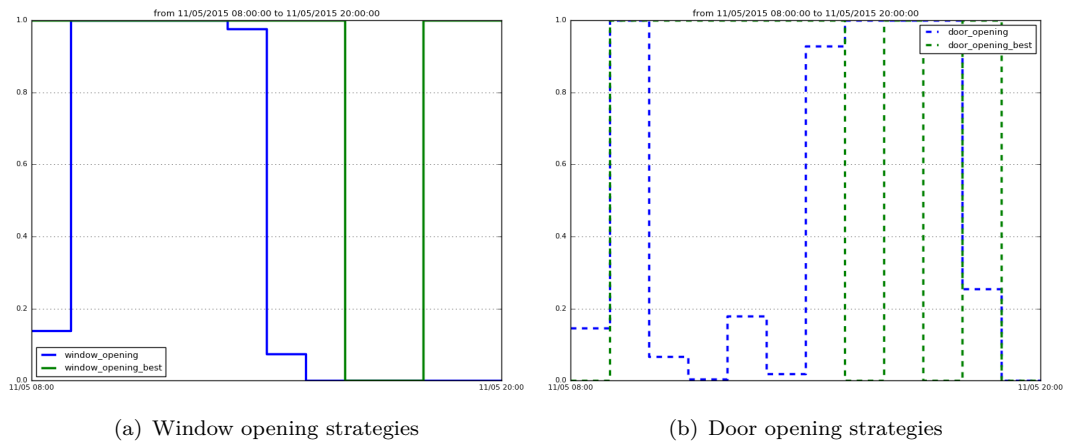


FIGURE 5.4: Comparison of different opening in office H358

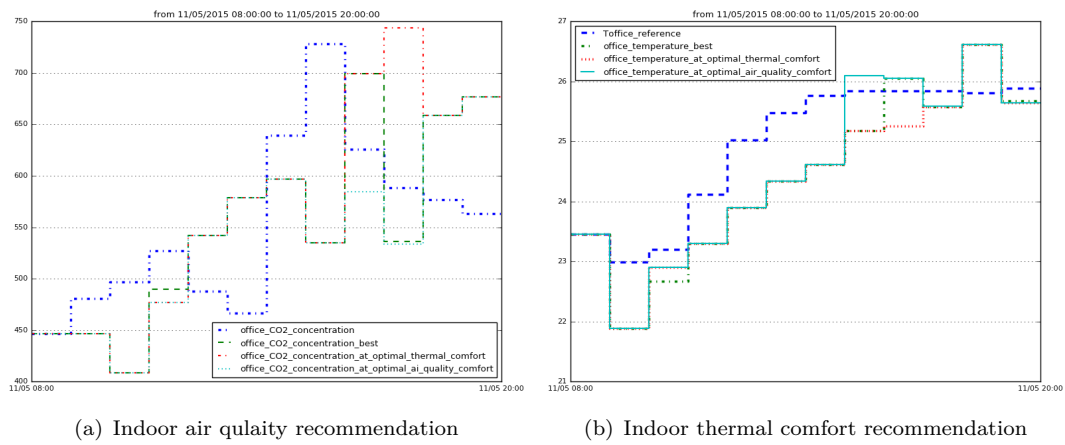


FIGURE 5.5: Indoor comfort recommendation for office H358

also shows how indoor temperature varies taking into account the indoor air quality.

## 5.5 Abnormal building system state

Abnormal building system state is mainly caused by unplanned context. These unplanned scenarios cannot be predicted in the beginning of the operation. For instance, unplanned occupancy and weather prediction failure could cause discomfort. Indeed, it is difficult to compute exact occupancy in the buildings, similarly, real weather also differs from predicted. In such cases, building system needs online corrective actions. Actions could lead to change in heating or cooling set-point along with ventilation tuning.



### 5.5.1 corrective action: Online action, short-term optimization

In order to cope with short-term discomfort, an optimization method is proposed in present work. However, this type of corrective actions only worked for the building equipped with full automation and HVAC control. The optimization result suggest a short-term update ( $\Delta_r = 10$  minute) in set-point. These updates quickly resolve or try to resolve the issue before the next anticipative hour ( $\Delta_a = 1$  hour). Moreover, a detailed discussion of reactive on-line actions is given in chapter 3, refer to figure (3.8) and algorithm 1. A reactive optimization problem is formulated in next subsection. The primary goal of optimization is to meet the global comfort by adjusting the control parameter and satisfying the global comfort criteria ( $D_G$ ) i.e.  $0 \leq D_G \leq 1$ . Moreover, such kind of optimization is known as constraints satisfaction. The optimization scheme updates the indoor temperature and air quality respectively.

#### 5.5.1.1 Formulation of short-term optimization

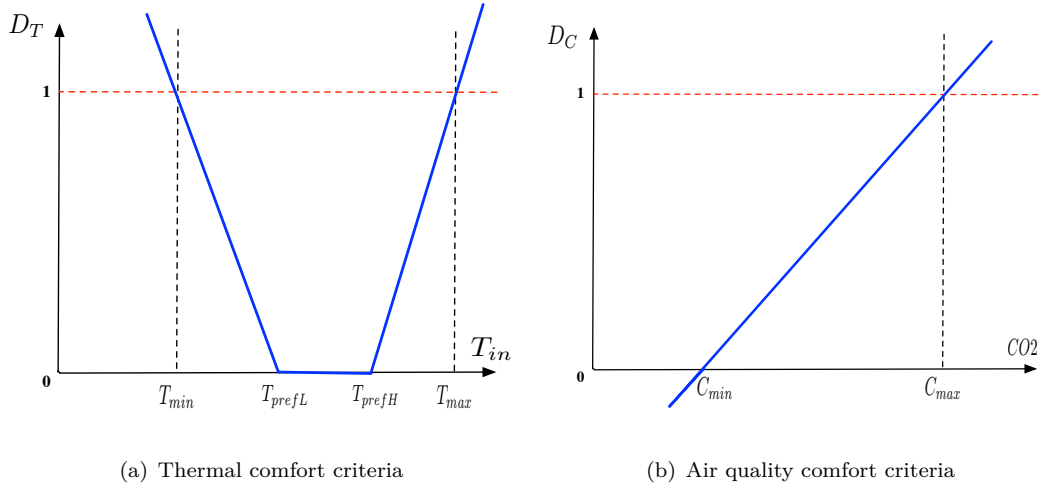


FIGURE 5.6: Thermal and Air quality comfort criteria

Thermal comfort criteria:

$$D_T = \begin{cases} \frac{T_{prefL} - T}{T_{prefL} - T_{min}} & \text{if } T < T_{refL}, \text{ occupancy} > 0 \\ \frac{T - T_{prefH}}{T_{max} - T_{prefH}}, & \text{if } T > T_{refH}, \text{ occupancy} > 0 \\ = 1 & \text{if } T_{refL} \leq T \leq T_{refH} \\ = 0 & \text{if } \text{occupancy} = 0 \end{cases}$$

Air quality dissatisfaction comfort criteria:

$$D_C = \begin{cases} \frac{C-C_{min}}{C_{max}-C_{min}} & \text{if } occupancy > 0 \\ 0 & \text{if } occupancy = 0 \end{cases}$$

Global comfort criteria:

$$D_G = \alpha_1 * D_T + \alpha_2 * D_C$$

Where :

$T_{min}$  = minimum thermal comfort boundary

$T_{max}$  = maximum thermal comfort boundary

$T_{prefL}$  = Lower value of preferred indoor temperature

$T_{prefH}$  = Higher value of preferred indoor temperature

$C_{min}$  = minimum CO2 concentration

$C_{max}$  = maximum CO2 concentration

$$\alpha_1 + \alpha_2 = 1 \tag{5.1}$$

In above formulation  $D_T$ ,  $D_C$ ,  $D_G$  refer to thermal comfort, indoor air quality and global discomfort criteria respectively.

### **Differential evolution optimization**

Nevertheless, plenty of classical and meta-heuristic optimization schemes are available, each method has its own advantages and limitations. In the present work, differential evolution (DE) which is metaheuristics optimization has been used. Differential evolution (DE) is a stochastic method introduced by (Storn and Price, 1997). This is a population based method and basically used for global optimization problems. DE generates random initial population between upper and lower bound defines a search space to find a satisfactory solution. DE works on the principle of *cross over* and *mutation*. (Fleetwood, 1999) Differential evolution<sup>1</sup> does not offer the guaranteed best solution but it provides an good solution for the concerned problem. Moreover, DE could possibly a

<sup>1</sup>[https://docs.scipy.org/doc/scipy-0.15.1/reference/generated/scipy.optimize.differential\\_evolution.html](https://docs.scipy.org/doc/scipy-0.15.1/reference/generated/scipy.optimize.differential_evolution.html)

good solution for the complex problems such as nonlinear and non-differentiable continuous space functions problem.

### An example

In the following figure, an example of online optimization action is illustrated. A scenario of unplanned occupancy is considered. Unplanned occupancy causes thermal discomfort along with the poor air quality. Optimization based actions are for short duration and try to improve the thermal comfort and air quality.

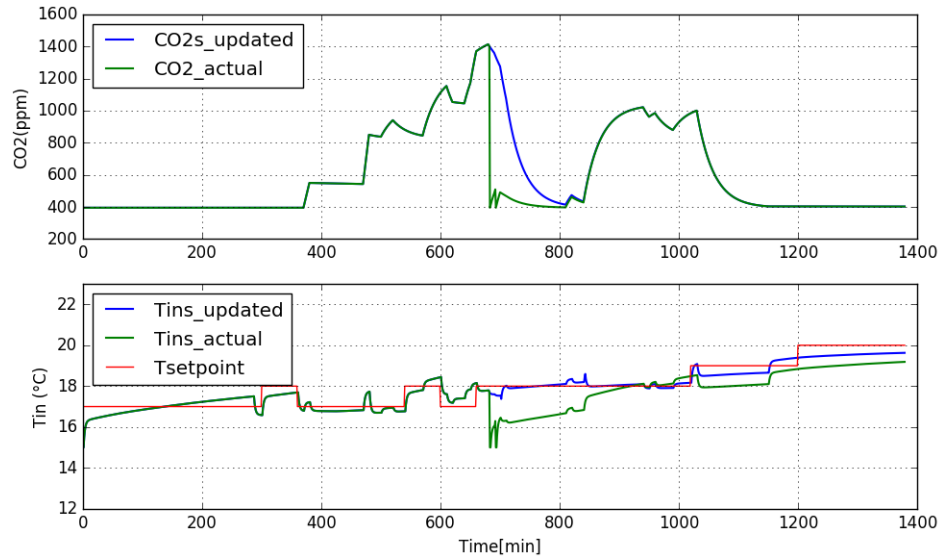


FIGURE 5.7: Reactive update of CO2 and indoor temperature

Global comfort criteria ( $D_G$ ) is used as constraints to check the global comfort level. An equal weight is given for thermal comfort with air quality. The optimizer chooses a new operating point heating and ventilation air flow. Moreover, a maximum and minimum bounds are used for heater power and ventilation air flow.

### 5.5.2 Anticipative actions

Anticipative actions are triggered when a major discrepancy in building operation cannot be managed by short actions such as set-point tuning. These actions are end-up with re-computation of a new plan for the remaining hour. Usually, these situations arise due to major changes in building operation. Failure or inefficient working equipment could also lead to the modification in the building plan. In the following discussion a study about the anticipative corrective actions have been described.

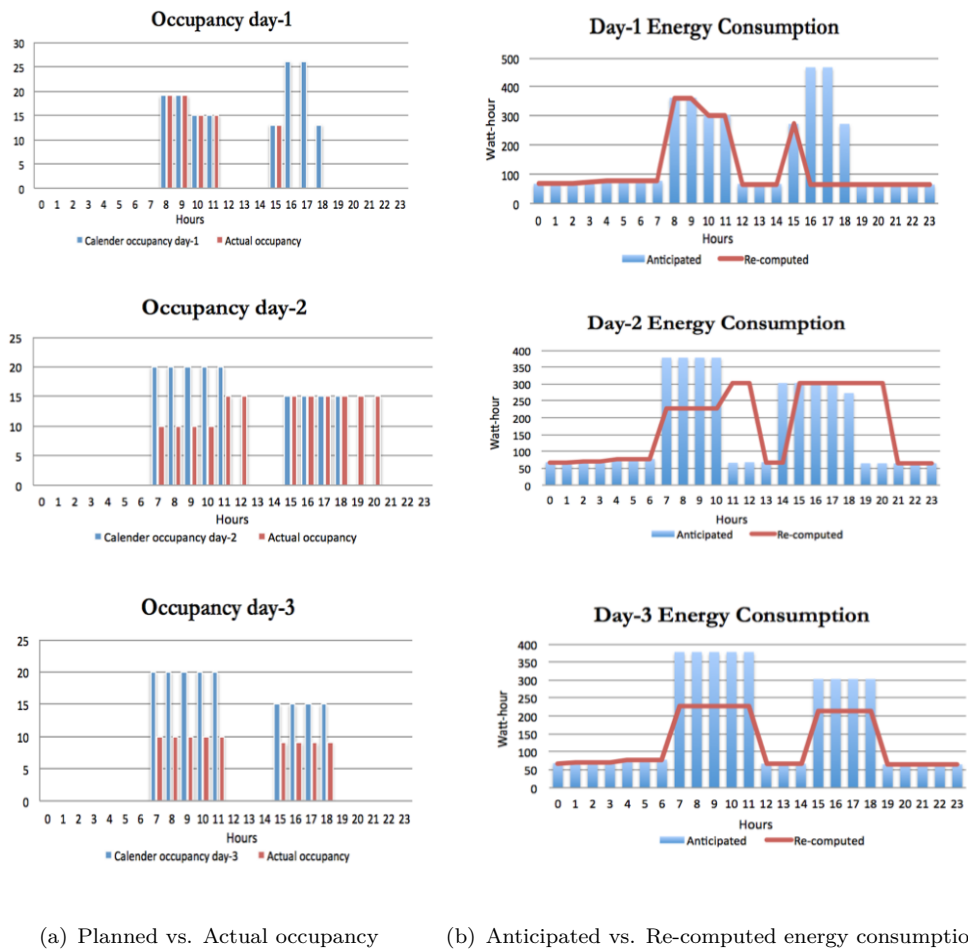


FIGURE 5.8: Example for Anticipative actions

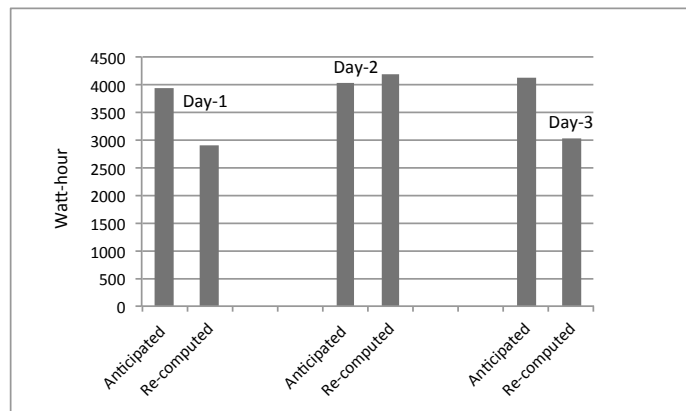


FIGURE 5.9: Comparison of total energy consumption with anticipated and re-computed plan

Figure 5.8(b) shows the computation of new set-point corresponding to the respective variation in occupancy schedule for considered days. In detail, ARD-BMS triggers an anticipative action at the beginning of the 15 hour of day-1 and re-compute

the energy plan for the remaining hours. Similar actions were launched for day-2 at the beginning of plan and also during the plan due to unplanned occupancy. On the other hand, ARD-BMS request a new plan due to change in planned occupancy. Eventually, figure 5.9 shows the total energy consumption for anticipated and re-computed, where day-1 and day-3 require the less energy as planned whereas day-2 expected to consume more energy as planned.

## 5.6 Conclusion

This chapter discusses the different maintenance strategies for buildings. Anticipative Reactive Diagnosing-BMS capable to take various online and off-line actions depending on fault and building type. Buildings equipped with automation and sensor measurement techniques are eligible for online control of indoor environment. The limitation of ARD-BMS is lack of fault diagnosis and isolation capability. However, in order to have an appropriate action building management must go for deep diagnosis. In the following chapters a diagnosis method is proposed to discover all possible fault explanation in buildings. Fault diagnosis is still a challenging issue at whole building level. A new concept of validity and behavioral constraints is introduced in the terms of building fault management.

## Chapter 6

# Fault Detection and Diagnosis in Building: issues and state-of-the-art

### Contents

---

<b>6.1</b>	<b>Introduction</b>	<b>86</b>
<b>6.2</b>	<b>Diagnosability challenge in Buildings</b>	<b>87</b>
<b>6.3</b>	<b>Terminology and Definition</b>	<b>89</b>
6.3.1	Fault Detection and Diagnosis (FDD) in Buildings	90
<b>6.4</b>	<b>The FDI approach</b>	<b>92</b>
6.4.1	Limitation of FDI	96
<b>6.5</b>	<b>The DX Approach</b>	<b>97</b>
6.5.1	Diagnosis with DX	97
6.5.2	Concept of Hitting set and conflict	102
6.5.3	Limitation of DX	102
<b>6.6</b>	<b>FDI and DX: A Bridge approach framework</b>	<b>103</b>
<b>6.7</b>	<b>Conclusion</b>	<b>106</b>

---

*Abstract- Following chapter demonstrates the different issues in building fault diagnosis and available techniques. Often building comfort and energy management systems are challenged by the conflicting situations with interacting building subsystems. It is important to mention here, that a wide range of FDD tools are only*

*capable of performing the fault detection or fault trending analysis. However, these tools are unable to pin-point the root cause and validity of diagnosed faults. A tool or methodology inherent with the diagnostic feature and test validity can improve and save a significant amount of time and energy. The limitations of an existing model-based FDD tools encourages to develop a fault diagnosis technique that can consider fault isolation issues beyond the controller action. An automatic minimum diagnosis is required to launch short and long-term corrective actions with an appropriate building planning. At the beginning, the key issue and diagnosability challenge are described along with a succinct state-of-the-art for existing FDD methods. Further, few model-based diagnosis scheme has been explained to develop the underlying background for the proposed diagnosis. The concept of model and test validity has been added*

## 6.1 Introduction

*Anything that can go wrong, will go wrong*

---

*Murphy's law*

Nowadays, most of the energy efficient and smart buildings are equipped with modern building automation system (BAS) and supervisory controllers. Controller strategies play an important role in achieving the desired level of indoor comfort after post-commissioning of existing building management systems. Thanks to the available communication technologies that allow a reliable and efficient access to information for building automation. In the future, smart buildings are going to be more complex due to continuous integration of different emerging technologies and higher user expectations. In this context, technical failures or unplanned situations can cause huge impact over building operation and occupant's comfort. To make a resilient building management system, it is important to identify the severity and type of each fault. An insignificant fault with less impact can be ignored deciding the reactive strategies whereas faults that might lead to critical discomfort or excess energy consumption cannot be avoided by the building management.

**Why a Diagnosing-BMS?** Building control alone is not enough to maintain the indoor comfort or over energy consumption issues. Existing building management either sketches a long hour planning or corrects the building anomalies by applying the rule-based controller actions. Another available solution is the set-point tracking such as a MPC controller, without knowing building inconsistencies. However, in various situations, building operations enter in conflicting situations when pre-defined corrective actions or set-point tracking is not enough to maintain the desired building performance. Tracking the set-point or following the rule-based controller actions could result in a poor energy building performance. Customarily, building managements are challenged with **interacting** building sub-systems, that make it difficult to apply the corrective actions. In recent years, FDD became an appealing area of research for building researchers. Various methodologies and tools have been developed to identify the faults in buildings that affect the whole building performance. This chapter is organized as follows: the next section provides diagnosis issue in buildings followed by detailed terminology and brief state-of-the-art. Further, existing FDD methods are covered from sections 6.4 to 6.5. Lastly, in section 6.6 a bridge methodology is explained.

## 6.2 Diagnosability challenge in Buildings

The European Intelligent buildings group defines the smart building as that one that “*creates an environment which maximizes the effectiveness of the building’s occupants while at the same time enabling efficient management of resources with minimum lifetime costs of hardware and facilities*”. However, in reality a difference lies in the fact that each building system is unique because of its conditions and occupants whose behavior is highly impacting.

Considering the above definition, a smart building is a complex system with several interacting sub-systems just like other complex engineering systems such as aircraft and manufacturing units.

In general, all the major approaches that have been used for detection and diagnoses in buildings are quantitative (model-based) or qualitative (rule-based model). In connection with buildings, it is really impossible to develop a complete physical model matching accurately the reality for a whole building system. The various phenomenon



like heat transfer from facade or occupant behavior is challenging jobs to model. On the other hand, qualitative models are not enough to cover all the possible actions by following rules. Moreover, Test derived from rules are challenged by their **validity** and **constraints**. For instance, testing indoor temperature *without validating outdoor temperature* might lead to false alarm.

Existing building fault diagnosis techniques rely on model-based fault diagnosis and isolation techniques (FDI). FDI assumes model represents the reality of building operation and any fault can be modeled by measuring the abnormal behavior and fault expert knowledge. However, in reality, whole building models are too complex to model and does not represent the building's reality. Further, another key challenge in building diagnostic is that, an integrated whole building energy FDD system do not exist. Major building sub-systems are independently controlled with limited, add-on FDD and controller capability. Indeed, both control and FDD do not adequately capture the functional and behavioral interactions between building sub-systems resulting in sub-optimal performance. Isolating fault causes is also a labor intensive process and require an experienced human interference. Tremendous effort has been made by the building researcher to model the different malfunctions in buildings moreover these models able to target the well acknowledged and implicit faults (Katipamula et al., 1999; Katipamula and Brambley, 2005b). These model or rule-based diagnoses are limited to knowledge what is encoded in the model and difficult to adopt to building level faults or unplanned situations in buildings. An hypothesis based model could measure how the model is close to the reality but this explanation is able to isolate flawed system with the optimal fault location. In addition, whole building fault diagnoses is challenged by modeling and measurements constraints.

In buildings, a huge amount of metered data is available from sensor measurement and a time-series based statistical analysis could generate the fault pattern of particular appliances showing abnormal behavior. However, this method is challenged by the building complexity and interconnecting devices. On the other hand, occupants feedback based diagnosis system are expensive to deploy in building due to lack of man-machine language interface. The delicacy of these methods is to support an easy detection and giving the first impression about the faults (Schumann et al., 2011).

Let's consider a very common situation in building operation where a building

alarm detected that indoor temperature is going below the desired set-point and the following most likely faults could represent this fault

- a window or door is left open leading to significant heat loss.
- the temperature sensor is not working and giving the wrong measurement to the building controller.
- the ventilation system is not working properly because of faulty air handling unit that cause inefficient transport of heat.
- the heating system is not running effectively and heater power consumption differs from normal use.
- heat flow between the zones.
- different building zones have different properties. In this case, there is a lack of information for building diagnostic system to decide the correct corrective actions corresponding to considered building zone.

The limitation of existing building diagnosis techniques encourages to develop a new tool for building diagnosis that must support at least some minimum explanations for non-modeled faults. At the same time, it could sense multiple faults if it is the case.

### 6.3 Terminology and Definition

Various definitions and terminologies have been used in the field of FDD. The major terminologies used for FDD in this dissertation are given below:

- *System*: A system consists of a set of interconnected components and items.
- *Faults*: An abnormal state of a component or an item that potentially yields abnormal behavior.
- *Symptom or Alarms*: A measurable change in the behavior of a system from its normal behavior i.e., an indication of faults.
- *Test*: A test is a processing yielding a symptom.

- *Residual*: A residual is a signal representing the difference between an expected behavior and an actual one. Symptoms may appear in residual.
- *Fault detection*: Determination of the existence of faults in a system.
- *Fault isolation*: Determination of faults type, location, and possible time of detection of a fault.
- *Fault estimation*: Determination of the characteristic of a fault.
- *Fault diagnosis*: It includes fault detection, isolation and possibly estimation.
- *Fault signature matrix (FSM)*: A matrix representation of faults in the form of tests with (0) and (1) where (1) means a fault is potentially detected for the related test.
- *Hazard*: Risk of losses or harm.

### 6.3.1 Fault Detection and Diagnosis (FDD) in Buildings

Fault detection and diagnosis is a well-proven and known tool for several industrial processes like aerospace, automotive, nuclear and process industry. There are various on-line and off-line techniques are available, considering the application domain (Venkatasubramanian et al., 2003b,a; Frank, 1996).

In August 1996 (Revised in 2001), International energy agency (IEA) published Annex-25, “Building optimization and fault diagnosis source book” (Hyvärinen et al., 1996; Dexter, Arthur, 2001). This work could be considered as a beginning of FDD in smart building research domain. The purpose of this publication was to enlist all technical faults focusing on HVAC and controllers. Additionally, this work had proposed an expert rule-based top-down and bottom-up approach for anomaly detection at the whole building level. In 2002, a technical report called NBCIP<sup>1</sup> was jointly published by Iowa energy center and United states environmental protection agency (USEPA) (Ardehali and Smith, 2001). The report articulates 67 case studies with 110 field studies for buildings. Findings persuaded, the major category of control-related faults in buildings come from hardware, software, and human factor, a fourth category is qualified as **unspecified**.

---

<sup>1</sup>The National Building Controls Information Program

In more recent works, diagnostic tools were developed to identify the whole building level faults, for example, Automatic building commissioning analysis tool (ABCAT), and Whole building diagnostician (WBD) developed by Texas A&M University and Pacific Northwest National Laboratory (PNNL) respectively (Katipamula et al., 2004; Bynum et al., 2012). Recently a model-based real-time automated FDD tool has been developed at Lawrence Berkeley national laboratory and simulation were performed over chiller model (Bonvini et al., 2014). Moreover, these works are either inspired by physical model-based or data-based models. In parallel, a contemporary group of researchers also focused on qualitative models for fault diagnosis analysis. In buildings, rule-based qualitative models are used to diagnose faults in air handling units or other part of HVAC (Katipamula et al., 1999; Schein et al., 2006; Roos et al., 1995). Few works also found in literature adopted the rule-based diagnosis models for entire building operation management (Doukas et al., 2007). Few interesting works related to artificial intelligence (Magoulès et al., 2013), ARX model (Yan et al., 2014) and Bayesian network based FDD are also present in literature (Zhao et al., 2013).

A detailed review of FDD methods applied for buildings has been presented in review paper, “Method for fault detection and diagnostics and pro-diagnostics for buildings system, Review-1, 2” (Katipamula and Brambley, 2005a,b). In this framework of reference, thanks to a European projects PERFORMER<sup>2</sup> led by the French building research organization CSTB (Centre Scientifique et Technique du Bâtiment) (Derouineau, 2013). The project outcome was published in March 2015. This report analyses all technical aspects of major commercial diagnostic tools and FDD practices in smart building domain. The key performance index for diagnostic tools and methods was assessed by comparing gap between real-time building performance with predictions and comfort level of occupants.

Model-based diagnosis (MBD) uses an explicit model of the system under diagnosis. It can be qualitative or quantitative models. In general, all the model-based diagnosis approaches consist of three important stages: symptom generation, symptom evaluation, and fault isolation. Quantitative model-based approaches are based on physical models and require detailed mathematical relations among all the operating variables with the characteristic of all components within the system. Mostly, these

---

<sup>2</sup>PERFORMER-Portable, Exhaustive, Reliable, Flexible and Optimized appRoach to Monitoring and Evaluation of building eneRgy performance

models are in form of differential equation or state-space model and presume to have additional knowledge of the normal operation of system under the investigation. Unlike, the quantitative model-based diagnosis, qualitative model-based uses qualitative reasoning or knowledge-based information to conclude whether system or its components are in the faulty or normal state.

Qualitative model-based approach uses a set of predetermined rule to diagnose the system abnormality. The major privilege of model-based techniques is that it only requires knowledge of the normal operation and follow consistency based reasoning method. Principally, the model-based diagnosis has been developed by two parallel communities i.e. Fault Detection and Isolation (FDI) and Diagnosis (DX). They have been developed in fields of automatic control (AC) and artificial intelligence (AI) respectively. In summary, most of the works related to FDD in buildings are fundamentally concerned about the equipment failures leading to indoor discomforts or maintenance. These techniques does not cover the whole building operation and unable to capture the internal relation between the other building components. Further, a short-term discomfort issues and whole building performance tracking is not possible considering existing diagnostic techniques. In following sections, FDI and DX methods are explained in detail.

## **6.4 The FDI approach**

Fault detection and Isolation (FDI) methodology for fault diagnosis has been proposed by control community and statistical decision making theory. Till now, FDI methodology has matured and a number of good review articles have been found in the literature (Isermann, 2005, 1997). FDI counts on Analytical redundancy relations (ARR) approach or Structured parity relation (SPR) and follows Fault signature matrix (FSM) table with column interpretation. A system model, which provides the observations, is considered as a set of components and sensors. Though, FDI decomposes a system model in a behavioral model (BM) and an observation model (OM). FDI assumes the correct behavior of all components and considers deviation from normal behavior as the faulty situation (Travé-Massuyès, 2014a).

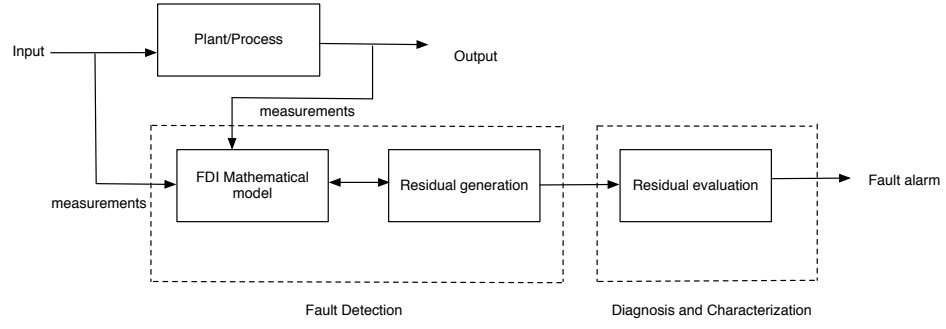


FIGURE 6.1: Fault detection and isolation (FDI)

Consider a continuous time state-space fault-less system model (SM) is modelled by:

$$\begin{aligned} \dot{x}_t &= f_t(x_{t-1}, u_t) \\ y_t &= g_t(x_t, u_t) \end{aligned} \quad (6.1)$$

where  $x_t \in R^n$ ,  $u_t \in R^r$ , and  $y_t \in R^m$  are state, input, and output respectively with given  $f$  and  $g$  vector field. For a system model, a set of variables can be decomposed into the set of unknown variables  $K$  and the set of observable variables  $O$ . When a fault occurs, the system dynamics is described as:

$$\begin{aligned} BM : \dot{x}_t &= f_t(x_{t-1}, u_t, v_t) \\ OM : y_t &= g_t(x_t, u_t, v_t) \end{aligned} \quad (6.2)$$

with fault vector  $v_t \in R^q$ . Moreover, faults can be modeled as an input signal, changes in parameter or change in stochastic properties such as variance. The behavior model (BM) of the above system model establish the constraints between the system input and output, whereas observation model (OM) consists of the set of relation to define the observations performed on the system model. Under the influence of faulty components, system changes its behavior and observed measurements contradict to expected or normal behavior measurements. The discrepancy between input and output observed variables, mathematically, can be represented as :

$$u_t^{obs} = (u_t + u_{sensor}) + v_{tu} \quad (6.3)$$

$$y_t^{obs} = (y_t + y_{sensor}) + v_{ty} \quad (6.4)$$

where  $(u_t^{obs}, y_t^{obs})$ ,  $(u_{sensor}, y_{sensor})$ ,  $(v_{tu}, v_{ty})$  are observed values, sensor errors and faults in input and output measurements respectively. The central concept of FDI diagnosis

methods is residual generation, ARR and signature matrix. They are described below in detail.

### Residual generation

Residuals (symptoms) are fault bearing information signals and invoked when a fault occurs in the system model. Residuals are generated by comparing the measurements from physical variable and their estimation. In Eq. (6.5) time dependent residual  $r_t$  is expressed in terms of observed  $y_t^{obs}$  and estimated  $y_{est}$ :

$$r_t = y_t^{obs} - y_{est} \quad (6.5)$$

Residuals may have directional properties (fault specific direction) or structured property (Boolean structure). Moreover, a residual space  $\mathcal{R}$  consists of a set of residual measurements such that  $\forall r_t \in \mathcal{R}$ . The simplest fault detection achieved by performing a limit checking on the residual measurements in given as time domain. It is achieved by comparing the residual values  $r_t$  with a threshold value  $\tau$  for a given parameter. Accordingly, a fault detection for a given system is performed as:

$$\begin{aligned} |r_t| < \tau &\Rightarrow v_t = 0 \quad for \quad \forall t \in [t_1, t_2] \\ |r_t| \geq \tau &\Rightarrow v_t \neq 0 \quad for \quad \forall t \in [t_1, t_2] \end{aligned}$$

### Analytical redundancy relations (ARR)

ARRs are deduced from the system-model and contains no longer unknown variables. All the tests are built on residuals (symptoms) of ARR. ARR depend only on inputs, outputs, and faults. They are used to check the inconsistency with respect to the system-model. For a given observation  $obs \in \mathcal{O}$ , if residual  $|r_t| = 0$  implies that observation satisfies the ARR. If an ARR satisfies the system behavior entails a zero residual. Non-zero residuals corresponds to violated ARRs, evaluated by signature matrix following boolean values (0 or 1).

**Fault signature matrix (FSM)**

Fault signature matrix (FSM) illustrates the dependency between faults and corresponding residuals. Each row of the matrix represents the coded form of residuals while column contains analogous faults to each residuals. For a theoretical signature matrix  $M_{i,j}$ , an element of row  $i$  equal to 1 if a fault of that column  $j$  affects the residuals. Referring to Eq. (6.6) where limit check have been performed, gives a signature vector  $S = [s_{11}, s_{12}, s_{13}, \dots, s_{ij}]$  for some set of faults  $F$  mathematically,

$$\begin{aligned} |r_t| < \tau, s_{ij} &= 0 \\ |r_t| \geq \tau, s_{ij} &= 1 \end{aligned} \quad (6.6)$$

The explanation of  $s_{ij} = 0$  means fault  $f_j \in F$  does not affect the ARR $_i$ . In contrast,  $s_{ij} = 1$  interpreters fault  $f_j$  is expected to affect ARR $_i$ . The signature matrix is used to perform the fault isolation i.e. to find the similarity between theoretical signature  $s_{ij}$  and observed signature ( $s_k$ ). Faults  $f_i, f_j \in F$  are isolable if their signatures are different. The closeness between the signatures are measured in term of *Hamming Distance* (HD). It is the summation of logical *XOR* operation among theoretical and observed signature. Diagnosis is achieved by following the minimum hamming distance  $HD_{min}$ , to announcing which fault is possibly affecting the system.

*An example:* Lets consider the theoretical signature matrix  $M_{i,j}$  consists of a set of faults  $F = \{f_1, f_2, f_3, f_4\}$  and an associated signature as  $S = \{s_1, s_2, s_3, s_4\}$ . The signature matrix with for three active ARRs can be represented as:

TABLE 6.1: Theoretical Signature table

	$f_1$	$f_2$	$f_3$	$f_4$
ARR1	1	1	0	1
ARR2	0	1	1	1
ARR3	0	1	1	0



If the detected signature is  $s_{k1} = \{0, 1, 1\}$  then Hamming distances ( $d_H$ ) for this signature are:

$$d_1 = d_H \{(0, 1, 1), (1, 0, 0)\} = 3 \quad (6.7)$$

$$d_2 = d_H \{(0, 1, 1), (1, 1, 1)\} = 1 \quad (6.8)$$

$$d_3 = d_H \{(0, 1, 1), (0, 1, 1)\} = 0 \quad (6.9)$$

$$d_4 = d_H \{(0, 1, 1), (1, 1, 0)\} = 2 \quad (6.10)$$

From the above calculation, it is obvious that signature of  $d_3$  has minimum hamming distance  $d_{Hmin} = 0$ , implies that system is more likely affected by fault  $f_3$ .

#### 6.4.1 Limitation of FDI

FDI has been used very successfully in detection and isolation of faults in various practical setups. Even though FDI has obvious advantages such as representation of real process based on the physical model, estimation of output, etc, it still has certain limitations. Few of the limitations of FDI are listed below:

- FDI assumes the occurrence of faults are always observable i.e. all the sensitive residuals will yield alarms, though in many cases this assumption is not valid for fault detection
- Requirement of physical model, that can represent equivalent behavior of process is one of the biggest challenges for FDI
- FDI explicitly does not use the concept of component modeling. It pre-assumes that fault signature contains the component definition and describe the whole system as behavior and observation model. Very often, observations do not vouch for the presence or absence of a faulty component
- The application of FDI for the complex process such as buildings operation might require an intensive computation for parameter estimation
- Considering FDI application in whole building level it is very complex to model complete building system to generate model-based ARRs

## 6.5 The DX Approach

The limitation of FDI leads off to a new mean of diagnosis called DX. In contrast to FDI, it is a logical approach and often referred to as *Diagnosis from the first principle*. The foundation of DX approach belongs to computer science and artificial intelligence research group (Reiter, 1987; De Kleer and Williams, 1987; De Kleer et al., 1992; De Kleer and Williams, 1992). It is a qualitative model-based diagnosis method and utilizes the  $\{\text{system description } (SD), \text{ components } (COMPS), \text{ observations } (OBS)\}$  to diagnose a system. DX is component-oriented diagnosis and relies on first order logic. In the further development, it is referred as consistency-based approach and few modifications were proposed in original DX theory (Greiner et al., 1989). The main strength of DX is multiple fault isolation that makes an easier fault isolation for a complex process. The key definitions needed to represent DX are given below which are based on Reiter theory of DX.

**Definition 6.1. (system)** A system is described as a pair  $(SD, COMPS)$  where  $SD$  represents the system description. It is a set of logical sentences and  $COMPS$  stands for system components. It is a finite set of components.

**Definition 6.2. (observation)** An observation  $OBS$  of a System  $(SD, COMPS)$  is a finite set of first order sentences.

### 6.5.1 Diagnosis with DX

DX acts in accordance with the component modeling and conflicts arise when certain components of system start behaving abnormally. To exemplify, let's consider a system  $S$  with signature  $P:(SD, COMPS, OBS)$  where set of components  $\{c_1, c_2, c_3, \dots, c_i\} = COMPS$  and set of observations  $\{o_1, o_2, o_3, \dots, o_n\} = OBS$ . Further, the system description uses a predicate  $\mathbb{K}$  which interpenetrated as  $\neg\mathbb{K}(c)$  behaves correctly for some component  $c \in COMPS$ . Under the assumption that all components are behaving normally, following equation shows the non-faulty behavior of the system.

$$SD \cup \{\neg\mathbb{K}(c) \mid c \in COMPS\} \tag{6.11}$$

The diagnosis problem arise when some observation  $o \in OBS$  announces conflict with expected behavior of system, in such case inconsistency is assigned as :

$$SD \cup \{\neg\mathbb{K}(c) \mid c \in COMPS\} \cup OBS \quad (6.12)$$

**Definition 6.3.** (Diagnosis) A diagnosis for given system  $S:(SD, COMPS, OBS)$  is a set of component  $\Delta_d$  such that  $SD \cup OBS \cup \{\mathbb{K}(c) \mid c \in \Delta_d\} \cup \{\neg\mathbb{K}(c) \mid c \in COMPS - \Delta_d\}$  is consistent and  $\Delta_d$  is minimum iff  $\forall \Delta \subset \Delta_d, \Delta$  is not a diagnosis.

Now back to the DX modeling approaching. Let's consider a system with single-input and single-output normal behavior model related to component  $c$  whose behavior depends on the parameter  $\gamma_1$  and  $\gamma_2$ . The DX representation for this system is given as :

$$COMP(c) \wedge \neg\mathbb{K} \Rightarrow output(c) = f(input(c)) \quad (6.13)$$

In the above formulation,  $f$  represents the first order logic describing the correct behavior of component  $c$ . Further, this approach could be extended to the parameter, because the component can be described in terms of related parameters (Travé-Massuyès, 2014a; Cordier et al., 2004). However, the second approach requires a clear understanding of relations between component and parameter. That does not easily available for the complex system such as Buildings.

$$COMP(c) \wedge parameter(\gamma_1) \wedge parameter(\gamma_2) \wedge \neg\mathbb{K}(\gamma_1) \wedge \neg\mathbb{K}(\gamma_2) \Rightarrow output(c) = f(input(c), \gamma_1, \gamma_2) \quad (6.14)$$

In the above component modeling approach, the valued variables only appear in SD. This representation does not allow us to understand abstraction because of the same phenomenological variables, belonging to the structural modeling. They could be represented by several evaluated variables (Chittaro and Ranon, 2004). Moreover, in diagnosis, not all behavioral relationships are implicitly related to the expected normal behavior of a component. In global speaking, data from the observable behavior does not vouch for the complete diagnosis. Indeed, data only reveals that some sensors or actuators are behaving properly. Some relationships may be related to a specific fault

---

$\cup$  : union  
 $\neg\mathbb{K}$  : predicate logic  
 $\wedge$  : Logical AND  
 $f$  : First order logic formula

mode. The first principle of diagnosis uses the logical relation and behavioral analysis to perform diagnoses. Nevertheless, a phenomenological or physical system behavior cannot be completely derived from the first principle. The phenomenological models are claimed to be true only if they satisfying some constraints and explanation. Every physical system connected to a phenomena that manifest the information about the state of the system and modeled by a physical variable.

The notion of an elementary model for diagnosis formalizes the link between a constraint descriptive of a behavior and a mode. Further, Struss (Struss, 1991) introduced the notion of at least one mode i.e., *ok*, which corresponds to the normal behavior. However, there are some faults modes which are clearly identified by a specific name and fault mode. Further, in diagnosis, it is interesting to distinguish several modes characteristic of the state of a system. Quang-Huy (Giap et al., 2009) proposed an interactive method of logical diagnosis considering the top-down decomposition. In-fact, in physical modeling it is important to consider structural, behavioral and functional aspects. Finally, there remains the set of states that are neither normal nor specific fault modes. This set, united under the label complementary fault mode, denoted by *cfm*, it represents all the abnormal behaviors that have not been modeled (Ploix, 2009; Yassine et al., 2010). Further, (Ploix, 2009) adopted the term *item* to replace *COMP* because in actual physical system different types of element may be encountered such as function, operation, components (Giap et al., 2009).

For an *item<sub>i</sub>* :

$$Modes_i(item_i) = \{ok, [fault_1, \dots, fault_n] cfm\}$$

In the field of intelligent reality, the valued variables are associated with the phenomenological variable. For any valued variable  $v$ , the known domain of values is represented as  $dom(v)$ . Moreover, it is essential to establish a relation between the valued variable. These relations are modeled as mathematical constraints  $\mathcal{J}(V) = 0$  that model subsets of a phenomenological space. Where  $V$  represents a set of valued variables, are a priori non-oriented.

$$\mathcal{J}(V) = 0, \{v|V(v)\}$$

---

*cfm* :complementary fault mode

The notion of elementary model for the diagnosis formalizes the link existing between a descriptive constraint of a behavior and a mode :

$$mode(item) \leftrightarrow \forall V \text{ observable}, \mathcal{J}(V) = 0 \quad (6.15)$$

where  $\mathcal{J}(V) = 0$  is an elementary constraints. An elementary model corresponds to a single mode, but since several elementary models can relate to the same mode, a mode can be described by several constraints (Struss, 1991). There are also non-elementary models, generally resulting from the assembly of elementary models, which generally relate to conjunctions of modes.

$$\bigwedge_i mode_i(item_i) \leftrightarrow \forall V \text{ observable}, J(V) = 0 \quad (6.16)$$

where  $J(V) = 0$  represents the all constraints need to be satisfied. Thus far, following formulation is often used for elementary (Eq.6.17) and non-elementary (Eq.6.18) model.

$$mode(item) \rightarrow \exists V, \text{ observable}, \mathcal{J}(V) = 0 \quad (6.17)$$

$$\bigwedge_i mode_i(item_i) \rightarrow \exists V, \text{ observable}, J(V) = 0 \quad (6.18)$$

Further, the above equations are reduced to:

$$(mode(item), \mathcal{J}(V) = 0) \quad (6.19)$$

$$(\bigwedge_i mode_i(item_i), J(V) = 0) \quad (6.20)$$

It is important to mention here, that data streams are included in the constraints and do not appear explicitly. Each sensor corresponds to an elementary model.

Let's consider, sensors  $c_1$  and  $c_2$  measure a variable  $v$  then :

$$\forall t, (ok(c_1), v - obs_1(t, v) = 0) \text{ and } \forall t, (ok(c_2), v - obs_2(t, v) = 0) \quad (6.21)$$

where  $obs_1(t, v)$  and  $obs_2(t, v)$  represent the data streams provided respectively by the sensors  $c_1$  and  $c_2$ . These constraints are called terminal constraints because they contain

only one valued variable. Further,

$$mode(item) \rightarrow (J(V) = 0) \vee \neg \left( \bigwedge_i J'_i(V) = 0 \right) \quad (6.22)$$

$$\bigwedge_i mode_i(item_i) \rightarrow (J(V) = 0) \vee \neg \left( \bigwedge_k J'_k(V) = 0 \right) \quad (6.23)$$

where  $J'_i(V = 0)$  and  $J'_k(V = 0)$  is the domain of validity constraints described by a set of elementary constraints and non-elementary constraints (Ploix, 2009). Further, above equation is deduced to:

$$(J(V) \neq 0) \wedge (J'_k(V) = 0) \rightarrow \bigvee_i \neg mode_i(item_i) \quad (6.24)$$

behavioral constraints $J(V)$	validity constraints $J'_k(V)$	conclusion
$= 0$	$= 0$	-
$= 0$	$\neq 0$	-
$\neq 0$	$= 0$	$\bigvee_i \neg mode_i(item_i)$
$\neq 0$	$\neq 0$	-

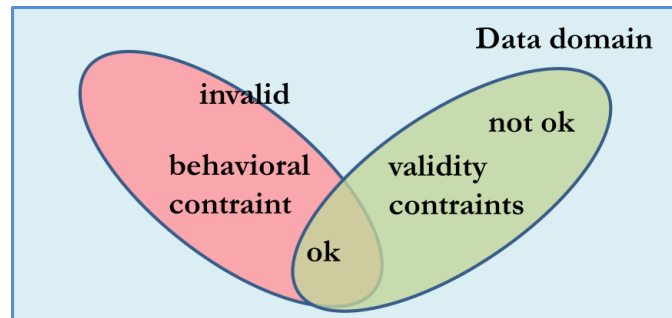


FIGURE 6.2: Test and validity constraints representation

where  $J(V)$  and  $J'_k(V)$  is the domain of behavioral and validity constraints for considered test respectively. In order to detect a test, it must violate the test constraints and satisfy the validity. Test result declares a behavioral change for the system under test under the test validity. In the context of building fault management, it is very important to validate test because a test alone cannot claim a faulty behavior.

---

$\wedge$  : and  
 $\vee$  : or  
 $\neg$  : negation  
 $\leftrightarrow$  : implies(propositional logic)  
 $\rightarrow$  : implies(if..then)

### 6.5.2 Concept of Hitting set and conflict

Possibly, all the diagnosis are obtainable by checking the inconsistency between test on all subsets of components and observations. Nevertheless, due to the inefficiency of this method, DX introduced the concept of conflict or R-conflict (in some literature (Cordier et al., 2004)) and Hitting set for minimum diagnosis.

**Definition 6.4.** (Conflict) A conflict for  $S:(SD, COMPS, OBS)$  is a set of components  $\{c_1, c_2, c_3 \dots c_n\} \subseteq COMPS$  such that  $SD \cup COMPS \cup \{\neg\mathbb{K}(c_1), \neg\mathbb{K}(c_2), \dots \neg\mathbb{K}(c_n)\}$  is inconsistent. A conflict  $c$  is minimal if  $\top \subseteq c$  and  $\top$  is not a conflict.

**Definition 6.5.** (Hitting set) A hitting set  $H$  for the  $C = \{c_1, c_2, c_3 \dots c_i\} \subseteq COMPS$  if  $H \subseteq \bigcup_{1 \leq k \leq n} c_k$ , and  $H \cap c_k \neq \{\}$ . Set  $H$  is minimal if and only if  $\forall X \subset H, X$  is not a hitting set.

Conflict accounts as a subset of components, assumed to behave normally are not consistent with the observation. Thus far, at least one of the component belonging to conflict set is faulty. Potentially, a minimum diagnosis could be achieved taking into account the hitting set. In order to examine minimum diagnosis Reiter (Reiter, 1987) proposes a Hitting set tree (HS-Tree). Though, it was found that HS tree is not efficient for non-minimal conflicts. To handle it, Greiner proposed an extension of HS-tree which is considered as a Direct acyclic graph (DAG) (Greiner et al., 1989).

### 6.5.3 Limitation of DX

DX had proven a strong outcome for fault isolation and diagnosis within artificial intelligence and computer research community. It is important to acknowledge here, DX have certain issues over off-line conflict detection for a dynamic system, qualify it for the static and on-line system. Subsequently, FDI techniques focus on dynamic system ARRs are determined off-line. Buildings are highly dynamic system and involve various sub-system and components, in such case DX alone is not sufficient for fault detection and diagnosis in buildings. Hence to overcome the limitation of FDI and DX community, a group of researchers from control theory and artificial intelligence came together and propose a framework hailed as *Bridge approach* of diagnosis.

---

$\subseteq$ : subset

## 6.6 FDI and DX: A Bridge approach framework

Before the 2000s, FDI and DX have been considered as completely isolated groups. Intuitively, both methodologies had their own terminologies and paradigm for fault detection and diagnosis. The FDI approach mainly focuses on dynamic system and utilizes a two-step diagnosis process i.e *Detection* and *Isolation*, whereas DX approach mainly deals with the static system and adopt the consistency-based diagnosis (CBD). FDI believes, abnormality in modeled behavior implies faults in the system, on the contrary, DX assumes that faulty behavior cannot be determined only from behavior, it should involve component discretion. Multiple fault diagnosis is also a challenging task for FDI, though DX can deal with them easily. FDI and DX require a formalized model that avail the system information. A more detailed comparison between FDI and DX has been presented in (Cordier et al., 2004). Concurrently, a *Bridge approach* have been proposed to bridge the data based and physical model-based diagnosis. It is applicable for both static and dynamic systems under certain conditions. The mainstay of bridge approach that is capable of finding the diagnosis with the component level explanation. Thanks to some of the big projects that gave more recognition and attention to Bridge community, few of them are listed below :

- The french research group “Intégration de Méthod Alliant Automatic and AI (IMALAIA), supported by CNRS
- The BRIDGE project <http://cs2ac.upc.edu/en/research-projects/ue-projects/monet>, funded by MONET under European Bridge community
- The MAGIC European project <http://projects.laas.fr/ANR-MAGIC-SPS/>, developed under MAGIC-SPS consortium

Along with above, a number of remarkable publications were found in literature, considered as a seminal contribution to Bridge approach (Ploix, 2009; T. Marcu, M. Capobianco, S. Gentil, 2003; Ploix et al., 2003). Formal diagnosis or FDI analysis exploits only valid test revealing a behavior abnormality of the system gives an easy mean to fault detection. However, with the notion of Hamming distance and signature table, faults localization is not adequate to address the component or sub-system level faults. Aforementioned, FDI solely rest on ARRs and DX follow the conflict analysis to diag-



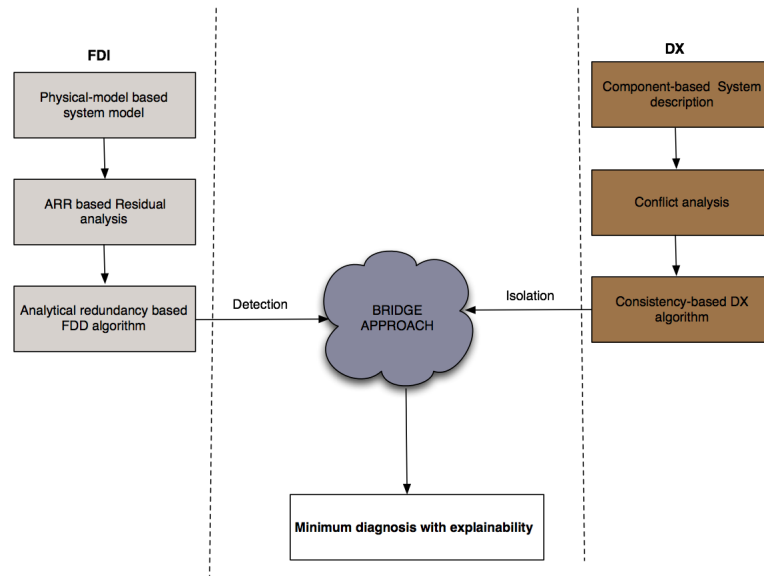


FIGURE 6.3: Bridge approach of diagnosis

nose the system. In 2004, Cordier (Cordier et al., 2004) came up with the concept of *support* and *scope* and made an effort to establish a link between ARR and conflict.

**Definition 6.6.** (ARR Support) Support for an ARR i.e.,  $support(ARR)$ , is the set of components  $\{c_j\}$  (columns of FSM) with a non-zero element in the row corresponding to given ARR.

**Definition 6.7.** (Scope) The scope interpreted as the set of ARRs (row of FSM) with a non-zero element in the column corresponding to component  $\{c_j\}$ .

Further various bridge techniques have been proposed in recent years notably; cause model-based bridge diagnosis approach (Gentil et al., 2004), using set membership approach (Fagarasan et al., 2004; Ploix and Follot, 2001), model-based hybrid diagnosis (Hofbaur and Williams, 2002; Benazera and Travé-Massuyès, 2009), and hypothesis testing (Delmaire et al., 1994). In addition, few review papers are also available which cover current trends of bridge approach (Travé-Massuyès, 2014b; Biswas et al., 2004). In the wider context, bridge approach consists in, benefits of FDI on the detection side and benefits of DX on the fault localization aspects.

---

$\perp$ : *contradiction*  
 $\forall$ : *Forall*  
 $\exists$ : *exists*  
 $\Rightarrow$ : *Implies (if then)*  
 $\models$ : *entails*

## Logical diagnosis

The logical diagnosis approach adopted in this work follows a two-step procedure: detection and localization, but also isolating the formal diagnostic reasoning from the DX approach in fault localizing phase. The main interest of formal reasoning is that, unlike coincidental approaches, no assumption of exoneration is implicitly assumed. In other words, it is not assumed that an absence of symptoms implies an absence of the defect. After the detection phase, a list of explanations is obtained for each test leading to a conclusion. Therefore, the formal diagnosis problem  $\mathbb{P}$  to be resolved as:

$$\mathbb{P} = \bigwedge_{test_i} \bigvee_{mode_j \in Explanation(test_i)} mode_j \quad (6.25)$$

An algorithm adapted from the Hitting-set tree (HS) allows to finding the minimal conjunctions of modes that solve  $\mathbb{P}$  and gives the formal diagnostics. In a multi-modal context, the algorithm must be careful not to combine different modes of the same item in the same conjunction. If there are malfunction tests, that is to say, testing fault modes, certain minimal diagnoses obtained will include the *ok* mode which is less interesting because it is implicit. Attention must be given to removing these modes before communicating the diagnostics. The absence of an implicit exoneration hypothesis also has a consequence on the analysis of the symptoms because it is sufficient that a defect once reveals itself in the symptoms so that it is considered permanent: *when a test detects a fault, the presence of fault modes is proven until a restoration event is recognized*

Let  $\mathbb{P} = \bigwedge_{test_i} \bigvee_{mode_j \in Explanation(test_i)} mode_j$  a diagnostic problem which led to a time  $t$  at diagnosis  $\mathbb{P}_D$  (A conjunction of mode disjunctions) At time  $t' > t$ , the only event that can occur is the triggering of one or more new tests. Let us  $TEST$  is one of these new tests. The principle of monotony says that:

$$\mathbb{P} \models D \rightarrow \left( \mathbb{P} \wedge \bigvee_{mode_i \in Explanation(TEST)} mode_i \models D \right) \quad (6.26)$$

Thus, the new diagnosis will never be contradictory with that of the instant  $t$ : it will only specify it. The formal diagnostic analysis only uses valid tests that reveal a behavioral abnormality. Other tests are ignored. To complete the results of this analysis, it is possible to use, like coincidence approaches, Hamming's notion of signature and distance.

The distance measurement is obtained by considering that (Eq 6.22) can be tested, that is to say, that the whole domain of the observables has been accessed. under the exemption hypothesis, this leads to:

behavioral constraints $J(V)$	constraints validity $J'_k(V)$	conclusion
$= 0$	$= 0$	$\wedge_i(\overline{item_i})$
$= 0$	$\neq 0$	$\wedge_i(item_i)$
$\neq 0$	$= 0$	$\bigvee_i \neg mode_i(item_i)$
$\neq 0$	$\neq 0$	$\wedge_i(item_i)$

Bridge method is mainly applicable diagnostic analysis. In order to apply bridge method for building's fault analysis, it is important to discover a global signature table. This table must include different type of test symptoms comping for building sub-systems.

## 6.7 Conclusion

This chapter inculcates a short introduction about the fault detection and diagnosis technique. Different issues and available diagnosis techniques have been described. A so-called bridge method has been introduced in detail. In this framework, existing pure model-based diagnoses approaches are too complex because of the detailed modeling knowledge requirement. In addition, model-based approaches are obliged to have an intensive computation and induce ambiguous explanations. A model-based diagnosis has some limitations over the multiple faults and do not consider the building component-model. In order to overcome the modeling issue, a hybrid approach between model-based and heuristics has been proposed in the next chapter.

## Chapter 7

# Proposed diagnosis approach for buildings

### Contents

---

<b>7.1</b>	<b>Introduction</b>	<b>108</b>
<b>7.2</b>	<b>New concept of validity for partial Test</b>	<b>109</b>
<b>7.3</b>	<b>Proposed diagnosis methodology</b>	<b>110</b>
<b>7.4</b>	<b>Generation of rule and range-based test using HAZOP</b>	<b>111</b>
7.4.1	Example of range-based test: Test1 (indoor temperature test leading to the set-point deviation)	112
7.4.2	Example of rule-based test: Test2 (airflow)	115
<b>7.5</b>	<b>Model-based test leading to zonal-test</b>	<b>117</b>
7.5.1	Example of Model-based: Test3 (zonal thermal test)	117
<b>7.6</b>	<b>Analyzing heterogeneous tests using Bridge approach</b>	<b>119</b>
<b>7.7</b>	<b>Application of proposed approach</b>	<b>120</b>
<b>7.8</b>	<b>Conclusion</b>	<b>123</b>

---

*Abstract- This chapter proposes a fault detection and diagnosis methodology at the whole building level. Whole building modeling is a challenging task due to the lack of detailed knowledge of various building's component and sub-system properties. Pure rule-based or heuristics approaches are unable to cover the real-time building fault analysis. These methods are limited in the terms of completeness. Conversely, model-based approaches are systematic but they are very dominating in the terms of detailed modeling. Taking into account the whole building modeling and rule-based*

*limitation, a hybrid approach between heuristics and model-based approach have been adopted in the proposed method.*

*A heuristics based HAZOP method is combined with the model-based tests. Range, rule, and model-based tests are developed with the help of behavioral and validity constraints. In order to get a valid diagnosis, all tests have to satisfy their linked validity constraints.*

## 7.1 Introduction

While accounting the whole building performance, different faults can be categorized in three major categories: an inefficient or poor performance of building appliances, physical failures, and finally, unplanned situations. To make a resilient building management system, it is important to identify the severity and fault-type. Detail challenges in the building FDD have been described in the previous chapter. However, to recall, the key challenges are summarized below:

- modeling complete building fault-model integrated with all building components is too complicated and a tremendous job to model
- pure rule-based approaches alone are not able to cover all possible tests
- current building FDD vendors do not offer *validity* of the test and alarm

The limitation of existing FDD tools and modeling challenges leads to develop a new fault diagnosis tool or scheme that could overcome the above issues. In the following discussion, a generic fault diagnosis method has been proposed in section 7.3. Further, each element of the proposed method is described in details. The focus is given on the proposition behavioral and validity constraints. Lastly, an illustration of the proposed method is followed by a conclusion.

---

The term FDD accounts for both FDI and DX

## 7.2 New concept of validity for partial Test

The theoretical concept of behavioral constraint  $J(V)$  and validity constraint  $J'(V)$  has been discussed in previous chapter 6. These set of constraints are used to develop a testable system. However, to recall the approach a table is given below from the previous chapter. This section provides a practical discussion of the validity constraints in

behavioral constraints $J(V)$	validity constraints $J'(V)$	conclusion
<i>satisfied</i>	<i>satisfied</i>	<i>consistent</i>
<i>satisfied</i>	<i>unsatisfied</i>	<i>invalid</i>
<i>unsatisfied</i>	<i>satisfied</i>	<i>inconsistent</i>
<i>unsatisfied</i>	<i>unsatisfied</i>	<i>invalid</i>

terms of building fault diagnosis. Current building diagnosis approaches do not use the validity constraints as the part of the diagnostic analysis. A conventional building test is used to generate the only symptom and it is assumed that test could be applied to any situation, without taking into account any validity statement. In contrary, partial tests are more global and offer an easy way to test a whole building system considering the validity statement. Further, diagnostic approaches mainly consider testing the abnormal behavior of building taking into account the building system behavioral analysis and measurements. However, measurements are values and do not consider any validity statement. Similarly, behavioral analysis alone does not signify faulty behavior of building system valid under the pre-defined constraints. Hence, tests are alone not sufficient to check the relevant building performance.

Testing a building system without checking the validity constraints could lead to an erroneous test result. In more generic explanation validity is defined as a set of elementary constraints. Few examples of validity considering the building thermal performance test is given below:

- Testing indoor temperature without verifying occupancy level might lead to a false alarm
- The door and window position need to be verified
- Similarly, predicted outdoor weather condition needs to be validated while checking the building thermal performance

These set of validity constraints are developed considering the whole building system thermal performance test. In order to launch a valid diagnosis analysis, each test needs to satisfy the validity and behavioral constraints simultaneously. Further, these constraints are discussed for few tests in more detail in section 7.4.

### 7.3 Proposed diagnosis methodology

In this section, a fault detection and diagnosis scheme is has been proposed for reactive building management (Singh et al., 2016). The fundamental objective of the proposed scheme is to develop all possible diagnosis analysis considering the whole building operation. The proposed scheme is depicted in figure 7.1. The proposed method uses a

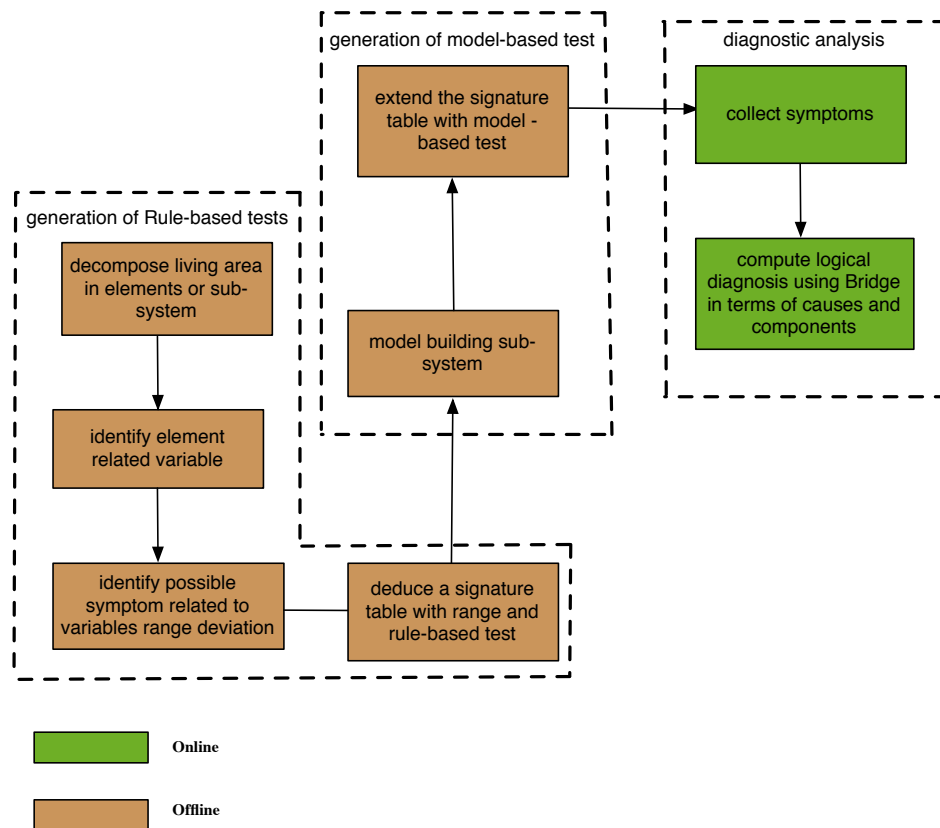


FIGURE 7.1: Enumerated scheme with HAZOP and Diagnosis for buildings

heuristic HAZOP based approach to overcome the modeling limitation. HAZOP is going to be used to discover possible detection tests because systematic approach for tests generations ends up with a huge number of tests difficult to handle. The outcome of HAZOP leads to rule and range-based tests with test support, behavioral and validity

constraints. Notwithstanding, qualitative models like HAZOP are not enough to cover all the possible discrepancies with a set of rules. Aberrant building phenomenon could arise due to one or more than one faulty sub-system. A significant time and effort involved making deep diagnoses for the entire building and turn-out to be with complex results.

Further, to address to the zonal attributes of the building system, model-based tests leading to zonal-tests have been used. Finally, all heterogeneous tests are collected together and a bridge approach with formal diagnosis is used for the diagnostic analysis, handling heterogeneous tests.

In summary, the illustrated scheme involves three main stages namely;

- generation of rule-based tests using HAZOP (Hazards and Operability Analysis) as heuristics analysis that leads to global range-based tests along with local rule-based tests
- simplified model-based tests generation limited to building zones i.e., zonal-test
- finally, a logical diagnosis analysis taking into accounts all the heterogeneous tests

This work follows the principle that how quickly building management can identify and generate the explanation for the flawed sub-systems and components without interrupting the other building operation. Further, in order to generate symptoms derived from continuous building operation, the approach has been extended to the model-based test generation. Model-based diagnosis has some limitations over the multiple faults. To address this issue a Bridge approach has been used. The Bridge diagnosis generates the minimum possible explanation for each symptom. In the following sections, each element of the proposed methodology is described in details.

## **7.4 Generation of rule and range-based test using HAZOP**

An offline heuristic tool i.e., Hazards and Operability Analysis (HAZOP) is used to analyze the building system performance under distinct failures. HAZOP is a qualitative approach, widely accepted and used in industrial automation to identify critical and non-critical hazards with their severity (Nemeth et al., 2009; Venkatasubramanian et al.,



2000). The outcome of HAZOP is leading to the potential range and rule-based test that valid under certain constraints. These tests check whether building sub-system working properly or not. Figure 7.2 shows the general HAZOP scheme in detail. In

TABLE 7.1: Ontology for HAZOP

building zone or node	$\langle \textit{subsystem}/\textit{name} \rangle$
relation	$\langle \textit{subsystem}/\textit{variable} \rangle$
change in behavior	$\langle \textit{symptom} \rangle$
fault characterization	$\langle \textit{detection} \rangle$
consequences and explanation	$\langle \textit{description} \rangle$
generation of test and rule	$\langle \textit{validity}/\textit{constraints} \rangle$

this analysis, the system to be diagnosed is divided into various elements or sub-systems and associated with the related variables. This analysis is usually done on the basis of prior knowledge of input-output or cause-consequences relations between the variables and sub-systems. HAZOP analysis systematically identifies all the possible causes and consequences for each hypothesized deviations of different variables (Crawley and Tyler, 2015). Deviations of variables from its normal range generate symptoms and signify some problems or disorders in building’s operation. The motivation behind combining HAZOP with model-based diagnosis is, to develop a diagnostic methodology for buildings, which can cover a maximum number of distinct modeled and non-modeled faults in buildings. An XML implementation is used to manage all HAZOP related information (Refer Appendix A).

An example of range-based and rule-based test derived from HAZOP is given below. However, these tests are taken from the next chapter to demonstrate an example of range and rule-based test. The Test1 is a range-based test while Test2 is a rule-based test.

#### **7.4.1 Example of range-based test: Test1 (indoor temperature test leading to the set-point deviation)**

It is a range-based test and checks the indoor temperature due to abnormal behavior of a building system. Indoor temperature relies on the normal behavior of building’s sub-systems and sensor measurements. Test function  $\mathbf{T}_1(T_{in})$  generates test results for the deviation of indoor thermal building performance, where (1) stands for a declared symptom while (NA) for an inconsistent test. According to the BEMS, it is considered

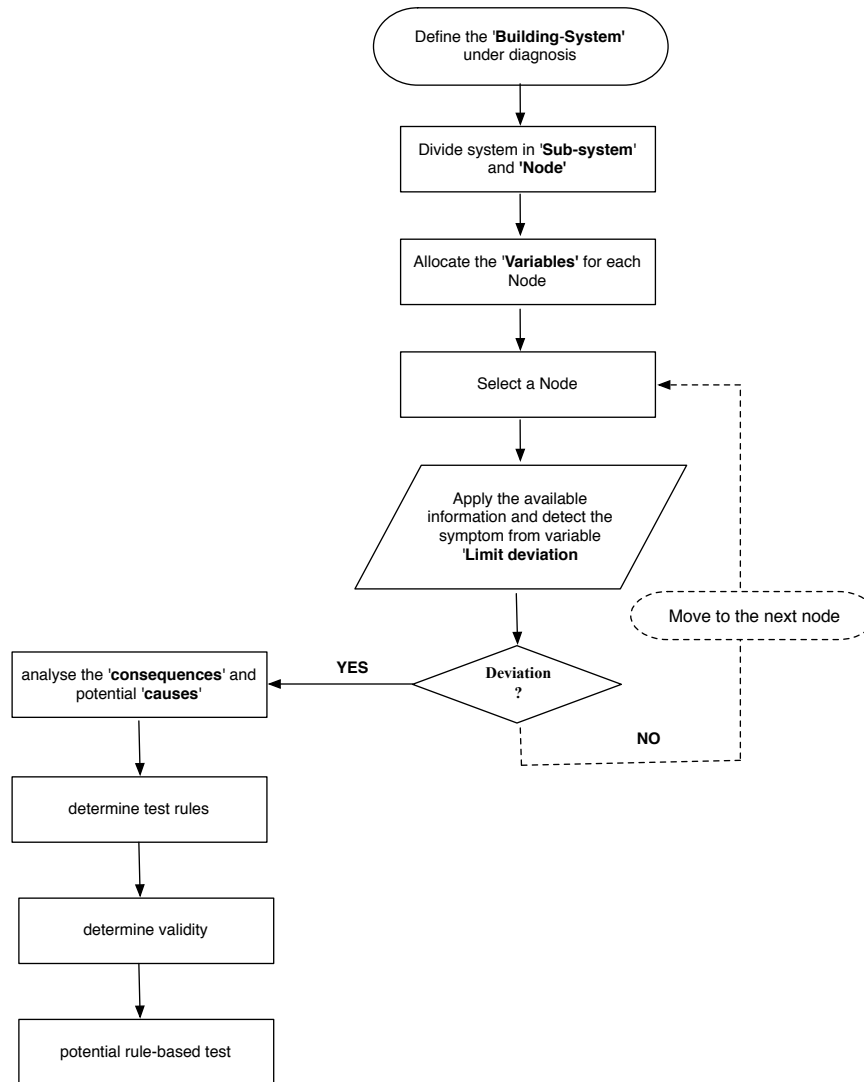


FIGURE 7.2: HAZOP process

that thermal limit depends on the BEMS, and they are assumed as the normal range for a BEMS. Now recalling the approach *mode (ok, cfm)* described in subsection 6.5.1. *cfm* represents the *complementary fault mode* leading to an abnormal behavior. Each sensor is considered as non-faulty i.e. *ok state* only. In addition to above, test function needs to satisfy the certain behavioral constraints and validity constraints.

Following sensors are required to perform the indoor thermal test:

*Required sensors:* indoor temperature sensor, outdoor temperature sensor, door contact sensor, motion detection sensor

Indoor temperature test function is given as:

$$\mathbf{T}_1(T_{in}) = \begin{cases} 0 & \text{if } : J \wedge J' \\ 1 & \text{if } : \neg J \wedge J' \\ NA & \text{if } : J \wedge \neg J' \end{cases}$$

*support:*

$$\begin{aligned} & cfm(ventilation\ pipes) \vee cfm(filter) \\ \vee & cfm(heat\ exchanger) \vee cfm(supply\ and\ return\ fan) \\ & \vee cfm(electrical\ drive) \vee cfm(radiator) \\ & \vee cfm(occupancy) \vee cfm(unplanned\ appliances) \\ & \vee cfm(building\ envelope) \vee cfm(boiler) \vee cfm(thermostate) \\ & \vee cfm(heating\ pipes) \vee cfm(duct) \vee cfm(reconfiguration\ system) \end{aligned}$$

*behavioral constraints J:*

$$\text{indoor temperature } (T_{in}) \in (T_{min}, T_{max})$$

*validity constraints J':*

$$\begin{aligned} T_{out} \in & (T_{min}^{weather}, T_{max}^{weather}) \wedge (occupancy(O) < occupancy_{max}^{allowed}) \\ & \wedge (\text{normal door and window position}) \end{aligned}$$

*assumption:*

$$\begin{aligned}
&ok(sensor : T_{in}) \rightarrow obs(T_{in}) = T_{in} \\
&ok(sensor : T_{out}) \rightarrow obs(T_{out}) = T_{out} \\
&ok(sensor : motion\ detector) \rightarrow \\
&\quad estimated(occupancy) = actual\ occupancy \\
&ok(sensor : air\ flow) \rightarrow obs(air\ flow) = air\ flow \\
&ok(sensor : door\ contact\ sensors) \rightarrow \\
&\quad obs(door\ or\ window\ position) = (actual\ door\ or\ window\ position)
\end{aligned}$$

*test explanation:*

This test determines the thermal performance of the building. The variable  $T_{in}$  depends on several building components such as ventilation, weather and, occupancy etc. Test *support* integrates all major building component that could affect building's thermal performance. For instance, clogged filter *or* ( $\vee$ ), unplanned occupancy could be responsible for poor thermal performance. On the other hand, behavioral constraint signifies the normal behavior range for indoor temperature. Further, there are following validity constraints have been introduced:

- occupancy level
- outdoor weather
- normal door and window position

These constraints are validated whether the test result is valid or not. In order to detect a symptom, the test result must violate behavioral constraints and at the same time it needs to satisfy validity constraints. For instance, if a symptom is detected and valid it signifies that the problem could be from ventilation pipes, filter or supply, and return fan etc. The variable  $T_{in}$  offers a mean to test further building component.

#### **7.4.2 Example of rule-based test: Test2 (airflow)**

This test checks the airflow in the building. Further, the test is performed against the planned and measured airflow values.

---

*obs* : *observed value*  
 $\vee$ : logical OR  
 $\wedge$ : logical AND

*Required sensors:* door contact sensors, airflow sensor, motion detection sensor

$$\mathbf{T}_2(Q_{air}) = \begin{cases} 0 & \text{if } J \wedge J' \\ 1 & \text{if } \neg J \wedge J' \\ NA & \text{if } J \wedge \neg J' \end{cases}$$

*support:*

$$\begin{aligned} & cfm(ventilation\ pipes) \vee cfm(filter) \\ \vee & cfm(heat\ exchanger) \vee cfm(supply\ and\ return\ fan) \\ \vee & cfm(electrial\ drive) \vee cfm(radiator) \\ \vee & cfm(building\ envelope) \vee cfm(ducts) \\ \vee & cfm(reconfiguration\ system) \end{aligned}$$

*behavioral constraints:*  $J$

$$Q_{air}^{measured} < Q_{air}^{plan}$$

*validity constraints:*  $J'$

*(normal door and window position)*

*assumption:*

$$\begin{aligned} & ok(sensor : air\ flow) \rightarrow obs(air\ flow) = air\ flow \\ & ok(sensor : door\ contact\ sensors) \rightarrow \\ & obs(door\ or\ window\ position) = (actual\ door\ or\ window\ position) \end{aligned}$$

*test explanation:*

This test determines the airflow in the building. The comparison of  $Q_{air}^{measured}$  and  $Q_{air}^{plan}$  is used as a deciding rule. Poor airflow in a building might come from problems in

ventilation pipes, filter etc. Further, there are following validity constraint has been introduced to validate the test.

- normal door and window position

**Limitation of HAZOP based test** It was said before, HAZOP concludes only range and rule-based test. Rule-based tests are not systematic in fact it is a guess of all kinds of possible faults based on experience and rules. Further, these tests are limited to certain rules and unable to check the building performance at zonal-level. Building system encompasses several zones with different zonal properties. In order to develop a global diagnosis approach the present approach is extended to low level model-based zonal test.

## 7.5 Model-based test leading to zonal-test

Modeling of the whole building including building components require a huge effort and there are various practical limitations. For instance, there are several variables shared among the building sub-system and difficult to model because of their intricate relations. A model close to the building reality used to simulate various faulty situations in buildings. These models include all major building sub-systems such as ventilation, heating system, occupants and, appliances etc. On the other hand, real-time measurements have been performed with the help of sensors and compared against the predicted values. However, these models also depend on the building zone and available *a priori* modeling knowledge. In the present approach, the model-based test is used to generate an easy symptom generation. Likewise, rule and range-based test model-based test also have to satisfy the behavioral and validity constraints.

### 7.5.1 Example of Model-based: Test3 (zonal thermal test)

*Required sensors:* indoor temperature sensor, outdoor temperature sensor, door contact sensor, motion detection sensor

Modal-based zonal test:

$$\mathbf{T}_3(T_{zone}) = \begin{cases} 0 & \text{if } J \wedge J' \\ 1 & \text{if } \neg J \wedge J' \\ NA & \text{if } J \wedge \neg J' \end{cases}$$

*support:*

$$cfm(ventilation\ system) \vee cfm(building\ envelope) \\ \vee cfm(heating\ system) \vee cfm(occupancy) \vee cfm(BEMS)$$

*behavioral constraints J:*

$$\text{zonal temperature } (T_{estimated}) \in (T_{predicted} - \Delta T, T_{predicted} + \Delta T)$$

*validity constraints J':*

$$T_{out} \in (T_{min}^{weather}, T_{max}^{weather})$$

*assumption:*

$$\begin{aligned} ok(sensor : T_{zone}) &\rightarrow obs(T_{zone}) = T_{zone} \\ ok(sensor : T_{out}) &\rightarrow obs(T_{out}) = T_{out} \\ ok(sensor : motion\ detector) &\rightarrow \\ estimated(occupancy) &= actual(occupancy) \\ ok(sensor : door\ contact\ sensors) &\rightarrow \\ obs(door\ or\ window\ position) &= (actual\ door\ or\ window\ position) \end{aligned}$$

*test explanation:*

This is a model-based test and encompasses the major building sub-system that could be possible to model. In present test problem in any specific building zone further encourage

to test the modeled sub-system such as ventilation, building envelope, occupants and behavior or heating system. The behavior of zonal temperature is checked against the predicted zonal temperature.  $T_{predicted}$  is computed from the building anticipative model. However, the zones were provided the ability to adjust the local temperature by  $\Delta T \sim (2^\circ C)$ . Validity constraints must need to satisfied. Assumptions are used to describe the correct sensor performance.

## 7.6 Analyzing heterogeneous tests using Bridge approach

The outcome of the different type of tests leads to a combination of heterogeneous tests. All type of rule and range-based test are merged into a single table for further analysis. This table does not include the non-detectable and non-discriminable building components. However, the detail table from all type of test is explained is next chapter. In order to explain the proposed approach a short and concrete example is chosen below. Let's consider following signature table that combines a rule, range and model-based test with few support. In above table test  $\mathbf{T}_1$  and  $\mathbf{T}_2$  is range and rule-based test, and

TABLE 7.2: Heterogeneous test signature table

Test	$cfm(ventilation\ system)$	$cfm(heating\ system)$	$cfm(duct)$	$cfm(boiler)$
$\mathbf{T}_1$ (range-based)	1	1	1	1
$\mathbf{T}_2$ (rule-based)	1	0	1	0
$\mathbf{T}_3$ (model-based)	1	1	0	0

coming from HAZOP analysis (explained before). These tests are derived from building sub-system and their associated components. Thus far, all linked components and sub-system are check as (1) for these tests. Further, test  $\mathbf{T}_3$  is a model-based test and only accounts the related sub-system such as ventilation system and heating system. The advantage of above signature table is that it combine both modeled sub-system fault and non-modeled fault i.e, component level. This table represents a global signature table with building components and sub-system. The purpose of heterogeneous test signature table is to combine all possible diagnosable and detectable faults for further diagnosis analysis.

A logic based Bridge approach has been explained in chapter 6 (6.6) in detail. Bridge method is used to develop diagnosis analysis considering a global signature table



with all type of test.

Bridge uses the notion of Hamming distance or a prior probability to generate the minimum diagnosis explanation. It is not assumed that an absence of symptoms does not imply an absence of the defect. Further, the concept of test *support* is defined in 6.6. However, to illustrate a practical example the underlying knowledge developed in chapter 6 is directly applied here.

Now the support for all test is computed below:

$$support(\mathbf{T}_1) = cfm(ventilation\ system), cfm(heating\ system), cfm(duct), cfm(boiler)$$

$$support(\mathbf{T}_2) = cfm(ventilation\ system), cfm(duct)$$

$$support(\mathbf{T}_3) = cfm(ventilation\ system), cfm(heating\ system)$$

Further, these supports are used to compute minimum diagnosis using bridge approach. Bridge explicitly uses the diagnosis based on the row analysis of the signature table that combines modeled and non-modeled faults from the building system. In order to compute logical diagnosis, bridge uses the concept of Hitting-set (Definition 6.5) and conflict analysis (Definition 6.4). Next section, shows an illustration how these supports are used to compute diagnosis analysis.

## 7.7 Application of proposed approach

To demonstrate the diagnostic result, a minimum diagnosis from bridge approach is given below. Let's consider an active symptom coming from above three test (taking into account the validity and behavioral constraints) and have an effective signature:

$$symptom = \begin{bmatrix} 1 \\ 1 \\ 1 \end{bmatrix}$$

Each 1s in above symptom signifies the abnormal behavior in system. Thus far, this symptom could be explained in the terms of combination of non-zero elements in each row from the signature table 7.2. The conventional column based diagnoses approach such as FDI could detect only ventilation system as fault. In contrary, bridge approach

develop a row based test *Explanation* for each negative symptom. Further, the test explanation for symptom could be given as:

$$Expl(test\mathbf{T}_1) = cfm(ventilation\ system), cfm(heating\ system), cfm(duct), cfm(boiler)$$

$$Expl(test\mathbf{T}_2) = cfm(ventilation\ system), cfm(duct)$$

$$Expl(test\mathbf{T}_3) = cfm(ventilation\ system), cfm(heating\ system)$$

These explanations are considered as all possible set of conflict that could responsible for the related fault. Then a HS-tree ?? for conflict sets is depicted in figure 7.3, it

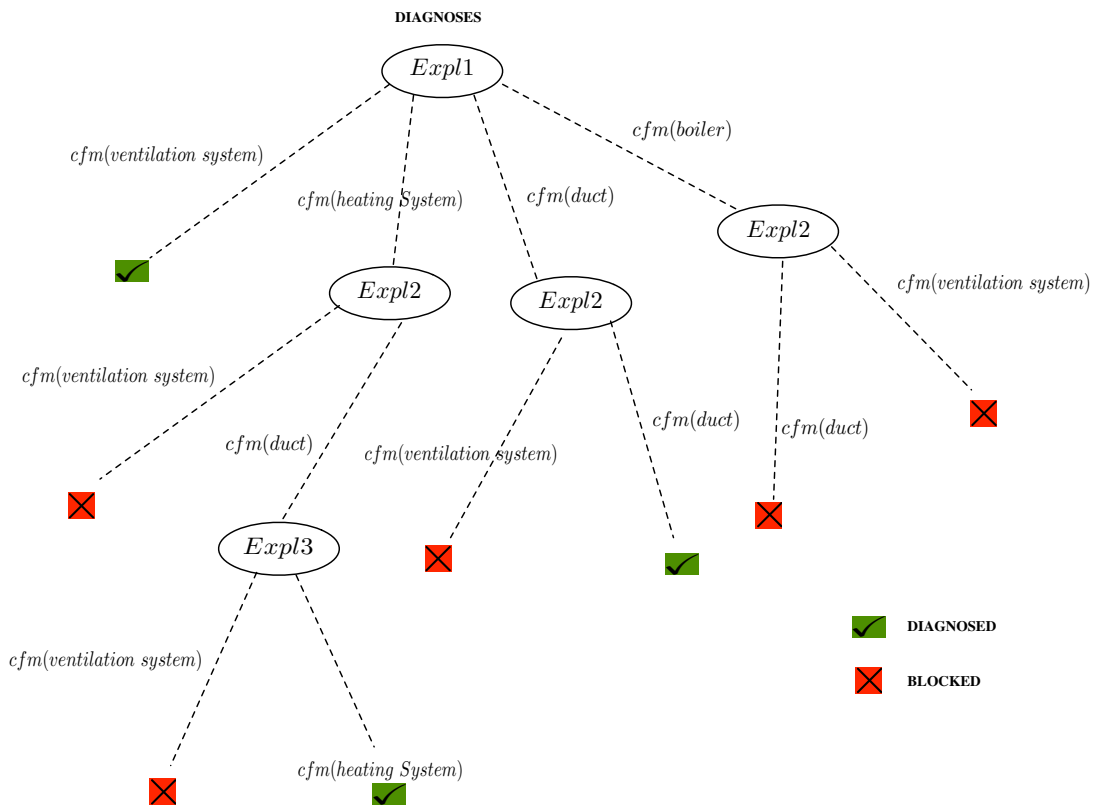


FIGURE 7.3: HS-tree

explains how logical diagnosis (subsection:6.6) are carried out using conflict analysis. In the above figure, nodes with green label show the diagnosed *item* while the node in red represent the termination or blocked of diagnosis process so that no further work is required. The Hamming normalized distance ( $d_H$ ) between each element and signature

table is given below:

$$d_H(cfm(ventilation\ system)) = 0$$

$$d_H(cfm(heating\ system)) = 0.33$$

$$d_H(cfm(duct)) = 0.33$$

$$d_H(cfm(boiler)) = 0.66$$

Using hamming distance analysis it is very obvious that  $cfm(ventilation\ system)$  is a declared fault because of it closer to the first column in test signature table. However, the bridge goes to the further analysis based on test explanations. Indeed, ventilation is present in all test explanation marked as green in the beginning of HS-tree. Now the other nodes follow an expansion considering the next set of conflict. The following equation shows the set diagnosed component achieved from figure 7.3.

$$\text{computed diagnosis} = \{cfm(ventilation\ system) \wedge (cfm(heating\ system) \vee cfm(duct))\} \quad (7.1)$$

**Result discussion** The objective of the above explanation is to show applicability of the proposed approach for buildings. Building diagnosis a complex process and often dealt with pure model or rule based approaches. In proposed approach, the limitation of both model and rule based approaches are accounted. The contribution of the proposed approach looks first into a complete sub-system and further go into the decomposition of that particular sub-system. In this example, diagnosis detect the problem in both i.e. ventilation system and duct. Hence, it will easy to say the actual problem in ventilation system came from the duct. However,  $cfm(heating\ system)$  is next sub-system fault. Finally, the fault  $cfm(boiler)$  is least interesting and does not taken into account. In the next chapter few case studies have been presented in detail to demonstrate the applicability of the proposed method for different building.

---

Hamming distance i.e., the bit-wise distance between two equal length binary signature

## 7.8 Conclusion

The key finding of this chapter is the proposition of a fault diagnosis scheme at the whole building level. In addition, the lessons learned are; how to model the various partial tests considering the building globality? The concept of the partial test including the validity statement. Conventional model-based diagnosis approach ignores the interaction between building's sub-systems and only one fault get explained at a time. In contrary, present approach consider multiple faults explanation along with all possible diagnosis.

A bridge algorithm is applied to determine the minimum possible causes. The whole building modeling issue is tackled in form of simplified zonal-building model. Moreover, proposed diagnosis could help to design a resilient building management so that building performance could be updated actively. A bridge approach of mode-based and heuristics, is used to perform the minimum possible diagnoses.

# Chapter 8

## Case study for the proposed diagnosis method

### Contents

---

<b>8.1</b>	<b>Introduction</b>	<b>125</b>
<b>8.2</b>	<b>Presentation of Predis/MHI platform</b>	<b>125</b>
8.2.1	HAZOP analysis for range and rule-based test of Predis/MHI system	125
8.2.2	Generation of rule, range model-based test using HAZOP	126
8.2.3	Range-based test: Test4 (indoor CO2 concentration leading to air quality)	127
8.2.4	Deduced signature table from heterogeneous test	130
8.2.5	Diagnostic analysis	132
<b>8.3</b>	<b>Presentation of the CECP/CEREMA building</b>	<b>145</b>
8.3.1	Tests analysis for CECP building	147
8.3.2	Rule-based thermal test: Test1	147
8.3.3	Model-based zonal thermal test: Test3	147
8.3.4	Symptoms analysis for CECP/CEREMA building	151
8.3.5	Diagnoses and comments	152
<b>8.4</b>	<b>Conclusion</b>	<b>154</b>

---

## 8.1 Introduction

This chapter discuss two consecutive case studies to validate the diagnosis approach proposed in chapter 7. The developed diagnosis methodology and knowledge is applied to two real building system namely; **Predis/MHI** and **CEREMA**. In the first case study, different tests and validity statements are developed. In the second application few tests are directly used taking into account the previously developed tests.

### Case Study 1

## 8.2 Presentation of Predis/MHI platform

In this section, a case study is presented to show an application of the proposed diagnosis approach. The considered platform is known as Predis/MHI and presented in details in chapter 2, section 2.2. An anticipative building management computes the best set-point for every anticipative hour ( $\Delta_a = 1$  hour) taking into account an anticipative model. At various occasions, occupants complain about the indoor discomfort. Tracking or re-computing the anticipative plan is not a good solution because of some other issues like insufficient ventilation or opening of the door/window significantly affect the indoor comfort. Identifying ventilation issues or building's openings could be an interesting diagnostic solution for these kinds of short-term discomforts. Corrective strategies derived from the controller actions may be insufficient because they do not acknowledge the building faults and operational issues. The proposed diagnosis method is applied to the Predis/MHI platform to discover all possible sources of failures and discrepancies.

### 8.2.1 HAZOP analysis for range and rule-based test of Predis/MHI system

In order to develop different test to cover all possible sources of the building's anomalies, a HAZOP study is performed over the Predis/MHI platform. The whole building is considered as a complete system-level (upper-level) subject to analyze. Further it

is divided into sub-system and components level. Each sub-system is assigned with a variable related to its functionality. Eventually, the component level consists of all parts considered as elementary or “non-divisible”. This layer determines the diagnostic resolution for HAZOP analysis. In the present approach, the sensor-level is not emphasized. It is assumed that all sensors are measuring correct value and performing their normal job i.e. *mode (ok)*. The fundamental concern is given to diagnose the faulty sub-system and their components that could affect the overall building performance. Figure 8.1 illustrates the complete division for HAZOP examination. However, detail explanation is given in Appendix A.

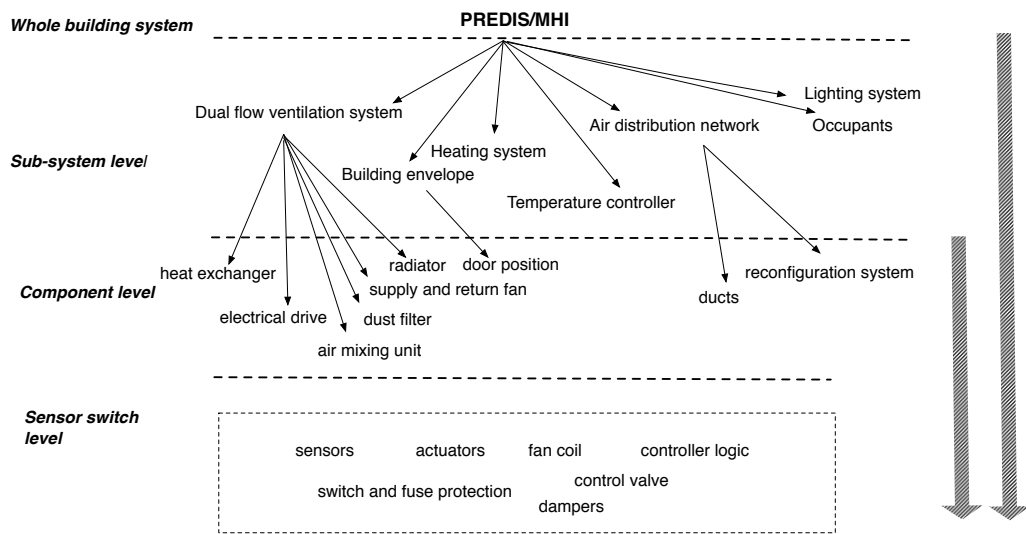


FIGURE 8.1: System-level analysis of Predis/MHI

*Remark 8.1.* Lighting system and building control is also an integral component of a building system. However, due to advanced sensors and alarm management, it is easy to detect the problem with lighting and controller. In the present work, these are not accounted for fault diagnosis purpose.

In order to follow simplicity in the proposed approach, only major fault types in buildings are grouped under the linked sub-system. The behavioral relation between variables and their corresponding fault is used to develop different tests.

### 8.2.2 Generation of rule, range model-based test using HAZOP

An example of a rule, range, and the model-based test is explained in the previous chapter 7, section (7.4) in detail. Three tests are already discussed in chapter 7, sections

(7.4.1, 7.4.2, 7.5.1) and they are directly going to be used here. Moreover, two additional tests are developed and explained in the following discussion.

### 8.2.3 Range-based test: Test4 (indoor CO2 concentration leading to air quality)

CO2 concentration test is related to the indoor air quality level. This test requires measurements along with the constraints and validity. Moreover, occupancy estimation is also an important criterion to decide the test. Though, outdoor CO2 concentration is almost constant.

*Required sensors:* indoor CO2 sensors, occupancy estimation, motion detection sensor

The following CO2 concentration function is modeled to test fault related to the air quality level.

$$\mathbf{T}_4(CO2_{in}) = \begin{cases} 0 & \text{if } : J \wedge J' \\ 1 & \text{if } : \neg J \wedge J' \\ NA & \text{if } : J \wedge \neg J' \end{cases}$$

*support:*

$$\begin{aligned} & cfm(ventilation\ pipes) \vee cfm(filter) \\ & \vee cfm(heat\ exchanger) \vee cfm(supply\ and\ return\ fan) \\ & \vee cfm(duct) \vee cfm(reconfiguration\ system) \\ & \vee cfm(electrical\ drive) \vee cfm(radiator) \vee cfm(occupancy) \end{aligned}$$

*behavioral constraints:*  $J$

$$\text{indoor CO2 } (CO2_{in}) \in (CO2_{min}, CO2_{max})$$

*validity constraints:*  $J'$

$$\left( occupancy(O) < occupancy_{max}^{allowed} \right) \wedge (air\ flow > air\ flow_{minimum})$$



*assumptions:*

$$\begin{aligned}
 &ok(sensor : CO2_{in}) \rightarrow obs(CO2_{in}) = CO2_{in} \\
 &ok(sensor : air\ flow) \rightarrow obs(air\ flow) = air\ flow \\
 &ok(sensor : motion\ detector) \rightarrow \\
 &estimated(occupancy) = actual(occupancy)
 \end{aligned}$$

### Range-based test: Test5 (power consumption test)

This test determines the abnormal power consumption due to faulty building components or unplanned situations. However, an anticipative building management could provide a plan or an anticipation for day-ahead consumption. This plan is computed from the building anticipation model. Often, power consumption plan significantly exceeds to the real consumption. In such situations, a detection function  $\mathbf{T}_5(P_{consumption})$ , is used for comparing current and planned consumption.

*Required sensors:* power consumption measurement, door contact sensors, motion detection sensor

$$\mathbf{T}_5(P_{consumption}) = \begin{cases} 0 & \text{if } : J \wedge J' \\ 1 & \text{if } : \neg J \wedge J' \\ NA & \text{if } : J \wedge \neg J' \end{cases}$$

*support:*

$$\begin{aligned}
 &cfm(ventilation\ system) \vee cfm(appliances) \\
 &\vee cfm(heating\ system) \vee cfm(building\ envelope) \vee cfm(BEMS)
 \end{aligned}$$

*behavioral constraints:*  $J$

$$(P_{consumption}) \in (P_{anticipated} - \Delta, P_{anticipated} + \Delta)$$

*validity constraints: J'*

$$\begin{aligned} & \left( \text{occupancy}(0) < \text{occupancy}_{\max}^{\text{allowed}} \right) \wedge T_{\text{out}} \in \left( T_{\min}^{\text{weather}}, T_{\max}^{\text{weather}} \right) \\ & \wedge (\text{normal door and window position}) \end{aligned}$$

*assumptions:*

$$\begin{aligned} & \text{ok}(\text{sensor} : \text{power sensors}) \rightarrow \text{obs}(\text{power}) = \text{real consumption} \\ & \text{ok}(\text{sensor} : \text{motion detector}) \rightarrow \\ & \text{estimated}(\text{occupancy}) = \text{actual}(\text{occupancy}) \\ & \text{ok}(\text{sensor} : \text{door contact sensors}) \rightarrow \\ & \text{obs}(\text{door or window position}) = (\text{actual door or window position}) \end{aligned}$$

### 8.2.4 Deduced signature table from heterogeneous test

Above tests are developed to diagnose the whole building performance. With the help of tests and their supports. The following theoretical signature table 8.1 is developed.

TABLE 8.1: Theoretical signature table

Test	$f_1$	$f_2$	$f_3$	$f_4$	$f_5$	$f_6$	$f_7$	$f_8$	$f_9$	$f_{10}$	$f_{11}$	$f_{12}$	$f_{13}$	$f_{14}$	$f_{15}$	$f_{16}$	$f_{17}$
Test1	1	1	1	1	1	1	1	1	1	1	1	1	1	1	0	0	0
Test2	1	1	1	1	1	1	0	0	1	0	0	0	1	1	0	0	0
Test3	0	0	0	0	0	0	1	0	1	0	0	0	0	0	1	1	1
Test4	1	1	1	1	1	0	1	0	0	0	0	0	1	1	0	0	0
Test5	0	0	0	0	0	0	0	1	1	0	0	0	0	0	1	1	1

#### Test support:

- $f_1 \rightarrow cfm(\text{ventilation pipe})$
- $f_2 \rightarrow cfm(\text{filter})$
- $f_3 \rightarrow cfm(\text{heat exchanger})$
- $f_4 \rightarrow cfm(\text{supply and return fan})$
- $f_5 \rightarrow cfm(\text{electrical drive})$
- $f_6 \rightarrow cfm(\text{radiator})$
- $f_7 \rightarrow cfm(\text{occupancy})$
- $f_8 \rightarrow cfm(\text{appliances})$
- $f_9 \rightarrow cfm(\text{building envelope})$
- $f_{10} \rightarrow cfm(\text{boiler})$
- $f_{11} \rightarrow cfm(\text{thermostat})$
- $f_{12} \rightarrow cfm(\text{heating pipes})$
- $f_{13} \rightarrow cfm(\text{duct})$
- $f_{14} \rightarrow cfm(\text{reconfiguration system})$
- $f_{15} \rightarrow cfm(\text{ventilation system})$
- $f_{16} \rightarrow cfm(\text{heating system})$
- $f_{17} \rightarrow cfm(\text{BEMS})$

A dynamic memory see figure 8.2 is used to store the fault symptoms. Each fault symptom is stored in individual memory unit and processed for the next level of analysis. The purpose of adding a memory is to store the fault history. A fault symptom must stay into memory until the final diagnosis analysis. Indeed, it is assumed that once a fault appear it could not disappear without performing any corrective action, except for auto-repairable or auto-corrective faults such as closing or opening window. In table 8.1

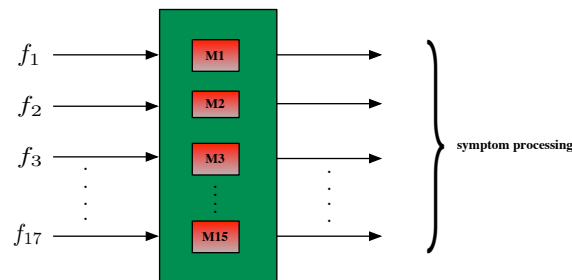


FIGURE 8.2: Fault memory organization

few columns have the same signature and undiagnosable in diagnostic analysis. Thus far, these faults are combined as new fault type, in the reduced signature table 8.2.

TABLE 8.2: Reduced signature table

Test	$f_{VCOMP}$	$f_{VHBEMS}$	$f_{BTHP}$	$f_6$	$f_7$	$f_8$	$f_9$
Test1 (range-based)	1	0	1	1	1	1	1
Test2(rule-based)	1	0	0	1	0	0	1
Test3(model-based)	0	1	0	0	1	0	1
Test4(range-based)	1	0	0	0	1	0	0
Test5(range-based)	0	1	0	0	0	1	1

where:

- $f_{VCOMP} \rightarrow f_1 \vee f_2 \vee f_3 \vee f_4 \vee f_5 \vee f_{13} \vee f_{14}$
- $f_{VHBEMS} \rightarrow f_{15} \vee f_{16} \vee f_{17}$
- $f_{BTHP} \rightarrow f_{10} \vee f_{11} \vee f_{12}$

## 8.2.5 Diagnostic analysis

This section presents a diagnosis case study for Predis/MHI. A typical day has been chosen from the school calendar. Five tests described before are used to test the whole building sub-system. A bridge methodology is used to develop all possible minimum diagnoses from the different test.

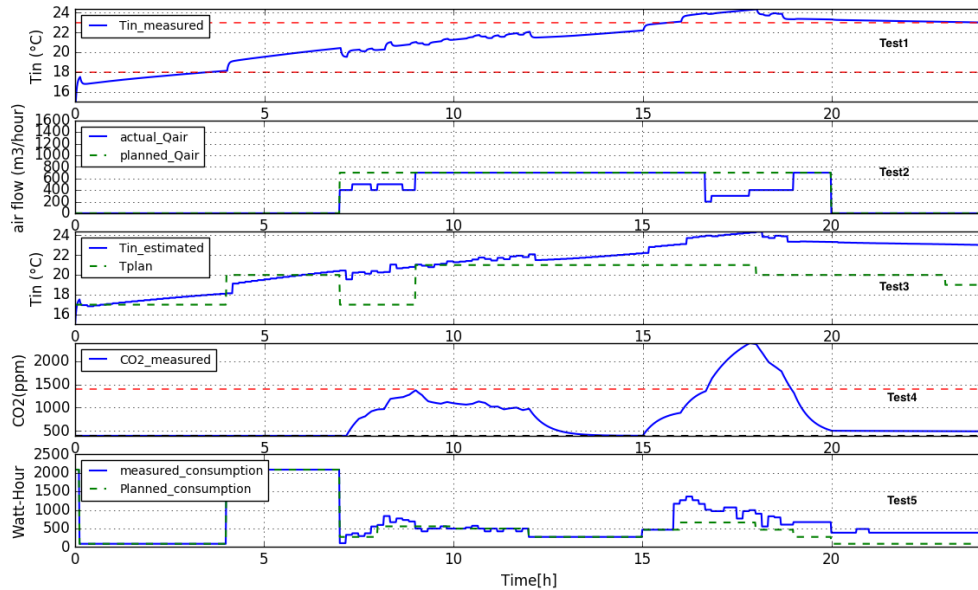


FIGURE 8.3: Different Tests for Predis/MHI

Moreover, bridge method is described in chapter 6, section (6.6) and chapter 7, section (7.7) in details. Model-based zonal thermal test is performed with the help of a simplified (1R-1C) thermal model and described in chapter 4 section (4.6.2) in more details. This model is used for estimating the indoor temperature ignoring slow dynamics of buildings. Figure (8.3) illustrates the combination of different tests and corresponding symptoms taking into account the different types of validity described in the previous discussion.

### 8.2.5.1 Simulated fault scenario

In order to simulate different fault, a fault-model is used. The fault-model is activated to create a discrepancy in normal behavior of the system. This model includes different building system and able to simulate abnormal behavior in building operation. Though, it is very complex to model a fault-model considering the each component of the building system. Thus far, few important and most frequent faults are simulated to perform the

TABLE 8.3: Simulated fault scenario

hour	Simulated Fault
0-1	heating system failure, inefficient ventilation system
1-2	heating system failure, inefficient ventilation system
2-3	-
3-4	-
4-5	-
5-6	-
6-7	-
7-8	inefficient ventilation, unplanned occupancy
8-9	inefficient ventilation, unplanned occupancy
9-10	-
10-11	-
11-12	-
12-13	-
13-14	-
14-15	-
15-16	inefficient ventilation, unplanned occupancy, failure of BEMS system
16-17	inefficient ventilation, unplanned occupancy, unplanned appliances
17-18	inefficient ventilation, unplanned occupancy, unplanned appliances
18-19	-
19-20	-
20-21	-
21-22	-
22-23	-
23-24	-

diagnosis analysis. However, it is important to mention **How** and **When** these faults are simulated. In the present context, faults mainly come from failure, abnormal performance or unplanned situations. It was mentioned before that sensors are considered as non-faulty and not considered in this analysis. The objective of simulated fault scenario is to illustrate both i.e. low sensitive (not easy to detect) and high sensitive (relatively easy to detect) faults. For instance, complete failure of heating system is relatively easy to detect in comparison to inefficient ventilation or unplanned appliances.

Table 8.3 shows the simulated fault scenario for 24-hour duration. Moreover, faults are simulated adding or tuning different parameter in fault model. The detail of simulated fault is given below:

- heating system failure: heating system failure is simulated as a non working heating system. Replacing heater on pattern in model by zero
- inefficient ventilation system: in the ideal case ventilation system works with efficiency ( $\eta = 0.85$ ) but in the faulty scenario it is considered  $\eta = 0.5$ .

- unplanned occupancy: is considered as abnormal occupancy i.e. more number of occupants present than allowed. This fault is simulated by injecting unplanned occupants in the different hour.
- failure of BEMS system: is simulated as false thermal set-point. This fault could be easily simulated by changing the predicted set-point
- unplanned appliances: use of additional appliances, causing internal heat gain and over-consumption. The unplanned appliance is simulated as the use of an additional appliance with the rating 700 watt-Hour.

### **Validity and Behavioral constraints analysis**

In order to perform a valid diagnosis, it is important to analyze behavioral ( $J$ ) and validity ( $J'$ ) constraints. Validity constraints evaluate whether tests are meaningful or not. Validity and behavioral constraints give a valid reason to perform further diagnosis. Further, in the following table 8.4 and 8.5, both types of constraints are examined with test conclusion. Tests are performed for the 24-hour time-period considering behavioral and validity constraints in different hours.

TABLE 8.4: Validity and Behavioral constraints for Tests

hour	Test1	Test2	Test3	Test4	Test5
0-1	$J \neq 0, J' = 0$	$J = 0, J' = 0$	$J = 0, J' = 0$	$J = 0, J' = 0$	$J = 0, J' = 0$
1-2	$J \neq 0, J' = 0$	$J = 0, J' = 0$	$J = 0, J' = 0$	$J = 0, J' = 0$	$J = 0, J' = 0$
2-3	$J \neq 0, J' = 0$	$J = 0, J' = 0$	$J = 0, J' = 0$	$J = 0, J' = 0$	$J = 0, J' = 0$
3-4	$J = 0, J' = 0$	$J = 0, J' = 0$	$J = 0, J' = 0$	$J = 0, J' = 0$	$J = 0, J' = 0$
4-5	$J = 0, J' = 0$	$J = 0, J' = 0$	$J = 0, J' = 0$	$J = 0, J' = 0$	$J = 0, J' = 0$
5-6	$J = 0, J' = 0$	$J = 0, J' = 0$	$J = 0, J' = 0$	$J = 0, J' = 0$	$J = 0, J' = 0$
6-7	$J = 0, J' = 0$	$J = 0, J' = 0$	$J = 0, J' = 0$	$J = 0, J' = 0$	$J = 0, J' = 0$
7-8	$J = 0, J' \neq 0$	$J \neq 0, J' = 0$	$J \neq 0, J' = 0$	$J = 0, J' \neq 0$	$J \neq 0, J' \neq 0$
8-9	$J = 0, J' \neq 0$	$J \neq 0, J' = 0$	$J \neq 0, J' = 0$	$J = 0, J' \neq 0$	$J \neq 0, J' \neq 0$
9-10	$J = 0, J' = 0$	$J = 0, J' = 0$	$J = 0, J' = 0$	$J = 0, J' = 0$	$J = 0, J' = 0$
10-11	$J = 0, J' = 0$	$J = 0, J' = 0$	$J = 0, J' = 0$	$J = 0, J' = 0$	$J = 0, J' = 0$
11-12	$J = 0, J' = 0$	$J = 0, J' = 0$	$J = 0, J' = 0$	$J = 0, J' = 0$	$J = 0, J' = 0$
12-13	$J = 0, J' = 0$	$J = 0, J' = 0$	$J = 0, J' = 0$	$J = 0, J' = 0$	$J = 0, J' = 0$
13-14	$J = 0, J' = 0$	$J = 0, J' = 0$	$J = 0, J' = 0$	$J = 0, J' = 0$	$J = 0, J' = 0$
14-15	$J = 0, J' = 0$	$J = 0, J' = 0$	$J = 0, J' = 0$	$J = 0, J' = 0$	$J = 0, J' = 0$
15-16	$J \neq 0, J' = 0$	$J = 0, J' = 0$	$J \neq 0, J' = 0$	$J = 0, J' = 0$	$J \neq 0, J' = 0$
16-17	$J \neq 0, J' = 0$	$J \neq 0, J' = 0$	$J \neq 0, J' = 0$	$J \neq 0, J' = 0$	$J \neq 0, J' = 0$
17-18	$J \neq 0, J' = 0$	$J \neq 0, J' = 0$	$J \neq 0, J' = 0$	$J \neq 0, J' = 0$	$J \neq 0, J' = 0$
18-19	$J \neq 0, J' = 0$	$J \neq 0, J' = 0$	$J \neq 0, J' = 0$	$J \neq 0, J' = 0$	$J \neq 0, J' = 0$
19-20	$J \neq 0, J' = 0$	$J = 0, J' = 0$	$J \neq 0, J' = 0$	$J = 0, J' = 0$	$J \neq 0, J' = 0$
20-21	$J \neq 0, J' = 0$	$J = 0, J' = 0$	$J \neq 0, J' = 0$	$J = 0, J' = 0$	$J \neq 0, J' = 0$
21-22	$J \neq 0, J' = 0$	$J = 0, J' = 0$	$J \neq 0, J' = 0$	$J = 0, J' = 0$	$J \neq 0, J' = 0$
22-23	$J \neq 0, J' = 0$	$J = 0, J' = 0$	$J \neq 0, J' = 0$	$J = 0, J' = 0$	$J \neq 0, J' = 0$
23-24	$J \neq 0, J' = 0$	$J = 0, J' = 0$	$J \neq 0, J' = 0$	$J = 0, J' = 0$	$J \neq 0, J' = 0$

Further, different scenarios and test conclusion is summarised in table 8.8 and 8.5 respectively. Moreover, important conclusion from both table is given below:

- during the hour 0 to 3, Test1 is inconsistent that leads to a valid symptom. Other test satisfies the behavioral and validity constraints.
- in the hours 3 to 7 all tests satisfied both constraints. Symptom from the previous inconsistency is still present in memory.



TABLE 8.5: Tests conclusion

hour	Test1	Test2	Test3	Test4	Test5
0-1	<i>inconsistent</i>	<i>consistent</i>	<i>consistent</i>	<i>consistent</i>	<i>consistent</i>
1-2	<i>inconsistent</i>	<i>consistent</i>	<i>consistent</i>	<i>consistent</i>	<i>consistent</i>
2-3	<i>inconsistent</i>	<i>consistent</i>	<i>consistent</i>	<i>consistent</i>	<i>consistent</i>
3-4	<i>consistent</i>	<i>consistent</i>	<i>consistent</i>	<i>consistent</i>	<i>consistent</i>
4-5	<i>consistent</i>	<i>consistent</i>	<i>consistent</i>	<i>consistent</i>	<i>consistent</i>
5-6	<i>consistent</i>	<i>consistent</i>	<i>consistent</i>	<i>consistent</i>	<i>consistent</i>
6-7	<i>consistent</i>	<i>consistent</i>	<i>consistent</i>	<i>consistent</i>	<i>consistent</i>
7-8	<i>invalid</i>	<i>inconsistent</i>	<i>inconsistent</i>	<i>invalid</i>	<i>invalid</i>
8-9	<i>invalid</i>	<i>inconsistent</i>	<i>inconsistent</i>	<i>invalid</i>	<i>invalid</i>
9-10	<i>consistent</i>	<i>consistent</i>	<i>consistent</i>	<i>consistent</i>	<i>consistent</i>
10-11	<i>consistent</i>	<i>consistent</i>	<i>consistent</i>	<i>consistent</i>	<i>consistent</i>
11-12	<i>consistent</i>	<i>consistent</i>	<i>consistent</i>	<i>consistent</i>	<i>consistent</i>
12-13	<i>consistent</i>	<i>consistent</i>	<i>consistent</i>	<i>consistent</i>	<i>consistent</i>
13-14	<i>consistent</i>	<i>consistent</i>	<i>consistent</i>	<i>consistent</i>	<i>consistent</i>
14-15	<i>consistent</i>	<i>consistent</i>	<i>consistent</i>	<i>consistent</i>	<i>consistent</i>
15-16	<i>inconsistent</i>	<i>consistent</i>	<i>inconsistent</i>	<i>consistent</i>	<i>inconsistent</i>
16-17	<i>inconsistent</i>	<i>inconsistent</i>	<i>inconsistent</i>	<i>inconsistent</i>	<i>inconsistent</i>
17-18	<i>inconsistent</i>	<i>inconsistent</i>	<i>inconsistent</i>	<i>inconsistent</i>	<i>inconsistent</i>
18-19	<i>inconsistent</i>	<i>inconsistent</i>	<i>inconsistent</i>	<i>inconsistent</i>	<i>inconsistent</i>
19-20	<i>inconsistent</i>	<i>consistent</i>	<i>inconsistent</i>	<i>consistent</i>	<i>inconsistent</i>
20-21	<i>inconsistent</i>	<i>consistent</i>	<i>inconsistent</i>	<i>consistent</i>	<i>inconsistent</i>
21-22	<i>inconsistent</i>	<i>consistent</i>	<i>inconsistent</i>	<i>consistent</i>	<i>inconsistent</i>
22-23	<i>inconsistent</i>	<i>consistent</i>	<i>inconsistent</i>	<i>consistent</i>	<i>inconsistent</i>
23-24	<i>inconsistent</i>	<i>consistent</i>	<i>inconsistent</i>	<i>consistent</i>	<i>inconsistent</i>

- an invalid test combination was appeared for the Test1, Test4, and Test5 during the hour 7 to 9 due to higher occupancy from allowable while other tests are inconsistent.
- further, during the period 9-15 hour, all tests are consistent i.e. they satisfy both behavioral and validity constraints with three fault symptoms in memory from Test1, Test2, and Test3.
- in the hours 15-16, a multiple fault scenario arises because Test1, Test3, and Test5 are inconsistent. Test1 and the Test3 symptom were already present in the memory and one new symptom Test5 came.
- another multiple fault scenario arises during the hour 16-19 when all tests are inconsistent and all symptoms are observed.
- finally, in hours 19-24, Test1, Test3 and Test5 are inconsistent while other tests are consistent. However, this is a similar situation as 15-16 hour.

## Observed symptom

There are four symptoms obtained from test analysis, see table 8.6. The first symptom is detected from the Test1 between hours 1-3. However, a fault from symptom 1 is still present in memory and present again in symptom 3 and 4. Further, in symptom

TABLE 8.6: Observed Symptom table

Test	<i>symptom 1</i>	<i>symptom 2</i>	<i>symptom 3</i>	<i>symptom 4</i>
Test1	1	<i>invalid</i>	1	1
Test2	0	1	0	1
Test3	0	1	1	1
Test4	0	<i>invalid</i>	0	1
Test5	0	<i>invalid</i>	1	1
Hours	0-1	7-8	16-17	17-18

2 only two tests show the valid detection and others are invalid. In symptom 3, Test1, Test2, and Test5 have valid detection with the previous detection from Test2 in memory. Finally, all symptoms are observed in symptom 4. These tests satisfy the validity statements. Table 8.6 shows all the inconsistent test symptoms from tests. The underlying assumption in proposed diagnosis is that once symptoms detected it means that there could be a fault in the system. The memory unit stores symptom and looks for other fault combination. When this symptom appears in other observation again it signifies that this fault has a strong presence and conflicting with others. The diagnosis analysis of each observed symptom is discussed in the next discussion.

## Bridge diagnosis

scenario 1 column-1 table 8.6

$$\text{symptom 1} [\text{Test1, Test2, Test3, Test4, Test5}] = \begin{bmatrix} 1 \\ 0 \\ 0 \\ 0 \\ 0 \end{bmatrix}$$

This symptom arises from all active and valid test. Moreover, the test symptom could arise due to the combination of various faults such as inefficient heating, broken radiator etc. The hamming distance ( $d_H$ ) between observed signature and each column of the

reduced signature table 8.2 is given below:

$$\begin{aligned}
 d_H(cf\mathit{m}(f_{VCOMP})) &= 0.4 \\
 d_H(cf\mathit{m}(f_{VHBEMS})) &= 0.6 \\
 d_H(cf\mathit{m}(f_{BTHP})) &= 0 \\
 d_H(cf\mathit{m}(radiator)) &= 0.2 \\
 d_H(cf\mathit{m}(occupancy)) &= 0.4 \\
 d_H(cf\mathit{m}(appliances)) &= 0.2 \\
 d_H(cf\mathit{m}(building\ envelope)) &= 0.6
 \end{aligned}$$

where,

$$cf\mathit{m}(f_{BTHP}) = cf\mathit{m}(boiler) \vee cf\mathit{m}(thermostat) \vee cf\mathit{m}(heating\ pipes)$$

has zero hamming distance and more likely to be responsible for this symptom. Thus far, the possible faults for this symptom is the problem in boiler, thermostat or heating pipes. However, other feasible faults could be from the radiator or internal heat gain due to unplanned appliances. Considering the occupancy sensor information there are no occupants present during the hour 0-1 hence there is no faults due to unplanned occupants. Further, the test explanation for this symptom is given below:

$$\begin{aligned}
 Expl(test\mathbf{T}_1) &= \{cf\mathit{m}(f_{VCOMP}), cf\mathit{m}(f_{BTHP}), cf\mathit{m}(radiator)\} \\
 &\quad cf\mathit{m}(occupancy), cf\mathit{m}(appliances), cf\mathit{m}(building\ envelope)\}
 \end{aligned}$$

However, there is only one explanation and it has is no conflicting situation examined in diagnosis analysis.

### **Result explanation**

The actual fault scenario for this symptom was the failure of the heating system and inefficient ventilation system i.e. efficiency is (60% less). The simulated fault scenario is explained in table 8.3. This fault is simulated during the hour 0-2 however, fault symptom is detected in the hour 0-3. Both faults are responsible for Test symptom 1. The diagnosis conclusion came in the terms of potential fault in heating system component i.e. broken boiler, thermostat or heating pipes ( $d_H(cf\mathit{m}(f_{BTHP}) = 0)$ ). Due to less

sensitivity of inefficient ventilation fault, it is diagnosed as in-combination with other faulty sub-system. In such scenario is difficult to detect the faulty ventilation due to interrelated faults. Further, next relevant fault is the faulty radiator. Moreover, diagnosis of unplanned appliances could be also a favorable fault, however, it has less significance during the night period. Other diagnosis such as  $cfm(occupancy)$  are disqualified because of the absence of occupants during the night. Often during the night, doors and windows are closed and no issue with the building envelope. Likewise, others faults are combinational and have less significance. Finally, the diagnosis points out the issue with the heating system and that is close to the real fault scenario. However, at this stage, diagnosis is unable to diagnose inefficient ventilation as completely diagnosed fault.

**scenario 2** column-2 table 8.6

$$symptom\ 2\ [Test2,Test3] = \begin{bmatrix} invalid \\ 1 \\ 1 \\ invalid \\ invalid \end{bmatrix}$$

In this scenario, three tests are invalid due to abnormal occupancy and only Test2 and Test3 represent inconsistency in the system. In order to diagnose further, all invalid tests are discarded from the diagnosis analysis. The hamming distance is computed after

$$\overline{cfm(f_{VCOMP})} = \overline{cfm(ventilation\ pipe) \wedge cfm(filter) \wedge cfm(heat\ exchanger) \wedge cfm(supply\ and\ return\ fan) \wedge cfm(electrical\ drive) \wedge cfm(duct) \wedge cfm(reconfiguration\ system)}$$

removing the invalid signature from the theoretical signature table 8.2.

$$\begin{aligned}
 d_H(cf\text{m}(f_{VCOMP})) &= 0.5 \\
 d_H(cf\text{m}(f_{VHBEMS})) &= 0.5 \\
 d_H(cf\text{m}(f_{BTHP})) &= 1.0 \\
 d_H(cf\text{m}(radiator)) &= 0.5 \\
 d_H(cf\text{m}(occupancy)) &= 0.5 \\
 d_H(cf\text{m}(appliances)) &= 1.0 \\
 d_H(cf\text{m}(building\ envelope)) &= 0
 \end{aligned}$$

The explanation of this test is given below:

$$\begin{aligned}
 \text{Expl}(test\mathbf{T}_2) &= \{cf\text{m}(f_{VCOMP}), cf\text{m}(radiator), cf\text{m}(building\ envelope)\} \\
 \text{Expl}(test\mathbf{T}_3) &= \{cf\text{m}(f_{VHBEMS}), cf\text{m}(occupancy), cf\text{m}(building\ envelope)\}
 \end{aligned}$$

$$\begin{aligned}
 \text{minimum diagnoses} &= (cf\text{m}(building\ envelope), \\
 &\quad (cf\text{m}(f_{VCOMP})\ cf\text{m}(f_{VHBEMS})), \\
 &\quad (cf\text{m}(occupancy)\ cf\text{m}(f_{VCOMP})), \\
 &\quad (cf\text{m}(f_{VHBEMS})\ cf\text{m}(radiator)), \\
 &\quad (cf\text{m}(occupancy)\ cf\text{m}(radiator))
 \end{aligned}$$

Bridge diagnosis shows above diagnosis in the terms of minimal possible diagnosis in the case of two activated symptoms.

### **Result explanation**

The actual fault scenario for this test is inefficient ventilation and unplanned occupancy, (table 8.3). Inefficient ventilation implies poor efficiency and less sensitive in comparison to unplanned occupants. However, unplanned occupancy represents more number of occupants are present than expected. During the hour 8-9 there is no expected occupancy, however, the simulated scenario assumes higher occupancy level is ( $> 15$ ). This value of

occupancy is significantly higher than expected occupancy. Due to the violation of validity constraints Test1, 3 and 5 are removed. The bridge diagnosis shows building opening is the primary reason for this symptom, indeed this fault is not present in simulated scenario. The fault in ventilation system diagnosed in second stage of diagnosis with hamming distance ( $d_H = 0.5$ ). In the present case diagnosis is able to detect relatively low sensitive fault i.e inefficient ventilation system. The potential fault in ventilation could arise from faulty ventilation component or poor ventilation performance. Further, unplanned occupancy is detected in third stage of diagnosis. Indeed, diagnoses analysis found unplanned occupancy could be a possible reason for this scenario however, it is combined with other components of ventilation system. Bridge detect other faults as well such as unplanned appliances and failure of heating system system. These faults have higher hamming distance and far from the simulated fault. In the present case the diagnosis method is able to detect relatively low sensitive fault i.e inefficient ventilation system.

**scenario 3** column-3 table 8.6

$$symptom\ 3 [Test1, Test2, Test3\ Test4, Test5] = \begin{bmatrix} 1 \\ 0 \\ 1 \\ 0 \\ 1 \end{bmatrix}$$

This symptom corresponds to inconsistencies detected by Test1, Test3 and, Test5. These tests are the rule, range and, model-based (simplified thermal model) tests. Moreover, fault symptom form Test1 is already present in memory. The model-based test (Test3) is used for verifying zonal thermal performance thanks to simplified thermal model and estimated temperature. Further, measured hamming distances for this symptom is given

below:

$$\begin{aligned}
 d_H(cf\!m(f_{VCOMP})) &= 0.8 \\
 d_H(cf\!m(f_{VHBEMS})) &= 0.2 \\
 d_H(cf\!m(f_{BTHP})) &= 0.4 \\
 d_H(cf\!m(radiator)) &= 0.6 \\
 d_H(cf\!m(occupancy)) &= 0.4 \\
 d_H(cf\!m(appliances)) &= 0.2 \\
 d_H(cf\!m(building\ envelope)) &= 0.2
 \end{aligned}$$

Further,  $cf\!m(appliances)$ ,  $cf\!m(f_{VHBEMS})$  and,  $cf\!m(building\ envelope)$  have minimum hamming distance.

In order to perform further diagnosis analysis, supports for these tests are:

$$\begin{aligned}
 Expl(test\mathbf{T}_1) &= \{cf\!m(f_{VCOMP}), cf\!m(f_{BTHP}), cf\!m(radiator) \\
 &\quad cf\!m(occupancy), cf\!m(appliances), cf\!m(building\ envelope)\} \\
 Expl(test\mathbf{T}_3) &= \{cf\!m(f_{VHBEMS}), cf\!m(occupancy), cf\!m(building\ envelope)\} \\
 Expl(test\mathbf{T}_5) &= \{cf\!m(f_{VHBEMS}), cf\!m(appliances), cf\!m(building\ envelope)\}
 \end{aligned}$$

These faults explanations have conflicting components that requires fault analysis. Further, bridge method is used to compute set of all possible diagnosis.

$$\begin{aligned}
 minimum\ diagnoses &= cf\!m(building\ envelope), \\
 &\quad (cf\!m(f_{VHBEMS})\ cf\!m(f_{VCOMP})), \\
 &\quad (cf\!m(f_{VHBEMS})\ cf\!m(f_{BTHP})), \\
 &\quad (cf\!m(f_{VHBEMS})\ cf\!m(radiator)), \\
 &\quad (cf\!m(f_{VHBEMS})\ cf\!m(occupancy)) \\
 &\quad (cf\!m(occupancy)\ cf\!m(appliances)) \\
 &\quad (cf\!m(f_{VHBEMS})\ cf\!m(appliances))
 \end{aligned}$$

Bridge diagnose  $cf\!m(building\ envelope)$  as first diagnosed faults for this symptom. However, other diagnosis such as  $(cf\!m(f_{VHBEMS})\ cf\!m(radiator))$  diagnosed in next

stage of diagnosis

### Result explanation

In this test, actual fault scenario was inefficient ventilation system, unplanned occupancy along with faulty BEMS. Poor ventilation and unplanned occupancy faults are explained in scenario 2, further, faulty BEMS is simulated by changing the predicted set-point in fault-model. Diagnosis analysis confirms building openings as a diagnosis, however, it is far from the simulated scenario. Further, next stage of diagnosis gives a combined fault in heating, ventilation and faulty BEMS along with faulty ventilation components such as clogged filter, broken duct etc. The previous fault history suggests an issue with faulty heating system component. Further,  $cfm(occupancy)$  is detected with  $cfm(f_{VHBEMS})$ . This the most relevant diagnosis considering the simulated fault scenario. The unplanned appliance is detected with a combination of unplanned occupants and inefficient heating, ventilation or BEMS. On the other hand, other diagnosis combination has less significance and far from the real fault scenario.

**scenario 4** column-4 table 8.6

$$symptom\ 4 [Test1, Test2, Test3, Test4, Test5] = \begin{bmatrix} 1 \\ 1 \\ 1 \\ 1 \\ 1 \end{bmatrix}$$

---


$$\begin{aligned} cfm(f_{VHBEMS}) &= cfm(ventilation\ system) \wedge cfm(heating\ system) \wedge cfm(BEMS) \\ cfm(f_{BTHP}) &= cfm(boiler) \wedge cfm(thermostat) \wedge cfm(heating\ pipes) \end{aligned}$$



Symptom 4 is the last symptom with all valid test. Hamming distance indicate that  $cfm(\text{building envelope})$  has minimum value.

$$d_H(cfm(f_{VCOMP})) = 0.4$$

$$d_H(cfm(f_{VHBEMS})) = 0.6$$

$$d_H(cfm(f_{BTHP})) = 0.8$$

$$d_H(cfm(\text{radiator})) = 0.6$$

$$d_H(cfm(\text{occupancy})) = 0.4$$

$$d_H(cfm(\text{appliances})) = 0.6$$

$$d_H(cfm(\text{building envelope})) = 0.2$$

Further, bridge computes all the tests explanation and minimum diagnosis.

$$\begin{aligned} Expl(\text{test}\mathbf{T}_1) = \{ & cfm(f_{VCOMP}), cfm(f_{BTHP}), (cfm(\text{radiator})) \\ & cfm(\text{occupancy}), cfm(\text{appliances}), cfm(\text{building envelope})\} \end{aligned}$$

$$Expl(\text{test}\mathbf{T}_2) = \{ cfm(f_{VCOMP}), cfm(\text{radiator}), cfm(\text{building envelope}) \}$$

$$Expl(\text{test}\mathbf{T}_3) = \{ cfm(f_{VHBEMS}), cfm(\text{occupancy}), cfm(\text{building envelope}) \}$$

$$Expl(\text{test}\mathbf{T}_4) = \{ cfm(f_{VCOMP}), cfm(\text{occupancy}) \}$$

$$Expl(\text{test}\mathbf{T}_5) = \{ cfm(f_{VHBEMS}), cfm(\text{appliances}), cfm(\text{building envelope}) \}$$

$$\begin{aligned} \text{minimum diagnoses} = & (cfm(f_{VHBEMS}) cfm(f_{VCOMP})), \\ & (cfm(\text{building envelope}) cfm(f_{VCOMP})), \\ & (cfm(\text{building envelope}) cfm(\text{occupancy})), \\ & (cfm(\text{appliances}) cfm(\text{occupancy}) cfm(f_{VCOMP})), \\ & (cfm(\text{occupancy}) cfm(f_{VHBEMS}), cfm(\text{radiator})), \\ & (cfm(\text{appliances}) cfm(\text{occupancy}) cfm(\text{radiator})) \end{aligned}$$

The diagnosis analysis of this symptom gives fault isolation in the terms of combination of different faults.

### Result explanation

Considering the previous fault scenario (scenario 3) a new fault i.e. unplanned appliance added to the simulated fault. Moreover, the appliances used by unplanned occupants is also considered as unplanned appliances.

The diagnoses suggest the fault as the combination of a problem in heating, ventilation and faulty BEMS. In addition, an issue with faulty building envelope also appears in diagnosis analysis in-combination with faulty ventilation components such as a broken duct or faulty reconfiguration system. Unplanned occupancy and appliances are detected in combination with  $cfm(radiator)$ . However, this is a complex scenario in which all symptoms are activated from different tests. Relying on diagnosis analysis it is difficult to decide which fault combination is more effective. Comparing with the simulated scenario the faults are diagnosed in first four stages of diagnosis analysis. In the case of conflicting fault scenario, the idea is to discover all possible explanation of simulated and non-simulated faults to validate the diagnosis resolution of proposed diagnosis methodology.

*Remark 8.2.* The novelty of the proposed method is that it provides the diagnoses as a combination of all possible diagnosis that includes physical failures along with unplanned situations. Furthermore, it able to diagnose less sensitive fault along with strongly present fault. The set of diagnoses allows an easy identification of affected building subsystem and components. Indeed, diagnoses easily pin-point the set of faults from the conflict analysis and reduce the complexity of diagnosis process. Having the knowledge of set of the affected system and components it will easy to investigate at the deeper level.

## Case Study - 2

### 8.3 Presentation of the CECP/CEREMA building

In this section, a case study is presented to discuss the diagnosability issue in the CECP building. CECP building (often called CECP), is an energy-efficient building constructed in 2012 and located in Angers, France. The whole building is divided into the two major parts, namely: workshop area of  $700m^2$  and office area of  $1000m^2$ . The height of each

floor is 2.5m.



FIGURE 8.4: 3D view of CEPM Building

CECP follows the French energy efficiency building code, RT-2012. Its energy consumption is labeled as  $55.33 \text{ kWh/m}^2/\text{year}$  for workshop area and  $55.59 \text{ kWh/m}^2/\text{year}$  for the office area respectively. A 3-D view of CECP building is shown in figure 8.4. The building is equipped with a double flux air treatment system with a heat exchanger. The ventilation flow system exhausts stale air and improves indoor air quality. Further, a water loop system supplying low-temperature radiators, installed with a thermostatic valve.

The whole building divided into 74 zones. Each zone is different from other in terms of temperature and comfort requirement. The normal behavior of building considered as:

- windows and external doors are at normal position
- internal doors are often open
- indoor set temperature is the one that has been measured in each zone
- internal gains come from electrical appliances and occupants
- meteorological conditions have been measured

*Remark 8.3.* CECP is a complex building system. It is difficult to model the whole building under the one modeling equation. Further, a simplified model-based zonal test is used to test the thermal performance at zonal level. In order to simplify the approach, office room 009 of CECP building has been chosen for the diagnosis analysis.

### 8.3.1 Tests analysis for CECP building

In this case study, only thermal performance of the building has been tested. The range and model-based thermal performance tests are proposed in chapter 7, section (7.4.1, 7.5.1). It is applied to detect and locate faults at the whole building level.

### 8.3.2 Rule-based thermal test: Test1

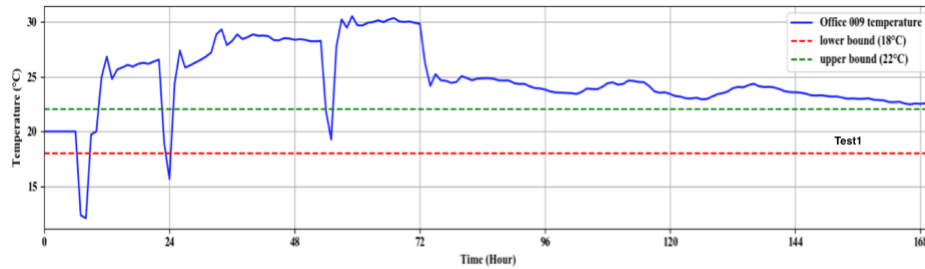


FIGURE 8.5: Rule-based thermal test for thermal discomfort

A range-based thermal test (refer to subsection 7.4.1) confirms a thermal discomfort. A symptom manifest when the indoor temperature goes beyond the comfort boundary i.e.  $18^{\circ}\text{C}$  ( $T_{min}$ ) and  $22^{\circ}\text{C}$  ( $T_{max}$ ). Figure 8.5 shows a thermal discomfort is detected between the hours 6 to 169. Beyond the maximum and minimum temperature range building enters into thermal discomfort zone. This test confirms the discrepancy in building's normal thermal performance.

### 8.3.3 Model-based zonal thermal test: Test3

A model-based zonal test (refer to 7.5.1) is used to verify the zonal temperature. This test performs a comparison of the measured and estimated temperature. The thermal model verifies the thermal discomfort at zonal or local level. This test yields the set-point deviation symptom along with the thermal discomfort. The zonal test is performed with

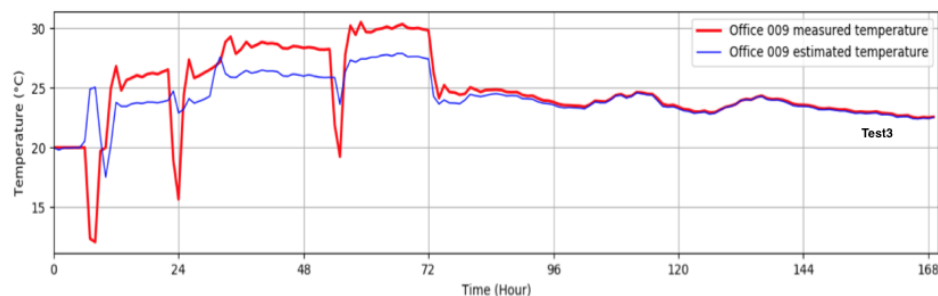


FIGURE 8.6: Zonal thermal test for thermal discomfort in office 009

the help of linear regression model (Eq. 8.1). It compares whether the corresponding measurement follow the estimated temperatures or not. However, zonal temperature are allowed to adjust  $\pm\Delta T^{\circ}C = 2^{\circ}C$ . The input and output details of the linear regression model for office 009 is given below (Eq. 8.1):

**Mathematical representation:**

$$\begin{aligned} Y[k] = & 0.226378Y[k-1] - 0.002148U_0[k] + 0.052236U_1[k] - 0.000062U_2[k] \\ & + 0.000029U_3[k] - 0.000228U_4[k] + 0.012467U_5[k] - 0.656953U_6[k] \\ & - 0.450027U_7[k] + 0.450887U_8[k] + 0.283410U_9[k] \\ & + 0.423809U_{10}[k] + 0.020218 \end{aligned} \quad (8.1)$$

**Input:**

- $U_0 = T_{ext}$  : Ambient temperature
- $U_1 = T_{corridor}$  : Air temperature in the corridor
- $U_2 = W_{electrical}$  : Electricity consumption in office 009
- $U_3 = Q_{horizontal}$  : The horizontal radiation
- $U_4 = Air\ flow$  : Air flow in the office 009
- $U_5 = T_{vent}$  : Temperature of air blown in the office 009
- $U_6 = Q_{radiator}$  : Radiator heat flow
- $U_7 = T_{office101}$  : Air temperature in neighboring office 101
- $U_8 = T_{office010}$  : Air temperature in neighboring office 010
- $U_9 = T_{atel-prod}$  : Air temperature in the room ATEL-PROD
- $U_{10} = Occupancy$  in office 009

**Output:**

- $Y = T_{office009}$  Output estimated temperature in office 009

Figure 8.6 shows the measured and estimated temperature value with simplified thermal model.

### Simulated fault scenario

TRNsys (simulation software) with interface TRNBuild and TRNsys Simulation Studio (graphical front-end) have been used to simulate the building faults. TRNBuild interface allows adding the non-geometrical properties such as wall and layer material properties, windows and door properties, thermal conductivity and different gains etc. In the present work, these values are taken from French building regulating agency CSTB (Centre Scientifique et Technique du Bâtiment) The table 8.7 and figure 8.8 shows the simulated

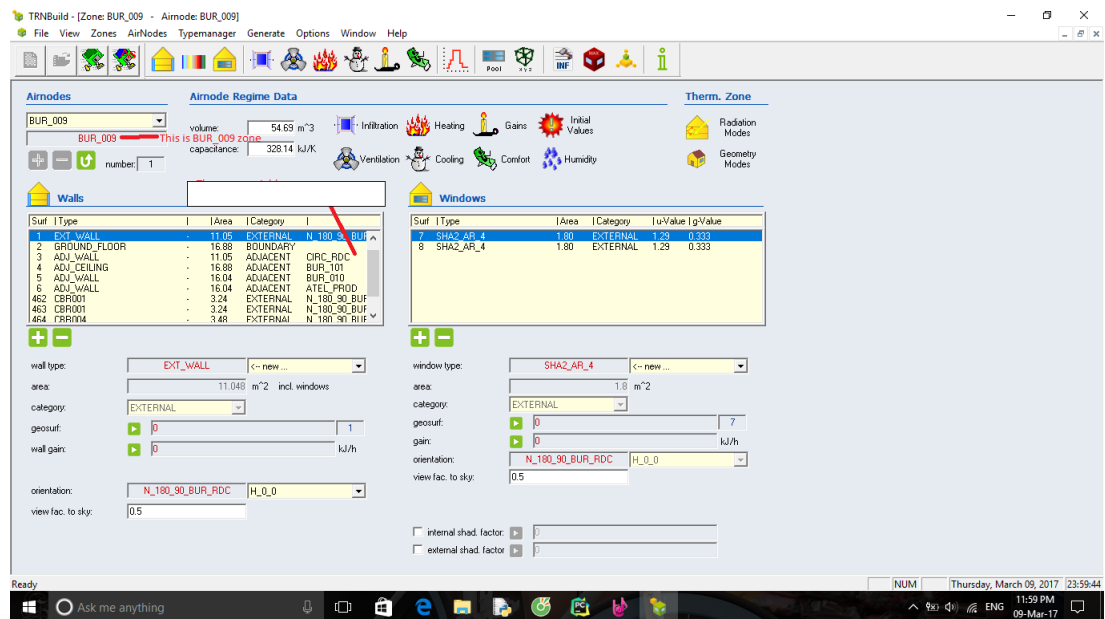


FIGURE 8.7: TRNsys model

fault scenario for 24-hour duration.

TABLE 8.7: Simulated fault scenario

hour	Simulated Fault
0-1	-
1-2	-
2-3	-
3-4	-
4-5	-
5-6	-
6-7	window is open
7-8	window is open
8-9	window is open
9-10	window is open
10-11	unplanned appliances, unplanned occupancy
11-12	unplanned appliances, unplanned occupancy
12-13	unplanned appliances, unplanned occupancy
13-14	unplanned appliances, unplanned occupancy
14-15	unplanned appliances
15-16	unplanned appliances
16-17	unplanned appliances
17-18	unplanned appliances
18-19	unplanned appliances
19-20	unplanned appliances
20-21	unplanned appliances
21-22	unplanned appliances
22-23	unplanned appliances
23-24	unplanned appliances

Moreover, faults are simulated adding or tuning different parameter in fault model. The detail of simulated fault is given below:

- open window: using TRNsys model
- unplanned occupancy: is considered as abnormal occupancy i.e. a large number of occupants are present than allowed. In this scenario 10 occupants are considered, however, the usual occupancy is 4.

- unplanned appliances: use of additional appliances, causing internal heat gain and over consumption. In present case a heater of 2KW is simulated as unplanned appliances.

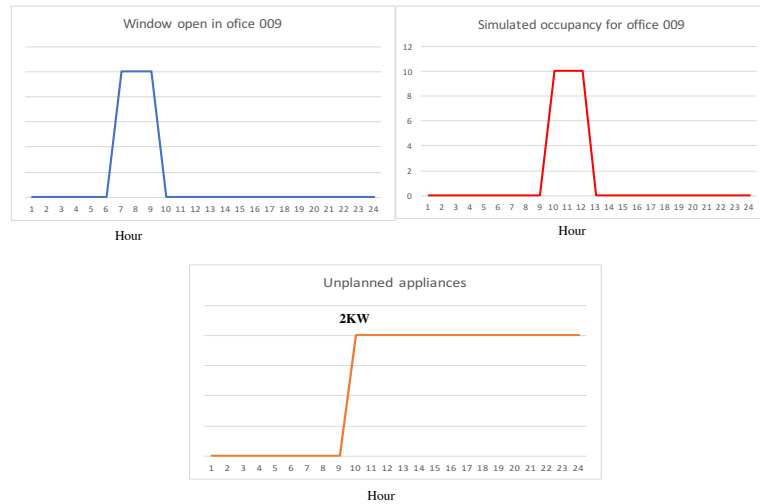


FIGURE 8.8: Simulated fault scenario

### 8.3.4 Symptoms analysis for CECP/CEREMA building

This section demonstrates the experimental validation of proposed diagnosis methodology. The tests had been performed for different building zone that includes several offices, and meeting rooms. The tests are derived from the one-week data collection from the CECP building. In order to make a concise explanation only first 24 hours i.e. one day is accounted for the fault analysis.

Table 8.8 represents behavioral and validity constraints along with test conclusion and presence of fault. Moreover, conclusions form this table 8.8:

- there is no inconsistency between the hours 0-5 that confirms the normal building operation.
- during the hour 5-6 only Test3 is inconsistent.
- further, in the period 6-10 Test1 is invalid due to open window in morning.
- finally, all tests demonstrate inconsistency in building performance during the 10 to 24.



TABLE 8.8: Validity and Behavioral constraints for Tests

hour	Test1	Test3	Conclusion (Test1)	Conclusion (Test3)
0-1	$J = 0, J' = 0$	$J = 0, J' = 0$	<i>consistent</i>	<i>consistent</i>
1-2	$J = 0, J' = 0$	$J = 0, J' = 0$	<i>consistent</i>	<i>consistent</i>
2-3	$J = 0, J' = 0$	$J = 0, J' = 0$	<i>consistent</i>	<i>consistent</i>
3-4	$J = 0, J' = 0$	$J = 0, J' = 0$	<i>consistent</i>	<i>consistent</i>
4-5	$J = 0, J' = 0$	$J = 0, J' = 0$	<i>consistent</i>	<i>consistent</i>
5-6	$J = 0, J' = 0$	$J \neq 0, J' = 0$	<i>consistent</i>	<i>inconsistent</i>
6-7	$J \neq 0, J' \neq 0$	$J \neq 0, J' = 0$	<i>invalid</i>	<i>inconsistent</i>
7-8	$J = 0, J' \neq 0$	$J = 0, J' = 0$	<i>invalid</i>	<i>inconsistent</i>
8-9	$J = 0, J' \neq 0$	$J \neq 0, J' = 0$	<i>invalid</i>	<i>inconsistent</i>
9-10	$J = 0, J' \neq 0$	$J \neq 0, J' = 0$	<i>invalid</i>	<i>inconsistent</i>
10-11	$J \neq 0, J' = 0$	$J \neq 0, J' = 0$	<i>inconsistent</i>	<i>inconsistent</i>
11-12	$J \neq 0, J' = 0$	$J \neq 0, J' = 0$	<i>inconsistent</i>	<i>inconsistent</i>
12-13	$J \neq 0, J' = 0$	$J \neq 0, J' = 0$	<i>inconsistent</i>	<i>inconsistent</i>
13-14	$J \neq 0, J' = 0$	$J \neq 0, J' = 0$	<i>inconsistent</i>	<i>inconsistent</i>
14-15	$J \neq 0, J' = 0$	$J \neq 0, J' = 0$	<i>inconsistent</i>	<i>inconsistent</i>
15-16	$J \neq 0, J' = 0$	$J \neq 0, J' = 0$	<i>inconsistent</i>	<i>inconsistent</i>
16-17	$J \neq 0, J' = 0$	$J \neq 0, J' = 0$	<i>inconsistent</i>	<i>inconsistent</i>
17-18	$J \neq 0, J' = 0$	$J \neq 0, J' = 0$	<i>inconsistent</i>	<i>inconsistent</i>
18-19	$J \neq 0, J' = 0$	$J \neq 0, J' = 0$	<i>inconsistent</i>	<i>inconsistent</i>
19-20	$J \neq 0, J' = 0$	$J \neq 0, J' = 0$	<i>inconsistent</i>	<i>inconsistent</i>
20-21	$J \neq 0, J' = 0$	$J \neq 0, J' = 0$	<i>inconsistent</i>	<i>inconsistent</i>
21-22	$J \neq 0, J' = 0$	$J \neq 0, J' = 0$	<i>inconsistent</i>	<i>inconsistent</i>
22-23	$J \neq 0, J' = 0$	$J \neq 0, J' = 0$	<i>inconsistent</i>	<i>inconsistent</i>
23-24	$J \neq 0, J' = 0$	$J \neq 0, J' = 0$	<i>inconsistent</i>	<i>inconsistent</i>

### 8.3.5 Diagnoses and comments

Further, test explanations are computed from the test support given in table 8.2. These explanations have conflicting components and require further analysis.

#### Hour (0-5)

In this duration, both tests are consistent and satisfying the behavioral and validity constraints. No inconsistency have been detected.

#### Hour (5-6)

In this hour only Test3 shows inconsistency. That confirms a zonal thermal discomfort. The test explanation for this test is given below:

$$Expl(test\mathbf{T}_3) = \{cfm(f_{VHBEMS}), cfm(occupancy), cfm(building\ envelope)\}$$

The fault explanation shows the problem could be, building envelope i.e. open window or unplanned appliances. Further, poor or faulty heating, ventilation system could be another explanation for this fault. Indeed, no simulated fault in this hour. So far, at this stage it is difficult to say what was the exact reason for this inconsistency.

### Hour (6-10)

During the hour 6-10 Test 1 is invalid due opening of window during the hour. However, Test3 is still inconsistent that means the fault is still present in the system. Test explanation is same as the previous scenario.

$$Expl(test\mathbf{T}_3) = \{cfm(f_{VHBEMS}), cfm(occupancy), cfm(building\ envelope)\}$$

However, comparing with simulated fault scenario the obvious reason behind this fault is  $cfm(building\ envelope)$ . The actual fault scenario is open window. However, diagnosis analysis detect this fault along with others. This fault is present in the diagnoses with the combination of other.

### Hour (10-24)

In this duration, both tests show inconsistencies and a conflicting situation arises in the diagnosis. Further, the hamming distance between observed symptom and theoretical signature table 8.2 is give below. In this case only Test1 and Test3 is considered to measure the normalized hamming distance.

$$d_H(cfm(f_{VCOMP})) = 0.5$$

$$d_H(cfm(f_{VHBEMS})) = 0.5$$

$$d_H(cfm(f_{BTHP})) = 0.5$$

$$d_H(cfm(radiator)) = 0.5$$

$$d_H(cfm(occupancy)) = 0$$

$$d_H(cfm(appliances)) = 0.2$$

$$d_H(cfm(building\ envelope)) = 0$$

---

$cfm(f_{VHBEMS}) = cfm(ventilation\ system) \wedge cfm(heating\ system) \wedge cfm(BEMS)$   
 $cfm(cfm(f_{BTHP})) = cfm(boiler) \wedge cfm(thermostat) \wedge cfm(heating\ pipes)$

Text explanations for both test is given below:

$$\begin{aligned} Expl(test\mathbf{T}_1) = \{ & cfm(f_{VCOMP}), cfm(f_{BTHP}), cfm(radiator) \\ & cfm(occupancy), cfm(appliances), cfm(building\ envelope)\} \end{aligned}$$

$$Expl(test\mathbf{T}_3) = \{ cfm(f_{BTHP}), cfm(occupancy), cfm(building\ envelope)\}$$

Further, bridge diagnosis analysis finds the following faults as possible diagnosis:

$$\begin{aligned} minimum\ diagnoses = & cfm(occupancy), cfm(building\ envelope), \\ & (cfm(f_{VHBEMS})\ cfm(f_{VCOMP})), \\ & (cfm(f_{VHBEMS})\ (cfm(f_{BTHP})), \\ & (cfm(f_{VHBEMS})\ cfm(radiator)), \\ & (cfm(f_{VHBEMS})\ cfm(appliances)) \end{aligned}$$

Further, bridge analyzes both test explanation and most reasonable issues are, occupancy and building openings i.e. door or window open. This confirms that faults with open window is still present in system. The simulated fault in this case is unplanned occupancy and unplanned appliances. However, in simulated scenario occupancy is abnormal during the few hours of the day. However, another simulated fault unplanned appliance is detected with faulty  $cfm(f_{VHBEMS})$  i.e. issue with ventilation system, heating or failure of BEMS.

## 8.4 Conclusion

In this chapter two case studies have been described. The focus is given to how to implement the proposed diagnosis techniques for different buildings. Indeed, presented case studies cover two different type of building differ in terms of complexity and operation. The issue of multiple faults often come from conflicting and faulty sub-system. The diagnosis of multiple faults lead to a complex analysis. Indeed, current diagnosis approached do not consider the validity statement and rely on only measurements and tests. The proposed approach in present work is consider the concept of the partial

$$\overline{cfm(f_{VCOMP})} = cfm(ventilation\ pipe) \wedge cfm(filter) \wedge cfm(heat\ exchanger) \wedge cfm(supply\ and\ return\ fan) \wedge cfm(electrical\ drive) \wedge cfm(duct) \wedge cfm(reconfiguration\ system)$$

test along with validity constraints and offer a meaningful way to test building system. Further, bridge approach is used to generate the minimum possible explication. Bridge use a formal diagnosis to generate explanations for all possible diagnoses. Further, the present approach validated under the whole building operation for two different building. In both cases faults are simulated using fault model and compared with the diagnosed fault. The fault sensitivity is important and described how bridge in capable to diagnose low sensitivity fault along with high sensitive fault. The limitation of proposed method is that it relies on some assumptions such as non-faulty sensors and actuators. Designing a test require a deep understanding of the interrelation between sensors. So far, it is challenging to perform a deep diagnosis using proposed approach. Other limitation is isolability of diagnosed faults. Bridge could provide the first explanation about the faults. In order to develop a deep analysis specific of particular building component requires more information and knowledge about the considered system.

# Conclusion and Future work

## Conclusion

Indoor discomforts are one of the underlying criteria for existing and future smart buildings. In order to achieve good indoor comfort at lower energy consumption, various advanced controller based on anticipative building energy management systems have been proposed and deployed. These methods rely on long-term planning and unable to handle the various sources of building fault. This dissertation proposes an Anticipative Reactive Diagnosing-Building Management System (ARD-BMS) to handle the fault diagnosis and isolation at the whole building level. In general, controller and rule-based building managements are unable to tackle unplanned situations and building failures.

This thesis focus on a new way of building management that less rely-on long term planning. Eventhough, most of the building management schemes are predictive or anticipative and suffer from the model mismatches from reality and weather data synchronization. Moreover, these BEMS's are unable to adjust the plan according to the current facade configuration or changing environment. Thus far, ARD-BMS uses plan/prediction as a reference and concurrently try to achieve global indoor comfort under the building discrepancies and faults.

A state-space fast dynamics model has been developed to get the current building dynamics. The fast dynamics model includes thermal model ( $1R-1C$ ) with CO<sub>2</sub> model and ignores all the slow dynamics. Fast dynamics thermal model is used to estimate the short-term indoor thermal dynamics. The sampling period for the proposed model is 10 minute.

The thesis proposes a global discussion for the whole building maintenance. In

order to apply diagnosis buildings need a generic methodology with corrective actions. These methods include two vital aspects i.e. abnormal building driving and abnormal building state to design a building maintenance strategies.

The fundamental issue with an existing building management is fault diagnosis and detection of fault causes. Though enough advancement is made in building fault diagnosis but still critical alarm based controller are conventionally used for fault detection. These faults require a noticeable effort and skills to find the exact faults and decide the actions. Present work came up with a new concept of **partial test** and **validity statement**. Conventional, model-based tests do not consider the concept of validity and tests are performed only with the help of residuals. However, in proposed methodology, each test has to satisfy linked validity and behavioral constraints.

Proposed diagnosis approach that encompasses a combination of the rule, model and, range-based tests. Moreover, tests cover all major types of faults, failures, and unplanned situations in buildings. The concept of *support* combines all major building components and sub-systems for further fault analysis.

Another typical issue with existing building fault management is that it only gives one explanation from the fault analysis. This situation becomes more complex in the case of multiple faults and conflicting sub-system. In this context, multiple fault isolation is still challenging task and requires a huge effort to other fault explanation.

A so called *bridge* method is proposed to analyze the multiple faults and conflicting issues. Bridge approach utilized the capabilities of FDI and DX. The contribution of this work is to develop a heterogeneous test to recommend the minimum possible diagnosis so that a quick decision can be taken by the facility manager. More likely faults with their consequences in building operation are listed in XML implementation followed by HAZOP analysis. Moreover, two case studies are presented to demonstrate the application of proposed diagnosis. Eventually, the main strength of ARD-BMS is short term building management with fault detection and diagnosis capabilities.

Existing building FDD vendors do not offer the concept of validity and partial tests. The relation between building components and sub-systems is very complex and a challenging task to develop a single model for whole building diagnosis purpose. The present approach try to combine different model derived from rule range and model to cover whole building performance.

## **Challenges and limitation**

Nevertheless, building management schemes improves the overall indoor comfort and energy saving. The main issue with ARD-BMS is the primary concern is given to the occupants comfort rather operational and maintenance cost. This consideration makes this approach an inexpensive solution. However, in some cases easy fault detection help to reduce the labor intensive diagnosis cost that improves the building performance.

Reactive management of building could be easily applicable for the buildings with frequent occupancy variation and less comprehensive planning, where indoor discomfort is of primary interest. For the building such as the residential or small office with less occupancy variation, it would not be very useful. However, in future, the proposed scheme could be extended for a small building with model less building management scheme.

In various cases, equipment replacement or long-term maintenance could interrupt the building operation. In this context, only reactive operations are not enough to manage the building discrepancy. However, a combination of predictive and reactive building management could deal with future failures and unplanned situations simultaneously.

## **Prospective Research**

ARD-BMS uses the 10 minute sampling period, however, it is still an open question how frequent occupants would like to involve with the building management. A very frequent alarm, maintenance call or recommendation might be annoying for occupants. In the present thesis, a fixed 10 minute time sample is adopted. However, in future development, a variable sampling period could be interesting. Serious faults need to be noticed immediately whereas less important issues can be delayed. Development of new technologies such as Internet of things (IOT) cloud techniques could help to develop a smart alert based remotely controlled buildings.

Future development of precise fast dynamics model is also a future aspect for this

work. Model parameter estimation will help to measure current building configuration more accurately. The major discrepancy in building operation comes from unmeasured quantities such: number of occupants, occupants behavior or activity and proper knowledge of building material. Further development such as occupancy estimation could help to develop a more legitimate reactive building system with less chance of improper action.

Prospective of this work is to develop a automatized online platform with advanced fault diagnosis algorithms to diagnose the building faults at more granular level. The future building fault system must act like a nervous system of building's that could senses the most important fault automatically and served it first. Moreover, the approach must have to extended to next level of fault so that it could sense a new type fault and abnormal building behavior. A small glitches or difference in two sensor measurement will consequently lead to misleading situation with false alarm and hindered building operation. These issues are also challenging and need to be addressed in future fault management.

Analyzing attitude of occupants towards the smart building with an advanced management is could also be a future research concern. In few studies, it was found that occupants do not follow or like the automatic corrective actions from the building management. Often people would like to engage with building control and prefer to have feedback and consequences of their action. It is still a complex issue how to combine user comfort expectancy with automated building actions.



## Appendix A

# XML Implementation of HAZOP

# Schema documentation for reactive-hazop.xsd

june 8, 2016

## Table of Contents

- Namespace: "reactive-hazop" ..... 1
  - Schema(s) ..... 1
    - Main schema reactive-hazop.xsd ..... 1
  - Element(s) ..... 1
    - Element system ..... 1
  - Complex Type(s) ..... 2
    - Complex Type System ..... 2
    - Complex Type Variable ..... 2
    - Complex Type Symptom ..... 3
    - Complex Type Cause ..... 3
    - Complex Type Remedy ..... 3
    - Complex Type frequency ..... 4
  - Simple Type(s) ..... 4
    - Simple Type CauseNature ..... 4
    - Simple Type RemedyNature ..... 5
- Namespace: "" ..... 5
  - Element(s) ..... 5
    - Element System / name ..... 5
    - Element System / description ..... 5
    - Element System / subsystem ..... 6
    - Element System / variable ..... 6
    - Element Variable / name ..... 6
    - Element Variable / symptom ..... 7
    - Element Symptom / description ..... 7
    - Element Symptom / detection ..... 7
    - Element Symptom / ambiguity ..... 7
    - Element Symptom / cause ..... 8
    - Element Cause / type ..... 8
    - Element Cause / description ..... 8
    - Element Cause / remedy ..... 9
    - Element Remedy / type ..... 9
    - Element Remedy / description ..... 9
    - Element Remedy / maintenance\_actions ..... 10
    - Element Remedy / reactive\_actions ..... 10
    - Element Remedy / anticipative\_actions ..... 10
    - Element Cause / frequency ..... 10
    - Element frequency / type ..... 10
    - Element frequency / description ..... 11
    - Element frequency / maintenance\_actions ..... 11
    - Element frequency / reactive\_actions ..... 11
    - Element frequency / anticipative\_actions ..... 11

### Namespace: "reactive-hazop"

#### Schema(s)

#### Main schema reactive-hazop.xsd

Namespace	reactive-hazop
Properties	attribute form default: unqualified
	element form default: unqualified

#### Element(s)

#### Element system

Namespace	reactive-hazop
-----------	----------------

Diagram	
Type	System
Properties	content: complex
Model	name , description{0,1} , subsystem* , variable*
Children	description, name, subsystem, variable
Instance	<pre>&lt;system xmlns="reactive-hazop"&gt;   &lt;name&gt;{1,1}&lt;/name&gt;   &lt;description&gt;{0,1}&lt;/description&gt;   &lt;subsystem&gt;{0,unbounded}&lt;/subsystem&gt;   &lt;variable&gt;{0,unbounded}&lt;/variable&gt; &lt;/system&gt;</pre>
Source	<code>&lt;xs:element name="system" type="System" /&gt;</code>

## Complex Type(s)

### Complex Type System

Namespace	reactive-hazop
Diagram	
Used by	Elements System/subsystem, system
Model	name , description{0,1} , subsystem* , variable*
Children	description, name, subsystem, variable
Source	<pre>&lt;xs:complexType name="System"&gt;   &lt;xs:sequence&gt;     &lt;xs:element name="name" type="xs:string" /&gt;     &lt;xs:element name="description" type="xs:string" minOccurs="0" /&gt;     &lt;xs:element name="subsystem" type="System" minOccurs="0" maxOccurs="unbounded" /&gt;     &lt;xs:element name="variable" type="Variable" minOccurs="0" maxOccurs="unbounded" /&gt;   &lt;/xs:sequence&gt; &lt;/xs:complexType&gt;</pre>

### Complex Type Variable

Namespace	reactive-hazop
Diagram	
Used by	Element System/variable
Model	name , symptom*

Children	name, symptom
Source	<pre>&lt;xs:complexType name="Variable"&gt;   &lt;xs:sequence&gt;     &lt;xs:element name="name" type="xs:string"/&gt;     &lt;xs:element name="symptom" type="Symptom" minOccurs="0" maxOccurs="unbounded"/&gt;   &lt;/xs:sequence&gt; &lt;/xs:complexType&gt;</pre>

### Complex Type Symptom

Namespace	reactive-hazop
Diagram	
Used by	Element Variable/symptom
Model	description , detection{0,1} , ambiguity{0,1} , cause*
Children	ambiguity, cause, description, detection
Source	<pre>&lt;xs:complexType name="Symptom"&gt;   &lt;xs:sequence&gt;     &lt;xs:element name="description" type="xs:string"/&gt;     &lt;xs:element name="detection" type="xs:string" minOccurs="0" maxOccurs="1"/&gt;     &lt;xs:element name="ambiguity" type="xs:string" minOccurs="0"/&gt;     &lt;!-- ambiguity with other symptoms --&gt;     &lt;xs:element name="cause" type="Cause" minOccurs="0" maxOccurs="unbounded"/&gt;   &lt;/xs:sequence&gt; &lt;/xs:complexType&gt;</pre>

### Complex Type Cause

Namespace	reactive-hazop
Diagram	
Used by	Element Symptom/cause
Model	type , description , remedy* , frequency{0,1}
Children	description, frequency, remedy, type
Source	<pre>&lt;xs:complexType name="Cause"&gt;   &lt;xs:sequence&gt;     &lt;xs:element name="type" type="CauseNature"/&gt;     &lt;xs:element name="description" type="xs:string"/&gt;     &lt;xs:element name="remedy" type="Remedy" minOccurs="0" maxOccurs="unbounded"/&gt;     &lt;xs:element name="frequency" type="xs:string" minOccurs="0" maxOccurs="1"/&gt;     &lt;!-- Frequent, Occasional, Probable,Rare --&gt;   &lt;/xs:sequence&gt; &lt;/xs:complexType&gt;</pre>

### Complex Type Remedy

Namespace	reactive-hazop
-----------	----------------

Diagram	
Used by	Element Cause/remedy
Model	type , description{0,1} , maintenance_actions{0,1} , reactive_actions{0,1} , anticipative_actions{0,1}
Children	anticipative_actions, description, maintenance_actions, reactive_actions, type
Source	<pre> &lt;xs:complexType name="Remedy"&gt;   &lt;xs:sequence&gt;     &lt;xs:element name="type" type="RemedyNature"/&gt;     &lt;xs:element name="description" type="xs:string" minOccurs="0"/&gt;     &lt;xs:element name="maintenance_actions" type="xs:string" minOccurs="0"/&gt;     &lt;xs:element name="reactive_actions" type="xs:string" minOccurs="0"/&gt;     &lt;xs:element name="anticipative_actions" type="xs:string" minOccurs="0"/&gt;   &lt;/xs:sequence&gt; &lt;/xs:complexType&gt; </pre>

### Complex Type frequency

Namespace	reactive-hazop
Diagram	
Model	type , description{0,1} , maintenance_actions{0,1} , reactive_actions{0,1} , anticipative_actions{0,1}
Children	anticipative_actions, description, maintenance_actions, reactive_actions, type
Source	<pre> &lt;xs:complexType name="frequency"&gt;   &lt;xs:sequence&gt;     &lt;xs:element name="type" type="RemedyNature"/&gt;     &lt;xs:element name="description" type="xs:string" minOccurs="0"/&gt;     &lt;xs:element name="maintenance_actions" type="xs:string" minOccurs="0"/&gt;     &lt;xs:element name="reactive_actions" type="xs:string" minOccurs="0"/&gt;     &lt;xs:element name="anticipative_actions" type="xs:string" minOccurs="0"/&gt;   &lt;/xs:sequence&gt; &lt;/xs:complexType&gt; </pre>

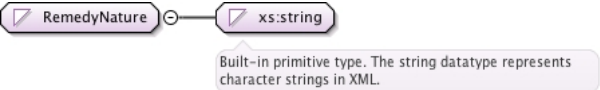
### Simple Type(s)

#### Simple Type CauseNature

Namespace	reactive-hazop				
Diagram					
Type	restriction of xs:string				
Facets	<table border="0"> <tr> <td>enumeration</td> <td>complete failure</td> </tr> <tr> <td>enumeration</td> <td>partial failures</td> </tr> </table>	enumeration	complete failure	enumeration	partial failures
enumeration	complete failure				
enumeration	partial failures				

	enumeration	unplanned
	enumeration	misusage
Used by	Element	Cause/type
Source	<pre>&lt;xs:simpleType name="CauseNature"&gt;   &lt;xs:restriction base="xs:string"&gt;     &lt;xs:enumeration value="complete failure"&gt;       &lt;!------&gt;     &lt;/xs:enumeration&gt;     &lt;xs:enumeration value="partial failures"/&gt;     &lt;xs:enumeration value="unplanned"/&gt;     &lt;xs:enumeration value="misusage"/&gt;   &lt;/xs:restriction&gt; &lt;/xs:simpleType&gt;</pre>	

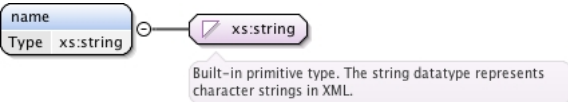
### Simple Type RemedyNature

Namespace	reactive-hazop	
Diagram		
Type	restriction of xs:string	
Facets	enumeration	reactive
	enumeration	anticipative
	enumeration	maintenance
Used by	Elements	Remedy/type, frequency/type
Source	<pre>&lt;xs:simpleType name="RemedyNature"&gt;   &lt;xs:restriction base="xs:string"&gt;     &lt;xs:enumeration value="reactive"/&gt;     &lt;xs:enumeration value="anticipative"/&gt;     &lt;xs:enumeration value="maintenance"/&gt;   &lt;/xs:restriction&gt; &lt;/xs:simpleType&gt;</pre>	

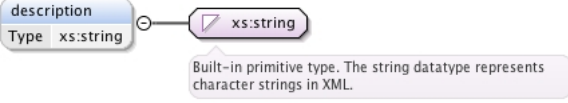
### Namespace: ""

### Element(s)

#### Element System / name

Namespace	No namespace	
Diagram		
Type	xs:string	
Properties	content:	simple
Source	<pre>&lt;xs:element name="name" type="xs:string"/&gt;</pre>	

#### Element System / description

Namespace	No namespace	
Diagram		
Type	xs:string	
Properties	content:	simple
	minOccurs:	0
Source	<pre>&lt;xs:element name="description" type="xs:string" minOccurs="0"/&gt;</pre>	

### Element System / subsystem

Namespace	No namespace						
Diagram							
Type	System						
Properties	<table border="1"> <tr> <td>content:</td> <td>complex</td> </tr> <tr> <td>minOccurs:</td> <td>0</td> </tr> <tr> <td>maxOccurs:</td> <td>unbounded</td> </tr> </table>	content:	complex	minOccurs:	0	maxOccurs:	unbounded
content:	complex						
minOccurs:	0						
maxOccurs:	unbounded						
Model	name , description{0,1} , subsystem* , variable*						
Children	description, name, subsystem, variable						
Instance	<pre>&lt;subsystem&gt;   &lt;name&gt;{1,1}&lt;/name&gt;   &lt;description&gt;{0,1}&lt;/description&gt;   &lt;subsystem&gt;{0,unbounded}&lt;/subsystem&gt;   &lt;variable&gt;{0,unbounded}&lt;/variable&gt; &lt;/subsystem&gt;</pre>						
Source	<code>&lt;xs:element name="subsystem" type="System" minOccurs="0" maxOccurs="unbounded"/&gt;</code>						

### Element System / variable

Namespace	No namespace						
Diagram							
Type	Variable						
Properties	<table border="1"> <tr> <td>content:</td> <td>complex</td> </tr> <tr> <td>minOccurs:</td> <td>0</td> </tr> <tr> <td>maxOccurs:</td> <td>unbounded</td> </tr> </table>	content:	complex	minOccurs:	0	maxOccurs:	unbounded
content:	complex						
minOccurs:	0						
maxOccurs:	unbounded						
Model	name , symptom*						
Children	name, symptom						
Instance	<pre>&lt;variable&gt;   &lt;name&gt;{1,1}&lt;/name&gt;   &lt;symptom&gt;{0,unbounded}&lt;/symptom&gt; &lt;/variable&gt;</pre>						
Source	<code>&lt;xs:element name="variable" type="Variable" minOccurs="0" maxOccurs="unbounded"/&gt;</code>						

### Element Variable / name

Namespace	No namespace
Diagram	
Type	xs:string

Properties	content: simple
Source	<code>&lt;xs:element name="name" type="xs:string"/&gt;</code>

### Element Variable / symptom

Namespace	No namespace						
Diagram							
Type	Symptom						
Properties	<table border="1"> <tr> <td>content:</td> <td>complex</td> </tr> <tr> <td>minOccurs:</td> <td>0</td> </tr> <tr> <td>maxOccurs:</td> <td>unbounded</td> </tr> </table>	content:	complex	minOccurs:	0	maxOccurs:	unbounded
content:	complex						
minOccurs:	0						
maxOccurs:	unbounded						
Model	description , detection{0,1} , ambiguity{0,1} , cause*						
Children	ambiguity, cause, description, detection						
Instance	<pre>&lt;symptom&gt;   &lt;description&gt;{1,1}&lt;/description&gt;   &lt;detection&gt;{0,1}&lt;/detection&gt;   &lt;ambiguity&gt;{0,1}&lt;/ambiguity&gt;   &lt;cause&gt;{0,unbounded}&lt;/cause&gt; &lt;/symptom&gt;</pre>						
Source	<code>&lt;xs:element name="symptom" type="Symptom" minOccurs="0" maxOccurs="unbounded"/&gt;</code>						

### Element Symptom / description

Namespace	No namespace
Diagram	
Type	xs:string
Properties	content: simple
Source	<code>&lt;xs:element name="description" type="xs:string"/&gt;</code>

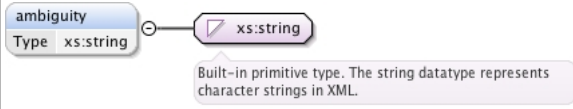
### Element Symptom / detection

Namespace	No namespace						
Diagram							
Type	xs:string						
Properties	<table border="1"> <tr> <td>content:</td> <td>simple</td> </tr> <tr> <td>minOccurs:</td> <td>0</td> </tr> <tr> <td>maxOccurs:</td> <td>1</td> </tr> </table>	content:	simple	minOccurs:	0	maxOccurs:	1
content:	simple						
minOccurs:	0						
maxOccurs:	1						
Source	<code>&lt;xs:element name="detection" type="xs:string" minOccurs="0" maxOccurs="1"/&gt;</code>						

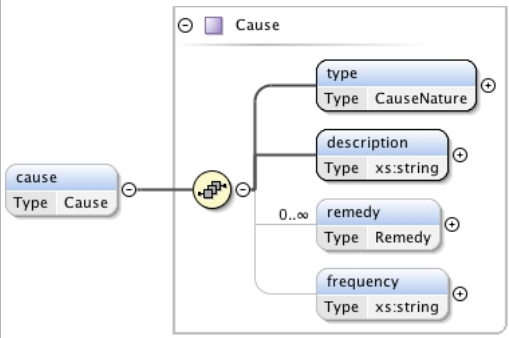
### Element Symptom / ambiguity

Namespace	No namespace
-----------	--------------

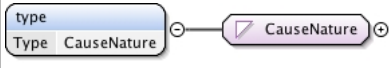


Diagram					
Type	xs:string				
Properties	<table border="1"> <tr> <td>content:</td> <td>simple</td> </tr> <tr> <td>minOccurs:</td> <td>0</td> </tr> </table>	content:	simple	minOccurs:	0
content:	simple				
minOccurs:	0				
Source	<code>&lt;xs:element name="ambiguity" type="xs:string" minOccurs="0"/&gt;</code>				

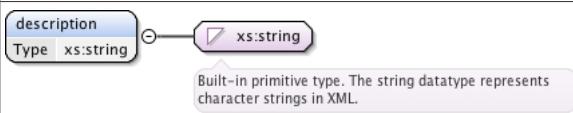
### Element Symptom / cause

Namespace	No namespace						
Diagram							
Type	Cause						
Properties	<table border="1"> <tr> <td>content:</td> <td>complex</td> </tr> <tr> <td>minOccurs:</td> <td>0</td> </tr> <tr> <td>maxOccurs:</td> <td>unbounded</td> </tr> </table>	content:	complex	minOccurs:	0	maxOccurs:	unbounded
content:	complex						
minOccurs:	0						
maxOccurs:	unbounded						
Model	type , description , remedy* , frequency{0,1}						
Children	description, frequency, remedy, type						
Instance	<pre> &lt;cause&gt;   &lt;type&gt;{1,1}&lt;/type&gt;   &lt;description&gt;{1,1}&lt;/description&gt;   &lt;remedy&gt;{0,unbounded}&lt;/remedy&gt;   &lt;frequency&gt;{0,1}&lt;/frequency&gt; &lt;/cause&gt; </pre>						
Source	<code>&lt;xs:element name="cause" type="Cause" minOccurs="0" maxOccurs="unbounded" /&gt;</code>						

### Element Cause / type

Namespace	No namespace								
Diagram									
Type	CauseNature								
Properties	<table border="1"> <tr> <td>content:</td> <td>simple</td> </tr> </table>	content:	simple						
content:	simple								
Facets	<table border="1"> <tr> <td>enumeration</td> <td>complete failure</td> </tr> <tr> <td>enumeration</td> <td>partial failures</td> </tr> <tr> <td>enumeration</td> <td>unplanned</td> </tr> <tr> <td>enumeration</td> <td>misusage</td> </tr> </table>	enumeration	complete failure	enumeration	partial failures	enumeration	unplanned	enumeration	misusage
enumeration	complete failure								
enumeration	partial failures								
enumeration	unplanned								
enumeration	misusage								
Source	<code>&lt;xs:element name="type" type="CauseNature" /&gt;</code>								

### Element Cause / description

Namespace	No namespace
Diagram	

Type	xs:string
Properties	content: simple
Source	<code>&lt;xs:element name="description" type="xs:string"/&gt;</code>

### Element Cause / remedy

Namespace	No namespace						
Diagram							
Type	Remedy						
Properties	<table border="1"> <tr> <td>content:</td> <td>complex</td> </tr> <tr> <td>minOccurs:</td> <td>0</td> </tr> <tr> <td>maxOccurs:</td> <td>unbounded</td> </tr> </table>	content:	complex	minOccurs:	0	maxOccurs:	unbounded
content:	complex						
minOccurs:	0						
maxOccurs:	unbounded						
Model	type , description{0,1} , maintenance_actions{0,1} , reactive_actions{0,1} , anticipative_actions{0,1}						
Children	anticipative_actions, description, maintenance_actions, reactive_actions, type						
Instance	<pre> &lt;remedy&gt;   &lt;type&gt;{1,1}&lt;/type&gt;   &lt;description&gt;{0,1}&lt;/description&gt;   &lt;maintenance_actions&gt;{0,1}&lt;/maintenance_actions&gt;   &lt;reactive_actions&gt;{0,1}&lt;/reactive_actions&gt;   &lt;anticipative_actions&gt;{0,1}&lt;/anticipative_actions&gt; &lt;/remedy&gt; </pre>						
Source	<code>&lt;xs:element name="remedy" type="Remedy" minOccurs="0" maxOccurs="unbounded"/&gt;</code>						

### Element Remedy / type

Namespace	No namespace						
Diagram							
Type	RemedyNature						
Properties	content: simple						
Facets	<table border="1"> <tr> <td>enumeration</td> <td>reactive</td> </tr> <tr> <td>enumeration</td> <td>anticipative</td> </tr> <tr> <td>enumeration</td> <td>maintenance</td> </tr> </table>	enumeration	reactive	enumeration	anticipative	enumeration	maintenance
enumeration	reactive						
enumeration	anticipative						
enumeration	maintenance						
Source	<code>&lt;xs:element name="type" type="RemedyNature"/&gt;</code>						

### Element Remedy / description

Namespace	No namespace
Diagram	
Type	xs:string
Properties	content: simple

	minOccurs: 0
Source	<code>&lt;xs:element name="description" type="xs:string" minOccurs="0"/&gt;</code>

### Element Remedy / maintenance\_actions

Namespace	No namespace				
Diagram					
Type	xs:string				
Properties	<table border="1"> <tr> <td>content:</td> <td>simple</td> </tr> <tr> <td>minOccurs:</td> <td>0</td> </tr> </table>	content:	simple	minOccurs:	0
content:	simple				
minOccurs:	0				
Source	<code>&lt;xs:element name="maintenance_actions" type="xs:string" minOccurs="0"/&gt;</code>				

### Element Remedy / reactive\_actions

Namespace	No namespace				
Diagram					
Type	xs:string				
Properties	<table border="1"> <tr> <td>content:</td> <td>simple</td> </tr> <tr> <td>minOccurs:</td> <td>0</td> </tr> </table>	content:	simple	minOccurs:	0
content:	simple				
minOccurs:	0				
Source	<code>&lt;xs:element name="reactive_actions" type="xs:string" minOccurs="0"/&gt;</code>				

### Element Remedy / anticipative\_actions

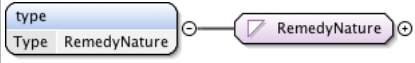
Namespace	No namespace				
Diagram					
Type	xs:string				
Properties	<table border="1"> <tr> <td>content:</td> <td>simple</td> </tr> <tr> <td>minOccurs:</td> <td>0</td> </tr> </table>	content:	simple	minOccurs:	0
content:	simple				
minOccurs:	0				
Source	<code>&lt;xs:element name="anticipative_actions" type="xs:string" minOccurs="0"/&gt;</code>				

### Element Cause / frequency

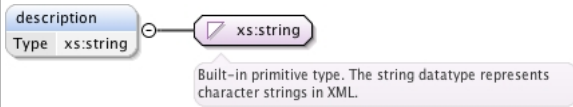
Namespace	No namespace						
Diagram							
Type	xs:string						
Properties	<table border="1"> <tr> <td>content:</td> <td>simple</td> </tr> <tr> <td>minOccurs:</td> <td>0</td> </tr> <tr> <td>maxOccurs:</td> <td>1</td> </tr> </table>	content:	simple	minOccurs:	0	maxOccurs:	1
content:	simple						
minOccurs:	0						
maxOccurs:	1						
Source	<code>&lt;xs:element name="frequency" type="xs:string" minOccurs="0" maxOccurs="1"/&gt;</code>						

### Element frequency / type

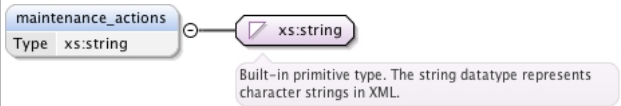
Namespace	No namespace
-----------	--------------

Diagram	
Type	RemedyNature
Properties	content: simple
Facets	enumeration reactive enumeration anticipative enumeration maintenance
Source	<code>&lt;xs:element name="type" type="RemedyNature"/&gt;</code>

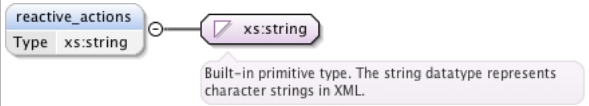
### Element frequency / description

Namespace	No namespace
Diagram	
Type	xs:string
Properties	content: simple minOccurs: 0
Source	<code>&lt;xs:element name="description" type="xs:string" minOccurs="0"/&gt;</code>

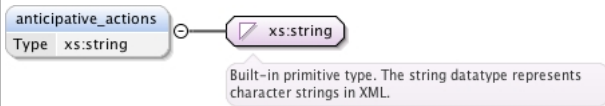
### Element frequency / maintenance\_actions

Namespace	No namespace
Diagram	
Type	xs:string
Properties	content: simple minOccurs: 0
Source	<code>&lt;xs:element name="maintenance_actions" type="xs:string" minOccurs="0"/&gt;</code>

### Element frequency / reactive\_actions

Namespace	No namespace
Diagram	
Type	xs:string
Properties	content: simple minOccurs: 0
Source	<code>&lt;xs:element name="reactive_actions" type="xs:string" minOccurs="0"/&gt;</code>

### Element frequency / anticipative\_actions

Namespace	No namespace
Diagram	
Type	xs:string
Properties	content: simple

	minOccurs: 0
Source	<code>&lt;xs:element name="anticipative_actions" type="xs:string" minOccurs="0"/&gt;</code>



```

<?xml version="1.0" encoding="UTF-8"?>
<?xml-stylesheet type="text/css" href="misusage.css"?>
<ns1:system xmlns:ns1="reactive-hazop" xmlns:xsi="http://www.w3.org/2001/XMLSchema-
instance" xsi:schemaLocation="reactive-hazop file:reactive-hazop.xsd">
  <name>predis-MHI </name>
  <description> Reactive-HAZOP for Building consisting Mechanical
ventilation,heating system,controller and lighting system</description>
  <subsystem>
    <name>dual flow ventilation system, A big metal box</name>
    <description>Air handling unit(AHU) is uses a supply and return fan to
recirculate air inside the building and extract stale air from diffrent zone. </description>
    <subsystem>
      <name>filter</name>
      <description>remove unwanted particle concentration</description>
    </subsystem>
    <subsystem>
      <name>supply fan and return fan</name>
      <description>remove unwanted particle concentration Fans are used to
mix the air inside the AHU. </description>
    </subsystem>
    <subsystem>
      <name>heat exchanger</name>
      <description>remove unwanted particle concentration Fans are used to
mix the air inside the AHU. </description>
    </subsystem>
    <variable>
      <name>supply air pressure</name>
      <symptom>
        <description>Due to dust in filter the pressure difference created
at both sides</description>
        <detection>Pressure drop measurement</detection>
        <cause>
          <type>complete failure</type>
          <description>filters are completely
clogged</description>
          <remedy>
            <type>maintenance</type>
            <maintenance_actions>call the building service
and replace old filter by new</maintenance_actions>
          </remedy>
          <frequency>(twice in a month)</frequency>
        </cause>
      </symptom>
    </variable>
    <variable>
      <name>fan electric consumption, and rotational speed </name>
      <symptom>
        <description>electric consumption differ from normal operation
under the similar condition. </description>
        <detection>electric consumption measurement </detection>
      </symptom>
    </variable>
  </subsystem>
</ns1:system>

```

```

    <ambiguity>Door opening, weather failure, poor insulation,
electric drive out of order </ambiguity>
    <cause>
        <type>complete failure</type>
        <description>supply fan is completely out of order or
have very poor efficiency due to performance degradation such as dirty blade significantly
reduces fan performance and speed </description>
        <remedy>
            <type>maintenance</type>
            <maintenance_actions>A maintenance
action need to perform in case of complete failure such as motor failure, however performance
evaluation should be done weekly, monthly or yearly </maintenance_actions>
        </remedy>
    </cause>
    <cause>
        <frequency>(once in a month)</frequency>
        <type>complete failure</type>
        <description>power disconnected or fuse protection
</description>
        <remedy>
            <type>maintenance</type>
            <reactive_actions>minor issues such as power
failure or blown fuse can be resolved by occupants or BEMS supervisor</reactive_actions>
        </remedy>
    </cause>
    <frequency>(once in a month operation)</frequency>
</symptom>
</variable>
<variable>
    <name>rotation speed of the wheel</name>
    <symptom>
        <description>wheel should turn but does not</description>
        <detection>rotation is requested but no power
consumption</detection>
    <cause>
        <type>complete failure</type>
        <description>electric drive is out of order</description>
        <remedy>
            <type>maintenance</type>
            <maintenance_actions>call the maintenance
service </maintenance_actions>
        </remedy>
        <frequency>Remote (once in a month )</frequency>
    </cause>
</symptom>
</variable>

```



```

    </subsystem>
  <subsystem>
    <name>air distribution duct-work</name>
    <description>Distribution system is used to provide ventilation in
space</description>
    <subsystem>
      <name>pipes</name>
      <description>pipes going from outdoor to ventilation system, from
ventilation system to heating system and from heating system to classroom</description>
      <variable>
        <name>air flow</name>
        <symptom>
          <description>air flow lower than expected</description>
          <detection>using the air flow sensors</detection>
          <ambiguity>ventilation system cannot renew air as it
should do, or blocked filter </ambiguity>
          <cause>
            <type>complete failure</type>
            <description>pipes are ripped or
pierced</description>
            <remedy>
              <type>maintenance</type>
              <maintenance_actions>Call the
maintenance service</maintenance_actions>
              <reactive_actions>tune the ventilation
system</reactive_actions>
            </remedy>
            <frequency>Remote (once in a month
)</frequency>
          </cause>
        </symptom>
      </variable>
    </subsystem>
  <subsystem>
    <name>reconfiguration system</name>
    <description>modes: recycling or normal</description>
    <variable>
      <name>air flow</name>
      <symptom>
        <description>air flow are not modified by
reconfiguration system</description>
        <detection>reconfiguration controls do not affect
injected air flow CO2 concentration</detection>
        <ambiguity>ventilation system cannot renew air as it
should do, supply or return fan failure</ambiguity>
        <cause>
          <type>complete failure</type>
          <description>control system no longer in
operation</description>
          <remedy>

```

```

        <type>maintenance</type>
        <maintenance_actions>call the
maintenance service </maintenance_actions>
        </remedy>
        <frequency>(twice in a month)</frequency>
        </cause>
        <cause>
        <type>complete failure</type>
        <description>air valve is stuck</description>
        <remedy>
        <type>maintenance</type>
        <maintenance_actions>call the
maintenance service </maintenance_actions>
        </remedy>
        <frequency>(once in a month) </frequency>
        </cause>
        </symptom>
        </variable>
        </subsystem>
        </subsystem>
        <subsystem>
        <name>Building envelop (predis) </name>
        <description>heat flow from adjacent office room or corridor and voice-
versa</description>
        <variable>
        <name>heat flow</name>
        <symptom>
        <description>heat-flux flow from inside (In winter) to outside or
voice-versa for summer, causing thermal discomfort </description>
        <description>heat flux sensor or temperature sensors used to
measure ambient temperature </description>
        <cause>
        <type>complete failure</type>
        <description>weather prediction failure</description>
        <remedy>
        <type>reactive</type>
        <reactive_actions>get the current weather
information and modify the set-point </reactive_actions>
        </remedy>
        <frequency>(10 times in a month) </frequency>
        </cause>
        <cause>
        <type>misusage</type>
        <description>poor insulation</description>
        <remedy>
        <type>maintenance</type>
        <maintenance_actions>call the building
service</maintenance_actions>
        </remedy>
        <frequency>(once in a month)</frequency>

```

```

    </cause>
    <cause>
        <type>unplanned</type>
        <description>Door or window is open </description>
        <remedy>
            <type>reactive</type>
            <reactive_actions>follow the door opening alarm
and close it as soon as possible </reactive_actions>
        </remedy>
        <frequency>(occur 20 times in a month) </frequency>
    </cause>
</symptom>
</variable>
</subsystem>

<subsystem>
    <name>heating system</name>

    <description>heating system used for indoor thermal comfort</description>

    <variable>
        <name>heating power consumption</name>
        <symptom>
            <description>heater power consumption differ from normal
operation </description>
            <detection>power consumption</detection>

            <ambiguity>weather change, Door opening, heater failure, poor
insulation </ambiguity>
            <cause>
                <type>complete failure</type>
                <description>heating system is not working or poor
efficiency </description>
                <remedy>
                    <type>maintenance</type>
                    <maintenance_actions>Call to maintenance
service</maintenance_actions>
                    <reactive_actions>change the ventilation mode to
get same comfort </reactive_actions>
                </remedy>
                <frequency>Remote (once in a month )</frequency>
            </cause>
        </symptom>
    </variable>
</subsystem>
<subsystem>
    <name>temperature controller</name>

    <description>Improper controller parameters may lead to thermal discomfort zone

```

```

</description>
  <variable>
    <name>control parameter</name>
    <symptom>
      <description>temperature sensor is not working and input
became improper for controller</description>
      <detection>Loop alarm or high temperature alarm</detection>
      <cause>
        <type>complete failure</type>
        <description>temperature sensor failure can cause wrong
input for controller </description>
        <remedy>
          <type>maintenance</type>
          <maintenance_actions>Replace the faulty sensors
or repair them</maintenance_actions>
          <reactive_actions>use virtual sensors to correct
faulty measurement and re-compute anticipative plan</reactive_actions>
        </remedy>
        <frequency>(once in a month)</frequency>
      </cause>
    </symptom>
  </variable>
</subsystem>
<subsystem>
  <name>thermal set-point deviation</name>
  <description>thermal set-point deviation</description>
  <detection>set-point deviation alarm </detection>
  <cause>
    <type>unplanned</type>
    <description>unplanned situations such as occupancy or
opening could affect thermal set-point </description>
    <remedy>
      <type>anticipative</type>
      <anticipative_actions>recompute next hour set-
point using curent information</anticipative_actions>
    </remedy>
    <frequency>(10 times in a month) </frequency>
  </cause>
</subsystem>
</variable>
</subsystem>
<subsystem>
  <name>unplanned occupants</name>
  <description>unplanned occupancy and their actions could cause indoor
discomfort </description>
  <variable>
    <name>Indoor temperature,CO2 concentration and power
consumption</name>
    <symptom>
      <description>Indoor thermal discomfort or discrepancy in
plan</description>
      <detection>temperature sensor</detection>

```

</ambiguity>1-ventilation system is not working well 2- failure of heating system 3-unpredicted opening of doors 4-poor thermal insulation </ambiguity>

<cause>  
<type>unplanned</type>  
<description>unplanned occupants causes thermal discomfort because of additional body heat</description>  
<remedy>  
<type>reactive</type>  
<reactive\_actions>1-change the thermal set point assuring minimum comfort must be achieved, 2-change the ventilation set-point if it is not possible to change thermal set-point</reactive\_actions>

<anticipative\_actions>1-recompute next hour anticipative plan based on current occupancy estimation </anticipative\_actions>

</remedy>  
<frequency>(10 times in a month) </frequency>  
</cause>

</symptom>  
<symptom>  
<description>Higher CO2 concentration i.e more than maximum limit</description>

<detection>CO2 sensors </detection>  
<ambiguity>1-ventilation system cannot renew air as it should do </ambiguity>

<cause>  
<type>unplanned</type>  
<description>unplanned occupants causes air quality problem because of CO2 produced by them, depending on there activity level </description>  
<remedy>  
<type>reactive</type>  
<reactive\_actions>change ventilation mode based on current occupancy estimation </reactive\_actions>  
<anticipative\_actions>re-compute next-hour CO2 set-point using current hour occupancy detection.</anticipative\_actions>

</remedy>  
<frequency>(10 times in a month) </frequency>  
</cause>  
</symptom>  
<symptom>  
<description>higher electrical consumption than normal operation</description>

<detection>power consumption</detection>  
<ambiguity>1-weather change 2-weather prediction failure 3-unpredicted opening of doors </ambiguity>

<cause>  
<type>unplanned</type>  
<description>use of unplanned appliaes such as laptop increases power consumption </description>

```

        <remedy>
          <type>anticipative</type>
          <anticipative_actions>recompute the future energy need based on the
current occupancy information</anticipative_actions>
        </remedy>
        <frequency>(10 times in a month) </frequency>
      </cause>
    </symptom>
  </variable>
</subsystem>
<subsystem>
  <name>lighting system</name>
  <description>To maintain interior illuminance level</description>
  <subsystem>
    <name/>
    </subsystem><variable>
      <name>Indoor illuminance</name>
      <symptom>
        <description>no lighting</description>
        <detection>illuminance (Threshold) detection</detection>
        <cause>
          <type>complete failure</type>
          <description>lighting system is no longer working or
complete failure of occupancy sensors</description>
          <remedy>
            <type>maintenance</type>
            <maintenance_actions>Replace faulty lights and
inform occupants, however day light can be used if available and follow minimum
illuminance requirement </maintenance_actions>
          </remedy>
          <frequency>(once in a month )</frequency>
        </cause>
      </symptom>
    </variable>
  </subsystem>
  <description>poor lighting</description>
  <detection>illuminance (Threshold) detection</detection>
  <cause>
    <type>partial failures</type>
    <description>erratic bias or constant output from occupancy detection sensors or
Improper placement of occupancy sensors</description>
    <remedy>
      <type>reactive</type>
      <reactive_actions>users need to turn on light manually and sensors correction
can be done by virtual sensor</reactive_actions>
    </remedy>
    <frequency>(10 times in a month) </frequency>
  </cause>
</symptom>
</variable>

```

</subsystem>

</ns1:system>

# Bibliography

- Abras, S., Calmant, T., Delinchant, B., Ploix, S., Wurtz, F., and Singh, M. (2014). Power Management of Laptops Batteries in Dynamic Heterogeneous Environments Using iPOPO. In *IBPSA 2014*.
- Aglan, H. A. (2003). Predictive model for CO<sub>2</sub> generation and decay in building envelopes. *Journal of Applied Physics*, 93(2):1287–1290.
- Ardehali, M. and Smith, T. F. (2001). Literature review to identify existing case studies of controls-related energy-inefficiency in buildings for national building controls information program. Technical report.
- Benazera, E. and Travé-Massuyès, L. (2009). Set-theoretic estimation of hybrid system configurations. *IEEE Transactions on Systems, Man, and Cybernetics, Part B: Cybernetics*, 39(5):1277–1291.
- Biswas, G., Cordier, M.-O., Lunze, J., Trave-Massuyes, L., and Staroswiecki, M. (2004). Diagnosis of Complex Systems: Bridging the Methodologies of the FDI and DX Communities. *Systems, Man, and Cybernetics, Part B: Cybernetics, IEEE Transactions on*, 34(5):2159–2162.
- Bonvini, M., Piette, M. A., Wetter, M., Granderson, J., and Sohn, M. D. (2014). Bridging the Gap Between Simulation and the Real World An Application to FDD. *ACEEE Summer Study on Energy Efficiency in Buildings*, pages 25–35.
- Braun, J. and Chaturvedi, N. (2002). An Inverse Gray-Box Model for Transient Building Load Prediction. *HVAC&R Research*, 8(1):73–99.
- Braun, J. E. (1990). Reducing energy costs and peak electrical demand through optimal control of building thermal storage. In *ASHRAE Transactions*, number pt 2, pages 876–888.



- Bynum, J. D., Claridge, D. E., and Curtin, J. M. (2012). Development and testing of an Automated Building Commissioning Analysis Tool (ABCAT). *Energy and Buildings*, 55:607–617.
- Candanedo, J., Dehkordi, V., and Lopez, P. (2013). A control-oriented simplified building modelling strategy. *IBPSA Building Simulation*, pages 3682–3689.
- Chen, T. Y. (2001). Real-time predictive supervisory operation of building thermal systems with thermal mass. *Energy and Buildings*, 33(2):141–150.
- Chittaro, L. and Ranon, R. (2004). Hierarchical model-based diagnosis based on structural abstraction. *Artificial Intelligence*, 155(1-2):147–182.
- Cigler, J., Gyalistras, D., Široký, J., Tiet, V.-N., and Ferkl, L. (2013). Beyond theory: the challenge of implementing Model Predictive Control in buildings. In *Clima 2013 -11th REHVA World Congress & 8th International Conference on IAQVEC - "Energy Efficient, Smart and Healthy Buildings"*, pages 1008–1018.
- Cole, R. J. and Brown, Z. (2009). Reconciling human and automated intelligence in the provision of occupant comfort. *Intelligent Buildings International*, 1(1):39–55.
- Cordier, M. O., Dague, P., Lévy, F., Montmain, J., Staroswiecki, M., and Travé-Massuyès, L. (2004). Conflicts versus analytical redundancy relations: A comparative analysis of the model based diagnosis approach from the artificial intelligence and automatic control perspectives. *IEEE Transactions on Systems, Man, and Cybernetics, Part B: Cybernetics*, 34(5):2163–2177.
- Crawley, F. and Tyler, B. (2015). *HAZOP: Guide to Best Practice*.
- De Kleer, J., Mackworth, A. K., and Reiter, R. (1992). Characterizing diagnoses and systems. *Artificial Intelligence*, 56(2-3):197–222.
- De Kleer, J. and Williams, B. C. (1987). Diagnosing multiple faults. *Artificial Intelligence*, 32(1):97–130.
- De Kleer, J. and Williams, B. C. (1992). Readings in Model-based Diagnosis. In *Readings in Non-Monotonic Reasoning*, pages 100–117.
- Delmaire, G., Cassar, J. P., and Staroswiecki, M. (1994). Comparison of identification and parity space approaches for failure detection in single input single output systems.

- In *Control Applications, 1994., Proceedings of the Third IEEE Conference on*, pages 865–870 vol.2.
- Derouineau, S. (2013). Specifications for energy management , fault detection and diagnosis tools. Technical report, CSTB.
- Dexter, Arthur, P. J. (2001). Demonstrating Automated Fault Detection and Diagnosis Methods in Real Buildings. In *VTT. SYMPOSIUM 217*. VTT Building and Transport, Finland.
- Doukas, H., Patlitzianas, K. D., Iatropoulos, K., and Psarras, J. (2007). Intelligent building energy management system using rule sets. *Building and Environment*, 42(10):3562–3569.
- Fagarasan, I., Ploix, S., and Gentil, S. (2004). Causal fault detection and isolation based on a set-membership approach. *Automatica*, 40(12):2099–2110.
- Fleetwood, K. (1999). An Introduction to Differential Evolution. *New ideas in optimization*, pages 79–108.
- Foster, B. and Mazur-Stommen, S. (2012). Results from Recent Real-Time Feedback Studies. Technical report.
- Fraisse, G., Viardot, C., Olivier, L., and Achard, G. (2002). Development of a simplified and accurate building model based on electrical analogy. *Energy and buildings*, 34:1017–1032.
- Frank, P. (1996). Analytical and Qualitative Model-based Fault Diagnosis: A Survey and Some New Results. *European Journal of Control*, 2(1):6–28.
- Froehlich, J. (2009). Promoting Energy Efficient Behaviors in the Home through Feedback: The Role of Human-Computer Interaction. Technical Report 1, DUB Institute, University of Washington.
- Fux, S. F. (2013). Short-term thermal and electric load forecasting in buildings. In *International Conference on Clean-tech for Smart Cities {E} Buildings: From Nano to Urban Scale*, number September, pages 4–6, Lausanne, Switzerland.
- Gayeski, N. T., Armstrong, P. R., and Norford, L. K. (2011). Predictive pre-cooling of thermo-active building systems with low-lift chillers. *HVAC&R Research*, 18(5):858–873.

- Gentil, S., Montmain, J., and Combastel, C. (2004). Combining FDI and AI approaches within causal-model-based diagnosis. *IEEE Transactions on Systems, Man, and Cybernetics, Part B: Cybernetics*, 34(5):2207–2221.
- Giap, Q.-H., Ploix, S., and FLAUS, J.-M. (2009). *Managing Diagnosis Processes with Interactive Decompositions*, pages 407–415. Springer US, Boston, MA.
- Gilbert, N. (2008). *Agent-Based Models*. SAGE Publications, Inc.
- Greiner, R., Smith, B. A., and Wilkerson, R. W. (1989). A correction to the algorithm in reiter’s theory of diagnosis. *Artificial Intelligence*, 41(1):79–88.
- Guillemin, A. and Morel, N. (1999). A self-adaptive and smart system for blinds control. In *CISBAT’99*, pages 143–148, Lausanne, Switzerland. CISBAT 1999.
- Ha, D. L., Joumaa, H., Ploix, S., and Jacomino, M. (2012). An optimal approach for electrical management problem in dwellings.
- Ha, D. L., Ploix, S., Jacomino, M., and Le, M. H. (2000). Home energy management problem : towards an optimal and robust solution. *INTECH Open Access Publisher*, pages 77–107.
- Hadj-Said, Y., Ploix, S., Galmiche, S., Bergeon, S., and Brunotte, X. (2013). Canopea, an energy-smart home integrable into a smart-grid. In *IEEE Grenoble Conference PowerTech, 2013*.
- Hofbaur, M. W. and Williams, B. C. (2002). *Mode Estimation of Probabilistic Hybrid Systems*, pages 253–266. Springer Berlin Heidelberg, Berlin, Heidelberg.
- Hudson, G. and Underwood, C. (1999). A simple building modelling procedure for MATLAB/SIMULINK. In *6th International Conference on Building Performance Simulation*, pages 1–7.
- Hyvärinen, J., Agency, I. E., and Kärki, S. (1996). *Building Optimization and Fault Diagnosis Source Book*. International Energy Agency energy conservation in buildings and community systems programme : [IEA-ECB & CS]: Real time simulation of HVAC systems for building optimization, fault detection and diagnosis. Technical Research Centre of Finland, VTT Building Technology.

- Isermann, R. (1997). *Supervision, fault-detection and fault-diagnosis methods - An introduction*, volume 5.
- Isermann, R. (2005). Model-based fault-detection and diagnosis - Status and applications. *Annual Reviews in Control*, 29(1):71–85.
- Janda, K. B. (2014). Building communities and social potential: Between and beyond organizations and individuals in commercial properties. *Energy Policy*, 67:48–55.
- Joumaa, H., Ploix, S., Abras, S., and De Oliveira, G. (2011). A MAS integrated into Home Automation system, for the resolution of power management problem in smart homes. *Energy Procedia*, 6:786–794.
- Kämpf, J. H. and Robinson, D. (2007). A simplified thermal model to support analysis of urban resource flows. *Energy and Buildings*, 39(4):445–453.
- Kang, S. J., Park, J., Oh, K.-Y., Noh, J. G., and Park, H. (2014). Scheduling-based real time energy flow control strategy for building energy management system. *Energy and Buildings*, 75:239–248.
- Kaplan, W. (1964). Linear System Theory, the State Space Approach (Lotfi A. Zadeh and Charles A. Desoer). *SIAM Review*, 6(3):319–320.
- Katipamula, S. and Brambley, M. R. (2005a). Methods for Fault Detection, Diagnostics, and Prognostics for Building Systems, A Review , Part II. *HVAC&R Research*, 11(1):3–26.
- Katipamula, S. and Brambley, M. R. (2005b). Review Article: Methods for Fault Detection, Diagnostics, and Prognostics for Building Systems: A Review, Part I. *HVAC&R Research*, 11(1):3–25.
- Katipamula, S., Brambley, M. R., Bauman, N. N., and Pratt, R. G. (2004). Enhancing Building Operations through Automated Diagnostics: Field Test Results. *Pacific Northwest National Laboratory*.
- Katipamula, S., Pratt, R. G., Chassin, D. P., Taylor, Z. T., Gowri, K., and Brambley, M. R. (1999). Automated fault detection and diagnostics for outdoor-air ventilation systems and economizers: methodology and results from field testing. *ASHRAE Transactions*, 105.

- Klein, L., Kavulya, G., Jazizadeh, F., Kwak, J.-y., Becerik-Gerber, B., Varakantham, P., and Tambe, M. (2010). Towards Optimization Of Building Energy And Occupant Comfort Using Multi-agent Simulation. In *28th International Symposium on Automation and Robotics in Construction*, pages 251–256.
- Kontes, G. D., Giannakis, G. I., Kosmatopoulos, E. B., and Rovas, D. V. (2012). Adaptive-fine tuning of building energy management systems using co-simulation. *2012 Ieee International Conference on Control Applications (Cca)*, pages 1664–1669.
- Kopecky, P. (2011). Experimental validation of two simplified thermal zone models. In *9th Nordic Symposium on Building Physics*, Tampere (Finland).
- Kramer, R., van Schijndel, J., and Schellen, H. (2013). Inverse modeling of simplified hygrothermal building models to predict and characterize indoor climates. *Building and Environment*, 68:87–99.
- Le, M. H., Ploix, S., and Wurtz, F. (2013). Application of an anticipative energy management system to an office platform. In *BS 2013 - Building Simulation 2013*.
- Lefort, A. (2014). *A smart grid ready building energy management system based on a hierarchical model predictive control*. PhD thesis, École supérieure d'électricité, France.
- Lefort, A., Bourdais, R., Ansanay-Alex, G., and Guéguen, H. (2013). Hierarchical control method applied to energy management of a residential house. *Energy and Buildings*, 64:53–61.
- Loveday, D. L. and Craggs, C. (1993). Stochastic modelling of temperatures for a full-scale occupied building zone subject to natural random influences. *Applied Energy*, 45(4):295–312.
- Lowry, G. and Lee, M. W. (2004). Modelling the passive thermal response of a building using sparse BMS data. *Applied Energy*, 78(1):53–62.
- Magoulès, F., Zhao, H.-x., and Elizondo, D. (2013). Development of an RDP neural network for building energy consumption fault detection and diagnosis. *Energy and Buildings*, 62:133–138.
- Missaoui, R., Joumaa, H., Ploix, S., and Bacha, S. (2014). Managing energy Smart Homes according to energy prices: Analysis of a Building Energy Management System. *Energy and Buildings*, 71:155–167.

- Missaoui, R., Warkozek, G., Bacha, S., and Ploix, S. (2011). PV integration by building energy management system. In *International Conference on Power Engineering, Energy and Electrical Drives*.
- Mitalas, G. and Stephenson, D. (1967). Room Thermal Response Factors. *ASHRAE Transactions*, 73(III.2):1–10.
- Molina, C., Anthony, C., Pickering, C., Valbjørn, O., and De Bortoli, M. (1989). Working Group I. Technical report, CSTB.
- Mortensen, R. E. (1975). System Theory: A Unified State-Space Approach to Continuous and Discrete Time Systems (Louis Padulo and Michael A. Arbib). *SIAM Review*, 17(4):699–703.
- Mustafaraj, G., Chen, J., and Lowry, G. (2010). Development of room temperature and relative humidity linear parametric models for an open office using BMS data. *Energy and Buildings*, 42(3):348–356.
- Mustafaraj, G., Lowry, G., and Chen, J. (2011). Prediction of room temperature and relative humidity by autoregressive linear and nonlinear neural network models for an open office. *Energy and Buildings*, 43(6):1452–1460.
- Nemeth, E., Lakner, R., Cameron, I. T., and Hangos, K. M. (2009). Fault diagnosis based on hazard identification results. In *7th IFAC Symposium on Fault Detection, Supervision and Safety of Technical Processes*.
- Nesler, C. (1986). Adaptive control of thermal processes in buildings. *IEEE Control Systems Magazine*, 6(4):9–13.
- Ngendakumana, P. (1988). *Modélisation simplifiée du comportement thermique d'un bâtiment et vérification expérimentale*". PhD thesis.
- Nicol, J. F. and Humphreys, M. A. (2002). Adaptive thermal comfort and sustainable thermal standards for buildings. *Energy and Buildings*, 34(6):563–572.
- Nielsen, T. (2005). Simple tool to evaluate energy demand and indoor environment in the early stages of building design. *Solar Energy*, 78(1):73–83.
- Patil, S. L., Tantau, H. J., and Salokhe, V. M. (2008). Modelling of tropical greenhouse temperature by auto regressive and neural network models. *Biosystems Engineering*, 99(3):423–431.

- Penman, J. (1990). Second order system identification in the thermal response of a working school. *Building and Environment*, 25(2):105–110.
- Persily, A. K. (1997). Evaluating building IAQ and ventilation with indoor carbon dioxide. *ASHRAE Transactions*, 103:193–204.
- Ploix, S. (2009). *Des systèmes automatisés aux systèmes coopérants application au diagnostic et à la gestion énergétique*. Habilitation à diriger des recherches.
- Ploix, S. and Adrot, O. (2006). Parity relations for uncertain dynamic systems. *Automatica*, 42:1553–1562.
- Ploix, S. and Follot, C. (2001). Fault diagnosis reasoning for set-membership approaches and application. In *CCA/ISIC'01*.
- Ploix, S., Touaf, S., and Flaus, J.-M. (2003). A logical framework for isolation in fault diagnosis. In *SafeProcess*, pages 1–6.
- Ramchurn, S., Vytelingum, P., Rogers, A., and Jennings, N. (2011). Agent-Based Control for Decentralised Demand Side Management in the Smart Grid. In *AAMAS 11, Taipei*, pages 5–12.
- Reiter, R. (1987). A theory of diagnosis from first principles. *Artificial Intelligence*, 32(1):57–95.
- Roos, M., Gruber, P., and Tödli, J. (1995). Qualitative model-based fault detection in air-handling units. *IEEE Control Systems Magazine*, 15(4):11–22.
- Schein, J., Bushby, S. T., Castro, N. S., and House, J. M. (2006). A rule-based fault detection method for air handling units. *Energy and Buildings*, 38(12):1485–1492.
- Schumann, A., Hayes, J., Pompey, P., and Verscheure, O. (2011). Adaptable Fault Identification for Smart Buildings. In *Proceedings of the 7th AAAI Conference on Artificial Intelligence and Smarter Living: The Conquest of Complexity, AAAIWS'11-07*, pages 44–47. AAAI Press.
- Singh, M., Amayri, M., Ploix, S., and Wurtz, W. (2014). A study of interactions between anticipative and reactive building energy management systems. In *Conference IBPSA Arras, France 2014*, pages 1–8.

- Singh, M., Ploix, S., and Wurtz, W. (2015a). An approach towards Reactive energy management coupled with an Anticipative BEMS. In *Building Simulation Conference*, pages 1361–1367.
- Singh, M., Ploix, S., and Wurtz, W. (2015b). Modeling for Reactive Building Energy Management. *Energy Procedia*, 83:207–215.
- Singh, M., Ploix, S., and Wurtz, W. (2016). Handling Discrepancies in Building Reactive Management Using HAZOP and Diagnosis Analysis. In *ASHRAE*, page 8, St. Louis, MO.
- Storn, R. and Price, K. (1997). Differential Evolution-A Simple and Efficient Heuristic for global Optimization over Continuous Spaces. *Journal of Global Optimization*, 11(4):341–359.
- Struss, P. (1991). What’s in SD Towards a Theory of Modeling for Diagnosis. In *Second International workshop on principles of diagnosis*, Milan, Italy.
- T. Marcu, M. Capobianco, S. Gentil, S. L. (2003). Magic: An integrated approach for diagnostic data management and operator support. In *Proceedings of IFAC Safeprocess’03*, Washington, USA.
- Tao Lu and Viljanen, M. (2009). Prediction of indoor temperature and relative humidity using neural network models: model comparison. *Neural Computing Applications*, 18(4):345–57.
- Travé-Massuyès, L. (2014a). *Bridges between Diagnosis Theories from Control and AI Perspectives*, pages 3–28. Springer Berlin Heidelberg, Berlin, Heidelberg.
- Travé-Massuyès, L. (2014b). Bridging control and artificial intelligence theories for diagnosis: A survey. *Engineering Applications of Artificial Intelligence*, 27:1–16.
- Turner, C. and Frankel, M. (2008). Energy Performance of LEED ® for New Construction Buildings. Technical report.
- Venkatasubramanian, V., Rengaswamy, R., and Kavuri, S. N. (2003a). A review of process fault detection and diagnosis part II: Qualitative models and search strategies. *Computers and Chemical Engineering*, 27(3):313–326.



- Venkatasubramanian, V., Rengaswamy, R., Yin, K., and Kavuri, S. N. (2003b). A review of process fault detection and diagnosis part I: Quantitative model-based methods. *Computers and Chemical Engineering*, 27(3):293–311.
- Venkatasubramanian, V., Zhao, J., and Viswanathan, S. (2000). Intelligent systems for HAZOP analysis of complex process plants. *Computers and Chemical Engineering*, 24(9-10):2291–2302.
- Wang, S. and Xu, X. (2003). Hybrid Model for Building Performance Diagnosis and Optimal Control. In *ICEBO - International Conference for Enhanced Building Operations*. Texas A&M University (<http://www.tamu.edu>).
- Wang, Z., Yang, R., and Wang, L. (2010). Multi-agent intelligent controller design for smart and sustainable buildings. In *2010 IEEE International Systems Conference Proceedings, SysCon 2010*, pages 277–282.
- Xu, X., Wang, S., Sun, Z., and Xiao, F. (2009). A model-based optimal ventilation control strategy of multi-zone VAV air-conditioning systems. *Applied Thermal Engineering*, 29(1):91–104.
- Yan, K., Shen, W., Mulumba, T., and Afshari, A. (2014). ARX model based fault detection and diagnosis for chillers using support vector machines. *Energy and Buildings*, 81:287–295.
- Yassine, A. A., Rosich, A., and Ploix, S. (2010). An optimal sensor placement algorithm taking into account diagnosability specifications. In *2010 IEEE International Conference on Automation, Quality and Testing, Robotics (AQTR)*, volume 2, pages 1–6.
- Zaheer-Uddin, M. and Zheng, G. R. (2000). Optimal control of time-scheduled heating, ventilating and air conditioning processes in buildings. *Energy Conversion and Management*, 41(1):49–60.
- Zavala, V. M., Wang, J., Leyffer, S., Constantinescu, E. M., Anitescu, M., and Conzelmann, G. (2010). Proactive energy management for next-generation building system. *SimBuild 2010*, pages 377–385.

Zhao, Y., Xiao, F., and Wang, S. (2013). An intelligent chiller fault detection and diagnosis methodology using Bayesian belief network. *Energy and Buildings*, 57:278–288.

Zong, Y., You, S., Hu, J., Han, X., Jiang, C., Zhang, Y., and Böning, G. M. (2015). Challenges of using model predictive control for active demand side management. In *Proceedings. The 4th International Conference on Microgeneration and Related Technologies (Microgen4)*.