



HAL
open science

Essays on the formation of social and economic networks

Liza Charroin

► **To cite this version:**

Liza Charroin. Essays on the formation of social and economic networks. Economics and Finance. Université de Lyon, 2018. English. NNT : 2018LYSEN003 . tel-01818090

HAL Id: tel-01818090

<https://theses.hal.science/tel-01818090>

Submitted on 18 Jun 2018

HAL is a multi-disciplinary open access archive for the deposit and dissemination of scientific research documents, whether they are published or not. The documents may come from teaching and research institutions in France or abroad, or from public or private research centers.

L'archive ouverte pluridisciplinaire **HAL**, est destinée au dépôt et à la diffusion de documents scientifiques de niveau recherche, publiés ou non, émanant des établissements d'enseignement et de recherche français ou étrangers, des laboratoires publics ou privés.



Numéro National de Thèse : 2018LYSEN003

THESE DE DOCTORAT DE L'UNIVERSITE DE LYON

opérée par

L'ECOLE NORMALE SUPÉRIEURE DE LYON

ECOLE DOCTORALE N° 486

ECOLE DOCTORALE DE SCIENCES ECONOMIQUES ET DE GESTION

DISCIPLINE : ECONOMIE

Soutenue publiquement le 8 mars 2018, par :

Liza CHARROIN

ESSAYS ON THE FORMATION OF SOCIAL AND ECONOMIC NETWORKS

ESSAIS SUR LA FORMATION DE RÉSEAUX SOCIAUX ET ÉCONOMIQUES

Devant le jury composé de :

- Bravard, Christophe** - Professeur, Université Grenoble Alpes, *Co-directeur de thèse*
Comola, Margherita - Professeure, Ecole d'Economie de Paris, *Examinatrice*
Rusinowska, Agnieszka - Directrice de Recherche, Ecole d'Economie de Paris, *Examinatrice*
Sarangi, Sudipta - Professeur, Virginia Tech, *Rapporteur*
Villeval, Marie Claire - Directrice de Recherche, CNRS, *Directrice de thèse*
Willinger, Marc - Professeur, Université Montpellier I, *Rapporteur*

L'Université n'entend donner aucune approbation aux opinions émises dans les thèses : ces opinions doivent être considérées comme propres aux auteurs.

Remerciements

J'ai commencé à étudier l'économie à l'Université Jean Monnet de Saint-Étienne il y a presque 10 ans. Je ne me doutais pas que mon professeur de microéconomie deviendrait par la suite mon co-directeur de thèse. La première personne que je souhaite donc remercier est Christophe Bravard. Grâce à lui et aux autres professeurs de l'Université Jean Monnet, mon désir d'étudier et de faire de la recherche en économie n'a cessé d'augmenter. Sa présence et ses conseils ont été un véritable atout durant toute la rédaction de cette thèse. Christophe m'a fait confiance et m'a permis de rencontrer Marie Claire Villeval, ma directrice de thèse. Je voudrais la remercier énormément pour son implication durant ces trois années. Marie Claire est une chercheuse exceptionnelle et par conséquent son temps est très précieux. Cependant, elle a toujours su trouver le temps pour me conseiller, me faire avancer et poser les bonnes questions. Elle m'a aiguillée pour la rédaction de cette thèse, mais aussi pour toutes les décisions que j'ai prises durant ces trois dernières années dans le monde de la recherche.

Je remercie également les membres de mon jury de thèse d'avoir accepté d'en faire partie. La présence de Sudipta Sarangi, Professeur à Virginia Tech, est particulière pour moi, car il est l'un des premiers chercheurs internationaux que j'ai pu rencontrer par le biais de Christophe. Je remercie également Marc Willinger, Professeur à l'Université Montpellier I, d'avoir accepté d'être rapporteur et d'apporter son expertise en économie expérimentale. Je remercie aussi Marguerita Comola, Professeure à l'Ecole d'Economie de Paris, et Agnieszka Rusinowska, Directrice de Recherche à l'Ecole d'Economie de Paris, qui sont deux spécialistes reconnues en économie des réseaux.

Je tiens également à remercier Michael Kosfeld, Professeur à l'Université Goethe, pour m'avoir accueillie à Francfort en Allemagne. Faire partie pendant 6 mois d'une équipe d'économistes expérimentalistes aussi dynamique m'a permis d'avancer énormément sur mon

deuxième chapitre de thèse entre autres. De plus, j'ai eu l'opportunité de présenter mes travaux à plusieurs reprises. Les commentaires et discussions que j'ai eus avec Guido Friebel et Ferdinand von Siemens en particulier m'ont beaucoup appris.

Je voudrais remercier mes co-auteurs. Tout d'abord, Corinne Touati, Chargée de Recherche à l'Inria, qui a contribué à la réalisation de mon premier chapitre de thèse grâce à son incroyable expertise en théorie des graphes. Je voudrais également remercier chaleureusement Bernard Fortin, Professeur à l'Université Laval, et co-auteur sur mon troisième chapitre pour sa gentillesse et son aide précieuse. Grâce à lui, j'ai pu améliorer mes connaissances en économétrie. Sa bonne humeur a rendu le travail beaucoup plus aisé.

Je remercie également tous les chercheurs qui ont été invités au GATE durant ces trois années et avec qui j'ai pu échanger. Chacun d'eux m'a permis d'avancer dans ma thèse et de mieux comprendre les attentes du monde académique.

J'aimerais remercier tous les membres du laboratoire du GATE qui font de ce lieu de travail, un lieu extrêmement accueillant, dynamique et enrichissant. Ces trois années sont passées très rapidement et durant ma thèse, venir au laboratoire a toujours été un plaisir. Je remercie tout d'abord Sonia Paty, directrice du laboratoire, mais aussi tous les post-doctorants, chercheurs et enseignants-chercheurs qui sont toujours disponibles pour nous aider (Adam Zylbersztein, Stéphane Robin et Fabio Galeotti entre autres) ainsi que le personnel administratif (Bruno, Nelly et Aude). Je remercie tous les autres doctorants et en particulier Vincent Théroude, Claire Rimbaud, Valentin Jouvanceau, Julien Benistant, Rémi Suchon, Tidiane Ly, Yohann Trouvé, Thomas Garcia et Tatiana Martinez Zavala qui ont été d'une grande aide, mais qui sont surtout devenus des amis.

Enfin, je souhaiterais dire un énorme merci à toute ma famille. Merci à mon papa, qui a soutenu sa thèse alors que j'avais 2 ans. Merci à ma maman et à ma sœur qui ont toujours été là pour moi et qui ont été un soutien personnel incroyable. Enfin, merci à Aurèle de me soutenir dans tout ce que j'entreprends.

Résumé de la thèse

0.1 Motivation de la thèse

Les réseaux sont omniprésents : réseaux d'amitié, réseaux de transport, réseaux neuronaux, etc. La notion de réseaux comprend plusieurs dimensions. La formalisation de ces réseaux s'effectue grâce aux outils de la théorie des graphes. Les réseaux sont composés de nœuds et de liens. Les nœuds de ces réseaux peuvent s'identifier à des individus, des villes, des neurones et les liens peuvent s'identifier à des liens d'amitié, des routes ou des synapses. Les liens permettent de connecter les nœuds directement entre eux, mais également de créer des *chemins* entre les nœuds. Des nœuds peuvent être directement connectés ou indirectement par un chemin de liens passant par d'autres nœuds. Par exemple, des individus qui sont éloignés géographiquement peuvent se connaître grâce à des connaissances communes. Milgram (1967) a étudié le niveau de connectivité des individus grâce à une expérience de terrain. Des individus, venus de différents endroits des États-Unis, devaient envoyer une lettre à un agent de change vivant sur la côte Est. Les individus, qui ne connaissaient pas directement la personne en question, devaient envoyer la lettre à des connaissances susceptibles de connaître l'agent de change. Très peu de lettres sont parvenues à destination, mais celles qui ont atteint l'agent de change sont arrivées très rapidement. Milgram (1967) a déduit de son expérience qu'en moyenne chaque personne aux États-Unis est à une distance de 6 personnes avec n'importe quel autre américain, sachant qu'une distance de 1 signifie que les individus se connaissent directement. C'est le concept des "six degrés de séparation". Cette expérience a été répliquée avec succès à l'international en utilisant des courriers électroniques (Dodds et al., 2003). L'inter-connectivité des individus a également été étudiée dans certains réseaux spécifiques comme les réseaux d'acteurs de cinéma pour calculer la distance entre deux acteurs. Un acteur est à une distance de 1 d'un autre acteur s'ils ont joué ensemble, à

une distance de 2 s'ils ont joué avec un acteur en commun, etc.¹ L'inter-connectivité dans le monde scientifique a été mesurée grâce au nombre d'Erdős qui est la distance entre un scientifique et le mathématicien Erdős, sachant qu'une distance de 1 représente la co-écriture d'un article avec celui-ci.² Plus récemment, le réseau social Facebook a calculé le degré de séparation de ses utilisateurs afin de mettre à jour ce chiffre avec l'avènement des réseaux sociaux sur Internet. Chaque utilisateur de Facebook (ils sont 1,6 milliards) est connecté à tous les autres utilisateurs avec un degré de séparation moyen de 3,57 (voir Figure 1). Plus le nombre d'utilisateurs augmente, plus la distance entre chaque utilisateur diminue. La croissance des réseaux sociaux rend le monde plus connecté et plus petit chaque jour.

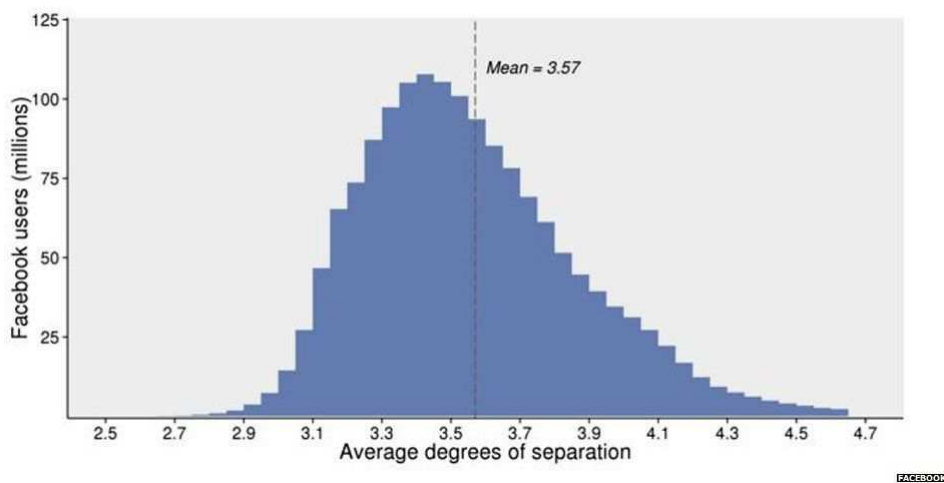

Source : <http://research.fb.com/three-and-a-half-degrees-of-separation/>

Figure 1: Degrés de séparation des utilisateurs de Facebook

Les réseaux sociaux ont connu un essor exponentiel sur Internet, mais d'autres réseaux se sont également développés fortement afin d'améliorer la communication, les déplacements et les échanges. Les réseaux de transport se densifient pour absorber de plus en plus de personnes et de marchandises. Nous communiquons quotidiennement d'un bout à l'autre du monde grâce à Internet et aux réseaux de télécommunication, ce qui permet aux entreprises de se développer à l'international. Nous échangeons des ressources physiques et virtuelles de plus en plus rapidement et en grande quantité.

¹Le site <http://oracleofbacon.org/> permet de calculer la distance entre l'acteur américain Kévin Bacon et n'importe quel autre acteur.

²Le site <http://www.ams.org/mathscinet/collaborationDistance.html> permet aux scientifiques de calculer leur nombre d'Erdős.

Dans un monde où les réseaux deviennent une forme dominante d'organisation, la structure des réseaux et la position des individus en leur sein affectent les comportements individuels et les résultats économiques agrégés. Au regard de l'accroissement de notre interconnectivité et de notre besoin de communiquer et d'échanger, cette thèse s'inscrit dans les réflexions sur la formation de réseaux et leurs impacts sur nos décisions économiques. Les réseaux peuvent être formés par un planificateur central qui gère la structure du réseau ou par les individus eux-mêmes. Cette thèse s'intéresse à ces deux cas. Plus précisément, trois problématiques sont étudiées dans cette thèse.

- Le Chapitre 1 étudie de manière théorique la formation et la protection optimale des réseaux par un planificateur central sachant qu'un agent externe peut détruire k liens. Comment le planificateur peut-il optimiser et garantir le fonctionnement du réseau ?
- Le Chapitre 2 explore la formation décentralisée de réseaux en laboratoire en analysant les décisions individuelles de formation de liens lorsque les agents sont hétérogènes et que le processus de formation de liens est séquentiel. Quelle structure de réseau émerge suite aux décisions de formation de liens individuelles ?
- Le Chapitre 3 étudie l'impact de la formation endogène du réseau sur l'importance des effets de pairs, avec une application aux comportements malhonnêtes. En quoi les effets de pairs dépendent-ils de l'endogénéité du choix des pairs ?

Les trois prochaines sections donnent un aperçu de chacune de ces problématiques et présentent les trois chapitres de cette thèse.

0.2 Formation centralisée de réseaux

L'un des plus vieux problèmes de la théorie des graphes consiste à trouver le chemin optimal à travers une ville ; c'est le problème des sept ponts de Königsberg résolu par Euler (1736). La ville de Königsberg, située en Prusse à l'époque, est organisée en quatre zones : deux îles (A et D sur la Figure 2) et deux rives (B et C sur la Figure 2) sont reliées par sept ponts au total. Ceci peut être vu comme un réseau composé de 4 nœuds et de 7 liens. Par exemple, le nœud A et le nœud B sont reliés par deux liens.

La question posée par les habitants de Königsberg était de savoir s'il existait ou non un chemin permettant de visiter les quatre zones de la ville en passant une seule fois par chaque

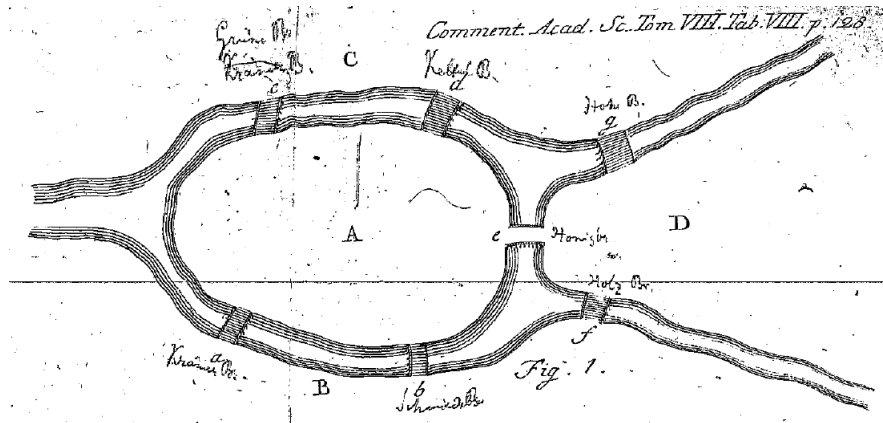

Figure 2: La ville de Königsberg et ses sept ponts.

pont et en revenant à son point de départ. Euler a démontré qu'un tel chemin n'existait pas. Pour que cela soit possible, il faudrait que chaque zone soit accessible par un nombre pair de ponts. Ce problème a constitué le début de la théorie des graphes.

L'utilité de la théorie des graphes est d'autant plus d'actualité étant donné notre dépendance aux réseaux de communication et d'électricité par exemple. Construire des réseaux efficaces et résistants est une tâche primordiale. Les réseaux de communication doivent être conçus de manière optimale afin de limiter leurs coûts. Ainsi, les réseaux de transport, de télécommunication, ou les réseaux informatiques sont formés de manière centralisée par une unité stratégique. SNCF Réseau par exemple a pour but de rendre ce service public "plus efficace pour tous les usagers et moins coûteux pour la collectivité".³ Enedis (anciennement Electricité Réseau Distribution France, ERDF) gère le réseau électrique afin que tous les Français aient accès à l'électricité.⁴ Les réseaux informatiques permettent aux entreprises d'échanger de l'information et des ressources. Ils doivent être connectés de manière à optimiser ces échanges et limiter les coûts de l'entreprise.

Cependant, ces réseaux peuvent être endommagés. En effet, le réseau ferroviaire peut être perturbé si certaines lignes ne sont pas fonctionnelles. Le réseau électrique peut être partiellement détruit par des catastrophes naturelles ou des problèmes techniques. Enfin, les réseaux informatiques peuvent être la cible d'attaques par des virus. Ces réseaux ont donc besoin d'être protégés : soit en créant plus de connexions entre les nœuds, pour créer des

³<http://www.sncf-reseau.fr>

⁴<http://www.enedis.fr/>

chemins alternatifs si une partie du réseau est détruite, soit en protégeant spécifiquement certains nœuds ou certains liens.

0.2.1 Formation centralisée de réseaux, attaque et protection dans la théorie des jeux sociale

Certains réseaux sont formés par une unité stratégique afin d'optimiser leur efficacité. Cette unité doit optimiser la communication, la production et la diffusion au sein du réseau. Un problème auquel ces réseaux font face est une potentielle détérioration. En effet, certains liens ou certains nœuds peuvent être endommagés soit par une détérioration naturelle plus ou moins aléatoire, soit par une attaque stratégique d'un agent externe. Pour modéliser le premier cas, Bala et Goyal (2000b) ont développé un modèle de formation de réseaux stratégique où les liens sont imparfaitement fiables.⁵ Ils peuvent être inefficaces avec une certaine probabilité. Si la probabilité qu'un lien ne fonctionne pas est trop importante par rapport au coût de lien, il est optimal que les liens soient redondants afin qu'il existe un chemin alternatif. Les réseaux peuvent également être endommagés par une unité intelligente qui vise à les détruire en attaquant certaines parties du réseau. Dans cette littérature, les auteurs se sont surtout focalisés sur l'attaque et la protection de nœuds. Dans le Chapitre 1 de cette thèse, nous élargissons cette littérature avec un modèle d'attaque et de protection de liens où les nœuds sont complémentaires et donc doivent tous survivre à une attaque stratégique.

Dans la littérature théorique, la formation et la protection des réseaux attaqués par une unité stratégique sont modélisées par un jeu à deux joueurs avec un designer (planificateur central) et un adversaire. Le designer forme et protège le réseau et l'adversaire peut attaquer un certain nombre de nœuds. L'objectif du designer est de maintenir la connexion entre un maximum de nœuds et l'objectif de l'adversaire est de déconnecter le réseau en attaquant des nœuds spécifiques. Afin de résister à ces attaques, l'une des solutions est que le réseau contienne suffisamment de liens pour que les nœuds survivants puissent maintenir la communication entre eux après l'attaque de l'adversaire (Hoyer et Jaegher, 2016). La deuxième solution pour résister aux attaques de nœuds est de protéger certains nœuds spécifiques du réseau. La littérature qui étudie les attaques et les protections de nœuds met en avant un type de réseau relativement simple à protéger et peu coûteux : le réseau en étoile, où chaque nœud a un unique lien avec le nœud central. Protéger le nœud central suffit à maintenir le

⁵Dans ce modèle, les liens sont formés par les nœuds eux-mêmes.

réseau connecté (Dziubinski et Goyal, 2013).⁶ En effet, seuls les nœuds périphériques peuvent être attaqués et détruits. Par conséquent, le nœud central et certains nœuds périphériques résisteront à l'attaque.

Ces modèles ont également été développés pour étudier les attaques contagieuses pour simuler des épidémies ou des propagations de virus par exemple. En effet, l'essor des réseaux accroît également les risques de contagion ou la diffusion de virus sur les ordinateurs. L'exemple récent du virus Petya, qui a infecté des milliers d'ordinateurs et a affecté le fonctionnement de nombreuses entreprises, montre que les réseaux digitaux sont très difficiles à protéger.⁷ Goyal et Vigier (2014) ont étendu le modèle de Dziubinski et Goyal (2013) en rendant l'attaque contagieuse. Si un nœud non-protégé est attaqué, il est détruit et il contamine tous les nœuds qui ont un lien avec lui et qui ne sont pas protégés. Ces études sont cruciales pour comprendre la transmission de maladies contagieuses et pour prévenir la contamination d'autres membres de la société en donnant des vaccins aux personnes les plus susceptibles d'être touchées par la maladie et de contaminer d'autres personnes. Acemoglu et al. (2016) modélisent une épidémie où la formation du réseau est aléatoire et les nœuds sont attaqués avec une certaine probabilité. S'ils ne sont pas protégés, ils sont contaminés ainsi que tous les nœuds non-protégés qui sont liés à eux. Cerdeiro et al. (2015) proposent un jeu à trois étapes. Le designer crée le réseau et les nœuds décident eux-mêmes de se protéger ou non sachant que la protection est coûteuse. Enfin, l'adversaire peut attaquer un certain nombre de nœuds. Cet article introduit une problématique intéressante : comment l'unité stratégique (le designer) peut inciter les nœuds à se protéger de manière optimale ? D'un autre point de vue, comprendre ces phénomènes de contagion peut permettre de démanteler des réseaux criminels en ciblant les nœuds clés du réseau pour faire tomber l'ensemble du réseau. Le nœud (ou joueur) clé du réseau est défini par Ballester et al. (2006) comme le nœud qui a le plus d'influence dans le réseau et qui, une fois retiré, va permettre de diminuer au mieux le niveau agrégé de la criminalité.

⁶Le réseau en étoile, s'il n'est pas protégé, résiste bien aux attaques aléatoires, mais est très fragile si l'attaque est ciblée, car la destruction du nœud central détruit le réseau en entier. Par exemple, les réseaux Ethernet en informatique sont souvent structurés en étoile avec au centre, le commutateur, et où chaque ordinateur est relié directement au commutateur. Cela permet une plus grande flexibilité dans la gestion du réseau. Cependant, si le commutateur est défectueux, l'ensemble du réseau ne fonctionne plus.

⁷http://www.lemonde.fr/pixels/article/2017/06/28/comment-fonctionne-petya-le-virus-qui-a-touche-de-nombreuses-tres-grandes-entreprises_5152547_4408996.html

0.2.2 Chapitre 1 : Formation et protection optimale de réseaux dont les liens sont attaqués

Le premier projet est théorique et vise à étudier la formation et la protection de réseaux de communication. La littérature s'est focalisée sur la protection et l'attaque de nœuds dans les réseaux. Or, de nombreux réseaux peuvent être endommagés via une attaque de leurs liens. De nombreux réseaux de communication sont primordiaux car leurs liens servent à transférer des informations ou des biens. Les réseaux de télécommunication ou de transport en sont des exemples. Nous montrons dans ce chapitre que la destruction de liens n'aura pas le même impact que la destruction de nœuds sur la stratégie optimale à adopter par le planificateur central.

Nous étudions ce problème grâce à un jeu séquentiel à deux joueurs modélisé par Dziubinski et Goyal (2013). Le premier joueur est le designer du réseau. Son rôle est de construire un réseau de communication résistant aux attaques du deuxième joueur appelé l'adversaire. Le designer peut construire deux types de liens : des liens non-protégés ou des liens protégés, plus coûteux mais indestructibles. Son objectif est de maintenir une connexion entre tous les nœuds qui sont complémentaires. L'adversaire peut attaquer k liens. Son objectif est de détruire le flux de communication en déconnectant le réseau, c'est-à-dire en isolant au moins un nœud du reste du réseau.

Afin de construire un réseau résistant aux attaques de l'adversaire, le designer fait face à un arbitrage entre construire des liens plus coûteux mais indestructibles et des liens moins coûteux mais qui peuvent être détruits. Pour construire un réseau de n nœuds résistants à k attaques de liens, il existe deux solutions polaires : construire uniquement des liens protégés ou uniquement des liens non-protégés. Dans le premier cas, $n - 1$ liens protégés sont suffisants pour que le réseau résiste à l'attaque car tous les nœuds sont connectés et resteront connectés après l'attaque. Dans le deuxième cas, chaque nœud nécessite $k + 1$ liens afin de ne pas être isolé des autres après l'attaque de l'adversaire. Bien sûr, il existe des réseaux où sont construits des liens protégés et des liens non-protégés qui résistent à l'attaque. En d'autres termes, il existe un compromis entre le nombre de liens protégés et de liens non-protégés : l'ajout d'un lien protégé permet de diminuer le nombre de liens non-protégés nécessaires à la survie du réseau. Cependant, les réseaux qui utilisent les deux types de liens sont au total plus coûteux que les réseaux qui utilisent uniquement des liens protégés ou des liens

non-protégés. Les résultats montrent que les deux solutions polaires sont les seuls équilibres parfaits en sous-jeu. Nous étendons le modèle en limitant les possibilités de protection du designer de deux manières. Premièrement, nous lui imposons un nombre limité de liens protégés. Dans ce cas, des stratégies qui allient liens protégés et liens non-protégés peuvent être des solutions optimales. Deuxièmement, nous avons également étendu le modèle en rendant les liens protégés imparfaitement indestructibles, i.e. il existe une probabilité positive que la protection ne résiste pas à l'attaque. Nous donnons les conditions sous lesquelles les résultats avec des liens parfaitement protégés sont préservés.

La contribution de ce chapitre à la littérature existante est d'étudier l'attaque et la protection de liens plutôt que l'attaque et la protection de nœuds. En effet, les stratégies de formation de réseaux et de protection optimale ne sont pas les mêmes si les cibles de l'adversaire sont les nœuds ou si ce sont les liens. Plus précisément, la structure en étoile n'est jamais optimale dans notre cas. De plus, les nœuds sont complémentaires dans notre modèle alors qu'ils sont substituables dans le reste de la littérature. En effet, le designer doit garantir la communication entre tous les nœuds dans notre modèle pour que le réseau ait une valeur positive. Si les nœuds étaient substituables, un lien protégé entre deux nœuds serait suffisant pour que le designer protège efficacement le réseau, ce qui n'est pas très réaliste. Par exemple, pour les réseaux de télécommunication, l'objectif n'est pas de maintenir la communication entre deux nœuds au minimum, mais de garantir la communication entre tous les nœuds du réseau. Lorsque le coût de formation de liens est trop élevé, dans les modèles avec protection de nœuds complémentaires, une unité de protection est suffisante pour garantir la survie du réseau, alors que dans notre modèle $n - 1$ protections sont nécessaires. Après avoir étudié la formation centralisée de réseaux, nous allons maintenant nous intéresser à la formation décentralisée de réseaux, c'est-à-dire la formation de liens par les nœuds eux-mêmes.

0.3 Formation décentralisée de réseaux

La formation des réseaux sociaux dépend des décisions individuelles de création de liens. Ces décisions dépendent de facteurs sociologiques, psychologiques, ou économiques. Certaines raisons sont purement rationnelles dans le sens où elles visent à maximiser l'utilité de l'individu. Par exemple, un étudiant peut préférer former des liens avec des étudiants ayant de bons résultats scolaires afin de profiter de leurs savoirs et d'améliorer ses chances

de réussite (Hsieh et Lee, 2017). Des critères démographiques comme l'âge ou le sexe sont aussi importants pour la formation de liens. On observe souvent dans les réseaux sociaux la présence d'*homophilie* qui est un phénomène selon lequel les individus sont plus attirés par des individus qui leur ressemblent. McPherson et al. (2001) ont étudié divers réseaux et montrent que les individus d'un même réseau ont souvent des caractéristiques similaires. Par exemple, Currarini et al. (2009) montrent que les étudiants d'une même origine ethnique ont tendance à créer des liens entre eux. Ces différents déterminants vont impacter les décisions individuelles de formation de liens, la position des nœuds dans le réseau et par conséquent, la structure du réseau dans sa globalité. Une autre caractéristique importante des réseaux est la distribution des *degrés* des nœuds, c'est-à-dire le nombre de liens de chaque nœud. La structure des réseaux, aussi appelée architecture, est souvent complexe, car les individus ont des degrés différents. Certains individus sont très connectés et centraux dans le réseau. D'autres individus au contraire vont se situer dans la périphérie du réseau et avoir un degré faible. Si l'on reprend l'exemple des réseaux d'amitié à l'école, Bramoullé et Rogers (2009) ont étudié la base de données Add Health pour analyser le niveau de popularité des étudiants. Les étudiants peuvent citer au maximum cinq amis. Les liens reçus représentent le nombre de fois où un étudiant a été cité et cela représente son niveau de popularité. Ils ont ensuite créé un graphique représentant la distribution des degrés entrants des étudiants, c'est-à-dire le nombre de liens d'amitié reçus par chaque individu. La Figure 3 montre que beaucoup d'étudiants ont peu de liens entrants et que quelques étudiants ont un nombre de liens entrants très important et sont donc populaires.

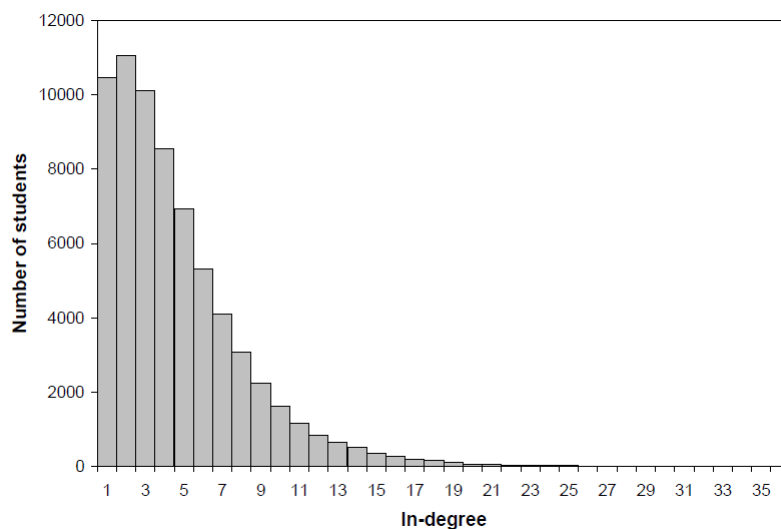

Figure 3: Distribution des degrés entrants des étudiants.

Dans ce chapitre, ces réseaux où peu de nœuds sont très connectés et beaucoup de nœuds sont peu connectés sont appelés des *réseaux asymétriques*. De nombreuses autres études empiriques ont montré que les réseaux ont souvent une structure asymétrique. Dans le Chapitre 2, nous nous intéressons aux déterminants qui influent la formation des liens et la coordination des individus sur une structure de réseau asymétrique.

0.3.1 La formation décentralisée de réseaux dans la théorie des jeux

Nous commençons par étudier la problématique de formation décentralisée de réseaux avec une approche théorique. Dans la littérature théorique, la formation décentralisée de réseaux a été beaucoup étudiée au début des années 2000.

Deux articles de référence ont servi de base à cette littérature : Jackson et Wolinsky (1996) et Bala et Goyal (2000a). Le premier est un modèle de formation de réseau où les liens sont non-orientés. Un lien est *non-orienté* ou *bilatéral* si les deux agents maintiennent un lien d'un commun accord (un accord entre entreprises ou une relation familiale par exemple). Un lien est formé si les deux agents impliqués dans celui-ci sont d'accord pour le former et le coût de formation du lien est partagé équitablement. Jackson et Wolinsky (1996) distinguent deux modèles : le *modèle de connexions* et le *modèle de co-auteurs*. Dans le modèle de connexions, les agents bénéficient de leurs liens directs et indirects. Cependant, la valeur d'un lien peut décroître avec la distance entre deux agents ; un lien indirect peut avoir une valeur plus faible qu'un lien direct. Dans ce cas, on appelle cela un modèle avec *decay*. Si le coût du lien est faible, le réseau efficace – c'est-à-dire celui qui maximise la somme des paiements individuels – est le *réseau complet* où il existe un lien entre chaque agent (voir Figure 4a). Si le coût est plus élevé, le *réseau en étoile* est efficace (voir Figure 4b). L'agent central est en position désavantageuse car il est connecté à tous les autres agents et supporte donc un coût élevé. Le réseau est instable car l'agent central ne veut pas rester dans cette position.⁸ Il y a donc dans ce modèle une tension entre efficacité et stabilité. Une solution efficace d'un point de vue agrégé n'est pas forcément optimale pour chaque agent. Dans le modèle de co-auteurs de Jackson et Wolinsky (1996), les liens indirects ont même un effet négatif. Les auteurs prennent l'exemple du réseau des chercheurs scientifiques. Si deux chercheurs (A et B) décident de travailler ensemble, ils peuvent consacrer tout leur temps à ce projet commun.

⁸Jackson et Wolinsky (1996) définissent un réseau stable de la manière suivante : c'est un réseau où aucun joueur ne souhaite supprimer un de ses liens et où aucun nouveau lien ne peut être créé sans diminuer le gain d'un autre agent.

Cependant, si un troisième chercheur (C) veut travailler avec l'un de ces chercheurs (disons A), A aura moins de temps à consacrer au projet avec B et donc cela va diminuer l'utilité de B. Le réseau efficace consiste à former des paires (voir Figure 4c). Cependant, comme dans le précédent modèle, ce type de réseau n'est pas stable, car les individus sont tentés de créer un autre lien pour augmenter leur nombre de liens directs. Mais cela va diminuer le bénéfice moyen de chaque lien, car les bénéfices seront partagés entre plus d'agents. Là encore, il y a une tension entre les intérêts individuels et collectifs.

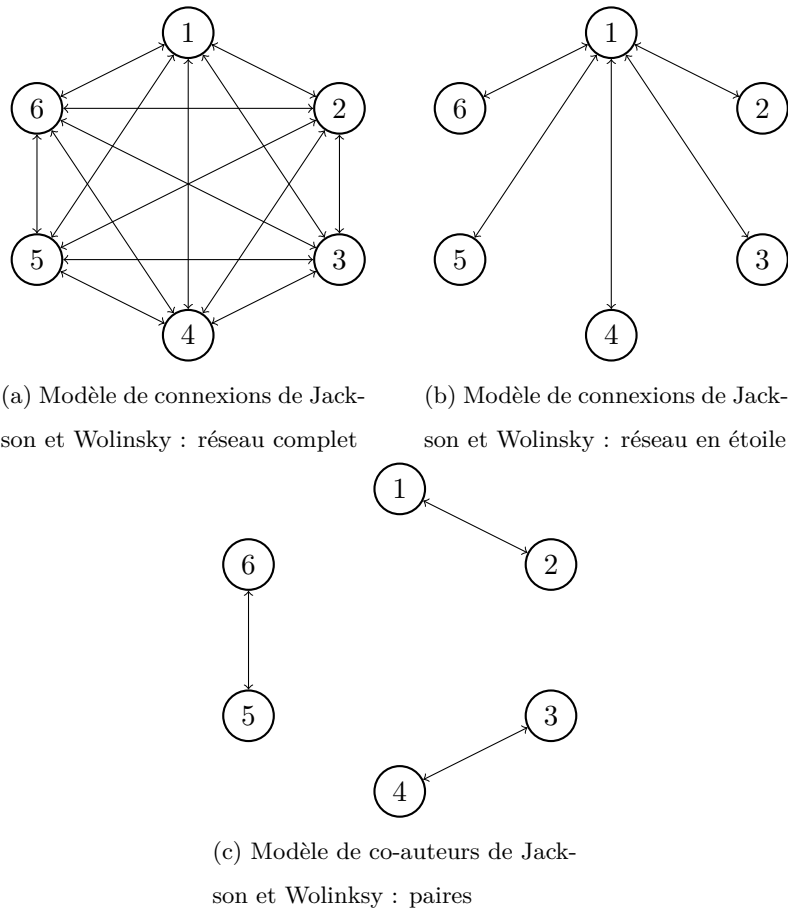

Figure 4: Modèle de Jackson et Wolinsky : réseaux efficaces. Les liens non-orientés sont représentés par des flèches avec une pointe à chaque extrémité.

Le modèle de Bala et Goyal (2000a) est un modèle de formation de réseaux où les nœuds peuvent former des liens unilatéralement (appel téléphonique ou envoi d'une demande d'amitié sur Facebook par exemple) et où le coût du lien est supporté uniquement par le créateur du lien. Bala et Goyal (2000a) développent eux-aussi deux modèles : le modèle *one-way* où seul le créateur du lien bénéficie du lien qu'il a créé et le modèle *two-way* où les

deux individus impliqués dans le lien bénéficient du lien. L'équilibre strict de Nash dans le modèle one-way est le *cercle* où chaque agent forme et reçoit un lien (voir Figure 5a). Le réseau d'équilibre strict dans le modèle two-way est le réseau en étoile où le nœud central doit créer tous les liens du réseau. Ce réseau est appelé la Center-Sponsored Star (CSS, voir Figure 5b). La position de nœud central est désavantageuse comme dans le modèle de Jackson et Wolinsky (1996). Contrairement au cercle, ce réseau est inégalitaire et instable. Les réseaux en étoile émergent souvent dans la littérature théorique. Malgré l'homogénéité des nœuds, des structures asymétriques peuvent émerger.

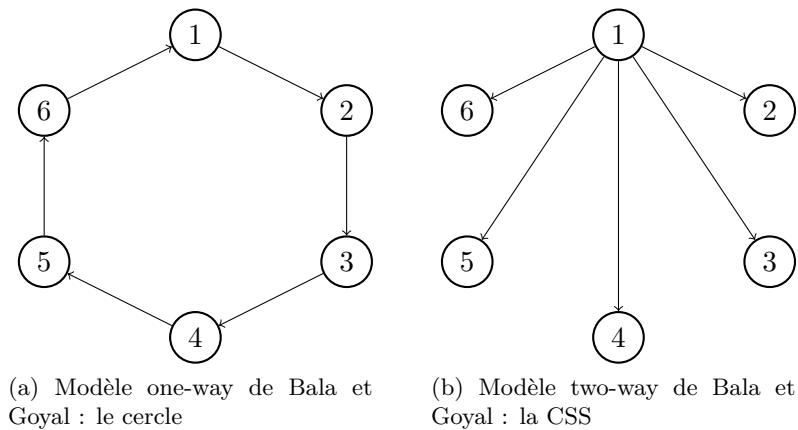

Figure 5: Modèle de Bala et Goyal : équilibres de Nash stricts et réseaux efficaces. Les liens orientés sont représentés par des flèches partant de l'initiateur du lien et pointant le partenaire visé.

0.3.2 La formation décentralisée de réseaux dans le laboratoire

A la suite des articles théoriques sur la formation de réseaux, les expériences en laboratoire sur les réseaux ont connu un certain essor afin de tester les prédictions de ces modèles. Kosfeld (2004) propose une revue de littérature des expériences sur les réseaux. Sa conclusion en ce qui concerne les expériences sur la formation de réseaux est que l'équilibre de Nash ne prédit pas souvent les résultats expérimentaux. Deck et Johnson (2004) ont testé les deux types de modèles développés dans la section précédente (Jackson et Wolinsky (1996) et Bala et Goyal (2000a))⁹ en variant la manière dans les coûts de lien sont répartis. Dans le traitement égalitaire, le consentement mutuel est requis et les coûts sont partagés équitablement (comme dans Jackson et Wolinsky (1996)). Dans le traitement direct, chaque individu spécifie combien

⁹Ils n'utilisent pas tout à fait les modèles originaux de Bala et Goyal (2000a) et Jackson et Wolinsky (1996) mais une variante de ces modèles où les nœuds sont positionnés dans l'espace et les coûts de liens dépendent de la distance. C'est un modèle créé par Johnson et Gilles (2003).

il veut payer pour ses liens directs. L'un des individus de la paire peut payer la totalité du coût du lien (comme dans Bala et Goyal (2000a)). Dans le traitement indirect, les individus donnent leur disposition à payer pour leurs liens directs mais aussi pour leurs liens indirects. Le réseau peut ici être vu comme un bien public. L'efficacité et la coordination sont plus faciles dans le traitement égalitaire (qui se rapproche le plus du modèle de Jackson et Wolinsky (1996)), alors qu'il y a des problèmes de coordination dans les deux autres traitements qui sont plus proches du modèle de Bala et Goyal (2000a). Plus particulièrement, il y a une tendance à créer trop de liens pour s'assurer un bénéfice positif, ce qui accroît les coûts. Nous allons maintenant détailler les expériences sur la formation de réseaux basées sur des modèles à la Jackson et Wolinsky et à la Bala et Goyal.

Expériences avec liens non-orientés et consentement mutuel

Les expériences basées sur le modèle de Jackson et Wolinsky (1996) étudient la tension entre stabilité et efficacité ainsi que la capacité des individus à anticiper les choix de formation de liens des autres et à se coordonner.

L'objectif de l'étude pilote de Vanin (2002) est de tester si cette tension efficacité/stabilité est présente dans le laboratoire et sous quelles conditions elle peut être résolue. Pour renforcer la coordination, les individus sont autorisés à communiquer avant de prendre leurs décisions pour construire le réseau. Malgré cela, les réseaux efficaces ont du mal à émerger, surtout lorsque ces réseaux sont inégalitaires en termes de profit. La communication permet aux individus de choisir des structures symétriques et donc égalitaires. La littérature a cherché des moyens pour faciliter l'émergence de réseaux stables et efficaces. Carrillo et Gaduh (2012) ont ainsi utilisé le modèle de Jackson et Watts (2002) où les bénéfices du réseau sont distribués de manière égalitaire à l'intérieur du réseau formé, de sorte que les décisions de formation de liens ne sont pas impactées par l'aversion à l'inégalité. L'expérience montre que les réseaux formés sont stables et les individus parviennent à anticiper les décisions de création de lien des autres afin de se coordonner sur des réseaux plus efficaces. Burger et Buskens (2009) ont utilisé un processus de formation de liens dynamique plutôt que simultané afin de faciliter la coordination ; les individus peuvent mettre à jour de manière simultanée leurs liens pendant des périodes de 30 secondes. Les résultats montrent que les groupes convergent vers des réseaux stables et le processus de convergence est plus rapide lorsque ces réseaux sont efficaces et égalitaires. Caldara et McBride (2014) ont ajouté une caractéristique réaliste

dans leur expérience : les individus ne peuvent observer qu'une partie limitée du réseau (leurs liens directs et leurs liens indirects à distance 2 maximum). En effet, on connaît ses propres amis et parfois les amis de nos amis mais il est difficile d'avoir une vision générale du réseau. Ici, le but est principalement d'étudier l'impact de l'observation limitée sur l'efficacité. Si les individus n'observent qu'une partie du réseau, les croyances sur le reste du réseau ont une grande importance. L'observation partielle mène à plus de cycles dans le réseau, c'est-à-dire à des liens redondants qui sont coûteux et n'augmentent pas le bénéfice des nœuds, car un chemin existe déjà. Les auteurs trouvent plus de stabilité avec des coûts faibles et l'observation totale du réseau alors que l'observation limitée du réseau empêche les groupes de former des réseaux stables et efficaces.

La capacité des individus à anticiper les décisions de création de liens des autres individus est cruciale pour former des réseaux stables et efficaces. Pantz (2006), Carrillo et Gaduh (2012) et Kirchsteiger et al. (2016) analysent dans leurs expériences sur la formation de réseaux à quel niveau les individus peuvent anticiper les décisions des autres. Les individus peuvent être myopes s'ils n'ont aucune capacité à prévoir les liens formés par les autres. De manière générale, les auteurs montrent que les individus ne sont pas totalement myopes. En effet, ils anticipent les actions des autres mais ont un niveau de réflexion limité, ce qui les empêche parfois de converger vers un réseau stable.

La littérature s'est également intéressée à l'analyse des décisions de création de liens au niveau de l'individu. Conte et al. (2015) montrent que la coordination sur des réseaux minimalement connectés n'est pas facile et beaucoup de liens redondants persistent. Trois types de comportements individuels sont identifiés : le comportement "meilleure réponse" (45% des individus incluent les individus isolés et suppriment les liens redondants pour que le réseau devienne minimalement connecté), le comportement "réciproque" (30% des individus maximisent leur nombre de liens directs en répondant positivement aux propositions de liens) et le comportement "opportuniste" (25% des individus maximisent leur nombre de liens indirects). Les deux derniers types de comportements sont néfastes à la formation de réseaux efficaces. D'autres facteurs peuvent influencer les décisions individuelles de création de lien comme les préférences sociales. Les préférences sociales sont très souvent présentes dans toutes les expériences que nous avons cité plus tôt. En effet, les individus ont souvent des préférences pour l'efficacité et l'égalité des gains. L'objectif de Van Dolder et Buskens (2009) est de

mesurer ces préférences sociales au niveau individuel dans un jeu de formation de réseaux. Les résultats montrent que les agents créent des liens si cela augmente leur propre profit et les profits du groupe (efficacité). Cependant, contrairement aux hypothèses des auteurs, la volonté d'égaliser les profits (égalité) n'a qu'un faible impact sur les décisions de création de liens.

Pour résumer, dans les expériences inspirées du modèle de Jackson et Wolinsky (1996), les groupes ont du mal à se coordonner sur des réseaux efficaces, car ils sont souvent instables et inégalitaires. De plus, les individus ont des difficultés à parfaitement anticiper les décisions de création de liens des autres joueurs. Des réseaux symétriques et trop connectés, donc trop coûteux, ont tendance à émerger.

Expériences avec des liens orientés

Les expériences sur la formation de réseaux avec liens orientés sont majoritairement basées sur le modèle two-way de Bala et Goyal (2000a). En effet, l'asymétrie dans ce modèle – le fait qu'un nœud paye pour créer un lien, mais que les deux nœuds en bénéficient – a intéressé beaucoup de chercheurs. Falk et Kosfeld (2012) ont réalisé la première expérience qui teste le modèle one-way et le modèle two-way. Ils testent ces deux modèles dans des groupes de quatre joueurs et varient le coût de lien. Les individus prennent leurs décisions simultanément. Leurs résultats montrent que les réseaux d'équilibre émergent dans le modèle one-way ; les résultats théoriques et expérimentaux concordent.¹⁰ Par contre, les réseaux d'équilibre n'émergent pas dans le traitement représentant le modèle two-way. Les auteurs donnent deux raisons pour expliquer pourquoi la Center-Sponsored Star n'émerge pas :

- L'asymétrie de stratégie : la CSS est complexe et asymétrique. Un nœud (joueur/individu) doit créer tous les liens et les autres doivent rester passifs. Par conséquent, la coordination est difficile.
- L'asymétrie de gains : les inégalités sont fortes dans la CSS alors qu'avec le cercle, les

¹⁰Bernasconi et Galizzi (2005) ont répliqué l'expérience de Falk et Kosfeld (2012) en se focalisant sur le rôle de l'apprentissage dans les instructions et sur certaines caractéristiques prépondérantes du design. Les caractéristiques prépondérantes sont les noms donnés aux nœuds dans l'expérience, qui facilitent la coordination des individus sur le cercle. En effet, nommer les nœuds A, B, C, D, etc. a tendance à influencer les individus. A peut être plus enclin à créer un lien avec B, B avec C, etc. En ce qui concerne l'apprentissage, dans l'expérience de Falk et Kosfeld (2012), les participants durant les instructions doivent réfléchir au réseau le plus efficace, c'est-à-dire celui où l'information se diffuse d'une manière optimale. Cette étape facilite la coordination des individus. Les auteurs montrent qu'en changeant les noms des nœuds et les instructions, la coordination est beaucoup moins aisée.

gains sont parfaitement répartis. La position du nœud (joueur/individu) central n'est pas avantageuse et rend le réseau instable.

En introduisant de la communication avant la formation des liens, les agents parviennent à se coordonner sur la CSS grâce à la permutation des positions dans le réseau. Ils implémentent un processus où la position de nœud central est adoptée par chaque joueur l'un après l'autre afin d'égaliser les gains ce qui permet l'émergence du réseau efficace et l'égalité des gains. Par la suite, dans cette littérature, les chercheurs se sont surtout focalisés sur le modèle two-way.

Goeree et al. (2009) étudient l'émergence de réseaux en étoile en laboratoire. Ils étendent le modèle de Bala et Goyal (2000a) en introduisant de l'hétérogénéité via la présence d'un individu spécial dans un groupe comptant six personnes. Ils introduisent de l'hétérogénéité de coût avec un agent spécial qui peut créer des liens pour un coût plus faible que les autres et de l'hétérogénéité de valeur grâce à la présence d'un agent spécial qui a une valeur supérieure aux autres. La CSS avec l'individu à faible coût comme nœud central reste le réseau d'équilibre et est le réseau efficace. L'individu à faible coût est censé faciliter l'émergence de la CSS. A cause du decay, l'introduction de l'hétérogénéité par la présence d'un individu à forte valeur impacte la détermination de l'équilibre de Nash strict. Les nœuds périphériques ont intérêt à créer chacun un lien avec le nœud central, en l'occurrence l'individu à forte valeur. Ce réseau est appelé la *Periphery-Sponsored Star* (PSS, voir Figure 6).

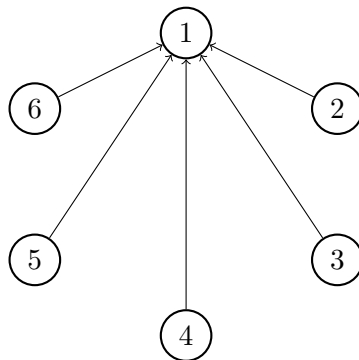

Figure 6: La Periphery-Sponsored Star (PSS).

L'expérience montre que la présence d'un individu avec une plus forte valeur facilite l'émergence de la PSS alors que la présence d'un agent avec un coût plus faible ne facilite pas l'émergence de la CSS. L'une des explications est que ce dernier réseau reste inégalitaire

malgré le fait que le nœud central ait un coût de formation de liens plus faible.

Par la suite, de nombreux papiers expérimentaux ont analysé l'émergence des réseaux en étoile. Rong et Houser (2015) étudient comment faciliter l'émergence des réseaux en étoile en laboratoire, mais contrairement à Goeree et al. (2009), ils veulent savoir si leur émergence est possible avec des individus homogènes. Rong et Houser (2015) testent le modèle de Galeotti et Goyal (2010) qui est similaire au modèle de Bala et Goyal (2000a) sauf que les individus ont deux choix à faire : (i) investir dans un bien – dans ce cas, ils gagnent un montant positif avec certitude – et/ou (ii) créer des liens pour bénéficier de l'investissement d'un partenaire qui a investi. Créer des liens est moins coûteux qu'investir, mais le bénéfice n'est pas certain car le lien peut être créé avec quelqu'un qui n'a pas investi. Quand le coût de création de liens est plus faible que le coût de l'investissement, l'équilibre de Nash unique est la PSS où le nœud central est l'investisseur. Ce réseau est aussi efficace. Ce modèle est testé dans différents types d'environnement qui varient le processus de décision : les décisions de création de liens sont soit simultanées soit séquentielles (les agents décident les uns après les autres après avoir observé les décisions des précédents joueurs), les investissements peuvent être limités ou non par des contraintes de ressources, c'est-à-dire que les agents peuvent soit créer un lien, soit investir, mais pas les deux. Les résultats montrent que la séquentialité n'augmente pas l'émergence de réseaux en étoile. Par contre, la limitation de l'investissement a un effet positif car un individu investit et les autres se lient avec lui. Malgré l'homogénéité des individus, les auteurs montrent que certaines institutions facilitent l'émergence des réseaux en étoile. Comme Rong et Houser (2015), Van Leeuwen et al. (2015) ont utilisé le modèle de Galeotti et Goyal (2010) pour étudier l'émergence de réseaux en étoile. La position de nœud central et d'investisseur est rendue plus attractive grâce à une rente. Les individus peuvent investir dans un bien public et sont en compétition pour la rente et le statut de plus gros investisseur. La popularité est ainsi récompensée. Par conséquent, l'équilibre de Nash strict est la PSS où le nœud central est le seul investisseur (ce qui était déjà le cas dans Galeotti et Goyal (2010)).

Berninghaus et al. (2004) s'appuient sur le constat des limites à l'émergence du réseau en étoile : sa complexité et l'aversion à l'inégalité pour modifier le modèle de Bala et Goyal (2000a). Ils incluent une discrimination entre les "voisins actifs" et les "voisins passifs". Un lien est actif si l'individu i paye pour la formation de ce lien (lien sortant). Un lien est passif si un individu paye pour former un lien avec i (lien entrant). Les individus bénéficient de

leurs liens directs, qu'ils soient actifs ou passifs. Par contre, ils ne bénéficient pas de tous leurs liens indirects. Ils bénéficient seulement des liens avec les voisins de leurs voisins actifs. Avec cette modification, l'équilibre de Nash strict devient la PSS. Leurs résultats montrent que 50% des groupes forment la PSS ou un réseau proche de la PSS.

D'autres expériences ont tenté de faciliter l'émergence de réseaux d'équilibre grâce à différents processus de création de liens. Callander et Plott (2005) ont réalisé l'une des premières expériences sur la formation de réseaux s'appuyant sur le modèle one-way de Bala et Goyal (2000a). Les auteurs ont analysé les principes qui déterminent l'émergence des réseaux, leur évolution et comment ils sont influencés par le contexte du jeu. Ils ont fait l'expérience de manière manuelle avec un processus de formation de liens simultanée et sur ordinateur avec un processus de formation de liens continu. Dans le processus continu, les individus peuvent cliquer sur les nœuds avec lesquels ils veulent créer des liens et supprimer leurs liens en cliquant sur leurs liens existants. Le réseau est mis à jour en continu sur leur écran durant deux minutes. Leurs résultats montrent que les réseaux émergent, évoluent avec le temps et convergent vers des structures stables. La stabilité est facilitée par le processus continu. En utilisant le même modèle que Berninghaus et al. (2004), avec la discrimination entre les liens actifs et passifs, Berninghaus et al. (2007) étudient la formation de réseaux avec un processus simultané et un processus continu. Là aussi, la simultanéité de la formation de liens rend la coordination difficile. Dans le traitement continu, le jeu de formation de liens dure 30 minutes et les individus peuvent changer leurs décisions autant de fois qu'ils le souhaitent. Ils ont une information complète sur tous les liens du réseau et connaissent leur gain en temps réel. Plus de PSS émergent, en comparaison avec le traitement simultané.

Dans le Chapitre 2, nous contribuons à cette littérature en utilisant un processus de formation de liens séquentiel afin de faciliter la coordination. Les individus font leur choix de liens l'un après l'autre et peuvent observer les décisions précédentes. Nous introduisons également de l'hétérogénéité pour mesurer son impact sur la formation de réseaux asymétriques. En plus de l'hétérogénéité monétaire testée par Goeree et al. (2009), nous introduisons une hétérogénéité non-monétaire avec la présence d'un individu avec un statut différent.

0.3.3 Chapitre 2 : Hétérogénéité et séquentialité dans les jeux de formation de réseaux

Le deuxième chapitre étudie les décisions de formation de liens de manière décentralisée dans le laboratoire. Plus précisément, nous étudions la formation de réseaux asymétriques, i.e. de réseaux dans lesquels quelques individus centraux sont davantage connectés que les individus périphériques. Les nœuds de ce réseau sont hétérogènes en termes de connectivité. De nombreux exemples de réseaux asymétriques existent dans la vie. Par exemple, les réseaux de co-auteurs sont asymétriques (Newman, 2004), ainsi que les réseaux d'amitié et familiaux (Smith et Christakis, 2008). La contribution de ce chapitre est de faciliter la coordination des agents grâce à un processus séquentiel de formation de liens et d'analyser l'impact de l'hétérogénéité des caractéristiques des agents sur les décisions de formation de liens et la structure des réseaux qui émerge. Empiriquement, nous montrons que la séquentialité du processus de formation de liens permet l'émergence de réseaux stables, efficaces et égaux. Enfin, ce chapitre examine également le rôle potentiel d'une hétérogénéité de statut et non-monnaire dans l'émergence de réseaux asymétriques.

Théoriquement, nous nous basons sur le modèle two-way de Bala et Goyal (2000a). Dans ce modèle, l'équilibre de Nash strict est un réseau en étoile où le joueur central crée tous les liens : la *Center-Sponsored Star* (CSS). Le joueur central est donc dans une situation désavantageuse, car il supporte tous les coûts. Même avec des nœuds homogènes, ce modèle montre que le réseau d'équilibre est asymétrique. Ce modèle a été testé en laboratoire à plusieurs reprises. Cependant, comme indiqué précédemment, l'émergence de réseaux asymétriques est rare en laboratoire pour deux raisons : des problèmes de coordination et les inégalités de gains entre joueurs. Afin de faciliter la coordination des joueurs, nous intégrons dans le modèle et dans le design expérimental deux caractéristiques : la séquentialité du processus de formation de liens et l'hétérogénéité entre les joueurs. La plupart des expériences sur la formation de réseaux utilisent un processus de formation de liens simultané. Or, il est très difficile pour les joueurs d'anticiper les décisions des autres, ce qui rend la coordination difficile. De plus, dans de nombreuses situations sociales, les liens sont formés de manière séquentielle. La séquentialité modifie légèrement le réseau d'équilibre par rapport au modèle de Bala et Goyal (2000a). En effet, le réseau d'équilibre parfait en sous-jeu devient une CSS où le nœud central est le dernier joueur du processus séquentiel. L'hétérogénéité des individus est introduite grâce à la présence d'un *individu spécial* qui a soit une valeur plus forte que

les autres individus (être lié à ce joueur rapporte plus de bénéfices), soit un statut différent. Théoriquement, l'hétérogénéité n'a aucune incidence théoriquement sur le réseau d'équilibre, car être lié directement ou indirectement (via d'autres individus) à l'individu spécial génère le même bénéfice.

Les résultats de l'expérience montrent que la séquentialité permet bien de faciliter la coordination des individus sur des réseaux efficaces et stables et ce tout au long de l'expérience. Cependant, les réseaux qui émergent sont relativement symétriques car les individus ont tendance à créer chacun un lien et par conséquent à partager les coûts de formation de réseaux. On retrouve l'aversion à l'inégalité observée dans de nombreuses expériences de formation de réseaux. L'hétérogénéité des individus a un effet sur la formation de réseaux, contrairement à ce que prédit la théorie, mais uniquement lorsque l'individu spécial a une valeur monétaire supérieure aux autres. Dans ce cas, l'individu spécial est plus populaire que les autres individus, même si être indirectement connecté à lui, suffit à bénéficier de sa forte valeur. Il polarise les liens sur sa personne, car les individus préfèrent assurer une connexion avec ce joueur tôt dans le jeu et qu'il agit comme un outil de coordination pour créer des réseaux stables et égaux. Par conséquent, les réseaux formés sont plus asymétriques que dans le cas homogène ou lorsque l'individu spécial a seulement un statut différent des autres individus. Pour résumer, la contribution de ce papier à la littérature existante est double. Nous étudions la formation de réseaux avec un processus séquentiel, ce qui rend la coordination sur des réseaux efficaces et stables plus aisée et nous introduisons de l'hétérogénéité pour comprendre pourquoi les réseaux formés peuvent être asymétriques.

Après avoir étudié la formation de réseaux centralisée et décentralisée, nous nous intéressons maintenant à l'impact du réseau sur les comportements individuels et les résultats économiques agrégés. En effet, nos comportements dépendent de notre environnement social et du fait que nous formons nous-mêmes nos réseaux sociaux.

0.4 Homophilie et effets de pairs dans les réseaux.

Faire partie d'un réseau donne de nouvelles opportunités, influence les décisions individuelles ou encore change les opinions politiques. C'est pourquoi les comportements économiques doivent être analysés dans un contexte social. Jackson et Zenou (2017) expliquent dans leur

revue de littérature comment certaines caractéristiques du réseau (homophilie, degré, centralité, etc.) impactent les comportements économiques. Nous allons donner quelques exemples pour illustrer l'impact des réseaux sur les décisions individuelles et les résultats agrégés.

Opportunités. Le sociologue Granovetter a étudié l'influence du réseau sur les opportunités de travail (Granovetter, 1995). Dans la plupart des modèles, un lien est une variable binaire : le lien existe ou n'existe pas. Granovetter permet aux liens de ne pas être seulement binaire. Il différencie les liens forts, qui sont des relations fortes, avec beaucoup d'interactions, et les liens faibles, qui sont des relations plus éloignées et moins fréquentes. Son modèle ainsi que ses expériences de terrain montrent qu'il est plus facile de trouver un emploi via des liens faibles, car ils permettent d'accéder à un réseau qui est moins familier. Les liens faibles ouvrent donc plus de portes.

Effets de pairs. La plupart des décisions individuelles ne sont pas prises de manière isolée, mais dans un cadre collectif. Mais même lorsqu'une décision paraît personnelle, l'environnement social et en particulier les personnes qui nous entourent exercent une influence sur nos choix et modifient notre perception des normes sociales. Les décisions et les caractéristiques de nos pairs, c'est-à-dire les membres de notre réseau (famille, amis, collègues, co-auteurs, etc.) influencent nos propres décisions. C'est ce qu'on appelle des *effets de pairs*. Manski (1993) met en avant deux types d'effets de pairs : les effets de pairs endogènes et les effets de pairs exogènes (ou contextuels). Les premiers représentent les effets des comportements de nos pairs sur nos propres comportements. Par exemple, si un étudiant a des amis qui sont de bons élèves, il va avoir tendance à travailler plus et donc à avoir de meilleures performances à l'école. Les effets de pairs exogènes représentent l'effet des caractéristiques de nos pairs (leur âge, leur salaire, etc.) sur nos propres comportements. Par exemple, la réussite scolaire d'un étudiant peut dépendre des caractéristiques exogènes de ses amis comme leur âge, leur genre ou leur niveau de vie. Ce phénomène peut être accru par la présence d'homophilie. Certains individus vont avoir des caractéristiques individuelles qui favorisent leur réussite scolaire par exemple. Ils vont être tentés de créer des liens avec des individus qui leur ressemblent (les filles ont plus d'amies que d'amis par exemple) et qui sont eux-mêmes plus enclin à être de bons élèves.

Influence sur les opinions personnelles. Aujourd'hui, les informations relayées par les réseaux sociaux sont la première source d'information pour 40% des personnes qui ont entre

18 et 24 ans.¹¹ Ce fait est d'une importance cruciale pour les élections présidentielles par exemple. Les partis politiques les plus ancrés sur la toile vont parvenir à diffuser leurs idées plus facilement auprès des jeunes. Le potentiel problème de cette diffusion d'information spécifique sur les réseaux sociaux est que cela enferme les individus d'un même réseau dans une bulle où la seule information qui leur parvient est l'information de leurs amis. Cela peut avoir comme conséquence de créer des communautés et de radicaliser les opinions. Là encore, ce phénomène est amplifié par l'homophilie qui crée de la ségrégation. Des individus qui ont les mêmes caractéristiques, les mêmes préférences et les mêmes opinions vont être connectés avec une plus grande probabilité et l'information qu'ils se transmettent ne fait que confirmer les informations qu'ils ont déjà. Cela a tendance à ralentir l'apprentissage et la diffusion. Golub et Jackson (2012) illustrent leur modèle sur la diffusion dans les réseaux avec l'exemple suivant. Aux Etats-Unis, les Républicains et les Démocrates ont des croyances très différentes sur la détention d'armes de destruction massive par l'Irak. Ces croyances sur un fait sont opposées et n'évoluent que très peu dans le temps. Il n'y a pas de convergence des croyances, car les informations échangées par les individus le sont entre des individus qui ont des croyances semblables.

Les réseaux et la manière dont nous formons nos réseaux (choix de pairs) vont influencer nos comportements individuels. Dans le Chapitre 3, nous étudions les effets de pairs en analysant les comportements individuels de malhonnêteté dans le laboratoire.

0.4.1 Les effets de pairs : théorie économique et modèles économétriques

Le modèle linéaire en moyenne de Manski (1993) est le modèle de référence pour étudier les effets de pairs. Les comportements individuels dépendent des caractéristiques individuelles mais également des caractéristiques moyennes des pairs et de leur comportement moyen. Beaucoup d'études ont utilisé et étendu ce modèle pour comprendre les effets de pairs. Dans ce chapitre, nous nous intéressons principalement aux effets de pairs endogènes (les effets des comportements des pairs). Deux types de mécanisme peuvent expliquer l'influence des pairs sur les décisions individuelles. D'une part, il peut y avoir une *complémentarité stratégique* entre les individus et leurs pairs (Scheinkman, 2008). La complémentarité stratégique reflète la synergie entre les comportements individuels, ce qui crée un multiplicateur social. Par

¹¹http://www.francetvinfo.fr/internet/reseaux-sociaux/reseaux-sociaux-et-presidentielle-cinq-bonnes-raisons-detre-prudent_2145674.html

exemple, si l'on étudie la productivité de travailleurs, la complémentarité stratégique reflète le fait que la productivité moyenne des collègues de travail impacte de manière positive la productivité individuelle. Comme la productivité de l'individu a augmenté, ses collègues vont augmenter à leur tour leur productivité, ce qui va accroître la productivité de l'individu, etc. D'autre part, les individus peuvent vouloir se conformer aux autres. La *conformité* reflète le fait que les individus veulent se conformer au niveau de productivité de leurs collègues. C'est dû principalement aux normes sociales générées par le groupe. Ces deux mécanismes sont difficiles à distinguer (Boucher et Fortin, 2016).

Comme l'a montré Manski (1993), les effets de pairs peuvent être très difficiles à identifier dans les travaux empiriques. Une difficulté soulevée par Manski (1993) est que l'influence des individus s'exerce de manière simultanée entre eux. Cela crée un problème d'identification appelé problème de réflexion. Dans chaque groupe, chaque membre est influencé et peut influencer les membres de ce groupe. Les membres d'un groupe s'influencent donc mutuellement et simultanément.

Une autre difficulté pour identifier les effets de pairs est la présence de l'homophilie, i.e. les individus ayant des caractéristiques similaires choisissent de se lier entre eux et ont tendance à agir de la même manière.¹² Cependant, ce n'est pas dû à des effets de pairs mais à l'auto-sélection. Par exemple, le fait qu'un étudiant fume ou non va dépendre des amis qu'il va choisir et de l'influence de ses amis sur ses actions. Il est donc difficile de dissocier les effets de pairs purs de l'homophilie. L'effet de l'homophilie amplifie artificiellement les effets de pairs et biaise l'analyse. Prendre en compte ce problème d'endogénéité est donc primordial pour mesurer les effets de pairs. L'endogénéité du choix de pairs requiert des modèles et des techniques économétriques avancés pour identifier les véritables effets de pairs.

0.4.2 Malhonnêteté et effets de pairs dans le laboratoire

Il y a eu de nombreuses expériences en laboratoire pour étudier les effets de pairs. En effet, d'un point de vue méthodologique, le laboratoire offre de nombreux avantages. Dans le laboratoire, nous pouvons parfaitement identifier le groupe de référence d'un individu, c'est-à-dire les pairs d'un individu, alors qu'il est difficile d'en avoir une parfaite connaissance dans

¹²Voir la revue de littérature en sociologie de McPherson et al. (2001) qui décrit les différents types d'homophilie (genre, âge, religion, etc.).

un cadre purement empirique. Afin d'éviter les problèmes d'auto-sélection et de potentielle homophilie dont nous avons parlé plus haut, le laboratoire nous permet de former les réseaux de manière exogène et parfaitement aléatoire.

Dans le troisième chapitre, nous nous focalisons sur les effets de pairs sur la malhonnêteté. Il existe en effet de nombreuses situations où les actes ou décisions malhonnêtes sont influencés par les autres. Par exemple, des comportements non-éthiques peuvent se diffuser dans une compagnie (Cohn et al., 2014), la criminalité d'un individu dépend du niveau de criminalité de ses pairs (Glaeser et al., 1996) et la décision de tricher à un examen dépend de la décision des autres candidats de tricher ou non (Carrell et al., 2008).

Dans l'expérience de Gino et al. (2009), les individus doivent réaliser une tâche et peuvent mentir pour accroître leur performance et donc leurs gains. Les individus ont tendance à tricher un peu pour augmenter légèrement leurs gains. La présence de complices qui évoquent clairement la possibilité de tricher accroît encore la décision de mentir de l'individu. Un individu peut se comporter de manière malhonnête parce qu'il a fait l'expérience de cette malhonnêteté ou parce qu'il a observé de la malhonnêteté (influence par un tiers). Par exemple, dans l'expérience de Falk et Fischbacher (2002), des groupes de quatre sont formés et les individus peuvent gagner des points lors d'une tâche et par la suite voler les points des membres de leur groupe. Les individus ont tendance à plus voler lorsqu'ils se sont eux-mêmes fait voler des points. Agir de manière malhonnête est conditionnel à la malhonnêteté des autres. Observer des actes malhonnêtes (influence par un tiers) peut également influencer les actes d'un individu. Robert et Arnab (2013) ont utilisé le "deception game" de Gneezy (2005) pour étudier les effets de pairs sur la malhonnêteté. Dans ce jeu, l'Envoyeur possède une information privée sur le profit de deux options. Le Receveur doit choisir une de ces deux options après avoir reçu le message de l'Envoyeur. Dans ce message, l'Envoyeur conseille l'option qui rapporterait un profit plus élevé au Receveur. Bien sûr, l'Envoyeur peut mentir en conseillant l'option qui favorise son propre profit. Robert et Arnab (2013) étudient la manière dont un message envoyé aux joueurs avec une information signalant la malhonnêteté de participants à de précédentes sessions va influencer leur décision de mentir. Leurs résultats montrent que la malhonnêteté augmente lorsque les individus observent des comportements malhonnêtes. Diekmann et al. (2011) et Rauhut (2013) appliquent le même principe avec le jeu du dé. Les joueurs lancent un dé et sont rémunérés en fonction du nombre qu'ils reportent.

Ils le lancent d'abord seuls puis observent une information sur la distribution des nombres reportés par d'autres joueurs et relancent le dé. Après avoir observé cette distribution où il est clair que des joueurs ont menti, les individus mentent plus. Fortin et al. (2007) et Lefebvre et al. (2015) étudient les effets de pairs sur les décisions d'évasion fiscale. Fortin et al. (2007) étudient comment l'observation d'évasion fiscale par d'autres joueurs impacte les décisions d'évasion fiscale de l'individu. Ils ne trouvent pas d'effets de conformité significatifs (effets de pairs endogènes après avoir contrôlé la présence d'effets de pairs exogènes). Lefebvre et al. (2015) étudient l'influence de deux types d'information : une information sur le plus haut taux d'évasion fiscale lors de sessions précédentes (message révélant la malhonnêteté d'autres joueurs) et une information sur le plus bas taux d'évasion fiscale (message sur l'honnêteté d'autres joueurs). Leur conclusion est que les effets de pairs peuvent être asymétriques. En effet, les individus réagissent plus lorsqu'ils sont confrontés au mauvais exemple que lorsqu'ils sont confrontés au bon exemple. Deux mécanismes peuvent expliquer cela. Apprendre que les autres individus mentent induit que mentir devient une option potentielle ; ils deviennent conscients de cette possibilité. Deuxièmement, si les autres mentent, cela change la perception des normes sociales au sein du groupe (Fosgaard et al. (2013) et Gino et al. (2009)).

0.4.3 Chapitre 3 : Effets de pairs, homophilie et malhonnêteté

Notre environnement social et en particulier les membres de nos réseaux ont un impact sur nos décisions individuelles. Dans ce chapitre, nous nous intéressons aux effets de pairs endogènes, c'est-à-dire à l'influence des actions de nos pairs sur nos propres actions, et en particulier sur la prise de décisions malhonnêtes. La décision de mentir d'un individu dépend de ses caractéristiques individuelles, du coût moral qu'il ressent à mentir mais également de l'influence de ses pairs. L'originalité de ce chapitre est que l'on étudie les effets de pairs dans le cadre de la formation de réseaux.

De nombreux travaux empiriques ont été menés afin de comprendre comment la criminalité (Calvo-Armengol et Zenou, 2004) ou la triche lors d'examen (Carrell et al., 2008) peuvent se propager. L'influence de personnes malhonnêtes sur les autres est loin d'être négligeable. Cependant, les effets de pairs "purs" de la malhonnêteté sont difficiles à identifier dans les travaux empiriques à cause de l'auto-sélection.¹³ L'une des difficultés classiques à l'identification des effets de pairs est la présence d'homophilie : les individus avec des car-

¹³Pas seulement pour la criminalité, mais aussi pour l'obésité par exemple (Fortin et Yazbeck, 2015).

actéristiques similaires ont tendance à s'associer et à se comporter de la même manière. Cependant, ce n'est pas dû aux effets de pairs, mais à leurs caractéristiques similaires. Économétriquement, cela crée un problème d'endogénéité comme certaines variables (parfois non-observées) peuvent impacter le choix de pairs ainsi que le comportement de l'individu. La base de données Add Health a été beaucoup utilisée pour étudier les liens d'amitié entre étudiants ainsi que différents types de comportements comme le fait de fumer. Les auteurs ont développé des techniques économétriques très avancées pour résoudre ce problème d'endogénéité (voir par exemple Goldsmith-Pinkham et Imbens (2013) ou Hsieh et Lee (2016)). De plus, les individus peuvent créer des liens avec certains pairs pour optimiser leur fonction d'utilité (voir par exemple Hsieh et Lee (2017) où les étudiants choisissent de se lier à des étudiants qui ont de bonnes notes pour accroître leur chance de succès académique). De manière générale, dans ces papiers, les résultats montrent que les effets de l'endogénéité de formation de réseau sont faibles. Cependant, les résultats varient selon les techniques et les modèles utilisés et sont donc difficiles à comparer.

Nous proposons une méthode expérimentale pour mesurer l'effet de l'endogénéité du réseau sur les décisions malhonnêtes. Nous créons deux environnements dans le laboratoire : un où les pairs sont imposés et un où les individus peuvent choisir leurs pairs. Plus précisément, notre design est le suivant. Les individus doivent effectuer une tâche à effort réel simple ; ils doivent compter le nombre de 0 dans des tableaux contenant des 0 et des 1. Les individus ont le choix entre deux versions d'évaluation de la performance : la version Automatique et la version Manuelle. Dans la version Automatique, leurs performances sont calculées automatiquement par le programme informatique. Dans la version Manuelle, les individus doivent eux-mêmes calculer et reporter leur performance. Ils ont donc la possibilité de reporter une performance supérieure afin d'augmenter leurs gains. L'expérience se déroule en deux parties. Au début de la première partie, les individus doivent choisir l'une des versions. Puis, ils effectuent la tâche pendant cinq périodes. Ensuite, en début de deuxième partie, les pairs sont assignés soit de manière complètement aléatoire et exogène (traitement EXO) soit les individus choisissent eux-mêmes leurs pairs (traitement ENDO). Plus précisément, dans chaque traitement, nous leur présentons deux paires de joueurs d'une session précédente (qui ont joué dans le traitement Baseline sans aucune interaction sociale¹⁴) : une paire de joueurs

¹⁴Ce traitement de contrôle est exactement le même que les deux autres traitements, sauf qu'il n'y a aucune interaction sociale dans les deux parties. Ce traitement a été effectué avant les deux autres pour récolter des données et éviter le problème de réflexion.

qui avaient choisi la version Automatique et une paire de joueurs qui avaient choisi la version Manuelle. Dans le traitement EXO, une paire est assignée au joueur avec une probabilité de 50%, alors que dans le traitement ENDO, le joueur choisit la paire qu'il préfère. Dans la deuxième partie, les individus refont la même tâche durant cinq périodes mais observent à chaque période la performance moyenne de leurs pairs, i.e. la performance réelle de leurs pairs si ceux-ci avaient choisi la version Automatique ou la performance reportée (et donc potentiellement mentie) de leurs pairs si ceux-ci avaient choisi la version Manuelle.

Nos résultats montrent que les individus ayant des pairs de type Manuel mentent significativement plus mais seulement lorsqu'ils ont eux-mêmes choisi leurs pairs (traitement ENDO). En effet, les effets de pairs sont non significatifs dans le traitement EXO. L'effet significatif des pairs de type Manuel est amplifié par la présence d'homophilie. En effet, les individus qui choisissent la version Manuelle ont tendance à choisir des pairs de type Manuel qui sont potentiellement des menteurs. De plus, ces sujets mentaient déjà plus que ceux qui choisissent des pairs de type Automatique en partie 1 lorsqu'il n'y a pas d'interaction sociale.

Bibliography

- Acemoglu, D., A. Malekian, et A. Ozdaglar (2016). Network security and contagion. *Journal of Economic Theory* 166, 536–585.
- Bala, V. et S. Goyal (2000a). A noncooperative model of network formation. *Econometrica* 68(5), 1181–1229.
- Bala, V. et S. Goyal (2000b). A strategic analysis of network reliability. *Review of Economic Design* 5(3), 205–228.
- Ballester, C., A. Calvó-Armengol, et Y. Zenou (2006). Who's who in networks. wanted: The key player. *Econometrica* 74(5), 1403–1417.
- Bernasconi, M. et M. Galizzi (2005). Coordination in networks formation: Experimental evidence on learning and salience.
- Berninghaus, S. K., K.-M. Ehrhart, M. Ott, et B. Vogt (2007). Evolution of networks—an experimental analysis. *Journal of Evolutionary Economics* 17(3), 317–347.

- Berninghaus, S. K., M. Ott, et B. Vogt (2004). On networks and stars: Recent results in network experiments.
- Boucher, V. et B. Fortin (2016). Some challenges in the empirics of the effects of networks. *Oxford Handbook on the Economics of Networks*, Oxford: Oxford University Press.
- Bramoullé, Y. et B. W. Rogers (2009). Diversity and popularity in social networks.
- Burger, M. J. et V. Buskens (2009). Social context and network formation: An experimental study. *Social Networks* 31(1), 63–75.
- Caldara, M. et M. McBride (2014). An experimental study of network formation with limited observation. Technical report, University of California-Irvine, Department of Economics.
- Callander, S. et C. R. Plott (2005). Principles of network development and evolution: An experimental study. *Journal of Public Economics* 89(8), 1469–1495.
- Calvó-Armengol, A. et Y. Zenou (2004). Social networks and crime decisions: The role of social structure in facilitating delinquent behavior. *International Economic Review* 45(3), 939–958.
- Carrell, S. E., F. V. Malmstrom, et J. E. West (2008). Peer effects in academic cheating. *Journal of human resources* 43(1), 173–207.
- Carrillo, J. D. et A. Gaduh (2012). The strategic formation of networks: Experimental evidence.
- Cerdeiro, D., M. Dziubinski, et S. Goyal (2015). Contagion risk and network design.
- Cohn, A., E. Fehr, et M. A. Maréchal (2014). Business culture and dishonesty in the banking industry. *Nature* 516(7529), 86–89.
- Conte, A., D. T. Di Cagno, et E. Sciubba (2015). Behavioral patterns in social networks. *Economic Inquiry* 53(2), 1331–1349.
- Currarini, S., M. O. Jackson, et P. Pin (2009). An economic model of friendship: Homophily, minorities, and segregation. *Econometrica* 77(4), 1003–1045.
- Deck, C. et C. Johnson (2004). Link bidding in laboratory networks. *Review of Economic Design* 8(4), 359–372.

- Diekmann, A., W. Przepiorka, H. Rauhut, et al. (2011). Lifting the veil of ignorance: An experiment on the contagiousness of norm violations. *Nuffield Centre for Experimental Social Sciences Discussion Paper Series 4*.
- Dodds, P. S., R. Muhamad, et D. J. Watts (2003). An experimental study of search in global social networks. *Science 301*(5634), 827–829.
- Dziubinski, M. et S. Goyal (2013). Network design and defence. *Games and Economic Behavior 79*, 30–43.
- Euler, L. (1736). Solutio problematis ad geometriam situs. *Commentarii academiae scientiarum imperialis Petropolitanae*.
- Falk, A. et U. Fischbacher (2002). "crime" in the lab-detecting social interaction. *European Economic Review 46*(4), 859–869.
- Falk, A. et M. Kosfeld (2012). It's all about connections: Evidence on network formation. *Review of Network Economics 11*(3).
- Fortin, B., G. Lacroix, et M.-C. Villeval (2007). Tax evasion and social interactions. *Journal of Public Economics 91*(11), 2089–2112.
- Fortin, B. et M. Yazbeck (2015). Peer effects, fast food consumption and adolescent weight gain. *Journal of health economics 42*, 125–138.
- Fosgaard, T. R., L. G. Hansen, et M. Piovesan (2013). Separating will from grace: An experiment on conformity and awareness in cheating. *Journal of Economic Behavior & Organization 93*, 279–284.
- Galeotti, A. et S. Goyal (2010). The law of the few. *The American Economic Review*, 1468–1492.
- Gino, F., S. Ayal, et D. Ariely (2009). Contagion and differentiation in unethical behavior: The effect of one bad apple on the barrel. *Psychological science 20*(3), 393–398.
- Glaeser, E. L., B. Sacerdote, et J. A. Scheinkman (1996). Crime and social interactions. *The Quarterly Journal of Economics 111*(2), 507–548.
- Gneezy, U. (2005). Deception: The role of consequences. *The American Economic Review 95*(1), 384–394.

- Goeree, J. K., A. Riedl, et A. Ule (2009). In search of stars: Network formation among heterogeneous agents. *Games and Economic Behavior* 67(2), 445–466.
- Goldsmith-Pinkham, P. et G. W. Imbens (2013). Social networks and the identification of peer effects. *Journal of Business & Economic Statistics* 31(3), 253–264.
- Golub, B. et M. O. Jackson (2012). How homophily affects the speed of learning and best-response dynamics. *The Quarterly Journal of Economics* 127(3), 1287–1338.
- Goyal, S. et A. Vigier (2014). Attack, defence, and contagion in networks. *The Review of Economic Studies* 81(4), 1518–1542.
- Granovetter, M. (1995). *Getting a job: A study of contacts and careers*. University of Chicago Press.
- Hoyer, B. et K. D. Jaegher (2016). Strategic network disruption and defense. *Journal of Public Economic Theory* 18(5), 802–830.
- Hsieh, C.-S. et L. F. Lee (2016). A social interactions model with endogenous friendship formation and selectivity. *Journal of Applied Econometrics* 31(2), 301–319.
- Hsieh, C.-S. et L.-F. Lee (2017). Specification and estimation of network formation and network interaction models with the exponential probability distribution.
- Jackson, M. O. et A. Watts (2002). The evolution of social and economic networks. *Journal of Economic Theory* 106(2), 265–295.
- Jackson, M. O. et A. Wolinsky (1996). A strategic model of social and economic networks. *Journal of economic theory* 71(1), 44–74.
- Jackson, Matthew O, R. B. W. et Y. Zenou (2017). The economic consequences of social network structure. *Journal of Economic Literature* 55, 49–95.
- Johnson, C. et R. P. Gilles (2003). Spatial social networks. In *Networks and Groups*, pp. 51–77. Springer.
- Kirchsteiger, G., M. Mantovani, A. Mauleon, et V. Vannetelbosch (2016). Limited farsightedness in network formation. *Journal of Economic Behavior & Organization* 128, 97–120.
- Kosfeld, M. (2004). Economic networks in the laboratory: A survey. *Review of Network Economics* 3(1).

- Lefebvre, M., P. Pestieau, A. Riedl, et M. C. Villeval (2015). Tax evasion and social information: an experiment in Belgium, France, and the Netherlands. *International Tax and Public Finance* 22(3), 401–425.
- Manski, C. F. (1993). Identification of endogenous social effects: The reflection problem. *The review of economic studies* 60(3), 531–542.
- McPherson, M., L. Smith-Lovin, et J. M. Cook (2001). Birds of a feather: Homophily in social networks. *Annual review of sociology* 27(1), 415–444.
- Milgram, S. (1967). Six degrees of separation. *Psychology Today* 2, 60–64.
- Newman, M. E. (2004). Who is the best connected scientist? a study of scientific coauthorship networks. In *Complex networks*, pp. 337–370. Springer.
- Pantz, K. (2006). *The strategic formation of social networks: experimental evidence*.
- Rauhut, H. (2013). Beliefs about lying and spreading of dishonesty: Undetected lies and their constructive and destructive social dynamics in dice experiments. *PloS one* 8(11).
- Robert, I. et M. Arnab (2013). Is dishonesty contagious? *Economic Inquiry* 51(1), 722–734.
- Rong, R. et D. Houser (2015). Growing stars: A laboratory analysis of network formation. *Journal of Economic Behavior & Organization* 117, 380–394.
- Scheinkman, J. A. (2008). Social interactions. *The new palgrave dictionary of economics* 2.
- Smith, K. P. et N. A. Christakis (2008). Social networks and health. *Annual Review of Sociology* 34, 405–429.
- Van Dolder, D. et V. Buskens (2009). Social motives in network formation: An experiment. In *Game Theory for Networks, 2009. GameNets' 09. International Conference on*, pp. 593–602. IEEE.
- Van Leeuwen, B., T. Offerman, et A. J. Schram (2015). Competition for status creates superstars: An experiment on public good provision and network formation.
- Vanin, P. (2002). Network formation in the lab: a pilot experiment.

Contents

Remerciements	v
Résumé de la thèse	i
0.1 Motivation de la thèse	i
0.2 Formation centralisée de réseaux	iii
0.3 Formation décentralisée de réseaux	viii
0.4 Homophilie et effets de pairs dans les réseaux.	xx
Bibliography	xxvii
General introduction	1
0.1 Motivation of the dissertation	1
0.2 Centralized formation of networks	3
0.3 Decentralized formation of networks	8
0.4 Homophily and peer effects in networks	19
Bibliography	25
1 Optimal Design and Defense of Networks Under Link Attacks	33
1.1 Introduction	35
1.2 Model setup	40
1.3 Model Analysis	45
1.4 Limited number of protected links and imperfectly protected links	53
1.5 Conclusion	61
1.6 Appendix	63
Bibliography	82
2 Heterogeneity and Sequentiality in Network Formation Games	85
2.1 Introduction	86

2.2	Related literature	89
2.3	Theoretical model	92
2.4	Experimental design	101
2.5	Experimental results	107
2.6	Conclusion and discussion	117
2.7	Appendix	120
	Bibliography	149
3	Homophily, Peer Effects and Dishonesty	153
3.1	Introduction	154
3.2	Related literature	157
3.3	Theoretical model and hypotheses	161
3.4	Experimental design and procedures	169
3.5	Results	173
3.6	Discussion and conclusion	184
3.7	Appendix	185
	Bibliography	201
	General conclusion	207
	Bibliography	210
	Conclusion générale	211
	Bibliography	214

List of Figures

1	Degrés de séparation des utilisateurs de Facebook	ii
2	La ville de Königsberg et ses sept ponts.	iv
3	Distribution des degrés entrants des étudiants.	ix
4	Modèle de Jackson et Wolinsky : réseaux efficaces. Les liens non-orientés sont représentés par des flèches avec une pointe à chaque extrémité.	xi
5	Modèle de Bala et Goyal : équilibres de Nash stricts et réseaux efficaces. Les liens orientés sont représentés par des flèches partant de l’initiateur du lien et pointant le partenaire visé.	xii
6	La Periphery-Sponsored Star (PSS).	xvi
1	Degrees of separation of Facebook users	2
2	The city of Königsberg and its seven bridges.	4
3	Distribution of in-degrees of students.	9
4	Jackson and Wolinsky’s model: efficient networks. Undirected links are represented by arrows pointing at both nodes.	10
5	Bala and Goyal’s model: strict Nash equilibria and efficient networks. Directed links are represented by arrows from the initiator of the link and pointing towards the targeted partner.	12
6	The Periphery-Sponsored Star (PSS).	16
1.1	Examples of (κ, n) -Harary-networks.	44
1.2	Subnetworks associated with Example 1: the solution network is (N, E_P, E_{NP}) with $E_{NP} = E_{NP}(g') \cup E_{NP}(g'')$	47
1.3	Subnetworks associated with Example 2: the solution is (N, E_P, E_{NP}) with $E_{NP}(g) = E'_{NP} \cup E''_{NP}$	48
1.4	Intuition of Proposition 2 when $n(k + 1) \bmod 2 = 0$	52

1.5	Intuition of Proposition 2 when $n(k + 1) \bmod 2 = 1$ and $k < n - 3$	53
1.6	Example with $n = 31$, $k = 27$. The optimal strategy for D depends on the value of c_P/c_L	55
1.7	Networks of Example 4. Thick lines represent protected links and dashed lines represent links that are targeted by A	57
1.8	Networks of Example 5: $n = 5$, $k = 2$. Optimal strategies for D for different numbers of protected links and when A attacks (up to) 2 links. The captions of the figures give the Designer's expected benefit.	59
1.9	Illustration of the E_P -contraction: the links 12 and 34 are contracted.	64
2.1	Examples of networks, labels represent the rule of order ρ	96
2.2	Examples of networks with their centrality measures, labels represent the rule of order ρ	98
2.3	Average efficiency and fairness levels of networks across periods	109
2.4	In-degree centrality of networks	112
2.5	In-degree of normal and special individuals	114
2.6	Decisions to form a link over order in the sequential process for normal and special individuals	115
2.7	Screenshot of treatments ENDO and EXO	121
2.8	Screenshot of treatment NM	121
2.9	Percentage of times where the individual already had a link, over order in the sequential process	123
2.10	Distribution of in-degrees of normal and special individuals in ENDO and EXO	123
3.1	Choice of peers, by type of subjects and according to lying behavior in part 1	181
3.2	Mean difference in the size of lies between part 1 and part 2 conditional on the choice of peers, by treatment	183
3.7.1	Example of matrices with 25 figures.	185
3.7.2	Example of matrices with 50 figures.	186
3.7.3	Example of a recap chart	186
3.7.4	Example of a matrix with 10 columns and 5 rows. The correct answer is 23. .	191
3.7.5	Example of a matrix with 5 columns and 5 rows. The correct answer is 18. .	191

List of Tables

2.1	Summary statistics at the network level	107
2.2	Marginal effects, probit, clustered standard errors at the group level	122
3.1	Timeline of each treatment	172
3.2	Summary statistics: Performances and lies in part 1, total treatments	174
3.3	Summary statistics: Evolution of performance in the Baseline treatment	175
3.4	Summary statistics: Reported performance and size of lies in part 2 of subjects who chose the Manual mode depending on their peers' mode, by treatment	177
3.5	Size of lies in part 2, Heckman selection models	179
3.7.1	Summary of the sessions	186
3.7.2	Summary statistics: Socio-demographic individual characteristics	187
3.7.3	Actual performance in part 1, marginal effects	188
3.7.4	Summary statistics: Lying behavior of Manual subjects in the ENDO treatment	189
3.7.5	Summary statistics: Lying behavior of Manual subjects in the EXO treatment	189

General introduction

0.1 Motivation of the dissertation

Networks are ubiquitous: friendship networks, transportation networks, neuronal networks, etc. The notion of networks encompasses several dimensions. The formalization of networks can be done by means of graph theory tools. Networks are composed of nodes and links. The nodes can represent individuals, cities or neurons, and links can represent friendships, roads or synapses. Links ensure the direct connection of nodes, but they also allow to create *paths* between nodes. Nodes may be directly connected or indirectly connected by a path of links via other nodes. For example, individuals who are geographically distant can know each other thanks to mutual friends. Milgram (1967) studied the level of connectivity of individuals by means of a field experiment. Individuals from different places in the United States had to send a letter to a stockbroker living on the East coast. If the individuals did not know directly this stockbroker, they had to send the letter to acquaintances who were likely to know him. Very few letters reached their destination, but the letters which successfully reached the stockbroker arrived very rapidly. Milgram (1967) concluded from his experiment that on average, every person living in the United States is at a distance of six people with every other American, knowing that a distance of one means that the individuals directly know each other. This is the “six degrees of separation” concept. This experiment has been successfully replicated at the international level by using e-mails (Dodds et al., 2003). This inter-connectivity has been studied in some specific networks, like the network of movie actors, to calculate the distance between any two actors. An actor is at distance one of another actor if they played together, at distance two if they played with a common actor, etc.¹ The inter-connectivity in the academic world has been measured thanks to the Erdős number which is the distance between a scientist and the mathematician Erdős, knowing

¹The website <http://oracleofbacon.org/> allows to calculate the distance between the American actor Kevin Bacon and any other actor.

that distance one represents a co-authorship with Erdős.² More recently, the social network Facebook has calculated the degree of separation of its users in order to update this number with the advent of social networks on the Internet. Each Facebook user (they are 1.6 billion) is connected to any other user with an average degree of separation equal to 3.57 (see Figure 1). The more users there are, the smaller is the distance between users. The development of social networks makes our world more connected and smaller every day.

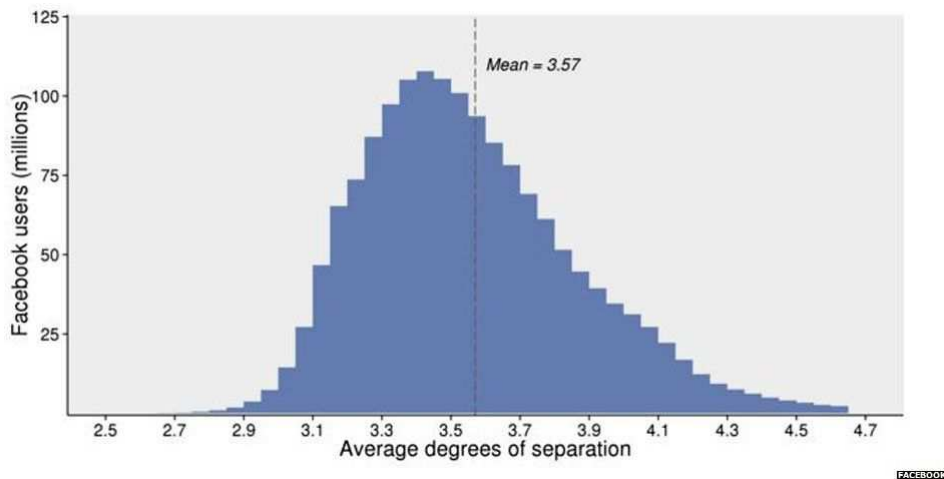

Source: <http://research.fb.com/three-and-a-half-degrees-of-separation/>

Figure 1: Degrees of separation of Facebook users

Social networks are exponentially growing on the Internet, but other networks are also rapidly developing in order to improve communication, transportation and exchanges. Transportation networks are getting denser to absorb more and more people and merchandise. We communicate daily throughout the world thanks to Internet and to telecommunication networks, which allows firms to expand internationally. We exchange physical and virtual resources more and more quickly and in larger quantities.

In a world where networks are becoming a dominant form of organization, the structure of networks and the position of individuals within these networks affect individual behavior and aggregated economic outcomes. In view of our increasing inter-connectivity and our need to communicate and to exchange, this dissertation aims at contributing to the analysis of the formation of networks and their impact on economic decisions. Networks can be formed by a

²The website <http://www.ams.org/mathscinet/collaborationDistance.html> allows scientists to calculate their Erdős number.

central planner who designs the structure of the network or by individuals themselves. This dissertation studies both cases. More precisely, three issues are studied.

- Chapter 1 theoretically studies the optimal formation and protection of networks by a central planner, knowing that an external agent can destroy k links. How can the central planner optimize and secure the network?
- Chapter 2 explores the decentralized formation of networks in the laboratory by analyzing individual decisions of link formation when agents are heterogeneous and that the linking formation process is sequential. Which structure emerges from the individual linking decisions?
- Chapter 3 studies the impact of the endogenous formation of networks on the measurement of peer effects, with an application to the study of dishonest decisions. To which extent are peer effects influenced by the endogeneity of the choice of peers?

The next three sections give an insight of each of these issues and present the three chapters of this dissertation.

0.2 Centralized formation of networks

One of the oldest problems of graph theory consists in finding the optimal walk within a city; this is the problem of the seven bridges of Königsberg solved by Euler (1736). The city of Königsberg, located in Prussia at the time, is organized in four areas: two islands (A and D on Figure 2) and two mainland portions (B and C on Figure 2) are linked via seven bridges in total. This represents a network of 4 nodes and 7 links. For example, node A and node B are linked by two links.

The question asked by the inhabitants of Königsberg was to know if there exists or not a walk to visit the four areas of the city by crossing each of the bridges once and only once. Euler demonstrated that this walk did not exist. In order to be possible, each area should be accessible by an even number of bridges. This problem has been at the beginning of graph theory.

Graph theory is topical due to our dependence on communication networks or electricity distribution networks, for example. Building efficient and resistant networks is a crucial

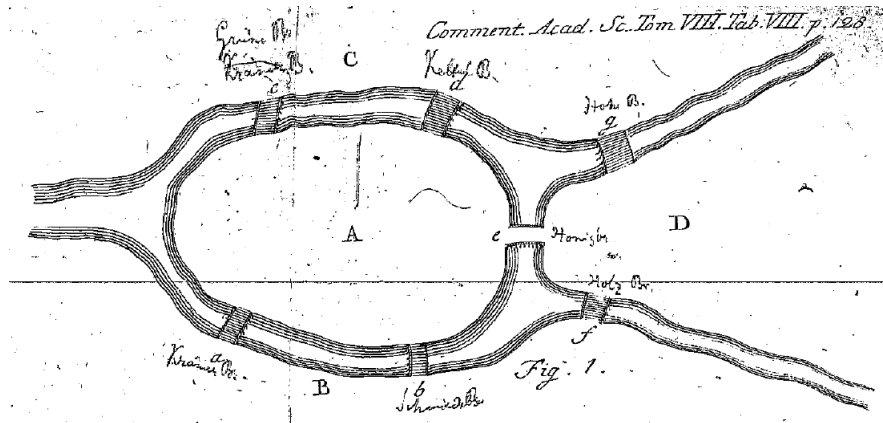

Figure 2: The city of Königsberg and its seven bridges.

task. Communication networks must be designed in an optimal way in order to limit their costs. Thus, transportation networks, telecommunication networks or computer networks are centrally formed by a strategic entity. SNCF Réseau for example aims at making this public utility “more efficient for all the users and less costly for the community”³. Enedis (previously Electricité Réseau Distribution France, ERDF) manages the public electricity distribution network so that all the French population have access to electricity.⁴ Computer networks allow firms to exchange information and resources. They must be connected in such a way as to optimize exchanges and limit the costs of the firm.

Nevertheless, these networks may be damaged. Indeed, the railroad network can be disrupted if some railways are not functioning. The electricity distribution network can be partially destroyed by natural disasters or technical problems. Finally, computer networks can be targeted by viruses. Consequently, these networks must be protected: either by creating more links between nodes, to create alternative paths if a part of the network is destroyed, or by protecting specifically some nodes or some links.

0.2.1 Centralized formation of networks, attacks and protection in game theory

Some networks are formed by a strategic entity in order to optimize their efficiency. This intelligent entity must optimize communication, production and diffusion within the network. One of the issues of these networks is a potential deterioration. Indeed, some links or some nodes may be damaged either because of a more or less random natural deterioration or

³<http://www.sncf-reseau.fr>

⁴<http://www.enedis.fr/>

because of a strategic attack of an external agent. To formalize the first situation, Bala and Goyal (2000b) have developed a strategic network formation model where links are imperfectly reliable.⁵ They may be inefficient with a certain probability. If the probability that a link is not functioning is too high relative to the link cost, it is optimal that every link is redundant such that there exists an alternative path if the link is not functioning. Networks may also be damaged by an intelligent unity which aims at destroying some parts of the network. In this literature, authors mainly focused on attack and protection of nodes. In the first Chapter of this dissertation, we extend this literature with a model of attack and protection of links where nodes are complementary and so, must all survive to the strategic attack.

In the theoretical literature, the formation and protection of networks attacked by a strategic unit are formalized with a two-player game with a designer (central planner) and an adversary. The designer forms and protects the network and the adversary can attack a certain number of nodes. The objective of the designer is to maintain the connection between a maximum number of nodes and the objective of the adversary is to disconnect the network by attacking specific nodes. In order to resist the adversary's attacks, one of the solutions is that the network contains enough links, such that the surviving nodes can maintain the communication between them after the attack of the adversary (Hoyer and Jaegher, 2016). The second solution for resisting node attacks is to protect some specific nodes of the network. The literature that studies attacks and protection of nodes highlights a type of networks relatively easy to protect at a minimum cost: the star networks, where each node has a unique link with the central node. Protecting the central node is enough to maintain a connected network (Dziubinski and Goyal, 2013).⁶ Indeed, only peripheral nodes can be attacked and destroyed. Consequently, the central node and some peripheral nodes will resist the attack.

These models have also been developed to study contagious attacks to design epidemics or diffusion of viruses for example. Indeed, the development of networks also increases the risks of contagion or the diffusion of viruses on computers. The recent example of the virus Petya

⁵In this model, links are formed by the nodes themselves.

⁶The star network, if it is not protected, resists well random attacks, but is very fragile if the attack is intelligent, because the destruction of the central node destroys the whole network. For example, Ethernet networks are often structured as star networks with the switch in the center and each computer is directly linked to the switch. It allows more flexibility in the management of the network. However, if the switch is not functioning, the whole network does not function anymore.

which infected thousands of computers and affected the functioning of many firms shows that digital networks are very difficult to protect.⁷ Goyal and Vigier (2014) extended the model of Dziubinski and Goyal (2013) by making the attack contagious. If a non-protected node is attacked, it will be destroyed and will contaminate all the nodes with which it is connected and that are not protected. These studies are crucial to understand the diffusion of contagious diseases and to prevent the contagion of other members of the society by providing vaccines to the people who are the most likely to be contaminated by the disease and who are the most likely to contaminate others. Acemoglu et al. (2016) designed a model with a contagious attack where the network formation is random and nodes are attacked with a certain probability. If they are not protected, they are infected as well as all the non-protected nodes that are linked to them. Cerdeiro et al. (2015) designed a three-stage game. The designer creates the network and nodes decide to protect themselves or not, at a cost. Finally, the adversary can attack a certain number of nodes. This article introduces an interesting issue: how can the strategic entity (central planner) encourage nodes to protect in an optimal way? From another angle, understanding these phenomena of contagion can help to dismantle criminal networks by targeting the key node of the network to destroy the whole network. The key node (or key player) of the network is defined by Ballester et al. (2006) as the node that is the most influential in the network and whose removal allows to reduce the aggregated level of criminality.

0.2.2 Chapter 1: Optimal formation and protection of networks under link attacks

The first chapter is theoretical and aims at studying the formation and protection of communication networks. The literature focuses on the protection and the attack of nodes in networks, yet many networks can be damaged because of a link attack. Many communication networks are crucial because their links allow to transfer information or goods. In this chapter, we show that the destruction of links will not have the same impact than the destruction of nodes on the optimal strategy of the central planner.

We study this problem thanks to a sequential two-player game designed by Dziubinski and Goyal (2013). The first player is the designer of the network. His role is to build a

⁷http://www.lemonde.fr/pixels/article/2017/06/28/comment-fonctionne-petya-le-virus-qui-a-touche-de-nombreuses-tres-grandes-entreprises_5152547_4408996.html

communication network that can resist the attacks of the second player, called the adversary. The designer can build two types of links: non-protected or protected links, more costly but indestructible. His objective is to maintain a connection between all the complementary nodes. The adversary can attack k links. His objective is to destroy the communication flow by disconnecting the network, i.e., by isolating at least a node from the rest of the network.

In order to build a network that resists the attacks of the adversary, the designer faces a trade-off between building more costly but indestructible links and less costly links but that can be destroyed. To build a network of n nodes resisting k attacks of links, there exist two polar solutions: building only protected links or only non-protected links. In the first case, $n - 1$ protected links are enough for the network to resist the attack because all the nodes are connected and remain connected after the attack. In the second case, each node requires $k + 1$ links in order not to be isolated from the others after the adversary's attack. Of course, there exist networks where both protected and non-protected links are built, that can resist the attack of the adversary. In other words, there is a trade-off between the number of protected links and non-protected links: adding one protected link allows to reduce the number of non-protected links necessary for the survival of the network. However, networks that use both types of links are on aggregate more costly than networks that use only protected links or only non-protected links. Our results show that the two polar solutions are the only Sub-game Perfect Equilibria.

We extend the model by limiting the available protection strategies of the designer in two different ways. First, we impose a limited number of protected links. In this case, strategies that combine protected and non-protected links can be optimal solutions. Second, we extend the model by making protected links imperfectly indestructible, i.e., there exists a positive probability that the protection does not resist the attack. We give the necessary conditions in which our results with perfectly protected links are preserved.

The contribution of this chapter to the existing literature is to study the attack and protection of links instead of the attack and protection of nodes. Indeed, the strategies of network formation and of optimal protection are not the same if the targets of the adversary are nodes or if they are links. In fact, the star structure is never optimal in our case. Moreover, nodes are complementary in our model while they are substitutable in the rest of

the literature. The designer must guarantee the communication between all the nodes in our model for the network to have a positive value. If the nodes were substitutable, a protected link between two nodes would be enough for the designer to protect efficiently the network, but this is not very realistic. For example, for telecommunication networks, the objective is not to maintain the communication between two nodes at minimum, but to guarantee the communication between all the nodes of the network. When the cost of link formation is too high, in models with protection of complementary nodes, one protection unit is enough to guarantee the survival of the network, while in our model $n - 1$ protections are necessary.

After studying the centralized formation of networks, the dissertation studies the decentralized formation of networks, i.e., the formation of links by the nodes.

0.3 Decentralized formation of networks

The formation of social networks depends on individual linking decisions. These decisions depend on sociological, psychological or economic features. Some reasons are purely rational, in the sense that the individuals aim at maximizing their utility. For example, a student may prefer to form links with students who are academically successful in order to take advantage of their knowledge and to improve his chances of success (Hsieh and Lee, 2017). Demographic criteria, like age or gender, are also important for the formation of links. We often observe in social networks the presence of *homophily*, which is a phenomenon whereby similar individuals tend to interact with each other. McPherson et al. (2001) studied different networks and show that individuals from a network often have similar characteristics. For example, Currarini et al. (2009) show that students from the same ethnic origin have a tendency to create links between them. These different determinants will impact the individual decisions of link formation, the position of nodes in the network and thus, the entire network structure.

Another important characteristic of networks is the distribution of *degrees* of nodes, i.e., the number of links of each node. The structure of networks, also called architecture, is often complex because individuals have different degrees. Some individuals are very connected and central in the network; they are called *hubs*. Conversely, other individuals are located at the periphery of the network and have a low degree. If we take the example of the friendship network(s) at school, Bramoullé and Rogers (2009) made an empirical study (based on the

Add Health database) where students cite five friends at maximum. The links received represent the number of times a student has been cited, which figures his level of popularity. Then, they created a graph representing the distribution of in-degree of students, i.e., the number of friendship links that each individual received. Figure 3 shows that many students have a low in-degree and that few students have a very large number of links and so, are very popular.

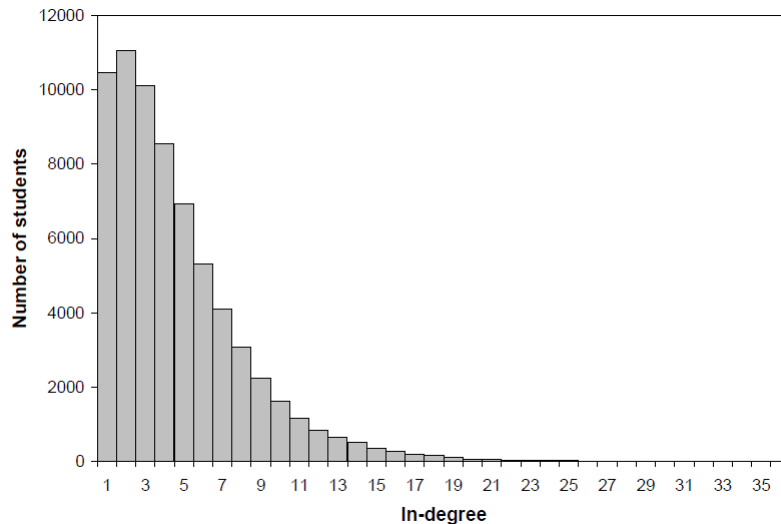

Figure 3: Distribution of in-degrees of students.

This kind of networks where few nodes are highly connected and many nodes have few connections are called *asymmetric networks*. In Chapter 2, we explore the determinants of the formation of links and the coordination of individuals on an asymmetric network structure.

0.3.1 The decentralized formation of networks in game theory

We start studying the decentralized formation of networks with a theoretical approach. In the theoretical literature, the decentralized formation of networks has been studied a lot at the beginning of the 2000s.

Two seminal articles are at the origin of this literature: Jackson and Wolinsky (1996) and Bala and Goyal (2000a). The former is a network formation model where links are undirected. A link is *undirected* or *bilateral* if both agents maintain a link together with mutual consent (e.g., an agreement between firms or a family relationship). A link is created if both agents agree to form it and the linking cost is equally shared. Jackson and Wolinsky

(1996) distinguish two models: the *connections model* and the *co-authors model*. In the connections model, agents benefit from their direct and indirect links. But the value of a link may decrease with the distance between two agents; an indirect link may have a lower value than a direct link. If this is the case, this is called a model with *decay*. If the linking cost is small, the efficient network – the network that maximizes the sum of individuals profits – is the *complete network* where there exists a link between each pair of nodes (see Figure 4a). If the linking cost is higher, the *star network* is efficient (see Figure 4b). The central agent is in a disadvantageous position because he is connected to every other agent and thus, he has to bear high linking costs. The network is unstable because the central agent does not want to be in this position.⁸

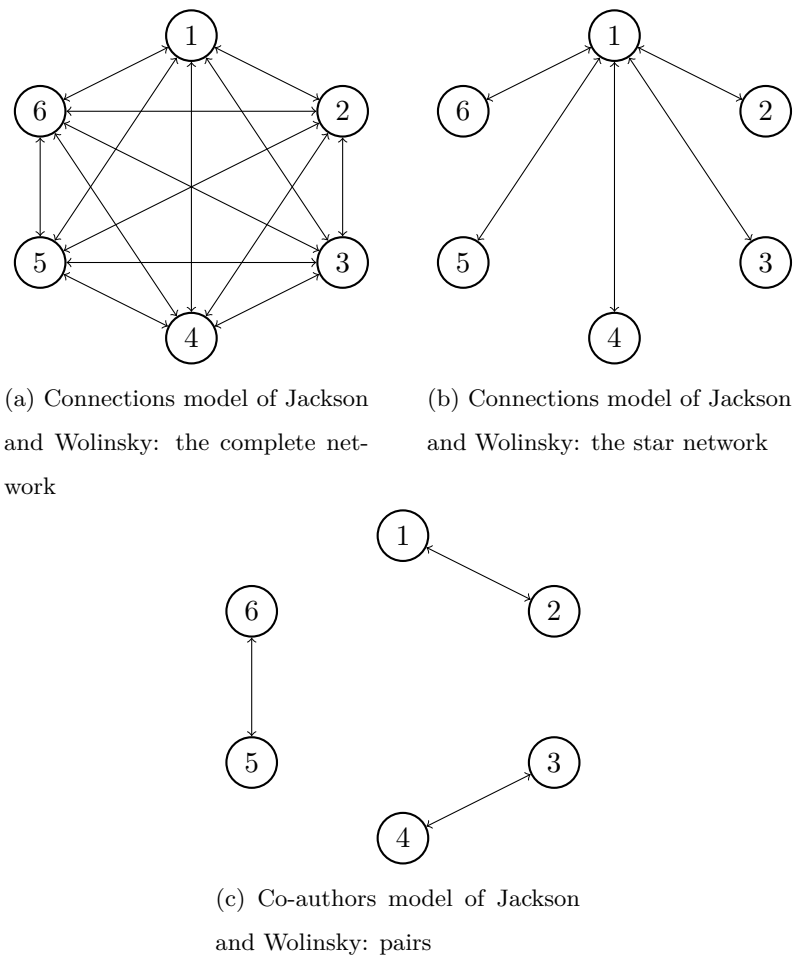

Figure 4: Jackson and Wolinsky’s model: efficient networks. Undirected links are represented by arrows pointing at both nodes.

⁸Jackson and Wolinsky (1996) define a stable network in the following way: this is a network where each player does not wish to remove one of his links and where no link can be created without reducing the profit of an agent.

Thus, in this model there is a tension between efficiency and stability. An efficient solution from an aggregated point of view is not necessarily optimal for each agent. In the co-authors model of Jackson and Wolinsky (1996), indirect links have a negative impact on individuals' payoffs. The authors take the example of the academic network. If two researchers (A and B) decide to work together, they can devote all their time to this mutual project. However, if a third researcher (C) wants to work with one of these researchers (say A), A will have less time to devote to the project with B and it will reduce the utility of B. The efficient network is composed of pairs (see Figure 4c). However, as in the previous model, this type of network is not stable, because individuals are willing to create another link to increase their number of direct links. But this will reduce the average benefit of each link because the benefits will be shared across more agents. Here again, there is a tension between the individual and the collective interest.

The model of Bala and Goyal (2000a) is a model of network formation where nodes can unilaterally form links (e.g., phone calls or inviting a new friend on Facebook) and where the link cost is only supported by the initiator of the link. Bala and Goyal (2000a) also develop two models: the *one-way flow model* where only the initiator of the link benefits from the link he created and the *two-way flow model* where both individuals benefit from it. The strict Nash equilibrium in the one-way flow model is the *circle* where each agent forms and receives one link (see Figure 5a). The strict equilibrium in the two-way flow model is the star network where the central node must create all the links of the network. This network is called the Center-Sponsored Star (CSS, see Figure 5b). The position of central node is disadvantageous as in the model of Jackson and Wolinsky (1996). Contrary to the circle, this network is unfair and unstable. Star networks often emerge in the theoretical literature. Despite the homogeneity of nodes, asymmetric structures may emerge.

0.3.2 The decentralized formation of networks in the laboratory

Laboratory experiments have been developed to test the theoretical models on network formation. Kosfeld (2004) reviews the literature on networks experiments. His conclusion on network formation is that the Nash equilibrium does not predict the experimental results very often. Deck and Johnson (2004) tested both models (Jackson and Wolinsky (1996) and Bala and Goyal (2000a))⁹ by varying the determination of costs. In the Equal Split treat-

⁹They do not use exactly the original models of Bala and Goyal (2000a) and Jackson and Wolinsky (1996) but a variant of these models where nodes are located in space and linking costs depend on distance. This is

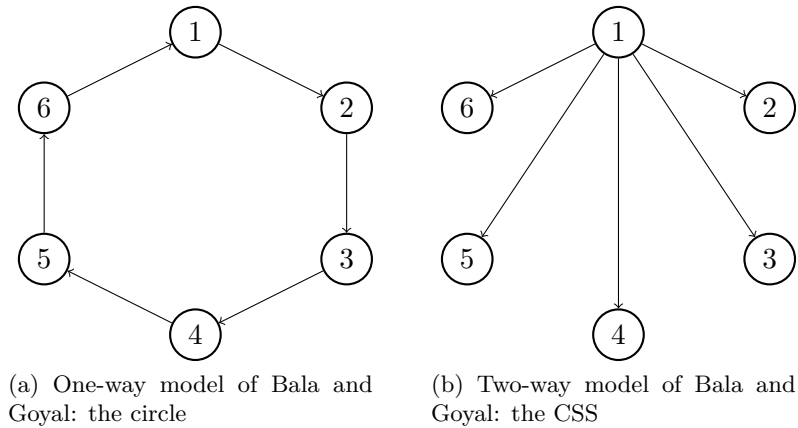

Figure 5: Bala and Goyal’s model: strict Nash equilibria and efficient networks. Directed links are represented by arrows from the initiator of the link and pointing towards the targeted partner.

ment, mutual consent is required and costs are equally shared (like in Jackson and Wolinsky (1996)). In the Direct treatment, each individual specifies how much he is willing to pay for his direct links. One of the individuals of the pair can pay the whole cost (like in Bala and Goyal (2000a)). In the Indirect treatment, individuals give their willingness to pay for their direct links but also for their indirect links. The network can be seen as a public good in this case. Efficiency and coordination are easier in the Equal Split treatment (the closest from the Jackson and Wolinsky’s model) while there are coordination problems in the two other treatments, which are close to the model of Bala and Goyal (2000a). More particularly, there is a tendency to create too many links to insure a positive payoff, which is very costly. We will now detail the experiments on network formation based on the models of Jackson and Wolinsky (1996) and Bala and Goyal (2000a).

Experiments with undirected links and mutual consent

Experiments based on the model of Jackson and Wolinsky (1996) study the tension between stability and efficiency and the ability of individuals to anticipate the linking decisions of others and to coordinate.

The objective of the pilot study of Vanin (2002) is to test whether this efficiency/stability tension is present in the laboratory and under which conditions it can be solved. To reinforce coordination, individuals can communicate before making their decisions to build the model created by Johnson and Gilles (2003).

network. Yet, efficient networks do not always emerge, especially when these networks are unfair in terms of profits. Communication allows individuals to choose symmetric structures that are fair.

The literature looked for different ways to facilitate the emergence of stable and efficient networks. Carrillo and Gaduh (2012) have used the model of Jackson and Watts (2002) where the benefits of the network are equally distributed within the network, in such a way that linking decisions are not impacted by inequality aversion. The experiment shows that the networks that are formed are stable and individuals manage to anticipate the linking decisions of others in order to coordinate on efficient networks. Burger and Buskens (2009) used a dynamic process of linking formation instead of a simultaneous one to facilitate coordination; individuals can simultaneously update their links during periods of 30 seconds. Results show that groups converge to stable networks and that the convergence process is faster when networks are efficient and fair. Caldara and McBride (2014) added a realistic feature in their experiment: individuals can only observe a limited part of the network (their direct links and their indirect links at distance 2 maximum). Indeed, we know our own friends and sometimes the friends of our friends but it is difficult to have a general vision of the network. Here, the main objective is to study the impact of limited observation on the efficiency of the network. If individuals only observe a part of the network, beliefs on the rest of the network matter a lot. Partial observation leads to more cycles in the network, i.e., redundant links that are costly and do not increase the benefits of nodes, because a path already exists. The authors find more stability when costs are low and observation is complete while a partial observation of the networks prevents groups from forming stable and efficient networks.

The ability of individuals to anticipate the linking decisions of others is crucial to form stable and efficient networks. Pantz (2006), Carrillo and Gaduh (2012) and Kirchsteiger et al. (2016) analyze in their experiments on network formation the level of anticipation of individuals. Individuals are said myopic if they cannot anticipate links formed by others. In general, the authors show that individuals are not completely myopic, but are not perfectly farsighted. Indeed, they anticipate the actions of others but are limitedly farsighted, which sometimes prevent them from converging to stable networks.

The literature also took an interest in the analysis of linking decisions at the individual

level. Conte et al. (2015) show that coordination on minimally-connected networks is not easy and many redundant links persist. Three types of individual behavior are identified: the “best response” behavior (45% of the individuals include isolated individuals and remove redundant links to lead to a minimally-connected network), the “reciprocal” behavior (30% of the individuals maximize their number of direct links by answering positively to link proposals) and the “opportunistic” behavior (25% of individuals maximize their number of indirect links). The last two types of behavior are detrimental for the formation of efficient networks. These individual decisions may also depend on social preferences. Social preferences are very often present in all the experiments that we cited earlier. Indeed, individuals often have preferences for efficiency and equality of payoffs. The objective of Van Dolder and Buskens (2009) is to measure these social preferences at the individual level in a network formation game. The results show that agents create links if it increases their own profit and the profits of the group (efficiency). However, contrary to the hypotheses of the authors, the willingness to equalize payoffs (fairness) only has a weak impact on linking decisions.

To sum up, in the experiments inspired by the model of Jackson and Wolinsky (1996), groups have difficulties to coordinate on efficient networks, because they are often unstable and unfair. Moreover, individuals have difficulties to perfectly anticipate the linking decisions of the other players. Symmetric and over-connected networks, that are costly and not efficient, are likely to emerge.

Experiments with directed links

The experiments on network formation with directed links are mainly based on the two-way flow model of Bala and Goyal (2000a). Indeed, the asymmetry of this model – the fact that one node pays to create a link, but that both nodes benefit from the link – has interested many researchers. Falk and Kosfeld (2012) ran the first experiment testing both the one-way and the two-way flow model. They tested them with groups of four players and varied the cost of a link. Individuals make decisions simultaneously. Their results show that the equilibrium networks emerge in the one-way flow model; the theoretical and experimental results are comparable.¹⁰ However, equilibrium networks do not emerge in the treatment

¹⁰Bernasconi and Galizzi (2005) replicated the experiment of Falk and Kosfeld (2012) and focused on the role of learning in the instructions and on some salient characteristics of the design. The salient characteristics are the names given to nodes in the experiment, which facilitate the coordination of individuals on the circle. Indeed, naming the nodes A, B, C, D, etc. may influence the individuals. A is more likely to create a link with B, B with C, etc. Concerning learning, in the experiment of Falk and Kosfeld (2012), participants during

representing the two-way flow model. The authors give two reasons that explain why the Center-Sponsored Star does not emerge:

- Strategic asymmetry: the CSS is complex and asymmetric. A node must create all the links and others must remain passive. Consequently, coordination is difficult.
- Payoffs asymmetry: inequalities are strong in the CSS while gains are perfectly equal with the circle. The position of central node is not advantageous and makes the network unstable.

The introduction of a communication stage before the formation of links allows agents to coordinate on the CSS thanks to the permutation of positions within the network. They implement a process where the position of central node is adopted by each player one after the other in order to equalize payoffs. It allows the emergence of efficient networks and the equality of payoffs. Afterward, in this literature researchers focused mainly on the two-way flow model.

Goeree et al. (2009) study the emergence of star networks in the laboratory. They extend the model of Bala and Goyal (2000a) by introducing heterogeneity via the presence of a special individual in a group of six people. They introduce cost-heterogeneity with a special agent that can create links for a lower cost than the others and value-heterogeneity thanks to the presence of a special agent with a higher value than the others. The CSS with the low-cost individual as central node remains the equilibrium network and is the efficient network. The low-cost individual is supposed to facilitate the emergence of the CSS. Because of decay, the introduction of heterogeneity with the presence of a high-value individual impacts the determination of the strict Nash equilibrium. The equilibrium is the *Periphery-Sponsored Star* (PSS, see Figure 6) where peripheral nodes create each one link with the high-value agent (central node). The experiment shows that the presence of an individual with a higher value facilitates the emergence of the PSS while the presence of an agent with a lower linking cost does not facilitate the emergence of the CSS. One of the explanations is that this CSS remains unfair, even if the central node has a lower linking cost.

the instructions had to think about the most efficient network, i.e., the one where information can optimally spread. This stage facilitates the coordination of individuals. The authors show that changing the names of nodes and the instructions makes the coordination much less easy.

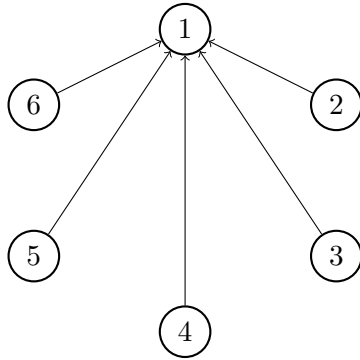

Figure 6: The Periphery-Sponsored Star (PSS).

Afterward, many experimental papers analyzed the emergence of star networks. Rong and Houser (2015) study how to facilitate the emergence of star networks in the laboratory, but contrary to Goeree et al. (2009), they check whether their emergence is possible with homogeneous individuals. Rong and Houser (2015) test the model of Galeotti and Goyal (2010), which is similar to the model of Bala and Goyal (2000a) except that individuals have to make two choices: (i) investing in a good – in this case, they earn a positive amount with certainty – and/or (ii) creating links to benefit from the investment of a partner who invested. Creating links is less costly than investing, but the benefit is not certain as the link may be created with someone who does not invest. When the linking cost is lower than the investment cost, the unique Nash equilibrium is the PSS where the central node is the investor. This network is also efficient. This model is tested in different types of environment that vary the decision process: linking decisions are either simultaneous or sequential (agents decide one after another after observing the decisions of previous players), investments can be limited or not by resources constraints, i.e., agents can either create a link or invest, but not both. The results show that sequentiality does not improve the emergence of star networks. However, limiting the investment has a positive effect because one individual invests and the others create a link with him. Despite the homogeneity of individuals, the authors demonstrate that some institutions facilitate the emergence of star networks.

Like Rong and Houser (2015), Van Leeuwen et al. (2015) used the model of Galeotti and Goyal (2010) to study the emergence of star networks. The position of central node and of investor is made more attractive thanks to a status rent. Individuals can invest in a public good and compete for the rent and the status of biggest investor. Popularity is rewarded.

Consequently, the strict Nash equilibrium is the PSS where the central node is the unique investor (that was already the case in Galeotti and Goyal (2010)). Berninghaus et al. (2004) tend to solve the limitations of the emergence of star networks by modifying the model of Bala and Goyal (2000a). They include a discrimination between “active” and “passive” neighbors. A link is active if individual i pays for the formation of this link (outgoing link). A link is passive if an individual pays to create a link with i (incoming link). Individuals benefit from their direct links, active and passive ones. However, they do not benefit from all their indirect links. They benefit only from the links with the neighbors of their active neighbors. With this modification, the strict Nash equilibrium becomes the PSS. Their results show that 50% of the groups form the PSS or a network close to the PSS.

Other experiments tried to facilitate the emergence of equilibrium networks by modifying the process of link formation. Callander and Plott (2005) designed one of the first experiments on the formation of networks based on the one-way flow model of Bala and Goyal (2000a). The authors analyzed the principles that determine the emergence of networks, their evolution and how they are influenced by the context of the game. They ran the experiment both manually with a simultaneous process of link formation, and in a computerized way with a continuous process of link formation. In the continuous process, individuals can click on nodes with whom they want to create a link and sever their links by clicking on the existing links. The network is continuously updated on their screen during two minutes. Their results show that networks emerge, evolve over time and converge to stationary structures. Stability is facilitated by the continuous process. By using the same model as Berninghaus et al. (2004), with a discrimination between active and passive links, Berninghaus et al. (2007) study the formation of networks with a simultaneous process and a continuous process. Once more, the simultaneity of linking decisions makes coordination difficult. In the continuous treatment, the network formation game lasts 30 minutes and individuals can change their decisions as many times as they want. They have a complete information on the links of the network and know their profit in real time. More PSSs emerge, in comparison with the simultaneous treatment.

In Chapter 2, we contribute to this literature by using a sequential network formation process in order to facilitate coordination. Individuals make their linking choices one after the other and can observe the previous decisions. We also introduce heterogeneity to measure its

impact on asymmetric network formation. We do not only test monetary heterogeneity like in Goeree et al. (2009), but we also introduce non-monetary heterogeneity with the presence of an individual with a different status.

0.3.3 Chapter 2: Heterogeneity and sequentiality in network formation games

The second Chapter studies decentralized link formation in the laboratory. Precisely, we study the formation of asymmetric networks, i.e., networks in which few central individuals are more connected than peripheral individuals. The nodes of these networks are heterogeneous in terms of connectivity. Many examples of asymmetric networks exist in real life. For example, the academic networks are asymmetric (Newman, 2004), as well as friendship and family networks (Smith and Christakis, 2008). The contribution of this Chapter is to test whether it is possible to facilitate the coordination of agents using a sequential link formation process, and to analyze the impact of heterogeneity of individual characteristics on the linking decisions and on the structure of networks that emerges. Empirically, we show that a sequential linking process leads to the emergence of stable, efficient and fair networks. Finally, this Chapter examines the potential role of non-monetary heterogeneity in the emergence of asymmetric networks.

Theoretically, we build on the two-way flow model of Bala and Goyal (2000a). In this model, the strict Nash equilibrium is a star network where the central player creates all the links: the *Center-Sponsored Star* (CSS). The central player is in a disadvantageous situation, because he bears all the costs. Even with homogeneous nodes, in this model, the equilibrium network is asymmetric. This model has been tested multiple times in the laboratory. However, as indicated earlier, the emergence of asymmetric network is rare in the laboratory for two reasons: coordination problems and payoffs inequalities across players. In order to facilitate the coordination of players, we introduce in the model and in the experimental design two features: sequentiality of the linking process and heterogeneity across players. Most of the experiments on network formation use a simultaneous link formation process. However, it is very difficult for players to anticipate the decisions of others, which makes coordination difficult. Moreover, in many social situations, links are formed sequentially. Sequentiality slightly modifies the equilibrium network compared to the model of Bala and Goyal (2000a). Indeed, the Sub-game Perfect Equilibrium becomes a CSS where the central node is the last player of the sequential process. Heterogeneity across individuals is introduced by means of a

special individual who has either a higher value than the other individuals (being connected with this player generates more benefits), or a different status. Heterogeneity has no impact theoretically on the equilibrium network, because being directly or indirectly linked (via other individuals) to the special individual generates the same benefit.

The experimental results show that sequentiality facilitates the coordination of individuals on efficient and stable networks throughout the experiment. However, networks are relatively symmetric, because individuals tend to create each one link and so share the cost of network formation. We also observe inequality aversion. Heterogeneity across individuals has an impact on the formation of networks, contrary to what the theory predicts, but only when the special individual has a higher monetary value than others. In this case, the special player is more popular than the other players, even if being indirectly connected with him is sufficient to benefit from him. He polarizes links on him, because individuals want to make sure that they have a connection with him early in the game. His presence acts as a coordination device to create stable and fair networks. Consequently, the networks formed are more asymmetric than in the homogeneous case or when the special individual has only a different status.

To sum up, the contribution of this chapter to the existing literature is twofold. We study the formation of networks with a sequential process, which makes coordination on efficient and stable networks easier, and we introduce heterogeneity to understand why networks may be asymmetric.

The dissertation examines the impact of networks on individual behavior and on aggregated outcomes. Indeed, our behavior depends on our social environment and on the fact that we contribute to shape our social networks.

0.4 Homophily and peer effects in networks

Being part of a network provides new opportunities, influences individual decisions and can change political opinions. That is why economic behavior must be analyzed in a social context. Jackson and Zenou (2017) explain in their literature review how some network characteristics (homophily, degree, centrality, etc.) impact economic behavior.

Opportunities. The sociologist Granovetter studied the influence of network on job opportunities (Granovetter, 1995). In most models, a link is a binary variable: the link exists or not. Granovetter differentiates strong links, which are strong relationships, with many interactions, and weak links, which are more distant and less frequent relationships. His model and his field experiments show that it is easier to find a job via weak ties, because they give access to a less familiar network that brings different opportunities. Weak links open more doors.

Peer effects. Most individual decisions are not made in isolation. Some decisions can be made in group. But even when a decision seems personal, our social environment, and in particular the people around us, exert an influence on our choices and modify our perception of social norms. The decisions and characteristics of our peers, i.e., the members of our network (family, friends, colleagues, co-authors, etc.) influence our own decisions. These are called *peer effects*. Manski (1993) highlights the importance of separating two types of peer effects: endogenous and exogenous (or contextual) peer effects. The former represent the effects of our peers' behavior on our own behavior. For example, if a student has friends who are good students, he will be more likely to work harder and so will get better grades at school. Exogenous peer effects represent the effects of peers' characteristics (their age, their salary, etc.) on our own behavior. For example, the academic achievement of a student may depend on his friends' characteristics like their age, their gender or their standard of living. This phenomenon can be amplified by the presence of homophily. Some individuals have individual characteristics that favor their academic success. They are more likely to create links with individuals who have similar characteristics (for example girls have more girlfriends than boyfriends) and who are themselves more likely to be good students. In that case, people tend to behave similarly not because they imitate each other but because they are similar to others.

Influence on personal opinions. Today, social networks are the first source of information for 40% of people between 18 and 24 years old.¹¹ This fact is crucial for presidential elections for example. Political parties that are well settled on the Internet will manage to disseminate their ideas more easily among young people. The potential issue of this diffusion of specific information on social networks is that it confines people inside a bubble where the only information they get is the information of their friends. This may create communities

¹¹http://www.francetvinfo.fr/internet/reseaux-sociaux/reseaux-sociaux-et-presidentielle-cinq-bonnes-raisons-detre-prudent_2145674.html

and radicalize political opinions. Once again, this phenomenon is amplified by homophily which creates segregation. Individuals with similar characteristics, preferences and opinions will be more likely to be connected and the information that they transfer to each other only confirms the information they already possess. This leads to a slower learning process and a slower diffusion. Golub and Jackson (2012) illustrate a model of diffusion in networks with the following example. In the United States, Republicans and Democrats have very different beliefs on the possession of weapons of mass destruction by Iraq. These beliefs are contradictory and do not evolve over time. There is no convergence of beliefs, because the information they exchange are transferred among individuals who have similar beliefs.

Networks and the way people build networks (their choice of peers) influence their individual behavior. In Chapter 3, we study peer effects by analyzing individual cheating behavior in the presence of social interactions in the laboratory.

0.4.1 Peer effects: Theory and econometric models

The linear-in-means model of Manski (1993) is the benchmark model used to study peer effects. Individuals' behavior depends on exogenous individual characteristics, on the average characteristics of peers and on the average behavior of peers. Many studies have used and extended this model to understand peer effects. In this Chapter, we focus mainly on endogenous peer effects (effects of peers' behavior). Two mechanisms can explain the influence of peers' behavior on individual decisions. On the one hand, there may be strategic complementarity between the individual and his peers (Scheinkman, 2008). Strategic complementarity reflects the synergy between individuals' behavior that creates a social multiplier. For instance, if we study the productivity of workers, strategic complementarity reflects the fact that the average co-workers productivity impacts positively the individual's productivity. As the individual's productivity has increased, the co-workers will increase their productivity, which will increase the individual's productivity, etc. On the other hand, individuals may be willing to conform. Conformity reflects the fact that individuals are willing to conform to his co-workers' productivity. It is mainly due to social norms. These two mechanisms are hard to disentangle (Boucher and Fortin, 2016).

As Manski (1993) stated, peer effects may be difficult to identify in empirical works. A difficulty is that individuals influence each other in a simultaneous way. This creates an iden-

tification problem called the “reflection problem”. In a group, each member may be influenced and can influence other group members: group members influence each other mutually and vice-versa.

Another difficulty for identifying peer effects is the presence of homophily; individuals with similar characteristics choose to gather together and are more likely to act in a similar way.¹² This is not due to peer effects but to self-selection. For example, the fact that a student smokes or not depends on his choice of friends and on the behavior of his friends. Thus, it is difficult to disentangle pure peer effects from homophily. Taking this endogeneity problem into account is crucial to measure peer effects. The endogeneity of the choice of peers requires advanced econometric models and techniques to identify true peer effects. The effect of homophily may artificially amplify peer effects as there is a selection bias.

0.4.2 Dishonesty and peer effects in the laboratory

Many laboratory experiments aim at studying peer effects. From a methodological point of view, the laboratory offers many advantages. In the laboratory, the reference group of an individual is perfectly controlled, i.e., the individual’s peers, while it may be difficult to have a complete information in the field. In order to avoid self-selection problems and homophily biases, it is possible to form exogenous and random networks.

In the third Chapter, we focus on peer effects with an application on dishonest behavior. There exist many examples in real settings where dishonest acts and decisions are influenced by others. For example, unethical culture can spread within a company (Cohn et al., 2014), the criminality of an individual depends on the level of criminality of his peers (Glaeser et al., 1996), and the decision to cheat during an exam depends on other students’ habits to cheat (Carrell et al., 2008).

In Gino et al. (2009), individuals have to perform a task and can over-report their performance and so their earnings. Individuals tend to lie a little bit to slightly increase their payoffs. The presence of confederates who signal the possibility to cheat increases the individuals’ decision to lie. An individual may be dishonest because he experienced dishonesty

¹²See the sociological survey of McPherson et al. (2001) that describe all the different types of homophily (gender, age, religion, etc.).

or because he observed others' dishonest behavior. For example, in the experiment of Falk and Fischbacher (2002), groups of four are formed and individuals can earn points during a task and then steal points to their group members. Individuals steal more when they have been stolen themselves. Acting unethically is conditional on the dishonesty of others. Observing dishonest acts (influence by a third party) can also influence individuals' behavior. Robert and Arnab (2013) used the deception game of Gneezy (2005) to study peer effects on dishonesty. In this game, the Sender possesses private information on the payoffs of two options. The Receiver must choose one of these two options after receiving a message from the Sender saying which option would provide him (the Receiver) the highest payoff. Of course, the Sender can lie in the message to favor his own payoff. Robert and Arnab (2013) study how providing information to the Senders about the dishonesty of players from previous sessions affects their decision to lie. They find that observing dishonesty increases individuals' dishonesty. Diekmann et al. (2011) and Rauhut (2013) apply the same principle to the die game. Players roll a die and are paid according to the number they report. They first roll the die alone and then observe some information on the distribution of the numbers reported by other players and roll the die one more time. After observing this distribution, which clearly signals that players lied, individuals lie more. Fortin et al. (2007) and Lefebvre et al. (2015) study peer effects on tax evasion. Fortin et al. (2007) study how observing the tax compliance of other players impacts one's evasion decision. They do not find any significant conformity effects (endogenous peer effects after controlling for exogenous peer effects). Lefebvre et al. (2015) use two types of information: information on the highest rate of tax evasion in previous sessions and information on the lowest past rate of tax evasion. Their conclusion is that peer effects are asymmetric. Indeed, individuals react more to a bad than a good example. Two mechanisms can explain these findings. Learning that other individuals lie makes the decision to lie a potential option; they become aware of this possibility. Second, if others lie, it changes the perception of the social norm in the group (Fosgaard et al. (2013) and Gino et al. (2009)).

0.4.3 Chapter 3: Peer effects, homophily and dishonesty

Our social environment, and in particular the members of our networks, may have an impact on our individual decisions. In this Chapter, we study endogenous peer effects, i.e., the influence of our peers' behavior on our own behavior, with an application on dishonesty. The decision to lie of an individual depends on his individual characteristics, his moral cost but

also on the influence of his peers. The originality of this Chapter is that we study peer effects in the context of network formation.

Many empirical works have been made to understand how criminality (Calvó-Armengol and Zenou, 2004) or cheating during exams (Carrell et al., 2008) can disseminate among peers. The influence of dishonest people on others is not trivial. However, pure peer effects on dishonesty are hard to identify in empirical works because of self-selection.¹³ One of the main difficulties is the presence of homophily: individuals tend to gather with similar others and tend to behave in the same way. However, this is not due to peer effects, but simply because of their similar characteristics. Econometrically, it creates an endogeneity problem as some variables (sometimes unobserved) may impact the choice of peers as well as the behavior of individuals. Many authors studied behavior of students with the Add Health data that provide students' friendships as well as many different kinds of behavior such as smoking behavior. They had to develop very advanced techniques to solve this endogeneity problem (see for example Goldsmith-Pinkham and Imbens (2013) or Hsieh and Lee (2016)). Additionally, individuals may create links with some peers to optimize their utility function (see for example Hsieh and Lee (2017) where the authors show that students choose friends who are good students in order to increase their chance of academic success.). Overall, in these papers, the results show that the effect of the endogeneity of network formation is weak. However, results vary depending on the techniques and the models used and so are hard to compare.

We propose to deal with this endogeneity issue in the context of dishonesty by designing a laboratory experiment with two environments: one in which peers are imposed and one in which individuals can choose their peers. More precisely, our design is the following. Individuals must perform a simple real-effort task; they have to count the number of zeros in tables containing zeros and ones. Individuals have the choice between two modes of performance evaluation: the Automatic and the Manual mode. In the Automatic mode, their performance is automatically calculated by the computer program. In the Manual mode, individuals self-report their performance. Thus, they have the possibility to over-report their performance to increase their earnings. The experiment comprises two parts. At the beginning of the first part, individuals must choose one of the modes. Then, they perform the task during five

¹³Not only for criminality, but also for obesity for example (Fortin and Yazbeck, 2015).

periods. Then, at the beginning of the second part, peers are either assigned exogenously and randomly (EXO treatment) or are chosen by individuals themselves (ENDO treatment). More precisely, in each treatment, they receive some information on two pairs of players from past sessions (who played the Baseline treatment without any social interactions¹⁴): a pair of players who chose the Automatic version and a pair of players who chose the Manual version. In the EXO treatment, one of the pairs of peers is assigned to the individual with a 50% chance, while in the ENDO treatment, the individual chooses his favorite pair of peers. Then, in the second part of the EXO and ENDO treatments, individuals perform the task again during five periods, but observe at each period the average performance of their peers, i.e., the actual performance of their peers if their peers chose the Automatic version or the reported performance (and so potentially over-reported performance) of their peers if their peers chose the Manual version.

Our results show that individuals who have peers of Manual type lie significantly more than individuals who have peers of Automatic type but only when they can choose their peers themselves (ENDO treatment). Peer effects in the EXO treatment are insignificant. However, we show that the peers effects in the ENDO treatment are artificially amplified by the presence of homophily. Indeed, individuals who choose the Manual mode tend to choose peers who made the same choice and so, who are more likely to be liars. Moreover, these subjects were already lying more than others in the first part, when there is no social interaction.

Bibliography

- Acemoglu, D., Malekian, A. and Ozdaglar, A. (2016). Network security and contagion, *Journal of Economic Theory* **166**: 536–585.
- Bala, V. and Goyal, S. (2000a). A noncooperative model of network formation, *Econometrica* **68**(5): 1181–1229.
- Bala, V. and Goyal, S. (2000b). A strategic analysis of network reliability, *Review of Economic Design* **5**(3): 205–228.

¹⁴This treatment is exactly the same as the two others except that there is no social interaction at all in both parts. It was run before the two other treatments to avoid reflection problems.

- Ballester, C., Calvó-Armengol, A. and Zenou, Y. (2006). Who's who in networks. wanted: The key player, *Econometrica* **74**(5): 1403–1417.
- Bernasconi, M. and Galizzi, M. (2005). Coordination in networks formation: Experimental evidence on learning and salience.
- Berninghaus, S. K., Ehrhart, K.-M., Ott, M. and Vogt, B. (2007). Evolution of networks—an experimental analysis, *Journal of Evolutionary Economics* **17**(3): 317–347.
- Berninghaus, S. K., Ott, M. and Vogt, B. (2004). On networks and stars: Recent results in network experiments.
- Boucher, V. and Fortin, B. (2016). Some challenges in the empirics of the effects of networks, *Oxford Handbook on the Economics of Networks*, Oxford: Oxford University Press .
- Bramoullé, Y. and Rogers, B. W. (2009). Diversity and popularity in social networks.
- Burger, M. J. and Buskens, V. (2009). Social context and network formation: An experimental study, *Social Networks* **31**(1): 63–75.
- Caldara, M. and McBride, M. (2014). An experimental study of network formation with limited observation, *Technical report*, University of California-Irvine, Department of Economics.
- Callander, S. and Plott, C. R. (2005). Principles of network development and evolution: An experimental study, *Journal of Public Economics* **89**(8): 1469–1495.
- Calvó-Armengol, A. and Zenou, Y. (2004). Social networks and crime decisions: The role of social structure in facilitating delinquent behavior, *International Economic Review* **45**(3): 939–958.
- Carrell, S. E., Malmstrom, F. V. and West, J. E. (2008). Peer effects in academic cheating, *Journal of human resources* **43**(1): 173–207.
- Carrillo, J. D. and Gaduh, A. (2012). The strategic formation of networks: Experimental evidence.
- Cerdeiro, D., Dziubinski, M. and Goyal, S. (2015). Contagion risk and network design.
- Cohn, A., Fehr, E. and Maréchal, M. A. (2014). Business culture and dishonesty in the banking industry, *Nature* **516**(7529): 86–89.

- Conte, A., Di Cagno, D. T. and Sciubba, E. (2015). Behavioral patterns in social networks, *Economic Inquiry* **53**(2): 1331–1349.
- Currarini, S., Jackson, M. O. and Pin, P. (2009). An economic model of friendship: Homophily, minorities, and segregation, *Econometrica* **77**(4): 1003–1045.
- Deck, C. and Johnson, C. (2004). Link bidding in laboratory networks, *Review of Economic Design* **8**(4): 359–372.
- Diekmann, A., Przepiorka, W., Rauhut, H. et al. (2011). Lifting the veil of ignorance: An experiment on the contagiousness of norm violations, *Nuffield Centre for Experimental Social Sciences Discussion Paper Series* **4**.
- Dodds, P. S., Muhamad, R. and Watts, D. J. (2003). An experimental study of search in global social networks, *Science* **301**(5634): 827–829.
- Dziubinski, M. and Goyal, S. (2013). Network design and defence, *Games and Economic Behavior* **79**: 30–43.
- Euler, L. (1736). Solutio problematis ad geometriam situs, *Commentarii academiae scientiarum imperialis Petropolitanae* .
- Falk, A. and Fischbacher, U. (2002). "crime" in the lab-detecting social interaction, *European Economic Review* **46**(4): 859–869.
- Falk, A. and Kosfeld, M. (2012). It's all about connections: Evidence on network formation, *Review of Network Economics* **11**(3).
- Fortin, B., Lacroix, G. and Villeval, M.-C. (2007). Tax evasion and social interactions, *Journal of Public Economics* **91**(11): 2089–2112.
- Fortin, B. and Yazbeck, M. (2015). Peer effects, fast food consumption and adolescent weight gain, *Journal of health economics* **42**: 125–138.
- Fosgaard, T. R., Hansen, L. G. and Piovesan, M. (2013). Separating will from grace: An experiment on conformity and awareness in cheating, *Journal of Economic Behavior & Organization* **93**: 279–284.
- Galeotti, A. and Goyal, S. (2010). The law of the few, *The American Economic Review* pp. 1468–1492.

- Gino, F., Ayal, S. and Ariely, D. (2009). Contagion and differentiation in unethical behavior: The effect of one bad apple on the barrel, *Psychological science* **20**(3): 393–398.
- Glaeser, E. L., Sacerdote, B. and Scheinkman, J. A. (1996). Crime and social interactions, *The Quarterly Journal of Economics* **111**(2): 507–548.
- Gneezy, U. (2005). Deception: The role of consequences, *The American Economic Review* **95**(1): 384–394.
- Goeree, J. K., Riedl, A. and Ule, A. (2009). In search of stars: Network formation among heterogeneous agents, *Games and Economic Behavior* **67**(2): 445–466.
- Goldsmith-Pinkham, P. and Imbens, G. W. (2013). Social networks and the identification of peer effects, *Journal of Business & Economic Statistics* **31**(3): 253–264.
- Golub, B. and Jackson, M. O. (2012). How homophily affects the speed of learning and best-response dynamics, *The Quarterly Journal of Economics* **127**(3): 1287–1338.
- Goyal, S. and Vigier, A. (2014). Attack, defence, and contagion in networks, *The Review of Economic Studies* **81**(4): 1518–1542.
- Granovetter, M. (1995). *Getting a job: A study of contacts and careers*, University of Chicago Press.
- Hoyer, B. and Jaegher, K. D. (2016). Strategic network disruption and defense, *Journal of Public Economic Theory* **18**(5): 802–830.
- Hsieh, C.-S. and Lee, L. F. (2016). A social interactions model with endogenous friendship formation and selectivity, *Journal of Applied Econometrics* **31**(2): 301–319.
- Hsieh, C.-S. and Lee, L.-F. (2017). Specification and estimation of network formation and network interaction models with the exponential probability distribution.
- Jackson, M. O. and Watts, A. (2002). The evolution of social and economic networks, *Journal of Economic Theory* **106**(2): 265–295.
- Jackson, M. O. and Wolinsky, A. (1996). A strategic model of social and economic networks, *Journal of economic theory* **71**(1): 44–74.
- Jackson, Matthew O, R. B. W. and Zenou, Y. (2017). The economic consequences of social network structure, *Journal of Economic Literature* **55**: 49–95.

- Johnson, C. and Gilles, R. P. (2003). Spatial social networks, *Networks and Groups*, Springer, pp. 51–77.
- Kirchsteiger, G., Mantovani, M., Mauleon, A. and Vannetelbosch, V. (2016). Limited farsightedness in network formation, *Journal of Economic Behavior & Organization* **128**: 97–120.
- Kosfeld, M. (2004). Economic networks in the laboratory: A survey, *Review of Network Economics* **3**(1).
- Lefebvre, M., Pestieau, P., Riedl, A. and Villeval, M. C. (2015). Tax evasion and social information: an experiment in belgium, france, and the netherlands, *International Tax and Public Finance* **22**(3): 401–425.
- Manski, C. F. (1993). Identification of endogenous social effects: The reflection problem, *The review of economic studies* **60**(3): 531–542.
- McPherson, M., Smith-Lovin, L. and Cook, J. M. (2001). Birds of a feather: Homophily in social networks, *Annual review of sociology* **27**(1): 415–444.
- Milgram, S. (1967). Six degrees of separation, *Psychology Today* **2**: 60–64.
- Newman, M. E. (2004). Who is the best connected scientist? a study of scientific coauthorship networks, *Complex networks*, Springer, pp. 337–370.
- Pantz, K. (2006). *The strategic formation of social networks: experimental evidence*.
- Rauhut, H. (2013). Beliefs about lying and spreading of dishonesty: Undetected lies and their constructive and destructive social dynamics in dice experiments, *PloS one* **8**(11).
- Robert, I. and Arnab, M. (2013). Is dishonesty contagious?, *Economic Inquiry* **51**(1): 722–734.
- Rong, R. and Houser, D. (2015). Growing stars: A laboratory analysis of network formation, *Journal of Economic Behavior & Organization* **117**: 380–394.
- Scheinkman, J. A. (2008). Social interactions, *The new palgrave dictionary of economics* **2**.
- Smith, K. P. and Christakis, N. A. (2008). Social networks and health, *Annual Review of Sociology* **34**: 405–429.

Van Dolder, D. and Buskens, V. (2009). Social motives in network formation: An experiment, *Game Theory for Networks, 2009. GameNets' 09. International Conference on*, IEEE, pp. 593–602.

Van Leeuwen, B., Offerman, T. and Schram, A. J. (2015). Competition for status creates superstars: An experiment on public good provision and network formation.

Vanin, P. (2002). Network formation in the lab: a pilot experiment.

Chapter 1

Optimal Design and Defense of Networks Under Link Attacks

Abstract

Networks facilitate the exchange of goods and information and create benefits. We consider a network with n complementary nodes, i.e., nodes that need to be connected to generate a positive payoff. This network may face intelligent attacks on links. To study how the network should be designed and protected, we develop a strategic model inspired by Dziubinski and Goyal (2013) with two players: a Designer and an Adversary. First, the Designer forms costly protected and non-protected links. Then, the Adversary attacks at most k links given that attacks are costly and that protected links cannot be removed by her attacks. The Adversary aims at disconnecting the network shaped by the Designer. The Designer builds a protected network that minimizes her costs given that it has to resist the attacks of the Adversary. We establish that in equilibrium the Designer forms a minimal 1-link-connected network which contains only protected links, or a minimal $(k + 1, n)$ -link-connected network which contains only non-protected links, or a network which contains one protected link and $\lceil (n - 1)(k + 1)/2 \rceil$ non-protected links. We also examine situations where the Designer can only create a limited number of protected links and situations where protected links are imperfect, that is, protected links can be removed by attacks with some probabilities. We show that if the available number of protected links is limited, then, in equilibrium, there exists a network which contains several protected and non-protected links. In the imperfect defense framework, we provide conditions under which the results of the benchmark model

are preserved.

Keywords: attacks on links; network defense; network design.

JEL code: D74, D85.

This chapter corresponds to an article published in 2017 with Christophe Bravard and Corinne Touati in Journal of Mathematical Economics, 68, pp 62-79.

1.1 Introduction

Networks can be seen as communication structures. They are composed of nodes and links, where links represent the flow of information. Networks represent a crucial feature in our society, and are of particular interest in different fields such as military defense, telecommunication or computer networks. Some networks can be damaged by natural disasters or intelligent attacks. Attacks can affect nodes (agents, computers, telecommunication antennas, ...) or links (roads, communications flows, ...), and may disconnect a network.¹ In this paper, we examine a model where attacks target links. To illustrate the type of situations we model, consider a firm which has several production units (nodes of the network). Each production unit produces a part of the product and the pieces are assembled by a given production unit. The links of the network allow the parts of the product to be transferred among the units. If one unit is not connected to the rest of the units, its production cannot be transferred and the production has no value. Recall that during the Second World War, the production units for the weapons (nodes) were buried, so they were impossible to target, and attacks had to target the roads (links) in order to destroy the production process of the enemy. Therefore, the issue was to design a communication network between the production units that the enemy could not disconnect.

Our goal is to examine how to design and protect the network in an optimal way, such that the network remains connected after an intelligent link attack.² We say that a network is designed and protected in an optimal way if the costs associated with the design and the protection of the network are minimized.

We consider a two-stage game with two players: a Designer (D) and an Adversary (A).

- Stage 1. The Designer moves first and chooses both a set of protected, and a set of non-protected links. Protected links cannot be removed by the attacks of the Adversary.
- Stage 2. After observing the protected network (strategy) formed by the Designer, the Adversary attacks the network by allocating attacks to specific links. Since the attacks are costly, the Adversary has an incentive to attack at most k links.

Creating protected and non-protected links is costly for the Designer. The benefits ob-

¹A network is connected if no set of nodes is isolated from the others.

²Note that an intelligent attack can also be seen as the worst case scenario.

tained by the Designer at the end of the game depend on the connectivity of the residual network, that is, the network obtained after the attack of the Adversary. If the residual network is connected, then the Designer wins the game: her benefits are equal to 1 and the benefits of the Adversary are 0. If the residual network is not connected, then the Adversary wins the game: her benefits are equal to 1 and the benefits of the Designer are 0. The pay-offs obtained by the players are equal to the difference between their benefits and the costs associated with their strategies.³

We are interested in the Sub-game Perfect Equilibrium (SPE) of the two-stage game. We assume that the cost of protected links and non-protected links are sufficiently low so that the Designer has some profitable strategies which allow the residual network to be connected. First, we provide for each number of protected links, the minimal number of non-protected links that the Designer has to form in order to prevent the Adversary from disconnecting the network as well as a method to construct a solution network. Second, we establish that only three polar non-empty networks may arise in equilibrium in the benchmark model.

1. A minimal $(k + 1, n)$ -link-connected network which contains no protected links.⁴
2. A minimal $(1, n)$ -link-connected network which contains $n - 1$ protected links.
3. A network which contains one protected link and $\lceil (n - 1)(k + 1)/2 \rceil$ non-protected links.

The first family of networks constitutes the optimal strategy of the Designer when the cost of forming non-protected links is sufficiently low relative to that of forming protected links. The second one is the optimal strategy when the cost of forming non-protected links is sufficiently high relative to that of forming protected links. The third one is optimal for intermediate relative costs (cost of a protected link / cost of a non-protected link) when the number of nodes is odd and the number of attacks is even.

Additionally to the benchmark model described above, we study some variations of the game to develop a larger understanding of optimal design of protected networks. We take into account two types of limitations concerning protections. First, we consider that D cannot

³If we take again our military example, and assume that node $i - 1$ is the supplier of node i , then the Designer has to maintain a path between each pair of nodes $i - 1$ and i to obtain some end products. In other words, the residual network has to be connected to allow some production.

⁴A network g , which contains n nodes, is a minimal $(k + 1, n)$ -link-connected network, if it is not possible to disconnect it by removing k links, and such that there is no network which cannot be disconnected by removing k links and contains a smaller number of links.

create as many protected links as in the benchmark model.⁵ Then, we consider a framework where each protected link has a probability π to be removed when it is attacked by A .⁶

In the framework where the number of protected links available for D is limited, we show that for intermediate relative costs, the optimal strategy of D consists in designing a network which contains both protected links and non-protected links. In the framework where protected links are removed by attacks with some probabilities, we provide conditions under which the results obtained in our benchmark model are preserved.

We now relate our paper to the existing literature on networks. This literature has become broader in the recent years (Jackson (2010), Goyal (2012) and Vega-Redondo (2007)). The two seminal papers on the formation of social and economic networks are the paper of Jackson and Wolinsky (1996) and the paper of Bala and Goyal (2000a). Bala and Goyal (2000b) and Haller and Sarangi (2005) introduce imperfectly reliable links in the Bala and Goyal model. Bala and Goyal (2000b) show that, for certain ranges of linking cost and probability of failure, the equilibrium network is at least $(2, n)$ -link-connected, i.e., any two nodes are connected by at least two paths. Haller and Sarangi (2005) extend the model of Bala and Goyal (2000b) by allowing heterogeneity in probabilities of link failure. These authors model random link failure but not an intelligent attack that seeks to interrupt the communication flow. In the present paper, we study the robustness of a network that must be designed and protected to resist an intelligent attack on links.

A growing literature on attacked networks studies the optimal strategy of a Designer whose network is under node attack. Dziubinski and Goyal (2013) (DG) study the optimal design and defense of networks under an intelligent attack. In their framework, there are two players: the Designer and the Adversary; the Designer can form links between n nodes, and protect these nodes to ensure their survival. The model we propose is close to the model of DG, with the following major differences:

- The Adversary attacks nodes in the DG's framework while she attacks links in our framework;
- In our framework, the Designer wins the game if every node is able to communicate

⁵If we take again our military example, the Designer may not have enough resources to protect the whole network.

⁶Despite the effort of the Designer (of the army) to protect the communication flow, the Adversary (the enemy) may still be able to succeed in destroying protected links with some probabilities.

with any other node in the residual network. In the DG's framework, the Designer wins the game if the residual network is connected regardless of the number of nodes removed by the Adversary. Thus, our setting is based on the complementarity of nodes while DG assume that nodes are substitutable.

DG show that in an SPE, the Designer protects 0 or 1 node. If the Designer protects 0 nodes, then she designs a minimal $(k + 1, n)$ -node-connected network.⁷ We obtain the same type of networks when the Designer uses no protection. At first sight, this result seems intriguing since the Adversary attacks nodes in DG's paper and links in our paper. However, a minimal $(k + 1, n)$ -node-connected network defined in DG is also a network that contains the minimal number of links and resists the Adversary who attacks links. In DG's paper, if the Designer protects nodes, she designs a star network⁸ and protects 1 node, the central node. In our framework, when D uses protections, she designs either a network which contains 1 protected link and $\lceil (n - 1)(k + 1)/2 \rceil$ non-protected links, or a network which contains $n - 1$ protected links. The results differ because in our framework every node needs to be connected with any other node in the residual network. Moreover, we establish that if we limit the number of available protections, then there exist optimal strategies for D where she designs networks which contain several protected and non-protected links. This result follows the fact that the number of non-protected links that each protected link allows the Designer to save is not constant. DG examine imperfect defense through an example. They assume that the protections used by the Designer can fail when they are attacked by the Adversary. More precisely, an attack on an unprotected target always destroys the target, and an attack on a protected target destroys the target with a positive probability. A recent independent work of Landwehr (2015) extends the analysis of imperfect defense. It shows that for a certain range of protection cost and link formation cost, strategies that use both protections and several links are equilibria.

Hoyer and Jaegher (2016) consider a framework where the Designer has to shape the network and form enough links in order to resist the attacks. In this framework, the Designer cannot protect specific parts of the network. The authors study the optimal way to design a network under link or node deletion with various cost levels. They show that if the costs

⁷A minimal $(k + 1, n)$ -node-connected network is a network, which contains n nodes, that cannot be disconnected by removing k nodes, and such that there is no network which cannot be disconnected by removing k nodes and contains a smaller number of links.

⁸A star network is a network where one node, the central one, is linked with all other nodes, and other nodes are only linked with the central node.

of forming links are low, a regular network⁹ with a sufficient number of links is the optimal network for the Designer. If costs are high and links are attacked, then a star network is optimal for the Designer. The difference with our paper (except for the fact that they do not use protected links) is that in our framework, nodes are complementary and the Designer cannot sacrifice any node to minimize her costs. Haller (2015) extends the model of Hoyer and Jaegher (2016) by adding the possibility for two nodes to be connected by more than one link. In that case, it is harder for the Adversary to disconnect the network. Allowing multiple links between nodes can be seen as a different way to protect a connection between specific nodes than ours.

A part of the literature on attacked networks examines the role played by the contagion of attacks in networks. Goyal and Vigier (2014) extend the work of DG by allowing the contagion of attacks (or threats). They find that the star network with a protected central node remains an equilibrium network. Cabrales et al. (2014) and Baccara and Bar-Isaac (2008) study the contagion of attacks in networks respectively in the field of financial firms where a financial risk can spread between connected firms and in the field of criminal networks where connectivity increases vulnerability because of external threats.¹⁰ Cerdeiro et al. (2015) and Acemoglu et al. (2016) identify nodes to players. Specifically, Cerdeiro et al. (2015) propose a three-stage game. First, the Designer chooses the network. Second, each player observes the network and chooses independently and simultaneously if she invests in protection or not. Third, the Adversary observes the protected network and chooses the players to infect. In Acemoglu et al. (2016) nodes/players are connected in a random network. Players have to invest in protection to be immune. Their investment depends on their links and the probability of being infected in the random network. This model allows to examine for instance the impact of a contagious disease on the individual behavior. These papers are different from the present one for two reasons. First, we study a framework where an attack on a link can remove only this specific link. Indeed, literature on contagious attacks reflects situations such as epidemics or virus spreading while our paper is focused on the study of specific link removal (for military strategies for instance). Second, in our model nodes cannot influence

⁹A network where all nodes have the same number of links.

¹⁰McBride and Hewitt (2013) study the best way to dismantle a criminal network with imperfect information on its architecture. There also exists a literature which examines the particular cases of terrorist attacks, transportation network security, and homeland security (see Brown et al. (2006), Tambe (2011), and Hong (2009)).

the architecture of the network by their decision.¹¹

The rest of the paper is organized as follows. In section 1.2, we present the model setup. In section 1.3, we present our main results. In section 1.4, we extend our model by examining a framework where the number of protected links available for the Designer is limited, and a framework where protected links have some probabilities to be removed by an attack. In section 1.5, we conclude.

1.2 Model setup

To simplify the notations, we set $\llbracket a, b \rrbracket = \{i \in \mathbb{N}, a \leq i \leq b\}$. Moreover, $\lfloor x \rfloor$ and $\lceil x \rceil$ are respectively the largest integer smaller or equal to x and the smallest integer larger or equal to x , and $\text{abs}(x) = \max\{-x, x\}$. Further, for every set X , $\#X$ is its cardinality.

Network. For any integer $n > 4$, let $N = \llbracket 1, n \rrbracket$ and $L(N)$ be the set of *unordered* pairs of N , i.e., $L(N) = \{(i, j) \in N \times N, i \neq j\}$. Throughout the paper, the elements of N are referred to as *nodes* while those of $L(N)$ are called *links*. An unordered pair $(i, j) \in L(N)$ is thus a link said to join nodes i and j and the link is denoted by ij . We introduce the notion of *protected network* as a triplet $g = (N, E_P, E_{NP})$ with $E_P \subseteq L(N)$, $E_{NP} \subseteq L(N)$ and $E_P \cap E_{NP} = \emptyset$. We call *protected links* the elements of E_P and *non-protected links* the elements of E_{NP} . Let G be the set of all protected networks. The significance of this refinement on the links will be made explicit in the two-player game formulation. To simplify the notations, we let $p = \#E_P$. In the rest of the paper, we will interchangeably use the term network or protected network.

For any network g , let $E_P(g)$ (respectively $E_{NP}(g)$) refer to the set of protected (respectively non-protected) links of g , and $E(g) = E_P(g) \cup E_{NP}(g)$. If there exists a link between

¹¹Additionally to economics, several fields investigate problems close to the one we deal with. In an early graph theoretic work, Harary (1962) exhibits a family of (k, n) -node-connected networks with a total number of links that is minimal. This family of networks is crucial to establish our results. Groetschel et al. (1995) study a model where a firm has to prevent a communication network to be disconnected given that there exist possibilities of communication failure. As some connections may be interrupted, the firm has to design the least costly network that guarantees the best service for the consumers. Moreover, there also exists a literature on the design of survivable networks (see the survey of Kerivin and Mahjoub (2005)) in Computer Science. Cunningham (1985) studies network security and considers a model where the Designer allocates a different number of defense units to each link. A defended link has a level of resistance that depends on the number of defense units the Designer has allocated to it. The Adversary allocates attack units to remove a link. A link is removed if more attack units than defense units have been allocated to this link. The author proposes an algorithm which exhibits how some links have to be reinforced in order to protect the network.

i and j in g (i.e., if $ij \in E(g)$), then i and j are called *adjacent*. For each node i , $d_i(g)$ is its *degree* in g , that is the number of links incident to i in g : $d_i(g) = \#\{ij \in E(g)\}$. A *path* between two nodes i_0 and i_q of a network g is a finite alternating sequence of nodes and *distinct* links: $i_0, i_0i_1, i_1, i_1i_2, i_2, \dots, i_{q-1}i_q, i_q$ where $i_l \in N$ for all $l \in \llbracket 0, q \rrbracket$ and $i_l i_{l+1} \in E(g)$ for all $l \in \llbracket 0, q-1 \rrbracket$. A *cycle* is a path where $i_0 = i_q$. Finally, a network $g = (N, E_P, E_{NP})$ is *connected* if there exists a path between any two nodes $i, j \in N$. We say that network $g' = (N', E_{P'}, E_{NP'})$ is a subnetwork of $g = (N, E_P, E_{NP})$ if $N' \subseteq N$, $E_{P'} \subseteq E_P$ and $E_{NP'} \subseteq E_{NP}$. Subnetwork $g' = (N', E_{P'}, E_{NP'})$ is a component of network g if g' is connected and if there is no connected subnetwork $g'' = (N'', E_{P}'', E_{NP}'')$ of g , with $g'' \neq g'$ and such that $N' \subseteq N''$ or $E(g') \subseteq E(g'')$. By convention, a node $i \in N$ such that $d_i(g) = 0$ is a component.

Two-player game. The players are the Designer (D) and the Adversary (A). We consider a two-stage game where D plays first and A moves at the second stage. Given N , a strategy s^D for D is (identified with) a protected network (N, E_P^D, E_{NP}^D) . In other words, D chooses to create some links from $L(N)$ and to protect some of them:

$$s^D = (N, E_P^D, E_{NP}^D), \quad E_P^D \subseteq L(N), \quad E_{NP}^D \subseteq L(N), \quad \text{and} \quad E_P^D \cap E_{NP}^D = \emptyset.$$

A strategy for the Adversary is a mapping that assigns to each protected network g a subset of links E^A of $E(g)$. In other words, A chooses to attack some links of g :

$$s^A : \begin{cases} G \rightarrow 2^{L(N)}, \\ g \mapsto s^A(g) = E^A, \quad \text{with } s^A(g) \subseteq E(g). \end{cases}$$

Residual network and benefits. At the first stage, D designs a protected network s^D . Then, the attack of A leads to a second protected network of the form $g^R = (N, E_P^D, E_{NP}^D \setminus E^A)$, which we call *residual network*. Note that, by construction, g^R is a subnetwork of s^D . The benefits of D are given by

$$\phi(g^R) = \begin{cases} 1, & \text{if } g^R \text{ is connected,} \\ 0, & \text{otherwise.} \end{cases} \quad (1.1)$$

Network and costs.

We assume that attacking a link has a unitary cost c_A . Therefore, the cost of the Adver-

sary associated with $s^A(g) = E^A$ is

$$c^A(E^A) = c_A \# E^A, \quad (1.2)$$

where $c_A \in [1/(n-3), 1)$.¹² Note that the cost of a strategy is less than 1 if and only if the Adversary attacks less than $k = \lfloor 1/c_A \rfloor$ links.

Similarly, both protected and non-protected links are costly to create: each protected link has a strictly positive cost $c_P > 0$ and each non-protected link has a strictly positive cost $c_L > 0$. We assume that $c_P > c_L$. The cost of a strategy s^D of the Designer is thus:

$$c^D(s^D) = c_P \# E_P^D + c_L \# E_{NP}^D. \quad (1.3)$$

If the cost of creating protected or non-protected links is too large, then D cannot use a strategy where she forms protected or non-protected links. Therefore, to obtain non trivial results, we assume that the costs of creating protected and non-protected links are sufficiently low: $c_P < 1/(n-1)$ and $c_L < 1/(n(n-1)/2)$.¹³

Payoffs. The payoff of the Designer for choosing s^D when the Adversary responds with s^A is:

$$\Pi^D(s^D, s^A(s^D)) = \phi(g^R) - c^D(s^D). \quad (1.4)$$

Since $c_P < 1/(n-1)$, D obtains a strictly positive payoff when she designs a network with $n-1$ protected links and 0 non-protected links and the residual network is connected. Similarly, since $c_L < 1/(n(n-1)/2)$, D obtains a strictly positive payoff when she designs a network with 0 protected links and $n(n-1)/2$ non-protected links and the residual network is connected.

¹²It will be clear in the following that if $c_A < 1/(n-3)$, then A may attack at least $n-2$ links. Due to our assumptions on the cost of protected and non-protected links and on the payoff function of D , if A can attack $n-2$ links, then in equilibrium, the only protected network without protected links that D may design is the complete network. Moreover, if A can attack strictly more than $n-2$ links, then in equilibrium D cannot design any protected network without protected links.

¹³It will be clear in the following that when $c_P < 1/(n-1)$ and $c_L < 1/(n(n-1)/2)$, then D builds a non-empty protected network in equilibrium.

The payoff of the Adversary is

$$\Pi^A(s^D, s^A(s^D)) = 1 - \phi(g^R) - c^A(s^A(s^D)). \quad (1.5)$$

If there exist two strategies of A that lead to the same payoff, A chooses the one having the highest value of $\#E^A$.¹⁴

In a nutshell, in our framework the objective of the Designer is to obtain a connected residual network at a minimal cost. The objective of the Adversary is to obtain a residual network that is disconnected. Note that A does not attack strictly more than $n - 3$ links. Indeed, A obtains $\Pi^A(s^D, s^A(s^D)) \leq 1 - \lfloor 1/c_A \rfloor \#E^A < 0$, when $\#E^A > n - 3$, while A obtains a payoff equal to zero when she attacks no links. We now provide some illustrations where equation (1.1) captures the benefits of D . Suppose that D has n production units identified to nodes. Let y_i be the output of production unit i , and δ_i be such that $\delta_i = 1$ if there is a path between $i \in \llbracket 2, n \rrbracket$ and production unit $i - 1$, and $\delta_i = 0$ otherwise. Here, production unit $i - 1$ can be interpreted as the *unique* supplier of production unit i . We assume that $y_1 = \gamma$, $\gamma > 0$, and $y_i = \delta_i y_{i-1}$ for $i \in \llbracket 2, n \rrbracket$. If the total output obtained by D from the production units is $Y = y_n$, then the total output function is in line with the benefits function of D . The same conclusion occurs if we assume $Y = \min_{i \in N} \{y_i\}$ or $Y = \prod_{i \in N} (y_i)^{\rho_i}$ with $\rho_i > 0$.

We now provide another example. Let nodes be identified to cities and links be identified to communication flows between cities. Public authorities may have an incentive to maintain communication between all the cities when some communication flows are broken because of a natural disaster or a strategic attack. Indeed, if some cities are isolated from the others, then it is difficult for the public authorities to rescue inhabitants of these cities.

Sub-game Perfect Equilibrium (SPE).

An SPE is a pair (s_*^D, s_*^A) that prescribes the following strategic choices. At Stage 2, A plays a best response $s_*^A(s^D)$ to $s^D \in G$:

$$s_*^A(s^D) \in \operatorname{argmax}_{X \subseteq E(s^D)} \{\Pi^A(s^D, X)\}.$$

¹⁴In particular, note that the strategy \emptyset for the Adversary leads to a payoff that equals zero. If $1/c_A$ is an integer, then there may exist a strategy such that $\#E^A = 1/c_A = k$ that disconnect the network. That strategy also has a payoff that equals zero and is chosen by the Adversary according to the tie-breaking rule (if no strategy with $\#E^A < k$ can disconnect the network).

Note that $s_*^A(s^D) \subseteq E_{NP}^D$ since attacks cannot remove protected links. Let $g_*^R(s^D)$ be the residual network obtained when D plays strategy s^D and A plays a best response to s^D , that is $s_*^A(s^D)$. Given the best response outcome $g_*^R(s^D)$, D achieves payoff $\phi(g_*^R(s^D)) - c^D(s^D)$ when choosing s^D .

At stage 1, D plays s_*^D such that

$$s_*^D \in \operatorname{argmax}_{X \in G} \{\Pi^D(X, s_*^A(X))\}.$$

Specific architectures. The *empty network* is the network which contains no links. A *tree* is a connected and acyclic network. A network g which contains n nodes is a (κ, n) -link-connected network if any subnetwork g' obtained from g by removing $\kappa - 1$ links is connected, and there exists a subnetwork g' obtained from g by removing κ links that is not connected. Let $\mathcal{G}(\kappa, n)$ be the set of minimal (κ, n) -link-connected networks with n nodes, i.e., if $g \in \mathcal{G}(\kappa, n)$, then there does not exist a (κ, n) -link-connected network, g' , such that $\#E(g') < \#E(g)$. It is easy to see that every node i of a network $g \in \mathcal{G}(\kappa, n)$ satisfies $d_i(g) \geq \kappa$, as otherwise it could be separated by removing all links incident to i . Consequently, the number of links in a minimal (κ, n) -link-connected network, $\kappa \geq 2$, is at least $\lceil n\kappa/2 \rceil$. As was shown by Harary (1962), this condition is also sufficient. The proof of this result is constructive – Harary describes how to obtain a family of solution graphs when $\kappa \geq 2$. The minimal (κ, n) -link-connected networks described by Harary are called (κ, n) -*Harary-networks*. To give the reader some idea of what (κ, n) -Harary-networks look like, we provide some examples in Figure 1.1 with 5 nodes. For full description of the construction the interested reader is referred to Harary (1962).

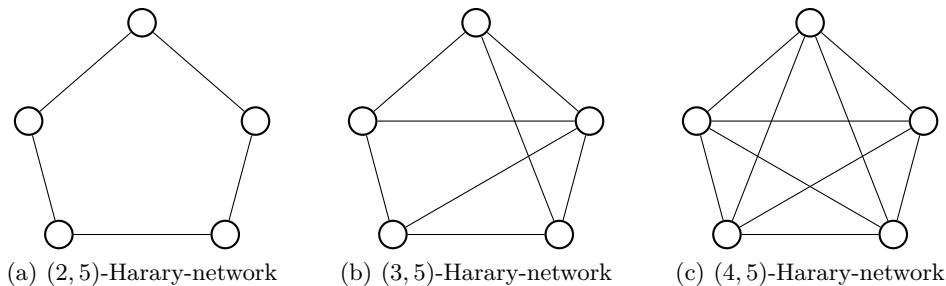

Figure 1.1: Examples of (κ, n) -Harary-networks.

Specific strategies. We define specific strategies that play a crucial role in the rest of the paper. $(N, \emptyset, \emptyset)$ is the *empty network*. Let $S_{p,k}^D$ be the set of protected networks that

(i) cannot be disconnected by k attacks, (ii) contain p protected links, and (iii) contain a minimal number of non-protected links. Protected networks which belong to the same set induce the same costs for D . Protected networks associated with two specific values of p play a crucial role in our analysis.

- $S_{0,k}^D$ is the set of protected networks which contain no protected link, and which are minimal $(k+1, n)$ -link-connected networks. For instance, $(k+1, n)$ -Harary-networks belong to $S_{0,k}^D$.
- $S_{n-1,k}^D$ is the set of protected networks $s^D = (N, E_P, E_{NP})$ which only contain protected links ($E_{NP} = \emptyset$) and such that (N, E_P, \emptyset) is a tree.¹⁵

1.3 Model Analysis

Our first result provides, for any number of protected links, the minimal number of non-protected links that the Designer has to form in order to prevent the Adversary from disconnecting the network.

To establish the first result, for any pair $(n, k) \in \mathbb{N} \times \llbracket 1, n-3 \rrbracket$, we set $p_1(k, n)$ and $p_2(k, n)$ as follows:

$$\left\{ \begin{array}{l} \Delta = (3k+5)^2 - 8n(k+1) \\ p_1(k, n) = \left\lfloor \frac{4n-3k-5-\sqrt{\Delta}}{8} \right\rfloor + 1 \quad \text{if } \Delta \geq 0, \quad \text{and } p_1(k, n) = -1 \text{ otherwise,} \\ p_2(k, n) = \left\lfloor \frac{4n-3k-5+\sqrt{\Delta}}{8} \right\rfloor - 1 \quad \text{if } \Delta \geq 0, \quad \text{and } p_2(k, n) = -1 \text{ otherwise.} \end{array} \right.$$

When no confusion is possible, we let $p_1 = p_1(k, n)$ and $p_2 = p_2(k, n)$.

Proposition 1 *Suppose that A attacks exactly k links in an optimal way. Let $n_1(p, k) = \left\lceil \frac{(n-p)(k+1)}{2} \right\rceil$ and $n_2(p, k) = (n-2p)(k+1+p) + (n-1)p - \frac{n(n-1)}{2}$. For $s^D \in S_{p,k}^D$,*

¹⁵Indeed, if the subnetwork of s^D , (N, E_P, \emptyset) , is a tree and $E_{NP} = \emptyset$, then $s^D \in S_{n-1,k}^D$ cannot be disconnected by k attacks. Otherwise – that is if (N, E_P, \emptyset) contains a cycle – the network is not connected unless $\#E_{NP}^D > 0$. Therefore, that network does not satisfy condition (iii) and thus is not in $S_{n-1,k}^D$.

$$\#E_{NP}^D = \begin{cases} n_1(p, k), & \text{for } p \in \llbracket 0, n-2 \rrbracket \setminus \llbracket p_1(k, n), p_2(k, n) \rrbracket, \\ n_2(p, k), & \text{for } p \in \llbracket 0, n-2 \rrbracket \cap \llbracket p_1(k, n), p_2(k, n) \rrbracket, \\ 0, & \text{for } p = n-1. \end{cases} \quad (1.6)$$

So, if D forms p protected links and A attacks k links, then the optimal cost function associated with the pair (p, k) is

$$C^*(p, k) = c_L \#E_{NP}^D + c_P p, \text{ with } s^D \in S_{p,k}^D. \quad (1.7)$$

Proof The proof is given in Appendix. \square

Let us provide the intuition of Proposition 1. If D forms $n-1$ protected links, then there exists a set of strategies (i.e., a set of protected networks) for D that allows to resist k attacks without non-protected links, $S_{n-1,k}^D$. Otherwise, let D form $p \in \llbracket 0, n-2 \rrbracket$ protected links and build a protected network $s^D = (N, E_P, E_{NP})$ in $S_{p,k}^D$.

First, (N, E_P, \emptyset) is acyclic. Indeed, if s^D contains a cycle, then there exists a protected link, say ij , that can be removed without altering the fact that s^D resists k attacks. Hence, it is possible for D to remove the protected link ij and replace a non-protected link $i'j'$ by the protected link $i'j'$, and so reduce the number of non-protected links.

Second, consider the following sequence of networks: $g_0 = (N, \emptyset, \emptyset)$ and for any $l \in \llbracket 1, p \rrbracket$, $g_l = (N, E_P(g_{l-1}) \cup ij, \emptyset)$ for some $ij \in E_P \setminus E_P(g_{l-1})$. Hence $g_p = (N, E_P, \emptyset)$. Since there is no cycle in (N, E_P, \emptyset) , then, for any l , the extra link of $E_P(g_l)$ allows to merge two components of $E_P(g_{l-1})$. Since g_0 has n components, then by an immediate recurrence, (N, E_P, \emptyset) has exactly $n-p$ components.

Third, observe that each component of (N, E_P, \emptyset) has to be incident to at least $k+1$ non-protected links, otherwise A can disconnect the protected network s^D with k attacks. Since there are $n-p$ such components, $n_1(p, k)$ is the minimal number of non-protected links to form. In the following example, we illustrate that there exist some values of p and k for which $n_1(p, k)$ non-protected links are sufficient to resist k attacks.

Example 1 Suppose $N = \llbracket 1, 10 \rrbracket$, $k = 6$ and $p = 5$. We describe a strategy s^D where

$\#E_{NP}^D = n_1(5, 6)$. Consider the networks of Figure 1.2 and s^D the protected network such that g', g'', g''' are all subnetworks of s^D , with $E_P^D = E_P(g''')$ and $E_{NP}^D = E_{NP}(g') \cup E_{NP}(g'')$. Note that subnetwork g' is a complete network and g'' is a $(3, 5)$ -Harary-network. Finally, we observe that each component in (N, E_P, \emptyset) is incident to at least 7 non-protected links and there is no possibility for A to disconnect s^D with 6 attacks.

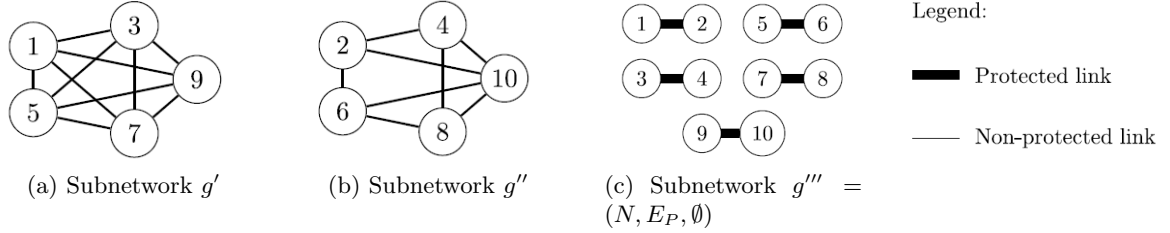

Figure 1.2: Subnetworks associated with Example 1: the solution network is (N, E_P, E_{NP}) with $E_{NP} = E_{NP}(g') \cup E_{NP}(g'')$.

Recall that each component of (N, E_P, \emptyset) has to be incident to at least $k+1$ non-protected links in order to resist k attacks. This fact implies that for some parameters p and k , networks in $S_{p,k}^D$ contains $n_2(p, k)$ non-protected links. We illustrate these cases through the following example.

Example 2 Suppose $N = \llbracket 1, 10 \rrbracket$, $k = 7$, and $p = 2$. We assume that D forms a protected network s^D in $S_{p,k}^D$, with a protected link between nodes 1 and 2 and between nodes 3 and 4. Then s^D contains 8 components. We denote by \mathcal{C} the component which contains nodes 1 and 2, and by \mathcal{C}' the component which contains nodes 3 and 4. Each of these components has to be incident to 8 non-protected links. Networks g' and g'' given in Figure 1.3 are subnetworks of s^D , with $E_P^D = E_P(g')$ and $E_{NP}^D = E_{NP}(g') \cup E_{NP}(g'')$. Each node $a \in \llbracket 5, 10 \rrbracket$ can form at most 5 non-protected links with each other. Hence each of them has to form at least 3 non-protected links with nodes in $\llbracket 1, 4 \rrbracket$. Altogether, nodes 5, 6, 7, 8, 9 and 10 have to form a total of $3 \times 6 = 18$ non-protected links with nodes 1, 2, 3 and 4. As for components \mathcal{C} and \mathcal{C}' , they should be incident to a total of 16 non-protected links. Hence, D cannot form a protected network with $n_1(2, 7)$ protected links that resists k attacks. More precisely, a network that cannot be disconnected by A with 7 attacks has to contain $18 + (5 \times 6)/2 = 33$ non-protected links while $n_1(2, 7) = 32$.

In Example 2, we have assumed that D uses protected links to form two components of size two in (N, E_P, \emptyset) . Now, assume instead that (N, E_P, \emptyset) has a unique component of size

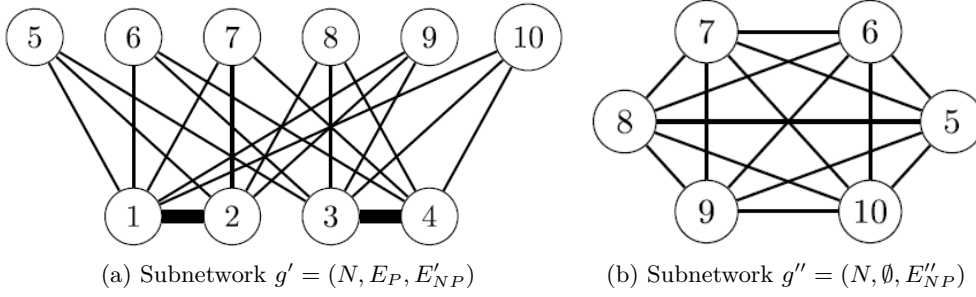

Figure 1.3: Subnetworks associated with Example 2: the solution is (N, E_P, E_{NP}) with $E_{NP}(g) = E'_{NP} \cup E''_{NP}$.

strictly greater than 1. For instance, D forms protected links between nodes 1 and 2 and between nodes 2 and 3. Then, each node $a \in \llbracket 4, 10 \rrbracket$ can form at most 6 non-protected links with other nodes in $\llbracket 4, 10 \rrbracket$. Consequently, since $k = 7$ each node $a \in \llbracket 4, 10 \rrbracket$ has to form at least 2 non-protected links with nodes in $\llbracket 1, 3 \rrbracket$. The component which contains nodes 1, 2 and 3 is incident to at least 14 non-protected links. It follows that D forms $21 + 14 = 35$ non-protected links instead of 33 links in Example 2. This example illustrates how D designs (N, E_P, \emptyset) in order to minimize the costs of forming links.

We now generalize Example 2 to provide some intuition for $p_1(k, n)$ and $p_2(k, n)$. Consider a protected network in $S_{p,k}^D$ where each component of (N, E_P, \emptyset) contains either one or two nodes. There are thus $n - 2p$ components of size 1 and p components of size 2. We observe that components of size 1 need to be incident to at least $k + 1$ non-protected links. Since the number of links between a component of size 1 and other components of size 1 is at most $(n - 2p - 1)$, the total number of non-protected links between components of size 1 and those of size 2 is at least equal to $(n - 2p)((k + 1) - (n - 2p - 1))$. Moreover, to minimize the number of links, the total number of the non-protected links incident to components of size 2 should be equal to $(k + 1)p$. Let x_1 and x_2 be the roots (when they exist) of $(n - 2x)((k + 1) - (n - 2x - 1)) = (k + 1)x$. Since $p_1(k, n) = \lfloor x_1 \rfloor + 1$ and $p_2(k, n) = \lceil x_2 \rceil - 1$, the number of non-protected links required to resist k attacks is given by $n_2(p, k)$ when $p \in \llbracket 0, n - 2 \rrbracket \cap \llbracket p_1(k, n), p_2(k, n) \rrbracket$.

We now characterize the SPE according to the costs of forming protected and non-protected links.

Proposition 2 *Let the payoff functions be given by equations (1.4) and (1.5), and let (s_*^D, s_*^A)*

be an SPE.¹⁶

1. Suppose that $n(k+1) \bmod 2 = 0$.

(a) If $\frac{c_P}{c_L} < \binom{n}{n-1} \binom{k+1}{2}$, then $s_*^D \in S_{n-1,k}^D$ and $s_*^A(s_*^D) = \emptyset$.

(b) If $\binom{n}{n-1} \binom{k+1}{2} < \frac{c_P}{c_L}$, then $s_*^D \in S_{0,k}^D$ and $s_*^A(s_*^D) = \emptyset$.

2. Suppose that $n(k+1) \bmod 2 = 1$.

(a) If $\frac{c_P}{c_L} < \binom{n-1}{n-2} \binom{k+1}{2}$, then $s_*^D \in S_{n-1,k}^D$ and $s_*^A(s_*^D) = \emptyset$.

(b) If $\binom{n-1}{n-2} \binom{k+1}{2} < \frac{c_P}{c_L} < \frac{k+2}{2}$, then $s_*^D \in S_{1,k}^D$ and $s_*^A(s_*^D) = \emptyset$.

(c) If $\frac{k+2}{2} < \frac{c_P}{c_L}$, then $s_*^D \in S_{0,k}^D$ and $s_*^A(s_*^D) = \emptyset$.

Proof Let $\Delta = (3k+5)^2 - 8n(k+1)$, by straightforward calculations, we have

$$\left\lfloor \frac{4n-3k-5-\sqrt{\Delta}}{8} \right\rfloor \geq 0. \text{ Hence, we have either } p_1(k,n) = p_2(k,n) = -1, \text{ or } p_1(k,n) \geq$$

1. Therefore, from Proposition 1, if D builds a protected network in $S_{0,k}^D$, then her cost equals $C^*(0,k) = n_1(0,k)c_L$. Similarly, by Proposition 1, $C^*(n-1,k) = (n-1)c_P$. Moreover, by Lemma 3, we know that $n_2(p,k) \geq n_1(p,k)$ when $p \in \llbracket p_1(k,n), p_2(k,n) \rrbracket$. Hence by Proposition 1, for all $p \in \llbracket 1, n-2 \rrbracket$, $C^*(p,k) \geq n_1(p,k)c_L + pc_P$. We prove successively the two parts of the proposition.

1. Let $n(k+1) \bmod 2 = 0$. For $p \in \llbracket 1, n-2 \rrbracket$, $C^*(p,k) - C^*(0,k) \geq p(c_P - c_L(k+1)/2) > 0$, if $c_P/c_L > (k+1)/2$. Moreover, $C^*(n-1,k) - C^*(0,k) > 0$ if $c_P/c_L > \binom{n}{n-1} \binom{k+1}{2}$.

Assume that $c_P/c_L > \binom{n}{n-1} \binom{k+1}{2}$. Then, $c_P/c_L > (k+1)/2$ and $s_*^D \in S_{0,k}^D$.

For $p \in \llbracket 1, n-2 \rrbracket$, $C^*(p,k) - C^*(n-1,k) > 0$ if $c_P/c_L < \binom{n-p}{n-p-1} \binom{k+1}{2}$.

Assume that $c_P/c_L < \binom{n}{n-1} \binom{k+1}{2}$. Then, $c_P/c_L < \binom{n-p}{n-p-1} \binom{k+1}{2}$ for all $p \in \llbracket 1, n-2 \rrbracket$. Consequently, $s_*^D \in S_{n-1,k}^D$.

¹⁶The case of equality follows the same pattern, that is:

1. If $n(k+1) \bmod 2 = 0$ and $\frac{c_P}{c_L} = \binom{n}{n-1} \binom{k+1}{2}$, then $s_*^D \in S_{n-1,k}^D \cup S_{0,k}^D$ and $s_*^A(s_*^D) = \emptyset$.

2. Suppose that $n(k+1) \bmod 2 = 1$.

(a) If $\frac{c_P}{c_L} = \binom{n-1}{n-2} \binom{k+1}{2}$, then $s_*^D \in S_{n-1,k}^D \cup S_{1,k}^D$ and $s_*^A(s_*^D) = \emptyset$.

(b) If $\frac{k+2}{2} = \frac{c_P}{c_L}$, then $s_*^D \in S_{0,k}^D \cup S_{1,k}^D$ and $s_*^A(s_*^D) = \emptyset$.

By assumption, $C^*(0, k) < 1$ and $C^*(n-1, k) < 1$. It follows that D has an incentive to build a protected network in $S_{0,k}^D$ or $S_{n-1,k}^D$ since she obtains benefits equal to 1. Hence, A cannot disconnect s_*^D with k attacks. Consequently, $s_*^A(s_*^D) = \emptyset$.

2. Let $n(k+1) \bmod 2 = 1$. By Proposition 1, we know that:

$$\begin{aligned} C^*(0, k) - C^*(1, k) &> 0 \text{ if } c_P/c_L < (k+2)/2, \\ C^*(1, k) - C^*(n-1, k) &> 0 \text{ if } c_P/c_L < \left(\frac{n-1}{n-2}\right) \left(\frac{k+1}{2}\right), \text{ and} \\ C^*(0, k) - C^*(n-1, k) &> 0 \text{ if } c_P/c_L < \frac{1}{n-1} \left\lceil \frac{n(k+1)}{2} \right\rceil. \end{aligned}$$

By using the same argument as in the previous point, we establish that for $p \in \llbracket 2, n-2 \rrbracket$, if $s^D \in S_{p,k}^D$, then s^D is not an optimal strategy for D . Assume that $c_P/c_L < \left(\frac{n-1}{n-2}\right) \left(\frac{k+1}{2}\right)$. Then $c_P/c_L < \left(\frac{n}{n-1}\right) \left(\frac{k+1}{2}\right)$ and $s_*^D \in S_{n-1,k}^D$. Assume that $c_P/c_L > \left(\frac{n-1}{n-2}\right) \left(\frac{k+1}{2}\right)$. There are two possible cases. If $c_P/c_L < (k+2)/2$, then $C^*(1, k) - C^*(n-1, k) < 0$ and $C^*(1, k) - C^*(0, k) < 0$, and $s_*^D \in S_{1,k}^D$. If $c_P/c_L > (k+2)/2$, then $C^*(0, k) - C^*(n-1, k) < 0$ and $C^*(0, k) - C^*(1, k) < 0$, and $s_*^D \in S_{0,k}^D$.

Since D has an incentive to build a network s_*^D in $S_{0,k}^D$, $S_{1,k}^D$ or $S_{n-1,k}^D$, A cannot disconnect s_*^D with k attacks. Consequently, $s_*^A(s_*^D) = \emptyset$.

□

Let us provide the intuition of Proposition 2. Note that if D builds a protected network that A cannot disconnect with k attacks (which is the maximal number of attacks that A has an incentive to choose), then A attacks no link in an SPE since each attack is costly. Also, due to the costs of forming protected and non-protected links, in an SPE D always has an incentive to build a protected network that A cannot disconnect.

We now compare the costs of protected networks that belong to different sets $S_{p,k}^D$, $p \in \llbracket 0, n-1 \rrbracket$, with respect to the values of c_L and c_P .

First, we consider point 1 of Proposition 2: $n(k+1) \bmod 2 = 0$. In Figure 1.4, we draw lines $(d_{p,p'})$ whose slopes $\sigma_{p,p'}$ can be interpreted as the *average number* of non-protected links that each protected link allows to save between a protected network in $S_{p,k}^D$, $p \in \llbracket 0, n-1 \rrbracket$, and a protected network that belongs to $S_{p',k}^D$, $p' \neq p$. We draw four such lines:

- Line $(d_{0,p'})$ whose slope $\sigma_{0,p'}$ shows the average saving of non-protected link *per protected link* between networks in $S_{0,k}^D$ and those of $S_{p',k}^D$, for $p' \in \llbracket 1, n-2 \rrbracket \setminus \llbracket p_1, p_2 \rrbracket$, and similarly:
- Line $(d_{0,\tilde{p}})$ of slope $\sigma_{0,\tilde{p}}$ between networks in $S_{0,k}^D$ and in $S_{\tilde{p},k}^D$, with $\tilde{p} \in \llbracket 0, n-2 \rrbracket \cap \llbracket p_1, p_2 \rrbracket$
- Line $(d_{0,n-1})$ of slope $\sigma_{0,n-1}$ between networks in $S_{0,k}^D$ and in $S_{n-1,k}^D$.
- Line $(d_{n-1,p'})$ of slope $\sigma_{n-1,p'}$ between networks in $S_{n-1,k}^D$ and in $S_{p',k}^D$, with $p' \in \llbracket 1, n-2 \rrbracket$.

Observe that for any $p' \in \llbracket 1, n-2 \rrbracket \setminus \llbracket p_1, p_2 \rrbracket$ and any $\tilde{p} \in \llbracket 0, n-2 \rrbracket \cap \llbracket p_1, p_2 \rrbracket$, $\text{abs}(\sigma_{0,\tilde{p}}) < \text{abs}(\sigma_{0,p'})$. Similarly, for any $p' \in \llbracket 1, n-2 \rrbracket \setminus \llbracket p_1, p_2 \rrbracket$, $\text{abs}(\sigma_{0,p'}) < \text{abs}(\sigma_{0,n-1})$. Moreover, for any $p \in \llbracket 1, n-2 \rrbracket$, $\text{abs}(\sigma_{0,n-1}) < \text{abs}(\sigma_{n-1,p'})$.

Suppose $c_P/c_L > \text{abs}(\sigma_{0,n-1})$. Then, costs of forming links with a strategy in $S_{0,k}^D$ are lower than the costs of forming links with a strategy in $S_{n-1,k}^D$. Moreover, $c_P/c_L > \text{abs}(\sigma_{0,n-1}) > \text{abs}(\sigma_{0,p'}) > \text{abs}(\sigma_{0,\tilde{p}})$, with $p' \in \llbracket 1, n-2 \rrbracket \setminus \llbracket p_1, p_2 \rrbracket$ and $\tilde{p} \in \llbracket 0, n-2 \rrbracket \cap \llbracket p_1, p_2 \rrbracket$. It follows that the costs of forming links are minimized for strategies in $S_{0,k}^D$. Conversely, suppose $c_P/c_L < \text{abs}(\sigma_{0,n-1})$. Then $c_P/c_L < \text{abs}(\sigma_{n-1,p'})$, for $p' \in \llbracket 1, n-2 \rrbracket$. It follows that the costs of forming links are minimized for strategies in $S_{n-1,k}^D$. Finally, note that $\text{abs}(\sigma_{0,n-1}) = \binom{n}{n-1} \binom{k+1}{2}$.

We now consider the second part of Proposition 2: $n(k+1) \bmod 2 = 1$. The intuition is similar to the case where $n(k+1) \bmod 2 = 0$ except for protected networks which belong to $S_{0,k}^D$ and $S_{1,k}^D$. Consequently, we focus only on three sets of protected networks: $S_{0,k}^D$, $S_{1,k}^D$ and $S_{n-1,k}^D$. In Figure 1.5, the slope $\sigma_{0,1}$ of $(d_{0,1})$, can be interpreted as the number of non-protected links that the protected link allows to save between a protected network in $S_{0,k}^D$ and a protected network in $S_{1,k}^D$. The same interpretation is valid for the slope $\sigma_{1,n-1}$ of $(d_{1,n-1})$, which relates a protected network in $S_{1,k}^D$ and a protected network in $S_{n-1,k}^D$, and for the slope $\sigma_{0,n-1}$ of the line $(d_{0,n-1})$, which relates a protected network in $S_{0,k}^D$ and a protected network in $S_{n-1,k}^D$.

Suppose that $c_P/c_L < \text{abs}(\sigma_{1,n-1})$. Then, $c_P/c_L < \text{abs}(\sigma_{0,n-1})$, and networks in $S_{n-1,k}^D$ have a minimal link formation cost. Conversely, suppose that $c_P/c_L > \text{abs}(\sigma_{1,n-1})$. If $k < n-3$,¹⁷ then there are two possibilities. If $c_P/c_L > \text{abs}(\sigma_{0,1})$, then protected networks in $S_{0,k}^D$ minimize the cost of forming links. If $c_P/c_L < \text{abs}(\sigma_{0,1})$, then protected networks

¹⁷For $k = n-3$, $\frac{k+2}{2} = \binom{n-1}{n-2} \binom{k+1}{2}$, and thus the case 2.(b) of Proposition 2 never occurs.

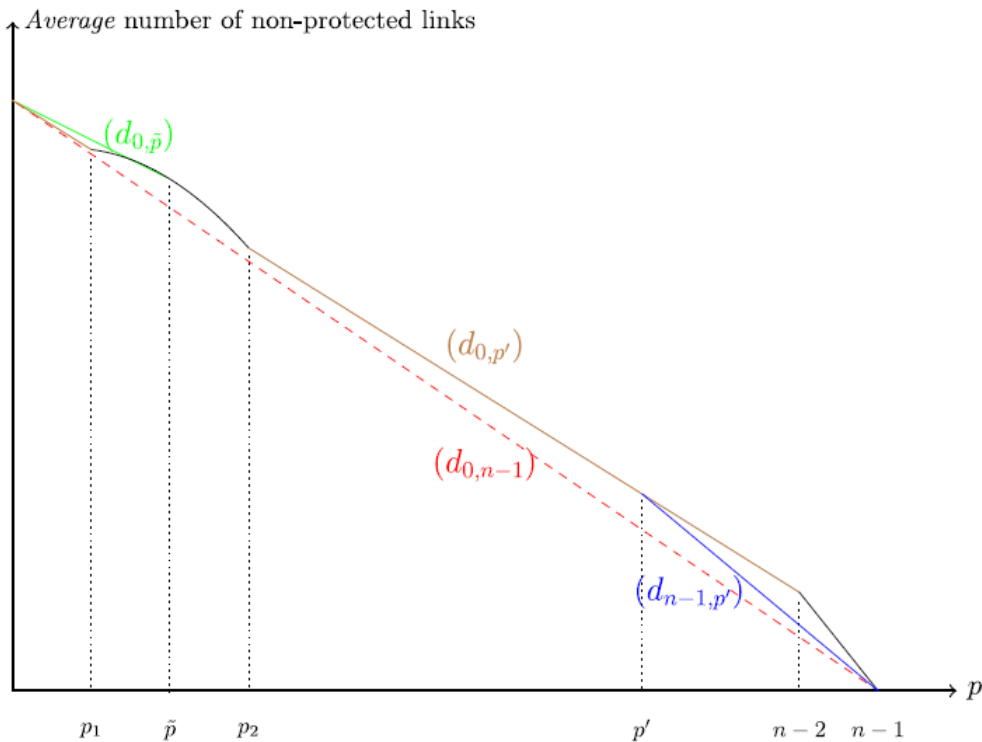

Figure 1.4: Intuition of Proposition 2 when $n(k+1) \bmod 2 = 0$.

in $S_{1,k}^D$ minimize the cost of forming links. Finally, note that $\text{abs}(\sigma_{0,1}) = (k+2)/2$, and $\text{abs}(\sigma_{1,n-1}) = \binom{n-1}{n-2} \binom{k+1}{2}$.

We now compare the results obtained in our framework where A attacks links and the results obtained in DG's framework where A attacks nodes (Proposition 1 in Dziubinski and Goyal (2013)). Recall that in DG's paper, the non-empty networks formed by D at equilibrium are either a star network with a protected central node, or a minimal $(k+1, n)$ -node-connected network without any protection. Hence, (s^D, \emptyset) , with $s^D \in S_{0,k}^D$, is an SPE when the cost of links (non-protected links in our case) is sufficiently low relative to the cost of protection in both frameworks.

However, when A attacks nodes, D uses at most one protected node at equilibrium. The role played by the protections is different since in DG, if D builds a star network, one protection is sufficient to protect the network and resist any attack of A . By contrast, in our framework, D may use more than one protected link in an SPE: indeed, when the cost of protected links is sufficiently low relative to the cost of non-protected links, D designs a $(1, n)$ -link-connected network which contains $n-1$ protected links. Protecting a network

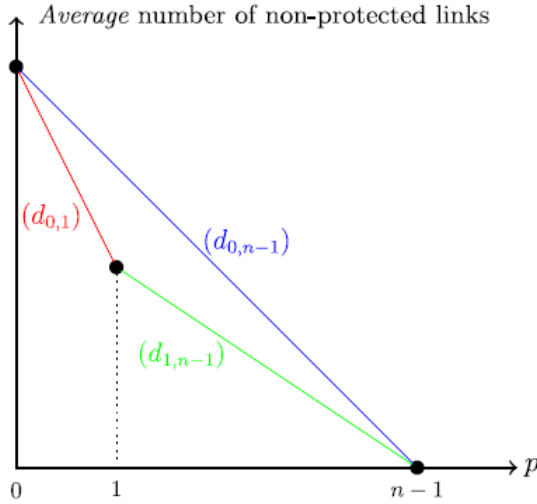

Figure 1.5: Intuition of Proposition 2 when $n(k+1) \bmod 2 = 1$ and $k < n-3$.

under link-attack is thus more costly than protecting a network under node-attack. This is because our framework calls for the survival of every node, a requirement which does not hold in the DG's framework.

1.4 Limited number of protected links and imperfectly protected links

In this section, we consider two potential types of restrictions on the protection of the network for the Designer. First, we consider the case where D can only use a limited number of protected links and we focus on situations where this number is smaller than $p_2(k, n)$. Then, we consider a framework where links are imperfectly protected and can be removed by the Adversary with some a priori known probability $\pi \in (0, 1)$.

1.4.1 Limited number of protected links

We examine a framework where the maximal number of protected links, \bar{p} , that D can form is strictly smaller than $n-1$. More precisely, we are interested in the case where $\bar{p} \in \llbracket p_1(k, n), p_2(k, n) \rrbracket$.¹⁸

Proposition 2 establishes that for $n(k+1) \bmod 2 = 0$, there exists no SPE in which D uses both protected and non-protected links. In contrast, when $\bar{p} \in \llbracket p_1, p_2 \rrbracket$, there exist values where the SPEs are of the form (s^D, \emptyset) with $s^D \in S_{p_1-1, k}^D$. Note that networks in $S_{p_1-1, k}^D$

¹⁸This interval is non empty if $p_2 > p_1$ which implies that $\Delta > 0$, that is $n < \frac{(3k+5)^2}{8(k+1)}$.

contain both protected and non-protected links when $p_1 > 1$.¹⁹ The following proposition gives a condition on the values of the parameters upon which such situations arise.

To simplify the analysis, we assume that $(k + 1) \bmod 2 = 0$.

Proposition 3 *Assume that $(k + 1) \bmod 2 = 0$ and $n < (3k + 5)^2 / (8(k + 1))$. Assume further that $p_1 > 1$, $p_2 - p_1 \geq 2$ and that the maximal number of protected links is $\bar{p} \in \llbracket p_1, p_2 \rrbracket$.*

Let (s_^D, s_*^A) be an SPE. There exists $\varepsilon > 0$ such that if $(k + 1)/2 - \varepsilon < c_P/c_L < (k + 1)/2$, then $s_*^D \in S_{p_1-1, k}^D$ and $s_*^A(s_*^D) = \emptyset$.*

Proof

If $p_1 > 1$, for all $p \in \llbracket 1, p_1 - 1 \rrbracket$, $C^*(0, k) - C^*(p, k) = p(\frac{k+1}{2}c_L - c_P)$. If $c_P/c_L < (k+1)/2$, then $C^*(0, k) - C^*(p, k) > 0$. Therefore, if $c_P/c_L < (k+1)/2$, then $\operatorname{argmin}_{p \in \llbracket 0, p_1 - 1 \rrbracket} \{C^*(p, k)\} = p_1 - 1$.

Now, let $p \in \llbracket p_1, \bar{p} \rrbracket$. We have $C^*(p, k) - C^*(p_1 - 1, k) = (p - p_1 + 1)c_P + (n_2(p, k) - n_1(p_1 - 1, k))c_L$. Consider $\varepsilon = \frac{k+1}{2} - \max_{p \in \llbracket p_1, \bar{p} \rrbracket} \left\{ \frac{n_1(p_1 - 1, k) - n_2(p, k)}{p - p_1 + 1} \right\}$. Since $\llbracket p_1 - 1, \bar{p} \rrbracket$ is a discrete non-empty set, then ε is well defined. If $(k + 1)/2 - \varepsilon < c_P/c_L$, then $C^*(p, k) - C^*(p_1 - 1, k) > ((p - p_1 + 1)((k + 1)/2 - \varepsilon) + n_2(p, k) - n_1(p_1 - 1, k))c_L \geq ((p - p_1 + 1)\frac{n_1(p_1 - 1, k) - n_2(p, k)}{p - p_1 + 1} + n_2(p, k) - n_1(p_1 - 1, k))c_L = 0$. Thus, $\operatorname{argmin}_{p \in \llbracket p_1 - 1, \bar{p} \rrbracket} \{C^*(p, k)\} = p_1 - 1$.

It remains to show that $\varepsilon > 0$. If $p \in \llbracket p_1 - 1, \bar{p} \rrbracket$, then $(n - 2p)((k + 1) - (n - 2p - 1)) > (k + 1)p$. Moreover, by straightforward calculations if $(k + 1) \bmod 2 = 1$ and $(n - 2p)((k + 1) - (n - 2p - 1)) > (k + 1)p$, then $n_2(p, k) > n_1(p, k)$. Thus

$$\frac{n_1(p_1 - 1, k) - n_2(p, k)}{p - p_1 + 1} < \frac{n_1(p_1 - 1, k) - n_1(p, k)}{p - p_1 + 1} \leq \frac{(k + 1)(n - p_1 + 1 - n + p)}{2(p - p_1 + 1)} = \frac{k + 1}{2}.$$

Since this holds for any $p \in \llbracket p_1, \bar{p} \rrbracket$, then $\varepsilon > 0$. Finally, since (i) $s_*^D \in S_{p_1-1, k}^D$, (ii) any network in $S_{p_1-1, k}^D$ cannot be disconnected with k attacks and (iii) attacks are costly for A , then $s_*^A(s_*^D) = \emptyset$. \square

We illustrate this result with an example:

Example 3 *Suppose that $n = 31$ and $k = 27$. Then, $p_1 = 3$ and $p_2 = 7$. Let $\bar{p} = 6$. Figure 1.6 shows the number of non-protected links in networks of $S_{p, k}^D$ as a function of the*

¹⁹Indeed, note that $p_1 \leq \frac{4n}{8} + 1 \leq n - 1$ since $n \geq 4$ and therefore $S_{p_1-1, k}^D$ always contains non-protected links.

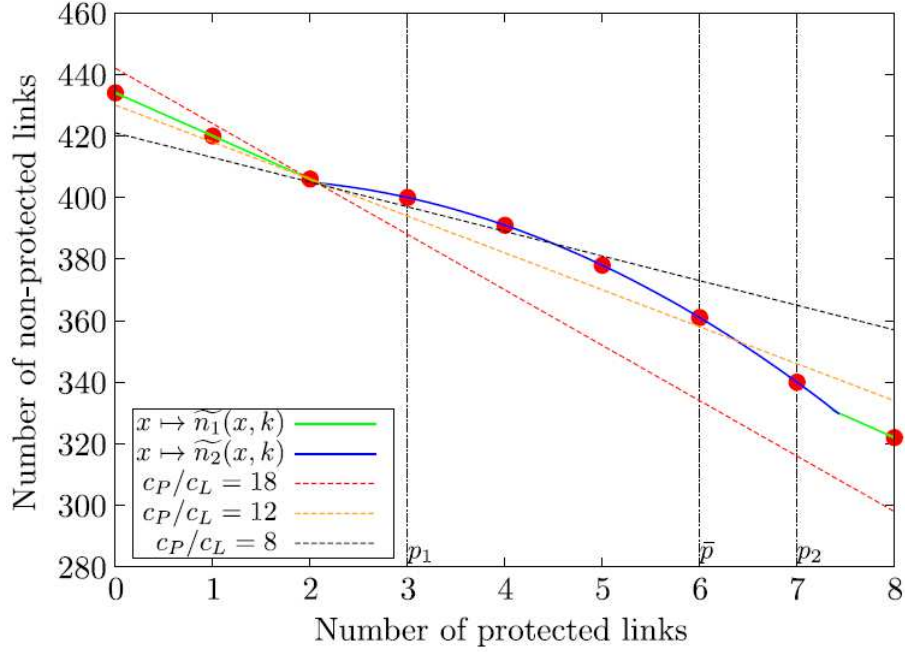

Figure 1.6: Example with $n = 31$, $k = 27$. The optimal strategy for D depends on the value of c_P/c_L .

number of protected links (large dots in red).

Let us consider the following function:

$$\widetilde{E}_{NP} : x \mapsto \begin{cases} \tilde{n}_1(x) = \frac{(n-x)(k+1)}{2} & \text{if } x \in [0, p_1) \cup (p_2, n-2], \\ \tilde{n}_2(x) = (n-2x) \left(k+1 - \frac{n-2x-1}{2} \right) & \text{otherwise.} \end{cases}$$

Note that since $(k+1) \bmod 2 = 0$, then for any $p \in \llbracket 1, n-2 \rrbracket$ we have $\tilde{n}_1(p) = n_1(p, k)$, $\tilde{n}_2(p) = n_2(p, k)$ and $\widetilde{E}_{NP}(p) = \#E_{NP}(s^D)$ for any $s^D \in S_{p,k}^D$. Therefore the functions \tilde{n}_1 , \tilde{n}_2 and \widetilde{E}_{NP} can be interpreted as the natural continuous extensions of $p \mapsto n_1(p, k)$, $p \mapsto n_2(p, k)$ and $p \mapsto \#E_{NP}(s^D)$, $s^D \in S_{p,k}^D$, respectively.

The functions \tilde{n}_1 and \tilde{n}_2 are plotted in green and blue plain lines respectively in Figure 1.6.

Let us consider a value of c_P and c_L . The lines of equal costs (isocost lines) have slope $-c_P/c_L$, thus have equations of the type

$$y = c c_L - p c_P, \tag{Iso}$$

with $c c_L$ being the y -coordinate of the y -intercept. The value of c corresponds to the associated cost for the Designer normalized by c_L .

The optimal cost for D corresponds to the smallest value c such that the associated element of (Iso) intersects with the plot of \widetilde{E}_{NP} for some integer value p . Then, the optimal strategies of D belong to $S_{p,k}^D$.

Figure 1.6 shows the optimal strategies of D for three different values of c_P/c_L , namely 18, 12 and 8 (in dashed lines):

For large values of c_P/c_L (value 18 in Figure 1.6) the slope of the line of (Iso) is larger (in absolute value) than that of \widetilde{n}_1 and thus the optimal strategy for D is obtained with $p = 0$ protected links. In other words, if $c_P/c_L > \frac{k+1}{2}$, then the optimal strategies for D belong to $S_{0,k}^D$.

For small values of c_P/c_L (value 8 in Figure 1.6) the slope of the line (Iso) is low, hence favoring strategies with maximal values of p . In Figure 1.6, one can see that for $c_P/c_L = 8$, the optimal strategy for the Designer is obtained for $p = \bar{p}$ protected links.

For intermediate values of c_P/c_L (value 12 in Figure 1.6) the optimal strategy for the Designer is obtained when using $p_1 - 1$ protected links, which is the inflection point of \widetilde{E}_{NP} .

Dziubinski and Goyal (2013) show that when A attacks nodes, there exist situations where the optimal strategy of D is a star network with a protected central node. In this case, D uses both node protections and link creations to protect her network. In our framework, D may use both protected and non-protected links to protect her network if the number of protected links available to D belongs to $\llbracket p_1, p_2 \rrbracket$. This result is a consequence of the discontinuity in the number of non-protected links that each protected link allows the Designer to save (given that D builds a network that resists k attacks).

1.4.2 Imperfectly protected links

We now assume that each protected link has a probability $\pi \in (0, 1)$ to be removed when it is attacked by A . Let $g = (N, E_P, E_{NP})$ be an (imperfectly) protected network, and E^A an attack over the links of g . In the benchmark model, g^R is obtained by removing the links of E_{NP} that are targeted by A , i.e., $g^R = (N, E_P, E_{NP} \setminus E^A)$. Now, a realization of the attack, g^e , is a subnetwork of g^R of the form $g^e = (N, E_e, E_{NP} \setminus E^A)$ with $E_e \subseteq E_P \setminus E^A$.

We illustrate these networks in the following example.

Example 4 Suppose $N = \llbracket 1, 5 \rrbracket$, $E_{NP}(g) = \{13, 15, 25, 34, 35, 45\}$, $E_P(g) = \{12, 24\}$ and $E^A = \{12, 34\}$ (see Figure 1.7). The subnetwork g^R obtained when removing the non-protected links that are attacked (i.e., $E^A \cap E_{NP}$), is drawn in Figure 1.7b. The two possible realizations are drawn in Figures 1.7c and 1.7d. Note that g_1^g occurs with probability $1 - \pi$, and g_2^g occurs with probability π .

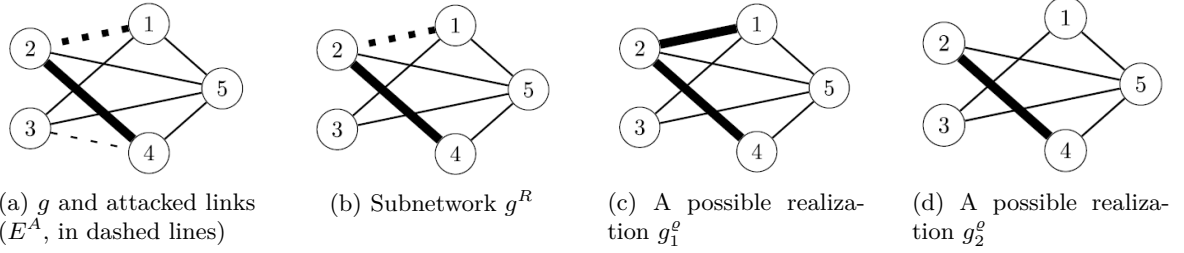

Figure 1.7: Networks of Example 4. Thick lines represent protected links and dashed lines represent links that are targeted by A .

Let g^e be a realization and $\lambda(g^e|g^R, E^A)$ be the probability that g^e is realized given g^R and E^A . We have

$$\lambda(g^e|g^R, E^A) = \prod_{\substack{ij \in E_P(g^e), \\ ij \in E_P^D \cap E^A}} (1 - \pi) \prod_{\substack{ij \notin E_P(g^e), \\ ij \in E_P^D \cap E^A}} \pi.$$

The expected benefits obtained by D , $\mathbb{E}\phi(g^R, E^A)$, when she builds a protected network g and A chooses E^A is

$$\mathbb{E}\phi(g^R, E^A) = \sum_{\substack{g^e = (N, E_e, E_{NP}^D \setminus E^A) \\ E_e \subseteq E_P^D}} \lambda(g^e|g^R, E^A) \phi(g^e).$$

We assume that the costs incurred by D when she chooses a strategy are given by equation (1.3), the costs incurred by A when she chooses a strategy are given by equation (1.2). The expected payoffs obtained by D , $\mathbb{E}\Pi^D$, is the difference between the expected benefits and the costs of forming protected and non-protected links:

$$\mathbb{E}\Pi^D(s^D, s^A(s^D)) = \mathbb{E}\phi(g^R, E^A) - c^D(s^D). \quad (1.8)$$

Finally, the expected payoffs obtained by A are

$$\mathbb{E}\Pi^A(s^D, s^A(s^D)) = 1 - \mathbb{E}\phi(g^R, E^A) - c^A(s^A(s^D)). \quad (1.9)$$

Recall that $c_A \geq 1/(n-3)$.

Proposition 4 *Let the payoff functions be given by equations (1.8) and (1.9). Suppose that $\pi < c_A$. Then, results provided in Proposition 2 are preserved.*

Proof

Let $s_*^D = (N, E_P, E_{NP})$ and let $s_*^A(s_*^D) = E^A$ with $E^A = (E_P^A, E_{NP}^A)$, where $E_P^A \subseteq E_P$ and $E_{NP}^A \subseteq E_{NP}$.

If A can disconnect the protected network s_*^D with $E^A = (\emptyset, E_{NP}^A)$, then her best response is to not attack any protected links, i.e., $E_P^A = \emptyset$, since attacks are costly.

If A cannot disconnect the protected network s_*^D with (\emptyset, E_{NP}^A) , then (E_P^A, E_{NP}^A) should disconnect the network with a strictly positive probability (otherwise A would not be playing a best response). The highest probability to disconnect network (N, E_P, E_{NP}) occurs when the deletion of any protected link implies that (N, E_P, E_{NP}) is disconnected. This probability is $1 - (1 - \pi)^{\#E_P^A}$. Since $1 - \pi \in (0, 1)$, by Taylor's expansion $1 - (1 - \pi)^{\#E_P^A} = \sum_{l=0}^{\infty} \binom{\#E_P^A}{l} (-1)^{l+1} \pi^l$. Then by Leibniz's rule on alternating series $1 - (1 - \pi)^{\#E_P^A} \leq \pi \#E_P^A$. Hence, A disconnects the network with a probability lower or equal to $\pi \#E_P^A$ when she attacks the links in E^A . So, the expected benefits associated with E^A are at most $\pi \#E_P^A$ with a cost of at least $c_A \#E_P^A$. Hence, if $E_P^A \neq \emptyset$ and $\pi < c_A$, then the expected payoff associated to E^A is (strictly) negative and thus A does not play a best response. Therefore $E_P^A = \emptyset$.

Since no optimal strategy of A targets any protected link, the situation is equivalent to the one examined in Proposition 2. \square

Proposition 4 examines situations where probability π is low relative to c_A , the cost of attacking links. We now examine other situations through an example.

Example 5 *Suppose that $N = \llbracket 1, 5 \rrbracket$ and $k = 2$, thus the maximum number of attacks that A has an incentive to do is 2. To simplify the analysis, we assume that $c_P > (3/2)c_L$. Figure 1.8 shows the networks that maximize the expected payoff of D for different numbers of protected links $p = 1, \dots, 5$ and all of A potential best response attacks. As in the previous figures, the protected links are represented by thick lines and dashed lines identify the links potentially attacked by A . The captions represent the Designer's expected benefit. Depending on the value of c_A , the Adversary may attack 0, 1 or 2 links leading to different values of D 's expected benefit.*

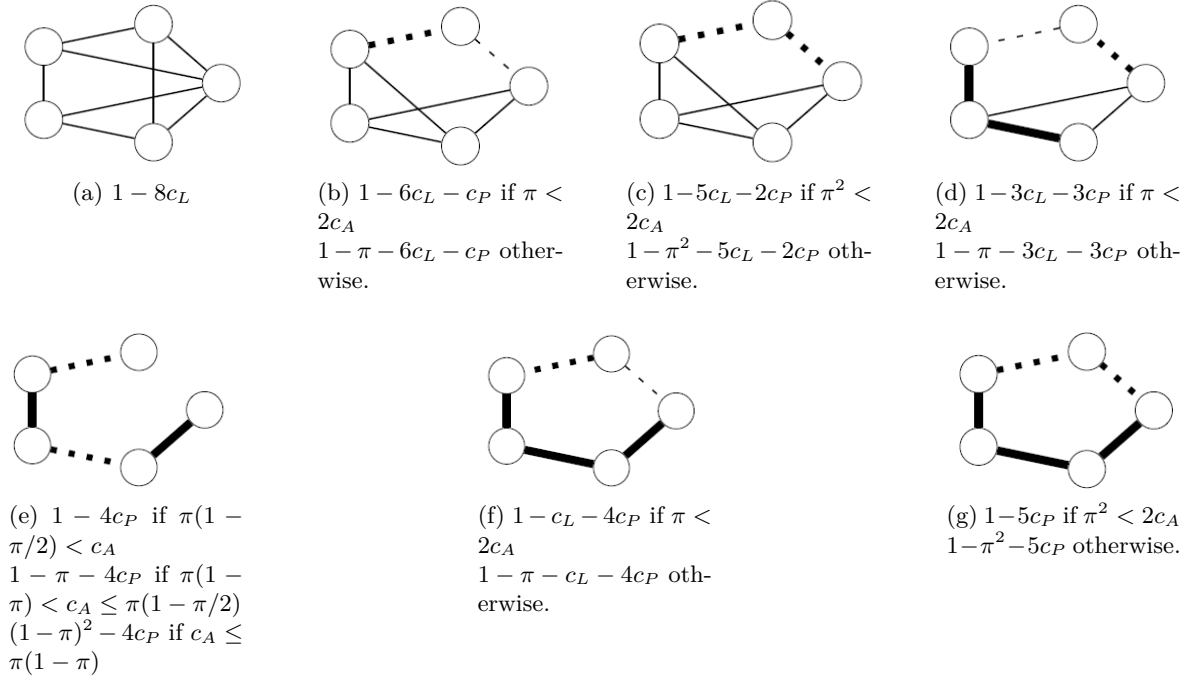

Figure 1.8: Networks of Example 5: $n = 5$, $k = 2$. Optimal strategies for D for different numbers of protected links and when A attacks (up to) 2 links. The captions of the figures give the Designer's expected benefit.

Note that the (3, 5)-Harary-network (in $S_{0,k}^D$ represented in Figure 1.8a) contains 0 protected links and 8 non-protected links and is fully protected against any attack of 2 links. Therefore, all other strategies that can be optimal for D induce networks which contain at most 7 links, which in turn implies that there exists at least one node of degree lower or equal to 2. Further, the expected benefit associated to any network for the Designer is always bounded by the probability of its weakest node to be disconnected. Hence, the expected benefits of any protected network not in $S_{0,k}^D$ are lower or equal to $1 - \pi^2$. Figure 1.8g shows a network with such expected benefits and 5 protected links. Since $c_P > c_L$, D has no incentive to form networks which contains 6 protected links or more. Based on these observations, Figure 1.8 contains all potential optimal strategies of D under imperfectly protected links.

Let us now focus on the optimal strategies of A . Networks 1.8b-1.8d and 1.8f-1.8g can only be disconnected if at least two links fail. Therefore the Adversary has no incentive to attack only 1 link in these networks. Further, since $c_P > (3/2)c_L$, we have $3c_L + 3c_P > 6c_L + c_P$, and thus the strategy depicted in 1.8d is never an optimal strategy for D . Further, suppose that for some value of π , the strategy of D depicted in Figure 1.8c is optimal for D , then it has a greater or equal expected payoff than that of Figure 1.8g and thus $5c_L \leq 3c_P$. But,

then its expected payoff is no more than $1 - 5c_L - 10c_L/3 < 1 - 8c_L$ and thus is strictly dominated by strategy depicted in Figure 1.8a which is a contradiction. Thus, building the network of Figure 1.8c is never an optimal strategy. It follows that only strategies depicted in Figures 1.8a, 1.8b, 1.8e, 1.8f, 1.8g are candidate to be optimal for D .

Let us now compare these strategies with that of the case of perfectly protected links. From Proposition 2, since $n(k+1) \bmod 2 = 1$, three potential SPEs could occur, resulting in the networks of Figure 1.8a, 1.8b and 1.8e. However, as in this case $k = n - 3$, then protected networks in $S_{1,k}^D$ (depicted in Figure 1.8b) are never optimal when $\pi = 0$ (as explained in Footnote 17). For small values of π , the networks of Figure 1.8a and 1.8e can occur. For instance for $\pi = c_A = 0.1$ and $c_P = 0.2$ and $c_L = 0.075$, then the networks of $S_{0,k}^D$ are optimal, while for $c_P = 0.12$ and $c_L = 0.075$ the networks of $S_{n-1,k}^D$ are optimal. Note that in that cases, A does not attack any link in SPEs.

Suppose that $c_P/c_L > (k+2)/2$, then for perfectly protected links (i.e., $\pi = 0$), building the network of Figure 1.8a is an equilibrium strategy for D and an equilibrium strategy for A is to attack no link. Observe now that the expected payoff of D associated with this network is not modified when π changes, while her expected payoff associated with all other networks drawn in Figure 1.8e decreases with π and reaches negative values. Consequently, given c_P and c_L there exists a probability $\bar{\pi}$ such that for $\pi > \bar{\pi}$ strategies in $S_{0,k}^D$ are optimal for D . Moreover, for $\pi = 0.45$, $c_P = 0.113$, and $c_L = 0.075$ and $c_A = 0.2$, the network of Figure 1.8g is induced by an optimal strategy for D given that A chooses an optimal attack. Further, for $c_P = 0.12$, $c_L = 0.075$, $\pi = 0.3$ and $c_A = 0.2$, the network of Figure 1.8f is induced by an optimal strategy for D given that A plays an optimal strategy. Note that D never builds these protected networks in our benchmark model.²⁰

Example 5 establishes three main insights. First, $S_{0,k}^D$ are the unique optimal strategies when π is sufficiently high. Second, there exist situations where the Designer's best strategy is to build a network where each node is incident to m protected links, with $m = k$. Note that since $c_P > c_L$, D has no incentive to form a protected network where each node is incident to $k+1$ protected links. Third, there exist optimal strategies for D where nodes which belong to the same component in (N, E_P, \emptyset) are linked with a non-protected link (see Figure 1.8f) in an optimal strategy for D .

²⁰Note that in Figure 1.8g, each node is incident to 2 protected links and $k = 2$. Interestingly, Dziubinski and Goyal (2013) and Landwehr (2015) establish that in models with imperfect defense, there exist parameters where D designs a $(2, n)$ -Harary-networks in equilibrium.

Dziubinski and Goyal (2013) examine the impact of imperfect defense in a framework where D protects nodes instead of links. They use an example and provide two insights. First, there exist parameters such that the SPEs obtained in the perfect defense model remain equilibria in the imperfect defense model, namely the empty network, the center protected star, and the minimal $(k + 1, n)$ -node-connected networks. Second, they establish that richer strategies than those played by D in the perfect defense model may appear in equilibrium. In particular, for some parameters an optimal strategy for D is to protect several nodes and create a network which generalizes the center protected star network, or to design a $(2, n)$ -node-connected network and to protect all the nodes.

It is worth noting that imperfect defense has the same type of impact in the framework of DG and in our framework. First, if the probability of successful attacks π is sufficiently high and the cost of forming non-protected links is sufficiently low, then strategies in $S_{0,k}^D$ are the unique optimal strategies for D . Second, the set of strategies candidate to be an equilibrium is larger in the imperfect defense framework than in the perfect defense framework. In particular, for sufficiently high π , D has an incentive to use more protections than in a situation where $\pi = 0$: there exist parameters where D protects all the nodes in DG's framework, and there exist parameters where D designs a network where each node is incident to k protected links in our framework. Third, in both frameworks it is difficult to obtain general results when imperfect defense is introduced. However, Landwehr (2015) provides equilibrium strategies for D when the number of attacks is very small. In particular, he establishes that if $k = 2$, then there exist 6 types of strategies that D may play in equilibrium according to the value of π , c_P , and c_L .

1.5 Conclusion

In this paper, we have studied the optimal way to design and protect a network under strategic link attacks. In our benchmark model, the number of protected links available for the Designer is not bounded, and protected links cannot be removed by the Adversary. Our main findings in this model are the following. In equilibrium, three types of networks may arise according to the value of the parameters of the model (which are the number of nodes and the costs of link creation and attack). First, if the relative cost of protections (cost of a protected link/cost of a non-protected link) is low comparatively to the number of attacks,

then D forms a $(1, n)$ -link-connected network which contains only protected links. Second, if the relative cost of protection is high in regards to the number of attacks, then the Designer forms a minimal $(k+1, n)$ -connected network which contains only non-protected links. Third, for intermediate relative costs of protection, there exist situations where the Designer forms a network which contains one protected link and $\lceil (n-1)(k+1)/2 \rceil$ non-protected links. To sum up, in this paper we provide the minimal costs that D incurs to protect her network against an intelligent attack (i.e., the worst attack).

We have also examined a framework where the number of protected links available for the Designer is limited. In that case, we have established that for intermediate relative costs, the Designer forms a network which contains several protected and non-protected links. Finally, we have discussed the case of imperfectly protected links. We cannot provide a full characterization of the SPEs in the imperfect defense model, but we have given conditions under which results obtained in the framework with perfect defense are preserved. Moreover, we have established through an example that the set of equilibria is larger in the framework with imperfect defense links than in the framework with perfect defense.

In this paper, we have assumed that the Designer incurs the same costs if she forms protected links that are adjacent and if they are not adjacent. It would be interesting to examine a situation where it is more costly for the Designer to form protected links that are not adjacent. As we explained after Example 2, if D protects adjacent links, it can lead her to form strictly more non-protected links than in the optimal strategies described in Proposition 1.

Adding constraints on the location of protected links can be applied in different contexts. Indeed, it is more costly for a company to protect some cables (by reinforcing them or replacing them with new equipments) in different locations. For instance, the company has to send several teams of workers to protect cables which are far from each other instead of a single team when they are close to each other.

1.6 Appendix

1.6.1 Appendix I: Proof of Proposition 1

The proof of Proposition 1 is organized in the following way. We first establish that the subnetwork (N, E_P, \emptyset) of $s^D \in S_{p,k}^D$ is acyclic (Lemma 1). In Appendix A, first given a number of nodes and a number of components, we provide an alternative optimization problem whose optimum corresponds to the optimal Designer's strategy (Lemma 2). Second, we provide a lower bound on the number of non-protected links in a protected network $s^D \in S_{p,k}^D$ (Lemma 3). In Appendices B and C, we provide the solutions of the optimization problem, both in terms of value (i.e., the minimum number of non-protected links) as well as a constructive method for the Designer to obtain an optimal set of non-protected links according to the number of protected links and the number of attacks.

The following lemma will allow us to establish that if D forms p protected links in $s^D \in S_{p,k}^D$, then s^D contains $n - p$ components.

Lemma 1 *Let $s^D = (N, E_P, E_{NP})$, $s^D \in S_{p,k}^D$. The subnetwork (N, E_P, \emptyset) of s^D is acyclic.*

Proof If $p = n - 1$, the result holds from Footnote 15. Otherwise, to introduce a contradiction, suppose that the subnetwork (N, E_P, \emptyset) of $s^D \in S_{p,k}^D$ contains a cycle. Then, there exists a link $ij \in E_P$ such that $(N, E_P \setminus \{ij\}, E_{NP})$ cannot be disconnected by an optimal attack of A . Moreover, since $p \in \llbracket 1, n - 2 \rrbracket$ and g^R cannot be disconnected by an optimal attack of A , we have $E_{NP} \neq \emptyset$. Let $i'j' \in E_{NP}$. Network $(N, E_P \setminus \{ij\} \cup \{i'j'\}, E_{NP} \setminus \{i'j'\})$ contains p protected links and $\#E_{NP} - 1$ non-protected links, a contradiction. \square

Appendix A: An equivalent optimization formulation

The equivalent problem formulation relies on the concept of multigraph and contraction of networks which we now develop.

Multigraphs. A *multigraph* is a graph where multiple links and loops are allowed. Formally, an (undirected) multigraph \hat{g} is an ordered triplet $(\hat{N}, \hat{E}, \hat{\psi})$ consisting of a non-empty set of nodes, \hat{N} , a set of links, \hat{E} , disjoint with \hat{N} , and an incidence function $\hat{\psi} : \hat{E} \rightarrow \hat{N}^2$ that associates to each link an *unordered* pair of nodes of \hat{g} . If e is a link and i and j are

nodes such that $\hat{\psi}(e) = (i, j)$, then e is said to join i and j .²¹ We define the adjacency matrix $\mathcal{M}(\hat{g})$ of a multigraph $\hat{g} = (\hat{N}, \hat{E}, \hat{\psi})$ as $\forall(a, b) \in \hat{E}^2$, $\mathcal{M}_{a,b}(\hat{g}) = \#\{e \in \hat{E} : \hat{\psi}(e) = (a, b)\}$, i.e., the number of links between nodes a and b in \hat{g} . Note that the adjacency matrix of an undirected multigraph is symmetric. We note $|\cdot|$ the sum of elements of a matrix or a vector, that is, for any matrix $\mathcal{A} \in \llbracket 1, a \rrbracket \times \llbracket 1, b \rrbracket$, $|\mathcal{A}| = \sum_{i \in \llbracket 1, a \rrbracket, j \in \llbracket 1, b \rrbracket} \mathcal{A}_{i,j}$.

Contractions of networks. Let g be a network. Given a link $ij \in E(g)$, the network $g \circledast ij$ is obtained by contracting the link ij ; that is, by merging the two nodes i and j into a single node $\{i, j\}$, and making any node a adjacent to the (new) node $\{i, j\}$ in $g \circledast ij$ if and only if a is adjacent to i or j in the network g . In other words, all links, other than those incident to neither i nor j , are included in $E(g \circledast ij)$ if and only if they are included in $E(g)$.

For any set $F \subseteq E(g)$, we define the F -contraction of network g and denote by \hat{g}^F the network obtained from g by sequences of link contractions for all links in F . Note that the resulting network does not depend on the order of links contractions. In particular, we are interested in the case where $F = E_P(g)$, that is the contraction over all protected links of the network. We illustrate the E_P -contraction of a network g in Figure 1.9.

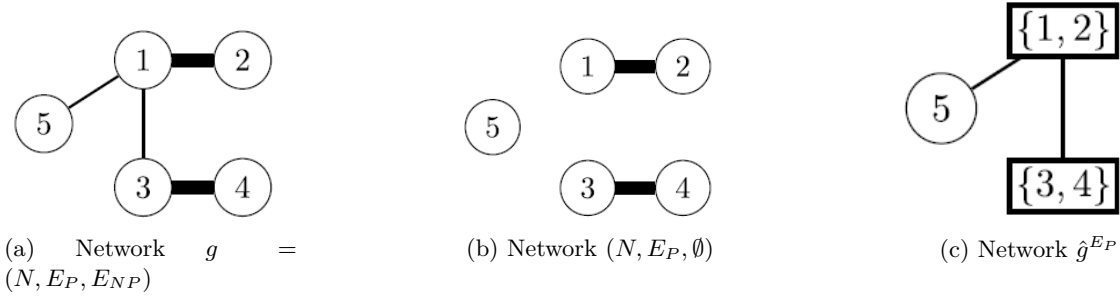

Figure 1.9: Illustration of the E_P -contraction: the links 12 and 34 are contracted.

Multigraphs and E_P -contractions of networks. Let $g = (N, E_P, E_{NP})$ be a protected network and $\Gamma_1(g), \dots, \Gamma_l(g), \dots, \Gamma_\nu(g)$ be the components of the subnetwork (N, E_P, \emptyset) with $\gamma_l(g)$ the number of nodes of the component $\Gamma_l(g)$. When no confusion is possible, we simplify notations by removing (g) . By construction, the E_P -contraction of g is $\hat{g}^{E_P} = (\llbracket 1, \nu \rrbracket, \hat{E}_g, \hat{\psi}_g)$

²¹By definition a simple graph does not contain a loop, that is a link joining a node to itself; neither does it contain multiple links, that is, several links joining the same two nodes. Therefore, it is a multigraph for which $\hat{\psi}$ is injective and for which there is no $e \in E$ such that $\hat{\psi}(e) = (i, i)$ with $i \in \hat{N}$.

with $\hat{E}_g = \{e_{ij} : ij \in E_{NP}(g)\}$ and

$$\forall (a, b) \in \llbracket 1, \nu \rrbracket^2, \forall i \in \Gamma_a(g), \forall j \in \Gamma_b(g), \quad \hat{\psi}_g(e_{ij}) = (a, b).$$

Note that a protected network g induces one and only one E_P -contraction \hat{g}^{E_P} (up to ordering). However the converse is not true: a multigraph can be the E_P -contraction of two (or more) distinct protected networks. However, these graphs have the same number of non-protected links (which is given by $\sum_{a,b \in \llbracket 1, \nu \rrbracket^2} \mathcal{M}_{a,b}(\hat{g}^{E_P})$), and the same minimum number of protected links (which is equal²² to $n - \nu$). Therefore, all protected networks resulting in a given E_P -contraction have the same minimal cost.

An optimal strategy for the Designer is the choice of vector $(\Gamma_l(g))_{1 \leq l \leq \nu}$ and matrix $\mathcal{M}(g)$, that is the number and size of the components and the number of non-protected links, under some constraints, which we develop below:

Lemma 2 *For a given number of components ν , an optimal strategy for D is a solution of the following optimization problem:*

$$\min_{\substack{\gamma \in \mathbb{N}^\nu, \\ \mathcal{M} \in \mathbb{N}^{\nu \times \nu}}} \frac{1}{2} \sum_{i \in \llbracket 1, \nu \rrbracket} \sum_{j \in \llbracket 1, \nu \rrbracket} \mathcal{M}_{i,j} \quad s.t. \quad \left\{ \begin{array}{ll} \forall (i, j) \in \llbracket 1, \nu \rrbracket^2, \mathcal{M}_{i,j} = \mathcal{M}_{j,i}, & \text{(CS-1)} \\ \forall (i, j) \in \llbracket 1, \nu \rrbracket^2, \mathcal{M}_{i,j} \leq \gamma_i \gamma_j, & \text{(CS-2)} \\ \forall i \in \llbracket 1, \nu \rrbracket, \mathcal{M}_{i,i} \leq \gamma_i(\gamma_i - 1)/2 - (\gamma_i - 1), & \text{(CS-3)} \\ \forall I \subseteq \llbracket 1, \nu \rrbracket, \sum_{i \in I} \sum_{j \in \llbracket 1, \nu \rrbracket \setminus I} \mathcal{M}_{i,j} \geq k + 1, & \text{(CS-4)} \\ n = \sum_{i \in \llbracket 1, \nu \rrbracket} \gamma_i. & \text{(CS-5)} \end{array} \right.$$

Proof

Consider any matrix $\mathcal{M} = (\mathcal{M}_{i,j})_{i \in \llbracket 1, \nu \rrbracket, j \in \llbracket 1, \nu \rrbracket}$. Build $\hat{N} = \llbracket 1, \nu \rrbracket$, $\hat{E} = \cup_{(i,j) \in \hat{N} \times \hat{N}} \hat{E}_{ij}$, with $\hat{E}_{ij} = \{e_{ij}^1, \dots, e_{ij}^{\mathcal{M}_{i,j}}\}$, and $\hat{\psi}(e) = (i, j)$ if and only if $e \in \hat{E}_{ij}$. The triplet $(\hat{N}, \hat{E}, \hat{\psi})$ is an (undirected) multigraph if and only if the links are undirected (constraint (CS-1)).

²²Since \hat{g}^{E_P} results of the contraction of p links, then $\nu \geq n - p$. The equality is attained when the subnetwork (N, E_P, \emptyset) contains no cycle.

In turns, this multigraph is the E_P -contraction of a protected network $g = (N, E_P, E_{NP})$, such that (N, E_P, \emptyset) has ν components of size $\gamma_1, \gamma_2, \dots, \gamma_\nu$, if and only if all nodes of g belong to exactly one component (constraint (CS-5)), if each node in one component is connected to any other node in a different component by at most one link (constraint (CS-2)), and if the network does not contain any loop. The latter requires that each node in a component Γ_i is linked with at most $\gamma_i - 1$ nodes which belong to Γ_i . From Lemma 1, each component of size γ_i contains exactly $\gamma_i - 1$ protected links (since it is connected and does not contain any loops). This is reflected in constraint (CS-3). The goal of the Designer is to minimize her number of non-protected links, which are given by $\frac{1}{2} \sum_{i \in [1, \nu]} \sum_{j \in [1, \nu]} \mathcal{M}_{i,j}$.

Finally, no component of (N, E_P, \emptyset) should be vulnerable to an attack of A , that is, every component of (N, E_P, \emptyset) should be incident to at least $k + 1$ non-protected links in g : this means that $\forall i \in [1, \nu]$, $\sum_{j \in [1, \nu] \setminus \{i\}} \mathcal{M}_{i,j} \geq k + 1$. This should also hold for any group of components, as reflected by constraint (CS-4). \square

This formulation allows us to directly derive a lower bound on the number of (non-protected) links that are necessary in the construction of a network that resists k attacks. We will show in the subsequent paragraphs that this bound can be reached under some assumptions on n , ν and k (Lemmas 5 and 9).

Lemma 3 *The number of non-protected links induced by any strategy is at least $\underline{n}_1 = \left\lceil \frac{\nu(k+1)}{2} \right\rceil$.*

Proof This is a direct consequence of constraint (CS-4). Indeed, for any i , eq. (CS-4) implies that $\sum_{j \in [1, \nu], j \neq i} \mathcal{M}_{i,j} \geq k + 1$. Therefore, $\sum_{i \in [1, \nu]} \sum_{j \in [1, \nu]} \mathcal{M}_{i,j} \geq \sum_{i \in [1, \nu]} (k + 1) = \nu(k + 1)$. \square

In the rest of the proof, we provide, for each number of components ν , the optimal value of the optimization problem given in Lemma 2 as well as the corresponding optimal vector γ and matrix \mathcal{M} . The constructions will rely heavily on the following definitions:

$$\alpha_1 = \left\lfloor \frac{n}{\nu} \right\rfloor, \quad \alpha_2 = n \bmod \nu, \quad \beta_1 = \left\lfloor \frac{k+1}{\nu-1} \right\rfloor, \quad \text{and } \beta_2 = (k+1) \bmod (\nu-1). \quad (1.11)$$

Note that by construction $n = \alpha_1\nu + \alpha_2$ and $k + 1 = \beta_1(\nu - 1) + \beta_2$. Also, one specific vector of component sizes, $\bar{\gamma} = (\bar{\gamma}_1, \dots, \bar{\gamma}_\nu)$, will come in handy in the proofs. Consider

$$\bar{\gamma}_i = \begin{cases} \alpha_1 & \text{if } i \leq \nu - \alpha_2, \text{ and} \\ \alpha_1 + 1 & \text{otherwise.} \end{cases} \quad (1.12)$$

Then $\sum_{i \in [1, \nu]} \bar{\gamma}_i = \alpha_1(\nu - \alpha_2) + (\alpha_1 + 1)\alpha_2 = \alpha_1\nu + \alpha_2 = n$, which satisfies constraint (CS-5). Roughly speaking, if we create ν almost equally sized components over n nodes, then there will be $\nu - \alpha_2$ components of size $\alpha_1 = \lfloor \frac{n}{\nu} \rfloor$ and α_2 components of size $\alpha_1 + 1$ (this is reflected in the definition of $\bar{\gamma}$). Consider one of the ν components. Recall that we have to satisfy (CS-4). If we distribute $k + 1$ links between this component and the $(\nu - 1)$ others in a way as balanced as possible, then $\nu - 1 - \beta_2$ components will be incident to $\beta_1 = \lfloor \frac{k + 1}{\nu - 1} \rfloor$ links and β_2 components will be incident to $\beta_1 + 1$ links to the considered component.

We distinguish two cases depending on the values of α_1 and β_1 , that lead to different constructions and optimal numbers of non-protected links. These two cases depend on the average size of the components relatively to the number of required links.

Appendix B: Solution of the case where $\alpha_1^2 \geq \beta_1 + 1$.

Intuitively, in this case, the average size of the components is high enough compared to the number of required links. Thus, we are able to form a sufficient number of links incident to each component without contradicting constraint (CS-2). In this case, an optimal matrix \mathcal{M} that reaches the lower bound given by Lemma 3 can be built. It relies on the matrices of (a, b) -Harary-networks $\mathcal{H}(a, b)$ (for any $a < b$). In the following paragraph, we give the general formula of the adjacency matrices obtained by the construction of Harary (1962). Consider the squared matrices $\mathcal{D}(b)$ of size b which are defined by $\mathcal{D}(b)_{i,j} = 1$ if $(j - i) \bmod b = 1$ and 0 otherwise. Similarly, the squared matrices $\mathcal{E}(b)$ of size b which are defined by $\mathcal{E}(b)_{i,j} = 1$ if $j - i = 1$ and 0 otherwise.

That is,

$$\mathcal{D}(b) = \begin{pmatrix} 0 & 1 & & \\ & 0 & 1 & 0 \\ & & \ddots & \ddots \\ & 0 & & 0 & 1 \\ 1 & & & & 0 \end{pmatrix} \quad \text{and} \quad \mathcal{E}(b) = \begin{pmatrix} 0 & 1 & & \\ & 0 & 1 & 0 \\ & & \ddots & \ddots \\ & 0 & & 0 & 1 \\ & & & & 0 \end{pmatrix}.$$

Note that the powers of $\mathcal{D}(b)$ and $\mathcal{E}(b)$ have a specific structure. They satisfy, for any $a \in \mathbb{N}$, $\mathcal{D}(b)_{i,j}^{(a)} = 1$ if $(j - i) \bmod b = a$ and 0 otherwise and similarly $\mathcal{E}(b)_{i,j}^{(a)} = 1$ if $j - i = a$ and 0 otherwise.

Let us also define the matrix $\mathcal{F}(a, b) = \mathcal{D}(b)^{(a)} + (\mathcal{D}(b)^{(a)})^\top$ (with \cdot^\top the transpose operator). Note that if $0 < 2a < b$, then $\mathcal{F}(a, b)$ is an adjacency matrix of a network.²³ Finally, $\mathcal{G}(a, b) = \mathcal{E}(b)^{(a)} + (\mathcal{E}(b)^{(a)})^\top$ is also the adjacency matrix of a network for any $a, b > 0$.

Then, following the processes provided by Harary (1962), when $a \in \llbracket 2, b - 1 \rrbracket$, a matrix of a (a, b) -Harary-network is given by:

$$\mathcal{H}(a, b) = \begin{cases} \sum_{i=1}^{a/2} \mathcal{F}(i, b) & \text{if } a \bmod 2 = 0, \\ \sum_{i=1}^{\lfloor a/2 \rfloor} \mathcal{F}(i, b) + \mathcal{G}\left(\left\lfloor \frac{b}{2} \right\rfloor, b\right) & \text{if } a \bmod 2 = 1. \end{cases}$$

We also consider the situation where $a = 1$, and we assume that matrix $\mathcal{H}(1, b)$ is given by the previous formula, i.e., $\mathcal{H}(1, b) = \mathcal{G}\left(\left\lfloor \frac{b}{2} \right\rfloor, b\right)$. We have the following important lemma which is a very slight extension of Harary (1962).

Lemma 4 *If $ab \bmod 2 = 0$ then each node of the network whose adjacency matrix is $\mathcal{H}(a, b)$ has a degree of a . Otherwise, all nodes have a degree of a except for the node $\lfloor b/2 \rfloor + 1$, that has a degree of $a + 1$.*

Consequently, for any a and b , we have

$$|\mathcal{H}(a, b)| = \begin{cases} ab & \text{if } ab \bmod 2 = 0, \\ ab + 1 & \text{if } ab \bmod 2 = 1. \end{cases}$$

²³Indeed, \mathcal{F} is symmetric by construction and $\mathcal{F}(a, b)_{i,j} \in \{0, 1\}$. Suppose $\mathcal{F}(a, b)_{i,j} = 2$. Then, by construction $(j - i) \bmod b = a$ and $(i - j) \bmod b = a$. It follows that $((j - i) + (i - j)) \bmod b = 2a \bmod b$. Hence, $2a \bmod b = 0$, a contradiction since $0 < 2a < b$.

Proof For $a > 1$, the result follows from Harary (1962). For $a = 1$, the result follows from the construction of $\mathcal{G}\left(\left(\left\lfloor \frac{b}{2} \right\rfloor, b\right)\right)$: a link is formed between i and j if and only if $(j - i) = \left\lfloor \frac{b}{2} \right\rfloor$. \square

Note that $\mathcal{H}(b - 1, b) = \begin{pmatrix} 0 & & & & \\ & 0 & & & \\ & & \ddots & & \\ & & & 1 & \\ & 1 & & & 0 \\ & & & & & 0 \end{pmatrix}$ is the adjacency matrix of a clique.

We can now describe the optimal strategy when $\alpha_1^2 \geq \beta_1 + 1$. An optimal strategy consists in overlapping cliques and a Harary-network.

Lemma 5 *Suppose that $\alpha_1^2 \geq \beta_1 + 1$. Then, any optimal strategy has exactly \underline{n}_1 non-protected links.*

Proof Consider vector $\bar{\gamma}$ as defined in eq. (1.12), so (CS-5) is satisfied. Intuitively, each node should be incident to $k + 1$ links. If $k + 1 \geq \nu - 1$, multi-links are needed. Since $k + 1 = \beta_1(\nu - 1) + \beta_2$, we consider the matrix \mathcal{M} which is the sum of the adjacency matrices of β_1 cliques (i.e., $(\nu - 1, \nu)$ -Harary-networks) and one (β_2, ν) -Harary-network. More precisely, let \mathcal{M} be given by:

$$\mathcal{M} = \beta_1 \mathcal{H}(\nu - 1, \nu) + \mathcal{H}(\beta_2, \nu).$$

Let us first check that \mathcal{M} is an admissible matrix (i.e., that it satisfies the constraints (CS-1)-(CS-4)):

CS-1 is satisfied by construction.

CS-2 Further, $\forall i, j, \mathcal{M}_{i,j} \leq \beta_1 + 1 \leq \alpha_1^2 \leq \bar{\gamma}_i \bar{\gamma}_j$, which complies with constraint (CS-2).

CS-3 By construction Harary-networks do not contain loops. Hence $\forall i, \mathcal{M}_{i,i} = 0$ which satisfies constraint (CS-3).

CS-4 Finally, let $I \subseteq \llbracket 1, \nu \rrbracket$:

- If I is the singleton $\{i\}$, by definition of a Harary-network, $\sum_{j \in \llbracket 1, \nu \rrbracket \setminus \{i\}} \mathcal{M}_{i,j} = \beta_1(\nu - 1) + \beta_2 = k + 1$.
- Similarly, if $\#I = \nu - 1$, then $\exists j \in \llbracket 1, \nu \rrbracket, I = \llbracket 1, \nu \rrbracket \setminus \{j\}$. Then $\sum_{i \in I} \sum_{j \in \llbracket 1, \nu \rrbracket \setminus I} \mathcal{M}_{i,j} = \sum_{i \in \llbracket 1, \nu \rrbracket, i \neq j} \mathcal{M}_{i,j} = k + 1$.

- Finally, suppose that $2 \leq \#I \leq \nu - 2$. Note that if $2 \leq \#I \leq \nu - 2$, then $\nu > 3$. By construction, we have $\sum_{j \in [1, \nu]} \mathcal{M}_{1,j} = k + 1$. We establish that I resists a number of attacks greater or equal to the number of attacks node 1 resists. By definition of an (a, ν) -Harary-network, for $a \in [2, \nu - 1]$ and $I \subset [1, \nu]$, $\#I \in [2, \nu - 2]$, we have $\sum_{i \in I} \sum_{j \in [1, \nu] \setminus I} \mathcal{H}(a, \nu)_{i,j} \geq a = \sum_{j \in [1, \nu]} \mathcal{H}(a, \nu)_{1,j}$ and for $\nu > 3$, $\sum_{i \in I} \sum_{j \in [1, \nu] \setminus I} \mathcal{H}(\nu - 1, \nu)_{i,j} \geq \#I(\nu - \#I) \geq 2(\nu - 2) > \nu - 1 = \sum_{j \in [1, \nu]} \mathcal{H}(\nu - 1, \nu)_{1,j}$. We now deal with $\mathcal{H}(a, \nu)$ for $a = 1$. We have for $\nu > 3$, $\sum_{i \in I} \sum_{j \in [1, \nu] \setminus I} \mathcal{H}(\nu - 1, \nu)_{i,j} \geq \nu = \sum_{j \in [1, \nu]} \mathcal{H}(\nu - 1, \nu)_{1,j} + \sum_{j \in [1, \nu]} \mathcal{H}(1, \nu)_{1,j}$. Note that since $k \geq 1$, if $\beta_2 = 1$, then $\beta_1 \geq 1$. Consequently, we have $\sum_{i \in I} \sum_{j \in [1, \nu] \setminus I} \mathcal{M}_{i,j} = \sum_{i \in I} \sum_{j \in [1, \nu] \setminus I} (\beta_1 \mathcal{H}(\nu - 1, \nu)_{i,j} + \mathcal{H}(\beta_2, \nu)_{i,j}) \geq \sum_{j \in [1, \nu]} (\beta_1 \mathcal{H}(\nu - 1, \nu)_{1,j} + \mathcal{H}(\beta_2, \nu)_{1,j}) = k + 1$.

Hence constraint (CS-4) is satisfied.

Let us now compute the number of links induced by this strategy. We have:

$$|\mathcal{M}| = \begin{cases} \beta_1 \nu (\nu - 1) + \beta_2 \nu & \text{if } \beta_2 \nu \bmod 2 = 0 \\ \beta_1 \nu (\nu - 1) + \beta_2 \nu + 1 & \text{if } \beta_2 \nu \bmod 2 = 1 \end{cases} = \begin{cases} \nu(k + 1) & \text{if } \beta_2 \nu \bmod 2 = 0 \\ \nu(k + 1) + 1 & \text{if } \beta_2 \nu \bmod 2 = 1. \end{cases}$$

But then, $(k + 1) \bmod 2 = (\beta_1(\nu - 1) \bmod 2 + \beta_2 \bmod 2) \bmod 2$. Hence $\beta_2 \nu \bmod 2 = 1 \Rightarrow (k + 1) \bmod 2 = 1 \Rightarrow \nu(k + 1) \bmod 2 = 1 \Rightarrow \left\lceil \frac{\nu(k + 1) + 1}{2} \right\rceil = \left\lceil \frac{\nu(k + 1)}{2} \right\rceil$. Therefore, in all cases, the number of links is \underline{n}_1 , which is optimal from Lemma 3. \square

Hence, when $\alpha_1^2 \geq \beta_1 + 1$, the lower bound on the number of links is attained. An important special case is when $2\nu \leq n$, that is when the number of protections is large. In that case, $\bar{\gamma}_i > 1$, and the components we consider in our construction have a size strictly higher than 1.

Lemma 6 *If $2\nu \leq n$, then $\alpha_1^2 \geq \beta_1 + 1$.*

Thus, if $2\nu \leq n$, then any optimal strategy has exactly \underline{n}_1 non-protected links.

Proof Indeed, $2\nu \leq n \Rightarrow \nu(2\nu - n) \leq 2(2\nu - n) \Rightarrow 2\nu^2 + 2n \leq n\nu + 4\nu$
 $\Rightarrow \nu n - 2\nu \leq 2n\nu - 2n - 2\nu^2 + 2\nu \Rightarrow \nu(n - 2) \leq 2(n - \nu)(\nu - 1)$
 $\Rightarrow \frac{n - 2}{\nu - 1} \leq \frac{2(n - \nu)}{\nu}$.

Hence $\frac{k + 1}{\nu - 1} \leq \frac{n - 2}{\nu - 1} \leq 2\frac{n}{\nu} - 2$. Thus, if $2\nu \leq n$, then $\left\lfloor \frac{n}{\nu} \right\rfloor \geq 2$ and hence $\left\lfloor \frac{n}{\nu} \right\rfloor^2 \geq 2 \left\lfloor \frac{n}{\nu} \right\rfloor > 2 \left(\frac{n}{\nu} - 1 \right) \geq \frac{k + 1}{\nu - 1}$. Finally $\left\lfloor \frac{n}{\nu} \right\rfloor^2 \geq \left\lfloor \frac{k + 1}{\nu - 1} \right\rfloor + 1$. \square

Appendix C: Solution of the case where $\alpha_1^2 < \beta_1 + 1$.

Intuitively, in this case, the average size of the components is low compared to the number of required links. However, small sized components cannot bear too many multiple links. Thus, the constraint (CS-2) may be harder to satisfy. More precisely, with the condition that $\alpha_1^2 < \beta_1 + 1$, the construction based on Harary networks of Lemma 5 is no longer valid (it violates constraint (CS-2)).

By Lemma 6, when $\alpha_1^2 < \beta_1 + 1$, we have $2\nu > n$ and thus $\alpha_1 = 1$ and $\alpha_2 = n - \nu$. To provide a lower bound on the minimal number of links required for the network to resist k attacks, we need to establish bounds concerning δ , the number of components of size 1 in a network at equilibrium. More precisely, we successively establish that $\delta \geq 2\nu - n$ and $\delta \leq k + 1$.

Let $\gamma = (\gamma_1, \dots, \gamma_\nu)$ be any (non-decreasing) vector satisfying constraint (CS-5). Then, $\gamma_1 = 1$, otherwise we would have $\sum_{i \in [1, \nu]} \gamma_i \geq 2\nu > n = \sum_{i \in [1, \nu]} \gamma_i$ which is impossible. Let δ be such that for all $i \leq \delta$, $\gamma_i = 1$ and for all $i > \delta$, $\gamma_i > 1$. Hence, δ is the maximal number such that $\gamma_\delta = 1$. Note that $n = \sum_{i \in [1, \nu]} \gamma_i = \delta + \sum_{i \in [\delta+1, \nu]} \gamma_i \geq \delta + 2(\nu - \delta)$. We have $\delta < \nu$ since $\nu < n$ as there exists at least one protected link. Hence, $\delta \geq 2\nu - n$. Finally, $\alpha_1^2 < \beta_1 + 1$ gives $\beta_1 \geq 1$ and thus $k + 1 \geq \nu - 1$ which implies $k + 1 \geq \delta$ by definition of δ as soon as $\nu < n$ (that is, there exists at least 1 protected link).

Up to a reordering of the nodes, any solution matrix \mathcal{M} has the following form:

$$\mathcal{M} = \left(\begin{array}{c|c} \overbrace{\mathcal{A} \quad \mathcal{B}}^{\delta \quad \nu - \delta} \\ \hline \mathcal{B}^\top \quad \mathcal{C} \end{array} \right) \left. \begin{array}{l} \delta \\ \nu - \delta \end{array} \right\} . \quad (1.13)$$

Note that adjacency matrix \mathcal{A} captures links between nodes in $\llbracket 1, \delta \rrbracket$, that is components of size 1. Adjacency matrix \mathcal{B} captures links between nodes in $\llbracket 1, \delta \rrbracket$ and nodes in $\llbracket \delta + 1, \nu \rrbracket$ (we will see below that nodes in $\llbracket \delta + 1, \nu \rrbracket$ are identified with components of size 2). Finally, adjacency matrix \mathcal{C} captures links between nodes in $\llbracket \delta + 1, \nu \rrbracket$.

In the next lemma, we establish that if $\alpha_1^2 < \beta_1 + 1$, then the number of non-protected links may be strictly higher than \underline{n}_1 .

Lemma 7 *If $\alpha_1^2 < \beta_1 + 1$ then the required number of non-protected links is at least:*

- $\underline{n}_2 = (2\nu - n)(k + 1) - \frac{(2\nu - n)(2\nu - n - 1)}{2}$ if $(3\nu - 2n)(k + 1) > (2\nu - n)(2\nu - n - 1)$.
- \underline{n}_1 otherwise.

Proof The bound \underline{n}_1 has been established in Lemma 3. Further, in the case of $\alpha_1^2 \geq \beta_1 + 1$, the optimal bound of \underline{n}_1 can be achieved (Lemma 5) because the elements of each row of \mathcal{M} add up to $k + 1$ with at most one row whose elements add up to $k + 2$.

From eq. (1.13), constraint (CS-2) imposes that each row of \mathcal{A} adds up to at most $\delta - 1$. Thus, to comply with constraint (CS-4), the elements of each row of \mathcal{B} need to add up to at least $k + 1 - (\delta - 1)$. Thus, the total sum of elements of matrix \mathcal{B} , that is, $|\mathcal{B}|$ is at least $\delta(k + 1 - (\delta - 1))$. Thus, the total number of links required is $\left\lceil \frac{|\mathcal{M}|}{2} \right\rceil \geq \left\lceil \frac{(|\mathcal{A}| + |\mathcal{B}|) + |\mathcal{B}^\top|}{2} \right\rceil \geq \left\lceil \frac{\delta(k + 1) + |\mathcal{B}|}{2} \right\rceil \geq \left\lceil \frac{\delta(k + 1) + \delta(k + 1 - (\delta - 1))}{2} \right\rceil = \delta(k + 1) - \frac{\delta(\delta - 1)}{2}$. The function $\delta \mapsto \delta(k + 1) - \frac{\delta(\delta - 1)}{2}$ is concave, quadratic and its maximum is obtained at $k + 3/2$; so this function is increasing in the interval $[2\nu - n, k + 3/2]$. Since $2\nu - n \leq \delta \leq k + 3/2$, then $\left\lceil \frac{|\mathcal{M}|}{2} \right\rceil \geq (2\nu - n)(k + 1) - \frac{(2\nu - n)(2\nu - n - 1)}{2} = \underline{n}_2$.

This bound is attained when the sum of elements of each row of \mathcal{B}^\top is larger than or equal to $k + 1$ (hence leading to a zero matrix \mathcal{C}). This happens necessarily when $|\mathcal{B}| \geq (k + 1)(\nu - \delta)$, that is $\delta(k + 1 - (\delta - 1)) \geq (k + 1)(\nu - \delta)$, i.e., $(2\delta - \nu)(k + 1) \geq \delta(\delta - 1)$. Since $\delta \geq 2\nu - n$, this implies that $(3\nu - 2n)(k + 1) \geq (2\nu - n)(2\nu - n - 1)$. We now establish that \underline{n}_1 occurs when $(3\nu - 2n)(k + 1) = (2\nu - n)(2\nu - n - 1)$. Suppose $\nu(k + 1) \bmod 2 = 1$ and $(3\nu - 2n)(k + 1) = (2\nu - n)(2\nu - n - 1)$, by straightforward calculations we have $\underline{n}_2 < \underline{n}_1$, a contradiction since by definition $\underline{n}_2 \geq \underline{n}_1$. Moreover, if $\nu(k + 1) \bmod 2 = 0$ and $(3\nu - 2n)(k + 1) = (2\nu - n)(2\nu - n - 1)$, then by straightforward calculations we have $\underline{n}_2 = \underline{n}_1$. Finally, by straightforward calculations we have $\underline{n}_2 \geq \underline{n}_1$ when $(3\nu - 2n)(k + 1) > (2\nu - n)(2\nu - n - 1)$. The result follows. \square

We now introduce the last two lemmas. In Lemma 8, we provide a construction that allows us to build exactly \underline{n}_2 non-protected links for resisting k attacks when $(2\nu - n)(2\nu - n - 1) < (3\nu - 2n)(k + 1)$. Similarly, in Lemma 9 we provide a construction that allows us to build exactly \underline{n}_1 links for resisting k attacks when $(2\nu - n)(2\nu - n - 1) \geq (3\nu - 2n)(k + 1)$. The proofs of these lemmas rely on the properties of a type of matrices which we denote as $\bar{\mathcal{Z}} \in \mathbb{N}^{\delta \times (\nu - \delta)}$,

$\bar{Z}_{i,j} \in \{0, 1\}$, that are such that:

$$\forall i \in \llbracket 1, \delta \rrbracket, \quad \sum_{j \in \llbracket 1, \nu - \delta \rrbracket} \bar{Z}_{i,j} = (k + 1) - (\nu - 1), \text{ and} \quad (1.14)$$

$$\forall d \in \llbracket 1, \delta \rrbracket, \quad \forall x, y \in \llbracket 1, \nu - \delta \rrbracket, \quad \left| \sum_{i \in \llbracket 1, d \rrbracket} \bar{Z}_{i,x} - \sum_{i \in \llbracket 1, d \rrbracket} \bar{Z}_{i,y} \right| \leq 1. \quad (1.15)$$

In other words, these matrices have δ rows and $\nu - \delta$ columns and elements in $\{0, 1\}$. The sum of elements of each row is equal to $(k + 1) - (\nu - 1)$ (eq. 1.14) while the partial sums of the columns are balanced, i.e., their values differ by at most 1 (eq. 1.15). \bar{Z} is well defined as $(k + 1) - (\nu - 1) \geq 0$ (since $\beta_1 > 0$ from $\alpha_1^2 < \beta_1 + 1$) and $(k + 1) - (\nu - 1) \leq \nu - \delta$ (since $k + 1 \leq n - 1$). Also, note that the size of \bar{Z} complies with that of \mathcal{B} as defined in eq. (1.13). We have $|\bar{Z}| = \delta((k + 1) - (\nu - 1))$. Matrix \bar{Z} captures the links formed by the following process. At step 0 there is no link between nodes in $\llbracket 1, \delta \rrbracket$ and nodes in $\llbracket \delta + 1, \nu \rrbracket$. At each step $t = 1, \dots, \tau$, we consider the set of nodes in $\llbracket 1, \delta \rrbracket$ which are involved in the lowest number of links formed during the process (links formed at steps $1, \dots, t - 1$), and we pick the node, say i_t , with the lowest index in this set. Similarly, we consider the subsets of $\llbracket \delta + 1, \nu \rrbracket$ whose size is equal to $k + 1 - (\nu - 1)$ and such that the sum of links incident to the nodes of these subsets is minimal. We pick one of this subset and call it W_t (for instance the one such that the sum of indices of nodes is minimal). Then we form a link between i_t and each node in W_t . The process stops after each node in $\llbracket 1, \delta \rrbracket$ is involved in $k + 1 - (\nu - 1)$ links, i.e., $\tau = \delta$.²⁴

In Lemmas 8 and 9, \bar{Z} allow us to capture some of the links between nodes in $\llbracket 1, \delta \rrbracket$ and nodes in $\llbracket \delta + 1, \nu \rrbracket$. Roughly speaking, these links allow us to ensure that nodes in $\llbracket 1, \delta \rrbracket$ have a degree equal to $k + 1$ and these links are distributed in a way as balanced as possible between nodes in $\llbracket \delta + 1, \nu \rrbracket$.

In the following lemma, we form links for satisfying the condition that each node in $\llbracket 1, \delta \rrbracket$ has a degree equal to $k + 1$; these links are captured by adjacency matrices \mathcal{A} and \mathcal{B} . When these links are formed, nodes in $\llbracket \delta + 1, \nu \rrbracket$ have degrees strictly higher than $k + 1$. Hence we do not form any links between nodes in $\llbracket \delta + 1, \nu \rrbracket$, and \mathcal{C} is the zero matrix. Moreover, the number of links required to ensure that each node has a degree at least equal to $k + 1$ is strictly higher than n_1 . We provide a construction that leads to a network that resists k

²⁴We present a formal construction of \bar{Z} in Appendix II.

attacks and contains \underline{n}_2 non-protected links.

Lemma 8 *If $\alpha_1^2 < \beta_1 + 1$ and $(2\nu - n)(2\nu - n - 1) < (3\nu - 2n)(k + 1)$ then, optimal strategies require exactly \underline{n}_2 non-protected links.*

Proof We have already shown in Lemma 7 that \underline{n}_2 is a lower bound on the required number of links. We now show that this bound can be reached by providing a solution adjacency matrix.

Consider the following construction: let $\bar{\gamma}$ be as in eq. (1.12), that is, the nodes are ordered such that the $\delta = 2\nu - n$ components are of size 1 and the others are of size 2. Moreover, let (i) all components of size 1 be connected to all the other components (i.e., both the components of size 1 and 2), (ii) no component of size 2 be connected to any other component of size 2 and (iii) some components of size 2 have two links with a component of size 1. More precisely, we consider a solution matrix \mathcal{M} of the shape given by eq. (1.13) with:

$$\left\{ \begin{array}{l} \mathcal{A} = \mathcal{H}(\delta - 1, \delta), \\ \mathcal{B} = \underbrace{\begin{pmatrix} 1 \\ \vdots \\ 1 \end{pmatrix}}_{\nu - \delta} \delta + \bar{\mathcal{Z}}, \text{ and} \\ \mathcal{C} = \underbrace{\begin{pmatrix} 0 \\ \vdots \\ 0 \end{pmatrix}}_{\nu - \delta} \quad (\text{i.e., } \mathcal{C} \text{ is the zero matrix}). \end{array} \right. \quad (1.16)$$

It is important to note that the assumption of Lemma 8 imposes that $3\nu - 2n > 0$. Hence, in this construction, $\delta > \nu - \delta$. Let us show that this construction satisfies the problem constraints altogether with the desired value of $\lceil |\mathcal{M}|/2 \rceil$.

CS-1 is verified, since by construction \mathcal{A} and \mathcal{C} are symmetric.

CS-2 $\forall i, j \in \llbracket 1, \delta \rrbracket$, $\mathcal{A}_{i,j} \leq 1 = \gamma_i \gamma_j$, $\forall i \in \llbracket 1, \delta \rrbracket, j \in \llbracket 1, \nu - \delta \rrbracket$ $\mathcal{B}_{i,j} \leq 2$ and $\forall i, j \in \llbracket 1, \nu - \delta \rrbracket$, $\mathcal{C}_{i,j} = 0 \leq 4$ and thus constraint (CS-2) is satisfied.

CS-3 is verified by construction since $\forall i$, $\mathcal{A}_{i,i} = \mathcal{C}_{i,i} = 0$.

CS-4 Let $I \subseteq \llbracket 1, \nu \rrbracket$.

- If I is a singleton $\{i\} \subseteq \llbracket 1, \delta \rrbracket$, then $\sum_{j \neq i} \mathcal{M}_{i,j} = (\delta - 1) + (\nu - \delta) + ((k + 1) - (\nu - 1)) = k + 1$.
- If I is a singleton $\{i\} \subseteq \llbracket \delta + 1, \nu \rrbracket$, then $\sum_{j \neq i} \mathcal{M}_{i,j} \geq \delta + \left\lfloor \frac{\delta((k + 1) - (\nu - 1))}{\nu - \delta} \right\rfloor = (2\nu - n) + \left\lfloor \frac{(2\nu - n)((k + 1) - (\nu - 1))}{n - \nu} \right\rfloor = \left\lfloor (2\nu - n) \frac{(k + 1) - (2\nu - 1 - n)}{n - \nu} \right\rfloor > \left\lfloor \frac{(2\nu - n)(k + 1) - (k + 1)(3\nu - 2n)}{n - \nu} \right\rfloor$ by the lemma's assumption. Hence $\sum_{j \neq i} \mathcal{M}_{i,j} > \left\lfloor \frac{(-\nu + n)(k + 1)}{n - \nu} \right\rfloor = k + 1$.
- Otherwise, note that since $\sum_{i \in I} \sum_{j \in \llbracket 1, \nu \rrbracket \setminus I} \mathcal{M}_{i,j} = \sum_{j \in \llbracket 1, \nu \rrbracket \setminus I} \sum_{i \in I} \mathcal{M}_{i,j}$, wlog we can suppose that $\#I \leq \lfloor \nu/2 \rfloor$. (Indeed, if $\#I \geq \lfloor \nu/2 \rfloor$, then consider $J = \llbracket 1, \nu \rrbracket \setminus I$. By construction, $\#J = \nu - \#I \leq \lfloor \nu/2 \rfloor$. Then $\sum_{i \in J} \sum_{j \in \llbracket 1, \nu \rrbracket \setminus J} \mathcal{M}_{i,j} = \sum_{i \in \llbracket 1, \nu \rrbracket \setminus I} \sum_{j \in I} \mathcal{M}_{i,j}$. Thus $\sum_{i \in J} \sum_{j \in \llbracket 1, \nu \rrbracket \setminus J} \mathcal{M}_{i,j} \geq k + 1 \Rightarrow \sum_{i \in I} \sum_{j \in \llbracket 1, \nu \rrbracket \setminus I} \mathcal{M}_{i,j} \geq k + 1$.) Further, since $k + 1 \geq \nu - 1$, then we can suppose that $\#I \leq \left\lfloor \frac{k}{2} \right\rfloor + 1$. Then, note that for all $i, j \in \llbracket 1, \nu \rrbracket$, we have $\mathcal{M}_{i,j} \leq 2$. Then, $\sum_{i \in I} \sum_{j \in \llbracket 1, \nu \rrbracket \setminus I} \mathcal{M}_{i,j} \geq \#I((k + 1) - (\#I - 1) \max_{i,j} \mathcal{M}_{i,j})$. Consider function $x \mapsto x((k + 3) - 2x)$. It is concave quadratic and attains its maximum at $(k + 3)/4$. Therefore, its minimum in $[1, \left\lfloor \frac{k}{2} \right\rfloor + 1]$ is $1(k + 3 - 2) = k + 1$. Hence $\sum_{i \in I} \sum_{j \in \llbracket 1, \nu \rrbracket \setminus I} \mathcal{M}_{i,j} \geq k + 1$.

Hence constraint (CS-4) is satisfied.

Finally, $|\mathcal{M}| = |\mathcal{A}| + 2|\mathcal{B}| + |\mathcal{C}| = (\delta - 1)\delta + 2\delta((\nu - \delta) + (k + 1) - (\nu - 1)) = (\delta - 1)\delta + 2\delta(1 - \delta + (k + 1)) = \delta(1 - \delta + 2(k + 1))$ which leads to the result by substituting $\delta = 2\nu - n$. \square

In the following lemma, first we form links for satisfying the condition that nodes in $\llbracket 1, \delta \rrbracket$ have a degree exactly equal to $k + 1$; these links are captured by adjacency matrices \mathcal{A} and \mathcal{B} . When these links are formed, nodes in $\llbracket \delta + 1, \nu \rrbracket$ have a degree strictly lower than $k + 1$. Hence we add links between nodes in $\llbracket \delta + 1, \nu \rrbracket$. These links are captured by adjacency matrix \mathcal{C} which is a non zero matrix. In the proof of Lemma 9, we describe a specific way to form links between nodes in $\llbracket \delta + 1, \nu \rrbracket$, and so a way to build adjacency matrix \mathcal{C} . This construction leads to a network that resists k attacks and contains \underline{n}_1 non-protected links.

Lemma 9 *If $\alpha_1^2 < \beta_1 + 1$ and $(2\nu - n)(2\nu - n - 1) \geq (3\nu - 2n)(k + 1)$, then optimal strategies have exactly \underline{n}_1 non-protected links.*

Proof Consider $\bar{\gamma}$ as in eq. (1.12). We construct a solution matrix \mathcal{M} of the shape of eq. (1.13) with $\delta = 2\nu - n$, and \mathcal{A} and \mathcal{B} defined as in eq. (1.16). Recall that adjacency matrix \mathcal{A} captures links between nodes in $\llbracket 1, \delta \rrbracket$, i.e., links between components of size 1,

and adjacency matrix \mathcal{B} captures links between nodes in $\llbracket 1, \delta \rrbracket$ and nodes in $\llbracket \delta + 1, \nu \rrbracket$, i.e., links between components of size 1 and components of size 2. We now build matrix \mathcal{C} , which captures the links formed between nodes in $\llbracket \delta + 1, \nu \rrbracket$.

Recall that the matrix $\overline{\mathcal{Z}}$ has the property that the sum of elements between two columns should differ by at most 1 (from eq. (1.15)). Thus, by construction each column of matrix \mathcal{B} has a sum of either $\left\lfloor \frac{|\overline{\mathcal{Z}}|}{\nu - \delta} \right\rfloor + \delta$, or $\left\lceil \frac{|\overline{\mathcal{Z}}|}{\nu - \delta} \right\rceil + \delta + 1$. Let us denote by K the corresponding set of columns of the first kind:

$$K = \left\{ j, \sum_{i \in \llbracket 1, \delta \rrbracket} \mathcal{B}_{i,j} = \left\lfloor \frac{|\overline{\mathcal{Z}}|}{\nu - \delta} \right\rfloor + \delta \right\}.$$

Note that by construction of $\overline{\mathcal{Z}}$, we have $\#K = (\nu - \delta) - |\overline{\mathcal{Z}}| \bmod (\nu - \delta)$.

Thus, intuitively, so as to resist k attacks, we need to construct matrix \mathcal{C} in such a way that:

- \mathcal{C} is symmetric, all diagonal elements are either 0 or 1, all other elements are 0, 1 or 2,
- the sum of elements of each row in K should be (at least) equal to $k + 1 - \left\lfloor \frac{|\overline{\mathcal{Z}}|}{\nu - \delta} \right\rfloor - \delta$
 while the sum of elements of each other row should be (at least) equal to $k - \left\lceil \frac{|\overline{\mathcal{Z}}|}{\nu - \delta} \right\rceil - \delta$.

For ease of notations, let us introduce

$$f = k - \left\lceil \frac{|\overline{\mathcal{Z}}|}{\nu - \delta} \right\rceil - \delta.$$

Thus \mathcal{C} is a matrix with minimal value $|\mathcal{C}|$ for which: (i) the sum of elements of each row in K is (at least) equal to $f + 1$ and (ii) the sum of elements of each row not in K is (at least) equal to f , so that each node $i \in \llbracket \delta + 1, \nu \rrbracket$ has a degree of $k + 1$.

We construct \mathcal{C} as the sum of 2 matrices, \mathcal{C}^1 and \mathcal{C}^2 , which we define below. So, we have $\mathcal{C} = \mathcal{C}^1 + \mathcal{C}^2$. In the first one, \mathcal{C}^1 , the sum of elements of each row associated with nodes in K is equal to 1 (except possibly for one node in K , for this node, this sum is equal to 0 or 2) while the sum of elements of other rows is equal to zero. In other words, adjacency matrix \mathcal{C}^1 captures the fact that we add a degree to each node in K (except possibly one). So if we restrict our attention to adjacency matrices \mathcal{B} and \mathcal{C}^1 each node in $\llbracket \delta + 1, \nu \rrbracket$ has the same degree, equal to $\left\lfloor \frac{|\overline{\mathcal{Z}}|}{\nu - \delta} \right\rfloor + \delta + 1$ (except possibly for one node which has a degree equal to $\left\lceil \frac{|\overline{\mathcal{Z}}|}{\nu - \delta} \right\rceil + \delta$).

In the second one, \mathcal{C}^2 each row adds up to f (except possibly one which adds up to $f + 1$). Let us now explain the role played by the adjacency matrix \mathcal{C}^2 . Due to the construction of adjacency matrices \mathcal{B} and \mathcal{C}^1 , we know that we have to add f degrees to each node in $[[\delta + 1, \nu]]$ (except possibly for one). For these nodes, we use the same method as in Lemma 5: we overlap some cliques and a Harary network. Matrix \mathcal{C}^2 captures this building process.

Construction of \mathcal{C}^1 : Matrix \mathcal{C}^1 is a symmetric matrix which satisfies the following conditions

- (i) all elements are either 0 or 1: $\mathcal{C}_{i,j}^1 \in \{0, 1\}$;
- (ii) each row (resp. column) whose index is not in the set K contains only elements equal to zero: $\forall i, j, \mathcal{C}_{i,j}^1 = 1 \Rightarrow (i \in K \text{ and } j \in K)$;
- (iii) each row whose index is in K admits at most one non-zero element;
- (iv) there exists at most one column with two elements which are not equal to zero.

To construct \mathcal{C}^1 , let σ be an ordering of the elements of K , that is $K = \{\sigma_1, \sigma_2, \dots, \sigma_{\#K}\}$, with $\sigma_1 < \sigma_2 < \dots < \sigma_{\#K}$. Let $\mathcal{J}(i, j, b)$ be the squared matrix of size b whose elements are all zero except for the one at row i and column j and its symmetric element (at row j and column i) whose value is 1. We set:

$$\mathcal{C}^1 = \sum_{i \in \left[0, \left\lfloor \frac{\#K}{2} \right\rfloor - 1\right]} \mathcal{J}(\sigma_{2i+1}, \sigma_{2i+2}, \nu - \delta) + \begin{cases} 0 & \text{if } \#K \bmod 2 = 0 \text{ or } (\nu - \delta)f \bmod 2 = 1, \\ \mathcal{J}(\sigma_{\#K}, \sigma_1, \nu - \delta) & \text{otherwise.} \end{cases}$$

\mathcal{C}^1 is symmetric as a sum of symmetric matrices. Note that in the case where $\#K \bmod 2 = 1$ and $f(\nu - \delta) \bmod 2 = 0$, the column of index σ_1 adds up to 2: node σ_1 is incident to 2 links while other nodes in K are incident to 1 link.

Let us briefly comment on the special status of $\mathcal{J}(\sigma_{\#K}, \sigma_1, \nu - \delta)$. In the case where $\#K \bmod 2 = 1$, there exists no network such that each node in K has a degree of 1 while each node not in K has a degree of 0 (since in any network the sum of degrees is always even). In other words, there exists no adjacency matrix such that all rows (resp. columns) in the set K add up to 1 and all rows (resp. columns) out of the set K add up to 0. Therefore, to ensure that each row (resp. column) in K adds up to 1, an additional degree is required. However, in the case where $(\nu - \delta)f \bmod 2 = 1$, we will see below that the matrix \mathcal{C}^2 , whose

construction is based on Harary networks contains exactly one node whose degree is $f + 1$. Therefore, in that case, we construct \mathcal{C}^2 in such a way that this extra link is incident to node $\sigma_{\#K}$.

Construction of \mathcal{C}^2 : Matrix \mathcal{C}^2 can be constructed in an analogous way as \mathcal{M} in Lemma 5. Indeed, \mathcal{C}^2 is analogous to the adjacency matrix of a multigraph in which each node (among $\nu - \delta$ nodes) should be incident to f links. Since it may be that $f \geq \nu - \delta - 1$, then multiple links may be required. Therefore, we introduce f_1 and f_2 such that $f = (\nu - \delta - 1)f_1 + f_2$ and $f_2 < \nu - \delta - 1$, i.e.,

$$f_1 = \lfloor f / (\nu - \delta - 1) \rfloor, \quad \text{and} \quad f_2 = f \bmod (\nu - \delta - 1).$$

Let us give some intuitions for f_1 and f_2 . Consider one component in $[\delta + 1, \nu]$. If we distribute f links between this component and the $(\nu - \delta - 1)$ others in a way as balanced as possible, then $(\nu - \delta - 1) - f_2$ components will be incident to f_1 links and f_2 components will be incident to $f_1 + 1$ links to the considered component. Consider now the adjacency matrix, \mathcal{X} , which is the sum of the adjacency matrices of f_1 cliques (i.e., $(\nu - \delta - 1, \nu - \delta)$ -Harary networks) and one $(f_2, \nu - \delta)$ -Harary network, that is:

$$\mathcal{X} = f_1 \mathcal{H}(\nu - \delta - 1, \nu - \delta) + \mathcal{H}(f_2, \nu - \delta).$$

Recall that in the case where both $\#K \bmod 2 = 1$ and $(\nu - \delta)f \bmod 2 = 0$, an extra link is required that is adjacent to node $\sigma_{\#K}$. Due to this link, σ_1 has a degree equal to 2 in \mathcal{C}^1 . In \mathcal{M} , σ_1 has a degree equal to $k + 2$. Note that $(\nu - \delta)f \bmod 2 = 1 \Leftrightarrow (\nu - \delta)f_2 \bmod 2 = 1$. Hence, in the case where $\#K \bmod 2 = 0$ and $(\nu - \delta)f \bmod 2 = 1$, in the network whose adjacency matrix is $\mathcal{H}(f_2, \nu - \delta)$, the node of index $\left\lfloor \frac{\nu - \delta}{2} \right\rfloor + 1$ has a degree equal to $f_2 + 1$ (from Lemma 4). In \mathcal{M} , this node has a degree equal to $k + 2$. Moreover, in the case where $\#K \bmod 2 = 1$ and $(\nu - \delta)f \bmod 2 = 0$, node $\sigma_{\#K}$ has a degree equal to 0 in \mathcal{C}^1 and in the network whose adjacency matrix is $\mathcal{H}(f_2, \nu - \delta)$, the node of index $\left\lfloor \frac{\nu - \delta}{2} \right\rfloor + 1$ has a degree equal to $f_2 + 1$. Therefore, when $\#K \bmod 2 = 1$, consider as matrix \mathcal{C}^2 the matrix obtained

from \mathcal{X} by interchanging indices $\sigma_{\#K}$ and $\left\lfloor \frac{\nu - \delta}{2} \right\rfloor + 1$ when $\#K \bmod 2 = 1$.²⁵ Note that, by construction and the permutation of indices, if $\#K \bmod 2 = 1$ and $(\nu - \delta)f_2 \bmod 2 = 1$, then node $\sigma_{\#K}$ has the same degree as the other nodes.

Let us now show that this construction satisfies the optimization problem's constraints:

CS-1 is satisfied, since by construction \mathcal{A} and \mathcal{C} are both symmetric.

CS-2 Recall that $\nu - \delta = n - \nu$ and $2\nu - n = \delta$. From the choice of $\bar{\gamma}$, the constraint (CS-2) translates into: $\forall i, j \in \llbracket 1, 2\nu - n \rrbracket$, $\mathcal{A}_{i,j} \leq \gamma_i \gamma_j = 1$, $\forall i \in \llbracket 1, 2\nu - n \rrbracket, j \in \llbracket 2\nu - n + 1, \nu \rrbracket$, $\mathcal{B}_{i,j} \leq \gamma_i \gamma_j \leq 2$ and $\forall i, j \in \llbracket 2\nu - n + 1, \nu \rrbracket$, $\mathcal{C}_{i,j} \leq \gamma_i \gamma_j \leq 4$. The construction of \mathcal{M} induces that $\forall i, j$ $\mathcal{A}_{i,j} \leq 1$, $\mathcal{B}_{i,j} \leq 2$ and $\mathcal{C}_{i,j} \leq f_1 + 1 + 1$. Then,

$$\begin{aligned}
 f_1 &\leq \frac{(k+1) - \frac{|\bar{\mathcal{Z}}|}{n-\nu} - (2\nu - n)}{n - \nu - 1} \\
 &\leq \frac{(k+1)(n-\nu) - (2\nu - n)((k+1) - (\nu - 1)) - (2\nu - n)(n-\nu)}{(n - \nu - 1)(n - \nu)} \\
 &= \frac{(k+1)(2n - 3\nu) + (2\nu - n)(2\nu - n - 1)}{(n - \nu - 1)(n - \nu)} \\
 &\leq \frac{(n-2)(2n - 3\nu) + (2\nu - n)(2\nu - n - 1)}{(n - \nu - 1)(n - \nu)} = 4 - \frac{n}{n - \nu} < 3.
 \end{aligned} \tag{1.17}$$

Since f_1 is an integer, then $f_1 \leq 2$ and thus $\mathcal{C}_{i,j} \leq 4$, hence, satisfying constraint (CS-2).

CS-3 \mathcal{A} and \mathcal{C}^2 have a zero diagonal as they are sums of matrices with zero diagonals. Since $\sigma_1 < \sigma_2 < \dots < \sigma_{\#K}$ then all \mathcal{J} matrices involved in the construction of \mathcal{C}^1 have zero diagonals. Therefore $\forall i, \mathcal{M}_{i,i} = 0$ and constraint (CS-3) is satisfied.

CS-4 Finally, let $I \subseteq \llbracket 1, \nu \rrbracket$.

- If I is a singleton, then by construction $\sum_{j \neq i} \mathcal{M}_{i,j} = k + 1$.
- Otherwise, note that from eq. 1.17 $\forall i, j, \mathcal{M}_{i,j} \leq 2$. Therefore, the proof is similar to that of Lemma 8: $\sum_{i \in I} \sum_{j \notin I} \mathcal{M}_{i,j} \geq \#I(k + 1 - (\#I - 1)(\max_{i,j} \mathcal{M}_{i,j})) \geq 1((k + 1) - 0) = k + 1$.

²⁵Let us define formally the required permutation:

$$\forall i, \tilde{\sigma}_i = \begin{cases} i & \text{if } i \neq \sigma_{\#K} \text{ and } i \neq \left\lfloor \frac{\nu - \delta}{2} \right\rfloor + 1 \\ \sigma_{\#K} & \text{if } i = \left\lfloor \frac{\nu - \delta}{2} \right\rfloor + 1 \\ \left\lfloor \frac{\nu - \delta}{2} \right\rfloor + 1 & \text{if } i = \sigma_{\#K} \end{cases} \quad \text{and } \forall i, j, \mathcal{C}_{i,j}^2 = \mathcal{X}_{\tilde{\sigma}_i, \tilde{\sigma}_j}$$

Hence, constraint (CS-4) is satisfied.

We now compute the number of links induced by \mathcal{M} . By construction, all nodes in $\llbracket 1, \delta \rrbracket$ have a degree equal to $k+1$. Similarly, all nodes in $\llbracket \delta+1, \nu \rrbracket$, except possibly one, say i , have a degree equal to $k+1$. We now examine situations where node i has a degree strictly higher than $k+1$. If $\#K \bmod 2 = 1$ and $(\nu - \delta)f \bmod 2 = 0$, then node i is identified with node σ_1 defined in \mathcal{C}^1 and has a degree equal to $k+2$. Similarly, if $\#K \bmod 2 = 0$, i.e., all nodes in K have exactly one degree due to the construction of \mathcal{C}^1 , and if $f_2(\nu - \delta) \bmod 2 = 1$, then node i is identified with node $\left\lfloor \frac{\nu - \delta}{2} \right\rfloor + 1$. In that case, node i has a degree equal to $k+2$. It remains to establish that the degree of i is equal to $k+2$ if and only if $\nu(k+1) \bmod 2 = 1$. We have to examine the different possibilities associated with $\nu(k+1) \bmod 2 = 0$ or $\nu(k+1) \bmod 2 = 1$, and $\delta \bmod 2 = 0$ or $\delta \bmod 2 = 1$.

Suppose that $\nu(k+1)\delta \bmod 2 = 1$. By construction of set K , we have $|\bar{\mathcal{Z}}| = x(\nu - \delta) + ((\nu - \delta) - \#K)$, with $x \in \mathbb{N}$, that is $\delta((k+1) - (\delta - 1) - (\nu - \delta)) = x(\nu - \delta) + ((\nu - \delta) - \#K)$, with $x \in \mathbb{N}$. We have $\delta((k+1) - (\delta - 1) - (\nu - \delta)) \bmod 2 = 1$, so $((\nu - \delta) - \#K) \bmod 2 = 1$ since $(\nu - \delta) \bmod 2 = 0$. Moreover, since $(\nu - \delta) \bmod 2 = 0$, we have $\#K \bmod 2 = 1$. Therefore, the degree of node i is equal to $k+2$ since $\#K \bmod 2 = 1$ and $f(\nu - \delta) \bmod 2 = 0$. The examination of the different other possibilities associated with $\nu(k+1) \bmod 2 = 0$ or $\nu(k+1) \bmod 2 = 1$, and $\delta \bmod 2 = 0$ or $\delta \bmod 2 = 1$ is done by using the same arguments as in the case where $\nu(k+1)\delta \bmod 2 = 1$. This fastidious examination allows us to conclude that the degree of node i is $k+2$ if and only if $\nu(k+1) \bmod 2 = 1$.

It follows that $\frac{|\mathcal{M}|}{2} = \left\lfloor \frac{\nu(k+1)}{2} \right\rfloor$, i.e. $\frac{|\mathcal{M}|}{2} = \underline{n}_1$. □

We now conclude the proof of Proposition 1. First, let us observe the conditions of Lemma 8. These are:

$$\left(\left\lfloor \frac{n}{\nu} \right\rfloor \right)^2 < \left\lfloor \frac{k+1}{\nu-1} \right\rfloor + 1 \quad (1.18a)$$

$$(2\nu - n)(2\nu - n - 1) < (3\nu - 2n)(k+1) \quad (1.18b)$$

Suppose that eq. (1.18b) is satisfied and $n > \nu$. Then:

1. Consider the quadratic $x \mapsto (2\nu - x)(2\nu - x - 1)$. It is always non negative except in the (open) interval $(2\nu - 1, 2\nu)$. Since n is an integer, for any n and ν , we have $(2\nu - n)(2\nu - n - 1) \geq 0$. Therefore, $3\nu - 2n > 0$. Thus $2\nu + \nu > 2n$, and hence $\nu > 2(n - \nu) > n - \nu$ (since $\nu < n$). Thus $2\nu > n > \nu$, or in other words $\left\lfloor \frac{n}{\nu} \right\rfloor = 1$.

2. Since $\nu > n - \nu$ and $n > \nu$, we have $\nu > 1$.
3. Now, suppose that $\nu - 1 > k + 1$. Then, $(2\nu - n)(2\nu - n - 1) < (3\nu - 2n)(k + 1) \Rightarrow (2\nu - n)(2\nu - n - 1) < (3\nu - 2n)(\nu - 1) \Rightarrow 4\nu^2 + n^2 - 4\nu n + n - 2\nu < 3\nu^2 - 2n\nu - 3\nu + 2n \Rightarrow \nu^2 + n^2 - 2\nu n + \nu < n \Rightarrow (n - \nu)^2 < n - \nu \Rightarrow n - \nu = 0$, which is impossible. Thus $\nu - 1 \leq k + 1$. Since $\nu > 1$, we have $\left\lfloor \frac{k+1}{\nu-1} \right\rfloor \geq 1$.

Now if $n = \nu$, then eq. (1.18b) implies that $n(n - 1) < n(k + 1)$. Since $n > 0$, this implies that $\nu - 1 < k + 1$, that is $\left\lfloor \frac{k+1}{\nu-1} \right\rfloor \geq 1$.

We have shown that for all $n \geq \nu$, any solution of eq. (1.18b) satisfies $\left(\left\lfloor \frac{n}{\nu} \right\rfloor\right)^2 = 1 < 1 + 1 \leq 1 + \left\lfloor \frac{k+1}{\nu-1} \right\rfloor$. Therefore, constraint (1.18a) is implied by constraint (1.18b) and can thus be omitted.

Second, we have $\sum_{l=1}^{\nu} \gamma_l = n$ and by Lemma 1, $\sum_{l=1}^{\nu} (\gamma_l - 1) = p$ since (N, E_P, \emptyset) is acyclic. It follows that $\nu = n - p$. Since $\nu = n - p$, $\left\lfloor \frac{\nu(k+1)}{2} \right\rfloor = \left\lfloor \frac{(n-p)(k+1)}{2} \right\rfloor$, so $\underline{n}_1 = n_1(p, k)$. Similarly, $(2\nu - n) \left((k+1) - \frac{2\nu - n - 1}{2} \right)$ is equal to $(n - 2p) \left(k + 1 - \frac{n - 2p - 1}{2} \right)$, and so $\underline{n}_2 = n_2(p, k)$. Finally, note that equation $(n - 2p)((k+1) - (n - 2p - 1)/2) = (k+1)p$ is quadratic in p . Let x_1 and x_2 be the two real roots of the polynomial when they exist (which occurs when $n \leq \frac{(3k+5)^2}{8(k+1)}$). Then, $p_1(k, n) = \lfloor x_1 \rfloor + 1$ and $p_2(k, n) = \lceil x_2 \rceil - 1$.

1.6.2 Appendix II: A construction for Matrix $\overline{\mathcal{Z}}$

A possible construction for matrix $\overline{\mathcal{Z}}$ is to proceed according to the following process:

Input: Number of rows δ , columns $\nu - \delta$ and value of row sum $(k + 1) - (\nu - 1)$

Output: A possible matrix $\overline{\mathcal{Z}}$

- 1 Initialize matrix $\overline{\mathcal{Z}}$ to the zero matrix
- 2 Set $\overline{\mathcal{Z}}_{1,j} = 1$ for all $j \leq (k + 1) - (\nu - 1)$
- 3 **for** each row r from 2 to δ **do**
- 4 **for** each column q from 1 to $\nu - \delta$ **do**
- 5 Compute the partial sum $w_q = \sum_{i \in [1,r]} \overline{\mathcal{Z}}_{i,q}$
- 6 Select exactly $(k + 1) - (\nu - 1)$ columns among the $\nu - \delta$ columns having the lowest sum of w_q , i.e.,
- 7 finds $W_r \in \operatorname{argmin}_{C \subseteq [1, \nu - \delta]} \left\{ \sum_{q \in C} w_q, \#C = (k + 1) - (\nu - 1) \right\}$
- 8 Set these elements to one: $\overline{\mathcal{Z}}_{r,j} = 1$ with $j \in W_r$

Bibliography

- Acemoglu, D., Malekian, A. and Ozdaglar, A. (2016). Network security and contagion, *Journal of Economic Theory* **166**: 536–585.
- Baccara, M. and Bar-Isaac, H. (2008). How to organize crime, *The Review of Economic Studies* **75**(4): 1039–1067.
- Bala, V. and Goyal, S. (2000a). A noncooperative model of network formation, *Econometrica* **68**(5): 1181–1229.
- Bala, V. and Goyal, S. (2000b). A strategic analysis of network reliability, *Review of Economic Design* **5**(3): 205–228.
- Brown, G., Carlyle, M., Salmeron, J. and Wood, K. (2006). Defending critical infrastructure, *Interfaces* **36**(6): 530–544.
- Cabrales, A., Gottardi, P. and Vega-Redondo, F. (2014). Risk-sharing and contagion in networks.
- Cerdeiro, D., Dziubinski, M. and Goyal, S. (2015). Contagion risk and network design.
- Cunningham, W. H. (1985). Optimal attack and reinforcement of a network, *Journal of the ACM (JACM)* **32**(3): 549–561.
- Dziubinski, M. and Goyal, S. (2013). Network design and defence, *Games and Economic Behavior* **79**: 30–43.
- Goyal, S. (2012). *Connections: an introduction to the economics of networks*, Princeton University Press.
- Goyal, S. and Vigier, A. (2014). Attack, defence, and contagion in networks, *The Review of Economic Studies* **81**(4): 1518–1542.
- Groetschel, M., Monma, C. L. and Stoer, M. (1995). Design of survivable networks, *Handbooks in operations research and management science* **7**: 617–672.
- Haller, H. (2015). Network vulnerability: a designer-disruptor game.
- Haller, H. and Sarangi, S. (2005). Nash networks with heterogeneous links, *Mathematical Social Sciences* **50**(2): 181–201.

- Harary, F. (1962). The maximum connectivity of a graph, *Proceedings of the National Academy of Sciences* **48**(7): 1142–1146.
- Hong, S. (2009). Enhancing transportation security against terrorist attacks.
- Hoyer, B. and Jaegher, K. D. (2016). Strategic network disruption and defense, *Journal of Public Economic Theory* **18**(5): 802–830.
- Jackson, M. O. (2010). *Social and economic networks*, Princeton university press.
- Jackson, M. O. and Wolinsky, A. (1996). A strategic model of social and economic networks, *Journal of economic theory* **71**(1): 44–74.
- Kerivin, H. and Mahjoub, A. R. (2005). Design of survivable networks: A survey, *Networks* **46**(1): 1–21.
- Landwehr, J. (2015). Network design and imperfect defense.
- McBride, M. and Hewitt, D. (2013). The enemy you can't see: An investigation of the disruption of dark networks, *Journal of Economic Behavior Organization* **93**: 32–50.
- Tambe, M. (2011). *Security and game theory: algorithms, deployed systems, lessons learned*, Cambridge University Press.
- Vega-Redondo, F. (2007). *Complex social networks*, number 44, Cambridge University Press.

Chapter 2

Heterogeneity and Sequentiality in Network Formation Games

Abstract

In the benchmark model of Bala and Goyal (2000) on network formation, the equilibrium network is the Center-Sponsored Star where one player creates a link with every other player. This network does not emerge in the laboratory because of coordination failure and fairness concerns. In this paper, we use a sequential linking decision process to ease coordination on asymmetric networks. We also test whether the presence of a special agent who has either a higher monetary value or a different status than other agents modifies the structure of the network. Our experimental results show that thanks to sequentiality, individuals coordinate on fair and efficient networks but that does not correspond to the Sub-game Perfect Equilibrium. Monetary heterogeneity increases the asymmetry of the networks that emerge thanks to the popularity of the special individual.

Keywords: network formation; heterogeneity; centrality; experiment.

JEL code: C72, C92, D85, Z13.

2.1 Introduction

Individuals are embedded in social and economic networks that are often created by the individuals themselves. One of the characteristics of most networks is that they are asymmetric, i.e., few nodes (individuals, firms, websites, etc.) have more links and are more central than other peripheral nodes. For example, friendship networks at school (Bramoullé and Rogers, 2009), scientific co-authorship networks (Newman, 2004) and the World Wide Web (Barabási et al., 2000) exhibit an asymmetric structure. Network formation models have been designed to understand the formation of asymmetric networks. The seminal model in this literature is the model of Bala and Goyal (2000) (henceforth BG), where links are unilaterally formed and paid by the initiator of the link. The equilibrium network is asymmetric. More precisely, the Center-Sponsored Star (CSS) – where one central agent creates a link with all the peripheral agents – is the strict Nash equilibrium network. Asymmetric networks are prominent in theoretical works and in many real-life situations. However, the emergence of asymmetric networks is rare in the laboratory. Falk and Kosfeld (2012) test the model of BG and highlight the fact that the CSS does not emerge in the laboratory because of coordination failure and fairness concern. In fact, strategies and payoffs are different between the central and the peripheral agents. However, some experimental works manage to facilitate the emergence of asymmetric networks. Goeree et al. (2009), Rong and Houser (2015), Van Leeuwen et al. (2015) and Berninghaus et al. (2007) test the emergence of asymmetric networks and found that the Periphery-Sponsored Star (PSS), where each peripheral agent creates a link with the central agent, emerges more easily than the CSS in the laboratory. Indeed, strategies are almost similar across agents and linking costs are nearly equally shared. However, coordination remains difficult even with the PSS, as linking decisions are often taken simultaneously in these experiments. This leads to over-connection as agents want to make sure that they are part of the network.

Our primary objective with this paper is to improve the coordination of agents in the laboratory thanks to a sequential process. Instead of making their linking decisions simultaneously like in the main part of the literature (some exceptions are described in section 2.2), individuals decide one after another and can observe the decisions of the previous individuals. The introduction of this feature allows individuals to act more strategically and with less uncertainty than in a simultaneous process. Additionally, it reflects many real-life situations.

For instance, Facebook users can observe the “friends” of a person before “adding” this person as a friend. We slightly extend the connections model of Bala and Goyal (2000) by replacing the simultaneous process of linking formation by a sequential one. In their model, links are formed unilaterally at a cost for the agent who initiates the link, but both agents involved in the connection benefit from it. Direct and indirect links are equally valuable (agents benefit as well from their friends, than the friends of their friends, etc.): there is *no decay*. Theoretically, based on backward induction, the introduction of sequentiality leads to a Sub-game Perfect Equilibrium that is a CSS where the last agent of the sequential process has to create a link with every other agent. The equilibrium network is both asymmetric and unfair as agents apply different strategies that lead to unequal payoffs. But sequentiality should act as a coordination device that facilitates the emergence of the equilibrium in the laboratory.

Our second objective is to analyze whether heterogeneity across agents impacts the structure of the network. Indeed, it is a realistic feature that can modify individual linking choices, determine one’s position in a social network (Girard et al., 2015) and consequently transform the structure of networks. We implement heterogeneity with the presence of a special agent, who is singled out from the others. We introduce two types of heterogeneity: monetary and non-monetary heterogeneity. We introduce monetary heterogeneity with the presence of an individual with a higher value than the other individuals and non-monetary heterogeneity via the election of an individual by his group members based on personal characteristics that provides him a particular status. Non-monetary as well as monetary heterogeneity do not impact the determination of the equilibrium. Indeed, due to the no decay assumption, agents are indifferent between being directly or indirectly linked with the special agent. Consequently, the last agent creates all the links in both settings. As heterogeneity does not impact the determination of the theoretical equilibrium, we can capture the behavioral responses to heterogeneity.

We design four treatments to study whether heterogeneity affects the structure of the network. In the baseline treatment (BT), individuals are homogeneous, i.e., they have the same value to others. In the heterogeneous treatments, one individual is singled out from the others and has the status of special individual. In the exogenous treatment (EXO), the special individual is randomly selected by the computer program. In the endogenous treatment (ENDO), the selection of the special individual is based on his relative performance in

a preliminary real-effort task. We vary the selection of the special individual to test whether merit has an impact on linking decisions. In these two treatments, heterogeneity is monetary; creating a link with the special individual generates a higher benefit than with any other individual. In the non-monetary treatment (NM), the special individual has no additional monetary value. The determination of the special individual is based on the procedure of Galeotti and Zizzo (2014) where individuals rank their group members based on personal attributes. This treatment is designed to investigate whether heterogeneity based on non-monetary parameters may influence the linking decisions.

Our experimental results show that thanks to the sequential process, individuals coordinate on efficient and fair networks during the whole experiment, but that does not correspond to the Sub-game Perfect Equilibrium. Even if it is not payoff maximizing for non-last movers to create links, individuals tend to share the cost of network formation by creating one link each. Two explanations are possible to explain these “early links”: fairness concerns and the fear of isolation. First, individuals may be willing to reduce payoff inequalities because of fairness concerns. In fact, 38% of individuals decide to form one link while they are already linked and sure to earn a positive payoff when it is their turn to play. They want to participate to the network formation cost. Second, if an individual has no existing link when it is his turn to play and does not participate to the cost of network formation, subsequent movers may punish him by not creating any link with him: they exclude defectors. As a consequence, in 90% of the cases, individuals create at least one link when they have no existing links. Consequently, first movers (who cannot have any existing link) are more likely to create links than subsequent movers.

Concerning heterogeneity, it impacts the linking decision process in some cases. At the aggregate level, networks formed in ENDO and EXO are more asymmetric than in BT and NM. It is due to the fact that normal individuals create more links with the special individual than with any other individual. The special individual polarizes links on him and does not need to create any links. What can explain his popularity? First, creating a link with him increases one’s attractiveness. Second, creating a link with the special individual insures being part of his network at the end of the period. Indeed, in ENDO and EXO, the first link is often formed with the special individual. Non-monetary heterogeneity does not impact the linking decisions. In fact, individuals are not more attracted by the special individual than by

any other individual. The salience of the special individual is not sufficient to impact linking decisions. Since there is no significant difference between the attractiveness of the special individual in ENDO and EXO and that the special individual in NM is not more attractive than normal individuals, there is no entitlement effect on linking decisions.

The paper is organized as follows. In section 2.2, we review the papers related to asymmetric network formation and status. In section 2.3, we develop our theoretical model and describe the Sub-game Perfect Equilibrium. In section 2.4, we describe our experimental design and provide some behavioral predictions. In section 2.5, we develop our experimental results. Finally, section 2.6 concludes.

2.2 Related literature

Goeree et al. (2009) (henceforth GOE) study the reason of the gap between theoretical and experimental findings concerning the emergence of asymmetric networks by implementing agents' heterogeneity. The authors extend the model of BG with decay (agents benefit less from their indirect links than their direct links) and heterogeneous agents. With the introduction of value-heterogeneity, where creating a link with the high-value agent generates a higher monetary benefit than with any other agent,¹ the equilibrium network is not the Center-Sponsored Star but the Periphery-Sponsored Star, where each peripheral agent creates a link with the central agent (the high-value agent in this case).² Their experimental results show that the presence of a high-value individual facilitates the emergence of Periphery-Sponsored Stars. The high-value individual is more attractive and the other individuals tend to create direct links with him to fully benefit from his higher value. In their paper, heterogeneity facilitates the coordination on asymmetric networks. The main differences between our paper and the paper of GOE are twofold. First, we implement heterogeneity in a monetary and non-monetary way, and endogenously and exogenously to understand which characteristics are important to increase the attractiveness of an individual in a network formation game. In GOE, the special individual is exogenously determined and has a higher monetary value. Moreover, in our model, there is no decay. As a consequence, we do not attempt to facilitate

¹They also study cost-heterogeneity by introducing a low-cost agent who induces a lower linking cost than the others.

²A theoretical work of Galeotti et al. (2006) extended the model of BG with value-heterogeneity and cost-heterogeneity. Additionally to the work of GOE, they study heterogeneity where costs and values vary across agents but also across the targeted agents for the link formation.

the emergence of star networks but to study the effect of heterogeneity on the structure of networks. More particularly, we focus on whether heterogeneity fosters or not the coordination on central networks and whether it impacts the level of fairness. Second, we use a sequential process instead of a simultaneous one to facilitate coordination on stable networks across periods. For example, despite the strong attractiveness of the high-value individual in GOE, it takes several periods for the individuals to coordinate on the Periphery-Sponsored Star. Indeed, in the first half of the experiment, only few stars emerge. Besides GOE, several other studies have designed environments to promote the emergence of star networks in the laboratory.

Berninghaus et al. (2007) modify the design of the model of BG by discriminating between actively and passively reached agents. When an agent i creates a link with agent j , j is actively reached by i while i is passively reached by j . In their setting, an agent does not benefit from all indirect links, but only from the agents actively or passively linked with his actively reached agents. With this restriction, the PSS is the equilibrium network and emerges frequently during the experiment. The PSS is more likely to emerge in the laboratory than the CSS, even when individuals are homogeneous, because it is easier to coordinate on a PSS that is more symmetric as every individual but one creates one link and so contributes to the network formation.

Rong and Houser (2015) keep the homogeneity assumption but designed some institutions that reflect some real-life situations to promote the emergence of star networks. Among others, they design a treatment with sequential decisions. Based on the model of Galeotti and Goyal (2010), agents have the choice of investing to acquire valuable information or obtaining it by forming a link with an agent who invested in information. The SPE is a PSS where the central agent is the first mover and the sole investor of the network. Surprisingly, the sequentiality property does not affect the frequency of star emergence.

Based on the same kind of network formation model, Van Leeuwen et al. (2015) show that competition for status (being the center of the star) facilitates the emergence of the PSS, because every peripheral individual wants to be linked with this central individual. Rosenkranz and Weitzel (2012) use a different model based on public good provision and still find that agents have less difficulty to coordinate on a PSS and that this network is more stable during

the experiment.

The objective of the paper is to analyze whether heterogeneity impacts the structure of networks such as their fairness or efficiency levels and their asymmetry. Contrary to the experimental papers we cited, in our paper, the equilibrium network is the CSS and not the PSS. Moreover, the sequential models are designed in the context of a public good game while we purely study network formation. Our goal is not to facilitate the emergence of stars in the laboratory, but to facilitate the coordination on stable networks and to study the impact of heterogeneity on the formation of these networks.

With the introduction of heterogeneity, our work is related to the literature on status as individuals are labeled differently: normal or special individuals. For a general review on the quest for status and the effect of status with a sociological and economic approach, we refer to the survey of Weiss and Fershtman (1998) and Heffetz and Frank (2008). The experimental works of Ball et al. (2001) and Ball and Eckel (1998) show that high-status individuals are better treated in a competitive environment and consequently earn a higher payoff than low-status individuals. Their status influences their own behavior and the behavior of others. Finally, Eckel and Wilson (2007) find that individuals are more influenced by high status individuals, who foster coordination. This leads to a more frequent occurrence of the efficient equilibrium. In summary, high-status individuals contribute more, but also earn more and influence the behavior of other individuals. We expect that the status of special individual will modify the preferences for linking. Additionally, the way the status is implemented can impact differently individuals' behavior. For example, in the dictator game literature, dictators who earn their status behave more selfishly than exogenously chosen dictators (see for example Hoffman and Spitzer (1985) and Cherry et al. (2002)).

Our contribution to this literature is that we study the impact of status on attractiveness and on the structure of networks in a network formation game. To our knowledge, this is the first experimental paper considering status as a support for network formation.

2.3 Theoretical model

We extend the two-way flow model of BG without decay (Bala and Goyal, 2000) with two properties: heterogeneity and sequentiality.

2.3.1 Notations

Let $N = \{1, \dots, n\}$ be the set of agents, with two typical agents i and j . Agents can form links with every other agent. Let agent i 's links be represented by the linking vector $g_i = (g_{i1}, \dots, g_{in})$ where $g_{ij} \in \{0, 1\}$, $\forall i, j \in N$ and $g_{ii} = 0, \forall i \in N$. We write $g_{ij} = 1$ if agent i has formed a link with j and $g_{ij} = 0$ otherwise. Unilateral consent is sufficient to form a link, so $g_{ij} = 1$ does not imply $g_{ji} = 1$. A *network* g consists of all agents in N and their links, i.e., $g = (g_1, \dots, g_n)$. Let G be the set of all possible networks, i.e., $g \in G$.

If $g_{ij} = 1$ or $g_{ji} = 1$, then i and j are *adjacent* agents, we also say that they are *directly linked*. The closure of g , \bar{g} , is defined by $\bar{g}_{ij} = \max\{g_{ij}, g_{ji}\}$, $\forall i, j \in N$ and $i \neq j$. A *path* between agent i and j is a sequence of distinct agents $(i, j_1, \dots, j_{k-1}, j)$ where $\bar{g}_{ij_1} = \bar{g}_{j_1 j_2} = \dots = \bar{g}_{j_{k-1} j} = 1$. In the following, we say that two agents are *indirectly linked* if there exists a path between them but they are not adjacent. Let $N_i(g)$ represent the set of agents directly or indirectly linked with agent i . The *out-degree* of agent i is the number of links created by i : $\sum_{i \neq j} g_{ij}$, $\forall j \in N$. The *in-degree* of agent i is the number of agents $j \neq i$ who created a link with i : $\sum_{i \neq j} g_{ji} = \mu_i^p(g)$, $\forall j \in N$. This represents the attractiveness of an agent. The *degree* of an agent i is the sum of the in-degree and the out-degree of agent i : $\sum_{i \neq j} \bar{g}_{ij}$, $\forall j \in N$, denoted $d_i(g)$ in the following of the paper.

Let g_{-i} be the actions taken by agents other than i . With a slight abuse of notation, we write $g = (g_i, g_{-i}), \forall i \in N$. Let $g_i^- = (g_1, \dots, g_{i-1})$ and $g_i^+ = (g_{i+1}, \dots, g_n)$ respectively represent the actions of agents that made their linking decisions before and after i .

A non-empty subset of agents $N' \subset N$ is a component of g if there exists a direct or indirect link between every two distinct members of N' but no agents in N' are directly or indirectly linked with any agent in $N \setminus N'$. An *isolated* agent has a degree zero and by convention forms a component.

The *empty* network is the network g which contains no links. A *connected* network g contains a unique component. A network g is *minimally connected* if the network is connected and there is no cycle in the network.

2.3.2 Cost, value and heterogeneity

In our two-way flow model, one agent, say i , creates a link with j and both agents benefit from it. A direct or indirect link between agent i and j generates a positive value v_j for agent i and v_i for agent j . Values may differ among agents. Indeed, being linked with a particular agent may be more valuable than with another agent. As there is no decay in our model, values do not decrease with the length of the path, i.e., an agent benefits as much from direct links as indirect links.³ Two agents may be linked by more than one path. See Figure 2.1c for example, where agent 5 and agent 1 are directly connected but also indirectly connected because $g_{12} = g_{23} = g_{34} = g_{45} = g_{51} = 1$. In this case, they only benefit once from each other.

Forming a link is valuable but is also costly. We assume that the cost of forming a link c_i is the same for every agent ($c_i = c, \forall i \in N$). Indeed, we focus our interest on value-heterogeneity as we are mostly interested in the attractiveness of special agents. Moreover, GOE did not find any evidence that cost-heterogeneity facilitates the emergence of star networks.

We assume a linear payoff function where linking costs are subtracted from the benefits of linking. The payoff of agent i in network g is given by

$$\pi_i(g) = \sum_{j \in N_i(g)} v_j - \sum_{\substack{j \in N \\ i \neq j}} g_{ij} c. \quad (2.1)$$

2.3.3 Sequential setting

The main difference with the major part of the literature on network formation is that we use a sequential setting. Indeed, instead of creating links simultaneously, agents form links one after another in a certain order. Let $\rho = 1, 2, \dots, n$ be the rule of order. The order is random.

³De Jaegher and Kamphorst (2015) extend the two-way flow model of BG with small decay. If we relax the no decay assumption in our heterogeneous model, agents with a higher value to others become more attractive, as being directly connected with them is necessary to fully benefit from their higher value. Note that it is the case in GOE, such that agents have a strong incentive to form a link with the agent that generates a higher value.

Agents are informed of their decision order in the sequential process. The first agent makes his decisions. Then the second agent observes the decisions of the previous agent and makes his decisions. The game stops when the last agent has made his decisions.

Information is complete. Agents know their own value to others and the value of the others. They also know the cost of a link and their decision order in the sequential process.

2.3.4 Equilibrium, efficiency, fairness and centrality

We are interested in the *Sub-game Perfect Equilibrium* (SPE) of this game. Each agent i wants to maximize his payoff $\pi_i(g)$ that depends on the strategies of the other agents. Agent i has to solve:

$$\begin{aligned} & \max\{\pi_i(g) : (g_i|g_{-i})\} \\ & \text{st. } g \in G. \end{aligned}$$

Using backward induction, we first study the case of the last agent.

The strategy of the last agent (n^{th} agent of the sequential process ρ) is to maximize his payoff according to the actions of the preceding agents (this set is already fixed). As there are no agents after him, he does not have to take into account what the following agents may decide. Formally, agent n solves:

$$\begin{aligned} & \max\{\pi_n(g) : (g_n|g_n^-)\} \\ & \text{st. } g \in G \end{aligned}$$

where g_n^- is fixed. The actions available for agent n are represented by:

$$\hat{G}_{n-1} = \{g \in G : \pi_n(g) = \max\{\pi_n(g) : (g_n|g_{-n})\}\}.$$

His decision is the last decision of the game.

In our setting, due to the no decay assumption, two actions may lead to the same payoff. Let a and b be two possible linking actions of an agent. If one action leads to a higher payoff, this action is preferred. However, if both actions lead to the same payoff, the agent is indifferent between these two actions. Concretely, if two agents i and j form a component and that a third agent k wants to create a link with this component, he is indifferent between

creating a link with i or j . In order to have uniqueness of equilibrium, we define a tie-breaking rule. Let suppose that we have two possible linking actions a and b that lead to the same payoff for the agent. We look at the lexicographical order $(a_1, a_2) = a \succ (b_1, b_2) = b$ if $a_1 > b_1$ or if $a_1 = b_1$ and $a_2 > b_2$. In our setting, if an agent has more than one action that leads to the same payoff, he chooses the lexicographically greater linking vector. Concretely, due to our tie-breaking rule, he chooses to link with the agents who play earlier in the sequential process ρ . Formally, the restricted feasible actions for the agent are:

$$G_{n-1} = \{g \in \hat{G}_{n-1} : \pi_n(g) = \pi_n(g') \implies g_n \succ g'_n, \forall g' \in \hat{G}_{n-1}\}.$$

The second to last agent knows the action taken by the agents before him. However, the last agent has not already chosen his action. When the second to last agent takes his decision this will define the actions that the last agent should take to maximize his payoff. Formally, agent $n - 1$ solves:

$$\begin{aligned} & \max\{\pi_{n-1}(g) : (g_{n-1}|g_{n-1}^-)\} \\ & \text{st. } g \in G_{n-1}. \end{aligned}$$

Then we generalize the problem at the i -level. Formally, the potential actions are given by:

$$\hat{G}_i = \{\hat{g} \in G_{i+1} : \pi_{i+1}(\hat{g}) = \max\{\pi_{i+1}(g) : (g_{i+1}|g_{i+1}^-)\}\}.$$

We restrict the feasible actions with our tie-breaking rule:

$$G_i = \{g \in \hat{G}_i : \pi_{i+1}(g) = \pi_{i+1}(g') \implies g_{i+1} \succ g'_{i+1}, \forall g' \in \hat{G}_i\}.$$

The maximization problem of agent i can be written as:

$$\begin{aligned} & \max\{\pi_i(g) : (g_i|g_i^-)\} \\ & \text{st. } g \in G_i. \end{aligned} \tag{2.2}$$

The Sub-game Perfect Equilibrium is a network where each agent $i \in N$ solves the maximization problem given in equation 2.2.

We also present the concept of *efficiency*. Traditionally, we assess the welfare of a network

with the sum of individual payoffs:

$$W(g) = \sum_{i \in N} \pi_i(g).$$

A network is efficient if $W(g) \geq W(g'), \forall g' \in G$ (see Figure 2.1a and Figure 2.1b for examples of efficient networks). We measure the level of efficiency of network g with the ratio $W(g)/W(g^*)$, where g^* is an efficient network.

We provide a measure of fairness at the network level. We measure the fairness level of network g , $f(g) \in [0, 1]$, with the ratio between the lowest and the highest payoffs. Formally:

$$f(g) = \frac{\min \pi_i(g)}{\max \pi_j(g)}, \forall i, j \in N, i \neq j.$$

A network is perfectly fair if $f(g) = 1$ (see Figure 2.1c for an example).

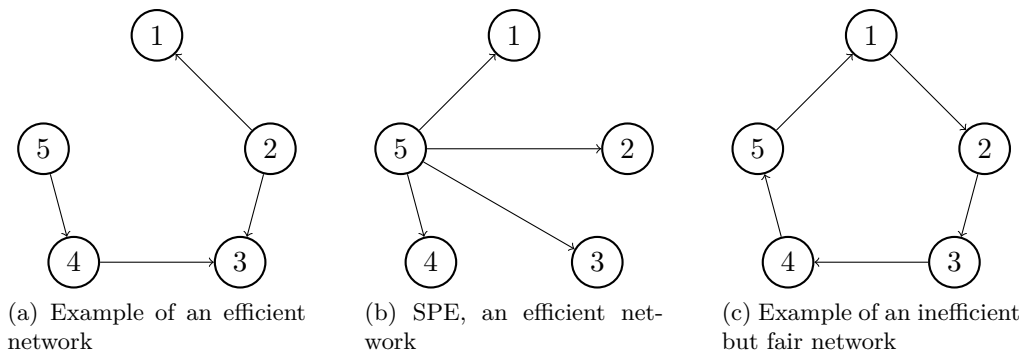

Figure 2.1: Examples of networks, labels represent the rule of order ρ .

Concerning the asymmetry of networks, we now describe formally star networks. A *star* network is a network g where an agent, say agent i , is adjacent with all the other agents while agents $j \neq i$ are adjacent only with i . We say that i is the *central agent* of the star and agents $j \neq i$ are *peripheral agents*. There are different types of star networks. In the *Periphery-Sponsored Star* (denoted g^{PSS}), all peripheral agents form a link with the central agent. On the contrary, in the *Center-Sponsored Star* (denoted g^{CSS}) the central agent forms a link with all peripheral agents. The *Mixed-Sponsored Star* (denoted g^{MSS}) is a star where both peripheral agents and the central agent form links. The PSS, the CSS and the MSS are represented in Figure 2.2.

To measure the symmetry/centrality of a network, we use the standard definition of degree centrality of a network (Freeman, 1978). The *degree centrality* of a network can be computed by comparing the degree of the most central agent (agent who has the highest degree) with the degree of all the other agents of the network. Formally, we have:

$$S(g) = \frac{\sum_{i \in N} [\max_{j \in N} d_j(g) - d_i(g)]}{(n-1)(n-2)}, \forall i, j \in N, i \neq j.$$

$S(g) \in [0, 1]$, where 0 represents the least central network where each agent has the same degree and 1 represents the most central network: the star network. The denominator represents the most central network: the star network where one agent has a degree of $n-1$ and $n-1$ agents have a degree of 1. This simple measure allows us to evaluate if the network is asymmetric, but not the attractiveness or influence of an agent for example. An increasing centrality index reflects a network that is closer to a star network than a less central network. Moreover, this centrality measure of networks has been used in GOE. However, as links are formed unilaterally, we define an *in-degree centrality* measure that takes the in-degree of agents as variable instead of the degree to assess whether there is an agent that is more attractive than others within the network. The in-degree centrality of a network is computed by comparing the in-degree of the most central agent with the in-degree of all the other agents of the network. Formally, we have:

$$S^p(g) = \frac{\sum_{i \in N} [\max_{j \in N} \mu_j^p(g) - \mu_i^p(g)]}{(n-1)(n-1)}, \forall i, j \in N, i \neq j.$$

The denominator represents the most central network: the PSS where one agent has an in-degree of $n-1$ and $n-1$ agents have an in-degree of 0. Like the degree centrality measure, our in-degree centrality measure lies between 0 and 1 where 0 represents a network where every agent has an equal in-degree and 1 represents the PSS. Note that the denominators of $S(g)$ and $S^p(g)$ are different. The denominator of $S^p(g)$ can be higher than the denominator of $S(g)$ as an agent can have a null in-degree and still be part of the network if he creates a link but no one creates a link with him. Figure 2.2 shows the three types of stars with their centrality measures.

2.3.5 Theoretical results

We present two major results. The first result determines the efficient networks. The second result explains that due to sequentiality, the SPE is a CSS where the last agent creates a

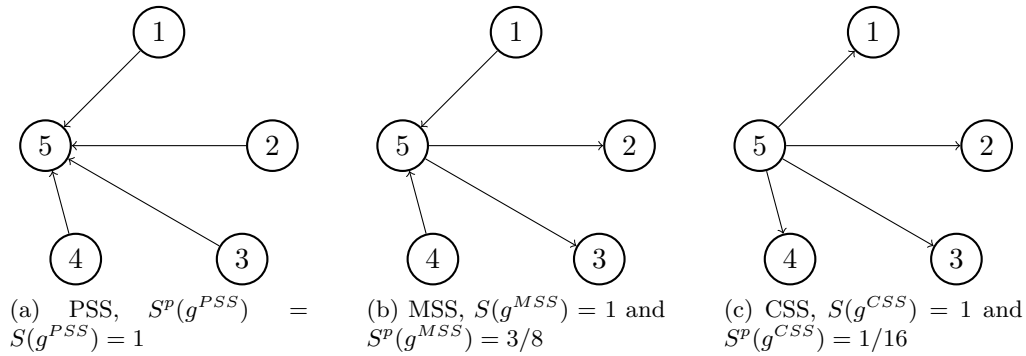

Figure 2.2: Examples of networks with their centrality measures, labels represent the rule of order ρ .

link with every other agent. Consequently, his payoff is always smaller than the payoff of the other agents. The SPE is the same in the homogeneous setting and in the heterogeneous setting due to the no decay assumption. The main determinant of our model is sequentiality.

First, note that a network should always have no more than $n - 1$ links if it creates a unique component.

Proposition 1 *Let the payoff be given by (2.1) and $c < v_i, \forall i \in N$. A network is a non-empty efficient network if and only if it is minimally connected.*

Even if they are linked by more than one path, agents only benefit once from being linked with an agent and due to the no decay assumption, all the connected networks lead to the same overall benefit. The benefits are maximized as every agent benefits from each other agent in a connected network. By definition, minimally-connected networks minimize the costs of network formation. Consequently, they maximize the overall payoff. Note that $n - 1$ links are sufficient for n agents to benefit from every agent and to minimize the costs of network formation.

We now study the SPE of our game in both the homogeneous and heterogeneous settings where an agent has a higher value than others.

Proposition 2 *We assume $c < v_i, \forall i \in N$. Let the payoff be given by (2.1). The SPE is the CSS with the last agent as central agent.*

We begin the proof with the homogeneous setting, where $v_i = v, \forall i \in N$ to give the intuition of the general result. Agents 1 to $n - 1$ in the rule of order ρ know that the last agent can

create enough links to connect all the agents and so can maximize the overall benefit. They also know that he will maximize his payoff when it will be his turn. Consequently agents 1 to $n - 1$ remain passive. When the last agent faces an empty network, he has no choice but maximizing the number of links to maximize his payoff. Due to the sequential process, the last agent creates all the links of the network. As there is no decay and the benefit of a link is always higher than the cost of a link, the SPE is a CSS with the last agent as central agent. The order of agents in the sequential process defines their strategy. As only the initiator of a link pays the linking cost, the last agent has a smaller payoff than peripheral agents. Formally, $\pi_n(g) = (n - 1)(v - c)$ while $\pi_i(g) = (n - 1)v, \forall i \in N \setminus \{n\}$.

Now, we study the case where one agent generates a higher value than others. We assume $c < v_i, \forall i \in N$ such that each agent can create $n - 1$ links and keeps a positive payoff. However, links are costly and due to the no decay assumption, there is no need to be directly connected with the special agent to fully benefit from him. Heterogeneity does not change the structure of the equilibrium network. The SPE remains the CSS with the last agent of the sequential process as central agent.⁴ Regardless of whether the last agent is a normal or a special agent, he can create all the links and so the others remain passive.⁵

The same types of network structures – minimally-connected networks and star networks – emerge in the model of BG. However, due to sequentiality, one agent is always the center of the CSS at the equilibrium: the last agent. Additionally, because of the no decay assumption the introduction of a special agent does not affect the determination of the SPE. The SPE is represented in Figure 2.1b.

⁴In the presence of decay, the distance (shortest length of the path) between two agents becomes important. Peripheral agents of the CSS become less advantaged than without decay as they are at distance 1 from the central agent, but at distance 2 from any other agents, while the central agent is at distance 1 of all other players. If we add decay, the CSS with the last agent as central agent remains SPE, because the linking cost is relatively high compared to the cost of decay. See the Appendix for more details.

⁵It is easy to generalize our results for the cases where $c > v_i$ for some i or for all i . Even if creating a link is more costly than it is beneficial, agents also benefit from their indirect links. So by creating one link, if other agents create links, they can also benefit from indirect links. Because of the sequentiality of the process, the last agent always has to create the maximum number of links he can, given the parameters. And the preceding agent needs to create the links that the last agent cannot create, etc. For example if $c > v_j$ and $(n - 1)v_j > c > (n - 2)v_j \forall j \in N$, the SPE is a network where each agent (except the first agent) creates a link with the first agent of the sequential process ρ .

2.3.6 Fairness

Fairness could influence the linking decisions of agents, as the equilibrium leads to unequal payoffs because the last agent bears all the linking costs. We use the model of Fehr and Schmidt (1999) to capture the impact of inequality aversion in our model. In Fehr and Schmidt's model, additionally to their own monetary payoff, agents are concerned with disadvantageous inequality (envy) and with advantageous inequality (guilt), respectively denoted by the coefficients α_i and β_i for agent i where $0 \leq \beta_i < 1$ and $\beta_i \leq \alpha_i$. The utility of agent i is given by:

$$u_i(\pi_i(g)) = \pi_i(g) - \frac{\alpha_i}{n-1} \sum_{\substack{j \in N \\ j \neq i}} \max\{\pi_j(g) - \pi_i(g), 0\} - \frac{\beta_i}{n-1} \sum_{\substack{j \in N \\ j \neq i}} \max\{\pi_i(g) - \pi_j(g), 0\} \quad (2.3)$$

Inequalities between agents decrease the utility of agent i . We take the example of a network of 5 agents where one is the special agent and four are normal agents to be consistent with our experimental design. If no link has been created until it is his turn, the last agent can decide to create between 0 and 4 links. If he is not inequality averse, the last agent should create 4 links to create a unique component of 5 agents and maximize his own payoff (as well as the overall payoff). However, if his envy coefficient is high enough, i.e., if $\alpha_5 > 0.4$ in the homogeneous setting, $\alpha_5 > 0.571$ in the monetary heterogeneous setting where the last agent is not the special agent and $\alpha_5 > 0.348$ where the last agent is the special agent, the last agent will prefer not to create any link and have a null payoff.⁶ The emotional cost of creating these links is higher than the monetary payoff. Consequently, if the last agent of the sequential process is a bit inequality averse, he will not create any link and the network will be empty.

Similarly, agents in decision order 1, 2, 3 and 4 in the sequential process may not be purely selfish and may anticipate that the last agent will not want to create all the links. Their guilt coefficient pushes them to create at least one link, but their envy coefficient retains them from creating too many links, otherwise the others would earn more than them. Consequently, fairness concerns should encourage agents to form fair networks.

Proposition 3 *If the envy coefficient of the last agent and/or the guilt coefficient of the*

⁶We compute α thanks to the payoff function (2.1) and the utility function (2.3) with $n = 5$, $c = 25$, $v_j = 35$ if j is a not a special agent and $v_j = 50$ if j is the special agent.

other agents are too high, agents will share linking costs.

If agents are inequality averse, they will tend to reduce inequalities of payoffs. As the linking formation process is sequential, that four links in total need to be created to build an efficient network, and that in case of indifference, an agent creates a link with the agent that played the earliest in the sequential process, the first agent will not create any link and the four other agents will tend towards the PSS with the first mover as central agent. With a PSS, the first mover has the maximal payoff while the 4 other agents have slightly lower payoffs. The utility of the first mover is the same with the CSS and the PSS as he does not create any links. However, as the second mover for example creates one link in the PSS, his utility is different in the two cases. With the CSS, $u_2(\pi_2(g^{CSS})) = 140 - 25\beta_2$ and with the PSS, $u_2(\pi_2(g^{PSS})) = 115 - 6.25\alpha_2$. His utility is higher with the PSS if $\beta_2 > \frac{1}{4}\alpha_2 + 1$. According to Fehr and Schmidt (1999), $\alpha \in [0, 4]$ represent “natural levels” of envy. Even if $\alpha = 0$ (the agent is not envious at all), β_2 must be greater than 1 for the second mover to prefer the PSS. $\beta = 1$ is not a “natural level” of guilt as defined by Fehr and Schmidt (1999) ($\beta \in [0, 0.6]$).

To summarize, the CSS is not a SPE if the last agent is too envious. In this case, the SPE is the empty network, but it is not efficient. When inequality aversion is high enough, the PSS with the first mover as central agent becomes more attractive but not for natural levels of inequality aversion. Of course, α_i and β_i may differ from one agent to another.

2.4 Experimental design

We design an experiment to analyze whether sequentiality facilitates the coordination of groups and whether heterogeneity modifies the structure of networks that emerge.

2.4.1 Treatments

Our experiment uses a between-subject design. In each treatment, we randomly form fixed groups of 5 individuals.⁷ We first present the *baseline treatment* (BT) where individuals characteristics (values and costs) are homogeneous. After being assigned to a group of five individuals, participants are informed about the cost and the value of a link. We fix $c = 25$

⁷We do not use a stranger matching design to have a sufficient number of independent observations for our econometric analysis.

and $v = 35$. Then, we allocate randomly the decision order in the sequential process and we randomly allocate a Greek symbol to each individual to avoid focal points. Letters or numbers to identify individuals may influence their decisions. For example, A may be more likely to form a link with B who may be more likely to form a link with C, etc. The first individual of the sequential process begins. At this stage, no links have been formed yet. The first mover has to decide whether to create a link or not with the 4 other players. He can create between 0 and 4 links and can choose the players he wants to be linked with. Individual 2 observes the linking decisions of individual 1 and can also create 0, 1, 2, 3 or 4 links. Individuals can create a link with all the other individuals, including those who have already played. Individuals 3, 4 and 5's decision rules are similar. Once individual 5 has made his decisions, the period is over and another period can start. The game lasts 10 periods. We randomly change the order of the sequential process at the beginning of each period, such that individuals do not remain in the same order during the whole experiment. Additionally, we reallocate the symbols to avoid reciprocity within the network from one period to another.

At the end of each period, we display a map of the network with the number of links initiated by each individual and we give them a feedback on their payoff for the period. At the end of the experiment, we randomly draw one period to determine their earnings for the experiment.

To study the effect of monetary heterogeneity, in each group of five individuals, four are normal individuals and one is the special individual with a higher value. Creating a link with this special individual leads to a higher benefit than with any other individual. We design two treatments with different ways to select the special individual. In the *endogenous treatment* (ENDO), the special individual is selected based on his relative performance during a preliminary task. After the formation of groups and before the network formation game, individuals compete in a real-effort task: the slider task (Gill and Prowse, 2012).⁸ Then we tell individuals if they were the best performer of their group or not. The best performer is singled out from the other individuals in the network formation game. In the *exogenous treatment* (EXO), the special individual is randomly drawn after the formation of the groups.

⁸The screen displays 20 sliders. All the sliders are positioned on 0. Individuals can move the sliders between 0 and 100 as many times as they want. The objective of the task is to position the maximum number of sliders at 50 in two minutes. When individuals put all the sliders displayed on their screen at 50, a new page appears with other sliders, so that they can continue the task.

The information about the type of each individual is public information within the group. The network formation game has the same setting as in the baseline treatment. The only difference is that the special individual has a higher value to others. The parameters are the following: the cost is unchanged, $c = 25$, but forming a link with a special individual generates a gain of 50 points instead of 35 for the other individuals.

In the *non-monetary heterogeneous* treatment (NM), individuals have the same monetary value but one individual is singled out from the others. Like in ENDO, this difference is endogenous. We use the procedure of Galeotti and Zizzo (2014). After the formation of groups, individuals have to fill a form with personal information⁹ to create their “profile”. Then individuals can observe and rank the profile of their group members from the most preferred to the least preferred profile. Their profile is only associated with a letter such that it remains anonymous. The computer allocates a certain number of points to each individual corresponding to the ranking made by his group members. Being ranked first by another individual gives four points, being ranked second gives three points, etc. We compute the total number of points received by each individual. This ranking procedure is a Borda count. The individual with the highest number of points is the special individual of the group in the rest of the experiment. Our purpose for this treatment is to explore whether a non-monetary difference can impact the linking decisions.

In the three heterogeneous treatments, we inform participants that there is no monetary incentive to become the special individual. It allows us to avoid a wealth effect that could impact the linking decisions in the network game. We tell participants that special agents will be singled-out and named differently in the following of the experiment. The special individual is graphically represented on the screen in a different color in the network formation part so that participants can recognize him (see Figure 2.7 and 2.8 in Appendix).

2.4.2 Behavioral hypotheses

We now make some behavioral hypotheses as payoff maximization is not the sole determinant of economic decisions.

⁹The criteria are the following: gender, marital status, name of school or employer, sport, favorite dish, favorite music style, frequency of Facebook use, favorite journal and favorite movie.

The purpose of sequentiality is to facilitate coordination and the emergence of the CSS with the last mover as central player. However, there are four sorts of limitations that may prevent the emergence of the SPE. The first one is cognitive. Participants can have difficulties to compute the best strategies to maximize their payoff. Understanding that remaining passive is the best strategy is not obvious. There is also a debate in network economics about the farsightedness of individuals.¹⁰ They can take rational decisions in the short term that are not beneficial in the future. In our sequential setting, participants may find it difficult to guess what could be the decisions of their subsequent group members.

Second, additionally to their self-interest, individuals may be concerned with social motives and can be inequality averse. In our setting, the benchmark equilibrium is unfair, as the last individual has to form all the links and so bears all the costs of network formation. As we showed with the model of Fehr and Schmidt (1999), the SPE may not emerge if the last individual is inequality averse and/or if the other individuals are not purely payoff-maximizers.

The CSS is no longer the SPE if the last agent is too envious. However, the empty network is not efficient. Individuals should form fairer networks than the CSS. Efficiency is the third concern that can impact the network formation. Fair and efficient networks are likely to emerge.

Finally, as we use a fixed matching and that the game is repeated, it may impact individuals' behavior. Indeed, the network formation game is repeated 10 times and the order of decision in the sequential process changes at each period. The SPE may still emerge as the last individual of the sequential process is chosen randomly from one period to another. Indeed, a rotation is induced by the computer program. This rotation has been witnessed in the laboratory. In Falk and Kosfeld (2012), individuals make the decision in a pre-play communication to change position inside the network to equalize payoffs in the overall experiment. In Berninghaus et al. (2004), thanks to a continuous setting, individuals can change position in the network not to remain in the position of central individual too long. Each

¹⁰See Kirchsteiger et al. (2016), Van Dolder and Buskens (2014) for experimental works on the farsightedness of individuals, Dufwenberg and Van Essen (2016) for an experimental paper on the ability of individuals to use backward induction, and Morbitzer et al. (2014) and Herings et al. (2009) for theoretical works on farsightedness.

individual sacrifices one after another. Moreover, in our setting, individuals do not need to coordinate on which individual is going to create the links for the period as the computer program assigns the order of decision. However, limited farsightedness and coordination complexity make this rotation process complicated without any pre-play communication and individuals are uncertain about the behavior of the individuals in the next periods. We design three features to reduce the effect of repetition: (i) symbols are reallocated at each period to avoid negative reciprocity, (ii) orders in the sequential process are reallocated at each period such that an individual does not remain in the same position during the whole experiment and (iii) we randomly select one period for the payment to encourage individuals to play in the same way at each period.

These limitations lead to our first hypothesis.

Hypothesis 1 *Thanks to sequentiality, CSS will be able to emerge. But due to fairness and efficiency concerns and bounded rationality, more fair and efficient networks may also emerge.*

We now make some predictions about heterogeneity. Theoretically, monetary and non-monetary heterogeneity do not change the equilibrium. However, it may have an impact experimentally. Sequentiality should facilitate the coordination of individuals thanks to the observation of previous decisions while heterogeneity can modify their linking decisions, like the level of fairness or the symmetry of the network.

Indeed, as we expect that some fair networks will emerge, individuals will have to choose with which individual they prefer to form a link. They may be more attracted by the special individual than by the others for many reasons. Social image, merit, monetary incentives and the fact that special individuals are a focal point may make them more attractive. We expect the attractiveness of the special individual in the three heterogeneous treatments. More precisely, special individuals in ENDO and EXO may be more attractive because of their monetary value that guarantees a certain payoff. We expect the special individuals in ENDO to be more attractive than in EXO due to merit. There may be an entitlement effect as the special individual in ENDO earned his status. The same entitlement effect may arise in NM and make the special individual more attractive as he has been elected by the others. Special individuals may be attractive because of their social status. For the case of the special individual in NM, two reactions are possible. He deserves his status because he

has been elected and preferred by the others. However, being the sole individual of the group having this status may increase the social distance between him and the normal individuals. Our setting creates a social distance as individuals have different status in the experiment. This social distance may create a negative feeling towards the special individual and leads to his discrimination by the 4 normal individuals. In fact, they could be less willing to create links with the special individual as he has no additional monetary value and is in a “different group” than them. This feeling may be reinforced by the fact that normal individuals have not been selected by their group and feel envious.

Finally, special individuals may be more attractive because they are displayed in another color than the others, they are a focal point.

Hypothesis 2 • *The special individual is more attractive than normal individuals in the three heterogeneous treatments.*

- *The special individual in NM is less attractive than in ENDO and EXO because in spite of his status he has no additional monetary value.*
- *The special individual is more attractive in ENDO than in EXO due to merit.*

Consequently, we expect more asymmetry with the presence of a special individual due to their special status and their monetary value.

Hypothesis 3 *Networks in ENDO, EXO and NM are more asymmetric than in BT due to heterogeneity.*

2.4.3 Procedures

The experimental sessions were conducted at GATE-Lab, Lyon, France. We ran two sessions of each treatment with 20 individuals in each session. In total we had 160 participants. 57% of them are female, and 84% are undergraduate students, 10% are employees and 6% are unemployed. At the beginning of the experiment, we randomly allocated each participant to a computer. Instructions were read out loud and the experimenters checked the individuals' understanding and answered additional questions in private. When participants indicated that there were no more questions, the experiment started.

Before the network formation part, we elicited risk attitudes using the procedure of Gneezy and Potters (1997).¹¹ At the end of the experiment, individuals participated in the Social Value Orientation test (Murphy et al., 2011) to evaluate their social preferences.¹²

Participants were recruited online through H-root (Bock et al., 2014). Each session lasted about 75 minutes. Participants earned on average 15.26 Euros (SD 1.96).

2.5 Experimental results

First, we present our results concerning the type of networks groups coordinated on with the sequential process. Then we look at the impact of heterogeneity on the structure of networks and on individual linking decisions. Table 2.1 summarizes the most important variables at the network level.

Table 2.1: Summary statistics at the network level

Treatment	BT	ENDO	EXO	NM
Efficiency (%)	93.74 (14.84)	93.50 (15.69)	93.14 (16.96)	93.86 (15.58)
Fairness (%)	69.28 (29.12)	71.66 (31.03)	73.29 (32.94)	69.91 (28.23)
Centrality	0.32 (0.21)	0.35 (0.26)	0.41 (0.24)	0.32 (0.24)
Indegree centrality	0.27 (0.16)	0.34 (0.21)	0.39 (0.22)	0.27 (0.20)

Note: The numbers represent means by treatment and standard deviations are given in parentheses. *Efficiency (%)* represents the average efficiency level of networks, calculated as the ratio between the overall payoff of the network and the maximum overall payoff. *Fairness (%)* represents how equal payoffs are in the network formed, calculated as the ratio between the lowest payoff and the highest payoff in the network. *Centrality* represents the average level of degree centrality of networks and *In-degree centrality* represents the average level of in-degree centrality of networks. The formal definitions are given in Section 2.3.4. The statistical tests to measure the differences across treatments are given in the body of the text.

2.5.1 Network structure with a sequential process

We collected data from eight groups in each treatment. Each group formed 10 networks (10 periods), so 80 networks are formed in each treatment. Each group represents an independent observation. In this section, statistical tests are based on aggregated measures of these

¹¹Individuals have to choose the amount of points between 0 and 100 points that they want to invest in a risky investment. There is a 50% chance that the investment succeeds. If it is a success, the investment is multiplied by 2.5. However, if it is not a success, the investment is lost. Individuals keep for them the points they did not invest. In our experiment, 78.75% are risk-averse while the rest is risk-neutral or risk-lover.

¹²In this test, they have to allocate a certain amount of points between themselves and another individual. There are nine possible allocations for each of the six decisions to make. Afterward, agents can be ranked in four different categories: altruistic, competitive, individualist and pro-social. In our experiment, 35% of the agents are pro-social, 64.38% are individualist, less than 1% are competitive and none of them is altruistic. This kind of distribution is standard in the experimental economics literature.

independent groups. For each non-parametric test on network emergence, we compare means by group across treatments. The tests are two-tailed.

Result 1 (SPE, efficiency and fairness) *No SPE emerge. However, groups coordinate on efficient and fair networks in all treatments and during the whole experiment.*

Our first observation is that no SPE, the CSS with the last individual as central agent, emerge whatever the treatment. It contradicts our theoretical predictions but partly supports Hypothesis 1. We observe that 80.94% of networks are efficient, i.e., groups maximized the overall payoff by creating minimally-connected networks. Moreover, on average networks have an efficiency level, calculated as the ratio between the overall payoff and the maximum overall payoff, of 93%. As shown in Table 2.1, the efficiency levels are very close across treatments. There is no significant difference of efficiency levels across treatments (Mann-Whitney test). The sequential process allows individuals to form the number of links that maximizes the overall payoff. In the literature on network formation with a simultaneous process, groups tend to over-connect or under-connect as they cannot anticipate the links created by their group members,¹³ which leads to welfare losses.

Second, we see that payoffs across players within a network are very similar. On average, the level of fairness is of 71%. There is no significant difference across treatments. Payoffs are very equally distributed because individuals tend to create each one link per period and so share the cost of network formation. More precisely, 71.63% of the decisions are to create exactly one link and only 2.82% of the decisions are to create more than one link. Individuals form what we call “early links”, i.e., links created by non-last movers, while theory predicts that only the last mover should create links. What can explain the formation of early links? Based on the answers of participants given in the ex-post questionnaire as well as our results, we see two possible explanations.

The first one is the fairness concerns of individuals, i.e., individuals are willing to minimize the inequalities of payoffs. Even when individuals have already a link when it is their turn to decide, 38% still create a link to contribute to the network formation. They are willing to contribute to the network formation even if they are sure to be part of the network and to earn something. This idea of fairness across players is mentioned by few participants in

¹³See for example Buechel and Hellmann (2012) and Callander and Plott (2005) for experimental evidence and Morrill (2011) for a theoretical work.

the answers of the ex-post questionnaire when we ask them “For which reasons did you create links despite their cost?”. They also mentioned an efficiency reason by saying that they wanted to extend the network. We could think that fairness would reduce across periods especially at the final period, but it is not the case. The emergence of networks with high level of fairness is very stable across periods. Groups maintain high levels of fairness and efficiency from period 1 to period 10 as we can see in Figure 2.3.

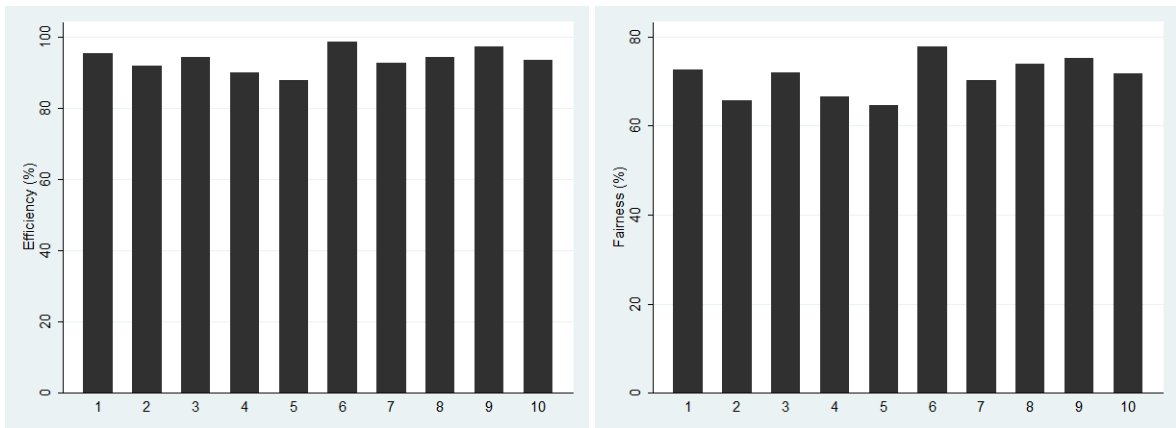

Note: *Efficiency (%)* represents the average level of efficiency of networks, calculated as the ratio between the overall payoff of the network and the maximum overall payoff. *Fairness (%)* represents the average level of fairness of networks, calculated as the ratio between the lowest payoff and the highest payoff in the network.

Figure 2.3: Average efficiency and fairness levels of networks across periods

More precisely, individuals’ behavior during the 10th period allows us to analyze whether individuals behave similarly in a situation where they know that there will be no subsequent periods. The mean fairness levels in period 10 and in periods 1 – 9 are respectively 72% and 71%. Additionally, in period 10, among the individuals who already have a link when it is their turn to decide, 38% decide to form a link. This is exactly the same percentage as in periods 1 – 9. We have no end effect.

Another reason can explain the formation of links even if individuals are not in last position: the fear of isolation. Only 10% of the decisions are to create no link when the individual has no existing link, while this choice is rational, as the goal of the individual is to minimize his costs. However, some groups excluded individuals who did not create links to punish them for not participating to the network formation cost. 37 individuals (23% of the individuals) have been isolated at least once during the network formation process in total regardless of the treatment. Isolation happened 45 times: 11 times in BT, 10 times

in ENDO and NM and 14 times in EXO and affected the formation of 40 networks, namely 12.5% of the networks. Many participants talked about their fear of exclusion in the ex-post questionnaire as a motive to create links. The fear of isolation was mentioned much more than fairness reasons. However, the exclusion of these non-collaborative individuals leads to welfare losses. This exclusion is costly for the group as creating a link is always valuable and not isolating this individual would increase the overall payoff. For instance, if one individual is isolated and the four others are minimally connected, it leads to a welfare loss of 255 points (17 Euro) for the group compared to an efficient network where the five individuals are minimally connected. Exclusion is sub-optimal for the whole group as one period is randomly selected for the payment. But individuals who have been isolated tend to cooperate more in the subsequent periods of the experiment; this is a trigger strategy. Only 7 individuals have been isolated more than once. Individuals who have been isolated once create a link in 80% of the cases in the subsequent rounds, while individuals who have never been isolated create a link in 74% of the cases. The difference is significant (comparison of individual decisions across treatments, $p = 0.049$). It seems that in the experiment, the repetition of the game makes exclusion a credible threat. Groups implement the norm of creating each one link, so that every one participates. Exclusion reinforces the coordination of individuals on networks with equal payoffs. Riedl and Ule (2002) have already identified this phenomenon in their experiment on network formation and collaboration. Indeed, individuals who are able to exclude defectors from the group at a cost can maintain high levels of cooperation.

More particularly, first movers cannot have an existing link at the time of their decisions. The risk of being excluded if they do not create any links is high. Contrary to what the theory says, being first mover is not an advantageous position.

Result 2 (First movers) *Second movers are 16% less likely to create links than first movers.*

While individuals create a link in 74% of the times, if we look at the first mover, he creates at least one link in 82% of the times. The first mover creates significantly more links than subsequent movers. The percentage reaches 89% and 91% in NM and BT. This is confirmed in our regression (see Table 2.2 in Appendix) that shows marginal effects on the decision to create at least one link. We use a probit model with clustered standard errors by group. The variables *Order 2-5* are dummy variables that accounts for the order in the sequential process. Playing later in the sequential process increases the likelihood of being already connected with another individual when it is one's turn to decide. Consequently, it decreases the likelihood to

create a link.¹⁴ Theoretically, on one side, not being the first mover decreases the probability of being isolated when the player makes his decision as it is possible that previous players created a link with him, so it decreases his likelihood to create a link. Moreover, it decreases his envy feelings as it is likely that previous players created links. But on the other side, if previous players created links, he may feel guilty if he does not create any link when it is his turn to decide. We find that if individuals do not already have a link when it is their turn to decide, the decision to create at least one link increases slightly with the position. Indeed, if the last mover has no existing link, he has to create at least one link to earn a positive payoff.

To sum up, individuals create links for fairness reasons or threat of exclusion. If an individual creates a link while he is already linked, it is for fairness reasons. However, if he decides to create a link while he has no existing link, it may be because of fairness concerns or because of the fear of isolation. The experiment was not designed to study the formation of early links and to disentangle both effects. Typically, the first mover must weigh the benefits of each option. If his fear of being isolated and/or his guilt feelings are too high, he will prefer to create one link. Of course, it depends on his beliefs about others' actions. Sequentiality allows more coordination on efficient networks but does not foster the formation of asymmetric networks. Groups create a social norm where everyone has to contribute.

2.5.2 Effect of heterogeneity on network structure and individual linking decisions

We now turn to the analysis of the impact of heterogeneity on the structure of networks.

Result 3 (Centrality) *Networks formed in ENDO and EXO are more asymmetric than in NM and BT. The symmetry level of networks in NM and BT is similar.*

This result partly supports Hypothesis 3. Heterogeneity increases the asymmetry of networks when heterogeneity is monetary but not when heterogeneity is non-monetary. Networks are more central in EXO than in BT ($p = 0.074$) and than in NM ($p = 0.058$). Centrality is also higher in ENDO than in BT or NM, but not significantly. This centrality measure is not sufficient to analyze the asymmetry of networks as links are unilaterally formed and that the potential attractiveness of the special agent is an important feature in our setting.

¹⁴We prefer to control for the order rather than by the fact of already having a link at the time of the decision. The order in the sequential process and the probability of being already linked are correlated and the fact of being already linked depends on the status of the individual. In ENDO and EXO, there is a high probability that the special agent is already linked when it is his turn to play. See Figure 2.9 in Appendix.

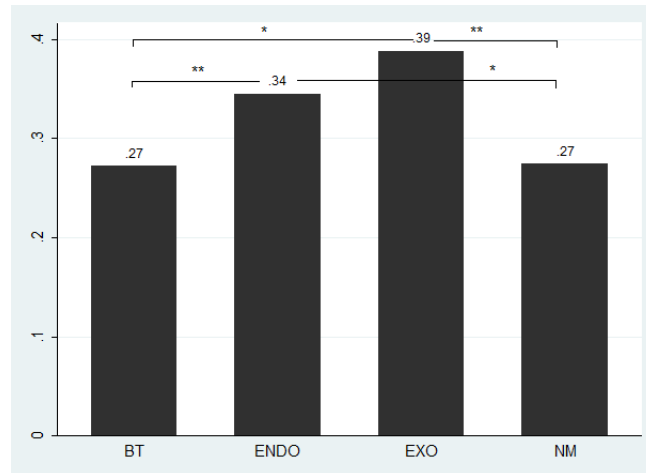

Note. *In-degree centrality* represents the asymmetry of network by taking the direction of links into account. The level of in-degree centrality is higher in EXO and in ENDO than in the two other treatments. * $p < 0.1$; ** $p < 0.05$; *** $p < 0.01$.

Figure 2.4: In-degree centrality of networks

Figure 2.4 shows the level of in-degree centrality of networks across treatments. We notice that the level of in-degree centrality is significantly higher in ENDO and EXO compared to BT and NM ($p = 0.035$ between ENDO and BT, $p = 0.051$ between ENDO and NM and $p = 0.083$ between EXO and BT and $p = 0.046$ between EXO and NM.). However, the in-degree centrality levels are not significantly different between BT and NM ($p > 0.999$) and between ENDO and EXO ($p = 0.752$). Monetary heterogeneity leads to the coordination of individuals on more central networks. We now focus on individual linking decisions of normal and special individuals to analyze the reasons of this greater asymmetry.

We analyze the individual linking decisions in the presence of heterogeneity. In the following, the comparison tests are made at the individual level. Each individual represents an independent observation. In each heterogeneous treatment, we have 8 special individuals and 32 normal individuals. We compare the aggregated decisions of individuals with non-parametric tests. All the tests are two-tailed.

Result 4 (Attractiveness of special individuals) *The special individuals in ENDO and EXO attract more links than normal individuals while the special individuals in NM do not. There is no significant difference between the results in ENDO and EXO. Entitlement has no effect on the attractiveness of the special individual.*

Result 4 refutes the first part of Hypothesis 2 as special individuals in NM are not attrac-

tive, but it confirms the second part of the Hypothesis. Indeed, special individuals in ENDO and EXO are more attractive than normal individuals, and more attractive than special individuals in NM. It refutes the third part of Hypothesis 2 as there is no significant difference between ENDO and EXO. More generally, it shows that entitlement has no effect on linking decisions. Figure 2.5 shows the average in-degree received by each type of individual in each treatment. Normal individuals have an average in-degree¹⁵ per period of 0.57 in ENDO and 0.51 in EXO, while the special individual has an average in-degree of 1.8 in ENDO and 1.79 in EXO. The difference of average in-degree is significant in ENDO and EXO between the special and the normal individuals ($p < 0.001$). As we said, merit has no effect on the level of attractiveness. Indeed, there is no significant difference between the in-degree of special individuals in ENDO and EXO ($p = 0.673$). In NM, the special individual does not attract more links than normal individuals. Indeed, on average the special and normal individuals have an in-degree of 0.78 links during the experiment (0.79 for the special individual and 0.77 for normal individuals). The difference is not significant ($p = 0.905$). For the comparison, in BT, individuals have on average an in-degree of 0.79. There is no significant difference between the number of links received by individuals in BT and in NM ($p = 0.941$). Having the favorite profile in the group in terms of personal attributes and tastes is not sufficient to attract the other individuals. In the ex-post questionnaire, many respondents in NM said that the special individual was not worth receiving more links. They say that they considered this special individual as a normal individual, as if they were a bit jealous. This special status created a social distance with normal individuals.

Additionally, we see in Figure 2.10 in Appendix the distribution of in-degrees of normal and special individuals in ENDO and EXO. A majority of normal individuals have an in-degree of 0 or 1, while special individuals have mainly an in-degree of 2. Despite the popularity of the special individuals, only five networks over 160 formed in ENDO and EXO, are a PSS with the special individual as central agent. The fact that groups only formed 5 PSS show that they understood that being indirectly connected to the special agent is sufficient to benefit from his higher value.

If we look at the mean number of links formed depending on the order in the sequential process (see Figure 2.6), we see that we have different patterns between the treatments with

¹⁵Recall that the in-degree of individual i is the number of links that individuals $j \neq i$ created with i .

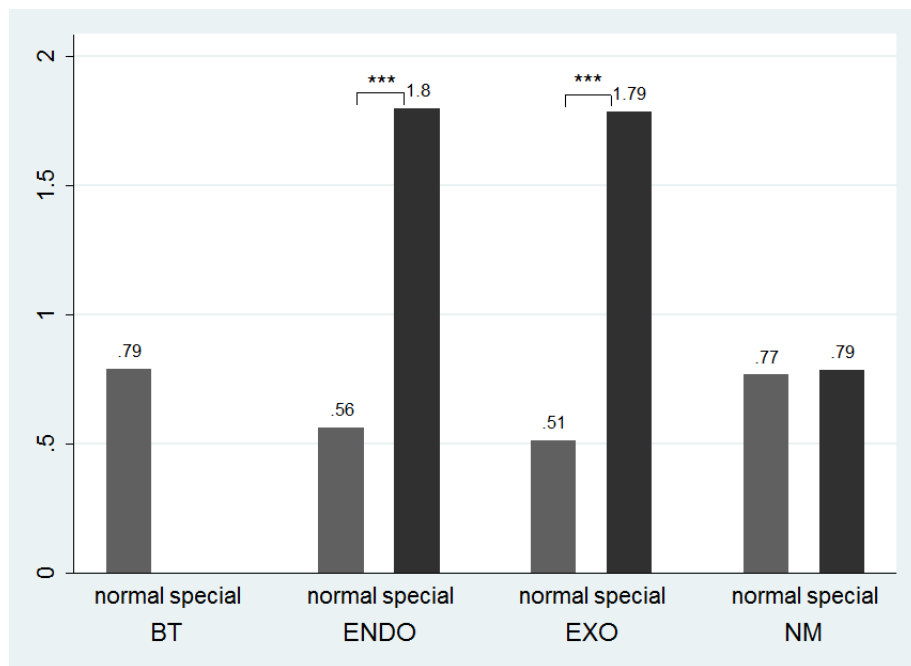

Note. The difference in *in-degree* (i.e., the in-degree of i is the number of links that individuals $j \neq i$ created with i) is significant between normal and special individuals in ENDO and EXO ($p < 0.001$) while it is not in NM ($p = 0.905$). The difference in in-degree for special and normal individuals is not significant between ENDO and EXO ($p > 0.999$). Finally, there is no significant difference between the in-degree of individuals between BT and NM ($p = 0.941$). * $p < 0.1$; ** $p < 0.05$; *** $p < 0.01$.

Figure 2.5: In-degree of normal and special individuals

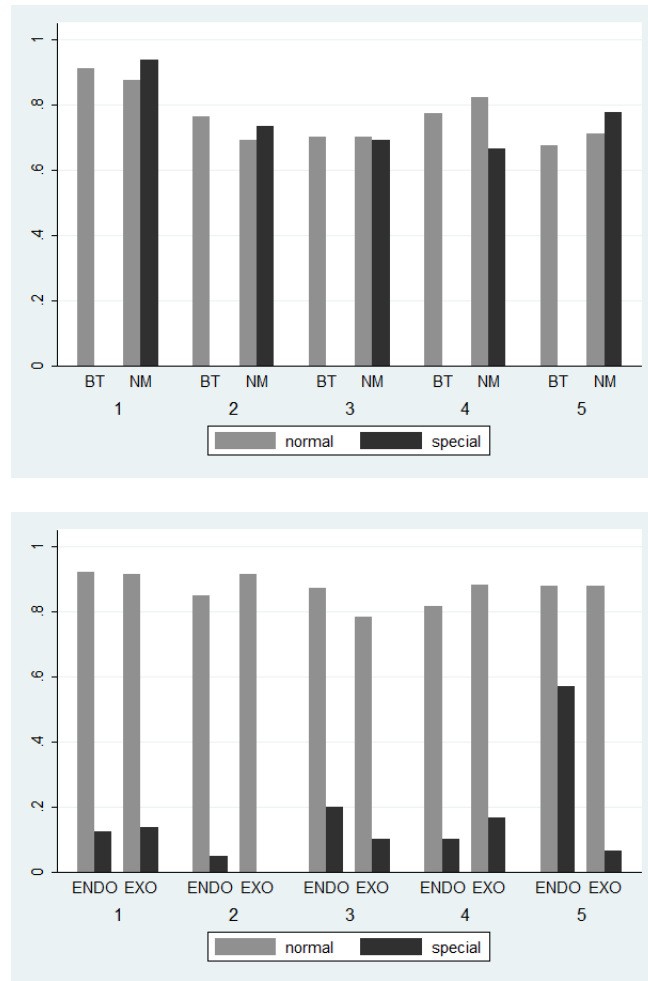

Figure 2.6: Decisions to form a link over order in the sequential process for normal and special individuals

a special individual with a higher monetary value and the other treatments. In BT and in NM, first movers create more links than subsequent movers. The pattern of link formation is very similar between both treatments and there is no difference between normal and special individuals. However, the graph is very different if we look at the ENDO and EXO treatments. In both treatments, normal individuals very often create links regardless of their order in the sequential process. Special individuals on the contrary, create much less links. There is one exception when the last mover is the special agent in ENDO. However, it is a mean on only 14 decisions. Indeed, when it is their turn to decide, they very often already have an existing link (see Figure 2.9 in Appendix). More generally, when an individual has already an existing link, in 61.6% of the cases on average in all treatments, this individual decides not to create any link regardless of the decision order. Indeed, there is no risk of isolation in this case. However, there exists a significant difference between normal and special individuals in this

case. When a normal individual has no existing link, he only remains passive in less than 10% of the decisions (BT: 5.68%, ENDO: 7.81%, EXO: 8.74% and NM: 7.55%). Special individuals also remain passive in less than 10% of the time in NM (5.66%) but special individuals in ENDO and EXO respectively remain passive in 87.5% and 80.77% of the time when they have no existing links. With the regression (see Table 2.2), we confirm our results and observe that being the special individual in ENDO and EXO (*SpecialENDO* and *SpecialEXO*) significantly decreases the likelihood of creating a link while it has no significant effect in NM (*SpecialNM*). On the contrary, normal individuals in these treatments have to compensate by creating more links.

Why are special individuals more attractive?

Now, we will try to understand why individuals are more attracted by special individuals while theoretically it should not have any impact. Few reasons that can explain the popularity of the special individual in the ex-post questionnaire have been mentioned. First, many participants talked about the monetary value of the special individual without more details. Few participants were more precise and mentioned the fact that creating a link with the special individual makes the component formed by the individual and the special individual very attractive and that other individuals will be willing to join them. Second, note that the special individuals in ENDO and EXO can earn less than normal individuals because they can only be linked with normal individuals, while normal individuals can benefit from the higher value of special individuals. Individuals may create links with the special individual to compensate, equalize payoffs and reduce their guilt feelings. Finally, many participants talked about a link with the special individual as an insurance to be part of the network and to be linked with this high-value individual.

Result 5 (1st link created) *The first link is created with the special individual in 60% of the cases in ENDO and 77% in EXO, which gives an insurance to be linked with the special individual.*

Creating directly a link with the special individual can be seen as an insurance: it guarantees some benefits that are higher than when the individual connects to someone else and the individual knows that others will want to join them. Consequently, if an individual creates a link with the special individual, he becomes more attractive as he is part of the same component as the special individual. A large majority of first links are made with the special

individual in ENDO and EXO. Another result can confirm this phenomenon. We studied the links created with the special individual in ENDO and EXO over the decision order in the sequential process. Individuals who play first in the sequential process create more links with the special individuals than individuals who play later ($p < 0.001$ between the individual who play 1st and the 2nd, 3rd and 5th agent and $p = 0.004$ with the 4th individual in the sequential process). When a link has been created with the special individual, individuals understand that they can create links with any individual of the component created. So the special individual becomes less and less popular over the sequential process.

In comparison with this result, in NM only 28% of the first links are made with the special individual. Note that when an individual faces an empty network of four individuals and creates the first link, if he chooses at random there is a 25% chance that he chooses to create a link with the special individual. Overall, there is a significant difference between the number of first links created with the special individual in the three heterogeneous treatments. The pairwise comparison of the average number of first links with the special individual shows that there is significantly more first links created with the special individual in ENDO and EXO than in NM (comparison at the decision level, $p < 0.001$ for both). The difference is also significant between ENDO and EXO, $p = 0.017$.

2.6 Conclusion and discussion

Asymmetric networks are prominent in real-life settings. However, in the laboratory, due to coordination failure and fairness concerns, they do not emerge. Even if our theoretical model predicts the formation of a highly unfair and asymmetric networks – the Center-Sponsored Star is the Sub-game Perfect Equilibrium – the networks formed in our sequential network formation game have a high level of fairness as individuals tend to create one link each. The sequential process of link formation allows groups to coordinate on fair and efficient networks and to build very stable networks. Agents who do not play last in the sequential process should not create any link if they were perfectly “rational”. However, because of the fear of isolation, individuals create links, especially the first mover of the sequential process. Indeed, 90% of individuals who have not already been linked when they take their linking decision create a link, while only 38% of individuals who have already been linked when they take their linking decision create a link. Moreover, individuals who have been isolated contribute

to the network formation in the subsequent periods. The fear of isolation seems to drive fairness. First movers tend to create more links. Indeed, 80% of first movers decisions are to create at least one link while the proportion of link creation in subsequent positions is around 74%. It is partly due to the fact that first movers cannot have an existing link as they decide first. Moreover, fairness concern is a driver of link creation. Even if they have already a link when it is their turn to decide, 38% decide to create a link. The fact that individuals isolate non-cooperators increases the fairness level.

When we introduce heterogeneity via the presence of a special individual with a higher monetary value, the asymmetry of networks increase. The in-degree centrality of networks is higher in treatments with heterogeneity if this heterogeneity is monetary. It is due to the fact that special individuals are more attractive than normal individuals in ENDO and EXO. Normal individuals tend to create more links with the special individuals than with any other individual. Nevertheless, non-monetary heterogeneity is not sufficient to lead to the attractiveness of the special individual. However, theoretically heterogeneity does not modify the SPE. What drives the attractiveness of the special individual in ENDO and EXO? The special individual in ENDO and EXO is not attractive because of merit, because there is no significant difference of attractiveness between the two treatments. He is not more attractive than any others because he is a focal point. Indeed, if that would be the case, the special individual in NM would also be attractive. It shows that there is no entitlement effect. We showed that the first link is often created with the special individual in ENDO and EXO compared to NM. When individuals decide which link to create, creating a link with the special individual is the “safe option” and the insurance to benefit from his higher value. Individuals tend to create each one link for fairness concerns and by fear of isolation. By creating one link with the special individual, the individual is sure to benefit from this higher value and that others will create links with him or the special individual. Another point can confirm this insurance result. There are much more links created with the special individuals by first movers than by subsequent movers.

Our paper shows that heterogeneity is one of the determinants of the asymmetry of networks in real life. However, if we compare our results to the results in the paper of GOE, centrality levels are much higher in the latter. It seems that the decay assumption in GOE allows to increase the centrality of networks as the special individual becomes very

attractive. Consequently, in real-life settings, the impact of heterogeneity can be more or less strong. For example, in a company network, having a valuable supplier may benefit all the network. On the contrary, in the scientific co-authorship network, it is very valuable to write a paper with a well-known author while being indirectly linked with him does not really impact one's reputation. Additional experimental works on network formation and the effect of heterogeneity are necessary to better understand its impact on the structure of networks.

2.7 Appendix

2.7.1 The case of decay

The payoff function with decay becomes:

$$\pi_i(g) = \sum_{j \in N_i(g)} \delta^{d(i,j,g)} v_j - \sum_{\substack{j \in N \\ i \neq j}} g_{ij} c$$

where $\delta \in [0, 1]$ ($\delta = 1$ in our model) and $d(i, j, g)$ represents the shortest distance between two players i and j in g . Even if two agents are linked by more than one path, the value is computed using the shortest distance between them. Being linked by more than one path does not make the link more valuable. We first study the case of a strong decay, i.e., when δ is close to 0. Theoretically, if $(\delta - \delta^2)v_j > c$, it becomes more interesting for i to create a direct link with j than having an indirect link of distance 2 (as it is the case in the CSS between any two peripheral agents) and the complete network becomes the unique SPE. With our choice of parameters for the laboratory experiment, creating a direct link instead of having an indirect link is beneficial if and only if $(\delta - \delta^2)35 > 25$ for a normal agent and $(\delta - \delta^2)50 > 25$ for the special agent. There is no solution for these inequalities. The linking cost is too big to make a direct link more valuable than an indirect link of distance 2. Second, if decay is smaller, i.e., δ is close to 1, stars become more interesting than complete networks. More precisely, the PSS may be interesting as distances are small. However, because of the sequential process, the first agent of the process does not want to create links as he knows that the subsequent movers can form $n - 1$ links. First movers cannot earn more by creating themselves a link. Concerning subsequent movers, between the CSS where they do not sponsor any links and the PSS where they sponsor one link, they prefer the former that is as beneficial and less costly. Consequently, with a strong or a small decay, the CSS remains the SPE with our model and choice of parameters.

2.7.2 Screenshots

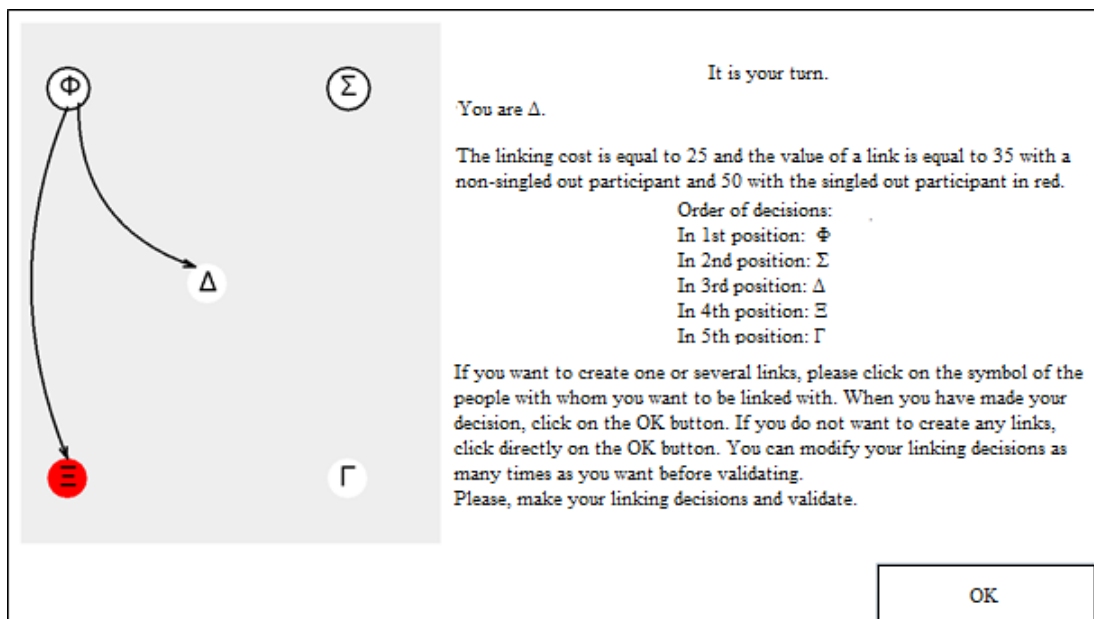

Figure 2.7: Screenshot of treatments ENDO and EXO

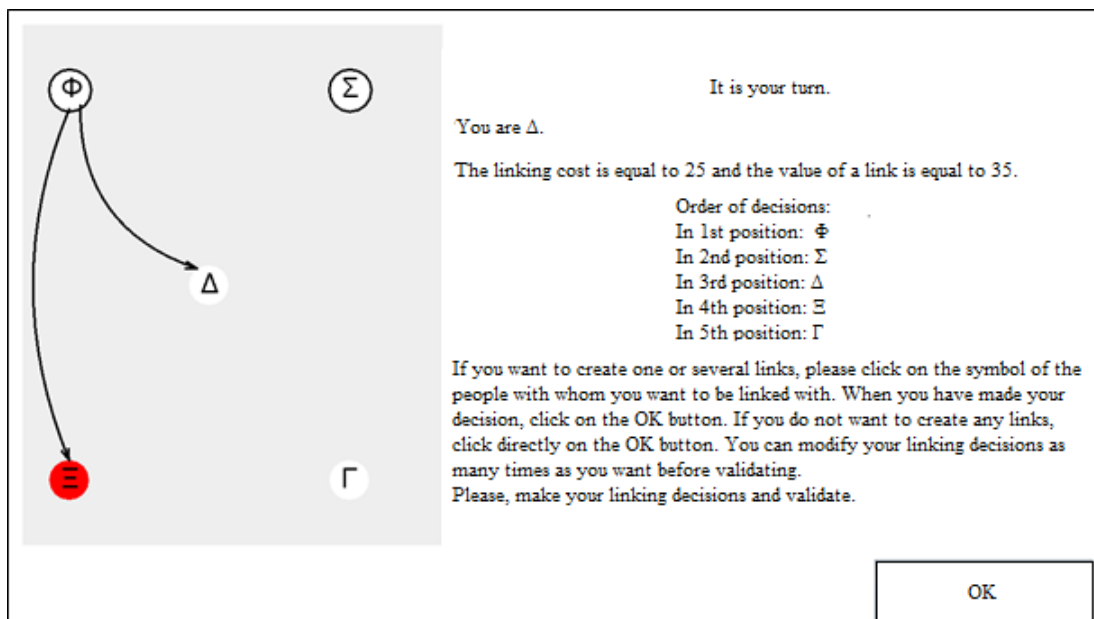

Figure 2.8: Screenshot of treatment NM

2.7.3 Additional material

Table 2.2: Marginal effects, probit, clustered standard errors at the group level

	<i>Decision to create link(s)</i>	
	(1)	(2)
ENDO	-0.027 (0.036)	0.118** (0.047)
EXO	-0.052 (0.036)	0.121** (0.045)
NM	0.006 (0.023)	0.004 (0.028)
SpecialENDO	-	-0.677*** (0.053)
SpecialEXO	-	-0.754*** (0.041)
SpecialNM	-	0.005 (0.058)
Order 2	-0.107*** (0.043)	-0.163*** (0.041)
Order 3	-0.132*** (0.049)	-0.192*** (0.052)
Order 4	-0.087* (0.053)	-0.135** (0.06)
Order 5	-0.093* (0.052)	-0.147*** (0.054)
Risk averse	0.065 (0.042)	0.055 (0.035)
Prosocial	0.038 (0.039)	0.021 (0.023)
Period 1	0.007 (0.02)	0.009 (0.025)
Period 10	0.096 (0.061)	0.094 (0.057)
Observations	1600	1600
Pseudo r ²	0.014	0.194

Note: * $p < 0.1$; ** $p < 0.05$; *** $p < 0.01$.

ENDO, *EXO* and *NM* are dummy variables for the treatments. *SpecialENDO*, *SpecialEXO* and *SpecialNM* are dummy variables that take value 1 when the individual is the special agent in each heterogeneous treatment. The decision order is given by the dummy variables *Order 2-5*. *Risk averse* is a dummy variable that equals 1 for risk-averse individuals. *Prosocial* is a dummy variable that equals 1 for pro-social individuals. *Period 1* controls for the possible effect of the first period. *Period 10* is a dummy variable for the 10th period of the first session where we ran 15 periods instead of 10. The 5 additional periods of this session are omitted.

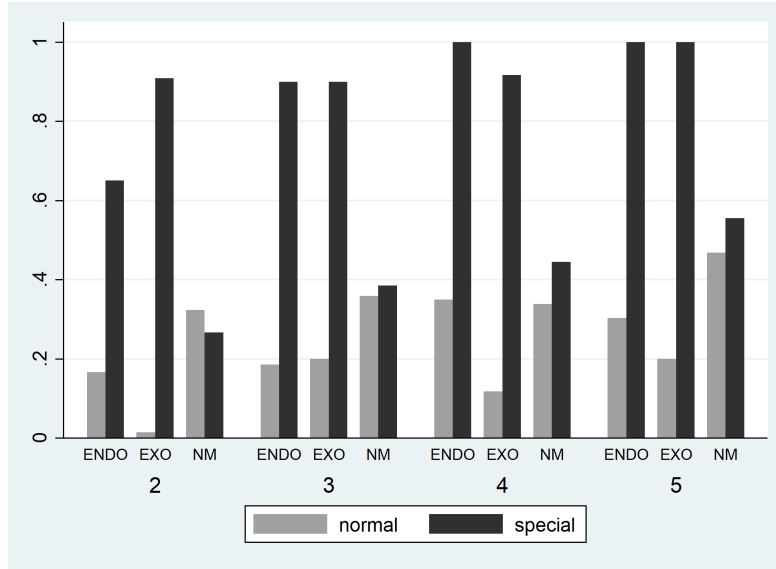

Figure 2.9: Percentage of times where the individual already had a link, over order in the sequential process

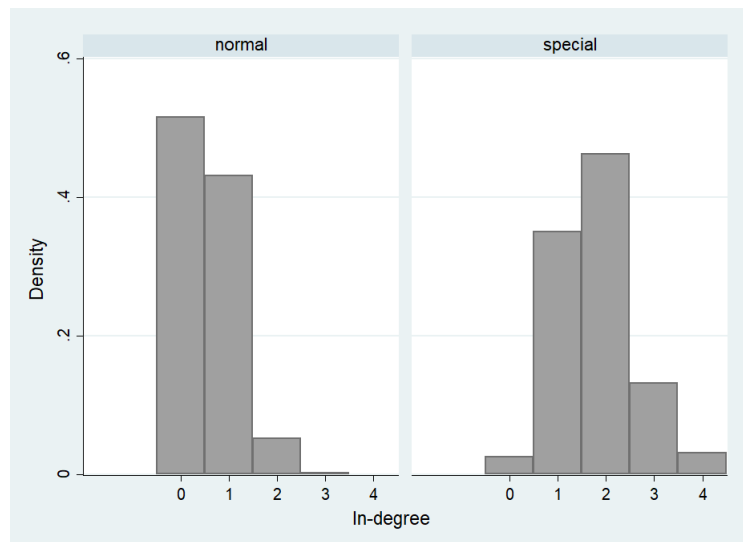

Figure 2.10: Distribution of in-degrees of normal and special individuals in ENDO and EXO

2.7.4 Instructions

Baseline treatment

Welcome to this experiment on decision making. Please turn your cellphones off. In this experiment, you can earn money. The amount you are going to earn depends on your decisions and the decisions of the other participants. Please read these instructions attentively. During the experiment, we will not talk about Euro but points. You will be able to earn money in several successive parts. The amount earned will be the sum of your profits in the different

parts. You are informed at the beginning of each part of the conversion rate in effect of your points in Euro. You will be paid in cash in a separated room and confidentially at the end of the experience.

During the whole experiment you are not allowed to communicate with the other participants. All your decisions are anonymous. The experiment comprises several parts. The instructions for the next parts will be given to you at the end of each part.

PART 1:

For this part, the conversion rate is the following: 60 points = 1 Euro. You receive 100 points. We ask you to choose the amount of points (between 0 and 100 points included) that you want to invest in a risky investment. You keep the points that are not invested. There is a 50% chance that the investment succeeds. If it is a success, you receive 2.5 times the amount you invested. If the investment is not a success, you lose the amount you invested.

1st example: You choose to invest 0 point. You earn $(100 - 0) = 100$.

2nd example: You choose to invest 50 points. If the investment is a success, you earn: $(100-50) + 2.5 \text{ times } (50) = 175$. If the investment is not a success, you earn: $(100-50) + 0 = 50$.

3rd example: You choose to invest 100 points. If the investment is a success, you earn: $(100-100) + 2.5 \text{ times } (100) = 250$. If the investment is not a success, you earn: $(100-100) + 0 = 0$.

Once you made your choice, a random draw by the computer program will determine if the investment is a success or not. Your benefit will be known only at the end of the experiment.

To sum up: You choose the invested amount, then you click on the OK button. At the end of the experiment, a random draw determines your profits.

Please, read these instructions again. If you have any questions, please raise your hands

or push the red button and we will answer you in private.

PART 2:

At the beginning of this part, the computer program forms groups of 5 participants. The composition of the groups remains the same during the whole part. You always have the same four group members. You will not know their identity and they will not know yours. Everyone is identified by a Greek symbol. Symbols are randomly reallocated at the beginning of each period. Consequently, you do not always have the same symbol from one period to another.

This part lasts 10 periods. You receive an initial endowment of 100 points before the beginning of the first period. This initial endowment is a starting capital and will be deduced from your final benefit. At the end of the experiment, a period will be randomly drawn for the payment. Your benefit for this part will be the number of points earned during the randomly drawn period, converted in Euro. The conversion rate for this part is the following: 15 points = 1 Euro.

Description of each period:

At each period, you can decide to create links with the other members of your group. You can create 0, 1, 2, 3 or 4 links. Links are only created for the current period. You can be “directly connected”, “indirectly connected” or “not connected” with another group member.

- You are “directly connected” with another member if you created a link with this person or if this person created a link with you. We call “neighbor” a group member with whom a direct link has been created.
- You are “indirectly connected” with a group member if this person is not your direct neighbor, but it exists a sequence of links between you and this person (he (she) is the neighbor of one of your neighbors or the neighbor’s neighbor of your neighbor, etc.).
- If it does not exist any sequence of links between you and a group member, you are not connected (either directly or indirectly) with this person.

A link between two people is represented by an arrow linking the two symbols. The arrow starts from the person who created the link and points the targeted partner. The screen below shows an example of link creation.

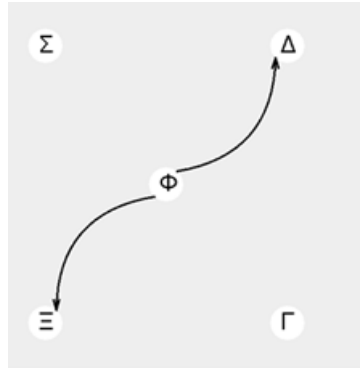

In this example, Φ created a link with Δ and Ξ and so is directly connected to these two agents. Δ and Ξ are directly connected to Φ . Consequently, Δ is indirectly connected to Ξ . Σ and Γ have neither direct links nor indirect links.

Creating a direct link leads to a cost: 25 points. This cost is the same for everyone, during the whole part. You only pay for the links you create. You do not bear any cost for the links others create with you. Every link generates a profit of 35 points for each connected person, directly or indirectly. A direct link and an indirect link give exactly the same profit. You benefit as much from your neighbors as your neighbors' neighbors, as your neighbors' neighbors of your neighbors, etc. To sum up, only the initiator of a link pays for the link formation but both persons benefit from the link, as well as agents that are indirectly connected. A link with any member of your group provides a similar gain.

Your benefit for the period is the sum of values of your links, direct or indirect, minus the cost of the links you created yourself.

Remark: It is possible to be (indirectly) connected with the same person by more than one sequence of links. In this case, the links with this person generate the gain of one link. You do not earn more points by being connected (directly or indirectly) by several links to the same person.

How to create a link?

Within your group, you make your decisions one after the other. The order in which members make decisions is randomly determined by the computer program at each period. At the beginning of each period, you will know if you make your decisions in 1st, 2nd, 3rd,

4th or 5th position. When the first group member makes his (her) decision, no link has been created yet. Then, the second group member makes his (her) decisions, after observing the decisions made by the first member. The following group members can also observe all the previous decisions before making their own decisions.

On your screen, each group member (including you) is represented by his (her) symbol. To create a link, you just have to click on the symbol of the group member with whom you want to be connected to. The symbols of the group members who have already made their decisions are encircled to differentiate them from the other members who have not made their decision yet. The screen below shows a group during the process of link creation. On the right side of the screen is displayed the participants' order for the decision making process.

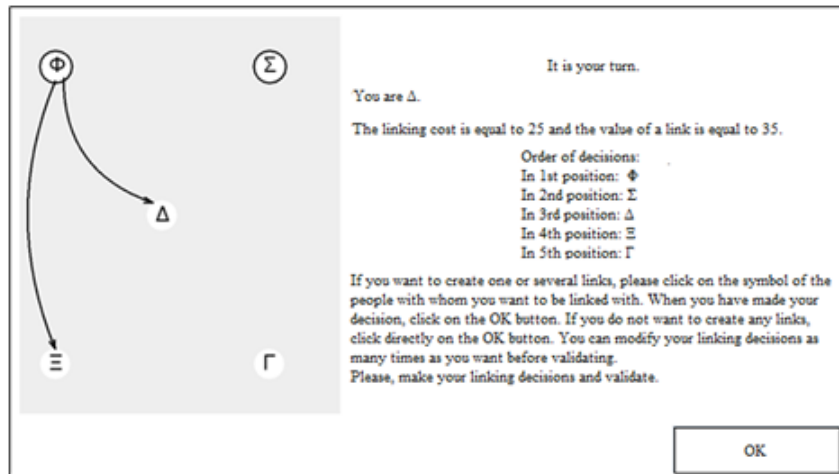

In this example, you are participant Δ . Participants Φ and Σ , respectively in 1st and 2nd position in the game, have already made their decisions and so are encircled. Φ has created two links, including one with you. Σ has not created any link. Participants Ξ and Γ have not played yet and will be able to make their decisions when it is their turn.

When the 5th (last) participant has made his (her) decisions, the period is over. The network formed by all the participants is displayed on your screen and on the screen of each group member. The following screen shows an example of a final network.

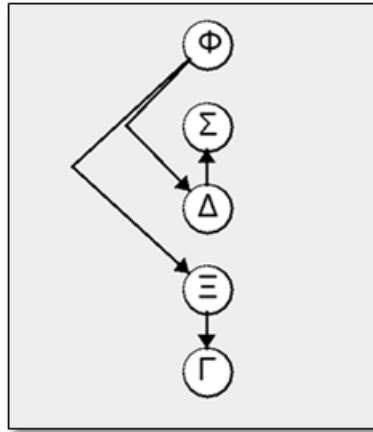

In this example, Δ (in 3rd position) is directly connected to Φ (in 1st position) and to Σ (in 2nd position). Δ is also indirectly connected to Ξ and to Γ . So, he (she) benefits from the 4 other group members. His (her) benefits come to: $4 \times 35 = 140$. Δ has created a direct link with Σ . His (her) costs come to: $1 \times 25 = 25$. His (her) profit for the period is: $140 - 25 = 115$.

Then, a new period automatically begins. The symbols and the order of decision making are randomly reallocated.

To sum up, during a period:

- You are member of a group of five people.
- You decide one after the other to create or not links with the other members of your group.
- Links that have already been created are visible at the time of the decision making.
- Creating a link is costly and generates a gain.

Please, read these instructions again. If you have any questions, raise your hand or push the red button and we will come to answer you in private. We thank you for answering to few questions on these instructions. When all the participants will properly answer questions, the experiment will begin.

PART 3:

This part is independent from the previous parts. The benefits during this part will be added to those of the previous parts. The conversion rate for this part is the following: 60

points = 1 Euro. For this part, the computer program will randomly form pairs. The formation of pairs does not depend on the previous parts. Your partner (called “other person”) is not necessarily someone who was part of your group in part 2.

This part is composed of 6 decisions. For each decision, you need to choose the allocation of a certain amount of points between yourself and the other person. There are 9 possible allocations for each decision. You will have to place the slider on the preferred allocation. The slider is placed by default in the middle (5th allocation). You must click on OK to move on to the next decision.

To determine your benefit, at the end of the session the computer program will randomly select one of the participants of the pair, then one of his (her) 6 decisions. This decision will be used to compute the benefits of the two members within the pair.

Please, read again these instructions. If you have questions, please raise your hand or push the red button and we will come to answer you in private.

ENDO treatment

Welcome to this experiment on decision making. Please turn your cellphones off. In this experiment, you can earn money. The amount you are going to earn depends on your decisions and the decisions of the other participants. Please read these instructions attentively. During the experiment, we will not talk about Euro but points. You will be able to earn money in several successive parts. The amount earned will be the sum of your profits in the different parts. You are informed at the beginning of each part of the conversion rate in effect of your points in Euro. You will be paid in cash in a separated room and confidentially at the end of the experience.

During the whole experiment you are not allowed to communicate with the other participants. All your decisions are anonymous. The experiment comprises several parts. The instructions for the next parts will be given to you at the end of each part.

PART 1:

For this part, the conversion rate is the following: 60 points = 1 Euro. You receive 100

points. We ask you to choose the amount of points (between 0 and 100 points included) that you want to invest in a risky investment. You keep the points that are not invested. There is a 50% chance that the investment succeeds. If it is a success, you receive 2.5 times the amount you invested. If the investment is not a success, you lose the amount you invested.

1st example: You choose to invest 0 point. You earn $(100 - 0) = 100$.

2nd example: You choose to invest 50 points. If the investment is a success, you earn: $(100-50) + 2.5 \text{ times } (50) = 175$. If the investment is not a success, you earn: $(100-50) + 0 = 50$.

3rd example: You choose to invest 100 points. If the investment is a success, you earn: $(100-100) + 2.5 \text{ times } (100) = 250$. If the investment is not a success, you earn: $(100-100) + 0 = 0$.

Once you made your choice, a random draw by the computer program will determine if the investment is a success or not. Your benefit will be known only at the end of the experiment.

To sum up: You choose the invested amount, then you click on the OK button. At the end of the experiment, a random draw determines your profits.

Please, read these instructions again. If you have any questions, please raise your hands or push the red button and we will answer you in private.

PART 2:

At the beginning of this part, the computer program forms groups of 5 participants. The composition of the groups remains the same during the whole part. You always have the same four group members. You will not know their identity and they will not know yours.

This part comprises two stages.

Stage 1: The first stage consists in performing a task. Each participant performs the same task. On your screen are displayed some bars with a slider that can move from 0 to 100. The goal of the task is to put the slider exactly on 50. The person within your group

who made the best score will be the winner and will be singled out in the following of the part. When you put all the sliders displayed on your screen on 50, a new screen will automatically appear to continue the task. Please, read these instructions again. If you have any questions, please raise your hand or push the red button and we will answer you in private.

Stage 2: This second stage lasts 10 periods. You are still part of the same group of 5 people. Everyone is identified by a Greek symbol. Symbols are randomly reallocated at the beginning of each period. Consequently, you do not always have the same symbol from one period to another.

You receive an initial endowment of 100 points before the beginning of the first period. This initial endowment is a starting capital and will be deduced from your final benefit. At the end of the experiment, a period will be randomly drawn for the payment. Your benefit for this part will be the number of points earned during the randomly drawn period, converted in Euro. The conversion rate for this part is the following: 15 points = 1 Euro.

Description of each period

At each period, you can decide to create links with the other members of your group. You can create 0, 1, 2, 3 or 4 links. Links are only created for the current period. You can be “directly connected”, “indirectly connected” or “not connected” with another group member.

- You are “directly connected” with another member if you created a link with this person or if this person created a link with you. We call “neighbor” a group member with whom a direct link has been created.
- You are “indirectly connected” with a group member if this person is not your direct neighbor, but it exists a sequence of links between you and this person (he (she) is the neighbor of one of your neighbors or the neighbor’s neighbor of your neighbor, etc.).
- If it does not exist any sequence of links between you and a group member, you are not connected (either directly or indirectly) with this person.

A link between two people is represented by an arrow linking the two symbols. The arrow starts from the person who created the link and points the targeted partner. The screen below shows an example of link creation.

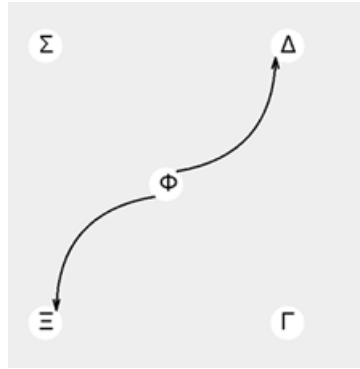

In this example, Φ created a link with Δ and Ξ and so is directly connected to these two agents. Δ and Ξ are directly connected to Φ . Consequently, Δ is indirectly connected to Ξ . Σ and Γ have neither direct links nor indirect links.

Creating a direct link leads to a cost: 25 points. This cost is the same for everyone, during the whole part. You only pay for the links you create. You do not bear any cost for the links others create with you. Every link generates a profit for each connected person, directly or indirectly. A link with two different members does not necessarily give the same profit. Indeed, a link with the group member who won the task in Stage 1 (called “singled out participant”) generates a higher profit than with any other group member: 50 points for a link with the singled out participant and 35 points for a link with a non-singled out participant. The benefits associated to the links with the singled out participant and with the other group members remain the same during the whole part.

A direct link and an indirect link give exactly the same profit. You benefit as much from your neighbors as your neighbors’ neighbors, as your neighbors’ neighbors of your neighbors, etc. To sum up, only the initiator of a link pays for the link formation but both persons benefit from the link, as well as agents that are indirectly connected.

Your benefit for the period is the sum of values of your links, direct or indirect, minus the cost of the links you created yourself.

Remark: It is possible to be (indirectly) connected with the same person by more than one sequence of links. In this case, the links with this person generate the gain of one link. You do not earn more points by being connected (directly or indirectly) by several links to

the same person.

How to create a link?

Within your group, you make your decisions one after the other. The order in which members make decisions is randomly determined by the computer program at each period. At the beginning of each period, you will know if you make your decisions in 1st, 2nd, 3rd, 4th or 5th position.

When the first group member makes his (her) decision, no link has been created yet. Then, the second group member makes his (her) decisions, after observing the decisions made by the first member. The following group members can also observe all the previous decisions before making their own decisions. On your screen, each group member (including you) is represented by his (her) symbol. The group member who has made the best performance at Stage 1 is singled out from the other members. His (her) symbol is not always the same from one period to another but is always displayed in a different color.

To create a link, you just have to click on the symbol of the group member with whom you want to be connected to. The symbols of the group members who have already made their decisions are encircled to differentiate them from the other members who have not made their decision yet. The screen below shows a group during the process of link creation. On the right side of the screen is displayed the participants' order for the decision making process.

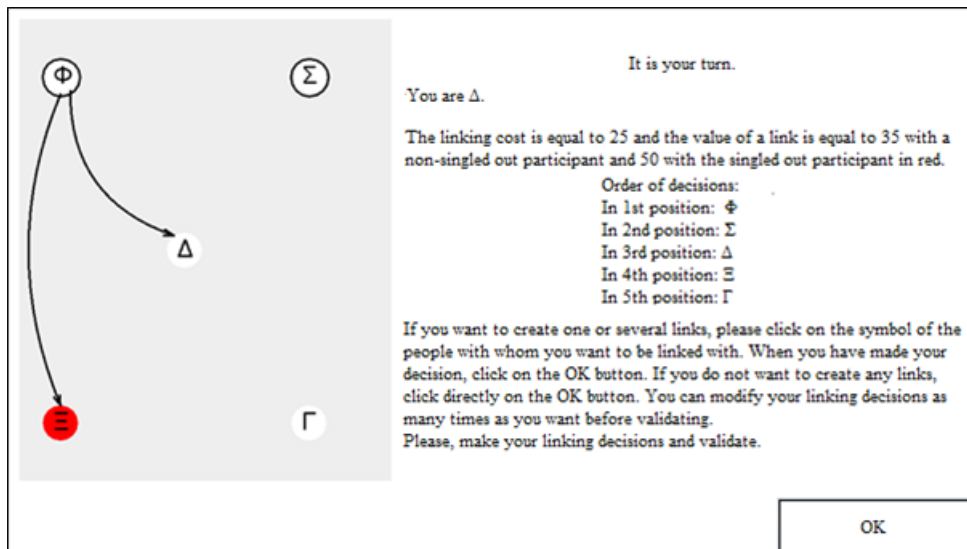

In this example, you are participant Δ . Participants Φ and Σ , respectively in 1st and 2nd position in the game, have already made their decisions and so are encircled. Φ has created two links, including one with you. Σ has not created any link. Participants Ξ (the singled out participant) and Γ have not played yet and will be able to make their decisions when it is their turn.

When the 5th (last) participant has made his (her) decisions, the period is over. The network formed by all the participants is displayed on your screen and on the screen of each group member. The following screen shows an example of a final network.

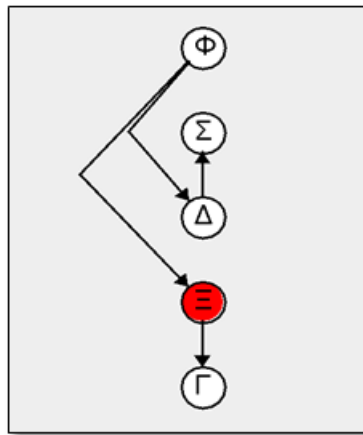

In this example, Δ (in 3rd position) is directly connected to Φ (in 1st position) and to Σ (in 2nd position). Δ is also indirectly connected to Ξ (the singled out participant) and to Γ . So, he (she) benefits from 3 non-singled out members and from the singled out participant. His (her) benefits come to: $3 \times 35 + 50 = 155$. Δ has created a direct link with Σ . His (her) costs come to: $1 \times 25 = 25$. His (her) profit for the period is: $155 - 25 = 130$.

Then, a new period automatically begins. The symbols and the order of decision making are randomly reallocated.

To sum up, during a period:

- You are member of a group of five people.
- You decide one after the other to create or not links with the other members of your group.

- Links that have already been created are visible at the time of the decision making.
- Creating a link is costly and generates a gain.
- A link with the winner of Stage 1 (singled out participant by a different color) generates a higher benefit than a link with a non-singled out group member.

Please, read these instructions again. If you have any question, raise your hand or push the red button and we will come to answer you in private. We thank you for answering to few questions on these instructions. When all the participants will properly answer questions, the experiment will begin.

PART 3

This part is independent from the previous parts. The benefits during this part will be added to those of the previous parts. The conversion rate for this part is the following: 60 points = 1 Euro.

For this part, the computer program will randomly form pairs. The formation of pairs does not depend on the previous parts. Your partner (called “other person”) is not necessarily someone who was part of your group in part 2. This part is composed of 6 decisions. For each decision, you need to choose the allocation of a certain amount of points between yourself and the other person. There are 9 possible allocations for each decision.

You will have to place the slider on the preferred allocation. The slider is placed by default in the middle (5th allocation). You must click on OK to move on to the next decision.

To determine your benefit, at the end of the session the computer program will randomly select one of the participants of the pair, then one of his (her) 6 decisions. This decision will be used to compute the benefits of the two members within the pair.

Please, read again these instructions. If you have questions, please raise your hand or push the red button and we will come to answer you in private.

EXO treatment

Welcome to this experiment on decision making. Please turn your cellphones off. In this experiment, you can earn money. The amount you are going to earn depends on your decisions and the decisions of the other participants. Please read these instructions attentively. During the experiment, we will not talk about Euro but points. You will be able to earn money in several successive parts. The amount earned will be the sum of your profits in the different parts. You are informed at the beginning of each part of the conversion rate in effect of your points in Euro. You will be paid in cash in a separated room and confidentially at the end of the experience.

During the whole experiment you are not allowed to communicate with the other participants. All your decisions are anonymous. The experiment comprises several parts. The instructions for the next parts will be given to you at the end of each part.

PART 1:

For this part, the conversion rate is the following: 60 points = 1 Euro. You receive 100 points. We ask you to choose the amount of points (between 0 and 100 points included) that you want to invest in a risky investment. You keep the points that are not invested. There is a 50% chance that the investment succeeds. If it is a success, you receive 2.5 times the amount you invested. If the investment is not a success, you lose the amount you invested.

1st example: You choose to invest 0 point. You earn $(100 - 0) = 100$.

2nd example: You choose to invest 50 points. If the investment is a success, you earn: $(100-50) + 2.5 \text{ times } (50) = 175$. If the investment is not a success, you earn: $(100-50) + 0 = 50$.

3rd example: You choose to invest 100 points. If the investment is a success, you earn: $(100-100) + 2.5 \text{ times } (100) = 250$. If the investment is not a success, you earn: $(100-100) + 0 = 0$.

Once you made your choice, a random draw by the computer program will determine if the investment is a success or not. Your benefit will be known only at the end of the experiment.

To sum up: You choose the invested amount, then you click on the OK button. At the end of the experiment, a random draw determines your profits.

Please, read these instructions again. If you have any questions, please raise your hands or push the red button and we will answer you in private.

PART 2:

At the beginning of this part, the computer program forms groups of 5 participants. The composition of the groups remains the same during the whole part. You always have the same four group members. You will not know their identity and they will not know yours.

Then, one of your group members will be randomly drawn. Each group member has the same probability to be drawn. The group member who has been drawn will be singled out in the following of the part and will be called “singled out participant”. The singled out participant is the same during part 2. This second part lasts 10 periods. Everyone is identified by a Greek symbol. Symbols are randomly reallocated at the beginning of each period. Consequently, you do not always have the same symbol from one period to another.

You receive an initial endowment of 100 points before the beginning of the first period. This initial endowment is a starting capital and will be deduced from your final benefit. At the end of the experiment, a period will be randomly drawn for the payment. Your benefit for this part will be the number of points earned during the randomly drawn period, converted in Euro. The conversion rate for this part is the following: 15 points = 1 Euro.

Description of each period

At each period, you can decide to create links with the other members of your group. You can create 0, 1, 2, 3 or 4 links. Links are only created for the current period. You can be “directly connected”, “indirectly connected” or “not connected” with another group member.

- You are “directly connected” with another member if you created a link with this person or if this person created a link with you. We call “neighbor” a group member with whom a direct link has been created.
- You are “indirectly connected” with a group member if this person is not your direct

neighbor, but it exists a sequence of links between you and this person (he (she) is the neighbor of one of your neighbors or the neighbor's neighbor of your neighbor, etc.).

- If it does not exist any sequence of links between you and a group member, you are not connected (either directly or indirectly) with this person.

A link between two people is represented by an arrow linking the two symbols. The arrow starts from the person who created the link and points the targeted partner. The screen below shows an example of link creation.

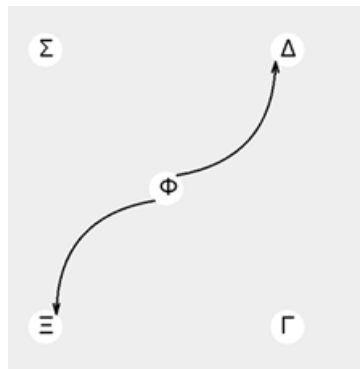

In this example, Φ created a link with Δ and Ξ and so is directly connected to these two agents. Δ and Ξ are directly connected to Φ . Consequently, Δ is indirectly connected to Ξ . Σ and Γ have neither direct links nor indirect links.

Creating a direct link leads to a cost: 25 points. This cost is the same for everyone, during the whole part. You only pay for the links you create. You do not bear any cost for the links others create with you. Every link generates a profit for each connected person, directly or indirectly. A link with two different members does not necessarily give the same benefit. Indeed, a link with the group member who has been drawn in Stage 1 (called “singled out participant”) generates a higher benefit than with any other group member: 50 points for a link with the singled out participant and 35 points for a link with a non-singled out participant. The benefits associated to the links with the singled out participant and with the other group members remain the same during the whole part. A direct link and an indirect link give exactly the same profit. You benefit as much from your neighbors as your neighbors’ neighbors, as your neighbors’ neighbors of your neighbors, etc. To sum up, only the initiator of a link pays for the link formation but both persons benefit from the link, as well as agents that are indirectly connected.

Your benefit for the period is the sum of values of your links, direct or indirect, minus the cost of the links you created yourself.

Remark: It is possible to be (indirectly) connected with the same person by more than one sequence of links. In this case, the links with this person generate the gain of one link. You do not earn more points by being connected (directly or indirectly) by several links to the same person.

How to create a link?

Within your group, you make your decisions one after the other. The order in which members make decisions is randomly determined by the computer program at each period. At the beginning of each period, you will know if you make your decisions in 1st, 2nd, 3rd, 4th or 5th position. When the first group member makes his (her) decision, no link has been created yet. Then, the second group member makes his (her) decisions, after observing the decisions made by the first member. The following group members can also observe all the previous decisions before making their own decisions.

On your screen, each group member (including you) is represented by his (her) symbol. The group member who has been drawn in Stage 1 is singled out from the other members. His (her) symbol is not always the same from one period to another but is always displayed in a different color. To create a link, you just have to click on the symbol of the group member with whom you want to be connected to. The symbols of the group members who have already made their decisions are encircled to differentiate them from the other members who have not made their decision yet. The screen below shows a group during the process of link creation. On the right side of the screen is displayed the participants' order for the decision making process.

In this example, you are participant Δ . Participants Φ and Σ , respectively in 1st and 2nd position in the game, have already made their decisions and so are encircled. Φ has created two links, including one with you. Σ has not created any link. Participants Ξ (the singled out participant) and Γ have not played yet and will be able to make their decisions when it is their turn.

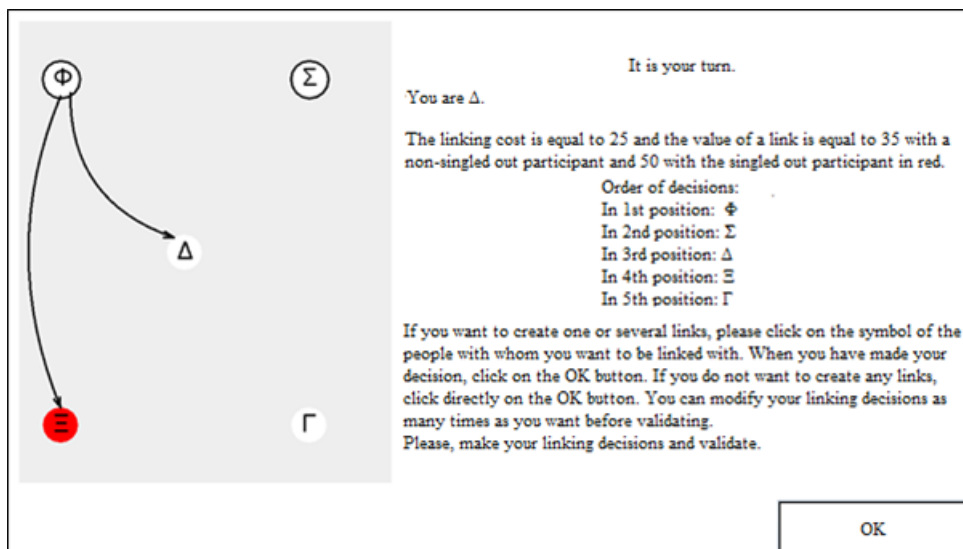

When the 5th (last) participant has made his (her) decisions, the period is over. The network formed by all the participants is displayed on your screen and on the screen of each group member. The following screen shows an example of a final network.

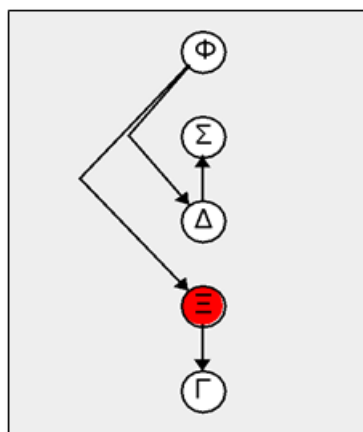

In this example, Δ (in 3rd position) is directly connected to Φ (in 1st position) and to Σ (in 2nd position). Δ is also indirectly connected to Ξ (the singled out participant) and to Γ . So, he (she) benefits from 3 non-singled out members and from the singled out participant. His (her) profits come to: $3 \times 35 + 50 = 155$. Δ has created a direct link with Σ . His (her) costs come to: $1 \times 25 = 25$. His (her) profit for the period is: $155 - 25 = 130$.

Then, a new period automatically begins. The symbols and the order of decision making are randomly reallocated.

To sum up, during a period:

- You are member of a group of five people.
- You decide one after the other to create or not links with the other members of your group.
- Links that have already been created are visible at the time of the decision making.
- Creating a link is costly and generates a gain.
- A link with the randomly drawn participant in Stage 1 (singled out participant by a different color) generates a higher benefit than a link with a non-singled out group member.

Please, read these instructions again. If you have any questions, raise your hand or push the red button and we will come to answer you in private. We thank you for answering to few questions on these instructions. When all the participants will properly answer questions, the experiment will begin.

PART 3

This part is independent from the previous parts. The benefits during this part will be added to those of the previous parts. The conversion rate for this part is the following: 60 points = 1 Euro.

For this part, the computer program will randomly form pairs. The formation of pairs does not depend on the previous parts. Your partner (called “other person”) is not necessarily someone who was part of your group in part 2.

This part is composed of 6 decisions. For each decision, you need to choose the allocation of a certain amount of points between yourself and the other person. There are 9 possible allocations for each decision. You will have to place the slider on the preferred allocation. The slider is placed by default in the middle (5th allocation). You must click on OK to move on to the next decision.

To determine your benefit, at the end of the session the computer program will randomly select one of the participants of the pair, then one of his (her) 6 decisions. This decision will

be used to compute the benefits of the two members within the pair.

Please, read again these instructions. If you have questions, please raise your hand or push the red button and we will come to answer you in private.

NM treatment

Welcome to this experiment on decision making. Please turn your cellphones off. In this experiment, you can earn money. The amount you are going to earn depends on your decisions and the decisions of the other participants. Please read these instructions attentively. During the experiment, we will not talk about Euro but points. You will be able to earn money in several successive parts. The amount earned will be the sum of your profits in the different parts. You are informed at the beginning of each part of the conversion rate in effect of your points in Euro. You will be paid in cash in a separated room and confidentially at the end of the experience.

During the whole experiment you are not allowed to communicate with the other participants. All your decisions are anonymous. The experiment comprises several parts. The instructions for the next parts will be given to you at the end of each part.

PART 1:

For this part, the conversion rate is the following: 60 points = 1 Euro. You receive 100 points. We ask you to choose the amount of points (between 0 and 100 points included) that you want to invest in a risky investment. You keep the points that are not invested. There is a 50% chance that the investment succeeds. If it is a success, you receive 2.5 times the amount you invested. If the investment is not a success, you lose the amount you invested.

1st example: You choose to invest 0 point. You earn $(100 - 0) = 100$.

2nd example: You choose to invest 50 points. If the investment is a success, you earn: $(100-50) + 2.5 \text{ times } (50) = 175$. If the investment is not a success, you earn: $(100-50) + 0 = 50$.

3rd example: You choose to invest 100 points. If the investment is a success, you earn: $(100-100) + 2.5 \text{ times } (100) = 250$. If the investment is not a success, you earn: $(100-100) + 0 = 0$.

Once you made your choice, a random draw by the computer program will determine if the investment is a success or not. Your benefit will be known only at the end of the experiment.

To sum up: You choose the invested amount, then you click on the OK button. At the end of the experiment, a random draw determines your profits.

Please, read these instructions again. If you have any questions, please raise your hands or push the red button and we will answer you in private.

PART 2:

At the beginning of this part, the computer program forms groups of 5 participants. The composition of the groups remains the same during the whole part. You always have the same four group members. You will not know their identity and they will not know yours.

This part comprises two stages.

Stage 1: The first stage is a questionnaire about personal attributes. The questions are the following:

- Gender
- Marital status
- Name of the school or of the employer
- Sport played
- Favorite dish
- Favorite music style
- Frequency of use of social networks (like Facebook)
- Favorite journal
- Favorite movie

When all your group members have filled their questionnaire, you will be able to read the profile of your group members. These pieces of information are totally anonymous. We only associate your pieces of information to a letter between A and D. You will be able to observe the profile of your four group members and to rank their profiles according to your preferences by allocating a certain number to each profile (1 represents your favorite profile and 4 represents the profile that you appreciate the least). When you have ranked the four profiles, you can validate your choice. The group member who was the best ranked by your group members and yourself will be named “favorite member”. In case of equality between several participants, the favorite member will be randomly chosen between them.

Please, read these instructions again. If you have any questions, please raise your hand or push the red button and we will answer you in private.

Stage 2: This second stage lasts 10 periods. You are still part of the same group of 5 people. Everyone is identified by a Greek symbol. Symbols are randomly reallocated at the beginning of each period. Consequently, you do not always have the same symbol from one period to another.

You receive an initial endowment of 100 points before the beginning of the first period. This initial endowment is a starting capital and will be deduced from your final benefit. At the end of the experiment, a period will be randomly drawn for the payment. Your benefit for this part will be the number of points earned during the randomly drawn period, converted in Euro. The conversion rate for this part is the following: 15 points = 1 Euro.

Description of each period:

At each period, you can decide to create links with the other members of your group. You can create 0, 1, 2, 3 or 4 links. Links are only created for the current period. You can be “directly connected”, “indirectly connected” or “not connected” with another group member.

- You are “directly connected” with another member if you created a link with this person or if this person created a link with you. We call “neighbor” a group member with whom a direct link has been created.
- You are “indirectly connected” with a group member if this person is not your direct

neighbor, but it exists a sequence of links between you and this person (he (she) is the neighbor of one of your neighbors or the neighbor's neighbor of your neighbor, etc.).

- If it does not exist any sequence of links between you and a group member, you are not connected (either directly or indirectly) with this person.

A link between two people is represented by an arrow linking the two symbols. The arrow starts from the person who created the link and points the targeted partner. The screen below shows an example of link creation.

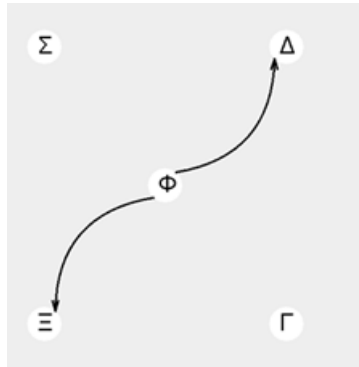

In this example, Φ created a link with Δ and Ξ and so is directly connected to these two agents. Δ and Ξ are directly connected to Φ . Consequently, Δ is indirectly connected to Ξ . Σ and Γ have neither direct links nor indirect links.

Creating a direct link leads to a cost: 25 points. This cost is the same for everyone, during the whole part. You only pay for the links you create. You do not bear any cost for the links others create with you. Every link generates a profit of 35 points for each connected person, directly or indirectly.

A direct link and an indirect link give exactly the same profit. You benefit as much from your neighbors as your neighbors' neighbors, as your neighbors' neighbors of your neighbors, etc. To sum up, only the initiator of a link pays for the link formation but both persons benefit from the link, as well as agents that are indirectly connected. A link with any member of your group provides a similar gain.

Your benefit for the period is the sum of values of your links, direct or indirect, minus the cost of the links you created yourself.

Remark: It is possible to be (indirectly) connected with the same person by more than one sequence of links. In this case, the links with this person generate the gain of one link. You do not earn more points by being connected (directly or indirectly) by several links to the same person.

How to create a link?

Within your group, you make your decisions one after the other. The order in which members make decisions is randomly determined by the computer program at each period. At the beginning of each period, you will know if you make your decisions in 1st, 2nd, 3rd, 4th or 5th position.

When the first group member makes his (her) decision, no link has been created yet. Then, the second group member makes his (her) decisions, after observing the decisions made by the first member. The following group members can also observe all the previous decisions before making their own decisions.

On your screen, each group member (including you) is represented by his (her) symbol. The group member who has been designated favorite member at Stage 1 is singled out from the other members. His (her) symbol is not always the same from one period to another but is always displayed in a different color.

To create a link, you just have to click on the symbol of the group member with whom you want to be connected to. The symbols of the group members who have already made their decisions are encircled to differentiate them from the other members who have not made their decision yet. The screen below shows a group during the process of link creation. On the right side of the screen is displayed the participants' order for the decision making process.

In this example, you are participant Δ . Participants Φ and Σ , respectively in 1st and 2nd position in the game, have already made their decisions and so are encircled. Φ has created two links, including one with you. Σ has not created any link. Participants Ξ (the favorite member) and Γ have not played yet and will be able to make their decisions when it is their

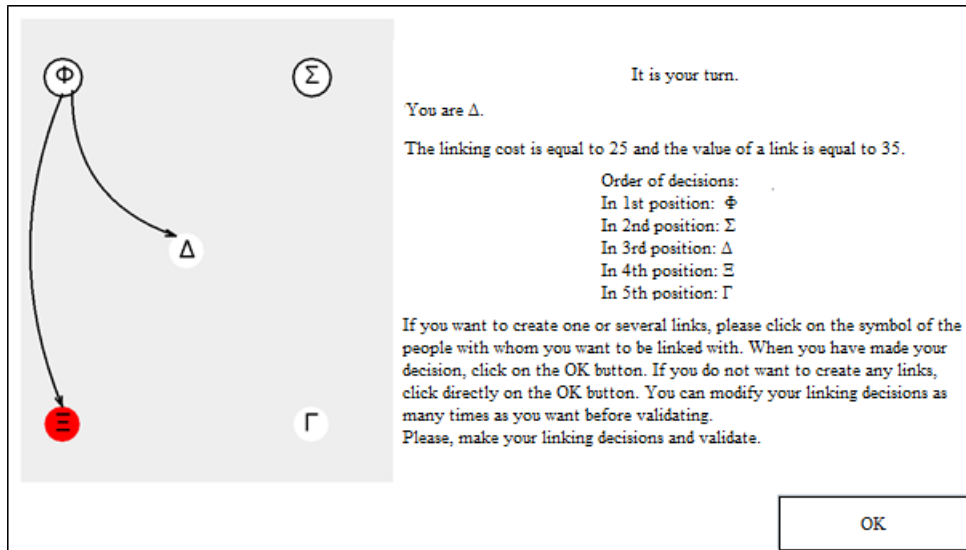

turn.

When the 5th (last) participant has made his (her) decisions, the period is over. The network formed by all the participants is displayed on your screen and on the screen of each group member. The following screen shows an example of a final network.

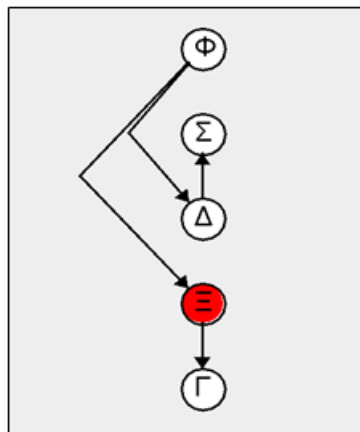

In this example, Δ (in 3rd position) is directly connected to Φ (in 1st position) and to Σ (in 2nd position). Δ is also indirectly connected to Ξ (the favorite member) and to Γ . So, he (she) benefits from his (her) 4 group members. His (her) profits come to: $4 \times 35 = 140$. Δ has created a direct link with Σ . His (her) costs come to: $1 \times 25 = 25$. His (her) profit for the period is: $140 - 25 = 115$.

Then, a new period automatically begins. The symbols and the order of decision making

are randomly reallocated.

To sum up, during a period:

- You are member of a group of five people.
- You decide one after the other to create or not links with the other members of your group.
- Links that have already been created are visible at the time of the decision making.
- Creating a link is costly and generates a gain.
- A link with the favorite member designated at Stage 1 (singled out participant by a different color) generates a higher benefit than a link with a non-singled out group member.

Please, read these instructions again. If you have any questions, raise your hand or push the red button and we will come to answer you in private. We thank you for answering to few questions on these instructions. When all the participants will properly answer questions, the experiment will begin.

PART 3

This part is independent from the previous parts. The benefits during this part will be added to those of the previous parts. The conversion rate for this part is the following: 60 points = 1 Euro. For this part, the computer program will randomly form pairs. The formation of pairs does not depend on the previous parts. Your partner (called “other person”) is not necessarily someone who was part of your group in part 2.

This part is composed of 6 decisions. For each decision, you need to choose the allocation of a certain amount of points between yourself and the other person. There are 9 possible allocations for each decision. You will have to place the slider on the preferred allocation. The slider is placed by default in the middle (5th allocation). You must click on OK to move on to the next decision.

To determine your benefit, at the end of the session the computer program will randomly select one of the participants of the pair, then one of his (her) 6 decisions. This decision will

be used to compute the benefits of the two members within the pair.

Please, read again these instructions. If you have questions, please raise your hand or push the red button and we will come to answer you in private.

Bibliography

- Bala, V. and Goyal, S. (2000). A noncooperative model of network formation, *Econometrica* **68**(5): 1181–1229.
- Ball, S. B. and Eckel, C. C. (1998). Stars upon thars: status and discrimination in ultimatum games.
- Ball, S. B., Eckel, C. C., Grossman, P. J. and Zame, W. (2001). Status in markets, *Quarterly Journal of Economics* **116**(1): 161–188.
- Barabási, A.-L., Albert, R. and Jeong, H. (2000). Scale-free characteristics of random networks: the topology of the world-wide web, *Physica A: Statistical Mechanics and its Applications* **281**(1): 69–77.
- Berninghaus, S. K., Ehrhart, K.-M., Ott, M. and Vogt, B. (2007). Evolution of networks—an experimental analysis, *Journal of Evolutionary Economics* **17**(3): 317–347.
- Berninghaus, S. K., Ott, M. and Vogt, B. (2004). On networks and stars: Recent results in network experiments.
- Bock, O., Baetge, I. and Nicklisch, A. (2014). Hroot: Hamburg registration and organization online tool, *European Economic Review* **71**: 117–120.
- Bramoullé, Y. and Rogers, B. W. (2009). Diversity and popularity in social networks.
- Buechel, B. and Hellmann, T. (2012). Under-connected and over-connected networks: the role of externalities in strategic network formation, *Review of Economic Design* **16**(1): 71–87.
- Callander, S. and Plott, C. R. (2005). Principles of network development and evolution: An experimental study, *Journal of Public Economics* **89**(8): 1469–1495.
- Cherry, T. L., Frykblom, P. and Shogren, J. F. (2002). Hardnose the dictator, *The American Economic Review* **92**(4): 1218–1221.

- De Jaegher, K. and Kamphorst, J. (2015). Minimal two-way flow networks with small decay, *Journal of Economic Behavior & Organization* **109**: 217–239.
- Dufwenberg, M. and Van Essen, M. (2016). King of the hill: Giving backward induction its best shot.
- Eckel, C. C. and Wilson, R. K. (2007). Social learning in coordination games: does status matter?, *Experimental Economics* **10**(3): 317–329.
- Falk, A. and Kosfeld, M. (2012). It’s all about connections: Evidence on network formation, *Review of Network Economics* **11**(3).
- Fehr, E. and Schmidt, K. M. (1999). A theory of fairness, competition, and cooperation, *Quarterly journal of Economics* pp. 817–868.
- Freeman, L. C. (1978). Centrality in social networks conceptual clarification, *Social networks* **1**(3): 215–239.
- Galeotti, A. and Goyal, S. (2010). The law of the few, *The American Economic Review* pp. 1468–1492.
- Galeotti, A., Goyal, S. and Kamphorst, J. (2006). Network formation with heterogeneous players, *Games and Economic Behavior* **54**(2): 353–372.
- Galeotti, F. and Zizzo, D. J. (2014). What happens if you single out? an experiment, *Social Choice and Welfare* **43**(3): 703–729.
- Gill, D. and Prowse, V. (2012). A structural analysis of disappointment aversion in a real effort competition, *The American economic review* pp. 469–503.
- Girard, Y., Hett, F. and Schunk, D. (2015). How individual characteristics shape the structure of social networks, *Journal of Economic Behavior & Organization* **115**: 197–216.
- Gneezy, U. and Potters, J. (1997). An experiment on risk taking and evaluation periods, *The Quarterly Journal of Economics* pp. 631–645.
- Goeree, J. K., Riedl, A. and Ule, A. (2009). In search of stars: Network formation among heterogeneous agents, *Games and Economic Behavior* **67**(2): 445–466.

- Heffetz, O. and Frank, R. H. (2008). Preferences for status: Evidence and economic implications, *Handbook of social economics*, Jess Benhabib, Alberto Bisin, Matthew Jackson, eds **1**: 69–91.
- Herings, J.-J. P., Mauleon, A. and Vannetelbosch, V. (2009). Farsightedly stable networks, *Games and Economic Behavior* **67**(2): 526–541.
- Hoffman, E. and Spitzer, M. L. (1985). Entitlements, rights, and fairness: An experimental examination of subjects' concepts of distributive justice, *The Journal of Legal Studies* **14**(2): 259–297.
- Kirchsteiger, G., Mantovani, M., Mauleon, A. and Vannetelbosch, V. (2016). Limited farsightedness in network formation, *Journal of Economic Behavior & Organization* **128**: 97–120.
- Morbitzer, D., Buskens, V., Rosenkranz, S. and Raub, W. (2014). How farsightedness affects network formation., *Analyse & Kritik* **36**(1).
- Morrill, T. (2011). Network formation under negative degree-based externalities, *International Journal of Game Theory* **40**(2): 367–385.
- Murphy, R. O., Ackermann, K. A. and Handgraaf, M. (2011). Measuring social value orientation, *Judgment and Decision Making* **6**(8): 771–781.
- Newman, M. E. (2004). Who is the best connected scientist? a study of scientific coauthorship networks, *Complex networks*, Springer, pp. 337–370.
- Riedl, A. and Ule, A. (2002). Exclusion and cooperation in social network experiments.
- Rong, R. and Houser, D. (2015). Growing stars: A laboratory analysis of network formation, *Journal of Economic Behavior & Organization* **117**: 380–394.
- Rosenkranz, S. and Weitzel, U. (2012). Network structure and strategic investments: An experimental analysis, *Games and Economic Behavior* **75**(2): 898–920.
- Van Dolder, D. and Buskens, V. (2014). Individual choices in dynamic networks: An experiment on social preferences, *PloS one* **9**(4).
- Van Leeuwen, B., Offerman, T. and Schram, A. J. (2015). Competition for status creates superstars: An experiment on public good provision and network formation.
- Weiss, Y. and Fershtman, C. (1998). Social status and economic performance:: A survey, *European Economic Review* **42**(3): 801–820.

Chapter 3

Homophily, Peer Effects and Dishonesty

Abstract

It is widely believed that the dishonest behavior of an individual is influenced by his/her peers. The peer effects on dishonesty are hard to identify in empirical works because of self-selection. Indeed, individuals with common preferences or characteristics tend to associate together and this may explain that they behave similarly (homophily). In this paper, we use a laboratory experiment to disentangle peer effects on behavior from the influence of endogenous network formation with an application on lying behavior. We create two controlled environments: one in which peers are randomly assigned to participants and one in which participants can choose their peers. Our results show that participants tend to be homophilious, i.e., those who lie to a larger extent choose peers that are more likely to be liars. In contrast, we find little evidence of pure peer effects on behavior.

Keywords: social networks; peer effects; dishonesty; homophily; experiment.

JEL code: C91, C92, D83, D85.

This chapter is co-authored with Bernard Fortin (Université Laval) and Marie Claire Villeval (GATE, CNRS).

3.1 Introduction

Most parents are anxious about the friendship networks of their children because they assume that the bad behavior of some others can exert a negative influence on their own children. And indeed, there is some evidence that unethical behavior or anti-social behavior can disseminate along networks and organizations. For example, some corporate cultures favor the dissemination of unethical behavior (Cohn et al., 2014), criminal acts depend on social interactions (Glaeser et al., 1996) and individual cheating in an academic context increases in peers' cheating (Carrell et al., 2008). However, the development of a norm of dishonesty does not only depend on the fact that people are influenced by others they can observe, but also by the tendency of individuals to gather with similar others. Therefore, one of the issues when trying to identify peer effects in empirical works is the presence of self-selection. Indeed, the choice of peers is often homophilous, i.e., individuals with common preferences or characteristics tend to associate together. They behave similarly, perhaps not because of peer effects, but because of homophily. The endogenous choice of peers makes it hard to disentangle peer effects from self-selection effects. Our objective in this paper is to analyze peer effects on dishonest decisions by disentangling pure peer effects from the effect of endogenous network formation. The laboratory offers a controlled environment where it is possible to build exogenous networks as well as endogenous networks. The comparison between the two environments allows us to disentangle the two effects.

The econometric literature on social networks can be divided in three strands. The first strand analyzes the effect of peers on individual behavior within a predetermined network that is either a stochastic network or an exogenous non-stochastic network. The second strand of this literature explores how networks are strategically formed. Finally, a very recent and emerging approach tries to combine these two strands by simultaneously analyzing peer effects within endogenous networks, i.e., where individuals choose simultaneously their peers and their actions. However, it may create an endogeneity problem, as unobserved variables may impact both the choice of network and individuals' behavior. In order to study both network formation and individuals' behavior, many researchers used the Add Health data to study link formation (students' friendships) and various kinds of behavior such as smoking behavior or academic achievement.¹ The identification of endogenous peer effects, i.e., the

¹See for example Goldsmith-Pinkham and Imbens (2013), Badev (2013), Hsieh and Lee (2016), Hsieh and Lee (2017) or Boucher (2016).

effects of peers' behavior on individual decisions, is difficult and requires technical models² and econometric techniques like control functions, Markov Chain Monte Carlo, parametric and semi-parametric Instrumental Variables,³ that are still being developed. We will describe in more details these technical aspects in Section 3.2.

In addition to the self-selection problem, the study of peer effects is complicated in empirical works by the so-called "reflection problem" due to the simultaneity of individuals' and peers' behavior (Manski, 1993). In a group, each member may be influenced and can influence other group members at the same time. Moreover, endogenous peer effects have to be disentangled from exogenous peer effects, i.e., the fact that individuals may be influenced by the characteristics of their peers such as their age, gender, wealth, etc.

In order to address these econometric issues, we use a controlled laboratory experiment to identify the effect of network endogeneity and homophily on peer effects.⁴ First, we design and compare two social environments: one in which the network is formed exogenously and imposed to the participants and one in which individuals choose their peers. This allows us to measure the effect of self-selection and more particularly the homophily bias. Moreover, in the laboratory, we avoid the measurement errors due to an imperfect observation of the reference group of the individuals, their behavior and the behavior of peers. Finally, we can control the information that is given to the player about their peers, as well as the sequence of information provision to avoid reflection problems.

We design an experiment where individuals have to perform a standard task (counting the number of zeros in matrices). Before performing this task, subjects have to choose between an Automatic and a Manual mode to measure their performance. With the Automatic mode, performances are directly calculated by the computer program. This does not allow

²See for example the Spatial Auto Regression models employed in Hsieh and Lee (2016).

³See Arduini et al. (2015) for estimations using a control function approach, see Goldsmith-Pinkham and Imbens (2013), Badev (2013), Hsieh and Lee (2016) or Hsieh and Lee (2017) for estimations using a Bayesian approach with Markov Chain Monte Carlo simulations and Arduini et al. (2015) for the estimation method with two-step parametric and semi-parametric Instrumental Variables.

⁴There is a large experimental literature on peer effects, notably on effort and productivity. After the seminal paper of Kandell and Lazear (1992), there have been many experiments in the laboratory on the positive effect of peers' performance on one's performance. Falk and Ichino (2006) studied peer effects in the laboratory with a simple task where participants are alone or with peers in the room. Kuhnen and Tymula (2012) show that providing information on the performances of others increases the performance of individuals. Some studies do not find any significant peer effects on performance (see for example Eriksson et al. (2009) and van Veldhuizen et al. (2014)). However, there are less experimental studies on peer effects in dishonesty decisions.

any cheating. With the Manual mode, performances are calculated and self-reported by the individual, which allows them to over-report their performance to earn more. The difference between the actual and the reported performance of participants who chose the Manual version gives a precise measure of the lie. In a first part, individuals do not receive any social information. In the second part, they have to perform the same task, but after receiving information about the average actual or reported performance of other participants from a control treatment. It is common knowledge that these subjects participated in past sessions, and performed the same task but without any information on others' performance. This avoids simultaneity problems.

To disentangle the effect of self-selection from pure peer effects, we compare two treatments. In one treatment, each subject is matched with peers exogenously. In the other treatment, subjects can choose between two pairs of peers: either peers who chose the Automatic version (in which lying is impossible) or peers who chose the Manual version (in which lying is possible). In each period, individuals who chose peers or who were assigned peers who chose the Automatic version observe the actual performance of these peers. Individuals who chose or who were assigned peers who chose the Manual version observe the reported performance of their peers. In both cases, payoffs are individual: they do not depend on peers' performance.

We develop a linear-in-means model where preferences depend on individual characteristics, the moral cost of cheating and peers' decisions. In our model, we focus on conformity effects and we do not allow for payoff dependence between individuals.⁵ We assume that individuals are willing to reduce the gap between their (actual or reported) performance and the (actual or reported) performance of their peers. If they observe peers who chose the Manual version and who report a very high performance, they may inflate their own performance.

Our results show that peer effects are almost null when networks are exogenous. In con-

⁵Peers can impact on others' behavior via two mechanisms of social interactions: strategic complementarity or conformity. Strategic complementarity reflects the synergy between individuals' behavior. Conformity reflects the willingness of individuals to conform with their peers. For example, if we study the productivity of workers, strategic complementarity reflects the fact that the average co-workers productivity impacts positively the individual's productivity, which creates a synergy and increases the productivity of workers. On the other hand, conformity reflects the fact that the individual is willing to conform to his/her co-workers' productivity and is mainly due to social norms. Only the presence of complementarity leads to the presence of a social-multiplier. However, these two mechanisms are hard to disentangle in the linear-in-means model (Boucher and Fortin, 2016).

trast, when networks are endogenous, individuals who select peers who chose the Manual version cheat much more than individuals who select peers who chose the Automatic version. Participants who chose the Manual version are homophilious: they choose peers of the same type. We show that those who select peers who chose the Manual version already lied more when performing the task in isolation than those who select peers who chose the Automatic version. Participants sort themselves, i.e., liars choose peers who are also more likely to be liars. The homophily bias artificially amplifies the effect of peers on behavior.

The remainder of this paper is organized as follows. In section 3.2, we briefly review the related literature. In section 3.3, we develop our theoretical model. In section 3.4, we describe our experimental design and procedures. In section 3.5, we present our experimental results. Finally, section 3.6 concludes.

3.2 Related literature

In this section, we present some empirical works on peer effects on unethical behavior. Then, we review the models and econometric techniques to identify peer effects with endogenous networks. Finally, we present experimental studies on peer effects and dishonesty, and on homophily.

The empirical literature on unethical behavior and peer effects in the field has mainly focused on the study of criminality. According to Glaeser et al. (1996), the high variance of crime across time and space cannot be only explained by economic and social conditions but by the influence of each agent on his/her neighbors. Crime is a mutually reinforcing activity (Schrag and Scotchmer, 1997). This explains why criminality grows exponentially in some neighborhoods and not in others. The Add Health database on students that reports their friendship networks as well as various activities (including criminal activities) has been used to study the effects of peers on delinquency. Patacchini and Zenou (2009) analyze the role of conformity in juvenile delinquency, i.e., the effect of the average level of delinquency of peers. They find that conformism is very important especially for small crimes. In another article, Patacchini and Zenou (2008) design a model where interactions involve strong or weak ties (à la Granovetter (1973)). While students are choosing their friends (strong ties), they do not choose the friends of their friends (weak ties), thus it avoids partly the endogeneity issue.

They can analyze the effect of the number of weak ties on individual's criminality. They find that weak ties have a positive impact on criminal activities. Finally, Haynie (2001) shows that the structural features of the Add Health network (position in the network, density of connections, popularity) influence peer effects: students who have dense networks and who are centrally located in the network are more influenced by their peers. However, these studies do not address the issue of the endogeneity of networks, which may bias the identification of peer effects. Different models and econometric techniques have been used to that purpose. Goldsmith-Pinkham and Imbens (2013) analyze peer effects on academic achievement in a friendship network at school (Add Health data). They design a linear-in-means model for the outcome equation and a network formation model. They incorporate unobserved variables in both equations. For the estimation, they use a Bayesian method and run Markov Chain Monte Carlo simulations, and do not find that the unobserved component matters a lot for the outcome. Hsieh and Lee (2016) study the same type of behavior but use a Spatial Auto Regression model. In this type of model, contrary to Goldsmith-Pinkham and Imbens (2013), links are directed and represented in an adjacency matrix. Moreover, in this paper, they have multidimensional continuous unobservables instead of a single binary unobservable that impact both network formation and behavior. They also use a Bayesian estimation method and run Markov Chain Monte Carlo simulations. Contrary to Goldsmith-Pinkham and Imbens (2013), they find a significant friendship selection bias. Qu and Lee (2015) and Arduini et al. (2015) also design a Spatial Auto Regression model with an endogenous spatial weight matrix. They use a control function approach by modeling endogeneity in the error term thanks to a two-step approach. Qu and Lee (2015) explain that three estimation methods are possible: the two-stage instrumental variable (2SIV), the quasi-maximum likelihood estimation (QMLE) and a Generalized Method of Moments (GMM) approach in which the outcome equation has control variables for endogeneity. They find that the three estimates converge to the true parameters when the sample is large enough and that the selection bias is non negligible. Arduini et al. (2015) extend the work of Qu and Lee (2015) by developing two estimation techniques: a two-stage instrumental variable estimator with a parametric selection procedure (2SPIV) and a two-stage semi-parametric instrumental variable estimator (2SSPIV). They run Monte Carlo simulations and find that their estimation is more efficient, general and less time-demanding than a Bayesian approach. The source of endogeneity in these papers is the presence of omitted variables that explain network formation and behavior. But there may be another source of endogeneity: the fact that individuals self-select into

the social network to optimize their utility function (see Badev (2013), Boucher (2016) or Hsieh and Lee (2017)). For example, Hsieh and Lee (2017) find significant incentive effects (benefits from network interactions) from grades; students create more links with good students to learn from them and increase their chance of academic success.

Overall, these papers find a weak effect of the endogeneity of network formation, but the results depend deeply on the models developed and on the econometric techniques employed. Consequently, the estimates across these different models are hard to compare.

Due to the difficulty of observing and measuring dishonesty in the field and to deal with the endogeneity issue, the experimental literature on unethical behavior has grown dramatically (see surveys by Rosenbaum et al. (2014), Irlenbusch and Villeval (2015) and Jacobsen et al. (2017)). While most of this literature has focused on the individual determinants of dishonesty, some papers have explored the role of social norms and of peers on individual behavior.

In particular, Falk and Fischbacher (2002) have shown that when individuals can steal their group members, they steal more when they have been stolen themselves. But simply observing dishonest acts by a third party also influences individuals. In Gino et al. (2009), individuals have to perform a task and can over-report their performance to increase their earnings. It is found that the presence of confederates who signal the possibility to cheat increases individuals' dishonesty. Robert and Arnab (2013) extend the deception game of Gneezy (2005)⁶ by exposing the Sender to the behavior of previous Senders before making a decision. They show that a message containing some information about the dishonesty of other Senders increases lying. Diekmann et al. (2011) and Rauhut (2013) apply the same principle to a die game. Players roll a die and are paid according to the number they report. They first roll the die alone and then observe an information on the distribution of numbers reported by peers. After observing a message where the distribution of reported numbers makes it clear that others lied, individuals tend to lie more. Fortin et al. (2007) and Lefebvre et al. (2015) study peer effects on tax evasion. Fortin et al. (2007) study the impact

⁶This is a two-player game where the Sender has private information about the payoffs of two options and the uninformed Receiver has to choose one of the options after receiving a message from the Sender. The payoffs of each option are not the same for both players. In the message, the Sender can indicate which option would provide the greatest payoff to the Receiver. But, the Sender can lie in order to favor his/her own payoff.

of information on mean reported income on tax compliance of another group. They find that the exogenous characteristics of peers impact individuals' behavior, while they reject the presence of conformity effects (endogenous peer effects). Lefebvre et al. (2015) compare the impact of information about the highest rate of tax evasion observed in previous sessions and of information about the lowest rate of tax evasion. They state that peer effects are asymmetric: receiving information that peers have been honest does not increase honesty, but receiving information that peers have been dishonest increases dishonesty. To sum up, observing others lying can have two effects on individuals. Honest people become aware that cheating is a potential option. Second, it changes the perception of the moral norm (Gino et al., 2009). The first mechanism is called "Grace" by Fosgaard et al. (2013) to describe people who are not even aware of the possibility of cheating and who change their behavior when they observe cheaters. The second one is called "Will" to describe people who are aware of this option but resist the temptation of lying. In all these studies, groups are exogenously and randomly formed by the experimenter. In contrast, we measure the influence of the choice of peers separately from peer effects.

Since the article of McPherson et al. (2001) on the various types of homophily in terms of gender, age, religion, etc., the impact of homophily on dishonest behavior has not been explored by means of experimental methods. Homophily has been studied experimentally to analyze cooperation in public good games or health behavior. For example, Centola (2011) studied the impact of homophily in the spread of health behavior in an online social network. The networks were formed by the experimenters based on personal characteristics of individuals to vary the degree of homophily. Diffusion of healthy behavior is higher in homophilious networks. Currarini and Mengel (2016) analyze in-group bias (the fact that individuals treat more favorably in-group members) when the choice of partner is endogenous and when it is exogenous. They find that participants are homophilious, i.e., they tend to choose in-group members, and homophilious agents are more reciprocal towards in-group than out-group members.

In contrast, in our experiment, we study the homophilious choice of links, while in Centola (2011), networks are formed exogenously by the experimenter. And we study whether the endogenous choice of peers amplifies peer effects, while Currarini and Mengel (2016) test the effect of homophily on reciprocity.

3.3 Theoretical model and hypotheses

In our model (and in our experiment, as described later), individuals have first to perform a task in isolation and second, in some treatments, they are matched with peers and receive information about these peers' performance before performing again the same task. Precisely, we consider three situations in this second part: when individuals perform a task in isolation without any social information (Baseline treatment), when they receive social information about peers that are exogenously assigned to them (EXO treatment), and when they are informed about peers that they can select themselves (ENDO treatment). In ENDO and EXO, peers are individuals who worked in isolation in the Baseline treatment. Information about peers' performance flows one-way from isolated individuals in the Baseline to individuals in the ENDO and EXO treatments. Before performing the task, individuals have to choose between two modes of performance evaluation. With the Automatic mode, performance and payoffs are computed automatically. With the Manual mode, performance and payoffs have to be computed and self-reported by the individual, which introduces a cheating opportunity.

3.3.1 Choice of the mode of payoff calculation

Each treatment comprises two parts of t periods each, where $i = 1, \dots, n$ individuals perform a task. In the first part, individuals are isolated, i.e., there are no social interactions. Before performing the task, individuals have to choose between the Automatic and the Manual mode of performance calculation. In the following, we define performance the payoff from the task.

Using backward induction, we first define the utility function with each mode and derive the optimal performances, i.e., the actual performance if the individual chooses the Automatic mode and the actual and reported performances if s/he chooses the Manual mode. Then, we determine the mode that the individual should choose based on these optimal performances. We omit the index i for ease of reading.

y_1 is defined as a binary choice between the Automatic and the Manual modes. $y_1 = 1$ if the individual chooses the Manual mode and $y_1 = 0$ if s/he chooses the Automatic mode. Individuals choose only once and their choice applies to the t periods.

Automatic mode

With the Automatic mode, the computer program computes automatically the individual's performance. The actual performance in each period t is denoted y_{3t} . The utility function is given by:

$$\begin{aligned} u &= u(y_{3t}, \mathbf{x}_3, u_{3t}) \\ &= (\mathbf{x}'_3 \beta_3 + u_{3t})y_{3t} - \frac{y_{3t}^2}{2} \end{aligned} \quad (3.1)$$

y_{3t} is the actual performance, \mathbf{x}'_3 is a vector of individual exogenous characteristics⁷ that are constant over time, β_3 are the associated parameters and u_{3t} is the error term. $\frac{y_{3t}^2}{2}$ represents the increasing and convex cost of effort function.

The first order condition is:

$$y_{3t} = \mathbf{x}'_3 \beta_3 + u_{3t} \quad (3.2)$$

Manual mode

With the Manual mode, the performance of the individual is self-reported and denoted y_{4t} . The actual performance is y_{3t} and can differ from the reported performance. The size of a lie is defined by y_{2t} . Thus, $y_{4t} = y_{3t} + y_{2t}$. The utility function depends on the actual performance y_{3t} and on the lie y_{2t} and is given by:

$$\begin{aligned} v &= v(y_{3t}, \mathbf{x}_3, u_{3t}, y_{2t}, \mathbf{x}_2, u_{2t}, C) \\ &= (\mathbf{x}'_3 \beta_3 + u_{3t})y_{3t} - \frac{y_{3t}^2}{2} + (\mathbf{x}'_2 \beta_2 + u_{2t})y_{2t} - \frac{y_{2t}^2}{2} - C \end{aligned} \quad (3.3)$$

The first two parts of the equation represent the actual performance and its associated cost; they are the same as with the Automatic mode. The last three parts characterize the utility of choosing the Manual mode. \mathbf{x}'_2 is a vector of individual exogenous characteristics with β_2 the associated parameters and u_{2t} is the error term. Choosing the Manual mode and over-reporting one's performance is morally costly⁸ and this cost is defined by $\frac{y_{2t}^2}{2}$. Finally, we assume that choosing the Manual mode generates also a fixed moral cost per period C even in honest individuals. C can capture two motivations. If C is positive, it can capture the disutility due to the fear of looking suspicious in the eyes of others when choosing a mode

⁷In the experiment, they include age, gender, degree, school, monthly expenses.

⁸The existence of moral costs of lying can be inferred from the fact that some individuals do not lie even when there is no risk of being caught and although it would increase their payoff (see, e.g., Abeler et al. (2014)).

that allows for cheating (see, e.g., Dufwenberg (2016), Gneezy et al. (2017)). It can also capture the cost of the effort requested at each period to compute scores and payoffs. If C is negative, it can represent the fixed benefit of controlling one's payoff rather than letting the computer determine this payoff.

We assume that $y_{3t} > 0$, which means that even with the Manual mode, the individual is willing to put some effort in performing the task, in particular because lying is morally costly (the previous literature has shown that lying in full is very rare because of self-concept maintenance, e.g., Fischbacher and Föllmi-Heusi (2013)). Finally, we assume that our utility function is separable.

From the first order conditions, we get:

$$y_{3t} = \mathbf{x}'_3 \beta_3 + u_{3t} \quad (3.4)$$

$$y_{2t}^* = \mathbf{x}'_2 \beta_2 + u_{2t} \quad (3.5)$$

$$y_{2t} = \mathbf{1}(y_{2t}^* > 0)y_{2t}^* \quad (3.6)$$

Note that because of the separability condition, we have exactly the same equation for the actual performance with the Automatic and with the Manual modes (equation 3.2 = equation 3.4). It means that individuals have the same incentive to perform with both modes.

Individuals compare utility with the Automatic mode, u (equation 3.1), and utility with the Manual mode, v (equation 3.3). They choose the mode only once at the beginning of the game at round $t = 0$. The choice of a mode is given by:

$$y_1 = \begin{cases} 0 & \text{if } y_1^* = v(\cdot) - u(\cdot) < 0 \\ 1 & \text{if } y_1^* = v(\cdot) - u(\cdot) \geq 0 \end{cases} \quad (3.7)$$

If $y_1^* < 0$, it means that the individual should choose the Automatic mode, while if $y_1^* \geq 0$, s/he should choose the Manual mode. If we substitute $v(\cdot)$ and $u(\cdot)$ for their expressions, we obtain:

$$\begin{aligned} y_1^* &= (\mathbf{x}'_3 \beta_3 + u_{30})y_{30} - \frac{y_{30}^2}{2} + (\mathbf{x}'_2 \beta_2 + u_{20})y_{20} - \frac{y_{20}^2}{2} - C - (\mathbf{x}'_3 \beta_3 + u_{30})y_{30} - \frac{y_{30}^2}{2} \\ &= (\mathbf{x}'_2 \beta_2 + u_{20})y_{20} - \frac{y_{20}^2}{2} - C \end{aligned} \quad (3.8)$$

Replacing y_2 by its expression at the optimum, we obtain:

$$y_1^* = \begin{cases} \frac{1}{2}(\mathbf{x}'_2\beta_2 + u_{20})^2 - C & \text{if } y_{2t}^* > 0 \\ -C & \text{if } y_{2t}^* \leq 0 \end{cases} \quad (3.9)$$

The difference in utility between the Manual and the Automatic modes depends on individual characteristics and on the fixed cost of choosing the Manual mode. If C is high enough, utility is higher with the Automatic mode. If C is relatively low or even negative, utility is higher with the Manual mode.

3.3.2 Social interactions

Suppose now that individuals receive information about the mean performance of peers. Peers are drawn from the Baseline treatment in which they performed the task in isolation. Individuals form with their peers a network where average information about the performance (actual or reported) flows one-way from individuals in the Baseline treatment to individuals in the treatments with social information, which avoids reflection problems. As detailed in the next section, there are two types of peers' assignment: in the EXO treatment, peers are assigned exogenously and randomly and in the ENDO treatment individuals can choose their peers. Peers can be either individuals who chose the Automatic mode or individuals who chose the Manual mode and individuals are informed on the choice of their peers after they have made their own choice and worked in isolation.⁹ Thus, we have four categories of individuals in the ENDO and EXO treatments: individuals who chose the Automatic mode and select peers who made the same choice, individuals who chose the Automatic mode and select peers who made the opposite choice, individuals who chose the Manual mode and select peers who made the same choice, and individuals who chose the Manual mode and select peers who made the opposite choice.

In the ENDO treatment, where people can choose their peers, we define a choice of peers as homophilious when an individual selects peers who chose the same mode as him/her. Individuals can observe the average peers' actual performance if their peers chose the Automatic mode, or the average peers' reported performance if their peers chose the Manual mode. In the latter case, they do not know if peers lied and to which extent, i.e., they do not know

⁹For simplification, peers cannot be of mixed type because the information received, i.e., the mean of an actual and a self-reported performance, would be very noisy and hard to interpret for the individual.

the value of y_{-i2} . Individuals may have a preference for conformism, in which case they will try to reduce the gap between their own performance and the performance of their peers: if peers have a high actual or reported performance, individuals will increase their actual performance and/or the size of their lie to conform to the actions of their peers.

3.3.3 EXO treatment

The choice between the Automatic and the Manual modes has already been made in $t = 0$ and it is now considered as predetermined to simplify the analysis. We define the utility function with each mode and derive the optimal actual performance and the optimal size of a lie. The individual's utility depends on his/her characteristics, his/her cost of effort, his/her moral cost and the actual or reported performance of peers.

If the individual chose the Automatic mode

With this mode, there is no lying opportunity. We rewrite the previous utility function with additional terms capturing the mean peers' performance.

$$\begin{aligned}
 u &= u(y_{3t}, \mathbf{x}_3, u_{3t}, y_{-i1}, \bar{y}_{-i3t}, \bar{y}_{-i4t}) \\
 &= (\mathbf{x}'_3 \beta_3 + u_{3t})y_{3t} - \frac{y_{3t}^2}{2} - (1 - y_{-i1}) \frac{\lambda_1}{2} (y_{3t} - \bar{y}_{-i3t})^2 - \underbrace{y_{-i1} \frac{\lambda_2}{2} (y_{3t} - \bar{y}_{-i4t})^2}_{= -y_{-i1} \frac{\lambda_2}{2} (y_{3t} - (\bar{y}_{-i3t} + \bar{y}_{-i2t}))^2} \quad (3.10)
 \end{aligned}$$

β_3 are the parameters associated with individual characteristics. y_{-i1} is a binary variable that equals 0 if peers chose the Automatic mode and 1 if peers chose the Manual mode. In the first case, the individual's performance can be influenced by the average peers' actual performance \bar{y}_{-i3t} ; in the second case, it can be influenced by the average peers' reported performance \bar{y}_{-i4t} . When matched with peers who chose the Manual mode, the individual may form beliefs about the proportion of the reported performance that is a lie but we assume that s/he is indifferent about this proportion and that s/he is simply willing to reduce the gap between this peers' reported performance and his/her own actual performance. We expect that if there is a conformity effect, λ_1 and λ_2 are positive: utility increases when the gap between the average peers' actual or reported performance and the individual's performance decreases.

The first order condition is:

$$y_{3t} = \frac{\mathbf{x}'_3 \beta_3 + u_{3t} + (1 - y_{-i1}) \lambda_1 \bar{y}_{-i3t} + y_{-i1} \lambda_2 \bar{y}_{-i4t}}{1 + (1 - y_{-i1}) \lambda_1 + y_{-i1} \lambda_2} \quad (3.11)$$

The average peers' actual or reported performance has a positive impact on the individual's actual performance. We denote $\tilde{\beta}_3 = \frac{\beta_3}{1 + (1 - y_{-i1}) \lambda_1 + y_{-i1} \lambda_2}$. As $|\tilde{\beta}_3| < |\beta_3|$, it means that compared to the Baseline, the effect of the individual characteristics (\mathbf{x}'_3) should be lower if there is a conformity effect.

If the individual chose the Manual mode

With this mode, the payoff of the individual depends on his/her reported performance, y_{4t} .

$$\begin{aligned} v &= v(y_{3t}, \mathbf{x}_3, u_{3t}, y_{2t}, \mathbf{x}_2, u_{2t}, y_{-i1}, \bar{y}_{-i3t}, \bar{y}_{-i4t}, C) \\ &= (\mathbf{x}'_3 \beta_3 + u_{3t}) y_{3t} - \frac{y_{3t}^2}{2} + (\mathbf{x}'_2 \beta_2 + u_{2t}) y_{2t} - \frac{y_{2t}^2}{2} - C \\ &\quad - (1 - y_{-i1}) \frac{\lambda_1}{2} (y_{3t} - \bar{y}_{-i3t})^2 - y_{-i1} \frac{\lambda_2}{2} (y_{3t} - \bar{y}_{-i4t})^2 - y_{-i1} \frac{\lambda_3}{2} (y_{2t} - \bar{y}_{-i4t})^2 \\ &\quad - (1 - y_{-i1}) \frac{\lambda_4}{2} (y_{2t} - \bar{y}_{-i3t})^2 \end{aligned} \quad (3.12)$$

β_3 and β_2 are the parameters associated with the individual's characteristics. Since the individual chose the Manual mode, the reported performance can differ from the actual performance. If the individual is matched with peers who chose the Automatic mode, his/her actual performance may be influenced by his/her peers' actual performance (the effect is denoted λ_1); If s/he is matched with peers who chose the Manual mode, his/her actual performance may be influenced by his/her peers' reported performance (the effect is denoted λ_2). Moreover, the decision to over-report performance and the size of the lie may be influenced by the peers' reported performance if these peers chose the Manual mode (the effect is denoted λ_3), and by the peers' actual performance if these peers chose the Automatic mode (the effect is denoted λ_4): the higher is the peers' average performance, the more the individual is willing to over-report his/her performance.

We assume the separability of the utility function. From the first order conditions, we get:

$$y_{3t} = \frac{\mathbf{x}'_3\beta_3 + u_{3t} + (1 - y_{-i1})\lambda_1\bar{y}_{-i3t} + y_{-i1}\lambda_2\bar{y}_{-i4t}}{1 + (1 - y_{-i1})\lambda_1 + y_{-i1}\lambda_2} \quad (3.13)$$

$$y_{2t} = \frac{\mathbf{x}'_2\beta_2 + u_{2t} + y_{-i1}\lambda_3\bar{y}_{-i4t} + (1 - y_{-i1})\lambda_4\bar{y}_{-i3t}}{1 + y_{-i1}\lambda_3 + (1 - y_{-i1})\lambda_4} \quad (3.14)$$

Thus, the actual performance when the individual chooses the Manual mode is the same as in the case s/he chooses the Automatic mode. Here also, we expect that due to the conformity effect, the effect of the individual's characteristics is lower than in the Baseline.

3.3.4 ENDO treatment

In this treatment, y_{-i1} is no longer exogenous. Individuals can choose between peers who selected the Automatic mode and peers who selected the Manual mode. However, we assume that the effect of peers is the same in the ENDO and in the EXO treatment.

There are two main reasons that can influence the choice of peers. First, individuals may be willing to link with peers who have similar characteristics, in our case peers who chose the same mode than them, for homophilious reasons. Consequently, Automatic subjects are more likely to choose peers who chose the Automatic mode and Manual subjects are more likely to choose peers who chose the Manual mode.

A second reason influences the choice of peers: the comparability of performances. We assumed that subjects are willing to conform to their peers' behavior. Individual i does not know what will be the actual and reported performances of his/her peers. But his/her choice can be based on his/her expectations about the performances of his/her potential peers.¹⁰ Because of the possibility of lying, reported performances will be on average higher than actual performances. If the individual has chosen the Automatic mode, conforming to actual performance is easier. Choosing peers who selected the Automatic mode allows the individual to compare his/her actual performance to the mean actual performance of his/her peers. Similarly, it is more easy for a subject who chose the Manual mode to conform to the reported performance of peers. If the peers' reported performance is higher, s/he has the possibility to increase his/her actual performance and/or the size of the lie.

¹⁰Moreover, in the experiment, before subjects choose their peers, we give them their average performance (actual or reported) in part 1 as well as the average actual performance of the Automatic pair of peers in part 1 and the average reported performance of the Manual pair of peers in part 1.

In the EXO treatment, there is no selection bias in peer effects as peers are exogenously and randomly assigned. In contrast, there is a potential selection bias in the ENDO treatment as individuals who are potentially dishonest (those who chose the Manual mode) are more likely to choose peers that are also potentially dishonest. This homophily bias can be measured by comparing the estimates of λ in the EXO treatment and in the ENDO treatment.

3.3.5 Hypotheses

We derive the following main hypotheses from our theoretical model.

Hypothesis 1 (Peer effects on lying) *In the EXO and in the ENDO treatments, individuals who choose the Manual mode and who are matched with peers who made the same choice lie to a larger extent than individuals who choose the Manual mode but are matched with peers who selected the Automatic mode, since on average reported performances are higher than actual performances.*

Hypothesis 2 (Choice of peers) *In the ENDO treatment, individuals who selected the Automatic (Manual) mode choose peers who selected the Automatic (Manual) mode for homophilious reasons and because it is easier to conform when the nature of performance is comparable (actual with actual, reported with reported).*

Our last hypothesis is about the differences between treatments.

Hypothesis 3 (Difference in the size of lies between treatments) *On aggregate, lies are bigger in the ENDO treatment than in the EXO treatment.*

This is not because peer effects (conformity) are higher but because individuals who chose the Manual mode select peers with the same preferences whose reported performance is higher than the actual performance of peers who chose the Automatic mode. We assume that peers who chose the Manual mode have the same impact on an individual's performance and lies regardless of whether they are randomly assigned or chosen by the individual.

3.4 Experimental design and procedures

3.4.1 Design

In this section, we describe the three treatments that allow us to disentangle the impact of peer effects driven by conformity and of homophily on performance. These treatments have been conducted between subjects. We first describe the task that is performed in all the treatments and then, we detail the differences between the treatments.

The task

In all the treatments, subjects have to perform a task inspired by the $(0, 1)$ -matrix task of Falk et al. (2006). In each period, they have two minutes to count the number of zeros in matrices that contain zeros and ones. Matrices appear one by one on the subject's screen. After the subject validates an answer, whether correct or not, a new matrix is displayed on the screen. Individuals can see a maximum of 20 matrices in each period.¹¹ Matrices have two different sizes, each with a different piece-rate: 5×5 matrices pay 1 point and 5×10 matrices pay 2 points if solved correctly (see illustrations in Figure 3.7.1 and Figure 3.7.2 in Appendix). Matrices were randomly generated before the experiment with a 50% chance for each type of matrix before each draw. Every participant faces the same matrices, in the same order, such that performances are perfectly comparable across individuals. This task is simple, and does not require prior knowledge; thus, performance mainly captures effort and not ability. At the end of each period, a recap chart is displayed on the subject's screen (see Figure 3.7.3 for an example of recap chart). This chart indicates for each matrix its piece-rate, the answer provided by the subject, and the correct answer. We define the performance of an individual as the sum of points earned in the period (i.e., in the case of the actual performance, the number of matrices solved multiplied by their corresponding piece-rate).

We now describe our different treatments.

Baseline treatment

In the Baseline treatment, individuals make all their decisions in isolation. This treat-

¹¹Only two participants over 352 managed to solve 20 matrices in two minutes and only once.

ment consists of two parts of five periods each. At the beginning of part 1, after subjects have tested the task in a two-minute practice period and observed a recap chart, they have to choose between two modes of payoffs calculation that will apply to the two parts: the Automatic mode or the Manual mode.¹² With the Automatic mode, the subject's performance is automatically calculated by the computer program at the end of each period. After observing the recap chart, the subject is informed about his/her performance for the period. This corresponds to the *actual performance* (y_{3t}) in the model. With the Manual mode, the subject has to compute his/her performance. Based on the recap chart, the subject has to check whether s/he has solved each matrix and to sum the number of points earned for each matrix solved depending on the piece-rate (1 or 2 points). Then, the subject has to self-report his/her performance. This corresponds to the *reported performance* (y_{4t}) in the model. The reported performance can differ from the actual performance; lying is possible. It is cognitively costly for an individual to choose the Manual mode since payoffs have to be computed manually. Therefore, the main reason for choosing this mode rather than the Automatic mode should be the opportunity to over-report performance. This design allows us to observe perfectly the size of the lies since the program records both the actual performance and the reported performance. After having chosen their mode, subjects perform the matrix task during two identical parts of five periods each. These two parts allow us to control for time effects or for fatigue. Between the two parts, we impose a five-minute break to mimic the timeline of the other treatments. At the end of the session one period per part is randomly drawn for payment.

The baseline treatment has been run before the other treatments since its main aim is to collect data on the performance and lying behavior of subjects who play the task in isolation. Indeed, the subjects from the Baseline become the peers of the subjects participating in the other treatments, as explained below.¹³

EXO treatment

In this treatment, a session also comprises two parts of five periods each, and at the

¹²Note that in the instructions (see Appendix), the Automatic mode is called the Direct version and the Manual mode is called the Indirect version.

¹³To avoid deception, subjects were informed at the beginning of the sessions that their data could be communicated, anonymously, to other participants in subsequent sessions. For symmetry, we also informed subjects in the other treatments that their data could be communicated to other participants in future sessions.

beginning of part 1 subjects have to choose between the Automatic and the Manual modes. In the first part, subjects play the matrix-task in isolation, exactly like in the Baseline treatment. In the second part, they perform the same task but at the beginning of part 2 they are matched with two peers, and they receive information about their peers' performance at the beginning of each period. Thus, the difference with the Baseline is that in part 2 subjects are no longer isolated.

At the beginning of part 2, the subject receives information about two pairs of peers who participated in the Baseline treatment, i.e., who performed the task in isolation. One pair includes two peers who chose the Automatic mode, and the other pair includes two peers who chose the Manual mode. The subject is informed of the average actual performance in part 1 of the pair who chose the Automatic mode and on the average reported performance in part 1 of the pair who chose the Manual mode, and this is common knowledge.¹⁴ Then, the subject is randomly matched with one of these two pairs with a 50% chance for each pair. S/He keeps the same peers throughout part 2. Then, at the beginning of each period of part 2, the subject is informed of the average performance of these two peers in the same period of part 2 (i.e., when facing the same matrices to solve).¹⁵ If the subject has peers who selected the Automatic version, it is common knowledge that s/he observes the average peers' actual performance. If the subject has peers who selected the Manual mode, s/he observes the average peers' reported performance with no information on the existence and size of lies.

ENDO treatment

Like in the EXO treatment, subjects perform the task in isolation in part 1 and at the beginning of part 2, they are matched randomly with two pairs of subjects from the Baseline and they are informed of the average actual performance in part 1 of two peers who chose the Automatic mode and the average reported performance in part 1 of two peers who chose the Manual mode.¹⁶ But contrary to the EXO treatment, subjects have to make a choice

¹⁴In EXO, the observed average actual performance of pairs who chose the Automatic mode in part 1 is 12.86 (minimum = 6.2, maximum = 18.8) and the average reported performance of pairs who chose the Manual mode is 21.18 (minimum = 11.3, maximum = 38.9). In 89% of the cases, individuals in the EXO treatment observed an average reported performance of the pair that chose the Manual mode greater than the average actual performance of the pair that chose the Automatic mode. The mean difference between the two averages is 8.32 points.

¹⁵We provide them the average performance instead of the performance of each peer separately because the objective is to estimate a linear-in-means model of peer effects.

¹⁶In ENDO, the average actual performance of pairs of peers who chose the Automatic mode in part 1 is

between these two pairs. Then, at the beginning of each of the five periods of part 2, they receive information about the average actual or the average reported performance of the two peers they have selected before performing the task.

Finally, at the end of the session, in each treatment, subjects had to fill out questionnaires, including a short version of the Machiavellianism test of Christie and Geis (1970) (Mach IV test), the Honesty-Humility part of the Hexaco test (Ashton et al., 2014), a guilt proneness test (Cohen et al. (2011)), and a standard demographic questionnaire. The treatments are summarized in Table 3.1.

Table 3.1: Timeline of each treatment

Treatment	Baseline	EXO	ENDO
Part 1	Choice of mode / Task in isolation	Choice of mode / Task in isolation	Choice of mode / Task in isolation
Matching	No peers	Random assignment of peers	Choice of peers
Part 2	Task in isolation	Task with information on peers	Task with information on peers

3.4.2 Procedures

The experimental sessions were conducted at GATE-Lab, Lyon, France. 352 subjects, mainly undergraduate students from local engineering, business and medical schools, were recruited online using H-root (Bock et al., 2014). As outlined in Table 3.7.1 in Appendix, we ran 15 sessions: four sessions with the Baseline treatment (72 subjects), five sessions with the EXO treatment (126 subjects) and six sessions with the ENDO treatment (154 subjects). The EXO and ENDO treatments requested more subjects because the protocol generates four categories of subjects instead of two in the Baseline because of the matching procedure. We ran one more session in the ENDO treatment than in the EXO treatment to collect a sufficient

12.91 (minimum = 6.1, maximum = 18.5); the average reported performance of pairs of peers who chose the Manual mode is 20.55 (minimum = 12, maximum = 38.9). In 90% of the cases, individuals in the ENDO treatment observed an average reported performance of the pair that chose the Manual mode greater than the average actual performance of the pair that chose the Automatic mode. The mean difference between the two averages is 7.64 points.

number of observations in the rare case where subjects choosing the Manual mode selected peers who chose the Automatic mode. Table 3.7.2 in Appendix reports some statistics on the subjects' socio-demographic characteristics, by treatment.

Upon arrival, subjects were assigned a computer terminal after drawing a computer tag from an opaque bag. The instructions for each part were distributed at the beginning of each part and read out loud. Before starting the first part, subjects had to answer a computerized comprehension questionnaire and practiced the task for two minutes. At the end of the session, subjects received a feedback on the periods randomly drawn for payment in the first two parts and they answered the various questionnaires described earlier.

On average, sessions lasted about 75 minutes. Subjects earned on average 16.38 Euros (standard deviation = 3.75), including a 5 Euros show-up fee.

3.5 Results

First, we briefly analyze behavior in part 1 when people are isolated. Then, we compare behavior in the two parts of the Baseline treatment to measure time effects when individuals remain isolated throughout the experiment. Second, we analyze lying in part 2 to identify peer effects in each treatment by comparing behavior depending on the peers' chosen mode. Finally, we compare the difference of behavior between part 1 and part 2 in BT, ENDO and EXO to disentangle the impact of time, peer effects and homophily.

Each individual played 5 periods in part 1 and 5 periods in part 2. Thus, non-parametric tests are based on averaged measures per individual, such that we have one independent observation per individual in each part. We use either two-tailed Mann-Whitney tests (MW, hereafter) or Wilcoxon tests (W, hereafter).

3.5.1 Individual behavior in isolation

Our first result is as follows:

Result 1 *A small majority of people lie when they work in isolation and when they have an opportunity to do it.*

Support for Result 1. We first study performance and lying in part 1. We pool the data of the three treatments since all the subjects play in isolation in part 1.¹⁷ Table 3.2 summarizes the means, standard deviations, minimal and maximal values of the actual performance, the reported performance and the size of lies per individual in this part, for those subjects who chose the Automatic mode and for those who chose the Manual mode. This table also reports the percentage of participants who over-report their performance at least once among the subjects who selected the Manual mode.

Table 3.2: Summary statistics: Performances and lies in part 1, total treatments

Mode	Automatic			Manual		
	Mean	Min	Max	Mean	Min	Max
Actual performance	13.66 (4.03)	2	26	13.05 (5.19)	0	26
Reported performance	-	-	-	19.93 (8.59)	5	40
Size of lies	-	-	-	6.89 (10.72)	-5	40
% liars	0%	-	-	65.70%	-	-
N	180			172		

Note: Standard deviations are in parentheses. The size of the lie is the difference between the reported performance and the actual performance of the subjects who chose the Manual mode. % *liars* is the percentage of subjects who over-reported their performance at least once.

Table 3.2 indicates that 65.70% of the subjects who work in isolation and chose the Manual mode lied at least once (32.10% of all the subjects).¹⁸ Thus, contrary to our expectations, some subjects chose the Manual version without lying, although it generates an additional cognitive cost.¹⁹ Interestingly, the average actual performance is the same for subjects who chose the Manual mode and for those who chose the Automatic mode (MW test, $p = 0.615$).²⁰ Even when there is an opportunity to lie, individuals perform as well as when no such op-

¹⁷There is no significant difference across treatments in part 1 concerning the actual performance of Manual participants, the reported performance and the size of lies. However, the actual performance of subjects who chose the Automatic mode is higher in the EXO treatment (mean = 14.78) compared to the BT (mean = 12.87) and to the ENDO treatment (mean = 13.25): MW, $p = 0.015$ and $p = 0.006$.

¹⁸It is possible that some of these subjects did a mistake in their calculation. If we look only at subjects whose average lies are greater than 1 on average in part 1, they represent 25.57% of the subjects in total and 52.32% of those who chose the Manual version. With both definitions, there is no significant differences across treatments in the percentage of subjects who lied.

¹⁹The reasons mentioned in the post-experimental questionnaire by individuals who chose the Manual version and did not lie are that they wanted to have more control on their earnings, to calculate themselves and to test their honesty.

²⁰This is also true if we take each treatment separately, except for the EXO treatment where those who choose the Automatic version perform better than those who choose the Manual version (MW, $p = 0.020$).

Table 3.3: Summary statistics: Evolution of performance in the Baseline treatment

Mode	Part 1		Part 2		p-value	p-value
	Auto	Manual	Auto	Manual	Auto	Manual
Actual performance	12.87 (4.29)	13.79 (5.34)	14.64 (4.51)	15.49 (5.98)	<0.001	<0.001
Reported performance	-	21.05 (9.82)	-	25.21 (10.48)	-	<0.001
Size of lies	-	7.26 (12.07)	-	9.72 (13.24)	-	0.004
N	41	31	41	31		

Notes: Standard deviations are in parentheses. *Size of lies* is the difference between the reported performance and the actual performance. *p-value Auto* reports the p-values from Wilcoxon tests when we compare the behavior between part 1 and part 2 of subjects who chose the Automatic mode. *p-value Manual* reports the p-values from Wilcoxon tests when we compare the behavior between part 1 and part 2 of subjects who chose the Manual mode.

portunity exists. However, if we only consider the subjects who chose the Manual mode and over-reported their performance, we find a significant difference in the actual performance with the subjects who chose the Automatic mode (MW tests, $p = 0.004$). Still, the actual performances are far from 0 for those who over-report their performance. Only 2.33% of the actual performances of Manual subjects are null. Lying is not used as a substitute for effort. When people lie, on average they inflate by 52.80% their actual performance (the average size of the lie is 6.89 and the average actual performance is 13.05). This analysis is confirmed by Table 3.7.3 in Appendix which displays the marginal effects of a regression in which the dependent variable is the actual performance in part 1. We use GLS models since the task is repeated. In model (1), the independent variables include a number of individual characteristics (age, gender, degree, grade at Baccalauréat, field of study, monthly expenses, and number of past participations in experiments). In model (2), we control for the choice of mode (equal to 1 if the subject chose the Manual mode). Finally, in model (3), we control for treatment effects by adding dummy variables for the EXO and the ENDO treatments, with the Baseline as the reference category. Table 3.7.3 shows that the actual performance differs between the Automatic and the Manual mode at the 10% level. Lying and working are not substitutes but choosing the Manual mode reduces slightly the actual performance. The treatment has no impact on the actual performance in part 1.

Performance and lying increase over time. This is shown in Table 3.3 that reports summary statistics comparing performance and the size of lies in part 1 and in part 2 in the Baseline treatment. Table 3.3 shows a time effect, as the actual performance is significantly

higher in part 2 than in part 1 both with the Automatic and the Manual modes (W test, $p < 0.001$ for both). The reported performance is also significantly higher in part 2 than in part 1 (W test, $p < 0.001$) as well as the size of the lies (W test, $p = 0.004$). As there is a time effect, we will also need to consider the time dimension in the EXO and ENDO treatment.

3.5.2 Identification of peer effects

Next, we consider lying behavior when people receive information about their peers' performance. In this sub-section, to identify peer effects on lying we focus on part 2 and we compare behavior according to the type of peers both within and between treatments when people receive social information. Our second result can be stated as follows:

Result 2 *In the ENDO treatment people lie marginally significantly more, when they chose peers who selected the Manual mode than when they chose peers who selected the Automatic mode. In contrast, lying does not differ according to the type of peers when subjects are matched exogenously with their peers in the EXO treatment.*

This result confirms the first part of Hypothesis 1 and rejects its second part.

Support for Result 2. Table 3.4 displays summary statistics about the lying behavior of subjects who chose the Manual mode in the two treatments with peers. We compare within each treatment the difference between those who have peers who chose the Automatic mode and those who have peers who chose the Manual mode (see the two columns *p-value peers*). We compare between treatments those who have peers who chose the Automatic mode and those who have peers who chose the Manual mode (see the two columns *p-value treatments*). First, Table 3.4 shows that in the ENDO treatment, subjects who choose peers who selected the Manual mode report a higher performance and lie more than those who choose peers who selected the Automatic mode (MW test, $p = 0.001$ and $p = 0.023$, respectively). The difference is only significant at the 10% level in the EXO treatment for the reported performance (MW test, $p = 0.087$) and is not significant for the size of lies (MW test, $p = 0.138$). The effect of having peers who selected the Manual mode is stronger in the ENDO treatment than in the EXO treatment. However, there is no significant difference in the reported performance nor in the size of lies between the two treatments (MW tests, $p = 0.127$ and $p = 0.490$ for the reported performance of subjects who chose the Automatic mode or the Manual mode, respectively and $p = 0.444$ and $p = 0.667$ for the size of the lies of subjects who chose the Automatic mode or the Manual mode, respectively).

Table 3.4: Summary statistics: Reported performance and size of lies in part 2 of subjects who chose the Manual mode depending on their peers' mode, by treatment

Treatment	ENDO		EXO		p-value peers		p-value treatments	
	Automatic	Manual	Automatic	Manual	ENDO	EXO	Automatic	Manual
Mode selected by peers								
Reported performance	19.74 (7.55)	25.17 (8.38)	23.08 (8.67)	26.60 (9.42)	0.001	0.087	0.127	0.490
Size of lies	4.86 (9.64)	11.58 (12.00)	9.31 (12.75)	12.74 (13.01)	0.023	0.138	0.444	0.667
N	20	53	32	36				

Notes: Standard deviations are given in parentheses. *Size of lies* represents the difference between the reported and the actual performance of subjects of Manual type. The columns *p-value peers* report within each treatment the p-values from Mann-Whitney tests when comparing the types of peers. The columns *p-value treatments* report the p-values from Mann-Whitney tests when comparing treatments for each given type of peers.

We also conducted a regression analysis of the size of lies in part 2 (see Table 3.5). In order to control for a potential selection bias due to the endogenous choice of mode, we estimated Heckman selection models. In the selection equation, estimated with a simple Probit model, the dependent binary variable is the choice of the Manual mode. In the second equation, estimated with GLS, the dependent variable is the size of lies conditional on the mode chosen. Table 3.5 reports the estimates of three models: model (1) pools the data of the EXO and the ENDO treatment; model (2) restricts the sample to the EXO treatment and model (3) restricts the sample to the ENDO treatment. The selection equation controls for the score at the psychological tests (Mach test, Guilt test and Hexaco test) and for other individual characteristics (like in Table 3.7.3). We use the squared values of the individual characteristics to conform to our model (see equation 3.9). The outcome equation includes the same individual characteristics, as well as the interaction terms *Influence Manual* (defined as the peers' average reported performance if peers chose the Manual mode) and *Influence Auto* (defined as the peers' average actual performance if peers chose the Automatic mode). We include the Inverse Mills Ratio taken from the selection equation.

The estimates of the selection equation in Table 3.5 indicate that the choice of the Manual mode is more likely for younger subjects, males, more educated subjects, students in business, and subjects who are not new comers in experiments. The influence of peers who selected the Manual mode is positive and significant in the ENDO treatment only at the 10% level but it is insignificant in the EXO treatment. This suggests that peers have an impact only when they have been chosen by the subjects. Note that the coefficients of the variables *Influence Auto* and *Influence Manual* in the ENDO treatment are potentially biased because of the self-selection of peers. These coefficients reflect both a conformity effect and a homophily bias.

Table 3.5: Size of lies in part 2, Heckman selection models

	(1) EXO + ENDO	(2) EXO	(3) ENDO
Outcome equation. Dep. var.: Size of lies			
Influence Manual	0.345 (0.210)	0.283 (0.187)	0.155* (0.0813)
Influence Auto	0.194 (0.375)	0.128 (0.326)	-0.148 (0.146)
Age	1.058 (0.932)	1.967 (2.383)	0.564 (0.534)
Gender	-9.156 (8.972)	-8.305 (8.253)	-0.244 (1.487)
Degree	-0.407 (1.746)	-3.215 (3.215)	2.127 (1.450)
Grade	-1.861 (2.052)	-2.077** (0.974)	1.449** (0.722)
Student	-9.170 (27.44)	(omitted)	4.196 (7.504)
Business	-2.197 (5.109)	-2.304 (4.535)	5.121*** (1.594)
Monthly expenses	-0.00754 (0.00871)	0.0000891 (0.00483)	-0.0107*** (0.00261)
First participation	2.561 (8.753)	-2.212 (3.291)	-9.460 (7.503)
Hexaco test	-0.686 (3.597)	5.781 (3.992)	-5.984*** (1.979)
Guilt test	-11.73 (12.08)	-11.51 (8.415)	1.177 (3.029)
High Mach	-2.440 (11.21)	3.641 (6.893)	-1.499 (4.178)
_cons	122.8 (137.6)	67.29 (46.19)	-19.68 (31.90)
N	700	335	365
Selection equation. Dep. var.: Choice of the mode			
Age square	-0.000215	-0.00368***	-0.000338*

	(0.000155)	(0.00109)	(0.000201)
Gender	0.261***	0.596***	-0.0764
	(0.0749)	(0.119)	(0.103)
Degree square	0.00204	0.0195***	-0.00908**
	(0.00241)	(0.00442)	(0.00357)
Grade square	0.00188***	0.00163	0.00133
	(0.000637)	(0.00104)	(0.000918)
Student	0.422	5.413***	0.437
	(0.349)	(0.600)	(0.505)
Business	0.0933	0.265**	0.0153
	(0.0883)	(0.134)	(0.125)
Expenses square	0.000000129**	0.000000107	5.66e-08
	(5.68e-08)	(7.71e-08)	(9.63e-08)
First participation	-0.247***	-0.102	-0.507***
	(0.0824)	(0.118)	(0.127)
Hexaco square	-0.00486	-0.0328*	0.0176
	(0.0108)	(0.0177)	(0.0145)
Guilt square	0.0465***	0.0782***	0.0239**
	(0.00852)	(0.0139)	(0.0113)
High Mach	0.320***	0.513***	0.265**
	(0.0852)	(0.130)	(0.124)
__cons	-1.763***	-6.351	-0.630
	(0.426)	(.)	(0.624)
IMR	-51.61	-27.19	4.845
	(52.29)	(22.55)	(24.00)
<i>N</i>	1355	605	750
chi2	17.75	29.77	244.4

Standard errors in parentheses

* $p < 0.1$, ** $p < 0.05$, *** $p < 0.01$

Heckman selection model in all columns. Model (1) pools the ENDO and the EXO treatments. Model (2) is for the EXO treatment. Model (3) is for the ENDO treatment.

3.5.3 Time effects, peer effects or homophily?

The evolution of behavior between part 1 and part 2 in the EXO and ENDO treatments can be driven by time, the imitation of peers' performance when receiving social information (conformity), or by the selection of peers who are more similar (homophily). We first establish

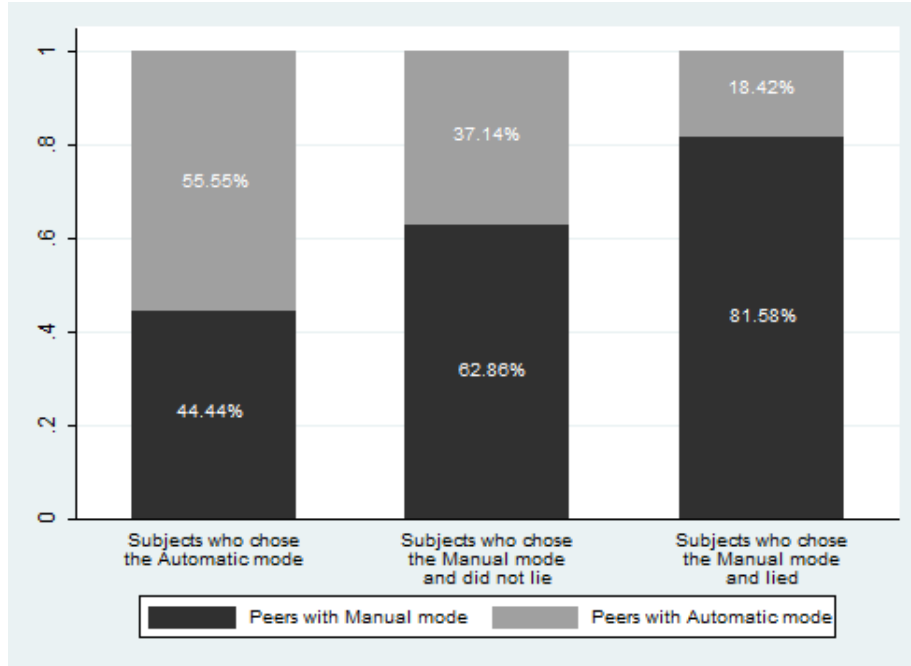

Figure 3.1: Choice of peers, by type of subjects and according to lying behavior in part 1

the presence of homophily and state the following result:

Result 3 *There is evidence of homophily among individuals who chose the Manual mode but not among individuals who chose the Automatic mode.*

This result partly confirms Hypothesis 2.

Support for Result 3. In the ENDO treatment, 57.79% of the subjects choose peers who selected the Manual mode. However, this percentage differs across types as shown by Figure 3.1. 55.55% of the subjects who chose the Automatic mode select peers who have made the same choice. This is not significantly different from 50% (binomial test, $p = 0.374$); therefore, this does not reveal any homophily. In contrast, 72.60% of the subjects who chose the Manual mode select peers who also chose the Manual mode. This is significantly higher than a random choice of peers (binomial test, $p < 0.001$). This shows evidence of homophily for those subjects who probably have the intention to lie. Additionally, if we select only the subjects whose average size of lies in part 1 (without social information) is greater than 1, this percentage is even larger: 81.58% vs. 62.86% for those who chose the Manual mode but did not lie in part 1.

Why are subjects who chose the Automatic mode not homophilious? The post-experimental questionnaire suggests two possible explanations. First, participants were curious having an

immediate information about the performance of peers who selected the Manual mode (although they knew they would get this feedback at the end of the session). Second, expecting to observe a high performance from these subjects was reported by some subjects as a source of motivation.

Now, we compare the behavior between part 1 and part 2 in ENDO and EXO to consider the time effect.

Result 4 *The increase in the size of lies between part 1 and part 2 in the ENDO treatment is significantly higher for the subjects who chose peers who selected the Manual mode than for the subjects who chose peers who selected the Automatic mode. This difference is not significant in the EXO treatment.*

It provides support to Hypothesis 3.

Support for Result 4. We analyze the difference in behavior between part 1 and part 2 when the subjects choose the Manual mode according to whether the triplet is homogeneous (peers chose the Manual mode as well) or heterogeneous (peers chose the Automatic mode). Figure 3.2 displays the differences in the size of lies between part 1 and part 2 for each of the four categories and in the Baseline treatment for control; by definition, this figure only considers the subjects who selected the Manual mode. In all the treatments, the size of lies is higher in part 2 than in part 1. In the EXO treatment, the increase of the size of lies between part 1 and part 2 is not significantly different between subjects who have peers who selected the Automatic mode and subjects who have peers who selected the Manual mode (MW test, $p = 0.354$). On the contrary, the difference is significant in the ENDO treatment (MW test, $p = 0.024$). Subjects who chose peers who selected the Manual mode made bigger lies in part 2 than in part 1, compared to the EXO treatment (MW test, $p = 0.039$) and compared to the Baseline treatment (MW test, $p = 0.091$). Observing peers who chose also the Manual mode increased their level of cheating. This indicates that being able to choose peers affects reporting behavior. This is confirmed by a difference-in-differences analysis, with clustered standard errors at the individual level. Indeed, when we compare the lying behavior in the Baseline treatment and in the ENDO treatment and between part 1 and part 2 (subjects of the ENDO treatment in part 2 are our treated subjects), we find a positive and significant effect of the ENDO treatment (DID, p -value = 0.037). On the contrary, when we compare the lying behavior in the Baseline treatment and in the EXO treatment and between part 1 and part 2, we find no significant effect in the EXO treatment (DID, p -value = 0.769). It

suggests that there is only a timing effect in EXO, like in the Baseline.

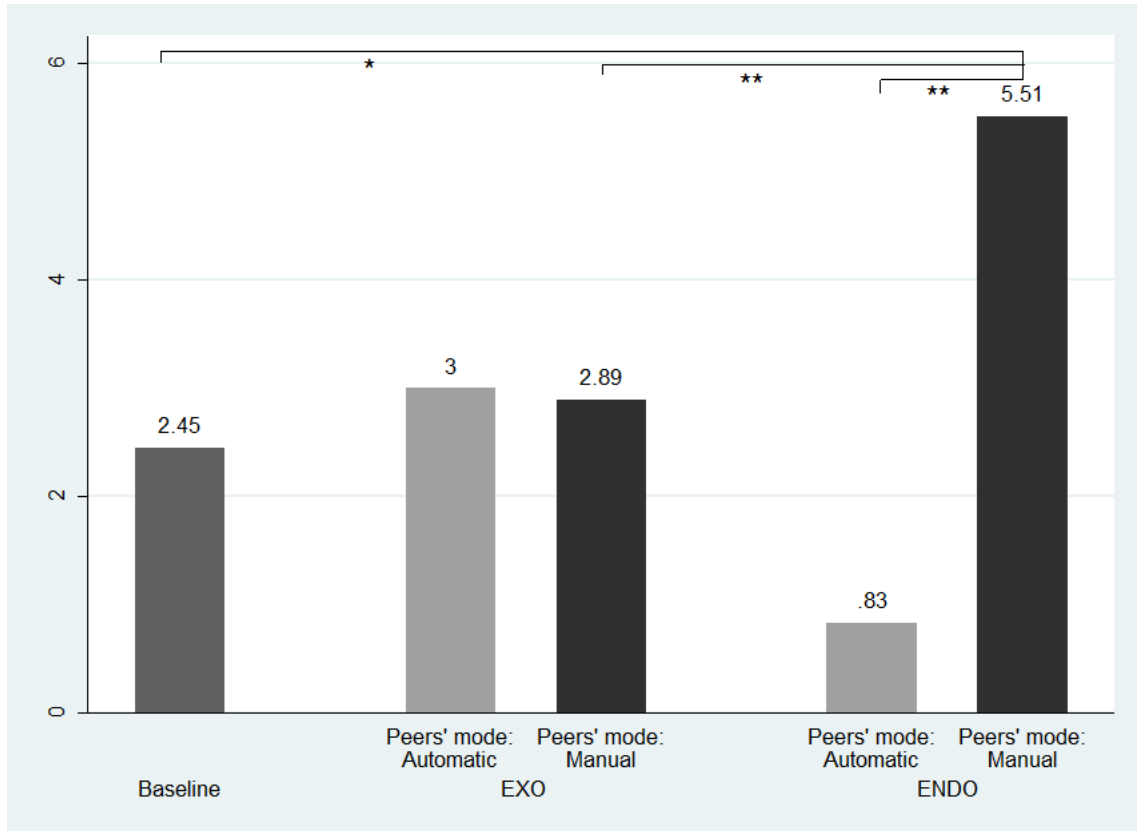

Notes: We report the p-values of the Mann-Whitney tests. In EXO, the difference between the type of peers is not significant: $p = 0.354$, while it is in ENDO: $p = 0.024$. Subjects with peers who chose the Manual mode increased their lies significantly more in ENDO than in EXO: $p = 0.039$ between ENDO and EXO and the difference across treatments is not significant for subjects with peers who chose the Automatic mode: $p = 0.237$. When we compare the subjects from the Baseline with the other treatments, we find that the difference between subjects in BT and those in EXO who have peers who chose the Automatic mode or peers who chose the Manual mode is not significant ($p = 0.576$ and $p = 0.717$). The difference between subjects in BT and subjects who selected peers who chose the Automatic mode in ENDO is not significant ($p = 0.524$) while it is significant when we compare with subjects who selected peers who chose the Manual mode in ENDO ($p = 0.091$).

Figure 3.2: Mean difference in the size of lies between part 1 and part 2 conditional on the choice of peers, by treatment

Our last result is the following:

Result 5 *In the ENDO treatment, the subjects who choose peers who selected the Manual mode were already reporting higher performances and lied more in part 1.*

Support for Result 5. In Appendix Table 3.7.4 and Appendix Table 3.7.5, we compare within each part the behavior between the four categories of subjects (*p-value peers*). We can

see that in ENDO in part 1, individuals who chose the Manual mode and selected peers who made the same choice report higher performances and cheat more (MW tests, $p = 0.014$ and $p = 0.047$). In EXO, the difference is not significant for any variable (MW tests, $p = 0.129$ and $p = 0.138$). This shows that in ENDO, the subjects who chose the Manual mode and who chose peers who selected the same option were already lying more in part 1 than those who chose peers who selected the Automatic mode.

To sum up, we can see with the Baseline treatment that there is a time effect as the size of lies is larger in part 2 than in part 1. In the EXO treatment, we see an increase in the size of lies between part 2 and part 1, however, there is no difference between subjects who have peers who selected the Manual mode and those who have peers who selected the Automatic mode. Based on that and on the regression (see Table 3.5), we can say that there are no significant peers effects in the EXO treatment. As we assumed that peer effects are the same in EXO and in ENDO, it means that the difference in the size of lies in ENDO between part 1 and part 2 of the subjects who chose peers who selected the Manual mode, is due to time effects and to the self-selection bias (homophily). The increase in the size of lies of these subjects, that could be interpreted as peer effects, is in fact only the consequence of the presence of homophily.

3.6 Discussion and conclusion

In this chapter, we aim at identifying both the effect of the endogenous choice of peers and peer effects on individuals' cheating behavior. In the laboratory, we created three environments: one where individuals have no peers, one where peers are exogenously and randomly assigned, and one where peers are chosen endogenously.

Our main findings show that the participants who have peers who chose a version of the task that allows for lying cheat more than those who have peers who chose a version that forbids lying. However, the difference is only significant when individuals choose their peers. However, this may be due to a self-selection effect. And indeed, individuals who choose the Manual mode are homophilious: they prefer to be linked with peers who also chose the Manual mode. In addition, the individuals who make these homophilious choices are also those who cheat more when they work in isolation. Peer effects are artificially amplified by the

selection effect (homophily bias). Indeed, those who lie to a greater extent choose peers who are more likely to be liars. Consequently, they lie more than those who already lie less in isolation and who choose peers who did not lie. The increase of the size of lies in ENDO between part 1 and part 2 is due to time effect and to the self-selection bias. This is of great importance for the analysis of peer effects in the laboratory and to understand empirically the diffusion of criminality (criminals choose their partners-in-crime) and to define efficient policies to reduce criminality.

In our model and in our experiment, we only focus on conformity effects. A possible extension of our experiment would be to design additional treatments with a different payment scheme in order to compare peer effects driven by conformity and peer effects driven by strategic complementarities (that are excluded by design in our experiment). In these new treatments, the payment scheme would depend on peers' performance. If the better peers perform, the more the individual earns, the choice of peers becomes strategic, as it impacts earnings and creates a strategic complementarity between them. This is left for further research.

3.7 Appendix

3.7.1 Screenshots

0	0	1	1	0
0	1	0	1	0
1	1	0	0	0
0	1	0	0	0
0	0	0	0	0

Figure 3.7.1: Example of matrices with 25 figures.

0	0	1	1	0	1	1	1	1	0
0	0	1	1	0	1	0	0	0	1
1	1	1	0	0	1	1	0	1	0
1	1	1	0	0	0	1	0	1	0
1	0	0	0	0	1	1	1	1	1

Figure 3.7.2: Example of matrices with 50 figures.

Table number	Gain solved table	Your answer	Solution	Table number	Gain solved table	your answer	Solution
1	1	15	15	11	X	X	X
2	2	25	25	12	X	X	X
3	2	24	23	13	X	X	X
4	1	16	16	14	X	X	X
5	1	11	10	15	X	X	X
6	1	10	10	16	X	X	X
7	1	17	17	17	X	X	X
8	1	14	14	18	X	X	X
9	2	27	27	19	X	X	X
10	X	X	X	20	X	X	X

Figure 3.7.3: Example of a recap chart

3.7.2 Appendix Tables

Table 3.7.1: Summary of the sessions

Sessions	Treatment	Number of participants
Session 1	Baseline	18
Session 2	Baseline	22
Session 3	Baseline	17
Session 4	Baseline	15
Session 5	ENDO	23
Session 6	ENDO	23
Session 7	ENDO	30
Session 8	ENDO	27
Session 9	ENDO	27
Session 10	EXO	26
Session 11	EXO	31
Session 12	EXO	23
Session 13	EXO	27
Session 14	ENDO	24
Session 15	EXO	19
Total		352

Table 3.7.2: Summary statistics: Socio-demographic individual characteristics

Treatments	Baseline	EXO	ENDO
Age	23.74 (6.51)	21.13 (4.65)	22.86(7.81)
Male (%)	36.11	52.38	50.65
Student (%)	80.55	97.62	92.21
Business school (%)	30.55	57.14	61.69
Grade	14.50 (2.34)	15.15 (2.17)	15.72 (1.99)
Monthly expenses	819.58 (372.74)	834.53 (379.47)	849.13 (291.68)
First participation (%)	36.11	56.35	66.88
N	72	126	154

Note: Standard deviations are in parentheses.

Table 3.7.3: Actual performance in part 1, marginal effects

	(1)	(2)	(3)
	Actual performance	Actual performance	Actual performance
Choice of mode		-0.805*	-0.818*
		(0.429)	(0.431)
ENDO treatment			-0.164
			(0.611)
EXO treatment			0.146
			(0.622)
Age	-0.0814	-0.0896	-0.0839
	(0.0554)	(0.0554)	(0.0566)
Gender	-1.111***	-1.070**	-1.070**
	(0.426)	(0.425)	(0.430)
Degree	-0.291*	-0.282*	-0.278*
	(0.163)	(0.163)	(0.166)
Grade	0.0215	0.0364	0.0474
	(0.112)	(0.112)	(0.114)
Student	-0.200	-0.154	-0.144
	(1.350)	(1.345)	(1.367)
Business	-0.260	-0.244	-0.229
	(0.538)	(0.536)	(0.540)
Monthly expenses	-0.00111	-0.00104	-0.00106
	(0.000680)	(0.000678)	(0.000681)
First participation	-0.210	-0.271	-0.237
	(0.471)	(0.470)	(0.478)
<i>N</i>	1695	1695	1695

Marginal effects; Standard errors in parentheses

(d) for discrete change of dummy variable from 0 to 1

* $p < 0.1$, ** $p < 0.05$, *** $p < 0.01$

GLS model (panel) for the three columns. In (1), there are only demographic characteristics. *Age* is the age of the subject. *Gender* is a binary variable that equals 1 for males. *Degree* represents the level of degree of the subject, from 0 that represents no degree and to 9 that represents a PhD degree. *Grade* is the grade of the subject at the Baccaulauréat. *Student* is a binary variable that equals 1 if the subject is a student. *Business* is a binary variable that equals 1 if the subject is a business student. *Monthly expenses* represents the monthly expenses of the subject. *First participation* is a binary variable that equals 1 if it is the first time that the subject participated in an experiment. In (2), we add the choice of version (*Choice mode* = 1 if Manual type) and in (3), we also control for the treatments. *EXO treatment* and *ENDO treatment* are binary variables that equal 1 if the subject played respectively the EXO or the ENDO treatment.

Table 3.7.4: Summary statistics: Lying behavior of Manual subjects in the ENDO treatment

Peers' mode	Part 1		Part 2		p-value peers	
	Automatic	Manual	Automatic	Manual	Part 1	Part 2
Reported performance	16.99 (7.72)	19.38 (6.68)	19.74 (7.55)	25.17 (8.38)	0.014	0.001
Size of lies	4.03 (8.75)	6.07 (8.47)	4.86 (9.64)	11.58 (12.00)	0.047	0.023
N	20	53	20	53		

Note: Standard deviations are in parentheses. The size of the lie is the difference between the reported performance and the actual performance of the subjects who chose the Manual mode.

Table 3.7.5: Summary statistics: Lying behavior of Manual subjects in the EXO treatment

Peers' mode	Part 1		Part 2		p-value peers	
	Automatic	Manual	Automatic	Manual	Part 1	Part 2
Reported performance	18.76 (7.99)	22.46 (10.06)	23.08 (8.67)	26.60 (9.42)	0.129	0.087
Size of lies	6.31 (11.27)	9.85 (12.24)	9.31 (12.75)	12.74 (13.01)	0.117	0.138
N	32	36	32	36		

Note: Standard deviations are in parentheses. The size of the lie is the difference between the reported performance and the actual performance of the subjects who chose the Manual mode.

3.7.3 Instructions

Baseline treatment

Welcome to this experiment on decision making. Please turn your cellphones off. You are not allowed to communicate with the other participants throughout the experiment, in any form, subject to exclusion of the session and cancellation of the gains. In this experiment, you can earn money. The amount you can earn depends on your decisions. Please read these instructions attentively.

This session comprises several successive parts. The amount earned at the end of this session is the sum of your earnings in the different parts. During the session, your payoffs are expressed in points and not in Euro. The conversion rate of points into Euro is: 4 points = 1 Euro. You will be paid at the end of the session in cash and in private in a separate room.

Your decisions are anonymous: you will never enter your name into the computer. The decisions you will make may be shown to other participants in future sessions of this experiment, but always in an anonymous way such that it is impossible to identify you personally.

PART 1

This part comprises 5 periods. One period will be randomly drawn at the end of the session to determine your payoff for this part. During this part, you will have to perform a task.

The task:

This task consists of counting the number of zeros in matrices of 5 columns and 5 rows or in matrices of 10 columns and 5 rows, containing zeros and ones. The figures below represent examples of matrices with 25 figures and matrices with 50 figures similar to those you will see on your computer screen.

Description of each period:

Each period lasts two minutes. You will see one matrix at a time on your computer screen, and for each matrix, you are requested to enter the number of zeros you count in this matrix. Then, you have to validate your answer by clicking OK.

Whether your answer is correct or not, another matrix will appear as soon as you have

0	0	1	1	0	1	1	1	1	0
0	0	1	1	0	1	0	0	0	1
1	1	1	0	0	1	1	0	1	0
1	1	1	0	0	0	1	0	1	0
1	0	0	0	0	1	1	1	1	1

Example of a matrix with 10 columns and 5 rows. The correct answer is 23.

0	0	1	1	0
0	1	0	1	0
1	1	0	0	0
0	1	0	0	0
0	0	0	0	0

Example of a matrix with 5 columns and 5 rows. The correct answer is 18.

validated your answer. You have to enter a number and validate it to make a new matrix appear. You cannot get back to the previous matrix.

A matrix is solved if your answer is correct, i.e., if the number of zeros you counted is equal to the solution. A matrix solved containing 25 figures pays 1 point. A matrix solved containing 50 figures pays 2 points.

During each period, you will see a maximum of 20 matrices. All the participants can see the same matrices and in the same order as you. The computer program randomly displays matrices containing 25 or 50 figures.

At the end of each 2-minute period, a recap chart indicates for each of the 20 matrices the value of a solved matrix (1 or 2 points), your answer and the correct answer. If your answer is equal to the solution, your answer is considered as correct; otherwise, it is considered as incorrect. If you have not validated an answer for a given matrix, a cross appears in all the columns.

Before the first period:

Before the beginning of the first period, you have to choose between two versions for the calculation of your payoffs: the Direct version or the Indirect version.

Table number	Gain solved table	Your answer	Solution	Table number	Gain solved table	your answer	Solution
1	1	15	15	11	X	X	X
2	2	25	25	12	X	X	X
3	2	24	23	13	X	X	X
4	1	16	16	14	X	X	X
5	1	11	10	15	X	X	X
6	1	10	10	16	X	X	X
7	1	17	17	17	X	X	X
8	1	14	14	18	X	X	X
9	2	27	27	19	X	X	X
10	X	X	X	20	X	X	X

- In the Direct version, your payoff in each period is directly calculated by the computer program. After comparing your answer and the solution for each matrix, the computer program sums the points earned by adding 1 or 2 points per matrix solved according to the value indicated in the column “Payoff for a solved matrix”.

In the Direct version, the computer program indicates on your screen your payoff for the period and this amount automatically calculated by the program will be paid to you if this period is randomly drawn for payment at the end of the session.

- In the Indirect version, your payoff in each period is not directly calculated by the computer program. You have to calculate your payoff yourself using the recap chart, as the computer program does in the Direct version. After comparing your answer and the solution for each matrix, you have to sum the points earned by adding 1 or 2 points per matrix solved according to the value indicated in the column “Payoff for a solved matrix”. You have at your disposal a pen and a sheet of paper to help you if needed.

In the Indirect version, you have to enter yourself your payoff for the period on your screen and this amount that you report will be paid to you if this period is randomly drawn for payment at the end of the session.

Below is an example of a recap chart. The payoffs per matrix solved and the solutions are given by way of illustration and do no prejudice the true values during the part.

Table number	Gain solved table	Your answer	Solution	Table number	Gain solved table	your answer	Solution
1	1	15	15	11	X	X	X
2	2	25	25	12	X	X	X
3	2	24	23	13	X	X	X
4	1	16	16	14	X	X	X
5	1	11	10	15	X	X	X
6	1	10	10	16	X	X	X
7	1	17	17	17	X	X	X
8	1	14	14	18	X	X	X
9	2	27	27	19	X	X	X
10	X	X	X	20	X	X	X

In this example, the person tried to solve 9 matrices. S/He solved 7 matrices: 5 matrices of size 25 and 2 matrices of size 50. His/Her payoffs are:

$$\text{Payoffs for this period} = (5 \times 1 \text{ point}) + (2 \times 2 \text{ points}) = 9 \text{ points.}$$

If you choose the Direct version, the program will directly indicate the value 9 points. If you choose the Indirect version, you have to enter the value into your computer.

Attention: you choose the version of the task only once, and this choice applies to the 5 periods. Once you have chosen one of the two versions, you will not be able to modify your choice.

Before the beginning of the first period and before choosing between the two versions, you will have a chance to test the task during a practice period of 2 minutes to familiarize yourself with the task. This practice period will not be taken into account in the calculation of your payoffs for the part.

To sum up, this part comprises 3 steps:

1. You test the task in a practice period.
2. You choose once between the Direct and the Indirect version for the calculation of your payoffs.
3. You perform the task during 5 periods.

Please read these instructions again. If you have any questions, raise your hand or press the red button on the side of your desk and we will answer to your questions in private.

PART 2

This part comprises 5 periods. The rules are the same as in part 1, in particular, you will have to perform the same task, except that you do not choose your version of payoff calculation. The version, Direct or Indirect, which applies is the one you chose at the beginning of part 1.

If you chose the Direct version in part 1, your payoff in each period of part 2 is automatically calculated by the computer program. Otherwise, your payoff in each period of this part has to be calculated by yourself, using the recap chart. One period will be randomly drawn at the end of the session to determine your payoff for this part.

Please read these instructions again. If you have any questions, raise your hand or press the red button on the side of your desk and we will answer to your question in private.

PART 3

This part comprises three questionnaires. Please answer to these questions. Do not spend too much time on each question, answer spontaneously and sincerely. Your answers to these questionnaires are anonymous and confidential and will never be transferred to other participants. Completing these questionnaires yields a payoff of 2 Euros.

END OF THE SESSION

After you complete the questionnaires, we will ask you a few socio-demographic questions and questions about the session. Finally, you will be informed on your screen of your payoff in each part and of your total payoff for the session. Your total payoff is calculated as follows:

$$\begin{aligned} \text{Final payoff} = & \text{payoff for the task in part 1} + \text{payoff for the task in part 2} \\ & + 2 \text{ Euros for the questionnaires} + 5 \text{ Euros as a show-up fee} \end{aligned}$$

Then, please remain seated until an experimenter invites you to proceed to a separate room for your payment. You will be called one by one. Please, bring with you your computer tag and your receipt of payment.

—

EXO treatment

Parts 1 and 3 are the same as in the Baseline treatment.

PART 2

This part comprises 5 periods. The rules are the same as in part 1, in particular you have to perform the same task, except that you do not choose your version of payoff calculation. The version which applies, Direct or Indirect, is the one you chose at the beginning of part 1.

If you chose the Direct version in part 1, your payoff in each period of part 2 is automatically calculated by the computer program. Otherwise, your payoff in each period of this part has to be calculated by yourself, using the recap chart. A period will be randomly drawn at the end of the session to determine your payoff for this part.

Before the task:

- Information on 4 participants from a past session:

Before starting performing the task, the computer program will match each of you with 4 participants from a past session: two participants who chose the Direct version and two participants who chose the Indirect version. These people are not present in the laboratory today. Your screen will display the average payoff in part 1 of these two participants who chose the Direct version and the average payoff of these two participants who chose the Indirect version.

- Matching process:

Next, the computer program will match you randomly with one of these two pairs: you have a 50% chance to be matched with the two participants who chose the Direct version and a 50% chance to be matched with the two participants who chose the Indirect version. This pair will be called your “peers”: we will call them peers of Direct type or peers of Indirect type, depending on which pair has been assigned to you by the computer program.

Description of each period:

During the counting task, in each period you will see the average payoff of your peers from a past session in the same period in part 2. Precisely, you will be able to observe the average payoff of your peers in this period, i.e., their payoff calculated by the computer program if your peers are of Direct type, or their payoff calculated and reported by themselves if your

peers are of indirect type.

Examples:

- In period 1, if the program assigned you peers of Direct type, the program will inform you of the average payoff of your peers calculated by the program in period 1 of part 2. In period 4, it will inform you of their average payoff in period 4.
- Similarly, in period 1, if the program assigned you peers of Indirect type, the program will inform you of the average payoff of your peers calculated by themselves in period 1 of part 2. In period 3, it will inform you of their average payoff in period 3.

Unlike you, these peers were not matched with other participants and thus, they did not receive any information on the choices or payoffs of other participants. In each period, they saw the same tables as you and in the same order as you.

In each period, you will be informed of the average payoff in that period of the pair of peers that has been assigned to you. In contrast, you will not be informed of the average payoff in that period of the pair of peers that has not been assigned to you; nevertheless, you will be informed at the end of the session of the average payoff in each period of the pair of peers that has not been assigned to you.

Your payoffs are computed according to the version you chose in part 1. The payoff of your peers are not taken into account in the calculation of your payoffs.

To sum up, this part comprises 2 steps:

1. Your screen displays the average payoff in part 1 of two participants from a past session who chose the Direct version of the task and two participants who chose the Indirect version. The program matches you with one of these two pairs.
2. You perform the task during 5 periods. During each period, you can observe the payoff of your two peers in the same period in part 2.

Please read these instructions again. If you have any questions, raise your hand or press the red button on the side of your desk and we will answer to your questions in private.

ENDO treatment

Parts 1 and 3 are the same as in the Baseline treatment.

PART 2

This part comprises 5 periods. The rules are the same as in part 1, in particular you have to perform the same task, except that you do not choose your version of payoff calculation. The version which applies, Direct or Indirect, is the one you chose at the beginning of part 1.

If you chose the Direct version in part 1, your payoff in each period of part 2 is automatically calculated by the computer program. Otherwise, your payoff in each period of this part has to be calculated by yourself, using the recap chart. A period will be randomly drawn at the end of the session to determine your payoff for this part.

Before the task:

- Information on 4 participants of a past session:

Before starting performing the task, the computer program will match each of you with 4 participants from a past session: two participants who chose the Direct version and two participants who chose the Indirect version. These people are not present in the laboratory today. Your screen will display the average payoff in part 1 of these two participants who chose the Direct version and the average payoff of these two participants who chose the Indirect version.

- Choice of peers: Next, you will choose one of these two pairs. This pair will be called your “peers”: we will call them peers of Direct type or peers of Indirect type, depending on which pair you have chosen.

Description of each period:

During the counting task, in each period you will see the average payoff of your peers from a past session in the same period in part 2. Precisely, you will be able to observe the average payoff of your peers in this period, i.e., their payoff calculated by the computer program if your peers are of Direct type, or their payoff calculated and reported by themselves if your

peers are of indirect type.

Examples:

- In period 1, if you chose peers of Direct type, the program will inform you of the average payoff of your peers calculated by the program in period 1 of part 2. In period 4, it will inform you of their average payoff in period 4.
- Similarly, in period 1, if you chose peers of Indirect type, the program will inform you of the average payoff of your peers calculated by themselves in period 1 of part 2. In period 3, it will inform you of their average payoff in period 3.

Unlike you, these peers were not matched with other participants and thus, they did not receive any information on the choices or payoffs of other participants. In each period, they saw the same tables as you and in the same order as you.

In each period, you will be informed of the average payoff in that period of the pair of peers that you have chosen. In contrast, you will not be informed of the average payoff in that period of the pair of peers that you have not chosen; nevertheless, you will be informed at the end of the session of the average payoff in each period of the pair of peers that you have not chosen.

Your payoffs are computed according to the version you chose in part 1. The payoff of your peers are not taken into account in the calculation of your payoffs.

To sum up, this part comprises 2 steps:

1. Your screen displays the average payoff in part 1 of two participants from a past session who chose the Direct version of the task and two participants who chose the Indirect version. You choose one of these two pairs.
2. You perform the task during 5 periods. During each period, you can observe the payoff of your two peers in the same period in part 2.

Please read these instructions again. If you have any questions, raise your hand or press the red button on the side of your desk and we will answer to your questions in private.

3.7.4 Questionnaires

The Machiavellianism test: Mach-IV scale

For each of the statement, indicate your level of agreement:

1. Never tell anyone the real reason you did something unless it is useful to do so.
2. The best way to handle people is to tell them what they want to hear.
3. One should take action only when sure it is morally right.²¹
4. Most people are basically good and kind.²¹
5. It is safest to assume that all people have a vicious streak and it will come out when they are given a chance.
6. Honesty is the best policy in all cases.²¹
7. There is no excuse for lying to someone else.²¹
8. It is hard to get ahead without cutting corners here and there.
9. All in all, it is better to be humble and honest than important and dishonest.²¹
10. When you ask someone to do something for you, it is best to give the real reasons for wanting it rather than giving reasons that carry more weight.²¹
11. Most people who get ahead in the world lead clean, moral lives.²¹
12. Anyone who completely trusts anyone else is asking for trouble.
13. The biggest difference between most criminals and other people is that criminals are stupid enough to get caught.
14. Most men are brave.²¹
15. It is wise to flatter important people.
16. It is possible to be good in all respects.²¹
17. Barnum was very wrong when he said that there's a sucker born every minute.²¹
18. Generally speaking, men won't work hard unless they're forced to do so.

²¹Reverse coded.

19. People suffering from incurable diseases should have the choice of being put painlessly to death.
20. Most men forget more easily the death of their father than the loss of their property.

The Honesty-Humility test (from the HEXACO test)

For each of the statement, indicate your level of agreement:

1. If I want something from a person I dislike, I will act very nicely toward that person in order to get it.²²
2. If I knew that I could never get caught, I would be willing to steal a million dollars.²²
3. Having a lot of money is not especially important to me.
4. I am an ordinary person who is no better than others.
5. I wouldn't use flattery to get a raise or promotion at work, even if I thought it would succeed.
6. I would be tempted to buy stolen property if I were financially tight.²²
7. I would like to live in a very expensive, high-class neighborhood.²²
8. I wouldn't want people to treat me as though I were superior to them.
9. If I want something from someone, I will laugh at that person's worst jokes.²²
10. I would never accept a bribe, even if it were very large.
11. I would like to be seen driving around in a very expensive car.²²
12. I think that I am entitled to more respect than the average person is.²²
13. I wouldn't pretend to like someone just to get that person to do favors for me.
14. I'd be tempted to use counterfeit money, if I were sure I could get away with it.²²
15. I would get a lot of pleasure from owning expensive luxury goods.²²
16. I want people to know that I am an important person of high status.²²

²²Reverse coded.

The Guilt Proneness test

In this set of questions you will read about situations that people are likely to encounter in day-to-day life, followed by common reactions to those situations. As you read each scenario, try to imagine yourself in that situation. Then indicate the likelihood that you would react in the way described.

1. After realizing you have received too much change at a store, you decide to keep it because the salesclerk doesn't notice. What is the likelihood that you would feel uncomfortable about keeping the money?
2. You give a bad presentation at work. Afterwards your boss tells your coworkers it was your fault that your company lost the contract. What is the likelihood that you would feel incompetent?
3. At a coworker's party, you spill red wine on their new cream colored carpet. You cover the stain with a chair so that nobody notices. What is the likelihood that you would feel that the way you acted was pathetic?
4. You lie to people but they never find out about it. What is the likelihood that you would feel terrible about the lies you told?
5. You successfully exaggerate your damages in a lawsuit. Months later, your lies are discovered and you are charged with perjury. What is the likelihood that you would think you are a despicable human being?
6. You make a mistake at work and find out a coworker is blamed for the error. Later, your coworker confronts you about your mistake. What is the likelihood that you would feel like a coward?

Bibliography

- Abeler, J., Becker, A. and Falk, A. (2014). Representative evidence on lying costs, *Journal of Public Economics* **113**: 96–104.
- Arduini, T., Patacchini, E., Rainone, E. et al. (2015). Parametric and semiparametric iv estimation of network models with selectivity, *Technical report*, Einaudi Institute for Economics and Finance (EIEF).

- Ashton, M. C., Lee, K. and De Vries, R. E. (2014). The hexaco honesty-humility, agreeableness, and emotionality factors: A review of research and theory, *Personality and Social Psychology Review* **18**(2): 139–152.
- Badev, A. (2013). Discrete games in endogenous networks: Theory and policy.
- Bock, O., Baetge, I. and Nicklisch, A. (2014). Hroot: Hamburg registration and organization online tool, *European Economic Review* **71**: 117–120.
- Boucher, V. (2016). Conformism and self-selection in social networks, *Journal of Public Economics* **136**: 30–44.
- Boucher, V. and Fortin, B. (2016). Some challenges in the empirics of the effects of networks, *Oxford Handbook on the Economics of Networks*, Oxford: Oxford University Press .
- Carrell, S. E., Malmstrom, F. V. and West, J. E. (2008). Peer effects in academic cheating, *Journal of human resources* **43**(1): 173–207.
- Centola, D. (2011). An experimental study of homophily in the adoption of health behavior, *Science* **334**(6060): 1269–1272.
- Christie, R. and Geis, F. (1970). Scale construction, *Studies in machiavellianism* pp. 10–34.
- Cohen, T. R., Wolf, S. T., Panter, A. T. and Insko, C. A. (2011). Introducing the gasp scale: a new measure of guilt and shame proneness., *Journal of personality and social psychology* **100**(5): 947.
- Cohn, A., Fehr, E. and Maréchal, M. A. (2014). Business culture and dishonesty in the banking industry, *Nature* **516**(7529): 86–89.
- Currarini, S. and Mengel, F. (2016). Identity, homophily and in-group bias, *European Economic Review* **90**: 40–55.
- Diekmann, A., Przepiorka, W., Rauhut, H. et al. (2011). Lifting the veil of ignorance: An experiment on the contagiousness of norm violations, *Nuffield Centre for Experimental Social Sciences Discussion Paper Series* **4**.
- Dufwenberg, M. (2016). Lies in disguise—a theoretical analysis of cheating.
- Eriksson, T., Poulsen, A. and Villeval, M. C. (2009). Feedback and incentives: Experimental evidence, *Labour Economics* **16**(6): 679–688.

- Falk, A. and Fischbacher, U. (2002). "crime" in the lab-detecting social interaction, *European Economic Review* **46**(4): 859–869.
- Falk, A., Huffman, D. and Mierendorff, K. (2006). Incentive effects and political acceptability of workfare, *Institute for the Study of Labour (IZA)* .
- Falk, A. and Ichino, A. (2006). Clean evidence on peer effects, *Journal of labor economics* **24**(1): 39–57.
- Fischbacher, U. and Föllmi-Heusi, F. (2013). Lies in disguise—an experimental study on cheating, *Journal of the European Economic Association* **11**(3): 525–547.
- Fortin, B., Lacroix, G. and Villeval, M.-C. (2007). Tax evasion and social interactions, *Journal of Public Economics* **91**(11): 2089–2112.
- Fosgaard, T. R., Hansen, L. G. and Piovesan, M. (2013). Separating will from grace: An experiment on conformity and awareness in cheating, *Journal of Economic Behavior & Organization* **93**: 279–284.
- Gino, F., Ayal, S. and Ariely, D. (2009). Contagion and differentiation in unethical behavior: The effect of one bad apple on the barrel, *Psychological science* **20**(3): 393–398.
- Glaeser, E. L., Sacerdote, B. and Scheinkman, J. A. (1996). Crime and social interactions, *The Quarterly Journal of Economics* **111**(2): 507–548.
- Gneezy, U. (2005). Deception: The role of consequences, *The American Economic Review* **95**(1): 384–394.
- Gneezy, U., Kajackaite, A. and Sobel, J. (2017). Lying aversion and the size of the lie.
- Goldsmith-Pinkham, P. and Imbens, G. W. (2013). Social networks and the identification of peer effects, *Journal of Business & Economic Statistics* **31**(3): 253–264.
- Granovetter, M. S. (1973). The strength of weak ties, *American journal of sociology* **78**(6): 1360–1380.
- Haynie, D. L. (2001). Delinquent peers revisited: Does network structure matter?, *American journal of sociology* **106**(4): 1013–1057.
- Hsieh, C.-S. and Lee, L. F. (2016). A social interactions model with endogenous friendship formation and selectivity, *Journal of Applied Econometrics* **31**(2): 301–319.

- Hsieh, C.-S. and Lee, L.-F. (2017). Specification and estimation of network formation and network interaction models with the exponential probability distribution.
- Irlenbusch, B. and Villeval, M. C. (2015). Behavioral ethics: how psychology influenced economics and how economics might inform psychology?, *Current Opinion in Psychology* **6**: 87–92.
- Jacobsen, C., Fosgaard, T. R. and Pascual-Ezama, D. (2017). Why do we lie? a practical guide to the dishonesty literature, *Journal of Economic Surveys* .
- Kandel, E. and Lazear, E. P. (1992). Peer pressure and partnerships, *Journal of political Economy* **100**(4): 801–817.
- Kuhnen, C. M. and Tymula, A. (2012). Feedback, self-esteem, and performance in organizations, *Management Science* **58**(1): 94–113.
- Lefebvre, M., Pestieau, P., Riedl, A. and Villeval, M. C. (2015). Tax evasion and social information: an experiment in belgium, france, and the netherlands, *International Tax and Public Finance* **22**(3): 401–425.
- Manski, C. F. (1993). Identification of endogenous social effects: The reflection problem, *The review of economic studies* **60**(3): 531–542.
- McPherson, M., Smith-Lovin, L. and Cook, J. M. (2001). Birds of a feather: Homophily in social networks, *Annual review of sociology* **27**(1): 415–444.
- Patacchini, E. and Zenou, Y. (2008). The strength of weak ties in crime, *European Economic Review* **52**(2): 209–236.
- Patacchini, E. and Zenou, Y. (2009). Juvenile delinquency and conformism, *The Journal of Law, Economics, & Organization* **28**(1): 1–31.
- Qu, X. and Lee, L.-f. (2015). Estimating a spatial autoregressive model with an endogenous spatial weight matrix, *Journal of Econometrics* **184**(2): 209–232.
- Rauhut, H. (2013). Beliefs about lying and spreading of dishonesty: Undetected lies and their constructive and destructive social dynamics in dice experiments, *PloS one* **8**(11).
- Robert, I. and Arnab, M. (2013). Is dishonesty contagious?, *Economic Inquiry* **51**(1): 722–734.

Rosenbaum, S. M., Billinger, S. and Stieglitz, N. (2014). Let's be honest: A review of experimental evidence of honesty and truth-telling, *Journal of Economic Psychology* **45**: 181–196.

Schrag, J. and Scotchmer, S. (1997). The self-reinforcing nature of crime, *International Review of Law and Economics* **17**(3): 325–335.

van Veldhuizen, R., Oosterbeek, H. and Sonnemans, J. (2014). Peers at work: From the field to the lab.

General conclusion

This dissertation contributes to the literature on network economics in a theoretical and experimental way. In a more and more connected world, it is primordial to understand how networks can be optimally formed, how individuals make their linking decisions and how it impacts individual behavior as well as aggregated economic outcomes.

First, this dissertation contributes to the theoretical literature on optimal formation and protection of networks under link attacks (Chapter 1). To our knowledge, this is the first time that link attacks (and not node attacks) are studied in this literature. The objective in this Chapter is to maintain the communication between all the nodes of a network while its links are attacked. It allows us to compare our results with the literature on node attacks. In the models where the adversary attacks nodes, if the protection cost is too high compared to the linking cost, nodes must be connected with enough links to resist the attack. If the protection cost is lower, protections are more advantageous. Designing a star network and protecting the central node is sufficient to maintain connection between several nodes. In our model, if the protection cost is relatively high, like in the other models, it is better to build enough non-protected links to resist the attack. If the protection cost is relatively low, it is advantageous to build protected links. We show that protecting links is more costly than protecting nodes, because to maintain a connection between n nodes, it requires $n - 1$ links. Indeed, as nodes are complementary in our model, maintaining the connection between all the nodes is necessary. In both cases (node and link attacks), there exist two polar optimal solutions: one which only uses protections and one which uses no protections at all.

Chapter 2 also contributes to the theoretical literature on network formation when nodes make themselves their linking decisions. Indeed, we slightly extend the model of Bala and Goyal (2000) by implementing a sequential instead of a simultaneous process of link forma-

tion. The strict Nash equilibrium is also the CSS but where the central node is always the last node of the sequential process.

Chapter 2 contributes to the experimental literature on network formation by testing this extension of the model of Bala and Goyal (2000) in the laboratory. In most experiments on network formation, the linking process is simultaneous. It generates coordination difficulties, because individuals cannot anticipate the linking decisions of others. In Chapter 2, we show that sequentiality facilitates the coordination of individuals in the laboratory. Indeed, they form efficient and stable networks. However, the equilibrium network, the CSS, does not emerge, like in many other network experiments. In fact, it is unfair and individuals have a tendency to create at least one link to make sure that they are part of the network. We introduce heterogeneity thanks to the presence of a high-value individual or with a different status. The presence of an individual with a high monetary value allows to increase the asymmetry of the network, because he polarizes links on him.

Finally, the dissertation contributes to the econometric and experimental literature on peer effects (Chapter 3). Thanks to the laboratory, we can identify pure peer effects, by creating exogenous and random networks to remove the endogeneity problem due to the choice of peers. Moreover, we can measure the homophily bias by allowing individuals to choose their peers in another treatment. The laboratory is a controlled environment that allows us to identify these different effects. We show that peer effects on dishonesty are artificially amplified by the homophily bias.

Network economics requires different methodologies to comprehend networks as they are multi-faceted. Nevertheless, each methodology has some limits.

Chapter 1: limits and extensions This Chapter aims at understanding the mechanisms when links are under attack and to understand the differences with models where nodes are attacked. At the end of this Chapter, we add more realism in our model by limiting the possible protection strategies of the designer (limitation of protection resources and imperfect reliability of protections). An interesting extension of Chapter 1 would be to vary the costs of protection according to the location of these protections. Indeed, protecting adjacent links

or adjacent nodes is less costly and easier for the central planner. In this Chapter, we assume that the designer has a perfect information concerning the attack of the adversary: he knows the number of links that can be attacked. A second interesting extension would be to make this information incomplete. It would reflect many real-life situations like military attacks where the enemy resources are not perfectly known.

Chapter 2: limits and extensions The laboratory provides many advantages to control variables (costs, values, information, time, etc.) that influence individual choices. However, the study of networks in the laboratory has several limits. Two strands of literature have been developed: the game theory approach where networks with few nodes are studied and the stochastic approach that studies networks of large size. The study of large networks is difficult to apply in the laboratory for physical reasons.¹ In Chapter 2, groups of 5 people are formed. It limits the external validity of this kind of experiment. In our experiment, increasing the number of nodes could change the results. Indeed, it is more difficult to coordinate when the number of nodes is large. The social preferences (fairness concerns for example) would be different in an experiment where individuals are not in a small group. Another limit of our experiment is that links are binary relationships; the link exists or not. We do not test the strength of these links. More generally, the other limitation is that interactions are very abstract and limited in the laboratory. It does not reflect all the subtleties of real-life networks. It would be interesting to introduce in laboratory experiments on networks more interactions and more communication.

Chapter 3: limits and extensions In Chapter 3, the influence of peers is studied in a particular case: performance and dishonesty. It would be interesting to replicate the experiment in other contexts in order to see whether it can be applied to other types of behavior. Moreover, in our experiment, we cannot disentangle strategic complementarity and conformity. We would like to extend our study thanks to two other treatments that would help us to disentangle these two mechanisms. To achieve that, we propose a payment scheme that is no more individual but that depends on peers' behavior. Individuals' payoff will depend on their performance (actual performance if they chose the Automatic version or reported performance if they chose the Manual version) and on their peers' performance (actual performance of their peers if their peers chose the Automatic version or reported performance of their peers

¹Some experiments on Internet allow to create very large networks (Gracia-Lázaro et al., 2012).

if their peers chose the Manual version). We would like to test this complementary payment scheme with an exogenous and an endogenous network formation in order to test whether payoff complementarity modifies the choice of links of individuals and their behavior. Finally, we studied peer effects via the observation of information of others' behavior; we focus on observation effects. However, peers' actions may have direct consequences on individuals and modify their decisions. In our experiment, peers' dishonesty has no impact (positive or negative) on individuals. The experimental literature on dishonesty and more generally on social norms is growing rapidly. Understanding individual decisions and aggregated outcomes requires a full understanding of influence mechanisms that are complex, and still difficult to analyze.

Bibliography

- Bala, V. and Goyal, S. (2000). A noncooperative model of network formation, *Econometrica* **68**(5): 1181–1229.
- Gracia-Lázaro, C., Ferrer, A., Ruiz, G., Tarancón, A., Cuesta, J. A., Sánchez, A. and Moreno, Y. (2012). Heterogeneous networks do not promote cooperation when humans play a prisoner's dilemma, *Proceedings of the National Academy of Sciences* **109**(32): 12922–12926.

Conclusion générale

Cette thèse contribue à la littérature sur l'économie des réseaux de manière théorique, expérimentale et économétrique. Dans un monde de plus en plus connecté, il est primordial de comprendre comment les réseaux doivent être formés de manière optimale, comment les individus forment leurs réseaux et comment cela impacte sur leurs comportements individuels et sur les résultats économiques agrégés.

Tout d'abord, la thèse contribue à la littérature théorique sur la formation et la protection optimale des réseaux lorsque les liens de ces réseaux sont attaqués (Chapitre 1). C'est à notre connaissance la première fois que les attaques de liens (et non de nœuds) sont abordées dans cette littérature. L'objectif dans ce chapitre est de maintenir la communication entre tous les nœuds d'un réseau alors que leurs liens sont attaqués. Cela nous permet de comparer nos résultats aux résultats des autres modèles de la littérature sur l'attaque des nœuds. Dans les modèles où l'adversaire attaque les nœuds du réseau, si le coût de protection est trop élevé par rapport au coût de formation de liens, les nœuds doivent être connectés avec suffisamment de liens pour résister à l'attaque. Si le coût de protection est plus faible, les protections sont plus avantageuses. Former un réseau en étoile et protéger le nœud central suffit à maintenir la connexion entre plusieurs nœuds. Dans notre modèle, si le coût de protection est relativement élevé, il est préférable, comme dans les autres modèles, de créer suffisamment de liens non-protégés pour résister à l'attaque. Si le coût de protection est plus faible, il est plus avantageux de former des liens protégés. Nous montrons que protéger les liens est plus coûteux que de protéger les nœuds, car pour maintenir la connexion entre les n nœuds, il faut protéger $n - 1$ liens. En effet, comme les nœuds sont complémentaires dans notre modèle, maintenir la connexion entre tous les nœuds est nécessaire. Dans les deux cas (attaque de liens et attaques de nœuds), il existe deux solutions optimales polaires selon les coûts de protection par rapport au coût de formation de liens : une qui n'utilise aucune protection et

une qui utilise des protections.

Le Chapitre 2 contribue aussi à la littérature théorique sur la formation de réseaux lorsque les nœuds eux-mêmes décident de former leurs liens. En effet, nous étendons légèrement le modèle de Bala et Goyal (2000) en mettant en place un processus de formation de liens séquentiel plutôt qu'un processus simultané. L'équilibre strict de Nash est également la CSS mais où le nœud central est toujours le dernier nœud du processus séquentiel.

Le Chapitre 2 contribue également à la littérature expérimentale sur la formation de réseaux en testant cette adaptation du modèle de Bala et Goyal (2000) dans le laboratoire. Dans la plupart des expériences de formation de réseaux en laboratoire, le processus de formation de liens est simultané. Cela crée des difficultés de coordination, car les individus ont du mal à anticiper les décisions des autres. Dans le Chapitre 2, nous montrons que la séquentialité facilite la coordination des individus en laboratoire. En effet, ils forment des réseaux efficaces et stables. Cependant, la CSS, réseau d'équilibre, n'émerge pas, comme dans de nombreuses autres expériences. En effet, elle est inégalitaire et les individus ont tendance à créer au moins un lien pour être certain de faire partie du réseau. Nous introduisons de l'hétérogénéité grâce à la présence d'un individu à plus forte valeur monétaire ou avec un statut différent. La présence d'un individu avec une plus forte valeur monétaire permet d'augmenter l'asymétrie du réseau, car il polarise les liens.

Enfin, la thèse contribue à la littérature économétrique et expérimentale sur les effets de pairs (Chapitre 3). Grâce au laboratoire, nous pouvons identifier les effets de pairs purs, en créant des réseaux exogènes pour retirer le problème d'endogénéité dû au choix des pairs. De plus, nous pouvons mesurer l'effet de l'auto-sélection en permettant aux individus de choisir leurs pairs dans un autre traitement. Le laboratoire est un outil de contrôle nous permettant d'identifier ces différents effets. Nous montrons que les effets de pairs observés sur la malhonnêteté sont en grande partie dus à la présence d'homophilie.

L'économie des réseaux utilise des méthodologies diverses pour tenter d'appréhender leurs multiples facettes. Chaque méthodologie a cependant des limites.

Chapitre 1 : limites et extensions Ce chapitre a pour vocation de comprendre les mécanismes lorsque les liens peuvent être attaqués et également de comprendre les différences avec les modèles où les nœuds sont attaqués. A la fin de ce Chapitre, nous ajoutons plus de réalisme à notre modèle en limitant les possibilités de défense du designer (limitation des ressources de protection et probabilité d'échec de la protection). Une extension intéressante de ce Chapitre 1 serait de varier les coûts de protection selon la localisation de ces protections. En effet, protéger des liens ou des nœuds adjacents est moins coûteux et plus simple pour le planificateur central. Dans ce Chapitre, nous faisons l'hypothèse que le designer a une information parfaite concernant l'attaque de l'adversaire, à savoir le nombre de liens qu'il peut attaquer. Une deuxième extension intéressante serait donc de rendre l'information incomplète. Ceci pourrait refléter de nombreuses situations comme des attaques militaires où les ressources de l'ennemi ne sont pas parfaitement connues.

Chapitre 2 : limites et extensions Le laboratoire prodigue de nombreux avantages pour contrôler les variables (coûts, valeurs, information, temps, etc.) qui influencent les choix des agents. Cependant, l'étude des réseaux en laboratoire a plusieurs limites. Deux branches ont été développées : l'approche de la théorie des jeux où les réseaux avec peu de nœuds sont étudiés et l'approche stochastique qui étudie des réseaux de grandes tailles. L'étude de réseaux de grandes tailles est difficilement applicable en laboratoire.¹ Dans le Chapitre 2, l'expérience porte sur des groupes de 5 personnes. Cela limite la validité externe de ce type d'expérience. Dans notre expérience, augmenter le nombre de nœuds pourraient donner des résultats différents. En effet, il est plus difficile de se coordonner lorsque le nombre de nœuds est grand. Le niveau des préférences sociales (volonté d'égaliser les profits) serait peut être différent dans une expérience où les individus ne sont pas en petit groupe. Une autre limite dans notre expérience est que les liens sont des relations binaires : le lien existe ou non. Nous ne contrôlons pas la force de ces liens. Plus généralement, les interactions sont très abstraites et limitées dans le laboratoire. Cela ne reflète pas toutes les subtilités des réseaux dans la vie. Il serait intéressant d'introduire dans les expériences sur la formation de réseaux davantage d'interactions et de communication.

¹Certaines expériences sur Internet permettent toutefois de créer des réseaux très larges (Gracia-Lázaro et al., 2012).

Chapitre 3 : limites et extensions Dans le Chapitre 3, l'influence des pairs est étudiée dans un cadre particulier : la performance et la malhonnêteté. Il serait intéressant de réitérer l'expérience sur d'autres décisions économiques afin de voir si nous pouvons confirmer nos résultats. De plus, dans notre expérience, nous ne pouvons pas distinguer les effets de complémentarité stratégique et de conformité. Nous prévoyons d'étendre notre étude grâce à deux autres traitements qui nous permettront de distinguer ces deux mécanismes. Afin d'y parvenir, nous proposons un mécanisme de paiement non plus individuel mais qui dépend des décisions des pairs. Le gain des individus dépendra donc de leurs décisions (performance réelle s'ils ont choisi la version Automatique ou performance reportée s'ils ont choisi la version Manuelle) et des décisions de leurs pairs (performance réelle de leurs pairs si ceux-ci ont choisi la version Automatique ou performance reportée de leurs pairs si ceux-ci ont choisi la version Manuelle). Nous voudrions tester ce mécanisme de paiement complémentaire avec une formation de réseau exogène et endogène afin de tester si la complémentarité des paiements modifie les choix de liens des individus et leurs comportements. Enfin, nous étudions les effets de pairs via l'observation d'information sur le comportement d'autres membres. Nous nous focalisons donc sur des effets d'observation. Cependant, les actions des pairs peuvent avoir une conséquence directe sur les individus et modifier leurs décisions. Dans notre expérience, la malhonnêteté des pairs n'a pas d'impact (positif ou négatif) sur les individus. La littérature sur la malhonnêteté et sur les normes sociales de manière générale est en pleine expansion en laboratoire. Comprendre les décisions individuelles et les résultats agrégés demande une compréhension des mécanismes d'influence qui sont complexes, et encore aujourd'hui difficiles à identifier.

Bibliography

- Bala, V. et S. Goyal (2000). A noncooperative model of network formation. *Econometrica* 68(5), 1181–1229.
- Gracia-Lázaro, C., A. Ferrer, G. Ruiz, A. Tarancón, J. A. Cuesta, A. Sánchez, et Y. Moreno (2012). Heterogeneous networks do not promote cooperation when humans play a prisoner's dilemma. *Proceedings of the National Academy of Sciences* 109(32), 12922–12926.

Abstract

In a world where networks become a dominant form of organization, the structure of networks and the position of individuals in these networks affect individual behavior and aggregate economic outcomes. The analysis of network formation by a central planner or by individuals themselves is at the heart of this thesis on the economics of networks.

Chapter 1 theoretically studies the optimal formation and protection of networks by a central planner knowing that an external agent can destroy k links. The protection of the network can be guaranteed either by densifying the links between nodes, or by protecting the links. When the cost of protection is relatively small, a minimally connected network composed of protected links guarantees the communication flow; if this cost is high, the optimal solution is to form a symmetric network where each node has at least $k+1$ non-protected links.

Chapter 2 explores the decentralized formation of networks in the laboratory by analyzing individual linking formation decisions when one agent has a higher value than others and that the linking formation process is sequential. The results show that sequentiality facilitates the coordination on efficient networks but that do not correspond to the Sub-game Perfect Equilibrium. The heterogeneity across agents increases the asymmetry of networks because of the polarization of links on the agent with a higher value.

Chapter 3 studies the impact of the endogenous formation of networks on the importance of peer effects, applied to dishonest behavior. In order to identify the effects of social comparisons, two controlled environments are designed in the laboratory in which individuals choose or not their peers, and then observe their behavior. The results show that peer effects on dishonest behavior are significantly higher when individuals can choose their peers.

Keywords: economics of networks; formation and protection of networks; peer effects.

Résumé

Dans un monde où les réseaux deviennent une forme dominante d'organisation, la structure des réseaux et la position des individus en leur sein affectent les comportements individuels et les résultats économiques agrégés. L'analyse de la formation des réseaux par un planificateur central ou par les individus est au cœur de cette thèse en économie des réseaux.

Le Chapitre 1 étudie de manière théorique la formation et la protection optimale des réseaux par un planificateur central sachant qu'un agent externe peut détruire k liens. La protection s'effectue soit en densifiant les liens entre les nœuds, soit en protégeant les liens. Lorsque le coût de protection est suffisamment faible, un réseau minimalement connecté constitué de liens protégés garantit le flux de communication; si ce coût est élevé, la solution optimale est de former un réseau symétrique où chaque nœud possède au moins $k+1$ liens non-protégés.

Le Chapitre 2 explore la formation décentralisée de réseaux en laboratoire en analysant les décisions individuelles de formation de liens lorsqu'un agent a une valeur supérieure aux autres et que le processus de formation de liens est séquentiel. Les résultats montrent que la séquentialité facilite la coordination sur des réseaux efficaces mais qui ne correspondent pas à l'équilibre parfait en sous-jeu. L'hétérogénéité entre les agents accroît l'asymétrie du réseau en raison de la polarisation des liens sur l'agent à valeur supérieure.

Le Chapitre 3 étudie l'impact de la formation endogène d'un réseau sur l'importance des effets de pairs, avec une application aux comportements malhonnêtes. Afin d'identifier les effets des comparaisons sociales, deux environnements contrôlés sont créés en laboratoire dans lesquels les individus choisissent ou non leurs pairs, puis observent leur comportement. Les résultats montrent que les effets de pairs sur les comportements malhonnêtes sont significativement accrus lorsque les individus peuvent choisir leurs pairs.

Mots-clés: économie des réseaux ; formation et protection de réseau ; effets de pairs.