



HAL
open science

Representation of Monoids and Lattice Structures in the Combinatorics of Weyl Groups

Joël Gay

► **To cite this version:**

Joël Gay. Representation of Monoids and Lattice Structures in the Combinatorics of Weyl Groups. Discrete Mathematics [cs.DM]. Université Paris Saclay (COMUE), 2018. English. NNT : 2018SACLS209 . tel-01861199

HAL Id: tel-01861199

<https://theses.hal.science/tel-01861199>

Submitted on 24 Aug 2018

HAL is a multi-disciplinary open access archive for the deposit and dissemination of scientific research documents, whether they are published or not. The documents may come from teaching and research institutions in France or abroad, or from public or private research centers.

L'archive ouverte pluridisciplinaire **HAL**, est destinée au dépôt et à la diffusion de documents scientifiques de niveau recherche, publiés ou non, émanant des établissements d'enseignement et de recherche français ou étrangers, des laboratoires publics ou privés.



Representation of Monoids and Lattice Structures in the Combinatorics of Weyl groups

Thèse de doctorat de l'Université Paris-Saclay,
préparée à l'Université Paris-Sud

École doctorale 580 : Sciences et technologies de
l'information et de la communication (STIC)
Spécialité de doctorat : Informatique

Thèse présentée et soutenue à Orsay, le 25 juin 2018, par
GAY Joël

Composition du jury :

M.	Nantel BERGERON	Research Chair York University Dpt of Maths. and Statistics	Rapporteur
M.	Riccardo BIAGIOLI	Maître de conférences Université Claude Bernard Institut Camille Jordan	Rapporteur
Mme	Viviane PONS	Maîtresse de conférences Université Paris Sud Labo. de Recherche en Informatique	Examinatrice
M.	Marc BABOULIN	Professeur Université Paris Sud Labo. de Recherche en Informatique	Président
M.	Jean-Christophe NOVELLI	Professeur Université Paris-Est Institut Gaspard Monge	Examinateur
M.	Patrick DEHORNOY	Professeur émérite Université de Caen Labo. de Maths. Nicolas Oresme	Examinateur
M.	Florent HIVERT	Professeur Université Paris Sud Labo. de Recherche en Informatique	Directeur
M.	Vincent PILAUD	Chargé de recherches CNRS & École Polytechnique Labo. d'Informatique de l'X (LIX)	Directeur

Contents

Remerciements	1
Introduction (Français)	7
Introduction	23
I Background	39
1 Combinatorics and operators	43
1.1 Permutations	43
1.1.1 Permutation and matrices	43
1.1.2 Generation by elementary transpositions	44
1.1.3 Inversions and weak order	45
1.1.4 Descent set and bubble sort	46
1.1.5 Compositions and ribbons	48
1.1.6 Lehmer code and presentation	49
1.1.7 Partitions, cycle decomposition and Foata transformation	50
1.2 Posets	51
1.2.1 First definitions	51
1.2.2 Construction of posets	52
1.2.3 Lattice	54
1.3 Elementary semigroup theory	55
1.3.1 Green relations	55
1.3.2 Subsemigroup of monoids	57
1.4 Geometry	58
1.4.1 Polytopes and permutahedron	58
1.4.2 Cones and fans	59
1.5 Rooks	61
1.6 Tamari lattice	63
1.6.1 Dyck paths and trees	63
1.6.2 Tamari order and weak order	65
1.7 Vector spaces and algebras on combinatorial objects	68

2	Weyl groups	71
2.1	Reflections groups and root systems	71
2.1.1	First definitions and examples	71
2.1.2	Root systems	71
2.1.3	Relations between two roots	72
2.1.4	Positive and simple systems	74
2.1.5	Conjugation and inversions	75
2.1.6	Generators and relations	76
2.1.7	Geometry and parabolic subgroup	77
2.1.8	Irreducible root systems	79
2.2	Classification	80
2.2.1	Coxeter system and reflection group	80
2.2.2	Coxeter graph and classification	81
2.2.3	Presentation and Matsumoto's theorem	82
2.2.4	Tits system and linear algebraic group theory	83
2.3	Some properties in type A , B and D	84
2.3.1	Type A	84
2.3.2	Type B and C	85
2.3.3	Type D	87
2.4	The Iwahori-Hecke algebra	89
2.4.1	Type A	89
2.4.2	Coxeter types	91
2.4.3	Rook monoid and Solomon's algebra	92
3	Representations	95
3.1	Introduction: representations of finite groups	95
3.1.1	Representation and subrepresentations	95
3.1.2	Character theory	96
3.1.3	Some examples	97
3.2	Representation of finite dimensional algebras	97
3.2.1	Simple modules	98
3.2.2	Indecomposable modules	100
3.2.3	Idempotents	101
3.2.4	Quiver	102
3.3	Representations of \mathcal{J} -trivial monoids	104
3.3.1	\mathcal{J} -classes and representations	104
3.3.2	Simple modules	105
3.3.3	Projective indecomposable modules	106
3.3.4	Ext-quiver	108
3.4	Induction and restriction	108
3.4.1	Definitions	108
3.4.2	Hopf algebra	109
3.4.3	Grothendieck groups	113
3.4.4	Tower of algebra and categorification	114
3.5	The tower of $(\mathfrak{S}_n)_{n \in \mathbb{N}}$	115
3.5.1	Partition and Young tableaux	115

3.5.2	Representations of the symmetric group and Schur functions	117
3.5.3	Induction, restriction and categorification	118
3.6	The tower of $(H_n^0)_{n \in \mathbb{N}}$	119
II	Presentation and representation of 0-Rook monoid	121
4	The 0-rook monoid	125
4.1	Definition of R_n^0 by generators and relations	125
4.2	Definition by action and R -codes	128
4.2.1	R -code and rooks	129
4.2.2	Counting rook according to the position of the first 0	133
4.3	Equivalence of the definitions of R_n^0	135
4.4	A Matsumoto theorem for rook monoids	143
4.5	More actions of R_n^0	145
5	The \mathcal{R}-order on rooks	149
5.1	\mathcal{R} -triviality of R_n^0	149
5.2	The lattice of the \mathcal{R} -order	153
5.3	Chains in the rook lattice	158
5.4	Geometrical remarks	161
6	Representation theory of the 0-Rook monoid R_n^0	165
6.1	Idempotents and simple modules	165
6.2	Indecomposable projective modules	167
6.3	Ext-Quivers	169
6.4	Restriction functor to H_n^0	171
6.5	Tower of monoids	175
6.5.1	Simple modules	176
6.5.2	Projective indecomposable modules	183
6.6	Tables	185
III	Presentation and representation of 0-Renner monoids	187
7	Renner monoids	191
7.1	Definition	191
7.2	B and D -elements, with associated μ -vectors	192
7.2.1	Type B	192
7.2.2	Type D	196
7.2.3	Twist in type D	202
8	0-Renner monoid of type B and D	205
8.1	0-Hecke monoid	206
8.1.1	Reduced and action-reduced words	206
8.1.2	Description of $H_\ell^0(B)$ and $H_\ell^0(D)$	206
8.2	Grassmannian elements	208

8.2.1	Definition	208
8.2.2	Descents and grid representation in type A	208
8.2.3	Type B	209
8.2.4	Type D	211
8.3	0-Renner as transformation monoids	213
8.4	Generators	218
8.4.1	Type B	218
8.4.2	Type D	225
8.5	Code and programming	233
9	Order and representations of the 0-Renner monoids	237
9.1	\mathcal{J} -triviality	237
9.2	Representation theory	239
9.2.1	Idempotents and simple modules	239
9.2.2	Projective indecomposable modules	244
9.2.3	Restriction to $H_\ell^0(T)$	245
9.2.4	Ext-quivers	246
IV	Lattice Structure on sets of roots	249
10	Poset on posets	253
10.1	The weak order on integer posets	253
10.1.1	The weak order on integer binary relations	253
10.1.2	The weak order on integer posets	254
10.2	Weak order induced by some relevant families of posets	257
10.2.1	From the permutahedron	258
10.2.2	From the associahedron	262
10.2.3	From other associahedra	265
10.2.4	From the cube	269
11	Poset on sets of roots	273
11.1	Subsets of root systems	273
11.1.1	Φ -posets	273
11.1.2	Sums of roots in crystallographic root systems	275
11.2	Weak order on Φ -posets	277
11.2.1	Weak order on all subsets	277
11.2.2	Weak order on antisymmetric subsets	278
11.2.3	Weak order on closed subsets	278
11.2.4	Weak order on Φ -posets	281
11.3	Some relevant subposets	286
11.3.1	Permutahedron	287
11.3.2	Generalized associahedra	294
11.3.3	Cube	300
Index		315

List of Figures

0.1	Le graphe de Cayley à droite de H_4^0 et le Permutoèdre associé.	9
0.2	Le graphe de Cayley à droite de R_2^0 et R_3^0	14
0.3	L'ordre faible sur les posets de A_2	21
0.4	L'ordre faible sur les posets de G_2	22
0.5	The right Cayley graph of H_4^0 , and the associated Permutohedron.	25
0.6	The right Cayley graph of R_2^0 and R_3^0	30
0.7	The weak order on A_2 -posets.	36
0.8	The weak order on G_2 -posets.	37
1.1	Cayley graph of \mathfrak{S}_4	45
1.2	Representations and properties in \mathfrak{S}_n	47
1.3	The right-action of the bubble sort operators on \mathfrak{S}_4	48
1.4	The ribbon diagram of the permutation 3541276.	49
1.5	Example of a Hasse diagram.	52
1.6	Examples of construction of posets.	53
1.7	Example of linear extensions of a poset.	54
1.8	Example and counter-example of a lattice.	55
1.9	Green relations and Cayley graph.	56
1.10	A cyclic semigroup in a general monoid.	57
1.11	A cyclic semigroup in an aperiodic monoid.	58
1.12	The 3-permutohedron $\text{Perm}(4)$	59
1.13	The 3-dimensional braid fan $\mathcal{BF}(4)$	60
1.14	The 3-dimensional permutohedron $\text{Perm}(4)$	61
1.15	Posets inside the braid fan $\mathcal{BF}(4)$	61
1.16	The rotation of Dyck paths, Dyck words and bracketing.	63
1.17	The Tamari order on Dyck paths of length 3 and 4.	64
1.18	Rotation on binary trees.	64
1.19	The Tamari lattices of size 3 and 4 on binary trees.	65
1.20	The correspondance between Dyck paths and binary trees.	65
1.21	The infix labeling.	66
1.22	Insertion in a binary search tree and linear extensions.	66
1.23	Order of Tamari as a quotient of the right weak order.	67
1.24	The associahedron is obtained from the Permutohedron by deleting some facets.	68

1.25	Product of trees.	70
2.1	The Dihedral group of order 8.	72
2.2	Dimension 2 root systems.	73
2.3	Root space of A_3	74
2.4	Root spaces of A_3 and B_3	74
2.5	Fundamental chamber of A_2	77
2.6	Coxeter arrangement of A_3	78
2.7	Coxeter arrangement of B_3	78
2.8	Coxeter arrangement of H_3	78
2.9	Faces of the Permutohedron of size 3.	79
2.10	The Coxeter graph of \mathfrak{S}_n	81
2.11	Coxeter graphs of finite Coxeter groups.	82
2.12	Examples of Dynkin diagrams.	82
2.13	Dynkin diagrams of finite Weyl groups.	83
2.14	The root poset of A_4	85
2.15	The duality between the root systems of B_3 (left) and C_3 (right).	86
2.16	The root posets of B_4 (left) and C_4 (right).	86
2.17	The root posets of D_4	88
2.18	Descent sets of type D	89
3.1	The character table of \mathfrak{S}_3	97
3.2	The character table of \mathfrak{S}_4	98
3.3	Quiver with one admissible ideal.	103
3.4	The decomposition of H_4^0 into projective indecomposables modules.	107
3.5	The quiver of $H^0(A_4) = H_5^0$	109
3.6	Young diagram, labeling and removable boxes.	116
3.7	Standard and semi-standard Young tableau.	116
3.8	The bottom of the Young branching graph of \mathbb{Y}	117
3.9	Number of paths between partitions of \mathbb{Y}	119
5.1	The right Cayley graph of R_2^0 and R_3^0	150
5.2	The flip of a valley on special Dyck paths.	160
5.3	The lattice of \mathcal{MCR}_4 , \mathcal{MCT}_5 and all bijections.	162
5.4	The Cayley graph of R_3 embedded in a 3-dimensional space.	163
6.1	R -descent sets for R_4^0	168
6.2	The lattice of R -descent sets for R_4^0	168
6.3	Some R -descent classes.	170
6.4	An R -descent class which is not an interval of the \mathcal{R} -order.	171
6.5	The decomposition of a R_4^0 -projective module into H_4^0 -projective modules.	174
6.6	The left dual branching graph of R_n^0	181
6.7	The right dual branching graph of R_n^0	182
6.8	First counterexample for the restriction of projective modules.	183
6.9	Second counterexample for the restriction of projective modules.	184
8.1	Grid representation of type A	209

8.2	Right descents sets of right grassmannian in type B .	209
8.3	Grid representation of type B .	210
8.4	Descents sets of right grassmannian in type D .	211
8.5	Grid representations of type D .	214
8.6	Descent set of right grassmannian element in $\pi_1^e \pi_1^f$ in type D .	229
9.1	The monoid $R_2^0(B)$.	238
9.2	The monoid $R_2^0(D)$.	239
9.3	Idempotents of $R_2^0(D)$.	242
9.4	Idempotents of $R_4^0(D)$.	243
9.5	The star lattice on idempotents of $R_3^0(D)$.	245
9.6	Descent classes of $R_2^0(B)$ and $R_2^0(D)$.	246
9.7	The Quiver of $R_3^0(D)$.	247
10.1	The weak order on integer binary relations of size 3.	255
10.2	The meet and join of two antisymmetric relations.	256
10.3	Two semi-transitive relations and their different meets.	256
10.4	Two transitive relations and their different meets.	257
10.5	The weak order on integer posets of size 3.	258
10.6	A Weak Order Element Poset (WOEP).	259
10.7	A Weak Order Interval Poset (WOIP).	260
10.8	A Weak Order Face Poset (WOFP).	261
10.9	A Tamari Order Element Poset (TOEP).	263
10.10A	Tamari Order Face Poset (TOFP).	264
10.11A	Cambrian tree and its linear extensions.	266
10.12	Rotations in Cambrian trees.	267
10.13	Two ε -Cambrian lattices on ε -Cambrian trees.	267
10.14A	Cambrian Order Element Poset (COEP).	268
10.15	Two ε -snakes.	269
10.16A	Boolean Order Element Poset (BOEP).	270
10.17A	Boolean Order Interval Poset (BOIP).	271
11.1	The weak order on closed subsets of roots.	282
11.2	The weak order on A_2 -posets and on B_2 -posets.	283
11.3	The weak order on G_2 -posets.	284
11.4	The sets of the standard parabolic cosets in type A_2 and B_2 .	293
11.5	The subsets of roots corresponding to elements, intervals and faces of type B_2 .	294
11.6	The sets for the faces of the c -associahedron in type A_2 and B_2 .	299
11.7	The subsets of roots corresponding to cambrian elements and intervals of type B_2 and G_2 .	300
11.8	The sets $R(F)$ for the faces F of the cube in type A_2 and B_2 .	302
11.9	The subsets of roots corresponding to boolean elements and intervals of type G_2 .	304

Remerciements

C'est avec une grande joie mais aussi beaucoup de reconnaissance que j'écris ces dernières lignes de mon manuscrit de thèse. J'arrive donc aujourd'hui au bout de trois années officielles de thèse, auxquelles s'ajoute une année de stage. C'est la conclusion, presque dix ans jour pour jour après l'obtention de mon Baccalauréat, de mon parcours étudiant, et le début de ma vie professionnelle. Certains diront : "enfin", et je suis d'accord par plusieurs aspects... Fini les demandes perpétuelles "mais tu es encore étudiant?", "explique moi ce que tu fais", et autres "concrètement tes journées, ça ressemble à quoi?" de mes amis et famille (j'ai notamment à mes grands-parents pour qui j'ai une pensée toute particulière pour avoir réussi (ou pas) à suivre mes pérégrinations estudiantines). Fini aussi les avantages de la carte étudiante, quoique pour plusieurs la limite d'âge était déjà atteinte !

Cela marque aussi la fin de certaines relations privilégiées tissées au gré des années alors que je vais embrasser ma carrière d'enseignant (quoique, il semblerait que j'en rencontre encore un certain nombre dans les années à venir...) Cette partie se veut donc les honorer, et exprimer à eux toute ma reconnaissance.

Je commence bien évidemment avec mes directeurs de thèse, *Florent Hivert* et *Vincent Pilaud*. Disponibles, attentifs, mais aussi profondément relationnels et humains, ils ont su me guider et me diriger au cours de la jungle tumultueuse qu'est tout travail de recherche (du moins de ma courte expérience). Ils ont été généreux en temps pour moi, bien au delà du simple travail de recherche, me recommandant ou me conseillant sur mon orientation professionnelle. J'espère simplement avoir été à la hauteur de cet investissement important qu'ils ont placés en moi.

J'ai eu l'immense privilège de travailler avec *Vincent* pendant quatre années et demi. Au cours de ces échanges, il a pu me transmettre sa passion pour les arbres, canopées et autres flores combinatoires qui constituent cette jungle. Il a su m'émerveiller par ses richesses géométriques, des treillis d'arbres enracinés aux murs de briques construits au détour d'une clairière, nouvelles ruines aztèques aux formes pyramidales qui n'attendent que des explorateurs chevronnés (et très courageux). Son sens esthétique, que ce soit pour les belles mathématiques que pour les beaux exposés, a aiguisé mon œil, en témoigne mon ami *Josias* qui nous a entendu parler pendant plus d'une demi heure de la couleur de la banderole d'un poster. En plus de cette transmission scientifique et esthétique, je retiendrai aussi le maître organisateur, duquel j'ai beaucoup appris (et ai encore à apprendre...), capable de gérer simultanément une conférence en Colombie, la répartition épineuse des bureaux au LIX, l'administratif labyrinthique de ma soutenance, la conception de croquis et résumés sur chaque exposé (pour compenser sa mémoire qu'il prétend mauvaise) tout en offrant généreusement du temps pour voir comment j'avance et me proposer des routes

alternatives si je suis tombé sur un marécage. Un immense merci, en espérant avoir le privilège de continuer à le côtoyer !

Le travail avec *Florent* remonte quant à lui à quatre années. Géant à la voix de Stentor j'ai eu un plaisir scientifique évident à travailler avec lui. Ses connaissances mathématiques n'ont rien à envier aux plus éminents sages de l'antiquité, et sa mémoire digne de Mnémosyne impressionne tant il sait jongler entre les notions les plus algébriques de théorie des représentations, les algorithmes avancés sur SAGE ou encore les preuves formelles. Il allie pour ce faire simultanément une aisance que dénote l'habitude mais aussi la passion et vie qui lui sont propres. Enlisé que j'étais au bout de dix jours d'une guerre de Troie contre une preuve trop complexe, il sut en fin Ulysse trouver la brèche et me permettre de conquérir mon second article ! Mais il a plusieurs balles en son sac, et peut aussi jongler avec des sujets aussi divers que les explosifs faits maison ou que la politique russe. Un Hécatonchire bien entraîné n'arriverait pas à jongler entre autant de sujets tant bien même ce serait son supplice de Sisyphe au Tartare. Jongler, voici une activité qui lui est aussi propre, lui auprès duquel j'ai découvert l'art du cirque, des acrobaties, mais aussi de la jonglerie musicale. Nos sujets de conversation allaient aussi sur la musique minimaliste, les casse-tête à l'imprimante 3D, et je lui suis très reconnaissant de m'avoir fait découvrir le fablab rapidement ! Véritable Héraclès des mathématiques et d'à peu près tous les sujets sur lesquels on peut converser, je le remercie infiniment pour m'avoir accordé, à moi simple mortel, du temps et des rires. Je sais avec joie que nous nous croiserons encore !

Je serai plus concis dans les remerciements qui suivent, non que je n'eusse de raisons d'être prolix, mais parce que mon manuscrit est déjà bien long !

Je tiens à remercier tout particulièrement mes rapporteurs *Nantel Bergeron* et *Riccardo Biagioli* pour le travail de titan que fut cette relecture de thèse dans un temps imparti assez court. Ils ont relevé le défi, et ont su me faire nombre de retours très intéressants ! Je remercie *Nantel* d'avoir à deux reprises, à Montréal en 2016 et au LIX en 2018, pris du temps pour m'expliquer l'induction parabolique, et m'ouvrir à des sujets dont je ne soupçonnais même pas l'existence. En plus de corrections pertinentes, il a su me poser des questions que j'espère avoir le temps de creuser tant elles ont excité ma curiosité. Je n'ai pas eu le plaisir de côtoyer *Riccardo* mais ses retours et surtout son engouement pour ce travail, je cite, "plein de belles mathématiques", m'ont énormément touché.

Je remercie aussi tous mes examinateurs de jury. Merci à *Patrick Dehornoy* qui me fait l'immense honneur d'être présent pour cette soutenance. Je remercie aussi *Jean-Christophe Novelli* que j'ai côtoyé à plusieurs reprises dans ces années, autre géant de la combinatoire capable de reconnaître une suite de nombres parmi les milliers d'OEIS, ce qui fut d'ailleurs la source de résultats intéressants et amusants dans ma thèse sur les liens entre chaînes maximales dans le treillis de Tamari et le monoïde de placements de tours. Je le remercie aussi pour son amitié, ses connaissances culinaires avancées, ainsi que les temps de jeux que nous avons pu partager ! Merci encore à *Viviane Pons*, véritable grande sœur au cours de ma thèse, qui a su m'introduire dans le monde de la recherche, m'en expliquer toutes les facéties et étrangetés, mais aussi experte et aide précieuse en SAGE. J'ai eu un très grand plaisir de prodiguer des enseignements en commun avec elle, et de pouvoir ainsi discuter pédagogie, méthodes innovantes et psychologies des étudiants. Enfin je remercie *Marc Baboulin*, rencontré au LRI au moment de ma soutenance de mi-parcours où il m'avait fait plusieurs retours constructifs. Nous avons ensuite été en contact pour le travail que j'occuperai l'an prochain, et je veux le remercier pour le temps qu'il a pris avec moi pour me

présenter Polytech Paris Sud et me convaincre que c'était vraiment le travail où je voulais aller ! J'ai pu ainsi entrevoir son efficacité au travail et sa passion pour la transmission, et je me réjouis vivement de collaborer avec lui dans les années à venir !

Il est une personne dont je n'ai pas encore parlé, mais qui a eu quasiment la place d'un troisième directeur de thèse. Il s'agit de *Nicolas Thiéry*, autre géant à la belle voix d'Orphée, jongleur, mathématicien, informaticien, touche à tout... Je lui dois la métaphore de la jungle, quelques leçons de jonglerie en Israël, la programmation en ligne de commande de la découpeuse laser, mais aussi un profond respect et lui exprime tous mes remerciements pour le temps qu'il a pris avec moi à de nombreuses reprises, que ce soit pour des problèmes de maths ou de programmation. Il fut aussi un de mes référents de cours pendant trois années, et j'ai tant appris avec lui en enseignement que la liste en serait trop longue. Je me réjouis vivement d'échanger encore avec lui, et d'être amené à travailler peut-être directement ensemble !

Je veux remercier aussi tout ceux qui ont participé à mon ouverture mathématique et scientifique. Je pense à *Jean-Yves Thibon*, mon grand-père de thèse, dont chaque ligne d'exposé est sujet de réflexion pour les heures à venir, et qui nous a suggéré à Florent et moi le travail sur le monoïde de placements de tours. Je pense aussi à toute l'équipe de Marne-la-Vallée, *Arthur Nunge*, *Grégory Châtel*, *Samuele Girardo*, *Matthieu Joshua-Vergès* et *Zakaria Chemli*. Merci à *Yann Palu* et *Pierre-Guy Plamondon* pour leur sympathie et leur amitié dans le groupe de travail sur les algèbres et amassées. *Eric Fusy* pour des discussions au cours de ce même groupe de travail. Mais aussi *Salvatore Stella* pour des discussions sur SAGE. Enfin *Stuart Margiolis* qui nous a poussé dans la direction des monoïdes de Renner. Je crains d'en oublier...

Je remercie aussi mes deux équipes au milieu desquelles j'ai eu plaisir à évoluer. Du côté du LIX on trouve dans les permanents *Gilles Schaeffer*, *Marie Albenque*, *Eric Fusy*, *Jérémie Bettinelli*, *Luca Castelli-Aleardi*, *Maks Ovsjanikov*, *Ekaterina Vassilieva*, avec qui j'ai pu échanger au gré des séminaires et des mercredis (jours d'affluence par excellence). Je remercie aussi mes collègues et frères doctorants; *Thibault* grand frère si drôle quand il s'énerve ou stresse pour un déplacement; *Aram* frère arménien américain du Canada amateur de jeux de société; *Matthias* à l'humour piquant qui partage un de mes bureaux, mon bureau et mon jour de naissance; *Julian* qui m'a convaincu qu'on pouvait faire des mathématiques intéressantes sur le football; *Amedeo* qui m'a fait découvrir des spécialités italiennes, *Étienne* partenaire involontaire des problèmes de TER sur la ligne Lyon - Annecy; *Dorian* dont l'imagination (ou folie?) m'émerveille autant qu'elle m'amuse, et qui se retrouve toujours dans des situations cocasses; *Henri* à l'énergie posée et assurée. Du côté du LRI j'ajoute *Benjamin Hellouin de Menibus*, *Francesca Fiorenzi* à toute l'équipe GALAC, toute cette petite équipe dirigée par *Johanne Cohen* et *Yannis Manoussakis* que je remercie vivement pour ce travail de coordination pas toujours facile. Je mentionne également toute l'équipe logistique avec les chères *Martine Lelièvre*, *Béatrice Fixois*, *Myriam Joseph*, *Gladys Bakayoko* et *Sylvie Menou* toujours disponibles et souriantes, auxquelles s'ajoute le vaillant *Jean-Pierre Merlin* fidèle au poste ! Moins de collègues doctorants de ce côté, *Aladin* et *Jean-Baptiste* étant partis trop vite mais de qui j'ai beaucoup appris dans le cours qu'on a donné en commun. *Hugo* et *Arpad* ces derniers mois, avec qui j'espère pouvoir continuer à converser ! Mais bien sûr il y a *Justine*, éternelle victime du syndrome de l'imposteur, et je profite de ces lignes pour lui témoigner combien elle a déjà fait montre de ses capacités, et dont j'apprécie les qualités pédagogiques que ce soit en classe ou

en exposé. Dessinatrice sur tableau blanc hors-paire, elle a égayé notre bureau et je me réjouis de rester à côté pour la voir encore ! Je remercie aussi les personnes avec qui j'ai pu faire de l'enseignement et qui m'ont particulièrement marqués, entre autres et de façon non exhaustive *Laurent Rosaz, Cécile Germain, Aurélien Decelle, Ulysse Gérard, Adeline Pierrot* et *Rachid Gherbi*. Merci enfin à *Romain Di Vozzo* du Fablab pour les temps que j'ai pu passés là-bas et sa disponibilité à me montrer les machines.

Je tiens maintenant à remercier tous mes amis d'études qui ont su m'accompagner et me suivre de plus ou moins loin dans cette thèse. Je pense aux amis d'Ulm, *Diego* qui m'a tant apporté et reste le matheux le plus impressionnant que je connaisse; *Guillaume* avec lequel je partage tant de passions et de jeux de société; *Jhjh-Huang* cuisinier hors-pair et ami très cher; *Gabriel* musicien incroyable amateur d'étranges œuvres modernes; *Florence* à l'énergie décapante, cheffe des zigotis; *Maxime* au rire communicatif; *Médéric* qui continue sans cesse de me surprendre; *Miguel* suisse-colombien à l'humour bien marqué; *David* pince sans rire de l'étagé; *Joseph* pianiste au grand cœur; *Abel* partenaire fidèle dans le master.. Je pense aux amis d'agrégation (et de tarot), *Roxane, Michael, Quentin, Frédérique, Lucile, Didier*, etc. Je pense à mes amis de prépa, *Jean* au chapeau khâgneux et aux chaussures pointues; *Guillaume* bourreau de travail et fan de guild wars; *Martin* athlète scout et physicien pilote; *Pierre* et son flegmatisme; *Bruno* et son bagou; mais aussi *Mathilde, Emilie, Violette*. Je pense aussi à *Hannah, Thomas, Elisée, Duncan, Evan, Adrien, Angelina, Hélia, Amandine, Alain* et *Claudette* des scouts pour tous les moments partagés ensemble.

Un gros bloc maintenant, de loin le plus important en taille ! Je remercie tous mes amis chrétiens de l'église de Palaiseau, des Groupes Bibliques Universitaires, et de différentes associations. Ce sont des chers frères et sœurs qui, quoique souvent très éloignés de mes considérations mathématiques, on parfois mieux que mes collègues su me motiver pour mon travail en thèse, m'ont fait des piques régulières pour voir comment j'avancais, et n'ont pas hésité à me pousser quand je n'avancais pas. C'est tellement précieux de vous avoir tous, et Dieu sait combien je vous suis reconnaissant ! Vous m'avez entouré de prières, que ce soit pour ma vie ou pour mon travail. Vous avez été présents pour m'aider dans bien des moments et vous avez partagés beaucoup de mes joies et mes peines. La liste des personnes à remercier est longue, et chacun pour des raisons qui lui sont propres. Je pense à *Nathan G, Jérémie, Ivan, Dimitri, Pauline* et *Matthieu*, partenaires de foi et de thèse. Je pense à *Timothée B, Laetitia, Isabelle, Marion, Marie, Nicolas K, Nathan D, Sylvain, Jeremy, Florent*, auteurs de la plupart des piques qui ont su me motiver à bosser. Je pense aussi à *Eunice, James H, Josias, Anthony, Yann M, Keith* qui m'ont logé ou m'ont aidé à me loger dans les différentes conférences. Mais aussi à tous les autres, *Samuel* et *Sarah, Gaëtan, Mailys, Sophie, Cécile M, David M, Alix* et *Pierre-Olivier, Lucie, Guillaume Y, Marc, Julie* et *Yannick, Manu, Billy, Bèlèn, Laure* et *Joël, Honoré, Benjamin E, Alexandre* et *Sarah, Alicia V, Olivier, Jonathan V, Cynthia* et *Alex, Guillaume A, William* et *Eléonore, Robert, Mathilde R, Nicolas B, Timothée S, Jonathan S, Dylan, Johan* et *Miriam, Julie* et *Zacharie, Jean-Baptiste, Caillou, Yoann, Charles* et *Anneline, Nathanaël* et *Elysa, Julien, Victor, Julie* et *Julian, Jocelyne, Samuel C, Timothée F, Cyril, Dimitri C, Gwenaël, Jérémy A, Nia, Priscille* et *Gabi, Mucia, Henrique* et *Sofia, Jean-François, Sarah* et *Diego, Aiky, Jules, Paul L, Aline, Mikaël* et *Isaline, Samuel S, Meryl, Lise-Audrey* et *Amaury, Jeanne, Pierre, Eliott* et *Ony, Timothée, Nathalie* et *Jean-Marc, Hélène* et *Jean-Pascal, Lydie, Dominique* et *Yolande, Mamy* et *Niarintsoa, Mathilde, Jacques* et *Martine, Gisèle* et *Robert, Pierre, Yuko* et *Clément, Anne-Lise, François, Aurélie, Florence* et *Christophe, Elizabeth*

et Jacques, France-Lise, Katty et Clément, Philippe et Analee, Tracy et Joseph, Adonaï, Sarah S, Christelle, Pierre C, Nicolas C, David et Noémie, Timothée et Cerasela, Clément, Benjamin N, Timothée B, Guillaume et Louise, Buan, Cécile K, Nans, Jean-David et Noémie, Alexandre D, Sandrine et Franck, Élise K, Mino et James, Fanny, Thibault, Pascale et Olivier, Olivier et Lycia, David et Alice, Anne et Jean-Marc, Doris, Geneviève et Samuel, Naomi et Aymard, Benjamin et Cécile, Emmanuel et Ludmila, Jean-David et Aurélie, Pierre-Daniel et Pascale, Christian et Hélène, Audrey, Corinne, Micha, Guillaume et Pauline, Johanna, Rémi et Astrid, Simon, Cédric et Odile, Alicia, Jacques et Milena, et mes chers petits frères Emmanuel, Antoine et Raphaël. Je crains que la liste ne soit pas exhaustive, veuillez m'en excuser.

Je veux remercier ma famille. Mes cousins Oliver, Joanna, Léna, Laura et Claudia, ainsi que mon oncle parisien Patrick, que je vois peu mais qui m'encouragent dans cette voie étrange qu'ils ne comprennent pas. Mes parents surtout, Didier et Corinne, qui m'ont élevé en m'apprenant à aimer la découverte, la transmission, et ont suscité ma curiosité très tôt. Vos prières m'ont dirigé et conduit, et je sais que vous continuerez à penser à moi. Je remercie ma petite sœur Noémie et mon beau-frère Antoine pour leur soutien malgré la distance, la prise de nouvelles régulières, et les joies qu'on peut partager ensemble. Je remercie David et ma belle-sœur Noéline pour les temps d'échanges et de croissance, pour votre folie et simplicité. Je remercie enfin vivement Julie. Merci pour ta présence à mes côtés, pour tes encouragements et tes exhortations, merci pour tous les temps qu'on peut passer ensemble et tes prières pour ma vie. Je sais que ce manuscrit vous restera à tous imperméable, mais je vous aime !

Merci enfin Jésus-Christ, mon sauveur, mon seigneur et mon Dieu. Tu m'as donné toutes ces personnes pour veiller sur moi. Des directeurs géniaux pour m'encadrer dans ma thèse. Des collègues passionnants et encourageants pour avancer au quotidien. Des amis qui me poussent plus loin. Des frères qui m'encouragent dans les difficultés et me font aller de l'avant. Merci, car tu prends bien soin de moi, et tu continueras où que j'aille !

Un ami aime en tout temps, et quand survient l'adversité il se révèle un frère.
La Bible

Introduction

Cette thèse traite de combinatoire algébrique, c'est-à-dire la manière d'utiliser des méthodes combinatoires et des algorithmes pour étudier des calculs algébriques, et réciproquement comment appliquer des outils provenant de l'algèbre à des problèmes combinatoires tels l'énumération ou l'analyse d'algorithmes. Une des richesses de la combinatoire algébrique tient à diversité des points de vue qu'elle propose. Ainsi une simple permutation peut tantôt être vue comme un *vecteur*, tantôt aussi une *matrice*, ou de façon équivalente un *opérateur* sur un espace vectoriel. Mais on peut aussi la considérer comme un *mot* sur un alphabet donné, un mot sur un *ensemble générateur* soumis à certaines relations, ou encore à une fonction sur les mots. Cette diversité est illustrée dans cette thèse par l'interaction entre les *opérateurs du tri par bulle*, leur pendant algébrique appelé le *monoïde dégénéré de Hecke* et sa *théorie des représentations*, mais aussi la *structure de treillis de l'ordre faible*, ainsi que l'interprétation géométrique de ces opérateurs comme vecteurs du *permutaèdre*. Nous débutons par donner quelques motivations historiques.

Symétriseur de Jacobi, fonctions de Schur et formule des caractères de Weyl

La *théorie des représentations* a pour objectif de comprendre un *groupe* (ou plus généralement un *monoïde* ou une *algèbre*) à travers l'étude de tous les morphismes possibles de ce groupe vers le groupe des matrices. La philosophie générale est de considérer que ce dernier groupe est suffisamment bien compris grâce à l'algèbre linéaire classique, avec des outils théoriques et algorithmiques telles l'élimination Gaussienne, la théorie des valeurs propres et la réduction des endomorphismes. Historiquement tout ce processus a première été utilisé sur les *groupes symétriques* \mathfrak{S}_n et les *groupes linéaires généraux* $\mathbf{GL}_n(\mathbb{C})$. Ces groupes sont fondamentaux dans le sens qu'ils sont universels pour les groupes finis (c'est le *théorème de Cayley*) et pour les groupes de transformation géométriques. De surcroît la notion de groupe elle-même apparut comme une abstraction de ces groupes. L'une des questions les plus basiques est donc de trouver tous les morphismes possibles de $\mathbf{GL}_n(\mathbb{C})$ vers $\mathbf{GL}_m(\mathbb{C})$. Il est raisonnable de se restreindre aux morphismes *polynomiaux*, c'est-à-dire ceux dont les coefficients de la matrice image sont des polynômes en les coefficients de la matrice antécédente. Afin de classifier toutes les représentations, on peut se concen-

trer sur les représentations *irréductibles*, car toute représentation se trouve être une somme directe de représentation irréductibles.

Par sa *théorie des caractères*, Frobenius comprit le rôle fondamental de la *trace* des matrices. Il s'agit en effet d'un invariant par similitude, et par densité des matrices diagonalisables la trace d'une représentation est ainsi déterminée par ses valeurs sur les matrices diagonales. Un résultat fondamental de Schur explique qu'à une puissance du *déterminant* près, les représentations polynomiales *irréductibles* de $\mathbf{GL}_n(\mathbb{C})$ sont classifiés par les *partitions*, c'est-à-dire les suites de nombres de la forme $(\lambda_1 \geq \dots \geq \lambda_n \geq 0)$. En outre, Schur se rendit compte que la trace de la représentation ρ_λ associée à λ est donnée par le *quotient de Jacobi*:

$$s_\lambda := \text{tr} \left[\rho_\lambda \begin{pmatrix} x_1 & & 0 \\ & \ddots & \\ 0 & & x_n \end{pmatrix} \right] = \frac{\sum \varepsilon(\sigma) \sigma(x^{\lambda+r})}{\sum \varepsilon(\sigma) \sigma(x^r)},$$

où la somme est faite sur toutes les permutations $\sigma \in \mathfrak{S}_n$, où ε est la signature, r la partition $(n-1, n-2, \dots, 1, 0)$ et x^α est une notation pour le produit $x_1^{\alpha_1} \dots x_n^{\alpha_n}$. Dans cette formule il apparaît que le numérateur et le dénominateur sont des déterminants de matrices, et donc des polynômes antisymétriques en les valeurs propres x_1, \dots, x_n . De plus le dénominateur n'est autre que le *déterminant de Vandermonde* $\prod_{i < j} (x_i - x_j)$, et divise donc tout polynôme antisymétrique. Dès lors s_λ est un polynôme appelé de nos jours le *polynôme de Schur*.

La formule de Jacobi peut se voir au moyen du *symétriseur de Jacobi*

$$\mathbb{J}(f) := \frac{\sum \varepsilon(\sigma) \sigma(fx^r)}{\sum \varepsilon(\sigma) \sigma(x^r)},$$

appliqué au monôme x^λ . Le point crucial pour cette thèse est l'observation que cet opérateur se factorise :

$$\mathbb{J} = \pi_1 \pi_2 \dots \pi_n \pi_1 \dots \pi_{n-1} \dots \pi_1 \pi_2 \pi_1,$$

où π_i est l'opérateur de Jacobi à deux variables appelé *la différence divisée de Newton*:

$$\pi_i(f) = \frac{x_i f - x_{i+1} f}{x_i - x_{i+1}}.$$

Ces opérateurs satisfont les relations suivantes:

$$\begin{aligned} \pi_i^2 &= \pi_i & 1 \leq i \leq n-1, \\ \pi_i \pi_{i+1} \pi_i &= \pi_{i+1} \pi_i \pi_{i+1} & 1 \leq i \leq n-2, \\ \pi_i \pi_j &= \pi_j \pi_i & |i-j| \geq 2. \end{aligned}$$

Ils engendrent un monoïde H_n^0 dont l'algèbre est connue comme l'*algèbre dégénérée d'Iwahori-Hecke*, notée $H_n(0)$. Un point intéressant est que ces relations sont très similaires à celles du groupe symétrique \mathfrak{S}_n engendré par les *transpositions élémentaires* $s_i = (i \ i+1)$, à savoir:

$$\begin{aligned} s_i^2 &= 1 & 1 \leq i \leq n-1, \\ s_i s_{i+1} s_i &= s_{i+1} s_i s_{i+1} & 1 \leq i \leq n-2, \end{aligned}$$

$$s_i s_j = s_j s_i \quad |i - j| \geq 2.$$

Les similarités entre ces deux *présentations* ainsi que le *théorème de Matsumoto* assurent pour tout mot réduit $s_{i_1} \dots s_{i_N}$ d'une permutation σ que l'élément $\pi_\sigma := \pi_{i_1} \dots \pi_{i_N}$ ne dépend que de σ et non du mot réduit choisi. En particulier, le symétriseur de Jacobi s'avère être $\mathbb{J} = \pi_{w_0}$ où w_0 est l'élément maximal du groupe symétrique \mathfrak{S}_n . Il se trouve que tout élément de H_n^0 s'écrit sous la forme π_σ de sorte que ce monoïde est de cardinalité $n!$.

D'un autre côté, comme on peut le voir illustré sur la Figure 0.1, le *graphe de Cayley* sans boucles de H_n^0 est acyclique et sa clôture transitive définit un ordre sur les permutations:

$$\sigma < \mu \quad \text{si et seulement si il existe } \nu \text{ tel que } \pi_\sigma \pi_\nu = \pi_\mu.$$

C'est équivalent à demander $\sigma\nu = \mu$ avec $\ell(\sigma) + \ell(\nu) = \ell(\mu)$, où $\ell(\tau)$ désigne le *nombre d'inversions* de la permutation τ . Cet ordre est connu comme l'*ordre faible* sur les permutations, et a des propriétés remarquables: c'est un treillis et il peut être interprété comme une orientation linéaire du 1-squelette du *permutaèdre*:

$$\text{Perm}(n) := \text{conv}(\{\sigma((1, \dots, n)) \mid \sigma \in \mathfrak{S}_n\}).$$

L'existence de cet ordre est un argument central dans la théorie des représentations de H_n^0 .

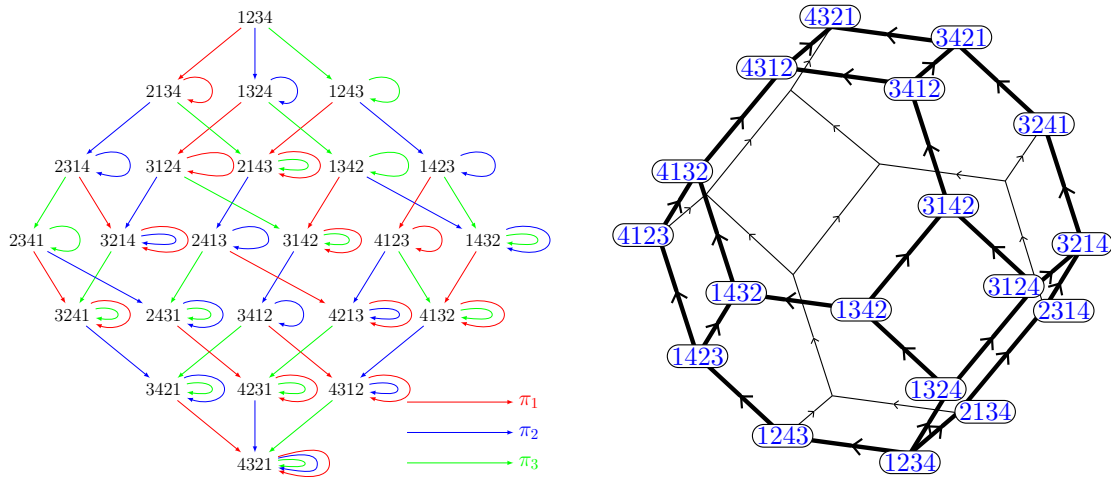

Figure 0.1: Le graphe de Cayley à droite de H_4^0 et le Permutaèdre associé.

Toute cette théorie centrée sur le groupe symétrique se généralise à d'autres groupes finis, appelés les groupes de *Coxeter* et de *Weyl*. Dans ce cadre, tout groupe de Weyl W est associé à une *algèbre de Lie semi-simple* qui joue le rôle de $\mathbf{GL}_n(k)$. Le quotient de Jacobi est un cas particulier de la *formule des caractères de Weyl*:

$$\chi_\lambda = \frac{\sum \varepsilon(w) x^{w(\lambda+r)}}{\sum \varepsilon(w) x^{w(r)}},$$

où la somme est faite sur tous les éléments $w \in W$, où λ est un *poids dominant*, r est la *somme des poids fondamentaux* et pour tout poids ω de coordonnées $(\omega_1, \dots, \omega_n)$ dans la base fondamentale des poids on écrit $x^\omega = x_1^{\omega_1} \dots x_n^{\omega_n}$. Les analogues des différences divisées de Newton s'appellent les *opérateurs de Demazure* et factorisent le *symétriseur de Weyl* comme auparavant. Ils engendrent également un monoïde de Iwahori-Hecke dégénéré $H_n^0(W)$ associé au groupe de Weyl W et dont la présentation est très semblable à celle de W . Dès lors, ceci permet de définir un symétriseur de Demazure partiel associé à chaque élément de W , ces symétriseurs ayant aussi une interprétation en terme de caractères. De plus, le graphe de Cayleur de $H_n^0(W)$ définit un *ordre faible* sur W . Cet ordre est là-encore un treillis, et une orientation du graphe du *W -permutaèdre* obtenu par enveloppe convexe de l'orbite sous W d'un point générique dans l'espace.

Motivations, contributions et sommaire de cette thèse

Cette thèse traite de différentes généralisations de l'ordre faible sur les permutations et du monoïde de 0-Hecke. La Partie I fait des rappels généraux, et nous référons à son sommaire pour avoir un aperçu de son contenu. Les Parties II et III traitent d'une première généralisation aux *monoïdes de placements de tours*. La Partie IV enfin étudie les *Φ -posets*.

Algèbre de Hecke, Monoïde de placements de tours et algèbre de Hopf

Le nom "algèbre dégénérée d'Iwahori-Hecke" provient d'une spécialisation de l'*algèbre de Iwahori-Hecke* [Iwa64]. Tout débute par l'étude du groupe général linéaire des matrices inversibles $G := \mathbf{GL}_n(\mathbb{F}_q)$ sur le corps fini \mathbb{F}_q à q éléments. Le sous-groupe B de G des matrices triangulaires supérieures est fini. Si l'on identifie une permutation avec sa matrice de permutation associée, la *décomposition de Bruhat* [BB05] qui est une application de l'élimination Gaussienne nous dit que pour tout $M \in G$ il existe une unique permutation $\sigma \in \mathfrak{S}_n$ telle que $M \in B\sigma B$. En d'autres termes :

$$G = \bigsqcup_{\sigma \in \mathfrak{S}_n} B\sigma B.$$

Iwahori a défini pour $w \in \mathfrak{S}_n$ l'élément T_w de l'algèbre de groupe $\mathbb{C}G$ par :

$$T_w := \frac{1}{|B|} \sum_{x \in BwB} x.$$

L'*anneau de Hecke* $\mathcal{H}(G, B)$ est défini comme le \mathbb{Z} -anneau engendré par les éléments T_w . Par ailleurs, pour $q \in \mathbb{C}$ on définit $\mathcal{H}_n(q)$ comme la \mathbb{Z} -algèbre définie par générateurs et relations comme suit:

$$\begin{aligned} T_i^2 &= q \cdot 1 + (q-1)T_i & 1 \leq i \leq n-1, \\ T_i T_{i+1} T_i &= T_{i+1} T_i T_{i+1} & 1 \leq i \leq n-2, \\ T_i T_j &= T_j T_i & |i-j| \geq 2. \end{aligned}$$

Si q est la cardinalité d'un corps fini, Iwahori a prouvé que l'application $T_i \mapsto T_{s_i}$ s'étend en un isomorphisme d'anneaux de $\mathcal{H}_n(q)$ vers $\mathcal{H}(G, B)$, et que les équations précédentes donnent une présentation. En étendant les scalaires à \mathbb{C} on obtient une \mathbb{C} -algèbre $\mathcal{H}_n(q)$ qui étend la définition d'anneau de Hecke au-delà des puissances des nombre premiers. Il est bien connu que quand q est non nul et n'est pas une racine de l'unité (hormis 1), l'*algèbre de Iwahori-Hecke* est isomorphe à l'algèbre complexe du groupe symétrique $\mathbb{C}\mathfrak{S}_n$.

En revanche, si dans la présentation précédente on pose $q = 0$ et que l'on définit soit $\pi_i := -T_i$ soit $\pi_i := T_i + 1$ on obtient la présentation déjà mentionnée du monoïde de 0-Hecke H_n^0 .

Dans [Sol90; Sol04] Solomon construit un analogue de la construction d'Iwahori en remplaçant le groupe général linéaire par son monoïde de matrices $M = \mathbf{M}_n(\mathbb{F}_q)$. Cette construction procède de la façon suivante : comme auparavant on désigne B l'ensemble des matrices triangulaires supérieures inversibles. Alors M admet une décomposition de Bruhat [Ren95] également : l'ensemble des matrices de permutations est remplacé par l'ensemble R_n des *matrices de placement de tours* de taille n , c'est-à-dire les matrices $n \times n$ de coordonnées dans l'ensemble $\{0, 1\}$ avec au plus une coordonnée non nulle par ligne et par colonne. Ainsi :

$$M = \bigsqcup_{r \in R_n} BrB$$

Pour toute matrice de placement de tours $r \in R_n$, Solomon définit aussi un élément T_r de l'algèbre du monoïde $\mathbb{C}M$ par

$$T_r := \frac{1}{|B|} \sum_{x \in BrB} x.$$

Ces éléments engendrent une sous-algèbre $\mathcal{H}(M, B)$ qui contient $\mathcal{H}(G, B)$ avec la même identité. Solomon a aussi défini l'algèbre $\mathcal{I}_n(q)$ qui étend la définition de $\mathcal{H}(M, B)$ en dehors des puissances de nombre premiers. La question de savoir s'il existe une dégénérescence intéressante à $q = 0$ de cet anneau et si tel est le cas, de savoir si c'est l'anneau d'un monoïde est un travail effectué avec F. Hivert [GH18b] est dès lors très naturelle. L'objectif de la Partie II est de construire un tel monoïde, appelé le monoïde de 0-placements de tours et noté R_n^0 de sorte que l'on complète le diagramme suivant :

$$\begin{array}{ccccc} \mathfrak{S}_n & \xleftarrow{q=1} & \mathcal{H}_n(q) & \xrightarrow{q=0} & H_n^0 \\ \downarrow & & \downarrow & & \downarrow \\ R_n & \xleftarrow{q=1} & \mathcal{I}_n(q) & \xrightarrow{q=0} & R_n^0 \end{array}$$

En parallèle, il est bien connu que la théorie des caractères de la famille des groupes symétriques $(\mathfrak{S}_n)_n$ peut être encodé dans les fonctions symétriques par l'*isomorphisme de Frobenius* [Mac95]. Par ce morphisme les caractères irréductibles χ_λ de \mathfrak{S}_n sont envoyés vers les fonctions de Schur s_λ de degré n . De plus l'*induction*

et la *restriction* le long du morphisme naturel d'inclusion $\mathfrak{S}_m \times \mathfrak{S}_n \longrightarrow \mathfrak{S}_{m+n}$ correspondent respectivement au produit et au coproduit (la fameuse *règle de Littlewood-Richardson*) de l'*algèbre de Hopf Sym* des *fonctions symétriques*.

Selon Krob-Thibon [KT97; Thi98], cette construction a un analogue pour les monoïdes de 0-Hecke $(H_n^0)_n$. Cependant, comme les monoïdes H_n^0 ne sont pas semi-simples la situation est davantage compliquée. On rappelle ici les différents points. Notez que la présentation classique de ces résultats se concentre sur l'algèbre $H_n(0)$ plutôt que sur le monoïde. Tout d'abord, les applications

$$\rho_{m,n} : \begin{cases} H_m^0 \times H_n^0 & \longrightarrow & H_{m+n}^0 \\ (\pi_i, \pi_j) & \longmapsto & \pi_i \pi_{j+m} = \pi_{j+m} \pi_i \end{cases}$$

sont des morphismes de monoïdes injectifs qui vérifient de plus certaines conditions d'associativité, ce qui dote $(H_n^0)_n$ d'une structure de *tour de monoïdes* [BL09; Vir14]. On peut construire deux analogues des anneaux de caractères, à savoir $\mathcal{G}_0 := \sum_n \mathbb{C}\mathcal{G}_0(H_n^0)$ la somme directe des *groupes de Grothendieck* (complexifiés) de H_n^0 -modules d'une part, et $\mathcal{K}_0 := \sum_n \mathbb{C}\mathcal{K}_0(H_n^0)$ la somme directe des groupes de Grothendieck de H_n^0 -modules projectifs de l'autre. Rappelons que \mathcal{G}_0 a pour base les modules simples S_I tandis que \mathcal{K}_0 admet pour base les modules projectifs indécomposables P_I .

Pour deux entiers m et n on désigne par $\text{Res}_{m,n}$ le foncteur de restriction des H_{m+n}^0 -modules aux $H_m^0 \times H_n^0$ -modules le long des morphismes $\rho_{m,n}$. Il s'avère que cela définit proprement des *coproduits* sur \mathcal{G}_0 et \mathcal{K}_0 . En particulier H_{m+n}^0 est projectif sur $H_m^0 \times H_n^0$. De façon duale, l'induction $\text{Ind}_{m,n}$ définit des *produits* sur \mathcal{G}_0 et \mathcal{K}_0 . Ces produits et coproduits sont compatibles et donnent une structure d'algèbre de Hopf. L'analogie de l'isomorphisme de Frobenius est alors le suivant : on désigne par QSym l'*algèbre de Hopf des fonctions quasi-symétriques de Gessel* [Ges84], et par NCSF l'*algèbre de Hopf des fonctions symétriques non commutatives* [Gel+95]. On rappelle que ces deux algèbres de Hopf duales ont une base indexée par les *compositions*. Alors l'application envoyant le module simple S_I vers l'élément F_I de la base fondamentale est un morphisme d'algèbre de Hopf de \mathcal{G}_0 vers QSym . De façon duale, l'application envoyant le module projectif indécomposable P_I vers l'élément R_I de la base ruban [Gel+95; KT97] est un morphisme d'algèbre de Hopf de \mathcal{K}_0 vers NCSF . La dualité entre QSym et NCSF se comprend alors simplement de la dualité de Frobenius entre \mathcal{G}_0 et \mathcal{K}_0 , l'image commutative $c : \text{NCSF} \rightarrow \text{QSym}$ n'étant que l'*application de Cartan*.

Ce résultat de [KT97] est la motivation principale derrière la Partie II. L'objectif était de comprendre si cette propriété sont conversées dans le cas des monoïdes de placements de tours. Ainsi au Chapitre 4 on définira notre monoïde R_n^0 tout d'abord en posant $q = 0$ dans la présentation de Halverson [Hal04] de l'algèbre de Solomon. Cela nous donnera une première définition (Définition 4.1.1 et Corollaire 4.1.6) de ce que nous appellerons dans la première partie du chapitre le monoïde G_n^0 :

Définition 1. Le monoïde G_n^0 est engendré par π_0, \dots, π_{n-1} soumis aux relations :

$$\begin{aligned} \pi_i^2 &= \pi_i & 0 \leq i \leq n-1, \\ \pi_i \pi_{i+1} \pi_i &= \pi_{i+1} \pi_i \pi_{i+1} & 1 \leq i \leq n-2, \end{aligned}$$

$$\begin{aligned} \pi_1 \pi_0 \pi_1 \pi_0 &= \pi_0 \pi_1 \pi_0 = \pi_0 \pi_1 \pi_0 \pi_1, \\ \pi_i \pi_j &= \pi_j \pi_i \quad 0 \leq i, j \leq n-1, \quad |i-j| \geq 2. \end{aligned}$$

On reconnaît dans ces relations le monoïde de 0-Hecke, mais aussi un générateur supplémentaire π_0 qui présente G_n^0 comme un quotient de $H_n^0(B)$. En fait on a la chaîne suivante de surjections (voir Équation 4.30):

$$H^0(B_n) \twoheadrightarrow R_n^0 \twoheadrightarrow H^0(A_{n+1}).$$

On introduit alors une seconde définition du monoïde de 0 placements de tours comme un monoïde de fonction agissant sur le monoïde de placements de tours. La première remarque est qu'une matrice de placement de tour (par souci de simplicité, nous ferons l'anglicisme d'appeler cela rook) peut être vu comme un vecteur d'une permutation partielle. En conservant cette idée en thèse on peut étendre l'action classique des différences divisées de Newton sur les permutations en tant qu'*opérateurs du tri par bulles* à tous les rooks:

$$\pi_i : \left\{ \begin{array}{l} R_n \longrightarrow R_n \\ r = r_1 \dots r_n \longmapsto \begin{cases} r \cdot s_i & \text{if } r_i < r_{i+1}, \\ r & \text{otherwise.} \end{cases} \end{array} \right.$$

Le nouveau générateur π_0 agit alors comme un *opérateur d'effacement*:

$$\pi_0 : \left\{ \begin{array}{l} R_n \longrightarrow R_n \\ r = r_1 \dots r_n \longmapsto 0r_2 \dots r_n. \end{array} \right.$$

Le monoïde de fonctions F_n^0 est ainsi défini (Définition 4.2.1) comme le monoïde des fonctions sur R_n engendré par π_0 et π_1, \dots, π_{n-1} . La Section 4.3 fournit une preuve que ces deux définitions sont en fait équivalentes (Corollaire 4.3.14):

Théorème 2. Le monoïde des fonctions F_n^0 et le monoïde défini par présentation G_n^0 sont isomorphes:

$$F_n^0 \simeq G_n^0$$

Dès lors on note $R_n^0 := F_n^0 \simeq G_n^0$. Notre preuve n'utilise pas la présentation bien connue du monoïde de rook classique, ni de la q algèbre de rook, mais les prouve à nouveau à partir de rien. Elle s'appuie sur un analogue du *code de Lehmer* (voir Section 1.1.6, Définition 4.2.8 et Remarque 4.2.7). Bien que ce soit combinatoirement très technique, nous soutenons que cette approche présente plusieurs avantages. Tout d'abord elle est auto contenue et purement monoïdale. Deuxièmement notre approche est explicite et fournit pour chaque rook et 0-rook un *mot réduit canonique* ainsi qu'un algorithme explicite pour amener tout mot sur un mot canonique. En particulier nous obtenons un analogue du *théorème de Matsumoto* (Théorème 4.4.3) pour R_n et pour R_n^0 , qui était un résultat qui avait été noté comme manquant dans [Sol04]:

Théorème 3 (Théorème de Matsumoto pour les monoïdes de rook). Si \underline{u} et \underline{v} sont deux expressions réduites sur $\{\pi_0, s_1, \dots, s_{n-1}\}$ (resp. $\{\pi_0, \pi_1, \dots, \pi_{n-1}\}$) du même

élément r dans R_n (resp. R_n^0), alors ils sont congrus en utilisant uniquement les relations de tresse suivantes:

$$\begin{aligned} s_i s_{i+1} s_i &= s_{i+1} s_i s_{i+1} & 1 \leq i \leq n-2, \\ s_i s_j &= s_j s_i & |i-j| \geq 2, \\ \pi_0 s_j &= s_j \pi_0 & j \neq 1. \end{aligned}$$

(resp.

$$\begin{aligned} \pi_i \pi_{i+1} \pi_i &= \pi_{i+1} \pi_i \pi_{i+1} & 1 \leq i \leq n-2, \\ \pi_i \pi_j &= \pi_j \pi_i & 0 \leq i, j \leq n-1, \quad |i-j| \geq 2.) \end{aligned}$$

Dès lors à chaque rook $r \in R_n$ on associe un 0-rook π_r . Réciproquement, r s'appelle le *vecteur de rook* de π_r . Au cours de la preuve, nous montrons aussi des résultats combinatoires sur les rooks dont le premier zéro est à une position donnée en Section 4.2.2, donnant pour cela une bijection entre certaines permutations partielles avec un nombre donné d'éléments dans un cycle, en utilisant un analogue de la *transformation de Foata* (voir Section 1.1.7 pour une définition).

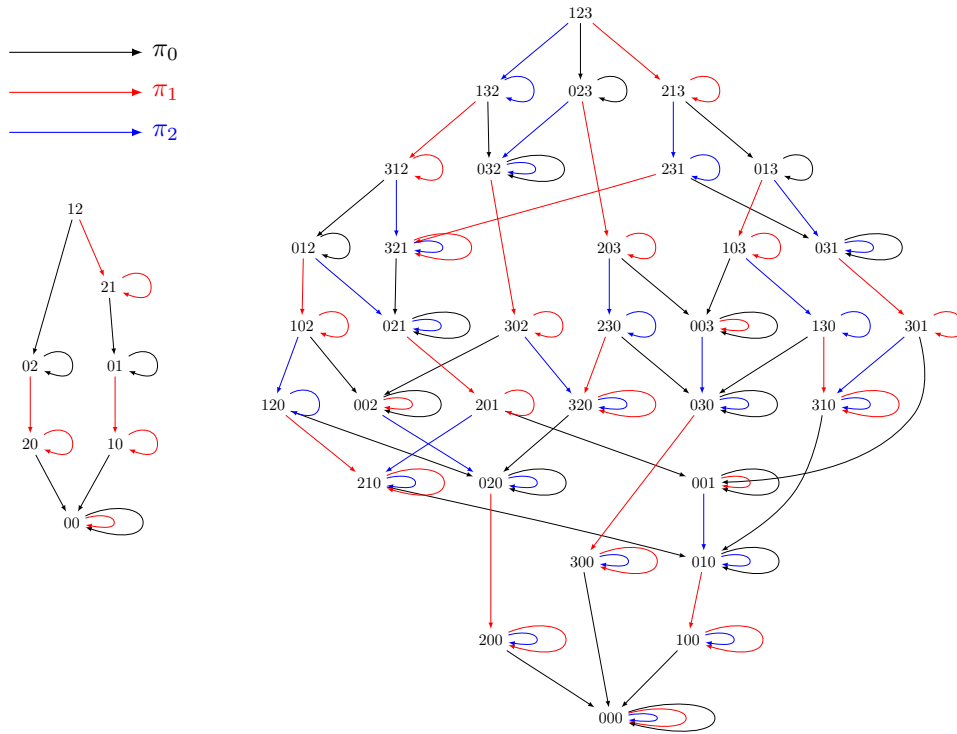

Figure 0.2: Le graphe de Cayley à droite de R_2^0 et R_3^0 .

Comme expliqué au début de l'introduction, nous sommes intéressés à des généralisations de *l'ordre faible*. Ainsi le Chapitre 5 étudie le \mathcal{R} -ordre du monoïde de 0-rook, c'est-à-dire l'ordre défini par $x \leq_{\mathcal{R}} y \iff \exists u \in R_n^0, x = yu$. À la Figure 0.2 on représente le \mathcal{R} -ordre sur le monoïde de 0-rook de taille 2 et 3.

Pour un rook $r \in R_n$ on définit (Définition 5.1.1):

- son *ensemble d'inversions* par $\text{Inv}(r) := \{(r_i, r_j) \mid i < j \text{ et } r_i > r_j > 0\}$.
- son *support* noté $\text{supp}(r)$ comme l'ensemble des lettres non nulles qui apparaissent dans son vecteur de rook.
- Pour chaque lettre $\ell \in \text{supp}(r)$, $Z_r(\ell)$ désigne le nombre de 0 qui apparaissent après ℓ dans le vecteur de rook de r .

Avec ces définitions, on obtient alors la caractérisation suivante du \mathcal{R} -ordre (Théorème 5.1.11):

Théorème 4. Si $r, u \in R_n$, alors:

$$\pi_r \leq_{\mathcal{R}} \pi_u \iff \begin{cases} \text{supp}(r) \subseteq \text{supp}(u), \\ \{(b, a) \in \text{Inv}(u) \mid b \in \text{supp}(r)\} \subseteq \text{Inv}(r), \\ Z_u(\ell) \leq Z_r(\ell) \text{ pour } \ell \in \text{supp}(r). \end{cases}$$

La principale conséquence est que le monoïde de 0-rook est \mathcal{J} -trivial, that c'est-à-dire que son graphe de Cayley bilatère est acyclique (Corollaire 5.1.12). On prouve alors que le \mathcal{R} -ordre est effectivement un *treillis* (Corollaire 5.2.2) et nous décrivons explicitement comment obtenir la *borne inférieure* (Théorème 5.2.1) et la *borne supérieure* (Théorème 5.2.5) de deux éléments. On donne aussi le nombre de bornes inférieures irréductibles pour le \mathcal{R} -ordre (Proposition 5.2.10):

Proposition 5. Le nombre de bornes inférieures irréductibles pour $\leq_{\mathcal{R}}$ est $3^n - 2^n$.

En Section 5.3 on donne une bijection entre les *chaînes maximales* de longueur minimale de R_n^0 dans le \mathcal{R} -ordre et les chaînes maximales de longueur maximale du *treillis de Tamari*. Cette bijection n'est en fait pas qu'entre les chaînes, mais entre les éléments des chaînes, qui sont les éléments appelés communément *singletons* (voir [HL07; HLT11; LL18] et les références qu'ils contiennent). Ils correspondent aux arbres binaires qui sont des chaînes, ou encore aux arbres binaires admettant exactement une extension linéaire. De façon équivalente ce sont les permutations qui évitent les motifs 132 et 312, ou encore les permutations avec exactement un élément dans leur classe sylvestre. Géométriquement, ce sont les vecteurs communs entre l'associaèdre et le permutaèdre.

Enfin, on s'intéresse aux propriétés géométriques des rooks en Section 5.4. Bien que le graphe de Cayley de R_n^0 ne soit pas le 1-squelette d'un polytope, on peut considérer l'enveloppe convexe des vecteurs de rooks. Le polytope obtenu,

$$\text{Stell}_n := \{\mathfrak{S}_n(0 \dots 0k \dots n) \mid k \in \llbracket 1, n \rrbracket\},$$

est déjà apparu sous le nom de *stelloèdre* dans [MP17, Figure18] où il était défini comme le graphe associaèdre d'un graphe d'étoile. C'est également le polytope secondaire de $\Delta_n \cup 2\Delta_n$, deux copies concentrique d'un simplexe de dimension n .

Le fait que R_n^0 soit \mathcal{J} -trivial est d'une grande importance pour sa théorie des représentations comme T. Denton, F. Hivert, A. Schilling et N. Thiéry l'expliquent dans [Den+10] (avoir aussi la Section 3.3). Ainsi le Chapitre 6 traite de la théorie des représentations. Nous décrivons l'ensemble des idempotents et leur structure de treillis (Proposition 6.1.6 et 9.2.8). Nous montrons ensuite que les modules simples sont tous de dimension 1 (Théorème 6.1.7), décrivons les modules projectifs indécomposables par des sortes de classes de descentes (Théorème 6.2.7) et décrivons

le carquois de R_n^0 (Théorème 6.3.1). On étudie ensuite comment la théorie des représentations de H_n^0 et de R_n^0 sont liées, et prouvons notamment que le dernier est projectif sur le premier monoïde (Théorème 6.4.5). De surcroît nous donnons le foncteur de décomposition de cette projectivité (Théorème 6.4.8).

Enfin la Section 6.5 est consacrée à la structure de tour de monoïdes de la suite des monoïdes de 0-rooks. Cependant les belles propriétés trouvées par D. Kroh et J-Y. Thibon ne fonctionnent pas de la façon espérée. Nous présentons une structure associative comme en Section 3.4.4 mais elle ne remplit pas les critères de N. Bergeron et H. Li [BL09] qui permettent d'obtenir une algèbre de Hopf. En particulier R_{m+n}^0 n'est pas projectif sur $R_m^0 \times R_n^0$. Nous explicitons toutefois la structure de la tour, et en particulier nous donnons la règle d'induction pour les modules simples (Théorème 6.5.16).

Théorie des monoïdes algébriques linéaires et monoïdes de Renner

La Partie III est une généralisation de la Partie II aux groupes de Weyl. C'est un travail effectué avec F. Hivert [GH18a] et la suite de l'article [GH18b]. Rappelons que les groupes de Weyl sont associés aux *algèbres de Lie semi-simples*. En fait ces groupes apparaissent dans de nombreux contextes (voir Chapitre 2, particulièrement la Section 2.2.4). Dans le contexte de la *théorie des groupes algébriques linéaires*, supposons que G soit un *groupe algébrique linéaire* sur un corps K et que T soit un *tore maximal* de G . Le *groupe de Weyl de T* , noté $W(T)$, est défini comme le groupe quotient du normalisateur $N_G(T)$ par le tore T :

$$W(T) := N_G(T)/T.$$

La *théorie des monoïdes algébriques linéaires*, développée principalement par M. Putcha, L. Renner et L. Solomon, a des connexions profondes avec la théorie des groupes algébriques. En particulier, le *monoïde de Renner* [Ren05] joue le rôle qu'a le groupe de Weyl en théorie des groupes algébriques linéaires. Ces monoïdes sont définis comme étant le quotient de la *complétion* du normalisateur d'un tore maximal d'un sous-groupe de Borel par ce sous-groupe dans un monoid algébrique irréductible régulier avec un élément zéro. On les désigne par $R(T)$. La raison pour laquelle nous introduisons ces objets est que le monoïde de Renner de type A , $R(A)$, est le monoïde de placements de tours R_n . On veut ainsi généraliser dans cette partie ce que nous avons fait pour le monoïde de 0-rook. Le prochain diagram montre à gauche ce que l'on connaît déjà en type A , tandis que notre objectif est présenté à droite.

$$\begin{array}{ccc} \mathfrak{S}_n = W(A) & \xrightarrow{\sim} & H_n^0 = H_n^0(A) & & W(T) & \xrightarrow{\sim} & H_n^0(T) \\ \downarrow & & \downarrow & & \downarrow & & \downarrow \\ R_n = \overline{\mathfrak{S}_n} & \xrightarrow{\sim} & R_n^0 & & R_n(T) = \overline{W(T)} & \xrightarrow{\sim} & R_n^0(T) \end{array}$$

Notez que dans ces diagrammes les flèches horizontales sont des bijections alors que les verticales sont des inclusions de monoïdes.

Afin de définir ces *monoïdes de 0-Renner*, nous avons besoin d'une présentation. Dans son article [God09], E. Godelle trouve une telle présentation pour un groupe

de Weyl générique. Son résultat est obtenu par la théorie générale des monoïdes linéaires algébriques. Malheureusement en donnant les présentations précises en type B et D il s'avère qu'il a oublié certaines relations et donne par conséquent des présentations fausses qui conduisent à des monoïdes infinis. Nous avons vérifié cela par programmation informatique et renvoyons le lecteur à la Section 8.5 pour plus de détails ainsi que les programmes utilisés. Par conséquent nous ne pouvons pas utiliser ces présentations comme point de départ de nos définitions des monoïdes de 0-Renner. Nous sommes alors partis d'une définition des monoïdes de Renner comme engendré par certaines matrices (Définitions 7.2.1 et 7.2.18, voir [BB05]):

Proposition 6. Dans R_{2n} on définit les éléments suivants :

- S_0 est la transposition $s_n = (n, n + 1)$.
- Pour $1 \leq i \leq n - 1$, S_i est la double transposition $s_{n-i}s_{n+i}$.
- Pour $0 \leq i \leq n$, $E_i := \begin{pmatrix} 0 & & & & \\ & \ddots & & & \\ & & 0 & & \\ & & & 1 & \\ & & & & \ddots \\ & & & & & 1 \end{pmatrix}$ avec les $n + i$ premières colonnes qui sont nulles.

Le monoïde de Renner de type B , noté $R_n(B)$, est engendré par ces éléments.

Proposition 7. Dans R_{2n} on définit les éléments suivants :

- S_1^f est la double transposition $(n - 1, n + 1)(n, n + 2)$.
- Pour $1 \leq i \leq n - 1$, S_i est la double transposition $s_{n-i+1}s_{n+i-1}$.
- Pour $0 \leq i \leq n$, $E_i := P_{n+i}$.
- La table $F := \begin{pmatrix} 0 & & & & \\ & \ddots & & & \\ & & 0 & & \\ & & & 1 & 0 \\ & & & & 1 \\ & & & & & \ddots \\ & & & & & & 1 \end{pmatrix}$, avec les $n - 1$ premières colonnes qui sont nulles.

Le monoïde de Renner de type D , noté $R_n(D)$, est engendré par ces éléments.

Nous considérons seulement les types B et D , d'abord parce qu'ils conduisent à des séries de monoïdes infinies, et deuxièmement parce que la programmation informatique ne nous a pas permis d'accéder à des grands monoïdes.

Comme nous le voyons dans les définitions précédentes, les éléments des monoïdes de Renner de type B et D peuvent être vus comme des éléments de type A comme permutations partielles de $\bar{n}, \dots, \bar{1}, 1, \dots, n$ (où $\bar{i} := -i$), que nous appelons μ -vectors. On désigne par \emptyset le zéro. Le premier résultat est de caractériser les éléments de ces monoïdes. Ce sont les *condition B* et *condition D* (Définitions 7.2.5 et 7.2.20):

Définition 8. Soit $r \in R_n$. On dit que le μ -vecteur $r = r_{\bar{n}} \dots r_{\bar{1}} \mid r_1 \dots r_n$ obéit à la *condition B* si les deux conditions suivantes sont respectées :

- *Centralement antisymétrique:* pour $1 \leq i \leq n$

$$\{r_i, r_{\bar{i}}\} \in \{\{\emptyset, \emptyset\}, \{\bar{k}, \emptyset\}, \{\emptyset, k\}, \{k, \bar{k}\}\}, \quad (0.1)$$

avec $k \in \{1, \dots, n\}$.

- *Casse toute les paires*: le μ -vecteur r n'a soit aucune lettre \emptyset , soit au moins n et au moins une des deux lettres i ou \bar{i} est manquante pour tout $1 \leq i \leq n$.

Définition 9. Si $r \in R_n$ est un μ -vecteur, on dit que r obéit à la *condition D* si et seulement si les deux conditions suivantes sont respectées :

- *B-rook*: r obéit à la condition B .
- *Parité*: Si $|r|_{\emptyset} = 0$ alors r doit avoir un nombre pair de nombres positifs dans sa première moitié. Si $|r|_{\emptyset} = n$ l'élément \tilde{r} obtenu par antisymétrie vérifiant $|\tilde{r}|_{\emptyset} = 0$ doit aussi avoir un nombre pair de nombres positifs dans sa première moitié.

En utilisant des algorithmes explicites (Algorithmes 7.2.13 et 7.2.32) on montre que ces conditions sont effectivement nécessaires et suffisantes (Théorèmes 7.2.14 et 7.2.33) :

Théorème 10. Soit $r \in R_{2n}$. Alors $r \in R_n(B)$ (resp. $r \in R_n(D)$) si et seulement si r obéit à la condition B (resp. D).

On utilise alors ces caractérisations pour compter le nombre d'éléments de type B -Renner (Corollaires 7.2.15) et D -Renner (Corollaire 7.2.34). Les résultats énumératifs étaient déjà connus par Z. Li, Z. Li et Y. Cao [LLC06] mais notre approche est davantage combinatoire.

On définit alors les monoïdes de 0-Renner de type B et D au Chapitre 8. Pour cela, on suit le même procédé qu'en Partie II, et nous référons le lecteur au sommaire du Chapitre 8 pour découvrir le plan d'action en détail car il est très technique. On conserve l'idée générale de donner deux définitions au monoïde, une par monoïde de fonctions et une par présentation. L'idée est alors premièrement de définir un monoïde de fonctions $F_n^0(T)$ avec $T \in \{B, D\}$ (Définition 8.3.1 et 8.3.2) et de prouver que leur action sur le monoïde de Renner associé procure une bijection (Théorème 8.3.9) comme en type A .

On introduit alors le monoïde $G_n^0(T)$ (Définitions 8.4.1 et 8.4.22). Nous présentons alors un type particulier de mots réduits, les *éléments grassmanniens* qui sont les éléments avec exactement une descente à gauche ou à droite. On introduit aussi un outil visuel que nous appelons *représentation par grille* pour trouver les éléments *bi-grassmanniens* (c'est-à-dire les éléments ayant une unique descente donnée à gauche et une unique descente donnée à droite) dans les groupes de Coxeter. Les algorithmes précédents nous permettent d'obtenir une expression réduite canonique pour chaque élément des monoïdes $R_n^0(T)$ et $R_n(T)$, de sorte que nous obtenons (Théorèmes 8.4.17 et 8.4.41) :

Théorème 11. Le monoïde des fonctions $F_n^0(T)$ et le monoïde défini par présentation $G_n^0(T)$ sont isomorphes :

$$F_n^0(T) \simeq G_n^0(T).$$

On note désormais $R_n^0(T) := F_n^0(T) \simeq G_n^0(T)$. Le même résultat est obtenu pour $R_n(T)$, par conséquent ce théorème corrige les présentations de Godelle [God09] et nous procure aussi une action naturelle des monoïdes de Renner.

Au Chapitre 9, nous établissons quelques propriétés de ces monoïdes comme nous l'avons fait en type A . Ces monoïdes $R_n^0(T)$ sont là encore \mathcal{J} -triviaux. Cependant nous ne sommes pas parvenus à donner une description précise de leur \mathcal{R} -ordre, et nous prouvons que ce ne sont pas des treillis.

Toutefois comme ces monoïdes sont \mathcal{J} -triviaux nous pouvons utiliser la théorie déjà mentionnée de T. Denton, F. Hivert, A. Schilling et N. Thiery pour étudier les idempotents (Propositions 9.2.6 et 9.2.15), pour déduire les modules simples (Théorèmes 9.2.7 et 9.2.16) et les modules projectifs indécomposables (Proposition 9.2.21). On prouve également la projectivité de $R_n^0(T)$ sur $H_n^0(T)$ comme en type A (Théorème 9.2.24), et donnons brièvement le résultat sur les carquois (Théorème 9.2.25).

Relations sur les entiers, ordre faible et systèmes de racines

Dans la Partie IV nous nous concentrons sur l'ordre faible de tout groupe de Coxeter. Il peut être défini comme l'ordre préfixe sur les expressions réduites des éléments du groupe, ou plus géométrique comme le poset d'inclusion des ensembles d'inversions des éléments du groupe. Pour les groupes de Coxeter finis, l'ordre faible est un treillis [Bjö84] et son diagramme de Hasse est le graphe du permutaèdre du groupe orienté dans une direction linéaire. La riche théorie des congruences de l'ordre faible [Rea04] a conduit à la construction des treillis Cambriens [Rea06] avec des connexions à la combinatoire de Coxeter Catalan et les algèbres amassées de type fini [FZ02; FZ03a]. Ce point de vue était fondamental dans la construction de l'associaèdre généralisé [HLT11]. Nous renvoyons à [Rea12; Rea16a; Hoh12] pour davantage de détails sur ces sujets.

Plus récemment des efforts ont été mis en place pour développer des extensions de l'ordre faible au delà des éléments du groupe. Ceci a conduit en particulier à la notion d'ordre faible facial d'un groupe de Coxeter, introduite en type A dans [Kro+01], définie pour un groupe de Coxeter fini arbitraire dans [PR06], et prouvé comme étant un treillis dans [DHP18]. Cet ordre est un treillis sur les faces du permutaèdre qui étend l'ordre faible sur les sommets.

En type A une notion encore plus générale de l'ordre faible sur les relations entières binaires a été récemment introduit dans [CPP17], et nous en résumerons les résultats au Chapitre 10. Cet ordre est défini comme suit (Définition 10.1.1) :

Définition 12. *L'ordre faible* sur les relations binaires sur $[n]$ est défini par :

$$R \preceq S \iff R^{\text{Inc}} \supseteq S^{\text{Inc}} \text{ et } R^{\text{Dec}} \subseteq S^{\text{Dec}},$$

où $R^{\text{Inc}} := \{(a, b) \in R \mid a < b\}$ et $R^{\text{Dec}} := \{(b, a) \in R \mid a < b\}$ définissent respectivement les sous-relations croissantes et décroissantes de R .

Il s'avère que le sous-poset de cet ordre faible induit par les posets sur $[n]$ est un treillis (Proposition 10.1.2):

Théorème 13 ([CPP17, Théorème 1]). L'ordre faible sur les posets d'entiers sur $[n]$ est un treillis.

De fait, plusieurs treillis connus peuvent être retrouvés comme des sous-treillis de l'ordre faible sur les posets induit sur une certaine famille de posets. Ainsi on peut retrouver par ce procédé les sommets, intervalles et faces du permutaèdre (Section 10.2.1), des associaèdres [Lod04; HL07] (Section 10.2.2), des permutreeèdre [PP16], du cube (Section 10.2.4), etc. En ce qui concerne uniquement les sommets, les treillis correspondants sont l'ordre faible sur les permutations, le treillis de Tamari sur les arbres binaires, les treillis Cambriens de type A , les treillis sur les permutarbres [PP16], le treillis booléen sur les séquences binaires, etc.

Le Chapitre 11 est un travail effectué avec V. Pilaud [GP18], dont l'objectif est d'étendre ces résultats du type A à tous les systèmes de racines cristallographiques finis. Pour un système de racines Φ , on définit *l'ordre faible* (Définition 11.2.1) par

Définition 14. *L'ordre faible* sur les sous-ensembles d'un système de racines Φ est défini par :

$$R \preceq S \iff R^+ \supseteq S^+ \text{ et } R^- \subseteq S^-. \quad (0.2)$$

Cet ordre est clairement un treillis sur la collection $\mathcal{R}(\Phi)$ de tous les sous-ensembles de Φ . Ces ensembles sont les analogues des relations binaires sur les entiers en type A . De façon similaire, l'analogue de type A des posets d'entiers sont les Φ -posets, c'est-à-dire les sous-ensembles R de Φ qui sont simultanément antisymétriques ($\alpha \in R$ implique $-\alpha \notin R$) et clos (au sens de [Bou02], $\alpha, \beta \in R$ and $\alpha + \beta \in \Phi$ implique $\alpha + \beta \in R$). Notre résultat principal est que le sous-ensemble de cet ordre faible induit sur les Φ -posets est aussi un treillis (Théorème 11.2.16):

Théorème 15. L'ordre faible sur les Φ -posets est un treillis.

Ainsi les ordres faibles sur A_{2-} et G_{2-} sont représentés aux Figures 0.7 et 0.8. La Figure 0.7 montre la correspondance de représentations entre [CPP17] et [GP18]: une racine $\alpha = e_i - e_j \in \Phi_A$ correspond à un intervalle $[\min(i, j), \max(i, j)]$. Afin d'obtenir le Théorème 15, on dit qu'une somme de racines est *sommable* si c'est encore une racine. Dès lors un de nos outils principaux est de savoir comment retirer certaines racines à un ensemble sommable de racines de sorte qu'un conserve des ensembles sommables de racines. Ces résultats sont présentés en Proposition 11.1.11 et aux Théorèmes 11.1.12 et 11.1.13:

Théorème 16. Soit Φ un système de racine cristallographique. Tout ensemble sommable $X \subseteq \Phi$ sans sous-somme qui s'annule admet une filtration de sous-ensembles sommables

$$\{\alpha\} = X_1 \subsetneq X_2 \subsetneq \cdots \subsetneq X_{|X|-1} \subsetneq X_{|X|} = X$$

pour tout $\alpha \in X$.

On étudie alors l'ordre faible sur certaines familles de Φ -posets, à savoir les Φ -posets correspondant aux sommets, intervalles et faces du permutaèdre, des associaèdres et du cube de type Φ (Section 11.3). Considérer les sous-posets de l'ordre faible induit sur ces familles spécifiques de Φ -posets nous permet de retrouver l'ordre faible classique, les treillis Cambriens, leurs treillis d'intervalles et leur treillis de faces.

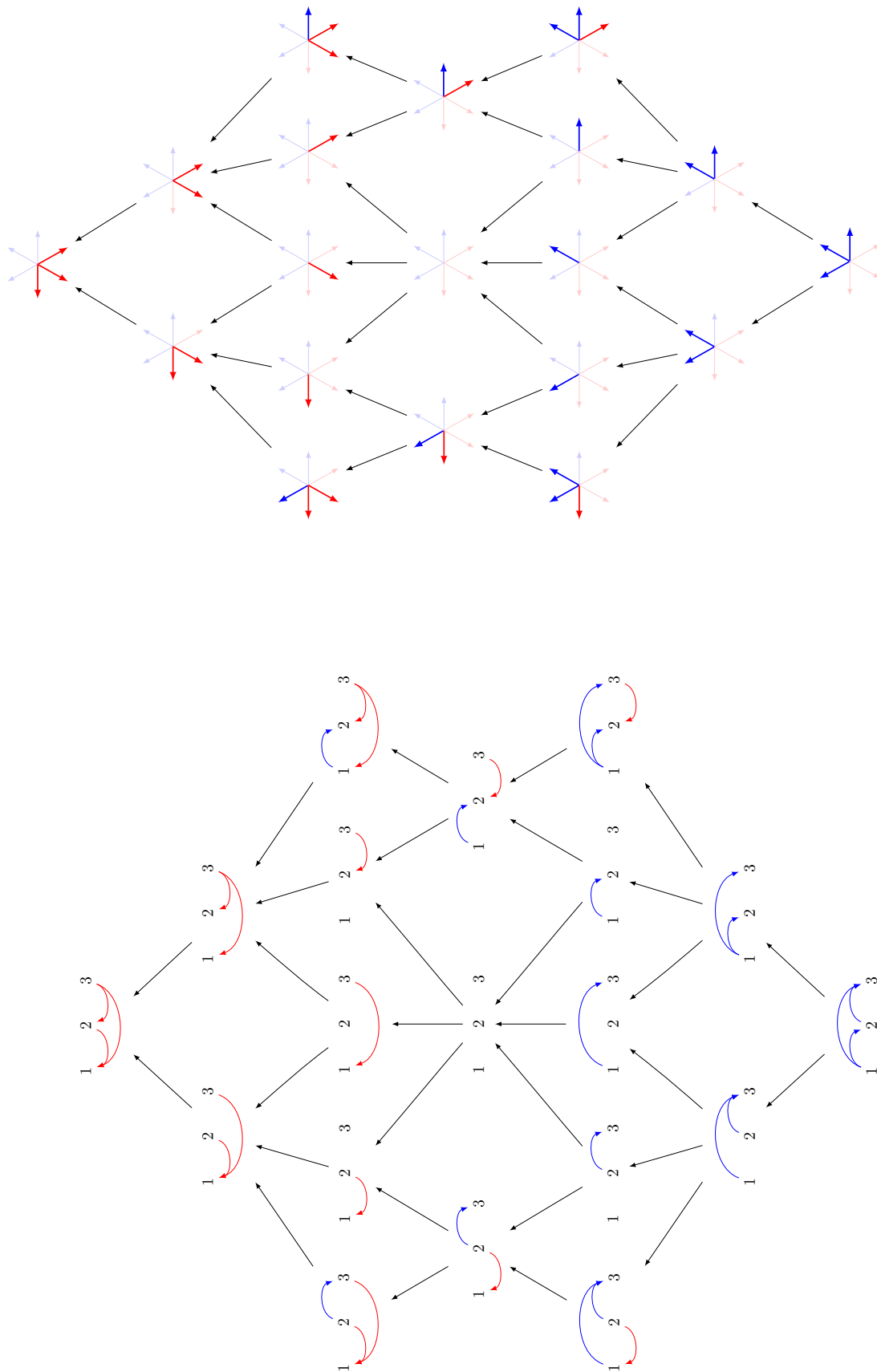

Figure 0.3: L'ordre faible sur les posets de A_2 comme présenté dans [CPP17] (gauche) et [GP18] (droite.)

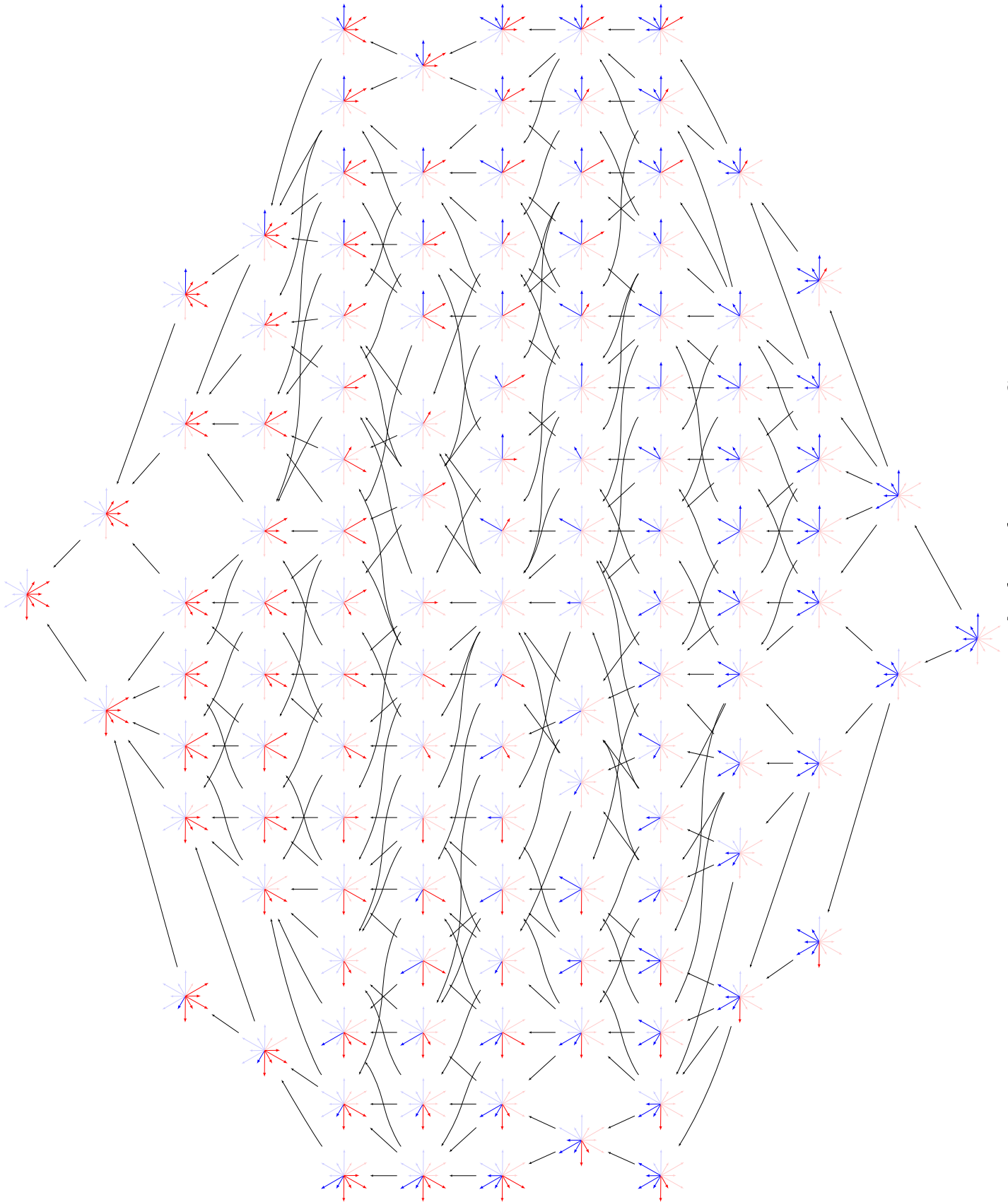

Figure 0.4: L'ordre faible sur les posets de G_2 .

Introduction

This thesis deals with algebraic combinatorics: how to use combinatorial methods and algorithms to study algebraic computation, and conversely how to apply algebraic tools to combinatorial problems such as enumeration or algorithm analysis. One of the richness of algebraic combinatorics is the diversity of points of view. For instance, a mere permutation can be seen as a *vector*, a *matrix*, equivalently an *operator* on some vector space, but it can also be seen as *word* over a given alphabet, word over a *generating set* subject to some relations, or else as a function over words. This diversity is illustrated in this thesis by the interplay between the *bubble sort operators*, their algebraic counterpart called the *degenerated Hecke monoid* and its *representation theory*, the *lattice structure of the weak order*, and their geometric interpretation as vertices of the *permutahedron*. We start with historical motivations.

Jacobi symmetrizer, Schur functions and Weyl character formula

Representation theory aims at understanding a *group* (or more generally a *monoid* or an *algebra*) through all its possible morphisms to matrices. The philosophy is that the latter is sufficiently understood thanks to classical linear algebra, with theoretical and algorithmic tools such as Gaussian elimination, eigenvalue theory and endomorphism reduction. Historically this machinery was first applied to the *symmetric groups* \mathfrak{S}_n and the *general linear groups* $\mathbf{GL}_n(\mathbb{C})$. These groups are fundamental: they are universal for finite groups (*Cayley's theorem*) and for geometrical transformation groups, and the notion of groups itself arose as an abstraction of them. One of the most basic questions is therefore to find all possible morphisms from $\mathbf{GL}_n(\mathbb{C})$ to $\mathbf{GL}_m(\mathbb{C})$. It is reasonable to restrict to *polynomial* morphisms, that is, where the coefficients of the output matrix are polynomial functions of the coefficients of the input matrix. In order to classify all representations, one focuses on *irreducible* representations, as any representation is a direct sum of irreducible ones.

With his *character theory*, Frobenius identified the fundamental role of the *trace*. By invariance of the trace under similarity and by density of the diagonalizable matrices, the trace of a representation is determined by its values on diagonal matrices. A fundamental result of Schur states that, up to a power of the *determinant*, the

irreducible polynomial representations of $\mathbf{GL}_n(\mathbb{C})$ are classified by *partitions*, that is integer sequences of the form $(\lambda_1 \geq \dots \geq \lambda_n \geq 0)$. Moreover, Schur recognized that the trace of the representation ρ_λ associated to λ is given by *Jacobi's quotient*:

$$s_\lambda := \text{tr} \left[\rho_\lambda \begin{pmatrix} x_1 & & 0 \\ & \ddots & \\ 0 & & x_n \end{pmatrix} \right] = \frac{\sum \varepsilon(\sigma) \sigma(x^{\lambda+r})}{\sum \varepsilon(\sigma) \sigma(x^r)},$$

where the sums run over all permutations $\sigma \in \mathfrak{S}_n$, ε is the signature, r is the partition $(n-1, n-2, \dots, 1, 0)$, and x^α is a short hand for $x_1^{\alpha_1} \dots x_n^{\alpha_n}$. In this formula, the numerator and the denominator are determinants of matrices, hence antisymmetric polynomials in the eigenvalues x_1, \dots, x_n . Moreover, the denominator is the *Vandermonde determinant* $\prod_{i < j} (x_i - x_j)$, and thus divides any antisymmetric polynomial. Hence, s_λ is a polynomial, nowadays called *Schur polynomial*.

Jacobi's formula can be seen as *Jacobi's symmetrizing operator* defined as

$$\mathbb{J}(f) := \frac{\sum \varepsilon(\sigma) \sigma(f x^r)}{\sum \varepsilon(\sigma) \sigma(x^r)},$$

applied to the monomial x^λ . The crucial observation is that this operator factorizes as:

$$\mathbb{J} = \pi_1 \pi_2 \dots \pi_n \pi_1 \dots \pi_{n-1} \dots \pi_1 \pi_2 \pi_1,$$

where π_i is the two variables Jacobi operator called *Newton's divided difference*:

$$\pi_i(f) = \frac{x_i f - x_{i+1} f}{x_i - x_{i+1}}.$$

These operators satisfy the following relations:

$$\begin{aligned} \pi_i^2 &= \pi_i & 1 \leq i \leq n-1, \\ \pi_i \pi_{i+1} \pi_i &= \pi_{i+1} \pi_i \pi_{i+1} & 1 \leq i \leq n-2, \\ \pi_i \pi_j &= \pi_j \pi_i & |i-j| \geq 2. \end{aligned}$$

They generate a monoid H_n^0 whose algebra is known as the *degenerated Iwahori-Hecke algebra* $H_n(0)$. These relations are very similar to those of the symmetric group \mathfrak{S}_n generated by the *elementary transpositions* $s_i = (i \ i+1)$, namely:

$$\begin{aligned} s_i^2 &= 1 & 1 \leq i \leq n-1, \\ s_i s_{i+1} s_i &= s_{i+1} s_i s_{i+1} & 1 \leq i \leq n-2, \\ s_i s_j &= s_j s_i & |i-j| \geq 2. \end{aligned}$$

The similarity between these two *presentations*, and *Matsumoto's theorem* ensure that for any reduced word $s_{i_1} \dots s_{i_N}$ of a permutation σ , the element $\pi_\sigma := \pi_{i_1} \dots \pi_{i_N}$ depends only on σ and not on the chosen reduced word. In particular, Jacobi's symmetrizing operator actually factorizes as $\mathbb{J} = \pi_{w_0}$ for any reduced word of the maximal element w_0 of the symmetric group \mathfrak{S}_n . In fact, the elements π_σ exhaust all elements of H_n^0 which is therefore of cardinality $n!$.

On the other hand, as illustrated in Figure 0.5, the loopless *Cayley graph* of H_n^0 is acyclic, and its transitive closure defines an order on permutations:

$$\sigma < \mu \quad \text{if and only if} \quad \text{there exists } \nu, \text{ such that } \pi_\sigma \pi_\nu = \pi_\mu.$$

This is equivalent to $\sigma\nu = \mu$ and $\ell(\sigma) + \ell(\nu) = \ell(\mu)$, where $\ell(\tau)$ denotes the *number of inversions* of the permutation τ . This order is known as the *weak order* on permutations, and has remarkable properties: it is a lattice and it can be seen as a linear orientation of the 1-skeleton of the *permutahedron*:

$$\text{Perm}(n) := \text{conv}(\{\sigma((1, \dots, n)) \mid \sigma \in \mathfrak{S}_n\}).$$

The existence of this order is a central argument in the study on the representation theory of H_n^0 .

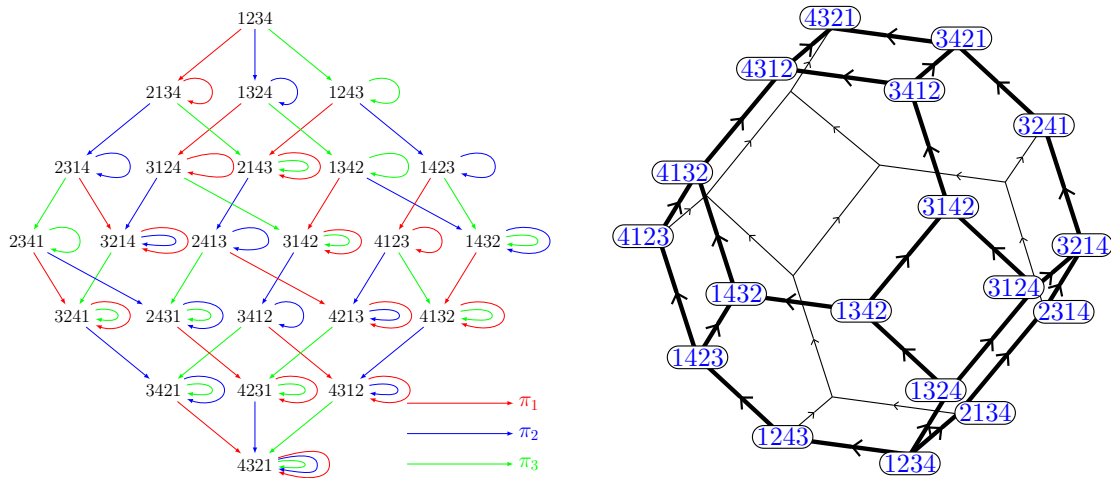

Figure 0.5: The right Cayley graph of H_4^0 , and the associated Permutahedron.

All this theory, centered on the symmetric group, generalizes to other finite groups, namely *Coxeter* and *Weyl groups*. Any Weyl group W is associated to a *semisimple Lie algebra* which plays the role of $\mathbf{GL}_n(k)$. The Jacobi's quotient is a particular case of *Weyl's character formula*:

$$\chi_\lambda = \frac{\sum \varepsilon(w)x^{w(\lambda+r)}}{\sum \varepsilon(w)x^{w(r)}},$$

where the sums run over $w \in W$, λ is a *dominant weight*, r is the *sum of fundamental weights* and for any weight ω with coordinates $(\omega_1, \dots, \omega_n)$ in the fundamental weight basis, we write $x^\omega = x_1^{\omega_1} \dots x_n^{\omega_n}$. The analogues of Newton's divided differences are called *Demazure's operators*, and factorize the *Weyl's symmetrizer* as before. They also generate a degenerated Iwahori-Hecke monoid $H_n^0(W)$ associated to the Weyl group W , whose presentation is similar to that of W . This allows us to define a partial Demazure symmetrizer associated to any element of W which also admits a character interpretation. Furthermore, the Cayley graph of $H_n^0(W)$ defines a *weak order* on W . This order is again a lattice, and is an orientation of the graph of the *W-permutahedron* obtained as the convex hull of the W -orbit of a generic point.

Motivations, contributions and outline of this thesis

This thesis deals with different generalizations of the weak order on permutations and the 0-Hecke monoid. Part I recalls some general background, and we refer to its summary for an overview of its content. Parts II and III deal with a first kind of generalization to *rook monoids*. Part IV studies Φ -posets.

Hecke algebra, Rook monoid and Hopf algebra

The name “degenerated Iwahori-Hecke algebra” stems from a specialization of the *Iwahori-Hecke algebra* [Iwa64]. It starts with the study of the general linear group of invertible matrices $G := \mathbf{GL}_n(\mathbb{F}_q)$ over the finite field \mathbb{F}_q with q elements. The subgroup B of G of upper triangular matrices is finite. If one identifies a permutation with its associated permutation matrix, the Bruhat decomposition [BB05] which is an application of Gaussian elimination tells that for all $M \in G$ there is a unique permutation $\sigma \in \mathfrak{S}_n$ such that $M \in B\sigma B$, that is:

$$G = \bigsqcup_{\sigma \in \mathfrak{S}_n} B\sigma B.$$

Iwahori defined for $w \in \mathfrak{S}_n$ the element T_w of the group algebra $\mathbb{C}G$ by:

$$T_w := \frac{1}{|B|} \sum_{x \in BwB} x.$$

The *Hecke ring* $\mathcal{H}(G, B)$ was defined to be the \mathbb{Z} -ring spanned by the elements T_w . For $q \in \mathbb{C}$, let $\mathcal{H}_n(q)$ denote the \mathbb{Z} -algebra defined by generators and relations as follows:

$$\begin{aligned} T_i^2 &= q \cdot 1 + (q-1)T_i & 1 \leq i \leq n-1, \\ T_i T_{i+1} T_i &= T_{i+1} T_i T_{i+1} & 1 \leq i \leq n-2, \\ T_i T_j &= T_j T_i & |i-j| \geq 2. \end{aligned}$$

If q is the cardinality of a finite field, Iwahori proved that the maps $T_i \mapsto T_{s_i}$ extends to a full ring isomorphism from $\mathcal{H}_n(q)$ to $\mathcal{H}(G, B)$ and that the equations above give a presentation. By extending the scalar to \mathbb{C} we get a \mathbb{C} -algebra $\mathcal{H}_n(q)$ which extends the definition of the Hecke ring outside of prime powers. It is well known that when q is neither zero nor a root of the unity, the *Iwahori-Hecke algebra* is isomorphic to the complex group algebra $\mathbb{C}\mathfrak{S}_n$.

In the previous presentation if instead we let $q = 0$ and define either $\pi_i := -T_i$ or $\pi_i := T_i + 1$ we get the above mentioned presentation of the 0-Hecke monoid H_n^0 .

In [Sol90; Sol04], Solomon constructed an analogue of Iwahori’s construction replacing the general linear group by its full matrix monoid $M = \mathbf{M}_n(\mathbb{F}_q)$. It goes as follows: as before, let B denote the set of invertible upper triangular matrices. Then M admits a Bruhat decomposition [Ren95] too: the set of permutation matrices is

replaced by the set R_n of so-called *rook matrices* of size n , that is $n \times n$ matrices with entries $\{0, 1\}$ and at most one nonzero entry in each row and column. Then

$$M = \bigsqcup_{r \in R_n} BrB$$

For any rook matrix $r \in R_n$, Solomon also defined an element T_r of the monoid algebra $\mathbb{C}M$ by

$$T_r := \frac{1}{|B|} \sum_{x \in BrB} x.$$

Those elements span a subalgebra $\mathcal{H}(M, B)$ which contains $\mathcal{H}(G, B)$ with the same identity, and defined the algebra $\mathcal{I}_n(q)$ which extends the definition of $\mathcal{H}(M, B)$ outside of prime powers. The question whether there exists a proper degeneracy at $q = 0$ of this ring and if it exists, whether it is the ring of a monoid is a work with F. Hivert [GH18b] is therefore very natural. The objective of Part II is to construct such a monoid, called the 0-rook monoid, and denoted R_n^0 , so filling the following diagram:

$$\begin{array}{ccccc} \mathfrak{S}_n & \xleftarrow{q=1} & \mathcal{H}_n(q) & \xrightarrow{q=0} & H_n^0 \\ \downarrow & & \downarrow & & \downarrow \\ R_n & \xleftarrow{q=1} & \mathcal{I}_n(q) & \xrightarrow{q=0} & R_n^0 \end{array}$$

In the meantime, it is well known that character theory of the family of symmetric groups $(\mathfrak{S}_n)_n$ can be encoded into symmetric functions via the *Frobenius isomorphism* [Mac95]. Under this morphism, the irreducible characters χ_λ of \mathfrak{S}_n are mapped to the Schur functions s_λ of degree n . Furthermore, the *induction* and *restriction* along the natural inclusion $\mathfrak{S}_m \times \mathfrak{S}_n \rightarrow \mathfrak{S}_{m+n}$ correspond respectively to product and coproduct (the so called *Littlewood-Richardson rule*) of the *Hopf algebra* Sym of *symmetric functions*.

According to Krob-Thibon [KT97; Thi98], this construction has an analogue for the 0-Hecke monoids $(H_n^0)_n$. However, due to the non semi-simplicity of H_n^0 , the situation is more complicated. Note that the classical presentation deals with the algebra $H_n(0)$ rather than the monoid. First of all, the maps

$$\rho_{m,n} : \begin{cases} H_m^0 \times H_n^0 & \longrightarrow & H_{m+n}^0 \\ (\pi_i, \pi_j) & \longmapsto & \pi_i \pi_{j+m} = \pi_{j+m} \pi_i \end{cases}$$

are injective monoid morphisms which moreover verify some associativity conditions endowing $(H_n^0)_n$ with a structure of *tower of monoids* [BL09; Vir14]. One can build two analogues of character rings, namely $\mathcal{G}_0 := \sum_n \mathbb{C}\mathcal{G}_0(H_n^0)$ the direct sum of the (complexified) *Grothendieck groups* of H_n^0 -modules on the one hand, and $\mathcal{K}_0 := \sum_n \mathbb{C}\mathcal{K}_0(H_n^0)$ the direct sum of the Grothendieck groups of projective H_n^0 -modules on the other. Recall that \mathcal{G}_0 has for basis the simple module S_I whereas \mathcal{K}_0 has for basis the indecomposable projective modules P_I .

Now for two integers m and n we denote by $\text{Res}_{m,n}$ the restriction functor from H_{m+n}^0 -modules to $H_m^0 \times H_n^0$ -modules along the morphism $\rho_{m,n}$. It turns out that this defines proper *coproducts* on \mathcal{G}_0 and \mathcal{K}_0 . In particular, H_{m+n}^0 is projective over $H_m^0 \times$

H_n^0 . Dually, the induction $\text{Ind}_{m,n}$ defines *products* on \mathcal{G}_0 and \mathcal{K}_0 . These products and coproducts are compatible giving the structure of a Hopf algebra. The analogue of the Frobenius isomorphism goes as follows: let QSym denote *Gessel's* [Ges84] *Hopf algebra of quasi-symmetric functions*, and NCSF denote the *Hopf algebra of noncommutative symmetric functions* [Gel+95]. Recall that these two dual Hopf algebras have their bases indexed by *compositions*. Then the map sending the simple module S_I to the element F_I of the fundamental basis is a Hopf algebra morphism from \mathcal{G}_0 to QSym . Dually, the map sending the indecomposable projective module P_I to the so-called ribbon basis element R_I [Gel+95; KT97] is a Hopf algebra morphism from \mathcal{K}_0 to NCSF . The duality between QSym and NCSF mirrors Frobenius duality between \mathcal{G}_0 and \mathcal{K}_0 , the commutative image $c : \text{NCSF} \rightarrow \text{QSym}$ being nothing but the *Cartan map*.

This result of [KT97] is the main motivation for Part II. The goal was to understand how this picture translates to rook monoids. So in Chapter 4, we will define our monoid R_n^0 first by putting $q = 0$ in Halverson's presentation [Hal04] of Solomon's algebra. This gives us a first definition (Definition 4.1.1 and Corollary 4.1.6) of, what we will call for the first part of the chapter, the monoid G_n^0 :

Definition 17. The monoid G_n^0 is generated by π_0, \dots, π_{n-1} together with the relations:

$$\begin{aligned} \pi_i^2 &= \pi_i & 0 \leq i \leq n-1, \\ \pi_i \pi_{i+1} \pi_i &= \pi_{i+1} \pi_i \pi_{i+1} & 1 \leq i \leq n-2, \\ \pi_1 \pi_0 \pi_1 \pi_0 &= \pi_0 \pi_1 \pi_0 = \pi_0 \pi_1 \pi_0 \pi_1, \\ \pi_i \pi_j &= \pi_j \pi_i & 0 \leq i, j \leq n-1, \quad |i-j| \geq 2. \end{aligned}$$

We recognize in these relations the 0-Hecke monoid, but also an additional generator π_0 which makes G_n^0 a quotient of $H_n^0(B)$. Actually we have the following chain of surjections (see Equation 4.30):

$$H^0(B_n) \twoheadrightarrow R_n^0 \twoheadrightarrow H^0(A_{n+1}).$$

We then use a second definition of the 0-rook monoid as functions acting on the rook monoid. The first remark is that a rook matrix (or only *rook*) can be seen as a one-line vector of a partial permutation. With this in mind, we extend the classical action of Newton's divided differences on the permutations as the *bubble sort operators* to all rooks:

$$\pi_i : \left| \begin{array}{ccc} R_n & \longrightarrow & R_n \\ r = r_1 \dots r_n & \longmapsto & \begin{cases} r \cdot s_i & \text{if } r_i < r_{i+1}, \\ r & \text{otherwise.} \end{cases} \end{array} \right.$$

We make the new generator π_0 acting as a *deletion operator*:

$$\pi_0 : \left| \begin{array}{ccc} R_n & \longrightarrow & R_n \\ r = r_1 \dots r_n & \longmapsto & 0r_2 \dots r_n. \end{array} \right.$$

The monoid of functions F_n^0 is thus defined (Definition 4.2.1) as the monoid of functions over R_n generated by π_0 and π_1, \dots, π_{n-1} . Section 4.3 provides a proof that these two definitions are equivalent (Corollary 4.3.14):

Theorem 18. The monoid of functions F_n^0 and the monoid defined by presentation G_n^0 are isomorphic:

$$F_n^0 \simeq G_n^0$$

Therefore we call $R_n^0 := F_n^0 \simeq G_n^0$. Our proof does not use the well-known presentation of the classical rook monoid or of the q -rook algebra, but proves them again from scratch. It relies on an analogue of the *Lehmer code* (see Section 1.1.6, Definition 4.2.8 and Remark 4.2.7). Though it is combinatorially technical, we argue that our approach has several advantages. First it is self contained and purely monoidal. Second, our approach is explicit and provides a *canonical reduced word* for all rooks or 0-rooks together with an explicit algorithm transforming any word in its equivalent canonical one. In particular, we get an analogue of *Matsumoto's theorem* (Theorem 4.4.3) for both R_n and R_n^0 , an ingredient which was noticed missing in [Sol04]:

Theorem 19 (Matsumoto theorem for Rook monoids). If \underline{u} and \underline{v} are two reduced words over $\{\pi_0, s_1, \dots, s_{n-1}\}$ (resp. $\{\pi_0, \pi_1, \dots, \pi_{n-1}\}$) for the same element r of R_n (resp. R_n^0), then they are congruent using only the braid relations:

$$\begin{aligned} s_i s_{i+1} s_i &= s_{i+1} s_i s_{i+1} & 1 \leq i \leq n-2, \\ s_i s_j &= s_j s_i & |i-j| \geq 2, \\ \pi_0 s_j &= s_j \pi_0 & j \neq 1. \end{aligned}$$

(resp.

$$\begin{aligned} \pi_i \pi_{i+1} \pi_i &= \pi_{i+1} \pi_i \pi_{i+1} & 1 \leq i \leq n-2, \\ \pi_i \pi_j &= \pi_j \pi_i & 0 \leq i, j \leq n-1, \quad |i-j| \geq 2.) \end{aligned}$$

Therefore to every rook $r \in R_n$ we associate a 0-rook π_r . Conversely, r is called the *rook vector* of π_r . We prove in the way some combinatorial results on rooks whose first zero is in a given position in Section 4.2.2, giving a bijection with some partial permutations with given number of element in a cycle, using an analogue of *Foata's transformation* (see Section 1.1.7 for a definition).

As explained in the beginning of the introduction, we are interested in generalizations of the *weak order*. Therefore in Chapter 5 studies the \mathcal{R} -order on the 0-rook monoid, that is the order defined by $x \leq_{\mathcal{R}} y \iff \exists u \in R_n^0, x = yu$. In Figure 0.6 we represent the \mathcal{R} -order on the 0-rook monoid of size 2 and 3.

For a rook $r \in R_n$ we define (Definition 5.1.1):

- its *set of inversions* as $\text{Inv}(r) := \{(r_i, r_j) \mid i < j \text{ and } r_i > r_j > 0\}$.
- its *support* denoted $\text{supp}(r)$ as the set of non-zero letters appearing in its rook vector.
- For each letter $\ell \in \text{supp}(r)$, $Z_r(\ell)$ is the number of 0 which appear after ℓ in the rook vector of r .

With these definitions we thus obtain the following characterization of the \mathcal{R} -order (Theorem 5.1.11):

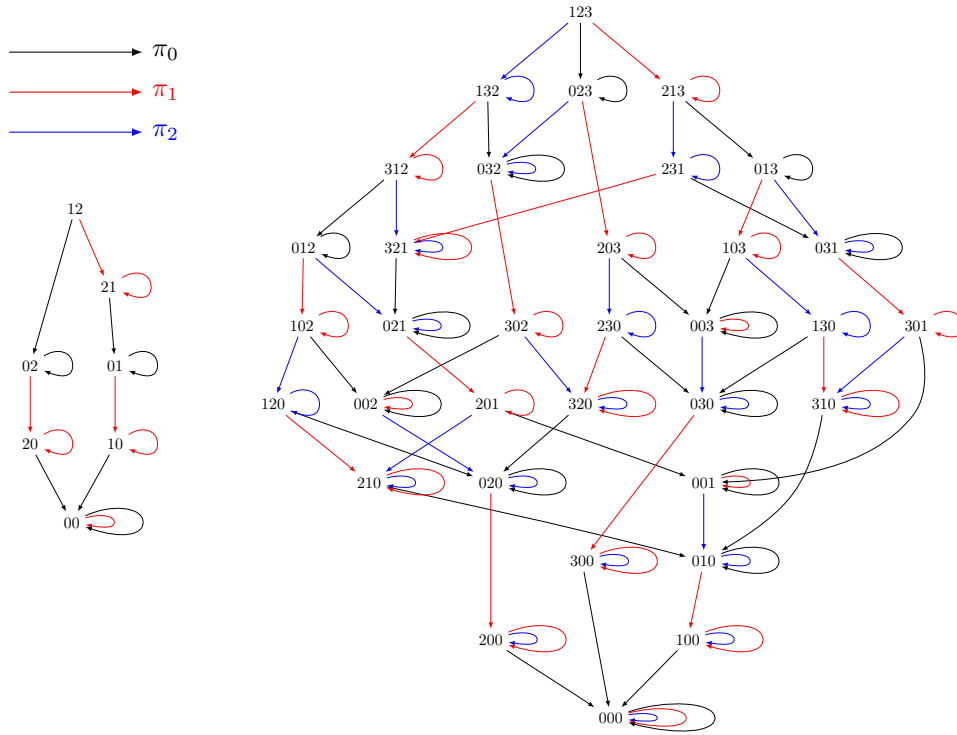

Figure 0.6: The right Cayley graph of R_2^0 and R_3^0 .

Theorem 20. If $r, u \in R_n$, then:

$$\pi_r \leq_{\mathcal{R}} \pi_u \iff \begin{cases} \text{supp}(r) \subseteq \text{supp}(u), \\ \{(b, a) \in \text{Inv}(u) \mid b \in \text{supp}(r)\} \subseteq \text{Inv}(r), \\ Z_u(\ell) \leq Z_r(\ell) \text{ for } \ell \in \text{supp}(r). \end{cases}$$

The main consequence is that the 0-rook monoid is *\mathcal{J} -trivial*, that is its bisided Cayley graph is acyclic (Corollary 5.1.12). We then prove that the \mathcal{R} -order is indeed a *lattice* (Corollary 5.2.2) and describe explicitly how to obtain the *meet* (Theorem 5.2.1) and the *join* (Theorem 5.2.5) of two elements. We also give the number of meet irreducibles for the \mathcal{R} -order (Proposition 5.2.10):

Proposition 21. The number of meet irreducibles for $\leq_{\mathcal{R}}$, is $3^n - 2^n$.

In Section 5.3 we give a bijection between *maximal chains* of minimal length of R_n^0 in the \mathcal{R} -order, and maximal chains of maximal length of the *Tamari lattice*. This bijection is in fact not only between chains, but between the elements of the chains, which are the so-called *singletons* (see [HL07; HLT11; LL18] and the references in the latter). They correspond to binary trees which are chains, that is also binary trees with exactly one linear extension. Equivalently they are permutations avoiding the patterns 132 and 312, or permutations with exactly one element in their sylvester class. Geometrically, they are common vertices between the associahedron and the permutahedron.

We finally look at some geometrical properties of rooks in Section 5.4. Although the Cayley graph of R_n^0 is not the 1-skeleton of a polytope, we can consider the convex hull of the rook vectors. The resulting polytope,

$$\text{Stell}_n := \{\mathfrak{S}_n(0 \dots 0k \dots n) \mid k \in \llbracket 1, n \rrbracket\},$$

already appeared under the name of *stellohedron* in [MP17, Figure18] where it was defined as the graph associahedron of a star graph. It is also the secondary polytope of $\Delta_n \cup 2\Delta_n$, two concentric copies of a n -dimensional simplex.

The fact that R_n^0 is \mathcal{J} -trivial is of great importance for its representation theory as T. Denton, F. Hivert, A. Schilling and N. Thiéry explained in [Den+10] (see also Section 3.3). Hence Chapter 6 deals with this representation theory. We describe the set of idempotents and their lattice structure (Proposition 6.1.6 and 9.2.8). We then show that the simple modules are all 1-dimensional (Theorem 6.1.7), describe the indecomposable projective modules as some kind of descent classes (Theorem 6.2.7) and describe the quiver of R_n^0 (Theorem 6.3.1). We then study how the representation theory of H_n^0 and R_n^0 are related, and notably prove that the later is projective on the former (Theorem 6.4.5). Furthermore, we give the decomposition functor of this projectivity (Theorem 6.4.8).

Finally Section 6.5, is devoted to the tower of monoids structure on the sequence of 0-rook monoids. Here the nice properties found by D. Krob and J-Y. Thibon do not work as nicely as expected. We present an associative structure as in Section 3.4.4 but it does not fulfill all the requirement of N. Bergeron and H. Li [BL09] to obtain a Hopf algebra. In particular, R_{m+n}^0 is not projective over $R_m^0 \times R_n^0$. We nevertheless explicit some structure and in particular the induction rule for simple modules (Theorem 6.5.16).

Linear algebraic monoid theory and Renner monoids

Part III deals with a generalization of Part II to Weyl groups. It is a work with F. Hivert [GH18a] which is the sequel of [GH18b]. Recall that Weyl groups are associated to *semisimple Lie algebra*. In fact these groups appear in many different contexts (see Chapter 2, especially Section 2.2.4). In the context of the *Linear Algebraic Group theory*, suppose that G is a *linear algebraic group* over a field K and T is a *maximal torus* of G . The *Weyl group of T* , denoted $W(T)$, is defined as the quotient group of the normalizer $N_G(T)$ by the torus T :

$$W(T) := N_G(T) / T.$$

Linear algebraic monoid theory, mainly developed by M. Putcha, L. Renner and L. Solomon, has deep connections with algebraic group theory. In particular, the *Renner monoid* [Ren05] plays the role that the Weyl group does in Linear Algebraic Group theory. These are originally defined to be the quotient of the *completion* of the normalizer of a maximal torus of a Borel subgroup by this subgroup in a regular irreducible algebraic monoid with a zero element. We denote them by $R(T)$. The reason why we are introducing these objects is that the Renner monoid of type A ,

$R(A)$ is the rook monoid R_n . Thus we want to generalize in this part what we did in the 0-rook monoid. We represent what we already know in type A in the following diagram on the left. The goal is to explain the right one.

$$\begin{array}{ccc} \mathfrak{S}_n = W(A) & \xrightarrow{\sim} & H_n^0 = H_n^0(A) \\ \downarrow & & \downarrow \\ R_n = \overline{\mathfrak{S}_n} & \xrightarrow{\sim} & R_n^0 \end{array} \qquad \begin{array}{ccc} W(T) & \xrightarrow{\sim} & H_n^0(T) \\ \downarrow & & \downarrow \\ R_n(T) = \overline{W(T)} & \xrightarrow{\sim} & R_n^0(T) \end{array}$$

Note that in these diagrams the horizontal arrows are bijections, while the vertical ones are inclusions of monoids.

In order to define these *0-Renner monoids*, we needed presentation of them. In his article [God09], E. Godelle found out such a presentation for a generic Weyl type, as we have for Coxeter groups. He obtained this result using some general Linear Algebraic Monoid theory. Unfortunately when he gave the precise presentation of type B and D , he happened to forget some relations, and consequently the presentations were wrong and lead to infinite monoids. We checked this by computer programming and refer the reader to Section 8.5 for more details and the programs used. Consequently we could not use these presentations as a starting point of our definitions of 0-Renner monoids. We then started from another definition of the Renner monoids as generated by some matrices (Definitions 7.2.1 and 7.2.18, see [BB05]):

Proposition 22. In R_{2n} we define the following elements:

- S_0 is the transposition $s_n = (n, n + 1)$.
- For $1 \leq i \leq n - 1$, S_i is the double transposition $s_{n-i}s_{n+i}$.
- For $0 \leq i \leq n$, $E_i := \begin{pmatrix} & & & 0 & & \\ & & & \dots & & \\ & & & 0 & 1 & \\ & & & & & \dots \\ & & & & & & 1 \end{pmatrix}$ with the first $n + i$ columns are null.

The Renner monoid of type B , denoted $R_n(B)$, is generated by these elements.

Proposition 23. In R_{2n} we define the following matrices:

- S_1^f is the double transposition $(n - 1, n + 1)(n, n + 2)$.
- For $1 \leq i \leq n - 1$, S_i is the double transposition $s_{n-i+1}s_{n+i-1}$.
- For $0 \leq i \leq n$, $E_i := P_{n+i}$.

- The table $F := \begin{pmatrix} & & & 0 & & \\ & & & \dots & & \\ & & & 0 & 1 & \\ & & & & 0 & 1 \\ & & & & & \dots \\ & & & & & & 1 \end{pmatrix}$, with the first $n - 1$ columns null.

The Renner monoid of type D , denoted $R_n(D)$, is generated by these elements.

We only considered type B and D , first because they lead to infinite series of monoids, and second because the computer programming did not allow us to look for huge monoids.

As seen in the previous definitions, the elements of the Renner monoids of type B and D can be seen as elements of type A as partial permutations over $\bar{n}, \dots, \bar{1}, 1, \dots, n$ (where $\bar{i} := -i$), or μ -vectors. We denote by \emptyset the zero. The first result is to characterize the elements of these monoids. These are the *B condition* and *D condition* (Definitions 7.2.5 and 7.2.20):

Definition 24. Let $r \in R_n$. We say that the μ -vector $r = r_{\bar{n}} \dots r_{\bar{1}} \mid r_1 \dots r_n$ obeys the *B condition* if the two following conditions hold:

- *Centrally antisymmetric*: for $1 \leq i \leq n$, $\{r_i, r_{\bar{i}}\} \in \{\{\emptyset, \emptyset\}, \{\emptyset, k\}, \{k, -k\}\}$, with $k \in \{\bar{n}, \dots, \bar{1}, 1, \dots, n\}$.
- *Break all pairs*: the μ -vector r has either no letter \emptyset , or at least n and at least one of the two letters i or \bar{i} is missing for all $1 \leq i \leq n$.

Definition 25. If $r \in R_n$ is a μ -vector, we say that r obeys the *D condition* if and only if the two following conditions hold:

- *B-rook*: r obeys the *B condition*.
- *Parity*: if $|r|_{\emptyset} = 0$ then r must have an even number of positive numbers in its first half. If $|r|_{\emptyset} = n$, the element \tilde{r} obtained by antisymmetry with $|\tilde{r}|_{\emptyset} = 0$ must also have an even number of positive numbers in the first half.

Using explicit algorithms (Algorithm 7.2.13 and 7.2.32) we show that these conditions are indeed necessary and sufficient (Theorem 7.2.14 and 7.2.33):

Theorem 26. Let $r \in R_{2n}$. Then $r \in R_n(B)$ (resp. $r \in R_n(D)$) if and only if r obeys the *B* (resp. *D*) condition.

We use these characterizations to count the *B*-Renner (Corollary 7.2.15) and *D*-Renner (Corollary 7.2.34) elements. The enumerative results were already known by Z. Li, Z. Li and Y. Cao [LLC06] but our approach is more combinatorial.

Then we define the 0-Renner monoid of type *B* and *D* in Chapter 8. We proceed in the same way as in Part II, and refer to the summary of Chapter 8 to see the plan of action in detail as it is very technical. We keep the general idea of giving two definitions, one with a monoid of functions and one with a presentation. The idea is first to define a monoid of functions $F_n^0(T)$ with $T \in \{B, D\}$ (Definition 8.3.1 and 8.3.2) and prove that its action on the corresponding Renner monoid leads to a bijection (Theorem 8.3.9) in the same vein than in type *A*.

Then we introduce the monoid $G_n^0(T)$ (Definition 8.4.1 and 8.4.22 for type *D*). We introduce there a certain kind of reduced word, the *grassmannian elements* which are elements with exactly one right or left descent. We also use a graphical trick called *grid representation* to find *bi-grassmannian* elements (element having exactly one left descent and one right descent) in the Coxeter groups. Then the previous algorithms enable us to get a canonical reduced expression for every element of the monoids $R_n^0(T)$ and $R_n(T)$, so that we obtain (Theorem 8.4.17 and 8.4.41):

Theorem 27. The monoid of functions $F_n^0(T)$ and the monoid defined by presentation $G_n^0(T)$ are isomorphic:

$$F_n^0(T) \simeq G_n^0(T).$$

We therefore define $R_n^0(T) := F_n^0(T) \simeq G_n^0(T)$. The same results holds for R_n , consequently this theorem corrects the presentation of Godelle [God09] and also gives a natural action on the Renner monoid.

In Chapter 9, we establish some properties of the monoid, as we did in type A . We get that the monoids $R_n^0(T)$ are \mathcal{J} -trivial. However we do not manage to have a precise description of the \mathcal{R} -order, and we prove that it is not a lattice.

However, since the monoid is \mathcal{J} -trivial we can use the already mentioned theory of T. Denton, F. Hivert, A. Schilling and N. Thiery to study the idempotents (Propositions 9.2.6 and 9.2.15) to deduce the simple modules (Theorems 9.2.7 and 9.2.16) and the projective indecomposables modules (Proposition 9.2.21). We also prove the projectivity of $R_n^0(T)$ over $H_n^0(T)$ as in type A (Theorem 9.2.24), and briefly give the result for the quivers (Theorem 9.2.25).

Integer relations, weak order and root systems

In Part IV we will focus on the weak order of any Coxeter group. It can be defined as the prefix order in reduced expressions of the elements of the group, or more geometrically as the inclusion poset of the inversion sets of the elements of the group. For finite Coxeter groups, the weak order is known to be a lattice [Bjö84] and its Hasse diagram is the graph of the permutahedron of the group oriented in a linear direction. The rich theory of congruences of the weak order [Rea04] yield to the construction of Cambrian lattices [Rea06] with its connection to Coxeter Catalan combinatorics and finite type cluster algebras [FZ02; FZ03a]. This point of view was fundamental for the construction of generalized associahedra [HLT11]. We refer to the survey papers [Rea12; Rea16a; Hoh12] for details on these subjects.

More recently, some efforts were devoted to develop certain extensions of the weak order beyond the elements of the group. This led in particular to the notion of facial weak order of a finite Coxeter group, pioneered in type A in [Kro+01], defined for arbitrary finite Coxeter groups in [PR06], and proved to be a lattice in [DHP18]. This order is a lattice on the faces of the permutahedron that extends the weak order on the vertices.

In type A , an even more general notion of weak order on integer binary relations was recently introduced in [CPP17], and which we will summarize in Chapter 10. This order is defined (Definition 10.1.1) as follows:

Definition 28. The *weak order* on binary relations on $[n]$ is defined as:

$$R \preceq S \iff R^{\text{Inc}} \supseteq S^{\text{Inc}} \text{ and } R^{\text{Dec}} \subseteq S^{\text{Dec}},$$

where $R^{\text{Inc}} := \{(a, b) \in R \mid a < b\}$ and $R^{\text{Dec}} := \{(b, a) \in R \mid a < b\}$ respectively define the increasing and decreasing subrelations of R .

It turns out that the subposet of this weak order induced by posets on $[n]$ is a lattice (Proposition 10.1.2):

Theorem 29 ([CPP17, Theorem 1]). The weak order on the integer posets on $[n]$ is a lattice.

In fact, many relevant lattices can be recovered as subposets of the weak order on posets induced by certain families of posets. Such families include the vertices, the intervals and the faces of the permutahedron (Section 10.2.1), associahedra [Lod04;

[HL07] (Section 10.2.2), permutreehedra [PP16], cube (Section 10.2.4), etc. For the vertices, the corresponding lattices are the weak order on permutations, the Tamari lattice on binary trees, the type A Cambrian lattices, the permutree lattices [PP16], the boolean lattice on binary sequences, etc.

Chapter 11 is a work with V. Pilaud [GP18], whose goal is to extend these results beyond type A to all finite crystallographic root systems. For a root system Φ , we define the *weak order* (Definition 11.2.1) by

Definition 30. The *weak order* on subsets of a root system Φ is defined as:

$$R \preceq S \iff R^+ \supseteq S^+ \text{ and } R^- \subseteq S^-. \quad (0.3)$$

This order is clearly a lattice on the collection $\mathcal{R}(\Phi)$ of all subsets of Φ . These sets are the analogues of type A integer binary relations. In turn, the analogues of type A integer posets are Φ -*posets*, *i.e.* subsets R of Φ that are both antisymmetric ($\alpha \in R$ implies $-\alpha \notin R$) and closed (in the sense of [Bou02], $\alpha, \beta \in R$ and $\alpha + \beta \in \Phi$ implies $\alpha + \beta \in R$). Our central result is that the subposet of this weak order induced by Φ -posets is also a lattice (Theorem 11.2.16):

Theorem 31. The weak order on the Φ -posets is a lattice.

For example, the weak orders on A_2 - and G_2 - are represented in Figures 0.7 and 0.8. Figure 0.7 shows the correspondance of representation between [CPP17] and [GP18]: a root $\alpha = e_i - e_j \in \Phi_A$ corresponds to an interval $[\min(i, j), \max(i, j)]$. In order to obtain Theorem 31, we say that a sum of root is *summable* if it is still a root. Then one of the main tool is to know how to remove some roots to a summable set of roots so that we still have a summable set of roots. These are the results presented in Proposition 11.1.11 and Theorems 11.1.12 and 11.1.13:

Theorem 32. Let Φ be a crystallographic root system. Any summable set $X \subseteq \Phi$ with no vanishing subsum admits a filtration of summable subsets

$$\{\alpha\} = X_1 \subsetneq X_2 \subsetneq \cdots \subsetneq X_{|X|-1} \subsetneq X_{|X|} = X$$

for any $\alpha \in X$.

We then switch to our motivation to study the weak order on Φ -posets. We consider Φ -posets corresponding to the vertices, the intervals and the faces of the permutahedron, associahedra and cube of type Φ (Section 11.3). Considering the subposets of the weak order induced by these specific families of Φ -posets allow us to recover the classical weak order and the Cambrian lattices, their interval lattices, and their facial lattices.

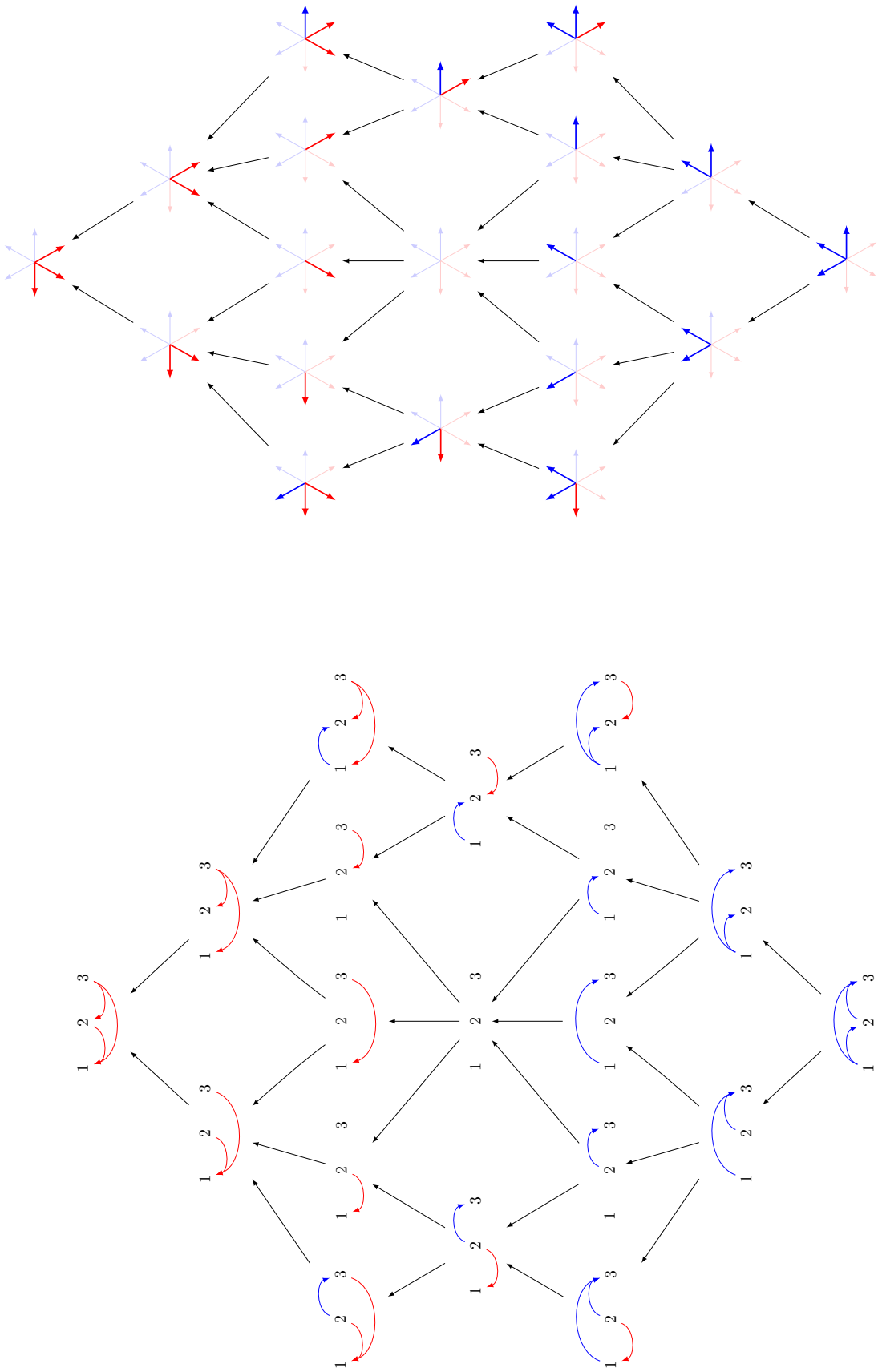
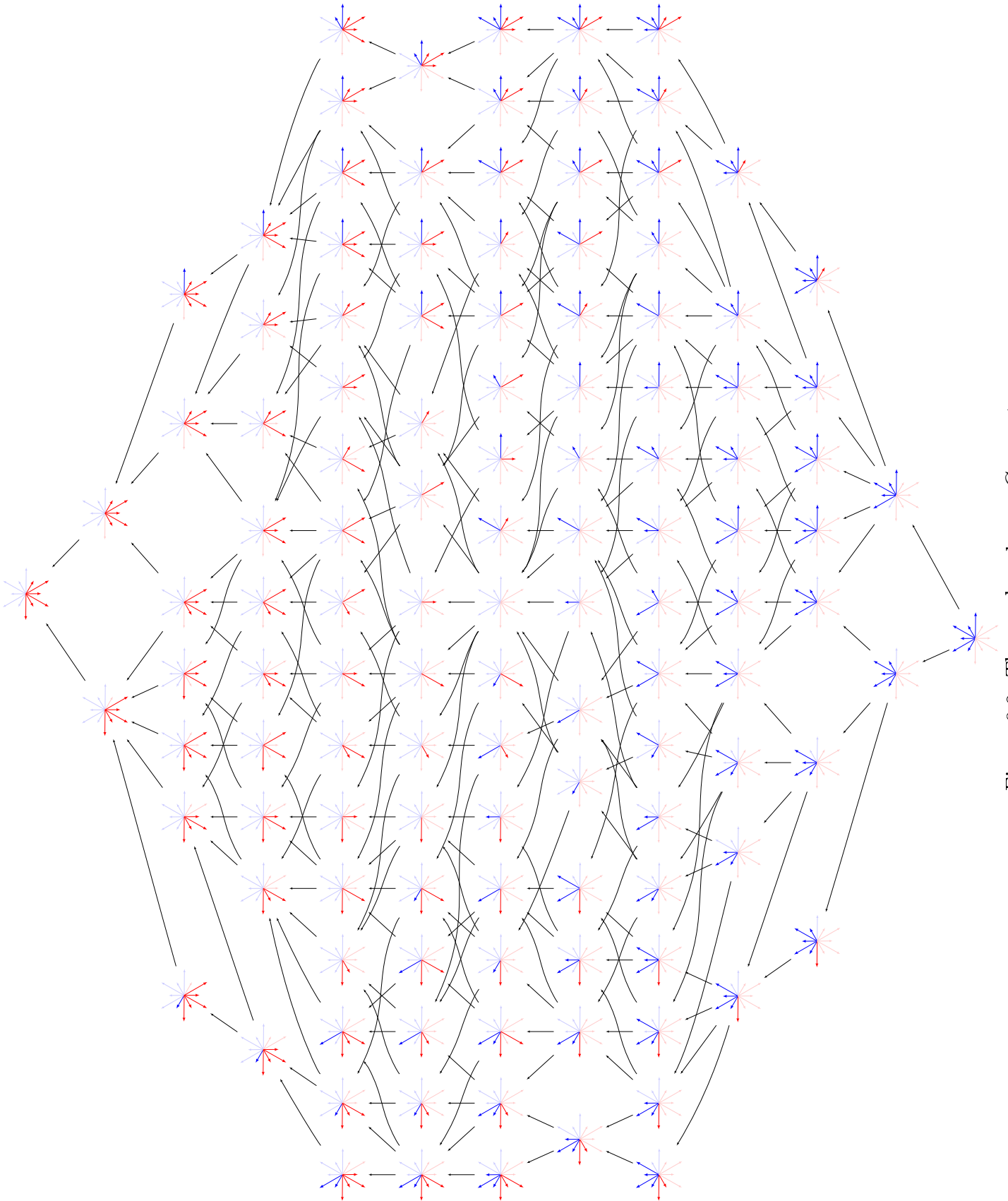

Figure 0.7: The weak order on A_2 -posets as seen in [CPPI17] (left.) and [GPI18] (right.)

Figure 0.8: The weak order on G_2 -posets.

Part I
Background

Summary

This part expose the background and necessary material to understand the thesis and the different objects we will be dealing with. No result here is from the author of the thesis, and we try to always give some reference from where the result can be found in a wider perspective.

One of the richness of algebraic combinatorics is the diversity of points of view. For instance, a mere permutation can be seen as a *vector*, a *matrix*, equivalently an *operator* on some vectorial space, but it can also be seen as *word* over a given alphabet, word over a *generating set*, or else as a function over words. It is also some vertex of a polytope, the *Permutahedron*, as well as a *linear extension* of a *poset*. In Chapter 1 we introduce all the objects that we will need. We begin with the permutations, in Section 1.1, and explain with them the question of expressing our objects in term of words. This will lead us to definitions of *length*, *reduced word* but also the so-called “*word problem*” that will be the main reason of technical arguments in Part II and III. We also introduce the weak order more precisely in this section, as well as natural objects when dealing with permutations (*inversions*, *descents*, *compositions* and *partitions*).

Then in Section 1.2 we explain that the idea of giving an order on combinatorial family is quite classic, which lead us to the notion of *posets*. This is also the main idea behind Part IV. In the monoidal case, there are natural order introduced by Green that we will present in Section 1.3. The posets and lattices obtained with these orders can also be the 1-skeleton of some polytopes, and we give the necessary geometric background in Section 1.4. Finally we introduce the rooks (Section 1.5), the Tamari lattice (Section 1.6) and another way to study these objects as some basis of a vectorial space (Section 1.7).

One good setup to study the question of reduced words and the “word problem” is the *Coxeter Group* theory which we introduce in Chapter 2. The *Coxeter Groups* can be defined as abstract groups defined by a presentation on some generating set (see Section 2.2) but the good way to understand them is to see them as a set of vectors (called *roots*) acting on an euclidian space (see Section 2.1). This duality of points of view enables us to classify them (Theorem 2.2.3) and especially a certain subclass of them, the *Weyl groups* (Theorem 2.2.3). After some properties (Section 2.3) we explain that this double approach is useful to understand the sorting algorithm with the Hecke algebra and its generalization (Section 2.4).

Finally, a better understanding of these groups, monoids and algebra can be obtained through the representation theory introduced in Chapter 3. There, after an introduction on representation theory of finite group in Section 3.1, we give some general results on algebra (Section 3.2) before going to the representation theory of \mathcal{J} -trivial monoids of T. Denton, F. Hivert, A. Schilling and N. Thiéry mentioned in the introduction (Section 3.3). We also give a proper setup of the notion of tower of monoids and end with some explicit examples (Sections 3.4, 3.5 and 3.6).

Combinatorics and operators

1.1 Permutations

1.1.1 Permutation and matrices

As explained in the introduction, our main object is the symmetric group \mathfrak{S}_n and its generalizations: the rook monoid R_n in Section 1.5, the 0-Hecke monoid H_n^0 in Section 2.4, and the Weyl groups in Section 2.1. Hence we will first present some properties of the permutations and the symmetric group that we will later generalize in these different contexts. We first define a permutation in terms of words:

Definition 1.1.1. *A permutation of size n is a word on the alphabet $[n] := \{1, \dots, n\}$ where each letter appears exactly once.*

For instance the permutations of size 3 are 123, 132, 213, 231, 312 and 321. The set of all permutations of size n is finite and has cardinality $n!$. It is indeed a well-known group, the symmetric group \mathfrak{S}_n . In order to see the multiplication of two permutations, it is more natural to see a permutation $\sigma = \sigma_1 \dots \sigma_n$ as the bijection

$$\sigma : \begin{array}{c|c} [n] & \longrightarrow [n] \\ i & \longmapsto \sigma_i \end{array} \tag{1.1}$$

With this functional perspective, the identity is the permutation $123 \dots n$ while the multiplication is the composition of functions: if $\sigma, \tau \in \mathfrak{S}_n$ then $\sigma \cdot \tau = \sigma \circ \tau$. For instance if $\sigma = 2431$ and $\tau = 2134$ then $\sigma \cdot \tau = \sigma \circ \tau = 4231$.

We can also represent a permutation as its *permutation matrix* which is an $n \times n$ matrix with a 1 in position (i, σ_i) for all $i \in [n]$ and a 0 in any other position, see Figure 1.2. An alternative way to define a permutation of size n is to say that it is an $n \times n$ matrix with entries in $\{0, 1\}$ and exactly one nonzero entry in each column and each row. We will come back to this point of view in Section 1.5. This representation of permutation as a matrix is also very useful. For instance it is clear by definition that σ^{-1} is the permutation of the transposed permutation matrix. It is also compatible with the multiplication of matrices.

We will study the permutation group as acting on the permutations. The action will just be right or left multiplication.

1.1.2 Generation by elementary transpositions

In the symmetric group \mathfrak{S}_n we consider the *elementary transpositions* $(s_i)_{1 \leq i \leq n-1}$. The transposition s_i exchanges the consecutive letters i and $i + 1$:

$$s_i(j) := \begin{cases} i + 1 & \text{if } j = i \\ i & \text{if } j = i + 1 \\ j & \text{otherwise.} \end{cases} \quad (1.2)$$

These elementary transpositions generate the symmetric group:

Proposition 1.1.2. *The symmetric group \mathfrak{S}_n is generated by s_1, \dots, s_{n-1} .*

Since $(s_i)_{1 \leq i \leq n-1}$ is a generating set, we obtain that a permutation of size n is also a word on the alphabet $(s_i)_{1 \leq i \leq n-1}$. Unfortunately, it is not easy to compare two elements in term of words on the generators. For instance the s_i are involutions, hence $s_i s_i = 1$. Another example are the *braid relations*: $s_i s_{i+1} s_i = s_{i+1} s_i s_{i+1}$ and $s_i s_j = s_j s_i$ if $|i - j| \geq 2$. For instance $s_1 s_2 s_1 = s_2 s_1 s_2 = 3214 \dots n$. Hence the permutation $3214 \dots n$ has at least two words representing it: $s_1 s_2 s_1$ and $s_2 s_1 s_2$. This problem is known as the “word problem”. It will indeed be the main issue behind the Part II and III of this manuscript. As explained in the introduction, in order to tackle this combinatorial problem we will rely on some geometry and algebraic actions.

As we will encounter such issues in other contexts, we give a general setup and definitions. As we said, we will naturally be dealing with words on some generators. We recall that a *monoid* is a set M endowed with a binary operation $\cdot : M \times M \rightarrow M$ such that we have

- *closure*: $x \cdot y \in M$ for all $x, y \in M$,
- *associativity*: $(x \cdot y) \cdot z = x \cdot (y \cdot z)$ for all $x, y, z \in M$,
- *identity*: existence of an element $1 \in M$ such that $1 \cdot x = x \cdot 1 = x$ for all $x \in M$.

In this thesis all monoids will be *finite*.

Let M be a monoid generated by a set S . As seen before, an element $m \in M$ can be represented by different words \underline{m} on S of different lengths $|\underline{m}|$. Hence the following definition:

Definition 1.1.3. [*Bou02*] *If $m \in M$, the length of m is the minimal length of a word in S whose product is m . Such a minimal length word is called reduced.*

This notion of reduced word is quite important for the word problem. For instance, in the case of the group \mathfrak{S}_n we saw that $1 = s_i^2$ for all i , but ϵ is the only reduced expression of 1. However in the case of $s_1 s_2 s_1 = s_2 s_1 s_2$ the two expressions are reduced. Hence a permutation may have more than one reduced word.

The reduced expressions of words of the symmetric group \mathfrak{S}_n in the generating system $S = \{s_1, \dots, s_{n-1}\}$ are encoded in the *right-Cayley graph* (resp. left) of \mathfrak{S}_n . It is the graph whose vertices are the element of \mathfrak{S}_n and for any $g \in \mathfrak{S}_n$ and $s \in S$ there is a directed edge (g, gs) (resp. (g, sg)) labeled with an s . The *bisided Cayley graph* of \mathfrak{S}_n is graph on \mathfrak{S}_n with both edges (g, sg) and (g, gs) for $g \in \mathfrak{S}_n$ and $s \in S$. We represent the bisided-Cayley graph of \mathfrak{S}_4 in Figure 1.1.

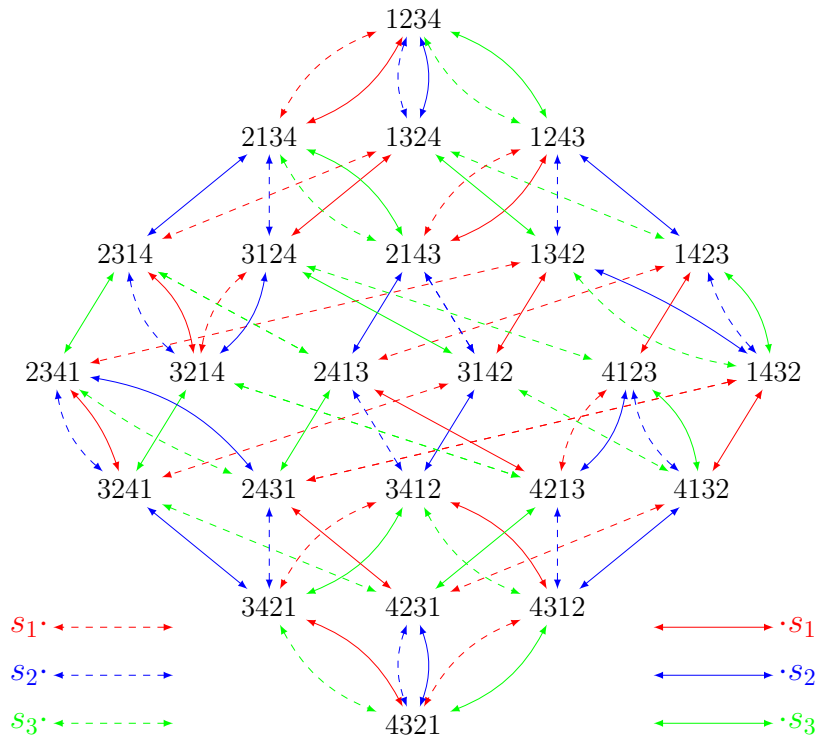

Figure 1.1: The bisided-Cayley graph of \mathfrak{S}_4 . The plain arrows represent the right action and the left action represent the dashed arrows.

1.1.3 Inversions and weak order

As explained in section 1.1.2, one of the main question of the word problem is the length of a word. It happens that in the case of the symmetric group, there is a combinatorial characterization of the length.

Definition 1.1.4. For $\sigma = \sigma_1 \dots \sigma_n \in \mathfrak{S}_n$ we define its **right-inversion set** by:

$$\text{Inv}_R := \{(\sigma_i, \sigma_j) \mid i < j \text{ and } \sigma_i > \sigma_j\} \tag{1.3}$$

We similarly define the **left-inversion set** by:

$$\text{Inv}_L := \{(j, i) \mid i < j \text{ and } \sigma_i > \sigma_j\} \tag{1.4}$$

In this thesis we will be mainly interested in right-inversions. So an inversion will be a right-inversion unless otherwise stated and we let $\text{Inv} := \text{Inv}_R$. It happens that a permutation is characterized by its inversion set. For instance the permutation in \mathfrak{S}_4 whose only inversion are $\{(2, 1), (4, 3), (4, 2), (4, 1)\}$ is 4213. However we can already note that not all subsets of $\Delta := \{(i, j) \mid i > j, i, j \in [n]\}$ are inversion sets of permutations. Here is the characterization of inversion sets of permutations; it uses the definition of transitivity (see Section 1.2):

Lemma 1.1.5 ([GR63]). *Given a set $I \subseteq \Delta$, there exists a permutation σ such that $\text{Inv}(\sigma) = I$ if and only if I and $\Delta \setminus I$ are both transitive. When this holds the permutation σ is unique.*

For instance the set $\{(2, 1), (4, 3), (4, 2)\}$ is not the inversion set of a permutation. In Chapter 10 such characterizations of relations will be the starting point of a study where we will follow an article of G. Châtel, V. Pilaud and V. Pons [CPP17].

From this definition of inversions we define the following order on \mathfrak{S}_n , which gives us a way to orient its Cayley graph:

Definition 1.1.6. *The **right-weak order** \preceq_R (resp. **left-weak order** \preceq_L) on \mathfrak{S}_n is defined, for $\sigma, \tau \in \mathfrak{S}_n$, by:*

$$\sigma \preceq_R \tau \Leftrightarrow \text{Inv}_R(\sigma) \subseteq \text{Inv}_R(\tau) \quad (\text{resp. } \sigma \preceq_L \tau \Leftrightarrow \text{Inv}_L(\sigma) \subseteq \text{Inv}_L(\tau)). \quad (1.5)$$

The minimal element is the identity permutation $\epsilon = 12\dots n$, while the maximal is the **maximal element** $w_0 := n\dots 321$ of \mathfrak{S}_n .

As before, we will mainly be interested in the right-weak order, called the weak order \preceq unless otherwise stated. This definition of the weak order has been recently generalized in [CPP17]. We will see this generalization in Part IV and extend it for other Coxeter types.

The following property comes quite naturally from the action of the elementary transpositions, and gives a first link between reduced expressions and inversions:

Proposition 1.1.7. *For any $\sigma \in \mathfrak{S}_n$, we have $\ell(\sigma) = |\text{Inv}(\sigma)|$.*

Finally, we note that the right weak order is also the prefix order in reduced expressions on the elements of the group.

1.1.4 Descent set and bubble sort

Instead of considering all inversions, we can just consider inversions in consecutive positions. These are called the descents.

Definition 1.1.8. *A **right-descent** (resp. **left-descent**) of σ is a position $i \in [n-1]$ so that $\sigma_i > \sigma_{i+1}$ (resp. $\sigma_i^{-1} > \sigma_{i+1}^{-1}$), or equivalently so that $\ell(\sigma s_i) < \ell(\sigma)$ (resp. $\ell(s_i \sigma) < \ell(\sigma)$). Their set, the **left-descent set** (resp. **right-descent set**) of $\sigma \in \mathfrak{S}_n$ is denoted by $D_R(\sigma)$ (resp. $D_L(\sigma)$).*

We now note a problem of convention. Looking at Figure 1.2 we note that “descents” in permutation matrices and descent sets are opposite. Hence we define the **permutation table** of $\sigma \in \mathfrak{S}_n$ as the $n \times n$ table with a 1 in the box (i, σ_i) for all $i \in [n]$, where boxes are indexed in **cartesian coordinates**. As we see in Figure 1.2, descents in permutation tables and descents of an element are the same. When we work with a permutation table, the transposition is done with respect to the $x = y$ diagonal.

A right-descent set D_R defines a graph on n vertices, called the **right-descent pattern**. To do that index the vertices by $[n]$ and set them in order from left to right. Only consecutive numbers are linked by an edge, and that this edge is going upward if $i \notin D_R$, and downward otherwise. See Figure 1.2.

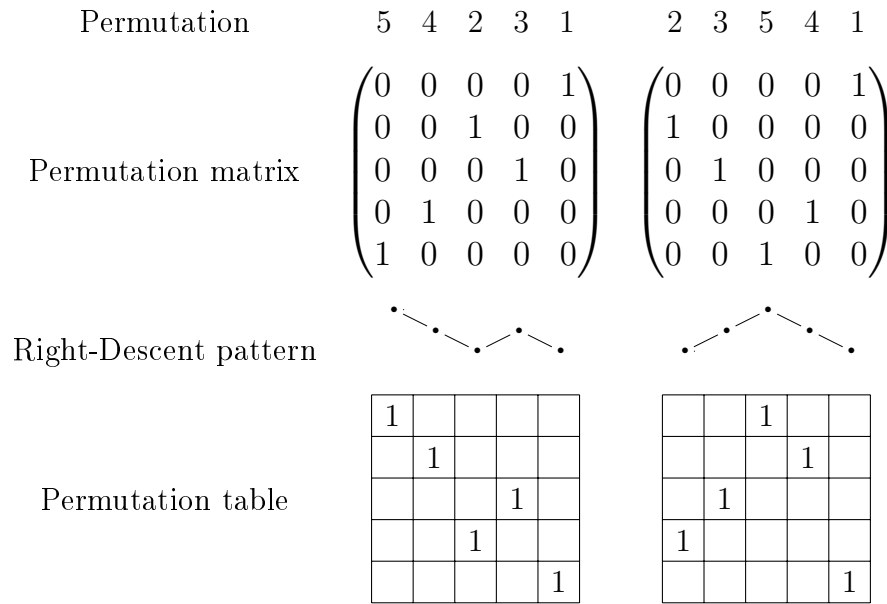

Figure 1.2: Some representations and properties of two permutations of \mathfrak{S}_5 .

When acting on σ with an elementary transposition s_i , we have the following property:

$$\text{Des}_R(\sigma \cdot s_i) = \begin{cases} \text{Des}_R(\sigma) \cup \{i\} & \text{if } i \notin \text{Des}_R(\sigma) \\ \text{Des}_R(\sigma) \setminus \{i\} & \text{otherwise.} \end{cases} \quad (1.6)$$

When sorting a list with the bubble sort algorithm, we are sorting numbers in decreasing order, hence we introduce the following operators:

Definition 1.1.9. For $i \in [n - 1]$, we define the bubble sort operator π_i as the function:

$$\pi_i : \begin{cases} \mathfrak{S}_n & \longrightarrow & \mathfrak{S}_n \\ \sigma = \sigma_1 \dots \sigma_n & \longmapsto & \begin{cases} \sigma \cdot s_i & \text{if } \sigma_i < \sigma_{i+1}, \\ \sigma & \text{otherwise.} \end{cases} \end{cases} \quad (1.7)$$

Note that $\sigma_i < \sigma_{i+1}$ if and only if $\ell(\sigma s_i) = \ell(\sigma) + 1$.

With this new formalism, we get another definition of descents:

Proposition 1.1.10. The left-descent set and right-descent set of $\sigma \in \mathfrak{S}_n$ are:

$$D_R(\sigma) := \{i \in [n - 1] \mid \sigma \pi_i = \sigma\}, \quad (1.8)$$

$$D_L(\sigma) := \{i \in [n - 1] \mid \pi_i \sigma = \sigma\}. \quad (1.9)$$

The bubble sort operators are by definition related to the elementary transpositions. In fact there are deep connections between these functions, as we will see in Section 2.4. For now we just mention that the graph of the action of π_1, \dots, π_{n-1} is in bijection with the Cayley-graph of \mathfrak{S}_n , see Figure 1.1 and Figure 1.3.

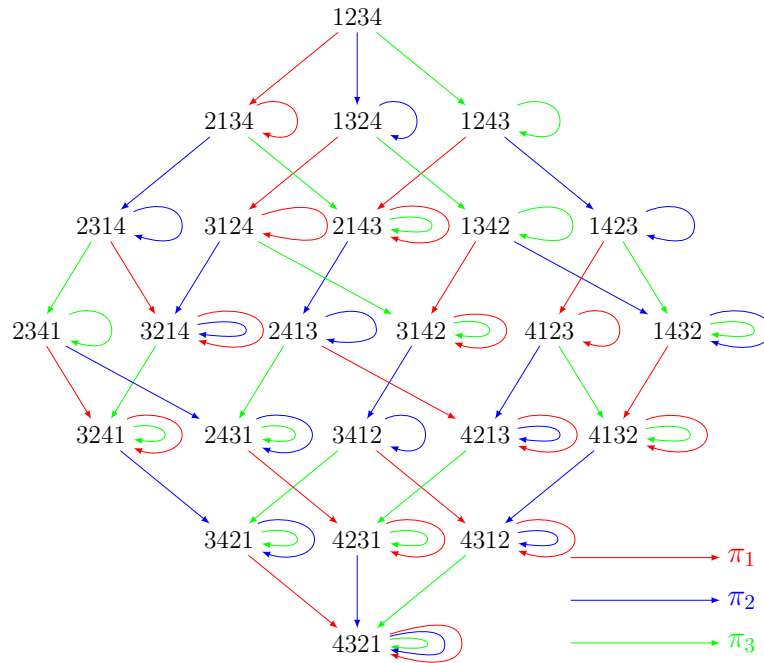

Figure 1.3: The right-action of the bubble sort operators on \mathfrak{S}_4 .

1.1.5 Compositions and ribbons

Here we introduce another combinatorial tool linked to the descent sets of a permutation $\sigma \in \mathfrak{S}_n$. Indeed, each subset S of $\llbracket 1, n-1 \rrbracket$ of cardinality p can be uniquely associated with a *composition of n* of length $p+1$ that is a tuple $I := (i_1, \dots, i_{p+1})$ of positive integers of sum n :

$$S = \{s_1 < s_2 < \dots < s_p\} \mapsto C(S) := (s_1, s_2 - s_1, s_3 - s_2, \dots, n - s_p). \quad (1.10)$$

The converse bijection, sending a composition to its *descent set*, is given by:

$$I = (i_1, \dots, i_p) \mapsto \text{Des}(I) = \{i_1 + \dots + i_j \mid j = 1, \dots, p-1\}. \quad (1.11)$$

We write $I \vDash n$ when I is a composition of n and write $\ell(I)$ for the length of I . We will sometimes extend this definition to subsets $J \subset \llbracket 0, n-1 \rrbracket$ by prepending a 0 to $C(S)$ when $0 \in S$. For instance, the composition $(3, 1, 2, 1, 2, 2) \vDash 11$ corresponds to the subset $\{3, 4, 6, 7, 9\}$ of $\llbracket 0, 10 \rrbracket$ and $(0, 3, 4, 1) \vDash 8$ corresponds to the subset $\{0, 3, 7\}$ of $\llbracket 0, 7 \rrbracket$.

Compositions can be pictured as *ribbon diagrams*, that is, a set of rows composed of square cells of respective lengths i_j , the first cell of each row being attached under the last cell of the previous one. I is called the *shape* of the ribbon diagram. We saw in Definition 1.1.8 the definition of the *descent set* $\text{Des}(\sigma)$ of a permutation σ , and the *descent composition* $C(\sigma)$ of σ is the unique composition I of n such that $\text{Des}(I) = \text{Des}(\sigma)$, that is, the shape of a filled ribbon diagram whose row reading is σ and whose rows are increasing and columns decreasing. For example, Figure 1.4 shows that the descent composition of $\sigma = 3541276$ is $I = (2, 1, 3, 1)$.

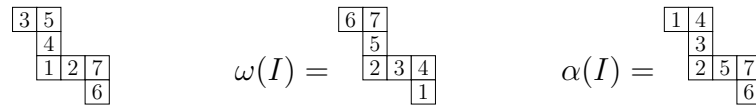

Figure 1.4: The ribbon diagram of the permutation 3541276.

Conversely, it is well known that the set of permutations whose descent composition is I is the right weak order interval $[\alpha(I), \omega(I)]$ (see *e.g.* [KT97, Lemma 5.2]). For example, if $I = (2, 1, 3, 1)$, $\omega(I) = 6752341$ and $\alpha(I) = 1432576$.

1.1.6 Lehmer code and presentation

The *Lehmer code* is an alternative way to encode a permutation. It provides a tool to obtain a presentation of the symmetric group. A *presentation* of a group (resp. of a monoid) is a way to express it as a quotient of a free group (resp. monoid), using equalities which generate all relations in the group (resp. monoid). There are different possible definitions of the Lehmer code. We have given the definition most connected to our work in Part II.

One purpose of the Lehmer code is to obtain a canonical reduced word for permutations by induction along the chain of inclusions

$$\mathfrak{S}_1 \subset \mathfrak{S}_2 \subset \dots \subset \mathfrak{S}_{n-1} \subset \mathfrak{S}_n \subset \dots \quad (1.12)$$

noticing that the number of cosets in $\mathfrak{S}_{n-1} \backslash \mathfrak{S}_n$ is exactly n . One can for example take $\{1, s_{n-1}, s_{n-1}s_{n-2}, s_{n-1}s_{n-2}s_{n-3}, \dots\}$ as a cross-section. In a more combinatorial setting, this is equivalent to say that given a permutation $\sigma \in \mathfrak{S}_{n-1}$ there are exactly n permutations which give back σ when erasing the letter n . Therefore any permutation can be encoded by a sequence $\mathbf{c} = (c_1 \dots c_n)$ satisfying $0 \leq c_i < i$:

Definition 1.1.11 ([Lot02, page 330]). *The Lehmer code of $\sigma \in \mathfrak{S}_n$ is defined by*

$$\text{Lehmer}(\sigma) = c_1 \dots c_n \quad \text{with} \quad c_i := |\{j > i \mid \sigma_i > \sigma_j\}| \quad (1.13)$$

Example 1.1.12. $\text{Lehmer}(516432) = 403210$ and $\text{Lehmer}(352614) = 231200$.

From there Lascoux obtained a canonical reduced expression for every element of \mathfrak{S}_n :

Lemma 1.1.13 ([Las02, Lemma 3]). *Let $\sigma \in \mathfrak{S}_n$ and let its Lehmer code be $\text{Lehmer}(\sigma) = c_1 \dots c_n$. The concatenation of right factors $(s_{n-1} \dots s_1) \dots (s_{n-1})()$ of respective lengths c_1, \dots, c_n is then a reduced word for σ .*

This allow to reprove algorithmically the following presentation of the symmetric group, whose relations were already mentioned in Section 1.1.2.

Theorem 1.1.14. *The symmetric group \mathfrak{S}_n is generated by the simple transpositions $(s_i)_{1 \leq i \leq n-1}$ with respect to the relations:*

$$s_i^2 = 1 \qquad 1 \leq i \leq n-1; \qquad (\text{A-1})$$

$$s_i s_j = s_j s_i, \qquad 1 \leq i, j \leq n-1 \text{ and } |i-j| \geq 2; \qquad (\text{A-2})$$

$$s_i s_{i+1} s_i = s_{i+1} s_i s_{i+1}, \qquad 1 \leq i \leq n-2; \qquad (\text{A-3})$$

The relation A-1 just says that the s_i are involutions. The relations A-2 and A-3 are called the *braid relations*. The next theorem, due to Matsumoto, shows one of their properties:

Theorem 1.1.15 (Matsumoto's theorem, [BB05, Theorem 3.3.1]). *If \underline{u} and \underline{v} are two reduced expressions over $\{s_1, \dots, s_{n-1}\}$ for the same element of \mathfrak{S}_n then they are congruent using only the braid relations A-2 and A-3.*

Theorems 1.1.14 and 1.1.15 give an answer to the word problem in \mathfrak{S}_n . A direct consequence of Matsumoto's Theorem is that an element σ has the descent i if and only if there is a reduced expression for it which ends by s_i .

1.1.7 Partitions, cycle decomposition and Foata transformation

Finally we give another bijection in \mathfrak{S}_n , called the *Foata transformation*. It was historically used to prove the equidistribution of cycles and left to right maxima. As far as we are concerned, this bijection will enable us to do some enumerations on rooks in Section 4.2.2. We also refer to [Lot02] for more details.

We first define a *partition* of an integer n to be a decreasing sequence of integers $\lambda = (\lambda_1, \dots, \lambda_m)$ so that $\lambda_1 \geq \lambda_2 \geq \dots \geq \lambda_m$ and $\lambda_1 + \lambda_2 + \dots + \lambda_m = n$. We denote this by $\lambda \vdash n$. It is a classical result that any permutation can be written as a product of cycles, even of length 1, so that all letters appear in exactly one cycle. For instance $\tau = 1256374$ admits the *cycle decomposition* $(1)(2)(3, 5)(4, 6, 7)$. If we consider the sequence length of the cycles of a given permutation $\sigma \in \mathfrak{S}_n$ in decreasing order, we obtain a partition of n . Here $7 = 3 + 2 + 1 + 1$. This partition associated with any given permutation also describes its *conjugation class*. Indeed it is another classical result that two permutations σ and τ are in the same conjugation class if and only if the partitions associated to their cycle decompositions are the same.

In order to get the Foata transformation $\mathcal{F}(\sigma) \in \mathfrak{S}_n$ of any $\sigma \in \mathfrak{S}_n$ we do the following steps:

- (i) Write the cycle decomposition of σ .
- (ii) Cyclically rearrange each cycle so that it begins with its largest element.
- (iii) Arrange the cycles in increasing order of their largest elements.
- (iv) Drop commas and parentheses: it is the one-line notation of $\mathcal{F}(\sigma)$.

For instance, for $\tau = 1256374$, $\tau = (1)(2)(3, 5)(4, 6, 7) = (1)(2)(5, 3)(7, 4, 6)$ so that $\mathcal{F}(\tau) = 1253746$. The reverse bijection \mathcal{F}^{-1} can be defined in the same vein. If $\sigma \in \mathfrak{S}_n$, the steps are the following:

- (i) Write σ in its one-line notation.
- (ii) Traverse through the word from left to right, and identify all the elements that are larger than the elements before them, called the the left-to-right maxima. The word starting with a given left-to-right maxima and ending just before the next form the word for the cycles in the canonical notation for the cycle decomposition of $\mathcal{F}^{-1}(\sigma)$.

For instance if $\sigma = 1253746$ we find back the cycle decomposition $(1)(2)(5, 3)(7, 4, 6)$ and the element τ , so that $\mathcal{F}^{-1}(\mathcal{F}(\tau)) = \tau$. The reader can prove that this is indeed general, so that $\mathcal{F} : \mathfrak{S}_n \rightarrow \mathfrak{S}_n$ is a bijection.

1.2 Posets

In this section we follow V. Pons in [Pon13] and borrow her pictures with permission. As we saw in Section 1.1, it is quite natural to define relations on combinatorial objects. Sets with a partial order are called *partially ordered sets*, or *posets* for short. Posets can be studied as combinatorial objects themselves as we will see in Part IV, but for now we will see them as a structure on combinatorial sets.

1.2.1 First definitions

Definition 1.2.1. A *preposet* P is a set with a relation \leq which is

- (i) **Reflexive:** $\forall x \in P, x \leq x$ if $x \leq y$ and $y \leq z$ then $x \leq z$;
- (ii) **Transitive:** $\forall x, y, z \in P$ if $x \leq y$ and $y \leq z$ then $x \leq z$.

A *poset* is a preposet with the following additional property:

- (iii) **Antisymmetric:** $\forall x, y \in P$ if $x \leq y$ and $y \leq x$ then $x = y$;

Furthermore, if for every $x, y \in P$, we have either $x \leq y$ or $y \leq x$ then the order is said **total** (sometimes also called **linear**). We write $x < y$ when $x \leq y$ and $x \neq y$.

In this thesis every posets and preposets P will be finite.

Definition 1.2.2. An element $x \in P$ is **minimal** (resp. **maximal**) if there is no $y \in P$, so that $y < x$ (resp. $y > x$).

Definition 1.2.3. For $x, y \in P$ we say that y **covers** x , and we write $x \triangleleft y$, if $x < y$ and there is no $z \in P$ so that $x < z < y$. Such relations are called **cover relations**.

The cover relations are enough to define the poset, as the other relations can be deduced by transitivity. Hence in order to represent a poset we can only give elements and cover relations: we show this in the *Hasse diagram* of the poset. Usually, the following convention is applied: $x < y$ if and only if x is linked to y by an edge and below it. Therefore the smallest elements are at the bottom of the image, cf. Figure 1.5.

For instance in Section 1.1.4, the descent pattern is the Hasse diagram of the poset given by the inversion set. For a descent set D on permutations of size n , its associated partial order \leq_D on $[n]$ is generated by the cover relations

$$\{i + 1 \leq_D i \mid i \in D\} \cup \{i \leq_D i + 1 \mid i \in [n - 1] \setminus D\}. \quad (1.14)$$

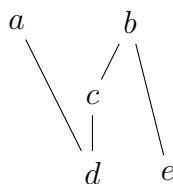

Figure 1.5: Example of a Hasse diagram. The cover relations are $d < c < b$, $d < a$ and $e < b$. The elements d and e are minimal. The order is partial since a and b can not be compared.

We now consider a relation R on a set S . Its *transitive closure* R^{tc} is the smallest relation on X that contains R and is transitive. For instance if P is a poset, the transitive closure of its cover relations is the poset itself.

Definition 1.2.4. A chain of a poset P is a set of elements $\{x_1, \dots, x_m\}$ such that

$$x_1 \leq x_2 \leq \dots \leq x_m. \quad (1.15)$$

If for all $i \in \llbracket 1, m-1 \rrbracket$ we have $x_i < x_{i+1}$ the chain is *saturated*.

For instance in Figure 1.5, $d < c < b$ is a saturated chain.

Definition 1.2.5. A poset P is *graded* if there is an application $\gamma : P \rightarrow \mathbb{N}$ such that:

- (i) $\gamma(x) = 0$ if x is minimal,
- (ii) $\gamma(y) = \gamma(x) + 1$ if $x < y$.

Equivalently, a poset is graded if the length of any saturated chain between an element $y \in P$ and a minimal element x does not depend on x nor the chain. Thus the poset of Figure 1.5 is not graded since $d < c < b$ and $e < b$ are two saturated chains of different length from minimal elements to b . We have already seen the following:

Example 1.2.6. The poset $(\mathfrak{S}_n, \preceq)$ of the weak order is graded by length. Saturated chains from 1 to w_0 correspond to reduced expressions of w_0 .

The reader could use Figure 1.1 to check the characterization on the length of saturated chains.

1.2.2 Construction of posets

The following definitions explain how to build new posets from old ones. Examples of any construction (subposet, interval, quotient, etc.) are shown in Figure 1.6.

Definition 1.2.7. A poset P' is a subposet of P if $P' \subseteq P$ as a set, and if the partial order of P' is that of P restricted to elements of P' .

For $x, y \in P$ we denote $[x, y] := \{z \in P \mid x \leq z \leq y\}$ the *interval* between x and y . A subset $P' \subseteq P$ is *closed by intervals* if for any $x, y \in P'$, $[x, y] \subseteq P'$.

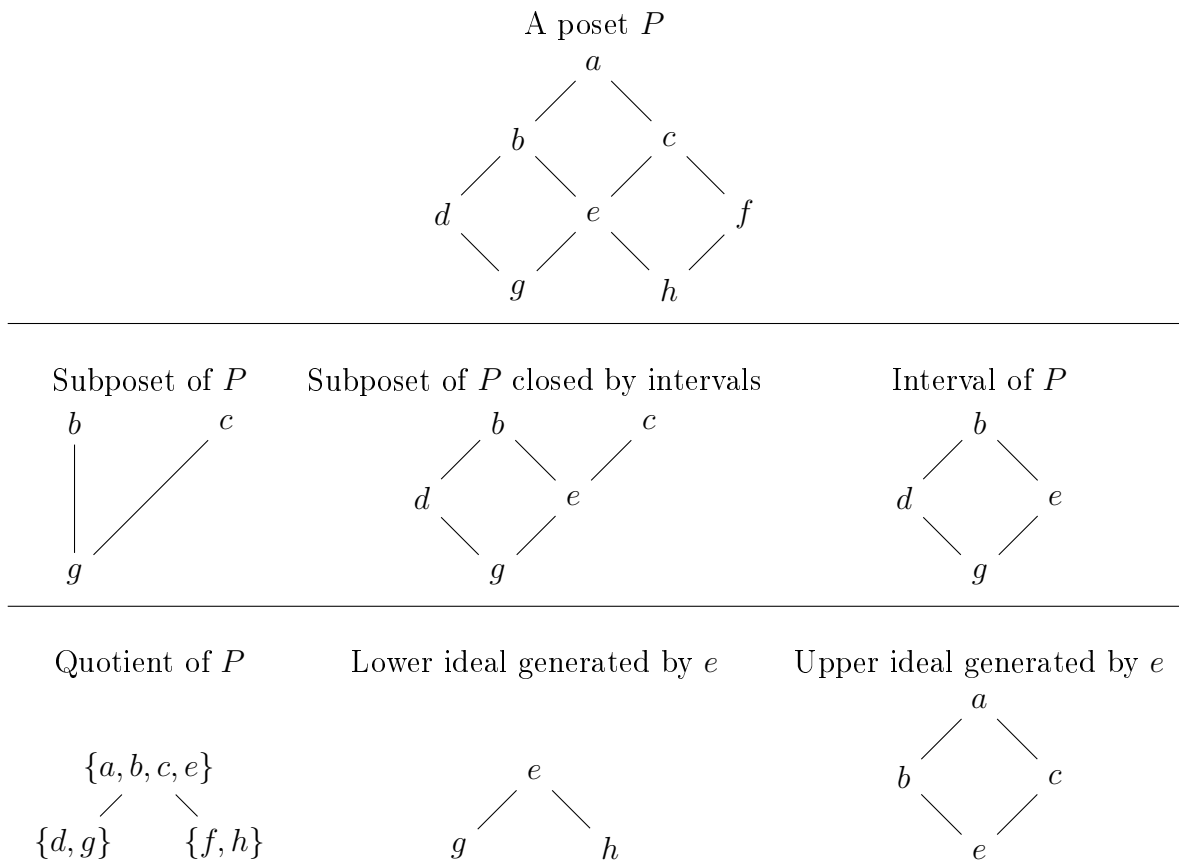

Figure 1.6: Examples of construction of posets.

Definition 1.2.8. Let \mathcal{P} be a partition of a poset P . Then \mathcal{P} is called a **quotient poset** of P if the relation defined on \mathcal{P} by

$$\dot{x} \leq \dot{y} \Leftrightarrow \exists x \in \dot{x}, y \in \dot{y} \text{ such that } x \leq y. \tag{1.16}$$

for any $\dot{x}, \dot{y} \in \mathcal{P}$ is an order relation.

In [CS98] we can find sufficient and necessary conditions for such a partition to generate a quotient poset.

Definition 1.2.9. Let P a poset and $x \in P$, the *lower ideal* (resp. *upper*) of P generated by x is the set of all elements $y \leq x$ (resp. $y \geq x$).

Finally we consider extensions of a poset. Let (P, \leq_P) and (Q, \leq_Q) be two posets over the same set E . If

$$x \leq_P y \Rightarrow x \leq_Q y \tag{1.17}$$

for any $x, y \in E$, then Q is an *extension* of P . Building an extension of P amounts to adding some relations to the poset P . If the order of Q is total, then Q is called a *linear extension* of P .

A linear extension of P can be represented as a word u whose letters are the elements of P with the rule that if $a \leq_P b$ then a must be before b in u . For

instance, the words $dceab$ and $edcba$ are linear extensions for the poset of Figure 1.5. If the elements of the poset are integers from 1 to n , the linear extensions of the poset can be seen as permutations, cf. Figure 1.7. We denote by $\mathcal{L}(P)$ the set of linear extensions of a poset P .

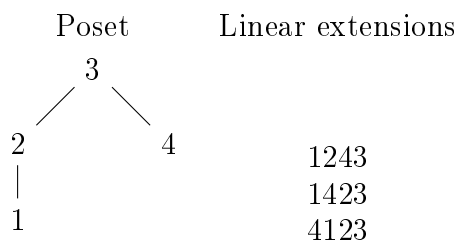

Figure 1.7: Example of linear extensions of a poset.

1.2.3 Lattice

Let X be a subset of the elements of a poset P . The *meet* of X , denoted by $\wedge X$, is the unique element z such that

$$y \leq z \Leftrightarrow \forall x \in X, y \leq x \quad (1.18)$$

if it exists, and \emptyset otherwise. Symmetrically, the *join* of X , denoted by $\vee X$ is the unique element z such that

$$y \geq z \Leftrightarrow \forall x \in X, y \geq x \quad (1.19)$$

if it exists, and \emptyset otherwise. When $X = \{x, y\}$ we also write $x \wedge y := \wedge X$ and $x \vee y := \vee X$.

Definition 1.2.10. A *meet-semilattice* (resp. *join semi-lattice*) is a poset P such that, for any subset X of P , $\wedge X$ (resp. $\vee X$) is different from \emptyset .

A *lattice* is a poset which is a meet-semilattice and a join semilattice.

It is a folklore result that a meet semilattice (resp. join semilattice) with a unique maximal element (resp. minimal element) is a lattice. The middle part of Figure 1.8 gives an example of a poset which is not a lattice. Indeed $b \wedge c = \emptyset$ and symmetrically $e \vee f = \emptyset$. In contrast the left poset is a lattice. Another example of a lattice is the boolean order on subsets of $[n]$, ordered by inclusion.

Another very important lattice is the weak order on \mathfrak{S}_n :

Theorem 1.2.11 ([BB05]). *The weak order on \mathfrak{S}_n is a lattice. The meet $\sigma \wedge \mu$ of σ and τ is characterized by: $\text{Inv}(\sigma \wedge \mu)$ is the transitive closure of $\text{Inv}(\sigma) \cup \text{Inv}(\mu)$. The join of σ and τ is characterized by: $\Delta \setminus \text{Inv}(\sigma \vee \mu)$ is the transitive closure of $(\Delta \setminus \text{Inv}(\sigma)) \cup (\Delta \setminus \text{Inv}(\mu))$.*

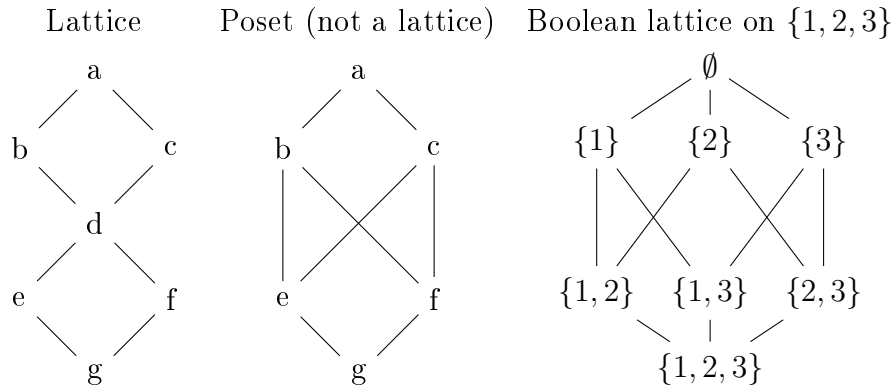

Figure 1.8: Example and counter-example of a lattice.

1.3 Elementary semigroup theory

1.3.1 Green relations

Let M be a finite monoid. We saw in Section 1.1.2 that we are often considering an element of M not as the element itself but as a word on some generating set. In Section 1.1.3 we explained that the weak order happens to be the order on the prefix on the reduced expressions of elements of \mathfrak{S}_n . Green defined a similar order on monoids which measure in a certain way how far the monoid is from a group. We refer to [Den+10; Pin10; Ste16] for more details. Recall that the left (resp. right, bi-sided) ideal of M generated by x is the set $Mx := \{mx \mid m \in M\}$ (resp. $xM := \{xm \mid m \in M\}$ and $MxM := \{mxn \mid m, n \in M\}$). In 1951, Green introduced several preorders on monoids related to inclusion of ideals. The standard terminology is to write \mathcal{R} for right ideal, \mathcal{L} for left and \mathcal{J} for bi-sided. We hence define the relations $\leq_{\mathcal{R}}, \leq_{\mathcal{L}}, \leq_{\mathcal{J}}$ as inclusion of ideals of the corresponding type. That is, if $x, y \in M$:

$$x \leq_{\mathcal{R}} y \iff xM \subseteq yM \iff x = yu \text{ for some } u \in M; \quad (1.20)$$

$$x \leq_{\mathcal{L}} y \iff Mx \subseteq My \iff x = uy \text{ for some } u \in M; \quad (1.21)$$

$$x \leq_{\mathcal{J}} y \iff MxM \subseteq MyM \iff x = uyv \text{ for some } u, v \in M. \quad (1.22)$$

These relations are clearly preorders (reflexive and transitive) and naturally give rise to equivalence relations:

$$x \mathcal{R} y \iff xM = yM; \quad (1.23)$$

$$x \mathcal{L} y \iff Mx = My; \quad (1.24)$$

$$x \mathcal{J} y \iff MxM = MyM. \quad (1.25)$$

Beware that 1 is the largest element of these preorders. As mentioned before in Section 1.2.1, this is the usual convention in the semigroup community, but is the converse convention from the closely related notions of left/right weak order in Coxeter groups, see also Chapter 2.

We give here a small result to see why \mathcal{J} -classes are very important in monoid theory. We define a *principal series* for M to be a saturated chain of ideals

$$\emptyset = I_0 \subsetneq I_1 \subsetneq \cdots \subsetneq I_s = M \quad (1.26)$$

This exist for any finite monoid, and it turns out that the differences I_k/I_{k-1} are precisely the \mathcal{J} -classes of M :

Proposition 1.3.1 ([Ste16, Proposition 1.18]). *Let 1.26 be a principal series for M . Then each difference I_k/I_{k-1} with $1 \leq k \leq s$ is a \mathcal{J} -class of M , and each \mathcal{J} -class arises exactly once in this manner.*

Next we wonder when Green preorders are orders.

Definition 1.3.2. *A monoid M is called \mathcal{K} -trivial with $\mathcal{K} \in \{\mathcal{R}, \mathcal{L}, \mathcal{J}\}$ if all \mathcal{K} -classes are of cardinality one, that is if the \mathcal{K} -preorder is antisymmetric and therefore an actual order. Specifically, M is \mathcal{J} -trivial if $MxM = MyM$ implies $x = y$.*

In term of Cayley graph, this means that the \mathcal{J} -sided Cayley graphs has only trivial (i.e. singletons) strongly connected components. We have seen such an example in Figure 1.3, and more examples of \mathcal{J} -trivial monoid of interest for this work will include the 0-Hecke monoid for any Coxeter group [Den+10] see also Section 2.4.

Example 1.3.3. Let M be the monoid generated by $\{a, b\}$ with $a^2 = a$, $b^2 = b$, $aba = ab$ and $bab = ba$. Figure 1.9 shows the three Cayley graphs of M .

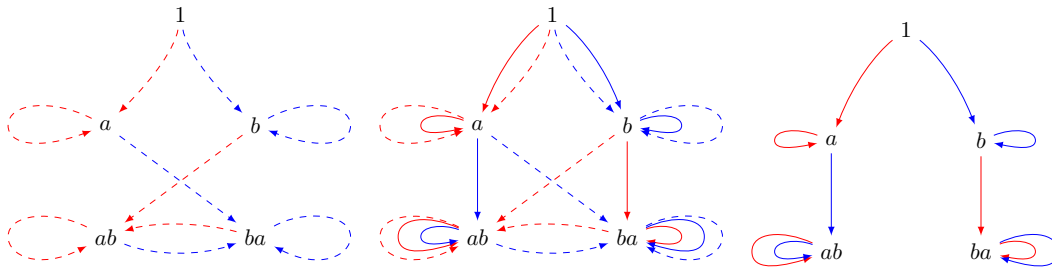

Figure 1.9: The left, bisided (middle) and right Cayley-graph of M . We see that M is \mathcal{R} -trivial but not \mathcal{L} -trivial nor \mathcal{J} -trivial since the strongly connected component $\{ab, ba\}$ is not a singleton.

An equivalent formulation of \mathcal{K} -triviality is given in terms of *ordered* monoids. A monoid M is called:

- right ordered* if $xy \leq x$ for all $x, y \in M$
- left ordered* if $xy \leq y$ for all $x, y \in M$
- left-right ordered* if $xy \leq x$ and $xy \leq y$ for all $x, y \in M$

for some partial order \leq on M .

Proposition 1.3.4 ([Den+10, Proposition 2.2]). *M is right ordered (resp. left ordered, left-right ordered) if and only if M is \mathcal{R} -trivial (resp. \mathcal{L} -trivial, \mathcal{J} -trivial). When M is \mathcal{K} -trivial for $\mathcal{K} \in \{\mathcal{R}, \mathcal{L}, \mathcal{J}\}$, then $\leq_{\mathcal{K}}$ is a partial order, called \mathcal{K} -order.*

Finally, for finite monoids, \mathcal{R}, \mathcal{L} and \mathcal{J} are related as follows:

Lemma 1.3.5 ([Pin10, V. Theorem 1.9]). *A finite monoid is \mathcal{J} -trivial if and only if it is both \mathcal{R} -trivial and \mathcal{L} -trivial.*

We are looking for another characterization of \mathcal{R} -trivial monoid. Let P be a finite poset, then a function $f : P \rightarrow P$ is called regressive if $f(x) \leq_P x$ for every $x \in P$. A function $f : P \rightarrow P$ is said to be *order-preserving* if for all $x, y \in P$, $x \leq_P y$ implies $f(x) \leq_P f(y)$. Then an \mathcal{R} -trivial monoid can be represented as a monoid of *regressive* functions on a finite poset P , and conversely any such monoid is \mathcal{R} -trivial. Furthermore, a monoid of regressive and order-preserving function is \mathcal{J} -trivial but the converse is false. An example of such a construction is the 0-Hecke monoid which we will introduce in Section 2.4.1. See [Den+10] for other examples (notably the *non decreasing parking functions*) and more details.

1.3.2 Subsemigroup of monoids

We follow [Ste16] in this section. We recall that a *semigroup* S is a set with a binary operation $\cdot : S \times S \rightarrow S$ which satisfies associativity. With this definition a monoid is just a semigroup with an identity.

Let M be a finite monoid and $x \in M$. Then $\langle x \rangle$ is a finite semigroup and therefore there exists a smallest positive integer c , called the *index* of x , such that $x^c = x^{c+d}$ for some $d > 0$. The smallest choice of d is called the *period* of x . See Figure 1.10. This gives us a way to know if two elements of $\langle x \rangle$ are equal:

Proposition 1.3.6 ([Ste16, Proposition 1.1]). *Let $x \in M$ have index c and period d . Then $x^i = x^j$ if and only if $i = j$ or $i, j \geq c$ and $i \equiv j \pmod{d}$.*

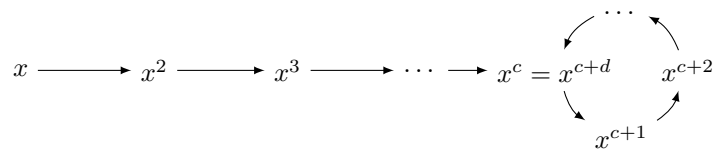

Figure 1.10: A cyclic semigroup in a general monoid.

This enables us to define an *idempotent* in the semigroup $\langle x \rangle$, that is an element $e \in M$ such that $e^2 = e$. These elements will happen to be very important in our thesis.

Corollary 1.3.7 ([Ste16, Corollary 1.2]). *Let $x \in M$ have index c and period d . Then the subsemigroup $C := \{x^n \mid n \geq c\}$ is a cyclic group of order d . The identity of C , denoted x^ω , is the unique idempotent of C and is given by x^m when $m \geq c$ and $m \equiv 0 \pmod{d}$.*

If the monoid M is \mathcal{K} -trivial for $\mathcal{K} \in \{\mathcal{L}, \mathcal{J}, \mathcal{R}\}$ then the period for every element is necessary 1. Hence if $x \in M$ has index c we deduce that $x^\omega = x^c = x^{c+1} = \dots$. Such a monoid M for which for every $x \in M$ there exist $N \in \mathbb{N}$ such that $x^N = x^{N+1}$ is called an *aperiodic monoid*. To see more on aperiodic monoids and the idempotent x^ω even in infinite monoids we refer to [Pin10]. See also Figure 1.11.

$$x \longrightarrow x^2 \longrightarrow x^3 \longrightarrow \dots \longrightarrow x^\omega \curvearrowright$$

Figure 1.11: A cyclic semigroup in an aperiodic monoid.

Finally we denote by $E(M) := \{x^\omega \mid x \in M\}$ the set of idempotents of M . This set will be of great importance in the representation theory of algebra (see Section 3.2.3). We just give the following property of idempotents:

Lemma 1.3.8 ([Den+10, Lemma 3.6]). *If M is \mathcal{J} -trivial, for $e \in E(M)$ and $y \in M$ the following three statements are equivalent:*

$$e \leq_{\mathcal{J}} y, \quad e = ey, \quad e = ye. \quad (1.27)$$

1.4 Geometry

1.4.1 Polytopes and permutahedron

This section is about the geometry of our combinatorial classes. These classes can frequently be realized geometrically as *polytopes*. A polytope \mathcal{P} is the convex hull of finitely many points in \mathbb{R}^n or, equivalently, a bounded intersection of finitely many closed affine half-spaces in \mathbb{R}^n . The *dimension* of \mathcal{P} is the dimension of its affine hull in \mathbb{R}^n and, if $\dim \mathcal{P} = d$, we say that \mathcal{P} is a d -polytope. A *supporting hyperplane* of \mathcal{P} is an affine hyperplane that does not separate any two points of \mathcal{P} . A *face* of \mathcal{P} is the intersection of \mathcal{P} with one of its supporting hyperplanes. Faces of a polytope are themselves polytopes, and we abbreviate “face of dimension k ” to k -face. We denote by $\mathcal{P}^{(k)}$ the set of k -faces of \mathcal{P} . The 0-faces are the *vertices*, the 1-faces are the *edges* and the $d - 1$ faces are the *facets*. The *1-skeleton* of \mathcal{P} is the graph whose vertices are the vertices of \mathcal{P} and whose edges are the pairs of vertices of \mathcal{P} belonging to a common edge of \mathcal{P} .

For instance, let us consider the combinatorial class of permutations. To each $\sigma \in \mathfrak{S}_n$ associate the point $\mathbf{x}_\sigma := (\sigma_1, \dots, \sigma_n) \in \mathbb{R}^n$. Then the *permutahedron* $\text{Perm}(n)$ is defined as the convex hull of all \mathbf{x}_σ for $\sigma \in \mathfrak{S}_n$. All its vertices live in the hyperplane H with:

$$H := \left\{ \mathbf{x} = (x_1, \dots, x_n) \in \mathbb{R}^n \mid \sum_i x_i = \binom{n+1}{2} \right\}. \quad (1.28)$$

It is a polytope of dimension $n - 1$. Furthermore, for any $I \subseteq [n]$, we define the hyperplane $H_I := \left\{ \mathbf{x} = (x_1, \dots, x_n) \in \mathbb{R}^n \mid \sum_{i \in I} x_i = \binom{|I|+1}{2} \right\}$. Then:

$$\text{conv}(\text{Perm}(n)) = H \cap \bigcap_{I \subseteq [n]} H_I. \quad (1.29)$$

We represent the 3-permutahedron $\text{Perm}(4)$ in Figure 1.12. If we compare with Figure 1.1 we see that the 1-skeleton of the n -permutahedron is the Hasse diagram of the right-weak order.

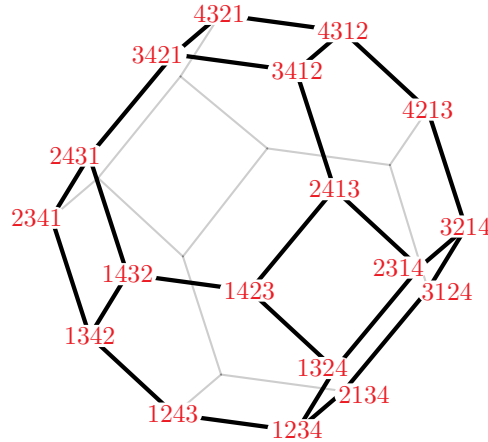

Figure 1.12: The 3-permutahedron $\text{Perm}(4)$.

1.4.2 Cones and fans

The definitions of cones and fans are closely related to those of polytopes, as they can be treated in a common setting [Zie95]. A *(polyhedral) cone* is the positive span of a finite set of vectors in \mathbb{R}^n . Equivalently a cone is the intersection of finitely many closed linear halfspaces. The *dimension* of a cone is the dimension of its linear span. The *faces* of a cone are its intersections with its supporting hyperplanes, that is the linear hyperplanes that do not strictly separate two of its elements. Faces of a cone are cones as well and the 1-dimensional faces of a *cone* are its *rays*. A cone is *simplicial* if it is generated by linearly independent vectors. A simplicial cone is then generated by its rays and any subset of its rays generate one of its faces.

A (polyhedral) *fan* is a set of cones closed by faces such that any two faces intersect in a common face. The maximal faces of the fan are its *facets*. A fan \mathcal{F} is *complete* if the union of all of its cones is V , *essential* (or *pointed*) if the intersection of all non-empty cones of \mathcal{F} is the origin, and *simplicial* if every cone is simplicial, that is, spanned by linearly independent vectors.

For instance we define the *braid fan* $\mathcal{BF}(n)$ as the fan defined by the collection of hyperplanes $\{\mathbf{x} \in \mathbb{R}^n \mid x_i = x_j\}$ for $1 \leq i \neq j \leq n$; that is to say, the closures of the connected components of $V \setminus \bigcup_{i \neq j} \{x \in \mathbb{R}^n \mid x_i = x_j\}$ together with all their faces. Note that this fan is not essential as the lines $\langle \sum_i e_i \rangle$ are in every hyperplane. But its intersection with the hyperplane H defined in Equation 1.28 is then essential, pointed and complete in H . We follow [Pil13] in describing this fan. Figures 1.13, 1.14 and 1.15 also come from this paper with permission and minor changes.

The k -dimensional cones of $\mathcal{BF}(n)$ correspond to the *surjections* from the set $[n]$ to the set $[k+1]$ or, equivalently, to the *ordered partitions* of $[n]$ into $k+1$ parts. We describe here the bijection between ordered partitions and surjections. The fibers of a surjection from $[n]$ to $[k+1]$ define an ordered partition of $[n]$ with $k+1$ parts.

Reciprocally, the positions of the elements of $[n]$ in an ordered partition of $[n]$ with $k + 1$ parts define a surjection from $[n]$ to $[k + 1]$. We refer to Figure 1.13.

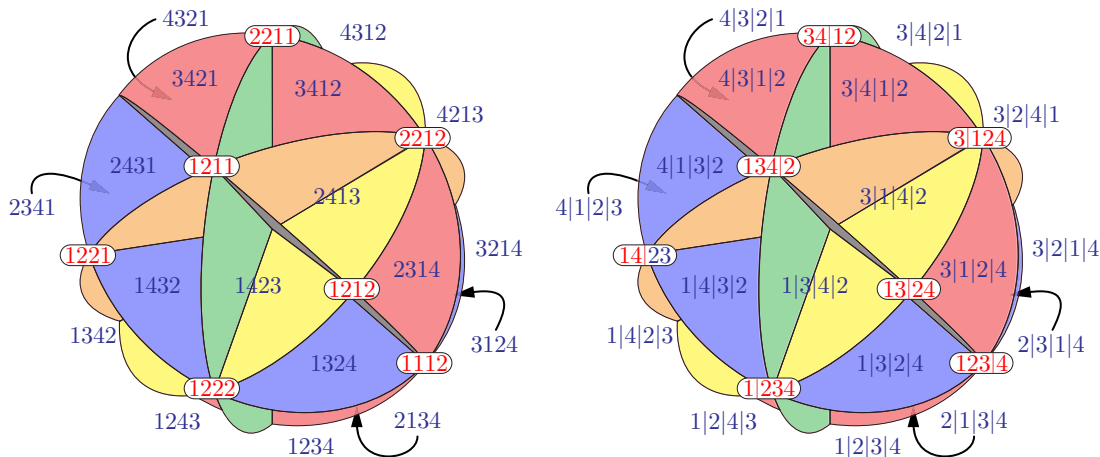

Figure 1.13: The 3-dimensional braid fan $\mathcal{BF}(4)$. The k -dimensional cones correspond to the surjections from $[4]$ to $[k + 1]$ (left) or, equivalently, to the ordered partitions of $[4]$ into $k + 1$ parts (right). Rays are in red while maximal cones are in blue. The remaining labels are left to the reader.

If F is a face of a polytope \mathcal{P} then the *normal cone* of F is the cone generated by the (outer) normal vectors of the facets of \mathcal{P} containing F . The *normal fan* of \mathcal{P} is the set of normal cones of all its faces. See [Zie95] for the connection to linear programming and maximisation of linear functionals. The normal fan of the permutahedron is the braid fan. In this fan the set of maximal cones is in bijection to the permutations via its *braid cone*:

$$C(\sigma) = \{\mathbf{x} \in \mathbb{R}^n \mid x_i \leq x_j \text{ if } \sigma_i < \sigma_j\}. \tag{1.30}$$

More generally if P is a poset on $[n]$ it corresponds to the following union of cones of the braid fan:

$$C(P) = \{\mathbf{x} \in \mathbb{R}^n \mid x_i \leq x_j \text{ if } i <_P j\}. \tag{1.31}$$

In Figure 1.14 we represent the permutahedron $\text{Perm}(4)$ and illustrate in comparison with Figure 1.13 that it is the dual of the braid fan.

Finally we can again generalize the definition of braid cone from Equation 1.31 to *preposets*. A preposet R on $[n]$ can always be decomposed as an equivalence $\equiv_R := \{(i, j) \in R \mid (j, i) \in R\}$ and a poset structure \prec_R on its equivalence classes. If R is a preposet on $[n]$ we define its braid cone by:

$$C(R) = \{\mathbf{x} \in \mathbb{R}^n \mid x_i \leq x_j \text{ if } (i, j) \in R\}. \tag{1.32}$$

For instance, the cones of $\mathcal{BF}(V)$ are precisely the cones of the *linear preposets*; that is, the preposets L on $[n]$ whose poset \prec_L is a linear order on the equivalence classes of \equiv_L . The dimension of $C(R)$ is the number of equivalence classes of \equiv_R minus 1. There is some correspondance between combinatorial properties of the

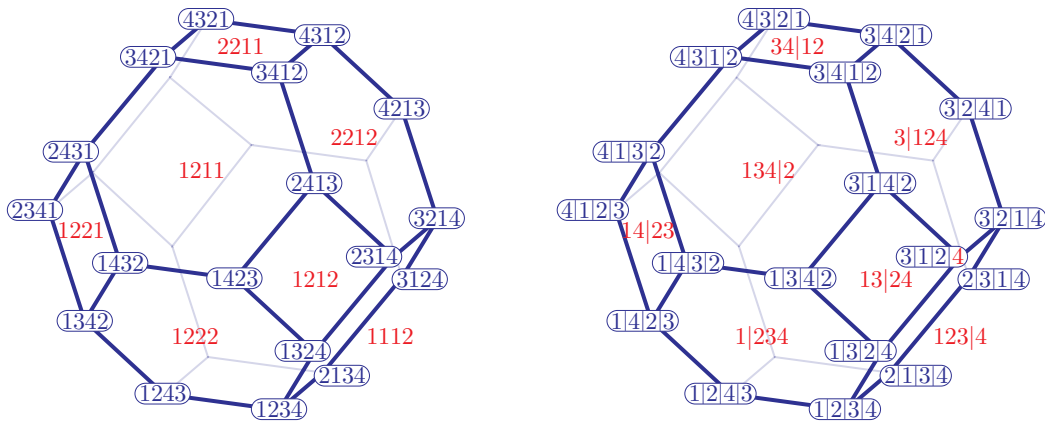

Figure 1.14: The 3-dimensional permutahedron $\text{Perm}(4)$. The k -dimensional cones correspond to the surjections from $[4]$ to $[4 - k]$ (left) or, equivalently, to the ordered partitions of $[4]$ into $4 - k$ parts (right). Facets are in red while vertices are in blue.

preposets and geometrical ones. In particular, If R and R' are two preposets on $[n]$, then the cone $C(R)$ contains the cone $C(R')$ if and only if R' is an extension of R . Furthermore, the cone $C(R)$ of any preposet R is the disjoint union of the cones of its linear extensions (hence total preposets or equivalently ordered partitions). We represent in Figure 1.15 such cones for posets.

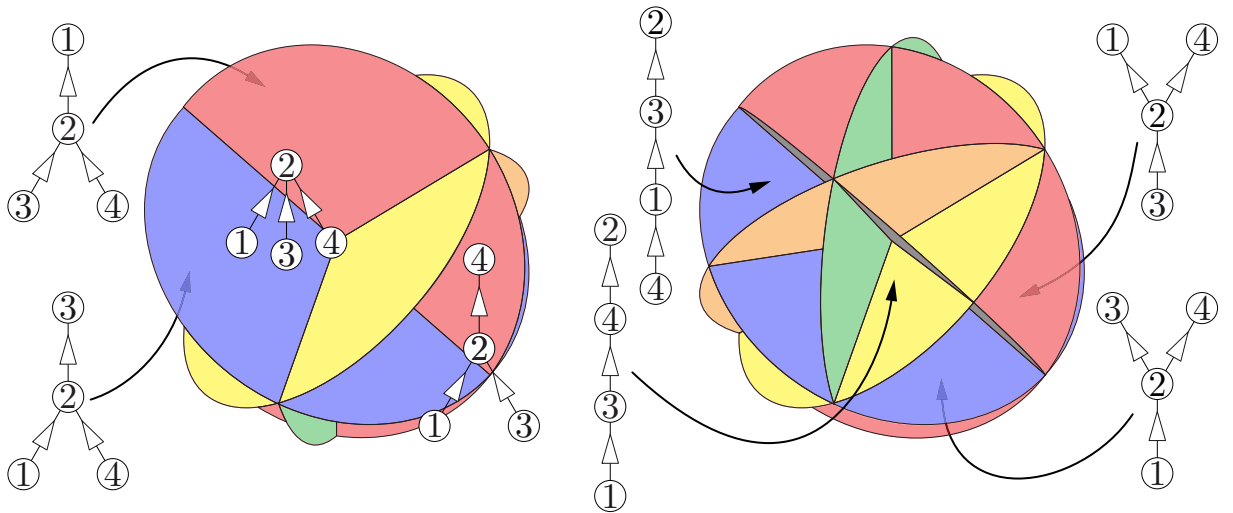

Figure 1.15: Some cones corresponding to posets on $[4]$ inside the braid fan $\mathcal{BF}(4)$.

1.5 Rooks

We introduce here a natural generalization of the symmetric group made of the monomial matrices, or the *rooks*, which will be the main object for Part II.

Definition 1.5.1. A rook matrix is an $n \times n$ matrix with entries $\{0, 1\}$ and at most one nonzero entry in each row and column.

Enumeration of rook matrices has received considerable research effort in the past (See *e.g.* [Rio02; But+10] and the references therein) and has recently been renewed by a connection with PASEP [JV11]. The product of two rook matrices is still a rook matrix. Thus the following definition:

Definition 1.5.2. The rook monoid of size n is the submonoid R_n of the matrix monoid containing the rook matrices of size n .

Identifying permutations with their matrices, we see that \mathfrak{S}_n is a submonoid of R_n . To deal with rook matrices it is easier to have an analogue of the so-called one line notation for permutations as in [CR12]:

Notation 1.5.3. We encode a rook matrix by its **rook vector** (or just **rook**) of size n whose i -th coordinate is 0 if there is no 1 in the i -th column of r and the index of the row containing the 1 in the i -th column otherwise.

Example 1.5.4. Here are two matrices with their associated rook vector:

$$\begin{pmatrix} 0 & 0 & 0 & 0 & 1 \\ 0 & 0 & 1 & 0 & 0 \\ 0 & 0 & 0 & 1 & 0 \\ 0 & 1 & 0 & 0 & 0 \\ 0 & 0 & 0 & 0 & 0 \\ 0 & 4 & 2 & 3 & 1 \end{pmatrix} \quad \begin{pmatrix} 0 & 0 & 0 & 0 & 1 \\ 0 & 0 & 0 & 0 & 0 \\ 0 & 1 & 0 & 0 & 0 \\ 0 & 0 & 0 & 1 & 0 \\ 0 & 0 & 0 & 0 & 0 \\ 0 & 3 & 0 & 4 & 1 \end{pmatrix}$$

Later, we identify rooks matrices and rook vectors and speak about rooks when there is no ambiguity. This representation as a vector is coherent with the way we defined permutation matrices. With this vector notation, we now consider rooks just as partial permutations, or words over $[n]_0 := \{0, 1, \dots, n\} = \{0\} \cup [n]$ with at most one letter for each element of $[n]$.

It is quite easy to count the number of rooks.

Proposition 1.5.5.

$$|R_n| = \sum_{k=0}^n \binom{n}{k}^2 k!. \quad (1.33)$$

Example 1.5.6. Here are the first few cardinalities of the rook monoids:

n	1	2	3	4	5	6	7	8
$ R_n $	2	7	34	209	1546	13327	130922	1441729

We not only want to count rooks but to also generate the rook monoids. We have the following result:

Definition 1.5.7. In the monoid R_n , let $(s_i)_{i=1..n-1}$ denote the rook matrices of the elementary transpositions $(i, i + 1)$. Let P_i denote the diagonal $n \times n$ matrix with the first i diagonal entries as zero and the remaining ones as 1.

For example, with $n = 4$, here are the matrices of $s_1, s_2, s_3, P_1, P_2, P_3, P_4$ and their associated vectors

$$\begin{array}{ccccccc}
 \begin{pmatrix} 0 & 1 & 0 & 0 \\ 1 & 0 & 0 & 0 \\ 0 & 0 & 1 & 0 \\ 0 & 0 & 0 & 1 \end{pmatrix} &
 \begin{pmatrix} 1 & 0 & 0 & 0 \\ 0 & 0 & 1 & 0 \\ 0 & 1 & 0 & 0 \\ 0 & 0 & 0 & 1 \end{pmatrix} &
 \begin{pmatrix} 1 & 0 & 0 & 0 \\ 0 & 1 & 0 & 0 \\ 0 & 0 & 0 & 1 \\ 0 & 0 & 1 & 0 \end{pmatrix} &
 \begin{pmatrix} 0 & 0 & 0 & 0 \\ 0 & 1 & 0 & 0 \\ 0 & 0 & 1 & 0 \\ 0 & 0 & 0 & 1 \end{pmatrix} &
 \begin{pmatrix} 0 & 0 & 0 & 0 \\ 0 & 0 & 0 & 0 \\ 0 & 0 & 1 & 0 \\ 0 & 0 & 0 & 1 \end{pmatrix} &
 \begin{pmatrix} 0 & 0 & 0 & 0 \\ 0 & 0 & 0 & 0 \\ 0 & 0 & 0 & 0 \\ 0 & 0 & 0 & 1 \end{pmatrix} &
 \begin{pmatrix} 0 & 0 & 0 & 0 \\ 0 & 0 & 0 & 0 \\ 0 & 0 & 0 & 0 \\ 0 & 0 & 0 & 0 \end{pmatrix} \\
 2\ 1\ 3\ 4 & 1\ 3\ 2\ 4 & 1\ 2\ 4\ 3 & 0\ 2\ 3\ 4 & 0\ 0\ 3\ 4 & 0\ 0\ 0\ 4 & 0\ 0\ 0\ 0
 \end{array}$$

It is well-known that the $(s_i)_i$ generate the symmetric group as a group of permutation matrices and $(s_i)_i, P_1$ generate the rook monoid. We will later give a presentation of the rook monoid (Remark 4.2.2).

1.6 Tamari lattice

In this section we follow [Pon13] and with her permission use her figures (Figures 1.16, 1.17, 1.19, 1.22 and 1.23, and the lower part of Figure 1.20).

1.6.1 Dyck paths and trees

The *Tamari order* is a well-studied order which we introduce here and refer the reader to [MHPS12; BW91; Rea06] for more details. It is an order on Catalan objects, and which we choose to describe first on Dyck paths; as was historically done by D. Tamari in [MHPS12]. A *Dyck path* of length n is a path on the plane starting from $(0, 0)$ and ending at $(2n, 0)$ made with north-east (NE) $(1, 1)$ and south-east (SE) $(1, -1)$ steps such that the path is always above the line $y = 0$.

We identify such paths with a *Dyck word*, that is a word on the binary alphabet $\{0, 1\}$ where a 1 is a NE step, and a 0 is a SE step. The number of 1s is then equal to the number of 0s and in every prefix of the word the number of 0s is less or equal to the number of 1s. This definition of Dyck word is equivalent with the definition on *bracketing*, see Figure 1.16 for some examples. A path is then called *primitive* if it is not empty and has no other contact with the line $y = 0$ except at the starting and ending points.

If u is a Dyck path such that u has a SE step d followed by a primitive path p the *rotation* on u is to exchange the decreasing step d with the primitive path p . The rotations are the cover relations of the Tamari order $\preceq_{\mathcal{T}}$, as shown in Figures 1.16 and 1.17. It is an order and even a lattice [HT72]. The minimal element is the Dyck word $(10)^n$ and the maximal element is the Dyck word $1^n 0^n$.

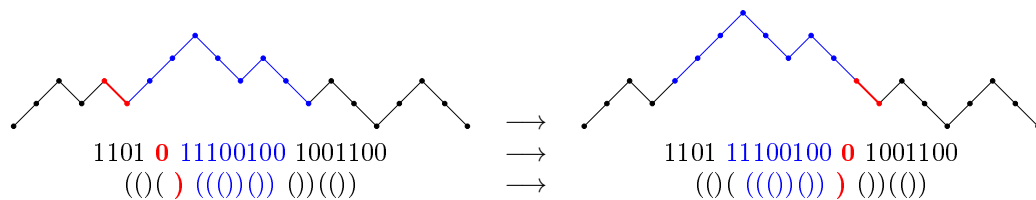

Figure 1.16: The rotation of Dyck paths, Dyck words and bracketing.

We now introduce another Catalan object. A *binary tree* T is defined recursively as either the empty tree \emptyset (also called a *leaf*), or a couple of binary trees, called *left*

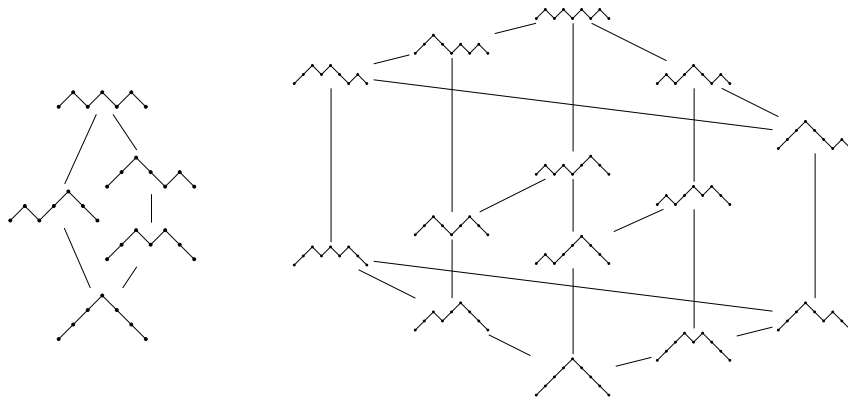
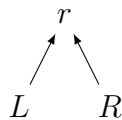

Figure 1.17: The Tamari order on Dyck paths of length 3 and 4.

child and *right child*, grafted on a *root node*. If r is the root, R the right child and L the left child, we represent the binary tree $T = (L, r, R)$ by:



The edges should be oriented towards the root, but we will often forget this convention and rely on the bottom-top order. The *height* $h(T)$ of a binary tree T is recursively defined by

$$h(\emptyset) = -1 \text{ and } h \left(\begin{array}{c} r \\ \swarrow \searrow \\ L \quad R \end{array} \right) = \max(h(R), h(L)) + 1. \quad (1.34)$$

The trees are objects used in several algorithms, for instance in sorting data [AVL62]. Some trees are easier to use in these algorithms: the *balanced trees*, which are characterized by the fact that the difference of height between the two children at any node is at most 1. When a tree is not balanced a *rotation* is applied on it which corresponds to the rotation on Dyck paths. The *left rotation* ρ_l and *right rotation* ρ_r are defined as shown in Figure 1.18. These two operations are inverse one from the other. Here again, these rotations are the cover relations of the Tamari order. See Figure 1.19.

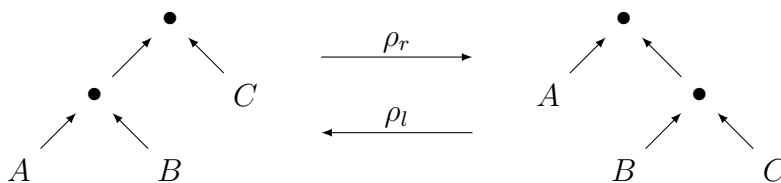
Figure 1.18: Rotation on binary trees. The operation ρ_r is called the *right rotation*, and ρ_l the *left rotation*.

We now give the correspondance between Dyck words and binary trees which shows that the lattices of Figure 1.17 and 1.19 are the same. A Dyck word D

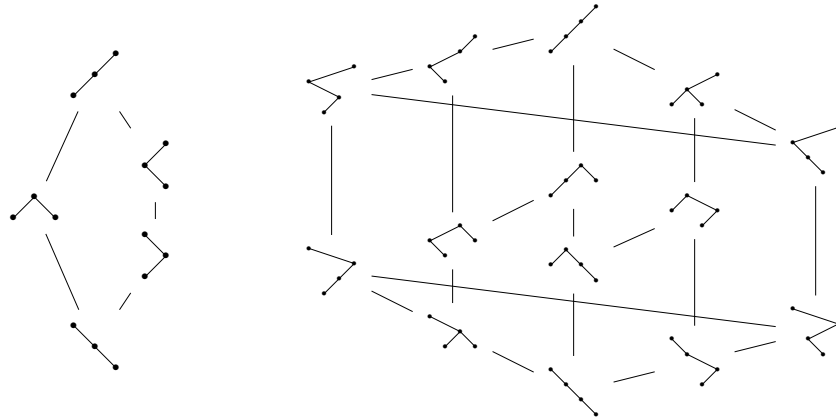

Figure 1.19: The Tamari lattices of size 3 and 4 on binary trees.

is either empty or can be written as $D = D_1 \mathbf{1} D_2 \mathbf{0}$ where D_1 and D_2 are Dyck words (take for D_1 the path from start to the penultimate return to 0). Then the corresponding tree is $T = (T_1, r, T_2)$ where T_1 and T_2 are binary tree corresponding respectively to D_1 and D_2 , and x is a root. In particular if D is primitive then D_1 is empty, whereas D_2 is empty if D ends by 10. See Figure 1.20.

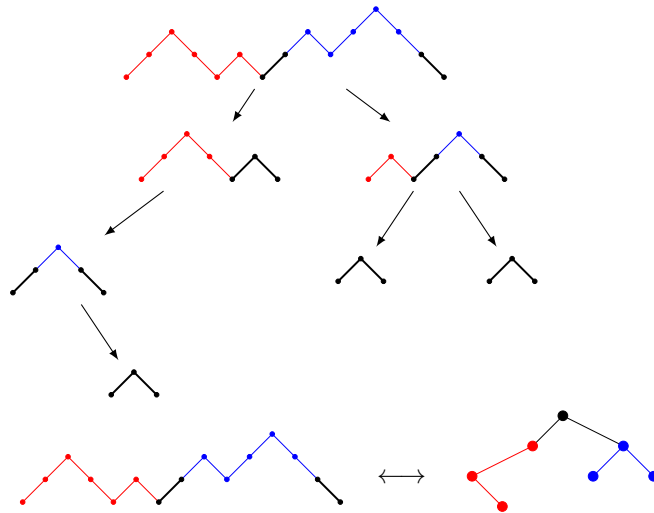

Figure 1.20: The correspondance between Dyck paths and binary trees. On top we present recursively the decomposition of the Dyck path. In red it is the left part and in blue the right part. In bold we represent the NE and SE steps which make the Dyck word split.

1.6.2 Tamari order and weak order

The connection with the weak order is made by a labeling of the nodes of the trees. When the nodes of a binary tree T are integers such that any node is greater (resp.

smaller) than all the nodes of its left (resp. right) child the tree T is called a *binary search tree*. If T has n nodes and each number of $[n]$ is a node it is called a *standard binary search tree* (SBST). Any binary tree can be labeled to make it a SBST using the *infix labeling*: label recursively the left child L then the root, and then the right child R . For instance, we represent an infix labeling in Figure 1.21

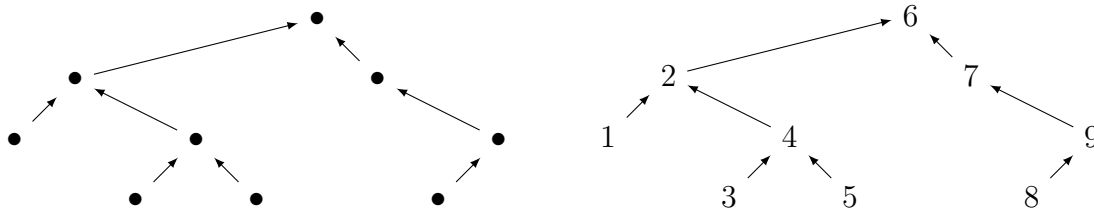

Figure 1.21: A binary tree and its infix labeling. We see that if the binary tree is well drawn it corresponds only to reading nodes from left to right.

The infix labeling is the only way to label a binary tree in order to get a SBST. The structure of binary search trees is often used in algorithmics to store the data of a sorted set. In particular, we define the recursive algorithm of insertion of the integer k in the SBST T as follows: if T is empty then k becomes the root of T , otherwise if $k \leq \text{root}(T)$ (resp. $k > \text{root}(T)$) insert k in the left (resp. right) child of T . We use this algorithm to associate to each $\sigma \in \mathfrak{S}_n$ a binary search tree $\text{BST}(\sigma)$ by successive insertions of integers of the one-line notation from right to left in an empty tree. This process is explained in Figure 1.22.

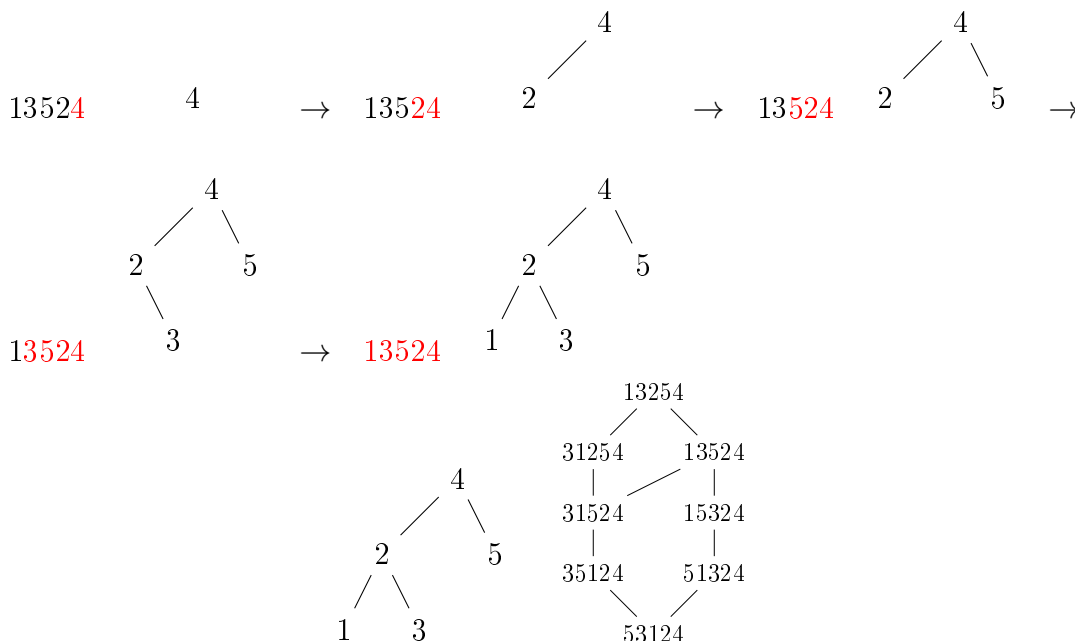

Figure 1.22: Insertion in a binary search tree and linear extensions.

Now we can look at a binary tree as a poset T with the relation that a root is above its children. If we consider all the possible linear extensions of T we get

a morphism from the binary trees with n nodes to the subsets of \mathfrak{S}_n . In [BW91] Björner and Wachs proved that the permutations giving the same binary search tree are all the linear extensions of this tree seen as a poset. Furthermore, these permutations form an interval in the right weak order on permutations. This set is called the *sylvestre class* of the tree. In Figure 1.22 we represent one sylvestre class.

The *sylvestre congruence* is defined on \mathfrak{S}_n as follows: if $\sigma, \tau \in \mathfrak{S}_n$ then $\sigma \equiv \tau \Leftrightarrow \text{BST}(\sigma) = \text{BST}(\tau)$. With this congruence one can prove that the Tamari lattice is not only a sublattice but also a lattice quotient of the right-weak order, see Figure 1.23 [HNT05; LR98; BW91].

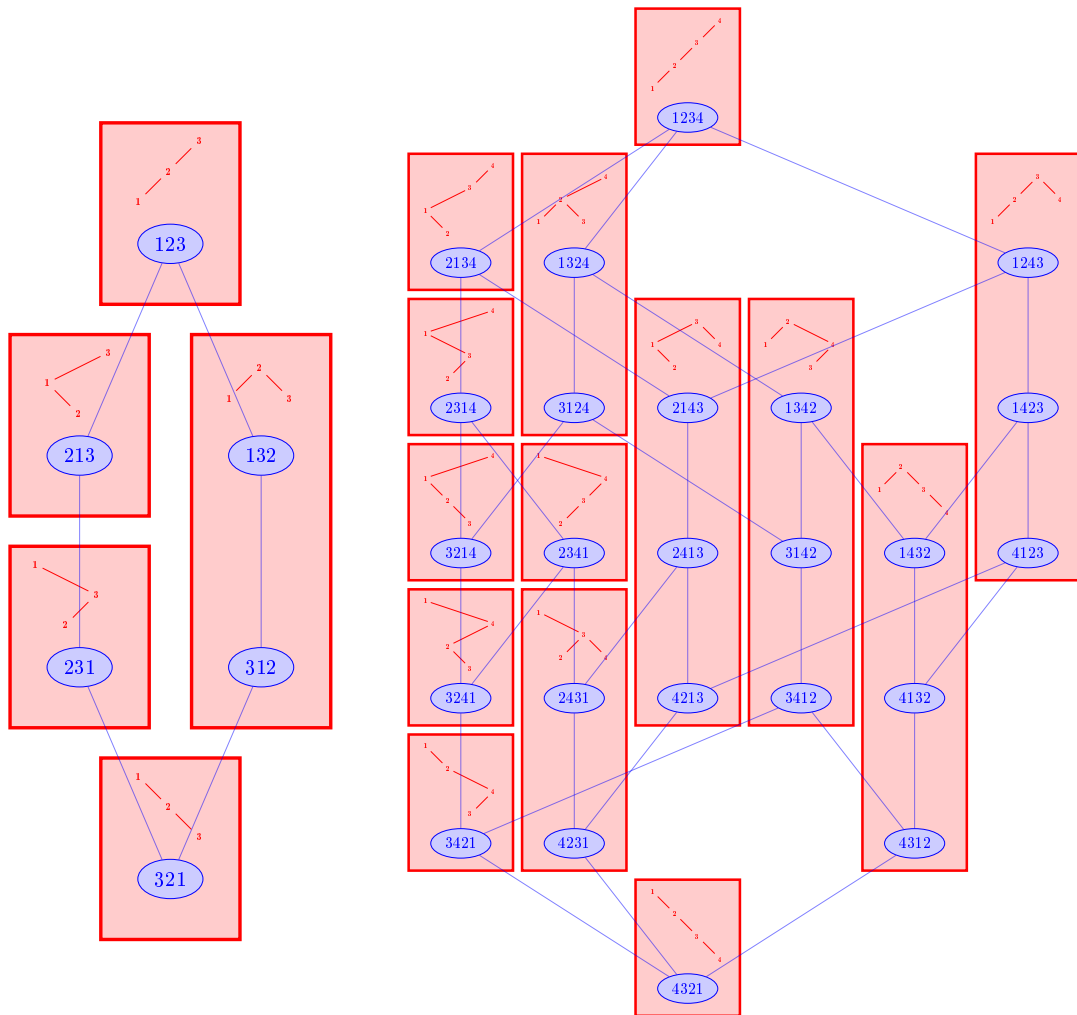

Figure 1.23: The order of Tamari as a quotient of the right weak order of sizes 3 and 4. Permutations are grouped by equivalence class. The reader can check that the quotient is a lattice quotient; that is that two comparables permutations have their associated binary search trees comparable in the Tamari lattice.

Finally, we can also look geometrically at the Tamari lattice. As we saw in Equation 1.31 we can associate to a poset a cone on the braid fan $\mathcal{BF}(n)$. We consider the fan:

$$\mathcal{FT} := \{C(T) \mid T \text{ tree with } n \text{ nodes}\}. \tag{1.35}$$

It is a complete essential simplicial fan. It just so happens that there is a polytope whose normal fan is the fan \mathcal{FT} . It is called the *associahedron* and is obtained from the permutahedron by deleting of some facets. More precisely we define the *singletons* to be the permutations with exactly one element in their sylvester class. Then the associahedron is obtained from the permutahedron by keeping only faces that contain a singleton. See Figure 1.24 taken from [DHP18] with permission, and also [HL07; HLT11; LL18] and the references therein for more details.

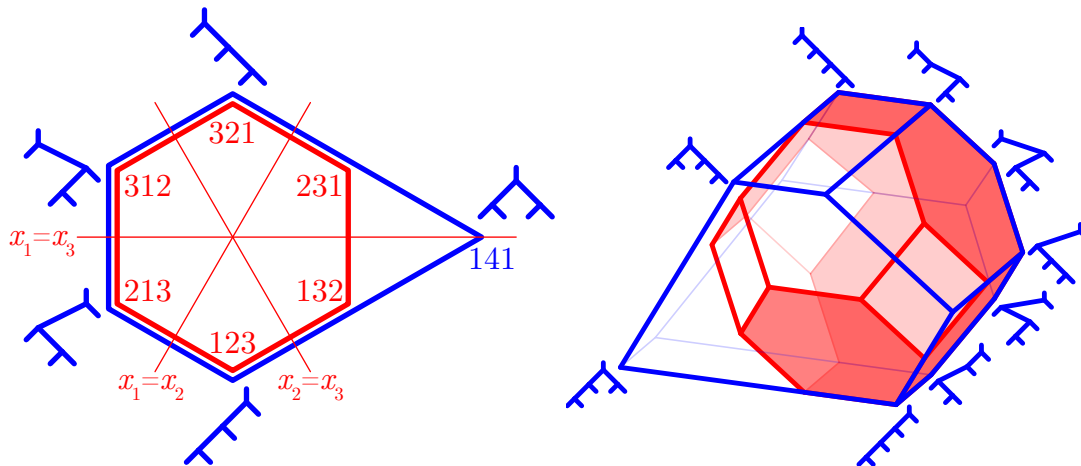

Figure 1.24: The associahedron is obtained from the Permutahedron by deleting some facets.

1.7 Vector spaces and algebras on combinatorial objects

Each combinatorial object that was introduced until now was a *combinatorial class* C ; that is a set of objects with a notion of size. In the case of permutations and rooks, it is the length n of the one-line word or rook vector. In the case of Dyck paths or equivalently Dyck words, it is half the length of the word. In the case of trees, it is the number of vertices. A common way to study such objects in algebraic combinatorics is to introduce formal linear combinations of them. This is done by considering a vector space E whose basis is indexed by the set C of all the objects. All vector spaces are considered to be over \mathbb{C} . Then E is *graded*; that is,

$$E = \bigoplus_{n \in \mathbb{N}} E_n \quad (1.36)$$

where E_n is of basis C_n , the combinatorial objects of size n .

In order to study these objects we often equip the vector spaces with a product in order to obtain an algebra. We will see in Section 3.4 that we also sometimes want to associate a coproduct. Nonetheless it is important to note that even if the combinatorial class C has a product (for instance if it has the structure of a monoid) the product of the algebra is not necessarily the product of the monoid. For instance,

in the case of the permutations the combinatorial class is $\mathfrak{S}_\infty = \sqcup_{n \in \mathbb{N}} \mathfrak{S}_n$ with each the union of the symmetric groups. But since the structure of group does not allow multiplying permutations of different sizes we give another product.

Example 1.7.1. If A is an alphabet the product on the vector space generated by A^* (that is words over A) is the *concatenation* of words:

$$\begin{aligned} A^* \times A^* &\longrightarrow A^* \\ u \cdot v &\longmapsto uv \end{aligned} \tag{1.37}$$

For instance if $A = \{a, b\}$ then $abbab \cdot aba = abbababa$. Similarly we define the *shifted concatenation* on permutations. If $\sigma \in \mathfrak{S}_n$ and $\tau \in \mathfrak{S}_m$ then:

$$\sigma \overset{\rightarrow}{\cdot} \tau = \sigma \bar{\tau}^n \tag{1.38}$$

where $\bar{\tau}^n$ is the word τ with all letters increased by n . Thus $\sigma \overset{\rightarrow}{\cdot} \tau \in \mathfrak{S}_{n+m}$. For instance $132 \overset{\rightarrow}{\cdot} 2431 = 1325764$.

Example 1.7.2. If A is an alphabet the *shuffle product* on words over A is defined recursively by:

$$u \sqcup v = \begin{cases} u & \text{if } v = \epsilon, \\ v & \text{if } u = \epsilon, \\ u_1(u' \sqcup v) + v_1(u \sqcup v') & \text{otherwise, where } u_1, v_1 \in A \text{ and } u = u_1 u', v = v_1 v'. \end{cases}$$

It is the sum of all possible shuffling between letters of u and v so that the order of letters of u and respectively v are preserved. For instance:

$$ab \sqcup ba = abba + abba + abab + baba + baab + baab \tag{1.39}$$

$$= 2abba + 2baab + abab + baba \tag{1.40}$$

As we did for concatenation, we can define the *shifted shuffle product* on permutations $\sigma \in \mathfrak{S}_n$ and $\tau \in \mathfrak{S}_m$:

$$\sigma \sqcup \tau = \sigma \sqcup \bar{\tau}^n. \tag{1.41}$$

For instance:

$$12 \sqcup 21 = 1243 + 1423 + 1432 + 4123 + 4132 + 4312. \tag{1.42}$$

Example 1.7.3. Let T_1 and T_2 be two binary trees. We define $T_1 \cdot_L T_2$ to be the binary tree obtained by grafting T_2 on the leftmost leaf of T_1 and $T_1 \cdot_R T_2$ to be the binary tree obtained by grafting T_2 on the rightmost leaf of T_1 . Then we define the following product on trees:

$$T_1 \times T_2 := \sum_{T_1 \cdot_L T_2 \leq T \leq T_1 \cdot_R T_2} T, \tag{1.43}$$

where \leq is the Tamari order. Then the elements appearing in the product $T_1 \times T_2$ is the interval $[T_1 \cdot_L T_2, T_1 \cdot_R T_2]$ of the tamari order. For an example see Figure 1.25 taken with permission from [Pon13], with minor changes.

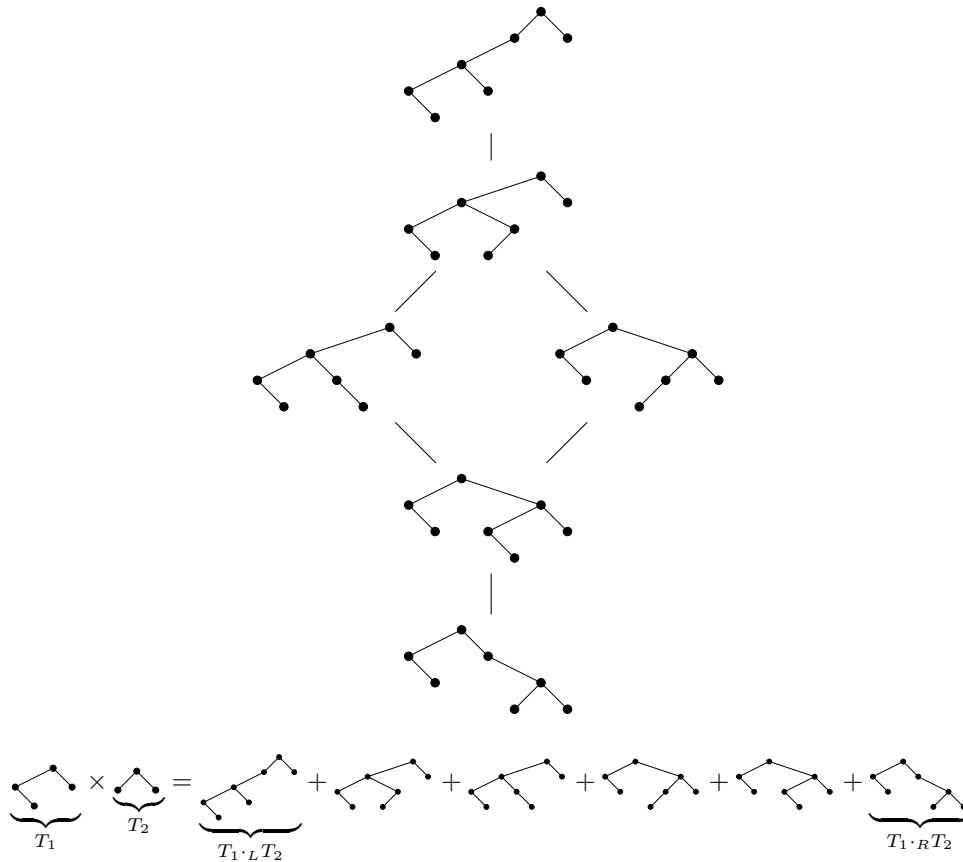

Figure 1.25: An interval of the Tamari order, and the associated product of trees.

Definition 1.7.4. *The algebra A of a combinatorial class is said to be **graded** if its product satisfies the property*

$$|x \times y| = |x| + |y| \tag{1.44}$$

for all $x, y \in A$. In other words, for all $n, m \in \mathbb{N}$ the product \times is an application from $A_n \times A_m$ to A_{n+m} .

The last two examples, the concatenation and shuffle products (resp. the shifted concatenation and shifted shuffle products) are graded products on words (resp. on permutations). The products \cdot_L, \cdot_R and \times are also products on trees.

The product \times on binary trees and the shifted shuffle product are linked in the following way: let T_1 and T_2 be two binary trees of respective size n and m . Then [LR98]:

$$T_1 \times T_2 = \text{BST} \left(\left(\left(\sum_{\substack{\sigma \in \mathfrak{S}_n \\ \text{BST}(\sigma) = T_1}} \sigma \right) \sqcap \left(\sum_{\substack{\tau \in \mathfrak{S}_m \\ \text{BST}(\tau) = T_2}} \tau \right) \right) \right) = \sum_{\substack{\sigma \in \mathfrak{S}_n, \tau \in \mathfrak{S}_m \\ \text{BST}(\sigma) = T_1, \text{BST}(\tau) = T_2}} \text{BST}(\sigma \sqcap \tau), \tag{1.45}$$

where BST is extended by linearity.

Chapter 2

Weyl groups

Coxeter and Weyl groups arise in a multitude of ways in several areas of mathematics. The symmetric group is what is called the type A Coxeter group, and a seminal example for it. The purpose of this chapter is to introduce them from geometric and algebraic points of view.

2.1 Reflections groups and root systems

2.1.1 First definitions and examples

We begin this section by a geometric definition of a family of groups. Our main reference is [Hum90]. Let V be a Euclidean space with its scalar product denoted by (\cdot, \cdot) . If $\alpha \in V \setminus \{0\}$ then s_α is the *reflection* of the hyperplane $H_\alpha = \mathbb{R}\alpha^\perp$ and line $L_\alpha = \mathbb{R}\alpha$. It is an involution. There is a simple formula for $x \in V$:

$$s_\alpha(x) = x - 2\frac{(x, \alpha)}{(\alpha, \alpha)}\alpha. \quad (2.1)$$

A *finite reflection group* is a finite group generated by reflections.

Example 2.1.1. The group which preserve a square in the Euclidean plane is the dihedral group of order 8.

Example 2.1.2. Another important example is the symmetric group \mathfrak{S}_n acting on \mathbb{R}^n by permutation of coordinates. The transposition (i, j) is then the reflection along $e_i - e_j$. In this example the action fixes pointwise the line spanned by $e_1 + \cdots + e_n$. Hence \mathfrak{S}_n acts on the hyperplane consisting of vectors whose coordinates add up to 0.

2.1.2 Root systems

These examples show that the normal vectors of the hyperplanes determine a reflection group. Hence the following definition.

Definition 2.1.3. Let Φ be a finite set of nonzero vectors of V such that

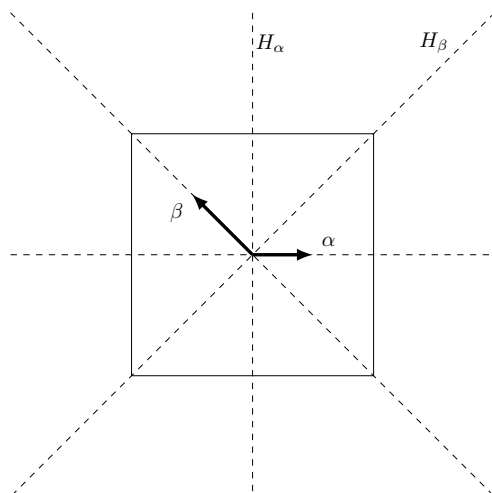

Figure 2.1: The Dihedral group of order 8.

- (i) $\Phi \cap \mathbb{R}\alpha = \{\alpha, -\alpha\}$ for all $\alpha \in \Phi$.
- (ii) $s_\alpha\Phi = \Phi$ for all $\alpha \in \Phi$.

Such a set is called a **root system** and its elements are the **roots**.

The group W generated by the reflections of roots in a root system Φ fixes no nonzero point in $\langle \Phi \rangle$ and permutes the roots, hence is finite.

It is possible to define the dual of a root system. We define the *dual root* as

$$\alpha^\vee = 2 \frac{\alpha}{(\alpha, \alpha)}, \quad (2.2)$$

and define the *dual* of a root system Φ as $\Phi^\vee = \{\alpha^\vee \mid \alpha \in \Phi\}$. We also define the *root lattice* as the \mathbb{Z} -span of Φ , denoted $L(\Phi)$. Now $\langle \beta, \alpha^\vee \rangle = 2 \frac{(\beta, \alpha)}{(\alpha, \alpha)}$ so that Equation 2.1 becomes

$$s_\alpha(x) = x - \langle x, \alpha^\vee \rangle \alpha. \quad (2.3)$$

If the number $\langle \alpha, \beta^\vee \rangle$ is an integer, it is known as a *Cartan integer*.

Definition 2.1.4. We say that a root system is **crystallographic** if it additionally satisfies:

- (iii) For all $\alpha, \beta \in \Phi$, $\langle \alpha, \beta^\vee \rangle$ is a Cartan integer.

This property is equivalent to W stabilizing $L(\Phi)$. When we are dealing with crystallographic root systems the length of a root (that is, its norm) is important because it must stabilize the lattice.

2.1.3 Relations between two roots

We will now be interested in relations between two roots in crystallographic type. This section is based upon [Bou02, Chap. 6, 1.3 and 1.4]. The first lemma is called the Finiteness Lemma.

Lemma 2.1.5 (Finiteness Lemma). *Let Φ be a crystallographic root system for the Euclidean space V . Let $\alpha, \beta \in \Phi$ so that $\alpha \neq \pm\beta$. Then*

$$\langle \alpha, \beta^\vee \rangle \langle \beta, \alpha^\vee \rangle \in \{0, 1, 2, 3\}. \tag{2.4}$$

Let α and β be two roots. We assume β is the longer of the two (they can be of equal length). From here we can use this lemma to classify all potential possibilities of multiplying two Cartan integers; hence the relative position of α and β . We also call θ the angle between α and β . By changing β to $-\beta$ we can assume that $0 \leq \beta \leq \pi$. Thus we see the following:

$\langle \alpha, \beta^\vee \rangle$	$\langle \beta, \alpha^\vee \rangle$	θ	$\frac{\ \beta\ ^2}{\ \alpha\ ^2}$
0	0	$\pi/2$	undefined
-1	-1	$2\pi/3$	1
1	1	$\pi/3$	1
-1	-2	$3\pi/4$	2
1	2	$\pi/4$	2
-1	-3	$5\pi/6$	3
1	3	$\pi/6$	3

This allows us to start drawing out what these roots spaces might look like. When $\dim(\langle \Phi \rangle) = 1$ then by the condition (i) we have $\Phi = \{\alpha, -\alpha\}$. So we begin with $\dim(\langle \Phi \rangle) = 2$.

Example 2.1.6. (i) If $\dim(\langle \Phi \rangle) = 2$. We take $\alpha, \beta \in \Delta$. From the study before, the only possible choices are represented in Figure 2.2 with their names.

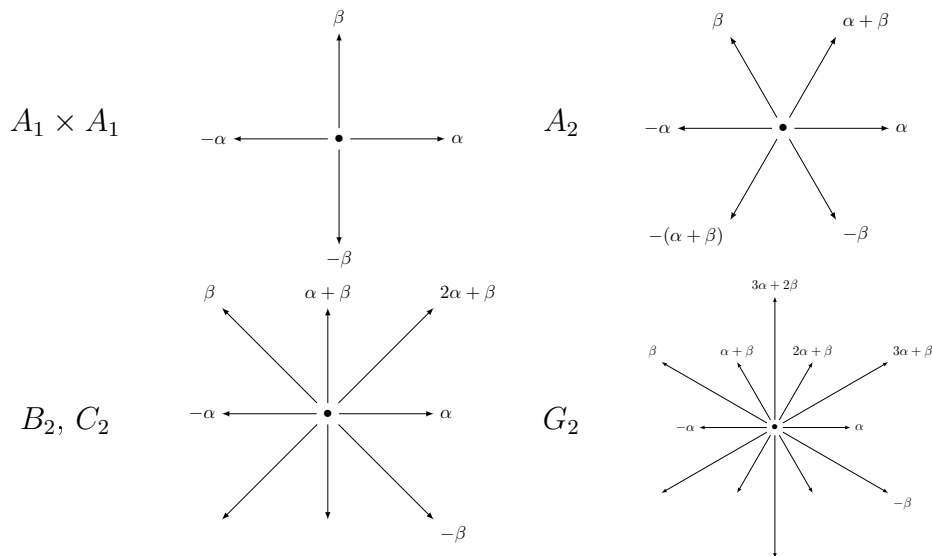

Figure 2.2: Dimension 2 root systems.

(ii) If $\dim(\langle \Phi \rangle) = 3$, we can always look at the roots pairwise. The subspace they generate must be of one of the previous type. For instance in type A_3 we have $\Delta = \{\alpha, \beta, \gamma\}$ with $\{\alpha, \beta\}$ and $\{\beta, \gamma\}$ of type A_2 , while $\{\alpha, \gamma\}$ is of type $A_1 \times A_1$. This lead to Figure 2.3. Another way to represent root spaces of

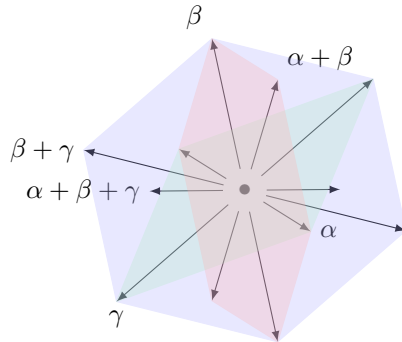

Figure 2.3: Root space of A_3 .

dimension 3 comes from [HLR14]. Define H to be the hyperplane spanned by the points corresponding to simple roots. Then the positive roots are in the convex hull of the simple roots and thus intersect H . We only represent H intersected with the cone generated by the simple roots. As an example, see Figure 2.4

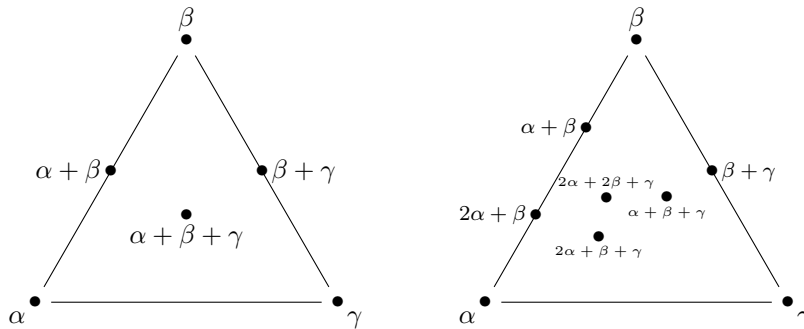

Figure 2.4: Root spaces of A_3 and B_3 .

2.1.4 Positive and simple systems

Fix a root system Φ in the Euclidean space V and W the reflection group associated to it. W is completely determined by Φ but the latter can be very large compared to the dimension of V . This is the case for dihedral groups for instance where we can have as many reflections as we want, but $\dim V = 2$. This led Humphreys [Hum90] to find linearly independant subset of Φ from which Φ can be generated. The first tool for this is a partition of the space between positive and negative roots. A very simple way to define such a partition is to take a generic linear form $\lambda : V \rightarrow \mathbb{R}$, i.e. $\lambda(\alpha) \neq 0 \forall \alpha \in \Phi$. The hyperplane $\ker \lambda$ then separates V between the positive

and negative vectors. Then the set Π of positive roots is called a *positive system*, while $-\Pi$ is a *negative system*. As every root comes in pairs we see that for each root either α or $-\alpha$ will be in Π (and the other will be in $-\Pi$), furthermore Π and $-\Pi$ are disjoint and therefore $\Phi = \Pi \oplus -\Pi$. From here we might wonder if we can use the elements of Π to form a basis for Φ . Although not trivial, this can be shown to be the case.

Definition 2.1.7. *Call a subset Δ of Φ a **simple system** (and call its elements **simple roots**) if*

1. Δ is a basis of $\langle \Phi \rangle$
2. Each $\alpha \in \Phi$ is a linear combination of Δ with coefficients of the same sign.

These systems exist and are linked to the positive ones:

Theorem 2.1.8 ([Hum90]). *Let Δ be a simple system and Π a positive system in a root system Φ .*

1. For any Δ there is a unique Π which contains Δ .
2. Every Π contains a unique Δ .

The proof of this theorem led to a small corollary worth mentioning:

Corollary 2.1.9. *If Δ is a simple system in Φ , then $(\alpha, \beta) \leq 0$ for all $\alpha \neq \beta$ in Δ .*

The cardinality of any simple system is an invariant of Φ called the *rank* of Φ . For instance the dihedral group has rank 2 while the symmetric group \mathfrak{S}_n has rank $n - 1$.

2.1.5 Conjugation and inversions

We would like to fix a positive system Π and its simple system Δ in Φ , but we have not ruled out the possibility that different choices of Π might differ drastically as geometric configurations. We hence examine the relationship between different system (which amounts to different choices of the generic linear form λ). The next proposition is the key element to prove the next theorem, and is linked to the definition of inversions in any Coxeter group.

Proposition 2.1.10. *Let Δ be a simple system, contained in the positive system Π . If $\alpha \in \Delta$ then $s_\alpha(\Pi \setminus \{\alpha\}) = \Pi \setminus \{\alpha\}$.*

In other words it characterizes α as the only positive root made negative by s_α . From there we deduce:

Theorem 2.1.11 ([Hum90, Theorem 1.4]). *Any two positive (resp. simple) systems in Φ are conjugate under W .*

We now fix Δ a simple system and its corresponding positive system Π . Since any two positive systems are conjugate, we denote Π by Φ^+ and $-\Pi$ by Φ^- so that $\Phi = \Phi^+ \sqcup \Phi^-$. Let $\alpha \in \Phi$, then $\alpha = \sum_{s \in \Delta} \lambda_s s$. We call $h(\alpha) := \sum_{s \in \Delta} \lambda_s$ the *height* of α , and $|h|(\alpha) := \sum_{s \in \Delta} |\lambda_s|$ its *absolute height*.

Proposition 2.1.10 is a generalization of what we saw in Section 1.1.3: in the symmetric group \mathfrak{S}_n , the action of an elementary transposition adds exactly one inversion. We have the same notion of inversions here:

Definition 2.1.12. *The inversion set of $w \in W$ is the set $\text{Inv}(w) = \Phi^+ \cap w^{-1}(\Phi^-)$ of positive roots sent to negative roots by w .*

This definition of inversion coincide in type A with right-inversion in a permutation. Furthermore, inversions are linked to the length of an element:

Theorem 2.1.13 ([Hum90]). *For $w \in W$,*

$$|\text{Inv}(w)| = \ell(w). \quad (2.5)$$

Because of Theorem 2.1.11 the permutation action of W is simply transitive. Furthermore it is obvious that when Φ^+ is a positive system, so is Φ^- . Hence there must exist a unique element $w_0 \in W$ sending Φ^+ to Φ^- . It is called the *longest element* of a W . By unicity it is an involution and every simple reflection occurs at least once in any of its reduced expressions.

Finally, we also define the *weak order* on W by the inclusion of inversions. If $u, v \in W$ then $u \leq v \Leftrightarrow \text{Inv}(u) \subseteq \text{Inv}(v)$. In type A we recover the right weak order.

The longest element w_0 is maximal in the weak order since $\text{Inv}(w) = \Phi^+$. The minimal element is the identity 1. This is again a lattice [Bjö84] which is graded by the length.

2.1.6 Generators and relations

We now want to find a presentation for the reflection group W . The following statements are tools in the proof of Theorem 2.1.16, but we mention them because they illustrate some notions on reduced words. We refer to [Hum90, Section 1.7] or [Bou02, Chap 4., 1.5] for the proofs.

Proposition 2.1.14 (Deletion condition). *For any non reduced expression $w = s_1 \dots s_r$ there exist indices $1 \leq i < j \leq r$ such that $w = s_1 \dots \hat{s}_i \dots \hat{s}_j \dots s_r$ where the hat denotes omission.*

Proposition 2.1.15 (Exchange condition). *Let $w = s_1 \dots s_r$ be a not necessarily reduced expression and s a simple reflection. If $\ell(ws) < \ell(w)$ then there exists $1 \leq i \leq r$ such that $ws = s_1 \dots \hat{s}_i \dots s_r$.*

Proposition 2.1.14 shows that successive omissions of pairs of factors eventually yield a reduced expression for an element while Proposition 2.1.15 makes explicit that w has a reduced expression ending with s if and only if $\ell(ws) < \ell(w)$.

Fix a simple system $\Delta \subseteq \Phi$. For $\alpha, \beta \in \Delta$, we denote by $m(\alpha, \beta)$ the order of the rotation $s_\alpha s_\beta$ in W . For instance $m(\alpha, \alpha) = 1$. Then $(s_\alpha s_\beta)^{m(\alpha, \beta)} = 1$ or equivalently $s_\alpha s_\beta s_\alpha \dots = s_\beta s_\alpha s_\beta \dots$ where both side of the equality contain $m(\alpha, \beta)$ generators. We define $|\alpha, \beta\rangle^m = s_\alpha s_\beta s_\alpha \dots$ with m generators on the left side. Hence we can rewrite the relation $|\alpha, \beta\rangle^{m(\alpha, \beta)} = |\beta, \alpha\rangle^{m(\alpha, \beta)}$. This notation will be more useful in Section 2.4.

Theorem 2.1.16. *Let Δ be a simple system in Φ . Then W is generated by the set $S := \{s_\alpha \mid \alpha \in \Delta\}$ subject only to the relations:*

$$(s_\alpha s_\beta)^{m(\alpha, \beta)} = 1 \quad (\alpha, \beta \in \Delta). \quad (2.6)$$

2.1.7 Geometry and parabolic subgroup

For $\alpha \in \Phi$, the corresponding hyperplane H_α separates the space in two half-spaces: $H_\alpha^+ = \{x \in V \mid (x, \alpha) > 0\}$ and H_α^- . We define the open cone $C := \bigcap_{\alpha \in \Delta} H_\alpha^+$, and D its closure. We can rewrite D as:

$$D = \{x \in V \mid (x, \alpha) \geq 0, \forall \alpha \in \Delta\}. \tag{2.7}$$

This domain D is a *fundamental domain* of the action of W , which means that every $x \in V$ has either a unique conjugate under W in $C = \overset{\circ}{D}$ or at least one conjugate in $\partial C = D \setminus C$.

More generally, the *Coxeter arrangement* $\mathcal{A} := \bigcup_{\alpha \in \Phi} H_\alpha$ for W is the collection of all reflecting hyperplanes for W . Its complement $V \setminus \mathcal{A}$ then consists of open cones, whose closures are called *chambers*. The chambers are in canonical bijective correspondence with the elements of W . For instance the chamber D corresponds to the identity, and an element $w \in W$ to the chamber $w(D)$. The chamber D is called the *fundamental chamber*, see Figure 2.5. The chambers of a Coxeter arrangement and all their faces \mathcal{A} define the *Coxeter fan* \mathcal{F} . This fan is complete, simplicial and essential, see for instance [Hum90, Sections 1.12–1.15] and [Hoh12].

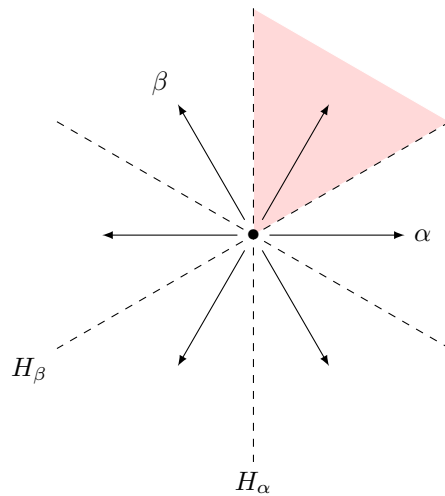

Figure 2.5: Fundamental chamber of A_2 .

The interesting property of chambers is that we can recover the reflection group from it. We call *walls* the hyperplane defining the chamber.

Proposition 2.1.17 ([Bou02]). *The reflections orthogonal to the walls of a chamber generate the reflection group.*

As in Section 1.4, we can define a polytope associated to each Coxeter group W . Take a point x of the complement $V \setminus \mathcal{A}$. The convex hull of its W -orbit is a polytope, called the *W -permutahedron* denoted by $\text{Perm}^x(W)$. Its normal fan is the Coxeter fan. See Figures 2.6, 2.7 and 2.8 taken with permission from [PS15].

Now we can wonder how the faces of the W -permutahedron are defined. More generally, the question of subgroups of W is really important. Let Δ be a simple

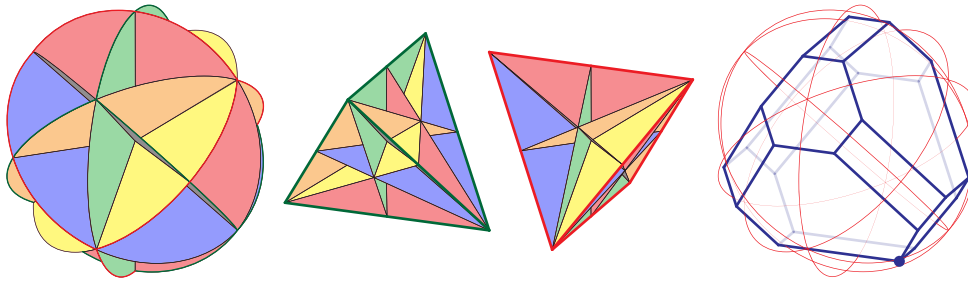

Figure 2.6: Coxeter arrangement of type A_3 and A_3 -permutahedron. It is the group of the tetrahedron.

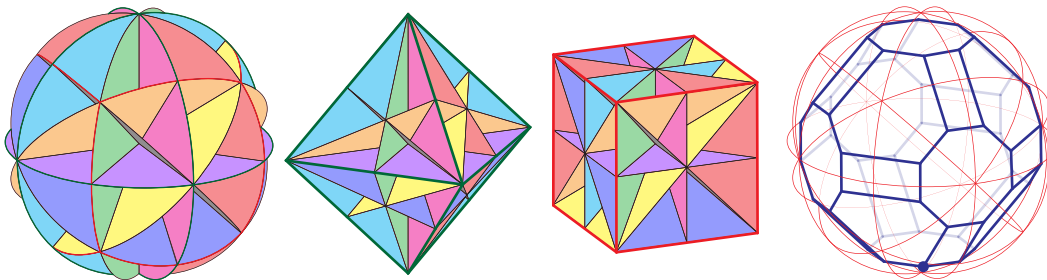

Figure 2.7: Coxeter arrangement of type B_3 and B_3 -permutahedron. It is the group of the cube and its dual the octaedron.

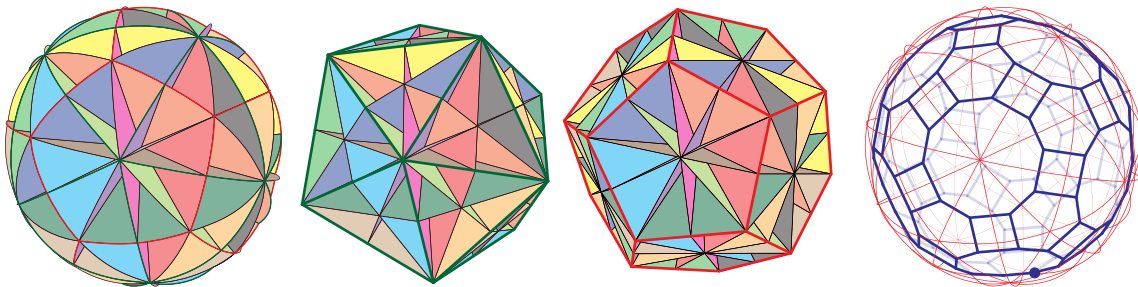

Figure 2.8: Coxeter arrangement of type H_3 and H_3 -permutahedron. It is the group of the icosahedron and its dual the dodecahedron

system and $S = \{s_\alpha \mid \alpha \in \Delta\}$. Then for every $I \subset S$, we define W_I to be the subgroup of W generated by all $s_\alpha \in I$, and let $\Delta_I = \{\alpha \in \Delta \mid s_\alpha \in I\}$. Such a subgroup W_I is called a *parabolic subgroup*. The set $\Phi_I := \Phi \cap \langle \Delta_I \rangle$ is a root system with corresponding reflection group W_I and its longest element is denoted by $w_{0,I}$.

The faces of the permutahedron $\text{Perm}^p(W)$ correspond to the cosets of the standard parabolic subgroups of W . A *standard parabolic coset* is a coset under the action of a parabolic subgroup W_I . Such a standard parabolic coset can be written as xW_I where x is its minimal length coset representative (thus x has no descent in I). See Figure 2.9 taken from [DHP18] with permission.

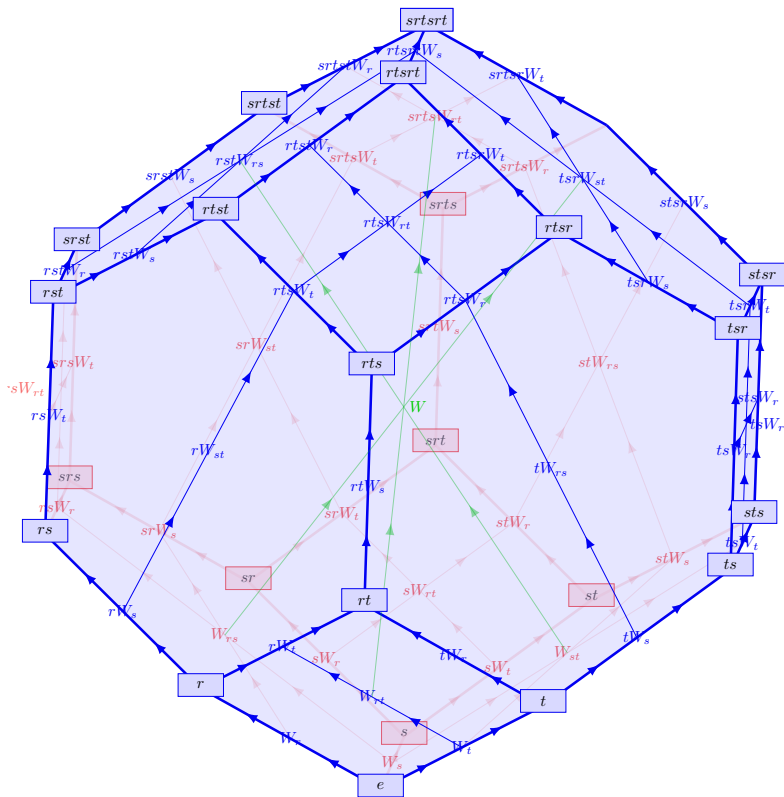

Figure 2.9: Faces of the permutohedron of size 3 with cosets. The arrows are linked to an order on faces that we will see in Chapter 10.

2.1.8 Irreducible root systems

There are a lot of root systems. One first idea to simplify is to find some elementary bricks of the root system. This is the idea of an *irreducible root system*. We say that Φ is *reducible* if $\Phi = \Phi_1 \cup \Phi_2$ such that $(\alpha, \beta) = 0$ for all $\alpha \in \Phi_1, \beta \in \Phi_2$. On the contrary, we say that Φ is an irreducible root system if it cannot be partitioned into the union of two proper subsets such that each root in one is orthogonal to each root in the other. As simple systems generate root systems we might then wonder whether the irreducibility of Φ is related to the ability to partition its simple system Δ . It turns out [Hum90] that they are very closely related:

Proposition 2.1.18. *Φ is irreducible if and only if Δ cannot be partitioned into the union of two proper subsets such that each root in one is orthogonal to each root in the other.*

Therefore we will now only consider irreducible root system, unless otherwise stated.

2.2 Classification

2.2.1 Coxeter system and reflection group

We now give a definition of a Coxeter group as a group described by a presentation, coded in a matrix.

Definition 2.2.1 ([Bou02]). *Let S be a set. A Coxeter matrix of type S is an $n \times n$ symmetric matrix $M = (m_{ij})_{i,j \in S}$ with $m_{ij} \in \mathbb{Z} \cup \{\infty\}$ and with conditions:*

- $m_{ii} = 1$ for all $i \in S$
- $m_{ij} \geq 2$ for all $i, j \in S, i \neq j$.

Now let S be a set of generators for a multiplicative group W such that W is finitely generated by S and every element of S has order 2. We again let $m(s, s')$ denote the order of ss' for all $s, s' \in S$ and define I as the set of pairs such that $m(s, s')$ is finite. Hence $M := (m(s, s'))_{s, s' \in S}$ is a Coxeter matrix. We define (W, S) to be a *Coxeter system* if the generating set S and the relations $(ss')^{m(s, s')} = 1$ for $(s, s') \in I$ form a presentation of a group W . The group is then a *Coxeter group*.

As we saw with Theorem 2.1.16, a finite reflection group is a finite Coxeter group. Bourbaki [Bou02, Chap. 4, 1.6] also proved that when a group W is generated by a set of involutions S , the pair (W, S) is a Coxeter system if and only if it satisfies the exchange condition of Proposition 2.1.15. As a matter of fact, a finite Coxeter group happens to be a finite reflection group. The idea of the proof is to associate to an abstract Coxeter group a set of hyperplans in a Euclidean space and to see that a chamber enables us to generate the group, in the same vein as Proposition 2.1.17. The reader could read [Bou02, Chap. 5, 4.8, Proposition 9] or [Hum90, section 6.4] to see that the two notions are equivalent:

Theorem 2.2.2 ([Bou02; Hum90]). *There is an equivalence between finite Coxeter groups and finite reflection groups.*

This theorem shows a connection between abstract groups and geometric ones. In this thesis, it is one of the main ideas behind Part II and Part III: we start with an abstract group defined by a presentation from which we want to find properties. In order to do that we associate to it a “geometric” group, that is, a group defined by an action on a set. Finally we prove the isomorphism between the two groups.

Note however that we should not simply refer to a Coxeter group as the group W without also referring to the reflections generating it. Indeed, a single group might be generated by two different reflection groups and thus the Coxeter system would be different and our theory would break down. A quick example can be found in [Arm09] where we see the dihedral group of order 12 can be represented as

$$D_6 \cong \langle a, b \mid a^2 = b^2 = (ab)^6 = 1 \rangle \text{ and} \quad (2.8)$$

$$D_6 \cong \langle x, y, z \mid x^2 = y^2 = z^2 = (xy)^3 = (xz)^2 = (yz)^2 = 1 \rangle. \quad (2.9)$$

We will see that the first Coxeter system is of type $I_2(6)$ and the second one is of type $A_2 \times A_1$. Thus we need to be careful.

2.2.2 Coxeter graph and classification

Let M be a Coxeter matrix of type I . We define $\Gamma(I, M)$ to be the graph with vertices S and with an edge between i and $j \in I$ if and only if $m_{ij} \geq 3$. The edges are labeled m_{ij} . Then $\Gamma(I, M)$ is the *Coxeter graph* of (I, M) . By convention the edges labeled with 3 are omitted. For instance we have seen the presentation of the symmetric group \mathfrak{S}_n in Theorem 1.1.14. The corresponding Coxeter graph is thus represented in Figure 2.10.

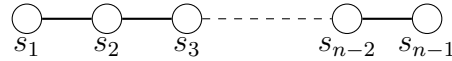

Figure 2.10: The Coxeter graph of \mathfrak{S}_n .

The first question is: is the Coxeter graph a criterion of isomorphism between Coxeter groups? The answer turns out to be positive [Hum90, Prop. 2.1]: if W and W' are two reflection groups with the same Coxeter graph then there is an isomorphism between W and W' .

As we saw Φ is irreducible if and only if Δ cannot be partitioned in two orthogonal sets. Therefore Φ is irreducible if and only if its Coxeter graph is connected. Furthermore if Γ is the Coxeter graph of the root system Φ , let $\Gamma_1, \dots, \Gamma_r$ be the connected components of Γ with corresponding root systems Φ_1, \dots, Φ_r . Then W_Φ is the direct product of the parabolic subgroups $W_{\Phi_1}, \dots, W_{\Phi_r}$ [Hum90, Prop. 2.2]. Therefore, from now on we will only consider irreducible root systems and connected Coxeter graphs unless otherwise stated.

In [Hum90], Humphreys proved that we can associate to a Coxeter graph a bilinear form (defined by what is called the *Cartan matrix* of the Coxeter group). He proved that a Coxeter group is finite if and only if this bilinear form is a scalar product, which leads to the following classification.

Theorem 2.2.3 ([Hum90]). *The Coxeter graphs of finite Coxeter groups are those of Figure 2.11.*

We now understand why the symmetric group \mathfrak{S}_n is the Coxeter group of type A_{n-1} : they have the same Coxeter graph, see Figure 2.10.

Actually in this thesis we will not be interested in every finite Coxeter group but only in the crystallographic ones. These groups are called *Weyl groups*, see Section 2.2.4. We see from Section 2.1.3 that their Coxeter graph's labels can only be 3, 4 and 6. The Weyl groups are encoded in *Dynkin diagram*. These are Coxeter graphs where an edge labeled 3 is a simple edge, an edge labeled 4 is a double edge without label, an edge labeled 6 is a triple edge without label. As we can deduce from Section 2.1.3, when an edge is labeled 4 or 6 that means that the two roots associated to the vertices have different lengths. We then draw an arrow from the longer root to the shorter root. See Figure 2.12 for some examples of Dynkin diagrams. We also represent below each vertex the length of the associated root. We let λ and λ' be two roots of (possibly) different length.

We now give the classification of Dynkin diagrams of finite type or, equivalently, finite Weyl groups:

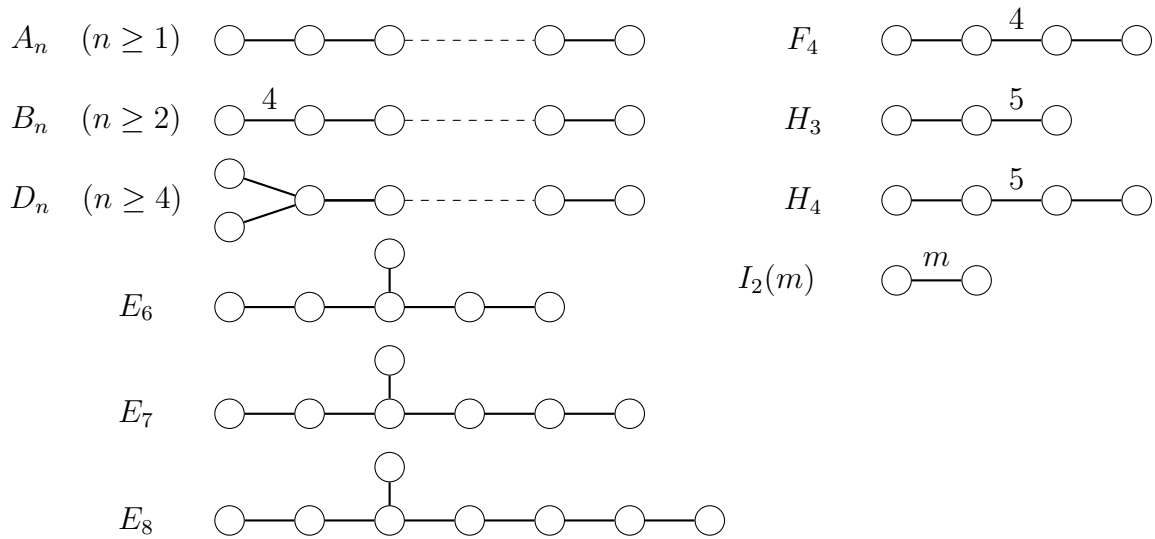

Figure 2.11: Coxeter graphs of finite Coxeter groups.

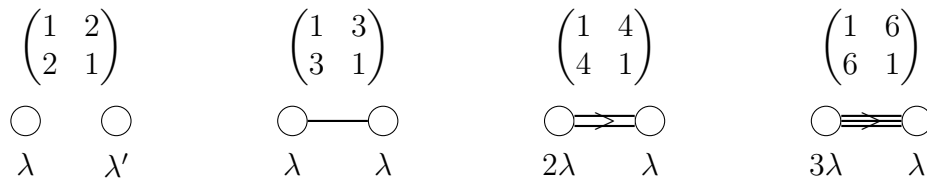

Figure 2.12: Examples of Dynkin diagrams for different Coxeter matrices. Note that the direction of the arrows are arbitrary.

Theorem 2.2.4 ([Hum90]). *The Dynkin diagrams of finite Weyl groups are those of Figure 2.13.*

The reader can now look back at Figure 2.2 to understand why we called our systems of dimension 2 and 3 like this.

Note that there are two ways of realizing the type B Coxeter group as a Weyl group: type B and C . This comes from the fact that the length of the root is important when we consider Weyl groups since these groups stabilize a lattice. The type B and C are dual root systems.

2.2.3 Presentation and Matsumoto’s theorem

For $\alpha, \beta \in \Phi$ we recall the notation $|\alpha, \beta\rangle^k = s_\alpha s_\beta s_\alpha \dots$ with k factors on the right hand side. We extend this notation to reflections $|s_\alpha, s_\beta\rangle^k := |\alpha, \beta\rangle^k$. As we have seen, by the definition of a Coxeter system, a Coxeter group generated by $S = \{s_\alpha \mid \alpha \in \Delta\}$ has the following presentation in terms of relations:

$$s^2 = 1 \quad \forall s \in S \tag{2.10}$$

$$|s, s'\rangle^{m(s,s')} = |s', s\rangle^{m(s,s')} \quad \forall s, s' \in S \tag{2.11}$$

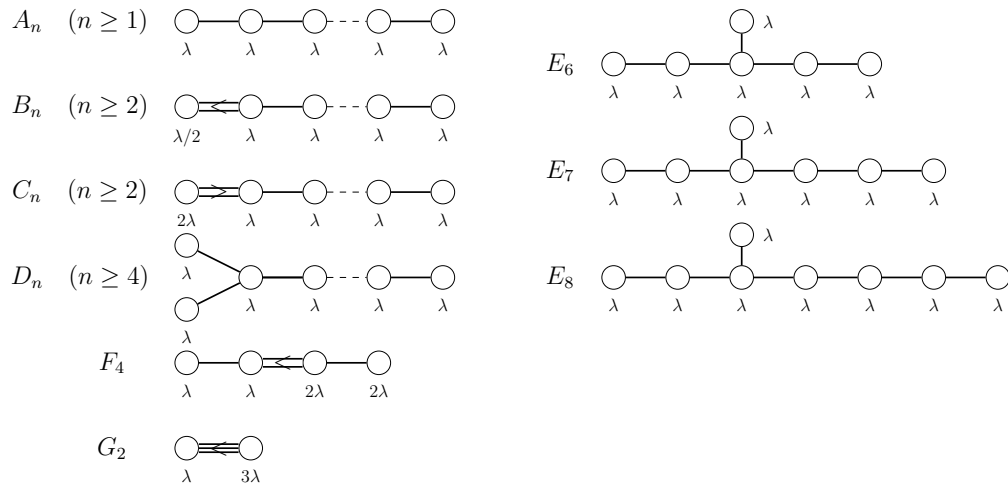

Figure 2.13: Dynkin diagrams of finite Weyl groups.

As in type A we call Relation 2.11 is a *braid relation*. In Theorem 1.1.15 we have already seen that in type A the braid relations are enough to characterize reduced elements in $W := W_\Phi$. More precisely one can rewrite a given reduced expression of an element of W to another reduced expression using only the braid relations (hence with all intermediate expressions which are also reduced). The same holds for Coxeter groups:

Theorem 2.2.5 (Matsumoto’s theorem, [BB05, Theorem 3.3.1]). *Let (W, S) be a Coxeter group associated to the root system Φ . If \underline{u} and \underline{v} are two reduced expressions over S for the same element $w \in W$ then they are congruent using only the braid relations 2.11.*

The Coxeter groups hence have a nice structure in regards to the word problem.

2.2.4 Tits system and linear algebraic group theory

This section presents another way to look at the crystallographic Coxeter groups, in other words the Weyl groups. Since they come from many different backgrounds we introduce here how they come from the linear algebraic group theory and a generalization to Tits system [Hum75; Bou02]. We will not give precise definitions since we will not use these objects.

The main purpose of linear algebraic group theory will be to introduce the definition of Renner monoids from Part III. Suppose G is a Linear Algebraic Group over a field K . A torus of G is a subgroup of G isomorphic over \overline{K} to a finite product of copies of the multiplicative group of K . Let then T be a maximal torus in G (that is a torus not contained in any proper torus of G). The Weyl group of T , denoted $W(T)$, is defined as the quotient group of the normalizer $N_G(T)$ by the torus T :

$$W(T) := N_G(T) / T. \tag{2.12}$$

Under the assumption that the algebraic group is connected and reductive, we find the same Weyl groups and the same classification. We give an example: take G to be the general linear group of degree n , denoted $\mathbf{GL}_n(K)$. Then we can take the maximal torus T of the subgroup of diagonal matrices, which is thus isomorphic to the direct power of n copy of the multiplicative group of K . Then $W(T)$ is the symmetric group \mathfrak{S}_n .

Actually, one does not need the linearity of these algebraic groups to define the Weyl groups. It can be defined inside group theory, with Tits systems. This comes from [Bou02, Chap. 4, 2]. We present these systems so that the definition of the Iwahori-Hecke algebra will be more natural in Section 2.4.2.

Let G be a group and B a subgroup of G . The group $B \times B$ acts on G by the action $(b, b') \cdot g = bgb'^{-1}$. The orbits of this action are the sets BgB for $g \in G$ and called the (B, B) -double coset of G . The quotient set is denoted by $B \backslash G / B$.

Then a *Tits system* is a quadruple (G, B, N, S) where G is a group, B and N are two subgroups of G , and S is a part of $N/B \cap N$, such that the following axioms hold:

- (i) G is generated by $B \cup N$, and $T := B \cap N$ is a normal subgroup of N .
- (ii) The group $W := N/T$ is generated by S and every element of S is of order 2.
- (iii) For all $s \in S$ and $w \in W$ we have $sBw \subseteq BwB \cup BswB$.
- (iv) For all $s \in S$ we have $sBs \not\subseteq B$.

The idea of this definition is that B is an analogue of the upper triangular matrices of the general linear group $\mathbf{GL}_n(K)$, T is called a *torus* and an analogue of the diagonal matrices, and N is an analogue of the normalizer of T . The subgroup B is sometimes called the *Borel subgroup*. Then the pair (W, S) is a Coxeter system. The result interesting to us here is the Bruhat decomposition [FH91; BB05]:

$$G = \coprod_{w \in W} BwB. \quad (2.13)$$

2.3 Some properties in type A , B and D

2.3.1 Type A

The Weyl group A_n admits the following Dynkin diagram and presentation:

$$A_n \quad (n \geq 1) \quad \begin{array}{ccccccccc} \circ & \text{---} & \circ & \text{---} & \circ & \text{---} & \cdots & \text{---} & \circ & \text{---} & \circ \\ \lambda & & \lambda & & \lambda & & & & \lambda & & \lambda \\ s_1 & & s_2 & & s_3 & & & & s_{n-1} & & s_n \end{array}$$

$$s_i^2 = 1, \quad 1 \leq i \leq n; \quad (A-1)$$

$$s_i s_j = s_j s_i, \quad 1 \leq i, j \leq n \text{ and } |i - j| \geq 2; \quad (A-2)$$

$$s_i s_{i+1} s_i = s_{i+1} s_i s_{i+1}, \quad 1 \leq i \leq n - 1; \quad (A-3)$$

We recognize here from Theorem 1.1.14 the presentation of the symmetric group of size $n + 1$. We have already studied many properties of this group in Section 1.1.

We recall that a permutation $\sigma \in \mathfrak{S}_{n+1} = A_n$ will be denoted either by its one-line word $\sigma = \sigma(1)\sigma(2)\dots\sigma(n+1)$ or by its *permutation table*.

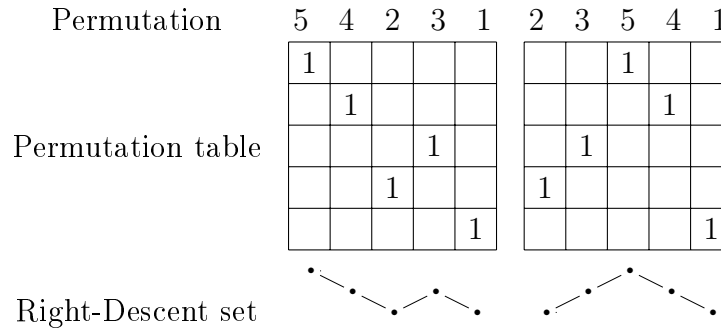

The root system is given by $\Phi_A = \{e_i - e_j \mid 1 \leq i \neq j \leq n+1\}$ where the (e_i) are the canonical basis of \mathbb{R}^{n+1} (see [Bou02]). The simple roots are the $\alpha_i := e_i - e_{i+1}$ which corresponds to the exchange of coordinates $x_i \leftrightarrow x_{i+1}$ and the positive roots are $\Phi_A^+ = \{e_i - e_j \mid 1 \leq i < j \leq n+1\}$. We represent in Figure 2.14 the *root poset* of A_4 , that is the Hasse diagram of the poset on Φ_A^+ defined as $\alpha \leq \beta$ if α is a subsum of β . This poset is graded by the *absolute height*.

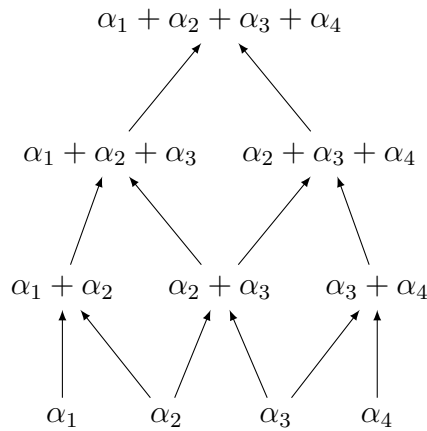

Figure 2.14: The root poset of A_4 .

2.3.2 Type B and C

The Weyl groups B_n and C_n admit the following Dynkin diagrams and the same following presentation:



$$\begin{aligned}
 s_i^2 &= 1, & 1 \leq i \leq n; & \quad \text{(BC-1)} \\
 s_i s_j &= s_j s_i, & 1 \leq i, j \leq n \text{ and } |i - j| \geq 2; & \quad \text{(BC-2)} \\
 s_i s_{i+1} s_i &= s_{i+1} s_i s_{i+1}, & 2 \leq i \leq n - 1; & \quad \text{(BC-3)}
 \end{aligned}$$

$$s_1 s_2 s_1 s_2 = s_2 s_1 s_2 s_1. \tag{BC-4}$$

The root systems are given in [Bou02] and live in \mathbb{R}^n with canonical basis (e_i) . In type B we have

$$\Phi_B = \{\pm e_i \pm e_j \mid 1 \leq i < j \leq n+1\} \cup \{\pm e_i \mid 1 \leq i \leq n\}, \tag{2.14}$$

and the simple roots are the $\alpha_i := e_i - e_{i-1}$ for $2 \leq i \leq n$ and $\alpha_1 := e_1$. In type C we have

$$\Phi_C = \{\pm e_i \pm e_j \mid 1 \leq i < j \leq n+1\} \cup \{\pm 2e_i \mid 1 \leq i \leq n\}, \tag{2.15}$$

and the simple roots are the $\alpha_i := e_i - e_{i-1}$ for $2 \leq i \leq n$ and $\alpha_1 := 2e_1$. These two root systems are dual to one another, see Figure 2.15. We represent in Figure 2.16 the root posets of B_4 and C_4 .

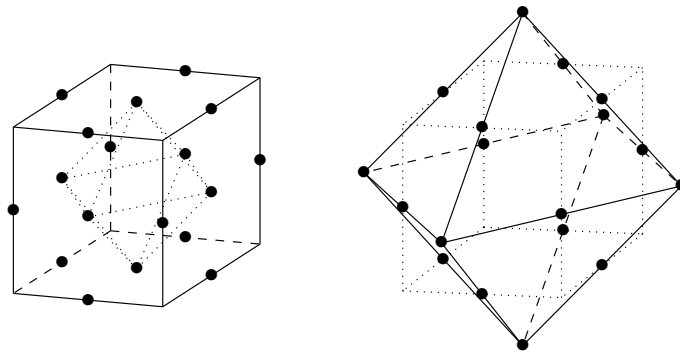

Figure 2.15: The duality between the root systems of B_3 (left) and C_3 (right).

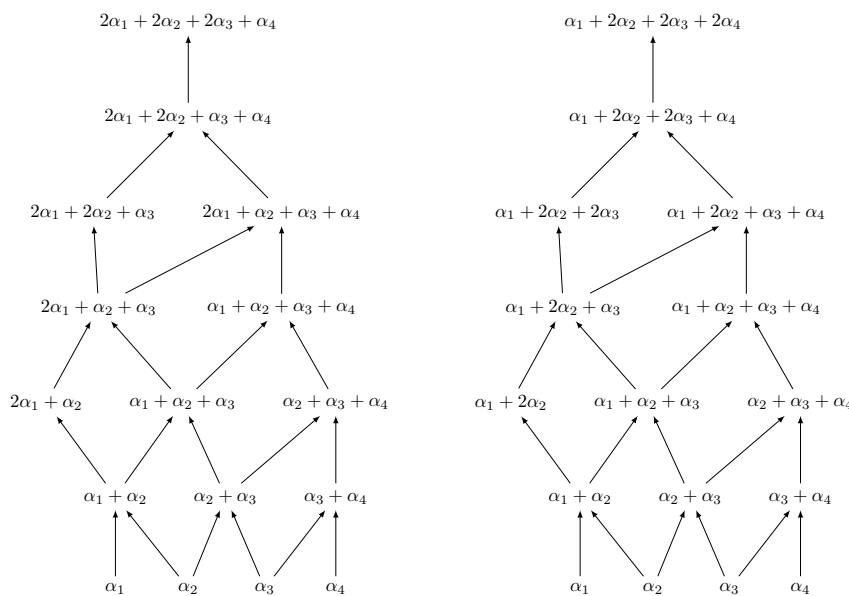

Figure 2.16: The root posets of B_4 (left) and C_4 (right).

The root systems of B and C may be different, but the presentation are the same, hence the groups are isomorphic. Hence we will only talk about C_n . The Weyl Group of type B and C is $B_n := \mathfrak{S}_n \wr \mathbb{Z}/2\mathbb{Z}$, where \wr is the *wreath product*. More explicitly, B_n is the set of signed permutations of size n . These are permutations of size n where each letter has a sign. For instance $142\bar{3}\bar{5}\bar{6}$ belongs to B_6 (denoting $\bar{i} = -i$). The group B_n is generated by the elementary transpositions $(s_i)_{1 \leq i \leq n-1}$ and the special generator: $t = \bar{1}23 \dots \ell$. We denote $[\bar{n}, n] := \{\bar{n}, \dots, \bar{1}, 1, \dots, n\}$. Another way to see the elements of B_n is to note that:

$$B_n \subseteq A_{2n-1} = \mathfrak{S}_{2n} \simeq \mathfrak{S}([\bar{n}, n]) =: \mathfrak{S}_{\bar{n}, n} \tag{2.16}$$

To see this we use a *mirror notation* or *antisymmetry notation*: the element $\sigma = 142\bar{3}\bar{5}$ will instead be denoted by $\bar{5}\bar{3}\bar{2}\bar{4}\bar{1} \mid 142\bar{3}\bar{5}$ or equivalently $\bar{5}\bar{3}\bar{2}\bar{4}\bar{1}142\bar{3}\bar{5}$. These words are called μ -vectors (μ stands for mirror). We then choose to index a μ -vector $\sigma \in B_n$ as $\sigma = \sigma_{\bar{n}} \dots \sigma_{\bar{1}} \mid \sigma_1 \dots \sigma_n$ rather than $\sigma = \sigma_1 \dots \sigma_{2n}$. The *mirror letter* of the letter σ_i is the letter $\sigma_{\bar{i}}$. Consequently the generator $s_0 \in \mathfrak{S}_{\bar{n}, n}$ exchanges the letters $\sigma_{\bar{1}}$ and σ_1 , while $s_i \in \mathfrak{S}_{\bar{n}, n}$ (resp. $s_{\bar{i}} \in \mathfrak{S}_{\bar{n}, n}$) exchanges the letters σ_i and σ_{i+1} (resp. $\sigma_{\bar{i}}$ and $\sigma_{\bar{i}+1}$) for $1 \leq i \leq n-1$.

The element $S_0 := s_0$ acts on μ -vectors by exchanging the letters in position 1 and $\bar{1}$ (it plays the role of the element t). The elements $S_i := s_{\bar{i}}s_i = s_i s_{\bar{i}}$ for $1 \leq i \leq n-1$ are double transpositions exchanging simultaneously the letters i and $i+1$, and the letters \bar{i} and $\bar{i}+1$. Hence B_n is generated by $(S_i)_{0 \leq i \leq n-1}$ [BB05, Section 8.1]. We borrow the table representation and the descent set from type A :

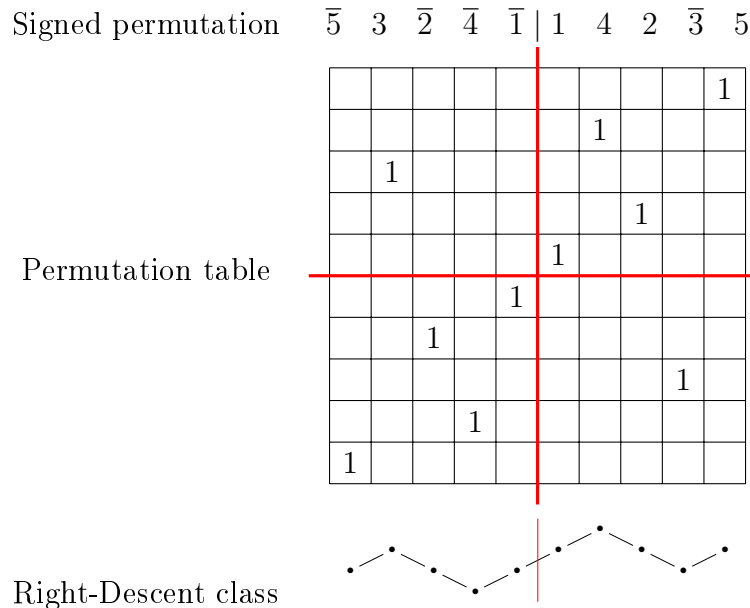

Because of the notation in μ -vectors, the permutation table and descent class of elements of B_n are symmetric. When we are dealing with type B (and latter type D) we will always represent a “mirror” to show the middle of elements, as seen above.

2.3.3 Type D

The Weyl group of type D_n ($n \geq 4$) admits the following Dynkin diagram and presentation:

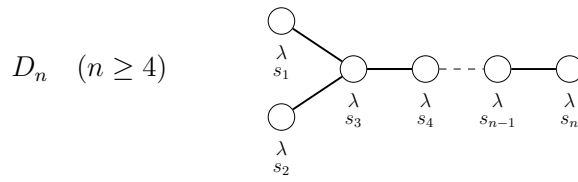

$$s_i^2 = 1, \quad 1 \leq i \leq n; \tag{D-1}$$

$$s_i s_j = s_j s_i, \quad 2 \leq i, j \leq n \text{ and } |i - j| \geq 2; \tag{D-2}$$

$$s_1 s_i = s_i s_1 \quad i \neq 3; \tag{D-3}$$

$$s_i s_{i+1} s_i = s_{i+1} s_i s_{i+1}, \quad 2 \leq i \leq n - 1; \tag{D-4}$$

$$s_1 s_3 s_1 = s_3 s_1 s_3. \tag{D-5}$$

The root system of type D lives in \mathbb{R}^n with canonical basis (e_i) [Bou02] and is given by $\Phi_D = \{\pm e_i \pm e_j \mid 1 \leq i < j \leq n + 1\}$. Its simple roots are the $\alpha_i := e_i - e_{i+1}$ for $1 \leq i \leq n - 1$ and $\alpha_n := e_{n-1} + e_n$. We represent in Figure 2.17 the root poset of D_4 .

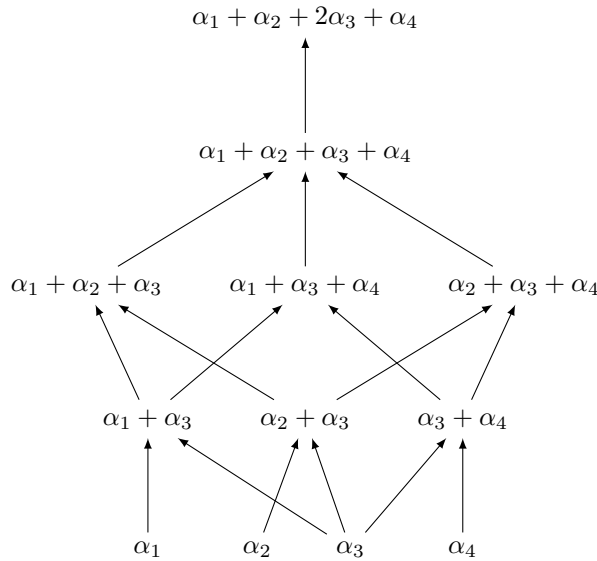

Figure 2.17: The root posets of D_4 .

The Weyl Group of type D consists of the elements of type B with an even number of positive numbers in the first half or, equivalently, an even number of negative numbers in the second half. We borrow from type B the μ -vectors and table representation [BB05]. Because of parity the generator S_0 does no longer belong to D_n . We introduce $S_1^f := (\bar{2}, 1)(\bar{1}, 2)$. We also denote $S_1^e := S_1$. Then D_ℓ is generated by $S_1^e, S_1^f, S_2, \dots, S_{\ell-1}$ [BB05, Section 8.2].

The element s_0 still plays an interesting role since the conjugation by s_0 stabilizes the set of generators: $s_0 \cdot S_1^e \cdot s_0 = S_1^f$ and $s_0 \cdot S_i \cdot s_0 = S_i$ for $i \geq 2$.

Now we look at the descent set of these elements. We call *neighbouring letters* two letters that can be exchanged by a generator. In type A and B the only neighbouring letters were consecutive ones. It is also true in type D , except for letters $\bar{1}$ and 1

which are no longer neighbouring, while the pairs $(\bar{2}, 1)$ and $(\bar{1}, 2)$ are. When we represent the descent set we link neighbouring letters rather than consecutive ones. As before, these links tell us if it is a descent or not. See Figure 2.18.

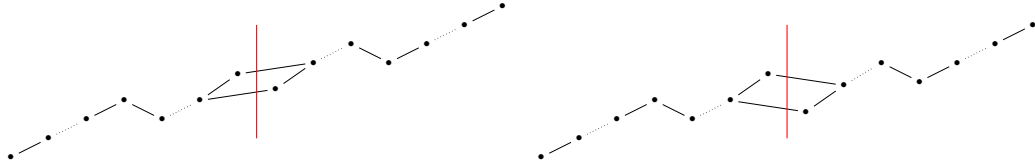

Figure 2.18: Some descent sets of type D .

2.4 The Iwahori-Hecke algebra

2.4.1 Type A

Before going to the general case, we explain here how the Iwahori-Hecke algebra was defined by Iwahori in [Iwa64]. Let \mathbb{F}_q be the finite field with q elements. Also, let $G := \mathbf{GL}_n(\mathbb{F}_q)$ be its general linear group of invertible $n \times n$ matrices and $B \subseteq G$ its subgroup of upper triangular matrices. Then B is finite of cardinality $|B| = (q-1)^n q^{\binom{n}{2}}$. We identify a permutation with its associated permutation matrix. The Bruhat decomposition seen in Equation 2.13 [BB05] tells that for all $M \in G$ there is a unique permutation $\sigma \in \mathfrak{S}_n$ such that $M \in B\sigma B$, that is:

$$G = \bigsqcup_{\sigma \in \mathfrak{S}_n} B\sigma B. \quad (2.17)$$

Let $W = \mathfrak{S}_n$ and, for $w \in W$, let T_w be the element of the group algebra $\mathbb{C}G$ defined by:

$$T_w := \frac{1}{|B|} \sum_{x \in BwB} x. \quad (2.18)$$

The Hecke ring $\mathcal{H}(G, B)$ is the \mathbb{Z} -ring spanned by the T_w . Its identity is then $\varepsilon = T_{\text{Id}} = \frac{1}{|B|} \sum_{b \in B} b$. Furthermore, $\mathcal{H}(G, B) = \varepsilon \mathbb{C}G \varepsilon$. Let $S = \{s_1, \dots, s_{n-1}\}$ be the elementary transpositions which generate W as a group. For $q \in \mathbb{C}$, let $\mathcal{H}_{\mathbb{Z}}(q)$ denote the \mathbb{Z} -algebra defined by generators and relations as follows:

$$T_i^2 = q \cdot 1 + (q-1)T_i \quad 1 \leq i \leq n-1, \quad (\text{H1})$$

$$T_i T_{i+1} T_i = T_{i+1} T_i T_{i+1} \quad 1 \leq i \leq n-2, \quad (\text{H2})$$

$$T_i T_j = T_j T_i \quad |i-j| \geq 2, \quad (\text{H3})$$

If q is the cardinality of a finite field, Iwahori proved that the maps $T_i \mapsto T_{s_i}$ extend to a full ring isomorphism from $\mathcal{H}_{\mathbb{Z}}(q)$ to $\mathcal{H}(G, B)$ and the equations above give us a presentation. By extending the scalars to \mathbb{C} we get a \mathbb{C} -algebra $\mathcal{H}_{\mathbb{C}}(q)$ which extends the definition of the Hecke ring outside of prime powers. It is well known that when q is neither zero nor a root of unity the *Iwahori-Hecke algebra* is isomorphic to the complex group algebra $\mathbb{C}W$.

We recognize in Relation H2 and H3 the braid relations of the symmetric group, see Relations A-2 and A-3. Because of Matsumoto's Theorem (Theorem 1.1.15), we know that the reduced expressions of an element of \mathfrak{S}_n depends only on these braid relations. Hence for every $w \in W$ we take $\underline{w} = s_{i_1} \dots s_{i_k}$ a reduced word for it, then we define

$$T_w := T_{s_{i_1}} \dots T_{s_{i_k}}. \quad (2.19)$$

By Matsumoto's theorem the element $T_w \in \mathcal{H}_{\mathbb{Z}}(q)$ is well-defined.

Now we study the degeneracy at $q = 0$. It has many interesting properties and applications. Its first appearance is perhaps in Demazure character formula [Dem74] through divided differences. Then, its central role in Schubert calculus was discovered by Lascoux [Las01; Las03a; Las03b], with further recent connection with K -theory through Grothendieck polynomials (see *e.g.* [Mil05; LSS10]). Its representation theory was first studied by Norton [Nor79] in type A and Carter [Car86] in the other types. In type A, Krob and Thibon [KT97] explained how induction and restriction of these modules give an interpretation of the products and coproducts of the Hopf algebras of noncommutative symmetric functions and quasi-symmetric functions, giving thus analogue of the well know Frobenius isomorphism from the character ring of the symmetric groups to symmetric functions (See *e.g.* [Mac95], and Section 3.6). This was the main motivation for Parts II and III at the beginning. Two other important steps were further made by Duchamp–Hivert–Thibon [DHT02] for type A and Fayers [Fay05] for the other types, using the Frobenius structure to get more results, including a description of the Ext-quiver (see Theorem 3.3.11). Denton [Den10] also gave a family of minimal orthogonal idempotents.

This degeneracy is defined by putting $q = 0$ in the relation of the q -Iwahori-Hecke algebra:

$$T_i^2 = -T_i \quad 1 \leq i \leq n-1, \quad (2.20)$$

$$T_i T_{i+1} T_i = T_{i+1} T_i T_{i+1} \quad 1 \leq i \leq n-2 \quad (2.21)$$

$$T_i T_j = T_j T_i \quad |i-j| \geq 2. \quad (2.22)$$

One interesting remark which has been discovered independently several times is that this is the algebra of a monoid [Den+10]. To see this, there are two possibilities: define either $\pi_i := -T_i$ or $\pi_i := T_i + 1$ and get the following presentation of the Hecke monoid at $q = 0$, which we denote H_n^0 (as opposite to its algebra denoted by $H_n(0)$):

$$\pi_i^2 = \pi_i \quad 1 \leq i \leq n-1, \quad (M1)$$

$$\pi_i \pi_{i+1} \pi_i = \pi_{i+1} \pi_i \pi_{i+1} \quad 1 \leq i \leq n-2, \quad (M2)$$

$$\pi_i \pi_j = \pi_j \pi_i \quad |i-j| \geq 2. \quad (M3)$$

For a permutation σ we define $\pi_\sigma := \pi_{s_{i_1}} \dots \pi_{s_{i_k}}$ where $s_{i_1} \dots s_{i_k}$ is any reduced word (word of minimal length) for σ . As before, thanks to the braid Relations M2, M3, the result is independent of the choice of the reduced word. Then H_n^0 is nothing but the set $\{\pi_\sigma \mid \sigma \in \mathfrak{S}_n\}$ and therefore of cardinality $n!$.

The choice of notation π_i is not harmless. Indeed the reader could think again at the bubble sort operator introduced in Definition 1.1.9. In fact, the monoid

generated by the bubble sort operator is precisely the Hecke monoid at $q = 0$:

$$H_n^0 \cong \langle \pi_1, \dots, \pi_{n-1} \rangle. \quad (2.23)$$

This is a new way to see that $|H_n^0| = n! = |\mathfrak{S}_n|$. Furthermore the inverse bijection of $\sigma \in \mathfrak{S}_n \mapsto \pi_\sigma \in H_n^0$ is just $\pi_\sigma \in H_n^0 \mapsto 1 \cdot \pi_\sigma \in \mathfrak{S}_n$. We hence have the following important result:

Proposition 2.4.1. *The application $H_n^0 \xrightarrow{h} \mathfrak{S}_n$ is a bijection. In other words, the action on the identity characterizes the element.*

For any composition $I = (i_1, \dots, i_p) \vDash n$, we consider the parabolic submonoid H_I^0 generated by $\{\pi_i \mid i \notin \text{Des}(I)\}$. This submonoid is hence isomorphic to the direct product $H_{i_1}^0 \times H_{i_2}^0 \times \dots \times H_{i_p}^0$. Each parabolic submonoid contains a unique zero element $\pi_J = \pi_{w_{0,J}}$ where $w_{0,J}$ is the maximal element of the parabolic Coxeter subgroup \mathfrak{S}_J . The collection $\{\pi_J \mid J \vDash n\}$ is exactly the set of idempotents in H_n^0 .

Finally, note that H_n^0 is \mathcal{R} -trivial. Indeed, the \mathcal{R} -order is defined as $\pi_\sigma \leq_{\mathcal{R}} \pi_\mu$ if and only if $\mu \leq_R \sigma$ where \leq_R is the right weak order of the symmetric group. The same holds on the left and actually H_n^0 is isomorphic to its opposite. Thanks to Lemma 1.3.5 it is then \mathcal{J} -trivial.

Theorem 2.4.2. *The monoid H_n^0 is \mathcal{J} -trivial.*

2.4.2 Coxeter types

The definition of the Iwahori-Hecke algebra is exactly the same as in Section 2.4.1. Now G is a connected reductive algebraic group over an algebraically closed field, B is a Borel subgroup of G and W is a Weyl group of G corresponding to a maximal torus T of B . The Bruhat decomposition from Equation 2.13 still holds and we can define elements T_w for $w \in W$ as before.

Let (W, S) be a Coxeter system. As before we can define the algebra $\mathcal{H}_{\mathbb{Z}}(W, q)$ by the \mathbb{Z} -algebra defined by generators $(T_s)_{s \in S}$ and relations:

$$T_s^2 = q \cdot 1 + (q - 1)T_s \quad s \in S, \quad (\text{HW1})$$

$$|T_s, T_{s'}\rangle^{m(s,s')} = |T_{s'}, T_s\rangle^{m(s,s')} \quad s, s' \in S. \quad (\text{HW2})$$

The relation HW2 are the braid relations. Thus using again Matsumoto's theorem 2.2.5 we can define the element T_w for $w \in W$ for any choice of a reduced word.

As in type A , the degeneracy at $q = 0$ of this algebra leads to the algebra of a monoid. This monoid is called the *Hecke monoid at $q = 0$* of type T , and is generated by $\Pi := \{\pi_s \mid s \in S\}$ subject to the relations:

$$\pi_s^2 = \pi_s \quad \pi_s \in S, \quad (\text{Hz1})$$

$$|\pi_s, \pi_t\rangle^{m(s,t)} = |\pi_t, \pi_s\rangle^{m(t,s)} \quad (\{s, t\}, m) \in \mathcal{E}(\Gamma). \quad (\text{Hz2})$$

We give the following two examples:

Example 2.4.3. The monoid $H_n^0(B)$ is generated by $\pi_0, \pi_1, \dots, \pi_{\ell-1}$ subject to the relations:

$$\pi_i^2 = \pi_i \quad 0 \leq i \leq \ell - 1; \quad (\text{H1-B})$$

$$\pi_i \pi_j = \pi_j \pi_i, \quad 0 \leq i, j \leq \ell - 1 \text{ and } |i - j| \geq 2; \quad (\text{H2-B})$$

$$\pi_i \pi_{i+1} \pi_i = \pi_{i+1} \pi_i \pi_{i+1}, \quad 1 \leq i \leq \ell - 2; \quad (\text{H3-B})$$

$$\pi_1 \pi_0 \pi_1 \pi_0 = \pi_0 \pi_1 \pi_0 \pi_1. \quad (\text{H4-B})$$

Example 2.4.4. The monoid $H_n^0(D)$ is generated by $\pi_1^e, \pi_1^f, \pi_2, \dots, \pi_{\ell-1}$ subject to the relations:

$$\pi_i^2 = \pi_i \quad 1 \leq i \leq \ell - 1; \quad (\text{H1-D})$$

$$\pi_i \pi_j = \pi_j \pi_i \text{ and } \pi_1^e \pi_1^f = \pi_1^f \pi_1^e, \quad 1 \leq i, j \leq \ell - 1 \text{ and } |i - j| \geq 2; \quad (\text{H2-D})$$

$$\pi_i \pi_{i+1} \pi_i = \pi_{i+1} \pi_i \pi_{i+1}, \quad 1 \leq i \leq \ell - 2. \quad (\text{H3-D})$$

Here, Relations [H1-D](#) to [H3-D](#) also hold for $\pi_i = \pi_1^e$ or π_1^f with $i = 1$.

As in type A , we can define the generators of type B and D as some special bubble sorting operators acting on the associated Weyl group. This action is a bijection given by the action on the identity of the Weyl group as in [Theorem 2.4.1](#). Since these results will only be used specifically in [Part III](#) we will introduce them there. We give the following important result that will be used in the next chapter.

Theorem 2.4.5. *The monoid $H_n^0(T)$ is \mathcal{J} -trivial for all types T .*

2.4.3 Rook monoid and Solomon's algebra

In [Section 1.5](#) we introduced the rook matrices and rook monoid. In [[Sol90](#); [Sol04](#)], Solomon constructed an analogue of Iwahori's construction replacing the general linear group by its full matrix monoid. The construction is as follows: recall that $B \subset M$ denotes the set of invertible upper triangular matrices. Then M admits a Bruhat decomposition [[Ren95](#)] too: the set of permutation matrices is replaced by the set R_n of *rook matrices* of size n , that is $n \times n$ matrices with entries $\{0, 1\}$ and at most one nonzero entry in each row and column. Then

$$M = \bigsqcup_{r \in R_n} BrB \quad (2.24)$$

For any rook matrix $r \in R_n$, Solomon defined as in [Section 2.4.2](#) an element T_r of the monoid algebra $\mathbb{C}M$ by

$$T_r := \frac{1}{|B|} \sum_{x \in BrB} x. \quad (2.25)$$

Those elements span a subalgebra $\mathcal{H}(M, B)$ which contains $\mathcal{H}(G, B)$ with the same identity ε and can also be defined by $\mathcal{H}(M, B) = \varepsilon \mathbb{C}M \varepsilon$.

Halverson [[Hal04](#)] further got a presentation of this ring. It is generated by the two families T_1, \dots, T_{n-1} and P_1, \dots, P_n together with the relations of the Iwahori-Hecke algebra ([Equations H1, H2, H3](#)) and the following extra relations:

$$P_i^2 = P_i \quad 1 \leq i \leq n, \quad (\text{RH4})$$

$$P_i P_j = P_j P_i \quad 1 \leq i, j \leq n, \quad (\text{RH5})$$

$$P_i T_j = T_j P_i \quad i < j \quad (\text{RH6})$$

$$P_i T_j = T_j P_i = q P_i \quad j < i \quad (\text{RH7})$$

$$P_{i+1} = q P_i T_i^{-1} P_i \quad 1 \leq i < n. \quad (\text{RH8})$$

Note that the last relation can also be reformulated using the first as

$$P_{i+1} = P_i T_i P_i - (q - 1) P_i \quad (\text{RH8}')$$

The question whether there exists a proper degeneracy at $q = 0$ of this ring and if it exists, if it is the monoid-ring of a monoid, is therefore very natural. The main goal of the Part II will be to construct such a monoid denoted R_n^0 , called the 0-rook monoid. Then in Part III we will generalize this to other Weyl group.

Representations

Historically the theory of representations was first defined for groups (Section 3.1 and [Ser78]). In this thesis however we are not interested in groups but in monoids. Monoids need the theory of representation of algebra (Section 3.2) since they are not semisimple.

3.1 Introduction: representations of finite groups

In this section we introduce the representation theory of finite groups as it is presented in [Ser78]. To avoid any complication we will assume that all our vector spaces are over \mathbb{C} and of finite dimension. We will also assume that our groups are finite.

3.1.1 Representation and subrepresentations

Let V be a \mathbb{C} -vector space of finite dimension and G a finite group. A *linear representation* (or *representation*) of G is a group morphism $\rho : G \rightarrow \mathbf{GL}(V)$. The dimension of V is called the *degree* of the representation. Such a representation (ρ, V) then gives V a structure of a G -module or equivalently of a $\mathbb{C}G$ -module. In this section we will therefore talk about representations as it was done historically, but in later sections we will adopt the module point of view. We will sometimes denote a representation (ρ, V) simply by V . Although it could be misleading this abuse of notation is standard in the domain.

Two representations (ρ, V) and (ρ', V') are called *isomorphic* if there exist an isomorphism $\tau : V \rightarrow V'$ so that the following diagram commutes:

$$\begin{array}{ccc}
 V & \xrightarrow{\tau} & V' \\
 \rho(g) \downarrow & & \downarrow \rho'(g) \\
 V & \xrightarrow{\tau} & V'
 \end{array}
 \quad \forall g \in G$$

If W is a subset of V stable under the action of G then the representation $(\rho|_W, W)$ is called a *subrepresentation* of (ρ, V) . Thus we can define the direct sum of representations and wonder when a subrepresentation $W \subseteq V$ admits a supplementary subrepresentation W' such that $V = W \oplus W'$. As we are working over the field \mathbb{C} , we can use Mashke's Theorem which will be formulated in all generality in Theorem 3.2.5.

Theorem 3.1.1 ([Ser78, Chap. 1, Thm. 1]). *Let (ρ, V) be a representation of G and W a subspace of V stable under G . Then there exist a supplementary W' of W in V stable under G .*

We say that a representation (ρ, V) is *irreducible* if $V \neq 0$ and the only subspaces of V stable under G are 0 and V . By Theorem 3.1.1 it is equivalent to the fact that V is not the direct sum of two nontrivial subrepresentations. This equivalence between no nontrivial stable subspace and no nontrivial decomposition which hold for groups is far from being a generality. This is the distinction between simple and indecomposable representations that will be seen in Section 3.2.

3.1.2 Character theory

Let (ρ, V) be a representation of G . Its associated *character* χ is the map $\chi : g \mapsto \text{Tr}(\rho(g))$ where $M \mapsto \text{Tr} M$ is the trace of endomorphisms. This definition is very useful; for instance the character of a direct sum is the sum of the characters of the subrepresentations. The character is also constant inside a conjugation class: such a function is called a *central function*. The set of central functions on G is denoted $\mathcal{FC}(G)$. On this set we define the following scalar product. If $\varphi, \psi \in \mathcal{FC}(G)$ then:

$$\langle \varphi | \psi \rangle := \frac{1}{|G|} \sum_{g \in G} \varphi(g) \overline{\psi(g)}. \quad (3.1)$$

We then have the following result:

Theorem 3.1.2 ([Ser78, Chap. 2, Theorem 3, 5 and 7]). *If χ is a character of a representation V then V is irreducible if and only if $\langle \chi | \chi \rangle = 1$. Furthermore the characters of irreducible representations form an orthonormal base of $\mathcal{FC}(G)$. Consequently the number of irreducible representations of G is equal to the number of conjugation classes of G .*

With this result we can decompose any given representation V :

Theorem 3.1.3. *Let V be a representation of G of character φ that we can decompose as*

$$W_1 \oplus W_2 \oplus \cdots \oplus W_k, \quad (3.2)$$

where all W_i are irreducible representations. Then if W is irreducible of character χ then the number of copies W_i isomorphic to W is equal to $\langle \varphi | \chi \rangle$. In particular two representations with the same character are isomorphic.

We apply this theory on the *regular representation*, that is the representation $\mathbb{C}G$ where G acts on $\mathbb{C}G$ by right-multiplication. We obtain the following results:

Theorem 3.1.4 ([Ser78, Chap. 2, Corr 1 and 2]). *Every irreducible representation W_i is contained in the regular representation with multiplicity equal to its degree. Furthermore if k is the number of irreducible representations of G , and W_1, \dots, W_k a complete set of irreducible non isomorphic representations of G of respective degree n_1, \dots, n_k , then $\sum_{i=1}^k n_i^2 = |G|$.*

3.1.3 Some examples

We will now study different groups and will give all their irreducible representations. We will do so by giving all irreducible characters. A character is completely determined by its value on representatives of all conjugation classes. This is represented in the *character table* of the group. In the top row we give one element by conjugation class and the number of such elements in subscript.

Example 3.1.5. We first give as an example the symmetric group \mathfrak{S}_3 . The number of irreducible representations is equal to the number of conjugation classes, that is the number of partitions of 3: $3 = 2 + 1 = 1 + 1 + 1$. There is always the trivial representation and the signature. Finally the last representation is the group which preserves an equilateral triangle in \mathbb{R}^2 (even if it is not a complex representation with this definition, we can check that it works).

\mathfrak{S}_3	1_1	$(1, 2)_3$	$(1, 2, 3)_2$
Id	1	1	1
ε	1	-1	1
Δ	2	0	-1

Figure 3.1: The character table of \mathfrak{S}_3 .

Example 3.1.6. Now we look at the symmetric group \mathfrak{S}_4 . There are 5 irreducible representations since there are 5 partitions of 4. We again find the trivial and signature. In \mathfrak{S}_4 the subgroup $K := \langle (1, 2)(3, 4), (1, 3), (2, 4) \rangle$ called the *Klein group* is distinguished and $\mathfrak{S}_4/K \cong \mathfrak{S}_3$. We call $p: \mathfrak{S}_4 \rightarrow \mathfrak{S}_4/K$ then $\Delta \circ p$ is an irreducible character of \mathfrak{S}_4 , where Δ was seen in Figure 3.1. To find the last two, we saw in Figure 2.6 that $A_3 = \mathfrak{S}_4$ is the group of isometry of a tetrahedron. Furthermore in Figure 2.7 we saw that $B_3 = \mathfrak{S}_4 \wr \mathbb{Z}/2\mathbb{Z}$ is the group of isometry of a cube acting on the four big diagonals, so that \mathfrak{S}_4 is the group of rotations of the cube. We hence find the character table of Figure 3.2.

3.2 Representation of finite dimensional algebras

In this section we will see how the results of Section 3.1 can be generalized to finite dimensional algebras. We will give here very general background material. However, we will not need the general results in this thesis as we will always be working in the case of \mathcal{J} -trivial monoids, which we will tackle in Section 3.3. We refer to [CR90;



\mathfrak{S}_4	1_1	$(1, 2)_6$	$(1, 2, 3)_8$	$(1, 2, 3, 4)_6$	$(1, 2)(3, 4)_3$
Id	1	1	1	1	1
ε	1	-1	1	-1	1
$\Delta \circ p$	2	0	-1	0	2
	3	-1	0	1	-1
	3	1	0	-1	-1

Figure 3.2: The character table of \mathfrak{S}_4 .

[Lam91; Ben98; ASS06] for more details or proofs of the material presented in this section. This section follows the presentation of [Ste16].

Following what we saw in Section 3.1 the notion of representation is equivalent to that of modules, so we will from now on only speak of modules. The main difference in finite dimensional algebras is that there are two types of “elementary brick” for any module. The simple ones and the indecomposable ones. In this section A will always be a finite dimensional algebra over a field k . In order to simplify, we will always suppose the field k to be algebraically closed.

3.2.1 Simple modules

An A -module S is *simple* if $S \neq 0$ and the only submodules of S are 0 and S . In other words, a non-zero module S is simple if and only if $Av = S$ for all non-zero vectors $v \in S$. Schur’s lemma [CR90, Lemma 27.3] asserts that there are very few homomorphisms between simple modules.

Lemma 3.2.1 (Schur). *If S, S' are two simple A -modules then every nonzero homomorphism $\varphi : S \rightarrow S'$ is an isomorphism. Furthermore $\text{End}_A(S) = k1_S \simeq k$.*

An A -module M is *semisimple* if $A = \bigoplus_{i \in I} S_i$ for some family of simple submodules $\{S_i \mid i \in I\}$.

Proposition 3.2.2 ([CR90, Theorem 15.3]). *Let M be an A -module. Then the following are equivalent:*

- (i) M is semisimple.
- (ii) $M = \sum_{i \in I} S_i$ with $S_i \subseteq M$ simple for all $i \in I$.
- (iii) For each submodule $N \subseteq M$, there is $N' \subseteq M$ such that $M = N \oplus N'$.

The subcategory of semisimple A -modules is closed under taking submodules, quotient modules and direct sums. If V is an A -module we define its *radical* $\text{rad}(V)$ to be the intersection of all maximal submodules of V . Then:

Proposition 3.2.3 ([ASS06, Corollary I.3.8]). *Let V be a finite dimensional A -module.*

- (i) V is semisimple if and only if $\text{rad}(V) = 0$.
- (ii) $V/\text{rad}(V)$ is semisimple.

(iii) If $W \subseteq V$, then V/W is semisimple if and only if $\text{rad}(V) \subseteq W$.

Now, as we did in Section 3.1, we can view A itself as a finite dimensional A -module called the *regular module*. This module will be of great importance. First note that its submodules are just its ideals. In this case $\text{rad} A$ has a lot of interesting properties. See [Ste16, Thm. 2.5] for some of them. For our purposes, we only need the following theorem due to Wedderburn, that we give over \mathbb{C} :

Theorem 3.2.4 (Wedderburn, [Ben98, Theorem 1.3.4]). *The following are equivalent:*

- (i) A is semisimple.
- (ii) Each A -module is semisimple.
- (iii) $\text{rad}(A) = 0$.
- (iv) $A \cong \prod_{i=1}^r M_{n_i}(\mathbb{C})$

Moreover, if A is semisimple, then A has finitely many simple modules S_1, \dots, S_r up to isomorphism and in (iv) after reordering one has $n_i = \dim S_i$. Furthermore, there is an A -module isomorphism

$$A \cong \bigoplus_{i=1}^r n_i S_i. \quad (3.3)$$

As before the quotient of a semisimple finite dimensional algebra is still semisimple. Furthermore if A is any finite dimensional algebra then $A/\text{rad}(A)$ is semisimple. In the case when A is the algebra of a group, the semisimplicity of A is given by Maschke's Theorem, which we have already seen in Theorem 3.1.1 in a less general context:

Theorem 3.2.5 ([CR90, Theorem 15.6]). *For a finite group G and a field k the group algebra kG is semisimple if and only if either the characteristic of k is zero or it does not divide the order of G .*

This theorem is quite logical if we compare it to the results of Section 3.1.

Finally we discuss the Jordan-Hölder theorem for finite dimensional modules which gives combinatorial data associated to a module. If V is a finite dimensional A -module a *composition series* for V is an unrefinable chain of submodules

$$0 = V_0 \subsetneq V_1 \subsetneq \dots \subsetneq V_n = V. \quad (3.4)$$

Then n is the *length* of the composition series and the modules V_i/V_{i-1} are simple and called the *composition factors*. The following theorem shows that this is unambiguous.

Theorem 3.2.6 (Jordan-Hölder, [CR90, Theorem 13.7]). *Let V be a finite dimensional A -module and let*

$$0 = V_0 \subsetneq V_1 \subsetneq \dots \subsetneq V_n = V, \quad (3.5)$$

$$0 = W_0 \subsetneq W_1 \subsetneq \dots \subsetneq W_n = V, \quad (3.6)$$

be two composition series for V . Then $m = n$ and there exists $\sigma \in \mathfrak{S}_n$ such that $V_i/V_{i-1} \cong V_{\sigma_i}/V_{\sigma_i-1}$ for $i \in [n]$.

It follows that we can unambiguously define the length of V to be the length of a composition series and we can define, for a simple A -module S , its multiplicity as a composition factor in V to be the number $[V : S]$ of composition factors in some composition series that are isomorphic to S .

3.2.2 Indecomposable modules

We introduce here the second notion of “elementary brick”: the indecomposable modules. A non-zero A -module M is *indecomposable* if $M = M' \oplus M''$ implies either $M' = 0$ or $M'' = 0$. For instance, every simple module is indecomposable, but the converse only holds when A is semisimple. This is the main difference with the group case presented in Section 3.1. The Krull-Schmidt theorem asserts that each finite dimensional module admits a unique decomposition into a direct sum of indecomposable modules.

Theorem 3.2.7 (Krull-Schmidt, [CR90, Theorem 14.5]). *If V is a finite dimensional A -module, then $V = \bigoplus_{i=1}^r P_i$ with the P_i indecomposable submodules of V . Moreover, if we also have $V = \bigoplus_{i=1}^s N_i$, then $r = s$ and there exists $\sigma \in \mathfrak{S}_r$ such that $P_i \cong N_{\sigma_i}$ for $1 \leq i \leq r$.*

In general it is difficult to classify all indecomposable modules of an algebra. That is why we will only be interested in projective indecomposable modules which can be counted. Recall that a A -module P is called *projective* if there exists another module N such that $P \oplus N \cong A^n$ for $n \geq 0$. Applying Krull-Schmidt’s theorem to the regular module A we have that $A = \bigoplus_{i=1}^r P_i$ where the P_i are indecomposable and projective. They will be our bricks to any projective modules. First we look at the regular module. The following theorem combines aspects of [CR90, Theorem 54.11, Corollary 54.13 and 54.14] and the discussion of [Ben98, page 14].

Theorem 3.2.8 ([CR90, Thm. 54.11, Cor. 54.13, Cor. 54.14]). *Suppose that we have the decomposition of A into indecomposable submodules:*

$$A = \bigoplus_{i=1}^r P_i \tag{3.7}$$

Then:

- (i) *Every projective indecomposable module is isomorphic to P_i for some $1 \leq i \leq r$.*
- (ii) *$P_i/\text{rad}(P_i)$ is simple.*
- (iii) *$P_i \cong P_j$ if and only if $P_i/\text{rad}(P_i) \cong P_j/\text{rad}(P_j)$.*
- (iv) *We have that*

$$A/\text{rad}(A) = \bigoplus_{i=1}^r P_i/\text{rad}(P_i). \tag{3.8}$$

In particular, each simple A -module is isomorphic to one of the form $P/\text{rad}(P)$ for some projective indecomposable P and the multiplicity of $P/\text{rad}(P)$ as a composition factor in $A/\text{rad}(A)$ coincides with the multiplicity of P as a direct summand in A .

Projective indecomposable modules are also called *principal indecomposable modules* in the literature. Therefore we have a bijection between projective indecomposable modules and simple modules. As another consequence, the multiplicity of a projective indecomposable module P_j in a projective module P is $\dim \operatorname{Hom}(P, S_j)$.

A notion linking the notion of simple modules and projective indecomposable modules is the *Cartan matrix*. As in the previous theorem, let S_1, \dots, S_r be a complete set of representatives of the isomorphism classes of simple A -modules and let P_1, \dots, P_r be a complete set of representatives of the isomorphism classes of projective indecomposable A -modules, ordered so that $P_i/\operatorname{rad}(P_i) \cong S_i$. Then the Cartan matrix of A is the matrix $C = (c_{ij})_{1 \leq i, j \leq r}$ with $c_{ij} = [P_j : S_i] = \dim \operatorname{Hom}(P_i, P_j)$ is the multiplicity of S_i in P_j .

3.2.3 Idempotents

We have already seen that idempotents naturally appear in the theory of monoids and semigroups. To every x in a finite semigroup there is an element x^ω which is associated to it. We will now see that idempotents in an algebra A (an element $e \in A$ such that $e^2 = e$) govern the representation theory. We will put these two ingredients together in section 3.3 where we will study the representations of finite \mathcal{J} -trivial monoids.

The idempotents $e_1, e_2 \in E(A)$ are said to be *orthogonal* if $e_1 e_2 = e_2 e_1 = 0$. The idempotent e is called *primitive* if e cannot be written as a sum $e = e_1 + e_2$ where e_1, e_2 are nonzero orthogonal idempotents of A . Every algebra A has two trivial idempotents 0 and 1. If an idempotent e of A is nontrivial, then $1 - e$ is also a nontrivial idempotent. Furthermore, the idempotents e and $1 - e$ are orthogonal, and there is a nontrivial decomposition of A in right A -module: $A = eA \oplus (1 - e)A$. Conversely, if $A = M_1 \oplus M_2$ is a nontrivial decomposition, then $1 = e_1 + e_2$, $e_i \in M_i$, then e_1 and $e_2 = 1 - e_1$ are orthogonal idempotents. Furthermore $M_i = e_i A$, and M_i is indecomposable if and only if e_i is primitive.

Now we look back at the decomposition of A given by Krull-Schmidt's Theorem 3.2.7, $A = \bigoplus_{i=1}^r P_i$ where P_i are indecomposable right ideals of A . Then, in the same way, each $P_i = e_i A$, where e_1, \dots, e_r are primitive pairwise orthogonal idempotents of A such that $1 = e_1 + e_2 + \dots + e_r$. Conversely, every set of idempotents with these properties induces a decomposition $A = P_1 \oplus \dots \oplus P_r$ with indecomposable right ideals $P_1 = e_1 A, \dots, P_r = e_r A$. Such a set $\{e_1, \dots, e_r\}$ is called a *complete set of primitive orthogonal idempotents* of A .

We conclude this study with a link between the idempotents of A and its semisimple quotient $A/\operatorname{rad}(A)$.

Theorem 3.2.9. [CR90] *The following statements holds*

1. *If $\{e_1, \dots, e_r\}$ is a complete set of primitive orthogonal idempotents of A , then so is $\{e_1 + \operatorname{rad} A, \dots, e_r + \operatorname{rad} A\}$ for $A/\operatorname{rad}(A)$.*
2. *Conversely every complete set of primitive orthogonal idempotents of $A/\operatorname{rad}(A)$ is of the form $\{e_1 + \operatorname{rad} A, \dots, e_r + \operatorname{rad} A\}$ with $\{e_1, \dots, e_r\}$ a complete set of primitive orthogonal idempotents of A .*

With the point of view of idempotents, the coefficient c_{ij} of the Cartan matrix is now just $\dim e_j A e_i$ [ASS06, Definition 3.7]. An algebra A is called *connected* if its Cartan matrix is not a block diagonal matrix.

Finally, we now consider a new class of algebras. If A is a k -algebra with a complete set $\{e_1, \dots, e_n\}$ of primitive orthogonal idempotents. The algebra A is called *basic* if $e_i A \not\cong e_j A$, for all $i \neq j$. It is shown in [ASS06, p. I.6.10] that any finite dimensional algebra can be associated to a basic algebra and that they have the same category of modules. Hence, we can always assume, regarding the representation theory of finite dimensional algebras, that we start with a connected basic algebra.

3.2.4 Quiver

In this section, we follow [ASS06, Chap. II]. We will show that to each finite dimensional algebra over \mathbb{C} corresponds a graphical structure, called a *quiver*, and that, conversely, to each quiver corresponds an associative \mathbb{C} -algebra, which may have an identity and be finite dimensional under some assumptions. We will not consider representations of quivers here. We refer to [ASS06, Chap. III] and [Gab72] for more details. In order to introduce the quiver of an algebra we will first give general definitions on quivers, eventhough we will not use them much in this thesis.

Definition 3.2.10. A *quiver* $Q = (Q_0, Q_1, s, t)$ is the quadruple consisting of two sets: Q_0 (whose elements are called *vertices*) and Q_1 (whose elements are called *arrows*), and of two maps: $s, t : Q_1 \rightarrow Q_0$ which associate to each arrow $\alpha \in Q_1$ its *source* $s(\alpha) \in Q_0$ and its *target* $t(\alpha) \in Q_0$, respectively.

Thus, a quiver is nothing more than an oriented graph which can have multiple arrows between two vertices, as well as loops and cycles. The quiver Q is said to be *connected* if Q is a connected graph. Then if $Q = (Q_0, Q_1, s, t)$ is a quiver and $a, b \in Q_0$, a *path* of length $\ell \geq 1$ with source a and target b is a sequence

$$(a \mid \alpha_1, \dots, \alpha_\ell \mid b), \quad (3.9)$$

where $\alpha_k \in Q_1$ for all $1 \leq k \leq \ell$, and so that $s(\alpha_1) = a$, $t(\alpha_k) = s(\alpha_{k+1})$ for each $1 \leq k \leq \ell$, and $t(\alpha_\ell) = b$. Such a path may be seen as:

$$a = a_0 \xrightarrow{\alpha_1} a_1 \xrightarrow{\alpha_2} a_2 \longrightarrow \dots \xrightarrow{\alpha_\ell} a_\ell = b. \quad (3.10)$$

The set of all paths in Q of length ℓ is denoted by Q_ℓ . Furthermore, to every vertex $a \in Q_0$ we associate a path of length 0, called the *stationary path* at a , and denoted by $\varepsilon_a = (a \mid \mid a)$. Finally a path of length $\ell \geq 1$ is called a *cycle* when its source and target coincide, and a *loop* when $\ell = 1$. The quiver is called *acyclic* if it contains no cycle. We now have all the elements needed to define the *path algebra* of Q :

Definition 3.2.11. Let Q be a quiver. The *path algebra* $\mathbb{C}Q$ of Q is the \mathbb{C} -algebra whose underlying \mathbb{C} -vector space has as basis the set of all paths $(a \mid \alpha_1, \dots, \alpha_\ell \mid b)$ of length $\ell \geq 0$ in Q and such that the product of two basis vectors is:

$$(a \mid \alpha_1 \dots \alpha_\ell \mid b)(c \mid \beta_1, \dots, \beta_k \mid d) = \delta_{bc}(a \mid \alpha_1, \dots, \alpha_\ell, \beta_1, \dots, \beta_k \mid d), \quad (3.11)$$

where δ_{bc} denotes the Kronecker delta which is 1 if $b = c$ and 0 otherwise.

For each length $\ell \geq 0$ we define $\mathbb{C}Q_\ell$ to be the subspace of $\mathbb{C}Q$ generated by Q_ℓ . We thus get a direct sum decomposition:

$$\mathbb{C}Q = \mathbb{C}Q_0 \oplus \mathbb{C}Q_1 \oplus \mathbb{C}Q_2 \oplus \cdots \oplus \mathbb{C}Q_\ell \oplus \dots \quad (3.12)$$

It is easy to see that $(\mathbb{C}Q_n) \cdot (\mathbb{C}Q_m) = \mathbb{C}Q_{n+m}$ for all $n, m \geq 0$, because the product in $\mathbb{C}Q$ of a path of length n by a path of length m is either zero or a path of length $n + m$. Then the decomposition 3.12 defines a *grading* on $\mathbb{C}Q$. The *arrow radical* R_Q of Q is the two-sided ideal of $\mathbb{C}Q$ generated by all arrows of Q . Note that $R_Q = \bigoplus_{\ell \geq 1} \mathbb{C}Q_\ell$ and more generally $R_Q^m = \bigoplus_{\ell \geq m} \mathbb{C}Q_\ell$. See [ASS06, Chap. II, ex. 1.3] for more details. The path algebra $\mathbb{C}Q$ has the following properties.

Proposition 3.2.12 ([ASS06, Chap. II, Lemma 1.4, 1.5 and 1.7]). *Let Q be a quiver and $\mathbb{C}Q$ be its path algebra. Then*

- (i) $\mathbb{C}Q$ has an identity element if and only if Q_0 is finite
- (ii) $\mathbb{C}Q$ is finite dimensional if and only if Q is finite and acyclic.
- (iii) $\mathbb{C}Q$ is connected if and only if Q is a connected quiver.

Furthermore if Q is finite, then the element $1 = \sum_{\alpha \in Q_0} \varepsilon_\alpha$ is the identity of $\mathbb{C}Q$ and the set $\{\varepsilon_\alpha \mid \alpha \in Q_0\}$ is a complete set of primitive orthogonal idempotents for $\mathbb{C}Q$.

We have defined how to go from a quiver to a path algebra, but the latter is not necessarily finite dimensional. We now explain how to get some finite dimensional algebra from a path algebra. This is the role of a certain ideal. Thus, let Q be a finite quiver and R_Q be the arrow ideal of the path algebra $\mathbb{C}Q$. A two-sided ideal \mathcal{I} of $\mathbb{C}Q$ is said to be *admissible* if there exists $m \geq 2$ such that $R_Q^m \subseteq \mathcal{I} \subseteq R_Q^2$. See Figure 3.3 for an example.

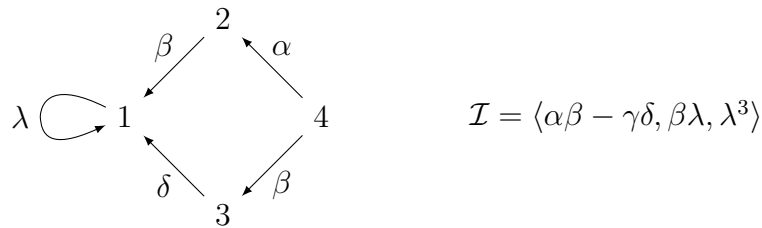

Figure 3.3: A quiver with the ideal \mathcal{I} which is admissible. See [ASS06, Chap. II, ex. 2.2] for more details.

We show that this notion of admissible ideal help us get some finite dimensional algebra:

Proposition 3.2.13 ([ASS06, Chap. II, Lemma 2.4, 2.5, Prop. 2.6]). *Let Q be a finite quiver and \mathcal{I} be an admissible ideal of $\mathbb{C}Q$. Then the algebra $\mathbb{C}Q/\mathcal{I}$ is finite dimensional. Furthermore the set $\{e_a = \varepsilon_a + \mathcal{I} \mid a \in Q_0\}$ is a complete set of primitive orthogonal idempotents of $\mathbb{C}Q/\mathcal{I}$.*

Conversely, let A be a finite dimensional algebra over \mathbb{C} . We want to associate a quiver to it. We have seen that we can assume that A is connected and basic.

We now show that, under these hypotheses, A is isomorphic to an algebra $\mathbb{C}Q/\mathcal{I}$, where Q is a finite connected quiver and \mathcal{I} an admissible ideal of $\mathbb{C}Q$. We begin by associating a finite quiver to each basic and connected finite dimensional algebra A .

Definition 3.2.14. *Let A be a basic and connected finite dimensional k -algebra, and $\{e_1, \dots, e_r\}$ be a complete set of primitive orthogonal idempotents of A . The **Ext-quiver** of A (also called the **ordinary quiver**, or simply **quiver**), denoted by Q_A , is defined by:*

- *The vertices of Q_A are the numbers 1 to r , which are in bijective correspondence with the idempotents e_1, e_2, \dots, e_r .*
- *Given two vertices $a, b \in (Q_A)_0$, the arrows $\alpha : a \rightarrow b$ are in bijective correspondence with the vectors in a basis of the k -vector space $e_a \text{rad}(A) / \text{rad}^2(A) e_b$.*

This Ext-quiver has a lot of properties:

Theorem 3.2.15 ([ASS06, Chap. II, Lemma 3.2, 3.4, 3.6 and Thm. 3.7]). *Let A be a basic and connected finite dimensional \mathbb{C} -algebra, and Q_1 its quiver. The following properties hold:*

- (i) *Q_A does not depend on the choice of a complete set of primitive orthogonal idempotents in A .*
 - (ii) *Q_A is connected.*
 - (iii) *There exists an admissible ideal \mathcal{I} of $\mathbb{C}Q_A$ such that $A \cong \mathbb{C}Q_A/\mathcal{I}$.*
- Furthermore, if Q is another finite connected quiver, \mathcal{I} an admissible ideal of $\mathbb{C}Q$, and $A' := \mathbb{C}Q/\mathcal{I}$ then $Q_{A'} = Q$.*

3.3 Representations of \mathcal{J} -trivial monoids

We have now given a lot of general definitions of objects of interest in doing representation theory. However in this thesis, we will only be interested in \mathcal{J} -trivial monoids. Their representation theory has been well studied by Denton, Hivert, Schilling and Thiéry [Den+10]. It turns out that it is combinatorial: more precisely, one can compute the simple, projective modules, the Cartan matrix and even the quiver by computations only in the monoid, without requiring linear combinations. For example, we saw that the representation theory of any algebra A is largely governed by its idempotents. However, when dealing with a finite \mathcal{J} -trivial monoid M , it is sufficient to look for idempotents in the monoid M itself rather than in its monoid algebra $\mathbb{C}[M]$ (or only $\mathbb{C}M$). Before dealing only with \mathcal{J} -trivial monoids, we make explicit in Section 3.3.1 why \mathcal{J} -classes are always interesting in the representation theory of monoids.

3.3.1 \mathcal{J} -classes and representations

Let S be a semigroup. We recall that a \mathcal{J} -class is called *regular* if it contains an idempotent. If e is an idempotent of S , we call G_e the maximal subgroup of S with e as the identity. It is also $eSe \cap \mathcal{J}(e)$ where $\mathcal{J}(e)$ is the \mathcal{J} -class of e . The regular \mathcal{J} -classes are associated with the simple modules by the following result, which we provide for reference.

Theorem 3.3.1 (Clifford, Munn, Ponizovskii, [Ste16, Theorem 6.2]). *Let S be a semigroup, $E = \{e_J\}$ an idempotent transversal over the regular \mathcal{J} -classes J of S . Let $G_J := G_{e_J}$. Then there is a bijection between simple S -modules and simple G_J -modules for all J .*

The aperiodic monoids turn out to be the monoids for which all G_J are trivial. In particular if S is \mathcal{J} -trivial then Theorem 3.3.1 says that all simple S -modules can be induced from the trivial representation of the G_J .

3.3.2 Simple modules

We now consider only \mathcal{J} -trivial monoids. As seen in Theorem 2.4.5 the Hecke monoids $H_n^0(T)$ are \mathcal{J} -trivial for all Weyl types, so that we will always give examples with these monoids. Let M be a finite \mathcal{J} -trivial monoid, we denote by $E(M)$ the set of idempotents of M . They parameterize the simple M modules:

Theorem 3.3.2 ([Den+10, Proposition 3.1 and 3.3]). *There are as many (isomorphism classes of) simple modules S_e as idempotents $e \in E(M)$, all of dimension 1. Their structure is as follows: S_e is spanned by some vector ϵ_e with the action of any $m \in M$ given by*

$$m \cdot \epsilon_e = \begin{cases} \epsilon_e & \text{if } me = e \\ 0 & \text{otherwise.} \end{cases} \quad (3.13)$$

Note that this result can also be obtained only for \mathcal{R} -trivial monoid.

One tool to obtain this result is the precise structure of the radical. As seen in Section 1.3 to each element $x \in M$ we can associate an idempotent $x^\omega = x^n$ for any large enough n .

Proposition 3.3.3 ([Den+10, Proposition 3.3 and Corollary 3.8]). *The set*

$$\{x - x^\omega \mid x \in M \setminus E(M)\} \quad (3.14)$$

is a basis for $\text{rad } \mathbb{C}M$. It can also be generated by the commutators $gh - hg$ for $g, h \in M$.

Theorem 3.3.4 ([Den+10, Theorem 3.4 and 3.7]). *Define a product \star on $E(M)$ by $x \star y := (xy)^\omega$. Then the restriction of $\leq_{\mathcal{J}}$ to $E(M)$ is a lower semi-lattice such that $x \wedge_{\mathcal{J}} y = x \star y$ where $x \wedge_{\mathcal{J}} y$ is the meet of x and y . In particular, $(E(M), \star)$ is a commutative monoid.*

Moreover $(\mathbb{C}[E(M)], \star)$ is isomorphic to $\mathbb{C}[M]/\text{rad}(\mathbb{C}[M])$ and the mapping $\phi : x \mapsto x^\omega$ is the canonical algebra morphism associated to this quotient.

Example 3.3.5 ([Den+10, Example 3.9]). Let $H_n^0(W)$ be the Hecke monoid of the Weyl group W , with index of simple roots $I = \{1, 2, \dots, n\}$. For any $J \subseteq I$, the submonoid parabolic $H_n^0(W_J)$ contains a unique longest element π_J . Consequently $E(H_n^0(W)) = \{\pi_J \mid J \subseteq I\}$ and the simple representations are indexed by subsets of I or, equivalently, (as seen in Section 1.1.5) compositions of $|I|$.

3.3.3 Projective indecomposable modules

We now want to describe the projective indecomposable modules of \mathcal{J} -trivial monoids. As seen in Section 3.2.3, we could try to find a decomposition of the identity into primitive orthogonal idempotents. We refer to [Den+10, Section 3.2 and 3.3] for such an explicit decomposition.

In order to define the projective indecomposable modules we define

$$\text{rAut}(x) := \{u \in M \mid xu = x\} \quad \text{and} \quad \text{lAut}(x) := \{u \in M \mid ux = x\}. \quad (3.15)$$

By [Den+10, Proposition 3.16] their \mathcal{J} -smallest elements are such that:

$$\text{rAut}(x) := \{u \in M \mid \text{rfix}(x) \leq_{\mathcal{J}} u\} \quad (3.16)$$

$$\text{and} \quad \text{lAut}(x) := \{u \in M \mid \text{lfix}(x) \leq_{\mathcal{J}} u\}. \quad (3.17)$$

These are called the *right* and *left symbol* of x . By Lemma 1.3.8 we deduce:

$$\text{rfix}(x) := \min\{e \in E(M) \mid xe = x\} \quad (3.18)$$

$$\text{and} \quad \text{lfix}(x) := \min\{e \in E(M) \mid ex = x\} \quad (3.19)$$

the min being taken over the \mathcal{J} -order.

Theorem 3.3.6 ([Den+10, Theorem 3.23]). *For $e \in E(M)$, denote $L(e) := Me$, and set*

$$L_=(e) := \{x \in Me \mid \text{rfix}(x) = e\} \quad (3.20)$$

$$\text{and} \quad L_<(e) := \{x \in Me \mid \text{rfix}(x) <_{\mathcal{L}} e\}. \quad (3.21)$$

Then the projective module P_e associated to S_e is isomorphic to $\mathbb{C}L(e)/\mathbb{C}L_<(e)$. In particular, taking as basis the image of $L_=(e)$ in the quotient, the action of $m \in M$ on $x \in L_=(e)$ is given by: $m \cdot x = mx$ if $\text{rfix}(mx) = e$ and 0 otherwise.

Of course the corresponding statement holds on the right. With this combinatorial description of projective indecomposable modules we also get a way to compute the Cartan matrix. Let $E(M) := \{e_1, \dots, e_n\}$ then:

Theorem 3.3.7 ([Den+10, Theorem 3.20]). *The Cartan matrix of $\mathbb{C}M$ defined by $c_{i,j} := \dim(e_i \mathbb{C}M e_j)$ is given by*

$$c_{i,j} = |\{x \in M \mid i = \text{lfix}(x) \text{ and } j = \text{rfix}(x)\}|. \quad (3.22)$$

Example 3.3.8 ([Den+10, Example 3.21]). Let $H_n^0(W)$ be the Hecke monoid of the Weyl group W indexed by simple roots $I = \{1, 2, \dots, n\}$. We recall from Definition 1.1.8 and Proposition 1.1.10 the definition of *left and right descent sets*, and define the *content* of $w \in W$ to be:

$$\begin{aligned} D_L(w) &= \{i \in I \mid \ell(s_i w) < \ell(w)\} = \{i \in I \mid \pi_i \pi_w = \pi_w\}, \\ D_R(w) &= \{i \in I \mid \ell(ws_i) < \ell(w)\} = \{i \in I \mid \pi_w \pi_i = \pi_w\}, \\ \text{cont}(w) &= \{i \in I \mid s_i \text{ appears in some reduced word for } w\}, \end{aligned}$$

where for cont “some” may be replaced by “any”. Write C_L, C_R and cont for the associated compositions of $n+1$. One has $\text{cont}(\pi_J) = D_L(\omega_J)$ or $\text{cont}(\pi_J) = D_R(\omega_J)$ equivalently. Then, for any $\sigma \in \mathfrak{S}_n$, we have $\pi_\sigma^\omega = \pi_{\text{cont}(\sigma)}$, $\text{lfix}(\pi_\sigma) = \pi_{C_L(\sigma)}$ and $\text{rfix}(\pi_\sigma) = \pi_{C_R(\sigma)}$.

The left projective module P_J corresponding to the idempotent π_J has its basis b_w indexed by the elements of w having J as right descent composition. The action of π_i coincides with the usual left action, except that $\pi_i \cdot b_w = 0$ if $\pi \cdot w$ has a different right descent composition than w . As noted in Section 1.1.5, all these descent classes are intervals (see Figure 3.4).

If J, K are two compositions of n then the entry $c_{J,K}$ of the Cartan matrix is given by the number of elements $w \in W$ having those left and right descent sets. In Part III we will be interested in finding all these elements for some special descent sets, and will introduce a tool, the grid representation, to find them.

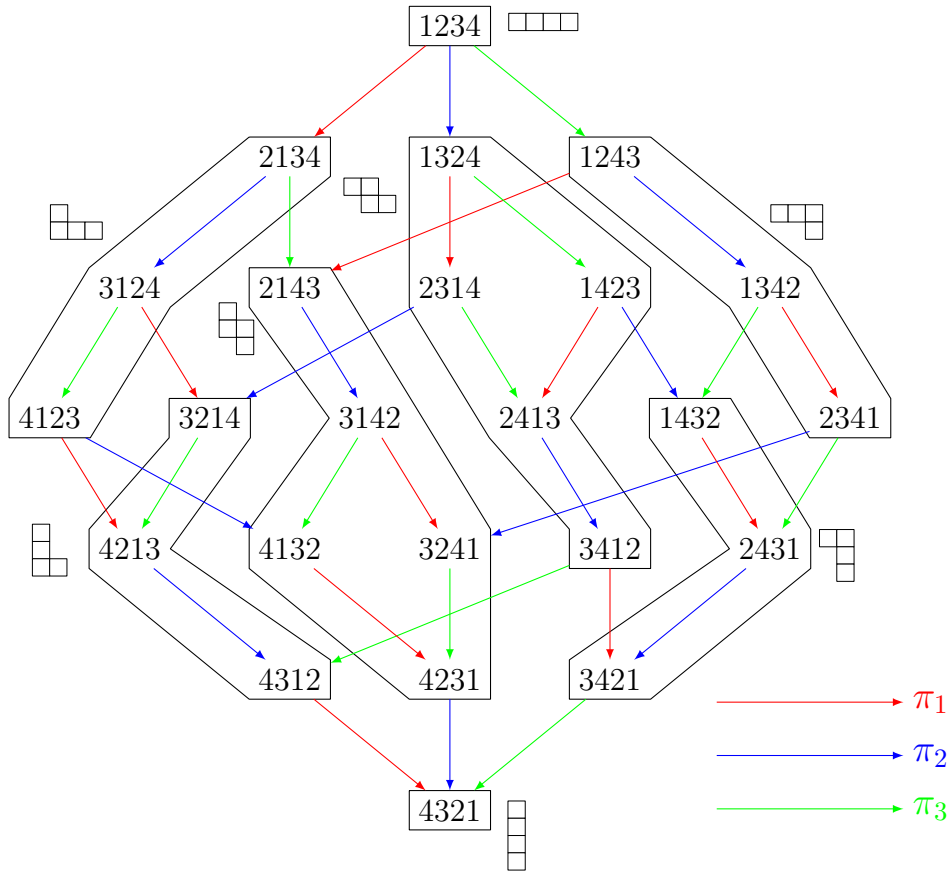

Figure 3.4: The decomposition of $H_4^0 = H^0(\mathfrak{S}_4)$ into projective indecomposables modules. We have not represented the loop of the generators for readability. Note that we are representing the right descents in ribbon and, consequently, are looking at the left action of H_4^0 . In each projective module the top element is the idempotent. The lattice quotient by these projective module is hence the boolean lattice.

3.3.4 Ext-quiver

We end by the Ext-quiver of \mathcal{J} -trivial monoids. Although we will not need this theory in Part II and III since we will prove everything from scratch, we will present it briefly to show the reader that it is again very combinatorial.

Definition 3.3.9 ([Den+10, Definition 3.25]). *Let $x \in M$ and let $e := \text{lfix}(x)$ and $f := \text{rfix}(x)$. A factorization $x = uv$ is:*

- **non-trivial** if $eu \neq e$ and $vf \neq f$
- **compatible** if u and v are non-idempotent and

$$\text{lfix}(u) = e, \quad \text{rfix}(v) = f, \quad \text{and} \quad \text{rfix}(u) = \text{lfix}(v). \quad (3.23)$$

It can be proven [Den+10, Proposition 3.31] that an element has a non-trivial factorization if and only if it has a compatible factorization. We call *c-irreducible* an element which admits no non-trivial factorization and denote by $Q(M)$ the set of c-irreducible non idempotent elements. Then [Den+10, Corollary 3.40] the family $(x - x^\omega)_{x \in Q(M)}$ is a basis of $\text{rad } \mathbb{C}M / \text{rad}^2 \mathbb{C}M$ so that we have the following theorem:

Theorem 3.3.10 ([Den+10, Theorem 3.35]). *The Ext-quiver of M is the following:*

- *There is one vertex v_e for each idempotent $e \in E(M)$.*
- *For every $x \in Q(M)$ there is an arrow from $v_{\text{lfix}(x)}$ to $v_{\text{rfix}(x)}$.*

Note that these results are algorithmic, and that they were implemented by Hivert, Saliola and Thiéry in `sage-semigroups` [HST12].

In the case of the Hecke monoid, the Ext-quiver was first described in [DHT02] in type A , then in [Fay05] for arbitrary type. Assume W is a Weyl group with n simple roots. The result is the following:

Theorem 3.3.11 ([Fay05, Theorem 5.1]). *The Ext-quiver of $H_n^0(W)$ has vertices indexed by $J \subseteq [n]$. Furthermore if $J, K \subseteq [n]$, there associated vertices are linked by an edge from K to J and from J to K if and only if:*

- *neither of J and K is contained in the other, and*
- *for any $j \in J \setminus K$ and $k \in K \setminus J$, we have $m_{jk} \geq 3$.*

See Figure 3.5 for an example.

3.4 Induction and restriction

3.4.1 Definitions

We first give definitions related to finite groups as this is easier, see [Ser78]. Let H be a subgroup of a finite group G . If (ρ, V) is a $\mathbb{C}G$ -module then $(\rho|_H, V)$ is a $\mathbb{C}H$ -module called the *restricted representation* of (ρ, V) to H and denoted by $\text{Res}_H^G V$. We call this operation the *restriction*.

It is also quite natural, though less easy, to ask how to turn any $\mathbb{C}H$ -module into a $\mathbb{C}G$ one. For this purpose let G/H be the set of left cosets $\{g_i H\}$ of H in G so

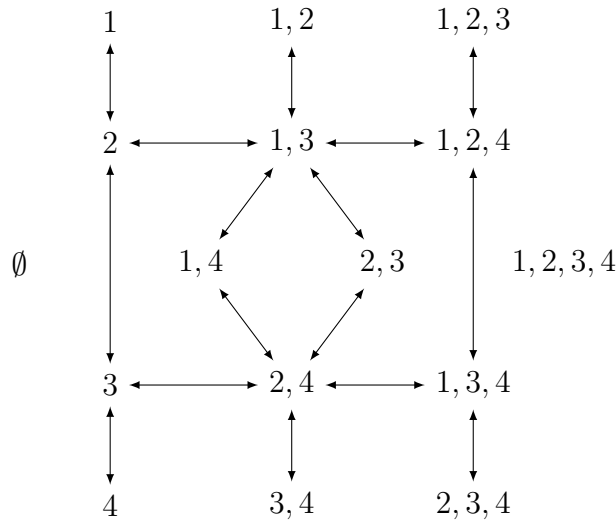

Figure 3.5: The quiver of $H^0(A_4) = H_5^0$.

that the elements $\{g_i\}$ are a set of coset representatives. If V is a $\mathbb{C}H$ -module, then the *induced representation* is defined as the following $\mathbb{C}G$ -module:

$$\text{Ind}_H^G(V) := \bigoplus_{g \in G/H} gV = \mathbb{C}G \otimes_{\mathbb{C}H} V, \quad (3.24)$$

where $\mathbb{C}G \otimes_{\mathbb{C}H} \cdot$ is the scalar extension. See [Ser78] or [CR90] for more details. This operation is called the *induction*. The induction and the restriction are linked by the *Frobenius reciprocity*:

Theorem 3.4.1 ([Ser78, Theorem 13]). *If ψ is a central function on H and φ on G then:*

$$\langle \psi \mid \text{Res } \varphi \rangle_H = \langle \text{Ind } \psi \mid \varphi \rangle_G. \quad (3.25)$$

More generally, let $\varphi : B \rightarrow A$ be a morphism from a ring B to a ring A such that $\varphi(1) = 1$. Then if M is an A -module we easily obtain the *restricted* B -module $\text{Res}_B^A M$ by:

$$b \cdot m := \varphi(b) \cdot m, \quad m \in M, b \in B. \quad (3.26)$$

For the reverse construction, note that A is an (A, B) -bimodule so that we can obtain from a B -module V the *induced* A -module $\text{Ind}_B^A V := A \otimes_B V$. See [CR90, Section 10] for more details. In this general context of rings we still have a Frobenius reciprocity:

Theorem 3.4.2 ([ML98]). *If V is an A -module and W a B -module then:*

$$\dim \text{Hom}(\text{Ind}_B^A W, V) = \dim \text{Hom}(W, \text{Res}_B^A V). \quad (3.27)$$

3.4.2 Hopf algebra

In Section 1.7 we saw that combinatorial classes are often seen in a graded algebra whose vector space admits as a basis the combinatorial class. We define here other

algebraic structures that can be put on combinatorial classes. We give all definitions over the field \mathbb{C} which is, of course, not necessary. The reader could refer to [BLL12; GR14] for more details on these constructions.

We begin by giving a formal definition of algebra so that the next definitions will be more natural to introduce.

Definition 3.4.3. An **algebra** A is a \mathbb{C} -vector space with a **multiplication** $\times : A \otimes A \rightarrow A$ and a **unit** $\iota : \mathbb{C} \rightarrow A$ so that the following diagrams commute:

$$\begin{array}{ccc}
 A \otimes A & \xrightarrow{\times} & A & \xleftarrow{\times} & A \otimes A & & A \otimes A \otimes A & \xrightarrow{\times \otimes id} & A \otimes A \\
 id \otimes \iota \uparrow & & id \uparrow & & \iota \otimes id \uparrow & & id \otimes \times \downarrow & & \times \downarrow \\
 A \otimes \mathbb{C} & \longleftarrow & A & \longrightarrow & A \otimes \mathbb{C} & & A \otimes A & \xrightarrow{\times} & A
 \end{array}$$

Let $\sigma : V \otimes W \rightarrow W \otimes V$ be the transposition function $\sigma(v \otimes w) = w \otimes v$. Then if A_1, A_2 are two algebras then $A_1 \otimes A_2$ is an algebra as well with product $\times_{A_1 \otimes A_2} := (\times_{A_1} \otimes \times_{A_2}) \circ (\text{id} \circ \sigma \circ \text{id})$ such that $\times_{A_1 \otimes A_2} : (a_1 \otimes b_1, a_2 \otimes b_2) \mapsto a_1 a_2 \otimes b_1 b_2$, and unit $\iota_{A_1 \otimes A_2} = \iota_{A_1} \otimes \iota_{A_2}$.

We can now easily introduce the dual notion:

Definition 3.4.4. A **coalgebra** C is a \mathbb{C} -vector space with a **comultiplication** $\Delta : C \rightarrow C \otimes C$ and a **counit** $\varepsilon : C \rightarrow \mathbb{C}$ so that the following diagrams commute:

$$\begin{array}{ccc}
 C \otimes C & \xleftarrow{\Delta} & C & \xrightarrow{\Delta} & C \otimes C & & C \otimes C \otimes C & \xleftarrow{\Delta \otimes id} & C \otimes C \\
 id \otimes \varepsilon \downarrow & & id \downarrow & & \varepsilon \otimes id \downarrow & & id \otimes \Delta \uparrow & & \Delta \uparrow \\
 C \otimes \mathbb{C} & \longrightarrow & C & \longleftarrow & C \otimes \mathbb{C} & & C \otimes C & \xleftarrow{\Delta} & C
 \end{array}$$

Similarly if C_1 and C_2 are two coalgebras then $C_1 \otimes C_2$ is a coalgebra as well with coproduct $\Delta_{A_1 \otimes A_2} := (\Delta_{A_1} \otimes \Delta_{A_2}) \circ (\text{id} \circ \sigma \circ \text{id})$ and counit $\varepsilon_{A_1 \otimes A_2} : c_1 \otimes c_2 \mapsto \varepsilon_{A_1}(c_1) \cdot \varepsilon_{A_2}(c_2)$.

These two definitions can be put together to form a new object:

Definition 3.4.5. A **bialgebra** B is a tuple $(B, \times, \Delta, \iota, \varepsilon)$ so that (B, \times, ι) is an algebra, (B, Δ, ε) is a coalgebra and so that the **compatibility relations** are verified:

- (i) Δ and ε are coalgebra morphisms.
- (ii) \times and ι are algebra morphisms.

Now a **Hopf algebra** is a bialgebra with some special antiautomorphism called the **antipode**. However, we are only dealing with graded bialgebras so that the antipode is automatically given. Hence we will not give a formal definition and will talk instead of Hopf algebras when dealing with bialgebras.

Finally, when we have an algebra (resp. a coalgebra) and a basis $(b_i)_i$, we look at the coefficients appearing in the product (resp. coproduct) of elements of the basis:

$$b_i b_j = \sum_k p_{i,j}^k b_k \quad \left(\text{resp. } \Delta(b_k) = \sum_{i,j} c_{i,j}^k b_i \otimes b_j \right). \quad (3.28)$$

The coefficients $(p_{i,j}^k)$ (resp. $c_{i,j}^k$) are called the *structure coefficients* of the product (resp. coproduct) in the basis $(b_i)_i$.

We now give some examples of Hopf algebras which are linked to the combinatorial objects we have presented thus far. On all these topics about combinatorial Hopf algebra, we refer the reader to [GR14] for more details.

Example 3.4.6. Let G be a group then $H := \mathbb{C}G$, the group algebra of G , is a Hopf algebra with coproduct $\Delta : g \mapsto g \otimes g$ and counit $\varepsilon : g \mapsto 1$.

Example 3.4.7. The Hopf algebra **Sym** of *symmetric functions* is a seminal example of Hopf algebra and categorification, see Section 3.5.3. The symmetric functions are formal series in an infinity of variables. For a formal definition and more details on symmetric functions the reader is referred to [Mac95].

We recall that a *partition* of n is a decreasing sequence of integers $\lambda = (\lambda_1, \dots, \lambda_m)$ so that $\lambda_1 \geq \lambda_2 \geq \dots \geq \lambda_m$ and $\lambda_1 + \lambda_2 + \dots + \lambda_m = n$, and we denoted it $\lambda \vdash n$. Let (x_1, x_2, \dots) be an infinite set of variables and $(\alpha_1, \dots, \alpha_n) \in \mathbb{N}^n$. We define $x^\alpha := x_1^{\alpha_1} x_2^{\alpha_2} \dots x_n^{\alpha_n}$ and the *monomial function* $m_\lambda := \sum x^\lambda$ where the sum is over all distinct permutations of the monomial x^λ , in other words the sum of all monomials whose permutation obtained by ordering the exponents is λ . For instance:

$$m_{(21)} = x_1^2 x_2 + x_2^2 x_1 + x_1^2 x_3 + x_3^2 x_1 + x_2^2 x_3 + \dots \quad (3.29)$$

We define the *elementary functions* e_n , *power functions* p_n and *homogeneous functions* h_n by:

$$e_n := m_{(1)^n} = \sum_{i_1 < \dots < i_n} x_{i_1} \dots x_{i_n}, \quad p_n := m_{(n)} = \sum_{i \geq 1} x_i^n, \quad h_n := \sum_{\lambda \vdash n} m_\lambda. \quad (3.30)$$

By convention $e_0 = h_0 = p_0 = 1$ and we define for $\lambda = (\lambda_1, \dots, \lambda_m)$ the functions $e_\lambda := \prod_{i=1}^m e_{\lambda_i}$, $p_\lambda := \prod_{i=1}^m p_{\lambda_i}$ and $h_\lambda := \prod_{i=1}^m h_{\lambda_i}$. The comultiplication on these basis is given by:

$$\Delta(p_n) = 1 \otimes p_n + p_n \otimes 1, \quad \Delta(e_n) = \sum_{i+j=n} e_i \otimes e_j, \quad \Delta(h_n) = \sum_{i+j=n} h_i \otimes h_j. \quad (3.31)$$

Example 3.4.8. The *free quasi symmetric functions* Hopf algebra **FQSym** is defined on permutations. If w is a word over \mathbb{Z} the *standardization* of w , denoted by $\text{Std}(w)$, is the unique permutation with the same inversions as w . For instance $\text{Std}(397381182) = 496571283$. Now if \mathcal{A} is a noncommutative alphabet we define the *quasi-ribbon*:

$$\mathbf{F}_\sigma := \sum_{\text{Std}(w)=\sigma^{-1}} w \quad \in \mathbb{Z}\langle \mathcal{A} \rangle. \quad (3.32)$$

For instance if $\mathcal{A} = \{a, b, c, \dots\}$ then $\mathbf{F}_{312} = bba + bca + cca + ccb + cda + cdb + \dots$. According to Malvenuto and Reutenauer [MR95a] (see also [DHT02, Proposition 3.2]), if $\alpha \in \mathfrak{S}_n$ and $\beta \in \mathfrak{S}_m$, the product is given by:

$$\mathbf{F}_\alpha \cdot \mathbf{F}_\beta = \sum_{\sigma \in \alpha \sqcup \beta} \mathbf{F}_\sigma, \quad (3.33)$$

where \sqcup has been defined in Equation 1.41. For instance $\mathbf{F}_{12}\mathbf{F}_1 = \mathbf{F}_{123} + \mathbf{F}_{132} + \mathbf{F}_{312}$. We thus define:

$$\text{FQSym} := \bigoplus_{n \geq 0} \bigoplus_{\sigma \in \mathfrak{S}_n} \mathbb{C}\mathbf{F}_\sigma. \quad (3.34)$$

It is a self-dual bialgebra with coproduct given by:

$$\Delta \mathbf{F}_\sigma = \sum_{u \cdot v} \mathbf{F}_{\text{Std}(u)} \otimes \mathbf{F}_{\text{Std}(v)}, \quad (3.35)$$

where $u \cdot v$ denotes the concatenation of u and v , see [DHT02, Proposition 3.4, Corollary 3.5].

The next two examples will have a major role in the theory of representations of the tower of monoids $(H_n^0)_{n \in \mathbb{N}}$, see Section 3.6.

Example 3.4.9. The application of FQSym sending each noncommutative variable a_i to a commutative one x_i sends FQSym to the *algebra of quasi-symmetric functions* denoted by QSym and introduced by Gessel in [Ges84].

If $X = x_1, x_2, \dots$ is a family of commutative variables then QSym is the space of formal series on X so that the coefficient of $[x_{i_1}^{\alpha_1} \dots x_{i_k}^{\alpha_k}]$ is equal to the coefficient of $[x_{j_1}^{\alpha_1} \dots x_{j_k}^{\alpha_k}]$ for all increasing sequence $j_1 < \dots < j_k$. It is not obvious that it is an algebra and we refer to [Gel+95] for more details. To every composition $I = (i_1, \dots, i_k) \models n$ we associate the *monomial quasi-symmetric functions* M_I as:

$$\mathbf{M}_I := \sum_{j_1 < \dots < j_k} x_{j_1}^{i_1} \dots x_{j_k}^{i_k}. \quad (3.36)$$

The family $(\mathbf{M}_I)_{I \models n}$ is a basis of QSym_n . We define the order \leq on compositions by $I \leq J \Leftrightarrow \text{Des}(I) \subseteq \text{Des}(J)$. Then the elements of the *basis of quasi-ribbons* are defined as $\mathbf{F}_I := \sum_{J \geq I} \mathbf{M}_J$. For instance $\mathbf{F}_{122} = \mathbf{M}_{122} + \mathbf{M}_{1112} + \mathbf{M}_{1211} + \mathbf{M}_{11111}$. This basis can also be obtained by the morphism $\text{commut} : \text{FQSym} \rightarrow \text{QSym}$ with $\text{commut}(\mathbf{F}_\sigma) =: \mathbf{F}_{\text{Des}(\sigma)}$. The coproduct is then defined as cutting the composition in two parts anywhere, as shown in the following example:

$$\Delta \mathbf{F}_{312} = \mathbf{F}_\emptyset \otimes \mathbf{F}_{312} + \mathbf{F}_1 \otimes \mathbf{F}_{212} + \mathbf{F}_2 \otimes \mathbf{F}_{112} + \mathbf{F}_3 \otimes \mathbf{F}_{12} + \mathbf{F}_{31} \otimes \mathbf{F}_2 + \mathbf{F}_{311} \otimes \mathbf{F}_1 + \mathbf{F}_{312} \otimes \mathbf{F}_\emptyset.$$

Hence, the rule of product can be computed as follows [Ges84; DHT02]. Let I and J be two compositions. Choose any permutation $\sigma \in \mathfrak{S}_n$ whose descent composition is $C(\sigma) = I$, for example $w_{0,I}$ the maximal element of the parabolic subgroup I , and μ such that $C(\mu) = J$. Then

$$F_I F_J = \sum_{\nu \in \sigma \sqcup \bar{\mu}^1} F_{C(\nu)}. \quad (3.37)$$

Example 3.4.10. The algebra of *non-commutative symmetric functions* introduced in [Gel+95] and denoted by **NCSF** is the subalgebra of **FQSym** generated as an algebra, for $k \in \mathbb{N}$, by the functions $S_k := \mathbf{F}_{12\dots k} = \sum_{i_1 \leq \dots \leq i_k} a_{i_1} \dots a_{i_k}$. If $I = (i_1, \dots, i_m) \vDash n$ we define $S_I := S_{i_1} \dots S_{i_m}$. We also defined the *Schur-ribbons functions* R_I for $I \vDash n$ by $R_I := \sum_{\text{Des}(\sigma) = \text{Des}(I)} \mathbf{F}_{\sigma^{-1}}$, or can be deduced by inclusion-exclusion from the relation $S_I = \sum_{I \geq J} R_J$. The name comes from the fact that the commutative image of R_I are the Schur functions of ribbon shape (see [Thi98]) that we will introduce in Equation 3.49. For any two compositions $I \vDash m$ and $J \vDash n$ we have

$$R_I R_J = R_{I \cdot J} + R_{I \triangleright J} \tag{3.38}$$

where $I \cdot J$ is the concatenation of I and J , and $I \triangleright J := (i_1, \dots, i_{k-1}, i_k + j_1, j_2, \dots, j_\ell)$. For example, $R_{312} R_{322} = R_{312322} + R_{31522}$.

In the previous examples we have described the following commutative diagram of Hopf algebras morphisms:

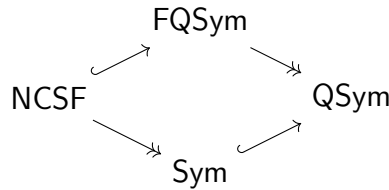

There is also the Loday-Ronco algebra **PBT** on binary trees, which is a quotient and a subalgebra of **FQSym**, but since it will not be of interest for our thesis, we refer to [HNT05] and [LR98] for more details.

3.4.3 Grothendieck groups

We introduce here the Grothendieck groups of a finite monoid M over \mathbb{C} which are some analogue of the abelian group of characters introduced in section 3.1.2. If V is a $\mathbb{C}M$ -module we denote by $[V]$ its isomorphism class. As an abelian group, the *Grothendieck group* $G_0(\mathbb{C}M)$ (resp. $K_0(M)$) of M is the free abelian group on the set of isomorphism classes of finite dimensional $\mathbb{C}M$ -modules (resp. finite dimensional projective $\mathbb{C}M$ -modules) modulo the relations $[V] = [U] + [W]$ if there is an exact sequence of the form:

$$0 \longrightarrow U \longrightarrow V \longrightarrow W \longrightarrow 0. \tag{3.39}$$

Of course if M is semisimple than $K_0(\mathbb{C}M) = G_0(\mathbb{C}M)$. The following proposition shows that the simple modules are really elementary blocks of the ring $G_0(\mathbb{C}M)$, and is just a consequence of Jordan-Hölder's theorem (Theorem 3.2.6):

Proposition 3.4.11 ([Ste16, Proposition 7.3]). *The additive group of $G_0(\mathbb{C}M)$ is free abelian with basis the isomorphism classes of simple $\mathbb{C}M$ -modules. Moreover if V is a finite-dimensional $\mathbb{C}M$ -module then the decomposition:*

$$[V] = \sum_{[S] \in \text{Irr}(M)} [V : S][S] \tag{3.40}$$

holds.

There is a natural abelian group morphism:

$$C : \begin{array}{ccc} K_0(\mathbb{C}M) & \longrightarrow & G_0(\mathbb{C}M) \\ [P] & \longmapsto & \sum_{[S] \in \text{Irr}(M)} [P : S][S]. \end{array} \quad (3.41)$$

If P_1, \dots, P_r is a complete set of projective indecomposable $\mathbb{C}M$ -modules and the $S_i := P_i / \text{rad}(P_i)$ are the corresponding simple modules then the matrix for C with respect to the bases $[P_1], \dots, [P_r]$ and $[S_1], \dots, [S_r]$ is the Cartan matrix that we have already seen.

3.4.4 Tower of algebra and categorification

Let A be a graded algebra, $A = \bigoplus_{n \geq 0} A_n$. The product of A preserves the degree so that $A_n A_m \subseteq A_{n+m}$. But we can also try to restrict and induce modules along this structure. We call such a structure a *tower of algebra*:

Definition 3.4.12. *Let $(A_i)_{i \geq 0}$ be a family of associative algebras endowed with a collection of algebra morphisms $(\rho_{m,n} : A_m \otimes A_n \rightarrow A_{n+m})_{n,m \geq 0}$ satisfying the following axioms:*

- (i) *For $i \geq 0$, A_i is a finite dimensionnal algebra with unit and $A_0 \simeq \mathbb{C}$.*
- (ii) *The outer product induced by the homomorphisms $\rho_{m,n}$ is associative.*

*Such a structure is called an **associative tower of algebras**.*

A tower of groups (resp. monoids) is thus a family of groups $(G_n)_n$ (resp. monoids $(M_n)_n$) so that the family of their algebras $(\mathbb{C}G_n)$ (resp. $(\mathbb{C}M_n)$) is a tower of algebras. The axiom ensures that the Grothendieck groups

$$G_0(A) := \bigoplus_{n \geq 0} G_0(A_n) \quad \text{and} \quad K_0(A) := \bigoplus_{n \geq 0} K_0(A_n) \quad (3.42)$$

are graded connected.

Now assume that $M = (M_n)_{n \geq 0}$ is a tower of monoids. Then we endow the Grothendieck group $G_0(\mathbb{C}M)$ (resp. $K_0(\mathbb{C}M)$) with the structure of product and coproduct as follows. If $[V]$ is a $(\mathbb{C}M_n)$ -(projective) module and $[W]$ is a $(\mathbb{C}M_m)$ -(projective) module then $[V] \cdot [W] := [\text{Ind}_{M_n \times M_m}^{M_{n+m}} V \otimes W]$, and $\Delta([V]) := \sum_{i+j=n} [\text{Res}_{M_i \times M_j}^{M_n} V]$. This defines a product and a coproduct on $G_0(\mathbb{C}M)$, and a product on $K_0(\mathbb{C}M)$. For the coproduct on $K_0(\mathbb{C}M)$ we need to add the following axiom:

- (iii) *For $i, j \geq 0$, $\mathbb{C}M_{i+j}$ is projective over $\mathbb{C}M_i \otimes \mathbb{C}M_j$.*

In Part II, this axiom will not be satisfied.

One of the interests for the Grothendieck group $G_0(\mathbb{C}M)$ is Equation 3.40, so that we can decompose the product and coproduct of simple modules. We keep the previous notations:

$$[V] \cdot [W] = \sum_{[S] \in \text{Irr}(M_{n+m})} p_{V,W}^S [S] \quad \text{and} \quad \Delta([V]) = \sum_{\substack{i+j=n \\ [S] \in \text{Irr}(M_i), [T] \in \text{Irr}(M_j)}} c_{S,T}^V [S] \otimes [T] \quad (3.43)$$

where the coefficients $(p_{V,W}^S)$ and $(c_{S,T}^U)$ are called the *structure coefficients* of the tower of monoids. In the case of the Grothendieck group $K_0(\mathbb{C}M)$ we also have

such a decomposition by Krull-Schmidt theorem (Theorem 3.2.7). However the product and coproduct on these structures are not always compatible so that the Grothendieck groups are just an algebra or a coalgebra. In [BL09], Bergeron and Li propose an axiomatic definition on different axioms (with axioms i, ii and 3.4.4 among others) of tower of algebras which guarantees that the Grothendieck groups of the simple and projective modules are a pair of dual Hopf algebras. They further prove in [BLL12] that those axioms are very strong, implying that the tower of algebras is of a precise graded dimension.

If we compare Equation 3.43 to Equation 3.28 where other structure coefficients were introduced we can explain the problem which first interested us in this thesis. If we have a tower of algebras, under some hypothesis as in [BL09], the Grothendieck groups of the simple and projective modules are a pair of dual Hopf algebras. In other words we can find two Hopf algebras such that their structure coefficients are the ones given by the induction and the restriction over the tower of algebra. The reverse question is much more difficult and is called the *categorification*: if we have a pair of dual Hopf algebras we look for a tower of algebras with the same structure coefficients. We will not address this problem in this thesis since the tower of monoids that we will introduce in Part II does not seem to provide Hopf algebras. We give two examples in the next sections and refer the interested reader to [Vir14] and [Vir16] for some other examples of partial categorification. In his article, Virmaux was notably interested in tower of \mathcal{J} -trivial monoids, and proved the following result, by induction, that we will use later :

Theorem 3.4.13 ([Vir14, Theorem 4.3]). *Let (M_i) be a tower of \mathcal{J} -trivial monoids and $A := (A_i)$ the related tower of algebras. Let $e \in E(M_n)$ (resp. $f \in E(M_m)$) and S_e (resp. S_f) the simple A_n -module (resp. A_m -module) associated by Theorem 3.3.2.*

We define $X(e, f)$ to be the subset of M_{m+n} which contains all the elements in $\rho_{m,n}(e, 1)\rho_{m,n}(1, f)M_{n+m}$ which are not in $\rho_{m,n}(R_{<}(e), 1)\rho_{m,n}(1, R_{<}(f))M_{n+m}$, where $R_{<}(e)$ is the set of elements of M_n strictly below e for the \mathcal{J} -order. In other words, identifying M_n and M_m with their copies in M_{n+m} :

$$X(e, f) := efM_{n+m} \setminus \bigcup_{\substack{e' \in eM_n, f' \in fM_m \\ (e', f') \neq (e, f)}} e'f'M_{n+m}. \quad (3.44)$$

Then the induction rule is given by:

$$\left[\text{Ind}_{M_n \otimes M_m}^{M_{n+m}} S_e \otimes S_f \right] = \sum_{x \in X(e, f)} \cdot [S_{\text{fix}(x)}] \quad (3.45)$$

3.5 The tower of $(\mathfrak{S}_n)_{n \in \mathbb{N}}$.

3.5.1 Partition and Young tableaux

As we have seen in Theorem 3.1.2, the number of irreducible representations up to isomorphisms of a group is equal to the number of its conjugation classes. We have also seen in Section 1.1.7 that the conjugation class of an element of \mathfrak{S}_n is given by the partition associated to its cycle decomposition.

A partition $(\lambda_1, \dots, \lambda_m)$ can be represented in a *Young diagram* (also called *Ferrers diagram*); that is a finite collection of boxes, arranged in left-justified rows with λ_1 is the first row (the bottom one), λ_2 is the second, etc. We call \mathbb{Y} the set of all partitions of any integer. The rows and columns are numbered from bottom to top and from left to right. A box (i, j) is said *removable* of a Young diagram of shape λ if there is no box in positions $(i + 1, j)$ and $(i, j + 1)$. See Figure 3.6 for an illustration of these concepts.

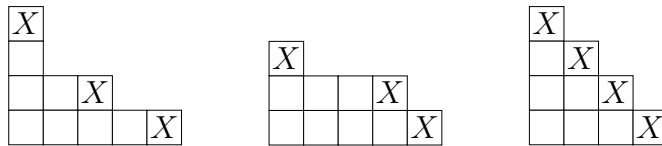

Figure 3.6: The Young diagrams of $(5, 3, 1, 1)$, $(5, 4, 1)$ and $(4, 3, 2, 1)$. The removable boxes are shown with an X . For instance, the removable boxes of the Young diagram $(5, 3, 1, 1)$ are the boxes $(4, 1)$, $(2, 3)$ and $(1, 5)$, while the removable boxes of the Young diagram $(5, 4, 1)$ are $(3, 1)$, $(2, 4)$ and $(1, 5)$.

A *Young tableau* of shape λ is a filling of the Young diagram of shape λ by some integers. A Young tableau is called *semi-standard* if the numbers filled into the boxes are strictly increasing from top to bottom and nondecreasing from left to right. A Young tableau is called *standard* if all integers from 1 to $|\lambda|$ appear and the numbers filled into boxes are strictly increasing both along rows (from left to right) and along columns (from bottom to top). Note that in a standard Young tableau the 1 is always in position $(1, 1)$ and the $|\lambda|$ is in a removable box. See Figure 3.7. We denote by $\text{Tab}(\lambda)$ the set of Young tableaux of shape λ .

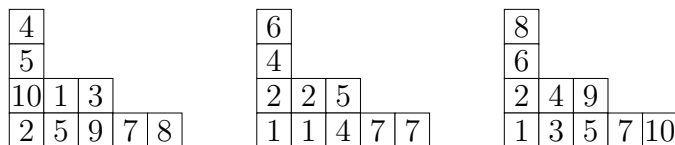

Figure 3.7: Two Young tableaux of shape $(5, 3, 1, 1)$, the first one is not semi-standard, the second one is semi-standard and the third one is standard.

If $\lambda \vdash n$ and $\mu \vdash n + 1$ are such that λ is obtained from μ by removing a removable box we say that μ *covers* λ . We call \preceq the transitive closure of these covers relations on \mathbb{Y} . We represent the bottom part of the Hasse diagram of \mathbb{Y} in Figure 3.8, which is also called the *branching graph* of \mathbb{Y} . In this poset a saturated chain of partitions of decreasing length is called a (*Young*) *path*. In other words it is a sequence $p = (\lambda^{(n)} \rightarrow \lambda^{(n-1)} \rightarrow \dots \rightarrow \lambda^{(k)})$ with $\lambda^{(i)} \vdash i$ for all i and such that $\lambda^{(i)}$ covers $\lambda^{(i-1)}$ for $i > 1$.

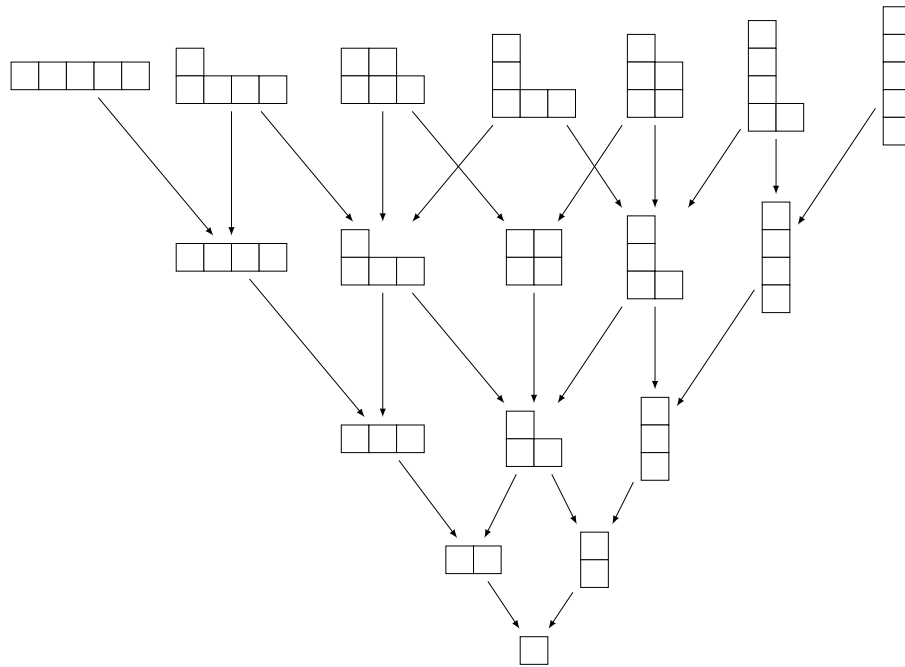

Figure 3.8: The bottom of the Young branching graph of \mathbb{Y} .

3.5.2 Representations of the symmetric group and Schur functions

For $\lambda \vdash n$, the symmetric group acts on the set $\text{Tab}(\lambda)$ by permutation of the coefficients. Let any $T \in \text{Tab}(\lambda)$ and define the two following subgroups of \mathfrak{S}_n :

$$P_T := \{\sigma \in \mathfrak{S}_n \mid \sigma \text{ preserves each row of } T\}, \tag{3.46}$$

$$Q_T := \{\sigma \in \mathfrak{S}_n \mid \sigma \text{ preserves each column of } T\}. \tag{3.47}$$

Corresponding to these subgroups, we define the two vectors in $\mathbb{C}\mathfrak{S}_n$ as:

$$a_T := \sum_{\sigma \in P_T} \sigma \quad \text{and} \quad b_T := \sum_{\tau \in Q_T} \varepsilon(\tau)\tau, \tag{3.48}$$

where ε is the signature. Then we finally define the *Young symmetrizer* $c_T := a_T \cdot b_T$, and we define $V_T := c_T \cdot \mathbb{C}\mathfrak{S}_n$. Then:

Theorem 3.5.1 ([FH91, Section 4]). *Let T and T' be two tableaux of respective shape $\lambda \vdash n$ and $\lambda' \vdash n$. Then the $\mathbb{C}\mathfrak{S}_n$ -module V_T is isomorphic to $V_{T'}$ if and only if $\lambda = \lambda'$. We denote one element of this isomorphism class by V_λ .*

Then the family $(V_\lambda)_{\lambda \vdash n}$ is a complete family of simple $\mathbb{C}\mathfrak{S}_n$ -modules with no two of them isomorphic. Furthermore $\dim V_\lambda = |\text{Tab}(\lambda)|$.

Now we introduce a new family of symmetric functions and will link them with the representation theory we have just presented in Section 3.5.3. If T is a semi-standard Young tableau the *weight* x^T of T over the variables (x_1, x_2, \dots) is the monomial $\prod_{j \in T} x_j$. In other words, if the maximal value of T is n , then it is $x_1^{t_1} \dots x_n^{t_n}$

where t_n is the number of n in T . For instance the monomial associated to the Young tableau in the middle of Figure 3.7 is $x_1^2 x_2^2 x_4^2 x_5 x_6 x_7^2$. For $\lambda \in \mathbb{Y}$, we then define the *Schur functions* s_λ as:

$$s_\lambda := \sum_T x^T, \quad (3.49)$$

where the summations is over all semi-standard Young tableaux. These functions are symmetric functions and a basis of \mathbf{Sym} . If $\lambda \vdash n$ and $\mu \vdash m$ then the multiplication is given by:

$$s_\lambda s_\mu = \sum_{\nu \vdash n+m} c_{\lambda, \mu}^\nu s_\nu, \quad (3.50)$$

where the $c_{\lambda, \mu}^\nu$ are called the Littlewood-Richardson coefficients and count a certain type of Young skew-tableaux. We refer to [Mac95] for more details on these topics.

3.5.3 Induction, restriction and categorification

We now look at the tower of groups $(\mathbb{C}\mathfrak{S}_n)_{n \geq 0}$. It is actually entirely combinatorial and encoded in the branching graph represented in Figure 3.8. We have the following theorem, illustrated in Figure 3.9:

Theorem 3.5.2 (Branching rule, [CSST10, Corollary 3.3.10 and 3.3.11]). *For every $\lambda \vdash n$ we have*

$$\mathrm{Res}_{\mathfrak{S}_{n-1}}^{\mathfrak{S}_n} V_\lambda = \bigoplus_{\substack{\mu \vdash n-1 \\ \lambda \rightarrow \mu}} V_\mu \quad (3.51)$$

that is, the sum runs over all partitions $\mu \vdash n-1$ that may be obtained from λ by removing one removable box. Moreover for every $\mu \vdash n-1$:

$$\mathrm{Ind}_{\mathfrak{S}_{n-1}}^{\mathfrak{S}_n} V_\mu = \bigoplus_{\substack{\lambda \vdash n \\ \lambda \rightarrow \mu}} V_\lambda. \quad (3.52)$$

Consequently if $0 \leq k < n$, $\lambda \vdash n$ and $\mu \vdash k$, the multiplicity $m_{\mu, \lambda}$ of V_μ in $\mathrm{Res}_{\mathfrak{S}_k}^{\mathfrak{S}_n} V_\lambda$ is equal to the number of paths in \mathbb{Y} from λ to μ (possibly zero). The similar result holds for the induction.

We give a new definition of a *branching graph* based on this example. If we have a tower of monoids $(M_n)_{n \geq 0}$ the branching graph of the restriction of simple modules is the graded poset on simple modules of M_i , graded by i , with as many arrows from the simple module V of M_n to a simple module V' of M_{n-1} as $[V : V']$. We define similarly the branching graph of the restriction/induction of simple/projective indecomposable modules.

The branching rule (Theorem 3.5.2) is a special case of the following result. If $\lambda \vdash n$, $\mu \vdash m$, we have:

$$\mathrm{Ind}_{\mathfrak{S}_n \times \mathfrak{S}_m}^{\mathfrak{S}_{n+m}} [V_\lambda] \otimes [V_\mu] = \sum_{\nu \vdash n+m} c_{\lambda, \mu}^\nu [V_\nu], \quad (3.53)$$

where the $c_{\lambda, \mu}^\nu$ are the Littlewood-Richardson coefficients introduced in Equation 3.50. Hence the tower of the symmetric groups $(\mathfrak{S}_n)_n$ is a categorification of the product

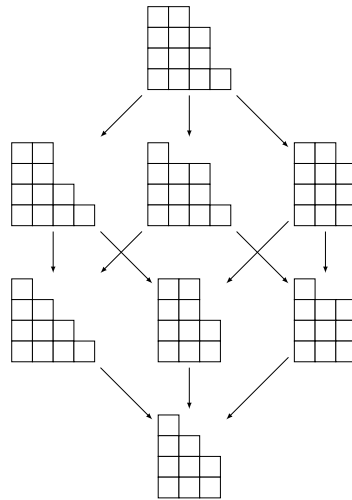

Figure 3.9: The 6 paths from $(4, 3, 3, 2) \vdash 12$ to $(3, 3, 2, 1) \vdash 9$. Hence the coefficient of $V_{(3,3,2,1)}$ in $\text{Res}_{\mathfrak{S}_9}^{\mathfrak{S}_{12}} V_{(4,3,3,2)}$ is 6.

of Sym over the basis $(s_\lambda)_{\lambda \in \mathbb{Y}}$. The same results hold for the coproduct. Hence we define the *Frobenius isomorphism* which maps a simple module V_λ ($\lambda \vdash n$) to the Schur function s_λ of degree n . We thus have seen that induction and restriction along the natural inclusion $\mathfrak{S}_m \times \mathfrak{S}_n \rightarrow \mathfrak{S}_{m+n}$ corresponds respectively to product and coproduct (the Littlewood-Richardson rule) of the Hopf algebra Sym of symmetric functions. See [Mac95] for much more details.

3.6 The tower of $(H_n^0)_{n \in \mathbb{N}}$.

The construction in the symmetric groups and the Littlewood-Richardson rule (Equation 3.53) has an analogue for $(H_n^0)_n$ according to Krob and Thibon [KT97; Thi98]. However due to the non semi-simplicity of H_n^0 the situation is a little more complicated, and we will not give all the details. We nevertheless recall here briefly the features as the following categorification was the idea for our work on rooks.

First of all, the maps

$$\rho_{m,n} : \begin{cases} H_m^0 \times H_n^0 & \longrightarrow & H_{m+n}^0 \\ (\pi_i, \pi_j) & \longmapsto & \pi_i \pi_{j+m} = \pi_{j+m} \pi_i \end{cases} \quad (3.54)$$

are injective monoid morphisms which, moreover, verify the associativity condition of Definition 3.4.12 endowing $(H_n^0)_n$ with a tower of monoids structure. As seen in Section 3.4.3, one can define the two Grothendieck groups, namely $\mathcal{G}_0 := \sum_n \mathbb{C} \mathcal{G}_0(H_n^0)$ the direct sum of the (complexified) Grothendieck groups of H_n^0 -modules on one hand and $\mathcal{K}_0 := \sum_n \mathbb{C} \mathcal{K}_0(H_n^0)$ the direct sum of the Grothendieck groups of projective H_n^0 -modules. As we have seen in the examples of Section 3.3, denoting by I the compositions of an integer, then \mathcal{G}_0 has for basis the simple module S_I , whereas \mathcal{K}_0 has for basis the indecomposable projective module P_I .

Now fixing two integers m and n , the restriction $\text{Res}_{m,n} := \text{Res}_{H_m^0 \times H_n^0}^{H_{m+n}^0}$ along the morphism $\rho_{m,n}$ defines coproducts on \mathcal{G}_0 and \mathcal{K}_0 . In particular, H_{m+n}^0 is projective

over $H_m^0 \times H_n^0$. Dually, the induction $\text{Ind}_{m,n} := \text{Ind}_{H_m^0 \times H_n^0}^{H_{m+n}^0}$ defines products on \mathcal{G}_0 and \mathcal{K}_0 . The nontrivial fact here is that these products and coproducts are compatible endowing the two Grothendieck groups with a structure of Hopf algebra.

We now look at an analogue of Frobenius isomorphism for the symmetric group. It is constructed as follows: let **QSym** denote Gessel's [Ges84] Hopf algebra of quasi-symmetric functions introduced in Example 3.4.9 and let **NCSF** denote the Hopf algebra of noncommutative symmetric functions [Gel+95] introduced in Example 3.4.10. We have seen that these two Hopf algebras have their bases indexed by compositions. The basis of **NCSF** which interests us is the basis of Schur ribbon functions R_I and of quasi-ribbons \mathbf{F}_I for **QSym**. Moreover these two Hopf algebras are dual for some duality product [MR95b; Gel+95]. Krob and Thibon proved the following theorem:

Theorem 3.6.1 ([KT97]). *The tower of monoids $(H_n^0)_n$ categorifies the couple of dual algebra (NCSF, R) and $(\text{QSym}, \mathbf{F})$. In other words:*

- (i) $\mathcal{K}_0 = \text{NCSF}$ with induction and restriction rule corresponding to the product on the basis R .
- (ii) $\mathcal{G}_0 = \text{QSym}$ with induction and restriction rule corresponding to the product on the basis \mathbf{F} .

The duality between **QSym** and **NCSF** mirrors Frobenius duality between \mathcal{G}_0 and \mathcal{K}_0 , the commutative image $c : \text{NCSF} \rightarrow \text{QSym}$ given by the diagram 3.4.2 being nothing but the Cartan map.

As an illustration, we give the induction rule on \mathcal{K}_0 then on \mathcal{G}_0 . For any two compositions $I \vDash n$ and $J \vDash m$:

$$\text{Ind}_{n,m}([P_I] \otimes [P_J]) = P_{I \cdot J} \oplus P_{I \triangleright J} \quad (3.55)$$

where $I \cdot J$ is the concatenation of I and J and $I \triangleright J := (i_1, \dots, i_k - 1, i_k + j_1, j_2, \dots, j_\ell)$. For example

$$\text{Ind}_{6,7}(P_{(3,1,2)} \otimes P_{(3,2,2)}) = P_{(3,1,2,3,2,2)} \oplus P_{(3,1,5,2,2)}. \quad (3.56)$$

This is the same rule as the multiplication rule of the ribbon basis of **NCSF** [Gel+95], see Equation 3.38. For the product on $\mathcal{G}_0 = \text{QSym}$ we recall from Example 3.4.9 that we have to choose any permutation $\sigma \in \mathfrak{S}_n$ whose descent composition is $C(\sigma) = I$ and μ such that $C(\mu) = J$. Then:

$$\text{Ind}_{n,m}[S_I] \otimes [S_J] = \sum_{\nu \in \sigma \sqcup \mu} [S_{C(\nu)}]. \quad (3.57)$$

As explained by Virmaux [Vir14] this is a direct consequence of Theorem 3.4.13. For example recalling the calculations of Equation 1.42 we have:

$$\begin{aligned} \text{Ind}_{2,2}[S_{(2)}] \otimes [S_{(1,1)}] &= \sum_{\nu \in 12 \sqcup 21} [S_{C(\nu)}] \\ &= [S_{C(1243)}] + [S_{C(1423)}] + [S_{C(1432)}] + [S_{C(4123)}] + [S_{C(4132)}] + [S_{C(4312)}] \\ &= [S_{(3,1)}] + [S_{(2,2)}] + [S_{(2,1,1)}] + [S_{(1,3)}] + [S_{(1,2,1)}] + [S_{(1,1,2)}]. \end{aligned}$$

We refer to Example 3.4.10 for the coproduct.

Part II

Presentation and representation of 0-Rook monoid

Summary

From now on we will introduce our original work. This part is based upon an article with F. Hivert [GH18b]. It is organized as follows: in Chapter 4, we turn to the definition of the 0-rook monoid. We actually give two equivalent definitions: The first definition is by generators and relations (Section 4.1): we show that a suitable rewriting of Halverson’s presentation when specialized at $q = 0$ is actually a monoid presentation (Definition 4.1.1). We then study some particular elements of this monoid which allows us to give a simpler equivalent presentation (Corollary 4.1.6).

The second definition is as operators acting on the rook monoid (Definition 4.2.1). To show that these two definitions are actually equivalent (Corollary 4.3.14), we choose to go a somewhat lengthy road, taking the following steps:

1. We first notice that the operators verify the relations of the presentation (Remark 4.2.2).
2. We generalize to rooks a variant of the notion of Lehmer code of permutations (Definition 4.2.5), building a bijection between rooks and the so-called R -code (Theorem 4.2.19).
3. After a little combinatorial detour (Section 4.2.2), we associate to each R -code \mathbf{c} , a canonical word $\pi_{\mathbf{c}}$ (Definition 4.3.2) and its corresponding $s_{\mathbf{c}}$ in the classical rook monoid such that (Proposition 4.3.4) for all rook $r \in R_n$ then $1_n \cdot \pi_{\text{code}(r)} = 1_n \cdot s_{\text{code}(r)} = r$.
4. We then translate on R -code \mathbf{c} the action on rook (Definition 4.3.6), and prove that, for any generator t , the element $\pi_{\mathbf{c}}t$ is equivalent to $\pi_{\mathbf{c},t}$ modulo the relations of the presentation (Theorem 4.3.9).
5. By induction this shows that any word is equivalent to a word $\pi_{\mathbf{c}}$, but since there are as many R -codes as rooks we will conclude that the two definitions are equivalent (Corollary 4.3.14).

Note that we do not use the well-known presentation of the classical rook monoid or of the q -rook algebra, but prove them again from scratch. Though it is combinatorially technical, we argue that our way of doing have several advantages. First it is self content and purely monoidal, providing arguments for monoid theory people which are not familiar with Coxeter group theory. Second, our approach is very

explicit and algorithmic providing a canonical reduced word for all rooks or 0-rooks together with an explicit algorithm transforming any word in its equivalent canonical one. Moreover, the Lehmer code is central ingredient in the theory of Schubert polynomials whose modern combinatorial incarnation is the pipedream theory. We find interesting to provide such a combinatorial tool. Finally, this allows us to have a much finer understanding of the combinatorics of reduced words. In particular, we get an analogue of Matsumoto's theorem (Theorem 4.4.3), an ingredient which was noticed missing in [Sol04]. As a consequence, all the previous proof of presentation had to rely on some dimension argument so that they were only valid on a field. Notice that, if we had this theorem from the beginning, we could have worked only on reduced words as we did previously in the usual case.

Chapter 5 is devoted to the study of the analogue of the weak permutohedron order on rooks or equivalently to Green's \mathcal{R} -order of the 0-rook monoid. Using a generalization of the notion of inversion sets (Definition 5.1.1), we provide a algorithm to compare two rooks (Definition 5.1.5 and Theorem 5.1.11). A very important consequence in particular for the representation theory is that R_n^0 is \mathcal{R} -trivial, \mathcal{L} -trivial and thus \mathcal{J} -trivial (Corollary 5.1.12). We then show that the right order, as for permutations, is actually a lattice (Corollary 5.2.2), giving algorithms to compute the meet and the join (Theorem 5.2.1 and 5.2.5). We moreover provide a formula enumerating the meet irreducibles (Proposition 5.2.11), give a bijection for a certain subposet with the subposet of singletons in the Tamari lattice (Section 5.3) and conclude this chapter by some geometric remarks.

Chapter 6 deals with the representation theory of the 0-rook monoid. It heavily uses the fact that R_n^0 is \mathcal{J} -trivial through the theory of Denton–Hivert–Schilling–Thiéry [Den+10] seen in Section 3.3. We describe the set of idempotents and their lattice structure (Proposition 6.1.6 and 9.2.8). We then show that the simple modules are all 1-dimensional (Theorem 6.1.7), describe the indecomposable projective module as some kind of descent classes (Theorem 6.2.7) and describe the quiver (Theorem 6.3.1). We then study how the representation theory of H_n^0 and R_n^0 are related. The main result here is that the later is projective on the former (Theorem 6.4.5). We moreover give the decomposition functor (Theorem 6.4.8).

Finally Section 6.5, is devoted to the tower of monoids structure on the sequence of 0-rook monoids. Here the work presented in Section 3.6 does not work as nicely as expected. We present an associative structure as in Section 3.4.4 but it does not fulfill all the requirement of Bergeron-Li [BL09]. In particular, R_{m+n}^0 is not projective over $R_m^0 \times R_n^0$. We nevertheless explicit some structure and in particular the induction rule for simple modules (Theorem 6.5.16).

A large part of the algorithms of this part are implemented in Sagemath [dev16]. The representation theory where computed using `sage_semigroups` [HST12] from the second author, F. Saliola and N. Thiéry. The code is freely accessible at

<https://github.com/hivert/Jupyter-Notebooks>

Thanks to the binder technology, one can experiment with in online at

<https://mybinder.org/v2/gh/hivert/Jupyter-Notebooks/master?filepath=rook-0.ipynb>

The 0-rook monoid

4.1 Definition of R_n^0 by generators and relations

This section is the sequel of Section 2.4.3 where we introduced Solomon’s algebra. To define the 0-rook monoid, we take back Halverson’s relations (Equations H1 to H3 and RH4 to RH8) and we put $q = 0$. In order to get a monoid, we write Equation RH8 as

$$P_{i+1} = P_i T_i P_i + P_i = P_i T_i P_i + P_i P_i = P_i (T_i + 1) P_i. \quad (4.1)$$

Setting $\pi_i := T_i + 1$, we obtain:

Definition 4.1.1. *We denote by G_n^0 the monoid generated by the two families π_1, \dots, π_{n-1} and P_1, \dots, P_n together with relations*

$$\pi_i^2 = \pi_i \quad 1 \leq i \leq n-1, \quad (\text{R1})$$

$$\pi_i \pi_{i+1} \pi_i = \pi_{i+1} \pi_i \pi_{i+1} \quad 1 \leq i \leq n-2, \quad (\text{R2})$$

$$\pi_i \pi_j = \pi_j \pi_i \quad |i-j| \geq 2. \quad (\text{R3})$$

$$P_i^2 = P_i \quad 1 \leq i \leq n, \quad (\text{R4})$$

$$P_i P_j = P_j P_i \quad 1 \leq i, j \leq n, \quad (\text{R5})$$

$$P_i \pi_j = \pi_j P_i \quad i < j \quad (\text{R6})$$

$$P_i \pi_j = \pi_j P_i = P_i \quad j < i \quad (\text{R7})$$

$$P_{i+1} = P_i \pi_i P_i \quad 1 \leq i < n. \quad (\text{R8})$$

Using Relation R8 we note that it is generated only by π_1, \dots, π_{n-1} and P_1 .

Notation 4.1.2. *To state that two words are equal in G_n^0 , we rather write explicitly that they are equivalent modulo the relations above as $e \equiv_0 f$.*

We recall here the plan we introduced in the summary. Definition 4.1.1 introduces a monoid defined by generators and relations. The G stands for “generators”. We will later give a definition of the monoid F_n^0 (Definition 4.2.1) as a monoid of operators acting on rooks (F stands for “functions”). We will actually prove in Corollary 4.3.14 that the two definitions actually coincide. We will then call this monoid the 0-rook monoid, and denote it by R_n^0 .

We start by focusing on the monoid generated by the (P_i) :

Lemma 4.1.3. $P_i P_k \equiv_0 P_{\max(i,k)}$.

Proof. Thanks to Relation R5, we may assume that $k \geq i$. Relation R8 shows us that there is a word for P_k beginning with P_i . Relation R4 says that P_i is an idempotent. \square

Lemma 4.1.4. *The element P_n is the unique zero of the monoid G_n^0 , that is for any $e \in G_n^0$ then $eP_n \equiv_0 P_n e \equiv_0 P_n$. Furthermore P_n have the two following expressions:*

$$\begin{aligned} P_n &\equiv_0 P_1 \pi_1 P_1 \pi_2 \pi_1 P_1 \pi_3 \pi_2 \pi_1 P_1 \dots P_1 \pi_{n-1} \pi_{n-2} \dots \pi_1 P_1 \\ &\equiv_0 P_1 \pi_1 \pi_2 \dots \pi_{n-2} \pi_{n-1} P_1 \dots P_1 \pi_1 \pi_2 \pi_3 P_1 \pi_1 \pi_2 P_1 \pi_1 P_1. \end{aligned} \quad (4.2)$$

Proof. We prove this by induction on $n \geq 1$. It is obvious that $P_2 \equiv_0 P_1 \pi_1 P_1$ by Relation R8. To show that P_2 is a zero, it is enough to prove that the generators π_1 et P_1 stabilize it. It is clear for P_1 which is idempotent, and $\pi_1 P_1 \pi_1 P_1 \equiv_0 \pi_1 P_2 \equiv_0 P_2$ by the Relation R7.

Assume that the result is proven for all $1 \leq k \leq n$. Let us prove it for $n + 1$:

$$\begin{aligned} P_{n+1} &\equiv_0 P_n \pi_n P_n \equiv_0 P_n \pi_n P_{n-1} \pi_{n-1} \pi_{n-2} \dots \pi_3 \pi_2 \pi_1 P_1 \text{ (by induction)} \\ &\equiv_0 P_n P_{n-1} \pi_n \pi_{n-1} \pi_{n-2} \dots \pi_3 \pi_2 \pi_1 P_1 \text{ (by R6)} \\ &\equiv_0 P_n \pi_n \pi_{n-1} \pi_{n-2} \dots \pi_3 \pi_2 \pi_1 P_1 \text{ (by Lemma 4.1.3)}. \end{aligned}$$

Thus the result holds. Since all the relations are symmetric, we get the other formula.

To show that P_{n+1} is a zero we prove that it is stabilized under multiplication by any generator among π_1, \dots, π_n, P_1 . The stability by P_1 is obvious by Lemma 4.1.3. For all the others, we deduce from Relation R7 that $\pi_i P_n \equiv_0 P_n$ since $i \leq n - 1$.

Finally, the uniqueness of the zero holds in any semigroup. \square

Corollary 4.1.5. *In the presentation of G_n^0 one can replace the Relations R4, R5, R6 and R7 by the following three and still get the same monoid:*

$$P_1^2 = P_1 \quad (R4.1)$$

$$P_1 \pi_j = \pi_j P_1 \quad j \neq 1 \quad (R5.1)$$

$$\pi_1 P_1 \pi_1 P_1 = P_1 \pi_1 P_1 = P_1 \pi_1 P_1 \pi_1 \quad (R6.1)$$

In particular the monoid G_n^0 is generated by $(\pi_i)_{1 \leq i \leq n-1}$ and P_1 subject to the Relations R1 to R3 and R4.1 to R6.1; the Relation R8 being seen as a definition for P_i for $i > 1$.

Proof. Deducing Relations R5.1 and R6.1 from Relations R1 to R8 is obvious: Relation R6.1 is only Relation R7 applied with $i = 2$ and $j = 1$.

Let us prove the converse: Relations R1 to R8 can be deduced from Relations R1 to R4, R5.1, R6.1 and R8 seen as a definition. We will now prove that Lemma 4.1.3 and Lemma 4.1.4 (and Relation R4) are still true. We prove simultaneously by induction on n the following statements

- for all $k \leq n$, the element P_k is given by the relation of Lemma 4.1.4.
- for all $i, k \leq n$, then $P_k^2 \equiv_0 P_k$ and $P_i P_k \equiv_0 P_{\max(i,k)}$.

The case $n = 1$ is obvious with Relation R4.

We now assume the statements for $n \geq 1$. We only have to prove that two words for P_{n+1} are given by Lemma 4.1.4, that $P_{n+1}^2 \equiv_0 P_{n+1}$ and that $\forall i \leq n+1$, $P_{n+1}P_i \equiv_0 P_{n+1}$.

Regarding the words for P_{n+1} , a close look to the proof of Lemma 4.1.4 shows that we use only Relation R6.1 (for the basis step), Relation R6 when $i < j \leq n$, Relation R4 when $i \leq n$ and Lemma 4.1.3 for $i, k \leq n$. But all these relations have already been proved by induction. Consequently we have the two expressions for P_{n+1} .

From there, the relation $P_iP_{n+1} \equiv_0 P_{n+1}P_i \equiv_0 P_{n+1}$ for $i \leq n$ is clear using these words and the fact that $P_i^2 = P_i$. We only have still to prove that P_{n+1} is idempotent.

$$\begin{aligned} P_{n+1}^2 &\equiv_0 P_1\pi_1\pi_2 \dots \pi_{n-1}\pi_n P_1 \dots P_1\pi_1\pi_2 P_1\pi_1 P_1 \cdot P_1\pi_1 P_1\pi_2\pi_1 P_1 \dots P_1\pi_n\pi_{n-1} \dots \pi_1 P_1 \\ &\equiv_0 P_1\pi_1\pi_2 \dots \pi_{n-1}\pi_n P_1 P_n P_n \pi_n \pi_{n-1} \dots \pi_2 \pi_1 P_1 \\ &\equiv_0 P_1\pi_1\pi_2 \dots \pi_{n-1}\pi_n P_1 P_n \pi_n \pi_{n-1} \dots \pi_2 \pi_1 P_1, \end{aligned}$$

by induction. Now using R3 and R5.1:

$$P_{n+1}^2 \equiv_0 P_1\pi_1\pi_2 \dots \pi_{n-1}\pi_n P_1\pi_1\pi_2 \dots \pi_{n-1}\pi_n P_1 \dots P_1\pi_1\pi_2\pi_3 P_1\pi_1\pi_2 P_1\pi_1 P_1 \quad (*)$$

We continue the beginning of the calculation below. Call ρ , the first part of the previous calculation:

$$\rho := P_1\pi_1\pi_2 \dots \pi_{n-1}\pi_n P_1\pi_1\pi_2 \dots \pi_{n-1}\pi_n.$$

Then

$$\begin{aligned} \rho &\equiv_0 P_1\pi_1\pi_2 P_1\pi_1\pi_2 \dots \pi_{n-1}\pi_n \pi_2 \pi_3 \dots \pi_{n-2}\pi_{n-1} && \text{(by R2, R3 and R5.1)} \\ &\equiv_0 P_1\pi_1 P_1\pi_2\pi_1\pi_2 \dots \pi_{n-1}\pi_n \pi_2 \pi_3 \dots \pi_{n-2}\pi_{n-1} && \text{(by R5.1)} \\ &\equiv_0 P_1\pi_1 P_1\pi_1\pi_2\pi_1\pi_3 \dots \pi_{n-1}\pi_n \pi_2 \pi_3 \dots \pi_{n-2}\pi_{n-1} && \text{(by R2)} \\ &\equiv_0 P_1\pi_1 P_1\pi_1\pi_2\pi_3 \dots \pi_{n-1}\pi_n \pi_1\pi_2\pi_3 \dots \pi_{n-2}\pi_{n-1} && \text{(by R3)} \\ &\equiv_0 P_1\pi_1 P_1\pi_2\pi_3 \dots \pi_{n-1}\pi_n \pi_1\pi_2\pi_3 \dots \pi_{n-2}\pi_{n-1} && \text{(by R6.1)} \\ &\equiv_0 P_1\pi_1\pi_2 \dots \pi_{n-1}\pi_n P_1\pi_1\pi_2 \dots \pi_{n-2}\pi_{n-1} && \text{(by R5.1)} \end{aligned}$$

Taking back Relation (*) we thus have:

$$\begin{aligned} P_{n+1}^2 &\equiv_0 P_1\pi_1\pi_2 \dots \pi_{n-1}\pi_n \\ &\quad P_1\pi_1\pi_2 \dots \pi_{n-2}\pi_{n-1} P_1\pi_1\pi_2 \dots \pi_{n-2}\pi_{n-1} P_1 \dots P_1\pi_1\pi_2\pi_3 P_1\pi_1\pi_2 P_1\pi_1 P_1 \end{aligned}$$

We recognize the end of the left term to be Equation * for n instead of $n+1$. Thus:

$$P_{n+1}^2 \equiv_0 P_1\pi_1\pi_2 \dots \pi_{n-1}\pi_n P_n P_n \equiv_0 P_1\pi_1\pi_2 \dots \pi_{n-1}\pi_n P_n \equiv_0 P_{n+1}$$

Finally we have proved that the statement holds for $n+1$: indeed, we have thus Relations R1 to R4 and the two Lemmas 4.1.3 and 4.1.4. Relation R5 follows directly from Lemma 4.1.3, and Relation R6 can be deduced from Lemma 4.1.4 using R5.1 and R3.

It remains to prove R7 using only R6.1 and Lemma 4.1.4. Since Lemma 4.1.4 and all the relations are symmetric, we only need to show that $\pi_j P_i \equiv_0 P_i$ for $j < i$, the proof of the other case could be conducted the same way.

For $j = 1$ and $i = 2$ it is exactly Relation R6.1. For $j = 1$ without condition on i , it comes from the fact that, because of Lemma 4.1.4, a word for P_i begin with $P_1 \pi_1 P_1$, and we conclude with R6.1.

Otherwise, for $j \geq 2$ and $i > j$, we get:

$$\pi_j P_i \equiv_0 \pi_j P_1 \pi_1 P_1 \pi_2 \pi_1 P_1 \dots P_1 \pi_{j-1} \pi_{j-2} \dots \pi_2 \pi_1 P_1 \pi_j \pi_{j-1} \dots \pi_2 \pi_1 P_1 \dots P_1 \pi_{i-1} \pi_{i-2} \dots \pi_1 P_1$$

with R3 and R5.1:

$$\begin{aligned} &\equiv_0 P_1 \pi_1 P_1 \pi_2 \pi_1 P_1 \dots P_1 \pi_j \pi_{j-1} \pi_{j-2} \dots \pi_2 \pi_1 P_1 \pi_j \pi_{j-1} \dots \pi_2 \pi_1 P_1 \dots P_1 \pi_{i-1} \pi_{i-2} \dots \pi_1 P_1 \\ &\equiv_0 P_1 \pi_1 P_1 \pi_2 \pi_1 P_1 \dots P_1 \pi_{i-1} \pi_{i-2} \dots \pi_1 P_1 = P_i \text{ (with } \rho \text{)}. \end{aligned}$$

Hence the result. \square

We finally get a new shorter presentation for G_n^0 , by setting $\pi_0 := P_1$.

Corollary 4.1.6. *The monoid G_n^0 is generated by π_0, \dots, π_{n-1} subject to the relations:*

$$\pi_i^2 = \pi_i \quad 0 \leq i \leq n-1, \quad (\text{RB1})$$

$$\pi_i \pi_{i+1} \pi_i = \pi_{i+1} \pi_i \pi_{i+1} \quad 1 \leq i \leq n-2, \quad (\text{RB2})$$

$$\pi_1 \pi_0 \pi_1 \pi_0 = \pi_0 \pi_1 \pi_0 = \pi_0 \pi_1 \pi_0 \pi_1, \quad (\text{RB3})$$

$$\pi_i \pi_j = \pi_j \pi_i \quad 0 \leq i, j \leq n-1, \quad |i-j| \geq 2, \quad (\text{RB4})$$

Proof. It is obvious from Corollary 4.1.5 by letting $\pi_0 = P_1$. \square

Remark 4.1.7. We can see that G_n^0 is a quotient of the Hecke monoid of type B at $q = 0$ (see [Fay05]).

4.2 Definition by action and R -codes

The goal of this section is to construct a bijection between R_n and R_n^0 which generalizes the bijection between \mathfrak{S}_n and H_n^0 seen in Proposition 2.4.1. We recall from Section 2.4 that Matsumoto's theorem (Theorem 1.1.15) is the key ingredient. Unfortunately, as noticed by Solomon [Sol04, p. 209, bottom of the middle paragraph], such a theorem is not known for the rook monoid. So we choose a different path (see the discussion in the summary of the part) effectively ending up proving the generalization of Matsumoto's theorem. We introduce another monoid defined in term of a faithful action of it on R_n . It will turns out (Corollary 4.3.17) that this action is nothing but the right multiplication.

Definition 4.2.1. *We denote F_n^1 the submonoid of the monoid of functions on R_n generated by s_1, \dots, s_{n-1}, P_1 acting on R_n by right multiplication of matrices. Namely, if (r_1, \dots, r_n) is a rook then:*

$$(r_1 \dots r_n) \cdot s_k = r_1 r_2 \dots r_{k-1} r_{k+1} r_k r_{k+2} \dots r_n, \quad (4.3)$$

$$(r_1 \dots r_n) \cdot P_1 = 0 r_2 \dots r_n \tag{4.4}$$

We denote F_n^0 the submonoid of the monoid of functions generated by π_1, \dots, π_{n-1} , P_1 acting on R_n by the action:

$$(r_1 \dots r_n) \cdot \pi_k := \begin{cases} (r_1 \dots r_n) \cdot s_k & \text{if } r_k < r_{k+1}, \\ (r_1 \dots r_n) & \text{otherwise.} \end{cases} \tag{4.5}$$

Remark 4.2.2. A simple calculation shows that the generators of F_n^0 satisfy the Relations R1 to R3 and R4.1 to R6.1. Similarly, the generators of F_n^1 satisfy

$$s_i^2 = 1 \qquad 1 \leq i \leq n-1, \tag{Rs1}$$

$$s_i s_{i+1} s_i = s_{i+1} s_i s_{i+1} \qquad 1 \leq i \leq n-2, \tag{Rs2}$$

$$s_i s_j = s_j s_i \qquad |i-j| \geq 2. \tag{Rs3}$$

$$P_1^2 = P_1 \tag{Rs4.1}$$

$$P_1 s_j = s_j P_1 \qquad j \neq 1 \tag{Rs5.1}$$

$$s_1 P_1 s_1 P_1 = P_1 s_1 P_1 = P_1 s_1 P_1 s_1 \tag{Rs6.1}$$

We denote by G_n^1 the monoid generated by $\{s_1, \dots, s_{n-1}, P_1\}$ with the relations above. We can rephrase Remark 4.2.2 as follows: there are two surjective morphisms of monoids:

$$\Phi_1 : G_n^1 \twoheadrightarrow F_n^1 \qquad \text{and} \qquad \Phi_0 : G_n^0 \twoheadrightarrow F_n^0. \tag{4.6}$$

Furthermore, these two morphisms give us an action of G_n^1 and G_n^0 over R_n .

Remark 4.2.3. The map $(r_1 r_2) \mapsto (r_1 0)$ is equal to the composition $s_1 P_1 s_1$ and therefore belongs to F_2^1 . However, it can be checked that it does not belong to F_2^0 , neither to its algebra $\mathbb{C}F_2^0$. More generally, in F_n^0 , for any subset $I \subset \llbracket 1, n \rrbracket$ which is not of the form $\llbracket 1, k \rrbracket$ the maps replacing the letter in position i by 0, does not belong to F_n^0 or $\mathbb{C}F_n^0$.

Our goal is now to show that Φ_1 and Φ_0 are actually isomorphisms.

4.2.1 R -code and rooks

In this subsection, we build a combinatorial tool, namely the *R-code*, which allows us to define for any rook a canonical reduced word. As seen in Section 1.1.6 a classical way to do that for permutations is done by the Lehmer code of the permutation (Definition 1.1.11, considering the chain of inclusions

$$\mathfrak{S}_1 \subset \mathfrak{S}_2 \subset \dots \subset \mathfrak{S}_{n-1} \subset \mathfrak{S}_n \subset \dots \tag{4.7}$$

See Remark 4.2.7 to see how the Lehmer codes relates to our generalized R -code.

The case of rooks is more involved because some times n does not appear in the rook vector and to go from R_n to R_{n-1} one has to erase a 0. It turns out that the right choice to minimize the number of moves (since we are looking for a reduced word) is to remove the *first* 0. However, this means that, given a rook r of size $n-1$, the number of rook of size n which give back r depends on r and more precisely on the position of its first 0. We now unravel the corresponding combinatorics, starting with some notations:

Notation 4.2.4 (Word and Letter). We recall that the length of a word w is denoted by $\ell(w)$. The empty word (the only word of length 0) will be denoted by ε . When we need to distinguish between words and letters (for example when matching a word), we use the convention that words will be underlined as in \underline{w} , while i will rather be a single letter. If the letter $i \in \mathbb{Z}$ appears in the word \underline{w} we write it $i \in \underline{w}$; it means for example that \underline{w} can be written as $\underline{w} = \underline{a}i\underline{b}$.

Definition 4.2.5. For a rook r of length n , we call the **code of r** and denote $\text{code}(r)$ the word on \mathbb{Z} of length n defined recursively by:

1. If $n = 0$ then $\text{code}(\varepsilon) := \varepsilon$.
2. Otherwise, if $n \in r$, then r can be written uniquely $r = \underline{b}n\underline{e}$. Let $r' := \underline{be}$ (that is, r' is the subword of r where the unique occurrence of n is removed). Then $\text{code}(r) := \text{code}(r') \cdot (\ell(\underline{b}) + 1)$.
3. Otherwise, $n \notin r$ and r can be written uniquely $r = \underline{b}0\underline{e}$ with $0 \notin \underline{b}$. Let $r' := \underline{be}$ (that is, r' is the subword of r where the first 0 is removed). Then $\text{code}(r) := \text{code}(r') \cdot (-\ell(\underline{b}))$.

Example 4.2.6. Let $r = 02401$. Then:

$$\text{code}(02401) = \text{code}(2401)0 = \text{code}(201)20 = \text{code}(21)\bar{1}20 = \text{code}(1)1\bar{1}\bar{2}0 = 11\bar{1}\bar{2}0.$$

An easy remark is that r is a permutation if and only if its code contains only positive letters.

Remark 4.2.7. When r is a permutation σ , the code and Lehmer code are related as follows: write the code as $\text{code}(\sigma) = r_1 \dots r_n$ and the Lehmer code as $\text{Lehmer}(\sigma) = c_1 \dots c_n$. Then $c_i = \sigma(i) - r_{\sigma(i)}$. For example taking $\sigma = 516432$, then $\text{code}(\sigma) = 122213$ and $\text{Lehmer}(\sigma) = 403210$.

We now describe a subset C_n of \mathbb{Z}^n that we call the set of R -codes. We will see in Proposition 4.2.14 and Theorem 4.2.19 that it is exactly the set of codes of a rook.

Definition 4.2.8. To each word \underline{w} over \mathbb{Z} , we associate a nonnegative number $m(\underline{w})$ defined recursively by: $m(\varepsilon) = 0$ and for any word \underline{w} and any letter d ,

$$m(\underline{w}d) := \begin{cases} -d & \text{if } d \leq 0; \\ m(\underline{w}) + 1 & \text{if } 0 < d \leq m(\underline{w}) + 1; \\ m(\underline{w}) & \text{if } d > m(\underline{w}) + 1. \end{cases} \quad (4.8)$$

A word on \mathbb{Z} is an **R -code** if it can be obtained by the following recursive construction: the empty word ε is a R -code, and $\underline{w}d$ is a R -code if \underline{w} is a R -code and $-m(\underline{w}) \leq d \leq n$. We denote by C_n the set of R -codes of size n .

Notation 4.2.9. In order to make the difference between the rook 1234 and the code 1234, we make the convention to write code in sans-serif font.

Example 4.2.10. $m(12836427) = 5$: there is no negative letter, thus it only increments on integers 1, 2, 3, 4 and 2 in this order. $m(364\bar{4}294\bar{3}52538) = 6$. Indeed, the last negative letter is -3 , thus $m(364\bar{4}294\bar{3}) = 3$ and it increments on letters 2, 5 and 3 in this order. Similarly, $m(021\bar{1}1254) = 4$.

Example 4.2.11. Here are the first R -codes: $C_1 = \{0, 1\}$, $C_2 = \{00, 01, 02, 1\bar{1}, 10, 11, 12\}$ and

$$C_3 = \{000, 001, 002, 003, 01\bar{1}, 010, 011, 012, 013, 020, 021, 022, 023, 1\bar{1}\bar{1}, 1\bar{1}0, 1\bar{1}1, 1\bar{1}2, 1\bar{1}3, 100, 101, 102, 103, 11\bar{2}, 11\bar{1}, 110, 111, 112, 113, 12\bar{2}, 12\bar{1}, 120, 121, 122, 123\}.$$

The R -codes of C_9 with prefix $021\bar{1}1254$ are $021\bar{1}1254\bar{4}$, $021\bar{1}1254\bar{3}$, \dots , $021\bar{1}12549$.

Remark 4.2.12. If $c \in C_n$, then necessarily we have $m(c) \leq \ell(c)$.

Definition 4.2.13. We note FZ (standing for *First Zero*) the function defined for any rook $r = r_1 \dots r_n$ by

$$FZ(r) := \min\{j \leq n \mid r_j = 0\} - 1, \tag{4.9}$$

with the convention that if there is no zero among the r_j (that is r is in fact a permutation), we set $FZ(r) = n$.

We now show that code is a bijection between R -codes and rook vectors of the same length.

Proposition 4.2.14. If $r \in R_n$ then $\text{code}(r) \in C_n$ and $FZ(r) = m(\text{code}(r))$.

Proof. We show the result by induction on n : it is trivial for $n = 0$. We now show the induction step, assuming that it holds for $n - 1$. Let $r \in R_n$. Let us first prove the case $n \in r$. We then write $r = \underline{bn}\underline{e}$ and $r' = \underline{be}$. By induction $\text{code}(r') \in C_{n-1}$ and $\text{code}(r) = \text{code}(r') \cdot (\ell(\underline{b}) + 1)$ with $(\ell(\underline{b}) + 1) \in \llbracket 1, n \rrbracket \subset \llbracket -m(\text{code}(r')), n \rrbracket$ so that $r \in R_n$.

The only remaining case is $n \notin r$. We write $r = \underline{b0}\underline{e}$ with $0 \notin \underline{b}$, $r' = \underline{be}$. By induction $\text{code}(r') \in C_{n-1}$ and $\text{code}(r) = \text{code}(r') \cdot -\ell(\underline{b})$. By definition of FZ we have $\ell(\underline{b}) = FZ(r')$, and $FZ(r') = m(\text{code}(r'))$ by induction. So $-\ell(\underline{b}) \in \llbracket -m(\text{code}(r')), 0 \rrbracket \subset \llbracket -m(\text{code}(r')), n \rrbracket$ and so $r \in R_n$.

We have proven the first part of the statement in every case. Let us now focus on the second part. First of all, if $0 \notin r$, then r is a permutation and its code $c_1 \dots c_n$ is such that $0 < c_i \leq i$. As a consequence $m(\text{code}(r)) = n = FZ(r)$.

We finally need to prove that when $0 \in r$ then $FZ(r) = m(\text{code}(r))$, knowing by induction that $FZ(r') = m(\text{code}(r'))$. We distinguish the two nontrivial cases:

- If $n \in r$ then $r = \underline{bn}\underline{e}$ and $r' = \underline{be}$. The number of 0 of r is the same that r' . We have two possibilities:
 - If $0 \notin \underline{b}$ then the first zero of r' is in \underline{e} . Thus $FZ(r) = FZ(r') + 1$. But also $\text{code}(r) = \text{code}(r') \cdot (\ell(\underline{b}) + 1)$ with $\ell(\underline{b}) + 1 \leq m(\text{code}(r')) = FZ(r')$. So, by definition of m , $m(\text{code}(r)) = m(\text{code}(r')) + 1$. Hence the equality.

- If $0 \in \underline{b}$ then $\text{FZ}(r) = \text{FZ}(r')$. Furthermore $m(\text{code}(r)) = m(\text{code}(r'))$ by definition of m . So that we get $\text{FZ}(r) = \text{FZ}(r') = m(\text{code}(r')) = m(\text{code}(r))$.
- If $n \notin r$, then $r = \underline{b0e}$ with $0 \notin \underline{b}$, $r' = \underline{be}$ and $\text{code}(r) = \text{code}(r') \cdot -\ell(\underline{b})$. Since $0 \notin \underline{b}$ we have $\text{FZ}(r) = \ell(\underline{b})$. We write $\text{code}(r) = \mathbf{c}_1 \dots \mathbf{c}_n$ then $\text{FZ}(r) = -\mathbf{c}_n$ by definition of code . Furthermore $m(\text{code}(r)) = -\mathbf{c}_n$ so that $\text{FZ}(r) = m(\text{code}(r))$. \square

We now define a candidate for the converse bijection.

Definition 4.2.15. For $\mathbf{c} = \mathbf{c}_1 \dots \mathbf{c}_n \in C_n$, we define inductively a vector $\text{decode}(\mathbf{c})$ as follows: first, set $\text{decode}(\varepsilon) := \varepsilon$. Then, let $r' := \text{decode}(\mathbf{c}_1 \dots \mathbf{c}_{n-1})$. If \mathbf{c}_n is nonnegative, insert the letter n in r' at the position \mathbf{c}_n . Otherwise insert 0 at $-\mathbf{c}_n + 1$.

Proposition 4.2.16. If $\mathbf{c} \in C_n$ then $\text{decode}(\mathbf{c}) \in R_n$.

Proof. It is clear that we get a rook, since only 0 can be repeated. The size is also clear. \square

Example 4.2.17. Let $\mathbf{c} = 11\bar{1}20$. Then $\text{decode}(1) = 1$. $\text{decode}(11) = 21$. $\text{decode}(11\bar{1}) = 201$. $\text{decode}(11\bar{1}2) = 2401$. Finally $\text{decode}(11\bar{1}20) = 02401$.

Proposition 4.2.18. Let $\mathbf{c} = \mathbf{c}_1 \dots \mathbf{c}_n \in C_n$. Then $\text{FZ}(\text{decode}(\mathbf{c})) = m(\mathbf{c})$. In particular, if $\mathbf{c}_n \leq 0$, $\text{FZ}(\text{decode}(\mathbf{c})) = -\mathbf{c}_n$.

Proof. We prove it by induction on n . The assertion is clear for words of length 0 . Otherwise, assume that we have proved the result for all words of length strictly less than n . Let $\mathbf{b} := \mathbf{c}_1 \dots \mathbf{c}_{n-1}$.

- If $\mathbf{c}_n > 0$:

By induction $\text{FZ}(\text{decode}(\mathbf{b})) = m(\mathbf{b})$. But $\text{FZ}(\text{decode}(\mathbf{c})) = \text{FZ}(\text{decode}(\mathbf{b})) + 1$ if $\mathbf{c}_n \leq \text{FZ}(\text{decode}(\mathbf{b})) + 1$ and $\text{FZ}(\text{decode}(\mathbf{c})) = \text{FZ}(\text{decode}(\mathbf{b}))$ otherwise. By definition of function m we get $\text{FZ}(\text{decode}(\mathbf{c})) = m(\mathbf{c})$.

- If $\mathbf{c}_n \leq 0$ we have two possibilities:

- If $\forall i \leq n-1, \mathbf{c}_i > 0$ then $0 \notin \text{decode}(\mathbf{b})$ by definition, and so $\text{decode}(\mathbf{c})$ has a single zero which is the one inserted between $\text{decode}(\mathbf{b})$ and $\text{decode}(\mathbf{c})$, and is thus at position $(-\mathbf{c}_n + 1) - 1 = m(\mathbf{c})$.
- Otherwise, by induction $m(\mathbf{b}) = \text{FZ}(\text{decode}(\mathbf{b}))$. By definition of m , $m(\mathbf{c}) = -\mathbf{c}_n$. By definition of R -codes we get $-\mathbf{c}_n \leq m(\mathbf{b}) = \text{FZ}(\text{decode}(\mathbf{b}))$. Thus the zero inserted at position $-\mathbf{c}_n + 1$ is left to the former first zero. Finally $\text{FZ}(\text{decode}(\mathbf{c})) = -\mathbf{c}_n = m(\mathbf{c})$. \square

Theorem 4.2.19. The functions code and decode are inverse one from the other: for all $\mathbf{c} \in C_n$ and $r \in R_n$ then

$$\text{code}(\text{decode}(\mathbf{c})) = \mathbf{c} \quad \text{and} \quad \text{decode}(\text{code}(r)) = r. \quad (4.10)$$

Proof. We proceed by induction on the size n of r and \mathbf{c} . The result is clear if $n = 0$. Assume now that we have proved the result up to $n - 1$. We begin with rooks. Let $r \in R_n$.

- If $n \in r$, write $r = \underline{bn\underline{e}}$ and $r' = \underline{be}$ with $\text{decode}(\text{code}(r')) = r'$ by induction. Since $\text{code}(r) = \text{code}(r') \cdot (\ell(\underline{b}) + 1)$, $\text{code}(r)$ is the word $\text{code}(r')$ with the position of n as final letter. Since $\text{decode}(\text{code}(r))$ inserts in $\text{decode}(\text{code}(r')) = r'$ the n at this position, we have the result.
- Otherwise $\text{code}(r)$ is the word $\text{code}(r')$ with at the end the opposite of the position minus 1 of the first zero of r . But $\text{decode}(\text{code}(r))$ insert a zero in $\text{decode}(\text{code}(r')) = r'$ at this position.

We now do the proof for R -codes in a similar way: Let $\mathbf{c} = c_1 \dots c_n \in C_n$ and $\mathbf{c}' = c_1 \dots c_{n-1}$, and assume that $\text{code}(\text{decode}(\mathbf{c}')) = \mathbf{c}'$.

- If $c_n > 0$ then $\text{decode}(\mathbf{c})$ inserts in $\text{decode}(\mathbf{c}')$ a letter n at position c_n . Computing further $\text{code}(\text{decode}(\mathbf{c}))$ adds at the end of $\text{code}(\text{decode}(\mathbf{c}')) = \mathbf{c}'$ this position.
- Otherwise, $\text{decode}(\mathbf{c})$ insert in $\text{decode}(\mathbf{c}')$ a letter 0 in position $-c_n + 1$. Since it is the first zero of $\text{decode}(\mathbf{c})$ by Proposition 4.2.18, $\text{code}(\text{decode}(\mathbf{c}))$ add c_n at the end of $\text{code}(\text{decode}(\mathbf{c}')) = \mathbf{c}'$. \square

In particular, there are as many R -codes of size n as rooks:

Corollary 4.2.20. *For all n : $|C_n| = |R_n|$.*

4.2.2 Counting rook according to the position of the first 0

This subsection is a little detour through enumerative combinatorics and permutations statistics. It is interesting to count rooks of size n according to the position of the first zero. We denote $R(n, k) := \{r \in R_n \mid \text{FZ}(r) = k\}$ and $r(n, k) := |R(n, k)|$. Here are the first values:

n/k	0	1	2	3	4	5	6	7
0	1							
1	1	1						
2	3	2	2					
3	13	9	6	6				
4	73	52	36	24	24			
5	501	365	260	180	120	120		
6	4051	3006	2190	1560	1080	720	720	
7	37633	28357	21042	15330	10920	7560	5040	5040

For example, here are the rooks of size 2 sorted according to their first zero:

$$R(2, 0) = \{00, 01, 02\}, \quad R(2, 1) = \{10, 20\}, \quad R(2, 2) = \{12, 21\}$$

Lemma 4.2.21. *The sequence $r(n, k)$ verifies the following recurrence relation for $n > 0$:*

$$r(n, k) = k r(n-1, k-1) + (n-k-1)r(n-1, k) + \sum_{i=k}^n r(n-1, i), \quad (4.11)$$

with the convention that $r(n, k) = 0$ if $k < 0$ or $k > n$.

Proof. To get the set of rooks of size n from the set of rooks of size $n-1$, one has either to insert n or to insert a 0. To make sure to get each rook only once, one has to insert 0 only before the first zero. According to the definition of FZ, in what follows, positions are counted starting with 0. Then

- $k \cdot r(n-1, k-1)$ is the number of rooks where n is (and therefore was inserted) before position FZ.
- $k(n-k-1)r(n-1, k)$ is the number of rooks where n is after the first 0.
- $\sum_{i=k}^n r(n-1, i)$ is the number of rooks where n doesn't appear. They are obtained by inserting a 0 in position k , in a rook r such that $i := \text{FZ}(r) \geq k$. \square

One recognizes the triangle A206703 of [Slo15]. It is defined as the number $C(n, k)$ of the injective partial function on $\llbracket 1, n \rrbracket$ where the union the cycle supports has cardinality k . Recall that a rook vector $r = (r_1, \dots, r_n)$ can be seen as an injective partial function by setting $r(i) = r_i$ if $r_i \neq 0$ and $r(i)$ is undefined otherwise. We consider the generalization of the notion of cycle of permutations to rooks (See [FS09, Example II.21, page 132]), this combinatorics was studied in details in [GM06]: the sequence of the iterated images $(r^n(i))_{n \in \mathbb{N}}$ of some integer i under r can have one of the two following behaviors:

- Either for some $n \geq 1$ one has $r^n(i) = i$ (the sequence must be periodic and not only ultimately periodic because of injectivity). We say that i belongs to a *cycle* of r .
- Or starting from some $n \geq 1$ the iterated image $r^n(i)$ stops being defined; we say that i belongs to a *chain* of r .

Rooks can therefore be decomposed as two sets: the set of its cycles (counting fixed points) and the set of its maximal chains, that is maximal finite sequences (c_1, \dots, c_k) such that $r(c_i) = c_{i+1}$ if $i < k$ and undefined otherwise. Clearly, the *supports* of the cycles and the chains of the rook r form a partition of $\llbracket 1, n \rrbracket$.

Example 4.2.22. Consider the rook vector $r = 205109706$, it corresponds to the function

$$\begin{pmatrix} 1 & 2 & 3 & 4 & 5 & 6 & 7 & 8 & 9 \\ 2 & \perp & 5 & 1 & \perp & 9 & 7 & \perp & 6 \end{pmatrix},$$

where \perp means undefined. It has two cycles $(6, 9)$ and (7) and three maximal chains $(4, 1, 2)$, $(3, 5)$ and (8) .

Proposition 4.2.23. *Let $C(n, k)$ be the set of rooks of size n where the union of cycle supports has cardinality k , and denote by $c(n, k)$ its cardinality. Then $c(n, k) = r(n, k)$ for all k and n .*

We show here the rooks of size 2 sorted according to their number of points in a cycle:

$$C(2, 0) = \{00, 01, 20\}, \quad C(2, 1) = \{10, 02\}, \quad C(2, 2) = \{12, 21\}$$

Proof. We define a bijection Φ from $C(n, k)$ to $R(n, k)$. It is an adaptation of Foata fundamental transformation seen in Section 1.1.7. For $r \in C(n, k)$, write its cycles starting from the smallest elements and sort the set of cycles according to their smallest element in decreasing order. By concatenating those words one obtains a first word $\text{CycleW}(r)$. Second, write the maximal chain backward replacing the last element of the chain (now the first of the word) by a 0 and sort the chains according to their last element in increasing order. By concatenating those words one obtains a second word $\text{ChainW}(r)$. Now define $\Phi(r) := \text{CycleW}(r) \cdot \text{ChainW}(r)$. Then $\Phi(r)$ is a rook of size n whose first zero is in position k , so that $\Phi(r) \in R(n, k)$.

We now explain how to recover r from $s := \Phi(r)$, that is the converse bijection: cut s at the places just before the zeros replacing those zeros by the values missing in s in increasing order. The various words obtained except the first one are the (reversed) chains of r . On recover the cycle of r by cutting the first word before the *lower records* (elements that are only preceded by larger ones) and interpret each part as a cycle. Knowing all the chains and cycles of r is sufficient to recover r . \square

Example 4.2.24. We get back to Example 4.2.22. The rook vector $r = 205109706$ has cycles (6, 9) and (7) and chains (4, 1, 2), (3, 5) and (8). Therefore we deduce $\text{CycleW}(r) = 769$ and $\text{ChainW}(r) = 014030$, so that $\Phi(r) = 769014030$.

To demonstrate the computation of the inverse, we start with 769014030. The missing numbers are {2, 5, 8}. Replacing the zeros by them and cutting gives 769|214|53|8. So that we already got the chains (4, 1, 2), (3, 5) and (8). Now the word 769 is cut as 7|69 recovering the cycles.

Using the so-called symbolic method (See [FS09, Example II.21, page 132]), the decomposition by cycles and chains shows that the generating series is given by

$$\sum_{n,k} r(n, k) \frac{x^n y^k}{n!} = \frac{\exp(x/(1-x))}{1-xy}. \quad (4.12)$$

4.3 Equivalence of the definitions of R_n^0

Thanks to the previously defined R -code, we are now in position to define the canonical reduced word π_c associated to a R -code and thus to a rook. The reader should compare our instruction to Lemma 1.1.13. To define π_c , the following notation is handy:

Notation 4.3.1. For $i, n \in \mathbb{N}$ we will write (with $\pi_0 := P_1$):

$$\boxed{\begin{matrix} n \\ \vdots \\ i \end{matrix}} := \begin{cases} 1 & \text{if } i > n, \\ \pi_n \dots \pi_i & \text{if } 0 \leq i \leq n, \text{ and} \\ \pi_n \dots \pi_1 \pi_0 \pi_1 \dots \pi_i & \text{if } i < 0, \end{cases} \quad \text{and} \quad \boxed{\begin{matrix} n \\ \vdots \\ i \end{matrix}} := \begin{cases} 1 & \text{if } i > n, \\ s_n \dots s_i & \text{if } 0 \leq i \leq n, \\ s_n \dots s_1 \pi_0 s_1 \dots s_i & \text{if } i < 0. \end{cases}$$

A priori $\boxed{\begin{matrix} n \\ \vdots \\ i \end{matrix}} \in G_n^0$ and $\boxed{\begin{matrix} n \\ \vdots \\ i \end{matrix}} \in G_n^1$. Using Φ_0 and Φ_1 of Remark 4.2.2 we will sometimes see them as elements of F_n^0 or F_n^1 .

Definition 4.3.2. For any R -code $\mathbf{c} = c_1 \dots c_n \in C_n$, we define $\pi_{\mathbf{c}} \in G_n^0$ and $s_{\mathbf{c}} \in G_n^1$ by

$$\pi_{\mathbf{c}} := \boxed{\begin{matrix} 0 \\ \vdots \\ c_1 \end{matrix}} \cdot \boxed{\begin{matrix} 1 \\ \vdots \\ c_2 \end{matrix}} \cdot \dots \cdot \boxed{\begin{matrix} n-1 \\ \vdots \\ c_n \end{matrix}}, \quad \text{and} \quad s_{\mathbf{c}} := \boxed{\begin{matrix} 0 \\ \vdots \\ c_1 \end{matrix}} \cdot \boxed{\begin{matrix} 1 \\ \vdots \\ c_2 \end{matrix}} \cdot \dots \cdot \boxed{\begin{matrix} n-1 \\ \vdots \\ c_n \end{matrix}}. \quad (4.13)$$

Example 4.3.3. Let $\mathbf{c} = 11\bar{1}20$. Then:

$$\pi_{\mathbf{c}} = \boxed{\begin{matrix} 0 \\ \vdots \\ 1 \end{matrix}} \cdot \boxed{\begin{matrix} 1 \\ \vdots \\ 1 \end{matrix}} \cdot \boxed{\begin{matrix} 2 \\ \vdots \\ -1 \end{matrix}} \cdot \boxed{\begin{matrix} 3 \\ \vdots \\ 2 \end{matrix}} \cdot \boxed{\begin{matrix} 4 \\ \vdots \\ 0 \end{matrix}} = 1 \cdot \pi_1 \cdot \pi_2 \pi_1 \pi_0 \pi_1 \cdot \pi_3 \pi_2 \cdot \pi_4 \pi_3 \pi_2 \pi_1 \pi_0$$

Going further, let us show how $\pi_{\mathbf{c}}$ acts on the identity rook 12345:

$$\begin{aligned} 12345 \cdot \pi_{\mathbf{c}} &= 12345 \cdot 1 \cdot \pi_1 \cdot \boxed{\begin{matrix} 2 \\ \vdots \\ -1 \end{matrix}} \cdot \boxed{\begin{matrix} 3 \\ \vdots \\ 2 \end{matrix}} \cdot \boxed{\begin{matrix} 4 \\ \vdots \\ 0 \end{matrix}} = 21\mathbf{3}45 \cdot \pi_2 \pi_1 \pi_0 \pi_1 \cdot \boxed{\begin{matrix} 3 \\ \vdots \\ 2 \end{matrix}} \cdot \boxed{\begin{matrix} 4 \\ \vdots \\ 0 \end{matrix}} = \\ &2\mathbf{3}145 \cdot \pi_1 \pi_0 \pi_1 \cdot \boxed{\begin{matrix} 3 \\ \vdots \\ 2 \end{matrix}} \cdot \boxed{\begin{matrix} 4 \\ \vdots \\ 0 \end{matrix}} = \mathbf{3}2145 \cdot \pi_0 \pi_1 \cdot \boxed{\begin{matrix} 3 \\ \vdots \\ 2 \end{matrix}} \cdot \boxed{\begin{matrix} 4 \\ \vdots \\ 0 \end{matrix}} = \mathbf{0}2145 \cdot \pi_1 \cdot \boxed{\begin{matrix} 3 \\ \vdots \\ 2 \end{matrix}} \cdot \boxed{\begin{matrix} 4 \\ \vdots \\ 0 \end{matrix}} = \\ &2\mathbf{0}145 \cdot \pi_3 \pi_2 \cdot \boxed{\begin{matrix} 4 \\ \vdots \\ 0 \end{matrix}} = 24\mathbf{0}15 \cdot \pi_4 \pi_3 \pi_2 \pi_1 \pi_0 = \mathbf{0}24\mathbf{0}1 = \text{decode}(\mathbf{c}). \end{aligned}$$

We see that the i -th column of $\pi_{\mathbf{c}}$ places the letter i (or the corresponding zero), at its place, effectively decoding \mathbf{c} . This is actually a general fact and it is also true replacing π_i by s_i :

Proposition 4.3.4. If $r \in R_n$ then $1_n \cdot \pi_{\text{code}(r)} = 1_n \cdot s_{\text{code}(r)} = r$.

Proof. We will prove it by induction on n . It is evident for $n = 0$. Assume that we have proved the result up to step $n - 1$, and let $r \in R_n$.

If $n \in r$ then r writes $r = \underline{b}n\underline{e}$, $r' = \underline{b}\underline{e}$ and $\text{code}(r) = \text{code}(r') \cdot (\ell(\underline{b}) + 1)$. By definition we have $\pi_{\text{code}(r)} = \pi_{\text{code}(r')} \boxed{\begin{matrix} n \\ \vdots \\ \ell(\underline{b})+1 \end{matrix}}$. By induction $1_{n-1} \cdot \pi_{\text{code}(r')} = r'$. So $1_n \cdot \pi_{\text{code}(r')} = r'n = \underline{b}en$, since $\pi_{\text{code}(r')}$ only acts on the first $n - 1$ coordinates. Since $0 < \ell(\underline{b}) + 1 \leq n$, a direct calculation gives us $\underline{b}en \cdot \boxed{\begin{matrix} n \\ \vdots \\ \ell(\underline{b})+1 \end{matrix}} = \underline{b}n\underline{e} = r$. So $1_n \cdot \pi_{\text{code}(r)} = r$.

Otherwise $n \notin r$. Then r writes $r = \underline{b}0\underline{e}$ with $0 \notin \underline{b}$, $r' = \underline{b}\underline{e}$ and $\text{code}(r) = \text{code}(r') \cdot -\ell(\underline{b})$. We get in the exact same way $1_n \cdot \pi_{\text{code}(r')} = r'n = \underline{b}en$. Since $-\ell(\underline{b}) \leq 0$, a simple calculation gives us $\underline{b}en \cdot \boxed{\begin{matrix} n \\ \vdots \\ -\ell(\underline{b}) \end{matrix}} = \underline{b}0\underline{e} = r$. So $1_n \cdot \pi_{\text{code}(r)} = r$.

The same proof works *mutatis mutandis* for s . \square

Corollary 4.3.5. For all n , $|G_n^0| \geq |F_n^0| \geq |R_n| = |C_n|$ et $|G_n^1| \geq |F_n^1| \geq |R_n| = |C_n|$.

Proof. All the functions $\pi_{\text{code}(r)}$ and $s_{\text{code}(r)}$ for $r \in R_n$ are distinct since they have a distinct action on identity 1_n . We conclude with Corollary 4.2.20 and Remark 4.2.2. \square

The next step is to transfer on R -codes the action on rooks:

Definition 4.3.6. For $\mathbf{c} = c_1 \dots c_n \in C_n$ and $t \in \{\pi_0, \pi_1, \dots, \pi_{n-1}\} \subset G_n^0$ we define $\mathbf{c} \cdot t$ recursively the following way:

If $n = 1$ and $t = \pi_0$ then $\mathbf{c} \cdot t := 0$

Otherwise we proceed by induction depending on the sign of c_n :

Pos. $c_n = i \geq 1$

- a. If $t = \pi_i$ then $\mathbf{c} \cdot t := \mathbf{c}$.
- b. If $t = \pi_{i-1}$ then $\mathbf{c} \cdot t := c_1 \dots c_{n-1}(c_n - 1)$.
- c. If $t = \pi_j$ with $j < i - 1$ then $\mathbf{c} \cdot t := [(c_1 \dots c_{n-1}) \cdot \pi_j] c_n$
- d. If $t = \pi_j$ with $j > i$ then $\mathbf{c} \cdot t := [(c_1 \dots c_{n-1}) \cdot \pi_{j-1}] c_n$

Neg. $c_n = -i \leq 0$

- a. If $t = \pi_i$ then $\mathbf{c} \cdot t := \mathbf{c}$
- b. If $t = \pi_j$ with $0 < j < i$ then $\mathbf{c} \cdot t := [(c_1 \dots c_{n-1}) \cdot \pi_j] c_n$.
- c. If $t = \pi_j$ with $j > i + 1$ then $\mathbf{c} \cdot t := [(c_1 \dots c_{n-1}) \cdot \pi_{j-1}] c_n$.
- d. If $t = \pi_0$ then $\mathbf{c} \cdot t := [(c_1 \dots c_{n-1}) \cdot \pi_0 \dots \pi_{i-1}] 0$. (In particular $\mathbf{c} \cdot t = \mathbf{c}$ if $i = 0$.)
- e. If $t = \pi_{i+1}$ (thus $i \neq n$) we have two possibilities:
 - α . If $m(c_1 \dots c_{n-1}) = i$ then $\mathbf{c} \cdot t := \mathbf{c}$.
 - β . Otherwise $\mathbf{c} \cdot t := c_1 \dots c_{n-1} \overline{i+1}$.

Lemma 4.3.7. For any code $\mathbf{c} = c_1 \dots c_n \in C_n$ and generator $t \in \{\pi_0, \pi_1, \dots, \pi_{n-1}\} \subset G_n^0$, then $\mathbf{c} \cdot t$ is a code of size n .

Proof. We will prove the result by induction on n , and we will prove along the way that $m(\mathbf{c} \cdot t) \geq m(\mathbf{c})$ if $t \neq \pi_0$. It is evident if $n = 1$.

For all subcases of case Pos. of Definition 4.3.6 it is evident that we get a code by induction since the last value is positive which do not lead to difficulties (we add to $c_1 \dots c_{n-1}$ either c_n or $c_n - 1$). The property of function m is clear for subcase a. In b. if $i - 1 \neq 0$ then $c_n - 1 > 0$ so $m(c_1 \dots c_{n-1}(c_n - 1)) \geq m(\mathbf{c})$. In c. the induction gives us $m((c_1 \dots c_{n-1}) \cdot \pi_j) \geq m(c_1 \dots c_{n-1})$ and we conclude with the definition of m to get $m([(c_1 \dots c_{n-1}) \cdot \pi_j] c_n) \geq m(c_1 \dots c_{n-1} c_n)$ (we do the same for d.).

The subcase Neg.a. is clear. We prove subcases Neg.b. and Neg.c. using the induction on the condition of m and the fact that in these two subcases $m(\mathbf{c} \cdot t) = c_n = m(\mathbf{c})$. The subcase Neg.d. is clear by induction (we do not have to prove the condition of m here), as subcase Neg.e. α . The subcase Neg.e. β remains, whose condition gives us $m(c_1 \dots c_{n-1}) > i$ (since $\mathbf{c} \in C_n$) so $\mathbf{c} \cdot t \in C_n$ and $m(\mathbf{c} \cdot t) = i + 1 > m(\mathbf{c}) = i$. \square

It therefore makes sense to apply the decode algorithm to $\mathbf{c} \cdot t$. The crucial fact that motivated the definition of the action on a code is that, for all R -code \mathbf{c}

$$\text{decode}(\mathbf{c} \cdot t) = \text{decode}(\mathbf{c}) \cdot t. \quad (4.14)$$

We could prove this fact right away, by a tedious explicit calculation, distinguishing all cases. We urge the reader who want to understand the motivation of Definition 4.3.6 to do so. For example, in case $\text{Neg.e.}\alpha$, the assumption that $m(\mathbf{c}_1 \dots \mathbf{c}_{n-1}) = i = -\mathbf{c}_n$ shows that, using Proposition 4.2.18, $\text{FZ}(\text{decode}(\mathbf{c}_1 \dots \mathbf{c}_{n-1})) = i$. Therefore $\text{decode}(\mathbf{c}_1 \dots \mathbf{c}_{n-1})$ is of the form

$$\text{decode}(\mathbf{c}_1 \dots \mathbf{c}_{n-1}) = r_1 \dots r_i 0 r_{i+2} \dots r_{n-1} n,$$

where none of the r_j for $j \leq i$ vanish. Decoding further, since $\mathbf{c}_n = -i$, one finds that

$$\text{decode}(\mathbf{c}_1 \dots \mathbf{c}_n) = r_1 \dots r_i 00 r_{i+2} \dots r_{n-1}.$$

So that, $\text{decode}(\mathbf{c}) \cdot \pi_{i+1} = \text{decode}(\mathbf{c})$. That's why, in case $\text{Neg.e.}\alpha$, we defined $\mathbf{c} \cdot \pi_{i+1} := \mathbf{c}$. Instead of doing the proof in all other cases, we will get the properties as a corollary of the much stronger fact that $\pi_{\mathbf{c} \cdot t} \equiv_0 \pi_{\mathbf{c}} t$ using the morphism $\Phi_0 : G_n^0 \rightarrow F_n^0$.

We turn now to the proof of that later statement. It will use intensively the following technical lemma:

Lemma 4.3.8. *If $i > 0$, $k < 0$ and $j < i - 1$ we have the following identities:*

$$\pi_j \begin{bmatrix} i \\ \vdots \\ k \end{bmatrix} = \begin{bmatrix} i \\ \vdots \\ k \end{bmatrix} \pi_j \quad \text{if } 0 < j < |k| \quad \text{and} \quad \pi_j \begin{bmatrix} i \\ \vdots \\ k \end{bmatrix} = \begin{bmatrix} i \\ \vdots \\ k \end{bmatrix} \pi_{j+1} \quad \text{if } j > |k|. \quad (4.15)$$

In particular, by immediate induction:

$$\begin{bmatrix} j \\ \vdots \\ l \end{bmatrix} \cdot \begin{bmatrix} i \\ \vdots \\ k \end{bmatrix} = \begin{bmatrix} i \\ \vdots \\ k \end{bmatrix} \cdot \begin{bmatrix} j \\ \vdots \\ l \end{bmatrix} \quad \text{if } 0 < l \leq j < \min(i, |k|). \quad (4.16)$$

Proof. We will only use relations (RB1 to RB4) of Remark 4.2.2 written according to Corollary 4.1.6. For the first equality we just apply successively in this order RB4, RB2, RB4, RB2 and RB4. For the second we only apply RB4, RB2 and RB4. \square

We may now proceed to the main theorem of this section:

Theorem 4.3.9. *For a code $\mathbf{c} = \mathbf{c}_1 \dots \mathbf{c}_n \in C_n$ and a generator $t \in \{\pi_0, \pi_1, \dots, \pi_{n-1}\} \subset G_n^0$, the congruence $\pi_{\mathbf{c} \cdot t} \equiv_0 \pi_{\mathbf{c}} t$ holds. Furthermore $\ell(\pi_{\mathbf{c} \cdot t}) \leq \ell(\pi_{\mathbf{c}}) + 1$.*

Proof. We will only use the relations of the proof of Lemma 4.3.8. We then prove the theorem by induction on n depending on \mathbf{c}_n and t . The remark on the length can be checked systematically in all the cases, we left it to the reader.

If $n = 1$ and $t = \pi_0$ then $\mathbf{c} \cdot t = 0$. Then $\pi_{\mathbf{c} \cdot t} = \pi_0 = \pi_{\mathbf{c}} t$ by RB1.

Otherwise we write $\mathbf{c}' := \mathbf{c}_1 \dots \mathbf{c}_{n-1}$ and we recall that $\pi_{\mathbf{c}} = \pi_{\mathbf{c}'} \begin{bmatrix} n-1 \\ \vdots \\ \mathbf{c}_n \end{bmatrix}$.

Pos. $c_n = i \geq 1$

- a. If $t = \pi_i$ then $c \cdot t = c$. Then $\pi_{c'} \begin{bmatrix} n-1 \\ \vdots \\ c_n \end{bmatrix} t = \pi_{c'} \pi_{n-1} \dots \pi_i \pi_i \equiv_0 \pi_{c'} \begin{bmatrix} n-1 \\ \vdots \\ c_n \end{bmatrix}$
by [RB1](#).
- b. If $t = \pi_{i-1}$ then $c \cdot t = c'(c_n - 1)$. The relation is just $\pi_{c'} \begin{bmatrix} n-1 \\ \vdots \\ c_n \end{bmatrix} \pi_{i-1} = \pi_{c'} \begin{bmatrix} n-1 \\ \vdots \\ c_n - 1 \end{bmatrix}$.
- c. If $t = \pi_j$ with $j < i - 1$ then $c \cdot t = (c' \cdot \pi_j)c_n$. Then

$$\pi_c t = \pi_{c'} \begin{bmatrix} n-1 \\ \vdots \\ c_n \end{bmatrix} \pi_j \equiv_0 \pi_{c'} \pi_j \begin{bmatrix} n-1 \\ \vdots \\ c_n \end{bmatrix} \equiv_0 \pi_{c'} \pi_j \begin{bmatrix} n-1 \\ \vdots \\ c_n \end{bmatrix} = \pi_{(c' \cdot \pi_j)c_n} = \pi_{c \cdot t}.$$

Indeed, the first congruency is Lemma [4.3.8](#), and the second holds by induction.

- d. If $t = \pi_j$ with $j > i$ then $c \cdot t = (c' \cdot \pi_{j-1})c_n$. We do the same than in Pos.c. using this time Relation [RB2](#) and Relation [RB4](#).

Neg. $c_n = -i \leq 0$

- a. If $t = \pi_i$ we do the same than in Pos.a. with [RB1](#).
- b. If $t = \pi_j$ with $0 < j < i$ we do the same than in Pos.c. with [RB4](#).
- c. If $t = \pi_j$ with $j > i + 1$ we do the same than in Pos.d. with [RB2](#) and [RB4](#).
- d. If $t = \pi_0$ ($i \neq 0$) then $c \cdot t = [(c_1 \dots c_{n-1}) \cdot \pi_0 \dots \pi_{i-1}] 0$. Furthermore

$$\begin{aligned} \begin{bmatrix} n-1 \\ \vdots \\ c_n \end{bmatrix} \pi_0 &= \pi_{n-1} \dots \pi_2 \pi_1 \pi_0 \pi_1 \pi_2 \dots \pi_i \pi_0 \\ &\equiv_0 \pi_{n-1} \dots \pi_2 \pi_1 \pi_0 \pi_1 \pi_0 \pi_2 \dots \pi_i && \text{by RB4} \\ &\equiv_0 \pi_{n-1} \dots \pi_2 \pi_0 \pi_1 \pi_0 \pi_2 \dots \pi_i && \text{by RB3} \\ &\equiv_0 \pi_0 \pi_{n-1} \dots \pi_2 \pi_1 \pi_0 \pi_2 \dots \pi_i = \pi_0 \begin{bmatrix} n-1 \\ \vdots \\ 0 \end{bmatrix} \pi_2 \dots \pi_i && \text{by RB4} \end{aligned}$$

Now using iteratively Lemma [4.3.8](#), one gets

$$\pi_0 \begin{bmatrix} n-1 \\ \vdots \\ 0 \end{bmatrix} \pi_2 \dots \pi_i \equiv_0 \pi_0 \pi_1 \begin{bmatrix} n-1 \\ \vdots \\ 0 \end{bmatrix} \pi_3 \dots \pi_i \equiv_0 \dots \equiv_0 \pi_0 \dots \pi_{i-1} \begin{bmatrix} n-1 \\ \vdots \\ 0 \end{bmatrix}. \quad (4.17)$$

$$\text{Thus } \pi_c \pi_0 \equiv_0 \pi_{c'} (\pi_0 \dots \pi_{i-1}) \begin{bmatrix} n-1 \\ \vdots \\ 0 \end{bmatrix} \equiv_0 \pi_{c' \cdot (\pi_0 \dots \pi_{i-1}) 0} = \pi_{c \cdot \pi_0}.$$

- e. If $t = \pi_{i+1}$ (so $i \neq n$) we have two possibilities:
- α . Either $m(c_1 \dots c_{n-1}) = i$;
- β . Or $m(c_1 \dots c_{n-1}) \neq i$. In this second case $c \cdot t = c' \overline{i+1}$, and we proceeds as in case Pos.b.

The last remaining case is then $c_n = -i \leq 0$ with $t = \pi_{i+1}$ and $m(c_1 \dots c_{n-1}) = i$. In this case we have $c \cdot t = c$.

Let k be the index of the last non-positive $c_k \leq 0$. Since, by hypothesis, $m(c_1 \dots c_{n-1}) = i$, there are $i - |c_k| = i + c_k$ further indexes where the value of m increase, we write them as $k < j_1 < \dots < j_{i+c_k} < n$. In other words, these are the steps of the inductive construction of $\text{decode}(c)$ where the value of FZ change. For each such index j_u , we split the columns of the corresponding decoded word into two parts as

$$\begin{bmatrix} j_u - 1 \\ \vdots \\ c_{j_u} \end{bmatrix} = \begin{bmatrix} j_u - 1 \\ \vdots \\ |c_k| + u + 1 \end{bmatrix} \begin{bmatrix} |c_k| + u \\ \vdots \\ c_{j_u} \end{bmatrix} \quad (4.18)$$

For the other indexes not belonging to the j_u , we consider them as first parts, leaving their second parts empty. Thanks to Lemma 4.3.8, all the second parts commute with the first parts on their right so that:

$$\begin{aligned} \pi_c t &= \pi_{c_1 \dots c_{k-1}} \begin{bmatrix} k-1 \\ \vdots \\ c_k \end{bmatrix} \dots \begin{bmatrix} j_1 - 1 \\ \vdots \\ c_{j_1} \end{bmatrix} \dots \begin{bmatrix} j_2 - 1 \\ \vdots \\ c_{j_2} \end{bmatrix} \dots \begin{bmatrix} j_{i+c_k} - 1 \\ \vdots \\ c_{j_{i+c_k}} \end{bmatrix} \dots \begin{bmatrix} n-1 \\ \vdots \\ -i \end{bmatrix} \pi_{i+1} \\ &= \pi_{c_1 \dots c_{k-1}} \begin{bmatrix} k-1 \\ \vdots \\ c_k \end{bmatrix} \dots \begin{bmatrix} j_1 - 1 \\ \vdots \\ |c_k| + 2 \end{bmatrix} \begin{bmatrix} |c_k| + 1 \\ \vdots \\ c_{j_1} \end{bmatrix} \dots \begin{bmatrix} j_2 - 1 \\ \vdots \\ |c_k| + 3 \end{bmatrix} \begin{bmatrix} |c_k| + 2 \\ \vdots \\ c_{j_2} \end{bmatrix} \dots \begin{bmatrix} j_{i+c_k} - 1 \\ \vdots \\ |c_k| + i + c_k + 1 \end{bmatrix} \begin{bmatrix} |c_k| + i + c_k \\ \vdots \\ c_{j_{i+c_k}} \end{bmatrix} \dots \begin{bmatrix} n-1 \\ \vdots \\ -i-1 \end{bmatrix} \\ &\equiv_0 \pi_{c_1 \dots c_{k-1}} \begin{bmatrix} k-1 \\ \vdots \\ c_k \end{bmatrix} \dots \begin{bmatrix} j_1 - 1 \\ \vdots \\ |c_k| + 2 \end{bmatrix} \dots \begin{bmatrix} j_2 - 1 \\ \vdots \\ |c_k| + 3 \end{bmatrix} \dots \begin{bmatrix} j_{i+c_k} - 1 \\ \vdots \\ i + 1 \end{bmatrix} \dots \begin{bmatrix} n-1 \\ \vdots \\ -i-1 \end{bmatrix} \cdot \begin{bmatrix} |c_k| + 1 \\ \vdots \\ c_{j_1} \end{bmatrix} \begin{bmatrix} |c_k| + 2 \\ \vdots \\ c_{j_2} \end{bmatrix} \dots \begin{bmatrix} i \\ \vdots \\ c_{j_{i+c_k}} \end{bmatrix} \cdot \end{aligned}$$

We similarly further split the column $\begin{bmatrix} k-1 \\ \vdots \\ c_k \end{bmatrix}$ into its negative and positive part, and commute the negative part as

$$\equiv_0 \pi_{c_1 \dots c_{k-1}} \begin{bmatrix} k-1 \\ \vdots \\ 1 \end{bmatrix} \dots \begin{bmatrix} j_1 - 1 \\ \vdots \\ |c_k| + 2 \end{bmatrix} \dots \begin{bmatrix} j_{i+c_k} - 1 \\ \vdots \\ i + 1 \end{bmatrix} \dots \pi_0 \pi_1 \dots \pi_{|c_k|} \begin{bmatrix} n-1 \\ \vdots \\ -i-1 \end{bmatrix} \begin{bmatrix} |c_k| + 1 \\ \vdots \\ c_{j_1} \end{bmatrix} \dots \begin{bmatrix} i \\ \vdots \\ c_{j_{i+c_k}} \end{bmatrix} \cdot$$

We now focus on the product of the the second parts which we call S . Using RB4, and stripping the second parts from their topmost element, we get:

$$\begin{aligned} S &:= \pi_0 \pi_1 \dots \pi_{|c_k|} \begin{bmatrix} n-1 \\ \vdots \\ -i-1 \end{bmatrix} \begin{bmatrix} |c_k| + 1 \\ \vdots \\ c_{j_1} \end{bmatrix} \dots \begin{bmatrix} i \\ \vdots \\ c_{j_{i+c_k}} \end{bmatrix} \\ &\equiv_0 \pi_0 \begin{bmatrix} n-1 \\ \vdots \\ -i-1 \end{bmatrix} \pi_1 \dots \pi_{|c_k|} \pi_{|c_k|+1} \dots \pi_i \begin{bmatrix} |c_k| \\ \vdots \\ c_{j_1} \end{bmatrix} \dots \begin{bmatrix} i-1 \\ \vdots \\ c_{j_{i+c_k}} \end{bmatrix} \\ &\equiv_0 \pi_0 \begin{bmatrix} n-1 \\ \vdots \\ 2 \end{bmatrix} \pi_1 \pi_0 \pi_1 \dots \pi_i \pi_{i+1} \pi_1 \dots \pi_{|c_k|} \pi_{|c_k|+1} \dots \pi_i \begin{bmatrix} |c_k| \\ \vdots \\ c_{j_1} \end{bmatrix} \dots \begin{bmatrix} i-1 \\ \vdots \\ c_{j_{i+c_k}} \end{bmatrix} \\ &\equiv_0 \begin{bmatrix} n-1 \\ \vdots \\ 2 \end{bmatrix} \pi_0 \pi_1 \pi_0 \pi_1 \dots \pi_i \pi_{i+1} \pi_1 \dots \pi_i \begin{bmatrix} |c_k| \\ \vdots \\ c_{j_1} \end{bmatrix} \dots \begin{bmatrix} i-1 \\ \vdots \\ c_{j_{i+c_k}} \end{bmatrix} \end{aligned}$$

We can now use RB3 and redistribute the colors:

$$\equiv_0 \begin{bmatrix} n-1 \\ \vdots \\ 2 \end{bmatrix} \pi_0 \pi_1 \pi_0 \pi_2 \dots \pi_{|c_k|+1} \pi_{|c_k|+2} \dots \pi_{i+1} \pi_1 \dots \pi_i \begin{bmatrix} |c_k| \\ \vdots \\ c_{j_1} \end{bmatrix} \dots \begin{bmatrix} i-1 \\ \vdots \\ c_{j_{i+c_k}} \end{bmatrix}$$

Now thanks to Lemma 4.3.8:

$$\begin{aligned}
 &\equiv_0 \pi_0 \begin{bmatrix} n-1 \\ \vdots \\ 1 \end{bmatrix} \pi_2 \dots \pi_{|c_k|+1} \pi_{|c_k|+2} \dots \pi_{i+1} \pi_0 \pi_1 \dots \pi_i \begin{bmatrix} |c_k| \\ \vdots \\ c_{j_i} \end{bmatrix} \dots \begin{bmatrix} i-1 \\ \vdots \\ c_{j_i+c_k} \end{bmatrix} \\
 &\equiv_0 \pi_0 \pi_1 \dots \pi_{|c_k|} \pi_{|c_k|+1} \dots \pi_i \begin{bmatrix} n-1 \\ \vdots \\ 1 \end{bmatrix} \pi_0 \pi_1 \dots \pi_i \begin{bmatrix} |c_k| \\ \vdots \\ c_{j_i} \end{bmatrix} \dots \begin{bmatrix} i-1 \\ \vdots \\ c_{j_i+c_k} \end{bmatrix} \\
 &= \pi_0 \pi_1 \dots \pi_{|c_k|} \pi_{|c_k|+1} \dots \pi_i \begin{bmatrix} n-1 \\ \vdots \\ -i-1 \end{bmatrix} \begin{bmatrix} |c_k| \\ \vdots \\ c_{j_i} \end{bmatrix} \dots \begin{bmatrix} i-1 \\ \vdots \\ c_{j_i+c_k} \end{bmatrix}
 \end{aligned}$$

Going back to the main computation we can undo the splitting of Equation 4.18:

$$\begin{aligned}
 \pi_c t &\equiv_0 \pi_{c_1 \dots c_{k-1}} \begin{bmatrix} k-1 \\ \vdots \\ 1 \end{bmatrix} \dots \begin{bmatrix} j_1-1 \\ \vdots \\ |c_k|+2 \end{bmatrix} \dots \begin{bmatrix} j_i+c_k-1 \\ \vdots \\ i+1 \end{bmatrix} \pi_0 \pi_1 \dots \pi_{|c_k|} \pi_{|c_k|+1} \dots \pi_i \begin{bmatrix} n-1 \\ \vdots \\ -i-1 \end{bmatrix} \begin{bmatrix} |c_k| \\ \vdots \\ c_{j_i} \end{bmatrix} \dots \begin{bmatrix} i-1 \\ \vdots \\ c_{j_i+c_k} \end{bmatrix} \\
 &\equiv_0 \pi_{c_1 \dots c_{k-1}} \begin{bmatrix} k-1 \\ \vdots \\ c_k \end{bmatrix} \dots \begin{bmatrix} j_1-1 \\ \vdots \\ |c_k|+1 \end{bmatrix} \dots \begin{bmatrix} j_i+c_k-1 \\ \vdots \\ i \end{bmatrix} \dots \begin{bmatrix} n-1 \\ \vdots \\ -i \end{bmatrix} \cdot \begin{bmatrix} |c_k| \\ \vdots \\ c_{j_i} \end{bmatrix} \dots \begin{bmatrix} i-1 \\ \vdots \\ c_{j_i+c_k} \end{bmatrix} \text{ by RB4} \\
 &\equiv_0 \pi_{c_1 \dots c_{k-1}} \begin{bmatrix} k-1 \\ \vdots \\ c_k \end{bmatrix} \dots \begin{bmatrix} j_1-1 \\ \vdots \\ c_{j_i} \end{bmatrix} \dots \begin{bmatrix} j_i+c_k-1 \\ \vdots \\ c_{j_i+c_k} \end{bmatrix} \dots \begin{bmatrix} n-1 \\ \vdots \\ -i \end{bmatrix} \text{ by Lemma 4.3.8.}
 \end{aligned}$$

So that we have proved that $\pi_c t = \pi_c$ in the last remaining case.

As told at the beginning of the proof, the remark on the length has been checked through all cases. \square

Example 4.3.10. Since this last calculation is huge using specific notations, we now give an explicit example of calculation in case Neg.e. α . We take $c = 1234\bar{2}126\bar{4}$. Then, with $t = \pi_5$:

$$\begin{aligned}
 \pi_c t &= \begin{bmatrix} 4 \\ \vdots \\ -2 \end{bmatrix} \cdot \begin{bmatrix} 5 \\ \vdots \\ 1 \end{bmatrix} \cdot \begin{bmatrix} 6 \\ \vdots \\ 2 \end{bmatrix} \cdot \begin{bmatrix} 7 \\ \vdots \\ 6 \end{bmatrix} \cdot \begin{bmatrix} 8 \\ \vdots \\ -4 \end{bmatrix} \pi_5 \\
 &\equiv_0 \begin{bmatrix} 4 \\ \vdots \\ -2 \end{bmatrix} \cdot \begin{bmatrix} 5 \\ \vdots \\ 4 \end{bmatrix} \cdot \begin{bmatrix} 6 \\ \vdots \\ 5 \end{bmatrix} \cdot \begin{bmatrix} 7 \\ \vdots \\ 6 \end{bmatrix} \cdot \begin{bmatrix} 8 \\ \vdots \\ -5 \end{bmatrix} \cdot \begin{bmatrix} 3 \\ \vdots \\ 1 \end{bmatrix} \cdot \begin{bmatrix} 4 \\ \vdots \\ 2 \end{bmatrix} \text{ by RB4 and Lemma 4.3.8} \\
 &\equiv_0 \begin{bmatrix} 4 \\ \vdots \\ 0 \end{bmatrix} \cdot \begin{bmatrix} 5 \\ \vdots \\ 4 \end{bmatrix} \cdot \begin{bmatrix} 6 \\ \vdots \\ 5 \end{bmatrix} \cdot \begin{bmatrix} 7 \\ \vdots \\ 6 \end{bmatrix} \cdot \begin{bmatrix} 8 \\ \vdots \\ -5 \end{bmatrix} \cdot \pi_1 \pi_2 \pi_3 \pi_4 \cdot \begin{bmatrix} 2 \\ \vdots \\ 1 \end{bmatrix} \cdot \begin{bmatrix} 3 \\ \vdots \\ 2 \end{bmatrix} \text{ by RB4} \\
 &\equiv_0 \begin{bmatrix} 4 \\ \vdots \\ 1 \end{bmatrix} \cdot \begin{bmatrix} 5 \\ \vdots \\ 4 \end{bmatrix} \cdot \begin{bmatrix} 6 \\ \vdots \\ 5 \end{bmatrix} \cdot \begin{bmatrix} 7 \\ \vdots \\ 6 \end{bmatrix} \cdot \begin{bmatrix} 8 \\ \vdots \\ 2 \end{bmatrix} \cdot \pi_0 \pi_1 \pi_0 \pi_1 \pi_2 \pi_3 \pi_4 \pi_5 \pi_1 \pi_2 \pi_3 \pi_4 \cdot \begin{bmatrix} 2 \\ \vdots \\ 1 \end{bmatrix} \cdot \begin{bmatrix} 3 \\ \vdots \\ 2 \end{bmatrix} \text{ by RB4} \\
 &\equiv_0 \begin{bmatrix} 4 \\ \vdots \\ 1 \end{bmatrix} \cdot \begin{bmatrix} 5 \\ \vdots \\ 4 \end{bmatrix} \cdot \begin{bmatrix} 6 \\ \vdots \\ 5 \end{bmatrix} \cdot \begin{bmatrix} 7 \\ \vdots \\ 6 \end{bmatrix} \cdot \begin{bmatrix} 8 \\ \vdots \\ 2 \end{bmatrix} \cdot \pi_0 \pi_1 \pi_0 \pi_2 \pi_3 \pi_4 \pi_5 \pi_1 \pi_2 \pi_3 \pi_4 \cdot \begin{bmatrix} 2 \\ \vdots \\ 1 \end{bmatrix} \cdot \begin{bmatrix} 3 \\ \vdots \\ 2 \end{bmatrix} \text{ by RB3 and redistributing.} \\
 &\equiv_0 \begin{bmatrix} 4 \\ \vdots \\ 1 \end{bmatrix} \cdot \begin{bmatrix} 5 \\ \vdots \\ 4 \end{bmatrix} \cdot \begin{bmatrix} 6 \\ \vdots \\ 5 \end{bmatrix} \cdot \begin{bmatrix} 7 \\ \vdots \\ 6 \end{bmatrix} \cdot \pi_0 \pi_1 \pi_2 \pi_3 \pi_4 \cdot \begin{bmatrix} 8 \\ \vdots \\ 2 \end{bmatrix} \cdot \pi_1 \pi_0 \pi_1 \pi_2 \pi_3 \pi_4 \cdot \begin{bmatrix} 2 \\ \vdots \\ 1 \end{bmatrix} \cdot \begin{bmatrix} 3 \\ \vdots \\ 2 \end{bmatrix} \text{ by RB2 and RB4} \\
 &\equiv_0 \begin{bmatrix} 4 \\ \vdots \\ -2 \end{bmatrix} \cdot \begin{bmatrix} 5 \\ \vdots \\ 3 \end{bmatrix} \cdot \begin{bmatrix} 6 \\ \vdots \\ 4 \end{bmatrix} \cdot \begin{bmatrix} 7 \\ \vdots \\ 6 \end{bmatrix} \cdot \begin{bmatrix} 8 \\ \vdots \\ -4 \end{bmatrix} \cdot \begin{bmatrix} 2 \\ \vdots \\ 1 \end{bmatrix} \cdot \begin{bmatrix} 3 \\ \vdots \\ 2 \end{bmatrix} \equiv_0 \begin{bmatrix} 4 \\ \vdots \\ -2 \end{bmatrix} \cdot \begin{bmatrix} 5 \\ \vdots \\ 1 \end{bmatrix} \cdot \begin{bmatrix} 6 \\ \vdots \\ 2 \end{bmatrix} \cdot \begin{bmatrix} 7 \\ \vdots \\ 6 \end{bmatrix} \cdot \begin{bmatrix} 8 \\ \vdots \\ -4 \end{bmatrix} = \pi_c \text{ by Lemma 4.3.8.}
 \end{aligned}$$

Remark 4.3.11. The Definition 4.3.6, the Lemma 4.3.7 and the Theorem 4.3.9 can be also adapted to the case of G_n^1 , using the transformation $\pi_i \mapsto s_i$ for $i \neq 0$ and $\pi_0 \mapsto \pi_0$. There are only few cases which differ; they are precisely those where relation RB1 is used (with $i \neq 0$), that is case Pos.a. and Neg.a. The modifications in the definition are thus the followings:

Pos.a. $c_n = i > 0$ and $t = s_i$ then $\mathbf{c} \cdot s_i = \mathbf{c}_1 \dots \mathbf{c}_{n-1}(\mathbf{c}_n + 1)$.

Neg.a. $c_n = -i \leq 0$ and $t = s_i$ then $\mathbf{c} \cdot s_i = \mathbf{c}_1 \dots \mathbf{c}_{n-1}(\mathbf{c}_n + 1)$.

The equivalent of Lemma 4.3.7 can be proved the same way. Finally the proof of Theorem 4.3.9 only use the relation $s_i^2 = 1$ in these two cases.

Corollary 4.3.12. *Let 1_n^ζ denote the code of the identity rook of size n . For any $\pi \in G_n^0$ and $s \in G_n^1$, the congruencies $\pi \equiv_0 \pi_{1_n^\zeta \cdot \pi}$ et $s \equiv_1 s_{1_n^\zeta \cdot s}$ hold.*

Proof. We use Theorem 4.3.9 and Remark 4.3.11 at $\mathbf{c} = 1_n^\zeta$ and proceed by induction on the length of the words π or s . \square

We now have an easy proof of the identities that motivated Definition 4.3.6:

Corollary 4.3.13. *For any generator t the following diagram is commutative:*

$$\begin{array}{ccc} R_n & \begin{array}{c} \xrightarrow{\text{code}} \\ \xleftarrow{\text{decode}} \end{array} & C_n \\ \downarrow \cdot t & & \downarrow \cdot t \\ R_n & \begin{array}{c} \xrightarrow{\text{code}} \\ \xleftarrow{\text{decode}} \end{array} & C_n \end{array}$$

Proof. We start by Theorem 4.3.9, $\pi_{\mathbf{c} \cdot t} \equiv_0 \pi_{\mathbf{c}t}$. Now since $\Phi_0 : G_n^0 \rightarrow F_n^0$ is a morphism, we can apply this relation to the rook 1_n . We obtain: $1_n \cdot \pi_{\mathbf{c} \cdot t} = 1_n \cdot (\pi_{\mathbf{c}} t) = (1_n \cdot \pi_{\mathbf{c}}) t$. We conclude thanks to Proposition 4.3.4 and Theorem 4.2.19. \square

Corollary 4.3.14. *The maps $\begin{cases} C_n \twoheadrightarrow G_n^0 \\ c \mapsto \pi_c \end{cases}$ and $\begin{cases} C_n \twoheadrightarrow G_n^1 \\ c \mapsto s_c \end{cases}$ are surjective; the following cardinalities coincide:*

$$|C_n| = |R_n| = |F_n^0| = |G_n^0| = |F_n^1| = |G_n^1|.$$

Moreover, $F_n^0 \simeq G_n^0$, $F_n^1 \simeq G_n^1$ as monoids.

Proof. Using both Remark 4.2.2 and Corollary 4.3.13, we get the following sequence of surjective maps: $C_n \twoheadrightarrow G_n^0 \twoheadrightarrow F_n^0$. Furthermore $|F_n^0| \geq |C_n|$ by Corollary 4.3.5. Consequently $|C_n| = |F_n^0| = |G_n^0|$ and $F_n^0 \simeq G_n^0$ as monoids. \square

Example 4.3.15. Let $r = 240503$ and $t = \pi_0$. Then $r \cdot t = 040503$. Let us check our algorithm.

Firstly $\text{code}(r) = 01323\bar{2}$. Our algorithm gives us the following serie of operations:

$$\begin{aligned} 01323\bar{2} \cdot \pi_0 &= [(01323) \cdot \pi_0 \pi_1] 0 \\ &= [((0132) \cdot \pi_0) 3 \cdot \pi_1] 0 = [((013) \cdot \pi_0) 23 \cdot \pi_1] 0 = [((01) \cdot \pi_0) 323 \cdot \pi_1] 0 \\ &= [00323 \cdot \pi_1] 0 = [0032 \cdot \pi_1] 30 \\ &= 003130 \end{aligned}$$

Finally we really have $\text{decode}(003130) = 040503$.

Now, there is no need to distinguish between the monoids of functions from the presented monoids, since we have the proof that they are isomorphic.

Notation 4.3.16. We denote $R_n^0 := F_n^0 \simeq G_n^0$ the 0-rook monoid.

For any rook r we also denote $\pi_r := \pi_{\text{code}(r)}$.

Corollary 4.3.17. π_r is the unique element of R_n^0 such that $1_n \cdot \pi_r = r$. With the identification $r \leftrightarrow \pi_r$, the action of R_n^0 on R_n is nothing but the right multiplication in R_n^0 : $\pi_r \pi_s = \pi_{r \cdot \pi_s}$.

Proof. The identity $1_n \cdot \pi_r = r$ is Proposition 4.3.4, and π_r is unique thanks to cardinalities. Finally, $1_n \cdot \pi_r \pi_s = (1_n \cdot \pi_r) \cdot \pi_s = r \cdot \pi_s$ and we conclude by unicity. \square

We have, by the way, re-proven the presentation for the classical rook monoid:

Corollary 4.3.18. For all n , We have the following isomorphisms of monoids: $F_n^1 \simeq R_n \simeq G_n^1$.

Proof. The monoid morphism $\left\{ \begin{array}{ccc} \langle s_1, \dots, s_{n-1}, \pi_0 \rangle \subseteq R_n & \longrightarrow & F_n^1 \subseteq \mathcal{F}(R_n, R_n) \\ r & \longmapsto & (r' \mapsto r' \cdot r) \end{array} \right.$ is well-defined, and surjective. By Corollary 4.3.14 we can deduce:

$$\langle s_1, \dots, s_{n-1}, \pi_0 \rangle \simeq R_n \simeq F_n^1.$$

\square

Here is a further immediate consequence of the presentation:

Corollary 4.3.19. The monoid R_n^0 is isomorphic to its opposite.

Proof. It comes from the fact that the relations of the presentation of R_n^0 are symmetrical. \square

4.4 A Matsumoto theorem for rook monoids

We now turn to the specific study of reduced words.

Proposition 4.4.1. The words $s_{\text{code}(r)}$ and $\pi_{\text{code}(r)}$ are reduced expressions (i.e. of minimal length) respectively for $r \in R_n$ and $\pi_r \in R_n^0$.

Proof. Corollary 4.3.12 tells us that every element of R_n and R_n^0 can be written as π_c and s_c for some code c . Moreover, according to Theorem 4.3.9 the rewriting of any word to π_c and s_c only decrease the length. To conclude, we still have to argue that π_c and s_c cannot be obtained with a different shorter code, which is clear from Proposition 4.3.4. \square

Remark 4.4.2. The Corollary 4.3.12 gives us a standard expression for every element of R_n^0 . We can now look back at Lemma 4.1.4 and realize that P_n corresponds to the R -code $00 \dots 0$ (n times), and thus to the action of replacing all the entries by 0.

A final important consequence of our construction is a proof of the analogue of Matsumoto's theorem (Theorem 1.1.15), answering a question of Solomon [Sol04, p. 209, bottom of the middle paragraph]:

Theorem 4.4.3 (Matsumoto theorem for Rook monoids). *If \underline{u} and \underline{v} are two reduced words over $\{\pi_0, s_1, \dots, s_{n-1}\}$ (resp. $\{\pi_0, \pi_1, \dots, \pi_{n-1}\}$) for the same element r of R_n (resp. R_n^0), then they are congruent using only the two Relations [RB2](#) and [RB4](#), namely the braid relations:*

$$s_i s_{i+1} s_i = s_{i+1} s_i s_{i+1} \quad 1 \leq i \leq n-2, \quad (\text{Rs2})$$

$$s_i s_j = s_j s_i \quad |i-j| \geq 2. \quad (\text{Rs3})$$

$$\pi_0 s_j = s_j \pi_0 \quad j \neq 1 \quad (\text{Rs5.1})$$

Respectively:

$$\pi_i \pi_{i+1} \pi_i = \pi_{i+1} \pi_i \pi_{i+1} \quad 1 \leq i \leq n-2, \quad (\text{RB2})$$

$$\pi_i \pi_j = \pi_j \pi_i \quad 0 \leq i, j \leq n-1, \quad |i-j| \geq 2, \quad (\text{RB4})$$

Proof. First of all, we only do the proof at $q = 0$, the $q = 1$ case is done similarly. Moreover, by transitivity, it is sufficient to work in the case where $\underline{v} = \pi_c$ with $c = \text{code}(1_n \cdot r)$. We proceed by induction on the common length ℓ of \underline{u} and \underline{v} . It is obvious when $\ell = 0$. We now consider a reduced word $\underline{v} = \underline{v}'t$ for an element r . Then \underline{v}' is also reduced for an element r' , so that $r't = r$. We assume by induction that \underline{v}' is congruent to $\pi_{c'}$ where $c' := \text{code}(1_n \cdot r')$ using only Relations [RB2](#) and [RB4](#). Therefore $\underline{v}'t$ and $\pi_{c'}t$ are congruent too. In the proof of Theorem 4.3.9, we explicitly gave how to go from $\pi_{c'}t$ to $\pi_{c \cdot t}$. Hence we only need to check that Relations [RB1](#) and [RB3](#) are only used in the case where $\underline{v}'t$ is not reduced that is when the length of $\underline{v}'t$ is larger than the length of $\pi_{c \cdot t}$. This indeed holds, namely, in cases Pos.a., Neg.a which use [RB1](#) on one hand, and cases Neg.d, Neg.e.α which use [RB3](#) on the other hand. \square

As a consequence reduced words for R_n^1 and R_n^0 are the same:

Corollary 4.4.4. *Let $\underline{w}^1 \in G_n^1$ a word for a rook r and \underline{w}^0 its corresponding word in G_n^0 obtained by replacing s_i by π_i and leaving P_1 . Then \underline{w}^1 is reduced if and only if \underline{w}^0 is reduced. Moreover, when they are, for any $k = 0, \dots, |w|$, one has $1_n \cdot w_1^1 \cdots w_k^1 = 1_n \cdot w_1^0 \cdots w_k^0$ and the elements $(1_n \cdot w_1^0 \cdots w_k^0)_{k=0 \dots |w|}$ are all distinct.*

Proof. Any reduced word is congruent by braid relations to a canonical one: s_c and π_c . Moreover, the canonical words corresponds by the exchange $s \leftrightarrow \pi$ and the braid relations keep this correspondence, so that the first statement holds. Now assume that a word \underline{w}^i is reduced. Thanks to Corollary 4.3.17, we know that the sequence of elements are distinct, otherwise it would imply that some products $w_1^i \cdots w_k^i$ are equal for two different values of k leading to a shorter word. Now Equation 4.5, prove the equality. \square

As explained by Solomon [Sol04], this is sufficient to give a presentation of the q -rook algebra. Here is a quick sketch on how to do that: fix a parameter q in a ring

\mathbf{R} and define an endomorphism T_i of $\mathbf{R}R_n$ interpolating between $q = 1$ and $q = 0$ by

$$r \cdot T_i := q(r \cdot s_i) + (1 - q)(r \cdot (\pi_i - 1)), \quad (4.19)$$

for $i = 1, \dots, n - 1$ (where s_i and π_i acts according to Equations 4.3 and 4.5). It is well known [Las03a; LS87] that these operators generate the Hecke algebra. We now consider the algebra generated by those generators plus P_1 defined as in Equation 4.5. Since P_1 commutes with s_i and π_i for $i \geq 2$, it commutes with T_i . Therefore for any rook r , it makes sense to define $T_r := T_{i_1} T_{i_2} \dots P_1 \dots T_{i_k}$ for any reduced word $s_{i_1} P s_{i_2} \dots P_1 \dots s_{i_k}$. Due to the braid relations the result is independent from the chosen reduced word. Moreover for each of those words

$$1 \cdot T_r = r + \text{shorter terms}, \quad (4.20)$$

so that these $(T_r)_{r \in R_n}$ are linearly independent. It finally suffices to add four more relations which explain how to simplify non reduced words. Namely:

$$(T_i + 1)(T_i - q) = 0 \quad (4.21)$$

$$P_1^2 = P_i \quad (4.22)$$

$$(P_1 - 1)T_1(P_1 - 1)T_1 = T_1(P_1 - 1)T_1(P_1 - 1) \quad (4.23)$$

$$P_1(T_1 - q)P_1(T_1(1 - P_1)T_1 - q) = 0 \quad (4.24)$$

We remark that this presentation is true over \mathbb{Z} and therefore over any ring, and not only on fields. As far as we know, this was unknown before.

4.5 More actions of R_n^0

In Definition 4.2.1, we have given a right action of R_n^0 on R_n . It is now clear from Corollary 4.3.17 that this action is nothing but the right multiplication in R_n^0 . Under this action, P_j acts by killing the first j entries:

$$(r_1 \dots r_n) \cdot P_j = 0 \dots 0 r_{j+1} \dots r_n. \quad (4.25)$$

The inverse of a permutation matrix is its transpose. Transposing a rook matrix still gives a rook matrix, so that one can transfer the notion to rook vectors. It is computed as follows: for a rook r , the i -th coordinate of r^t is the position of i in r if $i \in r$, and 0 otherwise. For instance $(105203)^t = 146030$.

Transposing the natural right action, we naturally get a left action of the opposite monoid on rooks. However R_n^0 is isomorphic to its oppose. It is therefore possible to define a left natural action:

Definition 4.5.1. For $0 \leq i \leq n$ and $r = r_1 \dots r_n \in R_n$, define

$$\pi_i \cdot r := (r^t \cdot \pi_i)^t \quad \text{so that} \quad r \cdot \pi_i = (\pi_i \cdot r^t)^t. \quad (4.26)$$

More explicitly, for $0 \leq j \leq n$, we write $j \in r$ if $j \in \{r_1, \dots, r_n\}$. Then for any rook r :

- π_0 replaces 1 by 0 in r if $1 \in r$, and fixes r otherwise.
- For $i > 0$, the action of π_i on r is
 - if $i, i + 1 \in r$, call k and l their respective positions. Then π_i fixes r if $l < k$, otherwise it exchanges i and $i + 1$.
 - if $i \notin r$ and $i + 1 \in r$, then π_i replaces $i + 1$ by i .
 - if $i + 1 \notin r$ then π_i fixes r .

Lemma 4.5.2. *The previous definition is a left monoid action of R_n^0 on R_n called the left natural action. Under this action, P_j acts by replacing the entries smaller than j by 0.*

Example 4.5.3. $\pi_0 \cdot 0342 = 0342$, $\pi_1 \cdot 0342 = 0341$, $\pi_2 \cdot 0342 = 0342$, $\pi_3 \cdot 0342 = 0432$, $\pi_0 \cdot 132 = 032$.

This sheds some light on the link with the type B : it is well known that type B can be realized using signed permutations. The quotient giving the 0-rook monoid can be realized by replacing the negative numbers by zeros.

Proposition 4.5.4. *π_r is the unique element of R_n^0 such that $\pi_r \cdot 1_n = r$. With the identification $r \leftrightarrow \pi_r$, the left action of R_n^0 on R_n is nothing but the left multiplication in R_n^0 : $\pi_r \pi_s = \pi_{\pi_r \cdot s}$.*

Proof. For a rook r , let us call temporarily ${}_r\pi$ the reverse of the word π_{r^t} . Transposing Corollary 4.3.17 we get that ${}_r\pi$ is characterized by ${}_r\pi \cdot 1_n = r$ and ${}_r\pi_s \pi = \pi_{r \cdot s} \pi$. However, at this stage it's not clear that ${}_r\pi = \pi_r$ (as element of R_n^0). Nevertheless, for generators that is words of length 1, the equality ${}_r\pi = \pi_r$ holds. Now given any reduced word $\underline{w} = w_1 \dots w_l$ for an element $x \in R_n^0$, set $r := 1_n \cdot \underline{w} = 1_n \cdot w_1 \cdot w_2 \dots w_l$ so that $x = \pi_r$ in R_n^0 . Since \underline{w} is reduced, using Corollary 4.4.4, one gets that $r = \underline{w}^1$ (the product of the corresponding word in R_n^1 which is nothing but a matrix product). But this gives that $r = \underline{w}^1 \cdot 1_n$ so that using the transpose of Corollary 4.4.4, $r = \underline{w} \cdot 1_n$. By unicity, one concludes that ${}_r\pi = \pi_r$. \square

Corollary 4.5.5. *The natural left and right actions of R_n^0 on R_n commute.*

Proof. Thanks to 4.3.17 and 4.5.4, this is just associativity in R_n^0 . \square

One can also extend the action of H_n^0 by isobaric divided differences on polynomials: the monoid R_n^0 acts also on the polynomials in n indeterminates over any ring k , $k[X_1, \dots, X_n]$ in the following way.

Lemma 4.5.6. *Let $f \in k[X_1, \dots, X_n]$. Define*

$$f \cdot \pi_0 := f|_{X_1=0} = f(0, X_2, \dots, X_n), \quad \text{and} \quad f \cdot \pi_i := \frac{X_i f - (X_i f) \cdot s_i}{X_i - X_{i+1}}. \quad (4.27)$$

This definition is a right monoid action of R_n^0 over $k[X_1, \dots, X_n]$. Under this action,

$$f \cdot P_j = f(0, \dots, 0, X_j, \dots, X_n). \quad (4.28)$$

Proof. It is a well-known fact [LS87] that isobaric divided differences give an action of the Hecke algebra at $q = 0$. It remains only to show the relation $\pi_1 P_1 \pi_1 P_1 = P_1 \pi_1 P_1 = P_1 \pi_1 P_1 \pi_1$. We easily check by an explicit computation that the three members are equals to the operator P_2 defined by $f \cdot P_2 = f(0, 0, X_2, \dots, X_n)$. The action of P_n can be easily obtained by induction with $P_{i+1} = P_i \pi_i P_i$. \square

Actually, there is an extra relation, which can be checked by an explicit computation:

$$f \cdot \pi_1 \pi_0 \pi_1 = f \cdot \pi_0 \pi_1 \pi_0. \quad (4.29)$$

This shows that the monoid which is actually acting is $H^0(A_{n+1})$ (Cartan type A_{n+1}) thanks to the following sequence of surjective morphisms:

$$H^0(B_n) \twoheadrightarrow R_n^0 \twoheadrightarrow H^0(A_{n+1}) \quad (4.30)$$

Finally, we note that it is actually possible to get an action of the full generic q -rook algebra by taking the same definition as Relation 4.19.

Chapter 5

The \mathcal{R} -order on rooks

In this chapter, we seek for combinatorial, order theoretic and geometric analogs of the permutohedron for rooks. Recall from Part I that the right Cayley graph of the symmetric group \mathfrak{S}_n has several interpretations, namely:

- the Hasse diagram of the right weak order of \mathfrak{S}_n seen as a Coxeter group, which is naturally a lattice [GR63];
- the Hasse diagram of Green's \mathcal{R} -order of the 0-Hecke monoid H_n^0 [Den+10];
- the skeleton of the polytope obtained as the convex hull of the set of points whose coordinates are permutations [Zie95, Example 0.10].

As we will see, some of these properties have an analog for rooks.

We first notice an important difference: on the contrary to \mathfrak{S}_n the right order is not graded. This has been already noted for R_2^0 . Indeed in the left part of Figure 5.1 we see two paths from 12 to 00 namely $\pi_0\pi_1\pi_0$ on the left and $\pi_1\pi_0\pi_1\pi_0$ on the right. Starting with $n = 3$ the right order is moreover not isomorphic to its dual order.

5.1 \mathcal{R} -triviality of R_n^0

In this section we study the right Cayley graph of R_n^0 showing that except for loops (edge from a vertex to itself) it is acyclic. In monoid theoretic terminology, one says that R_n^0 is \mathcal{R} -trivial. From Coxeter group point of view, this is the analogue on rook of the (dual) right weak order. Note that the order considered here is different to the (strong) Bruhat order. Its analogue for rook is the subject of [CR12].

Having shown this acyclicity, we will deduce from the symmetry of the relations of R_n^0 that the left sided Cayley graph is also acyclic. By Lemma 1.3.5, this will imply that the two-sided Cayley graph is acyclic too, that is that R_n^0 is actually \mathcal{J} -trivial.

We have seen in Section 2.4.1 that the \mathcal{R} -order of the 0-Hecke monoid is equivalent by definition to the dual right-weak order of the symmetric group seen as a Coxeter group [BB05]. The latter order is just defined by the inclusion of inversions (see Section 1.1.3). Note that, in accord with the monoid convention and contrary

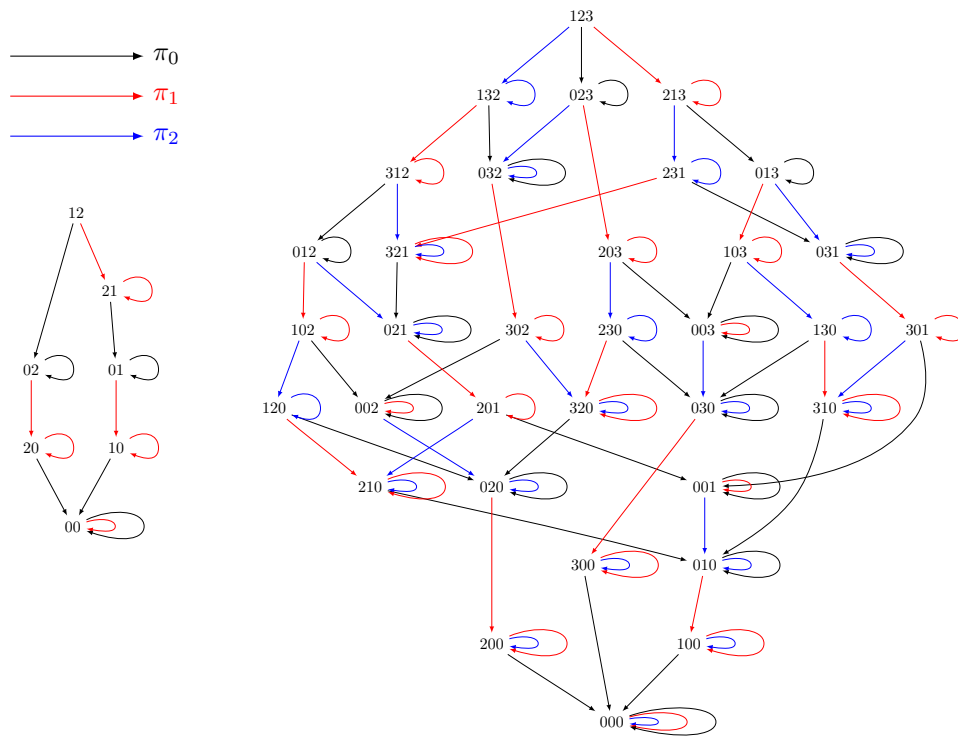

Figure 5.1: The right Cayley graph of R_2^0 and R_3^0 .

to the Coxeter group convention, the identity is the largest element for this order. We now show how this extends to rooks:

Definition 5.1.1. For a rook r , the set of inversions of r is defined by

$$\text{Inv}(r) := \{(r_i, r_j) \mid i < j \text{ and } r_i > r_j > 0\}. \tag{5.1}$$

The support of a rook r denoted $\text{supp}(r)$ the set of non-zero letters appearing in its rook vector. For each letter $\ell \in \text{supp}(r)$, we denote $Z_r(\ell)$ the number of 0 which appear after ℓ in the rook vector of r . We finally say that $(\text{supp}(r), \text{Inv}(r), Z_r)$ is the rook triple associated to r .

Example 5.1.2. For example for $r = 2054001$, one gets $\text{supp}(r) = \{1, 2, 4, 5\}$, together with $\text{Inv}(r) = \{(2, 1), (4, 1), (5, 4), (5, 1)\}$, $Z_r(1) = 0$, $Z_r(2) = 3$ and $Z_r(4) = Z_r(5) = 2$.

We recall from Section 1.1.3 that $\Delta := \{(i, j) \mid i > j, i, j \in [n]\}$. Here is a characterization of the rook triples:

Proposition 5.1.3. A triple (S, I, Z) where $S \subseteq \{1, \dots, n\}$, $I \subseteq \Delta$ and $Z : S \mapsto \mathbb{N}$ is the rook triple of a rook r if and only if:

- $I \subset \Delta \cap S^2$ and I and $(\Delta \cap S^2) \setminus I$ are both transitive.
- for $\ell \in S$, $0 \leq Z(\ell) \leq n - |S|$;

- if $(b, a) \in I$ then $Z(b) \geq Z(a)$ else $Z(b) \leq Z(a)$.

When this holds the rook r is unique.

Proof. We first prove the direct implication. The first statement says that if one erases the zeros from a rook, one gets a permutation of its support. The second statement says that there are $n - |\text{supp}(r)|$ zeros. The third statement says that if a is after b in r , then there are less 0 to the right of a than to the right of b .

Conversely, given such a triple, we can reconstruct a rook r in two steps: the first condition ensures that there is a unique permutation σ of the support S with this inversions set. The third statement says that the function Z is decreasing along the word for σ . As a consequence, writing σ_i^Z the subword of σ composed by the letters ℓ such that $Z(\ell) = i$, one has

$$\sigma = \sigma_{n-|\text{supp}(r)|}^Z \dots \sigma_2^Z \sigma_1^Z \sigma_0^Z. \quad (5.2)$$

Note that some of the σ_i^Z may be empty. Then the rook

$$r = \sigma_{n-|\text{supp}(r)|}^Z 0 \dots 0 \sigma_2^Z 0 \sigma_1^Z 0 \sigma_0^Z. \quad (5.3)$$

is indeed associated with the triple (S, I, Z) and is by construction unique. \square

Example 5.1.4. Going back to Example 5.1.2, consider the following triple with $n = 7$:

$$(S, I, Z) = (\{1, 2, 4, 5\}, \{(2, 1), (4, 1), (5, 4), (5, 1)\}, (\begin{smallmatrix} 1 & 2 & 4 & 5 \\ 0 & 3 & 2 & 2 \end{smallmatrix})) .$$

There is a unique permutation σ of S with inversion set I , namely 2541. Writing $Z(i)$ below i for each letter of σ , we get $(\begin{smallmatrix} 2 & 5 & 4 & 1 \\ 3 & 2 & 2 & 0 \end{smallmatrix})$ and see that Z is indeed decreasing. We then get that $\sigma_3^Z = (2)$, $\sigma_2^Z = (54)$, $\sigma_1^Z = ()$, $\sigma_0^Z = (1)$, so that we recover $r = 2054001$.

Our aim is now to show that the \mathcal{R} -order is actually an order. To do so, we start by defining combinatorially an order $r \leq_I u$, and then show that \leq_I and $\leq_{\mathcal{R}}$ are actually equivalent.

Definition 5.1.5. Let r and $u \in R_n$. We write $r \leq_I u$ if and only if the three following properties holds

- $\text{supp}(r) \subseteq \text{supp}(u)$
- $\{(b, a) \in \text{Inv}(u) \mid b \in \text{supp}(r)\} \subseteq \text{Inv}(r)$
- $Z_u(\ell) \leq Z_r(\ell)$ for $\ell \in \text{supp}(r)$.

Remark 5.1.6. If r and u are permutations, then $\text{supp}(r) = \text{supp}(u) = \{1, \dots, n\}$, so that $r \leq_I u$ if and only if $\text{Inv}(u) \subset \text{Inv}(r)$.

Moreover, as a consequence of the second condition, if $(b, a) \in \text{Inv}(u)$ and $b \in \text{supp}(r)$ then $a \in \text{supp}(r)$. We abstract this fact with the following definition and lemma:

Definition 5.1.7. Let $I \subseteq \Delta$ and $S \subset \llbracket 1, n \rrbracket$. We say that S is *I-compatible* if $(b, a) \in I$ and $b \in S$ implies $a \in S$, for all b, a .

Lemma 5.1.8. If $r \leq_{\mathcal{R}} u$ then $\text{supp}(r)$ is $\text{Inv}(u)$ -compatible.

We will further need the following basic facts about compatibility:

Lemma 5.1.9. The union $S_1 \cup S_2$ of two *I-compatible* sets S_1 and S_2 is *I-compatible*.

If S is I_1 and I_2 -compatible, then it is $I_1 \cup I_2$ -compatible.

If S is *I-compatible* then it is compatible with the transitive closure of I .

Proposition 5.1.10. The set R_n endowed with the relation \leq_I is a poset with maximal element 1_n and minimal element $0_n = 0 \dots 0$.

Proof. The relation \leq_I is reflexive, by definition.

If $r, u \in R_n$ are such that $r \leq_I u$ and $u \leq_I r$ then $\text{supp}(r) = \text{supp}(u)$ and therefore $\text{Inv}(r) = \text{Inv}(u)$ and $Z_r = Z_u$. As a consequence, the non-zero letters appear in the same order in r and u and the zeros are in the same places. Thus \leq_I is antisymmetric.

Let $r \leq_I u \leq_I v$. Then $\text{supp}(r) \subseteq \text{supp}(v)$. Let $(b, a) \in \text{Inv}(v)$ with $b \in \text{supp}(r)$. Necessarily $b \in \text{supp}(u)$ so that $(b, a) \in \text{Inv}(u)$ and consequently $(b, a) \in \text{Inv}(r)$. Finally if $\ell \in \text{supp}(r)$ then $Z_v(\ell) \leq Z_u(\ell) \leq Z_r(\ell)$. Thus \leq_I is transitive. \square

Theorem 5.1.11. Let $r, u \in R_n$. Then $\pi_r \leq_{\mathcal{R}} \pi_u$ if and only if $r \leq_I u$.

Proof. By definition, $\pi_r \leq_{\mathcal{R}} \pi_u$ if there exists $\pi \in R_n^0$ such that $\pi_r = \pi_u \pi$. Using the identification $r \leftrightarrow \pi_r$ of Corollary 4.3.17, this is equivalent to $r = u \cdot \pi$. By abuse of notation in this proof we will therefore write $r \leq_{\mathcal{R}} u$ if there exists $\pi \in R_n^0$ such that $r = u \cdot \pi$.

For the direct implication, by induction and transitivity, it is sufficient to assume that $r = u \cdot \pi_i$ with $r \neq u$ and show $r <_I u$.

- If $i \neq 0$. Then $\text{supp}(u) = \text{supp}(r)$. Since $r \neq u$ we must have $u_i < u_{i+1}$ and also $r = u_1 \dots u_{i+1} u_i \dots u_n$. If $u_i \neq 0$ then $\text{Inv}(r) = \text{Inv}(u) \sqcup \{(u_{i+1}, u_i)\}$ and $Z_r = Z_u$. On the contrary, if $r_i = 0$, then $\text{Inv}(r) = \text{Inv}(u)$ and $Z_r(\ell) = Z_u(\ell)$ for $\ell \neq u_{i+1}$ and $Z_r(u_{i+1}) = Z_u(u_{i+1}) + 1$.
- If $i = 0$. Since $r \neq u$ we have $r_1 \neq 0$ and $u = 0r_2 \dots r_n$. We can deduce that $\text{supp } r = \text{supp } u \cup \{r_1\}$. Furthermore,

$$\text{Inv}(r) = \{(u_i, u_j) \in \text{Inv}(u) \mid i \neq 1\} \cup \{(u_i, u_j) \in \text{Inv}(u) \mid u_i \in r\}. \quad (5.4)$$

Finally for $\ell \in \text{supp}(r)$, $Z_u(\ell) = Z_r(\ell)$

For the converse implication, assume that $r <_I u$. By induction and transitivity it is sufficient to show that there exists i such that $r \leq_I u \cdot \pi_i$ and $u \cdot \pi_i \neq u$. We proceed by a case analysis. First since $\text{supp}(u) \subseteq \text{supp}(r)$, we can distinguish whether $\text{supp}(u) = \text{supp}(r)$ or $\text{supp}(u) \subsetneq \text{supp}(r)$. In the equality case, we further distinguish whether $Z_u = Z_r$ or not.

- If $\text{supp}(u) = \text{supp}(r)$, and $Z_u \neq Z_r$, then there must exist $\ell \in \text{supp}(r)$ such that $Z_u(\ell) < Z_r(\ell)$. Pick the leftmost ℓ in u which verifies this condition. First, there must be some 0 on the left of ℓ in u because there are $Z_u(\ell)$ on the right and at least $Z_r(\ell)$ in the word. Thus ℓ is not the first letter of u .

Let k be the letter immediately preceding ℓ in u . We claim that either $k = 0$ or k is after ℓ in r . Indeed if $k \neq 0$ and k is before ℓ in r then we have $Z_r(k) \geq Z_r(\ell)$. Moreover $Z_u(\ell) = Z_u(k)$ because there is no zero in u between ℓ and k . Therefore $Z_r(k) \geq Z_r(\ell) > Z_u(\ell) = Z_u(k)$ which contradicts our choice of ℓ as being the leftmost.

Now, call i the position of this k in u . If $k = 0$, the only difference between the rook triples of u and $u \cdot \pi_i$ is that $Z_{u \cdot \pi_i}(\ell) = Z_u(\ell) + 1$ so that $r \leq_I u \cdot \pi_i$. On the contrary, if $k \neq 0$, then the only difference between the rook triples of u and $u \cdot \pi_i$ is that $\text{Inv}(u \cdot \pi_i) = \text{Inv}(u) \sqcup \{(l, k)\}$ so that again $r \leq_I u \cdot \pi_i$.

- If $\text{supp}(u) = \text{supp}(r)$, and $Z_u = Z_r$, then necessarily $\text{Inv}(u) \subsetneq \text{Inv}(r)$. Write \tilde{r} and \tilde{u} the words obtained by removing the zeros in r and u . The inclusion of inversions shows that $\tilde{u} \leq_S \tilde{r}$ where \leq_S is the right order for permutations of $S = \text{supp}(u)$. As a consequence, we know that it is possible to exchange two consecutive letters $a < b$ in \tilde{u} to get a permutation \tilde{v} of $\text{supp}(u)$ such that

$$\text{Inv}(\tilde{v}) = \text{Inv}(\tilde{u}) \sqcup \{(b, a)\} \subset \text{Inv}(\tilde{r}). \quad (5.5)$$

From the equality of Z , there cannot be any 0 between a and b in u , thus a and b are consecutive in u as well. Writing i for the position of a in u , we have $r \leq_I u \cdot \pi_i$.

- The remaining case is $\text{supp}(r) \subsetneq \text{supp}(u)$. Let $\ell := \max(\text{supp}(u) \setminus \text{supp}(r))$. If ℓ is in position 1 in u then $r \leq_I u \cdot \pi_0$ and we are done in this case.

Otherwise if ℓ is not in position 1, we claim that the letter k immediately preceding ℓ in u is smaller than ℓ . If not, then there is an inversion (k, ℓ) in u . Since $\text{supp}(r)$ is $\text{Inv}(u)$ -compatible, then $k \notin \text{supp}(r)$. This contradicts our choice of ℓ as being the maximum.

Writing i for the position of k in u , we proceed as in the end of the first case: the only difference between the rook triples of u and $u \cdot \pi_i$ is that $\text{Inv}(u \cdot \pi_i) = \text{Inv}(u) \sqcup \{(\ell, k)\}$ so that again $r \leq_I u \cdot \pi_i$. \square

Corollary 5.1.12. *The monoid R_n^0 is \mathcal{R} -trivial, \mathcal{L} -trivial and thus \mathcal{J} -trivial.*

Proof. A consequence Theorem 5.1.11 is that the \mathcal{R} -preorder is an order so that R_n^0 is \mathcal{R} -trivial. Moreover, it is isomorphic to its opposite by Corollary 4.3.19 and thus it is \mathcal{L} -trivial. We conclude with Lemma 1.3.5. \square

5.2 The lattice of the \mathcal{R} -order

Our goal here is to show that, similarly to the weak order of permutations, the \mathcal{R} -order for the rooks is a lattice. We start with an algorithm which computes the meet.

Theorem 5.2.1. *Let u and v be two rooks of size n . Define a new rook r by the following algorithm:*

- Let I_0 be the transitive closure of $\text{Inv}(u) \cup \text{Inv}(v)$.
- Let S be the largest (for inclusion) I_0 -compatible set contained in $\text{supp}(u) \cap \text{supp}(v)$.
- Let $I := I_0 \cap S^2$.
- Finally, for $x \in s$ let $Z(x) := \max\{Z_u(i), Z_v(i) \mid i = x \text{ or } (x, i) \in I\}$ with the convention that $Z_s(i) = 0$ if $i \notin \text{supp}(s)$.

Then (S, I, Z) is a rook triple whose associated rook r is the meet $u \wedge_{\mathcal{R}} v$ of u and v for the \mathcal{R} -order.

Proof. We first prove that (S, I, Z) is indeed a rook triple.

- By definition, $I \subset \Delta \cap S^2$, let us show that I and $(\Delta \cap S^2) \setminus I$ are transitive. We claim that I is the transitive closure of $(\text{Inv}(u) \cap S^2) \cup (\text{Inv}(v) \cap S^2)$. Indeed, for any $(b, a) \in I$, then $(b, a) \in I_0$. By definition of the transitive closure, there exists a decreasing sequence of integer $b = c_1 > c_2 > \cdots > c_k = a$ such that $(c_i, c_{i+1}) \in \text{Inv}(u) \cup \text{Inv}(v)$ for $i = 1, \dots, k-1$. By induction, since $b \in S$, compatibility ensures that all of the c_i belong to S . Hence the claim.

As a consequence, using Theorem 1.2.11, I is the inversion set of the meet in the permutohedron of the restriction of u and v to S so that I and $(\Delta \cap S^2) \setminus I$ are transitive.

- One has $|S| \leq \max(|\text{supp}(u), \text{supp}(v)|)$. So that the condition $0 \leq Z(x) \leq n - |S|$ holds.
- Write $\mathcal{Z}(x) := \{Z_u(i), Z_v(i) \mid i = x \text{ or } (x, i) \in I\}$ so that $Z(x) := \max \mathcal{Z}(x)$. If $(b, a) \in I$, the transitivity of I ensures that as sets $\mathcal{Z}(b) \supseteq \mathcal{Z}(a)$ so that $Z(b) \geq Z(a)$. Conversely write $\bar{I} := (\Delta \cap S^2) \setminus I$. If $(b, a) \in \bar{I}$, the transitivity of \bar{I} shows that $(a, i) \in \bar{I}$ implies $(b, i) \in \bar{I}$. By contraposition, $(b, i) \in I$ implies $(a, i) \in I$ so that $\mathcal{Z}(b) \subseteq \mathcal{Z}(a)$ and therefore $Z(b) \leq Z(a)$.

Hence, we have proved that (S, I, Z) is a rook triple. It remains to prove that its associated rook is the meet $u \wedge_{\mathcal{R}} v$. By construction, $r \leq_I u$ and $r \leq_I v$. So that we only need to prove that for any rook s such that $s \leq_I u$ and $s \leq_I v$ then $s \leq_I r$.

- Using the rephrasing of Remark 5.1.6 we know that then $\text{supp}(s)$ is $\text{Inv}(u)$ and $\text{Inv}(v)$ -compatible and therefore compatible with the transitive closure of their union I_0 . Since $S = \text{supp}(r)$ is defined as the largest such set, $\text{supp}(s) \subseteq \text{supp}(r)$.
- Suppose $(b, a) \in \text{Inv}(r)$, with $b \in \text{supp}(s)$. Then by construction of r , there is a decreasing sequence $b = c_1 > c_2 > \cdots > c_k = a$ such that $(c_i, c_{i+1}) \in \text{Inv}(u) \cup \text{Inv}(v)$ for $i = 1, \dots, k-1$. By induction, having $s \leq_I u$ and $s \leq_I v$, one prove $c_i \in \text{supp}(s)$ and $(c_i, c_{i+1}) \in \text{Inv}(s)$. One concludes by transitivity that $(b, a) = (c_1, c_k) \in \text{Inv}(s)$.

- Finally, assume $x \in \text{supp}(s)$. Then $Z_s(x) \geq Z_u(x)$ and $Z_s(x) \geq Z_v(x)$. Moreover for any i such that $(x, i) \in \text{Inv}(r)$, by the preceding item, $i \in \text{supp}(s)$ and $(x, i) \in \text{Inv}(s)$. One deduces that $Z_s(x) \geq Z_s(i) \geq Z_u(i)$ and $Z_s(x) \geq Z_s(i) \geq Z_v(i)$. We just showed that $Z_s(x) \geq \max \mathcal{Z}(x)$. \square

Corollary 5.2.2. *The \mathcal{R} -order of R_n^0 is a lattice.*

Proof. From the previous theorem, we know that R_n^0 is a meet semi-lattice. Now it is well known that a meet semi-lattice with a maximum element is a lattice. \square

From the proof, we have a more explicit algorithm to compute the meet:

- Start with $S := \text{supp}(u) \cap \text{supp}(v)$. Then while one can find a $(b, a) \in \text{Inv}(u) \cup \text{Inv}(v)$ with $b \in S$ and $a \notin S$, remove b from S . When no more such (b, a) can be found, S is the support of $u \wedge_{\mathcal{R}} v$.
- Using the usual algorithm for permutations (see the sketch of the proof of Lemma 1.1.5), compute the meet of the restriction $u|_S$ and $v|_S$.
- Compute the Z function using max as in the statement of Theorem 5.2.1.
- Finish inserting the zeros using $Z(x)$ as in the proof of Proposition 5.1.3.

Example 5.2.3. Let $u = 25104$ and $v = 12453$. So $\text{supp}(u) \cap \text{supp}(v) = \{1, 2, 4, 5\}$. But $(4, 3)$ and $(5, 3) \in \text{Inv}(v)$ and $3 \notin S$. So $S = \{1, 2\}$. We then get $I = \{(2, 1)\}$, So that $(u \wedge_{\mathcal{R}} v)|_S = 21$. It remains to insert the zeros. One compute $Z(2) = 1$ and $Z(1) = 1$ so that $u \wedge_{\mathcal{R}} v = 00210$. Here is a bigger example: Let us compute $r = 31086502 \wedge_{\mathcal{R}} 02178534$. One finds that $S = \{1, 2, 3\}$, and $I = \{(3, 2), (3, 1), (2, 1)\}$ and $Z = (\frac{1}{2} \frac{2}{2} \frac{3}{2})$, so that $r = 00032100$. Similarly

$$30175082 \wedge_{\mathcal{R}} 02154738 = 00308210 \quad 43017582 \wedge_{\mathcal{R}} 02154738 = 75430821$$

In the case of permutations, the involution $\sigma \rightarrow \tilde{\sigma} = \sigma\omega$ where ω is the maximal permutation (otherwise said, $\tilde{\sigma}$ is the mirror image of σ) is an isomorphism from the \mathcal{R} -order to its dual. As a consequence, one can compute the join using the meet: $\sigma \vee_{\mathcal{R}} \mu = \widetilde{\tilde{\sigma} \wedge_{\mathcal{R}} \tilde{\mu}}$. However, as seen for example on Figure 5.1 this doesn't work anymore for rooks. This asks for an algorithm to compute the join of two rooks. To describe this algorithm, we need a notion of non-inversion and a dual notion of compatibility:

Definition 5.2.4. *For any rook r , call **set of version** of r the set:*

$$\overline{\text{Inv}}(r) := (\Delta \setminus \text{Inv}(r)) \cup \{(b, a) \in \Delta \mid a \notin r \text{ and } b \in r\} \quad (5.6)$$

Let $I \subseteq \Delta$ and $S \subset \llbracket 1, n \rrbracket$. We say that S is **dual I -compatible** if $(b, a) \in \Delta \setminus I$ and $a \in S$ implies $b \in S$.

Theorem 5.2.5. *Let u and v be two rooks of size n . Define a new rook r by the following algorithm:*

- Let $I_0 := \Delta \setminus T$ where T is the transitive closure of $\overline{\text{Inv}}(u) \cap \overline{\text{Inv}}(v)$.

- Let S be the smallest dual I_0 -compatible set containing $\text{supp}(u) \cup \text{supp}(v)$.
- Let $I := I_0 \cap S^2$.
- Finally, for $x \in s$ let $Z(x) := \min\{Z_u(i), Z_v(i) \mid i = x \text{ or } (x, i) \in \Delta \setminus I\}$, with the convention that $Z_s(i) = +\infty$ if $i \notin \text{supp}(s)$.

Then (S, I, Z) is a rook triple whose associated rook r is the join $u \vee_{\mathcal{R}} v$.

The proof is very similar to the meet and left to the reader.

Example 5.2.6. Let us compute $r = 30175082 \vee_{\mathcal{R}} 72185043$. One finds $S = \{1, 2, 3, 4, 5, 7, 8\}$, $I = \{(7, 5), (4, 3)\}$ and $Z = \begin{pmatrix} 1 & 2 & 3 & 4 & 5 & 7 & 8 \\ 1 & 0 & 0 & 0 & 0 & 0 & 0 \end{pmatrix}$, so that $r = 10243758$.

We want to enumerate the join-irreducible elements. As in the classical permutohedron, they are related to descents, however, in the case of rooks, they are two different notions of descents.

Definition 5.2.7 (Weak and strict descents). *Let $r \in R_n$ be a rook. For any $0 \leq i < n$, we say that i is a **weak (right) descent** of r if $r \cdot \pi_i = r$. We say that i is a **strict (right) descent** if there exists a rook $s \neq r$ such that $s \cdot \pi_i = r$. Moreover, in the particular case $i = 0$, we say that 0 is a **strict descent with multiplicity k** , if there are exactly k rooks $s \neq r$ such that $s \cdot \pi_0 = r$.*

Any strict descent is a weak descent. Indeed if $s \cdot \pi_i = r$ then $r \cdot \pi_i = s \cdot \pi_i^2 = s \cdot \pi_i = r$. Weak descent and strict descents are equivalent when restricted to permutations, but they differ on rooks. For example, the rook 04003, has 3 weak descent namely 0, 2, 3, but only 0, 2 are strict ($04003 = 24003 \cdot \pi_0$ and $04003 = 00403 \cdot \pi_2$) and 0 has multiplicity 3: $04003 = 14003 \cdot \pi_0 = 24003 \cdot \pi_0 = 54003 \cdot \pi_0$.

Lemma 5.2.8. *The multiplicity of 0 as a strict descent in a rook r is 0 if r does not start with 0 and is the number of 0 in r otherwise.*

Definition 5.2.9. *An element z of a lattice L is called **meet irreducible** if it can not be obtained as a non trivial meet that is $z = z_1 \wedge z_2$ implies $z_1 = z$ or $z_2 = z$.*

An equivalent definition is that z has only one successor in the Hasse diagram of L . By definition, in a finite lattice, any element can be written as the meet of some meet irreducible elements. As a consequence, they form the minimal generating set of the meet semi-lattice.

For permutations, the number of meet irreducible for the \mathcal{R} -order (that is permutation with only one descent) is $a(n) = 2^n - n - 1$. It is a particular case of Eulerian numbers and is recorded as OEIS A000295. Here are the first values

$$0, 0, 1, 4, 11, 26, 57, 120, 247, 502, 1013, 2036, 4083, 8178, 16369, 32752 \quad (5.7)$$

For rooks, the number of meet irreducibles has a very simple expression too:

Proposition 5.2.10. *The number of meet irreducibles for $\leq_{\mathcal{R}}$, is $3^n - 2^n$.*

This sequence is recorded as OEIS A001047. Here are the first values

$$0, 1, 5, 19, 65, 211, 665, 2059, 6305, 19171, 58025, 175099, 527345, 1586131 \quad (5.8)$$

We will actually prove a stronger statement, the previous one will follow thanks to the identity:

$$3^n - 2^n = \sum_{i=1}^n 3^{n-i} 2^{i-1} \quad (5.9)$$

Proposition 5.2.11. *For any rook vector r denote $p(r)$ the first value r_0 if its non zero, and 1 if its zero. The number of meet-irreducibles r of R_n such that $p(r) = i$ is $3^{n-i} 2^{i-1}$.*

Proof. A rook is meet irreducible if and only if it has a unique strict descent (counting multiplicities). Consider a meet irreducible rook r with $p(r) = i$. There are two cases:

- if $i > 1$, then the rook is composed by two nondecreasing sequences, the first one starts with i . So each number smaller than i , either appears in the second subsequence or, do not appear at all so that the second sequence starts with some 0. Similarly each number larger than i , may appear in any of those two subsequences or not at all. So the number of choices is $2^{i-1} 3^{n-i}$.
- if $i = 1$, then if r start either with 0 or 1. We want to show that the number of each such rook is 3^{n-1} . We show that the set of those rooks is in bijection with the set of maps $f : \llbracket 2, n \rrbracket \rightarrow \{0, 1, 2\}$.

In the following, for any set S of integers we write $W(S)$ the word obtained by writing the letter of S in increasing order. Given such a map f , one build a sequence starting with 1, then ordering the preimage of 0, putting as many zero as the preimage of 1, and then ordering the preimage of 2:

$$r(f) := 1 \cdot W(f^{-1}(0)) \cdot 0^{|f^{-1}(1)|} \cdot W(f^{-1}(2)). \quad (5.10)$$

By definition, the result is a rook of size n with at most one descent. Moreover, each rook with only one descent is obtained exactly once as the image of some f .

It remains to show that the maps which give rooks with no descent by the preceding construction are in bijection with rooks having 0 as unique descent with multiplicity 1. The point is: $r(f)$ has zero descents, that is $r(f)$ is nondecreasing, if and only if there exists a $1 \leq k \leq n$ such that

$$f(i) = \begin{cases} 0 & \text{if } i \leq k \\ 2 & \text{otherwise} \end{cases} \quad (5.11)$$

If it is the case, we redefine $r(f)$ as

$$r_1(f) := 0 \cdot W(\{i - 1 \mid i \in f^{-1}(0)\}) \cdot W(\{f^{-1}(2)\}). \quad (5.12)$$

The set of the rooks obtained this way is the set of increasing rooks which start with a 0. According to Lemma 5.2.8, those are exactly the rooks having 0 as unique descent with multiplicity 1.

There are exactly 3^{n-1} rooks starting either by 0 or 1. □

Example 5.2.12. Consider the function $f = (\overset{2}{2} \overset{3}{0} \overset{4}{1} \overset{5}{0} \overset{6}{1} \overset{7}{0} \overset{8}{2} \overset{9}{1})$. Then $r(f) = 1 \cdot 357 \cdot 000 \cdot 28$ which has only one strict descent (the dots are only here to visualize the different part of the right hand side of Equation 5.10).

Now with $f = (\overset{2}{0} \overset{3}{0} \overset{4}{0} \overset{5}{0} \overset{6}{2} \overset{7}{2} \overset{8}{2})$, Equation 5.10 gives $r(f) = 1 \cdot 23456 \cdot 789$ which has no descent at all. So we take the second definition (Equation 5.12) and get the new value $r_1(f) = 0 \cdot 12345 \cdot 789$ which has 0 as unique strict descent.

On the contrary to permutations, the poset is not self dual. So there is no reason why the number of meet irreducible elements should be equal to the number of join irreducible elements. They indeed differ and we do not have a formula for the number of join irreducibles:

$$0, 1, 5, 16, 43, 106, 249 \tag{5.13}$$

5.3 Chains in the rook lattice

We now consider maximal chains of R_n (thus also R_n^0 by Corollary 4.3.17). We see in Figure 5.1 that all the maximal chains are not of equal length. Experimental computation of the numbers of maximal chains give the following sequence: 1, 2, 23, 3625, 16489243. We did not find any nice property: it is not referred in OEIS and the numbers contain big prime factor. A more interesting question is to only consider maximal chains of minimal length, that is reduced expressions of the maximal rook $P_n = 0 \dots 0 \in R_n$. Note by Lemma 4.1.4 that $\ell(P_n) = \binom{n+1}{2}$. We find the following numbers of such chains:

$$1, 2, 12, 286, 33592, 23178480. \tag{5.14}$$

This sequence is referred as OEIS A003121. It counts, among many other things, the number of maximal chains of length $\binom{n+1}{2}$ (hence maximal) in the *Tamari lattice* \mathcal{T}_{n+1} seen in Section 1.6. This suggests that there is a bijection between the chains. It turns out that the coincidence is much stronger: the two posets restricted to the elements appearing in their respective chains are isomorphic.

We first need to describe the elements appearing in a reduced expression of P_n .

Proposition 5.3.1. *The rook vectors appearing as a left factor of a reduced expression of P_n are the rooks:*

$$\mathcal{MCR}_n := \{0 \dots 0 \sqcup (k+1) \dots n \mid 0 \leq k \leq n\}, \tag{5.15}$$

where \sqcup is the shuffle product defined in Example 1.7.2.

Proof. Let $r \in \mathcal{MCR}_n$ as defined by Equation 5.15. We assume that r has k zeros, so that the nonzero letters appearing in r are $k+1, \dots, n$. Take the reduced expression for r given by the R -code (Definition 4.3.2). Since the nonzero letters are in order, this expression is of length $\ell(r) = 1 + 2 + \dots + k + \sum_{i=k+1}^n Z_r(i)$. In order to bring r to P_n by right action we repeat the following steps until we reach P_n : let i be the first nonzero letter and $p = i - Z_r(i)$ its position. Then multiplying r on the right by $s_{p-1} \dots s_1 \pi_0$ brings i to the front and kills it. The length of the word for P_n obtained this way is equal to

$$\ell(r) + \sum_{i=k+1}^n (i - Z_r(i)) = \sum_{i=1}^n i = \binom{n+1}{2}. \tag{5.16}$$

This is the length of P_n , hence the expression is reduced, and r appears in a maximal chain of minimal length.

Now we prove the converse inclusion by contradiction. Let $r \in R_n \setminus \mathcal{MCR}_n$, with k zeros. We want to show that there is no reduced word for P_n of the form $\underline{r} \underline{m}$ where \underline{r} is a word for r . Assume that we have such a word. Since $r \notin \mathcal{MCR}_n$, then either there is a nonzero letter k before a nonzero letter k' with $k' < k$, or there is a nonzero letter k' while a letter $k > k'$ is missing. The algorithm computing the canonical reduced word (Definition 4.3.2) shows that:

$$\ell(r) > 1 + 2 + \dots + k + \sum_{i \in r, i \neq 0} Z_r(i). \tag{5.17}$$

We call $\tilde{r} \in \mathcal{MCR}_n$ the rook vector obtained from r by replacing the nonzero letters by $k+1, \dots, n$ in this order, so that $\sum_{i \in r, i \neq 0} Z_r(i) = \sum_{i=k+1}^n Z_{\tilde{r}}(i)$. Then $\tilde{r} \underline{m}$ gives P_n as well. Thus $\ell(\underline{m}) \geq \sum_{i=k+1}^n (i - Z_{\tilde{r}}(i))$. So that $\ell(P_n) = |\underline{r} \underline{m}| > \binom{n+1}{2} = \ell(P_n)$, which is absurd. \square

In particular note that: $|\mathcal{MCR}_n| = \sum_{i=0}^n \binom{n}{i} = 2^n$.

Example 5.3.2. $\mathcal{MCR}_2 = \{12\} \cup \{0 \sqcup 2\} \cup \{00\} = \{12\} \cup \{02, 20\} \cup \{00\}$

$$\begin{aligned} \mathcal{MCR}_3 &= \{123\} \cup \{0 \sqcup 23\} \cup \{00 \sqcup 3\} \cup \{000\} \\ &= \{123\} \cup \{023, 203, 230\} \cup \{003, 030, 300\} \cup \{000\}, \end{aligned}$$

$$\begin{aligned} \mathcal{MCR}_4 &= \{1234\} \cup \{0 \sqcup 234\} \cup \{00 \sqcup 34\} \cup \{000 \sqcup 4\} \cup \{0000\} \\ &= \{1234\} \cup \{0234, 2034, 2304, 2340\} \cup \{0034, 0304, 3004, 0340, 3040, 3400\} \\ &\quad \cup \{0004, 0040, 0400, 4000\} \cup \{0000\}. \end{aligned}$$

We now introduce a sequence of bijections from \mathcal{MCR}_n to some special *Dyck paths*, that is vertices of the Tamari lattice. The first bijection sends an element of \mathcal{MCR}_n to a subset of $[n+1]$ the following way:

$$\eta : \begin{cases} \mathcal{MCR}_n & \longrightarrow [n+1] \\ r = r_1 \dots r_n & \longmapsto \{i \mid r_i \neq 0\}. \end{cases} \tag{5.18}$$

This application is clearly a bijection since the nonzero letters of $r \in \mathcal{MCR}_n$ are $k + 1, \dots, n$ in this order, where k is the number of zeros of r . Now that we have a subset of $[n]$ we can use the bijection C to compositions of $n + 1$ introduced in Equation 1.10. If $I = (i_1, \dots, i_m) \vDash n + 1$ the actions of the generators of R_n^0 through the bijection $C \circ \eta$ are as follows:

$$I \cdot \pi_0 = (i_1 + i_2, i_3, \dots, i_m), \tag{5.19}$$

$$I \cdot \pi_j = \begin{cases} I & \text{if } j \in \text{Des}(I); \\ (i_1, \dots, i_{j-1}, i_j - 1, i_{j+1} + 1, i_{j+2}, \dots, i_m) & \text{otherwise,} \end{cases} \text{ for } j > 0. \tag{5.20}$$

We finally send a composition of $n + 1$ to a Dyck path as follows:

$$\delta : (i_1, \dots, i_m) \vDash n + 1 \mapsto 1^{n-m} 0^{i_1} 1 0^{i_2} 1 0^{i_3} \dots 0^{i_{m-1}} 1 0^{i_m}. \tag{5.21}$$

It is easy to check that the Dyck paths we obtain this way are exactly those for whose the pattern 011 is forbidden. Note that the action of the generators of R_n^0 is thus to replace a 01 by 10 which pictorially inserts a diamond in a “valley”. See Figure 5.2. We say that a Dyck path D contains another Dyck path D' , and we denote it $D' \subseteq D$, if the path D is above the path D' . Then the \mathcal{R} -order on R_n^0 is mapped to the order \subseteq on Dyck paths avoiding the pattern 011 by the bijection $\delta \circ C \circ \eta$. See the first line of Figure 5.3 to see all these isomorphisms. We finally remark that all these posets are actually lattices.

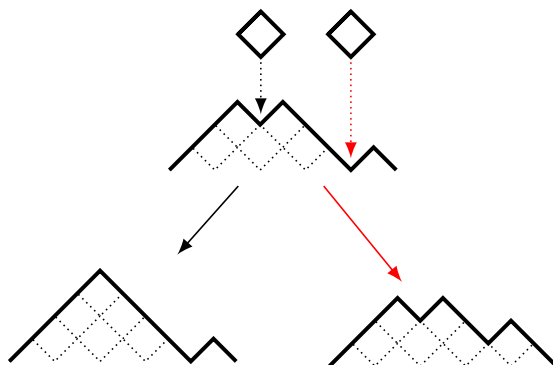

Figure 5.2: The flip of a valley in our special Dyck paths. The generator π_i adds a diamond in the $i + 1$ th valley, counting from the left. Thus π_0 reduces the number of valley.

We are interested in Dyck paths in a maximal chain of length $\binom{n}{2}$ in the Tamari lattice of size n . We denote by \mathcal{MCT}_n their set. We recall from Section 1.6 that the Tamari order is denoted by $\preceq_{\mathcal{T}}$.

Proposition 5.3.3. *The set \mathcal{MCT}_n is exactly the set of Dyck paths avoiding 011. Furthermore the order $\preceq_{\mathcal{T}}$ restricted to \mathcal{MCT}_n is equal to the order of inclusion \subseteq .*

Proof. The difference of diamonds between the minimal element $(10)^n$ and the maximal element $1^n 0^n$ is exactly $\binom{n}{2}$, so that each rotation must add only one diamond.

But a rotation on a SE step 0 followed by two NE steps 11 adds at least two diamonds, so that we can not rotate in such a SE step. Moreover the rotations on another licit SE step preserve the 011 pattern, so that an element with pattern 011 can not be in \mathcal{MCT}_n . On the contrary if D is a Dyck path avoiding 011, then a rotation is exactly to add a diamond in a valley, and the resulting Dyck path also avoids 011.

Now that we have the description of elements of \mathcal{MCT}_n , doing a rotation corresponds to adding a diamond on a valley, so that the order $\preceq_{\mathcal{T}}$ implies the order \subseteq . Furthermore, by definition of the order $\preceq_{\mathcal{T}}$, the converse also holds. \square

As a consequence we have proven that the order on \mathcal{MCT}_n obtained through the bijection $\delta \circ C \circ \eta$ is exactly the Tamari order, so that the posets of \mathcal{MCR}_n and \mathcal{MCT}_{n+1} are isomorphic.

The elements appearing in \mathcal{MCT}_n appears in many different contexts, and we have already seen them in Section 1.6, see [HL07; HLT11; LL18] and the references in the latters. They correspond to binary trees which are chains, that is also binary trees with exactly one linear extension. For this reason we called them *singletons*. Equivalently they are permutations avoiding the patterns 132 and 312, or permutations with exactly one element in their sylvester class, that is common vertices between the associahedron and the permutahedron. Furthermore the historic definition of the associahedron is to keep only the faces of the permutahedron which contains such a singleton. See Figure 5.3 for all the bijections seen in this section.

5.4 Geometrical remarks

Recall from Section 1.4 that the right Cayley graph of the symmetric group \mathfrak{S}_n is the 1-skeleton of the permutohedron, defined as the convex hull of the set of points whose coordinates are permutations.

Starting with $n = 3$, we can not hope that the right Cayley graph of R_n could be the 1-skeleton of a polytope. Indeed in R_n the element $1000\dots$ is always of degree 2, being linked only to $0000\dots$ and $0100\dots$, whereas the identity $123\dots$ is of degree n . Thus it is impossible to get a polytope.

Nevertheless, one can consider in a n -dimensional space the set of points whose coordinates are rook vectors (see Figure 5.4). The extremal points of its convex hull are the points in

$$\text{Stell}_n := \{\mathfrak{S}_n(0\dots 0k\dots n) \mid k \in \llbracket 1, n \rrbracket\} \tag{5.22}$$

This polyhedron appeared under the name of stellohedron in [MP17, Figure 18] where it was defined as the graph associahedron of a star graph. It is also the secondary polytope of $\Delta_n \cup 2\Delta_n$ (see [GKZ08]), two concentric copies of a n -dimensional simplex, which can also be defined as

$$\{e_i \mid i \in [n + 1]\} \cup \{(n + 2)e_i - \mathbf{1} \mid i \in [n + 1]\} \tag{5.23}$$

So we can see the Cayley graph of R_n as being drawn on the face of the stellohedron. One can recover this graph from the permutohedron by taking all its projections on coordinate planes. Indeed, it is just saying that a rook can be obtained from

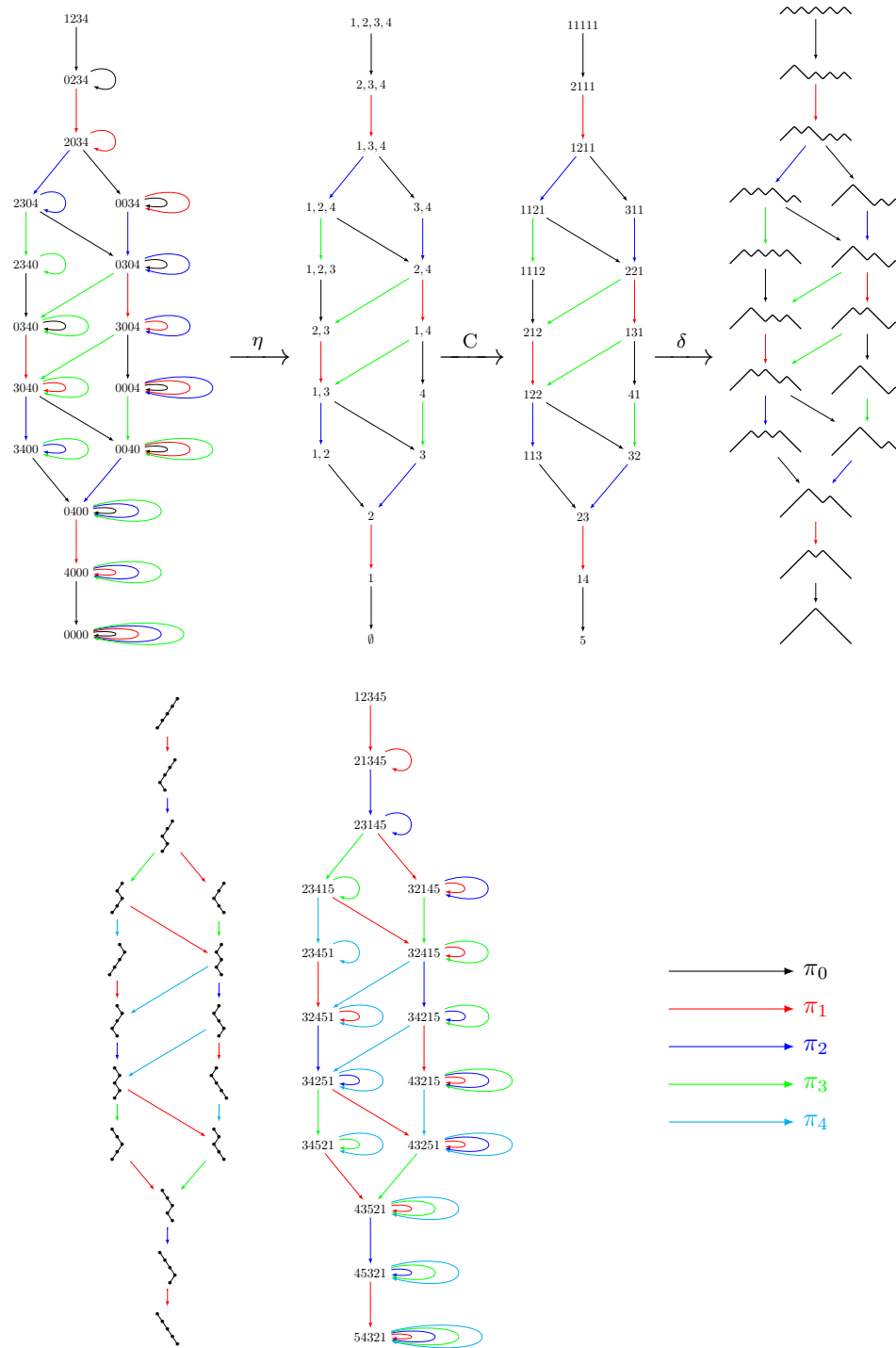

Figure 5.3: The lattice of \mathcal{MCR}_4 , send to subsets of $[4]$, compositions of 5 and \mathcal{MCT}_5 . On the second row we represent the poset \mathcal{MCT}_5 seen on binary trees which are chains, and permutations alone in their sylvester class or avoiding 132 and 312. We only represent loops on the rook vectors and the permutations, the other can be deduced by bijection. On the second line we apply generators of H_5^0 rather than R_4^0 . Note that the bijection on the generators is only $\pi_i \mapsto \pi_{i+1}$.

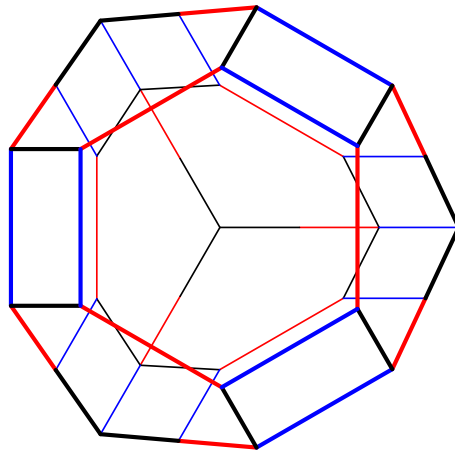

Figure 5.4: The Cayley graph of R_3 embedded in a 3-dimensional space.

a permutation replacing some entries by zeros and that edges are mapped to an identical edge or contracted.

Chapter 6

Representation theory of the 0-Rook monoid R_n^0

The goal of this section is to investigate the representation theory of R_n^0 . We write $\mathbb{C}[R_n^0]$ the monoid algebra of R_n^0 . In the sequel of the thesis P_1 will rather be denoted by π_0 . In this section the letter r will usually denote an element of R_n^0 rather than a plain rook. We know from Corollary 4.3.17 and Proposition 4.5.4 that for any $r \in R_n^0$ there is a unique rook $\mathbf{r} := 1_n \cdot r = r \cdot 1_n$ such that $\pi_{\mathbf{r}} = r$. When there is a need to distinguish, We will freely use this boldface notation.

We start by summarizing the main results (in particular Corollary 4.3.17) of the Section 4 which concerns the representations:

Theorem 6.0.1. *The maps*

$$f_R : \begin{array}{c} \mathbb{C}[R_n^0] \longrightarrow \mathbb{C}[R_n] \\ x \longmapsto 1_n \cdot x, \end{array} \quad \text{and} \quad f_L : \begin{array}{c} \mathbb{C}[R_n^0] \longrightarrow \mathbb{C}[R_n] \\ x \longmapsto x \cdot 1_n, \end{array}$$

extended by linearity, are two isomorphisms of representations of R_n^0 between the left and right regular representations and the natural one (acting on R_n).

6.1 Idempotents and simple modules

Since R_n^0 is a \mathcal{J} -trivial monoid, as shown in Section 3.3, the representation theory of R_n^0 is largely governed by its idempotent.

Proposition 6.1.1. *For any $S \subset \llbracket 0, n-1 \rrbracket$, we denote π_S the zero of the so-called parabolic submonoid generated by $\{\pi_i \mid i \in S\}$.*

Proof. This submonoid is finite since the monoid is finite. By Proposition 5.1.12 it contains a unique minimal element for the \mathcal{J} -order, which is a zero. \square

Proposition 6.1.2. *For any $S \subset \llbracket 0, n-1 \rrbracket$, write $S^c := \llbracket 0, n-1 \rrbracket \setminus S$ its complement and $I = C(S^c) = (i_1, \dots, i_\ell)$ its associated extended composition. Then $\pi_S = \pi_r$ where r is the block diagonal rook matrix of size n whose block are anti diagonal matrices of 1 of size (i_1, \dots, i_ℓ) , except the first block which is a zero matrix.*

Proof. We already know that R_n^0 has at least 2^n idempotents. We now have to prove this exhaust the idempotents of R_n^0 .

Let e an idempotent of R_n^0 . Recall that $\text{cont}(e)$ is the set of the π_i with $i \in \llbracket 0, n-1 \rrbracket$ appearing in any reduced word of e . Let us show that $e = \pi_{\text{cont}(e)}$: the zero of the parabolic generated by $\text{cont}(e)$. Indeed for $a \in \text{cont}(e)$, one can write $e = \underline{u}a\underline{v}$ for some \underline{u} and \underline{v} in R_n^0 . By definition of the \mathcal{J} -order, this means that $e \leq_{\mathcal{J}} a$. Using Lemma 1.3.8, this is equivalent to $ea = e$ and to $ae = e$, so that e is stable under all its support. \square

Theorem 6.1.7. *The monoid R_n^0 has 2^n left (and right) simple modules, all one-dimensional, indexed by the subsets of $\llbracket 0, n-1 \rrbracket$. Let $S \subset \llbracket 0, n-1 \rrbracket$. Its associated simple module S_S is the one-dimensional module generated by ε_S with the following action of generators:*

$$\pi_t \cdot \varepsilon_S = \begin{cases} \varepsilon_S & \text{if } t \in S \\ 0 & \text{otherwise.} \end{cases} \tag{6.1}$$

Proof. We apply Theorem 3.3.2 using Lemma 6.1.5. \square

We will describe the quiver later in Section 6.3.

Recall that we write x^ω any sufficiently large power of x which becomes idempotent, and that the star product of two idempotents is defined as $e * f = (ef)^\omega$. This endows the set of idempotents with a structure of a lattice. We now explicitly describe this lattice:

Proposition 6.1.8. *Let $S, T \subset \llbracket 0, n-1 \rrbracket$. Then $\pi_S * \pi_T = \pi_{S \cup T}$.*

Proof. First we note that $\pi_S * \pi_T$ is inside the parabolic $S \cup T$. It is enough to show that it is a zero of this submonoid, and we will conclude by unicity. This is again a consequence of Lemma 1.3.8. \square

Corollary 6.1.9. *The quotient $\mathbb{C}R_n^0 / \text{rad}(\mathbb{C}R_n^0)$ is isomorphic to the algebra of the lattice of the n -dimensional cube.*

6.2 Indecomposable projective modules

Extending the definition from the Hecke monoid, we define its *left and right R-descents sets* as:

$$D_R(r) = \{0 \leq i \leq n-1 \mid r\pi_i = r\} \quad (\text{resp. } D_L(r) = \{0 \leq i \leq n-1 \mid \pi_i r = r\}) \tag{6.2}$$

Example 6.2.1. Let $r = \mathbf{0423007} \in R_n^0$. We have $0 < 4 \geq 2 < 3 \geq 0 \geq 0 < 7$, and the first letter is 0. So $D_R(r) = \{0, 2, 4, 5\}$

Notation 6.2.2. *We choose to represent an element $r \in R_n^0$ by a ribbon notation the usual way, with the difference that two zeros are vertical and not horizontal: $\begin{array}{|c|} \hline 0 \\ \hline 0 \\ \hline \end{array}$ and*

not $\begin{array}{|c|c|} \hline 0 & 0 \\ \hline \end{array}$. This change of convention compared to e.g. [KT97] is due to our choice of taking the π and not the T_i for generator of the Hecke algebra. As a consequence, the eigenvalues 0 and 1 are exchanged.

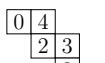
For example, $r = \mathbf{0423007}$ is represented by the ribbon  Figure 6.1

shows the ribbon together with their associated descent sets. Figure 6.2 depicts the associated boolean lattice. With this notation we can easily find the idempotents

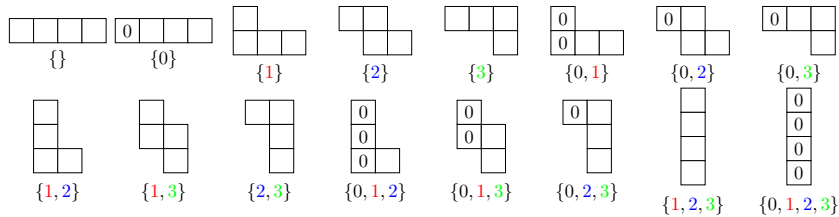

Figure 6.1: R -descent sets for R_4^0 .

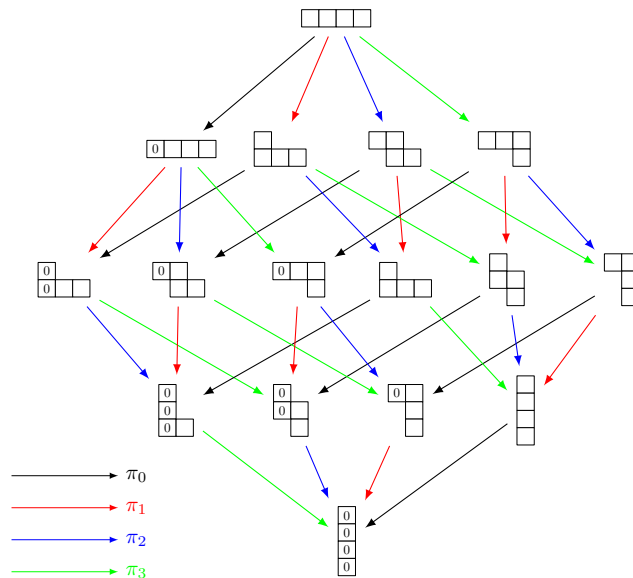

Figure 6.2: The lattice of R -descent sets for R_4^0 .

of each R -descent set.

Proposition 6.2.3. *In each R -descent class there is a unique idempotent. It is obtained by filling ribbon shape, going through the columns left to right, bottom to up by numbers 1 to n in this order. Then if 0 is in the descent class, fill the first column with zeros.*

Proof. The existence and the uniqueness come from Corollary 6.1.5. The way to fill in comes from Proposition 6.1.2. \square

Example 6.2.4. Consider the R -descent set $\{0, 1, 2, 5, 6, 7\}$ in size 8. We show

below its associated ribbon shape and its idempotent

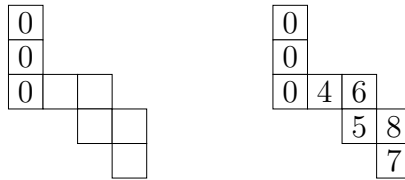

We now follow the theory of Section 3.3.3, specializing it to the combinatorics of R_n^0 .

Proposition 6.2.5. *Let $r \in R_n^0$. Then:*

$$\text{rAut}(r) = \langle \pi_i \mid i \in D_R(r) \rangle \quad \text{and} \quad \text{lAut}(r) = \langle \pi_i \mid i \in D_L(r) \rangle. \quad (6.3)$$

Proof. We do the proof for rAut . The first inclusion $\langle \pi_i \mid i \in D_R(r) \rangle \subseteq \text{rAut}(r)$ is clear.

Let $u \in \text{rAut}(r)$. So $ru = r$. Assume that $u \notin \langle \pi_i \mid i \in D_R(r) \rangle$. Let $\pi_{i_1} \dots \pi_{i_m}$ a reduced expression of u . Let j be the smallest index such that $i_j \notin D_R(r)$. Then $ru = r\pi_{i_j} \dots \pi_{i_m}$ by minimality. Since $i_j \notin D_R(r)$, $r\pi_{i_j} <_{\mathcal{J}} r$ and by \mathcal{J} -triviality we get $ru <_{\mathcal{J}} r$. This contradict the minimality. \square

From there we deduce the following corollary:

Corollary 6.2.6. *Let $r \in R_n^0$*

$$\text{rfix}(r) = \pi_{D_R(r)} \quad \text{and} \quad \text{lfix}(r) = \pi_{D_L(r)}. \quad (6.4)$$

Finally, applying Theorem 3.3.6, we get:

Theorem 6.2.7. *The indecomposable projective R_n^0 -modules are indexed by the R -descents sets and isomorphic to the quotient of the associated R -descent class by the finer R -descent classes.*

Remark 6.2.8. Contrary to the classical case presented in Section 1.1.5, these quotients are not intervals of the \mathcal{R} -order: in Figure 6.4 here we have two bottom elements.

6.3 Ext-Quivers

It turns out that the quiver of rook monoids are not different from 0-Hecke monoids (Theorem 3.3.11):

Theorem 6.3.1. *The kernel of the two following algebra morphisms*

$$\mathcal{C}H^0(B_n) \twoheadrightarrow \mathcal{C}R_n^0 \quad \text{and} \quad \mathcal{C}R_n^0 \twoheadrightarrow \mathcal{C}H^0(A_{n+1}) \quad (6.5)$$

are included in the square radical of their respective domains. As a consequence, these three algebras share the same quiver.

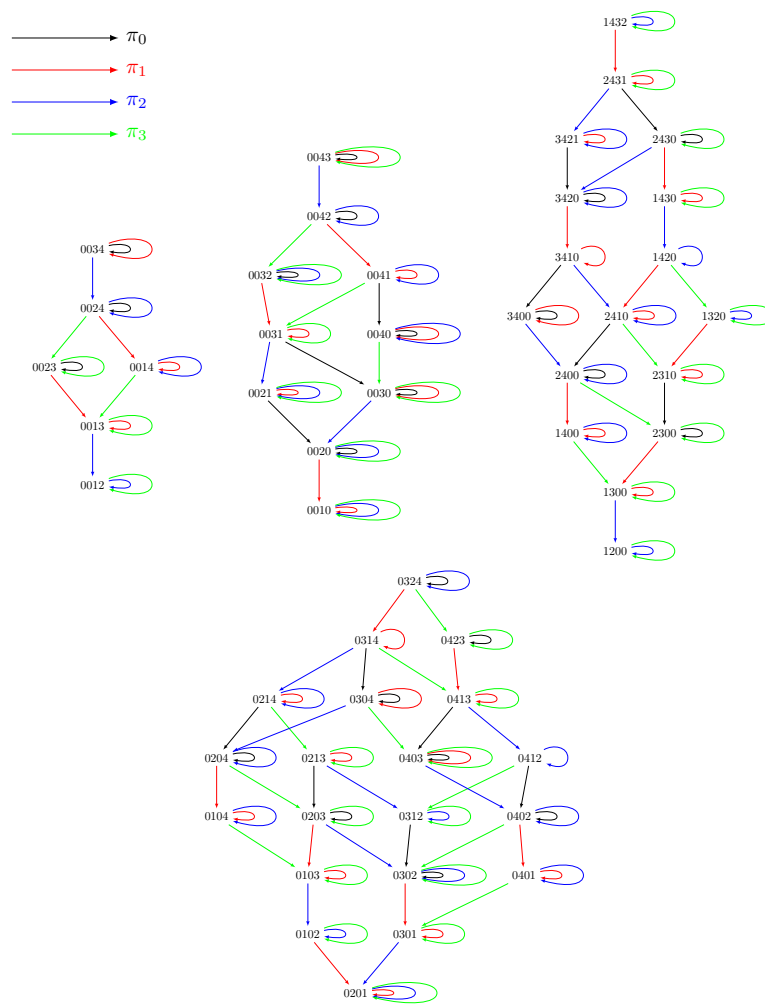

Figure 6.3: The R -descent classes $\{0, 1\}$, $\{0, 1, 3\}$, $\{2, 3\}$ and $\{0, 2\}$.

Proof. Recall that all of these algebras are monoid algebras of \mathcal{J} -trivial monoids. Thanks to [Den+10, Corollary 3.8], their radical is generated by commutators. Therefore, the following non zero elements: $\pi_0\pi_1\pi_0 - \pi_0\pi_1$ and $\pi_0\pi_1\pi_0 - \pi_1\pi_0$ lie in the radical of each of these three algebras. The first map has for kernel the ideal generated by the relation

$$\pi_0\pi_1\pi_0 - \pi_0\pi_1\pi_0\pi_1 = (\pi_0\pi_1\pi_0 - \pi_0\pi_1)(\pi_0\pi_1\pi_0 - \pi_1\pi_0)$$

which thus lies in the square radical. Similarly the kernel of the second map is the ideal generated by

$$\pi_1\pi_0\pi_1 - \pi_1\pi_0\pi_1\pi_0 = (\pi_0\pi_1\pi_0 - \pi_1\pi_0)(\pi_0\pi_1\pi_0 - \pi_0\pi_1) \quad \square$$

See Figure 3.5 for a picture of a quiver. Except for trivial cases, they are not of known type so that the representation theory of R_n^0 starting from $n = 3$ is wild.

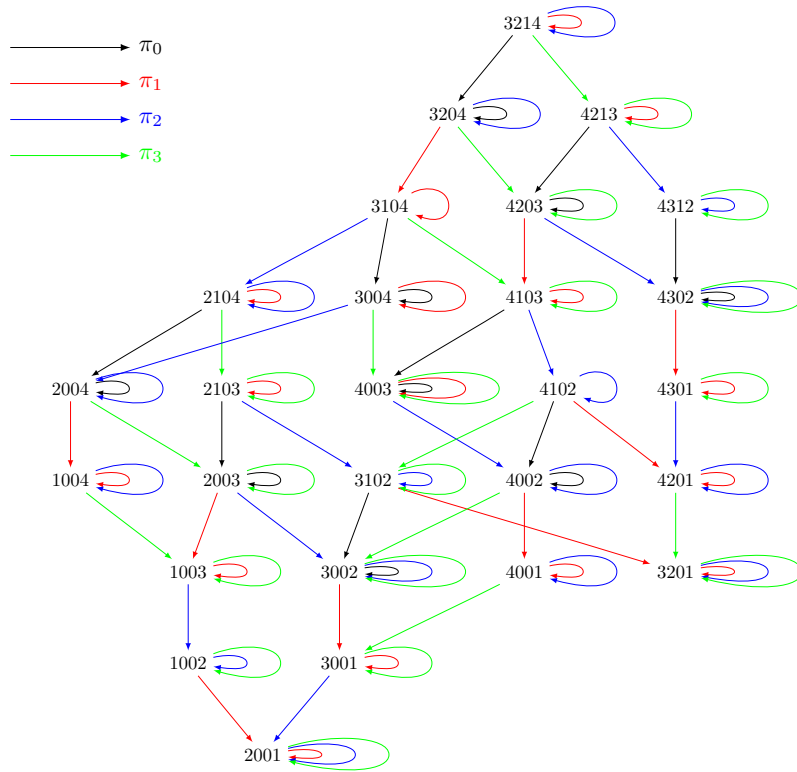

Figure 6.4: An example of a R -descent class which is not an interval of the \mathcal{R} -order.

6.4 Restriction functor to H_n^0

We now further examine the links between representations of H_n^0 and R_n^0 . Indeed H_n^0 is a submonoid of R_n^0 , thus it acts by multiplication on R_n^0 . We can see R_n^0 as an H_n^0 -module.

We first look at simple modules whose restriction rule is immediate:

Proposition 6.4.1. *Let $J \subset \llbracket 0, n-1 \rrbracket$, with associated simple R_n^0 -module S_J . Then:*

$$\text{Res}_{H_n^0}^{R_n^0} S_J = S_{J \setminus \{0\}}, \tag{6.6}$$

where S_I^H is the simple H_n^0 -module generated by the parabolic $I \subseteq \llbracket 1, n-1 \rrbracket$.

The rule of induction for simple H_n^0 -modules to R_n^0 -modules is otherwise quite intricate and would be very technical. It would be very similar to what we will do in section 6.5.1 for the induction of simple modules of R_n^0 to another R_m^0 , which is already very technical.

We now look at indecomposable R_n^0 -projective modules.

Proposition 6.4.2. *Let $I \subset \llbracket 1, n-1 \rrbracket$ and P_I^H the associated indecomposable H_n^0 -projective module. Then:*

$$\text{Ind}_{H_n^0}^{R_n^0} P_I^H = P_I \oplus P_{I \cup \{0\}}. \tag{6.7}$$

Proof. This is a consequence of Proposition 6.4.1 by Frobenius reciprocity (Theorem 3.4.2). Indeed, since the simple module S_J^R is the quotient of the indecomposable projective P_J^R by its radical, the multiplicity of P_J^R in a projective module P is equal to $\dim \operatorname{Hom}_R(P, S_J^R)$. By Frobenius reciprocity,

$$\operatorname{Mult}_{P_J^R}(\operatorname{Ind}_H^R P_I^H) = \dim \operatorname{Hom}_R(\operatorname{Ind}_H^R P_I^H, S_J^R) = \dim \operatorname{Hom}_H(P_I^H, \operatorname{Res} S_J^R) \quad (6.8)$$

Now, Proposition 6.4.1 says that this is 1 only if $I = J \setminus \{0\}$, otherwise it is 0. \square

The restriction of projective modules from R_n^0 to H_n^0 is much more interesting. We will show that R_n^0 -projective modules are still projective when restricted to H_n^0 , and that we have a precise combinatorial rule.

Definition 6.4.3. Let $I \subset \{1, \dots, n\}$ of size k , and $\sigma = i_1 \dots i_n \in \mathfrak{S}_n$. We define $\varphi_I(\sigma)$ to be the rook obtained by removing the first k entries of σ and inserting zeros in positions indexed by the elements of I .

We also denote $\psi : R_n \rightarrow \mathfrak{S}_n$ the map which takes a rook, put all zeros at the beginning of the word and replace them by the missing letters in decreasing order.

Example 6.4.4. For instance $\varphi_{\{1,3\}}(14235) = 02035$ and $\psi(02410) = 53241$.

For the next results, we will consider R_n^0 to be a left H_n^0 -module by left multiplication. Thus the action is on values as in Definition 4.5.1.

Theorem 6.4.5. R_n^0 is projective over H_n^0 . As a consequence any R_n^0 -projective module remains projective when restricted to H_n^0 .

Proof. The main remark is that according to Definition 4.5.1, the left action of π_i for $i > 0$ on any rook does not change the zeros: they remain at the same positions and no one are added.

For any $I \subset \llbracket 0, n-1 \rrbracket$, let C_I the set of rooks with zeros in the positions indexed by I . Since the action of H_n^0 does not move zeros, we have the following decomposition in H_n^0 -modules:

$$R_n^0 \simeq \bigoplus_{I \subset \llbracket 0, n-1 \rrbracket} C_I. \quad (6.9)$$

It is enough to prove that each summand C_J are projective since direct sums of projective modules are projective.

For such a summand where zeros are in positions $i \in I$, the map ψ of Definition 6.4.3 is an injective H_n^0 -module morphism. Its image is the set of permutations which start with $|I|-1$ descents which is a well known projective H_n^0 -module. Indeed it is the H_n^0 -module generated by the element $i, i-1, \dots, 2, 1, i+1, i+2, \dots, n$. This element is the maximal element of the parabolic submonoid $\{\pi_1, \dots, \pi_{i-1}\}$, hence idempotent. Consequently it generates a projective modules. This shows that C_I is projective on H_n^0 . \square

We now describe explicitly the restriction functor. Recall from Section 3.6 that the induction product of two indecomposable projective H_m^0 -Module (resp. H_n^0 -Module) P_I and P_J is given by $P_I \star P_J := \operatorname{Ind}_{m,n}^0(P_I \otimes P_J) \simeq P_{I \cdot J} \oplus P_{I \triangleright J}$.

Definition 6.4.6. Let I be an extended composition of n . A zero-filling of I is a ribbon of shape I with boxes either empty, either with 0 inside according to the following rules:

- In the first column, either every box contains 0 if $0 \in \text{Des}(I)$, or none otherwise.
- Outside of the first column, if a box contains 0 then there is no box on its left, and all the boxes below in the same column also contain zeros.

To each of these fillings f we associate a tuple $\text{Split}(f)$ of ribbon as follows

- the first entry of the tuple is a column whose size is the total number of zeros in f
- the other entries of the tuple are the (down-right) connected components of I where the boxes containing a 0 in f are removed.

To each splitting, it therefore makes sense to consider the \star -product $\prod_{r \in \text{Split}(f)} P_r$.

Example 6.4.7. The following picture shows an extended composition followed by some of its 0-fillings. There are $3 * 3 * 2$ of them.

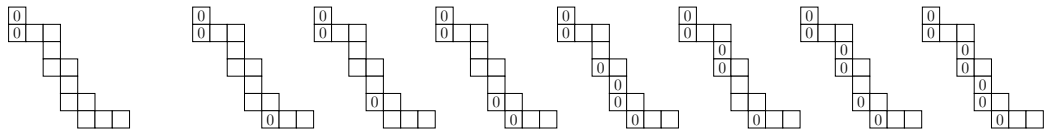

We now consider two particular 0-fillings and show the ribbons appearing in the associated respective products (the colors are just to show what happens of each box):

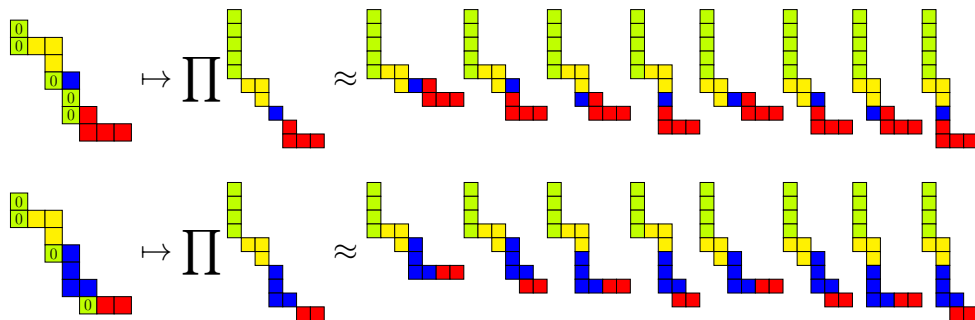

Theorem 6.4.8. The indecomposable projective R_n^0 -module P_I^R associated to an extended composition I splits as a H_n^0 -module as

$$P_I^R \simeq \bigoplus_f \prod_{r \in \text{Split}(f)} P_r, \tag{6.10}$$

where the direct sum spans along all the zero-fillings of I , and the product is for the induction product \star .

Before giving a proof, here is an example.

Example 6.4.9. This is an example of decomposition of a indecomposable projective R_n^0 -module into indecomposable projective H_n^0 -modules. The colors indicate the different products of zero-filling. See Figure 6.5.

$$\begin{array}{|c|} \hline 0 \\ \hline \square \\ \hline \end{array} = \begin{array}{|c|c|} \hline 0 & \\ \hline \square & \square \\ \hline \end{array} + \begin{array}{|c|c|} \hline 0 & \\ \hline \square & \square \\ \hline \end{array} = \begin{array}{|c|c|} \hline & \\ \hline \square & \square \\ \hline \end{array} + \begin{array}{|c|c|} \hline & \\ \hline \square & \square \\ \hline \end{array} = \begin{array}{|c|c|} \hline & \\ \hline \square & \square \\ \hline \end{array} + \begin{array}{|c|c|} \hline & \\ \hline \square & \square \\ \hline \end{array} + \begin{array}{|c|c|} \hline & \\ \hline \square & \square \\ \hline \end{array} + \begin{array}{|c|c|} \hline & \\ \hline \square & \square \\ \hline \end{array} + \begin{array}{|c|c|} \hline & \\ \hline \square & \square \\ \hline \end{array} = \begin{array}{|c|c|} \hline & \\ \hline \square & \square \\ \hline \end{array} + \begin{array}{|c|c|} \hline & \\ \hline \square & \square \\ \hline \end{array} + \begin{array}{|c|c|} \hline & \\ \hline \square & \square \\ \hline \end{array} + 2 \begin{array}{|c|c|} \hline & \\ \hline \square & \square \\ \hline \end{array} + \begin{array}{|c|} \hline \square \\ \hline \end{array}.$$

Proof. Let P_I be an indecomposable projective R_n^0 -module and look at it inside the regular representation. We proceed as in the proof of Theorem 6.4.5: we cut P_I according to the positions of zeros, which comes down to cutting along the zero-fillings. Indeed the conditions of zero-fillings give us only valid fillings, because they still have the good descent set. Moreover, we see all of them appearing in the descent class: for a given zero-filling f , we fill the diagram of I column after column, left to right, down to up, by the entries starting from the number of zeros in the zero-filling plus 1 to n . We get a rook of descent set I with zero in the positions given by f .

Let F be a zero-filling of shape I with i zeros in positions indexed by elements of $D \subset \llbracket 1, n \rrbracket$. Let $M_D \subset R_n^0$ be the associated H_n^0 -projective indecomposable module. We consider the restriction $\psi_F := \psi|_{M_D}$. We need to describe the image of ψ_F . First they start with i descents including zeros. We consider the connected components of $\llbracket 1, n \rrbracket \setminus I$: the letters at these positions are moved to the right by ψ_F , but keep their relative order. It is only between the connected components that we can have either a rise or a descent. Then we are getting a subset from a product associated to F . And we get them all: take one of them, and fill it with the same rule as before; one gets a permutation and then apply φ_I defined in 6.4.3 to get an element with the good descent set and positions of zeros which will be sent by ψ_F to an element of the product. \square

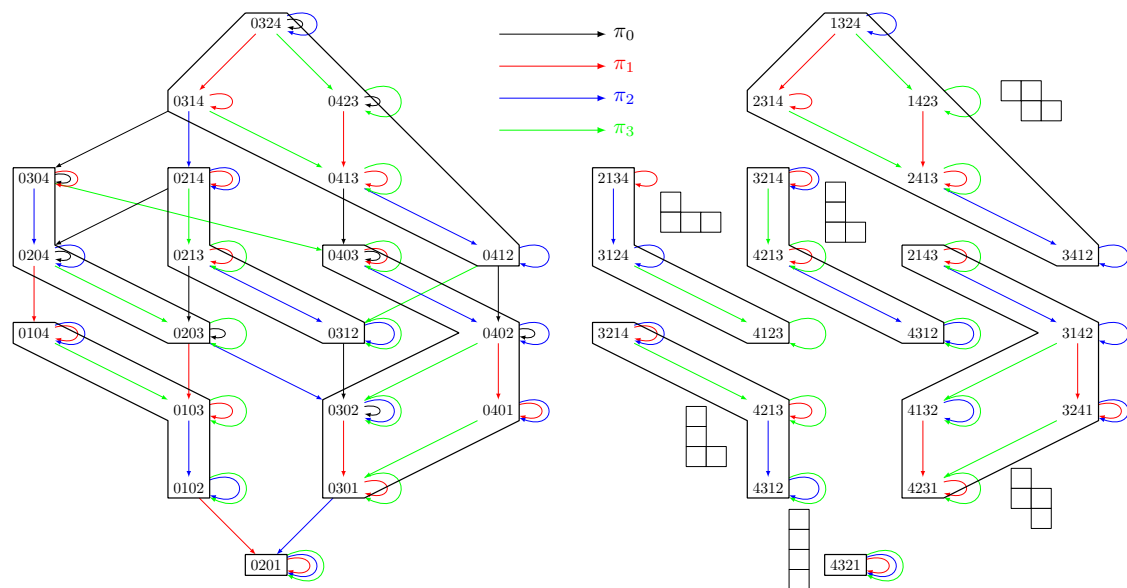

Figure 6.5: The decomposition of a R_4^0 -projective module associated to $\{0, 2\}$ into H_4^0 -projective modules.

We can be a little more precise:

Proposition 6.4.10. *Let P^R be an indecomposable projective module of R_n^0 . Write $P^R = \bigoplus P_I^H$ its decomposition into indecomposable H_n^0 -projective modules. Then the isomorphism of H_n^0 -module $\tilde{\varphi} : \bigoplus P_I^H \rightarrow P^R$ is triangular: $\tilde{\varphi}(e) = \varphi_I(e) + \sum_{e' < e} e'$, with φ_I defined in 6.4.3 and I the zero-set linked to P_I^H .*

Proof. We consider a R_n^0 indecomposable projective P^R , pick a $D \subset \llbracket 1, n \rrbracket$ and denote as in the proof of Theorem 6.4.8 the H_n^0 submodule M_D of rooks whose zeros are in positions indexed by the elements of D . The setwise map $\psi|_{M_D}$ extends linearly to an isomorphism to the projective but not necessarily indecomposable permutation module $\prod_{r \in \text{Split}(f)} P_r$. Using [Den+10, Theorem 3.11 and Corollary 3.19], we know that the basis change decomposing this module to its indecomposable component is uni-triangular. The statement follows by inverting this map. \square

Example 6.4.11. We know from Example 6.4.9 that there is a $\begin{smallmatrix} \square \\ \square \end{smallmatrix}$ module inside the Figure 6.5, coming from the zero-filling $\begin{smallmatrix} 0 & \square \\ 0 & \square \end{smallmatrix}$. This H_n^0 -module is well-known to have the elements 3214, 4213 and 4312. So ours must contains $\varphi_{\{0,2\}}(3214) = 0104$, $\varphi_{\{0,2\}}(4213) = 0103$ and $\varphi_{\{0,2\}}(4312) = 0102$. See Figure 6.5.

Remark 6.4.12. As in Proposition 6.4.2 we could use Frobenius reciprocity to describe the induction of simple modules from H_n^0 to R_n^0 . Another method will also given in the next section.

6.5 Tower of monoids

The goal of this section is to investigate if the chain of submonoids: $R_1^0 \subset R_2^0 \subset R_3^0 \subset \dots \subset R_n^0 \subset \dots$ can be endowed with a structure of a tower of monoids 3.4.4.

Proposition 6.5.1. *The maps*

$$\begin{array}{ccccccc}
 \rho_{n,m} : & R_n^0 & \times & R_m^0 & \longrightarrow & R_{n+m}^0 & \\
 & \pi_0, \dots, \pi_{n-1} & & & \longmapsto & \pi_0, \dots, \pi_{n-1} & \\
 & P_i & & & \longmapsto & P_i & (6.11) \\
 & & & \pi_1, \dots, \pi_{n-1} & \longmapsto & \pi_{n+1}, \dots, \pi_{n+m-1} & \\
 & & & P_i & \longmapsto & P_{i+n} &
 \end{array}$$

defines an associative tower of monoids.

Notation 6.5.2. *If $a \in R_n^0$ and $b \in R_m^0$ we denote $a \cdot b := \rho_{n,m}(a, b)$.*

Furthermore, if w a word on nonnegative integers, \bar{w}^n denotes the word w where all nonzero entries have been increased by n .

Proof. We first show that $\rho_{n,m}$ are morphisms. Let $a \in R_n^0$ et $b \in R_m^0$. Then, by relation of commutation and absorption we get $\rho(a, b) = \rho(a, 1) \cdot \rho(1, b) = \rho(1, b) \cdot \rho(a, 1)$.

The proof of the associativity rely on the following lemma:

Lemma 6.5.3. *Let $a \in R_n^0$ and $b \in R_m^0$. Then*

$$a \cdot b = \begin{cases} \mathbf{a}\bar{\mathbf{b}}^n & \text{if } 0 \notin \mathbf{b}, \\ 0 \dots 0\bar{\mathbf{b}}^n & \text{otherwise.} \end{cases} \quad (6.12)$$

Proof. Indeed $\rho(a, b) = \rho(a, 1)\rho(1, b)$. If $0 \notin b$ then π_0 does not appear in any reduced expression of b , thus the reduced expressions of a and b contain generators which do not act on 1_{n+m} on the same positions. Otherwise P_{n+1} appear in $\rho(1, b)$, and since all elements of $\rho(1, a)$ commute with those of $\rho(1, b)$, P_{n+1} absorbs all the $\rho(a)$. \square

We now can compute explicitly the products $(a \cdot b) \cdot c$ and $a \cdot (b \cdot c)$, do the four cases whether $0 \in B$ or not and $0 \in C$ and check associativity. \square

Remark 6.5.4. The embedding ρ is not injective since $\forall a, a' \in R_n^0$, and $b \in R_m^0$ with $0 \in b : a \cdot b = a' \cdot b$ by Lemma 6.5.3. So we do not have a tower of monoid in the sense of [BL09].

Remark 6.5.5. To map $R_n^0 \times R_m^0$ to R_{n+m}^0 , Remark 4.2.3 prevents us to use the trivial map $(a, b) \mapsto \mathbf{a}\bar{\mathbf{b}}^n$: it is not a monoid morphism.

6.5.1 Simple modules

The goal of this section is to describe the restriction and induction rule of the tower of the 0-rook monoids. Recall from Section 3.6 that for H_n^0 this gives the multiplication and comultiplication rule of the Hopf algebra of quasi-symmetric functions in the fundamental basis.

Restriction of simples modules

Theorem 6.5.6. *Let $J \subset \llbracket 0, n + m - 1 \rrbracket$ a parabolic of R_{n+m}^0 . Then:*

$$\text{Res}_{R_n^0 \times R_m^0}^{R_{n+m}^0} S_J = \begin{cases} S_{J \cap \llbracket 0, n-1 \rrbracket} \otimes S_{\overline{J \cap \llbracket n+1, n+m-1 \rrbracket}}} & \text{if } J \cap \llbracket 0, n \rrbracket \neq \llbracket 0, n \rrbracket \\ S_{\llbracket 0, n-1 \rrbracket} \otimes S_{\{0\} \cup \overline{J \setminus \llbracket 0, n \rrbracket}}} & \text{otherwise.} \end{cases} \quad (6.13)$$

where $\overline{X} := \{x - n \mid x \in X\}$.

Proof. We know that $S_J = \langle \varepsilon_J \rangle$, and that $\varepsilon_J \cdot \pi_i = \varepsilon_J$ if $i \in J$, and 0 otherwise. The action of $R_n^0 \otimes 1_m$ on S_J gives us $S_{J \cap \llbracket 0, n-1 \rrbracket}$. The generators $1_n \otimes \pi_1, \dots, 1_n \otimes \pi_{m-1}$ of $1_n \otimes R_m^0$ act as $\pi_{n+1}, \dots, \pi_{n+m-1}$. It remains only to see how $1_n \otimes \pi_0 = P_{n+1}$ acts on S_J . By Lemma 4.1.4 we have that $P_{n+1} = \pi_0 \pi_1 \pi_0 \pi_2 \pi_1 \pi_0 \dots \pi_n \dots \pi_2 \pi_1 \pi_0$. So if there is $0 \leq i \leq n$ with $i \notin J$, $\varepsilon_J \cdot \pi_i = 0$ thus $\varepsilon_J \cdot P_{n+1} = 0$. Otherwise, for all $i \in \llbracket 0, n \rrbracket$, $\varepsilon_J \cdot \pi_i = \varepsilon_J$ and so $\varepsilon_J \cdot P_{n+1} = \varepsilon_J$. \square

Induction of simple modules We can compute the induction of simple module thanks to the Theorem 3.4.13, which we reformulate in our context here. The comparisons are done with the \mathcal{R} -order in R_n^0 , which we described in Theorem 5.1.11.

Theorem 6.5.7. *If $e \in E(R_n^0)$ and $f \in E(R_m^0)$, then*

$$\text{Ind}_{R_n^0 \times R_m^0}^{R_{n+m}^0} S_e \otimes S_f = (e \cdot f)R_{n+m}^0 / [(R_{<e} \cdot f) + (e \cdot R_{<f})] R_{n+m}^0, \quad (6.14)$$

where $R_{<e}$ is the set of elements of R_n^0 strictly smaller than e , and $R_{<f}$ those of R_m^0 strictly smaller than f .

Notation 6.5.8. *In Equation 6.14, we will denote by $Q(e, f)$ the right hand side of the equality. It is a R_{n+m}^0 -module. It is also a quotient which is compatible with the canonical basis. By abuse of language, we will say that an element $r \in R_{n+m}^0$ remains in $Q(e, f)$ and write $r \in Q(e, f)$ if r is not sent to zero in the quotient.*

Our first goal is to rephrase Theorem 6.5.7 in a more combinatorial way.

Notation 6.5.9. *Until now, we used the notation π_I to design the idempotent of the parabolic submonoid associated to I in R_n^0 . In order to avoid confusion, we will now denote it by $\pi_{I,n}$. Note that as long as $n, m \geq \max I + 1$, then $\pi_{I,n}$ and $\pi_{I,m}$ have the same reduced expressions and thus the same action of the first $\min(n, m)$ -letters on the identity of size $\max(n, m)$.*

In the sequel of this section, we fix $I \subseteq \llbracket 0, n-1 \rrbracket$ and $J \subseteq \llbracket 0, m-1 \rrbracket$. They encode the data of two simple modules of R_n^0 and R_m^0 respectively, or equivalently of two idempotents. We denote $e := \pi_{I,n}$ and $f := \pi_{J,m}$ these two idempotents.

Before giving the induction of the simple modules, we go for a serie of lemmas.

Lemma 6.5.10. *The image of $(e, f) \in R_n^0 \times R_m^0$ in R_{n+m}^0 is the element of R_{n+m}^0 associated to $e\bar{\mathbf{f}}^n$ if $0 \notin J$ and to $0 \dots 0\bar{\mathbf{f}}^n$ otherwise. In particular we have the following cases:*

- If $J = \emptyset$ then $e \cdot f = \overline{e12 \dots m}^n = \pi_{I, n+m}$.
- If $I = \emptyset$ and $0 \notin J$ then $e \cdot f = 1 \dots n\bar{\mathbf{f}}^n = \pi_{\bar{J}, n+m}$.
- If $I = \llbracket 0, n-1 \rrbracket$ and $0 \in J$ then $e \cdot f = 0 \dots 0\bar{\mathbf{f}}^n = \pi_{(\llbracket 0, n \rrbracket \cup \bar{J} \setminus \{0\})^n, n+m}$.

Proof. It is straightforward application of Lemma 6.5.3. □

Remark 6.5.11. Note that because of the form of idempotents, $0 \notin I \Leftrightarrow 0 \notin e$.

Lemma 6.5.12. *Assume that $0 \in J$ and $I \neq \llbracket 0, n-1 \rrbracket$. Then $Q(e, f) = 0$.*

Proof. Since $0 \in J$ then $e \cdot f = 0 \dots 0\bar{\mathbf{f}}$ according to Lemma 6.5.10. On the other hand, let $j \in \llbracket 0, n-1 \rrbracket \setminus I$. Then in $Q(e, f)$ we are doing a quotient by $(e \cdot \pi_j) \cdot 1_m$ which is above $e \cdot f$ by Theorem 5.1.11. Hence $Q(e, f) = 0$. □

We are now considering cases where $0 \notin J$:

Lemma 6.5.13. *Assume $0 \notin J$. Let r be an element of R_{n+m}^0 which does not vanish in the quotient $Q(e, f)$. Let a and b be two letters of \mathbf{r} , not both zero. If a and b appear both in \mathbf{e} (resp. $a - n$ and $b - n$ appear both in \mathbf{f}) then they appear in the same order as in \mathbf{e} (resp. \mathbf{f}). Furthermore, all the nonzero letters of \mathbf{e} appear in \mathbf{r} . Finally, if $f_i + n$ is not in \mathbf{r} then $f_j + n$ is not in \mathbf{r} , for all $j < i$.*

Example 6.5.14. If $\mathbf{e} = \mathbf{023}$ and $\mathbf{f} = \mathbf{213}$ then neither $\mathbf{042356}$, or $\mathbf{005463}$, or $\mathbf{025306}$ remain in $Q(e, f)$, respectively because of the first, second or third rule.

Proof. For the first point, it is sufficient to do the proof when the two letters are consecutive ones in \mathbf{e} . Let $\mathbf{r} \in Q(e, f)$. So $r \leq \mathbf{e}\bar{\mathbf{f}}^n$. Assume $\mathbf{e} = \underline{LabR}$ with a and b non both zero, and both present in \mathbf{r} .

Suppose first that $a > b$, so that $a \neq 0$ and $b \neq 0$ since $0 \notin J$. Since $r < \mathbf{e}\bar{\mathbf{f}}^n$ we deduce that a is before b in \mathbf{r} .

Otherwise, $a < b$. Let $i := \ell(\underline{L})$ be the position of a in \mathbf{e} . So $i \notin I$. Then $e \cdot \pi_i < e$. Also $\text{Inv}(e \cdot \pi_i) = \text{Inv}(e) \cup \{(b, a)\}$. Thus, $\text{Inv}((\mathbf{e} \cdot \pi_i)\bar{\mathbf{f}}^n) = \text{Inv}(\mathbf{e}\bar{\mathbf{f}}^n) \cup \{(b, a)\}$ while $(b, a) \notin \text{Inv}(\mathbf{e}\bar{\mathbf{f}}^n)$. Since $r < \mathbf{e}\bar{\mathbf{f}}^n$ we get $\{(r_i, r_j) \in \text{Inv}(\mathbf{e}\bar{\mathbf{f}}^n) \mid r_i \in \mathbf{r}\} \subseteq \text{Inv}(r)$. Assume that b is left to a in \mathbf{r} . In this case we have $\{(r_i, r_j) \in \text{Inv}(\mathbf{e}\bar{\mathbf{f}}^n) \cup \{(b, a)\} \mid r_i \in \mathbf{r}\} \subseteq \text{Inv}(r)$, so $r < (\mathbf{e} \cdot \pi_i)\bar{\mathbf{f}}^n$, the latter being an element by which we quotient in $Q(e, f)$. It is a contradiction.

The proof is the same when a and b both come from \mathbf{f} once decreased. The only change are that the both letter are nonzero, and that we have to decrease by n .

Let us prove the second point by contradiction, assuming that a nonzero letter b in \mathbf{e} is not in \mathbf{r} . We first show that the first nonzero letter of \mathbf{e} , a is not either. Assume also that $a \in \mathbf{r}$. If $a > b$ then e has descent (a, b) . So r must also have it since $r < \mathbf{e}\bar{\mathbf{f}}^n$ and $a \in \mathbf{r}$, but it is not the case since $b \notin \mathbf{r}$, which is a contradiction. Otherwise $a < b$. Since $a \in \mathbf{r}$ and $b \notin \mathbf{r}$, and that the generator π_0 can only delete the first letter, r is in the \mathcal{R} -order between $\mathbf{e}\bar{\mathbf{f}}^n$ and a rook r' in which a is there and b is in first position. Because of the first point, this element r' has been sent to 0 in the quotient, and thus r which is below as well. So $r = 0$, contradiction. We can note that the latter arguments give also a proof of the third point just adapting some points.

Thus if there is a nonzero letter of \mathbf{e} lacking in \mathbf{r} , the first one at least is lacking. We now look at \mathbf{e} . If $0 \notin I$, \mathbf{e} begins with a . Then $\mathbf{q} := (\mathbf{e} \cdot \pi_0)\bar{\mathbf{f}}^n$ is an element by which we quotient. We have $r < \mathbf{e}\bar{\mathbf{f}}^n$ and $a \notin \mathbf{r}$ so $r < \mathbf{q}$, thus $r = 0$, contradiction.

Otherwise $0 \in I$ so $\mathbf{e} = 0 \dots 0a \dots$. We denote by i the position of the last 0 and $q := (\mathbf{e} \cdot \pi_i)\bar{\mathbf{f}}^n$ is an element by which we quotient. Since $a \notin \mathbf{r}$, r is in the \mathcal{R} -order between $\mathbf{e}\bar{\mathbf{f}}^n$ and a rook r' in which a is there in first position. In particular in \mathbf{r} , we have a 0 right to a . So $r < r' < \mathbf{e}\bar{\mathbf{f}}^n$ and $(a, 0) \in \text{Inv}(r')$, so $r' < q$ and thus $r = 0$, contradiction. \square

Remark 6.5.15. Let $K \subset \llbracket 1, n-1 \rrbracket$ and $g \in R_n^0$ the associated idempotent (hence $0 \notin g$). We write $\mathbf{g} = g_1 g_2 \dots g_n$. Because of Proposition 6.2.3 we have that if $g_1 = \ell$ then $g_2 = \ell - 1$, $g_3 = \ell - 2$, \dots , $g_{\ell-1} = 2$ and $g_\ell = 1$. Furthermore $\ell \notin K$ (since $g_{\ell+1} > g_\ell$) and $\ell = \min(\llbracket 1, n-1 \rrbracket \setminus I)$.

We are now in position to state give the formula giving the induction of simple modules. Recall that \sqcup denote the so-called shuffle product introduced in Example 1.7.2.

Theorem 6.5.16. *For $n, m \in \mathbb{N}$, we fix $I \subseteq \llbracket 0, n-1 \rrbracket$ and $J \subseteq \llbracket 0, m-1 \rrbracket$. Denoting $e := \pi_{I,n}$ and $f := \pi_{J,m}$, the induction of simple modules $S_I = S_e$ and $S_J = S_f$ is given by*

1. If $0 \in J$ and $I \neq \llbracket 0, n-1 \rrbracket$ then $\text{Ind}_{R_n^0 \times R_m^0}^{R_{n+m}^0} S_I \otimes S_J = 0$.
2. If $0 \in J$ and $I = \llbracket 0, n-1 \rrbracket$ then $\text{Ind}_{R_n^0 \times R_m^0}^{R_{n+m}^0} S_I \otimes S_J = \langle \mathbf{e}\bar{\mathbf{f}}^n \rangle \simeq S_{\llbracket 0, n \rrbracket \cup \overline{J \setminus \{0\}}^n}$
3. If $0 \notin J$ and $I = \llbracket 0, n-1 \rrbracket$ then $\text{Ind}_{R_n^0 \times R_m^0}^{R_{n+m}^0} S_I \otimes S_J = \langle 0 \dots 0 \sqcup \bar{\mathbf{f}}^n \rangle$.
4. If $0 \notin J$ and $0 \in I$, $I \neq \llbracket 0, n-1 \rrbracket$, let ℓ be the first letter of $\mathbf{f} = f_1 \dots f_m$. Then:

$$\text{Ind}_{R_n^0 \times R_m^0}^{R_{n+m}^0} S_I \otimes S_J = \left\langle \mathbf{e} \sqcup \bar{\mathbf{f}}^n + 0\mathbf{e} \sqcup \overline{f_2 \dots f_m}^n + 00\mathbf{e} \sqcup \overline{f_3 \dots f_m}^n + \dots + 0 \dots 0\mathbf{e} \sqcup \overline{f_{\ell+1} \dots f_m}^n \right\rangle, \quad (6.15)$$

where the last term begins with ℓ letters 0.

5. If $0 \notin J$ and $0 \notin I$, let ℓ be the first letter of $\mathbf{f} = f_1 \dots f_m$. Then

$$\text{Ind}_{R_n^0 \times R_m^0}^{R_{n+m}^0} S_I \otimes S_J = \left\langle \mathbf{e} \sqcup \bar{\mathbf{f}}^n + 0 \sqcup \mathbf{e} \sqcup \overline{f_2 \dots f_m}^n + 00 \sqcup \mathbf{e} \sqcup \overline{f_3 \dots f_m}^n + \dots + 0 \dots 0 \sqcup \mathbf{e} \sqcup \overline{f_{\ell+1} \dots f_m}^n \right\rangle, \quad (6.16)$$

where the last term begins with ℓ letters 0.

Proof. 1. This case follows directly from Lemma 6.5.12.

2. Let $K := \llbracket 0, n \rrbracket \cup \overline{J \setminus \{0\}}^n$. Then by Lemma 6.5.10, $e \cdot f = \pi_{K, n+m}$. Since $I = \llbracket 0, n-1 \rrbracket$ then

$$Q(e, f) = \pi_{K, n+m} R_{n+m}^0 / [(0 \dots 0 \cdot R_{<f})] R_{n+m}^0. \quad (6.17)$$

On the other hand, let $g := \pi_{K, n+m}$ be the idempotent associated to K in R_{n+m}^0 . By Theorem 6.5.7,

$$S_g = \text{Ind}_{1 \times R_{n+m}^0}^{R_{n+m}^0} 1 \otimes S_g = g R_{n+m}^0 / [R_{<g}] R_{n+m}^0. \quad (6.18)$$

But since $I = \llbracket 0, n-1 \rrbracket$ on has $R_{<g} = 0 \dots 0 \cdot R_{<f}$, so that $Q(e, f) \simeq S_g$.

3. Since $I = \llbracket 0, n-1 \rrbracket$ then $\mathbf{e} = 0 \dots 0$ and $e \cdot f = 0 \dots 0\mathbf{f}$. Let $\mathbf{r} \in 0 \dots 0 \sqcup \overline{\mathbf{f}}^n$. Clearly $r < e \cdot f$. We know that \mathbf{r} has the same number of zeros than $\mathbf{e} \cdot \mathbf{f}$ and also that its inversions are those of f increased by n . We deduce that r is not below $\mathbf{e}(\overline{\mathbf{f} \cdot \pi_j})^n$ in the \mathcal{R} -order for $j \in \llbracket 0, m-1 \rrbracket \setminus J$. Thus $r \in Q(e, f)$.

Conversely let $r \in Q(e, f)$. Since $0 \notin J$ then $r \not\prec \mathbf{e}(\overline{\mathbf{f} \cdot \pi_0})^n$. So the first letter of \mathbf{f} increased by n is in \mathbf{r} . By Lemma 6.5.13 all the letters of \mathbf{f} increased by n are in \mathbf{r} . Again by Lemma 6.5.13 they are in the same order, and so $\mathbf{r} \in 0 \dots 0 \sqcup \overline{\mathbf{f}}^n$.

4. Denote $S_{ef} := \mathbf{e} \sqcup \overline{\mathbf{f}}^n + 0\mathbf{e} \sqcup \overline{f_2 \dots f_m}^n + \dots + 0 \dots 0\mathbf{e} \sqcup \overline{f_{\ell+1} \dots f_m}^n$ and let $\mathbf{r} \in S_{ef}$. The same argument than the third point shows that $r \in Q(e, f)$.

Conversely, let $r \in Q(e, f)$. Since $0 \in I$ (or equivalently, $0 \in \mathbf{e}$) Lemma 6.5.13 tells us that the eventual new zeros of \mathbf{r} are before the nonzero letters of \mathbf{e} . By the same lemma, the letters of \mathbf{f} disappear in the same order than in \mathbf{f} . So that we have proven:

$$\mathbf{r} \in T_{ef} := \mathbf{e} \sqcup \overline{\mathbf{f}}^n + 0\mathbf{e} \sqcup \overline{f_2 \dots f_m}^n + \dots + 0 \dots 0\mathbf{e} \sqcup \overline{f_m}^n + 0 \dots 0\mathbf{e}. \quad (6.19)$$

We recall that $\ell = f_1$. We have to show that elements of $T_{ef} \setminus S_{ef}$ are not in $Q(e, f)$. A first immediate remark is that all these elements are below $t = 0 \dots 0\mathbf{e}\overline{f_{\ell+2} \dots f_m}^n$. But $t < \mathbf{e}f_1 \dots f_{\ell-1}f_{\ell+1}f_{\ell}f_{\ell+2} \dots f_m = (\mathbf{e} \cdot (\mathbf{f} \cdot \pi_{\ell}))$. Thus, since $\ell \notin J$ (by Remark 6.5.15), $t = 0$ in $Q(e, f)$, and so all $T_{ef} \setminus S_{ef}$ also, hence the result.

5. Denote $S_{ef} := \mathbf{e} \sqcup \overline{\mathbf{f}}^n + 0 \sqcup \mathbf{e} \sqcup \overline{f_2 \dots f_m}^n + \dots + 0 \dots 0 \sqcup \mathbf{e} \sqcup \overline{f_{\ell+1} \dots f_m}^n$. Let $\mathbf{r} \in S_{ef}$. The argument of the third point proves that $r \in Q(e, f)$.

Conversely, for $r \in Q(e, f)$, the argument of the fourth point shows that $\mathbf{r} \in S_{ef}$. \square

Recall that the corresponding rule for H_n^0 is the multiplication of the fundamental basis (F_I) of quasi-symmetric function [KT97]. To get the analogue of the product of quasi-symmetric functions, one has to use the Theorem 6.5.16 and then get the projection of the induced module in the Grothendieck ring. This amounts to compute the R -descent of every rook vector appearing in the sum $Q(e, f)$ according to Jordan-Hölder's theorem (Theorem 3.2.6).

Example 6.5.17. If $n = 2$, $m = 3$, $I = \{0, 1\}$ and $J = \{1\}$. Then $\mathbf{e} = 00$ and $\mathbf{f} = 213$. Theorem 6.5.16 says that

$$Q(e, f) = \langle 00 \sqcup 435 \rangle = \langle \mathbf{00435}, \mathbf{04035}, \mathbf{04305}, \mathbf{04350}, \mathbf{40035}, \mathbf{40305}, \mathbf{40350}, \mathbf{43005}, \mathbf{43050}, \mathbf{43500} \rangle.$$

This gives the following R -descent classes:

Element	$\mathbf{00435}$	$\mathbf{04035}$	$\mathbf{04305}$	$\mathbf{04350}$	$\mathbf{40035}$	$\mathbf{40305}$	$\mathbf{40350}$	$\mathbf{43005}$	$\mathbf{43050}$	$\mathbf{43500}$
Descents	0,1,3	0,2	0,2,3	0,2,4	1,2	1,3	1,4	1,2,3	1,2,4	1,3,4

$$\begin{aligned} \text{Finally: } \text{Ind } S_{\{0,1\}}^2 \times S_{\{1\}}^3 &= S_{\{0,1,3\}}^5 + S_{\{0,2\}}^5 + S_{\{0,2,3\}}^5 + S_{\{0,2,4\}}^5 + S_{\{1,2\}}^5 + S_{\{1,3\}}^5 \\ &\quad + S_{\{1,4\}}^5 + S_{\{1,2,3\}}^5 + S_{\{1,2,4\}}^5 + S_{\{1,3,4\}}^5 \end{aligned}$$

Example 6.5.18. If $n = 3$, $m = 2$, $I = \{0, 1\}$ and $J = \{1\}$. Then $e = 003$ and $f = 21$. Theorem 6.5.16 says that

$$\begin{aligned}
 Q(e, f) &= \langle 003 \sqcup 21 + 0003 \sqcup 1 + 00003 \rangle \\
 &= \langle \{00321, 00231, 00213, 02031, 02013, 02103, 20031, 20013, 20103, 21003\} \\
 &\quad \cup \{00031, 00013, 00103, 01003, 10003\} \cup \{00003\} \rangle
 \end{aligned}$$

Then:

Element	00321	00231	00213	02031	02013	02103	20031	20013
Descents	0,1,3,4	0,1,4	0,1,3	0,2,4	0,2	0,2,3	1,2,4	1,2
Element	20103	21003	00031	00013	00103	01003	10003	00003
Descents	1,3	1,2,3	0,1,2,4	0,1,2	0,1,3	0,2,3	1,2,3	0,1,2,3

$$\begin{aligned}
 \text{Ind } S_{\{0,1\}}^3 \times S_{\{1\}}^2 &= S_{\{0,1,3,4\}}^5 + S_{\{0,1,4\}}^5 + 2S_{\{0,1,3\}}^5 + S_{\{0,2,4\}}^5 + S_{\{0,2\}}^5 + 2S_{\{0,2,3\}}^5 + S_{\{1,2,4\}}^5 \\
 &\quad + S_{\{1,2\}}^5 + S_{\{1,3\}}^5 + S_{\{1,2\}}^5 + S_{\{0,1,2,4\}}^5 + S_{\{0,1,2\}}^5 + 2S_{\{1,2,3\}}^5 + S_{\{0,1,2,3\}}^5
 \end{aligned}$$

This defines the left (resp. right) dual branching graph, where the arrows $I \mapsto J$ are labelled by the multiplicity of S_J in the induction of S_I along the morphism $\rho_{1,n}$ (resp. $\rho_{n,1}$). The beginning of those two graphs are illustrated in Figures 6.6 and 6.7.

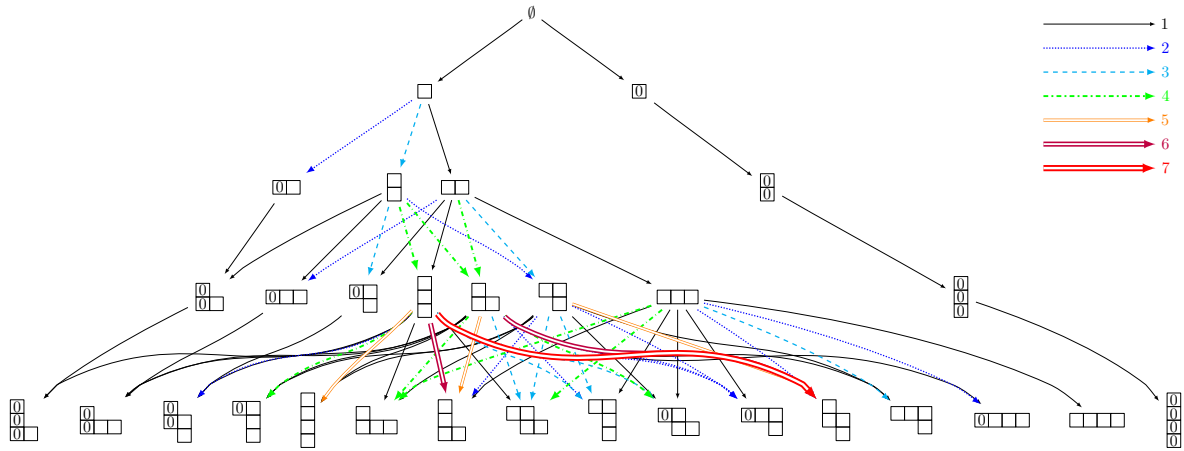

Figure 6.6: The left dual branching graph of R_n^0 .

Hopf algebra On the contrary to H_n^0 , we do not get a Hopf algebra. Indeed, the following diagram that express the compatibility of the product with the co-product does not commute:

$$\begin{array}{ccc}
 R_{a+b}^0 \times R_{c+d}^0 & \xrightarrow{\text{Ind}} & R_{a+b+c+d}^0 \\
 \text{Res} \times \text{Res} \downarrow & & \downarrow \text{Res} \\
 R_a^0 \times R_b^0 \times R_c^0 \times R_d^0 & \xrightarrow{\text{Ind} \times \text{Ind}} & R_{a+c}^0 \times R_{b+d}^0
 \end{array}$$

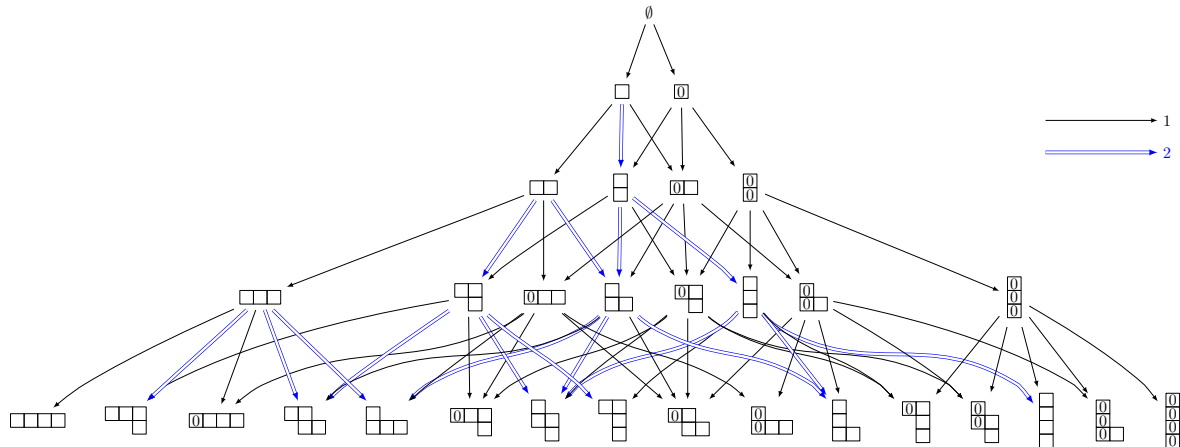

Figure 6.7: The right dual branching graph of R_n^0 .

Here is a counter example: Using Theorem 6.5.16, we get $\text{Res}_{R_1^0 \times R_2^0}^{R_3^0} S_{\{0,1\}}^3 = S_{\{0\}}^1 \otimes S_{\{0\}}^2$ and $\text{Res}_{R_1^0 \times R_1^0}^{R_2^0} S_{\{1\}}^2 = S_{\{1\}}^1 \otimes S_{\{1\}}^1$. Then

$$\begin{aligned} \text{Ind} \times \text{Ind} (\text{Res} \times \text{Res} S_{\{0,1\}}^3 \otimes S_{\{1\}}^2) &= \text{Ind}(S_{\{0\}}^1 \otimes S_{\{1\}}^1) \otimes \text{Ind}(S_{\{0\}}^2 \otimes S_{\{1\}}^1) \\ &= (S_{\{0\}}^2 + S_{\{1\}}^2) \otimes (S_{\{0\}}^3 + S_{\{0,1\}}^3 + S_{\{0,2\}}^3 + S_{\{1\}}^3) \end{aligned} \tag{6.20}$$

Hence this sum has 8 elements, with multiplicity. On the other hand, we saw in Example 6.5.18 that $\text{Ind} S_{\{0,1\}}^3 \times S_{\{1\}}^2$ is a sum of 16 elements (with multiplicity) and the Theorem 6.5.6 shows that the multiplicity does not change by restriction. Hence the result is false.

Induction with H_n^0 One can wonder what would happen if we rather consider the induction and restriction along $R_n^0 \times H_m^0 \rightarrow R_{n+m}^0$. It is not a tower of monoids, but the morphisms $\tilde{\rho}_{n,m} := (\rho_{n,m})|_{R_n^0 \times H_m^0}$ are injective. We just give the result of the induction of simple modules:

Theorem 6.5.19. *For $n, m \in \mathbb{N}$, let $I \subseteq \llbracket 0, n-1 \rrbracket$ and $J \subseteq \llbracket 1, m-1 \rrbracket$. Denoting $e := \pi_{I,n} \in R_n^0$ and $f := \pi_{J,m} \in H_m^0$, the induction of simple modules $S_I = S_e$ and $S_J = S_f$ is given by*

1. If $0 \in I$, let ℓ be the first letter of $\mathbf{f} = f_1 \dots f_m$. Then:

$$\begin{aligned} \text{Ind}_{R_n^0 \times H_m^0}^{R_{n+m}^0} S_I \otimes S_J &= \left\langle \mathbf{e} \sqcup \bar{\mathbf{f}}^n + 0\mathbf{e} \sqcup \overline{f_2 \dots f_m}^n + 00\mathbf{e} \sqcup \overline{f_3 \dots f_m}^n + \right. \\ &\quad \left. \dots + 0 \dots 0\mathbf{e} \sqcup \overline{f_{\ell+1} \dots f_m}^n \right\rangle, \end{aligned} \tag{6.21}$$

where the last term begins with ℓ letters 0.

2. If $0 \notin I$, let ℓ be the first letter of $\mathbf{f} = f_1 \dots f_m$. Then

$$\text{Ind}_{R_n^0 \times H_m^0}^{R_{n+m}^0} S_I \otimes S_J = \left\langle \mathbf{e} \sqcup \bar{\mathbf{f}}^n + 0 \sqcup \mathbf{e} \sqcup \overline{f_2 \dots f_m}^n + 00 \sqcup \mathbf{e} \sqcup \overline{f_3 \dots f_m}^n + \dots + 0 \dots 0 \sqcup \mathbf{e} \sqcup \overline{f_{\ell+1} \dots f_m}^n \right\rangle, \quad (6.22)$$

where the last term begins with ℓ letters 0.

Proof. This is a consequence of Theorem 6.5.16. □

6.5.2 Projective indecomposable modules

Restriction of indecomposable projective modules In order to get a co-product on the Grothendieck ring of projective modules, \mathcal{K}_0 , we need that R_{m+n}^0 is projective over $R_m^0 \times R_n^0$. Unfortunately, this is not the case. We will moreover give counterexamples to the fact that R_n^0 is projective over R_{n-1}^0 for both embeddings $\rho_{n-1,1}$ and $\rho_{1,n-1}$. This forbids to have any analogues of branching graphs for projective modules.

Let us take $P_{\{0,2,3\}}$. We want to restrict this projective indecomposable module of R_4^0 to $R_2^0 \times R_2^0$. In Figure 6.8 we have on the left the module $P_{\{0,2,3\}}^4$ where we

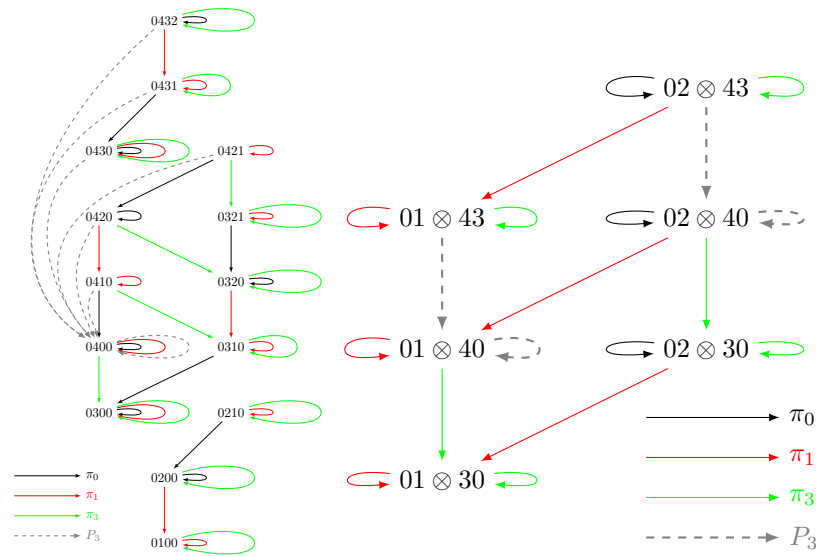

Figure 6.8: First counterexample for the restriction of projective modules.

deleted the arrows of π_2 and showed the action of P_3 . Here we see that P_3 has a stable subspace of dimension 1. On the right we represent what would be a necessary part of the decomposition of $P_{\{0,2,3\}}^4$, that is $P_{\{0\}}^2 \otimes P_{\{1\}}^2$. Here we see that P_3 (that is the π_0 of the right R_2^0 according to the embedding 6.5.1) as a stable subspace of dimension 2. Hence it is impossible to cut the left one to get a sum of projective indecomposable modules since the right one must be there and can not be.

We give now two counterexamples which show that it does not work also for the restriction along both embeddings $\rho_{n-1,1}$ and $\rho_{1,n-1}$. On the left of Figure 6.9 we have the projective module $P_{\{2\}}^4$. We see that no element of this module has two zeros, hence P_2 send every element to zero. In the middle of the figure we have

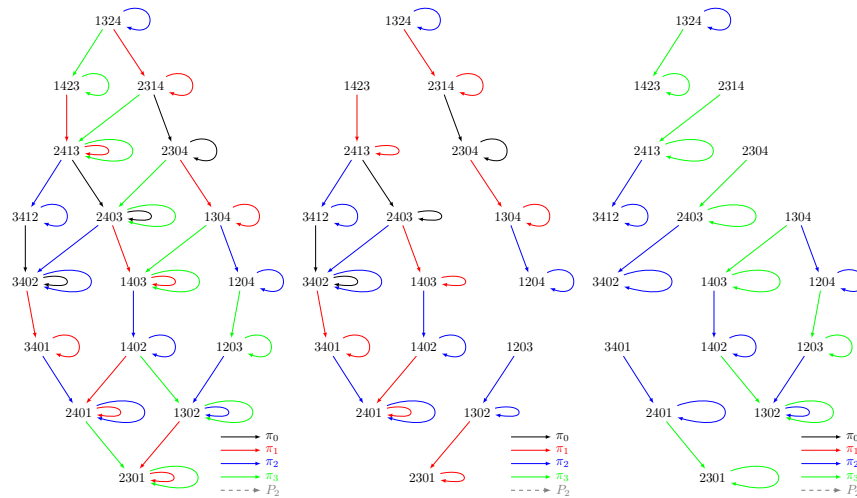

Figure 6.9: Second counterexample for the restriction of projective modules.

the same module where we forgot the action of π_3 , that is we are looking at the restriction $R_4^0 \rightarrow R_3^0 \otimes R_1^0$. In the left one we forgot the action of both π_0 and π_1 but put the action of P_2 (none here): we are looking at the restriction along $R_4^0 \rightarrow R_1^0 \otimes R_3^0$. If the middle and right modules were projective, these figures could be cut as projective modules of R_3^0 . We proceed step by step on the middle one. First we recognise the first chain of five elements which is $P_{\{2\}}^3$. Then the element 1423 is $P_{\{\}}^3$. All the cycles below with element on top 2413 is $P_{\{1\}}^3$. The element 1203 is again $P_{\{\}}^3$. But the last two elements do not correspond to any projective modules of R_3^0 (it should correspond to $P_{\{2\}}^3$ since 1302 only has the loop of π_2 , which is not the case).

We proceed the same way for the right module. We immediately have a contradiction with the first element which should generate $P_{\{1\}}^3$ (be careful of the labels!) which is not the case.

As a conclusion of this paragraph, since we do not have the restriction of indecomposable projective modules, we will not be able to have a tower of monoids as for the case of H_n^0 to get NCSF and QSym (Section 3.6).

Induction of indecomposable projective modules For this one we can use Frobenius reciprocity as we did in Proposition 6.4.2, using Theorem 6.5.6:

Theorem 6.5.20. *Let $I \subset \llbracket 0, n - 1 \rrbracket$ and $J \subset \llbracket 0, m - 1 \rrbracket$. Then*

$$\text{Ind}_{R_n^0 \times R_m^0}^{R_{n+m}^0} P_I \otimes P_J = \begin{cases} P_{I \cup \bar{J}^n} \oplus P_{I \cup \{n\} \cup \bar{J}^n} & \text{if } 0 \notin J \\ P_{\llbracket 0, n \rrbracket \cup \overline{J \setminus \{0\}}^n} & \text{if } 0 \in J \text{ and } I = \llbracket 0, n - 1 \rrbracket \\ 0 & \text{otherwise.} \end{cases}$$

Proof. We reason as in the proof of Proposition 6.4.2, using Frobenius reciprocity:

$$\text{Hom}_{R_{n+m}^0} \left(\text{Ind}_{R_n^0 \times R_m^0}^{R_{n+m}^0} P_I \otimes P_J, S_K \right) = \text{Hom}_{R_n^0 \otimes R_m^0} \left(P_I \otimes P_J, \text{Res}_{R_n^0 \times R_m^0}^{R_{n+m}^0} S_K \right). \tag{6.23}$$

We are looking for sets $K \subset \llbracket 0, n + m - 1 \rrbracket$ such that the simple R_{n+m}^0 -module S_K restricts to $S_I \otimes S_J$ over $R_n^0 \times R_m^0$. If $0 \notin J$ then $K \cap \llbracket 0, n - 1 \rrbracket = I$ and $K \cap \llbracket n + 1, n + m - 1 \rrbracket = \bar{J}^n$. We conclude considering the two cases whether $n \in K$ or not. On the contrary, if $0 \in J$ then we are in the second case of Theorem 6.5.6. So either $K \cap \llbracket 0, n \rrbracket = \llbracket 0, n \rrbracket$ that is $I = \llbracket 0, n - 1 \rrbracket$, and we have the second case, either it is wrong and in this case no restriction can be obtained. \square

As we have seen, the natural tower of monoids structure of $(R_n^0)_{n \in \mathbb{N}}$ described here does not have a very nice representation theory. However, this is not the only tower structure, and they may be nice tower structure on their algebras involving linear combination.

6.6 Tables

Decomposition functor We give the decomposition functor from projective R_n^0 -modules into H_n^0 -modules. They were computed according to Theorem 6.4.8.

$$\begin{array}{ll}
 P_{(1)}^R \simeq P_{(1)} & P_{(0,1)}^R \simeq P_{(1)} \\
 P_{(2)}^R \simeq P_{(2)} & P_{(0,2)}^R \simeq P_{(1,1)} + P_{(2)} \\
 P_{(1,1)}^R \simeq 2P_{(1,1)} + P_{(2)} & P_{(0,1,1)}^R \simeq P_{(1,1)} \\
 P_{(3)}^R \simeq P_{(3)} & P_{(0,3)}^R \simeq P_{(1,2)} + P_{(3)} \\
 P_{(2,1)}^R \simeq P_{(1,2)} + P_{(2,1)} + P_{(3)} & P_{(0,2,1)}^R \simeq 2P_{(1,1,1)} + P_{(1,2)} + P_{(2,1)} \\
 P_{(1,2)}^R \simeq P_{(1,1,1)} + 2P_{(1,2)} + P_{(2,1)} + P_{(3)} & P_{(0,1,2)}^R \simeq P_{(1,1,1)} + P_{(1,2)} \\
 P_{(1,1,1)}^R \simeq 3P_{(1,1,1)} + P_{(1,2)} + P_{(2,1)} & P_{(0,1,1,1)}^R \simeq P_{(1,1,1)}
 \end{array}$$

$$\begin{array}{l}
 P_{(4)}^R \simeq P_{(4)} \\
 P_{(0,4)}^R \simeq P_{(1,3)} + P_{(4)} \\
 P_{(3,1)}^R \simeq P_{(1,3)} + P_{(3,1)} + P_{(4)} \\
 P_{(0,3,1)}^R \simeq P_{(1,1,2)} + P_{(1,2,1)} + P_{(1,3)} + P_{(3,1)} \\
 P_{(2,2)}^R \simeq P_{(1,2,1)} + P_{(1,3)} + P_{(2,2)} + P_{(3,1)} + P_{(4)} \\
 P_{(0,2,2)}^R \simeq P_{(1,1,1,1)} + 2P_{(1,1,2)} + P_{(1,2,1)} + P_{(1,3)} + P_{(2,2)} \\
 P_{(2,1,1)}^R \simeq P_{(1,1,2)} + P_{(1,2,1)} + P_{(1,3)} + P_{(2,1,1)} + P_{(3,1)} \\
 P_{(0,2,1,1)}^R \simeq 3P_{(1,1,1,1)} + P_{(1,1,2)} + P_{(1,2,1)} + P_{(2,1,1)} \\
 P_{(1,3)}^R \simeq P_{(1,1,2)} + 2P_{(1,3)} + P_{(2,2)} + P_{(4)} \\
 P_{(0,1,3)}^R \simeq P_{(1,1,2)} + P_{(1,3)} \\
 P_{(1,2,1)}^R \simeq 2P_{(1,1,1,1)} + 2P_{(1,1,2)} + 3P_{(1,2,1)} + P_{(1,3)} + P_{(2,1,1)} + P_{(2,2)} + P_{(3,1)} \\
 P_{(0,1,2,1)}^R \simeq 2P_{(1,1,1,1)} + P_{(1,1,2)} + P_{(1,2,1)} \\
 P_{(1,1,2)}^R \simeq 2P_{(1,1,1,1)} + 3P_{(1,1,2)} + P_{(1,2,1)} + P_{(1,3)} + P_{(2,1,1)} + P_{(2,2)}
 \end{array}$$

Part III

Presentation and representation of 0-Renner monoids

Introduction

This part is based upon an article with F. Hivert [GH18a] and is the sequel of Part II (that is [GH18b]). In Chapter 2 we introduced as a special case of *Coxeter groups* the *Weyl groups* that is *crystallographic* Coxeter groups defined as Coxeter group which stabilize a lattice. Weyl groups appear in many parts of algebra such as *Lie algebra theory* or *linear algebraic group theory*. They are classified by Cartan type T and denoted by $W(T)$ [Hum75]. In the latter theory they are defined as the quotient of a normalizer of a maximal torus in an algebraic group by this torus (Section 2.2.4). *Linear algebraic monoid theory* mainly developed by Putcha, Renner and Solomon has deep connections with algebraic group theory. In particular, the *Renner monoid* [Ren05] plays the role that the Weyl group does in linear algebraic group theory. These are originally defined to be the quotient of the *completion* of the normalizer of a maximal torus of a *Borel subgroup* by this subgroup in a regular irreducible algebraic monoid with a zero element. We denote them by $R(T)$. In [God09] E. Godelle found out a presentation of these monoids for a generic Weyl type as we have for Coxeter groups. Unfortunately when he gave the precise presentation of type B and D he happened to forget some relations as we checked by computer programming, see Section 8.5.

One purpose of this part is hence to give the presentation of the Renner monoids in type B and D , but in a different way than in Godelle's work. His work was very algebraic; we will be more combinatorial and geometric. For this purpose, we try to adopt the double point of view on Coxeter groups as simultaneously reflection groups and groups given by a presentation. This will enable us not only to give correct presentations but also to give an effective proof with some explicit algorithms (Algorithms 7.2.13 and 7.2.32) and explicit decomposition and reduced expressions.

The Renner monoid of type A is the rook monoid introduced in Section 1.5 and studied in Part II. Recall from Section 2.4.3 that Solomon [Sol04] defined a deformation of this monoid denoted $\mathcal{I}_n(q)$. In Part II we defined a *rook monoid at $q = 0$* fitting the following picture:

$$\begin{array}{ccccc}
 \mathfrak{S}_n & \xleftarrow{q=1} & \mathcal{H}_n(q) & \xrightarrow{q=0} & H_n^0 \\
 \downarrow & & \downarrow & & \downarrow \\
 R_n & \xleftarrow{q=1} & \mathcal{I}_n(q) & \xrightarrow{q=0} & R_n^0
 \end{array}$$

The main goal for this part is hence to define a 0-Renner monoid in type B and D , denoted by $R_\ell^0(T)$ for $T \in \{B, D\}$, so that we get the following diagram:

$$\begin{array}{ccc} W(T) & \longleftrightarrow & H_n^0(T) \\ \downarrow & & \downarrow \\ R_n(T) = \overline{W(T)} & \longleftrightarrow & R_n^0(T) \end{array}$$

In this diagram the horizontal arrows are (setwise) bijections, while the vertical ones are inclusions of monoids.

In Chapter 7 we construct an explicit way to define the elements of the Renner monoids of type B and D as some special rook vectors. We give two generating systems for these monoids (Definitions 7.2.1 and 7.2.18). We then give a condition for a rook vector to be an element of the Renner monoids of type B and D (Definitions 7.2.5 and 7.2.20). Using explicit algorithms (Algorithms 7.2.13 and 7.2.32) we show that these conditions are indeed necessary and sufficient (Theorems 7.2.14 and 7.2.33). These characterizations allow to reprove in a short combinatorial way the enumeration results of Z. Li, Z. Li and Y. Cao [LLC06] (Corollary 7.2.15 and 7.2.34).

In Chapter 8 we go on defining the 0-Renner monoid of type B and D . After some combinatorial descriptions of 0-Hecke monoid of type B and D (Section 8.1) we introduce the key notion of *grassmannian words* (Definition 8.2.1) which are elements with exactly one descent (Proposition 8.2.3). In order to find them we will introduce the notion of *grid representation*, which is a visual tool to compute them, in Coxeter type A (Definition 8.2.4), B (Definition 8.2.9) and D (Definition 8.2.17). Then we will use these constructions in Sections 8.2.3 and 8.2.4 to give some characterization for grassmannian words in the Hecke monoids of type B and D and we will find some special bigrassmannian elements (Corollary 8.2.11 and Proposition 8.2.19).

After these combinatorial notions we come back to our first objective to define the 0-Renner monoids of type B and D . We refer to the beginning of Chapter 8 for a precise description of the strategy and of the results. The idea is first to define a monoid of functions $F_\ell^0(T)$ (Definition 8.3.1 and 8.3.2) and prove that its action on the corresponding Renner monoid leads to a bijection from $F_\ell^0(T)$ to the associated Renner monoid (Theorem 8.3.9) in the same vein than in type A (Proposition 8.1.1). Then we introduce the monoid $G_\ell^0(T)$ (Definition 8.4.1 and 8.4.22) by a presentation. Our objective is to prove that $F_\ell^0(T) \simeq G_\ell^0(T)$ so that we get a presentation and definition by action of our 0-Renner monoids (Theorems 8.4.17 and 8.4.41). For this purpose, the results over grassmannian elements enable us to get a canonical reduced expression for every element of the monoids $R_\ell^0(T)$ and $R_\ell(T)$.

Finally we look at some properties of the monoid as we did in type A in Chapters 5 and 6. We get that the monoids $R_\ell^0(T)$ are \mathcal{J} -trivial and use the theory developed by T. Denton, F. Hivert, A. Schilling and N. Thiery (Section 3.3) to study the idempotents (Propositions 9.2.6 and 9.2.15) to deduce the simple modules (Theorems 9.2.7 and 9.2.16) and projective indecomposables modules (Proposition 9.2.21). We also prove the projectivity of $R_\ell^0(T)$ over $H_\ell^0(T)$ as in type A (Theorem 9.2.24) and give the result for the Ext-quivers (Theorem 9.2.25).

Renner monoids

7.1 Definition

As explained in the introduction the Renner monoid is the quotient of the completion of the normalizer of a Borel subgroup by this subgroup in a regular irreducible algebraic monoid with a zero element, and denoted by $R(T)$. In [God09], Godelle gave the following presentation. We have already seen the Relations COX1 and COX2. The next three Relations, TYM1, TYM2 and TYM3, use new elements in a set Λ_0 which is called a *cross section lattice* [God09, Definition 1.12]. We refer to this article for precise definitions in order to understand the next definition. However it is not necessary as we will only use this definition as a starting point for our objects.

Definition 7.1.1. [God09, Theorem 0.1] *Let T be a Weyl Type with associated Dynkin diagram Γ and S the set of its vertices. The Renner Monoid $R(T)$ admits the monoid presentation whose generating set is $S \cup \Lambda_0$ and whose defining relations are:*

$$\begin{array}{lll}
 s^2 = 1, & s \in S; & \text{(COX1)} \\
 |s, t\rangle^m = |t, s\rangle^m, & (\{s, t\}, m) \in \mathcal{E}(\Gamma) & \text{(COX2)} \\
 se = es, & e \in \Lambda_0, s \in \lambda^*(e); & \text{(TYM1)} \\
 se = es = e, & e \in \Lambda_0, s \in \lambda_*(e); & \text{(TYM2)} \\
 e\bar{w}f = e \wedge_w f, & e, f \in \Lambda_0, w \in G^\uparrow(e) \cap D^\uparrow(f). & \text{(TYM3)}
 \end{array}$$

The difficult and important relation for this part is Relation TYM3. Hence it is crucial to understand and describe explicitly the sets Λ_0 , $G^\uparrow(e)$ and $D^\uparrow(f)$. In Weyl type A these sets are easy to compute: $\Lambda_0 = \{P_1, \dots, P_n\}$ and $G^\uparrow(P_i) \cap D^\uparrow(P_j) = \begin{cases} \{1, s_i\} & \text{if } i = j, \\ \emptyset & \text{otherwise.} \end{cases}$. This yields the following presentation:

Example 7.1.2. In type A_n the last presentation gives us the monoid generated by $s_1, \dots, s_{n-1}, e_0, e_1, \dots, e_{n-1}$ with the following relations:

$$s_i^2 = 1, \quad 1 \leq i \leq n - 1; \quad \text{(A-COX1)}$$

$$\begin{array}{lll}
s_i s_j = s_j s_i, & 1 \leq i, j \leq n-1 \text{ and } |i-j| \geq 2; & \text{(A-COX2a)} \\
s_i s_{i+1} s_i = s_{i+1} s_i s_{i+1}, & 1 \leq i \leq n-2; & \text{(A-COX2b)} \\
e_j s_i = s_i e_j, & 1 \leq i < j \leq n-1; & \text{(A-TYM1)} \\
e_j s_i = s_i e_j = e_j, & 0 \leq j < i \leq n-1; & \text{(A-TYM2)} \\
e_i^2 = e_i, & 0 \leq i \leq n-1; & \text{(A-TYM3a)} \\
e_i s_i e_i = e_{i-1}, & 1 \leq i \leq n-1. & \text{(A-TYM3b)}
\end{array}$$

We recognize here the presentation of the rook monoid given in Definition 4.1.1, with the change $e_i := P_{n-i}$. In Section 4.3 we gave an explicit algorithm to obtain a canonical reduced expression of the elements of this monoid.

In type B and D however it is more difficult to compute the sets $G^\uparrow(e)$ and $D^\uparrow(f)$. This difficulty led to incorrect presentations in [God09, section 2.2 and 2.3]. Indeed computer experiment showed that these presentations led to infinite monoids, see Section 8.5.

Our goal is now to develop a new point of view to give accurate presentation of $R(B)$ and $R(D)$. But it is not our only purpose: we will describe the Renner monoids both as a presentation and as acting on some matrices, but also define a Renner monoid at $q = 0$, following Part II. Since we do not start from the topological definition, neither the presentation of Godelle, our definition of Renner monoids will be based on the matrix definition of these monoids given in [LR03], [Li03b], and [Li03a], and recalled in [God09]. This will be Definitions 7.2.1 and 7.2.18.

Since the Renner monoid of type A is the rook monoid, we will also call elements of the Renner monoid $R_\ell(T)$ the T -rooks for $T \in \{B, D\}$.

7.2 B and D -elements, with associated μ -vectors

In all this section, we fix some $\ell \in \mathbb{N}$. As explained in Section 2.3 we consider the rook monoid over the set $[\bar{\ell}, \ell] := \{\bar{\ell}, \dots, \bar{1}, 1, \dots, \ell\}$ denoted by $R_{\bar{\ell}, \ell}$.

7.2.1 Type B

Recall that in Section 2.3.2 we already gave a generating set of B_ℓ . We recall this generating system with some new elements in the following definition:

Definition 7.2.1. *In $R_{\bar{\ell}, \ell}$ we define the following elements:*

- S_0 is the transposition $s_0 = (\bar{1}, 1)$.
- For $1 \leq i \leq \ell - 1$, S_i is the double transposition $s_{\bar{i}} s_i$.
- For $0 \leq i \leq \ell$, E_i is the rook diagonal table with the first $\ell + i$ entries which are zeros, and the remaining $\ell - i$ which are 1s.

We call $R_\ell(B)$ the monoid generated by these elements.

Example 7.2.2. We represent these elements in *rook tables*. The monoid $R_3(B)$ is

generated by:

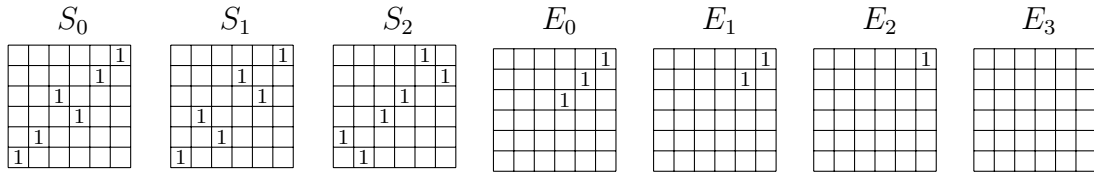

Notation 7.2.3. We now extend the definition of μ -vectors introduced in Section 2.3.2 to elements of $R_{\bar{\ell},\ell}$. A μ -vector is a word over letters $\emptyset, \bar{\ell}, \dots, \bar{1}, 1, \dots, \ell$ with every letter appearing at most once except \emptyset . This letter \emptyset will be called zero, and the only difference with a classical zero is that we have the following order on μ -vectors letters:

$$\emptyset < \dots < \bar{3} < \bar{2} < \bar{1} < 1 < 2 < 3 < \dots \tag{7.1}$$

Example 7.2.4. The rook $r =$ is denoted by its μ -vector $2\bar{1}\emptyset \mid 1\bar{3}\emptyset$.

Definition 7.2.5. We say that the μ -vector $r = r_{\bar{\ell}} \dots r_{\bar{1}} \mid r_1 \dots r_{\ell} \in R_{\bar{\ell},\ell}$ obeys the B condition if the two following conditions hold:

- **Centrally antisymmetric:** for $1 \leq i \leq \ell$ then

$$\{r_i, r_{\bar{i}}\} \in \{\{\emptyset, \emptyset\}, \{\bar{k}, \emptyset\}, \{\emptyset, k\}, \{k, \bar{k}\}\}, \tag{7.2}$$

for some $k \in \llbracket 1, \ell \rrbracket$.

- **Break all pairs:** the μ -vector r has either no letter \emptyset , or at least ℓ and at least one of the two letters i or \bar{i} is missing for all $1 \leq i \leq \ell$.

Example 7.2.6. The following μ -vectors obey the B condition: $\bar{1}\bar{3}\bar{2} \mid 2\bar{3}1, \bar{3}\emptyset 1 \mid \emptyset\emptyset\emptyset, \bar{3}\emptyset\emptyset \mid 21\emptyset$. The following ones do not: $\bar{3}\bar{2}\bar{1} \mid 321$ because the word is not antisymmetric, $\bar{2}\bar{1}3 \mid \emptyset 1\emptyset$ because there is too few \emptyset , finally $3\emptyset 1 \mid \emptyset\bar{3}\emptyset$ because the pair $\{3, \bar{3}\}$ is not broken while there is some \emptyset letter.

We recall that $1_{\bar{\ell},\ell} := \bar{\ell} \dots \bar{3}\bar{2}\bar{1} \mid 123 \dots \ell$ is the one of $\mathfrak{S}_{\bar{\ell},\ell}$ and $R_{\bar{\ell},\ell}$. The generators S_i act on μ -vectors on the right like the associated permutations, while the E_i replace the first $\ell + i$ letters by \emptyset . We note that these actions stabilise the B -condition: if r obeys the B condition, then so do $r \cdot S_i$ and $r \cdot E_i$. Our purpose is now to get the following result:

Theorem 7.2.7. Let $r \in R_{\bar{\ell},\ell}$ which obey the B condition. There exists an explicit word \underline{s} over the generators of $R_{\ell}(B)$ such that $r = 1_{\bar{\ell},\ell} \cdot s$.

In order to prove this theorem we will construct an element s with a three-step algorithm:

1. We act on $1_{\bar{\ell},\ell}$ to place in the first positions the letters in $1_{\bar{\ell},\ell}$ but not in r . We also want to minimize the number of elements acting.

2. We delete these letters with the corresponding E_i . We obtain an element with the same letters as r .
3. We reorder everything and also want to minimize the number of elements acting.

The similar first and third step of the algorithm need a tool which is an elementary transformation used to bring a given pair of mirror letters to a given pair of positions. A simple computation gives us the following results:

Lemma 7.2.8. *Let $i \in [\bar{\ell}, \ell]$, $r = r_{\bar{\ell}} \dots r_{\bar{1}} \mid r_1 \dots r_{\ell} \in R_{\bar{\ell}, \ell}$ and define the element $\tilde{r} := r_i r_{\bar{\ell}} \dots \widehat{r}_i \dots \mid \dots \widehat{r}_i \dots r_{\ell} r_{\bar{i}}$, where \widehat{r}_i means that this letter is missing. Then:*

- If $i < 0$: $\tilde{r} = r \cdot (S_i \dots S_{\ell-1})$.
- If $i > 0$: $\tilde{r} = r \cdot (S_{i-1} \dots S_1 S_0 S_1 \dots S_{\ell-1})$.

More generally if $\tilde{r} = r_{\bar{\ell}} \dots r_i \dots \widehat{r}_i \dots \mid \dots \widehat{r}_i \dots r_i \dots r_{\bar{\ell}}$ with r_i in j -th position with $j \leq i$ then:

- If $i < 0$: $\tilde{r} = r \cdot (S_i \dots S_{\ell-j})$.
- If $i > 0$: $\tilde{r} = r \cdot (S_{i-1} \dots S_1 S_0 S_1 \dots S_{j-1})$.

By symmetry we can also describe elements which bring a given pair of letters (i, \bar{i}) to a pair of positions (j, \bar{j}) with $j \geq i$.

Example 7.2.9.

$$\begin{aligned}
21\bar{4}\bar{3} \mid 3\bar{4}\bar{1}\bar{2} \cdot S_1 &= 21\bar{3}\bar{4} \mid 4\bar{3}\bar{1}\bar{2} \\
21\bar{3}\bar{4} \mid 4\bar{3}\bar{1}\bar{2} \cdot S_0 &= 21\bar{3}\bar{4} \mid \bar{4}\bar{3}\bar{1}\bar{2} \\
21\bar{3}\bar{4} \mid \bar{4}\bar{3}\bar{1}\bar{2} \cdot S_1 &= 21\bar{4}\bar{3} \mid 3\bar{4}\bar{1}\bar{2} \\
21\bar{4}\bar{3} \mid 3\bar{4}\bar{1}\bar{2} \cdot S_2 &= 2\bar{4}\bar{1}\bar{3} \mid 3\bar{1}\bar{4}\bar{2} \\
\bar{2}\bar{4}\bar{1}\bar{3} \mid 3\bar{1}\bar{4}\bar{2} \cdot S_3 &= \bar{4}\bar{2}\bar{1}\bar{3} \mid 3\bar{1}\bar{2}\bar{4}
\end{aligned}$$

Finally $21\bar{4}\bar{3} \mid 3\bar{4}\bar{1}\bar{2} \cdot S_1 S_0 S_1 S_2 S_3 = \bar{4}\bar{2}\bar{1}\bar{3} \mid 3\bar{1}\bar{2}\bar{4}$.

Let us give some definitions and a first example of the three steps of the algorithm.

Notation 7.2.10. *If $S \subseteq [\bar{\ell}, \ell]$ we define $\text{sort}(S)$ to be the word of size $|S|$ with the letter of S sorted in increasing order. We also denote $\bar{S} := \{\bar{s} \mid s \in S\}$.*

Definition 7.2.11. *Let $r \in R_{\bar{\ell}, \ell}$ which obeys the B condition. We denote by $m_1(r)$ the word obtained from r the following way. If $\emptyset \notin r$ then $m_1(r) := 1_{\bar{\ell}, \ell}$. Otherwise let I be the subset of $[\bar{\ell}, \ell]$ of missing letters of r . Then $I := P \sqcup R$ where P is symmetric ($x \in P \Rightarrow \bar{x} \in P$) and R is antisymmetric ($x \in R \Rightarrow -x \notin R$). Then $m_1(r)$ is the concatenation $\text{sort}(R) \text{sort}(P) \text{sort}(\bar{R})$. In particular, $m_1(r)$ is an element of $B_{\ell} \subseteq \mathfrak{S}_{\bar{\ell}, \ell}$ and obeys the B condition.*

We denote by $m_2(r)$ the word obtained from r by sorting all its letters in increasing order. It also obeys the B condition.

Proof. The word $m_1(r)$ is well-defined since if $\emptyset \in r$ then $|I| \geq \ell$ because r obeys the B condition and as such has at least ℓ letters \emptyset .

The word $m_2(r)$ obeys the B condition since it is either the identity, or a word with at least ℓ letters \emptyset which are then covering the first half of the word. \square

Example 7.2.12. Let $r = 5\bar{3}001 \mid 0\bar{2}000$ which obeys the B condition. We denote by I the set of missing letters. Here $I = \{\bar{5}, \bar{4}, \bar{1}, 2, 3, 4\} = P \sqcup R$ with $P = \{\bar{4}, 4\}$ and $R = \{\bar{5}, \bar{1}, 2, 3\}$. Then $\bar{R} = \{\bar{3}, \bar{2}, 1, 5\}$ and $m_1(r) = \bar{5}\bar{1}23\bar{4} \mid 4\bar{3}\bar{2}15$. We use Lemma 7.2.8 to transform $1_{\bar{\ell}, \ell}$ into $m_1(r)$. We proceed step by step so that at the i -th step the first i and last i letters are in place. (Here the first step is empty.)

$$\begin{aligned} \bar{5}4\bar{3}2\bar{1} \mid 12345 \cdot (S_1 S_2 S_3) &= \bar{5}\bar{1}4\bar{3}2 \mid 23415 \\ \bar{5}\bar{1}4\bar{3}2 \mid 23415 \cdot (S_0 S_1 S_2) &= \bar{5}\bar{1}2\bar{4}3 \mid 34\bar{2}15 \\ \bar{5}\bar{1}2\bar{4}3 \mid 34\bar{2}15 \cdot (S_0 S_1) &= \bar{5}\bar{1}2\bar{3}4 \mid 4\bar{3}\bar{2}15 = m_1(r). \end{aligned}$$

Then $m_1(r) = 1_{\bar{5}, 5} \cdot [(S_1 S_2 S_3)(S_0 S_1 S_2)(S_0 S_1)]$.

We delete the first $|I|$ letters to obtain $m_2(r) = 00000 \mid 0\bar{3}\bar{2}15 = m_1(r) \cdot E_1$.

Applying again Lemma 7.2.8 we want to transform $m_2(r)$ into r . We proceed step by step so that at the i -th step the first i and last i letters are in place. Take care that at each step we are putting a pair of mirror letters in a pair of mirror positions.

$$\begin{aligned} 00000 \mid 0\bar{3}\bar{2}15 \cdot (S_4 S_3 S_2 S_1 S_0 S_1 S_2 S_3 S_4) &= 50000 \mid 0\bar{3}\bar{2}10 \\ 50000 \mid 0\bar{3}\bar{2}10 \cdot (S_1 S_0 S_1 S_2 S_3) &= 5\bar{3}000 \mid 0\bar{2}100 \\ 5\bar{3}000 \mid 0\bar{2}100 \cdot S_1 S_2 &= 5\bar{3}000 \mid \bar{2}1000 \\ 5\bar{3}000 \mid \bar{2}1000 \cdot S_1 &= 5\bar{3}000 \mid 1\bar{2}000 \\ 5\bar{3}000 \mid 1\bar{2}000 \cdot S_0 &= 5\bar{3}001 \mid 0\bar{2}000 = r. \end{aligned}$$

Finally $r = m_2(r) \cdot [(S_4 S_3 S_2 S_1 S_0 S_1 S_2 S_3 S_4)(S_1 S_0 S_1 S_2 S_3)(S_1 S_2)(S_1)(S_0)]$.

With this example in mind we give the following algorithm for Theorem 7.2.7, whose name will be justified later (see Proposition 8.4.9)

Algorithm 7.2.13 (Grassmannian factorization). *Let $r \in R_{\bar{\ell}, \ell}$ which obeys the B condition. Then we define by the following algorithm a word \underline{s} on the generators of $R_\ell(B)$ such that $r = 1_{\bar{\ell}, \ell} \cdot s$.*

1. If $\emptyset \notin r$, go to step 3 with $S' = 1$. Otherwise apply Lemma 7.2.8 step by step to $1_{\bar{\ell}, \ell}$ in order to obtain $m_1(r)$ so that at the i -th step the first i and last i letters are in place. We get $S \in \langle S_0, \dots, S_{\ell-1} \rangle$ such that $1_{\bar{\ell}, \ell} \cdot S = m_1(r)$.
2. Apply to $m_1(r)$ the generator $E_{k-\ell}$, where $k = |r|_\emptyset$, that is the number of letters \emptyset in r . We obtain $m_2(r) = 1_{\bar{\ell}, \ell} \cdot S'$ where $S' = S E_{k-\ell}$.
3. Apply Lemma 7.2.8 step by step to $m_2(r)$ in order to obtain r , so that at the i -th step the first i and last i letters are in place. If a step must place a pair of \emptyset letters, we choose the closest one. Finally we get S'' such that $m_2(r) \cdot S'' = r = 1_{\bar{\ell}, \ell} \cdot S' S''$.

Finally $s := S' S''$. Furthermore s is a word for r .

Proof. It is enough to prove that the algorithm ends. It is evident that step 2 ends. For step 1 and 3, it comes from the fact that at the i -th step the first i and last i letters are in place, and the next generators do not move these letters. The assumption that \bar{s} is a word for r is also clear if we think of this algorithm not for μ -vectors but as the matrix product. \square

An important remark is that the algorithm is entirely deterministic and, as such, defines an actual word \bar{s} given by a rook r .

Theorem 7.2.14. *Let $r \in R_{\bar{i}, \ell}$. Then $r \in R_\ell(B)$ if and only if r obeys the B condition.*

Proof. For the first implication we note that the identity $1_{\bar{i}, \ell}$ obeys the B condition, and that if r obeys the B condition, so do the rooks $r \cdot S_i$ or $r \cdot E_i$ for every available i . Conversely, it is only Theorem 7.2.7. \square

This characterization of B -rook vectors enables us to count them, we recover a formula of [LLC06] in a combinatorial way, and the sequence of numbers is recorded in OEIS A121079:

Corollary 7.2.15. *The size of $R_\ell(B)$ is $\ell!2^\ell + \sum_{k=0}^{\ell} 4^k \binom{\ell}{k}^2 k!$.*

Proof. First we consider elements of $R_\ell(B)$ without \emptyset . For every pair $\{\bar{i}, i\}$ for $1 \leq i \leq \ell$ we choose which number is in the first half (2^ℓ choices) then the order of the first ℓ numbers ($\ell!$ choices). The word is then uniquely determined by antisymmetry.

For elements with \emptyset , i or \bar{i} is missing for all $1 \leq i \leq \ell$. Let k be the number of pairs (i, \bar{i}) where both letters are missing: $0 \leq k \leq \ell$. We need to choose these pairs ($\binom{\ell}{k}$ choices) and choose their positions (again $\binom{\ell}{k}$ choices since it is enough to choose the position of one element by antisymmetry). For the remaining pairs we have to choose which number remains ($2^{\ell-k}$ choices) and if this number is in the first or second half ($2^{\ell-k}$ choices again). Finally these numbers have to be ordered: $(\ell - k)!$ (since k numbers are already ordered and in position).

We obtain $\sum_{k=0}^{\ell} \binom{\ell}{k}^2 2^{\ell-k} 2^{\ell-k} (\ell - k)! = \sum_{i=0}^{\ell} 4^i \binom{\ell}{i}^2 i!$ \square

Example 7.2.16. The sizes of the first monoids are:

ℓ	1	2	3	4	5	6	7	8
$ R_\ell(B) $	7	57	757	13889	322021	8962225	289928549	10666353409

Remark 7.2.17. Another consequence of Theorem 7.2.14 is that the B condition is stable under multiplication.

7.2.2 Type D

We now proceed to a similar treatment of type D : we give the Renner generators, a condition to be an element of $R_\ell(D)$, and an explicit algorithm to generate every element.

Definition 7.2.18. *In $R_{\bar{i}, \ell}$ we define the following matrices:*

- S_1^e is the double transposition $(\bar{2}, \bar{1})(1, 2)$ (denoted by S_1 in type B context) while S_1^f is the double transposition $(\bar{2}, 1)(\bar{1}, 2)$.
- For $2 \leq i \leq \ell - 1$, S_i is the double transposition $s_{\bar{i}} s_i$.
- For $0 \leq i \leq \ell$, E_i is defined as in Definition 7.2.1.
- F is the rook diagonal table with first $\ell - 1$ diagonal entries are 0, then 1, then 0, then $\ell - 1$ entries 1.

We denote by $R_\ell(D)$ the monoid generated by all these elements.

Example 7.2.19. For $\ell = 3$, $R_3(D)$ is generated by:

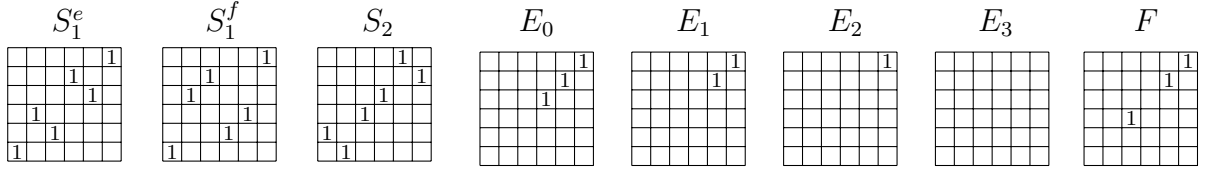

If r is a μ -vector, we denote by $|r|_\emptyset$ the number of letters \emptyset in r .

Definition 7.2.20. If $r \in R_{\bar{\ell},\ell}$ is a μ -vector, we say that r obeys the D -condition if and only if the two following conditions hold:

- **B -rook:** r obeys the B condition.
- **Parity:** if $|r|_\emptyset = 0$ then r must have an even number of positive numbers in its first half. If $|r|_\emptyset = \ell$, the element \tilde{r} obtained by antisymmetry with $|\tilde{r}|_\emptyset = 0$ must also have an even number of positive numbers in its first half.

Remark 7.2.21. The Parity condition is equivalent to have an even number of negative numbers in the second half. Note that when there is exactly ℓ letters \emptyset , it is the element obtained by antisymmetry which must observe the condition of parity. For instance $1\emptyset 3 \mid \emptyset \bar{2}\bar{\emptyset}$ does not obey the D condition since the element obtained by antisymmetry is $123 \mid \bar{3}\bar{2}\bar{1}$.

Example 7.2.22. The following words obey the D condition: $\bar{1}\bar{3}\bar{2} \mid \bar{2}\bar{3}\bar{1}$, $1\emptyset\emptyset \mid 2\emptyset\emptyset$, and $1\emptyset\emptyset \mid \bar{2}3\emptyset$.

The generators $S_1^e, S_1^f, (S_i)_{2 \leq i \leq \ell-1}$ act on $R_{\bar{\ell},\ell}$ as their associated permutations. The E_i replace the first $\ell + i$ letters by \emptyset , while F replaces the first $\ell - 1$ letters and the letter in position 1 by \emptyset . We remark that these actions stabilize the D condition: if r obeys the D condition, then so do the rook vectors $r \cdot S_1^f, r \cdot S_1^e, r \cdot S_i, r \cdot E_i$ and $r \cdot F$. Similarly to type B , we now wish to get the following result:

Theorem 7.2.23. Let $r \in R_{\bar{\ell},\ell}$ which obey the D condition. Then there exists a word \underline{s} on the generators of $R_\ell(D)$ such that $r = 1_{\bar{\ell},\ell} \cdot s$.

We will construct the element s explicitly, mimicking the same steps than in type B . The main difference is that we do not have S_0 to exchange letters in the middle of the word, but S_1^f which can only exchange two letters at the same time. We thus have to be more cautious.

1. We act on $1_{\bar{\ell},\ell}$ to move the letters appearing in $1_{\bar{\ell},\ell}$ but not in r in first positions. We also want to minimize the number of elements acting.
2. We delete these letters with the good E_i or F . We obtain an element with the same letters as r .
3. We reorder everything, and do it by minimizing the number of elements acting.

The similar first and third steps of the algorithm need an elementary tool which is to bring a given pair of elements to a given pair of positions. We recall that $S_1 = S_1^e$, and that $S_1^e S_1^f = S_1^f S_1^e$. A simple computation gives us the following results:

Lemma 7.2.24. *Let $i \in [\bar{\ell}, \ell]$, and $r = r_{\bar{\ell}} \dots r_{\bar{1}} \mid r_1 \dots r_{\ell} \in R_{\bar{\ell}, \ell}$. Then:*

- *If $i < 0$: $r_i r_{\bar{\ell}} \dots \widehat{r_i} \dots \mid \dots \widehat{r_{\bar{i}}} \dots r_{\ell} r_{\bar{i}} = r \cdot (S_i \dots S_{\ell-1})$.*
- *If $i > 0$: $r_i r_{\bar{\ell}} \dots \widehat{r_{\bar{i}}} \dots r_{\bar{2}} r_1 \mid r_{\bar{1}} r_2 \dots \widehat{r_i} \dots r_{\ell} r_{\bar{i}} = r \cdot (S_{i-1} \dots S_2 S_1^e S_1^f S_2 \dots S_{\ell-1})$.*

More generally, we could also bring a pair of mirror letters (\bar{i}, i) to mirror positions (\bar{j}, j) .

Remark 7.2.25. Because of the Parity condition, when a letter cross the middle, another cross it too (with S_1^f). We can see this in the second case when the two middle elements are exchanged. More generally, to bring a given pair of mirror letters to given mirror positions we will apply the action of a factor of

$$S_{\ell-1} \dots S_2 S_1^e S_1^f S_2 \dots S_{\ell-1} = S_{\ell-1} \dots S_2 S_1^f S_1^e S_2 \dots S_{\ell-1}. \quad (7.3)$$

Here factor means that we can delete some prefix and suffix.

The following lemma makes explicit how the parity works.

Lemma 7.2.26. *Let $r \in R_{\bar{\ell}, \ell}$ be a B -rook. We distinguish the letters by coloring them as red for the first ℓ entries, and blue for the last ℓ entries. We act by $S \in \langle S_1^f, S_1^e, S_2, \dots, S_{\ell-1} \rangle$, having the letter keeping their colors. Then for every S the numbers of blue letters in the first half of $r \cdot S$ is even.*

Proof. We prove the result by induction on the length of S . For $S = 1$ it is obvious. Assume it is true for $r' = r \cdot S$. It is enough to prove that the result holds for every element of $\{S_1^f, S_1^e, S_2, \dots, S_{\ell-1}\}$. The only nontrivial case is S_1^f since it is the only element which allows an element to cross the middle. We recall that if $r' := r_{\bar{\ell}} \dots r_{\bar{2}} r_{\bar{1}} \mid r_1 r_2 \dots r_{\ell}$ then $r' \cdot S_1^f = r_{\bar{\ell}} \dots r_1 r_2 \mid r_{\bar{2}} r_{\bar{1}} \dots r_{\ell}$. We have two cases:

- If r_1 and r_2 are of the same color, for instance blue, then $r_{\bar{1}}$ and $r_{\bar{2}}$ are both red (by antisymmetry) and the parity for $r' \cdot S_1^f$ is still even since it was the case for r' .
- If r_1 and r_2 are of different color, one is red and the other blue. The same is then true for $r_{\bar{1}}$ and $r_{\bar{2}}$, so the parity does not change. \square

The following definition is the case D of Definition 7.2.11:

Definition 7.2.27. *Let $r \in R_{\bar{\ell}, \ell}$ which obeys condition D . We associate to him the words $m_1^D(r)$ and $m_2^D(r)$ the following way. If $\emptyset \notin r$ then $m_1^D(r) := 1_{\bar{\ell}, \ell}$ and $m_2^D(r) := 1_{\bar{\ell}, \ell}$. Otherwise let I be the nonempty subset of $[\bar{\ell}, \ell]$ of missing letters of r . Then $I = P \sqcup R$ with P symmetric and R antisymmetric. Let $p(r)$ be the number of positives letters of R . We have two cases:*

- *If $p(r)$ is even then $\underline{m_1^D(r)} := \underline{m_1(r)}$ and $\underline{m_2^D(r)} := \underline{m_2(r)}$.*
- *Otherwise $m_1^D(r) = m_1(r)$, where $m_1(r)$ is the word $m_1(r)$ where the two mirror letters $\bar{1}$ and 1 have been exchanged. If $|I| > \ell$ then $m_2^D(r) := m_2(r)$, and if $|I| = \ell$ then $m_2^D(r) = m_1^D(r) \cdot F$.*

The words $m_1^D(r)$ and $m_2^D(r)$ obey the D condition.

Proof. The words $m_1^D(r)$ and $m_2^D(r)$ obey the D condition since $m_1(r)$ and $m_2(r)$ obey the B condition, and the change in the middle according to the parity of $p(r)$ is made so that the condition of parity is true, since $p(r)$ is the number of positives letters in the first half of $m_1(r)$. To prove this last part, use the Lemma 7.2.26. \square

Remark 7.2.28. If $|I| > \ell$ then $\widetilde{m_2(r)} = m_2(r)$ since the two central letters are both \emptyset .

Let us give some examples to see this algorithm and specificities of type D .

Example 7.2.29. We take back $r := 5\bar{3}\emptyset\emptyset 1 \mid \emptyset\bar{2}\emptyset\emptyset\emptyset$ from Example 7.2.12 which also obeys the D condition. Here we have, keeping the notations of Definition 7.2.27, $I = \{\bar{5}, \bar{4}, \bar{1}, 2, 3, 4\}$ and $p(r)$ is odd so that $m_1^D(r) = m_1(r) = \bar{5}\bar{1}23\bar{4} \mid 4\bar{3}\bar{2}15$.

For the first step we apply Lemma 7.2.24. We add colors when some other letters than the red ones are moved.

$$\begin{aligned} \bar{5}4\bar{3}\bar{2}\bar{1} \mid 12345 \cdot (S_1^e S_2 S_3) &= \bar{5}\bar{1}4\bar{3}\bar{2} \mid 23415 \\ \bar{5}\bar{1}4\bar{3}\bar{2} \mid 23415 \cdot (S_1^f S_2) &= \bar{5}\bar{1}\bar{2}\bar{4}\bar{3} \mid \bar{3}4\bar{2}\bar{1}5 \\ \bar{5}\bar{1}\bar{2}\bar{4}\bar{3} \mid \bar{3}4\bar{2}\bar{1}5 \cdot (S_1^e) &= \bar{5}\bar{1}\bar{2}\bar{3}\bar{4} \mid 4\bar{3}\bar{2}\bar{1}5 = m_1^D(r). \end{aligned}$$

Then $m_1^D(r) = 1_{\bar{5},5} \cdot \left[(S_1^e S_2 S_3) (S_1^f S_2) (S_1^e) \right]$.

For the second step we delete the first $|I| = \ell + 1$ letters using the action of E_1 and we obtain $m_2^D(r) = \emptyset\emptyset\emptyset\emptyset \mid \emptyset\bar{3}\bar{2}\bar{1}5 = m_1^D(r) \cdot E_1$.

For the third step we apply again Lemma 7.2.24 and we want to transform $m_2^D(r)$ into r . We proceed step by step so that at the i -th step the first i and last i letters are in place. As in type B , all \emptyset letters are not equivalent. We first do it do it without being cautious:

$$\begin{aligned} \emptyset\emptyset\emptyset\emptyset \mid \emptyset\bar{3}\bar{2}\bar{1}5 \cdot (S_4 S_3 S_2 S_1^e S_1^f S_2 S_3 S_4) &= 5\emptyset\emptyset\emptyset\emptyset \mid \emptyset\bar{3}\bar{2}\bar{1}\emptyset \\ 5\emptyset\emptyset\emptyset\emptyset \mid \emptyset\bar{3}\bar{2}\bar{1}\emptyset \cdot (S_1^e S_1^f S_2 S_3) &= 5\bar{3}\emptyset\emptyset\emptyset \mid \emptyset\bar{2}\bar{1}\emptyset\emptyset \\ 5\bar{3}\emptyset\emptyset\emptyset \mid \emptyset\bar{2}\bar{1}\emptyset\emptyset \cdot (S_1^e S_2) &= 5\bar{3}\emptyset\emptyset\emptyset \mid \bar{2}\bar{1}\emptyset\emptyset\emptyset \end{aligned}$$

Here we see that we are trapped: we can not change the subword $\emptyset\emptyset \mid \bar{1}\bar{2}$ into $\emptyset\bar{1} \mid \emptyset\bar{2}$ since the letters can only cross the middle two at a time. The mistake was when we moved the last couple of \emptyset letters. Let's do it in a different way:

$$\begin{aligned} \emptyset\emptyset\emptyset\emptyset \mid \emptyset\bar{3}\bar{2}\bar{1}5 \cdot (S_4 S_3 S_2 S_1^e S_1^f S_2 S_3 S_4) &= 5\emptyset\emptyset\emptyset\emptyset \mid \emptyset\bar{3}\bar{2}\bar{1}\emptyset \\ 5\emptyset\emptyset\emptyset\emptyset \mid \emptyset\bar{3}\bar{2}\bar{1}\emptyset \cdot (S_1^e S_1^f S_2 S_3) &= 5\bar{3}\emptyset\emptyset\emptyset \mid \emptyset\bar{2}\bar{1}\emptyset\emptyset \\ 5\bar{3}\emptyset\emptyset\emptyset \mid \emptyset\bar{2}\bar{1}\emptyset\emptyset \cdot (S_1^f S_2) &= 5\bar{3}\emptyset\emptyset\bar{2} \mid \emptyset\bar{1}\emptyset\emptyset\emptyset \\ 5\bar{3}\emptyset\emptyset\bar{2} \mid \emptyset\bar{1}\emptyset\emptyset\emptyset \cdot S_1^f &= 5\bar{3}\emptyset\emptyset\bar{1} \mid \emptyset\bar{2}\emptyset\emptyset\emptyset = r \end{aligned}$$

Finally $r = m_2^D(r) \cdot \left[(S_4 S_3 S_2 S_1^e S_1^f S_2 S_3 S_4) (S_1^e S_1^f S_2 S_3) (S_1^f S_2) (S_1^f) \right]$.

A question arising from this example is to know if we have been as fast as possible in sorting letters. Indeed we can see that some letters keep crossing the middle, which might be not optimal. In fact it is, as we will see later in Corollary 8.4.42.

This example showed us a difficulty of the type D . We will show two other examples to understand it in a better way.

Example 7.2.30. We define $r := 5\bar{3}01\bar{2} \mid 00000$. The first and second steps are the same. And here we do not have to be cautious.

$$\begin{aligned} 00000 \mid 0\bar{3}215 \cdot (S_4 S_3 S_2 S_1^e S_1^f S_2 S_3 S_4) &= 50000 \mid 0\bar{3}210 \\ 50000 \mid 0\bar{3}210 \cdot (S_1^e S_1^f S_2 S_3) &= 5\bar{3}000 \mid 0\bar{2}100 \\ 5\bar{3}000 \mid 0\bar{2}100 \cdot (S_1^e S_2) &= 5\bar{3}000 \mid \bar{2}1000 \\ 5\bar{3}000 \mid \bar{2}1000 \cdot (S_1^f S_1^e) &= 5\bar{3}01\bar{2} \mid 00000 = r. \end{aligned}$$

Example 7.2.31. Let us take $r = 908005607 \mid 040000000$. Here $m_1^D(r) = 1_{\bar{9},9}$ so the first step is trivial, and the second is $m_2^D(r) = 1_{\bar{9},9} \cdot E_3$. Let us do the third one:

$$\begin{aligned} 000000000 \mid 000456789 \cdot (S_8 S_7 S_6 S_5 S_4 S_3 S_2 S_1^e S_1^f S_2 S_3 S_4 S_5 S_6 S_7 S_8) &= 900000000 \mid 000456780 \\ 900000000 \mid 000456780 \cdot (S_3 S_4 S_5 S_6 S_7) &= 900000000 \mid 004567800 \\ 900000000 \mid 004567800 \cdot (S_6 S_5 S_4 S_3 S_2 S_1^e S_1^f S_2 S_3 S_4 S_5 S_6) &= 908000000 \mid 004567000 \\ 908000000 \mid 004567000 \cdot (S_2 S_3 S_4 S_5) &= 908000000 \mid 045670000 \end{aligned}$$

For the next step, if we do it forward we will be trapped again. So we have to make the last pair of zero cross the middle.

$$\begin{aligned} 908000000 \mid 045670000 \cdot (S_1^f S_2 S_3 S_4) &= 908000004 \mid 056700000 \\ 908000004 \mid 056700000 \cdot (S_1^f S_1^e S_2 S_3) &= 908005000 \mid 467000000 \\ 908005000 \mid 467000000 \cdot (S_1^f S_1^e S_2) &= 908005604 \mid 070000000 \\ 908005604 \mid 070000000 \cdot S_1^f &= 908005607 \mid 040000000 \end{aligned}$$

Finally the question of whether to make a zero pair cross or not seems to be only for the last pair: indeed it is a question of parity of crossing, and the last pair of zero is used to adjust this criterion. The reader could find strange that some letters keep crossing the middle. He could try to be more optimal in term of crossings, but he will discover that it takes the same number of generators (but will give him some nice relations between generators). Indeed we will show that the expressions obtained with this algorithm are reduced.

With these examples in mind we now give the algorithm to get Theorem 7.2.23. The name of this algorithm will be justified in Proposition 8.4.32:

Algorithm 7.2.32 (Grassmannian factorization). *Let $r \in R_{\bar{\ell},\ell}$ which obeys the D condition. We give an algorithm to get $s \in R_\ell(D)$ so that $r = 1_{\bar{\ell},\ell} \cdot s$.*

1. If $\emptyset \notin r$, go to step 3 with $S' = 1$. Otherwise apply Lemma 7.2.24 step by step in order to obtain $m_1^D(r)$ so that at the i -th step the first i and last i letters are in order. We get $S \in \langle S_1^f, S_1^e, S_2, \dots, S_{\ell-1} \rangle$ so that $1_{\bar{\ell},\ell} \cdot S = m_1^D(r)$.

2. Let $k := |r|_{\emptyset}$. If $k > \ell$ apply generator $E_{k-\ell}$ to $m_1^D(r)$: $m_2^D(r) := 1_{\bar{\ell},\ell} \cdot S'$ with $S' = SE_k$. If $k = \ell$ apply E_0 if $p(r)$ is even, and F otherwise.
3. Now r and $m_2^D(r)$ have the same letters with multiplicity. Apply again Lemma 7.2.24 to $m_2^D(r)$ step by step so that at the i -th step the first i and last i letters are in order. If a step must place a pair of \emptyset letters choose the closest one except if it is the last such pair. If it is the last pair of zero letters, count the number of nonzero letters in the first half of r : if it is even choose the closest zero, otherwise make its conjugate cross the middle. Finally we get $S'' \in \langle S_1^f, S_1^e, S_2, \dots, S_{\ell-1} \rangle$ so that $m_2^D(r) \cdot S'' = r$.

We define $s := S'S''$

Proof. It is enough to show that the algorithm terminates. For the first step, the different use of Lemma 7.2.24 put in place the first and last letters, and then do not touch them again. Applying Lemma 7.2.26 on $1_{\bar{\ell},\ell}$ we see that at every step the number of positive letters in the first half is even, as in m_1^D . There is no incompatibility. For the second step, all is entirely deterministic, and the choice between E_0 and F is linked to the very definition of m_2^D . For the last step, the argument is the same than in the first step. The only specific questions is linked to pairs of zeros. Applying Lemma 7.2.26 we see that the condition on the number of nonzero letters in the first part is the good one: the last pair of zero letters is used to adjust the coloring of Lemma 7.2.26. \square

An important remark is that the algorithm is also entirely deterministic and, as such, will always give us the same word s on a given rook r (up to the exchange $S_1^e S_1^f = S_1^f S_1^e$).

Theorem 7.2.33. *Let $r \in R_{\bar{\ell},\ell}$. Then $r \in R_{\ell}(D)$ if and only if r obeys the D condition.*

Proof. For the direct implication, we note that the identity $1_{\bar{\ell},\ell}$ obeys the D condition and that if r obeys the D condition, then so do the rook obtained under the action of every generators on r . The converse implication is only the algorithm of Theorem 7.2.23. \square

This characterization of D -rooks vectors enables us to count them, finding back a formula of [LLC06] and the sequence of numbers recorded in OEIS A121080:

Corollary 7.2.34. *The size of $R_{\ell}(D)$ is $\ell!2^{\ell-1}(1 - 2^{\ell}) + \sum_{k=0}^{\ell} 4^k \binom{\ell}{k}^2 k!$.*

Proof. We take back the proof of Corollary 7.2.15. Compared to the B condition we must delete the half of elements without \emptyset and the half of elements with exactly ℓ zeros.

The number of elements with no letter \emptyset in type B is $\ell!2^{\ell}$. With exactly ℓ zeros it is $\ell!4^{\ell}$. Then:

$$|R_{\ell}(D)| = \ell!2^{\ell-1} + \ell!2^{2\ell-1} + \sum_{k=0}^{\ell-1} 4^k \binom{\ell}{k}^2 k!$$

$$\begin{aligned}
 &= \ell!2^{\ell-1}(1 + 2^\ell) + \sum_{k=0}^{\ell-1} 4^k \binom{\ell}{k}^2 k! \\
 &= \ell!2^{\ell-1}(1 + 2^\ell) - \ell!4^\ell + \sum_{k=0}^{\ell} 4^k \binom{\ell}{k}^2 k! \\
 &= \ell!2^{\ell-1}(1 + 2^\ell - 2^{\ell+1}) + \sum_{k=0}^{\ell} 4^k \binom{\ell}{k}^2 k! \\
 &= \ell!2^{\ell-1}(1 - 2^\ell) + \sum_{k=0}^{\ell} 4^k \binom{\ell}{k}^2 k!
 \end{aligned}$$

□

Example 7.2.35. The sizes of the first monoids are:

ℓ	1	2	3	4	5	6	7	8
$ R_\ell(D) $	4	37	541	10625	258661	7464625	248318309	9339986689

Note that these monoids are really different from $R_n(A)$. Even if the Dynkin Diagram of D_3 and A_3 are the same, the Renner monoids do not have the same cardinality.

Remark 7.2.36. Another consequence of Theorem 7.2.14 is that the D condition is stable under multiplication, which is not obvious.

7.2.3 Twist in type D

In type D we see that the two middle rows and columns of a table play symmetric roles. This is due to the fact that the two left nodes of the Dynkin diagram of type D commute. To show this symmetry between the generators π_1^e and π_1^f we will use s_0 which is the transposition $(\bar{1}, 1)$. It acts on μ -vectors of type D , and its right action on μ -vectors exchanges the letters in position $\bar{1}$ and 1. Its left action on μ -vectors replaces the letter 1, if it exists, by $\bar{1}$, and conversely. In other words the conjugation by s_0 exchanges the two middle rows and the two middle columns of a table permutation of type D . We then have the two following lemmas:

Lemma 7.2.37. For all $v \in R_\ell(D)$, $s_0 \cdot (v \cdot s_0) = (s_0 \cdot v) \cdot s_0 =: s_0 \cdot v \cdot s_0$.

Proof. If there is no 1 nor $\bar{1}$ in v , or if this mirror pair of letter exist but is not in the positions $\bar{1}, 1$ the result is clear. We then assume that this pair of letter is in the middle. We have the following cases:

v	$v \cdot s_0$	$s_0 \cdot (v \cdot s_0)$	$s_0 \cdot v$	$(s_0 \cdot v) \cdot s_0$
... $\bar{1}$ 1...	... $\bar{1}$ $\bar{1}$ $\bar{1}$ 1...	...1 $\bar{1}$ $\bar{1}$ 1...
...1 $\bar{1}$ $\bar{1}$ 1...	...1 $\bar{1}$ $\bar{1}$ 1...	...1 $\bar{1}$...
... $\bar{1}$ 0...	...0 $\bar{1}$0 1...	...1 0...	...0 1...
...0 1...	...1 0...	... $\bar{1}$ 0...	...0 $\bar{1}$ $\bar{1}$ 0...
...1 0...	...0 1...	...0 $\bar{1}$ $\bar{1}$ 0...	...0 $\bar{1}$...
...0 $\bar{1}$ $\bar{1}$ 0...	...1 0...	...0 1...	...1 0...

The result of the third and fifth columns are always equal, hence the result. \square

Lemma 7.2.38. *For all $v \in R_\ell(D)$, $s_0 \cdot v \cdot s_0 \in R_\ell(D)$.*

Proof. We use the characterization of Theorem 7.2.33. First of all, the conjugation by s_0 does not change the fact that pairs of mirror letters are in mirror positions. Furthermore it does not create or delete \emptyset letters. So $s_0 \cdot v \cdot s_0$ is still centrally antisymmetric and still breaks all pair, hence it obeys the B condition. Now if v has strictly more than ℓ zeros then it is still the case for $s_0 \cdot v \cdot s_0$. So it obeys the D condition. Let $v \mapsto \tilde{v}$ be the operation of completion by antisymmetry. If v has no letter \emptyset or exactly ℓ letter \emptyset , then \tilde{v} does not have the \emptyset by antisymmetry (and $\tilde{v} = v$ in the first case). This word has an even number of positive letters in its first half since $v \in R_\ell(D)$. Hence $\tilde{v} \cdot s_0$ has an odd number of positive letters in its first half since we exchanged the middle pair. But once again $s_0 \cdot (\tilde{v} \cdot s_0) = s_0 \cdot \tilde{v} \cdot s_0$ has an even number of positive letters in its first half since we exchanged 1 and $\bar{1}$. Hence $s_0 \cdot \tilde{v} \cdot s_0$ obeys the D condition. Furthermore it is clear that $\widetilde{s_0 \cdot v \cdot s_0} = s_0 \cdot \tilde{v} \cdot s_0$, hence $s_0 \cdot v \cdot s_0$ also obeys the D condition. \square

Finally, a simple computation on tables gives the following result:

Lemma 7.2.39. *The application $v \in R_\ell(D) \mapsto s_0 \cdot v \cdot s_0$ is an involutive morphism which enjoys the following identities:*

$$s_0 \cdot S_1^f \cdot s_0 = S_1^e, \quad \forall i \geq 2, s_0 \cdot S_i \cdot s_0 = S_i, \quad s_0 \cdot F \cdot s_0 = E_0, \quad \forall i \geq 1, s_0 \cdot E_i \cdot s_0 = E_i.$$

0-Renner monoid of type B and D

The purpose of this chapter is to define an equivalent of the 0-rook monoid for Renner monoids in type B and D , following Part II. After some material on Hecke monoid (Section 8.1) and a study on grassmannian words, that is, words with exactly one descent (see Definition 8.2.1 and Proposition 8.2.3) we adopt the following strategy.

In Section 8.3, we introduce a monoid of functions $F_\ell^0(T)$ (Definition 8.3.1 for type B , Definition 8.3.2 for type D) which acts on its associated Renner monoid $R_\ell(T)$. We then study these actions in order to get Theorem 8.3.9 which is a bijection between $F_\ell^0(T)$ and $R_\ell(T)$ in the same vein as Proposition 8.1.1.

In section 8.4 we introduce the monoid $G_\ell^0(T)$ (Definition 8.4.1 for type B , Definition 8.4.22 for type D) defined by presentation on the generators of $H_\ell^0(T)$ and the elements of the cross section lattice Λ_0 (see [God09, Definition 1.12] and Definition 7.1.1). The relations to which the generators are submitted will show that only few elements of Λ_0 are necessary: E_0 in type B , E_0 and F in type D .

Our objective is to prove that $F_\ell^0(T) \simeq G_\ell^0(T)$ (Theorem 8.4.17 for type B , Theorem 8.4.41 for type D). The strategy of proof is the following:

1. We check in type B (resp. type D) that Algorithm 7.2.13 (resp. Algorithm 7.2.32) gives a unique way to decompose an element $w \in F_\ell^0(B)$ (resp. $w \in F_\ell^0(D)$) as the product of a right grassmannian element of B_ℓ (resp. D_ℓ), an element of the cross section Λ_0 , and an element of B_ℓ (resp. D_ℓ). We prove this uniqueness under two different conditions in Lemma 8.4.12 and Theorem 8.4.13 (resp. Lemma 8.4.35 and Theorem 8.4.36).
2. We prove that a reduced word of $G_\ell^0(B)$ (resp. $G_\ell^0(D)$) has at most two letters E_0 in Proposition 8.4.16 (resp. E_0 and F in Proposition 8.4.40)). We will get this result by studying the product of an element of Λ_0 , a bigrassmannian element of B_ℓ (resp. D_ℓ), and another element of Λ_0 . See Proposition 8.4.14 for $F_\ell^0(B)$ and Proposition 8.4.15 for $G_\ell^0(B)$ (resp. Proposition 8.4.38 for $F_\ell^0(D)$ and Proposition 8.4.39 for $G_\ell^0(D)$).
3. We finally prove the bijection $F_\ell^0(T) \simeq G_\ell^0(T)$ in Theorem 8.4.17 (resp. Theorem 8.4.41).
4. We deduce from this isomorphism the presentation of the Renner monoid of type B in Theorem 8.4.19 (resp. type D in Theorem 8.4.43).

The step 2 and 3 are very similar to what Godelle did [God09]. The step 1 using Algorithms 7.2.13 and 7.2.32 is an explicit description of a unique decomposition of elements of Renner monoids.

8.1 0-Hecke monoid

8.1.1 Reduced and action-reduced words

In Section 2.4.2 we introduced the 0-Hecke monoid $H_\ell^0(T)$ for all Weyl types T . Currently, an element of $H_\ell^0(T)$ is defined as an abstract word of some generating system $S = \{g_1, \dots, g_m\}$. To get rid of the word question, we will rather see $H_\ell^0(T)$ as acting on $W(T)$ as follows: by Matsumoto's Theorem (Theorem 2.2.5), the word obtained by replacing s_i by π_i (for all i) in a reduced word of $W(T)$ is a reduced word of $H_\ell^0(T)$. In other words to each $\sigma = s_{i_1} \dots s_{i_k} \in W(T)$ we associate $\pi_\sigma := \pi_{i_1} \dots \pi_{i_k} \in H_\ell^0(T)$. This definition makes sense since it does not depend on the reduced word chosen for σ . Therefore the right multiplication $\pi_\tau = \pi_\sigma \pi_\mu$ can be seen as a right action $\sigma \cdot \pi_\mu := \tau$. Using this right action the converse bijection of $\sigma \mapsto \pi_\sigma$ is as follows:

Proposition 8.1.1. *The application
$$H_\ell^0(T) \longrightarrow W(T) \\ h \longmapsto 1_W \cdot h$$
 is a bijection, where 1_W is the identity of $W(T)$. In other words, the action on the identity characterizes the element.*

We also consider a definition of reduced word with regard to this action:

Definition 8.1.2. *Let $m \in H_\ell^0(T)$ and $\underline{m} = g_1 \dots g_k$ a word for m . Then \underline{m} is **action-reduced** if and only if :*

$$\forall 1 \leq j \leq k-1, 1_W \cdot (g_1 \dots g_j) \neq (1_W \cdot (g_1 \dots g_j)) \cdot g_{j+1}. \quad (8.1)$$

The following remark gives a link between the two notions:

Remark 8.1.3. Using this definition by action of the $\pi_i \in H_\ell^0(T)$, we see that these generators do not stabilize an element of $W(T)$ if and only if they increase the length of this element. In particular $m \in H_\ell^0(T)$ is reduced if and only if it is action-reduced. Note that in general the two notions are not equivalent: for instance $s_i s_i$ is action reduced in \mathfrak{S}_n and not reduced.

8.1.2 Description of $H_\ell^0(B)$ and $H_\ell^0(D)$

We will now describe combinatorially the actions of the generators of $H_\ell^0(B)$ and $H_\ell^0(D)$. We will not deal with type A in this part, thus we denote the generators of the $H_n^0(A)$ by π_1^A, \dots, π_n^A . For instance in type A if $\sigma \in A_{n-1} = \mathfrak{S}_n$ and $1 \leq k \leq n-1$:

$$\sigma \cdot \pi_k^A := \begin{cases} \sigma \cdot s_k & \text{if } \sigma_k < \sigma_{k+1}, \\ \sigma & \text{otherwise.} \end{cases} \quad (8.2)$$

These operators are the bubble sort operators seen in Definition 1.1.9. In type B and D , to respect the antisymmetry we will rather act on $\mathfrak{S}_{\bar{\ell}, \ell} := \mathfrak{S}([\bar{\ell}, \ell])$.

Definition 8.1.4. For $i, j \in [\bar{\ell}, \ell]$ with $i < j$ we define $\pi_{i,j}^A$ to be the following functions on $\mathfrak{S}_{\bar{\ell}, \ell}$:

$$(\sigma_{\bar{\ell}} \dots \sigma_i \dots \sigma_j \dots \sigma_{\ell}) \cdot \pi_{i,j}^A = \begin{cases} \sigma_{\bar{\ell}} \dots \sigma_j \dots \sigma_i \dots \sigma_{\ell} & \text{if } \sigma_i < \sigma_j, \\ \sigma_{\bar{\ell}} \dots \sigma_{\ell} & \text{otherwise.} \end{cases} \quad (8.3)$$

We note that if i, j, k and h are all different, the operators $\pi_{i,j}^A$ and $\pi_{k,h}^A$ act on different coordinates, hence commute. On the contrary to what is suggested by the notation, $\pi_{i,j}^A$ belongs to $H_{\bar{\ell}, \ell}^0(A)$ if and only if $j = i + 1$. We define the following generators:

$$\pi_i^A := \begin{cases} \pi_{i,i+1}^A & \text{if } i > 0; \\ \pi_{i+1,i}^A & \text{if } i < 0. \end{cases} \quad (8.4)$$

We now give the description of the action of $H_{\ell}^0(B)$ and $H_{\ell}^0(D)$ and we will prove in Definitions 8.3.1 and 8.3.2 in a more general context that these actions stabilize the Weyl group.

Proposition 8.1.5. The monoid $H_{\ell}^0(B)$ acts on B_{ℓ} with the generators $\pi_0 := \pi_{\bar{1},1}^A$ and the elements $\pi_i := \pi_{\bar{i}}^A \pi_i^A = \pi_i^A \pi_{\bar{i}}^A$ for $1 \leq i \leq \ell - 1$.

Proposition 8.1.6. The monoid $H_{\ell}^0(D)$ acts on D_{ℓ} with the generators $\pi_1^e := \pi_1$, $\pi_2, \dots, \pi_{\ell-1}$ of type B , and the generator $\pi_1^f := \pi_{\bar{1},2}^A \pi_{2,1}^A = \pi_{2,1}^A \pi_{\bar{1},2}^A$.

Note that $H_{\ell}^0(B) \subset H_{\bar{\ell}, \ell}^0(A)$ while $H_{\ell}^0(D) \not\subset H_{\bar{\ell}, \ell}^0(A)$. Now we will just give some interesting properties on elements of these monoids. First as we see with Proposition 8.1.1 we have $|H_{\ell}^0(T)| = |W(T)| < \infty$. We can prove [Bjö84] that these monoids are in fact lattices, and hence have a maximal element. Because of Remark 8.1.3 these maximal elements are the element of longest length. We now describe their action. We recall that 1_{ℓ} is the permutation $12 \dots \ell$ while $1_{\bar{\ell}, \ell} := \bar{\ell} \dots \bar{2} \bar{1} 1 2 \dots \ell$.

Proposition 8.1.7. [BB05] Let $i \leq \ell$ and ω_i be the maximal element of $H_i^0(T)$. Then:

$$\begin{aligned} 1_{\ell} \cdot \omega_i &= i(i-1) \dots 321(i+1) \dots \ell && \text{if } T = A, \\ 1_{\bar{\ell}, \ell} \cdot \omega_i &= \bar{\ell}(\bar{\ell}-1) \dots (\bar{i}+1)i \dots 21 \mid \bar{1}\bar{2} \dots \bar{i}(i+1) \dots (\ell-1)\ell && \text{if } T = B, \\ 1_{\bar{\ell}, \ell} \cdot \omega_i &= \bar{\ell}(\bar{\ell}-1) \dots (\bar{i}+1)i \dots 21 \mid \bar{1}\bar{2} \dots \bar{i}(i+1) \dots (\ell-1)\ell && \text{if } T = D \text{ and } i \text{ even,} \\ 1_{\bar{\ell}, \ell} \cdot \omega_i &= \bar{\ell}(\bar{\ell}-1) \dots (\bar{i}+1)i \dots 2\bar{1} \mid 1\bar{2} \dots \bar{i}(i+1) \dots (\ell-1)\ell && \text{if } T = D \text{ and } i \text{ odd.} \end{aligned}$$

Lemma 8.1.8. Let $i \leq \ell$, and ω_i be the maximal element of $H_i^0(T)$. Let u, v in $H_{\ell}^0(T)$ so that $\omega_i u = \omega_i v$, with these two expressions reduced. Then $u = v$.

Proof. The two elements $\omega_i u$ and $\omega_i v$ are reduced, hence action reduced by Remark 8.1.3 hence every generator of u and v acts. Since the generator of $H_{\ell}^0(T)$ sort letters we deduce that u and v have the same action on 1 (a word with more letters in increasing order). Because of Proposition 8.1.1 we deduce that $u = v$. \square

8.2 Grassmannian elements

8.2.1 Definition

We are interested in reduced expressions of elements of $H_\ell^0(T)$. An interesting notion [LS96] is the notion of *grassmannian elements*:

Definition 8.2.1. *Let M be a monoid generated by a set S . For $s, t \in S$, an element $m \in M$ is called **left-grassmannian** in s (resp. **right-grassmannian** in t), or s -grass (resp. t -grass) for short, if all its reduced words begin with s (resp. end with t). It is called **bi-grassmannian** in (s, t) , or s -grass- t if it is both left-grassmannian in s and right-grassmannian in t .*

We will now describe precisely grassmannian elements of type B and D . We will need them to give the relations in the presentation of the Renner monoids. These relations were precisely the ones forgotten by Godelle in [God09]. We recall from Section 1.1.4 the following definition:

Definition 8.2.2. *Let x be an element of $H_\ell^0(T) = \langle (\pi_i)_{i \in I} \rangle$. For $i \in I$, x has the **right** (resp. **left**) **descent** i if and only if $x \cdot \pi_i = x$ (resp. $\pi_i \cdot x = x$). The **right** (resp. **left**) **descent set** of x is the set of every $i \in I$ which is a right (resp. left) descent of x .*

As another consequence, the grassmannian elements are more easily characterized:

Proposition 8.2.3. *An element $x \in H_\ell^0(T)$ is **right** (resp. **left**) **grassmannian** in π_i if and only if its right (resp. left) descent set is $\{i\}$.*

Proof. It is just an application of Matsumoto's theorem and more precisely the exchange condition [Hum90, Section 1.7]. \square

8.2.2 Descents and grid representation in type A

We are interested in the permutation tables with a given right-descent set and/or a given left-descent set. In other words permutations which are linear extensions of the associated posets defined in Section 1.2.1.

Definition 8.2.4. *Let R be a right-descent set given by its poset \leq_R over $[n]$. For $1 \leq j \leq n$ we define $u_j(R) := |\{k \in [n] \mid j <_R k\}|$ and $d_j(R) := |\{k \in [n] \mid j >_R k\}|$. The **grid representation** $gr_A - R$ is a table $n \times n$ where we cross vertically the top $u_j(R)$ boxes and the bottom $d_j(R)$ boxes of column j for all j . Let L be a left-descent class we also define the **grid representation** $L - gr_A$ by transposition, and the **grid representation** $L - gr_A - R$.*

The idea of this definition is that a box that is crossed can not be an acceptable position for a 1 in the permutation table with the given left and right descent set. A *linear extension* of the descent sets thus gives us a permutation whose table must have its 1 in the non crossed boxes.

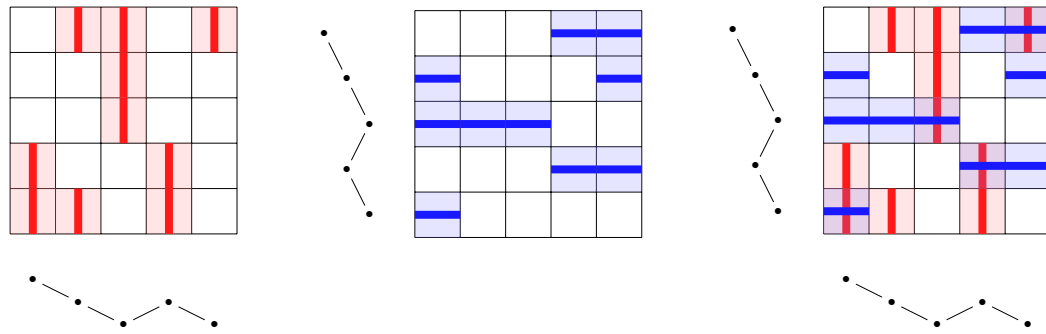

Figure 8.1: The grid representations $gr_A - \{1, 2, 4\}$, $\{1, 3, 4\} - gr_A$ and the two-sided $\{1, 3, 4\} - gr_A - \{1, 2, 4\}$. The boxes crossed vertically are colored red, while the boxes crossed horizontally are colored in blue.

Example 8.2.5. The grid representation on the right of Figure 8.1 shows that 54231 and 52143 are the only two permutations with left-descent set $[1, 3, 4]$ and right-descent set $[1, 2, 4]$.

We use the grid representation along the characterization of Proposition 8.2.3 between grassmannian elements and element with exactly one descent to find the grassmannian elements of type B and D . We do each case separately.

8.2.3 Type B

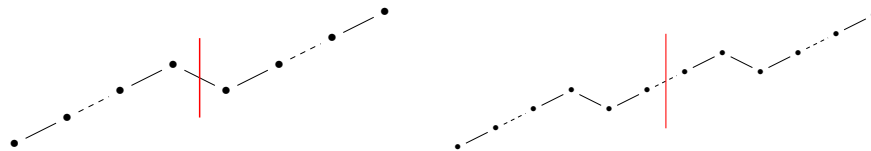

Figure 8.2: Right descent sets of right grassmannian in type B (in π_0 on the left, and π_i for $i > 0$ on the right).

Corollary 8.2.6. For $i \geq 0$ the descent set of right grassmannian elements of $H_\ell^0(B)$ in π_i is of the form of Figure 8.2. In other words, these elements are B -words of the form $\sigma = \sigma_{\bar{\ell}} \dots \sigma_{\bar{1}} \mid \sigma_1 \dots \sigma_\ell$ with:

- $\sigma_{\bar{\ell}} < \dots < \sigma_{\bar{2}} < \sigma_{\bar{1}} > \sigma_1 < \sigma_2 < \dots < \sigma_\ell$ if $i = 0$,
- $\sigma_{\bar{\ell}} < \dots < \sigma_{\bar{i+1}} > \sigma_{\bar{i}} < \sigma_{\bar{i-1}} < \dots < \sigma_{i-1} > \sigma_i < \sigma_{i+1} < \dots < \sigma_\ell$ otherwise.

Proof. As a consequence of Proposition 8.2.3 their right-descent is only $\{i\}$. So $\sigma_{\bar{1}} > \sigma_1$ (if $i = 1$) or $\sigma_{\bar{i+1}} > \sigma_{\bar{i}} \Leftrightarrow \sigma_i > \sigma_{i+1}$ otherwise. For all $j \neq i$, $w\pi_j \neq \pi_j$: all other two consecutives letters are in increasing order. \square

Proposition 8.2.7. We define in $H_\ell^0(B)$ for $0 \leq i \leq \ell - 1$ the following element:

$$\Pi_i := \pi_0 \dots \pi_i \pi_0 \dots \pi_{i-1} \pi_0 \dots \pi_{i-2} \dots \pi_0 \pi_1 \pi_0. \tag{8.5}$$

It is a π_0 -grass- π_0 element.

Proof. The action of Π_i on $1_{\bar{i}, \ell}$ is $\bar{\ell} \dots \overline{i+2} 1 2 \dots i i+1 \mid \overline{i+1} \bar{i} \dots \bar{2} \bar{1} i+2 \dots \ell$. Corollary 8.2.6 shows that Π_i is grass- π_i . Furthermore this permutation is equal to its inverse so it is also π_i -grass. \square

Example 8.2.8. We give the values of Π_i for $0 \leq i \leq 3$: $\Pi_0 = \pi_0$, $\Pi_1 = \pi_0\pi_1\pi_0$, $\Pi_2 = \pi_0\pi_1\pi_2\pi_0\pi_1\pi_0$ and $\Pi_3 = \pi_0\pi_1\pi_2\pi_3\pi_0\pi_1\pi_2\pi_0\pi_1\pi_0$.

We are now looking at the grid representations of elements π_i -grass- π_j . We borrow the definition of grid representation and adapt it to this particular case of type B and D for grassmannian elements.

Definition 8.2.9. Let L and R be two descent sets, and $\lambda = \min L$, $\mu = \min R$. The **grid representation** $L - gr_B - R$ is the grid representation $L - gr_A - R$ with an additional rule that the columns $-\lambda$ to λ (resp. rows $-\mu$ to μ) are also crossed above (resp. right to) the diagonal in the negative half, and below (resp. left to) the diagonal in the positive half.

The additional rule comes only from the antisymmetry of B -elements. See Figure 8.3 for some examples. When L or R only contains one descent $\{i\}$ we write i rather than $\{i\}$.

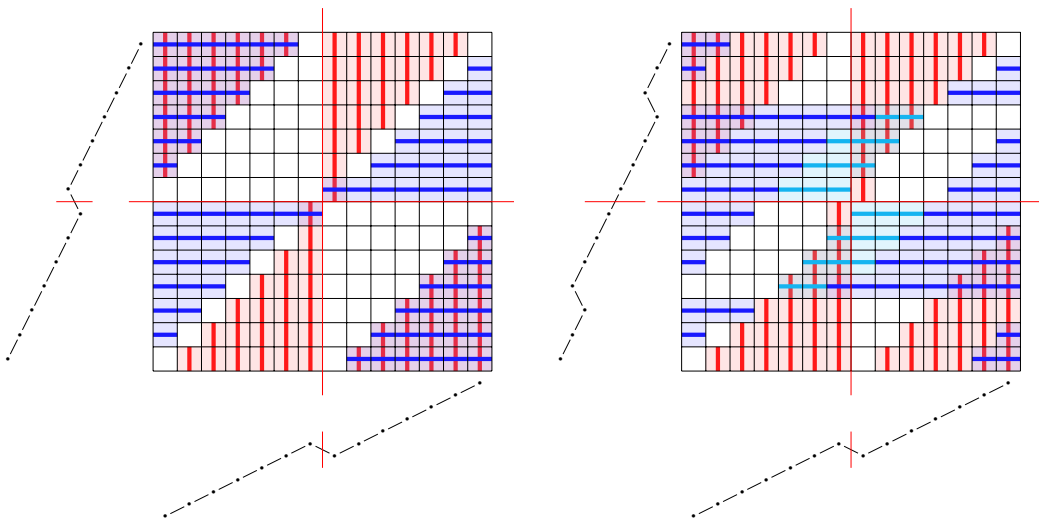

Figure 8.3: Grid representations $0 - gr_B - 0$ and $4 - gr_B - 0$ in size 7.

Proposition 8.2.10. Let $0 \leq i, j \leq \ell - 1$ and $i - gr_B - j$ the associated grid representation. Then the top right corner of the columns $j + 1$ to ℓ and of the rows $i + 1$ to ℓ rows is entirely crossed, except all boxes on the diagonal but the leftmost one.

Consequently, when we are looking for linear extensions of the grid representation, if there is a 1 in this diagonal, then all the following 1 are on the diagonal.

Figure 8.3 illustrates this proposition.

Proof. By antisymmetry of elements we can consider the first rows and columns. The rows $\bar{\ell}$ to \bar{i} (resp. columns $\bar{\ell}$ to \bar{j}) are precisely the rows (resp. columns) before the first descent. We consider the columns. Let $\bar{\ell} \leq k \leq \bar{i} + 2$, then k has $\ell - |k|$ elements below in the poset. Hence the strict subdiagonal is entirely filled in red. For the column $\bar{i} + 1$ there is even $\ell - i$ vertices below, hence the subdiagonal boxes and the diagonal box are crossed vertically. The same goes for rows. So all boxes of this corner are filled, except boxes of the diagonal but the leftest ($\bar{i} + 1$) one. The second property can be deduced easily from the fact that between columns $i + 1$ and ℓ , a linear extension of the poset must be increasing. \square

Corollary 8.2.11. *The bi-grassmannian elements in π_0 are precisely the elements $(\Pi_i)_{0 \leq i \leq \ell-1}$.*

Proof. We look at the grid representation $0 - gr_B - 0$ of size ℓ . The right descent graph has only one descent in the middle. So for the column k with $\bar{\ell} \leq k \leq \bar{2}$, we cross vertically the top $|k| - 1$ boxes and the bottom $\ell - |k|$. In column $\bar{1}$ we fill the bottom ℓ in red. The columns 1 to ℓ are filled antisymmetrically and the rows are crossed horizontally similarly. In the end, the grid representation has four quarters separated by the middle horizontal and vertical lines. By Proposition 8.2.10 the quarter below left and above right have all their boxes crossed except boxes on the diagonal but the ones in columns $\bar{1}$ and 1. The sector above left has all the blocks of its strict upperdiagonal filled, and subdiagonal for the below right sector.

We now look at linear extensions of this grid representation. Let k be the index of the first column where 1 is not in the diagonal. Note that $k \leq \bar{1}$. If $k = \bar{1}$ we find back the table of $\pi_0 = \Pi_0$. Otherwise we get the following block table, where I_k the table of square k with the diagonal bottomleft to topright filled with 1:

$$\begin{array}{|c|c|c|} \hline & & I_{\ell-k} \\ \hline & I_k & \\ \hline & & I_k \\ \hline I_{\ell-k} & & \\ \hline \end{array} = \Pi_{k-1}. \tag{8.6}$$

\square

8.2.4 Type D

We now switch to type D .

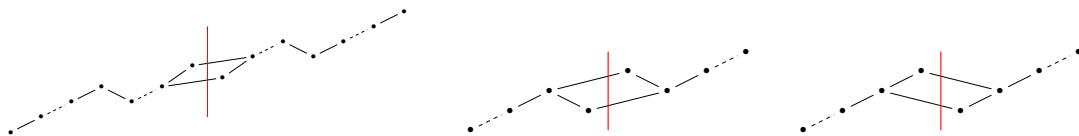

Figure 8.4: Descent sets of right grassmannian in type D (in π_i for $i > 1$ on the left, π_1^e on the middle and π_1^f on the right).

For the next proposition we use the following notation: $\pi_{1^e} := \pi_1^e$ and $\pi_{1^f} := \pi_1^f$.

Proposition 8.2.12. For $i \in \{1^e, 1^f, 2, \dots, \ell - 1\}$, the descent set of grass- π_i elements of $H_\ell^0(D)$ is of the form of Figure 8.4. As a consequence, such an element $\sigma = \sigma_{\bar{\ell}} \dots \sigma_{\bar{1}} \mid \sigma_1 \dots \sigma_\ell$ has the following shape:

- $\sigma_{\bar{\ell}} < \dots < \sigma_{\bar{2}} < \sigma_1 > \sigma_2 < \dots < \sigma_\ell$ and $\sigma_{\bar{2}} > \sigma_{\bar{1}} < \sigma_2$ if $i = 1^e$,
- $\sigma_{\bar{\ell}} < \dots < \sigma_{\bar{2}} < \sigma_{\bar{1}} > \sigma_2 < \dots < \sigma_\ell$ and $\sigma_{\bar{2}} > \sigma_1 < \sigma_2$ if $i = 1^f$,
- $\sigma_{\bar{\ell}} < \dots < \sigma_{\overline{i+1}} > \sigma_i < \sigma_{\overline{i-1}} < \dots < \sigma_{\bar{1}}$, $\sigma_1 < \dots < \sigma_{i-1} > \sigma_i < \sigma_{i+1} < \dots < \sigma_\ell$ and $\sigma_{\bar{2}} < \sigma_1 \Leftrightarrow \sigma_{\bar{1}} < \sigma_2$ if $i \geq 2$.

Proof. As a consequence of Proposition 8.2.3 the right-descent set is only $\{i\}$. So $\sigma_{\bar{1}} > \sigma_2 \Leftrightarrow \sigma_{\bar{2}} > \sigma_1$ if $i = 1^f$, and $\sigma_{\overline{i+1}} > \sigma_i \Leftrightarrow \sigma_i > \sigma_{i+1}$ otherwise. For all $j \neq i$, $w\pi_j \neq \pi_j$: all other two neighbouring letters are in increasing order. \square

Notation 8.2.13. We define the following two elements for $i \geq 0$:

$$\pi_{1,i}^{ef} := \begin{cases} \pi_1^e & \text{if } i \text{ is even,} \\ \pi_1^f & \text{otherwise.} \end{cases} \quad \pi_{1,i}^{fe} := \begin{cases} \pi_1^f & \text{if } i \text{ is even,} \\ \pi_1^e & \text{otherwise.} \end{cases}$$

Definition 8.2.14. We define for $i \geq 1$ the following elements.

$$\begin{aligned} \Delta_i^f &:= \pi_1^f \pi_2 \dots \pi_i \pi_1^e \pi_2 \dots \pi_{i-1} \pi_1^f \pi_2 \dots \pi_{i-2} \dots \pi_{1,i}^{fe} \pi_2 \pi_{1,i}^{ef} \\ &= \pi_1^f \pi_2 \pi_1^e \dots \pi_{i-2} \dots \pi_2 \pi_1^f \pi_{i-1} \dots \pi_2 \pi_{1,i}^{fe} \pi_i \dots \pi_2 \pi_{1,i}^{ef}, \\ \Delta_i^e &:= \pi_1^e \pi_2 \dots \pi_i \pi_1^f \pi_2 \dots \pi_{i-1} \pi_1^e \pi_2 \dots \pi_{i-2} \dots \pi_{1,i}^{ef} \pi_2 \pi_{1,i}^{fe} \\ &= \pi_1^e \pi_2 \pi_1^f \dots \pi_{i-2} \dots \pi_2 \pi_1^e \pi_{i-1} \dots \pi_2 \pi_{1,i}^{ef} \pi_i \dots \pi_2 \pi_{1,i}^{fe}. \end{aligned}$$

The equality between the two expressions of Δ_i^f and of Δ_i^e comes from Relation H2-D of the presentation of $H_\ell^0(D)$. We will see that $s_0 \Delta_i^f s_0 = \Delta_i^e$ by Lemma 7.2.39. We give some examples before going further.

Example 8.2.15. $\Delta_1^e = \pi_1^e$, $\Delta_1^f = \pi_1^f$, $\Delta_2^e = \pi_1^e \pi_2 \pi_1^f$, $\Delta_2^f = \pi_1^f \pi_2 \pi_1^e$, $\Delta_3^e = \pi_1^e \pi_2 \pi_3 \pi_1^f \pi_2 \pi_1^e$, $\Delta_3^f = \pi_1^f \pi_2 \pi_3 \pi_1^e \pi_2 \pi_1^f$, $\Delta_4^e = \pi_1^e \pi_2 \pi_3 \pi_4 \pi_1^f \pi_2 \pi_3 \pi_1^e \pi_2 \pi_1^f$ and $\Delta_4^f = \pi_1^f \pi_2 \pi_3 \pi_4 \pi_1^e \pi_2 \pi_3 \pi_1^f \pi_2 \pi_1^e$.

As suggested in Example 8.2.15, the next proposition explains the notation: the element Δ_i^f (resp. Δ_i^e) always begins with π_1^f (resp. π_1^e).

Proposition 8.2.16. Δ_i^e is π_1^e -grass- $\pi_{1,i}^{fe}$ while Δ_i^f is π_1^f -grass- $\pi_{1,i}^{ef}$.

Proof. It is just an explicit calculation of the action of Δ_i^e and Δ_i^f on the identity. There are four possibilities depending of the parity of i and which element we are looking at:

- If i even, $1_{\bar{\ell},\ell} \cdot \Delta_i^e = \bar{\ell} \dots \overline{i+2} \bar{1} 2 \dots i i + 1 \mid \overline{i+1} \bar{i} \dots \bar{2} 1 i + 2 \dots \ell$, hence Δ_i^e is π_1^e -grass- π_1^f .
- If i is even, $1_{\bar{\ell},\ell} \cdot \Delta_i^f = \bar{\ell} \dots \overline{i+2} 1 \dots i \overline{i+1} \mid i + 1 \bar{i} \dots \bar{1} i + 2 \dots \ell$, hence Δ_i^f is π_1^f -grass- π_1^e .
- If i is odd, $1_{\bar{\ell},\ell} \cdot \Delta_i^e = \bar{\ell} \dots \overline{i+2} \bar{1} 2 \dots i \overline{i+1} \mid i + 1 \bar{i} \dots \bar{2} 1 i + 2 \dots \ell$, hence Δ_i^e is π_1^e -grass- π_1^e .
- If i is odd, $\Delta_i^f, 1_{\bar{\ell},\ell} \cdot \Delta_i^f = \bar{\ell} \dots \overline{i+2} 1 \dots i i + 1 \mid \overline{i+1} \bar{i} \dots \bar{1} i + 2 \dots \ell$, hence Δ_i^f is π_1^f -grass- π_1^f .

We now apply Proposition 8.2.12 to see that each of these elements are right grassmannians. We finally inverse the word (transpose the table with respect to the $x = y$ diagonal) and see that they are left-grassmannian. \square

We adapt the definition of grid representation to type D :

Definition 8.2.17. For $i, j \in \{1^e, 1^f, 2, \dots, \ell-1\}$, the grid representation $i - gr_D - j$ is the grid representation $i - gr_A - j$ with the additional rule that the topleft quarter and bottomright quarter of a linear extension must have an even number of 1's.

See Figure 8.5 for some examples. As in type B we find the following Proposition:

Proposition 8.2.18. Let $i - gr_D - j$ be a grid representation of type D . Then the top right corner of the columns $j + 1$ to ℓ and of the rows $i + 1$ to ℓ rows is entirely crossed except the boxes on the diagonal but the leftmost one. Consequently, for linear extensions of the grid representation, if there is a 1 in this diagonal, then all the following 1 are on the diagonal.

Proof. The proof is exactly the same as in 8.2.10. Note that for column $\bar{2}$ there may be even more crossed elements below the diagonal. Also note that column $\bar{1}$ is never considered in this lemma. \square

Proposition 8.2.19. The elements both left and right grassmannian in π_1^e or π_1^f are exactly the Δ_i^e and Δ_i^f .

Proof. The proof is exactly the same as in Proposition 8.2.11, taking into account the question of parity. \square

8.3 0-Renner as transformation monoids

Let $\ell \in \mathbb{N}$. We extend the definition of generators of $H_\ell^0(B)$ from Proposition 8.1.5 by having them acting not only on permutations but on rooks:

Definition 8.3.1. Let $p_0, \dots, p_{\ell-1}, \varepsilon_0, \dots, \varepsilon_\ell$ be the following functions on $R_\ell(B)$:

- $p_0 := \pi_{\bar{1},1}^A$
- For $1 \leq i \leq \ell - 1$, $p_i := \pi_{\bar{i}}^A \pi_i^A = \pi_i^A \pi_{\bar{i}}^A$
- For $0 \leq i \leq \ell$, $\varepsilon_i := E_i$.

Let $F_\ell^0(B)$ be the monoid generated by these elements. It naturally has left and right actions on tables and, equivalently, μ -vectors.

Proof. We have to check that these elements stabilize $R_\ell(B)$. We do it on the right side and deduce the left side by transposition. We use the characterization of Theorem 7.2.14. The elements p_0 and $(\varepsilon_i)_{0 \leq i \leq \ell}$ stabilize the B condition. Let us check for $(p_i)_{1 \leq i \leq \ell-1}$. Since p_i is the product of the two generators $\pi_{\bar{i}}^A$ and π_i^A , we will show that one generator acts if and only if the other one does. This implies that the condition B is stabilized since p_i has either the action of S_i or that of the identity. In order to get this equivalence, we look at the different possibilities of type B in the following chart, according to the values of $r_i = j$ and $r_{i+1} = k$. In this chart $j \neq \emptyset$ and $k \neq \emptyset$.

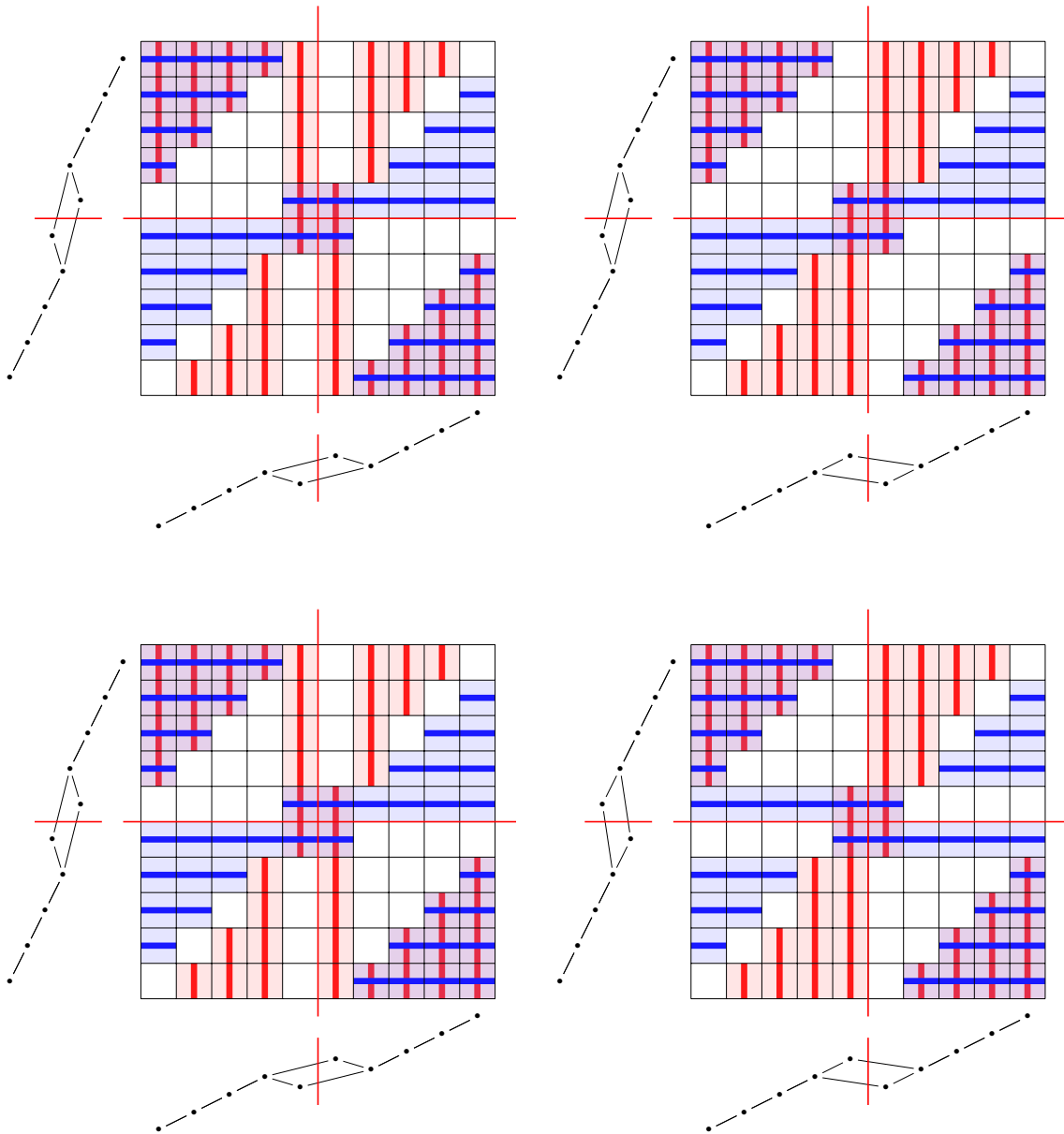

Figure 8.5: Grid representations of $1^e - gr_D - 1^e$ (topleft), $1^e - gr_D - 1^f$ (topright), $1^f - gr_D - 1^e$ (bottomleft) and $1^f - gr_D - 1^f$ (bottomright) of size 5.

$r_{\bar{i}+1}$	$r_{\bar{i}}$	r_i	r_{i+1}	Action of p_i
\bar{k}	\bar{j}	j	k	$j < k \Leftrightarrow \bar{k} < \bar{j}$ so $\bar{k}\bar{j} \dots jk$ or $\bar{j}\bar{k} \dots kj$
\emptyset	\bar{j}	\emptyset	k	$\bar{j}\emptyset \dots k\emptyset$
\bar{k}	\emptyset	j	\emptyset	$\bar{k}\emptyset \dots j\emptyset$
\emptyset	\emptyset	j	k	$\emptyset\emptyset \dots jk$ or $\emptyset\emptyset \dots kj$ whether $k < j$
\bar{k}	\bar{j}	\emptyset	\emptyset	$\bar{k}\bar{j} \dots \emptyset\emptyset$ or $\bar{j}\bar{k} \dots \emptyset\emptyset$ whether $\bar{k} > \bar{j}$
\emptyset	\emptyset	j	\emptyset	$\emptyset\emptyset \dots j\emptyset$
\emptyset	\emptyset	\emptyset	k	$\emptyset\emptyset \dots k\emptyset$
\bar{k}	\emptyset	\emptyset	\emptyset	$\bar{k}\emptyset \dots \emptyset\emptyset$
\emptyset	\bar{j}	\emptyset	\emptyset	$\bar{j}\emptyset \dots \emptyset\emptyset$
\emptyset	\emptyset	\emptyset	\emptyset	$\emptyset\emptyset \dots \emptyset\emptyset$

We see that in every case the condition B remains true, hence the result. □

We extend the definition of $\pi_{i,j}^A$ seen in Definition 8.1.4 to functions on $R_{\bar{\ell},\ell}$. Similarly we can also extend Definition 8.1.6:

Definition 8.3.2. We define on $R_\ell(D)$ the function $p_1^f := \pi_{2,1}^A \pi_{1,2}^A = \pi_{1,2}^A \pi_{2,1}^A$ and the function φ :

$$(r_1 \dots r_n) \cdot \varphi = \emptyset \dots \emptyset r_{\bar{1}} \mid \emptyset r_2 \dots r_\ell. \tag{8.7}$$

Then $p_1^f, p_1^e := p_1, p_2, \dots, p_{\ell-1}, \varepsilon_0, \dots, \varepsilon_\ell, \varphi$ are functions which stabilize $R_\ell(D)$. Let $F_\ell^0(D)$ be the monoid generated by these elements. It naturally has left and right actions on tables and, equivalently, μ -vectors.

Proof. We use Theorem 7.2.33. For $p_1^e = p_1, \dots, p_{\ell-1}$ and $\varepsilon_0, \dots, \varepsilon_\ell$ we have already seen that the condition B is stabilized, and the condition of parity also holds. For φ everything is clear. It remains to see for p_1^f . We have to check the different possible behaviors:

$r_{\bar{2}}$	$r_{\bar{1}}$	r_1	r_2	Action of p_1^f
\bar{k}	\bar{j}	j	k	$\bar{k} < j \Leftrightarrow \bar{j} < k$ so $\bar{k}\bar{j} \mid jk$ or $jk \mid \bar{k}\bar{j}$.
\emptyset	\bar{j}	\emptyset	k	$\emptyset k \mid \emptyset\bar{j}$ or $\emptyset\bar{j} \mid \emptyset k$ whether $\bar{j} < k$
\bar{k}	\emptyset	j	\emptyset	$j\emptyset \mid \bar{k}\emptyset$ or $\bar{k}\emptyset \mid j\emptyset$ whether $\bar{k} < j$
\bar{k}	\bar{j}	\emptyset	\emptyset	$\bar{k}\bar{j} \mid \emptyset\emptyset$
\emptyset	\emptyset	j	k	$jk \mid \emptyset\emptyset$
\bar{k}	\emptyset	\emptyset	\emptyset	$\bar{k}\emptyset \mid \emptyset\emptyset$
\emptyset	\bar{j}	\emptyset	\emptyset	$\emptyset\bar{j} \mid \emptyset\emptyset$
\emptyset	\emptyset	j	\emptyset	$j\emptyset \mid \emptyset\emptyset$
\emptyset	\emptyset	\emptyset	k	$\emptyset k \mid \emptyset\emptyset$
\emptyset	\emptyset	\emptyset	\emptyset	$\emptyset\emptyset \mid \emptyset\emptyset$

Finally, we see that p_1^f stabilize the B condition since the two comparisons of p_1^f are always equivalent. The condition of parity remains also true: check only the first five cases. □

The involutive element s_0 defined previously can be seen as an action on $R_\ell(D)$ which does not stabilize it. We can nevertheless obtain the following lemma by conjugation on functions:

Lemma 8.3.3. *For $v \in F_\ell^0(D)$, the function $s_0 \cdot v \cdot s_0 = s_0 v s_0$ is in $F_\ell^0(D)$. Furthermore, the application $v \in F_\ell^0(D) \mapsto s_0 \cdot v \cdot s_0$ is an involution of $F_\ell^0(D)$ acting on generators as follows:*

$$s_0 \cdot p_1^f \cdot s_0 = p_1^e, \quad \forall i \geq 2, \quad s_0 \cdot p_i \cdot s_0 = p_i, \quad s_0 \cdot \varphi \cdot s_0 = \varepsilon, \quad \forall i \geq 1, \quad s_0 \cdot \varepsilon_i \cdot s_0 = \varepsilon_i.$$

Proof. We first prove the special cases. For $i \geq 2$ and $j \geq 1$, $s_0 p_i = p_i s_0$ and $s_0 \varepsilon_j = \varepsilon_j s_0$ since they do not act on the same positions. Since s_0 is an involution we deduce that $s_0 p_i s_0 = p_i$ and $s_0 \varepsilon_j s_0 = \varepsilon_j$. For the last two equalities, we look directly at the action on some r :

$$\begin{aligned} r_{\bar{\ell}} \dots r_{\bar{2}} r_{\bar{1}} \mid r_1 r_2 \dots r_\ell &\xrightarrow{s_0} r_{\bar{\ell}} \dots r_{\bar{2}} r_1 \mid r_{\bar{1}} r_2 \dots r_\ell \\ &\xrightarrow{\varphi} \emptyset \dots \emptyset r_1 \mid \emptyset r_2 \dots r_\ell \\ &\xrightarrow{s_0} \emptyset \dots \emptyset \mid r_1 \dots r_\ell. \end{aligned}$$

Hence $s_0 \varphi s_0 = \varepsilon$. For the last case, first assume that $r_1 < r_2 \Leftrightarrow r_{\bar{2}} < r_{\bar{1}}$:

$$\begin{aligned} r_{\bar{\ell}} \dots r_{\bar{2}} r_{\bar{1}} \mid r_1 r_2 \dots r_\ell &\xrightarrow{s_0} r_{\bar{\ell}} \dots r_{\bar{2}} r_1 \mid r_{\bar{1}} r_2 \dots r_\ell \\ &\xrightarrow{p_1^f} r_{\bar{\ell}} \dots r_{\bar{1}} r_2 \mid r_{\bar{2}} r_1 \dots r_\ell \\ &\xrightarrow{s_0} r_{\bar{\ell}} \dots r_{\bar{1}} r_{\bar{2}} \mid r_2 r_1 \dots r_\ell \end{aligned}$$

Otherwise:

$$\begin{aligned} r_{\bar{\ell}} \dots r_{\bar{2}} r_{\bar{1}} \mid r_1 r_2 \dots r_\ell &\xrightarrow{s_0} r_{\bar{\ell}} \dots r_{\bar{2}} r_1 \mid r_{\bar{1}} r_2 \dots r_\ell \\ &\xrightarrow{p_1^f} r_{\bar{\ell}} \dots r_{\bar{2}} r_1 \mid r_{\bar{1}} r_2 \dots r_\ell \\ &\xrightarrow{s_0} r_{\bar{\ell}} \dots r_{\bar{2}} r_{\bar{1}} \mid r_1 r_2 \dots r_\ell \end{aligned}$$

Hence $s_0 p_1^f s_0 = p_1^e$. Since $s_0^2 = 1$ this application is an involution. Finally let t_1 and t_2 be generators. Then $s_0 \cdot t_1 \cdot s_0 = t_1'$ and $s_0 \cdot t_2 \cdot s_0 = t_2'$ are also generators. So:

$$s_0 \cdot t_1 t_2 \cdot s_0 : r \mapsto r \cdot (s_0 t_1 t_2 s_0) = r \cdot (s_0 t_1 s_0 s_0 t_2 s_0) = r \cdot (t_1' t_2') \in R_\ell(D). \quad (8.8)$$

Therefore $s_0 \cdot v \cdot s_0 \in F_\ell^0(D)$ for all $v \in F_\ell^0(D)$. \square

Proposition 8.3.4. *For $T \in \{B, D\}$ and every $v \in R_\ell(T)$ there exists $w_\pi \in F_\ell^0(T)$ such that $1_{\bar{\ell}, \ell} \cdot w_\pi = v$.*

Proof. In type B we use the word \underline{w}_s obtained by Algorithm 7.2.13, and replace all s_i by the corresponding p_i to get \underline{w}_π . We have to check that \underline{w}_π is action reduced. But we note that in part 1 and 3, when we are in step i setting the i -th letter, all letters between the first i and the last i positions are sorted in increasing order. This means that every p_k and s_k have the same action. Hence $1_{\bar{\ell}, \ell} \cdot \underline{w}_s = 1_{\bar{\ell}, \ell} \cdot \underline{w}_\pi = v$.

In type D we use Algorithm 7.2.32. The difference is that at step i , two consecutive letters between the first i and last i are not necessarily sorted in increasing order. Indeed there could be a problem between letters 1 and $\bar{1}$. However it is true for neighbouring letters which are the only one that can be exchanged. So again every generator p_k and s_k has the same action. \square

Remark 8.3.5. By transposition for every $v \in R_\ell(T)$ there exists $w_\pi \in F_\ell^0(T)$ such that $w_\pi \cdot 1_{\bar{\ell},\ell} = v$.

Now we also want to prove that the action on the identity is injective. We will use the left and right actions to do this, but we first have to prove that these actions commute. We begin with a technical lemma:

Lemma 8.3.6. *For $r \in R_\ell(B)$ and g a generator of $F_\ell^0(D)$, we have:*

$$s_0 \cdot (r \cdot g) = (s_0 \cdot r) \cdot g \quad \text{and} \quad g \cdot (r \cdot s_0) = (g \cdot r) \cdot s_0. \quad (8.9)$$

Proof. A generator g of $F_\ell^0(D)$ never exchanges mirror letters, hence can not exchange the letters $\bar{1}$ and 1 . These letters are exchanged, if they exist, by the left action of s_0 . Furthermore, since these two letters are two consecutive values, let a be a letter in r , then $1 < a \Leftrightarrow \bar{1} < a$ and $1 > a \Leftrightarrow \bar{1} > a$. Hence $s_0 \cdot (r \cdot g) = (s_0 \cdot r) \cdot g$. The other equality is obtained by transposition. \square

Proposition 8.3.7. *The right and left action of $F_\ell^0(T)$ over $R_\ell(T)$ commute.*

Proof. In type B it follows from the commutation between the right and left action of $R_n^0(A)$ over $R_n(A)$ (Corollary 4.5.5) since the generators of $F_\ell^0(B)$ are product of functions of type A . Type D is more involved. Since elements of $R_\ell(D)$ obey the B condition, we deduce from type B the commutation of generators in the set $\{p_1^e = p_1, p_2, \dots, p_{\ell-1}, \varepsilon_0, \dots, \varepsilon_\ell\}$:

$$\forall v \in R_\ell(D), \forall g, h \in \{p_1^e, p_2, \dots, p_{\ell-1}, \varepsilon_0, \dots, \varepsilon_\ell\}, (g \cdot v) \cdot h = g \cdot (v \cdot h). \quad (8.10)$$

We want to prove that $((s_0 \cdot g \cdot s_0) \cdot v) \cdot h = (s_0 \cdot g \cdot s_0) \cdot (v \cdot h)$. We have:

$$\begin{aligned} ((s_0 \cdot g \cdot s_0) \cdot v) \cdot h &= (s_0 \cdot (g \cdot (s_0 \cdot v))) \cdot h = s_0 \cdot ((g \cdot (s_0 \cdot v)) \cdot h) \quad \text{by Lemma 8.3.6} \\ &= s_0 \cdot (g \cdot ((s_0 \cdot v) \cdot h)) \quad \text{by (8.10)} \\ &= s_0 \cdot (g \cdot (s_0 \cdot (v \cdot h))) \quad \text{by Lemma 8.3.6.} \\ &= (s_0 \cdot g \cdot s_0) \cdot (v \cdot h) \end{aligned}$$

We also have $(g \cdot v) \cdot (s_0 \cdot h \cdot s_0) = g \cdot (v \cdot (s_0 \cdot h \cdot s_0))$. By Lemma 8.3.3 we then deduce from (8.10) the commutation of every generator of type D . \square

Corollary 8.3.8. *The application $r \in F_\ell^0(T) \mapsto 1_{\bar{\ell},\ell} \cdot r \in R_\ell(T)$ is injective.*

Proof. Let $r, r' \in F_\ell^0(T)$ be so that $1_{\bar{\ell},\ell} \cdot r = 1_{\bar{\ell},\ell} \cdot r'$. Let $v \in R_\ell(B)$ and $w_\pi \in F_\ell^0(T)$ according to Remark 8.3.5 so that $w_\pi \cdot 1_{\bar{\ell},\ell} = v$. Hence:

$$\begin{aligned} 1_{\bar{\ell},\ell} \cdot r &= 1_{\bar{\ell},\ell} \cdot r' \\ w_\pi \cdot (1_{\bar{\ell},\ell} \cdot r) &= w_\pi \cdot (1_{\bar{\ell},\ell} \cdot r') \\ (w_\pi \cdot 1_{\bar{\ell},\ell}) \cdot r &= (w_\pi \cdot 1_{\bar{\ell},\ell}) \cdot r' \quad \text{by Proposition 8.3.7,} \\ v \cdot r &= v \cdot r'. \end{aligned}$$

Finally the two functions r and r' are equal. \square

We conclude by a generalization of Proposition 8.1.1.

Theorem 8.3.9. *The map $r \in F_\ell^0(T) \mapsto 1_{\bar{\ell},\ell} \cdot r \in R_\ell(T)$ is a bijection. Therefore we have $|F_\ell^0(T)| = |R_\ell(T)|$.*

Proof. This map is injective by Corollary 8.3.8 and surjective by Proposition 8.3.4. \square

8.4 Generators

We now want to define a 0-Renner monoid of type B and D by generators and relations as we did in type A (Part II). These monoids will be generated by a set $\Pi = (\pi_s)_{s \in S}$ and the same cross-section Λ_0 than in the Renner monoid. Taking back Godelle's Definition 7.1.1, and changing the Coxeter Relations to Hecke Relations we would want to define $R_\ell^0(T)$ to be generated by $\Pi \cup \Lambda_0$ subject to the relations:

$$\pi_s^2 = \pi_s, \quad \pi \in \Pi; \quad (\text{H1})$$

$$|\pi_s, \pi_t\rangle^m = |\pi_t, \pi_s\rangle^m, \quad (\{s, t\}, m) \in \mathcal{E}(\Gamma) \quad (\text{H2})$$

$$\pi_s e = e \pi_s, \quad e \in \Lambda_0, s \in \lambda^*(e); \quad (\text{TYM1})$$

$$\pi_s e = e \pi_s = e, \quad e \in \Lambda_0, s \in \lambda_*(e); \quad (\text{TYM2})$$

$$e \overline{\pi_w} f = e \wedge_{\pi_w} f, \quad e, f \in \Lambda_0, w \in G^\uparrow(e) \cap D^\uparrow(f). \quad (\text{TYM3})$$

We note that with this definition the submonoid generated only by Π is the Hecke monoid $H_\ell^0(T)$. In Definition 8.4.1 and 8.4.22 we will give an explicit presentation and prove that the monoids defined by such a presentation are isomorphic to the corresponding monoids $F_\ell^0(T)$ in Theorems 8.4.17 and 8.4.41.

8.4.1 Type B

We will use the element Π_i defined in Proposition 8.2.7. This special element corresponds to the elements of Relation TYM3 for the type B . We will now describe precisely the 0-Renner monoid of type B with the following definition.

Definition 8.4.1. *The 0-Renner monoid of type B and size ℓ , denoted by $G_\ell^0(B)$, is generated by $\pi_0, \dots, \pi_{\ell-1}, e_0, \dots, e_\ell$ subject to the relations:*

$$\pi_i^2 = \pi_i \quad 0 \leq i \leq \ell - 1; \quad (\text{H1-B})$$

$$\pi_i \pi_j = \pi_j \pi_i, \quad 0 \leq i, j \leq \ell - 1 \text{ and } |i - j| \geq 2; \quad (\text{H2-B})$$

$$\pi_i \pi_{i+1} \pi_i = \pi_{i+1} \pi_i \pi_{i+1}, \quad 1 \leq i \leq \ell - 2; \quad (\text{H3-B})$$

$$\pi_1 \pi_0 \pi_1 \pi_0 = \pi_0 \pi_1 \pi_0 \pi_1, \quad (\text{H4-B})$$

$$e_j \pi_i = \pi_i e_j = e_j, \quad 0 \leq i < j \leq \ell; \quad (\text{Abs-B})$$

$$e_j \pi_i = \pi_i e_j, \quad 0 \leq j < i \leq \ell - 1; \quad (\text{Com-B})$$

$$e_i e_j = e_j e_i = e_{\max(i,j)}, \quad 0 \leq i, j \leq \ell; \quad (\text{E-B})$$

$$e_i \pi_i e_i = e_{i+1}, \quad 0 \leq i \leq \ell - 1; \quad (\text{Rec-B})$$

$$e_0 \Pi_i e_0 = e_{i+1}, \quad 0 \leq i \leq \ell - 1. \quad (\text{Red-B})$$

The Relations Rec-B and Red-B show that $G_\ell^0(B) = \langle \pi_0, \dots, \pi_{\ell-1}, e_0 \rangle$. The Relation Rec-B gives us a definition of $(e_i)_{i>0}$ (as in type A , Equation R8), and we will show that the Relation Red-B gives a reduced expression of these elements. We define $e := e_0$.

Example 8.4.2. Using Example 8.2.8, we explicit the relations Red-B for i from 0 to 5:

$$e \pi_0 e = e_1; \quad (\text{Red-0})$$

$$e\pi_0\pi_1\pi_0e = e_2; \quad (\text{Red-1})$$

$$e\pi_0\pi_1\pi_2\pi_0\pi_1\pi_0e = e_3; \quad (\text{Red-2})$$

$$e\pi_0\pi_1\pi_2\pi_3\pi_0\pi_1\pi_2\pi_0\pi_1\pi_0e = e_4; \quad (\text{Red-3})$$

$$e\pi_0\pi_1\pi_2\pi_3\pi_4\pi_0\pi_1\pi_2\pi_3\pi_0\pi_1\pi_2\pi_0\pi_1\pi_0e = e_5; \quad (\text{Red-4})$$

$$e\pi_0\pi_1\pi_2\pi_3\pi_4\pi_5\pi_0\pi_1\pi_2\pi_3\pi_4\pi_0\pi_1\pi_2\pi_3\pi_0\pi_1\pi_2\pi_0\pi_1\pi_0e = e_6. \quad (\text{Red-5})$$

Note that the relations missing in Godelle's work [God09] are precisely these relations for i equal or greater than 2.

Lemma 8.4.3. *The morphism of monoids $\Phi : G_\ell^0(B) \rightarrow F_\ell^0(B)$ defined by $\Phi(\pi_i) = p_i$ and $\Phi(e_i) = \varepsilon_i$ is a surjection.*

Proof. We have to show that the generators of $F_\ell^0(B)$ satisfy the relations of $G_\ell^0(B)$. Relations H1-B, H2-B, H3-B, Abs-B, Com-B, E-B and Rec-B are deduced from relations of type A (Corollary 4.1.6). Relation H4-B can be seen as the result of the classic folding $A_{2\ell-1} \rightarrow B_\ell$ or by computation:

$$\begin{aligned} p_0p_1p_0p_1 &= \pi_{1,1}^A \pi_{1,1}^A \pi_1^A \pi_{1,1}^A \pi_1^A \pi_{1,1}^A \\ &= \pi_{1,1}^A \pi_{1,1}^A \pi_{1,1}^A \pi_1^A \pi_{1,1}^A \pi_{1,1}^A \\ &= \pi_{1,1}^A \pi_{1,1}^A \pi_{1,1}^A \pi_1^A \pi_{1,1}^A \pi_{1,1}^A \\ &= \pi_{1,1}^A \pi_{1,1}^A \pi_1^A \pi_{1,1}^A \pi_{1,1}^A \pi_{1,1}^A \\ &= \pi_{1,1}^A \pi_{1,1}^A \pi_1^A \pi_{1,1}^A \pi_{1,1}^A \pi_{1,1}^A \\ &= \pi_{1,1}^A \pi_1^A \pi_{1,1}^A \pi_1^A \pi_{1,1}^A \pi_{1,1}^A = p_1p_0p_1p_0 \end{aligned}$$

Because of Theorem 8.3.9, we can deduce Relation Red-B only by considering the action on matrices of Π_i . We recall from the proof of Proposition 8.2.11 that $1_{\bar{i},i} \cdot \Pi_{i-1} = 12\dots i \mid \bar{i} \dots \bar{2}\bar{1}$ for all $i \geq 1$. Then $1_{\bar{\ell},\ell} \cdot e = \emptyset \dots \emptyset \mid 1 \dots \ell$, and $1_{\bar{\ell},\ell} \cdot (e\Pi_{i-1}) = \emptyset \dots \emptyset 1 \dots i \mid \emptyset \dots \emptyset(i+1) \dots \ell$, with $\ell - i$ zeros in the first half. Finally $1_{\bar{\ell},\ell} \cdot (e\Pi_{i-1}e) = \emptyset \dots \emptyset \mid \emptyset \dots \emptyset(i+1) \dots \ell = 1_{\bar{\ell},\ell} \cdot e_i$. \square

Because of Lemma 8.4.3 when speaking about words and actions we do not need to distinguish between π_i and p_i on the one hand, and e_i and ε_i . In other words, π_i is the element p_i of $F_\ell^0(B)$, and e_i the element ε_i . With this notation, we can give the definition of reduced words in our case. It is just the application of Definition 1.1.3 with the choice that $(e_i)_{i>0}$ are not in the generating set.

Definition 8.4.4. *A word on $F_\ell^0(B)$ or $G_\ell^0(B)$ is **reduced** if it is written with only a minimal number of e and π_i .*

Lemma 8.4.5. *A reduced word in $F_\ell^0(B)$ is also reduced in $G_\ell^0(B)$.*

Proof. Let $\underline{w} \in F_\ell^0(B)$ be reduced. By Lemma 8.4.3 let $\underline{\omega} \in G_\ell^0(B)$ so that $\Phi(\underline{\omega}) = \underline{w}$. If $\underline{\omega}$ is not reduced, then so do $\Phi(\underline{\omega}) = \underline{w}$ which is a contradiction. \square

Remark 8.4.6. Remark 8.1.3 provides an equivalence between reduced and action-reduced words for elements of $H_\ell^0(B)$. Let $w \in F_\ell^0(B)$, then it admits the word $\underline{w} = \underline{w}_1 e_i \underline{w}_2$ by Algorithm 7.2.13. The proof of the algorithm shows that every generator of \underline{w}_1 and \underline{w}_2 has a nontrivial action. Hence these two words are action-reduced so reduced. Furthermore the whole word $\underline{w}_1 e_i \underline{w}_2$ is action-reduced.

Corollary 8.4.7. *A reduced element $r \in F_\ell^0(B)$ is action-reduced.*

Proof. Let $\underline{r} = r_1 \dots r_k$ and assume by contradiction that there exists $j \leq k-1$ such that $1_{\bar{\ell}, \ell} \cdot (r_1 \dots r_j) = 1_{\bar{\ell}, \ell} \cdot (r_1 \dots r_{j+1})$. By Theorem 8.3.9 the elements $r_1 \dots r_{j+1}$ and $r_1 \dots r_j$ are equal since they have the same action on the one $1_{\bar{\ell}, \ell}$, hence r was not reduced. \square

The goal of this section is to prove that $F_\ell^0(B) = G_\ell^0(B)$. Algorithm 7.2.13 happens to give a canonical reduced element for each word. Before that, we first give a reduced expression for e_i with $i \geq 1$.

Proposition 8.4.8. *Relation Red-B gives a reduced expression of e_i for $i \geq 1$.*

Proof. We first consider $e_i \in F_\ell^0(B)$. Since e_i has at least $\ell + 1$ zeros, there are at least two e in a reduced word for e_i . Furthermore e only deletes the letters with negative positions. But e_i also deletes letters in position 1 to i . So these letters have to be brought to the negative part. To bring a letter from position k to position $\bar{1}$, we need at least the action of k generators $(\pi_{k-1}, \pi_{k-2}, \dots, \pi_1, \pi_0)$. Furthermore a generator π_k only move one letter in the positive part closer to the negative part at a time. Hence we need at least $1 + 2 + \dots + i = \frac{i(i+1)}{2}$ generators π_k to move all these letters in the negative part. But Π_{i-1} has precisely $\frac{i(i+1)}{2}$ generators π_k , and has the needed properties. Finally $e\Pi_{i-1}e$ is reduced, and is equal to e_i in $F_\ell^0(B)$. \square

We saw that if $w \in F_\ell^0(B)$ is written $\underline{w} = \underline{w_1}e_i\underline{w_2}$ by Algorithm 7.2.13, then $\underline{w_1}$ is reduced. We will now show that it is in fact either the identity, or right grassmannian in π_i . From there we will get that Algorithm 7.2.13 gives us a “unique” decomposition of every element. We must first describe the shape of w_1 .

Proposition 8.4.9. *If $w \in F_\ell^0(B)$ and $w = \underline{w_1}e_i\underline{w_2}$ is its B -factorization according to Algorithm 7.2.13, then w_1 is either the identity or is right grassmannian in π_i*

Proof. Indeed, by construction w_1 is either the identity or its descents are those described in Corollary 8.2.6. In the latter case, i is the number of pairs of \emptyset letters. \square

This proposition explains why the factorization of Algorithm 7.2.13 is called the *grassmannian factorization*.

Proposition 8.4.10 (Unicity of w_1). *If $w \in F_\ell^0(B)$ admits the two expressions $w = \underline{w_1}e_i\underline{w_2} = \underline{v_1}e_i\underline{v_2}$ with $w_1, w_2, v_1, v_2 \in H_\ell^0(B)$, and where w_1 and v_1 are both right grassmannian in π_i , then $w_1 = v_1$.*

Proof. Otherwise, since the action of w on the identity is well-defined, so are its missing letters. Since the letters are deleted by the action of e_i only, the actions of v_1 and w_1 take the same set of $\ell + i$ letters in the first positions. But since w_1 and v_1 are both right grassmannian in π_i , the action of w_1 and v_1 must have the shape of Corollary 8.2.6. And there is only one way to sort these letters with respect to the antisymmetry of B -elements and the poset conditions of Corollary 8.2.6: it is $m_1(w)$. By Proposition 8.1.1, we conclude that $w_1 = v_1$. \square

As a consequence, we see that the grassmannian factorization of Algorithm 7.2.13 gives us unicity on w_1 . We prove the same result for w_2 under the assumption that we have action-reduced elements.

Proposition 8.4.11 (Unicity of w_2). *If $w \in F_\ell^0(B)$ admits two action reduced expressions $w = \underline{w_1}e_i\underline{w_2} = \underline{w_1}e_iv_2$ with $w_1, w_2, v_2 \in H_\ell^0(B)$ and w_1 is right grassmannian in π_i or the identity, then $w_2 = v_2$.*

Proof. We first note that $1_{\bar{\ell},\ell} \cdot w_1e_i$ is of the shape $r = \emptyset \dots \emptyset r_{i+1} \dots r_\ell$, with $\ell + i$ zeros, and with $r_{i+1} < r_{i+2} < \dots < r_\ell$ by Proposition 8.2.6. Since the value of letters does not change the action, we conclude that w_2 and v_2 have the same actions on

$$\emptyset \dots \emptyset \mid \emptyset \dots \emptyset i + 1 i + 2 \dots \ell. \quad (8.11)$$

Since the generators of w_2 and v_2 act on every word antisymmetrically, they also have the same action on

$$\bar{\ell} \dots \overline{i + 2} \overline{i + 1} \emptyset \dots \emptyset \mid \emptyset \dots \emptyset i + 1 i + 2 \dots \ell. \quad (8.12)$$

Since the two words for w are action-reduced, every generator of w_2 and v_2 has a nontrivial action on $1_{\bar{\ell},\ell} \cdot w_1e_i$. In particular they never exchange a pair of nonzero letters. Hence they have the same actions on

$$\bar{\ell} \dots \overline{i + 2} \overline{i + 1} i \dots 2 1 \mid \bar{1} \bar{2} \dots \bar{i} i + 1 i + 2 \dots \ell. \quad (8.13)$$

Using Lemma 8.1.8 we conclude that $w_2 = v_2$. □

The following lemma considers only product of the type we_j with $w \in H_\ell^0(B)$.

Lemma 8.4.12. *Let $0 \leq i \leq \ell$ and $w \in F_\ell^0(B)$ so that $e_iw = e_i$. Choose a word \underline{w} for w . If $\pi_k \in \underline{w}$ then $k < i$. The same result holds for $we_i = e_i$.*

Proof. Assume $\underline{w} = \pi_{i_1} \dots \pi_{i_m}$ and suppose by contradiction that there is $k > 0$ so that $i_k \geq i$, and take such a k minimal. The action of e_i on the identity is $\emptyset \dots \emptyset \mid \emptyset \dots \emptyset i + 1 \dots \ell$ with i zeros in the second half. But $e_i\pi_{i_1} \dots \pi_{i_{k-1}} = e_i$ since it only acts on pair of \emptyset letters. Now $e_i\pi_{i_k} \neq e_i$. We standardize this B rook element, seeing it as a permutation. The standardization of e_i is $1_{\bar{\ell},\ell}$ and the standardization of $e_i\pi_{i_k}$ is $1_{\bar{\ell},\ell} \cdot (\pi_{i_k}^A \pi_{i_k}^A)$ (or $\pi_{\bar{1},1}^A$ if $i_k = 0$). Now we are inside elements of $H_{\bar{\ell},\ell}^0(A)$, and these elements are ordered by the inclusion of inversions. The last element is strictly below the identity, and since $H_{\bar{\ell},\ell}^0(A)$ is \mathcal{J} -trivial [Den+10] it is not possible to use generators of $H_{\bar{\ell},\ell}^0(A)$ to get back to $1_{\bar{\ell},\ell}$. But $e_iw = e_i$, so $1_{\bar{\ell},\ell} \cdot \tilde{w} = 1_{\bar{\ell},\ell}$, (where \tilde{w} is w seen as product of generators of $H_{\bar{\ell},\ell}^0(A)$) which is a contradiction. □

The following statement summarizes these results:

Theorem 8.4.13. *For any $w \in F_\ell^0(B)$, the grassmannian factorization of Algorithm 7.2.13 provides the unique action reduced expression $w = \underline{w_1}e_i\underline{w_2}$ with $w_1, w_2 \in H_\ell^0(B)$ and w_1 is either the identity or right grassmannian in π_i .*

Proof. Let $\underline{v_1 e_j v_2}$ be another reduced expression with v_1 either equal to the identity or right grassmannian in π_j . We first have $i = j$ since they are both equal to $|w|_\emptyset$. The missing letters of w being well-defined, the actions of $w_1 e_i$ and $v_1 e_i$ on the identity are the same. If $w_1 = 1$ then by Lemma 8.4.12 we get that v_1 can not be right grassmannian in π_i , so $v_1 = 1$. If $w_1 \neq 1$ then so do v_1 . Finally w_1 and v_1 are either both right grassmannian in π_i , either both equal to the identity. By unicity of w_1 (Proposition 8.4.10) we have $w_1 = v_1$ in both cases. By unicity of w_2 (Proposition 8.4.11) we finally get $w_2 = v_2$. \square

Theorem 8.4.13 gives uniqueness is the case where we have an action reduced word. We will sometimes want to drop this condition, and will use Lemma 8.4.12 to keep the unicity on w_2 . Now, we have finished the part 1 of the proof and move to part 2. From now on we will use these two ways to assert unicity of words to prove some special relations with left and right grassmannian elements. We first show these relations in the functions (Proposition 8.4.14), then in the presentation (Proposition 8.4.15). Finally this will be enough to get the necessary condition that reduced word of $G_\ell^0(B)$ have at most two letters e (Proposition 8.4.16).

Proposition 8.4.14. *Let $1 \leq i, j \leq \ell$, $w \in H_\ell^0(B)$ an element π_i -grass- π_j and \underline{w} a given word for it. Let $k := \max\{s \mid \pi_s \in \underline{w}\}$. Then $e_i w e_j = e_{k+1}$ in $F_\ell^0(B)$. Moreover k depends only on w and not of the choice of \underline{w} .*

Proof. We are looking at the action of $e_i w e_j$ on the identity. The action of w is given by a linear extension of the grid representation $i - gr_B - j$. Left-multiplying by e_i amounts to delete the first $\ell + i$ rows, and right-multiplying by e_j amounts to delete the first $\ell + j$ columns. By Proposition 8.2.10, in the table $e_i w e_j$ there is at most $\min(\ell - i - 1, \ell - j - 1)$ letters 1 on the diagonal. Consider the rightmost box on the diagonal which is zero. By Proposition 8.2.10, all the following boxes of the diagonal have a 1. Let k be the index of this column if it is in the second half, and 0 otherwise. So we got the rook table of e_k . By Lemma 8.4.12 \underline{w} does not contain generators $(\pi_s)_{s \geq k}$. By contraposition of Lemma 8.4.12 since $k \geq i$, \underline{w} contains π_{k-1} , otherwise the diagonal of the column $k - 1$ would be a 1. Since the action of $e_i w e_j$ is well defined, it also shows that it does not depend on the choice of the word for w . \square

The Relations 8.4.14 are a priori in $F_\ell^0(B)$ and not in $G_\ell^0(B)$. We will now show that we can deduce them from relations of $G_\ell^0(B)$ with a proof inspired from [God09, Proposition 1.24]. We recall that Proposition 8.4.8 gives the reduced expression and defines the length of e_i . The general idea is to change a word using commutation relations until it becomes bigrassmannian.

Proposition 8.4.15. *Let $1 \leq i, j \leq \ell$, w an element π_i -grass- π_j , \underline{w} any word for it, and $r := 1 + \max\{s \mid \pi_s \in \underline{w}\}$. The relation $e_i w e_j = e_r$ for w π_i -grass- π_j hold in $G_\ell^0(B)$, and the left side of this equality has a length greater than the right side.*

Proof. We prove the claimed result by induction of the length of w . If it has length 0 then it is the empty word, and the relation is $1^2 = 1$. Otherwise, let w an element π_i -grass- π_j , and choose \underline{w} a reduced expression for w . Assume that $j \neq 0$ or $i \neq 0$ otherwise we are only considering Relation Red-B by Corollary 8.2.11.

We first assume $i \neq j$, for instance $i < j$. Consider $\pi_k \in \underline{w}$ with $i \leq k < j$ (take π_i for instance). By E-B we get $e_i \underline{w} e_j = e_i \underline{w} e_k e_j = e_i \underline{w}_1 e_k \underline{w}_2 e_j$ where we used Relation Com-B and H2-B to H4-B to obtain w_1 right grassmannian in π_k and $\underline{w} = \underline{w}_1 \underline{w}_2$ with $|\underline{w}_1| > 0$. To see that we do not use Relation Abs-B, we check by an explicit computation that if an element would be absorbed by e_k it would also be absorbed by e_j . Since the Relation Abs-B was not used, w_1 is still left-grassmannian in π_i , and also right grassmannian in π_k . Furthermore since $k < j$, we have $|\underline{w}_2| > 0$ so $|\underline{w}_1| < |\underline{w}|$. By induction there is m such that $e_i w_1 e_k = e_m$. So $e_i \underline{w} e_j = e_m \underline{w}_2 e_j$. Applying Relations Abs-B, Com-B, and H2-B to H4-B we write $e_i \underline{w} e_j = e_m \underline{w}_2 e_j = \underline{w}_3 e_m \underline{w}_4 e_j \underline{w}_5$ with w_4 π_m -grass- π_j . Then $|\underline{w}_4| \leq |\underline{w}_2| < |\underline{w}|$ so $e_i \underline{w} e_j = \underline{w}_3 e_p \underline{w}_5$ in $G_\ell^0(B)$. Applying Relation Com-B, Abs-B and H2-B to H4-B we can assume that w_3 is right grassmannian in π_p . We also know that $e_i w e_j = e_r$ in $F_\ell^0(B)$. So the action of $w_3 e_m w_5$ is the same as the action of e_r in $F_\ell^0(B)$. By unicity of w_1 (Proposition 8.4.10) we deduce that $w_3 = 1$ in $F_\ell^0(B)$, so $w_4 = 1$ by Lemma 8.4.12. Since it is an element of $H_\ell^0(B)$ it also holds in $G_\ell^0(B)$.

We now consider the case $i = j$. We write $e_i w e_i = e_i w e_0 \Pi_{i-1} e_0$ by Relation Red-B and then we get back to the previous proof.

$$\begin{aligned} e_i \underline{w} e_i &= e_i \underline{w} e_0 \underline{\Pi}_{i-1} e_0 = e_i \underline{w}_1 e_0 \underline{w}_2 e_0 && \text{with } w_1 \text{ } \pi_i\text{-grass-}\pi_0, \\ &= e_k \underline{w}_2 e_0 && \text{by induction,} \\ &= \underline{w}_3 e_k \underline{w}_4 e_0 \underline{w}_5 && \text{with } w_4 \text{ } \pi_k\text{-grass-}\pi_0. \end{aligned}$$

We conclude in the same way. The assumption on the length can be checked by induction in each case. \square

Proposition 8.4.16. *A reduced word $w \in G_\ell^0(B)$ has at most two letters e .*

Proof. Let $w \in G_\ell^0(B)$. Assume that w has a reduced word \underline{w} with strictly more than three e . It is enough to prove that a word with three e can be reduced to two. Assume then that $\underline{w} = \underline{w}_1 e \underline{w}_2 e \underline{w}_3 e \underline{w}_4$. Applying Relation Com-B and H2-B to H4-B we can assume that w_3 is π_0 -grassmannian- π_0 . By Corollary 8.2.11, $w_3 = \Pi_i$ for some i . We use Relation Red-B to get $\underline{w} = \underline{w}_1 e \underline{w}_2 e_{i+1} \underline{w}_4$. Applying again Com-B and H2-B to H4-B we can assume that w_2 is π_0 -grass- π_{i+1} . By Proposition 8.4.14 and Proposition 8.4.15 we get $\underline{w} = \underline{w}_1 e_k \underline{w}_4$. In particular we managed to write \underline{w} with only two e , and the size of the word only decreased since the beginning of the proof. Hence the word with three e was not reduced. \square

With this proposition we conclude the part 2 of the proof. We now go for part 3. We prove the isomorphism between the monoid of functions $F_\ell^0(B)$ (Definition 8.3.1) and the monoid obtained by presentation $G_\ell^0(B)$ (Definition 8.4.1). The proof is inspired from [God09, Proposition 1.22].

Theorem 8.4.17. *We have the isomorphism of monoids $F_\ell^0(B) \simeq G_\ell^0(B)$.*

Proof. We have seen in Lemma 8.4.3 the surjection $\Phi : G_\ell^0(B) \twoheadrightarrow F_\ell^0(B)$. Let $w \in F_\ell^0(B)$, represented by the grassmannian factorization (Algorithm 7.2.13) by the word $\underline{w} = \underline{w}_1 e_i \underline{w}_2$. Let \underline{w}' be another reduced expression of w , hence action-reduced. Considering the number of e in \underline{w}' , we will prove that we can write w' as

$\underline{w}_1 e_i \underline{w}_2$ applying only relations of $G_\ell^0(B)$. By Proposition 8.4.16, \underline{w}' can not have more than two e letters. We will see separately the cases 0, 1 and 2 letters e .

If $e \notin \underline{w}'$ then w has no zeros and the grassmannian factorization gives $\underline{w} = \underline{w}_2$. But \underline{w}' and \underline{w}_2 have the same action on the identity and are elements of $H_\ell^0(\overline{B})$ so all the computation is in $H_\ell^0(B)$ applying only Relations H2-B, H3-B and H4-B (not H1-B by Matsumoto's Theorem).

If \underline{w}' contains exactly one e , then w has exactly ℓ zeros and so Algorithm 7.2.13 gives $\underline{w} = \underline{w}_1 e \underline{w}_2$. We write $\underline{w}' = v_1 e v_2$. Applying Relations Com-B, and H2-B to H4-B we can assume that v_1 is right grassmannian in π_0 . Since $v_1 e v_2$ is still action-reduced, by Theorem 8.4.13 we get $v_1 = w_1$ and $v_2 = w_2$ in $H_\ell^0(\overline{B})$, therefore we can get from one element to another by the relations of $H_\ell^0(B)$.

If \underline{w}' has exactly two e , then $\underline{w}' = v_1 e v_2 e v_3$. Applying Relation Com-B and H2-B to H4-B we can assume that v_2 is π_0 -grass- π_0 . By Corollary 8.2.11, $v_2 = \Pi_i$ for some i . Hence by Relation Red-B we write $\underline{w}' = v_1 e_{i+1} v_3$. So w has $\ell + i + 1$ zeros and so Algorithm 7.2.13 gives $\underline{w} = \underline{w}_1 e_{i+1} \underline{w}_2$ with w_1 right grassmannian in π_{i+1} . Applying again Relations Com-B and H2-B to H4-B we can assume that v_1 is also right grassmannian in π_{i+1} . Since $v_1 e_{i+1} v_2$ is still action-reduced, Theorem 8.4.13 ensures that $v_1 = w_1$ and $v_2 = w_2$ in $H_\ell^0(B)$ \square

We define $R_\ell^0(B) := G_\ell^0(B)$. Theorem 8.4.17 corrects the missing relations that were forgotten in [God09] and also gives an effective way to do the computation:

Corollary 8.4.18. *For any $w \in R_\ell^0(B)$ the grassmannian factorization of Algorithm 7.2.13 gives a canonical reduced expression.*

Proof. Let $w \in R_\ell^0(B)$. We saw in the proof of Theorem 8.4.17 that any word for w can be rewritten to the expression given by Algorithm 7.2.13, using only relations which reduce the length by Proposition 8.4.15. \square

Theorem 8.4.17 finally gave us a presentation of $R_\ell^0(B)$. Note that we deduce the presentation for $R_\ell(B)$ just by changing the Relation H1-B by $\pi_i^2 = 1$. So we also got canonical reduced expressions for the elements of $R_\ell(B)$.

Theorem 8.4.19. *The Renner monoid $R_\ell(B)$ is generated by $s_0, \dots, s_{\ell-1}, e_0, \dots, e_\ell$ subject to relations:*

$$s_i^2 = 1 \quad 0 \leq i \leq \ell - 1; \quad (\text{R1-B})$$

$$s_i s_j = s_j s_i, \quad 0 \leq i, j \leq \ell - 1 \text{ and } |i - j| \geq 2; \quad (\text{R2-B})$$

$$s_i s_{i+1} s_i = s_{i+1} s_i s_{i+1}, \quad 1 \leq i \leq \ell - 2; \quad (\text{R3-B})$$

$$s_1 s_0 s_1 s_0 = s_0 s_1 s_0 s_1, \quad (\text{R4-B})$$

$$e_j s_i = s_i e_j = e_j, \quad 0 \leq i < j \leq \ell; \quad (\text{AbsR-B})$$

$$e_j s_i = s_i e_j, \quad 0 \leq j < i \leq \ell - 1; \quad (\text{ComR-B})$$

$$e_i e_j = e_j e_i = e_{\max(i,j)}, \quad 0 \leq i, j \leq \ell; \quad (\text{ER-B})$$

$$e_i s_i e_i = e_{i+1}, \quad 0 \leq i \leq \ell - 1; \quad (\text{RecR-B})$$

$$e_0 s_i e_0 = e_{i+1}, \quad 0 \leq i \leq \ell - 1. \quad (\text{RedR-B})$$

with $S_i := s_0 \dots s_i s_0 \dots s_{i-1} s_0 \dots s_{i-2} \dots s_0 s_1 s_0$.

Proof. The proof is similar to that of Theorem 8.4.17. Let us define the monoid generated by this presentation $G_\ell(B)$. It is a simple computation that the tables of generators of $R_\ell(B)$ satisfy the same relations. The point is that an action-reduced element for the 0-Renner monoid has the same action on $R_\ell(B)$ than the element obtained by replacing each π_i by s_i . This follows exactly the same lines as the proofs of Proposition 8.3.4 to Theorem 8.4.17. \square

This proof illustrates that working at the level of the Hecke monoid rather than the Weyl group makes quite an advantage: we can use the idea of action reduced element. This also explains why we preferred to first find the presentation for $R_\ell^0(B)$ before the one for $R_\ell(B)$.

This proof also suggests us the following conjectures:

Conjecture 8.4.20. *Let \underline{s} be a word on $s_0, \dots, s_{\ell-1}, e_0, \dots, e_\ell$ and $\underline{\pi}$ the word on $\pi_0, \dots, \pi_{\ell-1}, e_0, \dots, e_\ell$ obtained by replacing s_i by π_i , then \underline{s} is reduced if and only if $\underline{\pi}$ is reduced.*

Conjecture 8.4.21 (Matsumoto's theorem for $R_\ell(B)$ and $R_\ell^0(B)$). *Two reduced words on $s_0, \dots, s_{\ell-1}, e_0, \dots, e_\ell$ (resp. on $\pi_0, \dots, \pi_{\ell-1}, e_0, \dots, e_\ell$) give the same element if and only if they are linked using only length-preserving relations of Theorem 8.4.19 (resp. Definition 8.4.1).*

8.4.2 Type D

We will do again the part 1 to part 4 of the proof, but in type D . Hence this section will be very similar to the previous one. The main difference is linked to the condition of parity of Definition 7.2.20, which add many difficulties that did not exist in type B . We will use the elements Δ_i^e and Δ_i^f defined in Definition 8.2.14. These elements correspond to the elements of Relation TYM3 of type D .

Definition 8.4.22. *The 0-Renner monoid of type D and size ℓ , denoted by $G_\ell^0(D)$, is generated by $\pi_1^f, \pi_1^e, \pi_2, \dots, \pi_{\ell-1}, f, e_0, e_1, \dots, e_\ell$ subject to the relations:*

$$\begin{aligned} \pi_i^2 &= \pi_i & 1 \leq i \leq \ell - 1; & \quad \text{(H1-D)} \\ \pi_i \pi_j &= \pi_j \pi_i \text{ and } \pi_1^e \pi_1^f = \pi_1^f \pi_1^e, & 1 \leq i, j \leq \ell - 1 \text{ and } |i - j| \geq 2; & \quad \text{(H2-D)} \\ \pi_i \pi_{i+1} \pi_i &= \pi_{i+1} \pi_i \pi_{i+1}, & 1 \leq i \leq \ell - 2; & \quad \text{(H3-D)} \\ e_j \pi_i &= \pi_i e_j = e_j, & 1 \leq i < j \leq \ell; & \quad \text{(Abs-D)} \\ e_j \pi_i &= \pi_i e_j \text{ and } f \pi_i = \pi_i f, & 0 \leq j < i \leq \ell - 1 \text{ and } i > 1; & \quad \text{(Com-D)} \\ \pi_1^e e &= e \pi_1^e \text{ and } f \pi_1^f = \pi_1^f f, & & \quad \text{(ComEF-D)} \\ e_i e_j &= e_j e_i = e_{\max(i,j)}, & 0 \leq i, j \leq \ell; & \quad \text{(E-D)} \\ e_i f = f e_i &= e_i \text{ and } f^2 = f & 1 \leq i \leq \ell; & \quad \text{(EF-D)} \\ e_0 f &= f e_0 = e_1 & & \quad \text{(E}_0\text{F-D)} \\ e_i \pi_i e_i &= e_{i+1}, & 1 \leq i \leq \ell - 1; & \quad \text{(Rec-D)} \\ f \Delta_i^e e_0 &= e_{i+1} \text{ and } e_0 \Delta_i^f f = e_{i+1}, & 1 \leq i \leq \ell - 1, i \text{ even.} & \quad \text{(Red-D-even)} \\ f \Delta_i^e f &= e_{i+1} \text{ and } e_0 \Delta_i^f e_0 = e_{i+1}, & 1 \leq i \leq \ell - 1, i \text{ odd.} & \quad \text{(Red-D-odd)} \end{aligned}$$

We define $e := e_0$ and $e_{-1} := f$. The Relations E_0F-D , $Rec-D$, $Red-D-even$ and $Red-D-odd$ show that $G_\ell^0(D) = \langle \pi_1^e, \pi_1^f, \pi_2, \dots, \pi_{\ell-1}, e, f \rangle$. The Relations E_0F-D and $Rec-D$ give us a definition of $(e_i)_{i>0}$, and we will show that the Relations $Red-D-odd$ and $Red-D-even$ are a reduced expression of the $(e_i)_i$ (Proposition 8.4.29).

Example 8.4.23. Using Example 8.2.15 we explicit the relations $Red-D-even$ and $Red-D-odd$ for i from 1 to 4:

$$f\pi_1^e f = e_2 \text{ and } e_2 = e\pi_1^f e; \quad (\text{Red-1})$$

$$f\pi_1^e \pi_2 \pi_1^f e = e_3 \text{ and } e_3 = e\pi_1^f \pi_2 \pi_1^e f; \quad (\text{Red-2})$$

$$f\pi_1^e \pi_2 \pi_3 \pi_1^f \pi_2 \pi_1^e f = e_4 \text{ and } e_4 = e\pi_1^f \pi_2 \pi_3 \pi_1^e \pi_2 \pi_1^f e; \quad (\text{Red-3})$$

$$f\pi_1^e \pi_2 \pi_3 \pi_4 \pi_1^f \pi_2 \pi_3 \pi_1^e \pi_2 \pi_1^f e = e_5 \text{ and } e_5 = e\pi_1^f \pi_2 \pi_3 \pi_4 \pi_1^e \pi_2 \pi_3 \pi_1^f \pi_2 \pi_1^e f; \quad (\text{Red-4})$$

The relation $Red-3$, $Red-4$ and further are precisely the ones missing in Godelle's presentation [God09].

Lemma 8.4.24. *The morphism of monoid $\Phi : G_\ell^0(D) \rightarrow F_\ell^0(D)$ defined by $\pi_i \mapsto p_i$, $\varphi \mapsto f$ and $e_i \mapsto \varepsilon_i$ is a surjection.*

Proof. We have to show that the generators of $F_\ell^0(B)$ satisfy the relations of $G_\ell^0(D)$. Relations $H1-D$, $H2-D$, $H3-D$, $Abs-D$, $Com-D$, $E-D$, $EF-D$, E_0F-D and $Rec-D$ are deduced from relations of type A (Definition 4.1.1). Because of Theorem 8.3.9, we can deduce Relations $Red-D-even$ and $Red-D-odd$ only by considering the action on matrices of Δ_i^e and Δ_i^f . In Proposition 8.2.16 we gave these actions (see below). Recall that the left-action of e deletes the letters $\bar{\ell}$ to $\bar{1}$, while its right-action deletes the first ℓ letters. Furthermore the left-action of w deletes the letters $\bar{\ell}$ to $\bar{2}$ and letter 1, while its right-action deletes the first $\ell - 1$ letters and the letter in position 1. We check case by case. (We color the generator and the elements they will delete in the same color. If an element is deleted by both we show it in gray.)

- i even, look at $f\Delta_i^e e$. But $1_{\bar{\ell}, \ell} \cdot \Delta_i^e = \bar{\ell} \dots \overline{i+2} \bar{1} 2 \dots i i + 1 \mid \overline{i+1} \bar{i} \dots \bar{2} 1 i + 2 \dots \ell$.
- i even, look at $e\Delta_i^f f$. But $1_{\bar{\ell}, \ell} \cdot \Delta_i^f = \bar{\ell} \dots \overline{i+2} 1 \dots i \overline{i+1} \mid i + 1 \bar{i} \dots \bar{1} i + 2 \dots \ell$.
- i odd, look at $f\Delta_i^e f$. But $1_{\bar{\ell}, \ell} \cdot \Delta_i^e = \bar{\ell} \dots \overline{i+2} \bar{1} 2 \dots i \overline{i+1} \mid i + 1 \bar{i} \dots \bar{2} 1 i + 2 \dots \ell$.
- i odd, look at $e\Delta_i^f e$. But $1_{\bar{\ell}, \ell} \cdot \Delta_i^f = \bar{\ell} \dots \overline{i+2} 1 \dots i i + 1 \mid \overline{i+1} \bar{i} \dots \bar{1} i + 2 \dots \ell$. \square

Because of this lemma, we can now call the generators of $F_\ell^0(D)$ via this surjection: $\pi_i \mapsto p_i$, $\varphi \mapsto f$ and $e_i \mapsto \varepsilon_i$. With this new notation, we can give the definition of reduced words in this new context. It is just the application of Definition 1.1.3 with the choice that $(e_i)_{i>0}$ are not in the generating set.

Definition 8.4.25. *A word on $F_\ell^0(D)$ or $G_\ell^0(D)$ is reduced if it is written with only a minimal number of e , f and π_i .*

Remark 8.4.26. As in type B , because of the surjection of Lemma 8.4.24, a reduced word in $F_\ell^0(D)$ is also reduced in $G_\ell^0(D)$.

Remark 8.4.27. As before, if $w \in F_\ell^0(D)$ it admits the word $\underline{w_1}e_i\underline{w_2}$ by Algorithm 7.2.32 (recall that $e_{-1} = f$). The proof of the algorithm shows that every generator of w_1 and w_2 has a nontrivial action. Hence these two words are action reduced elements of $H_\ell^0(D)$, so reduced. By the same argument, we see that Δ_i^e and Δ_i^f of Definition 8.2.14 are reduced.

As in Corollary 8.4.7 in type B , we have:

Corollary 8.4.28. *A reduced element $r \in F_\ell^0(D)$ is action-reduced.*

Before going to the properties of Algorithm 7.2.32 we check the reduced expression for the e_i .

Proposition 8.4.29. *Relations Red-D-even and Red-D-odd give two reduced expressions for e_i with $i \geq 1$.*

Proof. For $i = 1$ it is clear that $e_1 = ef$ is a reduced expression since e_1 deletes $\ell + 1$ letters while the only generator deleting letters, e and f , deletes ℓ letters only. So we need two of these, and ef is enough.

Now if $i \geq 2$, we first consider $e_i \in F_\ell^0(D)$. Since e_i has at least $\ell + 1$ zeros, there are at least two elements of $\{e, f\}$ in a reduced word for e_i . Furthermore e only deletes the letters with negative positions, and f deletes letter in position $\bar{\ell}$ to $\bar{2}$ and 1. But e_i also deletes letters in position 2 to i . So these letters have to be brought to a position $j \leq 1$. To bring a letter from position k to position $\bar{1}$ or 1, we need at least the action of $k - 1$ generators $(\pi_{k-1}, \pi_{k-2}, \dots, \pi_2$ and π_1^e or $\pi_1^f)$. Furthermore a generator π_k only move one letter in the positive part closer to the negative part at a time. This is not true for generator π_1^f , which can bring two letters in the negative part at a time. But this is compensated by the fact that we would need to put a letter in position 1, which uses one more generator. Finally we need at least $1 + 2 + \dots + i - 1 = \frac{i(i-1)}{2}$ generators π_k to move all these letters in the negative part. But Δ_{i-1}^e and Δ_{i-1}^f has precisely $\frac{i(i-1)}{2}$ generators π_k and all the needed properties. Finally the expressions $f\Delta_{i-1}^e e$ and $e\Delta_{i-1}^f f$ if i is even, $f\Delta_{i-1}^e f$ and $e\Delta_{i-1}^f e$ if i is odd, are reduced, and are equal to e_i in $F_\ell^0(D)$. Now we have a reduced expression in $F_\ell^0(D)$, hence it is reduced in $G_\ell^0(D)$ and is equal to e_i by Relations Red-D-even and Red-D-odd. \square

Again, we will see that if $w \in F_\ell^0(D)$ is written $w = w_1 e_i w_2$ by the grassmannian factorization of Algorithm 7.2.32, then w_1 is either the identity or right grassmannian in some π_i . But there is more cases in type D because of question of parity.

Example 8.4.30. Assume $|w|_\emptyset = \ell + 1$ and look at the results of Algorithm 7.2.13. We can find three different cases:

- $w = \emptyset\emptyset\emptyset\emptyset \mid \emptyset 1345$, then $m_1^D(w) = \overline{54312} \mid 21345$ and $w_1 = \pi_1^e$.
- $w = \emptyset\emptyset\emptyset\emptyset \mid \emptyset \bar{1}235$, then $m_1^D(w) = \overline{54214} \mid \bar{4}1245$ and $w_1 = \pi_3 \pi_2 \pi_1^f$.
- $w = \emptyset\emptyset\emptyset\emptyset \mid \emptyset \bar{2}345$, then $m_1^D(w) = \overline{54321} \mid \bar{1}2345$ and $w_1 = \pi_1^f \pi_1^e = \pi_1^e \pi_1^f$.

Recall that we identify an element of $F_\ell^0(D)$ with its image on the identity which is a D -rook. We see with these examples that some elements w_1 are no longer grassmannian in a π_i . We would like to consider $\pi_1^e \pi_1^f$ as a new element to mimic

what we did in type B . Recall that if $w \in F_\ell^0(D)$, we denote by $I(w)$ the set of the missing letters of w . Then $I(w) = P(w) \sqcup R(w)$ with $P(w)$ the symmetric part of $I(w)$ ($k \in P(w) \Rightarrow -k \in P(w)$) and $R(w)$ the antisymmetric part of $I(w)$ ($k \in R(w) \Rightarrow -k \notin R(w)$).

Definition 8.4.31. *If $w \in F_\ell^0(D)$ then we define:*

$$\delta_i(w) := \begin{cases} \pi_1^e & \text{if } i = -1, \\ \pi_1^f & \text{if } i = 0, \\ \pi_1^e & \text{if } i = 1 \text{ and } p(w) \text{ is even and } \max I(w) = \max P(w), \\ \pi_1^f & \text{if } i = 1 \text{ and } p(w) \text{ is odd and } \max I(w) = \max P(w), \\ \pi_1^f \pi_1^e = \pi_1^e \pi_1^f & \text{if } i = 1 \text{ otherwise,} \\ \pi_i & \text{if } i \geq 2. \end{cases} \quad (8.14)$$

Proposition 8.4.32. *If $w \in F_\ell^0(D)$ and $w = \underline{w_1} e_i \underline{w_2}$ is its D -factorization according to Algorithm 7.2.32, then w_1 is right grassmannian in $\delta_i(w)$ or is the identity.*

Proof. First note that the action of w_1 is the identity or the element $m_1^D(w)$ whose descents are always those described in Corollary 8.2.6. We check case by case the form of this element. We write $m_1(w) = r_{\bar{\ell}} \dots r_{\bar{1}} \mid r_1 \dots r_\ell$ and assume it is not the identity.

When $i \geq 2$, $m_1(w)$ is increasing in its first half except a descent between the letters $r_{\bar{i+1}}$ and $r_{\bar{i}}$. Between letters $r_{\bar{i}}$ to r_i it is increasing and antisymmetric. To get $m_1^D(w)$ there is sometimes an exchange between the two middle letters, but since $r_{\bar{2}} < r_{\bar{1}} < r_1 < r_2$ then $r_{\bar{2}} < r_1$. So w_1 is grass- π_i .

If $i = 1$ we have $r_{\bar{\ell}} < \dots < r_{\bar{2}} > r_{\bar{1}} < r_1 > r_2 < \dots < r_\ell$. If $p(w)$ is even then $m_1(w) = m_1^D(w)$ so there is the descent in $\pi_1^e = \pi_1$. Because of the order of elements, $\max R(w) = -r_2 = r_{\bar{2}}$, while $\max P(w) = r_1$. So if $r_{\bar{2}} > r_1$ we get the descent $\pi_1^e \pi_1^f$, and otherwise the descent π_1^e . So w_1 is right grassmannian in $\delta_i(w)$. When $p(w)$ is odd then $m_1^D(w) = r_{\bar{\ell}} \dots r_{\bar{2}} r_1 \mid r_{\bar{1}} r_2 \dots r_\ell$ with $r_{\bar{2}} > r_{\bar{1}}$ so there is the descent π_1^f . We also get $\max R(w) = r_{\bar{2}}$, and the two cases depending on the order between $r_{\bar{2}}$ and r_1 .

If $|w|_\emptyset = \ell$ we know that $r_{\bar{\ell}} < \dots < r_{\bar{2}} < r_{\bar{1}} > r_1 < r_2 < \dots < r_\ell$ in type B . If $p(w)$ is even, then $e_i = e$ and $m_1^D(w) = m_1(w)$. If $r_{\bar{2}} < 0$, then $r_{\bar{1}} < 0$ since $p(w)$ is even, thus $m_1(w) = 1$ which is absurd. So $r_{\bar{2}} > 0$ and $r_{\bar{1}} > 0$. Therefore $r_{\bar{2}} > r_1$ and the descents are those of type π_1^f . Now if $p(w)$ is odd, then $e_i = f$ and $m_1^D(w) = r_{\bar{\ell}} \dots r_{\bar{2}} r_1 \mid r_{\bar{1}} r_2 \dots r_\ell$. Since $r_{\bar{1}} > r_1$, $r_1 < 0$. If $r_{\bar{2}} < r_1$ then $r_{\bar{i}} < r_{\bar{2}} < 0$ for all $i \geq 2$. Hence $m_1^D(w)$ does not obey condition D , absurd. Hence $r_{\bar{2}} > r_1$, and w has the descents of type π_1^e . \square

As before this explains the name of Algorithm 7.2.32 the *grassmannian factorization* of D -rooks. Proposition 8.4.32 proved what we announced: we have to consider the elements grassmannian in the product $\pi_1^e \pi_1^f = \pi_1^f \pi_1^e$. In other words, since it is not a generator, such an element grassmannian in $\pi_1^e \pi_1^f$ has all its reduced expressions which begin by either π_1^e or π_1^f . For now we consider it as a whole new type of element, but by Proposition 8.4.39 we will see that we do not need this. In Figure 8.6 we give the descent set of such an element.

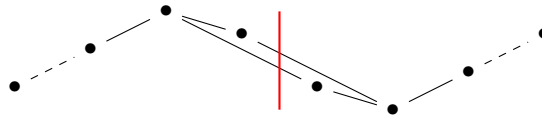

Figure 8.6: Descent set of right grassmannian element in $\pi_1^e \pi_1^f = \pi_1^f \pi_1^e$ in type D .

Proposition 8.4.33 (Unicity of w_1). *If $w \in F_\ell^0(D)$ admits the two expressions $w = \underline{w_1}e_i\underline{w_2} = \underline{v_1}e_i\underline{v_2}$ with $w_1, w_2, v_1, v_2 \in H_\ell^0(D)$, and where w_1 and v_1 are both right grassmannian in $\delta_i(w)$, then $w_1 = v_1$.*

Proof. Otherwise, consider the missing letters of w . Since the letters are deleted by the action of e_i only, the actions of v_1 and w_1 take the same set of $\ell + i$ letters in the first positions (and positions $\bar{\ell}$ to $\bar{2}$ and 1 when $i = -1$). We proceed as in Proposition 8.4.10 and check in each case according to the value of $\delta_i(w)$ that the only way to sort the first $\ell + i$ letters (and positions $\bar{\ell}$ to $\bar{2}$ and 1 when $i = -1$) is precisely $m_1^D(w)$. To prove each case, we use the poset conditions of Proposition 8.2.12 and Figure 8.6, the antisymmetry of words, and the condition of parity of $p(w)$. \square

Thus as in type B we have the unicity on the first element of the grassmannian factorization of Algorithm 7.2.32. We now look at the other element.

Proposition 8.4.34 (Unicity of w_2). *If $w \in F_\ell^0(D)$ admits two action reduced expressions $w = \underline{w_1}e_i\underline{w_2} = \underline{w_1}e_i\underline{v_2}$ with $w_1, w_2, v_2 \in H_\ell^0(D)$ and w_1 is right grassmannian in $\delta_i(w)$ or is the identity, then $w_2 = v_2$.*

Proof. If $i \geq 1$ then $1_{\bar{\ell}, \ell} \cdot w_1 e_i$ is of the shape $r = \emptyset \dots \emptyset r_{i+1} \dots r_\ell$, with $\ell + i$ zeros and $r_{i+1} < r_{i+2} < \dots < r_\ell$ by Proposition 8.2.6. Since the value of letters does not change the action, we conclude that w_2 and v_2 have the same actions on

$$\emptyset \dots \emptyset \mid \emptyset \dots \emptyset (i+1)(i+2) \dots \ell. \tag{8.15}$$

Since the generators of w_2 and v_2 act on every word antisymmetrically, they also have the same action on

$$\bar{\ell} \dots \overline{(i+2)} \overline{(i+1)} \emptyset \dots \emptyset \mid \emptyset \dots \emptyset (i+1)(i+2) \dots \ell. \tag{8.16}$$

Since the two words for w are action-reduced, every generator of w_2 and v_2 has a non-trivial action on $1_{\bar{\ell}, \ell} \cdot w_1 e_i$. In particular they never exchange a pair of nonzero letters. Hence they have the same actions on $\bar{\ell} \dots \overline{(i+2)} \overline{(i+1)} i \dots 2 \bar{1} \mid \bar{1} \bar{2} \dots \bar{i}(i+1)(i+2) \dots \ell$ if i is even, and on $\bar{\ell} \dots \overline{(i+2)} \overline{(i+1)} i \dots 2 \bar{1} \mid 1 \bar{2} \dots \bar{i}(i+1)(i+2) \dots \ell$ if i is odd. Because of Lemma 8.1.8 we can conclude that $w_2 = v_2$.

Now assume that $i \leq 0$. The letters different from \emptyset are in increasing order: we can replace them by the value of their position. Then if we do the antisymmetry we find that w_2 and v_2 have the same action on the identity, hence are equal. \square

The following lemma consider only product of the type $w e_j$ with $w \in H_\ell^0(D)$.

Lemma 8.4.35. *Let $-1 \leq i \leq \ell$ and $w \in H_\ell^0(D)$ so that $e_i w = e_i$, and we choose a word \underline{w} . Then if $\pi_k \in \underline{w}$, we have $k < i$. The same result holds for $w e_i = e_i$.*

Proof. If $e_i \neq f$ the proof is the same that in Lemma 8.4.12. If $e_i = f$ then we conjugate by s_0 : $s_0 \cdot fw \cdot s_0 = s_0 \cdot f \cdot s_0 \Leftrightarrow es_0 \cdot w \cdot s_0 = e$ by Lemma 8.3.3. So we apply the result to $s_0 \cdot w \cdot s_0 = 1$ hence $w = 1$. \square

The following statement summarizes these results:

Theorem 8.4.36. *For any $w \in F_\ell^0(D)$, Algorithm 7.2.32 provides the unique action reduced expression $w = \underline{w_1}e_i\underline{w_2}$ with $w_1, w_2 \in H_\ell^0(D)$ and w_1 is right grassmannian in $\delta_i(w)$ or is the identity.*

Proof. Let $\underline{v_1}e_j\underline{v_2}$ another reduced expression with v_1 either the identity or right grassmannian in π_i . The number $|w|_\emptyset$ and the parity of $p(w)$ gives that $i = j$. The missing letters of w being well-defined, the actions of w_1e_i and v_1e_i on the identity is the same. If $w_1 = 1$ then by Lemma 8.4.35 we get that v_1 can not be right grassmannian in π_i , so $v_1 = 1$. If $w_1 \neq 1$ then so do v_1 . Finally w_1 and v_1 are either both right grassmannian in π_i or both equal to the identity. By Proposition 8.4.33 we then have $w_1 = v_1$. By Proposition 8.4.34 we get $w_2 = v_2$. \square

As in type B , Theorem 8.4.36 gives uniqueness is the case where we have an action reduced word. We will sometimes want to drop this condition, and will use Lemma 8.4.35 to keep the unicity on w_2 . Now, we have finished the part 1 of the proof and move to part 2. From now on we will use these two ways to assert unicity of words to prove some special relations with left and right grassmannian elements. We first show these relations in the functions (Proposition 8.4.38), then in the presentation (Proposition 8.4.39). Finally this will be enough to get the necessary condition that reduced word of $G_\ell^0(D)$ have at most two letters e or f (Proposition 8.4.40). But first we have to define the following element.

Definition 8.4.37. *We define $\delta_i := \pi_i$ if $2 \leq i \leq \ell - 1$, $\delta_{-1} := \pi_1^e$, $\delta_0 := \pi_1^f$, and $\delta_1 \in \{\pi_1^e, \pi_1^f, \pi_1^e\pi_1^f\}$. For the later case we will say that a proposition is true for δ_1 if it true for all the three cases.*

Proposition 8.4.38. *Let $-1 \leq i, j \leq \ell$, $w \in F_\ell^0(D)$ an element δ_i -grass- δ_j and \underline{w} a given word for it. Let $k := \max\{s \mid \pi_s \in \underline{w}\}$. Then $e_iwe_j = e_{k+1}$. Moreover k depends only on w and not of the choice of \underline{w} .*

Proof. The proof is the same than Proposition 8.4.14 in type B . Simply apply Proposition 8.2.18 (resp. Lemma 8.4.35) instead of Proposition 8.2.10 (resp. Lemma 8.4.12). The only difference is that we also have to check that Proposition 8.2.18 which give the available boxes of the grid representations is also true for element right grassmannian in $\pi_1^e\pi_1^f$. \square

The following Proposition is very similar to Proposition 8.4.15. We nevertheless give the whole proof since the relations are not the same. We recall that according to Proposition 8.4.29 Relations [Red-D-even](#) and [Red-D-odd](#) give reduced expressions for e_i with $i \geq 2$. Here again the relations of commutation are used to change an element into a bigrassmannian element.

Proposition 8.4.39. *Let $1 \leq i, j \leq \ell$, w an element π_i -grass- π_j , \underline{w} any word for it, and $r := 1 + \max\{s \mid \pi_s \in \underline{w}\}$. The relation $e_iwe_j = e_r$ hold in $G_\ell^0(D)$, and the left side of this equality has a length greater than the right side.*

Proof. We do the proof by induction of the length of w . If w is of length 0 then it is the empty word, hence $i = j = -2$ and the identity is $1^2 = 1$. Otherwise, let w a δ_i -grass- δ_j element, and choose \underline{w} a reduced expression for it.

We first assume that $i \neq 1$ and $j \neq 1$. So δ_i and δ_j are π_k and not $\pi_1^e \pi_1^f$. If $i, j \in \{-1, 0\}$ then we are considering Relations [Red-D-even](#) and [Red-D-odd](#) by Corollary [8.2.19](#). Now $i \geq 2$ or $j \geq 2$. We assume that $i \neq j$, for instance $i < j$. Consider that there is $\pi_k \in w$ with $i \leq k < j$ (take π_i for instance). By [E-D](#) and [EF-D](#) we get $e_i \underline{w} e_j = e_i \underline{w} e_k e_j = e_i \underline{w}_1 e_k \underline{w}_2 e_j$ where we used Relation [Com-D](#), [ComEF-D](#), [H2-D](#) and [H3-D](#) to obtain w_1 right grassmannian in δ_k and $\underline{w} = \underline{w}_1 \underline{w}_2$, with $|\underline{w}_1| > 0$. To see that we do not use Relation [Abs-D](#), we check by an explicit computation that if an element would be absorbed by e_k it would also be absorbed by e_j . Therefore, the Relation [Abs-D](#) was not used, w_1 is still left-grassmannian in π_i , and also right grassmannian in δ_k . Furthermore since $k < j$, we have $|\underline{w}_2| > 0$ so $|\underline{w}_1| < |\underline{w}|$ (\underline{w} is reduced). By induction there is m such that $e_i \underline{w}_1 e_k = e_m$. So $e_i \underline{w} e_j = e_m \underline{w}_2 e_j$. Applying Relations [Abs-D](#), [Com-D](#), [ComEF-D](#), [H2-D](#) and [H3-D](#) we write $e_i \underline{w} e_j = e_m \underline{w}_2 e_j = w_3 e_m \underline{w}_4 e_j \underline{w}_5$ with w_4 δ_m -grass- π_j . Then $|\underline{w}_4| \leq |\underline{w}_2| < |\underline{w}|$ so $e_i \underline{w} e_j = \underline{w}_3 e_p \underline{w}_5$ in $G_\ell^0(B)$. Applying Relation [Com-D](#), [ComEF-D](#), [Abs-D](#), [H2-D](#) and [H3-D](#) we can assume that w_3 is right grassmannian in π_p . We also know that $e_i w e_j = e_r$ in $F_\ell^0(D)$. So the action of $w_3 e_m w_5$ is the same as the action of e_r in $F_\ell^0(D)$. By Proposition [8.4.33](#) we deduce that $w_3 = 1$ in $F_\ell^0(D)$, so $w_4 = 1$ by Lemma [8.4.35](#). Since it is an element of $H_\ell^0(D)$ it is also holds in $G_\ell^0(D)$. We now consider the case $i = j \neq 1$. We use Relations [Red-D-even](#) or [Red-D-odd](#) according to the parity of $i = j$ to get back to the previous case. We conclude as in Proposition [8.4.15](#).

Now assume that $i = 1$ or $j = 1$. For instance $i = 1$, and the case $j = 1$ is done similarly. Then $e_i \underline{w} e_j = e_1 \underline{w} e_j = e f \underline{w} e_j$. Applying Relation [Com-D](#), [ComEF-D](#), [H2-D](#) and [H3-D](#) we get $e f \underline{w} e_j = e w_1 f \underline{w}_2 e_j$ with w_2 is left-grassmannian in π_1^e and still right grassmannian in π_j . Since $|\underline{w}_1| \neq 0$ (at least $\pi_1^f \in w_1$) we can proceed by induction and get $e_i \underline{w} e_j = e w_1 e_r$, with $r > 1$ (since $|\underline{w}_2| \neq 0$). Again, we get $e_i \underline{w} e_j = \underline{w}_3 e w_4 e_r \underline{w}_5$ with w_4 π_1^f -grass- π_r . We are then brought back to the previous case, with just w_3 at the beginning and w_5 at the end, but they will again be equal to 1 in the last step using Proposition [8.4.33](#) and Lemma [8.4.35](#).

We check by induction that the size of words has decreased. Keep in mind that we use the reduced expression of e_i given in Proposition [8.4.29](#). In particular $\ell(e_1) = 2$. □

Proposition [8.4.39](#) hence shows that we do not need to consider the words grassmannian in $\pi_1^e \pi_1^f$ since we can bring them back to some product of π_1^e and π_1^f grassmannian element. Finally the next proposition concludes the part [2](#) of the proof.

Proposition 8.4.40. *A reduced word $w \in G_\ell^0(D)$ has at most two letters from the set $\{e, f\}$.*

Proof. For this proof, we denote for all k , $g_k \in \{e, f\}$. If $g \in \{e, f\}$ then $\pi_g := \pi_1^e$ if $g = e$ and $\pi_g := \pi_1^f$ otherwise. Let $w \in G_\ell^0(D)$. Assume that \underline{w} is a reduced word with strictly more than three g_k , for instance 3. Then $\underline{w} = \underline{w}_1 g_1 \underline{w}_2 g_2 \underline{w}_3 g_3 \underline{w}_4$. Applying Relation [Com-D](#), [ComEF-D](#), [H2-D](#) and [H3-D](#) we can assume that w_3 is

π_{g_2} -grass- π_{g_3} . By Corollary 8.2.19, $w_3 = \Delta_i^g$ for some i and some $g \in \{e, f\}$. We use the Relation Red-D-even or Red-D-odd to get $\underline{w} = \underline{w_1 g_1 w_2 e_{i+1} w_4}$. Applying again Com-D, ComEF-D, H2-D and H3-D we can assume that w_2 is π_{g_1} -grass- π_{i+1} . By Proposition 8.4.38 and Proposition 8.4.39 we get $\underline{w} = \underline{w_1 e_k w_4}$. In particular we managed to write \underline{w} with only two elements of $\{e, f\}$, and the size of the word only decreased since the beginning of the proof. Hence the first word was not reduced. \square

Finally we can prove the following result:

Theorem 8.4.41. *We have the isomorphism of monoids $F_\ell^0(D) \simeq G_\ell^0(D)$.*

Proof. We have seen in Lemma 8.4.3 the surjection $\Phi : G_\ell^0(D) \rightarrow F_\ell^0(D)$. Now let $w \in F_\ell^0(D)$ which we can write by grassmannian factorization (Algorithm 7.2.32) as $\underline{w} = \underline{w_1 e_i w_2}$. Let $\underline{w'}$ be another reduced expression for w , hence action-reduced. Considering the number of e and f in $\underline{w'}$, we will prove that we can write $\underline{w'}$ as $\underline{w_1 e_i w_2}$ applying only Relations of $G_\ell^0(D)$. By Proposition 8.4.40, $\underline{w'}$ can not have more than two elements of $\{e, f\}$. We will separate the three cases.

If $e \notin \underline{w'}$ and $f \notin \underline{w'}$ then w has no \emptyset and Algorithm 7.2.32 gives $\underline{w} = \underline{w_2}$. But w and w_2 have the same action on the identity and are elements of $H_\ell^0(D)$ so they are equal and all the computation is in $H_\ell^0(D)$ applying only Relations H2-D, and H3-D (not H1-D by Matsumoto's theorem).

If $\underline{w'}$ contains exactly one element of $\{e, f\}$, then w has exactly ℓ zeros. Algorithm 7.2.32 gives $\underline{w} = \underline{w_1 e w_2}$ or $\underline{w} = \underline{w_1 f w_2}$. We assume that $\underline{w} = \underline{w_1 e w_2}$, and the other case is done similarly. Because the parity of $p(w)$ depends only on w , it is necessary that $\underline{w'}$ contains the same generator e or f than \underline{w} . Here we write $\underline{w'} = \underline{v_1 e v_2}$. Applying Relations Com-D, ComEF-D, H2-D and H3-D we can assume that v_1 is right grassmannian in π_1^f . Since $\underline{v_1 e v_2}$ is still action-reduced, by Theorem 8.4.36 we get $v_1 = w_1$ and $v_2 = w_2$ in $H_\ell^0(D)$, therefore we can get from one element to another by the relations of $H_\ell^0(D)$.

If $\underline{w'}$ has exactly two elements of $\{e, f\}$, then $\underline{w'} = \underline{v_1 g_1 v_2 g_2 v_3}$ with $g_1, g_2 \in \{e, f\}$ as in proof of Proposition 8.4.40. Applying Relations Com-D, ComEF-D, H2-D and H3-D we can assume that v_2 is π_{g_1} -grass- π_{g_2} . By Corollary 8.2.19, $v_2 = \Delta_i^g$ for some i and $g \in \{e, f\}$. Hence by Relation Red-D-even or Red-D-odd we write $\underline{w'} = \underline{v_1 e_{i+1} v_3}$. So w has $\ell + i + 1$ zeros, so Algorithm 7.2.32 gives $\underline{w} = \underline{w_1 e_{i+1} w_2}$ with w_1 right grassmannian in π_{i+1} . Applying again Relations Com-D, ComEF-D, H2-D and H3-D we can assume that v_1 is also right grassmannian in π_{i+1} . Since $\underline{v_1 e_{i+1} v_2}$ is still action-reduced, Theorem 8.4.36 ensures that $v_1 = w_1$ and $v_2 = w_2$ in $H_\ell^0(D)$. \square

We define $R_\ell^0(D) := G_\ell^0(D)$. This theorem not only corrects the missing relations that were forgotten in [God09]. It also gives an effective way to do the computation:

Corollary 8.4.42. *For any $w \in R_\ell^0(D)$ the grassmannian factorization of Algorithm 7.2.32 gives a canonical reduced expression.*

Proof. Let $w \in R_\ell^0(B)$. We saw in the proof of Theorem 8.4.41 that any word for w can be rewritten to the expression given by Algorithm 7.2.32, using only relations which reduce the length by Proposition 8.4.39. \square

Theorem 8.4.41 finally gave us a presentation of $R_\ell^0(D)$. But we can deduce the presentation for $R_\ell(D)$ just by changing the Relation H1-D by $\pi_i^2 = 1$. So we also got canonical reduced expression of elements in $R_\ell(D)$.

Theorem 8.4.43. *The Renner monoid $R_\ell(D)$ is generated by $s_1^e, s_1^f, s_2, \dots, s_{\ell-1}, f, e_0, \dots, e_\ell$ subject to relations:*

$$\begin{aligned}
 s_i^2 &= 1 & 1 \leq i \leq \ell - 1; & \quad (\text{R1-D}) \\
 s_i s_j &= s_j s_i \text{ and } s_1^e s_1^f = s_1^f s_1^e, & 1 \leq i, j \leq \ell - 1 \text{ and } |i - j| \geq 2; & \quad (\text{R2-D}) \\
 s_i s_{i+1} s_i &= s_{i+1} s_i s_{i+1}, & 1 \leq i \leq \ell - 2; & \quad (\text{R3-D}) \\
 e_j s_i &= s_i e_j = e_j, & 1 \leq i < j \leq \ell; & \quad (\text{AbsR-D}) \\
 e_j s_i &= s_i e_j \text{ and } f s_i = s_i f, & 0 \leq j < i \leq \ell - 1 \text{ and } i > 1; & \quad (\text{ComR-D}) \\
 s_1^e e &= e s_1^e \text{ and } f s_1^f = s_1^f f, & & \quad (\text{ComEFR-D}) \\
 e_i e_j &= e_j e_i = e_{\max(i,j)}, & 0 \leq i, j \leq \ell; & \quad (\text{ER-D}) \\
 e_i f &= f e_i = e_i \text{ and } f^2 = f & 1 \leq i \leq \ell; & \quad (\text{EFR-D}) \\
 e_0 f &= f e_0 = e_1 & & \quad (E_0\text{FR-D}) \\
 e_i s_i e_i &= e_{i+1}, & 1 \leq i \leq \ell - 1; & \quad (\text{RecR-D}) \\
 f D_i^e e_0 &= e_{i+1} \text{ and } e_0 \Delta_i^f f = e_{i+1}, & 1 \leq i \leq \ell - 1, i \text{ even.} & \quad (\text{RedR-D-even}) \\
 f D_i^e f &= e_{i+1} \text{ and } e_0 \Delta_i^f e_0 = e_{i+1}, & 1 \leq i \leq \ell - 1, i \text{ odd.} & \quad (\text{RedR-D-odd})
 \end{aligned}$$

with D_i^f (resp. D_i^e) being the word obtained by replacing π_i by s_i in Δ_i^f (resp. Δ_i^e) of Definition 8.2.14.

Proof. The proof is similar to that of Theorem 8.4.41. Let us define the monoid generated by this presentation, named $G_\ell(D)$. It is a simple computation that the tables of generators of $R_\ell(D)$ satisfy the same relations. Then the point is to note that an action-reduced element for the 0-Renner monoid has the same action on $R_\ell(D)$ than the element obtained by replacing each π_i by s_i . This follows exactly the same lines as the proofs of Proposition 8.3.4 to Theorem 8.4.41. \square

This proof also suggests us the following conjectures:

Conjecture 8.4.44. *Let \underline{s} be a word on $s_1^e, s_1^f, s_2, \dots, s_{\ell-1}, f, e_0, \dots, e_\ell$ and $\underline{\pi}$ the word on $\pi_1^e, \pi_1^f, \pi_2, \dots, \pi_{\ell-1}, f, e_0, \dots, e_\ell$ obtained by replacing s_i by π_i , then \underline{s} is reduced if and only if $\underline{\pi}$ is reduced.*

Conjecture 8.4.45 (Matsumoto's theorem for $R_\ell(D)$ and $R_\ell^0(D)$). *Two reduced words on $s_1^e, s_1^f, s_2, \dots, s_{\ell-1}, f, e_0, \dots, e_\ell$ (resp. on $\pi_1^e, \pi_1^f, \pi_2, \dots, \pi_{\ell-1}, f, e_0, \dots, e_\ell$) give the same element if and only if they are linked using only length-preserving relations of Theorem 8.4.43 (resp. Definition 8.4.22).*

8.5 Code and programming

A huge part of this part aims to give a correct presentation for the monoid $R_\ell^0(B)$ and $R_\ell^0(D)$. We claimed that the presentation of Godelle [God09] led to infinite

monoid. Here we give the code in GAP to check this [Gap]. The reader could then use GAP with the package `kbmag` to check our computation.

In this code, we are computing the quotient the free monoid on the generators by the relations of our presentation. Then we use the algorithm of Knuth Bendix [KB70] in order to find a confluent system of rewriting rules, which would then enable to count the elements. This algorithm relies a lot on the order of the generators, and its behavior is quite unpredictable. For instance, in the next program, we apply a function to change the order of the generators in the end, and we obtain a result in about 3 seconds. Without changing the order it took us about 800 seconds on our computer. Another order ran for three weeks, without giving the results. This shows that this calculation is not easy and that these kinds of calculus is hard to check.

```
# Our presentation of R_5(B)
LoadPackage("kbmag");
F := FreeMonoid(11);
id := Identity(F);
s := GeneratorsOfMonoid(F);
s4 := s[1]; s3 := s[2]; s2 := s[3]; s1 := s[4]; s0 := s[5];
e5 := s[6]; e4 := s[7]; e3 := s[8]; e2 := s[9]; e1 := s[10]; e := s[11];
Q := F/ ([ \ # quotient by the relations
        # s_i are reflections
[s0^2, id], [s1^2, id], [s2^2, id], [s3^2, id], [s4^2, id], \
        # e_i are idempotents
[e^2, e], [e1^2, e1], [e2^2, e2], [e3^2, e3], [e4^2, e4], [e5^2, e5], \
        # braid relations
[(s0*s1)^2, (s1*s0)^2], [s1*s2*s1, s2*s1*s2], [s2*s3*s2, s3*s2*s3], \
[s3*s4*s3, s4*s3*s4], \
        # commutation between s_i
[s0*s2, s2*s0], [s0*s3, s3*s0], [s0*s4, s4*s0], [s1*s4, s4*s1], \
[s1*s3, s3*s1], [s2*s4, s4*s2], \
        # product of e_i
[e *e5, e5], [e *e4, e4], [e *e3, e3], [e *e2, e2], [e*e1, e1], \
[e1*e5, e5], [e1*e4, e4], [e1*e3, e3], [e1*e2, e2], [e1*e, e1], \
[e2*e5, e5], [e2*e4, e4], [e2*e3, e3], [e2*e1, e2], [e2*e, e2], \
[e3*e5, e5], [e3*e4, e4], [e3*e2, e3], [e3*e1, e3], [e3*e, e3], \
[e4*e5, e5], [e4*e3, e4], [e4*e2, e4], [e4*e1, e4], [e4*e, e4], \
[e5*e4, e5], [e5*e3, e5], [e5*e2, e5], [e5*e1, e5], [e5*e, e5], \
        # commutation between s_i and e_j
[e3*s4, s4*e3], [e2*s4, s4*e2], [e2*s3, s3*e2], [e1*s4, s4*e1], \
[e1*s3, s3*e1], [e1*s2, s2*e1], [e*s4, s4*e], [e*s3, s3*e], \
[e*s2, s2*e], [e*s1, s1*e], \
        # absorption between s_i and e_j
[s0*e1, e1], [e1*s0, e1], [s0*e2, e2], [e2*s0, e2], [s0*e3, e3], \
[e3*s0, e3], [s0*e4, e4], [e4*s0, e4], [s0*e5, e5], [e5*s0, e5], \
[s1*e2, e2], [e2*s1, e2], [s1*e3, e3], [e3*s1, e3], [s1*e4, e4], \
[e4*s1, e4], [s1*e5, e5], [e5*s1, e5], [s2*e3, e3], [e3*s2, e3], \
```

```

[s2*e4, e4], [e4*s2, e4], [s2*e5, e5], [e5*s2, e5], [s3*e4, e4], \
[e4*s3, e4], [s3*e5, e5], [e5*s3, e5], [s4*e5, e5], [e5*s4, e5], \
    # recurrence relation
[e*s0*e, e1], [e1*s1*e1, e2], [e2*s2*e2, e3], [e3*s3*e3, e4], \
[e4*s4*e4, e5],
    # reduced expression of e_i
[e*s0*s1*s0*e, e2], [e*s0*s1*s2*s0*s1*s0*e, e3], \
[e*s0*s1*s2*s3*s0*s1*s2*s0*s1*s0*e, e4], \
[e*s0*s1*s2*s3*s4*s0*s1*s2*s3*s0*s1*s2*s0*s1*s0*e, e5] \
]);
R := KBMAGRewritingSystem(Q);
# The Algorithm of Knuth Bendix relies a lot on the order of variables.
# The next order happens to be a fast one.
ReorderAlphabetOfKBMAGRewritingSystem(R, (4,1)(3,2)(10,5)(9,6)(8,7));
KnuthBendix(R);
Size(R);

```

The answer of the last instruction is 322021 which is the cardinality given in Example 7.2.16. We can reduce to $R_4(D)$ by deleting all relations containing s_4 and e_5 and will find 13889. On the contrary, in size 4 if we follow the presentation from Godelle we replace the previous relations which give reduced expression of e_i by the relations:

```

# reduced expression of e_i
[e*s0*s1*s0*e, e2], [e*s0*s1*s2*s0*s1*s0*e, e3]]);

```

Then the system will be found to be confluent, but the size is infinity.

As explained, these algorithms on GAP are hard to use so we received the help of James Mitchell which is one of the authors of the library `libsemigroup`. It uses different algorithms, but in particular an algorithm of Knuth Bendix in order to find a confluent system, then an algorithm of Froidiure-Pin which use the confluent system to count the number of elements. Thanks to his help we managed to check the size of the monoids $R_\ell(B)$ and $R_\ell^0(B)$ obtained with our presentation for ℓ from 2 to 5, and of the monoids $R_\ell(D)$ and $R_\ell^0(D)$ for ℓ from 2 to 6.

We also checked that the presentation of Godelle does not work for $R_3(B)$ and $R_4(D)$. In fact we were able to obtain the result that these monoids are infinite but it seemed to loop for ever, so we stopped it. At this time, the algorithm of Froidiure-Pin was already launched and we saw that it has found far more elements that what was expected, which prove that the latter presentation does not lead to the good monoid.

Order and representations of the 0-Renner monoids

In this section we present some properties of the 0-Renner monoids of type B and D . We will be mainly interested in the Green relations over these monoids, and the representation theory. We will not always go through all the details since the results do not change that much from type A (Chapters 5 and 6).

9.1 \mathcal{J} -triviality

We recall what we did in Chapter 5. For a rook $r \in R_n(A)$, we defined its *set of inversions* by

$$\text{Inv}(r) := \{(r_i, r_j) \mid i < j \text{ and } r_i > r_j > 0\}. \quad (9.1)$$

We also called its *support*, denoted $\text{supp}(r)$, the set of non-zero letters appearing in its rook vector. Furthermore, for each letter $p \in \text{supp}(r)$, we denoted $Z_r(p)$ the number of 0 which appear after p in the rook vector of r . We said that $(\text{supp}(r), \text{Inv}(r), Z_r)$ is the *rook triple associated to r* .

Then if $r, u \in R_n(A)$ we defined the partial order \leq_I as below. We wrote $r \leq_I u$ if and only if the three following properties holds:

- $\text{supp}(r) \subseteq \text{supp}(u)$
- $\{(b, a) \in \text{Inv}(u) \mid b \in \text{supp}(r)\} \subseteq \text{Inv}(r)$
- $Z_u(\ell) \leq Z_r(\ell)$ for $\ell \in \text{supp}(r)$.

Then given r and $u \in R_n^0(A)$ there exists $s \in R_n^0(A)$ such that $r = us$ if and only if $r \leq_I u$ (Theorem 5.1.11).

Let $T \in \{B, D\}$. We extend the latter definitions to $R_\ell(T)$ by replacing the letter 0 by the letter \emptyset . Let $r, u \in R_\ell^0(T)$ then:

- $\text{Inv}(r) := \{(r_i, r_j) \mid i < j \text{ and } r_i > r_j > \emptyset\}$.
- $\text{supp}(r)$ is the set of non- \emptyset letters appearing in the rook vector of r .

- For each $p \in \text{supp}(r)$, $Z_r(p)$ is the number of \emptyset which appear after p in r .

The relation \leq_I is then defined as before, we prove that $(R_\ell(T), \leq_I)$ is a poset.

Lemma 9.1.1. *The relation \leq_I is a partial order on $R_\ell(T)$ with maximal element $1_{\bar{\ell}, \ell}$ and minimal element $\emptyset_\ell = \emptyset \dots \emptyset$.*

Proof. The proof is the same than in Proposition 5.1.10. □

Hence let $T \in \{B, D\}$, $r \in R_\ell(T)$, and t a generator of $R_\ell^0(T)$. If we make explicit the action of t , we see that $r >_I r \cdot t$. From there we deduce that $R_\ell^0(T)$ is a monoid of regressive functions on the poset $R_\ell(T)$. By a result from [Den+10, Section 2.1] the monoid $R_\ell^0(T)$ is hence \mathcal{R} -trivial. Since the relations of the presentation of $R_\ell^0(B)$ and $R_\ell^0(D)$ are symmetrical (for Red-Blue use Proposition 8.2.7) these monoids are isomorphic to their opposites. Because these monoids are finite we know from Lemma 1.3.5 that these monoids are \mathcal{J} -trivial. See Figure 9.1 and Figure 9.2, where \emptyset is replaced by 0 for more lisibility. Hence we can carry on with the representation theory in the next subsection.

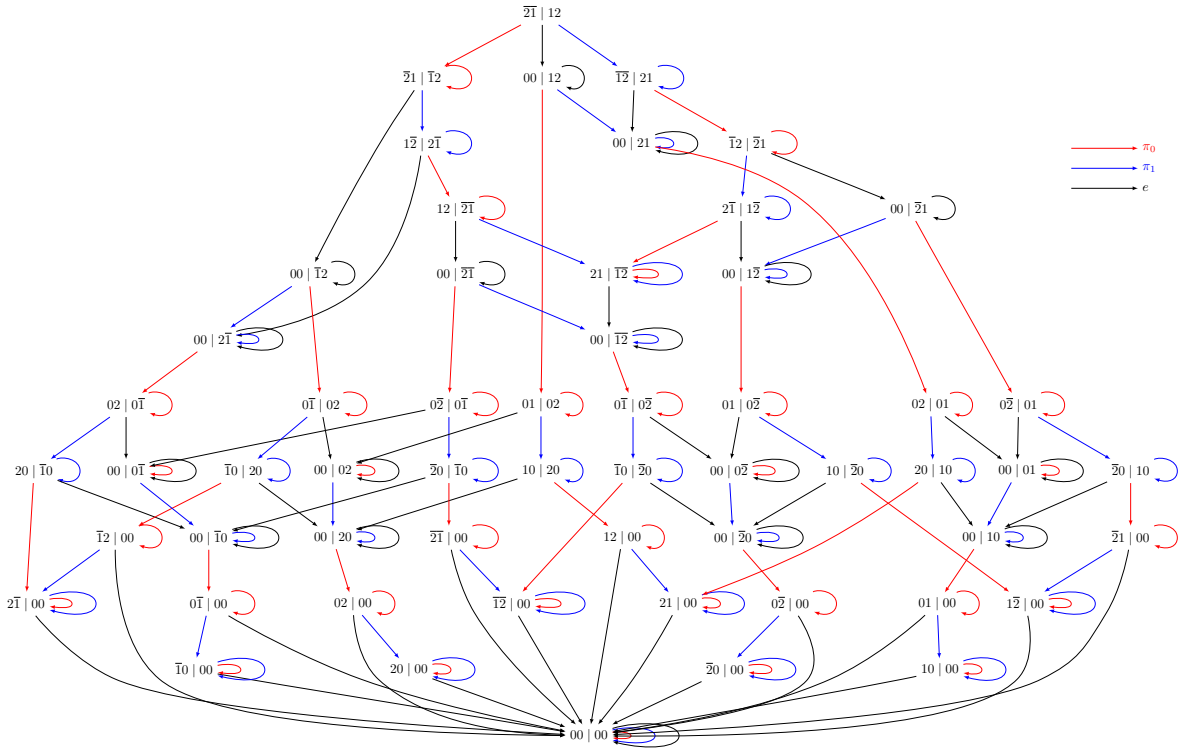

Figure 9.1: The monoid $R_2^0(B)$.

But before going there, we can wonder whether the order \leq_I is equivalent to the \mathcal{R} -order on $R_\ell(T)$, and if this monoid is a lattice, as it was the case in $R_n(A)$. However it is not the case for both statements. In type B for instance, let $a = 2\emptyset | 1\emptyset$ and $b = \emptyset 1 | \emptyset 2$. Then $a \leq_I b$ while a and b can not be compared in the \mathcal{R} -order, see Figure 9.1. Here the problem is linked to the antisymmetry condition. In type D let $a = \emptyset 2 | \emptyset \bar{1}$ and $b = 12 | \bar{2}\bar{1}$, then $a \leq_{\mathcal{R}} b$ see Figure 9.2, while a and b can not

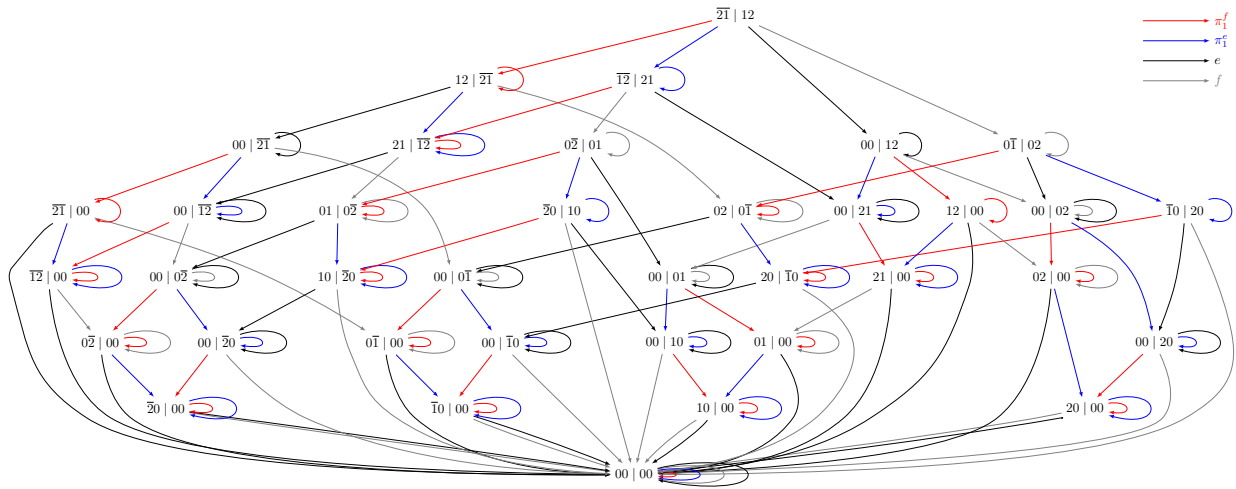

Figure 9.2: The monoid $R_2^0(D)$.

be compared in the \leq_I order. Hence in both type, the order \leq_I is not equivalent to order $\leq_{\mathcal{R}}$.

Concerning the question whether these monoids are lattices, the answer is no. Indeed let us take the elements $a = \bar{2}01 \mid \emptyset\bar{3}\emptyset$ and $b = 1\emptyset\bar{2} \mid \emptyset\bar{3}\emptyset$ in $R_3(D)$. Then we check on the computer than the elements $\emptyset\emptyset\emptyset \mid \emptyset\bar{3}\emptyset$ and $\bar{1}\bar{2}\emptyset \mid \bar{3}\emptyset\emptyset$ are two maximal elements below both a and b , and are not comparable. As these elements exist in type B and D , it gives a counterexamples in both types.

9.2 Representation theory

9.2.1 Idempotents and simple modules

As we did in Chapter 6 we recall that in Section 1.1.5 we associated to each subset S of $\llbracket 1, \ell - 1 \rrbracket$ of cardinality p a *composition of ℓ* of length $p + 1$.

Definition 9.2.1. *In type B (resp. D), we define $G(B) := \{\pi_0, \dots, \pi_{\ell-1}, e\}$ (resp. $G(D) := \{\pi_1^e, \pi_1^f, \pi_2, \dots, \pi_{\ell-1}, e, f\}$). For $I \subseteq G(B)$ (resp. $I \subseteq G(D)$) we define π_I^B (resp. π_I^D) to be the idempotent of the monoid generated by $(\pi_i)_{i \in I}$.*

Proof. These submonoids are finite since the monoids is finite. Since $R_\ell^0(B)$ and $R_\ell^0(D)$ are \mathcal{J} -trivial, they contain a unique minimal element for the \mathcal{J} -order, which is a zero. □

Since the two types B and D are quite different we first go for type B and describe its idempotents and simple modules. Then we will study the type D in a similar way.

Definition 9.2.2. *We call **antidiagonal block of size m** to be a diagonal rook table of 1 with respect to the $y = -x$ diagonal of size m .*

Proposition 9.2.3. *For any $S \subseteq \llbracket 0, \ell - 1 \rrbracket$ denote by $S^c := \llbracket 0, \ell - 1 \rrbracket \setminus S$ its complement, $I := C(S^c) = (i_1, \dots, i_p)$ its associated extended composition and define the*

associated set of generators $\tilde{S} := \{\pi_i \mid i \in S\}$. Then $1_{\bar{\ell}, \ell} \cdot \pi_S^B = r$ (resp. $1_{\bar{\ell}, \ell} \cdot \pi_{S \cup \{e\}}^B = r$) where r is the block diagonal rook table of size 2ℓ whose blocks are antidiagonal rook tables of size $(i_p, \dots, i_2, i_1 + i_1, i_2 \dots, i_p)$ (resp. $(\ell + i_1, i_2 \dots, i_p)$ except the first block which is a zero table).

Note that if $0 \notin S$ then $i_1 = 0$, therefore the middle block of size $i_1 + i_1$ vanishes. For readability, we write i for π_i , identifying S and \tilde{S} .

Example 9.2.4. If $\ell = 6$ and $S = \{1, 4, 5\}$ then $S^c = \{0, 2, 3\}$ so that we have $I := C(S^c) = (0, 2, 1, 3)$. Similarly if $T = \{0, 1, 4\}$ then $T^c = \{2, 3, 5\}$ so that $J := C(T^c) = (2, 1, 2, 1)$. Therefore the rook tables associated to π_S^B , π_T^B and $\pi_{T \cup \{e\}}^B$ are:

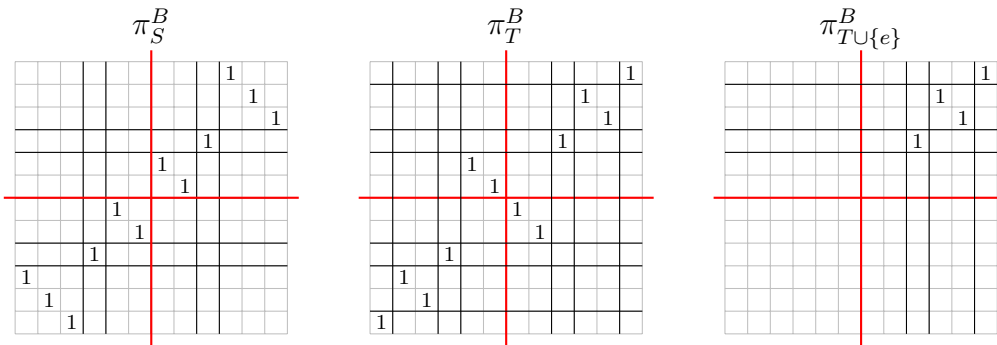

Proof of Proposition 9.2.3. We fix some S and consider r the associated rook table of π_S^B . The block diagonal structure ensures that π_S^B belongs to parabolic submonoid $\langle \pi_i \mid i \in S \rangle$. Indeed, suppose that there is a reduced word $\underline{w} = w_1 \dots w_n$ for π_S^B with some $w_i \notin \{\pi_i \mid i \in S\}$. This means that the table of $1_{\bar{\ell}, \ell} \cdot \underline{w}$ is r by Theorem 8.3.9. Choose the smallest such i . There are two cases whether $w_i = e$ or not.

- if $w_i = e$, then when computing $1_{\bar{\ell}, \ell} \cdot w_1 \dots w_{i-1} \cdot w_i$, the action of e will be to kill half of the column. In this case, the killed columns will never appear again so that there is no way to get the correct table.
- if $w_i = \pi_i$, when computing $1_{\bar{\ell}, \ell} \cdot w_1 \dots w_{i-1} \cdot w_i$, the action of w_i is to exchange two columns from two different blocks. However, acting by any π_j will never exchange those two columns again. So that it is not possible to get them back in the correct order.

Hence, we have proven that \underline{w} only contains π_i with $i \in S$ that is $\pi_S^B \in \langle \pi_i \mid i \in S \rangle$. Furthermore, using the action on tables one sees that $r \cdot \pi_i = r$ or equivalently that $\pi_S^B \pi_i = \pi_S^B$ if and only if $i \in S$, and that $\pi_S^B e \neq \pi_S^B$. This shows that π_S^B is the zero of $\{\pi_i \mid i \in S\}$.

The same proof works for $\pi_{S \cup \{e\}}^B$. □

During the proof, we got the following Lemma:

Lemma 9.2.5. *If $S \subseteq G(B)$, we have for $t \in G(B)$ that $\pi_S^B t = \pi_S^B$ if and only if $t \in S$.*

Proposition 9.2.6. *The monoid $R_\ell^0(B)$ has exactly $2^{\ell+1}$ idempotents: these are the zeros of every parabolic submonoid.*

Proof. We already know that $R_\ell^0(B)$ has at least $2^{\ell+1}$ idempotents. We now have to prove this exhaust the idempotents of $R_\ell^0(B)$.

Let m an idempotent of $R_\ell^0(B)$. We define $\text{cont}(m)$ to be the set of the π_i with $i \in \llbracket 0, n-1 \rrbracket$ appearing in any reduced word of m , and we define $\varepsilon_m := \emptyset$ if \emptyset is not in m , and $\varepsilon_m = e$ otherwise. Let us show that $m = \pi_{\text{cont}(m), \varepsilon_m}^B$: the zero of the parabolic generated by $\text{cont}(m)$ and ε_m . Indeed for $a \in \text{cont}(m) \cup \varepsilon_m$, one can write $m = \underline{u}a\underline{v}$ for some \underline{u} and \underline{v} in $R_\ell^0(B)$. By definition of the \mathcal{J} -order, this means that $m \leq_{\mathcal{J}} a$. Using Lemma 1.3.8, this is equivalent to $ma = m$ and to $am = m$, so that m is stable under all its support. \square

Theorem 9.2.7. *The monoid $R_\ell^0(B)$ has $2^{\ell+1}$ simple modules, all one-dimensional, indexed by the subsets of $G(B)$. Let $S \subseteq G(B)$. Its associated simple module S_S is the one-dimensional module generated by ε_S with the following action of generators:*

$$\varepsilon_S \cdot g = \begin{cases} \varepsilon_S & \text{if } g \in S \\ 0 & \text{otherwise.} \end{cases} \tag{9.2}$$

Proof. We apply Theorem 3.3.2 using Lemma 9.2.5. \square

Recall that we write x^ω any sufficiently large power of x which becomes idempotent, and that the star product of two idempotent is defined as $e * f = (ef)^\omega$. This endows the set of idempotents if a \mathcal{J} -trivial monoid with a structure of a lattice. We now explicitly describe this lattice:

Proposition 9.2.8. *Let $S, S' \subseteq G(B)$. Then $\pi_S^B * \pi_{S'}^B = \pi_{S \cup S'}^B$.*

Proof. First we note that $\pi_S * \pi_{S'}$ is inside the parabolic $\langle S \cup S' \rangle$. It is enough to show that it is a zero of this submonoid, and we will conclude by unicity. This is again a consequence of Lemma 1.3.8. \square

Corollary 9.2.9. *The quotient $\mathbb{K}R_\ell^0(B) / \text{rad}(\mathbb{K}R_\ell^0(B))$ is isomorphic to the algebra of the lattice of the $\ell + 1$ -dimensional cube.*

In type D the results are more intricate. The main problem is for the relations between π_1^e, π_1^f, e and f . So we begin by making explicit the idempotents of $R_2^0(D)$.

Definition 9.2.10. *Let $T \subseteq \{\pi_1^e, \pi_1^f, e, f\}$ then we define its D -closure \overline{T}^D by:*

$$\overline{T}^D := \begin{cases} \{\pi_1^e, \pi_1^f, e, f\} & \text{if } \{\pi_1^e, f\} \subseteq T \text{ or } \{\pi_1^f, e\} \subseteq T; \\ T & \text{otherwise.} \end{cases} \tag{9.3}$$

Proposition 9.2.11. *There are ten idempotents of $R_2^0(D)$: they are indexed by the closed subsets \overline{T}^D where $T \subseteq \{\pi_1^e, \pi_1^f, e, f\}$.*

Proof. Since $\{\pi_1^e, \pi_1^f, e, f\}$ is a generating idempotent set of $R_2^0(D)$, the same proof than Proposition 9.2.6 shows that there is at most $2^4 = 16$ idempotents, that is the idempotents of every parabolic submonoid. The Figure 9.2 shows that some of these idempotents are the same, we therefore find the list of Figure 9.3 with the corresponding rook tables. \square

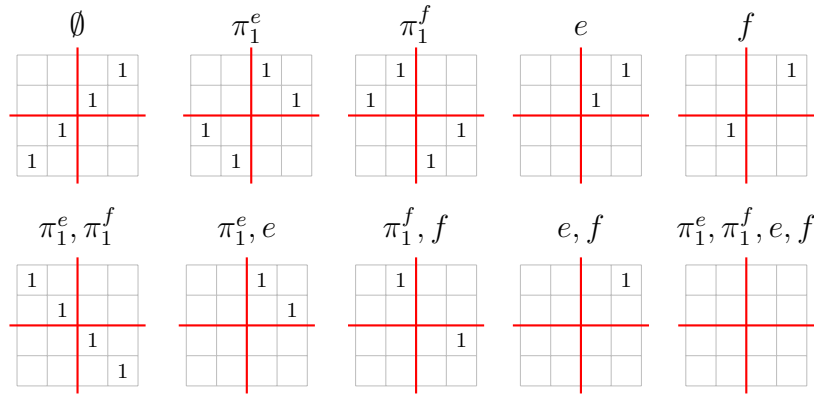

Figure 9.3: Idempotents of $R_2^0(D)$

Definition 9.2.12. We call **parity antidiagonal block of size $2m$** to be a antidiagonal rook table of size $2m$ with the two middle columns exchanged if m is odd.

Proposition 9.2.13. For any $S \subseteq \llbracket 2, \ell - 1 \rrbracket$, write $S^c := \llbracket 1, \ell - 1 \rrbracket \setminus S$ its complement with 1, $S_1^c := \llbracket 2, \ell - 1 \rrbracket \setminus S$ without 1, and define $I := C(S^c) = (i_1, i_2, \dots, i_p)$ and $J := C(S_1^c) = (j_1, \dots, j_m)$ the associated extended compositions. Then for any $T \subseteq \{\pi_1^e, \pi_1, e, f\}$ we have $1_{\bar{\ell}, \ell} \cdot \pi_{S \cup T}^D = r$ where r is a block diagonal rook table of size 2ℓ . There are different cases:

- If $\bar{T}^D = \emptyset$ the blocks are antidiagonal blocks of size $(i_p, \dots, i_2, 1, 1, i_2, \dots, i_p)$.
- If $\bar{T}^D = \{e\}$ the blocks are antidiagonal blocks of size $(\ell, 1, i_2, \dots, i_p)$ except the first one which is zero.
- If $\bar{T}^D = \{e, f\}$ the blocks are antidiagonal blocks of size $(\ell + 1, i_2, \dots, i_p)$ except the first one which is zero.
- If $\bar{T}^D = \{\pi_1^e\}$ the blocks are antidiagonal blocks of size $(j_m, \dots, j_2, j_1, j_1, j_2, \dots, j_m)$.
- If $\bar{T}^D = \{\pi_1^e, e\}$ the blocks are antidiagonal blocks of size $(\ell, j_1, j_2, \dots, j_m)$ except the first one which is zero.
- If $\bar{T}^D = \{\pi_1^e, \pi_1^f\}$ the blocks are antidiagonal blocks of size $(j_m, \dots, j_2, j_1 + j_1, j_2, \dots, j_m)$ with the middle one being a parity antidiagonal block.
- If $\bar{T}^D = \{\pi_1^e, \pi_1^f, e, f\}$ the blocks are antidiagonal blocks of size $(\ell + j_1, j_2, \dots, j_m)$ except the first one which is zero.
- In any other case then $r = s_0 \cdot (1_{\bar{\ell}, \ell} \cdot \pi_{s_0 \cdot (S \cup T) \cdot s_0}^D) \cdot s_0$ where $s_0 \cdot (S \cup T) \cdot s_0$ is the set $(S \cup T)$ where each element is conjugate by s_0 .

Note that by definition of \bar{T}^D , the last case amounts to the three possibilities $\bar{T}^D = \{f\}$, $\bar{T}^D = \{\pi_1^f\}$ or $\bar{T}^D = \{\pi_1^f, f\}$. For the conjugation by s_0 we use Lemma 8.3.3. See Figure 9.4 for some examples, where the idempotents obtained by conjugation are side by side.

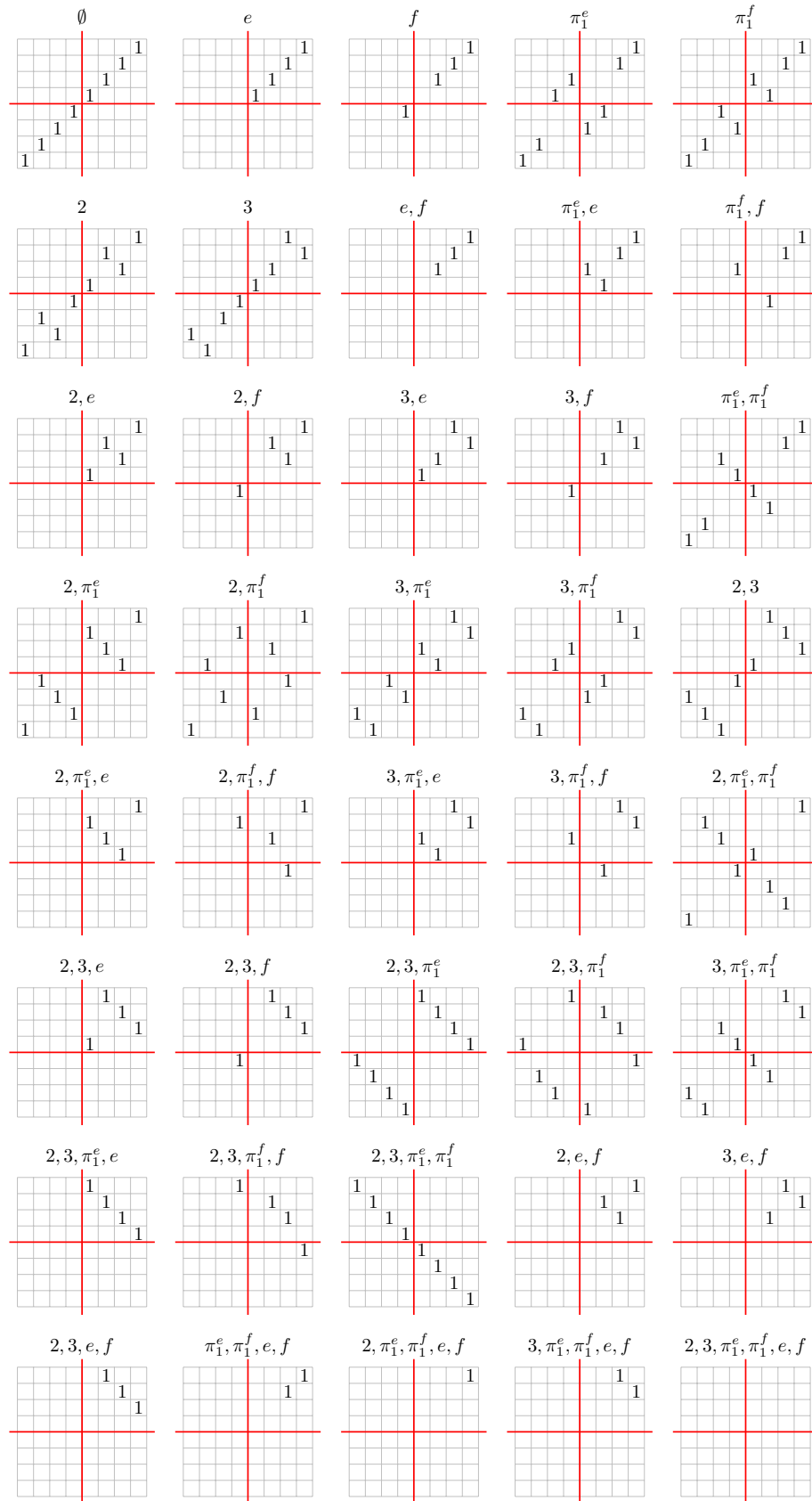

Figure 9.4: Idempotents of $R_4^0(D)$.

Proof. The proof is the same than the proof of Proposition 9.2.3. We see that every rook table is stable under the action of $\{\pi_i \mid i \in S\} \cup \overline{T}^D$. We then prove that for other generators the action on the rook table can not be reverted. Thus the given r are inside $\langle \{\pi_i \mid i \in S\} \cup \overline{T}^D \rangle$, and the zero of this submonoid. \square

During the proof, we also got the following Lemma:

Lemma 9.2.14. *Let $S \subseteq G(D)$. Then $\pi_{\overline{S}^D}^D t = \pi_{\overline{S}^D}^D$ if and only if $t \in \overline{S}^D$.*

Finally we get the following result whose proof is the same than in Proposition 9.2.5.

Proposition 9.2.15. *The monoid $R_\ell^0(D)$ has exactly $10 \cdot 2^{\ell-2}$ idempotents: these are the $\pi_{\overline{S}^D}^{D,\ell}$ for $S \subseteq G(D)$.*

Now that we have the idempotents we can deduce the representation theory.

Theorem 9.2.16. *The monoid $R_\ell^0(D)$ has $10 \cdot 2^{\ell-2}$ simple modules, all one-dimensional, indexed by the D -closure of subsets $S \subseteq G(D)$. Then $S_{\overline{S}^D}$ is the one-dimensional module generated by $\varepsilon_{\overline{S}^D}$ with the following action of generators:*

$$\varepsilon_{\overline{S}^D} \cdot t = \begin{cases} \varepsilon_{\overline{S}^D} & \text{if } t \in \overline{S}^D \\ 0 & \text{otherwise.} \end{cases} \quad (9.4)$$

Proof. We apply Theorem 3.3.2 using Lemma 9.2.14. \square

Proposition 9.2.17. *Let $S, S' \subseteq G(D)$. Then*

$$\pi_{\overline{S}^D}^D * \pi_{\overline{S'}^D}^D = \pi_{\overline{S \cup S'}^D}^D. \quad (9.5)$$

Proof. First we note that $\pi_S * \pi_{S'}$ is inside the parabolic $S \cup S'$. It is enough to show that it is a zero of this submonoid, and we will conclude by unicity. This is again a consequence of [Den+10, Lemma 3.6], \square

From [Den+10, Lemma 3.6], the star product is the meet of a lattice illustrated in Figure 9.5. Moreover the semisimple quotient $\mathbb{K}R_\ell^0(D) / \text{rad}(\mathbb{K}R_\ell^0(D))$ is isomorphic to the algebra of this lattice.

9.2.2 Projective indecomposable modules

Similarly to type A we also prove that the right (resp. left) descents sets describe the projective modules. See [Den+10] for precise definitions. Here we recall some definitions for M a monoid and $x \in M$.

$$\text{rAut}(x) := \{u \in M \mid xu = x\}, \quad \text{and} \quad \text{lAut}(x) := \{u \in M \mid ux = x\}, \quad (9.6)$$

$$\text{rfix}(x) := \min \text{rAut}(x) = \min\{e \in E(M) \mid xe = x\}, \quad (9.7)$$

$$\text{lfix}(x) := \min \text{lAut}(x) = \min\{e \in E(M) \mid ex = x\}, \quad (9.8)$$

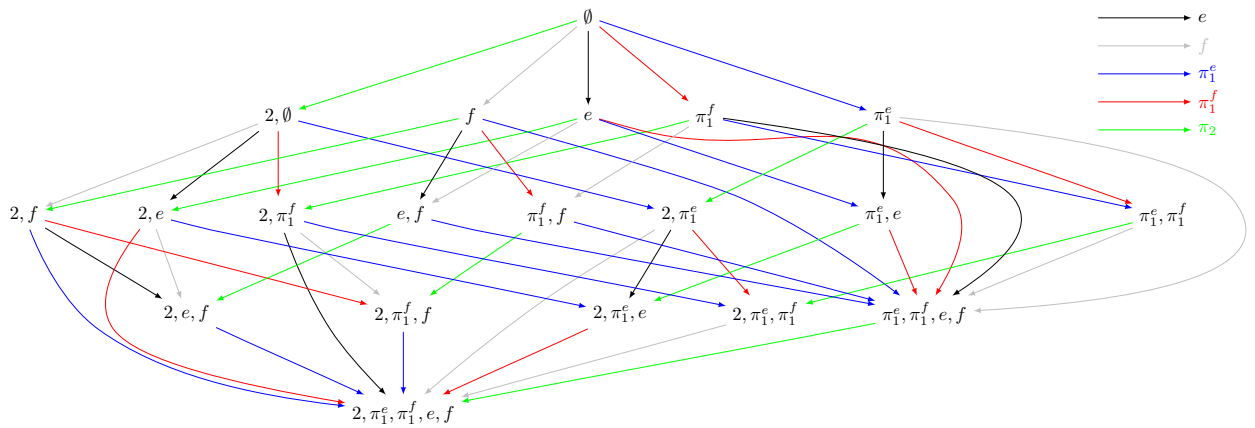

Figure 9.5: The star lattice on idempotents of $R_3^0(D)$.

the min being taken for the \mathcal{J} -order (which exists according to [Den+10, Proposition 3.16]).

We use these definitions in type T ($T \in \{B, D\}$). Let $G(B) := \{e, \pi_0, \dots, \pi_{\ell-1}\}$ and $G(D) := \{e, f, \pi_1^e, \pi_1^f, \pi_2, \dots, \pi_{\ell-1}\}$. We generalize the notion of descents to elements of $R_\ell^0(T)$:

Definition 9.2.18. *Let $x \in R_\ell^0(T)$. Then:*

$$D_R^T(x) := \{t \in G(T) \mid xt = x\} \quad \text{and} \quad D_L^T(x) := \{t \in G(T) \mid tx = x\} \quad (9.9)$$

We get the following result by the same proof than in type A (Proposition 6.2.5):

Proposition 9.2.19. *Let $x \in R_\ell^0(T)$. Then $\text{rAut}(x) = \langle D_R^T(x) \rangle$ and $\text{lAut}(x) = \langle D_L^T(x) \rangle$.*

We get the following immediate corollary for a \mathcal{J} -trivial monoid. We recall that when $S \subseteq G(T)$, then π_S is the idempotent of the submonoid of $R_\ell^0(T)$ generated by S (or its closure if $T = D$).

Corollary 9.2.20. *Let $x \in R_\ell^0(T)$, then $\text{rfix}(x) = \pi_{D_R^T(x)}^T$ and $\text{lfix}(x) = \pi_{D_L^T(x)}^T$.*

Applying [Den+10, Theorem 3.23]:

Proposition 9.2.21. *The indecomposable projective $R_\ell^0(T)$ -modules are indexed by the descents classes and isomorphic to the quotient of the associat descent class by the finer descent classes.*

9.2.3 Restriction to $H_\ell^0(T)$

As in Section 6.4 we consider the restriction of projective modules of $R_\ell^0(T)$ to $H_\ell^0(T)$.

Definition 9.2.22. *Let $T \in \{B, D\}$. We define $\Psi : R_\ell(T) \rightarrow W(T)$ to be the map which takes $r \in R_\ell(T)$, replaces the k nonzero letter by letters $\ell - k + 1$ to ℓ in the same order, replaces k zeros by antisymmetry, and replace all the others \emptyset by the missing letter in decreasing order (except in type D where it might exchange the smallest $(i, -i)$ pair of missing letters so as to obeys condition D).*

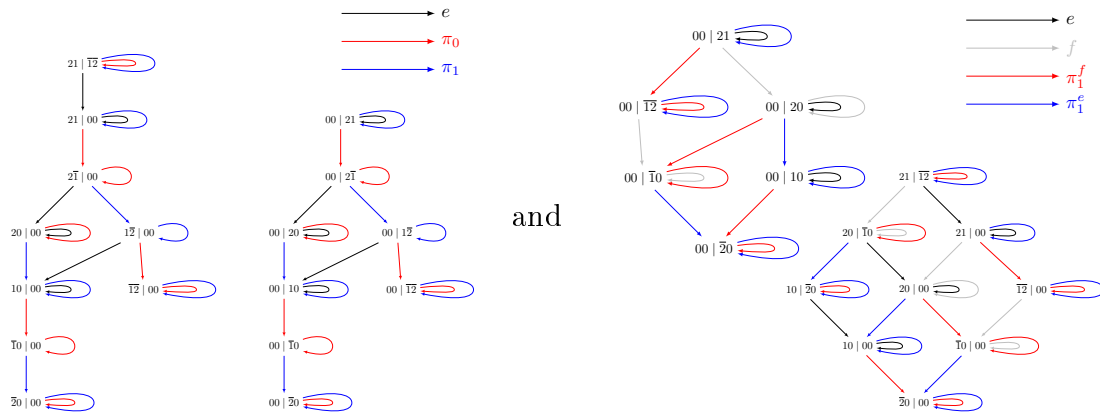

Figure 9.6: From left to right the descent classes $\{\pi_0, \pi_1\}$ and $\{e, \pi_1\}$ in $R_2^0(B)$, and the descent classes $\{\pi_1^e, e\}$ and $\{\pi_1^f, \pi_1^e\}$ in $R_2^0(D)$. The corresponding legends are above. Note that we are in the left Cayley graph since we consider right-descent.

Example 9.2.23. In type B , if $r := \emptyset 2\emptyset\bar{3}\emptyset \mid \emptyset\emptyset 4\emptyset\emptyset \in R_5(B)$ is first changed to $\emptyset 4\emptyset 3\emptyset \mid \emptyset\emptyset 5\emptyset\emptyset$, to $\emptyset 4\bar{5}3\emptyset \mid \emptyset\bar{3}5\bar{4}\emptyset$, finally to $24\bar{5}31 \mid \bar{1}3\bar{5}\bar{4}2 \in B_\ell$.

In type D , if $r := \emptyset\bar{5}31\emptyset \mid \emptyset\emptyset\emptyset\emptyset\emptyset \in R_5(D)$ is first changed to $\emptyset 354\emptyset \mid \emptyset\emptyset\emptyset\emptyset\emptyset$, to $\emptyset 354\emptyset \mid \emptyset 4\bar{5}3\emptyset$, finally to $2354\bar{1} \mid \bar{1}4\bar{5}3\bar{2} \in D_\ell$.

Theorem 9.2.24. *The monoid $R_\ell^0(T)$ is projective over $H_\ell^0(T)$. As a consequence any $R_\ell^0(T)$ -projective module remains projective when restricted to $H_\ell^0(T)$.*

Proof. Let $I \subseteq [\bar{\ell}, \ell]$, and C_I be the $H_\ell^0(T)$ -module spanned by the elements r of $R_\ell^0(T)$ with $\text{supp}(r) = I$ (note that a lot of C_I are empty because of the B condition). Since the right-action of $H_\ell^0(T)$ does not change the value of letters, we have the following decomposition in $H_\ell^0(T)$ modules:

$$R_\ell^0(T) = \bigoplus_{I \subseteq [\bar{\ell}, \ell]} C_I. \tag{9.10}$$

It is thus enough to prove that every C_I is projective over $H_\ell^0(T)$. Let $I \subseteq [\bar{\ell}, \ell]$ so that $C_I \neq \emptyset$. In other words, we ask I to obey the B condition (note that the parity condition of condition D does not determine the support).

Now for all $r \in C_I$, $\Psi(m_2(r))$ (resp. $\Psi(m_2^D(r))$ in type D) does not depend in $r \in C_I$ but only in I . We denote it by m_I . It is an idempotent, which can be seen by checking its table for instance. Hence the ideal $m_I H_\ell^0(T)$ is projective over $H_\ell^0(T)$. Furthermore it is isomorphic as $H_\ell^0(T)$ -module to C_I , and the isomorphism is given by Ψ . \square

9.2.4 Ext-quivers

Finally we look at the quivers of our two monoids $R_\ell^0(B)$ and $R_\ell^0(D)$ as we did in Section 6.3. It turns out that the result is the same than the general result of Fayers in 0-Hecke monoid [Fay05, Theorem 5.1]. We refer to this paper to see the proof, as it is the same here.

Theorem 9.2.25. *Let $T \in \{B, D\}$. The quiver is the digraph whose vertices are the idempotents π_I^T for $I \subseteq G(T)$. For $I, J \subseteq G(T)$, there is an edge between π_I^T and π_J^T iff $I \subsetneq J$, $J \subsetneq I$, and for every $u \in J \setminus I$ and $v \in I \setminus J$ the generators u and v do not commute.*

We have an example in Figure 9.7.

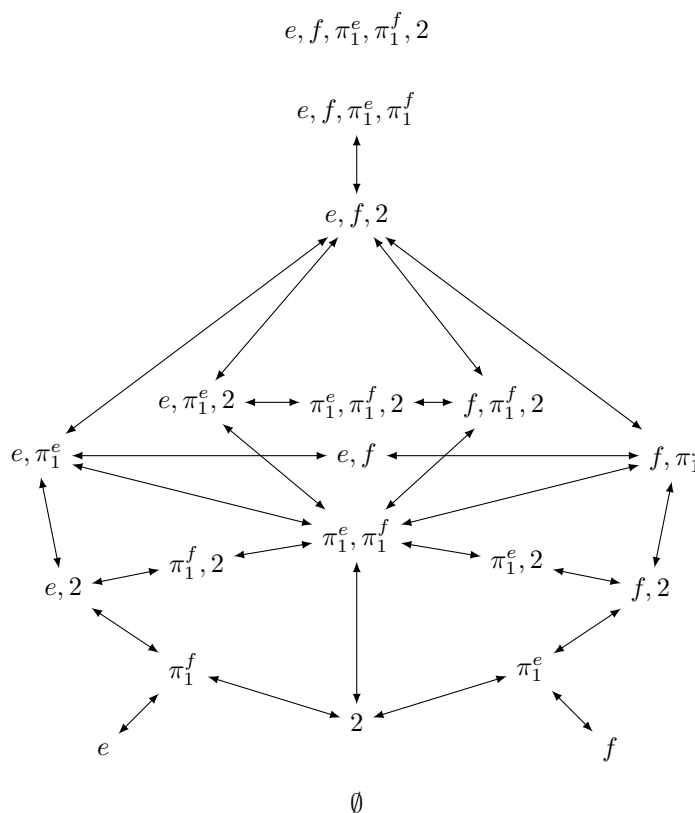

Figure 9.7: The Quiver of $R_3^0(D)$.

Part IV

Lattice Structure on sets of roots

Summary

This part deals with combinatorics of posets and combinatorial families that we have already met. More precisely its purpose is to understand some classical orders on these combinatorial families as a special case of an order on posets. We announced this in the introduction of Section 1.2.

Chapter 10 is a summary of the results of G. Chatel, V. Pilaud and V. Pons presented in [CPP17]. All results of this chapter were proved by them, and we refer to their article for some proofs. We have chosen to briefly present their results in this thesis as it provides the framework and the motivations necessary to present our work on Weyl groups. Their starting point is the *weak order* presented in Section 1.1.3, which is a lattice (Theorem 1.2.11) and is defined as the inclusion order of inversions. The weak order naturally extends to all *integer binary relations*, *i.e.* binary relations on $[n]$. Namely, for any two integer binary relations R, S on $[n]$, C. Chatel, V. Pilaud and V. Pons defined

$$R \preceq S \iff R^{\text{Inc}} \supseteq S^{\text{Inc}} \text{ and } R^{\text{Dec}} \subseteq S^{\text{Dec}},$$

where $R^{\text{Inc}} := \{(a, b) \in R \mid a \leq b\}$ and $R^{\text{Dec}} := \{(b, a) \in R \mid a \leq b\}$ respectively denote the increasing and decreasing subrelations of R . They called this order the *weak order* on integer binary relations, see Figure 10.1. The central result of their paper is the following, illustrated in Figure 10.5.

Theorem IV.1 ([CPP17, Theorem 1]). The weak order on the integer posets on $[n]$ is a lattice.

Their motivation for this result was that many relevant combinatorial objects can be interpreted by specific integer posets, and the subposets of the weak order induced by these specific integer posets often correspond to classical lattice structures on these combinatorial objects. By this systematic approach, they rediscovered and shed light on many lattice structures. Here we will only illustrate this with the study of specific integer posets corresponding to the elements, to the intervals, and to the faces in the classical weak order, the Tamari lattice [MHPS12], the type A Cambrian lattices and the boolean lattice. We refer to [CPP17] and the references therein for more details.

All the results of G. Chatel, V. Pilaud and V. Pons are dealing with “type A objects”: the symmetric group \mathfrak{S}_n , the Permutohedron, the Tamari lattice and the

boolean lattice, and all their derivatives. Chapter 11 will deal with a work with V. Pilaud [GP18] which extends all these definitions to the other types. The remark is that the roots of type A are $\Phi_A = \{e_i - e_j \mid 1 \leq i, j \leq n + 1\}$ (see Section 2.3.1). In other words binary relations corresponds to subsets of Φ_A . The notions of symmetry, antisymmetry and transitivity on binary relations translate to symmetry, antisymmetry and closedness of subsets of Φ_A . This provides a natural notion of Φ -posets for arbitrary root systems Φ . We obtain the following result:

Theorem IV.2. The weak order on the Φ -posets is a lattice.

From there we will see what we can conclude on this order with some other special families.

Note that this work is not just a mere translation of the work of [CPP17]. The most important question was to find the convenient notion of “transitivity” in subsets of Φ . In her article [Pil06], A. Pilkington proved that there are several non equivalent definitions of transitivity, and that they coincide in type A but not in other types (see Remark 11.1.4). In Remark 11.2.19 we will indeed see that not all of these notions of transitivity lead to a lattice on Φ -posets. In order to understand these differences, we will thus begin by studying very precisely the root poset of every Coxeter groups, and the properties of the sum of roots (Section 11.1). In particular, we will see that the “natural” geometric definition of transitivity given by conical hull does not lead to a lattice structure. We will thus focus on crystallographic Coxeter groups, aka Weyl groups. For example, the weak orders on A_2 -, B_2 - and G_2 -posets are represented in Figure 11.2 and 11.3.

We then switch to our motivation to study the weak order on Φ -posets. We consider Φ -posets corresponding to the vertices, the intervals and the faces of the permutahedron, the associahedra and the cube of type Φ . Considering the subsets of the weak order induced by these specific families of Φ -posets allow us to recover the classical weak order and the Cambrian lattices, their interval lattices, and their facial lattices.

Chapter 10

Poset on posets

10.1 The weak order on integer posets

10.1.1 The weak order on integer binary relations

Integer binary relations

As explained in the summary of this part, G. Chatel, V. Pilaud and V. Pons focused on binary relations on integers. An *integer (binary) relation* of size n is a binary relation on $[n] := \{1, \dots, n\}$, that is, a subset R of $[n]^2$. We have seen such relations in Section 1.2. However we were at the time the order induced by relations on some combinatorial family. We will now study them as combinatorial objects themselves. We therefore use a new formalism to denote them: we write equivalently $(u, v) \in R$ or $u R v$, and similarly, we write equivalently $(u, v) \notin R$ or $u \not R v$. In this formalism, we recall that a relation $R \in [n]^2$ is called:

- *reflexive* if $u R u$ for all $u \in [n]$,
- *transitive* if $u R v$ and $v R w$ implies $u R w$ for all $u, v, w \in [n]$,
- *antisymmetric* if $u R v$ and $v R u$ implies $u = v$ for all $u, v \in [n]$.

We will only consider reflexive relations. We denote by $\mathcal{R}(n)$ (resp. $\mathcal{T}(n)$, resp. $\mathcal{A}(n)$) the collection of all reflexive (resp. reflexive and transitive, resp. reflexive and anti-symmetric) integer relations of size n . We denote by $\mathcal{P}(n)$ the collection of *integer posets* of size n , that is, reflexive transitive antisymmetric integer relations.

A *subrelation* of $R \in \mathcal{R}(n)$ is a relation $S \in \mathcal{R}(n)$ such that $S \subseteq R$ as subsets of $[n]^2$. We say that S *coarsens* R and R *extends* S . The extension order defines a graded lattice structure on $\mathcal{R}(n)$ whose meet and join are respectively given by intersection and union. Note that $\mathcal{T}(n)$ and $\mathcal{A}(n)$ are stable by intersection but not by union. In other words, $(\mathcal{T}(n), \subseteq)$ and $(\mathcal{A}(n), \subseteq)$ are meet-semisublattice of $(\mathcal{R}(n), \subseteq, \cap)$ but not sublattices of $(\mathcal{R}(n), \subseteq, \cap, \cup)$. However, $(\mathcal{T}(n), \subseteq)$ is a lattice. To see it, we recall the definition of *transitive closure* of a relation $R \in \mathcal{R}(n)$:

$$R^{\text{tc}} := \{(u, w) \in [n]^2 \mid \exists v_1, \dots, v_p \in [n], u = v_1 R v_2 R \dots R v_{p-1} R v_p = w\}. \quad (10.1)$$

It follows that $(\mathcal{T}(n), \subseteq)$ is a lattice where the meet of $R, S \in \mathcal{R}(n)$ is given by $R \cap S$ and the join of $R, S \in \mathcal{R}(n)$ is given by $(R \cup S)^{\text{tc}}$.

Weak order

Let $I_n := \{(a, b) \in [n]^2 \mid a \leq b\}$ and $D_n := \{(b, a) \in [n]^2 \mid a \leq b\}$, so that $I_n \cup D_n = [n]^2$ while $I_n \cap D_n = \{(a, a) \mid a \in [n]\}$. We say that the relation $R \in \mathcal{R}(n)$ is *increasing* (resp. *decreasing*) when $R \subseteq I_n$ (resp. $R \subseteq D_n$). We denote by $\mathcal{I}(n)$ (resp. $\mathcal{D}(n)$) the collection of all increasing (resp. decreasing) relations on $[n]$. The *increasing* and *decreasing subrelations* of an integer relation $R \in \mathcal{R}(n)$ are the relations defined by:

$$R^{\text{Inc}} := R \cap I_n = \{(a, b) \in R \mid a \leq b\} \in \mathcal{I}(n) \quad (10.2)$$

$$R^{\text{Dec}} := R \cap D_n = \{(b, a) \in R \mid a \leq b\} \in \mathcal{D}(n). \quad (10.3)$$

In the pictures of this chapter, taken from [CPP17] with permission, we always represent an integer relation $R \in \mathcal{R}(n)$ as follows: we write the numbers $1, \dots, n$ from left to right and we draw the increasing relations of R above in blue and the decreasing relations of R below in red. Although we only consider reflexive relations, we always omit the relations (i, i) in the pictures. See *e.g.* Figure 10.1.

Besides the *extension lattice* mentioned above, there is another natural poset structure on $\mathcal{R}(n)$, whose name will be justified in Section 10.2.1.

Definition 10.1.1. *The weak order on $\mathcal{R}(n)$ is the order defined by*

$$R \preceq S \iff R^{\text{Inc}} \supseteq S^{\text{Inc}} \text{ and } R^{\text{Dec}} \subseteq S^{\text{Dec}}. \quad (10.4)$$

The weak order on $\mathcal{R}(3)$ is illustrated in Figure 10.1. Observe that the weak order is obtained by combining the *extension lattice* on increasing subrelations with the *coarsening lattice* on decreasing subrelations. In other words, $\mathcal{R}(n)$ is the square of an $\binom{n}{2}$ -dimensional boolean lattice. It explains the following statement:

Proposition 10.1.2 ([CPP17, Proposition 3]). *The weak order $(\mathcal{R}(n), \preceq)$ is a graded lattice whose meet and join are given by*

$$R \wedge_{\mathcal{R}} S = (R^{\text{Inc}} \cup S^{\text{Inc}}) \cup (R^{\text{Dec}} \cap S^{\text{Dec}}) \quad (10.5)$$

$$\text{and } R \vee_{\mathcal{R}} S = (R^{\text{Inc}} \cap S^{\text{Inc}}) \cup (R^{\text{Dec}} \cup S^{\text{Dec}}). \quad (10.6)$$

10.1.2 The weak order on integer posets

In this section, we show that the three subposets of the weak order $(\mathcal{R}(n), \preceq)$ induced by antisymmetric relations, by transitive relations, and by posets are all lattices (although the last two are not sublattices of $(\mathcal{R}(n), \preceq, \wedge_{\mathcal{R}}, \vee_{\mathcal{R}})$).

Antisymmetric relations

We first deal with antisymmetric relations. Figure 10.2 shows the meet and join of two antisymmetric relations, and illustrates the following statement.

Proposition 10.1.3 ([CPP17, Proposition 5]). *The meet $\wedge_{\mathcal{R}}$ and the join $\vee_{\mathcal{R}}$ both preserve antisymmetry. Thus, the antisymmetric relations $\mathcal{A}(n)$ induce a sublattice of the weak order $(\mathcal{R}(n), \preceq, \wedge_{\mathcal{R}}, \vee_{\mathcal{R}})$.*

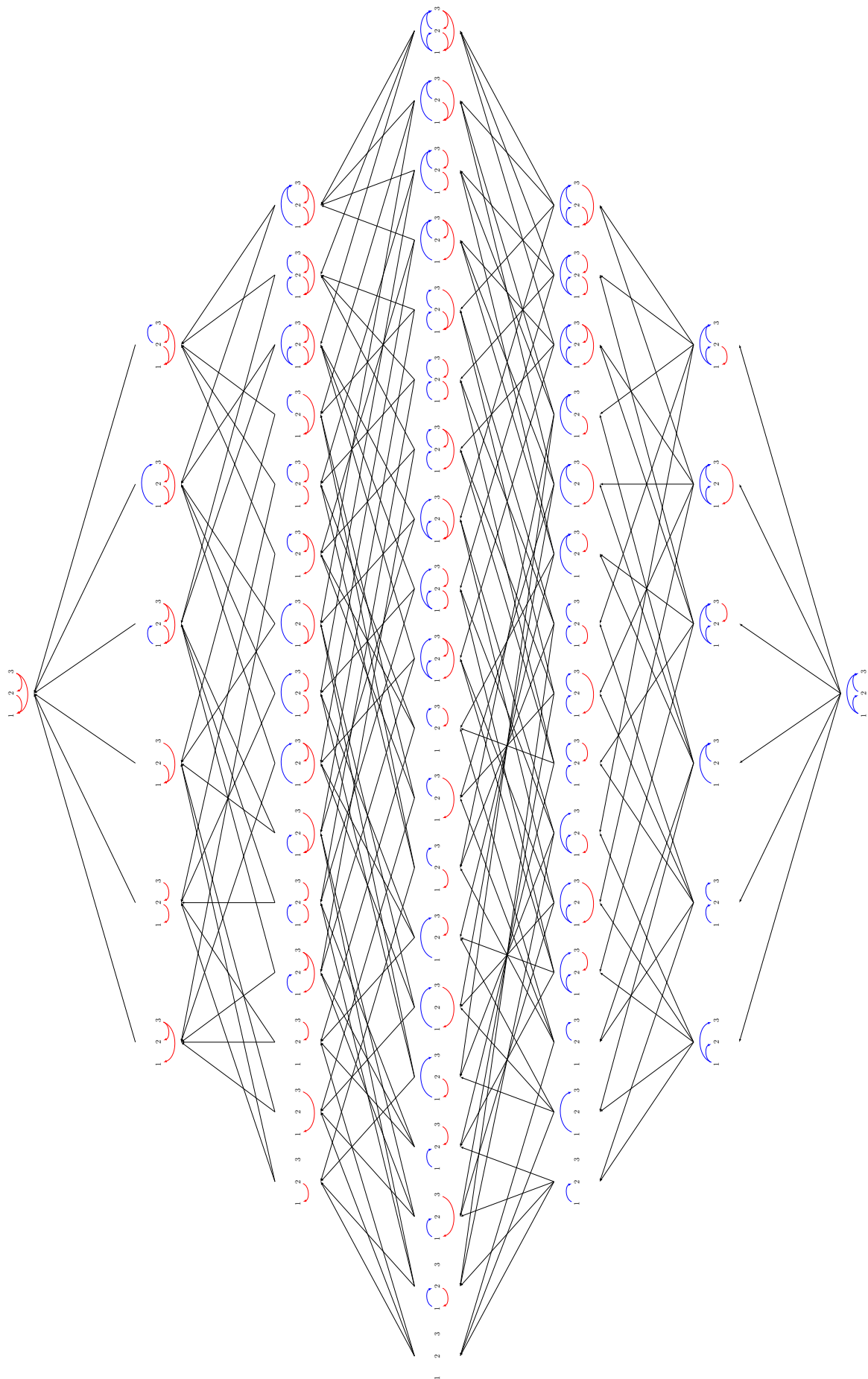

Figure 10.1: The weak order on (reflexive) integer binary relations of size 3. All reflexive relations (i, i) for $i \in [n]$ are omitted.

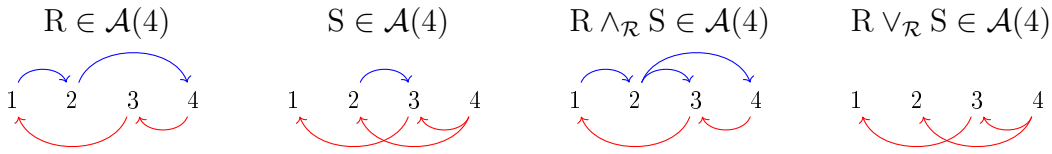

Figure 10.2: The meet $R \wedge_{\mathcal{R}} S$ and join $R \vee_{\mathcal{R}} S$ of two antisymmetric relations R, S .

Semitransitive relations

Note that the subposet $(\mathcal{T}(n), \preceq)$ of $(\mathcal{R}(n), \preceq)$ is not a sublattice since $\wedge_{\mathcal{R}}$ and $\vee_{\mathcal{R}}$ do not preserve transitivity (see *e.g.* Figure 10.4). The idea of G. Chatel, V. Pilaud and V. Pons [CPP17, Section 1.2] was therefore to transform $R \wedge_{\mathcal{R}} S$ to make it a transitive relation $R \wedge_{\mathcal{T}} S$. They proceeded in the two steps described below.

The first step is to introduce the intermediate notion of semitransitivity. A relation $R \in \mathcal{R}$ is called *semitransitive* when both R^{lnc} and R^{Dec} are transitive. We denote by $\mathcal{ST}(n)$ the collection of all semitransitive relations of size n . Figure 10.3 illustrates the following statement.

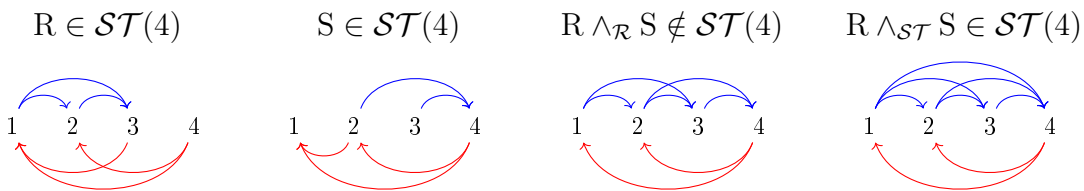

Figure 10.3: Two semi-transitive relations R, S and their meets $R \wedge_{\mathcal{R}} S$ and $R \wedge_{\mathcal{ST}} S$.

Proposition 10.1.4 ([CPP17, Proposition 8]). *The weak order on semi-transitive relations $(\mathcal{ST}(n), \preceq)$ is a lattice whose meet and join are given by*

$$R \wedge_{\mathcal{ST}} S = (R^{\text{lnc}} \cup S^{\text{lnc}})^{\text{tc}} \cup (R^{\text{Dec}} \cap S^{\text{Dec}}), \tag{10.7}$$

and
$$R \vee_{\mathcal{ST}} S = (R^{\text{lnc}} \cap S^{\text{lnc}}) \cup (R^{\text{Dec}} \cup S^{\text{Dec}})^{\text{tc}}. \tag{10.8}$$

Transitive relations

The second step is to pass from semitransitive to transitive relations. For $R \in \mathcal{R}$, define the *transitive decreasing deletion* of R as

$$R^{\text{td}} := R \setminus \{(b, a) \in R^{\text{Dec}} \mid \exists i \leq b \text{ and } j \geq a \text{ such that } i R b R a R j \text{ while } i \not R j\}, \tag{10.9}$$

and the *transitive increasing deletion* of R as

$$R^{\text{tid}} := R \setminus \{(a, b) \in R^{\text{lnc}} \mid \exists i \geq a \text{ and } j \leq b \text{ such that } i R a R b R j \text{ while } i \not R j\}. \tag{10.10}$$

Note that in these definitions, i and j may coincide with a and b since R is reflexive. Figure 10.4 illustrates the transitive decreasing deletion: the rightmost relation

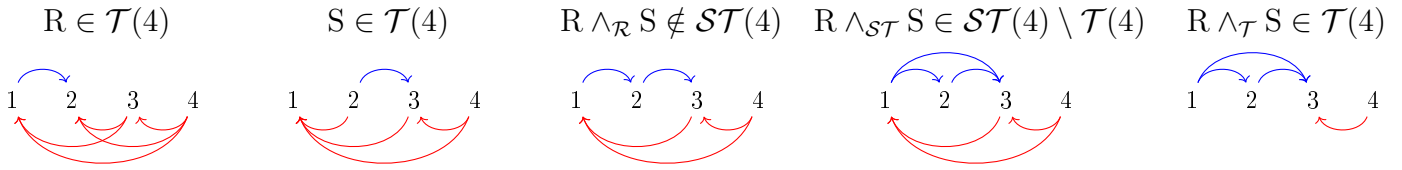

Figure 10.4: Two transitive relations R, S and their meets $R \wedge_{\mathcal{R}} S, R \wedge_{\mathcal{ST}} S$ and $R \wedge_{\mathcal{T}} S$.

$R \wedge_{\mathcal{T}} S$ is indeed obtained as $(R \wedge_{\mathcal{ST}} S)^{\text{tdd}}$. Observe that two decreasing relations have been deleted: $(3, 1)$ (take $i = 2$ and $j = 1$, or $i = 3$ and $j = 2$) and $(4, 1)$ (take $i = 4$ and $j = 2$). The idea of the transitive decreasing deletion is to delete all decreasing relations which prevent the binary relation to be transitive. We therefore have the following result:

Lemma 10.1.5 ([CPP17, Lemma 12]). *If $R \in \mathcal{R}$ is semitransitive, then R^{tdd} and R^{tid} are transitive.*

We use the maps $R \mapsto R^{\text{tdd}}$ and $R \mapsto R^{\text{tid}}$ to obtain the main result of this section. Figure 10.4 illustrates all steps of a meet computation in $\mathcal{T}(4)$.

Proposition 10.1.6 ([CPP17, Proposition 15]). *The weak order on transitive relations $(\mathcal{T}(n), \preceq)$ is a lattice whose meet and join are given by*

$$R \wedge_{\mathcal{T}} S = ((R^{\text{Inc}} \cup S^{\text{Inc}})^{\text{tc}} \cup (R^{\text{Dec}} \cap S^{\text{Dec}}))^{\text{tdd}}, \tag{10.11}$$

$$\text{and } R \vee_{\mathcal{T}} S = ((R^{\text{Inc}} \cap S^{\text{Inc}}) \cup (R^{\text{Dec}} \cup S^{\text{Dec}})^{\text{tc}})^{\text{tid}}. \tag{10.12}$$

Integer posets

We finally arrive to the subposet of the weak order induced by integer posets. The weak order on $\mathcal{P}(3)$ is illustrated in Figure 10.5. We now have all tools to show Theorem IV.1 announced in the introduction.

Proposition 10.1.7 ([CPP17, Proposition 18]). *The transitive meet $\wedge_{\mathcal{T}}$ and the transitive join $\vee_{\mathcal{T}}$ both preserve antisymmetry. In other words, $(\mathcal{P}(n), \preceq, \wedge_{\mathcal{T}}, \vee_{\mathcal{T}})$ is a sublattice of $(\mathcal{T}(n), \preceq, \wedge_{\mathcal{T}}, \vee_{\mathcal{T}})$.*

10.2 Weak order induced by some relevant families of posets

In this section we present how G. Chatel, V. Pilaud and V. Pons used Theorem IV.1 to revisit classical orders on some families of combinatorial objects [CPP17, Section 2]. The first observation is that many relevant combinatorial objects (for example permutations, binary trees, binary sequences, ...) can be interpreted by specific integer posets. We will see that the subposets of the weak order induced by these specific integer posets often correspond to classical lattice structures on these combinatorial objects (for example the classical weak order, the Tamari lattice, the boolean lattice, etc.). For each of these objects the authors gave:

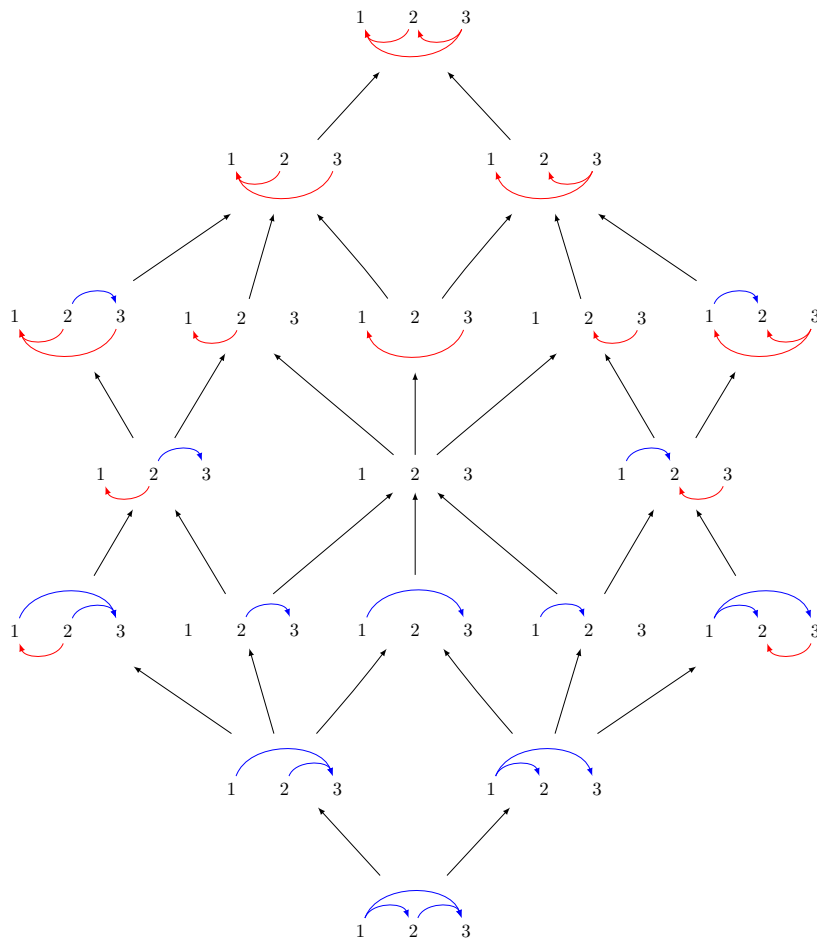

Figure 10.5: The weak order on integer posets of size 3.

- a combinatorial model using integer posets;
- a characterization of the resulting integer posets;
- a connection between the weak order induced by these posets and some classical order on the combinatorial objects;
- a detailed study of the lattice and sublattice properties of this order.

We follow them, and as we will only work with posets, we prefer to use the notation \triangleleft rather than R .

10.2.1 From the permutahedron

We start with relevant families of posets corresponding to the vertices, the intervals, and the faces of the permutahedron.

For $\sigma \in \mathfrak{S}_n$, we recall from Section 1.1.3 the definition of *inversion* and borrow from [KLR03] the definition of *version* defined as:

$$\text{Ver}(\sigma) := \{(a, b) \in [n]^2 \mid a \leq b \text{ and } \sigma^{-1}(a) \leq \sigma^{-1}(b)\}$$

$$\text{and } \text{Inv}(\sigma) := \{(b, a) \in [n]^2 \mid a \leq b \text{ and } \sigma^{-1}(a) \geq \sigma^{-1}(b)\}.$$

Clearly, the versions of σ determine the inversions of σ and *vice versa*. We have seen in Definition 1.1.6 that the *weak order* on \mathfrak{S}_n is defined as the inclusion order of inversions, or as the reverse inclusion order of the versions:

$$\sigma \preceq \tau \iff \text{Inv}(\sigma) \subseteq \text{Inv}(\tau) \iff \text{Ver}(\sigma) \supseteq \text{Ver}(\tau). \tag{10.13}$$

We denote by $\wedge_{\mathfrak{S}}$ and $\vee_{\mathfrak{S}}$ the meet and join of the weak order $(\mathfrak{S}_n, \preceq)$.

Weak Order Element Posets

A permutation $\sigma \in \mathfrak{S}_n$ is seen as a total order \triangleleft_{σ} on $[n]$ defined by $u \triangleleft_{\sigma} v$ if $\sigma^{-1}(u) \leq \sigma^{-1}(v)$ (i.e. u is before v in σ). In other words, \triangleleft_{σ} is the chain of relations $\sigma(1) \triangleleft_{\sigma} \dots \triangleleft_{\sigma} \sigma(n)$ as illustrated in Figure 10.6.

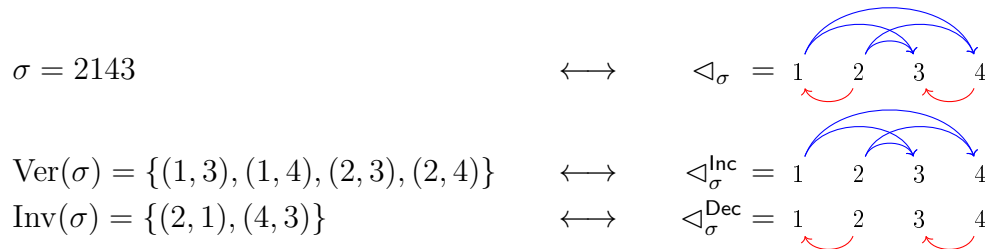

Figure 10.6: A Weak Order Element Poset (WOEP).

We say that \triangleleft_{σ} is a *weak order element poset*, and we denote by

$$\text{WOEP}(n) := \{\triangleleft_{\sigma} \mid \sigma \in \mathfrak{S}_n\} \tag{10.14}$$

the set of all total orders on $[n]$. The following characterization of these elements is immediate.

Proposition 10.2.1 ([CPP17, Proposition 22]). *A poset $\triangleleft \in \mathcal{P}(n)$ is in $\text{WOEP}(n)$ if and only if $\forall u, v \in [n]$, either $u \triangleleft v$ or $u \triangleright v$.*

The following proposition justifies the term “weak order” used in Definition 10.1.1:

Proposition 10.2.2 ([CPP17, Proposition 23]). *For any $\sigma \in \mathfrak{S}_n$, the increasing (resp. decreasing) relations of \triangleleft_{σ} are the versions (resp. the inversions) of σ : $\triangleleft_{\sigma}^{\text{Inc}} = \text{Ver}(\sigma)$ and $\triangleleft_{\sigma}^{\text{Dec}} = \text{Inv}(\sigma)$. Therefore, for any permutations $\sigma, \sigma' \in \mathfrak{S}_n$, we have $\sigma \preceq \sigma'$ if and only if $\triangleleft_{\sigma} \preceq \triangleleft_{\sigma'}$.*

Consequently, the subset of the weak order $(\mathcal{P}(n), \preceq)$ induced by the set $\text{WOEP}(n)$ is isomorphic to the weak order on \mathfrak{S}_n , and thus is a lattice. In fact we have the stronger statement:

Proposition 10.2.3 ([CPP17, Proposition 24]). *The set $\text{WOEP}(n)$ induces a sublattice of the weak order $(\mathcal{P}(n), \preceq, \wedge_{\mathcal{T}}, \vee_{\mathcal{T}})$.*

Weak Order Interval Posets

For two permutations $\sigma, \sigma' \in \mathfrak{S}_n$ with $\sigma \preceq \sigma'$, we denote by

$$[\sigma, \sigma'] := \{\tau \in \mathfrak{S}_n \mid \sigma \preceq \tau \preceq \sigma'\} \tag{10.15}$$

the weak order interval between σ and σ' . As illustrated in Figure 10.7, we can see such an interval as the set of linear extensions of a poset.

Proposition 10.2.4 ([CPP17, Proposition 25]). *The permutations of $[\sigma, \sigma']$ are precisely the linear extensions of the poset*

$$\triangleleft_{[\sigma, \sigma']} := \bigcap_{\sigma \preceq \tau \preceq \sigma'} \triangleleft_{\tau} = \triangleleft_{\sigma} \cap \triangleleft_{\sigma'} = \triangleleft_{\sigma'}^{\text{Inc}} \cup \triangleleft_{\sigma}^{\text{Dec}}. \tag{10.16}$$

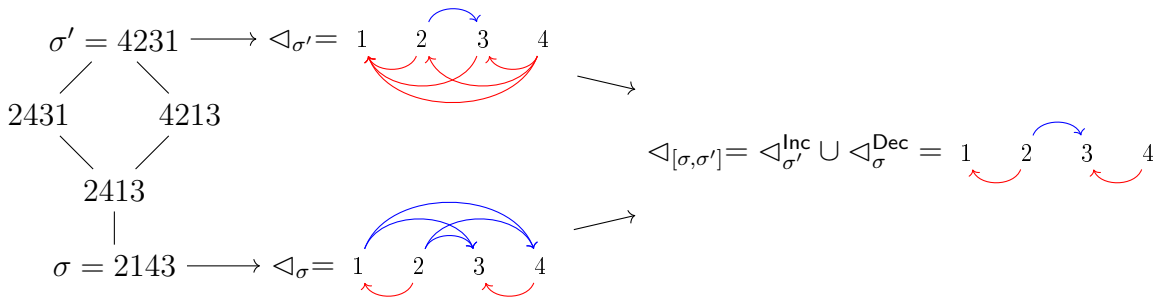

Figure 10.7: A Weak Order Interval Poset (WOIP).

We say that $\triangleleft_{[\sigma, \sigma']}$ is a *weak order interval poset*, and we denote by

$$\text{WOIP}(n) := \{\triangleleft_{[\sigma, \sigma']} \mid \sigma, \sigma' \in \mathfrak{S}_n, \sigma \preceq \sigma'\} \tag{10.17}$$

the set of all weak order interval posets on $[n]$. We get the following characterization of these posets:

Proposition 10.2.5 ([BW91, Theorem 6.8], [CPP17, Proposition 26]). *An integer poset $\triangleleft \in \mathcal{P}(n)$ is in $\text{WOIP}(n)$ if and only if $\forall a < b < c$,*

$$a \triangleleft c \implies a \triangleleft b \text{ or } b \triangleleft c \quad \text{and} \quad a \triangleright c \implies a \triangleright b \text{ or } b \triangleright c. \tag{10.18}$$

We now describe the weak order on $\text{WOIP}(n)$.

Proposition 10.2.6 ([CPP17, Proposition 27]). *For any $\sigma \preceq \sigma'$ and $\tau \preceq \tau'$:*

$$\triangleleft_{[\sigma, \sigma']} \preceq \triangleleft_{[\tau, \tau']} \iff \sigma \preceq \tau \text{ and } \sigma' \preceq \tau'. \tag{10.19}$$

It follows that $(\text{WOIP}(n), \preceq)$ gets the lattice structure of a product, described in the next statement. Another description of the order is given in the paper [CPP17, Section 2.1.4]. It consisted on defining a new operation compatible with the weak order in the same vein as the previously defined *transitive decreasing deletion*. We refer there for more details.

Corollary 10.2.7 ([CPP17, Proposition 28]). *The weak order $(\text{WOIP}(n), \preceq)$ is a lattice whose meet and join are given by*

$$\triangleleft_{[\sigma, \sigma']} \wedge_{\text{WOIP}} \triangleleft_{[\tau, \tau']} = \triangleleft_{[\sigma \wedge_{\mathfrak{S}\tau}, \sigma' \wedge_{\mathfrak{S}\tau'}]} \tag{10.20}$$

and
$$\triangleleft_{[\sigma, \sigma']} \vee_{\text{WOIP}} \triangleleft_{[\tau, \tau']} = \triangleleft_{[\sigma \vee_{\mathfrak{S}\tau}, \sigma' \vee_{\mathfrak{S}\tau'}]}. \tag{10.21}$$

Note however that the lattice $(\text{WOIP}(n), \preceq, \wedge_{\text{WOIP}}, \vee_{\text{WOIP}})$ is not a sublattice of $(\mathcal{P}(n), \preceq, \wedge_{\mathcal{T}}, \vee_{\mathcal{T}})$. For example,

$$\triangleleft_{[231, 321]} \wedge_{\mathcal{T}} \triangleleft_{[312, 321]} = \begin{array}{c} 1 \quad 2 \quad 3 \\ \curvearrowright \quad \curvearrowright \end{array} \wedge_{\mathcal{T}} \begin{array}{c} 1 \quad 2 \quad 3 \\ \curvearrowright \quad \curvearrowright \end{array} = \begin{array}{c} 1 \quad 2 \quad 3 \\ \curvearrowright \end{array}$$

while $\triangleleft_{[231, 321]} \wedge_{\text{WOIP}} \triangleleft_{[312, 321]} = \triangleleft_{[123, 321]} = \emptyset$ (trivial poset on $[3]$).

Weak Order Face Posets

We now come back to some notions we introduced in Section 2.1.7. As seen previously, the permutations of \mathfrak{S}_n correspond to the vertices of the permutahedron $\text{Perm}(n)$, and we now consider all the faces of the permutahedron, what we called previously *standard parabolic cosets*. We give here another description of these faces. The codimension k faces of $\text{Perm}(n)$ correspond to *ordered partitions* of $[n]$ into k parts, or equivalently to *surjections* from $[n]$ to $[k]$, see Figure 1.15. We see an ordered partition π as a poset \triangleleft_{π} on $[n]$ defined by $u \triangleleft_{\pi} v$ if and only if $u = v$ or $\pi^{-1}(u) < \pi^{-1}(v)$, that is, the part of π containing u appears strictly before the part of π containing v . See Figure 10.8. Note that a permutation σ belongs to the face of the permutahedron $\text{Perm}(n)$ corresponding to an ordered partition π if and only if \triangleleft_{σ} is a linear extension of \triangleleft_{π} .

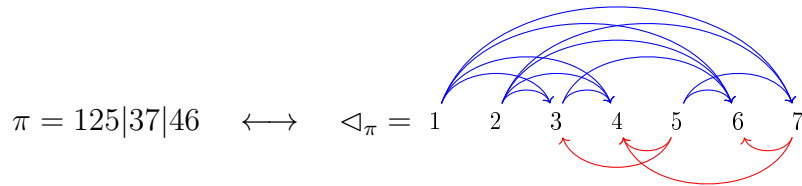

Figure 10.8: A Weak Order Face Poset (WOFP).

We say that \triangleleft_{π} is a *weak order face poset*, and we denote by

$$\text{WOFP}(n) := \{ \triangleleft_{\pi} \mid \pi \text{ ordered partition of } [n] \} \tag{10.22}$$

the set of all weak order face posets on $[n]$. We first characterize these posets.

Proposition 10.2.8 ([CPP17, Proposition 30]). *The following conditions are equivalent for a poset $\triangleleft \in \mathcal{P}(n)$:*

- (i) $\triangleleft \in \text{WOFP}(n)$,
- (ii) $\forall u, v, w \in [n], \quad u \triangleleft w \implies u \triangleleft v \text{ or } v \triangleleft w$,
- (iii) $\triangleleft \in \text{WOIP}(n)$ and for all $a < b < c$ with a, c incomparable in \triangleleft :

$$a \triangleleft b \iff b \triangleright c \text{ and } a \triangleright b \iff b \triangleleft c. \tag{10.23}$$

We now consider the weak order on $\text{WOFP}(n)$, which happens to be precisely the *facial weak order* on the permutahedron $\text{Perm}(n)$ studied by A. Dermeniĵian, C. Hohlweg and V. Pilaud in [DHP18]. Figure 2.9 illustrates this order, and was borrowed from the latter article. The authors proved in particular that this order coincides with the *pseudo-permutahedron* originally defined by D. Krob, M. Latapy, J.-C. Novelli, H.-D. Phan and S. Schwer [Kro+01] on ordered partitions as the transitive closure of the relations

$$\lambda_1 | \cdots | \lambda_i | \lambda_{i+1} | \cdots | \lambda_k \prec \lambda_1 | \cdots | \lambda_i \lambda_{i+1} | \cdots | \lambda_k \prec \lambda_1 | \cdots | \lambda_{i+1} | \lambda_i | \cdots | \lambda_k, \tag{10.24}$$

if $\max(\lambda_i) < \min(\lambda_{i+1})$. This order is known to be a lattice [DHP18; Kro+01].

Note however that the lattice $(\text{WOFP}(n), \preceq, \wedge_{\text{WOFP}}, \vee_{\text{WOFP}})$ is not a sublattice of $(\mathcal{P}(n), \preceq, \wedge_{\mathcal{T}}, \vee_{\mathcal{T}})$, nor a sublattice of $(\text{WOIP}(n), \preceq, \wedge_{\text{WOIP}}, \vee_{\text{WOIP}})$. For example,

$$\triangleleft_{2|13} \wedge_{\mathcal{T}} \triangleleft_{123} = \triangleleft_{2|13} \wedge_{\text{WOIP}} \triangleleft_{123} = \{(2, 3)\} \tag{10.25}$$

while

$$\triangleleft_{2|13} \wedge_{\text{WOFP}} \triangleleft_{123} = \triangleleft_{12|3} = \{(1, 3), (2, 3)\}. \tag{10.26}$$

10.2.2 From the associahedron

Similarly to the previous section, we now briefly discuss some relevant families of posets corresponding to the elements, the intervals, and the faces of the associahedron defined in Section 1.6.2. We denote by $\mathfrak{B}(n)$ the set of *rooted binary trees* with n nodes. As explained in Section 1.6, the vertices of a tree $T \in \mathfrak{B}(n)$ are labeled in a standard way, and we identify a vertex and its label. We described also an algorithm to associate to every permutation σ a *standard binary search tree* $\text{BST}(\sigma)$, so that the fiber of a tree T is precisely the set of linear extensions of T . Therefore it is an interval of the weak order whose minimal and maximal elements respectively avoid the patterns 312 and 132. Moreover, we saw that these fibers define a lattice congruence of the weak order and that the set $\mathfrak{B}(n)$ of binary trees is thus endowed with a lattice structure \preceq defined by

$$T \preceq T' \iff \exists \sigma, \sigma' \in \mathfrak{S}_n \text{ such that } \text{BST}(\sigma) = T, \text{BST}(\sigma') = T' \text{ and } \sigma \preceq \sigma' \tag{10.27}$$

whose meet $\wedge_{\mathfrak{B}}$ and join $\vee_{\mathfrak{B}}$ are given by

$$T \wedge_{\mathfrak{B}} T' = \text{BST}(\sigma \wedge_{\mathfrak{S}} \sigma') \quad \text{and} \quad T \vee_{\mathfrak{B}} T' = \text{BST}(\sigma \vee_{\mathfrak{S}} \sigma') \tag{10.28}$$

for any representatives $\sigma, \sigma' \in \mathfrak{S}_n$ such that $\text{BST}(\sigma) = T$ and $\text{BST}(\sigma') = T'$. This lattice structure is the already seen *Tamari lattice* (see Section 1.6).

Tamari Order Element Posets

We consider the tree T as a poset \triangleleft_T , defined by $i \triangleleft_T j$ when i is a child of j in T . In other words, the Hasse diagram of \triangleleft_T is the tree T oriented towards its root, as illustrated in Figure 10.9.

We say that \triangleleft_T is a *Tamari order element poset*, and we denote by

$$\text{TOEP}(n) := \{ \triangleleft_T \mid T \in \mathfrak{B}(n) \} \tag{10.29}$$

the set of all Tamari order element posets on $[n]$. We first characterize them:

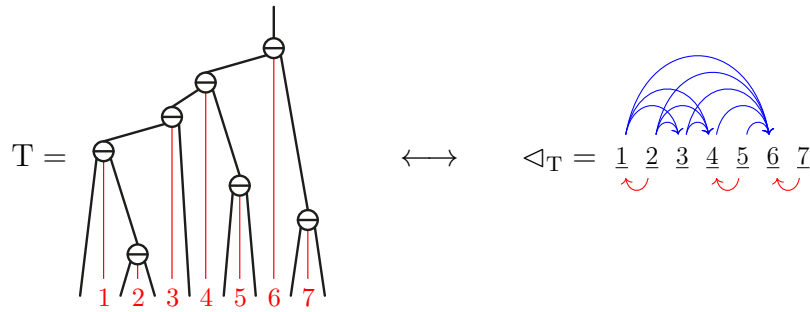

Figure 10.9: A Tamari Order Element Poset (TOEP).

Proposition 10.2.9 ([CPP17, Proposition 39]). *A poset $\triangleleft \in \mathcal{P}(n)$ is in $\text{TOEP}(n)$ if and only if*

- $\forall a < b < c, a \triangleleft c \implies b \triangleleft c$ and $a \triangleright c \implies a \triangleright b$,
- for all $a < c$ incomparable in \triangleleft , there exists $a < b < c$ such that $a \triangleleft b \triangleright c$.

Now we connect the Tamari order on $\mathfrak{B}(n)$ to the weak order on $\text{TOEP}(n)$:

Proposition 10.2.10 ([CPP17, Proposition 40]). *For any binary trees $T, T' \in \mathfrak{B}(n)$ we have $T \preceq T'$ in the Tamari lattice if and only if $\triangleleft_T \preceq \triangleleft_{T'}$ in the weak order on posets.*

It follows that the subposet of the weak order (\mathcal{P}, \preceq) induced by the set $\text{TOEP}(n)$ is isomorphic to the Tamari lattice on $\mathfrak{B}(n)$, and is thus a lattice. Finally we have on $\text{TOEP}(n)$ the following stronger statement:

Proposition 10.2.11 ([CPP17, Proposition 41]). *The set $\text{TOEP}(n)$ induces a sublattice of the weak order lattice $(\mathcal{P}(n), \preceq, \wedge_{\mathcal{T}}, \vee_{\mathcal{T}})$.*

Tamari Order Interval Posets

As we did for permutations, for two binary trees $T, T' \in \mathfrak{B}(n)$ with $T \preceq T'$, we denote by $[T, T'] := \{S \in \mathfrak{B}(n) \mid T \preceq S \preceq T'\}$ the Tamari order interval between T and T' . We can see this interval as the poset

$$\triangleleft_{[T, T']} := \bigcap_{T \preceq S \preceq T'} \triangleleft_S = \triangleleft_T \cap \triangleleft_{T'} = \triangleleft_{T'}^{\text{Inc}} \cap \triangleleft_T^{\text{Dec}}. \tag{10.30}$$

This poset $\triangleleft_{[T, T']}$ was introduced in [CP15] with the motivation that its linear extensions are precisely the linear extensions of all binary trees in the interval $[T, T']$. We say that $\triangleleft_{[T, T']}$ is a *Tamari order interval poset*, and we denote by

$$\text{TOIP}(n) := \{ \triangleleft_{[T, T']} \mid T, T' \in \mathfrak{B}(n), T \preceq T' \} \tag{10.31}$$

the set of all Tamari order interval posets on $[n]$. We have the following characterization of these posets:

Proposition 10.2.12 ([CP15, Theorem 2.8], [CPP17, Corollary 42]). *An integer poset $\triangleleft \in \mathcal{P}(n)$ is in $\text{TOIP}(n)$ if and only if for all $a < b < c$,*

$$a \triangleleft c \implies b \triangleleft c \quad \text{and} \quad a \triangleright c \implies a \triangleright b. \tag{10.32}$$

We now describe the weak order on $\text{TOIP}(n)$:

Proposition 10.2.13 ([CPP17, Proposition 43]). *For any $S \preceq S'$ and $T \preceq T'$*

$$\triangleleft_{[S,S']} \preceq \triangleleft_{[T,T']} \iff S \preceq T \text{ and } S' \preceq T'. \tag{10.33}$$

Proposition 10.2.14 ([CPP17, Corollary 44]). *The weak order $(\text{TOIP}(n), \preceq)$ is a lattice whose meet and join are given by*

$$\triangleleft_{[S,S']} \wedge_{\text{TOIP}} \triangleleft_{[T,T']} = \triangleleft_{[S \wedge_{\mathfrak{B}} T, S' \wedge_{\mathfrak{B}} T']} \tag{10.34}$$

$$\triangleleft_{[S,S']} \vee_{\text{TOIP}} \triangleleft_{[T,T']} = \triangleleft_{[S \vee_{\mathfrak{B}} T, S' \vee_{\mathfrak{B}} T']}. \tag{10.35}$$

In fact, G. Chatel, V. Pilaud and V. Pons derived the following statement:

Proposition 10.2.15 ([CPP17, Proposition 45]). *The set $\text{TOIP}(n)$ induces a sublattice of the weak order $(\mathcal{P}(n), \preceq, \wedge_{\mathcal{T}}, \vee_{\mathcal{T}})$.*

Tamari Order Face Posets

It would be natural now to do the same thing that was done in Section 10.2.1, and consider the faces of the associahedron $\text{Asso}(n)$ constructed *e.g.* by J.-L. Loday in [Lod04]. As explained in Section 1.6.2, its vertices correspond to the binary trees of $\mathfrak{B}(n)$. We now consider all the faces of the associahedron $\text{Asso}(n)$ which correspond to *Schröder trees*, *i.e.* rooted trees where each node has either none or at least two children. Given a Schröder tree S , we label the angles between consecutive children of the vertices of S in inorder, meaning that each angle is labeled after the angles in its left child and before the angles in its right child. Note that a binary tree T belongs to the face of the associahedron $\text{Asso}[n]$ corresponding to a Schröder tree S if and only if S is obtained by edge contractions in T . The set of such binary trees is an interval $[T^{\min}(S), T^{\max}(S)]$ in the Tamari lattice, where the minimal (resp. maximal) tree $T^{\min}(S)$ (resp. $T^{\max}(S)$) is obtained by replacing the nodes of S by left (resp. right) combs as illustrated in Figure 10.10.

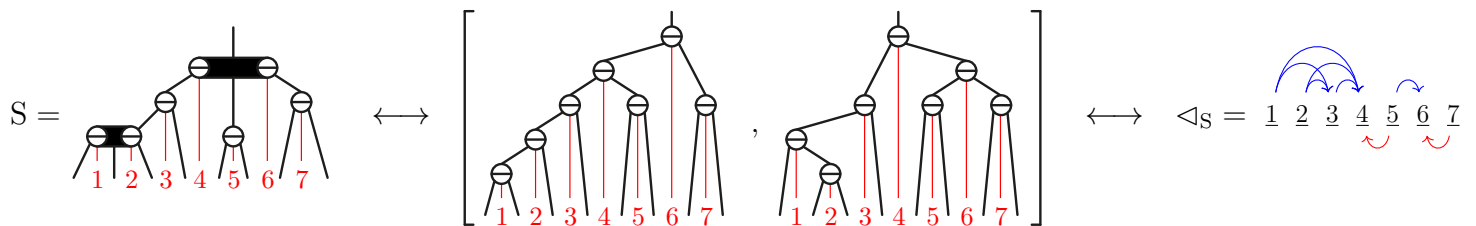

Figure 10.10: A Tamari Order Face Poset (TOFP).

We associate to a Schröder tree S the poset $\triangleleft_S := \triangleleft_{[T^{\min}(S), T^{\max}(S)]}$. Equivalently, $i \triangleleft_S j$ if and only if the angle i belongs to the left or the right child of the angle j . See Figure 10.10. Note that

- a binary tree T belongs to the face of the associahedron $\text{Asso}(n)$ corresponding to a Schröder tree S if and only if \triangleleft_T is an extension of \triangleleft_S , and
- the linear extensions of \triangleleft_S are precisely the linear extensions of \triangleleft_T for all binary trees T which belong to the face of the associahedron $\text{Asso}(n)$ corresponding to S .

We say that \triangleleft_S is a *Tamari order face poset*, and we denote by

$$\text{TOFP}(n) := \{ \triangleleft_S \mid S \text{ Schröder tree on } [n] \} \tag{10.36}$$

the set of all Tamari order face posets. We first give the characterization of these posets:

Proposition 10.2.16 ([CPP17, Proposition 46]). *A poset $\triangleleft \in \mathcal{P}(n)$ is in $\text{TOFP}(n)$ if and only if $\triangleleft \in \text{TOIP}(n)$ and for all $a < c$ incomparable in \triangleleft , either there exists $a < b < c$ such that $a \not\triangleright b \triangleleft c$, or for all $a < b < c$ we have $a \triangleright b \triangleleft c$.*

G. Chatel, V. Pilaud and V. Pons also proved that the weak order on $\text{TOFP}(n)$ on Schröder trees coincides with the *facial weak order* on the associahedron $\text{Asso}[n]$ studied in [PR06; NT06; DHP18]. This order is a quotient of the facial weak order on the permutahedron by the fibers of the Schröder tree insertion ST . In particular, the weak order on $\text{TOFP}(n)$ is a lattice.

The example of Equation 10.25 shows that $(\text{TOFP}(n), \preceq, \wedge_{\text{TOFP}}, \vee_{\text{TOFP}})$ is not a sublattice of $(\mathcal{P}(n), \preceq, \wedge_{\mathcal{T}}, \vee_{\mathcal{T}})$, nor a sublattice of $(\text{WOIP}(n), \preceq, \wedge_{\text{WOIP}}, \vee_{\text{WOIP}})$, nor a sublattice of $(\text{TOIP}(n), \preceq, \wedge_{\text{TOIP}}, \vee_{\text{TOIP}})$.

10.2.3 From other associahedra

Cambrian lattice

In Section 1.6 we introduced the binary trees, the Tamari order, and Loday’s associahedron [Lod04]. In [Rea06; RS09], N. Reading introduced a natural generalization to Cambrian lattices, and their polytopal realizations were later constructed by C. Hohlweg, C. Lange and H. Thomas [HL07; HLT11]. We follow [CP14] in this description and borrow their pictures with permission. We will focus on type A in the following description.

Consider a directed tree T on a vertex set V with $|V| = n$, and a vertex $v \in V$. As for binary trees, *children* (resp. *parents*) of v are the sources of the incoming arcs (resp. the targets of the outgoing arcs) at v , and *descendants* (resp. *ancestors*) *subtrees* of v the subtrees attached to them. The new object is the following:

Definition 10.2.17. *A Cambrian tree is a directed tree T with vertex set V endowed with a bijective vertex labeling $p : V \rightarrow [n]$ such that for each vertex $v \in V$:*

- (i) v has either one parent and two children (its descendant subtrees are called *left and right subtrees*) or one child and two parents (its ancestor subtrees are called *left and right subtrees*),
- (ii) all labels are smaller (resp. larger) than $p(v)$ in the left (resp. right) subtree of v .

The signature of T is the n -tuple $\varepsilon(T) \in \{+, -\}^n$ defined by $\varepsilon(T)_{p(v)} = -$ if v has two children and $\varepsilon(T)_{p(v)} = +$ if v has two parents. We denote by $\text{Camb}(n, \varepsilon)$ the set of all Cambrian trees on n vertices with signature ε

For instance the standard binary search trees are the Cambrian trees of signature $- - \dots -$. If T is a Cambrian tree and v a vertex of T with $\varepsilon(T)_{p(v)} = -$ (resp. $+$), we represent a “wall” under v (resp. above v) to separate its right and left subtrees, as represented in Figures 10.9 and 10.11. We define the signature on elements of $[n]$ by $\varepsilon(i) = \varepsilon(T)_i$.

A Cambrian tree T being a directed tree, it is naturally a poset on $[n]$. We denote by $\mathcal{E}(T)$ the set of permutations of size n which are linear extensions of the Cambrian tree T seen as a poset on $[n]$.

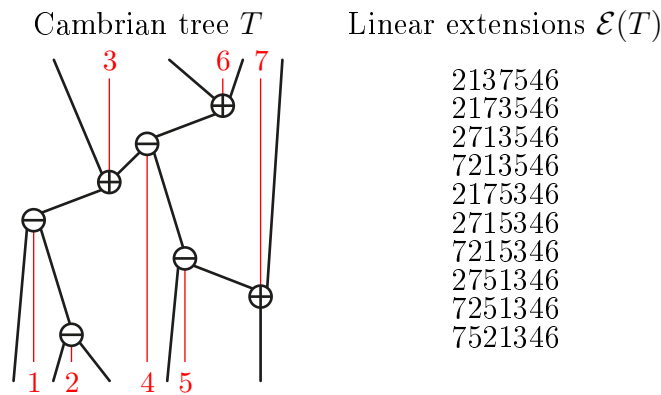

Figure 10.11: A Cambrian tree (left) and its linear extensions (right).

As in the case of binary trees, we have an operation called *rotation*, which maps a Cambrian tree to another Cambrian tree with the same signature. The main difference with the case of the binary trees is that rotations depend on the signs of the nodes involved. In Figure 10.12 we represent all cases, and recognize the classical rotation on binary trees when both signs are negative. The rotations are the cover relations of the *Cambrian order*.

Reading proved [Rea06] that Cambrian orders are lattices over the Cambrian trees of a given signature ε . Note that the first and last signs of the signature ε are not important regarding the Cambrian lattice. Compare Figure 1.19 which is the Cambrian lattice with signature $- - - -$ with the right one of Figure 10.13 of signature $+ - - -$.

Weak order on Cambrian trees

The end of this section is not in the original article [CPP17], but can be extracted from their general study on *permutrees*.

As explained in the previous paragraph, a Cambrian tree T corresponds to the following partial order \triangleleft_T on $[n]$ (see also Figure 10.14):

$$\triangleleft_T := \{i \triangleleft j \mid \exists \text{ an oriented path } i \rightarrow j \text{ in } T\}. \quad (10.37)$$

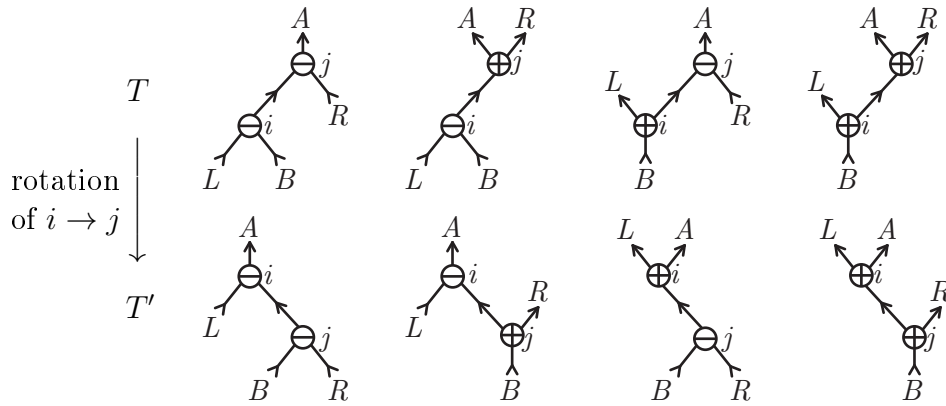

Figure 10.12: Rotations in Cambrian trees: the tree T (top) is transformed into the tree T' (bottom) by rotation of the edge $i \rightarrow j$. The four cases correspond to the possible signs of i and j .

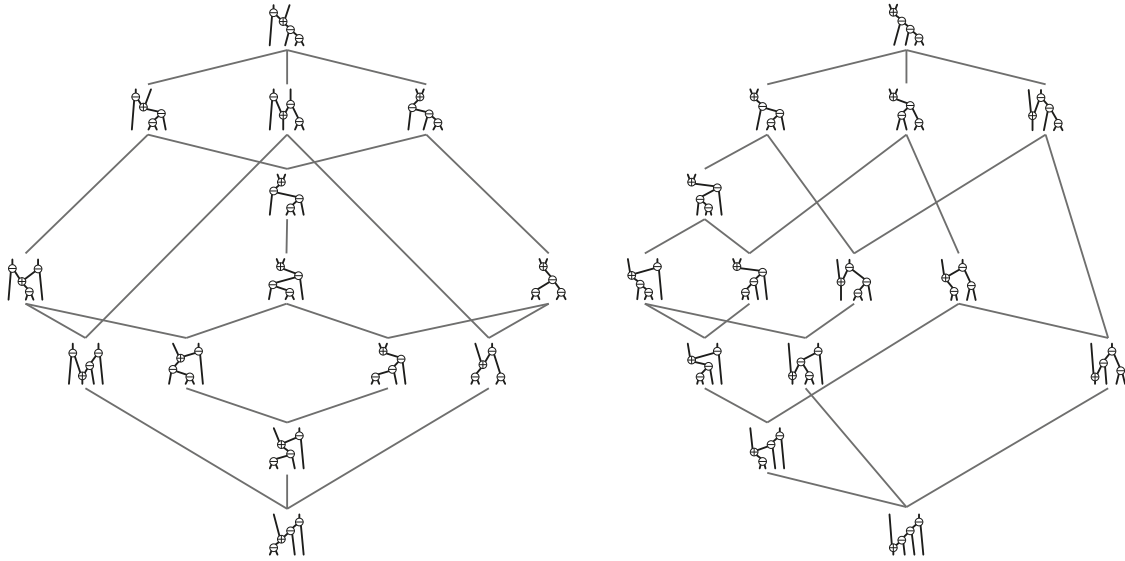

Figure 10.13: The ε -Cambrian lattices on ε -Cambrian trees, for the signatures $\varepsilon = - + --$ (left) and $\varepsilon = + - --$ (right).

In other words, \triangleleft_T is the transitive closure of the oriented tree T .

We say that \triangleleft_T is a *Cambrian order element poset*, and we denote their set by:

$$\text{COEP}(\varepsilon) := \{ \triangleleft_T \mid T \in \text{Camb}(\varepsilon) \}. \tag{10.38}$$

We have the following result on the comparisons of order:

Proposition 10.2.18 ([CPP17, Proposition 50]). *For any two Cambrian trees $T, T' \in \text{Camb}(\varepsilon)$, we have $T \preceq T'$ in the Cambrian lattice if and only if $\triangleleft_T \preceq \triangleleft_{T'}$ in the weak order on posets.*

Contrary to what we did for the permutahedron and classical associahedron we begin by the study of the intervals, as its characterization is easier.

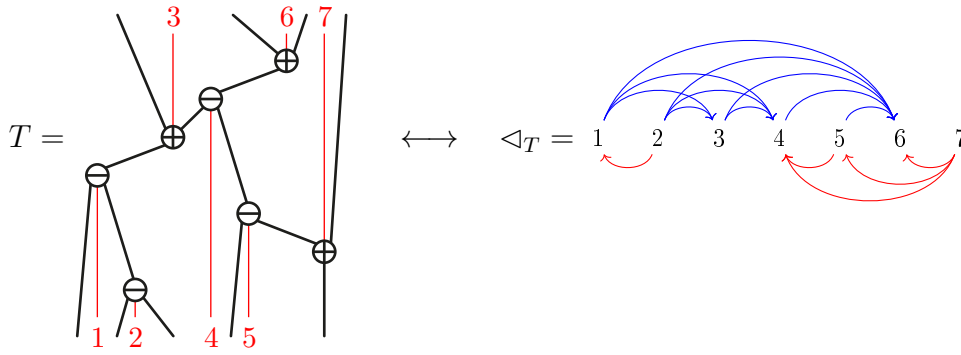

Figure 10.14: A Cambrian Order Element Poset (COEP).

Cambrian Order Interval Posets

For two Cambrian trees $T, T' \in \text{Camb}(\varepsilon)$ with $T \preceq T'$, we denote the Cambrian order interval between T and T' by $[T, T'] := \{S \in \text{Camb}(\varepsilon) \mid T \preceq S \preceq T'\}$. We see this interval as the poset

$$\triangleleft_{[T, T']} := \bigcap_{T \preceq S \preceq T'} \triangleleft_S = \triangleleft_T \cap \triangleleft_{T'} = \triangleleft_{T'}^{\text{Inc}} \cap \triangleleft_T^{\text{Dec}}. \tag{10.39}$$

We say that $\triangleleft_{[T, T']}$ is a *Cambrian order interval poset*, and we denote by

$$\text{COIP}(\varepsilon) := \{ \triangleleft_{[T, T']} \mid T, T' \in \text{Camb}(\varepsilon), T \preceq T' \} \tag{10.40}$$

the set of all Cambrian order interval posets with signature ε . We have the following characterization of these posets:

Proposition 10.2.19 ([CPP17, Corollary 55]). *A poset $\triangleleft \in \mathcal{P}(n)$ is in $\text{COIP}(\varepsilon)$ if and only if for all $a < b < c$,*

$$a \triangleleft c \implies \begin{cases} a \triangleleft b & \text{if } \varepsilon(b) = +, \\ b \triangleleft c & \text{if } \varepsilon(b) = -; \end{cases} \tag{10.41}$$

$$\text{and} \quad a \triangleright c \implies \begin{cases} b \triangleright c & \text{if } \varepsilon(b) = +, \\ a \triangleright b & \text{if } \varepsilon(b) = -. \end{cases} \tag{10.42}$$

This last statement should be compared with Corollary 10.2.12 which gives the characterization of TOIP. We now describe the weak order on $\text{COIP}(\varepsilon)$:

Proposition 10.2.20 ([CPP17, Proposition 57]). *For any $S \preceq S'$ and $T \preceq T'$*

$$\triangleleft_{[S, S']} \preceq \triangleleft_{[T, T']} \iff S \preceq T \text{ and } S' \preceq T'. \tag{10.43}$$

Corollary 10.2.21 ([CPP17, Corollary 58]). *For any signature $\varepsilon \in \{1, -1\}^n$, the weak order $(\text{COIP}(\varepsilon), \preceq)$ is a lattice whose meet and join are given by*

$$\triangleleft_{[S, S']} \wedge_{\text{COIP}(\varepsilon)} \triangleleft_{[T, T']} = \triangleleft_{[S \wedge_{\text{Camb} T}, S' \wedge_{\text{Camb} T'}]} \tag{10.44}$$

$$\text{and} \quad \triangleleft_{[S, S']} \vee_{\text{COIP}(\varepsilon)} \triangleleft_{[T, T']} = \triangleleft_{[S \vee_{\text{Camb} T}, S' \vee_{\text{Camb} T'}]}. \tag{10.45}$$

Furthermore, we also have the following results:

Proposition 10.2.22 ([CPP17, Theorem 81 and 84]). *For any signature $\varepsilon \in \{1, -1\}^n$ the set $\text{COIP}(\varepsilon)$ induces a sublattice of the weak order $(\mathcal{P}(n), \preceq, \wedge_{\mathcal{T}}, \vee_{\mathcal{T}})$ and also of $(\text{WOIP}(n), \preceq, \wedge_{\text{WOIP}}, \vee_{\text{WOIP}})$.*

Cambrian Order Element Posets

We now consider the Cambrian order element posets defined in Equation 10.2.3 and want to characterize them. We need a last definition, illustrated in Figure 10.15

Definition 10.2.23 ([CPP17, Section 2.3.3]). *For $\varepsilon \in \{+, -\}^n$ and $a, b \in [n]$, an ε -snake is a sequence $x_0 < x_1 < \dots < x_k < x_{k+1}$ such that:*

- *either $x_0 \triangleleft x_1 \triangleright x_2 \triangleleft x_3 \triangleright \dots$ such that for all $i \in [k]$, $\begin{cases} \varepsilon(i) = - & \text{if } i \text{ is odd,} \\ \varepsilon(i) = + & \text{if } i \text{ is even.} \end{cases}$*
- *or $x_0 \triangleright x_1 \triangleleft x_2 \triangleright x_3 \triangleleft \dots$ such that for all $i \in [k]$, $\begin{cases} \varepsilon(i) = + & \text{if } i \text{ is odd,} \\ \varepsilon(i) = - & \text{if } i \text{ is even.} \end{cases}$*

Such a snake is said to join x_0 and x_{k+1} .

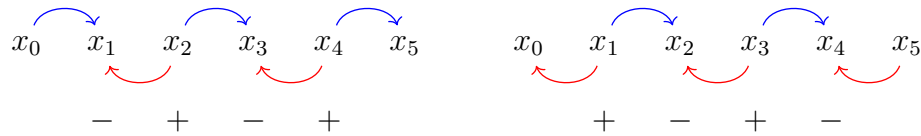

Figure 10.15: Two ε -snakes.

We finally get the following characterization:

Proposition 10.2.24 ([CPP17, Proposition 60]). *A poset $\triangleleft \in \mathcal{P}(n)$ is in $\text{COEP}(\varepsilon)$ if and only if $\triangleleft \in \text{COIP}(\varepsilon)$ and for every $a, b \in [n]$ there is a ε -snake joining a to b .*

Furthermore, we also have the following result:

Proposition 10.2.25 ([CPP17, Theorem 88]). *For any signature $\varepsilon \in \{1, -1\}^n$ the set $\text{COEP}(\varepsilon)$ induces a sublattice of the weak order $(\mathcal{P}(n), \preceq, \wedge_{\mathcal{T}}, \vee_{\mathcal{T}})$.*

Cambrian Order Face Posets

We will not give the rules for the faces of the Cambrian order. They are a mix between *Cambrian trees* and *Schröder trees*. We refer to [CPP17] for details.

10.2.4 From the cube

This last part is also not in the original article [CPP17], but can be extracted from their general study on *permutrees* and *permutreehedra* (see also [PP16] for a definition). The figures were made using theirs as a basis.

We denote by $\mathcal{B}(n)$ the set of all *binary sequences* of size n which are vertices of the n -dimensional cube. We shall represent them as a sequence of plus (+) and

minus (-). To every binary sequence $\mathbf{b} = \mathbf{b}_1\mathbf{b}_2 \dots \mathbf{b}_n \in \mathcal{B}(n)$ we associate its *binary set*:

$$\text{Bset}(\mathbf{b}) := \{i \mid \mathbf{b}_i = \text{"-"}\}. \tag{10.46}$$

The *boolean order* on binary sequences is just the inclusion on binary sets, its minimum being the sequence $+\dots+$ and the maximum being $-\dots-$.

A binary sequence $\mathbf{b} = \mathbf{b}_1\mathbf{b}_2 \dots \mathbf{b}_n$ of size n is seen as a poset $\triangleleft_{\mathbf{b}}$ on $[n+1]$ defined by the cover relations $i \triangleleft_{\mathbf{b}} (i+1)$ if $\mathbf{b}_i = \text{"+"}$ and $i \triangleright_{\mathbf{b}} (i+1)$ if $\mathbf{b}_i = \text{"-"}$, as illustrated in Figure 10.16.

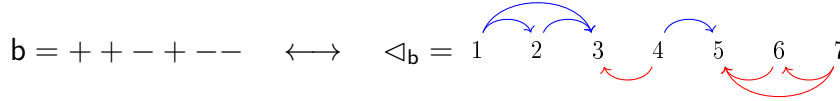

Figure 10.16: A Boolean Order Element Poset (BOEP).

We say that $\triangleleft_{\mathbf{b}}$ is a *boolean order element poset*, and we denote their set by:

$$\text{BOEP}(n) := \{\triangleleft_{\mathbf{b}} \mid \mathbf{b} \in \mathcal{B}(n-1)\}. \tag{10.47}$$

We have the following proposition:

Proposition 10.2.26. *For any binary sequences $\mathbf{b}, \mathbf{b}' \in \mathcal{B}(n)$ we have $\mathbf{b} \preceq \mathbf{b}'$ in the boolean lattice if and only if $\triangleleft_{\mathbf{b}} \preceq \triangleleft_{\mathbf{b}'}$ in the weak order on posets.*

As for the Cambrian order, we begin by the study of the intervals, as its characterization is easier.

Boolean Order Interval Posets

For two binary sequences $\mathbf{b}, \mathbf{b}' \in \mathcal{B}(n)$ with $\mathbf{b} \preceq \mathbf{b}'$, we denote the boolean order interval between \mathbf{b} and \mathbf{b}' by $[\mathbf{b}, \mathbf{b}'] := \{\mathbf{c} \in \mathcal{B}(n) \mid \mathbf{b} \preceq \mathbf{c} \preceq \mathbf{b}'\}$. We see this interval as the poset

$$\triangleleft_{[\mathbf{b}, \mathbf{b}']} := \bigcap_{\mathbf{b} \preceq \mathbf{c} \preceq \mathbf{b}'} \triangleleft_{\mathbf{c}} = \triangleleft_{\mathbf{b}} \cap \triangleleft_{\mathbf{b}'} = \triangleleft_{\mathbf{b}'}^{\text{Inc}} \cap \triangleleft_{\mathbf{b}}^{\text{Dec}}. \tag{10.48}$$

We illustrate this in Figure 10.17. We say that $\triangleleft_{[\mathbf{b}, \mathbf{b}']}$ is a *boolean order interval poset*, and we denote by

$$\text{BOIP}(n) := \{\triangleleft_{[\mathbf{b}, \mathbf{b}']} \mid \mathbf{b}, \mathbf{b}' \in \mathcal{B}(n-1), \mathbf{b} \preceq \mathbf{b}'\} \tag{10.49}$$

the set of all boolean order interval posets on $[n]$. We have the following characterization of these posets:

Proposition 10.2.27 ([CPP17, Corollary 55]). *A poset $\triangleleft \in \mathcal{P}(n)$ is in $\text{BOIP}(n)$ if and only if for all $a < b < c$,*

$$a \triangleleft c \implies a \triangleleft b \text{ and } b \triangleleft c \quad \text{and} \quad a \triangleright c \implies a \triangleright b \text{ and } b \triangleright c \tag{10.50}$$

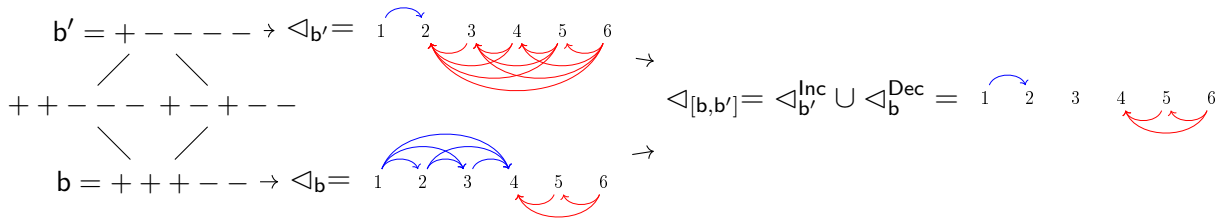

Figure 10.17: A Boolean Order Interval Poset (BOIP).

We now describe the weak order on $\text{BOIP}(n)$:

Proposition 10.2.28 ([CPP17, Proposition 57]). *For any $c \preceq c'$ and $b \preceq b'$*

$$\triangleleft_{[c,c']} \preceq \triangleleft_{[b,b']} \iff c \preceq b \text{ and } c' \preceq b'. \quad (10.51)$$

Corollary 10.2.29 ([CPP17, Corollary 58]). *The weak order $(\text{BOIP}(n), \preceq)$ is a lattice whose meet and join are given by*

$$\triangleleft_{[c,c']} \wedge_{\text{BOIP}} \triangleleft_{[b,b']} = \triangleleft_{[c \wedge_{\mathcal{B}} b, c' \wedge_{\mathcal{B}} b']} \quad (10.52)$$

$$\text{and } \triangleleft_{[c,c']} \vee_{\text{BOIP}} \triangleleft_{[b,b']} = \triangleleft_{[c \vee_{\mathcal{B}} b, c' \vee_{\mathcal{B}} b']}. \quad (10.53)$$

Furthermore, we also have the following results:

Proposition 10.2.30 ([CPP17, Theorem 81 and 84]). *The set $\text{BOIP}(n)$ induces a sublattice of the weak order $(\mathcal{P}(n), \preceq, \wedge_{\mathcal{T}}, \vee_{\mathcal{T}})$ and also of $(\text{WOIP}(n), \preceq, \wedge_{\text{WOIP}}, \vee_{\text{WOIP}})$.*

Boolean Order Element Posets

We now consider the boolean order element posets defined in Equation 10.47, and give its characterization:

Proposition 10.2.31 ([CPP17, Proposition 60]). *A poset $\triangleleft \in \mathcal{P}(n)$ is in $\text{BOEP}(n)$ if and only if:*

- $\triangleleft \in \text{BOIP}(n)$;
- for every $i < n$, $i \triangleleft i + 1$ or $i \triangleright i + 1$.

Furthermore, we also have the following result:

Proposition 10.2.32 ([CPP17, Theorem 88]). *The set $\text{BOEP}(n)$ induces a sublattice of the weak order $(\mathcal{P}(n), \preceq, \wedge_{\mathcal{T}}, \vee_{\mathcal{T}})$.*

Boolean Order Face Posets

The faces of the cube are the same as the intervals, hence we have already given the results.

Chapter 11

Poset on sets of roots

11.1 Subsets of root systems

In Chapter 2 we have already introduced some classical notions on finite root systems Φ and Coxeter groups, and referred to the books by J. Humphreys [Hum90], N. Bourbaki [Bou02], and A. Björner and F. Brenti [BB05] for more details. We are interested here in some subsets of Φ , and their properties regarding sum of roots.

11.1.1 Φ -posets

Let Φ be a root system. In Section 11.2, we will consider certain specific families of collections of roots. We start by the definition of closed sets. The next statement is proved by A. Pilkington [Pil06, Sect. 2] for subsets of positive roots. The proof for subsets of all roots is identical.

Lemma 11.1.1. *The following conditions are equivalent for $R \subseteq \Phi$:*

- (i) $\alpha + \beta \in R$ for any $\alpha, \beta \in R$ such that $\alpha + \beta \in \Phi$,
- (ii) $m\alpha + n\beta \in R$ for any $\alpha, \beta \in R$ and $m, n \in \mathbb{N}$ such that $m\alpha + n\beta \in \Phi$,
- (iii) $\alpha_1 + \dots + \alpha_p \in R$ for any $\alpha_1, \dots, \alpha_p \in R$ such that $\alpha_1 + \dots + \alpha_p \in \Phi$.

Definition 11.1.2. *A subset $R \subseteq \Phi$ is **closed** if it satisfies the equivalent conditions of Lemma 11.1.1. We denote by $\mathcal{C}(\Phi)$ the set of closed subsets of roots of Φ .*

Definition 11.1.3. *The **closure** of a subset $R \subseteq \Phi$ is the set $R^{\text{cl}} := \mathbb{N}R \cap \Phi$.*

The map $R \mapsto R^{\text{cl}}$ is a closure operator on Φ , meaning that

$$\emptyset^{\text{cl}} = \emptyset, \quad \Phi^{\text{cl}} = \Phi, \quad R \subseteq S \implies R^{\text{cl}} \subseteq S^{\text{cl}} \quad \text{and} \quad (R^{\text{cl}})^{\text{cl}} = R^{\text{cl}} \quad (11.1)$$

for all $R, S \subseteq \Phi$. Moreover R^{cl} is closed and R is closed if and only if $R = R^{\text{cl}}$.

Remark 11.1.4. As studied in details by A. Pilkington in [Pil06], there are other possible notions of closed sets of roots. Namely, one says that $R \subseteq \Phi$ is

- **\mathbb{N} -closed** if $m\alpha + n\beta \in \mathbb{R}$ for any $\alpha, \beta \in \mathbb{R}$ and $m, n \in \mathbb{N}$ such that $m\alpha + n\beta \in \Phi$,
- **\mathbb{R} -closed** if $x\alpha + y\beta \in \mathbb{R}$ for any $\alpha, \beta \in \mathbb{R}$ and $x, y \in \mathbb{R}$ such that $x\alpha + y\beta \in \Phi$,
- **convex** if $\mathbb{R} = \Phi \cap C$ for a convex cone C in V .

Note that convex implies \mathbb{R} -closed which implies \mathbb{N} -closed, but that the converse statements are wrong even for finite root systems [Pil06, p.3192]. In this chapter, we will only work with the notion of \mathbb{N} -closedness in crystallographic root systems, as it is discussed in [Bou02]. A good justification for this restriction will be presented in Remark 11.2.19.

Moreover, we will consider the following subsets of roots.

Definition 11.1.5. A subset of roots $\mathbb{R} \subseteq \Phi$ is **symmetric** if $-\mathbb{R} = \mathbb{R}$ and **antisymmetric** if $\mathbb{R} \cap -\mathbb{R} = \emptyset$. We denote by $\mathcal{S}(\Phi)$ (resp. $\mathcal{A}(\Phi)$) the set of symmetric (resp. antisymmetric) subsets of roots of Φ .

Example 11.1.6 (Type A). In Section 2.3.1, we have described the root system of type A . The roots are the vectors $e_i - e_j$ for $i, j \in [n]$. Therefore, a subset of roots can be seen as an integer binary relation via the bijection $(i, j) \in [n]^2 \longleftrightarrow e_i - e_j \in \Phi_A$. A subset of roots is antisymmetric (resp. closed) if the corresponding integer binary relation is antisymmetric (resp. transitive). (Note that in type A the three notions of closed sets of roots coincide.)

This example motivates the definition of the central object of this chapter.

Definition 11.1.7. A **Φ -poset** is an antisymmetric and \mathbb{N} -closed subset of roots of Φ . We denote by $\mathcal{P}(\Phi)$ the set of all Φ -posets.

We speak of Weyl posets when we do not want to specify the root system. We will introduce in Section 11.2.4 a natural lattice structure on Φ -posets. We will see in Section 11.3 various subfamilies of Φ -posets arising from classical Coxeter and Coxeter Catalan combinatorics.

To conclude this preliminary section on Φ -posets, we gather simple observations on their subsums and their extensions.

Lemma 11.1.8. For $\mathbb{R} \in \mathcal{P}(\Phi)$ and $\alpha_1, \dots, \alpha_p \in \mathbb{R}$ we have $\alpha_1 + \dots + \alpha_p \neq 0$.

Proof. Assume that \mathbb{R} is a Φ -poset and that there are $\alpha_1, \dots, \alpha_p \in \mathbb{R}$ such that $\alpha_1 + \dots + \alpha_p = 0$. Then $\alpha_2 + \dots + \alpha_p = -\alpha_1$ is a root, so Lemma 11.1.1 (iii) ensures that $\alpha_2 + \dots + \alpha_p \in \mathbb{R}$ since \mathbb{R} is closed. We obtain that $\alpha_1 \in \mathbb{R}$ and $-\alpha_1 \in \mathbb{R}$, contradicting the antisymmetry of \mathbb{R} . \square

Finally, we need Φ -poset extensions. The subsets of Φ are naturally ordered by inclusion, and we can consider the restriction of this inclusion order on Φ -posets. For $\mathbb{R} \in \mathcal{P}(\Phi)$, we call **extensions** of \mathbb{R} the Φ -posets \mathbb{S} containing \mathbb{R} , and we let $\mathcal{E}(\mathbb{R}) := \{\mathbb{S} \in \mathcal{P}(\Phi) \mid \mathbb{R} \subseteq \mathbb{S}\}$. Note that $\mathbb{R} \subseteq \bigcap \mathcal{E}(\mathbb{R})$ but that the reverse inclusion does not always hold (consider for example $\mathbb{R} = \{\alpha_1 + \alpha_2, \alpha_2\}$ in type B_2). For later purposes, we are interested in maximal Φ -posets in the extension order.

Proposition 11.1.9. *For $R \in \mathcal{P}(\Phi)$, we have:*

$$\mathcal{E}(R) = \{R\} \iff \forall \alpha \in \Phi, \{\alpha, -\alpha\} \cap R \neq \emptyset. \quad (11.2)$$

Proof. Clearly if $\{\alpha, -\alpha\} \cap R \neq \emptyset$ for all $\alpha \in \Phi$, then adding any root to R breaks the antisymmetry, so that $\mathcal{E}(R) = \{R\}$. Reciprocally, assume that there exists $\alpha \in \Phi$ such that $\{\alpha, -\alpha\} \cap R = \emptyset$. Let $S := (R \cup \{\alpha\})^{\text{cl}}$ and $T := (R \cup \{-\alpha\})^{\text{cl}}$. By definition, both S and T are closed, and we claim that at least one of them is antisymmetric, thus proving that R admits a non-trivial extension. Assume by means of contradiction that neither S nor T are antisymmetric. Let $\beta \in S \cap -S$ and $\gamma \in T \cap -T$. By definition of the closure, we can write

$$\beta = \sum_{\delta \in R} \lambda_{\delta} \delta + \lambda_{\alpha} \alpha = - \sum_{\delta \in R} \kappa_{\delta} \delta - \kappa_{\alpha} \alpha \quad (11.3)$$

$$\text{and } \gamma = \sum_{\delta \in R} \mu_{\delta} \delta - \mu_{\alpha} \alpha = - \sum_{\delta \in R} \nu_{\delta} \delta + \nu_{\alpha} \alpha, \quad (11.4)$$

where $\lambda_{\delta}, \kappa_{\delta}, \mu_{\delta}, \nu_{\delta}$ are non-negative integer coefficients for $\delta \in R$, and where $\lambda_{\alpha} + \kappa_{\alpha} \neq 0 \neq \mu_{\alpha} + \nu_{\alpha}$. This implies that

$$\sum_{\delta \in R} ((\lambda_{\alpha} + \kappa_{\alpha})(\mu_{\delta} + \nu_{\delta}) + (\mu_{\alpha} + \nu_{\alpha})(\lambda_{\delta} + \kappa_{\delta})) \delta = 0. \quad (11.5)$$

Lemma 11.1.8 thus ensures that $(\lambda_{\alpha} + \kappa_{\alpha})(\mu_{\delta} + \nu_{\delta}) + (\mu_{\alpha} + \nu_{\alpha})(\lambda_{\delta} + \kappa_{\delta}) = 0$ which in turns implies that $\lambda_{\delta} = \kappa_{\delta} = \mu_{\delta} = \nu_{\delta} = 0$ for all $\delta \in R$, a contradiction. \square

11.1.2 Sums of roots in crystallographic root systems

We conclude this preliminary section by gathering useful statements on sums of roots in crystallographic root systems that we consider interesting for their own sake. We start by a statement from [Bou02] providing sufficient conditions for the sum or difference of two roots to be again a root in a crystallographic root system Φ .

Theorem 11.1.10 ([Bou02, Chap. 6, 1.3, Thm. 1]). *For any α, β in a crystallographic root system Φ ,*

- (i) *if $\langle \alpha | \beta \rangle > 0$ then $\alpha - \beta \in \Phi$ or $\alpha = \beta$,*
- (ii) *if $\langle \alpha | \beta \rangle < 0$ then $\alpha + \beta \in \Phi$ or $\alpha = -\beta$.*

We say that a set $X \subseteq \Phi$

- is *summable* if its sum ΣX is again a root of Φ ,
- has *no vanishing subsum* if $\Sigma Y \neq 0$ for any $\emptyset \neq Y \subseteq X$.

Proposition 11.1.11 and Theorems 11.1.12 and 11.1.13 ensure that a summable set of roots with no vanishing subsum has many summable subsets. We start on sums of 3 roots.

Proposition 11.1.11. *Let Φ be a crystallographic root system. If $\alpha, \beta, \gamma \in \Phi$ are such that $\alpha + \beta + \gamma \in \Phi$ has no vanishing subsum, then at least two of the three subsums $\alpha + \beta$, $\alpha + \gamma$ and $\beta + \gamma$ are in Φ .*

Proof. By contradiction, assume that $\alpha + \beta \notin \Phi$ and $\alpha + \gamma \notin \Phi$. Since $\alpha + \beta + \gamma$ has no vanishing subsum, $\alpha \neq -\beta$ and $\alpha \neq -\gamma$. By contraposition of Theorem 11.1.10 (ii), we obtain that $\langle \alpha | \beta \rangle \geq 0$ and $\langle \alpha | \gamma \rangle \geq 0$. Therefore,

$$\langle \alpha + \beta + \gamma | \beta + \gamma \rangle = \langle \alpha | \beta \rangle + \langle \alpha | \gamma \rangle + \langle \beta + \gamma | \beta + \gamma \rangle > 0 \quad (11.6)$$

since $\beta + \gamma \neq 0$. It follows that either $\langle \alpha + \beta + \gamma | \beta \rangle > 0$ or $\langle \alpha + \beta + \gamma | \gamma \rangle > 0$. Assume for instance $\langle \alpha + \beta + \gamma | \beta \rangle > 0$. Theorem 11.1.10 (i) thus implies that either $\alpha + \gamma \in \Phi$ or $\alpha + \gamma = \beta \in \Phi$. \square

It is proved in [Bou02, Chap. 6, 1.6, Prop. 19] that any summable subset X of positive roots admits a filtration of summable subsets

$$X_1 \subsetneq X_2 \subsetneq \cdots \subsetneq X_{|X|-1} \subsetneq X_{|X|} = X. \quad (11.7)$$

We now use Proposition 11.1.11 to extend this property in two directions: first we consider subsets of all roots (positive and negative), second we show that we can additionally prescribe the initial set X_1 to be a chosen root of Φ .

This latter improvement will be crucial all throughout the chapter.

Theorem 11.1.12. *Let Φ be a crystallographic root system. Any summable set $X \subseteq \Phi$ with no vanishing subsum admits a filtration of summable subsets*

$$\{\alpha\} = X_1 \subsetneq X_2 \subsetneq \cdots \subsetneq X_{|X|-1} \subsetneq X_{|X|} = X$$

for any $\alpha \in X$.

Proof. The proof works by induction on $|X|$. It is clear for $|X| = 2$, so that we consider $|X| > 2$. By induction, it suffices to find a summable subset $X_{|X|-1}$ of size $|X| - 1$ such that $\alpha \in X_{|X|-1} \subset X$. Since $\sum_{\beta \in X} \langle \beta | \Sigma X \rangle = \langle \Sigma X | \Sigma X \rangle > 0$, there exists $\beta \in X$ such that $\langle \beta | \Sigma X \rangle > 0$. Since X has no vanishing subsum, $\beta \neq \Sigma X$. Theorem 11.1.10 (i) thus ensures that $X \setminus \{\beta\}$ is summable. If $\alpha \neq \beta$, then we set $X_{|X|-1} := X \setminus \{\beta\}$ and conclude by induction. Otherwise, we proved that both $\{\alpha\}$ and $X \setminus \{\alpha\}$ are summable. Let Y be inclusion maximal with $\alpha \in Y \subsetneq X$ such that both Y and $X \setminus Y$ are summable. Assume that $|X \setminus Y| \geq 2$. By induction hypothesis, there exists $Z \subset X \setminus Y$ summable with $|Z| = |X \setminus Y| - 1 \geq 1$. Let γ be the root in $(X \setminus Y) \setminus Z$. Since $\gamma, \Sigma Y$ and ΣZ are roots and $\gamma + \Sigma Y + \Sigma Z = \Sigma X \in \Phi$, Proposition 11.1.11 affirms that either $\{\gamma\} \cup Y$ or $Y \cup Z$ is summable, contradicting the maximality of Y . We therefore obtained a summable subset Y with $\alpha \in Y \subseteq X$ with $|Y| = |X| - 1$. We set $X_{|X|-1} := Y$ and conclude by induction. \square

Finally, we obtain the following generalization of Proposition 11.1.11.

Theorem 11.1.13. *Let Φ be a crystallographic root system. Then any summable set $X \subseteq \Phi$ with no vanishing subsum admits at least p distinct summable subsets of size $|X| - p + 1$, for any $1 \leq p \leq |X|$.*

Proof. Note that it holds for $p = 1$ and $p = |X|$. We now proceed by induction on $|X|$ to prove the result for $1 < p < |X|$. By Theorem 11.1.12, X admits a summable subset Y of size $|X| - 1$. Since $1 < p$, we can apply the induction hypothesis to find $p - 1$ distinct summable subsets Z_1, \dots, Z_{p-1} of Y of size $|Y| - p + 2 = |X| - p + 1$. Moreover, by Theorem 11.1.12 there exists at least one summable subset Z_p of X of size $|X| - p + 1$ containing the root α in $X \setminus Y$. This subset Z_p is distinct from all the subsets Z_1, \dots, Z_{p-1} of Y , since it contains α . This concludes the proof. \square

11.2 Weak order on Φ -posets

11.2.1 Weak order on all subsets

Let Φ be a finite root system, with positive roots Φ^+ and negative roots Φ^- . We denote by $\mathcal{R}(\Phi)$ the set of all subsets of Φ . For $R \in \mathcal{R}(\Phi)$, we denote by $R^+ := R \cap \Phi^+$ its positive part and $R^- := R \cap \Phi^-$ its negative part. The following order was considered in type A in [CPP17].

Definition 11.2.1. *The weak order on $\mathcal{R}(\Phi)$ is defined by $R \preceq S$ if and only if $R^+ \supseteq S^+$ and $R^- \subseteq S^-$.*

Remark 11.2.2. The name for this order relation will be transparent in Section 11.3. Note that there is an arbitrary choice of orientation in Definition 11.2.1. The choice we have made here may seem unusual, as the apparent contradiction in Proposition 11.3.5 suggests. However, it is more coherent with the case of type A as treated in Chapter 10 and it simplifies the presentation of Section 11.3.1.

Proposition 11.2.3. *The weak order \preceq on $\mathcal{R}(\Phi)$ is a graded lattice with meet and join*

$$R \wedge_{\mathcal{R}} S = (R^+ \cup S^+) \sqcup (R^- \cap S^-) \tag{11.8}$$

$$\text{and } R \vee_{\mathcal{R}} S = (R^+ \cap S^+) \sqcup (R^- \cup S^-). \tag{11.9}$$

Furthermore, its cover relations are all of the form $R \preceq R \setminus \{\alpha\}$, $\alpha \in R^+$ and $R \setminus \{\beta\} \preceq R$, $\beta \in R^-$. Therefore the weak order is graded by $R \mapsto |R^-| - |R^+|$.

Proof. It is the Cartesian product of two boolean lattices (on inclusion posets on the positive and on the negative parts respectively). \square

Example 11.2.4 (Type A). For the type A_n root system, a subset of roots $R \in \mathcal{R}_{A_n}$ can be considered as a reflexive binary relation. The weak order of Definition 11.2.1 was considered in this context in Chapter 10.

The end of this section is devoted to show that the restriction of the weak order to certain families of subsets of roots (antisymmetric, closed and Φ -posets) still defines a lattice structure and to express its meet and join operations. For example, the weak orders on A_2 -, B_2 - and G_2 -posets are represented in Figures 11.2 and 11.3.

11.2.2 Weak order on antisymmetric subsets

We start with the antisymmetry condition.

Proposition 11.2.5. *The meet $\wedge_{\mathcal{R}}$ and the join $\vee_{\mathcal{R}}$ both preserve antisymmetry. Thus, the set $\mathcal{A}(\Phi)$ of antisymmetric subsets of Φ induces a sublattice of the weak order on $\mathcal{R}(\Phi)$.*

Proof. Consider two antisymmetric subsets $R, S \in \mathcal{R}(\Phi)$ and let $\alpha \in (R \wedge_{\mathcal{R}} S)^+ = R^+ \cup S^+$. Assume for instance $\alpha \in R^+$. Since R is antisymmetric, $-\alpha \notin R^-$, so that $-\alpha \notin R^- \cap S^- = (R \wedge_{\mathcal{R}} S)^-$. We conclude that $R \wedge_{\mathcal{R}} S$ is antisymmetric. The proof for $R \vee_{\mathcal{R}} S$ is similar. \square

Proposition 11.2.6. *All cover relations in the weak order on $\mathcal{A}(\Phi)$ are cover relations in the weak order on $\mathcal{R}(\Phi)$. In particular, the weak order on $\mathcal{A}(\Phi)$ is still graded by $R \mapsto |R^+| - |R^-|$.*

Proof. Let $R \preceq S$ be a cover relation in the weak order on $\mathcal{A}(\Phi)$. We have $R^+ \supseteq S^+$ and $R^- \subseteq S^-$ where at least one of the inclusions is strict. Suppose first that $R^+ \neq S^+$. Let $\alpha \in R^+ \setminus S^+$ and $T := R \setminus \{\alpha\}$. Note that $T \in \mathcal{A}(\Phi)$ and $R \prec T \preceq S$. Since S covers R , we get $S = T = R \setminus \{\alpha\}$. Similarly if $S^- \neq R^-$ let $\alpha \in S^- \setminus R^-$ and $T := S \setminus \{\alpha\}$. Then $T \in \mathcal{A}(\Phi)$ and $R \preceq T \prec S$ implies that $T = R = S \setminus \{\alpha\}$. In both cases, $R \preceq S$ is a cover relation of the weak order on $\mathcal{R}(\Phi)$. \square

Corollary 11.2.7. *In the weak order on $\mathcal{A}(\Phi)$, the antisymmetric subsets that cover a given antisymmetric subset $R \in \mathcal{A}(\Phi)$ are precisely the relations*

- $R \setminus \{\alpha\}$ for any $\alpha \in R^+$,
- $R \cup \{\beta\}$ for any $\beta \in \Phi^- \setminus R^-$ such that $-\beta \notin R^+$.

11.2.3 Weak order on closed subsets

We aim at proving that the weak order on closed subsets of Φ is a lattice. Unfortunately, as $\mathcal{C}(\Phi)$ is stable by intersection but not by union, it is not preserved by the meet $\wedge_{\mathcal{R}}$ and the join $\vee_{\mathcal{R}}$, so that it does not induce a sublattice of the weak order on $\mathcal{R}(\Phi)$. Proving that it is still a lattice requires a little more work. Following [CPP17], we start with a weaker notion of closedness. We say that a subset $R = R^+ \sqcup R^-$ is *semiclosed* if both R^+ and R^- are closed. We denote by $\mathcal{SC}(\Phi)$ the set of semiclosed subsets of Φ . Note that $\mathcal{C}(\Phi) \subseteq \mathcal{SC}(\Phi)$ but that the reverse inclusion does not hold in general.

Proposition 11.2.8. *The weak order \preceq on $\mathcal{SC}(\Phi)$ is a lattice with meet and join*

$$R \wedge_{\mathcal{SC}} S = (R^+ \cup S^+)^{\text{cl}} \sqcup (R^- \cap S^-) \quad \text{and} \quad R \vee_{\mathcal{SC}} S = (R^+ \cap S^+) \sqcup (R^- \cup S^-)^{\text{cl}}. \quad (11.10)$$

Proof. Observe first that $R \wedge_{\mathcal{SC}} S$ is indeed semiclosed (T^{cl} is always closed and $\mathcal{C}(\Phi)$ is stable by intersection). Moreover, $R \wedge_{\mathcal{SC}} S \preceq R$ and $R \wedge_{\mathcal{SC}} S \preceq S$. Assume now that $T \subseteq \Phi$ is semiclosed such that $T \preceq R$ and $T \preceq S$. Then $T^+ \supseteq R^+ \cup S^+$ and $T^- \subseteq R^- \cap S^-$. Moreover, since T^+ is closed, we get that $T^+ \supseteq (R^+ \cup S^+)^{\text{cl}}$ so that $T \preceq R \wedge_{\mathcal{SC}} S$. We conclude that $R \wedge_{\mathcal{SC}} S$ is indeed the meet of R and S . The proof is similar for the join. \square

Proposition 11.2.9. *All cover relations in the weak order on $\mathcal{SC}(\Phi)$ are cover relations in the weak order on $\mathcal{R}(\Phi)$. In particular, the weak order on $\mathcal{SC}(\Phi)$ is still graded by $R \mapsto |R^-| - |R^+|$.*

Proof. Consider a cover relation $R \preceq S$ in the weak order on $\mathcal{SC}(\Phi)$. We have $R^+ \supseteq S^+$ and $R^- \subseteq S^-$ where at least one of the inclusions is strict. We distinguish two cases.

Suppose first that $R^+ \neq S^+$, and consider $\alpha \in R^+ \setminus S^+$ of minimal height in $R^+ \setminus S^+$. Observe that α cannot be decomposed in R^+ : if $\alpha = \gamma + \delta$ with $\gamma, \delta \in R^+$, then $h(\gamma), h(\delta) < h(\alpha)$, so $\gamma, \delta \notin S^+$ by minimality of $h(\alpha)$, which contradicts the closedness of S^+ . Consider now $T := R \setminus \{\alpha\}$. Let $\gamma, \delta \in T^+$ with $\gamma + \delta \in \Phi$. Then $\gamma, \delta \in R^+$ so that $\gamma + \delta \in R^+$ since R^+ is closed. Since $\gamma + \delta \neq \alpha$, this implies that $\gamma + \delta \in T^+$. This shows that T^+ is closed. Since $T^- = R^-$ is also closed, we obtain that T is semiclosed. Since $R \neq T$ and $R \preceq T \preceq S$, this proves that $T = S = R \setminus \{\alpha\}$.

Assume now that $R^- \neq S^-$, and let $\beta \in S^- \setminus R^-$ of minimal height (or equivalently maximal absolute height). Consider $T := R \cup \{\beta\}$. Let $\gamma, \delta \in T^-$ with $\gamma + \delta \in \Phi$. If $\gamma, \delta \in R^-$, then $\gamma + \delta \in R^-$ since R^- is closed. Assume now that $\delta = \beta$. Then $\gamma, \beta \in S^-$ and S^- is closed, we have $\gamma + \beta \in S^-$ and $h(\gamma + \beta) < h(\beta)$, which ensures that $\gamma + \beta \in R^-$ by minimality of $h(\beta)$. This shows that T^- is closed. Since $T^+ = R^+$ is also closed, we obtain that T is semiclosed. Since $R \neq T$ and $R \preceq T \preceq S$, this proves that $T = S = R \cup \{\beta\}$. \square

Corollary 11.2.10. *In the weak order on $\mathcal{SC}(\Phi)$, the semiclosed subsets of Φ that cover a given semiclosed subset $R \in \mathcal{SC}(\Phi)$ are precisely the relations:*

- $R \setminus \{\alpha\}$ for any $\alpha \in R^+$ such that there is no $\gamma, \delta \in R^+$ with $\alpha = \gamma + \delta$,
- $R \cup \{\beta\}$ for any $\beta \in \Phi^- \setminus R^-$ such that $\beta + \gamma \in \Phi \implies \beta + \gamma \in R$ for all $\gamma \in R^-$.

We now come back to closed subsets of Φ . Unfortunately, $\mathcal{C}(\Phi)$ still does not induce a sublattice of $\mathcal{SC}(\Phi)$. We thus need a transformation similar to the closure $R \mapsto R^{\text{cl}}$ to transform a semiclosed subset of Φ into a closed one. For $R \in \mathcal{R}(\Phi)$, we define the *negative closure deletion* R^{ncd} and the *positive closure deletion* R^{pcd} by

$$\begin{aligned} R^{\text{ncd}} &:= R \setminus \{\alpha \in R^- \mid \exists X \subseteq R^+ \text{ such that } \alpha + \Sigma X \in \Phi \setminus R\}, \\ R^{\text{pcd}} &:= R \setminus \{\alpha \in R^+ \mid \exists X \subseteq R^- \text{ such that } \alpha + \Sigma X \in \Phi \setminus R\}. \end{aligned}$$

As in Section 11.1.2, the notation ΣX in these formulas denotes the sum of all roots in X .

Remark 11.2.11. In the case that R is semiclosed, we can assume that the set X in the definitions of R^{ncd} and R^{pcd} is such that the $\alpha + \Sigma X$ has no vanishing subsum. Observe first that no vanishing subsum can contain α . Indeed, if $Y \subseteq X$ is such that $\alpha + \Sigma Y = 0$, then $X \setminus Y \subseteq R^-$ and R^- closed implies $\alpha + \Sigma X = \Sigma(X \setminus Y) \in R$. Now if $Y \subseteq X$ is such that $\Sigma Y = 0$, then $\alpha + \Sigma(X \setminus Y) = \alpha + \Sigma X \notin R$, so that we can replace X by $X \setminus Y$.

Lemma 11.2.12. *For any $R \in \mathcal{R}(\Phi)$, we have $R^{\text{ncd}} \preceq R \preceq R^{\text{pcd}}$.*

Proof. Since R^{ncd} (resp. R^{pcd}) is obtained from R by deleting negative (resp. positive) roots, we have $(R^{\text{ncd}})^+ = R^+ \supseteq (R^{\text{pcd}})^+$ and $(R^{\text{ncd}})^- \subseteq R^- = (R^{\text{pcd}})^-$, so that $R^{\text{ncd}} \preceq R \preceq R^{\text{pcd}}$. \square

Lemma 11.2.13. *If R is semiclosed, then both R^{ncd} and R^{pcd} are closed.*

Proof. Assume by means of contradiction that R is semiclosed and R^{ncd} is not closed. Then there are roots $\alpha, \beta \in R^{\text{ncd}}$ such that $\alpha + \beta \in \Phi \setminus R^{\text{ncd}}$. Consider two such roots such that $\alpha + \beta$ has minimal absolute height. We distinguish four cases:

- If $\alpha, \beta \in \Phi^+$, then $\alpha, \beta \in (R^{\text{ncd}})^+ = R^+$, which is closed, so that we obtain $\alpha + \beta \in R^+ = (R^{\text{ncd}})^+$. Contradiction.
- If $\alpha \in \Phi^-$ and $\beta \in \Phi^+$, we distinguish again two cases:
 - If $\alpha + \beta \notin R$, then the set $\{\beta\}$ ensures $\alpha \notin R^{\text{ncd}}$. Contradiction.
 - If $\alpha + \beta \in R$, then since $\alpha + \beta \in R \setminus R^{\text{ncd}}$, there exists $X \subseteq R^+$ such that $\alpha + \beta + \Sigma X \in \Phi \setminus R$. Since $\beta \in R^+$, the set $\{\beta\} \cup X$ ensures $\alpha \notin R^{\text{ncd}}$. Contradiction.
- If $\alpha \in \Phi^+$ and $\beta \in \Phi^-$, the argument is symmetric.
- If $\alpha, \beta \in \Phi^-$, then $\alpha + \beta \in R^-$ since R^- is closed. Since $\alpha + \beta \in R \setminus R^{\text{ncd}}$, there exists $X \subseteq R^+$ such that $(\alpha + \beta) + \Sigma X \in \Phi \setminus R$. By Remark 11.2.11, we can assume that $(\alpha + \beta) + \Sigma X$ has no vanishing subsum. By Theorem 11.1.12, there exists $\gamma \in X$ such that $\alpha + \beta + \gamma \in \Phi$. By Proposition 11.1.11, we can assume without loss of generality that $\beta + \gamma \in \Phi$. We now distinguish four cases:
 - If $\beta + \gamma \notin R$, then the set $\{\gamma\}$ ensures $\beta \notin R^{\text{ncd}}$. Contradiction.
 - If $\beta + \gamma \in R^+$, then we define $T := \{\beta + \gamma\} \cup (X \setminus \{\gamma\}) \subseteq R^+$ so that $\alpha + \Sigma T = \alpha + \beta + \Sigma X \in \Phi \setminus R$ and consequently $\alpha \notin R^{\text{ncd}}$. Contradiction.
 - If $\beta + \gamma \in R^- \setminus R^{\text{ncd}}$ there exists $T \subseteq R^+$ such that $\beta + \gamma + \Sigma T \in \Phi \setminus R$. Since $\gamma \in R^+$, the set $\{\gamma\} \cup T$ ensures that $\beta \notin R^{\text{ncd}}$. Contradiction.
 - If $\beta + \gamma \in (R^{\text{ncd}})^-$, then we have $\alpha \in R^{\text{ncd}}$ and $\beta + \gamma \in R^{\text{ncd}}$ with $\alpha + \beta + \gamma \in \Phi$. Moreover, $h(\alpha + \beta + \gamma) < h(\alpha + \beta)$ since $\alpha + \beta \in \Phi^-$ while $\gamma \in \Phi^+$ and $\beta + \gamma \in \Phi^-$. By minimality in the choice of $\alpha + \beta$, we obtain that $\alpha + \beta + \gamma \in R^{\text{ncd}}$. Observe now that $X \setminus \{\gamma\} \subseteq R^+$ and $\alpha + \beta + \gamma + \Sigma(X \setminus \{\gamma\}) = \alpha + \beta + \Sigma X \in \Phi \setminus R$. Therefore:
 - * If $\alpha + \beta + \gamma$ is negative, the set $X \setminus \{\gamma\}$ ensures $\alpha + \beta + \gamma \notin R^{\text{ncd}}$. Contradiction.
 - * If $\alpha + \beta + \gamma$ is positive, then R^+ is not closed. Contradiction.

In all cases, we have reached a contradiction. We conclude that if R is semiclosed, then R^{ncd} is closed. The proof is symmetric for R^{pcd} . \square

Proposition 11.2.14. *The weak order on $\mathcal{C}(\Phi)$ is a lattice with meet and join*

$$R \wedge_{\mathcal{C}} S = ((R^+ \cup S^+)^{\text{cl}} \sqcup (R^- \cap S^-))^{\text{ncd}}, \quad (11.11)$$

$$R \vee_{\mathcal{C}} S = ((R^+ \cap S^+) \sqcup (R^- \cup S^-)^{\text{cl}})^{\text{pcd}}. \quad (11.12)$$

Proof. First, the weak order \preceq on $\mathcal{C}(\Phi)$ is a subposet of the weak order \preceq on $\mathcal{R}(\Phi)$, and it is bounded below by Φ^+ and above by Φ^- . We therefore just need to show that there is a meet and a join and that they are given by the above formulas.

Let $R, S \in \mathcal{C}(\Phi)$ and $M = R \wedge_{\mathcal{SC}} S$ so that $M^{\text{ncd}} = R \wedge_{\mathcal{C}} S$. Observe that we have $M^{\text{ncd}} \preceq M \preceq R$ and $M^{\text{ncd}} \preceq M \preceq S$ by Lemma 11.2.12. Moreover, since M is semiclosed, M^{ncd} is closed by Lemma 11.2.13. Therefore, M^{ncd} is closed and below both R and S .

Consider now $T \in \mathcal{C}(\Phi)$ such that $T \preceq R$ and $T \preceq S$. Since $T \in \mathcal{SC}(\Phi)$ and $M = R \wedge_{\mathcal{SC}} S$, we have $T \preceq M$. Therefore, $T^+ \subseteq M^+ = (M^{\text{ncd}})^+$ and $T^- \subseteq M^-$. Assume by means of contradiction that $T \not\preceq M^{\text{ncd}}$. Then we have $T^- \not\subseteq (M^{\text{ncd}})^-$. Consider $\alpha \in T^- \setminus (M^{\text{ncd}})^-$ of minimal absolute height. By definition of M^{ncd} , there exists $X \subseteq M^+$ such that $\alpha + \Sigma X \in \Phi \setminus M$. Since $M^+ = (R \wedge_{\mathcal{SC}} S)^+ = (R^+ \cup S^+)^{\text{cl}}$, we can assume without loss of generality (up to developing each root of X) that $X \subseteq (R^+ \cup S^+)$. By Remark 11.2.11, we can moreover assume that $\alpha + \Sigma X$ has no vanishing subsum. By Theorem 11.1.12, there exists $\beta \in X$ such that $\alpha + \beta \in \Phi$.

Since $\beta \in X \subseteq (R^+ \cup S^+)$, we can assume that $\beta \in R^+$. Since $\alpha \in T^- \subseteq R^-$, $\beta \in R^+ \subseteq T^+$ and both R and T are closed, we obtain that $\alpha + \beta \in R \cap T$. We now distinguish two cases:

- If $\alpha + \beta$ is positive, then $\alpha + \beta \in R^+ \subseteq M^+$. Since $X \setminus \{\beta\} \subseteq M^+$ and M^+ is closed, we obtain that $\alpha + \Sigma X = (\alpha + \beta) + \Sigma(X \setminus \{\beta\}) \in M^+$. Contradiction.
- If $\alpha + \beta$ is negative, we have $\alpha + \beta \in T^-$. Moreover, $\alpha + \beta$ has smaller absolute height than α since $\alpha \in \Phi^-$, $\beta \in \Phi^+$ and $\alpha + \beta \in \Phi^-$. By minimality in the choice of α , we obtain that $\alpha + \beta \in M^{\text{ncd}}$. Since $X \setminus \{\beta\} \subseteq M^+$ this implies that $\alpha + \Sigma X = (\alpha + \beta) + \Sigma(X \setminus \{\beta\}) \in M$. Contradiction.

Since we reached a contradiction in both cases, we obtain that $T \preceq M^{\text{ncd}}$. Hence, M^{ncd} is indeed the meet of R and S for the weak order on $\mathcal{C}(\Phi)$. The proof is similar for the join. \square

Remark 11.2.15. In contrast to Propositions 11.2.6 and 11.2.9 and Corollaries 11.2.7 and 11.2.10, the cover relations in the weak order on $\mathcal{C}(\Phi)$ are more intricate and the weak order on $\mathcal{C}(\Phi)$ is not graded in general, see Figure 11.1.

11.2.4 Weak order on Φ -posets

Recall from Definition 11.1.7 that $\mathcal{P}(\Phi)$ denotes the set of Φ -posets, *i.e.* of antisymmetric closed subsets of Φ . We finally show that the restriction of the weak order to the Φ -posets still defines a lattice structure. The weak orders on A_2 -, B_2 - and G_2 -posets are represented in Figures 11.2 and 11.3. One could compare the weak order on A_2 with Figure 10.5.

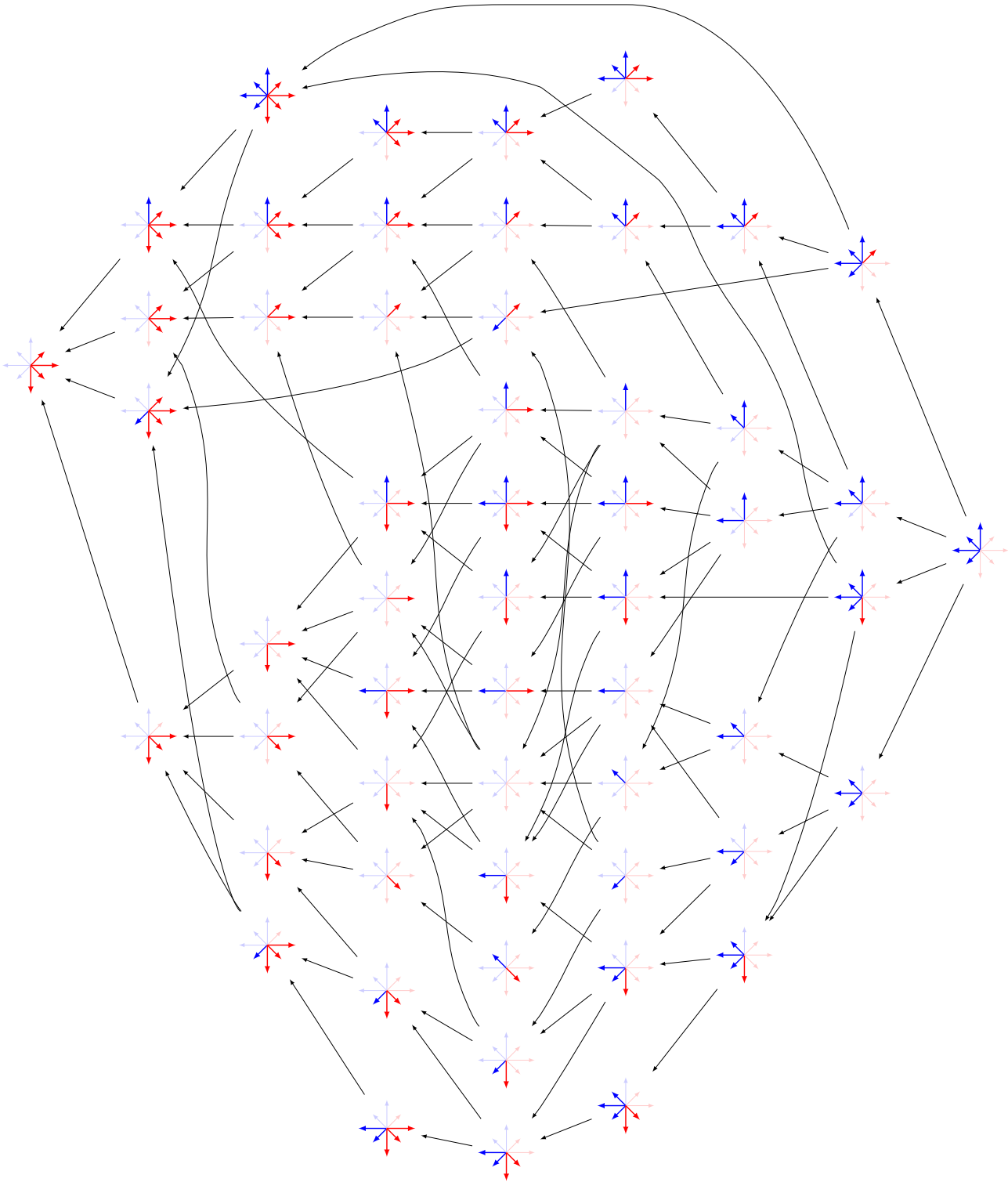

Figure 11.1: The weak order on closed subsets of roots of type B_2 .

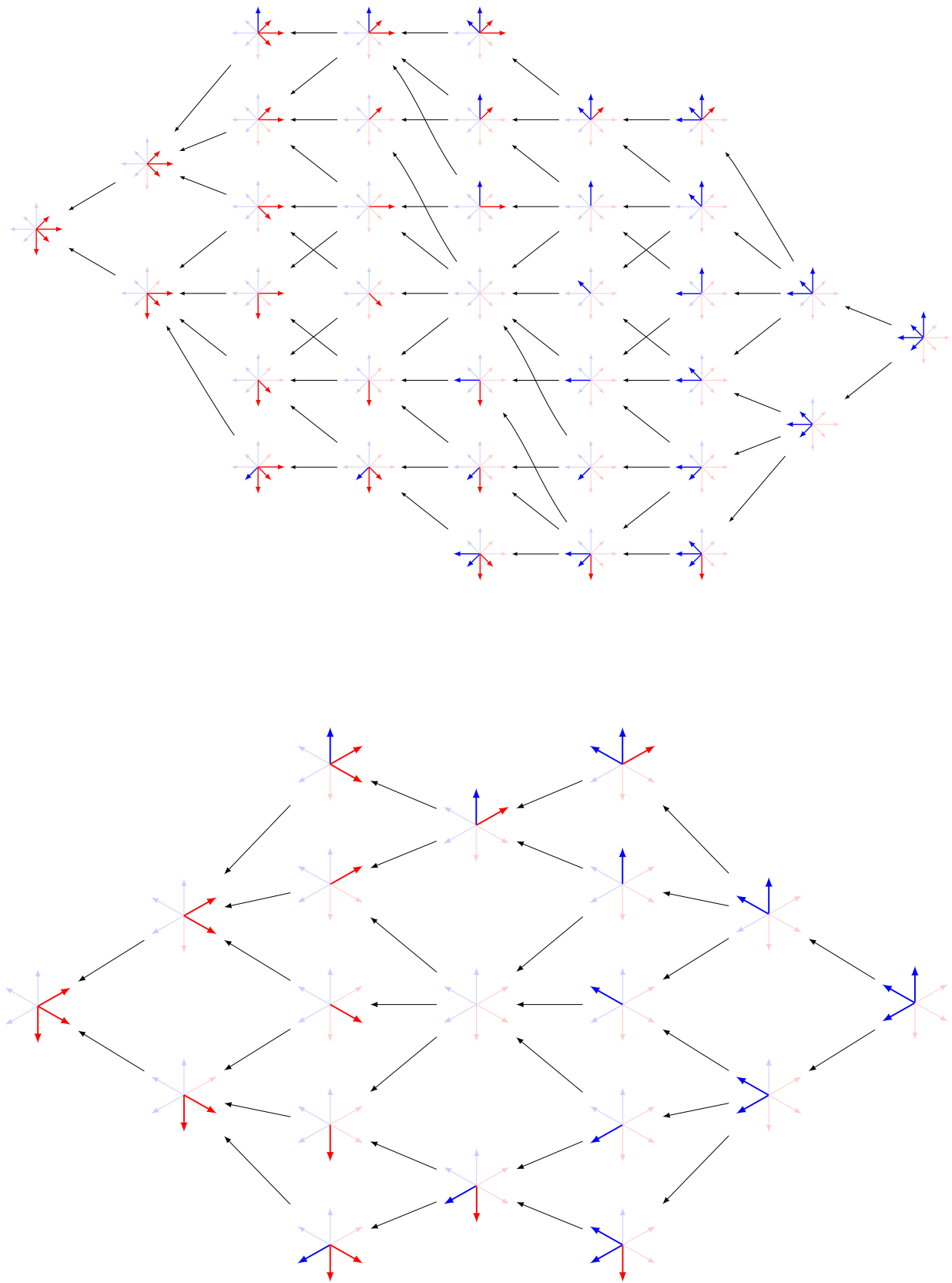
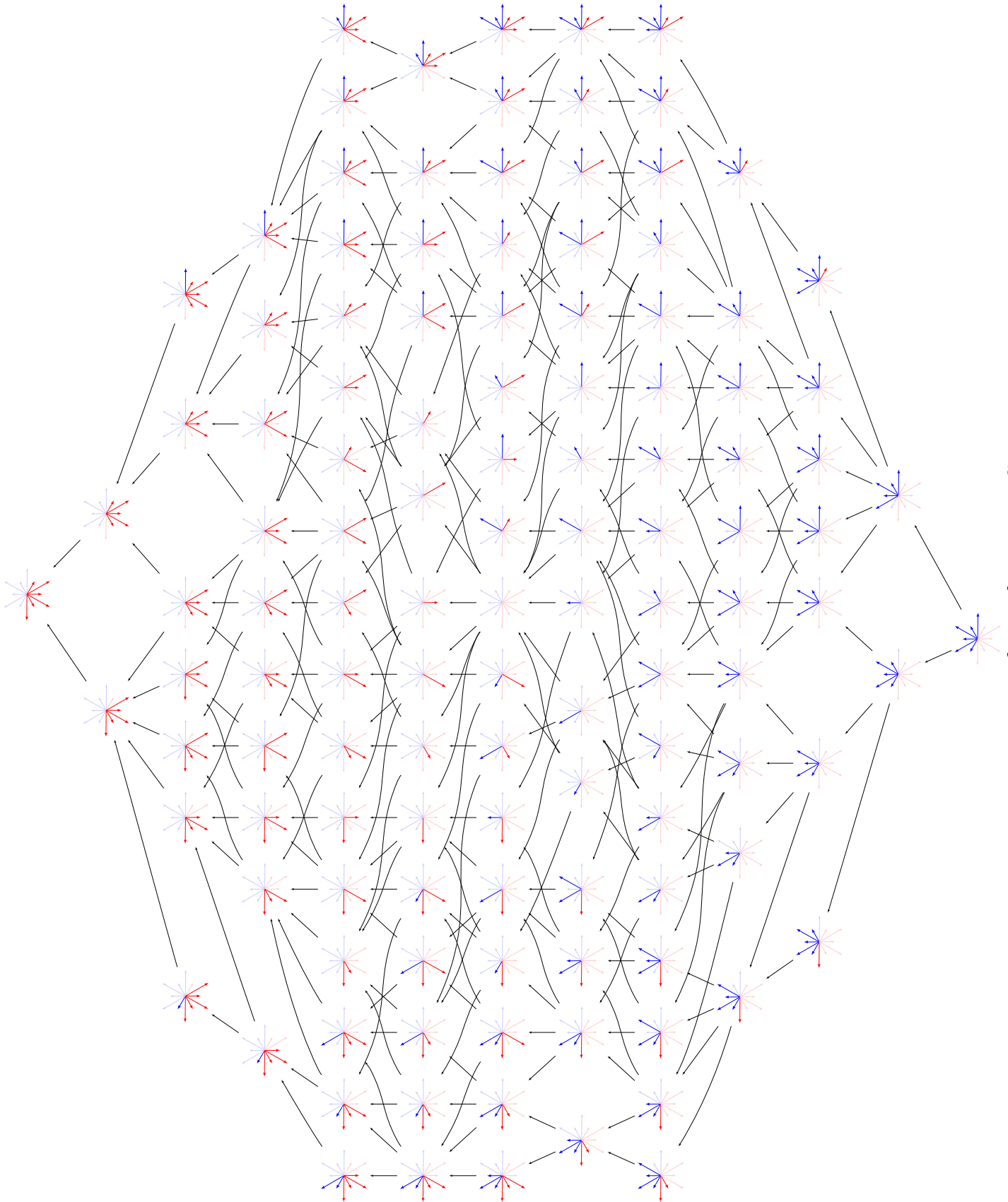

Figure 11.2: The weak order on A_2 -posets (left) and on B_2 -posets (right).

Figure 11.3: The weak order on G_2 -positets.

Theorem 11.2.16. *The meet $\wedge_{\mathcal{C}}$ and the join $\vee_{\mathcal{C}}$ both preserve antisymmetry. Thus, the set $\mathcal{P}(\Phi)$ of Φ -posets induces a sublattice of the weak order on $\mathcal{C}(\Phi)$.*

Proof. Let $R, S \in \mathcal{P}(\Phi)$ and $M = R \wedge_{\mathcal{C}} S$ so that $M^{\text{ncd}} = R \wedge_{\mathcal{C}} S$. Assume that M^{ncd} is not antisymmetric, and let $\alpha \in (M^{\text{ncd}})^+$ such that $-\alpha \in (M^{\text{ncd}})^-$. Since $(M^{\text{ncd}})^- \subseteq M^- = R^- \cap S^-$ and both R and S are antisymmetric, we obtain that $\alpha \notin R^+ \cup S^+$. Since $\alpha \in (M^{\text{ncd}})^+ = (R^+ \cup S^+)^{\text{cl}}$, there exists $X \subseteq R^+ \cup S^+$ such that $|X| \geq 2$ and $\alpha = \Sigma X$. By Theorem 11.1.12, there exists $\beta \in X$ such that $\Sigma(X \setminus \{\beta\}) \in \Phi$. Since $X \setminus \{\beta\} \subseteq M^+ \subseteq M^{\text{ncd}}$, $-\alpha \in M^{\text{ncd}}$ and M^{ncd} is closed, we obtain that $\Sigma(X \setminus \{\beta\}) + (-\alpha) = -\beta \in (M^{\text{ncd}})^- \subseteq R^- \cap S^-$. As $\beta \in R^+ \cup S^+$, this contradicts the antisymmetry of either R or S . \square

Proposition 11.2.17. *All cover relations in the weak order on $\mathcal{P}(\Phi)$ are cover relations in the weak order on $\mathcal{R}(\Phi)$. In particular, the weak order on $\mathcal{P}(\Phi)$ is still graded by $R \mapsto |R^-| - |R^+|$.*

Proof. Consider a cover relation $R \preceq S$ in the weak order on $\mathcal{P}(\Phi)$. We have $R^+ \supseteq S^+$ and $R^- \subseteq S^-$ where at least one of the inclusions is strict. Suppose first that $R^+ \supseteq S^+$ and consider the set $X := \{\alpha \in R^+ \setminus S^+ \mid \nexists \beta, \gamma \in R^+ \text{ with } \alpha = \beta + \gamma\}$. This set X is nonempty as it contains any α in $R^+ \setminus S^+$ with $|h|(\alpha)$ minimal. Consider now $\alpha \in X$ with $|h|(\alpha)$ maximal and let $T := R \setminus \{\alpha\}$. We claim that T is still a Φ -poset. It is clearly still antisymmetric. For closedness, assume by means of contradiction that there is $\beta, \gamma \in T$ such that $\alpha = \beta + \gamma$. Since $\alpha \in X \subseteq \Phi^+$ we can assume that $\beta \in R^-$ and $\gamma \in R^+$, and we choose β so that $|h|(\beta)$ is minimal. We claim that there is no $\delta, \varepsilon \in R^+$ such that $\gamma = \delta + \varepsilon$. Otherwise, since $\alpha = \beta + \gamma = \beta + \delta + \varepsilon \in \Phi$, we can assume by Proposition 11.1.11 that $\beta + \delta \in \Phi \cup \{0\}$. If $\beta + \delta \in \Phi^-$, then $\beta + \delta \in R^-$ (since R is closed) which contradicts the minimality of β . If $\beta + \delta \in \Phi^+$, then $\beta + \delta \in R^+$ (since R is closed), which together with $\gamma \in R^+$ and $(\beta + \delta) + \gamma = \alpha$ contradicts $\alpha \in X$. Finally, if $\beta + \delta = 0$, then $\beta = -\delta$ which contradicts the antisymmetry of R . This proves that there is no $\delta, \varepsilon \in R^+$ such that $\gamma = \delta + \varepsilon$. By maximality of $|h|(\alpha)$ in our choice of α this implies that $\gamma \in S$. Since $\beta \in R^- \subseteq S^-$, we therefore obtain that $\beta + \gamma = \alpha \in S$ and $\alpha \notin S$, contradicting the closedness of S . This proves that T is closed and thus it is a Φ -poset. Moreover, we have $R \neq T$ and $R \preceq T \preceq S$ where S covers R , which implies that $S = T = R \setminus \{\alpha\}$. We prove similarly that if $R^- \neq S^-$, there exists $\alpha \in \Phi^-$ such that $S = R \cup \{\alpha\}$. In both cases, $R \preceq S$ is a cover relation in the weak order on $\mathcal{R}(\Phi)$. \square

Corollary 11.2.18. *In the weak order on $\mathcal{P}(\Phi)$, the Φ -posets that cover a given Φ -poset $R \in \mathcal{SC}(\Phi)$ are precisely the relations:*

- $R \setminus \{\alpha\}$ for any $\alpha \in R^+$ so that there is no $\gamma, \delta \in R^+$ with $\alpha = \gamma + \delta$,
- $R \cup \{\beta\}$, for any $\beta \in \Phi^- \setminus R^-$ such that $-\beta \notin R^+$ and $\beta + \gamma \in \Phi \implies \beta + \gamma \in R$ for all $\gamma \in R$.

Remark 11.2.19. As mentioned in Remark 11.1.4, there are different possible notions of closed subsets (which all coincide in type A). The notion used here (Definition 11.1.2) only makes sense for crystallographic types. For non crystallographic

types, this notion is empty hence the result on posets (Theorem 11.2.16) is equivalent to the result on antisymmetric subsets of roots (Proposition 11.2.5). Unfortunately, it turns out that Proposition 11.2.14 and Theorem 11.2.16 do not hold for the other notions of closed sets. The smallest counter-example is in type B_3 . Consider the convex antisymmetric sets of roots

$$\begin{aligned} R &:= \{-\alpha_1, \alpha_3\} \\ S &:= \{-\alpha_1 - 2\alpha_2 - 2\alpha_3, \alpha_3\} \\ X &:= \{-\alpha_1 - \alpha_2 - \alpha_3, -\alpha_1, -\alpha_1 - 2\alpha_2 - 2\alpha_3\} \\ Y &:= \{-\alpha_1 - \alpha_2, -\alpha_1, -\alpha_1 - 2\alpha_2 - 2\alpha_3, -\alpha_1 - \alpha_2 - \alpha_3, \alpha_3\}. \end{aligned}$$

Then X and Y are two minimal convex antisymmetric sets of roots which are both bigger than R and S in weak order. In other words, R and S have no join in the weak order on convex antisymmetric sets of roots.

Note also that $R \vee_C S = \{-\alpha_1, -\alpha_1 - 2\alpha_2 - 2\alpha_3, \alpha_3\}$ is \mathbb{N} -closed but not \mathbb{R} -closed as $(-\alpha_1)/2 + (-\alpha_1 - 2\alpha_2 - 2\alpha_3)/2 = -\alpha_1 - \alpha_2 - \alpha_3 \in \Phi$.

Remark 11.2.20. We have gathered in Table 11.1 the number of Φ -posets for the root systems of type A_n , B_n , C_n and D_n for small values of n (the other lines of the table will be explained in the next section). Note that there are 1235 B_4 -posets and only 1225 C_4 -posets. This should not come as a surprise since the notion of closed sets used in this chapter (Definition 11.1.2) is not preserved when passing from roots to coroots.

type	A	B/C	D ($n \geq 4$)
# Φ -posets	1, 3, 19, 219, 4231 [A001035]	1, 3, 37, 1235 / 1225	219
# WOEP	1, 2, 6, 24, 120 [A000142]	1, 2, 8, 48, 384 [A000165]	192 [A002866]
# WOIP	1, 3, 17, 151, 1899 [A007767]	1, 3, 27, 457	3959
# WOFP	1, 3, 13, 75, 541 [A000670]	1, 3, 17, 147, 1697 [A080253]	865 [A080254]
# COEP	1, 2, 5, 14, 42 [A000108]	1, 2, 6, 20, 70 [A000984]	50 [A051924]
# COIP(bip)	1, 3, 13, 70, 433	1, 3, 18, 138, 1185	622
# COIP(lin)	1, 3, 13, 68, 399 [A000260]	1, 3, 18, 132, 1069	578
# COFP	1, 3, 11, 45, 197 [A001003]	1, 3, 13, 63, 321 [A001850]	233
# BOEP	1, 2, 4, 8, 16, 32 [A000079]	1, 2, 4, 8, 16, 32 [A000079]	16 [A000079]
# BOIP	1, 3, 9, 27, 81 [A000244]	1, 3, 9, 27, 81 [A000244]	81 [A000244]
# BOFP	1, 3, 9, 27, 81 [A000244]	1, 3, 9, 27, 81 [A000244]	81 [A000244]

Table 11.1: Numerology of Φ -posets in types A_n , B_n , C_n and D_n for small values of n . Further values can be found using the given references to [Slo15].

11.3 Some relevant subposets

In this section, we consider certain specific families of Φ -posets corresponding to the vertices, the intervals and the faces in the permutahedron (Section 11.3.1), the generalized associahedra (Section 11.3.2), and the cube (Section 11.3.3).

11.3.1 Permutahedron

The *W-permutahedron* $\text{Perm}^p(W)$ is the convex hull of the orbit under W of a point p in the interior of the fundamental chamber of W . It has one vertex $w(p)$ for each element $w \in W$ and its graph is the Cayley graph of the set S of simple reflections of W . Moreover, when oriented in the linear direction $w_\circ(p) - p$, its graph is the Hasse diagram of the *weak order* on W . Recall that the weak order is defined equivalently for any $v, w \in W$ by $v \preceq w$ if and only if

- $\ell(v) + \ell(v^{-1}w) = \ell(w)$,
- v is a prefix of w , in other words there exists $u \in W$ such that $w = vu$ and $\ell(w) = \ell(v) + \ell(u)$,
- $\text{Inv}(v) \subseteq \text{Inv}(w)$, where Inv denotes the *inversion set* $\text{Inv}(w) := \Phi^+ \cap w(\Phi^-)$,
- there is an oriented path from $v(p)$ to $w(p)$ in the graph of the permutahedron oriented in the linear direction $w_\circ(p) - p$.

In the sequel, we will often drop p from the notation $\text{Perm}^p(W)$ as the combinatorics of $\text{Perm}^p(W)$ is independent of p as long as this point is generic. Figure 11.5 represent the subsets of roots corresponding to elements, intervals and faces of a root system and summarize the results of this section.

Elements

For an element $w \in W$, we consider the Φ -poset

$$\mathbf{R}(w) := w(\Phi^+). \tag{11.13}$$

We say that $\mathbf{R}(w)$ is a *weak order element poset* and let $\text{WOEP}(\Phi) := \{\mathbf{R}(w) \mid w \in W\}$ denote the collection of all such Φ -posets.

Remark 11.3.1. Table 11.1 reports the cardinality of $\text{WOEP}(\Phi)$ in type A_n, B_n, C_n and D_n for small values of n . It is just the order of W , which is known as the product formula

$$|\text{WOEP}(\Phi)| = |W| = \prod_{i \in [n]} d_i, \tag{11.14}$$

where (d_1, \dots, d_n) are the degrees of W .

Remark 11.3.2. Geometrically, $\mathbf{R}(w)$ is the set of roots of Φ not contained in the cone of $\text{Perm}^p(W)$ at the vertex $w(p)$, *i.e.* $\mathbf{R}(w) = \Phi \setminus \text{cone}\{w'(p) - w(p) \mid w' \in W\}$. See Figure 11.4.

We now characterize the Φ -posets of $\text{WOEP}(\Phi)$.

Proposition 11.3.3. *A Φ -poset $\mathbf{R} \in \mathcal{P}(\Phi)$ is in $\text{WOEP}(\Phi)$ if and only if $\alpha \in \mathbf{R}$ or $-\alpha \in \mathbf{R}$ for all $\alpha \in \Phi$.*

Proof. This is folklore. See for instance [Bou02, Chap. 6, 1.7, Coro. 1]. □

Remark 11.3.4. We have already encountered these Φ -posets in Proposition 11.1.9: a poset is in $\text{WOEP}(\Phi)$ if and only if it is its unique extension. In other words, the maximal extensions of a Φ -poset R are all in $\text{WOEP}(\Phi)$, and it is thus natural to consider $\mathcal{L}(R) := \{w \in W \mid R \subseteq R(w)\}$. For example, in type A , $\mathcal{L}(R)$ are the set of linear extensions of the poset R .

The following statement connects the subposet of the weak order induced by $\text{WOEP}(\Phi)$ with the classical weak order on W , and thus justifies the name in Definition 11.2.1.

Proposition 11.3.5. *For $w \in W$, we have $\text{Inv}(w) = \Phi^+ \cap -R(w)$ and*

$$R(w) = (\Phi^+ \setminus \text{Inv}(w)) \sqcup -\text{Inv}(w). \quad (11.15)$$

In particular, for $v, w \in W$, we have that $R(v) \preceq R(w)$ in the weak order on $\text{WOEP}(\Phi)$ if and only if $v \preceq w$ in the weak order on W .

Proof. The first equality is just the definition of $\text{Inv}(w)$ and the second comes from the fact that $|\{\alpha, -\alpha\} \cap R(w)| = 1$, so that $R(w)^- = \Phi^- \setminus -R(w)^+ = \Phi^- \setminus -\text{Inv}(w)$. Finally, $v \preceq w$ in the weak order on W if and only if $\text{Inv}(v) \subseteq \text{Inv}(w)$ or equivalently $\Phi^+ \setminus \text{Inv}(v) \supseteq \Phi^+ \setminus \text{Inv}(w)$. This shows the equivalence with $R(v) \preceq R(w)$. \square

Remark 11.3.6. In fact we have the equivalences:

$$R(v) \preceq R(w) \iff R(v)^+ \supseteq R(w)^+ \iff R(v)^- \subseteq R(w)^- \iff v \preceq w. \quad (11.16)$$

Corollary 11.3.7. *The weak order on $\text{WOEP}(\Phi)$ is a lattice with meet and join*

$$R(v) \wedge_{\text{WOEP}} R(w) = R(v \wedge_{\mathfrak{S}} w) \quad \text{and} \quad R(v) \vee_{\text{WOEP}} R(w) = R(v \vee_{\mathfrak{S}} w). \quad (11.17)$$

See Figure 11.5 as an illustration. The following statement connects this lattice structure on $\text{WOEP}(\Phi)$ with that on $\mathcal{P}(\Phi)$.

Proposition 11.3.8. *The set $\text{WOEP}(\Phi)$ induces a sublattice of the weak order on $\mathcal{P}(\Phi)$.*

Proof. Let $R, S \in \text{WOEP}(\Phi)$ and $M = R \wedge_{\mathfrak{S}} S = (R^+ \cup S^+)^{\text{cl}} \sqcup (R^- \cap S^-)$ so that $M^{\text{ncd}} = R \wedge_{\mathfrak{C}} S$. Assume by means of contradiction that M^{ncd} is not in $\text{WOEP}(\Phi)$, and consider $\alpha \in \Phi^+$ with $|h|(\alpha)$ minimal such that $\{\alpha, -\alpha\} \cap M^{\text{ncd}} = \emptyset$.

Since $(M^{\text{ncd}})^+ = M^+ = (R^+ \cup S^+)^{\text{cl}}$, we have $\alpha \notin R^+$ and $\alpha \notin S^+$. Consequently, since $R, S \in \text{WOEP}(\Phi)$, we get $-\alpha \in R^-$ and $-\alpha \in S^-$, so that $-\alpha \in M^-$. Therefore $-\alpha \in M \setminus M^{\text{ncd}}$, so that there exists $X \subseteq M^+$ such that $\Sigma X - \alpha \in \Phi \setminus M$. Since $M^+ = (R^+ \cup S^+)^{\text{cl}}$, we can even assume that $X \subseteq R^+ \cup S^+$. We moreover choose an inclusion minimal such subset X .

Assume first that $X = \{\beta\}$. We have $\beta \in R^+ \cup S^+$, say for instance $\beta \in R^+$. Since $-\alpha \in M^- = R^- \cap S^-$, $\beta \in R$ and R is closed, we obtain that $\beta - \alpha \in R$. Since $\beta - \alpha \notin M^+$ we have $\beta - \alpha \in \Phi^-$. As $\beta \in \Phi^+$ we have $|h|(\beta - \alpha) < |h|(\alpha)$. By minimality of $|h|(\alpha)$, we obtain that $\alpha - \beta \in M^{\text{ncd}}$. We conclude that $\alpha - \beta \in M^{\text{ncd}}$ and $\beta \in R^+ \subseteq M^{\text{ncd}}$ while $\alpha \notin M^{\text{ncd}}$, contradicting the closedness of M^{ncd} .

Assume now that $|X| \geq 2$. Since $\alpha \notin M^+ = (R^+ \cup S^+)^d$ and $X \subseteq R^+ \cup S^+$, we obtain that $X \cup \{-\alpha\}$ has no vanishing subsums. Therefore, Proposition 11.1.13 ensures that $X \cup \{-\alpha\}$ has at least two strict summable subsets. In particular, there is $Y \subsetneq X$ such that $\Sigma Y - \alpha \in \Phi$. By minimality of X , we obtain that $\Sigma Y - \alpha \in M$. We distinguish two cases:

- If $\Sigma Y - \alpha \in M^+$, then $\Sigma X - \alpha \notin M^+$ while $\Sigma Y - \alpha \in M^+$ and $X \setminus Y \subseteq M^+$ contradicts the closedness of M^+ .
- If $\Sigma Y - \alpha \in M^-$, then $|h|(\Sigma Y - \alpha) < |h|(\alpha)$. By minimality of $|h|(\alpha)$, we obtain that
 - either $\Sigma Y - \alpha \in M^{\text{ncd}}$ thus $\Sigma X - \alpha = (\Sigma Y - \alpha) + (\Sigma(X \setminus Y)) \in M$, a contradiction.
 - or $\alpha - \Sigma Y \in M^{\text{ncd}}$ which implies $\alpha = (\alpha - \Sigma Y) + \Sigma Y \in M^{\text{ncd}}$, which contradicts our assumption on α .

As we reached a contradiction in all cases, we conclude that $M^{\text{ncd}} \in \text{WOEP}(\Phi)$. The proof is similar for the join. □

Intervals

For $w, w' \in W$ with $w \preceq w'$, we denote by $[w, w'] := \{v \in W \mid w \preceq v \preceq w'\}$ the *weak order interval* between w and w' . We associate to each weak order interval $[w, w']$ the Φ -poset

$$R(w, w') := \bigcap_{v \in [w, w']} R(v) = R(w) \cap R(w') = R(w)^- \sqcup R(w')^+. \quad (11.18)$$

Say that $R(w, w')$ is a *weak order interval poset* and we denote the collection of all such Φ -posets by:

$$\text{WOIP}(\Phi) := \{R(w, w') \mid w, w' \in W, w \preceq w'\}. \quad (11.19)$$

Table 11.1 reports the cardinality of $\text{WOIP}(\Phi)$ in type A_n, B_n, C_n and D_n for small values of n .

Recall from Remark 11.3.4 that we denote by $\mathcal{L}(R) := \{w \in W \mid R \subseteq R(w)\}$ the set of maximal extensions of a Φ -poset R .

Lemma 11.3.9. *A Φ -poset $R \in \mathcal{P}(\Phi)$ is in $\text{WOIP}(\Phi)$ if and only if $\mathcal{L}(R)$ has a unique weak order minimum w (resp. maximum w') that also satisfies $R(w)^- = R^-$ (resp. $R(w')^+ = R^+$).*

Proof. Remark 11.3.6 implies that $R(w, w') \subseteq R(v) \iff R(w)^- \subseteq R(v)^-$ and $R(w')^+ \subseteq R(v)^+ \iff v \in [w, w']$. Therefore, $\mathcal{L}(R(w, w'))$ has a unique weak order minimum w and a unique weak order maximum w' and $R(w)^- = R(w, w')^-$ while $R(w')^+ = R(w, w')^+$.

Conversely, if $\mathcal{L}(R)$ has a unique weak order minimum w and a unique weak order maximum w' with $R(w)^- = R^-$ and $R(w')^+ = R^+$, $R = R(w)^- \sqcup R(w')^+ = R(w, w')$ by definition. □

Remark 11.3.10. In Lemma 11.3.9, the final hypothesis is crucial as it may happen that $R \neq \bigcap \mathcal{E}(R)$ (consider for example $R = \{\alpha_1 + \alpha_2, \alpha_2\}$ in type B_2).

We can now characterize the Φ -posets of $\text{WOIP}(\Phi)$.

Proposition 11.3.11. *A Φ -poset $R \in \mathcal{P}(\Phi)$ is in $\text{WOIP}(\Phi)$ if and only if $\alpha + \beta \in R$ implies $\alpha \in R$ or $\beta \in R$ for all $\alpha, \beta \in \Phi^-$ and all $\alpha, \beta \in \Phi^+$.*

Proof. By Lemma 11.3.9, this boils down to show that the following assertions are equivalent:

- (i) $\mathcal{L}(R)$ has a unique weak order minimum w (resp. maximum w') that moreover satisfies $R(w)^- = R^-$ (resp. $R(w')^+ = R^+$),
- (ii) $\alpha + \beta \in R$ implies $\alpha \in R$ or $\beta \in R$ for all $\alpha, \beta \in \Phi^-$ (resp. for all $\alpha, \beta \in \Phi^+$).

We prove the result for the maximum and $\alpha, \beta \in \Phi^+$. The result for the minimum and $\alpha, \beta \in \Phi^-$ follows by symmetry.

Assume first that (ii) holds. Consider the subset of roots $S := R^+ \cup (\Phi^- \setminus -R^+)$. Note that $R \subseteq S$ (since R is antisymmetric), that S is antisymmetric, and that $T \preceq S$ for any antisymmetric T such that $R \subseteq T$ (as R has been completed with all possible negative roots to obtain S). We moreover claim that S is closed. Indeed, consider $\alpha, \beta \in S$ such that $\alpha + \beta \in \Phi$. We distinguish four cases:

- If $\alpha \in R$ and $\beta \in R$, then $\alpha + \beta \in R \subseteq S$.
- If $\alpha \notin R$ and $\beta \in R$, then $\alpha \in S \setminus R \subseteq \Phi^-$ so that $-\alpha \in \Phi^+ \setminus R^+$. Then,
 - if $\alpha + \beta \in \Phi^+$, then we have $-\alpha \in \Phi^+ \setminus R^+$ and $\alpha + \beta \in \Phi^+$ with $-\alpha + (\alpha + \beta) = \beta \in R$ so that Condition (ii) ensures that $\alpha + \beta \in R$,
 - if $\alpha + \beta \in \Phi^-$, then $-(\alpha + \beta) \notin R$ (as otherwise we would have the contradiction $-\alpha = -(\alpha + \beta) + \beta \in R$). Therefore $\alpha + \beta \in \Phi^- \setminus -R^+ \subseteq S$.
- If $\alpha \in R$ and $\beta \notin R$, the argument is symmetric.
- If $\alpha \notin R$ and $\beta \notin R$, then $\alpha, \beta \in S \setminus R \subseteq \Phi^-$ and $-\alpha, -\beta \in \Phi^+ \setminus R$. By condition (ii), this implies that $-\alpha - \beta \in \Phi^+ \setminus R$. Therefore, we deduce $\alpha + \beta \in \Phi^- \setminus -R \subseteq S$.

We thus obtained in all cases that $\alpha + \beta \in S$ so that S is closed. We conclude that S is a Φ -poset and that $T \preceq S$ for any antisymmetric T such that $R \subseteq T$. In particular, S is the unique maximum of the set $\mathcal{E}(R)$ of extensions of R . Moreover, $S^+ = R^+$. Using Propositions 11.1.9 and 11.3.3, we obtain that there exist $w' \in W$ such that $S = R(w')$. This concludes the proof that (ii) \implies (i).

Conversely, assume by means of contradiction that (i) holds but not (ii). Let w' denote the weak order maximal element of $\mathcal{L}(R)$, and let $\alpha, \beta \in \Phi^+ \setminus R$ be such that $\alpha + \beta \in R$. We then distinguish two cases:

- If $\alpha \in R(v)$ for all $v \in \mathcal{L}(R)$, then $\alpha \in R(w')^+ = R^+$. Contradiction.

- Otherwise, there exists $v \in \mathcal{L}(\mathbb{R})$ such that $-\alpha \in \mathbb{R}(v)$. Since $v \preceq w'$, this gives $-\alpha \in \mathbb{R}(w')$. Since $\alpha + \beta \in \mathbb{R} \subseteq \mathbb{R}(w')$ and $\mathbb{R}(w')$ is closed, we get $\beta \in \mathbb{R}(w')^+ = \mathbb{R}^+$. Contradiction. \square

We now describe the weak order on $\text{WOIP}(\Phi)$. It corresponds to the Cartesian product order on intervals of the weak order.

Proposition 11.3.12. *For $v \preceq v'$ and $w \preceq w'$, we have $\mathbb{R}(v, v') \preceq \mathbb{R}(w, w')$ if and only if $v \preceq w$ and $v' \preceq w'$.*

Proof. From the definition of $\mathbb{R}(w, w')$ and Remark 11.3.6, we have

$$\begin{aligned} \mathbb{R}(v, v') \preceq \mathbb{R}(w, w') &\iff \mathbb{R}(v, v')^+ \supseteq \mathbb{R}(w, w')^+ \quad \text{and} \quad \mathbb{R}(v, v')^- \subseteq \mathbb{R}(w, w')^- \\ &\iff \mathbb{R}(v')^+ \supseteq \mathbb{R}(w')^+ \quad \text{and} \quad \mathbb{R}(v)^- \subseteq \mathbb{R}(w)^- \\ &\iff v' \preceq w' \quad \text{and} \quad v \preceq w. \quad \square \end{aligned}$$

Corollary 11.3.13. *The weak order on $\text{WOIP}(\Phi)$ is a lattice with meet and join*

$$\mathbb{R}(v, v') \wedge_{\text{WOIP}} \mathbb{R}(w, w') = \mathbb{R}(v \wedge_{\mathfrak{S}} w, v' \wedge_{\mathfrak{S}} w'), \quad (11.20)$$

$$\mathbb{R}(v, v') \vee_{\text{WOIP}} \mathbb{R}(w, w') = \mathbb{R}(v \vee_{\mathfrak{S}} w, v' \vee_{\mathfrak{S}} w'). \quad (11.21)$$

Remark 11.3.14. It follows from the expressions of \wedge_{WOIP} and \vee_{WOIP} that $\text{WOEP}(\Phi)$ also induces a sublattice of $\text{WOIP}(\Phi)$. See Figure 11.5 as an illustration.

Remark 11.3.15. To conclude on intervals, we however observe that the weak order on $\text{WOIP}(\Phi)$ is not a sublattice of the weak order on Φ -posets. For example, in type A_2 we have

$$\{\alpha_1, \alpha_1 + \alpha_2\} \vee_{\mathcal{C}} \{\alpha_2, \alpha_1 + \alpha_2\} = \{\alpha_1 + \alpha_2\}, \quad (11.22)$$

$$\text{while} \quad \{\alpha_1, \alpha_1 + \alpha_2\} \vee_{\text{WOIP}} \{\alpha_2, \alpha_1 + \alpha_2\} = \emptyset. \quad (11.23)$$

Faces

The faces of the permutohedron $\text{Perm}^p(W)$ correspond to the cosets of the standard parabolic subgroups of W . Recall that a *standard parabolic subgroup* of W is a subgroup W_I generated by a subset I of the simple reflections of W . Its simple roots are the simple roots Δ_I of Δ corresponding to I , its root system is $\Phi_I = W_I(\Delta_I) = \Phi \cap \mathbb{R}\Delta_I$ and its longest element is denoted by $w_{\circ, I}$. A *standard parabolic coset* is a coset under the action of a standard parabolic subgroup W_I . Such a standard parabolic coset can be written as xW_I where x is its minimal length coset representative (thus x has no descent in I , see Section 11.3.3). Each standard parabolic coset xW_I (with $I \subseteq S$ disjoint from the descent set $\text{Des}(x)$ of x) corresponds to a face

$$F(xW_I) = x(\text{Perm}^p(W_I)) = \text{Perm}^{x(p)}(xW_Ix^{-1}). \quad (11.24)$$

See Figure 11.4 for an illustration in type A_2 and B_2 .

In [DHP18], A. Dermenjian, C. Hohlweg and V. Pilaud also associated to each standard parabolic coset xW_I the set of roots $\overline{\mathbb{R}}(xW_I) := x(\Phi^- \cup \Phi_I^+)$. These Φ -posets were characterized in [DHP18] as follows.

Proposition 11.3.16 ([DHP18, Coro. 3.9]). *The following assertions are equivalent for a subset of roots $R \in \mathcal{R}(\Phi)$:*

- (i) $R = \overline{R}(xW_I)$ for some parabolic coset xW_I of W ,
- (ii) $R = \{\alpha \in \Phi \mid \psi(\alpha) \geq 0\}$ for some linear function $\psi : V \rightarrow \mathbb{R}$,
- (iii) $R = \Phi \cap \text{cone}(R)$ is convex closed and $|R \cap \{\alpha, -\alpha\}| \geq 1$ for all $\alpha \in \Phi$.

Moreover, they used this definition to recover the following order on faces of the permutahedron, defined initially in type A in [Kro+01] and latter for arbitrary finite Coxeter groups in [PR06].

Proposition 11.3.17 ([DHP18]). *The following assertions are equivalent for two standard parabolic cosets $xW_I = [x, xw_{\circ,I}]$ and $yW_J = [y, yw_{\circ,J}]$ of W :*

- $x \preceq y$ and $xw_{\circ,I} \preceq yw_{\circ,J}$,
- $\overline{R}(xW_I)^+ \subseteq \overline{R}(yW_J)^+$ and $\overline{R}(xW_I)^- \supseteq \overline{R}(yW_J)^-$,
- $xW_I \preceq yW_J$ for the transitive closure \preceq of the two cover relations $xW_I \prec xW_{I \cup \{s\}}$ for $s \notin I \cup \text{Des}(x)$ and $xW_I \prec (xw_{\circ,I}w_{\circ,I \setminus \{s\}})W_{I \setminus \{s\}}$ for $s \in I$.

The resulting order on standard parabolic cosets is the **facial weak order** defined in [Kro+01; PR06; DHP18]. This order extends the weak order on the group W since $xW_{\emptyset} \preceq yW_{\emptyset} \iff x \preceq y$ for any $x, y \in W$. Moreover, it defines a lattice on standard parabolic cosets of W with meet and join

$$\begin{aligned} xW_I \wedge_{FW} yW_J &= z_{\wedge} W_{K_{\wedge}} \quad \text{where} \quad z_{\wedge} = x \wedge_{\mathfrak{S}} y \quad \text{and} \quad K_{\wedge} = \text{Des}(z_{\wedge}^{-1}(xw_{\circ,I} \wedge_{\mathfrak{S}} yw_{\circ,J})), \\ xW_I \vee_{FW} yW_J &= z_{\vee} W_{K_{\vee}} \quad \text{where} \quad z_{\vee} = xw_{\circ,I} \vee_{\mathfrak{S}} yw_{\circ,J} \quad \text{and} \quad K_{\vee} = \text{Des}(z_{\vee}^{-1}(x \vee_{\mathfrak{S}} y)). \end{aligned}$$

Note that $\overline{R}(xW_I)$ is not a Φ -poset as it is not antisymmetric when $I \neq \emptyset$. Here, we will therefore associate to xW_I the set of roots

$$R(xW_I) := \Phi \setminus \overline{R}(xW_I) = x(\Phi^+ \setminus \Phi_I^+). \quad (11.25)$$

Note that $R(xW_I)$ coincides with the weak order interval poset $R(x, xw_{\circ,I})$. We say that $R(xW_I)$ is a **weak order face poset** and we let

$$\text{WOFP}(\Phi) := \{R(xW_I) \mid xW_I \text{ standard parabolic coset of } W\} \quad (11.26)$$

denote the collection of all such Φ -posets. Table 11.1 reports the cardinality of $\text{WOFP}(\Phi)$ in type A_n, B_n, C_n and D_n for small values of n .

Remark 11.3.18. Geometrically, $R(xW_I)$ is the set of roots of Φ not contained in the cone of $\text{Perm}^p(W)$ at the face $F(xW_I)$, *i.e.*

$$R(xW_I) = \Phi \setminus \text{cone}\{w'(p) - w(p) \mid w \in xW_I, w' \in W\}. \quad (11.27)$$

See Figure 11.4.

Proposition 11.3.16 yields the following characterization of the Φ -posets in $\text{WOFP}(\Phi)$.

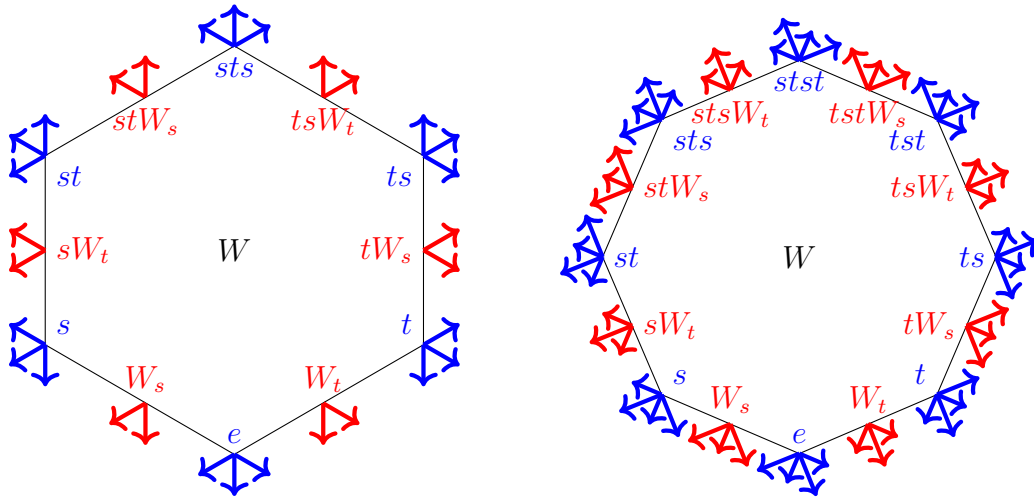

Figure 11.4: The sets $R(xW_I)$ of the standard parabolic cosets xW_I in type A_2 (left) and B_2 (right). Note that positive roots point downwards.

Proposition 11.3.19. *The following assertions are equivalent for $R \in \mathcal{R}(\Phi)$:*

- (i) R is a weak order face poset of $\text{WOFP}(\Phi)$,
- (ii) $R = \{\alpha \in \Phi \mid \psi(\alpha) < 0\}$ for some linear function $\psi : V \rightarrow \mathbb{R}$,
- (iii) $R = \Phi \cap \text{cone}(R)$ is convex closed and $|R \cap \{\alpha, -\alpha\}| \leq 1$ for all $\alpha \in \Phi$.

Proof. This immediately follows from the characterization of $\overline{R}(xW_I)$ in Proposition 11.3.16 and the definition $R(xW_I) := \Phi \setminus \overline{R}(xW_I)$. \square

We now observe that the weak order induced by $\text{WOFP}(\Phi)$ corresponds to the facial weak order of [PR06; DHP18].

Proposition 11.3.20. *For any standard parabolic cosets xW_I and yW_J , we have $R(xW_I) \preceq R(yW_J)$ in the weak order on $\text{WOFP}(\Phi)$ if and only if $xW_I \preceq yW_J$ in facial weak order.*

Proof. By definition of $R(xW_I)$ and Proposition 11.3.17, we have

$$\begin{aligned}
 R(xW_I) \preceq R(yW_J) &\iff R(xW_I)^+ \supseteq R(yW_J)^+ \quad \text{and} \quad R(xW_I)^- \subseteq R(yW_J)^- \\
 &\iff \overline{R}(xW_I)^+ \subseteq \overline{R}(yW_J)^+ \quad \text{and} \quad \overline{R}(xW_I)^- \supseteq \overline{R}(yW_J)^- \\
 &\iff xW_I \preceq yW_J. \quad \square
 \end{aligned}$$

Corollary 11.3.21. *The weak order on $\text{WOFP}(\Phi)$ is a lattice with meet and join*

$$R(xW_I) \wedge_{\text{WOFP}} R(yW_J) = R(xW_I \wedge_{FW} yW_J) \tag{11.28}$$

$$\text{and } R(xW_I) \vee_{\text{WOFP}} R(yW_J) = R(xW_I \vee_{FW} yW_J). \tag{11.29}$$

Remark 11.3.22. To conclude, note that the weak order on $\text{WOFP}(\Phi)$ is a lattice but not a sublattice of the weak order on $\mathcal{P}(\Phi)$, nor on $\text{WOIP}(\Phi)$. This was already observed in Section 10.2.1 in type A . See Figure 11.5 as an illustration.

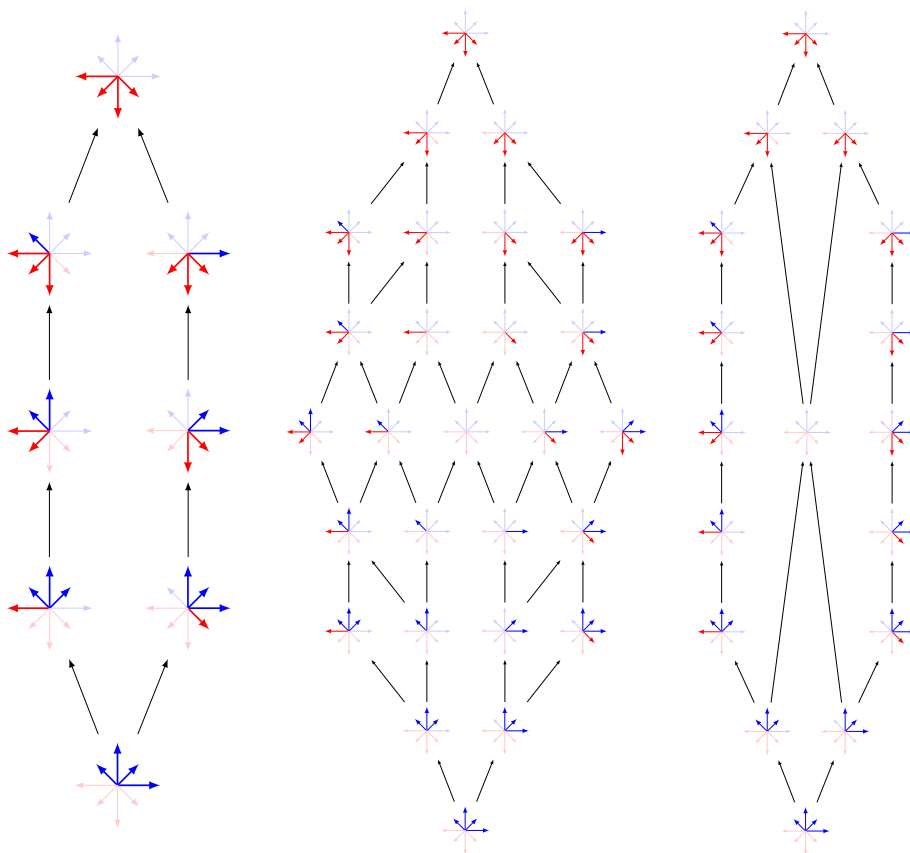

Figure 11.5: The subsets of roots corresponding to elements (left), intervals (middle) and faces (right) of type B_2 .

11.3.2 Generalized associahedra

We now consider Φ -posets corresponding to the vertices, the intervals and the faces of the generalized associahedra of type Φ . These polytopes provide geometric realizations of the type Φ cluster complex, in connection to the type Φ cluster algebra of S. Fomin and A. Zelevinsky [FZ02; FZ03a]. A first realization was constructed by F. Chapoton, S. Fomin and A. Zelevinsky in [CFZ02] based on the compatibility fan of [FZ03b; FZ03a]. An alternative realization was constructed later by C. Hohlweg, C. Lange and H. Thomas in [HLT11] based on the Cambrian fan of N. Reading and D. Speyer [RS09].

Although the sets of roots that we consider in this section have a strong connection to these geometric realizations (see Remarks 11.3.24 and 11.3.38), we do not really need for our purposes the precise definition of the geometry of these associahedra or of these Cambrian fans. We rather need a combinatorial description of their vertices and faces. The combinatorial model behind these constructions is the Cambrian lattice on sortable elements as developed by N. Reading [Rea06; Rea07a; Rea07b], which we briefly recall now.

Let c be a Coxeter element, *i.e.* the product of the simple reflections of W in an arbitrary order. The c -*sorting word* of an element $w \in W$ is the lexicographically smallest reduced expression for w in the word $c^\infty := cccc \cdots$. We write

this word as $w = c_{I_1} \dots c_{I_k}$ where c_I is the subword of c consisting only of the simple reflections in I . An element $w \in W$ is *c-sortable* when these subsets are nested: $I_1 \supseteq I_2 \supseteq \dots \supseteq I_k$. An element $w \in W$ is *c-antisortable* when ww_\circ is (c^{-1}) -sortable. See [Rea07a] for details on Coxeter sortable elements and their connections to other Coxeter-Catalan families.

For an element $w \in W$, we denote by $\pi_\downarrow^c(w)$ the maximal c -sortable element below w in weak order and by $\pi_c^\uparrow(w)$ the minimal c -antisortable element above w in weak order. The projection maps π_\downarrow^c and π_c^\uparrow can also be defined inductively, see [Rea07b]. Here, we only need that these maps are order preserving projections from W to sortable (resp. antisortable) elements, and that their fibers are intervals of the weak order of the form $[\pi_\downarrow^c(w), \pi_c^\uparrow(w)]$. Therefore, they define a lattice congruence \equiv_c of the weak order, called the *c-Cambrian congruence*. The quotient of the weak order by this congruence \equiv_c is the *c-Cambrian lattice*. It is isomorphic to the sublattice of the weak order induced by c -sortable (or c -antisortable) elements. In particular, for two c -Cambrian classes X, Y , we have $X \preceq Y$ in the c -Cambrian lattice \iff there exists $x \in X$ and $y \in Y$ such that $x \preceq y$ in the weak order on $W \iff \pi_\downarrow^c(X) \preceq \pi_\downarrow^c(Y) \iff \pi_c^\uparrow(X) \preceq \pi_c^\uparrow(Y)$. We denote by $X \wedge_c Y$ and $X \vee_c Y$ the meet and join of the two c -Cambrian classes X, Y .

Let $w_\circ(c) = q_1 \dots q_N$ denote the c -sorting word for the longest element w_\circ . It defines an order on Φ^+ by $\alpha_{q_1} <_c q_1(\alpha_{q_2}) <_c q_1q_2(\alpha_{q_3}) <_c \dots <_c q_1 \dots q_{N-1}(\alpha_{q_N})$. A subset R of positive roots is called *c-aligned* if for any $\alpha <_c \beta$ such that $\alpha + \beta \in R$, we have $\alpha \in R$. It is known that $w \in W$ is c -sortable if and only if its inversion set $\text{Inv}(w)$ is c -aligned [Rea07b]. We refer to Figure 11.7 for an illustration the pictures of this section.

Elements

For a c -Cambrian class X , we consider the Φ -poset

$$R(X) := \bigcap_{w \in X} R(w) = R(\pi_\downarrow^c(X)) \cap R(\pi_c^\uparrow(X)) = R(\pi_\downarrow^c(X))^- \sqcup R(\pi_c^\uparrow(X))^+. \tag{11.30}$$

By definition $R(X)$ coincides with the weak order interval poset $R(\pi_\downarrow^c(X), \pi_c^\uparrow(X))$. We say that $R(X)$ is a *c-Cambrian order element poset* and we denote the collection of all such Φ -posets by $\text{COEP}(c) := \{R(X) \mid X \text{ } c\text{-Cambrian class}\}$.

Remark 11.3.23. Table 11.1 reports the cardinality of $\text{COEP}(c)$ in type A_n, B_n, C_n and D_n for small values of n . Observe that this cardinality is independent on the choice of the Coxeter element c , and is the Coxeter-Catalan number (counting many related objects from clusters of type Φ to non-crossing partitions of W):

$$|\text{COEP}(c)| = \text{Cat}(W) = \prod_{i \in [n]} \frac{1 + d_i}{d_i}, \tag{11.31}$$

where (d_1, \dots, d_n) still denote the degrees of W .

Remark 11.3.24. Geometrically, $R(X)$ is the set of roots of Φ not contained in the cone of the vertex corresponding to X in the generalized associahedron $\text{Asso}(c)$ of C. Hohlweg, C. Lange and H. Thomas in [HLT11]. See Figure 11.6.

Let us now take a little detour to comment on a conjectured characterization of these Φ -posets, inspired from a similar characterization in type A proved in [CPP17, Prop. 60]. Note that it uses the c -Cambrian order interval posets formally defined in the next section and characterized in Proposition 11.3.32. It also requires the notion of c -snakes. A c -snake in a Φ -poset R is a sequence of roots $\alpha_1, \dots, \alpha_p \in R$ such that

- either $\alpha_{2i} \in \Phi^-, \alpha_{2i+1} \in \Phi^+$ and $\alpha_1 <_c -\alpha_2 >_c \alpha_3 <_c -\alpha_4 >_c \dots$
- or $\alpha_{2i} \in \Phi^+, \alpha_{2i+1} \in \Phi^-$ and $-\alpha_1 >_c \alpha_2 <_c -\alpha_3 >_c \alpha_4 <_c \dots$

A c -snake decomposition of a root α in R is a decomposition $\alpha = \sum_{i \in [p]} \lambda_i \alpha_i$, where $\lambda_i \in \mathbb{N}$ and $\alpha_1, \dots, \alpha_p$ is a c -snake of R . The following conjectural characterization of c -Cambrian order element posets was proved in type A in [CPP17, Prop. 60] and has been checked computationally for small Coxeter types using [dev16].

Conjecture 11.3.25. *A Φ -poset $R \in \mathcal{P}(\Phi)$ is in $\text{COEP}(c)$ if and only if it is in $\text{COIP}(c)$ (characterized in Proposition 11.3.32) and any root $\alpha \in \Phi$ admits a c -snake decomposition in R .*

Even without this characterization, we can at least describe the weak order on these posets.

Proposition 11.3.26. *For any two c -Cambrian classes X and Y , we have that $R(X) \preceq R(Y)$ in the weak order on $\text{COEP}(c)$ if and only if $X \preceq Y$ in the c -Cambrian lattice.*

Proof. By definition, a c -Cambrian class X admits both a minimal element $\pi_{\downarrow}^c(X)$ and a maximal element $\pi_{\uparrow}^c(X)$. Therefore, $R(X) = R(\pi_{\downarrow}^c(X), \pi_{\uparrow}^c(X)) \in \text{WOIP}(\Phi)$. Moreover, for two c -Cambrian classes X and Y , Proposition 11.3.12 implies that $R(X) \preceq R(Y)$ in the weak order on $\text{WOIP}(\Phi)$ if and only if $\pi_{\downarrow}^c(X) \preceq \pi_{\downarrow}^c(Y)$ and $\pi_{\uparrow}^c(X) \preceq \pi_{\uparrow}^c(Y)$ in weak order on W . But this is equivalent to $X \preceq Y$ in the c -Cambrian lattice as mentioned above. \square

Remark 11.3.27. In fact, we have the equivalences:

$$R(X) \preceq R(Y) \iff R(X)^+ \supseteq R(Y)^+ \iff R(X)^- \subseteq R(Y)^- \iff X \preceq Y.$$

Corollary 11.3.28. *For any Coxeter element c , the weak order on $\text{COEP}(c)$ is a lattice with meet and join*

$$R(X) \wedge_{\text{COEP}(c)} R(Y) = R(X \wedge_c Y) \tag{11.32}$$

$$\text{and } R(X) \vee_{\text{COEP}(c)} R(Y) = R(X \vee_c Y). \tag{11.33}$$

We refer to Figure 11.7 as an illustration. Although it anticipates on the c -Cambrian order interval posets studied in the next section, let us state the following result that will be a direct consequence of Corollary 11.3.34 and Proposition 11.3.35.

Proposition 11.3.29. *For any Coxeter element c , the set $\text{COEP}(c)$ induces a sublattice of the weak order on $\text{COIP}(c)$ and thus also a sublattice of the weak order on $\text{WOIP}(\Phi)$.*

We conclude our discussion on $\text{COEP}(c)$ with one more conjecture, which was proved in type A in [CPP17, Coro. 88] and checked computationally for small Coxeter types using [dev16]. Note that there is little hope to attack this conjecture before proving either Conjecture 11.3.25 or Conjecture 11.3.36.

Conjecture 11.3.30. *For any Coxeter element c , the set $\text{COEP}(c)$ induces a sublattice of the weak order on $\mathcal{P}(\Phi)$ and of the weak order on $\text{WOIP}(\Phi)$.*

Intervals

For two c -Cambrian classes X, X' with $X \preceq X'$ in the c -Cambrian order, we denote by $[X, X'] := \{Y \text{ } c\text{-Cambrian class} \mid X \preceq Y \preceq X'\}$ the c -Cambrian order interval between X and X' . We associate to each c -Cambrian order interval $[X, X']$ the Φ -poset

$$\mathbf{R}(X, X') := \bigcap_{Y \in [X, X']} \mathbf{R}(Y) = \mathbf{R}(X) \cap \mathbf{R}(X') = \mathbf{R}(X)^- \cup \mathbf{R}(X')^+. \quad (11.34)$$

By definition $\mathbf{R}(X, X')$ coincides with the weak order interval poset $\mathbf{R}(\pi_c^\downarrow(X), \pi_c^\uparrow(X'))$. We say that $\mathbf{R}(X, X')$ is a c -Cambrian order interval poset and we denote the collection of all such Φ -posets by

$$\text{COIP}(c) := \{\mathbf{R}(X, X') \mid X, X' \text{ } c\text{-Cambrian classes, } X \preceq X'\}. \quad (11.35)$$

Remark 11.3.31. Table 11.1 reports the cardinality of $\text{COIP}(c)$ in type A_n, B_n, C_n and D_n for small values of n and different choices of the Coxeter element c . We have denoted by bip the bipartite Coxeter element, and by lin the linear one (with the special vertex first in type B/C and the two special vertices first in type D). Note that in contrast to $\text{COEP}(c)$, the cardinality of $\text{COIP}(c)$ depends on the choice of the Coxeter element c (this comes from the fact that the c -Cambrian lattices for different choices of Coxeter element c are not isomorphic and have distinct intervals, although they have the same number of elements).

We now characterize the Φ -posets in $\text{COIP}(c)$.

Proposition 11.3.32. *A Φ -poset $\mathbf{R} \in \mathcal{P}(\Phi)$ is in $\text{COIP}(c)$ if and only if $\alpha + \beta \in \mathbf{R}$ and $\alpha <_c \beta$ implies $\beta \in \mathbf{R}$ for all $\alpha, \beta \in \Phi^+$ (resp. $\alpha \in \mathbf{R}$ for all $\alpha, \beta \in \Phi^-$).*

Proof. Let $\mathbf{R} \in \mathcal{P}(\Phi)$. By definition, \mathbf{R} is in $\text{COIP}(c)$ if and only if $\mathbf{R} = \mathbf{R}(w, w')$ is in $\text{WOIP}(\Phi)$ where w is c -sortable while w' is c -antisortable. However, w is c -sortable if and only if $\text{Inv}(w) = \Phi^+ \cap -\mathbf{R}(w) = -\mathbf{R}(w)^- = -\mathbf{R}(w, w')^- = -\mathbf{R}^-$ is c -aligned, i.e. if and only if $\alpha + \beta \in \mathbf{R}^- \implies \alpha \in \mathbf{R}^-$ for any $\alpha <_c \beta$. Similarly, w' is c -antisortable if and only if $\alpha + \beta \in \mathbf{R}^+ \implies \beta \in \mathbf{R}^+$ for any $\alpha <_c \beta$. \square

Proposition 11.3.33. *For two c -Cambrian intervals $X \preceq X'$ and $Y \preceq Y'$, we have $\mathbf{R}(X, X') \preceq \mathbf{R}(Y, Y')$ in the weak order on $\text{COIP}(c)$ if and only if $X \preceq Y$ and $X' \preceq Y'$ in the c -Cambrian order.*

Proof. By definition of $\mathbf{R}(X, X')$ and Remark 11.3.27, we obtain

$$\begin{aligned} \mathbf{R}(X, X') \preceq \mathbf{R}(Y, Y') &\iff \mathbf{R}(X, X')^+ \supseteq \mathbf{R}(Y, Y')^+ \text{ and } \mathbf{R}(X, X')^- \subseteq \mathbf{R}(Y, Y')^- \\ &\iff \mathbf{R}(X')^+ \supseteq \mathbf{R}(Y')^+ \text{ and } \mathbf{R}(X)^- \subseteq \mathbf{R}(Y)^- \end{aligned}$$

\square

Corollary 11.3.34. *For any Coxeter element c , the weak order on $\text{COIP}(c)$ is a lattice with meet and join*

$$\mathbf{R}(X, X') \wedge_{\text{COIP}(c)} \mathbf{R}(Y, Y') = \mathbf{R}(X \wedge_c Y, X' \wedge_c Y') \quad (11.36)$$

$$\text{and } \mathbf{R}(X, X') \vee_{\text{COIP}(c)} \mathbf{R}(Y, Y') = \mathbf{R}(X \vee_c Y, X' \vee_c Y'). \quad (11.37)$$

We refer to Figure 11.7 as an illustration. The following statement connects this lattice structure on $\text{COIP}(c)$ with that on $\text{WOIP}(\Phi)$.

Proposition 11.3.35. *For any Coxeter element c , the set $\text{COIP}(c)$ induces a sublattice of the weak order on $\text{WOIP}(\Phi)$.*

Proof. Consider two c -Cambrian intervals $X \preceq X'$ and $Y \preceq Y'$. By Corollary 11.3.13, we have

$$\begin{aligned} \mathbf{R}(X, X') \wedge_{\text{WOIP}} \mathbf{R}(Y, Y') &= \mathbf{R}(\pi_{\downarrow}^c(X), \pi_c^{\uparrow}(X')) \wedge_{\text{WOIP}} \mathbf{R}(\pi_{\downarrow}^c(Y), \pi_c^{\uparrow}(Y')) \\ &= \mathbf{R}(\pi_{\downarrow}^c(X) \wedge_{\mathfrak{S}} \pi_{\downarrow}^c(Y), \pi_{\downarrow}^c(X') \wedge_{\mathfrak{S}} \pi_{\downarrow}^c(Y')) \\ &= \mathbf{R}(\pi_{\downarrow}^c(X \wedge_c Y), \pi_{\downarrow}^c(X' \wedge_c Y')), \end{aligned}$$

where the last equality follows from the fact that c -sortable elements (resp. c -antisortable elements) induce a sublattice of the weak order. \square

The following conjecture indicates that $\text{COIP}(c)$ behaves much better than $\text{WOIP}(\Phi)$ as subposet of $\mathcal{P}(\Phi)$. This conjecture unfortunately remains open for now but was proved in type A in [CPP17, Coro. 82] and verified for small Coxeter types using [dev16]. Note that it is not implied by Proposition 11.3.35 since $\text{WOIP}(\Phi)$ is not a sublattice of $\mathcal{P}(\Phi)$. Observe also that it would imply Conjecture 11.3.30.

Conjecture 11.3.36. *For any Coxeter element c , the set $\text{COIP}(c)$ induces a sublattice of the weak order on $\mathcal{P}(\Phi)$.*

Faces

To remain at a combinatorial level and avoid any geometric description (see also Remark 11.3.38), we consider a combinatorial model for the faces of the associahedron $\text{Asso}(c)$ that rely on results of [DHP18, Sec. 4]. The c -Cambrian congruence \equiv_c extends to the *c -Cambrian facial congruence* on all faces of the permutahedron $\text{Perm}(W)$ defined by $xW_I \equiv_c yW_J \iff x \equiv_c y$ and $xw_{\circ,I} \equiv_c yw_{\circ,J}$. This relation is a lattice congruence of the facial weak order on faces of the permutahedron $\text{Perm}(W)$ [DHP18, Prop. 4.12] and we denote by Π_{\downarrow}^c and Π_c^{\uparrow} its down and up projections. Moreover, the c -Cambrian facial congruence classes precisely correspond to the faces of the associahedron $\text{Asso}(c)$ of [HLT11].

For a c -Cambrian facial congruence class F , we consider the Φ -poset

$$\mathbf{R}(F) := \bigcap_{xW_I \in F} \mathbf{R}(xW_I) = \mathbf{R}(\Pi_{\downarrow}^c(F))^- \cap \mathbf{R}(\Pi_c^{\uparrow}(F))^+. \quad (11.38)$$

Note that if $\Pi_{\downarrow}^c(F) = xW_I$ and $\Pi_c^{\uparrow}(F) = yW_J$, then $\mathbf{R}(F)$ coincides with the weak order interval poset $\mathbf{R}(x, yw_{\circ,J})$. We say that $\mathbf{R}(F)$ is a *c -Cambrian order face poset* and denote the set of such Φ -posets by

$$\text{COFP}(c) := \{\mathbf{R}(F) \mid F \text{ } c\text{-Cambrian facial congruence class}\}. \quad (11.39)$$

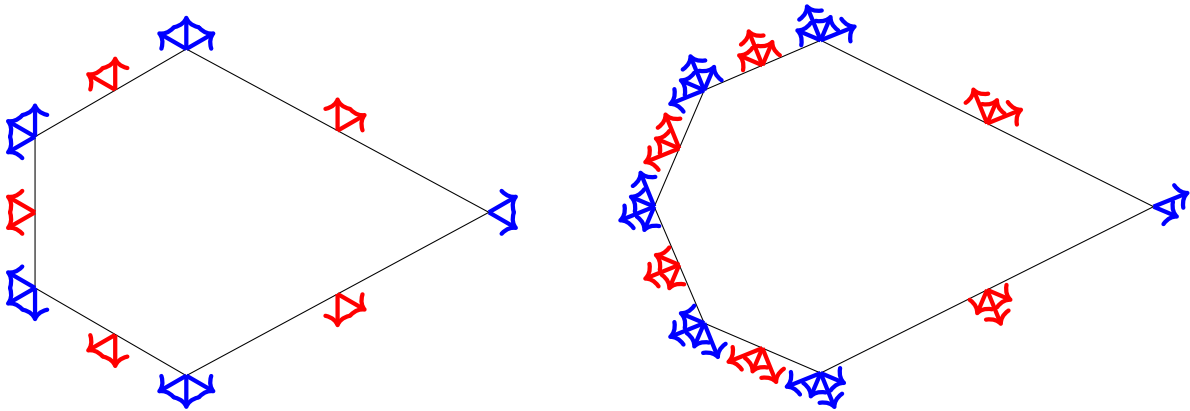

Figure 11.6: The sets $R(F)$ for the faces F of the c -associahedron in type A_2 (left) and B_2 (right). Note that positive roots point downwards.

Remark 11.3.37. Table 11.1 reports the cardinality of $\text{COFP}(c)$ in type A_n , B_n , C_n and D_n for small values of n . Note that this cardinality is again independent of the choice of the Coxeter element c (it is the number of faces in the generalized associahedron, *i.e.* the number of partial clusters in the corresponding cluster algebra).

Remark 11.3.38. Geometrically, $R(F)$ is the set of roots of Φ not contained in the cone of the face F in the generalized associahedron $\text{Asso}(c)$ of C. Hohlweg, C. Lange and H. Thomas in [HLT11]. See Figure 11.6.

It would be interesting to have a characterization of the Φ -posets in $\text{COFP}(c)$ similar to that given in [CPP17] in type A (see Proposition 10.2.16 for the Tamari faces and [CPP17, Prop. 63] for the type A Cambrian faces in general).

Here, we just connect the weak order on $\text{COFP}(c)$ with the facial weak order on the associahedron $\text{Asso}(c)$ considered in [DHP18, Sec. 4.7.2]. This order is the quotient of the facial weak order on the faces of the permutahedron $\text{Perm}(W)$ by the c -Cambrian facial congruence \equiv_c .

Proposition 11.3.39. *For any two c -Cambrian facial congruence classes F and G we have $R(F) \preceq R(G)$ in the weak order on $\text{COFP}(c)$ if and only if $F \preceq G$ in the c -Cambrian facial lattice.*

Proof. This is immediate from the definitions:

$$\begin{aligned} R(F) \preceq R(G) &\iff R(\Pi_c^\uparrow(F))^+ \supseteq R(\Pi_c^\uparrow(G))^+ \text{ and } R(\Pi_c^\downarrow(F))^- \subseteq R(\Pi_c^\downarrow(G))^- \\ &\iff \Pi_c^\uparrow(F) \preceq \Pi_c^\uparrow(G) \quad \text{and} \quad \Pi_c^\downarrow(F) \preceq \Pi_c^\downarrow(G) \\ &\iff F \preceq G. \end{aligned}$$

□

Corollary 11.3.40. *For any Coxeter element c , the weak order on $\text{COFP}(c)$ is a lattice.*

Remark 11.3.41. To conclude, note that the weak order on $\text{COFP}(c)$ is a lattice but not a sublattice of the weak order on $\mathcal{P}(\Phi)$, nor on $\text{WOIP}(\Phi)$, nor on $\text{COIP}(c)$.

This was already observed in Section 10.2.2 in type A . For example, consider the example of Remark 11.3.22 for the Coxeter element s_1s_2 in type A_2 .

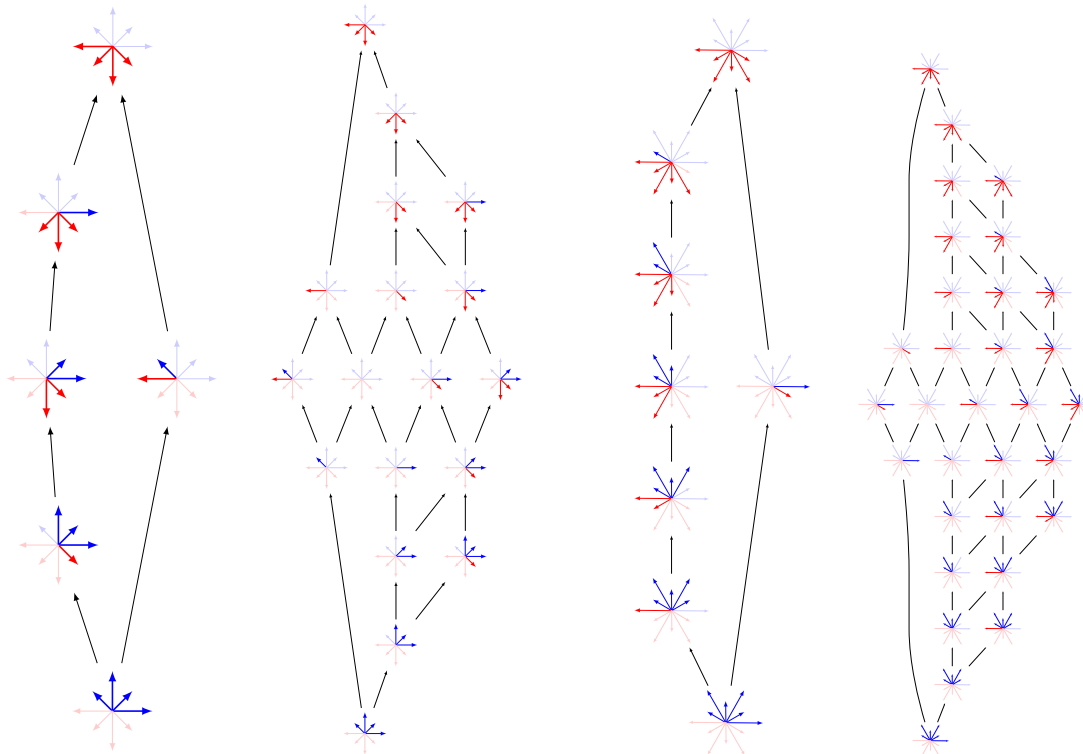

Figure 11.7: The subsets of roots corresponding to cambrian elements (first on the left) and intervals (second on the left) of type B_2 with coxeter element s_1s_2 , and cambrian elements (second on the right) and intervals (first on the right) of type G_2 with coxeter element s_1s_2 .

11.3.3 Cube

To conclude this chapter, we consider Φ -posets corresponding to the vertices, the intervals and the faces of the cube (see Remarks 11.3.42 and 11.3.48), corresponding to the descent congruence on W . We represent the results in Figure 11.9. Recall that a (left) *descent* of $w \in W$ is a simple root $\alpha \in \Delta$ such that $s_\alpha w \preceq w$, or equivalently $\alpha \in \text{Inv}(w)$. The *descent set* of w is $\text{Des}(w) := \text{Inv}(w) \cap \Delta$. The *descent class* of w is the set of elements of W that have precisely the same descent set as w . Note that descent classes correspond to subsets of Δ : for $A \subseteq \Delta$, we denote by Z_A the descent class of elements of W with A as descent set. These classes define the *descent congruence* on W , whose down and up projections we denote by π_\downarrow^d and π_\uparrow^d .

Elements

For a subset $A \subseteq \Delta$ corresponding to the descent class Z_A , we consider the Φ -poset

$$R(A) := (-A \sqcup (\Delta \setminus A))^{\text{cl}} = \Phi \cap \mathbb{N}(-A \sqcup (\Delta \setminus A))$$

$$= \bigcap_{w \in Z_A} R(w) = R(\pi_{\downarrow}^d(Z_A)) \cap R(\pi_{\uparrow}^d(Z_A)) = R(\pi_{\downarrow}^d(Z_A))^- \sqcup R(\pi_{\uparrow}^d(Z_A))^+$$

By definition $R(A)$ coincides with the weak order interval poset $R(\pi_{\downarrow}^c(Z_A), \pi_{\uparrow}^c(Z_A))$. We say that $R(A)$ is a *boolean order element poset* and we denote the collection of all such Φ -posets by $\text{BOEP}(\Phi) := \{R(A) \mid A \subseteq \Delta\}$. Note that there are 2^n many Φ -posets in $\text{BOEP}(\Phi)$, see Table 11.1.

Remark 11.3.42. Geometrically, $R(A)$ is the set of roots of Φ not contained in the cone of the vertex corresponding to A in the parallelepiped generated by the simple roots Δ . See Figure 11.8.

These Φ -posets are characterized in the next statement. Its proof is delayed to Section 11.3.3 as it requires the characterization of the boolean order interval posets.

Proposition 11.3.43. *A Φ -poset $R \in \mathcal{P}(\Phi)$ is in $\text{BOEP}(\Phi)$ if and only if*

- $\alpha + \beta \in R \implies \alpha \in R$ and $\beta \in R$ for all $\alpha, \beta \in \Phi^+$ and all $\alpha, \beta \in \Phi^-$,
- $\alpha \in R$ or $-\alpha \in R$ for any simple root $\alpha \in \Delta$.

The following statement characterizes the weak order induced by $\text{BOEP}(\Phi)$.

Proposition 11.3.44. *For any subsets $A, B \subseteq \Delta$, we have $R(A) \preceq R(B)$ in the weak order on $\text{BOEP}(\Phi)$ if and only if $A \subseteq B$ in boolean order.*

Proof. From the definition $R(A) = \Phi \cap \mathbb{N}(-A \sqcup (\Delta \setminus A))$, we obtain that

$$\begin{aligned} R(A) \preceq R(B) &\iff R(A)^+ \supseteq R(B)^+ \quad \text{and} \quad R(A)^- \subseteq R(B)^- \\ &\iff \Delta \setminus A \supseteq \Delta \setminus B \quad \text{and} \quad A \subseteq B. \end{aligned} \tag{11.40}$$

□

Remark 11.3.45. In fact we have the equivalences:

$$R(A) \preceq R(B) \iff R(A)^+ \supseteq R(B)^+ \iff R(A)^- \subseteq R(B)^- \iff A \subseteq B.$$

Corollary 11.3.46. *The weak order on $\text{BOEP}(\Phi)$ is a lattice with meet and join*

$$R(A) \wedge_{\text{BOEP}} R(B) = R(A \cap B) \tag{11.41}$$

$$\text{and} \quad R(A) \vee_{\text{BOEP}} R(B) = R(A \cup B). \tag{11.42}$$

This is illustrated in Figure 11.9. Although it anticipates on the boolean order interval posets studied in the next section, let us state the following result that will be a direct consequence of Corollary 11.3.51 and Proposition 11.3.52.

Proposition 11.3.47. *The set $\text{BOEP}(\Phi)$ induces a sublattice of the weak order on $\text{BOIP}(\Phi)$ and therefore on the weak orders on $\mathcal{P}(\Phi)$, on $\text{WOIP}(\Phi)$ and on $\text{COIP}(c)$ for all Coxeter element c .*

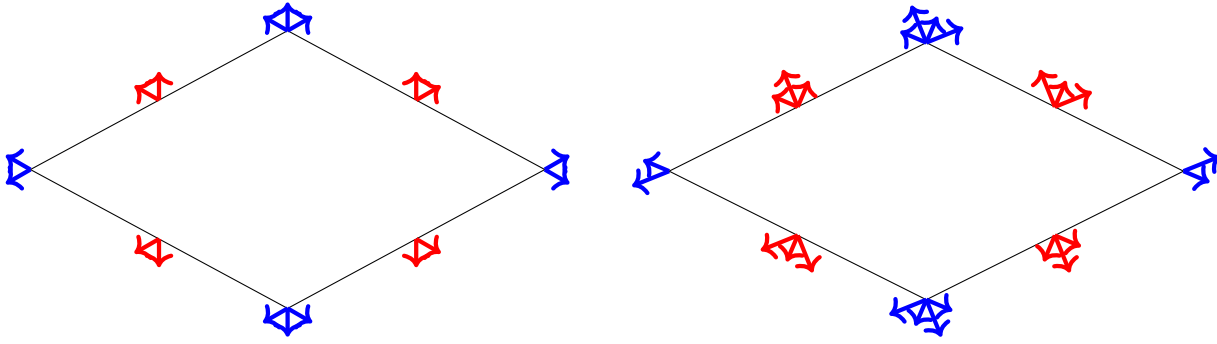

Figure 11.8: The sets $R(F)$ for the faces F of the cube in type A_2 (left) and B_2 (right). Note that positive roots point downwards.

Intervals and Faces

We finally consider intervals in the boolean order, or equivalently faces of the cube (see Remark 11.3.48). For two subsets $A \subseteq A'$ of Δ , we consider

$$R(A, A') := \bigcap_{A \subseteq B \subseteq A'} R(B) = R(A) \cap R(A') = R(A)^- \sqcup R(A')^+. \tag{11.43}$$

By definition $R(A, A')$ coincides with the weak order interval poset $R(\pi_{\downarrow}^c(Z_A), \pi_c^{\uparrow}(Z_{A'}))$. Observe also that $\text{BOIP}(\Phi) \subseteq \text{COIP}(c)$ for any Coxeter element c since the descent congruence coarsens the c -Cambrian congruence. We say that $R(A, A')$ is a *boolean order interval poset* and we denote the set of such Φ -posets by

$$\text{BOIP}(\Phi) := \{R(A, A') \mid A \subseteq A' \subseteq \Delta\}. \tag{11.44}$$

Remark 11.3.48. Geometrically, $R(A, A')$ is the set of roots of Φ not contained in the cone of the face corresponding to $A \subseteq A'$ in the parallelepiped generated by the simple roots Δ . See Figure 11.8.

These Φ -posets are characterized as follows.

Proposition 11.3.49. *For a Φ -poset $R \in \mathcal{P}(\Phi)$ we have:*

$$R \in \text{BOIP}(\Phi) \iff \forall \alpha, \beta \in \Phi^+ \text{ and } \forall \alpha, \beta \in \Phi^-, (\alpha + \beta \in R \implies \alpha, \beta \in R).$$

Proof. Consider first $R(A, A') \in \text{BOIP}(\Phi)$ and $\alpha + \beta \in R(A, A')$ with $\alpha, \beta \in \Phi^-$. For $\gamma \in \Delta$, denote by $[\alpha : \gamma]$ the coefficient of γ in the decomposition of α on the simple root basis. If $[\alpha : \gamma] \neq 0$, then we have $[\alpha + \beta : \gamma] \neq 0$ which implies that $\gamma \in A$ since $\alpha + \beta \in R(A, A')^- = R(A)^- \subseteq \mathbb{N}(-A)$. We therefore obtain that $\alpha \in \Phi \cap \mathbb{N}(-A) = R(A)^- \subseteq R(A, A')$. By symmetry, we conclude that $\alpha \in R(A, A')$ and $\beta \in R(A, A')$ for any $\alpha, \beta \in \Phi^-$ such that $\alpha + \beta \in R(A, A')$. The proof is similar when $\alpha, \beta \in \Phi^+$.

Conversely, consider $R \in \mathcal{P}(\Phi)$ such that $\alpha + \beta \in R \implies \alpha \in R$ and $\beta \in R$ for all $\alpha, \beta \in \Phi^+$ and all $\alpha, \beta \in \Phi^-$. Define $A := -(R \cap -\Delta)$ and $A' := \Phi \setminus (R \cap \Delta)$. We claim that $R = R(A, A')$, i.e. that $R^- = R(A)^-$ and $R^+ = R(A')^+$. We prove

the latter, as the former would be similar. Observe first that $\Delta \setminus A' \subseteq R$, so that $R(A')^+ = \Phi \cap \mathbb{N}(\Delta \setminus A') \subseteq R$ since R is closed. Conversely, we prove by induction on $|\gamma|$ that any $\gamma \in R^+$ belongs to $R(A')^+$. Consider $\gamma \in R^+$, and let X be the multiset of simple roots such that $\gamma = \Sigma X$. By Theorem 11.1.12, there exists $\alpha \in X$ such that $\beta = \Sigma(X \setminus \{\alpha\}) \in \Phi$. Since $\alpha + \beta = \gamma \in R$, we get that $\alpha \in R$ and $\beta \in R$. Therefore, we have $\alpha \in \Delta \cap R = \Phi \setminus A' \subseteq R(A')^+$ and $\beta \in R(A')^+$ (by induction hypothesis). Since $R(A')^+$ is closed, this shows $\gamma = \alpha + \beta \in R(A')^+$. \square

We are now in position to provide the proof of Proposition 11.3.43 postponed in Section 11.3.3.

Proof of Proposition 11.3.43. Observe first that for $A \subseteq \Delta$, the boolean order element poset $R(A)$ satisfies (i) by Proposition 11.3.49 and (ii) since $\alpha \in R(A)$ if $\alpha \in \Delta \setminus A$ and $-\alpha \in R(A)$ if $\alpha \in A$.

Conversely, consider a Φ -poset R satisfying (i) and (ii). The proof of Proposition 11.3.49 ensures that $R = R(A, A')$ where $A := -(R \cap -\Delta)$ and $A' := \Phi \setminus (R \cap \Delta)$. Condition (ii) ensures that $A = A'$ so that $R = R(A, A) = R(A) \in \text{BOEP}(\Phi)$. \square

The following statement characterizes the weak order induced by $\text{BOIP}(\Phi)$.

Proposition 11.3.50. *For two boolean intervals $A \subseteq A'$ and $B \subseteq B'$, we have $R(A, A') \preceq R(B, B')$ in the weak order on $\text{BOIP}(\Phi)$ if and only if $A \subseteq B$ and $A' \subseteq B'$ in boolean order.*

Proof. Using Remark 11.3.45, we obtain that

$$\begin{aligned} R(A, A') \preceq R(B, B') &\iff R(A, A')^+ \supseteq R(B, B')^+ \text{ and } R(A, A')^- \subseteq R(B, B')^- \\ &\iff R(A')^+ \supseteq R(B')^+ \text{ and } R(A)^- \subseteq R(B)^- \\ &\iff \Delta \setminus A' \supseteq \Delta \setminus B' \text{ and } A \subseteq B \\ &\iff A' \subseteq B' \text{ and } A \subseteq B. \quad \square \end{aligned}$$

Corollary 11.3.51. *The weak order on $\text{BOIP}(\Phi)$ is a lattice with meet and join*

$$R(A, A') \wedge_{\text{BOIP}} R(B, B') = R(A \cap B, A' \cap B') \quad (11.45)$$

$$\text{and } R(A, A') \vee_{\text{BOIP}} R(B, B') = R(A \cup B, A' \cup B'). \quad (11.46)$$

This is illustrated in Figure 11.9. We conclude with a connection between the lattice structure of the weak orders on $\text{BOIP}(\Phi)$ with that on $\mathcal{P}(\Phi)$, $\text{WOIP}(\Phi)$ and $\text{COIP}(c)$.

Proposition 11.3.52. *The set $\text{BOIP}(\Phi)$ induces a sublattice of the weak order on $\mathcal{P}(\Phi)$, on $\text{WOIP}(\Phi)$ and on $\text{COIP}(c)$ for all Coxeter element c .*

Proof. Let $R = R(A, A')$ and $S = R(B, B')$ be two boolean order interval posets, and consider $M = R \wedge_{\text{SC}} S$. Observe that

$$\begin{aligned} M^- &= R^- \cap S^- = -A^{\text{cl}} \cap -B^{\text{cl}} = -(A \cap B)^{\text{cl}} \\ \text{and } M^+ &= (R^+ \cup S^+)^{\text{cl}} = ((\Delta \setminus A')^{\text{cl}} \cup (\Delta \setminus B')^{\text{cl}})^{\text{cl}} = (\Delta \setminus (A' \cap B'))^{\text{cl}}. \end{aligned}$$

In other words, we obtain that $M = R \wedge_{\text{BOIP}} S$ is already in $\text{BOIP}(\Phi)$, and consequently

$$R \wedge_{\mathcal{C}} S = M^{\text{ncd}} = M = R \wedge_{\text{BOIP}} S \in \text{BOIP}(\Phi). \quad (11.47)$$

As $\text{BOIP}(\Phi) \subseteq \text{COIP}(c) \subseteq \text{WOIP}(\Phi) \subseteq \mathcal{P}(\Phi)$, we have

$$\mathbb{R} \wedge_{\text{BOIP}} S \approx \mathbb{R} \wedge_{\text{COIP}(c)} S \approx \mathbb{R} \wedge_{\text{WOIP}} S \approx \mathbb{R} \wedge_{\text{BOIP}} S \quad (11.48)$$

so that all these meets coincide. The proof is similar for the join. \square

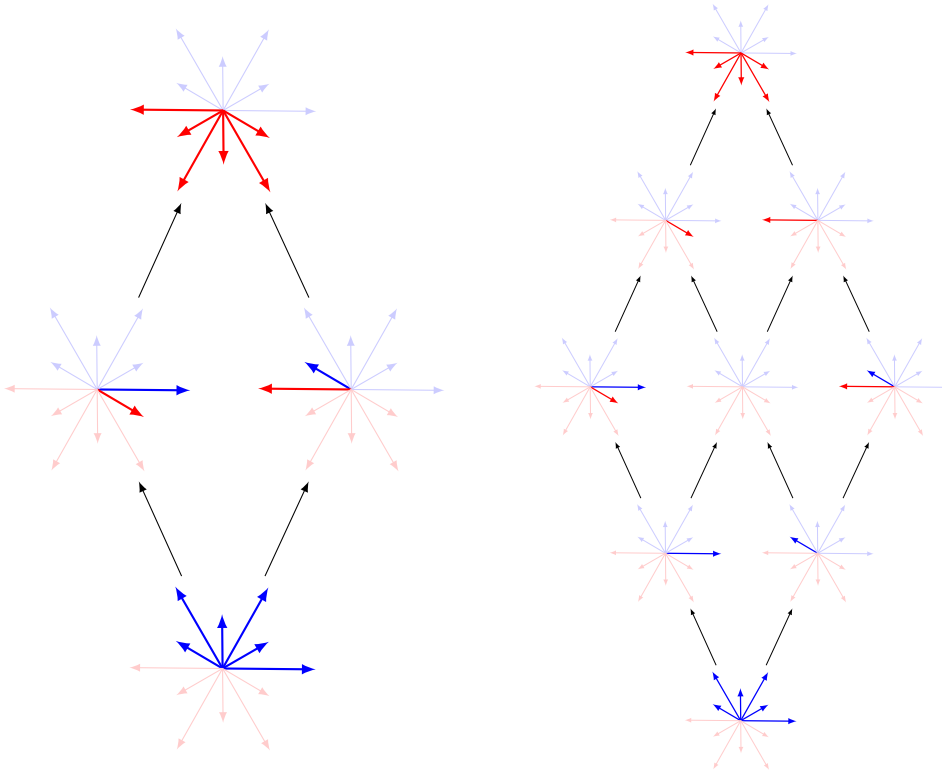

Figure 11.9: The subsets of roots corresponding to booleand elements (left) and intervals/faces (right) of type G_2 .

Bibliography

- [Arm09] Drew Armstrong. “Generalized noncrossing partitions and combinatorics of Coxeter groups”. In: *Mem. Amer. Math. Soc.* 202.949 (2009), pp. x+159. ISSN: 0065-9266. URL: <https://doi.org/10.1090/S0065-9266-09-00565-1>.
- [ASS06] Ibrahim Assem, Daniel Simson, and Andrzej Skowroński. *Elements of the representation theory of associative algebras. Vol. 1*. Vol. 65. London Mathematical Society Student Texts. Techniques of representation theory. Cambridge University Press, Cambridge, 2006, pp. x+458. ISBN: 978-0-521-58423-4; 978-0-521-58631-3; 0-521-58631-3. URL: <https://doi.org/10.1017/CB09780511614309>.
- [AVL62] G. M. Adelson-Velski and E. M. Landis. “An algorithm for organization of information”. In: *Dokl. Akad. Nauk SSSR* 146 (1962), pp. 263–266. ISSN: 0002-3264.
- [BB05] Anders Björner and Francesco Brenti. *Combinatorics of Coxeter groups*. Vol. 231. Graduate Texts in Mathematics. New York: Springer, 2005, pp. xiv+363. ISBN: 978-3540-442387; 3-540-44238-3.
- [Ben98] D. J. Benson. *Representations and cohomology. I*. Second. Vol. 30. Cambridge Studies in Advanced Mathematics. Basic representation theory of finite groups and associative algebras. Cambridge University Press, Cambridge, 1998, pp. xii+246. ISBN: 0-521-63653-1.
- [BEZ90] Anders Björner, Paul H. Edelman, and Günter M. Ziegler. “Hyperplane arrangements with a lattice of regions”. In: *Discrete Comput. Geom.* 5.3 (1990), pp. 263–288.
- [BFL99] Sara C. Billey, C. Kenneth Fan, and Jozsef Losonczy. “The parabolic map”. In: *J. Algebra* 214.1 (1999), pp. 1–7. ISSN: 0021-8693. URL: <https://doi.org/10.1006/jabr.1998.7687>.
- [Bjö84] Anders Björner. “Orderings of Coxeter groups”. In: *Combinatorics and algebra (Boulder, Colo., 1983)*. Vol. 34. Contemp. Math. Amer. Math. Soc., Providence, RI, 1984, pp. 175–195.

- [BL09] Nantel Bergeron and Huilan Li. “Algebraic structures on Grothendieck groups of a tower of algebras”. In: *J. Algebra* 321.8 (2009), pp. 2068–2084. ISSN: 0021-8693. URL: <https://doi.org/10.1016/j.jalgebra.2008.12.005>.
- [BLL12] Nantel Bergeron, Thomas Lam, and Huilan Li. “Combinatorial Hopf algebras and towers of algebras—dimension, quantization and functorality”. In: *Algebr. Represent. Theory* 15.4 (2012), pp. 675–696. ISSN: 1386-923X. URL: <https://doi.org/10.1007/s10468-010-9258-y>.
- [Bou02] Nicolas Bourbaki. *Lie groups and Lie algebras. Chapters 4–6*. Elements of Mathematics (Berlin). Translated from the 1968 French original by Andrew Pressley. Springer-Verlag, Berlin, 2002, pp. xii+300. ISBN: 3-540-42650-7. URL: <https://doi.org/10.1007/978-3-540-89394-3>.
- [But+10] Fred Butler et al. *Rook Theory Notes*. 2010.
- [BW91] Anders Björner and Michelle L. Wachs. “Permutation statistics and linear extensions of posets”. In: *J. Combin. Theory Ser. A* 58.1 (1991), pp. 85–114. ISSN: 0097-3165. URL: [https://doi.org/10.1016/0097-3165\(91\)90075-R](https://doi.org/10.1016/0097-3165(91)90075-R).
- [Car86] R. W. Carter. “Representation theory of the 0-Hecke algebra”. In: *J. Algebra* 104.1 (1986), pp. 89–103. ISSN: 0021-8693. URL: [https://doi.org/10.1016/0021-8693\(86\)90238-3](https://doi.org/10.1016/0021-8693(86)90238-3).
- [CFZ02] Frédéric Chapoton, Sergey Fomin, and Andrei Zelevinsky. “Polytopal Realizations of Generalized Associahedra”. In: *Canad. Math. Bull.* 45.4 (2002), pp. 537–566.
- [com16] The Sage-Combinat community. *Sage-Combinat: enhancing Sage as a toolbox for computer exploration in algebraic combinatorics*. <http://wiki.sagemath.org/combinat>. 2016.
- [CP14] Grégory Chatel and Vincent Pilaud. “Cambrian Hopf Algebras”. Preprint, [arXiv:1411.3704](https://arxiv.org/abs/1411.3704). 2014.
- [CP15] Grégory Châtel and Viviane Pons. “Counting smaller elements in the Tamari and m -Tamari lattices”. In: *J. Combin. Theory Ser. A* 134 (2015), pp. 58–97.
- [CPP17] Grégory Chatel, Vincent Pilaud, and Viviane Pons. “The weak order on integer posets”. Preprint, [arXiv:1701.07995](https://arxiv.org/abs/1701.07995). 2017.
- [CR12] Mahir Bilen Can and Lex E. Renner. “Bruhat-Chevalley order on the rook monoid”. In: *Turk J. Math* 36.2 (2012), pp. 499–519.
- [CR90] Charles W. Curtis and Irving Reiner. *Methods of representation theory. Vol. I*. Wiley Classics Library. With applications to finite groups and orders, Reprint of the 1981 original, A Wiley-Interscience Publication. John Wiley & Sons, Inc., New York, 1990, pp. xxiv+819. ISBN: 0-471-52367-4.
- [CS98] I. Chajda and V. Snášel. “Congruences in ordered sets”. In: *Math. Bohem.* 123.1 (1998), pp. 95–100.

- [CSST10] Tullio Ceccherini-Silberstein, Fabio Scarabotti, and Filippo Tolli. *Representation theory of the symmetric groups*. Vol. 121. Cambridge Studies in Advanced Mathematics. The Okounkov-Vershik approach, character formulas, and partition algebras. Cambridge University Press, Cambridge, 2010, pp. xvi+412. ISBN: 978-0-521-11817-0. URL: <https://doi.org/10.1017/CB09781139192361>.
- [Dem74] Michel Demazure. “Désingularisation des variétés de Schubert généralisées”. In: *Ann. Sci. École Norm. Sup. (4)* 7 (1974). Collection of articles dedicated to Henri Cartan on the occasion of his 70th birthday, I, pp. 53–88. ISSN: 0012-9593.
- [Den+10] Tom Denton et al. “On the representation theory of finite \mathcal{J} -trivial monoids”. In: *Sém. Lothar. Combin.* 64 (2010/11), Art. B64d, 44. ISSN: 1286-4889.
- [Den10] Tom Denton. “A combinatorial formula for orthogonal idempotents in the 0-Hecke algebra of the symmetric group”. In: (2010). eprint: [arXiv: 1008.2401v1](https://arxiv.org/abs/1008.2401v1).
- [dev16] The Sage developers. *Sage Mathematics Software*. <http://www.sagemath.org>. 2016.
- [DHP18] Aram Dermenjian, Christophe Hohlweg, and Vincent Pilaud. “The facial weak order and its lattice quotients”. In: *Trans. Amer. Math. Soc.* 370.2 (2018), pp. 1469–1507.
- [DHT02] Gérard Duchamp, Florent Hivert, and Jean-Yves Thibon. “Noncommutative symmetric functions. VI. Free quasi-symmetric functions and related algebras”. In: *Internat. J. Algebra Comput.* 12.5 (2002), pp. 671–717. ISSN: 0218-1967.
- [Fay05] Matthew Feyers. “0-Hecke algebras of finite Coxeter groups”. In: *J. Pure Appl. Algebra* 199.1-3 (2005), pp. 27–41. ISSN: 0022-4049. URL: <https://doi.org/10.1016/j.jpaa.2004.12.001>.
- [FH91] William Fulton and Joe Harris. *Representation theory*. Vol. 129. Graduate Texts in Mathematics. A first course, Readings in Mathematics. Springer-Verlag, New York, 1991, pp. xvi+551. ISBN: 0-387-97527-6; 0-387-97495-4. URL: <https://doi.org/10.1007/978-1-4612-0979-9>.
- [FS09] Philippe Flajolet and Robert Sedgewick. *Analytic combinatorics*. Cambridge University Press, Cambridge, 2009, pp. xiv+810. ISBN: 978-0-521-89806-5. DOI: [10.1017/CB09780511801655](https://doi.org/10.1017/CB09780511801655). URL: <http://dx.doi.org/10.1017/CB09780511801655>.
- [FZ02] Sergey Fomin and Andrei Zelevinsky. “Cluster algebras. I. Foundations”. In: *J. Amer. Math. Soc.* 15.2 (2002), pp. 497–529.
- [FZ03a] Sergey Fomin and Andrei Zelevinsky. “Cluster algebras. II. Finite type classification”. In: *Invent. Math.* 154.1 (2003), pp. 63–121.
- [FZ03b] Sergey Fomin and Andrei Zelevinsky. “Y-systems and generalized associahedra”. In: *Ann. of Math. (2)* 158.3 (2003), pp. 977–1018.

- [Gab72] Peter Gabriel. “Unzerlegbare Darstellungen. I”. In: *Manuscripta Math.* 6 (1972), 71–103; correction, *ibid.* 6 (1972), 309. ISSN: 0025-2611. URL: <https://doi.org/10.1007/BF01298413>.
- [Gap] *GAP – Groups, Algorithms, and Programming, Version 4.8.10*. The GAP Group. 2018. URL: [\verb+\(https://www.gap-system.org\)+](https://www.gap-system.org).
- [Gel+95] I.M. Gelfand et al. “Noncommutative Symmetrical Functions”. In: *Advances in Mathematics* 112.2 (1995), pp. 218–348. ISSN: 0001-8708. DOI: <https://doi.org/10.1006/aima.1995.1032>. URL: <http://www.sciencedirect.com/science/article/pii/S0001870885710328>.
- [Ges84] Ira M. Gessel. “Multipartite P -partitions and inner products of skew Schur functions”. In: *Combinatorics and algebra (Boulder, Colo., 1983)*. Vol. 34. Contemp. Math. Providence, RI: Amer. Math. Soc., 1984, pp. 289–317.
- [GH18a] Joël Gay and Florent Hivert. “Renner and 0-Renner monoids of type B and D ”. À paraître. 2018.
- [GH18b] Joël Gay and Florent Hivert. “The 0-rook monoid and its representation theory”. À paraître. 2018.
- [GKZ08] Israel Gelfand, Mikhail M. Kapranov, and Andrei Zelevinsky. “Discriminants, resultants and multidimensional determinants”. In: *Mod. Birkhäuser Class. Birkhäuser Boston* (2008).
- [GM06] Olexandr Ganyushkin and Volodymyr Mazorchuk. “Combinatorics and distributions of partial injections”. In: *Australasian J. of Comb.* 34 (2006), pp. 161–186. ISSN: 2202-3518.
- [God09] Eddy Godelle. “A note on Renner Monoids”. In: [hal-00373601](https://hal.archives-ouvertes.fr/hal-00373601) (2009).
- [GP18] Joël Gay and Vincent Pilaud. “The weak order on Weyl posets”. À paraître. 2018.
- [GR14] Darij Grinberg and Victor Reiner. *Hopf Algebras in Combinatorics*. 2014. eprint: [arXiv:1409.8356](https://arxiv.org/abs/1409.8356).
- [GR63] Georges Th. Guilbaud and Pierre Rosenstiehl. “Analyse algébrique d’un scrutin”. In: *Math. Sci. Hum.* 4 (1963), pp. 9–33.
- [Gre51] J. A. Green. “On the structure of semigroups”. In: *Ann. of Math. (2)* 54 (1951), pp. 163–172. ISSN: 0003-486X.
- [Hal04] Tom Halverson. “Representations of the q -rook monoid”. In: *J. Algebra* 273.1 (2004), pp. 227–251.
- [HL07] Christophe Hohlweg and Carsten E. M. C. Lange. “Realizations of the associahedron and cyclohedron”. In: *Discrete Comput. Geom.* 37.4 (2007), pp. 517–543. ISSN: 0179-5376. URL: <https://doi.org/10.1007/s00454-007-1319-6>.
- [HLR14] Christophe Hohlweg, Jean-Philippe Labbé, and Vivien Ripoll. “Asymptotical behaviour of roots of infinite Coxeter groups”. In: *Canad. J. Math.* 66.2 (2014), pp. 323–353. ISSN: 0008-414X. URL: <https://doi.org/10.4153/CJM-2013-024-6>.

- [HLT11] Christophe Hohlweg, Carsten E. M. C. Lange, and Hugh Thomas. “Permutahedra and generalized associahedra”. In: *Adv. Math.* 226.1 (2011), pp. 608–640. ISSN: 0001-8708. URL: <https://doi.org/10.1016/j.aim.2010.07.005>.
- [HNT05] F. Hivert, J.-C. Novelli, and J.-Y. Thibon. “The algebra of binary search trees”. In: *Theoret. Comput. Sci.* 339.1 (2005), pp. 129–165. ISSN: 0304-3975. URL: <https://doi.org/10.1016/j.tcs.2005.01.012>.
- [Hoh12] Christophe Hohlweg. “Permutahedra and associahedra: generalized associahedra from the geometry of finite reflection groups”. In: *Associahedra, Tamari lattices and related structures*. Vol. 299. Prog. Math. Phys. Birkhäuser/Springer, Basel, 2012, pp. 129–159. URL: https://doi.org/10.1007/978-3-0348-0405-9_8.
- [HST12] Florent Hivert, Franco Saliola, and Nicolas M. et al. Thiéry. *sage-semigroup: A semigroup (representation) theory library for SageMath*. <https://github.com/nthiery/sage-semigroups/>. 2012–2018.
- [HT72] Samuel Huang and Dov Tamari. “Problems of associativity: A simple proof for the lattice property of systems ordered by a semi-associative law”. In: *J. Combinatorial Theory Ser. A* 13 (1972), pp. 7–13.
- [Hua16] Jia Huang. “A tableau approach to the representation theory of 0-Hecke algebras”. In: *Ann. Comb.* 20.4 (2016), pp. 831–868. ISSN: 0218-0006. URL: <https://doi.org/10.1007/s00026-016-0338-5>.
- [Hum75] James E. Humphreys. *Linear algebraic groups*. Graduate Texts in Mathematics, No. 21. Springer-Verlag, New York-Heidelberg, 1975, pp. xiv+247.
- [Hum90] James E. Humphreys. *Reflection groups and Coxeter groups*. Vol. 29. Cambridge Studies in Advanced Mathematics. Cambridge University Press, Cambridge, 1990, pp. xii+204. ISBN: 0-521-37510-X. URL: <https://doi.org/10.1017/CB09780511623646>.
- [Iwa64] Nagayoshi Iwahori. “On the structure of a Hecke ring of a Chevalley group over a finite field”. In: *J. Fac. Sci. Univ. Tokyo Sect. I* 10 (1964), 215–236 (1964).
- [JV11] Matthieu Josuat-Vergès. “Rook placements in Young diagrams and permutation enumeration”. In: *Advances in Applied Mathematics* 47.1 (2011), pp. 1–22. ISSN: 0196-8858. DOI: <https://doi.org/10.1016/j.aam.2010.04.003>. URL: <http://www.sciencedirect.com/science/article/pii/S0196885810000515>.
- [KB70] D.E. Knuth and P.B. Bendix. “Simple word problems in universal algebras”. In: *Computational problems in abstract algebra*. Vol. 263. 1970, p. 297.
- [KLR03] Christian Kassel, Alain Lascoux, and Christophe Reutenauer. “The singular locus of a Schubert variety”. In: *J. Algebra* 269.1 (2003), pp. 74–108.

- [Kro+01] Daniel Krob et al. “Pseudo-Permutations I: First Combinatorial and Lattice Properties”. 13th International Conference on Formal Power Series and Algebraic Combinatorics (FPSAC 2001). 2001.
- [KT97] Daniel Krob and Jean-Yves Thibon. “Noncommutative symmetric functions. IV. Quantum linear groups and Hecke algebras at $q = 0$ ”. In: *J. Algebraic Combin.* 6.4 (1997), pp. 339–376. ISSN: 0925-9899. URL: <https://doi.org/10.1023/A:1008673127310>.
- [Lam91] T. Y. Lam. *A first course in noncommutative rings*. Vol. 131. Graduate Texts in Mathematics. Springer-Verlag, New York, 1991, pp. xvi+397. ISBN: 0-387-97523-3. URL: <https://doi.org/10.1007/978-1-4684-0406-7>.
- [Las01] A. Lascoux. “Transition on Grothendieck polynomials”. In: *Physics and combinatorics, 2000 (Nagoya)*. World Sci. Publ., River Edge, NJ, 2001, pp. 164–179.
- [Las02] Alain Lascoux. “The Symmetric Group”. Cours donné à l’Université de Marne-la-Vallée. 2002.
- [Las03a] A. Lascoux. *Symmetric Functions and Combinatorial Operators on Polynomials*. Conference board of the Mathematical Sciences regional conference series in mathematics 99. American Mathematical Society, 2003. ISBN: 9780821828717. URL: <https://books.google.de/books?id=RVj6MAAACAAJ>.
- [Las03b] Alain Lascoux. “Schubert & Grothendieck: un bilan bidécennal”. In: *Sém. Lothar. Combin.* 50 (2003/04), Art. B50i, 32 pp. (electronic). ISSN: 1286-4889.
- [Li03a] Zhenheng Li. “Idempotent lattices, Renner monoids and cross section lattices of the special orthogonal algebraic monoids”. In: *J. Algebra* 270.2 (2003), pp. 445–458. ISSN: 0021-8693. URL: <https://doi.org/10.1016/j.jalgebra.2002.08.001>.
- [Li03b] Zhenheng Li. “The cross section lattices and Renner monoids of the odd special orthogonal algebraic monoids”. In: *Semigroup Forum* 66.2 (2003), pp. 273–287. ISSN: 0037-1912. URL: <https://doi.org/10.1007/s002330010151>.
- [LL18] Jean-Philippe Labbé and Carsten Lange. *Cambrian acyclic domains: counting c -singletons*. 2018. eprint: [arXiv:1802.07978](https://arxiv.org/abs/1802.07978).
- [LLC06] Zhuo Li, Zhenheng Li, and You’an Cao. “Orders of the Renner monoids”. In: *J. Algebra* 301.1 (2006), pp. 344–359. ISSN: 0021-8693. DOI: [10.1016/j.jalgebra.2005.12.008](https://doi.org/10.1016/j.jalgebra.2005.12.008). URL: <http://dx.doi.org/10.1016/j.jalgebra.2005.12.008>.
- [Lod04] Jean-Louis Loday. “Realization of the Stasheff polytope”. In: *Arch. Math. (Basel)* 83.3 (2004), pp. 267–278.
- [Lot02] M. Lothaire. *Algebraic Combinatorics on Words*. Encyclopedia of Mathematics and its Applications. Cambridge University Press, 2002. DOI: [10.1017/CB09781107326019](https://doi.org/10.1017/CB09781107326019).

- [LR03] Zhenheng Li and Lex E. Renner. “The Renner monoids and cell decompositions of the symplectic algebraic monoids”. In: *Internat. J. Algebra Comput.* 13.2 (2003), pp. 111–132. ISSN: 0218-1967. URL: <https://doi.org/10.1142/S0218196703001304>.
- [LR98] Jean-Louis Loday and María O. Ronco. “Hopf algebra of the planar binary trees”. In: *Adv. Math.* 139.2 (1998), pp. 293–309. ISSN: 0001-8708. URL: <https://doi.org/10.1006/aima.1998.1759>.
- [LS87] A. Lascoux and M. P. Schützenberger. “Symmetrization operators on polynomial rings”. In: *Functional Analysis and Its Applications* 21.4 (1987), pp. 324–326. ISSN: 1573-8485. DOI: [10.1007/BF01077811](https://doi.org/10.1007/BF01077811). URL: <https://doi.org/10.1007/BF01077811>.
- [LS96] Alain Lascoux and Marcel-Paul Schützenberger. “Treillis et bases des groupes de Coxeter”. In: *Electron. J. Combin.* 3.2 (1996), Research paper 27, approx. 35. ISSN: 1077-8926. URL: http://www.combinatorics.org/Volume_3/Abstracts/v3i2r27.html.
- [LSS10] Thomas Lam, Anne Schilling, and Mark Shimozono. “ K -theory Schubert calculus of the affine Grassmannian”. In: *Compos. Math.* 146.4 (2010), pp. 811–852. ISSN: 0010-437X. DOI: [10.1112/S0010437X09004539](https://doi.org/10.1112/S0010437X09004539).
- [Mac95] I. G. Macdonald. *Symmetric functions and Hall polynomials*. Second. Oxford Mathematical Monographs. With contributions by A. Zelevinsky, Oxford Science Publications. The Clarendon Press, Oxford University Press, New York, 1995, pp. x+475. ISBN: 0-19-853489-2.
- [MHPS12] Folkert Müller-Hoissen, Jean Marcel Pallo, and Jim Stasheff, eds. *Assoiahedra, Tamari Lattices and Related Structures. Tamari Memorial Festschrift*. Vol. 299. Progress in Mathematics. Basel: Birkhäuser, 2012, pp. xx+433.
- [Mil05] Ezra Miller. “Alternating formulas for K -theoretic quiver polynomials”. In: *Duke Math. J.* 128.1 (2005), pp. 1–17. ISSN: 0012-7094. DOI: [10.1215/S0012-7094-04-12811-8](https://doi.org/10.1215/S0012-7094-04-12811-8).
- [ML98] Saunders Mac Lane. *Categories for the working mathematician*. Second. Vol. 5. Graduate Texts in Mathematics. Springer-Verlag, New York, 1998, pp. xii+314. ISBN: 0-387-98403-8.
- [MP17] Thibault Manneville and Vincent Pilaud. “Compatibility fans for graphical nested complexes”. In: *J. Combin. Theory Ser. A* 150 (2017), pp. 36–107. ISSN: 0097-3165. URL: <https://doi.org/10.1016/j.jcta.2017.02.004>.
- [MR95a] C. Malvenuto and C. Reutenauer. “Duality between quasi-symmetric functions and the Solomon descent algebra”. In: *J. Algebra* 177.3 (1995), pp. 967–982.

- [MR95b] C. Malvenuto and C. Reutenauer. “Duality between Quasi-Symmetrical Functions and the Solomon Descent Algebra”. In: *Journal of Algebra* 177.3 (1995), pp. 967–982. ISSN: 0021-8693. DOI: <https://doi.org/10.1006/jabr.1995.1336>. URL: <http://www.sciencedirect.com/science/article/pii/S0021869385713361>.
- [MT18] James d. Mitchell and Michael Torpey. *LibSemigroup: A library for semigroups and monoids - Version 0.6.3*. <https://james-d-mitchell.github.io/libsemigroups/>. 2018.
- [Nor79] P. N. Norton. “0-Hecke algebras”. In: *J. Austral. Math. Soc. Ser. A* 27.3 (1979), pp. 337–357. ISSN: 0263-6115.
- [NT06] Jean-Christophe Novelli and Jean-Yves Thibon. “Polynomial realizations of some triagebras”. 18th International Conference on Formal Power Series and Algebraic Combinatorics (FPSAC 2006). 2006.
- [Pil06] Annette Pilkington. “Convex geometries on root systems”. In: *Comm. Algebra* 34.9 (2006), pp. 3183–3202.
- [Pil13] Vincent Pilaud. *Signed tree associahedra*. 2013. eprint: [arXiv:1309.5222](https://arxiv.org/abs/1309.5222).
- [Pin10] Jean-Eric Pin. *Mathematical Foundations of Automata Theory*. 2010. URL: <http://www.liafa.jussieu.fr/~jep/MPRI/MPRI.html>.
- [Pon13] V. Pons. “Combinatoire algébrique liée aux ordres sur les permutations”. Thèse de Doctorat. Université Paris-Est Marne-la-Vallée, 2013.
- [PP16] Vincent Pilaud and Viviane Pons. “Permutrees”. Preprint [arXiv:1606.09643](https://arxiv.org/abs/1606.09643), to appear in *Algebraic Combinatorics*. 2016.
- [PR06] Patricia Palacios and María O. Ronco. “Weak Bruhat order on the set of faces of the permutohedron and the associahedron”. In: *J. Algebra* 299.2 (2006), pp. 648–678.
- [PS15] Vincent Pilaud and Christian Stump. “Brick polytopes of spherical subword complexes and generalized associahedra”. In: *Adv. Math.* 276 (2015), pp. 1–61.
- [Rea03a] Nathan Reading. “Lattice and order properties of the poset of regions in a hyperplane arrangement”. In: *Algebra Universalis* 50.2 (2003), pp. 179–205.
- [Rea03b] Nathan Reading. “Lattice and order properties of the poset of regions in a hyperplane arrangement”. In: *Algebra Universalis* 50.2 (2003), pp. 179–205.
- [Rea04] Nathan Reading. “Lattice congruences of the weak order”. In: *Order* 21.4 (2004), pp. 315–344.
- [Rea06] Nathan Reading. “Cambrian lattices”. In: *Adv. Math.* 205.2 (2006), pp. 313–353.
- [Rea07a] Nathan Reading. “Clusters, Coxeter-sortable elements and noncrossing partitions”. In: *Trans. Amer. Math. Soc.* 359.12 (2007), pp. 5931–5958.

- [Rea07b] Nathan Reading. “Sortable elements and Cambrian lattices”. In: *Algebra Universalis* 56.3-4 (2007), pp. 411–437.
- [Rea12] Nathan Reading. “From the Tamari Lattice to Cambrian Lattices and Beyond”. In: *Associahedra, Tamari Lattices and Related Structures – Tamari Memorial Festschrift*. Ed. by Folkert Müller-Hoissen, Jean Pallo, and Jim Stasheff. Vol. 299. Progress in Mathematics. Birkhäuser, 2012, pp. 293–322.
- [Rea15] Nathan Reading. “Noncrossing arc diagrams and canonical join representations”. In: *SIAM J. Discrete Math.* 29.2 (2015), pp. 736–750.
- [Rea16a] N. Reading. “Finite Coxeter groups and the weak order”. In: *Lattice theory: special topics and applications. Vol. 2*. Birkhäuser/Springer, Cham, 2016, pp. 489–561.
- [Rea16b] N. Reading. “Lattice theory of the poset of regions”. In: *Lattice theory: special topics and applications. Vol. 2*. Birkhäuser/Springer, Cham, 2016, pp. 399–487.
- [Ren05] Lex E. Renner. *Linear algebraic monoids*. Vol. 134. Encyclopaedia of Mathematical Sciences. Invariant Theory and Algebraic Transformation Groups, V. Springer-Verlag, Berlin, 2005, pp. xii+246. ISBN: 3-540-24241-4.
- [Ren95] Lex E. Renner. “Analogue of the Bruhat decomposition for algebraic monoids. II. The length function and the trichotomy”. In: *J. Algebra* 175.2 (1995), pp. 697–714.
- [Rio02] J. Riordan. *Introduction to Combinatorial Analysis*. Dover Books on Mathematics. Dover Publications, 2002. ISBN: 9780486425368. URL: <https://books.google.fr/books?id=zWgIPlds29UC>.
- [RS09] Nathan Reading and David E. Speyer. “Cambrian fans”. In: *J. Eur. Math. Soc.* 11.2 (2009), pp. 407–447.
- [Ser78] Jean-Pierre Serre. *Représentations linéaires des groupes finis*. revised. Hermann, Paris, 1978, p. 182. ISBN: 2-7056-5630-8.
- [Slo15] Neil J. A. Sloane. *The On-Line Encyclopedia of Integer Sequences Foundation Inc.* 2015. URL: <http://oeis.org> (visited on 07/15/2015).
- [Sol04] Louis Solomon. “The Iwahori algebra of $\mathbf{M}_n(\mathbf{F}_q)$. A presentation and a representation on tensor space”. In: *J. Algebra* 273.1 (2004), pp. 206–226.
- [Sol90] Louis Solomon. “The Bruhat decomposition, Tits system and Iwahori ring for the monoid of matrices over a finite field”. In: *Geom. Dedicata* 36.1 (1990), pp. 15–49.
- [Ste16] Benjamin Steinberg. *Representation Theory of Finite Monoids*. Universitext. New York: Springer, 2016. ISBN: 978-3-319-43930-3.
- [Thi98] Jean yves Thibon. “Lectures On Noncommutative Symmetric Functions”. In: *39–94, Math. Soc. Japan Memoirs* 11 (1998), pp. 39–94.

-
- [Vir14] Aladin Virmaux. “Partial categorification of Hopf algebras and representation theory of towers of \mathcal{J} -trivial monoids”. In: *Proceeding of FPSAC 2014 in DMTCS proc. AT* (2014), pp. 741–752.
- [Vir16] Aladin Virmaux. “Théorie des représentations combinatoires de tours de monoïdes, Application à la catégorification et aux fonctions de parking”. Thèse de Doctorat. Université Paris-Sud, 2016.
- [Zie95] Günter M. Ziegler. *Lectures on polytopes*. Vol. 152. Graduate Texts in Mathematics. Springer-Verlag, New York, 1995, pp. x+370. ISBN: 0-387-94365-X. URL: <https://doi.org/10.1007/978-1-4613-8431-1>.

Index

- 0-rook monoid, 143
- C_n , 130
- F_n^0 , 129
- F_n^1 , 128
- G_n^0 , 12, 28, 128
- G_n^1 , 129
- R -code, 130
- FQSym, 111
- Inv, 45, 150
- Lehmer, 49
- NCSF, 113
- PBT, 113
- FZ, 131
- Perm(n), 58
- Perm ^{x} (W), 77
- Φ -poset, 20, 35, 274
 - \mathbb{N} -closed, 274
 - \mathbb{R} -closed, 274
 - antisymmetric, 274
 - closed, 273
 - closure, 273
 - convex, 274
 - semiclosed, 278
 - symmetric, 274
- QSym, 112
- R_n^0 , 143
- Sym, 111
- \mathbb{Y} , 116
- code(r), 130
- decode, 132
- ε , 130
- $\mathcal{BF}(n)$, 59
- μ -vector, 87
- π_c , 136
- supp, 150
- \underline{w} , 130
- c -Cambrian congruence, 295
- c -antisortable, 295
- c -snake, 296
- c -sortable, 295
- c -sorting word, 294
- $m(\underline{w})$, 130
- Tab(λ), 116

- absolute height, 75
- action-reduced, 206
- admissible ideal, 103
- algebra, 110
- algebra of non-commutative symmetric functions, 113
- aperiodic monoid, 58
- arrow radical, 103
- associahedron, 68

- B-condition, 193
- basic algebra, 102
- bialgebra, 110
- bigrassmannian, 208
- binary
 - sequence, 269
 - set, 270
- boolean order, 270
- braid fan, 59
- braid relations, 50
- branching graph, 116, 118
- bubble sort operator, 47

- Cambrian
 - order, 266

- tree, 265
- Cambrian order interval poset, 268
- Cartan integer, 72
- Cartan matrix, 101
- categorification, 115
- Cayley graph, 44
- central function, 96
- chain, 52
 - saturated, 52
- chamber, 77
- character, 96
- coalgebra, 110
- code, 130
- combinatorial class, 68
- compatible, 152
- complete set of primitive orthogonal idempotents, 101
- composition, 48
- composition factor, 99
- composition series, 99
- concatenation, 69
 - shifted, 69
- cone, 59
- connected
 - algebra, 102
 - quiver, 102
- Coxeter
 - arrangement, 77
 - fan, 77
 - graph, 81
 - group, 80
 - matrix, 80
 - system, 80
- crystallographic, 72
- D-closure, 241
- D-condition, 197
- defn, 106
- descent, 46
 - composition, 48
 - pattern, 46
 - set, 46–48
 - strict, 156
 - weak, 156
- Dyck
 - path, 63
 - primitive, 63
 - rotation, 63
- Dyck word, 63
- Dynkin diagram, 81
- elementary transpositions, 44
- fan, 59
- Foata transformation, 50
- free quasi symmetric functions, 111
- Frobenius
 - isomorphism, 119
 - reciprocity, 109
- functions
 - elementary, 111
 - homogeneous, 111
 - monomial, 111
 - power, 111
 - symmetric, 111
- grassmannian, 208
 - factorization, 220, 228
- grid representation, 208, 210, 213
- Grothendieck group, 113
- Hasse diagram, 51
- Hecke
 - algebra, 11, 26, 89
 - monoid, 91
- height, 75
- Hopf algebra, 110
- idempotent, 57
- indecomposable module, 100
- induced
 - module, 109
 - representation, 109
- induction, 109
- interval, 52
- inversion, 45, 150, 258
- irreducible representation, 96
- join, 54
- lattice, 54
- Lehmer code, 49
- length, 44
- linear extension, 208
- longest element, 76

- meet, 54
- meet irreducible, 156
- monoid, 44
 - ordered, 56
- negative closure deletion, 279
- normal
 - cone, 60
 - fan, 60
- order
 - linear, 51
 - total, 51
- order-preserving, 57
- orthogonal idempotent, 101
- parabolic subgroup, 78
- partition, 50, 111
 - ordered, 261
- path, 102
 - algebra, 102
- permutahedron, 58
 - coxeter, 77
- permutation, 43
 - matrix, 43
 - table, 46
- polytope, 58
- poset, 51
 - closed by intervals, 52
 - extension, 53
 - graded, 52
 - ideal, 53
 - quotient, 53
 - subposet, 52
- positive closure deletion, 279
- preposet, 51
- presentation, 49
- primitive idempotent, 101
- principal series, 56
- projective, 100
- quasi-symmetric functions, 112
- quiver, 102
 - algebra, 104
- R-code, 130
- R-descent set, 167
- radical, 98
- regressive, 57
- regular \mathcal{J} -class, 104
- regular module, 99
- regular representation, 96
- relation
 - antisymmetric, 51, 253
 - cover, 51
 - decreasing, 254
 - increasing, 254
 - integer, 253
 - reflexive, 51, 253
 - semitransitive, 256
 - transitive, 51, 253
- representation, 95
- restricted
 - module, 108
 - representation, 108
- restriction, 108
- ribbon diagram, 48
- rook, 62
 - matrix, 62
 - monoid, 62
 - triple, 150
 - vector, 62
- root, 72
 - poset, 85
 - simple, 75
 - system, 72
- root system
 - irreducible, 79
- rotation, 266
- semigroup, 57
- semilattice, 54
- semisimple
 - module, 98
- shape ribbon, 48
- shuffle
 - product, 69
 - shifted, 69
- simple module, 98
- singletons, 68, 161
- snake, 269
- standardization, 111
- stationary path, 102
- structure coefficients, 111, 114

- summable, 275
- support, 150
- surjection, 261
- symmetric group, 43
- system
 - positive, 75
 - simple, 75
- Tamari order, 63
- Tits system, 84
- tower of algebras, 114
- transitive closure, 52
- transitive decreasing deletion, 256
- transitive increasing deletion, 256
- tree, 63
 - balanced, 64
 - Schröder, 264
- version, 155, 258
- weak order, 46, 76
- Weyl group, 81
- word
 - problem, 44
 - reduced, 44
- Young
 - diagram, 116
 - path, 116
 - symmetrizer, 117
 - tableau, 116
 - semi-standard, 116
 - standard, 116
 - weight, 117

Titre : Représentations de Monoïdes et Structures de Treillis en Combinatoire des groupes de Weyl

Mots-clés : Informatique fondamentale; Combinatoire algébrique et géométrique; Algorithmique; Représentations de groupe et des monoïdes; Combinatoire des permutations; des arbres et des tableaux; Théorie des polytopes.

Résumé : La combinatoire algébrique est le champ de recherche qui utilise des méthodes combinatoires et des algorithmes pour étudier les problèmes algébriques, et applique ensuite des outils algébriques à ces problèmes combinatoires. L'un des thèmes centraux de la combinatoire algébrique est l'étude des permutations car elles peuvent être interprétées de bien des manières (en tant que bijections, matrices de permutations, mais aussi mots sur des entiers, ordre total sur des entiers, sommets du permutaèdre...). Cette riche diversité de perspectives conduit alors aux généralisations suivantes du groupe symétrique. Sur le plan géométrique, le groupe symétrique engendré par les transpositions élémentaires est l'exemple canonique des groupes de réflexions finis, également appelés groupes de Coxeter. Sur le plan monoïdal, ces mêmes transpositions élémentaires deviennent les opérateurs du tri par bulles et engendrent le monoïde de 0-Hecke, dont l'algèbre est la spécialisation à $q = 0$ de la q -déformation du groupe symétrique introduite par Iwahori. Cette thèse se consacre à deux autres généralisations des permutations.

Dans la première partie de cette thèse, nous nous concentrons sur les matrices de permutations partielles, en d'autres termes les placements de tours ne s'attaquant pas deux à deux sur un échiquier carré. Ces placements de tours engendrent le monoïde de placements de tours, une généralisation du groupe symétrique. Dans cette thèse nous introduisons et étudions le 0-monoïde de placements de tours comme une généralisation du monoïde de 0-Hecke. Son algèbre est la dégénérescence à $q = 0$ de la q -déformation du monoïde de placements de tours introduite par Solomon. On étudie par la suite les propriétés monoïdales fondamentales du 0-monoïde de placements de tours (ordres de Green, propriété de treillis du \mathcal{R} -ordre, \mathcal{J} -trivialité) ce qui nous permet de décrire sa théorie des représentations (modules simples et projectifs, projectivité sur le monoïde de 0-Hecke, restriction et induction le long d'une fonction d'inclusion).

Les monoïdes de placements de tours sont en fait l'instance en type A de la famille des monoïdes de Renner, définis comme les complétés des groupes de Weyl (c'est-à-dire les groupes de Coxeter cristallographiques) pour la topologie de Zariski. Dès lors, dans la seconde partie de la thèse nous étendons nos résultats du type A afin de définir les monoïdes de 0-Renner en type B et D et d'en donner une présentation. Ceci nous conduit également à une présentation des monoïdes de Renner en type B et D , corrigeant ainsi une présentation erronée se trouvant dans la littérature depuis une dizaine d'années. Par la suite, nous étudions comme en type A les propriétés monoïdales de ces nouveaux monoïdes de 0-Renner de type B et D : ils restent \mathcal{J} -triviaux, mais leur \mathcal{R} -ordre n'est plus un treillis. Cela ne nous empêche pas d'étudier leur théorie des représentations, ainsi que la restriction des modules projectifs sur le monoïde de 0-Hecke qui leur est associé. Enfin, la dernière partie de la thèse traite de différentes généralisations des permutations. Dans une récente série d'articles, Châtel, Pilaud et Pons revisitent la combinatoire algébrique des permutations (ordre faible, algèbre de Hopf de Malvenuto-Reutenauer) en terme de combinatoire sur les ordres partiels sur les entiers. Cette perspective englobe également la combinatoire des quotients de l'ordre faible tels les arbres binaires, les séquences binaires, et de façon plus générale les récents permutarbres de Pilaud et Pons. Nous généralisons alors l'ordre faible aux éléments des groupes de Weyl. Ceci nous conduit à décrire un ordre sur les sommets des permutaèdres, associaèdres généralisés et cubes dans le même cadre unifié. Ces résultats se basent sur de subtiles propriétés des sommes de racines dans les groupes de Weyl qui s'avèrent ne pas fonctionner pour les groupes de Coxeter qui ne sont pas cristallographiques.

Title: Representation of Monoids and Lattice Structures in the Combinatorics of Weyl groups

Keywords: Theoretical computer science; Algebraic and geometric combinatorics; Algorithm; Representation of groups and monoids; Combinatorics of permutations, trees and tableaux; Polytope theory.

Abstract: Algebraic combinatorics is the research field that uses combinatorial methods and algorithms to study algebraic computation, and applies algebraic tools to combinatorial problems. One of the central topics of algebraic combinatorics is the study of permutations, interpreted in many different ways (as bijections, permutation matrices, words over integers, total orders on integers, vertices of the permutahedron...). This rich diversity of perspectives leads to the following generalizations of the symmetric group. On the geometric side, the symmetric group generated by simple transpositions is the canonical example of finite reflection groups, also called Coxeter groups. On the monoidal side, the simple transpositions become bubble sort operators that generate the 0-Hecke monoid, whose algebra is the specialization at $q = 0$ of Iwahori's q -deformation of the symmetric group. This thesis deals with two further generalizations of permutations.

In the first part of this thesis, we first focus on partial permutations matrices, that is placements of pairwise non attacking rooks on a n by n chessboard, simply called rooks. Rooks generate the rook monoid, a generalization of the symmetric group. In this thesis we introduce and study the 0-Rook monoid, a generalization of the 0-Hecke monoid. Its algebra is a proper degeneracy at $q = 0$ of the q -deformed rook monoid of Solomon. We study fundamental monoidal properties of the 0-rook monoid (Green orders, lattice property of the \mathcal{R} -order, \mathcal{J} -triviality) which allow us to describe its representation theory (simple and projective modules, projectivity on the 0-Hecke monoid, restriction and induction along an inclusion map).

Rook monoids are actually type A instances of the family of Renner monoids, which are completions of the Weyl groups (crystallographic Coxeter groups) for Zariski's topology. In the second part of this thesis we extend our type A results to define and give a presentation of 0-Renner monoids in type B and D . This also leads to a presentation of the Renner monoids of type B and D , correcting a misleading presentation that appeared earlier in the literature. As in type A we study the monoidal properties of the 0-Renner monoids of type B and D : they are still \mathcal{J} -trivial but their \mathcal{R} -order are not lattices anymore. We study nonetheless their representation theory and the restriction of projective modules over the corresponding 0-Hecke monoids.

The third part of this thesis deals with different generalizations of permutations. In a recent series of papers, Châtel, Pilaud and Pons revisit the algebraic combinatorics of permutations (weak order, Malvenuto-Reutenauer Hopf algebra) in terms of the combinatorics of integer posets. This perspective encompasses as well the combinatorics of quotients of the weak order such as binary trees, binary sequences, and more generally the recent permutrees of Pilaud and Pons. We generalize the weak order on the elements of the Weyl groups. This enables us to describe the order on vertices of the permutahedra, generalized associahedra and cubes in the same unified context. These results are based on subtle properties of sums of roots in Weyl groups, and actually fail for non-crystallographic Coxeter groups.

Université Paris-Saclay

Espace Technologique / Immeuble Discovery

Route de l'Orme aux Merisiers RD 128 / 91190 Saint-Aubin, France

