



HAL
open science

New advanced control strategy for steel making process

Mohamad Taki Asghar

► **To cite this version:**

Mohamad Taki Asghar. New advanced control strategy for steel making process. Automatic. Université de Lorraine, 2018. English. NNT : 2018LORR0077 . tel-01863343

HAL Id: tel-01863343

<https://theses.hal.science/tel-01863343>

Submitted on 28 Aug 2018

HAL is a multi-disciplinary open access archive for the deposit and dissemination of scientific research documents, whether they are published or not. The documents may come from teaching and research institutions in France or abroad, or from public or private research centers.

L'archive ouverte pluridisciplinaire **HAL**, est destinée au dépôt et à la diffusion de documents scientifiques de niveau recherche, publiés ou non, émanant des établissements d'enseignement et de recherche français ou étrangers, des laboratoires publics ou privés.



AVERTISSEMENT

Ce document est le fruit d'un long travail approuvé par le jury de soutenance et mis à disposition de l'ensemble de la communauté universitaire élargie.

Il est soumis à la propriété intellectuelle de l'auteur. Ceci implique une obligation de citation et de référencement lors de l'utilisation de ce document.

D'autre part, toute contrefaçon, plagiat, reproduction illicite encourt une poursuite pénale.

Contact : ddoc-theses-contact@univ-lorraine.fr

LIENS

Code de la Propriété Intellectuelle. articles L 122. 4

Code de la Propriété Intellectuelle. articles L 335.2- L 335.10

http://www.cfcopies.com/V2/leg/leg_droi.php

<http://www.culture.gouv.fr/culture/infos-pratiques/droits/protection.htm>

Nouvelles stratégies de contrôle avancé pour les procédés sidérurgiques

THÈSE

présentée et soutenue publiquement le 3 Mai 2018

pour l'obtention du

Doctorat de l'Université de Lorraine

Spécialité Automatique

par

Mohamad Taki ASGHAR

Composition du jury

<i>Président :</i>	E. LAROCHE	Professeur, Université de Strasbourg, ICube
<i>Rapporteurs :</i>	C. BONNET E. LAROCHE	Directrice de Recherche Inria, L2S-CentraleSupélec Professeur, Université de Strasbourg, ICube
<i>Examineurs :</i>	M. JUNGERS A. KHELASSI S. LESECQ I.-C. MORARESCU	Directeur de Recherche CNRS, CRAN (Directeur de thèse) Docteur ingénieur ArcelorMittal Maizières-les-Metz Directrice de Recherche CEA, HDR, Dept. DACLE, Lab. LIALP Maître de Conférences, HDR, Université de Lorraine, CRAN (Co-directeur de thèse)
<i>Invités :</i>	J. FRANCKEN P.-J. KRAUTH	Docteur ingénieur ArcelorMittal Maizières-les-Metz Docteur ingénieur ArcelorMittal Maizières-les-Metz

Acknowledgment

First and foremost, I would like to thank God Almighty for giving me the strength, knowledge, ability and opportunity to undertake this research study and to persevere and complete it satisfactorily. Without his blessings, this achievement would not have been possible.

I would like to express my sincere and profound gratitude to my thesis supervisor M. Marc Jungers, for his keen interest and sustained support at the time of admission as well as constant encouragement throughout my thesis period. His valuable suggestions and constructive comments, final evaluations helped a lot for the successful completion of my thesis work.

I would like to thank my thesis co-supervisor M. Irinel-Constantin Morarescu, for his guidance, his help, encouragement, support, and especially for providing me the friendly atmosphere. I would like to thank him for always pushing me to work hard, he always wanted the best for me. For all this, and more, I shall always be grateful.

I extend my thanks to M. Pierre-Jean Krauth, head of Measurement and Control Department - Process Center in ArcelorMittal Maizières Research Center. Thanks to him for providing me the opportunity and the support needed for working in this department.

I would like also to express my thanks for M. Julien Francken, M. Trong Son Cao and M. Tété Dossah from the Down Stream Service - Process Center. Thanks for all the time, effort, help, explanation, support and finance they have gave during this project.

I would like to thank my colleagues in ArcelorMittal Maizières, M. Faycal Lawayeb, M. Morvan Plunian, M. Xuan Manh Nguyen, M. Pham Thang, M. Abdoulaye Taram, Mme. Grace Shu Hui Ham and all the members in the Measurement and Control Department. Thanks a lot for their support, encouragement and amazing moments we have spent together.

I also extends my thanks to my friends, M. Hussein Zahr, M. Firas Saade, M. Mohammad Hassan Toufayli, M. Mohamad Taha Boudali, M. Hassan Karaki, M. Ali Sabra, Mme. Rana Omar, Mme. Issraa Shahine and all who have supported and stood by my side during this period.

Finally, but most important, I would like thank my mother and father who made me what I am today. Simply, without their love, support and prayers, this work would have not been completed. Thanks for my brothers and sisters, for all their support, encouragement, love and care.

Regards and regrets to those who have been close enough to be mentioned but not included by name in this acknowledgment. I also expect their grant of forgiveness and acknowledge their help and support.

*Gratefully dedicated to the Prophet of Mercy, Peace and Love, Mohamad (pbuh), his
successor Imam Ali (pbuh), to my mother, father, brothers and sisters*

Contents

List of figures	ix
List of tables	xi
Notations	1
Chapter 1 General Introduction	3
Chapter 2 Cold Rolling of Steel	9
2.1 Introduction	9
2.2 Process Overview	10
2.3 TCM Modeling and Control in Literature	12
2.3.1 Roll Force and Torque Mathematical models	14
2.3.2 Tandem Cold Mill Modeling and Control	15
2.4 Conclusion	18
Chapter 3 Mathematical Preliminaries	19
3.1 Introduction	19
3.2 Linear Quadratic Regulation	20
3.3 Stability	21
3.3.1 Basic Definitions	22
3.3.2 Lyapunov's Direct Method for Stability	22
3.4 Stability of Time Delay Systems	23
3.4.1 Time Delay Systems in Brief	24
3.4.2 Stability Concept for General TDS	25
3.4.2.1 Lyapunov-Krasovskii Direct Method	25
3.4.3 Stability of Linear Systems with Time-Varying Delays	26
3.4.4 Stabilization of Linear Systems with Time-Varying Delays	27
3.5 Stability of Singular Systems	29

3.5.1	Singular Systems in Brief	29
3.5.2	Preliminaries on Singular Systems	29
3.5.3	Stability of Linear Singular Systems	32
3.5.4	Stabilization of Linear Singular Systems	32
3.6	Stability of Time Delay Singular Systems	33
3.6.1	Preliminaries of Time Delay Singular Systems	33
3.6.2	Stability of Time Delay Singular System	35
3.6.3	Stabilization of Time Delay Singular System	36
3.7	Conclusion	36
Chapter 4 Tandem Cold Mill : Model and Current Control Strategy		37
4.1	Introduction	37
4.2	Description of the Tandem Stand	38
4.2.1	Stand Actuator	39
4.2.2	Stand Motor	41
4.2.3	Yield Stress Model	42
4.2.4	Sims' Gauge Relation	43
4.2.5	Mass Flow Conservation	43
4.2.6	Strip Exit Speed	44
4.2.7	Interstand Tension	44
4.2.8	Interstand Transport Delay	44
4.2.9	Rolling Force Model	46
4.3	TCM Multivariable Model	48
4.3.1	Exit Thickness Integral Action	48
4.3.2	Multivariable Non-linear Descriptor Model	49
4.4	TCM Linearized Model	52
4.4.1	TCM Time Delay Singular System	55
4.5	Current Multi-loop PID Control for Tandem Process	57
4.6	Conclusion	58
Chapter 5 State Feedback Control for TCM Process		61
5.1	Introduction	61
5.2	Existence and Uniqueness of Solution	62
5.3	Controller Synthesis Paradigm	65
5.3.1	Formulation of Controller Synthesis as a Constrained Optimization Problem	66

5.3.2	Process Performance translated as a Quadratic Cost	67
5.3.3	Stability and Performance Optimization via Lyapunov-Krasovskii Functional	68
5.3.4	Control solution of the Optimization Synthesis Problem	70
5.4	State Feedback Synthesis	71
5.4.1	Controller Synthesis via LMI Problem	71
5.4.2	Majorant Minimization	74
5.4.3	Numerical example	77
5.5	TCM Controller Synthesis	81
5.5.1	Controller Tuning	82
5.6	Conclusion	87
Chapter 6 Dynamic Output Feedback Control for TCM Process		91
6.1	Introduction	91
6.2	Output Feedback Synthesis	92
6.2.1	Problem Formulation	92
6.2.2	Closed Loop System Model	94
6.2.3	Control Design : Synthesis Analysis	95
6.2.4	LMI formulation of the Synthesis Problem	98
6.3	Dynamic Output Feedback Feasibility Problem	103
6.3.1	Controller Synthesis via LMI Feasibility Problem	104
6.3.2	Numerical example	105
6.4	DOF Synthesis for the TCM Process	111
6.5	Conclusion	111
Chapter 7 General Conclusion		113
Appendix A		117
References		121
Abstract		129

List of figures

1.1	Passage of the strip through rolling cylinders.	4
2.1	Principle of strip cold rolling	11
2.2	5 Stand Tandem Cold Mill	12
2.3	Representative interface for the idea of strip accumulator	13
2.4	Rolling deformation zone	14
4.1	Passage of strip through work rolls	39
4.2	Mill stand-interstand block diagram	39
4.3	Schema of the actuator in mill stand	40
4.4	Stand motor block diagram	41
4.5	Schema representing the roll bite zone	42
4.6	Schema representing the roll bite zone	47
4.7	Inputs/Outputs of Roll Gap model	47
4.8	2-D Roll-Gap linearization validation	54
4.9	3-D Roll-Gap linearization validation	55
4.10	TCM Linearized Model	57
4.11	Multi-loop PID Control Diagram	57
4.12	Simulink schema of multi-loop PID control of TCM	59
5.1	Summarize of the controller synthesis paradigm	67
5.2	System time delays τ_1 and τ_2 in function of time t	78
5.3	Growth function δ in function of time t	79
5.4	Simulating the closed loop system with $u_\delta(t) = \delta(t)Kx(t)$	80
5.5	Performance improvement induced by weighting tuning.	81
5.6	Step error in the entry thickness $h_{1,1}$	83
5.7	Errors in the entry and exit tension forces of TCM.	83
5.8	Closed loop system response in the case of K_0	85
5.9	Closed loop system response in the case of K_1	86
5.10	Closed loop system response in the case of K_2	88
6.1	Growth function δ in function of time t	107
6.2	System states x_1 and x_2 , inputs u_δ and u in function of time t	108
6.3	Simulation of the closed loop system.	109
6.4	Comparison of system states x_1 and x_2 and input u_δ between two weighing cases.	110
6.5	Simulation of the closed loop system.	110

List of tables

4.1	Constants of the linearized tensile stress expression	53
5.1	Tuning weighting coefficients α_i	87
6.1	System vector sizes in numerical example.	111

Notations

Sets and Spaces

- \mathbb{N} - The set of natural numbers
- \mathbb{R} - The set of real numbers
- $\mathbb{R}^{n \times n}$ - The set of real $n \times n$ matrices
- \mathbb{R}^n - The Euclidean space of dimension n
- $\mathcal{C}_{h,n} = \mathcal{C}([t_0 - h, t_0], \mathbb{R}^n)$ - The space of continuous functions $\phi : [t_0 - h, t_0] \rightarrow \mathbb{R}^n, h > 0$
- $\mathcal{C}[a, b]$ - The space of continuous functions $\phi : [a, b] \rightarrow \mathbb{R}^n$
- $L_p[a, b], p \in \mathbb{N}$ - Space of functions $\phi : [a, b] \rightarrow \mathbb{R}^n$ with $\|\phi\|_{L_p} = \left[\int_a^b |\phi(\theta)|^p d\theta \right]^{\frac{1}{p}}$
- $\|\phi\|_c$ - The continuous norm $\|\phi\|_c = \sup_{a \leq \theta \leq b} \|\phi(\theta)\|$, where $\phi \in \mathcal{C}[a, b]$

Vectors and Matrices

- x_i - i^{th} component of the vector x
- x^T - Transpose vector of x
- $x - y > 0$ - Inequality by component : $x_i - y_i > 0, \forall i = 1, \dots, n$
- $\|x\|$ - The Euclidean norm of the vector $x \in \mathbb{R}^n$
- \dot{x}, \ddot{x} - The first and second derivatives of x with respect to time t
- $x_t : [-h, 0] \rightarrow \mathbb{R}^n$ - $x_t(\theta) = x(t + \theta), \theta \in \mathbb{R}$
- I_n - Identity matrix of dimension $n \times n$
- 0_n - Null matrix of dimension $n \times n$
- $M_{i,j}$ - Component of matrix M situated in the i^{th} row and j^{th} column
- M^T - The transpose of matrix M
- M^{-1} - The inverse of matrix M
- M^{-T} - The transpose of inverse of matrix M
- $|M|$ - The determinant of square matrix M

$M > 0_n$ ($M < 0_n$ resp.)	- Positive (negative resp.) definite matrix of dimension $n \times n$
$M = \begin{bmatrix} A & B \\ \star & C \end{bmatrix}$	- Symmetric matrix with \star stands for B^T
$\lambda(M)$	- Eigenvalue of the squared matrix M
$\deg(p)$	- Degree of polynomial p
$\text{col}\{\dots\}$	- column vector
$\text{diag}(A, B)$	- Diagonal matrix with A and B on the principle diagonal
$\text{He}(M)$	- The Hermitien matrix $M + M^T$
$\text{Tr}(M)$	- The trace of matrix M
\otimes	- Kronecker matrix product

Abbreviations

<i>ARE</i>	- Algebraic Riccati Equation
<i>BIBO</i>	- Bounded-Input Bounded-Output
<i>DDE</i>	- Delay Differential Equation
<i>DOF</i>	- Dynamic Output Feedback
<i>IVP</i>	- Initial Value Problem
<i>ISS</i>	- Input to State Stability
<i>LHS</i>	- Left Hand Side
<i>LMI</i>	- Linear Matrix Inequality
<i>LTI</i>	- Linear Time Invariant
<i>LQG</i>	- Linear Quadratic Gaussian
<i>LQR</i>	- Linear Quadratic Regulation
<i>MIMO</i>	- Multi-Input Multi-Output
<i>ODE</i>	- Ordinary Differential Equation
<i>OP</i>	- Optimization Problem
<i>PID</i>	- Proportional-Integral-Derivative
<i>QP</i>	- Quadratic Programming
<i>RDE</i>	- Retarded Differential Equations
<i>RHS</i>	- Right Hand Side
<i>SDP</i>	- Semi-Definite Programming
<i>SISO</i>	- Single-Input Single Output
<i>SOF</i>	- Static Output Feedback
<i>TCM</i>	- Tandem Cold Mill
<i>TDS</i>	- Time Delay System

Chapter 1

General Introduction

Introduction

Steel industry is an advanced manufacturing sector. It includes several complex processes that transform the raw materials (iron, magnesium, aluminum, copper . . . etc, or mix of them) into steel products (coils, slabs, beams . . . etc) ready to be used in other industries (automobiles, trains, rails, food canning, construction . . . etc). These products must meet international industrial standards in terms of quality, dimensions, environmental and human health restrictions. During the industrial revolution at the end of the 19th century and due to the continuous request on metal products, many steelmakers were founded to supply various industries with their raw metallic products. The competition among those makers pushed them to look for all possible ways to improve their productivity, product quality and manufacturing costs. Also for the aim of widening their foundations, high level innovations and research centers are established to look out for new technology solutions that facilitate and enhance their manufacturing. As the demands for steel products with strict specifications keep growing, marketing and production challenges among steel companies keep growing as well to satisfy their customers. Thus, new technologies are needed to attain clients' product standards. One of these technologies are the multivariable control strategies of steelmaking processes. Therefore, the need to enhance control systems is becoming an urgent innovation aim to maintain a high level of productivity.

One of these processes is the cold rolling of steel, which aims to produce steel strips of desired dimensional and mechanical properties. In **Tandem Cold Mill (TCM)**, steel strips are rolled as shown in Figure 1.1 at normal ambient temperatures to reduce their thickness and produce hardened thin steel strips. The final product is obtained after successive rolling steps applied to the strip. In the last few years, the process has undergone a significant qualitative development to satisfy product mechanical constraints. However the new industrial specifications imposed by steel clients added to the necessity to achieve high production rate, require a more advanced tandem process control methodology.

In the framework of developing new advanced techniques for its factories, Arce-lorMittal the world leader steel making company, is sharing yearly many projects with

its collaborators to obtain new high tech solutions. The Measurement and Control Department (Process Center) in the largest center of ArcelorMittal Global Research and Development based in Maizières-lès-Metz with the collaboration with the Research Center for Automatic Control of Nancy (CRAN) - University of Lorraine, have proposed the present thesis in a frame of the knowledge building project. The present thesis treats the problem of establishing new advanced control strategies for cold rolling of steel that respond to the future production specifications.

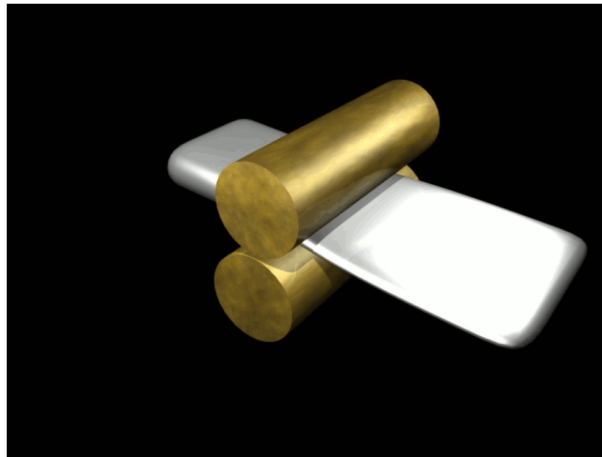

FIGURE 1.1 – Passage of the strip through rolling cylinders.

Motivations of this Research

Nowadays, competitiveness among steelmaking companies continuously motivates them to innovate and develop new technologies in the sake of improving their production lines and reducing the production costs. In the field of cold rolling, several motivations guide the manufacturing desire to look progressively for enhanced solutions. Let us highlight some of these motivations

- Steel clients nowadays look forward to obtain large quantities of steel products within determined time duration. This pushes steel industry to accelerate their productivity plans to finish fabrication in time. This increase in productivity rate must conserve high quality products, putting in mind that product quality may also need to be improved. However productivity rate is affected by the current control strategy, where strong intolerable process interactions are amplified if tandem line speed is increased under the actual PID loops.
- Steel products such as coils, beams, slabs, foils, . . .etc, are not oriented for people usage. They are dedicated for other industries and construction. The various usage of steel products as a raw material for other industries (air planes, marine ships, automotive, towers construction, military . . .etc.) require special product forms and dimensions. In cold rolling of steel, extremely thin hard coils are requested by clients for the purpose of tradeoff between their products' weight, durability and cost. Speaking about thin steel strip means that strips must have

a thickness around 0.15 mm. Such thickness may lead to strip rupture if it is not well treated.

- During steel cold rolling, lubricants are injected during the passage of the strip between rolling cylinders. This reduces the friction and high temperature resulting from this contact, the aim here is to protect strip surface from severe deformations. However this can generate perturbations in the system following the quantity of injected lubricant, both excessive and insufficient lubricant injection are harmful. Industry is aiming to introduce flexible lubrication instead of constant lubrication, to economize the lubricant cost and also to apply sufficient lubrication strategy.
- Energy consumption has recently become a significant issue, where companies try to optimize this consumption to save energy for environmental cause and reduce production cost for investment cause.
- An important point is that companies try to look for low cost solutions. A basic modification in the fabrication line is not usually the favorable solution, since it is an expensive solution. Industries in cold rolling avoids tandem structural changes as long as they are not essential. Software modifications are more preferable than machine or hardware changes.

Thesis Objectives

The main objective of this thesis is the synthesis of multivariable control for tandem cold mill. Such study includes several sub-objectives that are to be treated to reach our main goal. The present dissertation includes the following objectives as well :

- Establish a multivariable state space model of a typical 5 stand tandem mill. This model must be based on the functional analysis of the process and how it is operating nowadays. The obtained model is to be linearized for control design purposes.
- Propose a suitable multivariable control synthesis problem adapted to the process' desired performance and assuming that all variables are measured.
- Extend the established multivariable control strategy for the case of absence of several measurements in the tandem process.

Organization of this thesis

The dissertation began already with a general introduction in this chapter about the process of steel cold rolling which is a vital stage that produces thin hard flat steel layers. A brief illustration about the cold tandem mill was presented starting from how it is fed by steel coils till the end where the product is either enrolled to be shipped for the later production stages, or continue to be treated in the next stages directly. This thesis considers the application of multivariable control to the tandem cold rolling mill, so the other chapters are organized as follows :

Chapter 2

Cold Rolling of Steel : Overview about Process Modeling and Control : This chapter presents a short rich overview about the available literature regarding the modeling and control of the cold rolling process. Talking about this process, we can't avoid talking about the physical modeling of the rolling force and torque. Many literature [Rob78, Bry73] introduced this topic to be the starting point before moving to the modeling of the whole chain. Different models of those physical quantities are presented and detailed explaining the deformation of the metal strip at the level of roll bite, based on the contribution of [Oro43] and the later approximation models. After that a summarized part introducing the different tandem modeling and control is provided. Modeling of the chain includes the modeling of the different devices (motors, actuators), interstand dynamics and perturbations available in the system. A large part of these studies have used the state space modeling for the tandem process, where each one differed from the other according to the adapted hypotheses. Some of those multi-variable models are non-linear, which are linearized to obtain the aimed linear model to be used for the control objective. Various control strategies are mentioned showing the evolution of this vital sector in the rolling process and how it is improved during the last years.

Chapter 3

Mathematical Preliminaries : The aim of synthesis of multivariable control for such complex process added to its mathematical modeling, necessitates the usage of several mathematical theorems, definitions, lemmas . . . etc. This bench of mathematical preliminaries used for the modeling and control of this process are presented in this chapter, briefly and arbitrarily for general cases. In this chapter, the classical Linear Quadratic problem is presented due to its importance in the optimal control synthesis based on minimizing a quadratic cost function. Also notions about stability in the sense of Lyapunov are introduced therein. Moreover, theorems related to the stability and stabilization of time delay systems, descriptor systems and time delay descriptor systems are provided.

Chapter 4

Tandem Cold Mill : Model and Current Control Strategy : The modeling of the tandem chain is a basic step toward the synthesis of multivariable control. This chapter is concerned with the mathematical multivariable model development, where the tandem chain is presented in the form of state space. The homogeneity between mill stands reduces the difficulty to model such a large size process. Modeling an arbitrary stand in the tandem mill will lead us to the overall model, through the cascaded repetition of the stand model. Each stand contains a number of physical dynamics that govern certain physical laws. Some of these laws are differential and others are algebraic, with some of them being strongly non-linear. The transmission of the strip from a stand to another leads to the presence of variable time delays. The final tandem model is an algebraic-differential time delay non-linear system. For the purpose of multivariable control synthesis, the model is linearized around a nominal point. The nominal

point is determined depending on the product's mechanical and dimensional properties from one side, and the user plan to roll it from the other side. The last part of this chapter is dedicated for the actual control method used in the current operating of the tandem mill.

Chapter 5

State Feedback Control for TCM Process : This chapter is based on the process model obtained in Chapter 4. The established tandem state space linearized model permits us to proceed to the control synthesis. The class of time delay singular system where the tandem model belongs to, requires a special treatment in the sense of providing the sufficient conditions for the solution existence. The problem of solution existence and uniqueness for the tandem linearized system is investigated. Sufficient algebraic conditions are provided within theorems to guarantee the continuity of system trajectory. For the control part, a generalized paradigm is presented including control synthesis options. The class of this controller is one of the options in the paradigm, which is to be precised. The paradigm leads to the formulation of a control synthesis problem where the controller is the solution of this problem. In the first step toward control synthesis, all physical quantities in the process are assumed measurable and thus the system state vector is completely accessible. For that the simplest controller class is the state feedback controller. A numerical test illustrating the resolution of the control synthesis problem, is applied first to a small size arbitrary time delay singular system. After that, the state feedback synthesis for the tandem system is carried out via an iterative tuning algorithm to obtain the best controller that ensures the best performance of the system. Simulation of the closed loop system explaining the steps of the controller tuning are provided. Some conclusions regarding the numerical resolution of the controller synthesis problem are supplied at the end.

Chapter 6

Dynamic Output Feedback Control for TCM Process : In this chapter, the general control synthesis problem already presented in the previous chapter is used. This time the strict assumption regarding the complete accessibility of the system state vector is relaxed. Depending on the available process measurements, a dynamic output feedback controller is to be looked for. This control type is the solution of the general control synthesis, where new synthesis problem LMI constraints are produced with much higher size. A numerical explicative example of this synthesis is given to demonstrate the effectiveness of such method. Several conclusions are given at the end.

Finally, we conclude the dissertation with some suggestions regarding future directions for this research.

List of Publications

- ASGHAR Mohamad Taki, JUNGERS Marc, MORARESCU Irinel-Constantin, KHELASSI Ahmed, FRANCKEN Julien. Tandem Cold Rolling Mill Modeling for Multivariable Control Synthesis. 17th IFAC Symposium on Control, Optimization and Automation in Mining, Mineral and Metal Processing (MMM'16). Vienna, Austria, 2016. *Industrial paper without proceedings*.
- ASGHAR Mohamad Taki, JUNGERS Marc, MORARESCU Irinel-Constantin, KHELASSI Ahmed, FRANCKEN Julien. Guaranteed cost control design for descriptor systems with time-varying delays. 56th IEEE Conference on Decision and Control (CDC'17), Melbourne, Australia. December 2017. pp. 4878-4883.

Chapter 2

Cold Rolling of Steel

Contents

2.1 Introduction	9
2.2 Process Overview	10
2.3 TCM Modeling and Control in Literature	12
2.3.1 Roll Force and Torque Mathematical models	14
2.3.2 Tandem Cold Mill Modeling and Control	15
2.4 Conclusion	18

2.1 Introduction

The tandem cold mill (TCM) is a complex non-linear multivariable process. The final product emerging from the rolling chain must respect strenuous specifications regarding the physical dimensions (thickness, width or flatness) and the mechanical properties (hardness, roughness and rigidity). During strip rolling, many defects are encountered in metal coils. These defects in the annealed strip come in the form of thickness irregularities or material composite inhomogeneity, which lead to the generation of perturbations in the form of speed and tension variations. The structure of the tandem chain permits those perturbations to propagate through the system leading to rolling errors. In order to obtain a well rolled flat steel product in the presence of these errors, a control strategy is needed to supervise the system while processing. During the last few decades, this topic was investigated by numerous research studies. Several control strategies were used once man decided to automate the process, seeking for productivity and quality amelioration. On the other hand, many problems have faced the development of suitable control strategies such as system non-linearities, coupling between variables, disturbances, modeling uncertainties (neglected dynamics, process parameters), time dependent delays. . . etc. For that, optimization and proposition of new control methods are progressively treated for this large complex process. As this thesis shed the light on new advanced control strategies for tandem process, a basic step is to discover physically the rolling process and to have an overview about the

recent control strategies for such a domain. In this chapter, a short explanation about the process of metal cold rolling as well as the tandem installation is to be given in section 2.2. Next in section 2.3, we are going to have a short view over the history of cold rolling in terms of modeling and control methods developed in this domain. How did the experts model the mechanism of metal rolling? The idea is to present their advancements that have been done through time for process modeling and control. However this overview is not too long because we are going to highlight the most significant studies related to this topic. Beyond that, other studies are being developed today revealing the importance in enhancing the control of tandem mills. Finally a conclusion is to be given in section 2.4.

2.2 Process Overview

Metal Rolling is one of the most wide and important industrial manufacturing deformation processes [Rob78, Gin93a, Gin93b]. Many metal products nowadays are subjected to rolling stage. It is the first step that aims to create different metal forms and shapes (sheets, beams, rails... etc.). Rolling metal process aims to reduce gradually the rolled material cross sectional thickness, which permits to obtain certain metallic products with desired thickness and mechanical properties. In general, there are two types of metal rolling : cold and hot rolling. First the metal slabs which come from continuous casting, are heated to about 1200 °C which exceeds the recrystallization temperature and permits large ability of deformation. Then they are introduced to the hot rolling stage. The mechanical strength is enhanced and cavities are reduced during this stage, but it results degradation in the surface precision and flatness. After that the hot rolled product moves to the cold section before becoming a finalized product. The cold processing afford steel with the required final thickness and the final surface appearance and properties. The cold processing phase starts by the pickling stage [Rob78], where the coiled strip coming from hot rolling is unrolled and passed through acidic bath. This part is to remove the oxide residues formed during hot rolling and clean the surface of steel sheets. The cold rolling comes after lubrication inter-stage to prevent rusting and decreases later contact friction sequences. The cold rolling stage aims to improve product material properties, surface flatness and dimensional precisions by applying high pressures on the strip. It does not aim to change the form of the strip, it is only to reduce its thickness down to 0.15 mm without heating. It improves strip surface flatness and increases its hardness. Later on, the emerged strip enter an annealing stage to be heated in a furnace between 800 and 1200 °C to become well formed and reserve the actual thickness. Finally a coating stage is applied to cover the steel by certain material that extends product life and prevents its rusting. After the coating has been applied, the product goes to other later treatments according to its future use.

The present thesis is concerned by the stage of cold rolling where such a steelmaking process work to plastically deform metal strip by compressive forces between consecutive pairs of work rolls as shown in Figure 2.1. The rolled material is submitted to high forces sufficient to reach the aimed form and shape. The deformation caused by the high pressure, leads to the re-grouping of material crystals and sticks them together. The output product is then harder and more rigid. Moreover, the rolled sheets

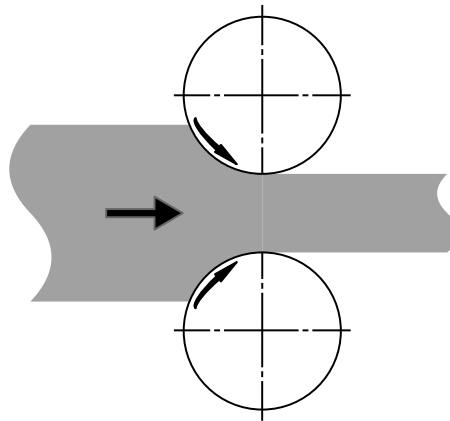

FIGURE 2.1 – Principle of strip cold rolling

have to attain certain level of flatness to be sure that this product is ready for all possible industrial usages.

During cold rolling of steel, metal strip passes through consecutive pairs of work cylinders to produce flat metal sheets. Each pair is fixed in a housing cage called mill stand, where the consecutive set of stands which are basically similar form the tandem mill-cold rolling process. The work rolls are driven by the stand motor and force variation is managed by the stand actuator. The work rolls in a stand are supported by another pair of backup cylinders, which are often larger in diameter. They receive the exerted rolling force applied by hydraulic rams and due to their high rigidity, the force is transmitted to the work rolls. As the strip passes in the roll gap area, its thickness is partially reduced due to the very high compression stress result form the applied force. In this small bite, the metal is plastically deformed. The contact with pressure between work rolls and the strip lead to a rise in its temperature, which is then cooled by means of air and lubricants. The necessity of several pairs of work rolls comes from the impossibility to reach our product with the required characteristics in just one passage. Applying forces intending to obtain the final product by one passage leads to strip sever damage, distorted flatness or even strip rupture. For that, continuous rolling protects the strip through performing partial thickness reduction in several cascaded stands. Between mill stands, the strip is dragged by the effect of tension, the strip propagates from a stand to another till it traverses the whole chain as depicted in Figure 2.2. Thus all mill stands are coupled by the rolled strip.

Various quantities are measured in the system, but usually not all of them. Generally there are sensors to measure roll force at each stand, interstand tension force, strip thickness and speed at the exit of the first and last stands, work roll speeds, actuator ram displacement. The existence of measurements differs from a tandem to another. There are two types of tandems, stand alone (push pull rolling) tandem mill and continuous tandem mill. The stand alone mill is isolated from the other steel treatment stages. Strips are introduced in the form of steel coils, where they are un-rolled at the entry of the first stand till the head of the coil reaches the last stand. The mill is then accelerated to work on the desired nominal speed with enrolling of the coil at the exit. Before the end of the coil, the mill is decelerated till the tail of the coil being reached.

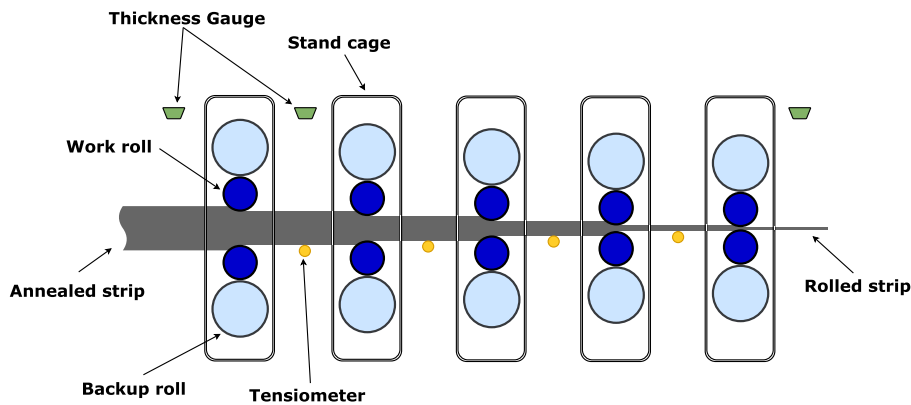

FIGURE 2.2 – 5 Stand Tandem Cold Mill

Coils are then transferred to the next stages in other places. On the other hand, the continuous mill works continuously in a continuous line that contains all processing stages cascaded one after another. The head of the coil introduced at the entry of the continuous line and welded to the tail of the coil being processed currently. The strip passes through the pickling stage, and is stored in an accumulator (Figure 2.3) to avoid process interruption. The difference in processing time between a stage and another, leads to the interruption of the previous stages. To avoid such blocking, this requires the presence of a queue system to store the finished strip from the previous stage before it moves to the next stage. The cold rolling comes after, then the annealing phase and finally the coating phase. Keep in mind that not all continuous lines are the same, it may happen that some of them miss certain stages or have additional stages.

In tandem mills, there is no specific form of the rolling line regarding the number of mill stands. Usually the commercial use and the aimed product determines this number. Moreover there are mill stands equipped with multiple pairs of backup cylinders [Rob78]. The difference is related to the product type being rolled. For example, rolling aluminum coils is different from rolling steel coils where the strip is harder. Not only the metal strip is deformed during the passage between the rolls, but also the work rolls and the backup cylinders are deformed though in much smaller rate. Some mills require to set 6, 8 or even 12 backup cylinders to have a full support for the working cylinders. For more information about mill structure, installation and schemes, general view about manufacturing industry and the application can be found in [KS89, KU89].

2.3 TCM Modeling and Control in Literature

According to [Bry73], cold rolling mills have been used since the 15th century in the form of manual rolling with very low industrial performance and weak productivity. During this time, metal sheets were obtained by means of hot rolling. Referring to [Rob78] hot mills for iron rolling was established in 1798. However there are limitations to obtain thin metal sheets using hot rolling. This is due to metal melting at high temperatures, which leads to a sever strip deformation and possible rupture of

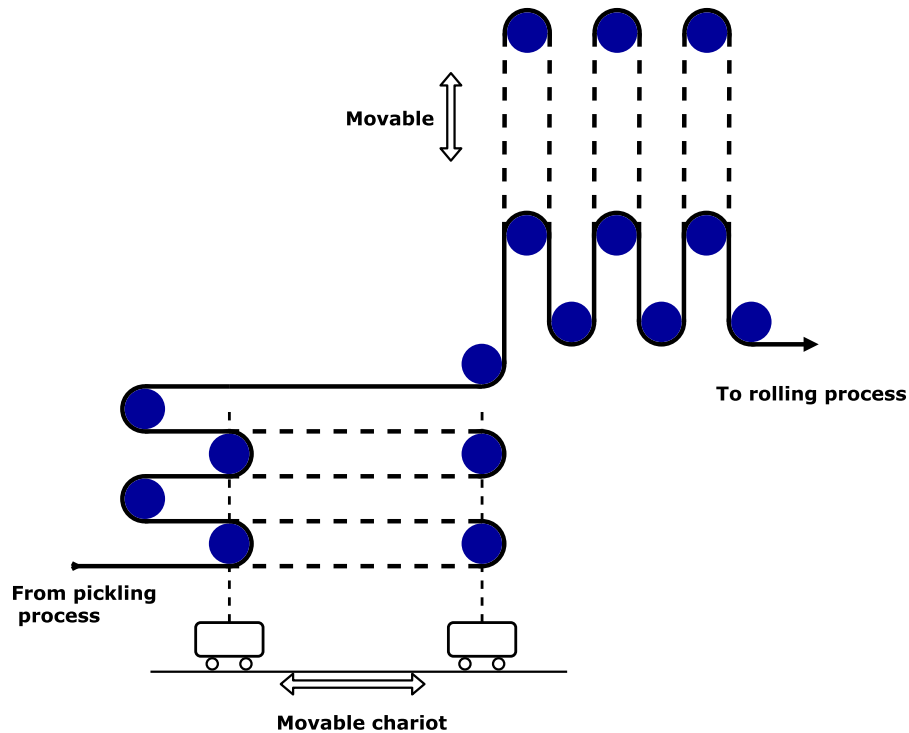

FIGURE 2.3 – Representative interface for the idea of strip accumulator

the sheets when rolled to thin layers. A rolling chain was needed based on metal pressing under force with no heating, to produce thin metal layers. A good work led to the built of the Lauth mill in the 1850, motivating the industry to process in its development. These mills were developed continuously till the first cold tandem was built in Czechoslovakia [Bry73] in 1892. Meanwhile this advancement was moving on in Germany [Ged98], where the first mill was built in 1923 and the second one did not finish until 1932. Roberts in [Rob78] concentrated on the development of cold mills in the United States of America with the beginning of the 19th century. In 1926, a 4 stand mill was finished. The early cold tandems were functioning with loosen strip between stands. Later on, mills were designed such that the strip between each two stands is tighten due to a tension force. This force plays a role in the rolling mechanism.

Since that time, the increasing requests on metal sheets due to the industrial evolution in the manufacturing of automobiles, trains, jets. . .etc, have motivated the development of this process to enhance its productivity and improve the final strip quality. One of these sophisticated improvements is the automation of the process, such step has opened a new research door between the fields of automation and steelmaking industry. Many reasons have played a role in this progress such as the necessity of larger and faster mills, improvements done in the domains of actuator driving, instrumentation and high level control technology. A brief overview about the existing studies related to the control of tandem cold mill will be given to enrich us on the road to our objective.

2.3.1 Roll Force and Torque Mathematical models

Since 1950, the research efforts were put in developing mathematical models that demonstrate the evolution of physical variables during the rolling process. These models are either related to the whole tandem setup such as state space model for a single stand mills, or for single physical quantities such as roll force, torque, yield stress . . . etc. One of the most complicated variables are the rolling force and torque, where they are applied by the work rolls on the strip to obtain the desired thickness reduction. These variables are the resultant contribution of several interactions among strip thickness and hardness, work roll radius and speed, entry and exit tensions. The majority of the rolling theories [PL91] are based on a specified cause-effect chronological order among the physical variables. In 1943, E. Orowan [Oro43] developed a detailed systematic calculation of the roll pressure for hot and cold rolling. This was the fundamental work for the existence of new generation of models in cold rolling. In 1948, R. Bland and H. Ford [BF48] presented the calculation of roll force and torque in cold strip rolling in the presence of tensions and assuming that the work rolls are deformed in an elliptical form according to Hitchcock's study [Hit35, Hil98]. It is one of the classical models that are generally used for the analogical calculation, though it possesses high complexity in its equations. It is composed of set of algebraic equations with integrals for the calculation of rolling force and torque needed to be applied to the strip to obtain a desired percentage reduction. The calculation of the force in this model version was based on

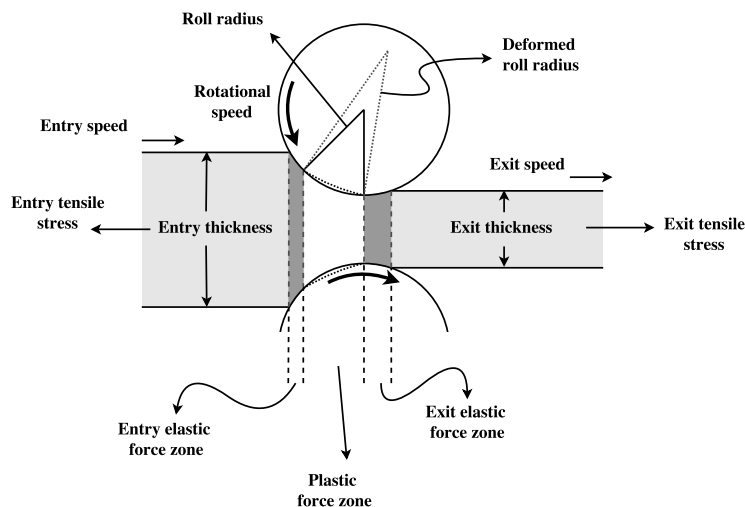

FIGURE 2.4 – Rolling deformation zone

the assumption that the rolling zone situated between the work rolls is divided into three regions as shown in Figure 2.4. The entry region, where the applied effort is the entry elastic force. The middle region where the applied effort is the plastic force and the exit region where the exit elastic force is applied. The rolling force is the sum of the three applied efforts. However the specialists in [BF48] have seen that the entry and exit elastic forces are much less than the plastic one, and thus they can be negligible. After that, a second version was presented in [BF52] where these elastic efforts are no more negligible and they are important in the aim to have a more precise total force values.

Thus algebraic expressions were assigned to these elastic quantities. It was followed by another study [BS53] which was given under a note related to the last developed roll force. This note states that the strip thickness reaches a minimum thickness within the rolling bite less than its exit thickness. This was interpreted by explaining that the strip recovers a little bit of its entry thickness after being deformed at the moment it is released by the work rolls. An additional algebraic expression was given to the minimal thickness, which was considered as a corrective parameter in the expression of the total roll force. The final obtained expressions of the rolling force and torque were algebraic non-linear coupled equations were used widely such as in [Ged98]. A simplified model was given in [FEB51] assuming some approximations for the entry and exit elastic forces which are summed in a single expression. Also the integrals are approximated by non-integral algebraic expressions, but this only reduces calculation effort. A noticeable coupling between the roll force and deformed radius was obtained. The number of algebraic expressions are less than the number of physical intermediate variables. For that and after some time, Bryant and Osborn in [Bry73, FPS08, ACMH12] have developed a set of algebraic non-coupled equations with much more approximations and much less calculative effort. Though it includes many assumptions and mean values replacing the integral expressions, acceptable results were obtained. This model was used in all Pittner's studies [PS04, Pit06, PS06, PS07a, PS07b] in proposing different multivariable control strategies for cold rolling.

These models are sets of analogical equations, but each one has a different level of complexity and non-linearity. Another point of view for calculating these variables was to use numerical finite element methods. Such methods [DMS⁺13, Cao15, Cao16] were proposed recently and aim to obtain highly precised values.

2.3.2 Tandem Cold Mill Modeling and Control

The aim of cold rolling is to produce flat sheets or high quality strips. Before starting, the mill setup configuration is important in the operation to fix some factors. For example the user has to determine the percentage reduction that should be achieved across each mill stand. This leads to estimate the rolling load needed to be submitted to the strip within each pair of work rolls. Also the configuration of the interstand tensions as well as the rolling speed references has to be precised. In ideal cold rolling where the strip does not encounter any physical or mechanical errors, these references would be sufficient to perform the objective. However ideal rolling does not exist in reality and strip errors show up continuously as long as the steel coil is not finished. Thus to arrive to the desired product quality, certain modifications applied to the strip by process actuators are needed. Moreover controlling these inputs also permit us to improve chain productivity and its performance. Another reasons revealing the essential role of control in tandem rolling mill, are the presence of system-entry strip uncertainties as well as the internal and external disturbances result form the environment of the complex system.

Tandem cold rolling is a complex multivariable process, where the internal physical quantities interact among each other. The passage of the strip between stands leads to the coupling of stand variables in the mill. The ability to regulate and manage these couplings is essential and difficult in the same time. This point becomes more and more

critical due to the increasing performance requisites. In [Bry73], Bryant has accomplished a basic rich study in the control of cold rolling process in 1973, treating general cases of tandem mill including the phase of modeling, simulation and control. For the control part, he followed a strategy based on the concept of non-interactive control structure. This strategy means that the set of actuators are designed to be able to apply independent changes to the strip at any location in the mill. Such strategy permits to separate the interstand tension control from the strip thickness control. This decomposition enables control methods based on single-input single-output form to be applied directly. Moreover the similarity between actuators promote the idea of identical controllers for the tension loops. Bryant proposed another control view which depends on adding the effect of feedforward to the feedback action. He had considered several structures based on this combination, the thickness variation measurement in the first stand was used to apply changes to the strip by feedforward. Also in [Edw78], the laser gauge thickness measurement just after the first stand is used as a feedforward for the next stands. In general, in this control loops the tension is controlled by the mill actuator through varying the work roll gap. Whereas the strip thickness control is achieved through varying the rolling speed via the stand motor. The control of thickness is affected by the number of mill stands with respect to the available number of laser gauge measurements. The mill structure is different from one to another regarding the available actuators and sensors. Different mill structures can be found in [Rob78, FS83, Smi87, Gin93a, Gin93b].

As the multivariable control [SP07, BEGFB94] design started to rise up in the field of process control, it attempts to manage the interaction between process variables. The application of such control view has been transferred to the rolling problem by many authors. In [HK93], a wide view of control objectives in the steel making industry has been given. In this study, more than one control strategies are presented such as bar gauge control, spindle torsional vibration control and others. These strategies are either model based or model free control synthesis.

In [HMF⁺88], a multivariable state space control technique is applied to the cold rolling of aluminum in 2 stand mill. The author tried to improve the results of the single-input single-output control approach done in [YK79]. The rolling force model have been linearized [HSM84] and used to construct the linear state space model. They focused on regulating the errors on the thicknesses, since they are the crucial points in his point of view. The disturbances in the system are modeled as constant ones, and they are estimated with the states by a linear estimator. A feed-forward compensating the effect of the disturbance is combined with the estimated state feedback. In the framework of a small system (actuators and motors are considered systems of first order) size, the gains of the controller are chosen manually by moving the poles of the system to the left hand side of the complex plane. The parameter uncertainty and transport delays are not mentioned in this study and play no role in the controller synthesis. Another study in [HSDB⁺11] has used the combination between the feed-forward and feedback loops. The rolling force model is based on the Orowan's equations [Oro43, Bry73]. The aim was to improve the performance of the control loops during the Flying Gauge Change, i.e. passage of inter-coil welding.

In the same field, the multivariable control problem of the aluminum cold tandem is treated this time by using model-based generalized predictive control in [KJ95]. They

have used the continuous state space model developed in [HMF⁺88], where they discretized it and then modified it by adding the constraints related to the input actuators and the interstand tension. In this study the transport delay is not considered as an explicit part of the process model. The thickness variation is considered as disturbance in the system which is to be rejected. The measurements of the strip exit thickness after each stand are considered available.

Another approach was adapted in [CJG94] where polynomial-based linear quadratic Gaussian (LQG) methods were applied to a single stand cold mill. This study aim to reject and regulate the backup cylinder eccentricity effect and the effects of both thickness and hardness variations of the incoming strip. The results obtained were motivating although it was applied on a fully measured system of one stand mill.

Other studies have treated the control of tandem cold mills using multiple SISO control loops. In [CCD⁺92, DTF91], multiple PID loops were proposed to solve the problem of thickness and tension control in cold mill. The resultant interactions between the control loops from a side and the interactions between the variables have shown the real challenge that must be managed. For that the idea of feedforward was proposed in [Bry73] to compensate the interaction effects. PID loops are used widely due to their low cost and easy maintenance. However they do have some limitations in their performance, where they can not manage such process interaction especially if they are strong.

A robust multivariable control was presented in [Ged98, GP94, GP94] where a non-linear tandem mathematical model is constructed based on the Bland and Ford Rolling model [BF48, BF52]. A detailed explanation was given for the modeling of each block in the tandem mill. The motors in the system are considered as first order systems with no resistive motor torque. The actuators are taken as second order systems with dead delays. The time delays are approximated using Padé approximation [Luk69, BGM96]. Thus more states are added to the state vector of the linearized model. Once the non-linear model was validated by real time data, it was linearized around a nominal point. A robust \mathcal{H}_∞ multivariable control was established using the frequency approach. The synthesis included loop shaping for high speeds, specifications for sensibility and complement sensibility functions and pole-zero cancellation.

Regarding the recent results for the tandem process control, the study presented in [BBCS10] treated the problem of automatic flatness control. This problem is related to the shape of the obtained strip. During the passage of strip through cylinders, the deformation of metal may lead to a slight concavity along the width of the strip. This work proposed control techniques based on quadratic optimization and delay compensation. One of these techniques is to establish a centralized solution using the quadratic programming (QP). The other control technique is a decentralized control where each actuator is controlled by its own controller where the latter is optimized locally.

In the last decade, significant studies were initiated by Pittner and his colleagues in the control of tandem hot and cold mills. His first work [PS04] was proposing a pointwise optimal linear quadratic control. After using the Bryant and Osborn model for expressing the roll force and torque, the aim was to establish a multivariable model based control that improves the performance and robustness of the system. The motors and actuators are taken simply as first order systems without any load counteractions. The time delays are approximated using fourth order Padé approximation which led

to the augmentation of the state vector. The non-linearities of the roll force model lead to build up a non-linear state space system where the dynamic matrix is function of the system state. The solution of the control problem was to establish a non-linear state feedback which minimizes a linear quadratic cost function assuming the availability of full state measurement. Notions about pointwise controllability and observability were necessary regarding system matrices and cost function weightings. The results can be found in details in [Pit06]. This study was denoted later under the name of state dependent Riccati approach [PS06, PS07b]. This idea was the base for Pittner's later studies [PS07a, PSS07, PS10], with the same used multivariable mathematical model of tandem mill. All his results about the control of cold tandem mill were capitalized in [PS11]. By the way, a similar linear state space multivariable model for tandem chain was established in [AMC12]. The roll force model used was also the Bryant and Osborn model, which is written in the form of numerical linearized equations. Once again, time delays are approximated by fourth order transfer function, the motors and actuators are approximated by first order systems. Another work was done by the same authors in [ACMH12], the objective of this study is to determine the matrices of the state space system including those partial derivatives coefficients of the linearized roll force model using numerical identification methods.

Some studies have used the $\mathcal{H}_2/\mathcal{H}_\infty$ mixed control such as that in [ZZS09] where a gauge and tension control is used in the process. The used roll force model was the one developed by H. Ford in [BF52, FEB51]. The purpose of the study is to improve the head and tail strip thickness accuracy in the first stand of a tandem cold rolling mill during steel rolling process.

Many research and studies are being initiated today to find control strategies for this process. The industrial requisites have put a priority to achieve a central multi-variable control for the whole process, for the capacity it has shown to manage system interactions. Some studies are concerned by the automation of the first two stands only, while others put their effort to control the exit thickness of the last stand. The difference between control objectives (tension regulation, thickness control, eccentricity . . . etc) dedicated to tandem mills of different structures gives each study its own importance. Meanwhile the continuity in searching for new control strategies enrich the field with more contributions.

2.4 Conclusion

As a conclusion, we took an overview about steel cold rolling in the first part of this chapter including the main stages of the continuous fabrication line. Next, a summarized history about TCM control that has been treated in various research in the past fifty years. Those studies had focused on the mathematical models of the rolling force and torque. Also some articles presented the mathematical modeling of the whole chain for the purposes of offline simulation or control synthesis. Several methods of control were proposed revealing the revolution of this process with time. Multivariable control have shown significant capability in managing the complexity and the resultant interactions in the process. For that, this class of control have motivated us to find a new control solution based on a MIMO tandem state space model.

Chapter 3

Mathematical Preliminaries

Contents

3.1	Introduction	19
3.2	Linear Quadratic Regulation	20
3.3	Stability	21
3.3.1	Basic Definitions	22
3.3.2	Lyapunov's Direct Method for Stability	22
3.4	Stability of Time Delay Systems	23
3.4.1	Time Delay Systems in Brief	24
3.4.2	Stability Concept for General TDS	25
3.4.3	Stability of Linear Systems with Time-Varying Delays	26
3.4.4	Stabilization of Linear Systems with Time-Varying Delays	27
3.5	Stability of Singular Systems	29
3.5.1	Singular Systems in Brief	29
3.5.2	Preliminaries on Singular Systems	29
3.5.3	Stability of Linear Singular Systems	32
3.5.4	Stabilization of Linear Singular Systems	32
3.6	Stability of Time Delay Singular Systems	33
3.6.1	Preliminaries of Time Delay Singular Systems	33
3.6.2	Stability of Time Delay Singular System	35
3.6.3	Stabilization of Time Delay Singular System	36
3.7	Conclusion	36

3.1 Introduction

In this chapter some mathematical tools and preliminaries, which will be used in the objective of the multivariable control synthesis for TCM process, are presented and explained briefly. Several definitions and mathematical topics among these, will be used during the presentation of our control point of view toward this process. In several studies [Bry73, Ged98, PS11] dealing with tandem control, each one contains

a mathematical modeling of the tandem system and some classical control methods. In the sake of multivariable control for the tandem process, a Multi-Input Multi-Output (MIMO) mathematical state space model is to be build. The special form of the physical relations governing the evolution of the tandem variables, including coupled relations and non-linearities require special treatment to reach our desired model. In our work and specifically in the control part, the known Linear Quadratic Regulation (LQR) will be presented for the characterization of the cost of the closed-loop system. Thus a short summary will be provided in section 3.2 of this chapter. After that the notion of stability will be presented in section 3.3 in general. Basic definitions about stability in the sense of Lyapunov as well as the direct Lyapunov method of stability will be provided. Section 3.4 will treat the notion of Time Delay System (TDS) as the tandem process model contains time dependent delays. In section 3.5, notions about singular systems will be explained with some definitions about this class of systems, because the physical variables in the tandem mill are either given by their differential or algebraic relations. Thus the use of this algebraic-differential system class is needed during the modeling of our physical system. Finally in section 3.6, a combination between the singular aspect and the time delay aspect will be treated in the time delay singular system.

3.2 Linear Quadratic Regulation

In the theory of system control, several methodologies treat the design of multivariable control [SP07, BEGFB94]. One of the most used fields is the *optimal control* [KFA69, KS72]. It is based on optimizing the performance of the system by optimizing a cost function that characterizes the behavior of the system and under a set of constraints. These constraints include the physical equations describing the dynamics evolution in the system. The optimal control uses either *Pontryagin's principle* or the *Hamilton-Jacobi-Bellman equation* [Bel13] and consequently the principle of dynamic programming for the objective of problem optimization. A special case of optimal control, is the *Linear Quadratic Regulation* (LQR). It is based on minimizing a quadratic cost function that depends on weighting matrices specified by the user. The usage of this model based control reduces the hardness of gain tuning through adjusting the weighting of the cost function. An iterative step of weighting will be applied by the user till he/she reaches the desired performance. In this case, consider the following *Linear Time Invariant* (LTI) system given by

$$\dot{x}(t) = Ax(t) + Bu(t), \quad x(t_0) = x_0, \quad t \geq t_0, \quad (3.1)$$

where $x(t) \in \mathbb{R}^n$ is the state vector that includes the dynamics of the system. $u(t) \in \mathbb{R}^{n_u}$ is the control input vector and $A \in \mathbb{R}^{n \times n}$ and $B \in \mathbb{R}^{n \times n_u}$ characterize the differential equations of the system. The objective is to find a control law that minimizes the following cost function

$$\mathcal{J}_{LQ}(x_0, u) := \int_0^\infty x^T(t)Qx(t) + u^T(t)Ru(t)dt, \quad (3.2)$$

where $0 \leq Q \in \mathbb{R}^{n \times n}$ and $0 < R \in \mathbb{R}^{n_u \times n_u}$ are the weighting symmetric matrices to be specified by the user. The optimal control will lead to an optimal cost value. The semi-definite positive matrix Q represents the penalty incurred at instant t by the deviation

of the state from its steady equilibrium point. Similarly the definite positive matrix R represents the control effort at an instant t trying to approach the state toward its equilibrium. The choice of the weightings Q and R reflects the tradeoff between the requirements of converging to the desired steady state and the consumption of control energy. According to [Won74, Ske88], the pair (A, B) must be stabilizable. The solution of the LQR problem starts as follows :

Theorem 3.1 ([KS72], Theorem 3.15)

Consider the LTI system (3.1) and the cost function (3.2) which is to be minimized. Assume that (A, B) is stabilizable and (Q, A) is detectable. Then the optimal control belongs to the class of state feedback and is given by $u^*(t) = Kx(t)$, where $K = -R^{-1}B^T P$ with $P > 0$ is the unique positive definite solution of the Algebraic Riccati Equation given by

$$A^T P + PA - PBR^{-1}B^T P + Q = 0, \quad (3.3)$$

In addition the optimal controller stabilizes the system, which means that the closed loop dynamic matrix $A + BK = A - BR^{-1}B^T P$ is Hurwitz. The optimal value of the cost is given by

$$\mathcal{J}_{LQ}^* = \mathcal{J}_{LQ}(x_0, u^*) = x_0^T P x_0. \quad (3.4)$$

In this thesis, it is interesting to reconstruct this solution with other tools that will be more suitable for our new contributions. The unique positive definite solution of the (ARE) is equivalently the solution of the Semi Definite Programming (SDP) [BV03, AT00, BEGFB94]

$$\begin{aligned} & \max_{P \in \mathbb{R}^{n \times n}} \quad \text{Tr}(P) \\ & \text{subject to} \quad \begin{cases} P > 0 \\ \begin{bmatrix} A^T P + PA + Q & PB \\ B^T P & R \end{bmatrix} \geq 0. \end{cases} \end{aligned} \quad (3.5)$$

It consists of adding a further inequality stating that $x_0^T P x_0$ is an upper bound of the cost \mathcal{J}_{LQ} and to minimize this upper bound. To summarize up, the LQ problem permits to obtain a multi-variable control law by minimizing a cost function over the trajectory of the system. The interest of using such method is that it avoids direct tuning of the controller gain and replace it by weighting tuning which is easier.

3.3 Stability

One of the most important notions in the theory of system control is *stability*. The stability theory basically is related to the solutions of differential equations. There are different kind of stability problems that have been studied in details for different types of systems, such as *Lyapunov* stability and other types (Structural stability, BIBO stability, ISS . . . etc). In this section we are going to present briefly the stability of non-linear systems at the beginning. After that we will move to the stability in the sense of Lyapunov for the linear case. Some definitions and tools are to be presented which will permit us to prove the stability for different system classes.

3.3.1 Basic Definitions

Based on the basics in [MLSS94, Vid02, Kha02] for stability of non-linear systems, consider a dynamical non-autonomous system given by

$$\dot{x}(t) = f(t, x(t)), \quad x(t_0) = x_0 \in \mathcal{D}, \quad (3.6)$$

where $x(t) \in \mathcal{D} \subset \mathbb{R}^n$, with \mathcal{D} is an open set containing the origin. Assume that the function $f : \mathbb{R} \times \mathcal{D} \mapsto \mathbb{R}^n$ satisfy the usual conditions to ensure the existence and uniqueness of the system trajectory $x(t)$. These conditions state that f is Lipschitz continuous in \mathcal{D} with respect to x , uniformly Lipschitz regarding t , and at least it must be piecewise continuous in t . Denote $x_e \in \mathcal{D}$ the equilibrium point of the autonomous system (3.6) such that $f(t, x_e) \equiv 0$. We say that the equilibrium point x_e is *locally stable* if all trajectories that start from x_0 in the neighborhood of x_e remain around it for all time $t \geq t_0$. The equilibrium point x_e is said to be *locally asymptotically stable* if x_e is locally stable and in addition if all trajectories that start near x_e converge to x_e as time tends to infinity. Talking about the convergence of the trajectory toward the equilibrium point, it is important to mention in details the famous *Lyapunov stability* [Lya92]. Consider the following definitions [LS76, LWY07, Kha15].

Definition 3.1 ([WHS10], Definition 2.1.1)

1. At instant $t_0 \geq 0$, if $\forall \varepsilon > 0$, there exists $\delta(t_0, \varepsilon) > 0$ such that

$$\|x_0 - x_e\| < \delta(t_0, \varepsilon) \Rightarrow \|x(t) - x_e\| < \varepsilon, \quad \forall t \geq t_0, \quad (3.7)$$

then the equilibrium point x_e is stable in the sens of Lyapunov. Moreover if $\delta(\varepsilon)$ can be chosen independent of t_0 , then the system is uniformly stable.

2. If the system is stable at the equilibrium point x_e and if there exists $\delta(t_0) > 0$ such that

$$\|x_0 - x_e\| < \delta(t_0) \Rightarrow \lim_{t \rightarrow \infty} x(t) = x_e, \quad (3.8)$$

then the system is asymptotically stable at the equilibrium point x_e . Moreover if δ can be chosen independent of t_0 , then the system is uniformly asymptotically stable. Furthermore if δ can be arbitrary large, finite number, then the system is globally asymptotically stable at the point x_e for every $x_0 \in \mathbb{R}^n$.

For the time-invariant autonomous systems, the uniform asymptotic stability is equivalent to asymptotic stability.

3.3.2 Lyapunov's Direct Method for Stability

In the previous definitions, we have seen that to prove the stability of the system (3.6) we need to follow its trajectory and verify if it stays in a defined region according to (3.7) and (3.8). However another way can be adapted to reach such conclusions, this way depends on mathematical criteria used to verify the stability of the system without integrating entirely the differential equation (3.6). The general idea of these tools

is to propose a function that characterizes the energy stored in the system, this is called the direct or second Lyapunov method. The study of energy change informs us if the system is damped and its energy is consumed (decreased), till it reaches a steady stable situation. Based on this link between stability and energy variation, Lyapunov constructed a function $V(t, x(t))$ which stands for the energy stored in the system. This function must satisfy

$$V(t, x(t)) \begin{cases} = 0, & \text{if } x = x_e, \\ > 0, & \text{otherwise,} \end{cases} \quad (3.9)$$

Denote $\dot{V}(t, x(t))$ the time derivative of V , which characterizes the variation of the energy in the system along its trajectory. It is generally given by

$$\dot{V}(x, t) \Big|_{\dot{x}=f(x,t)} = \frac{\partial V}{\partial t} + \frac{\partial V}{\partial x} f. \quad (3.10)$$

Assume now that the origin is the equilibrium point of the system (3.6) (i.e. $x_e = 0$ and $f(t, 0) = 0$). If it is not the case, a translation can be done by using a change of variable to reset the equilibrium at the origin. According to Lyapunov's direct method, stability of system (3.6) can be determined according to the following theorem.

Theorem 3.2 ([Kha15], Theorem 3.3)

Let $V : \mathbb{R}_+ \times \mathbb{R}^n \mapsto \mathbb{R}$ be a continuous non-negative function with $\dot{V}(t, x)$ its derivative along the trajectory of the system.

1. $V(t, x)$ is *positive definite* and $\dot{V}(t, x) \leq 0$, then the equilibrium point x_e is *locally stable* in the sense of Lyapunov.
2. $V(t, x)$ is *positive definite* and $\dot{V}(t, x) < 0$, then x_e is *locally asymptotically stable* in the sense of Lyapunov.
3. $V(t, x)$ is *positive definite* and *unbounded radially* with $\dot{V}(t, x) < 0$, then x_e is *uniformly asymptotically stable* in the sense of Lyapunov.

The term *unbounded radially* means that the function $V(t, x(t)) \rightarrow \infty$ as $\|x\| \rightarrow \infty$. This theorem gives sufficient conditions for the stability of the equilibrium point. In the next sections, for each type of system we will use suitable quadratic functions to verify their stability. The role of these functions can be extended, they can be used for the synthesis of control laws under certain sufficient conditions.

3.4 Stability of Time Delay Systems

As we are going to see later on, the tandem process contains time delays which means that the class of delayed systems will be an important part in the modeling of our process. These delays affect the stability of the rolling system and degrade its performance. In this section, we are going to study the stability of Time Delay Systems (TDSs) where this topic had been treated widely in many research [Nic01, MN14, Fri14]. But before that, we need to present some notions about this type of mathematical models. A short illustration will be given for this purpose.

3.4.1 Time Delay Systems in Brief

Time delay systems (TDSs) also called *retarded differential equations* (RDEs) belong to the class of functional differential equations [Hal71,HL93] which are infinite dimensional systems. These systems are also called delayed differential equation (DDE) [NVDD98, KNG99, Kha98]. The instantaneous time derivative of the system trajectory \dot{x} is given in terms of the function values at previous times. These systems are also called as hereditary systems or differential-difference equation systems [Ric03]. The aftereffect of these systems have motivated their usage and increased their appearance in process mathematical modeling. In the fields of industry, numerous processes contain delay effects such as communication networks with transport delays or such as in chemical process with dead delay effects. Recently TDS show more and more interest especially in the field of system control. The effects of time delays in the process usually can't be easily managed using the classical control methods, whereas some control studies proposed to approximate or neglect these delays. This might change the system model with respect to the real process especially in the case of time dependent delays. So lets start introducing some basic notions about this class of systems. The general form of TDS can be given by

$$\begin{aligned} \dot{x}(t) &= f(t, x_t), & t &\geq t_0, \\ x(\xi) &= \phi(\xi), & \xi &\in [t_0 - \tau, t_0], \end{aligned} \quad (3.11)$$

where $x \in \mathbb{R}^n$ is the trajectory of the system. Also $x_t(-\tau) = x(t - \tau)$ is the delayed state vector with $\tau > 0$ the time delay of the system. $f : \mathbb{R} \times \mathcal{C}_{\tau,n} \rightarrow \mathbb{R}^n$ is continuous in its both arguments and locally Lipschitz continuous in the second one. The function f indicates that the derivative of the state variable x at a time t depends on t and $x(\xi)$ for $\xi \in [t_0 - \tau, t_0]$. Thus to determine the future evolution of the state, it is necessary to specify the initial value of the state variable along an interval of length τ . This leads us to complete the definition of a TDS by providing its initial condition ϕ over $[t_0 - \tau, t_0]$. Usually in ordinary differential equation (ODE), the initial condition is referred to the single initial value $x_0 = x(t_0)$. However in TDS, the initial condition refers to the function $\phi \in \mathcal{C}_{\tau,n} = \mathcal{C}([t_0 - \tau, t_0], \mathbb{R}^n)$ which is the minimum data necessary to construct the solution of the system (3.11). A fundamental issue in the study of both ODE and DDE is the existence and uniqueness of a solution. For the case of ODE, the necessary arguments responding to this issue can be found in [Kha02]. On the other hand, it is little more complicated for TDS, referring to [Ric03, MVAN05, Fri14] we give the following definition assuming that the delay τ is constant.

Definition 3.2 ([Fri14], Definition 1.1)

The function $x : \mathbb{R} \rightarrow \mathbb{R}^n$ is a solution of (3.11) with the initial condition ϕ if $\exists a > 0$ such that $x(t)$ is continuous on $[t_0 - \tau, t_0 + a)$. The solution $x(t)$ is initialized by ϕ and satisfies (3.11) for $t \in [t_0, t_0 + a)$.

In other words, if f is continuous in all its arguments and locally Lipschitz in ϕ , then there exists a unique solution x traversing ϕ for the (TDS) in (3.11). Note that if the time delay $\tau = \tau(t)$ is a variable one, its must be strictly positive continuous function to ensure the existence, uniqueness and continuity of the solution $x(t)$. More results and explanation can be found in [KM99]. The solution x is constructed using the *step*

method proposed by Bellman [BC63]. Based on the continuous initial condition ϕ , the solution x is constructed for $[t_0, t_0 + \tau]$ by solving the following differential equation

$$t \in [t_0, t_0 + \tau], \quad \dot{x}(t) = f(t, \phi(t - t_0 - \tau)), \quad x(t_0) = \phi(t_0), \quad (3.12)$$

Then we continue in the same procedure for the intervals $t \in [t_0 + k\tau, t_0 + (k + 1)\tau]$ where $k \in \mathbb{N}$.

3.4.2 Stability Concept for General TDS

Consider the delayed functional differential equation given in (3.11). Without loss of generality, assume that the origin is the equilibrium point (i.e. $f(t, 0) = 0$) which leads us to say that this system has a trivial solution $x(t) = 0$. If it is not the case and the system has a non-trivial solution, to study the stability of it a simple translation change of variable can be made to arrive finally to a system with a trivial solution. In [GCK03, Fri14], some stability definitions are introduced for the case of time delay system.

Definition 3.3 ([Fri14], Definition 3.1)

1. If $\forall t_0 \in \mathbb{R}$ and $\forall \varepsilon > 0$, $\exists \delta(t_0, \varepsilon) > 0$ such that $\|x_{t_0}\|_C < \delta$ implies $\|x(t)\| < \varepsilon$ for $t \geq t_0$, then the trivial solution of (3.11) is stable. Moreover if the solution is stable and δ can be chosen independently from t_0 , thus it is uniformly stable.
2. If the trivial solution of (3.11) is stable, and if $\forall t_0 \in \mathbb{R}$ and $\forall \varepsilon > 0$, $\exists \delta(t_0, \varepsilon) > 0$ such that $\|x_{t_0}\|_C < \delta$ implies $\lim_{t \rightarrow \infty} x(t) = 0$, then the trivial solution is asymptotically stable.
3. If the trivial solution is uniformly stable and if $\exists \delta > 0$ such that, $\forall \eta > 0$, $\exists T(\delta, \eta)$ such that $\|x_{t_0}\|_C < \delta$ implies $\|x(t)\| < \eta$ for $t \geq t_0 + T$, and $t_0 \in \mathbb{R}$, then the trivial solution of (3.11) is uniformly asymptotically stable.
4. If the trivial solution is (uniformly resp.) asymptotically stable and the parameter δ can be arbitrary large, finite number, then the trivial solution of (3.11) is globally (uniformly resp.) asymptotically stable.

The system is uniformly asymptotically stable if its solution is uniformly asymptotically stable. For the time invariant autonomous delayed systems, the uniform asymptotic stability is equivalent to asymptotic stability.

3.4.2.1 Lyapunov-Krasovskii Direct Method

As we have seen in Theorem 3.2, Lyapunov functions are used to prove the stability of non-delayed differential systems. The same approach can be followed when investigating about the stability of TDSs. However in this approach, different functions were treated. In the case of non-delayed systems, Lyapunov functions are usually quadratic energy functions which depend on the instantaneous value of the state vector $x(t)$. In the case of TDS and due to the presence of past state values (i.e. x_t) in the differential equation, the energy function will also depend on x_t . Thus the Lyapunov function depends on all the values of the trajectory over the time interval of x_t , this means that

it is function of function and is called functional. N.N. Krasovskii and B.S. Razumikhin have proposed Lyapunov functionals [Kra63, EN73, KM99] to establish the direct method or the stability of these type of functional differential equations. The stability of the trivial solution is proved by ensuring the decrease of these functional. We will concentrate only on the Lyapunov-Krasovskii approach for the direct stability method. According to [GCK03], consider the following theorem.

Theorem 3.3 (Lyapunov-Krasovskii Stability Theorem) ([Fri14], Theorem 3.1)

Suppose that $f : \mathbb{R} \times \mathcal{C}[-\tau, 0] \rightarrow \mathbb{R}^n$ in (3.11) maps $\mathbb{R} \times (\text{bounded sets in } \mathcal{C})$ into bounded sets in \mathbb{R}^n , and let $u, v, w : \mathbb{R}_+ \rightarrow \mathbb{R}_+$ are continuous non-decreasing functions, where $u(s)$ and $v(s)$ are positive for $s > 0$, and $u(0) = v(0) = 0$. The trivial solution of (3.11) is uniformly stable if there exists continuous functional $V : \mathbb{R} \times \mathcal{C}[-\tau, 0] \rightarrow \mathbb{R}$ which is positive definite verifying

$$u(|\phi(0)|) \leq V(t, \phi) \leq v(\|\phi\|_{\mathcal{C}}), \quad (3.13)$$

and such that its derivative denoted $\dot{V}(t, x_t)$ is non-positive in the sense that

$$\dot{V}(t, \phi) \leq -w(|\phi(0)|), \quad (3.14)$$

If $w(s) > 0$ for $s > 0$, then the trivial solution is uniformly asymptotically stable. Moreover if $\lim_{t \rightarrow \infty} u(s) = \infty$, then V is radially unbounded and the trivial solution is globally uniformly asymptotically stable.

The proof of this theorem can be found in [HL93]. Note that if (3.14) is true, it means that $V(t, x_t) \leq V(t, x_{t_0})$ which is bounded from above. Let us consider the class of linear time invariant systems with discrete delays to apply the approach of Lyapunov-Krasovskii.

3.4.3 Stability of Linear Systems with Time-Varying Delays

In this part, we discuss the stability of linear TDS. We focus on the linear case due to the objective to model the tandem process in a linear multi-variable system. The stability of the linear case model will be investigated in the Lyapunov-Krasovskii sense. Consider the following autonomous time delay system

$$\dot{x} = A_0 x(t) + \sum_{i=1}^q A_i x(t - \tau_i(t)) + Bu(t), \quad t \geq t_0,$$

$$x_{t_0}(\theta) = x(t_0 + \theta) = \phi(t_0 + \theta), \quad \theta \in [-\tau_{max}, 0], \quad \phi \in \mathcal{C}_{\tau_{max}, n} = \mathcal{C}([t_0 - \tau_{max}, t_0], \mathbb{R}^n), \quad (3.15)$$

where $x \in \mathbb{R}^n$, $A_i \in \mathbb{R}^{n \times n}$ and $B \in \mathbb{R}^{n \times u}$ are constant matrices. The q time dependent delay are positive bounded delays such that $\tau_i(t) \in [0, \bar{\tau}_i]$. For the study of stability of this system, we are going to consider the case of autonomous system, i.e. $u \equiv 0$. Based on Theorem 3.3 for stability analysis we have to choose a Lyapunov functional associated to the system. Certain forms lead to delay dependent stability condition, whereas others lead to independent ones. We will focus on the functionals that lead to delay independent conditions. A simple Lyapunov-Krasovskii functional V [Ric03] has the form

$$V(t, x_t) = x^T(t)Px(t) + \sum_{i=1}^q \int_{t-\tau_i(t)}^t x^T(s)S_i x(s)ds, \quad (3.16)$$

where P and S_i are $n \times n$ symmetric positive definite matrices. Assume that the delays $\tau_i(t)$ are differentiable functions with assumed bounded derivatives from above, such that $\dot{\tau}_i(t) \leq d_i < 1$ for all i . For the objective of stability analysis, we differentiate the functional V along the system (3.15). We can see that V satisfies the positivity condition in (3.13) for some $\beta > 0$ such that $\beta|x(t)|^2 \leq V(t, x_t)$. For the stability of the system, we just need to prove the condition in (3.14). Denote $\dot{V}(t, x_t)$ the time derivative of the functional V . Differentiating V along the system (3.15), we obtain

$$\begin{aligned} \dot{V}(t, x_t) &= \frac{d}{dt}V(t, x_t) = \dot{x}^T(t)Px(t) + x^T(t)P\dot{x}(t) + \sum_{i=1}^q x^T(t)S_i x(t) \\ &\quad - \sum_{i=1}^q (1 - \dot{\tau}_i(t)) x^T(t - \tau_i(t))S_i x(t - \tau_i(t)), \end{aligned} \quad (3.17)$$

Furthermore substitute in (3.17) the value of $\dot{x}(t)$ given by its expression in (3.15). We arrive to the following inequality ([Fri14], Page 63)

$$\dot{V}(t, x_t) \leq \zeta^T(t)\Phi_1\zeta(t), \quad (3.18)$$

with

$$\Phi_1 = \begin{bmatrix} \Omega_1 & PA_1 & PA_2 & \cdots & PA_q \\ \star & -(1 - d_1)S_1 & 0 & \cdots & 0 \\ \star & \star & -(1 - d_2)S_2 & \ddots & \vdots \\ \star & \star & \star & \ddots & 0 \\ \star & \star & \star & \star & -(1 - d_q)S_q \end{bmatrix}, \quad (3.19)$$

where

$$\Omega_1 = A_0^T P + PA_0 + \sum_{i=1}^q S_i, \quad (3.20)$$

and $\zeta(t) = \text{col}\{x(t), x(t - \tau_1(t)), \dots, x(t - \tau_q(t))\} \neq 0$. According to Theorem (3.3), we introduce the following proposition.

Proposition 3.1 ([Fri14], Proposition 3.3)

The system (3.15) is uniformly asymptotically stable for all delays $\tau_i \in [0, \bar{\tau}_i]$ with $\dot{\tau}_i \leq d_i < 1$ if there exist $n \times n$ matrices $P > 0$ and $S_i > 0$ such that the sufficient condition $\Phi_1 < 0$ is feasible.

If Φ_1 is feasible, we conclude that $\Omega_1 < 0$. This means that A_0 should be Hurwitz. The stability condition given in (3.19) is a delay independent one. Using other Lyapunov functionals including additional terms [Ric03] lead to delay dependent stability conditions.

3.4.4 Stabilization of Linear Systems with Time-Varying Delays

Based on the stability results on the stability of linear delayed systems, another result can be deduced regarding the stabilization of an unstable time delay system.

Consider the same autonomous time delay system in (3.15) but with the forced case such that the input $u \neq 0$. The indicated system is to be stabilized by a state feedback control given by

$$u(t) = Kx(t), \quad (3.21)$$

where $K \in \mathbb{R}^{n_u \times n}$ is the feedback gain. The closed loop system equation can be written as

$$\dot{x} = (A_0 + BK)x(t) + \sum_{i=1}^q A_i x(t - \tau_i(t)), \quad (3.22)$$

The stability test by Lyapunov functional direct method gives us a tool for the synthesis of a stabilizing state feedback controller of the forced delayed system. Consider the following theorem.

Theorem 3.4 : *The closed loop system (3.15) with the state feedback control in (3.21) is uniformly asymptotically stable for all delays $\tau_i \in [0, \bar{\tau}_i]$ with $\dot{\tau} \leq d_i < 1$ if there exist $n \times n$ matrices $W > 0$ and $G_i > 0$ and a matrix $Y \in \mathbb{R}^{n_u \times n}$ such that the LMI*

$$\Phi_2 = \begin{bmatrix} \Omega_2 & A_1 W & A_2 W & \cdots & A_q W \\ * & -(1 - d_1)G_1 & 0 & \cdots & 0 \\ * & * & -(1 - d_2)G_2 & \ddots & \vdots \\ * & * & * & \ddots & 0 \\ * & * & * & * & -(1 - d_q)G_q \end{bmatrix} < 0, \quad (3.23)$$

is feasible with

$$\Omega_2 = \mathbf{He}(A_0 W + BY) + \sum_{i=1}^q G_i, \quad (3.24)$$

also with $W = P^{-1}$, $G_i = P^{-1}S_i P^{-1}$, $i \in \{1, \dots, q\}$ and $Y = KW$.

The proof of this theorem is very close to the steps made between (3.16) and (3.20). The key of this proof is based on the Lyapunov functional given in (3.16) defined by the same matrices P and S_i .

Proof : Assume that the LMI (3.23) is feasible, this means that there exist matrices W , G_i and Y satisfying $\Phi_2 < 0$. Through a congruence transformation, we multiply both sides of Φ_2 in (3.23) by $L = I_{q+1} \otimes W^{-1} > 0$. Using the backward change of variable $P = W^{-1}$, $S_i = W^{-1}G_i W^{-1}$ and $K = YW^{-1}$ we obtain

$$\Phi_3 = \begin{bmatrix} \Omega_3 & PA_1 & PA_2 & \cdots & PA_q \\ * & -(1 - d_1)S_1 & 0 & \cdots & 0 \\ * & * & -(1 - d_2)S_2 & \ddots & \vdots \\ * & * & * & \ddots & 0 \\ * & * & * & * & -(1 - d_q)S_q \end{bmatrix} < 0, \quad (3.25)$$

where

$$\Omega_3 = \mathbf{He}(PA_0 + PBK) + \sum_{i=1}^q S_i, \quad (3.26)$$

The sequel of this proof is the same as the one detailed for Proposition 3.1 by substituting A_0 by $A_0 + BK$.

3.5 Stability of Singular Systems

In this section, we are going to highlight over the class of singular systems. The form of such systems are widely used in modeling complex process. An interest is to study their properties, how to prove their stability and how to stabilize them or modify their performance. But first of all, let us take a short overview about singular continuous systems.

3.5.1 Singular Systems in Brief

In ODEs, a set of differential equations characterizes the evolution of the system dynamics. However there are systems where the dynamics are not characterized by time derivatives, they are given by static algebraic relations. These ones are called *Singular* or *Descriptor* systems. These systems are found in physical engineering systems such as chemical processes, power grid systems or electrical circuits. The form in modeling have pulled the attention of many scientist and researchers. Through literature, the treatment of such systems has been associated with several terms such as impulsiveness in solution, non-proper transfer function or compatible initial condition which render the study of them more sophisticated than the classical non-singular systems. The definitions of regularity and non-impulsiveness (in the continuous case) or causality (in the discrete case) have played important roles in the analysis of singular systems. It is good to mention that these systems contain different kinds of modes [Dai89], finite dynamic mode, infinite dynamic modes and infinite static modes. The infinite dynamic modes can generate impulses in the system solution. In the frame of our work, we will shed the light only on the case of autonomous continuous descriptor systems. Several conditions are to be presented regarding their characteristics. For that let us state down some preliminaries which are essential here and in the next chapters.

3.5.2 Preliminaries on Singular Systems

Consider a linear autonomous singular system given by

$$E\dot{x}(t) = Ax(t) + Bu(t), \quad x(t_0) = x_0, \quad t \geq t_0, \quad (3.27)$$

where $x(t) \in \mathbb{R}^n$ is the state vector. $E, A \in \mathbb{R}^{n \times n}$ and $B \in \mathbb{R}^{n \times n_u}$ are real constant matrices where $\text{rank}(E) = n_1 < n$. The pair (E, A) is called *pencil*. Let us consider the case of unforced system where $u \equiv 0$. Many research studied have treated the behavior of linear continuous singular systems such as [Dai89, Lew02, YS81] and the references therein. One of the particularities of such systems is their time response that may contain impulses, that is discontinuities of time derivatives. Let us introduce some definitions from [Dai89] regarding unforced singular systems.

Definition 3.4 ([XL06], Definition 2.1)

Consider the system (3.27) being unforced. The pencil (E, A) is said to be

1. *regular* if $|sE - A| \neq 0$.
2. *impulse-free* if $\deg(|sE - A|) = \text{rank}(E)$.

3. stable if all the roots of $|sE - A| = 0$ have negative real parts.
4. admissible if it is regular, impulse-free and stable.

The unforced system (3.27) is called respectively *regular, impulse-free, stable, or admissible* if the pair (E, A) is *regular, impulse-free, stable, or admissible*. According to [Dai89, XDSL02], if the pencil (E, A) is regular, this means that the system (3.27) being unforced admits a unique solution. Undesired impulsiveness in the solution can be due to the non satisfaction of free-impulsiveness, or due to inconsistent (incompatible) initial condition [Cam80b]. For that the existence of impulsive solutions is studied in terms of the *Weierstrass* canonical form and the index of the system. Let us first study the case of non-satisfaction of free-impulsiveness explained in the following lemma [Dai89].

Lemma 3.1 (*Canonical Decomposition*) ([Dai89], Lemma 1.2.2)

The pair (E, A) is regular if and only if there exist two non-singular $n \times n$ matrices M_1 and N_1 such that

$$M_1 E N_1 = \text{diag}(I_{n_1}, J), \quad M_1 A N_1 = \text{diag}(A', I_{n_2}), \quad (3.28)$$

with $n_2 = n - n_1$ and $J \in \mathbb{R}^{n_2 \times n_2}$ is a nilpotent matrix of index ν , i.e. $J^\nu = 0, J^{\nu-1} \neq 0$.

The index of the singular system is referred to ν . This decomposition permits us to write the system in the new basis $z = \text{col} \{z_1, z_2\} = N_1^{-1} x$ with the following canonical form

$$\begin{aligned} \dot{z}_1(t) &= A' z_1(t), \\ J \dot{z}_2(t) &= z_2(t), \end{aligned} \quad (3.29)$$

By solving (3.29), we obtain

$$\begin{aligned} z_1(t) &= e^{A't} z_1(t_0), \\ J z_2(t) &= - \sum_{k=0}^{\nu-2} \delta^k(t) J^{k+1} z_2(t_0^-), \end{aligned} \quad (3.30)$$

where $\delta(t)$ is the *Dirac* delta function and the subscript k denoted the k^{th} distributional derivative. If $\nu > 1$, the Dirac delta function will appear in the solution and hence the system will admit impulsive solutions. Therefore to have free impulsive solution, we must have $J = 0$, i.e. system of index one. Validating the free-impulsive condition mentioned in Definition 3.4 based on the result of $J = 0$, we have

$$\begin{aligned} |sE - A| &= |sM_1^{-1} M_1 E N_1 N_1^{-1} - M_1^{-1} M_1 A N_1 N_1^{-1}| \\ &= |M_1^{-1} ||N_1^{-1} ||\text{diag}(sI_{n_1} - A', -I_{n_2})| = |M_1^{-1} ||N_1^{-1} || - I_{n_2} ||sI_{n_1} - A'|, \end{aligned} \quad (3.31)$$

Obviously $|M_1^{-1} ||N_1^{-1} || - I_{n_2}| = \gamma \in \mathbb{R}^*$, which means that

$$\deg(|sE - A|) = \deg(\gamma |sI_{n_1} - A'|) = n_1 = \text{rank}(E). \quad (3.32)$$

Consider the following lemma that summarizes the conclusions around singular systems of index one [Dai89].

Lemma 3.2 ([XL06], Lemma 2.2)

Suppose that the pair (E, A) is regular and the two non-singular matrices M_1 and N_1 are chosen such that (3.28) holds, then the pair (E, A) is

1. impulse-free if and only if $J = 0$.
2. stable if and only if A is Hurwitz.
3. admissible if and only if $J = 0$ and A is Hurwitz.

The proof of this lemma can be found in the mentioned reference. Whenever we have a singular system, it is always possible to find two non-singular matrices M_2 and N_2 such that

$$M_2EN_2 = \begin{bmatrix} I_{n_1} & 0 \\ 0 & 0 \end{bmatrix}, \quad M_2AN_2 = \begin{bmatrix} A_1 & A_2 \\ A_3 & A_4 \end{bmatrix}, \quad (3.33)$$

This decomposition can be easily obtained depending on the singular value decomposition of E . The new basis state vector $w = \text{col} \{w_1, w_2\} = N_2^{-1}x$. The decomposition of the system in the new basis leads to

$$\begin{aligned} \dot{w}_1(t) &= A_1w_1(t) + A_2w_2(t), \\ 0 &= A_3w_1(t) + A_4w_2(t), \end{aligned} \quad (3.34)$$

We have the following lemma

Lemma 3.3 ([XL06], Lemma 2.3) *The pair (E, A) is impulse-free if and only if A_4 is non-singular.*

Another free impulsiveness condition is available according to the second decomposition in (3.33). The proof of this lemma can be also found in [Dai89]. As it has been said before, there is another reason that may induce impulses which is the inconsistent initial condition. According to [Cam80b, Fri02], the initial condition $x(t_0) = x_0$ must be compatible according to the algebraic relation in (3.27). Based on the decomposition (3.34), we substitute the initial condition in the new basis $w_0 = \text{col} \{w_1, w_2\} = N_2^{-1}x_0$ in the equation

$$\begin{aligned} \dot{w}_1(t_0) &= A_1w_1(t_0) + A_2w_2(t_0), \\ 0 &= A_3w_1(t_0) + A_4w_2(t_0), \end{aligned} \quad (3.35)$$

The compatibility of the initial condition meaning that the second algebraic relation in (3.35) holds. This prevents from the appearance of impulses in the solution of the system. The system considered here being unforced, in contrast if $u \neq 0$ then other algebraic relation must be valid where the initial condition w_0 must be compatible with the initial input value $u(t_0)$. Consider the forced system in (3.27), choosing M_2 and N_2 such that we have the decomposition (3.33) with $M_2B = \text{col} \{B_1, B_2\}$. Avoiding impulses or discontinuities in solution derivatives means that the initial condition satisfies

$$A_3w_1(t_0) + A_4w_2(t_0) + B_2u(t_0) = 0, \quad (3.36)$$

3.5.3 Stability of Linear Singular Systems

As it was presented for the non-singular system case, the stability is essential to be investigated in the present case. In this section we are going to present direct way for proving stability of linear continuous singular systems using Lyapunov direct method. Several research treated the present case such as [TMK95, Lew02, Liu12, FS02, XL06, Dai89, YS81, KKO99] and the references therein. Since we are only interested in the case of linear continuous singular systems, let us concentrate on obtaining sufficient conditions for the stability by using Lyapunov direct approach. Moving directly to the system (3.27) where we are examining the unforced case and that the system is regular and impulse free. Without loss of generality, we consider for simplicity a special case of singular matrix such that $E = \text{diag}(I_{n_1}, 0)$. If it is not the case, it is always possible to choose non-singular matrices M_2 and N_2 such that the decomposition in (3.33) holds. Then the next results are applied to the new basis system. Applying this approach we need to choose a Lyapunov candidate according to Theorem 3.2. This function characterizes the energy stored in the dynamics of the singular system. For this system, the proposed semi positive function is

$$V(x(t)) = x^T(t)E^T P x(t), \quad (3.37)$$

where $P \in \mathbb{R}^{n \times n}$ is a non-singular matrix. Consider the following theorem [XL06]

Theorem 3.5 ([XL06], Theorem 2.1)

: The regular and free impulsive unforced singular system in (3.27) is asymptotically stable if there exists a non-singular matrix P such that the algebraic relation

$$E^T P = P^T E \geq 0, \quad (3.38)$$

and the linear matrix inequality

$$A^T P + P^T A < 0, \quad (3.39)$$

are satisfied.

The proof can be found therein.

3.5.4 Stabilization of Linear Singular Systems

As it has been said before, Lyapunov direct method has been used as a tool for the synthesis of stabilizing state feedback controller that ensures the asymptotic stability of the closed loop system. Consider the forced singular system in (3.27) and the form of the state feedback controller given by

$$u = Kx, \quad (3.40)$$

The closed loop system simply becomes $E\dot{x} = (A + BK)x$. Using the same Lyapunov function in (3.37), the synthesis of this controller is given in the following theorem.

Theorem 3.6 ([XL06], Theorem 3.1)

The closed loop singular system in (3.27) is asymptotically stable with the state feedback control

given in (3.40), if there exists a non-singular matrix $W \in \mathbb{R}^{n \times n}$ and matrix $Y \in \mathbb{R}^{n_u \times n}$ such that the algebraic relation

$$W^T E^T = EW \geq 0, \quad (3.41)$$

and the linear matrix inequality

$$W^T A^T + AW + BY + Y^T B^T < 0, \quad (3.42)$$

are satisfied, where the matrices $W = P^{-1}$ and the state feedback gain $K = YW^{-1}$.

The proof can be found therein.

3.6 Stability of Time Delay Singular Systems

Now we arrive to a crossroad where both time delay systems and singular systems intermingle in the class of singular time delay systems. Let us go directly to some preliminaries related to this type of systems.

3.6.1 Preliminaries of Time Delay Singular Systems

Consider the general continuous autonomous linear system given by

$$\begin{aligned} E\dot{x}(t) &= A_0x(t) + \sum_{i=1}^q A_i x(t - \tau_i(t)) + Bu(t), \quad t \geq t_0, \\ x_{t_0}(\theta) &= x(t_0 + \theta) = \phi(t_0 + \theta), \quad \theta \in [-\tau_{max}, 0], \quad \phi \in \mathcal{C}_{\tau_{max}, n} = \mathcal{C}([t_0 - \tau_{max}, t_0], \mathbb{R}^n), \end{aligned} \quad (3.43)$$

where as always $x \in \mathbb{R}^n$ is the state vector, the matrices $E, A_i \in \mathbb{R}^{n \times n}$ and $B \in \mathbb{R}^{n \times n_u}$ are constant matrices. The matrix E is singular with $\text{rank}(E) = n_1 < n$. ϕ is a compatible vector valued function and the time delays τ_i satisfy the following

$$\begin{cases} 0 \leq \tau_i(t) \leq \bar{\tau}_i, \\ \dot{\tau}_i(t) \leq d_i < 1 \end{cases} \quad (3.44)$$

The existence and uniqueness of solution to a given algebraic differential delayed system is not always guaranteed and the system may also have undesired impulsive behavior. Discontinuities in the solution derivatives may also appear. Even if the time delay singular system is regular and impulse-free, the solution may exhibit impulses due to the incompatibility of initial condition ϕ . In addition, these jumps most probably propagate through the solution due to the existence of delayed terms. The interaction of the algebraic relation with the delayed terms in it leads a special behavior which can not happen neither in (TDSs) nor in singular systems. Based on [Fri02, FS02, Liu12] we introduce some definitions regarding this type of systems.

Definition 3.5 ([XL06], Definition 9.1) *System (3.43) is regular and impulse-free if the pencil (E, A_0) is regular and impulse-free.*

It can be shown that the free impulsiveness of this system is equivalent to say that the system is of index one [Fri02]. This can be proved easily using the same transformation in (3.28). The system matrices are given in the following form

$$E = \begin{bmatrix} I_{n_1} & 0 \\ 0 & 0 \end{bmatrix}; A_i = \begin{bmatrix} A_{i1} & A_{i2} \\ A_{i3} & A_{i4} \end{bmatrix}; B = \begin{bmatrix} B_1 \\ B_2 \end{bmatrix}, \quad (3.45)$$

Note that if the system matrices are not in the form given in (3.45), it can be always be transformed to this form by choosing conveniently two non-singular matrices M_2 and N_2 as presented in (3.33). Consider the case of autonomous system (3.43) where $u \equiv 0$. Based on the form in (3.45), the system can be written as the following

$$\begin{aligned} \dot{x}_1(t) &= A_{01} x_1(t) + A_{02} x_2(t) + \sum_{i=1}^q \sum_{j=1}^2 A_{i,j} x_j(t - \tau_i(t)), \\ 0 &= A_{03} x_1(t) + A_{04} x_2(t) + \sum_{i=1}^q \sum_{j=1}^2 A_{i,j+2} x_j(t - \tau_i(t)). \end{aligned} \quad (3.46)$$

with its initial condition

$$x_1(t) = \phi_1(t), \quad x_2(t) = \phi_2(t), \quad t \in [t_0 - \tau_{max}, t_0]. \quad (3.47)$$

Substituting the initial condition $\phi(t) = \text{col}\{\phi_1(t), \phi_2(t)\}$ in the second equation of (3.47), we obtain

$$0 = A_{03} \phi_1(t_0) + A_{04} \phi_2(t_0) + \sum_{i=1}^q \sum_{j=1}^2 A_{i,j+2} \phi_j(t_0 - \tau_i(t_0)). \quad (3.48)$$

Based on the results found in [Fri02, Fri14, HB08] regarding the solution of autonomous time delay singular systems, we have two cases related to the type of time delays. Assume the case that the time delays τ_i are constants. Then we have the following proposition.

Proposition 3.2 ([Fri02], Proposition 1)

For any continuous function $\phi(t) = \text{col}\{\phi_1(t), \phi_2(t)\}$ that satisfies (3.48), there exist a unique function $x(t)$ defined and continuous on $[t_0 - \tau_{max}, \infty)$ that satisfy the regular and impulse free system (3.46) on $[t_0, \infty)$ and initial condition (3.47).

This result is found also in [XDSL02, XL06, HL93]. Considering the other case where the time delays are time varying ones as given in (3.44), we present the following lemma in study stating that the function ϕ is a compatible vector values function.

Lemma 3.4 ([HB08], Lemma 3)

Suppose that the system (3.43) is regular and impulse free, then the solution of the system exists and it is impulse free and unique on $[t_0, \infty)$.

This result is also given in [LZ13, HB09, HBXL09]. The above lemma is supported and based on a master thesis (see reference in [HB08]). In this research, it was indicated that the proof of this lemma is the same as the proof given in [Fri02]. The latter treats the case of singular delay systems with multiple constant delays. However this proof

starts by transforming the system (3.46) into an equivalent neutral type differential equations (NDE) [HL93] with constant delay. The proof continues based on Theorem 7.2 in [HL93] related to solution existent of NDE. This theorem states that if the initial condition ϕ of the NDE is continuous on $[t_0 - \tau_{max}, t_0)$, then there exist a unique solution of the NDE on $[t_0 - \tau_{max}, \infty)$. The last step of this proof states that if (3.48) holds, then this solution is a unique continuous solution for the initial system (3.46).

From our point of view, we see that generalizing the results of singular systems with constant delays on systems with time varying delays is not strong enough. Furthermore another proof of the case with time varying delays will be provided later on in chapter 5. In the case of forced system (i.e. $u \neq 0$), the algebraic condition in (3.48) is going to be changed due to the presence of the term $B_2 u(t_0)$. The function ϕ must satisfy another algebraic relation, which is given below

$$A_{03}\phi_1(t_0) + A_{04}\phi_2(t_0) + \sum_{i=1}^q \sum_{j=1}^2 A_{i,j+2}\phi_j(t_0 - \tau_i(t_0)) + B_2 u(t_0) = 0, \quad (3.49)$$

Here we see a strong dependence between ϕ and $u(t_0)$. This algebraic relation risks to be broken in some times due to the non-compatibility of ϕ . This is to be discussed later on in details about the importance of such conditions.

3.6.2 Stability of Time Delay Singular System

In this part we are going to treat the stability of this type of system. As the previous case, we will focus on the linear autonomous continuous systems, we aim to develop sufficient conditions that ensure the asymptotic stability of system (3.43). Make use of the Lyapunov candidates (3.16) and (3.37), we propose the following functional candidate

$$V(t, x_t) = x^T(t)E^T P x(t) + \sum_{i=1}^q \int_{t-\tau_i(t)}^t x^T(s)S_i x(s)ds, \quad (3.50)$$

where $P \in \mathbb{R}^{n \times n}$ is a non-singular matrix while $S_i \in \mathbb{R}^{n \times n}$ are definite positive matrices for all i . The stability of (3.43) is given by the following theorem.

Theorem 3.7 : *The unforced regular and impulse-free time delay singular system (3.43) where the delays τ_i satisfy the conditions (3.44), is asymptotically stable if there exist $n \times n$ matrices P and $S_i > 0$ such that*

$$E^T P = P^T E \geq 0, \quad (3.51)$$

and the following LMI

$$\Phi_4 = \begin{bmatrix} \Omega_4 & P^T A_1 & P^T A_2 & \cdots & P^T A_q \\ \star & -(1-d_1)S_1 & 0 & \cdots & 0 \\ \star & \star & -(1-d_2)S_2 & \ddots & \vdots \\ \star & \star & \star & \ddots & 0 \\ \star & \star & \star & \star & -(1-d_q)S_q \end{bmatrix} < 0, \quad (3.52)$$

are satisfied with

$$\Omega_4 = A_0 P + P^T A_0 + \sum_{i=1}^q S_i. \quad (3.53)$$

This theorem gives delay independent conditions to prove the stability for this system. The proof of this theorem is not hard, based on the sequential order used to arrive to Proposition 3.1 and with the proof of Theorem 3.6 we can easily build the proof of Theorem 3.7.

3.6.3 Stabilization of Time Delay Singular System

Depending on the conditions found in Theorem 3.7, a useful method can be elaborated for the synthesis of state feedback controller for this type of system. Consider the forced system (3.43) with the Lyapunov candidate (3.50). The usual state feedback $u = Kx$ can be established using the following theorem.

Theorem 3.8 : *The closed loop system (3.43) with the state feedback control $u = Kx$ is uniformly asymptotically stable for all delays τ_i satisfying (3.44), if there exist $n \times n$ matrices $W > 0$ and $G_i > 0$ and a matrix $Y \in \mathbb{R}^{n_u \times n}$ such that*

$$W^T E^T = EW \geq 0, \quad (3.54)$$

and the LMI

$$\Phi_5 = \begin{bmatrix} \Omega_5 & A_1 W & A_2 W & \cdots & A_q W \\ \star & -(1-d_1)G_1 & 0 & \cdots & 0 \\ \star & \star & -(1-d_2)G_2 & \ddots & \vdots \\ \star & \star & \star & \ddots & 0 \\ \star & \star & \star & \star & -(1-d_q)G_q \end{bmatrix} < 0, \quad (3.55)$$

are satisfied with

$$\Omega_5 = \mathbf{He}(A_0 W + BY) + \sum_{i=1}^q G_i, \quad (3.56)$$

also with $W = P^{-1}$, $G_i = P^{-T} S_i P^{-1}$, $i \in \{1, \dots, q\}$ and the feedback gain $K = YW^{-1}$.

Once again delay independent conditions are given for the synthesis of state feedback gain K . The proof is build easily based on the proof of theorems 3.4 and 3.6.

3.7 Conclusion

This chapter provides basic knowledge and concepts on the classical optimal linear quadratic control. Moreover fundamental concepts regarding stability, including the concept of Lyapunov stability and some basic definitions and theorems were provided. We have addressed the stability of time delay continuous systems, linear continuous singular systems and linear time delay singular systems. For each class, we have provided necessary definitions about the existence and uniqueness of their solutions. Also for these system classes, we have presented sufficient conditions which guarantee the asymptotic stability of their solutions. These conditions are expressed in terms of LMI's, which can be efficiently handled by using standard numerical algorithms. It is worth mentioning that the stability results developed in this chapter played important roles in dealing with the stabilization problem of those systems. This knowledge is the foundation for the study of later chapters.

Chapter 4

Tandem Cold Mill : Model and Current Control Strategy

Contents

4.1	Introduction	37
4.2	Description of the Tandem Stand	38
4.2.1	Stand Actuator	39
4.2.2	Stand Motor	41
4.2.3	Yield Stress Model	42
4.2.4	Sims' Gauge Relation	43
4.2.5	Mass Flow Conservation	43
4.2.6	Strip Exit Speed	44
4.2.7	Interstand Tension	44
4.2.8	Interstand Transport Delay	44
4.2.9	Rolling Force Model	46
4.3	TCM Multivariable Model	48
4.3.1	Exit Thickness Integral Action	48
4.3.2	Multivariable Non-linear Descriptor Model	49
4.4	TCM Linearized Model	52
4.4.1	TCM Time Delay Singular System	55
4.5	Current Multi-loop PID Control for Tandem Process	57
4.6	Conclusion	58

4.1 Introduction

Tandem Cold Mill (TCM) as it has been mentioned before is a complex industrial process, which contains several mechanical and electromechanical subsystems [Rob78]. These ones interact among each other during strip rolling. The behavior of each subsystem and also the interaction between them are generally governed by physical or

phenomenological laws, which include the evolution of related physical quantities or static relations of others. In order to better know the process and to visualize the possible scenario of rolling, it is essential to have a mathematical model of the system that demonstrates the modes of operation for TCM. This model will be the base toward establishing a multivariable control law using a model based strategy. This chapter is dedicated to establish the model of the whole system, that will be used in the sequel. We start from the physical and phenomenological laws associated with each subsystem and its interactions. This first step has the benefit to consider elementary and well-known laws and to describe the suitable degrees of approximation that are chosen in our framework. Moreover it allows to understand very well the process from the engineer's point-of-view. The involved physical laws are presented in section 4.1. In section 4.2, for the controller design, additional states are concatenated to the real process model. The resulting model is then formalized as a non linear MIMO descriptor system with state dependent delays. To fit to an adequate framework for the controller design, further approximations are provided and validated in section 4.3. Finally, before a conclusion, section 4.4 presents the current multi-loop PID control strategy and the simulator that was available at the beginning of the PhD. The contribution of this chapter is related to [AJM⁺16]. It is important to notice that the method used for TCM can be useful for other industrial processes. Furthermore this method allows easily to change the model when modifying the real process, for instance by introducing new actuator as flexible lubrication.

4.2 Description of the Tandem Stand

For the reason of high material resistance (hardness), the final product thickness can not be reached in just one passage. Successive rolling passages are necessary to reach to the desired thickness. That's why we need a chain of cascaded stands. This avoids the product from rupture, undesirable deformations and damaged flatness. Rolling is carried out by pressing between cylinders and by slight strip elongation between stands. A cooling phase is made at the entry and exit of each stand to avoid high frictions and steel deformation for the strip and rolls. The mill installation is composed typically of five stands [Ged98]. These stands usually have the same structure unless for special cases. Describing the model of one of these stands can give a generalized model for all stands. It can then differs in the value of parameters for each stand. Mill stand contains a pair of work roll cylinders driven by an electric motor. This machine has special characteristics with very high delivered torque capable of accomplishing this task. The work rolls rotate in opposite direction during the passage of the strip between them as shown in figure 4.1.

Each work roll is supported by a backup cylinder with much higher rigidity, and with larger radius. The pair of backup cylinders exerts the rolling force on the work rolls, thus the effort is transmitted consequently to the strip. These massive support cylinders are displaced vertically by a hydraulic actuator. This displacement variates the work roll gap and thus it vary the rolling effort [Bry73] submitted to the strip. The actuator reacts rapidly for any input/output tension variations resulting from thickness or material resistance errors. Thus the role of actuators is to maintain nominal



FIGURE 4.1 – Passage of strip through work rolls

tensions between stands and avoid their variations at steady state rolling phase. In order to have a better view about the relations among the sub-parts of the mill stand, a block diagram of an arbitrary mill stand is given in figure 4.2. The functional diagram including several blocks is here to give a global view of the real process and to facilitate the description of each element. The distinct blocks may have different natures : some blocks represent a physical law, for instance mass flow conservation. Other blocks hide a real subsystem, like the motor or actuator, also some of them denote a physical quantity such as material yield stress. Each block of the schema 4.2 is described in the following subsections. In view of the final concatenation, and specific time dependency, all the dynamics will be coherently given by differential equation (partial state-space representation) instead of frequency domain representation. As final global remark, it is noteworthy that the numerical values related to the model are not mentioned for confidentiality reasons.

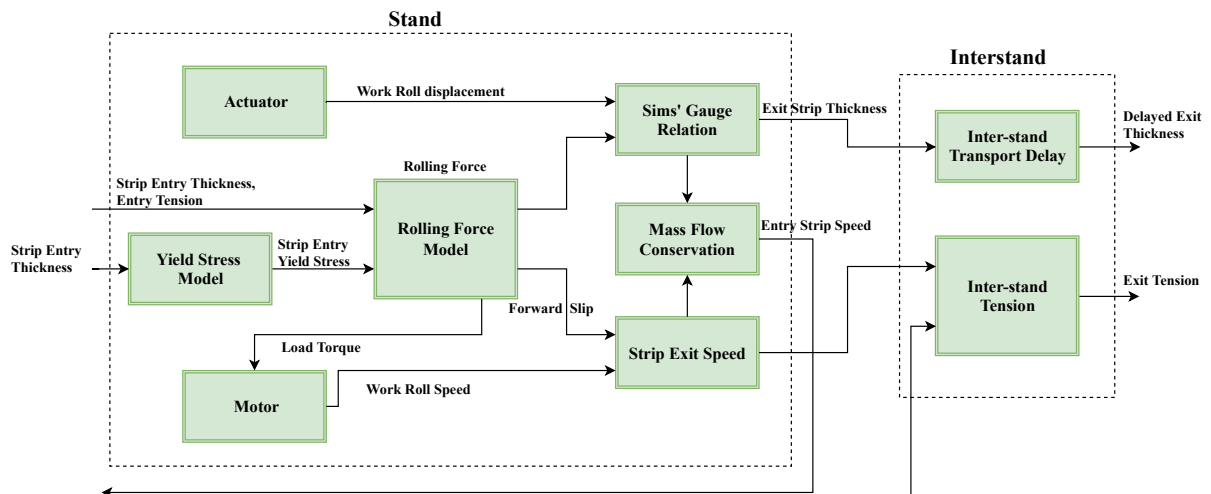

FIGURE 4.2 – Mill stand-interstand block diagram

4.2.1 Stand Actuator

During the passage of the strip through work rolls, the back up cylinders submit a high force to reduce its thickness. This rolling force is applied by the stand actuator on

the backup cylinders whom they transmit it to the work rolls. The actuator then has a very important role in strip thickness reduction. It is responsible not only applying the force, but also for its variation to manage any error in the strip thickness. The variations in the strip thickness or rigidity induce perturbations in stand forward slip as well as in pre and post tensions. In order to manage these perturbations, a compensation variation in the roll gap and thus in rolling force is needed. The vertical displacement of work rolls is done by the mill actuator as seen in Figure 4.3a. Basically the actuator is made up of servo valve or pump that drives a certain liquid (oil) with appropriate viscosity into a hydraulic ram (cylinder). The driven quantity of liquid moves vertically the cylinder in both senses (4.3b). The displacement of the cylinder leads to the variation of a screw which is attached to the upper back up cylinder. The backup cylinder is in direct contact with the upper work roll and thus variation in the work roll gap.

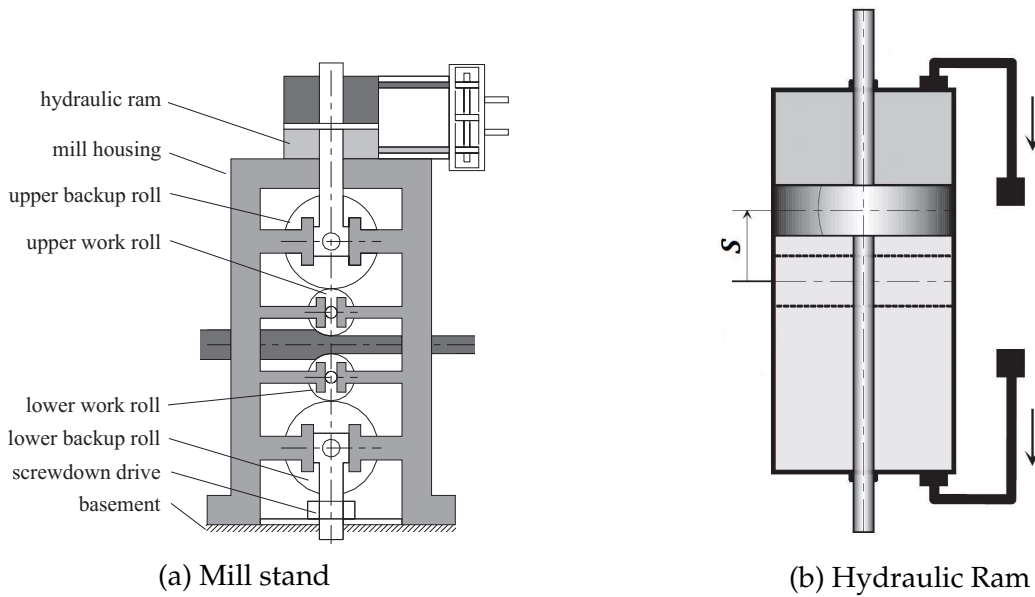

FIGURE 4.3 – Schema of the actuator in mill stand

The actuator system is a complex hydro-mechanical-electrical system. In [KNSA00, FWW02], the servo valve or pump is modeled as a 2^{nd} order system. Also according to the fluid mechanical relations, the hydraulic ram is modeled as 2^{nd} order non-linear system. Thus the actuator model is at least a 4^{th} order non-linear system. For that, the industrial service in IRSID - USINOR (previous steel company fused in ArcelorMittal after its emergent in 2006) has obtained a reduced actuator model by identification and experimental studies given in [SLM97]. The obtained model is a 2^{nd} order linear system for the i^{th} stand actuator with proper frequency ω_{A_i} and a damping parameter ξ_{A_i} . The state space model of the actuator is given below

$$\frac{d}{dt} \begin{bmatrix} S_i \\ \dot{S}_i \end{bmatrix} = \begin{bmatrix} 0 & 1 \\ -\omega_{A_i}^2 & -2\xi_{A_i}\omega_{A_i} \end{bmatrix} \begin{bmatrix} S_i \\ \dot{S}_i \end{bmatrix} + \begin{bmatrix} 0 \\ K_{A_i}\omega_{A_i}^2 \end{bmatrix} u_{A_i}, \quad (4.1)$$

where S_i is stand i work roll position. It can be seen also as roll gap variation size during the versicle displacement of work rolls. u_{A_i} is the i^{th} actuator input representing

the voltage applied to the servo valve. ξ_{A_i} is the damping coefficient. ω_{A_i} is the roper pulsation. K_{A_i} is the steady state gain.

4.2.2 Stand Motor

In each stand, the strip passage is due to the rotation of work rolls in opposite directions as shown in figure 4.1. The rolls are driven by an electrical motor. In TCM modeling [GP94, AMC12, PS11], mostly it is considered as a 1st order system. In order to have a more precise idea, a technical exchange with the production service in ArcelorMittal - Florange was made to collect as much information as possible about this block. The stand motor is a direct current (DC) separately excited motor of high nominal power (2MW). The model of the motor given by the support service is depicted in Figure 4.4

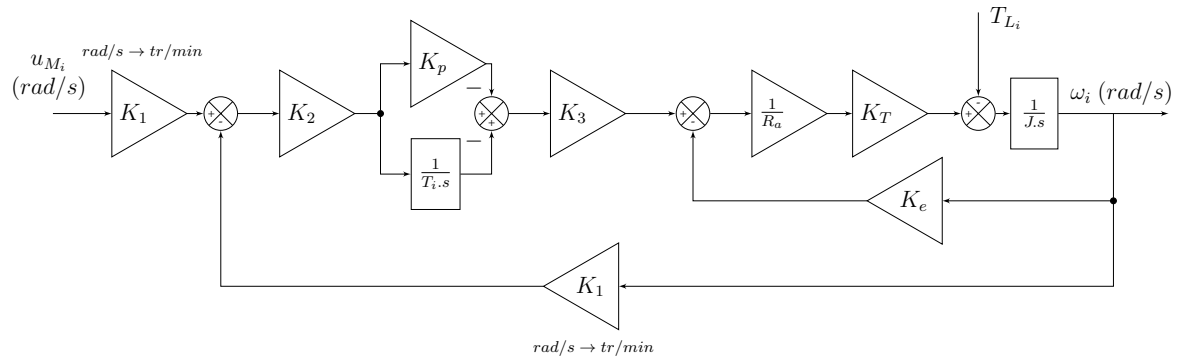

FIGURE 4.4 – Stand motor block diagram

In this figure, the constant K_1 is a conversion parameter from rad/s to tr/min. This conversion is necessary due to the existence of an internal PI controller inside the motor represented by the gains K_p and T_i . The internal controller is accompanied by pre and post gains needed for signal scaling conversion, which are K_2 and K_3 respectively. K_T is the torque constant and K_e is the back electro-motive force constant. This model is an approximation taking into account the following standard assumptions, that we detail as follows. Denote L_a the equivalent armature inductance, R_a the equivalent armature resistance, J the motor inertia and b the viscous damping friction. The first assumption is that the electrical time constant $\tau_e = L_a/R_a$ is neglected with respect to the mechanical time constant $\tau_m = J/b$. The second one is that the ratio b/J is too small and negligible. These approximations eliminate the inductance L_a and the damping friction b in motor modeling. Finally by writing down the equation relating the input to the outputs, the state space model of the stand i motor is obtained in the representation below

$$\frac{d}{dt} \begin{bmatrix} \omega_i \\ I_{M_i} \end{bmatrix} = \begin{bmatrix} -\frac{K_1 K_2 K_3 K_T K_p + K_T K_e}{J R_a} & \frac{K_1 K_2 K_3 K_T}{J R_a T_i} \\ -1 & 0 \end{bmatrix} \begin{bmatrix} \omega_i \\ I_{M_i} \end{bmatrix} + \begin{bmatrix} \frac{K_1 K_2 K_3 K_T K_p}{J R_a} \\ 1 \end{bmatrix} u_{M_i} + \begin{bmatrix} -\frac{1}{J} \\ 0 \end{bmatrix} T_{L_i}, \quad (4.2)$$

where ω_i is the rotation speed of motor i , I_{M_i} is the integral dynamic present in i^{th} motor internal controller. u_{M_i} is the motor input representing the voltage applied on the stator terminals, and T_{L_i} is load resistive torque. All numerical values of motor parameters are found depending on its data sheet.

4.2.3 Yield Stress Model

Yield stress is a physical quantity that reveals the hardness of material. During cold rolling, the strip thickness is reduced and thus the hardness of the exit strip is increased. Within the gap between work rolls, metal sheet is deformed as shown in Figure (4.5) and the yield stress increases.

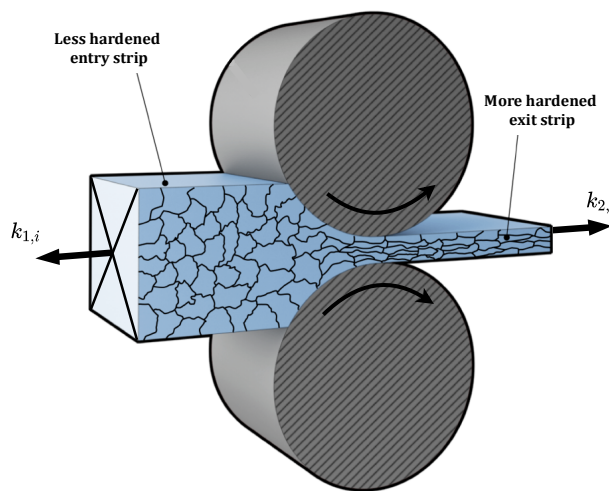

FIGURE 4.5 – Schema representing the roll bite zone

The rolling force, rolling speed, entry and exit tensions, contact friction, entry thickness and entry yield stress are all factors that impact directly the resulted exit yield stress of the output strip. In the available researches and articles on modeling of this quantity [PL91, Wan02, DMS⁺13], several models have been investigated to it. Each expert tries to establish certain relation between the mentioned factors and the exit yield stress. It seems that for each one a fitting curve method is used to fit some distributed points determined by physical tests, added to some corrective constants. Also several namings are given to this quantity such as hardness, yield compressive stress, compressive yield strength, flow stress, strip deformation resistance. All the provided models are non-linear and depend on constant coefficients which are determined statistically with the help of physical tests applied on the produced steel. These models are function of both plastic strain ε and plastic strain rate $\dot{\varepsilon}$ where the expression of the latter two quantities depends on strip thickness and the relative thickness reduction during its passage. The yield stress model used in ArcelorMittal Maizières is called **SMATCH Law** model. It depends also on statistical determined constants and function of strains. In order to present this model quantitatively, some quantities and notations are to be

identified. For the i^{th} stand, denote $k_{1,i}$ and $k_{2,i}$ the entry and exit yield stress respectively. By sequence, $k_{1,i}$ is the entry strip yield stress and $k_{2,i}$ is for the exit one. The subscript 1 refers to the entry values, while subscript 2 is for the exit value. Note that these subscripts will be used later for several physical quantities. The expression of the exit yield stress $k_{2,i}$ is given below

$$k_{2,i}(\varepsilon_p) = (\lambda_1 + \lambda_2 \varepsilon_p) [1 - \lambda_3 e^{-\lambda_4 \varepsilon_p}] + \lambda_0 \quad (4.3)$$

where $\lambda_0, \lambda_1, \lambda_2, \lambda_3$ and λ_4 are constants determined statistically for each class of steel coils. Note that steel coils are categorized according to their mechanical characteristics related to the manufacturing material composition. ε_p is the equivalent plastic strain given in the expression below

$$\varepsilon_p = \ln \left(\frac{h_0}{h_{2,i}} \right), \quad (4.4)$$

where h_0 is the annealed thickness (thickness of strip entering TCM). $h_{2,i}$ (respectively $h_{1,i}$) is the strip exit (entry) thickness of stand i . The strip entering stand i have same yield stress of that exiting stand $i - 1$, which leads consequently to the equality $k_{1,i} = k_{2,i-1}$.

4.2.4 Sims' Gauge Relation

During strip rolling, the frame body of the mill stand stretches. The force-mill stretch characteristic curve has a special form. It is non-linear for small rolling forces, but for high forces which is the case of cold rolling, it is linear. The major part of the curve is approximated by a linear slight line of slope M denoted mill modulus, and horizontal intercept S_0 . These linearized curves are called BISRA measurements. Based on this curve, a linear approximation is given to estimate the strip exit thickness [Rob78, Sim54]. Sims [SA52] has expressed the exit thickness $h_{2,i}$ by an affine relation given in (4.5) depending on the vertical position S_i of upper work roll (work roll gap variation) and the total rolling force F_i

$$h_{2,i} = S_0 + S_i + \frac{F_i}{M}. \quad (4.5)$$

4.2.5 Mass Flow Conservation

During the passage of the strip, the transferred material quantity is conserved. In order to reach the final mass conservation law, it is sufficient to start by the hypothesis : the entry mass flow equals to the exit one. Also assuming that both entry and exit strip have same homogenous material density, and the width of strip does not change after rolling. The resulting conservation law is given by

$$h_{1,i} V_{1,i} = h_{2,i} V_{2,i}, \quad (4.6)$$

where $V_{1,i}$ and $V_{2,i}$ are respectively the entry and exit strip speed in stand i .

4.2.6 Strip Exit Speed

Strip exit speed depends precisely on the motor's rotational speed. At the exit of the roll bite, the strip is dragged out (due to tension force) by the stand coming after. The strip slips forwardly with a speed $V_{2,i}$ slightly larger than that of the work roll periphery. The expression of this speed [Rob78,PS11] is given in the following equation

$$V_{2,i} = V_{M_i}(1 + f_i), \quad (4.7)$$

where $V_{M_i} = R_i\omega_i$ is the peripheral work roll speed, R_i is the work roll radius, and f_i is the absolute forward slip.

4.2.7 Interstand Tension

The transfer of strip from a stand to another is due to the existence of dragging tension forces between each two consecutive stands. The work roll speeds impact directly the value of these tensions, so the user follows carefully their variation to avoid strip rupture or deformation. In this section, we deal with the tensile stress denoted $\sigma_{i,i+1}$, that is the tension force per unit section. The tension force denoted $T_{i,i+1}$ will be obtained by multiplying the tensile stress by the cross section of the strip. Hook's law in the dynamic case leads to

$$\frac{d}{dt}\sigma_{i,i+1} = \lambda_{i,i+1}(V_{1,i+1} - V_{2,i}), \quad (4.8)$$

where $\sigma_{i,i+1}$ is the tensile stress in the strip passing from stand i to stand $i + 1$. The parameter $\lambda_{i,i+1}$ is a constant related to the stiffness of material, defined by

$$\lambda_{i,i+1} = \frac{E_m}{L_{i,i+1}}, \quad (4.9)$$

where E_m is the Young's modulus of steel, also $L_{i,i+1}$ is the interstand fixed distance between the stand i and $i + 1$. Note that with the usage of notation we have $\sigma_{i,i+1} = \sigma_{2,i} = \sigma_{1,i+1}$, where $\sigma_{2,i}$ is the stand i exit tensile stress and $\sigma_{1,i+1}$ is the stand $i + 1$ entry tensile stress. The tension force can be approximated by the expression (4.10) assuming that strip has a constant width w and a nominal thickness $\bar{h}_{2,i}$ between stand i and $i + 1$

$$T_{i,i+1} = \bar{h}_{2,i}w\sigma_{i,i+1}. \quad (4.10)$$

4.2.8 Interstand Transport Delay

While metal strip passes from one stand to another, it covers the interstand distance $L_{i,i+1}$ with a speed $V_{i,i+1}(t)$. This leads to the presence of transport state dependent delays denoted τ_i which are time dependent ones. These delays are expressed by

$$\tau_i(t) = \frac{L_{i,i+1}}{V_{i,i+1}(t)}, \quad (4.11)$$

where $i \in \{1, 2, 3, 4\}$ refers to the strip exit stand, in 5 stand mill we have 4 interstand delays. Based on the definition of this time delay, the relation between the strip exit thickness $h_{2,i}$ of stand i and the strip entry thickness $h_{1,i+1}$ of stand $i + 1$ is given by

$$h_{1,i+1}(t) = h_{2,i}(t - \tau_i(t)), \quad (4.12)$$

Denote $\tau(t) = [\tau_1(t) \ \tau_2(t) \ \tau_3(t) \ \tau_4(t)]$, the delay vector in this process. The interstand strip speed $V_{i,i+1}$ varies around its nominal value, this variation may be due to certain perturbations or error regulations. However its value $V_{i,i+1}(t)$ is still limited and bounded by a minimum value denoted $\underline{V}_{i,i+1} \neq 0$, and by a maximum value $\bar{V}_{i,i+1} \neq 0$. Consequently this leads to upper and lower bounds of the variable time delay τ_i . These boundaries are given in the expression below

$$\underbrace{\frac{L_{i,i+1}}{\bar{V}_{i,i+1}}}_{\underline{\tau}_i} \leq \tau_i \leq \underbrace{\frac{L_{i,i+1}}{\underline{V}_{i,i+1}}}_{\bar{\tau}_i}, \quad (4.13)$$

Denote the delay upper bound $\bar{\tau}_i = L_{i,i+1}/\underline{V}_{i,i+1}$ and lower bound $\underline{\tau}_i = L_{i,i+1}/\bar{V}_{i,i+1}$, this means that the variable time delay varies within the interval $[\underline{\tau}_i; \bar{\tau}_i]$. Knowing the interval of variation of these delays helps in the study of system robustness. To know more about these delays, it is important to study their variations. A significant term to be examined is the delay time derivative denoted $\dot{\tau}_i(t) = d\tau_i(t)/dt$. The analysis of the derivative gives an idea about its speed of variation. The expression of $\dot{\tau}(t)$ is given below

$$\dot{\tau}_i = -\frac{L_{i,i+1}}{V_{i,i+1}^2} a_{i,i+1}, \quad (4.14)$$

where $a_{i,i+1} = \dot{V}_{i,i+1}$ is the acceleration of the strip during its passage from a stand to another. The support service have mentioned in the specifications that both motor acceleration and deceleration are bounded. The acceleration and deceleration of the strip depends on that of the work rolls and thus they are bounded as well. This means that the delay derivative $\dot{\tau}_i$ is also bounded.

An important condition concerning delay derivative is to be discussed. Imagine that the strip between stands is sampled into cross-section elements called slices. While the strip moves forward, there is no recoiling or back fold of the strip. Thus all strip slices arrive to the next stand in the same order they have left the previous stand. The order of slices is conserved, and no overlapping between them. Consider a strip slice denoted s_1 arriving to stand $i+1$ at instant t_1 , this means it had left stand i at the instant $t_1 - \tau_i(t_1)$. Consider now another slice denoted s_2 lags s_1 and arrives to stand $i+1$ at instant t_2 such that $t_2 > t_1$. This means that s_2 had left stand i at instant $t_2 - \tau_i(t_2)$, and that due to the order conservation of slices s_1 and s_2 we have

$$t_2 - \tau_i(t_2) > t_1 - \tau_i(t_1), \quad (4.15)$$

Moving the terms in the inequality (4.15) to one side, the obtained sum appears the function $\int_{t_1}^{t_2} (1 - \dot{\tau}_i) dt$ such that

$$\int_{t_1}^{t_2} (1 - \dot{\tau}_i) dt = (t_2 - \tau_i(t_2)) - (t_1 - \tau_i(t_1)) > 0, \quad (4.16)$$

The approximation $\int_{t_1}^{t_2} (1 - \dot{\tau}_i) dt \approx (1 - \dot{\tau}_i) \delta t$ is always true for a small $\delta t = t_2 - t_1$. From the expression (4.16), this gives the condition below

$$1 - \dot{\tau}_i \geq 0 \Leftrightarrow \dot{\tau}_i \leq 1. \quad (4.17)$$

Based on the result in (4.17) which is independent of the stand number, we conclude that the derivative of all delays are upper bounded by 1. Nevertheless $\dot{\tau}_i$ will interfere in the stability conditions that are to be introduced later on. Based on the expression of these derivatives given in (4.14), we need to study quantitatively the variations of these time functions. Motors have maximum speeds, which means that we can say so for the strip speeds $V_{i,i+1}$. Based on the numerical values, we have calculated the maximum time delay derivatives considering the worst case and we found that they are less than 1. Hence for the rest of the work, we are going to assume the following hypothesis in the way that these time delay derivatives $\dot{\tau}_i$ are upper bounded by constants $0 < d_i < 1$ such that

$$\dot{\tau}_i(t) \leq d_i < 1, \quad \forall t \geq t_0. \quad (4.18)$$

In the present work, the variable time delays will be kept in their time domain mathematical form (i.e. time dependent functions). This not only creates a strong challenge to be resolved in tandem control, but also it motivates the research to discover new solutions for this type of process models. As a strong contribution here, TCM modeling will conserve the delays in their explicit form given in (4.11). Exploring a solution for this type of models will be very helpful not just for cold rolling of steel, but also for other problems included in this type of modeling.

4.2.9 Rolling Force Model

The rolling force is the central development of the TCM model, it includes the calculation of the specific rolling force, specific rolling torque and forward slip. The term "specific" means the value per unit width. In this part, theory and iterative methods collaborate to determine the values of these physical quantities taking place at the bite between work rolls. The rolling force resembles the interaction between the actuator and the strip which posses certain mechanical properties. Other variables contribute in this interaction such as the entry and exit tensions in the presence of material friction between strip and work rolls as seen in figure (4.6). The contribution of work roll speed is induced in the entry and exit tensions. In 1943, E. Orowan [Oro43] developed a detailed systematic calculation of the roll pressure for hot and cold rolling. This was the fundamental work for the existence of new generation of models in cold rolling. In 1948, R. Bland and H. Ford [BF48] have presented the calculation of roll force and torque in cold strip rolling in the presence of tensions. The model expressed in this study was the base of their later models. It was necessary to do further corrections to arrive to a more accurate model. The later corrections result in decomposing the rolling force into plastic and elastic parts. The Bland and Ford force model is one of the classical well known models in the field of cold rolling. Though it possesses high complexity in its equations, it is widely used. It is composed of a set of algebraic and differential equations for the calculation of rolling force, torque, forward slip and contact arc length. A significant point to mention is that the number of elaborated equations is less than the number of included variables, which led to a mutual coupled relation between the deformed work roll radius and rolling force. The derived expressions of the rolling force are too complicated as well as that for the rolling torque. The forward slip was also expressed by more than one expression in the literature [Ged98, PS11]. Other

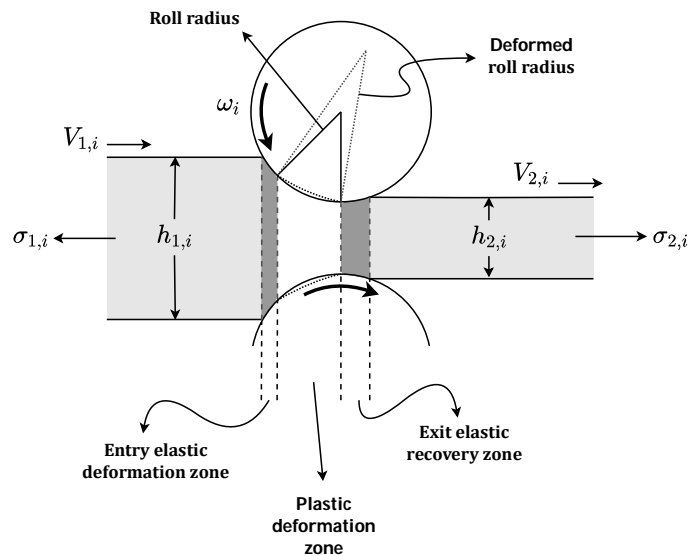

FIGURE 4.6 – Schema representing the roll bite zone

models for cold rolling force were developed [Rob78, PL91], these ones assume several hypotheses to reduce the complexity of these equations. These simplifications were performed to reduce time calculation, taking into account the importance to maintain an acceptable precision. In the present work, the dependent model to be used is called **Roll-Gap** [DMS⁺13, DML14]. This model was developed initially through collaborations between ArcelorMittal Maizières Research and academic partners. It is a protected code that works as a function which receives inputs and performs a number of iterations to give its outputs.

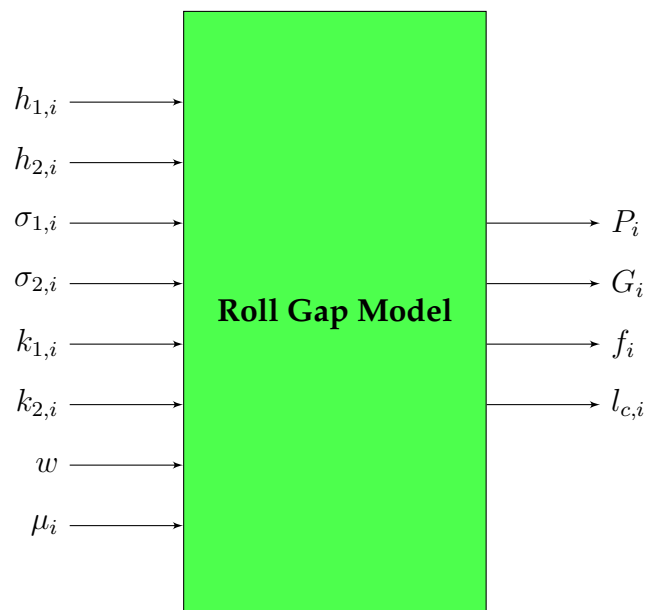

FIGURE 4.7 – Inputs/Outputs of Roll Gap model

Roll Gap is based on the well known slap method for the strip, in general it is a code including a non-linear algebraic list of equations with some coupled variables. The coded model is a protected one due to confidentiality reasons. Figure (4.7) represents the I/O block of Roll Gap. The inputs are already introduced above, while the outputs are the specific rolling force P_i of stand i . It is the force per unit width, thus the total rolling force applied to strip of width w is $F_i = wP_i$. Also G_i is the specific rolling torque per unit width, the total rolling torque is $T_{M_i} = wG_i$ which stands for the needed motor torque to roll the strip. f_i is the forward slip at the exit of roll bite. It is seen as the difference between the strip exit speed $V_{2,i}$ and V_{M_i} relative to the latter one. The output $l_{c,i}$ represents the length of arc contact between each work roll and the strip within the roll bite.

In the next section, a general multivariable model of TCM is to be presented. This model depends on the set of mathematical systems presented above for the different parts of mill stand. It is important to follow carefully the construction of this model, since there are 5 typical stands in the mill.

4.3 TCM Multivariable Model

In this section, the MIMO model will be established. In our framework, the construction of the 5-stand TCM model is carried out by concatenating the differential and algebraic equations that have been detailed in the previous section taking into account the interactions among them. In order to complete the model, few additional improvements are provided :

- Auxiliary dynamics are added to be ready for taking into account specific requirements related to the controller design.
- The presence of delays is pointed out by replacing delayed thicknesses (all the entry thickness, except the initial one which is considered as exogenous one) by auxiliary inputs. In addition, to maintain the validity of the model extra relations impose that these auxiliary inputs are the delayed exit thicknesses of the previous stands. This elegant presentation allows to decompose the difficulties of the model and treat separately the delays.
- A compact descriptor form of the system will be reached, which is adequate to represent the concatenation of the differential and algebraic equations. An additional advantage of considering a compact and generic form is that it can be used for others processes.

4.3.1 Exit Thickness Integral Action

One of the control aims is to ensure a zero static error of the i^{th} exit thickness $h_{2,i}$ with respect to its nominal value $\bar{h}_{2,i}$, that is the error denoted $\Delta h_{2,i} = h_{2,i} - \bar{h}_{2,i}$, tends to zero robustly with respect to perturbations. This property is guaranteed thanks to an integral action.

$$\Delta h_{2,i} = \Delta S_i + \frac{w}{M} \Delta P_i \quad (4.19)$$

The integral action added to the whole model, is described in (4.20)

$$\begin{cases} \frac{d}{dt}I_i(t) = \Delta h_{2,i} \\ I_i(t_0) = 0, \end{cases} \quad (4.20)$$

where $I_i(t)$ is the integral of the $h_{2,i}$ error and $I_i(t_0)$ is its initial condition at the initial instant t_0 , $i \in \{1, 2, 3, 4, 5\}$. Adding the artificial variable $I_i(t)$ to the TCM model is a tool that help us to reach our the desired behavior of the system.

4.3.2 Multivariable Non-linear Descriptor Model

As it has been shown, the subsystems in TCM are expressed by either differential or algebraic delayed equations. Therefore the final general model is an algebraic-differential non-linear time delay system. This class of mathematical models are also called singular or descriptor systems. Singular systems are widely used in representing complex processes such as cold rolling of steel [Dai89,Cam80b]. This representation encapsulates all internal inter-actions and coupling between sub-systems. The obtained model will depend on both differential and algebraic state vectors, as well as input, output and exogenous vectors. The general form of this model is given below in (4.21)

$$\begin{aligned} \begin{bmatrix} I & 0 \\ 0 & 0 \end{bmatrix} \frac{d}{dt}x(t) &= f(x(t), u(t), \mu(t), d(t), h_{en}(t)), \\ y(t) &= g(x(t), u(t)), \\ z(t) &= h(x(t), u(t)), \\ h_{en}(t) &= \Gamma(h_{ex}(t), \tau(t)). \end{aligned} \quad (4.21)$$

where the matrix denoted $E = \text{diag}\{I_{n_1}, 0_{n_2}\}$ is a singular matrix such that $\text{rank}(E) = n_1 < n$. The *input vector* $u(t) \in \mathbb{R}^{n_u}$, includes motor and actuator inputs. The *state vector* is $x(t) = \text{col}\{x_1(t), x_2(t)\} \in \mathbb{R}^n$. The *differential state vector* $x_1(t) \in \mathbb{R}^{n_1}$ contains dynamics of interstand tensile stress, motor, actuator and exit thickness integral dynamics. The *algebraic state vector* $x_2(t) \in \mathbb{R}^{n_2}$ includes the rolling forces, rolling torques and forward slips. The special structure of E comes from placing the differential vector x_1 above and the algebraic vector x_2 below. The *exogenous vector* $d(t) \in \mathbb{R}^{n_d}$ includes the entry annealed thickness, and TCM entry and exit tension stresses. The *measured output vector* $y(t) \in \mathbb{R}^{n_y}$ includes all measured quantities in the TCM process such as tension forces, rolling forces, work roll speeds... etc. *Entry thickness vector* $h_{en}(t) \in \mathbb{R}^{n_h}$ is the vector representing the entry thicknesses for all stands except the first one. *Exit thickness vector* $h_{ex}(t) \in \mathbb{R}^{n_h}$ includes the exit thicknesses of all stands except the last one. *Friction vector* $\mu(t) \in \mathbb{R}^{n_\mu}$ includes the frictions between strip and work rolls in all stands. *Complete output vector* $z(t) \in \mathbb{R}^{n_z}$ which includes all outputs in TCM process, where some of them are not measured in reality. Each vector size will be given in the description of the associated vector. The non-linear function f represents the evolution of the non-linear singular system, while the non-linear function g represents the measured outputs in the system. The function h represents all outputs in the system including non-measured ones. The function Γ is a delay function, which lags the i^{th} element of $h_{ex}(t)$ by the i^{th} element of $\tau(t)$ (i.e. $\tau_i(t)$) and affects it to the i^{th} element of $h_{en}(t)$.

This facilitates the representation of TCM model (4.21).

- **State vector** : The state vector x of the above model includes both differential state vector x_1 and algebraic state vector x_2 . Each stand i has a *differential state-part* $x_{1,i}$ and an *algebraic state-part* $x_{2,i}$. The concatenation of these parts build up both vectors x_1 and x_2 . The differential state-part $x_{1,i}$ contains the dynamics of its motor, actuator, exit tensile stress and exit thickness integral. The indexed form of the differential part of the first 4 mill stands ($i = 1 \dots, 4$) is given in (4.22)

$$x_{1,i} = [\sigma_{i,i+1} \quad \omega_i \quad I_{M_i} \quad S_i \quad \dot{S}_i \quad I_i]^T. \quad (4.22)$$

As the 5th stand is the last one, there is no tension force after it. Thus the differential state-part of this stand contains no tensile stress. So its form is given in (4.23)

$$x_{1,5} = [\omega_5 \quad I_{M_5} \quad S_5 \quad \dot{S}_5 \quad I_5]^T. \quad (4.23)$$

Concatenate the differential state-parts in one vector, we obtain the vector x_1 in (4.24)

$$x_1 = [x_{1,1}^T \quad x_{1,2}^T \quad x_{1,3}^T \quad x_{1,4}^T \quad x_{1,5}^T]^T. \quad (4.24)$$

The algebraic state-part $x_{2,i}$ depends on the chosen rolling force model. Since the numerical Roll-Gap model is adapted in this work to express the rolling force, the algebraic state-part will contain only its outputs whom are the rolling specific force, specific torque and forward slip. The algebraic state-part $x_{2,i}$ as well as the algebraic state vector x_2 is given in (4.25)

$$x_{2,i} = [P_i \quad G_i \quad f_i]^T; \quad x_2 = [x_{2,1}^T \quad x_{2,2}^T \quad x_{2,3}^T \quad x_{2,4}^T \quad x_{2,5}^T]^T. \quad (4.25)$$

Finally concatenate both vectors x_1 and x_2 of size $n_1 = 29$ and $n_2 = 15$ respectively to get the state vector x . The size of the state vector is $n = n_1 + n_2 = 44$.

- **Input vector** : It includes the inputs of TCM motors and actuators. The input of the motor u_{M_i} and that of actuator u_{A_i} in the i^{th} stand are put in the *stand-input vector* $u_i = \text{col}\{u_{M_i}, u_{A_i}\}$. The concatenation of the stand-input vectors gives out the input vector u in (4.26) of size $n_u = 10$.

$$u_{2,i} = [u_1^T \quad u_2^T \quad u_3^T \quad u_4^T \quad u_5^T]^T. \quad (4.26)$$

- **Friction vector** : This vector characterizes the friction variation in the five stands. The friction is due to the contact between the work rolls and the strip passing through them. Several expressions were given to friction parameter [Ged98, Wan02, PS11] depending on constant coefficient, work roll deformed radius, rolling speed, material hardness and others. Until the moment, there is no model expressing the friction parameter in function of the mentioned variables. Thus the friction parameter was considered as an external perturbing parameter. This vector denoted μ of size $n_\mu = 5$ is given by

$$\mu = [\mu_1 \quad \mu_2 \quad \mu_3 \quad \mu_4 \quad \mu_5]^T. \quad (4.27)$$

- **Exogenous vector** : During cold rolling, the mill is submitted to a strip of annealed thickness h_0 (Note that by stand indexing, $h_{1,1} = h_0$). The strip traverses the

five stands and is handled either by the strip accumulator (before 1st stand in the case of continuous rolling) or by uncoiler (in the case of push-pull rolling). This impose a mill entry tension denoted Σ_1 at the entry of the 1st stand. At the exit of the last stand, the strip is dragged by a tension denoted Σ_2 . These tensions rarely variate from their nominal values. These external signals are grouped in the vector d of size $n_d = 3$ given by

$$d = [h_0 \quad \Sigma_1 \quad \Sigma_2]^T. \quad (4.28)$$

- **Entry and Exit thickness vectors** : The time delays between mill stands are seen in the strip thicknesses. The strip entry thickness $h_{1,i+1}$ is that exiting the previous stand $h_{2,i}$ but delayed by the time dependent function τ_i . This permits to establish the following relation in (4.29)

$$h_{1,i+1}(t) = h_{2,i}(t - \tau_i(t)), \quad (4.29)$$

A 5-stand mill posses 4 time delays, and thus both entry and exit thickness vectors, denoted h_{en} and h_{ex} respectively, contain 4 signals each (i.e. $n_h = 4$). These vectors can be written as in (4.30)

$$h_{en} = [h_{1,2} \quad h_{1,3} \quad h_{1,4} \quad h_{1,5}]^T; \quad h_{ex} = [h_{2,1} \quad h_{2,2} \quad h_{2,3} \quad h_{2,4}]^T. \quad (4.30)$$

- **Measured output vector** : In TCM, some quantities are difficult to be measured such as strip exit speed $V_{2,i}$ or exit thickness $h_{2,i}$. Due to the complexity of process, some factors (lubrication, temperature...etc) prevent measuring physical values or lead to a noised measurements. This differs from tandem site to another, some companies have equipped the installation with full sensor network that is capable of providing complete measures. In the framework of this study, the production service has provided the available measurement, they are grouped in the measured output vector denoted y . The measurements in each stand is given in the output sub-vector y_i listed in (4.31)

$$y_1 = \begin{bmatrix} h_{2,1} \\ V_{2,1} \\ T_{1,2} \\ V_{M_1} \\ S_1 \\ F_1 \\ T_{M_1} \end{bmatrix}; \quad y_2 = \begin{bmatrix} T_{2,3} \\ V_{M_2} \\ S_2 \\ F_2 \\ T_{M_2} \end{bmatrix}; \quad y_3 = \begin{bmatrix} T_{3,4} \\ V_{M_3} \\ S_3 \\ F_3 \\ T_{M_3} \end{bmatrix}; \quad y_4 = \begin{bmatrix} T_{4,5} \\ V_{M_4} \\ S_4 \\ F_4 \\ T_{M_4} \end{bmatrix}; \quad y_5 = \begin{bmatrix} h_{2,5} \\ V_{2,5} \\ V_{M_5} \\ S_5 \\ F_5 \\ T_{M_5} \end{bmatrix} \quad (4.31)$$

The concatenation of these sub-vectors gives the output vector y , with $n_y = 28$

- **Complete output vector** : Due to the absence of several needed measurements in the output vector y , the signals needed to be examined regularly during strip rolling are grouped in the complete output vector z . Important variables such as strip exit thickness and forward slip are so important to be followed and seen at each instant. Their absence imposes to establish a larger set of outputs to be observed or estimated later on. The whole outputs in each stand is grouped in

the vector z_i given in the list below (4.32)

$$z_1 = \begin{bmatrix} h_{2,1} \\ V_{2,1} \\ T_{1,2} \\ V_{M_1} \\ I_{\omega_1} \\ S_1 \\ \dot{S}_1 \\ I_1 \\ F_1 \\ T_{M_1} \\ f_1 \end{bmatrix}; z_2 = \begin{bmatrix} h_{2,2} \\ V_{2,2} \\ T_{2,3} \\ V_{M_2} \\ I_{\omega_2} \\ S_2 \\ \dot{S}_2 \\ I_2 \\ F_2 \\ T_{M_2} \\ f_2 \end{bmatrix}; z_3 = \begin{bmatrix} h_{2,3} \\ V_{2,3} \\ T_{3,4} \\ V_{M_3} \\ I_{\omega_3} \\ S_3 \\ \dot{S}_3 \\ I_3 \\ F_3 \\ T_{M_3} \\ f_3 \end{bmatrix}; z_4 = \begin{bmatrix} h_{2,4} \\ V_{2,4} \\ T_{4,5} \\ V_{M_4} \\ I_{\omega_4} \\ S_4 \\ \dot{S}_4 \\ I_4 \\ F_4 \\ T_{M_4} \\ f_4 \end{bmatrix}; z_5 = \begin{bmatrix} h_{2,5} \\ V_{2,5} \\ V_{M_5} \\ I_{\omega_5} \\ S_5 \\ \dot{S}_5 \\ I_5 \\ F_5 \\ T_{M_5} \\ f_5 \end{bmatrix} \quad (4.32)$$

The concatenation of the sub-vectors z_i build up the complete output vector z of size $n_z = 54$.

4.4 TCM Linearized Model

In the previous section, a non-linear singular system (4.21) is established describing the process of cold rolling. In this section, we are going to deal with the non-linearity of the model and how the TCM model will be simplified in order to be adapted for the control synthesis. For that it is usual to define the steady state or equilibrium point for the TCM non-linear system. As it has been described in section 4.2, the steel coils are categorized according to their mechanical and chemical properties. Each coil possess a nominal profile characterized by its nominal annealed thickness $\bar{h}_{1,1}$, nominal yield stress (hardness) $\bar{k}_{1,1}$, and of nominal width \bar{w} . The operator chooses nominal interstand tensions $\bar{T}_{i,i+1}$ and forward slips \bar{f}_i to design the suitable nominal mode of operation. This mode results in nominal values of rolling force, torque, exit strip speed and motor speeds. Define the nominal state vector \bar{x} for the nominal vectors \bar{u} , \bar{d} , $\bar{\mu}$ and \bar{h}_{en} satisfying the following list of equations given in (4.33)

$$\begin{aligned} 0 &= f(\bar{x}, \bar{u}, \bar{\mu}, \bar{d}, \bar{h}_{en}), \\ \bar{y} &= g(\bar{x}, \bar{u}), \\ \bar{z} &= h(\bar{x}, \bar{u}). \end{aligned} \quad (4.33)$$

During rolling, the system deviates around this point due to the real time errors in the input exogenous or friction vector. Here comes the control task to maintain the system in its equilibrium point, and reject any error or perturbation. The linearization of the model in (4.21) will be in the neighborhood of this nominal point which is related to the rolling scenario of a specified coil. Let us define the notations which will be used later on, denote $\theta(t)$ any physical variable in the system (i.e. speed, force, thickness, ...etc). Denote $\bar{\theta}$ the nominal value of the arbitrary variable $\theta(t)$. The relative error denoted $\Delta\theta(t)$ defined by

$$\Delta\theta(t) = \theta(t) - \bar{\theta}, \quad (4.34)$$

In equation (4.34), $\Delta\theta$ can also be a vector (i.e. x, u, μ, \dots etc) expressing the relative error between the vector instantaneous value and its fixed nominal value.

The TCM model (4.21) has a compact explicit form. Around a nominal point, this model is linearized to obtain a unique linear model. Nevertheless, in practice and from the numerical point of view, the linearization should be done using a precise method that takes into account the variety of nature of the whole system components. The delicate points are as follows

- (i) Several subsystems are already linear. This is the case of the motor, actuator and integral action.
- (ii) "Simple" explicit non-linearities can be linearized analytically using the first order Taylor expansion. This technique is applied for the interstand tensile stress given in its detailed form (4.8). This form is obtained by using the mass conservation law in (4.6) to express the strip entry speed and the exit strip speed given in (4.7).

$$\frac{1}{\lambda_{i,i+1}} \frac{d}{dt} \sigma_{i,i+1} = \frac{h_{2,i+1}}{h_{1,i+1}} (1 + f_{i+1}) V_{M_{i+1}} - (1 + f_i) V_{M_i} \quad (4.35)$$

The first order Taylor expansion of the tensile stress is

$$\begin{aligned} \frac{d}{dt} \Delta\sigma_{i,i+1} = & A_{\sigma_{i,i+1}} \Delta h_{1,i+1} + B_{\sigma_{i,i+1}} \Delta h_{2,i+1} + C_{\sigma_{i,i+1}} \Delta f_{i+1} \\ & + D_{\sigma_{i,i+1}} \Delta V_{M_{i+1}} + E_{\sigma_{i,i+1}} \Delta f_i + F_{\sigma_{i,i+1}} \Delta V_{M_i} \end{aligned} \quad (4.36)$$

where the involved constants are given in Table (4.1).

$A_{\sigma_{i,i+1}} = -\lambda_{i,i+1} \frac{\bar{h}_{2,i+1}}{\bar{h}_{1,i+1}^2} (1 + \bar{f}_{i+1}) \bar{V}_{M_{i+1}}$	$B_{\sigma_{i,i+1}} = \lambda_{i,i+1} \frac{1}{\bar{h}_{1,i+1}} (1 + \bar{f}_{i+1}) \bar{V}_{M_{i+1}}$
$C_{\sigma_{i,i+1}} = \lambda_{i,i+1} \frac{\bar{h}_{2,i+1}}{\bar{h}_{1,i+1}} \bar{V}_{M_{i+1}}$	$D_{\sigma_{i,i+1}} = \lambda_{i,i+1} \frac{\bar{h}_{2,i+1}}{\bar{h}_{1,i+1}} (1 + \bar{f}_{i+1})$
$E_{\sigma_{i,i+1}} = -\lambda_{i,i+1} \bar{V}_{M_i}$	$F_{\sigma_{i,i+1}} = -\lambda_{i,i+1} (1 + \bar{f}_i)$

TABLE 4.1 – Constants of the linearized tensile stress expression

- (iii) "Complex" implicit non-linearities are handled in practice by using iterative algorithms. This is the case of the rolling force model, the Roll-Gap model, for which a numerical code (hidden protected code for confidentiality reasons) is provided by ArcelorMittal Maizières - Down Stream Service. The black box presented by the diagram of Figure (4.7) is only available statically via a code. The variations of the entry and exit yield stress ($k_{1,i}$ and $k_{2,i}$ respectively) are considered negligible and small enough to not affect the resultant rolling force and torque. Writing down the first order Taylor expansion to express the Roll-Gap outputs in linear

expressions function of its inputs. The obtained expressions are given below

$$\begin{aligned}
 P_i &= \bar{P}_i + \underbrace{\frac{\partial P_i}{\partial h_{1,i}} \Delta h_{1,i} + \frac{\partial P_i}{\partial h_{2,i}} \Delta h_{2,i} + \frac{\partial P_i}{\partial \sigma_{1,i}} \Delta \sigma_{1,i} + \frac{\partial P_i}{\partial \sigma_{2,i}} \Delta \sigma_{2,i} + \frac{\partial P_i}{\partial \mu_i} \Delta \mu_i}_{\Delta P_i}, \\
 G_i &= \bar{G}_i + \underbrace{\frac{\partial G_i}{\partial h_{1,i}} \Delta h_{1,i} + \frac{\partial G_i}{\partial h_{2,i}} \Delta h_{2,i} + \frac{\partial G_i}{\partial \sigma_{1,i}} \Delta \sigma_{1,i} + \frac{\partial G_i}{\partial \sigma_{2,i}} \Delta \sigma_{2,i} + \frac{\partial G_i}{\partial \mu_i} \Delta \mu_i}_{\Delta G_i}, \\
 f_i &= \bar{f}_i + \underbrace{\frac{\partial f_i}{\partial h_{1,i}} \Delta h_{1,i} + \frac{\partial f_i}{\partial h_{2,i}} \Delta h_{2,i} + \frac{\partial f_i}{\partial \sigma_{1,i}} \Delta \sigma_{1,i} + \frac{\partial f_i}{\partial \sigma_{2,i}} \Delta \sigma_{2,i} + \frac{\partial f_i}{\partial \mu_i} \Delta \mu_i}_{\Delta f_i},
 \end{aligned} \tag{4.37}$$

The coefficients in (4.37) are the partial derivatives of each output with respect to each input. To obtain them numerically we assume the standard approximation meaning that it is equal to the related rate of change. For instance

$$\frac{\partial P_i}{\partial h_{1,i}} = \left. \frac{P_i - \bar{P}_i}{\Delta h_{1,i}} \right|_{\Delta h_{2,i}=0, \Delta \sigma_{1,i}=0, \Delta \sigma_{2,i}=0, \Delta \mu_i=0} \tag{4.38}$$

where the other inputs are set to zero. The partial derivatives are obtained by a set of applications of the Roll-Gap code for elementary inputs. This approach has been validated numerically by comparing the non-linear Roll-Gap curves with the linearized expressions. Figure (4.8a) shows the normalized relative percentage variation ΔP_1 with respect to the normalized relative percentage variation $\Delta h_{1,1}$, the tangent drawn at the origin which corresponds to the normalized relative nominal point $(\bar{h}_{1,1}, \bar{P}_1)$. The discontinuities present in the blue curve are related to the numerical errors related to the convergence criteria in the Roll-Gap algorithm. The periodic repetition of this discontinuity proves that this error is neglected and not to be considered. It does not effect the results since they are too small in amplitude.

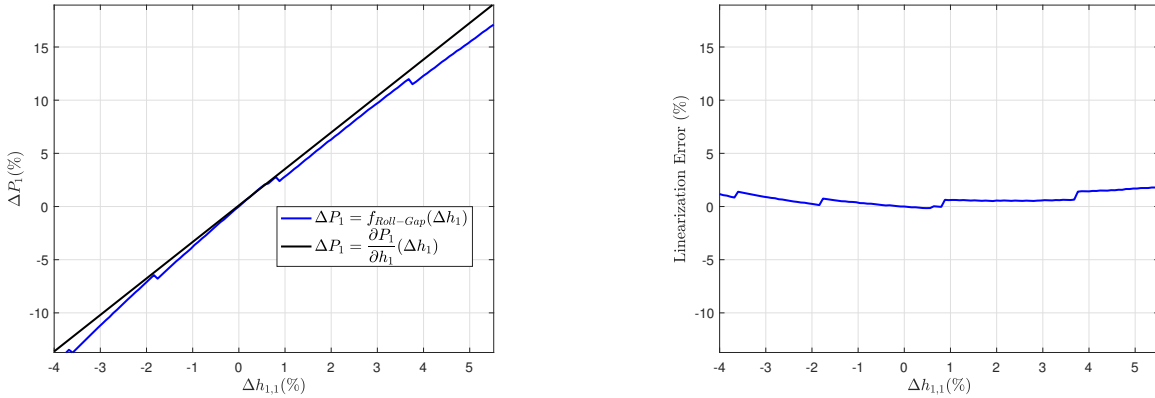

(a) 1D Linearization Validation

(b) Linearization Error

FIGURE 4.8 – 2-D Roll-Gap linearization validation

The curves shown in figure (4.8a) of the Roll-Gap curve $\Delta P_1 = f_{Roll\ Gap}(\Delta h_{1,1})$ in blue and the linearized model in black, validates that the linearization is acceptable. The non-linear model (blue) is quite close to the linearized one (black) in the neighborhood of the nominal operation. It is important to keep in mind that this approximation is valid just around the nominal point. An error around 2% in the linearized model for a 6% variation in $h_{1,1}$ is obtained as seen in figure (4.8b). This means that this error is small and the linearized model can replace the non-linear one. To see the validation in clearer side, a simultaneous variation of two inputs is applied to Roll-Gap to examine the surface 3D distance between the non-linear surface and linear surface. The inputs $h_{1,1}$ and μ_1 only are disturbed simultaneously around their nominal values, the output P_1 is examined for both Roll-Gap and linearized P_1 expression. The relative nominal surface percentage variation of both models are traced in figure (4.9a). The colored surface represents the output of Roll-Gap while the green plane surface represents the linearized model.

From the 3D plot, it is clear that the green plane superposes the colored surface in the central part and deviates from it at the edges. A 6% relative percentage variation in the entry thickness $h_{1,1}$, and 40% relative percentage variation in the friction μ_1 are introduced. The error at the edges is not more than 3% at most in ΔP_1 as seen in figure (4.9b). This means that once again the linearization of the force non-linear model is acceptable and valid.

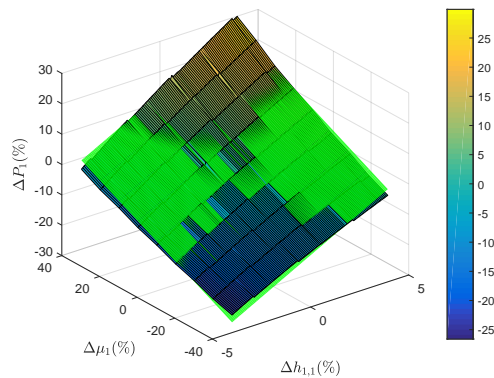

(a) Comparison between non-linear Roll-Gap model and linearized model

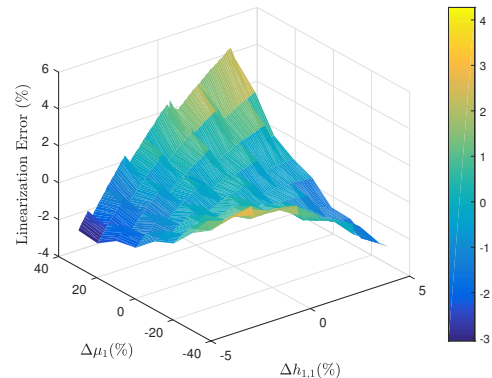

(b) Error in 3D between Roll-Gap and Linearized model

FIGURE 4.9 – 3-D Roll-Gap linearization validation

By this section, the non-linearities in the TCM process model are linearized and their validation are presented. In the next section the linearized multivariable model of TCM will be given.

4.4.1 TCM Time Delay Singular System

The model given in (4.21) is a singular non-linear multivariable one which contains variable time delays implicitly. The presence of time delays (4.11) in equation (4.29)

comes from the relation between the entry thickness $h_{1,i+1}$ of stand $i + 1$ and the exit thickness $h_{2,i}$ of the previous stand as expressed by the delay function Γ . Based on the Sims' mill stretch expression given in (4.5), the relation between the relative entry thickness $\Delta h_{1,i+1}$ and the relative delayed exit thickness $\Delta h_{2,i}$ is the following

$$\Delta h_{1,i+1}(t) = \Delta h_{2,i}(t - \tau_i(t)) = \Delta S_i(t - \tau_i(t)) + \frac{w}{M} \Delta P_i(t - \tau_i(t)) \quad (4.39)$$

Recall that the differential state ΔS_i is an element of the vector $x_{1,i}$ and the algebraic state ΔP_i is an element of $x_{2,i}$. Hence ΔS_i and ΔP_i are elements of x_1 and x_2 respectively. Therefore the entry thickness $\Delta h_{1,i+1}(t)$ can be written in function of the delayed state vector $x(t - \tau_i(t))$ as it is given below

$$\Delta h_{1,i+1}(t) = \Delta h_{2,i}(t - \tau_i(t)) = \Lambda_i \Delta x(t - \tau_i(t)), \quad (4.40)$$

where Λ_i is a matrix of appropriate dimension that transforms the equation (4.39) into a matrix form. This matrix form is important to transform the implicit delayed variables into explicit delayed vectors in the linearized system.

Using the linearizations given in (4.36) and (4.37) with the matrix explicit form of the entry thickness vector given in (4.40), the TCM linearized model expressed by the relative values is given below

$$E \frac{d}{dt} \Delta x(t) = A_0 \Delta x(t) + \sum_{i=1}^4 A_i \Delta x(t - \tau_i(t)) + B_u \Delta u(t) + B_d \Delta d(t) + B_\mu \Delta \mu(t),$$

$$\Delta y(t) = C_y \Delta x(t),$$

$$\Delta z(t) = C_z \Delta x(t),$$

$$\Delta x(t_0 + \xi) = \phi(t_0 + \xi); \quad \xi \in [-\tau_{max}; 0]; \quad \phi \in \mathcal{C}_{\tau_{max},n} = \mathcal{C}([t_0 - \tau_{max}, t_0], \mathbb{R}^n) \quad (4.41)$$

where the matrices $A_i, E \in \mathbb{R}^{n \times n}$, $B_u \in \mathbb{R}^{n \times n_u}$, $B_d \in \mathbb{R}^{n \times n_d}$, $B_\mu \in \mathbb{R}^{n \times n_\mu}$ have the following specific structure related to the decomposition of x in function of x_1 and x_2 basis

$$E = \begin{bmatrix} I_{n_1} & 0 \\ 0 & 0 \end{bmatrix}, A_i = \begin{bmatrix} A_{i1} & A_{i2} \\ A_{i3} & A_{i4} \end{bmatrix}, B_u = \begin{bmatrix} B_{u,1} \\ 0 \end{bmatrix}, B_d = \begin{bmatrix} 0 \\ B_{d,2} \end{bmatrix}, B_\mu = \begin{bmatrix} 0 \\ B_{\mu,2} \end{bmatrix}, \quad (4.42)$$

Also the fourth line in the equation (4.41) represents the history of the time delay singular system, this completes the definition of our system by introducing its initial condition. The function $\phi(t) = \text{col}\{\phi_1(t), \phi_2(t)\} \in \mathbb{R}^n$ is induced by the decomposition of x . The maximum delay $\tau_{max} = \max_i\{\bar{\tau}_i\}$ where $\bar{\tau}_i$ is given in (4.13). Additional conditions allowing $\phi(\cdot)$ to be compatible, that is ensuring the existence and the uniqueness of a continuous trajectory will be given later on.

In TCM non-linear model (4.21), the functions g and h are linear and represented respectively by the matrices $C_y \in \mathbb{R}^{n_y \times n}$ and $C_z \in \mathbb{R}^{n_z \times n}$. These functions generate respectively the output vectors y and z from the state vector x only, they are independent from the input or exogenous vectors. Figure (4.10) shows the inputs and outputs of the TCM linearized model looped with delayed exit thicknesses. These delayed thicknesses are seen as delayed states in the TCM linearized model.

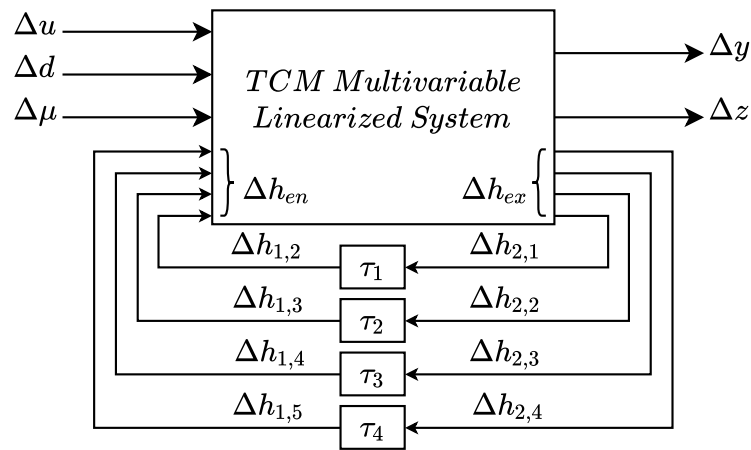

FIGURE 4.10 – TCM Linearized Model

4.5 Current Multi-loop PID Control for Tandem Process

Today the tandem cold rolling is controlled by means of multi-loop SISO (Single Input Single Output) PID controllers. In industrial processes the majority of controllers are PID's since they present a good range of advantages. The simplicity of their installation, cheap cost, easiness in tuning and maintenance explain their wide use in industry. For a complex process containing several actuators and numerous sensors such as cold rolling, it is possible to adjust a control strategy by several independent local loops with PID controllers as seen in the Figure (4.11). This strategy is useful as long as the internal interactions in the system are in the safe range. For tandem mill, the actual controllers show good performance regarding the requested industrial specifications for steel manufacturing. In TCM, the stands are coupled through the strip passing through the 5 pairs of work rolls in same time. The appearance of any error (thickness, yield stress, or flatness) leads to disturb the stand receiving this error.

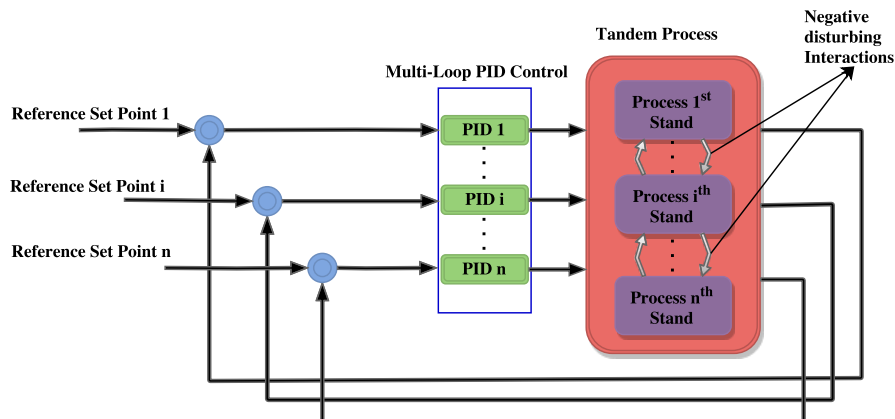

FIGURE 4.11 – Multi-loop PID Control Diagram

Since the PID local loops are independent, those in this stand will exert the ne-

cessary effort to reject this error either by motor speed or by roll bite variation. This provokes variations on strip speed and stand forward slip, result in variation in inter-stand tensions with the pre and post stands. Due to the presence of coupling, the error will be transmitted to other stands, especially if the rolling is done with high speeds or in supple coils. The loops of other stands will begin to apply their regulation each one independently no matter the error that can result from its own regulation. As a result, a set of internal perturbations propagate through the chain, which may lead to additional energy consumption and possible thickness and hardness errors. The SISO controller is capable of realizing only one error, and actuate only one input. This means that its effort has a perturbing effort on the other loops. On the other hand, the future industrial objectives require an increase in the productivity rate keeping the same high quality of steel. The interactions between stands become strong and no more negligible. The generated perturbations between loops prevent reaching these goals, the control loops attend their limits and are unable any more to compensate the transmitted perturbations in the system. Though the PIDs are easy to be tuned, the presence of several PID loops render the tuning to be hard and confusing. In addition, the first stand a feed-forward is used to reject the errors in the entry annealed thickness as seen in Figure (4.12). For the delay between the first two stands, a Smith predictor is used (usually this predictor is used for the case of constant delays, here it is used for the state dependent delay).

4.6 Conclusion

The tandem process is a complex process as it contains large number of physical quantities. The equations explaining the variation and evolution of these quantities are non-linear differential algebraic relations. The presence of variable time delays add more difficulty to the process equations. The resultant TCM model is build up by grouping the relations of all stands. The obtained non-linear system possess some difficulties due to the coupled non-linear algebraic set of equations. This model is linearized in the neighborhood of its nominal operating point, the linearization of some parts is validated with small range of error. The form of the linearized TCM model is a singular time delay system. The final part introduced the current control methodology used today in tandem mills. This control strategy has advantages and disadvantages which require to upgrade it to new control design convenient to the tandem process and its conflicts.

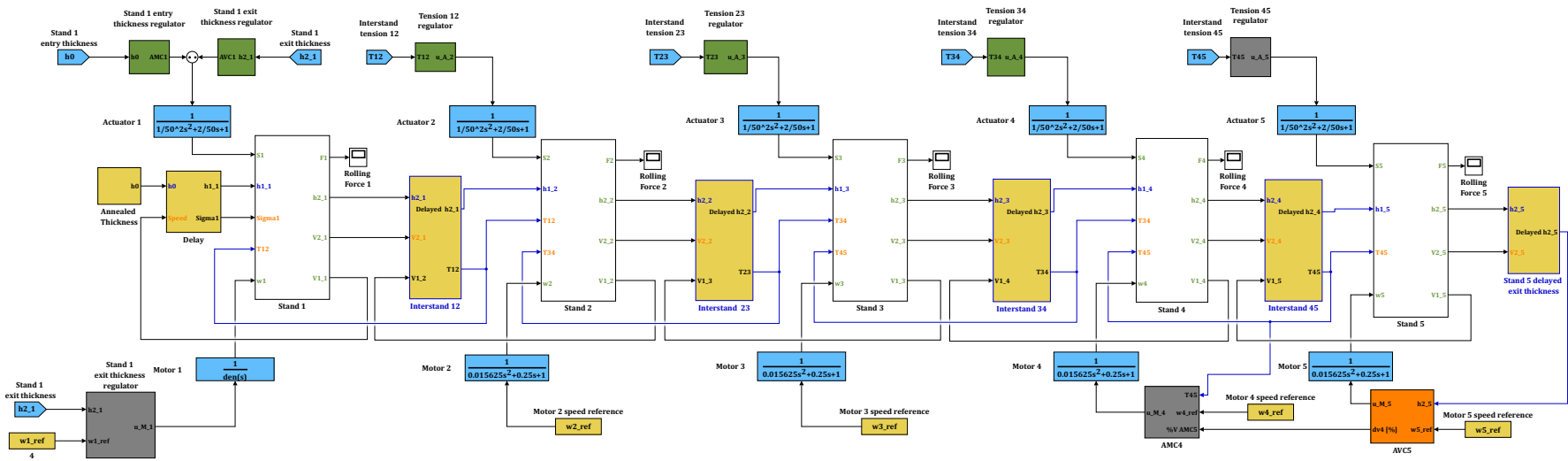

FIGURE 4.12 – Simulink schema of multi-loop PID control of TCM

Chapter 5

State Feedback Control for TCM Process

Contents

5.1	Introduction	61
5.2	Existence and Uniqueness of Solution	62
5.3	Controller Synthesis Paradigm	65
5.3.1	Formulation of Controller Synthesis as a Constrained Optimi- zation Problem	66
5.3.2	Process Performance translated as a Quadratic Cost	67
5.3.3	Stability and Performance Optimization via Lyapunov-Krasovskii Functional	68
5.3.4	Control solution of the Optimization Synthesis Problem	70
5.4	State Feedback Synthesis	71
5.4.1	Controller Synthesis via LMI Problem	71
5.4.2	Majorant Minimization	74
5.4.3	Numerical example	77
5.5	TCM Controller Synthesis	81
5.5.1	Controller Tuning	82
5.6	Conclusion	87

5.1 Introduction

In the previous chapter the linearized TCM model was established for a specified operating point. This opens now the road toward the control synthesis. The objective is to build up a multi-variable controller that takes into account the various TCM difficulties and industrial needs. But in order to reach this goal, an efficient study and analysis of the TCM linearized model is to be made regarding its form. In literature, stability

analysis and control design for time delay systems is a problem of continuous interest [Nic01,Ric03]. Although there exists already a wide literature on the analysis of systems affected by constant delays, there are many results related to dynamics affected by distributed [Ver95,Gu03,XC04] and time varying delays [GCK03,Kha12,MVAN05].

In the present chapter, the problem of controller synthesis of time delay singular system will be described in details. In section 5.2, an important discussion will be presented about the existence and uniqueness of the trajectory of this type of system class. In section 5.3, a general multivariable control paradigm will be presented in a well explained framework. This paradigm will be the generic framework for the present chapter as well as for chapter 6, by considering several assumptions and choices that are conditioned by the industrial constraints and specifications. Section 5.4 explains this paradigm in the case where the state vector is completely available for the design of the control law, and also provides a semi-definite algorithm to obtain the control solution. Academic examples are proposed to support further discussions. Section 5.5 applies the contributions of section 5.4 in the case of TCM process, before providing concluding remarks in section 5.6.

Remark 5.1 : To facilitate the reading of the following chapters, the relative quantity $\Delta\theta$ will be simply denoted θ except in the figures labeling to avoid confusions.

5.2 Existence and Uniqueness of Solution

Before moving to the formulation of control synthesis problem, it is essential to discuss important issues related to the solution of our treated time delay singular system. The existence and the uniqueness of a solution of the TCM system given in (4.41, 4.42) with the delay conditions in (4.13, 4.18), is not always guaranteed due to the presence of the singular matrix E . In this section, we are going to determine sufficient conditions on the initial condition $\phi(\cdot)$ ensuring the existence and uniqueness of a continuous trajectory of the system (4.41). Through studies on the solution of mathematical systems, many contributions already exist on the existence and uniqueness of solution for descriptor systems. According to [Cam80a,Dai89,XL06], the regularity and free impulsiveness of the delay-free singular system ensure the existence and uniqueness of its solution. In the case of singular systems with constant delays, as mentioned in [XDSL02,XL06] the regularity and the free impulsiveness accompanied by a compatible continuous initial condition $\phi(\cdot)$ ensure the existence and uniqueness of the solution. The regularity and free impulsiveness are required to be able to locally propagate the definition of a continuous trajectory. The compatible initial condition is required to avoid jumps at the initial instant t_0 . This issue is known as the *Initial Value Problem* (IVP). Inappropriate initial conditions can lead to jumps [HL93] which may propagate through the solution due to delays. This may affect the uniqueness of the solution.

A classical way of proving the existence and uniqueness of continuous solution for singular systems with constant delays is to reformulate the system as a *Neutral Functional Differential System* with constant coefficients [XDSL02,XL06,Fri14]. However it is not trivial to extend this approach to the case of descriptor systems with time varying delays. The main difficulty is related to the fact that, in this case, the delay derivative is not zero and supplementary terms appear in the neutral dynamics formulation. First

of all, a generic result will present sufficient conditions for the existence and uniqueness of a continuous solution for the general case of time delay singular system. In a second step, a detailed discussion will be provided about adjusting the results of Proposition 5.1 in order to be applied in the framework of TCM process. Necessary arguments are also to be given therein. Define a generic case of time delay singular system

$$E \frac{d}{dt} x(t) = A_0 x(t) + \sum_{i=1}^q A_i x(t - \tau_i(t)) + B_u u(t) + B_w w(t), \quad (5.1)$$

$$x(t_0 + \xi) = \phi(t_0 + \xi); \quad \xi \in [-\tau_{max}; 0]; \quad \phi \in \mathcal{C}_{\tau_{max}, n} = \mathcal{C}([t_0 - \tau_{max}, t_0], \mathbb{R}^n)$$

where $x \in \mathbb{R}^n$ is the state vector. Also we have the input vector $u \in \mathbb{R}^{n_u}$ as well as the exogenous vector $w \in \mathbb{R}^{n_w}$. The state vector will be partitioned without loss of generality such that $x = \text{col}\{x_1, x_2\}$ as in the case of TCM system. Denote x_1 the differential sub-vector and x_2 is the algebraic one. The matrices $A_i, E \in \mathbb{R}^{n \times n}$, $B_u \in \mathbb{R}^{n \times n_u}$, $B_w \in \mathbb{R}^{n \times n_w}$, have the following general structure

$$E = \begin{bmatrix} I_{n_1} & 0 \\ 0 & 0 \end{bmatrix}, A_i = \begin{bmatrix} A_{i1} & A_{i2} \\ A_{i3} & A_{i4} \end{bmatrix}, B_u = \begin{bmatrix} B_{u,1} \\ B_{u,2} \end{bmatrix}, B_w = \begin{bmatrix} B_{w,1} \\ B_{w,2} \end{bmatrix}, \quad (5.2)$$

This specific structure is considered to keep the same form as that of TCM system. This permits us to make use of the later obtained general results directly. If it is not the case of such structure, a regular impulse free system can be always written in this form using change of basis to obtain the *second equivalent form* in [Dai89]. As we see, the system contains q continuous time dependent delays where these delays $\tau_i(t)$ and their derivatives $\dot{\tau}_i(t)$ are bounded such such that

$$0 < \underline{\tau}_i \leq \tau_i(t) \leq \bar{\tau}_i \leq \tau_{max}, \quad \forall i \in \{1, \dots, q\}, \quad \forall t \geq t_0. \quad (5.3)$$

$$\dot{\tau}_i(t) \leq d_i < 1.$$

The function ϕ represents the initial condition of the system.

Remark 5.2 : According to Definition 3.4, the pair (E, A_0) in (5.2) can be shown that it is regular and impulse free. These properties for the tandem system (5.1) can be guaranteed by proving that $|sE - A_0| \neq 0$ and $\deg(|sE - A_0|) = \text{rank}(E)$. The complexity here lies in the large size of the system ($n = 44$). Using the MATLAB functions `charpoly` and `degree`, this can be easily carried out. Note that the matrix A_{04} is non-singular according to its numerical value, which is another proof that the pair (E, A_0) is impulse free following Lemma 3.3. Recall that if the pair (E, A_0) is regular and impulse free, this means that the corresponding time delay singular system has the same properties as well.

For the purpose of studying the solution existence of system (5.1), we are going to consider its isolated version (i.e. $w = 0$). The elements of the vector w represents the exogenous external signals in the system, which we don't know any thing about them except their range of variations. Generally these inputs are the perturbations (in the case of tandem process : stand 1 entry thickness, mill input and output tensions and

friction variation) which are not available or known. Discontinuities on the algebraic state $x_2(t)$ issued from the exogenous inputs are inevitable and can't be compensated by the control input generally. In the case where $B_{w,2}$ is not zero, we will impose that $w(t) = 0$ ensuring that $B_{w,2}w(t_0) = 0$ and thus we focus on the discontinuities generated by the system initial condition $\phi(\cdot)$. For that we are going to study the existence of system solution independently from these signals. Another assumption to be taken here is that we are going to treat also the autonomous version of system (5.1). This is to make use of the results already exist in the literature [XL06, Fri14, HB08, HL93], where most of them if not all, are given for the case of isolated autonomous systems.

Based on the matrices structure given in (5.2), the regular impulse free isolated autonomous system (5.1) can be written in the form of

$$\begin{aligned} \dot{x}_1(t) &= A_{01} x_1(t) + A_{02} x_2(t) + \sum_{i=1}^q \sum_{j=1}^2 A_{i,j} x_j(t - \tau_i(t)), \\ 0 &= A_{03} x_1(t) + A_{04} x_2(t) + \sum_{i=1}^q \sum_{j=1}^2 A_{i,j+2} x_j(t - \tau_i(t)). \end{aligned} \quad (5.4)$$

with its initial condition

$$x_1(t) = \phi_1(t), \quad x_2(t) = \phi_2(t), \quad t \in [t_0 - \tau_{max}, t_0]. \quad (5.5)$$

Substituting the initial condition $\phi(t) = \text{col}\{\phi_1(t), \phi_2(t)\}$ in the second equation of (5.4), we obtain

$$0 = A_{03} \phi_1(t_0) + A_{04} \phi_2(t_0) + \sum_{i=1}^q \sum_{j=1}^2 A_{i,j+2} \phi_j(t_0 - \tau_i(t_0)). \quad (5.6)$$

Based on the system description and properties, we can provide the following proposition in the same reasoning in [Fri02] regarding the existence and uniqueness of its trajectory.

Proposition 5.1 *For any continuous function $\phi(t) = \text{col}\{\phi_1(t), \phi_2(t)\}$ that satisfies (5.6), with $0 < \tau_i(t) \in \mathcal{C}^1[t_0, \infty)$ verifying (5.3), there exists a unique continuous function $x(t)$ defined on $[t_0 - \tau_{max}, \infty)$ that satisfy the regular and impulse free system (5.4) on $[t_0, \infty)$ and initial condition (5.5).*

The proof of this proposition is similar to the one in [Fri02] and [Fri14]. This same result is also referenced in [HB08, HB09, HBXL09].

Proposition 5.1 indicates that the initial condition (5.5) of the isolated autonomous regular impulse free delay singular system (5.4) must satisfy the algebraic relation in (5.6). However, this algebraic relation changes for the case of forced system (i.e. $u \neq 0$). According to the structure of matrix B_u in (5.2), the initial condition ϕ must satisfy the following algebraic relation

$$0 = A_{03} \phi_1(t_0) + A_{04} \phi_2(t_0) + \sum_{i=1}^q \sum_{j=1}^2 A_{i,j+2} \phi_j(t_0 - \tau_i(t_0)) + B_{u,2}u(t_0). \quad (5.7)$$

According to theorems 5.1 and 5.2 in [KM99], the input signal $u(t) \in L_1[t_0, \infty)$. This means implicitly that $u(t)$ must be continuous over $[t_0; \infty)$. The relation in (5.7) is a

strong relation between the initial condition $\phi(\cdot)$ and the control input $u(\cdot)$. This coupling is a constraint that should be taken into account in the synthesis of the control law. In practice, the dependency on the initial state $x(t_0) = \phi(t_0)$ must be avoided to allow an offline synthesis. For this purpose, we will consider later on the framework for which $B_{u,2}u(t_0) = 0$.

Remark 5.3 :The condition (5.6) reveals an easier case where the effect of control input at the initial instant $u(t_0)$ is absent. The provided algebraic condition is already presented in some studies such as [XDSL02, HBXL09, Fri14]. The compatibility of ϕ to this relation is sufficient to ensure the continuity of the trajectory. On the other hand, the algebraic relation in (5.7) is much more difficult to be respected. This is due to the presence of the term $B_{u,2}u(t_0)$ in the equation, which may lead to the presence of jumps in the trajectory of the system.

The framework $B_{u,2}u(t_0) = 0$ required to break the dependency between ϕ and $u(t_0)$ may be ensured via two possibilities :

- a) Concerning the specific application here for TCM model given in (4.41, 4.42), we have $B_{u,2} = 0$ which implies that $B_{u,2}u(t_0) = 0$ in particular. Then the design of the continuous control law $u(\cdot)$ has no additional constraints related to $u(t_0)$.
- b) In a more general case for which $B_{u,2} \neq 0$, we should impose $u(t_0) = 0$. For this purpose, we introduce a weighted control $u_\delta(t)$ replacing $u(t)$ such that it is defined by

$$u_\delta(t) = \delta(t)u(t), \quad \forall t \geq t_0, \quad (5.8)$$

where $u(t)$ is designed by a dedicated method allowing $u(t_0) \neq 0$ and the weight $\delta(t)$ is defined by :

$$\begin{cases} \delta(t_0) = 0 \\ \delta(\cdot) \in \mathcal{C}_{t_0} = \mathcal{C}[t_0; \infty) \text{ is an increasing function} \\ \exists \epsilon > 0 : \delta(t) = \delta(\epsilon) = 1, \forall t \geq \epsilon. \end{cases} \quad (5.9)$$

An example of the weight $\delta(\cdot)$ will be given at the end of this chapter for an academic illustration. The idea of this weighted control is to maintain a design that does not impose $u(t_0) = 0$. The duration ϵ is an extra parameter that can be interpreted as the transient of the control or establishing time of the control. Of course, this duration ϵ should be as small as possible to reduce the degradation of closed loop performance that are obtained by applying $u_\delta(\cdot)$ instead of $u(\cdot)$. The next section below introduce the controller synthesis paradigm.

5.3 Controller Synthesis Paradigm

The synthesis of a controller is a usual problem in control system theory. Several approaches exist, that are more or less dedicated to the class of systems under study and also the specifications/constraints of the control design. In the present thesis, it is focused on the list of the TCM process characteristics (time varying delays, descriptor model, possible uncertainties, lack in process measurements . . . etc) and the constraints

of the industrial requirements. Thus we need to present a generic framework for the controller synthesis that remains flexible in terms of the chosen tools, and furthermore compatible with the tandem system and the control objectives.

5.3.1 Formulation of Controller Synthesis as a Constrained Optimization Problem

As frequently encountered in the control system theory, the controller synthesis is carried out by formulating and solving a constrained optimization problem [ZDG⁺96, ZD98]. Roughly speaking, the control law is the variable and the solution of this optimization problem. Usually a cost function, translating the specific industrial requirements, is proposed. This cost is to be minimized. On the other hand, other control purposes such as stabilization and other points (process uncertainties, system limitations . . . etc) are taken into account as constraints of the optimization problem.

An intuitive approach to solve such synthesis optimization problem is to use the tools of optimal control (Dynamic programming or Pontryagin Maximum Principle) [Ber95, Bry75, Pon87]. However, that will not be a suitable track to be followed in our framework due to these reasons

- a) An optimal control result from applying Dynamic Programming [Bel13] or Pontryagin Maximum Principle, will require to have access to the whole state of the system. Even if it is possible assuming a hypothesis in a first step that all states measurements available, that will prevent in a second step to consider an output based control.
- b) Optimality is based on the full and exact knowledge of the model of the system. In order to keep the same framework in view of extension to treat uncertainties (model uncertainties issued from system linearization, parametric uncertainties and also unknown exogenous inputs seen as perturbations), optimal control is not an appropriate approach.

The provided general framework is inspired by the following observation about LQ regulator. It is pointed out in chapter 3 that this regulator problem is solved by an Algebraic Riccati Equation (ARE). The solution of this equation has been shown to be equivalently the solution of a Semi Definite Program (SDP) that consists of a cost to be minimized (i.e. an upper bound of the desired performance cost) where problem constraints are formulated as LMI's. In the case of LQR problem, the minimal upper bound is proved to be the optimal cost. Here in our study concerning the multivariable control of the TCM process, first we will adapt this idea to define an upper bound of the cost and second we will minimize this upper bound under the specifications of the system, even if the gap between the "optimal" cost and the upper bound is not completely filled. This controller synthesis paradigm [AJM⁺17] is depicted in Figure 5.1. The following subsection will discuss the different aspects of this constrained optimization problem and moreover their related choices.

It should be noticed that this general point-of-view may be considered for other industrial processes, for which the performance cost and the desired specifications are to be well chosen and formulated.

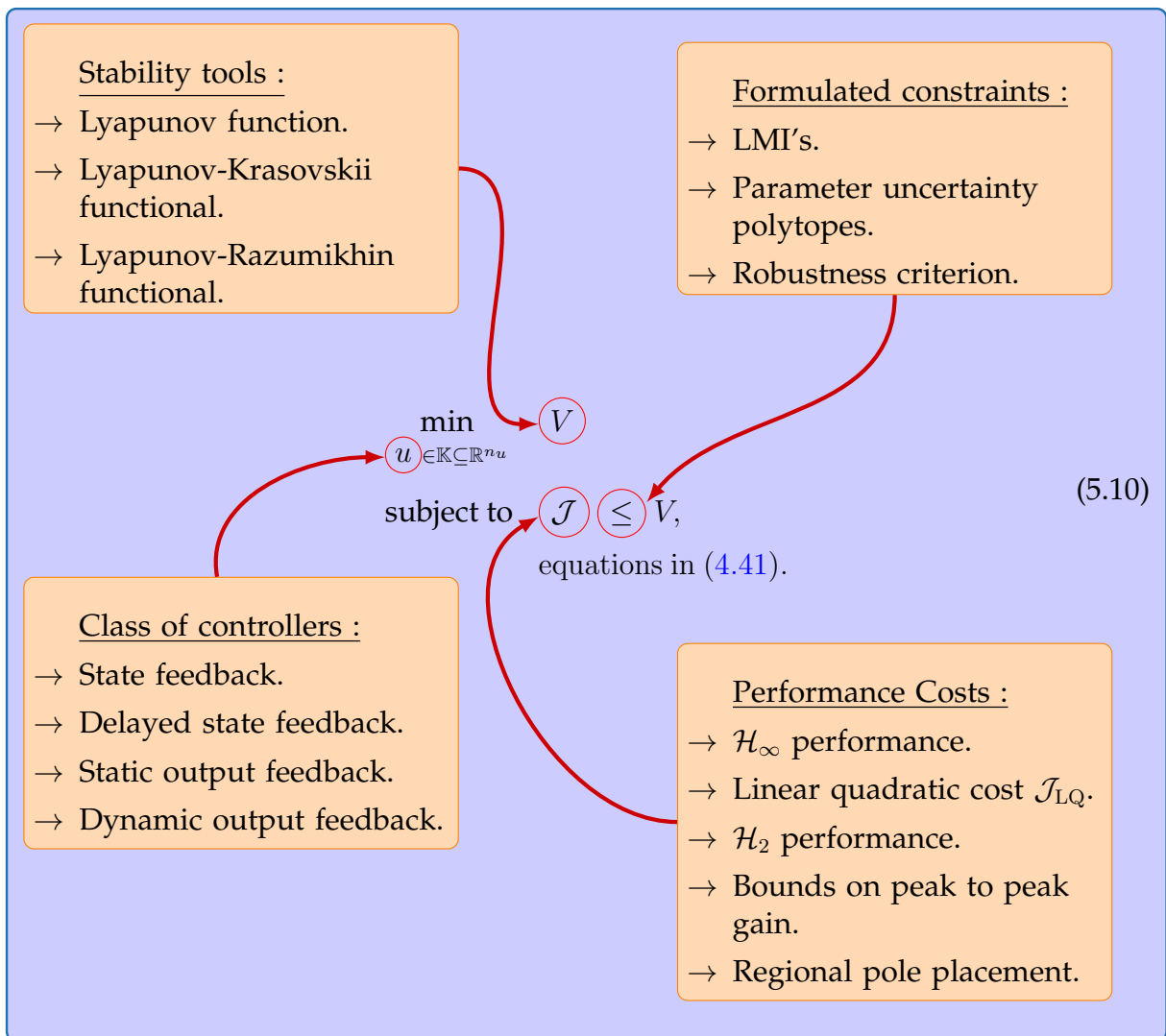

FIGURE 5.1 – Summarize of the controller synthesis paradigm

5.3.2 Process Performance translated as a Quadratic Cost

As a result, the industrial specifications create a multiple objective performance, which can be modeled by means of linear quadratic cost [ZDG⁺96]. The importance of such cost is that it gives a weighting factor for each dynamic, which affects priority for some dynamics with respect to others. Also the sum of quadratic terms can be seen as energetic sum (i.e. kinetic energy related to the speeds, potential energy related to the tensions) to be minimized over the system trajectory. Some physical quantities such as strip exit thickness ($h_{2,i}$) or strip exit speed ($V_{2,i}$) are expressed by algebraic relations and they are not included in the state vector x . The objective performance most probably imposes to tune the weightings of these values, thus the quadratic cost will depend on the whole outputs and the system inputs. The form of the total output vector z in (4.21) depends only on x , this advantage can be used to include all the elements of z in the quadratic cost without any change in the controller synthesis.

Another point to be mentioned here is that the cited performance cost integrates the instantaneous cost which is a sum of quadratic terms function of $x(t)$ and $u(t)$ over $[t_0; \infty)$. This means that the performance cost is dependent on the values of $\phi(t_0)$ and $u(t_0)$. Using the relation between z and x given in (4.41), its expression denoted by \mathcal{J}_{LQ} has the form

$$\mathcal{J}_{LQ}(\phi, u) = \int_{t_0}^{\infty} \left(x^T(s) \underbrace{C_z^T Q_z C_z}_{Q_x} x(s) + u^T(s) R_u u(s) \right) ds, \quad (5.11)$$

where the matrices $0 \leq Q_z = Q_z^T \in \mathbb{R}^{n_z \times n_z}$, $0 \leq Q_x = Q_x^T \in \mathbb{R}^{n \times n}$ and $0 < R_u = R_u^T \in \mathbb{R}^{n_u \times n_u}$ are the weighting matrices. These matrices ensure correct quantitative weighting between physical parameters in the presence of different units (i.e. tonnes and millimeters as an example). They have special structure in the presence of several industrial specifications. The desired requirements concerning the performance of the controlled system may be related to several quadratic energies to be minimized. For that, the integrand term is a sum of normalized weighted energies, which gives the matrices Q_z and R_u the following form given below

$$Q_z = \sum_i \alpha_i Q_i ; \quad R_u = \sum_j \beta_j R_j, \quad (5.12)$$

where $\alpha_i \geq 0$ is the weighting coefficient of the i^{th} output cost and Q_i is the normalized weighting matrix corresponding to it. $\beta_j \geq 0$ is the weighting of the j^{th} system input and R_j is the weighting matrix corresponding to it. The normalizing selective matrices Q_i and R_j given in (5.13) normalize the energies (dynamics and inputs quadratic terms) through dividing the corresponding physical quantity by the square of its nominal value. The matrix Q_i has a non zero value $\frac{1}{z_i^2}$ in the i^{th} diagonal element and zeros elsewhere, similarly the matrix R_j has the non-zero element $\frac{1}{u_j^2}$ and zeros elsewhere. Then the weightings α_i and β_j play the role of associating the priority within the energy sum.

$$Q_i = \begin{pmatrix} 0 & \cdots & 0 & 0 & 0 & \cdots & 0 \\ \vdots & \ddots & \vdots & \vdots & \vdots & \ddots & \vdots \\ 0 & \cdots & 0 & 0 & 0 & \cdots & 0 \\ 0 & \cdots & 0 & \frac{1}{z_i^2} & 0 & \cdots & 0 \\ 0 & \cdots & 0 & 0 & 0 & \cdots & 0 \\ \vdots & \ddots & \vdots & \vdots & \vdots & \ddots & \vdots \\ 0 & \cdots & 0 & 0 & 0 & \cdots & 0 \end{pmatrix}^{i^{th}} ; R_j = \begin{pmatrix} 0 & \cdots & 0 & 0 & 0 & \cdots & 0 \\ \vdots & \ddots & \vdots & \vdots & \vdots & \ddots & \vdots \\ 0 & \cdots & 0 & 0 & 0 & \cdots & 0 \\ 0 & \cdots & 0 & \frac{1}{u_j^2} & 0 & \cdots & 0 \\ 0 & \cdots & 0 & 0 & 0 & \cdots & 0 \\ \vdots & \ddots & \vdots & \vdots & \vdots & \ddots & \vdots \\ 0 & \cdots & 0 & 0 & 0 & \cdots & 0 \end{pmatrix}^{j^{th}}, \quad (5.13)$$

5.3.3 Stability and Performance Optimization via Lyapunov-Krasovskii Functional

The performance cost function \mathcal{J}_{LQ} introduces an easy way to include industrial constraints with the ability to apply tuning phase to adapt these weightings to the

precised specifications. The presence of time delays in the TCM model imposes a more general controller synthesis way than using the Algebraic Riccati Equation. In our case the optimization will be carried out by defining a majorant V which upper bounds the performance cost \mathcal{J}_{LQ} . This majorant will be minimized and consequently the value of \mathcal{J}_{LQ} is optimized. On the other hand, the upper bound V will ensure the stability of the closed loop system if it satisfies the conditions in the direct Lyapunov stability theorem. The chosen class of upper bounds is the set of Lyapunov functionals already used in many studies [Lya92, Vid02] to obtain sufficient stability conditions. Referring to the synthesis optimization problem mentioned in (5.10), the optimization strategy is based on upper bounding the the value of \mathcal{J}_{LQ} by the majorant initial value $V(t_0)$ at t_0 over the whole trajectory. For minimizing \mathcal{J}_{LQ} we need to minimize $V(t_0)$ and thus \mathcal{J}_{LQ} is optimized. The interpretation of this special case of upper bound comes from the comparison test of improper integrals. Assume that the instantaneous performance cost is upper bounded according to the following inequality

$$x^T(t)Q_x x(t) + u^T(t)R_u u(t) \leq -\dot{V}, \quad t \geq t_0. \quad (5.14)$$

then if the integral of the upper bound $-\dot{V}$ over $[t_0; \infty)$ converges, the integral of $x^T(t)Q_x x(t) + u^T(t)R_u u(t)$ on the same interval converges. By integrating both sides of (5.14) over $[t_0; \infty)$, we obtain the inequality below

$$\int_{t_0}^{\infty} (x^T(s)Q_x x(s) + u^T(s)R_u u(s)) ds \leq V(t_0) - \underbrace{V(\infty)}_0. \quad (5.15)$$

This inequality is the same as the one given in the synthesis problem (5.10), since at the infinite horizon the functional V vanishes (i.e. $\lim_{t \rightarrow \infty} x(t) = 0$) assuming that the closed-loop system is asymptotically stable. Thus if the inequality in (5.15) holds, the inequality in (5.14) holds. By moving all the terms in (5.14) to the LHS, we obtain that $x^T(t)Q_x x(t) + u^T(t)R_u u(t) + \dot{V} \leq 0$. This characterize the stability condition of the closed loop system.

After we have determined the class of this upper bound, the next step is to investigate the convenient form adapted to our problem regarding the class of TCM model. In the field of Time Delay Systems (TDS), many research had been done related to control of such systems. Time delays are examined in both time and frequency domains [Ric03, Fri14, GCK03, Kha12, Nic01]. Stability, robustness and analysis of this class of systems are widely studied for the cases of constant or variable time delays as well as for single or multiple delays. In the case of TCM model, the form of the function V must lead us to a condition or conditions satisfying the Lyapunov stability criterion. The usual quadratic Lyapunov function $V(x) = x^T P x$ with $P > 0$, may not be a suitable choice since it does not lead us to a direct explicit stability sufficient condition after time derivation of V . This is due to the presence of the singularity and delay aspects in the system. A function of this form may exist leading to sufficient stability condition, but it is hard to find it. More adaptable forms for the case of singular time dependent delay system already exist. Through literature, asymptotic stability for TDS are treated by different methods such as Lyapunov-Krasovskii and Lyapunov-Razumikhin methods. In these methods, Lyapunov like functions called functionals are proposed [Nic01, Fri14, Ric03] to derive stability sufficient conditions in the form of

Linear Matrix Inequality (LMI). In our work, we will select the Lyapunov-Krasovskii option since the Lyapunov-Razumikhin requires additional parameters. For time delay singular systems, there is a term to be added to manage the descriptor aspect of the system. This type of systems has also been studied in [Kha12, Cam80a, Fri02, FS02, Lew02, Liu12], many functionals were proposed to treat the associated different problems. The selected Lyapunov-Krasovskii functional denoted $V(t, x_t)$ is given in the expression below

$$V(t, x_t) = x^T(t)E^T P x(t) + \sum_{i=1}^4 \int_{t-\tau_i(t)}^t x^T(s)S_i x(s)ds, \quad (5.16)$$

where E is the singular matrix of the TCM linearized model given in (4.42). The presence of this matrix in the expression is to include the descriptor aspect of the TCM model (4.41). $P \in \mathbb{R}^{n \times n}$ is a non-singular matrix and the matrices $0 < S_i = S_i^T \in \mathbb{R}^{n \times n}$ are positive definite symmetric ones. The sum of integrals is for the delay aspect in the system. Finally giving the expression of the value $V(t_0, x_{t_0})$ in terms of the initial condition ϕ , we have the upper bound condition

$$\mathcal{J}_{LQ} \leq V(t_0, \phi) = \phi^T(t_0)E^T P \phi(t_0) + \sum_{i=1}^4 \int_{t_0-\tau_i(t_0)}^{t_0} \phi^T(s)S_i \phi(s)ds, \quad (5.17)$$

As we can see, the initial value $V(t_0, \phi)$ depends on the value of ϕ .

5.3.4 Control solution of the Optimization Synthesis Problem

In the previous sections of this chapter, we have formulated the control synthesis problem combining the performance as well as the stability of the closed loop system. A final point to be discussed about this problem is the control solution which is the key in the control of the TCM process. In the field of control for delayed singular system, several linear control input types are presented. In the paradigm of the synthesis problem in (5.10), we have seen the possible control types for the multi-variable linear case. The choice of the control type depends usually on the available measurements in the process. As we are dealing with time delays, it is possible to affect a state feedback with possible delayed state feedback such that $u = Kx + K_\tau x_\tau$ where x_τ includes all the delayed states for all delays and K and K_τ are the control gains. However the absence of time delay in the measured data prevents us from using delayed state feedback. In addition not all states in the vector x are available. By looking to the vector y in (4.31) and comparing it to the vector x in (4.22) and (4.23), we find that many variables are not measured, especially the exit thicknesses between stands as well as the inter-stand strip speeds and others. This guides us to use either the static output feedback (SOF) or dynamic one (DOF), which is a situation where all the challenges (time delay singular system control, large size system, unavailable measurements, system performance characterization) are accumulated one with the other and this is difficult to be solved. An obvious idea is to isolate the difficulties in this synthesis by assuming that all states in the process are measured at the beginning. After that and in the later steps, this assumption will be treated and raised to have a control type that deals with the present

situation. For the instant, a state feedback control will be used assuming that all the signals and necessary data are available. As a conclusion the solution of the optimization problem given in (5.10) is

$$u(t) = Kx(t) \quad (5.18)$$

with $K \in \mathbb{R}^{n_u \times n}$ is the control gain to be determined. The minimization of $V(t_0, \phi)$ will lead to the synthesis of optimal gain K which will guarantee an optimal trajectory under the specified weightings.

5.4 State Feedback Synthesis

This section is dedicated to the design of a state feedback control that is the solution of the problem in (5.10). Some mathematical tools will be presented in details for the solution of the optimization problem that is to be clarified.

5.4.1 Controller Synthesis via LMI Problem

Usually the stability of time delay singular system can be studied and verified based on Lyapunov-Krasovskii Functional [Ric03, FS02]. The synthesis of the controller can be carried out using stability sufficient conditions for the closed loop system. Proposing a convenient Lyapunov-Krasovskii functional V and by obtaining its time derivative, we can reach a sufficient stability condition by the fact that if $\dot{V} < 0$ then the closed loop system is asymptotically stable. In the present case we will use the combined performance stability inequality given in (5.10) to reach the aimed synthesis conditions. In the beginning, assume that the exogenous inputs are set to zero (i.e. $d(t) = 0, \mu(t) = 0$) to find the state feedback controller independent of their impact on the system. Consider the following theorem that explains the steps of synthesis.

Theorem 5.1 : Consider the regular impulse free time delay singular system given in (4.41). The closed loop system with the state feedback gain given in (5.18) is asymptotically stable if there exist symmetric positive definite matrices $G_i \in \mathbb{R}^{n \times n}$, a non-singular matrix $W \in \mathbb{R}^{n \times n}$ and a matrix $Y \in \mathbb{R}^{n_u \times n}$ such that the algebraic equality

$$W^T E^T = EW \geq 0, \quad (5.19)$$

and the LMI below

$$\begin{bmatrix} \Psi_1 & W^T H_x & Y^T & A_1 W & \cdots & A_4 W \\ \star & -I_n & 0 & 0 & \cdots & 0 \\ \star & \star & -R_u^{-1} & 0 & \cdots & 0 \\ \star & \star & \star & -(1-d_1)G_1 & \ddots & \vdots \\ \star & \star & \star & \star & \ddots & 0 \\ \star & \star & \star & \star & \star & -(1-d_4)G_4 \end{bmatrix} < 0, \quad (5.20)$$

are satisfied, with

$$\Psi_1 = \mathbf{He}(A_0 W + BY) + \sum_{i=1}^4 G_i, \quad (5.21)$$

and $H_x \in \mathbb{R}^{n \times n}$ defined by $Q_x = H_x H_x^T$, the matrices $P = W^{-1}$ and $S_i = P^T G_i P^{-1}$. The state feedback input is given by

$$u = \underbrace{YW^{-1}}_K x, \quad (5.22)$$

where $K = YW^{-1}$ is the state feedback gain that stabilizes asymptotically the TCM model. Also this gain will keep the value of the cost \mathcal{J} over the whole trajectory below the initial value of the majorant V .

Proof : Assume that the conditions (5.19) and (5.20) in Theorem 5.1 are verified. The algebraic equality in (5.19) gives a specific form of the non-singular $n \times n$ matrix W . Using the form of the singular matrix E given in (4.42), the form of W is

$$W = \begin{bmatrix} W_1 & 0 \\ W_3 & W_4 \end{bmatrix}, \quad (5.23)$$

with $0 < W_1 = W_1^T \in \mathbb{R}^{n_1 \times n_1}$, $W_3 \in \mathbb{R}^{n_2 \times n_1}$, and non-singular sub-matrix $W_4 \in \mathbb{R}^{n_2 \times n_2}$. From the LMI in (5.20), we have the LHS of the following equivalence

$$\begin{bmatrix} \Psi_1 & W^T H_x & Y^T \\ \star & -I_n & 0 \\ \star & \star & -R_u^{-1} \end{bmatrix} < 0 \iff \Psi_1 + W^T \underbrace{(H_x) I_n (H_x^T)}_{Q_x} W + Y^T R_u Y < 0 \quad (5.24)$$

Since $-I_n < 0$ and $-R_u^{-1} < 0$, the Schur's complement can be applied twice on the LHS of (5.24). This leads to the RHS of the same equivalence with $Q_x = H_x H_x^T$. From this transformation above, the inequality below is deduced directly from the LMI (5.20)

$$\begin{bmatrix} \Psi_1 + W^T Q_x W + Y^T R_u Y & A_1 W & A_2 W & \cdots & A_4 W \\ \star & -(1-d_1)G_1 & 0 & \cdots & 0 \\ \star & \star & -(1-d_2)G_2 & \ddots & \vdots \\ \star & \star & \star & \ddots & 0 \\ \star & \star & \star & \star & -(1-d_4)G_4 \end{bmatrix} < 0, \quad (5.25)$$

The non-singularity of the matrix W permits us to post-multiply and pre-multiply the inequality in (5.25) by $\text{diag}(W^{-1}, W^{-1}, W^{-1}, W^{-1}, W^{-1})$ and its transpose respectively, this leads to the following inequality

$$\Phi_1 = \begin{bmatrix} \Omega_1 & P^T A_1 & P^T A_2 & P^T A_3 & P^T A_4 \\ \star & -(1-d_1)S_1 & 0 & 0 & 0 \\ \star & \star & -(1-d_2)S_2 & 0 & 0 \\ \star & \star & \star & -(1-d_3)S_3 & 0 \\ \star & \star & \star & \star & -(1-d_4)S_4 \end{bmatrix} < 0, \quad (5.26)$$

where

$$\Omega_1 = \mathbf{He}(A_0^T P + K^T B^T P) + Q_x + K^T R_u K + \sum_{i=1}^4 S_i, \quad (5.27)$$

We denote

$$\zeta(t) = \begin{pmatrix} x(t) \\ x(t - \tau_1(t)) \\ x(t - \tau_2(t)) \\ x(t - \tau_3(t)) \\ x(t - \tau_4(t)) \end{pmatrix}. \quad (5.28)$$

From (5.26) we have $\zeta^T(t)\Phi_1\zeta(t) < 0$ for all $\zeta(t) \neq 0$. The equality condition in (5.19) with $W = P^{-1}$ induces the following relation through pre and post multiplying by P^T and P respectively

$$E^T P = P^T E \geq 0, \quad (5.29)$$

This algebraic condition introduces a specific form of P where the interpretation of this form is the same as that for W given in (5.23).

$$P = \begin{bmatrix} P_1 & 0 \\ P_3 & P_4 \end{bmatrix}, \quad (5.30)$$

with $0 < P_1 = P_1^T \in \mathbb{R}^{n_1 \times n_1}$, $P_3 \in \mathbb{R}^{n_2 \times n_1}$, and non-singular sub-matrix $P_4 \in \mathbb{R}^{n_2 \times n_2}$. Using the expression of $E\dot{x}(t)$ given in (4.41) and the equality in (5.29), the development of the quantity $\zeta^T(t)\Phi_1\zeta(t) < 0$ gives the middle side of the order relation in (5.31) for all $\zeta(t) \neq 0$.

$$\begin{aligned} & x^T(t) [Q_x + K^T R_u K] x(t) + \dot{x}^T(t) E^T P x(t) + x^T(t) E^T P \dot{x}(t) \\ & + \sum_{i=1}^4 x^T(t) S_i x(t) - \sum_{i=1}^4 (1 - \dot{\tau}_i(t)) x^T(t - \tau_i(t)) S_i x(t - \tau_i(t)) \\ & \leq x^T(t) [Q_x + K^T R_u K] x(t) + \dot{x}^T(t) E^T P x(t) + x^T(t) E^T P \dot{x}(t) \\ & + \sum_{i=1}^4 x^T(t) S_i x(t) - \sum_{i=1}^4 (1 - d_i) x^T(t - \tau_i(t)) S_i x(t - \tau_i(t)) < 0. \end{aligned} \quad (5.31)$$

Depending on the delay derivative boundedness $\dot{\tau}_i \leq d_i$ given in (4.18), the order relation in (5.31) can be easily deduced by doing simple mathematical ordering. The LHS of this relation stands for $x^T(t)Q_x x(t) + u^T(t)R_u u(t) + \dot{V}(t, x_t)$, where $\dot{V}(t, x_t)$ is the time derivative of $V(t, x_t)$ given by the expression below

$$\begin{aligned} \dot{V}(t, x_t) &= \frac{d}{dt} V(t, x_t) = \dot{x}^T(t) E^T P x(t) + x^T(t) E^T P \dot{x}(t) + \sum_{i=1}^4 x^T(t) S_i x(t) \\ & - \sum_{i=1}^4 (1 - \dot{\tau}_i(t)) x^T(t - \tau_i(t)) S_i x(t - \tau_i(t)). \end{aligned} \quad (5.32)$$

This derivative exists due to the conditions of boundedness and continuity for time delays. For that, from the relation (5.31) we obtain the following condition for all $\zeta(t) \neq 0$

$$\dot{V}(t, x_t) + x^T(t)Q_x x(t) + u^T(t)R_u u(t) \leq \zeta^T(t)\Phi_1\zeta(t) < 0, \quad (5.33)$$

From the definition of the cost function \mathcal{J}_{LQ} given in (5.11), the quadratic integrand term possess the following condition

$$0 \leq x^T(t)Q_x x(t) + u^T(t)R_u u(t). \quad (5.34)$$

This implies that $\dot{V}(t, x_t) < 0$, where according to Theorem 3.3 we deduce the global asymptotic stability for the system (4.41). This condition means that the trajectory of the system converges and that

$$\lim_{t \rightarrow \infty} V(t, x_t) = 0, \quad (5.35)$$

Integrating both sides of the inequality in (5.33) under the limit in (5.35), we obtain the upper bound condition given in (5.17). This completes the proof.

Solving the LMI synthesis problem introduced in Theorem 5.1 leads to a feasible solution with respect to the condition of functional V matrices existence. The obtained decision variables P , S_i and Y only respect the conditions (5.19) and (5.20) and are not optimized such that the functional V is minimized as stated in (5.10). The obtained values here will lead to one of the feasible state feedback gains $K = YW^{-1}$, which is not the optimal since the performance cost \mathcal{J}_{LQ} is not minimized. So in order to obtain an optimal gain K , the minimization of the upper bound $V(t_0, \phi)$ has to be performed as mentioned in the optimization problem. Consequently the value of the cost \mathcal{J}_{LQ} will be minimized over the whole trajectory x . In the next section we will present the necessary tools for this optimization.

5.4.2 Majorant Minimization

The Lyapunov-Krasovskii functional $V(t, x_t)$ is seen as a generic energetic functional for the TCM system. The existence of this functional satisfying some conditions ensures the asymptotic stability of the closed loop system. The previous section introduced the problem to arrive to a feasible solution which is a state feedback gain. Among the obtained results, we have the matrices P and S_i that define the expression of $V(t, x_t)$. Based on Theorem 5.1, these matrices including the controller are feasible solution to the LMI problem and does not correspond to the optimum (minimum) value of \mathcal{J}_{LQ} . Minimizing the upper bound $V(t_0, \phi)$ in (5.17) leads to the minimization of \mathcal{J}_{LQ} , then the solution of the LMI problem will be optimized. The minimization of the upper bound $V(t_0, x_{t_0}) = V(t_0, \phi)$ which is related to the initial condition ϕ needs to be well explained because this minimization has to be independent of ϕ . This function is seen as a stochastic variable that can take many forms. This follows on the value of $V(t_0, \phi)$ to be stochastic also, thus minimizing its value can be carried out through minimizing the value of its expectation, denoted $\mathbb{E}[V(t_0, \phi)]$ where \mathbb{E} is the expectation operator.

The value of this expectation still not obvious, since it is an expectation of a functional. The initial condition ϕ can be any continuous compatible function (constant, affine, harmonic, . . . , etc) that verifies the algebraic condition (5.6). Let Θ be the set of all the possible continuous compatible functions ϕ that verifies the equations of the TCM model. Obviously we do have a very large number (number of elements in Θ) of

choices for ϕ assumed finite, where all of them have the same possibility of occurrence. Thus the initial condition ϕ can be seen as a discrete random function with a discrete uniform distribution, since all elements $\phi \in \Theta$ have equal probabilities. For simplicity, we are not going to make difference between the random function (capital letter) and its values (small letter). Assume that this random function has a zero mean and unity variance, that is $\mathbb{E}[\phi(t)] = 0$ and $\mathbb{E}[\phi(t)\phi^T(t)] = I_n, \forall t \in [t_0 - \tau_{max}, t_0]$. Using the properties of the expectation and the trace operators, the expectation of the upper bound can be given by (see Appendix A for details)

$$\mathbb{E}[V(t_0, \phi)] = \text{Tr} \left(E^T P + \sum_{i=1}^4 \tau_i(t_0) S_i \right), \quad (5.36)$$

This expectation is not completely defined due to the existence of the terms $\tau_i(t_0)$ that depend on the value of the delay at the instant t_0 which is unknown. For that we can minimize an upper bound of this expectation deduced from $\tau_i(t) \leq \bar{\tau}_i, \forall i \in \{1, 2, 3, 4\}$.

$$\mathbb{E}[V(t_0, \phi)] \leq \text{Tr} \left(E^T P + \sum_{i=1}^4 \bar{\tau}_i S_i \right), \quad (5.37)$$

The obtained upper bound (5.37) depends only on the variable matrices P and S_i . These matrices do not exist explicitly in the LMI constraint (5.20) given in Theorem 5.1, but they are related implicitly through the variable matrices $W = P^{-1}$ and $G_i = P^{-T} S_i P^{-1}$. An additional upper bound of the right side of the inequality (5.37) denoted $U \in \mathbb{R}^{n \times n}$ is introduced. This produces an additional variable in the problem, but it will lead to an optimal solution for it. The minimization of $\text{trace}(U)$ leads to the minimization of $\mathbb{E}[V(t_0, \phi)]$. The tools behind this optimization of U will be presented and explained in the next lemma.

Lemma 5.1 Consider a symmetric positive definite matrix $U \in \mathbb{R}^{n \times n}$ verifying the following inequality

$$E^T P + \sum_{i=1}^4 \bar{\tau}_i S_i < U, \quad (5.38)$$

The inequality (5.38) holds as long as the following LMI holds :

$$\begin{bmatrix} U & \begin{bmatrix} I_{n_1} \\ 0 \end{bmatrix} & & & & \\ \star & W_1 & & & & \\ \star & \star & W + W^T - \bar{\tau}_1 G_1 & \ddots & & \\ \star & \star & \star & \ddots & & 0 \\ \star & \star & \star & \star & W + W^T - \bar{\tau}_4 G_4 & \end{bmatrix} > 0, \quad (5.39)$$

Proof : The variables in the LMI (5.39) are U , W and G_i . Assume that this LMI is feasible, then the positive definite matrices G_i exists. Consider the following matrix product as a tool idea to prove this lemma. The following inequality holds for all $G_i > 0$ and $\bar{\tau}_i > 0$:

$$(W - \bar{\tau}_i G_i) (\bar{\tau}_i G_i)^{-1} (W - \bar{\tau}_i G_i)^T \geq 0, \quad (5.40)$$

which leads to the following inequality

$$W + W^T - \bar{\tau}_i G_i \leq W (\bar{\tau}_i G_i)^{-1} W^T. \quad (5.41)$$

Based on the feasibility of the LMI (5.39), we deduce for the diagonal term that $W + W^T - \bar{\tau}_i G_i > 0$ for all i and this sum is invertible. By inverting both sides in (5.41), we deduce that

$$0 < W^{-T} (\bar{\tau}_i G_i) W^{-1} \leq (W + W^T - \bar{\tau}_i G_i)^{-1}. \quad (5.42)$$

which is equivalent to say that

$$-\sum_{i=1}^4 (W + W^T - \bar{\tau}_i G_i)^{-1} \leq -\sum_{i=1}^4 W^{-T} (\bar{\tau}_i G_i) W^{-1} < 0, \quad (5.43)$$

From the expression of W and P given in (5.23) and (5.30) respectively, also the form of matrix E given in (4.42) and the product $WP = I_n$ gives the following condition concerning the matrix $P_1 > 0$ and $W_1 > 0$

$$P_1 = W_1^{-1}; \quad E^T P = \begin{bmatrix} I_{n_1} \\ 0 \end{bmatrix} W_1^{-1} [I_{n_1} \quad 0], \quad (5.44)$$

Based on (5.43) with the LMI constraint (5.39) assumed to be true, using Schur's complement we can write the following inequality

$$\begin{aligned} 0 < U - \begin{bmatrix} I_{n_1} \\ 0 \end{bmatrix} W_1^{-1} [I_{n_1} \quad 0] - \sum_{i=1}^4 (W + W^T - \bar{\tau}_i G_i)^{-1} \\ \leq U - \begin{bmatrix} I_{n_1} \\ 0 \end{bmatrix} W_1^{-1} [I_{n_1} \quad 0] - \sum_{i=1}^4 W^{-T} (\bar{\tau}_i G_i) W^{-1}, \end{aligned} \quad (5.45)$$

Finally from (5.44) and (5.45), we deduce that

$$0 < U - E^T P - \sum_{i=1}^4 \bar{\tau}_i S_i, \quad (5.46)$$

where as it is defined before, we have $S_i = W^{-T} (G_i) W^{-1}$ and this completes the proof.

After introducing the feasibility synthesis problem in Theorem 5.1 and the optimization of this solution in Lemma 5.1, we have to relate these points in a single optimized control synthesis. The constraints for the synthesis problem which guarantee the feasibility given in (5.19) and (5.20) as well as the optimization one in (5.39) will all be included. To sum up the optimization synthesis problem under the attached constraint, consider below the following optimization problem.

$$\begin{aligned} \min_{U, W, G_1, \dots, G_4, Y} \quad & \text{Tr}(U) \\ \text{subject to} \quad & \text{equations in (5.19, 5.20, 5.39)}. \end{aligned} \quad (5.47)$$

Remark 5.4 : An important notification is to be mentioned regarding the above synthesis problem. In fact the variable decision matrices included in the optimization problem with LMI constraints are not all symmetric due the singularity of the TCM model. The matrix $W(P^{-1})$ is not symmetric, the sub-matrix W_4 is a non-singular full rank $n_2 \times n_2$ matrix. Usually, these problems nowadays are solved using MatLab (LMI toolbox or Yalmip package). From this point-of-view and through the algorithm of solving the SDP problem, it is very possible to obtain singularity in this matrix. This leads to obtain a set of decision variables where they do not satisfy the synthesis constraints, since the solver considers that W_4 is only a square full matrix with no condition provided for its non-singularity. In order to avoid such a problem and to guarantee a non-singular solution for W , the sub-matrix W_4 is considered as a symmetric positive definite (i.e. $W_4 > 0$). This conditioning is conservative, but it is sufficient to avoid singularity.

5.4.3 Numerical example

In order to illustrate the above results, a numerical example is proposed. The objective of this example is to consider an arbitrary small-size time-delayed singular system and establish a state feedback controller based on the optimization problem in (5.47). For that let us consider the following system with the same general form of (5.1) but with $n = 2$ and $n_1 = 1$, and with two time varying delays ($q = 2$) and for simplicity we set $B_w = 0$. The system is given by the following equation

$$E\dot{x}(t) = A_0x(t) + A_1x(t - \tau_1(t)) + A_2x(t - \tau_2(t)) + B_uu(t), \quad (5.48)$$

where the matrices are given below

$$E = \begin{bmatrix} 1 & 0 \\ 0 & 0 \end{bmatrix}, A_0 = \begin{bmatrix} 2 & -2 \\ -0.7 & -6.4 \end{bmatrix}, A_1 = \begin{bmatrix} -0.5 & 0.3 \\ 0 & -0.9 \end{bmatrix}, \quad (5.49)$$

$$A_2 = \begin{bmatrix} -0.4 & 0 \\ 1 & -0.6 \end{bmatrix}, B_u = \begin{bmatrix} 2 \\ 1 \end{bmatrix},$$

Note that the matrix A_0 is not Hurwitz. This system (5.48) presents the case given in 5.7 where $B_{u,2} \neq 0$. This case is not exactly the one for TCM model (4.41) where $B_{u,2} = 0$. This case which has been already presented in the mentioned theorem, is little more complicated than the one for TCM model since it will impose a discontinuity at t_0 . An intermediate solution is to be provided later on to guarantee a continuous solution. We set the initial instant $t_0 = 0$. The time varying delays are given by the following continuous-time functions

$$\tau_1(t) = 0.5 + 0.3 \sin(t), \quad \tau_2(t) = 1 + 0.5 \sin(0.4t), \forall t \geq 0, \quad (5.50)$$

The bounds concerning time delays and their derivatives are given numerically by $\bar{\tau}_1 = 0.8$, $\bar{\tau}_2 = 1.5$, $d_1 = 0.3$ and $d_2 = 0.2$. The maximum delay is $\tau_{max} = \bar{\tau}_2 = 1.5$. The plot of these continuous delays are given in the figure below.

The time delay descriptor system is not completely defined yet, we need to choose a compatible initial condition $\phi(\cdot)$ that verifies the relation (5.6) in the case of two delay

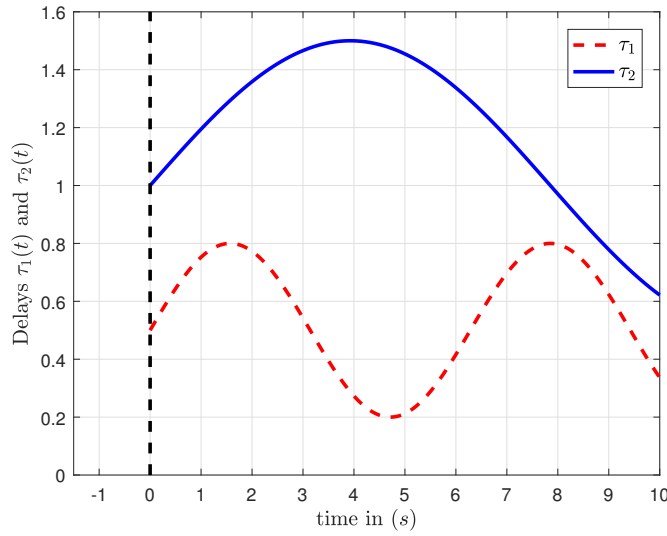

FIGURE 5.2 – System time delays τ_1 and τ_2 in function of time t .

descriptor system. ϕ can take any form. It is selected in the class of time affine functions of the form

$$\phi(t) = \begin{bmatrix} a_1 t + b_1 \\ a_2 t + b_2 \end{bmatrix}, \quad (5.51)$$

where the numerical values $a_1 = 1.3, b_1 = 2.5, b_2 = 0.2$ are chosen in the following way. For the aim of ensuring continuity in trajectory at instant t_0 , the value of a_2 will be determined verifying the relation (5.6) with $q = 2$. The found value is $a_2 = 2.028$. Unfortunately this is not sufficient for the continuity of the trajectory at t_0 , since the calculated value of a_2 stands for an autonomous system. Once the system is forced and enclosed by its state feedback gain, the equations of the system changes and ϕ is no more compatible. The discontinuity comes from the presence of the term $B_{u,2}u(t_0) = B_{u,2}K\phi(t_0)$. Forcing this term to be zero by using the input by using $u_\delta(t) = \delta(t)u(t)$ instead of $u(t)$, the continuity of the trajectory at t_0 can be guaranteed. $\delta(t)$ is a growth function that satisfies (5.9). Initializing the controller synthesis problem (5.47), the weighting matrices of this simple problem are chosen arbitrary such that

$$Q_x = \begin{bmatrix} 10 & 0 \\ 0 & 1 \end{bmatrix}, \quad R_u = 1, \quad (5.52)$$

The state feedback controller is obtained by solving the constrained optimization problem in (5.10) written in MATLAB R2016b using the SDP convex problem solver SDPT3-4.0 [TTT99, TTT03] and the convex programming package Yalmip [Löf04, Löf09, Löf12].

The numerical results are

$$\begin{aligned} W &= \begin{bmatrix} 0.192 & 0 \\ 0.168 & 1.220 \end{bmatrix}; P = W^{-1} = \begin{bmatrix} 5.200 & 0 \\ -0.719 & 0.819 \end{bmatrix}; G_1 = \begin{bmatrix} 0.005 & 0.070 \\ 0.070 & 1.764 \end{bmatrix}; \\ G_2 &= \begin{bmatrix} 0.034 & -0.098 \\ -0.098 & 0.333 \end{bmatrix}; S_1 = P^T G_1 P = \begin{bmatrix} 0.535 & -0.740 \\ -0.740 & 1.185 \end{bmatrix}; \\ S_2 &= P^T G_2 P = \begin{bmatrix} 1.838 & -0.617 \\ -0.617 & 0.224 \end{bmatrix}; U = \begin{bmatrix} 11.472 & -0.877 \\ -0.877 & 1.614 \end{bmatrix}; Y = [-2.000 \quad -1.000], \end{aligned} \quad (5.53)$$

The state feedback gain can be found by the relation $K = YW^{-1}$ giving the numerical value

$$K = [-9.682 \quad -0.819], \quad (5.54)$$

Note that the resolution of this optimization problem has resulted the values of $\text{trace}(U) = 13.087$ and $\text{trace}(E^T P + \sum_1^2 \bar{\tau}_i S_i) = 10.490$. The difference between these two values comes from the linearization of the non-linear inequality (5.38) in Lemma 5.1. As we have written for the definition of the compatible function ϕ , the used control input is $u_\delta(t) = \delta(t)u(t) = \delta(t)Kx(t)$ with $\delta(\cdot)$ is given by

$$\delta(t) = \begin{cases} \frac{1-e^{-500t^2}}{1-e^{-500\epsilon^2}}, & t \in [0, \epsilon], \\ 1, & t \geq \epsilon, \end{cases} \quad (5.55)$$

with $\epsilon = 0.5$. The weight δ is traced in the figure below. Simulating the closed loop

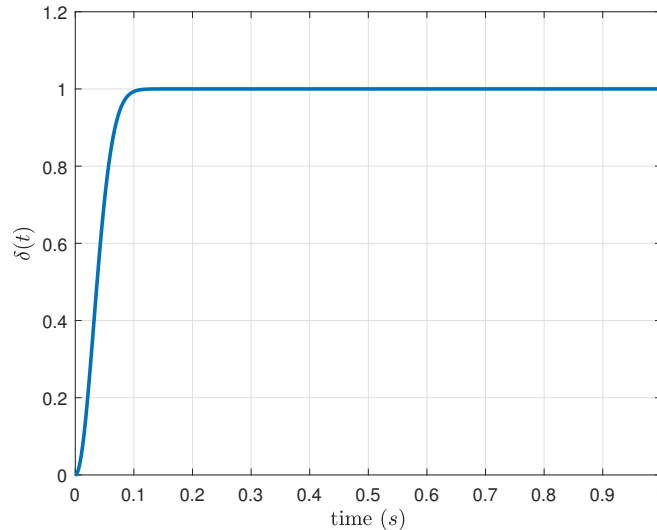
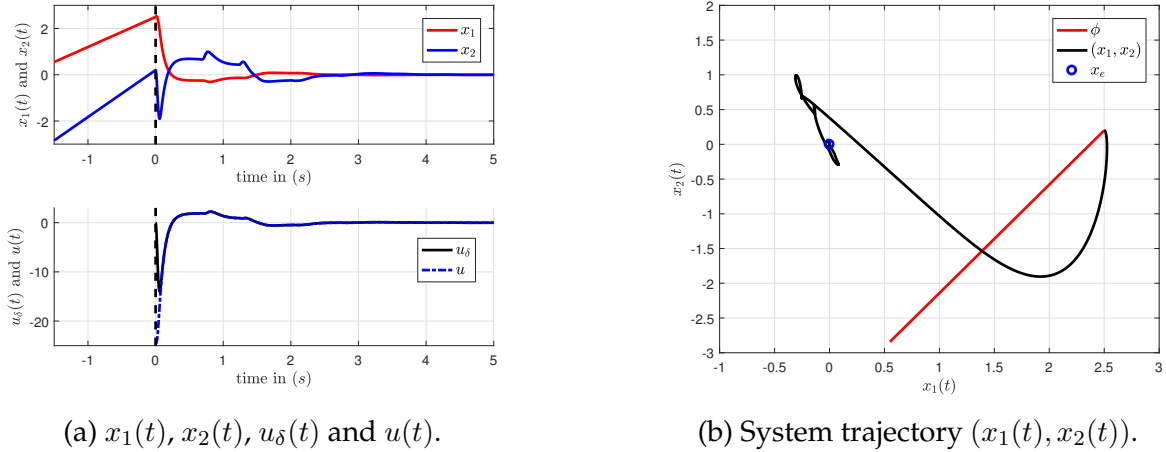

FIGURE 5.3 – Growth function δ in function of time t .

system under the effect of its initial condition ϕ , we obtain the curves in Figure 5.4 that show the evolution of the states x_1 and x_2 as well as control inputs $u_\delta(t)$ and $u(t)$. It is clear that the state trajectory converges to the origin.



(a) $x_1(t), x_2(t), u_\delta(t)$ and $u(t)$.

(b) System trajectory $(x_1(t), x_2(t))$.

FIGURE 5.4 – Simulating the closed loop system with $u_\delta(t) = \delta(t)Kx(t)$.

Looking carefully to the curves in the upper sub-plot of Figure 5.4a, we see the continuity of the states at the initial instant t_0 . This is obtained thanks to the effect of the continuous input u_δ that starts from 0 value (black curve) satisfying the algebraic relation (5.6) at t_0 . In contrast the initial value of the input u (blue dotted curve) at this instant is $u(t_0) = -24.37$ which will lead to a definite jump in the states trajectories if it is used instead of u_δ . Tracing down the trajectory of the system (x_1, x_2) in Figure (5.4b) in order to visualize the convergence, we see that it settles down at the origin corresponding to its equilibrium point denoted x_e . The red straight line corresponds to the history of the system defined by the compatible initial condition ϕ over the interval $[t_0 - \tau_{max}, t_0]$.

In order to point out how the user may modify the behavior of the trajectories $x(t)$ and the controlled input $u(t)$, the same optimization problem is considered by modifying only the weights of the cost \mathcal{J}_{LQ} , all other parameters kept the same.

$$Q_x = \begin{bmatrix} 10 & 0 \\ 0 & 1 \end{bmatrix}, \quad R_u = 0.001. \quad (5.56)$$

Without providing the obtained decision variable of the synthesis problem where they validate the associated synthesis constraints, the tuning of the performance weightings leads to the state feedback

$$K = [-1245.767 \quad -219.595], \quad (5.57)$$

The values of the components in the gain K in (5.57) are amplified compared to those in the previous gain (5.54), as if they are divided by the new value of R_u which was reduced from 1 to 0.001. Simulating once again the closed loop system with the new obtained gain under the same initial condition, we obtain the new state and input curves traced in the figure below.

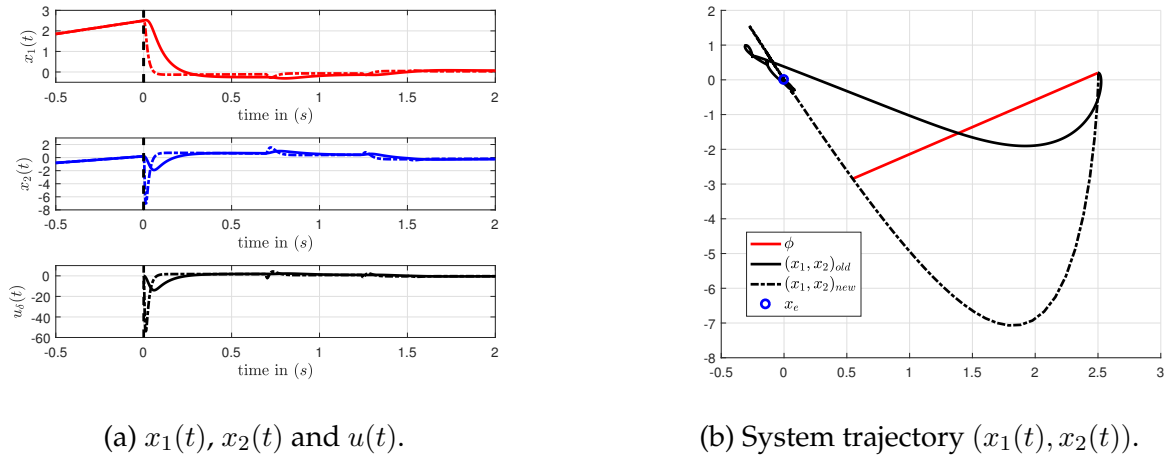

FIGURE 5.5 – Performance improvement induced by weighting tuning.

Based on the traced curves in Figure 5.5, the continuous line curves characterize the 1st case, while the dotted curves characterize the 2nd one. Comparing the plots associated with the state x_1 , the dotted curve associated to the 2nd weighting case tends to converge much more rapidly than the first one. For the other state $x_2(t)$, we can see the same rapidity in the convergence with small overshoot indicating the strong effort exerted by the input which contains approximately the same overshoot at the same instant. The difference in the obtained performance between the two weighting cases can be visualized more clearly by tracing the system trajectories, $(x_1, x_2)_{old}$ and $(x_1, x_2)_{new}$ for the 1st and 2nd cases respectively. The dotted black curve undergoes an overshoot before it is directed toward the equilibrium point x_e , which means that the control input accelerates the system to converge faster than the case before.

This short summarized example was given to motivate the methodology proposed in the synthesis (5.47). The same steps followed here will be applied for the TCM model. The scenario of controller synthesis is to be presented in details.

5.5 TCM Controller Synthesis

In this section the results obtained in section 5.2 concerning the state feedback synthesis will be applied on the TCM time delay singular system (4.41) as done in the previous numerical example. An important point to start with is to define completely the TCM system by providing its initial condition. According to Proposition 5.1, the system initial condition must satisfy certain algebraic conditions to ensure the continuity at the initial instant. Based on the TCM model given in (4.41) and (4.42) and comparing it to the arbitrary time delay singular system given in (5.1), we find that the matrix $B_{u,2}$ is zero. This recalls the case given in the algebraic condition (5.6). This means that the initial condition ϕ presented in (4.41) has to verify the relation in (5.6), such that it is compatible and ensures free impulsiveness within the trajectory. As the TCM process rolls cascaded steel coils consecutively, the history of the process can be easily recovered by visualizing the rolling measurement of the previous coil. For simplicity in the coming work, the function ϕ will be considered as a zero function for all the states

(i.e. $\phi = 0$). This chosen value satisfies the condition (5.6) and thus it guarantees the trajectory continuity at the instant t_0 .

The large size of the state vector as well as the input vector renders this step to be complicated, thus several consecutive synthesis of controllers are in need to arrive to the convenient one. Furthermore the numerical resolution and computation of the synthesis algorithm is not easy as in the case of the example given above, which takes few seconds to arrive to calculate the controller matrix and to simulate the closed loop system. The order of the TCM system impacts the resolution of the controller synthesis problem from the computational point of view, and also it impacts the simulation of the closed loop system under specific exogenous inputs. The cost function \mathcal{J}_{LQ} defined by the matrices Q_x and R_u are to be precised to initialize the synthesis problem. The idea behind precising these matrices is to force the system to attain certain performance in converging and rejecting the errors in the controlled outputs. This surely will need to tune these matrices conveniently according to the desired specifications. This tuning phase includes chronological steps which are to be applied to reach the targeted gain. These steps will be given as an algorithm in the next paragraph.

5.5.1 Controller Tuning

To start the simulation scenario of the TCM process, the tuning algorithm including the necessary steps are :

- Step 1 : Define the set of exogenous inputs (annealed thickness $h_{1,1}$, Tandem entry and exit tensions Σ_1 and Σ_2).
- Step 2 : Define or tune the matrices Q_z and R_u by precising the coefficients α_i and β_j .
- Step 3 : Initialize the optimization synthesis problem (5.47) under the constraints (5.20) and (5.39) and obtain the state feedback gain K .
- Step 4 : Simulate the closed-loop system and analyze the errors on the outputs as well as the transient behavior of the system.
- Step 5 : if the desired performance, error ranges and transient performances are acceptable, then the synthesis is done. If not, go back to Step 2.

Applying these steps will permit us to find the controller, starting by this list we have :

— Step 1 :

Defining the exogenous inputs : these inputs are chosen in a way to simulate the behavior of the system. Suppose that the tandem will face an error in the annealed thickness in the form of a single square signal which reveals deviation from the nominal value. An 0.4 mm error in the annealed thickness $h_{1,1}$ that resembles about 15% of the nominal thickness value, is applied at the instant $t = 10s$ as shown in the Figure (5.6). This error is considered to be high compared to the real industrial errors that usually do not exceed 7% of the annealed nominal value $\bar{h}_{1,1}$. Keep in mind that we plot here the relative values of the physical quantities denoted $(\Delta\theta)$.

As we look to this error, we find that it is not an exact square shaped one as already mentioned. At the instants $t = 10s$ and $dt = 30s$, we observe a respective smooth rise and smooth fall in this error. This shape is produced by filtering a

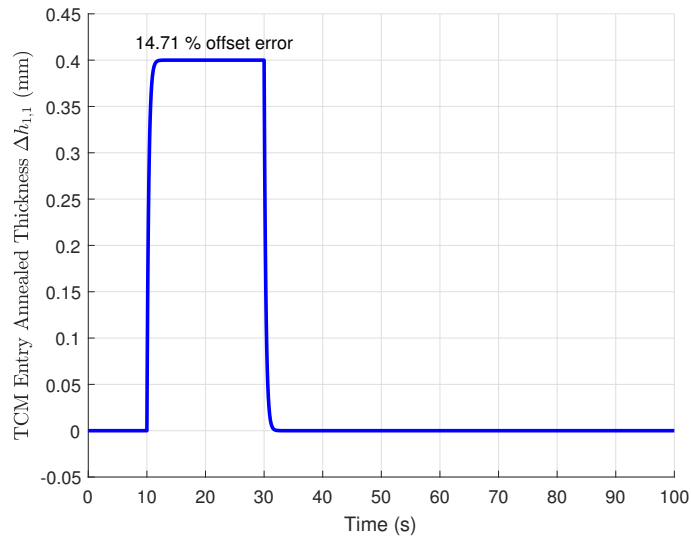
FIGURE 5.6 – Step error in the entry thickness $h_{1,1}$.

single period square signal by means of a first order lagging system. This filtering was applied to remove the sharp discontinuity produced at the instants $t = 10s$ and $t = 30s$, which they will be transmitted to the outputs in the case they were left in $\Delta h_{1,1}$. The propagation of discontinuities from inputs to the outputs can be easily interpreted according to the linearity property of the TCM system. For the other two exogenous inputs, the entry and exit tensions Σ_1 and Σ_2 we have done the same filtering to remove step rising discontinuity as it is shown in the Figure (5.7).

(a) Step error in the entry tension Σ_1 .(b) Step error in the exit tension Σ_2 .

FIGURE 5.7 – Errors in the entry and exit tension forces of TCM.

Errors of approximately 2.5% and 1% are applied to the entry and exit TCM tensions, these values are chosen conveniently with the real time variations of these quantities. They are applied respectively at the instants $t = 10s$ and $t = 20s$ to superpose them from the annealed thickness step error. This will permit us to

visualize separately the effect of each error on the system.

— Step 2 :

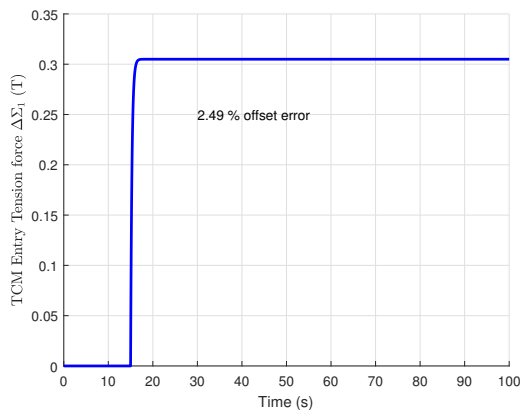
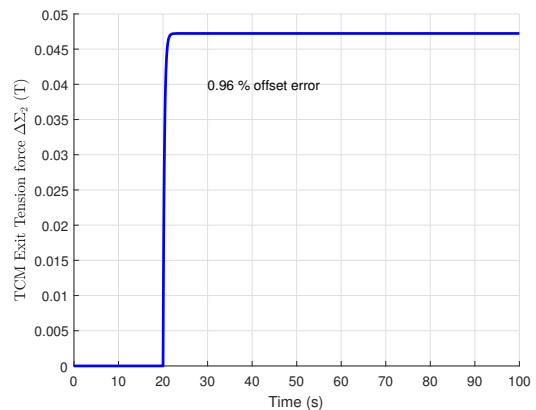
In this step the weighting matrices given in (5.12) have to be defined. As it is the case of first synthesized controller, the values of α_i and β_j are all set to unity (i.e. $\alpha_i = \beta_j = 1, \forall i, j$). Surely there will be a second tuning step after this one since in the first step, all the quantities have same importance thanks to the normalization matrices Q_i and R_j .

— Step 3 :

After initializing the necessary data, the resolution of the OP in (5.10) can be started.

Denote K_0 the controller established from the initial synthesis. The resolution of an execution of this algorithm for the synthesis of one controller takes about 35 minutes for 67 iterations. During the execution 6 GB of the available RAMs was used, it is important to mention that the computing machine needs to reserve a memory size larger than the average memory size used during LMI resolution. At the end, we obtain our state feedback gain K_0 and thus we can simulate now our closed loop system under the impact of the chosen exogenous inputs. Assume that the frictions in all stands are fixed to their nominal values (i.e. $\Delta\mu_i = 0$). Due to the large number of physical quantities in the TCM model (44 states, 10 inputs and 54 outputs), it is hard to present them all. For that we have chosen only some quantities that we can count-on in the evaluation of the system performance. The chosen quantities result from the closed loop simulation, are traced in Figure 5.8. Referring to Figure 5.8a the maximum error in the exit thickness of the first stand is about 13.2% while that in the fifth stand is about 16.4% as shown Figure 5.8b. Further more about 6% maximum error has obtained in the tension T_{12} as seen in Figure 5.8c as well as 28% in the tension T_{45} traced in Figure 5.8d. The stands exit thicknesses $h_{2,i}$ are traced in Figure 5.8e next to the interstand tensions in Figure 5.8f to visualize the errors in these quantities. We noticed that the variation in Σ_1 and Σ_2 have no direct effect on the system outputs. The errors mainly are affected by that in $h_{1,1}$. The presence of these errors requires a modification in the performance of the closed loop system. Tuning the weightings α_i and β_j in (5.12) in the cost \mathcal{J}_{LQ} in (5.11) permits to reduce these errors and improve the behavior of the closed-loop system. The errors are to be managed one by one in the tuning phase, hence we should go back to step 2. In order to decrease the error in the exit thickness of the first stand, we need to increase the weight of the integral action of $h_{2,1}$ which is I_1 the 8th component in the vector z , thus $\alpha_8 = 10^4$. Moving to step 3, we run the algorithm to obtain K_1 . The simulation of the closed loop system with the new gain K_1 gives the signals in Figure 5.9.

As we see in Figure 5.9a the maximum error of $h_{1,1}$ is reduced to about 10% with an exponential decreasing slope, but taking a look on the interstand tensions T_{12} and T_{45} we notice that they attain high overshoot error as shown in figures 5.9c and 5.9d. Also an increase in the error of the exit thickness $h_{2,5}$ from 5% to about 6.5%. Thus further tuning steps are necessary to arrive to an acceptable weighting configuration. Successive weighting combinations were tested and examined, but it is difficult to introduce all of them. For this reason only one more tuning step is to be presented just to show

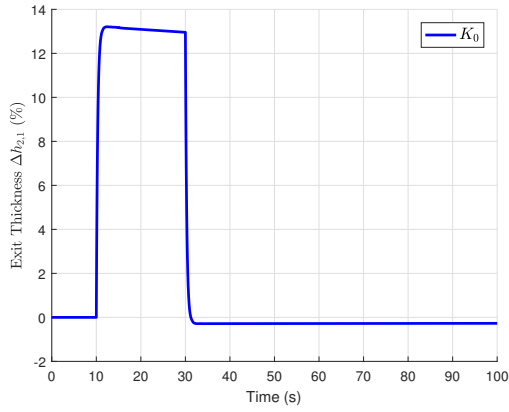

(a) Exit thickness $\Delta h_{2,1}$

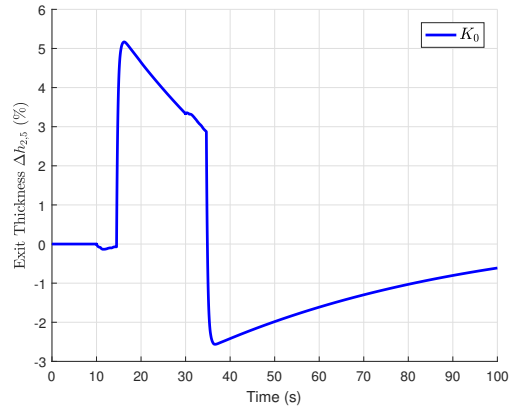

(b) Exit thickness $\Delta h_{2,5}$

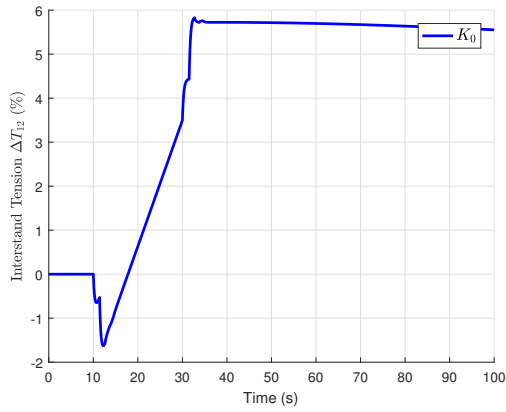

(c) Interstand tension ΔT_{12}

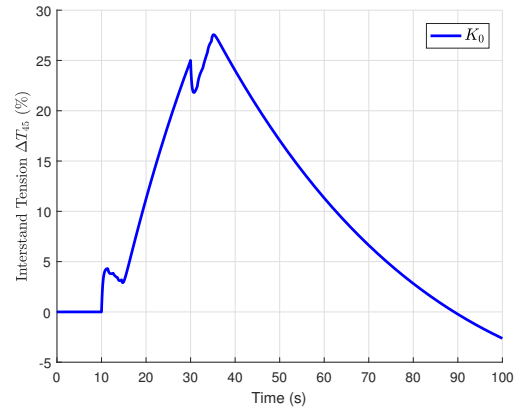

(d) Interstand tension ΔT_{45}

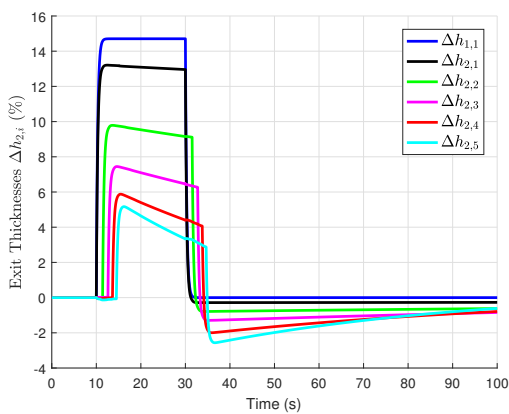

(e) Exit thicknesses $\Delta h_{2,i}$

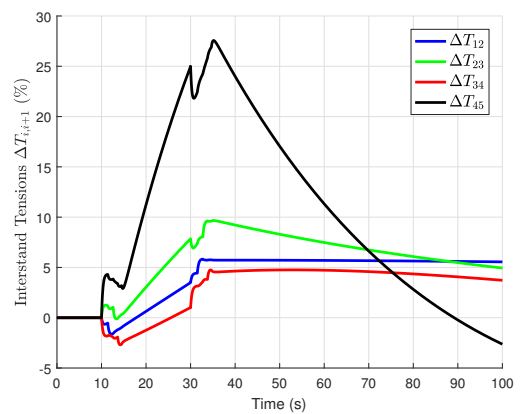

(f) Interstand tensions $\Delta T_{i,i+1}$

FIGURE 5.8 – Closed loop system response in the case of K_0

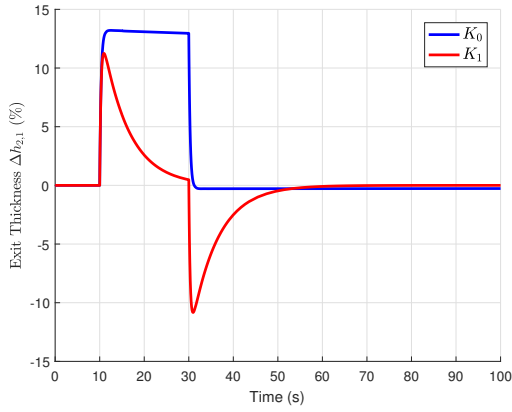

(a) Exit thickness $\Delta h_{2,1}$

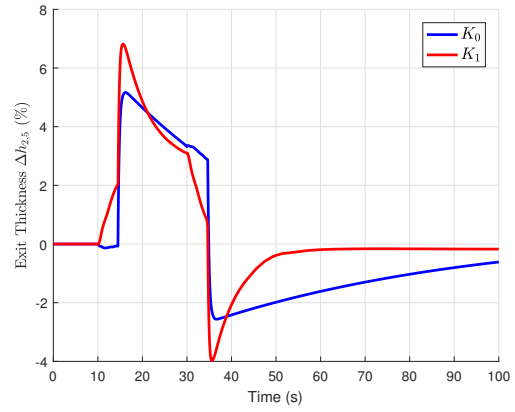

(b) Exit thickness $\Delta h_{2,5}$

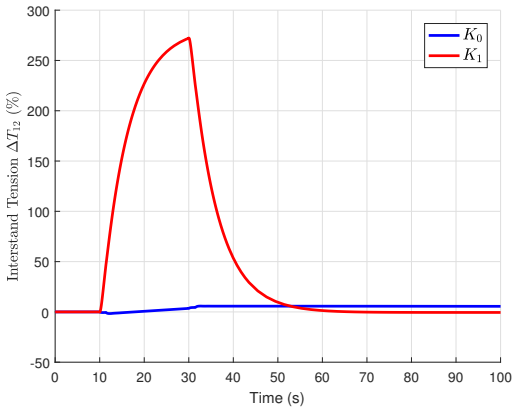

(c) Interstand tension ΔT_{12}

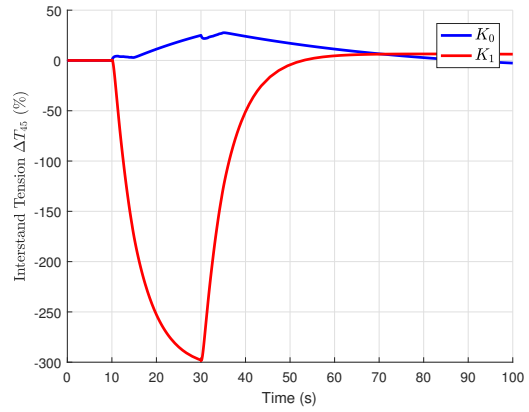

(d) Interstand tension ΔT_{45}

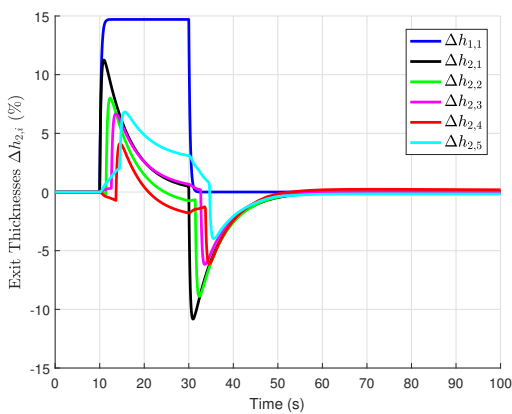

(e) Exit thicknesses $\Delta h_{2,i}$

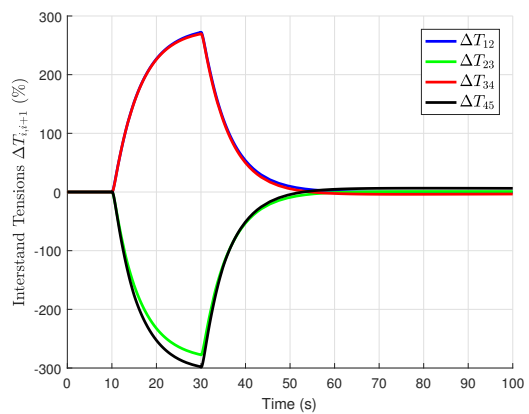

(f) Interstand tensions $\Delta T_{i,i+1}$

FIGURE 5.9 – Closed loop system response in the case of K_1

the scenario of tuning. A new combination given in the table 5.1 below produces K_2 . These parameters aim to reduce significantly the overshoot error in the all interstand tensions, and in priority the error in the exit thickness $h_{2,5}$.

weight $\alpha_i(\theta)$	Value
$\alpha_3(T_{12})$	10^7
$\alpha_8(I_1)$	10^8
$\alpha_{51}(I_5)$	10^6

TABLE 5.1 – Tuning weighting coefficients α_i

Recall that I_i are the integral actions defined in (4.20). Simulating the closed loop system under the exogenous inputs given in figures 5.6 and 5.7 we obtain the following curves shown in Figure 5.10.

Observing the results of the simulation of the TCM model coupled with the controller K_2 , we can see that the overshoot errors are reduced and minimized very well. Figure 5.10b shows an efficient regulation of the error in the exit thickness $h_{2,5}$, the error is reduced from 6.5% to 2% which is an acceptable result as required by the industrial specifications which demand an error less than 2.5%. Moreover the errors in interstand tensions are reduced very well from a value around 300% referring to the Figure 5.9f to a value below 80% as shown in Figure 5.10f which is permitted compared to the industrial tension variation limits that allow tensions to variate between 3 tonnes and 120 tonnes.

This simulation demonstrates that the tuning of the controller can be continued to investigate and treat other specifications. It is a suitable method for regulating such large size complicated process. A user can easily manage the control strategy through configuring the suitable combination of weightings. Behind this tuning, a mono-objective problem includes a multi-objective synthesis problem characterized by the different goals in the industrial specifications. Important issues are to be mentioned for the above simulations regarding the complexity of the resolved synthesis problem.

5.6 Conclusion

In this chapter, various fundamental points were treated regarding the treatment of the problem of multi-variable control for Tandem Cold Mill. After investigating the necessary conditions for the existence, uniqueness and continuity of the solution for the TCM model, a general control methodology was provided. It includes the various control options that can be considered during this multi-variable model based control. Meanwhile a first control approach for state feedback synthesis was presented. This synthesis based on proposing cost performance function and energy upper bound functional, was explained and treated. Many notifications and remarks were given to well explain and clarify the strategy of synthesis. Illustrative examples on arbitrary system case as well as on the TCM system was given with their associated simulating results. The case treating the example of the TCM process model provides detailed algorithm about controller tuning. This reveals that the state feedback synthesis has reached its objectives and the general control paradigm is suitable and can be

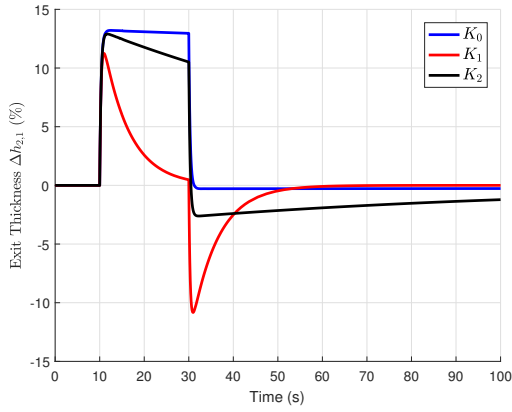

(a) Exit thickness $\Delta h_{2,1}$

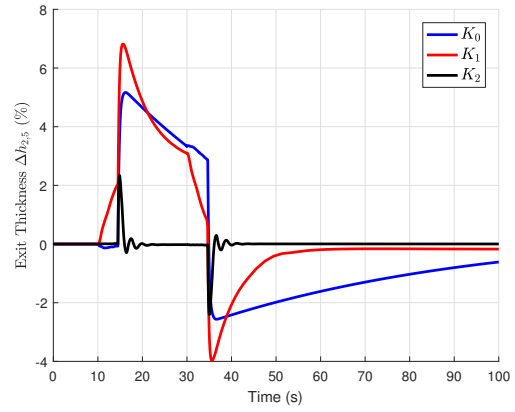

(b) Exit thickness $\Delta h_{2,5}$

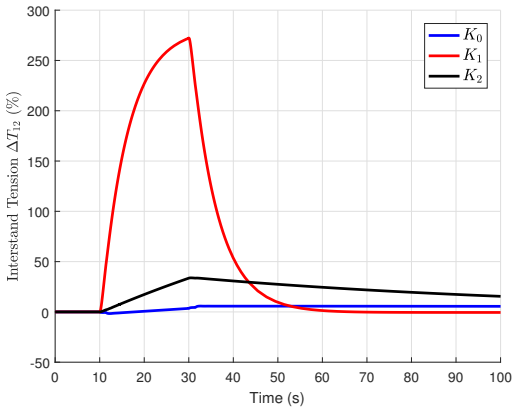

(c) Interstand tension ΔT_{12}

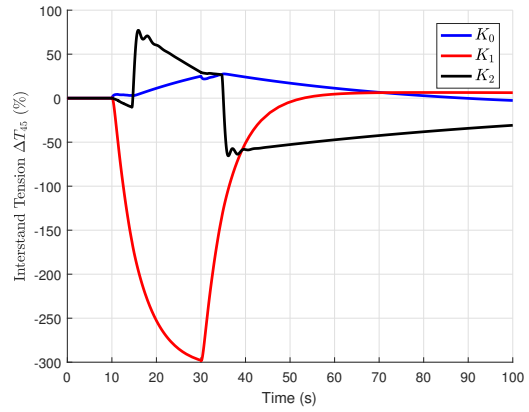

(d) Interstand tension ΔT_{45}

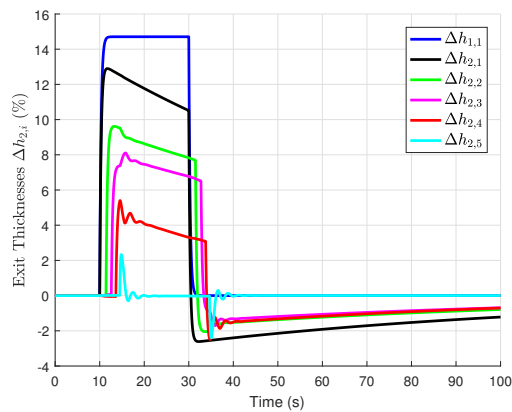

(e) Exit thicknesses $\Delta h_{2,i}$

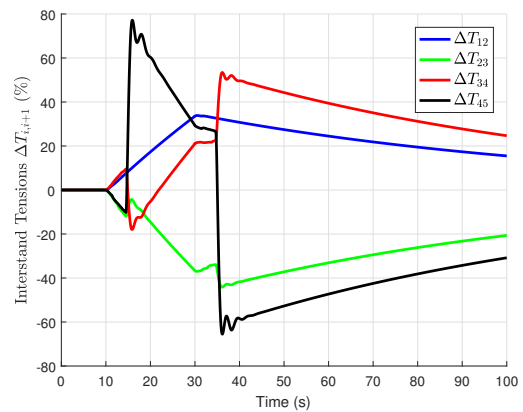

(f) Interstand tensions $\Delta T_{i,i+1}$

FIGURE 5.10 – Closed loop system response in the case of K_2

used generally for other multi-variable control synthesis. As a conclusion, this paradigm will be used furthermore in the next chapter to establish another control strategy for the process.

Chapter 6

Dynamic Output Feedback Control for TCM Process

Contents

6.1	Introduction	91
6.2	Output Feedback Synthesis	92
6.2.1	Problem Formulation	92
6.2.2	Closed Loop System Model	94
6.2.3	Control Design : Synthesis Analysis	95
6.2.4	LMI formulation of the Synthesis Problem	98
6.3	Dynamic Output Feedback Feasibility Problem	103
6.3.1	Controller Synthesis via LMI Feasibility Problem	104
6.3.2	Numerical example	105
6.4	DOF Synthesis for the TCM Process	111
6.5	Conclusion	111

6.1 Introduction

In the case of TCM multivariable control problem, a basic assumption is considered in the previous chapter to build up the state feedback gain. This solution was established assuming that all physical variables are measured, which is not the case in the real tandem process. Several physical quantities are unmeasured due to the complexity of the process or the absence of a corresponding sensor. For that a control solution based on the measured outputs is to be synthesized. The problem now is modified to a synthesis of an output based controller for the TCM process. The absence of several measurements in the tandem process imposes to find another solution for the associated control problem. It is possible to estimate the unmeasured quantities by establishing an estimator or observer such as Kalman-observer. For the TCM problem and due to the noises in the available measurements added to the model uncertainties issued from linearization, it requires a special control strategy. A dynamic output

feedback (DOF) controller can be a solution. In the literature, several LMI based analysis and synthesis methods have been introduced for singular system control problems such as [MKOS97, TK98]. In this chapter we consider the LMI approach for the multiple objective output feedback control problem for descriptor systems. The method for non-descriptor system is given in [SGC97] with different multiple objective characterization. The idea is to control a generalized linear plant such that the closed loop is asymptotically stable. The motivation of considering multiple objectives is due to the practical requirements, not only to have for example a desired performance but also to guarantee a certain robustness [Sch95b].

6.2 Output Feedback Synthesis

Here we consider the generic form of the optimization problem discussed in details in chapter 5. The single difference relies in the assumption relative to the state availability. In this chapter, only the measured output are accessible instead of the whole state. The main consequence is the class of controllers to reach a solution of the optimization problem : a dynamic output feedback (DOF) will be used.

6.2.1 Problem Formulation

In this chapter a multiple objective control by a dynamic output feedback for time delay singular system will be treated. Consider first of all the TCM system given in (4.41) with the including matrices given in (4.42). The initial condition ϕ of the TCM system verifies the compatibility condition given in (5.6), while those regarding time delay and their derivatives are provided in (4.13) and (4.18) respectively. These conditions added to the continuity constraint of the variable delays ensure the existence and uniqueness of the system trajectory. Our aim is to find a dynamic output feedback controller which is seen as another system coupled to the process system. Consider the following general model of the mentioned controller

$$\begin{aligned} E_K \frac{d}{dt} \eta(t) &= A_K^0 \eta(t) + \sum_{i=1}^4 A_K^i \eta(t - \tau_i(t)) + B_K y(t), \\ u(t) &= C_K \eta(t) + D_K y(t), \\ \eta(t_0 + \xi) &= \phi_K(t_0 + \xi); \quad \xi \in [-\tau_{max}; 0]; \quad \phi_K \in \mathcal{C}_{\tau_{max}, n_K} = \mathcal{C}([t_0 - \tau_{max}; t_0], \mathbb{R}^{n_K}), \end{aligned} \tag{6.1}$$

where $A_K^i, E \in \mathbb{R}^{n_K \times n_K}$, $B_K \in \mathbb{R}^{n_K \times n_y}$, $C_K \in \mathbb{R}^{n_u \times n_K}$ and $D_K \in \mathbb{R}^{n_u \times n_y}$. The matrix E_K will be discussed later if it is singular or not. The initial condition ϕ_K is a compatible function representing the history of the dynamic output feedback. The function ϕ_K satisfies certain conditions similar to that in (5.6) for ϕ , which ensures the continuity at the instant t_0 . This general time delay descriptor form should be discussed and explained in terms of its state vector size n_K , the existence of the delayed states $\eta(t - \tau_i(t))$ and the condition needed to be satisfied by ϕ_K to ensure continuity at the initial instant. The controller is taken in this form to include the same aspects as that of the TCM system (4.41). We are going to consider some assumptions in order to precise enough

the structure of the controller. So before proceeding to the synthesis of this controller, it is important to indicate some points.

(i) State vector size n_K

It is important to precise the size of the state vector of the controller in order to fix the size of the matrices we are looking for. In order to release the constraints, a full order controller is chosen, that is $n_K = n$.

(ii) Singularity of the dynamic controller

The presence of the singular matrix E in the model (6.1) asks here whether the output feedback controller is a simple LTI delayed system (E_K is invertible non-singular) or delayed descriptor system (E_K being singular). If the controller is taken as an LTI delayed system, this will introduce a number of differentials superior to that of the process. Using more derivatives in the controller than the TCM model will be redundant, so it is sufficient to take the differential part of the controller the same as that of the process system. Thus the matrix E_K is a singular matrix such that $E_K = E$, and the controller differential state vector denoted η_1 is of size n_1 same as x_1 . On the other hand, the rest of the state vector is the controller algebraic vector denoted η_2 of size n_2 same as x_2 .

(iii) Delayed states in the controller

The presence of delayed states in the dynamic controller (6.1) compensates the delay effects in the process system (4.41). But in our case, the controller input y contains no time delay states. Moreover, the delays in the process are not measured (inter-stand strip speeds $V_{i,i+1}$ are not measured). Thus we can't use controller delayed DOF state. Hence there will be no delayed states in the structure of the controller (i.e. $A_K^i = 0; i = 1, 2, 3, 4$). But the use of delayed time controllers to compensate the delays in processes is becoming more important in the domain of time delay control. If these delays or some of them are measured, it might be an alternative tool to manage directly the delays in the TCM model. For that we have introduced a generalized model for the controller in (6.1).

In the frame of the above mentioned points and for simplicity denote $A_K := A_K^0$, the output feedback dynamic controller can be written in the form below

$$\begin{aligned} E_K \frac{d}{dt} \eta(t) &= A_K \eta(t) + B_K y(t), \\ u(t) &= C_K \eta(t) + D_K y(t). \end{aligned} \quad (6.2)$$

The partition of the state vector between differential sub-vector η_1 and algebraic sub-vector η_2 permits to write the matrices E_K, A_K and B_K in the following form

$$E_K = \begin{bmatrix} I_{n_1} & 0 \\ 0 & 0 \end{bmatrix}; A_K = \begin{bmatrix} A_{1,K} & A_{2,K} \\ A_{3,K} & A_{4,K} \end{bmatrix}; B_K = \begin{bmatrix} B_{1,K} \\ B_{2,K} \end{bmatrix}. \quad (6.3)$$

The model of the controller in (6.1) is a descriptor system which has to be regular and impulse free [Dai89, HB09] for the existence and uniqueness of its solution trajectory which is already discussed for the TCM system. The initial condition $\eta_0 = \eta(t_0)$ must satisfy certain relation to avoid discontinuity at the initial instant t_0 . Rewriting

the first equation in (6.2) using the decomposition of controller matrices in (6.3) and the expression of $y(t)$ in (4.41), we obtain the differential and algebraic equation below

$$\begin{aligned}\dot{\eta}_1 &= A_{1,K} \eta_1(t) + A_{2,K} \eta_2(t) + B_{1,K} C_y x(t), \\ 0 &= A_{3,K} \eta_1(t) + A_{4,K} \eta_2(t) + B_{2,K} C_y x(t),\end{aligned}\tag{6.4}$$

The evolution of the states of the output feedback controller must be continuous, because any discontinuity in their evolution will lead to presence of discontinuities in the states of the process and the latter propagates through the trajectory due to the delay effect. From (6.4) we conclude that the initial condition in the controller $\eta_0 = \text{col} \{ \eta_1(t_0), \eta_2(t_0) \}$ satisfies the following condition

$$0 = A_{3,K} \eta_1(t_0) + A_{4,K} \eta_2(t_0) + B_{2,K} C_y x(t_0).\tag{6.5}$$

Remark 6.1 : As it was mentioned in the description of the DOF controller, it must be regular and impulse free. This means that the controller will not have impulses and will admit a unique trajectory solution $\eta(t, \eta_0)$ over $[t_0; \infty)$. The existence and uniqueness of this solution can be proved in the same way as $x(t, \phi)$ for the TCM system (4.41) given in Proposition 5.1. Note that free impulsiveness means that $A_{4,K}$ is a non-singular matrix [XDSL02, XL06]. Knowing the value of $x(t_0) = \phi(t_0)$, the value of $\eta_1(t_0)$ is to be fixed by the user and the value of $\eta_2(t_0)$ will be calculated using (6.5) to obtain a compatible initial condition η_0 . If the initial condition η_0 can not be chosen conveniently, an alternative tool may be used to avoid impulsiveness in the TCM trajectory $x(t)$. This tool is already used in the previous chapter in the case of $B_{u,2} \neq 0$. In order to impose the continuity of the closed loop trajectory, the control input will be modified to the new input $u_\delta(t) = \delta(t)u(t)$ where $\delta(t)$ is a weighting continuous growth function.

6.2.2 Closed Loop System Model

As it has been introduced in chapter 5, the controller has been obtained by the optimization problem given in (5.10). By considering here the DOF defined by (6.2) and by assuming for the moment that $\Delta d = 0$ and $\Delta \mu = 0$, we obtain the following closed loop system :

$$\begin{aligned}\mathcal{E} \frac{d}{dt} x_c(t) &= \mathcal{A}_0 x_c(t) + \sum_{i=1}^4 \mathcal{A}_i x_c(t - \tau_i(t)), \\ z(t) &= \mathcal{C}_z x_c(t), \\ \phi_c(t_0 + \xi) &= \begin{cases} \begin{bmatrix} \phi(t_0 + \xi) \\ 0 \end{bmatrix}, \forall \xi \in [-\tau_{max}; 0[\\ \begin{bmatrix} \phi(t_0) \\ \eta_0 \end{bmatrix}, \xi = 0,\end{cases}\end{aligned}\tag{6.6}$$

$$x_c(t_0 + \xi) = \phi_c(t_0 + \xi); \phi_c \in \mathcal{C}_{\tau_{max}, 2n} = \mathcal{C}([t_0 - \tau_{max}; t_0], \mathbb{R}^{2n}); \eta_0 \in \mathbb{R}^{n_K}$$

where $x_c = \text{col}\{x, \eta\} \in \mathbb{R}^{2n}$ as in our case we admitted that $n = n_K$. The matrices \mathcal{E} , \mathcal{A}_0 , $\mathcal{A}_i \in \mathbb{R}^{2n \times 2n}$ and $\mathcal{C}_z \in \mathbb{R}^{n_z \times 2n}$ have the following structure

$$\mathcal{E} = \begin{bmatrix} E & 0 \\ 0 & E_K \end{bmatrix}; \mathcal{A}_0 = \begin{bmatrix} A_0 + B_u D_K C_y & B_u C_K \\ B_K C_y & A_K \end{bmatrix}; \mathcal{A}_i = \begin{bmatrix} A_i & 0 \\ 0 & 0 \end{bmatrix}; \mathcal{C}_z = [C_z \ 0], \quad (6.7)$$

Also the initial conditions ϕ and η_0 satisfy respectively the algebraic equations (5.6) and (6.5), which render ϕ_c to be compatible. The controller compatible initial condition $\eta_0 = \text{col}\{\eta_1(t_0), \eta_2(t_0)\}$ depends only on the choice of $\eta_1(t_0)$, since $\eta_2(t_0)$ is deduced directly based on the algebraic relation (6.5) guaranteed by the non-singularity of $A_{4,K}$. This ensures that the closed loop system admits a solution and it is unique. If the user chooses both components of η_0 not respecting this relation, a discontinuity will appear for sure. Therefore it is important to consider this point at the moment of initial condition definition. On the other hand the regularity and free impulsiveness of the TCM model as well as its DOF controller render the same characterization for the closed loop system (6.6). The idea of this synthesis is to obtain finally the stability of the closed loop system.

6.2.3 Control Design : Synthesis Analysis

After the definition of the general form of the closed loop system, we can begin the design of our DOF controller. The solution of the paradigm in (5.10) is the DOF controller. Thus the synthesis algorithm under the constraint equations given in (6.6) and other derived LMI constraint will establish the DOF solution. In the frame of this type of control, various researches have been developed for the singular systems such as [TK98, MKOS97, RA99] with different performance characterizations in each one. But for the delayed descriptor systems, the work done is limited since the treated problem leads usually to non-linear matrix inequality constraints which are hard to be resolved. Some techniques to avoid non-linearity in problem constraint were developed. One of them is the change of variable technique given in [SGC97]. From the optimization problem given in the previous chapter, consider the same framework related to the performance cost function \mathcal{J}_{LQ} given in (5.11) and the general energetic Lyapunov-Krasovskii upper bound functional given in (5.16) to be used in this case. A homologous paradigm is going to be followed but with different mathematical tools to be adapted to arrive to LMI formulation. Shedding the light on the criterion inequality in (5.10), the cost \mathcal{J}_{LQ} is expressed in the previous chapter by the state vector x and the input vector u . For the closed loop system in the present case, the problem is based on the vector $x_c = \text{col}\{x, \eta\}$ and the vector $u = C_K \eta + D_K y = [D_K C_y \ C_K] x_c$. It is good to mention that the presence of time delays in the closed loop system establishes a dependency of the cost \mathcal{J}_{LQ} on the initial compatible conditions ϕ and η_0 (i.e. ϕ_c), since the cost integrates the trajectory from the initial instant t_0 . Also the control input u depends on the same initial conditions at initial instant, since we have $u(t_0) = C_K \eta(t_0) + D_K C_y x(t_0)$. Thus we can write $\mathcal{J}_{LQ} = \mathcal{J}_{LQ}(\phi_c)$. Referring to the equations in (6.3) and (6.6), \mathcal{J}_{LQ} can be expressed in terms of the vector x_c only as the following

$$\mathcal{J}_{LQ}(\phi_c) = \int_{t_0}^{\infty} (x^T(s) Q_x x(s) + u^T(s) R_u u(s)) ds = \int_{t_0}^{\infty} x_c^T(s) [Q_c + \mathcal{C}^T R_u \mathcal{C}] x_c(s) ds, \quad (6.8)$$

where the matrices Q_x and R_u are the same ones presented in (5.11) and (5.12). The new matrices Q_c and \mathcal{C} are defined by

$$Q_c = \begin{bmatrix} Q_x & 0 \\ 0 & 0 \end{bmatrix}; \quad \mathcal{C} = [D_K C_y \quad C_K], \quad (6.9)$$

This quadratic function which includes implicitly the weightings α_i and β_j ensures the desired performance of the closed loop system through tuning these coefficients. On the other hand, a Lyapunov-Krasovskii functional can be chosen as a candidate to be the upper bound energy functional of the closed loop system which is a time delay singular system. In this case, the functional is expressed below in terms of the closed loop system vector x_c .

$$\mathcal{V}(t, x_{ct}) = x_c^T(t) \mathcal{E}^T \mathcal{P} x_c(t) + \sum_{i=1}^4 \int_{t-\tau_i(t)}^t x_c^T(s) \mathcal{S}_i x_c(s) ds, \quad (6.10)$$

where $\mathcal{P} \in \mathbb{R}^{2n \times 2n}$ is a non-singular matrix and the matrices $\mathcal{S}_i \in \mathbb{R}^{2n \times 2n}$ are positive definite symmetric ones, the singular matrix \mathcal{E} is given already in (6.7). After we have defined the structure of the DOF controller, we will move now for LMI analysis to elaborate the constraint of the synthesis problem.

Theorem 6.1 : Consider the time delay singular system given in (6.6) under the conditions concerning the time delays given in (4.13) and (4.18), also the initial conditions ϕ and η_0 that validate the algebraic constraints in (5.6) and (6.5) respectively. The closed loop system with the DOF is asymptotically stable if there exist symmetric positive definite matrices $0 < \mathcal{S}_i = \mathcal{S}_i^T \in \mathbb{R}^{2n \times 2n}$, where $i \in \{1, 2, 3, 4\}$, a non-singular matrix $\mathcal{P} \in \mathbb{R}^{2n \times 2n}$ and the DOF matrices A_K, B_K, C_K and D_K such that the equation (6.11)

$$\mathcal{E}^T \mathcal{P} = \mathcal{P}^T \mathcal{E} \geq 0, \quad (6.11)$$

and the non-linear inequality below

$$\Phi_c = \begin{bmatrix} \Omega_1 & \mathcal{P}^T \mathcal{A}_1 & \mathcal{P}^T \mathcal{A}_2 & \mathcal{P}^T \mathcal{A}_3 & \mathcal{P}^T \mathcal{A}_4 \\ * & -(1-d_1)\mathcal{S}_1 & 0 & 0 & 0 \\ * & * & -(1-d_2)\mathcal{S}_2 & 0 & 0 \\ * & * & * & -(1-d_3)\mathcal{S}_3 & 0 \\ * & * & * & * & -(1-d_4)\mathcal{S}_4 \end{bmatrix} < 0, \quad (6.12)$$

are verified, with

$$\Omega_1 = \mathcal{A}_0^T \mathcal{P} + \mathcal{P}^T \mathcal{A}_0 + \sum_{i=1}^4 \mathcal{S}_i + Q_c + \mathcal{C}^T R_u \mathcal{C}, \quad (6.13)$$

and the constants d_i already defined in (4.18).

Proof : In the synthesis problem present in (5.10), the inequality criterion expressed with the new chosen functions is

$$\mathcal{J}_{LQ}(\phi_c) \leq \mathcal{V}(t_0, \phi_c) = \phi_c^T(t_0) \mathcal{E}^T \mathcal{P} \phi_c(t_0) + \sum_{i=1}^4 \int_{t_0-\tau_i(t_0)}^{t_0} \phi_c^T(s) \mathcal{S}_i \phi_c(s) ds. \quad (6.14)$$

If we look carefully to the inequality constraint (6.12), we'll realize that it is not linear. The non-linearity of the obtained constraint is again a problem and it need to be managed. Thus using some mathematical tools we can find an equivalent LMI sufficient for our controller synthesis.

The proof of the theorem here is easy and very close to that in theorem (5.1), for that we need to consider that the included assumptions (6.11) and (6.12) are verified. Denote the vector ζ_c given below

$$\zeta_c(t) = \begin{pmatrix} x_c(t) \\ x_c(t - \tau_1(t)) \\ x_c(t - \tau_2(t)) \\ x_c(t - \tau_3(t)) \\ x_c(t - \tau_4(t)) \end{pmatrix}. \quad (6.15)$$

By pre and post multiplying of $\Phi_c < 0$ by the vector $\zeta_c^T(t)$ and $\zeta_c(t)$ respectively, we obtain $\zeta_c^T(t)\Phi_c\zeta_c(t) < 0$ which is equivalent to the constraint (6.12) for all $\zeta_c(t) \neq 0$.

$$\begin{aligned} \zeta_c^T(t)\Phi_c\zeta_c(t) &= x_c^T(t) [Q_c + \mathcal{C}^T R_u \mathcal{C}] x_c(t) + \left[\mathcal{A}_0 x_c(t) + \sum_{i=1}^4 \mathcal{A}_i x_c(t - \tau_i(t)) \right]^T \mathcal{P} x_c(t) \\ &\quad + x_c^T(t) \mathcal{P}^T \left[\mathcal{A}_0 x_c(t) + \sum_{i=1}^4 \mathcal{A}_i x_c(t - \tau_i(t)) \right] + \sum_{i=1}^4 x_c^T(t) \mathcal{S}_i x_c(t) \\ &\quad - \sum_{i=1}^4 (1 - d_i) x_c^T(t - \tau_i(t)) \mathcal{S}_i x_c(t - \tau_i(t)) < 0, \end{aligned} \quad (6.16)$$

Analyzing carefully the inequality in (6.16), with the condition related to delay derivatives such that $\dot{\tau}_i(t) \leq d_i < 1$ given in (4.18), we can write the following ordered relation

$$\begin{aligned} &x_c^T(t) [Q_c + \mathcal{C}^T R_u \mathcal{C}] x_c(t) + \left[\mathcal{A}_0 x_c(t) + \sum_{i=1}^4 \mathcal{A}_i x_c(t - \tau_i(t)) \right]^T \mathcal{P} x_c(t) \\ &\quad + x_c^T(t) \mathcal{P}^T \left[\mathcal{A}_0 x_c(t) + \sum_{i=1}^4 \mathcal{A}_i x_c(t - \tau_i(t)) \right] + \sum_{i=1}^4 x_c^T(t) \mathcal{S}_i x_c(t) \\ &\quad - \sum_{i=1}^4 (1 - \dot{\tau}_i(t)) x_c^T(t - \tau_i(t)) \mathcal{S}_i x_c(t - \tau_i(t)) \leq \zeta_c^T(t)\Phi_c\zeta_c(t) < 0, \end{aligned} \quad (6.17)$$

Under the assumed valid equality condition given in (6.11), the LHS in the ordering relation given in (6.17) is the LHS given in the inequality below (6.18)

$$x_c^T(t) [Q_c + \mathcal{C}^T R_u \mathcal{C}] x_c(t) + \dot{\mathcal{V}}(t, x_{ct}) < 0, \quad (6.18)$$

where $\dot{\mathcal{V}}(t, x_{ct})$ is the time derivative of the Lyapunov-Krasovskii functional defined

in (6.10), where its expression is given by

$$\begin{aligned} \dot{\mathcal{V}}(t, x_{c_t}) &= \frac{d}{dt} \mathcal{V}(t, x_{c_t}) = \dot{x}_c(t) \mathcal{E}^T \mathcal{P} x_c(t) + x_c^T(t) \mathcal{E}^T \mathcal{P} \dot{x}_c(t) + \sum_{i=1}^4 x_c^T(t) \mathcal{S}_i x_c(t) \\ &\quad - \sum_{i=1}^4 (1 - \dot{\tau}_i(t)) x_c^T(t - \tau_i(t)) \mathcal{S}_i x_c(t - \tau_i(t)), \end{aligned} \quad (6.19)$$

By definition of the quadratic cost function \mathcal{J}_{LQ} given in (6.8), the quadratic integrand inside the integral $x_c^T(s) [Q_c + \mathcal{C}^T R_u \mathcal{C}] x_c(s) \geq 0$ leads to the conclusion based on the inequality (6.19) that

$$\dot{\mathcal{V}}(t, x_{c_t}) < 0, \quad (6.20)$$

This means that the TCM system (4.41) is stabilized asymptotically by the DOF (6.2) and that

$$\lim_{t \rightarrow \infty} \mathcal{V}(t, x_{c_t}) = 0. \quad (6.21)$$

Finally by integrating the inequality (6.18), and with the value of the limit in (6.21) we obtain the upper bound relation (6.14). This completes the proof.

The result obtained in the above theorem provides a non LMI constraint for the synthesis of the DOF for the TCM system. Nevertheless it is not easy to solve, it can lead us to an equivalent LMI constraint by applying some mathematical tools to the inequality (6.12). Note that the resolution of the mentioned inequality (if it is possible), will lead to one of the feasible solutions. The optimization synthesis problem in (5.10) requires to minimize $\mathcal{V}(t_0, x_{c_{t_0}})$ which is not included. The next step then is to find an LMI synthesis constraint from the obtained inequality in Theorem 6.1. In chapter 5, an LMI constraint in Theorem 5.1 was obtained by applying a congruence transformation and a simple change of variable. However the case of state feedback is much easier than the DOF case. Thus a more complex congruence transformation is to be applied now for the case of DOF synthesis. This transformation is the same as that given in [SGC97, RA99] where they treat the multiple objective output feedback synthesis for LTI systems. In our work the treated problem is different, so this needs to adjust their approach in order to be applicable to our case.

6.2.4 LMI formulation of the Synthesis Problem

Usually, a non-linear inequality constraint containing unknown variable matrices is not easy to solve. The limitation of the semi definite programming to be solved with just linear constraints imposes to linearize the constraint of a convex problem. This means that the constraint (6.12) will be submitted to some mathematical manipulations to change its form and to separate the product of unknown matrices. We propose chronological steps to turn it to an LMI constraint on the synthesis variables. But before moving to the LMI solution of this problem, let us make benefit of the equality condition given in (6.11) to decompose the decision matrix \mathcal{P} as well as its inverse denoted $\mathcal{W} = \mathcal{P}^{-1}$. The latter exists due to the non-singularity of \mathcal{P} as stated in Theorem 6.1. As we did for the decomposition of the matrix P and its inverse W in (5.23)

and (5.30) respectively, based on the form of the matrix \mathcal{E} given in (6.7) the matrix \mathcal{P} can be decomposed as the following form

$$\mathcal{P} = \left[\begin{array}{c|c} \mathcal{P}_1 & \mathcal{P}_2 \\ \hline \mathcal{P}_3 & \mathcal{P}_4 \end{array} \right] = \left[\begin{array}{cc|cc} \mathcal{P}_{11} & \mathcal{P}_{12} & \mathcal{P}_{13} & \mathcal{P}_{14} \\ \mathcal{P}_{21} & \mathcal{P}_{22} & \mathcal{P}_{23} & \mathcal{P}_{24} \\ \hline \mathcal{P}_{31} & \mathcal{P}_{32} & \mathcal{P}_{33} & \mathcal{P}_{34} \\ \mathcal{P}_{41} & \mathcal{P}_{42} & \mathcal{P}_{43} & \mathcal{P}_{44} \end{array} \right], \quad (6.22)$$

where $\mathcal{P}_i \in \mathbb{R}^{n \times n}$, the element matrices $\mathcal{P}_{11}, \mathcal{P}_{33} \in \mathbb{R}^{n_1 \times n_1}$ and $\mathcal{P}_{22}, \mathcal{P}_{44} \in \mathbb{R}^{n_2 \times n_2}$. The size of the other matrices \mathcal{P}_{ij} with $i \neq j$ are easily deduced from the matrices \mathcal{P}_{ii} . This decomposition is completely the same for \mathcal{W} . By applying a pre and post multiplying of the equality (6.11) by \mathcal{P} and \mathcal{P}^{-1} , we obtain the following equation in function of \mathcal{W}

$$\mathcal{W}^T \mathcal{E}^T = \mathcal{E} \mathcal{W} \geq 0. \quad (6.23)$$

As the decomposition of \mathcal{P} , the form of \mathcal{W} can be deduced directly as

$$\mathcal{W} = \left[\begin{array}{c|c} \mathcal{W}_1 & \mathcal{W}_2 \\ \hline \mathcal{W}_3 & \mathcal{W}_4 \end{array} \right] = \left[\begin{array}{cc|cc} \mathcal{W}_{11} & \mathcal{W}_{12} & \mathcal{W}_{13} & \mathcal{W}_{14} \\ \mathcal{W}_{21} & \mathcal{W}_{22} & \mathcal{W}_{23} & \mathcal{W}_{24} \\ \hline \mathcal{W}_{31} & \mathcal{W}_{32} & \mathcal{W}_{33} & \mathcal{W}_{34} \\ \mathcal{W}_{41} & \mathcal{W}_{42} & \mathcal{W}_{43} & \mathcal{W}_{44} \end{array} \right], \quad (6.24)$$

where the size of \mathcal{W}_{ij} is the same as $\mathcal{P}_{ij}, \forall i, j$. By a simple substitution of the matrices \mathcal{P} and \mathcal{W} in the equations (6.11) and (6.23) respectively, we deduce their following form

$$\begin{aligned} \mathcal{P} &= \left[\begin{array}{c|c} \mathcal{P}_1 & \mathcal{P}_2 \\ \hline \mathcal{P}_3 & \mathcal{P}_4 \end{array} \right] = \left[\begin{array}{cc|cc} \mathcal{P}_{11} & 0 & \mathcal{P}_{13} & 0 \\ \mathcal{P}_{21} & \mathcal{P}_{22} & \mathcal{P}_{23} & \mathcal{P}_{24} \\ \hline \mathcal{P}_{13}^T & 0 & \mathcal{P}_{33} & 0 \\ \mathcal{P}_{41} & \mathcal{P}_{42} & \mathcal{P}_{43} & \mathcal{P}_{44} \end{array} \right]; \\ \mathcal{W} &= \left[\begin{array}{c|c} \mathcal{W}_1 & \mathcal{W}_2 \\ \hline \mathcal{W}_3 & \mathcal{W}_4 \end{array} \right] = \left[\begin{array}{cc|cc} \mathcal{W}_{11} & 0 & \mathcal{W}_{13} & 0 \\ \mathcal{W}_{21} & \mathcal{W}_{22} & \mathcal{W}_{23} & \mathcal{W}_{24} \\ \hline \mathcal{W}_{13}^T & 0 & \mathcal{W}_{33} & 0 \\ \mathcal{W}_{41} & \mathcal{W}_{42} & \mathcal{W}_{43} & \mathcal{W}_{44} \end{array} \right], \end{aligned} \quad (6.25)$$

where we obtain that $\mathcal{P}_{11} = \mathcal{P}_{11}^T > 0$, $\mathcal{P}_{33} = \mathcal{P}_{33}^T > 0$, \mathcal{P}_{22} and \mathcal{P}_{44} are non-singular matrices. The same properties are obtained for \mathcal{W} such that $\mathcal{W}_{11}^T = \mathcal{W}_{11} > 0$, $\mathcal{W}_{33} = \mathcal{W}_{33}^T > 0$, also \mathcal{W}_{22} and \mathcal{W}_{44} to be non-singular. Also we have $\mathcal{P}_{31} = \mathcal{P}_{13}^T$ and $\mathcal{W}_{31} = \mathcal{W}_{13}^T$, they are replaced directly in (6.25). The form of the matrices \mathcal{P}_i and \mathcal{W}_i are easily deduced from (6.22), (6.24), and (6.25).

Back to the linearization of the inequality (6.12), a congruence multiplication and a change of variable is to be applied to obtain an LMI synthesis problem. Distinct to the state feedback case, the DOF case will use a more complicated change of variable already present in several studies for LTI systems [MP96, MOS98, MKOS97] which can be very useful in our case. Depending on the block partition in (6.25) and on the trivial equation $\mathcal{P} \mathcal{W} = I_{2n}$, we have $\mathcal{P} \begin{bmatrix} \mathcal{W}_1^T & \mathcal{W}_3^T \end{bmatrix}^T = \begin{bmatrix} I_n & 0 \end{bmatrix}^T$. This leads to define the

following transformation matrices

$$\begin{aligned}\Pi_1 &:= \left[\begin{array}{c|c} \mathcal{W}_1 & I_n \\ \hline \mathcal{W}_3 & 0 \end{array} \right] = \left[\begin{array}{cc|cc} \mathcal{W}_{11} & 0 & I_{n_1} & 0 \\ \mathcal{W}_{21} & \mathcal{W}_{22} & 0 & I_{n_2} \\ \hline \mathcal{W}_{13}^T & 0 & 0 & 0 \\ \mathcal{W}_{41} & \mathcal{W}_{42} & 0 & 0 \end{array} \right]; \\ \Pi_2 &:= \left[\begin{array}{c|c} I_n & \mathcal{P}_1 \\ \hline 0 & \mathcal{P}_3 \end{array} \right] = \left[\begin{array}{cc|cc} I_{n_1} & 0 & \mathcal{P}_{11} & 0 \\ 0 & I_{n_2} & \mathcal{P}_{21} & \mathcal{P}_{22} \\ \hline 0 & 0 & \mathcal{P}_{13}^T & 0 \\ 0 & 0 & \mathcal{P}_{41} & \mathcal{P}_{42} \end{array} \right],\end{aligned}\quad (6.26)$$

These transformation matrices lead to the equality $\mathcal{P}\Pi_1 = \Pi_2$. It is important to have the non-singularity condition of the used transformation matrices. Without loss of generality, the matrices \mathcal{P}_3 and \mathcal{W}_3 can be assumed to be non-singular matrices [SGC97] to guarantee the non-singularity of the matrices Π_1 and Π_2 respectively. Denote the matrix $\Xi := \text{diag}(\Pi_1, \Pi_1, \Pi_1, \Pi_1, \Pi_1)$ to be the congruence used matrix, applying a pre and post multiplying the matrix Φ_c in (6.12) by Ξ^T and Ξ respectively leads to the following identities to be expressed before giving the obtained LMI.

$$\begin{aligned}\Pi_1^T \mathcal{P}^T \mathcal{A}_0 \Pi_1 &= \Pi_2^T \mathcal{A}_0 \Pi_1 = \begin{bmatrix} A_0 \mathcal{W}_1 + B_u \hat{C} & A_0 + B_u \hat{D} C_y \\ \hat{A} & \mathcal{P}_1^T A_0 + \hat{B} C_y \end{bmatrix}, \\ \Pi_1^T \mathcal{P}^T \mathcal{A}_i \Pi_1 &= \Pi_2^T \mathcal{A}_i \Pi_1 = \begin{bmatrix} A_i \mathcal{W}_1 & A_i \\ \hat{A}_i & \mathcal{P}_1^T A_i \end{bmatrix}, \\ \mathcal{C} \Pi_1 &= [\hat{C} \quad \hat{D} C], \\ \Pi_1^T \mathcal{S}_i \Pi_1 &= \mathcal{G}_i,\end{aligned}\quad (6.27)$$

where the matrices A_0, A_i, B_u and C_y are given in (4.42). The matrices $\hat{A}_0 \in \mathbb{R}^{n \times n}$, $\hat{A}_i \in \mathbb{R}^{n \times n}$, $\hat{B} \in \mathbb{R}^{n \times n_y}$, $\hat{C} \in \mathbb{R}^{n_u \times n}$ and $\hat{D} \in \mathbb{R}^{n_u \times n_y}$ are the change of variable matrices defined by

$$\begin{aligned}\hat{A}_0 &:= \mathcal{P}_1^T (A_0 + B_u D_K C_y) \mathcal{W}_1 + \mathcal{P}_1^T B_u C_K \mathcal{W}_3 + \mathcal{P}_3^T B_K C_y \mathcal{W}_1 + \mathcal{P}_3^T A_K \mathcal{W}_3, \\ \hat{A}_i &:= \mathcal{P}_1^T A_i \mathcal{W}_1, \\ \hat{B} &:= \mathcal{P}_1^T B_u D_K + \mathcal{P}_3^T B_K, \\ \hat{C} &:= D_K C_y \mathcal{W}_1 + C_K \mathcal{W}_3, \\ \hat{D} &:= D_K,\end{aligned}\quad (6.28)$$

It is assumed that the matrices \mathcal{P}_3 and \mathcal{W}_3 are full ranked non-singular ones. This leads to unique matrices A_K, B_K, C_K and D_K . This change of variable was also used in [Gah96] in the context of \mathcal{H}_∞ control as well as in [MP96, Sch95a] in other multiple objective control synthesis. After introducing the necessary change of variable, it is the time to present the linearization of the constraint inequality (6.12). The congruence multiplication $\Xi^T \Phi_c \Xi$ leads to the following inequality

$$\begin{bmatrix} \Pi_1^T \mathcal{P}^T A_0 \Pi_1 + \Pi_1^T A_0^T \mathcal{P} \Pi_1 + \sum_{i=1}^4 \Pi_1^T \mathcal{S}_i \Pi_1 & \Pi_1^T \mathcal{P}^T A_1 \Pi_1 & \Pi_1^T \mathcal{P}^T A_2 \Pi_1 & \cdots & \Pi_1^T \mathcal{P}^T A_4 \Pi_1 \\ + \Pi_1^T Q_c \Pi_1 + \Pi_1^T C^T R_u C \Pi_1 & -(1-d_1) \Pi_1^T \mathcal{S}_1 \Pi_1 & 0 & \cdots & 0 \\ \star & \star & -(1-d_2) \Pi_1^T \mathcal{S}_2 \Pi_1 & \ddots & \vdots \\ \star & \star & \star & \ddots & 0 \\ \star & \star & \star & \star & -(1-d_4) \Pi_1^T \mathcal{S}_4 \Pi_1 \end{bmatrix} < 0, \quad (6.29)$$

For the term $\Pi_1^T Q_c \Pi_1$, we can write it in the form of

$$\Pi_1^T Q_c \Pi_1 = \begin{bmatrix} \mathcal{W}_1^T H_x & 0 \\ H_x & 0 \end{bmatrix} I_{2n} \begin{bmatrix} \mathcal{W}_1^T H_x & 0 \\ H_x & 0 \end{bmatrix}^T, \quad (6.30)$$

where $Q_x = H_x H_x^T$. Developing now the terms inside the inequality in (6.29) and using the change of variable defined in (6.27) and (6.28), we obtain another inequality given below

$$\begin{bmatrix} \Omega_2 & \begin{bmatrix} A_1 \mathcal{W}_1 & A_1 \\ \hat{A}_1 & \mathcal{P}_1^T A_1 \end{bmatrix} & \begin{bmatrix} A_2 \mathcal{W}_1 & A_2 \\ \hat{A}_2 & \mathcal{P}_1^T A_2 \end{bmatrix} & \begin{bmatrix} A_3 \mathcal{W}_1 & A_3 \\ \hat{A}_3 & \mathcal{P}_1^T A_3 \end{bmatrix} & \begin{bmatrix} A_4 \mathcal{W}_1 & A_4 \\ \hat{A}_4 & \mathcal{P}_1^T A_4 \end{bmatrix} \\ \star & -(1-d_1) \mathcal{G}_1 & 0 & 0 & 0 \\ \star & \star & -(1-d_2) \mathcal{G}_2 & 0 & 0 \\ \star & \star & \star & -(1-d_3) \mathcal{G}_3 & 0 \\ \star & \star & \star & \star & -(1-d_4) \mathcal{G}_4 \end{bmatrix} < 0, \quad (6.31)$$

where Ω_2 is given by

$$\begin{aligned} \Omega_2 = & \mathbf{He} \begin{bmatrix} A_0 \mathcal{W}_1^T + B_u \hat{C} & A_0 + B_u \hat{D} C_y \\ \hat{A}_0 & \mathcal{P}_1^T A_0 + \hat{B} C_y \end{bmatrix} + \sum_{i=1}^4 \mathcal{G}_i \\ & + \begin{bmatrix} \mathcal{W}_1^T H_x & 0 \\ H_x & 0 \end{bmatrix} I_{2n} \begin{bmatrix} \mathcal{W}_1^T H_x & 0 \\ H_x & 0 \end{bmatrix}^T + [\hat{C} \quad \hat{D} C_y]^T R_u [\hat{C} \quad \hat{D} C_y]. \end{aligned} \quad (6.32)$$

From the inequality (6.31), we have $\Omega_2 < 0$. Thus by applying the Schur's complement twice, we have

$$\Omega_2 < 0 \iff \begin{bmatrix} \Omega_3 & \begin{bmatrix} \mathcal{W}_1^T H_x & 0 \\ H_x & 0 \end{bmatrix} & [\hat{C} \quad \hat{D} C_y]^T \\ \star & -I_{2n} & 0 \\ \star & \star & -R_u^{-1} \end{bmatrix} < 0. \quad (6.33)$$

where Ω_3 is given by

$$\Omega_3 = \mathbf{He} \begin{bmatrix} A_0 \mathcal{W}_1^T + B_u \hat{C} & A_0 + B_u \hat{D} C_y \\ \hat{A}_0 & \mathcal{P}_1^T A_0 + \hat{B} C_y \end{bmatrix} + \sum_{i=1}^4 \mathcal{G}_i. \quad (6.34)$$

Using the transformation present in (6.33), we obtain the following LMI from the in-

equality (6.31)

$$\begin{bmatrix} \Omega_3 & \begin{bmatrix} \mathcal{W}_1^T H_x & 0 \\ H_x & 0 \end{bmatrix} & [\hat{C} \quad \hat{D}C_y]^T & \begin{bmatrix} A_1 \mathcal{W}_1 & A_1 \\ \hat{A}_1 & \mathcal{P}_1^T A_1 \end{bmatrix} & \cdots & \begin{bmatrix} A_4 \mathcal{W}_1 & A_4 \\ \hat{A}_4 & \mathcal{P}_1^T A_4 \end{bmatrix} \\ \star & -I_{2n} & 0 & 0 & \cdots & 0 \\ \star & \star & -R_u^{-1} & 0 & \cdots & 0 \\ \star & \star & \star & -(1-d_1)\mathcal{G}_1 & \ddots & \vdots \\ \star & \star & \star & \star & \ddots & 0 \\ \star & \star & \star & \star & \star & -(1-d_4)\mathcal{G}_4 \end{bmatrix} < 0, \quad (6.35)$$

The obtained LMI in (6.35) is not the only constraint for the synthesis problem given by Theorem 6.1. The equality condition given in (6.11) is also a constraint in the problem which determines the structure of the matrices \mathcal{P} and \mathcal{W} . As the latter matrices are no more included entirely in the LMI (6.35), the congruence transformation is also applied to the equality (6.11) to elaborate a new algebraic equality condition under the applied transformation. By pre and post multiplying by Π_1^T and Π_1 to both sides of the equality (6.11), the obtained equality $\Pi_1^T \mathcal{E}^T \mathcal{P} \Pi_1 = \Pi_1^T \mathcal{P}^T \mathcal{E} \Pi_1 \geq 0$ leads to the following matrix equality given below

$$\begin{bmatrix} \mathcal{W}_{11} & 0 & \mathcal{W}_{11}\mathcal{P}_{11} + \mathcal{W}_{13}\mathcal{P}_{13}^T & 0 \\ 0 & 0 & 0 & 0 \\ I_{n_1} & 0 & \mathcal{P}_{11} & 0 \\ 0 & 0 & 0 & 0 \end{bmatrix} = \begin{bmatrix} \mathcal{W}_{11} & 0 & I_{n_1} & 0 \\ 0 & 0 & 0 & 0 \\ \mathcal{P}_{11}\mathcal{W}_{11} + \mathcal{P}_{13}\mathcal{W}_{13}^T & 0 & \mathcal{P}_{11} & 0 \\ 0 & 0 & 0 & 0 \end{bmatrix} \geq 0. \quad (6.36)$$

The equality above uses the partition indicated in (6.25) which leads to two conditions. The first one is trivial and given in the equation below

$$\mathcal{W}_{11}\mathcal{P}_{11} + \mathcal{W}_{13}\mathcal{P}_{13}^T = I_{n_1} \iff \mathcal{W}_{13}\mathcal{P}_{13}^T = I_{n_1} - \mathcal{W}_{11}\mathcal{P}_{11}. \quad (6.37)$$

The other one depends on the RHS of (6.36) coming from $\Pi_1^T \mathcal{E}^T \mathcal{P} \Pi_1 \geq 0$. Using Schur's complement, the RHS of (6.36) leads to the inequality at the LHS of the following equivalence under the condition $\mathcal{P}_{11} > 0$

$$\mathcal{W}_{11} - (\mathcal{W}_{11}\mathcal{P}_{11} + \mathcal{W}_{13}\mathcal{P}_{13}^T) \mathcal{P}_{11}^{-1} \geq 0 \iff -\mathcal{W}_{13}\mathcal{P}_{13}^T \geq 0. \quad (6.38)$$

The RHS of (6.38) is obtained by developing the LHS of the same equivalence which will give $-\mathcal{W}_{13}\mathcal{P}_{13}^T \mathcal{P}_{11}^{-1} \leq 0$. An important assumption to be considered here is for the matrices \mathcal{P}_{13} and \mathcal{W}_{13} to be non-singular ones, which is a condition needed for the non-singularity of Π_1 and solution unicity of $\hat{A}_0, \hat{A}_i, \hat{B}, \hat{C}$ and \hat{D} . This assumption with the right hand side of the equivalence in (6.38) leads us to say that

$$\mathcal{W}_{13}\mathcal{P}_{13}^T < 0. \quad (6.39)$$

Thanks to equations (6.37) and (6.39), we have

$$\mathcal{W}_{13}\mathcal{P}_{13}^T < 0 \iff I_{n_1} - \mathcal{W}_{11}\mathcal{P}_{11} < 0 \iff \mathcal{P}_{11} - \mathcal{W}_{11}^{-1} > 0, \quad (6.40)$$

Finally by applying once again the Schur's complement on the inequality (6.40), we obtain our complementary LMI constraint of the synthesis problem.

$$\begin{bmatrix} \mathcal{P}_{11} & I_{n_1} \\ I_{n_1} & \mathcal{W}_{11} \end{bmatrix} > 0, \quad (6.41)$$

6.3 Dynamic Output Feedback Feasibility Problem

In this section, we have to propose a new theorem with the linear inequality constraints. But before this, it is important to discuss few points to complete the synthesis procedure. These points are essential to pay attention for, since they avoid algorithm failure.

- (i) As we visualize the LMI constraints (6.35) and (6.41) elaborated from (6.11) and (6.12), it is clear that the only matrices to be found automatically by the SDP algorithm are \mathcal{P}_1 , \mathcal{W}_1 , \mathcal{P}_{11} and \mathcal{W}_{11} . An important trivial question comes directly : What about the other sub matrices of \mathcal{P}_3 and \mathcal{W}_3 used in the change of variable in (6.28)? Don't forget to mention that they are also used to determine the matrices Π_1 and Π_2 and last but not least the matrices $\mathcal{P} := \Pi_2 \Pi_1^{-1}$ and $\mathcal{W} := \Pi_1 \Pi_2^{-1}$. A direct simple answer is that the other matrices are to be determined manually by the user under specified conditions. For sure they won't be chosen randomly, as algebraic equality or inequality conditions have to be respected. Referring to the inequality (6.39), the two matrices \mathcal{W}_{13} and \mathcal{P}_{13} of common size $n_1 \times n_1$ are chosen such that $\mathcal{W}_{13} \mathcal{P}_{13}^T < 0$. The latter matrices will be used to determine the values of \mathcal{P}_3 and \mathcal{W}_3 as given in (6.25) which still miss other matrices. The matrices \mathcal{P}_{41} , \mathcal{P}_{42} , \mathcal{W}_{41} and \mathcal{W}_{42} have to be chosen such that \mathcal{P}_3 and \mathcal{W}_3 are non singular as mentioned in [RA99]. A very important hidden point which was not mentioned before is needed to be highlighted though it seems obvious. Assume that the non-linear problem given in Theorem 6.1 admits a stabilizing solution. This means that the inequality (6.12) is true and we have $\Omega_1 < 0$. According to the expression of Ω_1 given in (6.13), we have

$$\Omega_1 = \mathcal{A}_0^T \mathcal{P} + \mathcal{P}^T \mathcal{A}_0 + \sum_{i=1}^4 \mathcal{S}_i + Q_c + \mathcal{C}^T R_u \mathcal{C} < 0. \quad (6.42)$$

The stabilizability solution of this problem means the existence of the non-singular matrix \mathcal{P} as well as the matrices $\mathcal{S}_i > 0$ such that (6.12) is true. From the definition of $Q_c \geq 0$ and $R_u > 0$ in (6.8), we have the following condition

$$\begin{cases} \Omega_1 < 0 \\ Q_c \geq 0, R_u > 0, \mathcal{S}_i > 0, \forall i. \end{cases} \iff \mathcal{A}_0^T \mathcal{P} + \mathcal{P}^T \mathcal{A}_0 < 0. \quad (6.43)$$

Consequently the stabilizability of the closed loop system (6.6) means that the matrix \mathcal{A}_0 is Hurwitz [Hur95, Kha02]. This means that, though the matrices \mathcal{P} and \mathcal{W} are non-symmetric, they are still full rank matrices with positive eigenvalues. As a result the matrices \mathcal{P}_{41} , \mathcal{P}_{42} , \mathcal{W}_{41} and \mathcal{W}_{42} have to be chosen such that the matrices \mathcal{P} and \mathcal{W} have no negative or zero eigenvalues.

- (ii) An important hint was given in [SGC97, RA99] to avoid the near singularity of the inequality $I_{n_1} - \mathcal{W}_{11} \mathcal{P}_{11} < 0$ given in (6.40). The resolution of the SDP synthesis may lead to saturation at the optimum and thus a bad conditioned LMI in (6.41). To avoid such difficulties, a useful idea might help which is to replace

the inequality (6.41) by the following one

$$\begin{bmatrix} \mathcal{P}_{11} & \rho I_{n_1} \\ \rho I_{n_1} & \mathcal{W}_{11} \end{bmatrix} > 0, \quad (6.44)$$

where $\rho > 0$ is an additional variable to be maximized. It is clear that if $\rho = 1$, we go back to the LMI in (6.41). This tool maximizes the minimal eigenvalue of $\mathcal{W}_{11}\mathcal{P}_{11}$ and hence its eigenvalues are pushed away from unity such that $I_{n_1} - \mathcal{W}_{11}\mathcal{P}_{11} < 0$ is expected to be well conditioned.

6.3.1 Controller Synthesis via LMI Feasibility Problem

In view of the obtained results in the previous section and also the above described points, it is useful to sum up the above work by a theorem based on Theorem 6.1, as well as synthesis steps and finally by illustrative examples.

Theorem 6.2 : Consider the time delay singular system given in (6.6) under the conditions concerning the time delays given in (4.13) and (4.18), also the initial conditions ϕ and η_0 that validate the algebraic constraints in (5.6) and (6.4) respectively. The closed loop system is asymptotically stable if there exist matrices $\mathcal{G}_i = \mathcal{G}_i^T > 0$, $\mathcal{P}_{11} = \mathcal{P}_{11}^T > 0$, $\mathcal{W}_{11} = \mathcal{W}_{11}^T > 0$, as well as the new variable matrices \hat{A}_0 , \hat{A}_i , \hat{B} , \hat{C} and \hat{D} such that the LMIs (6.35) and (6.41) are satisfied.

Proof : The proof of this theorem can be easily constructed using that of Theorem 6.1, and the steps followed for LMI formulation through congruence transformation and change of variable given from (6.22) till (6.41).

Once the decision matrices indicated in the above theorem are determined validating the corresponding LMIs, \mathcal{P}_3 and \mathcal{W}_3 are to be determined manually. The matrices \mathcal{P}_{13} and \mathcal{W}_{13} are to be chosen such that (6.38) is satisfied. Finally the matrices \mathcal{P}_{41} , \mathcal{P}_{42} , \mathcal{W}_{41} and \mathcal{W}_{42} have to be chosen such that \mathcal{P}_3 and \mathcal{W}_3 are non singular and the matrices \mathcal{P} (implicitly \mathcal{W}) has no negative eigenvalues. The matrices of the DOF controller A_K , B_K , C_K and D_K can be easily found through reversing the change of variable used in (6.28) by applying some mathematical manipulations. For that to give directly the controller matrices in function of the determined LMI variables, we have

$$\begin{aligned} D_K &:= \hat{D}, \\ C_K &:= \left(\hat{C} - D_K C_y \mathcal{W}_1 \right) \mathcal{W}_3^{-1}, \\ B_K &:= \mathcal{P}_3^{-T} \left(\hat{B} - \mathcal{P}_1^T B_u D_K \right), \\ A_K &:= \mathcal{P}_1^{-T} \left[\hat{A}_0 - \mathcal{P}_1^T (A_0 + B_u D_K C_y) \mathcal{W}_1 - \mathcal{P}_1^T B_u C_K \mathcal{W}_3 - \mathcal{P}_3^T B_K C_y \mathcal{W}_1 \right] \mathcal{W}_3^{-1}. \end{aligned} \quad (6.45)$$

Note that the manually chosen matrices to complete \mathcal{P}_3 and \mathcal{W}_3 affect directly the performance of the DOF controller. The methods state that these matrices are chosen as long as Π_1 and Π_2 are non-singular and \mathcal{P} (implicitly \mathcal{W}) does not have negative or zero eigenvalues, but it does not guarantee that any choice of these matrices will

lead to the same DOF controller with specified performance included in \mathcal{J}_{LQ} . Different set of choice will lead to different controller. Another point to be discussed is the size of synthesis problem from regarding the number of variables. Solving the problem given in Theorem 6.2 leads to a feasible solution which is the existence of the decision matrices that satisfy only the LMI constraints in (6.35) and (6.41). The upper bound $\mathcal{V}(t_0, \phi_c)$ is not minimized as well as the performance cost \mathcal{J}_{LQ} .

6.3.2 Numerical example

Consider in this part the same example already given in chapter 5, section 5.4.3 where the time delay singular system is given by the following equation

$$\begin{aligned} E\dot{x}(t) &= A_0x(t) + A_1x(t - \tau_1(t)) + A_2x(t - \tau_2(t)) + B_uu(t) \\ y(t) &= C_yx(t), \end{aligned} \quad (6.46)$$

and the matrices are given below

$$\begin{aligned} E &= \begin{bmatrix} 1 & 0 \\ 0 & 0 \end{bmatrix}; A_0 = \begin{bmatrix} 2 & -2 \\ -0.7 & -6.4 \end{bmatrix}; A_1 = \begin{bmatrix} -0.5 & 0.3 \\ 0 & -0.9 \end{bmatrix}; \\ A_2 &= \begin{bmatrix} -0.4 & 0 \\ 1 & -0.6 \end{bmatrix}; B_u = \begin{bmatrix} 2 \\ 1 \end{bmatrix}; C_y = [1 \ 0]. \end{aligned} \quad (6.47)$$

The time varying delays are given by the following continuous time functions

$$\tau_1(t) = 0.5 + 0.3 \sin(t), \quad \tau_2(t) = 1 + 0.5 \sin(0.4t), \quad \forall t \geq t_0. \quad (6.48)$$

The bounds concerning time delays and their derivatives are given numerically by $\bar{\tau}_1 = 0.8$, $\bar{\tau}_2 = 1.5$, $d_1 = 0.3$ and $d_2 = 0.2$. The maximum delay is $\tau_{max} = \bar{\tau}_2 = 1.5$. The plot of these continuous delays are given in Figure 5.2. Usually the initial condition ϕ_c has to be compatible and before the synthesis of the controller, but it is worthless since once the weighting matrices are tuned ϕ_c is no more compatible. Thus ϕ_c is chosen such that ϕ and η_0 independent from the algebraic condition (5.6) and (6.5). For that the modified input u_δ is to be used instead of using the input u directly to ensure the continuity of the closed loop trajectory. The function ϕ_c is defined by the following

$$\phi(t) = \begin{bmatrix} 1.3t + 2.5 \\ 2t + 0.2 \end{bmatrix}, \quad \forall t \in [t_0 - \tau_{max}; t_0]; \quad \eta_0 = \eta(t_0) = \begin{bmatrix} 0.3 \\ -0.8 \end{bmatrix}. \quad (6.49)$$

The weighting matrices characterizing the performance cost \mathcal{J}_{LQ} are fixed such that

$$Q_x = \begin{bmatrix} 10 & 0 \\ 0 & 1 \end{bmatrix}, \quad R_u = 1. \quad (6.50)$$

Solving the DOF synthesis problem present in Theorem 6.2 using the SDP solver SDPT3

and the Yalmip package in MATLAB, the numerical results are

$$\begin{aligned}
 \mathcal{P}_{11} &= 15.729; \mathcal{W}_{11} = 0.089; \mathcal{P}_1 = \begin{bmatrix} 15.72 & 0 \\ 4.40 & 5.11 \end{bmatrix}; \mathcal{W}_1 = \begin{bmatrix} 0.08 & 0 \\ 0.732 & 2.79 \end{bmatrix}; \\
 \mathcal{G}_1 &= \begin{bmatrix} 2.36 & 4.71 & -0.21 & 0.29 \\ 4.71 & 13.04 & -0.98 & 1.25 \\ -0.21 & -0.98 & 24.46 & -0.54 \\ 0.29 & 1.25 & -0.54 & 22.55 \end{bmatrix}; \mathcal{G}_2 = \begin{bmatrix} 2.18 & 3.94 & -0.07 & 0.05 \\ 3.94 & 9.93 & -0.38 & 0.24 \\ -0.07 & -0.38 & 21.68 & 0.21 \\ 0.05 & 0.24 & 0.21 & 20.36 \end{bmatrix}; \\
 \hat{A}_0 &= \begin{bmatrix} -2.22 & 2.85 \\ 0.869 & 2.48 \end{bmatrix}; \hat{A}_1 = \begin{bmatrix} -0.07 & 2.11 \\ -3.36 & -12.8 \end{bmatrix}; \hat{A}_2 = \begin{bmatrix} -2.36 & -7.36 \\ -2.16 & -8.55 \end{bmatrix}; \hat{B} = \begin{bmatrix} -69.7 \\ 63.5 \end{bmatrix}; \\
 \hat{C} &= [-1.79 \quad -0.67]; \hat{D} = [-0.04].
 \end{aligned} \tag{6.51}$$

From the obtained value of \mathcal{P}_{11} and \mathcal{W}_{11} we can find the product $\mathcal{W}_{13}\mathcal{P}_{13}^T$ from (6.38), the obtained value is $\mathcal{W}_{13}\mathcal{P}_{13}^T = -0.403$ which validates that the product is strictly negative as shown in (6.40). By choosing $\mathcal{W}_{13} = 0.08$ non-singular random value, we obtain $\mathcal{P}_{13} = -5.044$. Now it is the time to complete the non-singular matrices \mathcal{P}_3 and \mathcal{W}_3 by assigning the following values to the included sub-matrices

$$\mathcal{P}_{41} = 0.7; \mathcal{P}_{42} = -0.8; \mathcal{W}_{41} = 0.2; \mathcal{W}_{42} = 0.5 \tag{6.52}$$

These values in (6.52) as well as those for \mathcal{P}_{13} and \mathcal{W}_{13} are chosen such that the product $\Pi_2\Pi_1^{-1}$ gives an invertible matrix with no zero or negative eigenvalues. Now we can determine the value of the matrices $\mathcal{P} = \Pi_2\Pi_1^{-1}$ and $\mathcal{W} = \Pi_1\Pi_2^{-1}$, their obtained values

$$\mathcal{P} = \begin{bmatrix} 15.72 & 0 & -5.04 & 0 \\ 4.40 & 5.11 & 14.49 & -26.63 \\ -5.04 & 0 & 5.62 & 0 \\ 0.70 & -0.80 & -4.59 & 4.47 \end{bmatrix}; \mathcal{W} = \begin{bmatrix} 0.08 & 0 & 0.08 & 0 \\ 0.73 & 2.79 & 7.05 & 16.64 \\ 0.08 & 0 & 0.24 & 0 \\ 0.20 & 0.50 & 1.64 & 3.19 \end{bmatrix}. \tag{6.53}$$

As we see the obtained numerical values of \mathcal{P} and \mathcal{W} have the same form as that given in (6.27), also their eigenvalues are positive. Now all the matrices used in the change of variable in (6.35) are determined, to find the DOF controller it is sufficient to use the inverse of the change of variable given in (6.45). The obtained controller of this case is given by

$$\begin{aligned}
 \begin{bmatrix} 1 & 0 \\ 0 & 0 \end{bmatrix} \frac{d}{dt}\eta(t) &= \underbrace{\begin{bmatrix} -57.54 & -110.32 \\ 151.49 & -242.89 \end{bmatrix}}_{A_K} \eta(t) + \underbrace{\begin{bmatrix} 2.49 \\ -79.71 \end{bmatrix}}_{B_K} y(t), \\
 u(t) &= \underbrace{\begin{bmatrix} -19.05 & -1.34 \end{bmatrix}}_{C_K} \eta(t) + \underbrace{\begin{bmatrix} -0.04 \end{bmatrix}}_{D_K} y(t).
 \end{aligned} \tag{6.54}$$

An important point to be mentioned regarding the choice of the doublet $(\mathcal{P}_{13}, \mathcal{W}_{13})$ that satisfies (6.38). The above chosen doublet leads to the following transfer function of the DOF controller, denoted $G_{DOF}(s)$

$$G_{DOF}(s) = \frac{-0.04183s^2 + 47.29s - 174700}{s^2 + 300.4s + 30690}. \tag{6.55}$$

Just for information, we notice that trying another values of the doublet $(\mathcal{P}_{13}, \mathcal{W}_{13})$ satisfying the same condition such as $(-8.07, 0.05)$, $(-0.26, 1.5)$ or $(-0.016, 25)$, the same transfer function $G_{DOF}(s)$ is obtained. Meanwhile considering other values for the quadruplet $(\mathcal{P}_{41}, \mathcal{P}_{42}, \mathcal{W}_{41}, \mathcal{W}_{42})$ lead us to another controller. Let us consider the value of the quadruplet as $(10.7, -12.8, 0.2, 0.5)$ with the doublet $(\mathcal{P}_{13}, \mathcal{W}_{13}) = (-5.044, 0.08)$, they will lead us to another DOF controller given by the following transfer function denoted $G'_{DOF}(s)$

$$G'_{DOF}(s) = \frac{-0.04183s^2 - 53.32s - 10920}{s^2 + 73.67s + 1918}. \quad (6.56)$$

Looking for the numerator and denominator coefficients in 6.55 and 6.56, they are far from each other which may be seen as badly conditioned system. The difference between these coefficients is first due to the feasibility resolution of the SDP problem, which gives out the matrices once the LMI constraints are satisfied. Second, the difference is due to the randomness in the manual choice of some parameters of the matrices $\mathcal{P}_1, \mathcal{P}_3, \mathcal{W}_1$ and \mathcal{W}_3 .

Back to the case of the obtained controller in (6.54) and as it has been said about avoiding the discontinuity at the instant t_0 , $u_\delta(t)$ will be used instead of $u(t)$ in order to impose the continuity of the trajectories of the closed loop system under the incompatible condition (6.49) for all controller cases. The input u_δ is given by

$$u_\delta(t) = \delta(t)u(t) = C_K\delta(t)\eta(t) + D_KC_y\delta(t)x(t), \quad (6.57)$$

where the function δ is a rapid growth function defined over $[t_0; \infty)$ by

$$\delta(t) = \begin{cases} \frac{1-e^{-500t^2}}{1-e^{-500\epsilon^2}}, & t \in [0, \epsilon], \\ 1, & t \geq \epsilon, \end{cases} \quad (6.58)$$

where $\epsilon = 0.5$. The function $\delta(t)$ is traced in the figure below

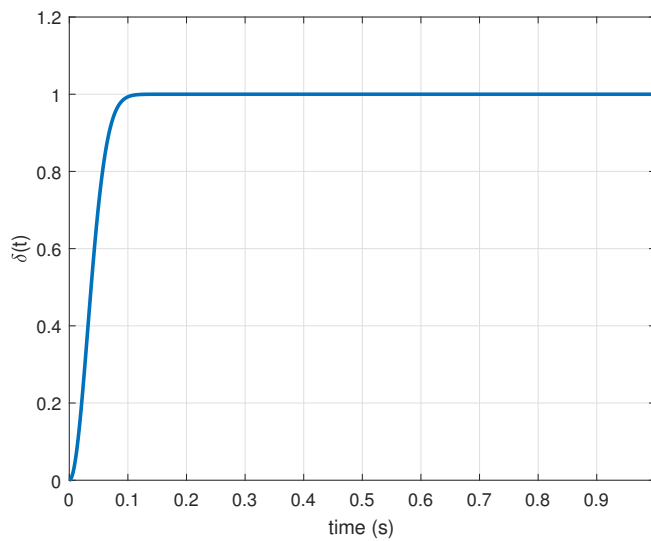

FIGURE 6.1 – Growth function δ in function of time t .

Simulating the closed loop system and plotting the states trajectories x_1 and x_2 , the inputs u and u_δ as well as that for the DOF controller η_1 and η_2 , the obtained curves are depicted in figures 6.2 and 6.3.

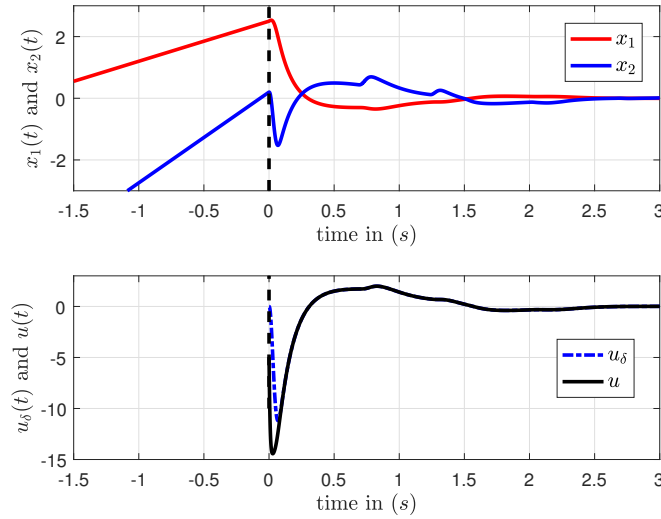

FIGURE 6.2 – System states x_1 and x_2 , inputs u_δ and u in function of time t .

Figure 6.2 shows the evolution of the system (6.46) states as well as its output $y(t) = x_1(t)$. The system is stabilized by the obtained DOF controller (6.54) and the states x_1 and x_2 converge to zero after 2.5 seconds as shown in the first plot of this figure. The second plot shows the two control inputs $u_\delta(t)$ in dotted blue which starts from zero as it is forced by $\delta(t)$, and also the input $u(t)$ in black. As we can see in the upper plots of x_1 and x_2 , they are continuous at the instant $t_0 = 0$ thanks to the modified control $u_\delta(t)$. The history ϕ (in red) of the system as well as its trajectory (in black) are traced in Figure 6.3a where the system converges to its equilibrium point denoted x_e . In Figure 6.3b, we have plotted the evolution of the states of the controller η_1 and η_2 to visualize what it was happening in the controller. As we can see the controller states converge to zero after stabilizing those of the system.

Now in order to modify the performance of the system and to show the possibility to change the behavior of the system, the same synthesis method is applied with tuning the weighting matrices of the cost \mathcal{J}_{LQ} so they become

$$Q_x = \begin{bmatrix} 10^5 & 0 \\ 0 & 1 \end{bmatrix}, \quad R_u = 1. \quad (6.59)$$

We have only modified the first weighting in the matrix Q_x , all the other parameters as well as the manual chosen matrices are kept the same, the obtained DOF controller in this case is given by

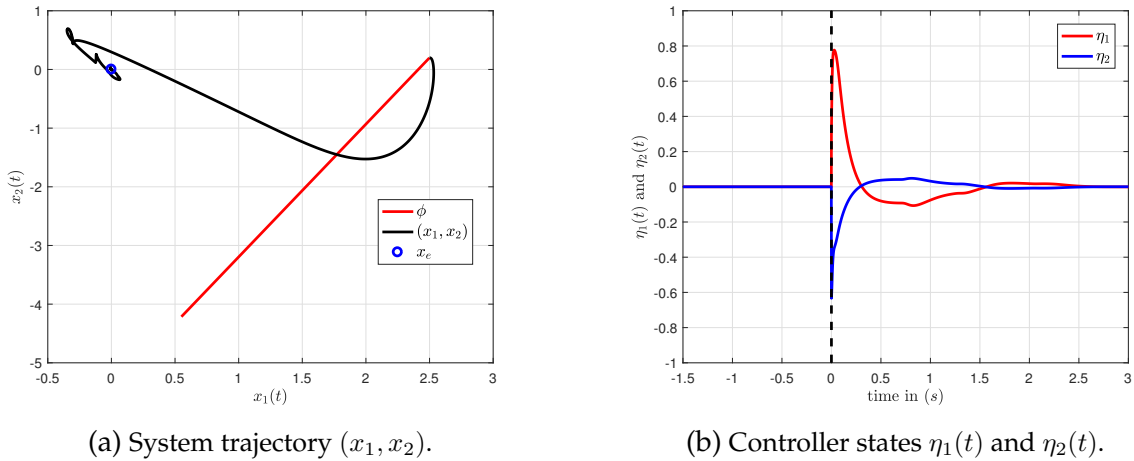

FIGURE 6.3 – Simulation of the closed loop system.

$$\begin{aligned}
 \begin{bmatrix} 1 & 0 \\ 0 & 0 \end{bmatrix} \frac{d}{dt} \eta(t) &= \underbrace{\begin{bmatrix} -743.08 & -1259.42 \\ 9579.54 & -93914.59 \end{bmatrix}}_{A_K} \eta(t) + \underbrace{\begin{bmatrix} -376.57 \\ -44113.98 \end{bmatrix}}_{B_K} y(t), \\
 u(t) &= \underbrace{\begin{bmatrix} -18.11 & -2.69 \end{bmatrix}}_{C_K} \eta(t) + \underbrace{\begin{bmatrix} -9.66 \end{bmatrix}}_{D_K} y(t),
 \end{aligned} \tag{6.60}$$

All obtained decision matrices elaborated from the synthesis problem verify their corresponding LMI constraints. As we compare the values of the controller matrices between the first case (6.54) and the second case (6.59), we can see the clear difference between the values. As we have forced the system to enhance its performance by increasing the x_1 weight from 10 to 10^5 in the second case, the numerical values of the matrices A_K and B_K have increased approximately in the same ratio (i.e. 10^4). This increment in the values of these matrices will speed up the states of the controller and thus will influence the rapidity of the states of the system (6.46). Figure 6.4 shows the evolution of the system states x_1 and x_2 as well as the modified input u_δ of both weighting cases. By looking to the dotted curves associated to the new weighting in (6.59), we can see that they converge faster than the previous case (continuous line curves). As seen in the figure of $u_\delta(t)$, a more energy is put to accelerate the system. Thanks to u_δ the continuity is always guaranteed.

The new trajectory in Figure 6.5a is different from the old case as indicated by the black dotted curve. The controller states are traced in Figure 6.5b. This reveals a more rapid aspect as shown for $\eta_2(t)$ by comparing the new curve (dashed blue) and the old one (continuous line). This is explained by the larger matrix values of A_K and B_K .

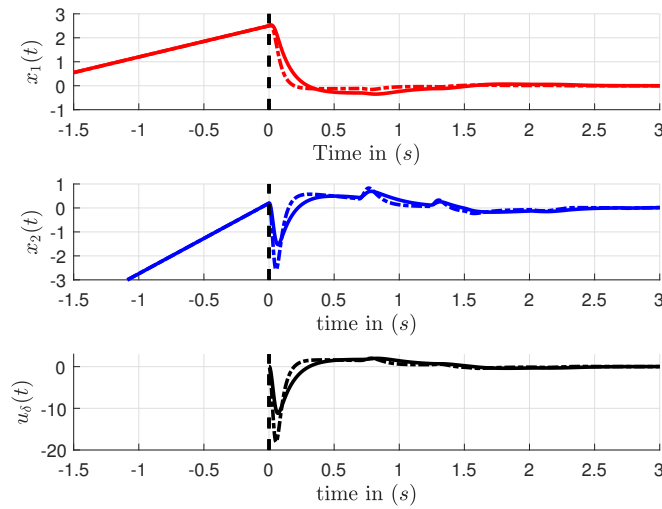
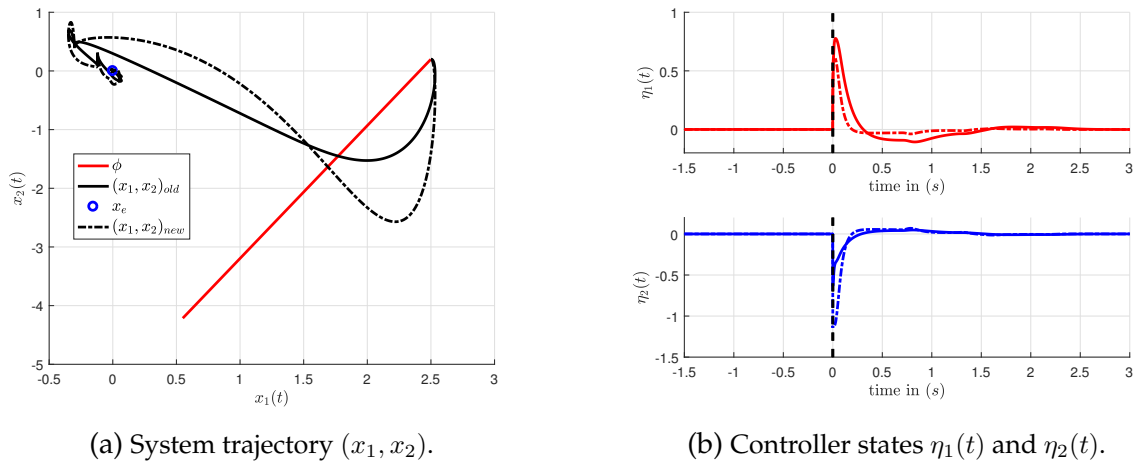

FIGURE 6.4 – Comparison of system states x_1 and x_2 and input u_δ between two weighing cases.



(a) System trajectory (x_1, x_2) .

(b) Controller states $\eta_1(t)$ and $\eta_2(t)$.

FIGURE 6.5 – Simulation of the closed loop system.

This small illustrative simulation is applied on a small size arbitrary system to validate the synthesis method. Solving the synthesis problem corresponding to this system takes no time (<6 seconds). For this system, the vector sizes are given in Table 6.1

vector	size
x_1	$n_1 = 1$
x_2	$n_2 = 1$
η_1	$n_1 = 1$
η_2	$n_2 = 1$
u	$n_u = 1$
y	$n_y = 1$

TABLE 6.1 – System vector sizes in numerical example.

Based on this table, we found that the synthesis problem contains 43 variables which is still an easy SDP problem to be solved. In the later part of this chapter, we will shed the lights on the synthesis of the DOF of the TCM system and we will look at this algorithm from an SDP problem size point of view.

6.4 DOF Synthesis for the TCM Process

After presenting the feasible synthesis of DOF for a time delayed singular system in Theorem 6.2, it is the time to try to apply this method on the TCM process model given in (4.41). The MATLAB has returned an error with "out of memory" message. It was not even capable to load the variable data necessary to start the first iteration of the algorithm. The LMI feasibility problem contains 29648 variable. It is important to mention that the used solver which is SDPT3-4.0 defines also itself another variables used in its iterations referring to [TTT03]. Such an SDP problem is impossible to be solved on an Intel core i5 4th generation with 16 GB RAMs. It is the time to start looking to the problem from the informatics point of view.

6.5 Conclusion

As a conclusion we have presented a multivariable control strategy of a time delayed singular system, this control method is associated with a performance cost that can be tuned following the desirable behavior of the system. The control method is applicable in the case of missing measurements of system dynamics, a dynamic output feedback replaces the estimator or observer of the system. This synthesis is based on SDP feasible algorithm with LMI constraints. An illustrative example is provided at the end to validate the capacity of the method. For the case of tandem cold rolling, the high size of the system results in a heavy synthesis SDP problem containing a large number of variables. Supplementary techniques should be examined to reduce the size of the SDP problem. The large LMI constraints are too heavy to be resolved and we need mathematical tools to reduce them. One of these techniques, is the use of Riccati like non-linear inequalities to replace these LMIs.

Chapter 7

General Conclusion

Cold rolling of steel is a vital manufacturing process. It is an important stage in the metal strip processing line. This chain supplies many heavy and light industries with steel sheets needed for their products. This process is very complex where several mechanical and electrical active and passive systems interfere to accomplish product finishing. Steel client continuous demands in improving tandem products have motivated steelmakers to enhance tandem mill performance. Moreover, the requests in production acceleration pushes the actual control strategy to attain its limit against the strong variations of tensions and thickness errors inside the system.

Through this dissertation, many studies dealing with the control of tandem process were over viewed in chapter 2. Several modeling and control approaches have been developed during the last few decades in the field of cold rolling. Each study concentrate on specified objective in its control. Many approximations and special case studies were treated and used. Different mathematical models for the mechanism of strip rolling were also found in the sake of cold rolling mathematical modeling. These models have high complexity and strong non-linearity in their equations dedicated to the calculation of the rolling force and torque. As our objective is to establish a multivariable control strategy for the tandem process, we started by building a multivariable mathematical model that presents the offline behavior of the process. This modeling was carried out in chapter 4 in details. By writing down the physical and algebraic equations describing the evolution of each physical quantity, the larger part of the system modeling is accomplished. The remaining part is related to the model of rolling force and torque. A numerical algorithm developed in ArcelorMittal Maizières for the purpose of calculation of these variables, was used as a part of tandem modeling. The advantage of this algorithm is that it is much more accurate than the rolling force models developed by Bland and Ford [BF52], Bryant and Osborn [Bry73] and others, since it is based on finite element methods for the calculation of the total rolling force. Hence a multivariable state space model representing the 5 stand tandem is obtained. This model is a non-linear time delay singular system, due to the presence of algebraic and differential equations as well as the presence of time dependent delays in the system. The non-linear part in the obtained state space system, concerning the roll force and torque model, is then linearized in the neighborhood of a nominal point. The comparison have shown that the error between the non-linear and the linearized models does not exceed 4% in the neighborhood of the nominal point. This linearization is done for

the purpose of multivariable control synthesis. A final singular time delay system is obtained and will be used in the control synthesis. At the end of this chapter, the current control strategy adapted today is illustrated by its advantages and disadvantages on the rolling process.

In chapter 5, we have started the procedures of system control by providing explanations about time delay singular systems. The problem of system trajectory existence and uniqueness was explained and guaranteed by providing sufficient algebraic conditions. In addition the continuity of the trajectory is also treated through giving the sufficient interpretations related to the class of the TCM model with its IVP. A mathematical tool is provided to ensure a definite continuity for this system in all cases by introducing a weighting function to be multiplied by the state feedback vector. The control approach is then started by indicating the major points that must be considered by the controller synthesis. The control approach used in this chapter, stands for proposing a cost function that characterizes the performance of the system (LQ, \mathcal{H}_2 , \mathcal{H}_∞ ... etc). This performance cost is bounded by a general energetic quadratic function, where the latter satisfies certain conditions related to the Lyapunov direct method for stability verification. The synthesis problem solution is the type of control, which is to be chosen by the user following problem environment. In the case of our work, the performance cost is chosen as a quadratic function. The upper bound energetic function is chosen as the Lyapunov-Krasovskii functional. The solution of the control synthesis problem is chosen to be a state feedback gain assuming that the state vector is fully accessible. The upper bound value is minimized to optimize the performance of the system by introducing additional LMI constraints. The synthesis of the state feedback is carried out through solving an optimization problem under linear inequality constraints. The control methodology is applied at the beginning on a small size system to validate it. The simulation have shown satisfying results and give the ability to modify system behavior through tuning the weightings of the performance cost function. The final part of this chapter was dedicated to apply the control synthesis problem of the case of tandem process. Using the linearized model of TCM, the state feedback controller was established by solving the optimization problem with its LMI constraints. An alternative method has been provided to reach a suitable controller answering the problem. Only some of the simulations outputs were introduced due to the large number of outputs in the system. The errors in the system were managed and the time responses of the process were improved.

Finally our attention was turned to the application of the formalized synthesis problem on the TCM process, but this time depending only on the available measurements. Chapter 6 examines in a systematic way the application of the Bounded Performance Method to the case of non-fully accessible state vector. The approach is to adapt the DOF as a solution of the synthesis problem. Our primary interest was to define the form of the DOF controller regarding its class and its size. This step replaces the idea of observer synthesis and ensure an asymptotic stability of the closed loop system by only using the available measurements. The considered class of the DOF is the singular system. Applying the control synthesis problem proposed in chapter 5, new inequality constraints were elaborated for the synthesis in the case of DOF. These constraints are much larger in size than those elaborated in the case of state feedback synthesis. In addition they are not linear, a special change of variable was used to solve the problem.

The complexity of the case study required special treatment in order the synthesis LMI constraints were obtained. The inverse change of basis was also provided to find the DOF controller matrices after solving the synthesis problem. Once again this method was applied to a small size arbitrary system to prove the capability of finding the DOF controller. The mission was accomplished and the controller matrices were calculated. This was followed by a simulation step and then performance tuning step to show that ability to modify the behavior of the closed loop system. The final step was the calculation of the DOF controller for the case of tandem process. This step was unable to be accomplished due to the unavailability of the necessary informatics material to performance the resolution of the synthesis problem.

Perspectives and Suggestions for Future Research

Cold rolling of steel is one of the major stages in the fabrication of steel sheets. It represents one of the major areas of technological development within the steel industry. New technologies are under rapid development and are driven by many factors including low capital and operating costs. Also these new technologies respect strict environmental and client requisites. Future development will be directed toward process control which opens many opportunities for cold rolling of metals.

In conclusion, the research study described herein have shown that the new method of synthesis is applicable and obtain very good results, at least in the case of full equipped tandems where state feedback control can be applied. The control strategy is very easy to be used by the tandem users, whom their aims is directly oriented toward reducing output errors and reduce internal strong interactions. Also it provides a significant improvement in performance over typical industrial control strategies such as multiple loop PIDs. However other challenges still remain and need to be investigated. Future directions of this research should include the following points.

- For the solution of the DOF controller for the case of tandem process, the usage of powerful calculator with the presence of large memory size is a necessity for the solution of the problem. In addition, manipulating the problem in other language than MATLAB such as C++ can be beneficial since it may reduce the calculation load and time.
- An effective approach may be helpful for such problem, which is reducing the size of the synthesis problem. This can be carried out by reducing the size of the TCM model through neglecting rapid dynamics in motors and actuators. The reduction of synthesis problem size can be also achieved through transforming the large LMI constraints into Riccati like inequalities. It is true that these inequalities will be non-linear, but by using some kind of matrix forms and assumptions it can be solved using iterative algorithms.
- The usage of Lyapunov-Krasovskii second method for the guarantee of stability is very effective. However it is very important to use other control frequency approach such as \mathcal{H}_∞ control.
- Inclusion of the yield stress model uncertainties in the controller design. The empirical formula of the SMATCH Law contains 5 estimated parameters. These parameters are not exact and the stress model of the strip varies longitudinally

and transversely. This is due to the material mixing during the continuous casting which is not homogeneous and in addition the coils enrolled after the hot rolling are put to cool down which results in non-uniformity in product yield stress. To add this effect to the TCM model, two additional inputs can be added to the rolling force model (ex. Roll-Gap) one for the input yield stress $k_{1,i}$ and another for the exit one $k_{2,i}$. The uncertainty in these parameters lead to uncertainty in the partial derivatives extracted for the linearization of the force model. Surely this will lead to complexity in the controller synthesis.

- Inclusion of the exogenous perturbations in the controller design. The controller in the thesis is designed without taking into consideration the presence of external perturbations, however it was tested and verified under these signals. This can be carried out using Input to State Stability or any other method. The methodology becomes more complicated since this will lead to the increase of the LMI constraints of the synthesis problem.
- The TCM mathematical model is a non-linear one, trying to apply one of the multivariable non-linear control methods could be useful such as sliding model control in its multivariable version [ES98, UGS09]. In addition, recent studies are treated using the well known Model Predictive Control for its convenience for time delay systems. The usage of this methodology does not require the linearization if the process and can be applied to the non-linear cases directly.
- Simulation of the obtained state feedback controller on the TCM non-linear simulator. This step is very important and shows if the controller synthesis is effective or not.
- Through TCM modeling, the multivariable model used for the synthesis is obtained by linearizing the TCM non-linear multivariable model. This can result in adding uncertainties in model matrices. In addition, process parameters (motors, actuators, yield stress) are probably inexact and can be as parametric uncertainties. Finally, external exogenous perturbations are signals of unknown form or model. Hence robustness is very essential and must be included in the TCM controller synthesis

Appendix A

Developing the expression of $\mathbb{E}[V(t_0, \phi)]$

Recall ϕ , the discrete random function with discrete uniform distribution and Θ is the finite set of its possible compatible forms. Denote $\mu_\phi := \mathbb{E}[\phi(t)]$ and $\Sigma_\phi := \text{Var}(\phi(t)) = \mathbb{E}[\phi(t)\phi^T(t)]$ for every $t \in [t_0 - \tau_{max}, t_0]$. For simplicity, we assume that $\mu_\phi = 0$ and $\Sigma_\phi = I_n$ since we don't know much information about the form of the random initial condition ϕ . Let us derive the expression of $\mathbb{E}[V(t_0, \phi)]$. According to the expression of $V(t_0, \phi)$ in (5.17), its expectation is

$$\mathbb{E}[V(t_0, \phi)] = \mathbb{E}\left[\phi^T(t_0)E^T P\phi(t_0) + \sum_{i=1}^4 \int_{t_0 - \tau_i(t_0)}^{t_0} \phi^T(s)S_i\phi(s)ds\right], \quad (\text{A.1})$$

where the matrices E , P and S_i are already presented therein. Based on the linearity property of the expectation operator, we obtain

$$\mathbb{E}[V(t_0, \phi)] = \mathbb{E}[\phi^T(t_0)E^T P\phi(t_0)] + \mathbb{E}\left[\sum_{i=1}^4 \int_{t_0 - \tau_i(t_0)}^{t_0} \phi^T(s)S_i\phi(s)ds\right], \quad (\text{A.2})$$

Since the integrals over $[t_0 - \tau_{max}, t_0]$ in the second part of the RHS of (A.2) is independent of the random function, it gives

$$\mathbb{E}[V(t_0, \phi)] = \mathbb{E}[\phi^T(t_0)E^T P\phi(t_0)] + \sum_{i=1}^4 \int_{t_0 - \tau_i(t_0)}^{t_0} \mathbb{E}[\phi^T(s)S_i\phi(s)] ds, \quad (\text{A.3})$$

Note that the product terms $\phi^T(t_0)E^T P\phi(t_0)$ and $\phi^T(s)S_i\phi(s)$ are scalars, which means that the value of the product equals to the trace of the product. Thus we have

$$\begin{aligned} \mathbb{E}[\phi^T(t_0)E^T P\phi(t_0)] &= \mathbb{E}\{\text{Tr}[\phi^T(t_0)E^T P\phi(t_0)]\}, \\ \mathbb{E}[\phi^T(s)S_i\phi(s)] &= \mathbb{E}\{\text{Tr}[\phi^T(s)S_i\phi(s)]\}. \end{aligned} \quad (\text{A.4})$$

where Tr is the trace operator. Using the linearity property of the both trace and expectation operators, the composition between the two operators is commutative. Thus we have

$$\begin{aligned} \mathbb{E}[\phi^T(t_0)E^T P\phi(t_0)] &= \text{Tr}\{\mathbb{E}[\phi^T(t_0)E^T P\phi(t_0)]\}, \\ \mathbb{E}[\phi^T(s)S_i\phi(s)] &= \text{Tr}\{\mathbb{E}[\phi^T(s)S_i\phi(s)]\}. \end{aligned} \quad (\text{A.5})$$

Recall the cyclic permutation property of the trace operator. For any three matrix A , B and C of appropriate dimensions, we have

$$\mathbf{Tr}(ABC) = \mathbf{Tr}(CAB) = \mathbf{Tr}(BCA). \quad (\text{A.6})$$

Based on this property, the expressions of (A.5) leads to

$$\begin{aligned} \mathbb{E} [\phi^T(t_0)E^T P \phi(t_0)] &= \mathbf{Tr} \{ \mathbb{E} [E^T P \phi(t_0)\phi^T(t_0)] \}, \\ \mathbb{E} [\phi^T(s)S_i \phi(s)] &= \mathbf{Tr} \{ \mathbb{E} [S_i \phi(s)\phi^T(s)] \}. \end{aligned} \quad (\text{A.7})$$

The matrices $E^T P$ and S_i are seen by the expectation operator as constant matrices. Thus once again the expressions in (A.7) gives

$$\begin{aligned} \mathbb{E} [\phi^T(t_0)E^T P \phi(t_0)] &= \mathbf{Tr} \{ E^T P \times \mathbb{E} [\phi(t_0)\phi^T(t_0)] \}, \\ \mathbb{E} [\phi^T(s)S_i \phi(s)] &= \mathbf{Tr} \{ S_i \times \mathbb{E} [\phi(s)\phi^T(s)] \}. \end{aligned} \quad (\text{A.8})$$

Recall the following relation for the expectation of product of random variables based on the formula of covariance. Suppose X and Y are two random variables, then

$$\mathbb{E} [XY^T] = \mathbb{E} [X] \mathbb{E} [Y]^T + \text{Cov}(X, Y). \quad (\text{A.9})$$

where Cov is the covariance operator. Applying the relation in (A.9) on the product of same random variable X , we obtain

$$\mathbb{E} [XX^T] = \mathbb{E} [X] \mathbb{E} [X]^T + \text{Var}(X). \quad (\text{A.10})$$

under the fact that $\text{Cov}(X, X) = \text{Var}(X)$, where Var is the variance operator. Based on the relation in (A.10), the expression in (A.8) can be written as

$$\begin{aligned} \mathbb{E} [\phi^T(t_0)E^T P \phi(t_0)] &= \mathbf{Tr} \left\{ E^T P \times \left[\mathbb{E} [\phi(t_0)] \mathbb{E} [\phi(t_0)]^T + \text{Var}(\phi(t_0)) \right] \right\}, \\ \mathbb{E} [\phi^T(s)S_i \phi(s)] &= \mathbf{Tr} \left\{ S_i \times \left[\mathbb{E} [\phi(s)] \mathbb{E} [\phi(s)]^T + \text{Var}(\phi(s)) \right] \right\}. \end{aligned} \quad (\text{A.11})$$

Based on the expressions in (A.11), the expression of $\mathbb{E} [V(t_0, \phi)]$ from (A.3) can be written as

$$\begin{aligned} \mathbb{E} [V(t_0, \phi)] &= \mathbf{Tr} \left\{ E^T P \times \left[\mathbb{E} [\phi(t_0)] \mathbb{E} [\phi(t_0)]^T + \text{Var}(\phi(t_0)) \right] \right\} \\ &+ \sum_{i=1}^4 \int_{t_0 - \tau_i(t_0)}^{t_0} \mathbf{Tr} \left\{ S_i \times \left[\mathbb{E} [\phi(s)] \mathbb{E} [\phi(s)]^T + \text{Var}(\phi(s)) \right] \right\} ds, \end{aligned} \quad (\text{A.12})$$

Recall $\mu_\phi = \mathbb{E} [\phi(t)]$ and $\Sigma_\phi = \text{Var}(\phi(t)) = \mathbb{E} [\phi(t)\phi^T(t)]$ for every $t \in [t_0 - \tau_{max}, t_0]$. From (A.12), we obtain

$$\begin{aligned} \mathbb{E} [V(t_0, \phi)] &= \mathbf{Tr} \left\{ E^T P \times [\mu_\phi \mu_\phi^T + \Sigma_\phi] \right\} + \sum_{i=1}^4 \int_{t_0 - \tau_i(t_0)}^{t_0} \mathbf{Tr} \left\{ S_i \times [\mu_\phi \mu_\phi^T + \Sigma_\phi] \right\} ds \\ &= \mathbf{Tr} \left\{ E^T P \times [\mu_\phi \mu_\phi^T + \Sigma_\phi] \right\} + \sum_{i=1}^4 \mathbf{Tr} \left\{ S_i \times [\mu_\phi \mu_\phi^T + \Sigma_\phi] \right\} \int_{t_0 - \tau_i(t_0)}^{t_0} ds \\ &= \mathbf{Tr} \left\{ E^T P \times [\mu_\phi \mu_\phi^T + \Sigma_\phi] \right\} + \sum_{i=1}^4 \tau_i(t_0) \mathbf{Tr} \left\{ S_i \times [\mu_\phi \mu_\phi^T + \Sigma_\phi] \right\}. \end{aligned} \quad (\text{A.13})$$

By substituting $\mu_\phi = 0_n$ and $\Sigma_\phi = I_n$, we obtain

$$\mathbb{E}[V(t_0, \phi)] = \mathbf{Tr} \left(E^T P + \sum_{i=1}^4 \tau_i(t_0) S_i \right). \quad (\text{A.14})$$

References

- [ACMH12] P. G. Alves, J. A. Castro, L. P. Moreira, and E. M. Hemerly. Modeling, simulation and identification for control of tandem cold metal rolling. *Materials Research*, 15(6) :928–936, 2012. [15](#), [18](#)
- [AJM⁺16] M.T. Asghar, M. Jungers, I.-C. Morarescu, A. Khelassi, and J. Francken. Tandem cold rolling mill modeling for multi-variable control synthesis. In *17th IFAC Symposium on Control, Optimization and Automation in Mining, Mineral and Metal Processing*, Vienna, Austria, 2016. [38](#)
- [AJM⁺17] M.T. Asghar, M. Jungers, I.-C. Morarescu, A. Khelassi, and J. Francken. Guaranteed cost control design for descriptor systems with time-varying delays. In *Proceedings of the 56th IEEE Conference on Decision and Control, 2017.*, volume 3, pages 4878–4883. IEEE, 2017. [66](#)
- [AMC12] P. G. Alves, L. P. Moreira, and J. A. Castro. Dynamic simulator for control of tandem cold metal rolling. In *Proceedings of Brazilian Society of Mechanical Science and Engineering (ABCM) Symposium Series in Mechatronics*, volume 21, 2012. [18](#), [41](#)
- [AT00] P. Apkarian and H. D. Tuan. Parameterized lmis in control theory. *SIAM Journal on Control and Optimization*, 38(4) :1241–1264, 2000. [21](#)
- [BBCS10] A. Bemporad, D. Bernardini, F. A. Cuzzola, and A. Spinelli. Optimization-based automatic flatness control in cold tandem rolling. *Journal of Process Control*, 20(4) :396–407, 2010. [17](#)
- [BC63] R. E. Bellman and K. L. Cooke. *Differential-difference equations*. Rand Corporation, 1963. [25](#)
- [BEGFB94] S. Boyd, L. El Ghaoui, E. Feron, and V. Balakrishnan. *Linear matrix inequalities in system and control theory*. SIAM, 1994. [16](#), [20](#), [21](#)
- [Bel13] R. Bellman. *Dynamic programming*. Courier Corporation, 2013. [20](#), [66](#)
- [Ber95] D. P. Bertsekas. *Dynamic programming and optimal control*, volume 1. Athena scientific Belmont, MA, 1995. [66](#)
- [BF48] D. R. Bland and H. Ford. The calculation of roll force and torque in cold strip rolling with tensions. In *Proceedings of the Institution of Mechanical Engineers*, volume 159, pages 144–153, June 1948. [14](#), [17](#), [46](#)
- [BF52] D.R. Bland and H. Ford. An approximate treatment of the elastic compression of the strip in cold rolling. *Journal of Iron and Steel Institute*, 171 :245–249, July 1952. [14](#), [17](#), [18](#), [113](#)

- [BGM96] G. A. Baker and P. Graves-Morris. *Padé approximants*, volume 59. Cambridge University Press, 1996. [17](#)
- [Bry73] G. F. Bryant. *The Automation of Tandem Mills*. The British Iron and Steel Institute, U.K., 1973. [6](#), [12](#), [13](#), [15](#), [16](#), [17](#), [19](#), [38](#), [113](#)
- [Bry75] A. E. Bryson. *Applied optimal control : optimization, estimation and control*. CRC Press, 1975. [66](#)
- [BS53] D.R. Bland and R.B. Sims. A note on the theory of rolling with tensions. In *Proceedings of the Institution of Mechanical Engineers*, volume 167, pages 371–374, 1953. [15](#)
- [BV03] V. Balakrishnan and L. Vandenberghe. Semidefinite programming duality and linear time-invariant systems. *IEEE Transactions on Automatic Control*, 48(1) :30–41, 2003. [21](#)
- [Cam80a] S.L. Campbell. Singular linear systems of differential equations with delays. *Applicable analysis*, 11 :129–136, 1980. [62](#), [70](#)
- [Cam80b] S.L. Campbell. *Singular Systems of differential equations*. Pitman Publishing Limited, London UK, 1980. [30](#), [31](#), [49](#)
- [Cao15] T.S. Cao. Back calculation programs for cold rolling, constructions and analysis. Technical report, ArcelorMittal, RDMP/2015/21681, Libra : 2015-13881, 2015. [15](#)
- [Cao16] T.S. Cao. Validation of the rollgap program. Technical report, ArcelorMittal, RDMP/2016/22041, Libra : 2016-18433, 2016. [15](#)
- [CCD⁺92] A.J. Carlton, G.H. Conway, R.G. Davies, W.J. Edward, and P.D. Spooner. Automation of the ltv steel hennepin tandem cold mill. In *Iron and Steel Engineer*, pages 17–28, 1992. [17](#)
- [CJG94] S. G. Choi, M. A. Johnson, and M. J. Grimble. Polynomial lqg control of back-up-roll eccentricity gauge variations in cold rolling mills. *Automatica*, 30(6) :975–992, June 1994. [17](#)
- [Dai89] L. Dai. *Singular control systems*. Springer, Berlin, 1989. [29](#), [30](#), [31](#), [32](#), [49](#), [62](#), [63](#), [93](#)
- [DML14] T. Dbouk, P. Montmitonnet, and N. Legrand. Two-dimensional roll bite model with lubrication for cold strip rolling. *Advanced Materials Research*, 966-967 :48–62, 2014. [47](#)
- [DMS⁺13] T. Dbouk, P. Montmitonnet, N. Suzuki, Y. Takahama, N. Legrand, T. Ngo, and H. Matsumoto. Advanced roll bite models for cold and temper rolling process. In *proceeding of 9th International and 6th European Rolling Conference*, June 2013. [15](#), [42](#), [47](#)
- [DTF91] P. Duval, J.C. Thomas, and G. Fellus. Latest agc technology installed at ltv’s cleveland 5 stand cold mill. In *Iron and Steel Engineer*, 1991. [17](#)
- [Edw78] W. J. Edwards. Paper : Design of entry strip thickness controls for tandem cold mills. *Automatica*, 14(5) :429–441, September 1978. [16](#)
- [EN73] L.E. El’sgol’ts and S. B. Norikin. *Introduction to the theory and application of differential equations with deviating arguments*, volume 105. Academic Press, 1973. [26](#)

- [ES98] C. Edwards and S. Spurgeon. *Sliding mode control : theory and applications*. Crc Press, 1998. 116
- [FEB51] H. Ford, F. Ellis, and D. R. Bland. Cold rolling with strip tension part i : A new approximate method of calculation and a comparison with other method. *Journal of Iron and Steel Institute*, 168 :57–72, 1951. 15, 18
- [FPS08] H. C. Ferreira, C. T. A. Pires, and R. M. Sales. Adequacy of cold rolling models to upgrade set-up generation systems. *Iron and Steel Institute International of Japan*, 48(10) :1389–1393, 2008. 15
- [Fri02] E. Fridman. Stability of linear descriptor systems with delay : a lyapunov based approach. *Journal of Mathematical Analysis and Applications*, 273 :24–44, 2002. 31, 33, 34, 64, 70
- [Fri14] E. Fridman. *Introduction to time delay systems*. Birkhäuser, 2014. 23, 24, 25, 26, 27, 34, 62, 64, 65, 69
- [FS83] D.J. Fapiano and D.E. Steeper. Thickness control in cold rolling. *Iron and Steel Engineer*, pages 21–31, 1983. 16
- [FS02] E. Fridman and U. Shaked. \mathcal{H}_∞ control of linear state delay descriptor systems : an lmi approach. *Linear algebra and its applications*, 351-352 :271–302, 2002. 32, 33, 70, 71
- [FWW02] Y. Frayman, L. Wang, and C. Wan. Cold rolling mill thickness control using the cascade correlation neural network. *Control and Cybernetics*, 31(2) :327–342, 2002. 40
- [Gah96] P. Gahinet. Explicit controller formulas for lmi-based \mathcal{H}_∞ synthesis. *Automatica*, 32(7) :1007–1014, 1996. 100
- [GCK03] K. Gu, J. Chen, and V. Kharitonov. *Stability of Time-Delay Systems*. Birkhauser Boston, 2003. 25, 26, 62, 69
- [Ged98] E. J. M. Geddes. *Tandem Cold Rolling and Robust Multivariable Control*. PhD thesis, University of Leicester, 1998. 13, 15, 17, 19, 38, 46, 50
- [Gin93a] V. B. Ginzburg. *High-quality steel rolling : theory and practice*. Marcel Dekker, New York, 1993. 10, 16
- [Gin93b] V. B. Ginzburg. *Steel-rolling technology : theory and practice*. Marcel Dekker, New York, 1993. 10, 16
- [GP94] E. J. M. Geddes and I. Postlethwaite. Multivariable control of a high performance tandem cold rolling mill. In *Proceedings of the International Conference on Control Applications*, volume 1, pages 202–207, 1994. 17, 41
- [Gu03] K. Gu. An improved stability criterion for systems with distributed delays. *International Journal of Robust and nonlinear control*, 13(9) :819–831, 2003. 62
- [Hal71] J. K. Hale. Functional differential equations. In *Analytic theory of differential equations*, pages 9–22. Springer, 1971. 24
- [HB08] A. Haidar and E.K. Boukas. Delay-range-dependent exponential stability of singular systems with multiple time-varying delays. *IFAC Proceedings Volumes*, 41(2) :271–276, 2008. 34, 64

- [HB09] A. Haidar and EK. Boukas. Exponential stability of singular systems with multiple time-varying delays. *Automatica*, 45(2) :539–545, 2009. [34](#), [64](#), [93](#)
- [HBXL09] A. Haidar, EK. Boukas, S. Xu, and J. Lam. Exponential stability and static output feedback stabilization of singular time delay systems with saturating actuators. *Institution of Engineering and Technology for Control Theory & Applications*, 3(9) :1293–1305, 2009. [34](#), [64](#), [65](#)
- [Hil98] R. Hill. *The mathematical theory of plasticity*, volume 11. Oxford university press, 1998. [14](#)
- [Hit35] J. Hitchcock. Elastic deformation of rolls during cold rolling, report of special research committee on roll neck bearings. Technical report, American Society of Mechanical Engineers, June 1935. [14](#)
- [HK93] T. Harakawa and T. Kawaguchi. Digital control in iron and steelmaking processes. *Automatica*, 29(5) :1185–1202, 1993. [16](#)
- [HL93] J.K. Hale and S.M.V. Lunel. *Introduction to function differential equations*. Springer, New York, 1993. [24](#), [26](#), [34](#), [35](#), [62](#), [64](#)
- [HMF⁺88] I. Hoshino, Y. Maekawa, T. Fujimoto, H. Kimura, and H. Kimura. Observer-based multivariable control of the aluminum cold tandem mill. *Automatica*, 24(6) :741–754, 1988. [16](#), [17](#)
- [HSDB⁺11] C.W.J. Hol, S. Sujoto, M. De Boer, V. Beentjes, M. Price, C.W. Scherer, and A.J.J. Van der Weiden. *Optimal feedforward filter design for flying gauge changes of a continuous cold mill*, pages 8545–8551. 18 IFAC World Congress, 2011. [16](#)
- [HSM84] I. Hoshino, A. Sugie, and Y. Maekawa. Linear model and characteristic analysis for thickness control of aluminum cold tandem mills. *Sumitomo Light Metal Technical Reports*, 25 :17–26, 07 1984. [16](#)
- [Hur95] A. Hurwitz. Ueber die bedingungen unter welchen eine gleichung nur wurzeln mit negativen reellen theilen besitzt. *Mathematische Annalen*, 46 :273 – 284, 1895. [103](#)
- [KFA69] R. E. Kalman, P. L. Falb, and M. A. Arbib. *Topics in mathematical system theory*, volume 1. McGraw-Hill, New York, 1969. [20](#)
- [Kha98] V. L. Kharitonov. Robust stability analysis of time delay systems : A survey. *IFAC Proceedings Volumes*, 31(18) :1–12, 1998. [24](#)
- [Kha02] H.K. Khalil. *Nonlinear systems*. Prentice-Hall, Englewood Cliffs, 2002. [22](#), [24](#), [103](#)
- [Kha12] V. Kharitonov. *Time-delay systems : Lyapunov functionals and matrices*. Springer Science & Business Media, 2012. [62](#), [69](#), [70](#)
- [Kha15] H. K. Khalil. *Nonlinear Control*. Pearson New York, 2015. [22](#), [23](#)
- [KJ95] M.R. Katebi and M.A. Johnson. Predictive control for hierarchically structured systems with application to the tandem rolling mill. *Proceedings of the European Control Conference*, 5 :3567–3572, 1995. [16](#)
- [KKO99] P. Kokotović, H. K. Khalil, and J. O’reilly. *Singular perturbation methods in control : analysis and design*. SIAM, 1999. [32](#)

- [KM99] V. Kolmanovskii and A. Myshkis. *Introduction to the theory and applications of functional differential equations*, volume 463. Springer Science & Business Media, 1999. [24](#), [26](#), [64](#)
- [KNG99] V.B. Kolmanovskii, S.-I. Niculescu, and K. Gu. Delay effects on stability : A survey. In *Proceedings of the 38th IEEE Conference on Decision and Control*, 1999., volume 2, pages 1993–1998. IEEE, 1999. [24](#)
- [KNSA00] A. Kugi, R. Novak, K. Schlacher, and K. Aistleitner. A flatness based approach for the thickness control in rolling mills. In *Proceedings of the 14th International Symposium on Mathematical Theory of Networks and Systems 2000*, 2000. [40](#)
- [Kra63] N.N. Krasovskii. *Stability of Motion*. Stanford University Press, 1963. [26](#)
- [KS72] H. Kwakernaak and R. Sivan. *Linear Optimal Control Systems*, volume 1. Wiley-Interscience, New York, 1972. [20](#), [21](#)
- [KS89] T. Kawaguchi and K. Sugiyama. *Steel Industry I : Manufacturing System*. Gordon and Breach Science, U.K., 1989. [12](#)
- [KU89] T. Kawaguchi and T. Ueyama. *Steel Industry II : Control System*. Gordon and Breach Science, U.K., 1989. [12](#)
- [Lew02] F. L. Lewis. A survey of linear singular systems. *Circuits, Systems and Signal Processing*, 5 :3–36, 2002. [29](#), [32](#), [70](#)
- [Liu12] P.L. Liu. Exponential stability if singular systems with multiple time varying delays. *International journal of innovative computing, information and control*, 8 :4015–4024, 2012. [32](#), [33](#), [70](#)
- [Löf04] J. Löfberg. Yalmip : A toolbox for modeling and optimization in matlab. In *In Proceedings of the Computer Aided Control System Design Conference*, Taipei, Taiwan, 2004. [78](#)
- [Löf09] J. Löfberg. Pre- and post-processing sum-of-squares programs in practice. *IEEE Transactions on Automatic Control*, 54(5) :1007–1011, 2009. [78](#)
- [Löf12] J. Löfberg. Automatic robust convex programming. *Optimization methods and software*, 27(1) :115–129, 2012. [78](#)
- [LS76] J. P. La Salle. *The stability of dynamical systems*. SIAM, 1976. [22](#)
- [Luk69] Y. L. Luke. *Special functions and their approximations*, volume 2. Academic press, 1969. [17](#)
- [LWY07] X. Liao, L. Wang, and P. Yu. *Stability of dynamical systems*, volume 5. Elsevier, 2007. [22](#)
- [Lya92] A. M. Lyapunov. The general problem of the stability of motion. *International Journal of Control*, 55(3) :531–534, 1992. [22](#), [69](#)
- [LZ13] F. Li and X. Zhang. Delay range dependent robust \mathcal{H}_∞ filtering for singular lpv systems with time variant delay. *International Journal of Innovative Computing, Information and Control*, 9(1) :339–353, 2013. [34](#)
- [MKOS97] I. Masubuchi, Y. Kamitane, A. Ohara, and N. Suda. \mathcal{H}_∞ control for descriptor systems : A matrix inequalities approach. *Automatica*, 33(4) :669–673, April 1997. [92](#), [95](#), [99](#)

- [MLSS94] Richard M Murray, Zexiang Li, S Shankar Sastry, and S Shankara Sastry. *A mathematical introduction to robotic manipulation*. CRC press, 1994. [22](#)
- [MN14] W. Michiels and S.-I. Niculescu. *Stability, control, and computation for time-delay systems : an eigenvalue-based approach*. SIAM, 2014. [23](#)
- [MOS98] I. Masubuchi, A. Ohara, and N. Suda. Lmi-based controller synthesis : A unified formulation and solution. *International Journal of Robust and Nonlinear Control*, 8 :669 – 686, 07 1998. [99](#)
- [MP96] Chilali M. and Gahinet P. \mathcal{H}_∞ design with pole placement constraints An lmi approach. *IEEE Transactions on Automatic Control*, 41 :358–367, 1996. [99](#), [100](#)
- [MVAN05] W. Michiels, V. Van Assche, and S.-I. Niculescu. Stabilization of time delay systems with a controlled time-varying delay and applications. *IEEE Transactions on Automatic Control*, 50(4) :493–504, 2005. [24](#), [62](#)
- [Nic01] S.-I. Niculescu. *Delay Effects on Stability : A Robust Control Approach*. Springer-Verlag, New York, 2001. [23](#), [62](#), [69](#)
- [NVDD98] S.-I. Niculescu, E. I. Verriest, L. Dugard, and J.-M. Dion. Stability and robust stability of time-delay systems : A guided tour. In *Stability and control of time-delay systems*, pages 1–71. Springer, 1998. [24](#)
- [Oro43] E. Orowan. The calculation of roll pressure in hot and cold flat rolling. In *Proceedings of the Institution of Mechanical Engineers*, volume 150, pages 140–167, 1943. [6](#), [14](#), [16](#), [46](#)
- [Pit06] J. R. Pittner. *Pointwise linear quadratic optimal control of a tandem cold rolling mill*. PhD thesis, University of Pittsburgh, 2006. [15](#), [18](#)
- [PL91] M. Pietrzyk and J. G. Lenard. *Thermal mechanical modeling of the flat rolling process*. Springer-Verlag, 1991. [14](#), [42](#), [47](#)
- [Pon87] L. S. Pontryagin. *Mathematical theory of optimal processes*. CRC Press, 1987. [66](#)
- [PS04] J. Pittner and M. A. Simaan. Pointwise linear quadratic optimal control of a tandem cold rolling mill. In *Industry Applications Conference, 2004. 39th IAS Annual Meeting. Conference Record of the 2004 IEEE*, volume 2, pages 903–910. IEEE, 2004. [15](#), [17](#)
- [PS06] J. Pittner and M. A. Simaan. State-dependent riccati equation approach for optimal control of a tandem cold metal rolling process. *IEEE transactions on Industry Applications*, 42(3) :836–843, 2006. [15](#), [18](#)
- [PS07a] J. Pittner and M. A. Simaan. A new strategy for control of tandem cold metal rolling. In *American Control Conference, 2007. ACC'07*, pages 4130–4135. IEEE, 2007. [15](#), [18](#)
- [PS07b] J. Pittner and M. A. Simaan. An optimal control method for improvement in tandem cold metal rolling. In *Industry Applications Conference, 2007. 42nd IAS Annual Meeting. Conference Record of the 2007 IEEE*, pages 382–389. IEEE, 2007. [15](#), [18](#)

- [PS10] J. Pittner and M. A. Simaan. A new strategy for optimal control of continuous tandem cold metal rolling. *IEEE Transactions on Industry Applications*, 46(2) :703–711, March/April 2010. 18
- [PS11] J. Pittner and M. A. Simaan. *Tandem Cold Metal Rolling Mill Control*. Springer, London UK, 2011. 18, 19, 41, 44, 46, 50
- [PSS07] J. Pittner, M. A. Simaan, and N. S. Samaras. A novel approach for optimal control of continuous tandem cold metal rolling. In *Industry Applications Conference, 2007. 42nd IAS Annual Meeting. Conference Record of the 2007 IEEE*, pages 374–381. IEEE, 2007. 18
- [RA99] A. Rehm and F. Allgöwen. Multiobjective output-feedback control of descriptor systems : An lmi approach. In *European Control Conference (ECC)*, 1999, pages 537–542. IEEE, 1999. 95, 98, 103
- [Ric03] J.P. Richard. Time-delay systems an overview of some recent advances and open problems. *Automatica*, 39 :1667–1694, 2003. 24, 26, 27, 62, 69, 71
- [Rob78] W. L. Roberts. *Cold Rolling of Steel*. Manufacturing Engineering and Materials Processing. Dekker, New York, USA, 1978. 6, 10, 12, 13, 16, 37, 43, 44, 47
- [SA52] R.B. Sims and D.F. Arthur. Speed-dependent variables in cold strip rolling. *Journal of Iron and Steel Institute*, 172(2) :285–295, 1952. 43
- [Sch95a] C. Scherer. From lmi analysis to multichannel mixed lmi synthesis a general procedure. *Selected Topics in Identification, Modeling and Control*, 8 :1–8, 1995. 100
- [Sch95b] C. Scherer. Multiobjective $\mathcal{H}_2/\mathcal{H}_\infty$ control. *IEEE Transactions on Automatic Control*, 40(6) :1054–1062, 1995. 92
- [SGC97] C. Scherer, P. Gahinet, and M. Chilali. Multiobjective output-feedback control via lmi optimization. *IEEE Transactions on Automatic Control*, 42(7) :896–911, 1997. 92, 95, 98, 100, 103
- [Sim54] R. B. Sims. Calculation of roll force and torque in hot rolling mills. In *Proceedings of the Institution of Mechanical Engineers*, volume 168, pages 191–200, January 1954. 43
- [Ske88] R. E. Skelton. *Dynamics Systems Control : linear systems analysis and synthesis*. John Wiley & Sons, 1988. 21
- [SLM97] C. Silvy-Leligois and R. Mieze. Régulation d’entrefer de la cage 1 d’un laminoir à froid. Technical report, IRSID, 1997. 40
- [Smi87] A.W. Smith. Modernization of a tandem cold mill with distributed digital control. *Iron and Steel Engineer*, pages 45–49, 1987. 16
- [SP07] S. Skogestad and I. Postlethwaite. *Multivariable feedback control : analysis and design*, volume 2. Wiley, New York, 2007. 16, 20
- [TK98] K. Takaba and T. Katayama. \mathcal{H}_2 output feedback control for descriptor systems. *Automatica*, 34(7) :841–850, July 1998. 92, 95
- [TMK95] K. Takaba, N. Morihira, and T. Katayama. A generalized lyapunov theorem for descriptor system. *Systems & Control Letters*, 24(1) :49–51, 1995. 32

- [TTT99] K. C. Toh, M.J. Todd, and R. H. Tütüncü. Sdpt3 – a matlab software package for semidefinite programming. *Optimization Methods And Software*, 11 :545–581, 1999. [78](#)
- [TTT03] R. H. Tütüncü, K. C. Toh, and M. J. Todd. Solving semidefinite-quadratic-linear programs using sdpt3. *Mathematical Programming*, 95(2) :189–217, Feb 2003. [78](#), [111](#)
- [UGS09] V. Utkin, J. Guldner, and J. Shi. *Sliding mode control in electro-mechanical systems*, volume 34. CRC press, 2009. [116](#)
- [Ver95] E.I. Verriest. Stability of systems with distributed delays. *IFAC Proceedings Volumes*, 28(8) :283–288, 1995. [62](#)
- [Vid02] M. Vidyasagar. *Nonlinear systems analysis*. SIAM, 2002. [22](#), [69](#)
- [Wan02] J.S. Wang. *Principle and application of flying gauge change for TWRSC Tandem Cold Mill*. PhD thesis, Northeastern University Shenyang, 2002. [42](#), [50](#)
- [WHS10] M. Wu, Y. He, and J.-H. She. *Stability analysis and robust control of time-delay systems*. Springer, 2010. [22](#)
- [Won74] W. M. Wonham. Linear multivariable control. In *Optimal control theory and its applications*, pages 392–424. Springer, 1974. [21](#)
- [XC04] S. Xu and T. Chen. An lmi approach to the \mathcal{H}_∞ filter design for uncertain systems with distributed delays. *IEEE Transactions on Circuits and Systems II : Express Briefs*, 51(4) :195–201, 2004. [62](#)
- [XDSL02] S. Xu, P.V. Dooren, R. Stefan, and J. Lam. Robust stability and stabilization for singular systems with state delay and parameter uncertainty. *IEEE Transactions on Automatic Control*, 47 :1122–1128, 2002. [30](#), [34](#), [62](#), [65](#), [94](#)
- [XL06] S. Xu and J. Lam. *Robust control and filtering of singular systems*. Springer-Verlag, Germany, 2006. [29](#), [31](#), [32](#), [33](#), [34](#), [62](#), [64](#), [94](#)
- [YK79] T. Yamada and H. Kimura. Multivariable control of cold tandem mill. *Transactions of the Society of Instrument and Control Engineers*, 15(5) :647–653, 1979. [16](#)
- [YS81] E.L. Yip and R.F. Sincovec. Solvability, controllability and observability of continuous descriptor systems. *IEEE Transactions on Automatic Control*, 26 :702–707, 1981. [29](#), [32](#)
- [ZD98] K. Zhou and J. C. Doyle. *Essentials of robust control*, volume 104. Prentice hall, Upper Saddle River, New Jersey, 1998. [66](#)
- [ZDG+96] K. Zhou, J. C. Doyle, K. Glover, et al. *Robust and optimal control*, volume 40. Prentice hall, New Jersey, 1996. [66](#), [67](#)
- [ZZS09] X. Zhang, Q. Zhang, and C. Sun. Gauge and tension control in unsteady state of cold rolling using mixed $\mathcal{H}_2/\mathcal{H}_\infty$ control. In *2009 IEEE International Conference on Control and Automation*, pages 2072–2076, Dec 2009. [18](#)

Abstract

The steel industry has been developing for years. The characteristics of the products intended for the various industrial sectors are becoming more and more demanded. Currently advanced PID controllers are used with a local multi-loop structure. In order to deal with the increasingly constrained specifications, it is interesting to review this control strategy. This CIFRE PhD thesis between ArcelorMittal and CRAN aims to propose new advanced control strategies for the cold rolling of thin sheet steel strips, including centralized control strategies replacing local and independent control loops, to broaden the scope of treatable materials, increase and optimize process productivity and capabilities, and minimize production costs. In a first part, a bibliographic study will be carried out in order to better define the various metallurgical and dynamic models of the system to be controlled. In a second part, the specifications will be translated in terms of an optimization problem whose solution is the state feedback controller. Finally, in a third and final part, a dynamic output feedback synthesis will be proposed to solve the problem of missing measurements.

Keywords : Cold rolling, Multivariable Control, Time Delay System.

Résumé

L'industrie sidérurgique rencontre depuis des années un développement important. Les caractéristiques des produits destinés aux différents secteurs industriels deviennent de plus en plus exigeantes. Actuellement des régulateurs avancés de type PID sont utilisés avec une structure multi-boucles locales. Afin de traiter les cahiers des charges de plus en plus contraints, il devient intéressant de revoir cette stratégie de contrôle. Ce sujet de thèse CIFRE entre ArcelorMittal et le CRAN a pour objectif de proposer de nouvelles stratégies de contrôle avancé pour le laminage à froid des bandes d'acier de type tôle fine, notamment des stratégies centralisées de contrôle remplaçant des boucles de régulation locales et indépendantes, afin d'élargir le champ des matériaux traitables, d'augmenter et d'optimiser la productivité et les capacités du procédé ainsi que de minimiser les coûts de production. Dans une première partie, une étude bibliographique sera effectuée afin de mieux cerner les différents modèles métallurgiques et dynamiques du système à piloter. Dans une seconde partie, le cahier des charges sera traduit en termes d'un problème d'optimisation dont la solution est un contrôleur de type retour d'état. Enfin dans une troisième et dernière partie, une synthèse de retour de sortie dynamique sera proposée pour résoudre le problème des mesures manquantes.

Mots-clefs : Laminage à froid, Commande Multivariable, système retardé.