



HAL
open science

Research on the route of sustainable development of China's traditional manufacturing industry : case study of garment enterprise

Jianhua Jin

► **To cite this version:**

Jianhua Jin. Research on the route of sustainable development of China's traditional manufacturing industry : case study of garment enterprise. Business administration. Université Grenoble Alpes, 2015. English. NNT : 2015GREAG007 . tel-01865838

HAL Id: tel-01865838

<https://theses.hal.science/tel-01865838v1>

Submitted on 2 Sep 2018

HAL is a multi-disciplinary open access archive for the deposit and dissemination of scientific research documents, whether they are published or not. The documents may come from teaching and research institutions in France or abroad, or from public or private research centers.

L'archive ouverte pluridisciplinaire **HAL**, est destinée au dépôt et à la diffusion de documents scientifiques de niveau recherche, publiés ou non, émanant des établissements d'enseignement et de recherche français ou étrangers, des laboratoires publics ou privés.

THÈSE

Pour obtenir le grade de

DOCTEUR DE L'UNIVERSITÉ GRENOBLE ALPES

Spécialité : **Sciences de gestion**

Arrêté ministériel : 7 août 2006

Présentée par

Jianhua JIN

Thèse dirigée par **Denis Dupré**

préparée au sein du **Laboratoire CERAG UMR 5820**
dans l'**École Doctorale de Sciences de gestion n°275**

Pilotage du développement durable dans l'industrie textile chinoise

Thèse soutenue publiquement le **3 juillet 2015**
devant le jury composé de :

M. Nicolas ANTHEAUME

Professeur, Université de Nantes, rapporteur

M. Denis DUPRE

Maître de conférences, HDR, Université Grenoble-Alpes, suffragant

Mme Catherine KARYOTIS

Professeur Neoma Business School, Reims, rapporteur

M. Yinochuan YU

Professeur, Université de Shanghai, Président du jury



Table of Contents

Table of Contents	1
List of Tables	5
List of Figures	10
Acknowledgements	11
General Introduction	13
1. Research thesis belonging to research-action.....	13
2. Green management in the context of sustainable development and Corporate Social Responsibility	15
3. The Chinese context of green management in the garment industry	18
4. The factors of green management in the garment industry.....	22
4.1. Internal factors of green management.....	24
4.2. External factors of green management	25
4.3. Social environment awareness.....	26
4.4. Conclusion	26
5. Conceiving a green management dashboard for small firms	27
6. A ranking method as a tool for strategic decisions in a stakeholder perspective	31
7. Map of the thesis.....	34
Chapter 1	36
Analysis of Influence Factors of Green Management in Garment Enterprise	36
1.1. Research Review	41
1.1.1. Summary of foreign research	41
1.1.2. Summary of domestic research	45

1.1.3. Conclusion.....	49
1.2. Research Background.....	50
1.3. Research Perspectives	51
1.4. Research Approaches and Procedure	53
1.5. Summary of the contents of the green management	54
1.5.1. The meaning and features of green management.....	54
1.5.2. The important processes of the green management	56
1.5.3. Phrase Summary.....	65
1.6. Factors on green management.....	65
1.6.1. Internal factors in company.....	66
1.6.2. Corporate external factors	74
1.7. Evaluation analysis of influencing factors of green management of clothing enterprise based on ANP	78
1.7.1. Summarize of ANP	78
1.7.2. The establishment of the evaluation model.....	87
1.7.3. The analysis based on evaluation of ANP.....	96
1.8. Conclusion.....	104
Bibliography of Chapter 1	106
Annex A of Chapter 1	114
Chapter 2.....	155
Towards Sustainable Production from A Stakeholder’s Perspective: A Dashboard Approach in China’s Garment Industry	155
2.1. Introduction and case study context	158
2.2. Stakes of a dashboard incorporating sustainable Key Performance Indicators ...	162
2.3. The complexity of international standards for small firms	164
2.4. Methodology of dashboard building for the Chinese textile industry.....	166
2.4.1. Methodology for building indicators and dashboard	167

2.4.2. Characteristics of performance metrics and indicators adapted to the garment industry	169
2.4.3. A straightforward way to communicate with stakeholders	170
2.4.4. The Territorial Responsibility	171
2.5. A case study: building a dashboard for a garment plant in China.....	173
2.5.1. Detailed assessment of the production process by product.....	175
2.5.2. The choice of Indicators at the plant level	176
2.5.3. Integrating data from the supply chain.....	186
2.6. Conclusion.....	189
Bibliography of Chapter 2.....	190
Annex A of Chapter 2: Indicator Methodology	194
Annex B of Chapter 2: air pollution in China - from a simple to a complex indicator	211
Annex C of Chapter 2: Cotton specifications according to the Sustainability Consortium	213
Annex D of Chapter 2: Indicators for sustainable development: GRI, EFFAS, ISO 26 000	217
Annex E: Forms to collect data from suppliers.....	220
Chapter 3.....	225
Decision Making in Sustainable Development: Supplier Choice in the Chinese Garment Industry	225
3.1. Introduction	227
3.2. Multi-criteria Decisions.....	227
3.2.1. Decision Theories.....	228
3.2.2. Multi-Stakeholder and Decision-Aid	229
3.2.3. The Involvement of Stakeholders	231
3.2.4. Criteria Selection and Indicator Construction	232
3.2.5. Multi-Criteria and Multi Stakeholders	233

3.3. Multi-Criteria/Multi-Stakeholders Analysis and PROMETHEE methods	236
3.4. Case study: textile factory and decisions on supplier’s choice and energy system selection	238
3.4.1. Step 1: Ranking alternatives for each stakeholder	245
3.4.2. Step 2: Ranking options by weighing stakeholders: strategic decision-making	248
3.5. Conclusion.....	251
Bibliography of Chapter 3	253
General Conclusion	255
1. Research action: three questions	255
1.1. The factors of green management in the garment industry.....	255
1.2. Conceiving a green management dashboard for small firms	255
1.3. A ranking method as a tool for strategic decisions in a stakeholder perspective	256
2. Perspectives of “green” management in the garment industry: solutions and suggestions.....	257
2.1. Firm Level	257
2.2. Social Level.....	266
2.3. Increase the Communication Ability of Enterprise.....	268
3. Prospect	269

List of Tables

Table 1 Dashboard	30
Table 1. 3 comparison and judgment matrix on three enterprises	114
Table 1. 4 comparison and judgment matrix on a11	114
Table 1. 5 comparison and judgment matrix on a12	114
Table 1. 6 comparison and judgment matrix on a13	114
Table 1. 7 comparison and judgment matrix on a14	115
Table 1. 8 comparison and judgment matrix on a15	115
Table 1. 9 comparison and judgment matrix on a21	115
Table 1. 10 comparison and judgment matrix on a22	115
Table 1. 11 comparison and judgment matrix on a23	116
Table 1. 12 comparison and judgment matrix on a24	116
Table 1. 13 comparison and judgment matrix on a25	116
Table 1. 14 comparison and judgment matrix on a31	116
Table 1. 15 comparison and judgment matrix on a32	117
Table 1. 16 comparison and judgment matrix on a33	117
Table 1. 17 comparison and judgment matrix on a34	117
Table 1. 18 comparison and judgment matrix on a35	118
Table 1. 19 comparison and judgment matrix on a36	118
Table 1. 20 comparison and judgment matrix on a41	118
Table 1. 21 comparison and judgment matrix on a42	118
Table 1. 22 comparison and judgment matrix on a43	119
Table 1. 23 comparison and judgment matrix on a44	119

Table 1. 24 comparison and judgment matrix on a45	119
Table 1. 25 comparison and judgment matrix on a51	119
Table 1. 26 comparison and judgment matrix on a52	120
Table 1. 27 comparison and judgment matrix on a53	120
Table 1. 28 comparison and judgment matrix on a54	120
Table 1. 29 comparison and judgment matrix on a61	120
Table 1. 30 comparison and judgment matrix on a62	121
Table 1. 31 comparison and judgment matrix on a63	121
Table 1. 32comparison and judgment matrix on a71	121
Table 1. 33 comparison and judgment matrix on a72	122
Table 1. 34 comparison and judgment matrix on a73	122
Table 1. 35comparison and judgment matrix on a74	122
Table 1. 36comparison and judgment matrix on A in the A1	122
Table 1. 37 comparison and judgment matrix on B in the A1	123
Table 1. 38 comparison and judgment matrix on C in the A1	123
Table 1. 39comparison and judgment matrix on a11 in the A1	123
Table 1. 40 comparison and judgment matrix on a12 in the A1	124
Table 1. 41 comparison and judgment matrix on a14 in the A1	124
Table 1. 42comparison and judgment matrix on A in the A2	124
Table 1. 43 comparison and judgment matrix on B in the A2	124
Table 1. 44 comparison and judgment matrix on C in the A2	125
Table 1. 45 comparison and judgment matrix on a22 in the A2	125
Table 1. 46 comparison and judgment matrix on a23 in the A2	125
Table 1. 47 comparison and judgment matrix on a24 in the A2	126
Table 1. 48 comparison and judgment matrix on A in the A3	126
Table 1. 49comparison and judgment matrix on B in the A3	126

Table 1. 50comparison and judgment matrix on C in the A3	127
Table 1. 51 comparison and judgment matrix on a31 in the A3	127
Table 1. 52comparison and judgment matrix on a32 in the A3	127
Table 1. 53comparison and judgment matrix on a33 in the A3	127
Table 1. 54comparison and judgment matrix on a34 in the A3	128
Table 1. 55 comparison and judgment matrix on a35 in the A3	128
Table 1. 56 comparison and judgment matrix on a36 in the A3	128
Table 1. 57comparison and judgment matrix on A in the A4	128
Table 1. 58 comparison and judgment matrix on B in the A4	130
Table 1. 59comparison and judgment matrix on C in the A4	130
Table 1. 60comparison and judgment matrix on a41 in the A4	130
Table 1. 61 comparison and judgment matrix on a45 in the A4	130
Table 1. 62 comparison and judgment matrix on a12 in the A5	131
Table 1. 63 comparison and judgment matrix on a52 in the A5	131
Table 1. 64comparison and judgment matrix on a53 in the A5	131
Table 1. 65 comparison and judgment matrix on a54 in the A5	131
Table 1. 66 comparison and judgment matrix on a63 in the A5	133
Table 1. 67 comparison and judgment matrix on a23 in the A6	133
Table 1. 68 comparison and judgment matrix on a61 in the A6	133
Table 1. 69 comparison and judgment matrix on a62 in the A6	133
Table 1. 70 comparison and judgment matrix on a63 in the A6	134
Table 1. 71 comparison and judgment matrix on a23 in the A7	134
Table 1. 72 comparison and judgment matrix on a24 in the A7	134
Table 1. 73 comparison and judgment matrix on a25 in the A7	134
Table 1. 74 comparison and judgment matrix on a71 in the A7	135
Table 1. 75 comparison and judgment matrix on a72 in the A7	135

Table 1. 76 comparison and judgment matrix on a73 in the A7	135
Table 1. 77 Un-weighted super matrixes	136
Table 1. 78 weighted super matrixes.....	143
Table 1. 79 the limit super matrixes	148
Table 1. 80 the weight of indexes of each factor.....	98
Table 2. 1 Energy Consumption and Water Consumption by Industry	Erreur ! Signet non défini.
Table 2. 2 Various sectors of energy efficiency bill of China (2011).....	154
Table 2. 3 Characteristics of performance metrics and indicators adapted to a specific industry	161
Table 2. 4 data collection required at the process level by local managers at JINGMENG Suit Co., LTD	168
Table 2. 5 ranking of indicators for various stakeholders of JINGMENG Suit Co., LTD's..	169
Table 2. 6 The dashboard's definition of "Water consumption" compared with UN and GRI Indicators	171
Table 2. 7 The dashboard's definition of "Water pollution" compared with UN and GRI Indicators	172
Table 2. 8 Energy (gas, oil, coal electricity) to produce 1000 units.....	172
Table 2. 9 The dashboard's definition of "Carbon Emission" compared with UN and GRI Indicators	173
Table 2. 10 emission factors (in kg Carbon equivalent) for gas, oil, coal and electricity used in China	174
Table 2. 11 The dashboard's definition of "Air Pollution" compared with UN and GRI Indicators	175
Table 2. 12 particular pollution (in kg equivalent of coal) for gas, oil, coal and electricity used in the plant.....	176
Table 2. 13 Energy (in kWh) for gas, oil, coal and electricity	176

Table 2. 14 the dashboard’s definition of “Energy” compared with UN and GRI Indicators	176
Table 2. 15 the dashboard’s definition of “Safety Ratio” compared with UN and GRI Indicators	177
Table 2. 16 the dashboard’s definition of “Quality” compared with UN and GRI Indicators	178
Table 2. 17 Global dashboard for JINGMENG Suit Co.,LTD and part of the supply-chain (weave and print).....	180
Table 3. 1 Actual global dashboard for JINGMENG Suit Co.,LTD and part of the supply-chain (weave and print)	234
Table 3. 2 Scenario 1 - Replacing « good machines » with less efficient machines... Erreur ! Signet non défini.	4
Table 3. 3 Scenario 2 - Changing the energy system in the plant of Wenzhou . Erreur ! Signet non défini.	4
Table 3. 4 Scenario 3 - Changing suppliers	Erreur ! Signet non défini.
Table 3. 5 Scenario 4 - Changing energy system in in the plant of Wenzhou + suppliers	Erreur ! Signet non défini.
Table 3. 6 evaluation of scenarios against each criterion.....	Erreur ! Signet non défini.

List of Figures

Figure 1. 1 Network diagram of ANP	80
Figure 1. 2 the relationship between internal and external factors of enterprise green management	Erreur ! Signet non défini. 9
Figure 1. 3 the relationship between the internal and external factors influencing the enterprise green management.....	Erreur ! Signet non défini. 1
Figure 1. 4 ANP model	93
Figure 1. 5 The sorting result	96
Figure 1. 6 the weights of the internal factors	97
Figure 2. 1 ISO 26000 Schematic Overview.....	Erreur ! Signet non défini. 58
Figure 2. 2 Links of main actual stakeholders with a company	163
Figure 3. 1 Use of multi criteria methods dealing with environmental issues ...	Erreur ! Signet non défini. 9
Figure 3. 2 evaluation of scenarios against each criterion	Erreur ! Signet non défini. 4
Figure 3. 3 shape of the chosen preference functions (“V-shape”).....	Erreur ! Signet non défini. 6
Figure 3. 4 evaluation of scenarios against each criterion	Erreur ! Signet non défini. 7
Figure 3. 5 a typology to describe scenarios	Erreur ! Signet non défini. 8
Figure 3. 6 Ranking of the State.....	Erreur ! Signet non défini. 8
Figure 3. 7 Ranking of the province.....	Erreur ! Signet non défini. 9
Figure 3. 8 Ranking for a 90% CEO weight	Erreur ! Signet non défini. 0
Figure 3. 9 Ranking for a 70% CEO weight	Erreur ! Signet non défini. 1

Acknowledgements

I would like to extend my sincere gratitude to all those who helped me during the writing of this thesis.

First, my deepest gratitude goes and foremost to my supervisor, Denis Dupré, whose guidance, patience, understanding and encouragement have offered me valuable suggestions in the academic studies. In the preparation of this thesis, he gives me as much patient instruction and expert guidance as he can, for his extensive knowledge and vision. In the writing process of this thesis, his inspiring advice and insightful criticism have been the source of innovation throughout my research. He has spent much time reading through each draft, without his expert guidance, the completion of this thesis would encounter greater resistance.

Second, I also owe a special debt of gratitude to all the professors for their valuable and constructive suggestions: Professor Karyotis, Professor Antheaume and Professor Yingchuan Yu. Professor Yingchuan Yu is my tutor while I studied in Shanghai University. It is him that encouraged and helped me to start my Ph.D. in France. I'm thankful to Professor Liying Yu and Qin Dong for their teaching and encouragement during my study in Shanghai and Madame Sylvaine Trinh with whom I had the pleasure and confidence to study in University Pairs Dauphine and finish my master degree. I would like to specially thank Professor Liying Yu for introducing me to the highlights of ANP that helped maintain my optimal level of functioning. I'm indebted to all these teachers for spotting the bright spot of me and encouraging me to pursue a doctorate. Else, many thanks to Meimei Pan and Yaoyao Cheng for spending time collecting the data that I analyzed in this dissertation and correcting my grammar and spelling errors at the final time of this paper.

Then, I'm particularly grateful to my colleagues in different factories like Wenzhou and Zibo city. I would like to extend my thanks to Meimei Pan and Miss Zheng for always patiently answering my programming and technical questions. I appreciate the administrative help provided by teacher Wu and teacher Shi. My special thanks are extended to all my former

colleagues for their encouragement and caring. It would have been a lonely study life without them.

Last, I should finally like to express my gratitude to my beloved parents and wife who have always been helping me out of difficulties and supporting without a word of complaint.

General Introduction

1. Research thesis belonging to research-action

This thesis can be said to belong to the research-action which flourishes during the 1970's. It arises from questions coming from the society and uses methodology coming from recent researchers and rooted in the validated theories.

In this way of researching, the answer to a question brings out most of time new questions and the continuous research process helps to clarify, change or inform practices and ways a community see the world and act on it together with a shared framework.

Jin Jinhua, the author of the thesis, as one of the actor of the community and a new researcher, tries to bridge the gap between practice and research.

Jin Jianhua, male, member of Communist Party of China, graduate degree, master of economics, senior economist, is the chairman and party secretary of Shanghai Baromon Group, the director of Shanghai New World Group and the chairman of Shanghai Bund Shoppes Ltd. He has been working in clothing industry for 25years and has been awarded Shanghai "Top Ten" Outstanding Young, Shanghai Outstanding Entrepreneurs, Shanghai Model Worker, National "May 1" Labor Medal, National Labor Model, Shanghai Quality Award etc.

The social positions he served are executive director of China National Garment Association, vice president of Shanghai Modern Association, vice president of Shanghai Garment Industry Association, director of Shanghai suit Committee, executive director of Shanghai Textile Association, and committee member of Chinese clothing Standards Committee. The political positions he served are deputy to the Shanghai People's Congress (the tenth and eleventh congress), member of the National Committee of CPPCC (the eleventh and twelfth). In 2009 and 2014, Mr Jin has been twice invited to participate in the International Conference of the International Federation of Textile Federation and is its member now.

Jin Jianhua is self-motivated and has a strong sense of professionalism. He has been conducting a comprehensive study of the cotton textile printing and dyeing processes in China.

In the last few years, he has been to the United Kingdom, France, Italy Germany and Japan several times in order to study the advanced textile and garment machinery technology.

Jin Jianhua has a strong sense of social responsibility. He advanced proposals and ideas on the strengthening of environmental protection and sustainable development of the textile industry, green development of the textile industry in the NPC (National People's Congress) and CPCC (Chinese People Consultative Conference). And he has been highly appreciated by the Ministry of Commerce of the People's Republic of China, SEPA and China Textile Association. Besides, he repeatedly calls on rejecting white pollution and protecting the ecological environment through public media, and makes numerous technical improvements during daily work. He promotes green energy and tries his best to achieve sustainable development goals in his companies.

“Baromon” is a famous brand in China which has a long history and reputation. In recent years, Baromon Group persists in reform and continuous innovation, adheres to brand strategy and gets awards like "China Famous Brand", "Shanghai Famous Brand", "Shanghai civilized enterprise" and so on. Moreover, Baromon Group has got the certification of ISO9001: 2000 quality management system, the integrated certification of ISO14001 environmental management system, OSHMS occupational health and safety management system. In 2011, Baromon’s sewing skills are also acknowledged by the State Council as a national intangible cultural heritage.

Baromon insists on the brand development and aims at doing fine custom, stronger chain, and bigger wholesale. With innovative ideas, approaches and talent workers, Baromon continues seeking new breakthroughs in the development of a Chinese brand and being ready to create another century glory.

2. Green management in the context of sustainable development and Corporate Social Responsibility

In 1996, manufacturing research association of Michigan state university puts forward the concept of green management for the first time. Green management is based on the traditional supply chain management, considering the impact of supply chain on the environment, from the point of view of optimal utilization of resources to consider the development of the supply chain. After then, more researches about green management came up. In terms of connotation of the green management, from the perspective of ethics and the environment, the thought of green supply chain gradually become the core idea of today's business during the past ten years. Some researchers have summarized the process of green supply chain innovation and the feasible path of green management. Although the organization factors, regulation, consumer, competitors and social institutions are both the inside and outside factors of the enterprises actualizing green management, the suppliers should not be ignored, which shows that it is much more important for the enterprise to strengthen the selection and evaluation of suppliers today.

Based on the analysis of domestic and international research, we found that, many empirical analyses draw more consistent conclusions: environmental cooperation with upstream suppliers often close integration with operation performance; and environmental cooperation with downstream vendors often associated with the product performance. Typically, collaboration with upstream suppliers having the green environmental protection is more likely to get benefits. This conclusion has overturned the conventional wisdom that the purpose of selection of suitable partners is mainly to reduce procurement costs, so as to achieve the purpose of reducing the cost of spending. For now, the choice of partners turns into a strategic activity, choosing the right partners in order to establish stable relations of cooperation, managing to stabilize the entire supply chain. This world calls for harmony and promote green development.

The author thinks that green management is the management that based on the traditional management, using the idea of sustainable development, combining the concept of circular economy with environmental protection. It has integrated green purchasing, green design, green production, green marketing, and green logistics and reasonable green recycle, which

means to form a highly resource configuration and coordinated development of the enterprise. To be more detailed, its main contents including green purchasing, green design, green production, green marketing, green recycling and other links of common logistics management. Green purchasing, green design, green production, green marketing, green logistics and green recycling are in four interrelated systems, and crossed in two or more systems, which respectively are production, consumption, society and environment.

Different from traditional supply-chain management, green management realizes the importance of environmental protection. So the corporate culture has become an important factor in green-house development of green management. Environmental awareness, employee recognition, managers' green consciousness, corporate' green practices and corporate social responsibility are the five corporate green culture, from which this article will elaborate the corporate green culture. Else, green specification in enterprise that has a leading role in the industry may develop into a green industry norm. This could bring advantages to enterprise that develops a specification and strictly implements at first.

In China, corporate social responsibility is one measure of the strength of green specification. This indicator is similar to the health factors of Herzberg two-factor theory: when the deterioration of these factors is below the level of considered acceptable for people, it will lead to satisfaction. However, when people think these factors are well, they just eliminates the dissatisfaction, and will not lead to a positive attitude. So companies should not be consider the pursuit of profit as the only business goals. Corporate Social Responsibility is the responsibility of corporate commitment to protect and promote the public interest and the long-term benefits, as well as the expectations and requirements to companies at this economic and social development times.

In the new century, the Chinese government and the community pays more and more attention to corporate social responsibility. 2006 is an important year for the development of in China, and in this year all aspects of laws and regulations, and other major national policies of corporate social responsibility have made the real definition of CSR. The Revised "Company Law" is the first law that clearly requires a company to be socially responsible, and comply with the specific requirements of regulations and social morality. When the resource and environmental problems have become increasingly prominent, corporate should better reflect social responsibility to be responsible for environmental and social benefits.

At last, the improvement of corporate social responsibility should be achieved through a multi-force. In addition to government guidance, enterprise conscious, public opinion, employees and consumers to enhance self-protection awareness, industry and employers' organizations to play an active role in corporate business partners to strengthen audit assessments, environmental organizations to strengthen supervision and publicity are indispensable. Corporate environmental awareness, employee recognition and green awareness of managers are sources of green management needs. When companies recognize the green culture from the inside, employees and managers are willing to allow enterprises towards environmentally friendly and sustainable direction, corporate would identity the green concept from bottom to top. Further, corporate can develop a reasonable corporate green norms. If reasonable green norms has been widely accepted, corporate social responsibility to reduce consumption and pollution of the environment will increase. In turn, it can promote understanding of green culture.

3. The Chinese context of green management in the garment industry

European countries experienced the period when its own development conflicts with its environmental resource, they realized that the importance of sustainable development, so they begin to deal with the environmental problem. Nowadays, the government of China are increasing emphasis on the solution of environmental problem, do its best to make the sustainable development mode applied better in practice, no matter what kind of industry.

Since China's reform and opening up, China's economy has achieved the sustained high growth, clothing export is an important component of China's exports. In 2012, the amount of Chinese textile clothing export is \$262.56 billion, has 3.3% growth year-on-year. In China, there has a rapid development of China's textile and garment industry between 1987 and 2010; the national average annual growth rate is about 17.23%. But there has a big gap between the provinces and cities nationwide on the index of increase rate and shares of gross products. The situation are getting worse, for that in recent years, Europe's economic environment deteriorating, trade protectionism becomes high, and the strict environmental requirements block the road of Chinese enterprises' export. At the same time, the costs of domestic raw materials and labor become rise, which exacerbate the plight of garment enterprises. Some enterprises that simply living on extensive processing on giving materials cannot easily survive.

So at the present stage, Chinese garment enterprises need to constantly improve their environmental performance. This is not only a challenge, but also an opportunity for them. Garment enterprises must take a way that resource environment and development is coordination, which need the constantly exploration and practice.

1. Research context

In order to deal with all kinds of green barriers, many experts pointed out that the implementation of green management is a wise choice. They put forward that clothing enterprise should also started to explore and try to implement green management and many of them have made a deep research.

From the perspective of system, combined with the country's 12th five-year plan and the current situation of enterprises implementing green management, Wang Xiaomu (2012), from the perspective of system, puts forward the suggestions for promoting the development of green management in China, like improve the government's conduct, guide and encourage enterprises to adopt green supply chain management; the reform of the internal environment; build green supply chain management mode strategic alliance; do the preliminary work of green supply chain management implementation;

In terms of the connotation of green management, according to the supply chain management and the sustainable development of green supply chain model, Wang Yingluo (2003) divided it into four subsystems: production system, consumption system, environment system and social system;

From the internal and external environment of enterprise, scholars classified the factors of green management. Gu Lijuan (2010) considers the internal factors of green management are environmental pollution and the environmental protection certification. Gong Mili and Tian Jie (2010) consider there are many factors of green management, the main restricting factors are green material, and high cost of green packaging, insufficient incentive and insufficient green technology, the effects of the green cost is the largest. Green management can bring the economic performance, at the same time; it may lead to higher costs.

Some study the application of green management in various fields. In view of the oil industry, Han Lihong, Zeng Jinfang (2007) put forward consummate the environmental regulations and green design, set up green enterprise cooperation, promote the development of circular economy and establish the performance evaluation system of green supply chain. Lu Qianlin and Yao Weixin (2009) put forward some feasible solutions of green management of enterprise whose economic strength is not strong in the garment industry.

The above research expounded the necessity and urgency of implementing green management from different angles, using quantitative and qualitative methods to study green management. Among them involves the research methods, strategic planning, implementation specification and tools, survey research, analysis the drivers and barriers and the practice content of all kinds of industry. It has laid a good foundation for the research and development of green management. Else, the research of the influence factors of green management has a valuable guidance for solving the development green strategy of enterprise in current, and provide

theoretical basis for the implementing rules of industry, the specifications of laws and regulations, the implementation of green management.

2. Practical context

In practice, green management is embedded in the whole supply chain. The main content includes green purchasing, green design, green production, green marketing, green recycling and other links of common logistics management. Green purchasing, green design, green production, green marketing, green logistics and green recycling in four interrelated systems, and is crossed in two or more systems, which are production, consumption, society and environment.

Among them, green manufacturing is the key to implement the target of the green purchasing and green design, reducing the waste emissions and energy consumption is our concerns in the process of production. Also, the purpose of the green manufacturing is not only completing process of production, providing the production results, reducing consumption and waste in the production, it also is the important purpose of green production. Obviously, the cost of green is one of the important factors affecting the green manufacturing. What we can't deny is that there are many different voices about whether green production can reduce or increase the cost. Many researches both theoretically or practically confirm that some companies or industries which use reasonable management methods can have a positive outcome at the same time during green production. So generally, green production can not only has a long-term indirect benefit, but also may lead to immediate short-term benefits.

Else, the most important part of green purchasing is the selection of excellent suppliers. To some extent, green purchasing can reduce cost; it includes the management cost of enterprise, cost of production and cost of material circulation. Reducing the cost is based on good communication with suppliers.

The major feature of green marketing is sticking the idea of sustainable development, reflecting social responsibility and maintaining improvement of ecological system and protecting the environment. On the basis of the traditional marketing, green marketing will have the environmental benefits as the core and make it with the economic interests neck and neck, this marketing way pay more attention to global environmental problems. For China, the gap between the beautiful vision of green management and theory and the overall level of enterprise green supply chain is very big, so it is yet to be developed.

To be conclude: green purchasing attaches great importance to the cost and communication with suppliers; green design need to communicate with consumers and sellers, as well as the corresponding research technology of enterprise; green production is the core link of green supply chain, has a higher request to the enterprise's technological innovation ability; green marketing is the process of showing enterprise implementing green management for outside world, under the influence of communication ability of corporate, it also affect the upstream and downstream parties of supply chain; green logistics and recycling need to make connect with many parties, also have certain requirements for the communication ability of enterprise.

4. The factors of green management in the garment industry

The first target of this thesis is to determine which main factors induce the green management in the garment industry. We define internal and external factors for companies.

We model three enterprises local clothing enterprises and each of them has different development situations, especially the green management development situations. They also have their own characteristic of green management development, so we can finish our discussions and assessment of the different factors that has an influence on different enterprises.

The three local clothing enterprises are as follows:

Company A is the dominant force of industry, and has the green sustainable development as the strategy of enterprise. It has carried out the implementation of green management, and input some resources so it has received some achievements. Company A is closely related to the local government.

Company B is slightly weaker in strength than A. It has a certain discourse in the industry, takes the following strategy at the moment, and imitates company A to implement green management. Although it has input certain resources, it ignores the cultural construction and has litter effect.

Company C is a local traditional clothing enterprise, and the strength is relatively close to A, and has a good relationship with government. The leadership of this company has no environment protection consciousness, and the company is fined many times by the environmental protection department.

Since we use the expert scoring method and 9th grade method to conduct the evaluation of ANP, these enterprises are asked questions by the experts, like development situations, development strategies, specific implementation measures

and so on, so that they can give the true comparison score based on different factors. Then the calculations made by the Super Decisions software and specific explanations of the results.

Else, the core concept of green management is reducing environmental pollution, reducing energy consumption, realizing the human and the nature harmonious coexistence. So in this paper, the author put up the new understanding of green management. Green management is the management that based on the traditional management, using the idea of sustainable development, combining the concept of circular economy with environmental protection. It also has the integration of green purchasing, green design, green production, green marketing, and green logistics and reasonable green recycle, form a highly resource configuration and coordinated development of the enterprise.

Since green management is very important, it is necessary to figure out the influence factors of green management. According to some researches, the influence factors of green management including external factors such as the government, market environment. It also has enterprise itself as the main body of the internal factors of business enterprise.

For some clothing enterprises, implementing green management requires that it should begin from its own perspective and analysis according to the actual situations. Enterprises are not only affected by external factors, the enterprise itself can also affect the external factors. But most of the researches all put the two parts of factors together and then study these factors. This will result in no rigorous studies. Besides, without exception, all the researches mentioned that the laws and regulations have influence on the implementation of green management of enterprise.

So, on the basis of elaboration on meaning and important parts of green management, this paper summarizes the internal factors and the external factors in the process of implementation of green management.

4.1. Internal factors of green management

(1) Green cost

The subdivision of green cost factors is on the basis of the analysis of production cost. So in this paper, green cost is measured by the cost of raw materials, the cost of energy consumption, R&D input and training costs. What's more, the green cost analysis needs to add environment input costs in this study, in order to reflect the green management invested cost impact of environmental construction and remediation.

(2) Green culture

The analysis of green culture can start from the enterprise's production management, resources management, environment and employees, combined with the eco-cultural. Green culture must have the basic characteristic of respecting nature, protecting the environment and promoting sustainable use of resource and emphasizing the harmonious development. So in this paper, green culture composes with the environmental consciousness, attitude of employee and managers, green specification, corporate social responsibility.

(3) Communication skills

Green communication skills mainly include supply chain management communication, green design green marketing communication and communication. This division is based on the understanding and analysis of green marketing theory: Green marketing includes the establishment of reasonable and appropriate interest intermediaries, focusing on aspects of the work-related marketing channels and improving green public relations. As the primary tool of green marketing, green communication skills should also be closer to these three areas. So, communications skills have the effective green supplier, supplier friendly environmental evaluation, based on the demand for green communication, based on green design, understanding

of policies and regulations and have the purpose of improving the performance of environment.

(4) Ability of green technology innovation

As a micro-economic enterprise, it is only take the road of green technology innovation in order to achieve sustainable development. The level of green technology innovation capability of an enterprise can be measured by several indicators below: environment friendly design capabilities, green patent, green production capacity, green management resilience and green management innovation ability. Among them, environment friendly design capabilities, green patent, green production capacity focus on building mechanisms; green management resilience and green management innovation ability focus on institution building. So you can better reflect the clothing business of green technology innovation capability development status.

4.2. External factors of green management

(5) Government and laws

The government and legal factors are measured by comprehensive central government laws and regulations, regional laws and regulations, national environmental standards and local government environmental policy. This is because in the process of growth and development of the current Chinese garment enterprises, government and legal factors are macroeconomic factors, which will corporate governance, consumption and other business-related activities and have a very significant influence. Else, the central government of a country's political system, institutions, policies, laws and regulations and other factors has a strong legal effect and affect the business activities of enterprises, especially affect longer-term investment behavior. So we can say that it is the most important political influence factor. Therefore, in the subsequent analysis, we believe that the central government comprehensive laws and regulations factor

will have a hug influence on development activities of garment enterprises and other influencing factors above.

4.3.Social environment awareness

Social environmental awareness composes with the demand of green consumer, consumer environmental awareness and social public opinion. This is mainly based on the relevant theoretical results of sociological research. In this paper, we classify consumer environmental awareness to social environmental awareness in order to highlight consumer environmental awareness' influence of the entire model.

(6) Competitors' environment pressure

Competition competitors, which is one of important aspects of Porter's five forces analysis model, is often reflected in the price, advertising, products, service and other aspects. And the competitive strength depends on many factors. So, in this paper, we will focus on analysis of the impact of environmental stress on green clothing business management caused by competitor. Therefore, in accordance with the relevant competition theory of the firm, the environmental pressure come from rival is reflected by green strategic of competitor, communication ability of competitors, industry trends of green production capacity of competitors.

4.4.Conclusion

The internal and external influencing factors are interacting. For instance, the green cost can be affected by the policy and law, and green culture can be affected by the social environment consciousness and the competitor environment pressure. Considering the external influence factors, policy and law may affect the social environmental awareness.

5. Conceiving a green management dashboard for small firms

Based on the above discussion, the second paper of this thesis focuses on the textile industry and proposes a specific dashboard at the plant level to evaluate the environmental, social and economic performances.

Some researchers have tried to make deep research on the dashboards. They have tried to add a concern about sustainability to the Balanced Scorecard measures and the Norton and Kaplan scorecard approach, but these researches have less actual operability, especially for a small firm. The changing of a strategy needs to have a better system of measurement, so if a small firm wants to take into account sustainability issues, a new type of dashboard has to be designed.

According to the relevant steps to build a dashboard, first is to make sure of the certain complexity of international standards. The international standard is a mixture of principles, norms and best practices. Among them, ISO 26 000 offers guidance on socially responsible behavior and possible actions but it does not contain requirements and is not certifiable. So for small firms, two main criticisms can be made: methods are general and don't focus on main concerns and they don't address the question of which process can be improved.

Second, the methodology of dashboard building for the Chinese textile industry should be clear too. Assessing, monitoring and reporting are part of a "green" strategy. Quantitative pressure/impact measurements are helpful for the decision process. This should encompass all aspects of the firm activity: buying, producing and selling. As Green marketing is considered, the dashboard should take into account the customer requirements and views on the importance of various indicators.

Third, the characteristics of performance metrics and indicators adapted to the garment industry should be confirmed. Despite numerous efforts to create a universally valid set of indicators for business companies, there still remains

uncertainty about how to identify the relevant key indicators. The characteristics should be manageable, relevant, measurable, agreed upon and meaningful, reliable, cost-effective and time-based. We decided to incorporate local impact indicators in our dashboard; such indicators are informed through expert assessment. More generally, we provide, in association to some indicators values, two complementary types of information: the “local impact factor”, which evaluates the environmental impact as low, and the “sustainability firm risk”, which estimate induced risk for the firm.

At last, make clear of the stakeholders and responsibilities. Many stakeholders including internal stakeholders and external stakeholders have to be considered. Their importance varies depending on countries, industries, management style. In China, main stakeholders may be internal customers (e.g. employees), external customers (e.g., suppliers or pressure groups).

The classical dashboard approach should take into account, not only the company interacting with its stakeholders for the direct social and environmental impacts, but also the Territorial Social Responsibility as the impact depends on the relative importance of factors on account of all aspects along with the supply chain and the life cycle assessment. In this paper, we consider water and air as two examples.

In order to show how the method works in the actual production process more clearly, in this paper, we make a case study: building a dashboard for a garment plant in China. In this case study, we define and validate the KPI through a two stage process. First, after presenting sustainability concerns at different levels (the world, china, the garment industry) made by a research team in management and industrial ecology of Grenoble University and sustainable development in Shanghai University, we define the targeted indicators in collaboration with the CEO and the management team of the plant, keeping in mind the methodological guidelines described earlier. Then, we decide how we can simplify the indicators to get relevant data within a single year.

The idea is to improve gradually in the future on the quality and complexity of the chosen set of indicators.

We illustrate our method by focusing on a single product, namely high quality suit. The choice of the environmental Key Performance Indicators in this case garment industry we focus on three environmental themes: water, “emissions effluent and waste” and energy, which are water consumption, water pollution carbon emission, air pollution and energy in detail. The data are from three plants: LUTHAI TEXTILE CO.,LTD, Zhe Jiang JINGMENG Suit Co.,LTD and Tai Cang JINJIA Bleaching And Dyeing CO.,LTD. They all have close relationship with the subject. So the data are real and convincing.

The dashboard shows as following. To conclude, this dashboard is a first attempt, both on the methodological and data collection front, towards building a global view on the impact of production in the garment industry in China at the level of individual production firms. In particular, the characteristics of some of the firms involved in the supply chain are taken into account in this work. We exemplify our methodology by showing how a small firm has introduced this dashboard in the decision process. Then we propose some guidelines about possible new regulations and enticements for firms to meet new quality standards. Taken together, the dashboard gives insights into the impacts of the processes from a triple angle: economic, social and ecological.

Table 5.1 Dashboard

KPI Group	Environment								Social			Economic			
KPI cluster	Water	Emissions, effluents, and waste							Energy	Employment		Health and safety	Consumer satisfaction	Yield	
KPI	Water consumption	Water discharge	gas	oil	coal	electricity	Carbon emission	Air pollution	Energy	working hours	Labor wages	Safety ratio	Quality	Net margin	Production
Unit	cubic meter	cubic meter	cubic meter	ton	ton	kWh	kg eq. C	eq. ton of coal	eq. kWh	hours	-	0	Level *****	Yuan	number / year
plant 1 - Zibo -															
plant 2 - Print -															
plant 3 - Suit -															
total															

6. A ranking method as a tool for strategic decisions in a stakeholder perspective

On the basis of the dashboard established in the second paper, the third paper of this thesis attempts to construct a decision making model for a small garment business who face a set of alternative choices. The model deals with multi-criteria from various stakeholders' perspectives to choose suppliers, change machines and switch the energy system.

Decision making has been under close scrutiny since the mid-20th century. Known as an interdisciplinary subject intersected with management, organizational sociology and political science, decision making science often deals with situations with various alternatives to compare, several decision makers (that is, multiple stakeholders), multiple and conflicting criteria, and uncertainty about the consequences of actions.

Our paper refers to the multi-criteria and multi-stakeholder framework to guide decision-making. Using a framework in this context is important as

(1) expressing individual judgments in a more precise and focused way is in general helpful to clarify alternatives and reduce their number with respect to more common, informal discussion processes

(2) a transparent and documented process favors the general interest,

(3) a careful identification of all stakeholders (especially the ones who have little political power but that are directly impacted by the decisions) can help to shift the balance of power.

The goal of the multi-criteria and multi-stakeholder framework is therefore for each participant to have a deeper view of the problem. He or she should be able to justify his/her own preferences that may evolve during the process, to understand better the

positions of others, and to identify the possible interactions or judgment traps that prevent to reach a decision that can be acceptable for all involved parties. From this perspective, the decision that will be taken at the end of the process is less important than the process itself. For instance, since we are dealing with complex systems, new information may appear in the future that is in contradiction with the original decision setting. If the original decision was taken unilaterally and in opacity, it will be hard to quickly converge towards a new decision whereas if a transparent multi-stakeholder framework was already implemented, the new information can be integrated quickly in the decision process.

The next question we address in this paper concerns the choice of method and related parameters in a complex decision situation with multiple criteria and multiple stakeholder. Especially, we distinguish between methods that allow compensation between criteria and methods that don't. The former, represented by the most commonly used AHP (Analytical Hierarchy Process) method, refers to the existence of trade-offs, i.e. the possibility of offsetting a disadvantage on some criteria by a sufficiently large advantage on another criterion (OECD, 2010). The later, represented by outranking methods such as Prométhée, doesn't reduce the complexity of the problem by only considering a single dimension. For instance, Prométhée considers two different rankings of alternatives, one for preference intensities and the other for rejection intensities. The results depend on the modalities of the aggregation of stakeholder preferences, by assigning weights to each stakeholder's choice.

With the help of the freely distributed software Visual Prométhée, we implement the Prométhée method for a textile factory that needs to make decisions on supplier, machinery quality and energy system selection. Specifically, four alternative scenarios are under investigation:

Scenario 1: choose between efficient expensive German machines and less efficient cheaper Chinese ones.

Scenario 2: replace the current energy system fueled with coals with an energy system fueled with gaz.

Scenario 3: push suppliers to make greener production in order to save energy, water and pollution. The costs of such green production won't be immediately embedded in consumer prices until a green label or green marketing allows increasing prices.

Scenario 4: switch energy system and promote green suppliers, that is, invest in both scenarios 2 and 3.

Two groups of criteria are considered. The first group is related to the environmental criteria, which include water consumption, water discharge, greenhouse gases emissions, air pollution and energy consumption. The second group is related to the economic criteria, which include quality of the production and net margin.

Accordingly, multiple stakeholders are taken into account: CEO, shareholders, local and central governmental authorities. Each stakeholder conducts the multi-criteria (as mentioned above) decision making process and will arrive at his or her own preference and rejection intensity rankings. Weights are attributed to stakeholders and a weighted average is computed for both the preference intensity ranking and the rejection intensity ranking. It is also possible to modify the weights of stakeholders to examine the dynamic impact on the two rankings. By progressively increasing the weights of the state and of the province), our results show that the ranking of the "business as usual" option, originally preferred by the CEO, starts to decrease. From a strategic perspective, as soon as public actors put a little pressure on the decision context of the company, for instance by enforcing regulations, creating taxes or quotas, the "switch energy" option will be preferable to the business as usual scenario. Our results also show that the action "green suppliers" should always be conducted jointly with "switch energy".

After all, this paper demonstrates that multi-criteria and multi-stakeholders method promote decision-making of firms in a strategic manner. In the context that CEO is the only decision-maker, his decision should be able to anticipate the influence of other stakeholders in short- and long-term, and take into account these values when making a decision.

7. Map of the thesis

This thesis consists of three papers and they are designated to be presented at conferences and published.

The first paper, presented in Chapter 1, was a theoretical work with a sort summary of domestic and foreign research, and analysis the present situation of development and research progress of green management. Then, based on the overview of green management theory, this paper states each link of green management and summarizes the internal factors of green management as green culture of enterprise, cost of green, ability of technology innovation and communication skills, as well as the external factors of green management as government and legal, consciousness of social environment, and pressure of competitors environment. Then the ANP model of this paper is set up. Finally, we use the method of the expert group to collect necessary data information. After that, with the help of Super Decision software, we run the ANP model and make evaluation of the internal and external factors of the green management, in order to reasonably explain the final results and provide the suggestions for the development of the green management of clothing enterprise. This paper has important implications for clothing enterprises to develop green management.

The second paper of the thesis attempts to establish a dashboard for small firms in the interest of building a global view of the impact of production from economic, social and ecological perspectives. We firstly outlines the stakeholders involved in

Chinese garment industry which is mainly composed of small- and medium-size businesses, the second largest water-consuming industry sector in China and a significant user of coal-based energy. Then motivated by the relevant Key Performance Indicators as suggested by the MBO (management by objectives) theories and the complexity of the international standards for small firms, we propose a specific dashboard at the plant level to evaluate environmental (e.g. emission of small particles), social (e.g. work accidents) and economic (e.g. profit) performances. Further, in a case study, we define methodological guidelines to design and validate the Key Performance Indicators through a two stages process. At the firm level, the dashboard was employed as a decision-aid tool for investing in new machines, saving energy and water, and challenging suppliers along the supply-chain. At the national level, the dashboard is useful in establishing new standards for the industry, providing benchmarks for other countries and determining the optimal level by trading off between ecological, financial and social targets.

The third chapter of the thesis constructs a decision making model, dealing with various stakeholders (CEO, shareholders, central and local governments) and different criteria (environment, social and financial). The first part of the paper gives a brief summary of decision theories, the involvement of stakeholders in the decision process, along with the compensatory and non-compensatory aggregation methods used in multi-criteria/multi-stakeholders analysis. The second part documents the rationale for the choice of multi-criteria/multi-stakeholders methods used in this paper, that is, PROMETHEE, in comparison with alternative methods. The next section presents a case study of a decision making model to choose suppliers, change the energy system and/or switch the machines for a Chinese textile factory, using the PROMETHEE methods based on the previously established dashboard. The resulting findings have profound implications for a firm to make strategic decision-making, caring about risk of developing long-term side effects.

Chapter 1

Analysis of Influence Factors of Green Management in Garment Enterprise

Abstract

This chapter investigates researches of green management home and abroad, focuses on the connotation of green management, research method of green management, the influence factors of green management and the application of green management in various industries and so on. Through the summary of these literatures, this paper has provided literature foundation for summing the main content of green management and refining internal and external influencing factors of enterprise.

We find that the above literatures home and abroad expounded the necessity and urgency of implementing green management in different aspects, using quantitative and qualitative methods to study green management. Else, the research of the influence factors of green management has a valuable guidance for solving the development green strategy of enterprise in current, and provide theoretical basis for the implementing rules of industry, the specifications of laws and regulations, and the implementation of green management.

Former studies have made achievements within the scope of their attention, and these efforts focused on the feasibility and methodology. With the advance in science and technology, as well as the improvement of management methods and the changing of social, the factors which haven't been considered in the former study of the green management should also be timely to join in. So this paper takes this opportunity to the follow-up research.

Clothing enterprise has also started to explore and try to implement green management. The core concept of green management are reducing environmental pollution, reducing energy consumption, realizing the human and the nature harmonious coexistence. Among the influence factors of green management, there are

external factors such as the government, market environment and so on. It also has enterprise itself as the main body of the internal factors of business enterprise. This paper embarks from the actual situation of clothing enterprise, focus on internal and external influencing factors of enterprise, and take green management as the object of the research, try to explore the key influence factors of clothing enterprise implementing green management.

In chapter 1, this paper makes a sort summary of domestic and foreign research, and analysis the present situation of development and research progress of green management. Then, based on the overview of green management theory, this paper states each link of green management and summarizes the internal factors of green management as green culture of enterprise, cost of green, ability of technology innovation and communication skills, as well as the external factors of green management as government and legal, consciousness of social environment, pressure of competitors environment. Then set up the ANP model of this paper. Finally, we use the method of the expert group to collect necessary data information. After that, with the help of Super Decision software, we run the ANP model and make evaluation of the internal and external factors of the green management, in order to reasonably explain the final results and provide the suggestions for the development of the green management of clothing enterprise. This has certain reference value for clothing enterprises to develop green management.

The innovation point of this article is making internal factors of the enterprise depart from many factors which affect the green management. In the internal and external different perspective of enterprise, we explore the factors which promote the development of green management of garment enterprise. This is closer to the actual situation of the enterprise. At the same time, this article using the method of ANP to evaluate the influence factors of green management, and have obtained some conclusions, which certainly can show significance for clothing enterprises to promote the implementation of green management.

Keywords: Green supply chain management (GSCM); ANP; impact factors analysis;

Green management

JEL classification: C22; G10; G11; G31; M11; M21; O14; O22; O32

1.1. Research Review

1.1.1. Summary of foreign research

In terms of connotation of the green management, from the perspective of ethics and the environment, Hokey (2012) think that the thought of green supply chain gradually become the core idea of today's business during the past ten years. He summarizes the process of green supply chain innovation and the feasible path of green management in today. He also thinks that the future of green management will be more profound influence the strategy and culture of enterprise. In each link of green management, Green purchasing was get the attention of the early scholars, Siferd (2001) puts forward the theoretical framework of green purchasing and points out three related concepts of green management: environmental management, the attitude of environmental management and the system of environmental management. Anantharaman (2003) think that there are many main steps of supply chain management, but the purchasing ability has become more and more important for the enterprise. He suggests that the enterprise need to strengthen the selection and evaluation of suppliers. Chia-wei Hsu (2009) joins the idea of hazardous substance management(HSM) into the process of supplier selection of the research of green management, which means that before selecting a supplier, company should first sort out the different kinds of supplier and set a different vendor level. In the process of supplier selection, he conducts the indicators of hazards management into catch-all category and explains the key indicators and levels of decision model, finally using ANP (Analytic Network Process) method, which is a typical hierarchical structure decision-making method based on AHP (Analytic Hierarchy Process), completed the whole process of supplier selection and evaluation.

In research methods, Mitra(2008) established a two-stage game model, contains giving subsidies to manufacturers and producers, by comparison, he found that the government subsidy is the important factor in the process of remanufacturing. Nagarajan and Bassok (2008) discussed the multiple games having game at the same time, studied the problems between a manufacturers gathering in the role of game and all suppliers and rank their importance and ability. For integrated supply chain of the dynamic analysis of in the process of environmental factors, Josem. Cruz(2008) established a supply chain network model and the corresponding decision goal, proposed a discrete sequence algorithm to implement compatibility assessment process of product flow, product prices, and compatibility dynamic environment, through the analysis of the balance between the three models, obtained some useful qualitative conclusions on the basis of dynamic trajectory analysis. By using the method of strategic management, Chen (2011) analyzed the possibility of implementing purchasing alliance in the green management. Through summarizing the green management theory, Sarkis (2011) summarized some theory suitable for the study of green management: diffusion of innovation theory, path dependence theory, social embedding theory, structure theory, agency theory.

In the level of implementation specifications of enterprise and enterprise operating, Kristy McIntyre (1998) studied the relationship between green purchasing and corporate performance; through quantitative method he got the conclusion: green purchasing can improve corporate environmental performance, at the same time it can improve the company's business performance. In terms of application of environmental management audit in the green management, Roger & Burritt (2004) discussed the problems and challenges existing in the current application, emphatically pointed out the relationship between investment evaluation, cost management and environmental management during the process of implementing environmental management. Irene Henriques (2007) analyzed the promoting effect of environmental management system (EMS) and total quality management (TQM) for

implementing green supply chain technology. In Canada, an empirical analysis of manufacturing industry found that: Enterprises adopting green standards are more vulnerable to the impact of TQM, instead of EMS; although administrative intervention may have some effect for the implementation of green supply chain technology, but the effect is not significant, while pressure of consumer and watchdog can increase the likelihood of enterprises adopting green production technology. According to the diffusion innovation theory and the reverse logistics theory, Benjamin (2011) puts forward some basic assumptions, in the form of a questionnaire to investigate, finally through the analysis of variance, he found that the dependent demand of consumer perceptual products for reverse logistics is higher; companies can promote green management by this kind of product. Tseng (2012) think that under the condition of incomplete information, when manufacturing industry carrying out the choice of key suppliers, it should consider this problem from the angle of system and the views of improving enterprise overall environmental performance. Subhani (2012) classified the factors that hindering and promoting green management, through the questionnaire to study the Pakistan's small and medium-sized enterprises, studied the organizational culture how to influence green management in the implement process of enterprise.

In the aspect of implementing obstacles and motivation, Christmann (2001) point out that Chinese enterprise are passively involved into improving environmental performance in order to increase exports and become excellent foreign suppliers. Walte (2005) point out that the green barriers of existing international goods mainly includes Information validity and information cost. Sean Gilbert (2008) consider that green management can produce direct competitive advantages (reduce cost, produce the products of green competitiveness, improve cooperation motivation of the supplier and so on), State-owned enterprises obtain the ability of green competition, at the same time it also can drive the implementation of green management in the middle and lower reaches of whole supply chain. Through carrying out questionnaire survey

and data analysis for the seven enterprises of UK, MaBain (2008) found that in the operation of the green supply chain, the influence from power is much more than the influence from the obstacle. He also point that although the organization factors, regulation, consumer, competitors and social institutions are both the inside and outside factors of the enterprises actualizing green management, the suppliers should not be ignored.

Some scholars also have the related exploration from the strategic level. R.Carter (2000) studies the effect of the ESP on financial performance, which is a useful enterprise management software, found that environmental consciousness procurement have positive effect on net income and cost of products. According to the survey of the British, the United States and Japan and other countries, Robert Handfield (2005) point that The decision-making model of core business of green supply chain strategy, this model has a certain significance on the green transformation of the existing supply chain model; finally he put forward we can by reasonable dealing with the environmental problems to improve the competition ability and performance of supply chain. From the perspective of operating strategy, AJAY (2012) study the multiple influencing factors of implementation of green management; put forward the suggestion for manufacturing enterprise to implement green supply chain.

At the industry level, scholars put the coordinate mechanism into the related model of the production process of energy. Based on the research of energy sectors, T.Metin (2004) found that the communication and coordination among members of green supply chain can make the economic benefit of supply chain improved; this is green supply chain coordination management from the perspective of economy and energy factors. Through studying the green management practice of enterprise such as the HP, Panasonic and other international leading enterprises, Sarkis (2006) found that supply chain management make them improving their environmental image and also bringing the competitive advantage for them. Miehelsen(2006) puts forward nine green

performance indicators of the evaluation of the operation of supply chain in the furniture industry; In the process of ascension green purchasing, he put forward higher requirements for green performance of six kinds of furniture model, final analysis suggest that the green performance of products is closely related to the cycle of product. After the questionnaire survey for IT executives of China's Taiwan region, Yi-chan Chung (2007) think that good behavior of green design can produce good consequences, and also can make the product strategy and product performance has a good performance. At the same time, product strategy has positive correlation with product performance. Based on the survey results of some North American manufacturing companies, StephanVachon (2008) point that there is some environment collaboration system are established within the system of supply chain. Through the empirical analysis, he found that environmental cooperation with upstream suppliers often close integration with operation performance; and environmental cooperation with downstream vendors often associated with the product performance. Typically, collaboration with upstream suppliers having the green environmental protection is more likely to get benefits.

1.1.2. Summary of domestic research

European countries experienced the period when its own development conflicts with its environmental resource, they realized that the importance of sustainable development, so they begin to deal with the environmental problem. In our country, we only have twenty years of industrialization, during the period of construction; we tend to neglect the environment benefit. In the field of supply chain, abroad scholars have long to explore green supply chain, but since the mid- 90s, our country didn't even have a certain research in this field.

From the perspective of system, according to the application software hierarchy, in the process of logistics software development of the whole process of prototype system framework model in green supply chain, Chao Jie (2004) discussed the feasibility of

the prototype system; at the same time, from the IT industry, he conduct the comprehensive evaluation on implementation of green supply chain in the process of production. Combined with the country's 12th five-year plan and the current situation of enterprises implementing green management, Wang Xiaomu (2012), from the perspective of system, puts forward the suggestions for promoting the development of green management in China.

In terms of the obstacles of green supply chain, Hu Jiling (2008) discussed the operation process of green supply chain, and the type of knowledge transfer between members of the company, explored the main obstacle of knowledge transfer, put forward the countermeasures and methods of knowledge transfer between enterprises in the green supply chain from the perspective of qualitative. Through analyzing the obstacles of enterprises implementing green management, Zhang Yanlian (2012) proposed that using environmental cost management between enterprises to deal with these obstacles.

In terms of the connotation of green management, according to the supply chain management and the sustainable development of green supply chain model, Wang Yingluo (2003) divided it into four subsystems: production system, consumption system, environment system and social system. Around these four subsystems, according to the basic principle of system dynamics, Zhao Yiping (2008) put forward a simplified dynamic mechanism model of green management further shows the relationship between green management and the general law. From view of the empirical, he summarized the root cause of the slow development of China's green management and proposed the corresponding countermeasure and the suggestion. Based on SCOR model, Niu Lihong (2010) put forward green supply chain logistics model, divided it into purchasing link, manufacturing link, cash link and recycling link; and studied respectively. Besides, the SCOR model(Supply-Chain Operations Reference model) is the first standard supply chain process reference model, as well

as a diagnostic tool for supply chain, and it covers all sectors. So Niu's research has a certain research value.

From the internal and external environment of enterprise, scholars classified the effect factors of green management. Fang Wei (2007) divided the influencing factors of green management into three aspects. Within the enterprise: concept of environment, green culture, key technology, enterprise BPR; Business-to-Business: enterprise integration BPR, communication platform, management between supplier, virtual organization; the government: the government guide, information platform, authentication and consumer opinion. Wang Huiting (2010) considers that factors influencing the implementation of green supply chain have internal enterprise, factors between enterprises and the government. Internal factors include changing of environment idea, establishing green enterprise culture, application of internal key technology of enterprise, restructuring process of internal business; factors between enterprises and enterprises including integration BPR between enterprise, effective communication between the enterprise, supplier's effective management, the establishment of the virtual organization; factors of government including, the government correct guidance to enterprise, establish information platform, government intensify certification, correctly guide consumer. Deng Linna (2010) consider that the obstruction factors of enterprises implementing green management are behind the green consciousness, institutions disorder, management level is low, the energy consumption high and pollution. In the framework of supply chain management, Yu Baoqin(2010) think factors of green management for the purpose of protecting the ecological environment and health have product life cycle, the production cycle, the company's performance, environmental performance and other factors. Gu Lijuan (2010) considers the internal factors of green management are environmental pollution and the environmental protection certification. Gong Mili and Tian Jie (2010) consider there are many factors of green management, the main restricting factors are green material, and high cost of green packaging, insufficient

incentive and insufficient green technology, the effects of the green cost is the largest. Green management can bring the economic performance, at the same time; it may lead to higher costs.

The application of Green management in various fields study, in view of the oil industry, Han Lihong, Zeng Jinfang(2007) put forward consummate the environmental regulations and green design, set up green enterprise cooperation, promote the development of circular economy and establish the performance evaluation system of green supply chain. Based on the analysis of the Chinese enterprises implementing green management, from the angle of the core enterprise and suppliers, Lei Xianghu (2008) discussed specific strategies to solve the obstacles of vertical electricity mechanism of green supply chain. Through discussing the green supply chain mode and the problems, Zhao Zhengyan (2008) put forward the standards and methods of the green supply chain; summarized the existing problems and put forward the related countermeasures. Through discussion, Lu Qianlin and Yao Weixin (2009) put forward some feasible solutions of green management of enterprise whose economic strength is not strong in the garment industry. Lin Jingliang (2010) analyzed the necessity of the green management in the ceramic industry and made a discussion about how this industry to implement green supply chain management, then proposed specific strategies, both in the strategic layer and business layer, for ceramic industry are high energy consumption and high emission. He concluded that environmental management strategy, information sharing platform and the government's strong push can surely optimization the green supply chain management of ceramic industry. Wang Hongchun and He Baizhou (2010) defined the content of the construction of green management. Cao Haiying and Wen Xiaoqing (2012) discussed the development of green management of retail industry which is dominated by the retailer's by the game model.

1.1.3. Conclusion

The above literature of home and abroad expounded the necessity and urgency of implementing green management, from different angles, using quantitative and qualitative methods to study green management. Among them involves the research methods, strategic planning, implementation specification and tools, survey research, analysis the drivers and barriers and the practice content of all kinds of industry. It has laid a good foundation for the research and development of green management. Else, the research of the influence factors of green management has a valuable guidance for solving the development green strategy of enterprise in current, and provide theoretical basis for the implementing rules of industry, the specifications of laws and regulations, the implementation of green management.

Former studies have make achievements within the scope of their attention, these efforts focused on the feasibility and methodology. With the advance in science and technology, the improvement of management methods, the changing of social, the factors which isn't considered in the former study of the green management should also be timely to join, the writer take this opportunity to the follow-up research:

For clothing enterprises, implementing green management requires that it should begin from its own perspective and analysis according to the actual situations. For example, the factors influencing enterprise green management is divided into two parts: internal factors and external factors. Most of the literature all put the two parts of factors together and then study these factors, without exception, all the literature mentioned that the laws and regulations has influence on the implementation of green management of enterprise. The author thinks that, although the laws and regulations has very big influence for enterprises implementing green management is, but the present domestic environmental legislation is not perfect, the implementation of green management cannot rely on the legal standard, it should also consider the enterprise's adapting ability and transformation ability of environmental protection laws and

regulations.

Enterprises are not only affected by external factors, the enterprise itself can also affect the external factors. Enterprises and external environment have Interaction influence between each other; this isn't considered this feature in numerous studies. For example, the enterprise culture is the enterprise's own label. Enterprise culture not only influences the internal employees of enterprise, it will also affect its upstream and downstream of the related parties. Enterprises with deep green culture can affect the whole development of the green supply chain; enterprise external propaganda will affect the public spending habits and environmental awareness. When this paper study the internal factors, it don't let the green culture of enterprise as the isolated agent, but one can interact with the other factors of elements.

The ability of technology innovation is sometimes an internal factor which hinders enterprises from implementing green management. Implementing green management requires not only technical green, it also need means and methods of green management. Most of the enterprises regard the enterprise's technological innovation ability as technological breakthroughs and innovation; it cannot fully reflect the entire contents of the technical innovation ability. In this paper, the author has a comprehensive consideration; the technical innovation ability is summarized as two aspects of technology and management methods of comprehensive ability.

1.2. Research Background

Since China's reform and opening up, China's economy has achieved the sustained high growth, clothing export is an important component of China's exports. In 2012, the amount of Chinese textile clothing export is \$262.56 billion, has 3.3% growth year-on-year, which is the lowest growth since 2010. In recent years, Europe's economic environment deteriorating, trade protectionism become high; the strict environmental requirements block the road of Chinese enterprises' export, at the same

time, the of costs domestic raw materials and labor become rise, which exacerbate the plight of garment enterprises, some enterprises simply living on extensive processing on giving materials cannot easy to survive. If we let this situation continues to develop, clothing enterprise in our country will lose the ability of sustainable development, and loss the competitiveness in the international market.

In 2007, a European Union environmental directive- EuP formally became a formal protection law of the European Union, before the EuP directive, both WEEE and RoHS has become major trade protection means for the European Union to limit developing countries. Compared with the former two instructions, the new instructions pay more attention to the ecological design concept, for China's garment enterprises which want to take a place in the European Union, this time is not only take a responsible environmental performance for their products, but also be responsible for its own environmental performance of management level.

The high standard of environmental requirements is a difficultly threshold for our country's enterprises which wish to enter the western market. Chinese enterprises need to constantly improve their environmental performance at present stage; this is not only a challenge, but also an opportunity for enterprises. In this context, enterprises must be taking a way that resource environment and development is coordination, which need the constantly exploration and practice. In order to deal with all kinds of green barriers, many experts pointed out that the implementation of green management is a wise choice. As environmental protection become more and more important, what the enterprise can do to effectively reduce the damaging of the environment in the process of production operation. Many companies are dealing with this kind of problem by the practical action of developing green management.

1.3. Research Perspectives

Today, the green consumption demand of consumer groups is growing; clothing

enterprises need to produce green products to meet customer demand through green management. And gradually implementing the green management of enterprise is a process from low-end to high-end for clothing enterprises, not only can reduce damage that human activities bring to the environment, protect the environment and achieve sustainable development, is responsible for all mankind, also can bring tangible benefits for the enterprise. In short, the implementation of green management is not only fulfilling the social responsibility of corporate, is also the effective means for helping enterprises to improve performance.

- **Research Significance**

This paper will analyze factors which are concerned by garment enterprises carrying out green management and the impact of the factors from the perspective of enterprise, basically has the following several aspects of the positive significance. First, this paper has the clothing enterprises as the main body; this can help enterprises more thoroughly understand the real meaning of green management. Second, trying to seek a solution, getting rid of the thought of without government intervention, the enterprise can't be environmental protection enterprises, this can provides guidance for the enterprise to independently develop the green management. Third, it can provide reference for government to protect the development of transformation and upgrading of clothing manufacturing industry from another point.

- **Research Objectives**

This paper collects some related research of green management, as well as some literature and resources, combs the main content of green management and category of green management and its impact. After the analysis of external factors of enterprise implementing green management and the relationship between each link of green management, this paper sets up ANP model. We expect that we can evaluate the influence factors of green management of clothing enterprise by combination of questionnaire and ANP model, and clear the influence of inner external factors bring

for the implementation of green management, provide the reference for clothing enterprise to make related policies for implementing green management.

1.4. Research Approaches and Procedure

This article has external influencing factors of green management of enterprises as the research object from the perspective of enterprise, through combing and analyzing the green management theory, summarizes up the green management model, summarizes internal and external factors of clothing enterprise implementing green management, by the combination of questionnaire and ANP model, evaluate the implementation of green management of clothing enterprises, finally draws relevant conclusions and give advices. Then it using the green management related theory, using ANP model as the main analysis tool, study both internal and external factors of green management of enterprise by using the combination of theoretical analysis, the questionnaire survey with practice and using the method of quantitative and qualitative interaction.

This article will study the research according to the following steps:

On the basis of carding theory and analysis literature, using the theory of green management to complete the study of the current green management model.

Using the method of theoretical research and practical research, refining the internal and external factors of green management of enterprise, set up the evaluation system of affecting factors of enterprise green management, and analyze the relationship between various factors.

Based on ANP model, construct the ANP network model of affecting factors of enterprise green management, and using the method of expert group to judgment the factors of subjective.

With Super decision software and use ANP model, obtain the evaluation result of the influence factor of green management and have a detailed analysis on the result.

With the principle of combination of qualitative and quantitative, based on the results of the quantitative analysis put forward the countermeasures and suggestions: on the one hand, from the angle of clothing enterprises put forward the proposal for each link of green management, on the other hand, starting from the internal influence factors of green management, provide advice on policies and regulations for the local governments.

1.5. Summary of the contents of the green management

In 1996, manufacturing research association of Michigan state university puts forward the concept of green management for the first time. Green management is based on the traditional supply chain management, considering the impact of supply chain on the environment, from the point of view of optimal utilization of resources to consider the development of the supply chain. On the basis of the above summarizing the domestic and foreign research, this chapter will focus on expound the meanings and characteristics of green management, the important part of the green management and the effect form of implementation of green management.

1.5.1. The meaning and features of green management

Green management (GSCM) is also called the supply chain management of environmental awareness, it considers the environmental problems of each link of the supply chain, has environmental protection as cores points, and promote the coordinated development of economy and environment. Its related research remains to be further study, from the point of existing research, there is no a unified, clear and authority statement, there is no a certain generalization to clearly defined the green management. Walton consider that green management is that one join the suppliers into the environmental strategic of the enterprise, its core idea is that using the integrated management thought into the field of green supply chain. Green management is an effective way to solve the development and the pollution of

environment, and using the viewpoint of system and integration of ideas to implement. There is another view of joining the environmental protection consciousness into supply chain management, having the no waste and pollution, without any bad components and without any side effects throughout the supply chain of green management. Some thought consider that green supply chain has the optimal configuration of resources, improving welfare and achieving compatibility with the environment as the goal; is a series of activities of obtaining materials, processing, packaging, storage, transportation and recycling based on principles of intergenerational fairness and fair from the process of developing resource to product consumption; is the system which is composed of elements such as rules and culture, consumer, environment, manufacturer, distributor, the supplier and the retailer; is the integration of the logistics, information flow and knowledge flow. Accordingly, the concept of green management is refers to has the basic principle of sustainable development theory and supply chain management as the guide to plan, leadership, coordinate and control logistics, information flow and cash flow between the whole main behavior body involved in the green supply chain, its purpose is through the way of optimization and improving the speed of the activity and certainty, degree of the environmental friendly to achieve the optimal allocation of resources, improve welfare and achieve goals of environmental compatibility.

The author thinks that, green management is the management that based on the traditional management, using the idea of sustainable development, combining the concept of circular economy with environmental protection. It has integrated green purchasing, green design, green production, green marketing, and green logistics and reasonable green recycle, which means to form a highly resource configuration and coordinated development of the enterprise. The implementation of green management is very complex, from the perspective of the role of participants including supply, manufacturing, distribution, retail, and using and providing logistics and recycling service; from the implementation of green management including green purchasing,

green design, green manufacturing, green distribution, green logistics, green consumption and green recycle. Green management involves many links. Within the enterprise, green management is usually affected by the following factors: green culture, cost of green, ability of technology innovation and ability of enterprise communication.

Green management inherits and carries forward the traditional supply chain management, and is different from traditional supply chain management, has the following characteristics:

(1) From the point of coverage, the green supply chain has a wider range of members than traditional supply chain. Compared with the traditional supply chain that is more emphasis on the production system, Green supply chain includes part of the supply traditional chain in outside, also includes the environment system, the external constraint mechanism, cultural values and environment, etc.

(2) The goal of green supply chain operation is the optimal configuration of resources, improving benefits of supply chain members, and achieving coordinated development with the environment. The three are coordinate and related with each other. If the resource isn't optimal allocation, the interests of stakeholders (manufacturers, sellers and suppliers) of production system in the supply chain will not be able to achieve, this will make the traditional supply chain business also has more competitive, the members also has no motive to do the work coordination with the environment; the continuing to buy the products for consumers comes from the pursuit of their own welfare, If the process of consumption of supply chain can't lead to the increase of consumers' welfare, so the products provided by the supply chain have no way to realize the value, making the phenomenon of the broken activity, so harmonious with environment is the foundation of any activity.

(3) Green management relies on the movement of logistics flow, cash flow, information flow and knowledge flow. Logistics flow is the main driver of green

logistics management, and mainly be responsible for the transportation of raw materials and finished products; cash flow and information flow are developed throughout green management, where cash flow is one of the concrete manifestations of green management business activities and information flow promotes green management to continue meeting the actual needs of the market. Besides, compared with the traditional supply chain, in order to implement the goal of homogeneity of interests and high environmental compatibility in the members of supply chain, it must have the corresponding techniques and knowledge as the support, so green supply chain is more emphasis on knowledge activities within the supply chain, knowledge flow become the important component of green supply chain. Its specific performance is that the environmental protection technology research, achievements (especially in environmental technology) transferring and sharing, early product design intervention and the restructuring of the production process etc.

1.5.2. The important processes of the green management

Green management is consists of the each link of supply chain. Its main contents including green purchasing, green design, green production, green marketing, green recycling and other links of common logistics management. Green purchasing, green design, green production, green marketing, green logistics and green recycling are in four interrelated systems, and crossed in two or more systems, which respectively are production, consumption, society and environment.

Products from product design, material procurement, production, processing, storage, disposal of scrap and the entire process is closely connected with the environment, how to minimize the impaction on the environment, which is green supply management should pay attention to. Green purchasing is the entry point of green management; the core problem is the optimization of the supplier and cultivating excellent partners. Green design is on the basis of green purchasing, make guidance for the green production, design the green products meeting the requirements of green;

at the same time consider the impact of whole green supply chain on the environment. Green manufacturing is the key to implement the target of the green purchasing and green design, reducing the waste emissions and energy consumption is our concerns in the process of production. Green marketing is the step to realize the profits, on the basis of effecting green design and green production, green marketing link up with the brand strategies, through propaganda green concept, enlarge green demand to win consumer recognition. The green recycling is important from for green supply chain different from the traditional supply chain. Green recycling embodies that the green supply chain is a never-ending cycle, from cradle to reproduce. Green logistics solves the harmless to the environment in the process of material transportation, raw material storage. Obviously, removing the green design, green purchasing, green production and green marketing, green recovery is link connected with green logistics.

Green procurement is the choice of suppliers for designers; green design is the selection of the designer's supplier for manufacturer; green manufacturing is the phase of a manufacturer providing products for distributors or retailers. Green marketing is the combination of green design and green production; broadcasting the green concept to consumer, the discovery of green demand, establishing a certain relationship between producer and consumers. Green recycling is the relationship between suppliers and consumers, by judging whether products can be recycled or not to recycle the products that consumers used for, this is an important link to achieve sustainable.

1.5.2.1. Green procurement

Green purchasing takes the procurement strategy that has no damage or less for environmental and ecological in the process of the three links of purchase order, procurement and distribution, purchasing after the disposal, selects the corresponding competitive products or services. General green procurement focus on whether

evaluating materials is the green material (evaluate its recycling and using again and could be depredated by cutting smash, harmlessly burning and another features).

The most important part of green purchasing is the selection of excellent suppliers. Steps of selecting suppliers in green procurement are as follows: competitive environment analysis, determining the selected supplier, establishing evaluation standard of the supplier, setting up evaluation team, selecting supplier and evaluation, choosing partners, the implementation of partnership of supply chain. Through these steps, looking for the best suppliers, which is first step to realize the green management.

To some extent, green purchasing can reduce cost; it includes the management cost of enterprise, cost of production and cost of material circulation. Reducing the cost is based on good communication with suppliers. Other scholar thinks that green procurement will be a burden for the enterprise, increase the cost.

In narrow sense, the biggest factor affected the cost of green purchasing is green cost, green purchasing need to make sure the survival of enterprise and the choice of green material achieve a balance between as far as possible. Green purchasing is also affected by the communication ability of enterprise, this is because choosing the suitable suppliers is a major link in green procurement, and another reason is that the green procurement relying on green logistics operation, achieving the goals of material circulation link to reduce waste and pollution as much as possible.

1.5.2.2. Green design

Green design refers to give full consideration for the performance, durability, life cycle and cost of product, advocate no waste recycled design technology in the idea stage, emphasis on products in the whole life cycle is in harmony with the environment, reducing the environmental impact and resource consumption to a minimum. Beautiful performance or design language is not so important for green

design, but the green design emphasis that with the minimum input to obtain maximum output, and attaches importance to using recycled materials, makes the circular economy reflected in the appearance of the product. In green design, small is beautiful, less is more. The content of green design includes material selection and management; detachable design; the recyclability design of product.

Two problems need to pay attention in green design. On the one hand, the harmful material and harmless material should be easy to identify, they cannot be mixed with each other; on the other hand, for the scrap products, its recyclable parts need to fully recycle, the one part which is not available to use need some method to disposal, make its impact on the environment to a minimum. The recyclability of product design usually considers the degree of recyclable materials, interest points of circulation as well as recycling technology and so on. Design for disassembling refers that the designed structure is easy to remove, convenient maintenance and be able to recycle after product scrap. In addition, it also need to measure the cost of green, establishes a database archived the results of product design.

Whether the implementation of green design is good or bad is closely related to the ability of green technology innovation. The enterprise has corresponding innovation personnel and management mechanism, reliable innovation process; it has great benefit for the green design. Green design, on the other hand, need to consider all aspects of problems, need to consider the internal and external communication ability of enterprise, so the green design is also affected by the communication ability of corporate.

1.5.2.3. Green production

Green production is also known as clean production, it requires the company has the clean production technology as the foundation, continuously improve the management and improvement, actively seeks the alternative materials replace the poisonous and harmful substances, by strengthening internal management to reduce the emissions of

waste and pollutants, and improve the utilization rate of resources, in order to reduce the harm to environment and human, cleaner production's essence lies in pollution prevention. Clean production thinks that improving the problems of resources and environment reflects in the process of enterprise production, which is through improving technology and technological process, replacing poisonous and harmful materials and auxiliary materials, researching and developing new production technology, replacing the old methods of harmful production, through strengthening management and improving the personnel and production tools, to achieve the purpose of reducing energy consumption, saving energy, reducing pollution, increasing efficiency and economic development with environment.

Production process is the link that translates the design into a product, as well; green production is the important process that translates the green design of green concept into green products. Reducing the waste pollution in the process of production reflects the whole green supply chain and green products.

The OECD has identified several main driving forces of green production: marketing demand, government welfare and development of technology, they are connected with each other and mutual influence each other. The OECD considers that it is the effective motivation factors that promote the implementation of cleaner production, normally these three driving forces shall jointly together. The author thinks that the green production has high technical requirements, it need the corresponding green production technology and the corresponding management technology, that is to say, green production is affected by the green technology innovation ability. Also, the purpose of the green manufacturing is not only completing process of production, providing the production results, reducing consumption and waste in the production, it also is the important purpose of green production. Obviously, the cost of green is one of the important factors affecting the green manufacturing. What we can't deny is that there are many different voices about whether green production can reduce or increase the cost. Many researches both theoretically or practically confirm that some

companies or industries which use reasonable management methods can have a positive outcome at the same time during green production. So generally, green production can not only has a long-term indirect benefits, but also may lead to immediate short-term benefits.

1.5.2.4. Green marketing

Sticking the idea of sustainable development, reflecting social responsibility and maintaining improvement of ecological system and protecting the environment is a major feature of green marketing. so, green marketing put forward higher requirements of environmental protection for various enterprises of supply chain in process of market research, requirements analysis, product development and product sales line feedback, require the development of the enterprise attaching great importance to the interests of consumers, make economic development consistent coordinate with environment. On the basis of the traditional marketing, green marketing will have the environmental benefits as the core and make it with the economic interests neck and neck, this marketing way pay more attention to global environmental problems.

Green marketing and traditional marketing all require the communication and coordination with R&D department to develop corresponding products according to customers demand. Different from traditional marketing, green marketing pay more attention on green consumption behavior, at the same time, broadcast the green concept and enterprise green idea to consumer, pull the green demand and guide customers buy green products to obtain its profit. Green marketing make the green design and green purchasing together, become a necessary element of the enterprise toward the environmental friendly direction. This has been put into practice in developed countries, for China, the gap between the beautiful vision of green management and theory and the overall level of enterprise green supply chain is very big.

Green marketing requires internal employees of enterprise have strong green environmental protection consciousness, both the management and marketing personnel need to clearly understand the meanings of green marketing and are willing to put it into practice, but don't increase customer only by green banner. So, green culture deeply influences the enterprise's green marketing. At the same time, the green marketing needs to coordinate the relationship between the parties, the enterprise can affect consumer spending habits, the green concept of suppliers and the competition strategy by green marketing, so we can say that the green marketing is the enterprise's external position and have higher requirements for communication ability of the enterprise.

1.5.2.5. Green logistics and recycling

The development of green recycling relies on the development of reverse logistics, and reverse logistics is an important part of green logistics, so in this paper we will introduce the two together.

The link of logistics can produce a variety of emissions which pollute the environment. The unreasonable logistics planning make the energy resources meaningless consumption. Compared with the traditional logistics, green logistics pay more attention to the damages of logistics links to the environment, by improving the logistics technology to improve logistics management performance and use the technical means to modify the logistics links, make the green logistics adapt to environmental coordination, promote the each link of green supply chain connect together, is a health system that can promote the development of economy and environment toward better. It is the link of the green supply chain; provide the supplies of production activities needed to each link of the green supply chain. The transportation and storage of raw materials, transportation and storage of finished product, transportation and storage of transferred material, processing and storage of incomplete products, transportation and storage of dangerous chemicals, all these

related to the link of physical flow will produce some serious environmental problems such as exhaust emissions of waste, harmful material leakage. By controlling the material flow of the whole green supply chain, from the transportation of raw materials, material flow, the transportation and distribution of product to the transportation of recycled contaminants, green logistics will be closely linked with each link of green supply chain. Large amount of the intermediate links need to closely communication, good operation of green logistics is closely related to the mutual communication between enterprises. If with sufficient communication within the green supply chain, establishing a trust mechanism and having the optimization of green logistics surely make the value of whole supply chain maximization.

Green recycling is the process of logistics activity from the users return to the manufacturer or supplier. It refers to that when the product reach to the using fixed number of year, it will recycle the part of the product which can be recycled, make the resources more circulation use and recycle. Green recycling reflects the high consistency of economic benefits and environmental benefits, resources recycling reduce grapping the natural resources, recycling production resources bring to lower production costs, reducing the exploitation of natural resources reduces the pollution of the natural environment. Usually, the recycle using of waste materials, waste energy and waste water can reduce the production cost, improve the overall benefit. When the enterprises has green recycling, it should be mainly from the production cost, quality of the raw material, production flexible and market demand to make decisions and take consider of the compatibility with the environment. Green recycling is based on circular economy, its core is improving the efficiency of recycling resources, has the idea of reuse, recycle and non-hazardous as the main goal. This cam both improve the utility of resource and reduce waste emissions at a certain extent, improve environmental quality and economic benefit. Green recycling has high degree of dependence on recycling technology and management technology, it test the ability of green technology innovation of enterprise.

1.5.3. Phrase Summary

This chapter has the main content of green management as the main line; straighten out the relationship between each link of green management and its influencing factors: green purchasing attaches great importance to the cost and communication with suppliers, the green cost and communication is the main influence factors of green purchasing; green design need to communicate with consumers and sellers, as well as the corresponding research technology of enterprise, enterprise technology innovation ability and communication ability is the main influencing factors; green production is the core link of green supply chain, has a higher request to the enterprise's technological innovation ability, in consideration of production cost accounting, process of the green production has also been constrained by green cost; green marketing is the process of showing enterprise implementing green management for outside world, under the influence of communication ability of corporate, it also affect the upstream and downstream parties of supply chain: supplier, customer and competition; green logistics and recycling has higher demand for technology, under the influence of technology innovation ability of enterprise, at the same time, green logistics and recycling need to make connect with many parties, also have certain requirements for the communication ability of enterprise. The concept and scope of the internal factors will are discussed in the fourth chapter.

1.6. Factors on green management

On the basis of elaboration on meaning and important parts of green management, this part summarizes the internal factors and external factors in the process of implementation of green management.

1.6.1. Internal factors in company

1.6.1.1. Green cost

Green cost is total cost expended in the implementation of environmentally harmless and resource optimization, mainly includes raw material cost, energy cost and waste management cost, as well as training and management expenses for environmentally harmless.

One desired effect of green management is to reduce the cost of business. The implement of green management is initially the result of commercial activity. The purpose is to create value by-products and reduce production costs through the adoption of new input, for example, saving operating costs by recycling of water, emissions, energy and materials (Roberts 2004) . The high cost of corporate green not only affects the implementation of green management, but also the survival of enterprises. Based on this, the author think that green costs should be a top priority issue for managers in implement of green management. Enterprises pursue profit. In order to pursue long-term benefits, they need to implement green management at acceptable green cost. Different from the traditional supply-chain management, green management focuses on the long-term interests of the enterprise. In particular, the introduction of the principle of recycling makes green management a closed loop, which is called “From the cradle to the reproduction”.

Green cost in green management needs to concern about the following issues: raw material cost, energy consumption, R&D, environmental inputs and raining costs. It is worth noting that impact of changes in policies and laws on these aspects cannot be ignored.

For enterprises, survival and development are constant problems. Enterprises who want to survive in the fierce competition and achieve development must consider the cost. The impact of green cost on the development of enterprise’s green management

is particularly important. Whether it is green procurement, green design, green production, or green marketing or green logistics and recycling, they are all closely linked with green costs. Green cost is of great significance to green management execution for the business. Simultaneously, the amount of money companies are willing to provide to improve the environment and increase the greenness of the company have an impact on consumers, employees, suppliers and even the whole society.

1.6.1.2. Green culture

Different from traditional supply-chain management, green management realizes the importance of environmental protection. Corporate culture has become an important factor in green-house development of green management. Employees are specific actors green ideas, and any corporate culture requires their integration. In environmental management, business operations goals are very closely linked with involvement of employees. Business managers' support is a major force in promoting green management. Senior leadership's support decides the success of corporate's green management. Environmental awareness, employee recognition, managers' green consciousness, corporate' green practices and corporate social responsibility are the five corporate green culture, from which this article will elaborate the corporate green culture.

Environmental awareness affects the relationship with suppliers, distributors and consumers. Environmental awareness requires long-term culture and cooperation. From the customer to the supplier, from partners to competitors, all need interaction, whose consequence is a long-term strategy. Environmental awareness can usually inspire concern for environmental issues and profound recognition of members of the supply chain and internal staff. Such awareness and understanding can bring considerable awareness support for cost savings and technology innovation. Simultaneously, the extension of environmental awareness has brought long-term

cooperation based on environmental protection in the supply-demand relationship, which makes some long-term strategic relationships are stable in the green supply chain.

Green management is based on a certain environmental awareness and responsible for natural resources. To achieve this goal, the members of the supply chain and corporate staff require certain environmental awareness, including managers and decision makers of enterprise even operators. So, many environmental measures in the production process can be properly implemented. Recognition of employees and managers of green consciousness in the same level have influence on green culture from different aspects. In the field of environmental management, business operations goals are very closely linked with involvement of employees. Awareness of decision makers and business managers can decide that whether green management can be implemented. Support senior leadership is crucial to the implementation of green management. Managers should be an advocate of corporate green culture, and the final perpetrators are all employees of enterprises. So, green culture needs to penetrate into each level of employees no matter employees or managers.

To achieve environmental-friendly type of development, enterprises need to implement green supply management starting from their own, and carry out the production activities in strict accordance with the green concept. Green standardize enterprise constrained the corporate's destruction of the environment from the inside in the form of self-regulation, which is a process of self-monitoring and self-regulation. Green specification in enterprise that has a leading role in the industry may develop into a green industry norm. This could bring advantages to enterprise that develops a specification and strictly implements at first.

Corporate Social Responsibility is the responsibility of corporate commitment to protect and promote the public interest and the long-term benefits. Companies should not be consider the pursuit of profit as the only business goals. Enterprises help

consumers obtain profits through the production of the corresponding products by completion in business environment. In the process of production and circulation, the environment and consumers may suffer some direct or indirect impact. When these impact on other stakeholders to produce harm, companies should bear the harm because of their fame and fortune. CSR requires companies to contribute to consumer, natural resources and society. Traditional social responsibility emphasis on corporate should comply with the principles of market competition, protect the interests of shareholders and maximize profit for them. When the resource and environmental problems have become increasingly prominent, corporate should better reflect social responsibility to be responsible for environmental and social benefits.

Corporate's environmental awareness, employee recognition and green awareness of managers are sources of green management needs. When companies recognize the green culture from the inside, employees and managers are willing to allow enterprises towards environmentally friendly and sustainable direction, corporate would identify the green concept from bottom to top. Further, corporate can develop a reasonable corporate green norms. If reasonable green norms has been widely accepted, corporate's social responsibility to reduce consumption and pollution of the environment will increase. In turn, it can promote understanding of green culture.

Corporate culture has an impact on corporate behavior in the enterprise development process. In the development process, the enterprise with a green culture will consider the problem of corporate and environmental compatibility unconsciously, which has a favorable impact on green business management execution. At the same time, corporate's green culture instills environmental philosophy to employees as well as effect on concept of consumers and consumer. And corporate's green culture is directly affected by the social environment and awareness. Managers' attitude has a tremendous impact on the corporate culture. Managers are concerned about the environmental performance of competitors. Thus, corporate's green culture is also affected by the environmental pressures of competitors.

1.6.1.3. Communication skills

Research shows that behavioral determinant is a key factor in achieving trust on supply chain and integration of business process. It is also an important part of business communication skills (Mohammad Asif Salam 2011) . Behavioral determinant is corporate's behavioral traits manifested during production activities with other companies or individuals when having dealings. The behavioral determinant can also be said to be the market position of the enterprise. Enterprises with different behavior determinants have different performance and company policies. The behavioral determinants consist of continuity of the supply chain, communication skills, enterprise strength and reliability. Green management is an extension of supply chain management. This article would not redundant state good links of supply chain management. Because corporate's communication skill effects the continuity and reliability of supply chain. This article will consider corporate communication skill as a factor in the development of green businesses.

In communication with suppliers, the corporate enable suppliers clear environmental policies and determination of itself to develop their own environmental policies via the web, instant messaging, or presentation and exchange environmental requirements by e-mail, letters, etc. Inter-enterprise communication and exchange of information on environmental protection, can give each other an opportunity for exchange of information, which can promote enterprises to adjust their own environmental policies based on market conditions, thereby the implementation of green management can be promoted. In addition, to regular and irregular spot check and announce the current environmental performance, extent of damage to the environment and as well as its long-term environmental strategies can make its partners (suppliers) and so understand their business development and the need to adjust; Combining the environmental review with quality control and certification partners is a means of ensuring to implement the environmental performance practices of green management effectively.

Communication is not just to communication with suppliers, or communication between the upstream and downstream enterprises across the green supply chain.

Communication efficiency of the supply chain between the upstream and downstream enterprises affects the entire supply chain efficiency. Effective communication of upstream and downstream enterprises can reduce the impact of information asymmetry, and it can also increase mutual trust between enterprises. Based on this, good communication skills, for green management, is also indispensable. Particularly in the area of green materials, green technology, transportation, waste recovery and recycling, etc, mutual communication and information sharing between enterprises can improve the efficiency of the entire supply green chain. Based on this, companies with strong communication skills can effectively reduce unnecessary friction and conflict in communication with the upstream and downstream enterprises and better establish effective cooperation.

Enterprises need to handle communication between industry and enterprise as well as enterprises and consumers. Compared to inter-enterprise communication, channels and means of communication between businesses and individual customers lack. Green marketing requires companies communicate with consumers while conducting marketing. Internal sales department and production R&D departments need to communicate too. It is a kind of outside-in communication.

Business association promoted by geographical proximity can develop the business environment means. Good relationships with suppliers will help business development and acceptance of innovative of environmentally friendly technologies. Interact with employees of suppliers and consumers, partner agreement and joint R&D can also promote the improvement of environmental performance.

In this paper, the following aspects can measure the ability of corporate communications: effective green supplier, environment-friendly assessment of suppliers, communication based on green demand, communication based on green

design, understanding and response to policies, sector cooperation aiming at improving the environmental performance.

Green supply chain operation bases on effective movement of knowledge flow, information flow, logistics and cash flow, in which the information flow plays a fundamental role. Movement of the information flow can effectively improve knowledge and logistics activities. Thereby, ability of communications has an influence on continuity and reliability of supply chain. In the traditional supply chain management, the quality of corporate communication determines whether the supply chain can operate effectively and efficiently. Corporate's communication skill is also important for the purposes of the green supply chain. Different from traditional supply chains, corporate communication includes not only these basic requirements such as production and demand, but also communication of the raw material and the green nature of product. It means that the corporate may be through effective cooperation and communication to ensure that the nature and sources of raw materials are environmental protection, so do the products, on the basis of green supply chain management and operations requirements.

In the process of green procurement, companies need to deal with suppliers and exchange views in order to achieve cooperation. In the process of green design, companies need to communicate with consumers, understand customer needs and then design. In the process of green marketing, companies need to deal with consumers and retailers, introduce the product to the customer to achieve the purpose of sales. These three processes reflect the impact of enterprise communication ability on the execution of the enterprise green management. When enterprises communicate with stakeholders and show themselves to the society, they always show their green culture and values and affect stakeholders of corporate communication virtually.

1.6.1.4. Ability of green technology innovation

The ability of green technology innovation is the sum of a series ability of technical

and management level when enterprises implement green management, including capabilities of resource use and allocation, industry competitiveness, right to speak on technical direction, processes and culture, and management level. For the purposes of this article, the scope of business green technology innovation capability broader, including not only technological innovation, but also business management capacity for environmental management and the ability to implement new green strategy, such as the technical capacity of improving existing products or creating new products, processes or the way of services. Green technology innovation capacity of enterprises should be manifested in the following aspect: a. the skill to develop green products; b. the skill to introduce or develop green technology; c. application and found of green materials d. green improvements or creation of significant production process; e. to achieve a breakthrough on traditional marketing and find new green marketing tools.

When external unable to provide enterprises with green technology or the cost of green technology from the outside is high, enterprises will have to attempt to develop green technology to complete requirements of green development .I think, technological innovation capability of enterprises can affect the level of the green cost.

Once companies have the power of new technologies, new energy, new materials technology, they can be the first to achieve green development, with new technology, new energy, and new materials to conduct green manufacturing, green logistics. The green of the product is able to bring products additional value-added, when there are green demand in the market, market mechanisms can help companies realize the benefits of whole green supply chain, and this interest is sustainable. I believe that, companies with high green technology innovation ability are more willing to implement green management, which can enhance the competitiveness of the industry standard level. Though advantage R&D, the corporate can be the leader in the industry, achieve the production and marketing of green products, and then obtain the advantage of monopoly in short-term, make profit for itself.

Corporate's development is linked with technology, and its motive power to develop is from innovation. When corporate carry out activities of green design, production, material flow and recycling, it needs advanced technology to sustain these links in order to reduce pollution and decrease energy consumption. Moreover, to overstep competitors and achieve long-term development, these links require to be innovated. Also, in the process of green procure and marketing, relevant strategic management ability is required. This paper sum up management skills into technological innovation ability, so the author believes that the technological innovation ability is important to the whole green management and helps to improve the corporate's production process and means of management, and then exerts an influence on suppliers, clients, and competitors in the supply chain.

1.6.2. Corporate external factors

Same as internal factor, external factor means factor which is not controlled by most corporate or not switching by corporate will. When the corporate is willing to develop green management or is at the crossroads of development or not, external factors will have an effect on the corporate's decision-making. The author surmises these factors as government, laws, social awareness, competitors' pressure of environment-protection. The difference between external and internal factors is that one external factor may affect any link in the green supply chain.

1.6.2.1. Government and laws

The government has strong tie on corporate's many activities. The behaviors of government which have an effect on corporate include: collecting tax, issuing subsidy, drafting policies, supervising, administration punish, industry supporting, introducing merits and so on. For laws, existing and upcoming laws may both affect corporate's production.

As the supplier of public products and owner of public resource, the government is

the most important supporter of public serving system in green-making society. The binding force of laws and rules on corporate is obvious. Some scholars find that local laws are the main pressure of the corporates' green chain.

In an area, both the government's actions and the enactment will greatly promoted the development of corporate's green management in the whole area, once they are in favor of the development of corporate's green supply chain. On the contrary, if the government does not take action or law is not perfect, it can also greatly hindered the development of green management.

The author believes that, in all external factors, government and law factors are particularly important factor. Government's "do it or not" will trigger business association and affect decision-makers' decisions. Compared to the means of government, legal requirements indicators are mandatory for enterprises and are not to be offended.

Studies have shown that corporate's environmental management and operational performance is positively related. To enhance the company's operational performance, innovative environmental policy and information management tools are required. This integration of new environmental policy and information management tools is known as the Environmental Management System.

Government and legal factors include the following aspects: central government's comprehensive laws and regulations, regional laws and regulations, national Environmental Standards, and local government environmental policy. Under normal circumstances, government and legal factors will affect all links of the green management.

1.6.2.2. Social environmental awareness

Social environmental awareness presents as green demand and consumers' awareness in green supply chain. Green demands focus on green marketing.

Consumer environmental awareness focuses on government education. Corporate pressure brought by consumers has always exists. But from the perspective of green management, this pressure is still in the stage of development. After comparing of green purchasing behavior between the two countries, this conclusion can be summed up: Americans are more willing to make green ideas into actual purchases. However, as the rising environmental awareness of young people, they are more inclined to buy green products.

Consumers or clients' pressure and corporate environmental planning is positively related. Product orientation of market is determined by customer demand. The main objective of production and operation is to meet customer needs. Under such conditions, consumers' acceptance of green products and advocate for green low-carbon lifestyle will encourage enterprises to implement green management in order to meet the market demand, thereby produce green products and culture green brand.

With the increasingly prominent environmental issues and environmental awareness awakening, customer's requirements are no longer confined to the traditional functional and technical aspects. Environmental protection and green performance are also gradually valued by customers. The rise of the green wave in 1990s makes 75% of customers of the United States think that their consumption decisions are affected by the reputation of corporate environment. 80% of customers are willing to pay more cost for environmentally friendly production. Green consumer behavior will be the consumer trend in the future.

In the long run, socially conscious environment can make a breakthrough from enterprises' green marketing and government's education. And in the short term, the level of awareness of social environment awareness affects the implementation of green management. Meanwhile, social environment awareness also affects the level of environmental awareness of employees within the enterprise. Thus, corporate's green effect and government's education are closely linked.

In the aspect of social environmental awareness, green management concern the following issues: consumers' green willingness to consume, consumers' environmentally conscious, and social public opinion guidance. As can be seen from the above aspects, social environmental awareness and consumers' attitudes and consumption patterns have great relevance. Thus, I believe that the greatest impact of social conscious of environment on enterprises is green marketing and green design.

1.6.2.3. Competitors' environmental pressures

When an enterprise implements green management and makes a decision, it will be affected from the impact of peer, which is called benchmarking effect and the demonstration effect. Some scholars against the status quo of China's green management proposed the demonstration mode of corporate manufacturing backbone to improve the competitiveness of the entire green industry chain. If corporate do not want to become the industry's laggards or have environmentally unfriendly reputation, they will take a more efficient green management practices in peer influence, which is the so-called environmental pressures from competitors. Many studies show that the pressure from competitors will make corporate to improve their environmental performance.

Corporate focusing on competitors usually affect their own decisions.

Corporate focus on other business excessively, especially competitors, but, on their own experience, level and mandatory laws, they seem to take insufficient attention, which will affect corporate on major environmental issues in the cognitive level. Similarly, competitors will give suppliers pressure to achieve their own green procurement.

In an industry, competitors take the lead in implementing a green strategy, thus corporate will subject to pressure of following-up the implementation of green supply chain to promote the full industry implementation of green management. Competitors'

environmental pressures manifests in the following aspects: competitors' green strategy, competition and communication skills, competitive green production capacity and industry trends. This shows that competitors' environmental pressures have a significant impact on the corporate strategy, thus it can affect all aspects of green management.

1.7.Evaluation analysis of influencing factors of green management of clothing enterprise based on ANP

1.7.1. Summarize of ANP

ANP (analytic network process) is a method that proposed by a famous professor of university of Pittsburgh Thomas I. Saaty in 1996, it developed based on the analytic hierarchy process (AHP). The core of AHP is that it divide the system into several levels such as destination layer, criterion layer and project layer, and only considers the dominance of the upper element effect on the lower element, the elements in the same level is considered to be independent of each other. Although this hierarchical structure bring convenient to deal with system problems, it also limit its application in complex decision-making problems. In many practical problems, the internal elements of various levels tend to be interdependent, low-level elements also has the dominant role for high-level elements, namely there exists feedback, the system structure is more similar to the network structure. ANP is adapt to the needs, it is the decision method of system which extended by AHP. In theory, ANP allows the decision makers to consider the interaction of various elements in the complex dynamic system, the relationship between the system elements are expressed in similar network structure, and is no longer a simple class hierarchy; ANP theory more accurately describe the relationship between objective things, is a kind of more effective and practical decision method. There is a table about the typical usage of ANP theory in different research field.

Table 1. 1 summary of the main theoretical and empirical researches on ANP

Title	Author and year	Abstract
Aligning supply chain collaboration using Analytic Hierarchy Process	Usha Ramanathan, 2013	This study analysis these trade-offs using an Analytic Hierarchy Process (AHP) model. The model is then implemented based on case studies conducted in two manufacturing firms. The AHP model ranks available information in terms of their contributions to improve forecast accuracy, and can provide vital clues to SC partners for preparing exchangeable data.
The analytic hierarchy process with stochastic judgements	Ian Durbach.et al,2014	The current paper integrates the AHP with stochastic multicriteria acceptability analysis (SMAA), an inverse-preference method, to allow the pairwise comparisons to be uncertain.
A business strategy selection of green supply chain management via analytic network process	Chiau-Ching Chen.et al,2012	This study proposes a network to clarify managerial levels and firm-related content. These functions and activities are a network's clusters and elements in an analytic network process (ANP) model with dependent relations.
An integrated green supplier selection approach with analytic network process and improved Grey relational analysis	Seyed Hamid Hashemi, Amir Karimi.et al, 2014	The analytic network process (ANP) is used to deal with the interdependencies among the criteria, and the traditional Grey relational analysis (GRA) has been modified to better address the uncertainties inherent in supplier selection decisions.
Application of fuzzy analytic network process for supplier selection in a manufacturing	S. Vinodh,R. Anesh Ramiya,2011	In this article, fuzzy analytic network process (fuzzy ANP) approach has been used for the supplier selection process. The case study has been carried out in an Indian

organisation		electronics switches manufacturing company.
Selection of new production facilities with the Group Analytic Hierarchy Process Ordering method	Alessio Ishizaka, Ashraf Labib, 2011	This paper presents the Group Analytic Hierarchy Process Ordering (GAHPO) method: a new multicriteria decision aid (MCDA) method for ordering alternatives in a group decision. The backbone of the method is the Analytic Hierarchy Process (AHP) which is separated into two hierarchies for a cost and a benefit analysis.
Supplier selection using fuzzy AHP and fuzzy multi-objective linear programming for developing low carbon supply chain	Krishnendu Shaw et al, 2012	This study presents an integrated approach for selecting the appropriate supplier in the supply chain, addressing the carbon emission issue, using fuzzy-AHP and fuzzy multi-objective linear programming. Fuzzy AHP (FAHP) is applied first for analyzing the weights of the multiple factors.
Assessing risk factors in collaborative supply chain with the analytic hierarchy process (AHP)	Andra Badea, Gabriela Prostean et al, 2014	This paper analyzes supply chain crisis, the main blockage to effective supply chain collaboration. The research methodology was combined with the application of the analytic hierarchy process (AHP).
Use of swot and analytic hierarchy process integration as a participatory decision making tool in watershed management	Fadim Yavuz, Tüzin Baycan, 2013	This study focuses on inhabitants' perceptions and approaches in order to find out the optimal watershed management strategies. The study illustrates the feasibility of SWOT analysis and Analytic Hierarchy Process (AHP) integration to incorporate stakeholder preferences in the decision making process.
Developing an assessment framework for managing sustainability programs: AND Analytic Network	Chinho Lin et al, 2014	This paper applies an Analytic Network Process (ANP) to supplier selection at a Taiwanese Electronics Company. It shows that the use of ANP helps to capture the imprecision in human judgment while TBL enables the consideration of social development, environmental protection, and

Process approach		economic development issues.
------------------	--	------------------------------

Because of the internal and external factors of green management is connected with each other, using ANP can handle the interaction relationship between factors index, so in this article we adopt the method of ANP to evaluate green management of clothing enterprise, and sort the importance degree of influence factors. For example, in S. Vinodh,R’s research “Application of fuzzy analytic network process for supplier selection in a manufacturing organisation”, the supplier selection weighted index has been put up as business improvement(BI),extent of fitness(EF),service (S),quality(Q),risks (R) for Layer 1, and reputation of industry (ROI),sharing of expertise (SOE).et.al for Layer 2. Then use triangular fuzzy numbers1,3,5,7,9 to indicate the relative importance of each pair of entities at the same level and came up with the selection conclusion at the finial discuss.

The specific steps of ANP are as follows:

(1) Identify the target and code

Firstly, describe the decision problems in detail, including the goal, criteria and the sub-target of decision-making problem, and the participants of this decision-making problem and its objectives, give the output of decision problem.

(2) Build the network according to the rule and target

The typical ANP network is shown in figure 1. It consists of two parts: one part is control layer or called target layer and criterion layer; the other part is the network layer, network layer formed based on the codes of control layer, and reflects the element or elements within the net group how to influence each other under the code of the corresponding target. This reflects the differences in the form structure of the ANP and AHP. In addition, the ANP can respectively construct subnet according to each criterion, per subnet is composed of the elements group reflecting the

corresponding control criteria.

Figure 1. 1 Network diagram of ANP

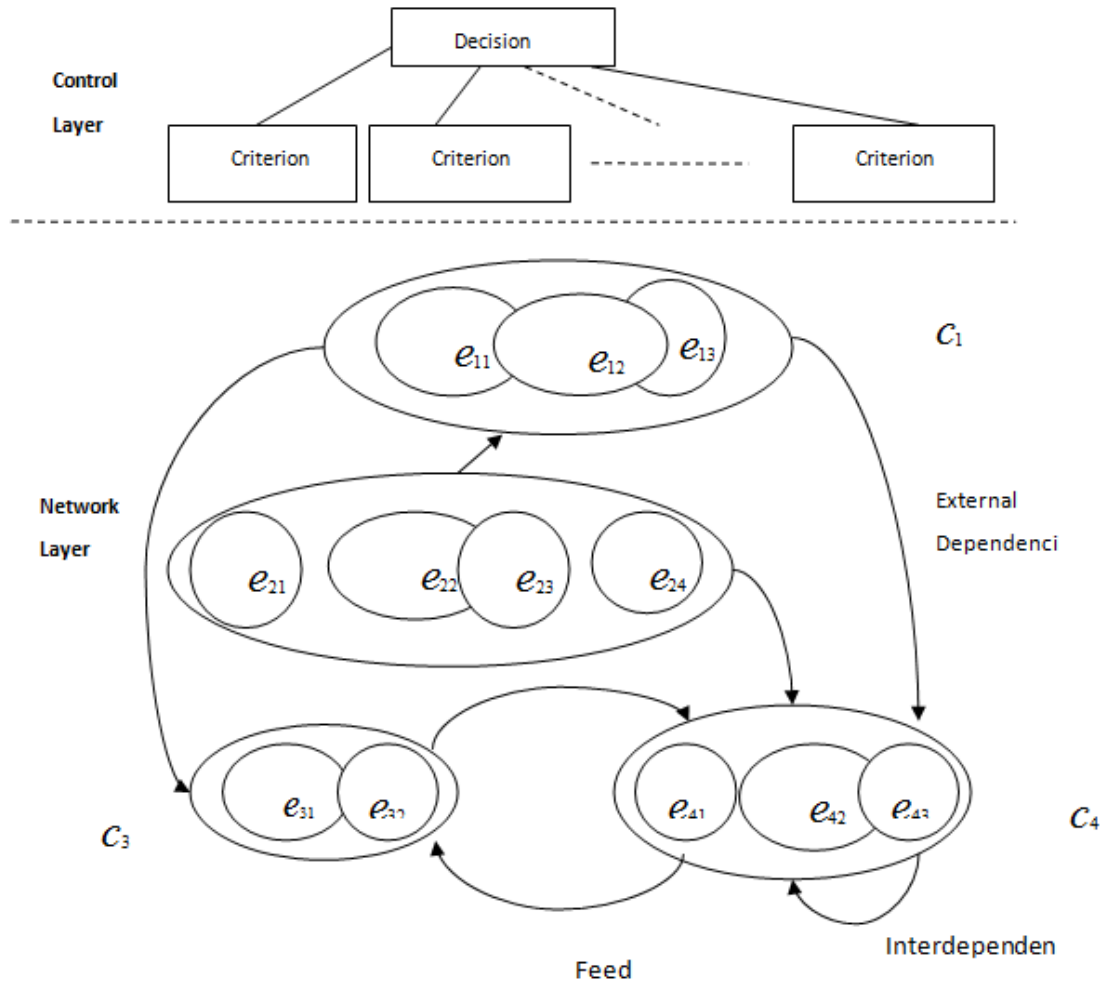

C_i express the element group; e_{ij} stands the element; wired express the relationship between elements including external and internal dependencies and feedback, The element in arrow tail elements group effect the elements in elements group which arrow points to.

(3) Build the non-weight hypermetric

Under the rule of each control, build non-weight hypermetric W_s s, namely using two comparison methods to compare two elements. In the process of building, Firstly, have the criteria of building a network P_s ($s = 1, 2, \dots, m$) as the main criterion; has

the elements e_{j_l} in the elements group C_j as the sub-criterion; build judgment matrix according to the degree of influence that the elements on elements or according to the influence degree of each element in the elements of elements group, and obtain the normalized eigenvector. In turn, has the each element of C_j as sub-criteria, Compare the element in C_i with the element in C_j , construct their own judgment matrix, and finally summary the judgment matrix of the normalized eigenvector to a matrix W_{ij} , so this matrix express the relationship between elements of C_j and elements of C_i .

$$W_{ij} = \begin{pmatrix} W_{i1}^{(j1)} & W_{i2}^{(j2)} & \dots & W_{in}^{(jn_j)} \\ W_{i2}^{(j2)} & W_{i2}^{(j2)} & \dots & W_{i2}^{(jn_j)} \\ \vdots & \vdots & \vdots & \vdots \\ W_{in}^{(j1)} & W_{in}^{(j2)} & \dots & W_{in}^{(jn_j)} \end{pmatrix} \quad (1.1)$$

The column vector of W_{ij} is the influence sequencing vector of the elements $e_{i1}e_{i2}\dots e_{im}$ in C_i , if the elements of C_j are not affected by the elements of C_i , so $W_{ij}=0$. Finally, we can get the P_s , the hyper matrix W_s .

So, have the P_s as the main criterion, compare the relationship of inside and outside between the each elements, finally we get the non-weight super matrix W_s .

$$W_s = \begin{matrix} & & & C_1 & & C_2 & & \cdots & & C_N \\ & & & e_{11}e_{12}\cdots e_{1n1} & & e_{12}e_{22}\cdots e_{2n2} & & \cdots & & e_{N1}e_{N2}\cdots e_{NnN} \\ C_1 & e_{11} \\ & e_{12} \\ & \vdots \\ C_2 & e_{21} \\ & e_{22} \\ & \vdots \\ & \vdots \\ & e_{2n2} \\ & \vdots \\ & e_{N1} \\ C_N & e_{N2} \\ & \vdots \\ & e_{NnN} \end{matrix} \begin{bmatrix} W_{11} & W_{12} & \cdots & W_{1N} \\ W_{21} & W_{22} & \cdots & W_{2N} \\ \vdots & \vdots & \ddots & \vdots \\ W_{N1} & W_{N2} & \cdots & W_{NN} \end{bmatrix} \quad (1.2)$$

(4) Build the weighed super matrix

Have the P_s as the main criterion, have the C_j as the sub-maxim, compare the elements group and build the judgment matrix a_j , have the normalized processing and get the normalized eigenvector $(a_{1j}, a_{2j}, \dots, a_{nj})^T$.

$$a_j = \begin{matrix} C_j \\ C_1 \\ C_2 \\ \vdots \\ C_N \end{matrix} \begin{bmatrix} C_1 & C_2 & \cdots & C_N \\ a_{11}^j & a_{12}^j & \cdots & a_{1N}^j \\ a_{21}^j & a_{22}^j & \cdots & a_{2N}^j \\ \vdots & \vdots & \ddots & \vdots \\ a_{N1}^j & a_{N2}^j & \cdots & a_{NN}^j \end{bmatrix} \rightarrow \rightarrow \begin{matrix} \text{normalized eigenvectors} \\ \begin{pmatrix} a_{1j} \\ a_{2j} \\ \vdots \\ a_{Nj} \end{pmatrix} \end{matrix} \quad (1.3)$$

So when under the certain criterion we can get the weight matrix A_s reflected the relationship between the element groups.

$$A_s = \begin{bmatrix} a_{11} & a_{12} & \cdots & a_{1N} \\ a_{21} & a_{22} & \cdots & a_{2N} \\ \vdots & \vdots & \vdots & \vdots \\ a_{N1} & a_{N2} & \cdots & a_{NN} \end{bmatrix} \quad (1.4)$$

Based on the weighted matrix, we can gain the weighted super matrix, so the weighted super matrix is that:

$$W = A_s W_s \quad (1.5)$$

(5) Obtain the limited super matrix

In AHP, each elements are independent, under the certain to judge the priority of two elements only need to compare the two elements, but in ANP, because join into the feedback and interdependent relationship, which make the process of determining the priority of elements become complex, the two elements can have the direct-vision comparison and have the indirect-vision comparison, so in ANP, we need to use the limited super matrix method to determine the stability priority of the elements.

$$W_s^l = \lim_{k \rightarrow \infty} W^k \quad (1.6)$$

(6) Combination of limit relative priority

Sum the weighted of limited vector of each control criteria according to the criteria, which mainly sum the weighted of various alternatives.

(7) Ranking the optional project

Rank according the weighted value of alternative project.

Now let's see a simple case studies about how does this methods work out. In LI Kangping's research on the evaluation and its software system of enterprises

technological innovation capability in Jiangsu Province based on ANP, he builds network structure of innovation management key factors and gets non-weight super matrix W with W_{33} denote the mutual influence of innovative mechanisms and innovative atmosphere inside each of three indicators,

$C_2 = \{e_{21}, e_{22}, e_{23}, e_{24}\}$ $C_3 = \{e_{31}, e_{32}, e_{33}\}$. After basic calculate he gets non-weight super matrix W :

$$W = \begin{matrix} & C_2 & C_3 \\ \begin{matrix} C_2 \\ C_3 \end{matrix} & \begin{pmatrix} W_{22} & 0 \\ 0 & W_{33} \end{pmatrix} \end{matrix} \quad (1.7)$$

$$W_{22} = \begin{pmatrix} 0 & 0.2970 & 0.4286 & 0.4433 \\ 0.3325 & 0 & 0.1428 & 0.1692 \\ 0.1397 & 0.5396 & 0 & 0.3875 \\ 0.5278 & 0.1634 & 0.4286 & 0 \end{pmatrix} \quad W_{33} = \begin{pmatrix} 0 & 0.2500 & 0.3333 \\ 0.5 & 0 & 0.6667 \\ 0.5 & 0.7500 & 0 \end{pmatrix} \quad (1.8)$$

	e_{21}	e_{22}	e_{23}	e_{24}	e_{31}	e_{32}	e_{33}
e_{21}	0	0.2970	0.4286	0.4433	0	0	0
e_{22}	0.3325	0	0.1428	0.1692	0	0	0
e_{23}	0.1397	0.5396	0	0.3875	0	0	0
e_{24}	0.5278	0.1634	0.4286	0	0	0	0
e_{31}	0	0	0	0	0	0.2500	0.3333
e_{32}	0	0	0	0	0.5	0	0.6667
e_{33}	0	0	0	0	0.5	0.7500	0

(1.9)

Then the weighed super matrix. After obtain the weight matrix A and making sure of each column of the matrix values being stable, he obtains the limited super matrix \overline{W}^∞ .

$$\bar{W}^{\infty} = \begin{pmatrix} \bar{w}_{22} & 0 \\ 0 & \bar{w}_{33} \end{pmatrix} \approx \bar{W}^{30} = \begin{pmatrix} 0.2865 & 0.2865 & 0.2865 & 0.2865 & 0 & 0 & 0 \\ 0.1791 & 0.1791 & 0.1791 & 0.1791 & 0 & 0 & 0 \\ 0.2477 & 0.2477 & 0.2477 & 0.2477 & 0 & 0 & 0 \\ 0.2867 & 0.2867 & 0.2867 & 0.2866 & 0 & 0 & 0 \\ 0 & 0 & 0 & 0 & 0.2264 & 0.2264 & 0.2264 \\ 0 & 0 & 0 & 0 & 0.3774 & 0.3774 & 0.3774 \\ 0 & 0 & 0 & 0 & 0.3962 & 0.3962 & 0.3962 \end{pmatrix} \quad (2.0)$$

At last, rank the optional project and find out the top 10 companies which has higher technological innovation capability.

1.7.2. The establishment of the evaluation model

1.7.2.1. The influence factors of green management in clothing enterprise and their mutual relations

In this paper, Table 1.2 shows the internal and external factors of green management affecting our country's clothing enterprise. So we can see that, the influence factors of green management in clothing enterprise of this paper has been divided into 7 parts: green cost, green culture, communications skills, green technology innovation ability, the government and legal factors, social environmental awareness and the competitor environment pressure. Each part of factors can be divided into several detailed indicators shown in Table 1.2.

To future explain why each part of factors can be divided into several detailed indicators:

(1) The subdivision of green cost factors is on the basis of the analysis of production cost. So in this paper, green cost is measured by the cost of raw materials, the cost of energy consumption, R&D input and training costs. What's more, the green cost analysis needs to add environment input costs in this study, in order to reflect the green management invested cost impact of environmental construction and remediation.

(2) The analysis of green culture can start from the enterprise's production management, resources management, environment and employees, combined with the eco-cultural. Green culture must have the basic characteristic of respecting nature, protecting the environment and promoting sustainable use of resource and emphasizing the harmonious development. So in this paper, green culture composes with the environmental consciousness, attitude of employee and managers, green specification, corporate social responsibility.

(3) Green communication skills mainly include supply chain management communication, green design green marketing communication and communication. This division is based on the understanding and analysis of green marketing theory: Green marketing includes the establishment of reasonable and appropriate interest intermediaries, focusing on aspects of the work-related marketing channels and improving green public relations. As the primary tool of green marketing, green communication skills should also be closer to these three areas. So, communications skills have the effective green supplier, supplier friendly environmental evaluation, based on the demand for green communication, based on green design, understanding of policies and regulations and have the purpose of improving the performance of environment.

(4) As a micro-economic enterprise, it is only take the road of green technology innovation in order to achieve sustainable development. The level of green technology innovation capability of an enterprise can be measured by several indicators below: environment friendly design capabilities, green patent, green production capacity, green management resilience and green management innovation ability. Among them, environment friendly design capabilities, green patent, green production capacity focus on building mechanisms; green management resilience and green management innovation ability focus on institution building. So you can better reflect the clothing business of green technology innovation capability development status.

The factors above attributed to internal factors in this paper. Correspond to internal factors, external factors including policy and legal, social, environmental awareness and environmental pressures competitors.

(5) The government and legal factors are measured by comprehensive central government laws and regulations, regional laws and regulations, national environmental standards and local government environmental policy. This is because in the process of growth and development of the current Chinese garment enterprises, government and legal factors are macroeconomic factors, which will corporate governance, consumption and other business-related activities and have a very significant influence. Else, the central government of a country's political system, institutions, policies, laws and regulations and other factors have a strong legal effect and affect the business activities of enterprises, especially affect longer-term investment behavior. So we can say that it is the most important political influence factor. Therefore, in the subsequent analysis, we believe that the central government comprehensive laws and regulations factor will have a hug influence on development activities of garment enterprises and other influencing factors above.

Social environmental awareness composes with the demand of green consumer, consumer environmental awareness and social public opinion. This is mainly based on the relevant theoretical results of sociological research. In this paper, we classify consumer environmental awareness to social environmental awareness in order to highlight consumer environmental awareness' influence of the entire model.

Competition competitors, which is one of important aspects of Porter's five forces analysis model, is often reflected in the price, advertising, products, service and other aspects. And the competitive strength depends on many factors. So, in this paper, we will focus on analysis of the impact of environmental stress on green clothing business management caused by competitor. Therefore, in accordance with the relevant competition theory of the firm, the environmental pressure come from rival is

reflected by green strategic of competitor, communication ability of competitors, industry trends of green production capacity of competitors.

Table 1. 2 the influencing factors indicators of green management in clothing enterprise

A1 Green Cost	a11 the cost of raw material
	a12 energy consumption
	a13 R&D input
	a14 environment input
	a15 Staff training costs
A2Green culture	a21 environmental awareness
	a22 Employee Attitudes
	a23 Managers attitude
	a24 Green code
	a25 Corporate social responsibility
A3 Communicational Ability	a31 Effective green supplier
	a32 the assessment of supplier environmental friendly
	a33 Based on the green demand of communication
	a34 Communication based on green design
	a35 Response and understanding of policies and regulations
	a36 For the purpose of environmental performance
A4green technological	a41 the design ability based on environment friendly
	a42 Green patents
	a43 Green production capacity

innovation ability	a44 Green management adaptability
	a45 Green management innovation ability
A5 policy and law	a51 the comprehensive laws and regulations of the central
	a52 Regional laws and regulations
	a53 state environmental standard
	a54 The local government environmental policy
A6 Social environmental awareness	a61 Green consumer demand
	a62 Consumer environmental awareness
	a63 The social public opinion direction
A7 The competitor environment pressure	a71 Green Strategy
	a72 Communication ability of competitors
	a73 green production capacity of competitors
	a74 industrial trends

The internal and external influencing factors will influence each other. Among them, the green cost would be affected by the policy and law; green culture will be affected by the social environment consciousness and the competitor environment pressure. In the external influence factors, policy and law will affect the social environmental awareness. The relationship between internal factors and external factors is shown in Figure 1.2.

Figure 1. 2 the relationship between internal and external factors of enterprise green management

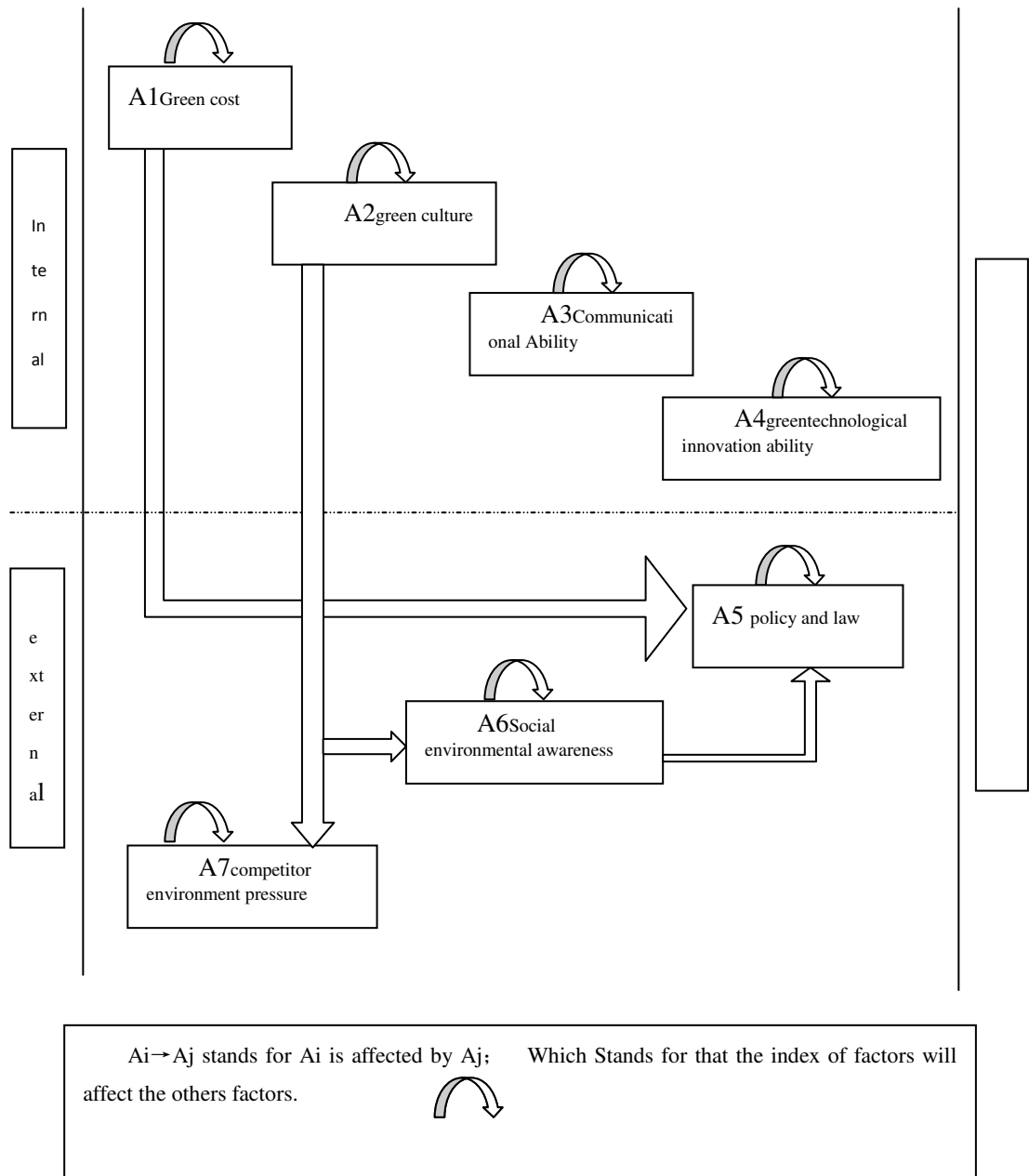

From Figure 1.2, we can that this seven internal and external factors, each factors includes many indexes; there is a certain relationship between various factors, the indicators of factors may be some relationship between each other, that's say that each index in factors may be affected by other index in factors, itself indicators also possible influence each other. The relationship between the various indicators is shown in Figure 1.3.

Figure 1. 3 the relationship between the internal and external factors influencing the enterprise green management

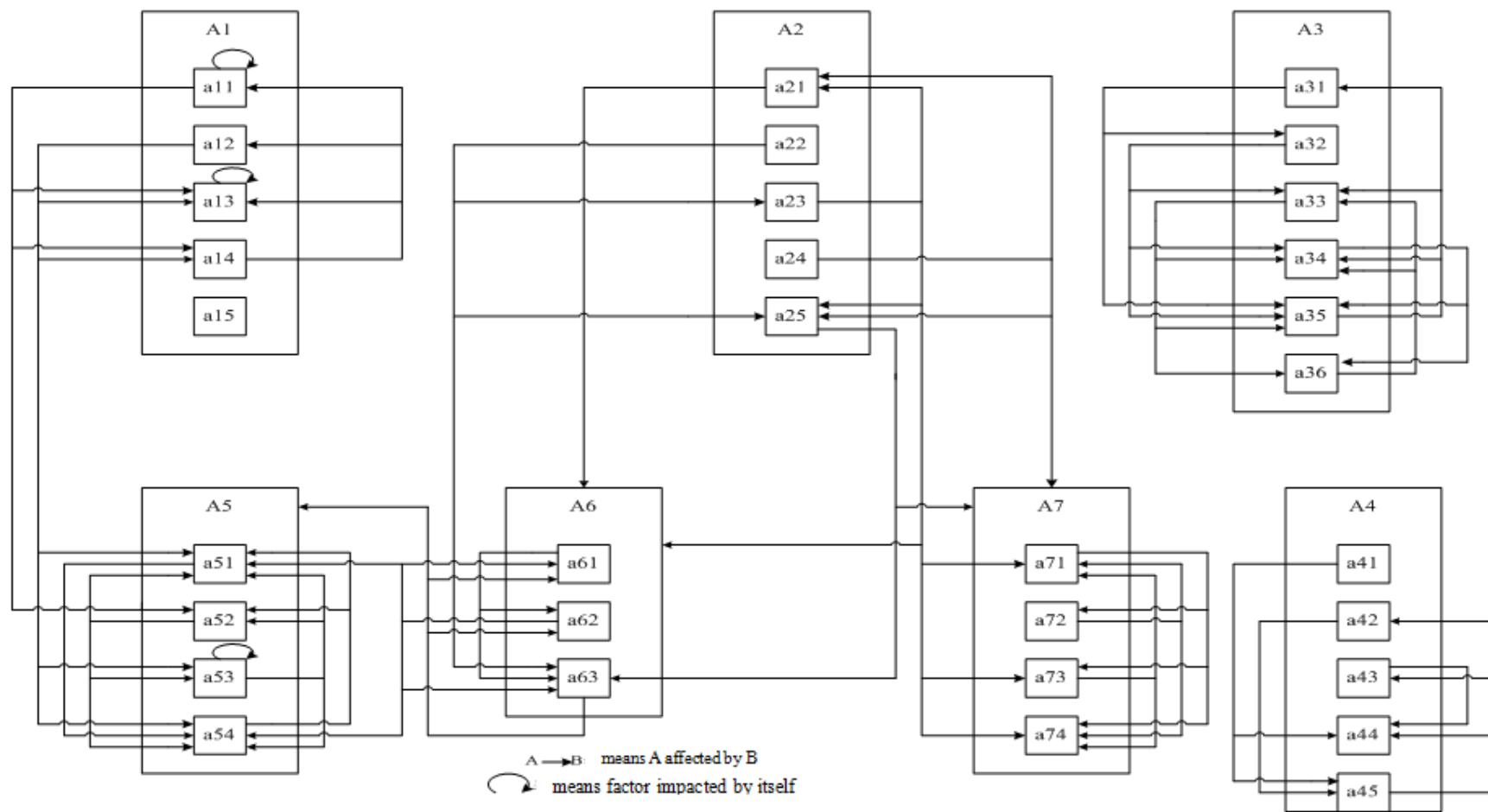

1.7.2.2. Network structure model of green management evaluation of clothing enterprise

In order to use the ANP model to evaluate the strength of the influence factors of green management in clothing, this article assumes that there are three local clothing enterprises, based on the relationship between the indexes in the figure 2.3, set up the ANP evaluation model of influence factors of green management, hoping to have a clear understanding of various influencing factors in the implementation of green supply chain. This article assumes that the three local clothing enterprises is as follows:

Company A is the dominant force of industry, and has the green sustainable development as the strategy of enterprise. It has carried out the implementation of green management, and input some resources so it has received some achievements. Company A is closely related to the local government.

Company B is slightly weaker strength than A. It has a certain discourse in the industry, takes the following strategy at the moment, and imitate company A to implement green management. Although it has input certain resources, it ignores the cultural construction and has litter effect.

Company C is a local traditional clothing enterprise, and the strength is relatively close to A, and has a good relationship with government. The leadership of this company has no environmental protection consciousness, and the company fines many times by the environmental protection department.

Now based on the four internal factors and three external influencing factors of green management, according to the above assumptions of three companies, set up the ANP evaluation model of green management (as shown in Figure 1.4)

Figure 1. 4 ANP model

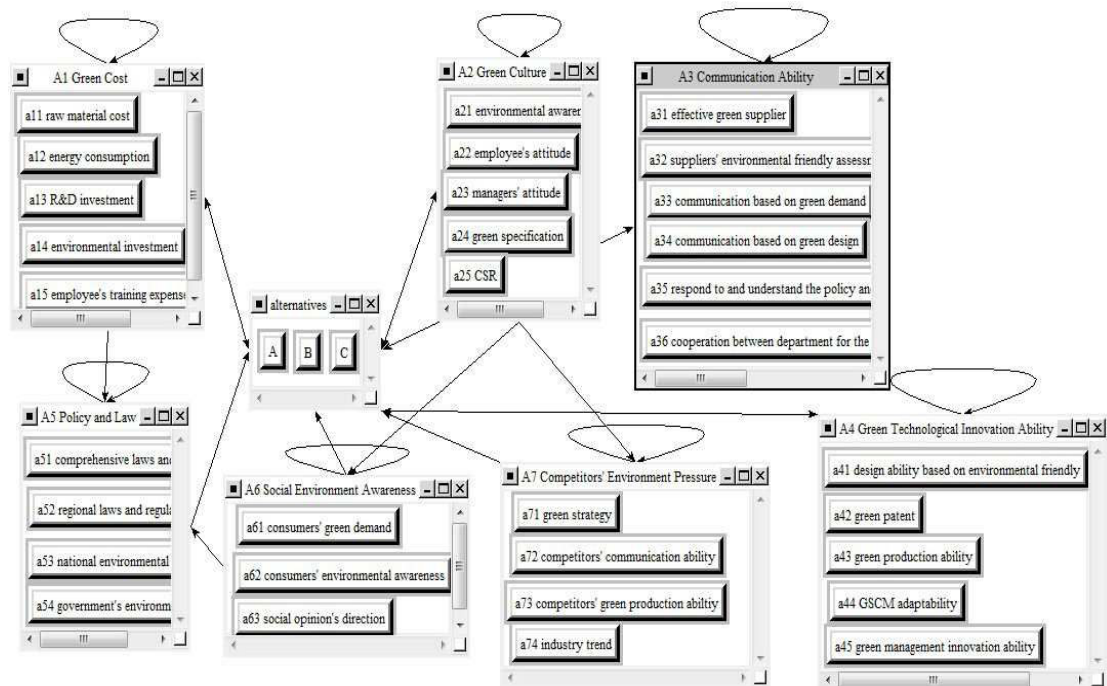

In ANP, the external influence factors through acting on enterprise internal influence factors to affect the enterprise, directly expression as the policy and legal effects the green cost and the consciousness of social environment, the social environment consciousness and the competitor environment pressure have influence on the enterprise green culture, but the internal influence factors (green cost, green culture, communicational ability, technological innovative ability) can directly affect the enterprise, the direct relationship of evaluation is based on evaluation of the internal factors, the index of internal factors can influence its own and other indicators under the same factors, such as employee attitude is affected by the attitude of management e and affected by the environmental consciousness, etc.

1.7.3. The analysis based on evaluation of ANP

Because the evaluation involving many indexes and the relationship between the indexes are complex, so this study uses the expert scoring method, which means that

relevant experts made anonymous comments, then to statistics, process, analysis and summary the comments and make a reasonable estimate about the indexes. After several rounds of consultation, feedback and adjustment, finish the quantitative analysis. Using the 9th grade method, the results will be as the basic data of the ANP operation and then use the Super Decisions software to complete the relevant calculation. The view of the 9th grade method is score 9 points is a perfect score, the higher the score the better the results represent data evaluation and the two indexes has larger importance gap. When the composite score gets 5 points or less, it means that the data evaluation is normal and the two indexes has a little importance gap.

The specific steps are as follows:

(1)Construct the judgment matrix. Using the nine points method and expert grading method, comparison between the factors and can get the judgment matrix, such as table 1.3 ~ 1.75 (Appendix A).

Table 1. 3 comparison and judgment matrix on three enterprises

Enterprise	A1	A2	A3	A4	Weighted
A1	1	5	4	4	0.583
A2	1/5	1	3	2	0.199
A3	1/4	1/3	1	1/2	0.087
A4	1/4	1/2	2	1	0.131

C.R. = 0.0756

In this table, A1~A4 refers to the internal four factors: green cost, green culture, communications skills, green technology innovation ability. Take one number to further explain, 5 means that comparing with A1, A2 gets composite score 5, which means that A2's data evaluation is normal and little important than A1. Then we get the number 1/5 between A2 and A1, and has the same meaning. Else, the weighted

numbers are calculated by the Super Decision software, so the 0.583, for example, means that the normalized weight is 0.583.

Then the following tables from 1.3 ~ 1.75 (Appendix A) are pairwise comparison matrix between the three companies based on each two degree indicators like a11~a74. Take table 1.4 for example.

Table 1. 4 comparison and judgment matrix on a11

a11	A	B	C	Weighted
A	1	5	7	0.740
B	1/5	1	2	0.167
C	1/7	1/2	1	0.094

C.R. =0.0136

After the analysis of two degree indicators comparison and judgment matrix, we also should figure out the relationship between internal interaction, for that the index of internal factors can influence its own and other indicators under the same factors, like table 1.39~1.41, 1.45~1.47, 1.51~1.56, 1.60~1.61. During the analysis, we also finish the argument of the internal influence factors (green cost, green culture, communicational ability, technological innovative ability) directly affection to each enterprise, like table 1.36~1.38, 1.42~1.44, 1.48~1.50, 1.57~1.59 (Appendix A). Take table 1.36 for example.

Table 1. 5 comparison and judgment matrix on A in the A1

A	a11	a12	a13	a14	a15	Weighted
a11	1	3	1/4	1/4	1/3	0.108
a12	1/3	1	1/2	1/3	1/2	0.086
a13	4	2	1	1/2	1/2	0.204
a14	4	3	2	1	2	0.358
a15	3	2	2	1/2	1	0.244

C.R.=0.0963

The following tables are comparison and judgment matrix on some internal two degree index like a12, a23, a24, a25 in each external factors A5~A7, as well as the internal influence of same factor(Appendix A).Take table 1.62 for example.

Table 1. 6comparison and judgment matrix on a12 in the A5

a12	a51	a53	a54	Weighted
a51	1	5	1/2	0.364
a53	1/5	1	1/4	0.099
a54	2	4	1	0.537

C.R.=0.0904



(2)Determine the non-weighted super matrix, such as 1.77.

(3) Determine the weighted super matrix, such as 1.78.

(4) Determine the limit super matrix, such as 1.79.

Calculate the limit super matrix to get the sorting results as shown in Figure 1.5. There are three main columns in this table: Ideals, Normal and Raw. Among them, the normalcolumn are normalized comprehensive weight, which is the most important index and shows the synthesized priority, Raw column can be directly from the super matrix of limit, Ideals data are the normal data divided the biggest number of each column. So we can see that, the normal data of A is 0.675785, bigger than other companies, so A company is the best, followed by B company, finally is C company. It means that the factors we discussed are affect the companies significantly, for A company has considered the factors in its development, so the synthesized priority of it is the best. This result is consistent with the practical significance.





Figure 1. 5 The sorting result

Name	Graphic	Ideals	Normals	Raw
A		1.000000	0.675785	0.227979
B		0.283552	0.191620	0.064644
C		0.196209	0.132595	0.044731

(5) The analysis of the importance of Influence factors

Using the SD software to calculate the weight of internal factors, whose result is shown in Figure 1.6.

Figure 1. 6 the weights of the internal factors

A1 Green Cost		0.583090
A2 Green Culture		0.199378
A3 Communication Ability		0.086711
A4 Green Technological Innovation Ability		0.130822

Green cost (0.583090) is the main factors influencing the enterprise green management. The rest in turn is green culture (0.130822), green technology innovation ability (0.199378) and the ability of communicate (0.086711). This is consistent with the condition of the green management at the present stage in China; enterprise for the environment protection is largely based on compliance with environmental laws and regulations and the writ of the government, still stay in the stage of action relying on external constraint. And the most direct effect of the government and law for the enterprise are tax and subsidy, reflecting the enterprise itself, is the problem of costs and expenses. Cost is still the current block for most of the enterprises implementing green management, green management make the garment enterprises invest more costs in the short term, which will cause the enterprise cash flow become nervous and lead to pressure of fund become high.

The overall ranking of green culture, communication ability and green technology innovation ability is after ranked. We think there are three reasons; first, because the green strategy of enterprises, following strategy of enterprise and traditional

enterprise has different understanding for the green management, its weight is also different; second, at present green management in our country only has its early development, enterprises still consider more factors on short-term costs and regulations; third, China's clothing enterprises generally have backward production equipment, it don't meet the requirements of high specifications of environmental protection. According to this, in recent years many scholars call for environmental management, the government and the legislature guide the enterprise development, through strengthening the soft power to promote green management, establish green culture of enterprises to reduce costs.

(6) The comparative analysis of the all indicators

According to the limit super matrix (table 1.80), and we can get all the weight of factors influence on the green management, is shown as table 1.81.

Table 1. 7 the weight of indexes of each factor

The index of influence factors		Index	Ranking	Factors
A1:Green Cost	a11 the cost of raw material	0.047349	3	0.323295
	a12 energy consumption	0.030420	5	
	a13 R&D input	0.134484	1	
	a14 environment input	0.066846	2	
	a15 Staff training costs	0.044196	4	
A2:Green culture	a21 environmental awareness	0.013731	15	0.081697
	a22 Employee Attitudes	0.012926	17	
	a23 Managers attitude	0.029703	6	
	a24 Green code	0.008107	24	
	a25 Corporatesocial responsibility	0.017230	12	
A3:Communicati	a31 Effective green supplier	0.005348	29	0.058503

onal Ability	a32 the assessment of supplier environmental friendly	0.005554	28	
	a33 Based on the green demand of communication	0.010002	21	
	a34 Communication based on green design	0.011204	19	
	a35Response, understanding of policies and regulations	0.019304	10	
	a36 For the purpose of environmental performance	0.007091	27	
A4:green technological innovation ability	a41 the design ability based on environment friendly	0.008631	23	0.066816
	a42 Green patents	0.007528	25	
	a43 Green production capacity	0.010943	20	
	a44 Green management	0.021449	9	
	a45 Green management	0.018265	11	
A5:policy and law	a51 the comprehensive laws and regulations of the central government	0.015171	14	0.069559
	a52 Regional laws and regulations	0.027097	7	
	a53 state environmental standard	0.004916	30	
	a54 The local government environmental policy	0.022375	8	
A6:Social environmental awareness	a61 Green consumer demand	0.013261	16	0.039831
	a62Consumerenvironmental	0.011339	18	
	a63 The social public opinion direction	0.015231	13	
A7:The competitor environment pressure	a71 Green Strategy	0.007106	26	0.022940
	a72 Communication ability of competitors	0.003485	32	
	a73 green production capacity of competitors	0.003547	31	

	a74 industrial trends	0.008802	22	
--	-----------------------	----------	----	--

From the table 1.80, we can see that: 1) Green cost is the most important factor between the seven factors, the environment input, R&D input, cost of raw material, cost of employee training, energy consumption, management attitude, regional environmental policy and laws, regulations of local government, resilience ability of green management, response and understanding of policies and regulations is the top 10 indexes in the 32 indexes; 2) The mainly restricting factors of clothing enterprise implementing the green management is green cost, R&D is the most difficult problem in the green cost of enterprise, followed by environmental input;3)The implementation of green management for clothing enterprises cannot leave the staff's and managers' actively participate in, which is closely related to their own ability of adapting to the outside world;4) Local laws and regulations and environmental policies can effectively promote the clothing enterprises to implement green management.

The evaluation result is consistent with the reality. On the one hand, because the profit ability of clothing enterprise is weak, companies pay more attention to the short-term financial situation, in the process of implementing green supply chain, it must be conducted to develop green products and improve the product lines and transform the old production system, however, the financial position of the clothing enterprises restrict the enterprises to carry out these inputs. At present, on the other hand, China's green materials and development of clean energy are relatively immature, which will cause the price is higher than traditional energy and materials, and in the real world many garment enterprises is small and medium-sized enterprises, many enterprises don't choose green materials and clean energy for getting short-term interests, which will restrict the clothing enterprises implementing green management. In addition, the green management for Chinese enterprises is exploratory work, it need the support of policy laws and regulations, and the current laws and regulations and policy are relatively lags behind, the government also need constantly improve the work in

practice.

1.8.Conclusion

Chapter 1 is part of empirical research. The main aim is to complete the evaluation analysis of influencing factors of green management of clothing enterprise based on ANP.

The main contents of this section include the following parts. First, we make a detailed analysis of ANP method definition, development and specific study procedures, as a theoretical basis for later analysis of the data. Second, the establishment of the evaluation model. Based on the discussing of the third quarter on green management factors, we make it more clearly about the influencing factors of the clothing business green management. And by plotting the relationship between factor analysis chart, we figure out the clear affecting relationship between internal and external factors. Then, after assuming three green management in the development of garment enterprises have some differences exist, we establish a green paper management ANP evaluation model of this paper. Third, combined with expert scoring method, nine scoring method and SD software, according to ANP evaluation and analysis steps, we draw some conclusions.

This section provides empirical findings include:

(1) Green cost is the main factors influencing the enterprise green management. The rest in turn is green culture, green technology innovation ability and the ability of communicate. This is consistent with the condition of the green management at the present stage in China. Among them, R&D is the most difficult problem in the green cost of enterprise, followed by environmental input.

(2) The implementation of green management for clothing enterprises cannot leave the staff's and managers' actively participate in, which is closely related to their own

ability of adapting to the outside world.

(3) At present, China green management only has its early development, enterprises still consider more factors on short-term costs and regulations. Therefore, the government and the legislature should guide the enterprise's development, promote green management through strengthening the soft power, and establish green culture of enterprises to reduce costs.

(4) For China enterprises, the green management is still an exploratory work, and it need the support of policy laws and regulations. Local laws and regulations and environmental policies can effectively promote the clothing enterprises to implement green management.

Bibliography of Chapter 1

Ajva, V. A. (2012). Study of green supply chain management and operation strategic in manufacturing industry, *International Journal of Management*, 3(3), 235 - 245.

Bergh, J. (2002). Do social movements matter to organizations? An institutional perspective on corporate responses to the contemporary environmental movement. PhD thesis. The Pennsylvania State University, State College, PA.

Burgelman, R. A., & Maidigue, M. A., & Wheelwright, S.C. (1996). *Strategy Management of Technology and Innovation*. IRWIN, 2, 1-31.

Cao, H. Y., & Wei, X. Q. (2012). Cooperative game analysis of retailers leading the green supply chain. *Business Management*, 7,186-188.

Carter, R., C., Kale, Rahul, Grimm, & M., C. (2000). Environmental purchasing and firm performance: an empirical investigation. *Transportation Research Part E: Logistics and Transportation Review*, 36(3), 219-228(10).

Chan, R. Y. K., & Lau, L. B. Y. (2001). Explaining green purchasing behavior, a cross-cultural study on American and Chinese consumers. *Journal of International Consumer Marketing*, 14, 9-41.

Chen, R. R., & Roma, P. (2011). Group buying of competing retailers. *Production and Operations Management*, 20(2), 181–197.

Christmann, P. T., & Glen. (2001). Globalization and the environment: determinants of firm self-regulation in China. *Journal of International Business Studies*, 32(3), 439-458.

Chung, Y., & Tsai, C. (2007). The effect of green design activities on new product strategies and performance: an empirical study among high-tech companies. *International Journal of Management*, 24(2), 276 – 288.

Cruz, J. M. (2008). Dynamics of supply chain networks with corporate social responsibility through integrated environmental decision-making. *European Journal of Operational Research*, 184(3), 1005–1031.

Deng, L. N. (2010). Analysis of the obstacles factors which effect China's enterprises implementing green management. *Journal of Henan Business College*, 6, 69-73.

Deng, Y. X. (2004). The decision-making study of in reverse logistics mode of enterprise. Shanghai Maritime University.

Desrochers, P. (2002). Regional development and inter-industry recycling linkages: some historical perspectives. *Entrepreneurship and Regional Development*, 14(1), 49-65(17).

Drumwright, M. E. (1994). Socially responsible organizational buying: environmental concern as a noneconomic buying criterion. *Journal of Marketing*, 58(3), 1-19.

Fang, W., Huang, H. T., & Liu, X. Y. (2007). The analysis of key factor and success stards of the implementation of green supply chain. *Science, Technology Progress and Policy*, 12,125-128.

Fujita, K., Oruç, C., Asakura, T., & Türkay, M. (2004). Multi-company collaborative supply chain management with economic and environmental considerations. *Computers & chemical engineering*, 28, 985-992.

Gilbert, S., (2001). Green supply China, enhancing competitiveness through green productivity. Taipei: Taiwan Press.

- Gong, M. I., & Tian, J. (2010). Green management Based on low carbon economy. *People's Tribune*, 32,120-121.
- Gu, L. J. (2010). Research on the influence factors of enterprise implementing green management. *Business Economics*, 9, 30-32.
- Han, L. H., & Zeng, J. F. (2007). The exploit of green management in oil industry. *Resources industrial economy*, 11, 17-21.
- Handfield, R., Sroufe, R., & Walton, S. (2005). Integrating environmental management and supply chain strategies. *Business Strategy and the Environment*, 14(1), 1-19.
- Hanna, M.D., Newman, W.R., & Johnson, P. (2000). Linking operational and environmental improvement through employee involvement. *International Journal of Operations & Production Management*, 20, 148-65.
- Hazen, B. T., Cegielski, C., & Hanna, J. B. (2011). Diffusion of green supply chain management: examining perceived quality of green reverse logistics. *The International Journal of Logistics Management*, 22(3), 373-389.
- Henriques, I., & Sadorsky, P. (2007). Environmental technical and administrative innovations in the canadian manufacturing industry. *Business Strategy and the Environment*, 16(2), 119–132.
- Hokey, M. & IIsuk, K., (2012), Green supply chain research, past, present and future, *Logistics Research*, 3(4), 39-47.
- Hsu, C., & Hu, A. H. (2009). Applying hazardous substance management to supplier selection using analytic network process. *Journal of Cleaner Production*, 17(2), 255–264.

Hu, J. I., Fan, T. J., & Lou, G. X. (2008). Research on knowledge transfer between enterprises in green management. *Science and Technology Management Research*, 28(2), 214-216.

Huang, H. T. (2010). The factor analysis of green supply chain implementation of key success factors. *Productivity Research*, 10, 215-216.

Jie, C., & Chen. (2004). Research on the prototype of green supply chain evaluation. *Journal of Southeast University (Natural Science Edition)*, 24(3), 406-409.

Klassen, R. D., & McLaughlin, C. P. (1996). The impact of environmental management on firm performance. *Management Science*, 42(8), 1199-1214.

L. Eskew, M. (1999). Profiting through environmental supply chain management. *Executive Speeches*.

Lei, X. H., & Sun, G. M. (2008). The discussion of green management strategy based on the core enterprise and view of supplier. *Commodity storage and maintenance*, 30(5), 34-37.

Li, J. B. (2008). Research on the green management of manufacturing enterprise in china. *Chinese excellent master library*.

LI, K. P. (2006). Research on the evaluation and its software system of enterprises technological innovation capability in Jiangsu Province based on ANP. *Southeast University*.

Lin, J. L. (2010). Research on green management in ceramic industry. *Science and Technology Management Research*, 15, 104-107.

Liu, B., Wang, W., & Zhao, J. I. (2007). Discuss the information sharing between procurement and supply in green management. *Industrial Technology Economics*, 6, 40-41.

Lo, C.W., & Leung, S.W. (2000). Environmental agency and public opinion in Guangzhou, the limits of a popular approach to environmental governance. *The China Quarterly*, 163, 677-704.

Lu, Q. L., & Yao, W. X. (2009). The exploit of green management model of small and medium-sized clothing enterprise. *Business Management*, 10, 56-57.

McIntyre, K., Smith, H. A., Henham, A., & Pretlove, J. (1998). Logistics performance measurement and greening supply chains: diverging mindsets. *International Journal of Logistics Management*, 9(12), 57-68.

Michelsen, O., Fet, A. M., & Dahlsrud, A. (2006). Eco-efficiency in extended supply chains: a case study of furniture production. *Journal of Environmental Management*, 79(3), 290–297.

Mitra, S. & Webster, C. (2008). Competition in remanufacturing and the effect of government subsidies, *International Journal of Production Economics* 111(2), 287 – 298.

Muralidharan, C., Anantharaman, N., & Deshmukh, S. G. (1980). Vendor rating in purchasing scenario: a confidence interval approach. *International Journal of Operations & Production Management*, 21(10), 1305-1326.

Nagarajan, M., & Sošić, G. (2008). Game-theoretic analysis of cooperation among supply chain agents: review and extensions. *Social Science Electronic Publishing*, 187(3), 719–745.

Niu, L. H., (2010). Study on green management model and operational research in pharmaceutical industry. *China's manufacturing industry information*, 13, 4-7.

Roberts, B. H. (2004). The application of industrial ecology principles and planning guidelines for the development of eco-industrial parks: an Australian case study. *Journal of Cleaner Production*, 12, 997–1010.

Salam, M. A. (2011). Supply chain commitment and business process integration: the implications of confucian dynamism. *European Journal of Marketing*, 45(3), 358-382.

Sarkis, J. (2006). *Greening the Supply Chain*. Berlin: Springer.

Seuring, S. (2004). Industrial ecology, life cycles, supply chains: differences and interrelations. *Business Strategy and the Environment*, 13(5), 306–319.

Shang, W. L. (2009). The legal regulation of social responsibility of corporate under the background of circular economy. *Ecological economy*, 8,103-105.

Shao, Z. Y. (2008). The exploit of problems and countermeasures of China's textile and apparel industry implementing green management. *Journal of Beijing institute of fashion technology*, 3, 13-17.

Subhani, M. I., Hasan, S. A., & Osman, M. A. (2012). Impact of organization culture on promoting green supply chain. *Amber Osman*, 82, 108-112.

Tseng, M., Lin, R., & Chiu, A. S. F. (2012). Evaluating green supply chain management with incomplete information. *Industrial Engineering & Management Systems*, 2, 165-169.

Vachon, S., & Klassen, R. (2008). Environmental management and manufacturing performance: the role of collaboration in the supply chain. *International Journal of Production Economics*, 111(2), 299-315.

Vermeulen, W. J. V., & J. Ras, P. (2006). The challenge of greening global product chains: meeting both ends. *Sustainable Development*, 14(4), 245–256.

Walker, H., Sisto, L. D., & McBain, D. (2008). Drivers and barriers to environmental supply chain management practices: lessons from the public and private sectors. *Journal of Purchasing and Supply Management*, 14, 69–85.

Walton, S. V., Handfield, R. B., & Melnyk, S. A. (1998). The green supply chain: integrating suppliers into environmental management processes. *International Journal of Purchasing and Materials Management*, 34(1), 2–11.

Wang, F., & Zhu, J. (2007). A new era of the mainstream design-green design. *New west*, 20, 218-219.

Wang, H. C., & He, B. Z. (2010). The application research of Green management in our country's construction industry. *Industry development BBS*, 6, 31-33.

Wang, H. G., & Han, W. X. (2002). The green management and implementation strategy. *Journal of Tianjin University*, 2, 97-100.

Wang, X. M. (2005). Research on the analysis of problems and countermeasures of enterprise management - based on the green supply chain. *Although space*, 05,85-87.

Wang, Y. B. (2009). The research and application of AHP in supplier selection under green purchasing. *The Wealth of Networks*, 10, 59-61.

Wang, Y. L. (2003). The basic principle of green management. *Chinese Engineering Science*, 11, 83-87.

Xu, Y. J. (2010). Study on the relationship between the selection of cleaner production technology and performance of enterprise. Shanghai Jiaotong University.

Yu, B. Q., Sun, C., Zhang, Y., & Wu, J. J. (2010). Analysis of risk factors of green management Based on fuzzy information entropy. *Science and Technology Management Research*, 12,178-180.

Zhang, X. F. (2009). Research on the green management of manufacturing enterprise in China. *Journal of north China institute of water resources and hydropower*, 5, 46-48.

Zhang, Y. I., Zhang, W. M., & Deng, D. S. (2012). The choice of the method and cost management across the organization environmental, a kind of effective green management. *Management discussion*, 02, 18-20.

Zhao, Y. P., Zhu, Q. H., & Xie, Y. D., (2008). Study on system dynamical mechanism of green management. *Science and Technology Management Research*, (2), 152-155.

Zhu, Q. H., & D. Y. (2002). Study on the influencing factors of enterprise green purchasing. *China Soft Science*, 11, 71-74.

Zsidisin, G. A., & Siferd, S. P. (2001). Environmental purchasing: a framework for theory development. *European Journal of Purchasing & Supply Management*, 7(0), 61-73.

Annex A of Chapter 1

Table 1. 8 comparison and judgment matrix on three enterprises

Enterprise	A1	A2	A3	A4	Weighted
A1	1	5	4	4	0.583
A2	1/5	1	3	2	0.199
A3	1/4	1/3	1	1/2	0.087
A4	1/4	1/2	2	1	0.131

C.R. = 0.0756

Table 1. 9 comparison and judgment matrix on a11

a11	A	B	C	Weighted
A	1	5	7	0.740
B	1/5	1	2	0.167
C	1/7	1/2	1	0.094

C.R. =0.0136

Table 1. 10 comparison and judgment matrix on a12

a12	A	B	C	Weighted
A	1	4	6	0.691
B	1/4	1	3	0.218
C	1/6	1/3	1	0.091

C.R.=0.0516

Table 1. 11 comparison and judgment matrix on a13

a13	A	B	C	Weighted
A	1	4	7	0.715

B	1/4	1	2	0.187
C	1/7	1/2	1	0.098

C.R.=0.0019

Table 1. 12 comparison and judgment matrix on a14

a14	A	B	C	Weighted
A	1	4	6	0.701
B	1/4	1	2	0.193
C	1/6	1/2	1	0.106

C.R.=0.0088

Table 1. 13 comparison and judgment matrix on a15

a15	A	B	C	Weighted
A	1	4	8	0.717
B	1/4	1	3	0.205
C	1/8	1/3	1	0.078

C.R.=0.0176

Table 1. 14 comparison and judgment matrix on a21

a21	A	B	C	Weighted
A	1	3	7	0.659
B	1/3	1	4	0.263
C	1/7	1/4	1	0.079

C.R.=0.0311

Table 1. 15 comparison and judgment matrix on a22

a22	A	B	C	Weighted
A	1	4	8	0.717
B	1/4	1	3	0.205
C	1/8	1/3	1	0.078

C.R.=0.0176

Table 1. 16 comparison and judgment matrix on a23

a23	A	B	C	Weighted
A	1	4	9	0.737
B	1/4	1	2	0.177
C	1/9	1/2	1	0.085

C.R.=0.0015

Table 1. 17 comparison and judgment matrix on a24

a24	A	B	C	Weighted
A	1	4	7	0.715
B	1/4	1	2	0.187
C	1/7	1/2	1	0.098

C.R.=0.0019

Table 1. 18 comparison and judgment matrix on a25

a	A	B	C	Weighted
A	1	4	7	0.715
B	1/4	1	2	0.187
C	1/7	1/2	1	0.098

C.R.=0.0019

Table 1. 19 comparison and judgment matrix on a31

a31	A	B	C	Weighted
A	1	5	3	0.637
B	1/5	1	1/3	0.105
C	1/3	3	1	0.258

C.R.=0.0370

Table 1. 20comparison and judgment matrix on a32

a32	A	B	C	Weighted
A	1	2	6	0.600
B	1/2	1	3	0.300
C	1/6	1/3	1	0.100

C.R.=0.0000

Table 1. 21comparison and judgment matrix on a33

a33	A	B	C	Weighted
A	1	3	6	0.667
B	1/3	1	2	0.222
C	1/6	1/2	1	0.111

C.R.=0.0000

Table 1. 22comparison and judgment matrix on a34

a34	A	B	C	Weighted
A	1	7	5	0.731
B	1/7	1	1/3	0.081
C	1/5	3	1	0.188

C.R.=0.0624

Table 1. 23comparison and judgment matrix on a35

a35	A	B	C	Weighted
A	1	3	6	0.667
B	1/3	1	2	0.222
C	1/6	1/2	1	0.111

C.R.=0.0000

Table 1. 24comparison and judgment matrix on a36

a36	A	B	C	Weighted
A	1	4	6	0.701
B	1/4	1	2	0.193
C	1/6	1/2	1	0.106

C.R.=0.0088

Table 1. 25comparison and judgment matrix on a41

a41	A	B	C	Weighted
A	1	6	4	0.701
B	1/6	1	1/2	0.106
C	1/4	2	1	0.193

C.R.=0.0088

Table 1. 26comparison and judgment matrix on a42

a42	A	B	C	Weighted
A	1	9	5	0.743
B	1/9	1	1/4	0.063
C	1/5	4	1	0.194

C.R.=0.0685

Table 1. 27comparison and judgment matrix on a43

a	A	B	C	Weighted
A	1	9	4	0.727
B	1/9	1	1/3	0.073
C	1/4	3	1	0.200

C.R.=0.0088

Table 1. 28comparison and judgment matrix on a44

a44	A	B	C	Weighted
A	1	4	6	0.701
B	1/4	1	2	0.193
C	1/6	1/2	1	0.106

C.R.=0.0088

Table 1. 29comparison and judgment matrix on a45

a45	A	B	C	Weighted
A	1	4	7	0.705
B	1/4	1	3	0.211
C	1/7	1/3	1	0.084

C.R.=0.0311

Table 1. 30comparison and judgment matrix on a51

a51	A	B	C	Weighted
A	1	4	6	0.701

B	1/4	1	2	0.193
C	1/6	1/2	1	0.106

C.R.=0.0088

Table 1. 31comparison and judgment matrix on a52

a53	A	B	C	Weighted
A	1	4	7	0.715
B	1/4	1	2	0.187
C	1/7	1/2	1	0.098

C.R.=0.0019

Table 1. 32comparison and judgment matrix on a53

a53	A	B	C	Weighted
A	1	4	7	0.715
B	1/4	1	2	0.187
C	1/7	1/2	1	0.0978

C.R.=0.0019

Table 1. 33comparison and judgment matrix on a54

a54	A	B	C	Weighted
A	1	4	6	0.701
B	1/4	1	2	0.193
C	1/6	1/2	1	0.106

C.R.=0.0088

Table 1. 34comparison and judgment matrix on a61

a61	A	B	C	Weighted
-----	---	---	---	----------

A	1	1	1	0.333
B	1	1	1	0.333
C	1	1	1	0.333

C.R.=0.0000

Table 1. 35comparison and judgment matrix on a62

a62	A	B	C	Weighted
A	1	4	3	0.625
B	1/4	1	1/2	0.137
C	1/3	2	1	0.238

C.R.=0.0176

Table 1. 36comparison and judgment matrix on a63

a63	A	B	C	Weighted
A	1	3	2	0.540
B	1/3	1	1/2	0.163
C	1/2	2	1	0.297

C.R.=0.0089

Table 1. 37comparison and judgment matrix on a71

a71	A	B	C	Weighted
A	1	5	5	0.714
B	1/5	1	1	0.143
C	1/5	1	1	0.143

C.R.=0.0000

Table 1. 38comparison and judgment matrix on a72

a72	A	B	C	Weighted
A	1	4	6	0.701
B	1/4	1	2	0.193
C	1/6	1/2	1	0.106

C.R.=0.0088

Table 1. 39comparison and judgment matrix on a73

a73	A	B	C	Weighted
A	1	8	4	0.707
B	1/8	1	1/4	0.070
C	1/4	4	1	0.223

C.R.=0.0515

Table 1. 40comparison and judgment matrix on a74

a74	A	B	C	Weighted
A	1	1	1	0.333
B	1	1	1	0.333
C	1	1	1	0.333

C.R.=0.0000

Table 1. 41comparison and judgment matrix on A in the A1

A	a11	a12	a13	a14	a15	Weighted
a11	1	3	1/4	1/4	1/3	0.108
a12	1/3	1	1/2	1/3	1/2	0.086
a13	4	2	1	1/2	1/2	0.204

a14	4	3	2	1	2	0.358
a15	3	2	2	1/2	1	0.244

C.R.=0.0963

Table 1. 42comparison and judgment matrix on B in the A1

B	a11	a12	a13	a14	a15	Weighted
a11	1	1	1/2	2	1	0.192
a12	1	1	1/2	2	1/2	0.168
a13	2	2	1	1	1/2	0.228
a14	1/2	1/2	1	1	1	0.152
a15	1	2	2	1	1	0.259

C.R.=0.0879

Table 1. 43comparison and judgment matrix on C in the A1

C	a11	a12	a13	a14	a15	Weighted
a11	1	5	4	5	4	0.515
a12	1/5	1	4	4	3	0.236
a13	1/4	1/4	1	2	2	0.108
a14	1/5	1/4	1/2	1	1	0.067
a15	1/4	1/3	1/2	1	1	0.075

C.R.=0.0808

Table 1. 44comparison and judgment matrix on a11 in the A1

a11	a11	a13	a14	Weighted
a11	1	1/4	1/3	0.122
a13	4	1	2	0.558
a14	3	1/2	1	0.320

C.R.=0.0176

Table 1. 45comparison and judgment matrix on a12 in the A1

a12	a13	a14	Weighted
a13	1	1/2	0.333
a14	2	1	0.667

C.R.=0.0000

Table 1. 46comparison and judgment matrix on a14 in the A1

a14	a11	a12	a13	Weighted
a11	1	2	1/2	0.311
a12	1/2	1	1/2	0.196
a13	2	2	1	0.493

C.R.=0.0516

Table 1. 47comparison and judgment matrix on A in the A2

A	a21	a22	a23	a24	a25	Weighted
a21	1	1/3	1/4	1	1/3	0.083
a22	3	1	1/2	2	1/2	0.188
a23	4	2	1	3	3	0.400
a24	1	1/2	1/3	1	1	0.122
a25	3	2	1/3	1	1	0.207

C.R.=0.0549

Table 1. 48comparison and judgment matrix on B in the A2

B	a21	a22	a23	a24	a25	Weighted
a21	1	1/2	1/2	2	1/2	0.142
a22	2	1	1	2	1	0.238

a23	2	1	1	3	1/2	0.237
a24	1/2	1/2	1/3	1	1	0.123
a25	2	1	2	1	1	0.260

C.R.=0.0690

Table 1. 49comparison and judgment matrix on C in the A2

C	a21	a22	a23	a24	a25	Weighted
a21	1	1/2	1/6	1	1	0.092
a22	2	1	1/5	1	2	0.148
a23	6	5	1	5	4	0.549
a24	1	1	1/5	1	1	0.110
a25	1	1/2	1/4	1	1	0.101

C.R.=0.0280

Table 1. 50comparison and judgment matrix on a22 in the A2

a22	a23	a25	Weighted
a23	1	5	0.833
a25	1/5	1	0.167

C.R.=0.0000

Table 1. 51comparison and judgment matrix on a23 in the A2

a23	a21	a25	Weighted
a21	1	4	0.800
a25	1/4	1	0.200

C.R.=0.0000

Table 1. 52comparison and judgment matrix on a24 in the A2

a24	a21	a25	Weighted
a21	1	1	0.500
a25	1	1	0.500

C.R.=0.0000

Table 1. 53comparison and judgment matrix on A in the A3

A		a31	a32	a33	a34	a35	a36	Weighted
a31		1	1/2	1/3	1/3	1/4	1/3	0.062
a32		2	1	2	2	1/2	1	0.192
a33		3	1/2	1	1	1/2	1/2	0.128
a34		3	1/2	1	1	1/2	1	0.143
a35		4	2	2	2	1	2	0.296
a36		3	1	2	1	1/2	1	0.179

C.R.=0.0268

Table 1. 54comparison and judgment matrix on B in the A3

B	a31	a32	a33	a34	a35	a36	Weighted
a31	1	2	3	2	1/2	2	0.239
a32	1/2	1	2	1	1/3	1	0.132
a33	1/3	1/2	1	1	1	1	0.121
a34	1/2	1	1	1	1	1	0.137
a35	2	3	1	1	1	1	0.234
a36	1/2	1	1	1	1	1	0.137

C.R.=0.0664

Table 1. 55comparison and judgment matrix on C in the A3

C	a31	a32	a33	a34	a35	a36	Weighted
a31	1	4	5	3	5	4	0.442
a32	1/4	1	1	1	1/3	1	0.090
a33	1/5	1	1	1	1/2	1/3	0.073
a34	1/3	1	1	1	1/2	1/2	0.087
a35	1/5	3	2	2	1	1/2	0.143
a36	1/4	1	3	2	2	1	0.165

C.R.=0.0550

Table 1. 56comparison and judgment matrix on a31 in the A3

a31	a32	a35	Weighted
a32	1	1/3	0.250
a35	3	1	0.750

C.R.=0.0000

Table 1. 57comparison and judgment matrix on a32 in the A3

a32	a33	a34	a35	Weighted
a33	1	1	1/4	0.160
a34	1	1	1/5	0.149
a35	4	5	1	0.691

C.R.=0.0033

Table 1. 58comparison and judgment matrix on a33 in the A3

a33	a34	a35	a36	Weighted
a34	1	1/4	1	0.160
a35	4	1	5	0.691

a36	1	1/5	1	0.149
-----	---	-----	---	-------

C.R.=0.0033

Table 1. 59comparison and judgment matrix on a34 in the A3

a34	a35	a36	Weighted
a35	1	3	0.750
a36	1/3	1	0.250

C.R.=0.0000

Table 1. 60comparison and judgment matrix on a35 in the A3

a35	a31	a33	a34	Weighted
a31	1	1/4	1/4	0.111
a33	4	1	1	0.444
a34	4	1	1	0.444

C.R.=0.0000

Table 1. 61comparison and judgment matrix on a36 in the A3

a36	a33	a34	Weighted
a33	1	1	0.500
a34	1	1	0.500

C.R.=0.0000

Table 1. 62comparison and judgment matrix on A in the A4

A	a41	a42	a43	a44	a45	Weighted
a41	1	4	2	1/3	1/3	0.180
a42	1/4	1	1	1/3	1/3	0.085
a43	1/2	1	1	1/2	1/2	0.113
a44	3	3	2	1	1	0.311

a45	3	3	2	1	1	0.311
-----	---	---	---	---	---	-------

C.R.=0.0653

Table 1. 63 comparison and judgment matrix on B in the A4

B	a41	a42	a43	a44	a45	Weighted
a41	1	1	1/3	1/2	1/2	0.124
a42	1	1	2	2	2	0.295
a43	3	1/2	1	2	2	0.265
a44	2	1/2	1/2	1	1	0.158
a45	2	1/2	1/2	1	1	0.158

C.R.=0.0784

Table 1. 64 comparison and judgment matrix on C in the A4

C	a41	a42	a43	a44	a45	Weighted
a41	1	4	1	3	4	0.376
a42	1/4	1	1/2	1	1	0.114
a43	1	2	1	3	2	0.286
a44	1/3	1	1/3	1	1	0.110
a45	1/4	1	1/2	1	1	0.114

C.R.=0.0131

Table 1. 65 comparison and judgment matrix on a41 in the A4

a41	a44	a45	Weighted
a44	1	1/3	0.250
a45	3	1	0.750

C.R.=0.0000

Table 1. 66 comparison and judgment matrix on a45 in the A4

a45	a42	a43	a44	Weighted
a42	1	1/2	1/2	0.200

a43	2	1	1	0.400
a44	2	1	1	0.400

C.R.=0.0000

Table 1. 67comparison and judgment matrix on a12 in the A5

a12	a51	a53	a54	Weighted
a51	1	5	1/2	0.364
a53	1/5	1	1/4	0.099
a54	2	4	1	0.537

C.R.=0.0904

Table 1. 68comparison and judgment matrix on a52 in the A5

a52	a51	a53	a54	Weighted
a51	1	2	1	0.400
a53	1/2	1	1/2	0.200
a54	1	2	1	0.400

C.R.=0.0000

Table 1. 69comparison and judgment matrix on a53 in the A5

a53	a51	a52	a53	a54	Weighted
a51	1	1/7	2	1/4	0.102
a52	7	1	5	2	0.536
a53	1/2	1/5	1	1/2	0.092
a54	4	1/2	2	1	0.269

C.R.=0.0736

Table 1. 70comparison and judgment matrix on a54 in the A5

a54	a51	a52	Weighted
-----	-----	-----	----------

a51	1	1/6	0.143
a52	6	1	0.857

C.R.=0.0000

Table 1. 71comparison and judgment matrix on a63 in the A5

a63	a51	a52	a53	a54	Weighted
a51	1	4	3	2	0.457
a52	1/4	1	1/4	1/3	0.080
a53	1/3	4	1	1/2	0.193
a54	1/2	3	2	1	0.271

C.R.=0.0577

Table 1. 72comparison and judgment matrix on a23 in the A6

a23	a61	a62	a63	Weighted
a61	1	6	5	0.729
a62	1/6	1	2	0.163
a63	1/5	1/2	1	0.109

C.R.=0.0824

Table 1. 73comparison and judgment matrix on a61 in the A6

a61	a62	a63	Weighted
a62	1	4	0.800
a63	1/4	1	0.200

C.R.=0.0000

Table 1. 74comparison and judgment matrix on a62 in the A6

a62	a61	a63	Weighted
a61	1	4	0.800
a63	1/4	1	0.200

C.R.=0.0000

Table 1. 75comparison and judgment matrix on a63 in the A6

a63	a61	a62	Weighted
a61	1	1	0.500
a62	1	1	0.500

C.R.=0.0000

Table 1. 76comparison and judgment matrix on a23 in the A7

a23	a71	a73	a74	Weighted
a71	1	6	1	0.472
a73	1/6	1	1/5	0.084
a74	1	5	1	0.444

C.R.=0.0020

Table 1. 77 comparison and judgment matrix on a24 in the A7

a24	a71	a72	a73	a74	Weighted
a71	1	7	4	1/2	0.351
a72	1/7	1	1/3	1/4	0.063
a73	1/4	3	1	1/5	0.115
a74	2	4	5	1	0.471

C.R.=0.0922

Table 1. 78comparison and judgment matrix on a25 in the A7

a25	a71	a72	a73	a74	Weighted
a71	1	1/2	3	4	0.309
a72	2	1	5	3	0.476
a73	1/3	1/5	1	2	0.122
a74	1/4	1/3	1/2	1	0.094

C.R.=0.0625

Table 1. 79 comparison and judgment matrix on a71 in the A7

a71	a72	a73	a74	Weighted
a72	1	1/3	1/2	0.163
a73	3	1	2	0.540
a74	2	1/2	1	0.297

C.R.=0.0089

Table 1. 80 comparison and judgment matrix on a72 in the A7

a72	a71	a74	Weighted
a71	1	1/3	0.250
a74	3	1	0.750

C.R.=0.0000

Table 1. 81 comparison and judgment matrix on a73 in the A7

a73	a71	a74	Weighted
a71	1	1/3	0.250
a74	3	1	0.750

C.R.=0.0000

Table 1.82 Un-weighted super matrixes

	a11	a12	a13	a14	a15	a21	a22	a23	a24	a25	a31	a32	a33
a11	0.122	0.000	0.000	0.311	0.000	0.000	0.000	0.000	0.000	0.000	0.000	0.000	0.000
a12	0.000	0.000	0.000	0.196	0.000	0.000	0.000	0.000	0.000	0.000	0.000	0.000	0.000
a13	0.558	0.333	1.000	0.493	0.000	0.000	0.000	0.000	0.000	0.000	0.000	0.000	0.000
a14	0.320	0.667	0.000	0.000	0.000	0.000	0.000	0.000	0.000	0.000	0.000	0.000	0.000
a15	0.000	0.000	0.000	0.000	0.000	0.000	0.000	0.000	0.000	0.000	0.000	0.000	0.000
a21	0.000	0.000	0.000	0.000	0.000	0.000	0.000	0.800	0.500	0.000	0.000	0.000	0.000
a22	0.000	0.000	0.000	0.000	0.000	0.000	0.000	0.000	0.000	0.000	0.000	0.000	0.000
a23	0.000	0.000	0.000	0.000	0.000	0.000	0.833	0.000	0.000	0.000	0.000	0.000	0.000
a24	0.000	0.000	0.000	0.000	0.000	0.000	0.000	0.000	0.000	0.000	0.000	0.000	0.000
a25	0.000	0.000	0.000	0.000	0.000	0.000	0.167	0.200	0.500	0.000	0.000	0.000	0.000
a31	0.000	0.000	0.000	0.000	0.000	0.000	0.000	0.000	0.000	0.000	0.000	0.000	0.000
a32	0.000	0.000	0.000	0.000	0.000	0.000	0.000	0.000	0.000	0.000	0.250	0.000	0.000
a33	0.000	0.000	0.000	0.000	0.000	0.000	0.000	0.000	0.000	0.000	0.000	0.160	0.000
a34	0.000	0.000	0.000	0.000	0.000	0.000	0.000	0.000	0.000	0.000	0.000	0.149	0.160
a35	0.000	0.000	0.000	0.000	0.000	0.000	0.000	0.000	0.000	0.000	0.750	0.691	0.691

a36	0.000	0.000	0.000	0.000	0.000	0.000	0.000	0.000	0.000	0.000	0.000	0.000	0.149
a41	0.000	0.000	0.000	0.000	0.000	0.000	0.000	0.000	0.000	0.000	0.000	0.000	0.000
a42	0.000	0.000	0.000	0.000	0.000	0.000	0.000	0.000	0.000	0.000	0.000	0.000	0.000
a43	0.000	0.000	0.000	0.000	0.000	0.000	0.000	0.000	0.000	0.000	0.000	0.000	0.000
a44	0.000	0.000	0.000	0.000	0.000	0.000	0.000	0.000	0.000	0.000	0.000	0.000	0.000
a45	0.000	0.000	0.000	0.000	0.000	0.000	0.000	0.000	0.000	0.000	0.000	0.000	0.000
a51	0.000	0.364	0.000	0.000	0.000	0.000	0.000	0.000	0.000	0.000	0.000	0.000	0.000
a52	1.000	0.000	0.000	0.000	0.000	0.000	0.000	0.000	0.000	0.000	0.000	0.000	0.000
a53	0.000	0.099	0.000	0.000	0.000	0.000	0.000	0.000	0.000	0.000	0.000	0.000	0.000
a54	0.000	0.537	0.000	0.000	0.000	0.000	0.000	0.000	0.000	0.000	0.000	0.000	0.000
a61	0.000	0.000	0.000	0.000	0.000	0.333	0.000	0.729	0.000	0.000	0.000	0.000	0.000
a62	0.000	0.000	0.000	0.000	0.000	0.333	0.000	0.163	0.000	0.000	0.000	0.000	0.000
a63	0.000	0.000	0.000	0.000	0.000	0.333	1.000	0.109	0.000	1.000	0.000	0.000	0.000
a71	0.000	0.000	0.000	0.000	0.000	0.000	0.000	0.472	0.351	0.309	0.000	0.000	0.000
a72	0.000	0.000	0.000	0.000	0.000	0.000	0.000	0.000	0.063	0.476	0.000	0.000	0.000
a73	0.000	0.000	0.000	0.000	0.000	0.000	0.000	0.084	0.115	0.122	0.000	0.000	0.000
a74	0.000	0.000	0.000	0.000	0.000	0.000	0.000	0.444	0.471	0.094	0.000	0.000	0.000

A	0.740	0.691	0.715	0.701	0.717	0.659	0.717	0.738	0.715	0.715	0.637	0.600	0.667
B	0.167	0.218	0.187	0.193	0.205	0.263	0.205	0.177	0.187	0.187	0.105	0.300	0.222
C	0.094	0.091	0.098	0.106	0.078	0.079	0.078	0.085	0.098	0.098	0.258	0.100	0.111
	a34	a35	a36	a41	a42	a43	a44	a45	a51	a52	a53	a54	a61
a11	0.000	0.000	0.000	0.000	0.000	0.000	0.000	0.000	0.000	0.000	0.000	0.000	0.000
a12	0.000	0.000	0.000	0.000	0.000	0.000	0.000	0.000	0.000	0.000	0.000	0.000	0.000
a13	0.000	0.000	0.000	0.000	0.000	0.000	0.000	0.000	0.000	0.000	0.000	0.000	0.000
a14	0.000	0.000	0.000	0.000	0.000	0.000	0.000	0.000	0.000	0.000	0.000	0.000	0.000
a15	0.000	0.000	0.000	0.000	0.000	0.000	0.000	0.000	0.000	0.000	0.000	0.000	0.000
a21	0.000	0.000	0.000	0.000	0.000	0.000	0.000	0.000	0.000	0.000	0.000	0.000	0.000
a22	0.000	0.000	0.000	0.000	0.000	0.000	0.000	0.000	0.000	0.000	0.000	0.000	0.000
a23	0.000	0.000	0.000	0.000	0.000	0.000	0.000	0.000	0.000	0.000	0.000	0.000	0.000
a24	0.000	0.000	0.000	0.000	0.000	0.000	0.000	0.000	0.000	0.000	0.000	0.000	0.000
a25	0.000	0.000	0.000	0.000	0.000	0.000	0.000	0.000	0.000	0.000	0.000	0.000	0.000
a31	0.000	0.111	0.000	0.000	0.000	0.000	0.000	0.000	0.000	0.000	0.000	0.000	0.000
a32	0.000	0.000	0.000	0.000	0.000	0.000	0.000	0.000	0.000	0.000	0.000	0.000	0.000
a33	0.000	0.444	0.500	0.000	0.000	0.000	0.000	0.000	0.000	0.000	0.000	0.000	0.000

a34	0.000	0.444	0.500	0.000	0.000	0.000	0.000	0.000	0.000	0.000	0.000	0.000	0.000
a35	0.750	0.000	0.000	0.000	0.000	0.000	0.000	0.000	0.000	0.000	0.000	0.000	0.000
a36	0.250	0.000	0.000	0.000	0.000	0.000	0.000	0.000	0.000	0.000	0.000	0.000	0.000
a41	0.000	0.000	0.000	0.000	0.000	0.000	0.000	0.000	0.000	0.000	0.000	0.000	0.000
a42	0.000	0.000	0.000	0.000	0.000	0.000	0.000	0.200	0.000	0.000	0.000	0.000	0.000
a43	0.000	0.000	0.000	0.000	0.000	0.000	0.000	0.400	0.000	0.000	0.000	0.000	0.000
a44	0.000	0.000	0.000	0.250	0.000	1.000	0.000	0.400	0.000	0.000	0.000	0.000	0.000
a45	0.000	0.000	0.000	0.750	1.000	0.000	0.000	0.000	0.000	0.000	0.000	0.000	0.000
a51	0.000	0.000	0.000	0.000	0.000	0.000	0.000	0.000	0.000	0.400	0.102	0.143	0.000
a52	0.000	0.000	0.000	0.000	0.000	0.000	0.000	0.000	0.000	0.000	0.536	0.857	0.000
a53	0.000	0.000	0.000	0.000	0.000	0.000	0.000	0.000	0.000	0.200	0.092	0.000	0.000
a54	0.000	0.000	0.000	0.000	0.000	0.000	0.000	0.000	1.000	0.400	0.269	0.000	0.000
a61	0.000	0.000	0.000	0.000	0.000	0.000	0.000	0.000	0.000	0.000	0.000	0.000	0.000
a62	0.000	0.000	0.000	0.000	0.000	0.000	0.000	0.000	0.000	0.000	0.000	0.000	0.800
a63	0.000	0.000	0.000	0.000	0.000	0.000	0.000	0.000	0.000	0.000	0.000	0.000	0.200
a71	0.000	0.000	0.000	0.000	0.000	0.000	0.000	0.000	0.000	0.000	0.000	0.000	0.000
a72	0.000	0.000	0.000	0.000	0.000	0.000	0.000	0.000	0.000	0.000	0.000	0.000	0.000

a73	0.000	0.000	0.000	0.000	0.000	0.000	0.000	0.000	0.000	0.000	0.000	0.000	0.000
a74	0.000	0.000	0.000	0.000	0.000	0.000	0.000	0.000	0.000	0.000	0.000	0.000	0.000
A	0.731	0.667	0.701	0.701	0.743	0.727	0.701	0.705	0.701	0.429	0.715	0.701	0.333
B	0.081	0.222	0.193	0.106	0.063	0.073	0.193	0.211	0.193	0.143	0.187	0.193	0.333
C	0.188	0.111	0.106	0.193	0.194	0.200	0.106	0.084	0.106	0.429	0.098	0.106	0.333
	a62	a63	a71	a72	a73	a74	A	B	C				
a11	0.000	0.000	0.000	0.000	0.000	0.000	0.108	0.192	0.515				
a12	0.000	0.000	0.000	0.000	0.000	0.000	0.086	0.168	0.236				
a13	0.000	0.000	0.000	0.000	0.000	0.000	0.204	0.228	0.108				
a14	0.000	0.000	0.000	0.000	0.000	0.000	0.358	0.152	0.067				
a15	0.000	0.000	0.000	0.000	0.000	0.000	0.244	0.259	0.075				
a21	0.000	0.000	0.000	0.000	0.000	0.000	0.083	0.142	0.092				
a22	0.000	0.000	0.000	0.000	0.000	0.000	0.188	0.238	0.148				
a23	0.000	0.000	0.000	0.000	0.000	0.000	0.400	0.237	0.549				
a24	0.000	0.000	0.000	0.000	0.000	0.000	0.122	0.123	0.110				
a25	0.000	0.000	0.000	0.000	0.000	0.000	0.207	0.260	0.101				
a31	0.000	0.000	0.000	0.000	0.000	0.000	0.062	0.239	0.442				

a32	0.000	0.000	0.000	0.000	0.000	0.000	0.192	0.132	0.090
a33	0.000	0.000	0.000	0.000	0.000	0.000	0.128	0.121	0.073
a34	0.000	0.000	0.000	0.000	0.000	0.000	0.143	0.137	0.087
a35	0.000	0.000	0.000	0.000	0.000	0.000	0.296	0.234	0.143
a36	0.000	0.000	0.000	0.000	0.000	0.000	0.179	0.137	0.165
a41	0.000	0.000	0.000	0.000	0.000	0.000	0.180	0.124	0.376
a42	0.000	0.000	0.000	0.000	0.000	0.000	0.085	0.295	0.114
a43	0.000	0.000	0.000	0.000	0.000	0.000	0.113	0.265	0.286
a44	0.000	0.000	0.000	0.000	0.000	0.000	0.311	0.158	0.110
a45	0.000	0.000	0.000	0.000	0.000	0.000	0.311	0.158	0.114
a51	0.500	0.457	0.000	0.000	0.000	0.000	0.000	0.000	0.000
a52	0.000	0.080	0.000	0.000	0.000	0.000	0.000	0.000	0.000
a53	0.000	0.193	0.000	0.000	0.000	0.000	0.000	0.000	0.000
a54	0.500	0.271	0.000	0.000	0.000	0.000	0.000	0.000	0.000
a61	0.800	0.500	0.000	0.000	0.000	0.000	0.000	0.000	0.000
a62	0.000	0.500	0.000	0.000	0.000	0.000	0.000	0.000	0.000
a63	0.200	0.000	0.000	0.000	0.000	0.000	0.000	0.000	0.000

a71	0.000	0.000	0.000	0.250	0.250	0.000	0.000	0.000	0.000
a72	0.000	0.000	0.163	0.000	0.000	0.000	0.000	0.000	0.000
a73	0.000	0.000	0.540	0.000	0.000	0.000	0.000	0.000	0.000
a74	0.000	0.000	0.297	0.750	0.750	0.000	0.000	0.000	0.000
A	0.625	0.540	0.714	0.701	0.707	0.333	0.000	0.000	0.000
B	0.137	0.163	0.143	0.193	0.070	0.333	0.000	0.000	0.000
C	0.238	0.297	0.143	0.106	0.223	0.333	0.000	0.000	0.000

Table 1.83 weighted super matrixes

	a11	a12	a13	a14	a15	a21	a22	a23	a24	a25	a31	a32	a33
a11	0.041	0.000	0.000	0.155	0.000	0.000	0.000	0.000	0.000	0.000	0.000	0.000	0.000
a12	0.000	0.000	0.000	0.098	0.000	0.000	0.000	0.000	0.000	0.000	0.000	0.000	0.000
a13	0.186	0.111	0.500	0.247	0.000	0.000	0.000	0.000	0.000	0.000	0.000	0.000	0.000
a14	0.107	0.222	0.000	0.000	0.000	0.000	0.000	0.000	0.000	0.000	0.000	0.000	0.000
a15	0.000	0.000	0.000	0.000	0.000	0.000	0.000	0.000	0.000	0.000	0.000	0.000	0.000
a21	0.000	0.000	0.000	0.000	0.000	0.000	0.000	0.200	0.167	0.000	0.000	0.000	0.000
a22	0.000	0.000	0.000	0.000	0.000	0.000	0.000	0.000	0.000	0.000	0.000	0.000	0.000
a23	0.000	0.000	0.000	0.000	0.000	0.000	0.278	0.000	0.000	0.000	0.000	0.000	0.000
a24	0.000	0.000	0.000	0.000	0.000	0.000	0.000	0.000	0.000	0.000	0.000	0.000	0.000
a25	0.000	0.000	0.000	0.000	0.000	0.000	0.056	0.050	0.167	0.000	0.000	0.000	0.000
a31	0.000	0.000	0.000	0.000	0.000	0.000	0.000	0.000	0.000	0.000	0.000	0.000	0.000
a32	0.000	0.000	0.000	0.000	0.000	0.000	0.000	0.000	0.000	0.000	0.125	0.000	0.000
a33	0.000	0.000	0.000	0.000	0.000	0.000	0.000	0.000	0.000	0.000	0.000	0.080	0.000
a34	0.000	0.000	0.000	0.000	0.000	0.000	0.000	0.000	0.000	0.000	0.000	0.074	0.080
a35	0.000	0.000	0.000	0.000	0.000	0.000	0.000	0.000	0.000	0.000	0.375	0.345	0.345

a36	0.000	0.000	0.000	0.000	0.000	0.000	0.000	0.000	0.000	0.000	0.000	0.000	0.074
a41	0.000	0.000	0.000	0.000	0.000	0.000	0.000	0.000	0.000	0.000	0.000	0.000	0.000
a42	0.000	0.000	0.000	0.000	0.000	0.000	0.000	0.000	0.000	0.000	0.000	0.000	0.000
a43	0.000	0.000	0.000	0.000	0.000	0.000	0.000	0.000	0.000	0.000	0.000	0.000	0.000
a44	0.000	0.000	0.000	0.000	0.000	0.000	0.000	0.000	0.000	0.000	0.000	0.000	0.000
a45	0.000	0.000	0.000	0.000	0.000	0.000	0.000	0.000	0.000	0.000	0.000	0.000	0.000
a51	0.000	0.121	0.000	0.000	0.000	0.000	0.000	0.000	0.000	0.000	0.000	0.000	0.000
a52	0.333	0.000	0.000	0.000	0.000	0.000	0.000	0.000	0.000	0.000	0.000	0.000	0.000
a53	0.000	0.033	0.000	0.000	0.000	0.000	0.000	0.000	0.000	0.000	0.000	0.000	0.000
a54	0.000	0.179	0.000	0.000	0.000	0.000	0.000	0.000	0.000	0.000	0.000	0.000	0.000
a61	0.000	0.000	0.000	0.000	0.000	0.167	0.000	0.182	0.000	0.000	0.000	0.000	0.000
a62	0.000	0.000	0.000	0.000	0.000	0.167	0.000	0.041	0.000	0.000	0.000	0.000	0.000
a63	0.000	0.000	0.000	0.000	0.000	0.167	0.333	0.027	0.000	0.333	0.000	0.000	0.000
a71	0.000	0.000	0.000	0.000	0.000	0.000	0.000	0.118	0.117	0.103	0.000	0.000	0.000
a72	0.000	0.000	0.000	0.000	0.000	0.000	0.000	0.000	0.021	0.159	0.000	0.000	0.000
a73	0.000	0.000	0.000	0.000	0.000	0.000	0.000	0.021	0.038	0.041	0.000	0.000	0.000
a74	0.000	0.000	0.000	0.000	0.000	0.000	0.000	0.111	0.157	0.031	0.000	0.000	0.000

A	0.247	0.230	0.358	0.350	0.717	0.329	0.239	0.184	0.238	0.238	0.318	0.300	0.333
B	0.056	0.073	0.093	0.096	0.205	0.131	0.068	0.044	0.062	0.062	0.052	0.150	0.111
C	0.031	0.030	0.049	0.053	0.078	0.039	0.026	0.021	0.033	0.033	0.129	0.050	0.056
	a34	a35	a36	a41	a42	a43	a44	a45	a51	a52	a53	a54	a61
a11	0.000	0.000	0.000	0.000	0.000	0.000	0.000	0.000	0.000	0.000	0.000	0.000	0.000
a12	0.000	0.000	0.000	0.000	0.000	0.000	0.000	0.000	0.000	0.000	0.000	0.000	0.000
a13	0.000	0.000	0.000	0.000	0.000	0.000	0.000	0.000	0.000	0.000	0.000	0.000	0.000
a14	0.000	0.000	0.000	0.000	0.000	0.000	0.000	0.000	0.000	0.000	0.000	0.000	0.000
a15	0.000	0.000	0.000	0.000	0.000	0.000	0.000	0.000	0.000	0.000	0.000	0.000	0.000
a21	0.000	0.000	0.000	0.000	0.000	0.000	0.000	0.000	0.000	0.000	0.000	0.000	0.000
a22	0.000	0.000	0.000	0.000	0.000	0.000	0.000	0.000	0.000	0.000	0.000	0.000	0.000
a23	0.000	0.000	0.000	0.000	0.000	0.000	0.000	0.000	0.000	0.000	0.000	0.000	0.000
a24	0.000	0.000	0.000	0.000	0.000	0.000	0.000	0.000	0.000	0.000	0.000	0.000	0.000
a25	0.000	0.000	0.000	0.000	0.000	0.000	0.000	0.000	0.000	0.000	0.000	0.000	0.000
a31	0.000	0.056	0.000	0.000	0.000	0.000	0.000	0.000	0.000	0.000	0.000	0.000	0.000
a32	0.000	0.000	0.000	0.000	0.000	0.000	0.000	0.000	0.000	0.000	0.000	0.000	0.000
a33	0.000	0.222	0.250	0.000	0.000	0.000	0.000	0.000	0.000	0.000	0.000	0.000	0.000

a34	0.000	0.222	0.250	0.000	0.000	0.000	0.000	0.000	0.000	0.000	0.000	0.000	0.000
a35	0.375	0.000	0.000	0.000	0.000	0.000	0.000	0.000	0.000	0.000	0.000	0.000	0.000
a36	0.125	0.000	0.000	0.000	0.000	0.000	0.000	0.000	0.000	0.000	0.000	0.000	0.000
a41	0.000	0.000	0.000	0.000	0.000	0.000	0.000	0.000	0.000	0.000	0.000	0.000	0.000
a42	0.000	0.000	0.000	0.000	0.000	0.000	0.000	0.100	0.000	0.000	0.000	0.000	0.000
a43	0.000	0.000	0.000	0.000	0.000	0.000	0.000	0.200	0.000	0.000	0.000	0.000	0.000
a44	0.000	0.000	0.000	0.125	0.000	0.500	0.000	0.200	0.000	0.000	0.000	0.000	0.000
a45	0.000	0.000	0.000	0.375	0.500	0.000	0.000	0.000	0.000	0.000	0.000	0.000	0.000
a51	0.000	0.000	0.000	0.000	0.000	0.000	0.000	0.000	0.000	0.200	0.051	0.071	0.000
a52	0.000	0.000	0.000	0.000	0.000	0.000	0.000	0.000	0.000	0.000	0.268	0.429	0.000
a53	0.000	0.000	0.000	0.000	0.000	0.000	0.000	0.000	0.000	0.100	0.046	0.000	0.000
a54	0.000	0.000	0.000	0.000	0.000	0.000	0.000	0.000	0.500	0.200	0.135	0.000	0.000
a61	0.000	0.000	0.000	0.000	0.000	0.000	0.000	0.000	0.000	0.000	0.000	0.000	0.000
a62	0.000	0.000	0.000	0.000	0.000	0.000	0.000	0.000	0.000	0.000	0.000	0.000	0.400
a63	0.000	0.000	0.000	0.000	0.000	0.000	0.000	0.000	0.000	0.000	0.000	0.000	0.100
a71	0.000	0.000	0.000	0.000	0.000	0.000	0.000	0.000	0.000	0.000	0.000	0.000	0.000
a72	0.000	0.000	0.000	0.000	0.000	0.000	0.000	0.000	0.000	0.000	0.000	0.000	0.000

a73	0.000	0.000	0.000	0.000	0.000	0.000	0.000	0.000	0.000	0.000	0.000	0.000	0.000
a74	0.000	0.000	0.000	0.000	0.000	0.000	0.000	0.000	0.000	0.000	0.000	0.000	0.000
A	0.365	0.333	0.350	0.350	0.371	0.363	0.701	0.352	0.350	0.214	0.358	0.350	0.167
B	0.040	0.111	0.096	0.053	0.032	0.037	0.193	0.105	0.096	0.071	0.093	0.096	0.167
C	0.094	0.056	0.053	0.096	0.097	0.100	0.106	0.042	0.053	0.214	0.049	0.053	0.167

Table 1. 84 the limit super matrixes

	a11	a12	a13	a14	a15	a21	a22	a23	a24	a25	a31	a32	a33
a11	0.047	0.047	0.047	0.047	0.047	0.047	0.047	0.047	0.047	0.047	0.047	0.047	0.047
a12	0.030	0.030	0.030	0.030	0.030	0.030	0.030	0.030	0.030	0.030	0.030	0.030	0.030
a13	0.134	0.134	0.134	0.134	0.134	0.134	0.134	0.134	0.134	0.134	0.134	0.134	0.134
a14	0.067	0.067	0.067	0.067	0.067	0.067	0.067	0.067	0.067	0.067	0.067	0.067	0.067
a15	0.044	0.044	0.044	0.044	0.044	0.044	0.044	0.044	0.044	0.044	0.044	0.044	0.044
a21	0.014	0.014	0.014	0.014	0.014	0.014	0.014	0.014	0.014	0.014	0.014	0.014	0.014
a22	0.013	0.013	0.013	0.013	0.013	0.013	0.013	0.013	0.013	0.013	0.013	0.013	0.013
a23	0.030	0.030	0.030	0.030	0.030	0.030	0.030	0.030	0.030	0.030	0.030	0.030	0.030
a24	0.008	0.008	0.008	0.008	0.008	0.008	0.008	0.008	0.008	0.008	0.008	0.008	0.008
a25	0.017	0.017	0.017	0.017	0.017	0.017	0.017	0.017	0.017	0.017	0.017	0.017	0.017
a31	0.005	0.005	0.005	0.005	0.005	0.005	0.005	0.005	0.005	0.005	0.005	0.005	0.005
a32	0.006	0.006	0.006	0.006	0.006	0.006	0.006	0.006	0.006	0.006	0.006	0.006	0.006
a33	0.010	0.010	0.010	0.010	0.010	0.010	0.010	0.010	0.010	0.010	0.010	0.010	0.010
a34	0.011	0.011	0.011	0.011	0.011	0.011	0.011	0.011	0.011	0.011	0.011	0.011	0.011

a35	0.019	0.019	0.019	0.019	0.019	0.019	0.019	0.019	0.019	0.019	0.019	0.019	0.019
a36	0.007	0.007	0.007	0.007	0.007	0.007	0.007	0.007	0.007	0.007	0.007	0.007	0.007
a41	0.009	0.009	0.009	0.009	0.009	0.009	0.009	0.009	0.009	0.009	0.009	0.009	0.009
a42	0.008	0.008	0.008	0.008	0.008	0.008	0.008	0.008	0.008	0.008	0.008	0.008	0.008
a43	0.011	0.011	0.011	0.011	0.011	0.011	0.011	0.011	0.011	0.011	0.011	0.011	0.011
a44	0.021	0.021	0.021	0.021	0.021	0.021	0.021	0.021	0.021	0.021	0.021	0.021	0.021
a45	0.018	0.018	0.018	0.018	0.018	0.018	0.018	0.018	0.018	0.018	0.018	0.018	0.018
a51	0.015	0.015	0.015	0.015	0.015	0.015	0.015	0.015	0.015	0.015	0.015	0.015	0.015
a52	0.027	0.027	0.027	0.027	0.027	0.027	0.027	0.027	0.027	0.027	0.027	0.027	0.027
a53	0.005	0.005	0.005	0.005	0.005	0.005	0.005	0.005	0.005	0.005	0.005	0.005	0.005
a54	0.022	0.022	0.022	0.022	0.022	0.022	0.022	0.022	0.022	0.022	0.022	0.022	0.022
a61	0.013	0.013	0.013	0.013	0.013	0.013	0.013	0.013	0.013	0.013	0.013	0.013	0.013
a62	0.011	0.011	0.011	0.011	0.011	0.011	0.011	0.011	0.011	0.011	0.011	0.011	0.011
a63	0.015	0.015	0.015	0.015	0.015	0.015	0.015	0.015	0.015	0.015	0.015	0.015	0.015
a71	0.007	0.007	0.007	0.007	0.007	0.007	0.007	0.007	0.007	0.007	0.007	0.007	0.007
a72	0.003	0.003	0.003	0.003	0.003	0.003	0.003	0.003	0.003	0.003	0.003	0.003	0.003
a73	0.004	0.004	0.004	0.004	0.004	0.004	0.004	0.004	0.004	0.004	0.004	0.004	0.004

a74	0.009	0.009	0.009	0.009	0.009	0.009	0.009	0.009	0.009	0.009	0.009	0.009	0.009
A	0.228	0.228	0.228	0.228	0.228	0.228	0.228	0.228	0.228	0.228	0.228	0.228	0.228
B	0.065	0.065	0.065	0.065	0.065	0.065	0.065	0.065	0.065	0.065	0.065	0.065	0.065
C	0.045	0.045	0.045	0.045	0.045	0.045	0.045	0.045	0.045	0.045	0.045	0.045	0.045
	a34	a35	a36	a41	a42	a43	a44	a45	a51	a52	a53	a54	a61
a11	0.047	0.047	0.047	0.047	0.047	0.047	0.047	0.047	0.047	0.047	0.047	0.047	0.047
a12	0.030	0.030	0.030	0.030	0.030	0.030	0.030	0.030	0.030	0.030	0.030	0.030	0.030
a13	0.134	0.134	0.134	0.134	0.134	0.134	0.134	0.134	0.134	0.134	0.134	0.134	0.134
a14	0.067	0.067	0.067	0.067	0.067	0.067	0.067	0.067	0.067	0.067	0.067	0.067	0.067
a15	0.044	0.044	0.044	0.044	0.044	0.044	0.044	0.044	0.044	0.044	0.044	0.044	0.044
a21	0.014	0.014	0.014	0.014	0.014	0.014	0.014	0.014	0.014	0.014	0.014	0.014	0.014
a22	0.013	0.013	0.013	0.013	0.013	0.013	0.013	0.013	0.013	0.013	0.013	0.013	0.013
a23	0.030	0.030	0.030	0.030	0.030	0.030	0.030	0.030	0.030	0.030	0.030	0.030	0.030
a24	0.008	0.008	0.008	0.008	0.008	0.008	0.008	0.008	0.008	0.008	0.008	0.008	0.008
a25	0.017	0.017	0.017	0.017	0.017	0.017	0.017	0.017	0.017	0.017	0.017	0.017	0.017
a31	0.005	0.005	0.005	0.005	0.005	0.005	0.005	0.005	0.005	0.005	0.005	0.005	0.005
a32	0.006	0.006	0.006	0.006	0.006	0.006	0.006	0.006	0.006	0.006	0.006	0.006	0.006

a33	0.010	0.010	0.010	0.010	0.010	0.010	0.010	0.010	0.010	0.010	0.010	0.010	0.010
a34	0.011	0.011	0.011	0.011	0.011	0.011	0.011	0.011	0.011	0.011	0.011	0.011	0.011
a35	0.019	0.019	0.019	0.019	0.019	0.019	0.019	0.019	0.019	0.019	0.019	0.019	0.019
a36	0.007	0.007	0.007	0.007	0.007	0.007	0.007	0.007	0.007	0.007	0.007	0.007	0.007
a41	0.009	0.009	0.009	0.009	0.009	0.009	0.009	0.009	0.009	0.009	0.009	0.009	0.009
a42	0.008	0.008	0.008	0.008	0.008	0.008	0.008	0.008	0.008	0.008	0.008	0.008	0.008
a43	0.011	0.011	0.011	0.011	0.011	0.011	0.011	0.011	0.011	0.011	0.011	0.011	0.011
a44	0.021	0.021	0.021	0.021	0.021	0.021	0.021	0.021	0.021	0.021	0.021	0.021	0.021
a45	0.018	0.018	0.018	0.018	0.018	0.018	0.018	0.018	0.018	0.018	0.018	0.018	0.018
a51	0.015	0.015	0.015	0.015	0.015	0.015	0.015	0.015	0.015	0.015	0.015	0.015	0.015
a52	0.027	0.027	0.027	0.027	0.027	0.027	0.027	0.027	0.027	0.027	0.027	0.027	0.027
a53	0.005	0.005	0.005	0.005	0.005	0.005	0.005	0.005	0.005	0.005	0.005	0.005	0.005
a54	0.022	0.022	0.022	0.022	0.022	0.022	0.022	0.022	0.022	0.022	0.022	0.022	0.022
a61	0.013	0.013	0.013	0.013	0.013	0.013	0.013	0.013	0.013	0.013	0.013	0.013	0.013
a62	0.011	0.011	0.011	0.011	0.011	0.011	0.011	0.011	0.011	0.011	0.011	0.011	0.011
a63	0.015	0.015	0.015	0.015	0.015	0.015	0.015	0.015	0.015	0.015	0.015	0.015	0.015
a71	0.007	0.007	0.007	0.007	0.007	0.007	0.007	0.007	0.007	0.007	0.007	0.007	0.007

a72	0.003	0.003	0.003	0.003	0.003	0.003	0.003	0.003	0.003	0.003	0.003	0.003	0.003
a73	0.004	0.004	0.004	0.004	0.004	0.004	0.004	0.004	0.004	0.004	0.004	0.004	0.004
a74	0.009	0.009	0.009	0.009	0.009	0.009	0.009	0.009	0.009	0.009	0.009	0.009	0.009
A	0.228	0.228	0.228	0.228	0.228	0.228	0.228	0.228	0.228	0.228	0.228	0.228	0.228
B	0.065	0.065	0.065	0.065	0.065	0.065	0.065	0.065	0.065	0.065	0.065	0.065	0.065
C	0.045	0.045	0.045	0.045	0.045	0.045	0.045	0.045	0.045	0.045	0.045	0.045	0.045

	a62	a63	a71	a72	a73	a74	A	B	C
a11	0.047	0.047	0.047	0.047	0.047	0.047	0.047	0.047	0.047
a12	0.030	0.030	0.030	0.030	0.030	0.030	0.030	0.030	0.030
a13	0.134	0.134	0.134	0.134	0.134	0.134	0.134	0.134	0.134
a14	0.067	0.067	0.067	0.067	0.067	0.067	0.067	0.067	0.067
a15	0.044	0.044	0.044	0.044	0.044	0.044	0.044	0.044	0.044
a21	0.014	0.014	0.014	0.014	0.014	0.014	0.014	0.014	0.014
a22	0.013	0.013	0.013	0.013	0.013	0.013	0.013	0.013	0.013
a23	0.030	0.030	0.030	0.030	0.030	0.030	0.030	0.030	0.030
a24	0.008	0.008	0.008	0.008	0.008	0.008	0.008	0.008	0.008

a25	0.017	0.017	0.017	0.017	0.017	0.017	0.017	0.017	0.017
a31	0.005	0.005	0.005	0.005	0.005	0.005	0.005	0.005	0.005
a32	0.006	0.006	0.006	0.006	0.006	0.006	0.006	0.006	0.006
a33	0.010	0.010	0.010	0.010	0.010	0.010	0.010	0.010	0.010
a34	0.011	0.011	0.011	0.011	0.011	0.011	0.011	0.011	0.011
a35	0.019	0.019	0.019	0.019	0.019	0.019	0.019	0.019	0.019
a36	0.007	0.007	0.007	0.007	0.007	0.007	0.007	0.007	0.007
a41	0.009	0.009	0.009	0.009	0.009	0.009	0.009	0.009	0.009
a42	0.008	0.008	0.008	0.008	0.008	0.008	0.008	0.008	0.008
a43	0.011	0.011	0.011	0.011	0.011	0.011	0.011	0.011	0.011
a44	0.021	0.021	0.021	0.021	0.021	0.021	0.021	0.021	0.021
a45	0.018	0.018	0.018	0.018	0.018	0.018	0.018	0.018	0.018
a51	0.015	0.015	0.015	0.015	0.015	0.015	0.015	0.015	0.015
a52	0.027	0.027	0.027	0.027	0.027	0.027	0.027	0.027	0.027
a53	0.005	0.005	0.005	0.005	0.005	0.005	0.005	0.005	0.005
a54	0.022	0.022	0.022	0.022	0.022	0.022	0.022	0.022	0.022
a61	0.013	0.013	0.013	0.013	0.013	0.013	0.013	0.013	0.013

a62	0.011	0.011	0.011	0.011	0.011	0.011	0.011	0.011	0.011
a63	0.015	0.015	0.015	0.015	0.015	0.015	0.015	0.015	0.015
a71	0.007	0.007	0.007	0.007	0.007	0.007	0.007	0.007	0.007
a72	0.003	0.003	0.003	0.003	0.003	0.003	0.003	0.003	0.003
a73	0.004	0.004	0.004	0.004	0.004	0.004	0.004	0.004	0.004
a74	0.009	0.009	0.009	0.009	0.009	0.009	0.009	0.009	0.009
A	0.228	0.228	0.228	0.228	0.228	0.228	0.228	0.228	0.228
B	0.065	0.065	0.065	0.065	0.065	0.065	0.065	0.065	0.065
C	0.045	0.045	0.045	0.045	0.045	0.045	0.045	0.045	0.045

Chapter 2

Towards Sustainable Production from A Stakeholder's Perspective: A Dashboard Approach in China's Garment Industry¹

This paper is a joint work: Jin Jianhua², Denis Dupre³, Pierre-Yves Longaretti⁴, Jean-Yves Courtonne⁵.

¹This paper will be presented at the conference of industrial ecology "Taking Stock of Industrial Ecology - University of Surrey, Guildford, UK - 7-10 July 2015

²Chairman and party secretary of Shanghai Baromon Group, Director of China National Garment Association, Director of Shanghai System & Engineer Society, Vice-chairman of the Shanghai Garment Association.

³Professor of Ethics and Sustainable Development at Grenoble University (France).

⁴ STEEP/INRIA and IPAG/CNRS & UJF, Grenoble.

⁵ STEEP/INRIA and ARTELIA

Abstract

This paper investigates the possibility of conceiving a dashboard in a middle-sized firm in China in the garment industry.

Recent years have witnessed a growing interest from both practitioners and academics in sustainable development. The development of standards and regulations has provided multinational companies, firstly in western countries, with efficient tools to tackle this issue. However, the case of small and medium-sized firms in developing countries has been inadequately studied, whereas generic tools often don't address their specific needs. China and the Chinese industry in particular are rapidly engaging in a transition from a single target of economic growth to the triple economic-ecologic-social bottom line of sustainable development. We focus our study on the textile industry, which is mainly composed of medium-sized businesses and accounts for about 3% of the country's production output. It is the second largest water-consuming industry sector in the country and also a significant user of coal-based energy.

We propose a specific dashboard at the plant level to evaluate environmental (e.g. emission of small particles), social (e.g. work accidents) and economic (e.g. profit) performances. This is the first attempt of the kind in the Chinese context, both on the methodological and data collection fronts. The characteristics of some of the firms involved in the supply chain are taken into account in this work. We exemplify our methodology by showing how a small firm of 400 employees has introduced this dashboard in its decision process.

In this case study, we define methodological guidelines to design and validate the Key Performance Indicators through a two-stage process. First, based on a presentation of sustainability concerns at different levels (the world, China, the garment industry) by two multidisciplinary research teams in Grenoble and Shanghai, we define the targeted indicators in collaboration with the CEO and the management team of the plant. Then, we decide how we can simplify the indicators to get relevant data within a single year. The idea is to improve gradually in the future on the quality and complexity of the chosen set of indicators.

This dashboard is used as a decision-help tool for investing in new machines, saving energy

and water, and challenging suppliers along the supply-chain. At a national level, this methodology will be useful to set new standards for the industry, to provide points of comparison with other countries and to determine the optimal level of trade-off between ecological, financial and social targets for the garment industry.

Keywords:Sustainability, CSR, Corporate Social Responsibility, Management Process, dashboard, Ecology, Environment, Social, Key Performance Indicators, strategic decision, cleaner production.

JEL classification: C22; G10; G11; G31; M11; M21; O14; O22; O32

2.1. Introduction and case study context

In recent years, both practitioners and academics have become interested in sustainable development issues. At the level of private companies, the Corporate Social Responsibility (CSR) guidelines induce new practices. For example, Colombian SMEs have benefited from CSR practices which improved organizational culture, image and reputation and customer loyalty, as well as satisfying their most relevant stakeholders⁶. Similar results are observed for UK fashion garment manufacturing firms. The same problem may be addressed for multinational industries through the elaboration of norms, standards and rules, starting with western countries. However, the question concerning small and medium-sized firms in developing countries has been little studied so far⁷. In a context of declining resources and of increasing demands for economic resources and economic services, sustainable development aims at addressing the triple social, environmental and economic bottom line (Jeurisson and Elkington 2000⁸). Only when what is measured can be properly managed, can companies be called socially and environmentally responsible when they implement adequate measures of the impact of their activities.

China is quickly moving from an only target of economic growth to the triple sustainable development objectives. In China, the 17th CPC National Congress proposed to build an ecological civilization, based on the industry and on growth and consumption models, promoting an efficient energy resource management and environmental conservation. The 18th CPC National Congress stressed the pivotal role of ecological concerns for the next five years. President Hu Jintao pointed out early on in 2012 that pollution poses a key challenge for China's sustainability drive: "We should preserve more farmland for farmers, and leave to our future generations a beautiful homeland with green fields, clean water and a blue sky. We should strengthen conservation efforts all the way through, drastically reduce energy, water and land consumption per unit of GDP, and use such resources in a better and more efficient

⁶Pastrana N.A., & Sriramesh K. (2014). Corporate social responsibility: perceptions and practices among SMEs in Colombia. *Public Relations Review*, 40 (1), 14– 24.

⁷Patsy Perry; Neil Towers. Determining the antecedents for a strategy of corporate social responsibility by small- and medium-sized enterprises in the UK fashion apparel industry. *Journal of Retailing and Consumer Services* 16 (2009) 377 – 385.

⁸Ronald Jeurissen, John Elkington, *Cannibals With Forks: The Triple Bottom Line of 21st Century Business*. *Journal of Business Ethics*, 2000, Vol.23 (2), pp.229-231.

way. We should better protect water sources, impose a cap on total water consumption, promote water recycling, and build a water-conserving society. We should take a holistic approach to intensifying prevention and control of water, air and soil pollution, putting prevention first and placing emphasis on serious environmental problems that pose health hazards to the people.”

The State Council has instated the Ministry of Environment Protection at the forefront, to develop an action plan for the protection of national air pollution, national water pollution and national countryside environment⁹.

The main challenges for firms are the availability, use and depletion of natural resources. Among them, water and air are the crucial concerns in China. From February to March 2013, the Ministry of Environmental Protection organized six provincial or municipal Environmental Protection Departments (Bureaus) in particular in Beijing, Tianjin and Hebei to investigate waste water discharge from the firms in the North of China. Altogether 25875 firms were investigated, 558 various types of environmental violations were discovered, and 55 firms use seepage wells, or pits, or no anti-leakage pits, or pond to discharge, deliver or store waste water¹⁰. On the 9th of May 2013, the Ministry of Environment Protection made public the investigation result of sewage firms in the North of China. 14 firms discharge waste water were unlawful in Shandong. About 64% of urban groundwater is heavily polluted in 118 cities, and only 3% of urban groundwater is basically clean¹¹.

Clean air is a basic public health issue. The pollution from private companies in China is so severe that it is now difficult to see a clear sky in Shanghai. In the 11th respiratory physician forum on the 3rd of August 2012, the specialists presented that the incidence of asthma has increased by 116.5% during the last decade in Beijing and Shanghai. In October 2014, the Chinese official newspaper China Daily, referring to a governmental study, recognized that air pollution caused every year more than 1 million deaths from air-borne particles causing lunges cancers. At APEC meeting in November 2014, president Xi declared that cracking

⁹China will introduce air and water pollution prevention plan of action, Reuters, <http://www.ditan360.com/TanSuo/Info-129097.html>, 2013-5-13

¹⁰MEP: 88companies in North are fined 6.13 million Yuan for illegal sewage, People Net, <http://politics.people.com.cn/n/2013/0509/c1001-21427066.html> 2013.5.9

¹¹groundwater pollution control needs action <http://info.water.hc360.com/2013/05/140850412161.shtml> 2013.5.14

down on corruption and fighting against pollution were the two main national targets and that an unprecedented level of efforts were to be mobilized to address these two issues.

Innovation and traceability are effective tools in this endeavor. Heavy industry is the primary target of this policy, but the garment industry is also of some importance.

In China, the government sets goals for specific regions and major industries in terms of energy consumption per unit of output per year, which is known as the “169 class industry output energy and water consumption”. The data collection and processing work is mainly conducted by the National Development and Reform Commission of China, the National Bureau of Statistics of China and trade associations for each industrial sector, and universities and other organizations also take active part in this work. The aim is to strengthen the regulation of the economy, to reduce energy and raw materials supplies and demands, to coordinate the reduction of energy consumption and pollutant emissions of various regions, and to protect farmland and other vital resources. So we can see the textile industry represents only 3% of the Gross National Product in 2011 with 6,7 trillion Yuan.

For energy and water, the textile industry as a whole (Textile Industry, textiles and clothing, footwear, headgear manufacturing, leather, fur, feathers and its products industry) is of secondary importance compared with the main heavy industries.

Table 2. 1 Energy Consumption and Water Consumption by Industry

Industry	Energy consumption	Water consumption
Textile Industry	1377773	61922507
Petroleum processing, coking and nuclear fuel processing industry	39124760	6152520
Chemical materials and chemical products manufacturing	9284201	67525373
General equipment manufacturing	1593887	37585882
Waste Resources and Materials Recycling and Processing	62903	738115

Electricity, heat production and supply industry	22792574	10305973
Gas Production and Supply	1500410	5492406
Water production and supply industry	278179	8236582

For each unit of GDP, the textile industry uses less energy (0.15 ton of coal equivalent per million Yuan) than the rest of the industry (0.24). But for water consumption it uses 3 times more, with 6.7 cubic meter per million of Yuan compared with 2.4 cubic meter per million of Yuan.

The total energy consumption for the textile industry represents 1 377 773 TCE (ton coal equivalent): 8% oil, 61 % electricity, 2% gas and 29% for coal.

Table 2. 2 Various sectors of energy efficiency bill of China (2011)

Industry	Total consumption (TCE)	Industrial output (million)	Water consumption (cubic meters)	Oil (tons)	Electricity (ten thousand kwh)	Gas (ten thousand cubic meters)	Coal (tons)
Textile Industry	944 203	3 595 462	37 039 358	43 226	132 056	736	425 277
Textiles and clothing, footwear, headgear manufacturing	341 739	4 282 929	19 221 143	27 648	51 825	986	109 246
Leather, fur, feathers and its products industry	91 831	1 304 316	5 662 006	4 147	15 546	109	16 450

There are traditionally two complementary approaches to dealing with important social and environmental issues in the production sector (quality of life being the problem at stake in this context). The first is the use of laws and regulations. The drawback is that it may impose too many constraints and may not be adapted to specific contexts. The second is the collection of data at the firm level to identify best practices which can later be used in the definition of labels and standards. Rosemann et al (2004) suggest various uses of process modeling at

various stages of system implementations. Process modeling is used for 1) model-based identification of process weaknesses 2) adopting best business practices. Our study focuses mainly on the second approach.

We focus on the textile industry and propose a specific dashboard at the plant level to evaluate the environmental, social and economic performances of any given production plant. This is the first attempt of the kind in the Chinese context, both on the methodological and data collection front. In particular, the characteristics of some of the firms involved in the supply chain are taken into account in this work. We exemplify our methodology by showing how a small firm has introduced this dashboard in its decision process.

We propose some guidelines about possible new regulations and enticements for firms to meet improved quality standards.

2.2. Stakes of a dashboard incorporating sustainable Key Performance Indicators

The management by objectives (MBO) was proposed by Drucker (1955). The major motivation behind MBO is linking evaluation to performance in order to help managers in their planning needs. The Balanced Scorecard (BS) was introduced by Kaplan and Norton (1998) as an approach within the broader field of total quality management as a tool for planning evaluation and not only planning design.

Some researchers (e.g., Paul Niven) have tried to add a sustainability component to the Norton and Kaplan scorecard approach. There are four application barriers of the intended improvement: communication and consensus barriers, management systems and organizational barriers, obstacle information exchange barriers, awareness of the obstacles to performance appraisal barriers. In fact, the Balanced Scorecard focuses on four aspects of management, namely, customer, financial, internal business, and learning and growth. Kaplan and Norton recognized the necessity to integrate sustainability in the Balanced Scorecard, by adding to the internal perspective only two aspects related to sustainability (Regulatory and Social Processes), but by doing so, they maintained the bias of the scoreboard evaluation towards profits over social and environmental aspects.

A major change of strategy requires a better evaluation system. If a small firm wants to take into account sustainability issues, a new type of dashboard has to be designed. Sustainability is also necessary for long term profitability. To take into consideration environmental and social concerns, the long term economic viability of the firm has to be addressed. Potential positive influence of sustainability on long term profitability, within a perspective of increasing regulation demands on environmental issues, comes from various opportunities: better reputation, reduced risks, and reduced costs. Better reputation includes positive customer perception that increases brand value and betters suppliers' relationships; reduced risks due to the availability of resources, sustainability of suppliers with alternative "greener" supply chain and safer and greener technologies; and reduced costs due to the removal of waste, energy savings, less problems on processes, and more stable prices along the supply chain.

In the future, the development of China's textile and garment industry will face a series of threats and difficulties. In the short term, the largest threat stems mainly from concerns of customers around the world over the social and environmental consequences of the conditions of production in China. But in the medium and long term, international trade protectionism and related issues in production and marketing are the main obstacles. In the high-end market, our products will continue to compete with those of the United States, European Union, Japan and other countries; and in the low-end market, our products will continue to compete with those of some Southeast Asian countries, Mexico, Caribbean, Central and South American countries. Vietnam, for example, became a WTO member country in January 2007 and its government supports the development of the textile industry. In order to expand the production scale and improve its technical level, the Vietnamese textile and garment industry constantly updates textile machinery, knitting machines and other plant equipments. Vietnam is more open to foreign investment, especially in the important textile and clothing sector, so they tend to align their environmental management and control of suppliers with the practices of developed countries, e.g., no waste, recycling-oriented and re-design of clothing. Green Management practices, like "Eco-Tex Standard", and more to the point, modern logistics management modes such as "low-volume, multi-batch, fast delivery" are fast becoming a targeted standard in this country.

The arbitration between environmental, social and financial consequences of a decision still remains a strategic question. In fact there is as yet no standard of reference in China on how

sustainability concerns are connected to financial performance. This follows because the perceived need for the overall design of a green accounting system is still relatively weak at the firm level, and there are still many problems and difficulties to build and implement such a standard at the institutional level. Two positions are considered in the literature. On the one side, the investment for sustainability can be considered as an immediate cost. On the other side, this investment prepares the future: firstly, because the customer's demand takes more and more into consideration the "green and social" values incorporated in the product; secondly, because future norms, regulations and laws are going to address citizens' concerns.

2.3. The complexity of international standards for small firms

The international standard is a mixture of principles, norms and best practices. The Global Compact from United Nations asks companies to embrace universal principles. The OECD Guidelines for Multinational Enterprises are recommendations for responsible business conduct. This general framework proposes for environment: "collection and evaluation of adequate and timely information regarding the environmental, health, and safety impacts of their activities; establishment of measurable objectives and, where appropriate, targets for improved environmental performance and resource utilization". The Global Reporting Initiative (GRI), ISO norms and EMAS and EFFAS propose efficient ways to apply these principles for firms.

The Global Reporting Initiative was launched in 1997. It promotes economic, environmental and social sustainability and produces one of the world's most prevalent standards for sustainability reporting — also known as ecological footprint reporting, environmental social governance (ESG) reporting, triple bottom line (TBL) reporting, and corporate social responsibility (CSR) reporting. It manages to capture sustainability performance in 81 indicators. But Isaksson and Steimle (2009) point out that for companies following the GRI-G3 guidelines in the cement industry, the environmental indicators report both level and progress, but compare neither level nor progress to industry benchmarks. It becomes very difficult to know how a particular company compares with another one. In other words, the guidelines are not sufficient for creating a report that answers the questions of how sustainable a company is and how quickly they are approaching sustainability. Conversely, our dashboard aims at a direct benchmarking which enables an easy comparison between plants as the detailed indicators are designed for a given product for each process.

EFFAS, the European Federation of Financial Analysts Societies, proposes to define Key Performance Indicators (KPIs) for ESG that reflect requirements of economic stakeholders in general and investment professionals in particular by subsector (see KPI for the clothing sector in Annex D).

The international standard ISO 26 000 offers guidance on socially responsible behavior and possible actions. It does not contain requirements and is not certifiable. It emphasizes the integration of responsibility throughout the organization and urges to identify and deal with all stakeholders.

Figure 2. 1 ISO 26000 Schematic Overview

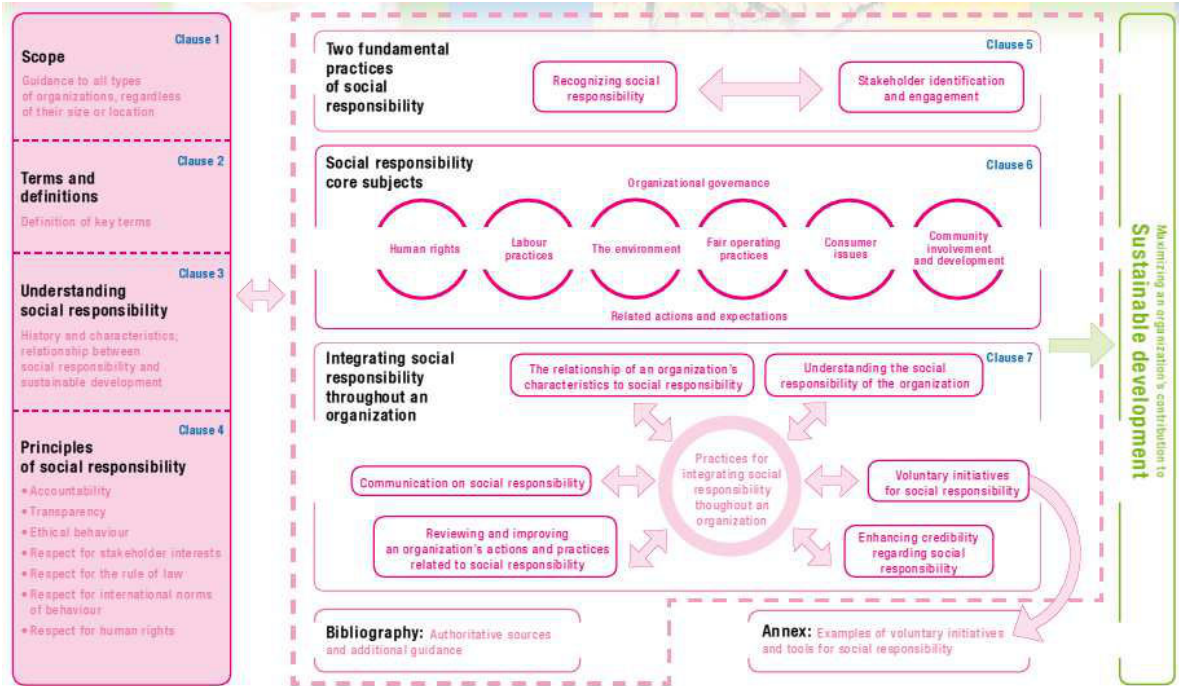

Source: International Organization for Standardization released: 2010 "Guidance on Social Responsibility" <http://www.iso.org>

ISO 26000 / "Guidance on Social Responsibility" was launched in 2010 and is considered as "too complex"¹² for small businesses.

¹²http://www.iso.org/iso/catalogue_detail?csnumber=42546

ISO 14000 deals with environmental management issues and helps firms to minimize the negative impact of processes on the environment (air, water, or land). But it appears to be complex for medium-sized firms and difficult to use to benchmark firms.

The Eco-Management and Audit Scheme (EMAS), the EU's voluntary environmental management instrument, addresses this question. The EU (rule (CE) No 1221/2009) specifies the compulsory data added by EMAS (e.g. emissions of SO₂, NO_x and PM for air pollution). EMAS adds to ISO 14001 stricter requirements on the measurement of environmental performance against set targets according to six environmental core indicators (Energy efficiency, Material efficiency, Water, Waste, Biodiversity and Emissions). This creates multi-annual comparability within and between organizations. In its environmental statement, the organization sets into relation input and output for each indicator, i.e. energy consumption per product produced.

For small firms, two main criticisms are still relevant for these standards. First, these methods are general and fail to focus on the main concerns of the firm. For example the question of air pollution is central today in China and the possibility to be more accurate on this data is not explicitly addressed in the norms where all the indicators have to be collected. Last, all these norms are not specific enough and don't address the question of determining the most critical processes, those for which improvements are mandatory.

2.4. Methodology of dashboard building for the Chinese textile industry

Assessing, monitoring and reporting are part of a "green" strategy. Quantitative pressure/impact measurements are helpful for the decision process. This should encompass all aspects of the firm activity: buying, producing and selling. As Green marketing is considered, the dashboard should take into account the customer requirements and views on the importance of various indicators. Green producing focuses on best practices to improve processes. In the specific context of the Chinese textile industry, this will also fuel the industry desire for comparative evaluations of process performance. Green purchasing is part of Life Cycle Assessment (LCA) strategies. Sustainability concerns pushes to document product origin and purchase specifications. As an example, Wal-Mart reputation, the main worldwide discount retail store, was damaged by consumers NGO campaigns who questioned

its environmental and social impacts¹³. As a response, Wal-Mart created the Sustainability Consortium (TSC) which aims at enforcing sustainability constraints along the whole supply chain. For example, the cotton used by Wal-Mart suppliers has to meet strict quality criteria (see Annex C: cotton specification according to the Sustainability Consortium).

Sustainability management has to consider indicators that have global worldwide impacts, such as greenhouse gas emissions, and local impacts such as quality and quantity of the water used in the process, air quality, etc.

2.4.1. Methodology for building indicators and dashboard

Annex A provides a summary of the important questions to address when one wishes to develop a set of indicators, and outlines a step by step procedure to achieve this purpose. The methodology briefly described there is quite comprehensive, and applies as well to simple as to very complex indicator strategies.

This methodology should not be taken as a rigid framework, but as a set of guidelines. One should decide at each step what is important and what is not for one's specific objectives, and not all steps need to be implemented, but they must all be considered to decide what is central for one's objectives and what can be left aside. The description provided in Appendix A is comprehensive if not detailed. Not all these elements are required in the first stages of the elaboration of an indicator set, and therefore a pragmatic view of what is to be considered and what can be left aside must be adopted; however, one should not lose sight of what has been discarded in future, more mature states of the indicator set.

The second thing to keep in mind is that unless the considered problem is very specific (targeted and focused), one quickly ends up with tens of relevant indicators. This is usually too much for practical use, e.g., to rank policy alternatives. Individual indicators must therefore be aggregated into a limited number of composite indicators, at least to some extent, to reduce the overall number of composite indicators to a few, a dozen at most. However, aggregation results in compensation between aggregated issues, and one must therefore decide what can be aggregated and what cannot. Secondly, one must decide how aggregation is performed. Appendix A does not discuss in detail the various aggregation methods. The most convenient source of information on practical aggregation methods is the OECD

¹³<http://news.sina.com.cn/>

handbook listed in the bibliography. Second, ranking policy alternatives with a number of indicator and various criteria, as well as various stakeholders, is the subject of multi-criteria analysis (MCA in short). AMCA is only briefly discussed here, being a broad and active subject in its own right.

An indicator is a (usually quantitative) measure that may be used to describe or illustrate a complex phenomenon. Indicators are needed for a number of objectives, such as monitoring the state of the environment, decision help (choice between policy alternatives), evaluation of policy and communication to the public. Generally speaking, a decision problem, political or other, involves a number of stages:

1. Identifying objectives
2. Identifying options for achieving the objectives
3. Identifying the criteria to be used to compare the options
4. Analysis of the options
5. Making choices, and
6. Feedback : policy evaluation and communication

Appropriately chosen sets of indicators are useful tools in the 3rd, 4th, 5th, and to some extent 6th stages of this process.

In order to define and chose relevant indicators, a number of questions related to indicator choice and design must be addressed. They bear, e.g., on criteria for indicator selection, on how indicators must be organized, if and to which extent they can/must be aggregated, etc. These issues are discussed here, along with a step by step procedure for (individual or composite) indicator construction.

The literature on indicators methodology is quite large, as well as the existing set of indicators, even if one restricts oneself to environmental issues. We have concentrated on a limited number of sources¹⁴, which are both conceptually detailed and practically oriented. These sources are briefly presented in Appendix A.

¹⁴Handbook on Constructing Composite Indicators – Methodology and User Guide. OECD, 2008.Environmental Indicator Report, EEA 2012.Digest of EEA indicators. EEA Technical Report, 2014.Core Set of Indicators Guide, EEA Technical Report, 2005.Frameworks for Environmental Assessment and Indicators at the EEA. Stanners et al., in Sustainability Indicators: A Scientific Assessment. Kak, Moldan& Dahl, eds. Island Press, 2007.

2.4.2. Characteristics of performance metrics and indicators adapted to the garment industry

Reineck et al (2011) confirm that despite numerous efforts to create a universally valid set of indicators for business companies, there still remains uncertainty about how to identify the relevant key indicators. However, the selected indicators should have some Characteristics defined in table 2.3.

Table 2. 3 Characteristics of performance metrics and indicators adapted to a specific industry

Manageable	Limited to the minimal number required to meet the measurement purpose. At the same time, the organization should be allowed to make the decision on the number and type of indicators to apply
Relevant	Provide useful sustainability information on manufacturing processes. It must fit the purpose of measuring performance and addressing all of the organization's major aspects and objectives.
Measurable	Capable of being quantitatively measured in a phenomenon that is of as sustainability concern and able to measure performance easily and objectively (e.g. use of x% recyclable packaging).
Agreed upon and Meaningful	Agreed between stakeholders and easy to understand by the community, especially, for those who are not experts (e.g. between buyer and supplier)
Reliable	address inputs (leading indicators)and outcomes (lagging indicators) of a process
Cost-Effective Data Access	available or can be gathered when it is necessary from existing sources or otherwise easily collected
Time based	Including a time frame for achievement

Source: Adapted from Feng et al. (2010) and Reineck et al (2011)

We decided to incorporate local impact indicators in our dashboard; such indicators are informed through expert assessment. More generally, we provide, in association with some indicators values, two complementary types of information: the “local impact factor” and the “firm sustainability risk”.

The “local impact factor” evaluates the environmental impact as low, medium or high. For example, let us consider the production of cotton, the same volume of water per kilogram of cotton produced could be of great concern if there is water shortage in the production region. In China, there was a rapid development of China's textile and garment industry between 1987 and 2010. Soothe national average annual growth rate is about 17.23%. But there is a big gap between the provinces and cities nationwide on the index of increase rate and shares of gross products. For example, Zhejiang Province, Guangdong Province, Jiangsu Province and Shandong Province, on the East coast of China, with more water available and a larger population, account for nearly the half of the production, whereas Tibet, Qinghai, Guizhou, Yunnan and other provinces, whose industrial development is very low and light industry little present, constitute just 15%¹⁵.

The “firm sustainability risk” estimates induced risk for the firm. It describes the major possible impact of the indicator on the firm’s activity. It could be, for example, a decrease in consumer’s confidence, the risk of losing a “green” label, or a conflict with major stakeholders. It could also relate to possible interruption of the firm’s activity depending on local authorities, for example if the garment plant is located in a town where the sharp increase of population and industry can lead to severe water shortages. These critical points have to be estimated by the CEO, experts and stakeholders.

2.4.3. A straightforward way to communicate with stakeholders

A firm is an element of the whole community. The corporation was first established by charter granted by a monarch or passed by a parliament with limited liability distinct from those of its members. In that way, the investor as a person evades direct community control. The firm as an institution pushes investors to take greater risk.

But as the corporation is embedded in the physical world, stakeholders ask the firm to be responsible for the social and environmental damage coming from processes and products. The expansion of tensions is the result of increasing frictions between communities, firms and financial pressures to reduce costs of processes. For those reasons, success in today’s economy is about developing new and innovative relationships with stakeholders. On the one

¹⁵WU Aizhi, LI Guoping et.al. Location shift of textile and garment industry in China. Geographical science progress, February 2013, p 32-46.

hand, the firm induces some stakeholder's behaviors. On the other hand, the stakeholders can contribute to the success of the firm when they feel comfortable with the firm practices.

Many stakeholders have to be considered. Their importance varies depending on countries, industries, management styles. In China, in most cases, stakeholders can be categorized as follows: shareholders/investors, customers, community, employees, NGO NPO, government, banks and other creditors, suppliers, advertisers, officers, unions, competitors, local and national governments, regulators, the media, public interest groups, political parties, religious and military groups of pressure. The most important internal stakeholders for small firms in the garment industry are: Stockholders, Board members, Employees, and the most important external stakeholders are: Customers, Government, Communities, Suppliers, and Creditors. We can draw a chart to show what these stakeholders brings to a company:

Figure 2. 2 Links of main actual stakeholders with a company



Source: <http://baike.haosou.com/doc/6413535-6627204.html>; Towards a More Holistic Stakeholder Analysis Approach-Mapping Known and Undiscovered Stakeholders from Social Media, Kristina Sedereviciute, Chiara Valentini, 2011

2.4.4. The Territorial Responsibility

The cultural aspect of some indicators is an important issue. Let us consider Water and Air as examples. Water and air can be considered as a common good. The decline of many civilizations was linked to water shortage, as in the case of Sumer.

The globalization and the need for application of the subsidiarity principle induce new thinking of Corporate Social Responsibility. The classical dashboard approach should take into account, not only the company interacting with its stakeholders and the accounting of direct social and environmental impacts, but also the Territorial Social Responsibility as the impact depends on the relative importance of factors and the accounting of all aspects along the supply chain and the life cycle assessment. Territorial Social Responsibility is known by people for CSR as a fragile concept if conceived only at the organizational level or driven only by leadership will. Many writers deal with aspects of social responsibility, but most deal with it as a kind of organizational and voluntary initiative. Few address the wider policy agenda. The contributors to Territories of Social Responsibility-researchers and practitioners from four continents - all participated in an international workshop coordinated by Patricia Ashley as part of her role as Chair in Development and Equity at the International Institute of Social Studies. They form a policy network contributing to studies on the concept of a multi-actor, multilevel and territorial approach to social responsibility and governance, oriented towards global, regional or local development and equity goals.¹⁶

An important concern is the cultural aspect of some indicators. Let us consider Water and air as two examples. Water and air can be considered as a common good¹⁷. The decline of many civilizations was linked to water shortage as in the case of Sumer's civilization¹⁸.

Complementary to the basic need for fresh water and pure air for each human being, there is a cultural aspect which is of great importance. The concern of drinking water and breathing pure air in China is both technical and cultural. China Environmental Monitoring Station will regularly publish reports of environmental quality, including air quality, water quality and environmental reporting. According to this report, during the whole 2014 year in China, national urban ambient air quality situation was grim, for only 4.1% among the 74 cities monitored ambient up to air quality standards, which are not yet very stringent. The ecological and environmental protection situation remains grim. And according to the 2014 National Surface Water Quality Monthly (January) monitoring report, the major rivers show

¹⁶Patricia Ashley , David Crowther, Territories of Social Responsibility: Opening the Research and Policy Agenda, Gower Publishing Ltd; New edition (2012)

¹⁷ElinorOstrom, Governing the Commons, the Evolution of Institutions for Collective Action, Cambridge University Press (1990).

¹⁸ Jared Diamond, Collapse, how Societies Choose to Fail or Succeed. Penguin Books, revised edition (2011).

light pollution while part of important lakes and reservoirs are heavily polluted. This situation is not bright.

The main challenge for firms is the availability, use and depletion of natural resources. Among them, water and air are crucial concerns in China as Chen and Huang (2010) underlined “China’s demand for natural resources like fresh water will continue to surge. On the other hand, the security level of these resources and the environmental carrying capability are in decline as the economic expansion is still in an upswing. China will inevitably face increasing resource and environmental pressures in the future, which will raise the requirements for energy conservation and emissions reductions as well.”

One of today’s main territorial issues in China is air pollution. Shanghai and Beijing first measurement of air quality index started in 2012. Every day, the Environmental Protection Department publishes the monitoring value of PM2.5. The description of the Air Quality Index in China is described in Annex B.

2.5. A case study: building a dashboard for a garment plant in China

The choice of indicators should depend on the availability of data and simplicity of analysis (Azapagic and Pergan, 2010). An approach is designed to be modular to allow gradual implementation of the framework. For instance, a company could start with the environmental indicators module and gradually introduce the other two modules, i.e. economic and social. Dreyer et al. (2005) addressed this issue by suggesting obligatory and optional components. According to Hutchins (2008), the first question that must be addressed in assessing the sustainability of a corporation is which impacts or indicators should be considered.

In this case study, we define and validate a KPI framework through a two stage process. First, after presenting sustainability concerns at different levels (the world, China, the garment industry) made by a research team in management and industrial ecology of Grenoble University and sustainable development at Shanghai University, we define the targeted indicators in collaboration with the CEO and the management team of the plant, keeping in mind the methodological guidelines described earlier. Then, we decide how we can simplify the indicators to get relevant data within a single year. The idea is to improve gradually in the future on the quality and complexity of the chosen set of indicators.

In the data collection process, the repeated exchange and communication with the CEO and the management team of the plant is essential. This part of the work is very simple at the operational level, and relies on surveys and interviews using a questionnaire and recording the exchange. The careful design of the questionnaire and the analysis of the answers are clearly the key points in this method. Our questionnaire includes questions on basic quantities and outputs, such as “How many square meters of materials have you weaved in 2012?” (Annex E presents this questionnaire in full). The main drawbacks of this approach is its lack of adaptability and the difficulty to perform an in-depth qualitative survey, a possible lack of sincerity in the answers, and a possible low response rate, which all induce a low overall efficiency. In order to ensure a high response rate to the questionnaire, we use interview survey as a data supplement method, getting a wider range of data through a detailed conversation.

To make up for the shortcomings of the above two methods and to get more detailed economic data of the industry, we also use information and documentation collection method. The main work of this method is to search various information, documents or other legal reporting obligations inasmuch as possible, including China's existing industry analysis reports, statistical yearbooks, annual reports and other data reporting data. Important Chinese statistical economic data come from "China Statistical Yearbook", "Apparel industry analysis report", "Industrial Economic Statistical Yearbook" and so on. A special effort has been devoted to this data collection work.

The main difficulty is to collect precise information concerning technical aspects and the various operations involved in the production process. In China, basic tasks are relatively simple, thus relatively easy to implement. The main contents of the second term is to work from design, procurement to manage the entire process of producing the finished product, while including logistics storage, cost, and quality of relevant content. But this is not ideal and most enterprises only have a breakthrough in the application inventory and other electronic books, while the real value of the production information systems, namely in terms of cost, quality, delivery and promotion still fall short of expectations. This creates a certain degree of negative impact on the data collection of this article. To fix this, we use the three methods mentioned above for cross-use, continue to use and continue inspection.

Our work focuses on a suit making plant but we also take into account part of the supply chain through integration of two processes from suppliers: weaving and printing. In this preliminary work, it is not possible to track the supply chain all the way to cotton sellers because the suppliers do not have relevant data. The plants are LUTHAI TEXTILE CO., LTD, Zhe Jiang JINGMENG Suit Co., LTD and Tai Cang JINJIA Bleaching And Dyeing CO.,LTD. Among them, LUTHAI TEXTILE CO., LTD is one of the biggest high-end, dyed fabrics production plants that integrate weaving, dyeing, and finishing as one set. Its annual output is about 65 million meters of fabric dyeing and production equipments are more than 500 pieces (sets), which are exported to Switzerland, Germany, Japan, Italy and other developed countries. Zhe Jiang JINGMENG Suit Co., LTD, taking "Quality is the life, service is the soul" as its business philosophy, aims to improve quality services to meet the needs of the market. It is a design, development, production and sales of the apparel business plant and the only designated suit manufacturing partners of the Shanghai Baromon Group. Tai Cang JINJIA Bleaching And Dyeing CO., LTD has a retreat, boiling, bleaching, pretreatment production line and its daily production amounts to 60,000 meters. It provides customers with high-quality non-iron cotton soft, elastic, polyester, cotton and other plain, twill, jacquard fabrics, etc.

2.5.1. Detailed assessment of the production process by product

The sustainable development requirements for a firm include the management of all the processes with environmental and issues in mind, by setting specific goals, planning the steps and schedule to reach these goals and motivating all firm members and stakeholders. In principle, the scope of integration of the KPI should encompass the whole supply chain. This includes the making of the material inputs of the various industrial processes, and aims not only at operative processes but also support processes (Purchasing, Financing, Servicing personnel, improving performance, and controlling performance). For these support processes, accounting for the cost of each KPI is necessary to affect the operative support contribution to the making of one unit of production.

We illustrate our method by focusing on a single product, namely high quality suits. Ultimately, the plant manager will have to build the final dashboard including all KPI for all type of products along the same lines. The complete line of products produced in this plant

includes suits of the best quality with special material, suits with ordinary material, suits with cotton, jackets of the best quality, trousers of the best quality, trousers of ordinary quality.

At the process level, the manager can reduce the firm environmental impacts through technological improvement, process reorganization, selection of environmental-friendly primary materials, and product end of life and recycling consideration. The objective here is to focus on the processes themselves in this broad list of options. To achieve this, one has to select a very small number of indicators that can easily be grasped by managers and stakeholders.

As we want to inform water consumption at the process level, the chosen indicators are in effect more detailed than the GRI framework, which considers the overall water consumption at the plant level. Proceeding in this way instead allows the CEO to analyze and address the discrepancy between its consumption and the best world-wide practices for each process. For illustration purposes Table 2.4 presents part of the Excel sheet used for data collection at the process level by local managers at JINGMENG Suit Co., LTD.

[Insert Table 2.4 about here]

2.5.2. The choice of Indicators at the plant level

The choice of Environmental Key Performance Indicators in the garment industry has been constructed through a discussion with the stakeholders about what matters to them. For practical purposes we decide not to limit the scope of possible indicators beforehand. From interviews, the following indicators emerge with varying levels of importance (ranked from 1 to 5) depending on stakeholder’s views, as shown on table 2.5.

[Insert Table 2.5 about here]

In consideration of industrial secrets, some data remain confidential and are not detailed above. For our dashboard, we have selected environmental, social and economic criteria. Environmental criteria cover water, “emissions effluent and waste” and energy.

Table 2. 4data collection required at the process level by local managers at JINGMENG Suit Co., LTD

Unit	Cubic meter/ 1000 products						
DEFINITION	The sum of all water drawn from all sources (including surface water, ground water, rainwater, and municipal water supply) in cubic meter /1000 suit						
Sustainability risk*							
* stress-test of major possible impact of this sustainable indicator (consumer confidence, loosing label, conflict with major stakeholders ...)							
** value with the best practice or technology. BPV source explains if it is a national value, an other firm practice or the use of a new machine							
*** (High, Medium, Low) according to the importance of the impacts of the KPI depending on the surrounding of the firm							
Who and Where				Value	Best Practice	BPV source **	Local impact
Process	Process type	Localisation	sub-processes	Value	Best practice value**	BPV source **	Impact factor***
Buy Materials	Internal		transport to plant	0	0		Low
Buy Materials	Internal	Wenzhou	storage	0	0		Low
Buy Materials	Internal	Wenzhou	transport to next process	0	0		Low
Cut	Internal	Wenzhou	Stress material	66,4	66,4	German machines	Low
Cut	Internal	Wenzhou	cut	0	0		Low
Cut	Internal	Wenzhou	store cut pieces	0	0		Low
Cut	Internal	Wenzhou	transport to next process	0	0		Low
Sew	Internal	Wenzhou	sew	0	0		Low
Sew	Internal	Wenzhou	iron	2	2		Low
Sew	Internal	Wenzhou	transport	0	0		Low
Quality control	Internal	Wenzhou	contrôle	0	0		Low
Quality control	Internal	Wenzhou	store product	2	2	German machines	Low
Sale	Internal	Wenzhou	wrap	0	0		Low
Sale	Internal	Wenzhou	send to client	0	0		Low
TOTAL				70,4	70,4		

Table 2. 5 ranking of indicators for various stakeholders of JINGMENG Suit Co., LTD's

	CEO	Stock-	Customers	Employees	National	Local
Water					5	3
Water			3		4	4
Carbon			5		3	
Air pollution	2		2	3	1	1
Energy	4	2			2	
Workinghours			4	2		2
Labour wages				1		5
Safety				4		
Quality	1	4	1	5		
Net margin	3	1				
Production	5	3				

KPI Group	Environment				
KPI cluster	Water	Emissions, Effluences, and Waste			Energy
KPI	Water consumption	Water pollution	Carbon emission	Air pollution	Energy
unit	Cubic meter		kg eq. carbon	kg eq. coal	kwh
value	13 939	no	830190	1 231679	8 121340

For water consumption, table 2.6 compares our dashboard with the required KPI for UN indicators and GRI.

Table 2. 6 The dashboard's definition of "Water consumption" compared with UN and GRI Indicators

Reference	Norm	Definition
Our Dashboard		The sum of all water drawn from all sources (including surface water, ground water, rainwater, and municipal water supply) in cubic meter / product
United Nations Indicator of Sustainable Development		Annual Withdrawals of Ground and Surface Water as a Percent of Total Renewable Water
Global Reporting Initiative (GRI)	EN8	Total water withdrawal by source. according to the following resources: a) surface water, including water in rivers, lakes and wetland; b) groundwater; c) rain water collected directly and stored by the organization; d) waste water from some organization and e) water supplies from water distribution system or other public water supply service.
	EN9	Water sources significantly affected by withdrawal of water
	EN10	Percentage and total volume of water recycled and reused.

Producing a single aggregated indicator for water pollution is made difficult by the great number of chemical pollutants and the legislation of each country. We follow the method proposed by Chapagain (2008) where the indicator quantifies the volume of water necessary to dilute pollutants to comply to limit concentrations defined by regulations. Furthermore, it is useful to produce a scale of water pollution depending on the actual dilution factor. However, such an analysis of the quality of the discharged water is not yet possible, although this would allow us to compare with the average values given by Chapagain (above) for cotton textile where BOD is the biological oxygen demand, and COD is the chemical oxygen demand, and TSS is the total suspended solids and TDS the total dissolved solids in the effluent.

For water pollution, table 2.7 compares our dashboard with the required KPI for UN indicators and GRI.

Table 2. 7The dashboard’s definition of “Water pollution” compared with UN and GRI Indicators

Reference	norm	Definition
Our Dashboard		Minimum water necessary to reach the required dilution of pollutants + effective scale of pollutant dilution
Global Reporting Initiative (GRI)	EN 21	Total water discharge by quality and destination.
	EN 25	Identity, size, protected status, and biodiversity value of water bodies and related habitats significantly affected by the reporting organization's discharges of water and runoff.

For carbon emission, we start from the energy used to produce 1000 suits at the process level in term of gas, oil, coal electricity as described in table 2.8.

Table 2. 8Energy (gas, oil, coal electricity) to produce 1000 units

Process	Localisation	sub-processes	gas	oil	coal	electricity
			cubic meter	ton	ton	kWh
Buy Materials		transport to plant				
Buy Materials	Wenzhou	storage				
Buy Materials	Wenzhou	transport to next process				
Cut	Wenzhou	Stress material			2,45	336
Cut	Wenzhou	cut				
Cut	Wenzhou	store cut pieces				
Cut	Wenzhou	transport to next process				
Sew	Wenzhou	sew			2,69	2790
Sew	Wenzhou	iron				
Sew	Wenzhou	transport				
Quality control	Wenzhou	contrôle			0,05	67
Quality control	Wenzhou	store product				
Sale	Wenzhou	wrap			0,02	67
Sale	Wenzhou	send to client				

Greenhouse gas emissions are a global environmental risk. Table 2.9 compares our dashboard with the required KPI for UN indicators and GRI.

Table 2. 9 The dashboard's definition of "Carbon Emission" compared with UN and GRI Indicators

Reference	norm	Definition
Our Dashboard		Total direct and indirect greenhouse gas emissions by weight including at least emissions of CO ₂ , CH ₄ , HFCs, PFCs and SF ₆ , expressed in ton of CO ₂
United Nations Indicator of Sustainable Development		Annual Emission of Greenhouse Gases
Global Reporting Initiative (GRI)	EN16	Total direct and indirect greenhouse gas emissions by weight. including at least emissions of CO ₂ , CH ₄ , HFCs, PFCs and SF ₆ , expressed in <i>tones of CO₂ equivalent</i> . including: generation of electricity, heat or steam; b) other combustion processes, like burning; c) physical or chemical processing; d) transportation of materials, products and waste; e) conveyance of combustion gases (out gassing) and f) volatile emissions.
	EN17	Other relevant indirect greenhouse gas emissions by weight
	EN18	Initiatives to reduce greenhouse gas emissions and reductions achieved

We convert direct use of energy into kg of equivalent carbon.

Table 2. 10emission factors (in kg Carbon equivalent) for gas, oil, coal and electricity used in China

Fuel	kg C eq. / kWh	kg C eq. / kg
Coal	0.093	0.674
Oil	0.072	0.836
Gas	0.056	0.771
Electricity	0.209	

Source: Base Carbone, Ademe

For carbon emission, we consider in the first step direct carbon emission through the energy used by the plant. In a second step the plant will calculate indirect carbon emission from all main purchased elements (amortization of plant construction, purchases).

For air pollution, we start from the energy use to produce 1000 suits at the process level in term of gas, oil, coal electricity as described in table 9. We calculate the equivalent pollution in PM10. That is to say the number of kg of coal burnt will bring the same amount of PM10.

Air pollution is today the major concern in China. The Chinese Academy of Environmental Planning reports that the cost of environmental degradation in China in 2010 was 3.5 percent of the GDP, three times that of 2004. Zhong Nanshan, the president of the China Medical Association, warned in 2012 that air pollution could become the biggest health threat in the country. PM2.5 (Particulate Matter smaller than 2.5 micrometers) was the main concern in early 2013 in Beijing. In most other countries PM10 is the standard. Table 2.11 compares our dashboard with the required KPI for UN indicators and GRI.

Table 2. 11The dashboard’s definition of “Air Pollution” compared with UN and GRI Indicators

Reference	norm	Definition
Our Dashboard		Pollution in Particulate Matters (PM) express in ton of coal pollution equivalent per unit of product
United Nations Indicator of Sustainable Development		Ambient Concentration of Air Pollutants in Urban Area
Global Reporting Initiative (GRI)	EN19	Emissions of ozone-depleting substances by weight
	EN20	NO, SO, and other significant air emissions by type and weight. NO x, SO x, Persistent organic pollutants (POP); Volatile organic compounds, Particulate Matters (PM).

In 2010, about 77% of the electricity in China was produced with coal, other fossil fuels accounting for less than 2% (source: IEA). Based on the emission factors of coal and electricity presented in table 10, we deduce that about 2.25 kWh of Coal are used when 1 kWh of electricity is consumed. Note that, based on these numbers, the average yield of Chinese coal power plants is about 34%.

Note that the emissions depend not only on the type of fuel, but also for a large part on the type of installation (quality of combustion, presence of filters etc.).

We deduce the pollution in equivalent kg of coal in table 2.12.

Table 2. 12 particular pollution (in kg equivalent of coal) for gas, oil, coal and electricity used in the plant

Energy	kg coaleq.
1 kWh of gaz	0,002
1 kWh of oil	0,043
1 kWh of coal	0.138
1 kWh of electricity	0.310

We propose in annex B a more complex indicator for air pollution.

Energy, as a key concern, is highly correlated with Gross Domestic Product and constitutes one of the main future challenges in terms of scarcity. To evaluate energy consumption at the plant level, we convert all energy into kWh in table 2.13.

Table 2. 13 Energy (in kWh) for gas, oil, coal and electricity

Energy	kWh
1 L of gas (liquid state)	9.0
1 m3 of gas (gas state)	11.0
1 kg of gas	13.8
1 L of oil	10.5
1 kg of oil	11.6
1 kg of coal	7.2
1 kWh of electricity	1

Table 2.14 compares our energy dashboard with the required KPI for UN indicators and GRI.

Table 2. 14 the dashboard’s definition of “Energy” compared with UN and GRI Indicators

Reference	Norm	Definition
Our Dashboard		direct and indirect energy used in kWh per unit of

		product
Global Reporting Initiative (GRI)	EN3	Direct energy consumption by primary energy source.
	EN4	Indirect energy consumption by primary source
	EN5	Energy saved due to conservation and efficiency improvements
	EN6	Initiatives to provide energy-efficient or renewable energy based products and services, and reductions in energy requirements as a result of these initiatives.
	EN7	Initiatives to reduce indirect energy consumption and reductions achieved

On the social front, we have selected two social themes: employment and “health and safety”.

KPI Group	Social		
KPI cluster	Employment		Health and safety
KPI	working hours	Labor wages	Safety ratio
Unit	Hours	Yuan/hour	Accident rate
Value	1 320 000	confidential	0

Working hours is the total number of working hours for one unit of product (including indirect supporting working hours of managers). Labor wages is the total wages in Yuan for one unit of product (including indirect supporting costs). Table 2.15 compares our dashboard with the required KPI for UN indicators and GRI.

Table 2. 15 the dashboard’s definition of “Safety Ratio” compared with UN and GRI Indicators

Reference	Norm	Definition
Our Dashboard		Number of injuries and diseases caused by the working tasks to produce 1 suit (or proportion of workers who quit because of diseases)
Global Reporting Initiative (GRI)	PR1	Life cycle stages in which health and safety impacts of products and services are assessed for improvement, and percentage of significant products and services categories subject to such procedures
	PR2	Total number of incidents of non-compliance with regulations and voluntary codes concerning health and safety impacts of products and services during their life cycle, by type of outcomes

On the economic front, we have selected two criteria: consumer satisfaction and yield.

KPI Group	Economic		
KPI cluster	Consumer satisfaction	Yield	
KPI	Quality	Net margin	Production
unit	Level	Yuan	number
value	90%	Confidential	198 000

Net margin is the benefit and production is the total number of units produced in one year.

Table 2.16 compares our dashboard with the required KPI for UN indicators and GRI.

Table 2. 16the dashboard’s definition of “Quality” compared with UN and GRI Indicators

Reference	Norm	Definition
Our Dashboard		Consumer satisfaction: quality of the production (percentage of no default suits)
Global Reporting Initiative (GRI)	PR3	Type of product and service information required by procedures, and percentage of significant products

Initiative (GRI)		and services subject to such information requirements.
	PR4	Total number of incidents of non-compliance with regulations and voluntary codes concerning product and service information and labeling, by type of outcomes.

2.5.3. Integrating data from the supply chain

Cuthbertson and Piotrowicz (2008) have found from their studies that current performance approaches do not generally include social and environmental aspects and are concentrated on economic aspects, therefore missing sustainability objectives. But with the growing environmental concerns, organizations have been redefining their supply chain evaluation process by taking such criteria into account. For example, Olugu et al. (2011) have developed green supply chain KPI set in the automobile industry for both forward and backward chains. This is also the case for Small and Medium scale Enterprises (Thakkar et al., 2009) where measures for green supply chains are proposed (Hervani et al., 2005). Bai et al. (2012) have introduced ecological and social sustainability measures to help to obtain broader corporate social responsibility and a general sustainability perspective on the supply chain.

Table 2.17 presents the Global dashboard for the production of 198 000 suits at JINGMENG Suit Co., LTD integrating part of the supply-chain (weave and print).

Table 2. 17 Global dashboard for JINGMENG Suit Co.,LTD and part of the supply-chain (weave and print)

PRODUCT :	Suit	SUSTAINABILITY DASHBOARD									
PROCESS :	All processes										
Yearly Production	198 000	KPI FOR ANNUAL SUIT PRODUCTION									
KPI Group	Environment					Social			Economic		
KPI cluster	WATER	EMISSIONS, EFFLUENTS, AND WASTE				Energy	Employment		Health and safety	Consumer satisfaction	Yield
KPI	Water consumption	Water discharge	Carbon emission	Air pollution	Energy	working hours	Labor wages	Safety ratio	Quality	Net margin	Production
Unit	cubic meter	cubic meter	kg eq. C	eq. kg of coal	eq. kWh	hours	-	0	Level *****	Yuan	number / year
plant 1 - Zibo - weave	6 627	6 627	33 012	28 667	339 821	41 174	-	-			
plant 2 - Print - Taicang	2 376	2 257	368 594	279 873	4 951 705	21 384	-	0,06			
plant 3 - Suit -Wenzhou	13 939	-	830 190	1 231 679	8 121 340	1 320 000	-	-	90%		198 000
total	22 942	8 884	1 231 796	1 540 219	13 412 867	1 382 558	-	-			
for one suit	0,12	0,04	6,22	7,78	67,74	6,98					

To get the relevant data, we have sent a form (shown in Appendix F) to the suppliers that allow us to calculate average values of the various indicators for one square meter of tissue.

The overall result of this analysis demonstrates that the production of each suit needs 120 liters of water, rejects 4 liters of polluted water, emits as many PM10 as 6 kg of coal and 6 kg equivalent carbon of greenhouse gas, and needs 70 kWh of energy and 7 hours of work.

2.6. Conclusion

This dashboard is the first attempt towards building a global view on the impact of production in the garment industry in China at the level of individual production firms. It gives insight on the impacts of the processes from a triple angle: economic, social and ecological. Stakeholders were involved from the start in the selection of relevant Key Performance Indicators. Four directions of using this dashboard can be underlined.

Firstly, it is an efficient decision-making tool with respect to future investments strategy. Which lines of actions are the most critical in the near future: renewing and improving machine tools efficiency? Saving alternative energy instead? Shifting from coal to gas? Challenging their suppliers for greener products at higher cost? Improving working conditions? Increasing water consumption efficiency and/or decreasing water pollution?

Secondly, this dashboard can help benchmarking different plants and promote best practices through their quantitative impacts. This is the concern for stockholders and stakeholders who want to limit ecological impacts.

Thirdly, this dashboard will help challenging suppliers to improve ecological impacts, control the whole supply chain and create a “green label” for the garment industry.

Lastly, should the CCPCC decide to enforce new constraints, mainly ecological, on water and air quality, one possibility would be imposing the industry’s creation of a national data center that could manage the annual data of all plants and all types of products for the garment industry. As a result, China will continue to accelerate the pace of information gathering, organization and dissemination. Garment enterprises will be more effective in evaluating and forecasting the industrial prospect in order to cope with the uncertainty of the global economy. What’s more, this research method sets up a good example to inspire other industrial sectors to improve economic development and help them achieve sustainable development goals.

Bibliography of Chapter 2

Ashley, P., & Crowther, D. (2012). *Territories of social responsibility: opening the research and policy agenda*. United Kingdom: Gower Publishing Ltd.

Azapagic, A., & Perdan, S. (2010). Indicators of sustainable development for industry: a general framework. *Process Safety and Environmental Protection*, 78 (4), 243–261.

Bai, C. G., Sarkis J., Wei, X. P., & Koh, L. (2012). Evaluating ecological sustainable performance measures for supply chain management. *Supply Chain Management: An International Journal*, 17 (1), 78 – 92.

Chapagain, A. K., Hoekstra, A. Y., Savenije, H. G. & Gautam, R. (2006). The water footprint of cotton consumption: an assessment of the impact of worldwide consumption of cotton products on the water resources in the cotton producing countries. *Ecological Economics*, 60 (1), 186-203.

Chen, J., & Huang, H. (2010). How much has China achieved in the first three years of its 11th Five-Year Plan? *China Economist*, 5(2), 132-143.

Cuthbertson, R., & Piotrowicz, W. (2008). Supply chain best practices – identification and categorization of measures and benefits. *International Journal of Productivity and Performance Management*, 57 (5), 389-404.

Diamond, J. (2011). *Collapse: how Societies Choose to Fail or Succeed*. United Kingdom: Penguin Books.

Dreyer, L. C., Hauschild, M. Z., & Schierbeck, J. (2005). A framework for social life cycle impact assessment. *International Journal of Life Cycle Assessment*, 11(2), 87–97.

Drucker, P. F. (1955). *Practice of Management*. London: William Heinemann Ltd.

Feng, S. C., Joung, C., & Li, G. (2010). Development overview of sustainable manufacturing metrics. *Proceedings of the 17th CIRP international conference on life cycle engineering*, 6-12.

Hahn, R. (2012). ISO 26000 and the standardization of strategic management processes for sustainability and corporate social responsibility. *Business Strategy and the Environment*, 22 (7), 442-455.

- Hervani, A. A., Helms, M. M. & Sarkis, J. (2005). Performance measurement for green supply chain management. *Benchmarking: An International Journal*, 12 (4). 330-53.
- Hu, J. T. (2012). Firmly march on the path of socialism with Chinese characteristics and strive to complete the building of a moderately prosperous society in all respects. Hu Jintao's report delivered at the 18th National Congress of the Communist Party of China (CPC) on Nov. 8, 2012.
- Hutchins, M. J., & Sutherland, J. W. (2008). An exploration of measures of social sustainability and their application to supply chain decisions. *Journal of Cleaner Production*, 16 (2008), 1688–1698.
- Isaksson, R., & Steimle, U. (2009). What does GRI-reporting tell us about corporate sustainability?. *The TQM Journal*, 21 (2), 168 – 181.
- Jeurissen, R., & Elkington R. (2000). Cannibals with forks: the triple bottom line of 21st century business. *Journal of Business Ethics*, 23 (2), 229-231.
- Ji, J. H. (2012). Analysis of several problems exist in the development of green accounting of the current. *Research of Finance and Accounting* 16, 27-29.
- Kaplan, R. S. (2003). Building strategy-focused organizations with the balanced scorecard. *Faculty seminar series: Great ideas from business thought leader*, 22-23
- Kaplan, R. S. & Norton (1996). *The balanced scorecard*. Technometrics, 40 (3).16-17
- Kaplan R. S. & Norton D. P. (2004). *Strategy maps*. Boston: Harvard Business School Press
- Lin, C. L., Su, T. S., Ho, L. H., & Chang, J. P. (2009). A comparative analysis ISO 14000 performance in Taiwan and China. *Journal of Statistics and Management Systems*, 12 (2), 341-369.
- McAdam, R., & O'Neill, E. (1999). Taking a critical perspective to the European business excellence model using a balanced scorecard approach: a case study in the service sector. *Managing Service Quality*, 9(3), 191-197.
- Niven, P., & Hu, Y. (2009). *The balanced scorecard practical guide*. Beijing: China Financial and Economic Publishing House.
- Pastranaa, N.A., & Sriramesh, K. (2014). Corporate social responsibility: perceptions and practices among SMEs in Colombia. *Public Relations Review*, 40 (1), 14– 24.

- Olugu, E.U., Wong, K.Y. & Shaharoun, A.M. (2011). Development of key performance measures for the automobile green supply chain. *Resources, Conservation and Recycling*, 55 (6), 567-79.
- Ostrom, E. (1990). *Governing the Commons, the Evolution of Institutions for Collective Action*. New York: Cambridge University Press
- Perry, P., & Towers, N. (2009). Determining the antecedents for a strategy of corporate social responsibility by small- and medium-sized enterprises in the UK fashion apparel industry. *Journal of Retailing and Consumer Services*, 16 (5), 377–385.
- Reineck, M., Poltermann, J., Michael, M. & Pelzeter, A. (2011). Measuring corporate sustainable development in facilities management with key performance indicators. *International Journal of Sustainable Development*, 2 (10), 69-76.
- Sedera, W., Gable, G., Rosemann M. & Smyth, R. (2004). A success model for Business process modeling: Findings from multiple case study, Eighth Pacific Asia Conference on Information Systems, Shanghai, China.
- Sedereviciute, K., & Valentini, C. (2011). Towards a more holistic stakeholder analysis approach-mapping known and undiscovered stakeholders from social media. *International Journal of Strategic Communication*, 5 (4). 221-239.
- Sully, R. (2012). ISO 26000: the business guide to the new standard on social responsibility. *Impact Assessment and Project Appraisal*, 30 (3), 214-215.
- Thakkar, J., Kanda, A. & Deshmukh, S.G. (2009). Supply chain performance measurement framework for small and medium scale enterprises. *Benchmarking: An International Journal*, 16 (5), 702-23.
- Wu, A.Z., & Li, G.P. (2013). Location shift of textile and garment industry in China. *China: Geographical Science Progress*.
- European Economic Association. (2014). *Environmental Indicator Report, Digest of EEA indicators*. Strasbourg
- European Economic Association. (2005). *Core Set of Indicators Guide*. Strasbourg
- European Economic Association. (2007). *Frameworks for Environmental Assessment and Indicators at the EEA*. Strasbourg: Stanners

Kak, Moldan & Dahl. (2007). Sustainability Indicators: A Scientific Assessment. Washington: Island Press

Organization for Economic Co-operation and Development. (2011). Guidelines for Multinational Enterprises. Paris

Organization for Economic Co-operation and Development. (2008). Handbook on Constructing Composite Indicators – Methodology and User Guide. Paris

Economic, U. N. D. O. (2001). Indicators of sustainable development: guidelines and methodologies. United Nations, Division for Sustainable Development, Department of Policy Coordination and Sustainable Development.

China will introduce air and water pollution prevention plan of action, Reuters, <http://www.ditan360.com/TanSuo/Info-129097.html>, May 13, 2013.

Ground water pollution control needs action, Chinese consumers newspaper, <http://info.water.hc360.com/2013/05/140850412161.shtml>, May 15, 2013.

ISO 26000: 2010, Guidance on social responsibility (2014). http://www.iso.org/iso/catalogue_detail?csnumber=42546, June 6, 2014.

MEP: 88 companies in North are fined 6.13 million Yuan for illegal sewage, People Net. <http://politics.people.com.cn/n/2013/0509/c1001-21427066.html>, May 9, 2013.

Participation volontaire des organisations à un système communautaire de management environnemental et d'audit (EMAS). abrogeant le règlement (CE) no 761/2001 et les décisions de la Commission 2001/681/CE et 2006/193/CE, RÈGLEMENT (CE) No 1221/2009 DU PARLEMENT EUROPÉEN ET DU CONSEIL du 25 novembre 2009.

Sell "expensive" green products, Business Week. <http://finance.sina.com.cn/leadership/mroll/20150306/180621664132.shtml>, March 6, 2015

Annex A of Chapter 2: Indicator Methodology

The literature on indicators methodology is quite large, as well as the existing set of indicators, even if one restricts oneself to environmental issues. This Appendix is not designed as an extended review of this field. Instead, it draws on a limited number of sources which are both conceptually detailed and practically oriented as well as reasonably comprehensive for the purpose of designing and building indicator sets for all sorts of purposes. The first OECD handbook on Constructing Composite Indicators has been frequently cited in the writing of this Appendix, and is further used as a source of additional information on methodology aspects that are not addressed here, such as aggregation methods. The EEA (European Environment Agency) references have been used mostly as a source of information on the Pressure-State-Response framework, as well as a source for the discussion of indicator quality. The last reference describes an interesting example of composite Well-Being indicator along with the methodology that has been applied in its construction.

- Handbook on Constructing Composite Indicators – Methodology and User Guide. OECD, 2008.
- Environmental Indicator Report, EEA 2012.
- Digest of EEA indicators. EEA Technical Report, 2014.
- Core Set of Indicators Guide, EEA Technical Report, 2005.
- Frameworks for Environmental Assessment and Indicators at the EEA. Stanners *et al.*, in *Sustainability Indicators: A Scientific Assessment*. Kak, Moldan & Dahl, eds. Island Press, 2007.
- The Canadian Index of Well-Being. Technical Paper. Michalos *et al.*, University of Waterloo, 2011.

Organization grids: focus and type

When engaging in the design of indicator sets for decision-help, one must keep in mind that indicator sets can only give a sketch of a situation that is inherently complex and not necessarily amenable to quantitative approaches. For this reason, it is important to choose indicators within a framework that is as comprehensive as possible. One of the most popular frameworks of this kind for environmental issues is the DPSIR framework (Driver – Pressure

– State – Impact – Response), or more compactly, PSR (Pressure – State – Response), in which case Driver indicators are ignored or merged into Pressure (drivers being indirect pressures) and similarly for state and impact.

The following description is extracted from technical reports produced by the European Environment Agency.

Simply put, following the DPSIR framework, social and economic developments drive (D) changes that exert pressure (P) on the environment. As a consequence, changes occur in the state (S) of the environment, which lead to impacts (I) on, for example, human health, ecosystem functioning and the economy. Finally societal and political responses (R) affect earlier parts of the system directly or indirectly.

From a policy perspective, there is a clear need for information and indicators on all parts of the DPSIR chain (Stanners et al., 2007):

- Driving force indicators describe the social and economic developments in societies and the corresponding changes in lifestyles and overall levels of consumption and production patterns. Primary driving forces are demographic changes and economic activities.

- Pressure indicators describe developments in the release of substances (e.g. emissions to air or water), physical and biological agents, the use of resources and use of land. The pressures exerted often manifest themselves in changes in environmental conditions.

- State indicators provide a description of the quantity and quality of physical phenomena (e.g. temperature), biological phenomena (e.g. species and habitat diversity) and chemical phenomena (e.g. nutrient critical loads) in a certain area.

- Impact indicators are used to describe the relevance of changes in the state of the environment, as well as the corresponding implications for ecosystems, the economy and human well-being and health.

- Response indicators refer to responses by society and policymakers that attempt to prevent, compensate, ameliorate, or adapt to changes in the state of the environment. Examples include recycling rates of domestic waste or use of renewable energy sources.

This framework describes the focus or intent of indicators:

D – Driving force indicators

P – Pressure indicators

S – State indicators

I – Impact indicators

R – Response indicators

Note that some types of indicators do not simply fit into this framework. For example, the ratio of a driver to a pressure (e.g., tons of pesticides/GDP of agriculture) is a measure of efficiency. Furthermore, some response indicators may fall in several categories. Because of this, the EEA (among others) defines another grid based on indicator type. This second framework is more clearly policy-oriented, e.g. in terms of measuring progress towards predefined targets, or evaluating the effectiveness of policies:

A – Descriptive indicators: 'What's happening?'

B – Performance indicators: 'Does it matter?' 'Are we reaching critical thresholds?'

C – Efficiency indicators: 'Are we improving?'

D – Policy effectiveness indicators: 'Are the measures working?', 'Are we reaching targets?'

E – Total welfare indicators: 'Are we on the whole better off?'

The first four categories are probably the most important for the present purpose. It is important, inasmuch as possible, to keep some balance in the choice of indicators across these two grids, for the set of indicators to be as comprehensive as possible. This is however clearly not possible when focusing on specific areas, such as water quality or waste management. But such an objective is a must in the development of comprehensive environmental indicator sets.

Selection criteria: general considerations

Several lines of questioning must be considered to identify/select relevant indicators, besides the framework issue discussed above:

- An indicator may be chosen either for its relevance for the phenomenon it characterizes or for its intended political use (decision-help, communication, etc); ideally, for both.

- A set of indicators can be either comprehensive, or on the contrary designed to inform on a limited number of critical or sensitive issues.

Once these questions are answered, the process of indicator definition and/or selection may be undertaken. The following list gives a number of frequently used selection criteria:

- Relevance
- Simplicity
- Reliability and sensitivity to changes
- Politically unbiased
- Timeliness; easy data collection
- Contribution to a coherent and comprehensive view (e.g., in terms of spatial coverage, and also in terms of relation between indicators)
- Any specific criterion for the particular problem to be addressed, as long as the criterion is defined in a transparent way.

Assessing the quality of individual and composite indicators

Developing a quality framework can be a complex task for complex composite indicators. A quality framework most commonly used is advocated in particular by the European statistics code of practice. This partially overlaps with selection criteria, as quality considerations are by design part of the selection process itself.

Six quality dimensions are considered:

- Relevance refers to the degree to which statistics meet current and potential needs of the users.
- Accuracy refers to the closeness of computations or estimates to the exact or true values.
- Timeliness and Punctuality. “Timeliness” refers to the length of time between the availability of the information and the event or phenomenon it describes.

“Punctuality” refers to the time lag between the target delivery date and the actual date of the release of the data.

- **Accessibility and Clarity.** “Accessibility” refers to the physical conditions in which users can access statistics: distribution channels, ordering procedures, time required for delivery, pricing policy, marketing conditions (copyright, etc.), availability of micro or macro data, media (paper, CD-ROM, Internet, etc). “Clarity” refers to the statistics’ information environment: appropriate metadata provided with the statistics (textual information, explanations, documentation, etc); graphs, maps, and other illustrations; and availability of information on the statistics’ quality (possible limitation in use).
- **Comparability** refers to the measurement of the impact of differences in applied statistical concepts, measurement tools and procedures when statistics are compared between geographical areas, non-geographical domains or over time;
- **Coherence** refers to the adequacy of the data to be reliably combined in different ways and for various uses.

The grid of analysis presented in Table XX is an alternative and related way to achieve indicator selection and to analyze their quality.

Two different strategies for sets of indicators

A study usually ends up with a very large number of indicators (a few tens to a few hundreds, typically) unless it focuses on a very specific question (e.g. water chemical quality). This is an unavoidable consequence of dealing with complex environmental and social phenomena. However, even though this may be useful for scientific purposes, such large numbers of indicators are usually unmanageable in a political context. Indicators must therefore be aggregated. The construction of composite (aggregated) indicators is the main object of the step by step procedure described next, but for the present, the issue to be addressed is whether indicators should be aggregated into a single composite indicator, or into a restricted number of second level indicators (typically between a half-dozen and a dozen).

If aggregation is complete, policy alternatives are easily compared: they are ranked according to their score with respect to the composite indicator; the simplicity of this choice however hides the complexity of the underlying aggregation method, and, worse, assumes that all aspects of the problem can compensate each other; for example, a bad water quality can be compensated by a good air quality, which makes little sense, neither in terms of

environmental quality or, e.g., health concerns. If such trade-offs are made, one needs to be aware of the fact.

When indicators are not fully aggregated, some way of comparing policy alternatives may nevertheless be devised. This is the objective of multi-criteria decision help. This section gives a brief overview of these questions, with a more detailed account postponed to a dedicated document.

Aggregation: pros and cons

The main pros and cons of using composite indicators are summarized in the OECD handbook on indicator methodology; the following list is taken from this handbook, where it has been adapted from Saisana & Tarantola, 2002 (see reference in the handbook):

Pros:

- Can summarize complex, multi-dimensional realities with a view to supporting decision-makers.
- Be easier to interpret than a battery of many separate indicators.
- Can assess progress over time.
- Reduce the visible size of a set of indicators without necessarily dropping the underlying information base
- Thus make it possible to include more information within the existing size limit.
- Place issues of performance and progress at the center of the policy arena.
- Facilitate communication with general public (i.e. citizens, media, etc.) and promote accountability.
- Help to construct/underpin narratives for lay and literate audiences.
- Enable users to compare complex dimensions effectively.

Cons:

- Send misleading policy messages if poorly constructed or misinterpreted.

- Invite simplistic policy conclusions
- Be misused, e.g. to support a desired policy, if the construction process is not transparent and/or lacks sound statistical or conceptual principles.
- The selection of indicators and weights could be the subject of political dispute/political bias.
- Disguise serious failings in some dimensions and increase the difficulty of identifying proper remedial action, if the construction process is not transparent.
- Lead to inappropriate policies if dimensions of performance that are difficult to measure are ignored

Due to these characteristics, it is advisable to aggregate indicators when they are “homogeneous”, i.e., comparable or dedicated to similar objectives (e.g., measuring the quantity of various pollutants in water, air or soils) and limit or avoid aggregation otherwise.

Generally speaking, composite indicators are much like mathematical or computational models. As such, their construction owes more to the craftsmanship of the modeler than to universally accepted scientific rules. Transparency in the construction of such indicators is therefore essential, so that political decision will not be confiscated by technical experts.

Aggregation Methods

Aggregation is usually perceived as a two-step process: first, weights must be attributed to each indicator; second, these weights are used to combine individual indicators into a single composite indicator. However the most sophisticated aggregation methods (such as AHP briefly described below) deal with the two aspects simultaneously.

One must not confuse the weighting step with the aggregation one. Aggregation can be performed in a number of different ways:

- Linear aggregation (the most common choice): indicators are multiplied by their weights to form weighted indicators, which are then summed together to form the composite indicator.

- Geometric aggregation: the weighted indicators are multiplied instead of being summed.

- “Ad hoc” aggregation: alternative aggregation methods may be used to limit some drawbacks of the aggregation process. For example, if one does not wish compensate some critically poor performance in one domain with good performance in other domains, a minimal value of all the indicators used, or any other more complex but focused aggregation method might be used.

- If aggregation is not performed, indicators have to be compared through specific multi-criteria analysis techniques called outranking methods, which are briefly presented below.

One must note that aggregation requires indicators to be normalized, otherwise a direct sum or product is meaningless; this question is to be discussed step by step.

Many methods have been devised to choose weights and perform aggregation. As the literature on the subject is too vast to be meaningfully discussed here, only a few widely used choices are briefly listed:

- Equal weights. This choice should be made when there is no reason, scientific, political or other, to favor one issue over another in the construction of the composite indicator. Note however if some indicators are correlated (e.g., waste production per household with household category of income) the correlation itself makes the issue more important in the final composite indicator. For this reason, when the composite indicator has a complex structure in terms of first order indicators (indicators from which it is constructed), one should first ensure that only independent indicators are selected (inasmuch as possible). This issue is probably not important in the context of the Santa Fe province environmental indicators exercise, at least in the first stages, but it should be kept in mind if the indicator set grows over time.

- Analytic Hierarchy Process (AHP). This method is based on pairwise comparison of indicators and relies on interaction with the political body and experts that implement this method. Weights are deduced from the relative ranking that decision makers impart to the various indicators.

- Choquet integrals. This very sophisticated method can minimize or remove some of the unwanted compensation effects that are inherent to composite indicators. However, it is somewhat involved mathematically, and as such not very transparent for decision-makers, in spite of its power and interest.

In practice, the multi-criteria analysis document will only describe the first two methods.

Outranking and multicriteria analysis

If indicators are not aggregated, or more precisely, not completely aggregated, some alternative way of comparing policy alternatives must be adopted. In general, the question involves two different layers of complexity:

- The various indicators usually do not all favor the same political option, but may help to identify relevant trade-offs.

- Various stakeholders usually will end up with various ways of ranking indicators and political options.

These problems are clearly millennia old, and modern complex societies have brought them to a still higher level of convolution. Usually they are tackled in a more or less (in)formal trial and error process. Multi-criteria analysis (MCA) provides a useful framework (or rather, a number of frameworks, as there are a number of MCA methods) to address these issues in a more organized way; of course, in the (most common) cases of conflict of interest, it will not lead to a direct change of the balance of power between stakeholders, but by introducing a more transparent process and therefore more directly useable for reporting to the general public, it contributes to bringing to light elements of the issues that may help to preserve general public interest.

MCA techniques are described in a separate document, as mentioned above.

Step by step procedure

It often seems easier for the general public to interpret composite indicators than to identify common trends across many separate indicators. However, composite indicators can send misleading policy messages if they are poorly constructed or misinterpreted. Their “big

picture” results may invite users (especially policy-makers) to draw simplistic analytical or policy conclusions. In fact, composite indicators must be seen as a means of initiating discussion and stimulating public interest. Their relevance should be gauged with respect to constituencies affected by the composite index.

1. Pros and cons of composite indicators

The main pros and cons of using composite indicators are the following (adapted from Saisana & Tarantola, 2002; see the OECD handbook for the exact reference):

Pros:

- Can summarize complex, multi-dimensional realities with a view to supporting decision-makers.
- Be easier to interpret than a battery of many separate indicators.
- Can assess progress of countries over time.
- Reduce the visible size of a set of indicators without dropping the underlying information base
- Thus make it possible to include more information within the existing size limit.
- Place issues of country performance and progress at the center of the policy arena.
- Facilitate communication with general public (i.e. citizens, media, etc.) and promote accountability.
- Help to construct/underpin narratives for lay and literate audiences.
- Enable users to compare complex dimensions effectively.

Cons:

- May send misleading policy messages if poorly constructed or misinterpreted.
- May invite simplistic policy conclusions.

- May be misused, e.g. to support a desired policy, if the construction process is not transparent and/or lacks sound statistical or conceptual principles.
- The selection of indicators and weights could be the subject of political dispute
- May disguise serious failings in some dimensions and increase the difficulty of identifying proper remedial action, if the construction process is not transparent.
- May lead to inappropriate policies if dimensions of performance that are difficult to measure are ignored

Composite indicators are much like mathematical or computational models. As such, their construction owes more to the craftsmanship of the modeler than to universally accepted scientific rules for encoding.

2. Steps in the construction of composite indicators:

Constructing composite independent or composite indicators is a multi-step process. The following list describes these steps; the most important are highlighted in bold italic: 1 (conceptual framework), 2 (data selection), 5 (normalization), 6 (weighting and aggregation), 10 (presentation and visualization).

Theoretical framework (what is badly defined is likely to be badly measured)

A conceptual framework should be developed to provide the basis for the selection and combination of single indicators into a meaningful composite indicator under a fitness-for-purpose principle.

Important points:

- One must get a clear understanding and definition of the multidimensional phenomenon to be measured. The definition should give the reader a clear sense of what is being measured and why.
- One must structure the various sub-groups of the phenomenon (if needed). Multi-dimensional concepts can be divided into several sub-groups. These sub-groups need not be (statistically) independent of each other, and existing linkages should be described theoretically or empirically to the greatest extent possible.

- A list of selection criteria and for the underlying variables must be compiled; same with a quality framework. The selection and quality criteria should work as a guide to whether an indicator should be included or not in the overall composite index.
- A clear documentation of the above should be produced.

Data selection (a composite indicator is the sum of its parts)

Generally speaking, indicators should be selected on the basis of their measurability, spatial coverage, relevance to the phenomenon being measured and relationship to each other; a list of relevant selection criteria has also been provided earlier, . The use of proxy variables should be considered when data are scarce. The quality and accuracy of composite indicators should evolve in parallel with improvements in data collection and indicator development

Indicators may also be chosen in order to inform the PSR or DPISR framework (Driver – Pressure – Impact –State – Response); in this case, it is important to include policy performance indicators.

Important points:

- Checking the quality of the available indicators: discussing the strengths and weaknesses of each selected indicator with respect to the adopted selection criteria.
- Creating a summary table on data characteristics, e.g., availability, source, type, etc.

Imputation of missing data (beware: both seductive and dangerous)

Consideration should be given to different approaches for imputing missing values. Extreme values should be examined as they can become unintended benchmarks.

Missing data often hinder the development of robust composite indicators. Data can be missing in a random or non-random fashion. There are three general methods for dealing with missing data: (i) case deletion, (ii) single imputation or (iii) multiple imputation.

Important points:

- Estimate missing values.

- Provide a measure of the reliability of each imputed value, so as to assess the impact of the imputation on the composite indicator results.
- Discuss the presence of outliers in the dataset
- Document and explain the selected imputation procedures and the results

Multivariate analysis (still more craft than science)

An exploratory analysis should investigate the overall structure of the indicators, assess the suitability of the data set and explain the methodological choices, e.g. weighting, aggregation.

Important points:

- To check the underlying structure of the data: is the nested structure of the composite indicator well-defined (see first step)?
- To identify groups of indicators that are statistically “similar” and provide an interpretation of the results (through PCA, cluster analysis, etc)
- To compare the statistically determined structure of the data set to the theoretical framework and discuss possible differences.
- To document and interpret the results of this analysis

Normalization (avoid adding up apples and oranges)

Indicators should be normalized to render them comparable. Attention needs to be paid to extreme values as they may influence subsequent steps in the process of building a composite indicator. Skewed data should also be identified and accounted for. Some of the most important normalization methods are (see the technical section of the report)

- Ranking
- Standardization: subtracting mean and normalizing variance for all indicators
- Min-max: identical range for all indicators

- Distance to a reference
- etc

Important points:

- To select suitable normalization procedure(s) that respects both the theoretical framework and the data properties.
- To discuss the presence of outliers in the dataset as they may become unintended benchmarks.
- To make scale adjustments, if necessary.
- To transform highly skewed indicators, if necessary.
- Documentation

Weighting and aggregation (source of contention and manipulation!!)

Indicators should be aggregated and weighted according to the underlying theoretical framework. Correlation and compensability issues among indicators need to be considered either corrected for or treated as features of the phenomenon that need to be retained in the analysis.

NB: aggregation is either linear, geometric, or based on multi-criteria analysis (MCA) methods. This is independent of the choice of the weights themselves for quite a number of weighting procedures.

Choosing what must be aggregated and what must be treated through multi-criteria analysis is one of the most important points. MCA is to be preferred when criteria cannot/must not compensate one another.

Important points:

- To select appropriate weighting and aggregation procedures respecting both the theoretical framework and the data properties.
- To discuss whether correlation issues among indicators should be accounted for.

- To discuss whether compensability among indicators should be allowed.
- Documentation

Robustness and sensitivity

Analysis should be undertaken to assess the robustness of the composite indicator in terms of, e.g., the mechanism for including or excluding single indicators, the normalization scheme, the imputation of missing data, the choice of weights and the aggregation method. One does not want that minor technical changes in the method lead to reversal of ranking of policy alternatives, for example.

The approach taken to assess uncertainties could include the following steps:

- Inclusion and exclusion of individual indicators.
- Modelling data error based on the available information on variance estimation.
- Using alternative editing schemes, e.g. single or multiple imputation.
- Using alternative data normalization schemes, such as Min-Max, standardization, use of rankings.
- Using different weighting schemes, e.g. methods from the participatory family (budget allocation, analytic hierarchy process) and endogenous weighting (benefit of the doubt).
- Using different aggregation systems, e.g. linear, geometric mean of un-scaled variables, and multi-criteria ordering.
- Using different plausible values for the weights

Important points:

- To consider a multi-modelling approach to build the composite indicator, and if available, alternative conceptual scenarios for the selection of the underlying indicators.
- To identify all possible sources of uncertainty in the development of the composite indicator and to assess the impact of uncertainties/assumptions on the final result.
- To conduct sensitivity analysis of the inference (assumptions) and determine what sources of uncertainty are more influential in the scores and/or ranks.

- Documentation

Back to the real data (keeping track of composite indicators components in a meaningful way)

Composite indicators should be transparent and fit to be decomposed into their underlying indicators or values, e.g., through bar charts or spider diagram decompositions

Important points:

- To reveal the main drivers for an overall good or bad performance. Transparency is primordial to good analysis and policy-making.

- To reveal what is driving the composite indicator results.

- To check for correlation and causality (if possible).

- To identify if the composite indicator results are overly dominated by few indicators and to explain the relative importance of the sub-components of the composite indicator.

- Documentation

Links to other variables

Attempts should be made to correlate the composite indicator with other published indicators, as well as to identify linkages through regressions, either geographically or temporally.

Important points:

- To correlate the composite indicator with other relevant measures, taking into consideration the results of sensitivity analysis.

- To develop data-driven narratives based on the results

- Documentation on the results and their explanation

Presentation and Visualization.

Composite indicators can be visualized or presented in a number of different ways, which can influence their interpretation. This is both an important and non-trivial issue.

Important points:

- To identify a coherent set of presentational tools for the targeted audience.
- To select the visualization technique most adapted to communicate information.
- To present the composite indicator results in a clear and accurate manner. Ideally a critical performance scale (e.g., very good, good, average, bad, very bad) in terms of environmental health or policy performance must be defined; for a number of environmental issues, though, critical thresholds are not known.

Annex B of Chapter 2: air pollution in China - from a simple to a complex indicator

Second targeted indicator: focus on air quality impact

Air Quality Index in China. An individual score is assigned to the level of each pollutant and the final AQI is the highest of those scores.

Air Quality Index in China

Score		PM10 <i>μg/m³ 24h</i>	PM2.5 <i>μg/m³ 24h</i>	SO2 <i>μg/m³ 24h</i>	O3 <i>μg/m³ 8h</i>	NOx <i>μg/m³ 24h</i>
0 - 50	Excellent	0	0	0	0	0
51 - 100	Good	50	35	50	100	40
101 - 150	Slightly polluted	150	75	150	160	80
151 - 200	Lightly polluted	250	115	475	215	180
201 - 300	Moderately polluted	350	150	800	265	280
> 300	Heavily polluted	420	250	1600	800	565

Source: China's Ministry of Environmental Protection (MEP)

Air quality index in US and Europe have complete different level values but we consider that these values reflect the preoccupation of various cultures in different pollution context and social requirements.

As the air quality depends on all the selected indicators, we calculate in table 25 the PM10, NOx and SO2 produced by Wenzhou garment factory due to the production of one suit.

Contribution of one unit of product (one suit) to air pollution in Wenzhou

	Consumption	NO _x (g)	SO ₂ (g)	PM ₁₀ (g)
Coal	5.21 kg	29.9	91.8	11.8
Electricity	3.26 kWh	5.8	17.8	2.1
Total	41.02 kWh	35.7	109.6	13.9

Note that for NO_x and SO₂ we take the average value of the intervals proposed in table 11

Annex C of Chapter 2: Cotton specifications according to the Sustainability Consortium

Cotton purchase and the need for traceability

The Sustainability Consortium (TSC) include cotton as a Category Sustainability Profile, or CSP, a summary of the best available, credible and actionable knowledge about the sustainability aspects related to a product over its entire life.

TSC has developed Key Performance Indicators which focus on the relevant environmental and social issues for a single product through a multi-stakeholder process, which included input from member and stakeholder organizations representing companies, NGOs, governmental organizations and academic experts.

We will define KPI values and KPI impact: the first are measure (for example liter of water used per kilogram produced), the second refers to the local or global impact of that use on hotspots

KPI Cotton KPI as defined by the Consortium Group, 2012.

KPI	
1	Supply Chain Engagement
2	Reduction of Human Health Toxicity Issues from Crop Protection Chemical & Harvest Aid Application
3	Integrated Pest Management
4	Fertilizer Tracking and Goals
5	Monitoring Soil Quality and Loss
6	Irrigation Water Use Tracking and Goals
7	Water Use and Scarcity

8	On-Farm Biodiversity and Ecosystems Management
9	Sourcing from Ecologically Sensitive Regions
10	Fossil Fuel Tracking and Goals
11	Energy Use in Cotton Ginning

One Life Cycle Hotspots associated with Water uses is "Irrigation for cotton production: Water used for irrigation as well as energy associated with its application and conveyance. In order to meet irrigation needs, rivers are diverted, dams constructed and groundwater pumped to surface, resulting in significant downstream effects. Freshwater depletion in water scarce areas can significantly decrease the amount of freshwater available for other human and environmental purposes. Irrigation with saline flows and high evapotranspiration rates can increase salinity of soil resulting in species decline within soil, terrestrial and aquatic (from run-off) communities. Increased soil salinity reduces soil quality for crops impacting production."

The Sustainability Consortium defines three KPI connected with water and some improvement opportunities concerning mainly the supply chain

Key Performance Indicators	
KPI	Question
6 : Irrigation Water Use Tracking and Goals	What percent of cotton fiber is provided by suppliers that track on-farm irrigation water use and have goals and a program in place to optimize irrigation water use?
7 : Water Use and Scarcity	What percent of cotton fiber has been mapped and determined if it is grown in water-scarce regions?
9 : Sourcing from Ecologically Sensitive Regions	What percent of cotton fiber is grown on recently cleared land or in ecologically sensitive regions?
Improvement opportunities : Supply Chain Engagement	

I. Benchmarking tools for crop production as well as subsequent supply chains: Better understanding of current performance allows for well-informed reduction targets.

X. Irrigation optimizing programs: Efficient irrigation practices are controlling of 1) volume, 2) frequency and timing of application and 3) flow rate & duration of application in an efficient manner. The Sustainability Consortium recommends management practices, implementation of equipment and technologies, soil characteristics and climatic factors to consider in irrigation.

VII. Biodiversity and Ecosystem Management Plan: Existence and implementation of an environmental management plan (EMP) taking into account endangered species, habitats and ecosystems and alien invasive plant and animal control. This includes managing planned biodiversity on the crop land and associated biodiversity in the surrounding environment to enhance the ecosystem function of the area.

The Sustainability Consortium defines three KPI connected with chemical uses and some improvement opportunities concerning mainly the supply chain

Key Performance Indicators	
KPI	Question
2 : Reduction of Human Health Toxicity Issues from Crop Protection Chemical and Harvest Aid Application	What percent of cotton fiber is provided by suppliers that have a program in place to minimize adverse health conditions to workers and communities from crop protection chemicals and harvest aids?
3 : Integrated Pest Management	What percent of cotton fiber is provided by suppliers that have a program in place to optimize crop protection chemical application according to the principles of Integrated Pest Management?
4 : Fertilizer Tracking and Goals	What percent of your cotton fiber is provided by suppliers that track fertilizer use and have goals and a program in place to optimize Fertilizer use?
Improvement opportunities : Supply Chain Engagement	
<p>II. Programs in place to reduce impacts of crop protection chemicals and harvest aids to human health: Providing proper information and safety equipment (masks, gloves) would help reduce exposure to crop protection and harvest aids in some cases. More necessary in developing countries.</p>	
<p>III. Following the 4Rs of nutrient management as recommended by the International Plant Nutrition Institute: The 4 Rs (Right source, Right rate, Right time, and Right place) aim to reduce on-farm fertilizer requirement.</p>	
<p>V. Precision farming - targeted use of fertilizer and crop protection chemicals and harvest aids: Efficient, targeted application of fertilizer and crop protection chemicals and harvest aids allows for reduced chemical use.</p>	

Annex D of Chapter 2: Indicators for sustainable development: GRI, EFFAS, ISO 26 000

The GRI defines other indicators we have not used in our dashboard

Environmental
MATERIALS
EN1 Materials used by weight or volume.
EN2 Percentage of materials used that are recycled input materials.
PRODUCTS AND SERVICES
EN26 Initiatives to mitigate environmental impacts of products and services, and extent of impact mitigation.
EN27 Percentage of products sold and their packaging materials that are reclaimed by category.
TRANSPORT
EN29 Significant environmental impacts of transporting products and other goods and materials used for the organization’s operations, and transporting members of the workforce
Labor Practices and Decent Work
EMPLOYMENT
LA1 Total workforce by employment type, employment contract, and region, broken down by gender
LA2 Total number and rate of new employee hires and employee turnover by age group, gender, and region.
OCCUPATIONAL HEALTH AND SAFETY
LA7 Rates of injury, occupational diseases, lost days, and absenteeism, and number of

<p>work related fatalities</p> <p>by region and by gender.</p>
<p>LA8 Education, training, counseling, prevention, and risk-control programs in place to assist workforce members, their families, or community members regarding serious diseases.</p>
<p>Society</p>
<p>LOCAL COMMUNITY</p>
<p>SO1 Percentage of operations with implemented local community engagement, impact assessments, and development programs.</p>
<p>Product Responsibility</p>
<p>PR5 Practices related to customer satisfaction, including results of surveys measuring customer satisfaction.</p>

EFFAS define general indicators for clothing industry:



3763

Clothing & Accessories

KPI	Spez.-ID	Scope	Specification
<i>(Scope I = Entry Level; Scope II = Midlevel; Scope III = Highlevel)</i>			
Energy Efficiency	E01-01	I	Energy consumption, total
GHG Emissions	E02-01	I	GHG emissions, total (scope I,II)
Staff turnover	S01-01	I	Percentage of FTE leaving p.a./total FTE
Training & qualification	S02-02	I	Average expenses on training per FTE p.a
Maturity of workforce	S03-01	I	Age structure/distribution (number of FTEs per age group, 10-year intervals)
Remuneration	S08-01	I	Total amount of bonuses, incentives and stock options paid out in €, \$
	S08-02	I	Total number of FTEs who receive 90 % of total amount of bonuses, incentives and stock options
	S08-03	I	Key Performance Narrative (Please answer the questions in max. 500 words) Do you take ESG performance into account in your performance agreements? How do you integrate ESG principals within performance agreements in your company and to what extent do you apply it?
Litigation risks	V01-01	I	Expenses and fines on filings, law suits related to anti-competitive behavior, anti-trust and monopoly practices
Corruption	V02-01	I	Percentage of revenues in regions with Transparency International corruption index below 6,0
Revenues from new products	V03-02	I	Percentage of new products or modified products introduced less than 12 months ago
Innovation	V04-01	I	Total R&D expenses
	V04-12	I	Total investments in research on ESG relevant aspects of business as defined by company (referred to Introduction 1.8.1. KPIs & Definitions)
	V04-13	I	Percentage of products or services for - increasing eco-efficiency of client applications or operations - developing and using clean technologies - offsetting climate change, carbon emissions , resource depletion - increasing fuel-efficiency - making ESG-relevant products operable (e.g. smart metering, green building technologies) - financing of ESG-relevant products or services
Waste Scope I	E04-01	II	Total waste in tonnes
Waste Scope II	E05-01	II	Percentage of total waste which is recycled
Water Consumption	E28-01	II	Water consumption in m ³
Sustainable, Organic & Fair Trade Products	E31-05	II	Percentage of textiles certified according to recognised certification schemes for sustainable textiles (Global Organic Textile Standard)
Certification of Facilities	S07-04	II	Percentage of total facilities certificated according to ISO 9001, SA 8000 or OHSAS18001 standards
Restructuring-related relocation of jobs	S11-01	II	Total cost of relocation in monetary terms i.e. currency incl. Indemnity, pay-off, outplacement, hiring, training, consulting
Utilisation	V13-01	II	Capacity utilisation as a percentage of total available facilities
Brand Value	V24-01	II	Value of brand as measured by third-party or external consultancy in monetary terms i.e. currency incl. name and/or method of valuation
Supply Chain	V28-01	II	Total number of suppliers
	V28-02	II	Percentage of sourcing from 3 biggest external suppliers
	V28-03	II	Turnover of suppliers in percent
Emissions to Water	E03-09	III	TOP 2 components of emissions to water by environmental importance (according to TRI; PRTR; and EPER) Rank 1
	E03-10	III	TOP 2 components of emissions to water by environmental importance (according to TRI; PRTR; and EPER) Rank 2
Water Consumption	E28-02	III	Water (in m ³) used per amount (e.g. in tonnes) of product manufactured
	E28-03	III	Groundwater consumption in m ³
	E28-04	III	Waste effluent water in cubic meters
Environmental Compatibility	E33-01	III	Number of sites with ISO 14001 certification / number of total sites
Supply Chain	V28-04	III	Key Performance Narrative (Please answer the questions in max. 500 words) How do you ensure that your suppliers adhere to a standard of ESG compliance similar to that of your company?
	V28-05	III	Key Performance Narrative (Please answer the questions in max. 500 words) When assessing the performance of your procurement and purchasing functions: Do you incentivise your procurement management for the selection of ESG-performing suppliers even if you might have to carry a premium over less expensive suppliers?

Annex E: Forms to collect data from suppliers

Here is the form we use to get the first data on the suppliers side. For confidential reasons, most data have been hidden in this Annex.

Indicators for sustainability / WEAVE

Name of the firm: [REDACTED]

Address: [REDACTED] Zichuan District of Zibo, Shandong
Province

If you weave cotton and synthetic materials, answer separately for cotton and for synthetic materials.

Please, answer questions 1 to 8 and, if possible, explain the way you calculate your data.

1. List your internal processes :

To help you, as an example, here are the internal processes of a garment plant:

Process	sub-processes
Buy Materials	transport to plant
	storage
	transport to next process
Cut	Stress material
	cut
	store cut pieces
	transport to next process
Sew	sew
	iron
	Transport to next process
Quality control	control
	store product
Sale	wrap
	send to client

2. Production

How many square meters of materials have you weaved in 2012?

104 million square meters

3. Input materials

What are all your input materials? (For example: cotton, oil, chemicals....)

Cotton

Other synthetic yarns

For each input materials, answer the following questions:

- How many cubic meters or tons have you used in 2012?

Cotton: 12,492 Tons

Other synthetic yarns: 1874 Tons

- What is the average distance in km from the suppliers to your plant?

Domestic: about 600 km

Foreign: bad statistics

4. Water consumption

How many cubic meters of water have been used in 2012?

1,292,300 cubic

How many cubic meters of water were recycled in 2012?

██████████

5. Water pollution

How many cubic meters of water have been rejected in 2012?

██████████

Which chemicals products have been rejected in water in 2012?

██████████

For each of them, how many kg in 2012?

██████████

6. Energy

How many kWh of electricity have been used in 2012?

19.1688 million KWH

How many tons of oil have been used in 2012?

Nothing

How many tons of coal have been used in 2012?

Nothing

How many cubic meter of gas have been used in 2012?

4.748408 Million Cubic meter

7. Air pollution

Which chemicals products have been rejected in the air in 2012?

██████████

For each of them, how many kg in 2012?

██████████

8. Workers

How many workers (including management staff) in your plant 2012?

2403 workers

How many total working hours in 2012?

██

How many injuries caused by the working tasks in 2012?

██████████

How many diseases caused by the working tasks in 2012?

██████████

Thanks for your help.

Chapter 3

Decision Making in Sustainable Development: Supplier Choice in the Chinese Garment Industry

This paper is a joint work: Denis Dupre¹⁹, Jin Jianhua²⁰, Sujiao Zhao²¹, Pierre-Yves Longaretti²², Antoine Rolland*²³, Jean-Yves Courtonne²⁴, Emmanuel Prados*²⁵

¹⁹Professor of Ethics and Sustainable Development at Grenoble University (France). Corresponding author : denis.dupre@upmf-grenoble.fr

²⁰Chairman and party secretary of Shanghai Baromon Group, Director of China National Garment Association, Director of Shanghai System & Engineer Society, Vice-chairman of the Shanghai Garment Association.

²¹ Researcher at CNRS UPS 3390, emma.zhao@eurofidqi.org

²² STEEP/INRIA and IPAG/CNRS & UJF, Grenoble.

²³ ERIC, UCBL1, Lyon

²⁴ STEEP/INRIA and ARTELIA

²⁵ STEEP/INRIA

Abstract

This paper constructs a decision making model for a garment factory which has created a sustainable dashboard. The model deals with multi-criteria decision making to choose suppliers, change the energy system and/or in the choice of machines. It captures the main indicators classified in three clusters: environment, social and financial, all at the processes level. It is specifically designed to meet the needs of the Chinese garment industry, and the set of criteria aims to make operational decisions. A case study in a garment factory offers some interesting insights about the use of PROMETHEE method in the context of small industry in China.

Keywords: Sustainability, Multiple Criteria Model to Aid Decision Making, CSR, Corporate Social Responsibility, Management Process, dashboard, Ecology, Environment, Social, KPI, Key Performance Indicators, strategic decision, multi-criteria methods, PROMETHEE methods, preference functions

JEL classification: C22; G10; G11; G31; M11; M21; O14; O22; O32

3.1. Introduction

This research focuses on three aspects of decision-making in the garment industry at the factory level. The first one is the choice of suppliers as cotton and printing processes induce major global pollution and waste problems. The second is the way the main stakeholder preferences can be captured and quantified by an appropriately chosen set of indicators. The last focuses on how the final common decision can be reached with the help of graphical representation of stakeholder preferences.

3.2. Multi-criteria Decisions

Multi-criteria decision help methods were firstly implemented in the 1990s to deal with environmental management (Janssen (1992), Rousseau and Martel (1996), Chevallier (1999)) and sustainable development issues (Faucheux et al. (1998)). Recently, Huang et al. (2011) analyzed over 300 articles employing multi-criteria methods in dealing with environmental decisions. They pointed out the increase in the number of papers using these methods and that AHP (Analytic Hierarchy Process), MAUT (Multi Attribute Utility Theory) and PROMETHEE (Preference Ranking Organization Method for Enrichment Evaluations) are among the most frequently used ones in the literature, as illustrated in the Figure below. Further in their manual, CLG (2009) provides a number of good practices deriving from experiences in multi-criteria decision process and multi stakeholders.

Figure 3. 1 Use of multi criteria methods dealing with environmental issues (in percentage, source: Huang et al., 2011)

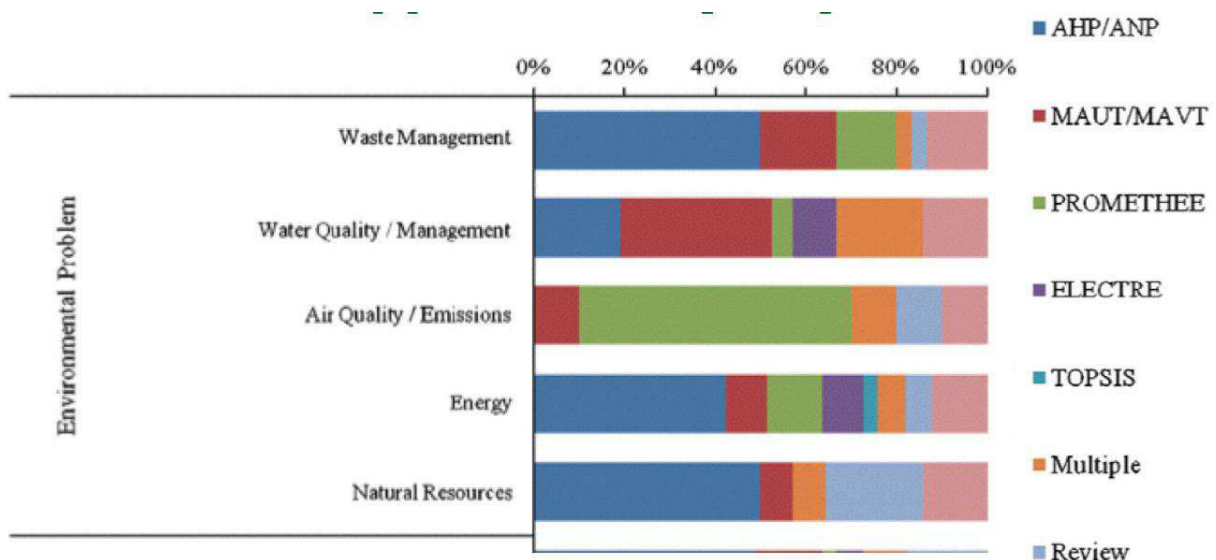

Source: Huang et al., 2011

In order to reach a decision, participants must build a deeper view of the problem discussed. They should be able to better identify and justify their own preferences (especially if these may evolve during the process) to understand more clearly the positions of others, and finally, to identify the possible lock-in(s) (interactions or judgment traps) that prevent to reach a decision acceptable for all involved parties. In this perspective, the decision that will be taken at the end of the process is to some extent less important than the process itself. For instance, since we are dealing with complex systems, new information may appear in the future that is in contradiction with the original decision. If the original decision was taken unilaterally and in opacity, it will be hard to quickly converge towards a new decision whereas if a transparent multi-stakeholder framework was already implemented, the new information can be quickly integrated in the decision process. The following sections will discuss the decision theories, stakeholders and multi-criteria decision making.

3.2.1. Decision Theories

A decision is the choice among various possible options, which is made based on the values, preferences and objectives of (a) decision-maker (s). Decision making has been under close scrutiny since the mid-20th century and has become an important discipline at the crossing of management, organizational sociology and political science.

In the rational model, the individual is able to order its preferences in a transitive way, that is, makes best use of its resources to maximize its utility function, anticipates and analyzes environment scenarios to make optimal decisions. The rational model is however facing several challenges arising from the fact that the decision making process is by no means neutral and objective (CEDIP (2012)).

In the model of bounded rationality, an individual is not able to achieve a perfect solution in terms of utility maximizing, but simply a satisfactory one. Due to imperfect information and

great environmental uncertainties, the decision maker has a limited ability to integrate the available information and the players may find themselves in situations of strategic interdependence. Ultimately, only a limited number of actions is studied (Simon (1957)).

In the political model, the decision process is a cycle of bargaining and negotiations among different decision makers who may conceal or distort information for the purpose of achieving their own objectives.

The garbage can model of policy making holds that decisions are generated by trading off between a problem flow, a solution flow, and a flow of participants and possibilities. The advantage of this model is to prevent the overestimation of actors' rationality. However, it is poorly suited to a planned decision.

Finally, in the hierarchy-of-effects cognitive model, decision makers can be classified into three categories: "cognitive decision makers" who make rational choices based on the information available to them, the "emotional decision makers" who are more sensitive to their own feelings than to facts, and "mixed decision makers" whose decision process lies somewhere in between. Typically, this model is frequently used to study consumer behaviors.

The above models demonstrate that a decision can be made alone or within groups. In the latter case, we identify three types of decisions: the "delegated decision" by an "expert" in whom the group has confidence, the "majority decision" which involves a voting procedure, and the "decision by consensus". Consensus is the most rewarding decision strategy although it can take longer time to achieve. Note that a consensus does not mean a completely unanimous agreement. Instead, it signifies that group members generally accept the decision and agree to support its implementation in the future in a way that their opinions are and will be respected and the decision does not go against their beliefs. We will return to these points in the section dedicated to the multi-criteria aggregation and multi stakeholders.

3.2.2. Multi-Stakeholder and Decision-Aid

The concept of decision-aid is defined by Roy and Bouyssou (1993) as an activity to facilitate the action. As they noted, by use of a clearly specified model which is not necessarily fully formalized, decision aid helps to provide tools to answer or clarify the questions and inquiries raised by actors who are involved in a decision process. The purpose is to provide useful elements to inform the actors and to promote the coherence of objectives and values between

various actors during the decision process. What is then the interest of encouraging participatory processes?

Froger (2002) emphasizes the incentives of the top executives to include sustainable development in their decision making procedures through the example of the Rio Declaration on Environment and Development in 1992 and the initiatives of Agenda 21. Two main reasons are put forward.

The first reason concerns “problem complexity and the presence of actors and groups with multiple interests.” Problem complexity means that actions or non-decisions may have different consequences in time and in space as the consequences are sometimes uncertain and there exists an interaction among the eco-systems at all geographical scales, and the economic, social and environmental spheres. The participation of different stakeholders can then be a way of managing this complexity such that actors address together the problem and justify their positions based on their experiences and knowledge. Furthermore, sustainability issues are characterized by the presence of various stakeholders whose short-term interests diverge. The participation allows to develop and promote the coordination of different stakeholders’ judgments and enhance the acceptability of the decision, even though it may fail to reconcile in the end.

The second reason is related to the fact that the decision model of policies and public projects advanced within a pool of states or experts has been increasingly questioned in recent decades. Part of the population challenges the legitimacy of the decisions taken by their political representatives and the issue appears more pronounced in times of crises. In this context, the participation of stakeholders in decision-making should be able to promote transparency by taking into account various viewpoints and thereby reduce the risk of conflict with a real deliberation between actors.

These reflections are directly linked to the concepts of governance, participatory democracy and deliberative democracy in the field of political philosophy. Note that definitions of these terms, in particular those of governance, vary in the literature. For example, Scorier (2012) identifies these concepts as a hierarchy of public authorities’ motivations. Thus, the issue of governance is not to make a legitimate decision which is supposed to be respected by all, but rather to legitimize the actions of public authorities and their partners. Governance motivates and empowers the stakeholders to achieve their ends. While in the context of participatory

democracy, the question is to consolidate the legitimacy of political decisions by involving non-elected citizens in the discussions. Finally, the participation considers the deliberative project (Habermas (2003)). Specifically, if participation acts as a way to anticipate or to relieve the conflict, deliberative project seeks instead to promote a critical activity. It aims to make room for communication by refining understanding, decode information, reveal strategies, and bargain between interest groups. In this sense, deliberative democracy can be considered as an ideal democracy.

The implementation of participatory multi-criteria methods requires several steps as detailed in the followings: the identification of stakeholders, the determination of their implications, the determination of possible actions to address the problem, the choice of action evaluation criteria, the construction of indicators and finally, the aggregation among criteria and among stakeholders.

3.2.3. The Involvement of Stakeholders

The concept of stakeholder is much broader than that of actor. Freeman (1984) defines stakeholder as "an individual or a group of individuals who can influence or be influenced by the achievement of the organizational goals. Those who are directly affected by certain decisions but not involved in problem formulating and solving can act as a good illustration of the distinction between stakeholders and actors. Banville et al. (1993) propose to classify stakeholders according to two criteria: their relationship to the problem (do they influence or are they influenced by the problem, or both?) and their level of participation (direct or indirect participation in decision-making). Meanwhile, Mitchell et al. (1997) propose an analytical framework that makes the distinction based on three criteria: power, legitimacy and urgency. Power is the potential ability of an actor to impose its will on others. Legitimacy is the positioning of a stakeholder as appreciated by other stakeholders. Urgency is the feeling of a stakeholder that the application is urgent or important. For example, the attribute "dependent" means urgency plus legitimacy; the attribute "dangerous" indicates power plus urgency; and the attribute "dominant" concerns power and legitimacy. Those who do not possess any attribute cannot be included in the process.

Participatory decision corresponds to a situation in the presence of several stakeholders: policy makers and/or decision help agencies, experts, interest groups, NGOs, individuals from the general population, etc. It means neither a simple consultation nor a negotiation, but an

intermediate form of decision. As we have discussed above, the involvement of each stakeholder in the process is essential to achieve a form of legitimacy. This legitimacy lies in an implicit consensus at the start: the stakeholders agree to attend the planned procedure for the interest of adopting the solution. This is the reason why it is important to clarify the power and the intervention procedure for each stakeholder at the beginning. Besides, the involvement varies according to the types of stakeholder, especially because most stakeholders do not have the ultimate decision-making power. Keeney (1992) further proposes to differentiate between values and facts. In this respect, Rousseau and Martel (1992) indicate that we can ask the experts to make judgements based on the facts (the relations between causes and effects for example), but as experts, they do not bear the responsibility to make valuable judgments on behalf of the general population. Similarly, we cannot ask the public to speculate about complex systems. An expert can also play an indirect role to help the decision process instead of acting directly on the decision.

3.2.4. Criteria Selection and Indicator Construction

The choice of criteria and corresponding indicators is a key step in the process which is supposed to be conducted in a transparent manner.

The determination of the criteria can be considered in two complementary ways. Keeney and Raiffa (1976) assume that certain stakeholders, for instance the promoters, have easier access to the project and therefore able to explain their point views by referring to their objectives which have motivated the actions. Nevertheless, Roy (1985) stresses that other stakeholders can better explain their perspectives by referring to the consequences of the actions as they are affected by the consequences of the solution chosen. It is therefore important to take into account the two methods “top-down” and “bottom-up” to ensure that we have properly addressed the interest of each.

The OECD (2008) proposes a practical manual for the construction of composite indicators in which it lists the factors to be accounted for when selecting indicators. They are relevance, simplicity, reliability, sensitivity, non-biased policy, feasibility in terms of data collection, and global contribution to the problem. Regarding the global distribution of indicators, the European Environment Agency advances to classify indicators according to DPSIR (Drivers, Pressures, State, Impacts, and Responses). Under this framework, adapted to the environmental issues, the drivers (e.g., economic activities) produce pressures (e.g.,

greenhouse gas emissions) that change the state of the system (e.g. the chemical composition of the atmosphere). This produces a series of cascading effects, often undesirable (e.g., climate change will cause a rise in sea level and population migration). Policymakers must then take steps (response) in order to target each of the previous steps (develop plans to accommodate climate change impacts, encourage businesses and households to emit less carbon etc.). One can build more efficient indicators under the DPSIR framework such as energy efficiency of the economy which can be measured by dividing the quantity of goods and services (driver indicator) by the energy consumption (pressure indicator).

Other critical points concern the method of indicator normalization and the choice of aggregating certain indicators to form composite indicators in particular. It is essential to maintain a manageable number of indicators in a decision process (efficient policy-making can rarely manage more than ten indicators). In return, it is critical to pay attention to possible compensation phenomena between incomparable issues. This leads us to address the multi criteria aggregation methods in the following paragraph.

3.2.5. Multi-Criteria and Multi Stakeholders

The various aggregation methods used in multi-criteria/multi-stakeholders analysis all amount to a particular choice of voting procedure. They are legitimate in as much as voting procedures are; and once one has noticed that election results depend on the procedure, one usually looks at them with some reasonable suspicion. This being said, it is important to note that voting is but one of two ways to reach a decision, the other being what has been dubbed “apparent consensus” by the French political scientist that pointed out its relevance in modern democratic deliberation processes (Urfalino, 2007).

Apparent consensus refers to a decision reached by a political body (e.g., a village assembly, or a shareholders’ meeting), when nobody finds it useful, constructive or profitable to further argue for or against the said decision. It does not mean that unanimity has been reached. And it is not either a majority rule: there is no denying of the rights or opinions of a minority in this process, and usually no oppression of the minority by the majority; furthermore, it may happen that the decision actually reflects the preferred choice of a minority, if it is also the least rejected option of the majority or of the largest but conflicting groups of influence. Apparent consensus also implies that good arguments may win, not simply the most authoritative ones — which does not imply that some people in the assembly are not more

influential than others, only that their influence is perceived as legitimate. Of course, this also implies a level of honesty in at least a majority of participants, and at least some willingness to make one's opinion evolve in the discussion process at the light of important/relevant arguments.

Apparent consensus is reached in several steps. A first round of discussion on the issue at stake is organized by the discussion leader, whom also at some point summarizes the options and opinions expressed thus far and sketches a possible decision or line of action. A second round follows if participants are not satisfied with the first sketch, leading to another summary and proposed option, and so on until apparent consensus as defined above is reached. Several remarks are important here:

- The role of the discussion leader is critical, both in the way he fosters discussions and opinions, and in the way he is able to recast what has been said in summarized form, or in different forms etc.
- Multi-criteria and multi-stakeholder decision analysis methods provide a powerful way to help achieving this purpose, and in organizing debates towards reaching apparent consensus, if feasible.
- Scientists do not only act here as expert of the Multi-Criteria Analysis (MCA) methods used in the process, but also ideally must provide alternative ways of enlarging or focusing the debate, present alternative options, etc; they should also be able to recast the problem in different forms for MCA analysis, either by capturing from the discussion forgotten criteria or forgotten options, or by pointing them out from their somewhat external point of view. This may be used either as a substitute for the discussion leader if the scientists are experienced enough in leading this type of discussion and can maintain a neutral stand with respect to all options, or instead, as an important expert help to the discussion leader, who should in any case be proficient in negotiation/mediation/deliberation techniques.
- If apparent consensus cannot be reached, then one needs to resort to a final voting procedure; the procedure is usually chosen by apparent consensus. Note also that "indicative" votes can also be made at various points in the course of the discussion in order to make further progress towards apparent consensus.

The widespread use of voting procedures in democratic countries is motivated by the huge amount of people involved in the decision process, and by the large geographic extent of

modern countries with respect to, e.g., the original democracy of the Greek polis (Athens in particular, whose constitution we know thanks to Aristotle). However, the second method (apparent consensus) is the method of choice in quite a number of traditional societies on the one hand, and quite a number of associations or political bodies in the modern world on the other. In public decision-making, the number of stakeholders rarely exceeds a dozen or so; therefore apparent consensus should be aimed at first, and formal votes used only as a last resort and with proper preliminary discussion of the voting procedure to be applied.

When apparent consensus is reached, participants feel much more implicated in the decision process, and as a consequence are usually much more committed to the decision reached as it is perceived as the best outcome considering all constraints, even if it is not their preferred option, except for those stakeholders whose agenda is possibly not to reach a common decision.

Two major multi-criteria approaches, compensatory and non-compensatory, are derived from the work of Condorcet and Borda on electoral processes which is also considered as the founder of the theory of social choice and rational choice (OECD (2008)). Before presenting these branches, two conclusions are worth noting. On the one hand, the final decision is partly affected by the voting system chosen. On the other hand, Arrow (1951) demonstrates that it's impossible to integrate multiple preferences into a collective one which bears all the desirable characteristics (universality, low unanimity, transitivity, independence vis-à-vis irrelevant alternatives) without using the dictatorship of various point views. Therefore, there can be no universal procedure. A voting or multi-criteria decision procedure must be formulated considering the context and the objectives, and focuses on certain features at the expense of others. The direct link between a voting procedure and a multi-criteria decision is that the alternatives to assess in the multi-criteria procedure can be likened to the candidates and the criteria of voters.

The compensatory approach advocates the existence of compromise, that is to say, the ability to neutralize or mitigate the consequences of a failure on certain criteria by insisting a sufficiently large advantage on others. The compensatory method commonly begins by aggregating and then compare. The most widely used one is the weighted arithmetic mean. However, this technique tends to favor extreme alternatives at the expense of balanced alternatives (in terms of their performance on each criterion). In this regard, the geometric mean is less compensatory than the arithmetic mean, while it tends to favor balanced

alternatives. The utility function such as the Multi Attribute Utility Theory (MAUT) is a generalization of these compensatory methods.

In certain circumstances, the compensation between criteria may not exist because criteria are incomparable. For example, in the family of environmental criteria, criteria for local and global pollution can be considered incomparable. Similarly, in a perspective of strong sustainability, one cannot compensate for weak environmental performance with good economic performance. The non-compensatory methods begin by comparing then aggregate. Most often the comparison step is characterized as a comparison between two alternatives, as in the PROMETHEE and ELECTRE methods, based on two scales of distinct values: a scale of preference and a scale of rejection. These methods enable to implement a dedicated analysis of the possible choices, eliminate certain alternatives, but generally do not generate a transitive preference relation among different alternatives, thus some can be considered incomparable. Therefore, the decision to be made concerns the prevalence of a system of values over another.

Ishizaka and Nemery (2013) present a review on the mathematical derivation of the existing methods which can be used to aggregate criteria among them and to aggregate the preferences of different stakeholders. In the latter, it may be noted that voting is not the only way to arrive at a decision. As discussed above, Urfalino (2007) emphasizes the relevance of apparent consensus in the modern democratic deliberation process. There is an apparent consensus when decision makers reach a decision and no stakeholder finds it useful to continue the argument against that decision.

In the interest of reaching apparent consensus, the multi-criteria approach is useful to structure the discussion because it requires explicit formulation of the judgments and the consideration of the problem complexity. In this perspective we emphasize again that the role of the facilitator (or mediator) is critical in order to encourage the free expression of views and discussion, as well as to restate or summarize the discussion results.

3.3. Multi-Criteria/Multi-Stakeholders Analysis and PROMETHEE methods

The choice of the method and its parameters in a complex decision situation with multiple criteria and multiple stakeholder is important. As discussed earlier, it is essential to point out

the distinction between methods that allow compensation between criteria and methods that don't. Note that compensability refers to the existence of trade-offs, i.e. the possibility of offsetting a disadvantage on some criteria by a sufficiently large advantage on another criterion (OECD, 2010). The most commonly used methods with compensation include the weighted average method and the AHP (Analytical Hierarchy Process). The weighted average penalizes balanced profiles because it allows full compensation between criteria. In many cases, this is not a desired property, so decision-makers should be aware of it. AHP assesses the performance of each alternative against a criterion using pairwise comparisons, then decides the relative weight of each criterion. AHP allows the decision-maker to better express his preferences, comparatively to the weighted average method. However this method still has a few drawbacks. Especially, the comparisons in AHP are not necessarily fully consistent from a purely rational point of view (no transitivity property) because each comparison is conducted independently due to the fact that AHP still allows compensation between criteria.

Outranking methods such as Promethee do not lead to the same type of results as compensation methods. The main advantage is that they don't reduce the complexity of the problem to the comparison of a single indicator. To be specific, Promethee leads to two different rankings of alternatives: one ranking according to preference intensities and a second ranking for rejection intensities. Prométhée shares with votes the problem that the result depends on the modalities of the aggregation of stakeholder preferences, by using a particular type of weight to aggregate stakeholder choices; in this respect, it may not be immune to dictatorship in the sense used in Arrow's theorem, and because of this, one might make use of this aggregation option only as a last resort when apparent consensus has not been reached and a particular voting procedure (i.e., a particular aggregation of stakeholder preferences) has been agreed upon. Similarly to AHP, Prométhée uses pairwise comparisons to compare alternatives relatively to each criterion. This is a way of simplifying the problem while still reflecting the preferences and values of decision-makers. The main drawback however is that some options can appear at the end of the process as incomparable. In the general case, outranking methods will not produce a complete ranking of alternatives. Note that the main goal of multi-criteria methods is not to so much to select the best alternative as to organize the discussions and to help the decision-maker to formalize his/her values. Many other methods exist and none is ideal. What matters is to be aware of the consequences of the choice of methods and parameters, and to conduct the process in a transparent way.

Behzadian et al (2010) proposed a literature review on application cases of the Prométhée methodology. The three main types of applications that emerge are:

- locating facilities or infrastructures (location of a landfill, path of a (rail)road...),
- choosing a technical solution (choice between various soil remediation techniques, choice between construction materials),
- choosing a policy mix (mix of taxes, subsidies, regulations to answer an environmental issue).

As this paper focuses on simultaneously taking into account the two relevant layers of choice (multi-criteria and multi-stakeholders) in choosing suppliers, changing the energy system and/or in the choice of machines, Prométhée acts as an appropriate approach to address this concern.

Specifically, we make use of a freely distributed software Visual Prométhée to implement the Prométhée method (VP Solutions, 2013). In this software, each stakeholder conducts the multi-criteria decision making process and arrives at his own preference and rejection intensity rankings. Then, weights are attributed to stakeholders and a weighted average is computed for the preference intensity ranking and for the rejection intensity ranking. It is also possible to modify the weights of stakeholders to see the impact on the two rankings.

3.4. Case study: textile factory and decisions on supplier's choice and energy system selection

The goal of this study is to compare a set of possible decisions from various stakeholders' perspectives.

The four possible scenarios are the following:

Scenario 1: at the next change of machines (in 2016), the plant could consider to buy either expensive efficient German machines or less efficient Chinese ones. The target will be to save energy, water and hours of work. We'll see that a simple consideration of KPI leads directly to the decision whoever is the stakeholder.

Scenario 2: the actual energy system in the plant in Wenzhou uses coal and could be replaced (in 2016) with an energy system fueled with gas. This is in line with the government target to replace coal by gas. In 2014, the Russian President Vladimir Putin and Chinese leader Xi Jinping held up a memorandum for a gas route from Russia to China which will lead to ship 30 billion cubic meters of gas a year added to 38 bmc after 2018.

Scenario 3: It is possible to push suppliers to make greener production in order to save energy and water and reduce pollution. In this case, additional costs won't be immediately embedded in consumer prices until a green label or green marketing allows an increase of prices.

Scenario 4: combining scenarios 2 and 3.

The global process includes the main plant which makes suits and the two suppliers which are involved in tissue weaving and printing. The general context of the main plant and the two suppliers are the following for 2012:

To make suits, the plant in Wenzhou has 400 workers and most of its machines are coming from Germany and Japan. The good quality of machines and suppliers permits a 95% "without default" suit production. The consumption of energy for a total of 198 000 suits produced is 645 480 kwh of electricity, 1031 tons of coal and 10 tons of oil, used as a second power when there is a shortage of electricity.

The weave supplier employs 2403 workers and has weaved 104 million square meters. It used 12 492 tons of cotton and 1874 tons of other synthetic yarns in year 2012. Such consumption may be large, but it makes sense, for this factory is running 24 hours a day and the huge number of workers are organized in three-shifts. The average distance to customer is 600 km. It uses 1 292 300 cubic meters of water, among which 510 800 are recycled. It uses 19.16 million kWh and 4.74 million cubic meter of gas.

The print supplier employs 300 workers and has printed 25 million square meters. It uses 10 500 tons of polyester fiber and 500 tons of chemical product. The average distance to customer is 30 km. It uses 120 000 cubic meters of water, 12.5 million kWh, 10 tons of oil, 10 000 tons of coal and 15 million cubic meter of gas.

The net margin is confidential, so the data used in the calculation are not available for the reader. The difference of net margin with the present situation is mainly due to two components: annual charges and amortization of investments in machines.

Scenario 1 is related to choosing machine quality. The impact on key performance indicators are now discussed (see also table 2). For water, new machines can bring hot water or steam, which can be used in ironing or heating. New machines are designed for environmental conservation as they can recycle part of the water used. Water consumption of one suit is reduced by about 1/4 compared to ordinary machines while energy savings amount to nearly 16.7%. On the employment front, differences in working hours vary among the 265 production processes from 1% to 99%. But on average, the new machines result in a 25% reduction of working hours. A quality rate of only 85% “without default” suit can be reached with ordinary machines. With new machines, this can rise to 98% for skilled workers, with an average of 95%.

The net margin is impacted by the different amortization amount as appeared in the income statement of the company between best machines and ordinary ones. Domestic machines made in china cost about 2 million Yuan for a complete production line, while imported machinery made in Japan or Germany cost about 8 million Yuan, 4 times more expensive than the domestic machines; however, the duration of machines is about 10 years, commonly 4 years longer than domestic machines. The choice between domestic and foreign machines impacts the annual profit through amortization. The second impact is about annual charges for water, gas, coal and electricity consumption. If a plant uses water and power as industrial consumption, it needs to pay a fee to the local governmental authorities. Industrial water costs 3.20 yuan per square meter. Industrial electricity costs 0.5 Yuan per kWh and industrial gas costs 3.0 yuan per square meter. The average coal price in China is about 500 Yuan per ton. So, when we are making comparison in the process of calculating profits, we should consider the cost of the consumption and waste of water, gas, energy and coal, as well as the cost of extra working hours to produce one suit with ordinary machines.

Scenario 2 consists in changing the energy system in the plant of Wenzhou. The impacts on Key Performance Indicators are summarized as follows (see table 3). 3480 cubic meters of gas will be needed to produce 1000 suits if the plant in Wenzhou replaces coal with gas. This transfer will impact carbon emission in air. The net margin is impacted by the difference of amortization in the income statement of the company between coal energy system and gas

energy system. The coal energy system costs about 0.8 million Yuan but the gas energy one amounts to about 2 million Yuan. The life-time of both systems is about 10 years. This impact the annual profit through amortization cost in the income statement.

Scenario 3 consists in pushing the suppliers to adopt greener production techniques at higher price. The impacts on Key Performance Indicators are now presented (see table 4). A reduction of 25% in water consumption can be obtained with greener techniques of printing and weaving. A reduction of 70% for polluted water can be obtained from reducing in particular 40% of acid substances, which are the main water pollution substance of textile enterprises. Savings in electricity and coal use amount to about 20% (from 15% to 38% depending on various hypotheses). Finally, 95% quality rate of “without default” suit production can be reached with greener suppliers by skilled workers, but the net margin will decrease by 30% because of higher costs for materials.

Scenario 4 consists of changing the energy system in the plant of Wenzhou and pushing the suppliers to greener production at higher price impacting Key Performance Indicators (table 5).

[Insert Table 3.1-Table 3.5 about here]

In the following we experiment the multi-criteria, multi-stakeholders Promethee method in order to properly rank alternative actions in the textile factory.

4 scenarios are considered:

- Business as usual: no change,
- Switch energy: coal is replaced by gas as the energy source,
- Green suppliers: suppliers are challenged so that they increase their environmental performance,
- Switch energy and green suppliers: implement both actions.

Two groups of criteria are considered: environmental criteria (water consumption, water discharge, greenhouse gases emissions, air pollution and energy consumption) and economic criteria (quality of the production and net margin²⁶). Originally a social criterion (number of working hours) was also implemented; however we removed it because all alternatives

²⁶ For confidentiality purposes, the net margin is hidden in the document.

perform similarly against it. Three stakeholders are considered: the CEO of the company, also representing the shareholders, the Chinese government and finally the province where the factory is located.

The first step is to evaluate each action against each criterion. These evaluations are common to all stakeholders and are presented in the following table.

[Insert Figure 3.2 about here]

Environmental criteria are represented in blue and economic criteria in yellow. The best performance is represented in green while the worst is represented in red. For instance, the switch energy action will save 276 t CO₂ eq. compared to the business as usual scenario while the green suppliers' action will save 2251 m³ of water consumption.

Table 3. 1 Actual global dashboard for JINGMENG Suit Co.,LTD and part of the supply-chain (weave and print)

KPI Group	Environment								Social			Economic			
	WATER	EMISSIONS, EFFLUENTS, AND WASTE						Energy	Employment	Health and safety	Consumer satisfaction	Yield			
KPI	Water consumption	Water discharge	gas	oil	coal	electricity	Carbon emission	Air pollution	Energy	working hours	Labor wages	Safety ratio	Quality	Net margin	Production
Unit	cubic meter	cubic meter	cubic meter	ton	ton	kWh	kg eq. C	eq. ton of coal	eq. kWh	hours	-	0	Level *****	Yuan	number / year
plant 1 - Zibo - weave	6 627	6 627	22 599	-	-	91 236	33 012	28 667	339 821	41 174	-	-			
plant 2 - Print - Taicang	2 376	2 257	297 000	0	198	247 500	368 594	279 873	4 951 705	21 384	-	0,06			
plant 3 - Suit - Wenzhou	13 939	-	-	-	1 032	645 480	830 190	1 231 679	8 121 340	1 320 000	-	-	90%		198 000
total	22 942	8 884					1 231 796	1 540 219	13 412 867	1 382 558	-	0			

Table 3. 2 Scenario 1 - Replacing « good machines » with less efficient machines

KPI Group	Environment								Social			Economic			
	WATER	EMISSIONS, EFFLUENTS, AND WASTE						Energy	Employment	Health and safety	Consumer satisfaction	Yield			
KPI	Water consumption	Water discharge	gas	oil	coal	electricity	Carbon emission	Air pollution	Energy	working hours	Labor wages	Safety ratio	Quality	Net margin	Production
Unit	cubic meter	cubic meter	cubic meter	ton	ton	kWh	kg eq. C	eq. ton of coal	eq. kWh	hours	-	0	Level *****	Yuan	number / year
plant 1 - Zibo - weave	6 627	6 627	22 599	-	-	91 236	33 012	28 667	339 821	41 174	-	-			
plant 2 - Print - Taicang	2 376	2 257	297 000	0	198	247 500	368 594	279 873	4 951 705	21 384	-	0,06			
plant 3 - Suit - Wenzhou	18 539	-	-	-	1 238	774 576	996 228	1 478 015	9 745 608	1 716 000	-	-	85%		188 000
total	27 542	8 884					1 397 834	1 786 555	15 037 135	1 778 558	-	0			

Nb : for confidential reasons, the net margin is not published in this paper.

Table 3. 3 Scenario 2 - Changing the energy system in the plant of Wenzhou

KPI Group	Environment								Social			Economic			
	WATER	EMISSIONS, EFFLUENTS, AND WASTE						Energy	Employment	Health and safety	Consumer satisfaction	Yield			
KPI	Water consumption	Water discharge	gas	oil	coal	electricity	Carbon emission	Air pollution	Energy	working hours	Labor wages	Safety ratio	Quality	Net margin	Production
Unit	cubic meter	cubic meter					kg eq. C	eq. ton of coal	eq. kWh	hours	-	0	Level *****	Yuan	number / year
plant 1 - Zibo - weave	6 627	6 627	22 599	-	-	91 236	33 012	28 667	339 821	41 174	-	-			
plant 2 - Print - Taicang	2 376	2 257	297 000	0	198	247 500	368 594	279 873	4 951 705	21 384	-	0,06			
plant 3 - Suit - Wenzhou	13 939	-	679 900	-	-	645 480	554 404	211 657	8 124 384	1 320 000	-	-	90%		198 000
total	22 942	8 884					956 010	520 198	13 415 910	1 382 558	-	0			

Table 3. 4 Scenario 3 - Changing suppliers

KPI Group	Environment								Social			Economic			
	WATER	EMISSIONS, EFFLUENTS, AND WASTE						Energy	Employment	Health and safety	Consumer satisfaction	Yield			
KPI cluster	Water consumption	Water discharge	gas	oil	coal	electricity	Carbon emission	Air pollution	Energy	working hours	Labor wages	Safety ratio	Quality	Net margin	Production
Unit	cubic meter	cubic meter					kg eq. C	eq. ton of coal	eq. kWh	hours	-	0	Level *****	Yuan	number / year
plant 1 - Zibo - weave	4 970	1 988	22 599	-	-	72 989	29 198	23 011	321 574	41 174	-	-			
plant 2 - Print - ecology	1 782	677	297 000	0	158	198 000	331 558	224 928	4 615 224	21 384	-	0,06			
plant 3 - Suit - Wenzhou	13 939	-	-	-	1 032	645 480	830 190	1 231 679	8 121 340	1 320 000	-	-	95%		198 000
total	20 691	2 665					1 190 946	1 479 618	13 058 138	1 382 558	-	0			

Table 3. 5 Scenario 4 - Changing energy system in in the plant of Wenzhou + suppliers

KPI Group	Environment								Social			Economic			
	WATER	EMISSIONS, EFFLUENTS, AND WASTE						Energy	Employment	Health and safety	Consumer satisfaction	Yield			
KPI cluster	Water consumption	Water discharge	gas	oil	coal	electricity	Carbon emission	Air pollution	Energy	working hours	Labor wages	Safety ratio	Quality	Net margin	Production
Unit	cubic meter	cubic meter					kg eq. C	eq. ton of coal	eq. kWh	hours	-	0	Level *****	Yuan	number / year
plant 1 - Zibo - weave	4 970	1 988	22 599	-	-	72 989	29 198	23 011	321 574	41 174	-	-			
plant 2 - Print - ecology	1 782	677	297 000	0	158	198 000	331 558	224 928	4 615 224	21 384	-	0,06			
plant 3 - Suit - Wenzhou	13 939	-	679 900	-	-	645 480	554 404	211 657	8 124 384	1 320 000	-	-	95%		198 000
total	20 691	2 665					915 160	459 596	13 061 182	1 382 558	-	0			

Figure 3. 2 evaluation of scenarios against each criterion

	Water consu...	Water disch...	Carbon emis...	Air pollution	Energy cons...	Quality	Net margin
Unit	m3	m3	kg C eq	kg coal eq	kWh	%	Yuan
Cluster/Group	◆	◆	◆	◆	◆	■	■
Evaluations							
<input checked="" type="checkbox"/> Business as usual	22942	8884	1231796	1540219	13412867	90	
<input checked="" type="checkbox"/> Switch energy	22942	8884	956010	520198	13415910	90	
<input checked="" type="checkbox"/> Green suppliers	20691	2665	1190946	1479618	13058138	95	
<input checked="" type="checkbox"/> Energy_suppliers	20691	2665	915160	459596	13061182	95	

3.4.1. Step 1: Ranking alternatives for each stakeholder

Step 1.1: Pairwise comparison of alternatives against each criterion

We used V-shape preference functions with absolute threshold types (the best option scores 1 against the worst, the worst option scores 0 against all options, any option scores 0 against the best option, the score of the best option against any option is difference/max_difference, same applies to the score of any option against the worst option).

Figure 3. 3 shape of the chosen preference functions (“V-shape”)



At the end of this step, Visual Promethee can compute preference and rejection flows for each scenario-criterion pair. Note that preference functions can differ from one stakeholder to another, although they don’t in this example.

Step 1.2: Weighing of criteria

Each actor assigns weights to the criteria depending on his set of values. Preference and rejection flows corresponding to each criterion are aggregated based on these weights.

Table 3. 6evaluation of scenarios against each criterion.

	Water consumption	Water discharge	Carbon emissions	Air pollution	Energy consumption	Quality	Net margin
CEO	3	3	0	14	0	20	60
State	10	10	20	40	10	0	10
Province	30	30	0	30	0	0	10

For the CEO (and the shareholders) the net margin is the most important criterion followed by the quality of the production (for brand image and customers satisfaction). Water and air pollution are also a concern for him because of existing regulations and potentially future ones. Conversely, in this simulation, for the Chinese government, the main stake is air pollution followed by carbon emission and water. It is also interested in having profitable companies to maintain employment. Note that the government would also be interested in the

quality of the production, however in this case the business as usual production is already very good so the government doesn't see the potential improvement as important. For the province, the most important stakes are the ones related to local environmental impacts: impacts on water and air pollution. For the same reason as in the case of the state government, profitability is also valued.

Result: rankings for each stakeholder

At the end of step 1.2, we have a partial ranking for each stakeholder, i.e. a ranking according to preference flows and a ranking according to rejection flows, and a complete ranking computed by subtracting rejection flows from preference flows.

Ranking of the CEO

Figure 3. 4evaluation of scenarios against each criterion

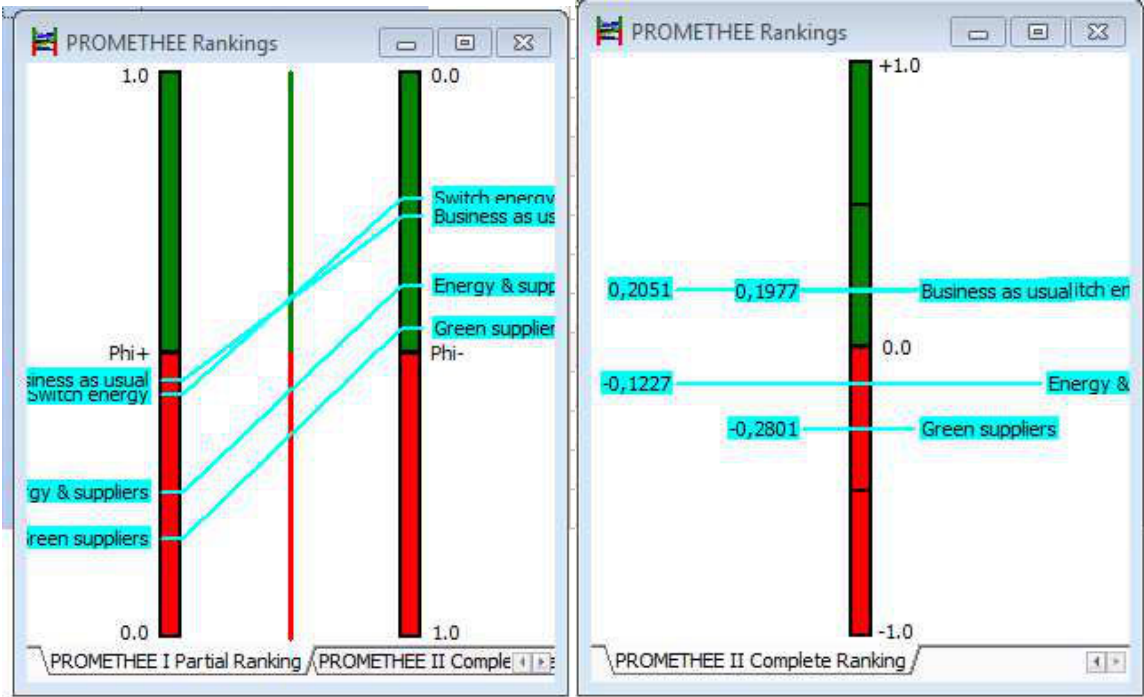

In the partial ranking window, preference flows are on the left (Phi +) and rejection flows on the right (Phi -). The complete ranking can in fact be seen in the partial ranking window, at the intersection between preference flows and rejection flows.

We see that in the complete ranking, the business as usual and switch energy actions are almost equal, followed by the “energy & suppliers” alternative and then by the “suppliers” alternative. Turning back to the partial ranking, we can make a few observations:

- Generally speaking the options are “by default” choices (see figure 5), meaning they are not strongly preferred nor strongly rejected,
- The preference ranking differs from the rejection ranking: the “business as usual” option is more preferred but also more rejected than the “switch energy” option.

Figure 3. 5a typology to describe scenarios

	Small rejection	Large rejection
Large preference	win-win	sensible
Small preference	by default	lose-lose

Figure 3. 6 Ranking of the State

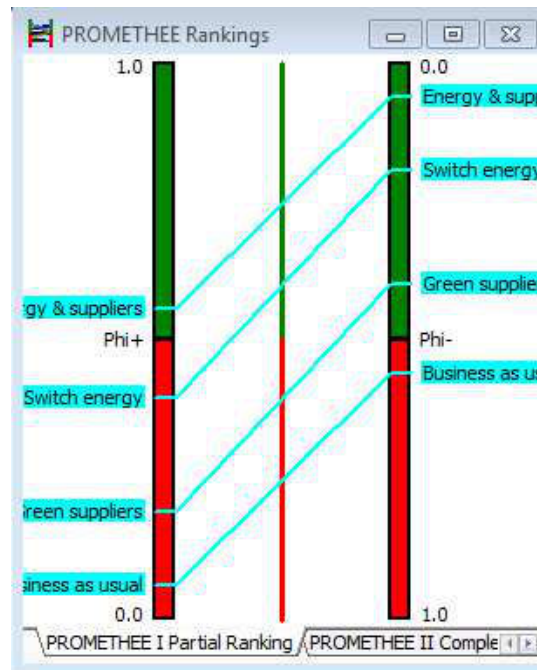

For the Chinese government the preference and rejection rankings are the same: the best option is to conduct the “switch energy” and “green suppliers” actions jointly, followed by the “switch energy” action, the “green suppliers” actions and the business as usual scenario. We see that according to our typology (figure 5), the “energy & suppliers” option is the only one that can be classified as a “win-win”, the others rather belonging to the “choice by default” category.

Figure 3.7 Ranking of the province

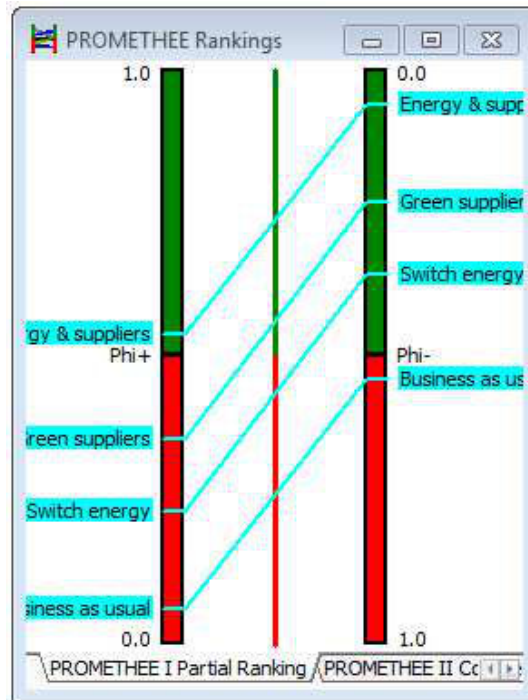

Similar observations apply to the province, except that it would rather support the “green suppliers” option than the “switch energy” one, due to its interest in reducing impacts on water.

3.4.2. Step 2: Ranking options by weighing stakeholders: strategic decision-making

Visual Prométhée makes it possible to aggregate the rankings of each stakeholder by assigning weights to them (representing their power in the final decision). The “balance of power” interface is used to study how the ranking evolves when changing decision weights.

This feature can be used in two ways:

- Literally, when they are indeed many decision-makers: then the feature is simply a kind of voting procedure,
- For strategic management purposes when there is in fact only one decision-maker. In this case, the goal is to take into account other stakeholder’s perspectives to

get a better grasp on the decision context and therefore take better (possibly longer-term) decisions.

Our example falls in the second category: the CEO is the only decision-maker but it is interesting for him to understand the views of other actors that may gain influence in the future. We illustrate this by changing the weights progressively from a CEO-only decision to a shared decision and analyzing the outcome in the rankings.

Decision weights: CEO: 100% - State: 0% - Province: 0%

The output ranking is the one presented above in the “*ranking of the CEO*” section. For the CEO the switch energy and business as usual scenarios are indifferent. He could therefore choose not to do anything.

Decision weights: CEO: 90% - State: 5% - Province: 5%

By progressively increasing the weights of the state and of the province (for instance to 5% each), we see that the “business as usual” option starts to fall in the ranking as shown by figure 8. In a strategic perspective, this means that as soon as public actors will get a little influence on the decision context of the company (for instance by enforcing regulations, creating taxes or quotas...), the “switch energy” option will be preferable to the business as usual scenario. Therefore, at this point the CEO knows it should consider the “switch energy” scenario.

Figure 3. 8Ranking for a 90% CEO weight

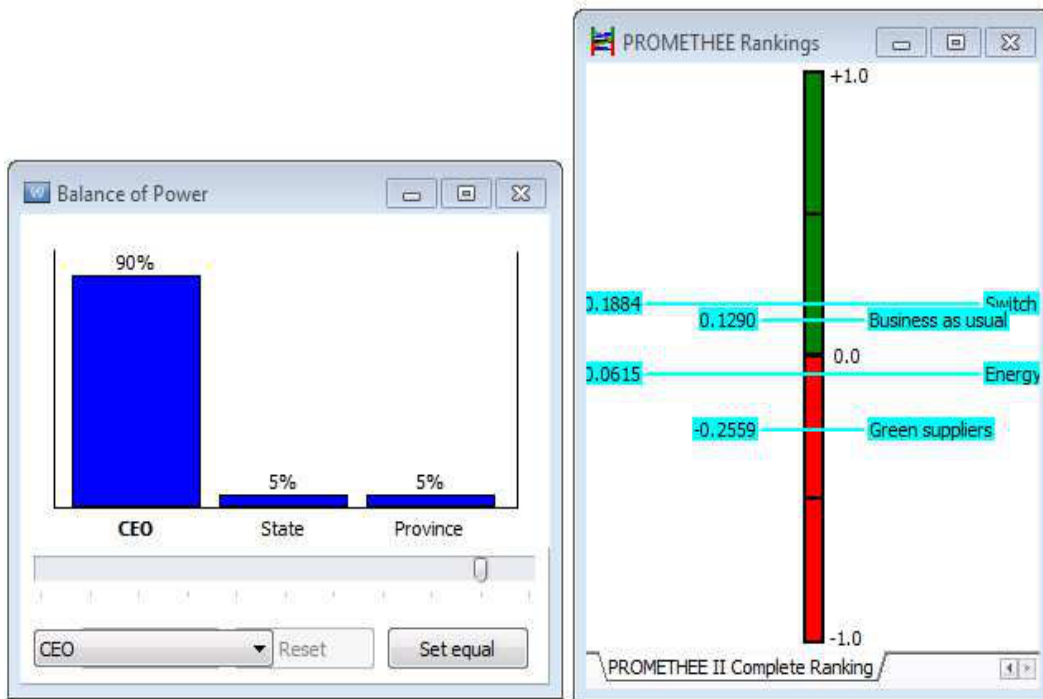

We continue to increase the weights of the state and of the province: if the environmental concerns keeps increasing, the population is likely to put pressure to take measures. We see that when the weight of the CEO reaches about 70%, the “switch energy” option is preferred to the “business as usual” scenario.

Figure 3. 9Ranking for a 70% CEO weight

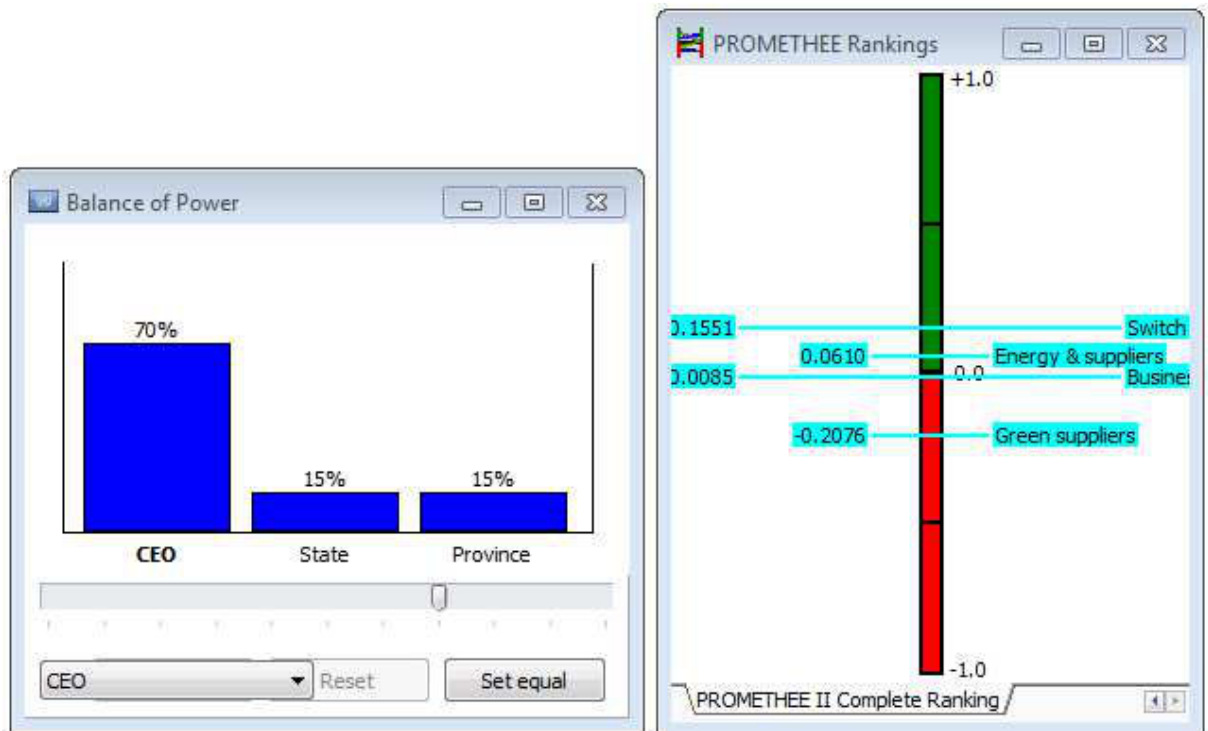

If environmental concern take even greater importance, regulations and taxes will increase which can be translated in larger weights for the state and the province. We see that when the decision weight of the CEO falls down to 50%, the “energy & suppliers” option is preferred to the “switch energy” option. It is interesting to note that the action “green suppliers” is never considered as the best one: it should always be conducted jointly with “switch energy”.

Figure 3. 10Ranking for a 50% CEO weight

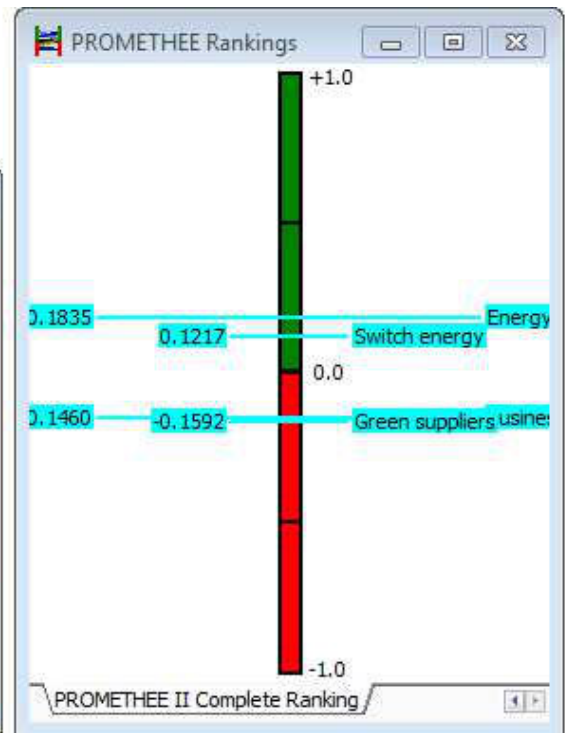
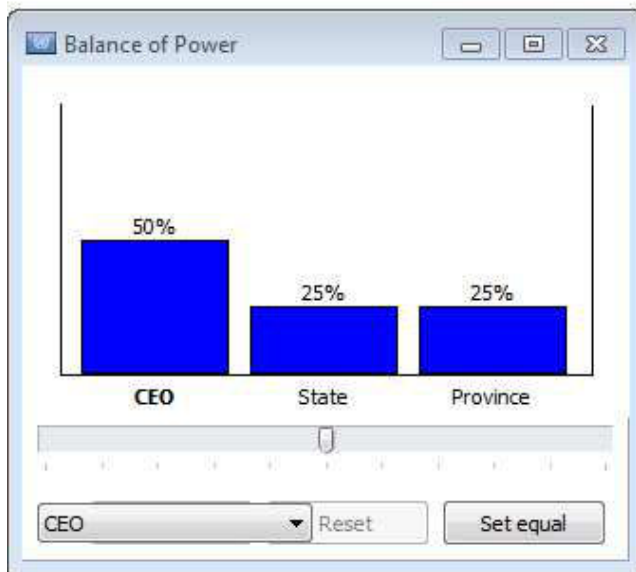

3.5. Conclusion

We believe this multicriteria – multi-stakeholders tool can help strategic decision-making: the CEO is the only decision-maker, however depending on what he thinks the future context will look like (in this case, a continuous rise of public concern for the environment), his decision can anticipate the future influence of other actors and take their values into account.

Bibliography of Chapter 3

Arrow. *Social Choice and Individual Values*. John Wiley and Sons, New-York. 1951.

Banville, Landry, Martel and Boulaire. *A Stakeholder's approach to MCDA*. Document de travail 93-79. CRAEDO, Faculté des Sciences de l'administration, Université Laval. 1993.

Centre d'Évaluation, de Documentation et d'Innovation Pédagogiques (CEDIP). *La prise de décision*. 2012. <http://www.cedip.equipement.gouv.fr/qu-est-ce-qu-une-decision-a22.html>

Chevalier. *DPM, Démarche Participative Multicritère pour la gestion environnementale*. Groupe de recherche interdisciplinaire pour le développement durable (GRIDD), Université de Laval, Québec. 1999.

Communities and Local Government (CLG). *Multi-criteria analysis: a manual*. 2009

Faucheux, Froger and Munda. *Multicriteria Decision Aid and the Sustainability Tree*. in S. Faucheux et M. O'Connor, (Eds), *Valuation for Sustainable Development : methods and policy indicators*, Edward Elgar, *Advances in Ecological Economics Series*, pp. 187-214. 1998.

Freeman. *Strategic Management: A Stakeholder Approach*. éd. Pitman. 1984.

Froger and Oberti. *L'aide multicritère à la décision participative : une démarche originale de gouvernance en matière de développement durable*. Eurocongrès « Développement local, développement régional, développement durable : quelles gouvernances ? ». 2002.

Habermas. *Au-delà du libéralisme et du républicanisme, la démocratie délibérative*. In *Raison publique*, n°1, pp 40-57. 2003.

Huang, Keisler and Linkov. *Multi-criteria decision analysis in environmental sciences: 10 years of applications and trends*. *Science of the Total Environment*. 409 (2011) 3578-3594.

Ishizaka and Nemery. *Multi-Criteria Decision Analysis, Methods and Software*. Wiley. 2013.

Janssen. *Multiobjective decision support for environmental problems*, Kluwer, Dordrecht. 1992.

Keeney and Raiffa. Decisions with multiple objectives: preferences and value tradeoff. John Wiley & Sons. 1976.

Keeney. Value focused thinking: a path to creative decision making. Harvard University Press, Cambridge. 1992.

Mitchell, Agle and Wood. Toward a theory of stakeholder identification and salience: Defining the Principle of Who or What Really Counts. Academy of Management Review, 22(4): 853-886. 1997.

OECD. Handbook on Constructing Composite Indicators - Methodology and User Guide. 2008.

Rousseau and Martel. La décision participative : une démarche pour gérer efficacement les conflits environnementaux, Document de travail 96-24, Centre de recherche sur l'aide à l'évaluation et à la décision dans les organisations, Faculté des sciences de l'administration de l'Université Laval, Québec. 1996.

Roy. Méthodologie multicritère d'aide à la decision. Economica, Paris. 1985.

Roy and Bouyssou. Aide Multicritère à la Décision : Méthodes et Cas. Economica. 1993.

Scorier. Démocratie managériale, démocratie délibérative et écologie politique. Université catholique de Louvain. 2012.

Simon. Models of Man. John Wiley. 1957.

Urfalino. La décision par consensus apparent : nature et propriétés. Revue européenne de sciences sociales, 136, 47-70. 2007.

General Conclusion

1. Research action: three questions

1.1. The factors of green management in the garment industry

The evaluation analysis of influencing factors of green management of clothing enterprise based on ANP leads to make more clearly the influencing factors of the clothing business green management.

This section provides empirical findings: Green cost is the main factors influencing the enterprise green management. The rest in turn is green culture, green technology innovation ability and the ability of communicate. This is consistent with the condition of the green management at the present stage in China. The implementation of green management for clothing enterprises cannot leave the staff's and managers' actively participate in. At present, China green management only has its early development, enterprises still consider more factors on short-term costs and regulations. For China enterprises, the green management is still an exploratory work, and it need the support of policy laws and regulations. Local laws and regulations and environmental policies can effectively promote the clothing enterprises to implement green management.

1.2. Conceiving a green management dashboard for small firms

The proposed dashboard is the first attempt towards building a global view on the impact of production in the garment industry in China at the level of individual production firms. It gives insight on the impacts of the processes from a triple angle: economic, social and ecological. Stakeholders were involved from the start in the selection of relevant Key Performance Indicators. Four directions of using this dashboard can be underlined.

Firstly, it is an efficient decision-making tool with respect to future investments strategy. Which lines of actions are the most critical in the near future: renewing and improving machine tools efficiency? Saving alternative energy instead? Shifting from coal to gas?

Challenging their suppliers for greener products at higher cost? Improving working conditions?
Increasing water consumption efficiency and/or decreasing water pollution?

Secondly, this dashboard can help benchmarking different plants and promote best practices through their quantitative impacts. This is the concern for stockholders and stakeholders who want to limit ecological impacts.

Thirdly, this dashboard will help challenging suppliers to improve ecological impacts, control the whole supply chain and create a “green label” for the garment industry.

Lastly, should the CCPCC decide to enforce new constraints, mainly ecological, on water and air quality, one possibility would be imposing the industry’s creation of a national data center that could manage the annual data of all plants and all types of products for the garment industry. As a result, China will continue to accelerate the pace of information gathering, organization and dissemination. Garment enterprises will be more effective in evaluating and forecasting the industrial prospect in order to cope with the uncertainty of the global economy. What’s more, this research method sets up a good example to inspire other industrial sectors to improve economic development and help them achieve sustainable development goals.

1.3. A ranking method as a tool for strategic decisions in a stakeholder perspective

This research focuses on three aspects of decision-making in the garment industry at the factory level. The first one is the choice of suppliers as cotton and printing processes induce major global pollution and waste problems. The second is the way the main stakeholder preferences can be captured and quantified by an appropriately chosen set of indicators. The last focuses on how the final common decision can be reached with the help of graphical representation of stakeholder preferences.

A multicriteria – multi-stakeholders tool can help strategic decision-making: the CEO is the only decision-maker, however depending on what he thinks the future context will look like (in this case, a continuous rise of public concern for the environment), his decision can anticipate the future influence of other actors and take their values into account.

2. Perspectives of “green” management in the garment industry: solutions and suggestions

2.1. Firm Level

At present, garment enterprises in our country have exposed some disadvantages in the implementation of green management:

(1) Enterprises mainly focus on and improve their level of green technology, when it implements the green management, such as the enterprise technology innovation ability and so on, but its green culture construction is not enough. On the term of its own green management performance evaluation, enterprises mainly focus on those hard indicators, such as the recovery rate, carbon emissions reduction and so on. In fact, for some soft power, enterprises also need pay attention, such as the environmental protection consciousness of employees, the supplier's environmental protection ability, their own corporate social responsibility initiative and so on.

(2) Enterprise's green culture has weak influence on inside and outside of organization, enterprise can't leave the green culture, the green culture can't affect the internal and external is another matter. At present, most of the companies don't produce green culture which fits company's development, and also lack of the influence of the supply chain and its employees.

(3) Most of enterprises think that if the enterprises implement green management, it needs to improve the existing technology, improve the green technology of production, it can produce green product, so the enterprise mainly focuses on the production technology and production capacity. Technological innovation capability of green management also stress that the enterprise's management ability, through good management ability, which make all sorts of the rules and regulations improving standards of environmental performance smoothly carry out, through people-oriented management system makes the enterprise's personnel willing to abide by the rules of green management. We can say that, the value system giving priority to with environmental protection did not reflect into the management, the process of skills did not improve the influence of the supply chain and the whole organization.

(4) In the process of implementing green management, enterprises attaches great importance to the calculation of the cost. Enterprise has the increased profit as the core, it must always pay close attention to their own situation of cost, specially, at present green management only

stay its rise stage, whether it can bring significant economic benefits to enterprises does not only depend on theory, this problem is still in a very complicated phase. Enterprise care about the green cost, on the one hand it for its own sake, on the other hand, it due to the external environment let the enterprise pay attention to the cost. Therefore, the green cost dictates whether the enterprise can smoothly implement green management.

(5) The attention of the technical innovation ability of enterprise is also evident. the impact of technology innovation ability of enterprise for green management executive force already are described in the above, the strong positive correlation of 0.944 illustrates at present the implementation of green management in this stage, enterprise depend on technology. However, it is important to note that enterprise's technological innovation ability is not only reflected in the production process and process, it also reflected in the level of innovation management and management level.

(6) Green management requires companies make integration with its own information flow, cash flow and physical flow, demand a high degree of information communication. Then, for the moment, our country did not get such a state. The author thinks that, causing this situation is not lack of hardware, but the enterprise lack of effective communication, whether from the terms of internal mechanism of enterprise or from the industry perspective or from the perspective of supply chain, at present our country's enterprise don't have the benign communication mechanism, let the clothing enterprises shout out its own needs, which is an important engineering on the road of green management.

(7) The operating state of enterprises needs work together within the organization departments, lacking of communication and information sharing spirit will bring the enterprise's internal flow become information lag, reduce the vitality of enterprises. Many enterprises are facing such problem: don't willing to communicate, don't plan to communicate, can't communicate, no channels of communication information, which have a negative impact to the enterprise implementation of green management, make an impact on the performance of green management, delayed the implementation schedule.

In view of the above situation, the author thinks that the solving method is that starts from the each link of green management, carefully analysis of the causes and effects, from parts of the green management the author puts forward some suggestions.

2.1.1. The proposals for green procurement of enterprise

Green purchasing is the most basic link determining green of green supply chain. If the enterprise green purchasing has done well, it can bring the real green materials and technology for green production, from raw material determines the green of the whole production. For green purchasing, the author thinks that our country's enterprise can do the following several points.

(1) Attaches great importance to the implementation of the ISO14001, cultivate the green consciousness of green purchasing personnel, help staff involved in the procurement policy and realize the strategic intention of enterprise, improve the initiative to purchasing department.

(2) In view of the established procurement indexes, add a clause consist with environmental compatibility, under the premise of without damaging its own economic benefits, in view of the enterprise oneself circumstance to add depth project, actively fulfill the social responsibility.

(3) Set up green procurement objectives, don't have cost as the only standard to measure the purchasing performance, green products, recyclable, decomposition characteristics, harmful to the environment are all content which must be considered.

(4) Do a good job in supplier selection, in green purchasing, excellent supplier selection is a very important link, let the high-quality chips supplier become a development partners, which will help enterprises reduce their risk, on the basis of mutual trust, the implementation of green management can be more smoothly.

(5) Through green purchasing positive propaganda the concept of green to suppliers. Through the propaganda of environmental compatibility making the potential partners in the supply chain understand the determination of green enterprise itself, create some cooperation opportunities, provides some momentum for green management. At the same time, this propaganda also make the enterprise's long-term suppliers understand the strategy of enterprises, make their own adjustments to adapt to the requirement of green society for the change of the enterprises.

(6) Set up a good communication platform related to finance and production, good

communication within the enterprise can reduce many potential risk through communication platform, through the information transparency between different departments, with the responsibility of the corresponding coordination mechanism, so it can follow up and resolve the problems of environmental pollution.

2.1.2. The proposals for green design of enterprise

Green design is the source of green management in production, it can be said that the green products is not produced, but designed. Design department should take responsible for product quality and green properties. Green design is the most important link in the green management. For the present condition of the green design in our country; the author thinks that the enterprises should do the following:

(1) Strengthen environmental consciousness of the designer. Green design as one of the most important green supply chain, the realization of its function completely comes from the control of the person. Only R&D personnel think that environment protection relate to enterprise development and human progress, they would like to work for green product design and produce a sense of achievement.

(2) Green design work should follow a few basic principles: use the green material as far as possible, try to use recycled materials, use without harmful material as far as possible, and try to use no dangerous materials. At the same time, it should also follow, small is beautiful. In the premise of guarantee the quality of product performance and value, as far as possible save the material and process steps of the design, design little process of green product.

(3) Green design is not only responsible for green products, it also responsible for the circulation and the production of green products, consider issues that need to be comprehensive, think of those constitutions which cause harm to the environment in the commercialization process, from the design level to damage the environment.

(4) Pay attention to cost. The price of green material is high, introducing green technology is difficulty, which are all significant problems, but it doesn't mean that the green design don't need to anything to save costs. The original purpose of design is designing products that meet the market rules and consumer habits, the cost in a certain extent determines the enterprise's competition advantage .as a result, the green design cannot ignore its same function, it should consider the cost problem.

(5) Actively participate in the green purchasing, green production, green marketing, green logistics and recycling communication. The link of green design is different from other aspects of green management; it must consider the production, marketing, logistics and recycling the four links of green management, at the same time, green purchasing need to be responsible for green design, so good communication is very important for green purchasing. Through the support of green purchasing, green design can precisely account the design cost; Through actively communicate with green production, green design can learn how to design products to reduce the cost of the production, easy to control pollution; Through the support and feedback of the green marketing, green design can understand the green demand in the market, what kind of product design can be welcomed by the masses; According to the requirements of the green logistics and recycling processes and technology, green design can design green products with good recovery ability and easy recycling.

2.1.3. The proposals for green production of enterprise

Green production is the core of the green management, the implementation of the green design depends on green production, the products of green marketing come from the green production, green purchasing is serving the green production, green logistics and recycling is the supporting system of green production. Green production is so important for the green management, in view of the situation of green management; the author put forward the following suggestions :

(1) Pay more attention to the role of people in the green production. Green production is also known as cleaner production, an important principle of cleaner production is people-oriented, attaches great importance to the interests of employees, from the perspective of reducing damage and harm to employees, consider for the employees is the bottom line which green production must stick on, staff belong to the valuable assets of corporate, the protection of employees is the protection of enterprises. At the same time, people are an important subject of green production. The green consciousness of the production personnel determine whether the implementation of cleaner production is smoothly. Environmental performance and the requirement of clean production shall be added to the employee's training and performance evaluation, from two aspects of thought and system, give employees green love and also give green expectations.

(2) Pay attention to production detail. Different factories use the same manufacturing process,

production process will be the same, but have the different costs, the reason mostly due to the mastery of detail, mobilize the enthusiasm of employees, make a line production personnel involved in the greening of production process modification, it not only improve the efficiency of production and also can suggest many improve enterprise environment compatibility.

(3) Add environmental impact factors into the cost accounting. Changing the old cost accounting method, adding some environmental impact factors, assessing the environmental costs, adapt themselves to the spirit of sustainable development.

(4) Encourage small innovation in the process of production, formulate a certain incentives, and reward those who advise suggestion in the production process, help improve the production environment compatibility, reduce the cost and loss, share the profits with employees, which can effective to stimulate staff to forge ahead.

(5) Emphasize the communication between the production and the green management. join the support of green purchasing, green design, green marketing, green logistics and transport module into the information sharing platform, let the other link also can obtain information from the green production database, let all the links serve green production, reduce the delay of information, convenient to solve the problem in the process of production, and reduce the possibility of harm.

2.1.4. The proposals for green marketing of enterprise

Green marketing is the only link in green management that can transform the enterprise's production capacity, competitiveness and green into actually cash flow and assets. Green marketing relates to whether the enterprise can survive. Green products provided by the green production need the link of green marketing to realize sale, this process involves many complicated aspects, such as market environment, consumption habits, and climate factors and so on. In terms of the present situation of green management, the author put forward the following suggestions for green marketing of the enterprise:

(1) Through the enterprise internal communication mechanism actively reflect the market situation to green purchasing and green design, help green design improve the product . Join green marketing module into information sharing system to help the production department to understand the orders and arrange production.

(2) Increase the green awareness of marketing personnel. Through training, strengthen the marketing personnel's environmental consciousness, gradually develop green marketing environment of product.

(3) Join the propaganda of green culture in the marketing, enterprises can make marketing strategy giving priority to green marketing and train their own distributors' environmental awareness, strengthen downstream sales' understanding of the green product production material and the level of technology, make consumers understand that the products of this enterprise reflected in which aspects, can improve the customer understanding of green products.

(4) Appropriate participation in public welfare activities related environmental protection. for the terms of enterprises' present situation of the industry, actively participate in some activities reducing damage to the environment in the industry process, let the consumer and the public see the endorsement and support of the enterprise for green action, its effect can gets a higher support in a particular user group and promote sales.

(5) Follow the principle of choosing nearby manufacturing sales. Positive analysis consumer habits and market in the manufacture market, and try to arrange the manufacture and sale in the same area, reduce resource waste and environmental pollution caused by logistics transportation.

2.1.5. The proposals for green logistics and recycling of enterprise

The link of green logistics and recycling of enterprise is support link of the whole process of green management. Though green logistics is closely related to green recycling, but its function is not the same. In this section, the author will put forward some suggestions of green logistics and green recovery.

Green logistics emphasis on reducing the damage to the environment in the link of material circulation, hope let the impact on the environment minimize. At the same time, green logistics is the link that connect the green purchasing, green production, green marketing and green recovery together, has realized the real flow in the operation of green management as a whole. In current, enterprise logistics usually use two ways: self-built logistics and outsourcing with a third party.

For the self-built logistics enterprises, the author has the following suggestions:

(1) Attaches great importance to the role of logistics in green management, have the logistics as an important link in reducing enterprise production cost, and share other logistics link to the same treatment of information sharing. The cost of self-built logistics is high, but this kind of mode makes the enterprise each link has high degree of consistency cohesion and can reduce the communication cost of the enterprise.

(2) Through training the logistics personnel to help them understand the company's green strategy. Logistics professionals usually focus on the delivery of material is timely, but in the green management, it shall submit logistics links can reduce pollution and waste to the logistics operation personnel, help them cultivate efficiency and the idea of protecting the environment.

(3) Use some equipment with clean energy for power in logistics activities, such as using natural gas vehicle, using hydraulic, wind power transfer device, and so on.

(4) On the basis of full communication, reasonable using of transportation resources, reduce the empty loading rate. In the last section proposal of green marketing, emphasized the principle of manufacturing sales nearby, this principle is also important for green logistics, it can make a transportation process, complete feed and the waste at the same time, or sales and recycling two things, enhance the efficiency and save cost.

(5) Have the green logistics innovation, marketing through the logistics links, cultivate consumption habits. Green logistics not only include internal and external logistics. Through internal logistics, enterprises can realize production ingredients, through external logistics, enterprise can reach consumers' hands, and this is actually a service process of enterprise, attaching great importance to the process can improve the overall quality of green products.

For enterprise using third party logistics, the author has the following suggestions:

(6) Have the third party logistics company as a logistics provider, evaluate the strict supplier. Entrusting the third party to do enterprise logistics activities is equal to buy the company's logistics service, so the enterprise need to audit the supplier, only meet the requirements of the corresponding environmental compatibility as a supplier.

(7) Cultivate the right third party logistics enterprise as its own long-term partner. When the

enterprises implement green management, in logistics link it need to those enterprises that have the same vision. The long-term cooperation can bring the convenience of communication, more tacitly deal with some of the crisis in the supply chain.

(8) Make the standards of packing and shipping for products and recycled materials. Through standardized means to do transport activities, which can bring convenience to the unified deployment and the reasonable planning, at the same time, it can avoid leaking the company's commercial secrets.

(9) Accordingly make money compensation and cut according to the environmental performance of the third party logistics. When the third party logistics innovate itself and provide more green and high quality service, the enterprise can compensate associated with the marketing. When the third party logistics has been found that the destruction of the environment, review evaluate its environmental performance and decide whether continue to our cooperation.

Green recycling is an important part that the green management is different from traditional supply chain management, is the importance process of realization of material recycling. In our country, green recovery of enterprise is still in a very primitive and extensive stage. Improving green recycling performance of enterprise, the author thinks that it should start from the following points:

(10) Attaches great importance to the green recycling technology. Most materials of commercial products are recycled, but in the end it is not recycled, the reason has a lot of. One of the main reasons is that there is no corresponding technology of waste, scrap product decomposition and in use.

(11) Strengthen cooperation with green design. Product's green properties were shooting out, whether can be recycled is done by design.

(12) Enterprise can use certain economic rewards to encourage consumers exchange their abandoned related products with enterprises, which both can be get the green materials at low prices, and can use green marketing to marketing a new round of consumer, driving the development of green recovery.

2.2. Social Level

From the social level, considering the development level of green management of various industries, government policy and legal factors, combined with the result of quantitative analysis, we can make the following conclusion:

(1) At present, there is a higher threshold for the implementation of green management of enterprises, one of the most important factor is the green cost, implementing green management don't reduce costs, instead of consuming the capital of the enterprise, this make many enterprises wait.

(2) The government's regulation of environmental protection is not enough, environmental protection laws and regulations still remains to be perfect. On the one hand, many local governments only one-sided pursuit the growth of GDP, blindly exaggerated industrial scale, ignore the excessive development and pollution of the environment problems. On the other hand, due to the imperfect legislation, a lot of behaviors damage to the environment are not clear stop, or after confirmation of the behavior without effective punishment, which make the efficiency is low.

(3) Supply chain is an integral part of the system, implementing green management not only focus on their own, supplier,partners and consumers are very important subjects, so in the implementation of green management, it need to raise their ability of communicate, which is also the problems existing between the industry and current industry.

(4) To solve these problems, the author put forward the following suggestions from creating green culture of enterprise; reducing cost of enterprise, promoting technology innovation ability of enterprise, enhancing communication of enterprise; hope to provide some positive effect for the development of green management in our country.

2.2.1. Create the green culture of enterprise

From a social perspective, we can start from the following points to help enterprise build the green culture:

(1) Government encourage enterprises to carry out green innovation, use the tax and capital support to support enterprises and individuals engaged in the development of green technology, it also regularly organize areas of green science and technology conference,

commend the outstanding individuals and businesses contribution in the field of green, build green atmosphere of industry.

(2) Strengthen the green consciousness of consumers. Through the public welfare advertisement form, go deep into the community, the country; promote green products of excellent enterprise, let consumers know the dangers of the current environment received.

(3) The government and the enterprises can use social networking site, weibo, television medium and portal website formed alliance to propaganda, build a green atmosphere in society, and raise the development of green management of enterprise into the level of incentive factors.

2.2.2. Decrease the green cost of enterprise

At present, the green cost is an important factor restricting the development of green management, from the view of social level; the author put forward the following suggestions:

(1) Increase the penalties for environmental damage behavior. Whether through fine, pay tax or restricting trade products, as long as you can through legal means to crack down those who destroy the environment of enterprise engaged in the environmental damage, for enterprises implementing green management, it cultivate their competitive advantage.

(2) Reduce the green cost by government subsidies, tax cuts and other measures.

(3) Joint together financial industries, offering financial products related environmental protection, provide financial support for the development of green products design, provide energy for the green management from the source of funds.

(4) Encourage the development of circular economy, development of recycled and recycling all kinds of goods. The development of circular economy can bring the rise of material recycling; recycling materials with its high degree of recyclability can save cost, which will bring considerable wealth.

2.2.3. Improve technology innovation ability of enterprise

Enterprises' technology innovation ability has been took attention by the enterprise and society, it is regarded as important symbol of national development and industry forward, it has always taken seriously. Based on the level of technological innovation ability, the author

put forward the following suggestions:

(1) Use the industry associations to advertise, help enterprises change ideas, it not only pay attention on the technological breakthrough, but also attach importance to the promotion of management ability.

(2) In industry, have the highly united industry cluster as a template, improve technology innovation ability on a regular basis, it not only communicate in technical, also on the production operation management problem for communication.

(3) Across industry, through the communication of the industry association drive the communication of enterprise, from the angle of the relationship between upstream and downstream of supply chain, from the breakthrough of technology and management to carry on the summary and study.

2.3. Increase the Communication Ability of Enterprise

The enhancement of communication ability of enterprise can help enterprise control the risk; reduce the bullwhip effect and so on for better performance. From social perspective, we can help enterprises enhance communication ability from the following aspects:

(1) Give aid to hardware and consulting provider engaged in the internal process integration of enterprise. Enterprise mostly focus on the production, ignore the internal communication, by consulting providers help enterprises set up the integration of the communication system, complete the internal communication of enterprise.

(2) Dominated by government and industry association, establish a communication platform of internal between enterprises and industry, help upstream and downstream enterprises of supply chain communicate, face the market volatility together, make a unified policy response.

(3) Encourage cooperation of college and enterprise. On the one hand, colleges and universities undertake some advisory and technical development tasks for enterprises, on the other hand, the enterprise strengthen the cooperation with research institutions, at the same time; college students can also receive the green idea of enterprise, which provide future development force for the enterprise.

3. Prospect

Today, environmental events always happen frequently, the bitter experiences make people realize the environment problem is urgent. Government formulate relevant policies to control and standardize all kinds of pollution problem, consumer also has demand for the environmentally friendly green products. But in the process of manufacture, traditional clothing enterprises cause serious impact on the environment with the large amount of waste water and pollutants. By reform the clothing enterprises to carry out green management, help clothing enterprises transform into green new enterprise is an effective way. This paper summarizes the research achievements of predecessors, applied the green management into the clothing enterprise's each link, look for the internal and external factors that influence the development of green management: green cost, green culture, technology innovation ability, communication ability of enterprise, the government and the legal, consciousness of social environment and competitors environmental pressure, combined these factors, through the construction of ANP model combined with a questionnaire study way, determine the weight of some factors, pointed out the direction for clothing enterprises implementing green management in the end, the author puts forward some suggestions from the enterprise level and social level, hope to promote the development of green management of garment industry.

We can see from above, the green cost in the process of clothing enterprises implementing green management has a high weight, which suggest that the cost control is very strict in enterprises implementing green management, it can also understand that cost restrict garment enterprises at present stage, it is the key for the implementation of green management. This also can be seen from the other side, for the green culture, the communication ability doesn't get attention by clothing enterprises, for technology innovation ability contains management innovation ability, the enterprise pay more overweight and equipment technology updates, and ignore the importance of green management.

The above problem is not a simple phenomenon; we can't solve them not only from the clothing enterprise, or from the perspective of a society. We need to recognize the complexity of the problem, from the enterprise, industry, government, law, social culture and other multiple perspectives to consider these issues, now we can effectively solve the dilemmas. for apparel enterprises, its green cost influence the development of green management, the government and regulatory departments shall start from the perspective of environmental

protection, formulate the destruction of the environment, and strictly carry out, encourage the development of clothing enterprises implementing the green management. Based on the situation of clothing enterprise having the rest of the material, we should rise materials recovery, establish a circular economy, encourage apparel industry cluster formation, set up information sharing platform in internal and external industry upstream and downstream of industry cluster, sharing the development of green management information, promote the exchange of the relevant parties and come into a virtuous cycle development of green management. At the same time, encourage the garment industry association and industry actively communicate with various research unit, in the development of green production technology and green clothing, spread the green concept, promote the formation of the green culture of clothing enterprise. We can cut taxes and provide rewards for some garment enterprises adopted green management, use the economy and culture two methods to encourage and help enterprise consciously training green management, help employees understand the meanings and purpose of the green management, by the construction of staff team complete the shaping of green culture.

In this study, with the thought of external factors affect the internal factors, again by the internal factors influence on the enterprise as the basic thought, construct the ANP model and finally complete the study. The thought of research in a closed green management environment, its result is reasonable. However, the normal operation of enterprises is obviously effected by government and law, social consciousness and the competitors' influence, these effects are not only effect the green management, but also involve all aspects of the enterprise operation, so in this article the research scope is greatly increased, which will deviate from the theme of this study. For such a situation, the subsequent research should pay attention to the comprehensive summary with green management, all the influence factors should are classified according to the characteristics of factors, spun off internal factors that will be affected by the external factors, for the situation of the macro impact of the external influence factors, we should make a comprehensive evaluation of the internal and external factors, so it can be more close to the enterprise actual situation.