



HAL
open science

A multi-agent based cooperative control model applied to the management of vehicles-trains

Bofei Chen

► **To cite this version:**

Bofei Chen. A multi-agent based cooperative control model applied to the management of vehicles-trains. Automatic Control Engineering. Université Bourgogne Franche-Comté, 2017. English. NNT : 2017UBFCA002 . tel-01870536

HAL Id: tel-01870536

<https://theses.hal.science/tel-01870536>

Submitted on 7 Sep 2018

HAL is a multi-disciplinary open access archive for the deposit and dissemination of scientific research documents, whether they are published or not. The documents may come from teaching and research institutions in France or abroad, or from public or private research centers.

L'archive ouverte pluridisciplinaire **HAL**, est destinée au dépôt et à la diffusion de documents scientifiques de niveau recherche, publiés ou non, émanant des établissements d'enseignement et de recherche français ou étrangers, des laboratoires publics ou privés.

SPIM

Thèse de Doctorat



école doctorale sciences pour l'ingénieur et microtechniques
UNIVERSITÉ BOURGOGNE FRANCHE-COMTÉ

A multi-agent based cooperative control model applied to the management of vehicles-trains

■ BOFEI CHEN

SPIM

Thèse de Doctorat



école doctorale sciences pour l'ingénieur et microtechniques
UNIVERSITÉ BOURGOGNE FRANCHE-COMTÉ

N° 0 | 0 | 2

THÈSE préparée à l'Université de Technologie de Belfort-Montbéliard

THÈSE présentée par

BOFEI CHEN

pour obtenir le

Grade de Docteur de

l'Université de Technologie de Belfort-Montbéliard

Spécialité : **Informatique**

A multi-agent based cooperative control model applied to the management of vehicles-trains

Unité de Recherche :
Laboratoire Électronique, Informatique et Image

Soutenue publiquement le 10 février 2017 devant le Jury composé de :

VINCENT CHEVRIER	Rapporteur	Professeur des Université de Lorraine - LORIA
YACINE OUZROUT	Rapporteur	Professeur des Université Lumière Lyon 2
SIDI-MOHAMMED SENOUCI	Examineur	Professeur des Université Bourgogne Franche Comté (ISAT - DRIVE)
ROMUALD AUFRERE	Examineur	Maître de Conférences, Institut Pascal, Université Clermont Auvergne
ABDERRAFIAA KOUKAM	Examineur	Professeur des Université Bourgogne Franche Comté (UTBM - LE2I)
FRANCK GECHTER	Directeur de thèse	Maître de Concerences HDR, Université Bourgogne Franche Comté (UTBM - LE2I)

*To my parents Xikun CHEN and Qiaoyun
LEI.*

SOMMAIRE

1	Introduction	1
1.1	Context	1
1.2	Issues	2
1.3	Goal of the thesis	3
1.4	Outline of the thesis	4
1.4.1	First part : state of the art	5
1.4.2	Second part : cooperation traffic control based on multi-agent paradigm	5
1.4.3	Third part : experiment and results	6
1.4.4	Fourth part : conclusion and future work	6
I	State of the art	7
2	Intelligent vehicle	9
2.1	Main technology of intelligent vehicles	9
2.1.1	Platforms and sensors	9
2.1.2	Perception	11
2.1.2.1	Global position perception	12
2.1.2.2	Local environment perception	12
2.1.2.3	Vehicle state perception	15
2.1.3	Navigation and control	15
2.1.4	Communication	16
2.2	Main programs on intelligent vehicles	17
2.2.1	United states	17
2.2.1.1	Department of transportation (DOT)	17
2.2.1.2	Defense advanced research projects agency (DARPA)	18

2.2.2	European commission framework program	18
2.2.3	Asian	19
2.3	Main application areas of intelligent vehicle	20
2.3.1	Convenience system	20
2.3.2	Safety system	21
2.3.3	Productivity system	22
2.3.4	Traffic-assist system	23
2.4	Intelligent vehicle in traffic management	23
2.4.1	Traffic management based on traffic light	24
2.4.2	Autonomous traffic management	25
2.5	Cooperate control based on intelligent vehicle	25
2.5.1	Cooperative control based on intersection	26
2.5.2	Platoon control	27
2.6	Conclusion	28
3	Multi-agent system	29
3.1	Definition of multi-agent system	29
3.1.1	Agents	29
3.1.1.1	Agent types	30
3.1.2	Multi-agent system	31
3.2	Application of multi-agent system	32
3.3	Multi-agent system in transportation system	32
3.3.1	Multi-agent in traffic management	32
3.3.2	Cooperative control based on multi-agent system	33
3.4	Conclusion	34
4	Conclusion	35
II	Cooperative control based on multi-agent model	39
5	Multi-agent model based on vehicle and train	41
5.1	From vehicle to vehicles-train	41

5.1.1	Vehicle physical description	42
5.1.1.1	Reference frame and coordinate system	42
5.1.1.2	Vehicle kinematic model	43
5.1.2	Vehicle and vehicles-train	44
5.2	Multi-agents model	45
5.2.1	Vehicle agent	46
5.2.1.1	Vehicle agent resources	46
5.2.1.2	Perception	48
5.2.1.3	Vehicle agent reaction framework	49
5.2.2	Vehicles-train agent	49
5.2.2.1	Vehicles-train agent resources	50
5.2.2.2	Vehicles-train agent reaction framework	51
5.2.3	Connection of agents	51
5.3	Conclusion	52
6	Agents organization and interaction	53
6.1	Organization structure	53
6.2	Agents communication	55
6.2.1	Between vehicle agent and vehicles-train agent	55
6.2.1.1	Run-in-train communication	55
6.2.1.2	Splitting communication	57
6.2.2	Between vehicles-train agents	58
6.3	Virtual vehicle agent	59
6.4	Conclusion	60
7	Cooperative control based on multi-level decision	61
7.1	Train-agent decision	61
7.1.1	Vehicles order	61
7.1.1.1	Principles for deciding the vehicles order	62
7.1.1.2	Arriving times	64
7.1.2	Preceding vehicle and role	65
7.1.2.1	Principle for setting preceding vehicle	66

7.1.2.2	Platoon strategy	67
7.1.2.3	Splitting strategy	67
7.1.2.4	Crossing strategy	69
7.1.2.5	Merging strategy	73
7.1.2.6	Reconfiguration decision strategy	76
7.2	Vehicle agent reaction	86
7.2.1	Platoon control model	86
7.2.2	Model parameters	87
7.2.2.1	Global stiffness	87
7.2.2.2	Damping coefficient	88
7.2.2.3	Two spring stiffness	88
7.3	Conclusion	90
III	Experiment and results	91
8	Experimental platform	93
8.1	Intelligent vehicles in our laboratory	93
8.1.1	Sensor configuration	93
8.2	Experiment platform	95
8.2.1	Architecture of experimental platform	95
8.2.2	Virtual Intelligent Vehicle Urban Simulator	95
8.2.2.1	VIVUS elements	96
8.2.2.2	Configuring scenarios in VIVUS	96
8.3	conclusion	98
9	Experiment in the road without intersections and results	99
9.1	One vehicles-train in one lane	99
9.1.1	Processing diagram	99
9.1.2	Speed and distance record	100
9.2	Vehicle splitting from its vehicles-train	101
9.2.1	Processing diagram	101

9.2.2	Speed and distance record	102
9.3	Vehicles-trains merging	104
9.3.1	Processing diagram	104
9.3.2	Speed and distance record	105
9.4	Reconfiguration inner-train	108
9.4.1	Processing diagram	108
9.4.2	Speed and distance record	110
9.5	Conclusion	111
10	Experiment in intersection and results	113
10.1	Vehicles-trains passing crossroad	113
10.1.1	Processing diagram	113
10.1.2	Recorded data	114
10.1.2.1	Distance	114
10.1.2.2	Passing time	115
10.2	Vehicles-trains passing roundabout	117
10.2.1	Processing diagram	117
10.2.2	Recorded data	118
10.2.2.1	Speeds	118
10.2.2.2	Distances	120
10.2.2.3	Times	122
10.3	Reconfiguration between two vehicles-trains in roundabout	123
10.3.1	Processing diagram	123
10.3.2	Speed and distance record	125
10.4	Reconfiguration between two vehicles-trains in crossroad	128
10.4.1	Processing diagram	128
10.4.2	Speed and distance record	131
10.5	Three vehicles-trains passing crossroad	134
10.5.1	Processing diagram	134
10.5.2	Recorded data	135
10.6	Conclusion	140

IV Conclusion and future work	143
11 Conclusion and future work	145
11.1 Conclusion	145
11.2 Future work	146

INTRODUCTION

1.1/ CONTEXT

The use of individual vehicles is becoming more and more important in inner cities, leading to many side effects such as traffic jam, air pollution and an increase of accidents. Many research works are still focusing on finding suitable and acceptable solutions to these problems and particularly dealing with traffic jam management. The focus of these works can be based on vehicle level or system level.

Thus, advanced intelligent vehicle (IV) technologies have been widely studied so as to overcome these problems. IV system can perceive environment for providing information to decision system and then assist the driver or control the vehicle directly in optimal operation. The IV research work is worldwide going on from governments to vehicle companies. Some of the solutions provided by these works are already available to the general public market such as parking assist, adaptive cruise control, lane departure warning system, collision avoidance system [Bishop, 2005],...

In order to expand the ability of transportation system, one idea based on IV is to group vehicles into platoons (vehicles-train) making possible a huge reduction of the longitudinal distance between vehicles and thus allowing an increase of roads capacity. Basically, two main trends can be found literature. On one side, global approaches are based on a common reference frame, generally tied to the vehicles playground, shared by all vehicles of the train. Then, each vehicle behaves according to this shared reference which can be either the trajectory of the first vehicle of the train or a reference trajectory built offline. On the other side, local approaches are based on vehicle local perception abilities. Some methods, based on classical control algorithms or physical-inspired and inter-vehicular interaction link, are developed. For instance, a platoon including three truck has already been tested in a trip right across Europe by Mercedes-Benz¹.

1. <https://www.mercedes-benz.com/en/mercedes-benz/next/connectivity/the-digital-future-of-the-truck/>



FIGURE 1.1 – Truck platoon developed by Mercedes-Benz

On the other side, traffic light systems have been used to control the traffic flow since long time. Traffic light systems provide a safety solution to the transportation systems through allocating priorities to different road with a fixed time schedule. People had found that the traffic flow can be optimized through adjusting the traffic light, such as providing a longer time to the road where more vehicles are. With the development of sensors and communication information, lots of progress had been carried out in traffic light systems. Furthermore, traffic flow management systems based on intersection has been developed based on the modern sensor and information technology [Chen et al., 2016].

1.2/ ISSUES

Although technologies have been developed as solutions to traffic problems, there are still issues which cannot be solved by the existing methods.

Vehicle platoons improve traffic safety through a decrease in reaction time for braking, save cost and reduce CO_2 emissions with smooth speed changing which efficiently boosts traffic flows ². However, there are some issues when several platoons meet at specific points. If several platoons run in the same road at same time, should they merge to one or not? How to merge? When two or more vehicles platoons encounter in one intersection or roundabout, which platoon or vehicle should pass first? How to share the intersection or roundabout at the same time with efficiency?

To find out answers to these issues, we can take inspiration from traffic management approaches. Thus, considering the traffic flow management based on intersection, lots of individual vehicles can be managed by one intelligent intersection. However, when platoons run in intersection, how to manage them? Whether it is possible to change to another platoon in intersection for one vehicle? How to execute it?

2. <https://www.eutruckplatooning.com/About/default.aspx>

We can abstract those problems or application scenario into three main issues :

1. How to organize vehicles and vehicle platoons ?
2. How the interactions is going on between vehicle platoons ?
3. What strategies can help to share the road infrastructure efficiently, reliably and safely ?

Solutions which are able to adapt to the constraints and able to take into account multi-level aspects can tackle with these issues.

1.3/ GOAL OF THE THESIS

The goal of this thesis is to define model for tackling with these issues. According to the expected properties, multi-agent systems are a valuable possibility. Thus, we propose in this thesis an approach, based on multi-agent system, which aims at dealing with systems level issues focusing mainly on interactions between vehicles platoons, also called **vehicles-train**. The proposed solutions can tackle the traffic jam problem whether on system level focusing on traffic light management or on individual vehicle providing better control and perception systems aimed at reducing time response and/or at increasing the road capacity. Thus, we propose a cooperative control system which relies on multi-level decision processes aimed at dealing with the interaction of platoons at road or network nodes.

Some vehicles bond together to group one vehicles-train. The relationship of vehicles and vehicles-train is shown in Figure 1.2.

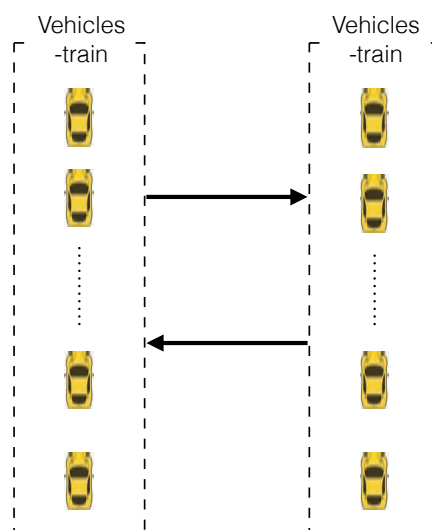


FIGURE 1.2 – Vehicle and vehicles-train

Each vehicle and vehicles-train are allocated one agent to respond the corresponding

physical entity. The structure is shown in Figure 1.3.

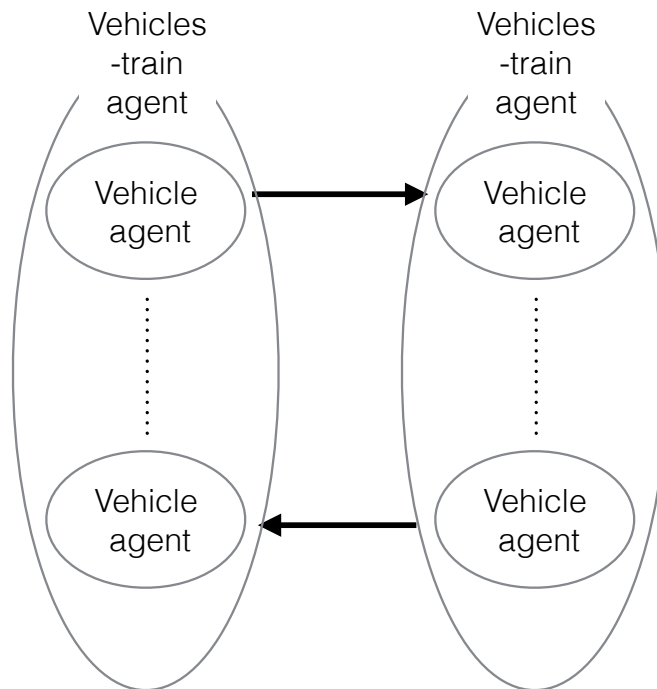


FIGURE 1.3 – Vehicle-agent and vehicles-train-agent

The vehicle information, including environment, planning and vehicle states information, is managed by vehicle agent. Parts of the information is shared to vehicles-train agent which the vehicle agent belong to. When vehicles-trains encounter and need to share the road or intersection, vehicles-trains agents can negotiate based on the shared information to gain the global optimal decision and send to its vehicles agents. Vehicles agents would move according the decision under the vehicle reaction control algorithm developed form platoon control. That can be a cooperative control system developed in this thesis.

Besides the goal of having an efficient approach so as to enable several vehicles-trains to share the road infrastructure, we also strategies to transform the meetings of vehicles-trains at road nodes into reconfiguration spots where trains can reconfigure and recombine. The developed algorithm are tested in simulation so as to obtain proper evaluation of our proposal using suitable indicators.

1.4/ OUTLINE OF THE THESIS

We organized our proposal into four parts : the first gives one brief review about the tied research work ; the second part describes the cooperation traffic control model based on multi-agent paradigm ; the third part presents the experiment and result ; the forth part concludes the proposal according to the results and previews the future work based on

this proposal.

1.4.1/ FIRST PART : STATE OF THE ART

In this part, research works is gathered and organized to show a background of our proposal for traffic issues. In Chapter 2, the development of intelligent vehicles is introduced from several different viewpoints. Firstly, main technologies of intelligent vehicles are introduced as one introduction. Secondly, we pick up some main projects about the IV and we sort out them according to countries and areas. Thirdly, main application areas of IV are shown. As a traditional traffic management method, the traffic light control system has been continually developed with the technology from optimization algorithm to autonomous traffic management. Therefore, a review about the traffic management progress based on intelligent vehicle is given in fourth part.

Since we decided to propose a multi-agent model for tackling with issues presented in 1.2, the Chapter 3 of this state of art is devoted to multi-agent system and their application, especially to intelligent vehicle and transportation system. The definition of multi-agent system is described firstly. Some examples are then shown in second section.

1.4.2/ SECOND PART : COOPERATION TRAFFIC CONTROL BASED ON MULTI-AGENT PARADIGM

In this part, one cooperation traffic control based on multi-agent system, is presented in Chapter 5. Then, the organization and interaction between elements are shown in Chapter 6. Finally, the cooperation control for the new transportation system is implemented based on multi-level decision in Chapter 7.

In Chapter 5, multi-agent models for vehicle and platoon are presented along two aspects : the physical world and agent world. The physical part is introduced firstly with vehicle and vehicle platoon (developed to vehicles-train) description. The basic features for the vehicle are depicted including mathematic models describing the movement law, and the real sensors necessary for collecting environment and vehicle information. Then the platoon physical model is described so as to define the characteristics of a vehicles-train. Agents are described into two parts : vehicle agent and vehicles-train agent. For both, elements are detailed including agent resources and reaction framework.

In Chapter 6, the agents organization and the interaction model are detailed. The way how agents are organized is spelled out firstly. As previously seen, the organization structure separates the agents into two levels : vehicle and train level. Under this structure, the information flow is also defined : the train agent collects the information from every vehicle agent including requests sent by vehicles ; then this information is exchanged between train agents for negotiation. Agents send request, receive answer and exchange informa-

tion through communication. On one hand, the processing of vehicle agent communicating with train agent is formalized in two situations : run-in-train and splitting. On the other hand, vehicles-trains exchange information for the implementation of cooperation control. In order to carry out the interaction movement, one tool called virtual vehicle is introduced which is a virtual entity, conveniently defined for formation control. .

In Chapter 7, the decision system is presented according the decision information flow : from train agent level decision to vehicle agent level decision. The train level decision algorithm carries out the preceding vehicle and role for every vehicle. Firstly, the vehicles order, a series of priority, is calculated according vehicle relative position and speed. Secondly, the preceding vehicle and the role for every vehicle are carried out according to the vehicles order and the route. Then, the speed and the angle commands are calculated by the vehicle level decision algorithm according to the preceding vehicle and the role based on the physical inspired model.

1.4.3/ THIRD PART : EXPERIMENT AND RESULTS

In Chapter 8, the experiment platform is introduced focusing on the simulator. Then, in Chapter 9, the results of experiments in the road without intersection were presented in four scenarios : (1) one vehicles-train running in one lane ; (2) one vehicle split form its vehicles-train in the two lanes road ; (3) two vehicles-trains merging to one in the two lanes road ; (4) one vehicles-train reconfiguring inner-train in the two lanes road.

In Chapter 10, experiments in intersection were presented including four scenarios : (1) two vehicles-trains passing the crossroad at the same time ; (2) two vehicles-trains passing the roundabout at the same time ; (3) two vehicles-trains reconfiguring in roundabout ; (4) two vehicles-trains reconfiguring in crossroad.

1.4.4/ FOURTH PART : CONCLUSION AND FUTURE WORK

In this part, the conclusion is given based on the experiment result. And the future work is forecast in several different points of the proposal.



STATE OF THE ART

INTELLIGENT VEHICLE

Intelligent vehicle (IV) is a strategic solution to the mobility problems through improving traffic flow efficiency and increasing security [Bishop, 2000]. The development of IV is based on kinds of advance sensors providing perception information, computer and intelligent algorithms giving optimal navigation and control command. The communication ability is also developed to achieve the vehicles cooperation. In the past decades years, lots of programs had been developed in many countries. And the IV has been used for lots of issues, for convenience reason, providing safety system, improving traffic productivity and as a traffic-assist system. The research work of IV is shown in this chapter detailing with different viewpoints as mentioned.

2.1/ MAIN TECHNOLOGY OF INTELLIGENT VEHICLES

In this section, several main technologies are presented from the physical platforms to the algorithms. There are lots of elements composing the intelligent vehicle. In our research work, just four parts are studied including sensors, on-board computers, actuators and communication module. Those parts make up the physical platform, introduced in Section 2.1.1. Three major elements of software architecture are also reviewed in this section including perception, navigation and control, communication.

2.1.1/ PLATFORMS AND SENSORS

The intelligent vehicle platform is the key equipment for research and validation of the technology of dealing with traffic issues [Tian et al., 2013]. As all the autonomous machine, three types of components are contained : sensors, on-board computers and actuators.

1. Sensors provide perception information including vehicles state information and environment information.
2. On-board computers decide the movement of the vehicle based on the collected

information by sensors.

3. The actuators executes the command sent from on-board computers to carry out the movement of vehicle.

Some of IV teams reform vehicles through equipping sensors, featuring electronically actuated throttle, shifter, parking brake and steering system [Broggi et al., 2013], several platform are shown in Figure 2.1.



(a) Vehicles in urban challenge



(b) Google car platform



(c) MIT vehicle platform in urban challenge



(d) Stanford vehicle platform in urban challenge

FIGURE 2.1 – Several intelligent vehicle platforms

For environment perception, some sensors are adapted in IV [John et al., 2008] :

1. **Camera** : Both monocular and stereo cameras are image-based sensors providing environment information through image.
2. **Lidar** : As one of the range sensors, Lidar (also called LIDAR, LiDAR, and LADAR) measures distance by illuminating that target with a laser light [LI, 2013].
3. **Radar** : Contrastingly with lidar, radar uses radio waves to determine the range, angle, or velocity of objects [Muller et al., 2009].
4. **GPS** : The Global Positioning System (GPS) sensor receives the location from the global navigation satellite system. The GPS system provides critical positioning capabilities to military, civil, and commercial users around the world [Werling et al., 2010]. The United States government created the system, maintains it, and makes it freely accessible to anyone with a GPS receiver. Other

country and district also develop the similar system, such as the Russian (GLO-NASS), Indian (IRNSS), Chinese (BeiDou-2), or European (Galileo).

- 5. Vehicle' motion sensors :** In order to collect data of the vehicle's movement, measurements form odometry and inertial sensors are equipped.

With the development of IV, the communication module is also equipped in vehicle to realize the vehicles cooperation and enhance the perception through exchanging information [Stiller et al., 2012].

2.1.2/ PERCEPTION

From sensors data, the vehicle distills navigation information and this task is finished by perception. There are three level processing for vehicle navigation, as shown in Figure 2.2.

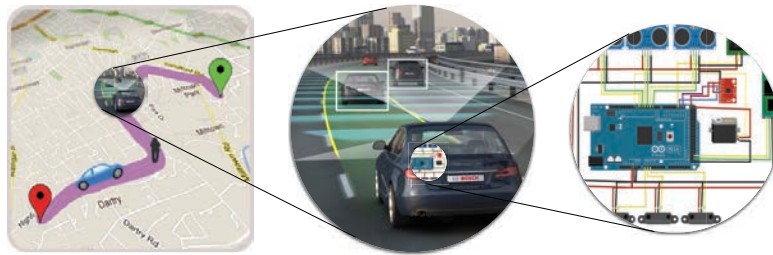


FIGURE 2.2 – Three navigation levels for autonomous vehicle

Three navigation levels are detailed for autonomous vehicle in below :

- 1. Global navigation :** deciding the route according the position information, the destination and maps, shown in the left sub-figure in Figure 2.2. This happens when we use navigation software for driving to a unfamiliar place.
- 2. Local driving :** staying the vehicle in safety and suitable lane under the guidance of environment information including obstacles information, other traffic participants and road shape, shown in the middle sub-figure in Figure 2.2.
- 3. Vehicle state control :** making sure the vehicle running in controlled stability speed and direction, shown in the right sub-figure in Figure 2.2. The tradition vehicle control is in charge of this goal on the assistance of speed and steering feedback.

According the information needed in different navigation level, the perception task is classified into the following categories :

- 1. Global position perception :** Normally, the global position information could be measured with GPS. Some sort of environment map can be used to improve localization by associating map features with that detected by local sensing. Such approaches are summarized as map-aided localization [Luettel et al., 2012].

- 2. Local environment perception :** Each vehicle need to perceive necessary information about its surrounding environment with sensors. The road shape perception directs the vehicle to run in the right position in the lane. Obstacles and other participations detection avoid traffic collisions.
- 3. Vehicle state perception :** Vehicle state includes the speed and direction of vehicle. The classic control algorithm could keep the system running in stability owing to the statement feedback. For the autonomous driving algorithm, the speed and the direction are two main feedback parameters. Therefore, the speed and direction perception is one essential features for autonomous vehicle.

2.1.2.1/ GLOBAL POSITION PERCEPTION

For the navigation purpose, the vehicle global position is one basic information. Lots of instruments and system are developed for global position perception. The GPS system, developed by United States, is widespread used in the research work and in commercial devices. Other global navigation satellite systems are also developed, such as the Russian global navigation satellite system (GLONASS), the European Union Galileo positioning system, the China BeiDou Navigation satellite system, the Japanese Quasi-Zenith Satellite System and the India's Indian Regional Navigation Satellite System.

However, the GPS signals get weak or corrupted in scurviness environment [Luettel et al., 2009]. Therefore, some methods are implemented to make up the disadvantage of GPS. Some researchers integrate inertial sensors to system to localize vehicle position [Ryu et al., 2004] [Limsoonthrakul et al., 2009] [Ippoliti et al., 2007]. There are more researchers to achieve at a diverging solution through building some associating map of the environment in other information, summarized as map-aided localization. The associating map features with characterizes detected by local sensing. In [Levinson et al., 2010], one alignment based on GPS, inertial and laser data is established to enhance vehicle localization robust. Vision-based map-aid is also an interesting approach [Wei et al., 2011] [Ave et al., 2006] [Pink et al., 2009].

For vehicle driving, the global position information isn't enough, local information, such as the lane situation, is also necessary.

2.1.2.2/ LOCAL ENVIRONMENT PERCEPTION

Autonomous driving is one feature of intelligent vehicle. In order to achieve the feature and keep itself and other object in safety, it is necessary to perceive the information about other vehicles, obstacles and local signal which composing the local environment [Li et al., 2014]. In the ExoMars Rover Module, the perception system was developed with the ability of analyzing stereo images in order to create 3D models of the terrain in front of the rover [Kevin Mcmanamon et al., 2013].

Traffic participants and other obstacles

From the sensor data, different objects are recognized through features. In [Song et al., 2002], an omni directional intelligent vehicle platform with the laser as sensor is constructed to develop a sensor data processing methods for both 1D and 2D laser scanners. One algorithms has been implemented to segmented laser raw data to lines, circles, ellipses, planes and corners. Then each subset of data is matched with template shapes to discriminate the shape for final object identification. A codebook containing high-dimensional features is established by training in [Pandey et al., 2012], and new perception of 3D lidar and camera imagery can be represented as a collection of codewords.

The perception solution for intelligent vehicle can be implemented in four parts : segmentation, fragmentation detection, clustering and tracking based on LIDAR data [Domínguez et al., 2011]. A new 3D segmentation method for object extraction based on LiDAR data incorporate the nonparametric and spectral graph clustering is presented in [Yao et al., 2009]. In order to classify dynamic data into sets of moving clusters, the dynamic states (position, velocity, acceleration, rotation, etc) is taken into account. For instance, a dynamic clustering method dealing with laser radar data has been developed based on multiple Kalman filters to track the dynamic states of the data points in [Cheok et al., 1998]. Based on integrating a powerful image processing hardware, efficient sensor fusion, terrain reconstruction and path planning algorithms has been developed in [Rieder et al., 2002]. Quantifies sensor performance and obstacle avoidance ability have been shown in several examples. A hierarchical data segmentation method from a 3D high-definition LIDAR laser scanner has been proposed for cognitive scene analysis through abstracting raw information from a parallel laser system [Steinhauser et al., 2008].

Data fusion is also a widespread method to perfect perception and process data. It is used especially for local environment detection. The data fusion based on lidar and camera information was developed in [Hwang et al., 2007] employing in two part : hypothesis generation and hypothesis verification part. These two parts deal with lidar and camera respectively. 3D Machine perception based on lidar and video sensors has been researched in several consecutive parts to represent and acquire metric, to building symbolic and conceptual knowledge from video and lidar data of a vehicle. The algorithm based on geometrical and topological reasoning and Markov Logic Networks is one of the efficient solution [Stiller et al., 2012].

Considering that the object should be detected, detection of moving obstacles and free space determination are key issues for driving assistance systems or autonomous vehicles. A lidar-based perception system has been implemented in two frames, the global one generates the mapping and the local is used to deal with moving objects [Moras et al., 2010]. The algorithm based on two steps to classify objects from

LIDAR's point cloud data has been developed for intelligent vehicle to recognize and avoid from moving obstacles in [Jang et al., 2011]. Particle filters have been also employed to track the shape independent objects based on two vehicle-borne lidar data in [Thuy et al., 2009]. Detection of moving objects for intelligent vehicle has been also formulated as a hypotheses testing problem that allows taking into account various constraints and assumptions simultaneously in [Erbs et al., 2011]. The optimal segmentation can be detected by means of dynamic programming based on the data from stereo image sequences. Moving vehicle detection also can be implemented using 3D model describing the characteristic vehicle geometry and appearance which is employed to estimate the 6DoF position [Manz et al., 2011]. In most of situation, the preceding vehicle is a special moving object. The Kinect sensor was used to detect the angle and distance of the preceding vehicle, the corresponding vision-based algorithm was developed to process RGBD data in [Zhao et al., 2013]. The fast motion detection is one of important branch in moving object perception. [Baig et al., 2012] improved it through transferring occupancy information between two consecutive data grids based on laser data.

Pedestrians and bicyclists are important traffic participants and vulnerable. And they are not easy detected through segment, some specific methods were developed in [Himmelsbach et al., 2012] including discerning static from moving objects. One algorithm for detecting and tracking walking humans with a 2D LIDAR (Light Detection and Ranging) on a mobile robot has been developed in [Taipalus et al., 2011] through defining lots of human features. The human features based on lidar information has been exploited to achieve the reliable detection and classification [Premebida et al., 2009].

Lane perception

To avoid vehicle run to unsuitable direction, the lane perception is also necessary. The detection of lane is made by road edge detection which is processed as a phenomena of perceiving gradient direction levels and traced the locus of vectors which correspond to dominant linear feature [Boudihir et al., 1998].

Considering the vehicle motion control, the vehicle pose is estimated with road curvature at the same time. In [Lee et al., 1999], sensor data from camera image, velocity meter, and steering wheel encoder are fused and a lane model was proposed as a series of connected rectangular plates. [Hariti et al., 2003] proposed a passive stereo-based approach for lane perception through matching which satisfies local and global constraints with one preset map with two-dimensional matrix formulation.

A development framework and novel algorithms for road situation analysis is implemented to predict the position and size of various on-road obstacles using multiple sensors including radar, lidar, and a camera in [Cheng et al., 2007].

2.1.2.3/ VEHICLE STATE PERCEPTION

Normally, the vehicle state includes the vehicle speed, direction, steering and rotation along the longitudinal and lateral axes. In our research work, we assume that our vehicles run in the flat terrain. Therefore, the speed, direction and steering are necessary.

Inertial sensors are typical instrument for obtaining those vehicle state information through detecting the accelerations, angular rates and attitude directly. Those information can be fused using filter, such as Kalman filter, to provide a smooth state estimated. The data fusion technology can be also used to fuse the vehicle state information with other global position information such as GPS information to optimize the perception.

2.1.3/ NAVIGATION AND CONTROL

The navigation is derived from perception information. Therefore, two types of navigation are divided according perception : global navigation and local navigation. Global navigation based on global position perception and a global map usually drive to rout/path planning. Local navigation is based on the local environment information to obtain the local guidance information such as obstacle avoidance [Schworer, 2005].

The classical vehicle routing problem is one of the most popular problems in combinator optimization, and its study has given rise to several exact and heuristic solution techniques of general applicability [Cordeau et al., 2007]. A genetic algorithm with NSGA-II framework has been presented for solving the path planning problem addressed in the complexity model [Davoodi et al., 2013]. One realistic path planner also has been developed based on a dynamic vehicle model [Pepy et al., 2006].

Considering the available information, different motion planning and control techniques have been implemented to autonomously driving on complex environments. The main goal is focused on executing strategies to improve safety, comfort, and energy optimization [Gonzalez et al., 2016]. The millimeter wave radar has been used as a guidance sensor to implement autonomous vehicle local navigation [Clark et al., 1998].

One vehicle guidance system of "Leonie" has been introduced in [Saust et al., 2011] which functions on several hundred kilometers in real urban traffic. The autonomous vehicle control issue has been settled on a reinforcement learning strategy studied through the training of a learning classifier system that controls the movement of an autonomous vehicle in simulated paths including left and right turns. Different design options and the role of various parameters have been investigated experimentally. The performance of vehicle movement under the proposed evolutionary approach is superior compared with that of other approaches based on reinforcement learning that have been applied previously to the same benchmark problem [Stafylopatis et al., 1998].

2.1.4/ COMMUNICATION

Communication is a powerful technology that can improve traffic safety and efficiency. The main motivation behind the development of vehicle communication is public safety applications by providing information and assistance to road users to prevent road accidents [Chekkouri et al., 2015].

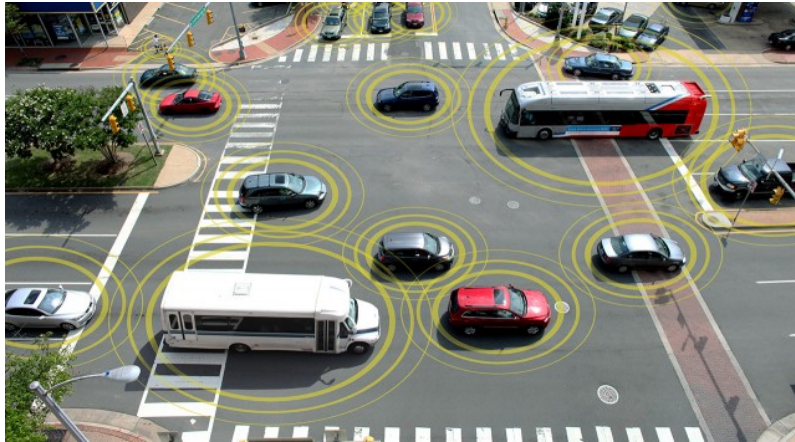


FIGURE 2.3 – Vehicle communication

Normally, the vehicle communication is sorted in two ways : vehicle to vehicle communication(V2V) and vehicle to intersection communication(V2I).

1. **V2V communications** : V2V communications use on-board dedicated short-range radio communication devices to transmit messages about a vehicle's speed, heading, brake status and other information to other vehicles and receive the same information from the messages, with range and "line-of-sight" capabilities that exceed current and near-term "vehicle-resident" systems. In this way, the vehicle communicates with others nearby. They can exchange or share information. The United States Department of Transportation and (National Highway Traffic Safety Administration) NHTSA has been conducted research on the vehicles communication for more than a decade focusing on safety [Harding et al., 2014]. Each car can, through network communication with others, perceive and get other cars information around the intersection. In this manner, they can infer the relative position and the speed direction.
2. **V2I communications** : Under the V2I communications, all information is sent to the infrastructure, such as the traffic light and so on. After the decision processing, the command is returned to all the cars. An intelligent transit signal priority logic that enables bus/signal cooperation and coordination among consecutive signals under the vehicle communication was optimized by person-delay-based method in [Hu et al., 2015b] [Hao et al., 2015].

With the development of vehicle communication, the cooperative driving system would be

used wide spread in the future [Jia et al., 2016].

The V2V communication has been employed to enhance environment perception through sharing view fields. Two types of information that should be changed were discussed in [Tischler et al., 2005] : the vehicle state information(position and speed), the objects detected and tracked.

One of the most important application about vehicle communication is cooperative driving to conducted the individual vehicle movement in a safe, deterministic and smooth manner [Li et al., 2006]. An on-board optical vehicle identification system was developed to enable telecoms and perception systems to cooperate [Arnim et al., 2007].

[Bergenheim et al., 2012] described a vehicle-to-vehicle (V2V) communication system that is developed in the SARTRE project which want to develop and integrate technology that enables vehicles to drive in platoons. Two antenna placements have been evaluated on the lead vehicle ; in front on the driver cabin and in the rear on top of the container. And results shown that the rear placement provides superior results, especially for distances above 70 meters.

In our research work, both of two ways could be adopted in different situation depending on the host which creates the vehicles-train agent and coordinate agent.

2.2/ MAIN PROGRAMS ON INTELLIGENT VEHICLES

2.2.1/ UNITED STATES

2.2.1.1/ DEPARTMENT OF TRANSPORTATION (DOT)

The U.S. DOT started the intelligent transportation system program around 1990 and the intelligent vehicle research and development has been payed attention since that time [Bishop, 2005]. The Intelligent Vehicle Initiative (IVI) program, continuing from 1998 to 2004, focused on the near-term safety to preventing traffic crashes. Four types of vehicles (light vehicles, commercial vehicles, transit vehicles and specialty vehicles) were focused on improving safety under three driving conditions : normal driving condition, degraded driving conditions and imminent crash situations.

From 2004 to 2014, nine initiatives were carried out by DOT and three of them were of interest from an IV perspective : integrated vehicle-based safety systems(IVBSS), cooperative intersection collision avoidance systems(CICAS) and vehicle infrastructure integration(VII).

The ITS strategic plan 2015-2019 presented two key ITS program priorities : realizing connected vehicle implementation and advancing automation [Barbaresso et al., 2014]. In addition, the necessary structure has been provided in several program categories :

connected vehicles, interoperability, enterprise data, automation, accelerating deployment, emerging capabilities.

2.2.1.2/ DEFENSE ADVANCED RESEARCH PROJECTS AGENCY (DARPA)

The DARPA Grand Challenge, held 3 times until 2007, attracted lots of people attention to IV¹. The team that took part in the competition constitutes a leading edge in IV research work. Different IV platforms were established and kinds of architectures were developed achieving to autonomous moving vehicles.

The Mobile Autonomous Robot Software (MARS) project aimed to develop the needed software technologies to enable the safe, reliable and cooperative operation of autonomous, free ranging systems for the real world. The DARPA wanted to enhance the autonomy of robot systems, the utility, ease of development and re-usability of robot software.

2.2.2/ EUROPEAN COMMISSION FRAMEWORK PROGRAM

European Commission (EC) research is defined by “framework programs” that set the tone and priorities for 4-5 year periods. The Fifth Framework Program (5FW, 1998-2002) led to a set of interesting results, especially in the research work of cooperative vehicle-highway systems and vehicle safety communications. The Sixth Framework Program (6FW) ran from 2003 to 2008 including the eSafety initiative developed based on the document Information and Communication Technologies for Safe and Intelligent Vehicles. In the eSafety project, several branches have been researched: emergency call (e-call), accident causation data, human-machine interaction, business rationale, deployment road maps, traffic and travel information and heavy-duty vehicles (CHAUFFEUR project).

The SARTRE project is a EC Co-Funded FP7 project that seeks to support a step change in transport utilization as the continuation of CHAUFFEUR project². The project vision is to develop and integrate solutions that allow vehicles to drive in platoons resulting in a reduction in fuel consumption (potentially up to 20%), improvement in safety (anticipated 10% reduction in fatalities) and increased driver convenience (autonomous systems for following vehicles) [Robinson et al., 2010].

InTraDE³ and FURBOT⁴ projects are particularly interested in the transport of goods. The InTraDE project focuses on improving the productivity of small and medium-sized ports in the North West Europe region. The project FURBOT is interested in the development of a mobile robotics unit dedicated to the transport of goods on the last kilometers. The FCE CRISTAL project (2007-2009) led by LOHR consisted of studying all the aspects

1. https://en.wikipedia.org/wiki/DARPA_Grand_Challenge

2. <http://www.sartre-project.eu/en/Sidor/default.aspx>

3. <http://www.intrade-nwe.eu/>

4. <http://www.furbot.eu/objectives.shtml>

concerning the implementation of a group of intelligent vehicles entering the station. The aim of the ANR-VTT-SafePlatoon project (2011-2014) was to study the problem of autonomous vehicle platoon by considering applications in urban, military and agricultural environments. One important aspect of the SafePlatoon project is that the proposed decision and control algorithms have been verified and validated by simulation and real vehicles.

2.2.3/ ASIAN

China faces lots of problem in transportation, one of major problems associated with the rapid growth in automotive production is an increase in traffic congestion and accidents, especially in big cities of China. To solve the problem, the government has been increasing funds for improving the traffic infrastructure, enforcing traffic laws, and educating drivers about traffic regulations. Chinese researchers focused on intelligent highway system defined as an integrative system based on the road infrastructure and providing the vehicle with information services, safety alert and automated operation. A testing system for intelligent highway system has been developed in the Ministry's proving ground for highway and traffic. In [Kai et al., 2003], the THMR-V system, developed by Tsinghua University, was presented providing a solution in a high-speed. The intelligent vehicle research group in Jilin University has implemented an intelligent vehicle system based on vision and laser sensor and designed a CyberCar vehicle for the 2008 Beijing Olympic Games. The Xi'an Jiaotong University (XJTU-"Jiao Tong" means transportation in Chinese) Institute of Artificial Intelligence and Robotics and the CAS have collaborated to develop intelligent driver-assistance and safety warning systems for passenger vehicles, particularly GPS-and vision-based systems [Zheng et al., 2004].

Japan, with a population density almost 12 times greater than the United States, has an abiding interest in developing intelligent transportation systems (ITS) to resolve its traffic congestion and other transportation problems [Hollborn, 2002]. From 1980 to 1995, the Road/Automobile Communication System (RACS) project was held in Japan, which formed the basis for our current car navigation system. With the developing of intelligent transportation system, more different research work were carried out toward different trends. The development projects began with advancing in navigation systems, then the automatic toll collection system was implemented. Considering about the security, the safe driving assistance was developed also. The traffic control system was also updated through the optimization of traffic management. A national ITS project named "Energy ITS", started in 2008, aims at energy saving and global warming prevention with ITS technologies [Tsugawa, 2013].

2.3/ MAIN APPLICATION AREAS OF INTELLIGENT VEHICLE

Intelligent vehicle system has been applied widespread with various types of vehicles : cars, trucks, bus and so on. Although there is some overlap between functions, we can still classify the intelligent vehicle application into four categories : convenience, safety, productivity and traffic assist.

2.3.1/ CONVENIENCE SYSTEM

Intelligent vehicle provides some benefit for driver in many ways. The most widely used one is the adaptive cruise control which keeps the vehicle in a desired speed or following the preceding vehicle.

The longitudinal control law for a following system of non-identical vehicles has been analyzed in [S. Sheikholeslam et al., 1990]. The vehicle dynamics within the platoon was presented based on a non-linear model. An autonomous intelligent cruise control system was developed to eliminate human errors and delays in vehicle following in [Ioannou et al., 1993]. And the performance of the AICC system was compared with that of the human driver models. In the vehicle following control, steering control keeps the vehicle in suitable situation. The vehicle following control based on a lane keeping method was proposed in [Fukao et al., 2013]. For a vehicle in slow and dense traffic, a technique has been developed at INRIA to automate the driving at speeds up to 10 km/h to follow preceding vehicle based on a linear camera and stroboscopic infrared lighting in [Parent et al., 1994]. A simplified car following model was also proposed in [Newell, 2002].

Following system could provide a lot of convenience to driver, however there also are some issues. Such as the curved, narrow roads, local obstacle avoidance, stop lights, roundabout and pedestrian areas. In [Muller et al., 2009], a following system was proposed to solving those issues. The perception part includes objects detecting, classifying and tracking, lane estimation based on Kalman filter. The appropriate control signal was generated based on the perception information and leading to smooth steering behavior in various scenarios.

Some researchers have done works towards the mixed traffic, furthermore the following control was divided into longitudinal and lateral control. In [Fritz, 1999], the image processing system provided the relative position of the leading and following truck. A longitudinal control was composed by two layered and lateral control was based on an electronic tow bar approach.

2.3.2/ SAFETY SYSTEM

The development of intelligent vehicle aims to solve lots of traffic issues, one of most important is the safety issue. Although the intelligent vehicle research work made significant progress, the special focus is still necessary.

One intelligent vehicle architecture was developed to increase the safety through warnings to the driver who interacts with one cooperative safety system in [Caveney, 2010]. A methodology for the certification of fully Automated Road Transport Systems, aimed at guaranteeing an adequate level of safety, has been developed in [Csepinsky et al., 2014]. The viewpoint was set at the road transport system through centralized fleet and infrastructure management system. A cooperative communications testing platform has been implemented to evaluate the operation and effectiveness of cooperative active safety applications under challenging driving and communications conditions in [Sepulcre et al., 2013].

The stability of an automated vehicle platoon has been investigated in [Wang et al., 1998]. The platoon system was trodden as an interconnected nonlinear system. The two individual stability theorems for the intra-platoon vehicles and a string stability theorem for the whole platoon was proposed to design suitable controllers. [Alvarez et al., 1997] cited that the safety have a relationship with the relative velocity threshold, therefore one state dependent safety regions was developed to make sure the platoon movement safety.

One potential dangerous for vehicle exists in obstacle, an approach to the obstacle avoidance problem was present in [Gechter et al., 2010] based on the multi-agent system. A decision, expressed as a proposed acceleration vector for the vehicle, is elaborated from the evaluation of a set of indicators characterizing the global state of a system of reactive agents.

Lane-keeping is the path of adaptive cruise control including vehicle following control. A vision-based lane-keeping automated steering system was proposed and was successfully verified in [Wu et al., 2005]. The accurate detection of the complicated road environment information was implemented firstly. Then, the virtual look-ahead method was presented as one important part of the lane-keeping steering system. Furthermore, a fuzzy control technology was also adapted to achieve manlike driving behavior. Lane changing is also one of the most challenging control mission involving safety guaranteeing and efficiency respectively. A distributed hybrid controls was developed based a methodology aiming at coordinated decentralized control strategy [Godbole et al., 1998].

The vehicle distance should be kept for guaranteeing safety. The relative distance was discussed in [Alam, Assad(RIT et al., 2014] for the heavy duty vehicle platooning. A framework has been established for analyzing safety aspects of heavy truck platooning based on a nonlinear underlying dynamical model.

The safe issue was also investigated in some specially scenario, such as the merging.

[Kim et al., 2012] provided one safe driver assisted protocol for the situation of merging with other vehicles. One architecture based upon the multiple hardware and communications platforms was established to achieve a cooperative driving protocol.

Safety assurance of vehicles is importance to improve the road transportation, especially at the intersections without signalization. To eliminate safety threat that is mostly caused by vehicle-to-vehicle collisions, technologies and methodologies of cooperative vehicle infrastructure system provide sufficient capabilities for a vehicle to share relevant information with other connected neighborhood vehicles, then identify and avoid potential collisions. In the design of collision avoidance solution, precise vehicle location is the most essential but enabling factor to support vehicle situation perception and collision avoidance decisions, which promotes location-based solutions for collision avoidance using real-time information of enhanced location from connected vehicles with wireless communication links. In [Jiang et al., 2012], a multi-sensor integration approach is presented with a GPS/DR structure where lane-level road map database for assistance is also integrated. A four-stage framework is designed to accomplish effective conflict resolution and safety assurance. Key issues including multi-sensor fusion with map match and the location-based collision avoidance mechanism are discussed. Although autonomous vehicle has taken a great advance, it is still a challenge to coordinate with each vehicles and guarantee safety. [Kim, 2013] provided a solution through generating a feasible trajectory based on a model predictive control(MPC). At the same time, several rules for vehicle-to-vehicle (V2V) and vehicle-to-infrastructure (V2I) coordination have been proposed to achieve system-wide safety and liveness.

2.3.3/ PRODUCTIVITY SYSTEM

For the commercial vehicles and transit buses, the cost and time should be payed more attention. The productivity system aims to decrease the cost such as the fuel consumption and lead to more efficient vehicle maneuvering.

The personal rapid transit has been presented and improved in [Parent et al., 1996] [Daviet et al., 1996] [Daviet et al., 1997] [Daviet et al., 1997] based on a vision technique for platoon driving of homogeneous cars supervised by a central computer. In this proposal, empty vehicles were picked up in various locations and redistributed to appropriate location.

In the Intelligent Transport system(ITS) project of Japan, the automated truck platoon have been studied [Tsgawa, 2013]. A platoon of three fully-automated heavy trucks and also a fully-automated light truck currently drives at 80 km/h with the gap of up to 4 m on a test truck and along an expressway before public use, under not only steady state driving but also lane changing. The lateral control is based on the lane marker detection by the computer vision, and the longitudinal control is based on the gap measurement by radar and lidar in addition to the inter-vehicle communications and infrared. A longitu-

dinal control for truck platooning based on distance measurement between the vehicles and on vehicle to vehicle communication without road infrastructure was proposed in [Gehring et al., 1997]. [Alam et al., 2015] proposed a decentralized controller for heavy-duty vehicle platooning based on establishing empiric results for a qualitative verification of a control design methodology.

2.3.4/ TRAFFIC-ASSIST SYSTEM

In the transportation system, there are more than one vehicles. Normally, the intelligent system just focus on the optimization for just ego-vehicle. Instead of that, the traffic-assist system provides one global optimization solution.

A new model for following vehicle response based on the assumption was developed in [Gipps, 1981] to predict the response of the vehicle and also to estimate the effect to driving environment. Longitudinal control of a platoon of automotive vehicles on a straight lane of a highway has been trodden as a constrained optimization problem [Sheikholeslam et al., 1993]. And one control laws has been proposed in the event of communication loss between the lead vehicle and the other vehicles in the platoon. A visual control system including image processing, recursive filtering, and a driving command generator was proposed in [Kehtarnavaz et al., 1991] for vehicle-following and the system has been tested on BART (Binocular Autonomous Research Team), a testbed vehicle developed at Texas A&M University for autonomous mobility.

The controller for dealing with the intersection management issue was presented in [Neuendorf et al., 2004], not only the platoon-stable was improved but also an enlarged functionality in comparison to a conventional platoon controller was implemented.

The optimal coordination of variable speed limits and ramp metering in a freeway traffic network can reduce congestion and time spent. Therefore, a coordinated freeway traffic control was proposed as finding the combination of control measures which is one predictive control based on a model for dynamic speed limits and for main-stream origins in [Hegyi et al., 2005].

2.4/ INTELLIGENT VEHICLE IN TRAFFIC MANAGEMENT

The transportation system is one gather of all participants(vehicles, passengers, bike and so on), roads and some establishment or people controlling the running of participants. Traffic flow is controlled by traffic management to avoid some accident and improve the efficiency of transportation system, normally this mission is carried out by traffic light which impacts us every day through controlling the traffic flow providing safety for transportation [Hirulkar et al.,]. Under the guidance of traffic signal, drivers, pedestrian and other traffic participation given their priority in different time to keep the transportation

system mobility and safety. The traffic signal also improved by the progress of technology to solve the vehicle density issue in the road. For decades, researchers have been studied a lot of method to find appropriate traffic light periods, so that the variables considered will be optimized. More and more optimal algorithms are developed for minimizing the waiting time and the delay to improve the efficiency of transportation system. The traffic issue can be also treated as an adaptation problem instead of an optimization problem, thus changed self-organizing traffic lights are promoted to adapt to traffic conditions, reducing waiting times, number of stopped cars, and increasing average speeds [Chavan et al., 2009] [Feng et al., 2015]. Especially, with the development of sensors and communication, more and more information can be gained to assist and thus to make a better decision including green light time and the switching time. The communication between intelligent vehicle and infrastructure provides the possibility of optimization of signal timing plans. In this section, an overview of the traffic management, based on traffic light and IV, is introduced.

2.4.1/ TRAFFIC MANAGEMENT BASED ON TRAFFIC LIGHT

The traffic light is one traditional method to manage and optimize traffic flow. Traffic lights were originally installed for safety crossing of antagonistic stream of vehicles and other traffic participant. With the increasing of vehicle density, the traffic light are used to increase the efficient of traffic network. Through assigning priority to different road according time sequence, vehicles pass the intersection or crossroad in proper order.

The traffic light in major-minor intersection has been studied in [Jiang et al., 2006]. The priority has been assigned to the vehicle platoon moving in the major roads which was defined by variables and mathematical distributions. A model depicting the relationship between the bus departure frequency, cycle length of signalized intersection and number of different signal status was developed in [Ma et al., 2007]. Furthermore, a bus signal control strategy was also presented.

Queuing models is one important issue in signal control, one was developed based on rolling horizon scheme in [Mirchandani et al., 2007] where one serving cyclic was implement including two movement. The intersection, controlled by an on-line scheduling agent, was addressed to the real-time dynamic flow optimization in [Xie et al., 2012b]. The locally effective was achieved around the intersection, then the scalable network-wide optimization. This schedule-driven intersection control strategy (SchIC) has been improve in the next work [Xie et al., 2012a] [Xie et al., 2012c]. And the scheduling problem was also solved by a forward recursive algorithm. The performance of SchIC with respect to both intersection control and implicit coordination between intersections was evaluated empirically on two ideal scenarios and a real-world urban traffic network.

2.4.2/ AUTONOMOUS TRAFFIC MANAGEMENT

The autonomous traffic management is benefit from the sensor, communication network and intelligent vehicle which provide the traffic information including the number of vehicles in different road even the speed and position.

Through exchange information among vehicles, the priori perception of potential dangers accordingly amendment of vehicle became possibility [Dimitrakopoulos et al., 2010] where the cognitive networking was discussed for the management of vehicles.

Based on the communication between robots and the controller, vehicles and infrastructure, a protocol of an autonomous intersection management has been proposed [Abbas-Turki et al., 2012] [Wu et al., 2012] [Ahmane et al., 2013]. The right of way is addressed to each robot individually, according to an optimized sequence. A on-board units negotiating the priority displays different color according the result : green for passing. The passing sequence was decided dynamically by a real time application.

A game theory framework was proposed for arranging the vehicles to minimize the delay time in [Zohdy et al., 2012]. Vehicles as reactive agents interact and collaborate with the intersection controller as manager agent. Based on the connected vehicles, all vehicles state were taken into consider under a model predictive control framework [Kamal et al., 2013].

Intersection management is one of the most challenging problems within the transport system. Traffic light-based methods have been efficient but are not able to deal with the growing mobility and social challenges [Chen et al., 2016]. Through managing the traffic of each intersection independently, a synchronization-based intersection control mechanism has been developed to allow the autonomous vehicle-agents to cross without stopping [Tlig et al., 2014b] [Tlig et al., 2014a].

A lot of autonomous traffic management model is based on the communication, however, accommodating the vehicle without communication is reasonable in recently. A legacy algorithm was proposed in [Bento et al., 2013] for the situation where a low percentage vehicles not equipped communication units.

2.5/ COOPERATE CONTROL BASED ON INTELLIGENT VEHICLE

The cooperate control is one of the most efficient method to realize the automatic traffic system with the development of intelligent vehicle. At beginning, the cooperate control was developed in robotics at the beginning to maintain a geometric configuration during movement, also called formation control problem. The virtual structure was introduced to solve this problem in [Tan et al., 1996]. [Fierro et al., 2002] presented a framework and the software architecture for the deployment of multiple autonomous robots in an un-

structured and unknown environment, with applications ranging from scouting and reconnaissance, to search and rescue, to manipulation tasks, to cooperative localization and mapping, and formation control. The group of robots can navigate to keep a geometric shape according a mobile robots cooperative method proposed in [Vilca et al., 2012]. This method was based on range data permitting to detect the position of the leader robot in the formation. [Guillet et al., 2014] proposed a control framework dedicated to the accurate control of a fleet of mobile robots operating in formation. Decentralized control relying on inter-robot communication had been favored. To ensure a high relative positioning, adaptive and predictive control techniques are considered, allowing to account for the influence of several phenomena (such as dynamic perturbations or bad grip conditions) depreciating the relevance of classical approaches based on ideal robots and ideal contact conditions assumptions. An architecture has been presented in three layers : the vehicle control layer, the vehicle management layer and the traffic management layer [Tsugawa et al., 2000]. The front two layer were set on each vehicle and the last layer was on the infrastructure. In this proposal, the visual information was fused with the information from inter-vehicle communications and inter-vehicle gap measurement. Another reference architecture for implementing a cooperative driving has been developed in [Behere et al., 2013] based on the existing vehicle architecture. In this architecture, each element contains diagnostic facilities and interfaces and supports synchronous asynchronous command interfaces. The capability of gaining status information, the signal filtering and calibration based on sensors were payed attention in [Tian et al., 2013] when intelligent vehicle platform was established for cooperative vehicle infrastructure.

For other transportation instrument, the coordination control was also developed for kinds of task. For a group of Unmanned Aerial Vehicles (UAVs), the problem is how to allocate task and trajectory. In [Richards et al., 2002], this problem was addressed in two methods : transforming as a single mixed-integer linear program, approximating the cost of different trajectories for rapid computation. Several examples were carried out to compare the performance and computational results from these two algorithms.

2.5.1/ COOPERATIVE CONTROL BASED ON INTERSECTION

For the vehicle cooperative issue, different scenarios were investigated to solve the problem. The intersection is one noticeable scenario where vehicles encounter and sometimes should stop to wait. A game theory algorithm was proposed in [Zohdy et al., 2012] to achieve the cooperative control in the intersection scenario. In the proposed system, vehicles as reactive agents interacted with the intersection controller as manager agent to minimize the total delay. A on-road demonstration of autonomous passenger vehicles performing cooperative passing and traversal of un-signalized intersections has been introduced in [Kolodko et al., 2003].

The communication provides the connected vehicle environment leading the possible

of cooperative vehicle intersection control. The cooperation between vehicles and infrastructure was one topic for automated vehicle which aims to the cooperative vehicle intersection control and management [Lee et al., 2012]. Considering with the ability of vehicle platooning, a platoon management protocol for cooperative adaptive cruise control has been developed in [Amoozadeh et al., 2015] based on wireless communication through vehicular ad-hoc network(VANET). The VANET has been investigated in [Campolo et al., 2015] and one brief review and future work has been introduced. In [Jia et al., 2016], the more general traffic model has been studied firstly which enables the cooperative driving behavior via a so-called inter-vehicle communication. Then, a consensus-based controller was provided to the cooperative driving system considering intelligent traffic flow that consists of many platoons moving together.

2.5.2/ PLATOON CONTROL

One of the famous cooperative case is platoon control which means that automated vehicles drive by forming a flexible platoon over a couple of lanes with a short inter-vehicle distance while performing lane changing, merging, and leaving the platoon. Part of the project PATH aimed at developing platoon control. The CHAUFFEUR project had the objective of heavy truck platoon control. And the CHAUFFEUR project has been continued as SARTRE which developed the embedded system to platoon control.

Vehicles equipped with automated lateral and longitudinal control functions were organized for the Demo 2000 cooperative driving [Kato et al., 2002]. The localization data came from differential global positioning system(DGPS) and the inter-vehicle communication also was implemented. The longitudinal control of platoons is one important issue which was investigated in [Maschuw et al., 2008]. Accounting for both the reduction of spacing errors and a limitation in velocities and accelerations of following vehicles, a mixed H_2/H_∞ formulation was carried out as criteria. The optimization is presented for different control structures and the effectiveness of reducing overshoots in velocities or accelerations is shown through simulation results. The extreme situation where just the distance between one vehicle and its immediate forward neighbor has been study in [Khatir et al., 2004]. A non-identical decentralized controller for the platoon problem was proposed and tested in a number of examples. The same issue was studied in [Yi et al., 2005] and an control system was carried out based on a serial chain of a spring-damper. At the same time, the state-space equation of vehicle motion was taken into consider leading to an unified algorithm fo lateral and longitudinal control. The spring-damper model also was developed by other researchers for local control approach to linear vehicle platooning [Contet et al., 2009]. For the design of a high-level cooperative platooning controller, a linear quadratic control framework has been presented in [Alam et al., 2015].

The transient formation strategy was developed as a new strategy for the formation of platoons in [Hobert, 2012] to improve the longitudinal control and achieving string stabi-

lity in a platoon. Communication as one important part has been improved by a general multi-cast protocol. When designing a cooperative control for vehicle platoon, the acceleration can be also a feedback to increase roadway traffic mobility [Ge et al., 2014]. The weighted and filtered accelerations of all preceding vehicles have been taken into account when designing real-time cooperative adaptive cruise controllers for guaranteeing the string stability of highway platoons in [Bayezit et al., 2013]. For developing a cooperative adaptive cruise control, the real experimental data has been employed ideally for a four vehicles platoon [Milanés et al., 2014] to gain simple but accurate vehicle following dynamics models.

2.6/ CONCLUSION

The development of intelligent vehicle was reviewed in this chapter. Many progress has been made since decades leading to solutions to the traffic issues. The perception system gives the navigation information in difference level. The control system carry out the correct demand driving the vehicle to achieve desired position. More and more vehicles were equipped with adaptive cruise control system to release the pressure of driver. The lane keeping system keeps vehicles in the right position in the road.

However, there still are some issues to be solved. Most of existing intelligent vehicle solutions provide local optimization and control for the traffic problem. Even the cooperative control for platoon control, the optimizing area is expend to one platoon including several vehicles. Therefore, more efficient solution should be searched in the traffic system point of view. The main issue is linked to scalability. Most of the work are dealing with vehicle or group of vehicles. Are the developed algorithm able to adapted to a rise in scalability (group of groups of vehicles). To steady this issue, instead of using a bottom up approach, research work we made likely to follow a top-down approach focusing first an traffic flow.

Traffic management provides a system point view for solving traffic issues through allocating the priority to different road. However, the waiting time just be reduced not eliminated. More important lays on that the system cannot adjust the vehicle directly. The development of intelligent vehicle can provide one solution allowing vehicles to pass the intersection or crossroad freely.

Cooperate control based on intelligent vehicle have been developed from two aspects : the cooperation based on intersection and the platoon control. Review about the cooperative control presented the research work which want to connect the traffic management and intelligent vehicle directly.

Obviously, we need a distributed model to tackle with the cooperation issue of intelligent vehicles to realize the efficient traffic flow.

MULTI-AGENT SYSTEM

As previously said, it seems obvious that solving the crossing issues for trains of vehicles in platoon required that are distributed. Among the models that can be found in literature, multi-agent system (MAS) is one of the most suitable because of its intrinsic properties, flexibility, adaptation, stability.

For several decades, there is always one controversy about whether the intelligent machine could overpass the human being. From a simple calculating machine, the computer has been developed to the level where it could win the match from human¹. It is one main aim to make the machine can think, act like the human being to solve problems. However, the theoretical difficulty, such as impossible to reproduce consciousness in a computer system, leads to practical problems [Ferber, 1999].

The agent concept has been introduced to solve problem based on simple or complex activities which emphasizes interactions and analyze the interaction systems existing between agents. The multi-agent, an powerful method for distribution system, is widely used such as manage the business [Böse et al., 2007] and so on [Siekman et al., 2009b], especially in traffic management [Doniec et al., 2008] [Kala, 2012]. This paradigm will be explained in this chapter. The agent concept is drawn into train system from allocating agent to vehicle.

3.1/ DEFINITION OF MULTI-AGENT SYSTEM

3.1.1/ AGENTS

An agent is a computer program that is situated in some environment and that is capable of autonomous action in this environment in order to meet its design objectives [Michael, 2002].

One definition has been given in [Ferber, 1999] :

1. <https://deepmind.com/research/alphago/>

Définition 1 : Agent

An agent is a physical or virtual entity

1. which is capable of acting in an environment,
2. which can communicate directly with other agents,
3. which is driven by a set of tendencies (in the form of individual objectives or of a satisfaction/survival function which it tries to optimize),
4. which possesses resources of its own,
5. which is capable of perceiving its environment,
6. which has only a partial representation of this environment,
7. which possesses skills and can offer services,
8. which may be able to reproduce itself,
9. whose behavior tends towards satisfying its objectives, taking account of the resources and skills available to it and depending on its perception, its representations and the communication it receives.

3.1.1.1/ AGENT TYPES

Agents can be divided into four types according two main themes : conduct and relationship to world, shown in Table 3.1.

TABLE 3.1 – Different types of agent

	Relationship with world	Cognitive agents	Reactive agents
Conduct			
	Teleonomic	Intentional agents	Drive-based agents
	Reflexes	Module-based agents	Tropistic agents

The conduct of agents is regulated by teleonomic behavior, directed towards explicit goals, and reflex behavior, driven by perceptions. The relationship between the agent and its environment could be referred as the classic problem of the subject/object pairing, that of knowing whether the agents has available a symbolic and explicit representation of the world. The intentional agent has explicit goals and motivating its actions. Its action follow a principle of rationality in relation to the goals that direct them. The module-based agent can be used as auxiliary agents, respond to questions or accomplishing tasks. Reactive agents can be directed by motivation mechanisms pushing them towards the accomplishing of a task. The driven-based agent can react for achieving the defined goal.

The tropistic agent can respond only to stimuli from the environment.

The reactive agents isn't so powerful. However, their strength comes from their capacity to form a group to adapt to their environment. The multi-agent system is defined in following section.

3.1.2/ MULTI-AGENT SYSTEM

The physical entity is something that exists in the real world, in our research work a vehicle. The virtual entity can be a software of computing module, the virtual vehicle is developed in our work as virtual entity. The concept of multi-agent systems is defined by [Ferber, 1999] :

Définition 2 : Multi-agent system

The multi-agent system (MAS) is applied to a system comprising the following elements :

1. An environment, E , that is, a space which generally has a volume.
2. A set of objects, O . These objects are situated, that is to say, it is possible at a given moment to associate any object with a position $i \in E$. These objects are passive, that is, they can be perceived, created, destroyed and modified by the agents.
3. An assembly of agents, A , which are specific objects ($A \subseteq O$), representing the active entities of the system.
4. An assembly of relations, R , which link objects (and thus agent) to each other.
5. An assembly of operations, O_p , making it possible for the agents of A to perceive, produce, consume, transform and manipulate objects from O .
6. Operators with the task of representing the application of these operations and the reaction of the world to this attempt at modification, which we shall call the laws of the universe.

Although the multi-agent system is a powerful tool for distributed system, the relationship and operation among agents are still issues which should be payed more attention. Co-operation logics have recently begun to attract attention within the multi-agent systems community. Using a cooperation logic, it is possible to represent and reason about the strategic powers of agents and coalitions of agents in game-like multi-agent systems. These powers are generally assumed to be implicitly defined within the structure of the environment, and their origin is rarely discussed. For instance, a cooperation logic has been developed in [Hoek et al., 2005], agents are each assumed to control a set of propositional variables - the powers of agents and coalitions then derive from the allocation

of propositions to agents.

3.2/ APPLICATION OF MULTI-AGENT SYSTEM

Lots of application of multi-agent have been exploited such as for telecommunication services, intercultural trade, emergent collective, social negotiation and so on [Siekmann et al., 2009a].

Among them, one can cite a detailed management models developed in [Hoshino et al., 2005] to deal with the issue of port authorities brought by highly efficient management methodology for an automated container terminal. MAS allow the simulation of complex phenomena that cannot easily be described analytically. A road traffic simulation system has been implement in [Doniec et al., 2008].

In the energy area, MAS constitute a possible technology that can be applied to control and monitor the operation of power grids [Basso et al., 2013]. A novel agent-based battery management system for large battery packs has been developed in [Yang et al., 2015] to realize cell balancing through local coordination of neighboring cells.

An agent-based travel demand model system has been developed for hurricane evacuation simulation, which is capable of generating comprehensive household activity-travel plans [Yin et al., 2014]. The range of applicability of teleoperated systems by means of the automatic cooperation of multiple slave robots has been increased by a methodology based on multi-agent system [Hernansanz et al., 2015].

Consensus problems for networks of dynamic agents with fixed and switching topologies have been discussed in three cases directed networks with fixed topology, directed networks with switching topology, undirected networks with communication time-delays and fixed topology [Olfati-Saber et al., 2004]. The consensus problem has also been investigated for a group of first-order agents in the cooperation-competition network, where agents can cooperate or even compete with each other in [Hu et al., 2015a].

3.3/ MULTI-AGENT SYSTEM IN TRANSPORTATION SYSTEM

3.3.1/ MULTI-AGENT IN TRAFFIC MANAGEMENT

The traffic system is composed by vehicles, pedestrian, bike and other participants which are independent however influence with each other like multi-agents system. Two multi-agent systems have been described in [Hernández et al., 2002] for real-time traffic management in the urban motorway network around Barcelona. Knowledge-based reasoning techniques was adapted as the traffic management agents algorithm. For traffic mana-

gement and dynamic routing, cooperative and distributed multi-agent systems has been adapted in [Adler et al., 2005].

CARTESIUS, an multi-agent architecture for the real-time traffic operation decision, has been presented in [Logi et al., 2002]. CARTESIUS is composed of two interacting knowledge-based agents for cooperative reasoning and conflicts resolving.

A verification methodology has been developed in [Damm et al., 2007] for cooperating traffic agents covering analysis of cooperation strategies, realization of strategies through control, and implementation of control. A novel serial coordination scheme based on Lagrange theory was proposed for the control of large-scale transportation networks in [Negenborn et al., 2008] to improve decision making. The subsystem can be multi-agent control schemes where each agent employs a model-based predictive control approach.

The control problem of large dynamic system is always divided into some small issue which already or easily to be solved. This method was use for solving the urban traffic networks control problem in [de Oliveira et al., 2010]. A multi-agent control framework has been proposed, which decomposes a centralized model predictive control problem into a network of coupled, but small sub-problems that are solved by the distributed agents.

A multi-agent bimodal urban traffic control strategy was proposed to regulate urban traffic but also to ensure the regularity of buses [Tlig et al., 2011].

3.3.2/ COOPERATIVE CONTROL BASED ON MULTI-AGENT SYSTEM

The cooperative control based on the multi-agent system not only takes the system point view, but also can adjust the vehicle directly.

A framework and software architecture has been presented in [Fierro et al., 2002] which can be deployed for cooperative and formation control. The framework allows a modular and hierarchical approach to programming deliberative and reactive behaviors in autonomous operation. And the multi-robot experimental testbed was introduced in [Fierro et al., 2005].

Other architecture of integrated application systems has been implemented as an agent community in distributed computation environments in [Gao et al., 2002]. This architecture was composed of nested agent federations in three aspects : architecture style, agent cooperation, and composition semantics. .

A hierarchical driving agent architecture has been developed based on three layers :guidance layer, management layer and traffic control layer [Hallé et al., 2005]. The multi-agent system was developed to simulate the bus-network including traveler behaviors and vehicle operation specific as numerous autonomous entities, called agents in [Meignan et al., 2007]. The cooperation of autonomous agents has been synthesized in order to satisfy demands imposed on a group of agents or on MAS (multi agent systems).

Petri nets were used for modeling the agents [Čapkovič, 2009] [Frantisek, 2011].

One multi-agent system for traffic control has been proposed in our laboratory. The multi-agent system were used to realize the approach of obstacle avoidance, platoon control [Gechter et al., 2010] [El-Zaher et al., 2011] [El Zaher et al., 2011] [Contet et al., 2011] [Dafflon et al., 2013] [Koukam et al., 2013].

3.4/ CONCLUSION

In this chapter, the multi-agent system was reviewed from definition to application points of view. The multi-agent system is a edge tool to deal with the distributed system. And there is already a lot of application example based on multi-agent system, especially for the transportation system.

CONCLUSION

In this part, including Chapter 2 and Chapter 3, research work has been reviewed.

Chapter 2 is a review about the intelligent vehicle research work. The intelligent vehicle is one of most important nuts for some traffic issue solution. The review work was presented in different point view. Most of IV research work focus on the individual vehicle, which is not sufficient for the optimization of whole transportation system. However, the traditional traffic management tool, traffic light, also has been improved by intelligent vehicle. The traffic light management for traffic flow has been investigated and some research work has developed it into autonomous traffic management system. The traffic management system provides a method to adapted the traffic flow leading to a global optimization result. Yet, the traffic light method is based on the assignment of roads priorities without controlling the vehicle directly, we want to find one balance between the traffic flow and individual vehicle. In that case, one method should be developed to cooperative vehicles ensemble which is a typical distributed system.

The multi-agent system, introduced in Chapter 3, is one professional method in dealing with distributed system. Definitions of agent and multi-agent system are presented firstly to show concept and establish the connection between agent and vehicle, transportation system and multi-agent system. Then, applications are shown in areas, focusing on transportation system. The traffic can be management in crossroads which was as hubs through reconfiguring vehicles train [Dafflon et al., 2011].

A transportation system is a typical distributed system, therefore it is natural to use a multi-agent model to optimize the system for increasing the safety and efficient. Especially for some special task, such as formation control, cooperative tasking, spatio-temporal planning, and consensus [Murray, 2007], the multi-agent system is the best choice. The performance of multi-agent system is decided by sort of reasons, the structure is one of most important key points. The structure is the description of how the system is organized, what is the relationship between different element. For coordinate control, the multi-agent method is introduced to improve the performance, and every real entity corresponds with one agent. However, there are some different features of multi-agent transportation model :

- 1. Distributed :** If the high efficient and safety running is set as the mission of transportation system, the safe and fluent movement of every single vehicle should be distributed. One fault, such as one accident, may lead to the transportation system stopping or just effect several vehicles or none. The most important thing is that every vehicle has its destination which is independent with other vehicles, coordinating with distributed vehicles can achieve the transportation system running efficient.
- 2. Independence :** For most of the distributed system, the mission for every single element is allocated by one superior element. However, this is impossible for the transportation system where every vehicle has its own aim. Every vehicle defines its own destination even sometimes the route is set by themselves. In this case, every vehicle is independent with other.
- 3. Homogeneity :** For each vehicle, their are equivalent to each other. When vehicles encountering, priorities are figured according the position, speeding and routes not vehicles themselves, except the ambulance, police, fire truck and so on. It also means one vehicle agent cannot control another one, all the coordinate work is done by superior agent.

The purpose of our research is to optimize the transportation system in considerable performances :

- 1. Safe :** Keeping people aways from accidents is always the most important issue for all the transportation research work. Normally, there are several reasons leading to the accident : the inattention, the wrong action, the view lack and so on. The local perception information complement the perception of driver. The intelligent control provides some suggestions and alarms to avoid the accident taken from the inattention and wrong action. The coordinate control, through synthesizing vehicles information, expands the view and also refrain from the bad decision from people.
- 2. Efficient :** As the increasing of the traffic, the transportation system faces on more and more constraining. Enhancing the transport capacity provides one solution through shortening the safe distance between vehicles. On other hand, reducing the waiting time even avoiding any vehicles stopping when them encounter promote the average speed. Those advantages are found in cooperation control where all vehicles are coordinated through communication connection.
- 3. Economic :** This item includes not only the economic in money but also the economic in environment. The coordinate control provides one smooth controlling method where all vehicles move under optimization situation : shortest distance, smoothly speed changing and non stop before arriving destination. That leads to a lower consummation and emission level.

The multi-agent is a appropriate method to deal with the traffic issues. Thus, this thesis proposes an approach, based on multi-agent paradigm, which aims at dealing with systems level issues focusing mainly on interaction between vehicles-trains of vehicles. We

also propose a cooperative control system which relies on multi-level decision processes aimed at dealing with the interaction of platoons at road network nodes. This cooperative control system allows both to maintain the coherence and the safety condition of each involved train of vehicles and to adapt each train components behavior so as to make train shared the road, and especially roundabouts and crossroads, efficiently (i.e. without stopping any vehicle). This cooperative control system is divided into three different levels. The global train state is managed at the train-level decision process based on the train level perceptions. The vehicle-level process makes the decision concerning each individual vehicle according to data provided by the train-level and to the interaction between vehicles. Finally, the motor-level process makes the link between the vehicle-level command and hardware level of vehicles.



COOPERATIVE CONTROL BASED ON
MULTI-AGENT MODEL

MULTI-AGENT MODEL BASED ON VEHICLE AND TRAIN

In this chapter, the developed model for vehicle and platoon is presented into two aspects : the physical and the logical, as shown in Figure 5.1. Describing the model from the physical part is reasonable and intelligible. Hence, in Section 5.1, the physical part is introduced including vehicle and vehicles-train description. The basic features for the vehicle are depicted including the mathematic model describing the movement law, and the real sensors necessary for collecting environment and vehicle information. Then the platoon physical model is described so as to define the characters of a vehicle train. In Section 5.2, logical model is described into two parts : vehicle agent and vehicles-train agent. For both, each element is detailed.

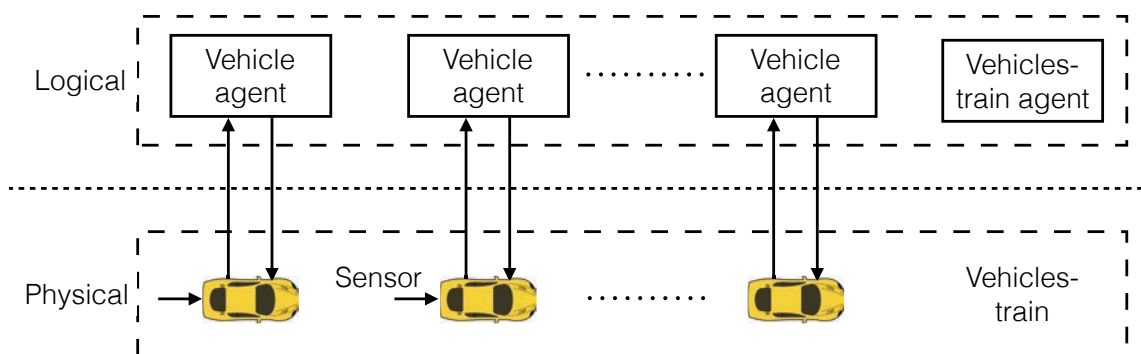


FIGURE 5.1 – Multi-agent model based on vehicles and train

5.1/ FROM VEHICLE TO VEHICLES-TRAIN

In this section, the two physical models are presented : vehicle and vehicles-train. The vehicle physical model is described by a kinematic model and sensors configuration. The

vehicle kinematic model gives the relationship between the movement (i.e. speed and steering angle) and the situation (i.e. position and direction). The sensor configuration figures out vehicle perception ability. Then, in order to centralize part of information to realize coordinate control, the vehicles-train is developed based on vehicle platoon. The vehicles-train is defined through describing the relationships between vehicles composing the train.

5.1.1/ VEHICLE PHYSICAL DESCRIPTION

The vehicle physical description is the basic of the implement of vehicle control. The vehicle mathematical model is the source to drive forward research and development in the area of autonomous and intelligent vehicles. Our model is based on one model, widely used for autonomous vehicle, therefore the mathematics model is one part of our vehicle model. In order to give the precise vehicle behavior description, mathematic tools are introduced starting with coordinate systems.

5.1.1.1/ REFERENCE FRAME AND COORDINATE SYSTEM

Reference frame

When describing one movement state, at least one reference frame is chosen. Let's take the situation shown in Figure 5.2 as an example, person *B* and one box in one moving truck, person *A* stand by side of road. Person *A* would say that the box is moving, cause the earth is chosen as the reference frame by person *A*. However, person *B* would believe that the box is motionless when he take the truck as reference.

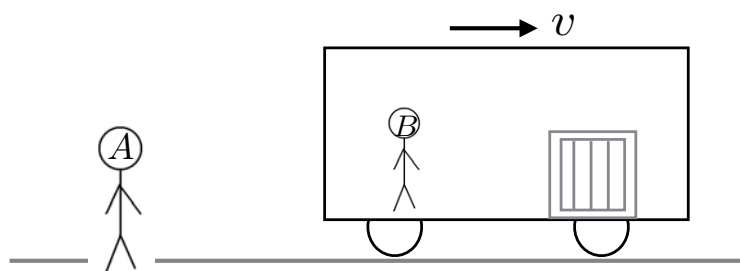


FIGURE 5.2 – Choosing reference frame

For describing the vehicle movement, reference frames are needed. According the existence of acceleration, there are inertial reference frame and non-inertial reference frame. However, in here, the vehicle speed is considered as constant one. It means all the reference frames are inertial reference frame. When we want to indicate the vehicle speed and direction, the earth should be taken as global reference frame. Yet, the best method to indicate the steering angle is taken the vehicle itself as reference frame. In addition to the

reference frame, we also need a mathematic abstracts for describing vehicle movement : the coordinate system.

Coordinate systems

Coordinate system is one of the mathematics basic for vehicle control. The classic vehicle model, developed according the physical theory, is carry out for generalized coordinate system. As shown in Figure 5.3, two coordinate systems are adopted in here according to [Kiencke et al., 2005].

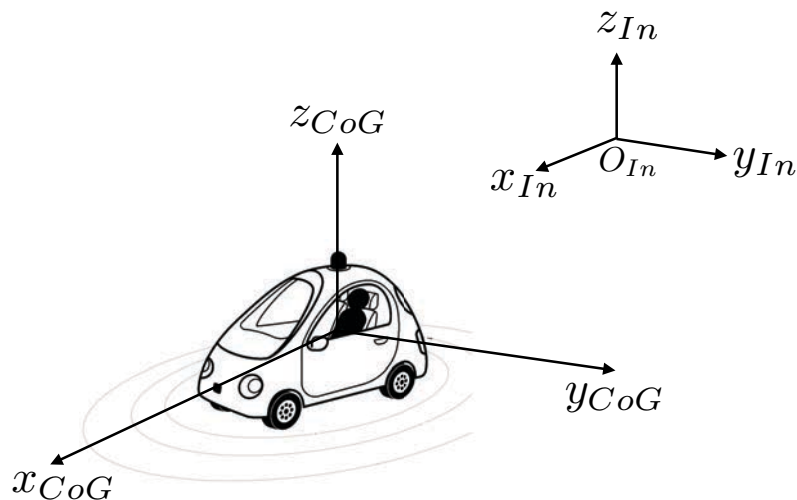


FIGURE 5.3 – Coordinate systems

1. **“CoG”** : the center of gravity coordinate system. The original point is fixed in the vehicle gravity center. The axis x_{CoG} direct to the vehicle direction from original point. Directions of axis y_{CoG} and z_{CoG} correspond to the “Right-hand rule”¹, as shown in Figure 5.3. It means that the coordinate system turns with vehicle.
2. **“In”** : the fixed inertial system. The original point O_{In} is one certain point on earth. The axis x_{In} points to north from O_{In} , and the other axes y_{In} and z_{In} also obey “Right hand rule”. Reversely, this coordinate system is fixed on relatively to earth.

With the *In* coordinate system fixed on earth, the *CoG* coordinate moves during travel, which has its origin at the vehicle center-of-gravity is of the most importance. All movement of the vehicle body are given with reference to this *CoG* coordinate system.

5.1.1.2/ VEHICLE KINEMATIC MODEL

The vehicle behavior could be divided into two part : the first part is the relationship between the force and the torque with the movement speed and rotate speed, called dynamic model. The second part is a kinematic model demonstrating how the movement

1. https://en.wikipedia.org/wiki/Right-hand_rule

speed and the steering angle influence the position and direction. However, in our research work, the command provided to the vehicle are the speed and steering. It means the influence of force and torque isn't studied in here. Hence, only the kinematic model is introduced in below.

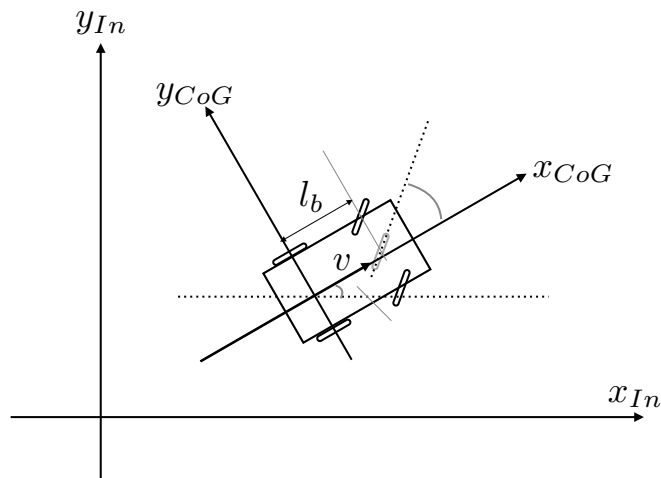


FIGURE 5.4 – Vehicle kinematic model

Assuming that the vehicle runs in flatness road with low speed, there is no slipping and no moving in z -axis. The vehicle direction is coinciding with speed direction. Therefore, the vehicle kinematic model is sufficient. The equations of vehicle kinematic model are [Dafflon et al., 2015] :

$$\begin{cases} \dot{x} = v \cos(\psi) \\ \dot{y} = v \sin(\psi) \\ \dot{\psi} = v \tan(\gamma) / l_b \end{cases} \quad (5.1)$$

where (x, y, θ) is the vehicle position in the inertial reference frame In . v and γ are respectively the linear velocity and the orientation of vehicle front wheel. l_b is the wheelbase of the vehicle.

5.1.2/ VEHICLE AND VEHICLES-TRAIN

If one or several vehicles run as group under certain preset form, we call those several vehicles as one platoon. In here, the platoon concept is extend to vehicles-train.

Définition 3 : Vehicles-train

Vehicles-train is a group of vehicles linked by the virtual connection which constitutes a platoon control model. The goal is to maintain a certain geometrical structure.

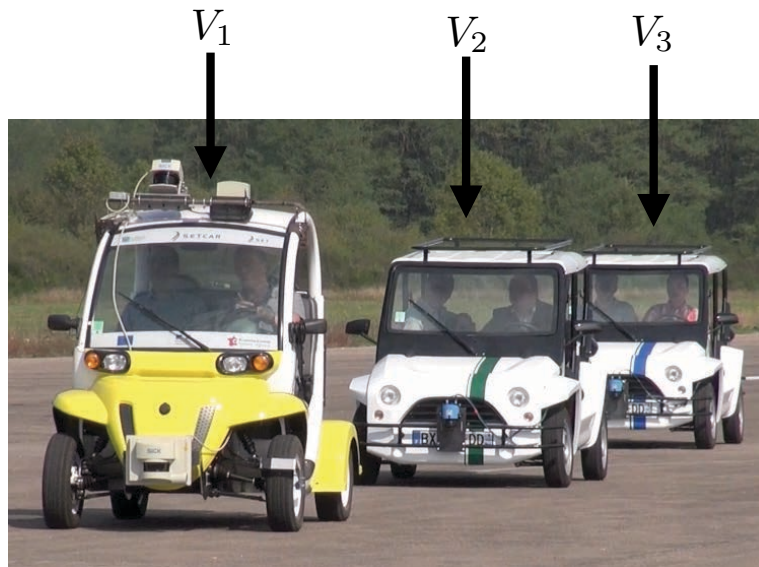


FIGURE 5.5 – A vehicles-train containing three vehicles in column configuration

In the example shown in Figure 5.5, three vehicles V_1 , V_2 and V_3 are composing one vehicles-train marked as $T = \{V_1, V_2, V_3\}$. In the Figure 5.5, V_1 is driven by a human as the leader of the vehicle train. However, in our work the leader of the vehicles-train can also be autonomous and can adapt its speed and angle depending on the context.

As explained in the definition, vehicles-train is one alliance composed of one or more vehicles. Normally, we combine vehicles running in the same lane into one vehicles-train. Their are organized through multi-agent model, which is introduced in next Section 5.2. Through the multi-agent model, the cooperation control is implemented into vehicle train. In a vehicle train, the distance between vehicles is kept for increasing the safety. When vehicle trains encounter, the cooperation control smooths the traffic flow to avoid the congestion through adapting vehicles speed. For each physical element, we associate one logical agent which are introduced in next section.

5.2/ MULTI-AGENTS MODEL

In this section, a multi-agent model is presented according the physical element introduced in Section 5.1. Two agent types are introduced corresponding to respectively vehicle

and vehicles-train. The vehicle agent is introduced in three parts : resources possessed by agent, perception task and reaction framework. For the vehicles-train agent, the resources and reaction framework are detailed. The connection of elements of two agents is presented in the last.

5.2.1/ VEHICLE AGENT

Vehicle agent is developed for implementing coordinate control based on multi-agent system. Three elements are composing to the vehicle agent : perception, vehicle resources and vehicle reaction.

1. **Vehicle resources** : includes vehicle route, vehicle role, preceding vehicle and vehicle physical information.
2. **Perception** : collecting environment and vehicle state information.
3. **Vehicle reaction** : giving the speed and steering command according vehicle local driving information and vehicle resources.

Définition 4 : Vehicle agent

For vehicle V , there is only one agent which processes the resources of vehicle V and controls V directly. We call this agent as V 's agent or agent VA . We use VA to present this vehicle agent.

The vehicle agent is implemented through combining three parameters(e.g., route, role and preceding vehicle) as resources, one task and one framework. The route is one important character involving the cooperation of train system(c.f. train description). Two roles(leader and follower) are defined for the vehicle in our model. Perception task, providing inputs and feedback to reaction system, is discussed in here. For reacting to local environment (e.g. preceding vehicle and obstacle), the behavior framework defines details of inputs and outputs.

5.2.1.1/ VEHICLE AGENT RESOURCES

Four types of information are chosen to make up the resources : 1. vehicle physical information ; 2. vehicle route ; 3. vehicle role ; 4. preceding vehicle.

Physical information

Vehicle physical information includes the size of each vehicle, the maximum acceleration and speed. The distance between vehicles is an important parameter to be considered for safety issues. When trains reconfigure or coordinate with each other, the distance should be adapted according the size of interrelated vehicle. This job is done through the virtual vehicle, concept introduced in Section 6.3. All vehicles adapt the distance

through adjusting speed, yet each vehicle has a limit speed (limited by motor or physical law). Limiting all vehicle in suitable speed could avoid part of the distance control and a decreasing adapting time.

Vehicle route

Running vehicle should possess one or more destinations for movement, such as delivering one or several passengers. We are supposing that the route is given by an outside algorithm or a human. For most of single vehicles, they can run to different destination. Therefore, most of vehicles hold different routes, even for vehicles with the same destination. However, vehicles, planned in different routes, have to share the same road in most cases.

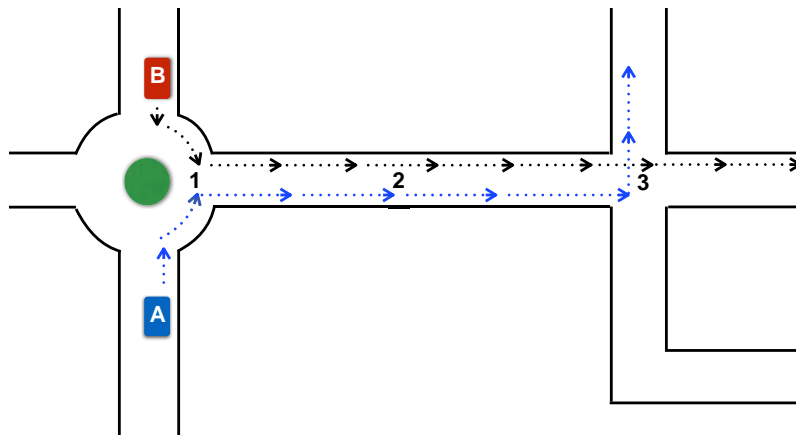


FIGURE 5.6 – Two vehicles share a segment route

Considering in two vehicles *A* and *B*, which would share one road as shown in Figure 5.6. Three periods, indicating with 1, 2 and 3 in Figure 5.6, should be discussed before they encounter till separate. In the first period, the two vehicle belong to two vehicle trains separately. Vehicles adjust speeds according the positions, routes and other information before encountering, under the cooperation of two vehicle trains. Second period is the vehicles-train period, where all vehicles in the same road are composing one single vehicles-train. The cooperation control inter vehicles-train works on the vehicles running. Then, vehicles separate in the second intersection. The third period is just as the first period, each vehicle composes one vehicle train, moving to different directions, shown in Figure 5.6.

Vehicle role

Two vehicle roles : leader and follower, are defined in our model. In one vehicles-train, which contains one vehicle or more, there must be one unique leader in one train, zero or several followers. When vehicles-trains encounter each other, the leader of each train should confront other train firstly. Followers run according to suitable parameters following

the leader. One simplification method is that the leader runs at one constant speed in the same situation. Therefore, the proper leader vehicle speed promises the smooth running of the train system. In other words, the leader vehicle speed should be smaller than the maximum of followers. One thing which should be indicated is that the leader isn't equal to the train-agent which is present in next section. The leader is determined by the form of the vehicles-train and arranged to one certain vehicle, however the train agent could be in anywhere.

Preceding vehicle

Let's take the vehicles-train in Figure 5.5 as an example again, V_1 and V_2 are the preceding vehicle of V_2 and V_3 respectively. For every following vehicle, the uniqueness of the preceding vehicle should be pre-set. Preceding vehicle, related to priorities, may change during trains meetings depending on the path of every individual. The preceding vehicle information includes position, direction, and speed. It could be real or virtual one. In the nominal situation (i.e. without any conflict in priorities), each following vehicle follows one real vehicle keeping the safety distance. The virtual vehicle concept has been introduced so as to adjust the vehicles-train parameters, e.g. adapting inter-vehicle longitudinal distance when trains are crossing without interfering directly on platoon control algorithm. This is detailed in Section 6.3 and shown in Figure 6.6.

Définition 5 : Preceding vehicle

For vehicle V_1 , if another vehicle V_2 's movement is directly decided by V_1 , therefore V_1 is called V_2 's preceding vehicle. Correspondingly, V_2 is called V_1 's follower.

5.2.1.2/ PERCEPTION

The perception collects and analyzes the sensors data and provides the environment and vehicle state information to agent. As like most of the commercial cars and research works, the obstacle could be detected by lidars. For instance, the lane could be received through visual pattern recognition. The global position of vehicle could be given by GPS and the movement, including speed and acceleration are measured by inertial measurement unit (IMU).

In our multi-agent model, the global position and vehicle state information are provided to the vehicles-train resources, the local environment information is sent to the vehicle reaction.

5.2.1.3/ VEHICLE AGENT REACTION FRAMEWORK

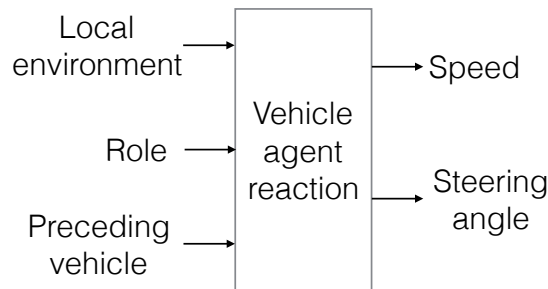


FIGURE 5.7 – Vehicle agent reaction framework

In terms of reacting to the local environment, the reaction framework defines the inputs and outputs (shown in Figure 5.7). One vehicle reacts to the preceding vehicle according to its role and local environment perception. We define the preceding vehicle, role, and perception information as inputs. Outputs are the reaction the vehicle carries out, including speed and steering angle as the basic control information.

Inputs

1. **Local environment information** : The perception information includes the obstacle and other traffic participants. The vehicle keeps the vehicles-train form and at the same time avoids obstacles and other participants.
2. **Preceding vehicle** : As one of the inputs of reaction logic, the preceding vehicle is the target to follow.
3. **Vehicle role** : The role indicates the way of adjusting vehicle speed. Leaders adapt the speed according to the environment and other vehicles' maximum speed. Followers chase the preceding vehicle.

Outputs

1. **Speed** : Vehicles move at suitable speed not only for efficiency, but also for safety. Through adjusting vehicle speed, vehicles maintain safety distance. When vehicles-trains coordinate with each other, the distance between two real vehicles is also changed according to strategies.
2. **Steering angle** : Steering angle changes the vehicle direction for turning, for instance to avoid one obstacle or change lane.

5.2.2/ VEHICLES-TRAIN AGENT

The vehicles-train agent includes two parts : train resources and vehicles-train reaction.

1. **Train resources** : including global position, state information and routes of vehicles in this train.
2. **Train reaction** : carrying out the preceding vehicle and roles command according the information provided by train resources, and send the command to the vehicle resources.

Définition 6 : Vehicles-train agent

Corresponding to vehicle train, vehicles-train agent gathers the information of its component vehicles. After negotiating with other vehicles-train agent, it send the command to its vehicles.

The vehicles-train agent resources part is implemented through centralizing part of vehicles information and perception information to achieve global coordinate control. The reaction framework figures out the inputs and outputs.

5.2.2.1/ VEHICLES-TRAIN AGENT RESOURCES

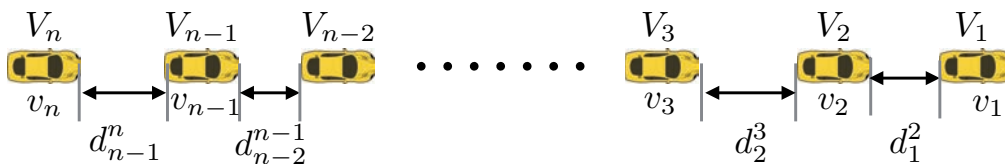


FIGURE 5.8 – Vehicles-train moving from left to right

Vehicles-train resources is one set of vehicle information in this train, including :

1. **Vehicles position information** : Global position could be used to not only navigation, such as planning route, but also deciding priorities and preceding vehicles. All the vehicles position in its vehicles-train are contained in vehicles-train resources.
2. **Vehicles state information** : Vehicle state includes the speed and direction of each vehicle which is also needed when assigning the priorities.
3. **Vehicles' planning routes** : All vehicles' planning routes are collected to achieve the coordination of all vehicles. According routes, one principle of deciding vehicles' priorities is "First out last in", i.e. the vehicle, which will split from train, runs in the last position. The route is also one parameter of assigning preceding vehicle, detailed in Section 7.1.

5.2.2.2/ VEHICLES-TRAIN AGENT REACTION FRAMEWORK

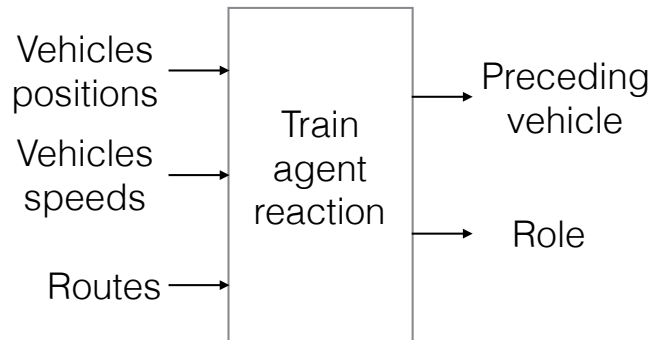


FIGURE 5.9 – Train agent reaction framework

Decision framework defines inputs and outputs of the train level reaction, shown in Figure 5.9. Inputs include vehicles positions information, vehicles states information and vehicles routes. And the reaction output preceding vehicle and role for each vehicle.

5.2.3/ CONNECTION OF AGENTS

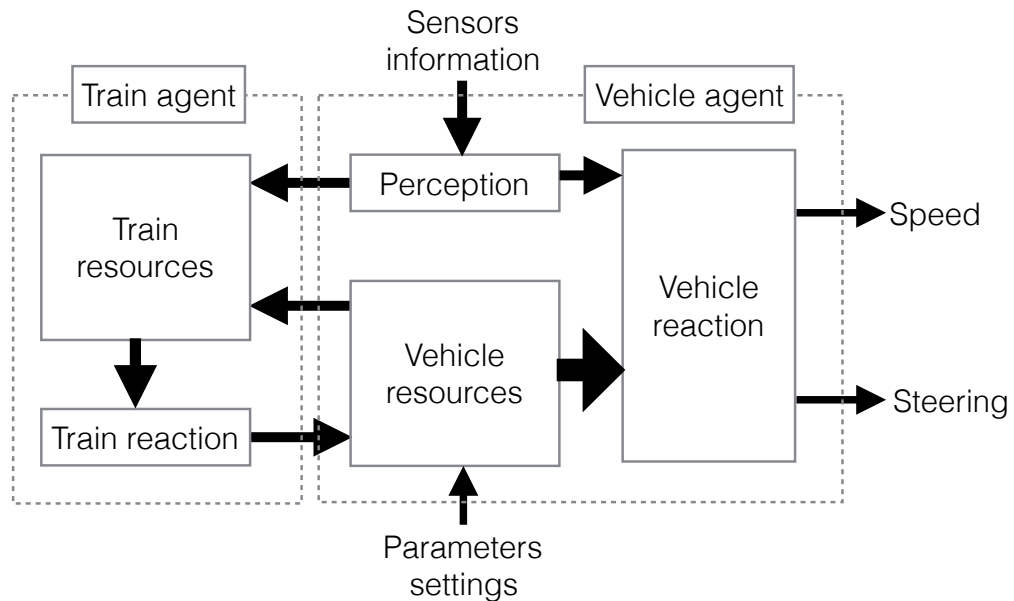


FIGURE 5.10 – Two type agents and connection

The connection of two types of agents is shown in Figure 5.10.

The train resources is fed by the perception and vehicle resources of the vehicle agent through gathering corresponding information. The train resources also provides informa-

tion to train reaction for decision making process. The perception collects information using sensors and transfer those to train resources and vehicle behavior.

The parameters setting appoints the vehicle route and vehicle physical information. Then, the vehicle resources converges the parameters set and the train reaction decision. The vehicle resources not only afford the information to vehicle behavior, but also gives feedback to train reaction through train resources. The information, driving the vehicle behavior into one command, is provided by perception and vehicle resources.

5.3/ CONCLUSION

In this chapter, the multi-agent mode has been developed. Considering the train system as a typical distributed system, the multi-agent paradigm has been adopted. Each vehicle, as one important participant of traffic, is allocated one agent, called vehicle agent. The vehicle parameters, perception task and reaction framework were announced as main parts of vehicle agent. Then, the vehicles-train agent was defined corresponding with vehicle train. The train agent level, as the superior level of vehicle agent level, is the place where the vehicles coordination happens. Thus, the reaction framework of the vehicles-train was delineated through detailing inputs and outputs. The connection of elements of agents is detailed in the last of this chapter.

For the multi-agent model, the interaction between agents, including communication and tools for reaction, is one key point to achieving satisfactory coordination. Thus, in Chapter 6, the interaction are defined. The other important concept - the organization structure, defining the relationship between different agents, is also described in next chapter.

6

AGENTS ORGANIZATION AND INTERACTION

In Chapter 5, a multi-agent model is presented. However, the relationship between agents and the interaction method has not been detailed yet. In this chapter, the way how agents are organized is spelled out firstly. As previously seen, the organization structure separates the agents into two level : vehicle and train level. Under this structure, the information flow is also defined : the train agent collects the information from every vehicle agent including requests sent by vehicles ; this information is then exchanged between train agents for negotiation.

Agents send request, receive answer and exchange information through communication. On one hand, the processing of vehicle agent communicating with train agent is formalized in two situation : run-in-train and splitting. On the other hand, vehicles-trains exchange information for the implementation of cooperation control. The request, answer and information exchanged in both of the two processing are detailed in Section 6.2.

In order to carry out the interaction movement, one tool called virtual vehicle is introduced. Virtual vehicle agent is a virtual entity, conveniently defined for formation control. The implementation of kind of vehicles-train missions could be dealt under the assist of virtual vehicle in decision strategy detailed in Chapter 7. In Section 6.3, virtual vehicle is introduced through the definition 7.

6.1/ ORGANIZATION STRUCTURE

In this section, the organization structure is presented from the physical (vehicle and train) to agent (vehicle agent and train agent). As presented in Chapter 5, the train is structured by vehicles, shown in Figure 6.1.

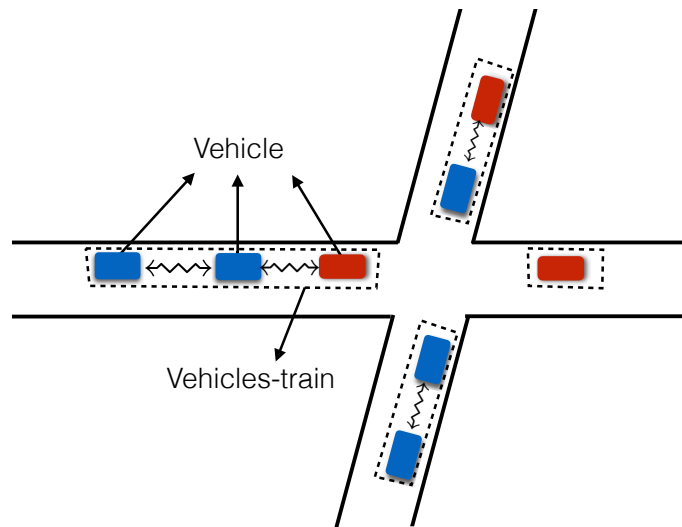


FIGURE 6.1 – Organization of vehicle and vehicles-train

Corresponding to the organization structure of vehicle and vehicles-train, the structure of our multi-agent model, introduced in Chapter 5, defines the relationship between agents, the train agent at the upper level and the low level for vehicle agent. The structure of our multi-agent system is shown in Figure 6.2 :

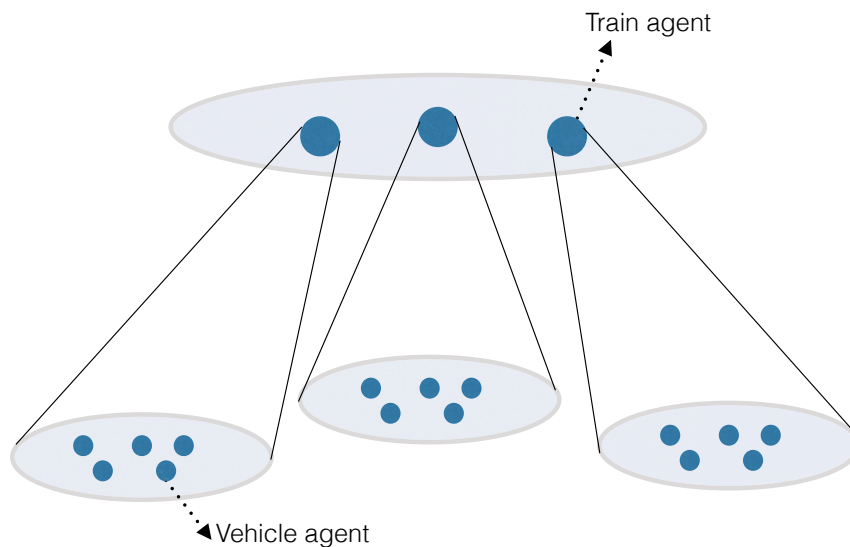


FIGURE 6.2 – Multi-agent system organization structure

The organization structure frames one element or agent in two aspects :

1. which class this element or agent belongs to according to the reaction framework of this element or agent.
2. what is the relationship between this element with others, the relationship decides the direction of information flow.

The two different types of agents indicate the two different agent levels. The vehicle level is composed of vehicle agent. Between two adjoining vehicles, they are connected through platoon control. There is no direct communication among vehicles agents. At the train level, trains agents exchange information with each other for negotiation. The train agent could exist in anyone vehicle, even could be created by intersection equipment. The train agent cannot be situated according to one real vehicle.

In our multi-agent model, parts of information is gathered to train agent from vehicle agent for arranging vehicles. In the next section, the communication between agents is detailed also in this two factors : communication between vehicle agent and train agent, between train agents.

6.2/ AGENTS COMMUNICATION

Communication is one important approach to realize coordinate control owing to negotiation and translating demand to each level according the structure described in Section 6.1. The communication in our model is separated into two part according the participants : communication between vehicle agent and train agent, communication between train agents.

The Petri nets graphic is used in here for representing communication between agents. A Petri net is defined as an oriented graph comprising two sorts of nodes : places and transitions. This graph is constituted in such a way that the arcs can only link places to transitions or transitions to places, in accordance with the rules for the formation of augmented transition network defined above. Places are graphically represented by circles and transitions by bars. Each agent is described by a Petri subnet, the place in which corresponds to the internal states of the agent. The transitions correspond either to synchronizations due to the receipt of messages or to conditions of application of actions, such as the essential or preparatory conditions for the associated speech acts. Messages being routed are represented by supplementary locations which link agents in such a way as to form a single net.

6.2.1/ BETWEEN VEHICLE AGENT AND VEHICLES-TRAIN AGENT

6.2.1.1/ RUN-IN-TRAIN COMMUNICATION

During the time where the vehicle is keeping run in vehicle train, the vehicle agent sends perception information to its representative vehicles-train agent and receives decision command, this communication mission is called run-in-train communication, as shown in Figure 6.3, and detailed in below.

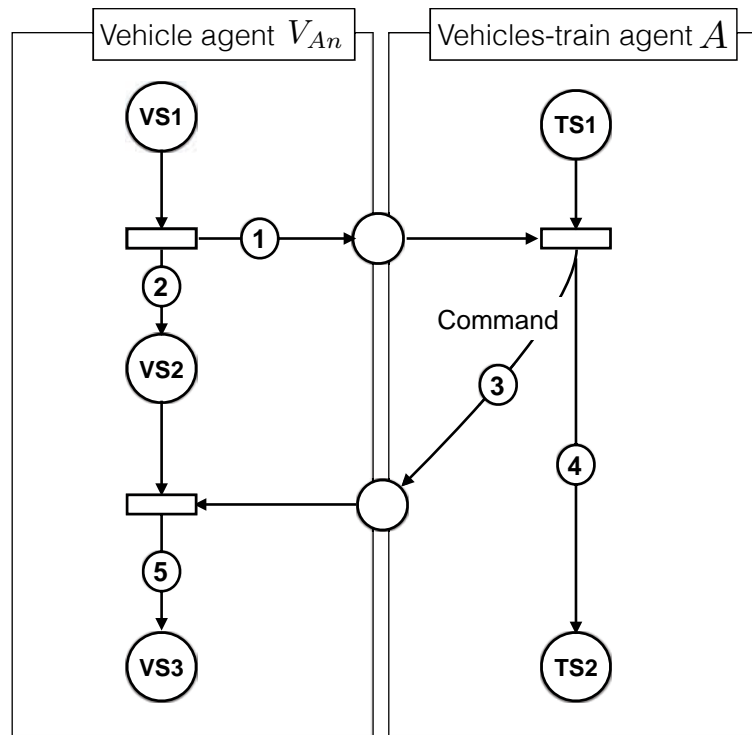


FIGURE 6.3 – Run-in-train communication framework

Places $VS1$ and $TS1$ describe the initial states in which the vehicle agents and train agents collect information and request before the beginning of the communication, and places $VS3$ and $TS2$ represent the end of communication states of vehicle agent and train agent.

1. At the beginning, the vehicle V_{An} is in the state $VS1$, the vehicle agent resources have been send to vehicles-train A in step ①. According routes of all vehicles in vehicles-train A , the vehicle V_{An} should stay in vehicles-train.
2. Then, the vehicle V_{An} arrives to the state $VS2$ for waiting the command from vehicles-train in step ②.
3. After the computation of vehicles-train A , the train agent command is sent to vehicle V_{An} according to step ③. If $n = 1$, it means that V_{An} is the leader of train A . There is no preceding vehicle in the command. Otherwise, the vehicle V_{An} runs under the algorithm presented in Section 7.2 and the preceding vehicle.
4. The command is executed in step ⑤ leading vehicle go to place $VS3$. At the same time, the vehicles-train updates itself to $TS2$ in step ④.

6.2.1.2/ SPLITTING COMMUNICATION

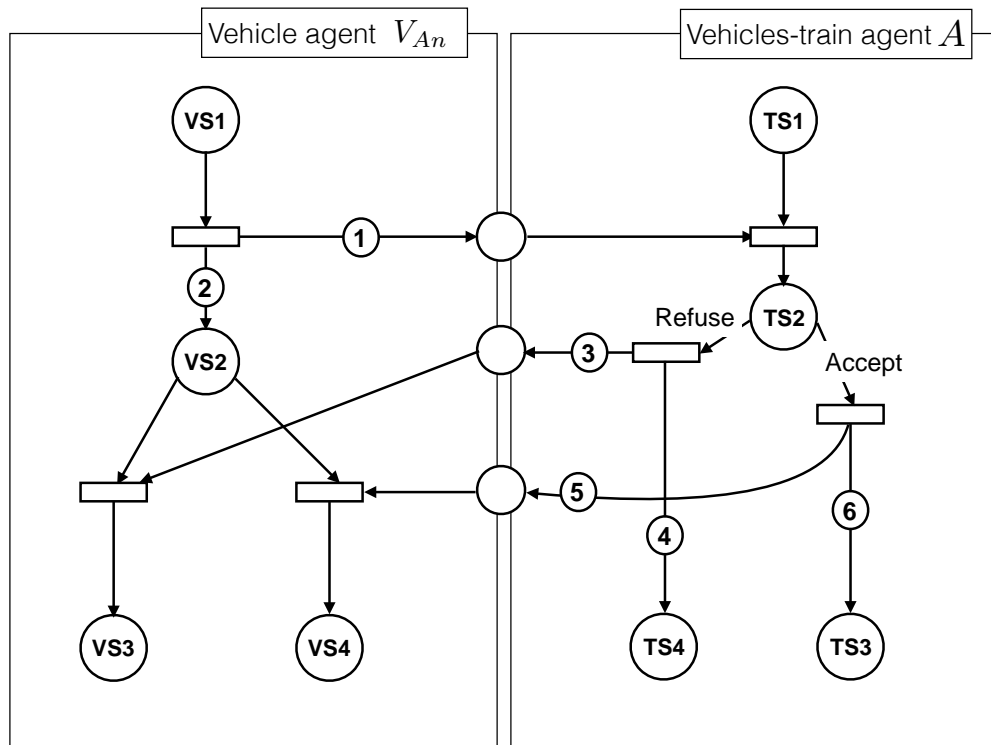


FIGURE 6.4 – Splitting communication framework

When one or several vehicles need to split from one vehicles-train, such as the vehicles-train goes straight yet one vehicle V_{An} wants turn to left, V_{An} need to split from vehicles-train, where the splitting communication happens. In here, one vehicle V_{An} which want to split from train is taken as the example shown in Figure 6.4.

1. At the beginning, the vehicle is in the state $VS1$ where the vehicle send vehicle agent resources and splitting request to vehicles-train in step ①.
2. Then, the vehicle transfers into the state $VS2$ to wait for the answering from vehicles-train shown as step ②. At the same time, the negotiation happens between trains taking the global situation into account, and the result leads train agent to place $TS2$.
3. In one case, the train agent refuses the request, the vehicle enters the state $VS3$ for sending a new request in step ③. The vehicles-train agent updates to a new state $TS4$ for other communication in step ④.
4. In another case, the train agent approves the splitting request. The train agent sends the preceding vehicle and role to each vehicle in this train. Through step ⑤, the vehicle V_{An} runs according the role and preceding vehicle to implement the splitting in place $VS4$ and the train updates the state to $TS3$ in step ⑥.

6.2.2/ BETWEEN VEHICLES-TRAIN AGENTS

There are two cases where the communication between train agents happens : the first case is that the request comes from the vehicle agent, as shown in Section 6.2.1. The second case is that the request comes from the train agents when trains encounter with each other. In the both case, the train request includes both the request form vehicle agent and train agent in this section also in Figure 6.5.

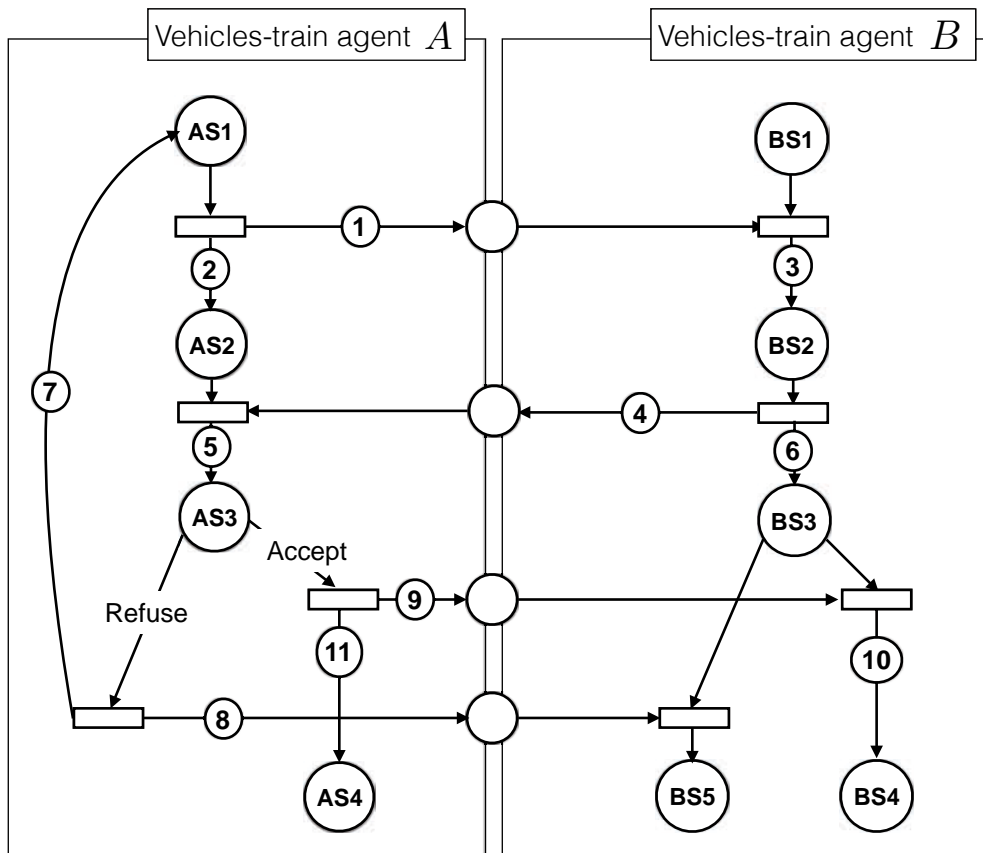


FIGURE 6.5 – Trains agents communication framework

In our example, two vehicles-train agents T_A and T_B launch one communication. The initial states are $AS1$ and $BS1$ for train T_A and train T_B .

1. At the beginning, the train T_A send its train resources to train T_B as labeled using ① in Figure 6.5. Train T_B organizes the information including itself and, if necessary other trains. Then the plan is decided according to coordination algorithm, such as which vehicle would pass the road first, which leads T_B to place $BS2$ through ③. At the same time, train T_A goes to place $AS2$ waiting for the reply through step ②.
2. In the step ④, train T_B reply to T_A with the plan. Then train T_A decides whether to accept or to refuse the plan given by T_B .

3. In one case, train T_A refuses the proposed plan, T_A would return to place $AC1$ to send one request agent, shown in (7). And the reply from T_A would be sent to T_B in (8).
4. In other case, the plan proposed by T_A is accepted. T_B agent moves to $AS4$ for executing the command in step (11). The answer to T_B is executed in step (9). The train T_B agent transfers to $BS4$ to carry out the command in the update step (10).

6.3/ VIRTUAL VEHICLE AGENT

For the optimizing of transportation system, reducing the calculate time is important for embedded system. The virtual vehicle is introduced in here to simplify the calculation when trains should be adjusted purposing for sharing the road with other trains or merging with other trains. Through the virtual vehicle, an artificial perception information is provided to the vehicle agent as a shortcut perception. The virtual vehicle is defined firstly, then one example is carried out to illustrate the usage.

Définition 7 : Virtual-vehicle agent

Virtual vehicle agent is a virtual entity, composed by some necessary information for platoon control : vehicle position, vehicle direction, vehicle speed and vehicle physical parameters(width and length).

As definition 7, the virtual vehicle is one combination of information. When one vehicles-train is sent to one vehicle as preceding vehicle, the follower would adjust the speed according the virtual vehicle speed and the distance between them. Therefore, through controlling the speed and position, the follower could be controlled to adapted to new speed and distance.

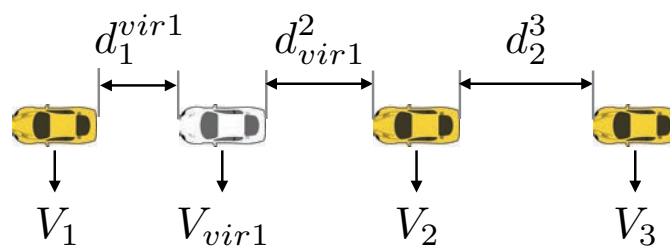


FIGURE 6.6 – Virtual vehicle in one vehicles-train

Shown in Figure 6.6, in one vehicles-train, composed vehicles V_1 , V_2 and V_3 , one virtual vehicle V_{vir1} is sent to vehicle V_2 . Here is one strategy for setting one virtual vehicle, the speed of V_{vir1} is the same with V_1 and the virtual vehicle is located in the middle between V_1 and V_2 . With the running of vehicles, the distance d_1^{vir1} between V_1 and V_{vir1} and the distance d_2^{vir1} between V_{vir1} and V_2 change while the speed is adjusting.

The changing of vehicles-train includes the adjusting of vehicles speed and distances between them. The difference of speed leads to the changing of distances, thus the speed is one key parameters for controlling the vehicles-train. However, if the speed is calculated directly by coordinate agent, the calculation should increase at an exponential rate with the vehicle number. The virtual-vehicle separates the mission in two part : setting the virtual vehicle in train agent, calculating the corresponding speed in vehicle agent. Both of two missions are simply enough, the former is described in Section 7.1 and the latter is given in Section 7.2.

6.4/ CONCLUSION

In this chapter, the interaction was defined including the system structure, the communication framework and the use of virtual vehicle. According the organization structure, there were two level in this structure : the vehicles-train agent level and vehicle agent level. The structure described the relationship between agents, not only at the same level agent but also at different level.

Above all, the structure and interaction of the new transportation system was proposed in this chapter. The relationship between agents and the information flow are detailed and one tool was announced.

COOPERATIVE CONTROL BASED ON MULTI-LEVEL DECISION

In Chapter 5, we introduced the multi-agent model. In Chapter 6, the interaction between agents has been presented including the organization structure and the communication framework.

In this Chapter, the cooperative control system is presented according the decision information flow : from train agent level decision to vehicle agent level reaction. The train level decision algorithm carries out the preceding vehicle and role for every vehicle. Firstly, the vehicles order, a series of priority, is calculated according vehicle relative position and speed. Secondly, the preceding vehicle and the role for every vehicle are carried out according to the vehicles order and the route. Then, the speed and the angle commands are calculated by the vehicle level reaction algorithm according to the preceding vehicle and the role based on the physical inspired model.

7.1/ TRAIN-AGENT DECISION

As previously said, there are two steps in the train agent decision algorithm : firstly, the vehicles order (Definition 8) is determined according the vehicle position and the speed, presented in Section 7.1.1. Then, the preceding vehicle and the role for every vehicle are carried out according the vehicles order, positions and routes. The preceding vehicle and the role are changed during the movement. According the routes and the vehicle information, the decision strategy for preceding vehicle and role is introduced in five different situation : platooning, splitting, crossing, merging and reconfiguration.

7.1.1/ VEHICLES ORDER

When vehicles encounter, the first thing which should be decided is the priority. The vehicles order concept is defined in below expending from the priority.

Définition 8 : Vehicles order

When encountering vehicles would through one same point, such as the point O_1 , O_2 or O_3 in Figure 7.1, the order of passing this point is called vehicles order. This point, O_1 , O_2 or O_3 , are called encountering point.

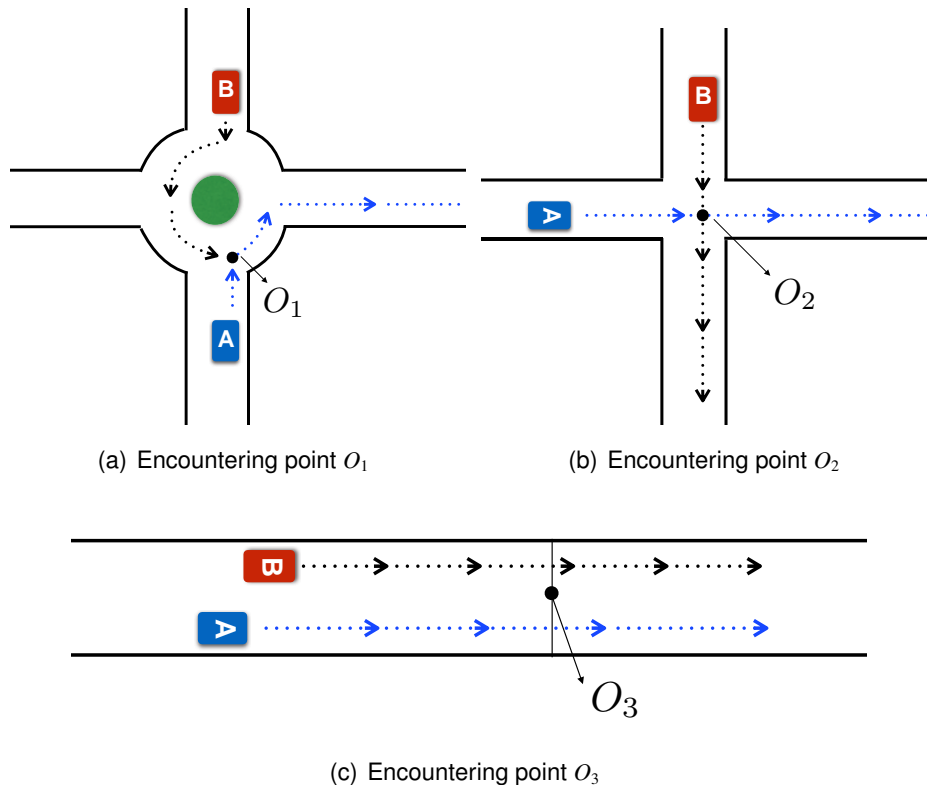


FIGURE 7.1 – Encountering points

The vehicles order is presented by one direction array indicating priorities of vehicles. The vehicles order is signed as VO , and $VO = \{V_{A1}^1, V_{B1}^2, \dots, V_{Xn}^k, \dots\} = \{VO_1, VO_2, \dots, VO_k, \dots\} (k, n \geq 1, X = \text{letter}(s)\text{symbol})$. For the vehicle V_{Xn} , the letter(s) symbol X indicates the corresponding train, n means that V_{Xn} is the n^{th} vehicle in the vehicles-train X . k indicates the order of one vehicle. For an instance, in the above vehicles order, $V_{A1} = V_{A1}^1 = VO_1$ is the first vehicle in the vehicles order.

We present several principles so as to decide the vehicles order for train agent, as like the traffic rules for the people driving condition.

7.1.1.1/ PRINCIPLES FOR DECIDING THE VEHICLES ORDER

As described in Section 6.1, each vehicle is equal to the other if we put aside the position and speed factors. In other words, the vehicle priority is determined by the vehicle situation including position and speed. Furthermore, the planned route and perception are

also important parameters to take into consideration. Here, three principles which decide the vehicles order are shown in below :

1. **Arriving time** : When vehicles encounter, the time when the vehicle arrives at the encountering point is called arriving time. The aim of using the arriving time to decide the priority is to smooth vehicle speeds changing, to avoid vehicles from stopping and waiting for others.
2. **Right first rule** : This is one traditional method for allocating priority without signal existing in most of countries. The priority is assigned to the vehicle in the right side : one vehicle must wait for another one which is in its right side. This rule could be modified according different situation, such as the local traffic law.
3. **Optimising vehicle order** : When the vehicle want to change direction or to goto another road, it would slow down firstly. This leads to following vehicles slowing down at the same time. In order to avoid that situation, the vehicle order in one vehicles-train is considered. One example, shown in Figure 7.2 below, is studied.

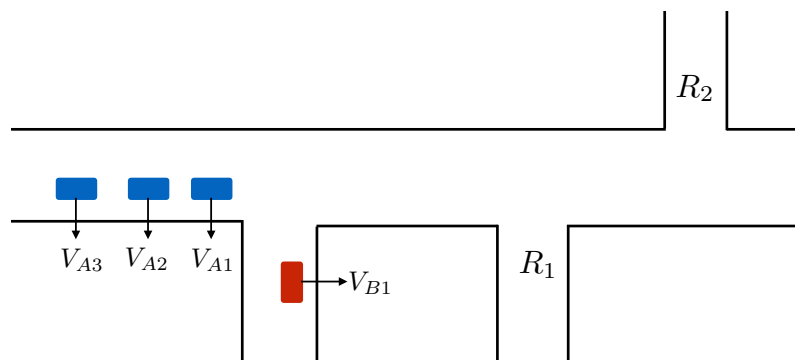


FIGURE 7.2 – Vehicles order based on leaving sequence

Train A including three vehicles : V_{A1} , V_{A2} and V_{A3} , runs from left to right. Another train composed by vehicle V_{B1} in the right side need to merge with train A. After that, vehicle V_{A3} would turn to right to road R_1 firstly, then vehicle V_{B1} would turn to left to road R_2 and other vehicles would go ahead. The order passing the encounter point is also the vehicle order in the new train. Considering with reducing the speed adapting, the vehicle order is arranged to V_{A1} , V_{A2} , V_{B1} , V_{A3} .

There could be other rules for improving the performance, such as according the vehicle speed and size, arranging the order so as to reduce the fuel consume. However, three basic rules are developed to carry out the vehicle order when trains encounter. The arriving time is the first crucial factor and right first rule is considered when the arriving times conflict with each other.

7.1.1.2/ ARRIVING TIMES

Arranging the priorities order according the arriving time for intelligent vehicle aims to reducing the speed changing even avoiding the vehicle stopping and waiting for other vehicles. In here, the algorithm to carry out the priorities order is presented. Firstly, the necessary parameters are stored in one matrix I . Secondly, the arriving time of each vehicle is calculated according the information in matrix I . Thirdly, the times are sorted in ascending order. The distance to the encountering point is marked as d , vehicle velocity v and vehicle length l . For all vehicles, the information matrix I as follows :

$$I = \begin{pmatrix} V_{i1} \\ V_{i2} \\ V_{i3} \\ \vdots \\ V_{m1} \\ V_{m2} \\ V_{m3} \\ \vdots \end{pmatrix} = \begin{pmatrix} d_{i1} & l_{i1} & v_{i1} \\ d_{i2} & l_{i2} & v_{i2} \\ d_{i3} & l_{i3} & v_{i3} \\ \vdots & \vdots & \vdots \\ d_{m1} & l_{m1} & v_{m1} \\ d_{m2} & l_{m2} & v_{m2} \\ d_{m3} & l_{m3} & v_{m3} \\ \vdots & \vdots & \vdots \end{pmatrix} \quad (7.1)$$

where V_{ij} , d_{ij} , l_{ij} and v_{ij} are respectively the representative vector, the distance to the node, the length and the speed of the j^{th} vehicle of i^{th} train. The arriving time could be carried out from the matrix I :

$$t = f(d, l, v) = \frac{d + l}{v}$$

Then, the matrix $TIME$, composed by all vehicle assume-finish times, is :

$$TIME = \{t_{i1}, t_{i2}, t_{i3}, \dots, t_{m1}, t_{m2}, t_{m3}, \dots\} \quad (7.2)$$

Then, times are sorted in ascending order :

$$TIME_{order} = \{\dots, t_{ij}^k, t_{mn}^{k+1}, \dots\} \quad (7.3)$$

Corresponding to the time matrix, the Vehicle Order matrix VO can be built as follows :

$$VO = \{\dots, V_{ij}^k, V_{mn}^{k+1}, \dots\}, (j, n, k = 1, 2, 3, \dots) \quad (7.4)$$

where V_{ij}^k is the k^{th} vehicle in priorities array as the j^{th} vehicle in platoon i associated to the vehicle V_{ij} and the time t_{ij}^k . Coordinately, V_{mn}^{k+1} is the $(k + 1)^{\text{th}}$ vehicle in priorities array as the n^{th} vehicle in platoon m associated to the vehicle V_{mn} and the time t_{mn}^{k+1} .

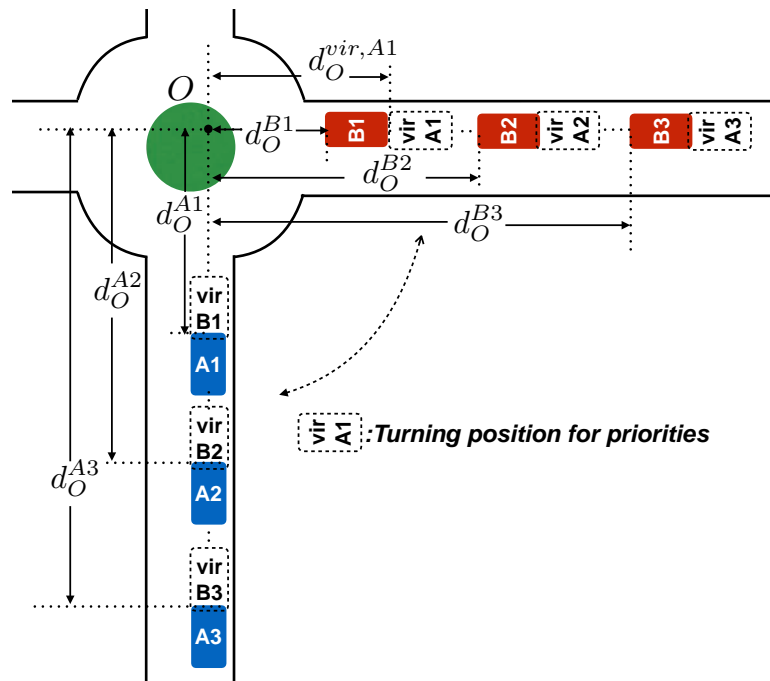


FIGURE 7.3 – Priorities decision

In this example, assuming that velocities and vehicle lengths are set to be the same for each vehicle ; hence, only distances are compared. As shown in Figure 7.3, vehicles-train A is turned to the same side of B around the intersection point O . Priorities are shown previously according to relative positions :

$$VO = \{V_{B1}^1, V_{A1}^2, V_{B2}^3, V_{A2}^4, V_{B3}^5, V_{A3}^6\}$$

7.1.2/ PRECEDING VEHICLE AND ROLE

As previously said, for every following vehicle, the uniqueness of the preceding vehicle should be pre-set. The preceding vehicle information includes position, direction, and speed. In the nominal situation (i.e. without any conflict in priorities), each following vehicle follows one preceding vehicle keeping the security distance. The virtual vehicle concept has been introduced in Section 6.3 so as to be able to adapt inter-vehicle longitudinal distance when trains are crossing without interfering on platoon control algorithm, shown in Figure 6.6. Consequently, the adaptation of distance between vehicles is made by introducing a virtual vehicle at a suitable position and speed (i.e. when two successive vehicles in the VO array are not belonging to the same train). Virtual vehicles have the same properties and behavior as real ones.

When different vehicles-train encounter, just one vehicle is set to leader role. All other

vehicles would be allocated one preceding vehicle (real one or virtual one). According the virtual vehicle setting principle, the distance between different vehicles and the distance from vehicle to encountering point are adapted before encountering.

7.1.2.1/ PRINCIPLE FOR SETTING PRECEDING VEHICLE

The preceding vehicle is set according the vehicle order and vehicle route. In the vehicles order VO , considering of vehicles V_{Yi}^{n-1} and V_{Xj}^n . If $n = 1$, it means the just one vehicle would pass the intersection. If $n > 1$ and $X = Y$, it means the vehicle V_{Yi}^{n-1} exists and is in the same vehicles-train with vehicle V_{Xj}^n . The preceding vehicle for V_{Xj}^n is set as V_{Yi}^{n-1} .

If $n > 1$ and $X \neq Y$, the preceding vehicle for V_{Xj}^n would be virtual one and concerning with V_{Yi}^{n-1} , marked as $V_{vir,Yi}$. The distance from encountering point O to vehicle V_{Yj} and $V_{vir,Yj}$ are d_O^{Yi} and $d_O^{vir,Yi}$, then the virtual vehicle position content :

$$\begin{cases} d_O^{Yi} & = d_O^{vir,Yi} \\ d(d_O^{Yi})/dt & = d(d_O^{vir,Yi})/dt \end{cases} \quad (7.5)$$

The virtual vehicle is the preceding vehicle of V_{Xj}^n , thus the virtual vehicle $V_{vir,Yi}$ is in the same route as V_{Xj}^n . Finally, the position of the virtual vehicle is determined by two sides : the relative position with encountering point and the route of following vehicle.

The scenario, shown in Figure 7.3, is taken as one example again. The vehicle order is :

$$VO = \{V_{B1}^1, V_{A1}^2, V_{B2}^3, V_{A2}^4, V_{B3}^5, V_{A3}^6\}$$

For the vehicle V_{B1} , it is set as leader role as the first vehicle in the vehicle priority order VO . There is no one preceding vehicle for the leader. Then, we take vehicle V_{B2} as one instance to illustrate how to get the preceding vehicle in virtual one situation. In the vehicle order VO , vehicle V_{A1}^2 is the closest front one for V_{B2}^3 . However, they belong to two different vehicles-train. Therefore, one virtual vehicle $V_{vir,A1}$ should be created along the route of V_{B2} , shown in Figure 7.3, and contents :

$$\begin{cases} d_O^{A1} & = d_O^{vir,A1} \\ d(d_O^{A1})/dt & = d(d_O^{vir,A1})/dt \end{cases} \quad (7.6)$$

For the vehicle V_{A1} , the preceding vehicle is $V_{vir,B1}$ which keeps the same distance to encountering point O with V_{B1} . All vehicles run likely in one vehicles-train where V_{B1} is

leader.

However, preceding vehicles are dynamic according the relative position and vehicles route. In other words, the preceding vehicle could be changed dynamically. And the role changes in different situation sometimes even during the same situation the changing happens. The situation where vehicles or trains encounter each other is separated in five scenarios according the train configuration and the changing of configuration : platoon and formation, splitting, crossing, merging and reconfiguration. The preceding vehicle and role in periods of every scenarios are detailed in below.

7.1.2.2/ PLATOON STRATEGY

Platoon control is the basic form to realize the coordinate control of vehicles. Vehicles in the platoon form run in the same lane. Two vehicles V_{An} and $V_{A(n+1)}$ are two continuous vehicle in one vehicles-train A . They continue also in the vehicles order, $VO = \{\dots, V_{An}^k, V_{A(n+1)}^{k+1}, \dots\}$. For the vehicle $V_{A(n+1)}$, the preceding vehicle is V_{An} .

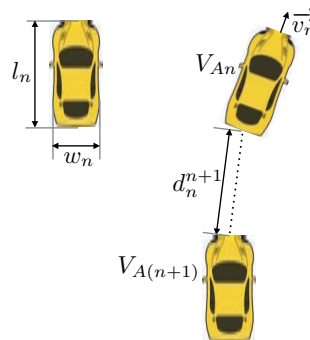


FIGURE 7.4 – Preceding vehicle information in platoon decision

7.1.2.3/ SPLITTING STRATEGY

In the splitting situation, one or more vehicles want to split from its vehicle train. The splitting happens in any situation, for instance, when train run in straight lane, in crossroad or roundabout. In here, one example of vehicles-train T_A containing three vehicles running in a straight lane, is presented shown in Figure 7.5. The vehicle V_{A2} want to split from train, marked in blue (or dark gray printing in black and white).



FIGURE 7.5 – One vehicles-train T_A FIGURE 7.6 – Creating two virtual vehicles

Assuming that there is no other vehicles or vehicles-train which would interrupt the movement of vehicles-train T_A and all the vehicles in the train run in the same speed with the leader V_{A1} , the speed is marked as v_{A1} . The vehicles-train agent accepts the splitting request from vehicle agent. However, the vehicles order is still the same, $VO = \{V_{A1}^1, V_{A2}^2, V_{A3}^3, \}$, according the principles introduced in Section 7.1.1.1.

In here, the vehicle V_{A2} want to split from train. Firstly, two virtual vehicle agent are created : $V_{vir,A1}$ and $V_{vir,A2}$, shown in Figure 7.6. At the beginning, they run in the same speed as v_{A1} . The positions are the same as V_{A1} and V_{A2} positions respectively.

The virtual vehicle agent $V_{vir,A1}$ is sent to V_{A2} as preceding vehicle. The preceding vehicle of V_{A3} is changed to $V_{vir,A2}$.

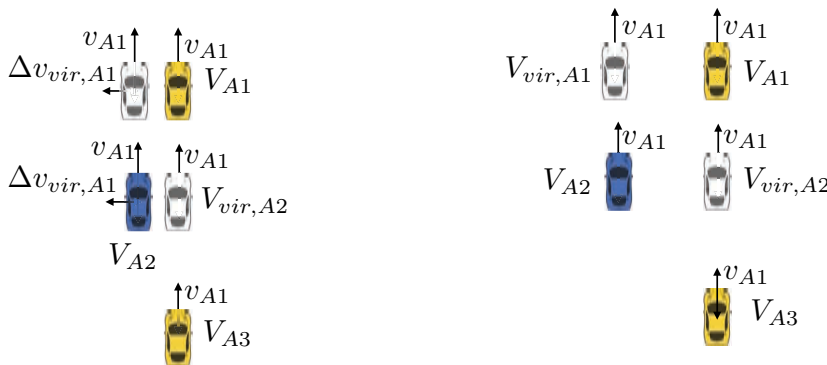


FIGURE 7.7 – Vehicle V_{A2} move to left FIGURE 7.8 – Vehicle V_{A2} arrive suitable position

Then, the speed of $V_{vir,A1}$ is add one lateral component $\Delta v_{vir,A1}$ leading the virtual vehicle $V_{vir,A1}$'s position move to left relative to V_{A1} , shown in Figure 7.7. $V_{vir,A1}$'s speed is changed to the same with V_{A1} after vehicles achieving suitable lateral distance, shown in Figure 7.8.



FIGURE 7.10 – Vehicle trains update

FIGURE 7.9 – Deleting virtual vehicles

After the lateral distance is kept for all vehicles, the virtual vehicles are deleted and then the leader role is sent to V_{B1} . In other words, another train is created, shown in Figure 7.9. Leaders of two trains, V_{A1} and V_{B1} , hold their speed in v_{A1} and v_{B1} , the follower V_{A2} adjusts its speed to follow its preceding vehicle V_{A1} shown in Figure 7.10.

Finally, the train composed with three vehicles splits to two vehicle trains.

7.1.2.4/ CROSSING STRATEGY

When vehicle trains encounter around crossroad or roundabout, if there is no vehicle which want to change its direction, vehicle trains would brush against with each other.

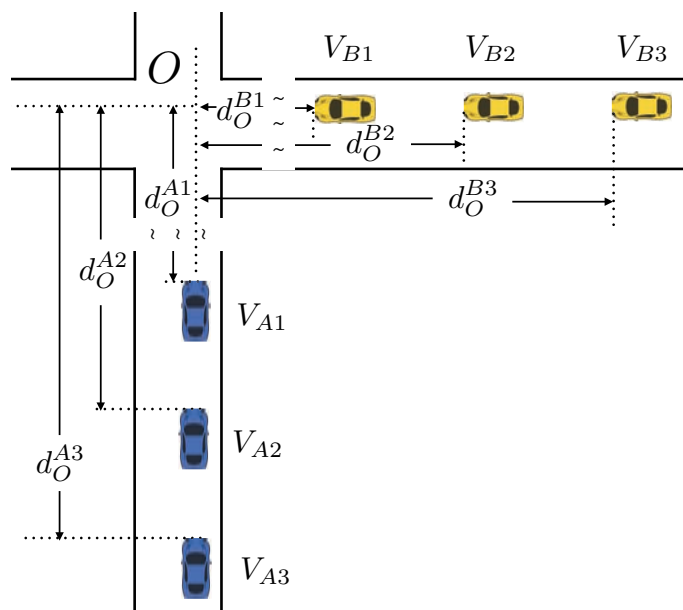


FIGURE 7.11 – Two train encountering in crossroad

In here, two vehicle trains T_A and T_B encountering in crossroad are taken as an example, shown in Figure 7.11. Both of the two trains contain three vehicles, vehicles in T_A colored with blue (or dark gray printing in black and white), vehicles in T_B colored with yellow (or

light gray printing in black and white). The vehicles-train T_B go to left and the T_A is upward. The distance of each vehicle to the encountering point O is shown, such as, the distance of vehicle V_{B1} is d_O^{A1} . According the distance and speed of every vehicle, the vehicles order passing the encountering point O is determined. In here, we give the vehicles order as $VO = \{V_{A1}^1, V_{B1}^2, V_{A2}^3, V_{B2}^4, V_{A3}^5, V_{B3}^6\}$.

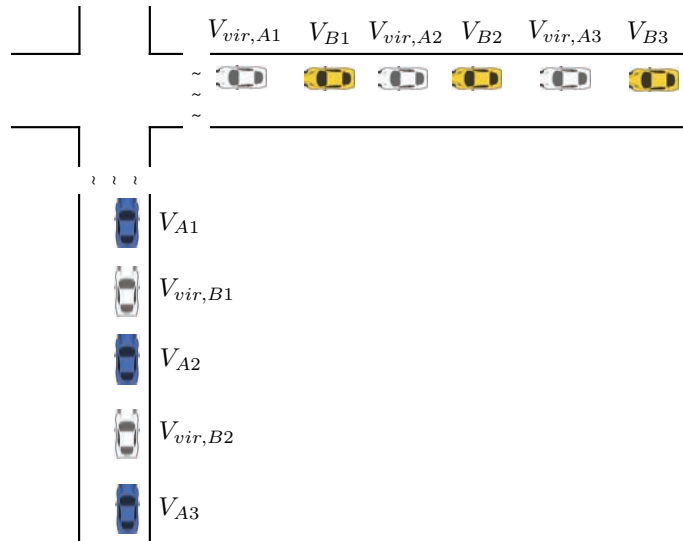


FIGURE 7.12 – Creating virtual vehicles for crossing

According the vehicles order, virtual vehicles are created (shown in Figure 7.12). $V_{vir,A1}$ is created as V_{B1} 's preceding vehicle corresponding to V_{A1} . The $V_{vir,A1}$ holds the same route with V_{B1} . If the distance of V_{A1} to encountering point O is d_O^{A1} ; the distance of $V_{vir,A1}$ is $d_O^{vir,A1}$, then :

$$d_O^{vir,A1} = d_O^{A1}$$

The role of V_{B1} is set to follower, for the preceding vehicle exists as $V_{vir,A1}$. In the same method, virtual vehicles $V_{vir,A2}$, $V_{vir,A3}$, $V_{vir,B1}$ and $V_{vir,B2}$ are created respectively corresponding V_{A2} , V_{A3} , V_{B1} and V_{B2} as preceding vehicle of V_{B2} , V_{B3} , V_{A2} and V_{A3} .

Under the guidance of virtual vehicle agent, vehicles adjust their distances to each other. Before they arrive the crossroad, the distance adjusting have been finished. Between vehicles, including virtual vehicle, the distance is kept in one unit distance d_{unit} which is a preset safety distance.

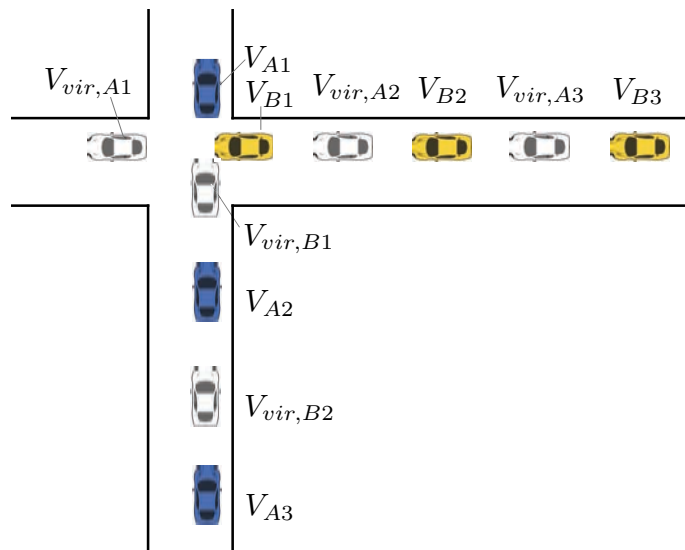


FIGURE 7.13 – V_{B1} encounter with $V_{vir,B1}$

All vehicles run at the same speed as V_{A1} according the creation of virtual vehicles. V_{A1} and $V_{vir,A1}$ arrive the encountering point at the same time. The same situation happens with V_{B1} and $V_{vir,B1}$, shown in Figure 7.13. V_{B1} and $V_{vir,B1}$ leave the encountering point at the same time.

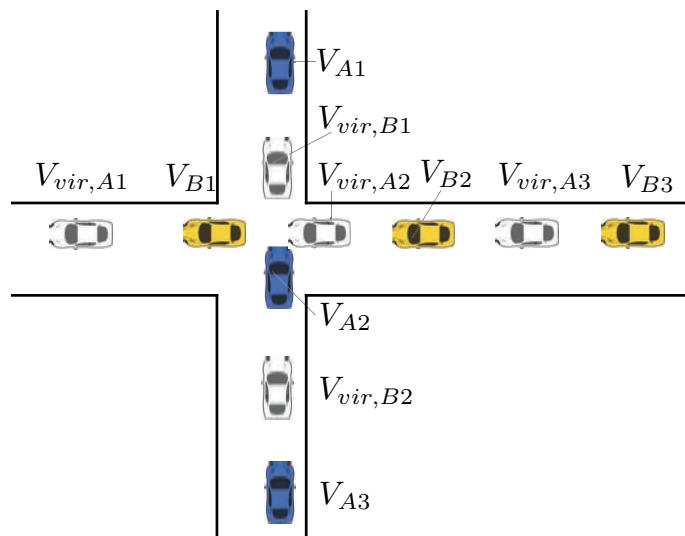


FIGURE 7.14 – V_{A2} encounter with $V_{vir,A2}$

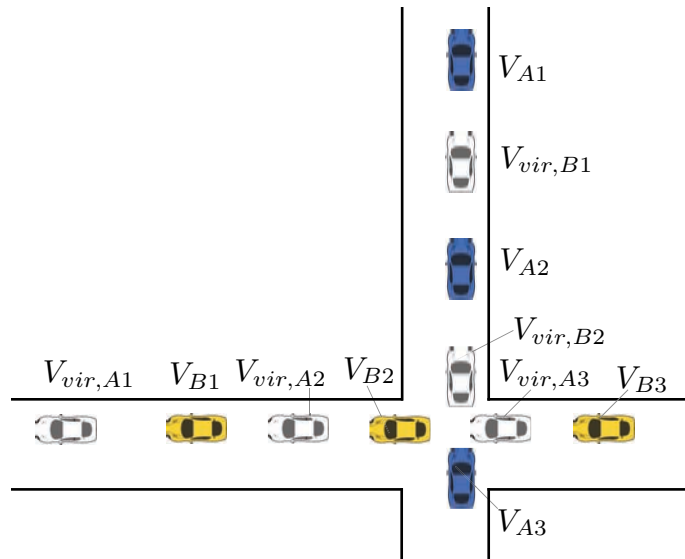


FIGURE 7.15 – V_{A3} encounter with $V_{vir,A3}$

The same processing happens in all the rest vehicles, parts of them are shown in Figure 7.14 and Figure 7.15.

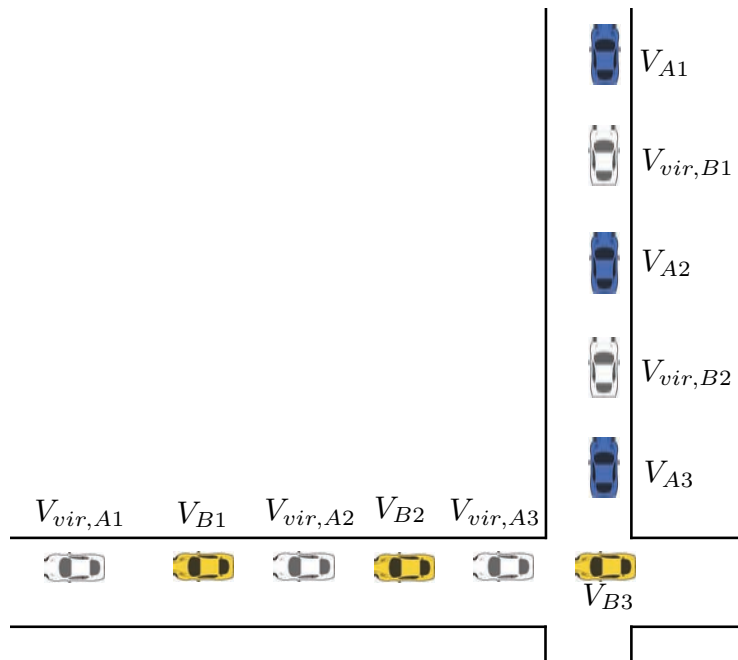


FIGURE 7.16 – V_{B3} passing encountering point

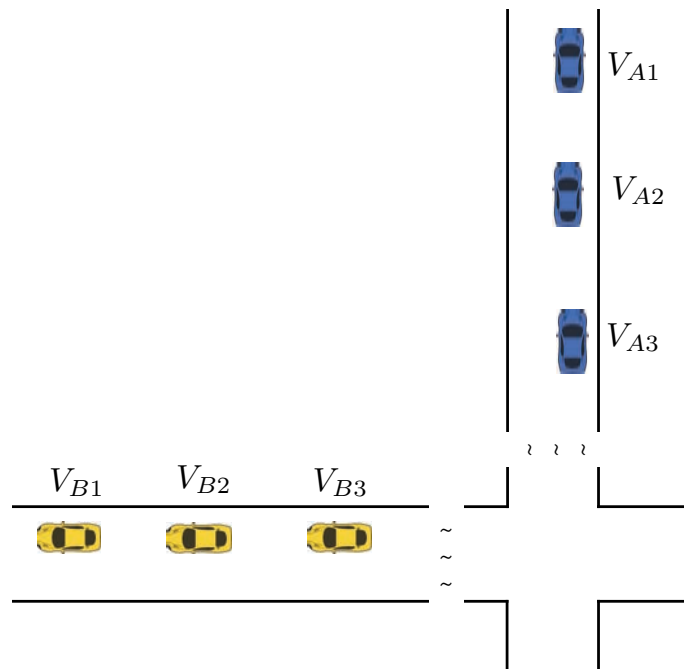


FIGURE 7.17 – Finishing of crossing

After the final vehicle, V_{B3} , pass the encountering point shown in Figure 7.16, all the virtual vehicle are deleted and the preceding vehicles are recovered. Train T_A runs under the leading of V_{A1} . The leader role is returned to V_{B1} which leads the train T_B . The distances between vehicles in the same train is adjusted also, shown in Figure 7.17.

7.1.2.5/ MERGING STRATEGY

When one road forms three lane reducing to two lanes, some of vehicles should change their lane to run in the same lane with other vehicles. When two or more vehicle trains, which run in different road, need to take the same route at the same time, they need to merge into one vehicle train. In here, two vehicle trains running in the same road but different lane is taken as an illustration for merging.

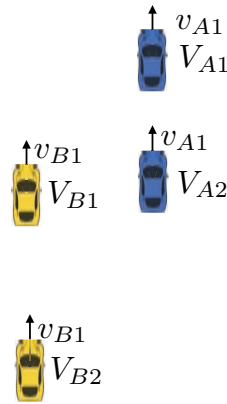


FIGURE 7.18 – Two trains for merging

In Figure 7.18, two vehicle trains, T_A and T_B , run in the same road but different lane and they need merge to one vehicle train. Vehicles in T_A are blue (or dark gray printing in black and white), vehicles in T_B are yellow (or light gray printing in black and white). Assuming that the new vehicles-train after merging is $T = \{V_{A1}, V_{B1}, V_{A2}, V_{B2}\}$, the vehicles order is the same $VO = \{V_{A1}^1, V_{B1}^2, V_{A2}^3, V_{B2}^4\}$.

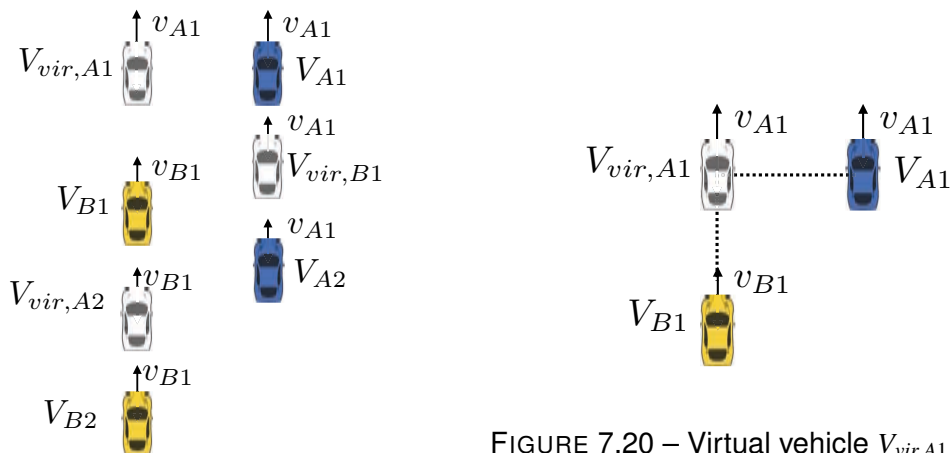


FIGURE 7.20 – Virtual vehicle $V_{vir,A1}$ position in merging

FIGURE 7.19 – Create virtual vehicles for merging

Then, three virtual vehicles are created to adapt the distance shown in Figure 7.19. For the vehicles-train T_A , virtual vehicle $V_{vir,B1}$ is created as the preceding vehicle of V_{A2} corresponding vehicle V_{B1} . $V_{vir,B1}$'s position is in the middle of V_{A1} and V_{A2} , moving at the same speed with V_{A1} as v_{A1} . For vehicles-train T_B , two virtual vehicles, $V_{vir,A1}$ and $V_{vir,A2}$ are created corresponding to V_{A1} and V_{A2} . $V_{vir,A1}$ keeps the same position with V_{A1} in the lane direction and one preset safety distance in the lateral direction, detailed in Figure 7.20. $V_{vir,A1}$ keeps the same speed with V_{A1} as V_{B1} 's preceding vehicle. Therefore, the role of V_{B1} is set to follower. The virtual vehicle $V_{vir,A2}$ is created in the middle of V_{B1}

and V_{B2} as V_{B2} 's preceding vehicle.

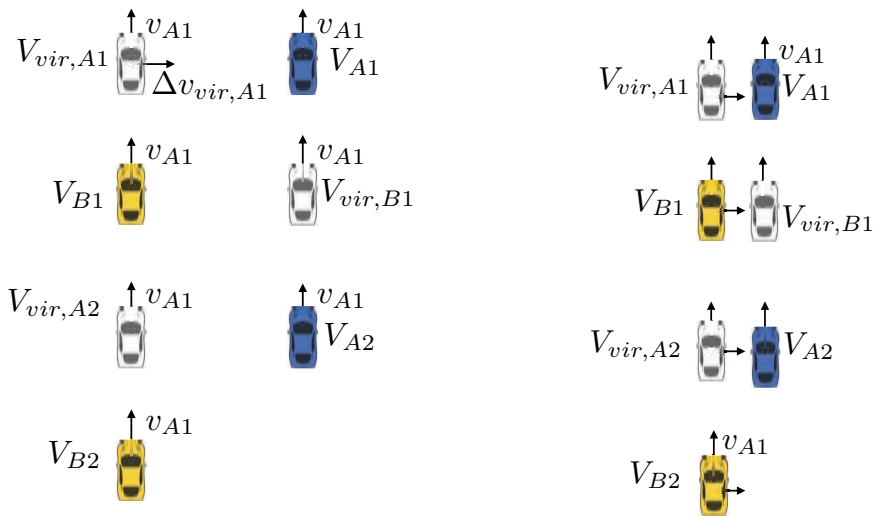


FIGURE 7.21 – Add lateral speed to $V_{vir,A1}$ FIGURE 7.22 – Train T_B move to right

Under the guidance of virtual vehicles, the distance of vehicles in the same train is adjusted firstly. When the really vehicle and the corresponding virtual vehicle (.i.e. V_{A1} and $V_{vir,A1}$) is the same position in the lane direction, one lateral speed $\Delta v_{vir,A1}$ is add to $V_{vir,A1}$, shown in Figure 7.21. Then, train T_B moves to the right until all the vehicles are in the same lane, shown in Figure 7.22.

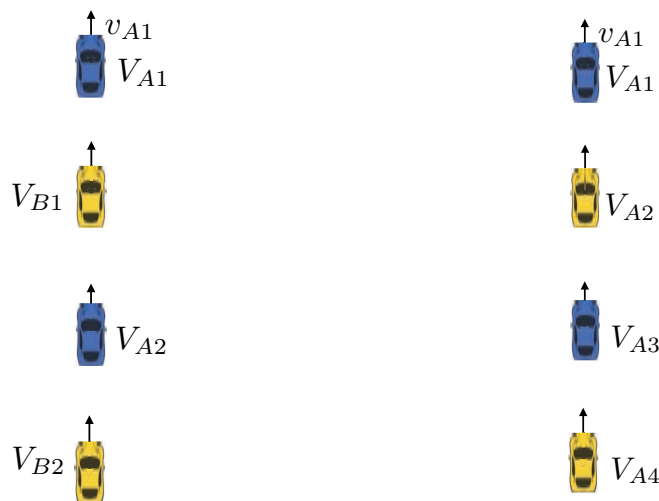


FIGURE 7.23 – Train T_B arrive right lane FIGURE 7.24 – Merging finished

When all vehicles arrive the same lane, the preceding vehicle of every vehicle is changed to one real vehicle according the vehicles order, $VO = \{V_{A1}, V_{B1}, V_{A2}, V_{B2}\}$. Then, virtual vehicles are deleted, shown in Figure 7.23. Finally, the train resources are updated, shown in Figure 7.24.

7.1.2.6/ RECONFIGURATION DECISION STRATEGY

The train configuration includes the vehicle and the order of vehicles. In this section, two kinds of reconfiguration are presented : the order changing in one train and the vehicles changing between two trains.

Reconfiguration inner vehicle train

The order of vehicles in one train could be changed for optimizing reason or one emergent event. We separate the reconfiguration into three steps : first, dividing train into several parts according the reconfiguration ; second, every part moves to suitable place for return the train again ; third, all parts merge into one train. Taking one train T_A as an example, which contain three vehicles and the second vehicle, marked in blue (or dark gray printing in black and white), should be changed to leader. The first step is to move the second vehicle V_{A2} out of the train in other lane. Secondly, moving the V_{A2} to front until a suitable place. Thirdly, V_{A2} return to the lane where the train run as leader. The details are explained in below through several figure step by step.

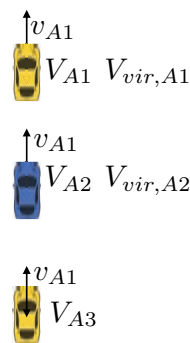


FIGURE 7.25 – Train T_A configuration FIGURE 7.26 – Create two virtual vehicles

The configuration of train T_A is shown in Figure 7.25 where vehicle V_{A2} is going to be reconfigured as leader. The beginning of reconfiguration is to create two virtual vehicles : $V_{vir,A1}$ and $V_{vir,A2}$ holding the same position and speed with V_{A1} and V_{A2} correspondingly, shown in Figure 7.26. Then, preceding vehicles of V_{A2} and V_{A3} are changed to $V_{vir,A1}$ and $V_{vir,A2}$ respectively.

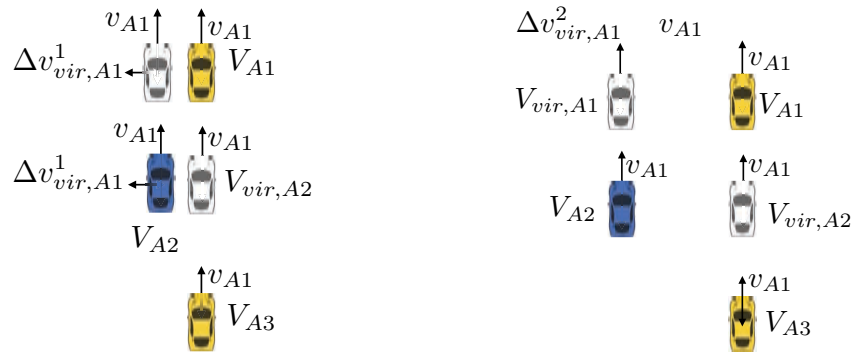


FIGURE 7.27 – Moving V_{A2} to left FIGURE 7.28 – Begin moving to front

After virtual vehicles are deployed, the first step of reconfiguration, dividing train, is executed. This step is almost likely with the splitting : one lateral speed, $\Delta v_{vir,A1}^1$, is added to virtual vehicle $V_{vir,A1}$ shown in Figure 7.27. Vehicle V_{A2} moves to left and hold the nearby lane. The lateral speed is reduced to zero and one speed in the same direction with V_{A1} is added to virtual vehicle $V_{vir,A1}$, shown in Figure 7.28. In below, the new speed of virtual vehicle $V_{vir,A1}$ is marked as $v_{A2} = \Delta v_{vir,A1}^2 + v_{A1}$. At the same time, virtual vehicle $V_{vir,A2}$ runs in speed v_{A2} instead of being deleted.

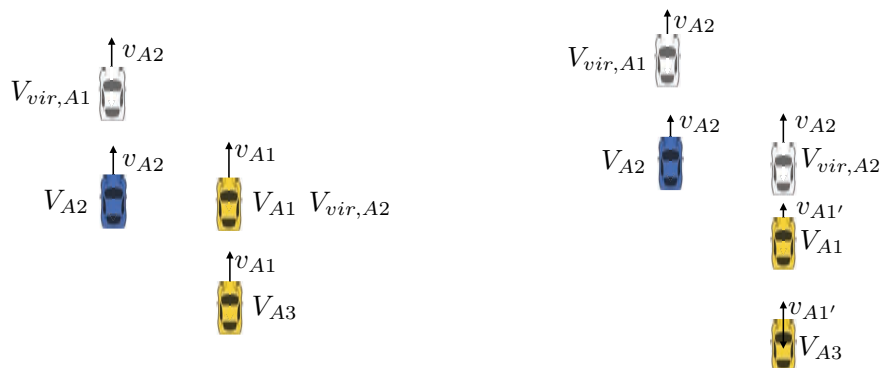


FIGURE 7.29 – Create virtual vehicle $V_{vir,A1}$ FIGURE 7.30 – Adjust longitudinal distance

When virtual vehicle $V_{vir,A2}$ arrives the same position with vehicle V_{A1} , preceding vehicles of V_{A1} and V_{A3} are changed to $V_{vir,A2}$ and V_{A1} respectively. Hence, the role of vehicle V_{A1} is changed to follower from leader, shown in Figure 7.29. Two virtual vehicles, assigned the speed v_{A2} , leading the three vehicles to adjust speeds and distances, shown in Figure 7.30.

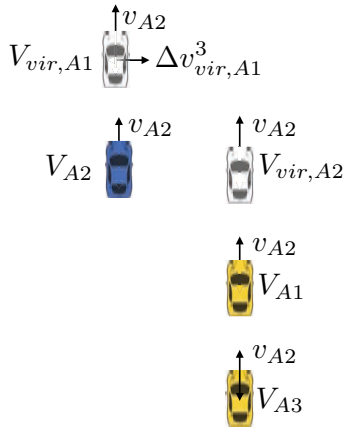


FIGURE 7.31 – Finished adjusting longitudinal distance

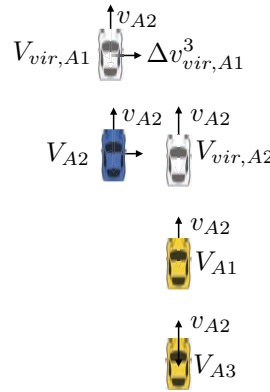


FIGURE 7.32 – V_{A2} moving to right

The second period of reconfiguration is to adjust the longitudinal between vehicles. When all distance between vehicles is in the safety distance, all vehicles run in the same speed v_{A2} in lane direction, shown in Figure 7.31. Then, the third step is to merge all the vehicles into one lane. Therefore, one lateral velocity to right is assigned to virtual vehicle $V_{vir,A1}$, shown in Figure 7.32.

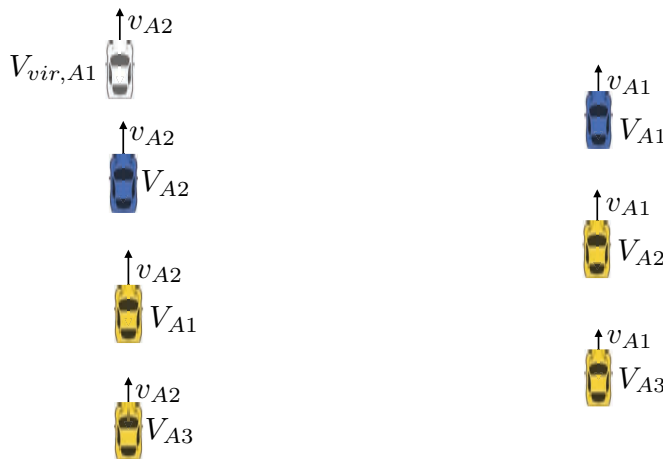


FIGURE 7.34 – Delete virtual vehicles

FIGURE 7.33 – All vehicles in one lane

After all vehicles run in one lane, preceding vehicles of V_{A2} , V_{A1} and V_{A3} are $V_{vir,A1}$, V_{A2} and V_{A1} correspondingly, as the order in Figure 7.33. Then, the virtual vehicle $V_{vir,A1}$ is deleted and the role of V_{A2} is changed to leader. Finally, vehicles-train is updated including the symbol. However, as the mark of vehicle color, the blue (or dark gray printing in black and white) one is changed to the head as leader.

Reconfiguration between vehicle trains When vehicle trains encounter with each other, if the configuration of train, including vehicles and their orders, are changed, the

reconfiguration happens. In the reconfiguration, the shifting of preceding vehicles is the key course.

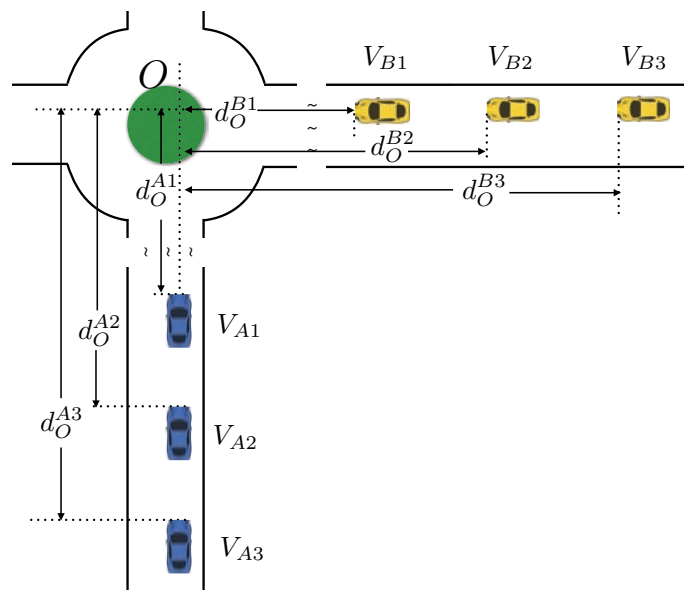


FIGURE 7.35 – Two vehicle trains encounter in the roundabout

One example is carried out in here : two vehicle train, $T_A = \{V_{A1}, V_{A2}, V_{A3}\}$ and $T_B = \{V_{B1}, V_{B2}, V_{B3}\}$, encounter in roundabout, vehicle V_{A2} and V_{B2} need change to T_B and T_A respectively, shown in Figure 7.35. We mark vehicles in the train T_A with blue (or dark gray printing in black and white), in the train T_B with yellow (or light gray printing in black and white). The color for vehicles isn't changed. According distances to encountering point O and position, the vehicles order is assigned as : $VO = \{V_{B1}, V_{A1}, V_{B2}, V_{A2}, V_{B3}, V_{A3}\}$.

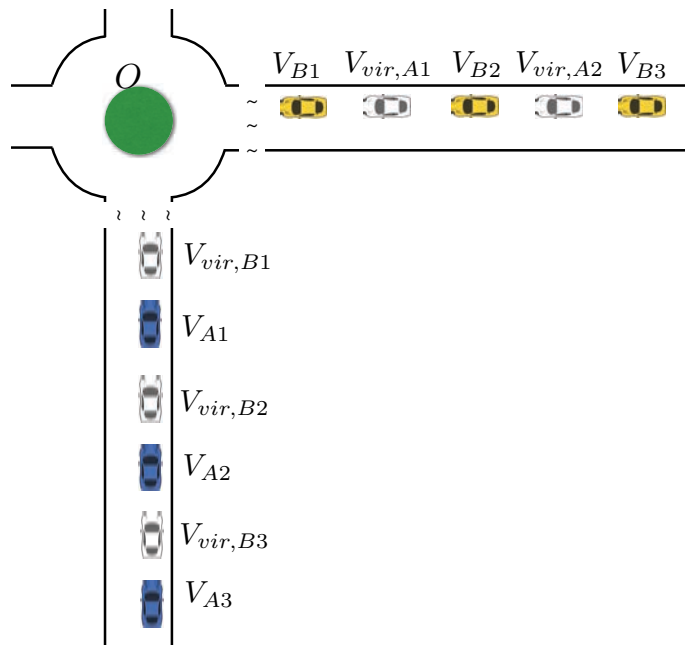


FIGURE 7.36 – Create virtual vehicles for reconfiguration

Five virtual vehicles are created : $V_{vir,A1}$, $V_{vir,A2}$, $V_{vir,B1}$, $V_{vir,B2}$ and $V_{vir,B3}$, show in Figure 7.36. The position of virtual vehicle $V_{vir,B1}$ corresponds with the position of vehicle V_{B1} : the distance of the two vehicles are equal, $d_O^{vir,B1} = d_O^{B1}$. However, virtual vehicle $V_{vir,B1}$ keep in the same route with vehicle V_{B1} . Positions of other virtual vehicles are in the middle of two nearby real vehicle (i.e. $V_{vir,A1}$ in the middle of V_{B1} and V_{B2}), as shown in Figure 7.36. Before vehicles arrive the roundabout, the longitudinal distance has already been adjusted to safety distance thanks to platoon control.

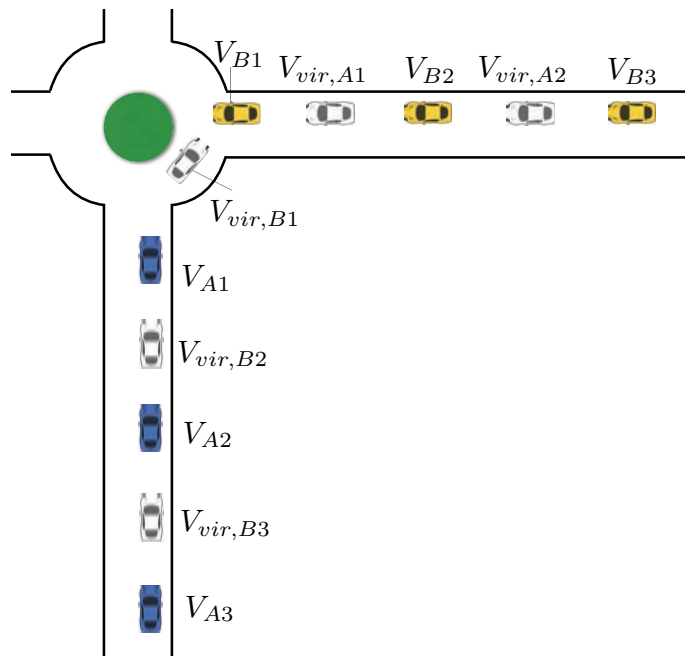


FIGURE 7.37 – Vehicle V_{B1} and virtual vehicle $V_{vir,B1}$ encounter each other

When vehicle V_{B1} encounters with virtual vehicle $V_{vir,B1}$ in roundabout, they keep the same speed shown in Figure 7.37.

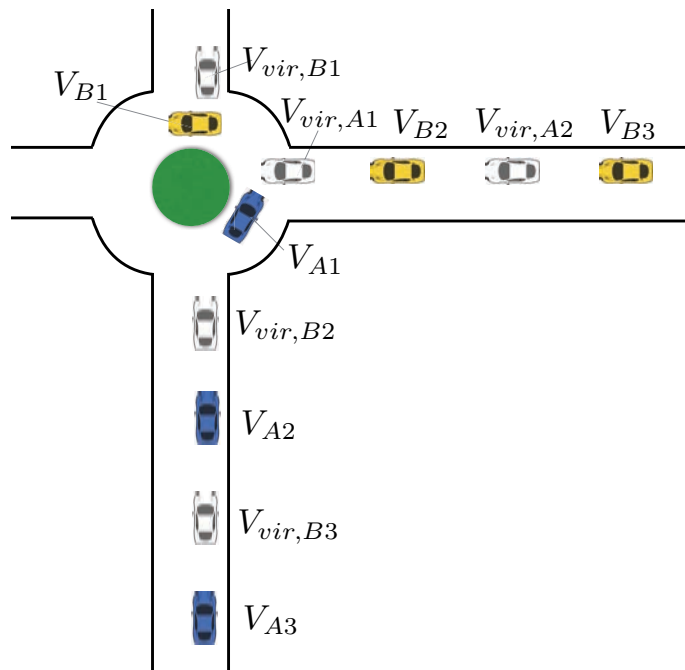


FIGURE 7.38 – Vehicle V_{A1} and virtual vehicle $V_{vir,A1}$ encounter each other

With moving of all vehicle in same speed, vehicle V_{A1} and virtual vehicle $V_{vir,A1}$ would encounter (shown in Figure 7.38).

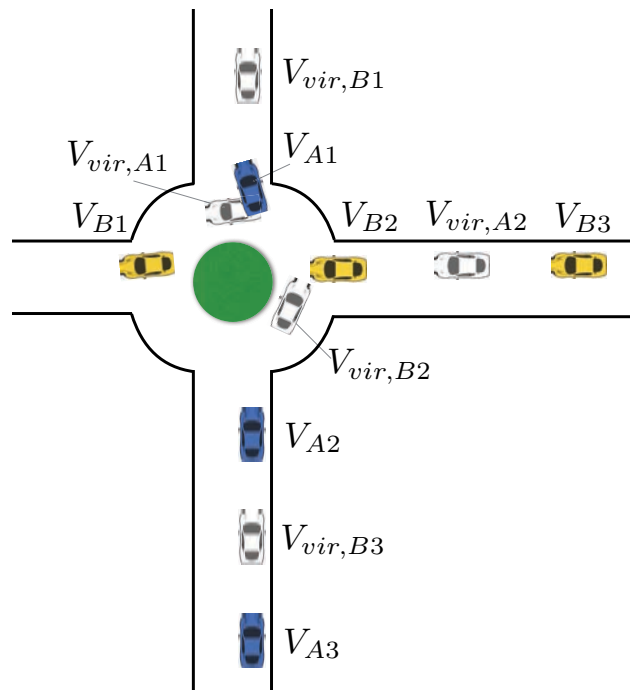


FIGURE 7.39 – Vehicle V_{B2} and virtual vehicle $V_{vir,B2}$ encounter each other

The third time of encountering happens between virtual vehicle $V_{vir,B2}$ and vehicle V_{B2} shown in Figure 7.39. When V_{B2} and $V_{vir,B2}$ arrive the same position, the preceding vehicle of V_{B2} is still virtual vehicle $V_{vir,A1}$.

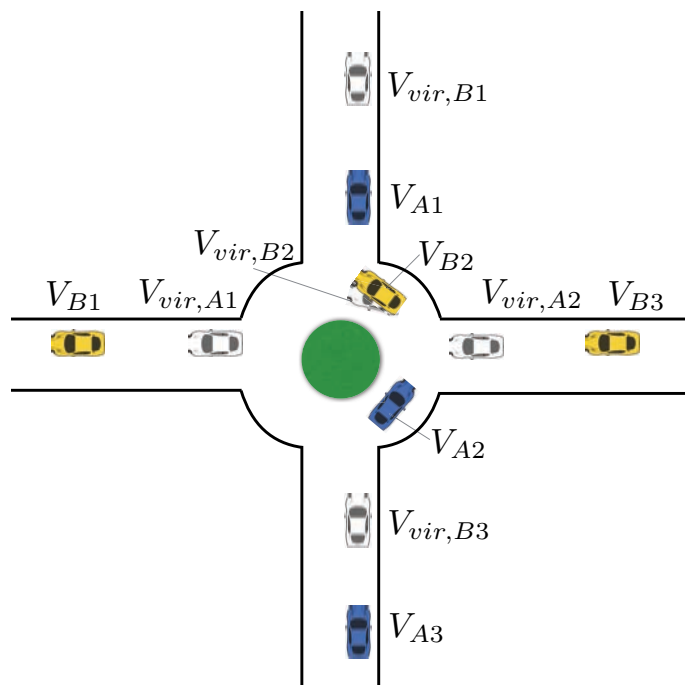


FIGURE 7.40 – V_{B2} change the direction and leave the point

As vehicle V_{B2} need to change direction to train T_A , while vehicle V_{B2} arrives the same position with virtual vehicle $V_{vir,B2}$, the preceding vehicle of V_{B2} is changed to V_{A1} . Virtual vehicle $V_{vir,B2}$ runs in the leading of $V_{vir,A1}$ as preceding vehicle, shown in Figure 7.40.

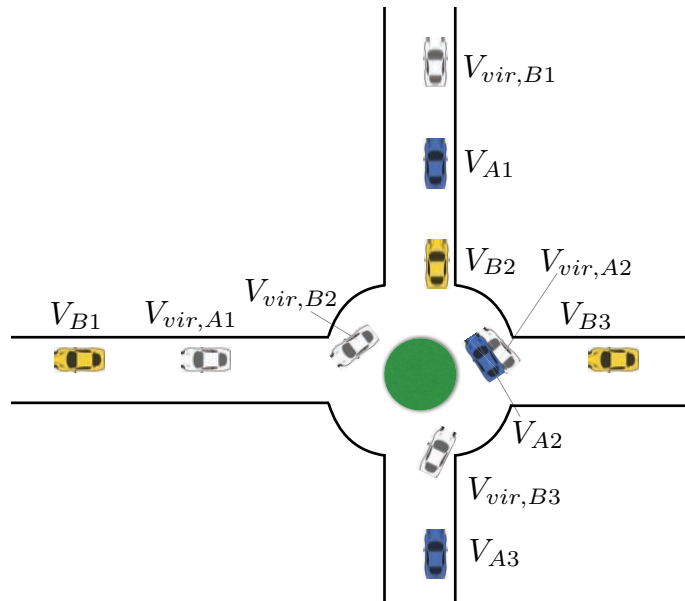


FIGURE 7.41 – V_{A2} and $V_{vir,A2}$ encounter each other

Following, vehicle V_{A2} and virtual vehicle $V_{vir,A2}$ meet in the roundabout shown in Figure 7.41.

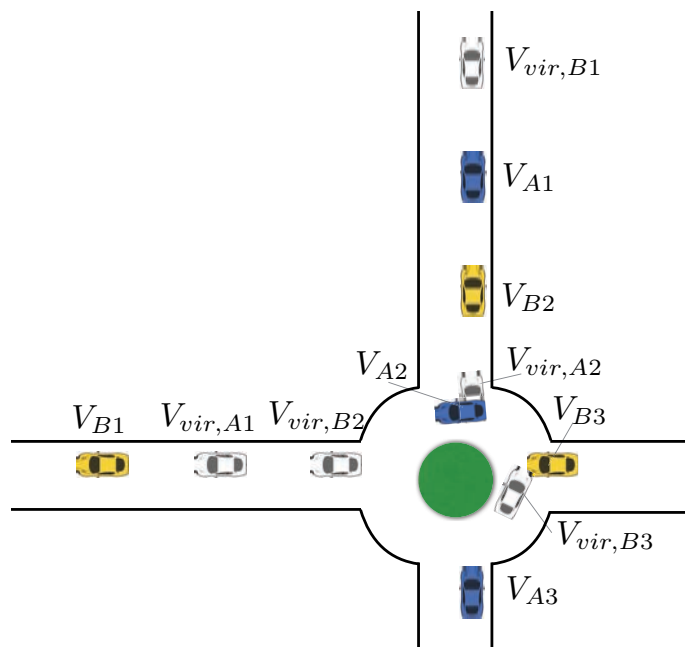


FIGURE 7.42 – V_{A2} and $V_{vir,A2}$ change the direction and leave the point

For vehicle V_{A2} , it keep the preceding vehicle as virtual vehicle $V_{vir,B2}$. With $V_{vir,B2}$ changing direction, V_{A2} also changes to vehicles-train T_B . This situation happens in virtual vehicle $V_{vir,A2}$ too which follows V_{B2} , shown in Figure 7.42. When V_{A2} and $V_{vir,A2}$ leave the roundabout, thinking about that V_{B3} and $V_{vir,B3}$ should keep their route as before, the preceding of V_{B3} and $V_{vir,B3}$ are changed to V_{A2} and $V_{vir,A2}$ respectively from $V_{vir,A2}$ and V_{A2} .

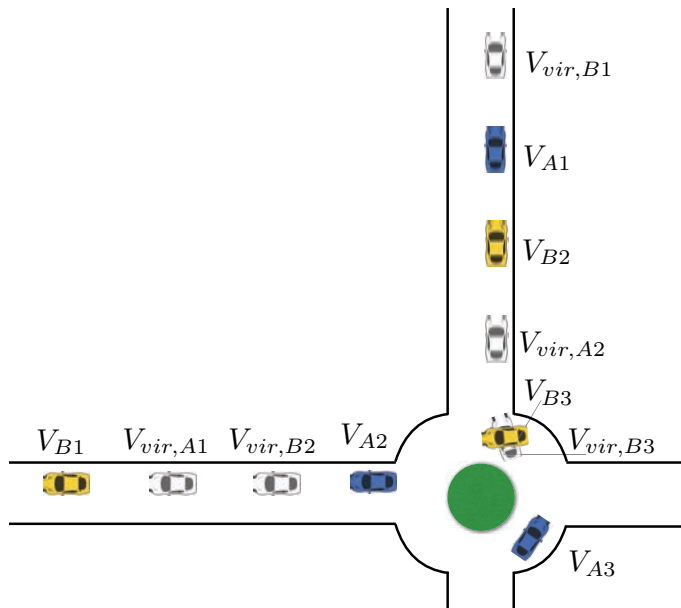


FIGURE 7.43 – V_{B3} and $V_{vir,B3}$ leave the roundabout

Under the leading of vehicle V_{A2} and virtual vehicle $V_{vir,A2}$, V_{B3} and $V_{vir,B3}$ leave the roundabout shown in Figure 7.43.

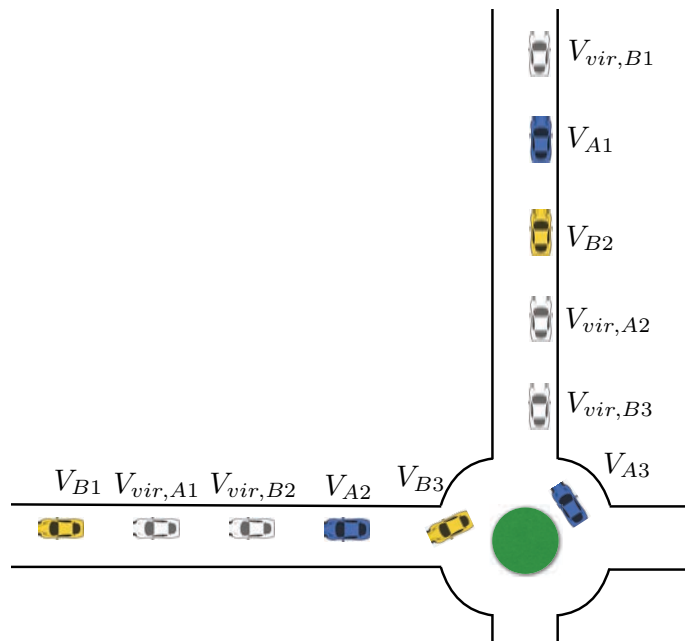


FIGURE 7.44 – V_{A3} leaves the roundabout

For the vehicle V_{A3} , the preceding vehicle is still $V_{vir,B3}$, shown in Figure 7.44.

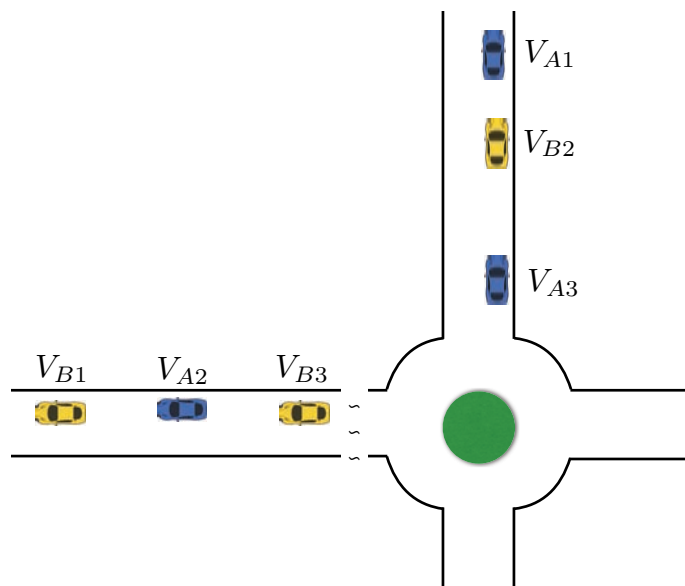


FIGURE 7.45 – Delete virtual vehicles

After vehicle V_{A3} exiting from roundabout, all virtual vehicles are deleted. Vehicles V_{A1} is assigned leader again. The preceding vehicle for every vehicle is shown in Figure 7.45.

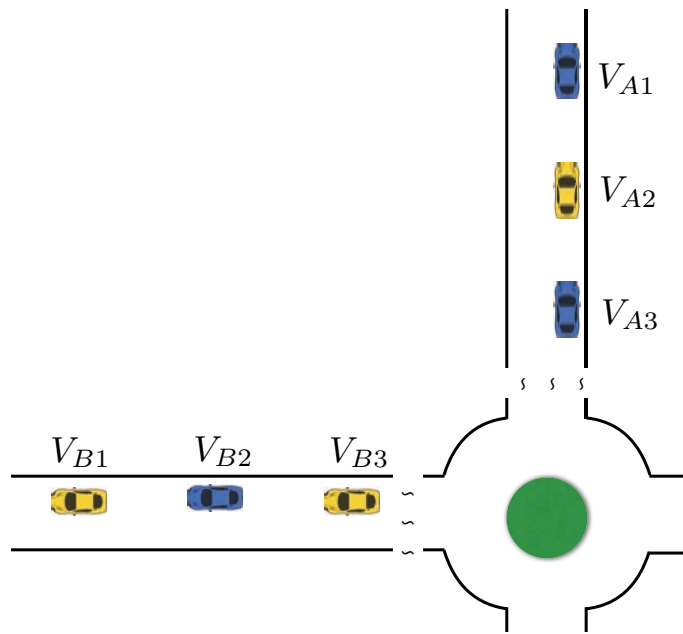


FIGURE 7.46 – Update vehicle trains

Two trains adjust the distance between vehicles with the leading of two leaders. And trains resources are updated, shown in Figure 7.46.

7.2/ VEHICLE AGENT REACTION

The vehicle agent reaction algorithm concerns the vehicle itself, and outputs the speed and steering angle corresponding the preceding vehicle and role. A classical platoon control model is adopted : the virtual link, between two close vehicles, is described by a physically inspired interaction model composed of two springs and a damper [Zaher, 2013].

7.2.1/ PLATOON CONTROL MODEL

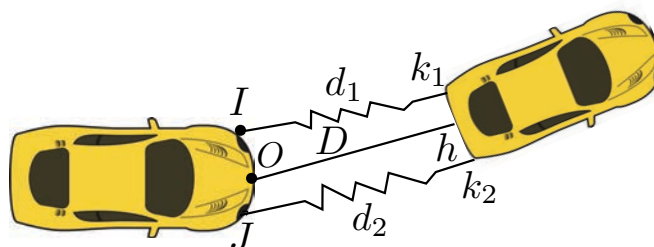


FIGURE 7.47 – Physical interaction model

The following vehicle receives the position and direction of the previous vehicle and itself. Hence, the three distances, d_1 , d_2 and D could be acquired, shown in Figure 7.47. d_1 and d_2 are the lengths of the two springs and D is the length of the damper. Hence, the three types forces acting on the following vehicle are :

1. Forces of both springs : $\vec{F}_i = k_i \vec{X}_i = k_i (\overrightarrow{d_i - l_0})$, $i \in \{1, 2\}$.

2. Force of damper : $\vec{F}_d = -h\vec{v} = -h(\|\frac{\Delta \vec{D}}{\Delta t}\|)$.

3. Friction force : $\vec{F}_f = -\mu R_n \frac{\vec{v}}{v} = -\mu mg \frac{\vec{v}}{v}$, $v \neq 0$.

Parameters involved in this model are shown in blow :

- m the mass of the vehicle.
- k_1 and k_2 are stiffness of each one of the springs.
- l_0 is the spring's resting length (both springs have the same resting length).
- h is the damping coefficient.
- μ is the friction coefficient.
- g represents the gravity of earth.
- v and a are the speed and acceleration of the vehicle.

Therefore, each following vehicle movement command (speed and direction) is computed according to Newton's second law of motion :

$$\vec{F} = m\vec{a} = \vec{F}_1 + \vec{F}_2 + \vec{F}_d + \vec{F}_f \quad (7.7)$$

7.2.2/ MODEL PARAMETERS

In this section, the method of calculating model parameters, including k_1 , k_2 and h , are described. Using the Newton's law of motion, we obtain a 2nd order differential equation, the resolution of which allows computation of the speed and angle to be applied to the vehicle [El-Zaher et al., 2011].

We define k as a global stiffness equating the sum of k_1 and k_2 ($k = k_1 + k_2$).

7.2.2.1/ GLOBAL STIFFNESS

To calculate the value of the global stiffness, we places the vehicle in the case of a linear motion, where the two springs have the same stiffness and the same length, which means $k_1 = k_2 = \frac{k}{2}$ and $X_1 = X_2 = X$. According equation 7.7, the following equation about the vehicle dynamic could be get :

$$m\vec{a} = k\vec{X} - h\vec{v} - \mu mg \frac{\vec{v}}{v} \quad (7.8)$$

Before the vehicle moving, $\vec{a} = \vec{v} = \vec{0}$, the friction force hold the same direction with forces of both springs and $\|\vec{F}_f\| = \|\mu mg\|$ thus we get :

$$0 = \|k\vec{X}\| - \mu mg \quad (7.9)$$

A motionless vehicle would keep still when $k(d - l_0) < \mu mg$. Therefore, we can define the global stiffness through giving one predefined distance d_0 to lead $k(d_0 - l_0) = \mu mg$. At this situation, the global stiffness is :

$$k = \frac{\mu mg}{d_0 - l_0} \quad (7.10)$$

7.2.2.2/ DAMPING COEFFICIENT

The damping coefficient h is deduced from a kinematic study. Assuming that the preceding vehicle is still. We get the relationship between acceleration and speed with the length of spring and damper : $\vec{a} = \ddot{X}$, $\vec{v} = \dot{X}$. Thanks to the fundamental principle of dynamics, we establish the following differential equation according equation 7.8 :

$$\ddot{X} - 2\xi\omega_0\dot{X} + \omega_0^2X = -\frac{\mu}{m}R_n \quad (7.11)$$

where, $2\xi\omega = \frac{h}{m}$ and $\omega_0 = \sqrt{\frac{k}{m}}$.

Then, we get the characteristic equation :

$$t^2 - 2\xi\omega_0t + \omega_0^2 = 0 \quad (7.12)$$

when $\Delta = \omega_0^2(\xi^2 - 1) = 0$, there is a double real root , which is real. The system is said to be critically damped. A critically damped system converges to zero as fast as possible without oscillating. Considering $\xi \geq 0$, we get :

$$\xi = \frac{h}{2\sqrt{km}} = 1 \quad (7.13)$$

Then, the damping coefficient is :

$$h = 2\sqrt{km} \quad (7.14)$$

7.2.2.3/ TWO SPRING STIFFNESS

When vehicles turn, the length of two virtual spring would be difference as like the difference, shown in Figure 7.47. The spring outside must bend to exert a greater force than the one inside for reducing the error. Consequently, the stiffnesses of two springs must

change dynamically during the turning movement.

We pick up one fixed point P in “In” reference framework. We get the torque of the force to the vehicle as blow :

$$\begin{aligned}\vec{T}_P(\vec{F}_1) &= \vec{PI} \wedge \vec{F}_1 \\ \vec{T}_P(\vec{F}_2) &= \vec{PJ} \wedge \vec{F}_2 \\ \vec{T}_P(\vec{F}_d) &= \vec{PO} \wedge \vec{F}_d \\ \vec{T}_P(\vec{F}_f) &= \vec{PO} \wedge \vec{F}_f\end{aligned}$$

The vehicle angular momentum for point P is :

$$\vec{L}_p = m\vec{PO} \wedge \vec{V} \quad (7.15)$$

Applying the kinetic momentum theorem for point P , we get :

$$\vec{M}_P = \frac{d\vec{L}_P}{dt} = \frac{d\vec{PO}}{dt} \wedge m\vec{v} + \vec{PO} \wedge m\vec{a} \quad (7.16)$$

Considering the the $\frac{d\vec{PO}}{dt}$ is parallel with \vec{v} , the following equation is gotten :

$$\vec{M}_P = \vec{PO} \wedge m\vec{a} = \vec{PO} \wedge (\vec{F}_1 + \vec{F}_2 + \vec{F}_d + \vec{F}_f) \quad (7.17)$$

In other side, we can also get the momentum :

$$\vec{M}_P = \sum \vec{T}_P = \vec{T}_P(\vec{F}_1) + \vec{T}_P(\vec{F}_2) + \vec{T}_P(\vec{F}_d) + \vec{T}_P(\vec{F}_f) \quad (7.18)$$

According equation 7.17 and equation 7.18, we get :

$$k_1\left(\frac{1}{2}\sin\alpha_1\right)\vec{X}_1 - k_2\left(\frac{1}{2}\sin\alpha_2\right)\vec{X}_2 = \vec{0} \quad (7.19)$$

A system of two equations with two unknowns :

$$\begin{cases} k_1 + k_2 = k \\ k_1\left(\frac{1}{2}\sin\alpha_1\right)\vec{X}_1 - k_2\left(\frac{1}{2}\sin\alpha_2\right)\vec{X}_2 = \vec{0} \end{cases} \quad (7.20)$$

Finally, two spring stiffness are :

$$\begin{cases} k_1 = k \frac{(d_2 - l_0) \sin \alpha_2}{(d_1 - l_0) \sin \alpha_1 + (d_2 - l_0) \sin \alpha_2} \\ k_2 = k \frac{(d_1 - l_0) \sin \alpha_2}{(d_1 - l_0) \sin \alpha_1 + (d_2 - l_0) \sin \alpha_2} \end{cases} \quad (7.21)$$

The physical interaction model is used for two main reasons. First, to maintain stable the desired vehicles distance. Second, to guarantee a good trajectory matching, by making the follower vehicle follow the same trajectory as its predecessor, the virtual leader. The parameters of the model are learned so as to ensure safety and stability. The cars vary over time depending on running condition (curvature, speed), see [El-Zaher et al., 2011] for more details.

7.3/ CONCLUSION

In this chapter, the multi-level cooperative control algorithm was detailed in two section : train level and vehicle level. The preceding vehicle and role were determined in train level through two steps. Firstly, the vehicles order was decided according principles including arriving time, relative position and planed routes. Secondly, the preceding vehicle and role were assigned according different scenario. Then, the speed and steering command were calculated by platoon control algorithm based on physical interaction model. Above all, the speed and steering of vehicle command were given by multi-level decision system with vehicles position, speed and routes as inputs. The vehicles controlled by multi-level decision system realized coordinate control to avoid stop for waiting when vehicles encounter. In the next chapter, the experiment is carried out to test the algorithm.



EXPERIMENT AND RESULTS

EXPERIMENTAL PLATFORM

In this chapter, the experimental platform is introduced. Our experimental platform is inspired from the intelligent vehicles of our laboratory. The intelligent vehicles are presented firstly. Then, one simulator, VIVUS (Virtual Intelligent Vehicle Urban Simulator), is introduced to test the proposed method. The architecture of this experimental platform is shown in the last to organizing different parts together.

8.1/ INTELLIGENT VEHICLES IN OUR LABORATORY

There are three intelligent vehicles in our laboratory one RobuCAB and two GEMCars, shown in Figure 8.1.



FIGURE 8.1 – Intelligent vehicles in SET laboratory

All these vehicles are electric, automated and instrumented with sensors and on-board computers. Sensors are detailed in following section.

8.1.1/ SENSOR CONFIGURATION

The ability to perceive information is one important base for the autonomous vehicles. As human using eyes and ears to collect information, the autonomous vehicle collects information through several kinds of sensors. As introduced in Section 2.1.1, camera provides information through images, lidar and radar detect distance information, GPS

feeds the global position to perception system, odometry and inertial sensors measure the movement information such as acceleration and speed.

The perception ability of our vehicles is inspired by the experimental vehicle in our lab which is equipped multi of sensors including lidar, camera and GPS (shown in Figure 8.2). The GPS sensor collects the vehicle position information. The lidar detects other traffic participant information nearby the vehicle, such as other vehicles, passengers and obstacle. The camera takes pictures in running to distill local environment information.



FIGURE 8.2 – Vehicle equipped sensors in our laboratory

Simulations are now a mandatory step in intelligent vehicle development. It allows to reduce the time and financial cost and limits the risk of false manipulation. Furthermore, in the topics dealt by this thesis, testing cooperative control algorithms for several vehicles-trains, composed by several vehicles, is nearly impossible for a laboratory due to a large number of required vehicles and their associated staff for ensuring security. Consequently, we decided to test our proposal using simulation platform.

8.2/ EXPERIMENT PLATFORM

8.2.1/ ARCHITECTURE OF EXPERIMENTAL PLATFORM

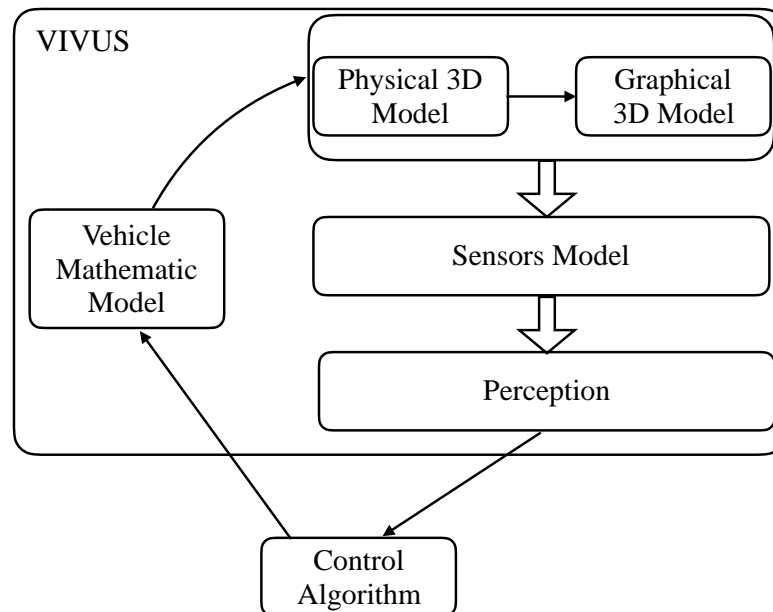


FIGURE 8.3 – Architecture of simulation platform

As shown in Figure 8.3, the experimental platform is composed by two parts : one is VIVUS for simulating the real world including vehicles, roads and other environment ; another one is the controller. The two parts communicate through network and will be introduced in this section. The controller is running under Java and isn't suitable to be show in here. Elements of VIVUS are introduced in next section. The configuring method of scenarios and interface for simulating in 3D virtual environments are also present after the introduction of VIVUS elements.

8.2.2/ VIRTUAL INTELLIGENT VEHICLE URBAN SIMULATOR

VIVUS [Lamotte et al., 2010], developed by the System and Transportation Laboratory of UTBM, has been already used in several academic project¹ [Gechter et al., 2012]. This can simulate vehicles and sensors within their physical properties.

1. <http://www.multiagent.fr/Platforms>

8.2.2.1/ VIVUS ELEMENTS

Physical 3D model

Physical model is based on the *PhysX* engine², which is good at obtaining realistic behavior [Gechter et al., 2012]. For each moving object inside the physical 3D model, a notification is sent to the 3D rendering engine to update its internal data structures.

Graphical 3D model

Graphical 3D model is used to display 3D models of environment, vehicles and their components (wheels, chassis). This model is driven by the physical 3D model.

Sensors model

Sensors model has the same output properties as the real sensors. Several sensors are included in VIVUS :1. geometric and location sensor providing position information ; 2. image sensor ; 3. state sensor.

Perception

The main aims of perception is to format sensors data to fit specific sensor transmitted information and integrate noise. The perception provides information directly to control algorithm

Vehicle mathematic model

Inputs of the vehicle mathematic model are command data from the control algorithm. Vehicle moves according the command and present state to achieve one new state (position and direction). This new state drives the physical 3D model.

8.2.2.2/ CONFIGURING SCENARIOS IN VIVUS

Different scenarios configuration in VIVUS include : 1. The numbers of vehicles ; 2. The original position and direction of individual vehicle ; 3. The planning path of each vehicles ; 4. Sensors for every vehicle, such as GPS, Lidar and camera ; 5. The network port of vehicle for receiving command from control algorithm ; 6. The network port of sensors for sending perception information. We can use the VIVUS editor to configure the scenario, shown in Figure 8.4.

2. <http://www.nvidia.fr/object/nvidia-physx-fr.html>

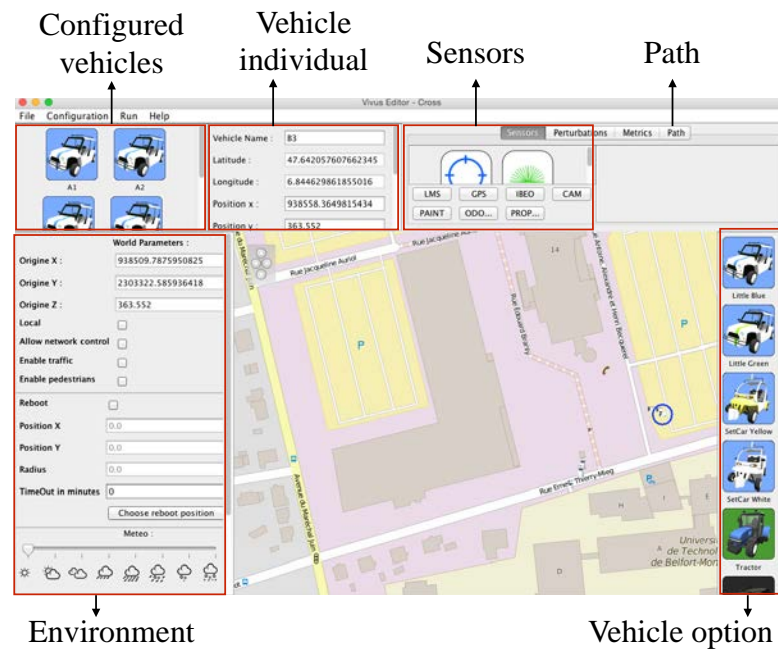


FIGURE 8.4 – VIVUS editor for configure vehicles

The configuration also could be changed through the configuration files, shown in Figure 8.5.

```

Vivus2.conf
#Network
Local=0
Controlbynetwork=0

#World Position (Lambert2e)
origineX=938509.7875950825 origineY=363.552 origineZ=2303322.585936418

#Meteo
Meteo=sunny Fog=0.0

#Time of day (24h format)
Time=12.0

#Traffic/Pedestrians
Traffic=0
Pedestrians=0

#Reboot
reboot=1 rebootX=0.0 rebootY=0.0 rebootRadius=0.0 rebootTimeOutInMin=0

#SetCars configuration
Entity=A1 path=./scenarios/roundabout-reconfig/A1/A1.conf x=938509.649557835 y=363.552 z=2303172.570327379 angle=0.0
avatar=0 entityType=autonomousLittleBlue bezierPath=./scenarios/roundabout-reconfig/paths/A1.xml

Entity=B1 path=./scenarios/roundabout-reconfig/B1/B1.conf x=938662.9349456049 y=363.552 z=2303327.933788865
angle=263.6598062540901 avatar=0 entityType=autonomousLittleBlue bezierPath=./scenarios/roundabout-reconfig/paths/B1.xml

Entity=A2 path=./scenarios/roundabout-reconfig/A2/A2.conf x=938509.6 y=362.555 z=2303166.0 angle=0.0 avatar=0
entityType=autonomousLittleBlue bezierPath=./scenarios/roundabout-reconfig/paths/A2.xml

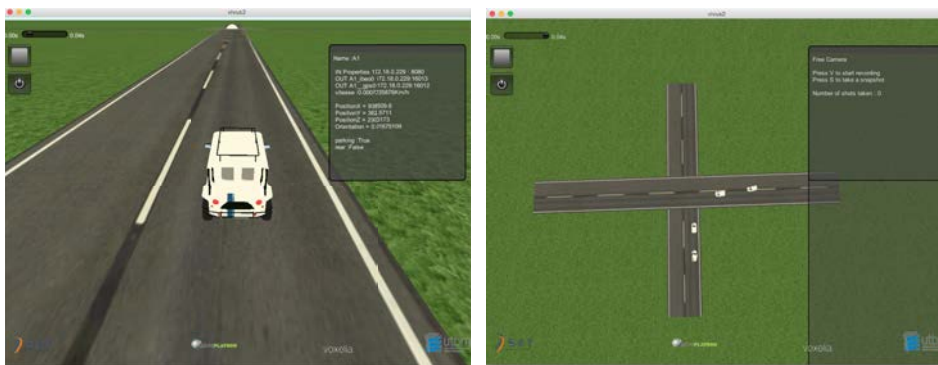
Entity=B2 path=./scenarios/roundabout-reconfig/B2/B2.conf x=938676.3 y=362.561 z=2303327.0 angle=278.0 avatar=0
entityType=autonomousLittleBlue bezierPath=./scenarios/roundabout-reconfig/paths/B2.xml

Entity=A3 path=./scenarios/roundabout-reconfig/A3/A3.conf x=938509.677977536 y=363.552 z=2303160.0919357156
angle=-3.179830119864249 avatar=0 entityType=autonomousLittleBlue bezierPath=./scenarios/roundabout-reconfig/paths/A3.xml

Entity=B3 path=./scenarios/roundabout-reconfig/B3/B3.conf x=938682.3649815434 y=363.552 z=2303327.404556117
angle=-85.91438322002514 avatar=0 entityType=autonomousLittleBlue bezierPath=./scenarios/roundabout-reconfig/paths/B3.xml
    
```

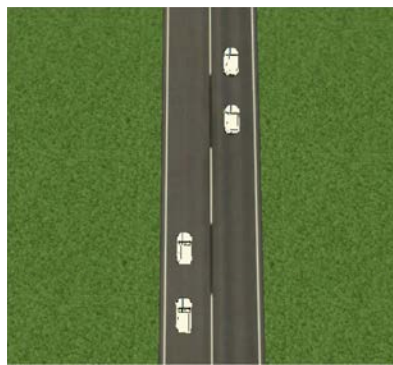
FIGURE 8.5 – Configuring scenario in files

We can get VIVUS interface through run different scenario files as shown in Figure 8.6 :

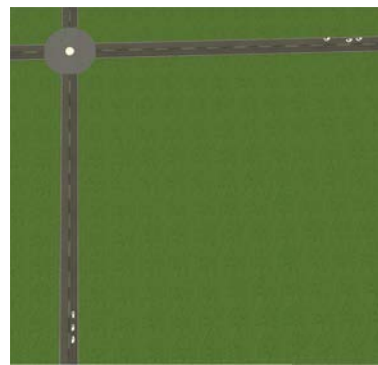


(a) One vehicle in the road

(b) Two trains in crossroad



(c) Two trains in two lanes



(d) Two trains encounter in roundabout



(e) Two trains encounter in crossroad

FIGURE 8.6 – Different scenarios VIVUS interface

The viewpoint could be also adapted which show a different in following experiment.

8.3/ CONCLUSION

In this chapter, the experimental platform is introduced focusing on the VIVUS. Elements of VIVUS are shown firstly, and then the method to configure different scenarios are presented. Experiments in different scenarios were carried out and are shown in the next two chapters.

EXPERIMENT IN THE ROAD WITHOUT INTERSECTIONS AND RESULTS

After a description of the experimental platform, this chapter presents the results of experiments in the road without intersection. Experiments are carried out in four scenarios : (1) one vehicles-train running in one lane ; (2) one vehicle split form its vehicles-train in the two lanes road ; (3) two vehicles-trains merging to one in the two lanes road ; (4) one vehicles-train reconfiguring inner-train in the two lanes road.

9.1/ ONE VEHICLES-TRAIN IN ONE LANE

9.1.1/ PROCESSING DIAGRAM

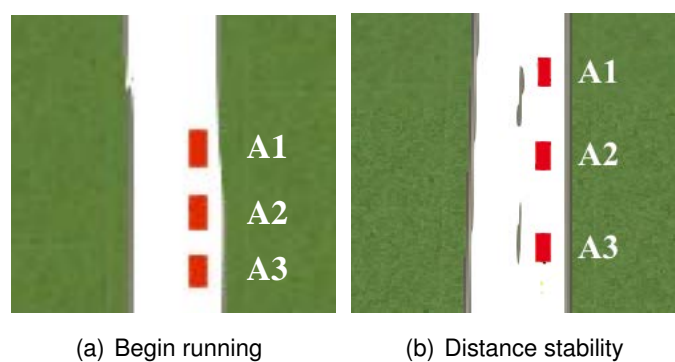


FIGURE 9.1 – Vehicles-train run in on lane

In this scenario, one vehicles-train composed by three vehicles, V_{A1} , V_{A2} and V_{A3} , were configured in VIVUS. The original position are shown in Figure 9.1(a). Considering the urban situation where the vehicle speed is limited to 30 or 50 km/h , it is reasonable to set the leader vehicle speed at 30 km/h . Therefore, most of situation, the leader vehicle's speed is 30 km/h , the other speed is also adopted to verify the stability in different speed.

In this test, the leader vehicle accelerates from zero to 30 km/h. Two follower run behind the leader and achieve the stability distance, shown in Figure 9.1(b).

9.1.2/ SPEED AND DISTANCE RECORD

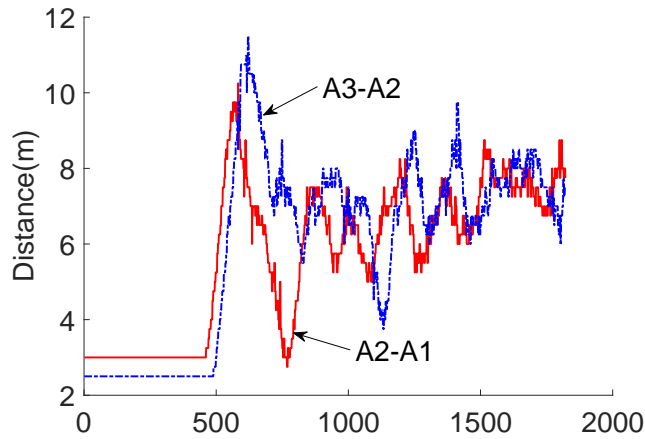


FIGURE 9.2 – Distances between vehicles

Distances between vehicles are changed with speeds adjusting, shown in Figure 9.2 and Figure 9.3. According the platoon control algorithm, the distance between two closest vehicle are adapted with the vehicle speed. As shown in Figure 9.2, vehicle distances are kept around 8 meters, when the leader run in 30 km/h.

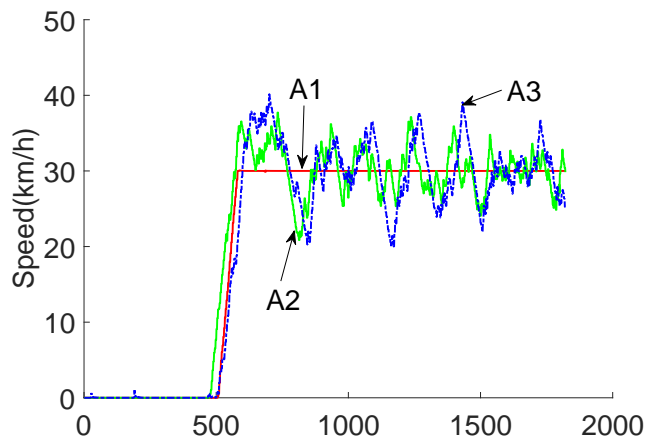


FIGURE 9.3 – Vehicles' speeds

Figure 9.3 show speeds changing of three vehicles. The vehicle V_{A1} keeps in 30 km/h after starting, other two vehicles adapt their speed, however the system vibration existing which should be reduce in the future work.

One important thing is that the distance is changed with the different speed. In this experiment, the vehicle speed is set to 30km/h , the distance is kept in 8 meters. However, if the speed decrease, the distance will also decrease. That is show in the experiment of passing the crossroad in 10.1, where the vehicle speed is set to 5km/h . This is impossible in the real word, yet it is one good strategy to compare the running time in our experiment.

9.2/ VEHICLE SPLITTING FROM ITS VEHICLES-TRAIN

9.2.1/ PROCESSING DIAGRAM

In this scenario, vehicle V_{A2} would split form its vehicles-train composed by three vehicle : V_{A1} , V_{A2} and V_{A3} . The original position is shown in Figure 9.4(a), then the leader begin to accelerate and achieve the speed of 30km/h .

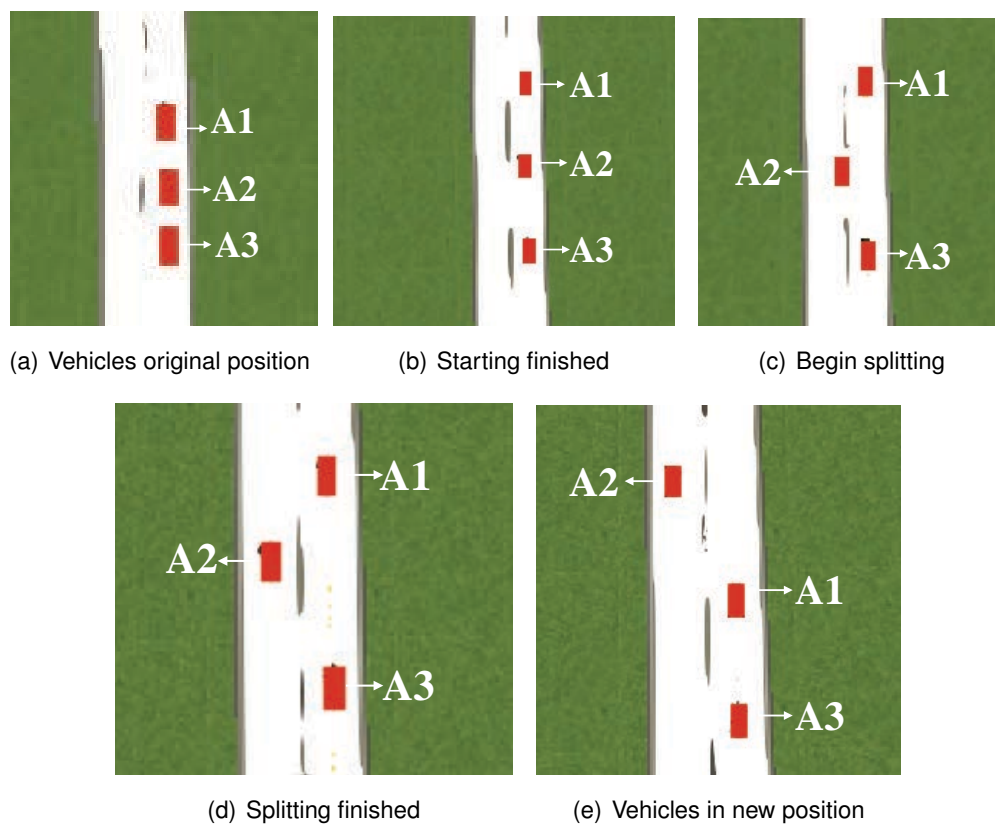


FIGURE 9.4 – Splitting process

The splitting process is shown in group Figure 9.4. Figure 9.4(b) shows the situation where two vehicle distances, V_{A2} to V_{A1} and V_{A3} to V_{A2} , have been adjusted to a stability distance, around 8 meters in here. Figure 9.4(c) shows the moment when the splitting is started, V_{A2} moved to another lane. Finally, vehicle V_{A2} stayed in another lane totally, shown in Figure 9.4(d). Considering about the safety issue, we also let V_{A1} and V_{A2} kept

one safety longitudinal distance.

9.2.2/ SPEED AND DISTANCE RECORD

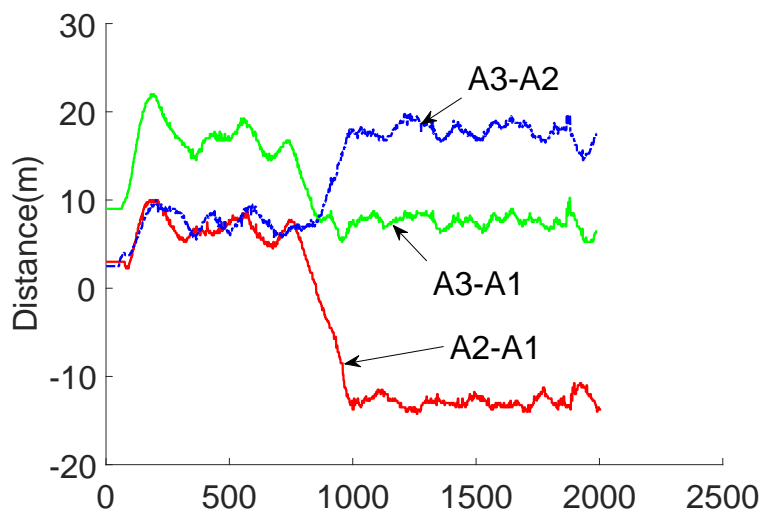
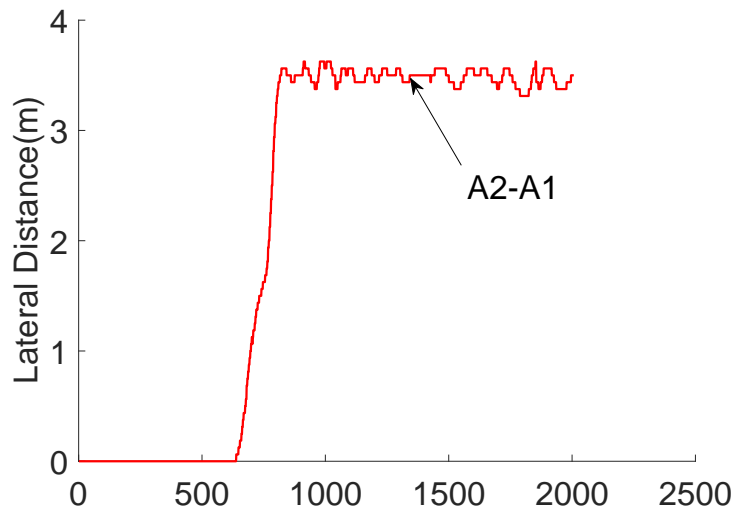


FIGURE 9.5 – Longitudinal distances between vehicles

Figure 9.5 shows the longitudinal distance changing. At the beginning, the distance from V_{A2} to V_{A1} and from V_{A3} to V_{A2} , marked as $A2 - A1$ and $A3 - A2$ respectively, are nearby 3 meters. Distances from V_{A3} to V_{A1} , marked as $A3 - A1$, are around 10 meters taking the length of V_{A2} (3.5 meters) into account. Then, the V_{A2} splitting led the distance changing : the distance $A2 - A1$ decreased to around -15 meters which means vehicle V_{A2} in the front of V_{A1} ; the distance $A3 - A1$ decreased to around 8 meters ; the distance $A3 - A2$ kept in 8 meters for a short time and then increased to 18 meters.

FIGURE 9.6 – Lateral distance between V_{A1} and V_{A2}

In Figure 9.6, the lateral distance between V_{A1} and V_{A2} , marked as $A2 - A1$, is shown. At the beginning, all the vehicles are in the same lane, the lateral distance is zero. Then, the lateral distance increased with the splitting processing. Finally, the lateral distance is kept around 3.5 meters when the splitting is finished.

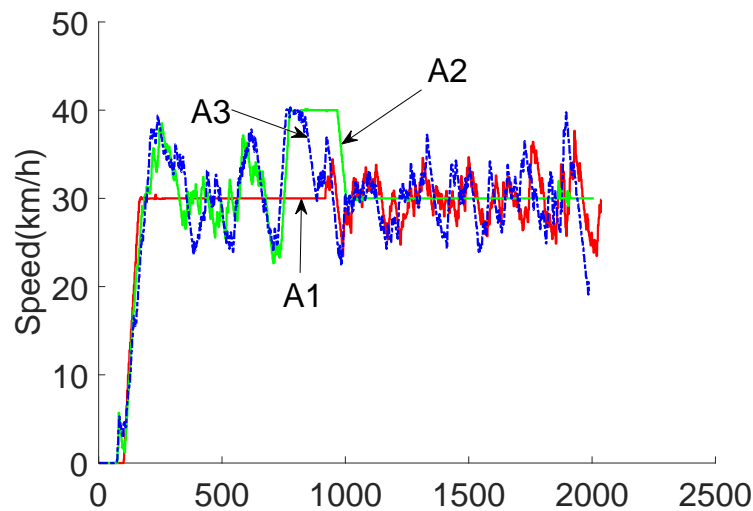


FIGURE 9.7 – Vehicles' speed

Figure 9.7 shows the vehicles speed changing. Something should be noted is that the leader speed is set to 30 km/h and the maximum follower speed is 40 km/h . At the beginning, the V_{A1} held the leader role, ran in 30 km/h . After splitting finished, the V_{A2} is given the leader role, adapted the speed to 30 km/h . V_{A1} adjusting its speed as follower.

9.3/ VEHICLES-TRAINS MERGING

9.3.1/ PROCESSING DIAGRAM

In this scenario, two vehicles-trains were configured on the two lane road, shown in Figure 9.8(a) ;. The vehicles-train T_A , composed by V_{A1} and V_{A2} , is set in the right lane. The vehicles-train T_B , composed by V_{B1} and V_{B2} , is set in the left lane.

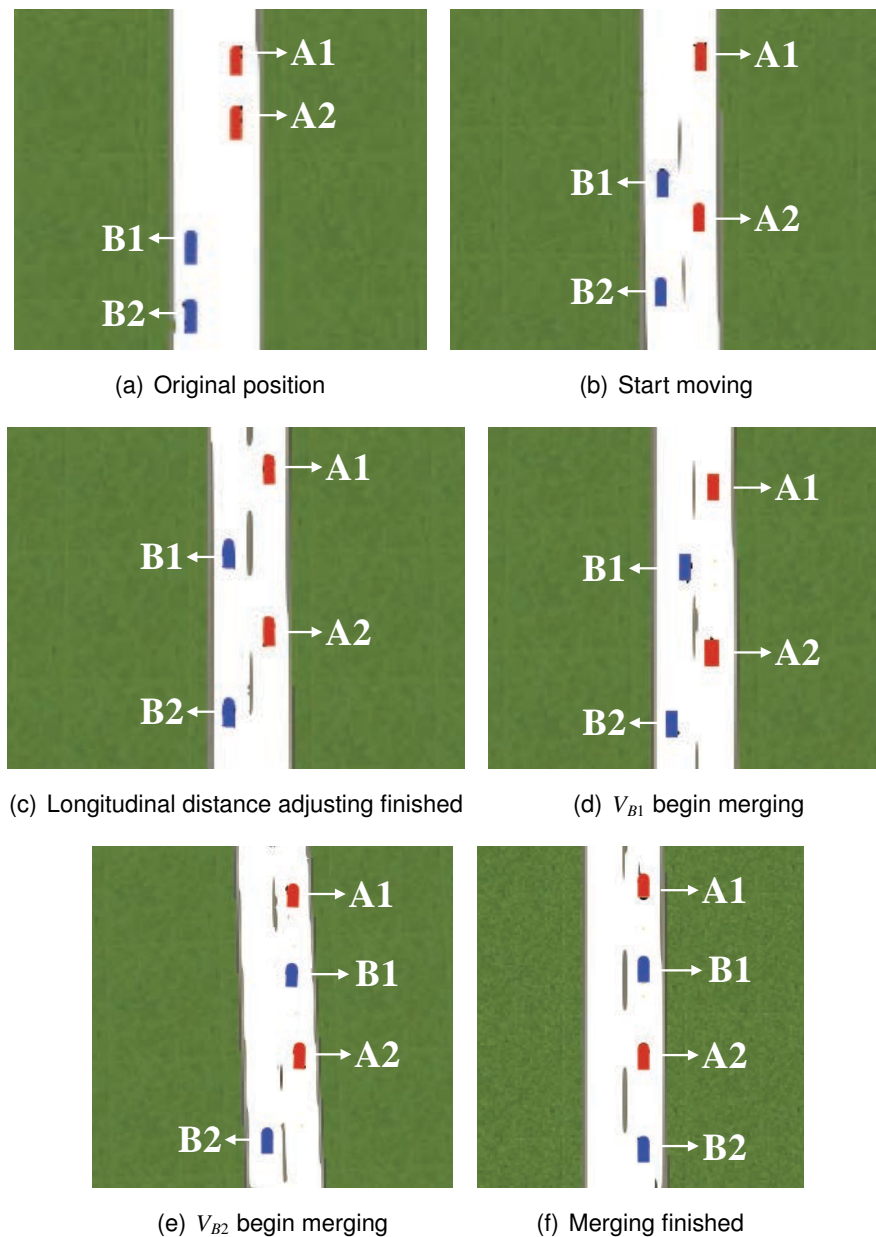


FIGURE 9.8 – Merging process

When all vehicles started to move, distances between vehicles are not very suitable for merging immediately as like shown in Figure 9.8(b). After running about 100 meters, the

longitudinal distance adjusting had been finished, shown in Figure 9.8(c). Then, merging started with V_{B1} moving to right lane (shown in Figure 9.8(d)). While V_{B1} arrived the right lane, V_{B2} also started to move to right lane (shown in Figure 9.8(e)). Finally, all vehicles are in the right lane and the longitudinal distances had been adapted shown in Figure 9.8(f).

9.3.2/ SPEED AND DISTANCE RECORD

Distances and speeds changing are figured out in this section.

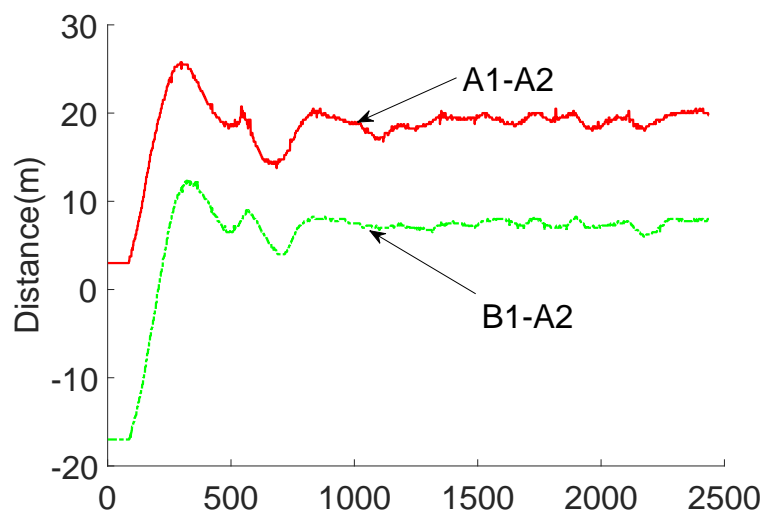


FIGURE 9.9 – Distances from V_{A1} and V_{B1} to V_{A2}

Figure 9.9 shows the distance from V_{A1} to V_{A2} and from V_{B1} to V_{A2} , marked as $A1 - A2$ and $B1 - A2$ respectively. Considering about the $A1 - A2$, the distance at beginning is 3 meters then the distance is adapted until to about 19 meters. And the distance $B1 - A2$ is - 17 meters, it means V_{B1} is in the behind of V_{A2} . After merging has been finished, V_{B1} is the preceding vehicle of V_{A2} and $B1 - A2$ is adjusted to 8 meters.

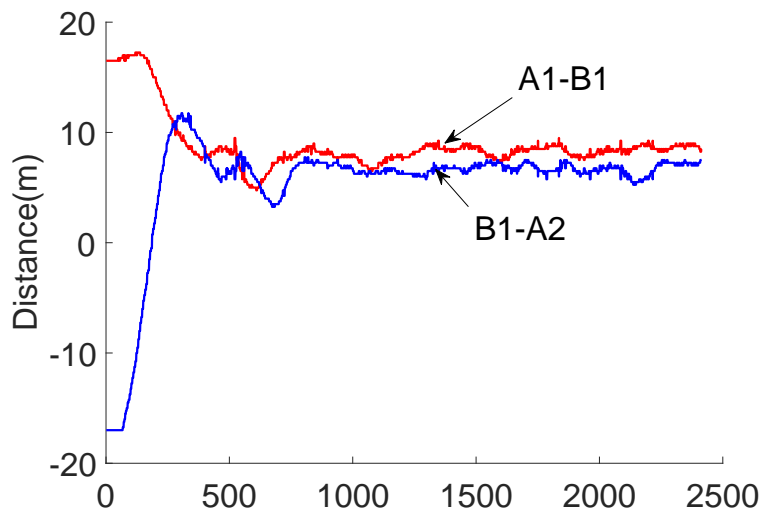
FIGURE 9.10 – Distances between V_{B1} with V_{A1} and V_{A2}

Figure 9.10 shows the distance from V_{A1} to V_{B1} and from V_{B1} to V_{A2} , marked as $A1 - B1$ and $B1 - A2$ respectively. $B1 - A2$ had been presented in the last figure. The original distance $A1 - B1$ is 17 meters at beginning. Then, $A1 - B1$ is adjusted until the merging is finished, the V_{A1} became the preceding vehicle of V_{A1} .

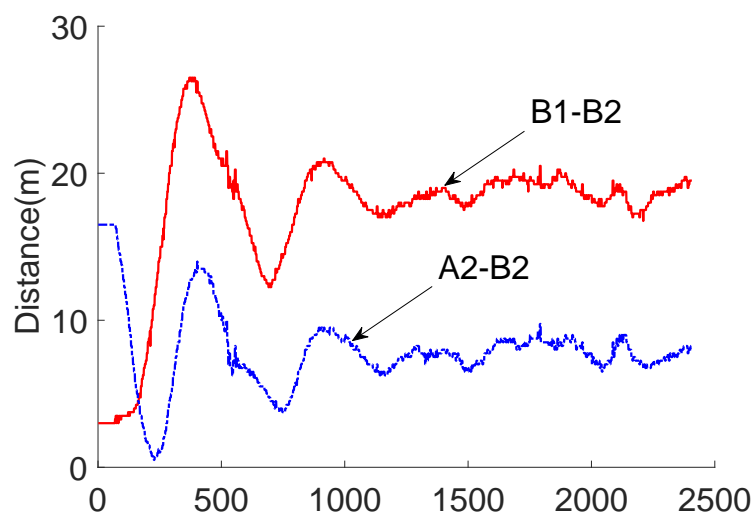
FIGURE 9.11 – Distance from V_{B1} and V_{A2} to V_{B2}

Figure 9.11 shows the distance from V_{B1} to V_{B2} and from V_{A2} to V_{B2} , marked as $B1 - B2$ and $A2 - B2$ respectively. The original distance of $B1 - B2$ is 3 meters, the distance is adjusted during merging resulted in that V_{A2} is inserted between V_{B1} and V_{B2} . After merging, $B1 - B2$ is around 20 meters. The original distance of $A2 - B2$ is 17 meters. Then, the distance is adjusted and the final distance is about 8 meters when merging is finished.

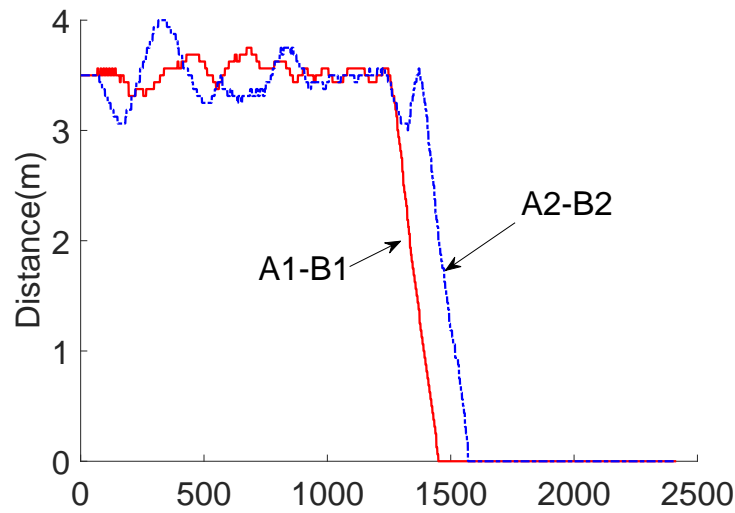


FIGURE 9.12 – Lateral distances from V_{A1} to V_{B1} and from V_{A2} to V_{B2}

Figure 9.12 shows the lateral distance from V_{A1} to V_{B1} and from V_{A2} to V_{B2} , marked as A1–B1 and A2–B2 respectively. Vehicles-trains A and B are in the different lanes at beginning. The lateral distance A1–B1 and A2–B2 are 3.5 meters. When merging happened, the A1–B1 decreased to 0 firstly then A2 – B2 corresponding V_{B1} merging firstly, V_{B2} in secondly.

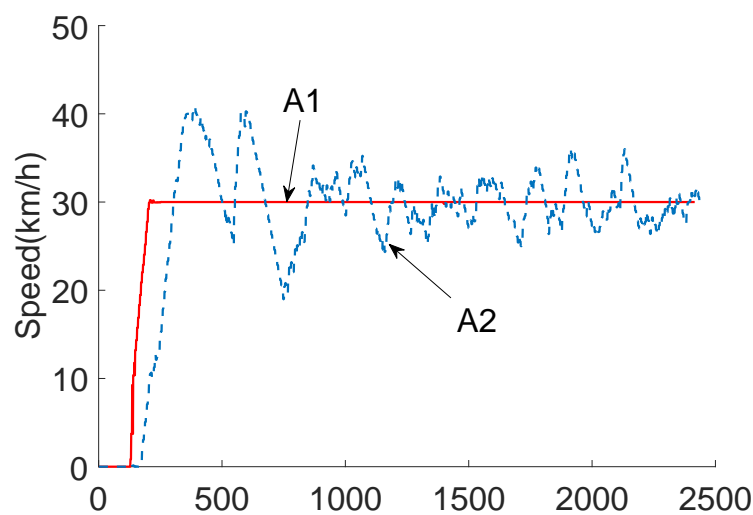


FIGURE 9.13 – Speeds of vehicles in train T_A

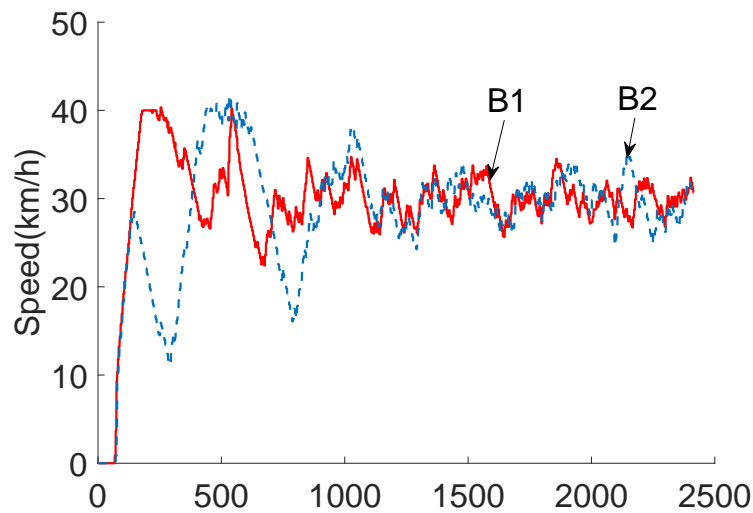
FIGURE 9.14 – Speeds of vehicles in train T_B

Figure 9.13 and Figure 9.14 show the speed changing of all vehicles. V_{A1} kept its speed in 30 km/h after acceleration and other vehicles adapted their speed as following vehicle of one real vehicle or virtual one. Finally, the speed of all vehicles is also kept in around 30 km/h to keeping the distance of 8 meters.

9.4/ RECONFIGURATION INNER-TRAIN

9.4.1/ PROCESSING DIAGRAM

In this scenario, one vehicles-train composed by three vehicles (V_{A1} , V_{A2} and V_{A3}) is configured in two lane road, shown in Figure 9.15(a). Under the leading of V_{A1} in speed of 30 km/h , distances between vehicles are adapted, shown in Figure 9.15(b).

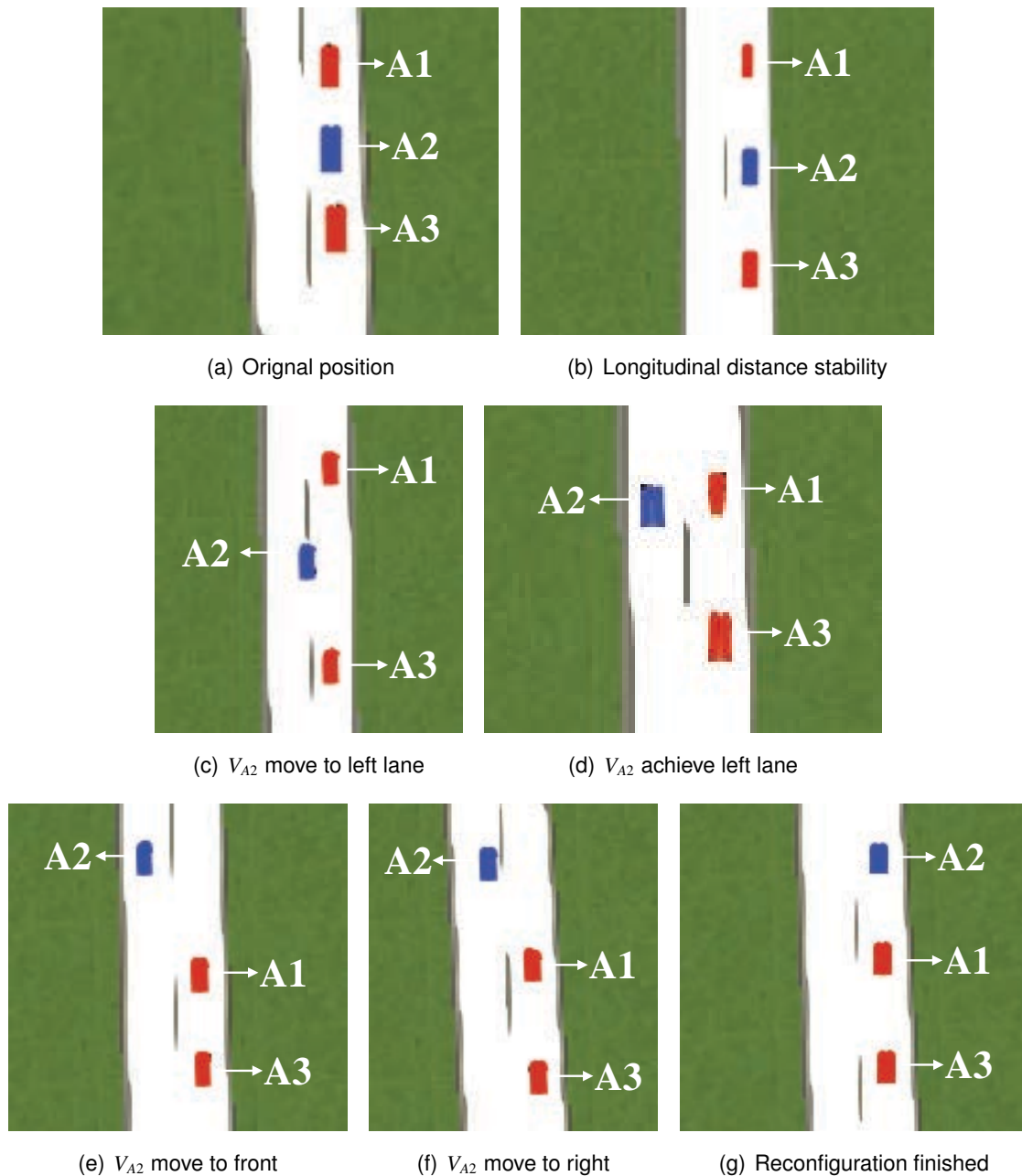


FIGURE 9.15 – Reconfiguration inner-train process

Figure 9.15(c) shows the moment when V_{A2} moved to left lane which is the beginning of reconfiguration. When V_{A2} arrived and stayed in the left lane, the first step for reconfiguration is finished, shown in Figure 9.15(d). Continuously, the longitudinal distance between V_{A1} and V_{A2} is adjusted until to 8 meters which is the distance between vehicles inner vehicles-train, shown in Figure 9.15(e). The final reconfiguration step is that V_{A2} returned back to the right lane, the beginning is shown in Figure 9.15(f). Figure 9.15(g) shows the final status where all the three vehicles ran in the right lane under the leading of V_{A2} .

9.4.2/ SPEED AND DISTANCE RECORD

In the next several figures, distances and speeds changing are introduced.

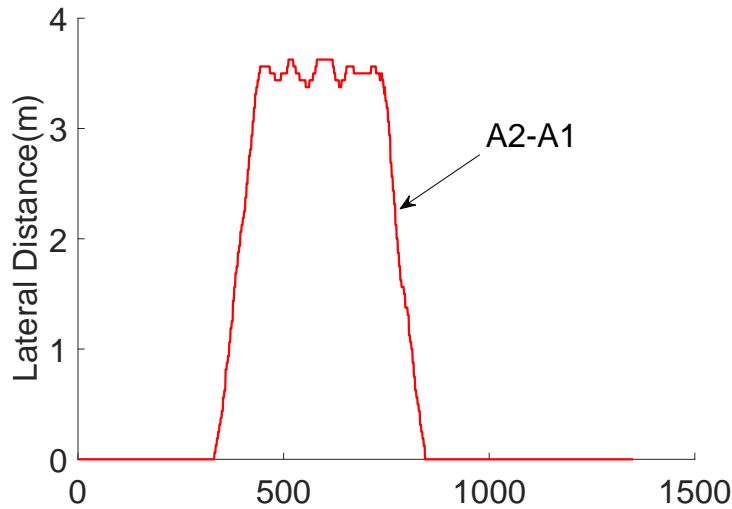


FIGURE 9.16 – Lateral distance between V_{A1} and V_{A2}

Figure 9.16 shows the lateral distance between V_{A1} and V_{A2} . At the beginning, all vehicles in the same lane, they kept the lateral distance in zero. When the reconfiguration is started, the distance increase quickly until to 3.5 meters which means V_{A2} already in the left lane. Then, the lateral distance decreased to zero with V_{A2} return back to the right lane.

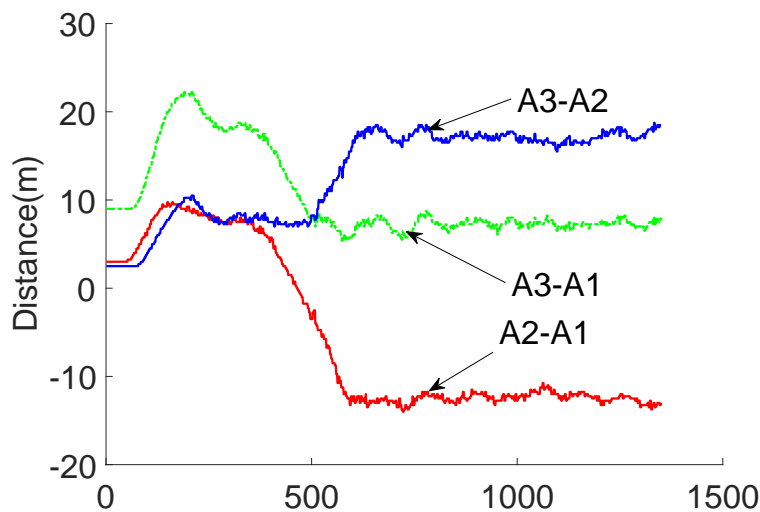


FIGURE 9.17 – Longitudinal distance between vehicles

Distance from V_{A2} to V_{A1} , from V_{A3} to V_{A2} and from V_{A3} to V_{A1} are marked $A2 - A1$, $A3 - A2$ and $A3 - A1$ respectively, shown in Figure 9.17. Before the reconfiguration happened,

vehicles adjusted their distance until $A2 - A1$ and $A3 - A2$ to 8 meters. After the starting of reconfiguration, $A2 - A1$ and $A3 - A1$ decreased until $A3 - A1$ to 8 meters and $A2 - A1$ to - 10 meters, which means that the V_{A3} followed V_{A1} and V_{A2} in the front of V_{A1} . $A3 - A2$ increased to around 18 meters considering the V_{A1} is in between V_{A2} and V_{A3} .

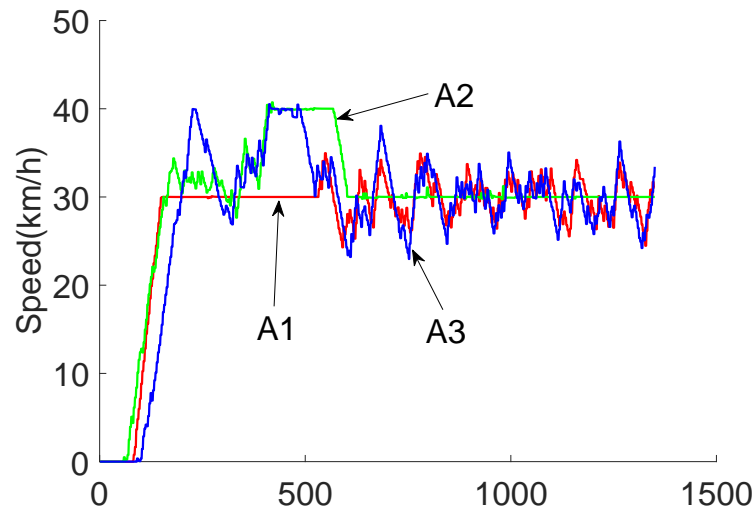


FIGURE 9.18 – Vehicles speed

Figure 9.18 shows the speed changing of all vehicles. When V_{A1} is assigned as the leader, it kept in 30 km/h after acceleration. V_{A2} and V_{A3} adapted the speed to keep in suitable distance. When V_{A2} moved in the front of V_{A1} , the leader role is attached to V_{A2} reducing the speed to 30 km/h, V_{A1} and V_{A3} adapted their speed to maintain in suitable relative position.

9.5/ CONCLUSION

In this chapter, experiment in the road without intersection is presented in several scenarios : (1) one vehicles-train running in one lane ; (2) one vehicle splitting from its vehicles-train ; (3) two vehicles-trains merging to one ; (4) reconfiguration happening inner-train in two lanes road. Experiments are shown through two types figures : first type figures are the screen shot as processing diagrams. Second type figures are some line about the distance and speed changing followed by brief illustration. The corresponding ability based on the proposed method had been proved by processing diagram figures and curves according recorded data of speed and distance.

EXPERIMENT IN INTERSECTION AND RESULTS

In this chapter, experiments in intersection are presented including four scenarios : (1) two vehicles-trains passing the crossroad at the same time ; (2) two vehicles-trains passing the roundabout at the same time ; (3) two vehicles-trains reconfiguring in roundabout ; (4) two vehicles-trains reconfiguring in crossroad ; (5) three vehicles-trains passing the crossroad at the same time. Especially, passing interaction times are compared with the traffic light control method. For all scenarios, the ability of proposed method is shown in diagrams and curves according recorded data like Chapter 9.

10.1/ VEHICLES-TRAINS PASSING CROSSROAD

In this experiment, the cooperative control algorithm is compared with a classical traffic light control algorithm where the priority is assigned to each road instead of vehicle. With this strategy, each vehicles-train behaves as a whole (i.e. it passes entirely before or after another vehicles-train so as to maintain the structure of each). The first train in the crossroad has got the priority and the second is waiting for the release of the crossroad. During the test, two features, distance and passing time, have been measured.

10.1.1/ PROCESSING DIAGRAM

The train, running from right to left, is called train T_A , the another is train T_B . Figure 10.1(a) shows the situation where vehicles are preparing for the road crossing. In this situation, distances between vehicles are adjusted to crossing distance, from 4 to 7 meters. In Figure 10.1(b), the crossing road is executed. Vehicles are keeping the same speed, 5 kilometers per hour, and the crossing distance is 7 meters. After all the vehicles passed the crossroad, the virtual-vehicles are deleted. The distance between vehicles is changed to platoon distance, 4 meters, shown in Figure 10.1(c).

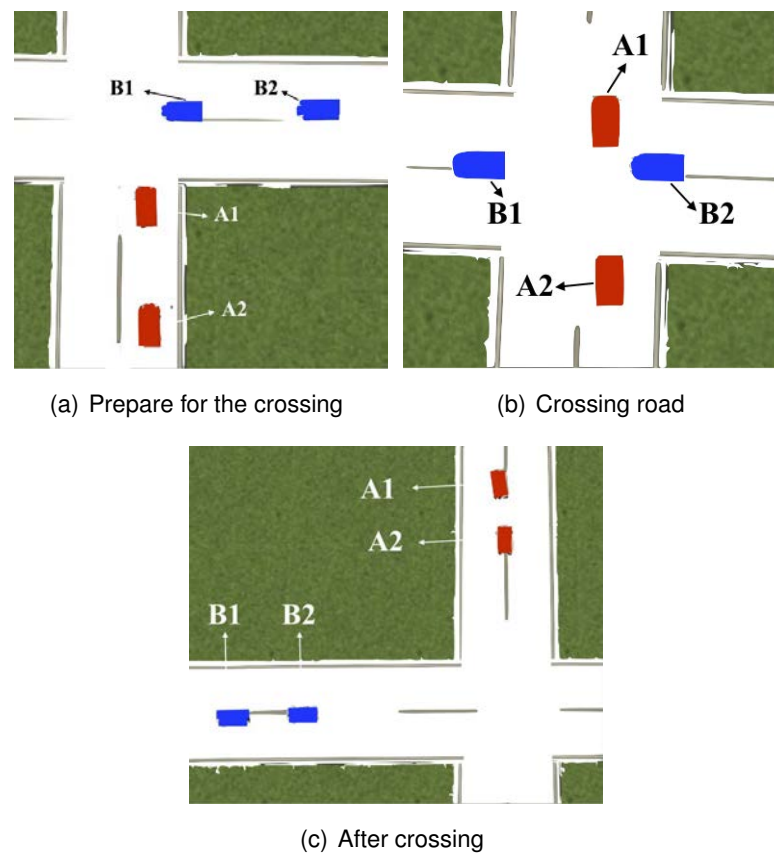


FIGURE 10.1 – The processing diagram of passing crossroad

Vehicle distances changing of the two trains are also shown in Figure 10.2.

10.1.2/ RECORDED DATA

10.1.2.1/ DISTANCE

Vehicle distances concern the safety of people and the efficiency of the transportation system. In cooperative control system, the distance changes with the different situations. Usually, the distance between two nearby vehicles is 4 meters. While crossing roads, the distance is changed to 7 meters with the inserting of virtual-vehicles.

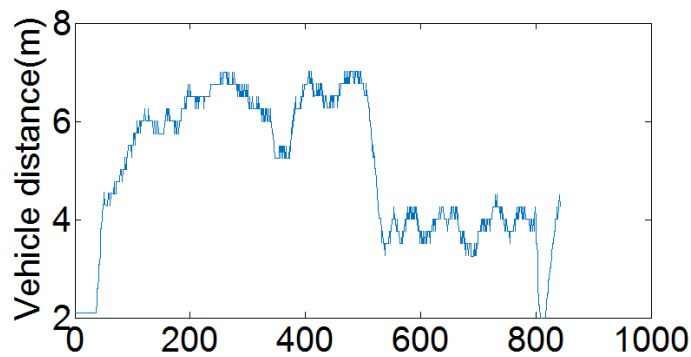
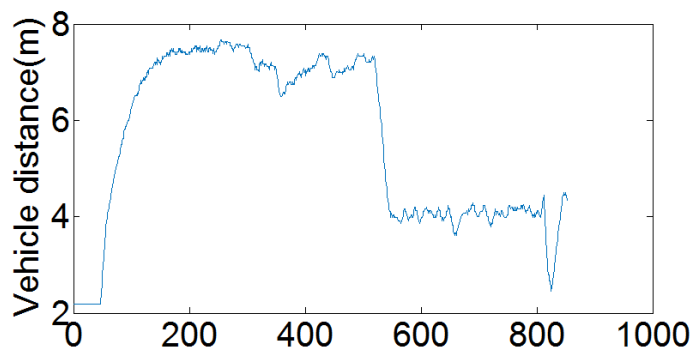
(a) Distance changing in train T_A (b) Distance changing in train T_B

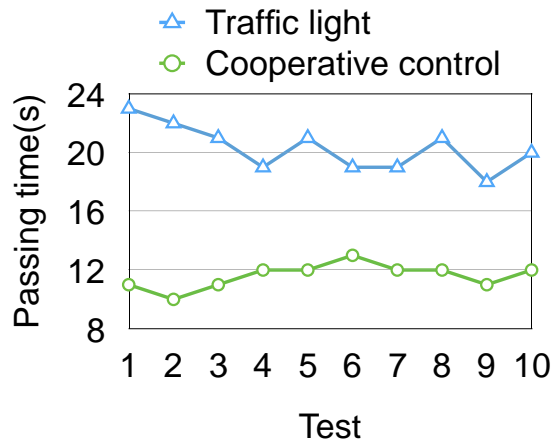
FIGURE 10.2 – Distance changing when crossing

As illustrated in Section 9.1, the distance is changed with the different speed. When the vehicle speed is set to 30km/h , distances are kept in 8 meters. However, if the speed decreases, the distance will also decrease. In this experiment of passing the crossroad, the vehicle speed is set to 5km/h , the normal distance is 3.5 meters. It is one strategy to compare the running time in our experiment. With the slowdown of vehicles, the passing time would be expended in both of the method, however the relative time, the cooperative control saving more time than traffic light, isn't changed.

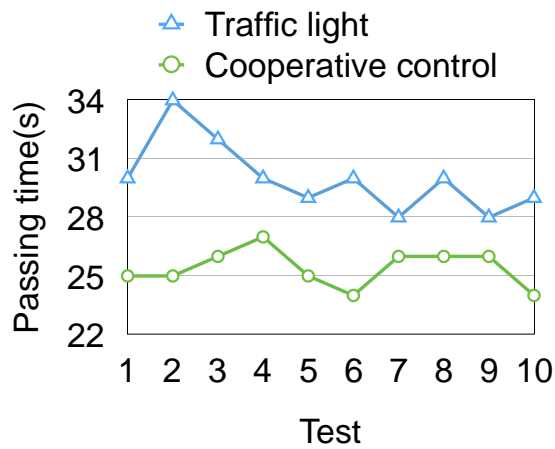
10.1.2.2/ PASSING TIME

As introduced in before, two approaches have been compared in this experiment : traffic light control and cooperative control method. In addition, two different crossing distances, 7 and 18 meters respectively corresponding to inserting one and four virtual-vehicles, are also carried out so as to compare the passing time in different crossing distance. Inserting four virtual-vehicles between two nearby vehicles is just for comparing the passing time.

Forty points, represent forty times test, are shown in Figures 10.3. The Figure 10.3(a) gives the twenty results of the two methods, where the crossing distance is set to 7 meters. As well as, the results, shown in Figure 10.3(b), are the results of eighteen meters. For each situation, average passing times are shown in Table 10.1.



(a) Crossing distance = 7 meters



(b) Crossing distance = 18 meters

FIGURE 10.3 – Passing time of each test

TABLE 10.1 – Mean crossing time

time(s) \ distance(m)	Method		
		Traffic light	Cooperative control
6		20.3	11.6
18		30.0	25.4

As show in Table 10.1, compared with the traffic light control, the crossing method saves time. With the increasing of the distance, the passing time is also increasing.

10.2/ VEHICLES-TRAINS PASSING ROUNDABOUT

As the experiment of passing crossroad, the cooperative control algorithm is also compared with a classic priority rule in this experiment.

During tests, two vehicles-train features (i.e. distance and speed) have been measured. Passing times are also compared as well. Figure 10.4 shows the diagram of the two trains sharing the roundabout under cooperative control.

10.2.1/ PROCESSING DIAGRAM

The train, running from right to left, is named train T_B , the train from bottom to top is named train T_A . Figure 10.4(a) shows the situation where vehicles are preparing for the road crossing. In this situation, distances between vehicles are adjusted according to virtual vehicles given by top-level decision process. In Figure 10.4(b), the mission is being executed. After all the vehicles passed the roundabout, distances are changed to platoon distance as shown in Figure 10.4(c). The distances changes of two trains are also shown in Figure 10.7.

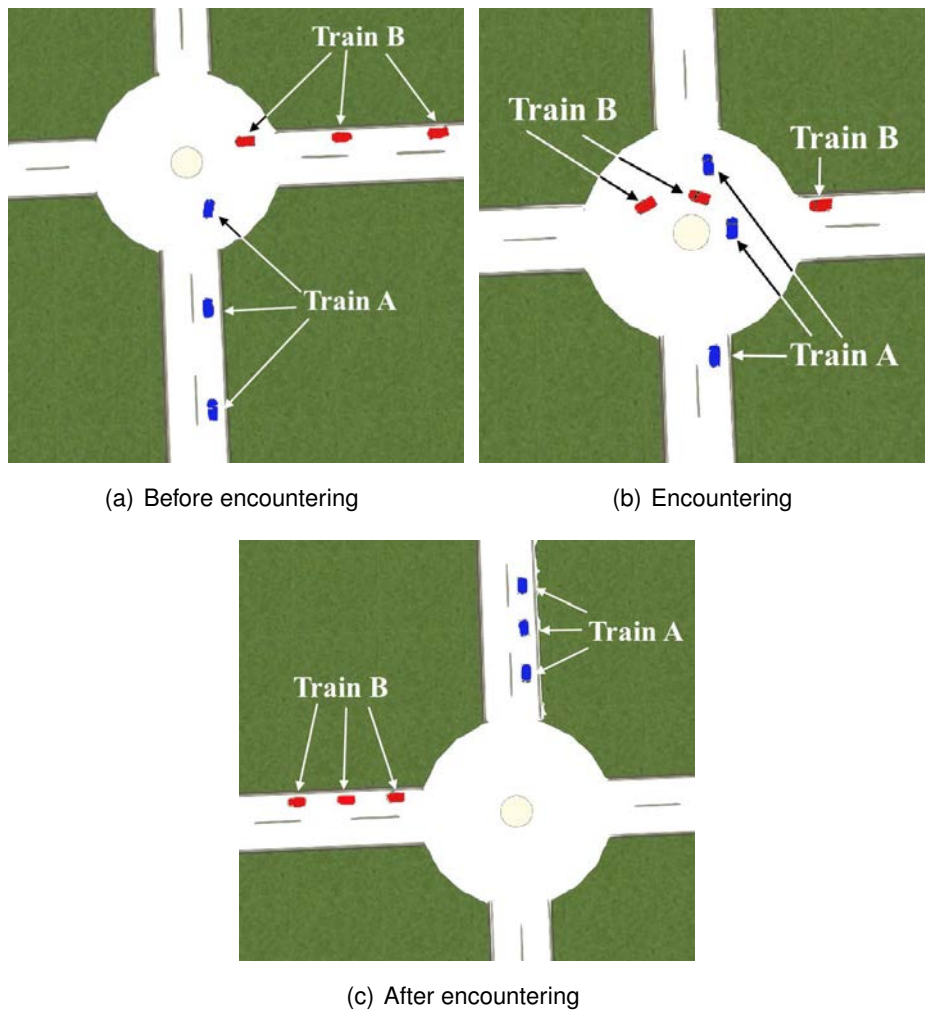


FIGURE 10.4 – The diagram of passing roundabout

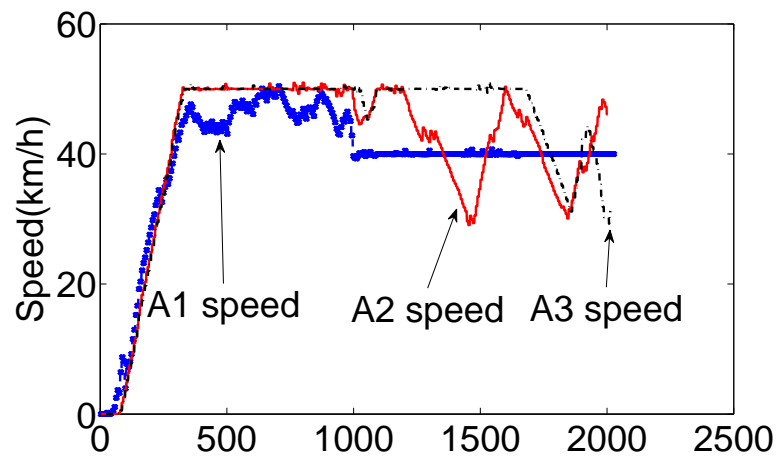
10.2.2/ RECORDED DATA

The recording of speeds are shown in Figure 10.5 and Figure 10.6. Meanwhile, distances are shown in Figure 10.7 and Figure 10.8.

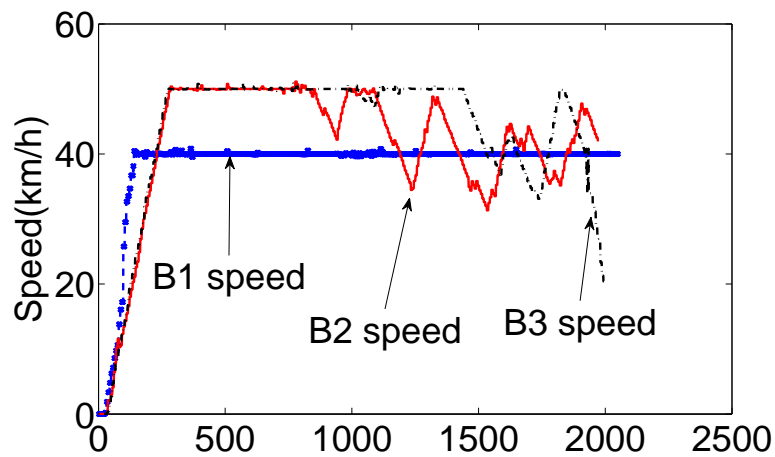
10.2.2.1/ SPEEDS

In both of methods, the normal speed is set to 40 *km/h* and the max speed to 50 *km/h*. The train T_B has the priority. For the multi-level decision algorithm, the vehicle V_{B1} , leader of train T_B , accelerates to 40 *km/h* and keeps this normal speed. In the train T_B , vehicles V_{B2} and V_{B3} adjust their speeds in order to hold the necessary distance, with a max speed set to 50 *km/h* as shown in Figure 10.5(b). Meanwhile, vehicle V_{A1} , the leader of train T_A , moves using a new speed so as to pass the roundabout after V_{B1} . Vehicle V_{A2} and V_{A3} are also adjusting their speed as V_{B2} and V_{B3} (cf. Figure 10.5(b)). With normal behavior,

train T_B passes roundabout first. V_{B1} is accelerating to normal speed, V_{B2} and V_{B3} are following V_{B1} as shown in Figure 10.6(b). As opposed to the previous solution, train T_A is waiting for the release of the roundabout and then enters into it (cf. Figure 10.6(a)).



(a) Speeds of train T_A



(b) Speeds of train T_B

FIGURE 10.5 – Speeds under cooperative control algorithm

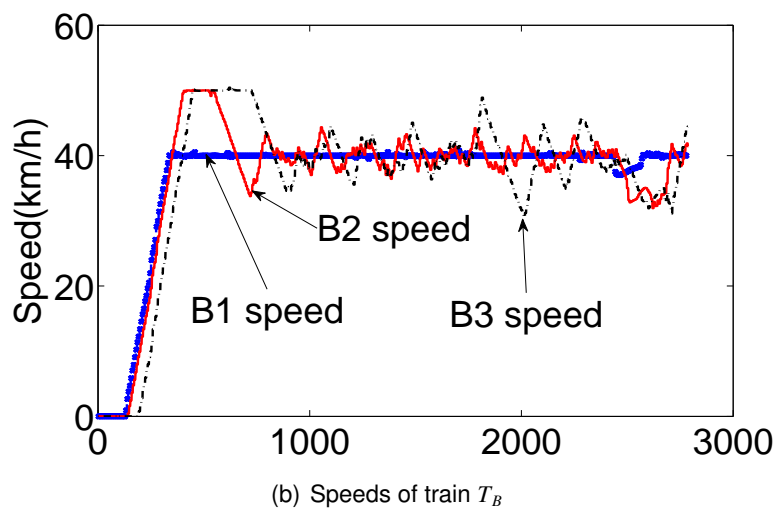
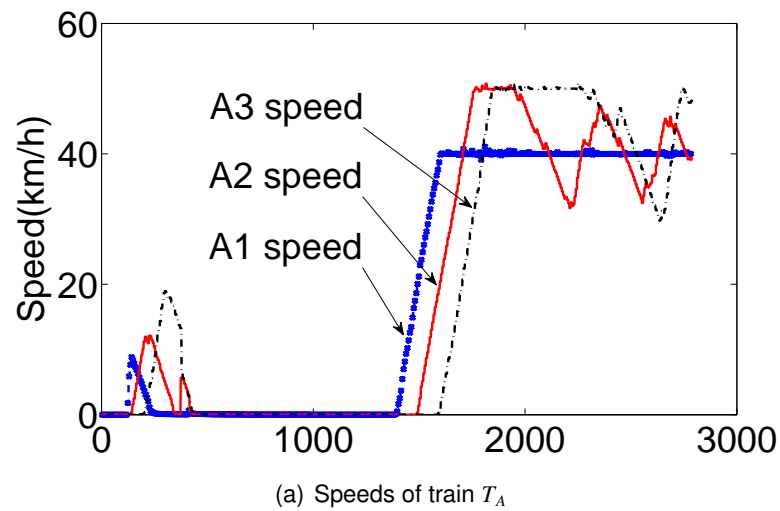
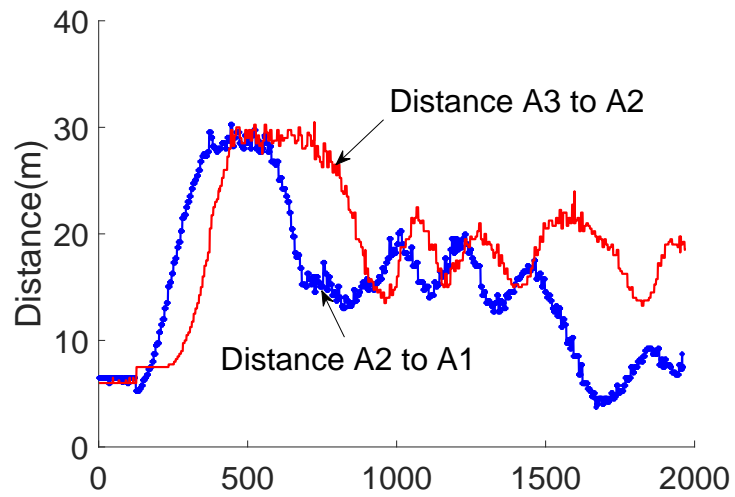


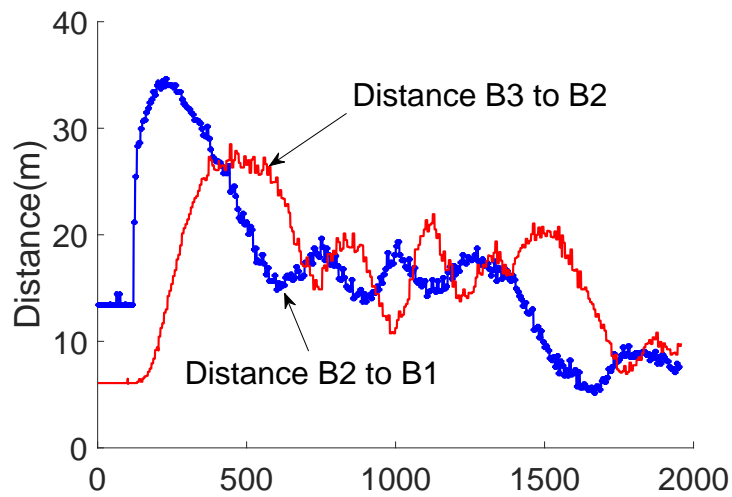
FIGURE 10.6 – Speeds under the traffic light control

10.2.2.2/ DISTANCES

Normally, vehicles keep a safety distance. For the cooperative control algorithm, one virtual vehicle is inserted, when necessary, between two vehicles when trains encounter. Each distances is then doubled as shown in Figure 10.7(a) and Figure 10.7(b). Nevertheless, for trains under traffic light control, distances are kept in safety distance as shown in Figure 10.8(a) and Figure 10.8(b).



(a) Distances in train T_A



(b) Distances in train T_B

FIGURE 10.7 – Distances under cooperative control algorithm

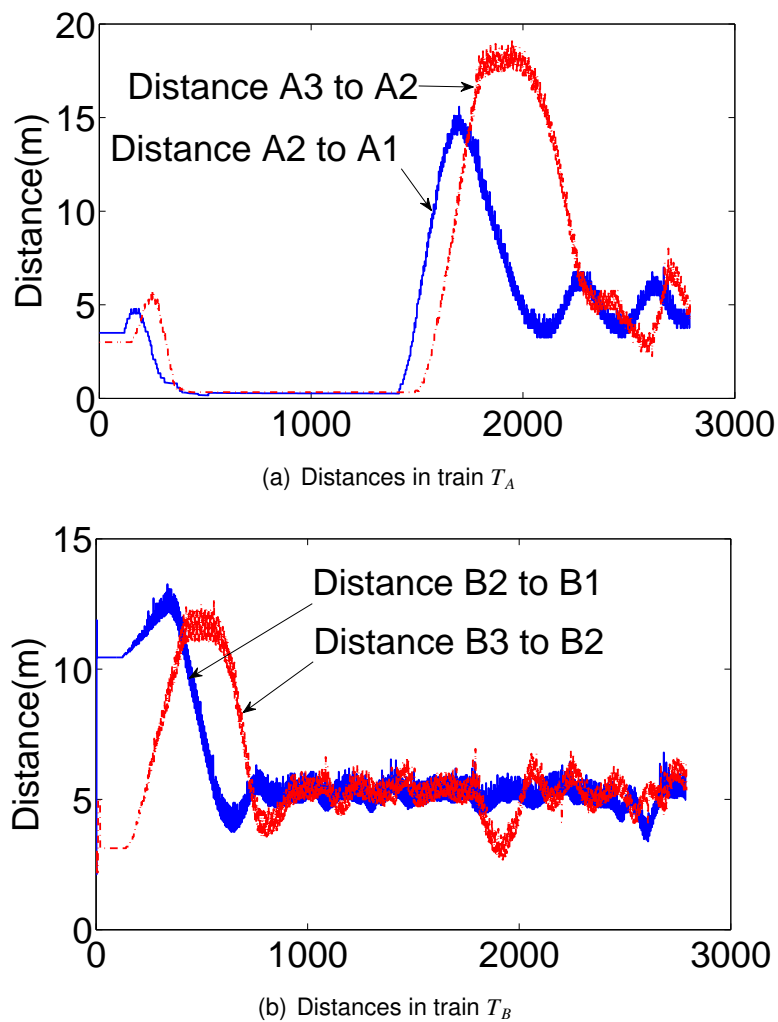


FIGURE 10.8 – Distances under the traffic light control

10.2.2.3/ TIMES

Passing times in different situation are also counted. For the traffic light control, one train should wait for the priority, speeds are kept in 0 for waiting as shown in Figure 10.6. However, vehicles under the cooperative control move steadily as shown in Figure 10.5. That leads different passing times, shown in Table 10.2. The time under traffic light control is about 23 seconds as opposed to 10 seconds for the cooperative control solution.

TABLE 10.2 – Different times passing roundabout

Method	Traffic light	Cooperative control
time(s)	23	10

10.3/ RECONFIGURATION BETWEEN TWO VEHICLES-TRAINS IN ROUNDABOUT

10.3.1/ PROCESSING DIAGRAM

In this scenario, two vehicles-train are configured in two different road which interact in roundabout. In Figure 10.9(a), the vehicles-train T_B , composed by V_{B1} , V_{B2} and V_{B3} , is configured in the right side of horizontal road. By contrast, the vehicles-train T_A , composed by V_{A1} , V_{A2} and V_{A3} , is configured in the down side of vertical road.

After they begin to run, the vehicle order is arranged firstly. According the vehicle order, the leader (V_{B1}) is chosen to run at speed 30 km/h and virtual vehicles are created to adjust the distance. Before they arrive the roundabout, the vehicle distance in the same vehicles-train have been reconfigured completely, shown in Figure 10.9(b).

Figure 10.9(c) shows the moment when V_{A1} encounter with V_{B1} , and V_{B1} is in the front. Then, the two vehicles leave the roundabout, shown in Figure 10.9(d).

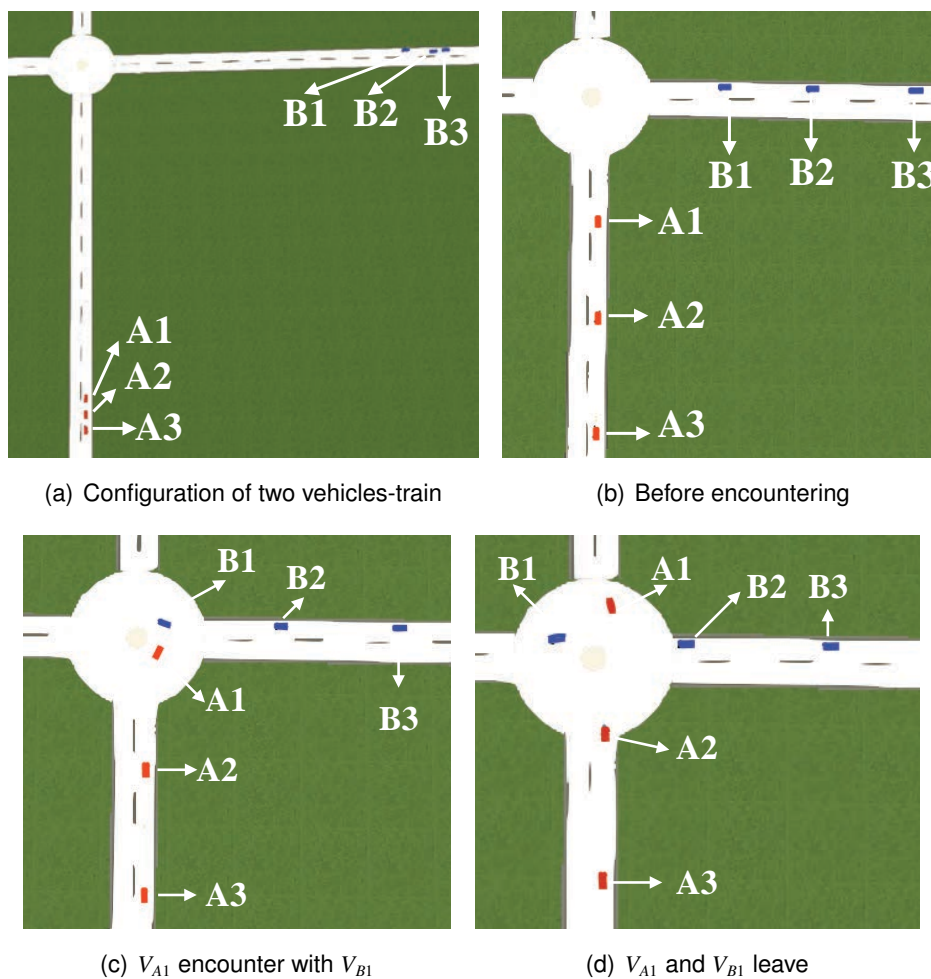


FIGURE 10.9 – Reconfiguration inner-train in roundabout (part 1)

The moment when V_{A2} and V_{B2} meet with each other is shown in Figure 10.10(a). When V_{A2} and V_{B2} leave the roundabout, V_{B2} turn to right to follow the V_{A1} ; V_{A2} turn to left to follow the V_{B1} , shown in Figure 10.10(b).

The encountering of V_{A3} and V_{B3} is shown in Figure 10.10(c). When they leave the roundabout, V_{A3} goes directly to follow V_{B2} ; V_{B3} goes straightly to follow V_{A2} , show in Figure 10.10(d).

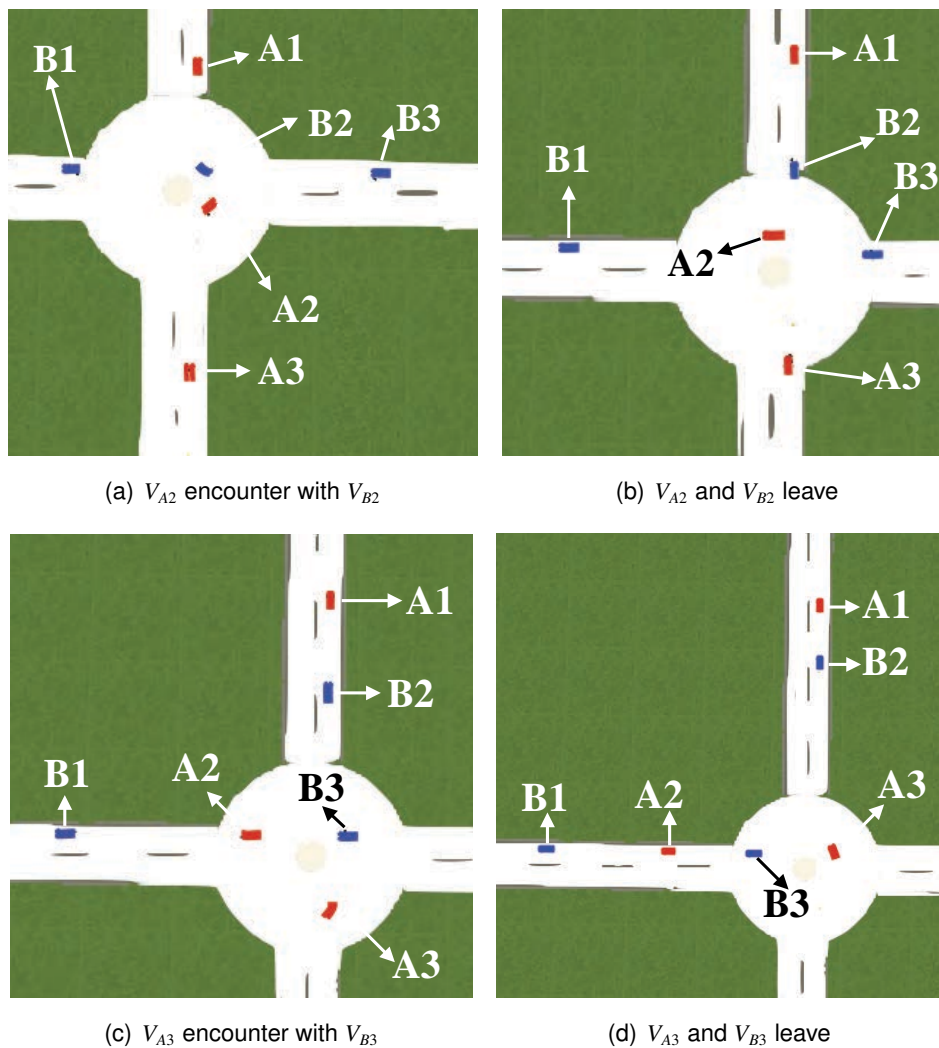


FIGURE 10.10 – Reconfiguration inner-train in roundabout (part 2)

After all the vehicles leave the roundabout, vehicles speeds are adapted to recover the vehicle distance, shown in Figure 10.11(a). And the distance is adjusted to around 8 meters, shown in Figure 10.11(b).

10.3. RECONFIGURATION BETWEEN TWO VEHICLES-TRAINS IN ROUNDABOUT125

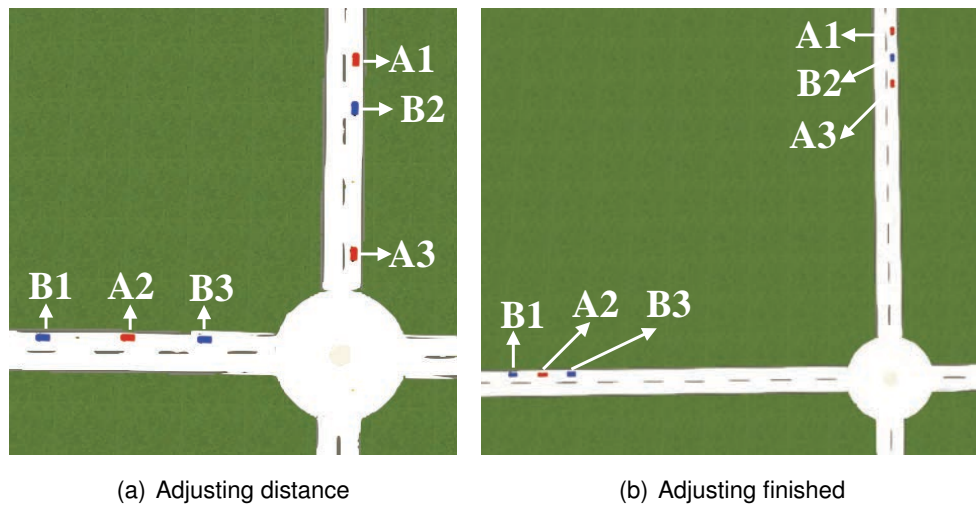


FIGURE 10.11 – Reconfiguration inner-train in roundabout (part 3)

10.3.2/ SPEED AND DISTANCE RECORD

The speed of all vehicles and some distance between vehicles are recorded and shown in following vehicle.

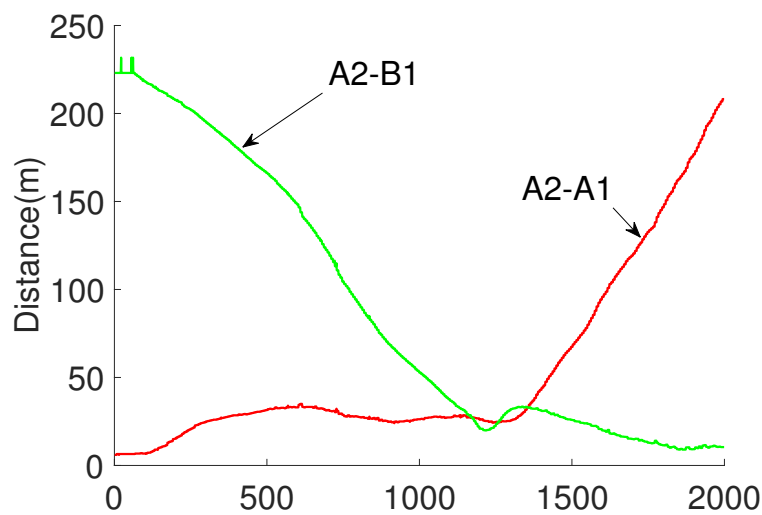
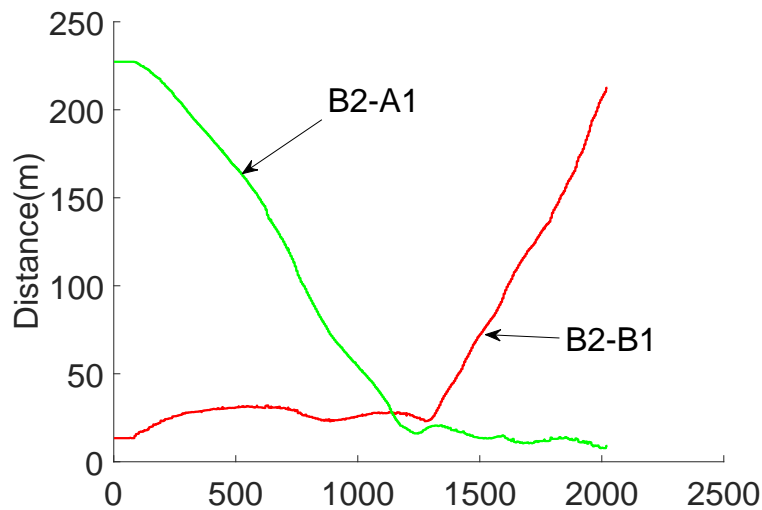
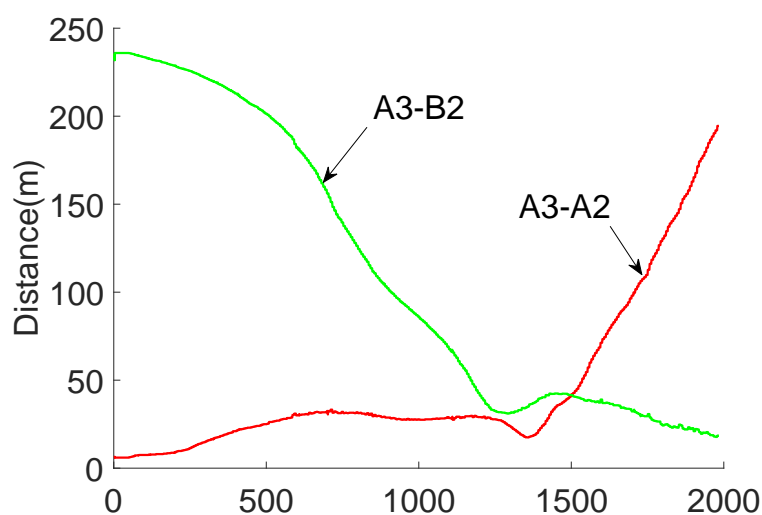


FIGURE 10.12 – Distances V_{A2} with V_{A1} and V_{B1}

FIGURE 10.13 – Distances V_{B2} with V_{A1} and V_{B1}

Distances from V_{A2} to V_{A1} and from V_{A2} to V_{B1} , marked as $A2-A1$ and $A2-B1$ respectively, are shown in Figure 10.12. V_{A2} is far away from V_{B1} , also could be checked in configuration from Figure 10.9(a). With vehicles moving, V_{A2} and V_{B1} close to each other, and finally the two vehicles are reconfigured to one vehicles-train leading to one stability distance around 8 meters. The same situation also happened in V_{B2} which also changed its vehicles-train. Distance changing from V_{B2} to V_{A1} and from V_{A2} to V_{B1} are shown in Figure 10.13.

FIGURE 10.14 – Distances V_{A3} with V_{A2} and V_{B2}

10.3. RECONFIGURATION BETWEEN TWO VEHICLES-TRAINS IN ROUNDABOUT127

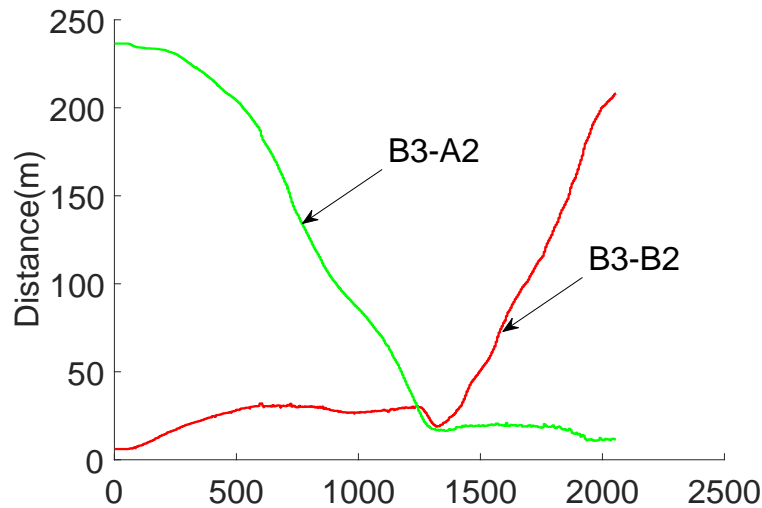


FIGURE 10.15 – Distances V_{B3} with V_{A2} and V_{B2}

Distance changing of V_{A3} with V_{A2} and V_{B2} , marked as $A3 - A2$ and $A3 - B2$ respectively, are shown in Figure 10.14. According to the configuration at the beginning, shown in Figure 10.9(a), V_{A3} isn't in the same vehicles-train with V_{B2} , the distance $A3 - B2$ is far. With all vehicles move to roundabout, the distance $A3 - B2$ is reducing. Contrary, the distance between $A3 - A2$ is around 8 meters. For preparing the reconfiguration, the distance $A3 - A2$ is increased to around 20 meters through virtual vehicle. After the reconfiguration is finished, V_{A3} and V_{A2} aren't in the same vehicles-train, $A3 - A2$ increased. V_{A3} followed V_{B2} , $A3 - B2$ decreased to around 8 meters. The same thing happened between V_{B3} with V_{A2} and V_{B2} , shown in Figure 10.15.

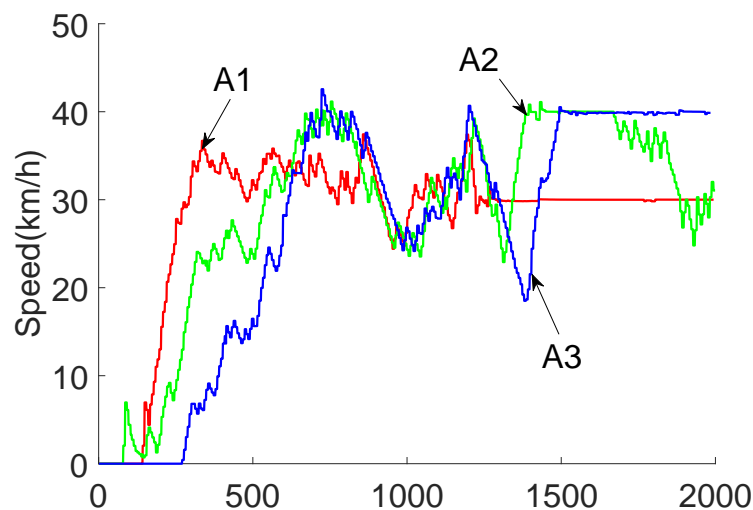


FIGURE 10.16 – Vehicles' speeds in train T_A

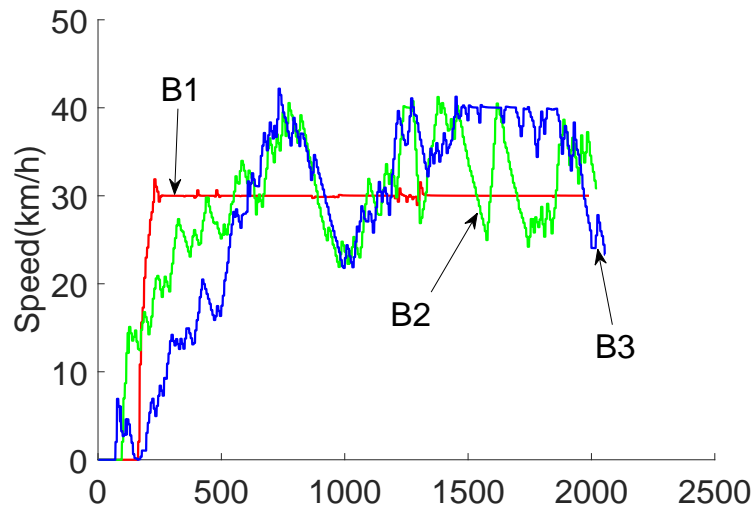


FIGURE 10.17 – Vehicles' speeds in train T_B

Speeds changing of all vehicles are shown in Figure 10.16 and Figure 10.17. According the reconfiguration process, shown in Figure 10.9, Figure 10.10 and Figure 10.11, V_{B1} is the leader which could be confirmed from the speed which is kept in 30 km/h after starting. After the reconfiguration is finished, V_{A1} is also assigned to leader role and its speed is kept in 30 km/h . Other vehicles adapted their speed in the assistant of virtual vehicle.

10.4/ RECONFIGURATION BETWEEN TWO VEHICLES-TRAINS IN CROSSROAD

10.4.1/ PROCESSING DIAGRAM

In this scenario, two vehicles-train are configured in two sides of crossroad, shown in Figure 10.18(a). The vehicles-train in right side is train T_B , composed by V_{B1} , V_{B2} and V_{B3} . The vehicles-train in the down side is train T_A , composed by V_{A1} , V_{A2} and V_{A3} . Before encountering, vehicles-train adjusted distances between vehicles (shown in Figure 10.18(b)).

10.4. RECONFIGURATION BETWEEN TWO VEHICLES-TRAINS IN CROSSROAD129

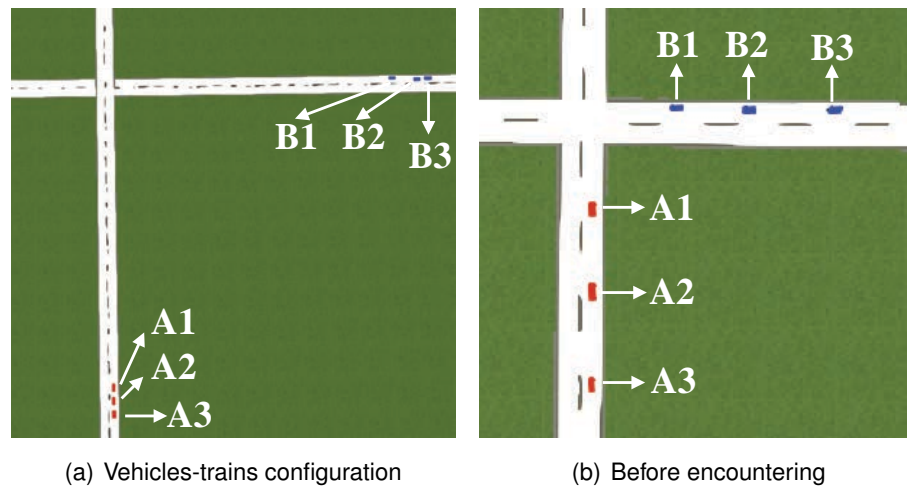


FIGURE 10.18 – Reconfiguration process in crossroad (part 1)

V_{B1} left crossroad firstly and at that moment V_{A1} arrived the crossroad shown in Figure 10.19(a). When V_{A1} left the crossroad, V_{B2} arrived as like shown in Figure 10.19(b).

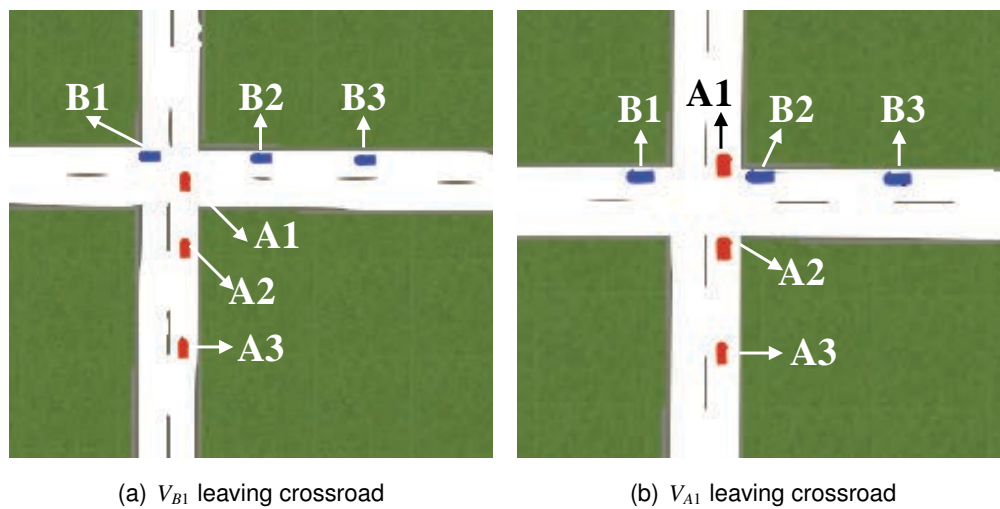


FIGURE 10.19 – Reconfiguration process in crossroad (part 2)

According the reconfiguration, V_{B2} turned to right to follow the V_{A1} , shown in Figure 10.20(a), at the same time V_{A2} also arrived crossroad. V_{A2} turned to left to follow V_{B1} as shown in Figure 10.20(b).

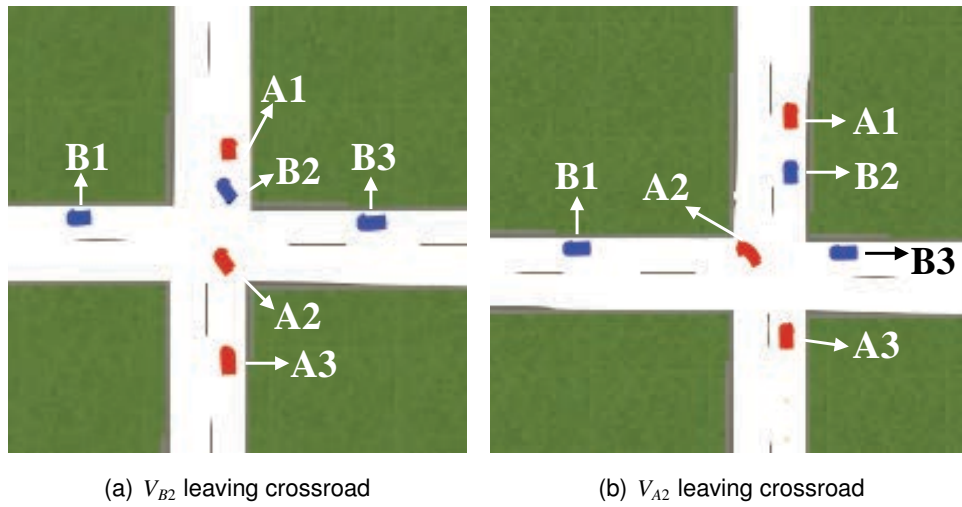


FIGURE 10.20 – Reconfiguration process in crossroad (part 3)

Figure 10.21(a) shows the moment when V_{B3} left and V_{A3} arrived the crossroad. V_{A3} left the crossroad in the last, shown in Figure 10.21(b).

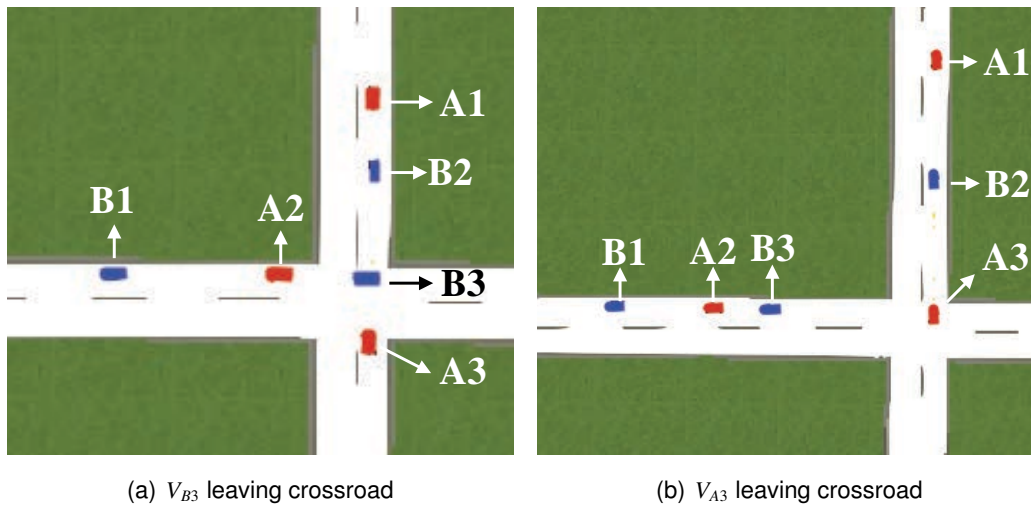
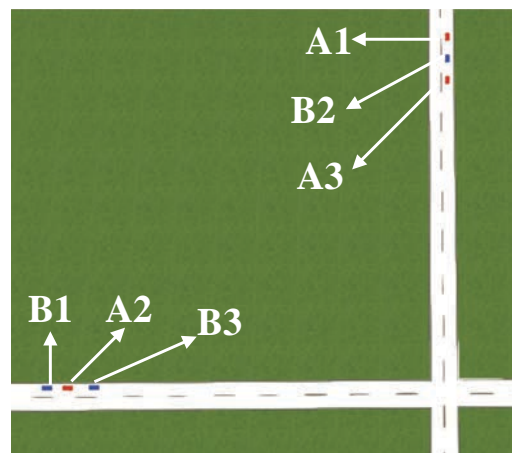


FIGURE 10.21 – Reconfiguration process in crossroad (part 4)

Two new vehicles-trains adapt their speed to achieve suitable distance between vehicles, shown in Figure 10.22(a).



(a) Adjusting distance

FIGURE 10.22 – Reconfiguration process in crossroad (part 5)

10.4.2/ SPEED AND DISTANCE RECORD

In the next figures, the distance and speed are recorded and shown to present the vehicle dynamic in reconfiguration.

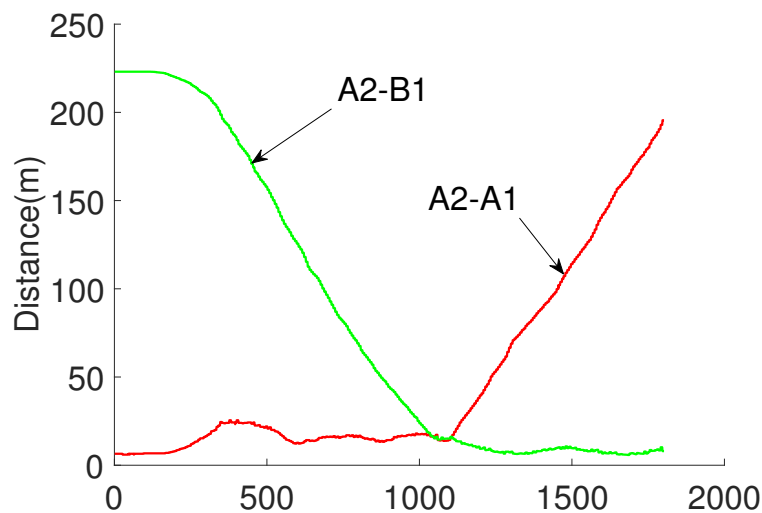
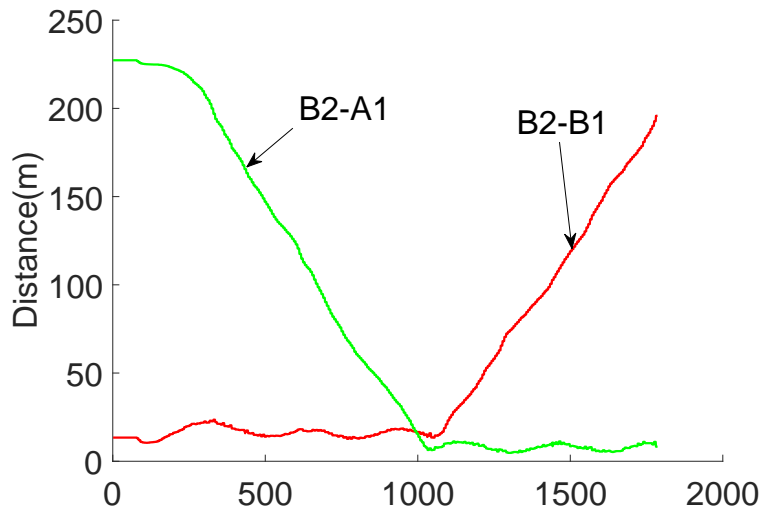
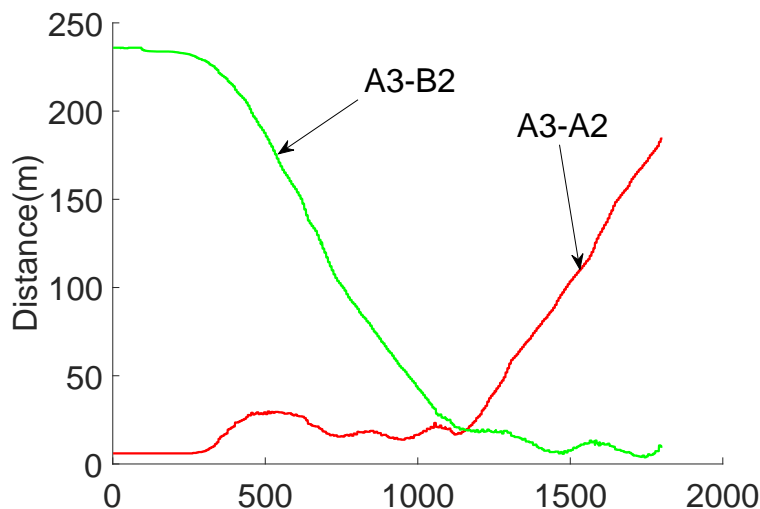


FIGURE 10.23 – Distances between V_{A2} and V_{A1} , V_{B1}

Figure 10.23 shows the distance changing between V_{A2} and V_{A1} , V_{B1} , marked as $A2 - A1$ and $A2 - B1$. At the beginning, V_{A2} and V_{B1} are so far away from each other. $A2 - B1$ decreased with vehicles moving. After V_{A2} passed the crossroad, V_{A2} followed V_{B1} and the distance $A2 - B1$ is kept in around 8 meters. Contrastingly, V_{A2} and V_{A1} are in the same vehicles-train at beginning. After reconfiguration, they move to different distance and $A2 - A1$ increased.

FIGURE 10.24 – Distances between V_{B2} and V_{A1} , V_{B1}

The distance changing between V_{B2} and V_{A1} , V_{B1} are the same situation with distance changing between V_{A2} and V_{A1} , V_{B1} , shown in Figure 10.24. At beginning, V_{B1} and V_{B2} are in the same vehicles-train, $B2 - B1$ is nearby 8 meters. When V_{B2} began to leave crossroad, the distance $B2 - B1$ began to increase. V_{B2} and V_{A1} isn't in the same vehicles-train and the distance $B2 - A1$ is large. When V_{B2} left crossroad, it followed V_{A1} leading to the distance $B2 - A1$ decrease to 8 meters.

FIGURE 10.25 – Distances between V_{A3} and V_{A2} , V_{B2}

Distances between V_{A3} and V_{A2} , V_{B2} are marked as $A3-A2$ and $A3-B2$, distance changing is shown in Figure 10.25. V_{A3} and V_{B2} aren't in the same train, $A3 - B2$ is large. $A3 - B2$ is decreasing with all vehicles moving toward crossroad. After crossroad, V_{A3} followed V_{B2} in the same train, the distance $A3 - B2$ is adjusted to 8 meters. Contrarily, $A3 - A2$ is little

10.4. RECONFIGURATION BETWEEN TWO VEHICLES-TRAINS IN CROSSROAD133

at beginning and increased after passing crossroad.

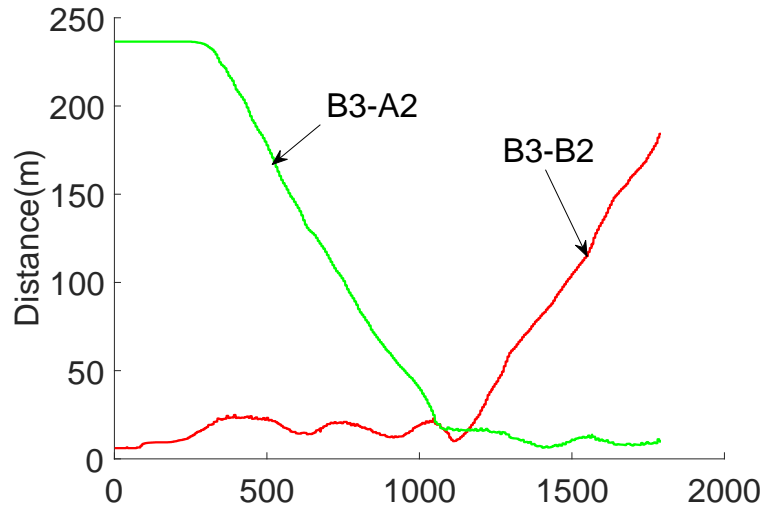


FIGURE 10.26 – Distances between V_{B3} and V_{A2} , V_{B2}

Distances between V_{B3} and V_{A2} , V_{B2} are marked as $B3 - A2$ and $B3 - B2$ and the changing is shown in Figure 10.26. The distance changing is the same situation with it between V_{A3} and V_{A2} , V_{B2} . At beginning, V_{B3} and V_{B2} are in the same train, the distance $B3 - B2$ increased after crossroad because V_{B2} changing its train. V_{B3} and V_{A2} aren't in different road, in the crossroad two vehicles-trains are reconfigured. V_{B3} followed V_{A2} and the distance is adapted to 8 meters.

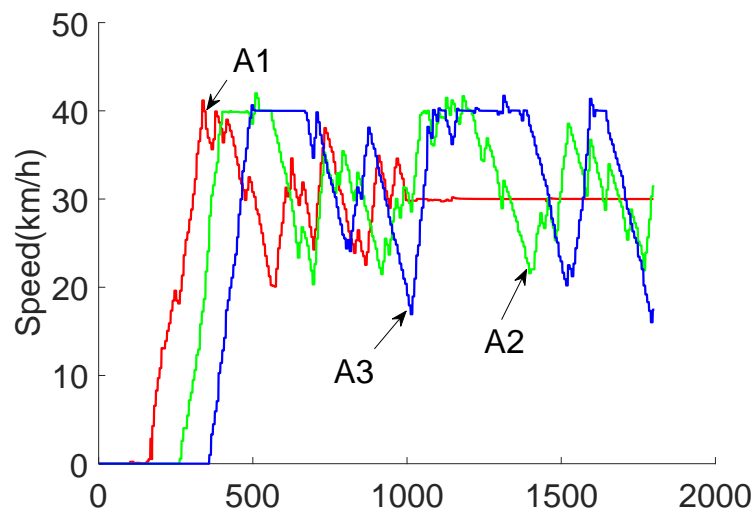


FIGURE 10.27 – Speeds of vehicles in train T_A

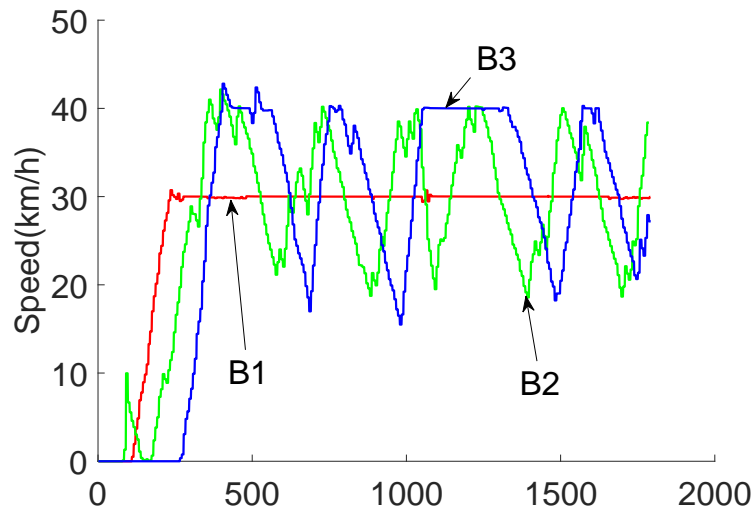


FIGURE 10.28 – Speeds of vehicles in train T_B

Speeds of two vehicles-train are shown in Figure 10.27 and Figure 10.28. After all vehicles began to move, the V_{B1} is set to leader, it keeps in constant speed (30 km/h). Other vehicles adapted their speed to maintain suitable distance. After all vehicle passed the crossroad, V_{A1} is set to leader leading to the speed being constant in 30 km/h also. Other vehicles adapted speed to achieve suitable distance.

10.5/ THREE VEHICLES-TRAINS PASSING CROSSROAD

In this scenario, three vehicles-trains are configured in crossroad and each train includes three vehicles. Vehicles-train T_A runs from bottom to top; vehicles-train T_B moves from right to left; vehicles-train T_C runs from top to bottom.

10.5.1/ PROCESSING DIAGRAM

In this experiment, the vehicles order passing crossroad is $VO = \{V_{C1}, V_{B1}, V_{A1}, V_{C2}, V_{B2}, V_{A2}, V_{C3}, V_{B3}, V_{A3}\}$. The processing of this three trains passing crossroad is shown through five figures in Figure 10.29, Figure 10.30 and Figure 10.31.

In Figure 10.29(a), V_{C1} arrives the crossroad and V_{B1} and V_{A1} are moving towards encountering point. V_{B1} is closer than V_{A1} , it means V_{B1} will arrive the encountering point firstly. Figure 10.29(b) shows the state where V_{A1} just leaves encountering point after V_{C1} and V_{B1} . And V_{C2} will arrives the encountering point soon.

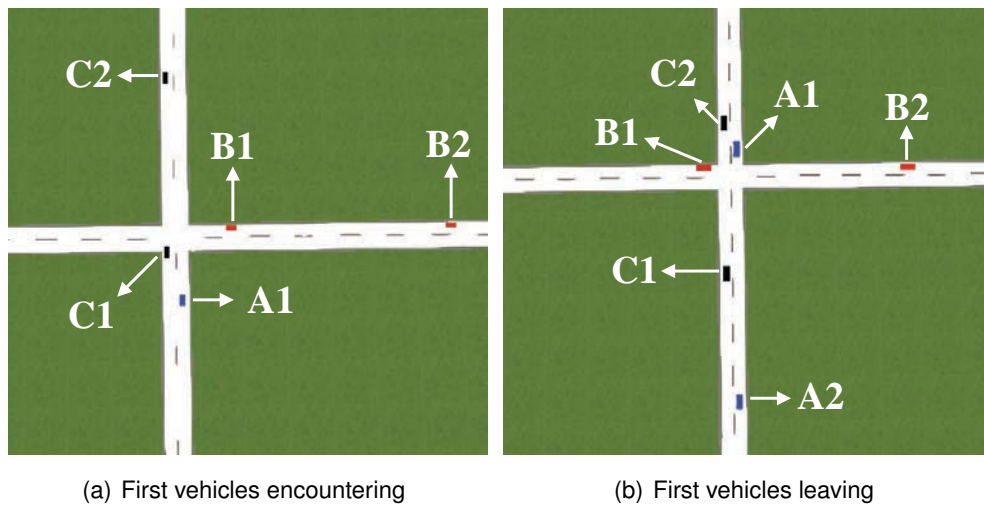


FIGURE 10.29 – Diagram of passing crossroad (part 1)

Figure 10.30(a) shows V_{C2} and V_{B2} leave the crossroad and V_{A2} arrives the crossroad already. In Figure 10.30(b), V_{C3} just passes the crossroad and V_{B3} will arrive the crossroad firstly and V_{A3} secondly.

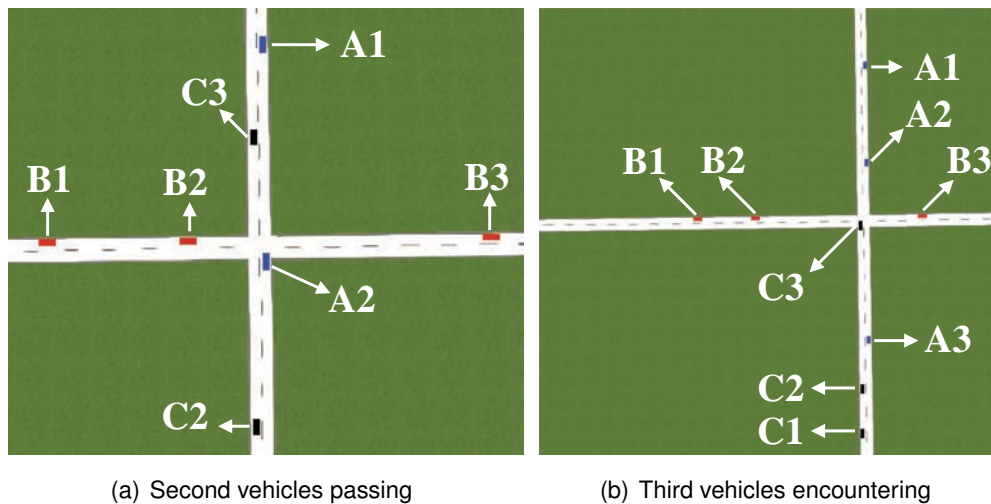


FIGURE 10.30 – Diagram of passing crossroad (part 2)

In Figure 10.31, V_{A3} will arrive the crossroad and other vehicles have left the crossroad already. The train T_C isn't displayed in Figure 10.31 because it has left the crossroad far already.

10.5.2/ RECORDED DATA

The recorded data is shown in here as curves. In Figure 10.32, Figure 10.33 and Figure 10.34, distances are shown respectively between V_{A1} , V_{B1} and V_{C1} (marked as

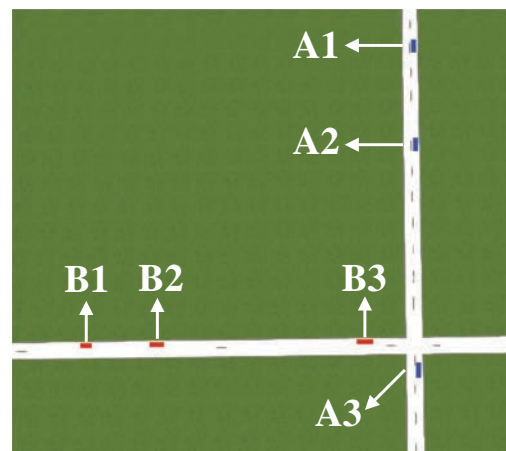
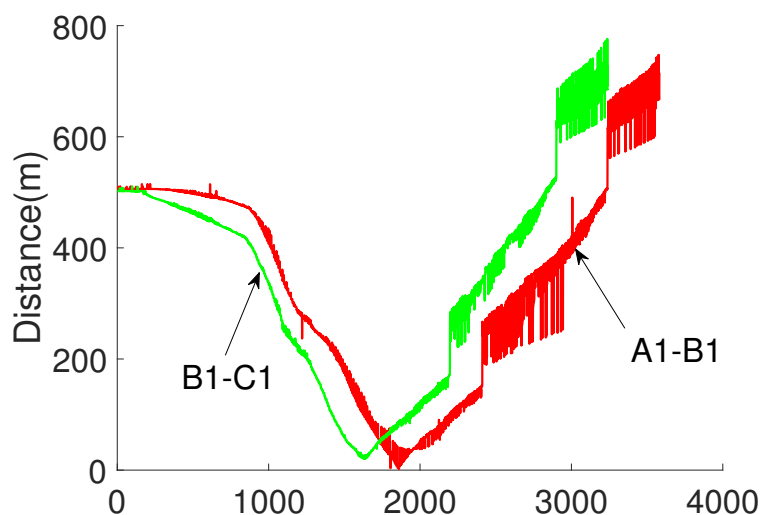
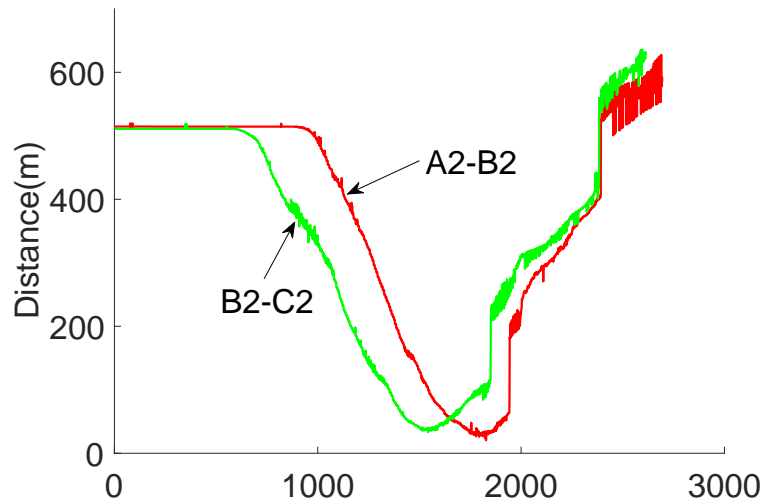
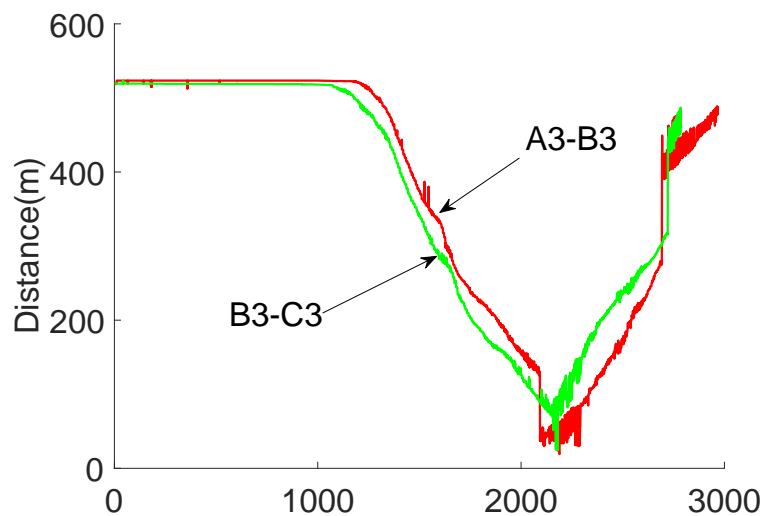


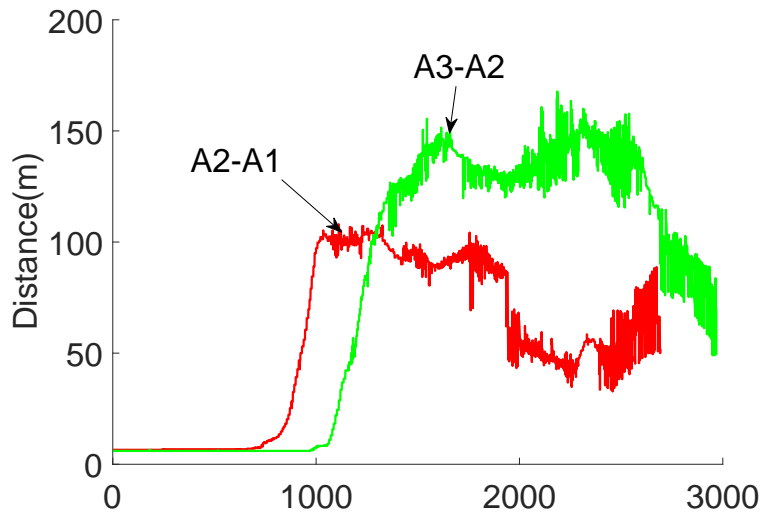
FIGURE 10.31 – Third vehicles leaving

$C1 - B1$ and $B1 - A1$), between V_{A2} , V_{B2} and V_{C2} (marked as $C2 - B2$ and $B2 - A2$), between V_{A3} , V_{B3} and V_{C3} (marked as $C3 - B3$ and $B3 - A3$). As shown in figures, $C1 - B1$, $C2 - B2$ and $C3 - B3$ arrive the minimum point firstly, $B1 - A1$, $B2 - A2$ and $B3 - A3$ reach the minimum point secondly. That means V_{C1} encounters the V_{B1} firstly, V_{B1} encounters the V_{A1} secondly. V_{C1} passes the crossroad firstly, V_{B1} secondly and V_{A1} thirdly. The same situation happens in other vehicles also as the vehicles order VO .

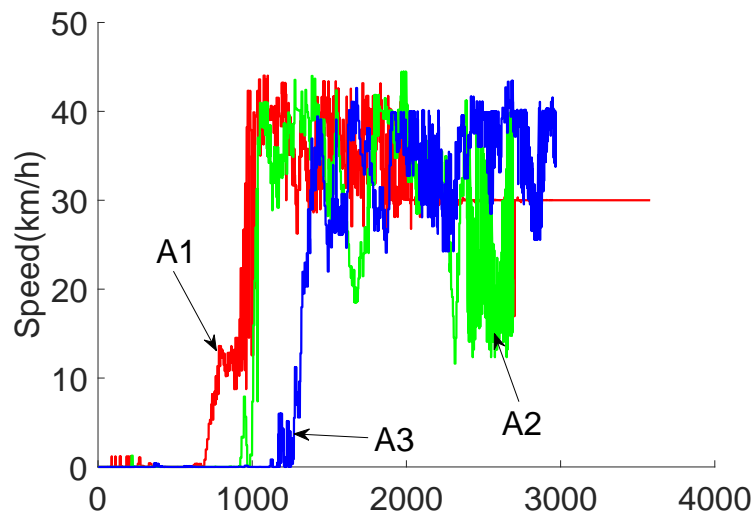
FIGURE 10.32 – Distances between V_{A1} , V_{B1} and V_{C1}

FIGURE 10.33 – Distances between V_{A2} , V_{B2} and V_{C2} FIGURE 10.34 – Distances between V_{A3} , V_{B3} and V_{C3}

Distances between vehicles and speeds of vehicles in train T_A , are shown in Figure 10.35 and Figure 10.36 respectively. Before vehicles encounter, distances are adjusted according to the vehicles order VO with the assistant of virtual-vehicles. At the beginning, distances are about 6 meters. Distances are adjusted to about 120 meters for other two vehicles sharing the crossroad. After passing crossroad, virtual-vehicles are deleted and distances are reduced to normal distance. However, the adjusting of distance is too slowly in here which should be improved.

FIGURE 10.35 – Distances between vehicles in train T_A

From speeds curves in Figure 10.36, we can get that V_{A1} moves firstly, V_{A2} secondly, V_{A3} thirdly which also could be proved by distances changing in Figure 10.35. The speed isn't stability, one of causes is the existing of measurement noisy. More important is that the platoon control also should be improved firstly for high speed condition.

FIGURE 10.36 – Speeds of vehicles in train T_A

Distances between vehicles and speeds of vehicles in train T_B and C , are also shown in Figure 10.37, Figure 10.38, Figure 10.39 and Figure 10.40 as the same situation of train T_A .

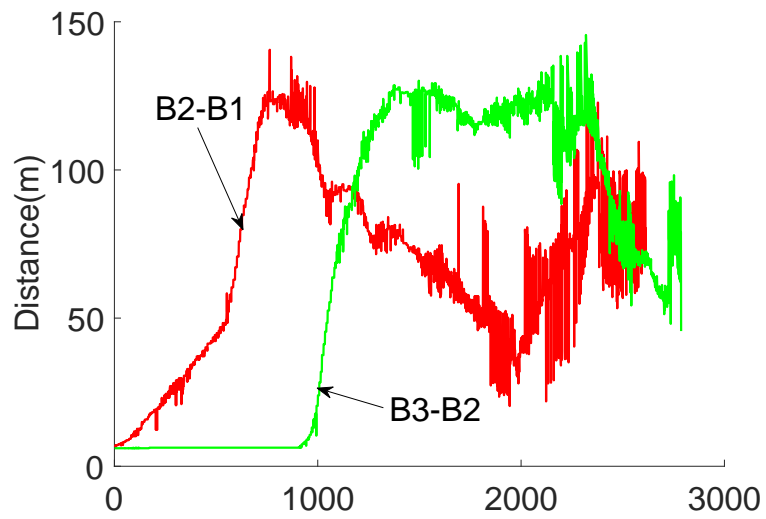


FIGURE 10.37 – Distances between vehicles in train T_B

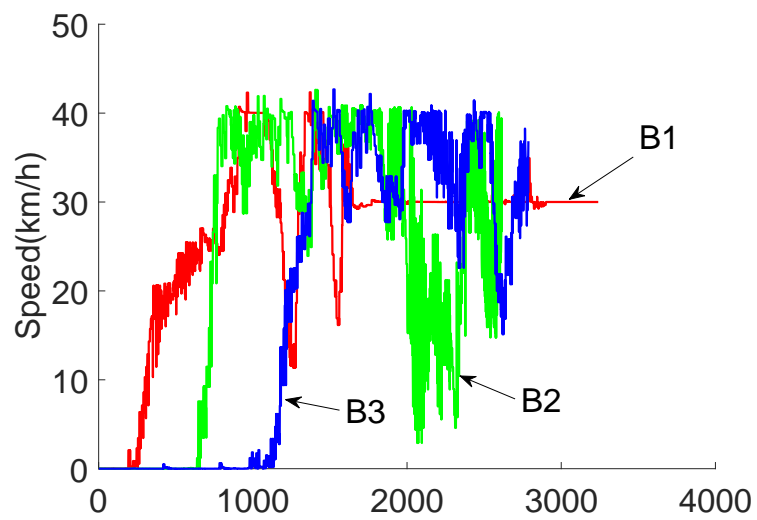
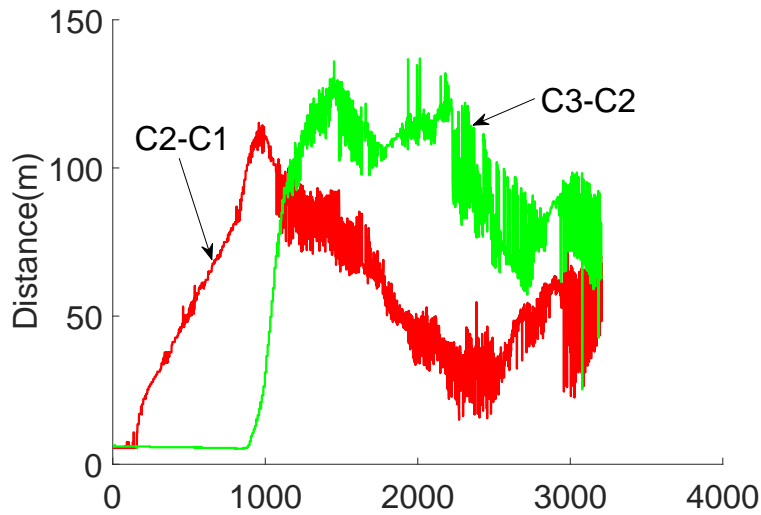
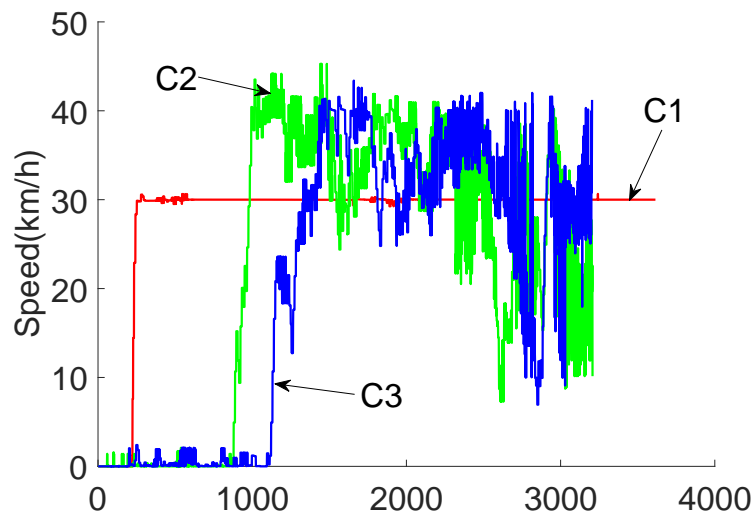


FIGURE 10.38 – Speeds of vehicles in train T_B

FIGURE 10.39 – Distances between vehicles in train T_C FIGURE 10.40 – Speeds of vehicles in train T_C

10.6/ CONCLUSION

In this chapter, experiments are presented in four scenarios : (1) two vehicles-train passing crossroad at same time ; (2) two vehicles-train passing roundabout at the same time ; (3) reconfiguration between two vehicles-trains in roundabout ; (4) reconfiguration between two vehicles-trains in crossroad ; (5) three vehicles-trains passing the crossroad at the same time. As the Chapter 9, two types figures are shown : processing diagrams and recorded data curves to presented the ability of proposed method. Especially, for experiments about two vehicles-train passing crossroad and roundabout at same time, passing

times are compared with the situation where the traffic light control the traffic flow to pass the crossroad and roundabout. It proved that the cooperative control system are more efficient. Especially in the fifth experiment : three vehicles-trains passing the crossroad at the same time, the ability of proposed method has been proved for arranging those vehicles, through the control could be improved in several different factors which are present in the next chapter as future work.

IV

CONCLUSION AND FUTURE WORK

CONCLUSION AND FUTURE WORK

11.1/ CONCLUSION

Vehicle provides a lot of convenience to people for daily life, such as traveling, going to work or school.... With the increasing of vehicle in the road, more and more problems appeared, for instance, traffic jam, air pollution and traffic accident. In order to deal with those traffic issues. We proposed a multi-agent based cooperative control model applied to the management of Vehicles-trains of vehicles.

The multi-agent model has been introduced in Chapter 5 from physical to logical, from vehicle to vehicles-train as a tool to organize vehicles and vehicles platoons. The vehicle model was described including the kinematic model and vehicle agent. Then, vehicles-train was defined based on platoon concept. Each vehicle, as one important participant of traffic, was allocated one agent, called vehicle agent. The vehicle parameters, perception task and reaction framework were announced as main parts of vehicle agent. The vehicles-train agent was defined corresponding with vehicle train. The train agent level, as the superior level of vehicle agent level, was the place where the vehicles coordination happens. Thus, the reaction framework of the vehicles-train was delineated through detailing inputs and outputs.

For the multi-agent model, the interaction between agents, including communication and reaction, was formulated in Chapter 6, which providing the interaction method between vehicles platoons (vehicles-trains). The other important concept - the organization structure, defining the relationship between different agents, was also described. According the organization structure, there were two level in this structure : the vehicles-train agent level and vehicle agent level. The structure described the relationship between agents, not only at the same level agent but also at different level. Then, the communication was introduced into two part : first, the communication between vehicle agent and train agent ; the second part was that between vehicles-train agents. The information flows continually among agents under the system structure, separating it into two part was justly for more suitable analysis. An essential tool for tune vehicles was offered, virtual vehicle. Owing to the virtual-vehicle, the adjusting mission was detached into all agents.

In Chapter 7, the cooperative control algorithm was detailed in two sections: train level and vehicle level as the strategies helping to share the road infrastructure efficiently, reliably and safely. The preceding vehicle and role were determined in train level through two steps. Firstly, the vehicles order was decided according to principles including arriving time, relative position and planned routes. Secondly, the preceding vehicle and role were assigned according to different scenarios and vehicles order. The preceding vehicle could be a virtual vehicle composed by position and direction information. Then, the speed and steering command were calculated by platoon control algorithm based on physical interaction model. Above all, the speed and steering of vehicle command were given by multi-level decision system with vehicles position, speed and routes as inputs. Vehicles controlled by multi-level decision system realized coordinate control to avoid stop for waiting when vehicles encounter.

In Chapter 8, the experiment platform was presented focusing on VIVUS. Then, in Chapter 9, experiments were carried out in the two-lane road without intersection including four scenarios: (1) one vehicle-train running in one lane; (2) one vehicle splitting from its vehicle-train; (3) two vehicle-trains merging to one; (4) reconfiguration happening inner-train. In Chapter 10, experiments in intersection were presented from four scenarios: (1) two vehicle-trains passing crossroad at same time; (2) two vehicle-trains passing roundabout at the same time; (3) reconfiguration between two vehicle-trains in roundabout; (4) reconfiguration between two vehicle-trains in crossroad; (5) three vehicle-trains passing the crossroad at the same time. Experiments were shown through two types of figures: the first type of figures was the screen shot to record scenes as processing diagrams. The second type of figures was some curves about the distance and speed changing followed by brief illustration. Especially, for experiments about two vehicle-trains passing crossroad and roundabout at same time, passing times were compared with the situation where the traffic light controls the traffic flow to pass the crossroad and roundabout. It proved that the proposed cooperative control system are more efficient. All scenarios also shown cooperative control ability in processing diagrams and data curves.

11.2/ FUTURE WORK

In this PhD, a protocol model has been developed in three parts: the element definition in this model, the organization and reaction between elements and the cooperative control method. Therefore, the future work is considered in these three areas firstly.

For the element in the model, more traffic participants can be treated as agents adding to the model, such as pedestrian, bikes, obstacles and some vehicles which cannot communicate with others. That can improve the robustness of the multi-agent system when putting them into real world. The environment should be also modeled as part of the system, such as the changing of the lane in the same road and so on.

The organization could be improved after some other traffic participants are added into system. The communication should be more precise through taking more different situation into consider to lead the communication more efficient and robust.

The cooperative control can be advanced through updating the vehicle order algorithm. The vehicles order decides the speed changing of involving vehicles. The suitable vehicles order can not only increase the efficient of traffic flow, but also decrease the fuel consumption. The vehicle agent reaction derives to the vehicle movement command which impact the vehicle directly. From the curves of the speed and distance of our experiment result, we known that the speed and distance aren't so smooth. For the real vehicle, that is a big problem for making people uncomfortable and reducing the vehicle life. Therefore, the reaction model should be improved to gain more precise and smooth control command.

Considering the whole system, the proposed method should be generalized to widely areas, such as a big road network including more intersection, not only in number but also different types. The corresponding tests should also be carried out. In tests, it is also necessary to find if there are inter-blocking situations where vehicles stop. Taking other traffic participant into account, mixing this algorithm with other traffic system (buses, tramway) is also a interesting and necessary work.

As shown in the experiment result, the vibration is existing in the result curves including distance and speed. The first reason is the distance adjusting need a long time especially in high speed. The second reason is the existing of noise which need filter to deal with it. The control system hold the natural vibration also. In order to improve the stability of system, feedbacks should be add into system to form one closed-loop control system.

BIBLIOGRAPHIE

- [**Abbas-Turki et al., 2012**] Abbas-Turki, A., Ahmane, M., Gao, F., Wu, J., El-Moudni, A., et Miraoui, A. (2012). **Using robots for prototyping Autonomous Intersection Management : Feasibility and feedbacks**. Dans *IFAC Proceedings Volumes*, pages 308–313.
- [**Adler et al., 2005**] Adler, J. L., Satapathy, G., Manikonda, V., Bowles, B., et Blue, V. J. (2005). **A multi-agent approach to cooperative traffic management and route guidance**. *Transportation Research Part B : Methodological*, 39(4) :297–318.
- [**Ahmane et al., 2013**] Ahmane, M., Abbas-Turki, A., Perronnet, F., Wu, J., El Moudni, A., Buisson, J., et Zeo, R. (2013). **Modeling and controlling an isolated urban intersection based on cooperative vehicles**. *Transportation Research Part C : Emerging Technologies*, 28 :44–62.
- [**Alam et al., 2015**] Alam, A., Martensson, J., et Johansson, K. H. (2015). **Experimental evaluation of decentralized cooperative cruise control for heavy-duty vehicle platooning**. *Control Engineering Practice*, 38 :11–25.
- [**Alam, Assad(RIT et al., 2014**] Alam, Assad(RIT, S., Gattami, Ather(RIT, S., Johansson, Karl H.(RIT, S., et Tomlin, C. J. B. (2014). **Guaranteeing safety for heavy duty vehicle platooning : Safe set computations and experimental evaluations**. *Control Engineering Practice*, 24 :33–41.
- [**Alvarez et al., 1997**] Alvarez, L., et Horowitz, R. (1997). **Safe platooning in automated highway systems**. Rapport technique.
- [**Amoozadeh et al., 2015**] Amoozadeh, M., Deng, H., Chuah, C. N., Zhang, H. M., et Ghosal, D. (2015). **Platoon management with cooperative adaptive cruise control enabled by VANET**. *Vehicular Communications*, 2 :110–123.
- [**Arnim et al., 2007**] Arnim, A. V., Perrollaz, M., Bertrand, A., et Ehrlich, J. (2007). **Vehicle identification using near infrared vision and applications to cooperative perception**. Dans *Proceedings of the 2007 IEEE Intelligent Vehicles Symposium*, pages 290–295.
- [**Ave et al., 2006**] Ave, R., et Park, M. (2006). **Real-time Localization in Outdoor Environments using Stereo Vision and Inexpensive GPS** Motilal Agrawal and Kurt Konolige. *Pattern Recognition*.
- [**Baig et al., 2012**] Baig, Q., Perrollaz, M., Nascimento, J. B. D., et Laugier, C. (2012). **Using fast classification of static and dynamic environment for improving Baye-**

- sian occupancy filter (BOF) and tracking.** Dans *12th International Conference on Control, Automation, Robotics and Vision*, pages 656–661.
- [Barbaresso et al., 2014] Barbaresso, J., Cordahi, G., Garcia, D., Hill, C., Jendzejec, A., Wright, K., et 9. (2014). **USDOT's Intelligent Transportation Systems (ITS) Strategic Plan 2015-2019.** Rapport technique.
- [Basso et al., 2013] Basso, G., Gaud, N., Gechter, F., Hilaire, V., et Lauri, F. (2013). **A framework for qualifying and evaluating smart grids approaches : focus on multi-agent technologies.** *Smart Grid and Renewable Energy*, 04(04) :333–347.
- [Bayezit et al., 2013] Bayezit, I., Fidan, B., et Huissoon, J. P. (2013). **Adaptive Cruise Control of Vehicle Platoons with Wireless State Information.** Dans *IFAC Workshop*.
- [Behere et al., 2013] Behere, S., Törngren, M., et Chen, D. J. (2013). **A reference architecture for cooperative driving.** *Journal of Systems Architecture*, 59 :1095–1112.
- [Bento et al., 2013] Bento, L. C., Parafita, R., Santos, S., et Nunes, U. (2013). **Intelligent traffic management at intersections : legacy mode for vehicles not equipped with V2V and V2I communications.** *IEEE Conference on Intelligent Transportation Systems, Proceedings*, pages 726–731.
- [Bergenheim et al., 2012] Bergenheim, C., Hedin, E., et Skarin, D. (2012). **Vehicle-to-Vehicle Communication for a Platooning System.** *Procedia - Social and Behavioral Sciences*, 48 :1222–1233.
- [Bishop, 2000] Bishop, R. (2000). **Intelligent vehicle applications worldwide.** *Intelligent Transport Systems*, 15(1) :78–81.
- [Bishop, 2005] Bishop, R. (2005). **Intelligent vehicle technology and trends.**
- [Böse et al., 2007] Böse, F., et Windt, K. (2007). **Business process modelling of autonomously controlled production systems.** Dans *Understanding Autonomous Cooperation and Control in Logistics : The Impact of Autonomy on Management, Information, Communication and Material Flow*, pages 73–83. Springer Berlin Heidelberg, Berlin, Heidelberg.
- [Boudihir et al., 1998] Boudihir, M. E., Nourine, R., Ziou, D., et Control, I. (1998). **Visual guidance of autonomous vehicle based on fuzzy perception.** Dans *IEEE International Conference on Intelligent Vehicles*, pages 23–28.
- [Broggi et al., 2013] Broggi, A., Buzzoni, M., Debattisti, S., Grisleri, P., Laghi, M. C., Medici, P., et Versari, P. (2013). **Extensive tests of autonomous driving technologies.** *IEEE Transactions on Intelligent Transportation Systems*, 14(3) :1403–1415.
- [Campolo et al., 2015] Campolo, C., Molinaro, A., et Scopigno, R. (2015). **From today's VANETs to tomorrow's planning and the bets for the day after.** *Vehicular Communications*, 2 :158–171.
- [Čapkovič, 2009] Čapkovič, F. (2009). **DES control synthesis and cooperation of agents.** *Lecture Notes in Computer Science (including subseries Lecture Notes in Artificial Intelligence and Lecture Notes in Bioinformatics)*, 5796 LNAI(1) :596–607.

- [Caveney, 2010] Caveney, D. (2010). **Cooperative vehicular safety applications**. *IEEE Control Systems*, 30(August) :38–53.
- [Chavan et al., 2009] Chavan, S. S., Deshpande, R. S., et Rana, J. G. (2009). **Design of intelligent traffic light controller using embedded system**. Dans *International Conference on Emerging Trends in Engineering & Technology*, pages 1086–1091. IEEE.
- [Chekkouri et al., 2015] Chekkouri, A., Ezzouhairi, A., et Pierre, S. (2015). **Connected vehicles in an intelligent transport system**. Dans *Vehicular Communications and Networks*, pages 193–221. Elsevier Ltd.
- [Chen et al., 2016] Chen, L., et Englund, C. (2016). **Cooperative Intersection Management : a survey**. *IEEE Transactions on Intelligent Transportation Systems*, 17(2) :570–586.
- [Cheng et al., 2007] Cheng, H., Zheng, N., Zhang, X., Qin, J., et Van De Wetering, H. (2007). **Interactive road situation analysis for driver assistance and safety warning systems : Framework and algorithms**. *IEEE Transactions on Intelligent Transportation Systems*, 8(1) :157–166.
- [Cheok et al., 1998] Cheok, K., Nishizawa, S., et Young, W. (1998). **Moving cluster classification technique with lidar traffic monitoring application**. Dans *American Control Conference*, pages 944–949.
- [Clark et al., 1998] Clark, S., et Durrant-Whyte, H. (1998). **Autonomous land vehicle navigation using millimeter wave radar**. *Proceedings. 1998 IEEE International Conference on Robotics and Automation (Cat. No.98CH36146)*, 4(May) :3697–3702.
- [Contet et al., 2011] Contet, J.-m., Gechter, F., Gruer, P., et Koukam, A. (2011). **Reactive multi-agent approach to local platoon control : stability analysis and experiments**. *Int. J. of Intelligent Systems Technologies and Applications*, 10 :231–249.
- [Contet et al., 2009] Contet, J.-m., Gechter, F., Gruer, P., Koukam, A., et Abderrafiaa, K. (2009). **Bending virtual spring-damper : a solution to improve local platoon control**. Dans *International Conference Baton Rouge*, pages 601–610.
- [Cordeau et al., 2007] Cordeau, J.-F., Laporte, G., Savelsbergh, M. W., et Vigo, D. (2007). **Chapter 6 Vehicle Routing**. Dans *Handbook in OR &MS*, volume 14, pages 367–428.
- [Csepinszky et al., 2014] Csepinszky, A., Giustianiani, G., Holguin, C., Parent, M., Flamentm, M., et Alessandrini, A. (2014). **Safe integration of fully automated road transport systems in urban environments : the basis for the missing legal framework**. *Transportation Research Board*, (January) :1–17.
- [Dafflon et al., 2011] Dafflon, B., Gechter, F., Contet, J.-m., Abbas-Turki, A., et GRUER, P. (2011). **Intelligent crossroads for vehicle platoons reconfiguration**. Dans Bouchachia, A., éditeur, *International Conference on Adaptive and Intelligent Systems*, Lecture Notes in Computer Science, pages 203–214, Berlin, Heidelberg. Springer Berlin Heidelberg.

- [Dafflon et al., 2013] Dafflon, B., Gechter, F., Gruer, P., et Koukam, A. (2013). **A layered multi-agent model for multi-configuration platoon control**. Dans *Proceedings of the 10th International Conference on Informatics in Control, Automation and Robotics*, pages 33–40. SciTePress - Science and Technology Publications.
- [Dafflon et al., 2015] Dafflon, B., Vilca, J., Gechter, F., et Adouane, L. (2015). **Adaptive Autonomous Navigation using Reactive Multi-agent System for Control Law Merging**. *Procedia Computer Science*, 51 :423–432.
- [Damm et al., 2007] Damm, W., Mikschl, A., Oehlerking, J., Olderog, E.-R., Pang, J., Platzer, A., Segelke, M., et Wirtz, B. (2007). **Automating verification of cooperation, control, and design in traffic applications**. *Formal methods and hybrid real-time systems*, pages 115–169.
- [Daviet et al., 1996] Daviet, P., et Parent, M. (1996). **Longitudinal and lateral servoing of vehicles in a platoon**. Dans *Conference on Intelligent Vehicles*, pages 41–46. IEEE.
- [Daviet et al., 1997] Daviet, P., et Parent, M. (1997). **Platooning for small public urban vehicles**. Dans *Experimental Robotics IV*, pages 343–354. Springer Berlin Heidelberg.
- [Davoodi et al., 2013] Davoodi, M., Panahi, F., Mohades, A., et Hashemi, S. N. (2013). **Multi-objective path planning in discrete space**. *Applied Soft Computing Journal*, 13(1) :709–720.
- [de Oliveira et al., 2010] de Oliveira, L. B., et Camponogara, E. (2010). **Multi-agent model predictive control of signaling split in urban traffic networks**. *Transportation Research Part C : Emerging Technologies*, 18(1) :120–139.
- [Dimitrakopoulos et al., 2010] Dimitrakopoulos, G., et Demestichas, P. (2010). **Intelligent transportation systems**. *IEEE Vehicular Technology Magazine*, 5(March 2010) :77–84.
- [Domínguez et al., 2011] Domínguez, R., Onieva, E., Alonso, J., Villagra, J., et González, C. (2011). **LIDAR based perception solution for autonomous vehicles**. Dans *International Conference on Intelligent Systems Design and Applications*.
- [Doniec et al., 2008] Doniec, A., Mandiau, R., Piechowiak, S., et Espi??, S. (2008). **A behavioral multi-agent model for road traffic simulation**. *Engineering Applications of Artificial Intelligence*, 21 :1443–1454.
- [El Zaher et al., 2011] El Zaher, M., Contet, J.-M., Gruer, P., et Gechter, F. (2011). **Towards a compositional verification approach for multi-agent systems : Application to platoon system**. *First International workshop on Verification and Validation of multi-agent models for complex systems*, pages 1–15.
- [El-Zaher et al., 2011] El-Zaher, M., Gechter, F., Gruer, P., et Hajjar, M. (2011). **A new linear platoon model based on reactive multi-agent systems**. Dans *2011 IEEE 23rd International Conference on Tools with Artificial Intelligence*, pages 898–899. IEEE.

- [Erbs et al., 2011] Erbs, F., Barth, A., et Franke, U. (2011). **Moving vehicle detection by optimal segmentation of the dynamic stixel world.** *IEEE Intelligent Vehicles Symposium, Proceedings*, (lv) :951–956.
- [Feng et al., 2015] Feng, Y., Head, K. L., Khoshmaghan, S., et Zamanipour, M. (2015). **A real-time adaptive signal control in a connected vehicle environment.** *Transportation Research Part C : Emerging Technologies*, 55 :460–473.
- [Ferher, 1999] Ferher, J. (1999). **Multi-agent systems : an introduction to distributed artificial intelligence.** Pearson Education Limited.
- [Fierro et al., 2005] Fierro, R., Clark, J., Hougen, D., et Commuri, S. (2005). **A multi-robot testbed for biologically-inspired cooperative control.** *Multi-Robots Systems. From Swarms to Intelligent Automata*, III :171–182.
- [Fierro et al., 2002] Fierro, R., Das, A., Spletzer, J., Esposito, J., Kumar, V., Ostrowski, J. P., Pappas, G., Taylor, C. J., Hur, Y., Alur, R., Lee, I., Grudic, G., et Southall, B. (2002). **A framework and architecture for multi-robot coordination.** *The International Journal of Robotics Research*, 21(10-11) :977–995.
- [Frantisek, 2011] Frantisek, C. (2011). **Cooperation of agents based on methods of DES supervising and control.** Dans Nguyen, N. T., éditeur, *Transactions on Computational Collective Intelligence III*, pages 1–24. Springer-Verlag Berlin Heidelberg.
- [Fritz, 1999] Fritz, H. (1999). **Longitudinal and lateral control of heavy duty trucks for automated vehicle following in mixed traffic : experimental results from the CHAUFFEUR project.** Dans *Proceedings of the 1999 IEEE International Conference on Control Applications (Cat. No.99CH36328)*, volume 2, pages 1348–1352. IEEE.
- [Fukao et al., 2013] Fukao, T., Aoki, T., Sugimachi, T., Yamada, Y., et Kawashima, H. (2013). **Preceding vehicle following based on path following control for platooning.** Dans *IFAC Symposium*. IFAC.
- [Gao et al., 2002] Gao, J., et Lin, D. H. (2002). **Agent cooperation based control integration by activity-sharing and joint intention.** *Journal of Computer Science and Technology*, 17(3) :331–339.
- [Ge et al., 2014] Ge, J. I., et Orosz, G. (2014). **Dynamics of connected vehicle systems with delayed acceleration feedback.** *Transportation Research Part C : Emerging Technologies*, 46 :46–64.
- [Gechter et al., 2010] Gechter, F., Contet, J.-M., Gruer, P., et Koukam, A. (2010). **Car-driving assistance using organization measurement of reactive multi-agent system.** *Procedia Computer Science*, 1(1) :317–325.
- [Gechter et al., 2012] Gechter, F., et Olivier, J.-m. C. (2012). **VIVUS : Virtual Intelligent Vehicle Urban Simulator : Application to Vehicle Platoon Evaluation.** *Simulation Modelling Practice and Theory*, 24(Complete) :103–114.

- [Gehring et al., 1997] Gehring, O., et Fritz, H. (1997). **Practical results of a longitudinal control concept for truck platooning with vehicle to vehicle communication**. Dans *Conference on Intelligent Transportation Systems*, pages 117–122.
- [Gipps, 1981] Gipps, P. G. (1981). **A behavioural car-following model for computer simulation**. *Transportation Research Part B*, 15(2) :105–111.
- [Godbole et al., 1998] Godbole, D. N., Sengupta, R., et Hagenmeyer, V. (1998). **Distributed hybrid controls for automated vehicle lane changes**. Dans *37th IEEE Conference on Decision & Control*.
- [Gonzalez et al., 2016] Gonzalez, D., Pérez, J., Milanés, V., et Nashashibi, F. (2016). **A review of motion planning techniques for automated vehicles**. *IEEE Transactions on Intelligent Transportation Systems*, 17(4) :1135–1145.
- [Guillet et al., 2014] Guillet, A., Lenain, R., Thuilot, B., et Martinet, P. (2014). **Adaptable Robot Formation Control : Adaptive and Predictive Formation Control of Autonomous Vehicles**. *IEEE Robotics & Automation Magazine*, 21(1) :28–39.
- [Hallé et al., 2005] Hallé, S., et Chaib-draa, B. (2005). **A collaborative driving system based on multiagent modelling and simulations**. *Transportation Research Part C : Emerging Technologies*, 13(4) :320–345.
- [Hao et al., 2015] Hao, X., Abbas-Turki, A., Perronnet, F., Bouyekhf, R., et El Moudni, A. (2015). **Intersection Management Based on V2I Velocity Synchronization**, pages 449–470. Springer International Publishing, Cham.
- [Harding et al., 2014] Harding, J., Powell, G., Yoon, R., Fikentscher, J., Doyle, C., Sade, D., Lukuc, M., Simons, J., et Wang, J. (2014). **Vehicle-to-Vehicle Communications : Readiness of V2V Technology for Application**. Rapport technique, Washington, DC : National Highway Traffic Safety Administration.
- [Hariti et al., 2003] Hariti, M., Ruichek, Y., et Koukam, A. (2003). **A fast stereo matching method for real time vehicle front perception with linear cameras**. Dans *IEEE Intelligent Vehicles Symposium, Proceedings*, pages 247–252.
- [Hegyí et al., 2005] Hegyí, A., De Schutter, B., et Hellendoorn, H. (2005). **Model predictive control for optimal coordination of ramp metering and variable speed limits**. *Transportation Research Part C : Emerging Technologies*, 13(3) :185–209.
- [Hernández et al., 2002] Hernández, J. Z., Ossowski, S., et Garcia-Serrano, A. (2002). **Multiagent architectures for intelligent traffic management systems**. *Transportation Research Part C*, 10 :473–506.
- [Hernansanz et al., 2015] Hernansanz, A., Casals, A., et Amat, J. (2015). **A multi-robot cooperation strategy for dexterous task oriented teleoperation**. *Robotics and Autonomous Systems*, 68 :156–172.
- [Himmelsbach et al., 2012] Himmelsbach, M., et Wuensche, H. J. (2012). **Tracking and classification of arbitrary objects with bottom-up/top-down detection**. Dans *IEEE Intelligent Vehicles Symposium*, pages 577–582. IEEE.

- [Hirulkar et al.,] Hirulkar, P., Deshpande, R., Bajaj, P., et Member, S. **Optimization of traffic flow through signalized intersections using PSO**. *International Journal of Computer Science and its Applications*, pages 434–437.
- [Hobert, 2012] Hobert, L. H. X. (2012). **A study on platoon formations and reliable communication in vehicle platoons**. PhD thesis.
- [Hoek et al., 2005] Hoek, W. V. D., et Wooldridge, M. (2005). **On the logic of cooperation and propositional control**. *Artificial intelligence*, 164(1-2) :81–119.
- [Hollborn, 2002] Hollborn, S. (2002). **Intelligent Transport Systems in Japan**.
- [Hoshino et al., 2005] Hoshino, S., Ota, J., Shinozaki, A., et Hashimoto, H. (2005). **Highly efficient AGV transportation system management using agent cooperation and container storage planning**. *2005 IEEE/RSJ International Conference on Intelligent Robots and Systems, IROS*, pages 2330–2335.
- [Hu et al., 2015a] Hu, H., Yu, W., Xuan, Q., Yu, L., et Xie, G. (2015a). **Consensus of multi-agent systems in the cooperation-competition network with inherent nonlinear dynamics : A time-delayed control approach**. *Neurocomputing*, 158 :134–143.
- [Hu et al., 2015b] Hu, J., Park, B. B., et Lee, Y.-J. (2015b). **Coordinated transit signal priority supporting transit progression under Connected Vehicle Technology**. *Transportation Research Part C : Emerging Technologies*, 55 :393–408.
- [Hwang et al., 2007] Hwang, J. P., Cho, S. E., Ryu, K. J., Park, S., et Kim, E. (2007). **Multi-classifier based LIDAR and camera fusion**. Dans *IEEE Conference on Intelligent Transportation Systems*, pages 467–472. Ieee.
- [Ioannou et al., 1993] Ioannou, P. A., et Chien, C. C. (1993). **Autonomous intelligent cruise control**. *IEEE Transactions on Vehicular Technology*, 42(4) :657–672.
- [Ippoliti et al., 2007] Ippoliti, G., Jetto, L., Longhi, S., et Monteriù, A. (2007). **Comparative analysis of mobile robot localization methods based on proprioceptive and exteroceptive sensors**. Dans *Mobile Robots : Perception & Navigation*.
- [Jang et al., 2011] Jang, S.-h., Yoon, D.-j., Kim, J.-h., et Kim, B.-w. (2011). **Research of object classification algorithm based on LIDAR for UGV**. Dans *International Conference on Control, Automation and Systems*, pages 746–749.
- [Jia et al., 2016] Jia, D., et Ngoduy, D. (2016). **Platoon based cooperative driving model with consideration of realistic inter-vehicle communication**. *Transportation Research Part C : Emerging Technologies*, 68 :245–264.
- [Jiang et al., 2012] Jiang, L., Cai, B. G., Wang, Y. P., et Jian, W. (2012). **Location-based cooperative vehicle collision avoidance for unsignalized intersections : A multi-sensor integration approach**. Dans *International Conference on Connected Vehicles and Expo*, pages 246–251. Ieee.
- [Jiang et al., 2006] Jiang, Y., Li, S., et Shamo, D. E. (2006). **A platoon-based traffic signal timing algorithm for major-minor intersection types**. *Transportation Research Part B : Methodological*, 40(7) :543–562.

- [John et al., 2008] John, L., How, J., Teller, S., Berger, M., Campbell, S., Fiore, G., Fletcher, L., et Al., E. (2008). **A perception-driven autonomous urban vehicle**. *Journal of Field Robotics* 25(10), 25(7) :727–774.
- [Kai et al., 2003] Kai, N. K. N., et Kezhong, H. K. H. (2003). **THMR-V : an effective and robust high-speed system in structured road**. Dans *IEEE International Conference on Systems, Man and Cybernetics. Conference Theme - System Security and Assurance*, pages 4370–4374.
- [Kala, 2012] Kala, R. (2012). **Multi-robot path planning using co-evolutionary genetic programming**. *Expert Systems with Applications*, 39(3) :3817–3831.
- [Kamal et al., 2013] Kamal, M. A. S., Imura, J., Ohata, A., Hayakawa, T., et Aihara, K. (2013). **Coordination of automated vehicles at a traffic-lightless intersection**. *16th IEEE Conference on Intelligent Transportation Systems*, pages 922–927.
- [Kato et al., 2002] Kato, S., Tsugawa, S., Tokuda, K., Matsui, T., et Fujii, H. (2002). **Vehicle control algorithms for cooperative driving with automated vehicles and intervehicle communications**. *IEEE Transactions on Intelligent Transportation Systems*, 3(3) :155–160.
- [Kehtarnavaz et al., 1991] Kehtarnavaz, N., Griswold, N. C., et Lee, J. S. (1991). **Visual control of an autonomous vehicle (BART)-the vehicle-following problem**. *IEEE Transactions on Vehicular Technology*, 40(3) :654–662.
- [Kevin Mcmanamon et al., 2013] Kevin Mcmanamon, Lancaster, R., et Nuno Silva (2013). **Exomars rover vehicle perception system architecture and test results**. Dans *ASTRA Conference 2013*, numéro 1.
- [Khatir et al., 2004] Khatir, M. E., et Davison, E. J. (2004). **Decentralized control of a large platoon of vehicles using non-identical controllers**. Dans *American Control Conference Proceedings of the 2004*, pages 2769–2776.
- [Kiencke et al., 2005] Kiencke, U., et Nielsen, L. (2005). **Automotive control systems**. Springer Berlin Heidelberg, 2nd édition.
- [Kim et al., 2012] Kim, B. H. J., et Maxemchuk, N. F. (2012). **A safe driver assisted merge protocol**. Dans *SysCon 2012 - 2012 IEEE International Systems Conference*, pages 163–166.
- [Kim, 2013] Kim, K.-d. (2013). **Collision free autonomous ground traffic : a model predictive control approach**. Dans *International Conference on Cyber-Physical Systems (ICCPS)*, pages 51–60.
- [Kolodko et al., 2003] Kolodko, J., et Vlacic, L. (2003). **Cooperative autonomous driving at the intelligent control systems laboratory**. *Intelligent Systems, IEEE*, 18(4) :8–11.
- [Koukam et al., 2013] Koukam, A., Gechter, F., Dafflon, B., et Gruer, P. (2013). **Vehicle platoon and obstacle avoidance : a reactive agent approach**. *IET Intelligent Transport Systems*, 7(3) :257–264.

- [Lamotte et al., 2010] Lamotte, O., Galland, S., Contet, J.-M., et Gechter, F. (2010). **Sub-microscopic and physics simulation of autonomous and intelligent vehicles in Virtual Reality**. Dans *Advances in System Simulation (SIMUL)*, pages 28–33. IEEE.
- [Lee et al., 2012] Lee, J., et Park, B. (2012). **Development and evaluation of a cooperative vehicle intersection control algorithm under the connected vehicles environment**. *IEEE Transactions on Intelligent Transportation Systems*, 13(1) :81–90.
- [Lee et al., 1999] Lee, S., Lee, J.-w., Shin, D., Kwon, W., Kim, D.-y., et Roh, K. (1999). **Estimation of vehicle pose and road curvature based on perception-net**. Dans *International Conference on Robotics and Automation Proceedings*, volume 3, pages 1966–1971.
- [Levinson et al., 2010] Levinson, J., et Thrun, S. (2010). **Robust vehicle localization in urban environments using probabilistic maps**. *2010 IEEE International Conference on Robotics and Automation*, pages 4372–4378.
- [Li et al., 2014] Li, H., Tsukada, M., Nashashibi, F., et Parent, M. (2014). **Multivehicle cooperative local mapping : a methodology based on occupancy grid map merging**. *IEEE Transactions on Intelligent Transportation Systems*, 15(5) :2089–2100.
- [Li et al., 2006] Li, L., et Wang, F. Y. (2006). **Cooperative driving at blind crossings using intervehicle communication**. *IEEE Transactions on Vehicular Technology*, 55(6) :1712–1724.
- [LI, 2013] LI, Y. (2013). **Stereo vision and LIDAR based dynamic occupancy grid mapping : application to scenes analysis for intelligent vehicles**. PhD thesis.
- [Limsoonthrakul et al., 2009] Limsoonthrakul, S., Dailey, M., et Parnichkun, M. (2009). **Intelligent Vehicle Localization using GPS, Compass, and Machine Vision**. *2009 IEEE/RSJ International Conference on Intelligent Robots and Systems*, (November) :3981–3986.
- [Logi et al., 2002] Logi, F., et Ritchie, S. G. (2002). **A multi-agent architecture for cooperative inter-jurisdictional traffic congestion management**. *Transportation Research Part C : Emerging Technologies*, 10 :507–527.
- [Luettel et al., 2009] Luettel, T., Himmelsbach, M., Hundelshausen, F., Manz, M., Mueller, a., et Wuensche, H. J. (2009). **Autonomous Offroad Navigation Under Poor GPS Conditions**. *Planning, Perception and Navigation for Intelligent Vehicles (PP-NIV)*, (September) :67.
- [Luettel et al., 2012] Luettel, T., Himmelsbach, M., Wuensche, H.-j., Luettel, T., Himmelsbach, M., et Wuensche, H.-j. (2012). **Autonomous Ground Vehicles - Concepts and a Path to the Future**. *Proceedings of the IEEE*, 100(Special Centennial Issue) :1831–1839.
- [Ma et al., 2007] Ma, W., et Yang, X. (2007). **A passive transit signal priority approach for bus rapid transit system**. Dans *2007 IEEE Intelligent Transportation Systems Conference*, pages 413–418. IEEE.

- [Manz et al., 2011] Manz, M., Luettel, T., Von Hundelshausen, F., et Wuensche, H. J. (2011). **Monocular model-based 3D vehicle tracking for autonomous vehicles in unstructured environment**. *IEEE International Conference on Robotics and Automation*, pages 2465–2471.
- [Maschuw et al., 2008] Maschuw, J. P., Kessler, G. C., et Abel, D. (2008). **LMI-based control of vehicle platoons for robust longitudinal guidance**. Dans *International Federation of Automatic Control*.
- [Meignan et al., 2007] Meignan, D., Simonin, O., et Koukam, A. (2007). **Simulation and evaluation of urban bus-networks using a multiagent approach**. *Simulation Modelling Practice and Theory*, 15 :659–671.
- [Michael, 2002] Michael, W. (2002). **An Introduction to Multiagent Systems**. Cambridge University Press, Cambridge.
- [Milanés et al., 2014] Milanés, V., et Shladover, S. E. (2014). **Modeling cooperative and autonomous adaptive cruise control dynamic responses using experimental data**. *Transportation Research Part C : Emerging Technologies*, 48 :285–300.
- [Mirchandani et al., 2007] Mirchandani, P. B., et Zou, N. (2007). **Queuing models for analysis of traffic adaptive signal control**. *IEEE Transactions on Intelligent Transportation Systems*, 8(1) :50–59.
- [Moras et al., 2010] Moras, J., Cherfaoui, V., et Bonnifait, P. (2010). **A lidar perception scheme for intelligent vehicle navigation**. Dans *11th International Conference on Control, Automation, Robotics and Vision*.
- [Muller et al., 2009] Muller, A., Manz, M., Himmelsbach, M., et Wunsche, H. J. (2009). **A model-based object following system**. Dans *IEEE Intelligent Vehicles Symposium, Proceedings*, pages 242–249. IEEE.
- [Murray, 2007] Murray, R. M. (2007). **Recent research in cooperative control of multi-vehicle systems**. *Journal of Dynamic Systems, Measurement, and Control*, 129(5) :571.
- [Negenborn et al., 2008] Negenborn, R. R., De Schutter, B., et Hellendoorn, J. (2008). **Multi-agent model predictive control for transportation networks : Serial versus parallel schemes**. *Engineering Applications of Artificial Intelligence*, 21(3) :353–366.
- [Neuendorf et al., 2004] Neuendorf, N., et Bruns, T. (2004). **The vehicle platoon controller in the decentralised, autonomous intersection management of vehicles**. Dans *Proceedings of the IEEE International Conference on Mechatronics, 2004. ICM '04.*, pages 375–380. Ieee.
- [Newell, 2002] Newell, G. F. (2002). **A simplified car-following theory : A lower order model**. *Transportation Research Part B : Methodological*, 36(3) :195–205.
- [Olfati-Saber et al., 2004] Olfati-Saber, R., et Murray, R. M. (2004). **Consensus problems in networks of agents with switching topology and time-delays**. *IEEE Transactions on Automatic Control*, 49(9) :1520–1533.

- [Pandey et al., 2012] Pandey, G., McBride, J. R., Savarese, S., et Eustice, R. M. (2012). **Toward mutual information based automatic registration of 3D point clouds.** Dans *International Conference on Intelligent Robots and Systems*, numéro 4, pages 2698–2704. Ieee.
- [Parent et al., 1996] Parent, M., et Daviet, P. (1996). **Automated urban vehicles : towards a dual mode PRT (Personal Rapid Transit).** *IEEE International Conference on Robotics and Automation*, 4(April 1996) :3129–3134.
- [Parent et al., 1994] Parent, M., Daviet, P., et Denis, J.-c. (1994). **Automatic driving in stop and go traffic.** Dans *Proceedings of the Intelligent Vehicles '94 Symposium*, pages 183–188. IEEE.
- [Pepy et al., 2006] Pepy, R., Lambert, A., et Mounier, H. (2006). **Path planning using a dynamic vehicle model.** Dans *Information and Communication Technologies*.
- [Pink et al., 2009] Pink, O., Moosmann, F., et Bachmann, A. (2009). **Visual features for vehicle localization and ego-motion estimation.** *IEEE Intelligent Vehicles Symposium, Proceedings*, pages 254–260.
- [Premebida et al., 2009] Premebida, C., Ludwig, O., et Nunes, U. (2009). **Exploiting LIDAR-based features on pedestrian detection in urban scenarios.** Dans *IEEE Conference on Intelligent Transportation Systems*, pages 18–23. Ieee.
- [Richards et al., 2002] Richards, A., Bellingham, J., et Tillerson (2002). **Coordination and control of multiple UAVs.** Dans *AIAA Guidance, Navigation, and Control Conference and Exhibit*, pages 1–11.
- [Rieder et al., 2002] Rieder, A., Southall, B., Salgian, G., Mandelbaum, R., Herman, H., Rander, P., et Stentz, T. (2002). **Stereo perception on an off-road vehicle.** Dans *IEEE Intelligent Vehicles Symposium*. Ieee.
- [Robinson et al., 2010] Robinson, T., Chan, E., et Coelingh, E. (2010). **Operating platoons on public motorways : An introduction to the SARTRE platooning programme.** Dans *17th world congress on intelligent transport systems*, volume 1.
- [Ryu et al., 2004] Ryu, J., et Gerdes, J. C. (2004). **Integrating Inertial Sensors With Global Positioning System (GPS) for Vehicle Dynamics Control.** *Journal of Dynamic Systems, Measurement, and Control*, 126(2) :243.
- [S. Sheikholeslam et al., 1990] S. Sheikholeslam, C. A. Desoer, et Anderson, J. E. (1990). **Longitudinal Control of a Vehicle.** Dans *American Control Conference, 1990*, volume 3, pages 291–296.
- [Saust et al., 2011] Saust, F., Wille, J. M., Lichte, B., et Maurer, M. (2011). **Autonomous vehicle guidance on Braunschweig's inner ring road within the stadtpilot project.** *IEEE Intelligent Vehicles Symposium, Proceedings*, (Iv) :169–174.
- [Schworer, 2005] Schworer, I. (2005). **Navigation and control of an autonomous vehicle.** PhD thesis.

- [Sepulcre et al., 2013] Sepulcre, M., Gozalvez, J., et Hernandez, J. (2013). **Cooperative vehicle-to-vehicle active safety testing under challenging conditions**. *Transportation Research Part C : Emerging Technologies*, 26 :233–255.
- [Sheikholeslam et al., 1993] Sheikholeslam, S., et Desoer, C. A. (1993). **Longitudinal control of a platoon of vehicles with no communication of lead vehicle information : a system level study**. *IEEE Transactions on Vehicular Technology*, 42(4) :546–554.
- [Siekmann et al., 2009a] Siekmann, J., Hartmanis, J., et Leeuwen, J. V. (2009a). **Computational Collective Intelligence. Semantic Web, Social Networks and Multiagent Systems**. Lecture Notes in Computer Science. Springer Berlin Heidelberg, Berlin, Heidelberg.
- [Siekmann et al., 2009b] Siekmann, J., Hartmanis, J., et Leeuwen, J. V. (2009b). **Lecture Notes in Artificial Intelligence**.
- [Song et al., 2002] Song, Z., Chen, Y., Chung, Y. C., et Motivation, A. (2002). **Some sensing and perception techniques for an omnidirectional ground vehicle with a laser scanner**. Dans *IEEE International Symposium on Intelligent Control*, pages 690–695.
- [Stafylopatis et al., 1998] Stafylopatis, A., et Blekas, K. (1998). **Autonomous vehicle navigation using evolutionary learning reinforcement**. *European Journal Of Operational Research*, 17(97) :306–318.
- [Steinhauser et al., 2008] Steinhauser, D., Ruepp, O., et Burschka, D. (2008). **Motion segmentation and scene classification from 3D LIDAR data**. *IEEE Intelligent Vehicles Symposium, Proceedings*, pages 398–403.
- [Stiller et al., 2012] Stiller, C., et Ziegler, J. (2012). **3D perception and planning for self-driving and cooperative automobiles**. Dans *International Multi-Conference on Systems, Signals and Devices*.
- [Taipalus et al., 2011] Taipalus, T., et Ahtiainen, J. (2011). **Human detection and tracking with knee-high mobile 2D LIDAR**. *IEEE International Conference on Robotics and Biomimetics*, pages 1672–1677.
- [Tan et al., 1996] Tan, K.-H., et Lewis, M. (1996). **Virtual structures for high-precision cooperative mobile robotic control**. Dans *IEEE/RSJ International Conference on Intelligent Robots and Systems*, volume 1, pages 132–139.
- [Thuy et al., 2009] Thuy, M., et Puente Leon, F. (2009). **Non-linear, shape independent object tracking based on 2D lidar data**. *2009 IEEE Intelligent Vehicles Symposium*, pages 532–537.
- [Tian et al., 2013] Tian, S., Zheng, S., Xie, B., et Qin, X. (2013). **Intelligent vehicle platform and signal processing method applied to cooperative vehicle infrastructure**. Dans *Intelligent Vehicle Platform and Signal Processing Method Applied to Cooperative Vehicle Infrastructure*, pages 33–39.

- [Tischler et al., 2005] Tischler, K., et Hummel, B. (2005). **Enhanced environmental perception by inter-vehicle data exchange**. Dans *Intelligent Vehicles Symposium*, pages 313–318. IEEE.
- [Tlig et al., 2011] Tlig, M., et Bhouiri, N. (2011). **A multi-agent system for urban traffic and buses regularity control**. *Procedia Social and Behavioral Sciences*, 20 :896–905.
- [Tlig et al., 2014a] Tlig, M., Buffet, O., et Simonin, O. (2014a). **Decentralized traffic management : A synchronization-based intersection control**. Rapport technique March.
- [Tlig et al., 2014b] Tlig, M., Buffet, O., et Simonin, O. (2014b). **Stop-free strategies for traffic networks : Decentralized on-line optimization**. Dans *Frontiers in Artificial Intelligence and Applications*, volume 263, pages 1191–1196.
- [Tsugawa, 2013] Tsugawa, S. (2013). **An overview on an automated truck platoon within the energy ITS project**. Dans *7th IFAC Symposium on Advances in Automotive Control*. IFAC.
- [Tsugawa et al., 2000] Tsugawa, S., Kato, S., Matsui, T., Naganawa, H., et Fujii, H. (2000). **An architecture for cooperative driving of automated vehicles**. Dans *2000 IEEE Intelligent Transportation Systems*.
- [Vilca et al., 2012] Vilca, J. M., Adouane, L., Benzerrouk, A., et Mezouar, Y. (2012). **Co-operative on-line object detection using multi-robot formation**. Dans *7th National Conference on Control Architectures of Robots*.
- [Wang et al., 1998] Wang, Y. U., et Han, Z. U. (1998). **Stability of an automated vehicle platoon**. Dans *Proceedings of American Control Conference*, volume 2, pages 950–954. IEEE.
- [Wei et al., 2011] Wei, L., Cappelle, C., Ruichek, Y., et Zann, F. (2011). **GPS and stereovision-based visual odometry : Application to urban scene mapping and intelligent vehicle localization**. *International Journal of Vehicular Technology*, 2011.
- [Werling et al., 2010] Werling, M., Gröll, L., et Bretthauer, G. (2010). **Invariant trajectory tracking with a full-size autonomous road vehicle**. *IEEE Transactions on Robotics*, 26(4) :758–765.
- [Wu et al., 2012] Wu, J., Abbas-Turki, A., et El Moudni, A. (2012). **Cooperative driving : An ant colony system for autonomous intersection management**. *Applied Intelligence*, 37(2) :207–222.
- [Wu et al., 2005] Wu, S. J., Chiang, H. H., Perng, J. W., Lee, T. T., et Chen, C. J. (2005). **The automated lane-keeping design for an intelligent vehicle**. Dans *IEEE Intelligent Vehicles Symposium, Proceedings*, pages 508–513. IEEE.
- [Xie et al., 2012a] Xie, X. F., Smith, S. F., Lu, L., et Barlow, G. J. (2012a). **Schedule-driven intersection control**. *Transportation Research Part C : Emerging Technologies*, 24 :168–189.

- [Xie et al., 2012b] Xie, X.-F. a., Smith, S. F. a., et Barlow, G. J. a. (2012b). **Schedule-driven coordination for real-time traffic network control**. Dans *11th International Conference on Autonomous Agents and Multiagent Systems*, volume 15213, pages 1271–1272.
- [Xie et al., 2012c] Xie, X.-F. a., Smith, S. F. a., et Barlow, G. J. a. (2012c). **Schedule-driven coordination for real-time traffic network control**. *Proceedings of the 11th International Conference on Autonomous Agents and Multiagent Systems (AAMAS '12)*, 15213 :1271–1272.
- [Yang et al., 2015] Yang, F., Roche, R., Gechter, F., Gao, F., et Koukam, A. (2015). **An agent-based approach for battery management systems**. Dans *IEEE Energy Conversion Congress and Exposition (ECCE)*.
- [Yao et al., 2009] Yao, W., Hinz, S., et Stilla, U. (2009). **Object extraction based on 3d-segmentation of LiDAR data by combining mean shift with normalized cuts : Two examples from urban areas**. *2009 Joint Urban Remote Sensing Event*, pages 1–6.
- [Yi et al., 2005] Yi, S.-Y., et Chong, K.-T. (2005). **Impedance control for a vehicle platoon system**. *Mechatronics*, 15(5) :627–638.
- [Yin et al., 2014] Yin, W., Murray-Tuite, P., Ukkusuri, S. V., et Gladwin, H. (2014). **An agent-based modeling system for travel demand simulation for hurricane evacuation**. *Transportation Research Part C : Emerging Technologies*, 42 :44–59.
- [Zaher, 2013] Zaher, M. E. (2013). **Approche réactive pour la conduite en convoi des véhicules autonomes : Modélisation et vérification**. PhD thesis, Université de Technologie de Belfort-Montbéliard.
- [Zhao et al., 2013] Zhao, C., Chen, W., Zhao, Z., et Liu, J. (2013). **An RGBD data based vehicle detection algorithm for vehicle following systems**. Dans *IEEE 8th Conference on Industrial Electronics and Applications (ICIEA)*, pages 1506–1511. IEEE.
- [Zheng et al., 2004] Zheng, N.-N. Z. N.-N., Tang, S. T. S., Cheng, H. C. H., Li, Q. L. Q., Lai, G., et Wang, F.-W. (2004). **Toward intelligent driver-assistance and safety warning system**. *IEEE Intelligent Systems*, 19(2) :8–11.
- [Zohdy et al., 2012] Zohdy, I. H., et Rakha, H. (2012). **Game theory algorithm for intersection-based cooperative adaptive cruise control (CACC) systems**. Dans *IEEE Conference on Intelligent Transportation Systems, Proceedings, ITSC*, pages 1097–1102.

TABLE DES FIGURES

1.1	Truck platoon developed by Mercedes-Benz	2
1.2	Vehicle and vehicles-train	3
1.3	Vehicle-agent and vehicles-train-agent	4
2.1	Several intelligent vehicle platforms	10
2.2	Three navigation levels for autonomous vehicle	11
2.3	Vehicle communication	16
5.1	Multi-agent model based on vehicles and train	41
5.2	Choosing reference frame	42
5.3	Coordinate systems	43
5.4	Vehicle kinematic model	44
5.5	A vehicles-train containing three vehicles in column configuration	45
5.6	Two vehicles share a segment route	47
5.7	Vehicle agent reaction framework	49
5.8	Vehicles-train moving from left to right	50
5.9	Train agent reaction framework	51
5.10	Two type agents and connection	51
6.1	Organization of vehicle and vehicles-train	54
6.2	Multi-agent system organization structure	54
6.3	Run-in-train communication framework	56
6.4	Splitting communication framework	57
6.5	Trains agents communication framework	58
6.6	Virtual vehicle in one vehicles-train	59
7.1	Encountering points	62

7.2	Vehicles order based on leaving sequence	63
7.3	Priorities decision	65
7.4	Preceding vehicle information in platoon decision	67
7.5	One vehicles-train T_A	68
7.6	Creating two virtual vehicles	68
7.7	Vehicle V_{A2} move to left	68
7.8	Vehicle V_{A2} arrive suitable position	68
7.9	Deleting virtual vehicles	69
7.10	Vehicle trains update	69
7.11	Two train encountering in crossroad	69
7.12	Creating virtual vehicles for crossing	70
7.13	V_{B1} encounter with $V_{vir,B1}$	71
7.14	V_{A2} encounter with $V_{vir,A2}$	71
7.15	V_{A3} encounter with $V_{vir,A3}$	72
7.16	V_{B3} passing encountering point	72
7.17	Finishing of crossing	73
7.18	Two trains for merging	74
7.19	Create virtual vehicles for merging	74
7.20	Virtual vehicle $V_{vir,A1}$ position in merging	74
7.21	Add lateral speed to $V_{vir,A1}$	75
7.22	Train T_B move to right	75
7.23	Train T_B arrive right lane	75
7.24	Merging finished	75
7.25	Train T_A configuration	76
7.26	Create two virtual vehicles	76
7.27	Moving V_{A2} to left	77
7.28	Begin moving to front	77
7.29	Create virtual vehicle $V_{vir,A1}$	77
7.30	Adjust longitudinal distance	77
7.31	Finished adjusting longitudinal distance	78
7.32	V_{A2} moving to right	78

7.33 All vehicles in one lane	78
7.34 Delete virtual vehicles	78
7.35 Two vehicle trains encounter in the roundabout	79
7.36 Create virtual vehicles for reconfiguration	80
7.37 Vehicle V_{B1} and virtual vehicle $V_{vir,B1}$ encounter each other	81
7.38 Vehicle V_{A1} and virtual vehicle $V_{vir,A1}$ encounter each other	81
7.39 Vehicle V_{B2} and virtual vehicle $V_{vir,B2}$ encounter each other	82
7.40 V_{B2} change the direction and leave the point	82
7.41 V_{A2} and $V_{vir,A2}$ encounter each other	83
7.42 V_{A2} and $V_{vir,A2}$ change the direction and leave the point	83
7.43 V_{B3} and $V_{vir,B3}$ leave the roundabout	84
7.44 V_{A3} leaves the roundabout	85
7.45 Delete virtual vehicles	85
7.46 Update vehicle trains	86
7.47 Physical interaction model	86
8.1 Intelligent vehicles in SET laboratory	93
8.2 Vehicle equipped sensors in our laboratory	94
8.3 Architecture of simulation platform	95
8.4 VIVUS editor for configure vehicles	97
8.5 Configuring scenario in files	97
8.6 Different scenarios VIVUS interface	98
9.1 Vehicles-train run in on lane	99
9.2 Distances between vehicles	100
9.3 Vehicles' speeds	100
9.4 Splitting process	101
9.5 Longitudinal distances between vehicles	102
9.6 Lateral distance between V_{A1} and V_{A2}	103
9.7 Vehicles' speed	103
9.8 Merging process	104
9.9 Distances from V_{A1} and V_{B1} to V_{A2}	105

9.10 Distances between V_{B1} with V_{A1} and V_{A2}	106
9.11 Distance from V_{B1} and V_{A2} to V_{B2}	106
9.12 Lateral distances from V_{A1} to V_{B1} and from V_{A2} to V_{B2}	107
9.13 Speeds of vehicles in train T_A	107
9.14 Speeds of vehicles in train T_B	108
9.15 Reconfiguration inner-train process	109
9.16 Lateral distance between V_{A1} and V_{A2}	110
9.17 Longitudinal distance between vehicles	110
9.18 Vehicles speed	111
10.1 The processing diagram of passing crossroad	114
10.2 Distance changing when crossing	115
10.3 Passing time of each test	116
10.4 The diagram of passing roundabout	118
10.5 Speeds under cooperative control algorithm	119
10.6 Speeds under the traffic light control	120
10.7 Distances under cooperative control algorithm	121
10.8 Distances under the traffic light control	122
10.9 Reconfiguration inner-train in roundabout (part 1)	123
10.10 Reconfiguration inner-train in roundabout (part 2)	124
10.11 Reconfiguration inner-train in roundabout (part 3)	125
10.12 Distances V_{A2} with V_{A1} and V_{B1}	125
10.13 Distances V_{B2} with V_{A1} and V_{B1}	126
10.14 Distances V_{A3} with V_{A2} and V_{B2}	126
10.15 Distances V_{B3} with V_{A2} and V_{B2}	127
10.16 Vehicles' speeds in train T_A	127
10.17 Vehicles' speeds in train T_B	128
10.18 Reconfiguration process in crossroad (part 1)	129
10.19 Reconfiguration process in crossroad (part 2)	129
10.20 Reconfiguration process in crossroad (part 3)	130
10.21 Reconfiguration process in crossroad (part 4)	130

10.22	Reconfiguration process in crossroad (part 5)	131
10.23	Distances between V_{A2} and V_{A1}, V_{B1}	131
10.24	Distances between V_{B2} and V_{A1}, V_{B1}	132
10.25	Distances between V_{A3} and V_{A2}, V_{B2}	132
10.26	Distances between V_{B3} and V_{A2}, V_{B2}	133
10.27	Speeds of vehicles in train T_A	133
10.28	Speeds of vehicles in train T_B	134
10.29	Diagram of passing crossroad (part 1)	135
10.30	Diagram of passing crossroad (part 2)	135
10.31	Third vehicles leaving	136
10.32	Distances between V_{A1}, V_{B1} and V_{C1}	136
10.33	Distances between V_{A2}, V_{B2} and V_{C2}	137
10.34	Distances between V_{A3}, V_{B3} and V_{C3}	137
10.35	Distances between vehicles in train T_A	138
10.36	Speeds of vehicles in train T_A	138
10.37	Distances between vehicles in train T_B	139
10.38	Speeds of vehicles in train T_B	139
10.39	Distances between vehicles in train T_C	140
10.40	Speeds of vehicles in train T_C	140

LISTE DES TABLES

3.1	Different types of agent	30
10.1	Mean crossing time	116
10.2	Different times passing roundabout	122

LISTE DES DÉFINITIONS

1	Définition : Agent	30
2	Définition : Multi-agent system	31
3	Définition : Vehicules-train	45
4	Définition : Vehicle agent	46
5	Définition : Preceding vehicle	48
6	Définition : Vehicules-train agent	50
7	Définition : Virtual-vehicle agent	59
8	Définition : Vehicules order	62

Résumé :

Le but de cette thèse est de proposer une approche basée sur le paradigme multi-agent se focalisant sur les problématiques liées aux intersections entre des trains de véhicules. Ainsi, nous proposons un modèle de contrôle coopératif reposant sur des processus décisionnels multi-niveaux. Ce contrôle permet à la fois de préserver la cohérence et la sécurité de chaque train de véhicule et d'adapter leur comportement de manière à rendre efficace le partage de l'infrastructure. Le modèle proposé est divisé en trois niveaux différents: au niveau du train, au niveau véhicule et au niveau composant de la chaîne de contrôle/commande. Cette thèse se focalise principalement sur les deux premiers niveaux. Ainsi, le processus décisionnel du train prend ses informations au niveau des autres trains et de ses constituants et envoi des requêtes au niveau véhicule. Le processus décisionnel au niveau véhicule fusionne les informations locales de sa perception propre et celles fournies par le train et produit des consignes appliquées par le niveau contrôle/commande. Cette thèse étudie également les possibilités de reconfiguration dynamique des trains en utilisant les intersections.

Mots-clés : Multi-agent, Contrôle coopératif, Multi-niveaux, Véhicules, Train de véhicules

Abstract:

The goal of this thesis is to propose an approach, based on multi-agent paradigm, which aims at dealing with systems level issues focusing mainly on interaction between vehicles-trains of vehicles. Thus, we propose a cooperative control system which relies on multi-level decision processes aimed at dealing with the interaction of platoons at road network nodes. This cooperative control system allows both to maintain the coherence and the safety condition of each involved train of vehicles and to adapt each train components behavior so as to make train shared the road, and especially roundabouts and crossroads, efficiently (i.e. without stopping any vehicle). This cooperative control system is divided into three different levels. The global train state is managed at the train-level decision process based on the train level perceptions. The vehicle-level process makes the decision concerning each individual vehicle according to data provided by the train-level and to the interaction between vehicles. Finally, the motor-level process makes the link between the vehicle-level command and hardware level of vehicles. In this thesis, we focus on the train-level and vehicle-level. When encountering, trains exchange information such as one part of their perceptions.

Keywords: Multi-agent, Cooperative control, Multi-level, Vehicle, Vehicles-train

The logo for SPIM (École doctorale SPIM) features the letters 'S', 'P', 'I', and 'M' in a large, white, sans-serif font. The 'S' is stylized with a blue horizontal bar to its left. The letters are arranged in a slightly staggered, overlapping manner.