



HAL
open science

Les centrales nucléaires comme une option pour aider à décarboner les secteurs de la chaleur Européens et Français ? Une analyse prospective tehnico-économique.

Martin Leurent

► To cite this version:

Martin Leurent. Les centrales nucléaires comme une option pour aider à décarboner les secteurs de la chaleur Européens et Français ? Une analyse prospective tehnico-économique.. Autre. Université Paris Saclay (COMUE), 2018. Français. NNT : 2018SACLC065 . tel-01891071

HAL Id: tel-01891071

<https://theses.hal.science/tel-01891071>

Submitted on 9 Oct 2018

HAL is a multi-disciplinary open access archive for the deposit and dissemination of scientific research documents, whether they are published or not. The documents may come from teaching and research institutions in France or abroad, or from public or private research centers.

L'archive ouverte pluridisciplinaire **HAL**, est destinée au dépôt et à la diffusion de documents scientifiques de niveau recherche, publiés ou non, émanant des établissements d'enseignement et de recherche français ou étrangers, des laboratoires publics ou privés.

Nuclear plants as an option to help decarbonising the
European and French heat sectors ?

A techno-economic prospective analysis

Thèse de doctorat de l'Université Paris-Saclay
préparée à CentraleSupélec

École doctorale n°573 Approches interdisciplinaires, fondements,
applications et innovation (Interfaces)

Spécialité de doctorat : Sciences et technologies industrielles

Thèse présentée et soutenue à Gif-sur-Yvette, le 21/09/2018, par

Martin Laurent

Composition du Jury :

Nadia Maïzi Professeur des universités, Mines ParisTech (Centre de Mathématiques Appliquées)	Rapporteuse
Harri Tuomisto Senior Nuclear Safety Officer, Fortum	Rapporteur
Yves Bréchet Haut-Commissaire à l'Energie Atomique	Président du jury
Jean-Guy Devezeaux de Lavergne Ingénieur chercheur, Docteur d'Etat, CEA (Institut de technico-économie des systèmes énergétiques)	Examineur
Jan Horst Keppler Professeur des universités, Université Paris-Dauphine (Centre de Géopolitique de l'Energie et des Matières Premières)	Examineur
Henri Safa Ingénieur chercheur, Docteur d'Etat, I2EN	Examineur
Pascal Da Costa Maître de Conférences HDR, CentraleSupélec (Laboratoire de Génie Industriel)	Directeur de thèse
Jean-Claude Bocquet Professeur émérite, CentraleSupélec (Laboratoire de Génie Industriel)	Co-Directeur de thèse

The CentraleSupélec School and the Commissariat à l'Energie Atomique and Energies Alternatives do not intend to give any approval or disapproval to the opinions expressed in this thesis; these opinions must be considered as their own.

« Une société qui survit en créant des besoins artificiels pour produire efficacement des biens de consommation inutiles ne paraît pas susceptible de répondre à long terme aux défis posés par la dégradation de notre environnement »

Pierre Joliot-Curie

Abstract

The Ph.D. Thesis studies the role that nuclear plants could play in decarbonizing the European and French heating sectors. A nuclear power plant is basically a thermal plant that convert the nuclear heat into electricity using a turboalternator. But it could also be used in a cogeneration mode producing simultaneously power and heat. The latter offers many advantages including the low carbon profile and the ability to provide flexibility to the power grid. The most widely spread operation of nuclear plants today is electricity only production, which imply the dumping into the environment a large amount of heat that has not been converted to electricity. Transferring part of this heat to nearby industrial sinks or district heating systems would reduce fossil fuel consumption and greenhouse gases (GHG) emissions. If this heat is replacing imported fossil-fuels that would also improve energy self-sufficiency, favouring long-term price stability.

The Ph.D. Report starts with the Introduction (Chapter 1) and ends with the conclusion (Chapter 9). Three Parts are composing the hearth of the Report. Part I evaluates the costs and benefits of diverse heat decarbonisation alternatives. Potentially cost-effective nuclear plant based heating systems are identified. At least seven out of the fifteen theoretical systems envisioned in Europe could prove to be overall beneficial to the society. They represent a good compromise between the diverse socioeconomic criteria affecting decision-making processes, such as costs, greenhouse gases and air pollutant emissions, land use planning, energy self-sufficiency or price stability. The uncertainty is however important, especially regarding transportation and distribution costs. While the expected increase of carbon and fossil fuels prices would favour the development of low carbon heating systems, the economic and environmental balance remains to be evaluated on a case by case basis using advanced engineering softwares. Part I is decomposed into three Chapters:

2. Cost-Benefit Analysis of district heating using heat from nuclear plants in Europe;
3. Nuclear plant based DH systems are compared to other heat decarbonisation options in Dunkirk;
4. Spatial analysis of feasible industrial symbiosis based on nuclear plant sourced steam in France.

Part II analyses multi-stakeholder interactions in real world projects. Challenges to concrete implementation are high, arising from social, political, institutional, financial and psychological dimensions. If nuclear plants are planned on a site that holds potential for cost-effective heat supply (e.g. Gravelines, Le Bugey, Loviisa, Oldbury), they should be built as 'cogeneration ready'. Cogeneration readiness can be delivered for a small incremental cost, and would ensure that the plants are ready for a complete cogeneration upgrade when the market, institutional and socio-political conditions are fulfilled. Alongside, the development of district heating networks and the co-location of diverse industrial factories within contiguous areas should be strongly supported through all channels, especially local ones. Part II is broken down into two Chapters:

5. Single case study of the Loviisa 3 project in Finland, offered by Fortum in 2009;
6. Multicriteria approach to help integrating viewpoints of various actors in a French urban area.

Part III investigates the French case in details through prospective and multi-level perspective approaches. Nuclear plant based heating systems could be progressively implemented between 2020 and 2050 without jeopardizing the development of renewable heat and power sources or other excess heat sources. Such systems are however barely mentioned in international and national energy scenario. While awareness, legitimacy and desirability can be stimulated by active and cross-boundary intermediation, external and unpredictable events can also influence decision-making processes. A pre-requisite to an efficient intermediation is to acknowledge the fact that legitimacy is based not on the knowledge itself but on the working conditions surrounding knowledge creation. Part III is split into two Chapters:

7. Prospective analysis in France towards 2050;
8. Open and active intermediation to enhance project experimentation in France.

Résumé

La thèse étudie le rôle que les centrales nucléaires pourraient jouer dans la décarbonisation des secteurs du chauffage en Europe et en France. Un réacteur nucléaire est d'abord une source de chaleur à longue durée de vie qui peut produire de l'électricité grâce à un turboalternateur. Mais il peut également être utilisé en mode cogénération en produisant à la fois de l'électricité et de la chaleur. Cette option présente plusieurs avantages dont celui de fournir une chaleur exempte d'émissions de gaz à effet de serre (GES) et celui d'offrir de la flexibilité au réseau électrique. Aujourd'hui, l'exploitation la plus courante des centrales nucléaires est la fourniture exclusive d'électricité. Cependant, cela entraîne le rejet dans l'environnement de grandes quantités de chaleur issues de la conversion en électricité. Le transfert d'une partie de cette chaleur aux puits industriels ou aux systèmes de chauffage urbain à proximité réduirait la consommation de combustibles fossiles et les émissions de GES. Si cette chaleur venait en substitution de combustibles fossiles importés, cela permettrait également d'améliorer l'indépendance énergétique, favorisant ainsi la stabilité des prix à long terme.

Le mémoire de doctorat commence avec l'introduction (chapitre 1) et se termine par la conclusion (chapitre 9). Trois parties distinctes constituent le cœur du rapport. La partie I évalue les coûts et les avantages des diverses solutions de chauffage faiblement émettrices de GES. Des systèmes utilisant principalement de la chaleur générée par une centrale nucléaire sont identifiés comme potentiellement compétitifs. Au moins sept des quinze projets de chauffage urbain nucléaire envisagés en Europe pourraient s'avérer globalement bénéfiques pour la société. Ils représentent un bon compromis entre les divers critères socioéconomiques qui influent sur les processus décisionnels, tels que le coût, les émissions de GES et de polluants atmosphériques, l'aménagement du territoire, l'autosuffisance énergétique ou la stabilité des prix. L'incertitude est cependant importante, notamment en ce qui concerne les coûts de transport et de distribution de la chaleur. Si l'augmentation attendue des prix du carbone et des combustibles fossiles favoriserait le développement de systèmes de chauffage à faible émission de carbone, l'équilibre économique et environnemental reste à évaluer au cas par cas en utilisant des logiciels d'ingénierie avancés. La partie I est décomposée en trois chapitres:

2. Une analyse coûts-avantages du chauffage urbain utilisant la chaleur des centrales nucléaires en Europe;
3. Un système de chauffage urbain basé sur une centrale nucléaire est comparé à d'autres options de décarbonisation thermique dans la zone urbaine de Dunkerque ;
4. Une analyse spatiale pour la France des possibles symbioses industrielles utilisant la vapeur d'origine nucléaire.

La partie II analyse les interactions multipartites dans des projets concrets. Les défis à la mise en œuvre concrète sont élevés, découlant des dimensions sociales, politiques, institutionnelles, financières et psychologiques. Si les centrales nucléaires sont prévues sur un site présentant un potentiel économique d'approvisionnement en chaleur (par exemple, Gravelines, Le Bugey, Loviisa, Oldbury), elles devraient être construites «prêtes à la cogénération ». Cela peut être réalisé pour un faible coût supplémentaire et garantirait que les centrales soient prêtes pour une transformation complète en mode cogénération si les conditions de marché, institutionnelles et sociopolitiques se remplissent ultérieurement. Parallèlement, le développement des réseaux de chauffage urbain et la co-implantation de diverses usines dans des zones contingentes devraient être fortement soutenus par tous les canaux, en particulier locaux. La partie II est divisée en deux chapitres:

5. Une étude qualitative du projet Loviisa 3 en Finlande, proposé par Fortum en 2009;
6. Une approche multicritère pour aider à intégrer les points de vue de divers acteurs dans une zone urbaine française.

La partie III du mémoire examine le cas français en détail par des approches prospectives à plusieurs niveaux. Les systèmes de chauffage à base de centrales nucléaires pourraient être mis en œuvre progressivement entre 2020 et 2050 sans compromettre le développement de sources de chaleur et d'électricité renouvelables, ou d'autres sources de chaleur excédentaires. De tels systèmes sont cependant à peine mentionnés dans les scénarios énergétiques internationaux et nationaux. Si la sensibilisation, la légitimité et la désirabilité peuvent être stimulées par une intermédiation active et transfrontalière, des événements externes et imprévisibles peuvent aussi influencer le processus décisionnel. Une condition préalable à une intermédiation efficace est de reconnaître le fait que la légitimité ne repose pas sur la connaissance elle-même mais sur les conditions de travail entourant la création du savoir. La partie III est divisée en deux chapitres:

7. Une analyse prospective de l'utilisation de chaleur en provenance de centrales nucléaires en France vers 2050;
8. Une intermédiation ouverte et active pour encourager l'expérimentation de projets de production de chaleur avec des centrales nucléaires en France.

List of publications

ISI (International Scientific Indexing) Articles

- Leurent, M., Jasserand, F., Locatelli, G., Palm, J., Rämä, M., Trianni, A., 2017. Driving forces and obstacles to nuclear cogeneration in Europe: Lessons learnt from Finland. *Energy Policy* 107, 138–150.
- Leurent, M., Da Costa, P., Rämä, M., Persson, U., Jasserand, F., 2018. Cost-benefit analysis of district heating systems using heat from nuclear plants in seven European countries. *Energy* 149, 454–472.
- Leurent, M., Da Costa, P., Jasserand, F., Rämä, M., Persson, U., 2018. Cost and climate savings through nuclear district heating in a French urban area. *Energy Policy* 115, 616–630.
- Leurent, M., Da Costa, P., Sylvestre, S., Berthélémy, M., 2018. Feasibility assessment of the use of nuclear plant-sourced steam for French factories considering spatial configuration. *Journal of Cleaner Production* 189, 529-538.

Non ISI Articles (Peer-Reviewed)

- Leurent, M., 2015. Pas de croissance soutenable sans innovations financière - La cogénération nucléaire, une innovation d'importance stratégique pour la transition écologique. *Entreprendre & Innover* 25, 75–85.
- Leurent, M., 2015. La cogénération nucléaire, analyse de l'expérience finlandaise. *Lettre I-Tésé* 26. Autumn 2015.
- Leurent, M., 2016. Biofuels production supported by nuclear cogeneration: Opportunities and challenges. Contribution to the working group of the Organisation for Economic Co-operation and Development (OECD) on the role and economics of nuclear cogeneration in a low carbon energy future. Paris, Sept. 2016.
- Berthélémy, M., Leurent, M., Locatelli, G., 2016. The development of small modular reactors: Which markets for which applications? *Lettre I-Tésé* 29. Autumn 2016.
- Leurent, M., 2018. Cost and climate savings through nuclear plant based heating systems. *Science Trends*, April 25. Available from: https://sciencetrends.com/?p=16146&preview=1&_ppp=4d771cbb08
- Leurent, M., 2018. GIS based analysis of the district heating potential in France. 3rd place winner of the 6th International DHC+ Student Award. *International Euroheat&Power Magazine*, issue IV/2018. Presented at the 2018 Global District Energy Days. Helsinki, September 2018.
- Leurent, M., 2018. Repenser les débats sur la transition énergétique: Vers une utilisation plus efficiente des centrales thermiques nucléaires? Dirigé par Martin Leurent dans le cadre des travaux menés par l'Institut Walden en collaboration avec le CEA.

Conference Articles

- Leurent, M., Cany, C., 2016. A Comprehensive Taxonomy of Non-electric Nuclear Markets: Application to the Market Perspectives for France. Proceeding of the 39th Conference of the International Association for Energy Economics (IAEE). Bergen, June 2016.
- Leurent, M. 2016. Economic assessment of district heating supplied with nuclear energy: A territorial analysis in France. Contribution to the technical meeting of the International Atomic Energy Agency (IAEA) on the socio-economic aspects of nuclear cogeneration. Vienna, November 2016.
- Leurent, M., 2016. Nuclear cogeneration: Linking heat and nuclear sector. A discourse coalition approach. Proceeding of Les Journées du Risque of Les Mines de Nantes. Nantes, November 2016.

- Leurent, M., Da Costa, P., Rämä, M., Persson, U., Jasserand, F., 2017. Cost-Benefit Analysis of District Heating using Heat from Nuclear plants in Europe. Proceeding of the 3rd International Conference on Smart Energy Systems and 4th Generation District Heating. Copenhagen, September 2017.
- Leurent, M., 2018. Cost-Benefit Analysis of District Heating using Heat from Nuclear plants in Europe. Presented at 'Les Jeudis du LGI'. Laboratoire de Génie Industriel, CentraleSupélec, January 2018.

Acknowledgements

This PhD thesis is first dedicated to my parents, Véronique and Philippe Leurent, for always being there for me. I am indebted to my sisters Gabrielle Baruteau and Valentine Marfaing, my brothers-in-law Alban and Pierre, my niece and nephews Louise, Baptiste and Antoine, for their affection and support. I would like to express my deepest thanks to my grand-parents Jacques and Bernadette Magimel-Pelonnier for their great generosity towards their family and, more importantly, beyond. Kind thanks also to Guy and Martine Leurent, to my uncles, aunts and cousins.

My sincere gratitude goes to my supervisors Jean-Claude Bocquet, Pascal Da Costa, Jean-Guy Devezeaux de Lavergne and Henri Safa for their visions, patient guidance, and useful criticisms of and comments on my research work. I am also grateful to Nadia Maïzi, Harri Tuomisto, Yves Bréchet and Jan-Horst Keppler for being part of the Ph.D. Jury. I thanks Michel Ciais and Bertrand Guillemot for their implication. Despite their busy schedule, their answers to my questions often became long discussions of technical details and of energy policies. I am greatly indebted to Michel Cruciani for his valuable advises and kindness. My thankfulness is extended to Frédéric Jasserand, for his friendly advices and his irreplaceable help in modeling. Many thanks also to Cédric Paulus and Sébastien Sylvestre for the enjoyable and cooperative exchanges we had. In general, all the people I met in CEA, including my colleagues from I-Tésé, have always been very nice and interesting people. The same can be said of the PhD students there, Antoine, Camille, Linh, Maryeme, Olfa and Robin. Special thanks to Patricia Thibaud for her sense of humor, and to Alain Le Duigou for his humor and discussions.

I am glad to acknowledge the support provided by VTT, the technical research center of Finland. The internship I did there prior to start the PhD has clearly fasten my comprehension of the stakes surrounding energy systems. Special thanks are given to Miika Rämä for carefully answering my numerous questions and for kindly offering his relevant advises, both in the energy and bouldering fields. I am also grateful to Kati Koponen whose nuanced and scientifically sound judgment has always been very much appreciated.

I want to thanks the many people who helped me one way or another. It includes the experts interviewed in Finland, either from the City of Helsinki Environment Center, the Environmental Committee of Helsinki, Helen, Fennovoima, Fortum, the Ministry of Employment and the Economy (TEM) or the Radiation and Nuclear Safety Authority (STUK). Equally interesting were discussions with the experts from the Ad-Hoc Expert Group on the Role and Economics of Nuclear Cogeneration in a Low Carbon Energy Future' from the Organisation for Economic Co-operation and Development (NEA/OECD), particularly with Henri Paillere. The same applies to the other French experts, either from ADEME, AMORCE, ANCRE, CEREMA, CLCV, Dalkia, the Dunkirk conurbation committee, EDF, Engie, FNCCR, the Hauts-de-France region, MNLE or PROSIM. I do not forget the researchers Giorgio Locatelli, Jenny Palm, CédUrban Persson and Andreas Trianni, whose scientific expertise have been of great help. My deep gratitude also goes to Pascal Vanhove, leading professor of the Ozenne preparatory school.

Finally, I am grateful to my friends for their enthusiastic support. All the moments shared with them represent a great source of joy and inspiration. Warm thanks to Adrien, Agathe, Alexandra, Alexandre (B. and C.), Alix, Antoine V., Céline, Camille, Clément, Coline, Diego, Elliott, Etienne, Fabien, Felipe, Florent, Germain, Guillaume, Lola, Louis, Luc, Mathieu, Nona, Nicolas, Paul, Pierre (F., G., T.), Pierre-Olivier, Rie, Valérie, Victor, Vincent (F. and R.). Special thanks to Antoine F. for his continuous friendship and the originality of his knowledge and discussions. I sincerely thanks Charlotte for always reminding me of the importance of altruism and psychology in life. Once is not custom I must acknowledge my large affective debt towards Bastien, Thibaut and Thomas. From high school dumb actions to parties, and from Helsinki to Patagonia, thanks for being there through it all.

Table of contents

Chapter 1: Introduction.....	15
I. Cost-Benefit Analysis of systems using heat from nuclear plants.....	48
Chapter 2: Cost-benefit analysis of district heating systems using heat from nuclear plants in seven European countries.....	50
Chapter 3: Cost-benefit analysis of plausible heat decarbonisation pathways in the French urban area of Dunkirk.....	91
Chapter 4: Feasibility assessment of the use of steam sourced from nuclear plants for French factories considering spatial configuration.....	167
II. Analysis of Multi-Stakeholder Interactions in real projects.....	191
Chapter 5: Driving forces and obstacles to nuclear cogeneration in Europe: Lessons learnt from Finland	193
Chapter 6: A multicriteria approach to evaluating heating options in the French urban area of Dunkirk.....	219
III. In-Depth Analysis of the potential in France.....	248
Chapter 7: Prospective analysis of nuclear plant sourced heat utilisation in France	250
Chapter 8: Stimulating niche nurturing process for heat production with nuclear plants in France. A multi-level perspective	276
Chapter 9: Conclusion	295
General References	297
List of Figures	326
List of Tables	334

Comments

The first pages of chapters 2-8 include a description of the content along with comments that help understanding the added value of a specific chapter relative to others. The numbers of these key pages are shown in the Table of Content here above. This approach should help saving time, and can help determining which Chapter(s) should be read more carefully. The comprehensive look-up Table 1.2 (p.37) is also useful to that purpose. Note that each Chapter can be read independently from one another.

Chapter 1

Introduction

Chapter 1 aims to provide a global overview of the stakes surrounding the Ph.D. Background informations are provided in Section 1. Section 2 presents and justifies the technological scope by reviewing the worldwide literature. Section 3 and 4 describes the research questions and the main methodology adopted, respectively. The introduction ends with a comprehensive description of the plan followed by the Ph.D. Report.

Research scope

Pressurised Water Reactors, Small and Modular Reactors, generation IV reactors, hydrogen, desalination, district heating, industrial process heating

Geographical boundary

Worldwide

Publications

Leurent, M. 2016. Biofuels production supported by nuclear cogeneration: Opportunities and challenges. Contribution to the working group of the Nuclear Energy Agency (NEA) on the role and economics of nuclear cogeneration in a low-carbon energy future. Paris, Sept. 2016.
Berthélemy, M., Leurent, M., Locatelli, G. 2016. The development of small modular reactors: Which markets for which applications? Lettre I-Tésé, autumn 2016.

1. Background

There is a growing concern about the unsustainability of the economic model in the developed countries; in particular with regards to climate change (EC (European Commission), 2014a; Lockie and Sonnenfeld, 2013). The greenhouse gases (GHG) generated by human activities has led to global warming. Among these GHG, carbon dioxide (CO₂) is the main contributor. Overall the earth, averaged near-surface air temperature rose by around 0.8°C between 1850 and 2012, and the rate of temperature increase has nearly doubled in the last 50 years (GISTEMP Team, 2016). The clearest present-day impacts of climate change are seen in the natural environment, and are associated with warming temperatures and increase in the number, duration and severity of heatwaves (Australian academy of science, 2015). Impacts include changes in the growth and distribution of plants, animals and insects; poleward shifts in the distribution of marine species. In the business as usual case (i.e. if the current trend of GHG emissions is prolonged) that sees the average temperature rise by 4.5°C in 2100 compare to 1850 is prolonged, two thirds of insects and plants, and 40% of mammals, would lose more than half their geographic range by 2100 (Warren *et al.*, 2018). In the case of a 2°C rise, these estimations are of 18%, 16% and 8% for insects, plants and vertebrates, respectively (Warren *et al.*, 2018). Even half a degree makes a huge difference for the biodiversity, including humans. In India, the amount of heat waves killing more than 100 people has been multiplied by 2.5 times during 1960 and 2009 while the average temperature has increased by 0.5°C during the same time period (Mazdiyasi *et al.*, 2017). According to Mora *et al.* (2017), up to 75% of humans could be exposed to deadly heat waves towards 2100 if the average temperature at that time is 4.5°C higher than it was in 1850. Besides, climate change also affect human activities through ecosystem services (e.g. the effects of changing distributions of fishes and other marine organisms on commercial and recreational fisheries). To maintain the possibility of keeping global warming below 2°C towards 2100, annual energy-related GHG emissions should be reduced by 43% towards 2040 compare to 2014 levels (IEA (International Energy Agency), 2017a). However, the same report also emphasizes that the global energy demand should increase by 30% during this time period (New Policies Scenario; IEA, 2017a), leading to an increase in GHG emissions by 13%.

There is clearly an urgent need to transform our economic model so as to reduce GHG emissions. Advisable changes include, but are not limited to, the transition towards sustainable energy production systems. According to the International Panel on Climate Change (IPCC, 2014), electricity and heat production are responsible for 25% of worldwide GHG emissions. The IEA's 2 degree scenario (2DS; IEA, 2017) considers that the electricity sector could be totally decarbonise towards 2050 by replacing all fossil-fuel generation capacities with renewables or nuclear capacities and deploying carbon capture and storage solutions. With regards to the heat sector, improved energy efficiency and implementation of low fossil-carbon energy based systems are often considered as the most direct and cost-effective approach to reduce GHG emissions (see e.g. Chang, 2015; Chertow and Lombardi, 2005; Connolly *et al.*, 2014; Huisingh *et al.*, 2015; IEA, 2011). As often recalled in the literature, it is crucial to implement the energy systems that shows the best compromise between GHG emissions and cost. The importance of the energy sector in the economy has recently been reconsidered by Giraud (2014) and Safa (2017). According to Giraud (2014), most of modern economic models tend to underestimate the role of energy in our economy. These models often assume that energy market are a perfect equilibrium, while in practice there are many market failures (e.g. business consortium, speculation). As a consequence, they consider that the correlation between the primary energy consumption and the Gross Domestic Product (GDP) is approximately equal to 10%. Empirical results obtained by Giraud (2014) and Safa (2017) have shown that, in reality, this correlation vary from 40% to 70% depending on countries, with an average of 60%. Policy makers and stakeholders should be informed of how important it is to minimise the cost of energy systems while following decarbonisation pathways. If not, the transition towards sustainable energy systems could negatively affect the GDP growth; which may in turn lead to lower the public acceptance for capitalistic energy projects. The low

carbon solutions to be implemented should be chosen carefully, on a case by case basis, and with the aim to prioritise the least-cost alternatives.

Combined heat and power plants (CHP) can offer significant competitive advantages. The fundamental idea of CHP is to use heat resources that would otherwise be wasted. That is, the heat that cannot be converted into electricity due to the Carnot efficiency constraint (Ginley and Cahen, 2011). CHP goals are in line with the European Union (EU) plans for a low-carbon society (EC, 2012), particularly energy efficiency (European Parliament, 2012, 2009). About 5% of the final energy consumption for space and water heating in the EU is provided with CHP plants (EC, 2016a; IEA, 2015). CHP are also commonly used in industrial complexes for process heat applications.

In those countries which are using nuclear energy for power production, operating future nuclear units in a CHP mode is an option that generate a growing interest (see e.g. EC, 2015a; EUROPAIRS, 2009; IAEA (International Atomic Energy Agency), 2016a; NC2I (Nuclear Cogeneration Industrial Initiative), 2015; NEA (Nuclear Energy Agency), 2015). These reports rarely make the distinction between nuclear combined heat and power plants (NCHP) and nuclear plants solely dedicated to heat production (as envisioned by the Thermos project (CEA (French nuclear and alternatives energies commission, 1976; cited by IAEA, 1997) or, more recently, by China (Decentralized energy, 2017). To avoid any misunderstanding, nuclear plant based heat production (or nuclear plant-sourced heat) is used in the PhD when referring indifferently to NCHP or heat-only reactors. All the above mentioned reports aim to highlight the economic and environmental potential of nuclear heat production. Yet, the academic literature mostly address technical aspects (e.g. Hirsch *et al.*, 2016; Safa, 2012; Le Pierrés *et al.*, 2009). Even though preliminary economic evaluation do exist (e.g. Jaskólski *et al.*, 2014; Jasserand and Lavergne, 2016; Jaskólski *et al.*, 2017), many research aspects remain unexplored. E.g. there is no suitable analytical tool to assess the costs and benefits of those systems which are designed to use the heat from nuclear plants. Besides, discussions currently disregard the social, political and institutional dimensions.

This Ph.D. aims to improve the knowledge on the potential of nuclear plant-sourced heat to help achieving the EU and French energy policy objectives towards 2050, by adopting an interdisciplinary approach. This Introduction is organised as follow. Section 2 reviews the worldwide literature on nuclear non-electric applications. Section 2 also serves to justify the reasons behind the limitation of the research scope, which is precisely defined in Section 3. Section 4 exposes the main methodological approaches supporting the Ph.D. Section 5 finally provides a comprehensive plan of the Report.

2. Literature review

Section 2 provides an overview of the literature related to the use of heat from nuclear plants. The existing literature is considering very diverse nuclear technologies, and the range of market applications is equally heterogeneous. The underlying objective of Section 2 is to justify the choices made to restrain the scope of the Ph.D. (precisely defined in Section 3). Section 2.1 presents the literature on nuclear hybrid systems. Section 2.2 then focuses on the heat applications of Pressurized Water Reactors (PWR) in Europe and France. Section 2.3 finally discusses the stakes specific to district heating (DH) systems and the potential supply of DH with PWR.

2.1. Nuclear hybrid systems

Section 2.1 highlights the diversity of nuclear hybrid systems while explaining the reasons that drove us to discard some of them. Sub-section 2.1.1 briefly depicts the worldwide literature on nuclear hybrid systems. Sub-section 2.1.2 and 2.1.3 then restrict the technological scope to PWR and discuss

the possibility to produce hydrogen and to desalinate seawater with these reactors. Sub-section 2.1.4 finally presents the on-going discussion on small and modular PWR.

2.1.1. A great diversity of nuclear technologies and market applications

Nuclear hybrid energy systems are schemes designed to provide multiple services (e.g. electricity, heating, cooling, freshwater, synthetic fuels) with centralised nuclear facilities. The literature is considering a large range of technological options for nuclear hybrid energy systems, from Light Water Reactor (LWR) based designs to Generation IV reactor concepts. As shown in Figure 1.1, the range of potential application is equally diversified, depending on the supply temperature of nuclear reactors. Techno-economic aspects regarding non-electric applications of future nuclear technologies are discussed in e.g. Fütterer *et al.*, 2014; IAEA, 2017a; Locatelli, 2013). Given that most nuclear reactors operating today in the world (277 out of 438) and tomorrow (59 out of 69 under construction; IAEA, 2017a) are PWR (the most conventional type of LWR), the largest amount of heat generated by nuclear plants towards 2050 will be PWR sourced. This is why this Ph.D. is limited to the study of heat generation with PWR. PWR can be safely designed and operated in CHP mode (STUK, 2009), as confirmed by at least 51 commercial experiences (IAEA, 2017b, 2003). PWR can also be dedicated to the sole production of heat (IAEA, 1997; Decentralized energy, 2017).

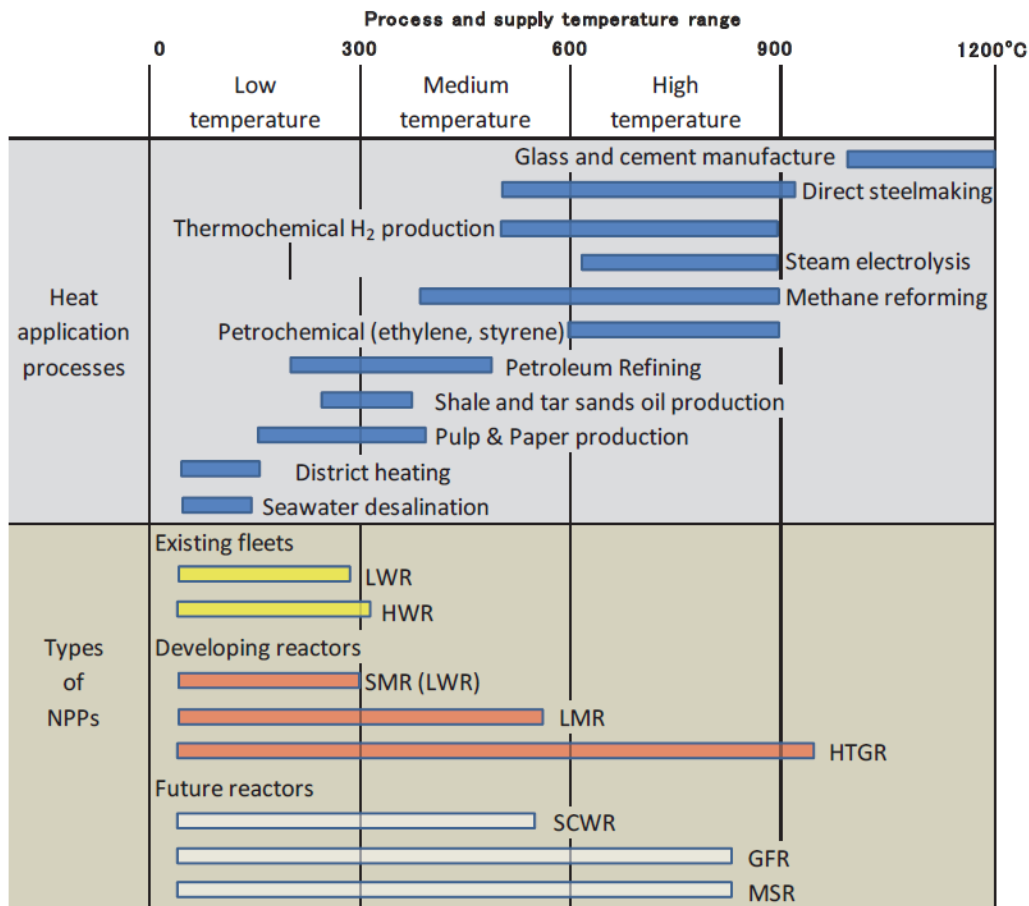

Figure 1.1: Temperature ranges of heat applications and types of nuclear plants. Data source: IAEA, 2017.

Notes:

(*) GFR — gas cooled fast reactor; HTGR — high temperature gas reactor; HWR — heavy water reactor; LMR — liquid metal reactor; LWR — light water reactor; MSR — molten salt reactor; SCWR — supercritical water reactor; SMR — small modular reactor.

(**) Despite not being shown in this Figure, hydrogen can also be produced with LWR through alkaline electrolysis and steam electrolysis (see e.g. Baurens *et al.*, 2013).

2.1.2. Hydrogen production with PWR

While being of great interest for future energy systems, nuclear plant based hydrogen production is not studied here since it does not require a large amount of heat and hence cannot be associated to the underlying Ph.D. concept. That is, increased efficiency achieved by using heat for non-electric applications. Besides, hydrogen production as a way to do load-following with nuclear plants has already been subject to in-depth investigations (see e.g. Cany, 2017; Mansilla *et al.*, 2007; Orhan and Babu, 2015; Scamman and Newborough, 2016; Sorgulu and Dincer, 2017). In the context of the French energy system, such systems could allow further penetration of intermittent renewables while maintaining favourable economic conditions for nuclear plants (Cany *et al.*, 2016).

2.1.3. Seawater desalination

Some EU countries (e.g. Spain, Italia, Greece) may suffer significant water scarcity issues by 2030 (IEEP (Institute for European Environmental Policy), 2008). The Water Exploitation Index (WEI, the mean annual total demand for freshwater divided by the long term average freshwater resources) of French (Rhône, Seine and Scheldt) and UK (Anglian, Humber and Themes) river basins could be comprised between 23.2% and 55.9% towards 2030 (IEEP, 2008). A WEI above 20 % implies that a water resource is under stress and values above 40 % indicate clearly unsustainable use of the water resource (EEA (European Environment Agency), 2009; citing Raskin *et al.*, 1997). Even though it should increase, the energy demand for desalination in the EU will likely remain lower than the energy demand for space heating and domestic hot water. Worldwide, however, sea water desalination is one of the most promising nuclear non-electric market, and this because:

- (i)** Water scarcity issues are gaining importance;
- (ii)** Nuclear technologies can provide cost-effective desalination solutions (see e.g. Karagiannis and Soldatos, 2008; Misra, 2007; Nisan and Dardour, 2007). In particular, multi-effect distillation plants can be operated below 70°C, thus allowing the use of wasted heat or, in case of a CHP, minimising the electricity losses due to heat generation;
- (iii)** Desalination do not require heat continuously, facilitating the coupling with those thermal plants which aim to provide flexibility services to the power grid (Locatelli *et al.*, 2017).

While this Ph.D. does not study this option in-depth, the deployment of nuclear plant based seawater desalination plants in the EU cannot be excluded. In a context of rising water scarcity issues, such an option deserve further investigations.

2.1.4. Small and Modular Reactors

Those Small and Modular Reactor (SMR) concepts which target non-electric applications can also be defined as nuclear hybrid systems. Among the four SMR market studies reviewed by Berthlémy *et al.* (2017; referring to Chénais *et al.*, 2014; NEA, 2011; NNL (National Nuclear Laboratory), 2014; Uxc (Ux consulting company), 2013), three do see potential for CHP applications with LWR based SMR. Compared to large nuclear reactors, SMR may be advantageous to address cogeneration markets (see in Section 2.1 of Chapter 5 for further discussion); and this because:

- (i)** SMR may be easier to deploy close to urban areas thanks to high safety standards, thus limiting the major cost of building a heat transport pipeline (e.g. Kessides, 2012; Locatelli *et al.*, 2015; Rowinski *et al.*, 2015);
- (ii)** The smaller size of SMR matches with a wider range of heating needs;
- (iii)** If SMR are largely deployed in the future, they could benefit from positive learning by doing effects, so that the deployment time may be lower than larger reactors.

Overall, it is reasonable to say that the optimal size of a NCHP should be determined on a case by case basis. Questions which may help making a choice are e.g. ‘What is the size of the heat demand?’; ‘Is the building of SMR instead of larger reactors likely to allow the siting of nuclear units closer to consumption sites?’; ‘Can we expect a shorter deployment time if building several SMR?’

SMR could represent 1% to 20% of the total new built nuclear capacity towards 2035 (see Figure 1.2), and most of SMR projects are being planned out of the EU (Berthélemy *et al.*, 2016). Stakeholders do not seem to think that SMR will have a major impact on the realization of the EU and French energy policy objectives towards 2050. This should nonetheless be considered with caution given that prospective studies often fail to foresee radical changes, which are unpredictable by nature.

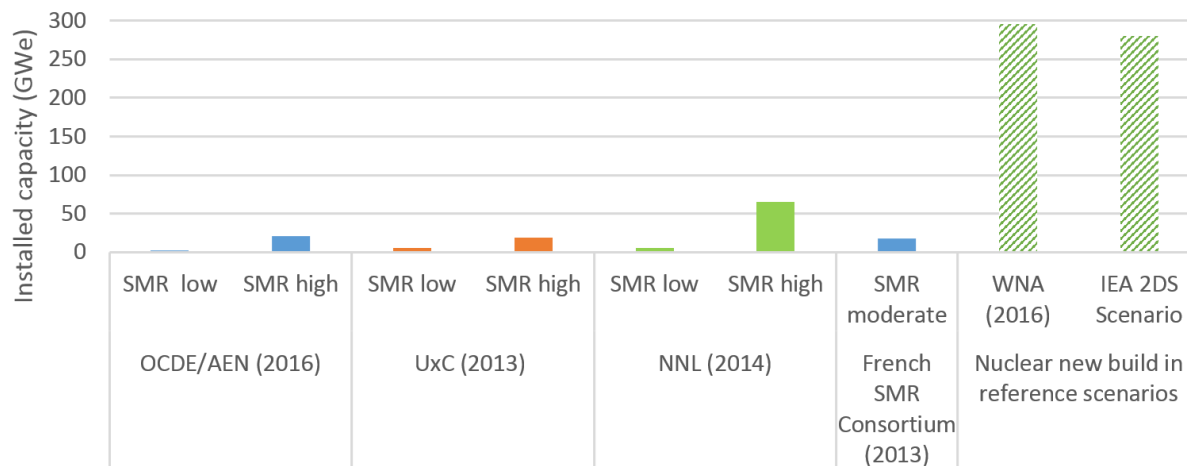

Figure 1.2: Benchmarking of recent SMR market studies (2035 time horizon). Data source: Berthélemy *et al.* (2016).

For the same reasons as for large reactors (see 2.1.1), only LWR based SMR are considered in this Ph.D. The results presented in this Ph.D. are, to some extent, valid whatever the size of the PWR is. The modelling approach (simulation approach considering the marginal cost attributable to heat production with the nuclear plant) adopted could indeed be applied to SMR without modifications (see Section 3 for further explanations).

2.2. Heat applications of PWR in Europe

The Ph.D. investigates the potential of PWR (often referred simply as nuclear plants) to supply space heating and domestic hot water to residential and commercial buildings through DH networks, and to supply industrial plant factories (process heating only). Nuclear plants have already been supplying heat for commercial applications, at temperatures up to 250°C (Verfondern, 2013). This can be done without jeopardizing the reactor’s safety (STUK, 2009: p. 6). DH applications are investigated for 15 urban areas located in seven European countries (see Chapter 2), while industrial applications are studied within the French boundaries only (see Chapter 4). Overall, the Ph.D. mostly investigate DH supply. There are three reasons behind this choice:

(i) In Europe (including Russia, Ukraine and the UK), DH is the most tried-and-tested nuclear non-electric application, and it certainly has the highest potential in the short run. As depicted in Figure 1.3, space heating and domestic hot water demand in residential and commercial buildings represent the largest market for nuclear heat production in France (>100 TWh_{th}; see Chapter 2). All together, the industrial plant factories identified as relevant to be supplied with nuclear heat require approximately 30 TWh_{th}/a of heat below 250 °C (see Chapter 4). Besides, this amount (30 TWh_{th}/a) considers the needs of all plant factories located in a 100km radius from a French nuclear site, while in reality only the closest factories could be cost-effectively supplied with nuclear units. While the creation of industrial symbiosis complexes based on nuclear plants does hold significant potential for cost and GHG emissions savings, it require optimal relocation of plant factories closer to nuclear sites to reach the full possibility (see Chapter 4). On the contrary, the geographic location of residential and commercial heat demand should remain relatively stable and a large part of this demand will remain attractive to DH markets for many decades (see Chapter 7). Given that the number of heating degree

days is lower in France than in most of European countries (see Figure 1.3), it is reasonable to say that DH holds the largest potential for heat supply with nuclear plants overall Europe.

(ii) If the aim of operating a nuclear plant in a CHP mode is to increase the flexibility of the power production while maintaining reasonable load-factors, stakeholders may prefer DH, hydrogen or desalination applications (Locatelli *et al.*, 2017). To be flexible, a NCHP might operate at full load during the night when the request of electricity is low, and be turned off during most of the daytime. This criterion discards all the applications that have high thermal inertia and/or do not allow daily load variations (with rather fast dynamics), which is the case of many industrial processes (see Chapter 4). On the contrary, DH + NCHP systems with sufficient storage capacity can fulfill the requirements for flexible power generation (Rämä, 2018). Industrial applications, if they do not suit to a business model in which the main service offered by nuclear plants are electricity generation and flexibility, do however open opportunities for smaller units following new business rules (see Chapters 4, 7 and 8);

(iii) The evaluation of systems coupling nuclear plants with industrial plant factories requires to collect many data. Information such as the size of the plant factories and the plants location together would give information on the ease of access. In addition, the viability of the project cannot be established unless industries provide details on planned and unplanned plant shutdowns. The information on source availability appears to be crucial to the design of industrial complexes based on nuclear plants. Data collection is however be difficult due to confidentiality issues. In the frame of this Ph.D., valuable data were obtained for France (thanks to ANCRE (French National Alliance for Energy Research Coordination), 2015; see Chapter 4), but no data were obtained for other European countries.

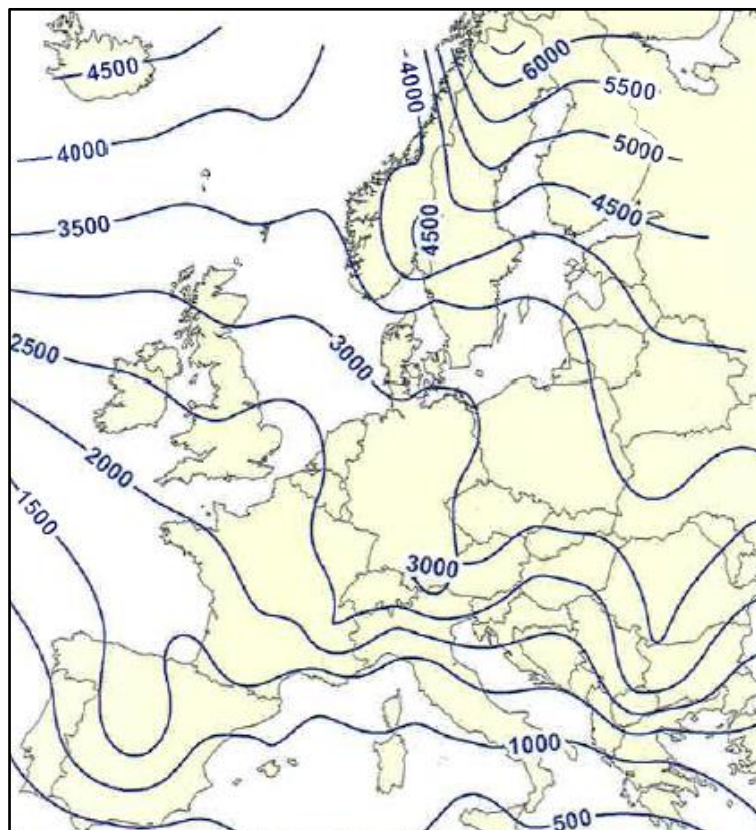

Figure 1.3: Climatological degree-days in Europe for the time period 1981-2000 with an effective indoor temperature of 17°C and a threshold temperature of 13°C. Data source: Frederiksen and Werner (2013).

Notes:

(*) HDD are a measure of how much (in degrees), and for how long (in days), the outside air temperature was below a certain level.

(**) The map is not representative of all locations in each country since the data grid consists only of 80 locations.

2.3. Residential and commercial applications of PWR in Europe

Section 2.3 aims to provide a comprehensive overview of the stakes specific to the European DH sector, as well as of the role played by nuclear plants in the supply of DH networks. Sub-section 2.3.1 first provides a state-of-the-art of DH systems in Europe. Sub-section 2.3.2 then presents the stakes surrounding DH systems in a context of increasing energy performance of buildings. Sub-section 2.3.3 exposes the previous and planned experiences of nuclear DH production. Sub-section 2.3.4 finally discusses the expansion of the cooling demand and the possibility to use the heat of nuclear plants to supply district cooling systems (using absorption cooling chillers).

2.3.1. State of DH systems in Europe and France

Energy consumption in residential and commercial buildings represents approximately 40% of the total energy produced in the EU, and is associated with 36% of the total EU' CO₂ emissions (European Parliament, 2010). Space heating and domestic hot water demand correspond to approximately 80% of the total energy consumed in these buildings (European Parliament, 2010). As detailed in Table 1.1, direct burning of fossil-fuels within on-site boilers represents 68% of the final energy used to provide EU heat loads, while DH accounts for 7% (EC, 2016b). The share of buildings served by DH nonetheless varies widely among countries (see Figure 1.5), from about 60% in Denmark down to 7% and 2% in France and the UK, respectively (IEA, 2014).

Heat source / fuel	EU regions		
	South	Central & East	North & West
Biomass	27%	20%	21%
Electricity	18%	1%	13%
Oil	32%	3%	20%
Gas	23%	7%	39%
DH	0	29%	6%
Coal	0	41%	1%

Table 1.1: Heating sources in European residential buildings. Data source: Intelligent Energy Europe Programme (2015).

According to Frederiksen and Werner (2013), the fundamental idea of DH is 'to use local fuel or heat resources that would otherwise be wasted, in order to satisfy local customer demands for heating, by using a heat distribution network of pipes as a local market place'. In general, the DH systems within EU have been faithful to this concept, with only 17% (against 68% when considering all heating systems) of the heat demand supplied through the direct use of fossil-fuels within heat-only boilers (Werner, 2017; using data from IEA, 2015). The major DH heat sources in EU are shown in Figure 1.4, including the direct use of renewables, the use of renewables in CHP plants, and the use of fossil fuels in CHP plants. Future DH systems should further integrate CHP, renewable or excess heat sources, as promoted by the directive 2012/27/EC (European Parliament, 2012).

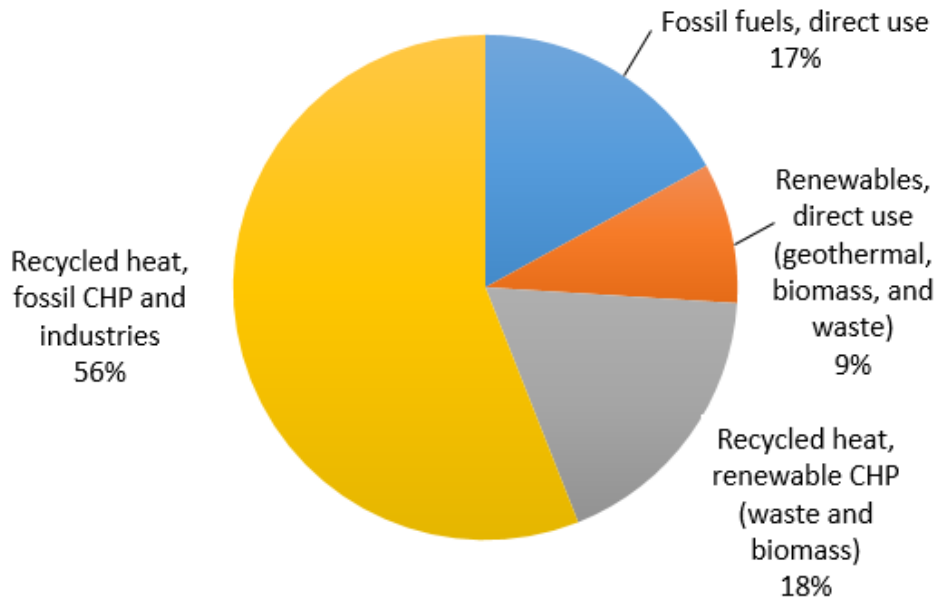

Figure 1.4: Heat supplied into all DH systems in the EU according to four heat supply methods, 2014. Data source: Werner (2017); using data from IEA (2015).

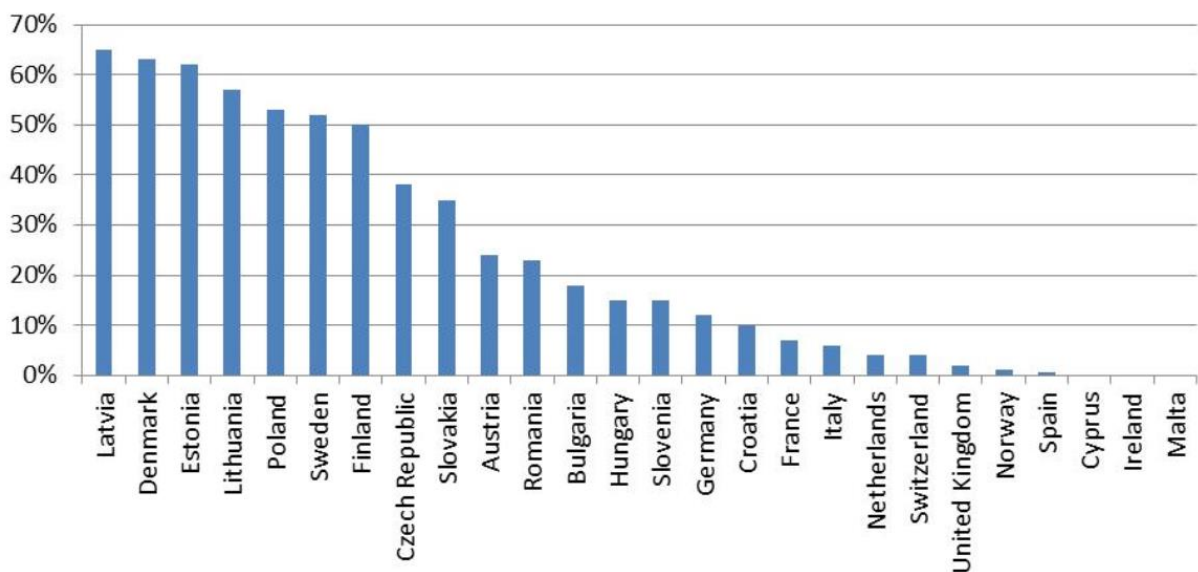

Figure 1.5: Percentage of the population served by DH systems. Data source: EC (2016c), using data from Euroheat & Power (2015a).

In ‘DH learning countries’ such as France and the UK, DH expansion is encouraged by public authorities (AMORCE (French DH association), 2015; BuroHappold Engineering, 2016). The share of renewable or excess heat sources in the total DH deliveries to French networks increased from 7.9 TWh_{th}/a in 2009 to 13.8 TWh_{th}/a in 2017 (SNCU (French National Union for DH), 2017). This leap can be partly attributed to the public DH support set up by the government in 2009 (SNCU, 2017). The ‘Fonds Chaleur’ offers a financial contribution of about €5/MWh_{th} to DH projects aiming to use more than 50% renewable or excess heat sources, provided that the linear heat density exceeds 1.5 MWh_{th}/m. a (ADEME, 2017). However, ADEME (2017) emphasizes that the number of subsidized DH projects will have to more than double to achieve the French policy objectives. If the development trend of 2009-2017 is prolonged, renewable and excess DH deliveries should total 23 TWh_{th}/a in 2030 (ADEME, 2017), yet the national 2030 objective is 39 TWh_{th}/a (*Assemblée nationale* (French national assembly), 2015). The underlying requirement of such an ambitious target is the replacement of

current heating equipments with DH systems. Local electricity and gas boilers supply 33% and 44% of French dwellings with heating and domestic hot water, respectively (AMORCE, 2015). Previous research have shown that direct heating is not the most efficient use of electricity (see e.g. Webb, 2015). Three main reasons can be advanced:

(i) Despite low initial investment, the levelised cost of heating buildings with electric heaters is 25 to 35% higher than with an average DH system (in a French average building, including all taxes; see AMORCE, 2015);

(ii) Using direct electric heaters increases the power load variations, and hence lead to larger volatility of electricity prices (in particular during the heating season). ADEME (2016) have shown that replacing direct electric heaters with heat pumps could reduce the French power consumption, leading in turn to lower electricity prices. A similar result can be expected when replacing electric heating with DH systems, which have a relatively low electricity consumption (see Chapters 2 and 3) and can adjust their consumption profiles thanks to water tank energy storages (Rämä, 2018).

(iii) The impact of electric heating on climate change is complex to assess. It relies on the CO₂ content of electricity, which vary widely depending on hours, days and seasons. The average CO₂ content of electricity in France is relatively low (62 kg CO₂/MWh_{th}, *Ministère de l'environnement, de l'énergie et de la mer* (French Ministry of the environment, energy and seas), 2017). Due to the high variation of the power load profile in the heating season however, the marginal power plants used to supply peak demand largely rely on fossil-fuels. These plants are either located in France or in a neighbouring country with interconnected grids (Olkkonen and Syri, 2016). Based on empirical data for 2003, ADEME and RTE (2007) showed that the direct and lifecycle CO₂ emission of marginal power production in France was 560 kg eCO₂/MWh_e during peak periods. Extrapolating to 2030 based on the factor reduction trend followed by ADEME and RTE (2007) for 2010-2020, electric heaters in operation in 2030 would have a CO₂ content of about 180-260 kg eCO₂/MWh_{th}. This is lower than lifecycle CO₂ emissions from natural gas boilers (424 kg eCO₂/MWh_{th}; IPCC, 2006) but higher than DH based on renewable, NCHP or excess heat (50-150 kg eCO₂/MWh_{th} depending on the heating mix; see Chapter 3).

2.3.2. DH systems facing increased energy performance of buildings

Figure 1.6 summarizes the elements that are expected to affect the future competitiveness of DH systems. Significantly increasing the rate of renovating the aging building stock in the EU and providing high energy efficiency in new buildings is key to meeting EU climate targets (EC, 2012). In 2010, the annual space heating and domestic hot water consumption of EU buildings ranges from about 40 kWh_{th}/m².a (Cyprus) to 240 kWh_{th}/m².a (Finland, Latvia), with an average of approximately 160 kWh_{th}/m².a (EEA, 2013). Nearly 40% of EU buildings were built before the 1960s and only 18% of them fulfill the strict energy performance requirements (Economidou *et al.*, 2011). Following the Energy Performance Building Directive 2002/91/EC (European Parliament, 2003), the annual energy consumption of new buildings should be comprised between 34 and 125 kWh_{th}/m².a depending on countries. Given that the renovation rate of the existing building stock is about 1% per year however (Chirat and Denisart, 2016), most of the buildings that will be occupied in 2050 have already been built. Therefore, the specific heat demand (kWh_{th}/m².a) observed in average in EU countries should not be drastically diminished towards 2050. As further justified in Chapter 7, a reduction of 20-30% towards 2050 compare to 2008 is a realistic projection for France.

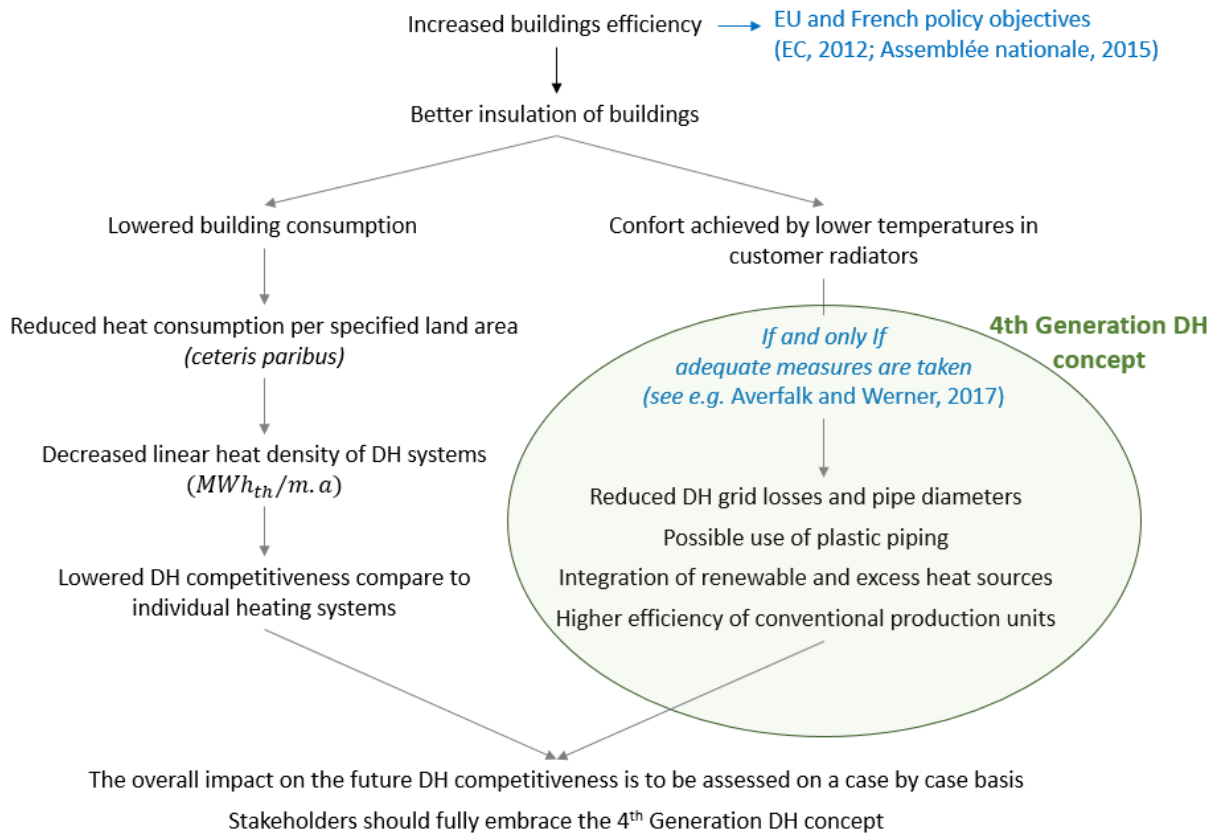

Figure 1.6: Impact of increased buildings efficiency on the competitiveness of DH systems.

By reducing the annual heat consumed within a specific land area ($GWh_{th}/km^2 \cdot a$), building renovation should nonetheless lead to a decrease in the linear heat density ($MWh_{th}/m \cdot a$) of DH networks. The linear heat density indicates the length of DH pipelines required to connect all dwellings to the network, and thus strongly affects the cost of DH systems (Persson and Werner, 2011). Hence, the penetration of energy efficient buildings could reduce the competitiveness of future DH systems. This is an idea that often serve to minimise the interest of DH systems in future energy systems. However, the reality is more complex. Some papers address the reduction of heat demands in existing buildings and conclude that such an effort involves a significant investment cost (Zvingilaite, 2013). The Heat Roadmap Europe study illustrates how a least-cost energy efficiency solution can be reached for Europe, if energy conservation is combined with an expansion of DH (and cooling; Connolly *et al.*, 2014). In the case of Denmark, Nielsen and Möller (2013) have shown that DH could be cost-effectively expanded by 1-12% even if the specific heat demand of buildings is reduced by 75%. Similarly, Reidhav and Werner (2008) highlight the profitability of DH systems in low density areas. Chapter 7 shows that the potential for DH expansion in France remains 9 times higher than current DH deliveries in a scenario that sees the heat demand of buildings uniformly decreased by 50% (national target towards 2050; *Assemblée nationale*, 2015).

If DH systems want to secure their economic advantages yet, they must be improved by changing fuels and minimising grid losses. The reduction of heating demands in existing buildings can be exploited by DH systems in several ways (Dalla Rosa and Christensen, 2011). Better insulation of buildings means that confort is achieved by lower supply temperatures. Lower temperatures requirements in radiators can allow to reduce DH grid losses and pipe diameters (Averfalk and Werner, 2017). Since the implementation of the first schemes in the 1880's, energy efficiency of distribution systems have increased, confirming the adaptation of DH systems to building standards (see Figures 1.7 and .8). In addition, supply temperatures below $80^{\circ}C$ allow the use of plastic piping, which can be more cost effective than conventional DH metal based pipes (Schmidt *et al.*, 2017). Plastic piping also

have a longer statistical lifetime (see Figure 1.9). This concept, referred as 4th generation DH (Lund *et al.*, 2014), also enable further integration of renewable and excess heat sources, as well as a higher efficiency of conventional production units. The DH literature however emphasizes numerous obstacles inhibiting the implementation of the 4th DH concept, in particular in existing DH systems (Rämä and Sipilä, 2017). Averfalk and Werner (2017) identify seven specific bottlenecks, including e.g. lack of individual metering systems (requiring apartment sub-stations), lack of systemic supervision of substations by DH utilities, short thermal lengths in sub-stations heat exchangers and customer radiator systems.

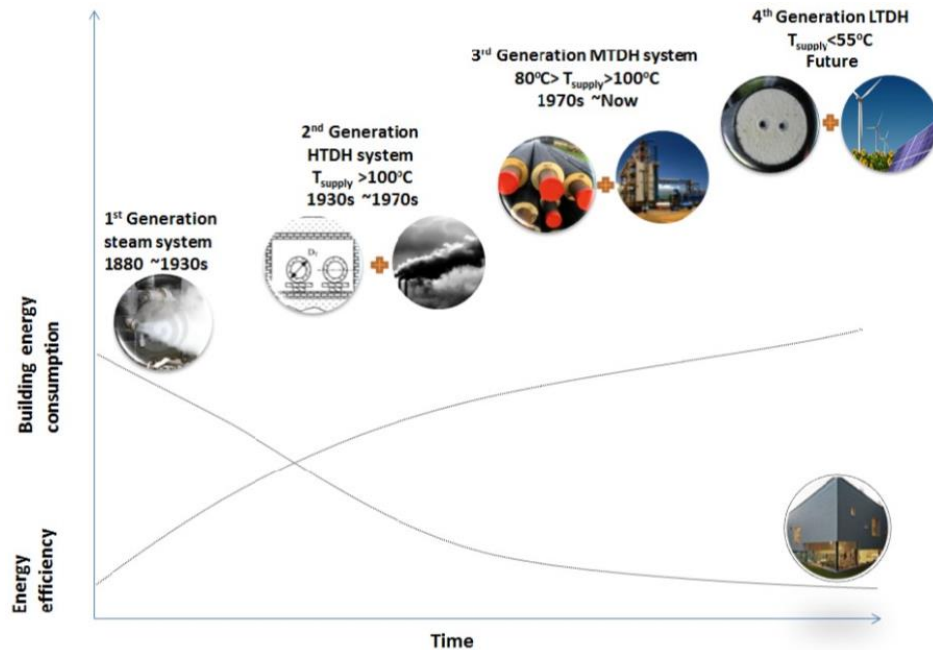

Figure 1.7: Illustration of the concept of 4th Generation District Heating in comparison to the previous three generations. Data source: Lund *et al.* (2014).

Notes:

Distribution heat losses were equal to 35% to 50% of the heat transported in the 1st generation of DH systems. They can be reduced to below 10% for 3^d and 4th generations.

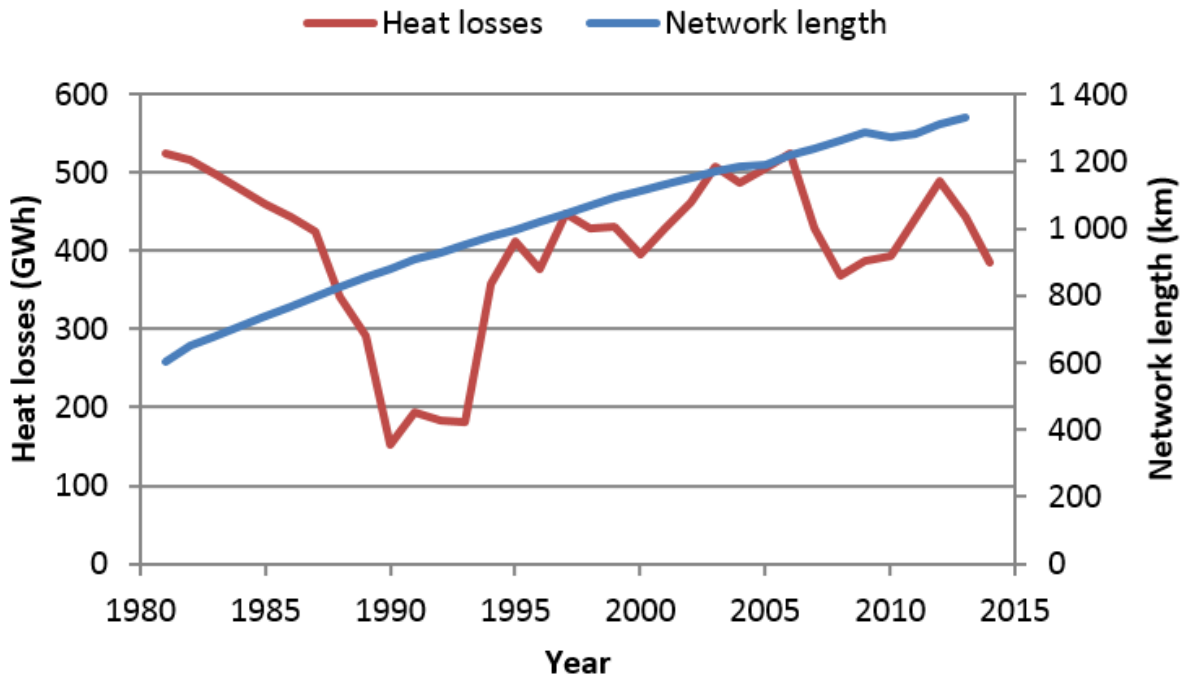

Figure 1.8: Evolution of heat losses (GWh_{th}) and network length (km) of the Helsinki DH network between 1982 and 2013.

Notes:

Heat losses (GWh_{th} lost per kilometer per year) and linear heat density (MWh_{th} distributed per meter per year) both decreased by 66% from 1982 to 2013. There are several possible factors potentially affecting heat losses such as the linear heat density, the temperatures, the heat conductivity ($\text{W}/\text{m}\cdot\text{K}$) of insulation materials or the outdoor temperatures. What can be said is that the improved efficiency of the Helsinki network (either because of temperature levels or insulation of new pipes) has overall counterbalanced the negative impact that reduced linear heat density have on the heat losses as the network has expanded.

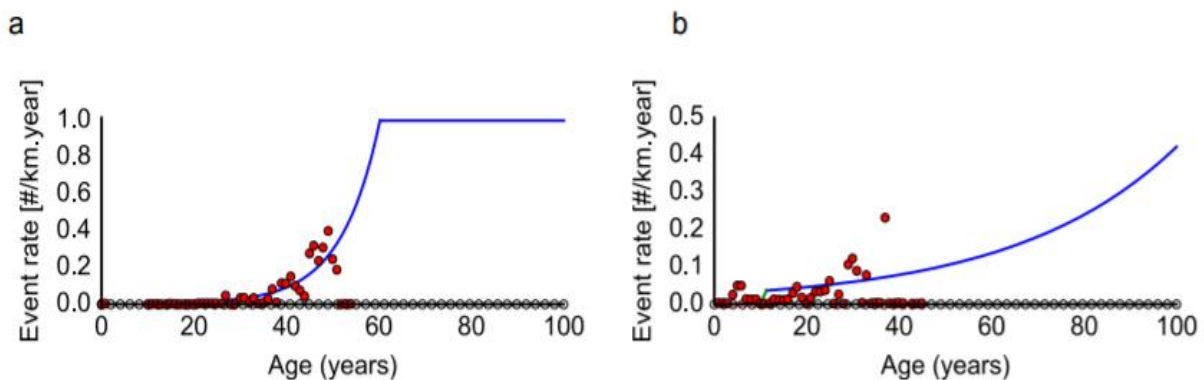

Figure 1.9: Estimated future need for replacement of two different types of district heating pipes in Vattenfall's grid in Uppsala. (a) Prognosis for steel pipes in concrete culverts; and (b) Prognosis for modern plastic sheathed pipes. The graphs show the proportion of a given pipe type expected to remain after a specific number of years. Data source: Sernhed and Jönsson (2017).

Low temperature distribution is a design choice for new systems, while refurbishing existing systems is much more complex. The 4th generation DH concept is thus easier to implement in DH learning countries, where most of the DH potential remain unexploited (see Chapter 7 for an evaluation of the DH potential in France). In those countries, knowledge exchange across multiple actors and countries is crucial to unlock the DH potential and implement desirable actions for 4th

generation DH systems (Bush *et al.*, 2017). The expected benefits of lowering supply temperature should encourage stakeholders to do the desirable actions: e.g. If the heat is generated by CHP, the low temperature of the used heat can lead to a higher electricity generation and therefore improved revenues from energy sales. When considering NCHP, establishing a DH system with supply temperature of 70°C would reduce electric losses due to heat extraction on the Rankine cycle of the plant by approximately 50% compared to a DH system with supply temperature of 100°C. In the case of very low DH system such as envisioned by Schmidt *et al.* (2017), recovering the excess heat from nuclear plants (40°C) may allow fulfilling the needs of nearly zero energy buildings (in which heat is used mostly for hot water purposes). Chapter 3 assesses the competitiveness of plausible DH + NCHP system given different performances of buildings (e.g. shallowly renovated, deeply renovated, newly built energy-efficient building), providing analytical tools to determinate the pros and cons of diverse combination of building envelope and heating systems.

2.3.3. State of the art of nuclear plant based heating systems

Nuclear plant based heating systems are not innovative systems from a technical perspective. Existing DH + NCHP systems were listed in IAEA (2003) at 18 locations, among which 4 are in EU countries (Bulgaria, Czech Republic, Slovakia and Hungary; see Figure 1.10). Russian DH + NCHP experiences (10 out of 18 locations), with VK-300 Boiling Water Reactor, were presented in Kuznetsov *et al.* (2008a; 2008b) and Smirnov *et al.* (2008). There are at least four experiences of nuclear heat use for industrial applications (see Table I.4.1). There are no commercial experience of heat-only reactors, yet the CEA has studied this alternative in the 1970's in the frame of the Thermos project (Dalmasso, 2008; IAEA, 1997), and CNNC (Chinese National Nuclear Corporation) is currently considering this option (see e.g. CNNC, 2017; Decentralized energy, 2017).

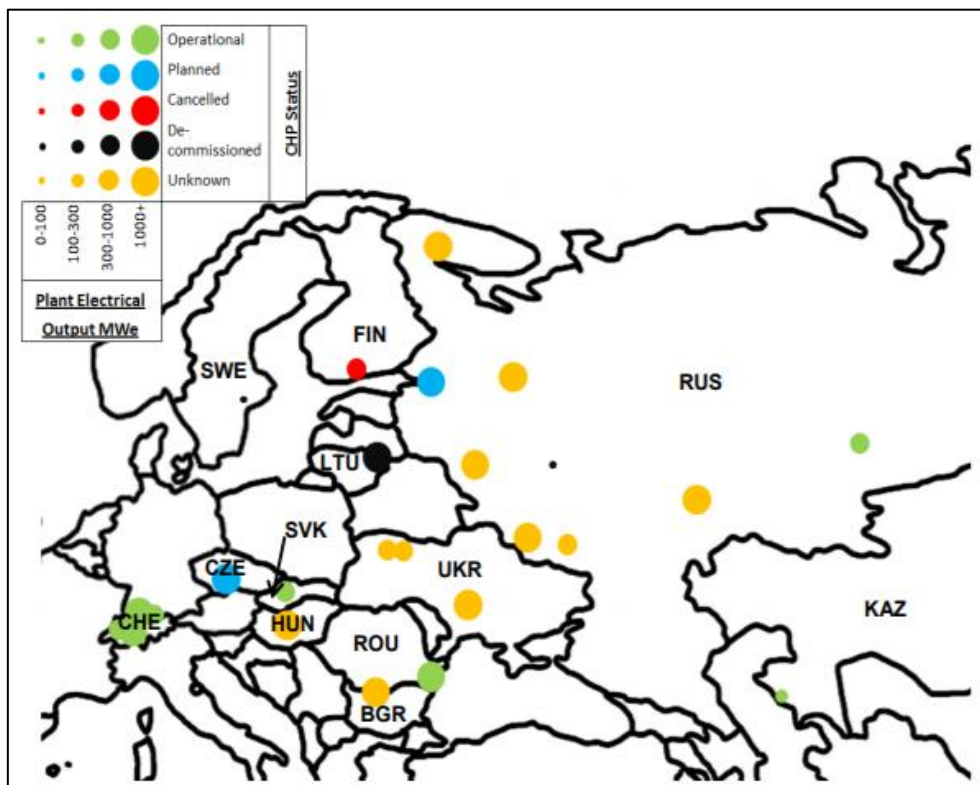

Figure 1.10: Mapping of NCHP experiences and projects in Europe. Data source: ETI (Energy Technology Institute), 2016.

Notes:

Please refer to Table II.5.1 for an exhaustive list of existing DJ + NCHP systems in Europe, and to Table I.4.1 for the listing of industrial nuclear plant sourced utilisation.

Supplying DH systems with heat from nuclear plants could participate in achieving the EU energy policy objectives by:

- (i)** Decreasing the carbon content of DH systems relying mostly on fossil-fuels (see Chapter 2);
- (ii)** Contributing to the development of low carbon heating systems in DH learning countries (see Chapters 2 and 3);
- (iii)** Improving the EU independence from external suppliers. The European Energy Security Package has stated that energy efficiency and the use of renewable or excess heat sources increase energy security when replacing fossil-fuels (EC, 2014b);
- (iv)** Providing competitive and affordable energy to EU consumers (to be assessed on a case by case basis; see Chapters 2 and 3), which is one of the goal set out in the Framework Strategy of the European Energy Union (EC, 2015b).

Nuclear plants however accounted in 2014 for only 0.17% (0.11 TWh_{th}/a) of the heat supplied to EU's DH systems. There are many explanations for this low market share of nuclear plants across the EU heating sector, such as the often long distance between nuclear sites and urban areas, local governance, economic feasibility, institutional structures, and the historical development of the different national energy systems. The 2012/27/EC directive on energy efficiency (European Parliament, 2012) obligates the facilities emitting a significant amount of excess heat to the surrounding environment to consider DH supply, but explicitly allow the member states to exempt nuclear plants from the duty. The European Parliament (2012) justifies this exception by the often long distance that separate nuclear sites from dense urban areas. The EC (2011) yet recognizes this alternative. In France, precise guidelines are provided to those facilities which have the obligation to perform a cost-benefit analysis to determine whether or not DH supply have economic and GHG reduction potential (*Ministère de l'écologie, du développement durable et de l'énergie* (French Ministry of ecology, sustainable development and energy), 2014), but nuclear plants are not targeted. Nuclear plants are however recognised as a heating option in the Energy Technology Perspective report (IEA, 2017), stating that 'Nuclear energy is also a low carbon source of heat and can play a relevant role in decarbonising other parts of the energy system where heat is being consumed, e.g. district heating, seawater desalination, industrial production processes and fuel synthesis'.

From a technical viewpoint, previous research suggests that technical improvements in DH technologies may allow to transport hot water over long distances (up to 100km) with affordable heat losses (below 2%, see e.g. Hirsch *et al.*, 2016; 2017; Ma *et al.*, 2009; Paananen and Henttonen, 2009; Safa, 2012). Coupled to the rising awareness on the urgency to reduce GHG emissions, this has led to a renewed interest in nuclear plant based heating schemes at both national and international levels (see Chapters 2 and 5). CNNC have recently run a demonstration reactor in swimming pools (at <100°C) to heat around 50 households for 168 hours (CNNC, 2017), i.e. corresponding to a heat output of about 150-200 kW_{th} (personal estimation). The cost of building a 400 MW_{th} heat-only reactor were estimated at 160 million euros (Decentralized energy, 2017). Real costs would however be known only if the CNNC' plan of building a 400 MW_{th} deep pool low-temperature heating reactor is realised.

The UK has also shown a vivid interest for supplying DH to urban areas through small and modular PWR operated in a CHP mode (ETI, 2016). The engineering consulting firm MacDonald (for ETI, 2016) has studied the technical feasibility of 6 different options for extracting heat in a small and modular PWR (two kind of SMR designs are considered). Figure 1.11 shows in detail the preferred technical solution. To extract the steam from between the intermediate pressure and low pressure stages of the steam turbine, a crossover is required with a throttling valve. This throttling valve maintains the upstream pressure to allow steam extraction across the steam turbine load range. The steam control valve then controls the steam flow rate to match the DH demand. The steam is depressurized and de-superheated so that the saturated steam entering the DH condenser transfers its energy to the water for the DH network. The steam condensate is then returned to an appropriate location in the steam/condensate cycle via the DH condensate pump. Jaskólski *et al.* (2017) also emphasized that, to adapt nuclear turbines to partial cogeneration mode and to meet peak thermal load it would likely be necessary to extract steam not only from LP bleeder, but also from either the

HP/LP crossover pipe (for two-section turbines as e.g. in AP1000 and ESBWR) or from IP/LP crossover pipe (for three-section turbines as e.g. in EPR or Figure 1.11). For safety reasons, BWR-type reactors require separate on-site intermediate circuit due to the radioactivity inherently present in the turbine processes in this type of reactor (Fortum, 2013). Besides, operating a NCHP implies to reduce the electricity output compare to purely electricity generation mode. The loss in electricity production depends on the temperature and the amount of heat considered, and represents one sixth of the thermal energy produced in the case of DH supply at 100°C (IAEA, 2016). Jaskólski *et al.* (2017) showed that the loss of electric power was the lowest for EPR, compare to AP1000 and ESBWR reactor types.

Despite the renewal of interest, however, there is currently no up to date academic study investigating the potential for DH + NCHP systems in Europe. By combining approaches from engineering, economic and social sciences, this Ph.D. fills up the research gap.

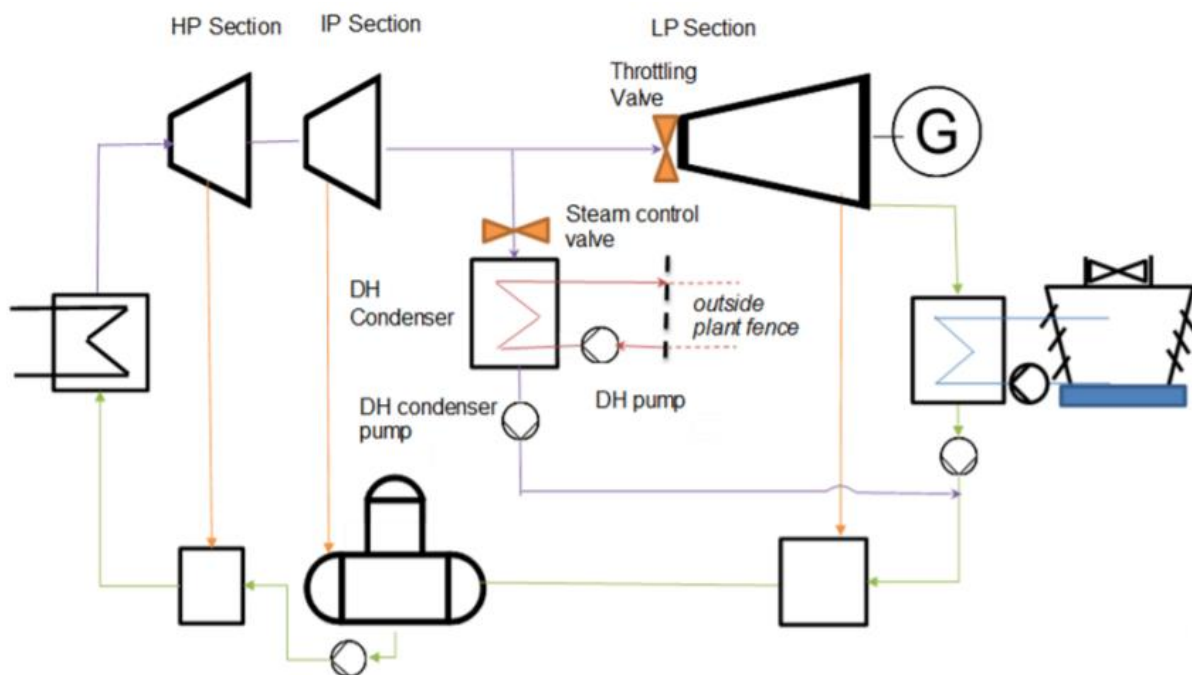

Figure 1.11: Schematic showing equipment within the nuclear plant boundary to achieve heat extraction for DH. Data source: ETI (2016).

2.3.4. Increasing cooling demand and the future of district cooling

Cooling demand is the fastest growing end use in buildings worldwide. The IPCC estimates that the demand for residential space cooling will rise from 300 TWh_{th} in 2000 to 4000 TWh_{th} in 2050 and 10 000 TWh_{th} in 2100 (Arent *et al.*, 2014). The EU Heating and cooling strategy also foresees a strong increase in the EU' residential cooling consumption, from about 35 TWh_{th} in 2015 to 75-137 TWh_{th} in 2050 (depending on scenario; EC, 2016a). Jakubcionis and Carlsson (2017) yet emphasize that the majority of the EU member states have poor or limited data on current cooling demands and even less knowledge about the future tendencies. Based on the average temperatures during the last 20 years, Jakubcionis and Carlsson (2017) show that the cooling demand potential in the EU residential sector could rise up to 292 TWh_{th} towards 2050, much higher than what projected by the EC (2016a). If all this cooling potential would be achieved, and supplied using electricity driven air conditioners (i.e. Compression Cycle (CC) chillers; which are currently the dominant space cooling equipment), electricity consumption would increase by 68 TWh_e/a in the whole EU by 2050 (i.e. plus 2.5% compare to electricity consumption of 2015; Jakubcionis and Carlsson (2017).

Less stress on the power system can be achieved by implementing alternative cooling supply systems, such as district cooling. District cooling systems are currently used only in limited quantities and only in some countries of the EU, the most notable example being the Nordic countries (Sweden

and Finland; Euroheat & Power, 2015b). However, interest in district cooling as more sustainable alternative to traditional space cooling technologies and as a business opportunity for existing and new DH systems is increasing. District cooling is currently seen as a prominent part of future European energy system and is addressed in a number of European energy legislative documents such as the Energy Efficiency Directive (European Parliament, 2012).

District cooling allows the use of heat sources that would otherwise be wasted through absorption cooling (AC) chillers. Unlike CC chillers, AC chillers use a source of heat to produce cold. The main difference being that the compressor is replaced by a chemical cycle taking place between the absorber, pump, and regenerator (CIBSE (Chartered Institution of Building Services Engineers), 2012). Instead of compressing refrigerant vapour (in CC chillers), the absorption cycle dissolves this vapour in a liquid (called the absorbent), pumps the solution to a higher pressure (with much less work input than required by a compressor) and then uses heat input to evaporate the refrigerant vapour out of the solution. The main advantage of AC chiller is the possibility to utilise different heat sources, such as industrial waste heat, heat from power plants and CHP installations or renewable sources. Other advantages include low electrical power requirements, fewer moving parts, quieter operation, and the use of low Global Warming Potential refrigerants (CIBSE, 2012).

Whether or not AC chillers are energetically and economically more efficient than CC chillers must however be determined on a case by case basis; the balance strongly depending on the heat source used to drive AC chillers. Hondeman (2000) showed that for electricity-optimised CHP systems based on coal and natural gas, CC technology is more favourable than AC technology from an energy perspective if the Coefficient of Performance (COP) of CC chillers is higher than 6, as achievable today. Poredos and Kitanovski (2011) nonetheless claim that from an exergy perspective, hot water AC chillers are almost 10% more efficient than CC chillers considering a COP of 6.6. The performance of CC chillers have been increasing lately, with a COP equals to approximately 7 in full load operation, under Swedish climate conditions (Ueda *et al.*, 2009). For lower outdoor temperatures, variable speed CC chillers can reach a COP of 22 in part load operation. In comparison, AC chillers have a COP of about 0.7-0.8 when the heat source is at 100°C (Difs *et al.*, 2009; Poredos and Kitanovski, 2011; Svensson and Moshfegh, 2011; Trygg and Amiri, 2007). Nonetheless, if low-cost excess heat from industries or waste incineration plant do exist, DH driven AC technology may still lead to cost-effective GHG emissions reduction despite the recent advances of CC chillers (see e.g. Chorowski *et al.*, 2016; Jakubcionis and Carlsson, 2017; Svensson and Moshfegh, 2011; Trygg and Amiri, 2007).

Considering the expected COP values of AC chillers (0.75) and the heat to power ratio of NCHP (6 for 100°C heat extraction), NCHP based district cooling system would have a COP of 4.5 (MWh_{th} of cold generated per MWh_e electricity used). This seems to discard NCHP based cooling to the benefit of CC chillers (COP above 5), and this is why cooling applications of NCHP are not studied in-depth in this PhD. Such general COP values must however be considered with caution; real values should be determined on a case by case basis. Besides, the choice would also depend on other criteria such as the land surface requirement, the density of the demand or the availability of a local excess heat source. Future research could aim to determine upon which NCHP based cooling system becomes attractive (e.g. environmental criteria, lower nuclear load factors in summer due to a high share of solar power).

3. Research scope

This Ph.D. focuses on the study of low temperature (below 250°C) heat production with PWR. It aims to participate improving the knowledge on the potential of nuclear plant-sourced heat to help achieving the EU and French energy policy objectives towards 2050. Even though this is not a new research field (see Section 2, and in particular Section 2.3.3), many aspects remain unexplored. Firstly, there is no suitable analytical tool to assess the costs and benefits of nuclear based heating systems

on an equal footing, and to compare them to the other heating systems of relevance. Secondly, discussions currently disregard the social, political and institutional dimensions, while these are critical when considering large and collective energy systems (see e.g. Van de Graaf and Sovacool, 2014). Thirdly, no research has yet assessed the development potential of such systems in France considering real-world phenomenon.

These problematics will be answered through three successive research questions, which frame the structure of the Ph.D. Report (see Table 1.2, Section 4):

- a) What are the costs and benefits associated to the use of heat from nuclear plants? What are the associated uncertainties? How does this kind of system perform compare to the other heating systems of relevance? Which criteria can be used for the comparison?
- b) What are the stakes surrounding the concrete implementation of such systems in Europe? To what extent the great variety of stakeholders involved in decision-making processes can impact the choice of the optimal system to be used for space heating and domestic hot water supply?
- c) To what extent using heat from nuclear plants could help achieving the French energy policy objectives towards 2050? How to stimulate niche creation for experimenting such a system in France?

As further described in Section 5, the methods used to answer these questions are diverse and interdisciplinary. Both quantitative and qualitative approaches are applied. In our view, the main added value of the Ph.D. relies in the gathering of methods and data (answering question (a)). Even though many aspects remain to be explored, this Ph.D. represents, to the best of our knowledge, the most comprehensive techno-economic analysis of nuclear plant based heating systems ever provided. Besides, this Ph.D. constitutes an attempt to move beyond purely techno-economic analysis by considering social, institutional and market dimensions (answering question (b)), which are rarely investigated in-depth. The Ph.D. also participates to improve the understanding of the ins and the outs of the potential and practical implementation of such systems in the case of France (answering question (c)).

The conceptual approach adopted to model NCHP must be well understood from the start. This Ph.D. only considers the cost of 'CHP readiness', a term coined by the Energy Technology Institute (ETI, 2016) to name the equipments necessary to the commercial production of heat in a new PWR (e.g. heat exchangers, pumps). In simple words, this Ph.D. accounts for the capital costs specific to heat production in a specifically designed PWR, but excludes the costs attributable to electricity production. If it proves to be safely feasible, the cost of retrofitting existing PWR into NCHP may also be of similar magnitude. According to nuclear scientists (e.g. Jaskólski *et al.*, 2017), small thermal outputs (<3-7% of the nominal thermal capacity of the reactor; e.g. 100-300 MW_{th} for a 1600 MW_e reactor) could be safely extracted from most of existing PWR, but larger heat outputs may require specific modifications of the primary circuit from designs stages. The technical feasibility of such projects must however be assessed on a case by case basis through detailed engineering studies, which do not exist for any French nuclear reactor. Following this, it appeared reasonable to model NCHP based heating systems considering the theoretical deployment of new nuclear plants, which could be designed as CHP from the start. Since new nuclear plants, if they are commissioned in an EU member state, would probably replace decommissioned plants on existing sites, the Ph.D. excludes the study of potential new sites.

The advantage of this approach is that our results are, to some extent, valid both for large and small PWR. Indeed, reviewing the literature and discussing with experts have led us to the conclusion that the cost of CHP readiness is not very dependent on the reactor' size. Besides, the cost of CHP readiness represents a minor fraction of the total cost of NCHP based heating systems (see Part I). The drawback of this approach is that it does not allow to reach any conclusions as to whether a NCHP offers more benefits than other systems generating the same amount of electricity and heat. To answer this, further analysis would be needed, taking into account the entire investment cost of a new NCHP. The Ph.D. nonetheless provides a solid basis that can help stakeholders and policy makers maximizing the socioeconomic advantages of future nuclear units considering both the electricity and heat sectors.

4. Methodology

The objective of Section 4 is to expose the main methodological approaches used through the Ph.D., namely techno-economic simulation, Geographic Information System (GIS) based analysis and case study. The set of methods and assumptions used in Chapters 2-6 is precisely detailed within each Chapter. A general presentation is however necessary. While Column 5 of Table 1.2 (Section 5) describes the main methodology supporting each Chapter, several methodological approaches are sometimes applied simultaneously in a single Chapter. Techno-economic simulation is largely employed in Chapters 2, 3, 4 and, to a lesser extent, in Chapter 7. GIS supports the analysis performed in Chapters 2, 3, 6, and is of particular importance in Chapters 4 and 7. Case studies allowed to study multi-stakeholder' interactions surrounding concrete projects in Chapters 3 and 6 (Dunkirk conurbation committee) and Chapter 5 (Helsinki metropolitan area). In Table 1.2, the main methodology of Chapters 7 and 8 (Part III) is referred as 'mixed' because these Chapters use methodological approaches and results from Chapters 2-6 in order to explore the French case in details.

4.1. Techno-Economic simulation

In order to answer the research question (a) concerning the costs and benefits of heating alternatives, it is necessary to collect detailed information on the technical features, and to parameterise costs and environmental assumptions in accordance with all the heating systems. The detail of the assumptions made is further described in Part I (e.g. coefficient of performance of technologies, capital and operational costs), alongside with references. Chapter 2 details the methods and assumptions made to assess cost and GHG emissions savings potential of DH systems based on heat from NCHP (80-120°C). Chapter 3 depicts the parameter values used to model ten alternative heating systems which could be deployed in order to provide space heating and domestic hot water to a French urban area (Dunkirk). Chapter 4 investigates the techno-economic potential of steam (250°C) transfer from NCHP to factories for process heating use.

In recent years, several tools and models have been developed and used for the design and analysis of future national energy systems. The models are diverse and often end up with different results and recommendations. Lund *et al.* (2017) analyse this diversity of models and their implicit or explicit theoretical backgrounds. Two archetypal models are defined and compared:

- (i)** The optimisation approach assumes that optimal solutions can be identified through mathematically solving objective functions with respect to optimal energy unit sized. This is a computational process before the political decision-making takes place. Politicians receive authoritative results from experts.
- (ii)** The simulation approach assumes a variety of options that should be analysed and compared considering different parameters. Relevant options should be presented in a political decision-making process where alternatives are assessed. Politicians receive different options and substantiated recommendations.

According to Lund *et al.* (2017), both kinds of models have strengths and weaknesses, but simulation models have an advantage that make them suited for long-term decision-making in democratic societies. They present the citizens and politicians with a variety of possibilities that are shown to depend on political choices about controversial issues. These choices may not all follow the techno-economic rationality, but they present a variety of choices with quantitative and qualitative distinctions. Optimisation models may also calculate different options, but in practice the models are not very well suited for this as they need to be nudged to include other technologies. It therefore follows that simulation approaches are the best suited to answer our research question (a) (see Section 3). Among simulation approaches, cost-benefit analysis is the most often used in the evaluation of

energy projects (see e.g. Bachmann and van der Kamp, 2014; Boardman, 2010; Florio, 2014; Pearce *et al.*, 2006).

In the following, sub-section 5.1.1 first exposes the general philosophy of the approach adopted to model the costs and benefits of energy systems. Sub-section 2.1.2 then details how the uncertainty has been considered.

5.1.1. Cost-Benefit Analysis (CBA) from the public welfare perspective

CBA is the preferred tool of the EC to provide policy makers with an assessment of large energy projects (EC, 2014c). In this Ph.D., different indicators are used for the CBA of heating systems (including environmental and economic criteria, both quantitative and qualitative). The main economic indicator is the levelised cost of heat (LCOH; Short *et al.*, 1995). The LCOH is the cost of generating heat for a specific system at a specific temperature of the working fluid (Gabbrielli *et al.*, 2014). It is an economic assessment of the cost of a heating system, including all costs over its entire lifetime: initial capital costs, fixed and variable operational costs. LCOH can eventually include taxation or subsidies to evaluate the impact of diverse policy instruments on the relative competitiveness of systems.

Other common financial indicators are also used for CBA, such as the Net Present Value (NPV) or the payback period (see Appendix I.2.A). When computing the LCOH or the NPV, costs are discounted to present values by referring to equation (1):

$$r_{IF} = I_{CC} \frac{i}{1 - \left(\frac{1}{1+i}\right)^t} \quad (1)$$

Where r_{IF} is the discounted cost (€/MWh_{th}), I_{CC} is the capital cost (€/MWh_{th}), i is the discount rate and t is the time (year).

The first issue to resolve in discounting is whether it is the social or private discount rate that is used. Standard financial appraisal practice within private companies would almost certainly apply private discount rates, set to reflect their real opportunity cost of capital (typically around 5-8%, although this vary substantially). When the objective is to consider the costs and benefits of a project to society at large, the social rate of discount is however a more appropriate choice. The social discount rate is defined as the social rate of time preference. This represents the rate at which society would trade a unit of benefit between the present and the future. In France, the '*Rapport Lebègue*' has fixed the social discount rate at 4% (*Commissariat Général du Plan* (French institution for economic planning), 2005). In this Ph.D., the social discount rate used is 3.5%, as recommended by the EC (2014c). The practical effect is that more distant benefits will carry more weight in the CBA (in comparison to the use of private discount rates). The sensitivity of results to the variation of the discount rate is nonetheless tested (see Chapters 2 and 3). It worth noticing that recent developments in the theory and practice of discounting has highlighted a potential case for using declining discount rates in the application of investment with a long time horizon. According to Arrow *et al.* (2014), investment horizons higher than 75 years can make the choice of a declining discount rate of practical relevance (the rate could decline e.g. from 4% to 2%). However, given that the time horizons of the systems here studied are of 40 years (60 years maximum in Chapter 3), the use of declining rates would have little effect on the evaluation.

5.1.2. Dealing with the uncertainty

Nuclear plant based heating systems can be considered as megaprojects in the sense of Van de Graaf and Sovacool (2014) since the initial investments required often exceed 1-2 billion euros (see Part I), and that close collaboration between separate stakeholders would be required (see Part II). Similarly to other megaprojects (Flyvbjerg, 2016; Sanderson, 2012), the uncertainty that affects the cost parameters can be high, and thus require specific attention.

There are different ways of dealing with the uncertainty of energy projects. Several project evaluation methods are associating probability to parameter values. E.g. Monte Carlo simulations are used to model the probability of different outcomes in a process that cannot easily be predicted due

to the intervention of random variables (see e.g. Fonseca and Oliveira Panão, 2017; Yi *et al.*, 2011). In France, Monte Carlo simulations were often used for the assessment of public investments (*Commissariat Général du Plan*, 2005). The same report yet emphasizes that caution is needed when performing Monte Carlo analysis given that it is hard to assess the probability of cost deviations from average values. This is particularly true for large energy projects with a lack of experience feedbacks (Flyvbjerg, 2016; Miller and Hobbes, 2009), such as nuclear plant based heating projects. Because of their size and relative novelty, the uncertainty affecting these projects cannot be evaluating precisely i.e. the risk is unknown. The distinction between risk and uncertainty has been put forward in the frame of the classical discussion between Keynes and Knight (Keynes, 1921). While risk can be quantified, uncertainty simply cannot be quantified. When evaluating projects with unknown risks, the '*Rapport Gollier*' (Gollier, 2011) and the EC (2014c) both recommend to prefer sensitivity analysis to Monte-Carlo analysis. That is, to evaluate the impact of varying input parameters on output parameters so as to highlight and discuss the key controversial points. As recalled by Gollier (2011), the discount rate should not serve as an instrument to integrate the uncertainty that can affect projects.

The above discussion led us to restrain the Ph.D. to the evaluation of uncertainty, leaving aside the notion of risk. Throughout the Part I of the Ph.D., parameter values which are rather consensual are distinguished from those subject to diverging opinions. The results obtained when considering different parameter values (e.g. discount rate, energy prices, capital costs) are shown. This so-called sensitivity analysis (see e.g. EC, 2014c; Heiselberg *et al.*, 2009) aims to help policy makers and stakeholders understanding which parameters should be evaluated carefully.

4.2. Geographic Information System based analysis

The simulation of costs and benefits of diverse heating systems can only be carried out on the basis of a combination of, on the one hand, detailed data on the location of heat demands and, on the other hand, knowledge on the future system of which the studied systems should be a part. This requires the use of Geographical Information System (GIS; see e.g. Gils *et al.*, 2013; Nielsen, 2014; Nielsen and Möller, 2013). Thanks to the spatial allocation of heat demand centers (e.g. urban areas or factories) and nuclear sites, GIS allows to identify the most promising locations for nuclear plant based heating systems. The GIS used in this Ph.D. is QGIS (2017), an open-source software. GIS based analyses depend heavily on the quality of the data source available; better sources allow for much more detailed analyses. In this Ph.D., three major data sources have been used as GIS input:

(i) Data from Heat Roadmap Europe (2015) are used in Chapters 2 and 3. The spatialized residential and commercial heat consumption (TJ/a) for EU countries in 2015 (resolution: km²) allowed to evaluate the cost of DH distribution systems (see Section 3.1 of Chapter 2 for methods and Section 3.1.5 of Chapter 7 for limitations);

(ii) Data from the National Centre for Analysis and Research on Energy (CEREN) have been used in Chapter 4. Data were first gathered for a study of the French National Alliance for Energy Research Coordination (ANCRE, 2015). Information such as the size and temperature of the heat demand and the location of factories are provided at the 5-digit level of disaggregation of the NACE revision 2 classification with 114 sub-sectors (EC, 2008). It has allowed to determine the cost and GHG emission savings potential of steam transfer from nuclear plants to industrial sinks for France.

(iii) Data from CEREMA (French Research Centre on Risks, Environment, Mobility and Territorial Planning, 2015) have been used in Chapter 7. The spatialized residential and commercial heat consumption (kWh_{th}/a) for metropolitan France in 2015 (resolution: 200m×200m) allowed to precisely evaluate the DH potential in France by region.

4.3. Case study

Qualitative analysis is required to answer the research question (b) concerning the stakes surrounding the implementation of nuclear plant based heating projects. By interviewing stakeholders and policy makers, case studies enable to gather valuable information which can improve the comprehension of complex, real world phenomenon. If nuclear heating systems are ever integrated into the EU and French sustainable energy transition, there will be a number of obstacles to overcome as e.g. inexpediency of business models and regulatory frameworks or electioneering of local authorities (see Chapters 5, 6 and 8). Prospective explorations are important to reduce the likelihood of future projects being overwhelmed by hidden costs and to limit delay in implementation. The two case studies performed in Part II allow to take a step back from purely techno-economic aspects and invite multi-stakeholder interactions into the debate:

(i) Chapter 5 investigates the forces and obstacles to DH + NCHP projects by looking at the Loviisa 3 DH + NCHP project in Finland. The aim of the project was to develop a new PWR (or boiling water reactor, both options were investigated) to be operated in cogeneration (800-1300 MWh_e and 1000 MWh_{th}; Bergroth, 2010; Fortum, 2013), alongside with a 80km long heat transportation system (Paananen and Henttonen, 2009). It was proposed by Fortum as a part of an application for a decision-in-principle concerning the construction of the Loviisa 3 reactor (Fortum, 2009: p.26-28).

(ii) Chapter 6 studies the stakeholder's interaction that would occur if a DH + NCHP project would be planned In France. Five groups are identified who affect the decision on the heating system to be used for the future Dunkirk urban area including developers, national public authorities, local public authorities, community representative groups, and the national nuclear plant operator.

5. Comprehensive plan

Table 1.2 exposes the logical structure of the Ph.D. Report. There is a total of five Parts. The Report starts with the introduction (Chapter 1) and ends with the conclusions (Chapter 9). Part I, II and III aim to answer questions (a), (b) and (c), respectively, and hence constitute the hearth of the report. A total of seven Chapters compose the core Parts I, II and III. Part I adopts a positive scientific philosophy (in the sense of Comte, 1853) to study techno-economic related issues. Part II also is in the positivism tradition but widen the research scope to non-purely techno-economic aspects such as sociology, politics, business models or project financing. Part III is by nature normative given that it explores the role that nuclear plant based heating systems could play to fulfill the French energy and climate objectives, considering both techno-economic and socio-political angles.

Part	Chapter	Technological scope	Geographical boundaries	Main methodology
	Chapter 1	PWR, SMR, Gen IV reactors, hydrogen, desalination, DH, process heat	Worldwide	
I. Cost-Benefit Analysis <i>(question (a))</i>	Chapter 2	PWR, DH	Europe	Simulation
	Chapter 3	PWR, 11 heating systems	Dunkirk	Simulation
	Chapter 4	PWR, Process heat	France	GIS
II. Analysis of Multi-stakeholder Interactions <i>(question (b))</i>	Chapter 5	PWR, DH	Helsinki	Case study
	Chapter 6	PWR, 6 heating systems	Dunkirk	Case study
III. In-Depth Analysis of the potential in France <i>(question (c))</i>	Chapter 7	PWR, DH, Process heat	France	Mixed
	Chapter 8	PWR, DH, Process heat	France	Mixed
	Chapter 9	PWR, DH, Process heat	Europe	

Table 1.2: Comprehensive presentation of the plan followed by the Ph.D. Report. Complete name of Chapters can be found in the Table of Contents, p. 13.

References

- ADEME (French Agency for Environment and Energy Supervision), RTE (French power network operator), 2007. Le contenu en CO₂ du kWh électrique : Avantages comparés du contenu marginal et du contenu par usages sur la base de l'historique.
- ADEME, 2016. Etude de valorisation du stockage thermique et du power-to-heat. Available from: <<http://www.ademe.fr/sites/default/files/assets/documents/valorisation-stockage-thermique-power-to-heat-2016-rapport.pdf>> [in French].
- ADEME, 2017. 13^{ième} Rencontres des réseaux de chaleur (13th national DH meeting). Round Table of the 12/12. Presentation by Rémi Chabrilat "Factor 5 for renewable and excess heat sources: Which means for which objectives?" [in French].
- AMORCE (French DH association), 2011. Solutions techniques pour optimiser les réseaux de chaleur dans un contexte de développement de bâtiments basse consommation. Available from: <http://www.amorce.asso.fr/media/filer_public/12/15/12155959-eaba-447c-9785-27dbba635e34/rct34_optimisationrc.pdf>.
- AMORCE, 2015. Comparatif des modes de chauffage et prix de vente de la chaleur. Data for 2014. Available from: <<http://www.amorce.asso.fr/fr/espace-adherents/publications/rdc/prix-de-la-chaleur/comparatif-des-modes-de-chauffage-et-prix-de-vente-de-la-chaleur-rapport-2015-donnees-2014/>> [in French].
- ANCRE (French National Alliance for Energy Research Coordination), 2013. Scénarios de l'ANCRE pour la transition énergétique. Rapport 2013. Available from: <http://www.allianceenergie.fr/imageProvider.asp?private_resource=984&fn=Doc+complet+ANCRE+version+finale+15+Janv_0%2Epdf> [in French].
- ANCRE, 2015. Cogénération nucléaire: Intérêts et potentiels d'une offre de chaleur basse température pour l'industrie française. Agence Nationale de Coordination de la Recherche pour l'Energie.
- Arent, D., Tol, R.S.J., Faust, E., Hella, J.P., Kumar, S., Strzepek, K.M., Yan, D., 2014. FINAL DRAFT IPCC WGII AR5 Chapter 14.
- Arrow, K.J., Cropper, M.L., Gollier, C., Groom, B., Heal, G.M., Newell, R.G., Nordhaus, W.D., Pindyck, R.S., Pizer, W.A., Portney, P.R., Sterner, T., Tol, R.S.J., Weitzman, M.L., 2014. Should Governments Use a Declining Discount Rate in Project Analysis? *Rev Environ Econ Policy*.
- Assemblée nationale (French national assembly), 2015. Loi n° 2015–992 du 17 août 2015 Relative à la transition énergétique pour la croissance verte, 2015–2992. Available from: <<http://www.legifrance.gouv.fr/affichTexte.do?cidTexte%40JORFTEXT000031044385&categorieLien%id>> [in French].
- Australian academy of science, 2015. The science of climate change. Questions and answers. Available from: <<https://www.science.org.au/files/userfiles/learning/documents/climate-change-wr.pdf>>.
- Averfalk, H., Werner, S., 2017. Essential improvements in future district heating systems. *Energy Procedia*, 15th International Symposium on District Heating and Cooling, DHC15-2016, 4-7 September 2016, Seoul, South Korea 116, 217–225.
- Bachmann, T.M., van der Kamp, J., 2014. Environmental cost-benefit analysis and the EU (European Union) Industrial Emissions Directive: Exploring the societal efficiency of a DeNO_x retrofit at a coal-fired power plant. *Energy* 68, 125–139.
- Baurens, P., Carles, P., Cren, J., Duhamet, J., Gilardi, F., Le Naour, F., Leybros, J., Mansilla, C., Mougin, J., Noirot, I., Poitou, S., Robin, J.C., Saturnin, A., Yvon, P., Cany, C., 2013. Performances and economic competitiveness comparison of advanced hydrogen production processes coupled to a nuclear reactor. Workshop of the Organisation for Economic Co-operation and Development (OECD) on economics of nuclear cogeneration. 4-5 April 2013.

- Bergroth, N., 2010. Large-Scale Combined Heat and Power (CHP) Generation at Loviisa Nuclear Power Plant Unit 3. Contribution to the 8th Conference on Nuclear option in countries with small and medium electricity grids.
- Berthélemy, M., Leurent, M., Locatelli, G., 2016. The development of small modular reactors: Which markets for which applications? *Lettre I-Tésé* 29. Autumn 2016. Available from: <http://i-tese.cea.fr/fr/Publications/Lettreltese/Lettre_iteese_29/files/5_Lettre_iteese_AUTOMNE_2016_Eclairage_The_development_of_small_modular_reactors....pdf>.
- Boardman, N.E., 2010. *Cost-Benefit Analysis: Concepts and Practice*, fourth ed., Prentice Hall, Upper Saddle River, NJ.
- Braun, H.-J., 1992. Symposium on “failed innovations.” *Social Studies of Science* 22, 210–215.
- BuroHappold Engineering, 2016. UK Spatial District Heating Analysis. Available from: <<http://fes.nationalgrid.com/media/1215/160712-national-grid-dh-summary-report.pdf>>.
- Bush, R.E., Bale, C.S.E., Powell, M., Gouldson, A., Taylor, P.G., Gale, W.F., 2017. The role of intermediaries in low carbon transitions – Empowering innovations to unlock district heating in the UK. *Journal of Cleaner Production* 148, 137–147.
- Cany, C., Mansilla, C., da Costa, P., Mathonnière, G., Duquesnoy, T., Baschwitz, A., 2016. Nuclear and intermittent renewables: Two compatible supply options? The case of the French power mix. *Energy Policy* 95, 135–146.
- Cany, C., 2017. Interactions entre énergie nucléaire et énergies renouvelables variables dans la transition énergétique en France : adaptations du parc électrique vers plus de flexibilité. Available from: <<https://www.theses.fr/200224255>> [in French].
- CEREMA (French Research Centre on Risks, Environment, Mobility and Territorial Planning), 2015. Carte nationale de chaleur – France. Available at: <<http://reseaux-chaleur.cerema.fr/carte-nationale-de-chaleur-france>> [in french].
- Chang, N., 2015. Changing industrial structure to reduce carbon dioxide emissions: a Chinese application. *Journal of Cleaner Production, Carbon Emissions Reduction: Policies, Technologies, Monitoring, Assessment and Modeling* 103, 40–48.
- Chénaïs, J., Diet, A., Grondin, Y., Perrier, S., 2014. L’approche française par le consortium SMR (CEA, EDF, AREVA, DCNS). *RGN* 95–97.
- Chertow, M.R., Lombardi, D.R., 2005. Quantifying economic and environmental benefits of co-located firms. *Environmental Science and Technology* 39, 6535–6541.
- Chirat, J.-P., Denisart, F., 2016. Nouvelles dynamiques de rénovation des logements. Rapport de synthèse et proposition. Jean-Pascal Chirat (Club de l’Amélioration de l’habitat) et Frédéric Denisart (Conseil National de l’Ordre des Architectes). Available from: <http://www.planbatimentdurable.fr/IMG/pdf/plan_batiment_durable_rapport_nouvelles_dynamiques_de_renovation_des_logements.pdf> [in French].
- Chorowski, M., Rogala, Z., Pyrka, P., 2016. System options for cooling of buildings making use of district heating heat. *International Journal of Refrigeration* 70, 183–195.
- CIBSE (Chartered Institution of Building Services Engineers), 2012. Absorption Cooling. Datasheet 07 of the CHP Group of the Chartered Institution of Building Services Engineers (CIBSE). Available from: <<https://www.cibse.org/getmedia/5c9a9e15-5103-4b70-8aa1-1b7456fdf9a5/Datasheet-7-Absorption-Cooling.pdf.aspx>>.
- Comte, A., 1853. *The positive philosophy of Auguste Comte*. Freely translated and condensed by Harriet Martineau with an introduction of Frederic Harrison. Batoche books, Kitchener 2000 Edition. In three Volumes. Volume 1 available from: <<https://socialsciences.mcmaster.ca/econ/ugcm/3ll3/comte/Philosophy1.pdf>>
- CNNC (Chinese National Nuclear Corporation), 2017. CNNC launches pool-type low-temperature heating reactor. 2017-12-12. Available from: <http://en.cnn.com.cn/2017-12/12/c_118604.htm>.
- Commissariat Général du Plan (French institution for economic planning), 2005. Révision du taux d’actualisation des investissements publics. Report directed by Danial Lebègue. Available

- from:
<http://www.documentation.eaufrance.fr/entrepotsOAI/OIEAU/44/223176/223176_doc.pdf> [in French].
- Connolly, D., Lund, H., Mathiesen, B.V., Werner, S., Möller, B., Persson, U., Boermans, T., Trier, D., Østergaard, P.A., Nielsen, S., 2014. Heat Roadmap Europe: Combining district heating with heat savings to decarbonise the EU energy system. *Energy Policy* 65, 475–489.
- Dalla Rosa, A., Christensen, J.E., 2011. Low-energy district heating in energy-efficient building areas. *Energy* 36, 6890–6899.
- Dalmaso, A., 2008. Le projet Thermos (1975-1981) ou l'échec de « l'atome au coin du feu. Colloque Nucléaire et développement régional, Tours, CEHMVI, Fondation EDF, 17-18 décembre 2008. [in French].
- Decentralized energy, 2017. Chinese firm to develop nuclear district heating plant. Available from: <<http://www.decentralized-energy.com/articles/2017/12/chinese-firm-to-develop-nuclear-district-heating-plant.html>>.
- Difs, K., Danestig, M., Trygg, L., 2009. Increased use of district heating in industrial processes – Impacts on heat load duration. *Applied Energy* 86, 2327–2334.
- EC (European Commission), 2008. NACE rev. 2. Statistical Classification of Economic Activities in the European Community, Rev. 2 (2008). Available from: <http://ec.europa.eu/eurostat/ramon/nomenclatures/index.cfm?TargetUrl=LST_NOM_DTL&StrNom=NACE_REV2&StrLanguageCode=EN&IntPcKey=&StrLayoutCode=HIERARCHIC>.
- EC, 2011. Commission staff working paper. Impact assessment. Energy roadmap 2050. COM (2011) 885 final {SEC (2011) 1566 final; SEC (2011) 1569 final}.
- EC, 2012. Background Report on EU27 District Heating and Cooling Potentials, Barriers, Best Practice and Measures of Promotion. Available from: <<https://setis.ec.europa.eu/publications/jrc-setis-reports/background-report-eu-27-district-heating-and-cooling-potentials-0>>.
- EC, 2014a. Special Eurobarometer 416: Attitudes of European Citizens towards the Environment. Available from: <http://ec.europa.eu/public_opinion/archives/ebs/ebs_416_en.pdf>.
- EC, 2014b. European Energy Security Strategy. COM (2014) 0330 final. Available from: <<http://eur-lex.europa.eu/legal-content/EN/ALL/?uri=CELEX:52014DC0330&qid=1407855611566>>.
- EC, 2014c. Guide to Cost-Benefit Analysis of Investment Projects for Cohesion Policy 2014-2020.
- EC, 2015. Strategic Energy Technology Plan (SET-Plan). Available from: <<http://ec.europa.eu/energy/en/topics/technology-and-innovation/strategic-energy-technology-plan>>.
- EC, 2016a. Communication from the Commission to the European Parliament, the Council, the European Economic and Social Committee and the Committee of the Regions on an EU Strategy for Heating and Cooling. Available from: <https://ec.europa.eu/energy/sites/ener/files/documents/1_EN_autre_document_travail_service_part1_v6_0.pdf>.
- EC, 2016b. Energy in Buildings. Available from: <<https://ec.europa.eu/energy/en/topics/energy-efficiency/buildings>>.
- EC, 2016c. Communication from the Commission to the European Parliament, the Council, the European Economic and Social Committee and the Committee of the Regions on an EU Strategy for Heating and Cooling. Available from: <<http://eur-lex.europa.eu/legal-content/ES/TXT/?uri=CELEX:52016SC0024>>.
- Economidou, M., Lautsen, J., Strong, D., Zinetti, S., 2011. Europe's buildings under the microscope: A country-by-country review of the energy performance of buildings. Available from: <http://bpie.eu/wp-content/uploads/2015/10/HR_EU_B_under_microscope_study.pdf>.
- EEA (European Environment Agency), 2009. Water resources across Europe — confronting water scarcity and drought.

- EEA, 2013. Progress on energy efficiency in Europe. Available from: <<https://www.eea.europa.eu/data-and-maps/indicators/progress-on-energy-efficiency-in-europe/assessment>>.
- ETI (Energy Technology Institute), 2016. System Requirements for Alternative Nuclear Technologies - Phase 3. Technical assessment of SMR heat extraction for district heat networks. Available from: <<http://www.eti.co.uk/library/system-requirements-for-alternative-nuclear-technologies-phase-3>>.
- Euroheat & Power, 2015a. District Heating and Cooling country by country Survey 2015. Available from: <<http://www.euroheat.org/wp-content/uploads/2016/03/2015-Country-by-country-Statistics-Overview.pdf>>.
- Euroheat & Power, 2015b. Country by country survey of district heating and cooling. 2015 statistics. Available from: <<http://euroheat.org/Statistics-69.aspx>>.
- European Parliament, 2003. Directive 2002/91/EC. On the Energy Performance of Buildings.
- European Parliament, 2009. Directive 2009/28/EC on the promotion of the use of energy from renewable sources and amending and subsequently repealing Directives 2001/77/EC and 2003/30/EC.
- European Parliament, 2010. Directive 2010/31/EU of the European Parliament and of the Council of 19 May 2010 on the energy performance of buildings (recast).
- European Parliament, 2012. Directive 2012/27/EU of the European Parliament and of the Council of 25 October 2012 on energy efficiency, amending Directives 2009/125/EC and 2010/30/EU and repealing Directives 2004/8/EC and 2006/32/EC.
- Florio, M., 2014. Applied Welfare Economics: Cost-Benefit Analysis of Projects and Policies, 1 edition. ed. Routledge, New York.
- Flyvbjerg, B., 2016. The Oxford Handbook of Megaproject Management. Terry Williams, Knut Samset, and Kjell Sunneveg, eds.
- Fonseca, J.N.B., Oliveira Panão, M.J.N., 2017. Monte Carlo housing stock model to predict the energy performance indicators. *Energy and Buildings* 152, 503–515.
- Fortum Power and Heat Oy, 2009. Application for a Decision-in-Principle Concerning the Construction of a Nuclear Power Plant Unit - Loviisa 3.
- Fortum, 2013. Nuclear District Heating Plans from Loviisa to Helsinki Metropolitan Area. Presentation by Harri Tuomisto. Available from: <https://www.oecd-neo.org/ndd/workshops/nucogen/presentations/3_Tuomisto_Nuclear-District-Heating-Plans.pdf>.
- Frederiksen, S., Werner, S., 2013. District heating and cooling. Lund Studentlitteratur.
- Fütterer, M.A., Carlsson, J., de Groot, S., Deffrennes, M., Bredimas, A., 2014. European energy policy and the potential impact of HTR and nuclear cogeneration. *Nuclear Engineering and Design, SI : HTR 2012* 271, 73–78.
- Gabbrielli, R., Castrataro, P., Del Medico, F., Di Palo, M., Lenzo, B., 2014. Levelized Cost of Heat for Linear Fresnel Concentrated Solar Systems. *Energy Procedia* 49, 1340–1349.
- Gils, H.C., Cofala, J., Wagner, F., Schöpp, W., 2013. GIS-based assessment of the district heating potential in the USA. *Energy* 58, 318–329.
- Ginley, D.S., Cahen, D., 2011. Fundamentals of Materials for Energy and Environmental Sustainability. Cambridge University Press.
- Giraud, G., 2014. How Dependent is Growth from Primary Energy ? Output Energy Elasticity in 50 Countries (1970-2011). Available from: <<https://www.parisschoolofeconomics.eu/IMG/pdf/article-pse-medde-juin2014-giraud-kahraman.pdf>>.
- GISTEMP Team, 2016. GISS Surface Temperature Analysis (GISTEMP). NASA Goddard Institute for Space Studies. Available from: <<https://data.giss.nasa.gov/gistemp/>>.

- Gollier, C., 2011. Le calcul du risque dans les investissements publics. Available from: <<http://www.ladocumentationfrancaise.fr/var/storage/rapports-publics/114000605.pdf>> [in French].
- Heat Roadmap Europe, 2015. Heat Roadmap Europe 2050. Research project co-funded by the European Commission. Peta, the Pan-European Thermal Atlas: renewable energy. Available from: <<http://maps.heatroadmap.eu/maps/31157/Renewable-Resources-Map-for-EU28?preview=true#>>.
- Heiselberg, P., Brohus, H., Hesselholt, A., Rasmussen, H., Seinre, E., Thomas, S., 2009. Application of sensitivity analysis in design of sustainable buildings. *Renewable Energy, Special Issue: Building and Urban Sustainability* 34, 2030–2036.
- Hirsch, P., Duzinkiewicz, K., Grochowski, M., Piotrowski, R., 2016. Two-phase optimizing approach to design assessments of long distance heat transportation for CHP systems. *Applied Energy* 182, 164–176.
- Hirsch, P., Duzinkiewicz, K., Grochowski, M., 2017. Multicriteria optimization approach to design and operation of district heating supply system over its life cycle. Presented at the E3S Web of Conferences.
- Hondeman, H., 2000. Electrical compression cooling versus absorption cooling – a comparison, IEA Heat pump Centre Newsletter Volume 18, no. 4/2000. Available from: <etkhpcorderapi.extweb.sp.se/api/file/35>.
- Huisingh, D., Zhang, Z., Moore, J.C., Qiao, Q., Li, Q., 2015. Recent advances in carbon emissions reduction: policies, technologies, monitoring, assessment and modeling. *Journal of Cleaner Production, Carbon Emissions Reduction: Policies, Technologies, Monitoring, Assessment and Modeling* 103, 1–12.
- IAEA (International Atomic Energy Agency), 1997. Design approaches for heating reactors. IAEA-TECDOC-965.
- IAEA, 2003. Market Potential for Non-electric Applications of Nuclear Energy. STI/DOC/010/410.
- IAEA, 2016. Desalination Thermodynamic Optimization Program (DE-TOP). Available from: <https://www.iaea.org/NuclearPower/NEA_Desalination/index.html>.
- IAEA, 2017a. Nuclear power reactors in the world. IAEA-RDS-2/37.
- IAEA, 2017b. Opportunities for Cogeneration with Nuclear Energy. IAEA Nuclear Energy Series No. NP-T-4.1. Available from: <<http://www-pub.iaea.org/books/iaeabooks/10877/Opportunities-for-Cogeneration-with-Nuclear-Energy>>.
- IEA (International Energy Agency), 2011. Technology roadmap energy-efficient buildings: heating and cooling equipment. Tech rep.
- IEA, T., 2014. Status Report on District Heating in IEA countries. Prepared for the International Energy Agency (IEA) Bioenergy Task 32 and the Swiss Federal Office of Energy. Available from: <http://www.ieabcc.nl/publications/IEA_Task32_DHS_Status_Report.pdf>.
- IEA, 2015. Energy Balances of OECD countries.
- IEA, 2017a. World Energy Outlook.
- IEA, 2017b. Energy Technology Perspectives 2017, OECD/IEA, Paris.
- IEEP (Institute for European Environmental Policy), 2008. Potential impacts of desalination development on energy consumption. Available from: <<http://ec.europa.eu/environment/water/quantity/pdf/desalination.pdf>>.
- Intelligent Energy Europe Programme, 2015. Energy Efficiency Trends and Policies in the EU an analysis based on the ODYSSEE and MURE databases. Available from: <<http://www.odyssee-mure.eu/publications/br/synthesis-energy-efficiency-trends-policies.pdf>>.
- IPCC (Intergovernmental Panel on Climate Change), 2006. Guidelines for National Greenhouse Gas Inventories, Volume 2 Energy.
- IPCC, 2014. The fifth assessment report. Available from: <<https://www.ipcc.ch/report/ar5/>>.
- Jakubcionis, M., Carlsson, J., 2017. Estimation of European Union residential sector space cooling potential. *Energy Policy* 101, 225–235.

- Jaskólski, M., Reński, A., Duzinkiewicz, K., Kaczmarek-Kacprzak, A., 2014. Profitability criteria of partial cogeneration in nuclear power plant. *Rynek Energii*.
- Jaskólski, M., Reński, A., Minkiewicz, T., 2017. Thermodynamic and economic analysis of nuclear power unit operating in partial cogeneration mode to produce electricity and district heat. *Energy* 141, 2470–2483.
- Jasserand, F., Lavergne, J.-G., 2016. Initial Economic Appraisal of Nuclear District Heating in France. *EPJ Nuclear Sci. Technol.* 2, 39.
- Karagiannis, I.C., Soldatos, P.G., 2008. Water desalination cost literature: review and assessment. Desalination, European Desalination Society and Center for Research and Technology Hellas (CERTH), Sani Resort 22–25 April 2007, Halkidiki, Greece European Desalination Society and Center for Research and Technology Hellas (CERTH), Sani Resort 223, 448–456.
- Kessides, I.N., 2012. The future of the nuclear industry reconsidered: Risks, uncertainties, and continued promise. *Energy Policy* 48, 185–208.
- Keynes, J.M., 1921. *A Treatise on Probability*, Londres, McMillan (2e éd., 1948).
- Kuznetsov, Y.N., Khrilev, L.S., Brailov, V.P., 2008a. The technical and economic principles and lines of development of nuclear district heating cogeneration. *Therm Eng* 55: 939-46.
- Kuznetsov, Y.N., Khrilev, L.S., Brailov, V.P., Livshits, I.M., Smirnov, I.A., Svetlov, K.S. 2008b. An analysis of technical and economic indicators characterizing the development of nuclear cogeneration stations in the Northwestern region. *Therm Eng* 55: 913-25.
- Locatelli, G., 2013. Generation IV nuclear reactors: Current status and future prospects. *Energy Policy* 61, 1503–1520.
- Locatelli, G., Boarin, S., Pellegrino, F., Ricotti, M.E., 2015. Load following with Small Modular Reactors (SMR): A real options analysis. *Energy* 80, 41–54.
- Locatelli, G., Fiordaliso, A., Boarin, S., Ricotti, M.E., 2017. Cogeneration: An option to facilitate load following in Small Modular Reactors. *Progress in Nuclear Energy* 97, 153–161.
- Lockie, D., Sonnenfeld, D., 2013. *Routledge International Handbook of Social and Environmental Change*, Routledge. Fisher (Eds).
- Lund, H., Werner, S., Wiltshire, R., Svendsen, S., Thorsen, J.E., Hvelplund, F., Mathiesen, B.V., 2014. 4th Generation District Heating (4GDH). *Energy* 68, 1–11.
- Lund, H., Arler, F., Østergaard, P.A., Hvelplund, F., Connolly, D., Mathiesen, B.V., Karnøe, P., 2017. Simulation versus Optimisation: Theoretical Positions in Energy System Modelling. *Energies* 10, 840.
- Mansilla, C., Sigurvinnson, J., Bontemps, A., Maréchal, A., Werkoff, F., 2007. Heat management for hydrogen production by high temperature steam electrolysis. *Energy*, ECOS 05. 18th International Conference on Efficiency, Cost, Optimization, Simulation, and Environmental Impact of Energy Systems 32, 423–430.
- Ma, Q., Luo, L., Wang, R.Z., Sauce, G., 2009. A review on transportation of heat energy over long distance: Exploratory development. *Renewable and Sustainable Energy Reviews* 13, 1532–1540.
- Mazdiyasn, O., AghaKouchak, A., Davis, S.J., Madadgar, S., Mehran, A., Ragno, E., Sadegh, M., Sengupta, A., Ghosh, S., Dhanya, C.T., Niknejad, M., 2017. Increasing probability of mortality during Indian heat waves. *Science Advances* 3, e1700066.
- Miller, R., Hobbes, B., 2009. The Complexity of Decision-Making in Large Projects with Multiple Partners: Be Prepared to Change. In: *Making Essential Choices with Scant Information: Front-End Decision Making in Major Projects*. Terry Williams, Knut Samset, and Kjell Sunnevag, eds. pp. 375–389.
- Ministère de l'écologie, du développement durable et de l'énergie (French Ministry of Ecology, Sustainable development and Energy), 2014. Ministère de l'écologie, du développement durable et de l'énergie, 2014. Application de l'article 14.5 de la directive 202/27/EU sur la valorisation de la chaleur fatale industrielle via des réseaux de chaleur. Décret n° 2014-1363 du 14 Novembre 2014.

- Misra, B.M., 2007. Seawater desalination using nuclear heat/electricity — Prospects and challenges. *Desalination* 205, 269–278.
- Mora, C., Dousset, B., Caldwell, I.R., Powell, F.E., Geronimo, R.C., Bielecki, C.R., Counsell, C.W.W., Dietrich, B.S., Johnston, E.T., Louis, L.V., Lucas, M.P., McKenzie, M.M., Shea, A.G., Tseng, H., Giambelluca, B.W., Leon, L.R., 2017. Global risk of deadly heat. *Nature Climate Change* 7, 501–506.
- NEA (Nuclear Energy Agency), 2011. Current Status, Technical Feasibility and Economics of Small Nuclear Reactors. Organisation for Economic Co-operation and Development (OECD). Available from: <<https://www.oecd-nea.org/ndd/reports/2011/current-status-small-reactors.pdf>>.
- Nielsen, S., Möller, B., 2013. GIS based analysis of future district heating potential in Denmark. *Energy* 57, 458–468.
- Nielsen, S., 2014. A geographic method for high resolution spatial heat planning. *Energy* 67, 351–362.
- Nisan, S., Dardour, S., 2007. Economic evaluation of nuclear desalination systems. *Desalination* 205, 231–242.
- NNL (National Nuclear Laboratory), 2014. Small Modular Reactors (SMR) – Feasibility Study, NNL report. Available from: <<http://www.nnl.co.uk/media/1627/smr-feasibility-study-december-2014.pdf>>.
- Olkkonen, V., Syri, S., 2016. Spatial and temporal variations of marginal electricity generation: the case of the Finnish, Nordic, and European energy systems up to 2030. *Journal of Cleaner Production* 126, 515–525.
- Orhan, M.F., Babu, B.S., 2015. Investigation of an integrated hydrogen production system based on nuclear and renewable energy sources: Comparative evaluation of hydrogen production options with a regenerative fuel cell system. *Energy* 88, 801–820.
- Paananen, P., Henttonen, T., 2009. Investigations of a Long-Distance 1000 MW Heat Transport System with APROS Simulation Software. Contribution to the 20th International Conference on Structural Mechanics in Reactor Technology (SMiRT 20).
- Pearce, D., Atkinson, G., Mourato, S., 2006. Cost-Benefit Analysis and the Environment: Recent Developments Organisation for Economic Co-operation and Development (OECD).
- Persson, U., Werner, S., 2011. Heat distribution and the future competitiveness of district heating. *Applied Energy* 88, 568–576.
- Pierrès, N.L., Luo, L., Berthiaud, J., Mazet, N., n.d. Heat transportation from the Bugey power plant. *International Journal of Energy Research* 33, 135–143.
- Poredos, A., Kitanovski, A., 2011. District heating and cooling for efficient energy supply. In: 2011 International conference on electrical and control engineering (ICECE 2011), Yichang, China, September 16–18, 2011, p. 5238–41.
- QGIS, 2017. Geographical Information system (GIS). Open source software. Available from: <<http://www.qgis.org/fr/site/>>.
- Rämä, M., Sipilä, K., 2017. Transition to low temperature distribution in existing systems. *Energy Procedia*, 15th International Symposium on District Heating and Cooling, DHC15-2016, 4-7 September 2016, Seoul, South Korea 116, 58–68.
- Rämä, M., 2018. Flexible nuclear cogeneration. *Lettre I-Tésé* 33. Spring 2018. Available from: <http://itese.cea.fr/fr/Publications/LettreItese/Lettre_itese_33/files/04_Lettr_itese_printemps_2018_Eclairages_Flexible_nuclear_cogen.pdf>.
- Raskin, P., Gleick, P.H., Kirshen, P., Pontius, R.G.J., Strzepek, K., 1997. Comprehensive assessment of the freshwater resources of the world. Stockholm Environmental Institute, Sweden. Document prepared for the fifth session of the United Nations Commission on Sustainable Development, 1997.
- Reidhav, C., Werner, S., 2008. Profitability of sparse district heating. *Applied Energy* 85, 867–877.
- Rowinski, M.K., White, T.J., Zhao, J., 2015. Small and Medium sized Reactors (SMR): A review of technology. *Renewable and Sustainable Energy Reviews* 44, 643–656.

- Safa, H., 2012. Heat recovery from nuclear power plants. *International Journal of Electrical Power & Energy Systems* 42, 553–559.
- Safa, H., 2017. The Impact of Energy on Global Economy. *International Journal of Energy Economics and Policy* 7, 287–295.
- Sanderson, J., 2012. Risk, uncertainty and governance in megaprojects: A critical discussion of alternative explanations. *International Journal of Project Management* 30, 432–443.
- Scamman, D., Newborough, M., 2016. Using surplus nuclear power for hydrogen mobility and power-to-gas in France. *International Journal of Hydrogen Energy* 41, 10080–10089.
- Schmidt, D., Kallert, A., Blesl, M., Svendsen, S., Li, H., Nord, N., Sipilä, K., 2017. Low Temperature District Heating for Future Energy Systems. *Energy Procedia*, 15th International Symposium on District Heating and Cooling, DHC15-2016, 4-7 September 2016, Seoul, South Korea 116, 26–38.
- Sernhed, K., Jönsson, M., 2017. Risk management for maintenance of district heating networks. *Energy Procedia*, 15th International Symposium on District Heating and Cooling, DHC15-2016, 4-7 September 2016, Seoul, South Korea 116, 381–393.
- Short, W., Daniel, J., Holt, T., 1995. *A Manual for the Economic Evaluation of Energy Efficiency and Renewable Energy Technologies*. NREL/TP-462-5173/.
- Smil, V., 2010. *Energy Transitions: History, Requirements, Prospects*. Praeger publishing.
- Smirnov, I.A., Svetlov, K.S., Khrilev, L.S., 2008. Selecting main technical solutions for heat supply systems equipped with nuclear cogeneration stations. *Therm Eng* 55: 939-46.
- SNCU (French National Union for DH), 2017. *Enquête annuelle sur les réseaux de chaleur et de froid. Rapport 2017. Chiffres 2016. Edition nationale*. Available from: <<https://www.actu-environnement.com/media/pdf/news-29857-enquete-sncu-2017.pdf>> [In French].
- Sorgulu, F., Dincer, I., 2017. Cost evaluation of two potential nuclear power plants for hydrogen production. *International Journal of Hydrogen Energy*.
- Sovacool, B.K., 2014. What are we doing here? Analyzing fifteen years of energy scholarship and proposing a social science research agenda. *Energy Research & Social Science* 1, 1–29.
- STUK (Finnish Radiation and Nuclear Safety Authority), 2009. *Preliminary Safety Assessment of the Fennovoima Oy Nuclear Power Plant Project*. Available from: <https://www.stuk.fi/documents/88234/148256/STUK-Fennovoima_preliminarysafetyassessment_letter.pdf/2b9012c5-0d9a-4253-8efd-c2070fdc2cb7>.
- Svensson, I.-L., Moshfegh, B., 2011. System analysis in a European perspective of new industrial cooling supply in a CHP system. *Applied Energy* 88, 5164–5172.
- Trygg, L., Amiri, S., 2007. European perspective on absorption cooling in a combined heat and power system – A case study of energy utility and industries in Sweden. *Applied Energy* 84, 1319–1337.
- Ueda, K., Togano, Y., Shimoda, Y., 2009. Energy conservation effects of heat source systems for business use by advanced centrifugal chillers. *ASHRAE Trans* 2009; 115(00012505):640–53.
- Uxc (Uxc consulting company), 2013. *SMR market outlook and deployment prospects*. Presentation of Uxc at the 4th annual Platts SMR conference. Available from: <<https://www.uxc.com/smr/documents/UxC%20Hinze-Platts%20SMR%202013-05-29.pdf>>.
- Van de Graaf, T., Sovacool, B.K., 2014. Thinking big: Politics, progress, and security in the management of Asian and European energy megaprojects. *Energy Policy* 74, 16–27.
- Verfondern, K., 2013. *Overview of Nuclear Cogeneration in High-Temperature Industrial Process Heat Applications*. OECD-IAEA Workshop, April 4-5, 2013, Paris. Available from: <https://www.oecd-nea.org/ndd/workshops/nucogen/presentations/15_Verfondern_2013-OECD-IAEA-Workshop.pdf>.
- Warren, R., Price, J., Graham, E., Forstenhaeusler, N., VanDerWal, J., 2018. The projected effect on insects, vertebrates, and plants of limiting global warming to 1.5°C rather than 2°C. *Science* 360, 791–795.

Chapter 1
Introduction

- Webb, J., 2015. Improvising innovation in UK urban district heating: The convergence of social and environmental agendas in Aberdeen. *Energy Policy* 78, 265–272.
- Werner, S., 2017. International review of district heating and cooling. *Energy* 137, 617–631.
- Yi, L., Xiao-Bai, C., Chun-Yan, W., 2011. Monte Carlo Simulation of Energy Distribution of Radiation Field. *Procedia Engineering, CEIS 2011* 15, 3299–3307.
- Zvingilaite, E., 2013. Modelling energy savings in the Danish building sector combined with internalisation of health related externalities in a heat and power system optimisation model. *Energy Policy, Special section: Long Run Transitions to Sustainable Economic Structures in the European Union and Beyond* 55, 57–72.

I. Cost-Benefit Analysis of systems using heat from nuclear plants

Part I aims to answer the research question (a) relative to the costs and benefits of nuclear plant based heating systems. Chapter 2 consists in a techno-economic assessment of fifteen theoretical district heating systems using heat from nuclear plants in Europe. Chapter 3 then models ten alternative systems designed to supply space heating and domestic hot water to the Dunkirk conurbation committee and compare them with a nuclear plant based heating system (Gravelines site). Chapter 4 finally evaluates the feasibility of steam transfer from nuclear plants to nearby factories through spatial analysis for France.

Research scope

PWR, DH, Process heat, Simulation, GIS

Geographical boundary

Europe

Publications

- Leurent, M. 2016. Economic assessment of district heating supplied with nuclear energy: A territorial analysis in France. Contribution to the technical meeting of the International Atomic Energy Agency (IAEA) on the socio-economic aspects of nuclear cogeneration. Vienna, November 2016.
- Leurent, M., Da Costa, P., Rämä, M., Persson, U., Jasserand, F., 2017. Cost-Benefit Analysis of District Heating using Heat from Nuclear plants in Europe. Proceeding of the 3rd International Conference on Smart Energy Systems and 4th Generation District Heating. Copenhagen, September 2017.
- Leurent, M., Da Costa, P., Rämä, M., Persson, U., Jasserand, F., 2018. Cost-benefit analysis of district heating systems using heat from nuclear plants in seven European countries. *Energy* 149, 454–472.
- Leurent, M., Da Costa, P., Jasserand, F., Rämä, M., Persson, U., 2018. Cost and climate savings through nuclear district heating in a French urban area. *Energy Policy* 115, 616–630.
- Leurent, M., Da Costa, P., Sylvestre, S., Berthélémy, M., 2018. Feasibility assessment of the use of nuclear plant-sourced steam for French factories considering spatial configuration. *Journal of Cleaner Production* 189, 529-538.

'The greatest enemy of knowledge is not ignorance, it is the illusion of knowledge.'

Stephen Hawking

Chapter 2

Cost-benefit analysis of district heating systems using heat from nuclear plants in seven European countries ¹

Abstract

This Chapter aims to evaluate and compare the cost savings and greenhouse gas (GHG) reduction potential of district heating (DH) systems using nuclear combined heat and power plants (NCHP) as heat supply in 7 European countries and for 15 DH + NCHP systems. The selection was made in collaboration with 'the Ad-Hoc Expert Group on the Role and Economics of Nuclear Cogeneration in a Low Carbon Energy Future' from the Organisation for Economic Co-operation and Development (OECD). Firstly, the linear heat density of the modelled DH networks was determined including locations with poorly developed DH networks. A large potential for extending DH networks was identified for France and the United Kingdom despite the expected decrease in the heat demand due to building renovation. Secondly, the costs and GHG emissions of DH + NCHP systems were evaluated via cost-benefit analysis. It concluded that 7 projects (out of 15) could be cost-effective when 25% of the total urban heat demand is supplied. Implementing NCHP based systems would reduce GHG emissions approximately by 10 Mt eCO₂/a. Four additional DH + NCHP systems may become competitive if a larger share of the total demand is supplied. Finally, a sensitivity analysis was performed to evaluate the uncertainty affecting the key parameters.

Keywords

District heating, cost benefit analysis, nuclear energy, cogeneration, Europe

Highlights

- Large potential for extending district heating (DH) networks in France and the UK
- Nuclear combined heat and power plants (NCHP) could provide low carbon DH services
- Costs and benefits of DH + NCHP systems are assessed for 15 European urban areas
- 7 to 11 cases could be cost-effective, depending on the connexion rate
- Sensitivity analysis reveals key parameters (e.g. heat transportation cost)

Comments

- The two input parameters specific to each urban areas are the annual residential and commercial demand for space heating and domestic hot water (determined on a square kilometer basis) and the distance from the NCHP to the city. All the other input parameters are either country specific or common to all cases (e.g. capital costs and energy prices). The benefit of this procedure is that the costs are transparent and comparable. The downside is that the local variations are not included. The sensitivity analysis performed compensate this methodological limit to some extent, highlighting the uncertainty affecting key parameters (see Section 3.2.3).
- Chapter 3 uses assumptions more specific to the urban area of Dunkirk, so as to better reflect the local specificities of this area.
- With regards to the accounting of CO₂ emissions, this Chapter adopts the average approach (the CO₂ emitted when consuming electricity equal to the average CO₂ content of electricity in the country). Chapter 3 introduces the marginal CO₂ approach.

¹ Leurent, M., Da Costa, P., Rämä, M., Persson, U., Jasserand, F., 2018. Cost-benefit analysis of district heating systems using heat from nuclear plants in seven European countries. *Energy* 149, 454–472.

1. Introduction

Space heating and domestic hot water in residential and tertiary buildings represent approximately 25% (3150 TWh_{th}) of the European Union's (EU) final energy consumption (EC (European Commission), 2016a; IEA (International Energy Agency), 2015). In terms of the final energy demand, the direct burning of fossil fuels in on-site boilers represents 68% of the total, while district heating (DH) accounts for 7% (see Figure I.2.1). According to (Frederiksen and Werner, 2013), the fundamental idea of DH is 'to use local fuel or heat resources that would otherwise be wasted, in order to satisfy local customer demands for heating, by using a heat distribution network of pipes as a local market place'. In general, the DH systems in the EU reflect this fundamental idea with only 17% of heat demand supplied through heat-only boilers burning fossil fuels (IEA, 2015; Werner, 2017). The major DH sources in the EU are shown in Figure I.2.2, including the direct use of renewables, the use of renewables in combined heat and power plants (CHP), and the use of fossil fuels in CHP. Despite the fact that 83% of the heat supplied to DH networks comes from recycled, renewables sources or CHP plants, the fact nonetheless remain that about 73% is fossil fuels sourced (see Figure I.2.3). There is clear potential to decarbonise the residential and tertiary heating sector of the EU.

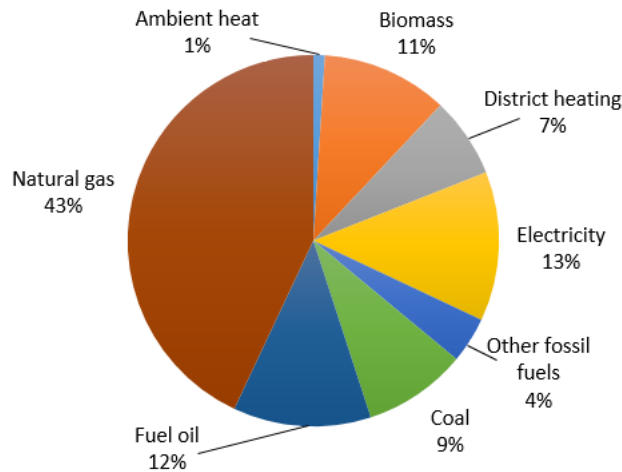

Figure I.2.1: Final energy consumption for space heating and domestic hot water in the EU per energy source, 2012 (%). Data source: (EC, 2016a).

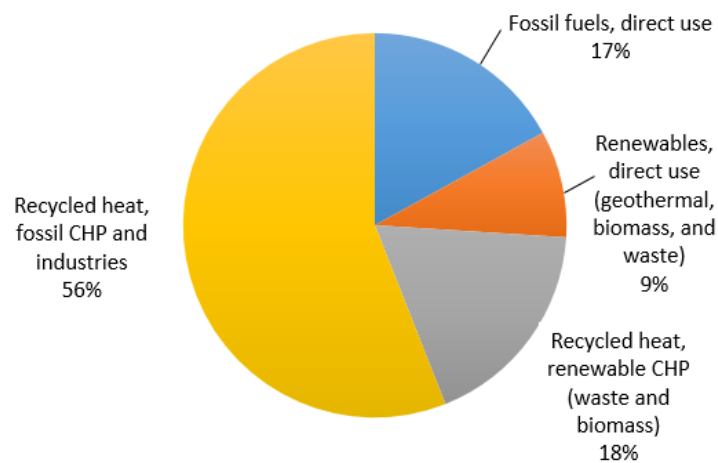

Figure I.2.2: Heat supplied to all DH systems in the EU categorised into four heat supply methods, 2014. Data source: Werner (2017), using data from IEA (2015).

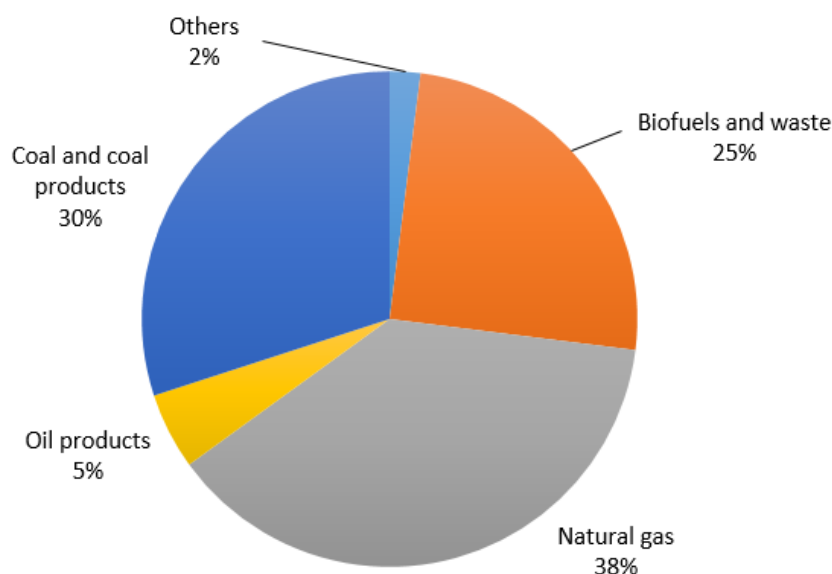

Figure I.2.3: Heat supplied to all DH systems in the current EU according to the energy supply sources used, 2014. Data source: Werner (2017), using data from IEA (2015).

Nuclear plants with heat recovery to DH systems were listed in (IAEA (International Atomic Energy Agency), 2003) for 18 different locations, among which 4 are in EU countries (Bulgaria, Czech Republic, Slovakia and Hungary). However, these nuclear combined heat and power plants (NCHP) accounted for 0.17% in 2014 (0.11 TWh_{th}/a) of the heat supplied to EU's DH systems (and thus are not listed in Figure I.2.2). There are many explanations for this low market share, such as the often long distance between nuclear sites and urban areas, local governance, economic feasibility, institutional structures, and the historical development of the different national energy systems (see Chapter 5, analysing the barriers to the deployment of a NCHP in the region of Helsinki, Finland).

From a technical viewpoint, however, previous research suggests that technical improvements in DH technologies (e.g. low thermal conductivity of modern insulation materials) may make it possible to transport hot water over long distances (up to 100 km) with affordable heat losses (below 2%) (Hirsch *et al.*, 2016; Ma *et al.*, 2009; Paananen and Henttonen, 2009). Coupled with the rising awareness of the urgency to reduce greenhouse gas (GHG) emissions (EC, 2014a; Lockie and Sonnenfeld, 2013), this has led to a renewed interest in DH + NCHP schemes at both national (e.g. Czech Republic (*Ministerstvo Průmyslu A Obchodu* (Czech Ministry of Industry and Trade), 2015), the United Kingdom (UK, ETI (Energy Technology Institute), 2016, 2015) and international levels (EC, 2015; EUROPAIRS, 2009; IAEA (International Atomic Energy Agency), 2016a; NC2I (Nuclear Cogeneration Industrial Initiative), 2015; NEA (Nuclear Energy Agency), 2015). Yet, there is no suitable analytical tool to assess the costs and benefits of these local systems. A cost-benefit analysis (CBA) can be used to inform policy makers and stakeholders of the potential of DH + NCHP systems in contribution to the transition towards low-carbon energy systems.

The Chapter is organised as follow. The scope of the research is defined in Section 2 emphasising the main objectives of the Chapter. Section 3 describes the methods utilised and the main assumptions made in the analysis. The results are presented and discussed in Section 4. Section 5 summarises the content and results of the Chapter highlighting the key findings, limitations and implications.

2. Research scope

The aim of this Chapter is to evaluate and compare the cost and climate savings potential of the DH + NCHP systems that were recently discussed by diverse working groups dealing with NCHP (ETI (Energy Technology Institute), 2015; IAEA (International Atomic Energy Agency), 2016a; NEA, 2015). Most insight was gained through the 'Ad hoc Expert Group of the Nuclear Energy Agency on the Role and Economics of Nuclear Co-generation in a Low-carbon Energy Future (2015-2017) (NEA, 2015). As shown in Figure I.2.4, the DH + NCHP systems here studied are located in 7 European countries (EU27+UK), and concern 12 nuclear sites and 15 distinctive urban areas (see Table I.2.1).

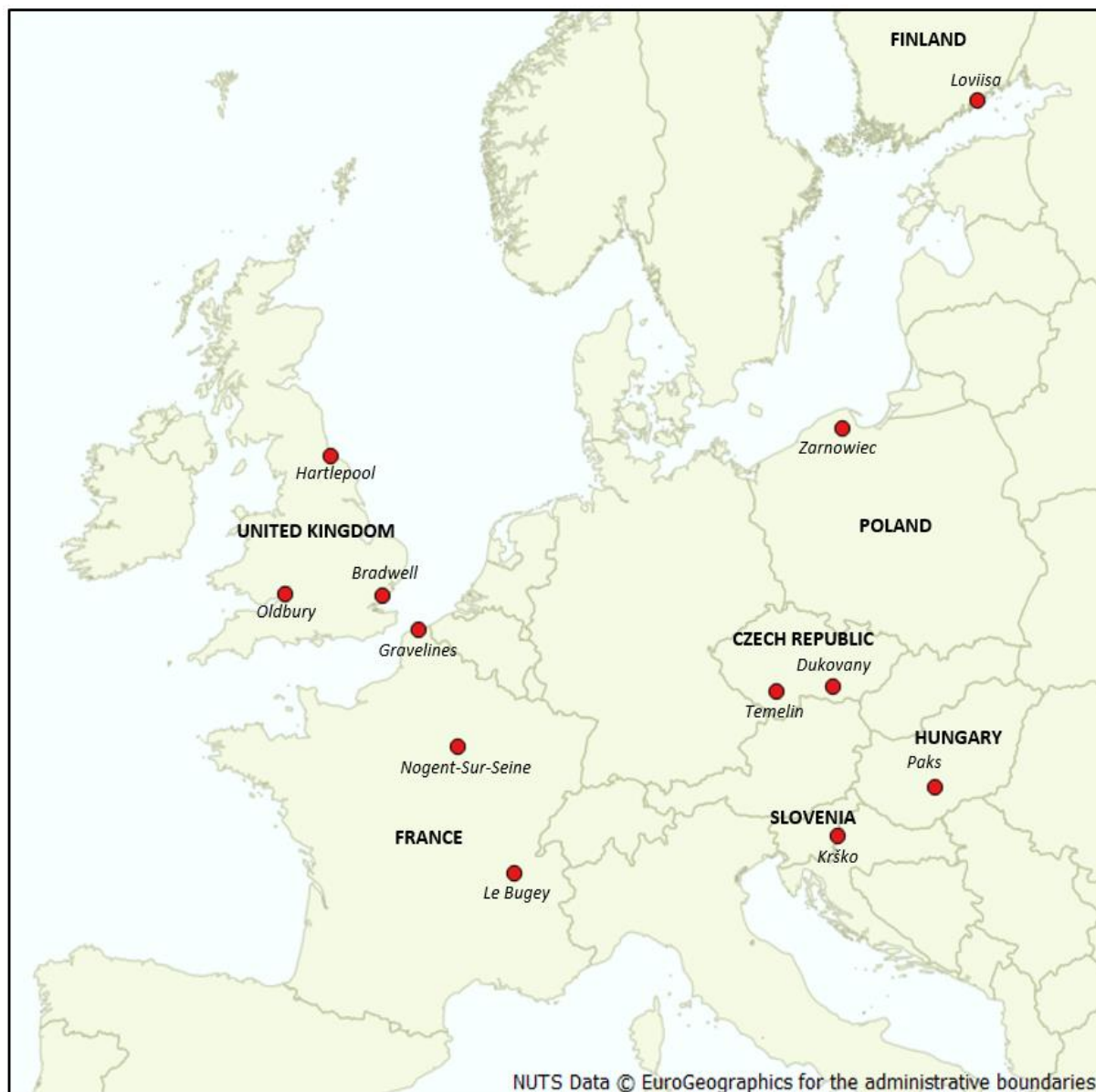

Figure I.2.4: The 12 nuclear sites considered for the CBA of DH + NCHP systems.

Notes:

Nuclear sites are located between 2.3 km and 90 km from the urban area to be supplied (see Table I.2.1).

Among these 7 countries, 2 already have experience of DH + NCHP (Czech Republic and Hungary; see Chapter 5 for details). All countries but Poland are currently operating nuclear power plants. While Poland does not yet have any operating nuclear reactor, the first plant may be commissioned by 2030 (two sites are being considered, (*Ministerstwo Gospodarki* (Polish Ministry of the Economy), 2014). According to the Polish Ministry of the Economy (*Ministerstwo Gospodarki*, 2014), nuclear energy could help decarbonise the power sector, currently heavily dependent on coal (80% of the power mix). Coal is also dominant in the heating sector, representing 66.7% of the total Polish heat supply (ENTRANZE, 2017a). As a result, around 80% of the Polish population in urban areas breaths air that does not meet EU standards (*Ministerstwo Energii*, 2016). Poland is also a member of the international NCHP working groups (IAEA, 2016a; NC2I, 2015; NEA, 2015), and academics have highlighted the potential of the Zarnowiec site for operating a NCHP (Hirsch *et al.*, 2016, 2015). While the technical feasibility of a local DH + NCHP system has been shown (Hirsch *et al.*, 2016), the costs and benefits associated with these systems remain poorly assessed. At this point, no study concludes which of the following alternatives would show the highest potential from an environmental and economic point of view:

- Supplying heat only to the closest city, Weljherowo;
- Supplying heat not only to Weljherowo but also to Rumia and Gdynia. While this would increase the DH potential, it will also require transporting heat over a longer distance (see Table I.2.1), rendering the economic feasibility rather uncertain;
- Supplying heat also to Gdansk (going through Weljherowo, Rumia and Gdynia). As for the second alternative, the economic attractiveness of this option relative to others remains undetermined.

In Slovenia, a similar question arises with regards to the Krško and Brežice municipalities. Overall, DH + NCHP systems are being investigated by various stakeholders such as energy companies, policy makers and researchers. The leveraged factors are: energy efficiency, decarbonisation of the heat sector, independence from imported fossil fuels, synergies between nuclear and renewable energies, and strategic considerations with regards to future nuclear technologies.

Table I.2.1 provides a brief overview of the current state-of-the-art of DH + NCHP studies. It lists the interested stakeholders, along with the published reports or papers. Despite providing valuable insight, the studies presented in Table I.2.1 do not assess the economic potential or the possible GHG emission reductions of DH + NCHP systems based on a common set of assumptions. No conclusion can be reached with regards to:

- Economic performance of each DH + NCHP system (both in absolute and relative terms);
- Global economic potential and possible GHG emission reductions.

Similarly to other DH systems, these projects must be evaluated at a local level. This is because they strongly depend on the heat density of the urban area supplied (which determines the economic feasibility of the distribution side, see e.g. Persson and Werner, 2011; Werner, 2017), as well as on the distance from the nuclear site to the urban area (which impacts the economic feasibility of the transportation side; see e.g. Hirsch *et al.*, 2016). Each urban area studied in this Chapter was modelled using real data on the heat density, the distance from nuclear site to city, and the GHG emissions from business-as-usual heating sources. However, the CBA uses a common set of assumptions with regards to other parameters (e.g. energy prices, investment cost of DH pipelines). The advantage of this approach is that a methodological framework can be developed to compare DH + NCHP systems despite heterogeneous operational contexts.

The drawback of this approach is that it does not account for all local characteristics. In particular, the studied urban areas are at different stages of deploying DH networks. National heat market shares vary significantly between EU members, from 40–60% in the Scandinavian and Baltic Member States down to 2% and 6% in the UK and France respectively (IEA, 2014; Werner, 2017). The investment cost related to the distribution side will vary significantly depending on the technical compatibility with existing heating systems. The issue is even more complex given the fact that certain

old DH networks are designed for steam transportation while other more recent networks are designed for hot water transportation (see e.g. Dalla Rosa *et al.*, 2014) for a description of the different generations of DH networks, and the trend towards 4th generation DH). However, accounting for all local characteristics would have been an extensive task considering the scope of the study. The values of the parameters used in this Chapter could be modified if more detailed data is available to produce new, more accurate results. A sensitivity analysis was carried out in order to assess the impact of varying the key parameter values.

Country	Party showing interest in DH + NCHP projects	Metropolitan area	Plant location	Length of the heat transport line (km)
Czech Republic (*)	Policy makers (<i>Ministerstvo Průmyslu A Obchodu</i> , 2015), researchers (SUSEN (SUStainable ENergy), 2015) and energy company (CEZ Group)	České Budějovice	Temeline	25
		Brno	Dukovany	35
Finland	Energy company (Fortum Power and Heat Oy, 2009; Henttonen and Paananen, 2009; Paananen and Henttonen, 2009); and researchers (Leurent <i>et al.</i> , 2017)	Helsinki + surrounding	Loviisa	80
France	Researchers (Jasserand and Lavergne, 2016; Leurent <i>et al.</i> , 2018; Safa, 2012)	Dunkirk + sur.	Gravelines	15
		Lyon + sur.	Le Bugey	30
		Paris + sur.	Nogent-Sur-Seine	90
Hungary (*)	Researchers (HAS Centre for Energy Research, 2016) and energy company (MVM Group)	Paks	Szekszard	30
Poland (**)	Policy makers (<i>Ministerstwo Energii</i> , 2016) and researchers (Hirsch <i>et al.</i> , 2016, 2015)	Weljherowo	Zarnowiec	18
		Gdynia + Rumia + Wel.		40
		Gdansk + Gdy. + Rum. + Wel.		85
Slovenia	Energy company (GEN energia d.o.o, 2016)	Krško	Krško	2.3
		Brežice + Krško		7
UK	Researchers (ETI, 2016, 2015)	Bristol	Oldbury	20
		Newcastle	Hartlepool	40
		London + surr.	Bradwell	70

Table I.2.1: Description of the 15 DH + NCHP systems evaluated in this Chapter and references to previous studies.

Notes:

(*) Countries with industrial experience of DH supplied with NCHP (see Chapter 5 for details).

(**) Poland does not have nuclear plants today but this option is being considered (*Ministerstwo Gospodarki*, 2014); two sites are under investigation and construction could start by 2030.

3. Methods and main assumptions

This Chapter aims to evaluate the cost savings and GHG emissions reduction potential of 15 DH + NCHP projects in Europe by performing a CBA. CBA is the preferred tool of the European Commission to provide policy makers with an assessment of large energy projects (EC, 2014b). CBA are commonly used to assess energy projects (e.g. Bachmann and van der Kamp, 2014; Pikas *et al.*, 2017; Sardi *et al.*, 2017), including DH systems (e.g. Colmenar-Santos *et al.*, 2016; Groth and Scholtens, 2016; Hendricks *et al.*, 2016; Song *et al.*, 2017). In the past, CBA have been used to analyse the potential of specific DH + NCHP systems (Foskolos and Brogli, 1991; Immonen and Vuori, 1978). According to Lund *et al.* (2017), an approach such as CBA is well suited for long-term decision-making processes in democratic societies.

In this Chapter, the CBA was performed by comparing systems through:

- **Four economic criteria:** the levelised cost of the heat (LCOH; as in Gabbrielli *et al.*, 2014; Short *et al.*, 1995), the net present value (NPV), the internal rate of return (IRR) and the payback period.
- **One environmental criterion:** the life-cycle GHG emissions avoided due to the replacement of business-as-usual (BAU) heat systems with DH + NCHP.
- **One criterion reflecting both the economic and environmental potential:** the marginal GHG abatement cost. A marginal GHG abatement cost provides an effective way of visualising the cost-effectiveness of GHG abatement potential in energy systems; prominent in CBA of energy projects (Huang *et al.*, 2016).

Sub-sections 3.1. to 3.4 present and justify the main input parameters of the CBA following the system breakdown introduced in Figure I.2.5. Sub-section 3.5 presents the environmental assumptions. Appendixes provide a comprehensive description of input parameters to ensure the full reproducibility of the research carried out. Capital costs related to heat distribution, base-load heat generation, heat transportation and peak-load heat generation sub-models can be found in Appendix I.2.B. Operational, maintenance costs and technical efficiencies of sub-systems are presented in Appendix I.2.C. As shown in Appendix I.2.B, capital costs were scheduled for different time periods over the 2020-2030 decade, following project management principles. Capital costs were discounted to year 2018 (see Appendix I.2.A for economic formulas). As recommended by the European Commission for the CBA of large energy projects (EC, 2014b), the discount rate used is 3.5% and the time period is 40 years, corresponding to the technical lifetime of the major technical component of the systems evaluated (here, DH pipelines). As some technologies have shorter technical lifetimes (e.g. gas heat-only boilers), scheduled re-investments within the lifetime were included in the analysis. Technology lifetimes are shown in Appendix I.2.D.

The model used in the CBA can be decomposed in four sub-models, which were formulated as a linear programming problem using Python. The four sub-models are shown in Figure I.2.5, precisely described in sub-sections 3.1 to 3.4, and listed here:

- A base-load heat generation system, consisting in the heat generated with the NCHP. In addition to the infrastructure investment costs, generating heat with a nuclear plant has an opportunity cost. Extracting hot water (120°C) from an outlet of the secondary turbine will reduce the Carnot efficiency, implying electricity losses;
- A heat transportation system required to transport the hot water from the NCHP to the city DH distribution system;
- A DH distribution system, representing the DH network required to connect all dwellings to the heat transportation system;
- A peak-load heat generation system, including the gas heat-only boilers and water tank energy storage that would be installed within the city boundaries to provide winter peak-loads and to guarantee the security of supply in case of an unexpected disruption of the base-load source.

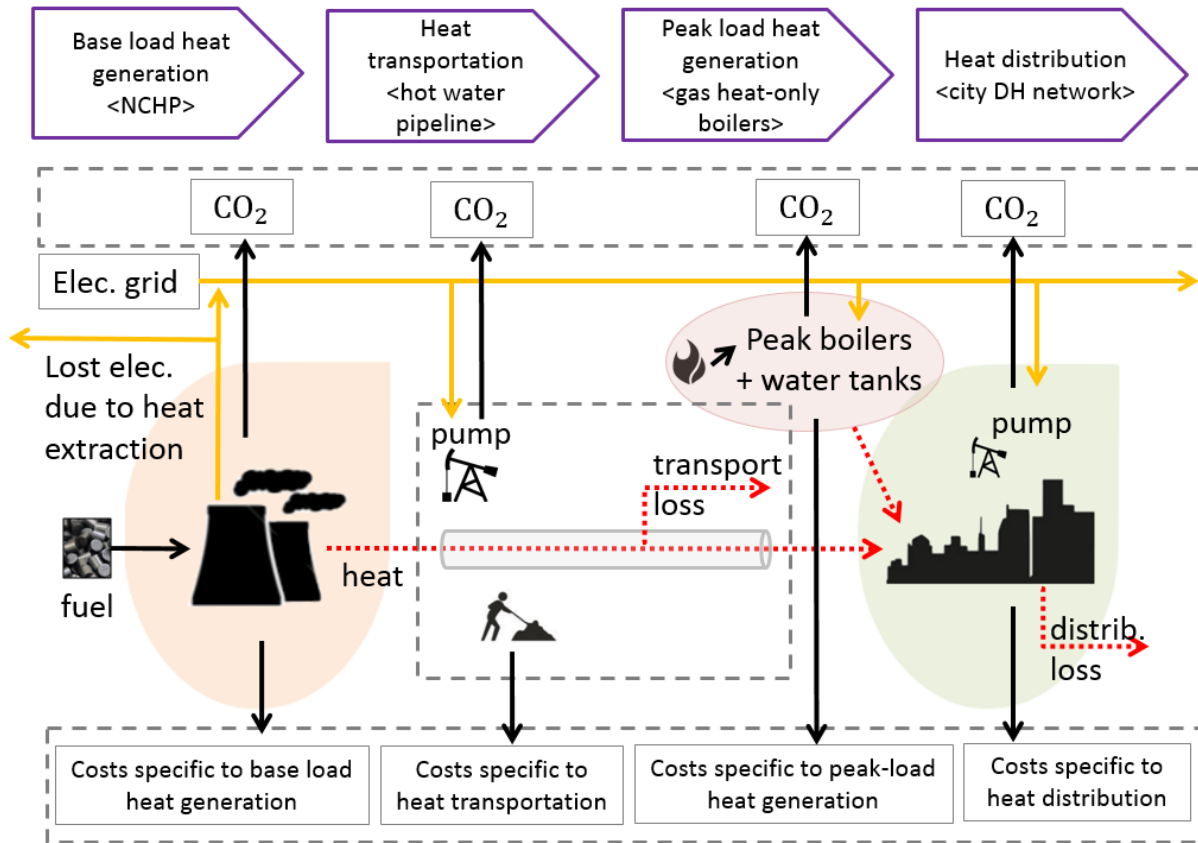

Figure 1.2.5: The structure of the techno-economic model used to estimate the costs and GHG emissions of DH + NCHP systems.

3.1. DH distribution system

As discussed in Section 2, the studied urban areas do not have the same market share of DH. To allow for comparison, it is assumed that DH distribution systems are built from scratch. Section 4.2.3 shows the sensitivity of our results to this hypothesis. Before describing the technical and costs assumptions made to determine the pipe diameter (m) and associated capital costs (€/m), the model and data used to assess the linear heat density ($MWh_{th}/m.a$) of the studied land areas is presented. Modelling the linear heat density determines the length of the DH pipelines required to supply a given area, thus strongly affecting the economic potential (Persson and Werner, 2011).

Evaluating the linear heat density of modelled DH networks

To model the linear heat density of DH networks, this Chapter uses the concept of effective width, w (m), as defined in equation (1):

$$w = \frac{A_L}{L} \quad (1)$$

Where A_L is the total land area (m^2), and L is the total length of DH pipes required to heat the buildings in the area. Based on real data from 83 EU cities in which DH provides on average 21% of the heat loads, Persson and Werner (2011) shows that w can also be expressed as in equation (2):

$$w = 61.8 \left(\frac{A_B}{A_L} \right)^{-0.15} \quad (2)$$

Where A_B is the total building space area (m^2). A_B can be computed using equation (3):

$$A_B = \frac{Q_s}{Q_B} \quad (3)$$

Where Q_s is the annual heat sold to DH consumers in the given area ($\text{kWh}_{\text{th}}/\text{a}$), and Q_B is the specific heat demand of buildings ($\text{kWh}_{\text{th}}/\text{m}^2 \cdot \text{a}$).

By referring to formulas (1) and (2), L , the total length of DH pipes required to heat the buildings in a given area (m), can be calculated. Q_s/L , the linear heat density ($\text{MWh}_{\text{th}}/\text{m} \cdot \text{a}$), directly results from these computations.

Finally, P_L , the number of inhabitants living in the area, is calculated by referring to formula (4):

$$P_L = \frac{A_B}{C_B} \quad (4)$$

Where A_B is the total building space area (m^2), and C_B is the building space per capita (m^2/capita).

The key data used in assessing the heat distribution system is from Heat Roadmap Europe (2015), providing the spatialised residential and tertiary heat consumption for EU countries in 2015 (unit: TJ/km^2). As illustrated in Figure I.2.6, the DH networks were modelled by only taking into account the surface areas with a heat demand density higher than $100 \text{ TJ}/\text{km}^2$. This is approximately equivalent to $28 \text{ GWh}_{\text{th}}/\text{km}^2$, and is above the feasibility threshold identified by (Persson and Werner, 2011) for the cost-effective creation or extension of DH networks ($90 \text{ TJ}/\text{km}^2$). However, areas with a heat demand density between 30 and $100 \text{ TJ}/\text{km}^2$ were considered for Paks (Hungary), Krško and Brežice (Slovenia) as these cities do not have densities greater than $100 \text{ TJ}/\text{km}^2$.

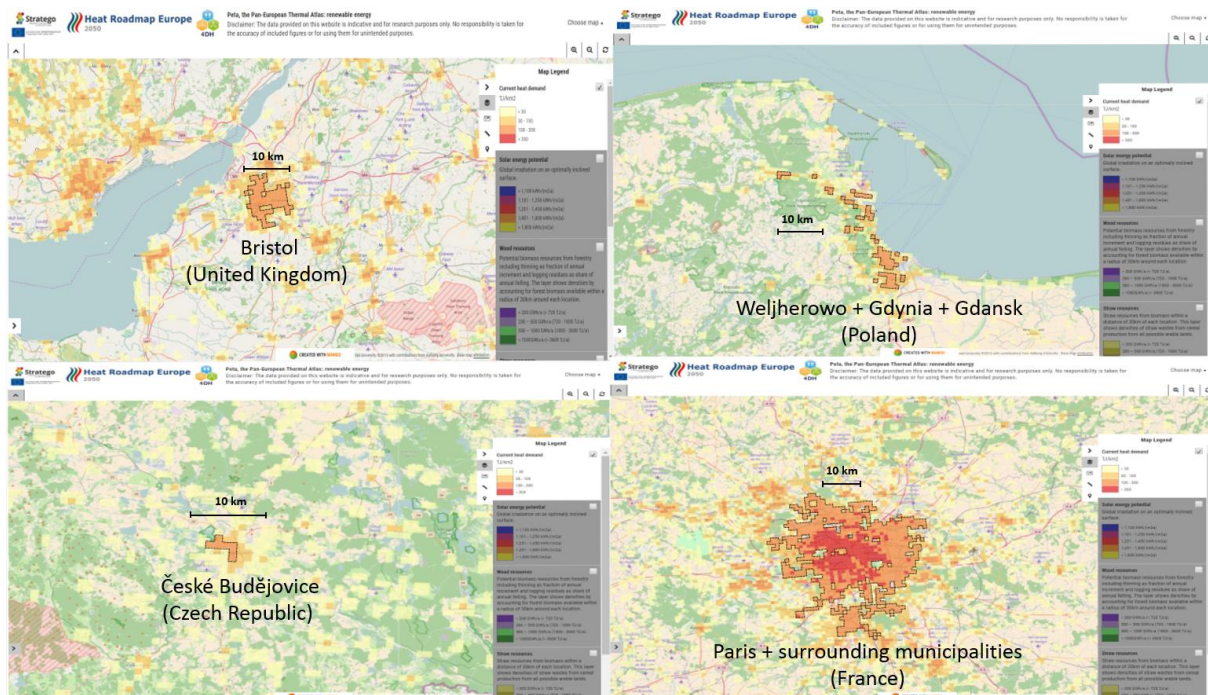

Figure I.2.6: Locations used to model DH networks in the Chapter (4 cases over 15). The DH network boundaries are indicated by the dashed lines. Data source: Heat Roadmap Europe (2015).

Annual heat loads are projected towards 2030 to account for the plausible penetration of energy-efficient buildings in future energy cities (see e.g. Cuce and Cuce, 2017; Dalla Rosa and Christensen, 2011; Soares *et al.*, 2017). ENTRANZE (2014) evaluated the expected decrease in the heat demand in the case where the current policies are continued (BAU scenarios) for each EU member and for the UK. The expected decreases are shown in Table I.2.2, alongside other parameters specific to each country. The values used for Q_s , the annual DH sold to customers ($\text{kWh}_{\text{th}}/\text{a}$), are based on data from Heat Roadmap Europe (2015; data for 2015), projected towards 2030 accounting for the

expected decrease in the heat demand of buildings between 2015 and 2030 (see Table I.2.2). The values used for Q_B , the specific heat demand of buildings ($\text{kWh}_{\text{th}}/\text{m}^2 \cdot \text{a}$), are based on (ENTRANZE, 2017b; data for 2008, see Table I.2.2) and projected towards 2030 accounting for the expected decrease in the heat demand of buildings between 2015 and 2030 (see Table I.2.2), and assuming that the observed decrease between 2008 and 2015 has followed the same trend as projected for the period 2015-2030.

Country	Expected decrease in the heat demand of buildings (%), residential & tertiary sectors, data from (ENTRANZE, 2014; BAU scenario) for the 2015-2030 period	specific heating demand of buildings ($\text{kWh}_{\text{th}}/\text{m}^2 \cdot \text{year}$), residential & tertiary sectors, data from (ENTRANZE, 2017b) for 2008	building space per capita (m^2/capita), residential sector, city averages, data from (Eurostat, 2015) for 2008	C_B , estimated building space per capita, residential & tertiary sectors, city averages, following evaluation from (Persson and Werner, 2011)
Czech Republic	9.7	184	28.7	35.6
Finland	5.5	223	38.9	48.6
France	8	157	39.9	49.9
Hungary	13.2 (*)	176	31.2	39
Poland	13.2 (*)	191	24.2	30.3
Slovenia	13.2 (*)	169	30.9	38.6
United Kingdom	8	204	44	55

Table I.2.2: Country-specific parameters used to evaluate the linear heat density ($\text{MWh}_{\text{th}}/\text{m} \cdot \text{a}$) of DH systems.

Notes:

(*): The EU average was used when country-specific data was not available in ENTRANZE (2014). While this has little influence on the results, future research should consider different values if possible.

Technical, cost assumptions and GHG emissions of heat distribution

In this Chapter, the computed linear heat density ($\text{MWh}_{\text{th}}/\text{m} \cdot \text{a}$) is an intermediate result for calculating the average diameter of the DH pipeline, average heat losses and distribution capital cost. Previous research has highlighted relationships between the linear heat density and average pipe diameter (Frederiksen and Werner, 1993), and between the linear heat density and heat losses (IEA, 2014). The formulas, derived from Frederiksen and Werner (1993) and IEA (2014), are shown in equations (5) and (6) respectively:

$$d_a = 0.0486 \ln(Q_s/L) + 0.06295 \quad (5)$$

$$\Delta Q = 17(Q_s/L)^{-0.5} \quad (6)$$

Where d_a is the average DH pipe diameter (m), Q_s/L is the linear heat density ($\text{MWh}_{\text{th}}/\text{m} \cdot \text{a}$), and ΔQ represents the average DH losses (%/a).

The pipeline installation cost, C_{DH} (€/m), is expressed in equation (7), using values from Dalla Rosa *et al.* (2012) and Togawa *et al.* (2014) that represent the sum of the pipe, civil works, sand filling, and labour costs:

$$C_{DH} = 1570 d_a + 235 \quad (7)$$

The GHG emissions from the heat distribution side, E_{DH} ($t \text{ eCO}_2$) are calculated as in (8):

$$E_{DH} = EF_{el} P_{DH} \quad (8)$$

Where EF_{el} is the GHG emission factor of electricity (t eCO₂/GWh_e; see 2.2), and P_{DH} is the electricity consumed for pumping in the DH system (GWh_e). The DH pumping power corresponds to 0.7% of the thermal output transported, as shown in AMORCE (French DH association, 2015).

3.2. Base-load heat generation

The cost of an NCHP is regarded as the investment cost of a Generation III pressurised water reactor (PWR) attributable to heat generation. Most nuclear reactors operating today in the world (277 out of 438) and those currently under construction (59 out of 70) are PWR (IAEA (International Atomic Energy Agency), 2017). The infrastructure cost, C_{CHP} (M€/MW_{th}) of a CHP upgrade in a PWR is expressed in formula (9):

$$C_{CHP} = Q_{MAX} C_{MCHP} \quad (9)$$

Where Q_{MAX} is the maximal thermal power required (MW_{th}), and C_{MCHP} is the marginal cost of a CHP upgrade in a PWR (€/W_{th}). ETI (2016) states that C_{MCHP} ranges between €0.05/W_{th} and €0.09/W_{th} including, for instance, DH pumps and condensers. As a conservative assumption, it is assumed herein that C_{MCHP} would be equal to €0.1/W_{th}.

Q_{MAX} was calculated to be able to supply 80% of the annual heat load of a typical DH network (see Figure I.2.7) in which a total of 60% of the demand falls during winter, 25% during spring/autumn and 15% during summer. The remaining 20% heat load (winter peak-loads) is supplied with peak boilers (see 2.1.4.). Given these considerations, the base-load heat source is operated at full capacity for 60% of the year (and 100% in winter). Nuytten *et al.* (2013) states that 60% is a reasonable assumption for modelling cost-effective CHP plants.

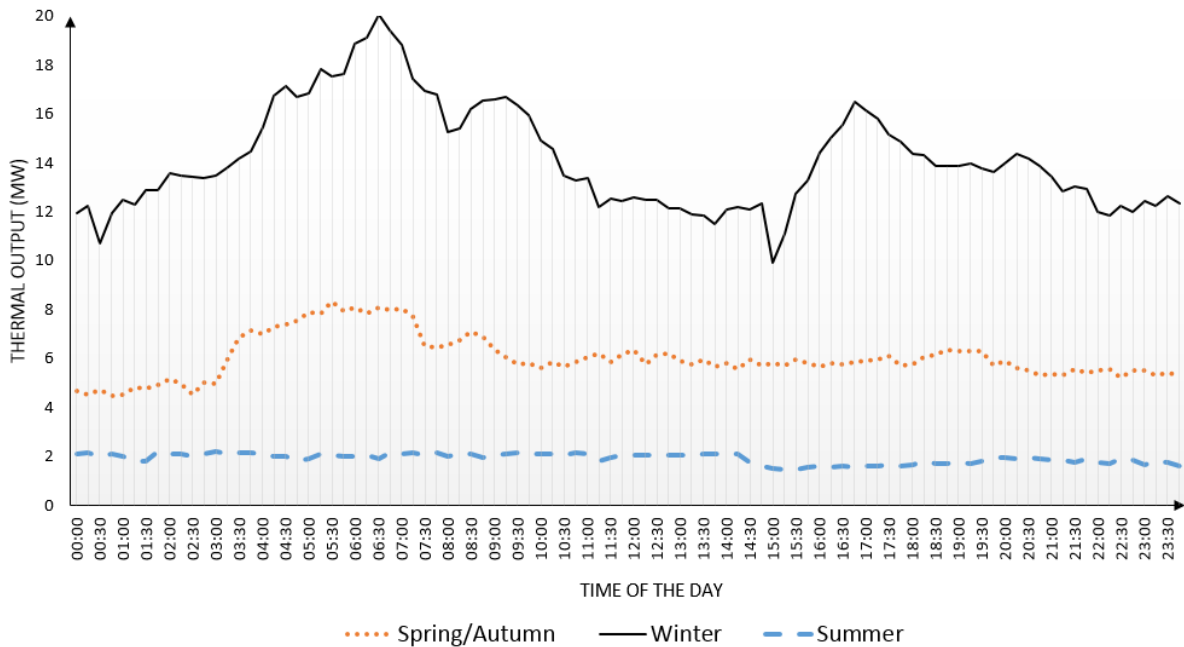

Figure I.2.7: Heat load profile used to assess the maximal thermal capacity of NCHP.

Notes:

The year was divided into three periods (according to the French seasons): spring/autumn (April, May, October and November; 2920 h); winter (January, February, March and December; 2920 h); and summer (June, July, August, and September; 2920h). Three typical days were used to represent the three seasons: Spring/autumn: 15/10/2015. Winter: 13/12/2015. Summer: 01/07/2015.

The model takes into account the reduction in power generation due to heat extraction on the Rankine cycle of a PWR. For the extraction of steam at 120°C from an outlet of the low-pressure turbine, E_{LS} , the electricity loss (MWh_e) represents one sixth of the thermal power generated (Safa, 2012). Given the above assumptions, the required cost (C_{pp} , unit: €) and additional CO₂ emissions (E_{pp}) to compensate for power generation loss are expressed in equations (10) and (11) respectively:

$$C_{pp} = P_{el} E_{LS} \quad (10)$$

$$E_{pp} = EF_{el} E_{LS} \quad (11)$$

Where P_{el} is the price of electricity (€/MWh_e), and EF_{el} is the CO₂ emission factor of the electricity (t eCO₂/GWh_e; see 2.2).

The global trend towards 4th generation DH networks is to decrease supply and return temperatures so as to favour the use of renewable and excess heat into DH networks (Dalla Rosa *et al.*, 2014; Frederiksen and Werner, 2013; Werner, 2017). The consequences for NCHP would be heat extraction at lower temperatures, thus reducing electricity losses due to heat extraction (Safa, 2012). Future research will examine the economic balance of such schemes.

3.3. Heat transportation system

Pipeline diameter, capital cost and heat loss

A heat transportation system is required to transport the heat from the nuclear plant to the city DH network. The hot water extracted from the nuclear plant is transported at a supply/return temperature of 120/50°C and a supply/return pressure of 4/18 bar.

The pipe diameter was calculated for each analytical case, using methods and data from Hirsch *et al.* (2016), Paananen and Henttonen (2009) and Safa (2012). First, G_s , the steam flux (kg/s) and \dot{v} , the volumetric flow rate (m³/s) were calculated as shown in equations (12) and (13):

$$G_s = \frac{Q_{MAX} 10^6}{C_p \Delta_T} \quad (12)$$

$$\dot{v} = \frac{G_s}{\rho} \quad (13)$$

Where Q_{MAX} is the maximal thermal power required (MW_{th}), C_p is the specific water heat capacity (Ws/kgK), Δ_T is the difference between supply and return temperatures (here equal to 70), and ρ is the density of water (kg/m³).

The pipeline inner diameter D (m) was then calculated using formula (14):

$$D = \sqrt{\left(\frac{4 \dot{v}}{\pi v}\right)} \quad (14)$$

Where v is the flow velocity (m/s), here assumed equal to 3 m/s, according to the results from Hirsch *et al.* (2016), Paananen and Henttonen (2009) and Safa (2012). Finally, C_{HTS} , the capital cost of the heat transportation system (HTS; €/m), was calculated referring to Hirsch *et al.* (2016), as expressed in equation (15):

$$C_{HTS} = 3000 D^2 + 4000 D + 1500 \quad (15)$$

Where D is the pipeline inner diameter (m). C_{HTS} includes two-way buried pipelines with 200 mm insulation thickness, pumping stations and labour cost.

Using a two-phase optimisation approach based on an optimisation-simulation framework, Hirsch *et al.* (2016) shows that an insulation thickness of 200 mm (polyurethane foam) can maintain heat losses below 2% of the thermal energy transported over at least 40 km, while the results from Safa (2012) indicate that a 300 mm thickness would limit losses to below 2% even for a 100km long

HTS. A value of 2% was considered in our study, but the impact of higher heat losses on the economic results is evaluated in Section 4.2.3.

Pumping power and GHG assessment

A pumping system is required to transport hot water. The electricity consumption of the system (W_e), P_{PM} , was calculated according to equation (16):

$$P_{PM} = \frac{g G_s H}{\eta_p} \quad (16)$$

Where g is the gravitational acceleration (m/s^2), η_p is the pump efficiency ratio (0.75), G_s is the steam flux (kg/s), and H is the lifting height (m). Referring to the Darcy–Weisbach equation, the lifting height is expressed in equation (17):

$$H = f \frac{L}{D} \frac{v^2}{2g} + c \quad (17)$$

Where L is the HTS length (m), D is the pipeline internal diameter (m), v is the media velocity (m/s), g is the gravitational acceleration (m/s^2), f is the friction loss coefficient, and c is the friction loss by local resistance (0.5).

From the above assumptions and assuming that the system is operational 100% of the year (8760 hours/a), the required cost, C_{PM} (€), and additional GHG emissions, E_{PM} (t eCO₂), associated with the operation of a pumping system are expressed in equations (18) and (19) respectively:

$$C_{PM} = P_{el} P_{PM} 8760 10^{-6} \quad (18)$$

$$E_{PM} = EF_{el} P_{PM} 8760 10^{-9} \quad (19)$$

Where P_{el} is the price of electricity (€/MWh_e) and EF_{el} is the CO₂ emission factor of the electricity (t eCO₂/GWh_e; see 2.2).

A 100% operating period for the NCHP is a theoretical assumption. Nuclear plants are regularly stopped for maintenance, usually in summer. For example, French nuclear plants can be operated up to 85% of the year (CEA (French Nuclear and Alternative Energies Commission), 2017). In order to avoid the use of natural gas boilers during maintenance outages (about 6% of the annual heat demand), it is possible to operate two reactors (or more) in a cogeneration mode (since nuclear plants are always composed of at least two reactors). Doing so would increase the reliability of the nuclear heat supply. Note that, in our model, natural gas boilers are still supplying the winter peak-loads (20% of annual heat demand; see Section 3.4).

3.4. Peak-load heat generation

DH + NCHP systems require gas heat-only boilers installed in very close proximity to the city DH network. The aim is two-fold:

- **Act as peak-shavers in periods of high demand.** In normal operation, gas boilers deliver 20% of the yearly heat demand (or 35% of winter loads, after accounting for heat losses and technology efficiencies). Similar proportions are assumed in Fang *et al.* (2015) when studying DH supplied with industrial excess heat recovery or in Lund *et al.* (2016) when investigating DH supplied with large-scale heat pumps. The capacity of these boilers is high enough to provide the yearly heat loads equal to 17% of the year. DH + NCHP also use heat storage (sensible heat, water), making it possible to reduce the gas boilers' installed capacity and natural gas consumption by 10% compared with systems without a daily storage (according to AMORCE, 2015).
- **Guarantee the security of supply.** Because the amount of heat from the NCHP may come to a temporary stop at times, boilers are dimensioned so as to be able to cover both peak and base loads if necessary.

GHG emissions from operating heat storage systems are neglected as they are minor (according to DEA (Danish Energy Agency), 2016). However, the additional GHG emissions, E_{GHOB} , generated during the operation of gas heat-only boilers are covered by the following equation (20):

$$E_{GHOB} = EF_{gas} Q_{GHOB} + EF_{el} E_{GHOB} \quad (20)$$

Where EF_{el} and EF_{gas} are the CO_2 emission factors of electricity and natural gas respectively ($t\ eCO_2/GWh$; see 2.2), Q_{GHOB} is the natural gas consumed in boilers (assuming an efficiency of 90%, (DEA, 2016), and E_{GHOB} is the electricity consumed for operational purposes (equal to 12% of the heat generated; DEA, 2016).

3.5. Environmental assumptions

To assess the decarbonisation potential of DH + NCHP systems, two parameters must be determined:

- $E_{DH+NCHP}$, the specific GHG emissions generated in operation of a DH + NCHP system. This can be obtained by summing up the values determined by formulas (8), (11), (19) and (20);
- E_{BAU} , the specific GHG emissions generated by the existing heat supply (BAU case).

In this Chapter, E_{BAU} is calculated by referring to EF_{BAU} , the average emission factor of the heating systems in each country ($t\ eCO_2/GWh_{th}$). EF_{BAU} is expressed in formula (21):

$$EF_{BAU} = EF_{gas} S_{gas} + EF_{biomass} S_{biomass} + EF_{fuel} S_{fuel} + EF_{coal} S_{coal} + EF_{el} S_{el} \quad (21)$$

Where EF_{gas} , $EF_{biomass}$, EF_{fuel} , EF_{coal} and EF_{el} are the emissions factors of natural gas, biomass, fuel oil, coal and electricity respectively. These factors are shown in Table I.2.3. S_{gas} , $S_{biomass}$, S_{fuel} , S_{coal} and S_{el} represent the share (%) of the alternatives used for heating. The composition of the heating mix for the residential and tertiary sectors of European countries for 2008 can be found in (ENTRANZE, 2017a). Since ENTRANZE (2017a) does not include Slovenia, data from the Statistical office of the Republic of Slovenia (2011) has been used for this country (data for 2008).

Finally, the marginal GHG abatement cost was computed to reflect both the economic and environmental features of systems within a single parameter. Cm_{GHG} , the marginal GHG abatement cost, was calculated according to equation (22):

$$Cm_{GHG} = \frac{LCOH Q_{DH}}{EF_{BAU} - E_{DH+NCHP}} \quad (22)$$

Where $LCOH$ is the levelised cost of the heat ($\text{€}/MWh_{th}$) and Q_{DH} is the annual DH delivery ($MWh_{th}/year$). The denominator represents the GHG emissions avoided through the implementation of a DH + NCHP system ($t\ eCO_2/year$). Literally, Cm_{GHG} is the levelised cost of avoiding the emission of one tonne of equivalent carbon dioxide through the implementation of a DH + NCHP system. Such a bottom-up, financial-accounting approach, is used in 37% of the Chapters dealing with marginal GHG abatement costs (Huang *et al.*, 2016). Despite presenting certain limits (e.g. sectoral interactions, see Kesicki and Strachan, 2011), it is an useful analytical tool that can complement the traditional, economic-only indicators (LCOH, NPV, IRR, payback period).

	Direct emissions (t eCO ₂ /GWh _{th}), IPCC (Intergovernmental Panel on Climate Change, 2006)	Lifecycle emissions, EU average (t eCO ₂ /GWh _{th}), Ecoinvent (Frischknecht and Rebitzer, 2005)
Biomass	0	0
Fuel oil	264,8	317.2
Natural gas	202.2	221.8
Coal	347.7	385.2
Electricity	Country average	
	<i>Data from 2009 (EEA (European Environment Agency), 2011) has been extrapolated to 2030 considering that the average GHG intensity of electricity generation will be decreased by 35% according to the results from (EC, 2013; EU average)</i>	

Table I.2.3: Direct and lifecycle GHG specific emissions of studied sources of energy.

Notes:

While zero is the value often used by public authorities to assess the GHG emissions from biomass boilers, it must be reminded that there are vivid discussions about the actual GHG emission factor of biomass. Evaluation of this factor vary from zero to more than two hundred depending on the reference. Please refer to Sections 4.1.1.5 and 5.3.1 of Chapter 3 for further discussion on this topic.

4. Results and discussions

This section presents and discusses results in two separate sub-sections. In sub-section 4.1, the DH distribution systems are described in terms of parameters such as the heat demand, linear heat density, and population supplied with DH network heat. In sub-section 4.2, the costs and GHG emissions of DH + NCHP systems are evaluated on the basis of a common set of assumptions. The economic competitiveness and potential for reducing the GHG emissions of DH + NCHP systems are assessed by way of comparison with the BAU sources used for heating.

In this Section, urban areas are referred by the name of the corresponding major city. For a precise definition of all the municipalities included in each location, please refer to Table I.2.1 of Section 2.

4.1. DH distribution systems

Figure I.2.8 depicts the heat demand and density of the modelled DH networks. The linear heat density provides insight into the economic attractiveness of DH systems (IEA, 2014; Persson and Werner, 2011).

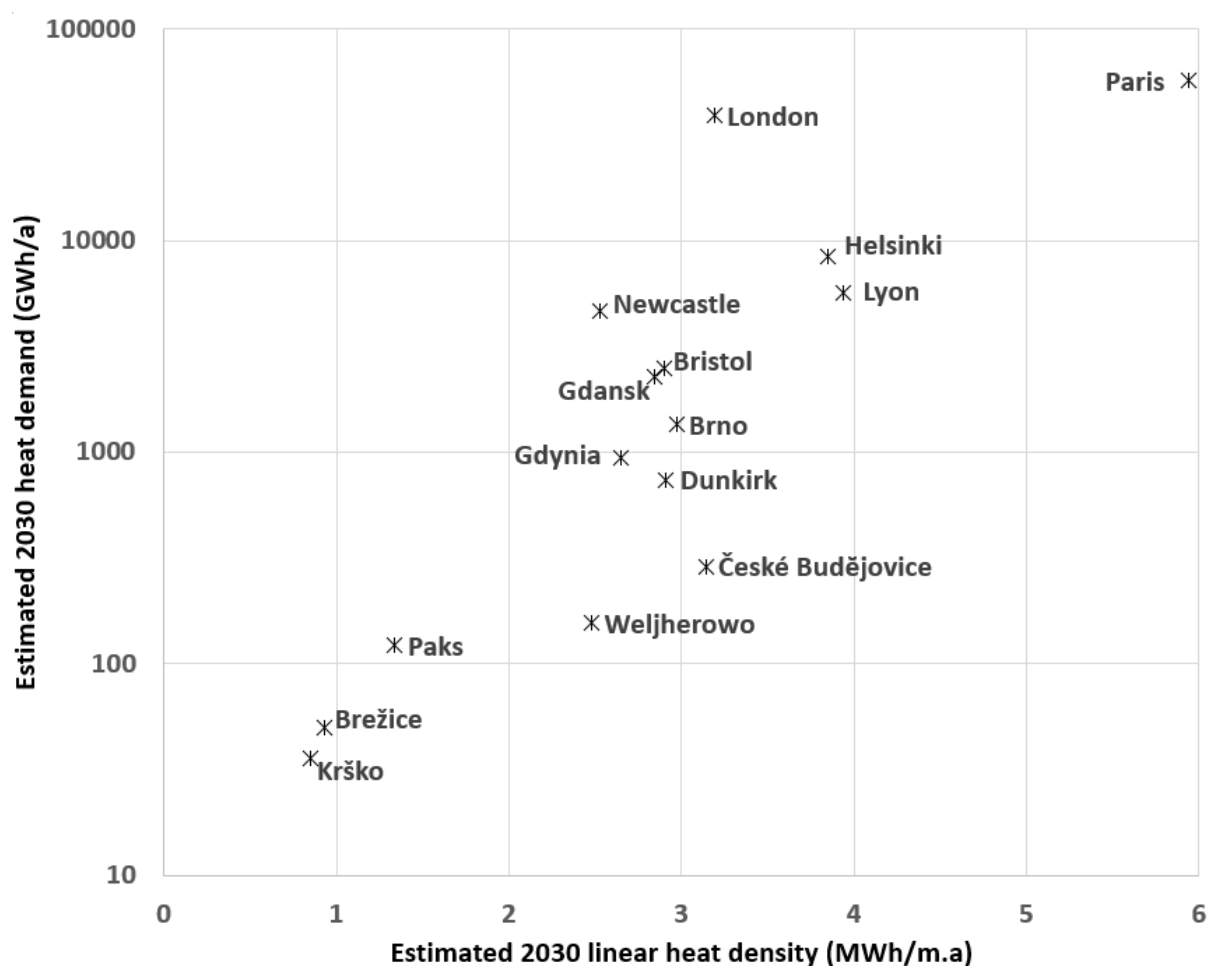

Figure I.2.8: Estimated 2030 heat demand and linear heat density of the modelled DH networks.

Threshold values for economically and environmentally beneficial DH scenarios reported in the literature range between 1 MWh_{th}/m. a for biomass installations down to 0.2 MWh_{th}/m. a for fossil-

fueled CHP installations (Dalla Rosa and Christensen, 2011; Fröling *et al.*, 2006; Reidhav and Werner, 2008). Using data on 800 EU DH networks, IEA (2014) has shown that DH systems can be seen as economically competitive (or at least have the potential to bring DH prices under €65/MWh_{th}, the EU average) when the linear heat density is above 2-3 MWh_{th}/m. a.

Table I.2.4 shows the total length of DH networks if they were to supply all the dwellings in the studied areas, given the levels of heat demand and density shown in Figure I.2.8. The thresholds discussed above are highlighted with colours. Table I.2.4 also shows the length of the existing DH networks in the cities in question and the country-specific GHG emission factors of the BAU energy sources used for heating.

Country	GHG emission factor of BAU heating sources (t eCO ₂ /GWh _{th})	Urban area	Population supplied with modelled DH networks (k capita)	Linear heat density of modelled DH networks (MWh _{th} /m. a)	Length of modelled DH networks (km)	Length of existing DH networks (km)
Czech Republic	453	České Budějovice	48.3	3.14	91.7	101.9, (Magistrát města České Budějovice, 2016)
		Brno	167.2	2.97	454.4	1349, (Brněnské vodárny a kanalizace, 2017)
Finland	288	Helsinki	639.9	3.85	2198.2	2750, (Finnish Energy, 2016)
France	332	Dunkirk	101.9	2.91	252.2	40, (Dalkia, 2015)
		Lyon	788.8	3.94	1443.3	185.4, (Viaséva, 2016)
		Paris	7913.9	5.24	9602.7	1239.9, (Viaséva, 2016)
Hungary	347	Szekszard	20.5	1.34	91.0	85.5, (Duna Center Therm Kft, 2016)
Poland	510	Weljherowo	31.1	2.48	62.9	42, (OPEC, 2016)
		Gdynia	188.3	2.65	357.0	331, (OPEC, 2017)
		Gdansk	452.5	2.84	800.4	816, (DBDH, 2014)
Slovenia	256	Krško	6.4	0.85	42.4	61.4, (Bergant <i>et al.</i> , 2013)
		Brežice	8.9	0.93	53.8	78, (Bergant <i>et al.</i> , 2013)
UK	428	Bristol	241	2.89	858.6	10-13 (*)
		Newcastle	451	2.53	1841.9	18-23 (*)
		London	3784	3.19	12241.3	400-600 (*)

Table I.2.4: Estimated and empirical parameters for the countries and urban areas under investigation.

Notes:

Highlighted in green: urban areas with high DH potential (linear heat density above 3 MWh_{th}/m. a).

Highlighted in yellow: urban areas with moderate DH potential (linear heat density between 1.5 and 3 $MWh_{th}/m. a$).

Highlighted in orange: urban areas with low DH potential (linear heat density below 1.5 $MWh_{th}/m. a$).

(*) No references precisely stating the density and length of existing DH networks were found for the UK. The given values have been estimated using data from BuroHappold Engineering (2016) and DECC (Departement of Energy & Climate Change), (2013) on the volume of DH delivery.

By comparing the length of the modelled DH networks with the aggregated length of existing DH pipelines, it is possible to determine whether or not the modelled DH network for each urban area is larger than the existing DH network. The differences between estimated and existing DH networks can also be due to methodological limitations, e.g. the square kilometre scale of the heat roadmap used (see Section 2.1) or the fact that we neglected the industrial process heat demand. For implementation of real cases, further engineering studies would be required to determine the optimal distribution network, with a design based on the road network (see e.g. Unternährer *et al.*, 2017) and using real consumer data. Our results allow us, however, to distinguish between areas which have a large potential for implementing additional DH systems and those where a DH network is already well developed. In the French cities, DH schemes could reach 7-8 times the current size of the DH systems, and this for DH networks able to guarantee reasonable linear heat density levels (see Table I.2.4 and Figure I.2.8). The potential is even larger in the UK. Modelled DH networks are about 70 to 75 times larger than the existing schemes in Bristol and Newcastle, and 20 times larger in London.

The values for country specific GHG emission factors for the BAU heating sources were obtained applying equation (21). GHG emission factors are particularly high in Poland (coal represents 67% of total energy used, ENTRANZE, 2017a), in the Czech Republic (gas: 61%; coal: 22%) and in the UK (gas: 83%). Slovenia shows a relatively low GHG emission factor, if considering biomass burning as GHG neutral (biomass represents about 50% of the Slovenian heat supply; Statistical office of the Republic of Slovenia, 2011). In reality, the environmental balance of biomass is a complex and controversial issue (Parajuli *et al.*, 2014). Biomass can offer benefits in rural areas (Hendricks *et al.*, 2016), but fine particle emissions through biomass heaters should be avoided in dense urban areas (Petrov *et al.*, 2015). Future research should proceed carefully when comparing NCHP with biomass heat sources.

4.2. Cost-benefit analysis

Sub-section 4.2.1 evaluates the cost savings and GHG emissions reduction potential assuming that 25% of the heat loads identified in Table I.2.4 and Figure I.2.8 have been supplied with a DH + NCHP system (i.e. 25% connexion rate). By considering a fixed connexion rate, we were able to carry out an in-depth analysis of certain key results (e.g. LCOH breakdown). Then, sub-section 4.2.2 shows the results with varied connexion rates (from 0% to 100%). Since the distance between the nuclear site and the city is fixed, lower or higher connexion rates will lead to lower or higher economic performance levels of DH + NCHP systems, respectively. Finally, sub-section 4.2.3 assesses the sensitivity of the results to variations in the key parameters.

4.2.1. 25% connexion rates

Figure I.2.9 depicts the LCOH breakdown. Electricity and natural gas prices were both assumed to be $\text{€}40/MWh_{th}$, values which were commonly observed in the 2016 gross markets (Eurostat, 2016a, 2016b).

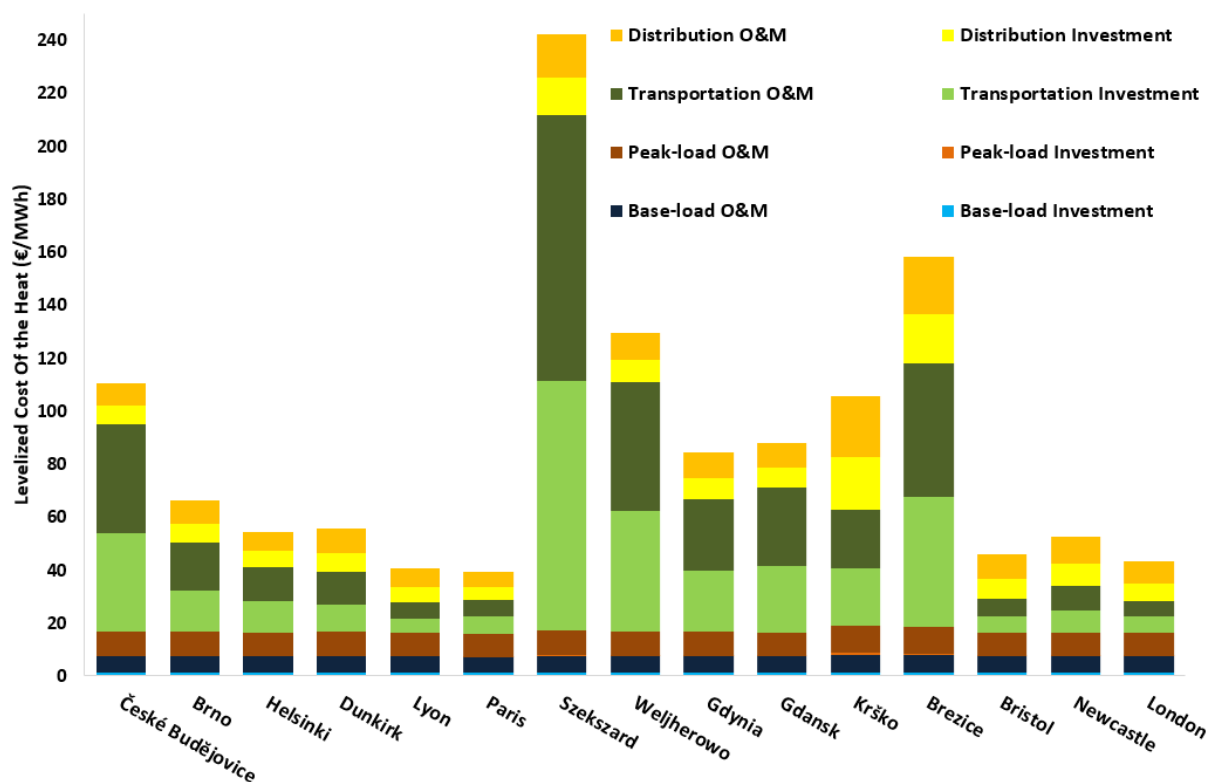

Figure I.2.9: LCOH breakdown of DH + NCHP systems considering 25% connexion rates.

Notes:

Including capital costs, fixed and variable operational costs. Excluding financial taxes, subsidies or levies. See Section 3 or appendixes for details.

Given the assumptions made, the transportation sub-system represents the most significant LCOH component in most cases. However, it decreases when the distance is small and/or the volume of heat transported is high. Figure I.2.9 can also be used to determine the heating cost in the cities where adequate DH networks already exist (see Table I.2.4) or when the investment has been paid back. In the case of an existing network, the LCOH can be lower due to already existing distribution system and peak-load capacity. In case of the investment having been paid back, the LCOH would decrease 30 % to 45 % due to the cost components related to the amortization of investments. Even though maintenance costs increase with ageing networks, this highlights the economic potential of DH systems in the long run.

The average DH prices observed in the countries under investigation are far from being uniform (Werner, 2016), ranging from €43/MWh_{th} in Hungary to €67/MWh_{th} in France, with an EU average of €65/MWh_{th} (2013 prices, see Werner, 2016). If the historical trend is to be continued (+80% over 2000-2015), DH prices may increase in the future, partly due to the fact that areas with the highest linear heat density are the first covered. It may nonetheless be argued that future DH systems could gain competitiveness in the future compared with individual heating systems (e.g. Dalla Rosa and Christensen, 2011; Schmidt *et al.*, 2017).

In this Chapter, three DH prices (€50, €65 and €80/MWh_{th}) were considered when calculating payback periods (Figure I.2.10) and IRR (Figure I.2.11) of DH + NCHP projects. The DH + NCHP systems with a payback period longer than 40 years or a negative IRR (i.e. the NPV is negative even for a 0% discount rate) are not shown in Figures I.2.9 and I.2.10.

Part I, Chapter 2

Cost-benefit analysis of district heating systems using heat from nuclear plants in seven European countries

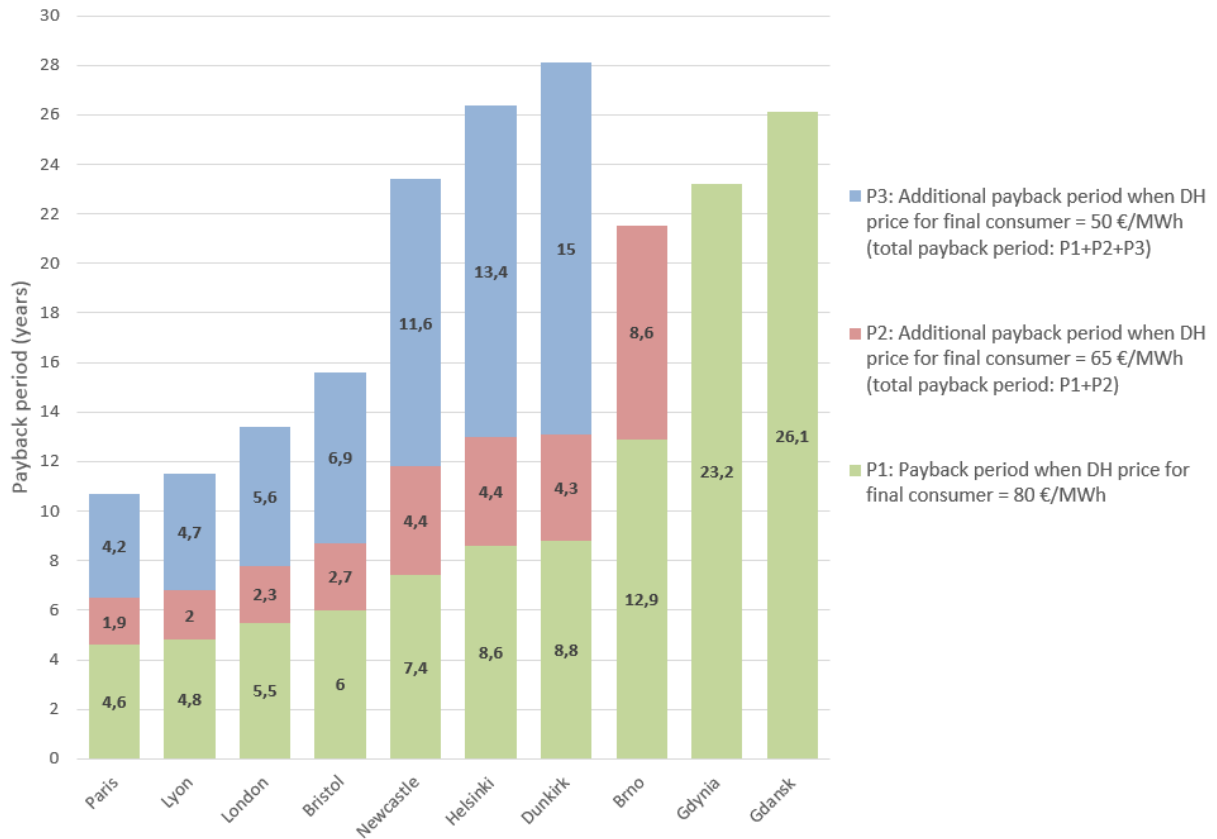

Figure I.2.10: Payback period of DH + NCHP systems for three different DH prices and 25% connexion rates. Only the payback periods less than 40 years are shown.

Notes:

Including capital costs, fixed and variable operational costs. Excluding financial taxes, subsidies and levies. See Section 3 or appendixes for details.

Part I, Chapter 2

Cost-benefit analysis of district heating systems using heat from nuclear plants in seven European countries

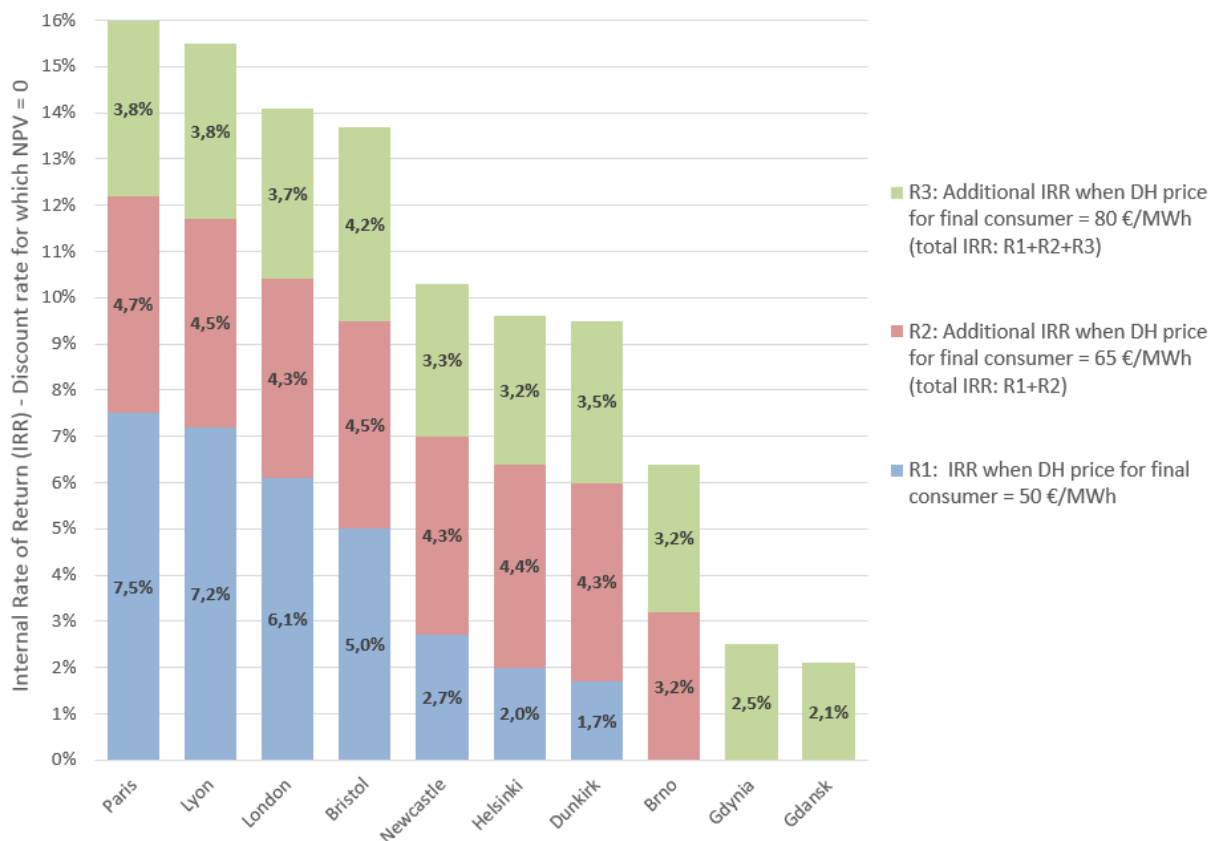

Figure I.2.11: IRR for three different DH prices and 25% connexion rates. Only the positive IRR are shown.

Notes:

Including capital costs, fixed and variable operational costs. Excluding financial taxes, subsidies and levies. See Section 3 or appendixes for details.

It is worth pointing out that the systems with the longest heat transportation lines are not necessarily those with the lowest economic performance. Figure I.2.12 shows the LCOH as a function of the distance between the NCHP and the city. London and Paris have DH + NCHP systems with some of the lowest LCOH, while the distances from the NCHP are among the highest (70 km and 90 km respectively). It confirms results from Jasserand and Lavergne (2016). This is because the LCOH is also affected by the amount of heat delivered, which is relatively large in these cities.

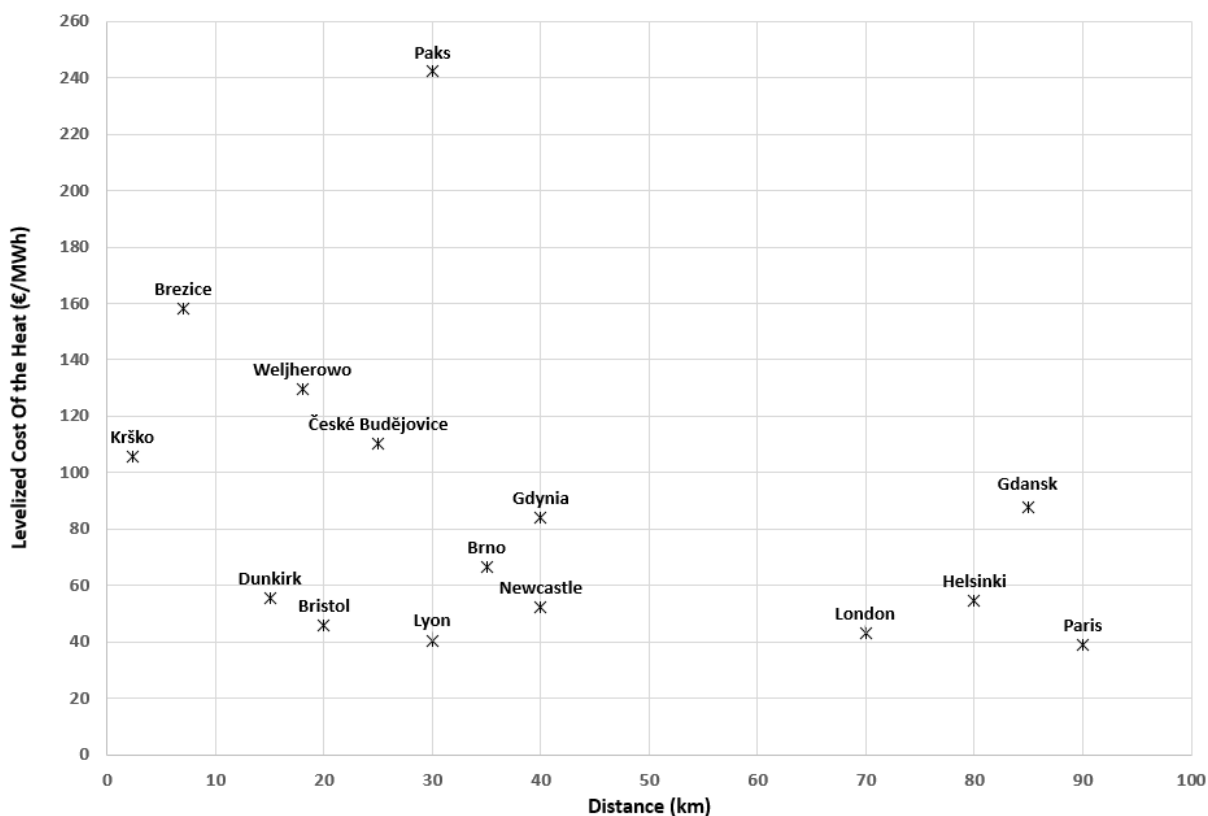

Figure I.2.12: LCOH as a function of the distance from the NCHP to the city considering a 25% connexion rate.

Notes:

Including capital costs, fixed and variable operational costs. Excluding financial taxes, subsidies and levies. See Section 3 or appendixes for details.

Figure I.2.13 shows the impact of GHG taxation on the NPV of DH + NCHP systems, considering that the GHG emissions avoided by the systems would generate additional revenue. The NPV was calculated assuming a DH price of €65/MWh_{th} (EU average, Werner, 2016).

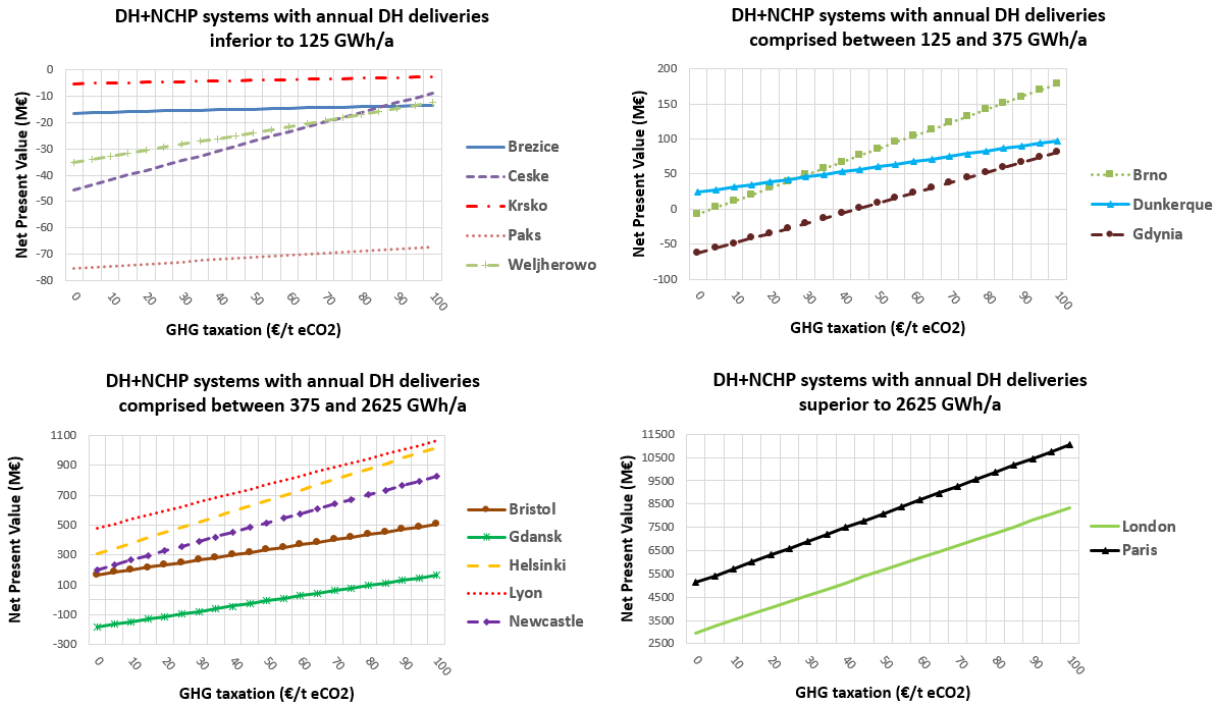

Figure I.2.13: NPV as a function of the GHG tax considering a 25% connexion rate and a DH price of €65/MWh_{th}.

Brno, Gdynia and Gdansk obtain positive NPV when the GHG tax is equal to approximately €5, €40 and €50/t eCO₂ respectively. However, all the systems with annual heat deliveries below 125 GWh_{th}/a still show a negative NPV even when the CO₂ price reaches €100/t eCO₂. These systems would need to provide more than 25% of the total heat loads of cities to eventually become economically attractive. This is studied in the Section 4.2.2.

4.2.2. Varying connexion rate

Figure I.2.14 illustrates the LCOH, NPV and payback periods of DH + NCHP systems as a function of the connexion rate.

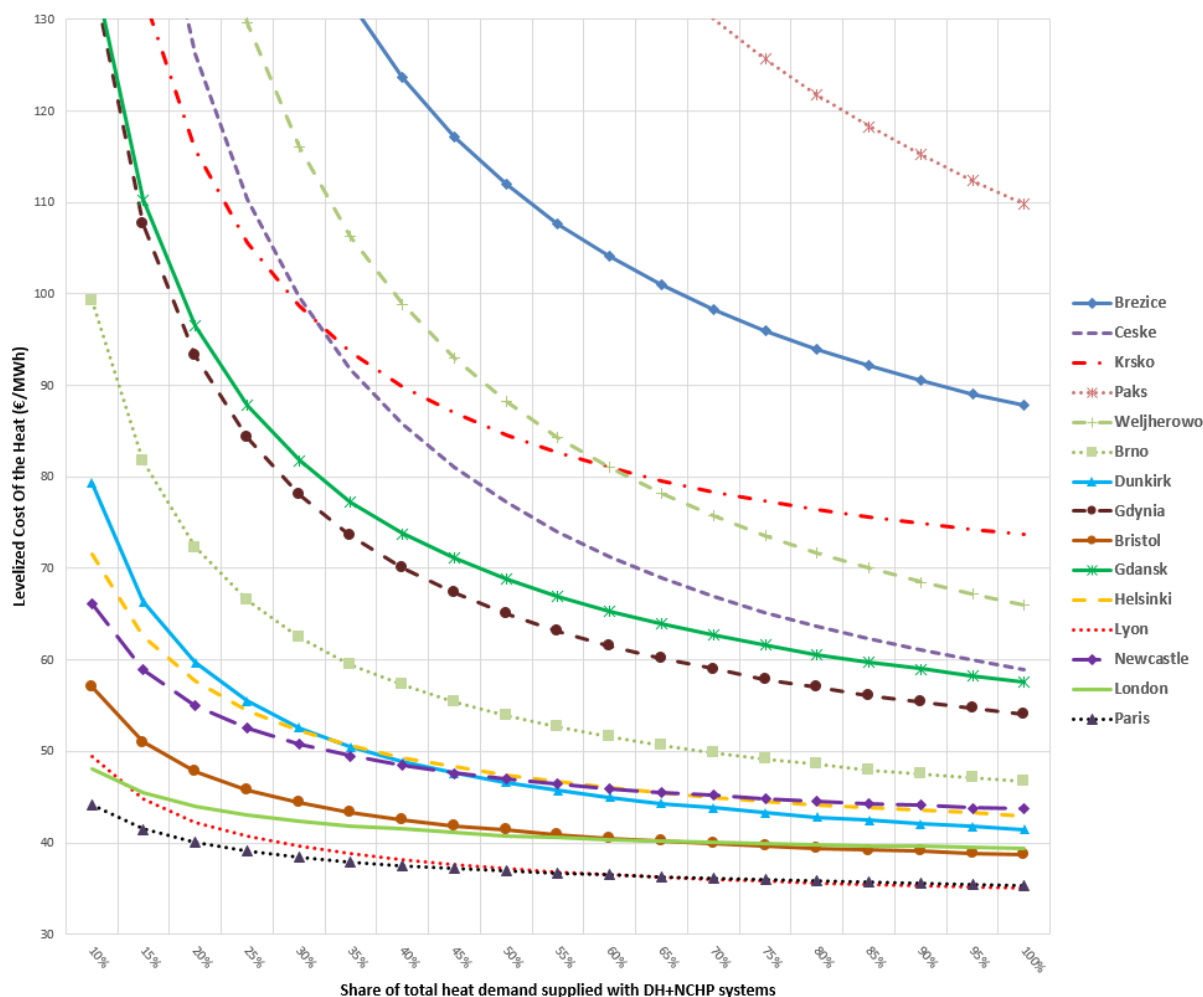

Figure I.2.14: LCOH as a function of the connexion rate.

Figure I.2.14 shows that the economic attractiveness of DH + NCHP systems increases with the connexion rate. LCOH curves are convex, meaning that there is an inflexion point at which the marginal benefits from increasing the connexion rate start to decrease. This inflexion point is reached at higher connexion rates for small projects than for larger ones. The smaller the DH + NCHP system (in terms of annual heat needs), the higher the interest for supplying a large share of the total heat demand.

Figure I.2.15 shows the marginal GHG abatement cost of DH + NCHP systems (€/t eCO₂), referring to equation (22).

Part I, Chapter 2

Cost-benefit analysis of district heating systems using heat from nuclear plants in seven European countries

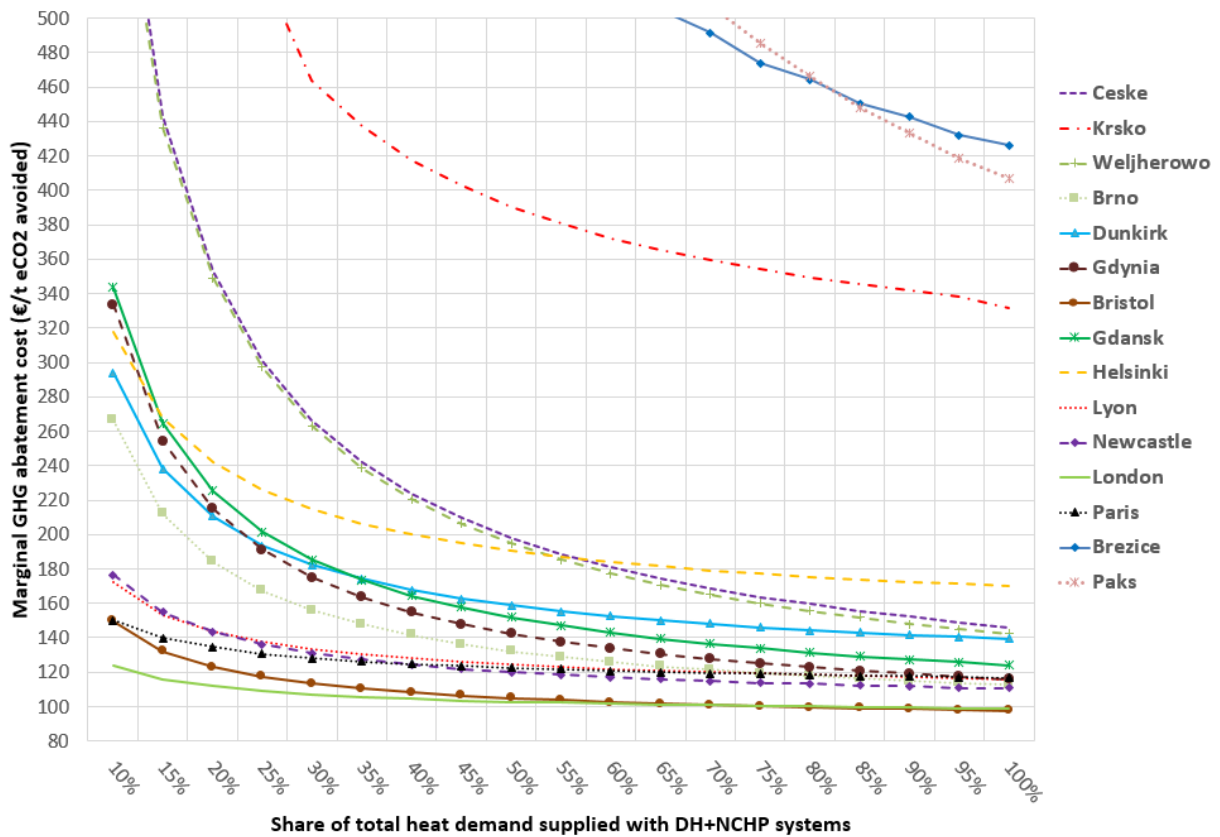

Figure I.2.15: Marginal GHG abatement cost as a function of the connexion rate considering a DH price of €65/MWh_{th}.

The most appealing systems purely from an economic point of view (LCOH, NPV, payback period) are not necessarily the same as those that would be chosen when considering GHG abatement costs. When considering connexion rates above 60%, all the Polish cities and České Budějovice show relatively good performance levels with regards to the marginal GHG abatement cost, while the purely economic indicators remain less attractive than for other projects. Conversely, Helsinki and all French projects become less attractive than UK projects for instance.

With the aim of providing a clear comparison of the DH + NCHP systems, Table I.2.5 shows the ranking of the DH + NCHP projects with regards to the payback period, LCOH and marginal GHG abatement cost. The same score has been attributed to those DH + NCHP systems in which the relative score differs depending on the connexion rate. Table I.2.5 also provides the NPV profitability threshold for each system i.e. the connexion rate from which the NPV becomes positive.

Metropolitan area	Connexion rate from which NPV becomes positive	Ranking of payback period (ascending order)	Ranking of LCOH (ascending order)	Ranking of GHG abatement cost (ascending order)
České Budějovice	75%	6	9	5
Brno	27%	4	6	3
Helsinki	13%	3	5	5
Dunkirk	16%	3	5	4
Lyon	5%	1	2	2
Paris	2%	1	1	2
Paks	NPV < 0	> 40 years	11	7
Weljherowo	NPV < 0	7	9	5
Gdynia	51%	4	7	4
Gdansk	61%	5	8	4
Krško	NPV < 0	8	9	6
Brežice	NPV < 0	> 40 years	10	7
Bristol	7%	2	4	1
Newcastle	11%	3	5	2
London	3%	2	3	1

Table I.2.5: Comparison of DH + NCHP systems according to different criteria.

Notes:

The DH price is €65/MWh_{th} (EU average, Werner, 2016).

4.2.3. Sensitivity analysis

Similarly to other large energy projects (Flyvbjerg, 2016; Sanderson, 2012), the uncertainty that affects the cost parameters of DH + NCHP systems can be high. A sensitivity analysis is required, as recommended by the EC guide to CBA (EC, 2014b). Two representative DH + NCHP systems (in terms of size) were subjected to a sensitivity analysis, namely Dunkirk (considering a 50% connexion rate, see Figure I.2.16) and London (considering a 10% connexion rate, see Figure I.2.17). Below, we have listed the parameters that were varied, the impact of these changes, and the main results derived from the observation of Figures I.2.15 and I.2.16:

- **Transportation heat losses.** The main assumptions are from engineering studies on long-distance heat transportation (Hirsch *et al.*, 2016; Safa, 2012; see 2.1.3), but higher heat losses could be observed in practice, depending on the operational conditions. Over 40 years of operation, even high-quality insulation would experience decreasing performance. However, the impact on NPV is relatively small as shown in Figures I.2.15 and I.2.16.
- **Discount rate.** In line with the EC recommendations (EC, 2014b), we considered a discount rate of 3.5%. Since DH + NCHP systems have high upfront investment costs, a higher discount rate strongly penalises the economics of projects. This highlights the importance of public support mechanisms.
- **Distribution investment cost.** It is relevant to consider both the cases in which DH networks are more expensive than assessed in Sections 4.2.1 and 4.2.2 (see formula (7)), and the cases in which no DH network has to be built (no distribution investment cost). In 9 out of 15 urban areas, an adequate DH network is already operating in the city (see Table I.2.4). In these cases, the investment related to the distribution side could be drastically reduced. However, the capital cost associated with the implementation of DH networks could be higher than what equation (7) suggests. In particular, equation (7) suggests that the cost of implementing DH pipelines in French cities would be about €450/m while, in practice, the CEREMA (French research centre on risks, environment, mobility and territorial planning, 2012) states that this cost can reach €1000/m in densely populated cities. Despite being widely used in academic literature (e.g. Dalla Rosa *et al.*, 2012; Togawa *et al.*, 2014), equation (7) do not suit all local contexts.

- **Transportation investment cost.** The capital cost expressed in equation (15) includes two-way buried pipelines (with 200 mm-thick insulation), pumping stations and labour costs [4,25]. In certain cases, however, it will not be possible to bury pipelines. Instead, tunnelling may be needed. Tunnelling may also be an option chosen to facilitate maintenance (Henttonen and Paananen, 2009). Yet, according to the estimate of the engineering consulting company Mott Mac Donald, the total cost of tunnelling could be 2 to 3 times higher than the buried pipe alternatives (ETI, 2016). Therefore, higher costs than what equation (15) suggests can be expected when the heat transportation system is required to cross (or bypass) dense urban areas, other underground tunnels or high speed ways.
- **DH price for final consumers.** As discussed in Section 4.2.1, DH is not priced similarly in all the investigated areas (see Werner, 2016), which impacts the NPV of projects.
- **Natural gas prices.** Since DH + NCHP systems use gas heat-only boilers for winter peak-loads (see 2.1.4), higher natural gas prices than those considered in the base case ($\text{€}40/\text{MWh}_{\text{th}}$), will have a negative impact on the NPV. However, this would increase the competitiveness of DH + NCHP systems relative to individual gas boilers and other systems using mostly natural gas.
- **Electricity prices.** An increase in the electricity prices increases the operational costs of systems, and hence reduces the NPV. Similarly to natural gas prices, such changes would affect the relative competitiveness of DH + NCHP systems compared with other heating systems (especially electricity-intensive ones). Future research will examine these market issues in more detail.

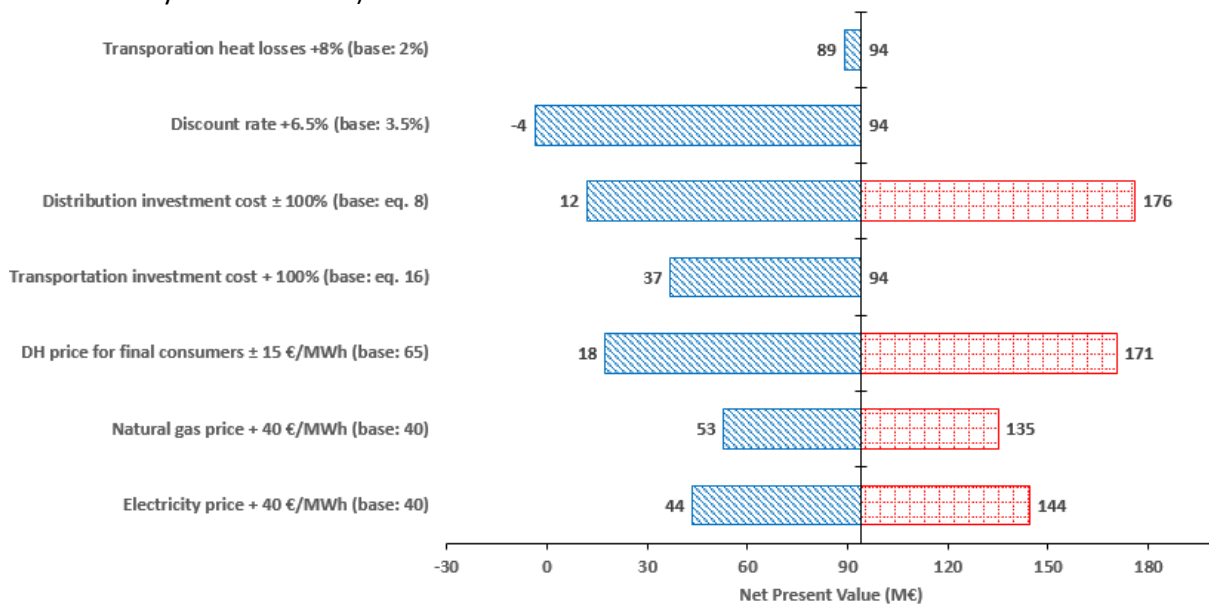

Figure I.2.16: Sensitivity analysis for the Dunkirk DH + NCHP system with a 50% connexion rate.

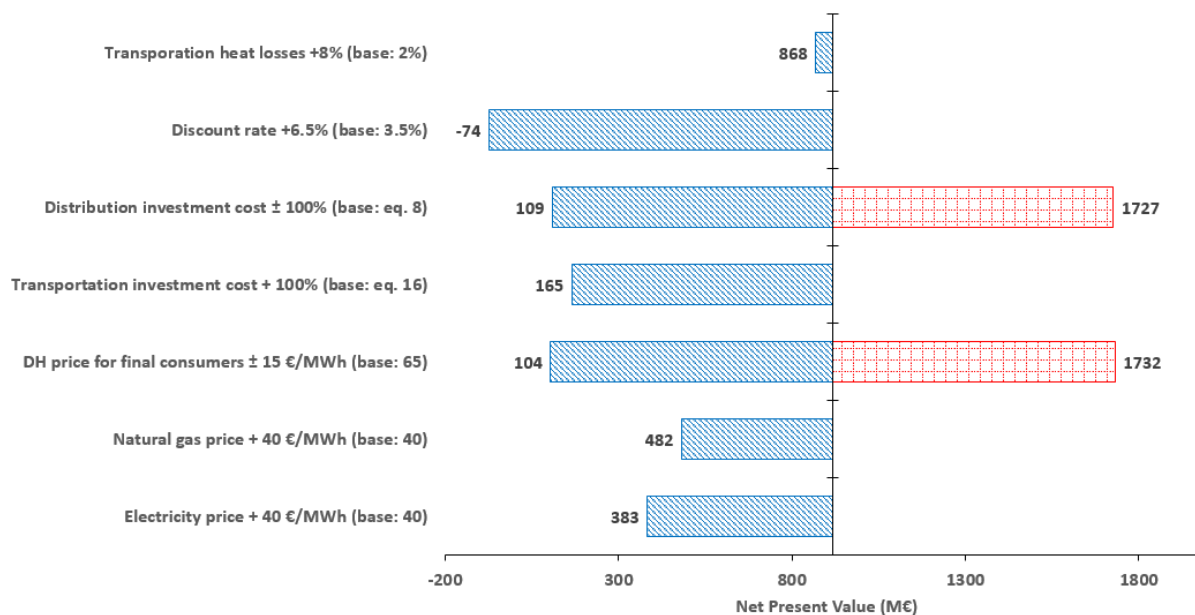

Figure I.2.17: Sensitivity analysis for the London DH + NCHP system with a 25% connexion rate.

Another source of uncertainty that affects the competitiveness of DH + NCHP systems is the reduction in the specific heat demand ($\text{kWh}_{\text{th}}/\text{m}^2 \cdot \text{a}$) of dwellings enabled by building renovations. This should lead to a heat demand density reduction, which may in turn reduce the competitiveness of DH systems. This idea is often used to minimise the relevance of DH in future energy systems. However, the reality is more nuanced. Some papers address the reduced heat demands in existing buildings and conclude that such efforts involve significant investment costs (Zvingilaite, 2013). The Heat Roadmap Europe study illustrates how a least-cost energy efficiency solution can be reached for Europe, if energy conservation is combined with an expansion of district heating (and cooling; Connolly *et al.*, 2014). In the case of Denmark, Nielsen and Möller (2013) showed that DH could be cost-effectively expanded by 1-12% even if the specific heat demand of buildings is reduced by 75%. Similarly, Reidhav and Werner (2008) highlights the profitability of DH systems in low-density areas. However, the same studies also emphasise that if DH systems want to keep their economic advantages, they must be improved by changing fuels and minimising grid losses.

The reduction of heating demands in existing buildings can be exploited by DH systems in several ways (Dalla Rosa and Christensen, 2011). The insulation of existing buildings means comfort is achieved by lower supply temperatures. If adequate measures are taken to minimise the return temperatures, the impact will be a reduction of DH grid losses and pipe diameters (AMORCE, 2011). DH utilities will also be able to use plastic piping, which can be more cost-effective than conventional DH metal-based pipes (Schmidt *et al.*, 2017). The use of low-temperature heat makes it possible to integrate additional heat sources into the DH scheme, such as solar thermal collectors, deep geothermal wells and low-temperature waste heat. If heat is generated by CHP, the low temperature of the heat can lead to higher electricity generation and therefore improved revenue from energy sales. In the case of an NCHP, installing a DH system with a supply temperature of 70°C would reduce electric losses due to heat extraction on the plant's Rankine cycle by approximately 50% compared with a DH system with a supply temperature of 120°C (IAEA, 2016b; Safa, 2012). In the case of very low-temperature DH systems in which the heat is used mostly for hot water purposes (see e.g. Schmidt *et al.*, 2017), recovering the excess heat from the nuclear plant (40°C) could be enough to fulfil the needs of nearly zero-energy buildings. Future research could assess the competitiveness of DH + NCHP systems based on different energy performance levels of buildings. Furthermore, spatial mapping should be used to identify where DH should or should not be installed, with the aim of achieving an optimal balance between investments in savings versus production.

5. Conclusion

This Chapter evaluates and compares district heating (DH) systems using heat from nuclear combined heat and power plants (NCHP). Fifteen European DH + NCHP systems have been assessed in terms of their economic attractiveness and potential for climate change mitigation. Five points should be highlighted:

- The 2030 heat demand and linear heat density of theoretical DH networks has been assessed using spatial mapping methods. The analysis suggests a potential for expanding DH by 700%, 2000% and 7000% compared with the current size (km) of DH networks in French metropolitan areas (Dunkirk, Lyon, Paris), London, and Newcastle/Bristol respectively. These large DH systems would show linear heat density levels exceeding 2.5 MWh_{th}/m.a, hence they can be considered as economically attractive.
- When considering DH + NCHP systems supplying 25% of the total demand for space heating and domestic hot water, the base-case CBA has concluded on the economic attractiveness of 7 of the 15 projects (positive NPV when the DH price for final consumer is €65/MWh_{th}, the EU average; Werner, 2016). These projects concern all the French and UK urban areas, plus the Helsinki area (Finland). Implementing these 7 projects has the potential to reduce GHG emissions by approximately 10 Mt eCO₂/a. As way of comparison, eco-design and energy labelling requirements for space and water heaters (which came into application in 2015 in the EU) are expected to make savings of 13.5 Mt eCO₂/a during the 2015-2030 period (EC, 2016b). Building renovations, modernisation of individual heaters, and implementation of low-carbon DH systems should be seen as complementary approaches.
- Four others DH + NCHP systems could become competitive if given the chance to supply a larger share of the total heat demand. The systems in Brno, Gdynia + Weljherowo, Gdansk + Gdynia + Weljherowo and České Budějovice reach a positive NPV when their connexion rates are above 27%, 51%, 61% and 75% respectively. The 4 remaining DH + NCHP systems (Paks, Weljherowo, Krško and Brežice + Krško) remain economically unattractive even with a 100% connexion rate.
- The marginal GHG abatement cost (€/t eCO₂ avoided) has been calculated for each system. The relative attractiveness of DH + NCHP system changed when considering this indicator instead of conventional economic indicators (e.g. LCOH; €/MWh_{th}). While the Slovenian projects (around Krško nuclear site) and the Hungarian project (Paks) still show low performance, the attractiveness of the Polish and Czech DH + NCHP projects is relatively higher. The implementation of a CO₂ tax would reinforce the economic competitiveness of these systems, especially in countries where the residential and tertiary heating sector is largely dominated by fossil fuels.
- While the base-case CBA has been performed with a common set of assumptions, the sensitivity analysis sheds light on the importance of choosing the right parameter values, specific to each national and local context. The parameters with the highest impact on the NPV are, in descending order: the discount rate, the distribution and transportation capital costs, the selling price of the heat to final consumers, the electricity and natural gas prices.

The limits must also be underlined. This Chapter only considers the cost of ‘cogeneration readiness’ in the NCHP. ‘Cogeneration readiness’ is a term coined in ETI (2016) to name the equipment required in a nuclear plants to enable DH supply (e.g. heat exchangers, DH pumps). This Chapter accounts for the capital costs specific to DH (generation, transportation and distribution of heat), but excludes the costs attributable to electricity production. Therefore, it does not allow us to reach any conclusion as to whether an NCHP offers more benefits than other systems generating the same amount of electricity and heat. To answer this question, further analysis will be needed taking into account the entire investment cost of a new nuclear power plant (see Jaskólski *et al.*, 2014). From an academic perspective, we evaluated the total cost and GHG emissions, rather than individual

stakeholder profit or cost. Researchers interested by business models, regulatory, social or financial issues related to DH + NCHP systems may want to consider Chapters 5, 6 and 8.

Despite these limits, this Chapter provides a thorough basis for further research on DH + NCHP systems, e.g. by considering the possibility of optimising the annual heat production through the use of seasonal heat storage (see e.g. McDaniel and Kosanovic, 2016; Stuttgart University, 2011), or by comparing DH + NCHP systems with other low-carbon heating systems of relevance. Such systems could help decarbonise the EU heat sector through the most efficient use of available technologies, in line with the ‘fundamental idea’ of district heating.

References

- AMORCE (French DH association), 2011. Solutions techniques pour optimiser les réseaux de chaleur dans un contexte de développement de bâtiments basse consommation. Available from: http://www.amorce.asso.fr/media/filer_public/12/15/12155959-eaba-447c-9785-27dbba635e34/rct34_optimisationrc.pdf [in French].
- AMORCE, 2015. Comparatif des modes de chauffage et prix de vente de la chaleur. Data for 2014. Available from: <http://www.amorce.asso.fr/fr/espace-adherents/publications/rdc/prix-de-la-chaleur/comparatif-des-modes-de-chauffage-et-prix-de-vente-de-la-chaleur-rapport-2015-donnees-2014/> [in French].
- Bachmann, T.M., van der Kamp, J., 2014. Environmental cost-benefit analysis and the EU (European Union) Industrial Emissions Directive: Exploring the societal efficiency of a DeNO_x retrofit at a coal-fired power plant. *Energy* 68, 125–139.
- Bergant, R., Ploj, T., Štrubelj, L., Androjna, G., Manojlović, S., 2013. Combined Heat and Power Production in NPP Krško. Contribution to the 22th International Conference Nuclear Energy for New Europe. Available from: http://www.djs.si/proc/nene2013/pdf/NENE2013_1003.pdf.
- Brněnské vodárny a kanalizace a.s. (Brno DH operator), 2017. Vodovodní síť (water supply network). Available from: <http://www.bvk.cz/o-spolecnosti/zasobovani-pitnou-vodou/vodovodni-sit/> [in Czech].
- BuroHappold Engineering, 2016. UK Spatial District Heating Analysis. Available from: <http://fes.nationalgrid.com/media/1215/160712-national-grid-dh-summary-report.pdf>.
- CEA (French Nuclear and Alternative Energies Commission), 2017. ELECNUC. Nuclear power plants in the world. Edition 2017. Available from: <http://www.cea.fr/multimedia/Documents/publications/ouvrages/Elecnucl-2017.pdf>.
- CEREMA (French Research Centre on Risks, Environment, Mobility and Territorial Planning), 2012. Coût d'investissement d'un réseau de chaleur : quelques repères. Available from: <http://reseaux-chaleur.cerema.fr/cout-dinvestissement-dun-reseau-de-chaleur-quelques-reperes> [in French].
- Chauvel, A., Fournier, G., Raimbault, C., 2001. Manuel d'évaluation économique des procédés. Editions TECHNIP [in French].
- Colmenar-Santos, A., Rosales-Asensio, E., Borge-Diez, D., Collado-Fernández, E., 2016. Evaluation of the cost of using power plant reject heat in low-temperature district heating and cooling networks. *Applied Energy* 162, 892–907.
- Connolly, D., Lund, H., Mathiesen, B.V., Werner, S., Möller, B., Persson, U., Boermans, T., Trier, D., Østergaard, P.A., Nielsen, S., 2014. Heat Roadmap Europe: Combining district heating with heat savings to decarbonise the EU energy system. *Energy Policy* 65, 475–489.
- Cuce, P.M., Cuce, E., 2017. Toward cost-effective and energy-efficient heat recovery systems in buildings: Thermal performance monitoring. *Energy* 137, 487–494.
- Dalkia (Groupe EDF), 2015. Energie Grand Littoral. Réseau de chauffage urbain. Compte-rendu technique et financier. Exercice 2015. Available from: https://www.communaute-urbaine-dunkerque.fr/fileadmin/documents/rapports/Reseau_de_chaleur_-_compte-rendu_d_activite_2015.pdf [in French].
- Dalla Rosa, A., Christensen, J.E., 2011. Low-energy district heating in energy-efficient building areas. *Energy* 36, 6890–6899.
- Dalla Rosa, A., Boulter, R., Church, K., Svendsen, S., 2012. District heating (DH) network design and operation toward a system-wide methodology for optimizing renewable energy solutions (SMORES) in Canada: a case study. *Energy* 45, 960–074.

- Dalla Rosa, A., Li, H., Svendsen, S., Werner, S., Persson, U., Ruehling, K., Felsmann, C., Crane, M., Burzynski, R., Bevilacqua, C., 2014. Toward 4th Generation District Heating: Experience and Potential of Low-Temperature District Heating.
- DBDH (Danish DH association), 2014. Mapping of Polish district heating market. Available from: <https://dbdh.dk/download/member_contries/poland/mapping%20poland.pdf>.
- DEA (Danish Energy Agency), 2016. Technology Data for Energy Plants Updated papers, August 2016. Available from: <https://ens.dk/sites/ens.dk/files/Analyser/update_-_technology_data_catalogue_for_energy_plants_-_aug_2016.pdf>.
- DECC (Department of Energy & Climate Change), 2013. Summary evidence on District Heating Networks in the UK. Available from: <https://www.gov.uk/government/uploads/system/uploads/attachment_data/file/212565/summary_evidence_district_heating_networks_uk.pdf>.
- Duna Center Therm Kft (Paks DH operator), 2016. Paks Város Környezeti állapotértékelése 2016 (Paks City Environmental status assessment 2016). Available from: <http://www.paks.hu/res/kornyezeti_allapotertekeles_2016.pdf> [in Hungarian].
- EC (European Commission), 2013. EU energy, transport and GHG emissions. Trends to 2050. Reference scenario 2013.
- EC, 2014a. Special Eurobarometer 416: Attitudes of European Citizens towards the Environment. Available from: <http://ec.europa.eu/public_opinion/archives/ebs/ebs_416_en.pdf>.
- EC, 2014b. Guide to Cost-Benefit Analysis of Investment Projects for Cohesion Policy 2014-2020.
- EC, 2015. Advanced Reactor for Cogeneration of Heat & Electricity. Available from: <<http://www.archer-project.eu/>>.
- EC, 2016a. Communication from the Commission to the European Parliament, the Council, the European Economic and Social Committee and the Committee of the Regions on an EU Strategy for Heating and Cooling. Available from: <https://ec.europa.eu/energy/sites/ener/files/documents/1_EN_autre_document_travail_service_part1_v6_0.pdf>.
- EC, 2016b. Communication from the Commission to the European Parliament, the council, the European Economic and Social Committee and the Committee of the Regions. An EU Strategy on Heating and Cooling. Available from: <https://ec.europa.eu/energy/sites/ener/files/documents/1_EN_ACT_part1_v14.pdf>.
- EEA (European Environment Agency), 2011. CO2 electricity per kWh. Available from: <https://www.eea.europa.eu/data-and-maps/figures/co2-electricity-g-per-kwh/co2-per-electricity-kwh-fig-1_2010_qa.xls>.
- ENERGINET, 2012. Technology data for energy plants. Generation of Electricity and District Heating, Energy Storage and Energy Carrier Generation and Conversion. Available from: <https://www.energinet.dk/SiteCollectionDocuments/Danske%20dokumenter/Forskning/Technology_data_for_energy_plants.pdf>.
- ENTRANZE, 2014. Policies to ENforce the TRAnstition to Nearly Zero Energy building in the EU27. Available from: <<http://www.entranze-scenario.enerdata.eu/site/>>.
- ENTRANZE, 2017a. Policies to ENforce the TRAnstition to Nearly Zero Energy building in the EU27. Research project co-funded by the European Commission. Breakdown of dwelling stock by energy used for space heating (at normal climate). Data for 2008. Available from: <<http://www.entranze.enerdata.eu/share-of-dwellings-with-biomass-systems.html#/share-of-dwellings-connected-to-district-heating.html>>.
- ENTRANZE, 2017b. Policies to ENforce the TRAnstition to Nearly Zero Energy building in the EU27. Research project co-funded by the European Commission. Total unit consumption per m2 in non-residential (at normal climate). Data for 2008. Available from: <<http://www.entranze.enerdata.eu/total-unit-consumption-per-m2-in-non-residential-at-normal-climate.html>>.

- ETI (Energy Technology Institute), 2016. System Requirements for Alternative Nuclear Technologies - Phase 3. Technical assessment of SMR heat extraction for district heat networks. Available from: <<http://www.eti.co.uk/library/system-requirements-for-alternative-nuclear-technologies-phase-3>>.
- ETI (Energy Technology Institute), M., 2015. The role for nuclear within a low carbon energy system. Energy Technology Institute (ETI). Available from: <<http://www.eti.co.uk/the-role-for-nuclear-within-a-low-carbon-energy-system/>>.
- ETSAP (Energy Technology Systems Analysis Programme), 2013. District Heating. Available from: <http://iea-etsap.org/E-TechDS/PDF/E16_DistrHeat_EA_Final_Jan2013_GSOK.pdf>.
- EUROPAIRS, 2009. FP7 End User Requirement for Process Heat Applications With Innovative Reactors for Sustainable Energy Supply (EUROPAIRS). Available from: <http://cordis.europa.eu/project/rcn/94416_en.html>.
- Eurostat, 2015. Urban Audit 2011-2014. Database. Luxembourg. Available from: <<http://ec.europa.eu/eurostat/web/gisco/geodata/reference-data/administrative-units-statistical-units/urban-audit>>. [Data collected for core cities].
- Eurostat, 2016a. Natural gas price statistics. Natural gas prices for industrial consumers. Available from: <[http://ec.europa.eu/eurostat/statistics-explained/index.php/File:Natural_gas_prices_for_industrial_consumers,_comparison_between_2015s2-2014s2_\(NAT_kWh\).png](http://ec.europa.eu/eurostat/statistics-explained/index.php/File:Natural_gas_prices_for_industrial_consumers,_comparison_between_2015s2-2014s2_(NAT_kWh).png)>.
- Eurostat, 2016b. Electricity price statistics. Available from: <http://ec.europa.eu/eurostat/statistics-explained/index.php/Electricity_price_statistics>.
- Fang, H., Xia, J., Jiang, Y., 2015. Key issues and solutions in a district heating system using low-grade industrial waste heat. *Energy* 86, 589–602.
- Finnish Energy, 2016. District heating in Finland 2015. Available from: <https://energia.fi/en/current_issues_and_material_bank/material_bank/district_heating_statistics.html>.
- Flyvbjerg, B., 2016. The Oxford Handbook of Megaproject Management. Terry Williams, Knut Samset, and Kjell Sunneveg, eds.
- Fortum Power and Heat Oy, 2009. Application for a Decision-in-Principle Concerning the Construction of a Nuclear Power Plant Unit - Loviisa 3.
- Foskolos, K., Brogli, R., 1991. Prospects of SMSNR development in Switzerland and the influence of the evolution of district heating networks. *Energy, High-temperature Helium Gas-cooled Nuclear reactors: Past Experience Current Status and Future Prospects* 16, 573–581.
- Frederiksen, S., Werner, S., 1993. Fjärrvärme – teori, teknik och funktion (District Heating – theory, technology and function). Studentlitteratur, Lund.
- Frederiksen, S., Werner, S., 2013. District heating and cooling. Lund Studentlitteratur.
- Frischknecht, R., Rebitzer, G., 2005. Theecoinvent database system: a comprehensive web-based LCA database. *Journal of Cleaner Production, Life Cycle Assessment* 13, 1337–1343.
- Fröling, M., Bengtsson, H., Ramnäs, O., 2006. Environmental performance of district heating in suburban areas compared with heat pump and pellets furnace, in: Chalmers Publication Library (CPL). Presented at the 10th International Symposium on District Heating and Cooling, September 3-5, 2006, Hanover, Germany.
- Gabrielli, R., Castrataro, P., Del Medico, F., Di Palo, M., Lenzo, B., 2014. Levelized Cost of Heat for Linear Fresnel Concentrated Solar Systems. *Energy Procedia* 49, 1340–1349.
- GEN energija d.o.o (Slovenian power company), 2016. Socio-economic Aspect of Cogeneration in Krško NPP. Available from: <<https://www.iaea.org/NuclearPower/Downloadable/Meetings/2016/2016-11-21-11-23-NPES/02-SLOVENIA-DEBELAK.pdf>>.

- Groth, T., Scholtens, B., 2016. A comparison of cost-benefit analysis of biomass and natural gas CHP projects in Denmark and the Netherlands. *Renewable Energy* 86, 1095–1102.
- HAS Centre for Energy Research, 2016. Socio-economic aspects of nuclear cogeneration development in the region of Paks. Available from: <<https://www.iaea.org/NuclearPower/Downloadable/Meetings/2016/2016-11-21-11-23-NPES/03-HUNGARY-BORCSOK.pdf>>.
- Heat Roadmap Europe, 2015. Heat Roadmap Europe 2050. Research project co-funded by the European Commission. Peta, the Pan-European Thermal Atlas: renewable energy. Available from: <<http://maps.heatroadmap.eu/maps/31157/Renewable-Resources-Map-for-EU28?preview=true#>>>.
- Hendricks, A.M., Wagner, J.E., Volk, T.A., Newman, D.H., Brown, T.R., 2016. A cost-effective evaluation of biomass district heating in rural communities. *Applied Energy* 162, 561–569.
- Henttonen, T., Paananen, P., 2009. Nuclear Combined Heat and Power - Analyses of Hot Water Pipeline Breaks in a Service Tunnel with APROS Simulation Software. Available from: <http://www.apros.fi/filebank/119-Conference_paper%3A_Loviisa_3_Nuclear_CHP_ENC2010.pdf>.
- Hirsch, P., Duzinkiewicz, K., Grochowski, M., Piotrowski, R., 2016. Two-phase optimizing approach to design assessments of long distance heat transportation for CHP systems. *Applied Energy* 182, 164–176.
- Hirsch, P., Grochowski, M., Duzinkiewicz, K., 2015. Pipeline System for Heat Transportation from Nuclear Power Plant – an Optimizing Approach. Faculty of Electrical and Control Engineering, Gdańsk University of Technology.
- Huang, S.K., Kuo, L., Chou, K.-L., 2016. The applicability of marginal abatement cost approach: A comprehensive review. *Journal of Cleaner Production* 127, 59–71.
- IAEA (International Atomic Energy Agency), 2003. Market Potential for Non-electric Applications of Nuclear Energy. STI/DOC/010/410.
- IAEA, 2016a. Technical Meeting on the Socio-Economic Aspects of Nuclear Cogeneration. Available from: <<https://www.iaea.org/NuclearPower/Meetings/2016/2016-11-21-11-23-NPTDS.html>>.
- IAEA, 2016b. Desalination Thermodynamic Optimization Program (DE-TOP). Available from: <https://www.iaea.org/NuclearPower/NEA_Desalination/index.html>.
- IAEA, 2017. Nuclear power reactors in the world. IAEA-RDS-2/37.
- IEA (International Energy Agency), 2014. Status Report on District Heating in IEA countries. Prepared for the International Energy Agency (IEA) Bioenergy Task 32 and the Swiss Federal Office of Energy. Available from: <http://www.ieabcc.nl/publications/IEA_Task32_DHS_Status_Report.pdf>.
- IEA, 2015. Energy Balances of OECD countries.
- Immonen, S., Vuori, S., 1978. Cost/benefit analysis of district heat transmission distance from a nuclear power plant. *Annals of Nuclear Energy* 5, 179–184.
- IPCC (Intergovernmental Panel on Climate Change), 2006. Guidelines for National Greenhouse Gas Inventories, Volume 2 Energy.
- Jaskólski, M., Reński, A., Duzinkiewicz, K., Kaczmarek-Kacprzak, A., 2014. Profitability criteria of partial cogeneration in nuclear power plant. *Rynek Energii*.
- Jasserand, F., Lavergne, J.-G., 2016. Initial Economic Appraisal of Nuclear District Heating in France. *EPJ Nuclear Sci. Technol.* 2, 39.
- Kesicki, F., Strachan, N., 2011. Marginal abatement cost (MAC) curves: confronting theory and practice. *Environmental Science & Policy* 14, 1195–1204.
- Leurent, M., Jasserand, F., Locatelli, G., Palm, J., Rämä, M., Trianni, A., 2017. Driving forces and obstacles to nuclear cogeneration in Europe: Lessons learnt from Finland. *Energy Policy* 107, 138–150.

- Leurent, M., Da Costa, P., Jasserand, F., Rämä, M., Persson, U., 2018. Cost and climate savings through nuclear district heating in a French urban area. *Energy Policy* 115, 616–630.
- Lockie, D., Sonnenfeld, D., 2013. *Routledge International Handbook of Social and Environmental Change*, Routledge. Fisher (Eds).
- Lund, R., Ilic, D.D., Trygg, L., 2016. Socioeconomic potential for introducing large-scale heat pumps in district heating in Denmark. *Journal of Cleaner Production* 139, 219–229.
- Lund, H., Arler, F., Østergaard, P.A., Hvelplund, F., Connolly, D., Mathiesen, B.V., Karnøe, P., 2017. Simulation versus Optimisation: Theoretical Positions in Energy System Modelling. *Energies* 10, 840.
- Magistrát města České Budějovice (Municipal Authority of České Budějovice), 2016. Územní Energetická Koncepce Statutárního Města České Budějovice (Territorial Energy Concept of the Statutory City of České Budějovice). Available from: <<http://www.c-budejovice.cz/cz/magistrat/odbory/osvs/aktuality/Documents/%C3%9AEK%20%C4%8CB%20final%202016.pdf>> [in Czech].
- Ma, Q., Luo, L., Wang, R.Z., Sauce, G., 2009. A review on transportation of heat energy over long distance: Exploratory development. *Renewable and Sustainable Energy Reviews* 13, 1532–1540.
- McDaniel, B., Kosanovic, D., 2016. Modeling of combined heat and power plant performance with seasonal thermal energy storage. *Journal of Energy Storage* 7, 13–23.
- Ministerstvo Průmyslu a Obchodu (Czech Ministry of Industry and Trade), 2015. Assessment of the potential for high-efficiency combined heat and power generation and efficient district heating and cooling for the Czech Republic. Available from: <https://ec.europa.eu/energy/sites/ener/files/documents/cz_report_eed_art_141_en.pdf>.
- Ministerstwo Gospodarki (Polish Ministry of the Economy), 2014. Polish Nuclear Power Programme. Available from: <<http://www.paa.gov.pl/sites/default/files/PPEJ%20eng.2014.pdf>>.
- Ministerstwo Energii (Polish Ministry of Energy), 2016. Economic impact of possible large LWR cogeneration in Poland. Available from: <<https://www.iaea.org/NuclearPower/Downloadable/Meetings/2016/2016-11-21-11-23-NPES/06-POLAND-SAWICKI.pdf>>.
- NC2I (Nuclear Cogeneration Industrial Initiative), 2015. Nuclear Cogeneration Industrial Initiative. Available from: <<http://www.snetp.eu/nc2i/>>.
- NEA (Nuclear Energy Agency), 2015. Ad hoc Expert Group of the Nuclear Energy Agency on the Role and Economics of Nuclear Co-generation in a Low-carbon Energy Future (COGEN-2015). Available from: <<http://www.oecd-nea.org/ndd/groups/cogen.html>>.
- Nielsen, S., Möller, B., 2013. GIS based analysis of future district heating potential in Denmark. *Energy* 57, 458–468.
- Nuytten, T., Claessens, B., Paredis, K., Van Bael, J., Six, D., 2013. Flexibility of a combined heat and power system with thermal energy storage for district heating. *Applied Energy* 104, 583–591.
- OPEC (Polish DH operator), 2016. Infrastruktura OPEC w Wejherowie (OPEC Infrastructures in Wejherowo). Available from: <<https://opecgdy.com.pl/dla-klienta/podlacz-sie-do-sieci/rozwijamy-sie-w-kazdym-kierunku/wejherowo/>> [in Polish].
- OPEC, 2017. OPEC Sp. z o.o z prestiżowym Godłem „Teraz Polska”! (press informations). Available from: <<https://opecgdy.com.pl/biuro-prasowe/informacje-prasowe/>> [in Polish].
- Paananen, P., Henttonen, T., 2009. Investigations of a Long-Distance 1000 MW Heat Transport System with APROS Simulation Software. Contribution to the 20th International Conference on Structural Mechanics in Reactor Technology (SMIRT 20).
- Parajuli, R., Løkke, S., Østergaard, P.A., Knudsen, M.T., Schmidt, J.H., Dalgaard, T., 2014. Life Cycle Assessment of district heat production in a straw fired CHP plant. *Biomass and Bioenergy* 68, 115–134.

- Persson, U., Werner, S., 2011. Heat distribution and the future competitiveness of district heating. *Applied Energy* 88, 568–576.
- Petrov, O., Bi, X., Lau, A., 2015. Impact assessment of biomass-based district heating systems in densely populated communities. Part I: Dynamic intake fraction methodology. *Atmospheric Environment* 115, 70–78.
- Pikas, E., Kurnitski, J., Thalfeldt, M., Koskela, L., 2017. Cost-benefit analysis of nZEB energy efficiency strategies with on-site photovoltaic generation. *Energy* 128, 291–301.
- Reidhav, C., Werner, S., 2008. Profitability of sparse district heating. *Applied Energy* 85, 867–877.
- Safa, H., 2012. Heat recovery from nuclear power plants. *International Journal of Electrical Power & Energy Systems* 42, 553–559.
- Sanderson, J., 2012. Risk, uncertainty and governance in megaprojects: A critical discussion of alternative explanations. *International Journal of Project Management* 30, 432–443.
- Sardi, J., Mithulananthan, N., Gallagher, M., Hung, D.Q., 2017. Multiple community energy storage planning in distribution networks using a cost-benefit analysis. *Applied Energy* 190, 453–463.
- Schmidt, D., Kallert, A., Blesl, M., Svendsen, S., Li, H., Nord, N., Sipilä, K., 2017. Low Temperature District Heating for Future Energy Systems. *Energy Procedia*, 15th International Symposium on District Heating and Cooling, DHC15-2016, 4-7 September 2016, Seoul, South Korea 116, 26–38.
- SDH (Solar District Heating), 2013. SUNSTORE4 Tool. Available from: <<http://sunstore4.eu/use-results/sunstore4-tool/>>.
- Short, W., Daniel, J., Holt, T., 1995. *A Manual for the Economic Evaluation of Energy Efficiency and Renewable Energy Technologies*. NREL/TP-462-5173/.
- Soares, N., Bastos, J., Pereira, L.D., Soares, A., Amaral, A.R., Asadi, E., Rodrigues, E., Lamas, F.B., Monteiro, H., Lopes, M.A.R., Gaspar, A.R., 2017. A review on current advances in the energy and environmental performance of buildings towards a more sustainable built environment. *Renewable and Sustainable Energy Reviews* 77, 845–860.
- Song, J., Li, H., Wallin, F., 2017. Cost Comparison Between District Heating and Alternatives During the Price Model Restructuring Process. *Energy Procedia*, 8th International Conference on Applied Energy, ICAE2016, 8-11 October 2016, Beijing, China 105, 3922–3927.
- Statistical office of the Republic of Slovenia, 2011. Development of detailed statistics on energy consumption in households. Final Report. Available from: <https://ec.europa.eu/eurostat/cros/system/files/SECH_final_report_Slovenia.pdf>.
- Stuttgart University, 2011. Seasonal Thermal Storage. State of the Art and Future Aspects. Available from: <http://www.rhc-platform.org/fileadmin/Events/4_-_Kerskes_seasonal_TES.pdf>.
- SUSEN (SUStainable ENergy), 2015. Sustainable energy project. Research centre Řež. Available from: <<http://www.snetp.eu/wp-content/uploads/2015/06/SUSEN-project.pdf>>.
- Togawa, T., Fujita, T., Dong, L., Fujii, M., Ooba, M., 2014. Feasibility assessment of the use of power plant-sourced waste heat for plant factory heating considering spatial configuration. *Journal of Cleaner Production* 81, 60–69.
- Unternährer, J., Moret, S., Joost, S., Maréchal, F., 2017. Spatial clustering for district heating integration in urban energy systems: Application to geothermal energy. *Applied Energy* 190, 749–763.
- Viaséva (French association for the promotion of district heating and cooling networks), 2016. *Annuaire des réseaux de chaleur et de froid*. Available from: <<http://reseaux.viaseva.com/>> [in French].
- Werner, S., 2017. International review of district heating and cooling. *Energy* In press, 1–15.
- Werner, S., 2016. European district heating price series. Report no. 2016:316 Energiforsk-Fjärrsyn. Available from: <<https://energiforskmedia.blob.core.windows.net/media/21926/european-district-heating-price-series-energiforskrapport-2016-316.pdf>>.

Part I, Chapter 2

Cost-benefit analysis of district heating systems using heat from nuclear plants in seven European countries

Zvingilaite, E., 2013. Modelling energy savings in the Danish building sector combined with internalisation of health related externalities in a heat and power system optimisation model. *Energy Policy, Special section: Long Run Transitions to Sustainable Economic Structures in the European Union and Beyond* 55, 57–72.

Appendix I.2.A

Definition of the economic indicators used in the Chapter. Costs were discounted to represent 2017 values. Initial investments occur during the 2020-2030 period (see Appendix I.2.B). Re-investments occur during the 2030-2070 period according to the lifetime of the technologies (see Appendix I.2.C). Operational & management costs, as well as cash flows from the selling of heat, occur during the 2030-2070 period.

The capital recovery factor (CRF) is expressed in equation (A1):

$$CRF_t = \frac{i}{1 - \left(\frac{1}{1+i}\right)^{t-2017}} \quad (A1)$$

Where i is the discount rate; and t is the year considered.

The levelised cost of the heat (LCOH) is expressed in equation (A2):

$$LCOH = \frac{\sum_{t=2017}^{2070} (I_t + OM_t) CRF_t}{\sum_{t=2030}^{2070} HG_t CRF_t} \quad (A2)$$

Where CRF_t is the capital recovery factor; I_t is the investment capital cost made in the year t (unit: €); R_t is the return in the year t (cash flows from the selling of heat; unit: €); OM_t is the operational and management expenses occurring in the year t (unit: €); and HG_t is the heat generated during the year t (unit: MW_{th}).

The LCOH does not include financial taxes, subsidies or levies, because they represent the redistribution of costs rather than the actual costs. In that sense, the LCOH can be considered as the price that final customers would pay without private profits or subsidies.

The net present value (NPV) is expressed in equation (A3):

$$NPV = - \sum_{t=2017}^{2070} I_t CRF_t + \sum_{t=2030}^{2070} (R_t - OM_t) CRF_t \quad (A3)$$

Where CRF_t is the capital recovery factor; I_t is the investment capital cost made in the year t ; R_t is the return in time period t (cash flows from the selling of heat); and OM_t is the operational and management expenses occurring in period t .

The Internal rate of return (IRR) is the value of the discount rate, i , which verifies equation (A4):

$$NPV = 0 \quad (A4)$$

The payback period is expressed in equation (A5):

$$Payback\ period = \frac{\sum_{t=2017}^{2070} I_t}{R_t - OM_t} \quad (A5)$$

Where I_t is the investment capital cost made in the year t , R_t is the annual return in a time period t (cash flows from the selling of heat during one year); and OM_t is the operational and management expenses occurring during the year t .

Appendix I.2.B

Capital cost component	Unit	Value	Payment period	References & comments
Heat distribution				
Distribution network	€/m	Equation (7)	2026-2030	<i>In dense urban areas</i>
Base-load heat generation				
Cost attributable to heat generation with NCHP	€/KW _{th}	100	2028-2030	ETI (Energy Technology Institute), 2016): <i>between 0.5 and 0.9</i>
Heat transportation				
HTS	€/m	Equation (15)	2026-2030	Two-way buried pipelines (ETI, 2016; Hirsch <i>et al.</i> , 2016)
Peak-load heat generation				
WTES (water tank energy storage)	€/MWh _{th}	13.6	2028-2030	SDH (Solar District Heating, 2013)
GHOB (gas heat-only boiler)	€/KW _{th}	50	2028-2030	DEA (Danish Energy Agency, 2016)

Table I.2.B.1. Initial capital costs and investment periods of DH + NCHP systems in the base case

Notes:

*Engineering studies represent an additional cost equal to 6% of the initial capital costs (see e.g. AMORCE (French DH association), 2015; Chauvel *et al.*, 2001).*

Safety studies represent an additional cost equal to 33% of the cost attributable to heat generation with the NCHP (see 2.1.2).

Appendix I.2.C

Parameter	Unit	Value	References & comments
Heat distribution			
Distribution fixed O&M	% of distribution capital cost	0.06	AMORCE (2015)
Distribution pumping	$MWh_e.used/MWh_{th}.transported$	0.007	AMORCE (2015)
Distribution heat loss	%	Equation (6)	ETSAP (Energy Technology Systems Analysis Programme), 2013; Lund <i>et al.</i> , 2016)
Base-load heat generation			
NCHP fixed O&M	% of O&M cost attributable to heat generation with NCHP	0.01	Fixed O&M specific to heat generation
NCHP opportunity cost of heat generation	$MWh_e.lost/MWh_{th}.produced$	1/6	IAEA (International Atomic Energy Agency), 2016b; Safa, 2012) Extraction of 120°C heat from an outlet of the low-pressure turbine
Heat transportation			
HTS fixed O&M	% of HTS capital cost	0.04	Paananen and Henttonen (2009)
HTS pumping power	€	Equation (18)	
HTS heat loss	%	0.02	Hirsch <i>et al.</i> (2016; Paananen and Henttonen (2009); Safa (2012)
Peak-load heat generation			
GHOB/WTES fixed O&M	% of GHOB/WTES capital cost	0.04	DEA (2016)
WTES efficiency	$MWh_e.unstored/MWh_{th}.stored$	0.8	SDH (2013)
GHOB efficiency	$MWh_{th}.used/MWh_{th}.produced$	0.9	DEA (2016)
GHOB electricity used	$MWh_e.used/MWh_{th}.produced$	0.0012	DEA (2016)

Table I.2.C.1: Parameters relative to the efficiency of DH + NCHP systems and the operational and maintenance (O&M) costs.

Appendix I.2.D

Technology	Technical lifetime (years)	References & comments
DH distribution system	40	AMORCE (2015)
Gas heat-only boilers	25	DEA (2016)
Water tank energy storages	30	ENERGINET (2012)
NCHP	40-60	<i>For a newly built nuclear plant</i>
Heat transportation system	40	(Paananen and Henttonen, 2009)

Table I.2.D.1: Technical lifetime of technologies comprised in DH + NCHP systems.

Chapter 3

Cost-benefit analysis of plausible heat decarbonisation pathways in the French urban area of Dunkirk

Abstract

This chapter analyses the heat decarbonisation pathways that could be adopted by the Dunkirk conurbation committee (France). The costs and benefits of eleven different heating systems designed to supply the existing building stock of the Dunkirk urban area are evaluated. There are seven district heating (DH) systems and four individual systems. Accurate data on the existing DH network of Dunkirk are used. When energy prices are those of 2015, implementing a nuclear combined heat and power plant (NCHP) on the Gravelines' nuclear site, transporting the hot water over 15km and distributing the heat through an enlarged district heating (DH) network would result in a levelised cost of the heat (LCOH) of €62/MWh_{th}. This is the second cheapest system, being €15/MWh_{th} more expensive than individual condensing gas boilers. The plausible impact of public support mechanisms and taxes is then assessed. When the heating systems benefit from the highest possible amount of subsidies, the DH + NCHP system has the lowest LCOH in two energy price scenario over three. When the carbon price is €100/tCO₂, the DH + NCHP system is more attractive than individual condensing gas boilers, and this even if natural gas prices remain low (€37/MWh_{th}). The possibility of reducing the energy consumption of the area by retrofitting buildings is finally considered. In the case here studied, DH systems allow to cut down greenhouse gases emissions at lower cost. Even if present and future costs and benefits are set on an equal footing (discount rate of 0%), the levelised cost of heat savings is twice higher than the LCOH of the DH + NCHP system. In the long run, lower building consumption will affect the competitiveness of DH systems. In our case, the competitiveness of DH systems relative to individual systems would be jeopardized when the reduction of buildings consumption exceeds 50%. If adequate measures are taken to benefit from the lower temperature requirement in buildings, heat losses and required pipe diameters of DH systems would nonetheless be lower. It is thus concluded that the DH + NCHP system, either coupled with the retrofitting of buildings or not, offer significant economic advantages to the studied urban area in a long term perspective.

Keywords: cost benefit analysis, urban, heating systems, building renovation

Highlights

- Four individual heating systems and 7 district heating (DH) systems are compared
- The modelled DH network is 5.5 times longer than the existing network
- Nuclear combined heat and power plant (NCHP) offers several non-economic advantages
- Under certain conditions, NCHP is the cheapest heating alternative
- Costs, benefits and impacts of renovating buildings are evaluated

Comments

- Data specific to the Dunkirk DH system were used to evaluate the heat losses and capital costs relative to the DH distribution system, under different configuration of energy building performances. Special thanks are given to Mr. Vergriette (Dalkia, *Energie Grand Littoral*) for providing valuable data.
- To help the readers going through this comprehensive Chapter, it is decomposed into three incremental steps. Each step aims to answer one research question identified in Section 2. The steps are precisely defined in Section 2 (research scope) and recalled in the beginning of Section 3 (methods) and 4 (results and discussions).

1. Introduction

In France, local electricity and gas boilers supply respectively 33% and 44% of residential dwellings with space heating and domestic hot water (AMORCE (French DH association), 2015a). Fuels, wood combustion and district heating (DH) account for 13%, 3% and 7%, respectively. When accounting in terms of energy delivered yet, electricity represents only 16,9% of the total, while natural gas, fuels, liquefied natural gas, district heating, coal and wood account for 36,5%, 14,8%, 1,2%, 3,3%, 2,2% and 25,1% of the total, respectively (*Ministère de la transition écologique et solidaire* (French ministry of the united and eco-friendly transition), 2016). The difference between the shares in terms of number of dwellings and amount of energy is due to the difference of specific heat demand among buildings ($\text{kWh}_{\text{th}}/\text{m}^2 \cdot \text{a}$). E.g. Electrical heaters supply, in average, buildings with a lower specific heat demand than district heating systems or wood fired systems. In order to promote sustainable energy systems, it would be beneficial to transfer excess heat from factories and power plants to dwellings through DH networks (Connolly *et al.*, 2014; Persson *et al.*, 2014; Werner, 2017). While there is potential for deploying new or extending existing DH networks in urban areas (see Chapter 7), most new urban habitations however still install local electricity or gas boilers (AMORCE, 2015a).

While being a source of low carbon electricity, French nuclear plants also produce excess heat currently rejected to the surrounding environment. This heat represents approximately two thirds of the total energy generated (Safa, 2012). The whole French nuclear fleet and most nuclear reactors operating today in the world (277 out of 438) and tomorrow (59 out of 69 under construction; IAEA (International Atomic Energy Agency), 2017) are Pressurized Water Reactors (PWR). Similarly to cogeneration plants based on fossil fuels or biomass, PWR can be designed to produce both electricity and heat without affecting the reactor's safety (STUK (Radiation and Nuclear Safety Authority of Finland), 2009). Doing so would involve to reduce the amount of heat which is converted to electricity (Carnot efficiency). For the temperatures useful to conventional 3rd generation DH networks (80-120°C), the thermal energy recovered is six times higher than the electricity losses (IAEA, 2016). Production of heat for DH application has been experienced with at least 51 nuclear combined heat and power plant (NCHP; see Chapter 5), hence providing valuable feedbacks for optimizing such energy systems.

The French Act on excess heat recovery obligates, under certain criteria, the energy production facilities and industrial factories to consider excess heat transfer to DH systems (*Ministère de l'environnement, de l'énergie et de la mer* (French Ministry of Environment, Energy and Seas), 2014). Those facilities which emit more than 250 $\text{GWh}_{\text{th}}/\text{a}$ of heat above 80°C to the surrounding environment must evaluate the feasibility of supplying DH networks located less than 40km away. Technically, the Gravelines' nuclear plants, located 15km away from Dunkirk, fulfil these criteria.

In the following, Section 2 further describes the research scope. Section 3 presents the heating system currently being used in Dunkirk. Section 4 shows the methods used and assumptions made to answer the questions identified in Section 2. Results are shown and discussed in Section 5. Chapter 3 ends with the conclusion.

2. Research scope

This Chapter assesses and compares different alternatives that could be chosen by the Dunkirk conurbation committee (France) to decarbonise space heating and domestic hot water production for the residential and commercial sectors. Four individual heating systems and seven DH systems are modelled (see Table I.3.1). The relative performance of these systems is evaluated under three different level of building efficiency (existing building stock, shallowly renovated buildings and completely renovated buildings). We are aware that all of the heating systems shown in Table I.3.1

may not be feasible everywhere but we assume they are in the studied area for the sake of the comparison (colour coding is yet introduced in Table I.3.1 to reflect the technical feasibility of systems).

Energy performance of buildings in 2030 (*)	Existing buildings (133 kWh _{th} /m ² . a)	Shallowly renovated buildings (96 kWh _{th} /m ² . a)	Completely renovated or new buildings (40 kWh _{th} /m ² . a)
Supply (**)/return temperatures (for DH systems only; maximal temperatures)	100/80°C <i>(data from Dalkia for the existing network)</i>	70/35°C <i>(projected temperatures)</i>	55/25°C <i>(projected temperatures)</i>
<i>Individual systems</i>			
Natural gas boiler			
Electric heater			
Electric HP, air to water			
Electric HP, brine to water			
<i>District heating systems</i>			
NCHP			
Nuclear excess heat + HP			
Electric HP, water to water			
Biomass straw HOB			
Biomass wood chips HOB			
Solar + Borehole TES + HP			
Solar + Pit TES + HP			

Table I.3.1: Heating systems and building envelopes studied in Chapter 3.

Notes:

HP: Heat pumps. HOB: Heat-Only Boilers. TES: Thermal Energy Storage.

Highlighted in green: technical feasibility of the heating system should not be an issue

Highlighted in yellow: technical feasibility of the heating system may be an issue

Highlighted in red: technical feasibility of the heating system would likely be an issue

(*) Methods and data used to evaluate the energy performance of buildings are shown in Section 4.3.

(**) Supply temperatures correspond to the highest temperatures required during the heating season. It could probably be lowered outside the heating season, as a function of outdoor temperatures.

This Chapter addresses three incremental research questions:

- (i) What are the respective costs and benefits of those heating systems which are designed to supply the existing building stock of the Dunkirk urban area (see Table I.3.1)?
- (ii) How could the relative costs and benefits of the heating systems be impacted when introducing public support mechanisms and taxes?
- (iii) What are the costs and benefits of renovating buildings? How could the relative costs and benefits of the heating systems be impacted when the building efficiency is increased?

The methods used and assumptions made to answer the research questions (i), (ii) and (iii) are presented in Section 4.1, 4.2 and 4.3, respectively. Results are shown in Section 5.1, 5.2 and 5.3, respectively. The following criteria are modelled and used to answer the research questions:

- **Levelised cost of the heat** (LCOH; €/MWh_{th}). Please refer to Appendix I.2.A for formula;
- **Payback period** (years). Please refer to Appendix I.2.A for formula;
- **Net present value** (NPV; M€). Please refer to Appendix I.2.A for formula;
- **Equivalent CO₂ emissions generated per unit of heat delivered** (t eCO₂/GWh_{th,a}). Greenhouse gas (GHG) emission factors are presented in Section 4.
- **The impact on public health caused by the emissions of air pollutants** (eg. particle matter less than or equal to 2.5 µm in diameter). This is further discussed in Sub-section 4.1.4;

- **The land surface occupied** (m^2) by all the equipment required (e.g. gas HOB, HP, solar collectors). It does not include the space requirements for e.g. housing or parking lots. Assumptions made for each system are described in Sub-section 4.1.
- **Traffic road (trucks/week)**. Traffic road concerns only biomass based DH systems (trucking from the biomass source to the facility; see 4.1.1.5). One of the community's concerns can be the trucking in the biomass to the facility and taking out the remained ash.

3. Case study: The Dunkirk conurbation committee

In 2015, the Dunkirk DH network (*Energie Grand Littoral*) was 40km long, providing 125 $\text{GWh}_{\text{th}}/\text{a}$ of heat to residential and commercial end-users (Dalkia (Groupe EDF), 2015). It has a carbon content of 0.127 $\text{kg CO}_2/\text{kWh}_{\text{th}}$ (Dalkia, 2015). As a comparison, French DH networks emit 0.151 $\text{kg CO}_2/\text{kWh}_{\text{th}}$ on average (SNCU (French National Union for District Heating), 2017). This low carbon profile is achieved through the recovery of excess heat from the Arcelor Mittal steel production factory, located 4km away. Excess heat represents approximately 60% of total DH deliveries (Dalkia, 2015). The remaining heat loads are covered with natural gas HOB (28%) and fuel HOB (12%). The Dunkirk network won the Global District Energy Climate Awards of the 2009' Copenhagen Climate Change Conference (*Communauté urbaine de Dunkerque* (Dunkirk Conurbation Committee), 2016), recognising the social added value of excess heat recovery practices.

The Dunkirk conurbation committee follows a rather fast dynamic of DH expansion. In 2015, there were at least 5 DH projects (creation or extension) in the direct proximity of Dunkirk, and one DH project in the Gravelines municipality, 15km away (*Communauté urbaine de Dunkerque*, 2016). Larger networks will provide new opportunities for those DH sources whose competitiveness is significantly affected by the amount of heat supplied (e.g. NCHP or solar based DH systems). It is therefore important to assess and compare the plausible network designs (e.g. centralized or decentralized) and heat sources so as to optimize the benefits of the future DH system. This Chapter is however limited to the research questions shown in Section 2.

Figure I.3.1 shows the studied land area, as well as the existing DH network. The heat loads supplied with the modelled heating systems include all the heat demand within the 'Modelled DH area' boundaries (see Figure I.3.1), diminished by the loads that are already supplied by the existing DH network (125 $\text{GWh}_{\text{th}}/\text{a}$). As a result, the annual heat loads covered by the modelled heating systems are equal to 673 $\text{GWh}_{\text{th}}/\text{a}$, and correspond to a land surface of about 16 km^2 (19 km^2 , the surface of the modelled land area of Figure I.3.1 minus the 3 km^2 , the surface of lands covered by the existing DH network). If there is still heat to be recovered in the steel factory, it could be used in the projected DH network without jeopardizing the validity of our results.

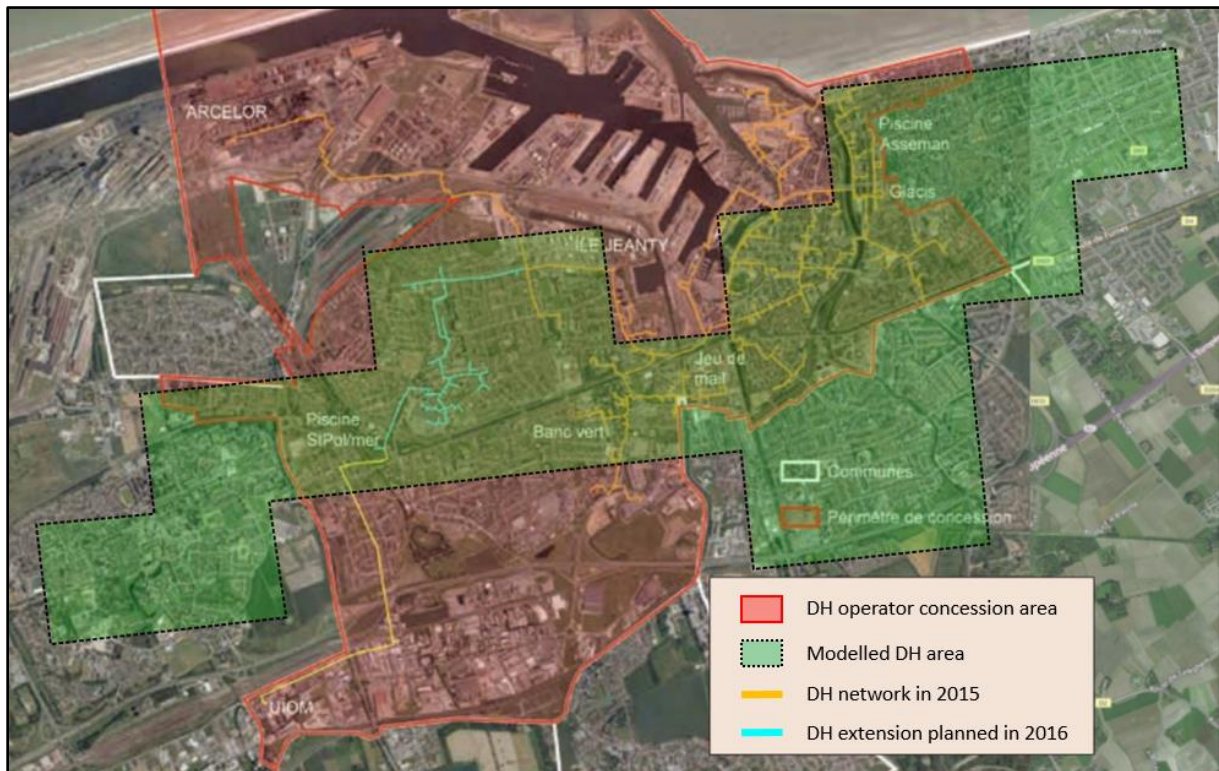

Figure I.3.1: Existing and modelled DH areas in the Dunkirk conurbation committee. Data source: Personal photomontage, using maps from Dalkia (2015) and Heat Roadmap Europe (2015).

Notes:

(*) The land areas within the ‘Modelled DH area’ boundaries have a heat density above $28 \text{ GWh}_{th}/\text{km}^2$. a. The corresponding land surface is 19 km^2 .

()** The modelled DH systems are dimensioned to supply approximately 85% of the heat loads in the corresponding area. The remaining 15% are supplied with the heat sources supplying the existing network (60% excess heat from the Arcelor Mittal steel production factory, 28% natural gas HOB and 12% fossil-fuel HOB).

4. Methods, modelling assumptions and data

In this Chapter, alternatives to decarbonise the residential and commercial heating sectors are analysed through three incremental steps. Each step aims to answer one research question identified in Section 2. Steps 2 and 3 use the results or assumptions informed in previous step(s):

- **Step 1:** Answering question (i): What is the relative performance of those heating systems which are designed to supply the existing building stock?
- **Step 2:** Answering question (ii): How could the relative performance of systems be impacted when introducing public support mechanisms and taxes?
- **Step 3:** Answering questions (iii): How could the relative performance of systems be impacted when the building efficiency is increased? What are the costs and benefits of renovating buildings?

Sub-sections 4.1, 4.2 and 4.3 present the methods, modelling approaches and data used in steps 1, 2 and 3, respectively.

4.1. Modelling heating systems designed to supply the existing building stock

In order to answer the research question (i), it is necessary to collect detailed information on the technical features, and to parameterise costs and environmental assumptions in accordance with all the heating systems and the existing building stock. Whenever possible, precise references to Chapter 2 are made, the aim being to provide only those methods and assumptions that are additional or different to those of Chapter 2. Chapter 2 and 3 ensure the full reproducibility of the research carried out.

Similarly to Chapter 2, capital costs are scheduled for different time periods over the 2020-2030 decade, following project management principles. Capital costs are discounted to year 2018 (see Appendix I.1.A for economic formulas). As recommended by the European Commission (EC) for the cost-benefit analysis of large energy projects (EC, 2014a), the discount rate used is 3.5% and the time period is 40 years, corresponding to the technical lifetime of the major technical component of the systems evaluated (here, DH pipelines). The sensitivity of results to variation of the operational lifetime is however tested (maximum 60 years). As some technologies have shorter technical lifetimes (e.g. gas heat-only boilers), scheduled re-investments within the lifetime are included in the analysis. Technology lifetimes are shown in sub-sections 4.1.1 and 4.1.2 for DH and individual systems, respectively. It is considered that all the studied heating systems require engineering studies before to be implemented. The cost of these studies equal to 6% of the initial investment, as recommended by Chauvel *et al.* (2001). For the sake of conciseness, engineering studies are however not mentioned in the Tables of this Chapter. Engineering expenses are spread over the three years preceding the investment period (e.g. if the investment period is 2028-2030, then the engineering studies are paid during 2024-2027).

4.1.1. DH systems

Sub-section 4.1.1.1 first describes the assumptions common to all DH systems (DH distribution network and peak-load heat generation). The assumptions specific to each base-load heat source (e.g. nuclear plant, biomass HOB) are then detailed separately in sub-sections 4.1.1.2 to 4.1.1.6.

4.1.1.1. DH distribution system

Similarly to Chapter 2, it is assumed that the base-load heat source provides 80% of the annual heat loads. The remaining 20% are supplied with natural gas HOB. All DH systems also utilise water tank energy storages (WTES) for short term storages (solar DH systems also use seasonal TES; see 4.1.1.6). Data from the Danish Energy Agency (DEA, 2016) are used to evaluate the space requirements of gas HOB and WTES, stating that they both occupy $6 \text{ m}^2/\text{MW}_{\text{th}}$ on average (with an uncertainty range

of 3-10). All the other assumptions relative to gas HOB and WTES are explicated in Section 3.4 of Chapter 2.

The method used to evaluate the linear heat density ($MWh_{th}/m \cdot a$) of the DH distribution system is the same as described in Section 3.1 of Chapter 2. Data from Heat Roadmap Europe (2015) are used, providing the spatialized demand for space heating and domestic hot water for residential and commercial buildings (here after often referred simply as heat demand) at a square kilometer resolution. Only the grid cells with heat density above $28 GWh_{th}/km^2$ are used, resulting in the DH modelled area shown in Figure I.3.1 (Section 3). $673 GWh_{th}/a$ are thus supplied with new heat sources (both base and peak load sources).

A parameter that vary in comparison to Chapter 2 is the specific heat demand of buildings ($kWh_{th}/m^2 \cdot a$). While Chapter 2 uses the national average of $157 kWh_{th}/m^2 \cdot a$ (data for 2008, which is projected towards 2030 in Chapter 2), Chapter 3 utilises data specific to the Dunkirk urban area. Correctly assessing this value is important since it affect the length of the modelled DH network, which represents a significant part of the total capital costs. The specific heat demand (input parameter) also impacts the size of the building surface area (m^2 ; output parameter), which is used to determine the levelised cost of heat savings achieved through buildings renovation (see Section 4.3). The specific heat demand of building is here assessed using the data shown in Table I.3.2. The average specific heat consumption of buildings in Dunkirk was $151 kWh_{th}/m^2 \cdot a$ in 2006. We assumed that the dwellings built between 2006 and 2018 have always replaced the oldest buildings at the business-as-usual rate of 1%/a (Chirat and Denisart, 2016). In addition, we considered that new buildings follow the energy efficiency guidelines of the French *RT2012* Act (maximum $40 kWh_{th}/m^2$; *Assemblée nationale*, 2009). These conservative hypothesis led us to use the value of $133 kWh_{th}/m^2 \cdot a$ as an input parameter for the specific heat demand of buildings in 2018.

Construction period of buildings	Distribution (%) of buildings in the Dunkirk conurbation committee in 2006 (*)	Specific heat consumption (**) of buildings ($KWh_{th}/m^2 \cdot a$) in Northern France (***)
< 1949	15.5%	176
1949-1974	40.1%	158
1975-1989	34.1%	139
1990-2005	10.3%	130
> 2006	0%	111

Table I.3.2: Distribution of the construction period and specific heat consumption of buildings in the Dunkirk conurbation committee.

Notes:

(*) Data source: INSEE (French National Institution for Statistics and Economics Studies) and Région Nord-Pas-de-Calais, 2009;

(**) For space and domestic hot water supply, representing 75% of the total final energy consumption of buildings (CEREMA (French Research Centre on Risks, Environment, Mobility and Territorial Planning), 2014);

(***) Northern France corresponds to the so-called 'H1' climate zone (ADEME (French Agency for Environment and Energy Supervision), 2012). Buildings in this area consume in average 6.25% more heat energy than the average French building (Ministère de l'écologie, du développement durable et de l'énergie (French Ministry of Ecology, Sustainable development and Energy), 2015).

This Chapter also uses data specific to the Dunkirk DH network to evaluate the capital cost associated to DH expansion. Data offered by the Dunkirk network (*Energie Grand Littoral*) are shown in Table I.3.3. As a conservative assumption, the cost of pipes, C_{DH} (€/m), represents the sum of the pipe, civil works, sand filling, and labor costs required to implement DH pipelines in roadway areas. The average pipeline diameter is calculated applying the formula (5) of Chapter 2, which is based on the observed correlation between the average linear heat density and the average pipe diameter of DH networks in Europe.

Pipes diameter (mm)	20	50	65	80	100	125	150	200	250
Capital Cost of DH pipelines in Dunkirk (€/m), including pipes, civil works, sand filling, and labor costs									
Park area	285	306	351	391	483	518	557	633	780
Sidewalk	312	344	389	428	521	556	595	671	812
Roadway	335	367	412	452	544	579	618	694	871

Table I.3.3: Capital cost of DH pipelines (€/m) in Dunkirk as a function of pipes diameter (mm). Data provided by Dalkia in 2017.

In addition to the capital cost derived from Table I.3.3, the cost of sub-stations is also taken into account assuming a cost of 330 €/kW_{th} (ADEME, 2015). The maximal thermal output required (kW_{th}) is calculated as described in Section 3.2 of Chapter 2. The heat losses of the existing network are equal to 11.7% (Dalkia, 2015). We used this value when DH systems supply existing buildings, but losses are modified when energy performance of buildings is increased (see Section 4.3.2). The investment period of the DH distribution system is 2026-2030 (as in Chapter 2).

4.1.1.2. NCHP

The DH + NCHP system is based on the deployment of a new NCHP on the site of Gravelines located 15km from the centre of Dunkirk. The modelling of NCHP is detailed in Section 3.2 of Chapter 2. Supply and return temperatures of the heat transportation system are 120°C and 50°C, respectively. Electricity losses due to heat extraction on the PWR represents one sixth of the heat produced (IAEA, 2016). Other assumptions made to model the heat transportation system are shown in Section 3.3 of Chapter 2.

4.1.1.3. Nuclear excess heat reheated with large-scale compression heat pumps (NEH + HP)

An additional DH system using heat from the nuclear plant is modelled in this Chapter. Excess heat from the outlet of a PWR condenser is available at 40°C (IAEA, 2016). Technically speaking, recovering this excess heat would be much easier than extracting heat from the low pressure turbine. It is thus considered that the investment associated to the heat recovery is five times lower than the capital cost associated to the generation of 120°C heat.

The heat transportation system is modelled using the formulas shown in Section 3.3 of Chapter 2. Supply and return temperatures of the heat transportation system are 90°C and 40°C, respectively. Excess heat is reheated with compression HP in the direct proximity of the nuclear plant (see Figure I.3.2 for a sketch of HP with components). This allows a higher supply temperature (90°C) of the heat transportation system, and thus a higher difference ($\Delta T=50$) with the return temperature (40°C). If the HP were located next to the city DH distribution network, the supply temperature of the heat transportation system would be about 40°C, and the ΔT would be 20. Low ΔT imply larger pipe diameter and heat losses (see Section 3.3 of Chapter 2), and hence should be avoided if possible. 90°C is often presented as the maximum temperatures reached by HP under realistic operating conditions (DEA, 2016a; Popovski *et al.*, 2017; Zvingilaite, 2013). It is assumed that, in the coldest period, gas heat-only boilers are sufficient to reach the temperature of 100°C required by the network in the coldest period.

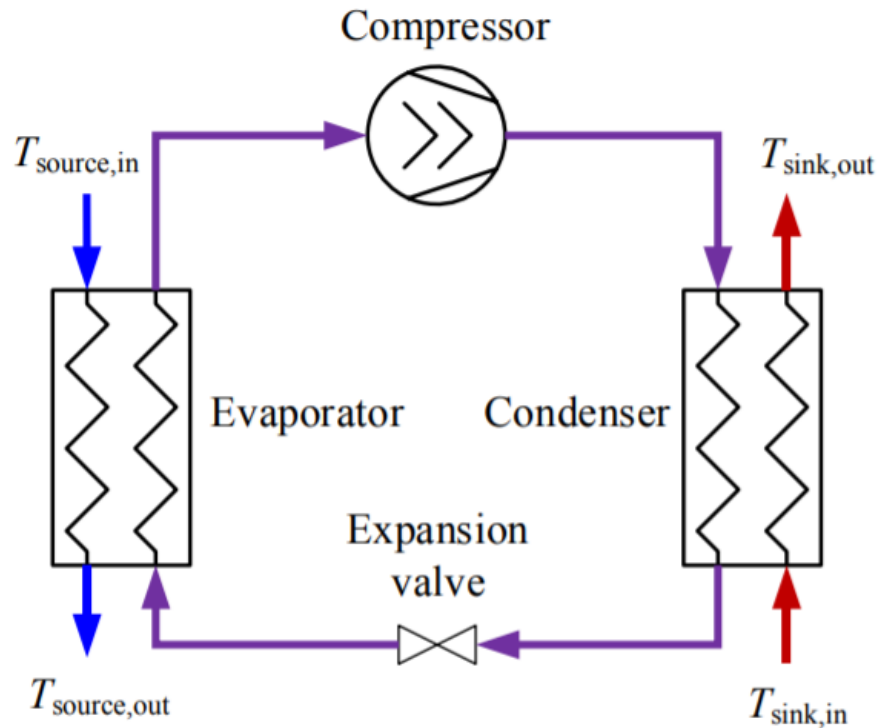

$$\text{COP}_{\text{Lorenz}} = \frac{T_{\text{lm,sink}}}{T_{\text{lm,sink}} - T_{\text{lm,source}}}, \quad \text{where} \quad T_{\text{lm}} = \frac{T_{\text{in}} - T_{\text{out}}}{\ln\left(\frac{T_{\text{in}}}{T_{\text{out}}}\right)}$$

Figure I.3.2: Sketch of the heat pump cycle with components. The Lorenz Coefficient of Performance (COP) is the theoretical maximum. Data source: Bach (2014).

The COP of HP is highly dependent on operating conditions, especially absolute temperature and relative temperature between sink and system. In the following, the COP of HP will always refer to the practical COP values, accounting for mechanical and thermal losses. Practical COP are typically around 40-60 % of the theoretical COP (DEA, 2016a). The COP is often graphed against expected operating conditions, as shown in Figure I.3.3. When reheating the nuclear excess heat from 40°C to 90°C, a COP of 3.2 is a realistic assumption (DEA, 2016a; Popovski *et al.*, 2017; Zvingilaite, 2013). The DH requirements would however reach 90°C only in the coldest periods, and hence 70-80°C should be sufficient most of the time. We have thus assumed an average COP of 3.5. Table I.3.4 summarizes the parameter values specific to HP used in the NEH + HP based DH system. The column entitled ‘uncertainty range’ is for informative purposes only.

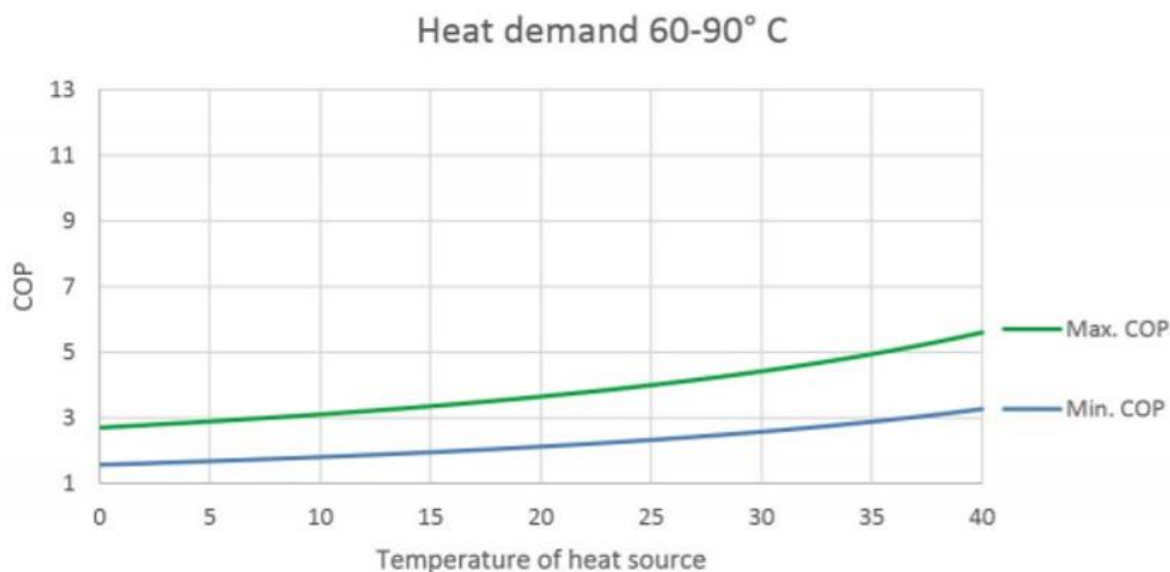

Figure I.3.3: Practical COP values of compression HP heating water up to 60 (Max. COP) or 90 (Min. COP) °C. For a heat source at 0° C that is cooled to -5° C, typical COP values will be 1.6-2.7 rising to 3.2-5.6 for a heat source at 40° C that is cooled to 35° C. Data source: DEA, 2016a.

Parameter	Unit	Value	Uncertainty range	Reference and comment
Elec. consumption	% of heat generated	7	4-9	DEA (2016a)
Technical lifetime	Years	25		DEA (2016a)
Initial investment	M€/MW _{th}	0.75	0.50-1.00	ADEME (2016); DEA (2016a)
Investment period	Years	2028-30		DEA (2016a)
Fixed O&M (*)	% of initial investment/a	0.25	0.02-0.03	DEA (2016a)
Variable O&M (excl. elec.)	€/MWh _{th}	1.75	1.5-2.0	DEA (2016a)
Surface requirement	m ² /MW _{th}	20	10-40	DEA (2016a)
COP		3.2	2.8-3.5	DEA (2016a); Popovski <i>et al.</i> (2017); Zvingilaite (2013)

Table I.3.4: Parameter values used to model electric compression HP for the NEH + HP DH system. Values projected towards 2030.

Notes:

(*) O&M: Operational and maintenance costs

4.1.1.4. Compression heat pumps heating sea water (water to water HP)

The Dunkirk conurbation committee is an inshore area and thus have access to a large quantity of sea water. Water to water HP could be used to upgrade this heat source to the adequate temperature, here 70/90°C depending on seasons and days. The temperature of the sea vary from 5°C to 20°C depending on seasons. Given the assumptions made with regards to the annual heat load profile (see Section 3.2 of Chapter 2), 60% of the heat loads occur in winter. It is hence reasonable to assume that the sea water used in water to water HP would have an average yearly temperature of about 10°C. Referring to DEA (2016a), Popovski *et al.* (2017) and Zvingilaite (2013), an average COP value of 1.8 is considered (see also Figure I.3.3). All other parameter values relative to compression HP are shown in Table I.3.4 of Section 4.1.1.3.

4.1.1.5. Biomass heat-only boilers (HOB)

Two type of biomass HOB are studied in this Chapter, namely wood chips HOB and straw HOB. Wood chips are small, cut pieces of wood, either forest chip or stump chip. Straw is a by-product from the growing of commercial crops, in France primarily cereal grain, rape and other seed-producing crops. Straw is often delivered as big rectangular bales from stores at the farms to the DH plants during the year depending on crop delivery contracts (DEA, 2012). For the sake of consistency (other DH systems use centralized heat sources), only large biomass plants ($>20\text{MW}_{\text{th}}$) are here considered; this makes sense also considering the large heat demand covered by the modelled DH network. Plants above $1\text{-}2\text{ MW}_{\text{th}}$ usually prefer the wood chip alternative to the wood pellet one as it is cheaper when it comes to large plants (DEA, 2012). This is why wood pellets HOB are not considered in this Chapter.

Sub-Section 4.1.1.5 first exposes the techno-economic assumptions. Hypothesis specific to the GHG emission factors of the different biomass fuels are then discussed.

Techno-economic assumptions relative to biomass HOB

Table I.3.5 details the parameters used to model biomass HOB, both wood chips and straw fired. In addition to the parameters provided for the other technologies (e.g. initial investment, investment period, space requirement), the number of trucks required to transport the biomass fuel to the facility has been evaluated. The community representative groups may be concerned whether trucking of this fuel would have major traffic burden for the community. N_{trucks} , the number of trucks required each week (1 year comprising 52 weeks) is calculated following formula (2):

$$N_{trucks} = \frac{Q_p}{LHV \cdot T_{cap} \cdot 52} \quad (2)$$

Where Q_p is the annual heat produced with the biomass HOB ($\text{MWh}_{\text{th}}/\text{a}$); T_{cap} is the average truck capacity (t); and LHV is the lower heating value ($\text{MWh}_{\text{th}}/\text{t}$) of the biomass fuel. Truck capacity and lower heating values are shown in Table I.3.5. Ash disposal can be scheduled such that the same truck is used and hence no additional truck would be required to commute to the facility (City of Vancouver, 2006).

Parameter	Unit	Value	Uncertainty range	Reference and comment
Parameters common to straw and wood chips HOB				
Technical lifetime	Years	20		DEA (2016a)
Initial investment	M€/MW _{th}	0.5	0.4-1.1	DEA (2016a); AMORCE (2015). For large plants (>20 MW _{th}) equipped with emission control system (see 4.1.4.1)
Investment period	Years	2028-30		DEA (2016a)
Surface requirement	m ² /MW _{th}	6	3-10	Assumed similar to gas HOB DEA (2016a)
Total efficiency (net)	%	98		DEA (2016a)
Trucks capacity	t	40		Ghafghazi <i>et al.</i> (2010)
Parameters specific to wood chips HOB				
Total O&M	€/MW _{th}	5.4		DEA (2016a)
Lower heating value	MW _{th} /t	3.9		For 25% moisture content; VTT (Technical Research Center of Finland, 2016)
Parameters specific to straw HOB				
Total O&M	€/MW _{th}	4		DEA (2016a)
Lower heating value	MW _{th} /t	3.75		For 20% moisture content; VTT (2016)

Table I.3.5: Parameter values used to model biomass HOB towards 2030.

GHG emissions of biomass HOB

Biomass energy facilities do emit GHG: about 403 kg CO₂/MW_{th} from the direct combustion of wood, while burning lignite and natural gas emit 364 and 202 kg eCO₂/MW_{th}, respectively (Chatham House, 2017). From a lifecycle perspective yet, they are often considered as GHG neutral. The idea supporting this assumption is that the GHG emitted through combustion counterbalances what would be generated through natural decomposition. The climate neutrality of such bioenergy has yet been disputed, especially for long-rotation biomass (see e.g. Haberl *et al.*, 2012; Holtsmark, 2012; Schulze *et al.*, 2012; Chatman House, 2017). As part of this discussion, GHG emission factors of different kinds of bioenergy have been presented for e.g. forest residues (Pingoud *et al.*, 2012) or primary biomass from harvest-regrowth rotation (Cherubini *et al.*, 2011). Recent discussions regarding the climate impact of wood chips and straw HOB are detailed below. As a simplified hypothesis, this Chapter relies on the recommendations offered by the EC (2016) regarding GHG emission factors of biomass fuels.

From an environmental viewpoint (not only for the climate), whether biomass energy is an interesting option depend on many factors as the application (e.g. electricity, heat, biofuels), the type of biomass (e.g. agricultural crops, forest residues, wood chips, wood pellets, straw), the type of energy which is replaced, the existing alternatives to the use of biomass (e.g. excess heat recovery, geothermal heat pumps), the land use changes (e.g. competition with food industries), the efficiency of the biomass conversion process, the material and energy inputs for cultivation, harvesting, processing and transport. Assessing the environmental impact of biomass HOB is a complex issue which deserve deep, case by case investigation, which were not performed in the frame of this Ph.D.

Wood Chips HOB

Several studies have shown that short rotation and fast-growing biomass plantations (e.g. annual crops, short rotation coppice, poplar) have lower global warming potential than biomass plantations with longer rotation periods (e.g. forest wood; Cherubini *et al.*, 2011; Liu *et al.*, 2017). However, Cherubini *et al.* (2011) also emphasize that this fact should not be over interpreted; it only means that short rotation biomass has less climate impact than long rotation biomass per unit of heat energy generated from the combustion of the biofuel, leaving aside other environmental criteria. Poplar represents 10% of forests in the region of Dunkirk (*Hauts-de-France*), with more than 40 000 hectares (*Peupliers de France* (French poplar association), 2017). It is therefore reasonable to assume that 75% of the woodchips required to supply the HOB of the Dunkirk DH network would come from short-rotation forestry cultivation of poplar (5 years cycles) and the remaining 25% from thinning of forest wood. EC (2016) states that wood chips obtained from short term rotation poplar plantations are responsible for 28 kg eCO₂/MWh_{th}; and this is the value here used. Higher values are nonetheless obtained from other life-cycle analysis such as Bartolozzi *et al.* (2017) or Ghafghazi *et al.* (2011a), recommending GHG emission factors up to 140 kg eCO₂/MWh_{th}. Further life-cycle analysis should be performed to determine the GHG emission factor of wood-chips HOB in the specific case of the Dunkirk area.

Straw HOB

Compared to other biomass sources, some of the strong advantages of straw include its minimum competition with food and feed industries and lower land use change impacts (Fan *et al.*, 2006). There are some debates related to the consequences of straw removal from agriculture fields (Clapp *et al.*, 2000, 2000; Dick *et al.*, 1998). Consequences mainly include a decline in soil carbon pools with the subsequent effect on the soil's water holding capacity, a loss of soil carbon sequestration potential and a loss of availability of nutrients from straw to the soil (Dick *et al.*, 1998). Parajuli *et al.* (2014) have performed a life-cycle analysis of DH using straw HOB accounting for the consequences of the straw removal process, i.e. negative GHG emission equivalent to the biogenic GHG release that would have occurred with the biomass incorporation to the soil, followed by the decay process. Results from Parajuli *et al.* (2014) and EC (2016) indicates that the straw option is responsible for 15 kg eCO₂/MWh_{th}, and this is the value retained in this Chapter. The Environment Agency (2017) however states that straw is responsible for 50 (best practices) to 110 kg eCO₂/MWh_{th} (worst practices). This highlights again the controversial nature of this debate, encouraging the readers to be aware of the complexity of the topic. The drawback of straw HOB is the higher amount of air pollutants emitted through combustion. The amount of air pollutants emitted by the heating systems and the impact on human health is assessed in Section 4.1.4.

4.1.1.6. Solar DH systems

Solar DH systems usually consist of an array of solar collectors to collect heat, storage to preserve this heat for a short or long term, and a heat transportation system to transport the heat from the solar field (usually located in remote areas) to the DH network. Solar heating systems are mainly evaluated according to their solar fraction, i.e. the amount of energy provided by the solar heating system divided by the total energy demand. Since all the base-load heat sources used in the other heating systems cover 80% of the yearly demand, the solar fraction here assumed is 80%. The remaining 20% being supplied with natural gas HOB (as for other DH systems; see 4.1.1). We are aware that such a solar fraction is still hard to reach in practice (often because of high heat loss from the storage; see Bauer *et al.*, 2010), but we assume that it is possible in our case for the sake of the comparison. There are however some concrete examples of solar systems (yet often small, 27-6000 MWh_{th}/a) with solar fraction of 80% (see Hesaraki *et al.*, 2017). Seasonal thermal energy storages (STES) are required to reach such a high solar fraction (ADEME, 2016; Bauer *et al.*, 2010; DEA, 2016a). Given the temperature profile of the Dunkirk DH network (100/80°C supply/return temperatures), HP would also be needed to upgrade the heat from the STES during the heating season (Hesaraki *et al.*,

2017). Sub-section 4.1.1.6 first details the hypothesis specific to solar collectors. Assumptions relative STES and HP are then discussed.

Solar collectors

The principle of energy flows in a solar collector is shown in Figure I.3.4. Table I.3.6 details the assumptions made for the techno-economic simulation. It is assumed that the solar field would be located 2km away from the city DH network. 2km is a reasonable distance considering the land surface occupied by solar collectors (see 5.1.3) and the land availability of the areas near Dunkirk. The investment period of solar collectors is not shown in Table I.3.6 given that it depends on the type of STES used, as discussed after.

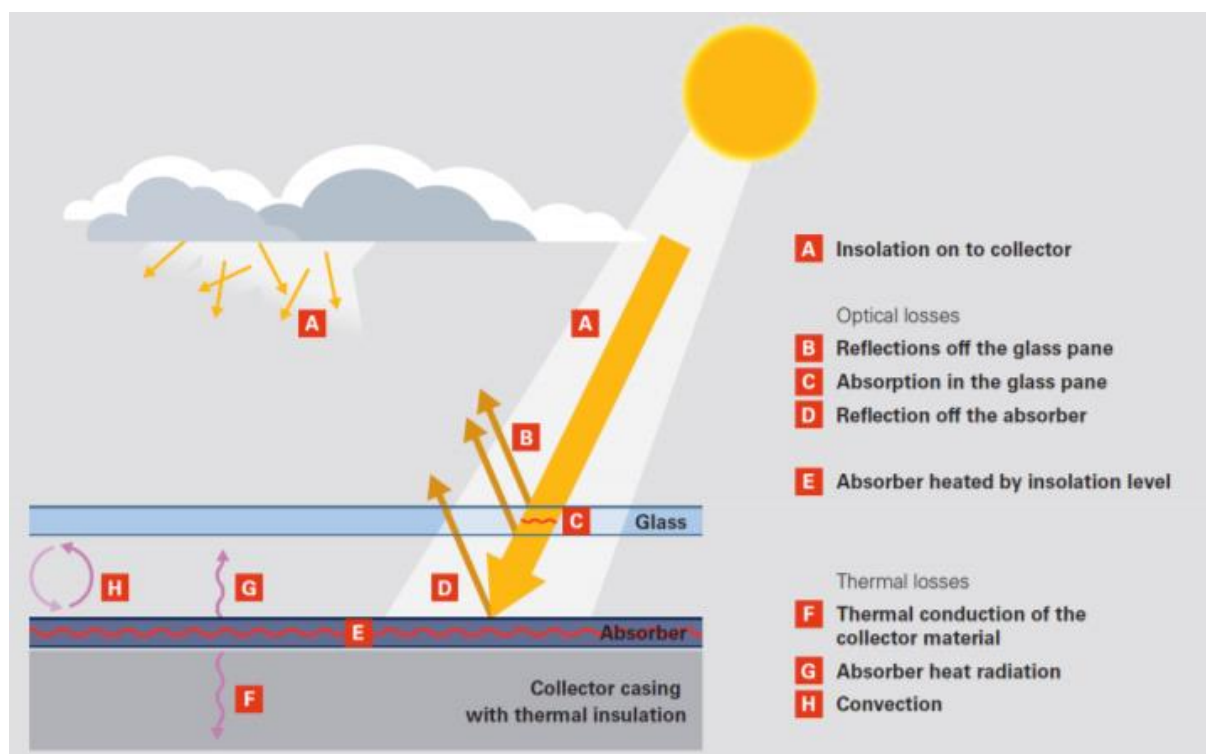

Figure I.3.4: Principle of energy flows in a solar collector. Data source: Viessmann GmbH (2009).

Parameter	Unit	Value	Uncertainty range	Reference and comment
Collector area/ heat demand	m^2/MWh_{th}	3.0	2.0-3.7	(*)
Initial investment	$\text{€}/m^2$	200	150-250	Solar District Heating (SDH, 2012)
Total O&M	$\text{€}/MWh_{th}$	0.57		DEA (2012)
Technical lifetime	Years	30		DEA (2012)
Distance from solar field to city	km	2		Field located 2km away from city (land use purposes)
COP of HP (**)		4.0		From 50 to 90°C. See Figure I.3.3, Section 4.1.1.4.

Table I.3.6: Parameter values used to model solar collectors towards 2030.

Notes:

(*) This was calculated with the help of Cédric Paulus (CEA INES). A solar productivity of $332 \text{ kWh}_{th}/m^2.a$ was estimated using the software Scenocalc under the following assumptions: global irradiation of $1280 \text{ kWh}_{th}/m^2.a$ for panels at 30° angle and facing due south (for Dunkirk; see EC,

2017); average collector's temperature of 70°C (max. 80°C); 25% solar energy used directly and 75% stored (see below); storage efficiencies shown in Tables I.3.7 and I.3.8.

(**) The COP is justified here below when introducing STES concepts. Other parameters used to model HP are similar to what is shown in Table I.3.5 of Section 4.1.1.4.

Seasonal thermal energy storage (STES)

To reach a solar fraction of 80%, a STES is required (ADEME, 2016; Bauer *et al.*, 2010; DEA, 2016a). It worth noticing that STES could be coupled to other kind of heat generation systems: e.g. Loiseaux *et al.* (2016) have compared the costs of nuclear based DH systems with and without STES, concluding that the option with STES would likely be more expensive. Considering this result, we have here considered that STES would be used only when it is technically necessary. In our study, this concerns only solar DH systems (because the target is to supply 80% of the annual heat loads; the necessity of a STES depends upon the solar fraction envisioned).

Thermal energy can be stored in three forms - sensible energy, latent energy and chemical reaction (Dincer and Dost, 1996). When adding or removing energy affects the temperature of a material, it is classified as sensible. Due to its simplicity, this concept is the most developed and well known technology (Hugo, 2008). The greatest concern in sensible STES is heat loss (Xu *et al.*, 2014), which depends on operating conditions (e.g. storage medium, temperature gradient, volume of storage; see Nordell, 2000). Large sensible STES are often more efficient than smaller ones of the same energy density (Dincer and Rosen, 2011). Other methods to reduce heat loss include e.g. lowering the STES temperature or the ratio of surface to volume. This is why existing STES often have rather low temperatures of 20-50°C, even though higher temperature (e.g. 95°C in Munich, Germany) is feasible (Hesaraki *et al.*, 2015). Even in high temperature storage with a thick insulation layer however, the stored temperature is not usually sufficient to be used directly during the whole heating season (heat stored at 80°C during summer is expected to be available at about 50°C during winter). In addition of a STES, solar DH systems with a solar fraction of 80% would require supporting equipment such as HP in order to increase the temperature to a useful level (Hesaraki *et al.*, 2015; Mohanraj *et al.*, 2017).

Sensible STES concepts include hot water TES, pit TES (PTES, also called gravel-water TES), aquifer TES and borehole TES (BTES). Hesaraki *et al.* (2015) have weighted the pros and cons of these different STES concepts. In this Ph.D. however, only the PTES and BTES concepts are considered; this because they are the most suitable when buildings only need heating (if cooling is required in large quantities, an aquifer TES can be preferred; Hesaraki *et al.*, 2015). To select a specific STES, many conditions that are not explored in this Ph.D. need to be considered (e.g. geological requirements, storage size, heat capacities of the storage medium). Caution is therefore needed when interpreting our results.

In line with the operational features of existing systems and of the Dunkirk DH system, the below assumptions are made for the modelling of solar DH systems:

- Direct heat from solar collectors is available at adequate temperature (80°C) to be used directly in the DH system (without using HP);
- The DH system uses heat from solar collectors whenever possible;
- Excess heat from solar collectors is always directed towards STES;
- The charged and uncharged temperatures of the STES are 80°C and 20°C, respectively, with an average of 50°C. Lower temperatures (25-5°C charge-uncharged) are often used, especially in BTES systems, since it significantly reduces heat losses (Hesaraki *et al.*, 2015). However the average storage temperature would be about 15°C in this case, which is only 5°C higher than the average sea water temperature (10°C; see 4.1.1.4).
- 25% of the heat produced by solar collectors is used directly in the DH system (80°C max; 70°C average);
- 75% is used indirectly through STES, and reheated with HP (from 50 to 80°C). The corresponding COP of HP is 4.5 (see Figure I.3.3, Section 4.1.1.4).

While the above hypothesis are common to borehole and Pit TES, these STES concepts however differ in terms of e.g. initial investment or land use. The specificities of each STES are discussed below.

Borehole Thermal Energy Storage (BTES)

A solar DH system with BTES is illustrated in Figure I.3.5. In BTES, the ground itself would be the storage media, through a number of vertical boreholes. In the borehole, the heat is exchanged through a double or single U-pipes or concentric pipes (Rad and Fung, 2016). The vertical boreholes lengths are usually in the range of 30–100 m with approximately 3–4m separation (Kjellsson *et al.*, 2010; Terziotti *et al.*, 2012), but the borehole depths in recent installations have gone up to 200m (Hesaraki *et al.*, 2015).

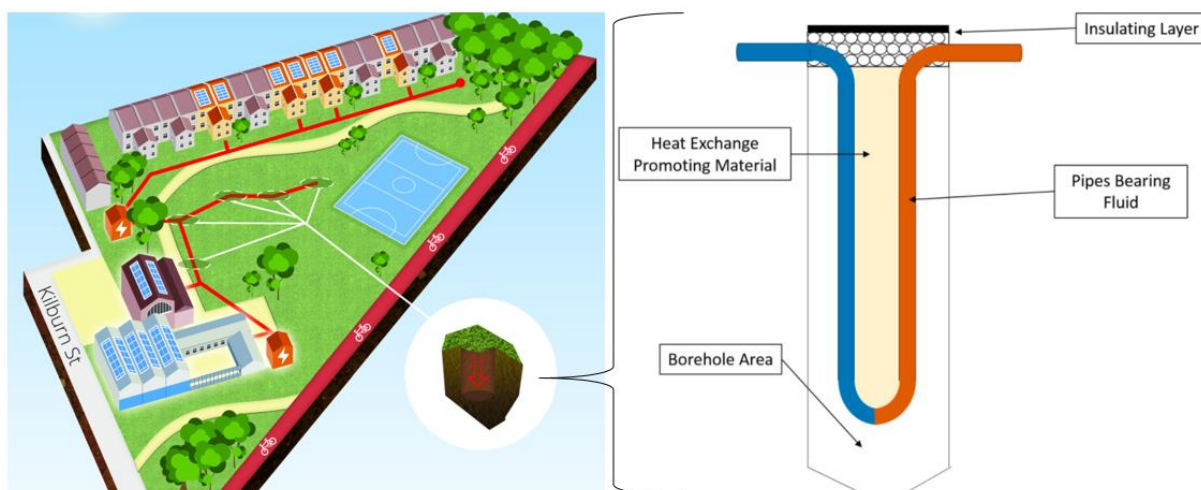

Figure I.3.5: Illustration of a solar DH system with BTES. Personal photomontage, using data from CEPRO (Clean Energy Prospector), 2015 and Lanahan and Tabares-Velasco (2017).

Table I.3.7 shows the parameter values used to model BTES. One important difference with the other heating systems is the investment period. In BTES the first three to five years of operation is the start-time needed to obtain normal operating conditions, slowly heating the underground surrounding the storage system and thereby decreasing heat loss (Pavlov and Olesen, 2012). The efficiency of the system is therefore lower in the first four years (Schmidt *et al.*, 2004). It is here considered that the solar collectors, HP and BTES would be built 4 years prior to the start of commercial DH operations, so that the system will be operated at full efficiency from 2030. For stores with limited thermal conductivity, Reuss *et al.* (1997) claims that the heat losses from BTES are rather moderate, and the storage efficiency can reach up to 70%. In practice however, 80°C heat storage implies higher losses, up to 60% (Sibbitt *et al.*, 2012). The intermediary value of 40% is here retained. Geological formation plays a significant role in defining the thermal capacity of BTES, which in turn determine the economic attractiveness. Normally rock or water saturated soil is the most suitable. When the ground meet the requirements, BTES is expected to be cheapest than PTES (Hesaraki *et al.*, 2015). Optimistic hypothesis is here made (see Table I.3.7), yet the adequacy of the geological formation in the Dunkirk area should be studied in-depth before to consider real case applications.

Parameter	Unit	Value	Uncertainty range	Reference and comment
Heat losses	% <i>heat stored</i>	40	30-60	For 80/20°C charged/uncharged temperatures; ADEME (2016); Reuss <i>et al.</i> (1997); Sibbitt <i>et al.</i> (2012)
Electricity consumed	MWh_e/MWh_{th} <i>stored-unstored</i>	0.05		ADEME (2016)
Maximal capacity	kWh_{th}/m^3	22.5	15-30	ADEME (2016); Hesaraki <i>et al.</i> (2015)
Initial investment	€/m	50	40-90	40: favourable ground conditions. ADEME (2016)
Linear thermal output	Wh_{th}/m	30		ADEME (2016)
Investment period	Years	2024-26		Concerns also the solar collectors
Charging-uncharging period	Months	6		DEA (2016a); Hesaraki <i>et al.</i> (2015); SDH (2012)
Technical lifetime	Years	100		DEA (2016a); ADEME (2016); Hesaraki <i>et al.</i> (2015)
Space requirement		0		Possibility to install buildings over BTES once it is operating (ADEME, 2016)

Table I.3.7: Parameter values used to model BTES towards 2030.

Pit Thermal Energy Storage (PTES)

PTES is a less-expensive version of WTES, which are generally buried in the ground. Figure I.3.6 shows a typical PTES system. These kinds of storage are mostly insulated on the side and the top. The storage media are normally a gravel and water mixture, but it can also be a sand or soil mixture with water (Novo *et al.*, 2010; Xu *et al.*, 2014). Heat extraction or injection could be either through direct water heat exchanger or by indirect heat transfer through piping installed at different layers of the store. The pipes are usually made of plastic for their longevity. The storage liner is usually made of advanced polymer material backed up with insulation. Because of the construction material used, the operating temperature is limited to less than 95 °C (Nielsen, 2003). Operating systems have registered heat losses of 30% on average (see Table I.3.6), yet some more recent systems have registered low losses of about 10% (e.g. in Denmark).

In Germany the first solar system with STES was PTES with HP (Hahne, 2000). This system consisted of a 211 m² solar collector and 1050 m³ storage volume, and was located on the campus of Stuttgart University. Despite initial difficulties (HP with low COP were replaced), this system has worked satisfactorily up to now, with a COP of 4.5 and a solar fraction of 60%.

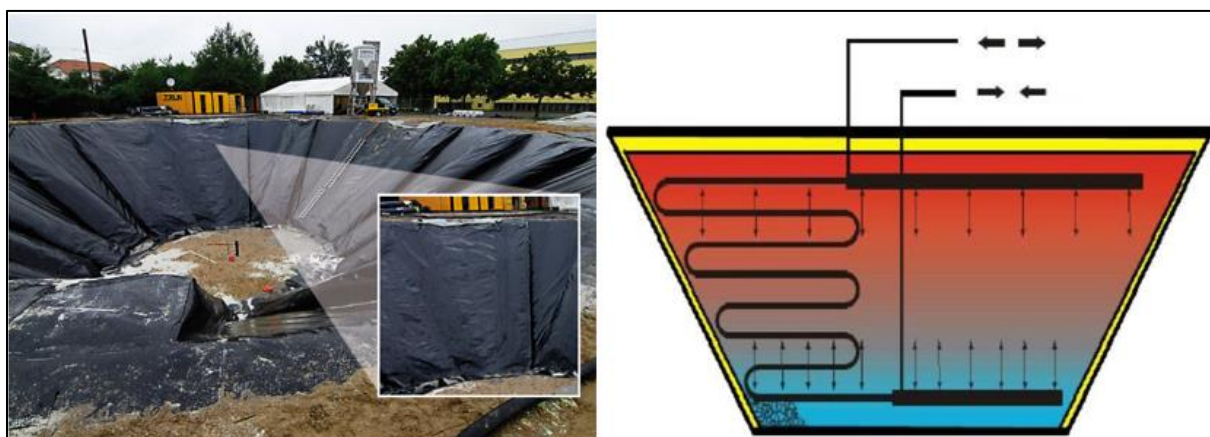

Figure I.3.6: Illustration of a PTES. Personal photomontage, using data from BINE information service (2017) and Socaciu (2012).

Table I.3.8 depicts the parameter values used to model PTES. Unlike BTES, PTES do not require 4 years operation before to reach full efficiency. The investment period is hence 2028-2030 (similarly to all heating systems but solar DH system with BTES). Table I.3.8 allows to calculate the PTES capacity, C_{ptes} (MWh_{th}), as well as the PTES thermal output, T_{ptes} (MW_{th}). The surface requirement of PTES (m^2), SR_{ptes} , is then calculated using the formula (3) derived from ADEME (2016):

$$SR_{ptes} = 17 T_{ptes} + C_{ptes} \quad (3)$$

Parameter	Unit	Value	Uncertainty range	Reference and comment
Heat losses	% heat stored	30	20-40	For 80/20°C charged/uncharged temperatures; ADEME (2016)
Electricity consumed	MWh_e / MWh_{th} stored-unstored	0.0095		DEA (2016a)
Maximal capacity	kWh_{th} / m^3	60	30-50	ADEME (2016); Hesaraki et al. (2015)
Initial investment	€/m ³	30	27-100	For 100 000m ³ ; DEA (2016a)
Investment period	Years	2028-30		Concerns also the solar collectors
Charging-uncharging period	Months	6		DEA (2016a); Hesaraki et al. (2015); SDH (2012)
Technical lifetime	Years	20		DEA (2016a)
Total O&M	% of initial investment/a	0.7		DEA (2016a)

Table I.3.8: Parameter values used to model PTES towards 2030.

4.1.2. Individual heating systems for existing buildings

The individual heating systems studied in this Chapter are natural gas condensing boiler, electric heaters, air to water HP and brine to water HP. Two hypothesis are common to all the individual heating systems:

- Individual systems are all evaluated as if they would be installed in apartment complexes. Heating systems are often more efficient and cheaper when installed in apartment blocks than when implemented in single-family houses (DEA, 2016c, 2013). Our assumption can be seen as overoptimistic, but it is reasonable when considering the uncertainty affecting the modelling of DH systems. Besides, apartment complexes represent 60% of the studied urban area (INSEE and Région Nord-Pas-de-Calais, 2009);
- The surface requirement of individual heating systems is considered equal to zero, as these would be installed on private lands and would not stimulate local debates about land use alternatives. In practice however, space requirement issues sometimes lead households to discard cumbersome systems such as brine-to-water HP (DEA, 2016c).

Gas driven absorption HP (air or brine to water), gas engine driven HP (air or brine to water) and gas driven adsorption HP (brine to water) are not studied in this Chapter. According to DEA (2016c), these systems are mature products for the apartment block market and users with a large heat demand (e.g. shopping center), but there are only a few market-ready appliances for single family houses, and there is a lack of experience (especially for the adsorption technology). Single family houses constitute 40% of dwellings in the Dunkirk conurbation committee (INSEE and Région Nord-Pas-de-Calais, 2009). It would thus be inconsistent to compare gas driven HP with other heating systems designed to supply the all area, including single family-houses. Besides, the COP of gas HP is comprised between 1.2 and 1.7 (towards 2030, according to DEA, 2016c), and hence use a rather significant amount of natural gas. DEA (2016c) suggest that, while these technologies could be suited for low demand dwellings in sparse areas, DH systems are likely to have higher performances in urban areas.

4.1.2.1. Natural gas condensing boiler

Individual gas boilers are often used for heating and domestic hot water production. In a gas boiler, gas is burnt in a combustion section. It may be a traditional flame or via specially designed low NO_x combustors (DEA, 2013). Condensing boilers include two stages of heat collection (see Figure I.3.7), compared to traditional boilers (non condensing boilers), which only include one stage. In the condensing boiler, a second heat exchanger is placed before the flue gas exit to collect the latent heat contained in the flue. Non condensing boilers can no longer be installed in certain countries (e.g. Denmark; see DEA, 2013), and this is expected to be generalised. Table I.3.9 shows the assumptions made to model natural gas condensing boilers towards 2030.

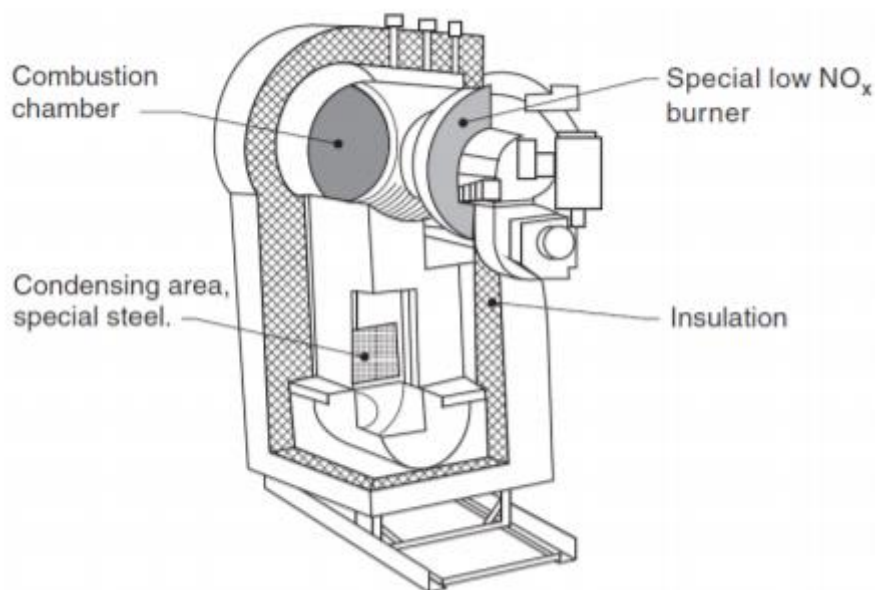

Figure I.3.7: A floor standing medium size condensing gas boiler for apartment blocks. Data source: DEA (2013), citing VarmeStåbi, Nyt Teknisk Forlag.

Parameter	Unit	Value	Uncertainty range	Reference and comment
Initial investment	$M\text{€}/MWh_{th}$	0.145	0.04-0.25	DEA (2013)
Investment period	Years	2028-30		
Technical lifetime	Years	25		DEA (2013)
Fixed O&M	% of initial investment/a	2.75		DEA (2013)
Variable O&M (all others than elec. Consumption)	$\text{€}/MWh_{th}$	7.2		DEA (2013)
Elec. consumption	KWh_e/KWh_{th}	5	2-8	DEA (2013)
Net efficiency	%	102	100-104	DEA (2013)

Table I.3.9: Parameter values used to model individual natural gas condensing boilers towards 2030.

4.1.2.2. Electric heaters

Electric radiators are mounted in each room. The bathrooms can be equipped with electric floor heating systems. The hot tap water is made by a hot water tank with an electric heating coil. Refined systems are available, making it possible to program a temperature schedule individually for each room. Electric heating can either be a supplement or a complete system. According to DEA (2013), the advantages of electric heaters are the low initial investment, the high flexibility, the efficient reheating after night setback, the precise room temperature control and easy possibility of remote control. For the hot water, periodic disinfection of tap water is easily done regularly without any loss of energy. Furthermore, distribution heat losses are saved compared to water based heating systems. The disadvantage is the high energy price paid by end-users and the thermodynamic loss of exergy. If widespread used, the power need can be critical in some areas. The impact on climate change due to the use of electricity depends on how the electricity is produced, especially during peak periods (see Section 4.1.3 for the GHG emission factors considered in this Chapter). Table I.3.10 shows the assumptions made to model individual electric heaters towards 2030.

Parameter	Unit	Value	Uncertainty range	Reference and comment
Initial investment	M€/MW _{th}	0.1	0.8-1.2	ADEME (2016); Lund <i>et al.</i> (2016)
Investment period	Years	2028-30		
Technical lifetime	Years	30		DEA (2013)
Fixed O&M	% of initial investment/a	1.25		DEA (2013)
Net efficiency	%	100	95-105	DEA (2013)

Table I.3.10: Parameter values used to model individual electric heaters towards 2030.

4.1.2.3. Individual electric compression heat pumps

Most of the small HP systems currently used for individual space heating are electrically driven compression HP utilising energy from the ambient air, exhaust ventilation outlets or ground heat (DEA, 2013). In this Chapter, only the air to water and brine (or ground) to water HP are studied. Sub-Section 4.1.2.3 first discusses the general principle of compression HP. Aspects specific to air-to-water and brine-to-water HP are then detailed.

General principles of compression HP

HP employ the same technology as refrigerators, moving heat from a low-temperature level to a higher temperature level. HP draw heat from a heat source and convert the heat to a higher temperature through a closed process. HP are often equipped with an electrical heater for supplement in peak load periods (DEA, 2013). Domestic hot water is in general preheated in a storage tank using direct electric heating as the heat capacity of HP is often inadequate for heating showering water directly (DEA, 2013). The general advantage of HP technologies is that the primary energy consumption is reduced compared to boilers or traditional electric heaters. For individual compression HP, the COP is usually comprised between 3 and 5. The temperature difference between the temperature level of the heat source and the temperature level of the heat delivered nonetheless strongly influence the COP. When the difference in temperature between the heat source and heat delivery decreases, the COP will increase and vice versa (see also Figure I.3.3 of Section 4.1.1.3).

In this Chapter, it is assumed that 80% of the annual heat loads are supplied directly with HP. The remaining 20% are supplied with electric heaters. The thermal capacity of HP and electric heaters are calculated similarly to what is done for base and peak load DH sources (see Section 3.4 of Chapter 2). Under the current state of buildings in Dunkirk, the temperature requirements in buildings is about 80°C (maximum). Following Figure I.3.3 (Section 4.1.1.3), the COP of HP would be of 1.5 and 2.0 for air to water HP and brine to water HP, respectively. While these COP are rather low, they would increase when supplying buildings with higher efficiency (see Section 4.3.2).

Air to water HP

As depicted in Figure I.3.8, air-to-Water HP draw heat from ambient air and supply heat through a hydraulic water based distribution system (radiator, convectors, floor heating). Compared to ground-source HP, air-to-water types are easier to install and do not require a large area for ground heat collectors. Air-to-water HP are however less efficient as the air temperature is lower than the ground temperature during winter periods. Moreover, ice can build up on the outdoor heat exchanger and thereby decrease the evaporation temperature and the efficiency. Table I.3.11 shows the assumptions made to model air-to-water HP towards 2030. Also, noise from air-to-water HP can be a problem. The EU' ECO design regulation of HP (EC, 2012a) includes specification of maximum noise from such HP.

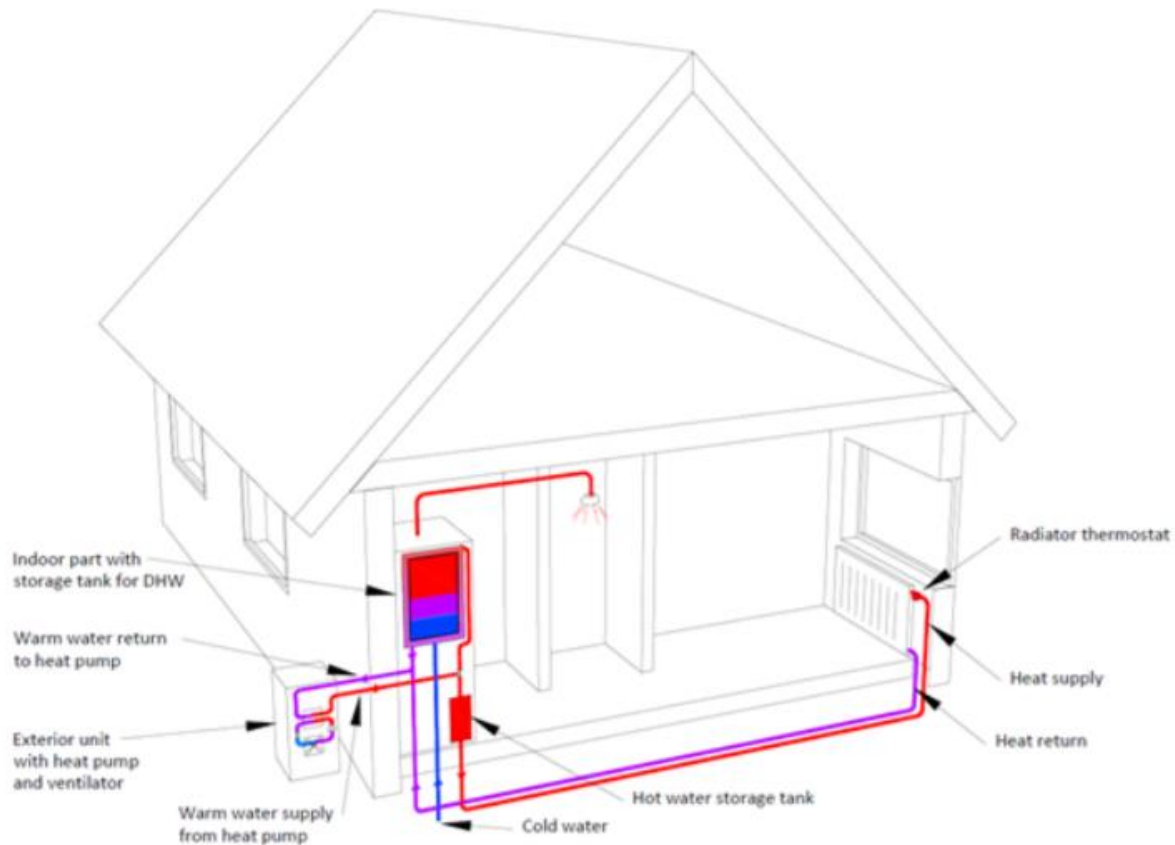

Figure I.3.8: Illustration of air to water HP. Data source: DEA (2013).

Parameter	Unit	Value	Uncertainty range	Reference and comment
Initial investment	$M\text{€}/MW_{th}$	1.5	1.0-2.0	DEA (2013)
Investment period	Years	2028-30		
Technical lifetime	Years	16	12-20	DEA (2013)
Fixed O&M	% of initial investment/a	0.8	0.7-0.9	DEA (2013)
Variable O&M	$\text{€}/MWh_{th}$	0.6	0.2-1.0	DEA (2013)
COP		1.3	2.0-4.1	DEA (2013)
Auxiliary elec. consumption	MWh_e/MW_{th}	25	24-26	DEA (2013)

Table I.3.11: Parameter values used to model individual air-to-water HP.

Brine to water HP

As depicted in Figure I.3.9, Brine-to-water HP draw heat from the ground and supply heat for space heating through a water based distribution system. As for air-to-water HP, brine-to-water HP can deliver heat through the water based heating system in several rooms, and it is possible to regulate the heat transfer individually in each room. A ground-source HP is approximately 15 % more efficient than an air-to-water HP, but require larger initial investment (DEA, 2013). Unlike air-to-water HP, there are no noise problems when the HP is running, which can make it the only possible solution in densely built areas. Table I.3.12 presents the parameter values used to model brine-to-water HP.

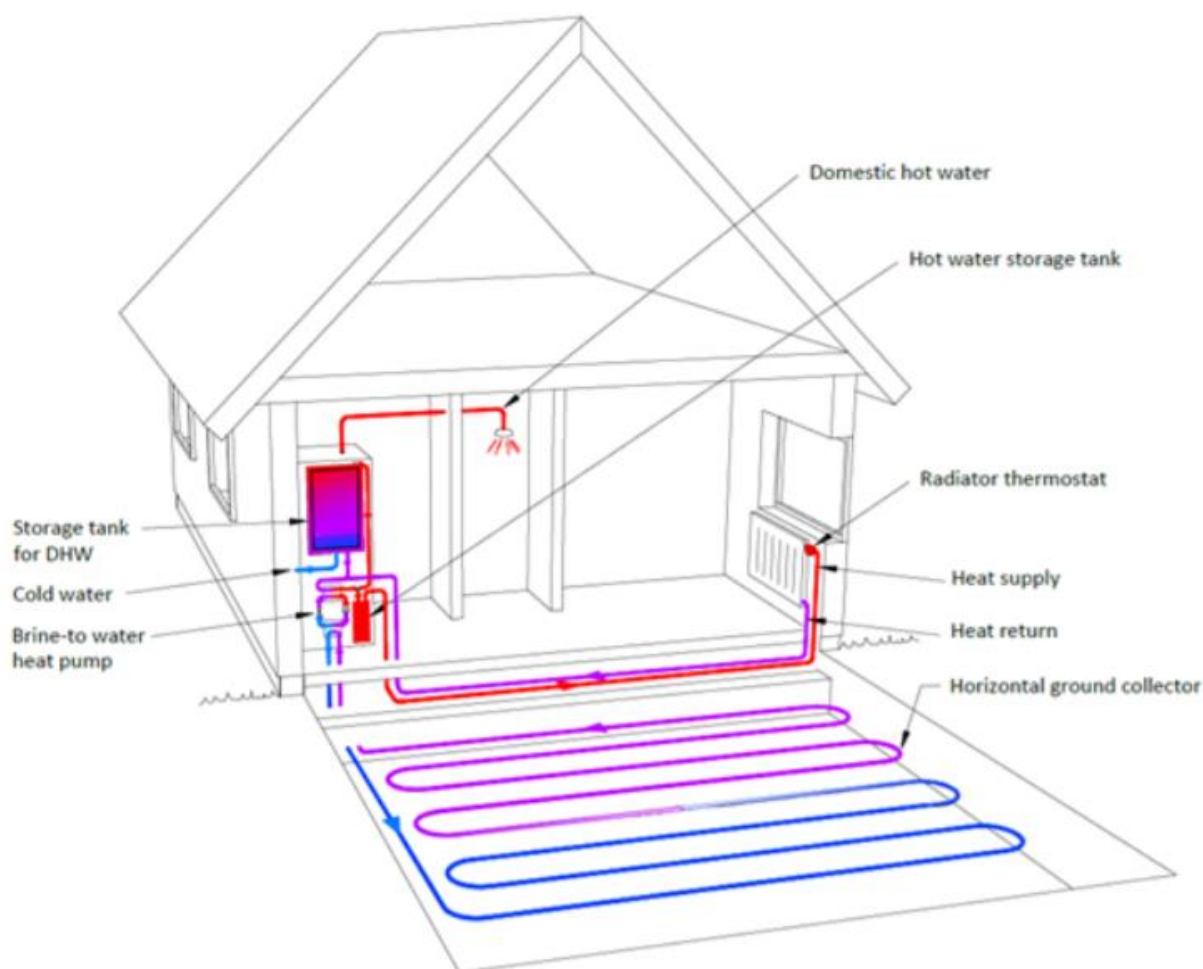

Figure I.3.9: Illustration of brine to water HP. Data source: DEA (2013).

Parameter	Unit	Value	Uncertainty range	Reference and comment
Initial investment	$M€/MW_{th}$	2.0	1.4-2.6	From 0.7 for large apartment blocks to 2.6 for single family houses (DEA, 2013)
Investment period	Years	2028-30		
Technical lifetime	Years	16	12-20	DEA (2013)
Fixed O&M	% of initial investment/a	0.7	0.4-1.0	DEA (2013)
Variable O&M	$€/MWh_{th}$	0.2	0.2-1.0	DEA (2013)
COP		1.6	2.8-4.30	DEA (2013)
Auxiliary elec. consumption	MWh_e/MW_{th}	25	0.08-0.16	DEA (2013)

Table I.3.12: Parameter values used to model brine-to-water HP.

4.1.3. Evaluating GHG emissions of heating systems

To compare the climate impact of heating systems, both direct and lifecycle emissions can be considered. This choice can significantly affect the relative climate performance of heating system and thus should be considered carefully. In particular, natural gas intensive systems are relatively advantaged when considering direct emissions only. Indirect emissions from natural gas can be due to

extraction and production or transport-related activities IPCC (Intergovernmental Panel on Climate Change; 2012). This Chapter uses both approaches so as to highlight the underlying importance of this choice. For each heating system, direct CO₂ emissions from fuel and electricity consumption are summed up following the values shown in Table I.3.13. Values in Table I.3.13 are those imposed by the French authorities when calculating the CO₂ emissions of DH networks (SNCU, 2017). When calculating lifecycle GHG emissions, direct CO₂ emissions are completed by indirect GHG emissions considering the values shown in Table I.3.14.

	Direct emissions (t CO₂/GWh_{th})	Reference and comment
Natural gas	205.0	SNCU (2017)
Electricity	180.0	SNCU (2017) ; for France
Wood Chips HOB (*)	0	SNCU (2017)
Straw HOB (*)	0	SNCU (2017)

Table I.3.13: Direct CO₂ emission factors specific to the studied sources of energy.

Notes:

(*) While zero is the value often used by public authorities (e.g. SNCU, 2014) to assess the GHG emissions from biomass boilers, it must be reminded that there are vivid discussions about the actual GHG emission factor of biomass. Evaluation of this factor vary from zero to more than two hundred depending on the reference. Please refer to Sections 4.1.1.5 and 5.3.1 of Chapter 3 for further discussion on this.

	Indirect emissions (t eCO₂/GWh_{th})	Reference and comment
Natural gas	221.8	Frischknecht and Rebitzer (2005)
Electricity (France)	100	Marginal approach projected towards 2030 for France; see Leurent <i>et al.</i> (2018)
Wood Chips HOB	28.0	EC (2016); see 4.1.1.5
Straw HOB	15.0	EC (2016); see 4.1.1.5

Table I.3.14: Indirect CO₂ emission factors specific to the studied sources of energy. The same comment as in Table I.3.13 also applies to the indirect emissions factors of biomass fuels.

4.1.4. Assessing the impact of heating systems on human health

Almost all the studied heating systems emit air pollutants potentially affecting human health. Air pollutants are emitted directly into the atmosphere or reformed secondarily (Lewtas, 2007). The concentration, the chemical composition, the quantity and the type of pollutants vary, depending on the sources of emissions, the air masses movement and the weather and topographical conditions. Short-term exposure can cause respiratory diseases, heart arrhythmia and allergic reactions, and prolonged exposure increases lung cancer risks, respiratory and cardiovascular diseases, arteriosclerosis and neurobehavioural changes (Sayegh *et al.*, 2017).

The literature emphasizes the fact that DH systems have lower negative impacts on human health than individual heating systems, provided that the same fuel is used (EEA (European Environment Agency), 2012; Ghafghazi *et al.*, 2011b; IEA (International Energy Agency), 2016; Ivner and Broberg Viklund, 2015). This is because the fuel combustion in DH applications takes place under controlled technological and ecological conditions. In particular, the smoke is rejected to the environment through stack of 5-30 meters long, depending on the fuel used and boiler size (*Ministère de la transition écologique et solidaire*, 1997). Higher stacks lead to lower air pollution at ground level, and so is the share of emitted pollutants that is ultimately inhaled by inhabitants (see 4.1.4.3). Besides, DH boilers can be located away from the densest areas, which is not possible with individual heating systems.

The approach here adopted makes several simplifications and results should be checked experimentally in the next step. It however provides valuable analytical tools for the comparison of

heating systems on the basis of the air pollutants that could be emitted through combustion stages. First, the amount of air pollutants (g) emitted by each heating systems is assessed (4.1.4.1). Two different approaches are then used to convert these mass into parameters that make sense for policy makers and stakeholders. Sub-section 4.1.4.2 presents the social cost approach, which aim to give a monetary value (€) to air pollutants emissions. Then, sub-Section 4.1.4.3 models the amount of years of life lost and disability years of life caused by the inhalation of air pollutants. Using these two different methods allow to illustrate how differing views can direct toward different technological choices.

4.1.4.1. Modelling the amount of air pollutants emitted

To compare the relative impact of heating systems on human health, it is necessary to assess the amount of air pollutants emitted through operational stages. The three air pollutants here evaluated are mono-nitrogen oxydes (NO_x), sulfur dioxide (SO_2), and particle matter less than or equal to 2.5 μm in diameter ($\text{PM}_{2.5}$). When considering heating systems, these three air pollutants are responsible for most of damages to human health (EEA, 2012). In our case, NO_x , SO_2 and $\text{PM}_{2.5}$ can be emitted through the combustion of natural gas, wood chip or straw. Particulate matters are classified as primary when it is emitted directly and secondary when it forms in the atmosphere due to secondary chemical reactions between other airborne substances. NO_x and SO_2 contribute to secondary $\text{PM}_{2.5}$ via ammonium nitrate and ammonium sulfate. Note that the supply of electricity required to operate the heating systems is here considered as harmless to human health; the justification being that the nearest power plant is located 15km away (Gravelines), and, as a nuclear plant, do not emit air pollutants.

Biomass HOB can be equipped with flue-gas cleaning technologies in order to reduce air pollutant emissions. When the moisture content of the biomass is above 30-35% (as it is the case for wood-chips and straw; VTT, 2016), flue-gas condensation are often required to comply with regulation standards (DEA, 2016b). There are two broad categories of flue-gas cleaning technologies, namely selective catalytic reduction (SCR) options (e.g. fabric filters, electrostatic precipitator), and selective non-catalytic reduction (SNCR) alternatives (e.g. cyclone). The advantage of SCR technologies is the efficiency in reducing air pollutant emissions (even particle matter less than or equal to 2.5 μm in diameter; see Figure I.3.10). The drawback is their high capital cost (DEA, 2016b). The most often used flue-gas cleaning technologies is SNCR (DEA, 2012), which can eliminate up to 65% of NO_x emissions and is more affordable than selective catalytic reduction alternatives. SNCR technologies (e.g. cyclone) are however not efficient for the removal of particle matter less than or equal to 2.5 μm in diameter, as shown in Figure I.3.10.

In this study, costs and air pollutants emissions of biomass HOB are derived from DEA (2016b), using data from NERI (National Environmental Research Institute, 2010). Straw HOB assumptions are based on the observations of six straw HOB operated in Denmark, among which five had filter bags and six had electrostatic precipitator (SCR technologies). Wood Chips HOB assumptions are based on the observation of six wood chips HOB operated in Denmark, equipped either with a filter bag, an electrostatic precipitator or a wet scrubber. Air pollutant factors ($\text{g}/\text{MWh}_{\text{th}}$) are shown in Table I.3.15 (including also natural gas combustion). These are used to evaluate the amount (g) of NO_x , SO_2 and $\text{PM}_{2.5}$ emitted by heating systems through operational stages. It worth noticing that the air pollutant factors here considered are below the upper threshold provided by the directive 2015/2193 on the limitation of emissions of certain pollutants into the air from medium combustion plants (MCP Directive; European Parliament, 2015). Under this directive, the particulate matter emissions (PM_{10}) must be inferior to 30 mg/m^3 , which often require the installation of new cleaning technologies. The EU directive 2015/2193 however allows member states to set up higher limits (maximum 150 mg/m^3 for PM_{10}) to those biomass HOB which use at least 50% of the heat generated for DH purposes. Nowadays cyclone separators are most often used for the primary dust collection purposes downstream of which a more efficient emission control system like an electrostatic precipitator or a baghouse is used (Ghafghazi *et al.*, 2011b). The costs associated to these cleaning systems are relatively small (maximum $\text{M€}20/\text{MWh}_{\text{th}}$; see DEA, 2016b; VTT, 2005) compare to the overall cost of biomass

HOB (here assumed equal to M€500/MWh_{th}; see Section 4.1.1.5); this however may vary substantially through cases and countries.

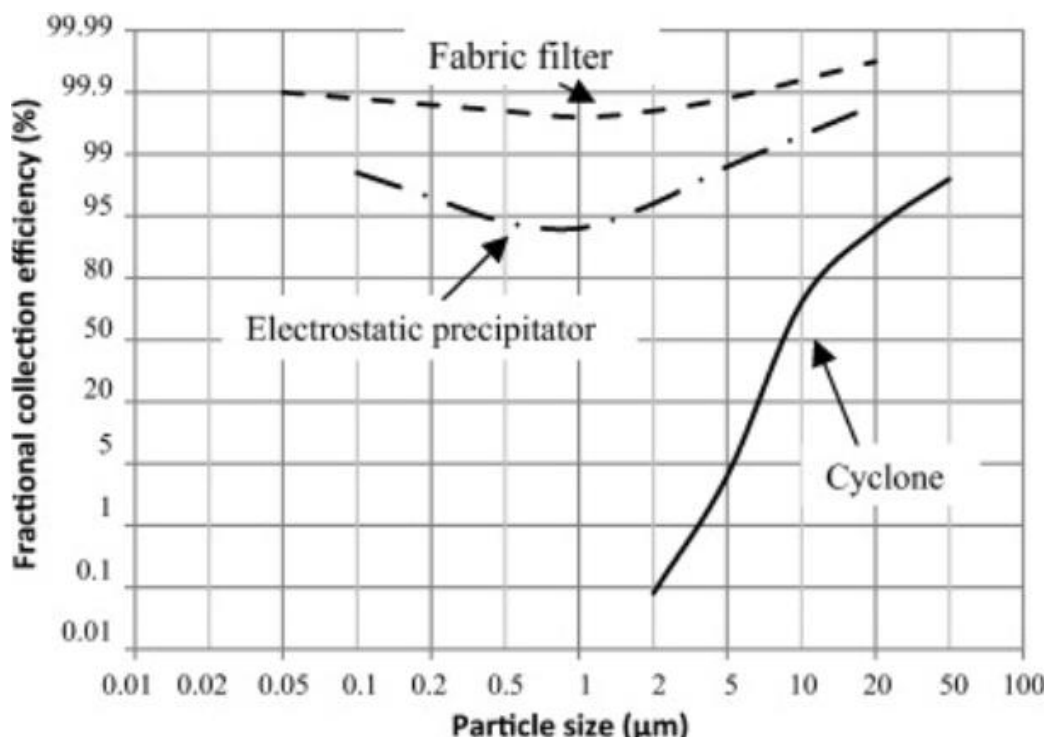

Figure I.3.10: Collection efficiency of conventional gas cleaning technologies. Data source: Ghafghazi *et al.* (2011b).

Heating source	NO _x (g/MWh _{th})	SO ₂ (g/MWh _{th})	PM _{2.5} (g/MWh _{th})	Reference and comment
Natural gas (*)	108 / 137	1.08	0.36	DEA (2016b); Zvingilaite (2013)
Straw HOB	450	175	100	DEA (2016b); NERI (2010)
Wood chips HOB	290	80	33	DEA (2016b); NERI (2010); Zvingilaite (2013)
EU limitation for biomass HOB	721	1220	166 (**)	European Parliament (2015; including possible exemption for DH purposes). Conversion from mg/m ³ to g/MWh _{th} were made using the method of AEA Technology plc (2012)

Table I.3.15: Air pollution emission factors, i.e. amount of air pollutants rejected in the air (g/MWh_{th}).

Notes:

(*) for individual boilers / for large DH boilers (see Zvingilaite, 2013). SO₂ and PM_{2.5} emission factors are however similar.

(**) 166 is the upper limit for PM₁₀; no upper limit is given for PM_{2.5} in the EU directive 2015/2193.

4.1.4.2. The social cost of air pollutants

The social cost of air pollutants is higher for individual systems than for DH systems. This is because a larger share of pollutants is inhaled by people when it is generated with ground-level individual systems, closer to habitations. While some argue that the social cost is 2 to 6 times higher for individual systems (depending on air pollutants; see Brandt *et al.*, 2001; Zvingilaite, 2013), Heath

and Nazaroff (2007) stated that it can be up to 20 times higher. As a conservative assumption, we here use the Brandt *et al.* (2001) and Zvingilaite (2013) findings, assessing the impact of air pollutants on human health using the THOR system. The average health external costs include all the costs related to the impact of air pollutants inhalation on human health. It however do not include other important externalities such as habitat protection or biodiversity. Moreover, one should keep in mind that these estimates are highly uncertain; an important subject for future research is experimental measures.

Heating source	NO _x (€/t)	SO ₂ (€/t)	PM _{2.5} (€/t)	Reference
Cost for DH systems	5 870	9 100	10 900	Brandt <i>et al.</i> (2009; Zvingilaite, 2013)
Cost for individual heating systems	9 222	32 550	29 200	Brandt <i>et al.</i> (2009; Zvingilaite (2013)

Table I.3.16: Social costs of air pollutants (euros per ton of pollutant emitted).

4.1.4.3. Years of life lost (YLL) and disability adjusted life years (DALY)

An accurate health characterization factor for PM, both primary and secondary, are YLL and DALY per kg particulate inhaled (Gronlund *et al.*, 2015). YLL is an estimate of the years people would have lived if they had not died prematurely. It is a measure of premature mortality. As an alternative to death rates, it is a method that gives more weight to deaths occurring among younger people. Another alternative is to consider the effects of both disability and premature death using DALY. DALY is a measure of overall disease burden, expressed as the number of years lost due to ill-health, disability or early death. DALY is simply calculated by summing up the YLL and the years lost due to disability. One DALY, therefore, is equal to one year of healthy life lost. DALY relies on an acceptance that the most appropriate measure of the effects of chronic illness is time, both time lost due to premature death and time spent disabled by disease.

Based on previous research work (Humbert *et al.*, 2011; Pope *et al.*, 2002; United States (US) Environmental Protection Agency, 2010), Gronlund *et al.* (2015) assess the amount of YLL and DALY per kg particulate inhaled. Table I.3.4 shows the results standardized to the world standard population. The median age of the worldwide and the Dunkirk populations are 29 and 39 years old, respectively. Given that the health impact of air pollutants is growing with the age of individuals (Gronlund *et al.*, 2015), the values shown in Table I.3.17 should be smaller than what could be observed for the Dunkirk population.

Effect factors	Cardiopulmonary	Lung cancer	All causes
YLL per kg PM _{2.5} inhaled	50	9.6	82
DALY per kg PM _{2.5} inhaled	65	9.7	110

Table I.3.17: Effect factors of PM_{2.5}. Data source: Gronlund *et al.* (2015).

Notes:

Estimations are based on the Global Burden of Disease 2010 Estimates of Deaths, DALY and YLL for the High-Income North America region, standardized to the World Health Organisation (WHO) World Standard Population.

Table I.3.15 of Section 4.1.4.1 allows to evaluate the amount of air pollutants emitted by heating systems. It is however the amount of inhaled air pollutants that needs to be assessed to determine the YLL and DALY (see Table I.3.17). We have thus estimated the fraction of emitted PM_{2.5} that is inhaled by inhabitants, i.e. the intake fraction. The intake fraction is a product of airborne concentrations, population density at a location of exposure, breathing rate and meteorological conditions (Evans *et al.*, 2002; Humbert *et al.*, 2011; Petrov *et al.*, 2015). For DH systems, the height of the stack must also be considered, as a higher stack results in lower intake factors (Humbert *et al.*, 2011). By reviewing more than 15 studies assessing PM_{2.5} intake factors (both primary and secondary), Humbert *et al.* (2011) offered recommendations for choosing reasonable intake fractions under

different conditions. Table I.3.18 describes the conditions which correspond the best to our case study, along with personal estimations of intake fractions specific to the Dunkirk conurbation committee. DALY and YLL are then calculated by multiplying the effect factor (YLL or DALY per kg PM_{2.5} inhaled; see Table I.3.17) with intake fractions (mgPM_{2.5} inhaled per kgPM_{2.5} emitted for primary PM_{2.5}, or mgPM_{2.5} inhaled per kg precursor emitted for secondary PM_{2.5}; see Table I.3.18).

Parameter	Value	Reference and Comment
Parameter values used by Humbert et al. (2011) to generate the recommended intake fractions (*)		
Population density (<i>capita/km²</i>)	8300	The population density of the Dunkirk area is approximately 5850 capita/km ²
Breathing rate (<i>m³/capita.day</i>)	13	Average breathing rate in the US. In Dunkirk, the breathing rate should be slightly lower given that it slowly decreases with ageing
Stack height (<i>m</i>)	25	25m complies with the French requirements for 15-20 MW _{th} biomass boilers (<i>Ministère de la transition écologique et solidaire, 1997</i>). For natural gas boilers, the stack height should be lower, around 10m for 15-20 MW _{th} units
Mixing height (<i>m</i>)	240	
Wind speed (<i>m/s</i>)	2.5	The wind speed in Dunkirk is about 6-7 m/s in average (inshore area)
Dilution rate (<i>m²/s</i>)	610	
Intake fractions (*) recommended by Humbert et al. (2011)		
Primary PM _{2.5}	15.0	
Secondary PM _{2.5} from SO ₂	1.0	
Secondary PM _{2.5} from NO _x	0.2	
Personal estimation of intake fractions (*) in the Dunkirk conurbation committee		
<i>For 15-20 MW_{th} biomass HOB</i>		
Primary PM _{2.5}	7.5	Recommendations from Humbert <i>et al.</i> (2011) are divided by two to account for parameter values specific to Dunkirk (population density and wind speed in particular)
Secondary PM _{2.5} from SO ₂	0.5	
Secondary PM _{2.5} from NO _x	0.1	
<i>For 15-20 MW_{th} natural gas HOB</i>		
Primary PM _{2.5}	15.0	Considering that natural gas boilers would have lower stack heights
Secondary PM _{2.5} from SO ₂	1.0	
Secondary PM _{2.5} from NO _x	0.2	
<i>For individual heating systems (ground level)</i>		
Primary PM _{2.5}	30.0	Following results from Zvingilaite (2013), stating that individual heating systems imply intake fractions 2 to 3 times higher than large HOB
Secondary PM _{2.5} from SO ₂	2.0	
Secondary PM _{2.5} from NO _x	0.4	

Table I.3.18: Comprehensive description of the assumptions made to assess the intake fractions of the heating systems in the case of the Dunkirk conurbation committee.

Notes:

(*) Intake fraction: mgPM_{2.5} inhaled per kgPM_{2.5} emitted for primary PM_{2.5}, or mgPM_{2.5} inhaled per kg precursor emitted for secondary PM_{2.5}. The method followed to assess the amount of PM_{2.5} and precursor (NO_x and SO₂) emitted is explicated in sub-Section 4.1.4.1.

4.2. Evaluating the plausible impact of public support mechanisms and taxes

In order to answer the research question (ii) concerning the impact of public support mechanisms and taxes on the relative LCOH of heating systems, it is necessary to collect data and make assumptions on the possible levels of public subsidies (4.2.1), GHG (4.2.2) and PM_{2.5} taxations (4.2.3).

4.2.1. Public support for heating systems in France

The share of renewable or excess heat sources in the total DH deliveries of French networks has increased from 7.9 TWh_{th}/a in 2009 to 13.8 TWh_{th}/a in 2017 (AMORCE, 2017a). This leap can be partly attributed to the public DH support set up by the government in 2009 (ADEME, 2017). The '*Fonds Chaleur*' offers a financial contribution of about €5/MWh_{th} to those DH projects aiming to use more than 50% renewable or excess heat sources, provided that the linear heat density is higher than 1.5 MWh_{th}/m.a (AMORCE, 2017a). However, AMORCE (2017a) emphasizes that the amount of DH projects subsidized should be more than doubled for reaching French policy objectives. If the development trend of 2009-2017 is prolonged, renewable and excess DH deliveries should total 23 TWh_{th}/a in 2030 (AMORCE, 2017a), while the national objective is 39 TWh_{th}/a (*Assemblée nationale*, 2015).

Table I.3.19 depicts the assumptions made in Chapter 3 to model the maximum amount of public subsidies that DH systems could benefit from (either from the '*Fonds Chaleur*' or from another scheme (e.g. call for projects for large solar installation, or for temperate water loop using HP). We are aware that all the DH systems here considered may not benefit from the maximum amount of public subsidies (either for technical or economic reasons), yet we use the maximum amount as a reference for the sake of the analysis. In reality, subsidies to DH projects using renewable or excess heat sources in France represent 30% of capital costs on average, provided that these low carbon sources constitute at least 50% of the total (with a growing pressure to reach 60-70%). The complete list of the conditions to be fulfilled in order to benefit from the '*Fonds Chaleur*' and the administrative steps to follow are thoroughly described by ADEME (2018) for each DH system component.

DH system component	Unit	Value	Reference and Comment
Distribution network (*)	€/m	546	Depends on the diameter of pipelines and on the type of fluid, vapor or hot water. 546 €/m is the upper limit for hot water networks with an average pipe diameter of 80-125mm (as it is the case here; see 5.1.1)
Excess heat recovery from the nuclear plant (**)	%	30	Assuming that nuclear plant based heat would have the same status as industrial excess heat. Inc. the costs related to excess heat recovery on the PWR and of the heat transportation from the plant to the distribution network.
Biomass HOB (**)	€/MWh	1.38	Depends on the annual heat production. €1.38/MWh _{th} is the upper limit for biomass HOB producing more than 11.63 GWh _{th} /a (as it is the case here; see 5.1.1). Installing flue-gas reduction technologies is an asset to get subsidies
Solar collectors (*)	%	55	Benefit from call for projects dedicated to large solar installations (ADEME, 2017)
STES (*)	%	55	TES are eligible to the <i>Fonds Chaleur</i> and we here assumed that STES would be considered as such. It is however uncertain given that no STES has been built in France (2018)
HP (*)	%	50	Subsidies for temperate water loop (inc. HP) are being discussed between ADEME and DGEC (French energy and climate general direction) and a support scheme should be decided by the end of 2018

Table I.3.19: Upper values of public subsidies for DH systems. Data source: ADEME (2018).

Notes:

(*) Subsidies are distributed as recommended by ADEME, a third on the first construction year, another third on the first year of operation, and the last third after two years of operation. Capital costs only, i.e. excluding engineering studies.

(**) Subsidies are distributed as recommended by ADEME, over the first 20 years of operation (2030-2050 in our case).

Some of the studied individual heating systems can benefit from tax credits. In line with the directive 206/2012 of the EC (2012a; implementing the directive 2009/125/EC), tax credits are granted when installing natural gas condensing boilers or HP, but electric heaters do not benefit from the scheme (*Ministère de l'action et des comptes publics* (French Ministry of actions and of public accountability), 2017). To assess the impact of the tax credits shown in Table I.3.20, it is simply assumed that a tax credit of 30% decrease the investment cost by 30% (while in reality the money would be recovered the year following the investment; but this is of minor importance here).

Heating system	Unit	Value	Reference and Comment
Condensing gas boilers	%	30	
HP	%	30	Air-to-water and brine-to-water HP are both eligible

Table I.3.20: Upper values of tax credits for individual heating systems. Data source: *Ministère de l'action et des comptes publics* (2017).

4.2.2. GHG taxation

The sensitivity of LCOH to variations of the GHG taxation is evaluated considering:

- Direct CO₂ emissions only. This is the approach usually followed by public authorities;
- Direct and indirect GHG emissions. This approach accounts for the emissions emitted overall the lifecycle of the heating systems.

The method used to assess the direct and indirect GHG emissions of heating systems is described in Section 4.1.3.

4.2.3. PM_{2.5} taxation

Air pollution are often undervalued in the health system (Rezaie and Rosen, 2012; Risom *et al.*, 2005). There are however no consensus on the optimal method to be used for accounting these externalities. Two approaches are here adopted to give monetary values to the negative externalities generated by the emissions of air pollutants, allowing to illustrate the impact of this methodological choice:

- The social cost approach (see 4.1.4.2);
- The Years of Life Lost (YLL) approach. The assessment of YLL (see 4.1.4.3), coupled to the monetary valuation of human life (from 0 to 10 M€ per life) and considering that the average life expectancy in the Dunkirk area is 79 years old (IRDES (French Institute for health economics research), 2011), allows to associate a yearly cost to YLL. These are spent each operating year (2030-70), hence enabling the evaluation of the levelised health cost of air pollutant inhalation.

4.3. Analyzing the costs and benefits of renovating buildings

In order to answer the research question (iii) concerning the costs and benefits associated to the renovation of buildings, it is necessary to gather techno-economic data on buildings retrofitting and to evaluate the possible impact of such renovation on the performance of heating systems. Sub-Section 4.3.1 depicts the different levels of building efficiency here considered. Sub-Section 4.3.2 then depicts and justifies the parameter values of heating systems that change when supplying buildings with higher efficiency (e.g. efficiency, heat losses).

4.3.1. Modelling the renovation of buildings

Significantly increasing the rate of renovating the aging building stock in the EU and providing high energy efficiency in new buildings is key to meeting EU (EC, 2012) and French (*Assemblée nationale, 2009*) energy policy targets. The levelised cost of heat savings achieved through the refurbishment of buildings is here assessed under two level of renovation efforts, namely shallow and complete. Sub-Sections 4.3.1.1 and 4.3.1.2 shows the assumptions made to model shallow and complete buildings retrofitting, respectively. Sub-Section 4.3.1.3 then depicts the method applied to evaluate the levelised cost of heat savings.

4.3.1.1. Shallow renovation of buildings

Shallow renovation consists of insulating attics and roofs of buildings in the Dunkirk urban area (see Figure I.3.1). Table I.3.21 depicts the average cost of shallow renovation and the associated reduction in energy consumption, as observed empirically in a French region (CeRCAD Midi-Pyrénées, 2015).

Construction period of buildings	Average cost of retrofitting (€/m ² of living area) (*)	Average reduction of the demand for space heating and domestic hot water (%)
< 1948	113	38%
1948-1974	101	33%
>1974	97	40%

Table I.3.21: Average cost of retrofitting buildings and average efficiency gains associated, for three category of buildings age. Data source: CeRCAD Midi-Pyrénées (2015).

Notes:

(*) Including all equipment and labor, but excluding taxes.

(**) While these costs are the reference used in this Chapter, actual costs may be higher. A French association for consumer's protection (UFC-Que Choisir, 2016) highlighted the great diversity of performances and prices proposed by building craftsmen. Actual costs can be 38% to 185% higher than what the best practices allow to expect. UFC-Que Choisir (2016) also states that the efficiency gains from the renovation are often lower in practice than what announced at the start. The reader should keep in mind that the above costs are optimistic assumptions.

By combining data from Table I.3.21 with data from Table I.3.2 (showing the distribution of the construction period of buildings in the Dunkirk conurbation committee), it is possible to assess the cost and efficiency gains associated to the shallow renovation of existing buildings in the Dunkirk conurbation committee (assuming that it would be of the same order as in the *Midi-Pyrénées* region). As a result, it is assumed that reducing the heat demand of buildings by 37% would cost 100 €/m² of living area. Once shallowly renovated, the modelled DH area (see Figure I.3.1 of Section 3) would have a global heat demand of 486 GWh_{th}/a and a specific heat consumption of 96 kWh_{th}/m². a.

4.3.1.2. Complete renovation of buildings

The latest French Act on the energy performance of buildings (RT2012; see article 4 of '*La Loi Grenelle*'; *Assemblée nationale*, 2009) obligates new buildings to be designed so as to maintain final energy consumption below 40 kWh_{th}/m². a. In this Chapter, complete renovation includes all the work required to retrofit existing buildings so as to comply with the RT2012 standards. In addition to the insulation of attics and roofs (i.e. shallow renovation), it includes the insulation of walls and floors and the installation of double-flow mechanical ventilation and triple-paned windows. According to Enertech (2010), the first French experiences of complete renovation (2006) costed about 330 €/m² of living area. Enertech (2010) however emphasized that learning by doing effects should be important, and hence recommend to consider 200 €/m² of living area as an assumption for any complete renovation led between 2020 and 2030. Once completely renovated, the modelled DH area (see Figure I.3.1) would have a global heat demand of 202 GWh_{th}/a and a specific heat consumption of 40 kWh_{th}/m². a.

4.3.1.3. Assessing the levelised cost of heat savings

The costs presented in Sub-Sections 4.3.1.1 and 4.3.1.2 (100 and 200 €/m² of living area for shallow and complete renovation, respectively) only are those related to energy (e.g. insulant, windows). In practice, other work non-related to energy arise when renovating buildings (e.g. painting). These non-energy costs represent 30 to 70% of the total renovation expenses, depending on the age and type of buildings (Enertech, 2010). When modelling the heating systems, all costs are included, both energy costs (e.g. natural gas consumption, insulant, pipelines) and non-energy costs (e.g. digging trenches, sand filling and labor costs). To be consistent, it is thus necessary to account for renovation expenses due to non-energy purposes. Assuming that non-energy expenses represent 50% of the total renovation cost, $C_{m_{renov}}$, the marginal cost of renovating buildings (€/m²), is calculated as equal to 200 and 400 €/m² of living area for shallow and complete renovation, respectively.

As indicated in Table I.3.21, the readers should keep in mind that these are optimistic assumption regarding the real costs and performances of renovation. It is impossible to provide general statements as it strongly depends on e.g. the operational conditions and the company

responsible for renovating. Following the study of UFC-Que Choisir (2016) yet, it seems reasonable to expect real costs (without taxes) of 300-400 and 500-700 €/m² of living area for shallow and complete renovation, respectively. It must also be acknowledged that complete renovation targeting 40 kWh_{th}/m².a of final energy consumption are still rare. Many buildings renovation projects are targeting 80 kWh_{th}/m².a of final energy consumption, but often fail to reach such a level (UFC-Que Choisir, 2016). This may be partly due to the lack of experience feedbacks: in France, 2013, residential buildings with a final energy consumption lower than 40 kWh_{th}/m².a and comprised between 40 and 80 kWh_{th}/m².a represented 0.3% and 2% of the total, respectively (*Inspection Générale des Finances* (French general inspection of finances), 2017).

The method followed in Step 1 allowed to estimate Q_B , the total building space area (m²) of the modelled urban area (see the formula (3) of Chapter 2). I_{renov} , The overnight cost of renovation (€) is then calculated following equation (4), for each type of renovation:

$$I_{renov} = Q_B \cdot C_{m_{renov}} \tag{4}$$

Where Q_B is the building space area (m²); and $C_{m_{renov}}$ is the marginal cost of renovation (€/m²).

The levelised cost of heat savings achieved through buildings retrofitting is then calculated, the aim being to compare it with the LCOH of heating systems. For the sake of the comparison, it is here considered that the investment related to renovation are distributed over 2026-2030 (as for DH systems); a longer period would however be required in practice. Other assumptions are similar to step 1 (discount rate of 3.5% and operational lifetime of 40 years).

4.3.2. Evaluating the impact of buildings renovation on the performance of heating systems

Table I.3.22 summarizes the main changes that would affect the DH modelled area (see Figure I.3.1) when renovating buildings. While the land surface (km²) is unchanged, the annual and specific heat demand would be reduced. This would lead to a reduction in the linear heat density (MWh_{th}/m.a) of the DH distribution network, thus inhibiting the competitiveness of DH systems relative to individual systems. DH systems could nonetheless benefit from lower temperature requirements in radiators (see e.g. Averfalk and Werner, 2017; Lund *et al.*, 2014; Rämä and Sipilä, 2017). The impact of building renovation on the relative attractiveness of DH schemes is summarized in Figure I.3.11, and more discussion on this topic can be found in Section 2.3 of Chapter 2.

Parameter	Existing buildings (133 kWh _{th} /m ² .a)	Shallowly renovated buildings (96 kWh _{th} /m ² .a)	Completely renovated buildings (40 kWh _{th} /m ² .a)
Supply/return temperatures (°C) (for DH systems only; maximal temperatures)	100/80 °C (data from Dalkia for the existing network)	70/35 °C (projected temperatures)	55/25 °C (projected temperatures)
Total land surface (km ²)	16	16	16
Annual heat demand (GWh _{th} /a)	673	486	202
Specific heat demand (kWh _{th} /m ² .a)	133	96	40

Table I.3.22: Main changes affecting the DH modelled area (see Figure I.3.1) when renovating buildings.

Notes:

Sub-Sections 4.1 and 4.3.1 together provide all the assumptions behind the parameter values shown in Table I.3.22.

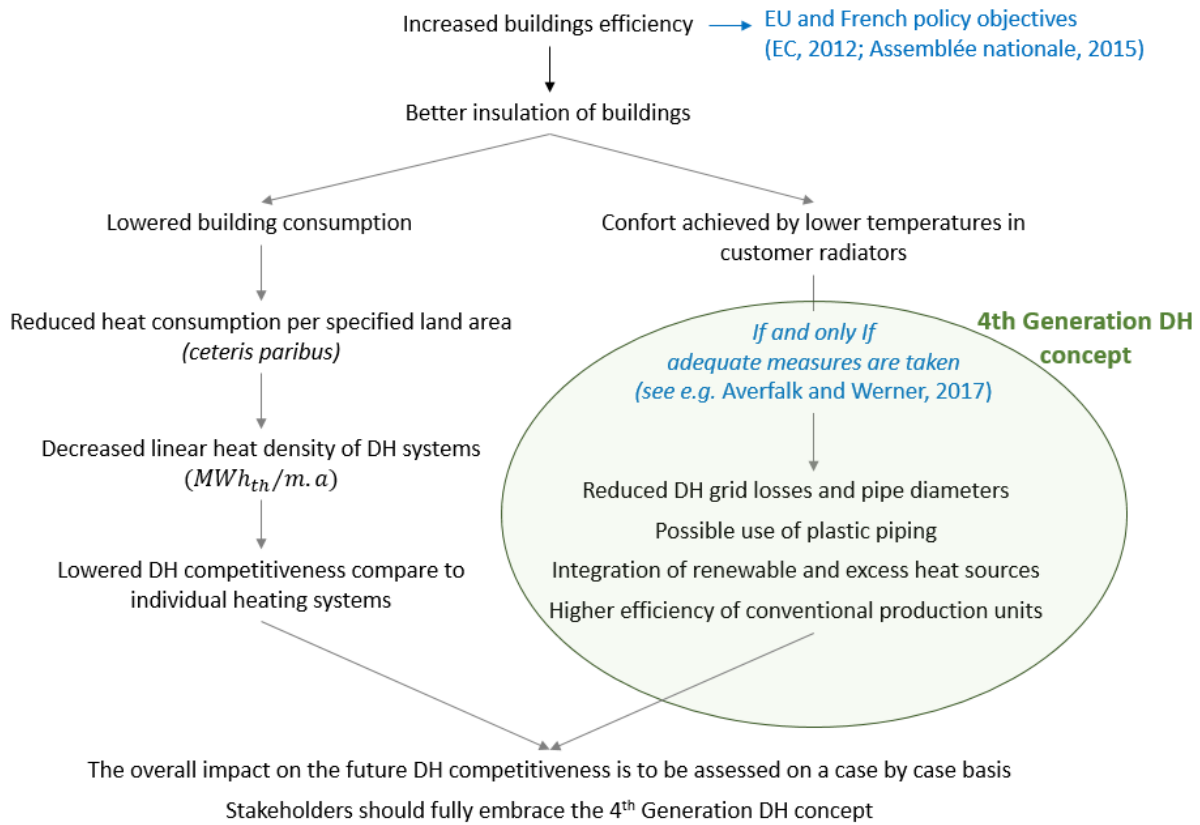

Figure I.3.11: Impact of increased buildings efficiency on the competitiveness of DH systems.

This sub-Section (4.3.2) aims to describe the method followed to study the impact of the 4th Generation concept (see Figure I.3.11). Engineering computations were made to evaluate the reduction of DH grid losses and pipe diameters enabled by the lower temperature requirements in buildings. Sub-Sections 4.3.2.1 and 4.3.2.2 shows assumptions relative to DH systems and individual systems, respectively.

If a parameter is not discussed in this Sub-section, it is implicitly assumed to be unchanged by the increased energy efficiency of buildings (and thus its value can be found in Section 4.1). Caution is needed when considering the assumptions here made; future studies would be required to confirm or infirm our results. Sub-section 4.3.2 however provide valuable indication on the expected impact of building renovation on the attractiveness of DH systems.

4.3.2.1. DH systems

The hypothesis common to all DH systems (DH distribution network and peak-load heat generation) are first depicted. The assumptions specific to each base load heat source (e.g. nuclear plant, solar collectors) are then detailed separately.

DH distribution system

An important value added of this Chapter is the accuracy of the data used to model the heat losses of theoretical DH networks designed to supply renovated buildings with lower temperature requirements (potentially positive impact; see Figure I.3.11) and lower linear heat density (negative impact). The Dunkirk DH system (*Energie Grand Littoral*, operated by Dalkia) provided us with the thermal output (MWh_{th}) at an hourly step for a full operating years (8760 hours), as well as the supply and return temperatures levels (100/80°C in the coldest period). Thanks to the help of Miika Rämä (VTT researcher, worked in CEA from November 2017 to October 2018), we were able to evaluate the evolution of the annual DH heat losses induced by a change in supply and return temperatures. Heat losses for different distribution temperature levels were evaluated using the following principle:

- a) The network was reduced to a single effective pipeline with supply and return pipes, using length of the network and the dimensions of a DN500 pipe as representative values;
- b) Based on measured supply and return temperatures from the Dunkirk system, heat losses were calculated for the reduced network, i.e. the representative pipeline. Temperature drop between the heat supply and consumers was assumed negligible;
- c) The resulting heat loss was adjusted with a correction coefficient to match the measured heat losses within the system;
- d) Heat losses with lower distribution temperatures were then calculated based on the representative pipe line and the correction coefficient;
- e) For future extension of the network, the heat loss (W/m) was assumed constant; the total heat loss was calculated by multiplying the result with ratio of future network length to current network length.

For heat loss calculation of single pipes, the method described by Bohm and Kristjansson (2005) was applied, using the parameter values defined in Table I.3.23. In addition to the heat losses (results shown in Section 5.3.2), other parameter values relative to DH distribution and peak-load system are modified when considering different supply and return temperatures; these are shown in Table I.3.24.

Parameter	Unit	Value	Reference and comment
Heat conductivity for the ground	$W/m.K$	1.000	
Heat conductivity for insulation	$W/m.K$	0.027	Polyurethane foam
Average ground temperature	$^{\circ}C$	10	
Pipe depth	m	0.50	
Diameter of insulation casing	mm	800.0	DN500 pipe
Inner diameter of pipe	mm	495.4	DN500 pipe
Distance between pipe centre and ground surface	m	1.10	DN500 pipe
Adjustment factor	-	0.88659	See points a) to e)

Table I.3.23: Parameter values used to evaluate DH heat losses of a network designed to operate at lower temperatures than the existing DH system.

Notes:

All parameter values correspond to the Finnish recommendations for DH (Energiateollisuus, 2013). While they might be different from country to country (only the steel pipe dimensions, and sometimes the insulation, should be the same), the impact should be negligible considering the simplifications made such as the use of an adjustment factor.

Parameter	Existing buildings (133 kWh _{th} /m ² .a)	Shallowly renovated buildings (96 kWh _{th} /m ² .a)	Completely renovated buildings (40 kWh _{th} /m ² .a)	Reference and comment
DH supply/return temperatures (°C)	100/80	70/35	55/25	
Elec. Consumption for pumps (MWh _e /MWh _{th})	0.005	0.01	0.015	Frederiksen and Werner (2013)
gas HOB net efficiency (%)	100	105	110	DEA (2016a)
WTES losses (%)	20	15	10	SDH (2013)

Table I.3.24: Parameter values relative to DH distribution and peak-load systems that are modified when supplying lower temperatures.

NCHP

When supplying shallowly renovated buildings, generating heat at 80°C would reduce electric losses due to heat extraction on the Rankine cycle of the plant by approximately 40% compared to the generation of 120°C heat (IAEA, 2016). In the case of a very low DH system such as envisioned in Schmidt *et al.* (2017), recovering the excess heat from the nuclear plant (40°C) could be enough to fulfill most of the heat loads of completely renovated buildings. Gas HOB could be used whenever higher temperature is required (heating period). It is however assumed in this Chapter that the temperature required in the case of a complete renovation is 60°C. Generating 60°C heat with a NCHP would imply electricity losses approximately equal to one twelfth of the heat generated. Table I.3.25 shows the parameter that are modified when NCHP is designed to supply DH networks with lower temperature requirements. The pipe diameter and cost as well as the pumping power of the heat transportation system (HTS) is calculated for each supply and return temperature levels following the method depicted in Section 3.3 of Chapter 2.

Parameter	Existing buildings (133 kWh _{th} /m ² .a)	Shallowly renovated buildings (96 kWh _{th} /m ² .a)	Completely renovated buildings (40 kWh _{th} /m ² .a)	Reference and comment
DH supply/return temperatures (°C)	100/80	70/35	55/25	
HTS supply/return temperatures (°C)	120/50	80/30	60/20	
Elec. Losses due to heat extraction on NCHP (MWh _e .lost/MWh _{th} .produced)	1/6	1/10	1/12	IAEA (2016)

Table I.3.25: Parameter values relative to NCHP system that are modified when supplying lower temperatures.

Nuclear excess heat (NEH)

Table I.3.26 shows the parameter that are modified when NEH is used to supply DH networks with lower temperature requirements.

Parameter	Existing buildings (133 kWh _{th} /m ² .a)	Shallowly renovated buildings (96 kWh _{th} /m ² .a)	Completely renovated buildings (40 kWh _{th} /m ² .a)	Reference and comment
DH supply/return temperatures (°C)	100/80	70/35	55/25	
HTS supply/return temperatures (°C)	90/40	80/30	60/20	
COP of HP	3.2 (ΔT=50)	4.0 (ΔT=40)	6.0 (ΔT=20)	DEA (2016a); Popovski <i>et al.</i> (2017); Zvingilaite (2013)

Table I.3.26: Parameter values relative to NEH + HP that are modified when supplying lower temperatures.

Compression heat pumps heating sea water (water to water HP)

Table I.3.27 shows the parameters that are modified when water to water HP is used to supply DH networks with lower temperature requirements.

Parameter	Existing buildings (133 kWh _{th} /m ² .a)	Shallowly renovated buildings (96 kWh _{th} /m ² .a)	Completely renovated buildings (40 kWh _{th} /m ² .a)	Reference and comment
DH supply/return temperatures (°C)	100/80	70/35	55/25	
COP of HP	1.8 (ΔT=80)	2.8 (ΔT=60)	3.7 (ΔT=45)	DEA (2016a); Popovski <i>et al.</i> (2017); Zvingilaite (2013)

Table I.3.27: Parameter values relative to water to water HP that are modified when supplying lower temperatures.

Biomass HOB

Table I.3.28 shows the parameters that are modified when biomass HOB are used to supply DH networks with lower temperature requirements.

Parameter	Existing buildings (133 kWh _{th} /m ² . a)	Shallowly renovated buildings (96 kWh _{th} /m ² . a)	Completely renovated buildings (40 kWh _{th} /m ² . a)	Reference and comment
DH supply/return temperatures (°C)	100/80	70/35	55/25	
Net efficiency of biomass HOB (%)	103	108	113	DEA (2016b)

Table I.3.28: Parameter values relative to biomass HOB that are modified when supplying lower temperatures.

Solar DH systems

Table I.3.29 shows the parameters that are modified when solar DH systems are used to supply DH networks with lower temperature requirements.

Parameter	Existing buildings (133 kWh _{th} /m ² . a)	Shallowly renovated buildings (96 kWh _{th} /m ² . a)	Completely renovated buildings (40 kWh _{th} /m ² . a)	Reference and comment
DH supply/return temperatures (°C)	100/80	70/35	55/25	
Collector area/heat demand (m ² /MWh _{th})	3.0 (80°C max. heat output)	2.7 (70°C max. heat output)	2.4 (50°C max. heat output)	DEA (2016); Hesaraki <i>et al.</i> (2015); SDH (2012)
Solar productivity (*) (kWh _{th} /m ²)	332	376	424	
STES charged-uncharged (peak) temperatures	80-20 (50)	70-15 (40)	50-10 (30)	Hesaraki <i>et al.</i> (2015)
BTES heat losses (%)	40	30	20	ADEME (2016); Hesaraki <i>et al.</i> , (2015); Rad and Fung (2016)
PTES heat losses (%)	30	20	10	ADEME (2016); Hesaraki <i>et al.</i> (2015); Rad and Fung (2016)
COP of HP (%)	4.0 (ΔT=40)	4.8 (ΔT=30)	7.0 (ΔT=10)	DEA (2016a); Popovski <i>et al.</i> (2017); Zvingilaite (2013)

Table I.3.29: Parameter values relative to solar DH systems that are modified when supplying lower temperatures.

Notes:

(*) This was calculated with the help of Cédric Paulus (CEA INES), using the software Scenocalc.

4.3.2.2. Individual heating systems

The assumptions specific to each individual heating system are detailed in Tables I.3.30 to I.3.33 for natural gas condensing boilers, electric heaters, air to water HP and brine to water HP, respectively.

Parameter	Existing buildings (133 kWh _{th} /m ² .a)	Shallowly renovated buildings (96 kWh _{th} /m ² .a)	Completely renovated buildings (40 kWh _{th} /m ² .a)	Reference and comment
Radiator/hot water system inlet temperature (max.)	80	60	45	
Net efficiency (%)	102	104	106	DEA (2013)

Table I.3.30: Parameter values relative to natural gas condensing boilers that are modified when supplying lower temperatures.

Parameter	Existing buildings	Shallowly renovated buildings	Completely renovated buildings	Reference and comment
Radiator/hot water system inlet temperature (max.)	80	60	45	
Net efficiency (%)	100	100	100	DEA (2013)

Table I.3.31: Parameter values relative to electric heaters that are modified when supplying lower temperatures.

Parameter	Existing buildings	Shallowly renovated buildings	Completely renovated buildings	Reference and comment
Radiator/hot water system inlet temperature (max.)	80	60	45	
COP	1.3	2.3	3.2	DEA (2013)

Table I.3.32: Parameter values relative to air to water HP that are modified when supplying lower temperatures.

Parameter	Existing buildings	Shallowly renovated buildings	Completely renovated buildings	Reference and comment
Radiator/hot water system inlet temperature (max.)	80	60	45	
COP	1.6	2.6	3.5	DEA (2013)

Table I.3.33: Parameter values relative to brine to water HP that are modified when supplying lower temperatures.

5. Results and discussions

Sub-sections 4.1, 4.2 and 4.3 present and discuss the results obtained by using the methods described in Section 3.1, 3.2 and 3.3, respectively.

5.1. Heating systems designed to supply the existing building stock (without GHG nor environmental taxation nor public support mechanisms)

Sub-Section 5.1.1 presents the levelised cost of the heat (LCOH) of each heating system. Sub-Section 5.1.2 then compares the systems in terms of overnight capital costs, payback periods and NPV. Sub-Section 5.1.3 finally focuses on non-economic indicators (e.g. health and climate impact, land surface required).

Table I.3.34 depicts the technical parameters of the DH distribution systems (i.e. common to all DH systems), as resulting from the method shown in Section 4.1.1.1. Figure I.3.12 then shows the overnight investment costs of heating systems, i.e. the non-discounted capital costs. It comprises all the capital costs required over a period of 40 years, thus including the re-investments required to replace the equipment whose technical lifetime is inferior to 40 years (e.g. gas heat-only boilers, PTES).

Parameter	Unit	Value	Reference & comment
Land area	km^2	16	See Figure I.3.1 of Section 3
Population	<i>thousand inhabitants</i>	98.4	
Average population density	<i>capita/km²</i>	6153	
Total length of DH network	<i>km</i>	217	
Annual DH deliveries	<i>GWh_{th}/a</i>	673	
Linear heat density	<i>MWh_{th}/m. c</i>	3.1	
Average pipe diameter	<i>mm</i>	120	
Capital cost of DH distribution system	<i>€/m</i>	917	Including pipes, sub-stations, civil works, sand filling, and labor costs

Table I.3.34: Main technical parameters of DH systems dimensioned to supply the existing building stock of the DH modelled area shown in Figure I.3.1 of Section 3.

Notes:

The individual heating systems are dimensioned so as to supply the same amount of heat than DH deliveries.

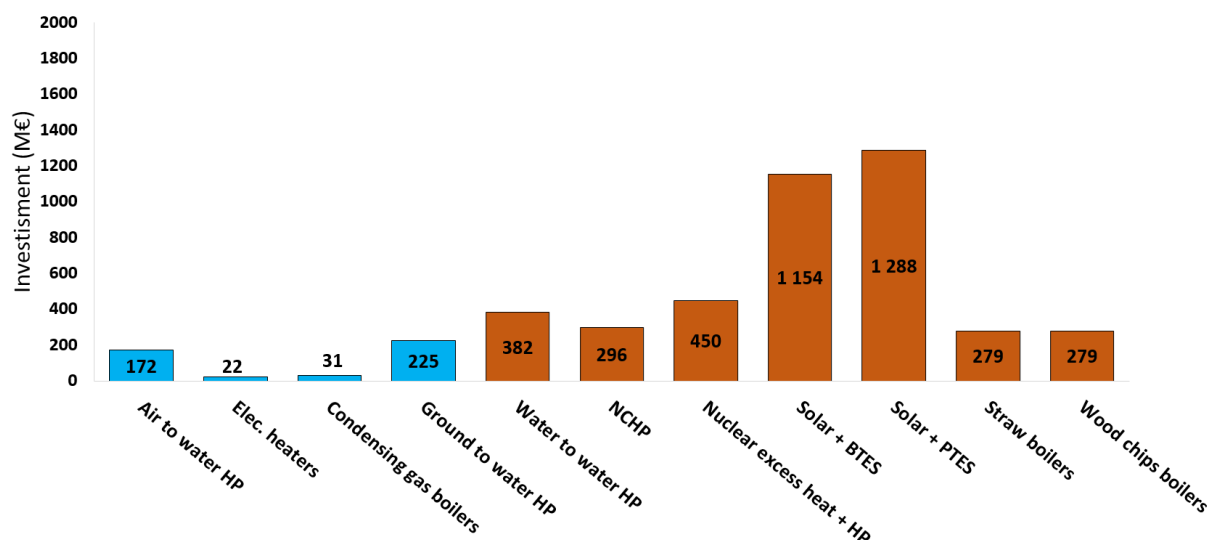

Figure I.3.12: Overnight investment cost of heating systems (millions euros).

Notes:

In Blue: Individual heating systems. In Brown: DH systems.

5.1.1. Levelised Cost of the Heat (LCOH)

Sub-Section 5.1.1.1 provides the detailed LCOH breakdown of each heating system, considering the 2015 energy prices. While sub-Section 5.1.1 assessed LCOH of the DH + NCHP system accounting for potential power losses as a cost attributable to the heat production, other modelling approaches can also be relevant (see Appendix I.3.A). Sub-Section 5.1.1.2 then compares LCOH under three different energy price scenario. Sub-Section 5.1.1.3 finally evaluates the sensitivity of LCOH to the variation of energy prices, discount rate and operational lifetime.

5.1.1.1. LCOH breakdown

As in Chapter 2, the discount rate and operational lifetime considered in sub-Section 5.1.1.1 are 3.5% and 40 years, respectively. Reinvestment required over the system lifetime are taken into account. Table I.3.35 presents the energy price assumptions made to compute the LCOH breakdown of heating systems. Environmental taxes and subsidies are not included here, but are studied in Section 5.2. Energy prices however include the usual French energy taxes (e.g. added value taxation, transportation and distribution) so as to reflect the final price paid by end-users without environmental taxes or public support mechanisms. Energy prices are those of 2015 and drawn from the following considerations:

- Households paid an average of €100/MWh_e for electricity, covering energy production, transmission and distribution costs (Eurostat, 2016a). Note that this cost is approximately €50/MWh_e higher when including all taxes, with a rise of about +20% between 2008 and 2018;
- DH operators benefit from deregulated electricity prices (on a contractual basis). The price paid by DH operators is closely related to the growth market trend (CRE (French Energy Regulation Commission), 2016). It is here assumed that the price paid by DH operators is equal to €72/MWh_e, covering energy production and transmission costs. A similar assumption is made by ADEME (2016);
- The electricity price used to compute the opportunity cost of heat generation with NCHP (power losses due to heat extraction) is €42/MWh_e, covering energy production only. This value represents the official cost of producing electricity with nuclear plants in France (*Ministère de l'environnement, de l'énergie et de la mer*, 2016b);

- DH operators are industrial users of natural gas, and paid in 2015 an average of €37/MWh_{th} in France (Eurostat, 2016b). French households however paid higher prices, about €62/MWh_{th} in 2015 (CRE, 2016b).

	Unit	2015 scenario	Reference and comment
Natural gas for DH systems	€/MWh _{th}	37	CRE (2016a)
Natural gas for individual systems	€/MWh _{th}	62	CRE (2016b)
Straw for biomass HOB	€/MWh _{th}	23	INAPG (Institut Nationale Agronomique de Paris-Grignon, 2006)
Wood chips for biomass HOB	€/MWh _{th}	30	ADEME (2016)
Electricity for DH systems	€/MWh _e	72	ADEME (2016)
Electricity for individual systems	€/MWh _e	100	CRE (2016b)
Opportunity cost of heat generation with NCHP	€/MWh _e	42	Price of producing electricity with French nuclear plant (<i>Ministère de l'environnement, de l'énergie et de la mer</i> , 2016)

Table I.3.35: Energy price used in the '2015 scenario'.

Figures I.3.13 to I.3.17 shows the LCOH breakdown of DH systems (NCHP, NEH + HP, seawater HP, biomass HOB and solar systems, respectively), considering the '2015 scenario' shown in Table I.3.35. The levelised costs attributed to the DH distribution system (€33.6/MWh_{th}) and to the peak-load generation system (WTES and gas HOB; €10.0/MWh_{th}) are the same for all the DH systems. Other LCOH components (e.g. heat transportation system, solar collectors, biomass HONB) yet vary widely depending on systems. Figures I.3.14 to I.3.17 could be used for preliminary discussion on business models and financial risk sharing among stakeholders. Figures I.3.18, I.3.19 and I.3.20 shows the LCOH breakdown for individual condensing gas boilers, electric heaters and HP, respectively, also considering the 2015 scenario.

Figure I.3.21 finally shows the distribution of capital costs and O&M costs in the LCOH of heating systems. DH systems tend to have larger capital costs and lower O&M costs than individual heating systems (this however vary depending on systems). The lower capital cost component of LCOH is observed for condensing gas boilers. The smaller O&M component of LCOH is reached by the DH + NCHP system. Figure I.3.21 can also be used to determine the heating cost when the investment has been paid back. Even though maintenance costs increase with ageing DH networks, this highlights the economic potential of DH systems in the long run, relatively to individual systems which require larger reinvestments and greater O&M costs.

Significant uncertainty affects the LCOH, regarding both the technical parameter values (all defined in Section 4.1) and the energy prices (see Table I.3.35). To frame the uncertainty, Sub-Section 5.1.1.2 performs a sensitivity analysis and Sub-Section 5.1.1.3 studies LCOH under three different energy price configurations.

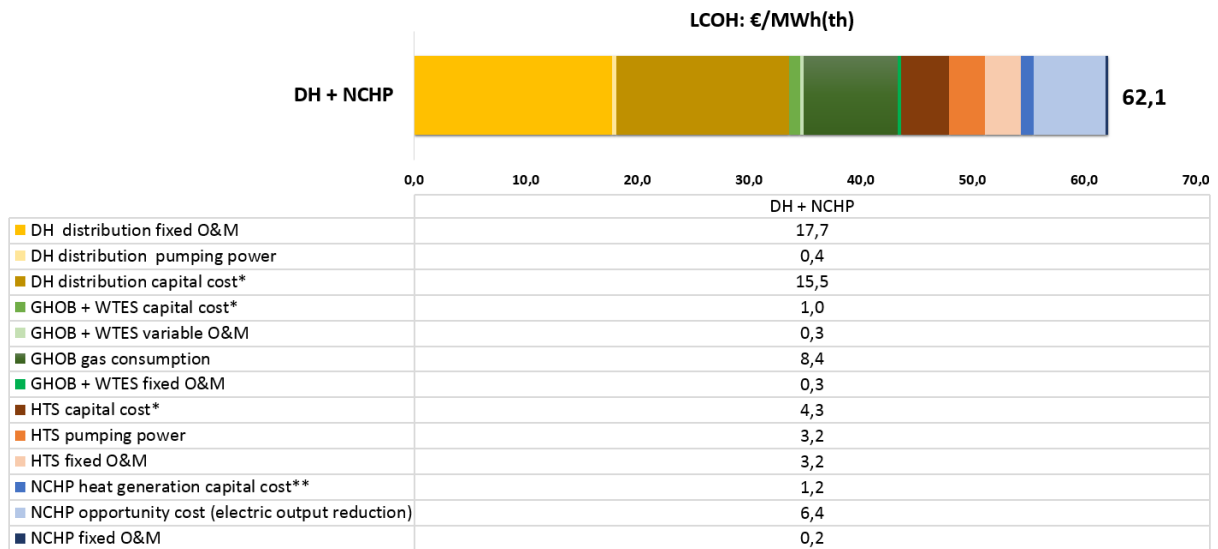

Figure I.3.13: LCOH breakdown of the DH + NCHP system (see Section 4.1.1.2 for assumptions).

Notes:

(*) including engineering studies;

(**) including engineering and safety studies.

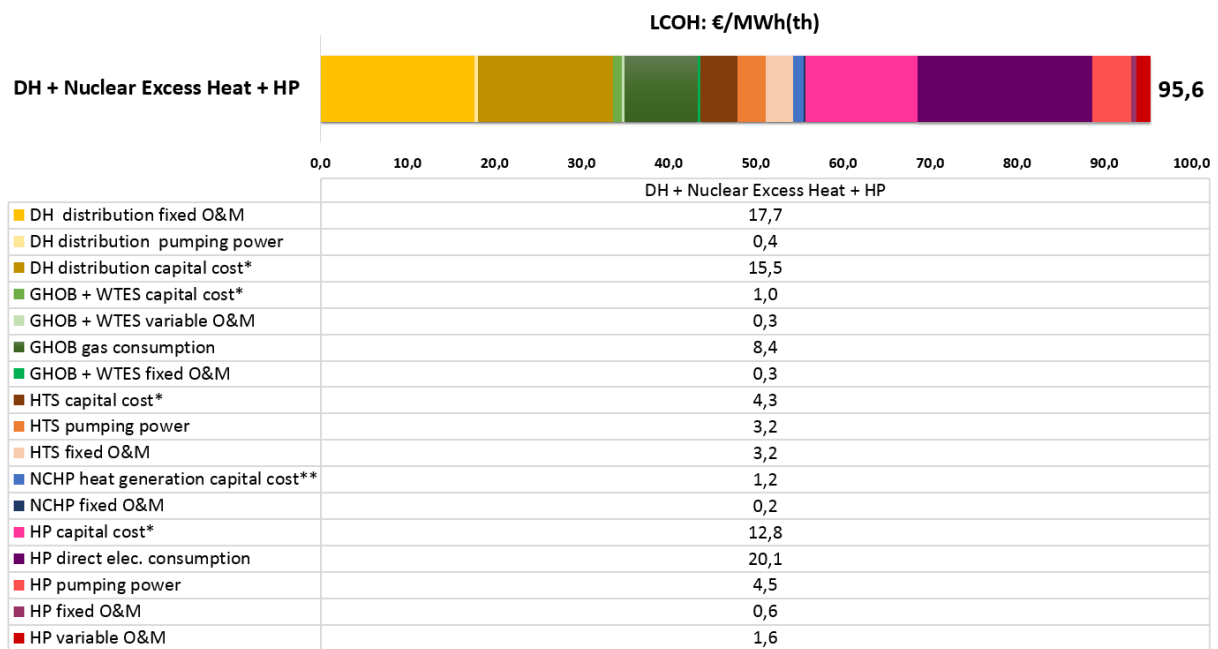

Figure I.3.14: LCOH breakdown of the DH + NEH + HP system (see Section 4.1.1.3 for assumptions).

Notes:

(*) including engineering studies;

(**) including engineering and safety studies.

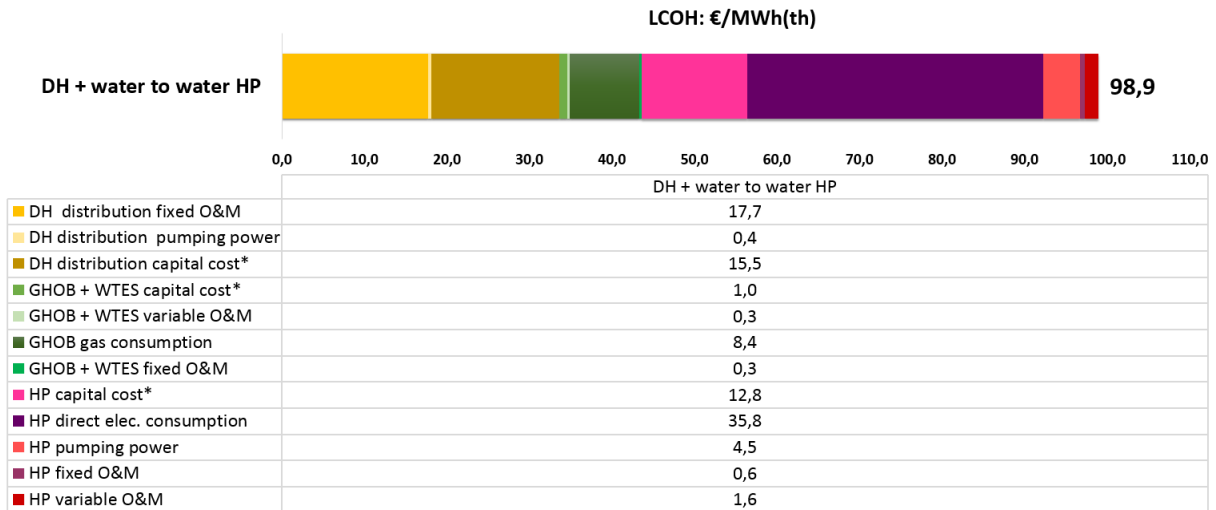

Figure I.3.15: LCOH breakdown of the DH + Water to Water HP system (see Section 4.1.1.4 for assumptions).

Notes:

(*) including engineering studies.



Figure I.3.16: LCOH breakdown of the DH + Biomass HOB systems (see Section 4.1.1.5 for assumptions).

Notes:

(*) including engineering studies.

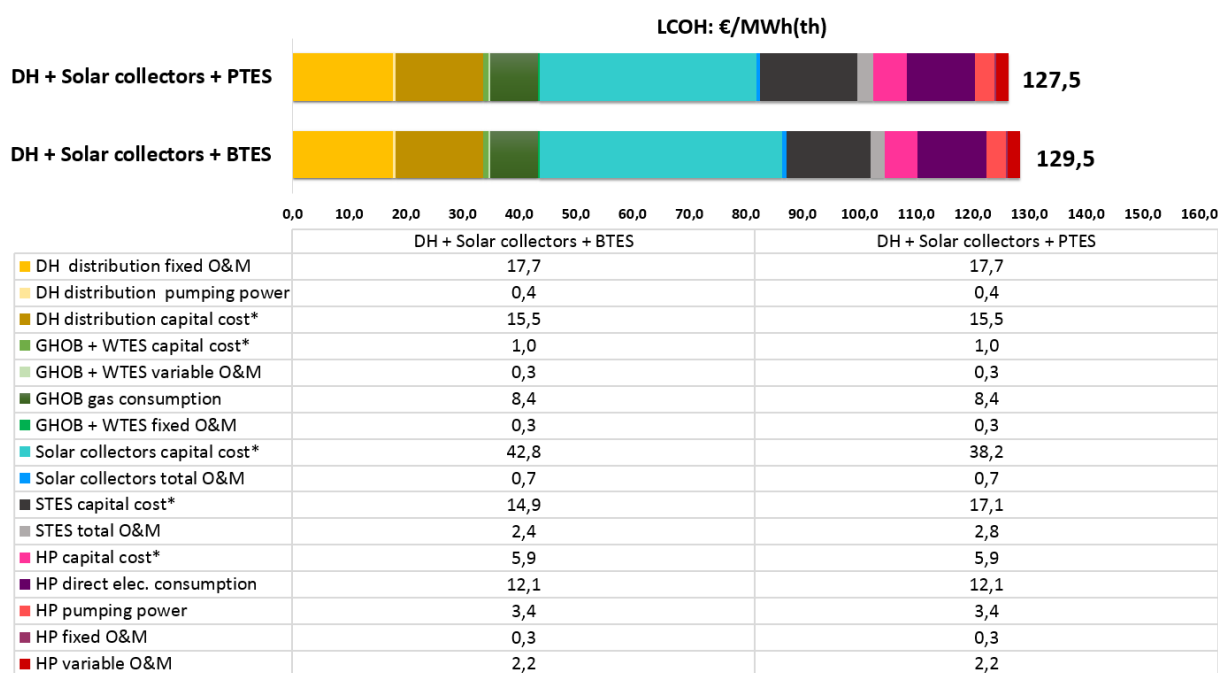

Figure I.3.17: LCOH breakdown of the DH + Solar collectors + STES systems (see Section 4.1.1.6 for assumptions).

Notes:

(*) including engineering studies.

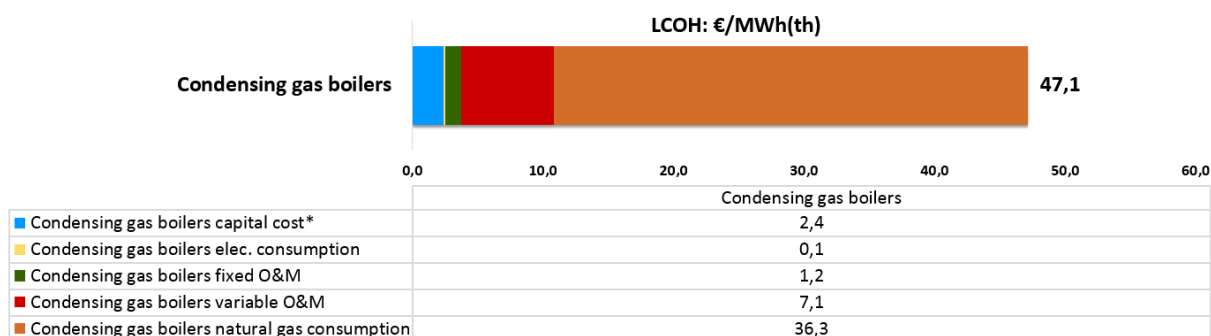

Figure I.3.18: LCOH breakdown of individual condensing gas boilers (see Section 4.1.2.1 for assumptions).

Notes:

(*) including engineering studies.

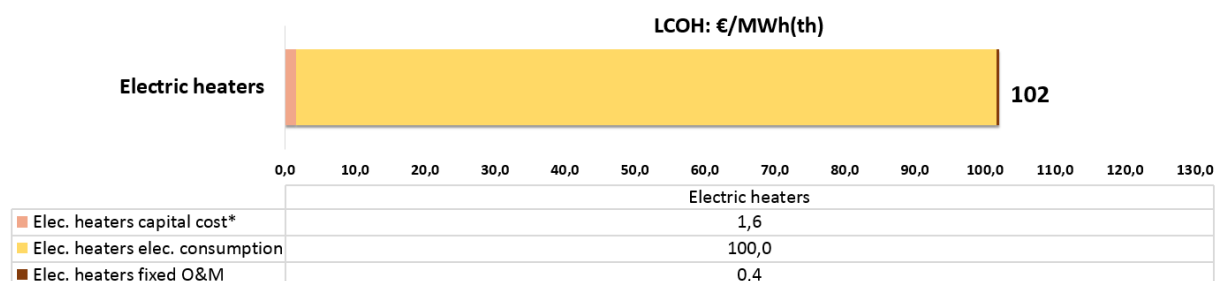

Figure I.3.19: LCOH breakdown of individual electric heaters (see Section 4.1.2.2 for assumptions).

Notes:

(*) including engineering studies.

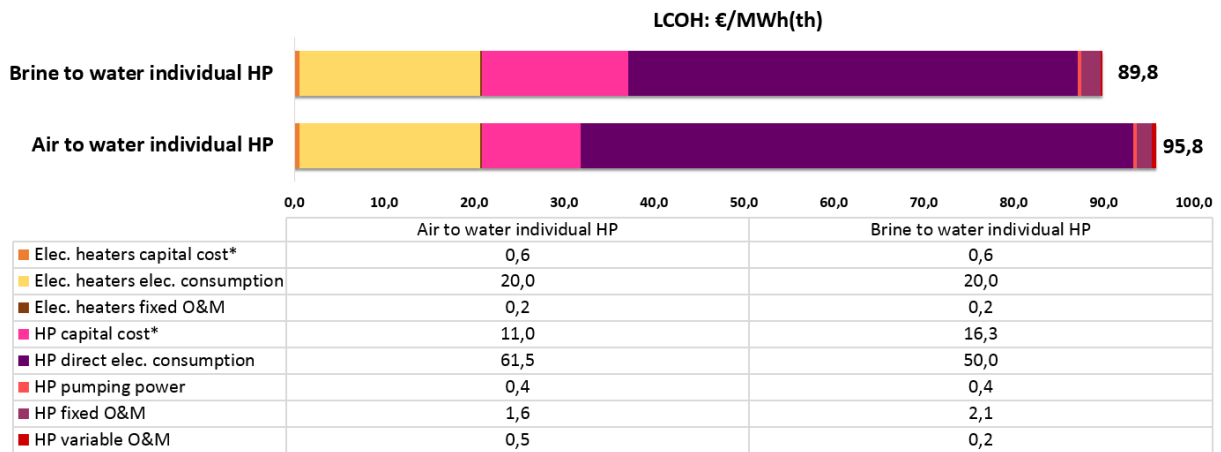

Figure I.3.20: LCOH breakdown of individual HP (see Section 4.1.2.3 for assumptions).

Notes:

(*) including engineering studies.

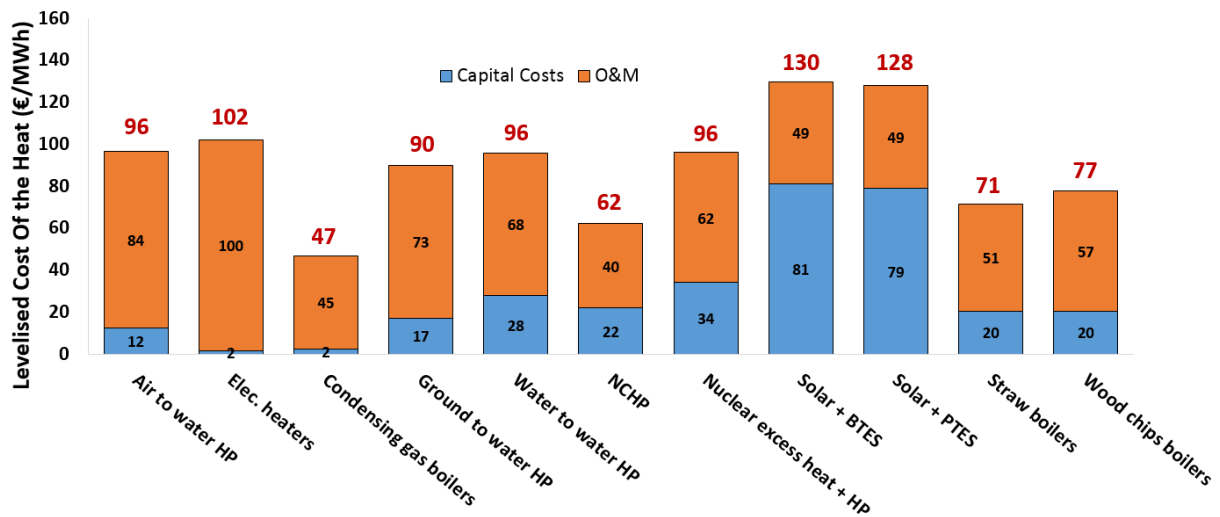

Figure I.3.21: Investment and O&M components of LCOH.

5.1.1.2. Sensitivity of LCOH to variation of key parameters

Figures I.3.22, I.3.23, I.3.24 and I.3.25 show the sensitivity of LCOH to, respectively:

- **Electricity prices.** The more electricity-intensive a heating system is, the larger is the sensibility of the LCOH to electricity prices. While the DH + NCHP system is not very sensitive to electricity price variations, condensing gas boilers and biomass HOB are even less impacted. This would however change if applying the method exposed in Appendix I.3.A (considering that heat extraction on the nuclear plant not responsible for any electrical losses).
- **Natural gas prices.** The more natural gas-intensive a heating system is, the larger is the sensibility of the LCOH to natural gas prices. The DH + NCHP system becomes more competitive than individual condensing gas boilers when natural gas prices exceed 2015 levels (€37/MWh_{th}) by 55% (*ceteris paribus*).
- **Discount rate.** The more capitalistic a heating system is, the larger is the sensibility of the LCOH to discount rates. When the value of future costs and benefits is equal to the value of presents costs and benefits (discount rate of 0%), the DH + NCHP system is only €5/MWh_{th} higher than individual gas boilers. The difference however increase when the discount rate rise.
- **Operational lifetime.** The more capitalistic a heating system is, the larger is the LCOH sensibility to the operational lifetime considered. The effect is however less significant than for the discount rate. The LCOH of the DH + NCHP system decrease from €62.1/MWh_{th} to €57.3/MWh_{th} when the

operational lifetime rises from 40 years to 60 years. This however assumes that the heat transportation and distribution systems have a technical lifetime of 60 years which, despite being an hypothesis sometimes used in academic papers, is not entirely true given that the proportion of a steel pipe expected to remain after a specific number of years rapidly decrease after 40 years of operation (Sernhed and Jönsson, 2017; see Figure 1.9). Before 40 years, most of the pipes remain used in normal conditions. Evaluating LCOH over a 40 years period (as in Chapters 2 and 3) is hence more realistic than evaluating the LCOH over a 60 years period.

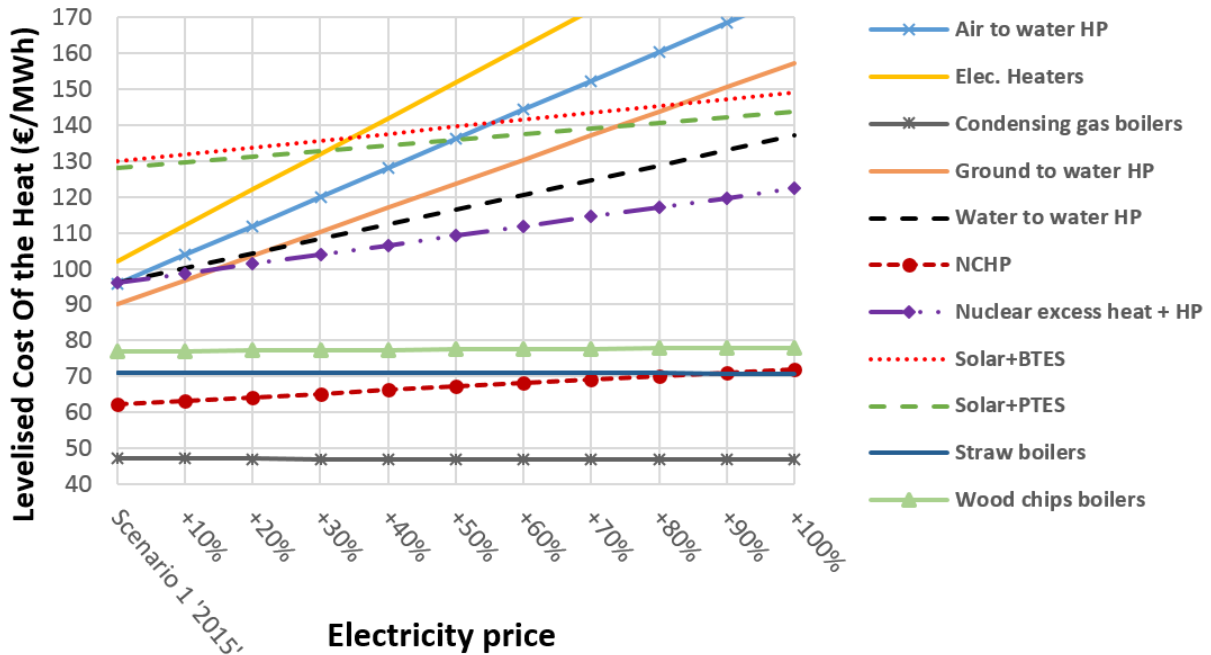

Figure I.3.22: LCOH as a function of electricity prices, *ceteris paribus* (see Table I.3.35).

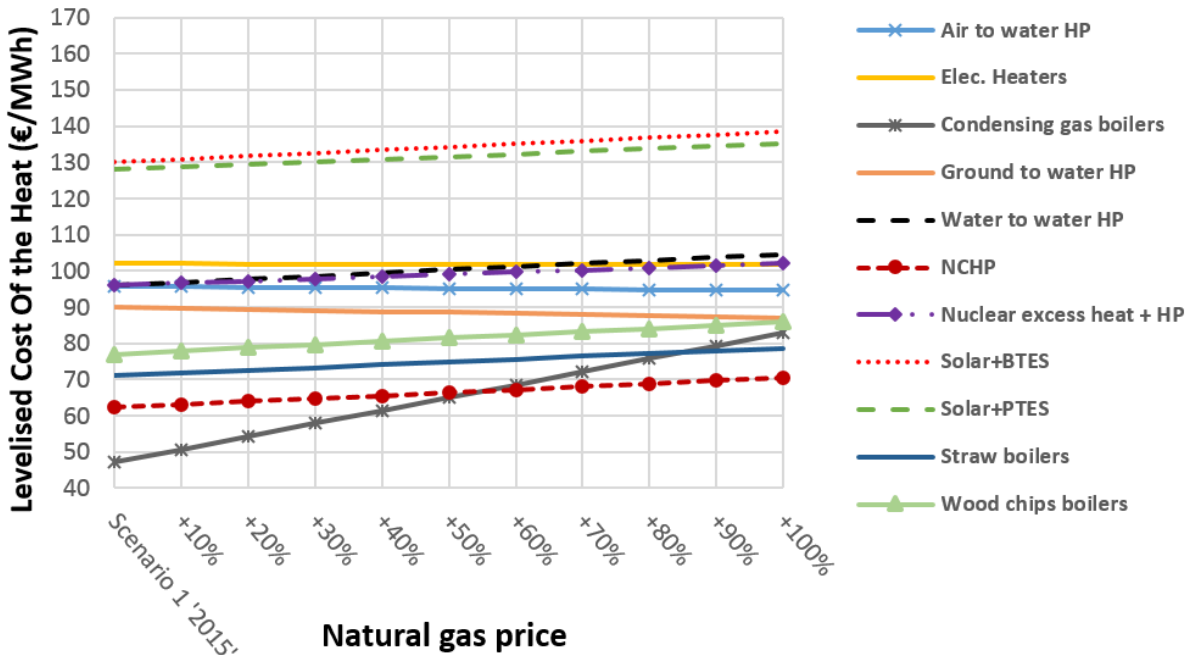

Figure I.3.23: LCOH as a function of natural gas prices, *ceteris paribus* (see Table I.3.35).

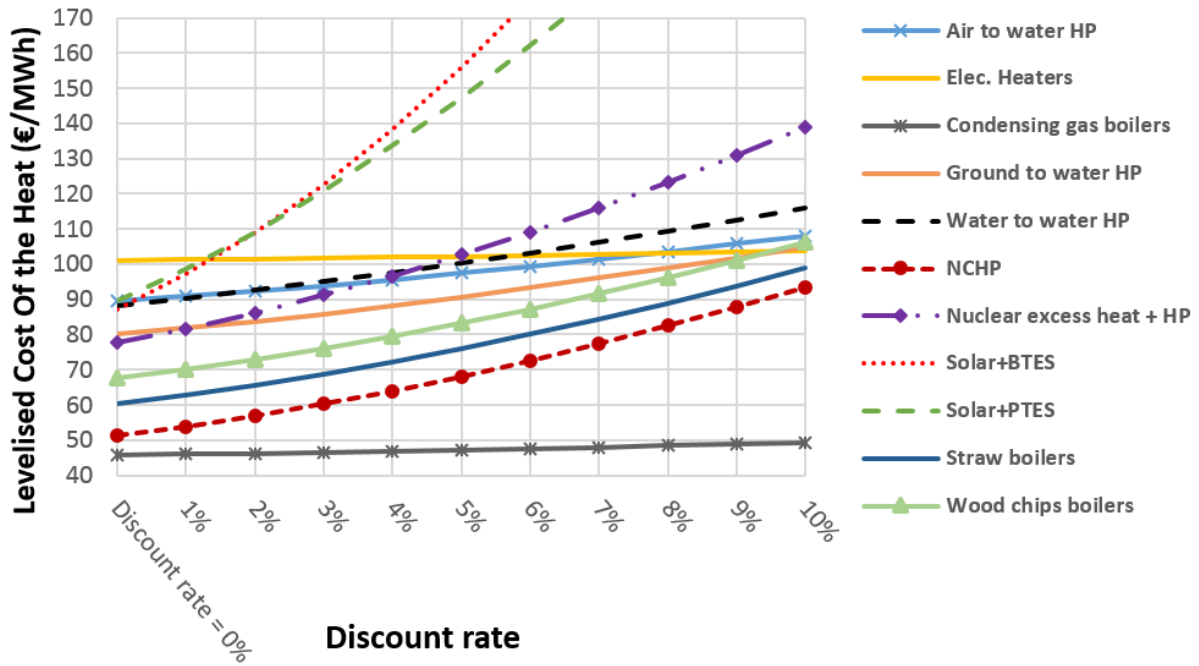

Figure I.3.24: LCOH as a function of discount rates, *ceteris paribus* (see Table I.3.35).

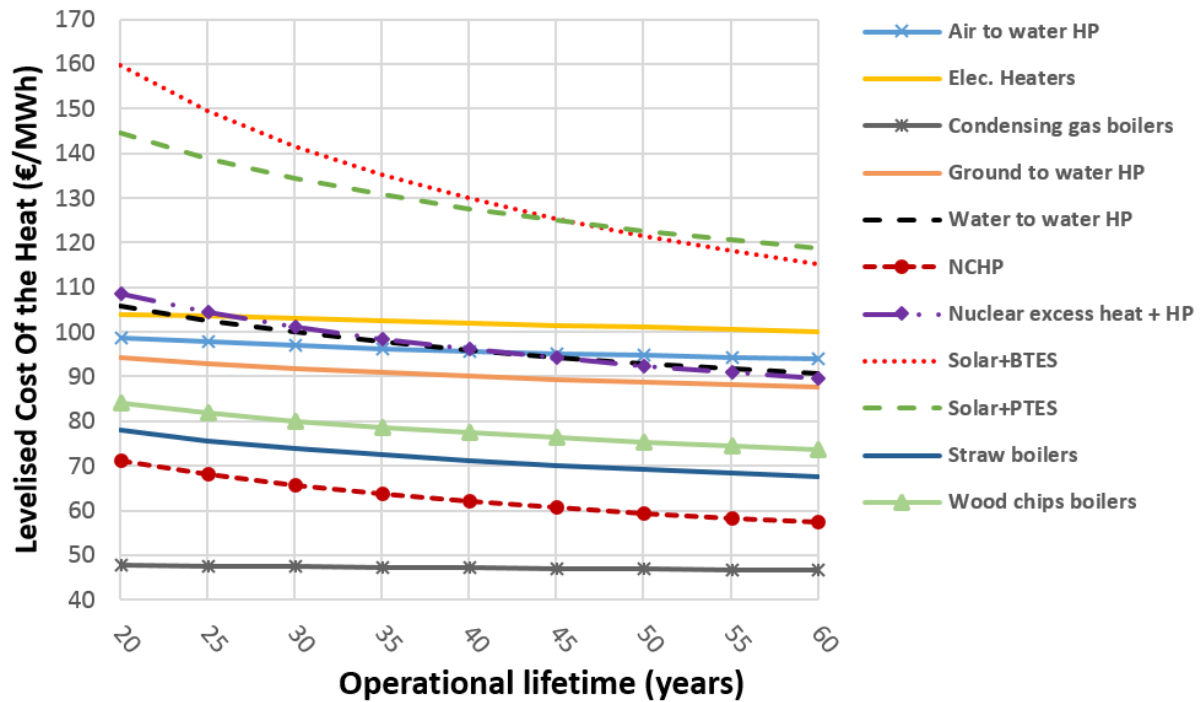

Figure I.3.25: LCOH as a function of operational lifetimes, *ceteris paribus* (see Table I.3.35).

5.1.1.3. LCOH comparison considering three energy price scenario

Sub-section 5.1.1.3 compares the LCOH of heating systems considering different energy price scenario. Public support mechanisms and environmental taxes are still not considered as this is the aim of Section 5.1.2. Scenarios differ with regards to the relative level of energy prices. The first scenario uses the 2015 energy prices (as in the rest of Section 5.1.1). Second and third scenario make assumptions on expected energy prices towards 2030. ADEME (2015) projects energy price dynamics over 2015-2035. The second scenario is based on these assumptions (around 2030). Another plausible future, perhaps one more relevant to the French case, sees electricity prices rising faster than natural

gas prices. The French commission for energy regulation pointed out that electricity costs may increase faster in France due to the necessary investments in infrastructures and generation capacity (CRE, 2014, 2013). The third scenario reflects this possibility. The price assumptions characterizing each scenario are shown in Table I.3.36.

The resulting LCOH are depicted in Figure I.3.26. The LCOH of condensing gas boilers is €4/MWh_{th} lower and €5/MWh_{th} larger than the LCOH of the DH + NCHP system, respectively in Scenario 3 'CRE' and in Scenario 2 'ADEME'. Following the energy price projections made by ADEME and CRE, it seems that the DH + NCHP system will become more attractive in the future. This is because the DH + NCHP system uses relatively little energy for operation, and hence is not very sensitive to the expected increase of energy prices (see Figures I.3.22 and I.3.23).

Parameter	Unit	Scenario 1 '2015'	Scenario 2 'ADEME'	Scenario 3 'CRE'
Natural gas for DH systems	€/MWh _{th}	37	68	60
Natural gas for individual systems	€/MWh _{th}	62	113	101
Straw	€/MWh _{th}	23	30	30
Wood chips	€/MWh _{th}	30	40	40
Electricity for DH systems	€/MWh _e	72	97	117
Electricity for individual systems	€/MWh _e	100	135	163
Opportunity cost of heat generation with NCHP	€/MWh _e	42	57	69

Table I.3.36: Energy price scenario considered in Section 5.1.1.3.

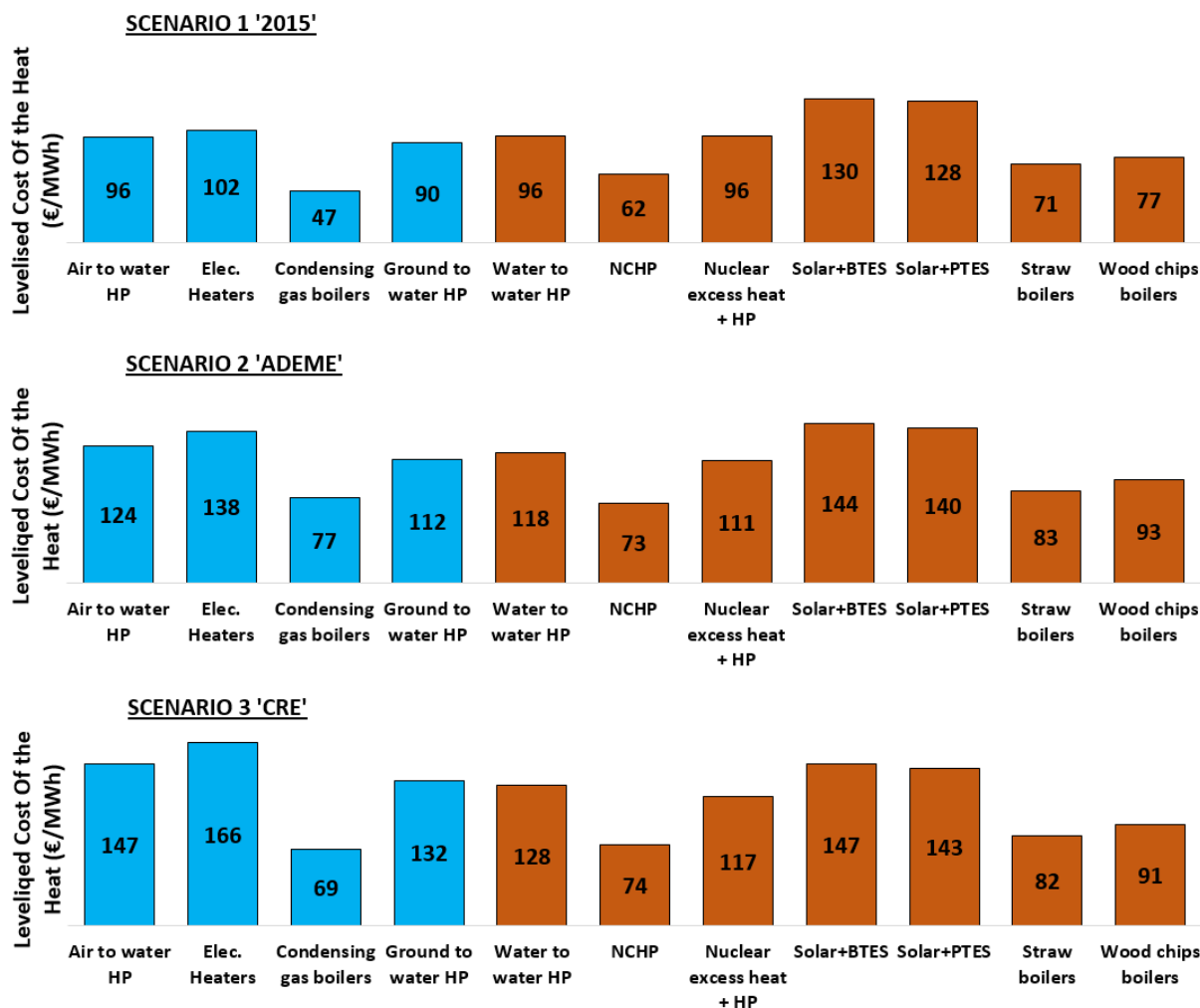

Figure I.3.26: LCOH of heating systems considering energy price scenario shown in Table I.3.36.

Notes:

In Blue: Individual heating systems. In Brown: DH systems.

5.1.2. Payback periods and NPV of DH systems

Sub-section 5.1.2 uses the same parameter values as sub-Section 5.1.1 (and also Chapter 2) with regards to discount rate (3.5%), operational lifetime (40 years) and energy prices ('2015 scenario' of Table I.3.35). Sub-Section 5.1.2 however introduces an additional parameter compared to sub-Section 5.1.1. That is, the price of the heat sold to final DH customer (hereafter referred as DH price). While the DH price impact the output values of payback periods and NPV, it does not enter in the calculation of the LCOH (see Appendix I.2.A).

The average DH prices observed in France is €67/MWh_{th} (2013 prices, see Werner, 2016). The price observed in the existing Dunkirk network is €79/MWh_{th} (Dalkia, 2015). If the historical trend is to be continued (+80% over 2000-2015), DH prices may increase in the future, partly due to the fact that areas with the highest linear heat density were the first covered. It may nonetheless be argued that future DH systems can also gain competitiveness if embracing the 4th generation DH concept (see e.g. Dalla Rosa and Christensen, 2011; Schmidt *et al.*, 2017).

In this Chapter, three DH prices (€70, €80 and €90/MWh_{th}) were considered when calculating payback periods (Figure I.3.27) and NPV (Figure I.3.28) of DH systems. The DH systems with a payback period longer than 40 years are not shown in Figure I.3.27. Given the assumptions made (and under the 2015 energy prices configuration), the payback period and NPV of the DH + NCHP range from 9 to 16 years and from 72 to 259 million euros, respectively.

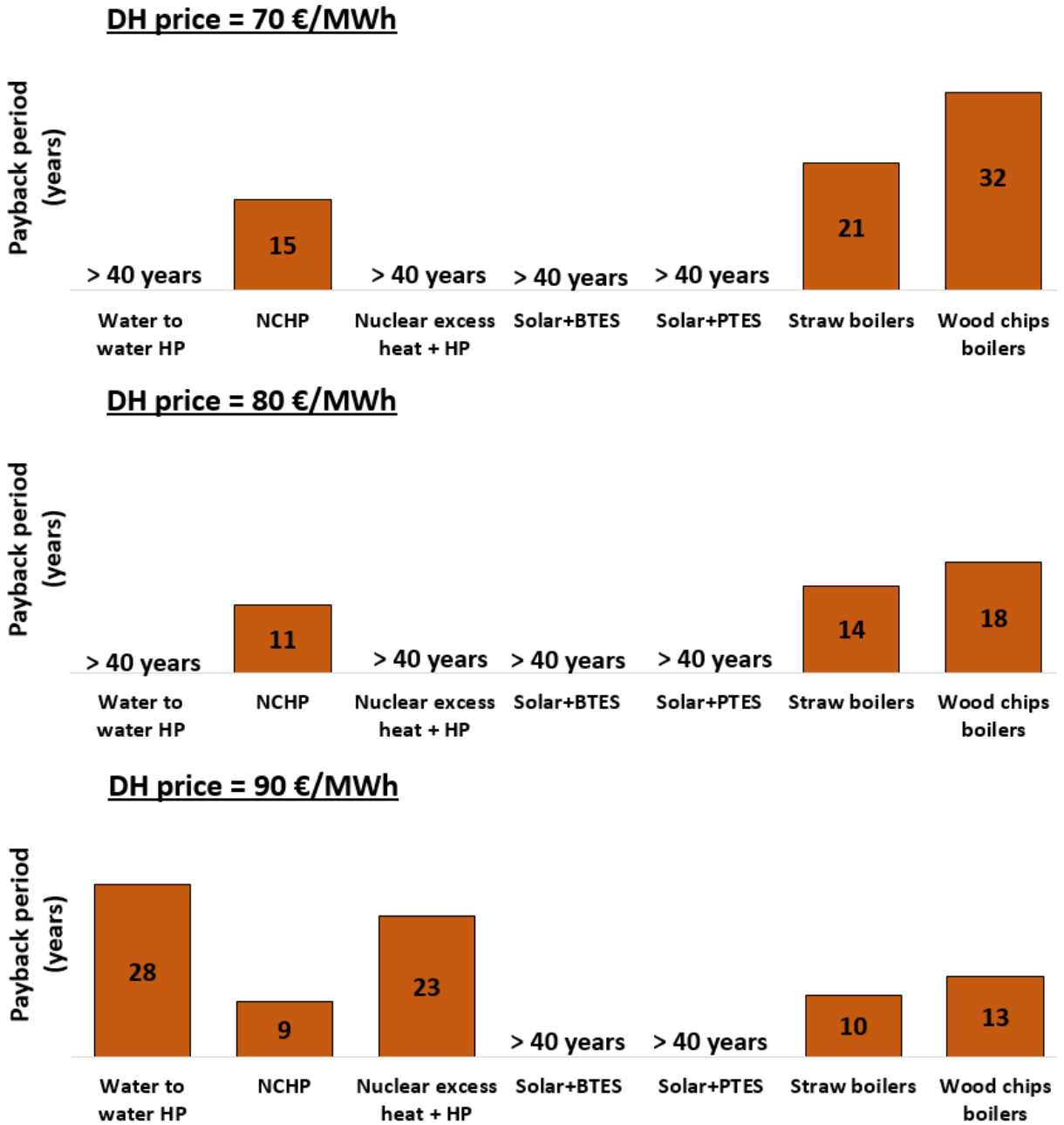

Figure I.3.27: Payback periods of DH systems considering the ‘2015 scenario’ and three different DH price to final consumer.

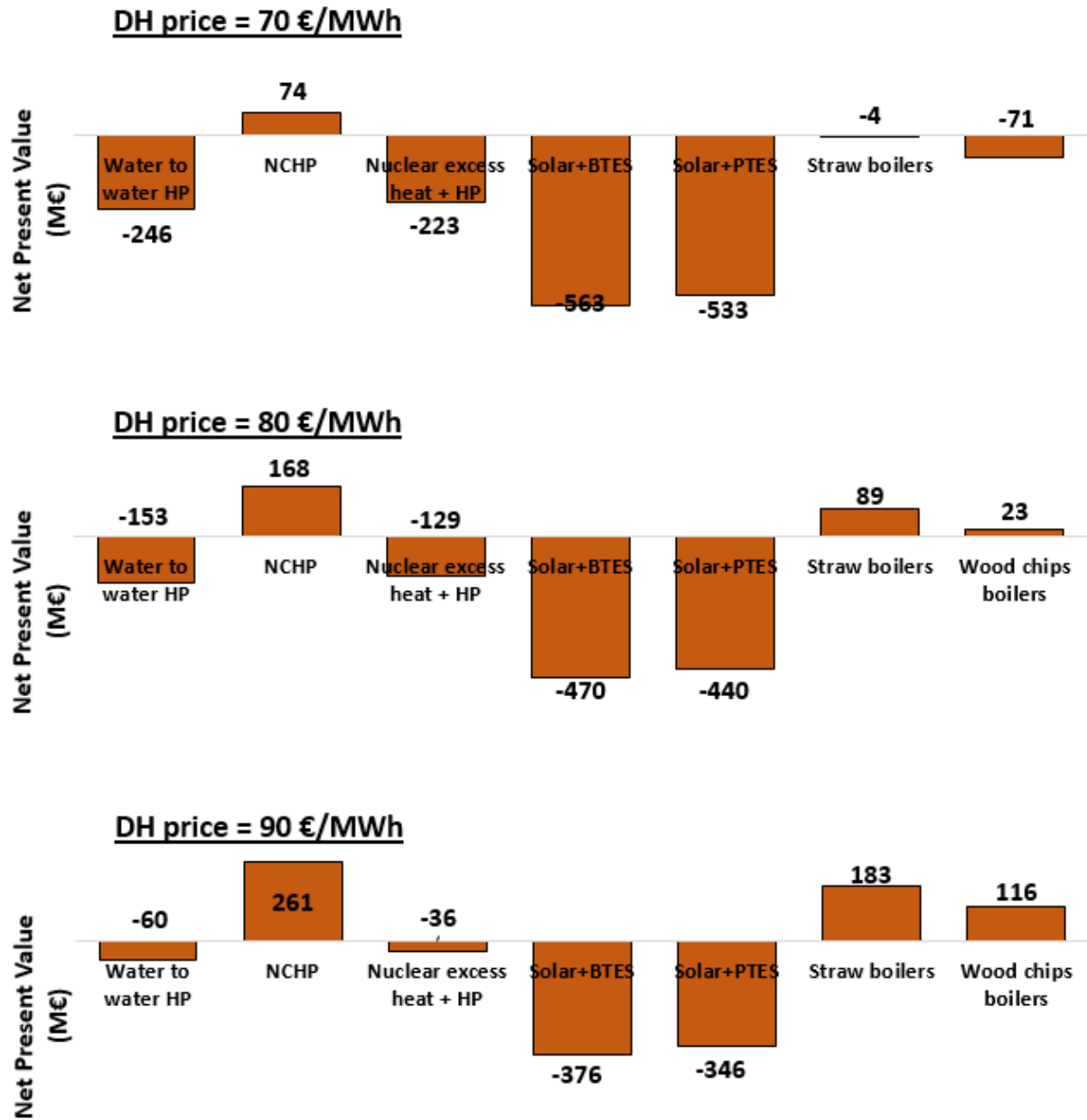

Figure I.3.28: NPV of DH systems considering the ‘2015 scenario’ and three different DH price to final consumer.

5.1.3. Non-economic indicators

Table I.3.37 provides non-economic parameters characterizing heating systems. There is no system that prove to be superior to all other systems whatever is the criterion considered. Table I.3.37 nonetheless allows the readers to weight the pros and cons of heating systems based on their personal preferences, keeping in mind the assumptions that serve to evaluate the mentioned parameters (Section 4). Solar DH systems show good health and climate performances; however they have the greatest impact on the land use. While this Chapter considers a solar fraction of 80% (to be consistent with other DH systems), solar collectors would have better result if targeting a smaller solar fraction, e.g. acting as a complementary renewable source that can be used in summer (without STES).

Biomass HOB imply increased traffic road, which may (or not) give cause for concerns in the community. Biomass HOB emit relatively few GHG but imply large inhalation of PM_{2.5} among the population (human health concerns of biomass HOB would however be reduced if implementing selective catalytic reduction technologies (see 4.1.4.1), more expensive but also more efficient). It must be reminded that there are vivid discussions on the lifecycle GHG emission factors of biomass (as already evocated in Section 4.1.1.5). EC (2014b), citing Searchinger *et al.* (2009) emphasizes that 'there are possible loopholes in the international accounting system for forestry carbon emissions, which may mean that the emissions accounted for underestimate their actual level'. The debate arises from the dual role of forests in climate change mitigation; forests provide a carbon storage and sink, but they can also provide a renewable energy source for replacing fossil fuels. The transformation of forest into biomass products can hence represent additional CO₂ emissions, via the reduction of the CO₂ storage capacity of forests (biogenic carbon). Many factors influence GHG emissions of forest bioenergy due to biogenic carbon, as analysed by Matthews *et al.* (2014). This Chapter uses the GHG emissions factors of wood-chip and straw HOB proposed by the EC (2016); which recommend to use very low values (see 4.1.1.5). It is however recognised that GHG emissions of bioenergy can vary from negligible levels to very significant levels, similar to or larger than GHG emissions of fossil energy sources (Matthews *et al.*, 2014). Great caution is therefore required when projecting the use of bioenergy at a large-scale. Meticulous life cycle analysis must be performed so as to determine, on a case by case basis, what is the most efficient use (or non-use, i.e. conserving or enlarging forests) of the available biomass.

Figure I.3.29 depicts the DALY (disability adjusted years of life lost over the entire operational period of 40 years); see 4.1.4.3) as a function of direct and lifecycle CO₂ emissions (see 4.1.3). It provides a comprehensive comparison of climate and health impact of heating systems. It worth noticing that the NCHP based system would show lower GHG emissions if considering that the extraction of heat in the NCHP is not responsible for the emissions due to the electricity generated for compensating the electricity losses (Appendix I.3.A).

Heating system	Direct and indirect CO ₂ emissions (see 4.1.3) (t eCO ₂ /GWh _{th})	Direct CO ₂ emissions (see 4.1.3) (t CO ₂ /GWh _{th})	Primary and secondary PM _{2.5} inhaled (see 4.1.4) (g/a)	DALY/a (see 4.1.4)	Land surface (see 4.1) (ha)	Traffic road (see 4.1.1.5) (trucks/week)
DH systems						
NCHP	134	76	4	22	0.1	0
NEH + HP	168	136	4	22	0.4	0
HP	197	148	4	22	0.4	0
Straw HOB	111	48	508	14521	0.2	73
Wood chips	98	48	183	6330	0.2	71
Solar + BTES	139	93	4	22	272.2	0
Solar + PTES	135	88	4	22	409.4	0
Individual systems						
Nat. gas	416	201	30	195	0	0
Electrical	260	180	0	0	0	0
Air to w. HP	212	147	0	0	0	0
Brine to w. HP	182	126	0	0	0	0

Table I.3.37: Non-economic indicators characterizing the heating systems.

Notes:

(*) Remind that DH systems all uses natural gas fired HOB, supplying 20% of annual heat loads (see Section 4.1.1.1).

(**) See Appendix I.3.A for an alternative, perhaps more realistic, method for accounting the GHG emissions of the DH + NCHP system.

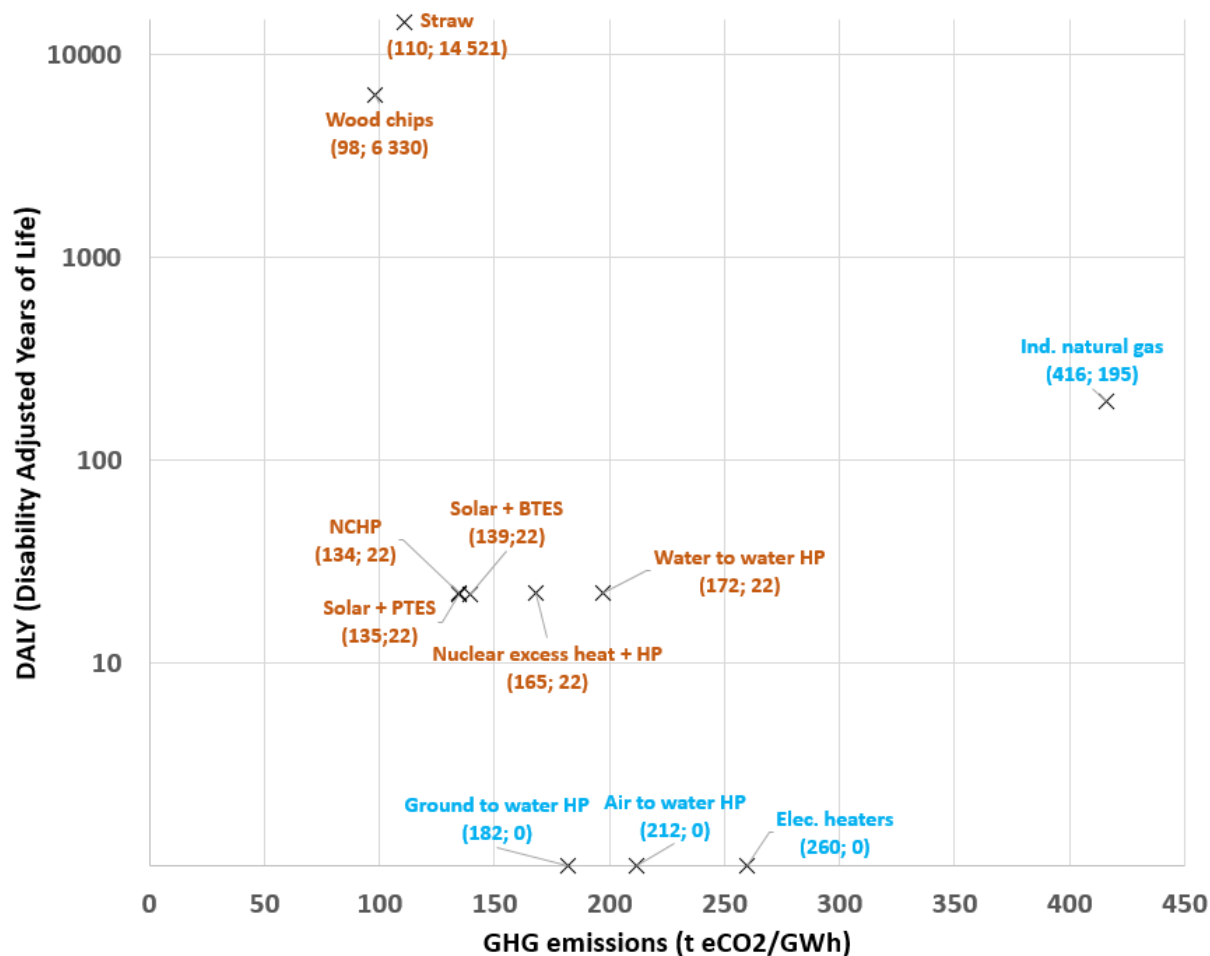

Figure I.3.29: DALY as a function of GHG emissions.

Notes:

(*) In Blue: Individual heating systems. In Brown: DH systems.

(**) See Appendix I.3.A for an alternative, perhaps more realistic, method for accounting the GHG emissions of the DH + NCHP system.

5.2. Plausible impact of public support mechanisms and taxes

Sub-section 5.2.1 shows the change in LCOH when heating systems obtain the maximum plausible amount of subsidies (see Section 4.2.1). Sub-Section 5.2.2 then studies the impact of carbon taxation on relative LCOH (see 4.2.2). Sub-Section 5.2.3 finally focuses on the LCOH variations that could occur if the emission (or inhalation) of particulate matter is taxed.

Throughout sub-Section 5.2, the usual parameter values are used for the discount rate (3.5%) and operational lifetime (40 years). If not specified, the energy price assumptions are those of the '2015 scenario' (see Table I.3.35).

5.2.1. Public subsidies (only subsidies; neither GHG nor air pollutants taxation are included)

Figure I.3.30 shows the maximum amount of public subsidies (as a percent of total capital costs) that heating systems could get under the current regulatory framework (described in Section 4.2.1). Subsidies provided by the 'Fonds Chaleur' for the implementation of the DH distribution network could represent up to 118 million euros. If the investment required for the implementation of the DH distribution system is equally distributed over the period 2020-2030, the 'Fonds Chaleur' could provide up to 11.8 M€/a (5-6% of the annual envelop of ADEME), allowing the construction of 21.7km pipes a year (7-8% of the total length of DH pipelines subsidized each year overall France).

Figure I.3.31 shows the LCOH when heating systems obtain the maximum plausible amount of subsidies, considering the energy scenario shown in Table I.3.36. The DH + NCHP system has the lowest LCOH in scenario 2 and 3. The LCOH of condensing gas boilers however remains €8/MWh_{th} lower in scenario 1 (without GHG taxation; GHG taxation is introduced in Sub-Section 5.2.2). This is partly due to the fact that condensing gas boilers can benefit from credit tax representing 30% of the investment. While condensing gas boilers emit less particulate matters than traditional gas boilers, their direct and lifecycle emissions remain stable (DEA, 2013). Providing tax credit to individual natural gas boilers can prevent the implementation of low carbon heating systems such as DH systems or HP which would otherwise have been more attractive. Between 2005 and 2008, this measure cost about 7.8 billion euros to France, without any fruitful impact (Charlier, 2015). We hence argue that it should be removed.

The limitations inherent to the study of public support mechanisms should be emphasized. Public support mechanisms can be precarious and variable (e.g. call for projects for solar installations, STES, HP are currently being discussed). French DH systems have benefited from the 'Fonds Chaleur' since 2009, and this has participated in the uptake of renewable and excess heat sources from 7.9 TWh_{th}/a in 2009 to 13.8 TWh_{th}/a in 2017 (SNCU, 2017). The 2018 financial Act has however planned to put the upper limit of 200 M€, going back on the promise of doubling the fund. The 2018 financial Act also offer the possibility to split the financial help to projects above 2M€ in two parts, direct subsidies and reimbursable advances. E.g. instead of getting 2M€ of subsidies, a DH project would gain 1.4 M€, plus 0.6 M€ which must be reimbursed if the adequate conditions are fulfilled, i.e. if the Dh system is correctly implemented and if the competitiveness is guaranteed regarding natural gas prices (ADEME, 2018). Several DH actors such as AMORCE (2017) however pointed out the inability of this scheme to help achieving the national DH target of 39 TWh_{th}/a (multiplication by 3 compare to 2017) renewable or excess DH sources. An underlying controversy is whether or not reimbursable advances will totally replace direct subsidies in the medium run. Another recent evolution of the French DH support schemes is the recognition of the potential of district cooling and solar DH systems (which do not benefit of the reduced 5.5% added value taxation yet). These debates highlight the potential variability of future support mechanisms, which should be followed carefully so as to evaluate their impact on the cost effectiveness of the diverse plausible heating decarbonisation pathways.

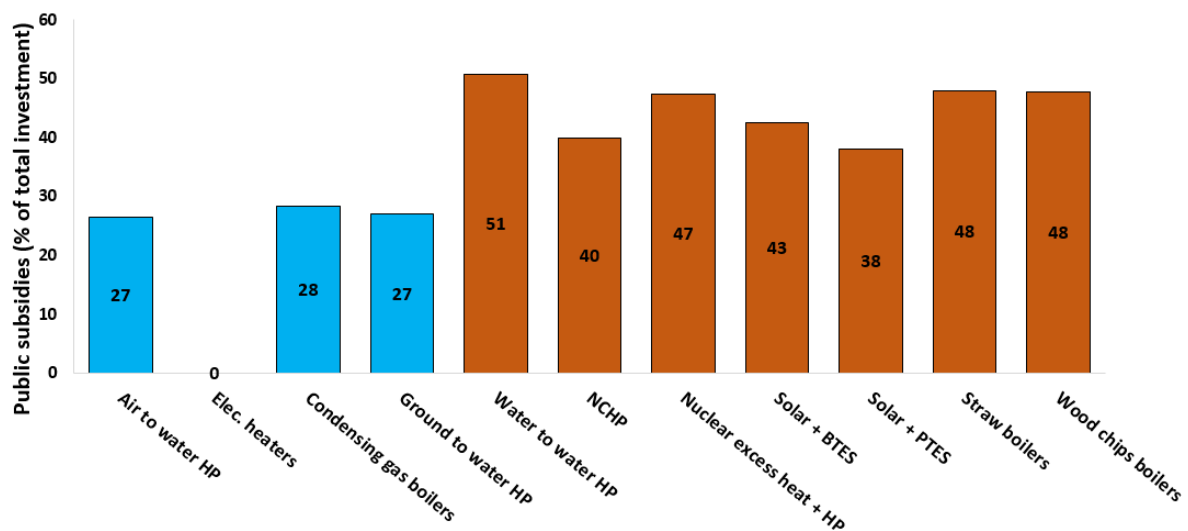

Figure I.3.30: Maximum amount (% of capital costs) of public subsidies that heating systems could get (see sub-section 4.2.1 for a description of public support mechanisms and Figure I.3.12 for the value of capital costs).

Notes:

In Blue: Individual heating systems. In Brown: DH systems.

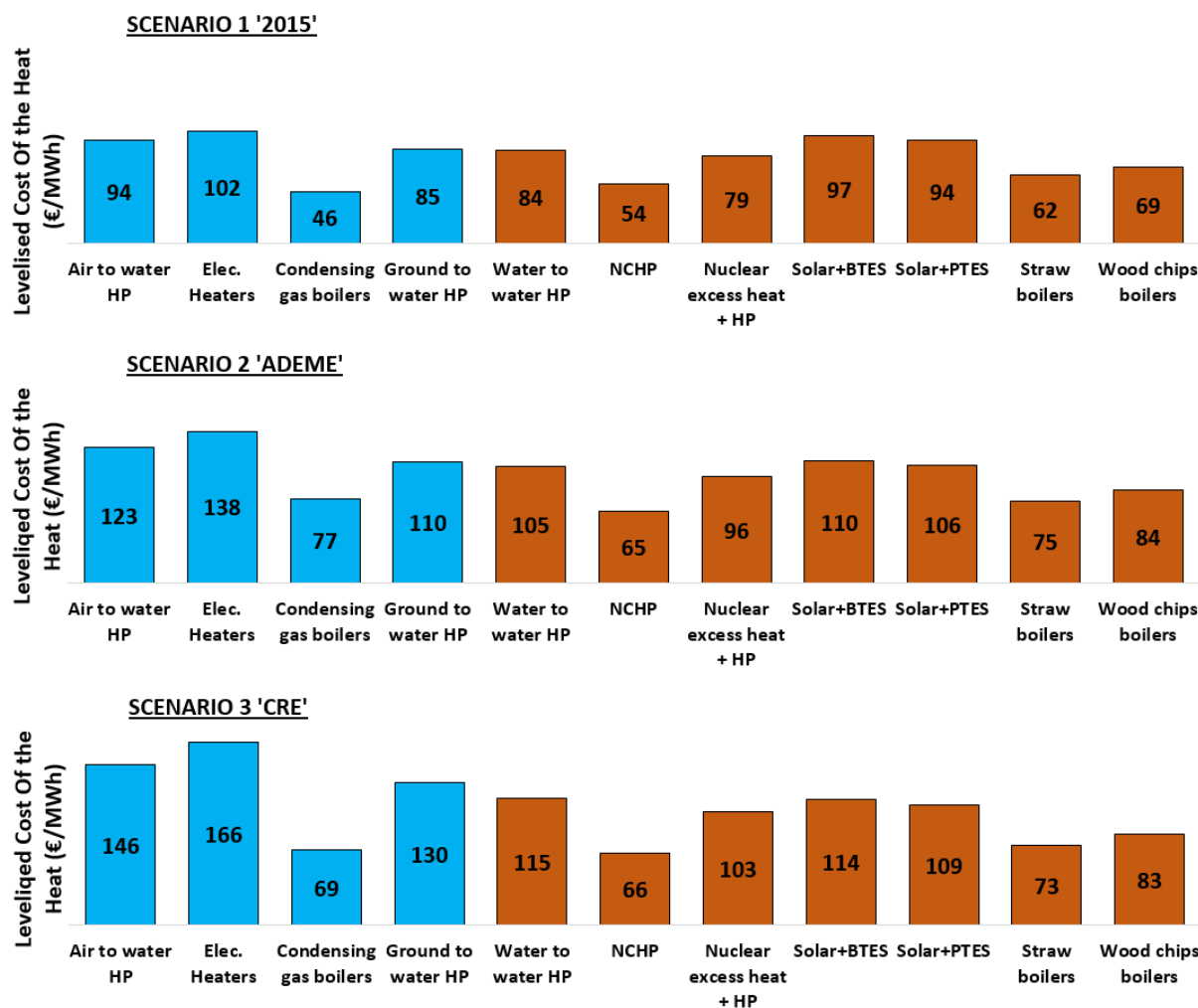

Figure I.3.31: LCOH of heating systems when the maximum amount of public subsidies (see Figure I.3.30) is obtained. Energy price scenario are shown in Table I.3.36.

Notes:

In Blue: Individual heating systems. In Brown: DH systems.

5.2.2. Climate policies (only GHG taxation; no subsidies nor air pollutants taxation)

The 2015 French Act on the energy transition and green growth (LTECV) targeted the setting up of a carbon taxation of €56/t CO₂ and €100/t CO₂ by 2020 and 2030, respectively (*Ministère de l'environnement, de l'énergie et de la mer*, 2015). The 2018 finance law is even more ambitious with regards to the 2022 target (€86.2/tCO₂), but do not fix any objective towards 2030 (*Assemblée nationale*, 2017). Sub-Section 5.2.2 shows the sensitivity of LCOH to the variations of carbon taxation considering:

- Direct CO₂ emissions only (see Figure I.3.32). This is the approach usually followed by public authorities, and the CO₂ emission factor here used are those imposed by French authorities when evaluating CO₂ emission of DH systems (see Section 4.1.3);
- Direct and indirect GHG emissions (see Figure I.3.33). This approach accounts for the GHG emitted overall the lifecycle of heating systems (see Section 4.1.3).

Under our assumptions, a CO₂ price of €100/t CO₂ would reduce the LCOH difference between the DH + NCHP system and condensing gas boilers to only €3/MWh_{th} (2015 energy prices). Given that energy prices are expected to rise in the future, and that the DH + NCHP system is less sensitive to these variations (see Figures I.3.22 and I.3.23), the French climate policies, if correctly implemented, could be a game changer for DH + NCHP systems. Figure I.3.33 shows that the competitiveness gained

by DH systems when introducing a carbon price would be much larger if indirect emissions are also taxed. E.g. A carbon price of €55/t eCO₂ would be sufficient to make the DH + NCHP system more cost-effective than condensing gas boilers, and this even with the low 2015 energy prices. This is because the lifecycle emissions of natural gas equal to more than the double of the direct emissions (see Section 4.1.3); lifecycle emissions are due to extraction and production of gas, and transport-related activities (IPCC, 2006).

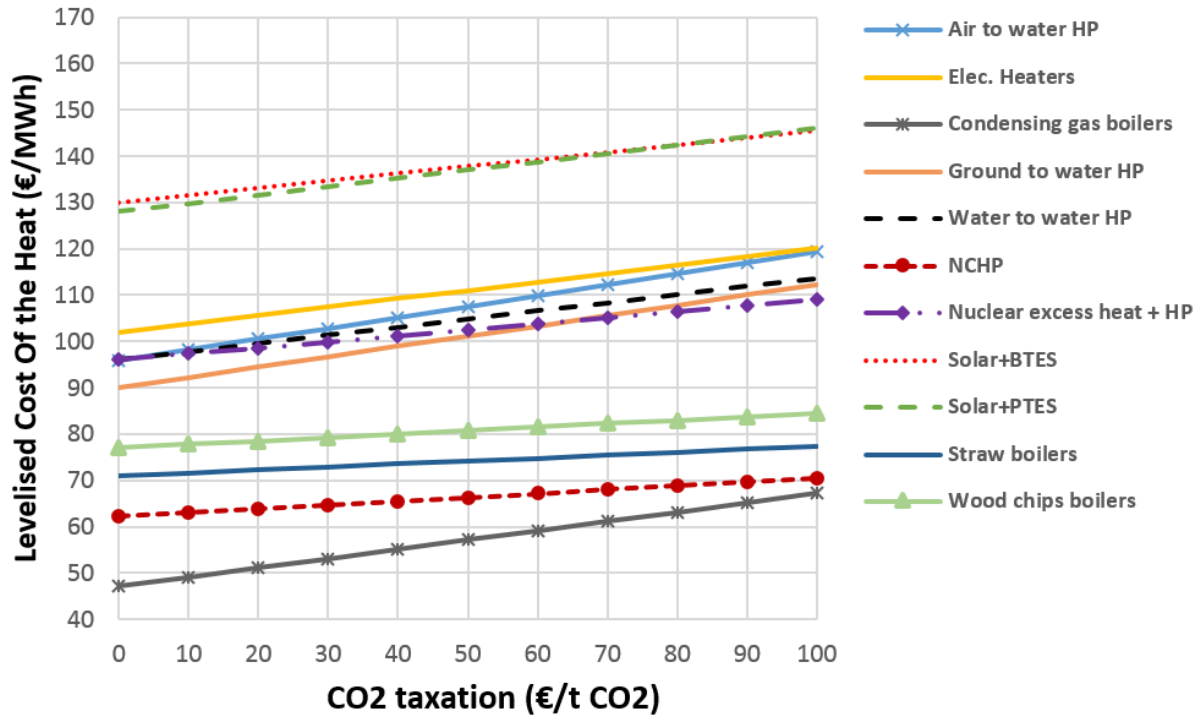

Figure I.3.32: LCOH as functions of CO₂ taxation (direct CO₂ emissions, see 4.1.3).

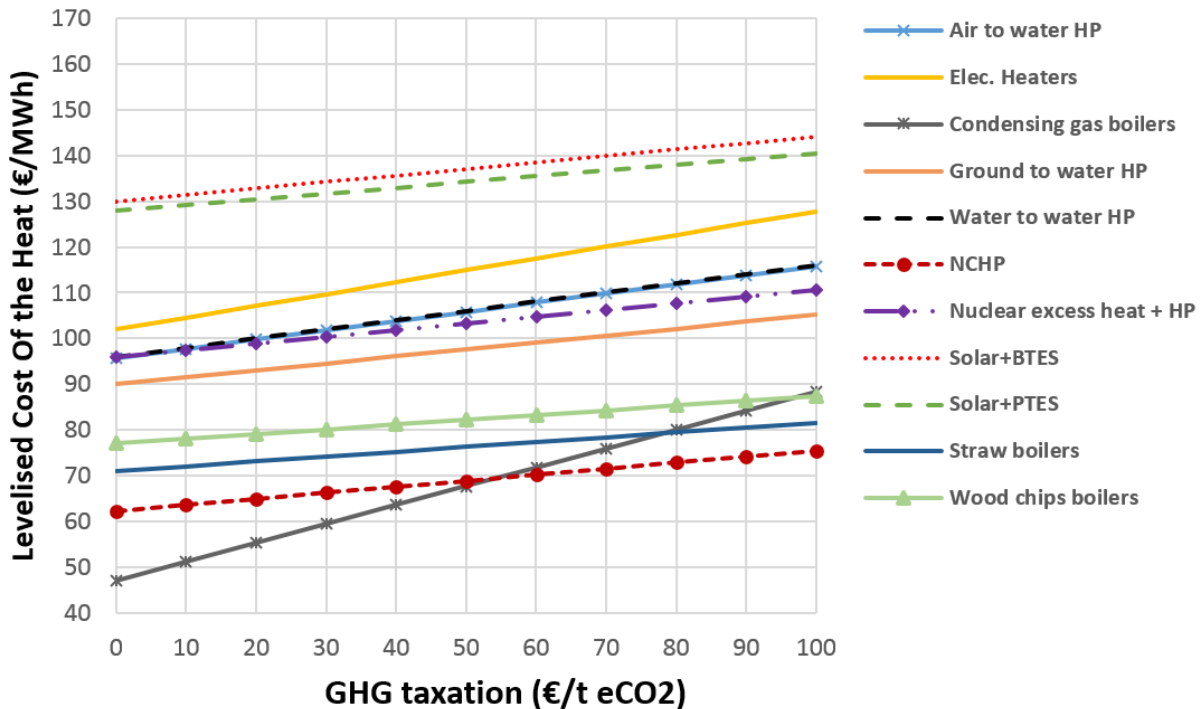

Figure I.3.33: LCOH as functions of GHG taxation (direct and lifecycle CO₂ emissions, see 4.1.3).

5.2.3. Public health policies (only air pollutant taxation; no subsidies nor GHG taxation)

Two approaches are adopted to give monetary values to the negative externalities generated by the emissions of air pollutants (human health only; see Section 4.1.4.1):

- The social cost approach. Including the social cost shown in sub-section 4.1.4.2 changes the LCOH. The LCOH increase (€/MWh_{th}) are shown in Figure I.3.34. The rise is relatively high for biomass HOB, but is negligible for other systems.
- The Years of Life Lost (YLL) approach. The sensitivity of LCOH to the variation of human life pricing (see 4.1.4.3 for methods) is stressed in Figure I.3.35. It confirms the findings obtained following the social cost approach. Exception being the biomass HOB (which are equipped with selective non catalytic reduction technologies such as cyclones; see 4.1.4.1), the impact of human life pricing on the LCOH is negligible. The impact of air pollutants on human health costs about €2/MWh_{th} for straw boilers when a human life is priced at 2.5 M€, while this cost is of €4.1/MWh_{th} under the social cost approach, which also assumed a human life pricing of 2.5 M€. This difference reminds us the importance of being cautious when interpreting results from the modelling of complex phenomenon.

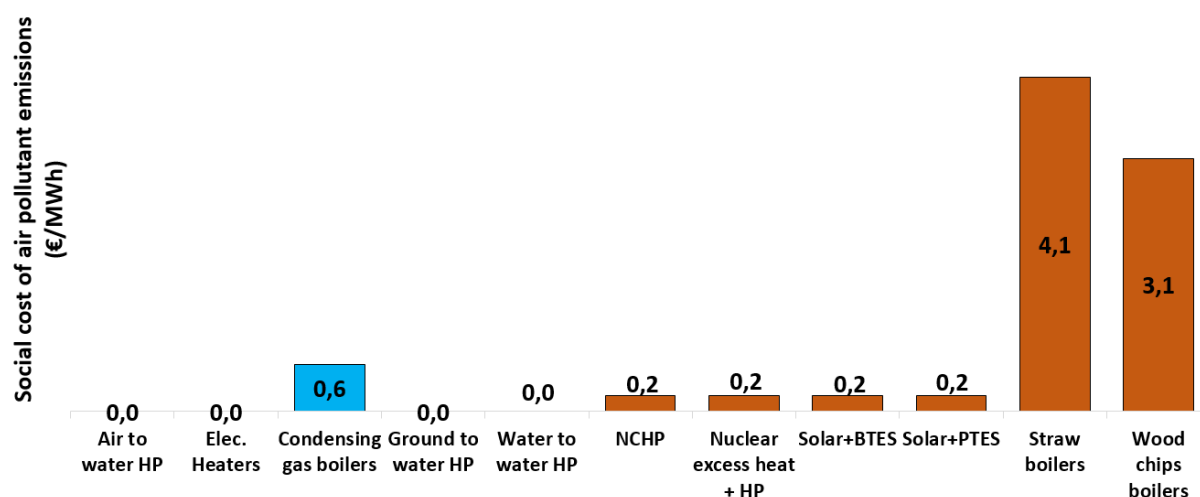

Figure I.3.34: LCOH increase when accounting for the social cost of air pollutants (see Section 4.1.4.2 for methods).

Notes:

In Blue: Individual heating systems. In Brown: DH systems.

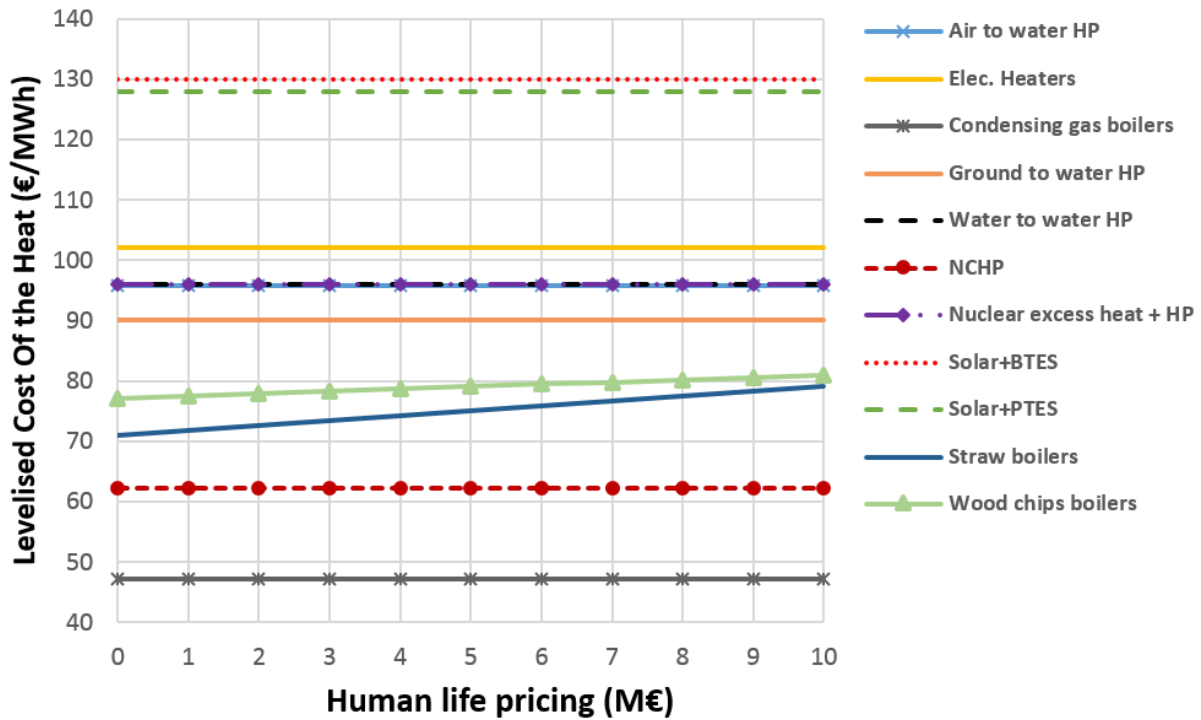

Figure I.3.35: LCOH as functions of human life pricing (see Section 4.1.4.3 for methods).

5.3. Buildings renovation (without public subsidies nor air pollutants taxation; but GHG taxation is introduced)

Sub-Section 5.3.1 compares the costs and benefits of building renovation to the cost and benefits of heating systems. Sub-Section 5.3.2 then analyses the changes that would affect the heating systems if designed to supply buildings with higher efficiency.

5.3.1. Cost and benefits of renovating buildings

Figure I.3.36 compares the levelised cost of heat savings achieved through shallow and complete renovation (see sub-Section 4.3.1.1 for methods) to the LCOH of heating systems implemented to supply the existing buildings stock. To be consistent with the rest of the Chapter, the lifetime considered is 40 years, the discount rate is 3.5% and the energy prices are those of scenario 1 '2015' (see Table I.3.35). Figure I.3.36 shows that building renovation is not attractive from a purely economic perspective. The economic performance of renovation would be larger if considering a lifetime longer than 40 years. The impact is however negligible if a discount rate of 3.5% is still applied. Figure I.3.37 shows the comparison considering a 40 years lifetime and a discount rate of 0%. When present and future costs and benefits are given the same value, complete renovation competes with certain heating systems (Solar PTES and electrical heaters), but remains twice more expensive than the most competitive heating systems (condensing gas boilers and NCHP). Figures I.3.36 and I.3.37 also suggest that, if the decision of renovating buildings is taken, then it is more cost-effective (in a levelised approach) to perform a complete renovation rather than a shallow renovation. It should however be reminded that a thorough building's retrofit evaluation is quite difficult to undertake, because a building and its environment are complex systems regarding technical, technological, ecological, social, comfort, esthetical, and other aspects. Besides, there are technical limitations to the real implementation of buildings with such a low energy demand ($40 \text{ kWh}_{\text{th}}/\text{m}^2 \cdot \text{a}$), as emphasized by e.g. Kaklauskas *et al.* (2005) or Soares *et al.* (2017). Following the study of UFC-Que Choisir (2016) for France, it seems reasonable to expect real costs (without taxes) 50% to 100% higher than what has been assumed in this Chapter (see Section 4.3.1.3).

Figure I.3.38 depicts the sensitivity of the levelised costs to the variation of direct and indirect GHG prices, considering a 0% discount rate. Despite the advantage that offer building renovation with regards to GHG emissions, the levelised cost of the heat saved through complete renovation becomes lower than the LCOH of condensing gas boilers only when the GHG taxation reach €150/t eCO₂. Competitiveness with the DH + NCHP system is not reached even when the GHG taxation is as high as €300/t eCO₂. While building renovation is not economically competitive in the studied area, the fact remains that it allows the savings of approximately 195 000 t eCO₂/a compare to the case in which condensing gas boilers are implemented without any renovation. Improving the building efficiency must be one of the climate objective pursued by governments. Broad targets can however generates side-effects such as a distrust in the long term potential of DH systems, which often represent a cost-efficient decarbonisation alternative in urban areas. Policy makers should focus on defining objectives specific to each area, considering local specificities in terms of density and availability of low carbon heat sources.

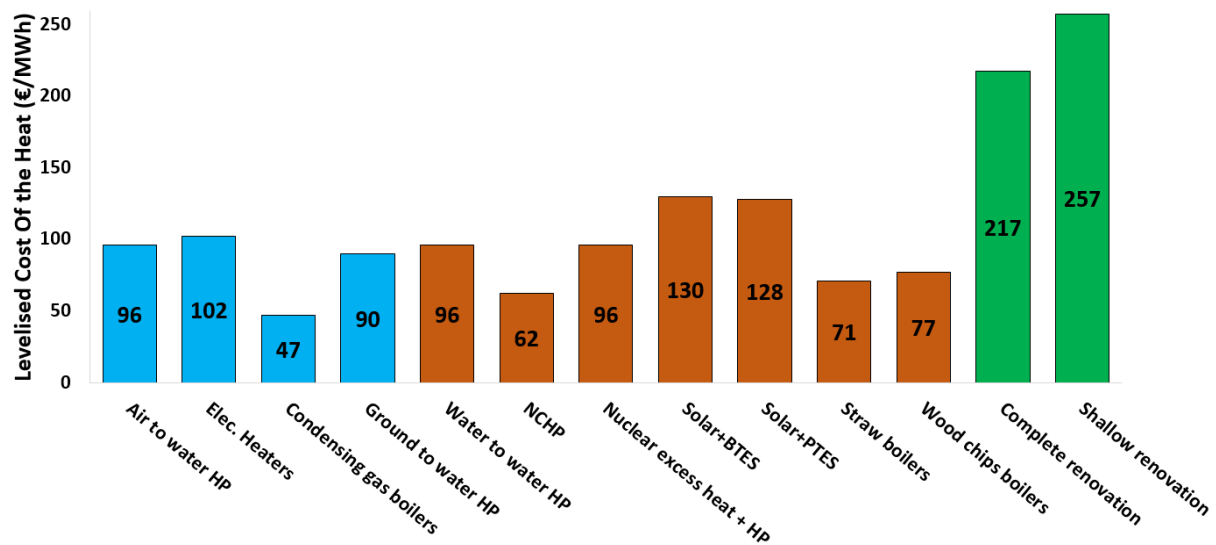

Figure I.3.36: Comparison of the levelised cost of renovation with the levelised cost of heating systems, considering a discount rate of 3.5%.

Notes:

(*) In Blue: Individual heating systems. In Brown: DH systems. In Green: Buildings renovation.

(**) The readers should keep in mind that the costs assumptions for renovating buildings are optimistic. Following the study of UFC-Que Choisir (2016), it seems reasonable to expect real costs (without taxes) 50% to 100% higher. Please refer to Section 4.3.1.3 for further discussions on this topic.

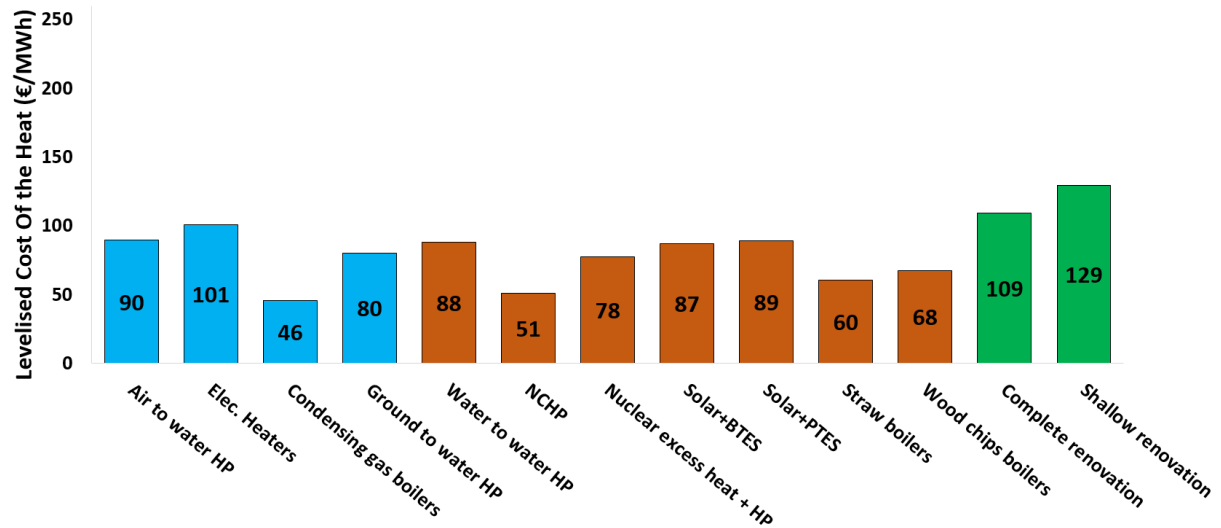

Figure I.3.37: Comparison of the levelised cost of renovation with the levelised cost of heating systems, considering a discount rate of 0%.

Notes:

(*) In Blue: Individual heating systems. In Brown: DH systems. In Green: Buildings renovation.

(**) The readers should keep in mind that the costs assumptions for renovating buildings are optimistic. Following the study of UFC-Que Choisir (2016), it seems reasonable to expect real costs (without taxes) 50% to 100% higher. Please refer to Section 4.3.1.3 for further discussions on this topic.

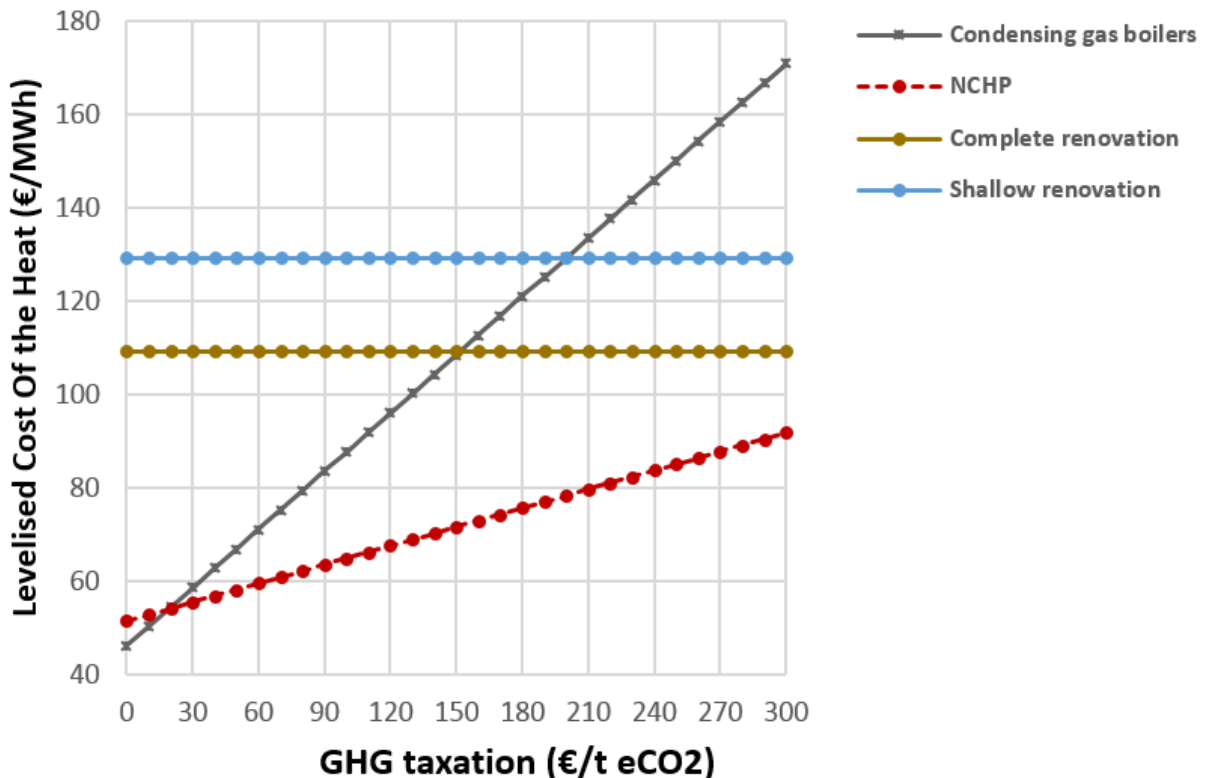

Figure I.3.38: Levelised costs as functions of lifecycle CO₂ price, considering a 0% discount rate.

Notes:

(*) For the ease of the reading, only the LCOH of the most competitive systems are shown.

(**) The readers should keep in mind that the costs assumptions for renovating buildings are optimistic. Following the study of UFC-Que Choisir (2016), it seems reasonable to expect real costs (without taxes) 50% to 100% higher. Please refer to Section 4.3.1.3 for further discussions on this topic.

5.3.2. The impact of building renovation on heating systems

Future buildings will have better energy performance than existing buildings. The time horizon upon which this will have a real impact on DH systems is however uncertain. In the business-as-usual scenario which see the existing building stock being renovated at a rate of 1% per year (Chirat and Denisart, 2016), an average consumption of 40 kWh_{th}/m².a would not be reached before 2100. A decrease by 20-30% in 2050 compare to 2015 is a reasonable assumption for France. The impact on the relative competitiveness of the heating systems worth to be analysed anyway.

The design of a DH distribution system depends on the temperature requirements on the secondary side (heat distribution infrastructure within buildings). This vary according to the temperature needed in the radiators of end-users, itself determined by the level of building insulation. Table I.3.38 depicts the parameter values of DH distribution systems designed to satisfy different building performance. As explained in sub-Section 4.3.2.1, these estimations are based on real data on the current DH network of Dunkirk. The output parameters that change are:

- **The average linear heat density** (MWh_{th}/m.a). It decreases when the energy performance of buildings increase, negatively affecting the competitiveness of DH systems;
- **The average pipe diameter** (mm). The decrease in linear heat density leads to a reduction in pipe diameters. The pipe diameter is also affected by the difference between supply and return temperatures (ΔT). The greater the ΔT the smaller the diameter is, and so are the capital costs. While the current Dunkirk network has a relatively low ΔT (=20), newly built (or retrofitted) network could have a greater ΔT , and this even when supplying the existing building stock.
- **The heat losses** (%/a). They are negatively affected by an increase in the ΔT and positively impacted by a decrease in the linear heat density. In the case of shallowly renovated buildings, the negative correlation with the width of the ΔT compensates the positive correlation with the linear heat density. As a result, the DH distribution network has lower heat losses. In the case of completely renovated buildings, heat losses are yet higher than in the current DH system.

Parameter	Existing buildings (133 kWh _{th} /m ² .a)	Shallowly renovated buildings (96 kWh _{th} /m ² .a)	Completely renovated buildings (40 kWh _{th} /m ² .a)	Reference and comment
Supply/return temperatures (°C) (for DH systems only; maximal temperatures)	100/80 °C	70/35 °C	55/25 °C	See 4.3.2
Total land surface (km ²)	16	16	16	See 4.3.2
Annual heat demand (GWh _{th} /a)	673	486	202	See 4.3.2
Average linear heat density (MWh _{th} /m.a)	3.1	2.2	0.9	See 4.1.1.1
Network length (km)	217	217	217	See 4.1.1.1
Heat losses (%/a)	11.4%	8.9%	14.2%	See 4.3.2.1
Average pipe diameter (mm)	120	80	60	See 4.1.1.1
Capital cost (€/m)	917	790	738	All included; see 4.1.1.1

Table I.3.38: DH distribution systems designed to satisfy buildings with different energy performances.

Figures I.3.39 and I.3.40 show the LCOH of heating systems when designed to supply shallowly renovated and completely renovated buildings, respectively. Computations are made considering 3.5%

discount rate, 40 years operational lifetime and 2015 energy prices (see Table I.3.35), and hence can be compared with the results presented in e.g. sub-Section 5.1.1, 5.2 or 5.3.1. The competitiveness of DH systems relative to individual heating systems is reduced in both cases. When buildings are shallowly renovated (i.e. reduction of building consumption by 28%; could be achieved towards 2050), the DH + NCHP system however remains attractive, especially when considering that, at that time, energy prices should be higher than in 2015 and that the DH + NCHP system is the less sensitive to these variations (see Section 5.1.1). Also, the GHG emissions taxation should be significantly higher than in 2015. Figure I.3.40 however shows that it would not be cost-efficient to supply the Dunkirk area with a DH system when the building consumption is reduced by 70% (perhaps possible towards 2100). In this case, the system that shows the best compromise between GHG emissions and heating cost may be individual HP. When analyzing these results, it should be kept in mind that significant uncertainty is at stake when projecting technologies and costs towards such long term horizons.

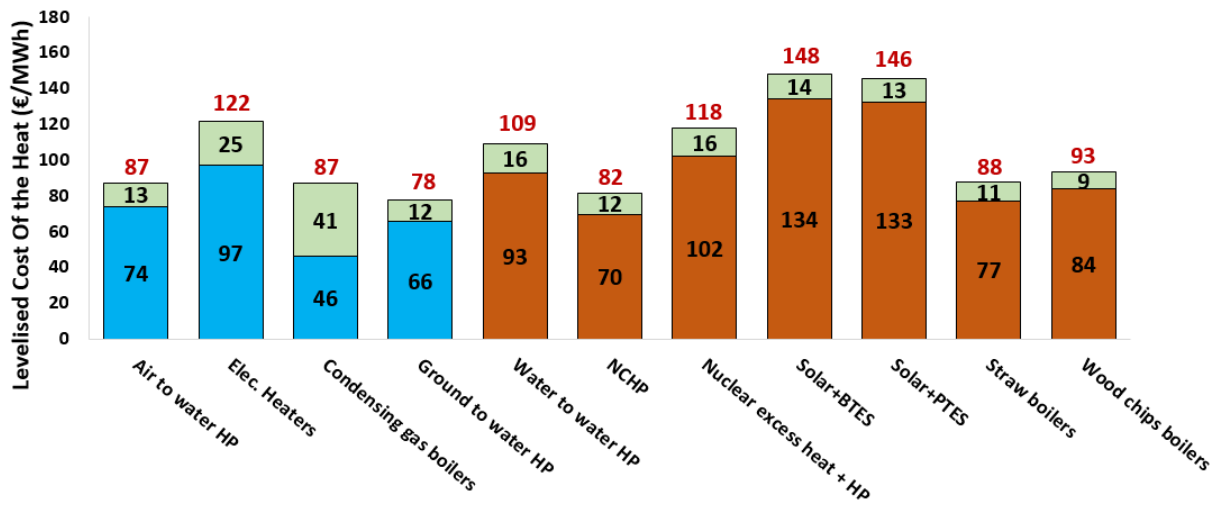

Figure I.3.39: LCOH of heating systems designed to supply shallowly renovated buildings. The carbon taxation concerns both direct and indirect CO₂ emissions.

Notes:

In Blue: Individual heating systems. In Brown: DH systems.

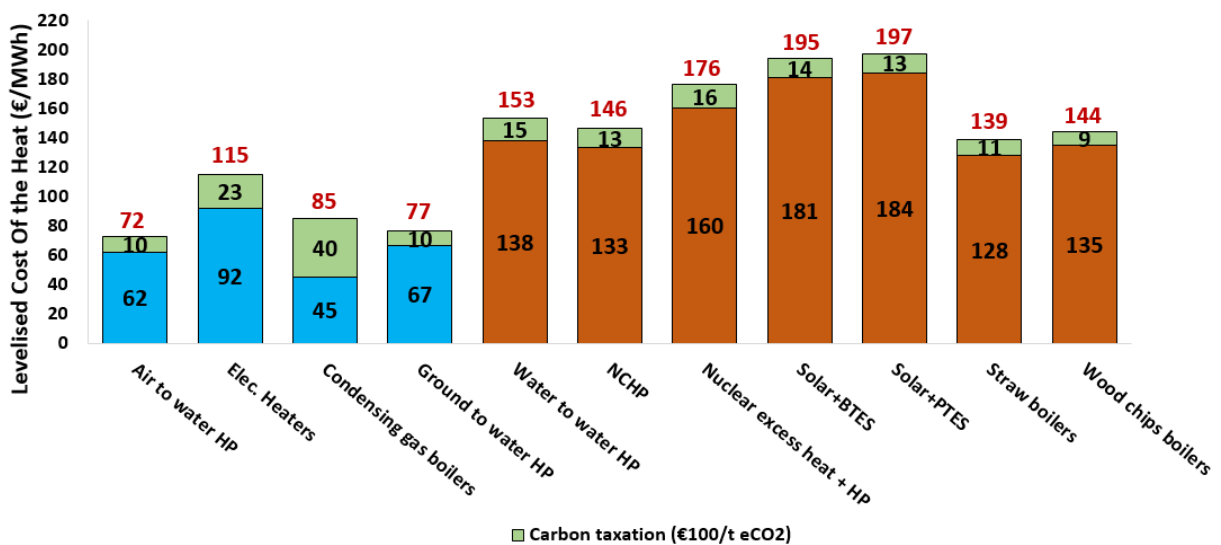

Figure I.3.40: LCOH of heating systems designed to supply completely renovated buildings. The carbon taxation concerns both direct and indirect CO₂ emissions.

Notes:

In Blue: Individual heating systems. In Brown: DH systems.

6. Conclusion

This Chapter analyses the heat decarbonisation pathways that could be followed in the French urban area of Dunkirk. The paper is decomposed into three incremental steps. Each step aims to answer one research question identified in Section 2. Steps 2 and 3 make use of the results from or the assumptions made in the previous step(s).

In step 1, the costs and benefits of eleven different heating systems designed to supply the existing building stock of the Dunkirk urban area are evaluated. Accurate data on the existing DH network is used. When energy prices are those of 2015, implementing a nuclear combined heat and power plant (NCHP) on the Gravelines nuclear site, transporting the hot water over 15km and distributing the heat through a newly built district heating (DH) network would result in a levelised cost of the heat (LCOH) of €62/MWh_{th}, i.e. €15/MWh_{th} higher than the cheapest option, individual condensing gas boilers. The DH + NCHP system is however less sensitive to the variations of energy prices and carbon taxation, which are expected to rise in the future. The DH + NCHP system has other relative advantages such as minor land surface requirement (especially compare to solar DH systems), low greenhouse gases (GHG) and air pollutants emissions.

Step 2 assesses plausible impacts of public support mechanisms and taxes on the relative competitiveness of heating systems (public support mechanisms could however change in a near future). When the heating systems benefit from the highest possible amount of public subsidies, the DH + NCHP system has the lowest LCOH in two energy price scenario over three. Individual condensing gas boilers, despite emitting a large amount of GHG (especially indirect emissions), can benefit from a tax credit of 30%. This can prevent the implementation of low carbon heating systems which would otherwise be more attractive, and is ineffective in the French context (Charlier, 2015). French authorities are willing to implement a carbon taxation of €86.2/tCO₂ by 2022 and €100/tCO₂ by 2030. Doing so would considerably increase the competitiveness of low carbon heating systems. When the carbon price is €100/t CO₂, the DH + NCHP system is more attractive than individual condensing gas boilers, and this even if natural gas prices remain low (€37/MWh_{th}). Step 2 also considers the negative health externalities generated by the emission of air pollutants (SO₂, NO_x and PM_{2.5}). Giving a monetary value to these emissions (e.g. 2-10 M€ for a human life) can discard biomass heat-only boilers equipped with non-selective catalytic reduction technologies. Implementing selective catalytic reduction technologies would reduce the air pollutant emissions of biomass boilers to almost nil but is more expensive (not assessed in this Chapter yet). The monetary valuation of air pollutant emissions has little impact on the LCOH of other heating systems.

In step 3, the possibility of reducing the energy consumption of the area by retrofitting buildings is studied. The levelised cost of heat savings achieved by renovating buildings is assessed and compared to the LCOH of heating systems. In the case here studied, DH systems allow to cut down GHG emissions at lower cost. Even if present and future costs and benefits are set on an equal footing (discount rate of 0%), the levelised cost of heat savings is twice higher than the LCOH of the DH + NCHP system. In the long run, lower building consumption will nonetheless affect the competitiveness of DH systems. Step 3 evaluates both the negative (decreased linear heat density) and positive (reduced pipeline diameter and, under certain conditions, heat losses) impacts that the lower temperature requirements of buildings could have on heating systems. Given our assumptions, the competitiveness of DH systems relative to individual systems would be jeopardized when the reduction of buildings consumption exceeds 50%. In practice, this level may not be reached before 2070. At that time, a DH system implemented during the period 2020-2030 would largely be amortized. We agree on the fact that all buildings must be renovated someday. We however argue that policymakers should first prioritise the least dense areas or the areas without low carbon heat sources locally available. The methodology offered by Hache *et al.* (2017) may help in defining relevant household group targets for France, which could replace the single energy consumption level target. The aim should be to find the

optimal balance between cost and GHG savings on a case by case basis, presenting DH networks, renovation and HP as combinatory rather than opposed systems.

Results from this Chapter are in line with ADEME (2015), stating that new regulations are required to discourage equipping new urban dwellings with local electric or gas boilers and to encourage the development of DH networks in dense areas. We further argue that NCHP should be explicitly recognised among those sources able to provide a DH base load with limited GHG emissions. The lifetime of an NCHP is rather predictable and long enough to allow for operation and amortisation during the same period as DH networks. This may provide long-term visibility for projects, which can be advantageous with regards to project financing issues. With this in mind, NCHP could effectively contribute to the development of sustainable heat production.

Limits should be highlighted. This chapter focuses on a broad techno-economic analysis, hence the results are not reliable enough to be applied directly to real cases. For implementation in real planning, these results should be checked experimentally in the next step. The cost of an NCHP is regarded as the investment cost of a Generation III nuclear power plant specific to heat generation (i.e. additional costs compared to a similar plant solely dedicated to electricity production). Therefore, this chapter does not allow us to reach any conclusions as to whether or not an NCHP offers more benefits than other systems generating the same amount of electricity and heat. To answer this, further analysis will be needed, taking into account the entire investment cost of a new nuclear power plant. Despite these limits, this chapter provides insights that may help optimising the future French energy system through the most efficient use of available technologies. A reasonable conclusion is that, if a new nuclear plant is planned in the Gravelines site (as it is currently being discussed between EDF and the 'Hauts-de-France' region), providing residential and commercial heat to the Dunkirk conurbation committee should be seriously considered.

References

- ADEME (French Agency for Environment and Energy Supervision), 2012. Les économies d'énergie dans le bâtiment. Les données météorologiques RT 2012. Available from: <<http://www.rt-batiment.fr/batiments-neufs/reglementation-thermique-2012/donnees-meteorologiques.html>> [in French].
- ADEME, 2015. Etude des coûts d'investissement et d'exploitation associés aux installations biomasse énergie des secteurs collectifs et industriels [in French].
- ADEME (French Environment and Energy Management Agency), 2016. Etude de valorisation du stockage thermique et du power-to-heat. Available from: <<http://www.ademe.fr/sites/default/files/assets/documents/valorisation-stockage-thermique-power-to-heat-2016-rapport.pdf>> [in French].
- ADEME, 2017. 13^{ième} Rencontres des réseaux de chaleur (13th national DH meeting). Round Table of the 12/12. Presentation by Rémi Chabrilat "Factor 5 for renewable and excess heat sources: Which means for which objectives?" [in French].
- ADEME, 2017. Appel à projets national Grandes Installations Solaires Thermiques. Available from: <<http://www.ademe.fr/appele-a-projets-national-grandes-installations-solaires-thermiques>> [in French].
- ADEME, 2018. *Fonds Chaleur* 2018 - Secteur réseaux de chaleur. Available from: <http://www.ademe.fr/sites/default/files/assets/documents/2reseaux_chaleur_fds_chal_2018_27-02-2018.pdf> [in French].
- AEA Technology plc, 2012. Conversion of biomass boiler emission concentration data for comparison with Renewable Heat Incentive emission criteria. AEA/R/ED46626/AEA/R/3296. Available from: <https://uk-air.defra.gov.uk/assets/documents/reports/cat07/1205310837_Conversion_of_biomass_boiler_emission_data_rep_Issue1.pdf>.
- AMORCE (French DH association), 2015a. Comparatif des modes de chauffage et prix de vente de la chaleur. Data for 2014. Available from: <<http://www.amorce.asso.fr/fr/espace-adherents/publications/rdc/prix-de-la-chaleur/comparatif-des-modes-de-chauffage-et-prix-de-vente-de-la-chaleur-rapport-2015-donnees-2014/>> [in French].
- AMORCE, 2015b. Contenu en CO₂ des réseaux. Available from: <http://webcache.googleusercontent.com/search?q=cache:aNZMVfLIgeIj:partage.amorce.asso.fr/20150923_Module_de_calcul-KIKjL.xlsx+&cd=3&hl=fr&ct=clnk&gl=fr> [in French].
- AMORCE, 2017. Fonds Chaleur: Les nouvelles propositions d'AMORCE pour un développement des réseaux de chaleur à la hauteur des objectifs. Available from: <<http://www.amorce.asso.fr/fr/reseaux-de-chaleur/actualites/Fonds-chaleur-les-nouvelles-propositions-damorcer-pour-un-developpement-des-reseaux-de-chaleur-la-hauteur-des-objectifs/>> [in French].
- Assemblée nationale (French national assembly), 2009. Loi Grenelle I (loi n° 2009-967 du 3 août 2009 de programmation relative à la mise en œuvre du Grenelle de l'environnement) [in French].
- Assemblée nationale, 2015. Loi n° 2015-992 du 17 août 2015 Relative à la transition énergétique pour la croissance verte, 2015-2992. Available from: <<http://www.legifrance.gouv.fr/affichTexte.do?cidTexte=JORFTEXT000031044385&categorieLien=id>>.
- Assemblée nationale, 2017. LOI n° 2017-1837 du 30 décembre 2017 de finances pour 2018. Available from: <<https://www.legifrance.gouv.fr/eli/loi/2017/12/30/CPAX1723900L/jo/texte/#>> [in French].
- Averfalk, H., Werner, S., 2017. Essential improvements in future district heating systems. Energy Procedia, 15th International Symposium on District Heating and Cooling, DHC15-2016, 4-7 September 2016, Seoul, South Korea 116, 217-225.

- Bach, B., 2014. Integration of Heat Pumps in Greater Copenhagen. Master Thesis hold in the Technical University of Denmark, Department of Mechanical Engineering, Thermal Energy. Available from: <https://www.researchgate.net/publication/314094868_Integration_of_Heat_Pumps_in_Greater_Copenhagen>.
- Bartolozzi, I., Rizzi, F., Frey, M., 2017. Are district heating systems and renewable energy sources always an environmental win-win solution? A life cycle assessment case study in Tuscany, Italy. *Renewable and Sustainable Energy Reviews* 80, 408–420.
- Bauer, D., Marx, R., Nußbicker-Lux, J., Ochs, F., Heidemann, W., Müller-Steinhagen, H., 2010. German central solar heating plants with seasonal heat storage. *Solar Energy, International Conference CISBAT 2007* 84, 612–623.
- BINE information service, 2017. Innovative approaches to the long-term heat storage tank. Available from: <<http://www.bine.info/en/publications/publikation/schulsanierung-mit-solarer-nahwaerme-verknuempft/innovative-ansaetze-beim-langzeitwaermespeicher/>>.
- Bohm, B., Kristjansson, H., 2005. Single, twin and triple buried heating pipes: on potential savings in heat losses and costs. *International Journal of Energy Research* 29, 1301–1312.
- Brandt, J., Christensen, J.H., Frohn, L.M., Berkowicz, R., 2001. Operational air pollution forecasts from regional scale to urban street scale. Part 1: system description. *Physics and Chemistry of the Earth, Part B: Hydrology, Oceans and Atmosphere* 26, 781–786.
- Brandt, J., Christensen, J., Frohn, L.M., Geels, C., Hansen, K.M., Hedegaard, G.B., Hvid, T., Hvidberg, M., Skjoth, C.A., 2008. THOR – An Operational and Integrated Model System for Air Pollution Forecasting and Management from Regional to Local Scale. In: *Seventh International Conference on Air Quality – Science and Application, Istanbul*. Available from: <<https://meetings.copernicus.org/www.cosis.net/abstracts/EGU2008/08257/EGU2008-A-08257.pdf>>.
- CEA (French Nuclear and Alternative Energies Commission), 2017. ELECNUC. Nuclear power plants in the world. Edition 2017. Available from: <<http://www.cea.fr/multimedia/Documents/publications/ouvrages/Elecnu-2017.pdf>>.
- CEPRO (Clean Energy Prospector), 2015. CHOICES solar district heat study. Available from: <<http://www.cepro.co.uk/2015/04/choices-solar-district-heat-study/>>.
- CeRCAD Midi-Pyrénées, 2015. Observatoire des coûts de la rénovation énergétique. Analyse de dossiers de financement de travaux de rénovation énergétique 2012. Available from: <http://www.cercad.fr/IMG/pdf/cercad_-_ocre_-_observatoire_des_coûts_de_la_renovation_energetique_en_midi-pyrenees_-_synthese_n1_-_sep2015-2.pdf> [in French].
- CEREMA (French Research Centre on Risks, Environment, Mobility and Territorial Planning), 2014. Consommation d'énergie dans les bâtiments. chiffres clés 2013. Available from: <<http://reseaux-chaleur.cerema.fr/consommation-denergie-dans-les-batiments-chiffres-cles-2013>> [in French].
- Charlier, D., 2015. Energy efficiency investments in the context of split incentives among French households. *Energy Policy* 87, 465–479.
- Chatman House, 2017. Woody Biomass for Power and Heat. Impacts on the Global Climate. Ducan Brack, Environment, Energy and Resources Department. Available from: <<https://www.chathamhouse.org/sites/default/files/publications/research/2017-02-23-woody-biomass-global-climate-brack-final2.pdf>>.
- Chauvel, A., Fournier, G., Raimbault, C., 2001. Manuel d'évaluation économique des procédés. Editions TECHNIP [in French].
- Cherubini, F., Peters, G.P., Berntsen, T., Strømman, A.H., Hertwich, E., 2011. CO₂ emissions from biomass combustion for bioenergy: atmospheric decay and contribution to global warming. *GCB Bioenergy* 3, 413–426.

- Chirat, J.-P., Denisart, F., 2016. Nouvelles dynamiques de rénovation des logements. Rapport de synthèse et proposition. Jean-Pascal Chirat (Club de l'Amélioration de l'habitat) et Frédéric Denisart (Conseil National de l'Ordre des Architectes). Available from: <http://www.planbatimentdurable.fr/IMG/pdf/plan_batiment_durable_rapport_nouvelles_dynamiques_de_renovation_des_logements.pdf> [in French].
- City of Vancouver, 2006. Trent Berry. Biomass permit analysis. City of Vancouver, Vancouver, BC.
- Clapp, C.E., Allmaras, R.R., Layese, M.F., Linden, D.R., Dowdy, R.H., 2000. Soil organic carbon and ¹³C abundance as related to tillage, crop residue, and nitrogen fertilization under continuous corn management in Minnesota. *Soil and Tillage Research* 55, 127–142.
- Communauté urbaine de Dunkerque (Dunkirk Conurbation Committee), 2016. Opportunités et stratégies de valorisation de la chaleur industrielle fatale . Available from: <http://atee.fr/sites/default/files/11_-_cud_-_f.mabille_-_oportunitr_stratrgie.pdf> [in French].
- Connolly, D., Lund, H., Mathiesen, B.V., Werner, S., Möller, B., Persson, U., Boermans, T., Trier, D., Østergaard, P.A., Nielsen, S., 2014. Heat Roadmap Europe: Combining district heating with heat savings to decarbonise the EU energy system. *Energy Policy* 65, 475–489.
- CRE (French energy regulation commission), 2013. Analyse des coûts de production et de commercialisation d'EDF dans le cadre des tarifs réglementés de vente d'électricité. Available from: <<http://www.cre.fr/documents/publications/rapports-thematiques/analyse-des-couts-de-production-et-de-commercialisation-d-edf>> [in French].
- CRE, 2014. La contribution au service public de l'électricité (CSPE) : mécanisme, historique et prospective. Available from: <<http://www.cre.fr/documents/publications/rapports-thematiques/rapport-sur-la-cspe-mecanisme-historique-et-prospective>> [in French].
- CRE, 2016a. Les marchés de gros de l'électricité, du gaz naturel et du CO₂. 2nd trimestre 2016 (Data on 30/06/2016). Available from: <<http://www.cre.fr/marches/observatoire-des-marches#section2>> [in French].
- CRE, 2016b. Les marchés de détail de l'électricité et du gaz naturel. 2nd trimestre 2016 (Data on 30/06/2016). Available from: <<http://www.cre.fr/marches/observatoire-des-marches#section1>> [in French].
- Dalkia (Groupe EDF), 2015. Energie Grand Littoral. Réseau de chauffage urbain. Compte-rendu technique et financier. Exercice 2015. Available from: <https://www.communaute-urbaine-dunkerque.fr/fileadmin/documents/rapports/Reseau_de_chaleur_-_compte-rendu_d_activite_2015.pdf> [in French].
- Dalla Rosa, A., Christensen, J.E., 2011. Low-energy district heating in energy-efficient building areas. *Energy* 36, 6890–6899.
- DEA (Danish Energy Agency), 2013. Technology Data for Energy Plants Individual Heating Plants and Energy Transport. Original version (2013). Available from: <https://ens.dk/sites/ens.dk/files/Analyser/old_technology_data_for_individual_heating_plants_and_energy_transport_aug2016.pdf>.
- DEA, 2016a. Technology Data for Energy Plants Updated chapters, August 2016. Available from: <https://ens.dk/sites/ens.dk/files/Analyser/update_-_technology_data_catalogue_for_energy_plants_-_aug_2016.pdf>.
- DEA, 2016b. Technology Data for Energy Plants. Generation of Electricity and District Heating, Energy Storage and Energy Carrier Generation and Conversion. Available from: <https://ens.dk/sites/ens.dk/files/Analyser/teknologikatalog_august_2016_08082016.pdf>.
- DEA, 2016c. Technology Data for Individual Heating Plants and Energy Transport. Updated chapters, August 2016. Available from: <https://ens.dk/sites/ens.dk/files/Analyser/technology_catalogue_individual_heating_plants_energy_transport_aug16.pdf>.

- Dick, W.A., Blevins, R.L., Frye, W.W., Peters, S.E., Christenson, D.R., Pierce, F.J., Vitosh, M.L., 1998. Impacts of agricultural management practices on C sequestration in forest-derived soils of the eastern Corn Belt. *Soil and Tillage Research* 47, 235–244.
- Dincer, I., Dost, S., 1996. A perspective on thermal energy storage systems for solar energy applications. *Int. J. Energy Res.* 20, 547–557.
- Dincer, I., Rosen, M., 2011. *Thermal energy storage: systems and applications* (2nd ed.), John Wiley & Sons.
- EC (European Commission), 2012a. Ecodesign and energy labelling - Air conditioners and comfort fans. Commission regulation (EU) No 206/2012 of 6 March 2012 implementing Directive 2009/125/EC of the European Parliament and of the Council with regard to eco-design requirements for air conditioners and comfort fans OJ L 72, 10.3.2012.
- EC, 2012b. Background Report on EU27 District Heating and Cooling Potentials, Barriers, Best Practice and Measures of Promotion. Available from: <<https://setis.ec.europa.eu/publications/jrc-setis-reports/background-report-eu-27-district-heating-and-cooling-potentials-0>>.
- EC, 2014a. Guide to Cost-Benefit Analysis of Investment Projects for Cohesion Policy 2014-2020.
- EC, 2014b. State of play on the sustainability of solid and gaseous biomass used for electricity, heating and cooling in the EU. Brussels, 28.7.2014 SWD(2014) 259 final. Available from: <https://ec.europa.eu/energy/sites/ener/files/2014_biomass_state_of_play_.pdf>.
- EC, 2016. Annexes to the Proposal for a Directive of the European Parliament and the Council on the promotion of the use of energy from renewable sources (recast). Available from: <<http://eur-lex.europa.eu/legal-content/EN/ALL/?uri=COM%3A2016%3A767%3AFIN>>.
- EC, 2017. Photovoltaic geographical information system. Available from: <http://re.jrc.ec.europa.eu/pvg_tools/en/tools.html#MR>.
- EEA (European Environment Agency), 2012. Air quality in Europe – 2012 report. Available from: <<https://www.eea.europa.eu/publications/air-quality-in-europe-2012>>.
- Energiategollisuus, 2013. Kaukolämpöjohtojen suunnittelu- ja rakentamishjeet Suositus L11/2013. Available from: <https://energia.fi/files/825/SuositusL11_2013_Ki-johtojen-suunnittelu-ja-rakentamishjeet.pdf> [in Finnish].
- Enertech, 2010. Notes techniques et réflexions . Coûts des premières rénovations « basse consommation » en France Perspectives. Available from: <<http://www.enertech.fr/modules/catalogue/pdf/73/Couts%20renovation%20basse%20consommation.pdf>> [in French].
- European Parliament, 2015. Directive (EU) 2015/2193 of the European Parliament and of the Council of 25 November 2015 on the limitation of emissions of certain pollutants into the air from medium combustion plants (MCP Directive).
- Eurostat, 2016a. Electricity price statistics. Available from: <http://ec.europa.eu/eurostat/statistics-explained/index.php/Electricity_price_statistics>.
- Eurostat, 2016b. Natural gas price statistics. Natural gas prices for industrial consumers. Available from: <[http://ec.europa.eu/eurostat/statistics-explained/index.php/File:Natural_gas_prices_for_industrial_consumers,_comparison_between_2015s2-2014s2_\(NAT_kWh\).png](http://ec.europa.eu/eurostat/statistics-explained/index.php/File:Natural_gas_prices_for_industrial_consumers,_comparison_between_2015s2-2014s2_(NAT_kWh).png)>.
- Evans, J.S., Wolff, S.K., Phonboon, K., Levy, J.I., Smith, K.R., 2002. Exposure efficiency: an idea whose time has come? *Chemosphere* 49, 1075–1091.
- Fan, Y.-T., Zhang, Y.-H., Zhang, S.-F., Hou, H.-W., Ren, B.-Z., 2006. Efficient conversion of wheat straw wastes into biohydrogen gas by cow dung compost. *Bioresource Technology* 97, 500–505.
- Frederiksen, S., Werner, S., 2013. District heating and cooling. Lund Studentlitteratur.
- Frischknecht, R., Rebitzer, G., 2005. The ecoinvent database system: a comprehensive web-based LCA database. *Journal of Cleaner Production, Life Cycle Assessment* 13, 1337–1343.
- Ghafghazi, S., Sowlati, T., Sokhansanj, S., Melin, S., 2010. A multicriteria approach to evaluate district heating system options. *Applied Energy* 87, 1134–1140.

- Ghafghazi, S., Sokhansanj, S., Sowlati, T., S., Bi, X., Melin, S., 2011a. Life cycle assessment of base-load heat sources for district heating system options. *Int J Life Cycle Assess* 16, 212–223.
- Ghafghazi, S., Sowlati, T., Sokhansanj, S., Bi, X., Melin, S., 2011b. Particulate matter emissions from combustion of wood in district heating applications. *Renewable and Sustainable Energy Reviews* 15, 3019–3028.
- Gronlund, C.J., Humbert, S., Shaked, S., O'Neill, M.S., Jolliet, O., 2015. Characterizing the burden of disease of particulate matter for life cycle impact assessment. *Air Qual Atmos Health* 8, 29–46.
- Haberl, H., Sprinz, D., Bonazountas, M., Cocco, P., Desaubies, Y., Henze, M., Hertel, O., Johnson, R.K., Kastrup, U., Laconte, P., Lange, E., Novak, P., Paavola, J., Reenberg, A., van den Hove, S., Vermeire, T., Wadhams, P., Searchinger, T., 2012. Correcting a fundamental error in greenhouse gas accounting related to bioenergy. *Energy Policy* 45, 18–23.
- Hache, E., Leboulenger, D., Mignon, V., 2017. Beyond average energy consumption in the French residential housing market: A household classification approach. *Energy Policy* 107, 82–95.
- Hahne, E., 2000. The ITW solar heating system: an oldtimer fully in action. *Solar Energy, Large Scale Solar Heating* 69, 469–493.
- Heath, G.A., Nazaroff, W.W., 2007. Intake-to-delivered-energy ratios for central station and distributed electricity generation in California. *Atmospheric Environment* 41, 9159–9172.
- Heat Roadmap Europe, 2015. Heat Roadmap Europe 2050. Research project co-funded by the European Commission. Peta, the Pan-European Thermal Atlas: renewable energy. Available from: <<http://maps.heatroadmap.eu/maps/31157/Renewable-Resources-Map-for-EU28?preview=true#>>.
- Hesaraki, A., Holmberg, S., Haghighat, F., 2015. Seasonal thermal energy storage with heat pumps and low temperatures in building projects—A comparative review. *Renewable and Sustainable Energy Reviews* 43, 1199–1213.
- Holtmark, B., 2012. Harvesting in boreal forests and the biofuel carbon debt. *Climatic Change* 112, 415–428.
- Hugo, A., 2008. Computer simulation and life cycle analysis of a seasonal thermal storage system in a residential building. Available from: <<https://spectrum.library.concordia.ca/976234/>> (masters). Concordia University.
- Humbert, S., Marshall, J.D., Shaked, S., Spadaro, J.V., Nishioka, Y., Preiss, P., McKone, T.E., Horvath, A., Jolliet, O., 2011. Intake Fraction for Particulate Matter: Recommendations for Life Cycle Impact Assessment. *Environ. Sci. Technol.* 45, 4808–4816.
- IAEA (International Atomic Energy Agency), 2016. Desalination Thermodynamic Optimization Program (DE-TOP). Available from: <https://www.iaea.org/NuclearPower/NEA_Desalination/index.html>.
- IAEA, 2017. Nuclear power reactors in the world. IAEA-RDS-2/37.
- IEA (International Energy Agency), 2016. CO2 Emissions from Fuel Consumption. 2016 World Edition.
- INAPG (Institut Nationale Agronomique de Paris-Grignon), 2006. Valorisation énergétique des biomasses agricoles en Pays d'Aunis. Etude réalisée par les étudiants de 2ème année de l'institut nationale agronomique Paris-Grignon. Available from: <<https://tice.agroparistech.fr/coursenligne/courses/INIP/document/INIP/inipespv06/projets/Paille.pdf>> [in French].
- INSEE (French National Institution for Statistics and Economics Studies), Région Nord-Pas-de-Calais, 2009. Se loger en Nord-Pas-de-Calais - Les parcours résidentiels se transformeront 1992-2006. Available from: <<https://www.insee.fr/fr/statistiques/1379099>> [in French]. Profils 93.
- Inspection Générale des Finances (French general inspection of finances), 2017. Revue de dépenses. Aides à la rénovation énergétique des logements privés. Available from: <<https://www.actu-environnement.com/media/pdf/news-29861-rapport-IFG-CGEDD-aides-publiques-renovations-energetiques.pdf>> [in French].

- IPCC (Intergovernmental Panel on Climate Change), 2012. Renewable Energy Sources and Climate Change Mitigation. Special Report of the Intergovernmental Panel on Climate Change.
- IRDES (French Institute for health economics research), 2011. Données de cadrage: Indicateurs d'état de santé. Available from: <<http://www.irdes.fr/EspaceEnseignement/ChiffresGraphiques/Cadrage/IndicateursEtatSant e/EsperanceVie.htm>> [in French].
- Ivner, J., Broberg Viklund, S., 2015. Effect of the use of industrial excess heat in district heating on greenhouse gas emissions: A systems perspective. *Resources, Conservation and Recycling* 100, 81–87.
- Kaivosoja, T., Jalava, P.I., Lamberg, H., Virén, A., Tapanainen, M., Torvela, T., Tapper, U., Sippula, O., Tissari, J., Hillamo, R., Hirvonen, M.R., Jokiniemi, J., 2013. Comparison of emissions and toxicological properties of fine particles from wood and oil boilers in small (20-25 kW) and medium (5-10 MW) scale. *Atmospheric Environment* 77, 193–201.
- Kaklauskas, A., Zavadskas, E.K., Raslanas, S., 2005. Multivariant design and multiple criteria analysis of building refurbishments. *Energy and Buildings* 37, 361–372.
- Kjellsson, E., Hellström, G., Perers, B., 2010. Optimization of systems with the combination of ground-source heat pump and solar collectors in dwellings. *Energy, 7th International Conference on Sustainable Energy Technologies* 35, 2667–2673.
- Lanahan, M., Tabares-Velasco, P.C., 2017. Seasonal Thermal-Energy Storage: A Critical Review on BTES Systems, Modeling, and System Design for Higher System Efficiency. *Energies* 10, 743.
- Leurent, M., Da Costa, P., Jasserand, F., Rämä, M., Persson, U., 2018. Cost and climate savings through nuclear district heating in a French urban area. *Energy Policy* 115, 616–630.
- Lewtas, J., 2007. Air pollution combustion emissions: Characterization of causative agents and mechanisms associated with cancer, reproductive, and cardiovascular effects. *Mutation Research/Reviews in Mutation Research, The Sources and Potential Hazards of Mutagens in Complex Environmental Matrices - Part II* 636, 95–133.
- Li, H., Svendsen, S., 2012. Energy and exergy analysis of low temperature district heating network. *Energy, The 24th International Conference on Efficiency, Cost, Optimization, Simulation and Environmental Impact of Energy, ECOS 2011* 45, 237–246.
- Liu, W., Zhang, Z., Xie, X., Yu, Z., von Gadow, K., Xu, J., Zhao, S., Yang, Y., 2017. Analysis of the Global Warming Potential of Biogenic CO₂ Emission in Life Cycle Assessments. *Sci Rep* 7.
- Loiseaux, B., Safa, H., Tamain, B., 2016. La cogénération nucléaire dans la production d'électricité. *Revue Générale Nucléaire* 6 Nov-Déc. 2016.
- Lund, H., Werner, S., Wiltshire, R., Svendsen, S., Thorsen, J.E., Hvelplund, F., Mathiesen, B.V., 2014. 4th Generation District Heating (4GDH): Integrating smart thermal grids into future sustainable energy systems. *Energy* 68, 1–11.
- Lund, R., Ilic, D.D., Trygg, L., 2016. Socioeconomic potential for introducing large-scale heat pumps in district heating in Denmark. *Journal of Cleaner Production* 139, 219–229.
- Matthews, R., Sokka, L., Soimakallio, S., Mortimer, N., Rix, J., Schelhaas, M.-J., Jenkis, T., Hogan, G., Mackie, E., Morris, A., Randle, T., 2014. Review of literature on biogenic carbon and life cycle assessment of forest bioenergy. Final Task 1 report, DG ENER project, "Carbon impacts of biomass consumed in the EU". Available from: <https://ec.europa.eu/energy/sites/ener/files/2014_biomass_forest_research_report_.pdf>.
- Ministère de l'action et des comptes publics (French Ministry of actions and of public accountability), 2017. IR - Crédit d'impôt pour la transition énergétique - Nature des dépenses éligibles au crédit d'impôt. Available from: <<http://bofip.impots.gouv.fr/bofip/3889-PGP.html?identifiant=BOI-IR-RICI-280-10-30>> [in French].
- Ministère de la transition écologique et solidaire (French ministry of the united and eco-friendly transition), 1997. Arrêté du 25/07/97 relatif aux prescriptions générales applicables aux installations classées pour la protection de l'environnement soumises à déclaration sous la

- rubrique n° 2910 : Combustion. Available from: <https://aida.ineris.fr/consultation_document/5683> [in French].
- Ministère de la transition écologique et solidaire, 2016. Observations et Statistiques. Secteur Résidentiel-Tertiaire. Available from: <<http://www.statistiques.developpement-durable.gouv.fr/energie-climat/s/consommations-secteur-residentiel-tertiaire.html>> [in French].
- Ministère de l'écologie, du développement durable et de l'énergie (French Ministry of Ecology, Sustainable development and Energy), 2015. Consommations énergétiques des ménages en 2012. Available from: <http://www.statistiques.developpement-durable.gouv.fr/fileadmin/documents/Produits_editoriaux/Publications/Chiffres_et_statistiques/2015/chiffres-stats645-conso-energetiques-des-menages2012-juin2015.pdf> [in French]. Chiffres et Statistiques 645.
- Ministère de l'environnement, de l'énergie et de la mer (French Ministry of Environment, Energy and Seas), 2014. Application of the article 14.5 of the Directive 2012/27/UE with regards to the connexion of utilities generating excess heat and district heating networks. Décret n° 2014-1363 of the 14th of November 2014 [in French], 2014-1363.
- Ministère de l'environnement, de l'énergie et de la mer, 2015. Loi relative à la transition énergétique pour la croissance verte (TECV). Available from: <<https://www.legifrance.gouv.fr/affichTexte.do?cidTexte=JORFTEXT000031044385&categorieLien=id>> [in French].
- Ministère de l'environnement, de l'énergie et de la mer, 2016. L'accès régulé à l'électricité nucléaire historique (ARENH). Available from: <<http://www.developpement-durable.gouv.fr/Le-prix-de-l-ARENH.html>> [in French].
- Mohanraj, M., Belyayev, Y., Jayaraj, S., Kaltayev, A., 2017. Research and developments on solar assisted compression heat pump systems – A comprehensive review (Part-B: Applications). *Renewable and Sustainable Energy Reviews*.
- NEA (Nuclear Energy Agency), 2016. Nuclear Energy Data Données sur l'énergie nucléaire. Available from: <<https://www.oecd-neo.org/ndd/pubs/2016/7300-ned-2016.pdf>>.
- NERI (National Environmental Research Institute), 2010. Emissions from decentralised CHP plants 2007. NERI Technical Report no. 786. Available from: <<http://www.dmu.dk/Pub/FR786.pdf>>.
- Nielsen, K., 2003. Thermal energy storage: a state-of-art, a report within the research program Smart Energy-Efficient Buildings at NTNU and SINTEF 2002–2006.
- Nordell, B., 2000. Large-scale thermal energy storage. WinterCities' 2000, Energy and Environment, Lulea, Sweden. Available from: <<http://large.stanford.edu/courses/2013/ph240/lim1/docs/nordell.pdf>>.
- Novo, A.V., Bayon, J.R., Castro-Fresno, D., Rodriguez-Hernandez, J., 2010. Review of seasonal heat storage in large basins: Water tanks and gravel–water pits. *Applied Energy* 87, 390–397.
- Parajuli, R., Løkke, S., Østergaard, P.A., Knudsen, M.T., Schmidt, J.H., Dalgaard, T., 2014. Life Cycle Assessment of district heat production in a straw CHP plant. *Biomass and Bioenergy* 68, 115–134.
- Pavlov, G., Olesen, B., 2012. Thermal energy storage — a review of concepts and systems for heating and cooling applications in buildings: Part 1—Seasonal storage in the ground. *HVAC&R Res*; 18:515–38.
- Persson, U., Möller, B., Werner, S., 2014. Heat Roadmap Europe: Identifying strategic heat synergy regions. *Energy Policy* 74, 663–681.
- Petrov, O., Bi, X., Lau, A., 2015. Impact assessment of biomass-based district heating systems in densely populated communities. Part I: Dynamic intake fraction methodology. *Atmospheric Environment* 115, 70–78.
- Peupliers de France, 2017. Associations des peupliers Nord-Pas-de-Calais-Picardie. Available from: <<http://www.peupliersdefrance.org/n/association-peuplier-nord-pas-de-calais-picardie/n:1124>> [in French].

- Pingoud, K., Ekholm, T., Savolainen, I., 2012. Global warming potential factors and warming payback time as climate indicators of forest biomass use. *Mitig Adapt Strateg Glob Change* 17, 369–386.
- Pope, C.A., Burnett, R.T., Thun, M.J., Calle, E.E., Krewski, D., Ito, K., Thurston, G.D., 2002. Lung cancer, cardiopulmonary mortality, and long-term exposure to fine particulate air pollution. *JAMA* 287, 1132–1141.
- Popovski, E., Fleiter, T., Steinbach, J., Aydemir, A., Büchele, R., Kranzl, L., Hummel, M., Münster, M., Amer-Allam, S.B., Petrovic, S., 2017. Cost-effectiveness of large-scale heat pumps in DH networks: a simulation model for a case study in Germany. Participation of the Progress Heat project to the 3rd International Conference on Smart Energy Systems and 4th Generation District Heating. Copenhagen, Sept. 2017. Available from: <http://www.4dh.eu/images/3__Eftim_Popovski.pdf>.
- Rad, F.M., Fung, A.S., 2016. Solar community heating and cooling system with borehole thermal energy storage – Review of systems. *Renewable and Sustainable Energy Reviews* 60, 1550–1561.
- Rämä, M., Sipilä, K., 2017. Transition to low temperature distribution in existing systems. *Energy Procedia*, 15th International Symposium on District Heating and Cooling, DHC15-2016, 4-7 September 2016, Seoul, South Korea 116, 58–68.
- Reuss, M., Beck, M., Müller, J.P., 1997. Design of a seasonal thermal energy storage in the ground. *Solar Energy*, Selected Proceeding of ISES 1995: Solar World Congress. Part III 59, 247–257.
- Rezaie, B., Rosen, M.A., 2012. District heating and cooling: Review of technology and potential enhancements. *Applied Energy*, (1) Green Energy; (2) Special Section from papers presented at the 2nd International Energy 2030 Conf 93, 2–10.
- Risom, L., Møller, P., Loft, S., 2005. Oxidative stress-induced DNA damage by particulate air pollution. *Mutation Research/Fundamental and Molecular Mechanisms of Mutagenesis, Linking Toxicology to Epidemiology: Biomarkers and New Technologies* 592, 119–137.
- Safa, H., 2012. Heat recovery from nuclear power plants. *International Journal of Electrical Power & Energy Systems* 42, 553–559.
- Sayegh, M.A., Danielewicz, J., Nannou, T., Miniewicz, M., Jadwiszczak, P., Piekarska, K., Jouhara, H., 2017. Trends of European research and development in district heating technologies. *Renewable and Sustainable Energy Reviews* 68, 1183–1192.
- Schmidt, D., Kallert, A., Blesl, M., Svendsen, S., Li, H., Nord, N., Sipilä, K., 2017. Low Temperature District Heating for Future Energy Systems. *Energy Procedia*, 15th International Symposium on District Heating and Cooling, DHC15-2016, 4-7 September 2016, Seoul, South Korea 116, 26–38.
- Schmidt, T., Mangold, D., Müller-Steinhagen, H., 2004. Central solar heating plants with seasonal storage in Germany. *Solar Energy*, Solar World Congress 2001 76, 165–174.
- Schulze, E.-D., Körner, C., Law, B.E., Haberl, H., Luysaert, S., 2012. Large-scale bioenergy from additional harvest of forest biomass is neither sustainable nor greenhouse gas neutral. *Glob. Change Biol. Bioenergy* 4, 611–616.
- SDH (Solar District Heating), 2012. Solar District Heating Guidelines. Solar collectors. Available from: <http://solar-district-heating.eu/Portals/0/Factsheets/SDH-WP3_FS-7-1_SolarCollectors_version3.pdf>.
- SDH, 2013. SUNSTORE4 Tool. Available from: <<http://sunstore4.eu/use-results/sunstore4-tool/>>.
- Searchinger, T.D., Hamburg, S.P., Melillo, J., Chameides, W., Havlik, P., Kammen, D.M., Likens, G.E., Lubowski, R.N., Obersteiner, M., Oppenheimer, M., Robertson, G.P., Schlesinger, W.H., Tilman, G.D., 2009. Fixing a Critical Climate Accounting Error. *Science* 326, 527–528.
- Sernhed, K., Jönsson, M., 2017. Risk management for maintenance of district heating networks. *Energy Procedia*, 15th International Symposium on District Heating and Cooling, DHC15-2016, 4-7 September 2016, Seoul, South Korea 116, 381–393.

- Sibbitt, B., McClenahan, D., Djebbar, R., Thornton, J., Wong, B., Carriere, J., Kokko, J., 2012. The Performance of a High Solar Fraction Seasonal Storage District Heating System – Five Years of Operation. *Energy Procedia*, 1st International Conference on Solar Heating and Cooling for Buildings and Industry (SHC 2012) 30, 856–865.
- SNCU (French National Union for District Heating), 2017. Enquête annuelle sur les réseaux de chaleur et de froid. Rapport 2017. Chiffres 2016. Edition nationale. Available from: <<https://www.actu-environnement.com/media/pdf/news-29857-enquete-sncu-2017.pdf>> [In French].
- Soares, N., Bastos, J., Pereira, L.D., Soares, A., Amaral, A.R., Asadi, E., Rodrigues, E., Lamas, F.B., Monteiro, H., Lopes, M.A.R., Gaspar, A.R., 2017. A review on current advances in the energy and environmental performance of buildings towards a more sustainable built environment. *Renewable and Sustainable Energy Reviews* 77, 845–860.
- Socaciu, L.G., 2012. THERMAL ENERGY STORAGE: AN OVERVIEW. ACTA TECHNICA NAPOCENSIS - Series: APPLIED MATHEMATICS, MECHANICS, and ENGINEERING 55.
- STUK (Radiation and Nuclear Safety Authority of Finland), 2009. Preliminary Safety Assessment of the Fennovoima Oy Nuclear Power Plant Project. Available from: <https://www.stuk.fi/documents/88234/148256/STUK-Fennovoima_preliminary_safety_assessment_letter.pdf/2b9012c5-0d9a-4253-8efd-c2070fdc2cb7>.
- Terziotti, L.T., Sweet, M.L., McLeskey, J.T., 2012. Modeling seasonal solar thermal energy storage in a large urban residential building using TRNSYS 16. *Energy and Buildings* 45, 28–31.
- UFC-Que Choisir (French association for consumer's protection), 2016. Rénovation énergétique. Des artisans du bâtiment qui n'ont toujours pas fait leur transition génétique pour répondre à la transition énergétique. Available from: <<https://www.quechoisir.org/action-ufc-que-choisir-renovation-energetique-performance-zero-des-professionnels-n23361/>> [in French].
- U.S. Environmental Protection Agency, 2010. Quantitative Risk Assessment for Particulate Matter. Office of Air and Radiation, Office of Air Quality Planning and Standards, Health and Environmental Impacts Division, U.S. Environmental Protection Agency; Research Triangle Park, NC 27711.
- Viessmann GmbH, 2009. Technical guide. Solar thermal systems. Available from: https://www.viessmann.co.uk/content/dam/vi-brands/UK/PDFs/Brochures/Technical%20Guide%20Solar%20Thermal%20Systems_05-2009_GB.pdf/_jcr_content/renditions/original.media_file.download_attachment.file/Technical%20Guide%20Solar%20Thermal%20Systems_05-2009_GB.pdf.
- VTT (Technical Research Center of Finland), 2005. Pienhiukkaspäästöt ja niiden vähentämismahdollisuudet Suomessa. Available from: <<http://www.vtt.fi/inf/pdf/tiedotteet/2005/T2300.pdf>> [in Finnish].
- VTT, 2016. Properties of indigenous fuels in Finland. Available from: <<http://www.vtt.fi/inf/pdf/technology/2016/T272.pdf>>.
- Werner, S., 2016. European district heating price series. Report no. 2016:316 Energiforsk-Fjärrsyn. Available from: <<https://energiforskmedia.blob.core.windows.net/media/21926/european-district-heating-price-series-energiforskrapport-2016-316.pdf>>.
- Werner, S., 2017. International review of district heating and cooling. *Energy* 137, 617–631.
- Xu, J., Wang, R.Z., Li, Y., 2014. A review of available technologies for seasonal thermal energy storage. *Solar Energy* 103, 610–638.
- Zvingilaite, E., 2013. Modelling energy savings in the Danish building sector combined with internalisation of health related externalities in a heat and power system optimisation model. *Energy Policy*, Special section: Long Run Transitions to Sustainable Economic Structures in the European Union and Beyond 55, 57–72.

Appendix I.3.A

An alternative approach to model the levelised cost of the heat (LCOH) and greenhouse gases (GHG) emissions of a nuclear combined heat and power plant (NCHP) supplying the district heating (DH) network of the Dunkirk urban area.

The method applied to model DH + NCHP systems in Chapters 2 and 3 assumes that the extraction of heat on the Rankine cycle of the nuclear plant is responsible for a reduction of power generation that cannot be offset (equals to €6.4/MWh_{th} for the Dunkirk case). In reality yet, the average load factor of the French nuclear fleet was about 70% in 2016, and the load factor of the six reactors being operated on the Gravelines site was 65% (CEA, 2017). In those cases it would be easy to compensate for the reduced electricity production by simply increasing the power output of the reactor. This would only require additional fuel costs, which are minor in the case of nuclear plants (NEA, 2016). Figures I.3.A.1 and I.3.A.2 shows the LCOH and GHG emissions of heating systems when considering that the power losses can be compensated by increasing the load factor of the plant (2015 energy prices, 3.5% discount rate, 40 years operational lifetime).

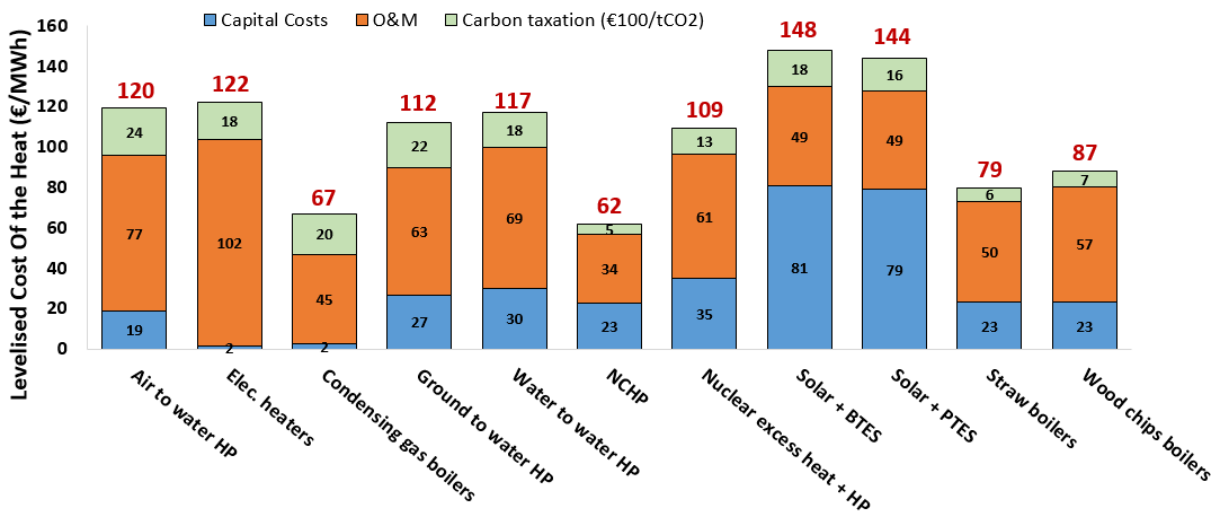

Figure I.3.A.1: LCOH comparison when the power losses due to heat generation with the NCHP can be compensated by increasing the load factor of the plant. The carbon taxation concerns direct CO₂ emissions only.

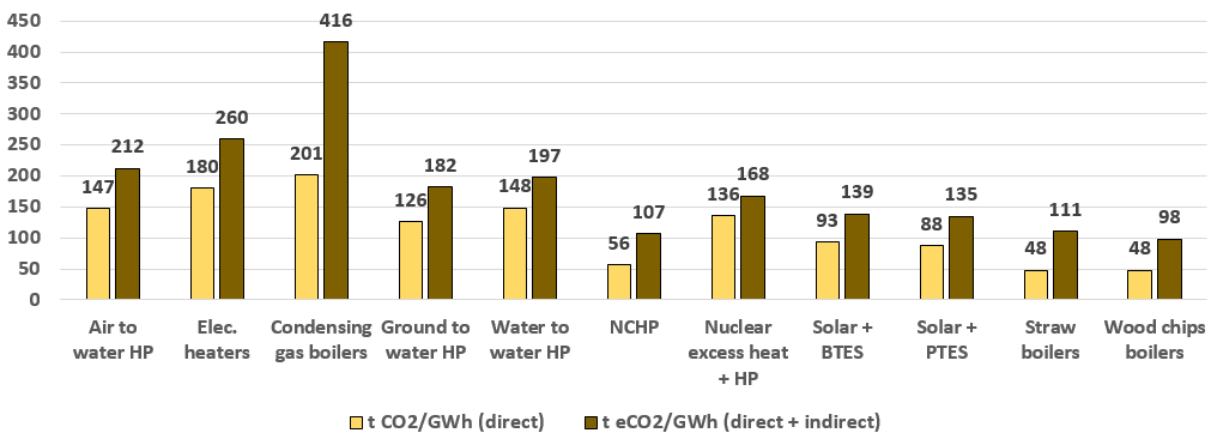

Figure I.3.A.2: Direct and indirect CO₂ emissions of heating systems when the power losses due to heat generation with the NCHP can be compensated by increasing the load factor of the plant.

Notes: All DH systems use natural gas HOB for peak loads, representing 20% of total loads (see 4.1.1.1).

Chapter 4

Feasibility assessment of the use of steam sourced from nuclear plants for French factories considering spatial configuration ²

Abstract

This Chapter provides the basis for the analysis and planning of industrial symbiosis in France, through the most efficient use of existing technologies. The French power mix has largely relied on nuclear plants and, despite an expected decrease of the installed capacity, these thermal plants could remain in the long term. Nuclear plants emit a significant amount of heat into the surrounding environment. Transferring some of this heat to nearby industrial sinks could lead to a reduction in fossil fuel consumption and CO₂ emissions. Relevant industrial subsectors for using 250°C power plant-sourced steam are determined based on empirical data at a 5-digit level of disaggregation of NACE revision 2 (including e.g. pulp & paper and basic organic chemicals). The regional and sectoral distribution of relevant facilities is then analysed using spatial mapping methods. Lastly, a techno-economic model is built to assess the feasibility of transferring steam sourced from nuclear plants to industrial users. Compare to on-site steam generation, power plant-sourced steam supply could reduce energy supply costs and CO₂ emissions in locations close to these plants. Optimum relocation of factories could make steam exchanges more cost-effective, and such considerations should be incorporated in future local planning strategies.

Keywords: Industry, energy symbiosis, spatial analysis, nuclear, France; techno-economic modelling

Highlights

- An energy analytical model combined with spatial energy is constructed
- Industrial symbiosis complexes are planned using data on 114 French subsectors
- The feasibility of steam provision from nuclear plants to factories is examined
- Potential energy and CO₂ emission savings in locations close to thermal plants
- Urban planning and relocation policies are required to achieve energy symbiosis

Comments

- This Chapter is based on the research work initiated by ANCRE (2013). Special thanks are given to Sébastien Sylvestre (SBEM, CEA Grenoble) who help defining the method used in this Chapter (see Sections 2.1 and 2.2 in particular). The ANCRE report shows the industrial market that French nuclear plants could potentially reach, based on the location of existing factories and nuclear sites.
- Chapter 4 goes further by redefining the hypothesis behind the potential market and assessing the costs and benefits of steam transfer from nuclear plants to factories. It is shown that the market potential identified by ANCRE (2013) is, to a wide extend, not economically reachable given the current location of nuclear sites and factories. It is yet demonstrated that industrial complexes composed of factory(ies) located close (0.5-5km) to a thermal plant holds significant cost and greenhouse gas savings potential. Public policies could use the expected heat costs and CO₂ emission savings as levers to promote such industrial complexes.

² Leurent, M., Da Costa, P., Sylvestre, S., Berthélemy, M., 2018. Feasibility assessment of the use of steam sourced from nuclear plants for French factories considering spatial configuration. *Journal of Cleaner Production* 189, 529-538.

1. Introduction

1.1. Background

There is growing concern about the unsustainability of the economic model in developed countries, in particular with regard to climate change (EC (European Commission), 2014a; Lockie and Sonnenfeld, 2013). The literature on industrial ecology emphasises that improved energy efficiency and implementation of low fossil-carbon energy based systems is the most direct and effective way of reducing equivalent- CO_2 emissions in the industrial sector (Chang, 2015; Chertow and Lombardi, 2005; Huisingh *et al.*, 2015). In France, the electricity has a relatively low average CO_2 content compared to other European countries ($62 \text{ t eCO}_2/\text{GWh}_{\text{th}}$, while the EU average is $347 \text{ t eCO}_2/\text{GWh}_{\text{th}}$ (*Ministère de l'environnement, de l'énergie et de la mer* (French Ministry of Environment, Energy and Seas), 2017). At the same time, the energy consumption within the industrial sector is responsible for 13.1% of total CO_2 emissions (*Ministère de l'environnement, de l'énergie et de la mer*, 2017). The fundamental idea of this Chapter is therefore to explore the opportunity for decarbonising the industrial sector through efficient use of existing technologies. This could include, in France, the use of heat sourced from nuclear plants for industrial applications.

Towards 2025-30, the nuclear installed capacity should remain significant (40 to 63 MW_e). This despite plans to reduce the share of nuclear production in the electricity mix from 75% (2016 level) to 50% (2025), as targeted by public authorities (*Ministère de l'environnement, de l'énergie et de la mer*, 2015). In the longer term, dispatchable power plants may present some new benefit to balance power systems with large amounts of intermittent renewables (Cany *et al.*, 2016; Wang *et al.*, 2016). Given the path dependence approach (past investments made), as well as the low carbon profile of this energy source, nuclear plants could remain in use for a number of decades in France (see e.g. Maïzi and Assoumou, 2014). In order to enhance the development of industrial ecology practices, some of these plants could be optimised to supply heat to nearby industrial sites.

Nuclear plants can be designed to provide both electricity and heat without jeopardising nuclear safety (STUK (Radiation and Nuclear Safety Authority of Finland), 2009: p. 6). Operating thermal plants in cogeneration mode enables the recovery of some of the thermal energy which is otherwise wasted in the surrounding environment. While the nuclear cogeneration application in which there is most experience is district heating (see Chapter 5), there is also some experience of steam supply to nearby industrial facilities, as shown in Table I.4.1. The French nuclear fleet, and most nuclear reactors operating in the world today (277 out of 438) and under construction (59 out of 69; IAEA, 2017) are Pressurised Water Reactors (PWR). In PWR, the steam at the steam generator outlet is superheated to 285°C . In France, the consumption of heat below 250°C represents approximately one third of the final energy used in the industrial sector (excluding energy production and refineries) and the bulk of the demand ranges from 80°C to 250°C (ADEME (French Environment and Energy Management Agency), 2015). Hence, it is clear that the feasibility of 250°C steam transfer from nuclear plants to industrial facilities is worth assessing for France. This Chapter is dedicated to this objective.

Country/ reactor type	Net power output (MW _e)	Heat delivery (MW _{th})	Supply temperature (°C)	Distance to factory (km)	Industrial application	Operation period of application
Norway/ Halden BWR (*)		20	-	Adjacent site	Paper mill	1964 -
Switzerland /Gösgen PWR	1 × 985	45	220	1.8	Cardboard factory	1979 -
Canada/ Bruce CANDU (**)	4 × 860	5350	-	On-site	Heavy water and others	1981 - 1997
Germany/ Stade PWR	1 × 630	30	190	1.5	Salt refinery	1984 - 2003

Table I.4.1: Experience of industrial use of steam sourced from nuclear plants. Data source: Verfondern (2013).

Notes:

(*) BWR: Boiling Water Reactor.

(**) CANDU: CANada Deuterium Uranium.

1.2. Research scope

Industrial symbiosis (IS) is one of the key concepts for using energy and resources effectively. Chertow (2000) defined IS as engaging “traditionally separate industries in a collective approach to competitive advantage involving physical exchanges of materials, energy, water, and/or by-products.” Reported examples of IS include energy exchange in chemical clusters (Shi *et al.*, 2010), iron/steel industrial parks (Zhang *et al.*, 2013), between power plants and industrial/residential areas (Jacobsen, 2006; Chertow and Lombardi, 2005). In France, there are currently 14 IS complexes and more than 60 new cooperations are being considered (OREE (French association of companies and local municipalities promoting circular economy), 2015). Although French complexes have focused mainly on effective material use, there is an increasing policy expectation that exhaust heat from power plants and industries should be valorised (*Ministère de l’environnement, de l’énergie et de la mer*, 2014: p. 14). In the town of Dunkirk, France, waste heat from a steel manufacturing plant is distributed to the city district heating network. This practice has reduced the energy demand and CO₂ emissions by 128 GWh_{th}/a and 30 kt eCO₂/a respectively, compared to the use of conventional energy systems (CEREMA (French Research Centre on Risks, Environment, Mobility and Territorial Planning), 2009).

However, heat exchange synergies are still rare in France. IS projects are complex systems that may have difficulty breaking through established routines and business models (Tudor *et al.*, 2007). The literature on IS emphasises the need to identify key organisations in a region around which the recycling network of industrial players could emerge (Wallner, 1999; Boons and Baas, 1997). According to Korhonen (2001), a combined heat and power plant can serve as a starting point for developing an IS strategy. According to these results, it seems that the implementation of IS in France could be facilitated by the use of steam sourced from nuclear plants. Nuclear plants could serve as the driver of some of the main material and energy flows of the regional energy supply system, and as a possible organisation around which the control and management of these flows are organised. This may be made easier by the fact that the French nuclear operator is a public company.

Yet, such projects can face considerable obstacles. Despite being widely available, there is no actual experience of nuclear plant-sourced heat utilisation in France. The attractiveness of this alternative is lessened by the policy challenges inherent in its wide diversity (Chapter 5). From a systemic point of view, the main investment involved in this kind of project will be in the pipeline required to transport the steam from the heat sources to the sinks. Unlike electricity, which has a well-developed grid network, new pipeline infrastructures must be carefully planned. It may not be cost-effective to transport the steam over distances of more than 3-5 km (NISP (National Industrial Symbiosis Project), 2008). The proximity of energy consumers to suppliers is therefore a key design factor for IS systems. To establish sustainable IS complexes in a low-carbon scenario, it is necessary to identify factories near power plants that may operate until 2050, or to establish power plants near the locations of future IS complexes. Since new nuclear plants, if they are commissioned, will probably replace decommissioned plants on existing sites, the former case is more likely.

Therefore, it is necessary to combine spatial planning and energy system modelling methods. Some studies have discussed the feasibility of using heat from power plants and have demonstrated considerable energy potential for each analytical area (Seck *et al.*, 2015; Bowman, 2012; Safa, 2012). Wang *et al.* (2017) proposes a model to improve the simulation of steam transportation pipelines that are crucial for heat exchanges in IS complexes. However, most of the previous research focused on the optimisation of existing heat exchanges with static systems, and only a few studies have considered land use planning issues. Fixed demand is not a reasonable assumption when assessing the long-term dynamics of the energy system, and the consideration of relocation issues is important. In this respect, the study led by Togawa *et al.* (2014) is significant. Using spatial mapping methods, Togawa *et al.* (2014) showed that the relocation of a tomato factory to within a 2 km radius of a thermal plant could reduce energy costs while reducing equivalent-CO₂ emissions by 47% compared to the use of an individual fuel oil-based boiler.

From an academic perspective, there is a need to further investigate the techno-economic feasibility of potentially new IS systems so as to inform policy makers and stakeholders on the cost and climate savings potential of such systems. However, accurate modelling of IS complexes requires the collection of a substantial amount of data. Information such as the size of the factories and the location of the plants in relation to one another would provide information on ease of access. In addition, the viability of the project cannot be established unless industries provide details on planned and unplanned plant outages. The information on source availability is therefore crucial for designing IS complexes but can be difficult to collect due to confidentiality issues. In that respect, a key added value of our research is the accuracy of the data used, which covers all French factories at a 5 digit-level of disaggregation of NACE revision 2, with 114 subsectors, for 2012.

1.3. Outline of the Chapter

Based on these research statements, this study aims to fill the research gap in three areas. Firstly, relevant subsectors for the use of power plant-sourced steam are determined. Secondly, combined with spatial analysis, the geographical and sectoral distribution of relevant factories is assessed. Thirdly, cost-effective land use considering relocation of the energy demand is analysed using two applied cases, so as to reduce equivalent-CO₂ emissions through the relocation of high-energy industrial consumers closest to the heat sources. Section 2 describes our key data, the data processing method and additional modelling assumptions. Then Section 3 gives the results and discusses them. Section 4 concludes.

2. Data processing and modelling assumptions

The methodology followed can be broken down into three consecutive steps. Step 1 uses our key data to characterise those subsectors which constitute relevant targets for replacement of conventional, individual steam generation systems with external steam supply. Following geo-referencing of all production facilities and nuclear sites in France, step 2 determines the geographical and sectoral distribution of the factories in the subsectors identified in step 1. Lastly, step 3 builds a model designed to assess the techno-economic potential of IS complexes using power plant-sourced steam.

2.1. Identification of the relevant industrial subsectors for external supply of 250°C steam

To build a prospective scenario for decarbonising the industrial sector, it is essential to have detailed information on the CO₂ emission factor of conventional heating systems, the frequency of factory shutdowns and the range of temperatures required. It is therefore important to understand the data used in this Chapter and the processing method used.

2.1.1. Presentation of the data

The core data used is based on a comprehensive study initiated by the French National Alliance for Energy Research Coordination (ANCRE, 2013). The database is constructed from more than 6000 data points incorporating energy knowledge of industrial sectors from the National Centre for Analysis and Research on Energy (CEREN) in 2012. These data were provided at a 5-digit level of disaggregation of the NACE revision 2 classification with 114 subsectors (EC, 2008). The information for each subsector concerns the amount of heat (GWh_{th}/a) that was:

- Generated using a particular type of energy: steam or other heating medium, natural gas, electricity, renewable energies, oil products or a mixture of these sources. Given that the direct and lifecycle CO₂ emission factors of these energies are known (see Table I.4.2), the average equivalent CO₂ emission factors of heat generation in factories can be assessed for each subsector;
- Consumed within a particular temperature range: 70°C, 100-150°C, 150-250°C, or >250°C;
- Used to operate a factory with a given working schedule: 1×8 hours, 2×8 hours, 3×8 hours with stops, 3×8 hours without stops. The average number of hours during which the factories in each subsector were operated was also available (<2000 h, 2000-4000 h, 4000-7000 h, >7000 h). This data enables to calculate $NH_{FT,j}$, the average number of hours per year during which factories in subsector j operated.

Energy source	Equivalent-CO ₂ emission factor (t eCO ₂ /GWh _{th})
Natural gas	469
Oil products	750
Heating fluid (mostly oil products, then gas) (*)	600
Mixed (mostly gas, then oil products) (*)	500
Renewable heat sources	15
Electricity (average in France)	150

Table I.4.2: Direct and lifecycle CO₂ emission factors of energy sources. Data source: IPCC (Intergovernmental Panel on Climate Change; 2012); EEA (European Environment Agency), 2011.

Notes:

(*) Discussions with experts from CEREN and ANCRE helped with the formulation of these assumptions.

2.1.2. Data processing using economic criteria

The higher the energy intensity, the higher the competitiveness risk related to CO₂ pricing policies (Meleo, 2014), and the greater the benefits expected from energy cost reduction. In order to provide insights into the potential interest of factory owners in reducing energy costs, EI_j , the average energy intensity observed in subsector j , is calculated using equation (1):

$$EI_j = \frac{\sum_e G_{e,j} P_e}{PV_j} \quad (1)$$

Where $G_{e,j}$ is the total amount of heat generated using energy e in subsector j ($GWh_{th}/year$); P_e is the price of energy e observed in 2012; and PV_j is the total production value of subsector j in 2012 (available from INSEE (French National Institution for Statistics and Economics Studies), 2016). Following the taxonomy established by Seck *et al.* (2016), this Chapter studies both energy intensive ($EI_j \geq 5\%$) and non-energy intensive subsectors. We have however discarded the subsectors which would show little interest in reducing energy costs ($EI_j < 1\%$).

We have chosen to use the production value as the preferred indicator of economic activity for the rest of the study. In our case, using the production value is preferable due to the difficulty of comparing added values across diverse subsectors (Seck *et al.*, 2016).

2.1.3. Data processing using environmental criteria

External steam supply is not the only way of improving the industrial energy efficiency. Factory owners should also consider internal energy efficiency investments, through the implementation of the technologies listed by e.g. Hasanbeigi *et al.* (2016) or Kwak *et al.* (2014). Despite the potential benefits, external steam supply may inhibit the will of factory owners to invest in internal energy efficiency technologies because they have invested in capital-intensive systems (e.g. steam transportation system), and are waiting for the payback from their investments (Korhonen, 2001). Following discussions with experts from CEREN and ANCRE, we have discarded factories that primarily consume heat above 250°C (>50% of total consumption).

2.2. Determining the spatial and sectoral distribution of relevant factories

While step 1 considers industries at a 5-digit level of NACE Rev. 2, step 2 goes down to factory level. The CO₂ emission factors, working schedule and ratio of heat costs over production value for specific factories are assumed to be equal to the average for the subsector (see 2.1). However, additional processing was performed to establish the heat consumption within all French industrial facilities. Firstly, C_j , the average heat consumption of a factory in subsector j (GWh_{th}/a) is expressed in equation (2):

$$C_j = \frac{TC_j}{N_j} \quad (2)$$

Where, TC_j is the total heat consumption in subsector j (GWh_{th}/a); and N_j is the total number of facilities in subsector j (INSEE, 2016).

Then, $C_{i,j}$, the heat consumed by factory i in subsector j (GWh_{th}/a), is expressed in equation (3):

$$C_{i,j} = C_j \frac{W_{i,j}}{W_j} \quad (3)$$

Where C_j , is the average heat consumption of a factory in subsector j ($GWh_{th}/year$); $W_{i,j}$ is the workforce of factory i in subsector j (INSEE, 2016); and W_j is the average workforce of a factory in subsector j (INSEE, 2016). The assumption supporting equation (3) is that the factories in each subsector are relatively homogeneous in terms of the amount of heat consumed per employee.

However, in a new factory one can expect technical progress to reduce the workforce required to produce a fixed output. In order to minimise this potential effect, this Chapter uses the more detailed disaggregation level of NACE rev. 2 (5-digit level) for the French industrial sector.

Using spatial mapping methods, the datasets produced for each French factory were plotted on a boundary map of France using a Geographical Information System. Together with the georeferencing of nuclear sites, the methodological use of our data enables us to assess the geographical and sectoral distribution of all facilities that are included in a subsector identified in step 1. The assessment boundaries are restricted to factories that are:

- Consuming more than 10 GWh_{th}/a of heat below 250°C. In practice, IS systems are mostly composed of large energy consumers (Chertow, 2000) as there may be a critical size for a company to support the related costs and be involved in long-term agreements with other firms (Maes *et al.*, 2011);
- Located less than 100 km from a nuclear site. When several sites were located within a 100 km radius of the company the closest site was chosen.

2.3. Assessing the techno-economic feasibility of transferring power plant-sourced steam to factories

In step 3, an energy model based on process analysis is established to assess an energy exchange system that incorporates spatial configuration. An outline of the model framework and system boundary is shown in Figure I.4.1. Here, we focus on spatial problems, such as energy decay for steam extraction and transportation, and new infrastructure construction costs. For the assessment of IS systems, there are three key issues:

- New infrastructure investment costs should be included, particularly those of pipelines and related equipments for transmitting heat energy;
- Energy conversion efficiency is expected to improve the utilisation of exhaust heat from thermal power plants. However, extracting steam from the Rankine cycle of the nuclear reactor inevitably reduces the amount of heat that is converted into electricity. Heat energy properties should also be considered, such as heat loss during pipeline transportation or the power used for conveyance;
- The heat energy demand fluctuates on a seasonal or daily basis depending on customers' needs. In our case, daily fluctuations are predictable since the heat would be used for continuous processes. Seasonal fluctuations will however affect the diameter of the pipeline needed. The energy simulation has thus been carried out based on the aggregated energy demand per year, taking into consideration the working schedules of factories (seasonal and weekly fluctuations, enabling the equivalent-full time utilisation of industrial processes to be calculated).

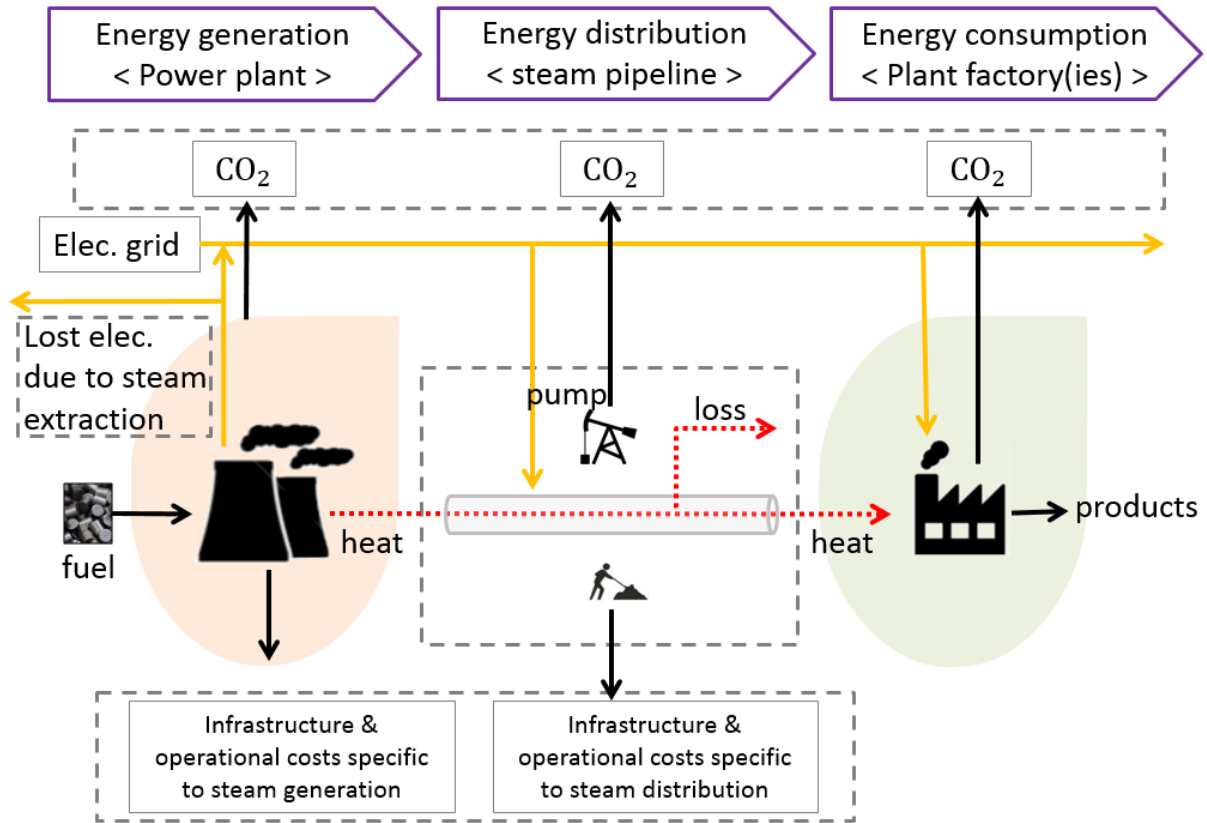

Figure I.4.1: Structure of the regional energy analytical model and system boundaries.

Notes:

The parameters assessed in this Chapter are shown in boxes with dotted lines.

The model system consists of three sub-models: an energy consumption system, an energy generation system and an energy distribution system. The energy consumption system sub-model consists of the factories consuming the steam. The energy generation system sub-model represents the extraction of steam from the Rankine cycle of the nuclear reactor. In the energy distribution system sub-model, equivalent- CO_2 emissions and energy transfer costs are calculated taking heat losses into consideration. These models were formulated as a linear programming problem using Python.

Energy consumption system

This system is mainly the result of the calculations described in Section 2.2. Q_{IS} , the maximum thermal power required to cover the annual heat needs of all consumers (MW_{th}), is expressed in formula (4):

$$Q_{IS} = \sum \frac{C_{i,j} 10^3}{NH_{FT,j}} \quad (4)$$

Where $C_{i,j}$ is the steam consumed by factory i in subsector j ($\text{GWh}_{\text{th}}/\text{year}$); and $NH_{FT,j}$ is the average number of hours per year during which facilities in subsector j are operated.

Energy generation model

The cost of steam generation with the nuclear plant is regarded as the investment cost of a Generation III PWR attributable to steam generation. The infrastructure cost, C_{CU} ($\text{€}/\text{MW}_{\text{th}}$), of a combined heat and power (CHP) upgrade in a PWR is expressed as in formula (5):

$$C_{CU} = Q_{IS} C_{MCU} \quad (5)$$

Where Q_{IS} is the maximum thermal power required (MW_{th}); C_{MCU} is the marginal cost of a CHP upgrade in a PWR ($\text{€}/MW_{th}$). The Energy Technology Institute (ETI, 2016) states that C_{MCU} is between $0.05 \text{ €}/MW_{th}$ and $0.09 \text{ €}/MW_{th}$, including e.g. pumps and condensers. As a conservative assumption, it is assumed here that C_{MCU} is $0.1 \text{ €}/MW_{th}$. Operational and maintenance costs are assumed to represent 1% of the capital cost.

The model takes into account the reduction in power generation due to heat extraction from the Rankine cycle of a PWR. For the extraction of steam at 285°C and 70 bar at the steam generator outlet, E_{LS} , the electricity loss (MWh_e) represents one third of the thermal power generated (IAEA, 2016). This represents the opportunity cost of operating a nuclear plant in a cogeneration mode. In this Chapter, we considered the most conservative case in which the heat loads always occur when the plant is providing electricity to the power grid. This is not true in practice since the load factor of nuclear plants is rarely of 100%, the French average for 2017 being 72% (CEA (French Nuclear and Alternative Energies Commission), 2017). A more detailed analysis, based on a real, experimental project, would want to consider the temporal correlation between electricity and heat production. In the frame of this study however such precise, case by case data were not available. Given the uncertainty at stake, retaining the conservative assumption mentioned above is reasonable.

Given the above assumptions, the required cost (C_{pp}) and additional CO_2 emissions (E_{pp}) to compensate for power generation losses are expressed as equations (6) and (7) respectively:

$$C_{pp} = C_{el} E_{LS} \quad (6)$$

$$E_{pp} = e_{el} E_{LS} \quad (7)$$

Where C_{el} is the electricity generation cost in a nuclear power plant ($\text{€}/MWh_e$), and e_{el} is the equivalent- CO_2 emission factor of the electricity ($t \text{ e}CO_2/GWh_e$; see Table I. 4.2).

Energy distribution model

The energy distribution model assesses costs and equivalent- CO_2 emissions as well as the infrastructure construction cost required for energy transfers. The 250°C steam extracted from the power plant would be transported to heat sinks through a single superheated pipe, the most commonly used type of pipeline for 250°C steam transportation (García-Gutiérrez *et al.*, 2015; Wang *et al.*, 2017). Heat energy flows out from the pipeline surface during transport, and this loss should be assessed under various conditions (e.g. pipe diameter, insulation thickness, distance). Furthermore, electricity is needed for pumping, to circulate the heating medium.

a) Pipe diameter

The pipe diameter is calculated using empirical data on existing pipeline networks transporting steam at 250°C (García-Gutiérrez *et al.*, 2015; Wang *et al.*, 2017). First, the steam flow G_s (kg/s) and the volumetric flow rate \dot{v} (m^3/s) are calculated as in equations (8) and (9):

$$G_s = \frac{Q_{IS}}{\lambda} 10^6 \quad (8)$$

$$\dot{v} = \frac{G_s}{\rho} \quad (9)$$

Where Q_{IS} is the maximum thermal power required (MW_{th}); λ is the latent vaporisation heat (Ws/kg); ρ is the water density (kg/m^3). Here, ρ is assumed to be $6.5 \text{ kg}/\text{m}^3$, as in e.g. Wang *et al.* (2017).

Then, the pipe diameter D (m) is calculated using formula (10):

$$D = \sqrt{\left(\frac{4 \dot{v}}{\pi v}\right)} \quad (10)$$

Where v is the flow velocity (m/s). If the steam flows at a low velocity or stagnates, there could be serious accidents (e.g. condensation induced water hammer). 21 m/s is a reasonable assumption to ensure safety of operation (García-Gutiérrez *et al.*, 2015; Wang *et al.*, 2017).

b) Heat loss assessment

To calculate heat loss, the pipeline energy balance must be understood. Referring to Yoshiyuki *et al.* (2001), the heat balance at a microscopic interval, dx , is expressed as equation (11). Integrated along pipe length l , equation (12) describes TH_{LS} , the thermal loss from heat transfer (W_{th}):

$$cG_s \frac{dT}{dx} = \pi DK(T_{out} - T) \quad (11)$$

$$\begin{aligned} TH_{LS} &= cG_s(T_s - T_d) \\ &= cG_s(T_s - T_{out}) \left\{ 1 - e^{-\left(\frac{\pi DK}{cG_s}\right)l} \right\} \end{aligned} \quad (12)$$

Where T_s is the steam temperature at the supply-side; T_d is the steam temperature at the demand side; T_{out} is the outside temperature; c is the steam heat ratio ($W/(kg \cdot K)$); G_s is the steam flow (kg/s); D is the pipeline diameter (m); l is the length of the pipeline (m); and K is the overall heat transfer coefficient ($W/m^2 \cdot K$). According to García-Gutiérrez *et al.* (2015) and Wang *et al.* (2017), a well-insulated pipeline can have a low heat transfer coefficient ($0.24 W/m^2 \cdot K$). For conservative reasons, we here assumed K equals to $0.5 W/m^2 \cdot K$. For real case applications yet, heat transfer coefficients would need to be assessed considering the operational conditions.

c) Pumping cost and CO₂ assessment

The operation of a pumping system is required for transferring steam. The energy consumption of the system (W_e), P_{PM} , is expressed as in equation (13):

$$P_{PM} = \frac{g G_s H}{\eta_p} \quad (13)$$

Where g is the gravitational acceleration (m/s^2), η_p is the pump efficiency ratio (0.75), G_s is the steam flow (kg/s), and H is the lifting height (m). Referring to the Darcy–Weisbach equation, the lifting height is expressed as equation (14):

$$H = f \frac{L}{D} \frac{v^2}{2g} + c \quad (14)$$

Where L is the pipeline length (m), D is the pipeline internal diameter (m), v is the velocity of the medium (m/s), g is the gravitational acceleration (m/s^2), f is the friction loss coefficient, and c is the friction loss by local resistance (0.5).

From the above assumptions, and assuming that the system is operational 100% of the year (8760 hours/a), the required cost, C_{PM} , and additional equivalent-CO₂ emissions, E_{PM} , involved in the operation of a pumping system are expressed in equations (15) and (16) respectively:

$$C_{PM} = C_{el} P_{PM} 8760 \quad (15)$$

$$E_{PM} = E_{el} P_{PM} 8760 \quad (16)$$

Where C_{el} is the generation cost in a nuclear plant ($€/MWh_e$), and E_{el} is the equivalent-CO₂ emission factor ($t eCO_2/GWh_e$).

In practice, nuclear plants would not provide heat throughout 100% of the year. The equivalent full-time utilisation would depend on the heat demand profile of the supplied factories (see Table I.4.3) and plant outages schedules. Assuming the conservative value of 100% (slightly) increases the costs and CO₂ emissions from pumping, which is reasonable considering the uncertainty at stake.

d) Pipeline installation cost

Dalla Rosa *et al.* (2012) and Hirsch *et al.* (2016) provide an equation expressing the pipeline cost as a function of the inner diameter. It represents the sum of the pipe, insulation layer, pumping stations, civil engineering work, sand filling and labour costs needed to build a pipeline designed to transport hot water (80-120°C). Discussions with French district heating companies highlighted that

the infrastructure cost should be 2 to 3 times higher for the construction of pre-insulated industrial pipes designed to carry superheated steam (250°C), and the conservative value of 3 is used in this Chapter. Given these considerations, C_{SP} , the capital cost of the single superheated pipeline (€/m) is expressed in equation (17), where D is the pipe diameter (m):

$$C_{SP} = 4500 D^2 + 6000 D + 900 \quad (17)$$

The operational and maintenance costs are assumed to represent 4% of the total pipeline cost (Dalla Rosa *et al.*, 2012).

Infrastructure costs related to steam generation and steam transport sub-models were converted to annual rental cost r_{IF} (€/MWh_{th}) applying a discount rate method, expressed as equation (18):

$$r_{IF} = I_{CC} \frac{i}{1 - \left(\frac{1}{1+i}\right)^t} \quad (18)$$

Where I_{CC} is the infrastructure capital cost (€/MWh_{th}), either for the CHP upgrade of a PWR (C_{CU} , see equation (5)) or for the superheated steam pipeline (C_{SP} , see equation (17)). i is the interest rate and t is the time (year).

3. Results and discussions

Each sub-section below (3.1, 3.2 and 3.3) present and discuss the results based on the methodological steps presented in the earlier sub-sections (2.1, 2.2 and 2.3, respectively). Sub-sections 3.1, 3.2 and 3.3 together answer the three research questions raised in sub-section 1.3.

3.1. Relevant industrial subsectors for using 250°C power plant-sourced steam

Based on the data and assumptions presented in Section 2.1, Table I.4.3 shows the parameters characterising the subsectors that could constitute relevant targets for those low carbon policies which aim at encouraging the external supply of 250°C steam to factories. The application of the restrictive criterion shown in 2.1 leads to just 14 of the 114 subsectors of the French industrial sector being selected for further analysis. The greatest potential for the creation of IS complexes is in subsectors in which the following parameters are relatively high:

- The share of heat consumption at temperatures lower than 250°C (which indicates the potential of external supply of steam at 250°C to replace all or part of the on-site steam generation);
- The average equivalent-CO₂ emissions from heat generation with on-site boilers (which determine the potential for reducing equivalent-CO₂ emissions by replacing on-site steam generation);
- The average consumption of heat <250°C per factory (which affects the cost of the external steam supply);
- The share of heat costs in the production value (which affects the interest of factory owners in reducing the cost of steam).

Subsector	NACE code	Average consumption of heat <250°C per factory (GWh _{th} /year)	Equivalent full-time utilisation (% of year)	Cost of heat generation < 250°C over production value (see equation (1))	Share of heat <250°C in total heat consumption	Equivalent-CO ₂ emissions (t eCO ₂ /GWh _{th})
Fruit & vegetables	1031Z-1039A-B	19	66%	1.1%	93%	548
Dairy products	1051A-B-C-D	32	74%	1%	94%	564
Starch products	1062Z	704	66%	7.3%	76%	549
Sugar refinery	1081Z	97	34%	6.6%	82%	599
Malt production	1106Z	88	66%	3.2%	100%	522
Wood panels	1621Z	39	65%	3.9%	71%	554
Pulp & paper	1711Z	695	87%	36.9%	91%	595
Card & paper	1712Z	133	87%	8.8%	87%	589
Corrugated card	1721A-B	15	87%	1.3%	99%	596
Dyes & pigments	2012Z	62	87%	3.7%	76%	587
Other basic organic chemicals	2014Z	136	87%	2.8%	57%	591
Basic pharmaceutical products	2110Z	27	87%	1.0%	92%	570
Basic plastic materials	2016Z	41	82%	1.1%	78%	566
Synthetic rubber	2017Z	131	82%	2.2%	54%	588

Table I.4.3: Industrial subsectors suitable for the integration of IS complexes.

Notes:

Highlighted in green: Agri-food industry;

Highlighted in red: Wood, pulp and paper;

Highlighted in blue: Chemical and pharmaceutical industries;

Highlighted in yellow: Plastic, rubber and other elastomers.

3.2. Spatial and sectoral distribution of relevant factories

Figure I.4.2 shows the spatial mapping of nuclear sites and factories in the subsectors identified in Table I.4.3. Using the calculations described in equations (2) and (3), the amount of heat consumed annually at temperatures below 250°C has been assessed for each industrial facility. Approximately 30 TWh_{th}/year of heat below 250°C is consumed in factories located less than 100 km from a nuclear site. Given the CO₂ emissions of each subsector, it has been estimated that the generation of heat below 250°C within these factories is responsible for the emission of 16,000 kt eCO₂/a. This is equivalent to 20% of the total equivalent-CO₂ emissions from the French industrial sector and 3.5% of the total French emissions (and 25% of emissions from the industrial sector; *Ministère de l'environnement, de l'énergie et de la mer*, 2017).

Figures I.4.3 and I.4.4 show respectively the sectoral and spatial distribution of the heat below 250°C consumed by the factories in the subsectors studied. Regions with an aggregated industrial heat consumption of less than 100 GWh_{th}/year have been discarded and are not shown in Figure 1.3.4. These represent less than 1% of the total. Figures I.4.2, I.4.3 and I.4.4 constitute a solid basis for analysing the regional potential of IS complexes using steam sourced from nuclear plants in France. When looking at these Figures, one should however keep in mind that they do not allow to distinguish those IS complexes which are economically feasible from the others. Figures I.4.2- I.4.4 considers the

heat demand of all factories located in a 100km radius from nuclear sites, while in practice transporting the steam over distances exceeding 3-5 km may not be cost-effective (NISP, 2008). Compared to the overall regional potential assessed in Figures 1.4.2-1.4.4, the potential for cost-effective implementation of IS complexes based on nuclear plants is limited given the location of existing plants. Under the current spatial configuration, relocation of the factory may be of interest for the card & paper and the malt factories located 3.2 km and 2.4 km from *Nogent-Sur-Seine*, respectively. The two chemical plants situated 1.8 km away from *Le Bugey* constitute another promising IS complex. The *Gravelines* area, with a pharmaceutical plant located 0.5 km away from the thermal plant, is also relevant.

To increase the number of feasible IS systems, ambitious urban planning policies would be needed at a regional level, so as to relocate the factories from relevant sub-sectors (see Table 1.4.3) in contingent areas centred on nuclear sites. The more contiguous the distribution of various factories within the same geographical area, the more likely IS are to emerge (Jensen, 2016). Those policies which aim at relocating factories from different sub-sectors within a contiguous area can thus expect positive spillover effects such as the sharing of services or additional recovery of waste materials (see e.g. Chertow, 2000).

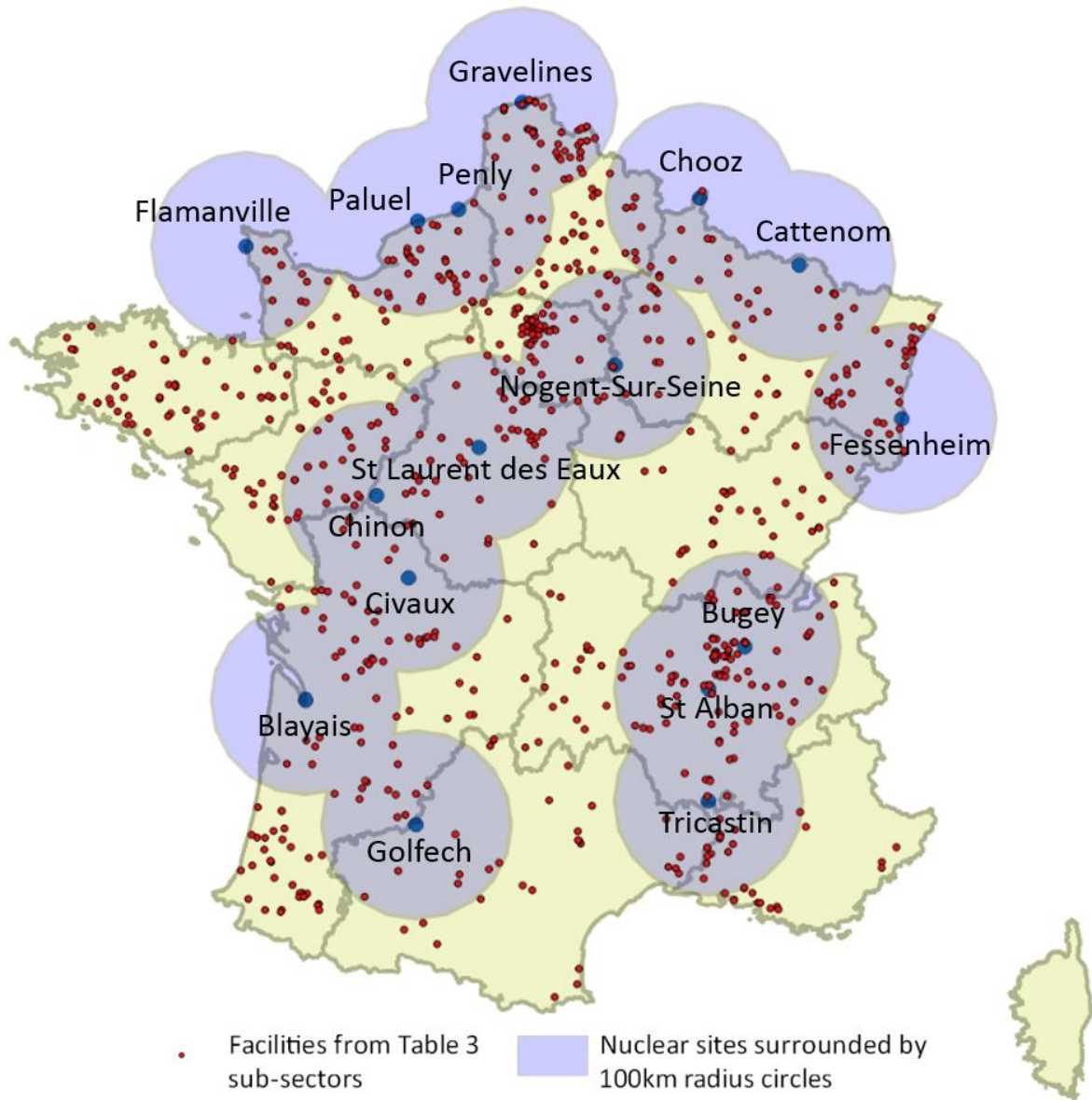

Figure I.4.2: Spatial mapping of nuclear sites and factories studied.

Feasibility assessment of the use of steam sourced from nuclear plants for French factories considering spatial configuration

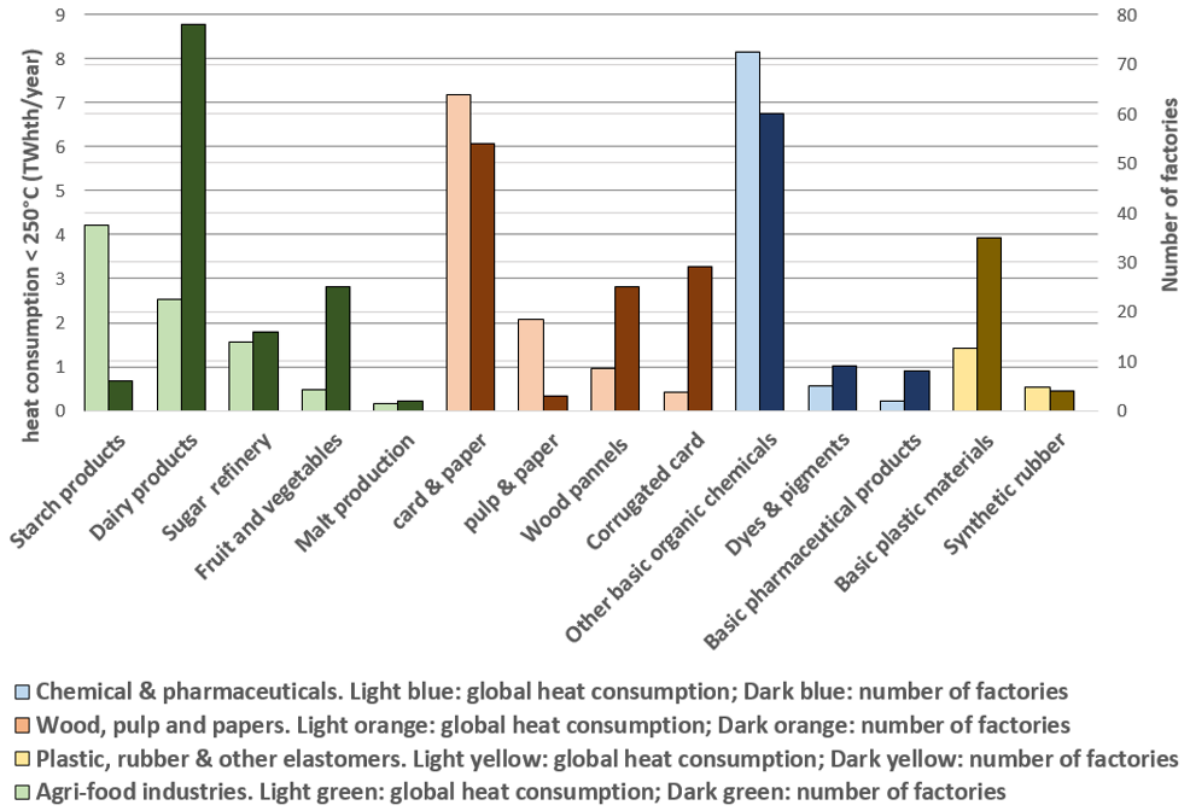

Figure I.4.3: Subsectoral distribution of heat consumption below 250°C and of corresponding factories, for the land areas shown in Figure I.4.2.

Notes: The average heat consumption of a single factory is shown in column 3 of Table I.4.3.

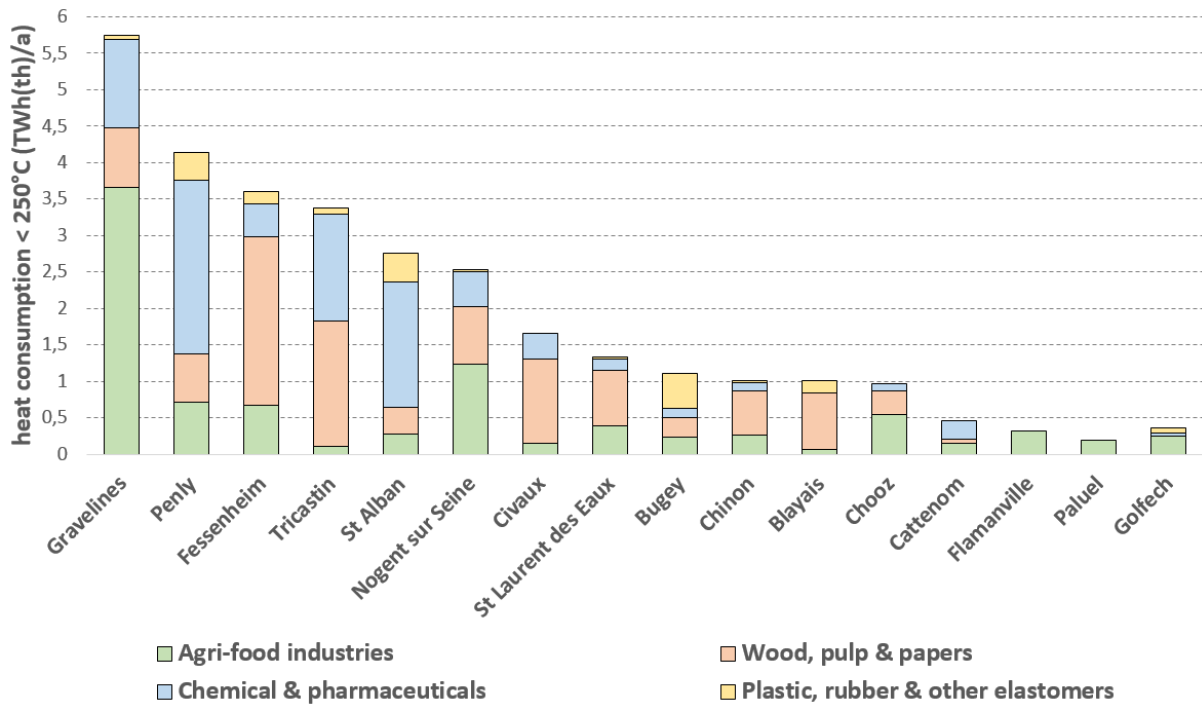

Figure I.4.4: Spatial distribution of heat consumption below 250°C, for the land areas shown in Figure I.4.2.

Notes: The average heat consumption of a single factory is shown in column 3 of Table I.4.3.

3.3. Techno-economic assessment of industrial symbiosis considering spatial configuration

Sub-Section 3.3 aims to determine the conditions upon which IS systems based on nuclear plants may become economically attractive compare to the usual heating solutions. To analyse and discuss the techno-economic feasibility of thermal plant-sourced steam transfer to nearby factories, two theoretical cases are considered, as described in Table I.4.4. IS complex 2 is not feasible in practice given the current location of the factories (located too far away from the thermal plant, see Table I.4.4). It is however interesting to evaluate the cost and climate savings that could exist if the factories identified in IS complex 2 would be relocated in the direct proximity of the *Nogent-Sur-Seine* nuclear site. As shown by Togawa *et al.* (2014), reducing energy costs may represent a sufficient incentive for a factory to be located near a thermal power plant, especially in a context of increasing pressure to reduce the environmental impact and dependence on fossil fuels.

Parameter	IS Complex 1	IS Complex 2
Number of factories	2	5
Products manufactured by the factories (and distance from the closest nuclear site)	Basic organic chemicals (1.8 km)	Card & Paper (3 km), Malt (3 km), card & paper (35 km), pulp & paper (60 km), basic organic chemicals (69 km)
Name of the closest nuclear site	<i>Le Bugey</i>	<i>Nogent-Sur-Seine</i>
Total amount of heat < 250°C consumed (GWh _{th} /a)	137	661
Equivalent-CO ₂ emissions from heat generation < 250°C using conventional individual heat systems (kt eCO ₂ /a)	82	696

Table I.4.4: Theoretical IS complexes assessed.

According to equations (7) and (16), the equivalent-CO₂ emissions avoided by the implementation of IS complexes 1 and 2 would be approximately 78 kt eCO₂/a and 377 kt eCO₂/a respectively. The total amount of emissions avoided depends on the distance over which the steam is transported (as the pumping power increases with the distance), but the effect is relatively small when replacing fossil fuels with power plant-sourced steam. The cost of the steam supplied was calculated based on a reference generation cost of electricity from French nuclear plant of 42 €/MWh_e (*Ministère de l'environnement, de l'énergie et de la mer*, 2016). Assuming a discount rate of 3.5% over 20 years, as recommended by the EC (2014b), and according to equation (18), the results are shown in Figure I.4.5 and compared to the business as usual (BAU) case where steam at 250°C is generated using conventional individual heating systems. In this Chapter, the reference is the average cost paid by large industrial users for the generation of steam at 250°C, 22 €/MWh_{th} (INSEE, 2014). In practice, this cost ranges from 12 €/MWh_{th} to 35 €/MWh_{th} depending on parameters specific to each factory (e.g. the region, the workforce and the subsector; see INSEE, 2014).

Figure I.4.5 shows that the distances over which the steam is transported should not exceed 4 km to ensure cost-effectiveness of the steam supply in IS complex 1 (transportation heat losses

represent 1.1% and 2.3% of the heat generated, respectively for 1.8km and 4km distances; following equations (11) and (12)). The cost of the steam in IS complex 2 is less sensitive to the distance than in IS complex 1, and may be competitive if the length of the pipeline required to connect the 6 factories to the thermal plant does not exceed 10-11 km (heat losses equal 2.7-2.9% of the heat generated; such low heat losses however require well insulated pipelines, as discussed in Section 2.3). The large amount of steam supplied in IS complex 2 (five times higher than in IS complex 1; see Table I.4.4) may justify the transport of heat over long distances. This highlights the importance of coordination and planning policies, which should encourage the location of relevant factories within contiguous areas.

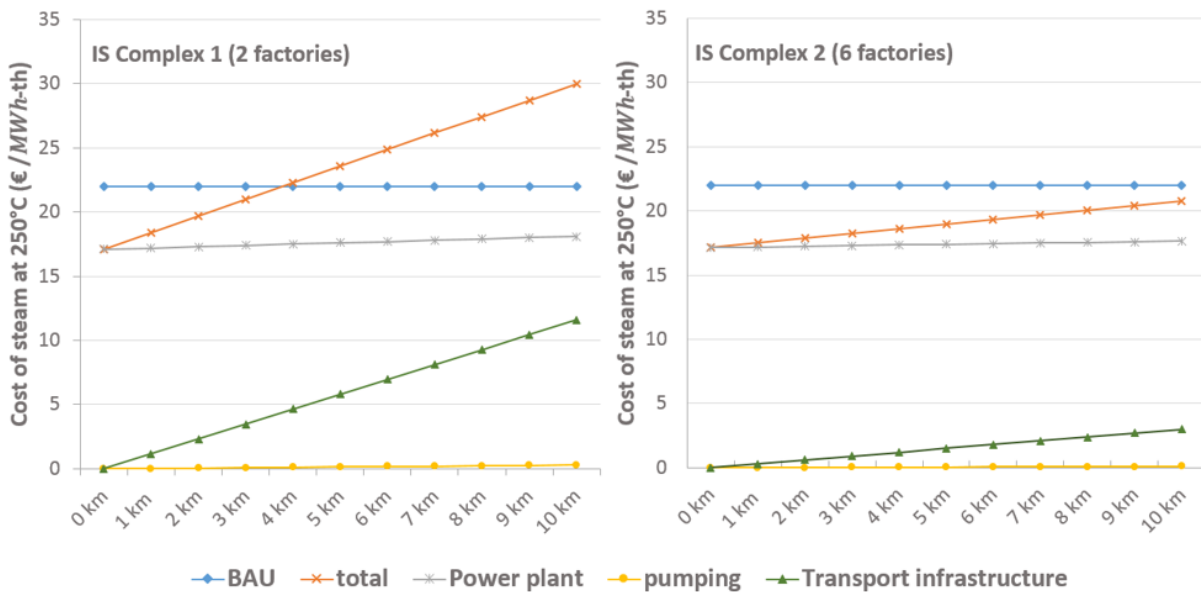

Figure I.4.5: Relationships between distance and cost of steam in IS complexes 1 and 2.

Because the electricity losses are approximately one third of the steam extracted at the steam generator outlet (see equation (6)), the main part of the cost and equivalent- CO_2 emissions occurs within the power plant boundaries. This means that the cost of the steam is highly dependent on the cost of electricity generation in the power plant, which is expected to be higher than 42 €/MWh_e for future nuclear plants (CRE (French Energy Regulatory Commission), 2013). However, fossil fuel prices are also expected to rise (see e.g. IEA (International Energy Agency), 2016); and the French public authorities are willing to establish a carbon price of 100 €/t eCO_2 by 2030. It is also possible to extract 120°C heat from the secondary turbine of the power plant, thus reducing power loss to one sixth of the thermal output. This would increase the cost-effectiveness of heat supply, but reduce the range of industrial applications, so that the potential for decarbonising the industrial sector would be reduced. Future research should examine these market and techno-economic issues in more detail. At this temperature level ($100\text{-}120^\circ\text{C}$), another plausible use of the heat from nuclear plants is space heating and domestic hot water supply to residential and commercial buildings (through district heating networks; see e.g. Chapters 2 and 3). When considering such applications, it must be kept in mind that other low carbon, potentially cost-effective heating solutions do exist (e.g. ground source heat pumps; see Esen *et al.*, 2007, 2006; or Esen and Yuksel, 2013), and these must be included in the comparison.

It was calculated that implementing a steam exchange system between the two plants of IS complex 1 and *Le Bugey* thermal plant could generate about 450 k€/a of energy savings (reducing annual heat costs by 15%), with a payback period of 8 years for recovery of the infrastructure investment costs (the costs of relocating the plants are not including). Small IS systems (e.g. IS complex 1, or connecting the *Gravelines* to the pharmaceutical factory located 0.5km away) could serve to demonstrate the benefits of such complexes. Small-scale projects are more likely to succeed than large projects involving many stakeholders, which can be penalised by the diversity of conflicting interests

or the diversity of technical requirements (see e.g. Tudor *et al.*, 2007). The power plant could serve as the key organisation around which discussions are organised. Government subsidies for pipeline construction would also be an important incentive for the implementation of large steam networks (as emphasised by e.g. Togawa *et al.*, 2014; Tudor *et al.*, 2007). A broad sense that the project is supported by national and local authorities would also be required.

Once a first IS system is implemented, and if it proves to be overall good to the society, policy makers and stakeholders could build on the experience to promote more ambitious IS projects implying the relocation of plant factories closer to nuclear sites. Future research could aim to analyse how a niche for the implementation of a demonstration project could be created and then developed to catalyse a generalisation of IS complexes. This would require the identification of the actors and institutions who could facilitate learning processes, establish shared visions of the future and form supportive networks.

4. Conclusions

Based on a detailed spatial analysis, this Chapter assesses the technical and economic feasibility of transferring steam sourced from nuclear plants to factories in France. The results are relevant for policies exploring the relationships between energy planning and urban design. Integrated land use and regional energy planning needs to be taken into consideration during the design process. Three points are highlighted:

- 14 industrial subsectors are identified as relevant for using power plant-sourced steam at 250°C. The involvement of large, long-term heat consumers such as manufacturers of starch products or pulp and paper would support the economic viability of IS complexes in the long term.
- Within a 100 km radius of existing nuclear reactors, factories in these 14 subsectors use 30 TWh_{th}/year of heat below 250°C. On-site heat generation, currently based on fossil fuels, is responsible for approximately 3.5% of French equivalent-CO₂ emissions.
- Power plant-sourced steam could reduce energy supply costs and equivalent-CO₂ emissions in locations close to these thermal power plants. As a concrete example, it was shown that implementing a steam exchange system between two chemical plants and *Le Bugey* thermal plant, 1.8 km away, could reduce the factories annual heat costs by approximately 15%. Expected cost reductions could affect the location of new factories, especially energy-intensive industries.

This study has been conducted using empirical data and planning examples. Future research could address a number of additional technical, economic and environmental issues:

- As this study focused on a broad techno-economic analysis, the results obtained cannot be directly applied to real cases. For implementation in real planning, some technical hypotheses should be assessed experimentally first (such as performed by e.g. Esen *et al.*, 2007, 2006; or Esen and Yuksel, 2013, in the case of heat supply to individual houses). Heat from sources must be transported to users in pipes economically and efficiently. This is not an easy task, especially in a pipe network connected to multiple sources and multiple users;
- A different approach is required to determine the market opportunities and challenges inherent to each of the subsectors studied, so that a long-term IS strategy can be planned. Constructing a network and engaging stakeholders such as energy companies, factory owners, local municipalities and so on, is an important consideration (Hein *et al.*, 2017). In this study we assessed the overall cost and equivalent-CO₂ emissions, rather than individual stakeholder profit or costs. Such an analysis is necessary for future research. Nonetheless, the data collected for this study do represent a significant added value, facilitating future research on IS complexes.

- Given the specific nature of the IS studied (based on nuclear plants), a broader assessment of how such IS would affect the environment is required. It is recognised that, by establishing several hydraulic barriers in the form of heat exchangers across which heat is transferred from plants to factories, the risk of hazardous exposure of humans to radioactivity via the transportation system, due to leakage, can be reduced to almost zero (STUK, 2009). Thorough engineering analysis would be required, ensuring compliance with the safety principles stated by Fortum (2013). Issues related to public opinion should also be considered as well as the attitude of the French nuclear safety regulator toward the localisation of industries near nuclear power plants.
- This Chapter only considers the cost of ‘cogeneration readiness’ in the nuclear plants. ‘Cogeneration readiness’ is a term coined by ETI (2016) to name the equipment required in a nuclear plants to enable heat supply (e.g. heat exchangers, pumps). This Chapter accounts for the capital costs specific to heat (generation and transportation), but excludes the costs attributable to electricity production. Therefore, it does not allow us to reach any conclusion as to whether nuclear plant-sourced steam transfer to industrial sinks offers more benefits than other systems generating the same amount of electricity and heat. To answer this question, further analysis would be needed taking into account the entire investment cost of a new nuclear power plant. A reasonable conclusion is that, if new nuclear plants are planned, energy systems should be optimized so as to make the most efficient use of the produced energy.

References

- ADEME (French Environment and Energy Management Agency), 2015. Climat, Air et Energie - Edition 2015. Available from: <<http://www.ademe.fr/sites/default/files/assets/documents/ademe-climat-energie-web.pdf>> [in French].
- ANCRE (French National Alliance for Energy Research Coordination), 2013. Scénarios de l'ANCRE pour la transition énergétique. Rapport 2013. Available from: <http://www.allianceenergie.fr/imageProvider.asp?private_resource=984&fn=Doc+complet+ANCRE+version+finale+15+Janv_0%2Epdf> [in French].
- Boons, F.A.A., Baas, L.W., 1997. Types of industrial ecology: The problem of coordination. *Journal of Cleaner Production*, Industrial Ecology 5, 79–86.
- Bowman, J.F., 2012. Electric Power Plant Waste Heat Utilisation. Proceedings of the ASME 2012 Summer Heat Transfer Conference.
- Cany, C., Mansilla, C., da Costa, P., Mathonnière, G., Duquesnoy, T., Baschwitz, A., 2016. Nuclear and intermittent renewables: Two compatible supply options? The case of the French power mix. *Energy Policy* 95, 135–146.
- CEA (French Nuclear and Alternative Energies Commission), 2017. ELECNUC. Nuclear power plants in the world. Edition 2017. Available from: <<http://www.cea.fr/multimedia/Documents/publications/ouvrages/Elecnucl-2017.pdf>>.
- CEREMA (French Research Centre on Risks, Environment, Mobility and Territorial Planning), 2009. Le réseau de chaleur de récupération industrielle de Dunkerque (59). Available from: <<http://reseaux-chaleur.cerema.fr/le-reseau-de-chaleur-de-recuperation-industrielle-de-dunkerque-59>> [in French].
- Chang, N., 2015. Changing industrial structure to reduce carbon dioxide emissions: a Chinese application. *Journal of Cleaner Production*, Carbon Emissions Reduction: Policies, Technologies, Monitoring, Assessment and Modeling 103, 40–48.
- Chertow, M.R., 2000. Industrial Symbiosis: Literature and Taxonomy. *Annual Review of Energy and the Environment* 25, 313–337.
- Chertow, M.R., Lombardi, D.R., 2005. Quantifying economic and environmental benefits of co-located firms. *Environmental Science and Technology* 39, 6535–6541.
- CRE (French energy regulation commission), 2013. Analyse des coûts de production et de commercialisation d'EDF dans le cadre des tarifs réglementés de vente d'électricité. Available at: <<http://www.cre.fr/documents/publications/rapports-thematiques/analyse-des-couts-de-production-et-de-commercialisation-d-edf>> [in French].
- Dalla Rosa, A., Boulter, R., Church, K., Svendsen, S., 2012. District heating (DH) network design and operation toward a system-wide methodology for optimizing renewable energy solutions (SMORES) in Canada: a case study. *Energy* 45, 960–974.
- EC (European Commission), 2008. NACE rev. 2. Statistical Classification of Economic Activities in the European Community, Rev. 2 (2008). Available from: <http://ec.europa.eu/eurostat/ramon/nomenclatures/index.cfm?TargetUrl=LST_NOM_DTL&StrNom=NACE_REV2&StrLanguageCode=EN&IntPcKey=&StrLayoutCode=HIERARCHIC>.
- EC, 2014a. Special Eurobarometer 416: Attitudes of European Citizens towards the Environment. Available from: <http://ec.europa.eu/public_opinion/archives/ebs/ebs_416_en.pdf>.
- EC, 2014b. Guide to Cost-Benefit Analysis of Investment Projects for Cohesion Policy 2014-2020.
- Energy Technology Institute (ETI), 2016. System Requirements for Alternative Nuclear Technologies - Phase 3. Technical assessment of SMR heat extraction for district heat networks. Available from: <<http://www.eti.co.uk/library/system-requirements-for-alternative-nuclear-technologies-phase-3>>.
- Esen, H., Inalli, M., Esen, M., 2006. Technoeconomic appraisal of a ground source heat pump system for a heating season in eastern Turkey. *Energy Conversion and Management* 47, 1281–1297.

- Esen, H., Inalli, M., Esen, M., 2007. A techno-economic comparison of ground-coupled and air-coupled heat pump system for space cooling. *Building and Environment* 42, 1955–1965.
- Esen, M., Yuksel, T., 2013. Experimental evaluation of using various renewable energy sources for heating a greenhouse. *Energy and Buildings* 65, 340–351.
- European Environment Agency (EEA), 2011. CO₂ electricity per kWh. Available from: <https://www.eea.europa.eu/data-and-maps/figures/co2-electricity-g-per-kwh/co2-per-electricity-kwh-fig-1_2010_qa.xls>.
- Fortum, 2013. Nuclear District Heating Plans from Loviisa to Helsinki Metropolitan Area. Presentation by Harri Tuomisto for the Joint NEA/IAEA Expert Workshop on the 'Technical and Economic Assessment of Non-Electric Applications of Nuclear Energy' OECD Headquarters, Paris, France, 4-5 April 2013. Available from: <https://www.oecd-nea.org/ndd/workshops/nucogen/presentations/3_Tuomisto_Nuclear-District-Heating-Plans.pdf>.
- García-Gutiérrez, A., Hernández, A.F., Martínez, J.I., Ceceñas, M., Ovando, R., Canchola, I., 2015. Hydraulic model and steam flow numerical simulation of the Cerro Prieto geothermal field, Mexico, pipeline network. *Applied Thermal Engineering* 75, 1229–1243.
- Hasanbeigi, A., Harrell, G., Schreck, B., Monga, P., 2016. Moving beyond equipment and to systems optimization: techno-economic analysis of energy efficiency potentials in industrial steam systems in China. *Journal of Cleaner Production* 120, 53–63.
- Hein, A.M., Jankovic, M., Feng, W., Farel, R., Yune, J.H., Yannou, B., 2017. Stakeholder power in industrial symbioses: A stakeholder value network approach. *Journal of Cleaner Production* 148, 923–933.
- Hirsch, P., Duzinkiewicz, K., Grochowski, M., Piotrowski, R., 2016. Two-phase optimizing approach to design assessments of long distance heat transportation for CHP systems. *Applied Energy* 182, 164–176.
- Huisingh, D., Zhang, Z., Moore, J.C., Qiao, Q., Li, Q., 2015. Recent advances in carbon emissions reduction: policies, technologies, monitoring, assessment and modeling. *Journal of Cleaner Production, Carbon Emissions Reduction: Policies, Technologies, Monitoring, Assessment and Modeling* 103, 1–12.
- IAEA (International Atomic Energy Agency), 2016. Desalination Thermodynamic Optimization Program (DE-TOP). Available from: <https://www.iaea.org/NuclearPower/NEA_Desalination/index.html>.
- IAEA, 2017. Nuclear power reactors in the world. IAEA-RDS-2/35.
- IEA (International Energy Agency), 2016. Projected Costs of Generating Electricity. 2016 Editions.
- IPCC (Intergovernmental Panel on Climate Change), 2012. Renewable Energy Sources and Climate Change Mitigation. Special Report of the Intergovernmental Panel on Climate Change.
- INSEE (French National Institution for Statistics and Economics Studies), 2014. Les consommations d'énergie dans l'industrie en 2014. Enquête annuelle sur les consommations d'énergie dans l'industrie (EACEI). Achats et consommation en unité propre, valeur d'achat et prix moyens des produits énergétiques. Available from: <<https://www.insee.fr/fr/statistiques/1912290?sommaire=1912292#titre-bloc-11>> [in French].
- INSEE, 2016. ESANE. Élaboration des statistiques annuelles d'entreprise. Available from: <<https://www.insee.fr/fr/metadonnees/definition/c1700>> [in French].
- Jacobsen, N.B., 2006. Industrial symbiosis in Kalundborg, Denmark: A quantitative assessment of economic and environmental aspects. *Journal of Industrial Ecology* 10, 239–255.
- Jensen, P.D., 2016. The role of geospatial industrial diversity in the facilitation of regional industrial symbiosis. *Resources, Conservation and Recycling* 107, 92–103.
- Korhonen, J., 2001. Co-production of heat and power: an anchor tenant of a regional industrial ecosystem. *Journal of Cleaner Production* 9, 509–517.

- Kwak, D.-H., Binns, M., Kim, J.-K., 2014. Integrated design and optimization of technologies for utilizing low grade heat in process industries. *Applied Energy* 131, 307–322.
- Lockie, D., Sonnenfeld, D., 2013. *Routledge International Handbook of Social and Environmental Change*, Routledge. Fisher (Eds).
- Maes, T., Van Eetvelde, G., De Ras, E., Block, C., Pisman, A., Verhofstede, B., Vandendriessche, F., Vandeveldel, L., 2011. Energy management on industrial parks in Flanders. *Renewable and Sustainable Energy Reviews* 15, 1988–2005.
- Maïzi, N., Assoumou, E., 2014. Future prospects for nuclear power in France. *Applied Energy* 136, 849–859.
- Meleo, L., 2014. On the determinants of industrial competitiveness: The European Union emission trading scheme and the Italian paper industry. *Energy Policy* 74, 535–546.
- Ministère de l'environnement, de l'énergie et de la mer (French Ministry of Environment, Energy and Seas), 2014. Application of the article 14.5 of the Directive 2012/27/UE with regards to the connexion of utilities generating excess heat and district heating networks. Décret n° 2014-1363 of the 14th of November 2014, 2014-1363.
- Ministère de l'environnement, de l'énergie et de la mer, 2015. Loi relative à la transition énergétique pour la croissance verte (LTECV). Available from: <<https://www.legifrance.gouv.fr/affichTexte.do?cidTexte=JORFTEXT000031044385&categorieLien=id>> [in French].
- Ministère de l'environnement, de l'énergie et de la mer, 2016. L'accès régulé à l'électricité nucléaire historique (ARENH). Available from: <<http://www.developpement-durable.gouv.fr/Le-prix-de-l-ARENH.html>> [in French].
- Ministère de l'environnement, de l'énergie et de la mer, 2017. Chiffres clés du climat. France et Monde. Editions 2017. Available from: <http://www.statistiques.developpement-durable.gouv.fr/fileadmin/documents/Produits_editoriaux/Publications/Datalab/2016/chiffres-cles-du-climat-edition2017-2016-12-05-fr.pdf> [in French].
- NISP (National Industrial Symbiosis Project), 2008. Potential uses of waste heat from a proposed new power station at Blyth. Report by Terra Infirma for the National Industrial Symbiosis Project (NISP).
- OREE (French association of companies and local municipalities promoting circular economy), 2015. Le recueil des démarches d'écologie territoriale. Available from: <<http://www.oree.org/ecologie-industrielle-territoriale/presentation.html>> [in French].
- Safa, H., 2012. Heat recovery from nuclear power plants. *International Journal of Electrical Power & Energy Systems* 42, 553–559.
- Seck, G.S., Guerassimoff, G., Maïzi, N., 2015. Heat recovery using heat pumps in non-energy intensive industry: Are Energy Saving Certificates a solution for the food and drink industry in France? *Applied Energy* 156, 374–389.
- Shi, H., Chertow, M., Song, Y., 2010. Developing country experience with eco-industrial parks: a case study of the Tianjin Economic-Technological Development Area in China. *Journal of Cleaner Production* 18, 191–199.
- STUK (Radiation and Nuclear Safety Authority of Finland), 2009. Preliminary Safety Assessment of the Fennovoima Oy Nuclear Power Plant Project. Available from: <https://www.stuk.fi/documents/88234/148256/STUK-Fennovoima_preliminarysafetyassessment_letter.pdf/2b9012c5-0d9a-4253-8efd-c2070fdc2cb7>.
- Togawa, T., Fujita, T., Dong, L., Fujii, M., Ooba, M., 2014. Feasibility assessment of the use of power plant-sourced waste heat for plant factory heating considering spatial configuration. *Journal of Cleaner Production* 81, 60–69.

- Tudor, T., Adam, E., Bates, M., 2007. Drivers and limitations for the successful development and functioning of EIPs (eco-industrial parks): A literature review. *Ecological Economics* 61, 199–207.
- Verfondern, K., 2013. Overview of Nuclear Cogeneration in High-Temperature Industrial Process Heat Applications. OECD-IAEA Workshop, April 4-5, 2013, Paris. Available from: <https://www.oecd-nea.org/ndd/workshops/nucogen/presentations/15_Verfondern_2013-OECD-IAEA-Workshop.pdf>.
- Wallner, H.P., 1999. Towards sustainable development of industry: networking, complexity and eco-clusters. *Journal of Cleaner Production* 7, 49–58.
- Wang, W.-C., 2016. Techno-economic analysis of a bio-refinery process for producing Hydro-processed Renewable Jet fuel from Jatropha. *Renewable Energy* 95, 63–73.
- Wang, H., Wang, H., Zhu, T., Deng, W., 2017. A novel model for steam transportation considering drainage loss in pipeline networks. *Applied Energy* 188, 178–189.
- Yoshiyuki, S., Kuniharu, Y., Minoru, M., 2001. Combined Heat and Power System Using Waste Heat from Refuse Incinerator with Considering Monthly Change of Heat Demand. *Transactions of the Society of Heating, Air-Conditioning and Sanitary Engineers of Japan* 27–35.
- Zhang, H., Dong, L., Li, H., Fujita, T., Ohnishi, S., Tang, Q., 2013. Analysis of low-carbon industrial symbiosis technology for carbon mitigation in a Chinese iron/steel industrial park: A case study with carbon flow analysis. *Energy Policy* 61, 1400–1411.

II. Analysis of Multi-Stakeholder Interactions in real projects

Part II aims to answer the research question (b) relative to the stakes surrounding the concrete implementation of nuclear plant based heating projects. Chapter 5 consists in a single case study of the Loviisa 3 project offered in 2009 by a Nordic energy company (Fortum). Obstacles that hindered the implementation of this project are analysed and lessons are drawn for eventual future projects of that kind. Chapter 6 then uses a multicriteria approach to study the decision-making process that could drive the choice of the heating system to be used in the Dunkirk area, France.

Research scope

PWR, DH, Case study

Geographical boundary

Europe

Publications

- Leurent, M., Jasserand, F., Locatelli, G., Palm, J., Rämä, M., Trianni, A., 2017. Driving forces and obstacles to nuclear cogeneration in Europe: Lessons learnt from Finland. *Energy Policy* 107, 138–150.
- Leurent, M., Da Costa, P., Jasserand, F., 2016. Nuclear cogeneration: Linking heat and nuclear sector. A discourse coalition approach. Proceedings of "Les journées du risque" of "Les Mines de Nantes", November 2016.

*« Ce qui est terrible sur cette terre est que tout
le monde a ses raisons. »*

Jean Renoir

Chapter 5

Driving forces and obstacles to nuclear cogeneration in Europe: Lessons learnt from Finland ³

Abstract

Nuclear power plants generate electricity and a large amount of waste heat which is valuable for cogeneration. District heating (DH) is a suitable technology to decarbonise the European heat sector. By contrast with most of nuclear non-electric applications, nuclear district heating (NDH) has already been implemented in Europe, thus providing us with some valuable empirical insights. This Chapter investigates the forces and obstacles to nuclear cogeneration by looking at the Loviisa 3 NDH project in Finland. The key forces are energy efficiency, decarbonisation of the heat sector, operational competitiveness of future nuclear technologies, and synergies with renewable energies. The key obstacles are split incentives, electricity prices volatility, inexpediency of business models and regulatory frameworks, electioneering of local authorities and pessimist expectations with regards to project financing. Policy makers should recognise nuclear plants alongside other utilities generating large amounts of wasted heat. International cooperation programs involving both nuclear and heat stakeholders should be encouraged. EU28 Member States wanting to promote nuclear cogeneration may consider providing support for the electricity generated by high-efficiency plants.

Keywords: Nuclear, cogeneration, district heating, energy megaproject, sustainability, Finland

Highlights

- Nuclear cogeneration could support a sustainable EU energy transition.
- A comprehensive case study of the Loviisa 3 nuclear district heating megaproject.
- Obstacles arise within market, institutional and financial frameworks.
- Distinctive stakeholders have opposed perceptions of benefits, costs and obstacles.
- Greater recognition of nuclear waste heat is needed in the future EU energy policy.

Comments

- This Chapter shows that, similarly to many other energy projects, debates about the techno-economic feasibility of NCHP projects are not merely technical debates, but highly political contests that revolve around social ideology, values and power.
- It confirms results from Dalmaso (University Grenoble 2), which carried out a single case study of the Thermos project, a heat-only nuclear reactor of about 100 MW_{th} planned by the CEA in the 1970's (first in Saclay and then in Grenoble). The contemporary president of the Grenoble DH company stated that: *"The rationality of economic choice is often the projection, through the formal techno-economic filter, of personal opinions and/or organisation's specific objectives which are disguised with considerations of technical rationality. The Thermos project have been a good example of this."*
- This calls for the development of analytical tools that can facilitate the establishment of an open, constructive social dialogue on alternative heating systems (see Chapters 6 and 8).

³ Leurent, M., Jasserand, F., Locatelli, G., Palm, J., Rämä, M., Trianni, A., 2017. Driving forces and obstacles to nuclear cogeneration in Europe: Lessons learnt from Finland. *Energy Policy* 107, 138–150.

1. Introduction

The most common type of nuclear power plant (NPP) in operation (277 out of 438) or under construction (59 out of 70) (IAEA (International Atomic Energy Agency), 2017) is the Pressurized Water Reactor (PWR). The thermodynamic efficiency of a PWR is around 33%. Therefore, about two thirds of the heat generated by the nuclear fuel is wasted. Since the steam exiting the high-pressure turbine is superheated, it could be used for non-electric applications such as district heating, desalination of sea water, industrial process heating etc. (IAEA, 2003). Nuclear combined heat and power plants (NCHP) are defined as NPP targeting a high thermal efficiency by generating both electricity and heat. A PWR can be converted into an NCHP without jeopardizing the reactor's safety (STUK, 2009: p. 6).

The thermal efficiency of NCHP could reach up to 66% (ISNP (International School on Nuclear Power), 2014), increasing the total energy output by at least 50% (IAEA, 2017a; Locatelli *et al.*, 2015) compared to a NPP of similar features generating only electricity. Operating a PWR as a NCHP implies to reduce the electricity output of the reactor. Lost electricity production depends on the temperature and the amount of heat considered. Several studies pointed out that, for the temperature ranges useful to district heating networks (85-115 °C), NCHP can be designed so that the amount of thermal energy (MW_{th}) recovered is five to six times greater than the electricity losses (MW_e) (IAEA, 2017; 2016a; 2003).

Among the nuclear non-electric applications, district heating (DH) and desalination benefit from the largest industrial experience worldwide (IAEA, 2017b, 2003). In Europe (including Russia and Ukraine), nuclear district heating (NDH) is the most tried-and-tested technology, and it certainly has the highest potential in the short run. Lately, technico-economic studies have been led to explore regional opportunities for the deployment of large-scale NDH projects. In Finland, Fortum (the second largest Nordic power company) offered to operate the planned Loviisa 3 NPP in a partial cogeneration mode (Fortum Power and Heat Oy, 2009: p. 26-28). In France, the possibility of transporting between 1500 MW_{th} to 3000 MW_{th} heat from the Nogent-Sur-Seine NPP to Paris over 110 km has been examined (Jasserand and Devezeaux, 2016; Safa, 2012). Similarly in Poland, an economic analysis was carried out for the Choczewo and Zarnowiec NPP (Jaskólski *et al.*, 2014). The thermal output was about 250 MW_{th} and the length of the main transport line varied between 22 km and 64 km depending on the town considered (Wejherowo, Reda, Rumia and Gdynia).

The implementation of such immense projects would imply an initial investment up to 1-2 billion euros alongside new agreements between utilities (Bergroth, 2010; Jasserand and Lavergne, 2016; Safa, 2012). For these reasons, they can be referred to as "megaprojects" in the sense of Sovacool and Cooper (2013). Similarly to other energy megaprojects, NDH would certainly attract a high level of public attention and political interest because of the substantial direct and indirect impacts on the community, environment, and budgets (Van de Graaf and Sovacool, 2014). If NCHP is ever integrated into the EU's sustainable energy transition, there will be a number of obstacles to overcome as e.g. inexpediency of business models and regulatory frameworks or electioneering of local authorities. Prospective explorations are important to reduce the likelihood of future projects being overwhelmed by hidden costs and to limit delay in implementation. Given these considerations, this Chapter sets out to answer and discuss the following questions:

- What are the driving forces for the deployment of nuclear cogeneration in the EU28?
- What are the obstacles to the deployment of nuclear cogeneration in the EU28?
- What can be done to enhance the recognition of nuclear cogeneration and to prevent the failure of future similar megaprojects?

To that purpose, we led a case study based on the Loviisa 3 NDH project in Finland. Our analysis suggests that NDH megaprojects will always involve trade-offs and invariably will create winners and losers.

The Chapter is organised as follows: Section 2 is an extensive background Section that introduces NDH to the literature on energy policy. It includes a discussion on the driving forces to nuclear cogeneration in the EU28 (2.1), an overview of NDH experiences (2.2), a description of the singular Loviisa 3 NDH project (2.3) as well as the conceptual framework which supported our analysis (2.4). Section 3 describes the methods followed to conduct the case study. Section 4 details the experience and lessons learnt from the Loviisa 3 NDH megaproject. Actions designed to improve the recognition of nuclear cogeneration are also discussed. Finally, our conclusions are drawn in the fourth and last section.

2. Background

2.1. Driving forces to the deployment of nuclear cogeneration with PWR

In the past, long-distance, large-scale NDH have been disregarded because of high losses and inefficiency, considering that the NPP is generally located far away from urban crowded areas. Nonetheless, the extension of DH over the last decades has led to improvements in low-temperature heat distribution, and there is potential to further reduce heat losses (Li and Wang, 2014). This opens new opportunities for energy projects involving the transport of heat over long distances (Ma *et al.*, 2009), such as nuclear cogeneration.

Cogeneration goals are in line with the EU plans for a low-carbon society (EC (European Commission), 2012), particularly energy efficiency (European Parliament, 2009; EC, 2012). The European heat sector accounts for about one third of the carbon emissions in the EU28 (EC, 2016). Although the heating sector is moving towards low-carbon energy, 75% of the heat still comes from fossil fuels (nearly half from gas; IEA (International Energy Agency), 2017). According to the recent Heat Roadmap Europe, DH is one of the main technologies to deploy if we intend to decarbonise the heat sector and should be increased from today's level of about 10% to 50% in 2050 (STRATEGO, 2015a). Application of the Directive 2012/27/EU require the industries and power plants producing large quantities of excess heat to consider connexion with DH networks through cost-benefit analysis (European Parliament, 2012: article 14). However, most EU member states chose to exempt their nuclear plants from analyses. And yet, similarly to excess heat recovered from industrial processes, the carbon emissions avoided by the use of NCHP are equivalent to the carbon dioxide emitted by the heat sources that the nuclear heat would effectively replace. Besides, the use of nuclear heat would reduce the energy dependence from imported fossil-fuels.

The directives and programs mentioned above are general and nuclear energy is not specifically mentioned. Nuclear technologies are, however, identified in the EUROPAIRS (2009) project under the European Union's 7th Framework Program (FP7) for European cogeneration markets (Angulo *et al.*, 2012). The sustainable nuclear energy technology platform (SNETP) in collaboration with the EC conducted the ARCHER (EC, 2015a) project and the Nuclear Cogeneration Industrial Initiative (NC2I, 2015a), which fall in line with the European Union's strategic energy technology plan (EC, 2015b). More recently, the Nuclear Energy Agency's working group focusing on the role and economics of nuclear cogeneration in a low-carbon energy future has been targeting the development of a generic method to assess the economic and environmental potential of nuclear cogeneration (Nielsen, 2014). The shared goal of these programs is to prepare the future nuclear cogeneration technologies and markets. On one hand, future reactors will generate higher-temperature heat, thus widening the range of market applications (Locatelli, 2013; NC2I, 2015b; Ruth *et al.*, 2014). On the other hand, small modular reactors (SMR) are increasingly regarded by policy makers and stakeholders as a viable option to decarbonise both electricity and heat sectors (Carlsson *et al.*, 2012). As for example, the Energy Technology Institute of the United Kingdom recommends to investigate further the potential of small

and modular reactors to provide low carbon district heating (ETI (Energy Technology Institute), 2015). A review of potential SMR technologies for cogeneration is presented in Locatelli *et al.* (2017), while a focus on desalination (one of the most attractive option) is presented in Locatelli *et al.* (2015). Compared to large nuclear reactors, SMR may be advantageous to address cogeneration markets; and this because:

- SMR may be easier to deploy close to urban areas thanks to high safety standards, thus limiting the major cost of building a heat transport pipeline (Kessides, 2012; Locatelli *et al.*, 2014; Sainati *et al.*, 2015).
- The smaller size of SMR matches with a wider range of heating needs. The heat loads require for operating DH networks or plant factories will rarely equal the maximal thermal output that large reactors can provide. Hence, the thermodynamic efficiency that large reactors operated in cogeneration can reached will often be limited by the heat load requirement. Besides, the smaller investment required to build SMR (in absolute terms) could make it a more attractive option for those DH operators and/or plant owners which are searching for low carbon, cost-effective heat supplier that match their heat needs.
- If SMR are largely deployed in the future, they could benefit from positive learning by doing effects (Boarin *et al.*, 2012), so that the deployment time may be reduced (time period from planning to operational phases). This could facilitate the development of suitable business models for those industrial clusters which aim to build and amortize a NCHP and industrial plant factories during the same period of time (Green *et al.*, 2009).

Overall, it seems reasonable to say that the optimal size of NCHP should be determined on a case by case basis. Questions which may help making a choice are e.g. ‘What is the size of the heat demand?’; ‘Is the building of SMR instead of larger reactors likely to allow the siting of nuclear units closer to consumption sites?’; ‘Can we expect a shorter deployment time if building several SMR?’

Another driver identified resides in the potential synergies which could be generated by the joint use of NCHP and renewable energies. Heat from nuclear plants could enhance biofuel feedstock production, thus making savings in valuable byproducts (such as lignin), which are currently consumed in the biorefinery boilers (Greene *et al.*, 2009; IAEA (International Atomic Energy Agency), 2009; NETNUC, 2011). Instead, these byproducts could be used for other industrial applications (e.g. automotive parts, wood panel products; Laurichesse and Avérous, 2014). As concerning the French case, Cany *et al.* (2016) argue that the nuclear fleet could take advantage of intermittent renewable sources to produce valuable byproducts and thus accomplish two feats with one action: provide flexible services for the power system and produce byproducts such as heat or hydrogen.

The various levers described above tend to show that NCHP can be a valuable asset for the sustainable EU28 energy transition. It is therefore important to better understand those mechanisms which can result in overwhelming costs and delay in implementation. For this reason, studying the obstacles that NCHP projects must overcome is essential if we intend to draw lessons for stakeholders and policymakers. NDH is the most experienced nuclear non-electric application in Europe and is thus ideal for empirical investigations.

2.2. NDH experiences

Experience in NDH includes 52 NCHP in 8 countries for over 30 years (see Table II.5.1). These cases all imply the cogeneration of heat and electricity, but experimental reactors dedicated to heat production only have also been considered (e.g. the 1976 “Thermos” project by the French Nuclear Energy Commission (CEA) which planned to build 50-100 MW_{th} reactors; IAEA, 1997). The heating capacity provided by these NCHP fall in the range of 5–250 MW_{th}, generally a minor fraction of the total reactor thermal power. In these systems the water is supplied to 130-150°C in winter by using steam from the lower pressure turbine (about 80-90 °C), which is reheated by steam extracted from

the back of the high pressure turbine. It is lowered in summer to 85°C by using only the low-temperature heat exchanger. Such high temperature were needed to compensate the high thermal losses of past heat transportation systems. Thanks to the improvement of insulation technologies, supply temperatures of DH networks tend to decrease and efficient networks range between 85-115°C (in a typical Finnish DH system, different countries have different settings, e.g. in Denmark the use of lower supply temperatures is common). It is thus expected that future NDH system will only require extracting steam from the lower pressure turbine, with fewer reduction of the electricity output. The heated water is then pumped in a closed pipeline to the distribution stations where the heat is transferred into the intended local DH network via heat exchangers. The distance between the NCHP and the DH system is relatively short in all cases: an average of 10 km, with two exceptions in Russia (Kola, 64 km and Novovoronezh, 50 km). Return water temperatures to the NCHP are approximately 50-70 °C. To meet high-reliability requirements, NDH systems require a backup heat source to be used when the nuclear heat supply is disrupted. These projects were relatively small financially speaking and almost never necessitated cooperation between an NCHP operator and DH network operator (the exception being Ågesta in Sweden; NC2I, 2015c). All these cases are of pretty low level of complexity and cannot be referred as megaprojects (in the sense of Sovacool and Cooper, 2013). Thus, they cannot be used to answer our research questions which concern NDH megaprojects with fragmented stakeholders.

Country	NCHP name and reactor number	Location	Length of main pipe (km)	Start operation reactor	Power output (MW _e)	Thermal output (MW _{th})	Temperatures (C°)
Bulgaria	Kozlodoy 5, 6	Kozlodoy	5	1987-91	2×953	2×20	150-70
Czech Republic	Temelin 1, 2	Tyn	5	2002	963	2×180	Unknown
Hungary	Paks 2, 3, 4	Paks	6	1983-87	3×433	3×30	130/70
Romania	Cernavoda 1	Cernavoda	2	1996	1×660	1×19	150-70
Russia	Bilibino 1-4	Bilibino	3.5	1974-81	4×12	4×47	150-70
	Novovoronezh 3, 4	Novovoronezh	50	1972-73	2×385	2×33	130/70
	Balakovo 1-4	Balakovo	12	1986-93	4×950	4×200	130/70
	Kalinin 1, 2	Udomlya	4	1985-87	2×950	2×80	128-70
	Kola 1-4	Apatit	64	1973-84	4×410	4×25	130/70
	Beloyarsk 3	Zarechny	-	1981	1×460	1×170	130/70
	Leningrad 1-4	St-Petersburg	5	1974-81	4×925	4×25	130/70
	Kursk 1	Kurchatov	3	1977	1×925	1×128	130/70
	Kursk 2-4	Kurchatov	3	1979-86	3×925	3×175	130/70
	Smolensk 1-2	Desno-gorsk	5	1983-1990	2×925	2×173	130/70
Slovakia	Bohunice 3, 4	Trnava	18	1985-87	2×410	2×240	150/70
Switzerland	Beznau 1, 2	Döttingen	35	1969-83	2×365	2×80	130/70
Ukraine	Rovno 1, 2	Rovno	4	1982	2×400	2×58	130/70
	Rovno 3	Rovno	4	1987	1×950	1×233	130/70
	South Ukraine 1, 2	Yuzhnoukrainsk	3	1976-83	2×950	2×151	150/70
	South Ukraine 3	Yuzhnoukrainsk	3	1976-89	1×950	1×232	150/70
	Zaporozhye 1-6	Energodar	5	1985-96	6×950	6×232	-

Table II.5.1: Worldwide experiences in nuclear district heating. Data sources: IAEA, private communication; IAEA, 2003.

Notes:

Reactors are all generation II reactors, mostly PWR and WWER (Water-Water Energetic Reactor).

2.3. Case description

In line with our research questions, we selected the only NDH megaproject that reached feasibility: the Loviisa 3 NDH megaproject from Finland. It was proposed by Fortum as a part of an application for a decision-in-principle concerning the construction of the Loviisa 3 reactor (Fortum, 2009: p.26-28). The aim of the project was to develop a new PWR (or boiling water reactor, both options were investigated) to be operated in cogeneration (800-1300 MW_e and 1000 MW_{th}; Bergroth, 2010; ISNP, 2014), alongside with a 1000 MW_{th} heat transportation system (Paananen and Henttonen, 2009). It was to be built on the existing site of the Loviisa twin-reactor NPP site, approximately 80 km east of the Helsinki metropolitan area (i.e. Helsinki, Espoo and Vantaa; see Figure II.5.1) with one million inhabitants. The DH consumption in the area typically varies from a minimum of 400 MW_{th} in summer to a peak of 3500 MW_{th} in winter. Around 90% of the heat is currently supplied by coal and natural gas-fired plants (Helen, 2015a), accounting for 50% of greenhouse gas emissions in Helsinki (City of Helsinki, 2015).

Unlike the previous operating systems described in Section 2.2, the Loviisa 3 NDH megaproject addressed three new main technical challenges:

- Cogeneration with a Generation III PWR or BWR;
- Extraction of the largest amount of DH from a reactor;
- Construction and operation of the longest pipeline required to transport the nuclear heat to the city.



Figure II.5.1: Heat transportation system routing from the Loviisa 3 NDH unit to the Helsinki metropolitan area, about 80 km long. Data sources: ISNP, 2014.

The amount of heat it planned to provide represented about 60% of the DH consumption in the Helsinki metropolitan area: 7 TWh_{th} out of 12 TWh_{th} per year (see e.g. ISNP, 2014). By contrast, the consumption of the DH network owned by Fortum accounts for only 2.5 TWh_{th}. Thus, close collaboration between Fortum and other DH operators (Helen and Vantaan Energia) would have been necessary. Because Helen and Vantaan Energia are municipality-owned (respectively by municipalities of Helsinki and Vantaa), the project would have required agreement or support from municipalities. The municipality-owned energy companies are subject to guidelines and regulations drawn up by municipal decision-making bodies such as the municipal council. The municipal council decides the objectives of energy companies and appoint their board of representatives. Companies need to have the formal endorsement of the municipal council before deciding on e.g. large investments, tariff changes or major policy issues. The municipality-owned energy companies also have to adhere to ordinary legislation governing private limited companies. Figure II.5.2 depicts the current configuration of stakeholders surrounding the Loviisa NPP and the DH networks of the Helsinki metropolitan area.

At present, the Loviisa 3 NDH megaproject is but an idea on paper and the obstacles hindering its implementation remain. Yet the inherent complexity makes it a very interesting case to study, providing lessons for future NDH megaprojects.

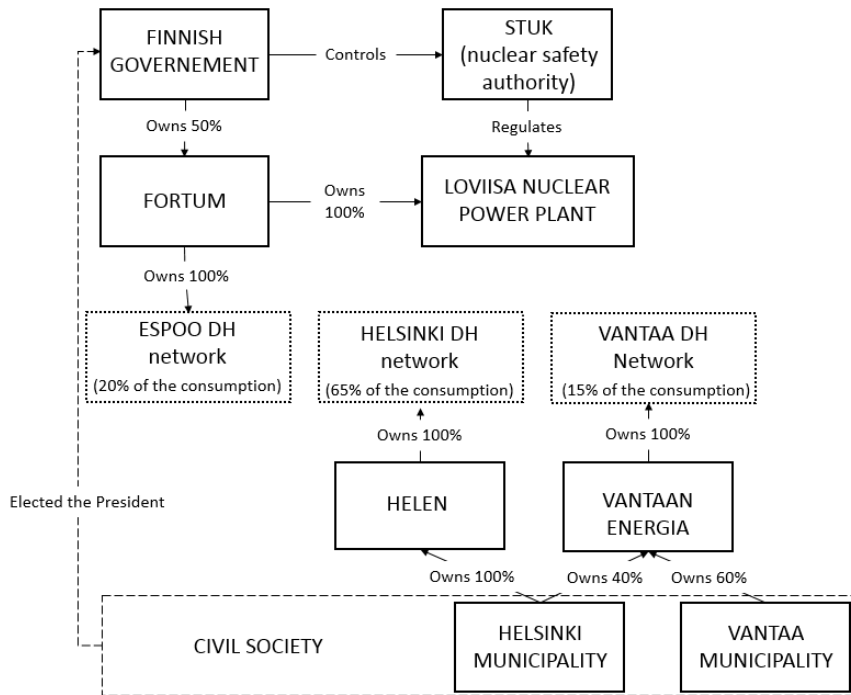

Figure II.5.2: Current configuration of stakeholders involved in the Loviisa NPP and the Helsinki metropolitan area DH networks. With dotted line we have shown the DH networks. By dashed line we have reported the electoral process (including all the Finnish citizens).

2.4. Conceptual framework

The problem with this case is that, despite being feasible, it did not go ahead. Regardless of the cogeneration option, Fortum has never been granted the license to start building the Loviisa 3 NPP. The Finnish law states that utilisation of nuclear energy must be “safe and not to cause harm or damage for the people, environment or property” and be “in aligned with the overall benefit of the society” (Ydinvoimalaki – Finnish law on nuclear energy, 1987: articles 5 and 6). Fortum’s application for a decision-in-principle on the construction of the new Loviisa 3 unit was rejected by the government in April 2010. In July 2010, the Finnish government approved the construction of the Olkiluoto 4 reactor (owned by an established company - TVO) and the Hanhikivi 1 reactor (owned by a new supplier – Fennovoima Oy; see e.g. World Nuclear Association, 2017). This was decided in line with the EU objective of opening electricity markets to competition (European Parliament, 2009: article 8; EC, 2012: article 1). Yet the decision-making process may have also been affected by other factors such as e.g. public discussions or considerations related to political party dynamics.

Nonetheless, the fact that our case “failed” does not make it less deserving of inquiry. Discussions on the technical development of technologies mostly investigate successes, leading to a biased narrative about “winners” that blind energy analysts to the multifarious ways that energy projects can fail (Sovacool, 2014). In the words of the historian Braun (1992: p.214), “*In analyzing technological development, failed innovations are just as important as, and possibly even more so than, successful ones.*” Because failure is more frequent and probable than success, we can learn even more by studying it (Smil, 2010).

For the literature on megaprojects, there exists a threshold above which projects generate so much interest, so much value, and so many variables that conflict overcomes rational discernment and the real costs exceed benefits (real costs in money, in social upheaval, in environmental damages; Flyvbjerg, 2016). The failure of megaprojects may result from biased and inflated projections made by project sponsors (Flyvbjerg, 2009). Given their size and complexity, megaprojects typically have many stakeholders involved, each pushing their own agendas (Miller and Hobbes, 2009). Authors agree on the fact that stakeholders are often ill-prepared to face the inevitable turbulence that such a project inevitably creates (Sanderson, 2012). To anticipate future difficulties, a broad assessment of how it affects corporations, communities, governments and ecosystems should be conducted (Van de Graaf and Sovacool, 2014).

The authors that study NPP projects have found sources of failure similar to others megaprojects as e.g.: overoptimistic estimations, first-of-a-kind related issues and undervaluation of regulatory requirements (Locatelli and Mancini, 2012). Analyzing the unforeseen problems that occurred during the construction of the Olkiluoto 3 NPP, Hellström *et al.* (2013) highlight the importance of building relationships and securing commitments between key players during the early stages of a project. In the same vein, Ruuska *et al.* (2011) developed a new theory of governance in large projects by adopting a project network view with multiple networked firms within a single project. It encourages a shift from the prevailing narrow view of a hierarchical project management system towards an open system view.

Despite providing useful analytical tools, these theories do not explore NCHP projects. The literature on nuclear cogeneration has always addressed technical or economic aspects (Bergroth, 2010; Reński *et al.*, 2014; Jasserand and Devezeaux de Lavergne, 2016; Safa, 2012; Paananen and Henttonen, 2009). Thus, debates on nuclear cogeneration currently disregard the social, political, institutional and psychological dimensions (exception being the conference paper mentioned in Section 3.1, which implied interviews with NDH utilities in Hungary, France, Switzerland, Norway and Japan: NC21, 2015c). To fill this research gap, comprehensive case studies of NDH experiences are necessary. It would help to anticipate and prevent future difficulties that are inevitable when dealing with real projects. Because of its unique features, the Loviisa 3 case justifies a specific analysis.

This Chapter employs a conceptual framework derived from the “barriers theories” to explore the sources responsible for the failure of the Loviisa 3 NDH megaproject. These theories study the mechanisms that inhibit the deployment of technologies which are both energy-efficient and (potentially) economically efficient (Sorrell *et al.*, 2000). An interesting contribution to the discussion is offered by Weber (1997), who has classified obstacles as institutional, economical, organisational, and behavioural. However, the taxonomy adopted in this Chapter is an adaptation of that proposed by Chai and Yeo (2012) which groups obstacles into the following categories:

- *Market failures:* As neoclassical economists posit, the allocation of goods and services is not always efficient. Energy projects can fail because of information asymmetries, split incentives, principal-agent problems, or externalities.
- *Physical constraints:* As technological systems theorists argue, energy projects can fail technologically. The larger and more complex energy projects become, the more susceptible they become to technical problems, delay, and costs overruns.
- *Institutional:* As energy politics theorists suggest, energy projects can fail because of their inability to break through deeply rooted regimes boundaries, unsuitable business models, regulations or enforcement and priorities, experience and electioneering of local authorities.
- *Financial:* As financial theorists predict, energy projects can fail because of features that are ill-suited to the current liberalised EU28 energy market. Energy projects often present long-term payback periods and are often considered by private investors as risky assets.
- *Behavioural:* As sociologists posit, energy projects can fail because of resistance to change from individuals, a lack of common objectives and values, or a low level of trust between stakeholders.

These five assumptions were deducted from the existing literature by Chai and Yeo (2012), and their plausibility was probed with regards to the Loviisa 3 NDH megaproject. The fifth category has been disregarded as behavioural aspects are implicitly present in all the other categories. Colmenar-Santos *et al.* (2015) also adopt this framework to discuss the obstacles blocking the deployment of fossil-fuel cogeneration plants. Furthermore, these assumptions overlap those made by Sovacool and Cooper (2013) to discuss the governance of energy megaprojects, namely social, economic, technical, political and psychological.

3. Methods

By applying the ‘barriers theories’ framework to the Loviisa 3 NDH megaproject, we conducted a disciplined interpretative case study, according to Odell (2001). Such research is particularly suited for cases that are “recent or seem intrinsically important” (Odell, 2001); it allows us to sharpen and refine existing theories while working with them. Easterby-Smith *et al.* (2015) helped design the case study, which aims at answering the research questions mentioned in the introduction. The sampling gathers views from a medium sample of people likely to have different perspectives and experiences (see Appendix A for the details of in-depth interviews). Individuals were selected with regards to their knowledge of Finnish energy systems and of the Loviisa 3 NDH megaproject in particular.

The data for the case study has been collected through semi-structured interviews as well as by examining the relevant documents. Following the principles suggested by Yin (2014), the topic guide has been designed to favor the emergence of plausible alternative explanations, avoiding predictable answers. The first set of questions were general questions such as e.g. “what are the factors driving the political process in Finland? In Helsinki? What are the most relevant technologies for the future heat sector of Helsinki? Why?”. With respect to question (ii): “*What are the sources of failure of NDH megaprojects?*”, insights from VTT (the largest technical research center in Finland), the Finnish Ministry of Employment and the Economy (TEM), the Finnish Radiation and Nuclear Safety Authority (STUK), the City of Helsinki Environment Center and the Environmental Committee of Helsinki, have been particularly relevant to our study. Moreover, triangulation was used, i.e. the same questions were put to all the respondents. This made it possible to obtain a broad assessment of how the project would affect stakeholders. Insights from the operators Fortum and Helen were particularly useful, as they would have been the most impacted by the implementation of NDH. With respect to (iii): “*What could be done to enhance the recognition of nuclear cogeneration and to prevent the failure of future NDH projects?*”, insight from the Ministry of Employment and the Economy has been highlighting. Also, some interviewees took part in the NC2I (2015a) international program on nuclear cogeneration, providing valuable materials.

All the interviews have been recorded (except for one due to confidentiality issues) and then transcribed. Using the principles offered by Silverman (2013), attempts were made to limit personal bias by:

- Looking for examples that might disconfirm current beliefs
- Constant comparison through triangulation
- Comprehensive data treatment and tabulations, implying greater rigor in Organising data and accepting the fact that quantitative methods can be relevant to complete a qualitative approach.

Cross-pollinating insight from the in-depth interviews with perspectives from the literature made it possible to build a questionnaire. It was based on views from 17 VTT individuals and 10 Fortum individuals. VTT individuals were chosen because of their expertise on energy systems, and in particular DH. Fortum individuals were chosen because of their implication in the feasibility study for the Loviisa 3 NDH megaproject. Quantification from the ranked questionnaire is as follow: “Always important=1;

Often important=0.66; Sometimes important=0.33; Never/Seldom important=0". As stated by Thollander *et al.* (2010), we must keep in mind that the analysis based on these quantifications relies on broad simplifications as the quantified results contain several more perspectives on the issue than merely a single ranking score. Furthermore, the respondents are not representative of the sampling addressed through the in-depths interviews. Nonetheless, it helped us to step back from vivid discussions which often involved strong social ideology.

4. Loviisa 3 NDH project: discussions and implications

This section answer questions (ii) and (iii) by analyzing and discussing the Loviisa 3 NDH megaproject. The complete details over obstacles to the Loviisa 3 NDH project as perceived by Fortum as well as VTT respondents are shown in Figures II.5.3 and II.5.4. Please refer to Section 2.3 for further information on technical aspects and stakeholders features.

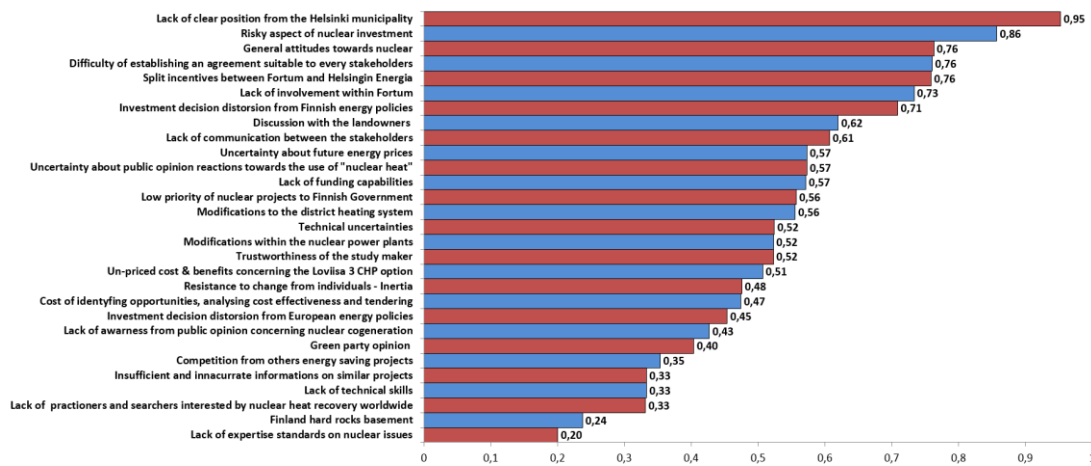

Figure II.5.3: Obstacles to the Loviisa 3 Nuclear District Heating projects as perceived by Fortum respondents (10 out of 27). Respondents were asked to rank the obstacles to the Loviisa 3 NDH project as "Always important (=1); often important (=0.66); sometimes important (=0.33); never/seldom important (=0).

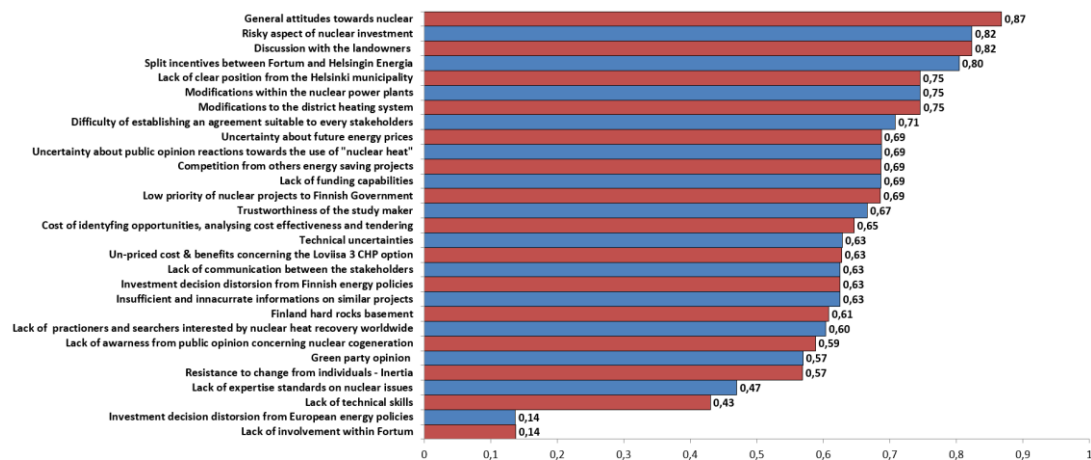

Figure II.5.4: Obstacles to the Loviisa 3 Nuclear District Heating project as perceived by VTT respondents (17 out of 27). Respondents were asked to rank the obstacles to the Loviisa 3 NDH project as "Always important (=1); often important (=0.66); sometimes important (=0.33); never/seldom important (=0).

4.1. Market failures and physical constraints

4.1.1. Market failures

Split incentives between the two main companies concerned by the Loviisa 3 NDH megaproject, Helen and Fortum, are perceived as a main source of failure by the interviewees. While this project is aligned with the Fortum long-term strategy to replace the old Loviisa nuclear power plants that are to be closed by 2027-2030 (TEM, 2011: p. 7), the impact on the heat and electricity markets would disturb the activities of Helen. Introducing such a large amount of heat (see Section 3.2. for details) in the market would inevitably imply the closure of a few fossil-fuels cogeneration plants since 90% of Helsinki's DH is provided by fossil-fuel cogeneration plants (Helen, 2015a). Without any suitable arrangement, Helen would have inevitably lost a significant market share in electricity to the benefit of Fortum. Helen is fully owned by the municipality of Helsinki, and therefore the municipality have a significant influence in the decision-making process of the company (see Section 2.3). The Helsinki municipality that owns Helen also owns 40% of the Vantaan Energia (the rest belonging to the Vantaa municipality), which operates the DH network of Vantaa. Thus, split incentives concern all the Helsinki metropolitan area, introducing further complexity. The Loviisa 3 NDH megaproject emphasizes the competition existing between NDH and the heat sources which are already in place. When replacing fossil-fuel cogeneration, the issue is even more complex as it implies reallocating the electricity output between energy players. This is in line with results from Broberg Viklund and Karlsson (2015) who state that the recovery of industrial excess heat in DH systems based on fossil-fuels cogeneration plants reduces the possibility of producing electricity from those plants. In the Loviisa 3 NDH case, the electricity generated from the NCHP would have compensated for the reduction due to the closure of fossil-fuel cogeneration plants. Connecting the NCHP to the DH system would have also reduced the need for fuel in the thermal production system. These fuel resources could have then been used by alternative users. On the system side, it is important to consider the integration of a NCHP into the DH system. Obstacles arise when considering interactions between established stakeholders and the resulting trade-offs.

The solution, if there is a problem to resolve, would be to limit market trade-offs by adapting suitable contractual rules. Finnish energy companies follow a unique ownership model, the so-called Mankala principle (Puikkonen, 2010). Mankala companies are jointly owned by a number of parties that bear the investment and operating costs of the resulting company, and secure an electricity supply which corresponds to their share of ownership. Applying the Mankala principle to the Loviisa 3 NDH megaproject may make it possible to reach an arrangement between Helen and Fortum. As the electricity and heat output of the nuclear plant is shared, it would help compensating the market losses feared by Helen (and similarly by Vantaan Energia). Figure II.5.5 depicts the ownership model that could prevent having split incentives between utilities. The pre-requisite of such a common agreement is stakeholder commitment at an early stage of the project (the lack of early commitment largely penalises the management of the Olkiluoto 3 project; Hellström *et al.*, 2013). With regards to the Loviisa 3 NDH option, these negotiations (if they occurred) did not lead to a conclusion. The decision-making process of such an agreement would inevitably imply further complexity. The Finnish parliament and government both play an important role in the licensing process of new NPPs in Finland. The decision-in-principle (the first step of the licensing process; TEM, 2011) needs to be approved by both the government and the parliament following a democratic process. Our empirical investigation has showed that political parties, and hence the public's opinion, must be convinced of the project's legitimacy. Once the decision-in-principle is granted, the technical requirements are elaborated with safety standards, which must be checked by the Finnish radiation and nuclear safety authority (STUK), and ultimately validated by the government. In such an immense project, foreign investors and multinationals may also be involved. Finally, the European Union (through the EC) would certainly need to support the project, or at least agree on its benefits.

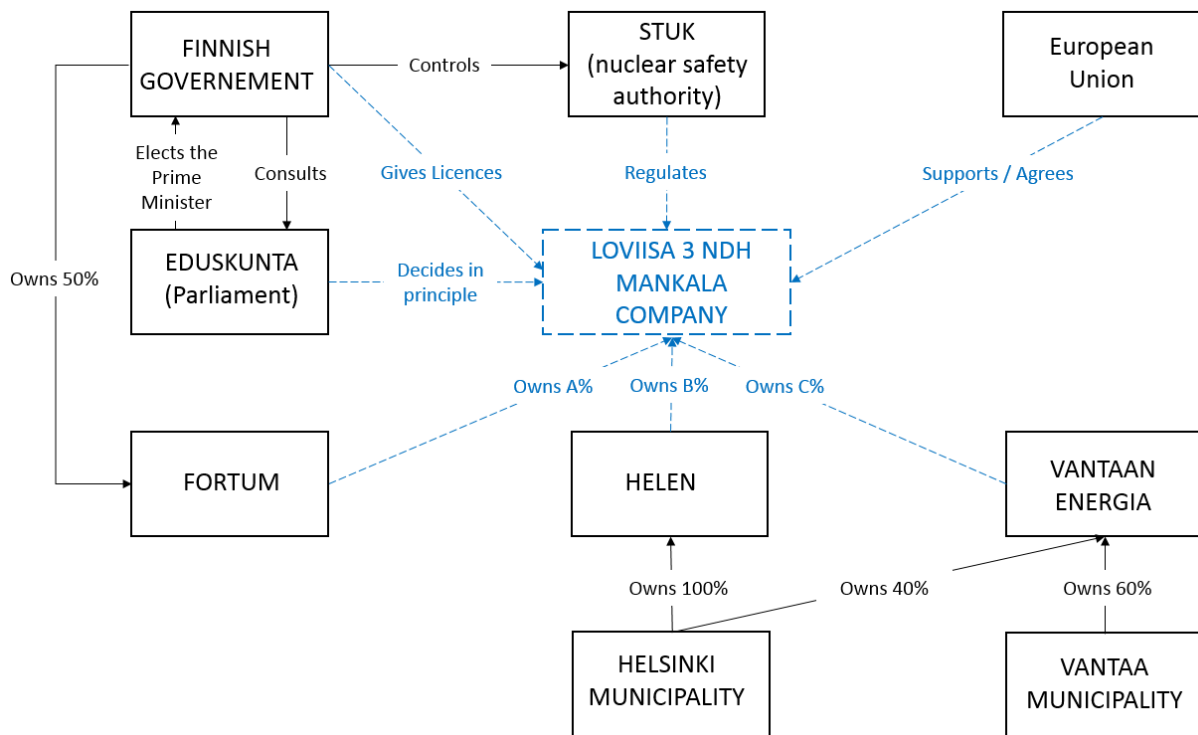

Figure II.5.5: Theoretical project governance of a sustainable Loviisa 3 NDH project. With blue dashed line we have sketched: Theoretical processes surrounding the hypothetical Loviisa 3 NDH Mankala Company. As additional assumption: $A + B + C = 100\%$ (i.e. there are only three owners of the Mankala company).

Interviewees pointed out that this lack of discussions is linked to the difficulty of precisely determining the contractual rules to apply. The value of market trade-offs strongly depends on the electricity prices, which are hard to predict on long term. It makes the respective benefits and losses of Helen, Vantaan Energia and Fortum impossible to assess with certainty. To overcome the volatility of electricity prices, one solution could be to publically guarantee support for the electricity produced from NDH plants. Such a mechanism could be inspired by e.g. feed-in-tariffs (UNDP (United Nations Development Programme), 2012) or by the recent United Kingdom electricity market reform (Contracts for difference). Guaranteeing support for the electricity generated from high-efficiency nuclear plants is another alternative to be explored. In this case, further quantitative studies would be needed to determine the efficiency rate upon which a facility could apply for public support. Another threshold to target could be the amount of carbon emissions saved by the project.

Adaptations of the Mankala principle can also lead to innovative business models for NDH megaprojects in different contexts. In the EU28 Member States where nuclear power plants are traditionally owned by a single company, it could be applied to the production of heat only, while leaving the electricity output to the initial plant owner. In that case, the costs and benefits of heat transport and delivery would be shared, but only one company would own the nuclear reactor. It would require rigorously establishing which costs account for electricity production and which costs account for heat production. It would also require long-term contracts in which the nuclear reactor owner agrees to provide a certain amount of heat, with a fixed annual and daily production. Such discussions would certainly be highly political and an arrangement very complex to establish. Any of the EU28 Member States wanting to encourage high-efficiency nuclear power plant could initiate and moderate the discussion process between stakeholders, eventually providing standardized, long-term contracts.

4.1.2. Physical constraints

Table II.5.2 shows the main arguments related to the Loviisa 3 NDH option as presented by Fortum and Helen respectively, as a support for the interviews. All the listed issues are relevant and true in principle. However the fact that Fortum and Helen emphasized different points shed light on their distinguished opinions and perceptions of NDH system, in accordance with the goals and strategies of utilities. Stakeholders pushing their own agendas is a common source of failure for megaprojects (Miller and Hobbes, 2009).

Fortum	Helen
Replacement of heat generated with fossil fuels	Cost for produced and transferred nuclear heat is higher compared with local heat production
Large reduction of carbon dioxide emissions (6% of the entire emissions in Finland)	A full back-up capacity for heat production is needed (technical and political risk)
Higher plant efficiency	Nuclear cogeneration does not increase electricity generation when replacing current cogeneration in Helsinki area
Steam extraction from the turbine (technically feasible)	Nuclear district heat is not renewable energy

Table II.5.2: Mains arguments exposed by Fortum and Helen respectively when addressing nuclear district heating for the Helsinki area. Data sources: Helen Ltd (2015b); ISNP (2014).

To illustrate the high degree of subjectivity in technical debates, let us consider one technical issue: the heat back-up capacity. For Helen, the heat backup capacity is a major constraint. They emphasize not only the technical risk (on the nuclear plant and on the transmission line), but also the political risk (closure of nuclear plants after a nuclear accident in another country, such as Fukushima Daiichi). For DH scientists from VTT, the answer is more nuanced. They highlight that there is always a significant capacity in boilers (at least in Helsinki). For Fortum and Fennovoima, the backup is not a major obstacle. They assume that the cost of building gas back-up is not prohibitive. Looking back to empirical experiences (NC2I, 2015c), most operational NDH systems require fossil-fueled back-up for operational and maintenance outages (planned in low-duty periods), and none of them encounter unexpected technical or financial difficulties related to the heat back-up system.

Quantifications from the questionnaire confirm that perceptions of the obstacles to the Loviisa 3 NDH alternative depend on the stakeholder interviewed. This is true for physical constraints (see Figure II.5.6) and can also be observed with other kinds of obstacles (e.g. obstacles related to the role of the public authorities; see Figures II.5.3 and II.5.4). Regardless of the relevance and relative importance of each obstacle, which must be analysed with caution, Figure II.5.6 shows that individuals from Fortum perceive the physical constraints to be less important compared with research scientists from VTT.

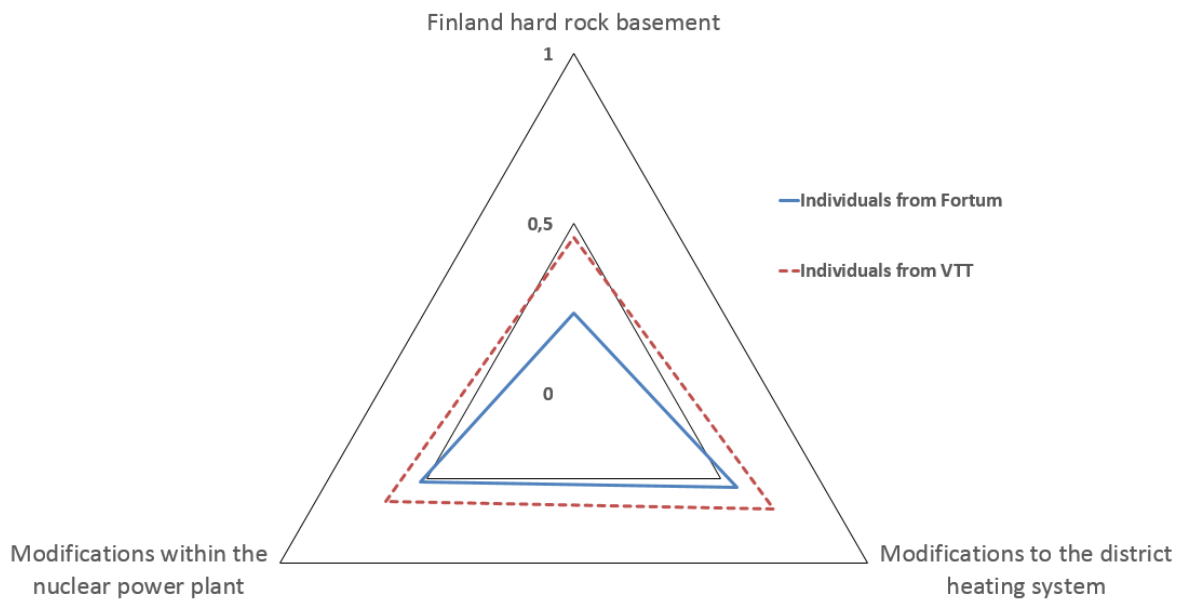

Figure II.5.6: Importance of physical constraints on the Loviisa 3 NDH project, as perceived by individuals from Fortum and VTT respectively.

Our analysis concludes that clashes over the technical feasibility of NDH megaprojects are not merely technical debates, but highly political contests that revolve around social ideology, values and power (confirming results from Van de Graaf and Sovacool, 2014). We clearly need a trustworthy feasibility study upon which all stakeholders can rely. For this reason, a joint cost-benefit analysis should be carried out, involving individuals from all the relevant organisations. Dynamic, multi-disciplinary working teams and trustworthy management processes focusing on the creation of shared visions are particularly important when addressing profound innovation (Raven and Verbong, 2009). Allocating the management of the study to a public research Organisation such as VTT should be considered. Academic institutions would also bring valuable skills to the discussion, particularly when comparing NDH to alternative solutions for decarbonizing the Helsinki DH system.

4.2. Institutional and financial obstacles

4.2.1. Institutional

Boundary-crossing innovation

Cooperation between a nuclear plant operator and a DH network operator to provide large quantities of heat to the network has not been experienced worldwide. As a matter of fact, NDH experiences are generally limited to small-scale cases where the nuclear plant operator also owns the DH network (NC2I, 2015c). Nuclear heat is obviously not among the low-carbon technologies usually considered by DH network operators (EC, 2012). Despite being hardly measurable, behavioural or psychological means such as “resistance to change” may have inhibited the will of investigating NDH for Helsinki.

Similar observations have been made by Colmenar-Santos *et al.* (2015), with regard to fossil-fuel cogeneration, which fall in line with a recent IEA (2014) report entitled “Integrating heat and electricity sectors”. It is important that nuclear and heat sectors also build connexions. Even though several European programs aim at discussing nuclear cogeneration openly (EC, 2015a; EUROPAIRS, 2009; NC2i, 2015a; NEA, 2015), these groups are largely composed of nuclear stakeholders. Future workshop, seminars, energy clusters or other open networks dealing with nuclear cogeneration should integrate stakeholders from other sectors, such as DH network operators. This would make it possible

to highlight and challenge established norms, routines and tacit knowledge, which are often deeply rooted (Raven, 2007). Opening these clusters can be more efficient than pure policy instruments, if the technology proves to be advantageous for society in general (Palm and Thollander, 2010).

Business model effect

Nuclear is not among the priorities of Helen, which nowadays only owns a small fraction of nuclear MWs through its ownership in Teollisuuden Voima, and produces 10% of its electricity production with nuclear (before Olkiluoto 3 start-up). In addition, such a large investment committing the DH supply of the area for decades is contradictory to the strategy of Helen (remaining open to new opportunities which may appear in the future).

Experiences in other sectors with natural monopolistic characteristics has shown that utilities will not embark on innovative activities without an incentive to do so (Greenwood *et al.*, 2011; Bauknecht *et al.*, 2007), and this incentive should undoubtedly come from the regulator (Hawkey and Webb, 2012). If the EU-28 Member States do not create a regulatory framework aimed at promoting NDH, then in spite of the implementation being technically and (potentially) economically feasible, the scheme cannot progress seeing that investment in NDH is less attractive than other projects that do not conflict with the utilities' distinctive business models and do not challenge established regime boundaries.

Open DH, or third party access, is an initiative that could allow nuclear operators to offer heat to the network, if priced competitively. Third-party access would mean the introduction of a daily heat production market. Any heat supplier providing competitive heat would be able to sell it to the network. By contrast, In Finland, the DH network operator determines, on a voluntary basis, how to set up the heat supply for the system. It then chooses, based on short- or long-term contracts, between own, available heat sources and possible external heat sources (Eduskunta (Parliament of Finland), 2009). While an open network is an option to consider, caution is needed before implementation. As a matter of fact, the practical impact of third-party access on the overall efficiency of the network is very uncertain, and could even lead to higher system costs without sizeable benefits (Bundeskartellamt (German Competition Authority), 2012). Based on empirical evidence from Sweden, Broberg *et al.* (2012) posit that it could generate profitable excess heat investments, while the Energimyndigheten (Swedish Energy Agency, 2015) disprove this finding.

Regulatory framework with regards to regional symbioses

Even though the government subsidised energy efficiency investments within the heat sector (TEM, 2014), it does not target specifically industrial excess heat recovery. Besides, the National climate and Energy strategy clearly prioritise the use of biomass to decarbonise the heat sector (TEM, 2013). Whereas Finland is in line with the objectives of the European Union concerning energy efficiency (Energy efficiency watch, 2013) and the use of renewable sources (Statistics Finland, 2015), the current state of the regulation does not encourage excess heat recovery through cooperation between utilities. This lack of political recognition of the decarbonisation potential of industrial excess heat recovery, and of nuclear among those industries, clearly penalises the Loviisa 3 NDH megaproject. Local authorities tend to over-prioritise renewable heat sources.

These observations are in line with the conclusions of Persson *et al.* (2014) and Connolly *et al.* (2014) for the EU28 (and also with EC, 2014). According to these authors, 31% of the total building heat demand in the EU28 could be provided by industrial excess heat recovery. It is argued that *“the importance of heat has long been underestimated in EU decarbonisation strategies and local heat synergies have often been overlooked in energy models used for such scenarios”* (Persson *et al.*, 2014: p.1). Despite its forceful intentions, the Directive 2012/27/EU (European Parliament, 2012) do not mention the potential of nuclear cogeneration. In line with the article 14 of this Directive, EU member states submitted in 2015 their notifications regarding their energy efficiency potential in the heating and cooling sector at national level. This comprises heat recoverable from industries and power plants, but rarely include nuclear plants. In that vein, the pan-European Thermal Atlas, , a project co-funded

by the EU's Horizon 2020 research program, has recently performed a thorough and valuable mapping of the EU residential and commercial heat demand, alongside with the mapping of existing excess heat sources (STRATEGO, 2015b). While fossil-fueled thermal plants producing electricity only are mapped as 'cogeneration excess heat', nuclear plants are excluded from this study.

The authors agree with Persson *et al.* (2014) on the fact that the Directive 2009/72/EC should be updated to explicitly allow long-term contracts to those suppliers of technologies that comply with the environmental obligations of the EU Member States. We further advocate that nuclear plants should be recognised by the EC (and the projects funded by EU research programs) alongside other utilities generating large amounts of waste heat to be recovered.

Priorities, experience and electioneering of local authorities

Local authorities in the EU28 did not use to consider energy as a priority (ESD, 2005). Actions carried out in this area are also often "non-transparent" (Cahn, 2000). Electorally speaking, it would be dangerous to go into debt for energy projects that are not essentially open to discussion with the general public; they choose not to embark on such projects in most cases (Peters *et al.*, 2013). In addition to these features, nuclear projects face political key obstacles related to economics, planning, public perception and waste management (Goodfellow *et al.*, 2011; Greenhalgh and Azapagic, 2009). Nuclear energy often generate fears, as shown by the impact of accidents on the public opinion (Hayashi and Hughes, 2013; Kim *et al.*, 2013; Thatcher *et al.*, 2015; Visschers and Wallquist, 2013). Distrust towards nuclear power is particularly strong in Helsinki where the second largest party in the city council is the Greens of Finland. The other party is historically against nuclear – the Left Alliance – and holds 30 seats over 85 (City of Helsinki, 2016). This, coupled to the fact that the Helsinki municipality owns 100% of Helen (Helsinki DH network operator) and 40% of Vantaan Energia (Vantaa DH network operator), makes it difficult to establish a constructive debate on the possibility of heating the city with nuclear cogeneration. As depicted in Section 2.3, energy companies have boards of representatives appointed by the municipality. When the board members assume their seats, they no longer represent their political parties but rather the company, and thus must act in the best interests of the company; this often raises conflicts of interests and values (Magnusson and Palm, 2011).

To counterbalance this trend, academicians should provide reliable, impartial and qualitative studies on NDH experiences, bringing the discussions a step back from purely technical aspects and inviting the civil society into the debate. Transparent and systematic data sharing of NDH experiences should be encouraged through international cooperation programs. Russia, which has the largest experience with NDH (IAEA (International Atomic Energy Agency), 2003), should actively take part in these programs. Local authorities experiencing NDH should be interviewed and the opinion of citizens heated by nuclear heat should be collected through large-sample questionnaires. This would highlight whether or not NDH is supported by the communities that use it. Eventually, it would also provide material for NDH promotion and dissemination programs, with the aim of increasing recognition of this alternative.

4.2.2. Financial

NDH requires a long payback period and a large capital input, compared with other public works of relevance. As a matter of fact, the life expectancy of the capital asset associated with those projects may be up to twenty years (Jasserand and Devezeaux, 2016; NC2I, 2015c: p. 17), depending on the operational environment and the energy market conditions. This makes it unattractive to energy markets that have already been privatized and opened to competition since they prefer projects with shorter payback periods and smaller capital asset (Euroheat & Power, 2006; UNDP, 2012). This fact, coupled with the higher risk involved in the implementation of heat transportation systems compared with other more conventional technologies (Oxera, 2009) and with risks specific to innovative nuclear projects (Locatelli and Mancini, 2012), means that the expectations on the required cost of capital are greater. It emerges from our empirical research that, even though the Loviisa 3 NDH megaproject has not reached the financing stage, pessimist expectations shaped the stakeholders'

negative perceptions of the project's feasibility. This brings to mind the so-called "self-fulfilling prophecies", a term coined by John Maynard Keynes (Keynes, 1936) to illustrate the impact of individual expectations on economic outputs. Expectations of difficulties during the project financing process may inhibit the will of stakeholders to be involved in preliminary stages.

It is complex to determine whether the risk is correctly estimated or not. What we know is that two thirds of the existing NDH systems have been financially successful (NC2i, 2015c). Failures are due to unexpected risk, changing boundary conditions, too small scale of projects (NC2i, 2015c: p. 18). NDH project assets could be valued positively by investors wanting to reduce the impact of geopolitical risks. Mari (2014) studied diversified portfolios of generating capacities and states that nuclear power is an important asset for minimising the electricity prices. In the EU28, the cost of fuel accounts for 35% of the total operational costs of nuclear units (IEA (International Energy Agency), 2017c). By comparison, these ratios are about 90% for combined-cycle gas turbines and 70% for coal technologies. Empirical experiences proved that the high volatility of gas prices relative to electricity significantly penalises fossil-fuels cogeneration plants (Colmenar-Santos *et al.*, 2015). NDH systems, once in operation, have the ability to maintain the price of heat within a given threshold range without jeopardizing the profitability of the infrastructure.

Mistrust commonly affects financial markets. Since the 2007 subprime crisis, a high-quality public guarantee has become a pre-requisite to the successful financing of large infrastructure projects (Weber and Alfen, 2010). Based on a comprehensive feedback of NDH projects that have been implemented, NC2I (2015c) states that two thirds of projects were financially successful, showing an average payback period of 20 years. However, these projects were relatively small compared to NDH megaprojects such as the Loviisa 3 one (see Sections 2.2 and 2.3). Our empirical investigation highlighted that the long term investment profile, nuclear and first-of-a-kind aspects of NDH megaproject assets could inhibit the will of investors to get involve in financing stages.

An approach to face this obstacle resides in the concept of 'cogeneration readiness' (ETI, 2016: p. 59-60). Nuclear plants build as 'cogeneration ready' could easily be upgraded to supply heat in the future by e.g. anticipating the additional space requirements for pipelines and heat exchangers. According to the ETI (2016), cogeneration readiness can be delivered for a small incremental cost, representing approximately 10% of the total capital costs required for an actual cogeneration upgrade. The implementation of such a design would allow nuclear operators to start operating the plant in an electricity-only generation mode while remaining open to the cogeneration option if the market, business and institutional conditions become favourable. In this way, the stakeholders would not have to bear the risk specific to the cogeneration application at the same time as the risk inherent to traditional electricity-only reactors.

Facilitating the risk-sharing of low carbon assets may also help reduce the risk premium associated to NDH projects (Aglietta and Rigot, 2012). Securitization of low carbon assets should be done within a secured, institutional framework (Leurent, 2015). In the EU, actions undertaken by the European Central bank (ECB) and the European Investment Bank (EIB) have served the sustainable financing of long term energy projects by guarantying the liquidity of the associated assets (Direction Générale du Trésor – French financial authority, 2013). These actions should be further developed, and priority given to those energy projects which value added have been demonstrated both for the economy and climate change mitigation. In that vein, the ECB could accept low carbon energy assets as collateral from banks, as pointed out by e.g. *La Direction Générale du Trésor* (2013). Another effective measure could be the large-scale implementation of emissions trading or carbon taxation systems (Stern, 2006). We further agree with Stiglitz and al. (2009) on the fact that new regulations are required to further integrate natural elements such as carbon dioxide in the calculation of economic and social performance indicators.

5. Conclusion and Policy Implications

The Loviisa 3 NDH megaproject examined herein reminds us of the many obstacles to overcome before being able to deploy future nuclear cogeneration megaprojects which require cooperation between utilities and other stakeholders. Debates about the technical feasibility may be biased by political contests and social ideology, split incentives may occur, electricity price volatility may undermine the establishment of contractual rules, business models may not be adapted, and electioneering of local authorities may inhibit the will of investing in this alternative. Disconnexion of nuclear and heat sectors makes it hard for such boundary-crossing innovation to break through established business models and routines. The lack of recognition of the heat wasted from industries, including nuclear, restrain the development of regional symbioses. Additionally, the financing of energy megaprojects has often been problematic in the EU28 liberalised energy markets. Whereas the main challenges have been addressed, a larger quantitative study would be needed to determine the relative importance of each factor.

Ultimately, our analysis suggests that NDH megaprojects will always involve trade-offs and invariably will create winners and losers. The “progress” that NDH may bring is value-laden, whether intentional or not. For engineers, NDH megaprojects are logistical puzzles whose value will be assessed on decarbonisation and economic potential. For nuclear operators, NDH megaprojects are management issues whose value will be evaluated on the basis of strategic considerations. For DH networks operators, NDH megaprojects are an alternative, risky source of heat whose value will be gauged by comparison with other NDH experiences. For investors, NDH megaprojects are capital assets whose value will be assessed on the expected return on investment. To communities chosen to host NDH megaprojects, they are exercises in democratic participation whose value will be judged on transparency and the perception of being “good for society” or not. To public authorities, NDH megaprojects are a potential decarbonisation pathway whose value will be appraised on energy transition scenarios. Alongside the feasibility study, a broad assessment of how future NDH megaprojects will affect corporations, communities, government and ecosystems must be conducted.

Stakeholders planning for NDH megaprojects may want to consider the creation of a new shared company, in line with the “Mankala principle” followed in Finland. Such project governance would reduce the trade-offs between stakeholders. In countries where nuclear power plants are traditionally owned by a single company, the Mankala principle could only be applied to the production of heat, while leaving the electricity output to the initial plant owner. In this case, costs and benefits of heat transport and delivery would be shared, but only one company would own the nuclear reactor. It would certainly require rigorously establishing which costs account for electricity production and which costs account for heat production. It would also require long-term contracts in which the owner of the nuclear reactor agrees to provide a certain amount, with a regularity to be fixed. In all cases, strong business relationships and commitment must be built from an early stage. It should start with a co-directed feasibility study, leading to results that can be trusted by everyone.

Stakeholders may also plan to build future reactors as ‘cogeneration ready’, even if they are initially required to supply electricity only. ‘Cogeneration readiness’ can be delivered for a small incremental cost and would ensure that nuclear plants are ready for a subsequent upgrade to allow DH supply. This would disconnect the decision-making process and investments related to the cogeneration application from those related to the electricity-only generation; hence facilitating project management issues and financing stages.

International cooperation is primordial if we wish to share NCHP experiences and provide policy makers and stakeholders with accurate data. Russia, which has the most extensive experience of NDH, should be more involved in international cooperation programs on nuclear cogeneration. These clusters should invite non-nuclear stakeholders, such as DH operators, to the debate. Last but

not least, academicians should explore the social, political, institutional and financial aspects of NCHP, thus allowing discussions to take a step back from purely technical aspects.

Despite not being excess heat recovery projects in the sense of Directive 2009/72/EC, we advocate that NCHP should be recognised by the EC alongside other utilities generating large amounts of wasted heat. Furthermore, an effective carbon pricing system should be implemented. EU28 Member States wanting to promote NDH may consider opening DH networks to third-party access. Another option, perhaps more relevant, is providing support for the electricity generated by high-efficiency NCHP.

It has been shown that, without adequate EU energy policies and EU28 Member State support, the potential of NCHP will continue to be underestimated. We encourage the EU and its members to seriously consider the deployment of NCHP with PWRs as a strategic pathway toward a sustainable EU energy system. The factors that could act as levers are: energy efficiency, decarbonisation of the heat sector, independence from imported fossil-fuels, synergies between nuclear and renewable energies, and strategic considerations with regards to future nuclear technologies. Nonetheless, our study relies on a single case so caution is needed when applying the results to other contexts, but majority of the relevant influencing factors are presented. The fact remains that the overall assessment of NCHP remains to be done on a case-by-case basis and both from an environmental and economic point of view.

References

- Aglietta, M. and Rigot, S., 2012. Investissements à long terme, régulation financière et croissance soutenable. *Rev. d'Economie Financ.*, 108, 189–200 [in French].
- Angulo, C., Bogusch, E., Bredimas, A., Delannay, N., Viala, C., Ruer, J., Muguerra, P., Sibaud, E., Chauvet, V., Hittner, D., Fütterer, M.A., de Groot, S., von Lensa, W., Verfondern, K., Moron, R., Baudrand, O., Griffay, G., Baaten, A., Segurado-Gimenez, J., 2012. EUROPAIRS: The European project on coupling of High Temperature Reactors with industrial processes. *Nuclear Engineering and Design*, 5th International Topical Meeting on High Temperature Reactor Technology (HTR 2010) 251, 30–37.
- Bauknecht, D., Leprich, U., Späth, P., Skytte, K., Esnault, B., 2007. DG-Grid: Regulating innovation & Innovating regulation. Brussels: Intelligent Energy.
- Bergroth, N., 2010. Large-Scale Combined Heat and Power (CHP) Generation at Loviisa Nuclear Power Plant Unit 3. Contribution to the 8th Conference on Nuclear option in countries with small and medium electricity grids.
- Boarin, S., Locatelli, G., Mancini, M., Ricotti, M.E., 2012. Financial Case Studies on Small- and Medium-Size Modular Reactors. *NT 178*, 218–232.
- Braun, H.-J., 1992. Symposium on “failed innovations.” *Social Studies of Science* 22, 210–215.
- Broberg, S., Backlund, S., Karlsson, M., Thollander, P., 2012. Industrial excess heat deliveries to Swedish district heating networks: Drop it like it’s hot. *Energy Policy* 51, 332–339.
- Broberg Viklund, S., Karlsson, M., 2015. Industrial excess heat use: Systems analysis and CO₂ emissions reduction. *Applied Energy* 152, 189–197.
- Bundeskartellamt (German Competition Authority), 2012. Final Report Sector Inquiry District Heating.
- Cahn, M., 2000. Liberalisation and its impact on municipalities in the participant countries and the UK: Summary of report. International Energy Agency Demand-Side Management Programme.
- Cany, C., Mansilla, C., da Costa, P., Mathonnière, G., Duquesnoy, T., Baschwitz, A., 2016. Nuclear and intermittent renewables: Two compatible supply options? The case of the French power mix. *Energy Policy* 95, 135–146.
- Carlsson, J., Shropshire, D.E., van Heek, A., Fütterer, M.A., 2012. Economic viability of small nuclear reactors in future European cogeneration markets. *Energy Policy* 43, 396–406.
- Chai, K.-H., Yeo, C., 2012. Overcoming energy efficiency barriers through systems approach—A conceptual framework. *Energy Policy* 46, 460–472.
- City of Helsinki, 2015. Helsinki’s Climate Roadmap - Towards a carbon neutral and climate resilient city.
- City of Helsinki, 2016. City council meetings and seats. Available from: <<http://www.hel.fi/www/Helsinki/en/administration/decision/council/seats/>>.
- Colmenar-Santos, A., Rosales-Asensio, E., Borge-Diez, D., Mur-Pérez, F., 2015. Cogeneration and district heating networks: Measures to remove institutional and financial barriers that restrict their joint use in the EU-28. *Energy* 85, 403–414.
- Connolly, D., Lund, H., Mathiesen, B.V., Werner, S., Möller, B., Persson, U., Boermans, T., Trier, D., Østergaard, P.A., Nielsen, S., 2014. Heat Roadmap Europe: Combining district heating with heat savings to decarbonise the EU energy system. *Energy Policy* 65, 475–489.
- Direction Générale du Trésor (French financial authority), 2013. Livre blanc sur le financement de la transition écologique. Directed by Dron, D. Direction Générale du Trésor, Commissariat général au développement durable [in French].
- Easterby-Smith, M., Thorpe, R., Jackson, P., 2015. *Management and Business Research*. Fourth ed. Sage Publishing.

- EC (European Commission), 2012. Background Report on EU27 District Heating and Cooling Potentials, Barriers, Best Practice and Measures of Promotion. Available from: <<https://setis.ec.europa.eu/publications/jrc-setis-reports/background-report-eu-27-district-heating-and-cooling-potentials-0>>.
- EC, 2014. European Union Horizon 2020 programme for Research and Innovation. Available from: <<https://ec.europa.eu/programmes/horizon2020/en/what-horizon-2020>> [WWW Document]. URL <https://ec.europa.eu/programmes/horizon2020/> (accessed 5.12.16).
- EC, 2015a. Advanced Reactor for Cogeneration of Heat & Electricity. Available from: <<http://www.archer-project.eu/>>.
- EC, 2015b. Strategic Energy Technology Plan (SET-Plan). Available from: <<http://ec.europa.eu/energy/en/topics/technology-and-innovation/strategic-energy-technology-plan>>.
- EC, 2016. Energy in Buildings. Available from: <<https://ec.europa.eu/energy/en/topics/energy-efficiency/buildings>>.
- Eduskunta (Parliament of Finland), 2009. The law regulates energy companies' energy services, including informing obligations and energy efficiency. Act No. 1211/2009 (Laki energiamarkkinoilla toimivien yritysten energiatehokkuuspalveluista).
- Energimyndigheten (Swedish Energy Agency), 2015. Energy in Sweden.
- Energy efficiency watch, 2013. Energy efficiency in Europe/Country report: Finland. Available from: <http://www.energy-efficiency-watch.org/fileadmin/eew_documents/Documents/EEW2/Finland.pdf>.
- ESD, 2005. Sustainable energy communities and sustainable development: conclusions and recommendations. Wiltshire: ESD Ltd.
- ETI (Energy Technology Institute), M., 2015. The role for nuclear within a low carbon energy system. Energy Technology Institute (ETI). Available from: <<http://www.eti.co.uk/the-role-for-nuclear-within-a-low-carbon-energy-system/>>.
- Euroheat & Power, 2006. Ecoheatcool - Reducing Europe's consumption of fossil fuels for heating and cooling.
- EUROPAIRS, 2009. FP7 End User Requirement for Process Heat Applications With Innovative Reactors for Sustainable Energy Supply (EUROPAIRS). Available from: <http://cordis.europa.eu/project/rcn/94416_en.html>.
- European Parliament, 2009. Directive 2009/28/EC on the promotion of the use of energy from renewable sources and amending and subsequently repealing Directives 2001/77/EC and 2003/30/EC.
- European Parliament, 2012. Directive 2012/27/EU of the European Parliament and of the Council of 25 October 2012 on energy efficiency, amending Directives 2009/125/EC and 2010/30/EU and repealing Directives 2004/8/EC and 2006/32/EC.
- Flyvbjerg, B., 2009. Optimism and misrepresentation in early project development. In: Making Essential Choices with Scant Information: Front-End Decision Making in Major Projects. Terry Williams, Knut Samset, and Kjell Sunnevag, eds. 147–148.
- Flyvbjerg, B., 2016. The Oxford Handbook of Megaproject Management. Terry Williams, Knut Samset, and Kjell Sunnevag, eds.
- Fortum Power and Heat Oy, 2009. Application for a Decision-in-Principle Concerning the Construction of a Nuclear Power Plant Unit - Loviisa 3.
- Goodfellow, M.J., Williams, H.R., Azapagic, A., 2011. Nuclear renaissance, public perception and design criteria: An exploratory review. Energy Policy, Sustainability of biofuels 39, 6199–6210.
- Greene, S.R., Flanagan, G.F., Borole, A.P., 2009. Integration of Biorefineries and Nuclear Cogeneration Power Plants - a Preliminary Analysis (No. ORNL/TM-2008/102). Oak Ridge National Laboratory (ORNL).

- Greenhalgh, C., Azapagic, A., 2009. Review of drivers and barriers for nuclear power in the UK. *Environmental Science & Policy* 12, 1052–1067.
- Hawkey, D., Webb, J., 2012. Multi-level governance of socio-technical innovation: the case of district heating in the UK. Contribution to the Jean Monnet International Workshop, Copenhagen Business School.
- Hayashi, M., Hughes, L., 2013. The Fukushima nuclear accident and its effect on global energy security. *Energy Policy* 59, 102–111.
- Helen Ltd, 2015a. Energy Production in Helsinki. Available from: <<https://www.helen.fi/en/helen-oy/about-us/energy-production/>>.
- Helen Ltd, 2015b. Nuclear District Heating. Private communication.
- Hellström, M., Ruuska, I., Wikström, K., Jåfs, D., 2013. Project governance and path creation in the early stages of Finnish nuclear power projects. *International Journal of Project Management* 31, 712–723.
- IAEA (International Atomic Energy Agency), 2003. Market Potential for Non-electric Applications of Nuclear Energy. STI/DOC/010/410.
- IAEA, 2009. Fuel ethanol production using nuclear steam. Contribution of Forsberg, C., Rosebloom, S. and Black, R. to the International conference on non-electric applications of nuclear power: Seawater desalination, hydrogen production and other industrial applications. IAEA-CN-152.
- IAEA, 2016a. Desalination Thermodynamic Optimization Program (DE-TOP). Available from: <https://www.iaea.org/NuclearPower/NEA_Desalination/index.html>.
- IAEA, 2017a. Opportunities for Cogeneration with Nuclear Energy. IAEA Nuclear Energy Series No. NP-T-4.1. Available from: <<http://www-pub.iaea.org/books/iaeabooks/10877/Opportunities-for-Cogeneration-with-Nuclear-Energy>>.
- IAEA, 2017b. Nuclear power reactors in the world. IAEA-RDS-2/37.
- IEA (International Energy Agency), 2014. Linking Heat and Electricity Systems - Co-generation and District Heating and Cooling Solutions for a Clean Energy Future.
- IEA, 2017. Projected Costs of Generating Electricity. 2017 Editions.
- ISNP (International School on Nuclear Power), 2014. Safety aspects related to deploying nuclear cogeneration for district heating: Case Helsinki. Contribution of Harri Tuomisto to the International School on Nuclear Power.
- Jaskólski, M., Reński, A., Duzinkiewicz, K., Kaczmarek-Kacprzak, A., 2014. Profitability criteria of partial cogeneration in nuclear power plant. *Rynek Energii*.
- Jasserand, F., Lavergne, J.-G., 2016. Initial Economic Appraisal of Nuclear District Heating in France. *EPJ Nuclear Sci. Technol.* 2, 39.
- Kessides, I.N., 2012. The future of the nuclear industry reconsidered: Risks, uncertainties, and continued promise. *Energy Policy* 48, 185–208.
- Keynes, J.M., 1936. *The General Theory Of Employment, Interest, And Money*, paperback. ed.
- Kim, Y., Kim, M., Kim, W., 2013. Effect of the Fukushima nuclear disaster on global public acceptance of nuclear energy. *Energy Policy* 61, 822–828.
- Laurichesse, S., Avérous, L., 2014. Chemical modification of lignins: Towards biobased polymers. *Progress in Polymer Science, Topical Issue on Biomaterials* 39, 1266–1290.
- Leurent, M., 2015. Pas de croissance soutenable sans innovations financière - La cogénération nucléaire, une innovation d'importance stratégique pour la transition écologique. *Entreprendre & Innover* 25, 75–85.
- Li, H., Wang, S.J., 2014. Challenges in Smart Low-temperature District Heating Development. *Energy Procedia* 61, 1472–1475.
- Locatelli, G., 2013. Generation IV nuclear reactors: Current status and future prospects. *Energy Policy* 61, 1503–1520.

- Locatelli, G., Bingham, C., Mancini, M., 2014. Small modular reactors: A comprehensive overview of their economics and strategic aspects. *Progress in Nuclear Energy* 73, 75–85.
- Locatelli, G., Boarin, S., Pellegrino, F., Ricotti, M.E., 2015. Load following with Small Modular Reactors (SMR): A real options analysis. *Energy* 80, 41–54.
- Locatelli, G., Mancini, M., 2012. Looking back to see the future: building nuclear power plants in Europe. *Construction Management and Economics* 30, 623–637.
- Ma, Q., Luo, L., Wang, R.Z., Sauce, G., 2009. A review on transportation of heat energy over long distance: Exploratory development. *Renewable and Sustainable Energy Reviews* 13, 1532–1540.
- Mari, C., 2014. Hedging electricity price volatility using nuclear power. *Applied Energy* 113, 615–621.
- Miller, R., Hobbes, B., 2009. The Complexity of Decision-Making in Large Projects with Multiple Partners: Be Prepared to Change. In: *Making Essential Choices with Scant Information: Front-End Decision Making in Major Projects*. Terry Williams, Knut Samset, and Kjell Sunnevag, eds. pp. 375–389.
- NC2I, 2015a. Nuclear Cogeneration Industrial Initiative (NC2i). Available from: <<http://www.snetp.eu/nc2i/>>.
- NC2I, 2015b. CHP and High Temperature Reactors. Contribution of R. Arnold to the NC2I Conference, CDMA Brussels.
- NC2I, 2015c. Experience Feedback from Nuclear Cogeneration. Contribution of C. Auriault, M.A. Fütterer, O. Baudrand to the NC2I Conference, CDMA Brussels.
- NETNUC, 2011. Contribution of Auterinen, I., Kangas, P. and Koukkari, P. to the New Type Nuclear Reactors 2008–2011 Final Report. *bioNuclear Refinery – A Concept for Integration of Nuclear Heat and Biorefineries*.
- Nielsen, S., 2014. A geographic method for high resolution spatial heat planning. *Energy* 67, 351–362.
- Odell, J.S., 2001. Case Study Methods in International Political Economy. *International Studies Perspectives* 2, 161 – 176.
- Oxera, 2009. The cost of capital for heat distribution and supply: final report. The Hague: Energiekamer eds. Available from: <http://www.acm.nl/download/documenten/nma/Oxera-Cost_of_capital_for_heat_Final.pdf>.
- Paananen, P., Henttonen, T., 2009. Investigations of a Long-Distance 1000 MW Heat Transport System with APROS Simulation Software. Contribution to the 20th International Conference on Structural Mechanics in Reactor Technology (SMiRT 20).
- Palm, J., Thollander, P., 2010. An interdisciplinary perspective on industrial energy efficiency. *Applied Energy* 87, 3255–3261.
- Persson, U., Möller, B., Werner, S., 2014. Heat Roadmap Europe: Identifying strategic heat synergy regions. *Energy Policy* 74, 663–681.
- Peters, M., Fudge, S., Wade, J., 2013. Local authority perspectives on energy governance and delivery in the UK: a thematic assessment of enabling and restricting factors. University of Surrey, Centre for Environmental Strategy Working paper 01/13.
- Puikkonen, I., 2010. Cooperative Mankala-Companies – the Acceptability of the company form in EC Competition Law. *Helsinki Law Review*, 1 139–156.
- Raven, R., 2007. Co-evolution of waste and electricity regimes: Multi-regime dynamics in the Netherlands (1969–2003). *Energy Policy* 35, 2197–2208.
- Raven, R.P.J.M., Verbong, G.P.J., 2009. Boundary crossing innovations: Case studies from the energy domain. *Technology in Society* 31, 85–93.
- Ruth, M.F., Zinaman, O.R., Antkowiak, M., Boardman, R.D., Cherry, R.S., Bazilian, M.D., 2014. Nuclear-renewable hybrid energy systems: Opportunities, interconnexions, and needs. *Energy Conversion and Management* 78, 684–694.

- Ruuska, I., Ahola, T., Artto, K., Locatelli, G., Mancini, M., 2011. A new governance approach for multi-firm projects: Lessons from Olkiluoto 3 and Flamanville 3 nuclear power plant projects. *International Journal of Project Management* 29, 647–660.
- Safa, H., 2012. Heat recovery from nuclear power plants. *International Journal of Electrical Power & Energy Systems* 42, 553–559.
- Sainati, T., Locatelli, G., Brookes, N., 2015. Small Modular Reactors: Licensing constraints and the way forward. *Energy* 82, 1092–1095.
- Sanderson, J., 2012. Risk, uncertainty and governance in megaprojects: A critical discussion of alternative explanations. *International Journal of Project Management* 30, 432–443.
- Silverman, D., 2013. *Doing Qualitative Research: A Practical Handbook*. Sage Publishing. Fourth ed.
- Smil, V., 2010. *Energy Transitions: History, Requirements, Prospects*. Praeger publishing.
- Sorrell, S., Schleich, J., Scott, S., O'Malley, E., Trace, F., Boede, U., Ostertag, A., Radgen, P., 2000. *Reducing barriers to energy efficiency in public and private organisations*. Brighton: Science Policy Research Unit - University of Sussex.
- Sovacool, B.K., 2014. What are we doing here? Analyzing fifteen years of energy scholarship and proposing a social science research agenda. *Energy Research & Social Science* 1, 1–29.
- Sovacool, B.K., Cooper, C.J., 2013. *The Governance of Energy Megaprojects: Politics, Hubris and Energy Security*.
- Statistics Finland, 2015. Production of electricity and heat. Available from: <http://www.stat.fi/til/salatuo/index_en.html>.
- Stern, N., 2006. *Stern Review: The Economy of Climate Changes*. Cambridge University Presse Publishing.
- Stiglitz, J., Amartya, S., Fitoussi, J.-P., 2009. Report by the Commission on the Measurement of Economic Performance and Social Progress (CMEPSP). Available from: <http://library.bsl.org.au/jspui/bitstream/1/1267/1/Measurement_of_economic_performance_and_social_progress.pdf>.
- STRATEGO, 2015a. Enhanced Heating and Cooling Plans to Quantify the Impact of Increased Energy Efficiency in EU Member States Translating the Heat Roadmap Europe Methodology to Member State Level.
- STRATEGO, 2015b. The fourth version of the fourth Pan-European Thermal Atlas. Peta 4_v1.0. Available from: <<http://www.heatroadmap.eu/Peta4.php>>.
- STUK (Finnish Radiation and Nuclear Safety Authority), 2009. Preliminary Safety Assessment of the Fennovoima Oy Nuclear Power Plant Project. Available from: <https://www.stuk.fi/documents/88234/148256/STUK-Fennovoima_preliminarysafetyassessment_letter.pdf/2b9012c5-0d9a-4253-8efd-c2070fdc2cb7>.
- TEM (Finnish Ministry of Employment and the Economy), 2011. *Nuclear Energy in Finland*.
- TEM, 2013. *National Energy and Climate Strategy (Kansallinen energia- ja ilmastostrategia)*.
- TEM, 2014. *Energy Efficiency Agreements in Finland 2008-2016 (Energiatehokkuussopimukset Suomessa)*.
- Thatcher, A., Vasconcelos, A.C., Ellis, D., 2015. An investigation into the impact of information behaviour on information failure: The Fukushima Daiichi nuclear power disaster. *International Journal of Information Management* 35, 57–63.
- Thollander, P., Palm, J., Rohdi, P., 2010. Categorizing Barriers to Energy Efficiency – an Interdisciplinary Perspective, in: Palm, J. (Ed.), *Energy Efficiency*. Sciyo.
- UNDP (United Nations Development Programme), 2012. *Transforming on-grid renewable energy markets: A review of UNDP-GEF support for feed-in tariffs and related price and market-access instruments*. United Nations Development Programme.
- Van de Graaf, T., Sovacool, B.K., 2014. Thinking big: Politics, progress, and security in the management of Asian and European energy megaprojects. *Energy Policy* 74, 16–27.

Part II, Chapter 5
Driving forces and obstacles to nuclear cogeneration in Europe:
Lessons learnt from Finland

- Visschers, V.H.M., Wallquist, L., 2013. Nuclear power before and after Fukushima: The relations between acceptance, ambivalence and knowledge. *Journal of Environmental Psychology* 36, 77–86.
- Weber, L., 1997. Some reflections on barriers to the efficient use of energy. *Energy Policy* 25, 833–835.
- Weber, B., Alfen, H.W., 2010. *Infrastructure as an Asset Class: Investment Strategies, Project Finance and Public-Private partnerships*. Wiley Finance eds.
- World Nuclear Association, 2017. Nuclear Power in Finland. Available from: < <http://www.world-nuclear.org/information-library/country-profiles/countries-a-f/finland.aspx>>.
- Yin, R., 2014. *Case Study Research: Design and Methods*. Sage Publishing. Fifth ed.

Appendix II.5.A

Stakeholder	Field	Function	Complementary sources
Nuclear Plant Operator (Fortum)	Power Division	Senior Nuclear Safety Officer	Conference papers and corporate reports
Nuclear Plant Operator (Fennovoima)	Nuclear Engineering	Manager <i>Notes: Co-lead the Loviisa 3 NDH feasibility study in 2009 as a Fortum employee</i>	Research paper
Helsinki District Heating network operator (Helen)	Energy Business Development	Head of Unit	Corporate reports
	Energy Development and Wholesale	Vice-President	Corporate reports
Ministry of Employment and the Economy (TEM)	Energy Department	Cogeneration expert	National Energy and Climate Strategy, TEM, 2013
Radiation and Nuclear Safety Authority (STUK)	Design of a nuclear power plant, systems and structures	Expert on nuclear power plant safety	Technical reports
City of Helsinki Environment Center	Environmental Protection Department	Environmental Inspector	Helsinki Climate Roadmap 2050
Environmental Committee of Helsinki	Politic	Deputy of Social Democrat Party	Political reports and newspapers
Technical Research Center (VTT)	Reactors Physics	Principal Scientist	NC2I reports
	District Heating	Principal Scientist	Ph.D Report
	District Heating	Research Scientist	Informal discussions
	Energy Systems	Research Team Leader	Informal discussions
	Energy Systems	Senior Scientist	Informal discussions
	Energy Systems	Senior Scientist	Technical reports
	Process Engineering and Sustainability	Senior Scientist	Technical reports

Table II.5.A.1: Details of the semi-structured interviews. All interviews were conducted in 2015.

Chapter 6

A multicriteria approach to evaluating heating options in the French urban area of Dunkirk

Abstract

This Chapter aims to evaluate and rank heating systems that could be implemented in the future urban area of Dunkirk, France, based on multiple criteria and the viewpoints of different stakeholders. District heating (DH) systems of biomass, sewer heat and heat production with a nuclear plant located 15km away are compared to three individual heating systems of condensing natural gas, electric and air to water heat pumps. The evaluation criteria include 3 quantitative criteria (cost, greenhouse gases emissions, particulate matter inhalation) and 4 qualitative criteria (e.g. whether the district heat is from a nuclear plant or not). The PROMETHEE method is used in order to rank the heating systems. In this Chapter, two different scenarios were developed to indicate how the sharing of information between the stakeholders could affect their preferences about criteria weights and would change the ranking of alternatives. The result of this study shows societal, qualitative criteria negatively affect the stakeholder's perceptions on DH systems (versus individual systems), in particular when using heat from a nuclear plant (versus other low carbon DH sources). Early discussions and systematic information sharing (through e.g. co-directed working groups) could result in a general consensus of using heat from the nearby nuclear plant.

Keywords: District heating systems, Multicriteria decision making, PROMETHEE

Highlights

- 3 quantitative and 4 qualitative criteria were used to characterize 6 heating systems
- National and local authorities, NGOs, nuclear and district heating utilities have ranked criteria
- PROMETHEE II method is used to determine the preferred heating option
- No consensus is reached among stakeholders in the business as usual case
- If the viewpoints of all stakeholders are integrated from the early stages of decision-making processes, using nuclear plant sourced heat could be favored

Comments

- Similarly to Chapter 3, this Chapter focuses on the Dunkirk urban area. It uses modelling outputs from Chapter 3 as an input in multicriteria algorithms. Chapters 3 and 6 together constitute an in-depth analysis of the Dunkirk case, answering both the quantitative question of the techno-economic potential and the qualitative challenge of the socio-political conditions to fulfill for reaching this potential.
- The underlying assumption of Chapter 6 is that both rational (quantitative) and non-rational (qualitative) criteria do influence decision making processes. The advantage of this approach is twofold: (i) starting a collective thinking process with the stakeholders that would be involved in a French DH + NCHP project; (ii) improving the understanding of societal factors. The drawback is that it can be perceived as an attempt to impose the techno-economic rationality of a system, while this 'rationality' can vary depending on stakeholders and individuals. In our view, this Chapter does include important limitations, as discussed in Section 6. The discussion Section (6) holds the true added value of this Chapter.
- Collective and open approaches that stress questions instead of solutions should be favored in the preliminary stages of decision-making processes, as advocated in Chapter 8.

1. Introduction

1.1. Background

District heating (DH) systems providing energy for space and hot water heating to buildings have several advantages compared with building or space specific systems. These advantages include increased energy efficiency, advanced equipment maintained professionally, lower life cycle costs and improved control over environmental impacts (Frederiksen and Werner, 2013; Werner, 2017). Although DH systems are commonplace in some countries, France is a developing country in this respect as building-level technologies make up 93% of all heating systems (AMORCE (French DH association), 2015). Given the high density and size of French cities, there is a large economic potential to deploy new or to extend existing DH networks (see Chapter 7), and public authorities do currently support DH systems. The 'Fonds Chaleur' offers a financial contribution of about €5/MWh_{th} to DH projects aiming to use more than 50% renewable or excess heat sources, provided that the linear heat density exceeds 1.5 MWh_{th}/m.a (AMORCE, 2017). However, AMORCE (2017) emphasises that the number of subsidised DH projects will have to more than double to achieve the French policy objectives. If the development trend of 2009-2017 is prolonged, renewable and excess DH deliveries should total 23 TWh_{th}/a in 2030, yet the national objective is 39 TWh_{th}/a (*Assemblée nationale* (French national assembly), 2015). One of the issues is that only 17.6% of French residential buildings are equipped with central heating systems (INSEE (French National Institution for Statistics and Economics Studies), 2014) and most new urban dwellings still install individual electric or gas boilers (AMORCE, 2015).

DH systems can have access to a wider range of energy sources compared with individual systems. Renewable or recoverable energy sources such as biomass, sewer heat and industrial excess heat can be more economic and more efficiently exploited in DH systems (Connolly *et al.*, 2014; Delmastro *et al.*, 2015; Persson and Münster, 2016). Similarly, DH systems open opportunities for using heat from nuclear plants (Hirsch *et al.*, 2016; Jasserand and Devezeaux, 2016; Safa, 2012). The suitability of a heating system, which depends on the type of energy source, characteristics of the system, policy objectives and building requirements, must be assessed carefully. Different alternatives are available for heating systems which should be assessed on the basis of economic, technical, environmental and social factors, either quantitative or qualitative. The importance of these factors may differ for various stakeholder groups involved in the decision-making process, as they may have different and sometimes conflicting interests and motives. The need to incorporate different factors and the viewpoints of various players in the analysis has promoted the use of multi-criteria approaches in energy planning. These approaches can help to better understand the decision-making process and may facilitate the negotiation and communication among different stakeholders (Kontu *et al.*, 2015).

This study focuses on the utilisation of different heat sources in the DH system in Dunkirk (France), extrapolated to 2030 so as to achieve the full DH potential identified in Chapter 3. Three DH options (biomass boilers, sewer heat, nuclear-plant-sourced heat) and three individual heating alternatives (natural gas boilers, electric heaters, air-to-water heat pumps) are ranked based on seven important criteria (e.g. costs, greenhouse gas (GHG) emissions, energy self-sufficiency) using the PROMETHEE method. This paper considers two different scenarios in order to show how the ranking of alternatives for stakeholder groups would change when all the information is shared and concerns of stakeholders are discussed from early stages. It is assumed the sharing of information and in-depth discussions between the stakeholders would change their criteria preferences, which would eventually affect the ranking of alternatives. The objective of this study is to assess the effect of information sharing between legitimate stakeholders in the decision-making process when multiple decision-related criteria exist, using the considered case as an example. In this paper, it is assumed that the French nuclear operator is willing to demonstrate the potential of nuclear plants to supply DH networks. This is a theoretical pre-requisite for studying the decision-making processes surrounding

an eventual feasibility study of DH production with a French nuclear plant. In practice, however, this condition has not yet been verified. The players that could motivate nuclear operators and other stakeholders, as well as plausible business models, are analysed in Chapters 5 and 8.

The literature review in Section 1.2 led us to select the PROMETHEE method. Section 2 describes the assumptions behind the multi-criteria approach used. Based on the analysis of the issues related to the Dunkirk metropolitan area (Section 3), we then specified five stakeholder groups (Section 3.1) and seven important criteria (Section 3.2). Section 4 examines two scenarios to evaluate the impact of information sharing and open discussions among stakeholders on the final decision about the most suitable heating system. Sections 5 and 6 present the results and the discussion respectively. Section 7 ends with the conclusion.

1.2. Literature review

It is important to involve or open discussions with the public with respect to all decisions on projects with public benefits or of public concern (Palm and Thollander, 2010). The purpose of public involvement is to: inform the general public, to integrate public values into decisions, to consider any consequences that may have been overlooked, and to provide 'due process' (Hobbs and Horn, 1997). Failure to involve the public in the decision-making process from the early stages can incite strong opposition during the final stages of the decision making process from the community representative groups and the media (Jami and Walsh, 2014; Langer *et al.*, 2017).

The need to incorporate the viewpoints of different players in the analysis promoted the use of multi-criteria decision making (MCDM) methods (Georgopoulou *et al.*, 1998; Ghafghazi *et al.*, 2010; Kontu *et al.*, 2015). In an MCDM approach, the first step is to clearly define the problem and to identify realistic alternatives. It is important to define the players involved in the decision-making process, select the evaluation criteria, and assess each alternative according to the set of criteria. Next, an MCDM method must be selected to aggregate the performance of each alternative. Most MCDM methods require weighting the selection criteria. The application of the MCDM method provides a ranking of alternatives. A wide range of MCDM methods have been applied in the energy planning area. Selection of an appropriate MCDM method is an MCDM problem in itself (Al-Shemmeri *et al.*, 1997). We need to use a weighting method that is reliable and easy to apply.

A review of more than 196 published papers on energy planning by Kontu *et al.* (2015) showed that the analytic hierarchy process (AHP) was the most commonly used MCDM method (24.87% of total) after 1995, especially in the area of renewable energy planning. The PROMETHEE method and fuzzy PROMETHEE method were applied in 5.10% of all the reviewed papers, while the ELECTRE method represents 4.59%. AHP has been used successfully for alternative energy source selection (Jaber *et al.*, 2008; Xiaohua and Zhenmin, 2002) and energy resource allocation (Hobbs and Horn, 1997; Ramanathan and Ganesh, 1995). The ELECTRE method has been applied for renewable energy planning (Georgopoulou *et al.*, 1998), energy planning (Beccali *et al.*, 1998), choosing the most suitable heating system for buildings, and community energy modernisation and development planning (Mróz, 2008). Georgopoulou *et al.* (1998) describes a group decision support system in which PROMETHEE was used for ranking the renewable energy sources. Haralambopoulos and Polatidis (2003) used the PROMETHEE II method to rank operational scenarios for geothermal resources on the island of Chios, Greece. Focus has been placed on finding the points of agreement and conflict among different stakeholders. Ghafghazi *et al.* (2010) used the PROMETHEE II method to analyse the decision-making process surrounding the choice of the heat source for the DH system in Vancouver (British Columbia) and concluded that the biomass option was the best alternative for all the stakeholders. It worth noticing that it exist open access software that allow to test and personalise diverse MCDM methods (e.g. DIVIZ; Decision Deck Consortium, 2018).

Based on the results of the literature review, we decided to choose the PROMETHEE method. Forty-eight of 217 papers reviewed by Behzadian *et al.* (2010) compared the performance of PROMETHEE methods with other MCDA methods, and most of them concluded that PROMETHEE

reached the best compromise between simplicity and performance. The selection of PROMETHEE methods is often justified by their mathematical properties and their user-friendliness (Brans and Mareschal, 2005). Brans *et al.* (1986) show that PROMETHEE is more stable than ELECTRE. In comparison with ELECTRE III, Al-Shemmeri *et al.* (1997) indicate that the PROMETHEE methods are easily understood by the decision-maker and simple to manage by the analyst. Gilliams *et al.* (2005) state that PROMETHEE II is slightly preferable to both ELECTRE III and AHP, based on user-friendliness, simplicity of the model's strategy, variation in the solution, and implementation. However, there is no MCDM method superior to others in all contexts. A number of papers developed hybrid methods, combining PROMETHEE with AHP (Babic and Plazibat, 1998; Wang and Yang, 2007) or ELECTRE III for instance (Goletsis *et al.*, 2003). According to Behzadian *et al.* (2010), hybrid methods may be more realistic than the stand-alone PROMETHEE. While MCDM methods can be useful, it must be reminded that the researcher behind the algorithms remain responsible for choosing assumptions and building scenario.

2. Methods

2.1. PROMETHEE

In this paper, the PROMETHEE II method is used to rank the plausible heating systems for the considered case based on stakeholder preferences. The PROMETHEE method introduced by Brans and Vincke (1985) belongs to the outranking methods.

In order to better explain the PROMETHEE method, we assumed a multi-criteria problem such as:

$$\{f_1(a), f_2(a), \dots, f_h(a), \dots, f_k(a) | a \in K\} \quad (1)$$

Where K is a (finite) set of possible alternatives, and $f_h(a)$, $h = 1; 2; \dots; k$, is the value of alternative a for criterion h . Ideally, a decision-maker is interested in finding an optimal alternative \hat{a} which dominates all other alternatives (i.e. has the highest value for all criteria compared with other alternatives), i.e. finding \hat{a} so that $f_h(\hat{a}) \geq f_h(a)$; $\forall a \in K, \forall h$. In general, such an optimal solution does not exist, and the dominance relationship between the alternatives defined as: a dominates b iff $f_h(a) \geq f_h(b)$; $\forall h \in \{1, 2, \dots, k\}$ is poor between all the two-by-two alternatives. Outranking methods such as PROMETHEE try to enrich the dominance relationship between the alternatives.

Considering two alternatives a and b , the preference structure can be defined as:

$$\begin{cases} aPb & \text{iff } f_h(a) > f_h(b) \\ aIb & \text{iff } f_h(a) = f_h(b) \end{cases} \quad (2)$$

aPb means that alternative a is preferred over alternative b , if alternative a is performing better than alternative b with regard to criterion h , and aIb means that alternatives a and b are indifferent with regard to criterion h . The PROMETHEE method gives a numerical value between 0 and 1 to the preference relationship in Eq. (2) by introducing the preference function $P_h(a, b)$ such that:

$$P_h(a, b) = \begin{cases} 0 & \text{if } f_h(a) \leq f_h(b) \\ p[f_h(a), f_h(b)] & \text{if } f_h(a) > f_h(b) \end{cases} \quad (3)$$

Where $0 < p[f_h(a), f_h(b)] \leq 1$. For practical applications, it is then reasonable to assume that:

$$p[f_h(a), f_h(b)] = p[f_h(a) - f_h(b)] \quad (4)$$

Let $D_h(a, b)$ be the difference between alternative a and alternative b for criterion h as shown in Eq. (5):

$$D_h(a, b) = f_h(a) - f_h(b) \quad (5)$$

(Brans and Vincke, 1985) recognised six types of preference functions that are most common in real-case situations. This paper applies the usual preference function, i.e.:

$$p[f_h(a), f_h(b)] = \begin{cases} 0 & \text{if } D_h(a, b) \leq 0 \\ 1 & \text{if } D_h(a, b) > 0 \end{cases} \quad (6)$$

As an example, suppose that the cost of energy for option a is €100,000 less than that for option b , then preference of alternative a over alternative b is 1 and preference of alternative b over a is 0.

Therefore, the PROMETHEE method uses the weighted preference index $\pi(a, b)$ to give an integrated overall preference of alternative a over b , shown in Eq. (7):

$$\pi(a, b) = \frac{\sum_{h=1}^k w_h \cdot P_h(a, b)}{\sum_{h=1}^k w_h} \quad (7)$$

Where w_h is the relative importance of criterion h , which is defined by the decision-makers. To build the outranking relation among the alternatives, PROMETHEE introduces three outranking measures for each alternative as follows:

- Outgoing flow $\phi^+(a) = \sum_{x \in K} \pi(a, x)$. The larger $\phi^+(a)$, the more alternative a outranks the other alternatives in the set K
- Incoming flow $\phi^-(a) = \sum_{x \in K} \pi(x, a)$. The smaller $\phi^-(a)$, the less alternative a has been outranked by other alternatives in the set K
- Net flow $\phi(a) = \phi^+(a) - \phi^-(a)$.

PROMETHEE II considers the net flow for each alternative $a \in K$ to find the total preorder (complete ranking) such that:

- a outranks b (aPb) iff $\phi(a) > \phi(b)$,
- a is indifferent to b (aIb) iff $\phi(a) = \phi(b)$.

In summary, to rank alternatives using the PROMETHEE II method, the analyst needs to identify the alternatives/criteria matrix, which is called the decision matrix, the relative importance of criteria over each other, and the preference functions for each criterion.

2.2. Expected value method to determine criteria weights

The selected criteria do not usually have equal importance and different players may perceive their importance differently. Different methods may be used to extract the decision makers' preferences. The direct method of assigning weights to criteria is the simplest one. Georgopoulou *et al.* (1998) used an indirect method based on a hierarchical ranking of criteria. In this paper, the expected value method (Nijkamp *et al.*, 1990) is used to extract the criteria weights. This method estimates the weights based on the decision makers' preferred ranking of the criteria. If there are k criteria in the analysis which are ranked in ascending order of importance based on the decision maker's preference, then the expected values in Eq. (8) are assigned as criteria weights.

$$\begin{aligned} E(w_1) &= \frac{1}{k^2} \\ E(w_2) &= \frac{1}{k^2} + \frac{1}{k(k-1)} \\ &\vdots \\ E(w_{k-1}) &= \frac{1}{k^2} + \frac{1}{k(k-1)} + \dots + \frac{1}{k \cdot 2} \end{aligned} \quad (8)$$

$$E(w_k) = \frac{1}{k^2} + \frac{1}{k(k-1)} + \dots + \frac{1}{k.2} + \frac{1}{k.1}$$

Where $E(w_i)$ is the expected value of the i th criterion and is used as the weight for that criterion, and k is the number of criteria.

3. Case study

A DH system to provide heating for buildings with approximately 5,000,000 m² of floor area in the Dunkirk wider community, France, was evaluated in Chapter 3. The supplied hot water would be used for space heating and providing hot water to buildings within the community (see Figure II.6.1), which consist of both collective buildings (60%) and single family houses (40%). The annual heat demand of the connected buildings to the modelled DH system was estimated to be 673 GWh_{th}/a. Approximately 217km of DH pipelines would be needed for distributing heat to all buildings, and the linear heat density would be 3.1 MWh_{th}/m.a (see Chapter 3). This is higher than the threshold for public support of 1.5 MWh_{th}/m.a (*Ministère de l'environnement, de l'énergie et de la mer* (French Ministry of Environment, Energy and Seas), 2014) and the threshold for economic attractiveness of 2 MWh_{th}/m.a identified by (Persson and Werner, 2011).

By comparison, the DH network currently in place (*the 'Energie Grand Littoral'* network, see Figure II.6.1) distributes 125 GWh_{th}/a and is 40 km in length. About 60% of the annual heat loads of the existing network is provided with excess heat from the nearby metal industry (Dalkia (Groupe EDF), 2015). Such a good practice must be preserved and encouraged. This is why this paper considers the modelled DH network as an extension of the existing network, which would not require replacing the heat sources already in place. To further exploit the DH potential, local public authorities fixed the objective of doubling the DH capacity towards 2021 compared with 2015. There are currently 5 projects of creating new or extending the existing network (Communauté Urbaine de Dunkerque, 2015; Dalkia, 2015).

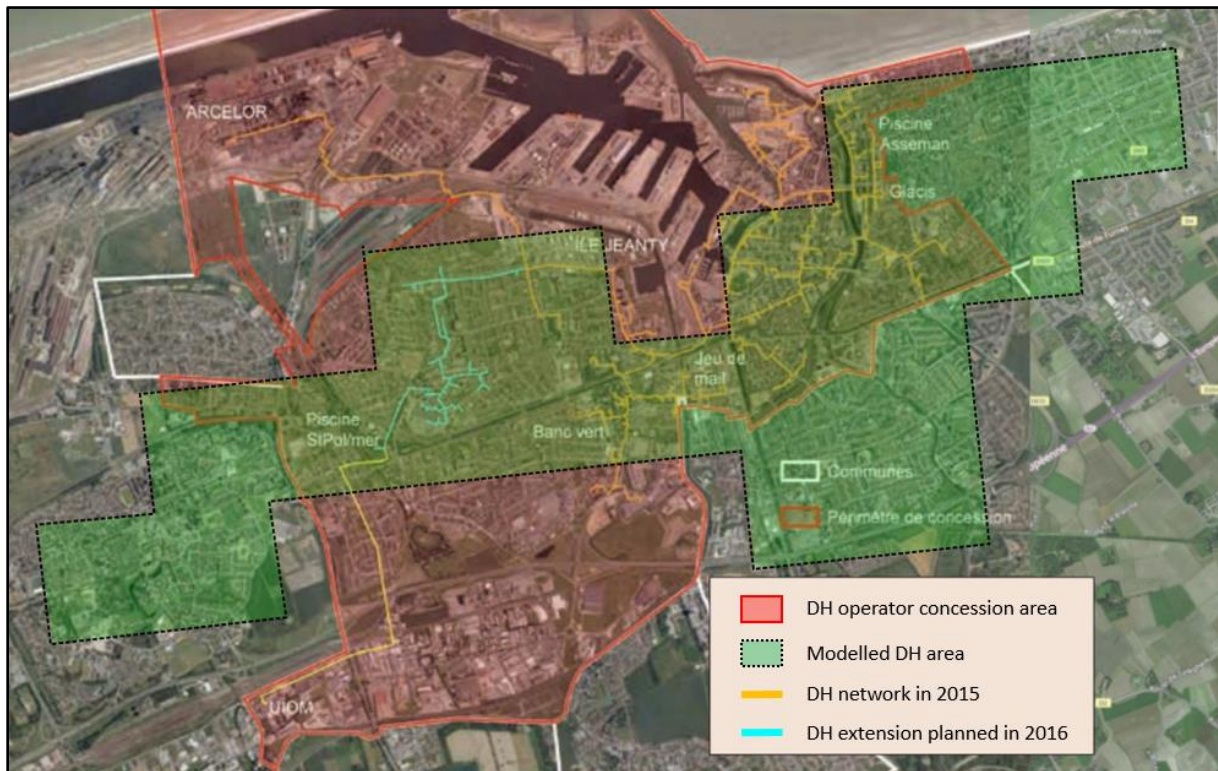

Figure II.6.1: Existing and modelled DH systems in the Dunkirk extended community. Data source: Personal photomontage, using maps from (Dalkia, 2015; Heat Roadmap Europe, 2015).

Notes:

The modelled DH system is designed to supply approximately 85% of the heat loads in the corresponding area (i.e. 673 GWh_{th}/a). The remaining 15% is supplied with existing DH sources (60% excess heat from the Arcelor Mittal steel production factory, 28% from natural-gas-based plants, and 12% from fuel-based plants).

In this paper, DH systems have been modelled considering the installation of a base load system to provide about 80% of the annual heat demand and to use a low capital cost system with a secure supply such as a natural gas boiler alongside the base load system for peak and back-up heat supply. Having a separate base-load system would make it possible to exploit alternative energy sources to meet the majority of the community's energy demand throughout the year. Using alternative renewable or recoverable energies for the base-load system would help the municipality meet its climate policy objectives. Specifically, it conforms to the actions "Encourage the use of renewable and recoverable energies" and "Reduction of GHG emissions" expressed by the Dunkirk conurbation community (*Communauté Urbaine de Dunkerque*, 2015).

Renewable or recoverable alternatives considered in this paper for base-load DH supply consist of biomass (wood chips), sewer heat and heat produced by the Gravelines nuclear plant 15 km away (as the crow flies). This paper only considers the cost of 'cogeneration readiness' for pressurised water reactors (PWR). Similar to Chapters 2 and 3, it accounts for the capital costs specific to heat production but excludes the costs attributable to electricity production. The advantage of this approach is that our results are, to some extent, valid for both for large and small PWRs. This because the cost of cogeneration readiness is not very dependent on the reactor size (see ETI (Energy Technology Institute), 2016; IAEA (International Atomic Energy Agency), 2003; Chapter 5; Safa, 2012). In addition, the cost of cogeneration readiness only represents a minor fraction of the system's cost, the major part being the cost of the heat transportation system required from the plant to the city DH network (Jasserand and Lavergne, 2016). However, the drawback of this approach is that it does not allow us to reach any conclusions as to whether or not this system offers more benefits than other systems generating the same amount of electricity and heat. It worth noticing that heat extraction of less than

3-7% of the nominal capacity should not imply any modification of the reactor primary circuit (Jaskólski *et al.*, 2017), which is here the case. Indeed, the thermal output required to supply the modelled DH area of Figure II.6.1 is about 115 MW_{th}, i.e. less than 5% of the nominal capacity of one of the six Gravelines reactors (2700 MW_{th} each). The existing Gravelines nuclear plant has however started operation in 1980 and thus will likely be decommissioned too early for the Dunkirk DH network to reach a sufficient size. If a new unit is planned on this site, however, DH applications should be considered from start.

Waste incineration and excess heat from industrial processes also have economic and environmental advantages (Persson and Münster, 2016), provided that these sources are practically available to the DH centre. Alternative energy production systems such as cogeneration systems based on fossil or biomass fuels would also enable DH systems to produce heat as well as electricity more efficiently (Delmastro *et al.*, 2015; Karschin and Geldermann, 2015). Nonetheless, the above mentioned options were beyond the objectives set for the considered DH network. Solar DH systems have also been disregarded due to the high temperature profile of the Dunkirk DH system (100/80°C supply/return temperatures; see Dalkia, 2015). Seasonal thermal energy storage, which is required to reach a solar fraction of 80% (Bauer *et al.*, 2010; Sibbitt *et al.*, 2012) would record high annual losses, up to 60% (Hesaraki *et al.*, 2015; Rad and Fung, 2016). In urban areas with high energy performance of buildings and where buildings are equipped with low-temperature radiators, solar collectors combined with seasonal thermal storage could however show interesting performance levels (Hesaraki *et al.*, 2015; Rad and Fung, 2016).

Because most new urban areas are currently installing individual condensing natural gas boilers or electric heaters (AMORCE, 2015), it was necessary to include these individual systems in the analysis. The paper also evaluates air-to-water heat pumps (HP), which represent a promising alternative to decarbonised heating systems, especially in low-density areas (Asaee *et al.*, 2017, 2017; Bianco *et al.*, 2017). We considered that HP would act as a base-load system providing 80% of annual loads while electric heating would supply the winter peak loads, thus reducing the use of HP when the outside air is at its coldest. The implementation of HP as a general solution on the scale of a city nonetheless raises a number of challenges (e.g. noise pollution; see DEA (Danish Energy Agency), 2013) which are not considered in this study.

3.1. Stakeholders

It is usually difficult, if not impossible, to reach at a single, globally agreed-upon decision during a decision-making process in which multiple decision-makers with diverse backgrounds and viewpoints exist. The case study led in Chapter 5 has highlighted that this is particularly true when studying the feasibility of base-load DH production with nuclear plants. In addition to being a controversial issue, this DH source challenges existing regime boundaries, practices and business models. When planning for DH production with nuclear plants, it is crucial to establish regular working groups or create room for discussion from the early stages of the project in order to discuss the objectives, values and/or concerns of all stakeholders (see e.g. Chapter 5).

Based on the theoretical case, this study has identified five groups that affect the decision with respect to the base-load energy source for the DH system including: (1) developer, (2) national public authorities, (3) local public authorities, (4) community groups, and (5) nuclear plant operator. The active involvement of the nuclear operator is a pre-requisite if the nuclear option is ever to be considered. The developer is responsible for the design and construction of the heating system. Technical information about the considered energy sources, generated by the developer (in close collaboration with the nuclear operator if considering nuclear heat production), would be reviewed by the local public authorities for obtaining any required permissions. National authorities (and the European Commission (EC) in the case of France) must also support or at least agree with the system

benefits. Furthermore, there has to be no objection from the community groups to issue permission on a selected energy source by the city.

Stakeholder preferences were extracted using the questionnaire shown in Appendix II.6.A, which was used to rank criteria. Appendix II.6.B shows the comments that respondents sometimes made to justify their choice. There were a total of 11 respondents: 3 national public authorities, 2 local governments, 2 developers, 3 community representative groups and 1 nuclear operator. For the sake of confidentiality, however, the stakeholders' names are not shown.

3.2. Alternative/criteria matrix

Various criteria can be considered when comparing energy systems against each other. The criteria depend to a large degree on the situation and nature of the case, provided that the performance of the energy systems varies with regard to the considered criterion. Usually these criteria are classified into economic, environmental, technological, and social sub-groups. They may be stated based on quantitative values or a given qualitative measure. Normally, those with well-established quantitative measures such as heating cost or system emissions are stated based on quantitative units. Stakeholders' judgmental values such as contribution to regional development or contribution to energy self-sufficiency can be shown on a binary measure; 1 being the worst and 0 being the best performance of an alternative (Ghafghazi *et al.*, 2010).

In this research, three DH system alternatives of biomass (wood chips) combustion, sewer heat recovery and heat production with a nuclear plant have been evaluated and compared with three individual heating systems using condensing gas boilers, electric heaters and air-to-water HP. The following seven criteria were considered to evaluate these different heating systems:

- Costs (economic factor, quantitative value). Costs were considered at their present value (2018 base year) for heating systems with a 3.5% discount rate (following EC recommendations; EC, 2014). The cost includes major equipment, electrical and mechanical installations, soft costs (engineering studies), maintenance costs, and operating costs (fuel and/or electricity and staff wages) over a 40-year service life for the system. For DH systems, this also includes sub-stations in buildings. The length of DH pipelines, and ultimately the cost of the distribution side, was determined according to the method described in Chapter 2. For the biomass energy source, the wood chip price was considered to be €30/MWh_{th} (following the 2030 projection in AMORCE, 2015). For the nuclear heat option, the extra costs of the system include the equipment needed to extract heat from low-pressure turbine, the electricity losses induced by heat extraction on the Rankine cycle, and the heat transportation system designed to transport hot water from the plant to the city DH system (see Chapter 2 for details). All the parameters used to assess the heating costs can be found in Chapters 2 and 3, so as to ensure that the results are fully reproducible. As some technologies have technical lifetimes shorter than 40 years (see Chapter 3), scheduled re-investments within the lifetime were included in the analysis. As a simplification, the energy prices are those of 2015. Price assumptions can be found in Chapter 3, which assesses the cost of fifteen nuclear-plant-based DH systems under three different energy price configurations. No carbon taxation plan was here considered, but this is studied in Chapter 2 and 3.
- Total GHG emissions of the system (global environmental impact, quantitative factor). This is the CO₂ equivalent emission of the heating systems. For DH systems, this includes peaking and back-up natural gas system. Biomass is considered to emit 28 kg eCO₂/MWh_{th} over its entire lifecycle, as recommended in (EC, 2016) for wood chips (this value is vividly discussed; see Sections 4.1.1.5 or 5.1.3 of Chapter 3). For the electricity used in systems, a marginal approach was used, assuming a GHG content of 260 and 180 kg eCO₂/MWh_{th} for electricity consumed during base-load periods and for electricity consumed during peak-load and base-load periods, respectively. All assumptions used to evaluate GHG emissions are shown in Appendix II.6.C.
- Particulate matter (PM) inhalation (local environmental impact, quantitative factor). This includes particulate matter less than or equal to 2.5 μm in diameter that are inhaled by inhabitants, either

from direct or indirect (nitrogen oxides and sulphur dioxide). Accounting for the inhaled fraction of PM_{2.5} (instead of emitted PM_{2.5}) allowed us to set ground-level emissions from individual heating systems on an equal footing with stack-level emissions from DH production facilities (Brandt *et al.*, 2001; Zvingilaite, 2013). Biomass boilers are equipped with selective non-catalytic reduction technologies, which can eliminate up to 65% of NO_x emissions and are more affordable than selective catalytic reduction technologies (DEA, 2013). The assumptions used to assess the amount of PM_{2.5} inhaled are given in Chapter 3, Section 4.1.4). Note that Section 4.1.4 also offers two methods in order to evaluate the impact of particulate matter inhalation on human health (disability adjusted years of life lost and social cost).

- DH system (qualitative factor). Concerns about contractual ‘lock-in’ or lack of transparency of DH companies can motivate the rejection of DH systems (CLCV (National consumer protection association), 2017; DECC (Department of Energy & Climate Change), 2013; Upham and Jones, 2012). Whether or not the heat is distributed through DH pipelines was considered as a binary criterion in this paper (0 = individual systems; 1 = DH systems).
- Energy self-sufficiency (qualitative factor). The motivation to increase the city’s self-sufficiency in energy or independence from volatile energy prices can also influence the choice of potential DH adopters (Balcombe *et al.*, 2014), provided that the DH sources evaluated in this paper are local sources (or regional for the biomass). Whether or not the heat is distributed through DH pipelines was considered as a binary criterion in this paper (0 = DH systems; 1 = individual systems).
- Renewable or recoverable source (RR source). Most stakeholders considered this to be a major criterion, either to improve public acceptance or as a pre-requisite to apply for public subsidies (*Ministère de l’environnement, de l’énergie et de la mer*, 2014b). Whether or not the energy source is renewable or recoverable or not was considered as a binary criterion in this paper (0 = renewable or recoverable source; 1 = non-renewable or recoverable source). The committed stance of this Chapter is that the heat from nuclear plants is a recoverable DH source i.e. that would be wasted otherwise.
- Nuclear source. Despite the fact that a DH supply with a nuclear plant is feasible from a technical and safety viewpoint (IAEA, 2003; STUK (Finnish Radiation and Nuclear Safety Authority), 2009), the use of ‘nuclear heat’ can generate psychological or behavioural obstacles which should not be neglected (Chapter 5). Whether or not the heat comes from a nuclear plant was considered as a binary criterion in this paper (0 = non-nuclear; 1 = nuclear).

Table II.6.1 shows the alternatives/criteria matrix of the decision-making problem. Quantitative parameters were assessed towards 2030, following the method described in Chapters 2 and 3 (see bullet points here below).

Criterion	Unit	DH system			Individual system		
		Nuclear	Biomass	Sewer heat	Nat gas	Electric	Air to water HP
Cost	€/MWh _{th}	62	79	99	47	118	94
GHG emissions	t eCO ₂ /GWh _{th}	135	98	172	416	260	192
PM _{2.5} inhalation	g/a	5	1438	5	45	0	0
DH system	Binary value (0, 1)	1	1	1	0	0	0
Self-sufficiency	Binary value (0, 1)	0	0	0	1	1	1
RR source	Binary value (0, 1)	0	0	0	1	1	0
Nuclear source	Binary value (0, 1)	1	0	0	0	0	0

Table II.6.1: Alternatives/criteria matrix.

Notes:

(*) For qualitative factors: 0: positively affect the ranking of the system; 1: negatively affect the ranking of the system.

(**) See Appendix I.3.A for an alternative, perhaps more realistic, method for accounting the GHG emissions of the DH + NCHP system.

4. Scenarios

This paper examines two main scenarios in order to assess the impact of communication and transparency of information among the stakeholders on the final decision about the most suitable heating system. Criteria weights were extracted based on stakeholder preferences (see 3.1) and the ranking of criteria using the expected value method (see 2.2). Stakeholder preferences were revealed through the questionnaire given in Appendix II.6.A. Some criteria generated different and sometimes even opposing opinions, while others were considered as non-significant for the actual decision-making process (see Appendix II.6.B). Scenario I ‘business as usual’ (Section 4.1) disregards the criteria that were subject to controversial interpretations (namely, RR source and energy self-sufficiency). Scenario II ‘theoretical variant’ (Section 4.2) considers that the information generated during the co-lead feasibility study and the communication between stakeholders would affect stakeholder preferences. As discussed and justified in Section 4.2, this scenario includes the criteria of RR source and energy self-sufficiency but excludes the criteria of nuclear source and DH source. Section 5 then discusses the impact of this change on the stakeholder preferences and their final decision, and Section 6 discusses the actions defined to be able to deploy Scenario II configuration in the real world.

4.1. Scenario I: Business as usual

A technical and economic analysis of heating systems in the Dunkirk extended community was performed, focusing on the economics, health and climate impacts of different heating systems that could be implemented around 2030. The results in Table II.6.1 show that there is no alternative superior to others regarding all criteria. Table II.6.1, however, reveals that DH systems (in particular those based on heat from the nearby nuclear plant) offer a good compromise between cost and environmental impacts. Considering that the timeframe of the economic analysis was 2020-2070, these results are nonetheless conditional to the construction of a new nuclear unit on the Gravelines site. What we can say is that if a new nuclear plant is planned in France, building it on the Gravelines site and operating it in a cogeneration mode to supply the Dunkirk DH network would be beneficial to the community compared with other heating alternatives. However, there are at least three major issues to overcome before such a heating system can be seriously considered by all stakeholders.

Firstly, a large DH network covering most of domestic and commercial areas of the Dunkirk extended community must be built. The larger the network, the more competitive the heating systems would be; they could consist of a large heat supplier located at a distance from the city, such as heat production with a nuclear plant. Reaching the DH capacity projected in this paper would require building approximately 20 km of network each year from 2020 to 2030. This is important but not unrealistic considering that other cities have already experienced such rapid DH expansion (e.g. Stockholm or Helsinki; (Magnusson, 2010). However, the rapid implementation of large DH systems on a city scale can face opposition from households and community groups, especially in ‘DH-learning countries’ such as France. The factors driving opposition to DH expansion are complex varying from a local context to another. Factors that are often emphasised are the lack of awareness of DH benefits (Bush *et al.*, 2017, 2016), the fear of contractual ‘lock-in’ (DECC, 2013; Upham and Jones, 2012; Zaunbrecher *et al.*, 2016), or the lack of trust in DH companies (CLCV, 2017). The desire for energy self-sufficiency could act as levers for heating systems capable of reducing the use of imported fossil fuels (Balcombe *et al.*, 2014; Praetorius *et al.*, 2010). One of the interviewed public authority however suggested that households are rarely aware of DH advantages in that area (unaware of the benefits that energy self-sufficiency could bring, such as protection against any unexpected variations in energy prices). As a result, Scenario I omits the energy self-sufficiency criterion.

Secondly, supplying DH via a nuclear plant would be a radical innovation from a socio-political perspective. Industrial experiences of nuclear DH do exist in Europe (IAEA, 2003; Chapter 5) and there has recently been an increasing interest in this field, either from public authorities, industries or

researchers (see Chapter 2). However, Chapter 5 stresses that the lack of political recognition of this alternative inhibits its deployment. Directive 2012/27/EC on energy efficiency (European Parliament, 2012) obligates the facilities emitting a significant amount of excess heat to the surrounding environment to consider the DH supply, but explicitly allow Member states to exempt nuclear plants from the duty. The European Parliament (2012) justifies this exception by the often long distance that separates nuclear sites from dense urban areas (European Parliament, 2012). In France, precise guidelines are provided to those facilities which must consider whether or not the DH supply have cost and GHG savings potential (*Ministère de l'écologie, du développement durable et de l'énergie* (French Ministry of Ecology, Sustainable development and Energy), 2014), but nuclear plants are not targeted. When gathering data within the framework of this paper, some community groups expressed concerns with regards to the matching of nuclear heat production with the national policy objective of decreasing the share of nuclear energy in the electricity mix (*Assemblée nationale*, 2015). Given the legal uncertainty surrounding the renewable or recoverable status of heat production with nuclear plants, it was complex to state whether or not this alternative is considered equivalent to other renewable or recoverable sources in the view of stakeholders. As a consequence, Scenario I omits the RR source criterion.

Last but not least, the use of 'nuclear heat' can generate psychological or behavioural obstacles which should not be neglected. Based on the analysis of interviews performed with 27 Finnish stakeholders, Chapter 5 revealed that general attitudes regarding nuclear energy may strongly inhibit the political will of getting involved in such controversial projects. This confirms results from (Dalmasso, 2008), studying the reasons behind the abandon of the French Thermos' nuclear DH project (1975-1981). According to one the French DH expert interviewed in the frame of this study, psychological obstacles of that kind also arise when discussing the recovery of excess heat from crematorium.

Based on the review of comments received from the five stakeholder groups involved directly or indirectly in the decision-making process (see 3.1), the below-ranking of decision-making criteria was inferred for each stakeholder:

1. Developer:

$$Cost > GHG\ emissions > PM_{2.5}\ inhalation = DH\ system > Nuclear\ source \quad (9)$$

2. National public authorities:

$$Cost = GHG\ emissions = PM_{2.5}\ inhalation > DH\ system > Nuclear\ source \quad (10)$$

3. Local public authorities

$$Cost = PM_{2.5}\ inhalation > GHG\ emissions > DH\ system > Nuclear\ source \quad (11)$$

4. Community groups:

$$Cost = Nuclear\ source > DH\ system > GHG\ emissions = PM_{2.5}\ inhalation \quad (12)$$

5. Nuclear operator:

$$Cost > DH\ system > GHG\ emissions = PM_{2.5}\ inhalation > Nuclear\ source \quad (13)$$

Table II.6.2 summarises the criteria weights considered for each stakeholder in Scenario I using equation (8). There are 5 criteria in this scenario and the average of weights was considered in a situation when criteria have equal importance. For example, the criteria weights for the two criteria 'PM_{2.5} inhalation' and 'DH source' considered for the DH operator based on the ranking expressed in Eq. (9) would be the average of the criteria weights when $PM_{2.5}\ inhalation > DH\ source$ and $PM_{2.5}\ inhalation < DH\ source$.

Stakeholder	Criterion (*)				
	Cost	GHG	PM _{2.5}	DH system	Nuclear source
Developer	0.457	0.257	0.123	0.123	0.04
National public authority	0.29	0.29	0.29	0.09	0.04
Local public authority	0.357	0.157	0.357	0.09	0.04
Community representative group	0.357	0.065	0.065	0.157	0.357
Nuclear operator	0.457	0.123	0.123	0.257	0.04

Table II.6.2: Criteria weights considered in Scenario I

Notes:

(*) The criteria weights are obtained from Eq. (8) with k equals to 5 and ranking stated in Eq. (9-13).

4.2. Scenario II: Theoretical variant in which (i) No stakeholder is concerned about the nuclear or DH status of the heating systems; and (ii) All stakeholders agree on the benefits of energy self-sufficiency and on the recoverable status of the nuclear heat

While scenario I reflects the business as usual situation and current stakeholder' opinions, scenario II only constitutes a theoretical projection in which the sharing of information have successfully reduced the divergence of qualitative ('non rational') opinions to nil. The reader should not consider Scenario II as an attempt to define a likely future, but rather as a mean of discussing the key controversial points.

In this scenario, the major concerns of stakeholder groups with regards to DH systems and DH production with a nuclear plant have been addressed. Non-economic reasons play an essential role in explaining community acceptance of DH systems, especially in countries such as France or the UK wherein the level of public awareness on the DH potential is relatively low (Bush *et al.*, 2017, 2016). Because DH is a technology that is not implemented for one household alone, decision-making and integration of citizens in the decision-making process is a critical issue (Åkerman and Peltola, 2006; Bardouille and Koubsky, 2000; Madlener, 2007). Concerns about contractual lock-in is a factor that can motivate rejection of DH systems (DECC, 2013; Upham and Jones, 2012; Zaunbrecher *et al.*, 2016). Some form of customer charter and/or standardised contract mechanism could help. DECC (2013) emphasised that the simplicity and flexibility of contracts is important to satisfy customers. In addition, DECC (2013) and CLCV (2017) suggested that transparency in pricing is an essential ingredient in obtaining customer confidence. Heating tariffs should reflect usage without confusing fixed elements (Pyrko and Darby, 2011). To implement billing based on individual user consumption, heat metering is required in each individual dwellings. Heat metering is also important to monitor DH supply and return temperatures so as to minimise heat losses and improve economic performance (Dalla Rosa *et al.*, 2014; DECC, 2012; Rämä and Sipilä, 2017).

An efficient communication strategy is crucial to successfully disseminating the expected benefits of the planned DH network, with a specific focus on the measures taken to guarantee transparent heating tariffs and energy efficiency improvements. A voluntary stakeholder-led consumer production scheme such as the Heat Trust in the UK (Association of decentralized energy, 2015) could help drive up standards and increase confidence in DH systems. Communication strategies should aim at increasing the awareness of energy self-sufficiency benefits for the local economy (Giraud, 2014; Safa, 2017) and for price stability. This could boost the uptake of technologies which reduce the use of imported fossil fuels (Balcombe *et al.*, 2014; Praetorius *et al.*, 2010). Communication strategies should further integrate numerical tools so as to counterbalance the distrust of experts that has been observed in developed countries (Kjeang *et al.*, 2017). A user-friendly mobile application with a measurement feed-back communication strategy, a presence on social media and the creation of dedicated forums and websites could help boost consumer engagement. The picture is, however, multifaceted and home visits encouraging dialogue between experts and laypeople are still very appreciated (Kjeang *et al.*, 2017; Rogers *et al.*, 2012). Recent initiatives from DH operators such as

Dalkia (implementing a smart digital platform for the Clervia network) or Engie (simplifying the heating tariffs for the Sevrans system) can serve as examples of best practices. It should be mentioned that in France, AMORCE provide a fair amount of soft benchmarking, linking cities and operators (see e.g. AMORCE, 2015).

A thorough communication strategy would also be required to share information on economic, safety and climate aspects of heat production with nuclear plants, so as to build up consumer trust. It is proven that the risk of hazardous exposure of humans to radioactivity via the transportation system, due to leakage, can be reduced to almost zero by implementing several hydraulic barriers (Frederiksen and Werner, 2013; IAEA, 2003; STUK, 2009). Besides, radioactive control mechanisms at the start of the transmission line would allow to stop the supply of water in case any leakage is detected. However, there are important psychological barriers to the use of nuclear heat (see Chapter 5). To address these concerns, it is important to perform a co-directed feasibility study leading to results that can be trusted by as many stakeholders as possible. Considering that distrust of nuclear experts is not rare in France, the integration of citizens and community groups from pre-feasibility stages would be primordial. For this to happen in practice, there need to be a large sense that this alternative is supported by the EC and the national public authorities (the local ones having a major role to play). Directive EC/27/2012 (European Parliament, 2012) and its French application (*Ministère de l'écologie, du développement durable et de l'énergie* (2014) should be updated so as to set nuclear heat on an equal footing with other RR sources such as fossil cogeneration, industrial excess heat or renewable thermal energies. The French government should also provide a clear long-term strategy so as to allow stakeholders to anticipate where the future energy system is going in terms of the relative share of renewable, nuclear and fossil energies, both for the electricity and heat sectors.

The distrust towards DH systems and fear of nuclear heat, when correctly addressed, was reflected in Scenario II by omitting the two respective criteria from the decision matrix. The RR status of nuclear heat and the importance of energy self-sufficiency (when properly communicated and approved by the stakeholder groups) were reflected in Scenario II by adding the two respective criteria to the decision matrix. Taking out the DH system and nuclear source criteria and adding the energy self-sufficiency and RR source criteria, the criteria ranking by each stakeholder would change as follows:

1. Developer:

$$Cost > RR\ source > Self\ sufficiency > GHG\ emissions > PM_{2.5}\ inhalation \quad (14)$$

2. National public authorities:

$$RR\ source > Cost = GHG\ emissions = PM_{2.5}\ inhalation = Self\ sufficiency \quad (15)$$

3. Local public authorities

$$Cost = PM_{2.5}\ inhalation > RR\ source > Self\ sufficiency > GHG\ emissions \quad (16)$$

4. Community groups:

$$RR\ source = Cost > Self\ sufficiency > GHG\ emissions = PM_{2.5}\ inhalation \quad (17)$$

5. Nuclear operator:

$$Cost > RR\ source = GHG\ emissions = PM_{2.5}\ inhalation > Self\ sufficiency \quad (18)$$

The criteria weights shown in Table II.6.3 are obtained from Eq. (8) with k equals 5 and equally important criteria are averaged as was done in the first scenario.

Stakeholder	Criterion (*)				
	Cost	RR source	Self-sufficiency	GHG	PM _{2.5}
Developer	0.457	0.257	0.157	0.09	0.04
National public authority	0.136	0.457	0.136	0.136	0.136
Local public authority	0.357	0.157	0.09	0.04	0.357
Community group	0.357	0.357	0.157	0.065	0.065
Nuclear operator	0.457	0.168	0.04	0.168	0.168

Table II.6.3: Criteria weights considered in Scenario II

Notes:

(*) The criteria weights are obtained from Eq. (8) with k equals to 5 and ranking stated in Eq. (14-18).

5. Results

Table II.6.4 shows the ranking of alternatives obtained by the PROMETHEE II method for the five stakeholder groups in Scenario I and Scenario II. The outcome of the PROMETHEE II method for Scenario I explicitly shows that stakeholder interpretations of the best option are diverse when communication is not facilitated and when major concerns of DH acceptance and the use of nuclear heat are not addressed. The fact that heat production with a nuclear plant is the second worst option for the community groups stems from the concerns of this group about the radioactive contamination of top water. It can also be seen that individual condensing boilers are the best option for two stakeholder groups and the second best for one. Therefore, if nothing is done to improve the social acceptance of DH systems (i.e. by recognising the potential of heat production with nuclear plants or increasing the carbon price), it can be expected that individual condensing natural gas boilers will continue to be the preferred alternative in most urban dwellings, confirming what can be observed in reality (AMORCE, 2015). The ranking of alternatives in Scenario II has changed, as the main point of conflict between stakeholders is addressed thanks to proper communication among them. This affected the stakeholder preferences and the ranking of criteria and resulted in general agreement.

Stakeholders	Ranking					
	1	2	3	4	5	6
<i>Scenario I: Business as usual</i>						
Developer	Nuclear ($\phi=1.57$)	Ind. gas ($\phi=1.55$)	Ind. HP ($\phi=0.07$)	Biomass ($\phi=-0.12$)	Sewer h. ($\phi=-1.44$)	Ind. elec. ($\phi=-1.64$)
National public authority	Nuclear ($\phi=1.27$)	Ind. HP ($\phi=0.31$)	Ind. gas ($\phi=0.02$)	Ind. elec. ($\phi=-0.27$)	Biomass ($\phi=-0.52$)	Sewer h. ($\phi=-0.81$)
Local public authority	Ind. HP ($\phi=1.31$)	Nuclear ($\phi=1.07$)	Ind. gas ($\phi=0.55$)	Ind. elec. ($\phi=-0.2$)	Sewer h. ($\phi=-1.14$)	Biomass ($\phi=-1.59$)
Community group	Ind. gas ($\phi=2.22$)	Ind. HP ($\phi=1.12$)	Biomass ($\phi=-0.47$)	Ind. elec. ($\phi=-0.76$)	Nuclear ($\phi=-0.99$)	Sewer h. ($\phi=-1.12$)
Nuclear operator	Ind. gas ($\phi=2.35$)	Ind. HP ($\phi=1.14$)	Nuclear ($\phi=0.77$)	Ind. elec. ($\phi=-1.1$)	Biomass ($\phi=-1.19$)	Sewer h. ($\phi=-1.98$)
<i>Scenario II: Theoretical variant</i>						
DH operator	Nuclear ($\phi=2.63$)	Biomass ($\phi=0.78$)	Ind. gas ($\phi=0.4$)	Ind. HP ($\phi=0.21$)	Sewer h. ($\phi=-0.3$)	Ind. elec. ($\phi=-3.71$)
National public authority	Nuclear ($\phi=2.14$)	Biomass ($\phi=1.19$)	Sewer h. ($\phi=1.05$)	Ind. HP ($\phi=0.5$)	Ind. gas ($\phi=-2.37$)	Ind. elec. ($\phi=-2.5$)
Local public authority	Nuclear ($\phi=1.77$)	Ind. HP ($\phi=1.63$)	Ind. gas ($\phi=-0.3$)	Sewer h. ($\phi=-0.45$)	Ind. elec. ($\phi=-1.29$)	Biomass ($\phi=-1.36$)
Community group	Nuclear ($\phi=2.45$)	Biomass ($\phi=0.83$)	Ind. HP ($\phi=0.54$)	Sewer h. ($\phi=-0.18$)	Ind. gas ($\phi=-0.5$)	Ind. elec. ($\phi=-3.49$)
Nuclear operator	Nuclear ($\phi=2.33$)	Ind. HP ($\phi=0.5$)	Ind. gas ($\phi=0.48$)	Biomass ($\phi=0$)	Ind. HP ($\phi=-0.75$)	Ind. elec. ($\phi=-2.57$)

Table II.6.4: Ranking of alternatives for each stakeholder based on PROMETHEE II

Notes:

In blue: Nuclear-plant-based DH system

In green: Biomass-based DH system

In grey: Sewer-heat-based DH system

In yellow: Individual electric heaters

In purple: Individual condensing natural gas boilers

In orange: Individual air-to-water heat pumps

6. Discussion

The extraction of stakeholder preferences revealed that social and environmental drivers are at least as prominent as economic motivations for public authorities. Local governments also grant more importance to local environmental criteria (PM_{2.5} inhalation) than global environmental criteria (GHG emissions). Our results are in line with (Bush *et al.*, 2017, 2016), suggesting that the prioritisation of criteria is a complex issue which depends strongly on local contexts. Community groups can disseminate the idea that an important criterion has been underestimated through the media or collective actions, which could ultimately change the ranking of criteria of other stakeholder groups (and local authorities in particular). It therefore follows that there is no one criterion that can be optimised in planning a scheme, which raises issues for understanding the prioritisation of criteria, and the use of MCDM methods. We however advocate that MCDM methods are a practical tool for collecting perceptions, viewpoints and concerns of all stakeholder groups and enhancing collective thinking.

The main limitation of our study relies in the limited amount of people interviewed (11). Our sample is not representative of the stakeholder groups. Gathering views from a larger sample of people, among which households and local associations, would be an important asset for real-case applications. Doing focus groups instead of sharing questionnaires would likely help more original ideas to emerge. More criteria could also be included such as e.g. land use planning. Despite these limitations, which are partly inherent to the exercise (one Ph.D. student as the only resource), we hope that this Chapter can serve as a basis for a possible future feasibility study of DH production with nuclear plants, taking into consideration additional aspects such as the cost of DH infrastructures inside buildings or the optimal balance with investment in building energy efficiency. The accurate data produced during the feasibility study of the system should then be conveyed to stakeholders properly.

This paper assumed that the French nuclear operator is willing to demonstrate the potential of nuclear plants to supply DH networks. This is a theoretical pre-requisite for studying the decision-making and communication processes surrounding an eventual feasibility study. Today, however, this condition is not fulfilled. There are several drivers which could lead the nuclear operator to re-examine its position (see Chapter 5). A general understanding that this alternative is supported by energy efficiency policies is determinant. While DH production with nuclear plants does exist in Europe, private investors often perceive such projects as risky or non-mature. Given that the appetite to take risks to enable the success of energy projects is often low (Bush *et al.*, 2017; Ghafghazi *et al.*, 2010; Chapter 5), case studies are an important tool for increasing awareness and confidence. There is, however, a lack of complete case studies sharing technical (e.g. operational management of heat production), economic (e.g. cost paid by final consumers) and social (e.g. public satisfaction, eventual difficulties in implementation) aspects of these projects. The recent initiatives of the International Atomic Energy Agency (IAEA, 2016a), the Nuclear Cogeneration Industrial Initiative (NC2I, 2015) and the Nuclear Energy Agency (NEA, 2015) are a step forward in this sense (see also Chapter 2). These efforts should be continued and the results disseminated through research papers and the media. Future working groups may consider including non-nuclear stakeholders such as DH players and community representative groups.

When preparing a feasibility study, caution is needed on how the objectives are communicated and interpreted. The French Thermos nuclear DH project (1975-1981) allowed us to draw useful lessons in this respect. According to Dalmasso (2008), the Thermos project initially aimed at generating clear economic benefits. During the decision-making process, however, opponents succeeded in disseminating the idea that Thermos would not be competitive relative to traditional coal plants. As a result, proponents change their strategies, arguing that Thermos must be seen as a demonstration project opening the path to more economical projects of the kind. A case study (Dalmasso, 2008) showed that this change of discourse eroded the confidence of the local government, which ultimately led to abandoning the project. It therefore follows that if the economic benefits of a nuclear DH project

are insufficient, implementation will prove difficult as opponents will always be able to discuss the rationality of technical and-economic modelling. In the case here studied, a pre-requisite to the economic rationality of long-distance (15 km) heat transportation from the plant to the city is the enlargement of the DH network. An indication of a sufficient extension is given in Section 3 as 217 km of DH pipelines supplying 673 GWh_{th}/a. The implantation of a large DH network on the scale of a city can nonetheless be a problem in itself.

This paper assesses the cost of heating systems by applying the social discount rate of 3.5% recommended by the EC (2014). Under the current approach of DH investments, however, private investors would, in reality, ask for higher rates of returns, which may jeopardize the implementation of DH schemes in the least-dense areas of the greater Dunkirk community. Domestic housing represents 40% of the dwellings covered by the modelled DH network (see Section 3), and hence represents a significant social and environmental potential. The connection of domestic housing areas is, however, challenging under the current public funding approach. National government policy currently focuses on encouraging leverage of private financial investment in DH schemes by providing public subsidies (*Ministère de l'environnement, de l'énergie et de la mer* (2014)). As a result, local governments and DH operators focus on accessing sources of public funding to cover all or part of the capital costs of a project and make financial returns more viable. While maintaining stable public funding over time is crucial, it is insufficient to allow for the deployment of large DH networks on the scale of a city. Without consideration of the longer-term outlook for the city or the project, this focused approach can lock out future opportunities for expansion in domestic areas. Moving beyond the current public funding approach to development requires challenging the traditional financial investment logic and empowering local governments and other public-sector organisations to stretch their processes for demonstrating value for money. This may require a form of 'cross-subsidy' between the most commercially viable sites with high heat-demand densities and other sites that offer wider social and environmental benefits. Local authorities can also force heat consumers to connect to the future DH network, provided this network uses more than 50% RR heat and is financially self-sufficient (*Assemblée nationale*, 2012a). Yet this option is rarely used in France due to the unwillingness of local policy makers to become indebted for energy projects. Implementing local heat strategies (including the development of regional peer networks sharing experiences and visions) is also a way to give long-term signals to investors about the potential which extends beyond the most commercially obvious sites. Examples of such city clusters are the networks in the UK (Core Cities, 2013) or those mentioned in Scotland (Heat Network Partnership for Scotland, 2015). In the Dunkirk region, the 'third industrial revolution' cluster (*Région Hauts-de-France*, 2017) is an interesting initiative for promoting a circular economy, even though it does not specifically target DH. The metropolitan energy cluster of Strasbourg is also a good example of an efficient scheme supporting the development of large DH networks (AMORCE, 2017). Importantly, the cooperation of DH companies with other energy companies should be improved so as to enhance affordable energy solutions based on smart multi-energy grids.

In practice, the challenges of limited staff and financial resources within local governments can restrict the full deployment of such projects (Bush *et al.*, 2016). Local governments are reliant on support mechanisms from national government to build up their capacities and skills. In addition to financial support, national authorities need to provide a clear long-term strategy of where the future energy system is going to go in terms of the energy efficiency levels of buildings and the implications of this for the long-term heat demands upon which DH business cases rest. We further advocate that long-term strategies should focus on achieving an optimal balance between investments in building efficiency versus heat and cold production on a city scale. The current law requires new buildings to be designed so as to maintain final energy consumption below 40 kWh_{th}/m².a (*Assemblée nationale*, 2012b), neglecting the GHG emissions. As a result, most new dwellings are equipped with individual condensing natural gas boilers, and this even in areas with DH potential (AMORCE, 2015). Replacing the final energy consumption threshold with a GHG emission threshold (including indirect emissions) would be a great step forward to the uptake of low-carbon energy systems. Another option to be considered is the use of GHG emission taxation.

7. Conclusion

This paper has compared three energy options of heat production (i.e. nuclear plants, biomass and sewer heat recovery) to provide the base-load heat demand of a projected DH system in Dunkirk (France) with three individual heating systems (i.e. condensing natural gas, electric and air-to-water heat pumps). The PROMETHEE II method was used to rank the alternatives against seven criteria (i.e. cost, GHG emissions, PM_{2.5} inhalation, DH systems, energy self-sufficiency, renewable or recoverable sources and nuclear sources). Five stakeholder groups (national and local public authorities, community groups, DH and nuclear operators) were asked to rank the criteria according to the importance they have in the decision making process. Two scenarios were investigated to indicate how a consensus between the stakeholder groups involved in DH project can be reached through information sharing during the feasibility study and the decision-making process.

The first scenario represented the business as usual case of decision-making where the stakeholder preferences were taken directly from the shared questionnaire. Based on the ranking, criteria weights were assigned using the expected value method. Despite the advantages of utilising heat from a nuclear plant located 15 km away (e.g. low heating costs and GHG emissions), it would not be chosen as the preferred option by all the stakeholder groups. Individual condensing gas boilers would likely be installed due to low capital costs and the fact that certain stakeholder groups are (i) ideologically (or psychologically i.e. afraid of) opposed to the use of heat from nuclear plants; (ii) afraid of contractual lock-in with regards to the DH option (relative to individual heating systems).

The second scenario is a theoretical variant in which: (i) No stakeholder is concerned about the nuclear or DH status of the heating source; and (ii) All stakeholders agree on the benefits of energy self-sufficiency and on the recoverable status of the nuclear heat. The PROMETHEE results showed general agreement among stakeholders. The top ranked alternative in this scenario for all stakeholders was the same, thus indicating that information sharing through the in-depth involvement of all stakeholders from early stages may help to reach a consensus. This result calls for the development of a method designed to encourage the emergence of such a co-built decision making process. Following this, Chapter 8 has been writing in an attempt to define the conditions upon which such a process could be set up.

References

- Åkerman, M., Peltola, T., 2006. Constituting the space for decision making—Conflicting calculations in a dispute over fuel choice at a local heating plant. *Geoforum* 37, 779–789.
- Al-Shemmeri, T., Al-Kloub, B., Pearman, A., 1997. Model choice in multicriteria decision aid. *European Journal of Operational Research* 97, 550–560.
- AMORCE (French DH association), 2015. Comparatif des modes de chauffage et prix de vente de la chaleur. Data for 2014. Available from: <<http://www.amorce.asso.fr/fr/espace-adherents/publications/rdc/prix-de-la-chaleur/comparatif-des-modes-de-chauffage-et-prix-de-vente-de-la-chaleur-rapport-2015-donnees-2014/>> [in French].
- AMORCE, 2017. 13ième Rencontres des réseaux de chaleur (13th national DH meeting). Round Table of the 12/12. Presentation by Rémi Chabrilat “Factor 5 for renewable and excess heat sources: Which means for which objectives?” [in French].
- Asaee, S.R., Ugursal, V.I., Beausoleil-Morrison, I., 2017. Techno-economic feasibility evaluation of air to water heat pump retrofit in the Canadian housing stock. *Applied Thermal Engineering* 111, 936–949.
- Assemblée nationale (French national assembly), 2012a. Arrêté du 22 décembre 2012 relatif au classement des réseaux de chaleur et de froid. JORF n°0012 du 15 janvier 2013 page 962. Available from: <<https://www.legifrance.gouv.fr/affichTexte.do;jsessionid=?cidTexte=JORFTEXT000026939712&dateTexte=&oldAction=rechJO&categorieLien=id>> [in French].
- Assemblée nationale, 2012b. Arrêté du 28 décembre 2012 relatif aux caractéristiques thermiques et aux exigences de performance énergétique des bâtiments nouveaux et des parties nouvelles de bâtiments autres que ceux concernés par l’article 2 du décret du 26 octobre 2010 relatif aux caractéristiques thermiques et à la performance énergétique des constructions. Available from: <<https://www.legifrance.gouv.fr/affichTexte.do?cidTexte=JORFTEXT000026871753&categorieLien=id>> [in French].
- Assemblée nationale, 2015. Loi n° 2015–992 du 17 août 2015 Relative à la transition énergétique pour la croissance verte, 2015–2992. Available from: <<http://www.legifrance.gouv.fr/affichTexte.do?cidTexte=JORFTEXT000031044385&categorieLien=id>> [in French].
- Association of decentralized energy, 2015. The Heat Trust.
- Babic, Z., Plazibat, N., 1998. Ranking of enterprises based on multicriterial analysis. *International Journal of Production Economics, Production Economics: The Link Between Technology And Management* 56-57, 29–35.
- Balcombe, P., Rigby, D., Azapagic, A., 2014. Investigating the importance of motivations and barriers related to microgeneration uptake in the UK. *Applied Energy* 130, 403–418.
- Bardouille, P., Koubsky, J., 2000. Incorporating sustainable development considerations into energy sector decision-making: Malmö Flintränen district heating facility case study. *Energy Policy* 28, 689–711.
- Bauer, D., Marx, R., Nußbicker-Lux, J., Ochs, F., Heidemann, W., Müller-Steinhagen, H., 2010. German central solar heating plants with seasonal heat storage. *Solar Energy, International Conference CISBAT 2007* 84, 612–623.
- Beccali, M., Cellura, M., Ardente, D., 1998. Decision making in energy planning: the ELECTRE multicriteria analysis approach compared to a FUZZY-SETS methodology. *Energy Conversion and Management* 39, 1869–1881.
- Behzadian, M., Kazemzadeh, R.B., Albadvi, A., Aghdasi, M., 2010. PROMETHEE: A comprehensive literature review on methodologies and applications. *European Journal of Operational Research* 200, 198–215.

- Bianco, V., Scarpa, F., Tagliafico, L.A., 2017. Estimation of primary energy savings by using heat pumps for heating purposes in the residential sector. *Applied Thermal Engineering* 114, 938–947.
- Brandt, J., Christensen, J.H., Frohn, L.M., Berkowicz, R., 2001. Operational air pollution forecasts from regional scale to urban street scale. Part 1: system description. *Physics and Chemistry of the Earth, Part B: Hydrology, Oceans and Atmosphere* 26, 781–786.
- Brans, J.P., Vincke, P., 1985. A preference ranking organisation method: (the PROMETHEE method for multiple criteria decision-making). *Management Science* 31, 647–656.
- Brans, J.P., Vincke, P., Mareschal, B., 1986. How to select and how to rank projects: The Promethee method. *European Journal of Operational Research, Mathematical Programming Multiple Criteria Decision Making* 24, 228–238.
- Brans, J.P., Mareschal, B., 2005. Multiple Criteria Decision Analysis: State of the Art Surveys. Springer Science + Business Media, Inc., pp. 163–196. In: Figueira, J., Greco, S., Ehrgott, M. (Eds.).
- Bush, R.E., Bale, C.S.E., Taylor, P.G., 2016. Realising local government visions for developing district heating: Experiences from a learning country. *Energy Policy* 98, 84–96.
- Bush, R.E., Bale, C.S.E., Powell, M., Gouldson, A., Taylor, P.G., Gale, W.F., 2017. The role of intermediaries in low carbon transitions – Empowering innovations to unlock district heating in the UK. *Journal of Cleaner Production* 148, 137–147.
- CLCV (National consumer protection association), 2017. Tarif, contrats, gouvernance Il faut reprendre en main le chauffage urbain. Available from: <http://www.clcv.org/images/CLCV/DP_chauffage_urbain_copy_copy_copy_copy_copy.pdf> [in French].
- Communauté Urbaine de Dunkerque (Dunkirk conurbation committee), 2015. Plan Air Climat Energie Territorial 2015-2021. Available from: <https://www.communaute-urbaine-dunkerque.fr/fileadmin/documents/rapports/Plan_Air_Climat_Energie_Territorial_2015-2021_cud.pdf> [in French].
- Connolly, D., Lund, H., Mathiesen, B.V., Werner, S., Möller, B., Persson, U., Boermans, T., Trier, D., Østergaard, P.A., Nielsen, S., 2014. Heat Roadmap Europe: Combining district heating with heat savings to decarbonise the EU energy system. *Energy Policy* 65, 475–489.
- Core Cities, 2013. Core Cities Growth Prospectus Policies Step 6: Power Up the Cities. Core Cities.
- Dalkia (Groupe EDF), 2015. Energie Grand Littoral. Réseau de chauffage urbain. Compte-rendu technique et financier. Exercice 2015. Available from: <https://www.communaute-urbaine-dunkerque.fr/fileadmin/documents/rapports/Reseau_de_chaleur_-_compte-rendu_d_activite_2015.pdf> [in French].
- Dalla Rosa, A., Li, H., Svendsen, S., Werner, S., Persson, U., Ruehling, K., Felsmann, C., Crane, M., Burzynski, R., Bevilacqua, C., 2014. Toward 4th Generation District Heating: Experience and Potential of Low-Temperature District Heating.
- Dalmasso, A., 2008. Le projet Thermos (1975-1981) ou l'échec de « l'atome au coin du feu. Colloque Nucléaire et développement régional, Tours, CEHMVI, Fondation EDF, 17-18 décembre 2008. [in French].
- DEA (Danish Energy Agency), 2013. Technology Data for Energy Plants Individual Heating Plants and Energy Transport. Original version (2013). Available from: <https://ens.dk/sites/ens.dk/files/Analyser/old_technology_data_for_individual_heating_plants_and_energy_transport_aug2016.pdf>.
- DECC (Department of Energy and Climate Change), 2012. District Heating - Heat Metering Cost Benefit Analysis.
- DECC, 2013. Research into barriers to deployment of district heating networks. Available from: <<https://www.cse.org.uk/downloads/reports-and-publications/policy/community-energy/insulation-and-heating/planning/renewables/research-into-barriers-to-deployment-of-district-heating-networks.pdf>>.

- Delmastro, C., Mutani, G., Schranz, L., 2015. Advantages of Coupling a Woody Biomass Cogeneration Plant with a District Heating Network for a Sustainable Built Environment: A Case Study in Luserna San Giovanni (Torino, Italy). *Energy Procedia*, 6th International Building Physics Conference, IBPC 2015 78, 794–799.
- Decision Deck Consortium, 2018. DIVIZ, workbench to design, execute and share complex MCDA algorithms and experiments. Available from: <<https://www.diviz.org/>>.
- EC, 2014. Guide to Cost-Benefit Analysis of Investment Projects for Cohesion Policy 2014-2020.
- EC (European Commission), 2016. Annexes to the Proposal for a Directive of the European Parliament and the Council on the promotion of the use of energy from renewable sources (recast). Available from: <<http://eur-lex.europa.eu/legal-content/EN/ALL/?uri=COM%3A2016%3A767%3AFIN>>.
- ETI (Energy Technology Institute), 2016. System Requirements for Alternative Nuclear Technologies - Phase 3. Technical assessment of SMR heat extraction for district heat networks. Available from: <<http://www.eti.co.uk/library/system-requirements-for-alternative-nuclear-technologies-phase-3>>.
- European Parliament, 2012. Directive 2012/27/EU of the European Parliament and of the Council of 25 October 2012 on energy efficiency, amending Directives 2009/125/EC and 2010/30/EU and repealing Directives 2004/8/EC and 2006/32/EC.
- Frederiksen, S., Werner, S., 2013. District heating and cooling. Lund Studentlitteratur.
- Georgopoulou, E., Sarafidis, Y., Diakoulaki, D., 1998. Design and implementation of a group DSS for sustaining renewable energies exploitation. *European Journal of Operational Research* 109, 483–500.
- Ghafghazi, S., Sowlati, T., Sokhansanj, S., Melin, S., 2010. A multicriteria approach to evaluate district heating system options. *Applied Energy* 87, 1134–1140.
- Gilliams, S., Raymaekers, D., Muys, B., Orshoven, J.V., 2005. Comparing multiple criteria decision methods to extend a geographical information system on afforestation. *Computers and Electronics in Agriculture, Decision Support Systems for Forest Management* 49, 142–158.
- Giraud, G., 2014. How Dependent is Growth from Primary Energy ? Output Energy Elasticity in 50 Countries (1970-2011). Available from: <<https://www.parisschoolofeconomics.eu/IMG/pdf/article-pse-medde-juin2014-giraud-kahraman.pdf>>.
- Goletsis, Y., Psarras, J., Samouilidis, J.-E., 2003. Project Ranking in the Armenian Energy Sector Using a Multicriteria Method for Groups. *Annals of Operations Research* 120, 135–157.
- Haralambopoulos, D.A., Polatidis, H., 2003. Renewable energy projects: structuring a multi-criteria group decision-making framework. *Renewable Energy* 28, 961–973.
- Heat Network Partnership for Scotland, 2015. District Heating Strategy Support: Proposal for HNP support for Local Authorities. HNP.
- Heat Roadmap Europe, 2015. Heat Roadmap Europe 2050. Research project co-funded by the European Commission. Peta, the Pan-European Thermal Atlas: renewable energy. Available from: <<http://maps.heatroadmap.eu/maps/31157/Renewable-Resources-Map-for-EU28?preview=true#>>.
- Hesaraki, A., Holmberg, S., Haghighat, F., 2015. Seasonal thermal energy storage with heat pumps and low temperatures in building projects—A comparative review. *Renewable and Sustainable Energy Reviews* 43, 1199–1213.
- Hirsch, P., Duzinkiewicz, K., Grochowski, M., Piotrowski, R., 2016. Two-phase optimizing approach to design assessments of long distance heat transportation for CHP systems. *Applied Energy* 182, 164–176.
- Hobbs, B.F., Horn, G.T., 1997. Building public confidence in energy planning: a multimethod MCDM approach to demand-side planning at BC gas. *Energy Policy, Model-based policy analysis* 25, 357–375.

- IAEA (International Atomic Energy Agency), 2003. Market Potential for Non-electric Applications of Nuclear Energy. STI/DOC/010/410.
- IAEA, 2016a. Technical Meeting on the Socio-Economic Aspects of Nuclear Cogeneration. Available from: <<https://www.iaea.org/NuclearPower/Meetings/2016/2016-11-21-11-23-NPTDS.html>>.
- IAEA, 2016b. Desalination Thermodynamic Optimization Program (DE-TOP). Available from: <https://www.iaea.org/NuclearPower/NEA_Desalination/index.html>.
- INSEE (French National Institution for Statistics and Economics Studies), 2014. Logements en France. Available from: <<https://www.insee.fr/fr/statistiques/3137421>> [in French].
- IPCC (Intergovernmental Panel on Climate Change), 2006. Guidelines for National Greenhouse Gas Inventories, Volume 2 Energy.
- Jaber, J.O., Jaber, Q.M., Sawalha, S.A., Mohsen, M.S., 2008. Evaluation of conventional and renewable energy sources for space heating in the household sector. *Renewable and Sustainable Energy Reviews* 12, 278–289.
- Jami, A.A.N., Walsh, P.R., 2014. The role of public participation in identifying stakeholder synergies in wind power project development: The case study of Ontario, Canada. *Renewable Energy* 68, 194–202.
- Jaskólski, M., Reński, A., Minkiewicz, T., 2017. Thermodynamic and economic analysis of nuclear power unit operating in partial cogeneration mode to produce electricity and district heat. *Energy* 141, 2470–2483.
- Jasserand, F., Lavergne, J.-G., 2016. Initial Economic Appraisal of Nuclear District Heating in France. *EPJ Nuclear Sci. Technol.* 2, 39.
- Karschin, I., Geldermann, J., 2015. Efficient cogeneration and district heating systems in bioenergy villages: an optimization approach. *Journal of Cleaner Production* 104, 305–314.
- Kjeang, A.E., Venkatesh, G., Ståhl, M., Palm, J., 2017. Energy consulting services in the information age - literature review. *Energ Sustain Soc* 7, 30.
- Kontu, K., Rinne, S., Olkkonen, V., Lahdelma, R., Salminen, P., 2015. Multicriteria evaluation of heating choices for a new sustainable residential area. *Energy and Buildings* 93, 169–179.
- Langer, K., Decker, T., Menrad, K., 2017. Public participation in wind energy projects located in Germany: Which form of participation is the key to acceptance? *Renewable Energy* 112, 63–73.
- Leurent, M., Da Costa, P., Jasserand, F., Rämä, M., Persson, U., 2018. Cost and climate savings through nuclear district heating in a French urban area. *Energy Policy* 115, 616–630.
- Madlener, R., 2007. Innovation diffusion, public policy, and local initiative: The case of wood-fuelled district heating systems in Austria. *Energy Policy* 35, 1992–2008.
- Magnusson, D., 2010. Between municipal and regional planning: the development of regional district heating systems in Stockholm from 1978 to 2010. *Local Environ* 16, 319–37.
- Ministère de l'écologie, du développement durable et de l'énergie (French Ministry of Ecology, Sustainable development and Energy), 2014. Application de l'article 14.5 de la directive 202/27/EU sur la valorisation de la chaleur fatale industrielle via des réseaux de chaleur. Décret n° 2014-1363 du 14 Novembre 2014.
- Ministère de l'environnement, de l'énergie et de la mer (French Ministry of Environment, Energy and Seas), 2014. Le Fonds Chaleur. Available from: <<http://www.developpement-durable.gouv.fr/Presentation-generale,25027.html>> [in French].
- Mróz, T.M., 2008. Planning of community heating systems modernization and development. *Applied Thermal Engineering* 28, 1844–1852.
- NC2I, 2015. Nuclear Cogeneration Industrial Initiative (NC2i). Available from: <<http://www.snetp.eu/nc2i/>>.
- NEA, 2015. Ad hoc Expert Group of the Nuclear Energy Agency on the Role and Economics of Nuclear Co-generation in a Low-carbon Energy Future (COGEN-2015). Available from: <<http://www.oecd-nea.org/ndd/groups/cogen.html>>.

- Nijkamp, P., Rietveld, P., Voogd, H., 1990. Multicriteria evaluation in physical planning. North-Holland: Amsterdam.
- Palm, J., Thollander, P., 2010. An interdisciplinary perspective on industrial energy efficiency. *Applied Energy* 87, 3255–3261.
- Persson, U., Werner, S., 2011. Heat distribution and the future competitiveness of district heating. *Applied Energy* 88, 568–576.
- Persson, U., Münster, M., 2016. Current and future prospects for heat recovery from waste in European district heating systems: A literature and data review. *Energy, Special issue on Smart Energy Systems and 4th Generation District Heating* 110, 116–128.
- Praetorius, B., Martiskainen, M., Sauter, R., Watson, J., 2010. Technological innovation systems for microgeneration in the UK and Germany – a functional analysis: *Technology Analysis & Strategic Management: Vol 22, No 6*.
- Pyrko, J., Darby, S., 2011. Conditions of energy efficient behaviour—a comparative study between Sweden and the UK. *Energy Efficiency* 4, 393–408.
- Rad, F.M., Fung, A.S., 2016. Solar community heating and cooling system with borehole thermal energy storage – Review of systems. *Renewable and Sustainable Energy Reviews* 60, 1550–1561.
- Rämä, M., Sipilä, K., 2017. Transition to low temperature distribution in existing systems. *Energy Procedia, 15th International Symposium on District Heating and Cooling, DHC15-2016, 4-7 September 2016, Seoul, South Korea* 116, 58–68.
- Ramanathan, R., Ganesh, L.S., 1995. Energy resource allocation incorporating qualitative and quantitative criteria: An integrated model using goal programming and AHP. *Socio-Economic Planning Sciences* 29, 197–218.
- Région Hauts-de-France, 2017. La troisième révolution en Hauts-de-France. Available from: <<http://rev3.fr/>> [in French].
- Rogers, J.C., Simmons, E.A., Convery, I., Weatherall, A., 2012. Social impacts of community renewable energy projects: findings from a woodfuel case study. *Energy Policy* 42, 239–247.
- Safa, H., 2012. Heat recovery from nuclear power plants. *International Journal of Electrical Power & Energy Systems* 42, 553–559.
- Safa, H., 2017. The Impact of Energy on Global Economy. *International Journal of Energy Economics and Policy* 7, 287–295.
- Sibbitt, B., McClenahan, D., Djebbar, R., Thornton, J., Wong, B., Carriere, J., Kokko, J., 2012. The Performance of a High Solar Fraction Seasonal Storage District Heating System – Five Years of Operation. *Energy Procedia, 1st International Conference on Solar Heating and Cooling for Buildings and Industry (SHC 2012)* 30, 856–865.
- STUK (Finnish Radiation and Nuclear Safety Authority), 2009. Preliminary Safety Assessment of the Fennovoima Oy Nuclear Power Plant Project. Available from: <https://www.stuk.fi/documents/88234/148256/STUK-Fennovoima_preliminarysafetyassessment_letter.pdf/2b9012c5-0d9a-4253-8efd-c2070fdc2cb7>.
- Upham, P., Jones, C., 2012. Don't lock me in: Public opinion on the prospective use of waste process heat for district heating. *Applied Energy, Special issue on Thermal Energy Management in the Process Industries* 89, 21–29.
- Wang, J.-J., Yang, D.-L., 2007. Using a hybrid multi-criteria decision aid method for information systems outsourcing. *Computers & Operations Research, Operations Research and Outsourcing* 34, 3691–3700.
- Werner, S., 2017. International review of district heating and cooling. *Energy In press*, 1–15.
- Xiaohua, W., Zhenmin, F., 2002. Sustainable development of rural energy and its appraising system in China. *Renewable and Sustainable Energy Reviews* 6, 395–404.
- Zaubrecher, B.S., Arning, K., Falke, T., Ziefle, M., 2016. No pipes in my backyard? *Energy Research & Social Science* 14, 90–101.

Zvingilaite, E., 2013. Modelling energy savings in the Danish building sector combined with internalisation of health related externalities in a heat and power system optimisation model. Energy Policy, Special section: Long Run Transitions to Sustainable Economic Structures in the European Union and Beyond 55, 57–72.

Appendix II.6.A

Table II.6.A.1 shows the questionnaire used to extract stakeholder preferences. The following information was clearly stated in the questionnaire:

- 1: Most important criterion ; 7: Least important criterion
- It is possible to give the same score to several criteria if they are considered to be of equal importance. In this case, the least important criteria is ranked below 7 but this is not an issue
- It is possible to state that some criteria are not relevant. In this case, do not rank it and please explain your reasons in the comments space.
- It is possible to add some criteria that may not be mentioned here, but that you consider as important. Please feel free to do so.
- Results will be strictly anonymous and never shared by referring directly to the name of the organization.

Table II.6.A.1 was then given to respondents so they could share their preferences. Sometimes, iterations via email were made to clarify a sentence or further discuss an interesting idea.

Criteria	Importance (descending order)	Comment or justification
Cost (including all capital and O&M costs; €/MWh _{th})		
Direct and lifecycle GHG emissions (t eCO ₂ /a)		
Inhalation of particulate matter less than or equal to 2.5 µm in diameter		
DH system (e.g. lack of awareness of DH benefits, fear of contractual lock-in, lack of trust in DH companies)		
Energy self-sufficiency		
Renewable or recoverable source		
Nuclear source		

Table II.6.A.1: Questionnaire used to extract stakeholder preferences.

Appendix II.6.B

Criterion	Unit	Value	Comments from interviews
Cost	€/MWh _{th}	see APPENDIX I.2.A	'Difficult to sell a project if the cost is much higher than alternatives' (10 respondents)
GHG emissions	teCO ₂ /GWh _{th}	see Section 3.5 of Chapter 2	'Only direct emissions are considered in most cases' (1 developer)
PM _{2.5} inhalation	g/a	see Section 4.1.4 of Chapter 3	'Can jeopardize the implementation of a system if there are negative public opinions' (1 community representative group)
Renewable or recoverable source	Qualitative	0: RNR 1: non RNR	'Essential both politically speaking and to get public support' (all respondents)
Nuclear source	Qualitative	0: non-nuclear 1: Nuclear	'Nuclear heat should be considered as other RNR sources' (8 respondents) 'Nuclear heat is not relevant given that France shall progressively phase out nuclear' (1 community representative group) 'Nuclear heat would likely generate strong public opposition' (1 community representative group, 1 public authority)
Energy self-sufficiency	Qualitative	0: DH systems 1: ind. Systems	'Essential to be independent from energy market fluctuations' (4 respondents) 'Not sure whether or not this is an important argument for households' (1 public authority)
DH source	Qualitative	0: ind. Systems 1: DH systems	'Not relevant criterion; we want a large public service and are opposed to competition' (1 community representative group) 'Duration and transparency of contracts is a key parameter for households; not very important for large customers' (3 respondents)

Table II.6.B.1: Comments from stakeholders when answering the questionnaire in Appendix A.*Notes:*

There were a total of 11 respondents: 3 national public authorities, 2 local governments, 2 developers, 3 community representative groups and 1 nuclear operator.

Appendix II.6.C

	Direct and lifecycle GHG emissions (t eCO₂/GWh_{th})	Reference and comment
Wood chips	28	EC (EC (European Commission), 2016)
Natural gas	424	IPCC (IPCC (Intergovernmental Panel on Climate Change), 2006)
Electricity consumed by peak-loads systems	260	<i>Marginal approach considering the French power mix towards 2030; see (Leurent et al., 2018)</i>
Electricity consumed by base-load systems	180	<i>Marginal approach considering the French power mix towards 2030; see (Leurent et al., 2018)</i>

Table II.6.C.1: Direct and lifecycle GHG emissions.

III. In-Depth Analysis of the potential in France

Part III aims to answer the research question (c) relative to the specificities of the French case. Chapter 7 builds and discusses scenarios that sees progressive implementation of nuclear plant based heating systems in France. Chapter 8 then uses a multi-level perspective approach to analyse how a niche for the implementation of a demonstration project could be created.

Research scope

PWR, DH, Process heat, GIS, Scenario, Strategic niche management

Geographical boundary

France

Publications

- Leurent, M., 2015. Pas de croissance soutenable sans innovations financières. La cogénération nucléaire, projet d'importance stratégique pour la transition écologique. *Entreprendre & Innover* 25, p. 75-85.
- Leurent, M. and Cany, C., 2016. A Comprehensive Taxonomy of Non-electric Nuclear Markets: Application to the Market Perspectives for France. *Proceeding of the 39th Conference of the International Association for Energy Economics (IAEE) in Bergen.*
- Leurent, M., 2018. GIS based analysis of the district heating potential in France. 3rd place winner of the 6th International DHC+ Student Award. *International Euroheat&Power Magazine*, issue IV/2018. Presented at the 2018 Global District Energy Days hold in Helsinki, September 2018.
- Leurent, M., 2018. Repenser les débats sur la transition énergétique: Vers une utilisation plus efficiente des centrales thermiques nucléaires? Dirigé par Martin Leurent dans le cadre des travaux menés par l'Institut Walden en collaboration avec le CEA.

« On doit échapper à l'alternative du dehors et du dedans: il faut être aux frontières. La critique, c'est l'analyse des limites et la réflexion sur elles »

Michel Foucault

Chapter 7

Prospective analysis of nuclear plant sourced heat utilisation in France ⁴

Abstract

This Chapter combines original data sets with methodological approaches introduced in the previous Chapters (e.g. spatial mapping methods), with the aim to evaluate the potential of nuclear plant based heating systems in France towards 2050. The underlying approach of this Chapter is to offer large intervals between lower and higher values so as to encourage the readers to go in the depth of the Chapter and make up their own opinion of the potential. Indeed, radical changes are unpredictable by nature. It is thus difficult, if not impossible, to state whether or not this alternative will be deployed and, if yes, to what extent. The prospective analysis shows that, towards 2050, district heating supply with nuclear plants could total 0-120 TWh_{th}/a (0-100% of the total potential for DH systems with a linear heat density higher than 1.5 MWh_{th}/m.a towards 2050). Heat supply from nuclear plants to industrial sinks also holds a potential of 0-120 TWh_{th}/a (0-100% of the 2012 French industrial heat demand below 250°C). Overall, a more efficient use of future nuclear plants could allow reducing French greenhouse gases emissions by 0% to 14% (0-240 TWh_{th}/a, considering both DH and industrial applications) relative to 2014 levels.

Keywords: prospective analysis, GIS, district heating, industrial symbiosis, nuclear, France

Highlights

- The stakes surrounding the French nuclear fleet towards 2050 are presented
- More than 50% of the heat demand in 2050 will be located in areas suitable for DH
- Costs and climate savings of eight couple of urban area-nuclear site in France are assessed
- Future large reactors planned on these sites could be built as 'cogeneration ready'
- Small reactors (100-500 MWh_{th}) to supply steam to continuous industrial processes

Comments

- This Chapter focuses on the justification of the provided quantitative values, i.e. on establishing plausible futures. It does not provide recommendations on how to stimulate the path towards such futures. As discussed in Chapter 8, the breaking through of such innovative and collective systems depends to a large extent on hardly predictable events such as e.g. increasing pressure on climate change mitigation, geopolitical energy shocks leading to a greater will to increase energy self-sufficiency, development of similar energy systems in other countries, nuclear incidents. There are yet a number of actions that policy makers and stakeholders could undertake in order to heighten the likelihood of nuclear plant based heating systems being experimented in France. These actions are discussed in Chapter 8.
- Actions designed to encourage the development of large, city-scaled DH networks are discussed overall the Ph.D. Report, and in particular in Section 5 of Chapter 6 (which can be read independently from the rest of Chapter 6). Large DH networks (such as modelled in Chapter 2) are a pre-requisite to make nuclear plant based DH supply economically sound.

⁴ Leurent, M., 2018. Repenser les débats sur la transition énergétique: Vers une utilisation plus efficiente des centrales thermiques nucléaires? Dirigé par Martin Leurent dans le cadre des travaux menés par l'Institut Walden en collaboration avec le CEA.

1. Introduction

While being a source of low carbon electricity, nuclear plants also produce excess heat currently rejected to the surrounding environment, representing approximately two thirds of the total energy generated (Safa, 2012). In France, this represents a total of about 930 TWh_{th}/a (MEEDDAT, 2008). The whole French nuclear plants are Pressurized Water Reactors (PWR). PWR (but also other kind of reactors; see e.g. Section 2.3.3 of Chapter 1) can be designed to produce both electricity and heat, or only heat, without affecting the reactor’s safety (STUK (Radiation and Nuclear Safety Authority of Finland), 2009). If also producing electricity, the nuclear plant is referred as a nuclear combined heat and power plants (NCHP). Operating a NCHP implies to reduce the electricity output compare to purely electricity generation mode. Lost electricity production depends on the temperature and the amount of heat considered (IAEA, 2016). Figure III.7.1 shows the major heat markets potentially accessible to nuclear plants in France, along with the lost electricity production that can be expected for each temperature level. While DH is the most common heat application of nuclear plants (at least 51 experiences; see Chapter 5), there are also some experiences of steam supply to nearby industrial facilities (at least four; see Chapter 4).

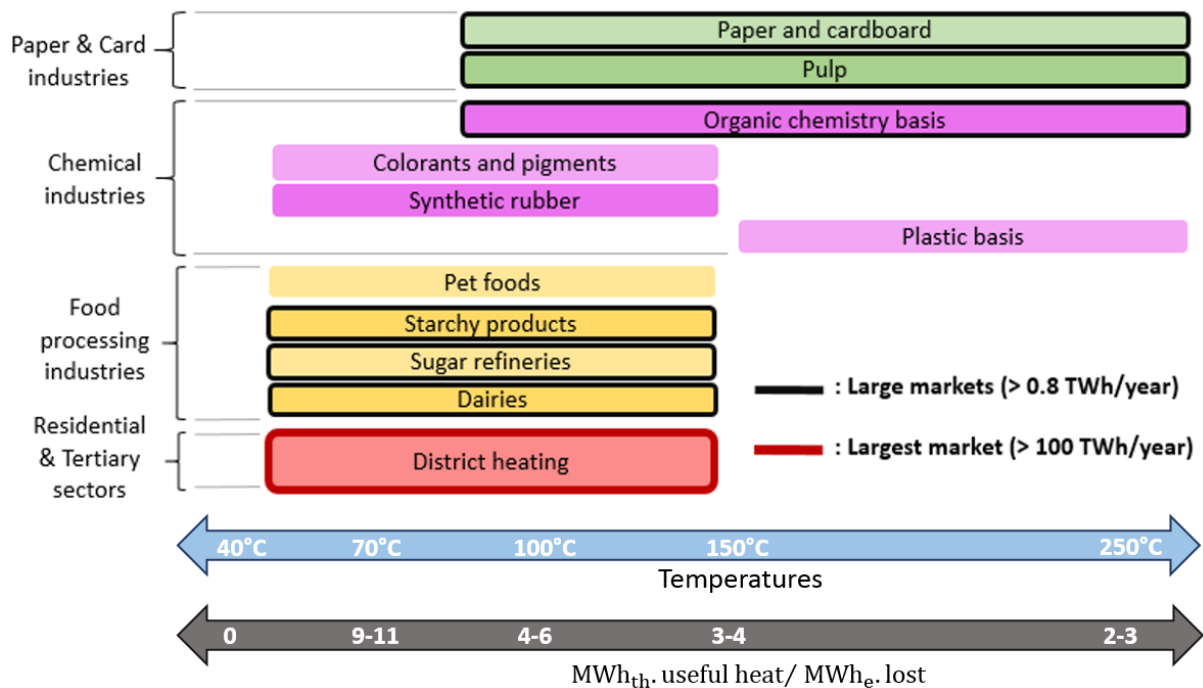

Figure III.7.1: Major heat markets for nuclear plants in France. Data source: Leurent and Cany (2016).

Notes:

(*) In the case of industrial sectors, the size of the market corresponds to the heat consumption below 250°C of all plant factories located within a 100km radius from a nuclear site (see Chapter 4).

(**) In the case of residential & commercial sectors, the market size corresponds to the residential and commercial demand for space heating and domestic hot water of the urban areas identified in Section 3.2.

The purpose of this Chapter is to assess the extent to which the heat from nuclear plants could help achieving the French energy objectives. Section 2 analyses the stakes that could affect the evolution of the French nuclear capacity by looking at policy schedules and decommissioning due to the ageing of existing reactors. Section 3 and 4 build and discuss prospective scenario introducing the transfer of heat from nuclear plants to DH systems and industrial sinks, respectively. The Chapter ends with the conclusion.

2. The stakes surrounding the future French nuclear fleet

Sub-Section 1.1 first describes the challenges faced by the nuclear fleet towards 2030. Sub-Section 1.2 then presents the stakes that could affect the fleet towards 2050.

2.1. Towards 2030

The share of the nuclear production in the French power mix was close to 75% in 2016 (RTE (French power network operator), 2016). In 2015, the French law on Energy Transition for Green Growth (LTECV; *Ministère de l'environnement, de l'énergie et de la mer* (French Ministry of Environment, Energy and Seas), 2015) has set up the target of reducing this share to 50% by 2025. In the short run, a decline in nuclear power generation would lead to a drop in the French external balance, which is characterized by a large surplus compared to all its neighbours since the 1980s (+65 TWh_e in 2016 and +36 TWh_e in 2017; RTE, 2018). EDF (French national nuclear operator) and the other operators would then have to compensate by:

- (i) Importing electricity during peak periods, drawing on the thermal capacities of the neighbouring countries (nowadays, mostly gas turbines and coal plants);
- (ii) Installing additional open cycle gas turbines.

This, to the detriment of its policy of reducing greenhouse gases (GHG) emissions (see e.g. ANCRE (French National Alliance for Energy Research Coordination), 2017). The 50% objective however remains theoretical to date. Decommissioning of nuclear reactors could start from 2029, but this will also depend on the *Programmation Pluriannuelle de l'Énergie* (PPE), currently being discussed (publication planned for 2018). The LTECV has however limited the installed net capacity of nuclear power to 63.2 GW_e, which requires discontinuation of an existing reactor for any new reactor commissioned. In particular, the Fessenheim station is to be closed before connecting the Flamanville's Evolutionary Power Reactor (EPR) to the grid (planned for 2019).

In practice, EDF is willing to extend the average plant's lifetime to at least 50 years, provided that the total net capacity do not exceed 63.2 GW_e. Figure III.7.2 depicts the net installed capacity of the French nuclear fleet considering three different reactor lifetime assumptions: 40, 50 or 60 years. If the reactors are decommissioned after 40 operating years, the installed capacity will be decreased by about 21 GW_e between 2017 and 2023. If reactors are decommissioned after 50 operating years, the installed capacity will remain constant until 2029, which may cope with the fuzzy policy objectives (to be re-defined in 2018 with the new PPE). EDF is also considering to build two additional EPR of 1650 MW_e each towards 2030, but this is still in the discussion stage. Doing so would require to simultaneously close previous reactors so as to cope with the 63.2 GW_e limit. EDF would have to determine which reactors are the best suited for early decommissioning, its aim being to optimize the cashflows while securing the power grid balance (discussing with Enedis). The decision would ultimately result from bilateral or multilateral negotiations between diverse stakeholders such as the nuclear operator, the nuclear safety agency and the public authorities. Alongside, the civil society (through e.g. non-governmental organisations) and the media could affect the results of these negotiations, which also depend on unpredictable events (e.g. occurrence of nuclear incidents, increasing pressure for climate change mitigation, variation of fossil-fuels prices).

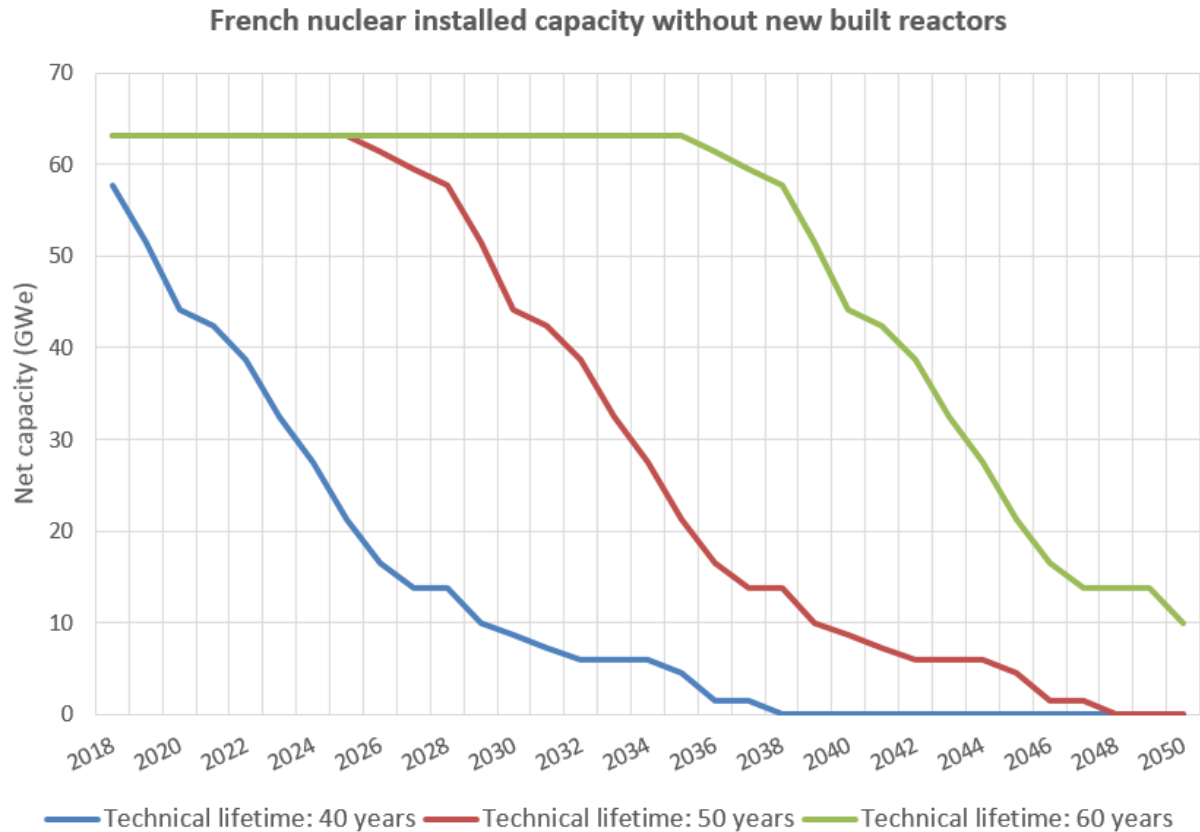

Figure III.7.2: The evolution of the French nuclear capacity if no new reactor is built.

Notes:

Data from CEA (French Nuclear and Alternative Energies Commission, 2017) were used, considering the date of the last ten-year check-up.

2.1. Towards 2050

If no new reactor is built, the nuclear phase out could occur between 2040 and 2050 (see Figure III.7.2). At this time horizon, a fully renewable power mix may not be possible in the EU. Wang *et al.* (2016) have shown that, under the most favourable conditions (e.g. increase of interconnexion capacities among EU members), renewables could technically reach a maximum of 60% of total EU power production. Wang *et al.* (2016) also emphasize that such a scenario present challenges in terms of dynamic stability, with frequency excursion potentially reaching security limit. Besides, the economics of such a system may be an issue, as the cost of integrating renewables grows along the share it represents in the system. Given the current maturity of technologies (in particular storage), Wang *et al.* (2016) have calculated that the main flexibility provider would be fossil backup plants (working less than 1500 hours/a) and curtailment. To achieve a 60% wind and solar share, the back-up capacity (combined cycle gas turbine and open cycle gas turbines) should be increased by 40-50% compare to a scenario without wind and solar. The need for base-load plants (i.e. working more than 4500 hours/a) in the EU would decrease by about 40% (from 390 GW_e without renewables down to 230 GW_e with 60% renewables).

In France, replacing base-load nuclear units with gas fired plants would lead to counterproductive effects on climate change mitigation. While nuclear plants can, to a large extent (technically speaking), provide further flexibility to the grid (Cany, 2017), doing so could decrease the load-factor of plants. This may in turn lead to higher production costs, which would be a financial issue for EDF. To help maintaining the competitiveness of nuclear power production in energy systems with large share of renewables, both the market rules and the technical requirements of nuclear plants (e.g.

increased flexibility) may need to evolve. Under this context, operating nuclear plants in a cogeneration mode could prove to be beneficial in at least three ways:

- Ensuring the flexibility of the power production while maintaining high load-factor levels;
- Reducing the GHG emissions of the heat sector;
- Providing affordable heat energy to consumers (to be determined on a case by case basis; see Part I or Section 3.2.2).

In addition to the two EPR (3.2 GW_e net total) possibly planned by EDF towards 2030, Figure III.7.2 suggests that new reactors will be required between 2030 and 2050, and this even if solar and wind are to play a greater role. Let us consider a radical case that sees a decrease in the electricity demand by 10% towards 2050 relative to 2015 levels, 80% of this demand being supplied with renewables (either intermittent or not) and 3% with fossil-fuelled power plants (divided by two compare to 2015). Without entering into the debate on the technical feasibility of such a mix, it is interesting to note that about 13 GW_e new nuclear capacity would still be required (see Figure III.6.2; considering 50 years old as the average lifetime of the nuclear fleet). Subtracting the three EPR that could be implemented before 2030 (Flamanville plus two others), five new reactors of 1650 MW_e would thus be required between 2030 and 2050. Several studies point out the need for a larger number of newly built reactors towards 2050 if the French electricity grid is to remain secured. E.g. SFEN (French nuclear energy association) and ANCRE consider that a total of 20 and 30 reactors are required, respectively (ANCRE, 2013; SFEN, 2018).

Whatever is the number of reactors built, there will always be heat that cannot be converted to electricity. When planning for a new nuclear plant, the siting and the construction schedule should be determined taken into account the potential benefits that this new unit could offer to the heat sector, either for DH purpose (see Section 3) or for industrial process heating (Section 4).

3. Potential for heat transfer from nuclear plants to DH systems

Sub-Section 3.1 first evaluates the DH potential in France using the best available data on the residential and commercial space heating and domestic hot water demand (hereafter simply referred to as 'heat demand'). Sub-Section 3.2 then builds and discusses prospective scenario that see a part of potential DH systems being supplied with NCHP.

3.1. GIS based analysis of the DH potential in France

Sub-section 3.1 is organised as follows: Sub-section 3.1.1 describes the scope of research, sub-section 3.1.2 details the data collection process and sub-section 3.1.3 explains the methodology and assumptions used. The results are accordingly given in sub-section 3.1.4. Sub-section 3.1.1 ends with discussions and limitations.

3.1.1. Research scope

Sub-Section 3.1 aims to assess the DH potential using a geographic information system (GIS). With increasing focus on the importance of local conditions for heat planning and the progress made in GIS and computer technology, the need for spatial methods such as GIS in heat planning is gaining ground. GIS based analysis of the DH potential has been carried out for countries such as Denmark (see Nielsen and Möller, 2013), revealing that 63% of the Danish built-up area is suitable for DH) or the United States (see Gils *et al.*, 2013), highlighting that 43% of residential and commercial heating could be cost-effectively supplied by DH systems. An interesting study focuses on the potential for DH in Europe (Connolly *et al.*, 2014), examining the possibilities based on the NUTS3 classification instead of

using the usual national perspective. Recently, the heat roadmap for Europe (2015) provided valuable information to GIS based DH research. However, surprisingly little attention has been given to the potential expansion of DH in France. Section 3.1 fills this research gap using the best available data.

The main focus of Sub-section 3.1 is defined by the following research questions:

- What is the DH potential under the current conditions in France on a regional and a global level?
- What is the DH potential if the heat demand in buildings is uniformly reduced by 50% (the target set by national authorities for 2050; see (*Assemblée nationale* (French national assembly), 2015)?

This study focuses on the linear heat density ($\text{MWh}_{\text{th}}/\text{m. a}$) of potential DH systems in order to determine the economic feasibility of the distribution side (Nielsen and Möller, 2013; Persson and Werner, 2011). This approach has the advantage of allowing each stakeholder to form its own opinion of the DH potential based on transparent indicators. The drawback is that it does not allow us to determine whether implementing DH networks in the identified areas would have a greater economic potential than individual heating solutions. To answer this question, future analysis could consider comparing the DH cost (including production, transmission and distribution costs) for each area against the least-expensive individual options (which are heat pumps in Denmark according to Nielsen and Möller, 2013). Section 3.1 nonetheless provides a unique assessment of the DH potential in France at a regional level, based on high-resolution data.

3.1.2. Data collection

Most of the data here used was taken from CEREMA (French Research Centre on Risks, Environment, Mobility and Territorial Planning, 2015), which provides the spatialized residential and commercial heat consumption ($\text{kWh}_{\text{th}}/\text{a}$) for France in 2015 using a resolution of $200\text{m}\times 200\text{m}$. This represents a total of 5,356,608 grid cells, thus implying time-consuming GIS calculations. Data from CEREMA (2015) was provided for the 13 new French regions (there were 22 regions in France prior to 2015).

Given the method adopted (see sub-section 3.1.3), information on the specific heat demand ($\text{kWh}_{\text{th}}/\text{m}^2. \text{a}$) of buildings at a regional level also appeared to be crucial. Data collection was however difficult due to large variations in the quality of data sources from region to region. The change in number and geographic boundaries of the French regions in 2015 has made collecting data an even more tedious task. Regional residential and commercial heat demands and buildings performance levels are not analysed on a regular basis. Thus, the most recent studies were often led before the new regional configuration. Given that the spatialized heat demand from (CEREMA (French Research Centre on Risks, Environment, Mobility and Territorial Planning), 2015) is given for the new regions only, the specific heat demand of these regions was required. Provided that the new regions were always strictly made of one or several previous regions, Q_N , the specific heat demand of residential and commercial buildings in these new regions ($\text{kWh}_{\text{th}}/\text{m}^2. \text{a}$) was calculated according to equation (1):

$$Q_N = \sum_{i=1}^n w_i \cdot Q_{P,i} \quad (1)$$

Where n is the number of previous regions composing the new region, $Q_{P,i}$ is the specific heat demand of buildings in the previous region i , and w_i is the share of the heat demand of the previous region i in the total heat demand of the new region.

Table III.7.1 shows the specific heat demand ($\text{kWh}_{\text{th}}/\text{m}^2. \text{a}$) of the new regions (resulting from formula (1)). For the sake of brevity, the 22 references of the studies carried out by the public authorities in the 22 previous French regions (providing $Q_{P,i}$ and w_i values) are not provided. We encountered a problem when collecting data from these 22 reports because that publication dates varied from 2005 to 2015. Due to the refurbishment and replacement of buildings, specific heat demands in 2015 can be slightly different from what there were in 2010 or 2005. The 2015 values were nonetheless required to increase accuracy, given the fact that data from CEREMA (2015) concerned the year 2015. The values in Table III.7.1 were extrapolated to 2015 to standardize the specific heat demands, taking into account the publication date of reports and a 0.5%/a decreasing rate. Building

consumption would decrease by 0.5%/a during the period 2008-2020 in France according to the business-as-usual scenario in the ENTRANZE study (ENTRANZE, 2014), a research program supported by the European Commission (EC).

	Population (millions)	Heat demand, (CEREMA, 2015) (TWh _{th} /a)	Specific demand (kWh _{th} /m ² . a)
Auvergne-Rhône-Alpes	7.7	95.8	158
Bourgogne-Franche-Comté	2.8	60.0	201
Bretagne	3.3	33.2	144
Centre-Val de Loire	2.6	137.5	150
Corse	0.3	3.7	129
Grand Est	5.6	81.1	155
Hauts-de-France	6.0	139.5	160
Île-de-France	12.0	108.6	158
Normandie	3.3	48.0	175
Nouvelle Aquitaine	5.8	97.8	129
Occitanie	5.7	72.3	149
Pays de la Loire	3.7	58.0	145
Provence-Alpes-Côte d'Azur	5.0	55.7	122

Table III.7.1: Population, heat demand and average specific heat demand by regions. Data for 2015.

Notes:

'Heat demand' refers to space heating and domestic hot water demand for residential and commercial buildings.

3.1.3. Methodology

Sub-section 3.1.3 first describes the model used to assess the length of DH pipes required to connect all buildings in a given grid cell, using data from Section 2.1.2. Sub-section 3.1.3 then describes the assumptions used to select the potential DH areas.

DH distribution model

The concept of effective width, w (m), is used to model the linear heat density of DH networks even in areas where no DH network is implemented, as defined in equation (2):

$$w = \frac{A_L}{L} \quad (2)$$

Where A_L is the total surface area (m²), and L is the total length of DH pipes required to heat the buildings in the area. Based on real data from 83 EU cities (including 31 in France) in which DH provides on average 21% of the heat load, (Persson and Werner, 2011) shows that w can also be expressed as in equation (3):

$$w = 61.8 \left(\frac{A_B}{A_L} \right)^{-0.15} \quad (3)$$

Where A_B is the total building space area (m²). A_B can be computed using equation (4):

$$A_B = \frac{Q_s}{Q_N} \quad (4)$$

Where Q_s is the annual heat sold to DH consumers in the given area (kWh_{th}/a), and Q_N is the specific heat demand of buildings (kWh_{th}/m².a). As explained in sub-section 3.1.2, Q_s is provided by (CEREMA, 2015) at a resolution of 200m×200m, and Q_N is shown in Table III.7.1 at a regional level.

By referring to formulas (2), (3) and (4), L , the total length of DH pipes required to connect all buildings in a given grid cell (m) can be calculated. Q_s/L , the linear heat density (MWh_{th}/m. a), results directly from these computations.

Identification of potential DH areas

Combined with the data collected in sub-section 3.1.2, the DH distribution model in sub-section 3.1.3.1 allowed us to identify grid cells in which the connexion of all residential and commercial buildings to a DH network would result in a high linear heat density ($\text{MWh}_{\text{th}}/\text{m. a}$). A high linear heat density is crucial for the economic viability of DH systems, since the capital costs of the distribution network dominate the DH system costs (Gils *et al.*, 2013; Persson and Werner, 2011). French public authorities consider that there is a DH potential when the linear heat density exceeds $1.5 \text{ MWh}_{\text{th}}/\text{m. a}$ (ADEME (French Environment and Energy Management Agency), 2017). Above this threshold, low-carbon DH networks can apply for public subsidies [3]. It worth stressing that $1.5 \text{ MWh}_{\text{th}}/\text{m. a}$ is often seen as a conservative assumption by the DH literature. For instance, Gils *et al.* (2013) has considered a feasibility threshold of $5 \text{ GWh}_{\text{th}}/\text{km}^2$ (about $0.4 \text{ MWh}_{\text{th}}/\text{m. a}$ with the method given in sub-section 3.1.3.1) to assess the DH potential in the United States.

In France, however, the average linear heat density of current DH networks vary from $2.5 \text{ MWh}_{\text{th}}/\text{m. a}$ in Corsica to $6.7 \text{ MWh}_{\text{th}}/\text{m. a}$ in Île-de-France (SNCU (French National Union for District Heating), 2017; Viaséva (French DH association), 2017). To provide additional insights, Section 3.1 considers three ranges of linear heat density, $1.5\text{-}4.0 \text{ MWh}_{\text{th}}/\text{m. a}$, $4.0\text{-}8.0 \text{ MWh}_{\text{th}}/\text{m. a}$ and above $8.0 \text{ MWh}_{\text{th}}/\text{m. a}$. After eliminating all grid cells with a potential linear heat density falling outside the selected range, neighbouring cells of corresponding linear heat density were grouped into agglomerations. In metropolitan areas, these agglomerations can have sizes representing many square kilometers, but there are also examples comprising a single cell. For further analysis, each agglomeration was assigned to one region before the annual heat demand ($\text{TWh}_{\text{th}}/\text{a}$), the share of potential DH in the total heat consumption (%), and the average size of agglomerations (km^2) were determined. These parameters provide the basis for our analysis of the DH potential in France.

3.1.4. Results

Considering the heat demand in 2015 and a minimum linear heat density of $1.5 \text{ MWh}_{\text{th}}/\text{m. a}$, the overall DH potential was estimated at $323 \text{ TWh}_{\text{th}}/\text{a}$, i.e. 62% of the total demand for space and hot water heating in residential and commercial buildings. The 43,565 agglomerations and the supplied heat are distributed rather unevenly across the country; half of the potential – around $164 \text{ TWh}_{\text{th}}/\text{a}$ – is located in the regions of Centre-Val de Loire, Hauts-de-France and Île-de-France (see Figures III.7.3, III.7.4 and III.7.5). Very little potential - less than $1 \text{ TWh}_{\text{th}}/\text{a}$ - is available in Corsica. Climate conditions, specific heat demands and population urban densities explain the significant differences in the potential. This distribution of the potential is also reflected by the potential DH share in the total heat demand. It ranges between 40% in Bretagne to 86% in Île-de-France. Figure III.7.5 reflects the variation in the number and size (km^2) of the agglomerations where DH is feasible. The average heat supply per agglomeration varies from 4.7 and 4.9 $\text{TWh}_{\text{th}}/\text{a}$ in Bretagne and Bourgogne-Franche-Comté respectively, to 20.6, 26.8 and 26.8 $\text{TWh}_{\text{th}}/\text{a}$ in Hauts-de-France, Centre-Val de Loire and Île-de-France respectively. The size and heat supply of the agglomerations increase with the increasing linear heat density because only the most 'attractive' agglomerations, which are generally the widest (in km^2), are still supplied with DH. Larger agglomerations involve larger DH networks and greater production unit capacities; they are therefore potentially more efficient.

Taking into account the national policy objective of reducing the global heat demand by 50% in 2050 compared with 2015 (*Assemblée nationale*, 2015), the DH potential has been assessed considering a uniform decrease in building consumption by 50% and a fixed population urban density. In this scenario (see Figure III.7.6), the DH potential above $1.5 \text{ MWh}_{\text{th}}/\text{m. a}$ is $122 \text{ TWh}_{\text{th}}/\text{a}$, i.e. 46% of the total reduced heat demand. This is 5 times larger than current DH deliveries to French networks, which are shown in Table III.7.2. A 50% reductions is however an ambitious objective towards 2050, which may not be achieved in practice. If the renovation rate remains equal to 1% per year (Chirat and Denisart, 2016) and if all new buildings respect the RT2012 requirements ($40 \text{ kWh}_{\text{th}}/\text{m}^2. \text{ a}$), the heat demand would be reduced by 15% and 30% towards 2030 and 2050, respectively (relative to 2012). Yet, all the new buildings do not respect the RT2012 standards (AMORCE, 2015). Besides, human

behaviour (e.g. windows being open or closed, temperature setting of the thermostatic valves in radiators) can lead to heat demand levels that are 50% higher than those anticipated in prospective studies (Dalla Rosa and Christensen, 2011). For example, the average temperature of French dwellings rose from 19°C to 21°C between 1986 and 2003 (ADEME, 2008), implying that the heat demand reduction was lower than what could have been expected in 1986. If the effort to increase the renovating rate and to inform consumers is not increased significantly, it is reasonable to expect lower heat demand reduction than what is targeted by the French law (LTECV). A diminution of 20 to 30% by 2050 compare to 2012 is a realistic assumption for France. This means that, in 2050, more than 50% of the heat demand will be located in areas suitable for DH.

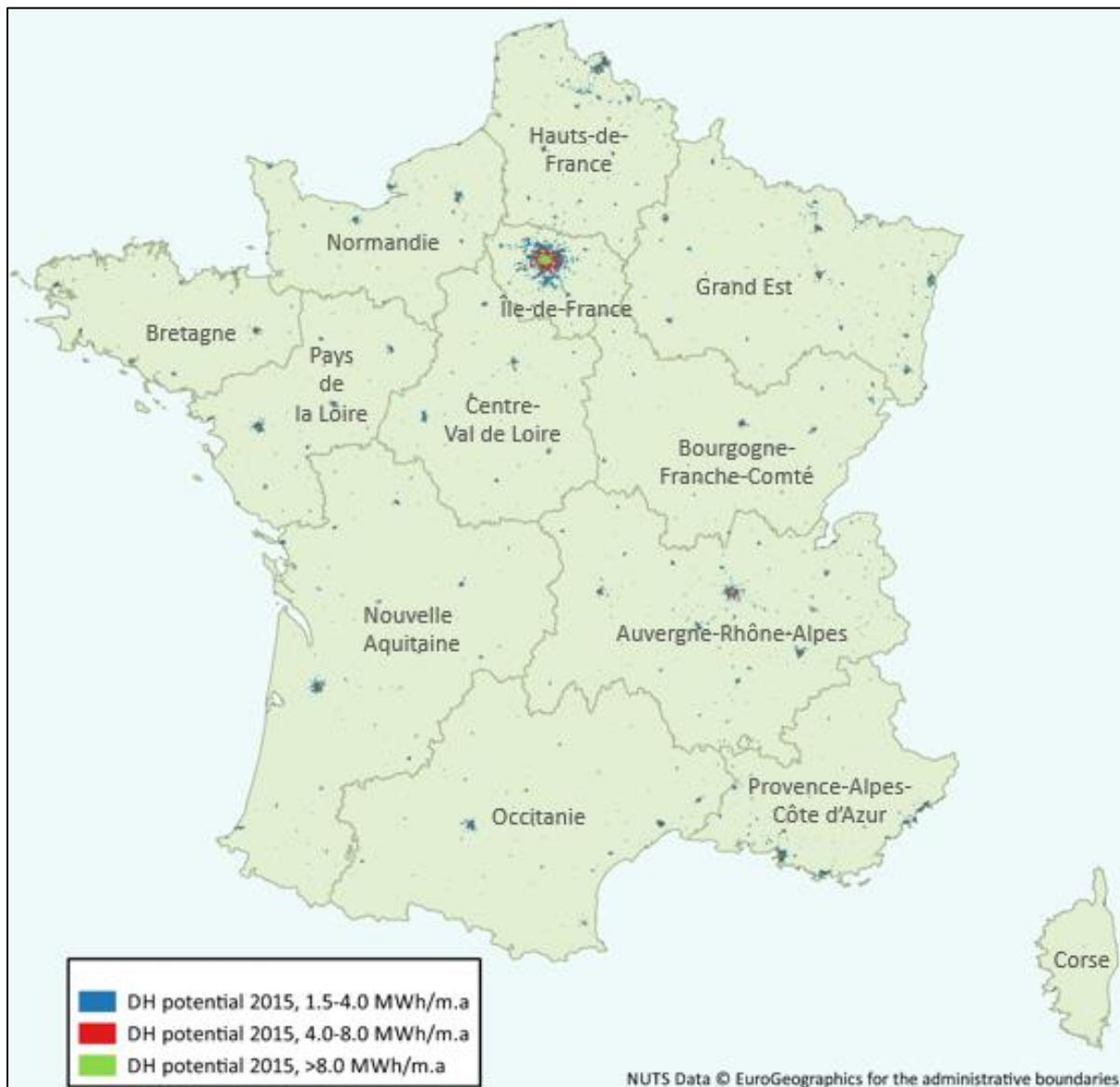

Figure III.7.3: Spatial mapping of the DH potential in France according to the three linear heat density ranges.

Notes:

For computational reasons, Figure 1 uses grid cells of 1 km². All results and other figures in Section 3.1 are however based on 200×200m grid cells (25 times smaller), as explained in sub-section 3.1.2.

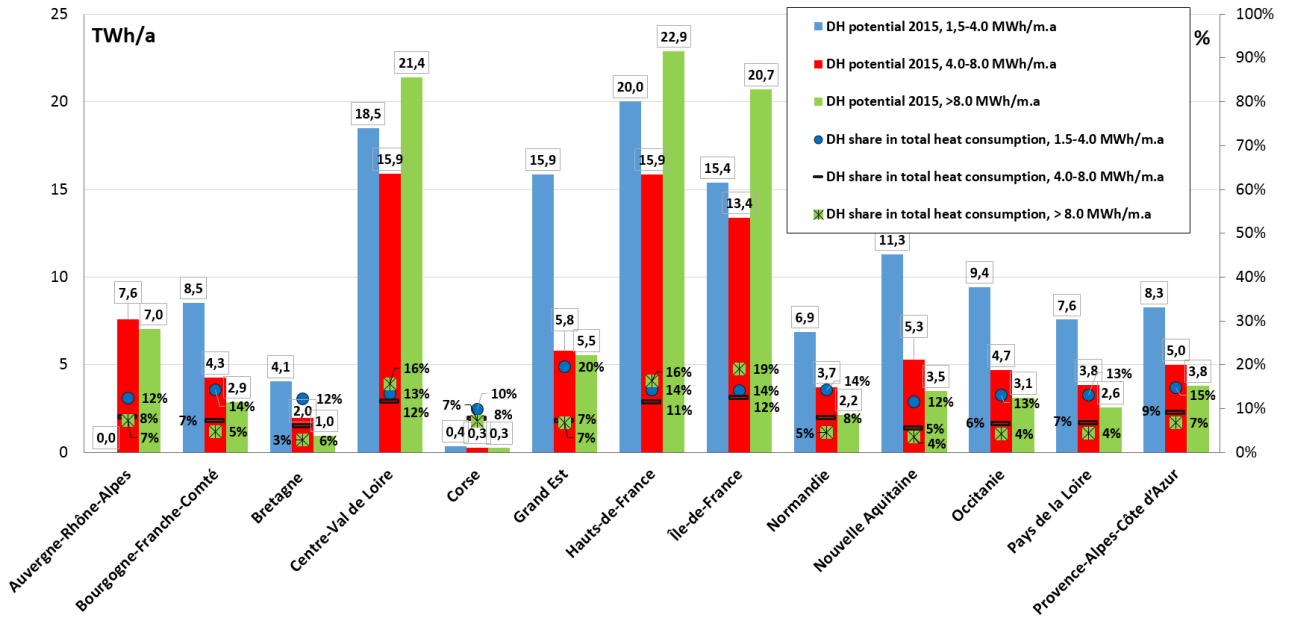

Figure III.7.4: DH potential by region based on the 2015 heat demand. Potential DH heat consumption (TWh_{th}/a) and DH share in the total heat demand (%) for three ranges of linear heat density.

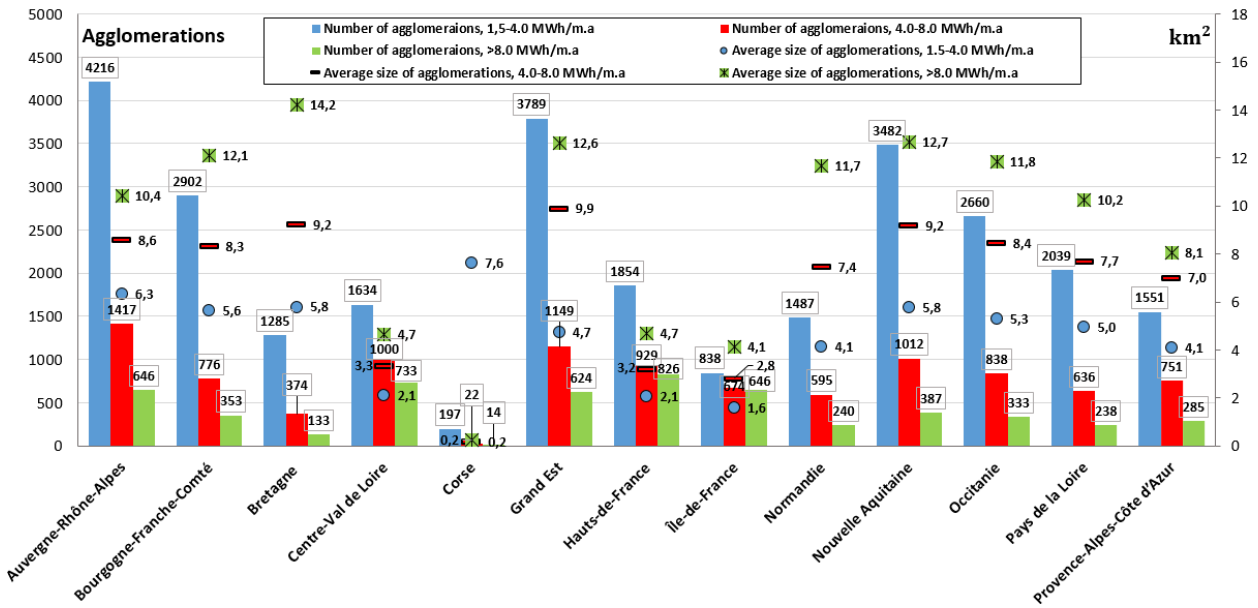

Figure III.7.5: Number of agglomerations and average size of agglomerations (km²) corresponding to the DH potential identified in Figure III.7.4.

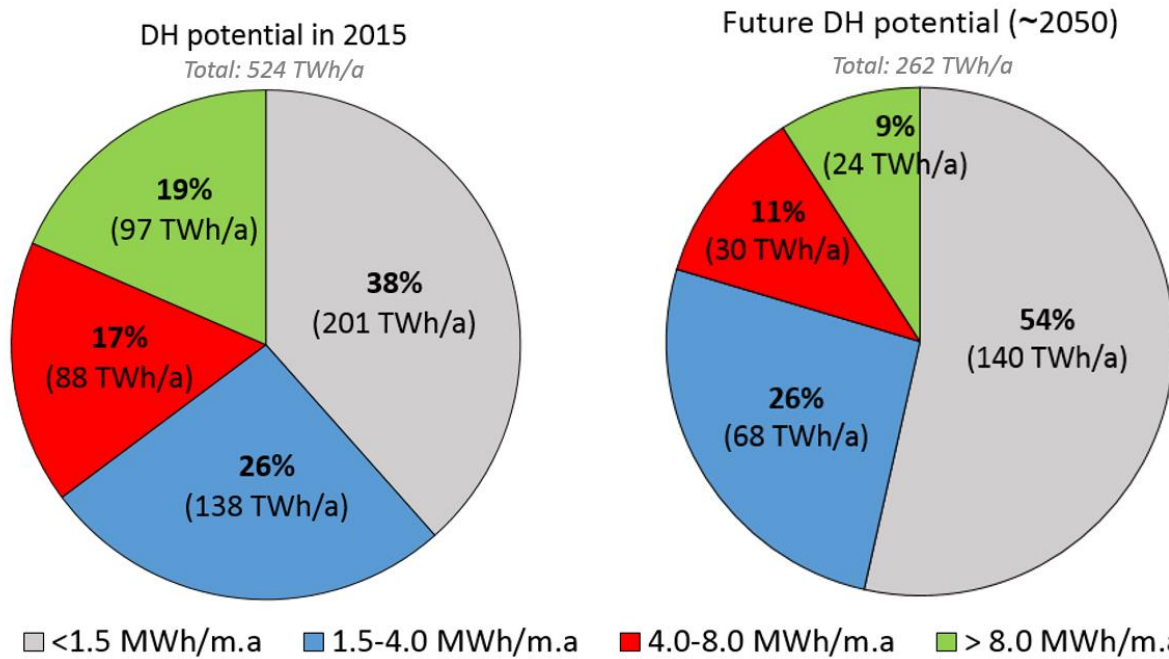

Figure III.7.6: Global DH potential in France. Left: DH potential based on the 2015 heat demand. Right: DH potential when the 2015 heat demand is uniformly reduced by 50%.

3.1.5. Discussions and limitations

If the national objective of reducing the heat consumption of buildings by 50% around 2050 compared with 2015 is achieved, the DH potential would still represent 46% of the total space heating and domestic hot water demand in residential and commercial buildings (122 TWh_{th}/a), which is 5 times higher than current DH deliveries. Furthermore, this does not consider the fact that the heat density thresholds for DH feasibility may decrease in the future. DH systems could indeed benefit from higher efficiency in buildings. If adequate measures are taken to minimise the return temperatures, lower temperature requirements in radiators would make it possible to reduce DH grid losses and pipe diameters (Averfalk and Werner, 2017). In addition, DH utilities would be able to use plastic piping, which can be more cost-effective than conventional DH metal-based pipes (Schmidt *et al.*, 2017). This concept, referred as 4th generation DH (Lund *et al.*, 2014), also enables the further integration of renewable and excess heat sources, as well as a higher level of efficiency for conventional production units. In areas with the lowest density (e.g. city boundaries and park areas in cities), a robust life cycle analysis should be led to determine whether the environmental benefits of the planned DH schemes are greater than those of efficient individual systems such as heat pumps.

	DH deliveries (GWh _{th} /a) (*)	Average heat density (MWh _{th} /m. a) (*)	linear density	Number of DH networks (*)	DH share in total heat demand (**)	Central heating share in residential buildings (INSEE, 2014)
Auvergne-Rhône-Alpes	3024	3.9		145	4.8%	21%
Bourgogne-Franche-Comté	1160	3.3		58	4.5%	16%
Bretagne	577	4.1		22	2.6%	7%
Centre-Val de Loire	857	6.1		23	3.6%	11%
Corse	9	2.5		1	0.3%	4.4%
Grand Est	2610	4.4		85	4.4%	17%
Hauts-de-France	1467	4.0		45	2.7%	11%
Île-de-France	11445	6.7		102	12.0%	38%
Normandie	1253	4.6		44	4.4%	15%
Nouvelle Aquitaine	668	4.1		51	1.3%	7%
Occitanie	548	3.0		41	1.4%	6%
Pays de la Loire	640	2.8		26	2.2%	10%
Provence-Alpes-Côte d'Azur	338	3.3		27	1.2%	19%

Table III.7.2: Existing DH networks by region.

Notes:

(*) All data is from SNCU (2017) but for the Corsica and Provence-Alpes-Côte d'Azur regions given that this reference not provide separate statistics for these two regions. Data from Viaséva (2017) was used instead.

(**) Data from SNCU (2017) and Viaséva (2017) was combined with data from column 3 of Table III.7.1, Section 2.

While sub-Section 3.1 offers a sound preliminary estimate of the DH potential in France, the fact remains that at least three simplifications were made:

- The heat demand density map tends to underestimate the demand because we limited ourselves to the residential and commercial sectors while neglecting the industrial process heat demand. Besides, there could be some statistical errors due to the key data source used (CEREMA, 2015).
- A GIS method similar to ours was previously applied in (Gils *et al.*, 2013; Nielsen and Möller, 2013; Persson and Werner, 2011). These approaches rely on an empirical correlation between the heat density in a given area (kWh_{th}/a) and the DH pipes required to connect all buildings in this area (see Section 3.1.3.1). Figure III.7.7 shows an example of built up areas of the same square meters and heat demand. While the statistical method here used would give the same linear heat density (MWh_{th}/m. a) for both the areas of Figure III.7.7, the total length of pipelines required to connect all buildings would be different in reality. To improve the accuracy of the assessment, future research could use existing geographic entities based on the road network, similar to what is done in Nielsen (2014) and Unternährer *et al.* (2017).
- The DH potential was assessed based on the assumption that all residential and commercial buildings would be supplied. In reality, buildings without central heating systems cannot be connected to DH without refurbishing the heating infrastructure. The problem lies in the fact that only 17.6% of French residential buildings are equipped with central heating systems (see Table III.7.2), and most of new urban dwellings still install individual electric or gas boilers (AMORCE, 2015). Given that individual systems are less efficient and generate larger operational costs than central heating systems (see Danish Energy Agency reports), it is crucial to reverse this trend. To increase connexion rates, DH actors should focus on building up consumer trust. This requires greater transparency (easier understanding) of heating tariffs, simplified access to data and smart metering systems (AMORCE, 2017). Recent initiatives from DH operators such as Dalkia (implementing a smart digital platform for the Clervia network) or Engie (simplifying the heating

tariffs for the Sevrans system) can serve as examples of best practices. The process of exchanging knowledge between multiple players and countries is also a crucial aspect of unlocking the DH potential in 'learning countries' such as France.



Figure III.7.7: Example of built-up areas with the heat density ($\text{GWh}_{\text{th}}/\text{km}^2$) but different DH pipe length (m). Data source: Nielsen (2014).

Notes: Please refer to the second bullet point here above for some comments on this Figure.

3.2. Prospective scenario introducing heat transfer from nuclear plants to DH systems

Sub-Section 3.2.1 first presents a scenario depicting the evolution of the energy sources used for space heating and domestic hot water production in the French residential and commercial sectors towards 2050. Sub-Section then builds and discusses a scenario that see the introduction of eight DH systems supplied with heat from nuclear plants. Sub-Section 3.2 ends with the conclusion.

3.2.1. Heat generation in residential and commercial sectors

France is still a 'DH learning-country' where DH systems supply about 7% of the total heat demand (AMORCE, 2015). The share of renewable or excess heat sources in the total DH deliveries to French networks increased from 7.9 $\text{TWh}_{\text{th}}/\text{a}$ in 2009 to 13.8 $\text{TWh}_{\text{th}}/\text{a}$ in 2017 (SNCU, 2017). This leap can be partly attributed to the public DH support set up by the government in 2009 (SNCU, 2017). However, DH supply based on renewable or excess heat sources will have to be tripled to achieve the French policy objectives towards 2030, the national objective being 39 $\text{TWh}_{\text{th}}/\text{a}$ (*Assemblée nationale*, 2015).

When tripling the renewable and excess DH deliveries, the amount of fossil-fuelled DH generation would also increase (e.g. for peak-load generations in winter). Assuming that DH systems will use on average 66% of renewable or excess heat sources towards 2030 (it was 53% in 2016; see SNCU, 2017) led us to consider that the overall DH deliveries would increase by 400% towards 2030 relative to 2015. The scenario shown in Figure III.7.8 combines the projection of the last PPE (*Ministère de l'environnement, de l'énergie et de la mer*, 2016) regarding the heating source targets (e.g. direct use of biomass, electric heaters) with the LTECV objective of reducing the total heat demand by 50% towards 2050 compare to 2012 (*Assemblée nationale*, 2015). The scenario copes with the PPE objective towards 2030 (increasing by 50% the heat generated with renewable or excess sources, and registering 25 MWh_{th} of DH deliveries from these sources). It also satisfy the PPE aim of multiplying by five the amount of renewable or excess DH deliveries towards 2023 compare to 2012 levels, as well as the

LTECV objective of multiplying by three these same sources towards 2030 compare to 2015 levels. National policies however do not provide targets for the evolution of the heating mix between 2030 and 2050. For DH systems, results from sub-Section 3.1 are used instead. For other technologies, we followed the tendencies targetted by the PPE. Under our scenario, DH systems represent 25%, 30% and 40% of total heat demand towards 2030, 2040 and 2050, respectively. Results from sub-Section 3.1 shows that this scenario could be realised while maintaining the linear heat density of DH networks above $1.5 \text{ MWh}_{\text{th}}/\text{m. a}$, and this despite the expected increase of buildings efficiency.

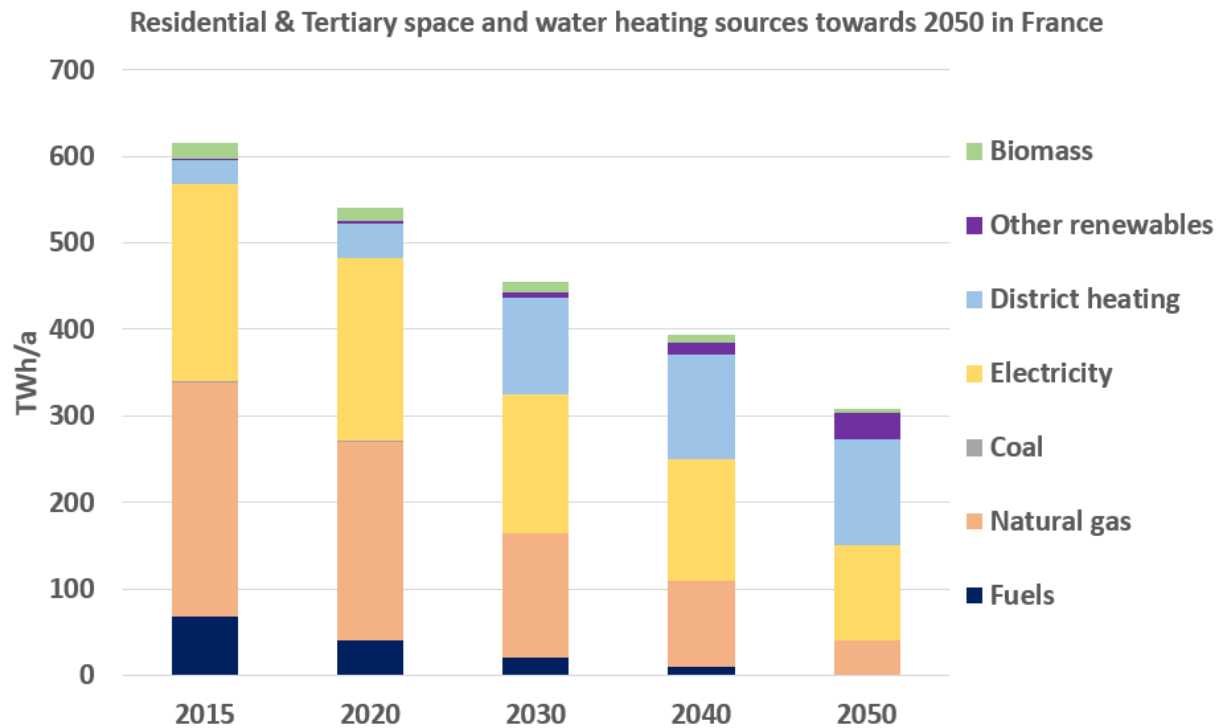

Figure III.7.8: Evolution of the energy sources used for residential and commercial space and water heating.

Notes:

(*) Data for 2015 are from CEREMA (2015).

(**) Projections towards 2020 and 2030 are derived from the latest PPE (2016) and the LTECV targets.

(***) Projections towards 2050 follows the LTECV objective of reducing the heat demand by 50% compare to 2012 levels. Personal estimations prolonging the PPE (2016) trend are made for the distribution of heating sources.

3.2.2. DH generation with nuclear plants

Sub-Section 3.2.2 aims to evaluate the decarbonisation potential of a DH + NCHP implementation scenario coherent with the scenario described in sub-Section 3.2.1. This scenario is shown in Table III.7.3. The nuclear reactors here considered are EPR with a thermal capacity of $4500 \text{ MW}_{\text{th}}$, i.e. the net electric capacity without heat production is about 1650 MW_e . This is the kind of reactor currently privileged by EDF, and this is why it is here used as an illustrative example. Since at least two reactors will be built in each site, the number of reactors to be operated in a CHP mode remain to be determined. The size of the reactors, and type of, could also be discussed (e.g. smaller reactors, heat only reactors).

Overall, the scenario of Table III.7.3 projects the installation of two EPR operated in a partial CHP mode by 2030 (3275 MW_e total), five between 2030 and 2040 (8060 MW_e total) and two between 2040 and 2050 (2880 MW_e total). In the sites where the heat output needed is relatively small, one CHP designed reactor could be enough. The other reactor (at least two reactors per site) could thus be operated in an electricity only generation mode. This means that the scenario of Table III.7.3 foresees

the implementation of 16 newly built reactors towards 2050 (11 in a CHP mode and 5 in an electricity only mode). Due to the ageing of the nuclear fleet and the expected decommissioning during these periods (see Figure III.7.2), the newly built nuclear plants projected in Table III.7.3 are not jeopardizing the reduction of nuclear power production targeted by national authorities (LTECV; see Section 2). 16 reactors over 8 sites, while there are currently 19 nuclear sites. The remaining eleven nuclear sites (19 minus 8) could either serve to install other nuclear plants, either be closed.

The levelised cost of the heat (LCOH; see Appendix I.2.A for formulas) of the DH + NCHP systems are shown in Figure III.7.9. LCOH are calculated using the methods and assumptions of Chapter 3, exception being the calculation of distribution heat losses that follows the equation (6) of Chapter 2. The assumptions regarding energy prices (2015), the discount rate (3.5%) and the operational lifetime (40 years) are the same as used in Chapters 2 and 3. The cost of DH pipelines is yet specific to France (917 €/m; as in Chapter 3), being slightly higher than the assumption made when studying DH + NCHP projects in Europe (formula (7) of Chapter 2, widely used in the DH literature). This explains why the LCOH of Dunkirk, Lyon and Paris systems is higher in this Chapter than what is shown in Chapter 2 (but the Dunkirk' LCOH here presented is similar to the LCOH shown in Chapter 3). These LCOH offer an estimation of the economic potential of each system. Many operational considerations would affect the real costs, which should also be compared with the other low carbon heating systems.

The ratio distance (km) over heat transported ($\text{GWh}_{\text{th}}/\text{a}$) is a good indicator of the techno-economic feasibility of a DH + NCHP project. For the systems shown in Table III.7.3, this ratio varies from 6.7 $\text{GWh}_{\text{th}}/\text{km.a}$ (Poitiers-Civaux) to 151 $\text{GWh}_{\text{th}}/\text{km.a}$ (Paris-Nogent), with 33 and 76 $\text{GWh}_{\text{th}}/\text{km.a}$ for Dunkerque-Gravelines and Lyon-Bugey, respectively. As a comparison, Dalkia is planning to implement (towards 2019) a heat transportation line from the waste-to-energy plant of Vert-Le-Grand to the city DH network (Grand Paris Sud, 2017). 160 $\text{GWh}_{\text{th}}/\text{a}$ of heat will be transported over 7km. Here, the ratio is thus 23 $\text{GWh}_{\text{th}}/\text{km.a}$. The capital investment is 11.7 M€ and the computed payback period is 3-4 years. This, despite the fact that the waste-to-energy plant, which is now producing electricity only, will reduce its electricity efficiency. 5 out of the 8 DH + NCHP systems envisioned in Table III.7.3 are above this threshold (23 $\text{GWh}_{\text{th}}/\text{km.a}$). If hot water DH networks become large enough in these areas, then the connexion to a NCHP would make sense from the techno-economic viewpoint of a French DH operator.

Table III.7.3 provides the length (km) of DH pipes to be installed within each urban area in order for the (hot water) DH network to be of a sufficient size (km; shown in Table III.7.3) so as to make a connexion with the nearby NCHP potentially cost-effective. Connexion would occur in 2030, 2040 or 2050, depending on systems. The deployment of large DH networks is not straight-forward but rather follows an organic growing process. In European cities with large DH share, the DH expansion has been spread over several decades (see Figures III.7.10 and III.7.11 for the examples of the Stockholm and Helsinki DH networks, respectively). Small DH networks are first built, then extended, and finally connected to other networks so as to constitute a large DH network covering most of the city loads. Implementing the DH networks of Table III.7.3 would require to build between 3km and 30km of DH pipes a year, depending on cities. As a comparison, an average of 23km of DH pipes a year were commissioned between 1982 and 2010 in the Helsinki agglomeration (see Figure III.7.11). The surface of the Helsinki municipality (213 km^2) is approximatively twice smaller than the surface of the Lyon agglomeration (534 km^2), and slightly lower than the size of the Dunkirk conurbation committee (300 km^2). The assumptions made in Table III.7.3 are realistic in the sense that the length of DH pipelines to be built per land area (km/km^2) is 1000 % to 20 % lower than what was observed in the Helsinki municipality between 1982 and 2010. Large, rapid DH expansion would nonetheless require ambitious and stable public support at all geographical scales (local, regional, national, international; see Chapter 6 and 7). The DH systems here considered overall require the implementation of 147km per year between 2020 and 2030, 93km per year between 2030 and 2040 and 30km per year between 2050 and 2050. As a comparison, 250 to 300km of DH networks have been built every year since the implementation of the *Fonds Chaleur in 2009* (ADEME, 2017). 114 to 197km were subsidized every year by this public fund, covering 30-37% of DH distribution capital costs on average.

Part III, Chapter 7
Prospective analysis of nuclear plant sourced heat utilisation in France

Metropolitan area DH + NCHP project	Dieppe	Dunkirk	Bordeaux	Lyon	Metz	Orléans	Poitiers	Paris
Nuclear site (and distance from the city center; km)	Penly (13)	Gravelines (15)	Blayais (50)	Bugey (30)	Cattenom (35)	Dampierre-en-Burly (50)	Civaux (30)	Nogent-Sur-Seine (90)
Deployment schedule								
DH + NCHP first operational year	2030	2030	2040	2040	2040	2040	2040	2050
DH pipelines to build from 2020 (km/a) (*)	4	20	30	30	18	12	3	30
Technical parameters								
Number of reactors (operated in a CHP mode)	1	1	2	2	1	1	1	2
NCHP thermal capacity (MW _{th})	1×4500	1×4500	1×4500	1×4500	1×4500	1×4500	1×4500	2×4500
NCHP net electric output (MW _e)	1×1645	1×1630	1×1600	1×1570	1×1620	1×1630	1×1640	2×1440
NCHP net DH output (MW _{th})	1×20	1×115	1×330	1×475	1×175	1×130	1×45	2×1250
Total DH supply with NCHP (TWh _{th} /a)	0.1	0.5	1.7	2.3	0.8	0.6	0.2	12.1
NCHP thermodynamic efficiency (%)	37	39	43	45	40	39	37	60
Share of the total heat demand supplied with NCHP (%)	90	70	60	50	70	60	70	30
Total DH length (km)	40	217	647	729	353	257	91	2903
Average linear heat density (MWh _{th} /m. a)	2.7	3.1	3.2	3.9	3.0	3.0	2.8	5.2
Decarbonisation potential								
Equivalent-CO ₂ saved when replacing heat sources used in 2015 (kt eCO ₂ /a)	32	160	544	736	256	192	64	3872

Table III.7.3: Potential deployment of DH + NCHP systems in France. The systems remain to be assessed on a case by case basis and compared with the other heating systems of relevance.

Notes:

The parameter values here presented are based on the research work performed in Chapters 2 and 3.

() Calculated considering the length of DH networks in 2016, using data from Viaséva (2017).*

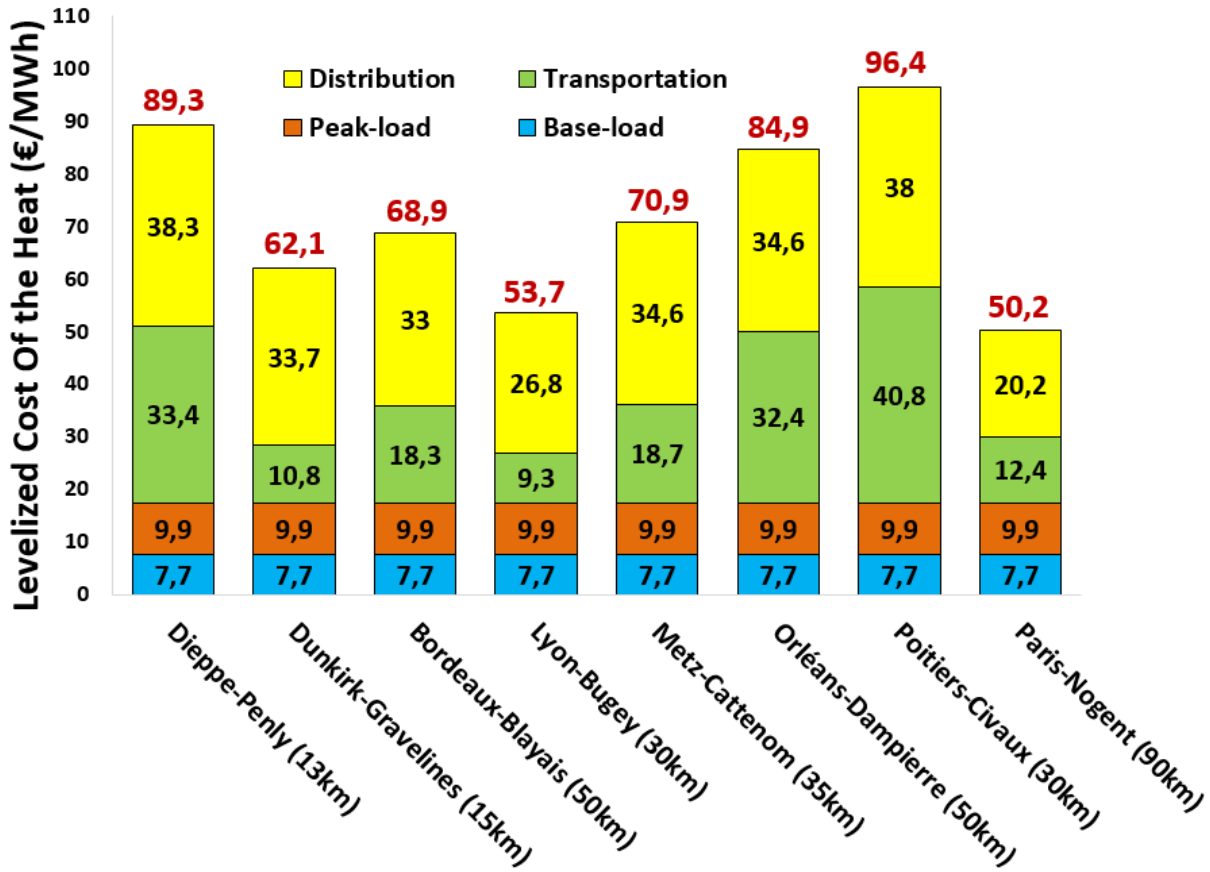

Figure III.7.9: LCOH of the DH + NCHP systems projected in Table III.7.3. Calculated with the method shown in Chapters 2 and 3.

Notes:

LCOH would be reduced by €6.3/MWh_{th} (part of the base-load component) if applying the method shown in Appendix I.3.A (considering that the heat extraction does not generate electricity losses).

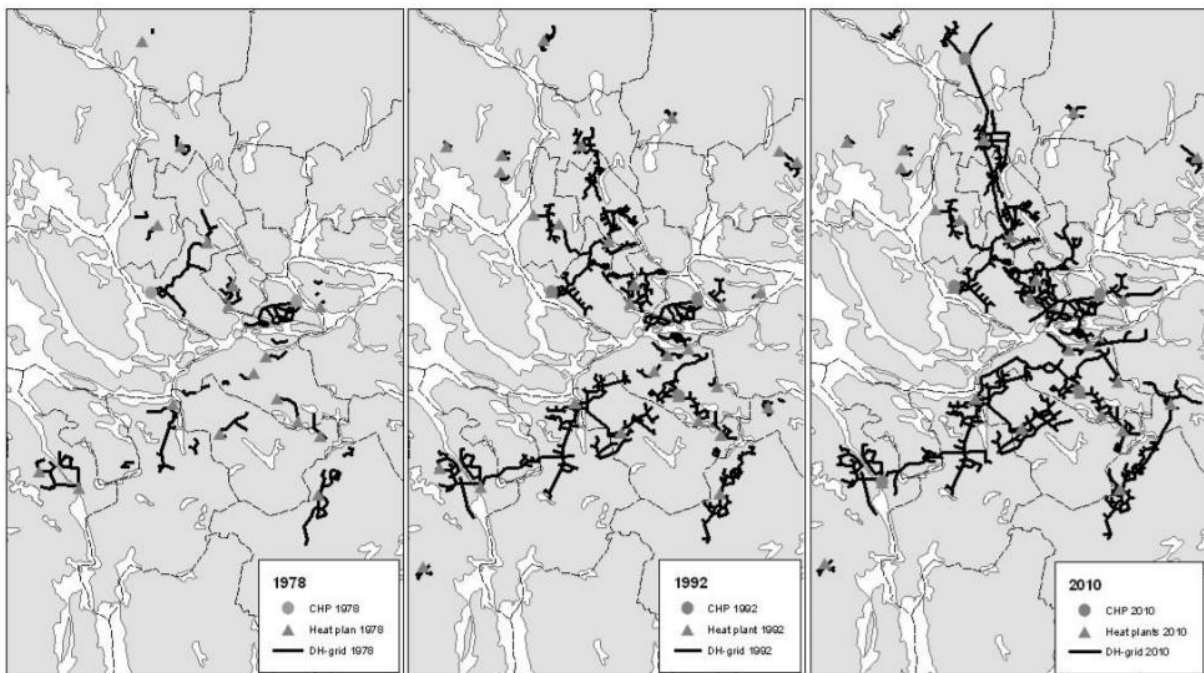

Figure III.7.10: The development of the Stockholm DH systems from 1978 to 2010.

Data source: Magnusson (2010).

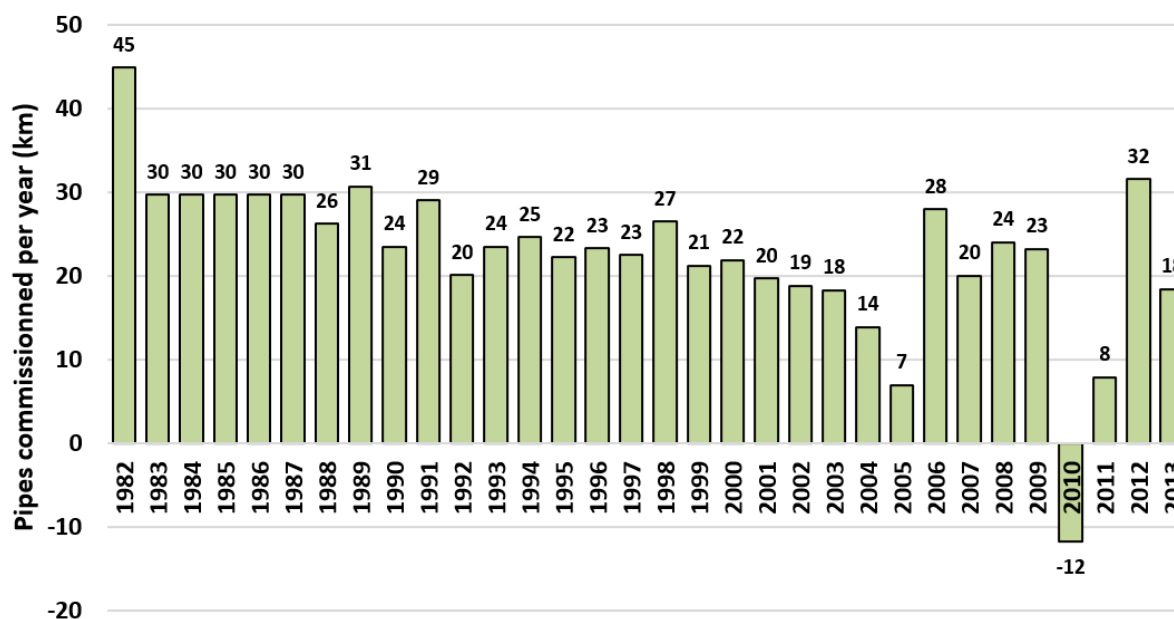

Figure III.7.11: The development of the Helsinki DH systems from 1982 to 2013. Data provided by Miika Rämä (VTT, Technical Research Center of Finland), using the Finnish Statistics (Finnish Energy, 2016).

The new nuclear units required for DH supply could be built and operated before to implement the transmission line from the nuclear plant to the DH distribution network (first operational year shown in Table III.7.3). Once the DH network have reached a sufficient size, the nuclear unit could be retrofitted for CHP applications while building the transmission line. This would require to build the nuclear reactors as ‘CHP ready’, i.e. ready for subsequent modifications so as to be operated in a CHP mode. According to the Energy Technology Institute (ETI, 2016), CHP readiness can be delivered for a small incremental cost, representing approximately 10% of the total capital costs required for an actual CHP upgrade. The implementation of such a design would allow the nuclear operator to start operating the plant in an electricity-only generation mode while remaining open to the CHP option if the market, business and institutional conditions become favourable. In this way, the stakeholders would not have to bear the risk specific to the CHP application at the same time as the risk inherent to traditional electricity-only reactors.

Figure III.7.12 shows how the heat sources of French DH networks could evolve towards 2050 when the DH + NCHP projects shown in Table III.7.3 are implemented. In this scenario, the share of the total heat demand supplied with the DH + NCHP system varies between 30% and 90%, depending on cities. This scenario is in line with the scenario of sub-Section 3.2.1 (Figure III.7.8), and thus cope with the current national policy objectives. The energy sources supplying DH networks towards 2020 are in line with the PPE (2016) objectives. The PPE (2016) targets for 2023 are then extrapolated towards 2050. Heat from NCHP is progressively introduced, following the scenario presented in Table III.7.3. The potential for additional DH networks is large enough to allow the simultaneous deployment of all the low carbon DH sources identified in the PPE, plus the NCHP projects. Under this scenario, the share of renewable and excess heat sources used in DH networks is 50%, 61%, 75%, 82% and 89% in 2015, 2020, 2030, 2040 and 2050, respectively. If the scenario shown in Figures III.7.8 and III.7.12 are both realised, the GHG emissions of the residential and commercial sector would be reduced by about 75% towards 2050 compare to 2015 levels (considering that renewable and excess heat sources are carbon neutral, as commonly assumed in national reports; see e.g. AMORCE, 2015).

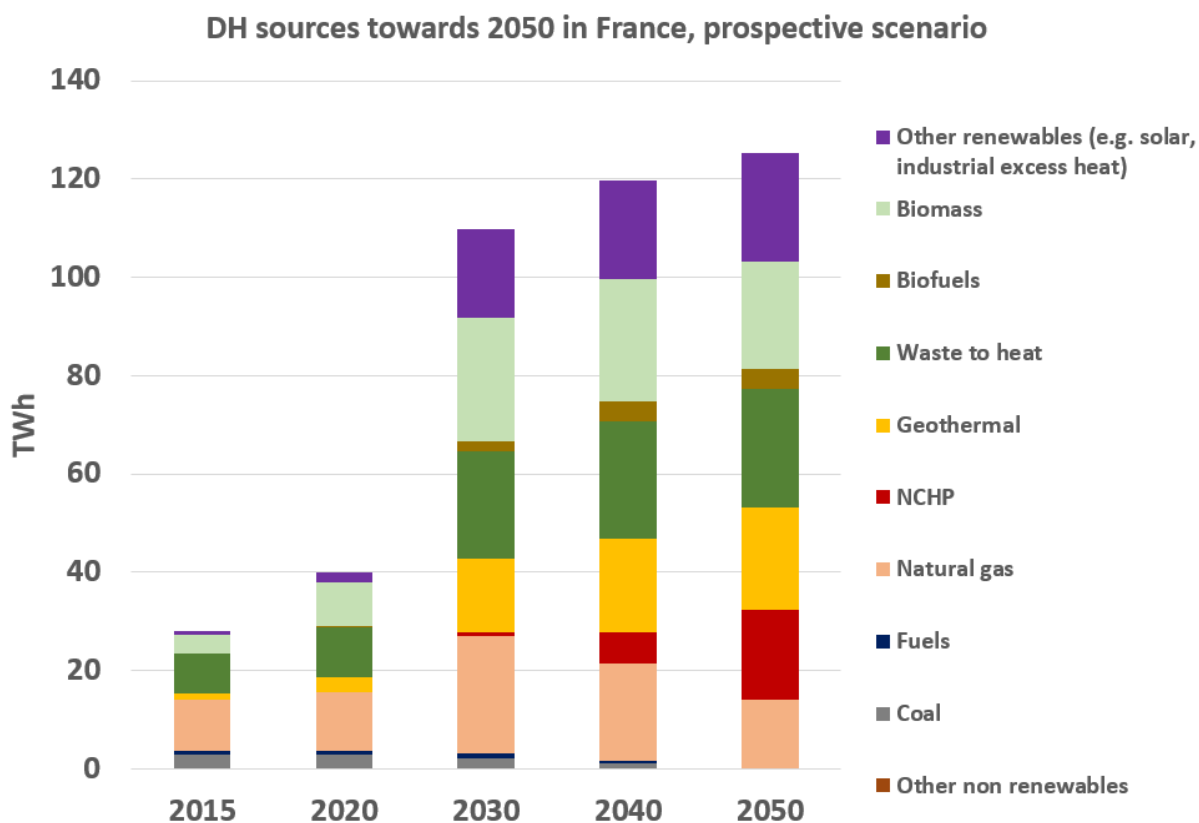

Figure III.7.12: Projected evolution of the energy sources used for DH in France towards 2050.

Notes:

The projection is based on recommendations from French public authorities: PPE (2016) and LTECV (2015) provide targets towards 2023 and 2030, respectively. This is coupled to personal computations introducing the DH + NCHP systems shown in Table III.7.3.

While the scenario of Figure III.7.12 presents $18.3 \text{ TWh}_{\text{th}}/\text{a}$ as a potentially realistic amount of heat supplied to DH networks by NCHP towards 2050, it must be reminded that it is impossible to foresee the exact level of deployment (or absence of deployment), given that radical changes are unpredictable by nature. To offer quantitative estimations of the overall French potential for DH based on NCHP, let us follow the underlying approach of this Chapter. That is, providing large intervals so as to let the reader make its own opinion of the potential. The minimum is zero. The maximum is here assumed to be equal to the total residential and commercial space heating and domestic hot water demand in areas with a potential for implementing DH networks with a linear heat density above $1.5 \text{ MWh}_{\text{th}}/\text{m.a}$ towards 2050, i.e. $120 \text{ TWh}_{\text{th}}/\text{a}$ according to the GIS based analysis performed in Section 3.1. The corresponding climate mitigation potential of NCHP is 0% (supplying 0% of total DH deliveries projected towards 2050) to 6% (supplying 100% of the total 2050 DH potential) of the French GHG emissions (compare to 2014 levels; see *Ministère de l'environnement, de l'énergie et de la mer, 2017*).

4. Potential for heat transfer from nuclear plants to industrial sinks

Section 4 often refer to Chapter 4, studying the feasibility of heat transportation from nuclear plants to factories in France. Sub-Section 4.1 discusses the key elements that need to be considered when planning such industrial symbiosis. Sub-Section 4.2 then builds and analyses the extent to which these symbiosis could help reaching the French energy and climate objectives.

4.1. Key elements to be considered

Before to build development scenario, the stakes surrounding industrial symbiosis using heat from nuclear plants must be well understood. Most of industrial processes are continuous, i.e. they cannot be suddenly stopped without affecting the success of the operation. It would thus be difficult (if not impossible) for the nuclear plant to adapt the heat production to the variation of the electricity demand. This is not an issue if the heat loads are small relative to the thermal output of the reactor. It should however be reminded that, unless the industrial processes can be disrupted without consequences (as e.g. in desalination plants), supplying heat to factories cannot be seen as a way to improve the flexibility of the nuclear plant. The uptake of industrial symbiosis concepts nonetheless opens opportunities for new business models in which the main services offered by the nuclear plant is heat production. This kind of unit could be dedicated solely to heat production, as envisioned by the Thermos project or, more recently, by a Chinese energy company (CNNC, 2017; Decentralized energy, 2017). Another option would be to adapt the electricity and heat loads to the load profiles of the factories, meaning that the first role of the nuclear unit is to continuously supply local industries at advantageous tariffs both for heat and power (as observed in industrial complexes using fossil-fueled CHP).

The load-factor of the nuclear plant should be maintained at high level in order to strengthen the economic competitiveness. If dedicating the unit to the supply of industrial symbiosis centers, this implies that the thermal capacity of the plant should match the factories' thermal requirements. Among the relevant factories identified in Chapter 4, the largest heat consumers are starch products and pulp & paper factories, consuming on average 122 and 94 MW_{th} of heat below 250°C, respectively. Biochemical refineries also need about 100 MW_{th} (Greene *et al.*, 2009). The size of industrial factories can hardly be scaled up, either for technical or economic reasons. Encouraging the creation of industrial symbiosis complexes made of several factories and centred on nuclear units would allow to increase the heat loads. Small nuclear reactors (relatively to the size of the EPR currently being implemented) would yet likely be required so as to match the industrial process loads.

Another key element to consider is the temperature level at which the heat is extracted from the nuclear plant. 250°C is nearly the maximum temperature that can be extracted from the Rankine cycle of PWR (IAEA, 2016). While the supply of lower temperature heat energy can also be considered, 250°C steam is the most promising option for at least three reasons:

- It enlarges the decarbonisation potential;
- It broadens the share of the total factories' demand supplied with the thermal plant, hence reducing the needs for alternative heat supply technologies within factories and increasing the expected cost savings;
- It increases the heat loads required within a single factory, facilitating the implementation of industrial complexes with a sufficient size to justify the investment in a nuclear unit.

4.2. Prospective scenario introducing heat transfer from nuclear plants to industrial complexes

Deployment scenario of steam transfer from nuclear plants to factories are defined in Table III.7.4. When considering the complete regional coverage scenario, one should keep in mind that it includes the heat demand below 250°C of the relevant factories located in a 100km radius from nuclear sites, while in practice transporting 250°C steam over distances exceeding 3-5 km may not be cost-effective (NISP (National Industrial Symbiosis Project), 2008). The relevant factories are defined in Chapter 4 based on economic and environmental criteria, representing 14 out of 114 sub-sectors (5-digit level of disaggregation of NACE revision 2). It would be difficult, if not impossible, to supply all this heat with nuclear plants. As stated previously, such large intervals between lower and higher

values are provided so as to encourage the reader to go in the depth of the Chapter and make its own opinion of the potential.

Compared to the complete regional potential envisioned in Table III.7.4, the potential for cost-effective implementation of IS complexes based on nuclear plants is limited given the location of existing plants. Under the current spatial configuration, steam supply from nuclear plants may be of interest for the factories shown in the business as usual scenario of Table III.7.4. To increase the number of feasible industrial symbiosis complexes, ambitious urban planning policies would be needed at local and regional levels, so as to relocate the factories from relevant sub-sectors in contingent areas centred on nuclear plants. Those policies can expect positive spillover effects such as the sharing of services or additional recovery of waste materials among factories (Chertow, 2000), especially if factories are from diverse sub-sectors (Jensen, 2016).

Implementing a steam exchange system between *Le Bugey* nuclear plant and the two basic organic chemistry plants located 1.8km away could generate about 450 k€/a of energy savings (reducing annual heat costs by 15%), with a payback period of 8 years for recovery of the infrastructure investment costs (the costs of relocating the plants are not including; see Chapter 4). Small industrial symbiosis projects of that kind could serve to confirm (or infirm) the benefits of such complexes. Small-scale projects are more likely to succeed than large projects involving many stakeholders, which can be penalised by the diversity of conflicting interests or the diversity of technical requirements (see e.g. Tudor *et al.*, 2007). The power plant could serve as the key organisation around which discussions are organised. Government subsidies for pipeline construction would be an important incentive for the implementation of large steam networks (as emphasised by e.g. Togawa *et al.*, 2014; Tudor *et al.*, 2007). A broad sense that the project is supported by European, national, regional and local authorities would also be required.

Once a first steam exchange system is implemented, and if it proves to be overall good to the society, policy makers and stakeholders could build on the experience to promote more ambitious projects implying the relocation of relevant plant factories closer to nuclear sites, encouraging the generalisation of industrial ecology practices. While the high development scenario consider only the regional market (relevant factories located less than 100km from a nuclear site), the global heat demand below 250°C of all French factories is four times larger, i.e 120 TWh_{th}/a, representing a maximum theoretical generalisation level. Note that we do not raise predictions of the future level of deployment but rather invite the readers to make up their own ideas.

Development scenario	Nuclear site	Plant factories (distance from nuclear site)	Heat consumption < 250°C (GWh _{th} /a)	Equivalent CO ₂ emissions avoided (kt eCO ₂ /a)
Business as usual	Nogent-Sur-Seine	Malt prod. (2.4km)	131	68
		Card&paper (3.2km)	101	59
	Bugey	2×Basic organic chemistry (1.8km)	137	78
	Gravelines	Pharmaceutical prod. (0.5km)	12	7
Complete regional coverage	See Figure I.4.2	All factories within a 100km radius from a nuclear site	30 000	16 000 (i.e 2% of total French GHG emissions)
Maximum theoretical generalisation level	Possibly all	All French factories	120 000	64 000 (i.e. 8% of total French GHG emissions)

Table III.7.4: Prospective scenario considering the deployment of industrial complexes using 250°C steam from nuclear plants in France (see also Chapter 4).

5. Conclusion

The aim of this Chapter is to quantitatively assess the potential of nuclear plant based heating systems in France. Lower and upper potential values are voluntarily large so as to encourage the reader going through the discussions underlying these quantitative assumptions. It is indeed difficult, if not impossible, to state whether or not this alternative will be deployed and, if yes, to what extent.

EDF is considering to build two additional Evolutionary Pressurized Reactor (EPR) of 1650 MW_e each towards 2030. Additional nuclear capacity will likely be required between 2030 and 2050. Whatever is the number of reactors ultimately built, there will always be heat that is not converted to electricity. Part of this heat can be used for DH or industrial applications without jeopardising the reactors' safety. Nuclear Combined Heat and Power plants (NCHP) supplying district heating (DH) systems could first be implemented in the Dunkirk and Dieppe area towards 2030. Five additional DH + NCHP systems could be set up towards 2040. The Parisian NCHP based DH system, by far the most ambitious (two thirds of the heat supplied with all the NCHP), could start operation between 2040 and 2050. Towards 2050, DH systems with linear heat density exceeding 1.5 MWh_{th}/m.a (i.e. potentially cost-efficient according to ADEME; this threshold could yet decrease in the future, as discussed in Section 3.1.5) could represent 40% of the total demand for space heating and domestic hot water. Several different low carbon DH sources would be required to supply all the DH potential. The overall climate mitigation potential of DH supply based on NCHP represents 0% (supplying 0% of total DH potential towards 2050) to 6% (supplying 100% of the total) of the French greenhouse gases (GHG) emissions (compare to 2014 levels; see *Ministère de l'environnement, de l'énergie et de la mer, 2017*).

The larger the DH network, the more likely is the connexion to a NCHP to be cost-effective. Since it is difficult to consider the co-construction of both the large DH network and the NCHP during the same period of time, it is crucial to build the future nuclear reactors as 'CHP ready', at least on the relevant sitting. CHP readiness would allow nuclear operators to start operating the plant in an electricity-only generation mode while remaining open to the CHP option if the market, business and institutional conditions become favourable. Once DH networks have reached a sufficient size, NCHP can be connected. The DH development trends here projected (3-30km of DH pipeline per year depending on cities) would require ambitious urban planning, but are consistent with the development path followed by Scandinavian cities.

The industrial market represents an opportunity to develop new kind of nuclear units based on new business rules. The potential for cost-effective implementation of steam transfer from nuclear plants to industrial sinks is yet limited given the location of existing utilities. If nuclear plant supply steam to the factories located less than 3km from a nuclear site in 2012 (i.e. potentially economically attractive systems considering the spatial configuration of 2012), the French GHG emissions would be reduced by 0.05%. Policy makers and stakeholders could build on first experiences (e.g. Le Bugey, Gravelines) to promote larger industrial symbiosis projects implying the relocation of relevant plant factories in contingent areas centred on nuclear plants. The overall climate mitigation potential represents 0% (no development) to 2% (supplying all the heat demand below 250°C of relevant factories located less than 100km from a nuclear site) of the French GHG emissions (compare to 2014 levels; see *Ministère de l'environnement, de l'énergie et de la mer, 2017*). The French industrial heat demand below 250°C is responsible for 8% of the total French GHG emissions. While it would be difficult, if not impossible, to supply all this heat with nuclear plants, it nonetheless represent an upper bound. As stated previously, such large intervals between lower and higher values are provided so as to encourage the reader to go in the depth of the Chapter and make its own opinion of the potential.

While it is feasible to supply steam with medium-large reactors, small reactors prioritising the stable and secure production of steam, perhaps occasionally producing electricity also, may be the most promising option if targeting a generalisation of the concept. The load-factor of nuclear plants should be maintained at high level in order to strengthen the economic competitiveness. If considering medium-large reactors (>300 MW_e i.e. 900 MW_{th}), industrial applications would not significantly

increase load-factors since the heat loads of a single factories rarely exceeds $100 \text{ MW}_{\text{th}}$, and can hardly be scaled up for technical and economic reasons. Besides, and contrary to those heat applications which can be disrupted or adjusted (e.g. seawater desalination, hydrogen production, district heating), industrial applications cannot be seen as a mean to valorise the heat energy of nuclear plants when electricity is produced with intermittent renewables. Conversely, smaller reactors could show high loads factors only by supplying steam to one or, preferably, several factories.

It is overall clear that the utilisation of future French nuclear plants sourced heat holds significant potential of heating costs and GHG emissions reduction while strengthening energy independence from imported fossil-fuels and enhancing the generalisation of industrial ecology practices. Towards 2050, cost-effective supply of heat from French nuclear plants to DH systems and industrial sinks could total $0\text{-}240 \text{ TW}_{\text{th}}/\text{a}$ ($0\text{-}120 \text{ TW}_{\text{th}}/\text{a}$ and $0\text{-}120 \text{ TW}_{\text{th}}/\text{a}$, respectively) representing a reduction of $0\text{-}14\%$ of the total French GHG emissions compare to 2014 levels ($0\text{-}6\%$ and $0\text{-}8\%$, respectively). This, without inhibiting the development of renewable or other low carbon energy solutions, either in the electricity or heat sectors. The fact nonetheless remains that the socioeconomic benefits of such systems must be assessed on a case by case basis and always compared with the other systems of relevance.

References

- ADEME (French Environment and Energy Management Agency), 2008. « Economies d'énergie. Faisons vite, ça chauffe ! ». Available from: <http://www.developpement-durable.gouv.fr/IMG/spipwwwmedad/pdf/Dossier_de_presse_cle2a2a21-1.pdf> [in French].
- ADEME, 2017. 13ième Rencontres des réseaux de chaleur (13th national DH meeting). Round Table of the 12/12. Presentation by Rémi Chabrilat "Factor 5 for renewable and excess heat sources: Which means for which objectives?" [in French].
- AMORCE (French DH association), 2015. Comparatif des modes de chauffage et prix de vente de la chaleur. Data for 2014. Available from: <<http://www.amorce.asso.fr/fr/espace-adherents/publications/rdc/prix-de-la-chaleur/comparatif-des-modes-de-chauffage-et-prix-de-vente-de-la-chaleur-rapport-2015-donnees-2014/>> [in French].
- AMORCE, 2017. 9 propositions du comité national des acteurs des réseaux de chaleur. Available from: <<http://www.amorce.asso.fr/fr/espace-adherents/publications/rdc/parties-prenantes/9-propositions-du-comite-national-des-acteurs-des-reseaux-de-chaleur/>> [in French].
- ANCRE (French National Alliance for Energy Research Coordination), 2013. Scénarios de l'ANCRE pour la transition énergétique. Rapport 2013. Available from: <https://www.allianceenergie.fr/wp-content/uploads/2017/06/Doc-complet-ANCRE-version-finale-15-Janv_0.pdf> [in French].
- ANCRE, 2017. Prospective énergétique France 2050: le scénario de l'ANCRE pour la Loi de Transition Énergétique. Available from: <<https://www.allianceenergie.fr/wp-content/uploads/2017/06/Sc%C3%A9nario-Loi-de-Transition-energ%C3%A9tique-croissance-verts-LTECV-25-11-2016.pdf>> [in French].
- Assemblée nationale (French national assembly), 2015. Loi n° 2015–992 du 17 août 2015 Relative à la transition énergétique pour la croissance verte, 2015–2992. Available from: <<http://www.legifrance.gouv.fr/affichTexte.do?cidTexte%40JORFTEXT000031044385&categorieLien%id>> [in French].
- Averfalk, H., Werner, S., 2017. Essential improvements in future district heating systems. Energy Procedia, 15th International Symposium on District Heating and Cooling, DHC15-2016, 4-7 September 2016, Seoul, South Korea 116, 217–225.
- Cany, C., 2017. Interactions entre énergie nucléaire et énergies renouvelables variables dans la transition énergétique en France : adaptations du parc électrique vers plus de flexibilité. Available from: <<https://www.theses.fr/200224255>> [in French].
- CEA (French Nuclear and Alternative Energies Commission), 2017. ELECNUC. Nuclear power plants in the world. Edition 2017. Available from: <<http://www.cea.fr/multimedia/Documents/publications/ouvrages/Elecnucl-2017.pdf>>.
- CEREMA (French Research Centre on Risks, Environment, Mobility and Territorial Planning), 2015. Carte nationale de chaleur – France. Available at: <<http://reseaux-chaleur.cerema.fr/carte-nationale-de-chaleur-france>> [in French].
- Chertow, M.R., 2000. Industrial Symbiosis: Literature and Taxonomy. Annual Review of Energy and the Environment 25, 313–337.
- Chirat, J.-P., Denisart, F., 2016. Nouvelles dynamiques de rénovation des logements. Rapport de synthèse et proposition. Jean-Pascal Chirat (Club de l'Amélioration de l'habitat) et Frédéric Denisart (Conseil National de l'Ordre des Architectes). Available from: <http://www.planbatimentdurable.fr/IMG/pdf/plan_batiment_durable_rapport_nouvelles_dynamiques_de_renovation_des_logements.pdf> [in French].
- CNNC (Chinese National Nuclear Corporation), 2017. CNNC launches pool-type low-temperature heating reactor. 2017-12-12. Available from: <http://en.cnncc.com.cn/2017-12/12/c_118604.htm>.

- Connolly, D., Lund, H., Mathiesen, B.V., Werner, S., Möller, B., Persson, U., Boermans, T., Trier, D., Østergaard, P.A., Nielsen, S., 2014. Heat Roadmap Europe: Combining district heating with heat savings to decarbonise the EU energy system. *Energy Policy* 65, 475–489.
- Dalla Rosa, A., Christensen, J.E., 2011. Low-energy district heating in energy-efficient building areas. *Energy* 36, 6890–6899.
- Decentralized energy, 2017. Chinese firm to develop nuclear district heating plant. Available from: <<http://www.decentralized-energy.com/papers/2017/12/chinese-firm-to-develop-nuclear-district-heating-plant.html>>.
- ENTRANZE, 2014. Policies to ENforce the TRAnSition to Nearly Zero Energy building in the EU27. Available from: <<http://www.entranze-scenario.enerdata.eu/site/>>.
- ETI (Energy Technology Institute), 2016. System Requirements for Alternative Nuclear Technologies - Phase 3. Technical assessment of SMR heat extraction for district heat networks. Available from: <<http://www.eti.co.uk/library/system-requirements-for-alternative-nuclear-technologies-phase-3>>.
- Finnish Energy, 2016. District heating in Finland 2015. Available from: <https://energia.fi/en/current_issues_and_material_bank/material_bank/district_heating_statistics.html>.
- Gils, H.C., Cofala, J., Wagner, F., Schöpp, W., 2013. GIS-based assessment of the district heating potential in the USA. *Energy* 58, 318–329.
- Grand Paris Sud, 2017. Grand Paris Sud Energie positive : vers un chauffage urbain propre et moins cher dès le 1er janvier 2017. Communiqué de presse. Available from: <https://publidata-prod.s3.amazonaws.com/production/documents/documents/000/000/303/original/Chauffage_urbain_grand_paris_sud.pdf?1484729133> [in French].
- Greene, S.R., Flanagan, G.F., Borole, A.P., 2009. Integration of Biorefineries and Nuclear Cogeneration Power Plants - a Preliminary Analysis (No. ORNL/TM-2008/102). Oak Ridge National Laboratory (ORNL).
- Heat Roadmap Europe, 2015. Heat Roadmap Europe 2050. Research project co-funded by the European Commission. Peta, the Pan-European Thermal Atlas: renewable energy. Available from: <<http://maps.heatroadmap.eu/maps/31157/Renewable-Resources-Map-for-EU28?preview=true#>>.
- IAEA (International Atomic Energy Agency), 2016. Desalination Thermodynamic Optimization Program (DE-TOP). Available from: <https://www.iaea.org/NuclearPower/NEA_Desalination/index.html>.
- INSEE (French National Institution for Statistics and Economics Studies), 2014. Logements en France. Available from: <<https://www.insee.fr/fr/statistiques/3137421>> [in French].
- Jensen, P.D., 2016. The role of geospatial industrial diversity in the facilitation of regional industrial symbiosis. *Resources, Conservation and Recycling* 107, 92–103.
- Leurent, M., Cany, C., 2016. A comprehensive taxonomy of nuclear non-electric markets: Application to the market perspectives for France. 39th annual conference of the International Association for Energy Economics (IAEE) on Energy, expectations and uncertainties.
- Lund, H., Werner, S., Wiltshire, R., Svendsen, S., Thorsen, J.E., Hvelplund, F., Mathiesen, B.V., 2014. 4th Generation District Heating (4GDH). *Energy* 68, 1–11.
- Magnusson, D., 2010. Between municipal and regional planning: the development of regional district heating systems in Stockholm from 1978 to 2010. *Local Environ* 16, 319–37.
- MEEDDAT, 2008. Direction générale de l'énergie et du climat. Programmation pluriannuelle des investissements de production de chaleur, Période 2009 – 2020.
- Ministère de l'environnement, de l'énergie et de la mer (French Ministry of Environment, Energy and Seas), 2015. Loi relative à la transition énergétique pour la croissance verte (TECV). Available from: <<https://www.legifrance.gouv.fr/affichTexte.do?cidTexte=JORFTEXT000031044385&categorieLien=id>> [in French].

- Ministère de l'environnement, de l'énergie et de la mer, 2016. Programmation pluriannuelle de l'énergie. Available from: <<http://www.developpement-durable.gouv.fr/Programmation-pluriannuelle-de-l,48569.html>> [in French].
- Ministère de l'environnement, de l'énergie et de la mer, 2017. Chiffres clés du climat. France et Monde. Editions 2017. Available from: <http://www.statistiques.developpement-durable.gouv.fr/fileadmin/documents/Produits_editoriaux/Publications/Datalab/2016/chiffres-cles-du-climat-edition2017-2016-12-05-fr.pdf> [in French].
- Nielsen, S., Möller, B., 2013. GIS based analysis of future district heating potential in Denmark. *Energy* 57, 458–468.
- Nielsen, S., 2014. A geographic method for high resolution spatial heat planning. *Energy* 67, 351–362.
- NISP (National Industrial Symbiosis Project), 2008. Potential uses of waste heat from a proposed new power station at Blyth. Report by Terra Infirma for the National Industrial Symbiosis Project (NISP).
- Persson, U., Werner, S., 2011. Heat distribution and the future competitiveness of district heating. *Applied Energy* 88, 568–576.
- RTE (French power network operator), 2018. Bilan électrique français 2017. Available from: <<http://bilan-electrique-2017.rte-france.com/>>.
- Safa, H., 2012. Heat recovery from nuclear power plants. *International Journal of Electrical Power & Energy Systems* 42, 553–559.
- Schmidt, D., Kallert, A., Blesl, M., Svendsen, S., Li, H., Nord, N., Sipilä, K., 2017. Low Temperature District Heating for Future Energy Systems. *Energy Procedia*, 15th International Symposium on District Heating and Cooling, DHC15-2016, 4-7 September 2016, Seoul, South Korea 116, 26–38.
- SNCU (French National Union for District Heating), 2017. Enquête annuelle sur les réseaux de chaleur et de froid. Rapport 2017. Chiffres 2016. Edition nationale. Available from: <<https://www.actu-environnement.com/media/pdf/news-29857-enquete-sncu-2017.pdf>> [In French].
- SFEN (French nuclear energy association), 2018. Le nucléaire français dans le système énergétique européen. Scénarios basés sur le modèle PRIME pour la SFEN. Available from: <http://www.sfen.org/sites/default/files/public/atoms/files/le_nucleaire_francais_dans_le_systeme_energetique_europeen_-_sfen_-_ppe.pdf> [in French].
- STUK (Finnish Radiation and Nuclear Safety Authority), 2009. Preliminary Safety Assessment of the Fennovoima Oy Nuclear Power Plant Project. Available from: <https://www.stuk.fi/documents/88234/148256/STUK-Fennovoima_preliminary_safety_assessment_letter.pdf/2b9012c5-0d9a-4253-8efd-c2070fdc2cb7>.
- Togawa, T., Fujita, T., Dong, L., Fujii, M., Ooba, M., 2014. Feasibility assessment of the use of power plant-sourced waste heat for plant factory heating considering spatial configuration. *Journal of Cleaner Production* 81, 60–69.
- Tudor, T., Adam, E., Bates, M., 2007. Drivers and limitations for the successful development and functioning of EIPs (eco-industrial parks): A literature review. *Ecological Economics* 61, 199–207.
- Unternährer, J., Moret, S., Joost, S., Maréchal, F., 2017. Spatial clustering for district heating integration in urban energy systems: Application to geothermal energy. *Applied Energy* 190, 749–763.
- Viaséva (French DH association), 2017. L'annuaire des réseaux de chaleur et de froid. Edition 2016/2017. Available from: <<http://Viaséva.org/wp-content/uploads/2017/07/Annuaire-2016-2017.pdf>> [in French].
- Wang, Y., Silva, V., Lopez-Botet-Zulueta, M., 2016. Impact of high penetration of variable renewable generation on frequency dynamics in the continental Europe interconnected system. *IET Renewable Power Generation* 10, 10–16.

Chapter 8

Stimulating niche nurturing process for heat production with nuclear plants in France. A multi-level perspective

Abstract

This Chapter examines how intermediaries could interact with other important actors identified by the multi-level perspective (MLP) framework, the niche actors and regime actors, to create niches (i.e. spaces where various technical, social and organisational innovations are created and tested) for nuclear heat production in France. Recovering the wasted heat is a matter of energy efficiency, whatever is the source. Nuclear plants could remain used for several decades in France. It is thus legitimate to investigate the possible niche nurturing processes which may allow a more efficient use of this technology. Challenges are high, and our conclusions modest regarding the possible breaking through of such systems. Without significant windows of opportunity, even the most willing intermediation may not be able to change the status quo. It is however important to study such exploratory systems in order to highlight the multifarious pathways that energy systems could follow. Drawing on lessons from the MLP, this Chapter proposes three key actions for intermediation willing to move beyond technology-push approaches that can lead to tension and low legitimacy. These are, sharing questions instead of knowledge; mobilise, interest, involve a legitimate place; and prevent or avoid conflicts among stakeholders. Regime changes possibly enhancing the deployment of sustainable heating systems, not only nuclear plant sourced, are also discussed.

Keywords: Multi-level perspective, nuclear, heat sector, strategic niche development, intermediary

Highlights

- Multi-level perspective to analyse exploratory and collective energy systems
- Nuclear plant sourced heat can be used for district heating or industrial purposes
- Such systems have difficulties breaking through deeply-rooted regimes
- Intermediaries can stimulate niche creation for first projects in France
- Windows of opportunity are required to enable any experimentation

1. Introduction

In those countries which are using nuclear energy for power production, the commercial production of heat with nuclear plants generate a growing interest (see e.g. EC (European Commission), 2015a; EUROPAIRS, 2009; IAEA (International Atomic Energy Agency), 2016a; NC2I (Nuclear Cogeneration Industrial Initiative), 2015; NEA (Nuclear Energy Agency), 2015). Towards 2025-30, the French nuclear capacity should remain significant (40 to 63 MW_e). This despite plans to reduce the share of nuclear production in the electricity mix from 75% (2016 level) to 50% (2025), as targeted by public authorities (*Ministère de l'environnement, de l'énergie et de la mer* (French ministry of the environment, energy and seas, 2015). In the longer term, dispatchable power plants may present some new benefit to balance power systems with large amounts of intermittent renewables (Cany *et al.*, 2016; Wang, 2016). Given the path dependence approach (past investments made), as well as the low carbon profile of this energy source, nuclear plants could remain in use for a number of decades in France. Some of these plants could be optimised to supply heat to nearby industrial sites or district heating (DH) networks. This would favour energy efficiency and decarbonisation of the heat sector while reducing the use of imported fossil-fuels. The cost and climate savings potential of DH production with nuclear plants have been explored for the Parisian, Lyon and Dunkirk metropolitan areas (Jasserand and Lavergne, 2016; Safa, 2012; Chapters 2, 3 and 7). Chapter 4 has studied the feasibility of supplying 250°C steam to industrial sinks, currently mostly using on-site fossil-fuels boilers, and found suitable locations for cost-effective experimentation. Chapter 5 however emphasized the importance of social, political, institutional and psychological obstacles. Without major evolution of these non-economic aspects, the heat from nuclear plants will likely remain under valorized.

In the case of France, it is legitimate to explore the conditions upon which nuclear plant based heating systems could be discussed and, if judged overall good to the society, implemented. Caution is however required when addressing such a controversial debate. One could be tempted to adopt a technology push approach, focusing on the accumulation of facts and data and considering consumers with given needs and preferences, with the aim to demonstrate the intrinsic value of the system. The logic underlying local decision-making processes is however far from being purely rational, but is rather derived from improvised economic, social and political principles, varying widely from a context to another (Bush *et al.*, 2016; Webb, 2015). An excessively narrow technology push approach (through top-down policies) can lead to unintended consequences of network tensions, low legitimacy and credibility, due to the fact that it neglects the importance of improvisation and shared learning (Barrie *et al.*, 2017; Schot and Geels, 2008). This is especially true in those countries in which citizens are increasingly willing to be part of the decision making process surrounding large infrastructure projects, such as France.

Figure III.8.1 shows the three stages of a development process and the types of activities that take place within each stage in a technology push approach. It suggests that project developments follow incremental stages, while in reality they are iterative. The willingness of stakeholders to be involved in the pre-feasibility stage can be strongly inhibited by pessimist expectations with regards to the delivery stage (see Chapter 5). This highlights the importance of articulating legitimate, shared visions of business models, contractual and financing aspects from the early beginning.

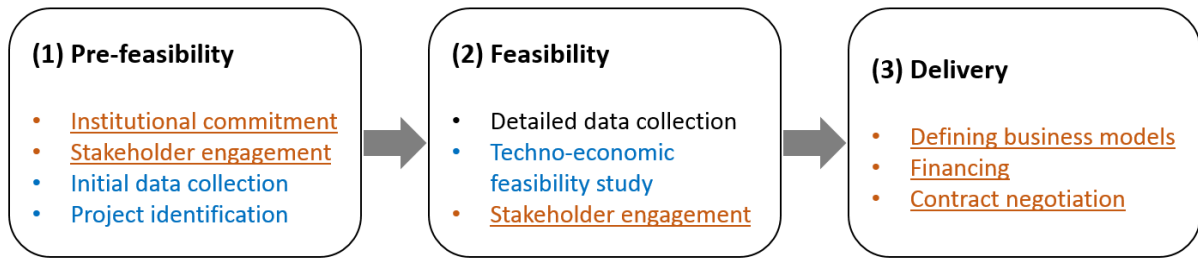

Figure III.8.1: Diagram describing the three stages of the development process in a technology push approach.

Notes:

In blue letters: activities performed or discussed in the Part I of the PhD Report

In orange letters: activities performed or discussed in the Part II of the PhD Report

In underlined letters: activities analysed in Chapter 8, focusing on the French case.

The above discussion calls for theoretical approaches specifically designed to analyse the emergence of innovative energy projects involving disconnected stakeholders and complex, real-world phenomenon. To that purpose, this Chapter adopts a multi-level perspective approach. The research scope is detailed in Section 2. Section 3 explores and discussed plausible actions designed to allow the experimentation of nuclear heat production in France. The Chapter ends with the discussion and conclusion.

2. Research scope

Section 2.1 first presents the MLP framework. Section 2.2 then discusses the specificity of multi-level perspective approaches addressing collective and exploratory systems such as heat production with nuclear plants.

2.1. Multi-level Perspective

Kivimaa and Kern (2016) explain that ‘transitions come about through interactions between landscape (e.g. macro-economic and macro-political trends, significant environmental changes, demographic trends), regime (e.g. the deep structure of the socio-technical system involving alignment between technologies, infrastructure, institutions, practices, behavioural patterns, markets, industry structures, etc.), and niches (spaces where various technical, social and organisational innovations are created and tested)’ (p. 206). Energy transitions, i.e. evolution of socio-technical regimes, are largely dependent on functions performed by stakeholders at various points in time (Loorbach and Rotmans, 2010; Fischer and Newig, 2016).

Under this background, the MLP literature aims to discuss development strategies that may help transforming socio-technical regimes that are path-dependent (Smith *et al.*, 2010). The challenge is to capitalise on external pressures on the landscape during windows of opportunity to allow niche experiments to scale-up and change the regime (Berkes and Ross, 2016; Wittmayer *et al.*, 2017). Employing the MLP in practice consists in exploring strategies and pathways for how change can occur (niche experiment), and then persist (larger development). The MLP distinguishes the revolt process (i.e. the drive for change from niches to encourage regime change), and the remember process (i.e. the processes enhancing the resilience of changes; Benson and Garmestani, 2011).

Within the MLP framework, the key actors are technology entrepreneurs (niche actors), policy entrepreneurs (regime actors), and intermediaries. These are broad categories including several

different actors. Section 3 will define which organization compose the niche actors, the regime actors and the intermediaries in the case of nuclear plant based heating systems in France. The general roles played by these actors in the development of innovative systems is depicted in Figure III.8.2 and explicated here below:

- *Technology entrepreneurs are niche actors that ‘focus on knowledge development and diffusion, articulation of visions, entrepreneurial activities, market formation, guidance of search activities, mobilization of resources, creation of legitimacy, and overcoming of resistance to change’* (Fischer and Newig, 2016: p. 13). Technology entrepreneurs can lead ‘inclusive, practice-based and challenge-led initiatives designed to promote system innovation through social learning under conditions of uncertainty’ (Sengers *et al.*, 2016: p.1). They are however rarely willing to explore those innovative systems which are perceived as risky, challenging deeply rooted regimes boundaries (see e.g. Section 4.2.1 of Chapter 5, discussing regime boundaries between nuclear and heat sectors; these ‘behavioural’ aspects may partly explain why EDF has not yet showed vivid interest for nuclear plant based heating systems).
- *Policy entrepreneurs are regime actors that are ‘supporters of transition by forming powerful coalitions to push through a reform agenda that fits incumbent regimes interest, or opponents of transition by downplaying the need for transformation’* (Fischer and Newig, 2016: p. 13). These actors can be political parties, national, regional or local authorities. They can have direct impacts on policy creation by linking a problem with solutions, and indirect impacts by changing the ideas flowing within the policy-making context (Kalafatis *et al.*, 2015; Pahl-Wostl, 2015). Key roles played by policy entrepreneurs include ‘raising issue awareness, reclassifying existing conditions into something more politically appealing, framing the problem and potential solutions, and working to align the problem, solution and political streams during windows of opportunity’ (Gliedt *et al.*, 2018). Policy entrepreneurs as regime actors have a set of skills that help to identify opportunities for making institutional changes. These skills, when coordinated with the help of innovation intermediaries, can be critical for changing conditions and allowing niche nurturing processes to emerge (see e.g. Hawkey and Webb, 2012, analyzing the importance of coordination among stakeholders to allow successful implementation of DH projects).
- *Intermediaries are actors connecting the niche and regime levels via organisational and institutional networks within and between clusters. They ‘provide and distribute necessary information, services, mediation, and diffuse new technologies and practices’* (Fischer and Newig, 2016: p. 14). The importance of intermediaries in innovation as change agents for coordinating niche and regime actions has been growing with the increased technological complexity and global competition (Howells, 2006; Mattes *et al.*, 2015). These actors can be individuals or a group of people within organisations that goes from public research bodies, to trade associations, non-governmental organisations (NGO) or labor unions (Küçüksayraç *et al.*, 2015). Universities can also participate to intermediation activities (Hayter and Link, 2015; Kivimaa *et al.*, 2017). MLP case studies revealed that public sector actors deliver most of the intermediary functions, but private sector actors also played intermediary roles for supporting learning processes. Intermediation is sometimes done by consultants, although national government funding is often needed to enable their involvement at the local level (see Bush *et al.*, 2017, analyzing DH development processes in the United Kingdom).

Critiques of the MLP include the fact that it does not make power, conflict and decision-making ‘visible and contestable’ as it treats the political landscape as neutral (Kenis *et al.*, 2016). Gliedt *et al.* (2018) however outlines how, precisely because it considers the political landscape as neutral, the MLP can offer direction to local and regional actors in creating green economic development as a politically feasible strategy during times of institutional uncertainty.

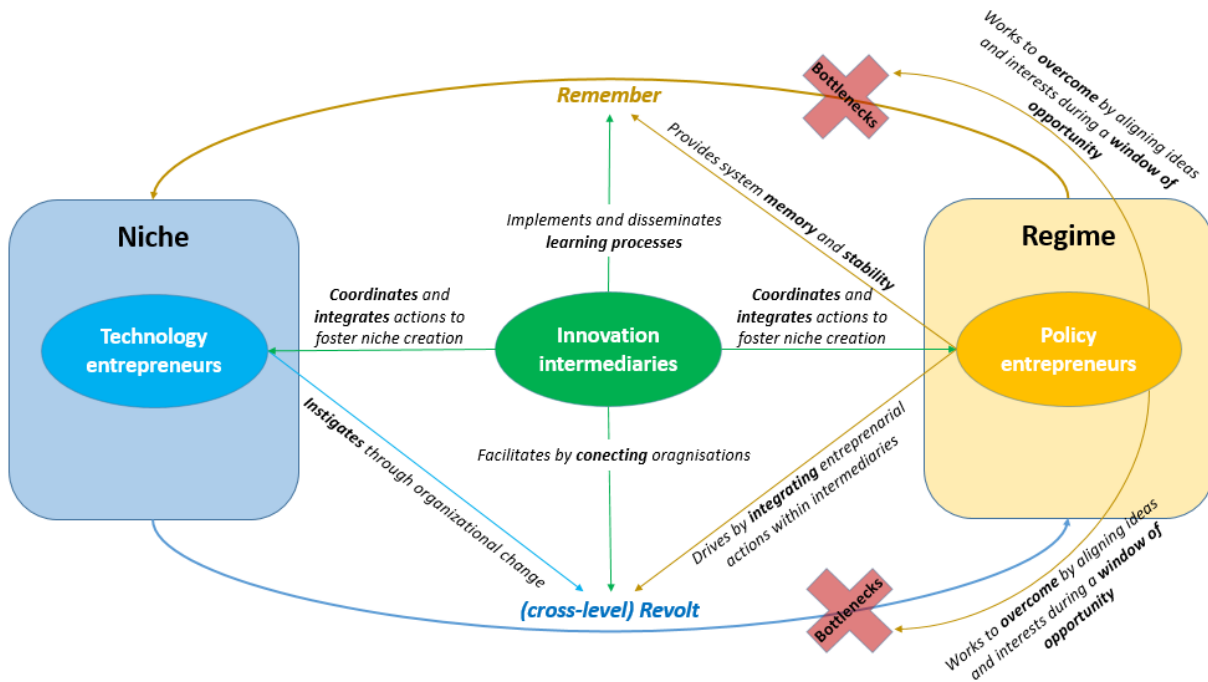

Figure III.8.2: MLP framework for the development of innovative systems: Intermediaries as agents for stimulating transitions.

Notes:

The research question of this Chapter (see Section 2.3) focuses on the revolt process. Future research could further investigate the remember process.

2.2. MLP addressing exploratory and collective innovations

There is a significant difference between being an intermediary in cases where problems are known, actors can be recognised and there is sufficient knowledge available to solve the problems (most likely to result in more incremental innovations), and cases where the problems are ill-defined and neither the role nor interest of actors is given (exploratory innovations). Research has emphasised that intermediaries face increasing difficulties in addressing the second type of innovation (Sieg *et al.*, 2010). Their activities get more diverse and more complex, which implies that their role and position within the innovation system becomes unclear and even sometimes problematic (Klerkx and Leeuwis, 2008). While there are several experiences of nuclear heat production (see IAEA, 2003; Chapter 5), none is located in France, leading this system to be considered as an exploratory innovation by policy and technology entrepreneurs. Besides, it is a collective innovation in the sense that it would require close collaboration between diverse, disconnected stakeholders (e.g. nuclear plant operator, distribution system operator, end-user(s)), and this over long time horizons (40 to 60 years minimum; see Part I).

In exploratory and collective innovations, the connexion role of intermediaries is all the more complicated because the relevant stakeholders are not always identified *ex ante* and successful intermediation requires ongoing multilateral exchange to be adopted within the network (Agogué *et al.*, 2017; Inkinen and Suorsa, 2010). The intermediary has the difficult charge of renewing the language of forms and values, inviting technology and policy entrepreneurs, dividing and coordinating the entrepreneurs' exploratory work, and handling conflicts between them. At least three core functions must be fulfilled by those intermediaries which are willing to address collective and exploratory innovations:

- *Stimulate innovative approaches.* According to van Lente *et al.* (2003: p. 256), intermediaries support the 'learning processes, by enhancing feedback mechanism and by stimulating experiments and mutual adaptations'. More generally, the challenge is to develop and offer favourable conditions for questioning, learning and experimenting.
- *Involve, commit, and mobilise.* Technology and policy entrepreneurs as well as the potential end-user(s) must be convinced and mobilised. Convincing is a matter of framing a common issue that is considered a problem by potential actors in the innovation system. Sufficient exogenous incentives (e.g. market growth potential, economic factors, pressure for climate change mitigation) are required but can be complemented by resource mobilisation (e.g., competence and human capital, financial capital, and complementary assets) in order to create and maintain a network for multilateral exchanges (Bergek *et al.*, 2008). The intermediary can facilitate the formation of an 'advocacy coalition', which places new objectives on the agenda and creates 'legitimacy for a new technological trajectory' (Hekkert *et al.*, 2007: p. 425).
- *Prevent or avoid conflicts.* The need for collaboration clearly implies a necessity to avoid sources of conflicts (van Lente *et al.*, 2003). The introduction of new technologies or systems often implies a need for change, to which established market actors often resist. Overcoming such resistance to change can require the introduction of innovative business models that unlocks the technology for deployment (Hawkey and Webb, 2012).

These key functions represent an useful analytical framework to explore possible niche nurturing processes in collective and exploratory innovations. Activities at the beginning of the process serve to raise interest and questioning key actors on issues not directly in their core business. It is then needed to convince key actors of the value of the innovation and potential benefits that could be realised with the use of the technology, foreseeing and providing solutions to the split incentives that would likely arise.

2.3. Research questions

This Chapter aims to examine how innovation intermediaries could interact with other important actors identified by the MLP, the niche actors and regime actors, to create niches for nuclear heat production in France (see Table III.8.1 for a clear definition of these actors in our case). As normative questioning involve normative answers, subjective judgements are inevitably included in the analysis and discussions. Normative questioning is however necessary to generate new ideas on collective and exploratory innovations in contexts where they have not been experienced yet.

3. An intermediary driven niche nurturing process

Section 3 aims to answer the research question regarding the role of intermediaries in stimulating experimentation of collective system using heat from a French nuclear plant. In order to provide further insights to policy makers and stakeholders, Table III.8.1 shows the names of organisations which can be categorised as technology or policy entrepreneurs and innovation intermediaries in the case of heat production with nuclear plants in France. Table III.8.2 then provides a summary of the actions that French intermediaries could lead, which are further discussed in sub-Sections 3.1 to 3.3.

Technology entrepreneurs	Innovation intermediaries	Policy entrepreneurs
Dalkia	ADEME	European Commission
EDF	AMORCE	Local authority & clusters (e.g. Metropole de Strasbourg)
Engie/Cofely	ANCRE	National authorities
Factory owners (e.g. Arkema, Bonduelle, Renault)	CEA	Regional authority & clusters
Idex	Consultants (e.g. Apave, Bureau veritas)	Political parties
Other equipment suppliers (e.g. Adionics, Idhelio, Inpal, Ryb, Trianon échangeurs)	Euroheat&Power	
	IAEA	
	Fedene	
	FNCCR	
	NEA/OECD	
	NGO (e.g. CLCV, MNLE, OREE)	
	SNCU	
	Universities & other research organisations (e.g. BRGM, CNRS, Locie)	

Table III.8.1: Actors that could be involved in the revolt and remember processes surrounding the development of heat production with nuclear plants in France.

Notes:

Please refer to Section 2 for a definition of the revolt and remember processes, and in particular Figure III.8.2.

Sharing an agenda of open issues instead of sharing knowledge (Section 3.1)	Mobilise, interest, involve a legitimate place (Section 3.2)	Prevent or avoid conflicts (Section 3.3)
Introducing open questions on the topic of interest and providing permanent domains for the exchange of ideas	Finding funding sources to support activities	Identifying and challenging institutionalized practices that obstruct new practices
Organising events, meetings or novel forum bringing together a large panel of participants likely to have different perspectives and experiences	Organising cross-sector workshops on a regular basis and over several years	Discussing new actor configurations (e.g. Mankala energy cluster; see 3.3.2)
Drawing (locally) new knowledge from participants	Collecting knowledge and examples from elsewhere (e.g. Russia, China, Switzerland, Norway; see Tables I.4.1 and II.5.1 for a complete list)	
	Identifying possible experimental projects in France	

Table III.8.2: Actions that could be led by intermediaries to nurture niche experiment.

3.1. Sharing an agenda of open issues instead of sharing knowledge

Because of the organisational complexity that collective and exploratory innovation fosters, one risk is to engage in the process as if it is already known which alternative is the best and which stakeholders are relevant. Schot and Geels (2008) note that in many technology experimental projects, networks have tended to be too narrow, following technology push approaches (accumulation and dissemination of facts and data). When stakeholders have different, deeply rooted, perceptions of the

pros and cons of energy alternatives, knowledge sharing activities can be seen as subjective, lobbyist discourses (see Chapter 5). Sharing questions and unsolved problems can be more efficient than sharing knowledge as it can help avoiding fixations (Hatchuel *et al.*, 2011). This is because legitimacy is based not on the knowledge itself but on the working conditions surrounding knowledge creation (Hatchuel *et al.*, 2011). Sharing open questions however require to recognise that the issue at stake goes beyond the expertise of the stakeholders and requires a real explorative approach. This is not easy in-itself, as overconfidence in what is currently known sometimes prevent actors from realizing how much is actually unknown (Agogué *et al.*, 2017).

When addressing collective and exploratory innovation, intermediaries should first conduct a diagnosis of the level of unknown prior to start the 'mobilise, interest and legitimate' step (3.2). This requires the organisation of events, meetings or novel forum (possibly online e.g. webinar) bringing together a large panel of participants likely to have different perspectives and experiences (niche and regime actors but also other intermediaries; see Table III.8.1). When organising and managing this diagnosis, intermediaries must not raise expectations regarding the solution but raise expectations regarding the capacity to generate multiple solutions. Discussions should go from general to narrow topics, possibly following an incremental set of open questions as proposed below (authors' proposition; to be refined through collective discussions):

1. Which transition pathway should be prioritised to decarbonise the French heating sector?
2. Which technology or system can be considered as innovative to that purpose?
3. Do you think that collective system such as eco-industrial parks are a good way of decarbonizing the industrial heat sector? If not, why? Do you see any obstacles to their experimentation and/or generalisation?
4. How could we enhance systemic thinking habits that consider the building envelop and the heating infrastructures as a whole instead of separate systems? Would it be overall beneficial to the decarbonisation objective?
5. What are the main challenges faced by the recovery of the waste heat from factories and thermal plants in France? How could it be facilitated?
6. Would it make any difference if the heat supplier were a nuclear plant? Why?

We advocate that this diagnostic stage is primordial in order to build-up trust among actors. The aim shall be the creation of a permanent domains for the exchange of ideas. Doing so, the intermediary work may influence the direction of transition through the change in the cognitive rules of the stakeholders (Geels and Raven, 2006). In order to avoid tensions among disconnected stakeholders, no pressure should be put on: (i) the sharing of results that existed previous to this step; (ii) the techno-economic rationality of a system compare to others. The identification of both the systems that could be relevant, the knowledge to acquire and the stakeholders to involve should be outputs and not input of this diagnosis step.

The financial investment of this diagnosis can be limited, especially if sharing questionnaire or organising webinar. The crucial point is the regularity and the framing of the initiative, not the form it takes. Involving the regime actors is important as it can enable a deeper institutional embedding of the new questioning. Intermediaries should however be aware that the outputs of such collective questioning could result in unexpected ideas. Whatever comes out of the discussion, it would nonetheless allow the collection of valuable materials (e.g. perceptions, goals, split incentives) that can serve to frame the future actions of intermediaries; that could aim to mobilise, interest and involve a legitimate place.

3.2. Mobilise, interest, involve a legitimate place

Research has improved our understanding of the managerial challenges inherent in exploratory intermediation. For instance, it is necessary to build trust among actors and to organise

specific learning processes (Fawcett *et al.*, 2012). Tensions between neutrality and advocacy of local intermediation has been an obstacle to project developments in several cases (Hodson and Marvin, 2010; Matschoss and Heiskanen, 2017). The building up of trust is however a complex and often ill-understood process. A public intermediary may need to be perceived as neutral in order to be regarded as reliable and legitimate to a critical range of stakeholders. The creation of complex intermediary combining public (local government agency, research institution) and private (environmental consultancy) organisations may be helpful in avoiding committed stance, either real or supposed (Klewitz *et al.*, 2012; Mattes *et al.*, 2015).

This may be even more critical when considering nuclear heat production in France, since suspicion of ‘nuclear-biased judgement’ is common place in this country. Intermediary actions should be co-organised by ‘non-nuclear actors’ (e.g. ADEME, AMORCE, FEDENE, OREE, DH utilities, factory owners) and ‘nuclear actors’ (e.g. CEA, NEA, IAEA, EDF), and this from early stages. It is not necessary to involve all of this actors; the exact organisations and persons would be determined latter, perhaps using the new relationships built during the diagnostic step (Section 3.1). Guarantying the diversity of backgrounds (niche and regime actors from energy efficiency, heat and nuclear sectors) is however crucial. Integrating NGO to the cluster could provide unexpected insights and thus should be encouraged.

Gathering these diverse actors together to set up common actions would be a great asset to legitimate the place of nuclear heat production in national energy transition debates. It however requires the overcoming of organisational routines and the creation of new business relationships. This can be enhanced through the establishment of cross-sectors working groups aiming to stimulate collective and exploratory heat decarbonisation alternatives. Intermediaries would however need to mobilise significant resources (e.g. competence and human capital, financial capital, and complementary assets) in order to make a success of these workshops, mobilising and interesting a wide variety of actors over several years. The objectives and composition of the working groups would be defined based on preliminar, open discussions generated during the diagnostic step (see Sub-section 3.1). Two key activities can nonetheless be suggested:

- *Collecting knowledge and experience from elsewhere.* Despite being hardly measurable, behavioural or psychological means such as “resistance to change” inhibit the will of investing in projects perceived as exploratory or risky. Case studies are an important tool for increasing confidence in exploratory innovations (Bush *et al.*, 2017). While there are at least 60 experiences of commercial heat production with nuclear plant, only a few case studies are providing feedbacks discussing the social, political or psychological dimensions (see Chapter 5; NC2I, 2015). There is thus a real need to lead additional case studies, interviewing those nuclear operators, distribution system operator; and, more importantly, local authorities, citizens, NGO and factory owners which have experienced local heat supply from nuclear plants. Despite being different from the EC context, gathering views from the on-going Chinese experimentation would also be an asset (see e.g. Decentralized energy, 2017).
- *Identifying possible experimental projects in France.* Real experimentation of nuclear heat production in France should be seriously discussed among participants. This is however a complex topic which must be address carefully and preferably when people have learnt to know each other and accepted to play this ‘exploratory game’. Without any national experimentation, however, the scheme cannot progress. Based on the analyses led in Chapters 4, 5 and 6, we came to the conclusion that small-scale projects targeting the supply of heat to a factory are less likely to suffer unexpected technical problems that may lead to overcosts and delays. They are also less likely to generate split incentives among stakeholders. Besides, supplying an industrial customer may rise less opposition in comparison to providing district heat to an urban area.

If an experimental project is discussed, caution is needed on how the objectives are communicated and interpreted. The French Thermos nuclear DH project (1975-1981) allow drawing useful lessons to that respect. According to Dalmaso (2008), the proponents of the Thermos project

initially aimed at generating clear economic benefits. During the decision-making process, however, opponents succeeded in disseminating the idea that Thermos would not be competitive relative to traditional coal fired heat-only boilers. As a result, proponents change their strategies arguing that Thermos should be seen as a demonstration project opening the path for future, more economical, projects of that kind. Dalmasso (2008) showed that this change of discourse have participated in reducing the legitimacy of the project, which ultimately led the local authority to nuance and then withdraw its support. It therefore follows that, if the economic benefits of any nuclear based heating project are not large enough, the implementation would be difficult due to the fact that opponents will always be able to discuss the techno-economic rationality. In France, opening the plausibility of economic attractiveness first require to develop larger heat demand centers, either in the form of DH networks or eco-industrial parks (see Chapter 6).

Under the current (2015) spatial configuration, the two chemical plants situated 1.8 km away from *Le Bugéy* could be an option. The *Gravelines* area, with a pharmaceutical plant located 0.5 km away from the thermal plant, is also relevant (see Chapter 7, Table III.7.4, for details). If not already invited, the owners of factories as well as the concerned local authorities would now be at the hearth of the discussions. The power plant could serve as the key organisation around which discussions are organised. A broad sense that the project is supported by national and local authorities would also be required. Actions aiming to limit or share the risks (both financial and media) should also be discussed (see 3.3). A pre-requisite to such discussions is the building-up of trust, which is a challenge as itself (see 3.1).

3.3. Prevent or avoid conflicts

It is well known that innovations are also marked by power relationships (Santos and Eisenhardt, 2009). The works on these topics have demonstrated that this power relationships are based precisely on the definition of boundaries. The intermediation in exploratory context consists of blurring existing boundaries by reinventing their definitions (new markets, new technological variants and combinations, new constraints understanding, questioning the identity of the object of conflict...), creating opportunities for new boundaries that correspond to possible common interests (Agogué *et al.*, 2017; Matschoss and Heiskanen, 2017). New combinations of partnerships may have a key role in sustainability transitions as they have the potential to challenge existing market configurations, incumbent companies and dominant regime practices, ultimately leading to a cultural shift in public and practitioner perceptions of energy transition pathways (Klerkx and Leeuwis, 2008). Besides, discussing business models and contractual arrangement from early stages is important since the perception of opposing interests may strongly penalised the establishment of an open and constructive dialogue on the matter. Based on previous work from Chapter 5 and NEA (2018), we distinguished two archetypal kind of business model for nuclear heat production in France, namely non-integrated cluster and Mankala cluster. These are presented in sub-section 3.3.1 and 3.3.2, respectively.

3.3.1. Non-integrated cluster

The organisational chart of a non-integrated energy cluster is shown in Figure III.8.3. This is the less challenging form of market configuration considering the current business models and governance structure of French actors. EDF would own and operate the nuclear plant, selling electricity to the external grid. EDF would also sell the heat to the distribution system owner and operator. The distribution system includes the pipelines and other equipments required to transport the heat from the thermal plant to the end-user (see Hirsch *et al.*, 2016 or Part I for techno-economic aspects). The heat is finally sold to the end-user. The advantages of non-integrated clusters are the limited alteration of existing regime boundaries, business models and routines; and the limited financial risks borne by the nuclear plant owner and operator. The inconvenients are:

- *High financial risk for the distributing system operator and owner.* This may inhibit its willingness to commit in such a long term, capitalistic project.
- *Limited control of the end-user(s) on decision-making processes (e.g. pricing, energy flows management).* This may lead to a lack of trust from the media and civil society. The end-user(s) would need important and trustworthy guarantees (possibly with financial penalty in case of non-respect) that the heat will be supplied whenever needed, without unplanned disruptions (especially when supplying continuous industrial processes; see Locatelli *et al.*, 2015; Chapter 4).
- *Possible conflict of interests.* In the case of DH networks mostly. The Loviisa 3 project emphasized the competition that may exist between a new heat supplier (here the nuclear plant owner and operator) and the heat sources already in place. Given the limited expansion potential of DH markets (which are slow to grow), the DH owner and operator in place may perceive the introduction of a new player in the heat market as a potential threat for its market share and control. If the project aims to replace cogeneration plants, the issue is even more complex as it implies reallocating the electricity output between energy players (see Chapter 5). The same can be expected if the new heat supply implies to prioritise the heat from nuclear plants over the renewable or recoverable heat sources which were previously used. This may be an issue in France given that most DH networks use more than 50% renewable or recoverable heat sources (SNCU (French National Union for District Heating), 2017), and that this share is expected to grow.

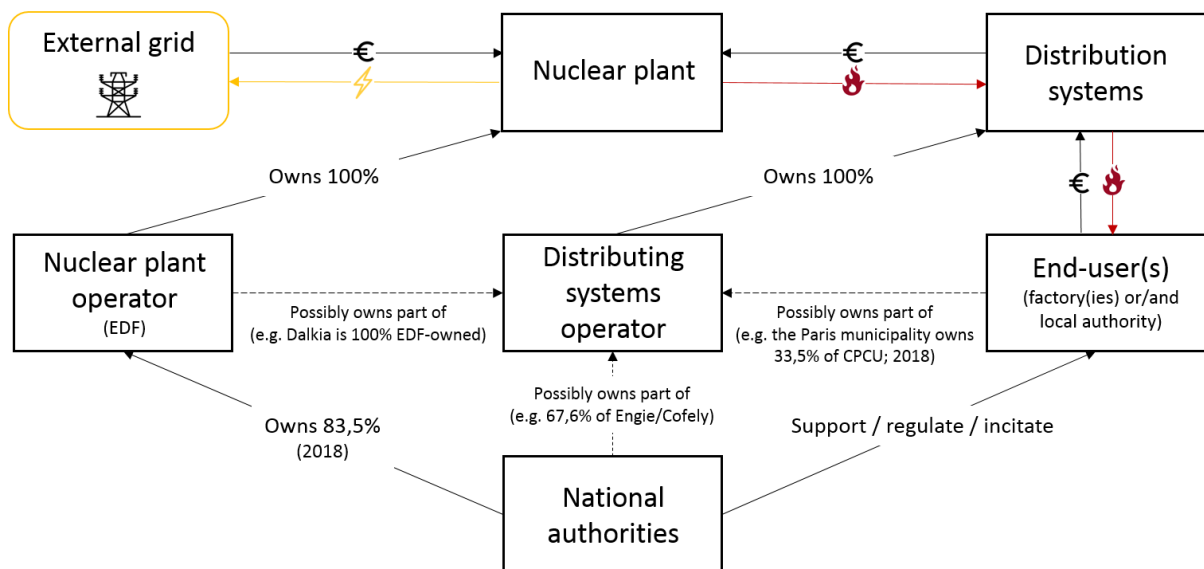

Figure III.8.3: Organisation chart of a non-integrated energy cluster.

Notes:

This is the less challenging form of market configuration considering the current business models and governance structure of French actors.

3.3.2. Mankala cluster (or ad-hoc society)

Finnish energy companies follow a unique ownership model, the so-called Mankala principle (Puikkonen, 2010). Mankala companies are jointly owned by a number of parties that bear the investment and operating costs of the resulting company, and secure an electricity supply which corresponds to their share of ownership. Mankala clusters are in line with the EC' competition law. Even though they are not always refer to the Mankala model, plant co-ownership by several utilities has existed in France (e.g. Chooz, Fessenheim). Similar business models (called 'ad hoc society') are commonly used for large (above 100 GWh_{th}/a) DH systems and/or fossil-fuelled combined heat and power plants as it allows to clearly delimit and control the respective role, rights and responsibilities of delegated organisations.

Possible business model and governance structure of a Mankala cluster are shown in Figure III.8.4. The ownership of the nuclear plant and the distribution system (all the equipments required to transfer the heat from the plant to the end-user side) would be split among at least three actors: the nuclear plant operator, the distribution system operator, and the end-user. The end-user would then buy heat to the jointly owned company, perhaps also benefiting from negotiated tariffs for electricity. The main inconvenient of Mankala clusters is the alteration of existing regime boundaries, business models and routines that is required. The advantages are:

- *Raising awareness.* Conducting an institutional innovation through the creation of a (public) company for joint development of heat distribution systems and nuclear plants could help raising awareness about the existence and potential of such systems (as suggested by Colmenar-Santos *et al.*, 2015, for traditional cogeneration plants). This may help avoiding potential electoral barrier, legitimating the financial debts that such projects can imply;
- *End-user participation to decision-making processes.* This may make it easier to get support from local authorities, plant owners, NGO and the general public. The end-user could also benefit from advantageous tariffs on the electricity market; adding further economic incentives and legitimacy;
- *Risk sharing.* Bush *et al.* (2017) suggest that business models aiming at sharing the risk (financial but also political or media) among stakeholders are more appropriate to enhance commitment in collective and exploratory projects. The pooling of operation and investment costs as well as the creation of an energy managing organisation fully empowered by the local authority have been key success factors in the implementation of innovative energy systems, such as the Saclay DH network in France (EC, 2016);
- *Risk reduction.* If the government is determined to create a company (or an ‘ad-hoc society’) combining all the necessary skills for the implementation and operation of nuclear plant based heating systems, then transaction costs could decrease significantly. The organisation would also have a larger ability to finance long-term access to capital;
- *Limited market trade-offs.* Sharing the electricity and heat output of the nuclear plant would help compensating the market losses that may be feared by the heat distribution actors already in place (especially if operating cogeneration plants; see Chapter 5).

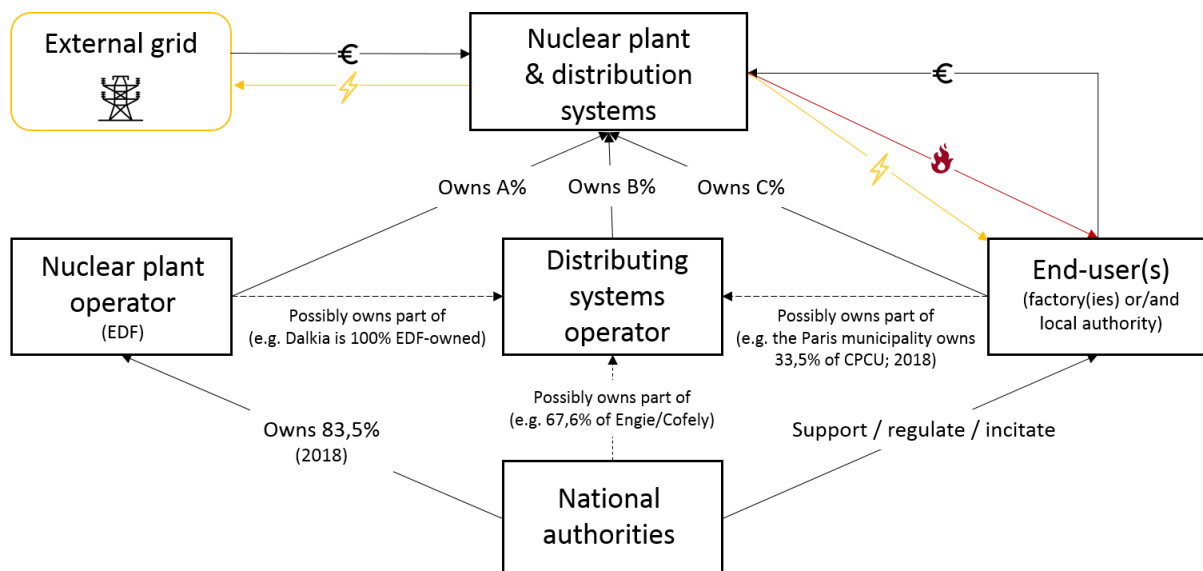

Figure III.8.4: Organisation chart of a Mankala energy cluster (or ‘ad-hoc society’ cluster).

4. Discussion and conclusion

Reducing energy costs is primordial both for providing affordable energy to households and to ensure the economic competitiveness of energy intensive industries. If the European Union confirms its will of totally decarbonising the energy sector towards 2050, strong attention should be put into the minimisation of costs under a long term perspective (i.e. levelised costs and not capital costs). If not, the transition towards sustainable energy systems could negatively affect the economic growth; which may in turn lead to lower the public acceptance for capitalistic energy projects. Using nuclear plant sourced energy for heat applications holds significant costs and greenhouse gases savings potential in France (see Chapter 7), and hence it is important to study the conditions upon which such energy systems could be developed. Yet, challenges to the development of systems using heat from French nuclear plants are high. While there are several experiences of nuclear heat production worldwide (see IAEA, 2003; or Chapter 5), none is located in France, and such systems are considered as an exploratory innovation by French policy and technology entrepreneurs. Besides, these systems are collective innovation in the sense that their implementation would require a close collaboration between diverse and disconnected stakeholders. Such exploratory and collective innovations often have difficulties breaking through established regimes, business models and routines. Nonetheless, it does not make them less deserving of inquiry.

This Chapter examines how innovation intermediaries could interact with other important actors identified by the multi-level perspective framework, the niche actors and regime actors, to create niches for nuclear heat production in France. Intermediary actions have been gaining importance as coordination agents facilitating the emergence of innovative energy systems. Well understanding their role is crucial as it may help moving beyond technology-push approaches, which often lead to tension, low legitimacy and credibility (Barrie *et al.*, 2017; Schot and Geels, 2008). Those intermediaries that aim to stimulate niche creation for nuclear plant based heating projects (see Table III.8.1) could provide permanent domains for the exchange of ideas and drawn upon these exchanges to build-up trustworthy business relationships among a wide variety of actors. Sharing questions instead of knowledge is important at preliminary stages, given that legitimacy is based not on the knowledge itself but on the working conditions surrounding knowledge creation. Such an open cluster could serve as a basis for mobilising actors through regular meetings or workshops aiming to discuss international experiences of nuclear heat production and identify suitable location for a first project in France. We advocate that these meetings should be regularly hold over several years with clear means (e.g. competence and human capital, financial capital). The objectives should however be defined through iterative and open preliminary discussions. More importantly, meetings shall be co-organised and co-animated by intermediaries from diverse sectoral backgrounds (e.g. industrial, heat, nuclear, energy efficiency). Non-governmental organisations, local authorities and plant owners should be included in preliminary discussions so as to generate new (perhaps unexpected) knowledge, leading to conclusions that can be trusted by everyone. Intermediaries should stimulate discussions on business models and actor configurations with the aim to prevent potential resistance to change and split incentives. Conducting an institutional innovation through the creation of a public company jointly owned by the nuclear plant operator, the distribution system operator and the end-user(s) is proposed as a mean to raise awareness about the existence and potential of the system. If the government is determined to create a company (or an 'ad-hoc society') that combine all the necessary skills for the implementation of distribution systems and nuclear plants, then transaction costs could decrease significantly, and the organisation would have a larger ability to finance long-term access to capital. This could legitimating the debt of the project, limiting potential electoral barrier.

Without significant windows of opportunity (i.e. landscape evolution) however, even the most willing intermediation may not be able to change the status quo. Windows of opportunity are largely due to external events (e.g. foreign experiences prove to cost-effectively reduce air pollutants and

greenhouse gas emissions; a geopolitical shock leads to difficulties in fossil-fuel importations). Such external events may enhance the political will to explore nuclear heat production. The opposite is also possible (e.g. nuclear incident). Windows of opportunity can nonetheless be stimulated internally by intermediaries, through the promotion and dissemination of the potential hold by nuclear plant based heating systems at different geographical scales. The 2012/27/EC directive on energy efficiency (European Parliament, 2012) obligates the facilities emitting a significant amount of excess heat to the surrounding environment to consider DH supply, but explicitly allow the member states to exempt nuclear plants from the duty. In France, precise guidelines are provided to those facilities which must consider whether or not DH supply have cost and climate savings potential (*Ministère de l'écologie, du développement durable et de l'énergie* (French Ministry of Ecology, Sustainable development and Energy), 2014), but nuclear plants are not targeted. In order to create windows of opportunity for the experimentation of heat production with nuclear plants in France, both the EC and French authorities need to support or at least recognise this alternative. If not, the nuclear heat will likely remain undervalued due to the fact that other heating systems that do not challenge existing regime boundaries and business models will always be prioritised.

Several other evolution of the French regime could also favor the creation of windows of opportunity for the development of low carbon heating systems, not only nuclear plant sourced. This is however a research topic as itself. The ideas below should rather be seen as suggestions for future studies that can explore these issues further. AMORCE (2017a) emphasizes that the number of subsidized DH projects will have to more than double to achieve the French policy objectives. If the development trend of 2009-2017 is prolonged, renewable and excess DH deliveries should total 23 TWh_{th}/a in 2030 (ADEME, 2017), yet the national objective is 39 TWh_{th}/a (*Assemblée nationale* (French national assembly), 2015). A list of the measures designed to enhance the deployment of low carbon DH schemes is provided in AMORCE (2017b). Alongside, the tax credit scheme supporting the installation of individual, condensing natural gas boilers should be removed considering the large amount of greenhouse gases emitted through natural gas combustion (IPCC (Intergovernmental Panel on Climate Change), 2006) and the demonstrated inefficiency of this mechanism in France (Charlier, 2015). Alteration of the market rules can also take the form of carbon taxation. To that respect, the ambitious carbon price targeted by the 2018 law on finance (€86.2/tCO₂ by 2022; *Assemblée Nationale*, 2017) must be recognised for its true value, provided that it is ultimately implemented.

In addition to the financial support, national authorities need to provide a clear long term visions and objectives for building renovation (based on scientific indicators such as population density and/or energy poverty), DH systems and industrial eco-parks. These visions must be shared across different geographical scales, with precise goals and means. Local authorities know the local geography, context and actors, and hence have the ability to facilitate long-term cooperative projects. The role that they can play in niche nurturing and empowering processes should be strengthened by being further recognised and resourced. The regional authorities also have an important role to play as a facilitator of knowledge sharing and cooperation between the neighbouring local authorities working on similar challenges. Finally, knowledge exchanges across diverse countries and cultures should be encouraged as these are key success factors for unlocking transition to sustainable energy systems. We sincerely hope that this Chapter can be useful to future research exploring niche nurturing processes of collective and exploratory systems holding potential for climate change mitigation.

References

- Agogué, M., Berthet, E., Fredberg, T., Masson, P.L., Segrestin, B., Stoetzel, M., Wiener, M., Yström, A., 2017. Explicating the role of innovation intermediaries in the “unknown”: a contingency approach. *Journal of Strategy and Mgt* 10, 19–39.
- AMORCE (French DH association), 2017a. 13ième Rencontres des réseaux de chaleur (13th national DH meeting). Round Table of the 12/12. Presentation by Rémi Chabrilat “Factor 5 for renewable and excess heat sources: Which means for which objectives?” [in French].
- AMORCE, 2017b. 9 propositions du comité national des acteurs des réseaux de chaleur. Available from: <<http://www.amorce.asso.fr/fr/espace-adherents/publications/rdc/parties-prenantes/9-propositions-du-comite-national-des-acteurs-des-reseaux-de-chaleur/>> [in French].
- Assemblée nationale (French national assembly), 2015. Loi n° 2015–992 du 17 août 2015 Relative à la transition énergétique pour la croissance verte, 2015–2019. Available from: <<http://www.legifrance.gouv.fr/affichTexte.do?cidTexte=JORFTEXT000031044385&categorieLien=id>> [in French].
- Assemblée nationale, 2017. LOI n° 2017-1837 du 30 décembre 2017 de finances pour 2018. Available from: <<https://www.legifrance.gouv.fr/eli/loi/2017/12/30/CPAX1723900L/jo/texte/#>> [in French].
- Barrie, J., Zawdie, G., João, E., 2017. Leveraging triple helix and system intermediaries to enhance effectiveness of protected spaces and strategic niche management for transitioning to circular economy. *International Journal of Technology Management and Sustainable Development* 16, 25–47.
- Benson, M.H., Garmestani, A.S., 2011. Embracing panarchy, building resilience and integrating adaptive management through a rebirth of the National Environmental Policy Act. *Journal of Environmental Management* 92, 1420–1427.
- Bergek, A., Jacobsson, S., Carlsson, B., Lindmark, S., Rickne, A., 2008. Analyzing the functional dynamics of technological innovation systems: A scheme of analysis. *Research Policy* 37, 407–429.
- Berkes, F., Ross, H., 2016. Panarchy and community resilience: Sustainability science and policy implications. *Environmental Science and Policy* 61, 185–193.
- Bush, R.E., Bale, C.S.E., Taylor, P.G., 2016. Realising local government visions for developing district heating: Experiences from a learning country. *Energy Policy* 98, 84–96.
- Bush, R.E., Bale, C.S.E., Powell, M., Gouldson, A., Taylor, P.G., Gale, W.F., 2017. The role of intermediaries in low carbon transitions – Empowering innovations to unlock district heating in the UK. *Journal of Cleaner Production* 148, 137–147.
- Cany, C., Mansilla, C., da Costa, P., Mathonnière, G., Duquesnoy, T., Baschwitz, A., 2016. Nuclear and intermittent renewables: Two compatible supply options? The case of the French power mix. *Energy Policy* 95, 135–146.
- Charlier, D., 2015. Energy efficiency investments in the context of split incentives among French households. *Energy Policy* 87, 465–479.
- Dalmaso, A., 2008. Le projet Thermos (1975-1981) ou l’échec de « l’atome au coin du feu. Colloque Nucléaire et développement régional, Tours, CEHMVI, Fondation EDF, 17-18 décembre 2008. [in French].
- Decentralized energy, 2017. Chinese firm to develop nuclear district heating plant. Available from: <<http://www.decentralized-energy.com/articles/2017/12/chinese-firm-to-develop-nuclear-district-heating-plant.html>>.
- EC (European Commission), 2016. Efficient district heating and cooling systems in the EU. Case studies analysis, replicable key success factors and potential policy implications. Available

from:

<http://publications.jrc.ec.europa.eu/repository/bitstream/JRC104437/study%20on%20efficient%20dhc%20systems%20in%20the%20eu%20-dec2016_final%20-%20public%20report6.pdf>.

- European Parliament, 2012. Directive 2012/27/EU of the European Parliament and of the Council of 25 October 2012 on energy efficiency, amending Directives 2009/125/EC and 2010/30/EU and repealing Directives 2004/8/EC and 2006/32/EC.
- Fawcett, S.E., Jones, S.L., Fawcett, A.M., 2012. Supply chain trust: The catalyst for collaborative innovation. *Business Horizons* 55, 163–178.
- Fischer, L.-B., Newig, J., 2016. Importance of Actors and Agency in Sustainability Transitions: A Systematic Exploration of the Literature. *Sustainability* 8, 476.
- Geels, F., Raven, R., 2006. Non-linearity and Expectations in Niche-Development Trajectories: Ups and Downs in Dutch Biogas Development (1973–2003). *Technology Analysis & Strategic Management* 18, 375–392.
- Gliedt, T., Hoicka, C.E., Jackson, N., 2018. Innovation intermediaries accelerating environmental sustainability transitions. *Journal of Cleaner Production* 174, 1247–1261.
- Hatchuel, A., Masson, P.L., Weil, B., 2011. Teaching innovative design reasoning: How concept-knowledge theory can help overcome fixation effects. *Artificial Intelligence for Engineering Design, Analysis and Manufacturing* 25, 77–92.
- Hawkey, D., Webb, J., 2012. Multi-level governance of socio-technical innovation: the case of district heating in the UK. Contribution to the Jean Monnet International Workshop, Copenhagen Business School.
- Hayter, C.S., Link, A.N., 2015. On the economic impact of university proof of concept centers. *J Technol Transf* 40, 178–183.
- Hekkert, M.P., Suurs, R.A.A., Negro, S.O., Kuhlmann, S., Smits, R.E.H.M., 2007. Functions of innovation systems: A new approach for analysing technological change. *Technological Forecasting and Social Change* 74, 413–432.
- Hirsch, P., Duzinkiewicz, K., Grochowski, M., Piotrowski, R., 2016. Two-phase optimizing approach to design assessments of long distance heat transportation for CHP systems. *Applied Energy* 182, 164–176.
- Hodson, M., Marvin, S., 2010. Can cities shape socio-technical transitions and how would we know if they were? *Research Policy, Special Section on Innovation and Sustainability Transitions* 39, 477–485.
- Howells, J., 2006. Intermediation and the role of intermediaries in innovation. *Research Policy* 35, 715–728.
- IAEA (International Atomic Energy Agency), 2003. Market Potential for Non-electric Applications of Nuclear Energy. STI/DOC/010/410.
- Inkinen, T., Suorsa, K., 2010. Intermediaries in Regional Innovation Systems: High-Technology Enterprise Survey from Northern Finland. *European Planning Studies* 18, 169–187.
- IPCC (Intergovernmental Panel on Climate Change), 2006. Guidelines for National Greenhouse Gas Inventories, Volume 2 Energy.
- Jasserand, F., Lavergne, J.-G., 2016. Initial Economic Appraisal of Nuclear District Heating in France. *EPJ Nuclear Sci. Technol.* 2, 39.
- Kalafatis, S.E., Grace, A., Gibbons, E., 2015. Making climate science accessible in Toledo: The linked boundary chain approach. *Climate Risk Management, Boundary Organisations* 9, 30–40.
- Kenis, A., Bono, F., Mathijs, E., 2016. Unravelling the (post-)political in Transition Management: Interrogating Pathways towards Sustainable Change. *Journal of Environmental Policy & Planning* 18, 568–584.
- Kivimaa, P., Kern, F., 2016. Creative destruction or mere niche support? Innovation policy mixes for sustainability transitions. *Research Policy* 45, 205–217.

- Klerkx, L., Leeuwis, C., 2008. Balancing multiple interests: Embedding innovation intermediation in the agricultural knowledge infrastructure. *Technovation* 28, 364–378.
- Kivimaa, P., Boon, W., Antikainen, R., 2017. Commercialising university inventions for sustainability—a case study of (non-)intermediating “cleantech” at Aalto University. *Sci Public Policy* 44, 631–644.
- Klewitz, J., Zeyen, A., Hansen, E.G., 2012. Intermediaries driving eco-innovation in SMEs: A qualitative investigation. *European Journal of Innovation Management* 15, 442–467.
- Küçüksayraç, E., Keskin, D., Brezet, H., 2015. Intermediaries and innovation support in the design for sustainability field: cases from the Netherlands, Turkey and the United Kingdom. *Journal of Cleaner Production* 101, 38–48.
- Loorbach, D., Rotmans, J., 2010. The practice of transition management: Examples and lessons from four distinct cases. *Futures* 42, 237–246.
- Matschoss, K., Heiskanen, E., 2017. Making it experimental in several ways: The work of intermediaries in raising the ambition level in local climate initiatives. *Journal of Cleaner Production, Experimentation for climate change solutions* 169, 85–93.
- Mattes, J., Huber, A., Koehrsen, J., 2015. Energy transitions in small-scale regions – What we can learn from a regional innovation systems perspective. *Energy Policy* 78, 255–264.
- Ministère de l’écologie, du développement durable et de l’énergie (French Ministry of Ecology, Sustainable development and Energy), 2014. Ministère de l’écologie, du développement durable et de l’énergie, 2014. Application de l’article 14.5 de la directive 202/27/EU sur la valorisation de la chaleur fatale industrielle via des réseaux de chaleur. Décret n° 2014-1363 du 14 Novembre 2014.
- Ministère de l’environnement, de l’énergie et de la mer (French Ministry of Environment, Energy and Seas), 2015. Loi relative à la transition énergétique pour la croissance verte (TECV). Available from: <<https://www.legifrance.gouv.fr/affichTexte.do?cidTexte=JORFTEXT000031044385&categorieLien=id>> [in French].
- NC2I, 2015. Experience Feedback from Nuclear Cogeneration. Contribution of C. Auriault, M.A. Fütterer, O. Baudrand to the NC2I Conference, CDMA Brussels.
- NEA (Nuclear Energy Agency), 2018. On the Role and Economics of Nuclear Cogeneration in a Low Carbon Energy Future. In Press.
- Pahl-Wostl, C., 2015. The Role of Institutions, Actors and Social Networks in Societal Change, in: *Water Governance in the Face of Global Change, Water Governance - Concepts, Methods, and Practice*. Springer, Cham, pp. 51–83.
- Puikkonen, I., 2010. Cooperative Mankala-Companies – the Acceptability of the company form in EC Competition Law. *Helsinki Law Review*, 1 139–156.
- Safa, H., 2012. Heat recovery from nuclear power plants. *International Journal of Electrical Power & Energy Systems* 42, 553–559.
- Santos, F.M., Eisenhardt, K.M., 2009. Constructing Markets and Shaping Boundaries: Entrepreneurial Power in Nascent Fields. *The Academy of Management Journal* 52, 643–671.
- Schot, J., Geels, F.W., 2008. Strategic niche management and sustainable innovation journeys: theory, findings, research agenda, and policy. *Technology Analysis & Strategic Management* 20, 537–554.
- Sengers, F., Wieczorek, A.J., Raven, R., 2016. Experimenting for sustainability transitions: A systematic literature review. *Technological Forecasting and Social Change*.
- Sieg, J.H., Wallin, M.W., von Krogh, G., 2010. Managerial Challenges in Open Innovation: A Study of Innovation Intermediation in the Chemical Industry (SSRN Scholarly Paper No. ID 1602201). Social Science Research Network, Rochester, NY.

- Smith, A., Voß, J.-P., Grin, J., 2010. Innovation studies and sustainability transitions: The allure of the multi-level perspective and its challenges. *Research Policy, Special Section on Innovation and Sustainability Transitions* 39, 435–448.
- SNCU (French National Union for District Heating), 2017. Enquête annuelle sur les réseaux de chaleur et de froid. Rapport 2017. Chiffres 2016. Edition nationale. Available from: <<https://www.actu-environnement.com/media/pdf/news-29857-enquete-sncu-2017.pdf>> [In French].
- van Lente, H., Hekkert, M., Smits, R., van Waveren, B., 2003. Roles of Systemic Intermediaries in Transition Processes. *Int. J. Innov. Mgt.* 07, 247–279.
- Wang, W.-C., 2016. Techno-economic analysis of a bio-refinery process for producing Hydro-processed Renewable Jet fuel from Jatropha. *Renewable Energy* 95, 63–73.
- Webb, J., 2015. Improvising innovation in UK urban district heating: The convergence of social and environmental agendas in Aberdeen. *Energy Policy* 78, 265–272.
- Wittmayer, J.M., Avelino, F., van Steenbergen, F., Loorbach, D., 2017. Actor roles in transition: Insights from sociological perspectives. *Environmental Innovation and Societal Transitions* 24, 45–56.

Chapter 9

Conclusion

The PhD studies the role that energy systems using heat from future pressurized water reactors (PWR) could play in the European and French energy transition. I came to the conclusion that three archetypal kind of nuclear plant could be considered to address the European and French low temperature (<250°C) heating demand:

(i) Nuclear units could provide base-load power services to the grid while producing heat. Heat would be a secondary output which should have the lower possible impact on the electricity production. Operating the plant in a partial, flexible cogeneration mode is easier when the heat loads have a discontinuous profile (e.g. district heating, desalination). Smaller units may provide competitive advantages (e.g. location), but are not crucial, especially in those countries in which new sites are unlikely to be developed.

(ii) Nuclear units could provide base-load heat services to industrial complexes while possibly producing electricity. The reactor should be optimized so as to continuously supply heat to those consumers which cannot suffer any disruption of their processes (a back-up would likely be needed anyway). Smaller nuclear units would provide decisive competitive advantages to match with the size of industrial plant factories (or complexes made of several factories). Producing 250°C steam (nearly the upper limit with PWR) would enlarge the decarbonisation potential and the possible cost savings compare to lower temperatures. Electricity would not be the main output but could however be produced whenever it does not endanger the heat production.

(iii) Nuclear units could be dedicated to low temperature (<100°C) heat production, either for district heating or industrial purposes. Swimming pool reactors may hold significant cost and safety advantages, perhaps allowing the location of the plants closer to dense heat demand centers. Reactors would be designed so as to match the size of the heat output, which are rarely higher than 100 MWh_{th} and 1000 MWh_{th} for a single factory and a large, city-scaled district heating system, respectively.

The Introduction presented the research scope, questions and main methodology of the Ph.D. Parts I, II and III then forms the heart of the Report. Potentially cost-effective projects with a more efficient use of the heat generated by possible future pressurized water reactors were identified in Part I. I have shown that at least seven out of the fifteen theoretical systems envisioned in Europe could prove to be overall good for the society. These systems can potentially show a good compromise between the diverse socioeconomic criteria that affect decision-making processes such as heating cost, greenhouse gases and air pollutant emissions, land use planning, energy self-sufficiency or price stability. I consider that several research questions worth to be studied in the future:

- What are the relative costs and benefits of systems generating the same amount of electricity and heat? What are the pros and cons of nuclear heat only reactors compare to combined heat and power reactors? To answer these questions, the entire investment cost of a new nuclear power plant needs to be taken into account (see e.g. Jaskólski *et al.*, 2017).
- Could the operation of a nuclear plant in partial cogeneration mode increase its load factor? Is it more reasonable to operate single or several units within a specific site in co-generation? What is the economic value of heat storages located nearby the nuclear plant? What is the optimal storage size and heat transportation line capacity from a techno-economic perspective? These questions are currently being studied by Senior Scientist Miika Rämä from VTT Technical Research Centre of Finland during a visiting researcher period at Itésé, CEA.
- Could the replacement of electric heaters by district heating systems in urban areas reduce the volatility of the French power demand, especially in winter seasons? If yes, to what extent, and what would be the benefits?

- What are the relevant operational criteria to determine whether a district heating solution is more efficient than individual heat pumps?
- How to design an useful analytical tool aiming to integrate both the heating and cooling infrastructure and the envelope of buildings at a city scale and within a single model?

Without any feedback from real world's project however, the uncertainty affecting the key parameter values would remain high. While techno-economic studies may help stimulating the creation of space for concrete experimentation, real cases are also required to provide more accurate data to the models. The case studies performed in Part II has yet revealed that challenges to concrete implementation are high, arising from social, political, institutional, financial and psychological dimensions. These aspects should be seriously considered by those stakeholders which are interested in implementing nuclear plant based heating systems. If nuclear plants are planned on a site that holds potential for cost-effective heat supply (e.g. Gravelines, Le Bugey, Loviisa, Oldbury), they should be built as 'cogeneration ready'. Cogeneration readiness can be delivered for a small incremental cost, and would ensure that the plants are ready for a complete cogeneration upgrade when the market, institutional and socio-political conditions are fulfilled. Alongside, the development of district heating networks and the co-location of diverse industrial factories within contiguous areas should be supported through all channels, especially local ones. To our opinion, the below research questions would deserve further investigations:

- What are the viewpoints of those citizens, non-governmental associations and factory owners which have experience in nuclear plant based heating systems in their municipality?
- Could multicriteria methods serve to enhance the discussions about practical experimentation? If not, which approaches could allow the emergence of innovative ideas while enhancing multi-stakeholder interactions?

Part III investigated the French case in details. Nuclear plant based heating systems could be progressively implemented between 2020 and 2050 without jeopardizing the development of renewable heat and power sources or other excess heat sources. Doing so could reduce greenhouse gases emissions of the heating sector while improving energy self-sufficiency. Such systems are however barely mentioned in international and national energy scenario. Without a large feeling that this alternative is supported by the public authorities (European, national, and also, importantly, regional and local ones), the scheme may not progress. Alongside, spaces for creating and testing technical, economic, social and organisational aspects of these systems would help increasing the awareness of policy makers and stakeholders. While legitimacy and desirability can be stimulated by active and cross-boundary intermediation, external, unpredictable, events also have a significant role. A pre-requisite to an efficient intermediation is to acknowledge the fact that legitimacy is based not on the knowledge itself but on the working conditions surrounding knowledge creation. I think that the following questions may be of interest for future researchers:

- How to fasten the adoption of 4th generation district heating practices in France (i.e. increasing energy efficiency and integrating renewable and recoverable sources; see Section 2.3.2 of Chapter 1)?
- How to design long term policies aiming to encourage the implementation of various industries in contiguous areas, so as to generate synergies? How to enhance the development of district heating and cooling networks in France?

In a broader view, I advocate that energy efficiency practices should be decoupled from the industrial interests underlying technological choices. Long term energy policy should aim at minimising the amount of wasted energy, acknowledging the fact that the economic attractiveness of energy efficient systems is not fixed but strongly depends on long term land use planning. Local public authorities thus have a great role to play in the concrete implementation of district heating systems and eco-industrial parks. They should be recognised as key players and be funded accordingly.

General References

- ADEME (French Agency for Environment and Energy Supervision), RTE (French power network operator), 2007. Le contenu en CO₂ du kWh électrique : Avantages comparés du contenu marginal et du contenu par usages sur la base de l'historique.
- ADEME, 2008. « Economies d'énergie. Faisons vite, ça chauffe ! ». Available from: <http://www.developpement-durable.gouv.fr/IMG/spipwwwmedad/pdf/Dossier_de_presse_cle2a2a21-1.pdf> [in french].
- ADEME, 2012. Les économies d'énergie dans le bâtiment. Les données météorologiques RT 2012. Available from: <<http://www.rt-batiment.fr/batiments-neufs/reglementation-thermique-2012/donnees-meteorologiques.html>> [in French].
- ADEME, 2015a. Etude des coûts d'investissement et d'exploitation associés aux installations biomasse énergie des secteurs collectifs et industriels [in French].
- ADEME, 2015b. Climat, Air et Energie - Edition 2015. Available from: <<http://www.ademe.fr/sites/default/files/assets/documents/ademe-climat-energie-web.pdf>> [in French].
- ADEME, 2016a. Etude de valorisation du stockage thermique et du power-to-heat. Available from: <<http://www.ademe.fr/sites/default/files/assets/documents/valorisation-stockage-thermique-power-to-heat-2016-rapport.pdf>> [in French].
- ADEME, 2016b. Le Fonds Chaleur en bref. Available from: <<http://www.fonds-chaaleur.ademe.fr/>> [in French].
- ADEME, 2017. 13ième Rencontres des réseaux de chaleur (13th national DH meeting). Round Table of the 12/12. Presentation by Rémi Chabrilat "Factor 5 for renewable and excess heat sources: Which means for which objectives?" [in French].
- ADEME, 2018. Fonds Chaleur 2018 - Secteur réseaux de chaleur. Available from: <http://www.ademe.fr/sites/default/files/assets/documents/2reseaux_chaleur_fds_chal_2018_27-02-2018.pdf> [in French].
- AEA Technology plc, 2012. Conversion of biomass boiler emission concentration data for comparison with Renewable Heat Incentive emission criteria. AEA/R/ED46626/AEA/R/3296. Available from: <https://uk-air.defra.gov.uk/assets/documents/reports/cat07/1205310837_Conversion_of_biomass_boiler_emission_data_rep_Issue1.pdf>.
- Aglietta, M. and Rigot, S., 2012. Investissements à long terme, régulation financière et croissance soutenable. *Rev. d'Economie Financ.*, 108, 189-200 [in French].
- Agogué, M., Berthet, E., Fredberg, T., Masson, P.L., Segrestin, B., Stoetzel, M., Wiener, M., Yström, A., 2017. Explicating the role of innovation intermediaries in the "unknown": a contingency approach. *Journal of Strategy and Mgt* 10, 19–39.
- Åkerman, M., Peltola, T., 2006. Constituting the space for decision making—Conflicting calculations in a dispute over fuel choice at a local heating plant. *Geoforum* 37, 779–789.
- Al-Shemmeri, T., Al-Kloub, B., Pearman, A., 1997. Model choice in multicriteria decision aid. *European Journal of Operational Research* 97, 550–560.
- AMORCE (French DH association), 2011. Solutions techniques pour optimiser les réseaux de chaleur dans un contexte de développement de bâtiments basse consommation. Available from: <http://www.amorce.asso.fr/media/filer_public/12/15/12155959-eaba-447c-9785-27dbba635e34/rct34_optimisationrc.pdf> [in French].
- AMORCE, 2015a. Comparatif des modes de chauffage et prix de vente de la chaleur. Data for 2014. Available from: <<http://www.amorce.asso.fr/fr/espace-adherents/publications/rdc/prix-de->

General References

- la-chaleur/comparatif-des-modes-de-chauffage-et-prix-de-vente-de-la-chaleur-rapport-2015-donnees-2014/> [in French].
- AMORCE, 2015b. Contenu en CO2 des réseaux. Available from: <http://webcache.googleusercontent.com/search?q=cache:aNZMVfLIGeJ:partage.amorce.asso.fr/20150923_Module_de_calcul-KIKjL.xlsx+&cd=3&hl=fr&ct=clnk&gl=fr> [in French].
- AMORCE, 2017a. Présentation of the 13^{ième} Rencontres des réseaux de chaleur (13th national DH meeting). Round Table of the 12/12/17. Presentation by Françoise Bey (Strasbourg Eurométropole) “Développement des réseaux de chaleur sur l’intercommunalité” [in French].
- AMORCE, 2017b. 13^{ième} Rencontres des réseaux de chaleur (13th national DH meeting). Round Table of the 12/12. Presentation by Rémi Chabrilat “Factor 5 for renewable and excess heat sources: Which means for which objectives?” [in French].
- AMORCE, 2017c. Fonds chaleur: Les nouvelles propositions d’AMORCE pour un développement des réseaux de chaleur à la hauteur des objectifs. Available from: <<http://www.amorce.asso.fr/fr/reseaux-de-chaleur/actualites/fonds-chaleur-les-nouvelles-propositions-damorce-pour-un-developpement-des-reseaux-de-chaleur-la-hauteur-des-objectifs/>> [in French].
- AMORCE, 2017d. 9 propositions du comité national des acteurs des réseaux de chaleur. Available from: <<http://www.amorce.asso.fr/fr/espace-adherents/publications/rdc/parties-prenantes/9-propositions-du-comite-national-des-acteurs-des-reseaux-de-chaleur/>> [in French].
- ANCRE (French National Alliance for Energy Research Coordination), 2013. Scénarios de l’ANCRE pour la transition énergétique. Rapport 2013. Available from: <http://www.allianceenergie.fr/imageProvider.asp?private_resource=984&fn=Doc+complet+ANCRE+version+finale+15+Janv_0%2Epdf> [in French].
- ANCRE, 2015. Cogénération nucléaire: Intérêts et potentiels d’une offre de chaleur basse température pour l’industrie française. Agence Nationale de Coordination de la Recherche pour l’Energie.
- ANCRE, 2017. Prospective énergétique France 2050: le scénario de l’ANCRE pour la Loi de Transition Énergétique. Available from: <<https://www.allianceenergie.fr/wp-content/uploads/2017/06/Sc%C3%A9nario-Loi-de-Transition-energie%C3%A9tique-croissance-verts-LTECV-25-11-2016.pdf>> [in French].
- Angulo, C., Bogusch, E., Bredimas, A., Delannay, N., Viala, C., Ruer, J., Muguerra, P., Sibaud, E., Chauvet, V., Hittner, D., Fütterer, M.A., de Groot, S., von Lensa, W., Verfondern, K., Moron, R., Baudrand, O., Griffay, G., Baaten, A., Segurado-Gimenez, J., 2012. EUROPAIRS: The European project on coupling of High Temperature Reactors with industrial processes. Nuclear Engineering and Design, 5th International Topical Meeting on High Temperature Reactor Technology (HTR 2010) 251, 30–37.
- Arent, D., Tol, R.S.J., Faust, E., Hella, J.P., Kumar, S., Strzepek, K.M., Yan, D., 2014. FINAL DRAFT IPCC WGII AR5 Chapter 14.
- Arrow, K.J., Cropper, M.L., Gollier, C., Groom, B., Heal, G.M., Newell, R.G., Nordhaus, W.D., Pindyck, R.S., Pizer, W.A., Portney, P.R., Sterner, T., Tol, R.S.J., Weitzman, M.L., 2014. Should Governments Use a Declining Discount Rate in Project Analysis? Rev Environ Econ Policy.
- Asaee, S.R., Ugursal, V.I., Beausoleil-Morrison, I., 2017. Techno-economic feasibility evaluation of air to water heat pump retrofit in the Canadian housing stock. Applied Thermal Engineering 111, 936–949.
- Assemblée nationale (French national assembly), 2009. Loi Grenelle I (loi n° 2009-967 du 3 août 2009 de programmation relative à la mise en œuvre du Grenelle de l’environnement) [in French].
- Assemblée nationale, 2012a. Arrêté du 22 décembre 2012 relatif au classement des réseaux de chaleur et de froid. JORF n°0012 du 15 janvier 2013 page 962. Available from: <<https://www.legifrance.gouv.fr/affichTexte.do;jsessionid=?cidTexte=JORFTEXT000026939712&dateTexte=&oldAction=rechJO&categorieLien=id>> [in French].

- Assemblée nationale, 2012b. Arrêté du 28 décembre 2012 relatif aux caractéristiques thermiques et aux exigences de performance énergétique des bâtiments nouveaux et des parties nouvelles de bâtiments autres que ceux concernés par l'article 2 du décret du 26 octobre 2010 relatif aux caractéristiques thermiques et à la performance énergétique des constructions. Available from: <<https://www.legifrance.gouv.fr/affichTexte.do?cidTexte=JORFTEXT000026871753&categorieLien=id>> [in French].
- Assemblée nationale, 2015. Loi n° 2015–992 du 17 août 2015 Relative à la transition énergétique pour la croissance verte, 2015–2992. Available from: <<http://www.legifrance.gouv.fr/affichTexte.do?cidTexte=JORFTEXT000031044385&categorieLien=id>> [in French].
- Assemblée nationale, 2017. LOI n° 2017-1837 du 30 décembre 2017 de finances pour 2018. Available from: <<https://www.legifrance.gouv.fr/eli/loi/2017/12/30/CPAX1723900L/jo/texte/#>> [in French].
- Association of decentralized energy, 2015. The Heat Trust.
- Australian academy of science, 2015. The science of climate change. Questions and answers. Available from: <<https://www.science.org.au/files/userfiles/learning/documents/climate-change-wr.pdf>>.
- Averfalk, H., Werner, S., 2017. Essential improvements in future district heating systems. Energy Procedia, 15th International Symposium on District Heating and Cooling, DHC15-2016, 4-7 September 2016, Seoul, South Korea 116, 217–225.
- Babic, Z., Plazibat, N., 1998. Ranking of enterprises based on multicriterial analysis. International Journal of Production Economics, Production Economics: The Link Between Technology And Management 56-57, 29–35.
- Bach, B., 2014. Integration of Heat Pumps in Greater Copenhagen. Master Thesis hold in the Technical University of Denmark, Department of Mechanical Engineering, Thermal Energy. Available from: <https://www.researchgate.net/publication/314094868_Integration_of_Heat_Pumps_in_Greater_Copenhagen>.
- Bachmann, T.M., van der Kamp, J., 2014. Environmental cost-benefit analysis and the EU (European Union) Industrial Emissions Directive: Exploring the societal efficiency of a DeNOx retrofit at a coal-fired power plant. Energy 68, 125–139.
- Balcombe, P., Rigby, D., Azapagic, A., 2014. Investigating the importance of motivations and barriers related to microgeneration uptake in the UK. Applied Energy 130, 403–418.
- Bardouille, P., Koubsky, J., 2000. Incorporating sustainable development considerations into energy sector decision-making: Malmö Flintränen district heating facility case study. Energy Policy 28, 689–711.
- Barrie, J., Zawdie, G., João, E., 2017. Leveraging triple helix and system intermediaries to enhance effectiveness of protected spaces and strategic niche management for transitioning to circular economy. International Journal of Technology Management and Sustainable Development 16, 25–47.
- Bartolozzi, I., Rizzi, F., Frey, M., 2017. Are district heating systems and renewable energy sources always an environmental win-win solution? A life cycle assessment case study in Tuscany, Italy. Renewable and Sustainable Energy Reviews 80, 408–420.
- Bauer, D., Marx, R., Nußbicker-Lux, J., Ochs, F., Heidemann, W., Müller-Steinhagen, H., 2010. German central solar heating plants with seasonal heat storage. Solar Energy, International Conference CISBAT 2007 84, 612–623.
- Bauknecht, D., Leprich, U., Späth, P., Skytte, K., Esnault, B., 2007. DG-Grid: Regulating innovation & Innovating regulation. Brussels: Intelligent Energy.
- Baurens, P., Carles, P., Cren, J., Duhamet, J., Gilardi, F., Le Naour, F., Leybros, J., Mansilla, C., Mougin, J., Noirot, I., Poitou, S., Robin, J.C., Saturnin, A., Yvon, P., Cany, C., 2013. Performances and economic competitiveness comparison of advanced hydrogen production processes coupled

- to a nuclear reactor. Workshop of the Organisation for Economic Co-operation and Development (OECD) on economics of nuclear cogeneration. 4-5 April 2013.
- Beccali, M., Cellura, M., Ardenete, D., 1998. Decision making in energy planning: the ELECTRE multicriteria analysis approach compared to a FUZZY-SETS methodology. *Energy Conversion and Management* 39, 1869–1881.
- Behzadian, M., Kazemzadeh, R.B., Albadvi, A., Aghdasi, M., 2010. PROMETHEE: A comprehensive literature review on methodologies and applications. *European Journal of Operational Research* 200, 198–215.
- Benson, M.H., Garmestani, A.S., 2011. Embracing panarchy, building resilience and integrating adaptive management through a rebirth of the National Environmental Policy Act. *Journal of Environmental Management* 92, 1420–1427.
- Bergant, R., Ploj, T., Štrubelj, L., Androjna, G., Manojlović, S., 2013. Combined Heat and Power Production in NPP Krško. Contribution to the 22th International Conference Nuclear Energy for New Europe. Available from: <http://www.djs.si/proc/nene2013/pdf/NENE2013_1003.pdf>.
- Bergek, A., Jacobsson, S., Carlsson, B., Lindmark, S., Rickne, A., 2008. Analyzing the functional dynamics of technological innovation systems: A scheme of analysis. *Research Policy* 37, 407–429.
- Bergroth, N., 2010. Large-Scale Combined Heat and Power (CHP) Generation at Loviisa Nuclear Power Plant Unit 3. Contribution to the 8th Conference on Nuclear option in countries with small and medium electricity grids.
- Berkes, F., Ross, H., 2016. Panarchy and community resilience: Sustainability science and policy implications. *Environmental Science and Policy* 61, 185–193.
- Berthélemy, M., Leurent, M., Locatelli, G., 2016. The development of small modular reactors: Which markets for which applications? *Lettre I-Tésé* 29. Automne 2016.
- Bianco, V., Scarpa, F., Tagliafico, L.A., 2017. Estimation of primary energy savings by using heat pumps for heating purposes in the residential sector. *Applied Thermal Engineering* 114, 938–947.
- BINE information service, 2017. Innovative approaches to the long-term heat storage tank. Available from: <<http://www.bine.info/en/publications/publikation/schulsanierung-mit-solarer-nahwaerme-verknuepft/innovative-ansaeetze-beim-langzeitwaermespeicher/>>.
- Boardman, N.E., 2010. *Cost-Benefit Analysis: Concepts and Practice*, fourth ed., Prentice Hall, Upper Saddle River, NJ.
- Boarin, S., Locatelli, G., Mancini, M., Ricotti, M.E., 2012. Financial Case Studies on Small- and Medium-Size Modular Reactors. *NT* 178, 218–232.
- Bohm, B., Kristjansson, H., 2005. Single, twin and triple buried heating pipes: on potential savings in heat losses and costs. *International Journal of Energy Research* 29, 1301–1312.
- Boons, F.A.A., Baas, L.W., 1997. Types of industrial ecology: The problem of coordination. *Journal of Cleaner Production, Industrial Ecology* 5, 79–86.
- Bowman, J.F., 2012. Electric Power Plant Waste Heat Utilisation. *Proceedings of the ASME 2012 Summer Heat Transfer Conference*.
- Brandt, J., Christensen, J.H., Frohn, L.M., Berkowicz, R., 2001. Operational air pollution forecasts from regional scale to urban street scale. Part 1: system description. *Physics and Chemistry of the Earth, Part B: Hydrology, Oceans and Atmosphere* 26, 781–786.
- Brandt, J., Christensen, J., Frohn, L.M., Geels, C., Hansen, K.M., Hedegaard, G.B., Hvid, T., Hvidberg, M., Skjoth, C.A., 2008. THOR – An Operational and Integrated Model System for Air Pollution Forecasting and Management from Regional to Local Scale. In: *Seventh International Conference on Air Quality – Science and Application, Istanbul*. Available from: <<https://meetings.copernicus.org/www.cosis.net/abstracts/EGU2008/08257/EGU2008-A-08257.pdf>>.
- Brans, J.P., Vincke, P., 1985. A preference ranking organisation method: (the PROMETHEE method for multiple criteria decision-making). *Management Science* 31, 647–656.

- Brans, J.P., Vincke, P., Mareschal, B., 1986. How to select and how to rank projects: The Promethee method. *European Journal of Operational Research, Mathematical Programming Multiple Criteria Decision Making* 24, 228–238.
- Brans, J.P., Mareschal, B., 2005. Multiple Criteria Decision Analysis: State of the Art Surveys. Springer Science + Business Media, Inc., pp. 163–196. In: Figueira, J., Greco, S., Ehrgott, M. (Eds.).
- Braun, H.-J., 1992. Symposium on “failed innovations.” *Social Studies of Science* 22, 210–215.
- Brněnské vodárny a kanalizace, a.s. (Brno DH operator), 2017. Vodovodní síť (water supply network). Available from: <<http://www.bvk.cz/o-spolecnosti/zasobovani-pitnou-vodou/vodovodni-sit/>> [in Czech].
- Broberg, S., Backlund, S., Karlsson, M., Thollander, P., 2012. Industrial excess heat deliveries to Swedish district heating networks: Drop it like it’s hot. *Energy Policy* 51, 332–339.
- Broberg Viklund, S., Karlsson, M., 2015. Industrial excess heat use: Systems analysis and CO2 emissions reduction. *Applied Energy* 152, 189–197.
- Bundeskartellamt (German Competition Authority), 2012. Final Report Sector Inquiry District Heating.
- BuroHappold Engineering, 2016. UK Spatial District Heating Analysis. Available from: <<http://fes.nationalgrid.com/media/1215/160712-national-grid-dh-summary-report.pdf>>.
- Bush, R.E., Bale, C.S.E., Taylor, P.G., 2016. Realising local government visions for developing district heating: Experiences from a learning country. *Energy Policy* 98, 84–96.
- Bush, R.E., Bale, C.S.E., Powell, M., Gouldson, A., Taylor, P.G., Gale, W.F., 2017. The role of intermediaries in low carbon transitions – Empowering innovations to unlock district heating in the UK. *Journal of Cleaner Production* 148, 137–147.
- Cahn, M., 2000. Liberalisation and its impact on municipalities in the participant countries and the UK: Summary of report. International Energy Agency Demand-Side Management Programme.
- Cany, C., Mansilla, C., da Costa, P., Mathonnière, G., Duquesnoy, T., Baschwitz, A., 2016. Nuclear and intermittent renewables: Two compatible supply options? The case of the French power mix. *Energy Policy* 95, 135–146.
- Cany, C., 2017. Interactions entre énergie nucléaire et énergies renouvelables variables dans la transition énergétique en France : adaptations du parc électrique vers plus de flexibilité. Available from: <<https://www.theses.fr/200224255>> [in French].
- Carlsson, J., Shropshire, D.E., van Heek, A., Fütterer, M.A., 2012. Economic viability of small nuclear reactors in future European cogeneration markets. *Energy Policy* 43, 396–406.
- CEA (French Nuclear and Alternative Energies Commission), 2017. ELECNUC. Nuclear power plants in the world. Edition 2017. Available from: <<http://www.cea.fr/multimedia/Documents/publications/ouvrages/Elecnucl-2017.pdf>>.
- CEPRO (Clean Energy Prospector), 2015. CHOICES solar district heat study. Available from: <<http://www.cepro.co.uk/2015/04/choices-solar-district-heat-study/>>.
- CeRCAD Midi-Pyrénées, 2015. Observatoire des coûts de la rénovation énergétique. Analyse de dossiers de financement de travaux de rénovation énergétique 2012. Available from: <http://www.cercad.fr/IMG/pdf/cercad_-_ocre_-_observatoire_des_coouts_de_la_renovation_energetique_en_midi-pyrenees_-_synthese_n1_-_sep2015-2.pdf> [in French].
- CEREMA (French Research Centre on Risks, Environment, Mobility and Territorial Planning), 2009. Le réseau de chaleur de récupération industrielle de Dunkerque (59). Available from: <<http://reseaux-chaleur.cerema.fr/le-reseau-de-chaleur-de-recuperation-industrielle-de-dunkerque-59>> [in French].
- CEREMA, 2012. Coût d’investissement d’un réseau de chaleur : quelques repères. Available from: <<http://reseaux-chaleur.cerema.fr/cout-dinvestisement-dun-reseau-de-chaleur-quelques-reperes>> [in French].

General References

- CEREMA, 2014. Consommation d'énergie dans les bâtiments. Chiffres clés 2013. Available from: <<http://reseaux-chaaleur.cerema.fr/consommation-denergie-dans-les-batiments-chiffres-cles-2013>> [in French].
- CEREMA, 2015. Carte nationale de chaleur – France. Available at: <<http://reseaux-chaaleur.cerema.fr/carte-nationale-de-chaaleur-france>> [in French].
- Chai, K.-H., Yeo, C., 2012. Overcoming energy efficiency barriers through systems approach—A conceptual framework. *Energy Policy* 46, 460–472.
- Chang, N., 2015. Changing industrial structure to reduce carbon dioxide emissions: a Chinese application. *Journal of Cleaner Production, Carbon Emissions Reduction: Policies, Technologies, Monitoring, Assessment and Modeling* 103, 40–48.
- Charlier, D., 2015. Energy efficiency investments in the context of split incentives among French households. *Energy Policy* 87, 465–479.
- Chatham House, 2017. Woody Biomass for Power and Heat. Impacts on the Global Climate. Research Paper by Duncan Brack, Environment, Energy and Resources Department. Available from: <<https://www.chathamhouse.org/sites/default/files/publications/research/2017-02-23-woody-biomass-global-climate-brack-final2.pdf>>.
- Chauvel, A., Fournier, G., Raimbault, C., 2001. Manuel d'évaluation économique des procédés. Editions TECHNIP [in French].
- Chénaïs, J., Diet, A., Grondin, Y., Perrier, S., 2014. L'approche française par le consortium SMR (CEA, EDF, AREVA, DCNS). *RGN* 95–97.
- Chertow, M.R., Lombardi, D.R., 2005. Quantifying economic and environmental benefits of co-located firms. *Environmental Science and Technology* 39, 6535–6541.
- Chertow, M.R., 2000. Industrial Symbiosis: Literature and Taxonomy. *Annual Review of Energy and the Environment* 25, 313–337.
- Cherubini, F., Peters, G.P., Berntsen, T., Strømman, A.H., Hertwich, E., 2011. CO₂ emissions from biomass combustion for bioenergy: atmospheric decay and contribution to global warming. *GCB Bioenergy* 3, 413–426.
- Chirat, J.-P., Denisart, F., 2016. Nouvelles dynamiques de rénovation des logements. Rapport de synthèse et proposition. Jean-Pascal Chirat (Club de l'Amélioration de l'habitat) et Frédéric Denisart (Conseil National de l'Ordre des Architectes). Available from: <http://www.planbatimentdurable.fr/IMG/pdf/plan_batiment_durable_rapport_nouvelles_dynamiques_de_renovation_des_logements.pdf> [in French].
- Chorowski, M., Rogala, Z., Pyrka, P., 2016. System options for cooling of buildings making use of district heating heat. *International Journal of Refrigeration* 70, 183–195.
- CIBSE (Chartered Institution of Building Services Engineers), 2012. Absorption Cooling. Datasheet 07 of the CHP Group of the Chartered Institution of Building Services Engineers (CIBSE). Available from: <<https://www.cibse.org/getmedia/5c9a9e15-5103-4b70-8aa1-1b7456fdf9a5/Datasheet-7-Absorption-Cooling.pdf.aspx>>.
- City of Helsinki, 2015. Helsinki's Climate Roadmap - Towards a carbon neutral and climate resilient city.
- City of Helsinki, 2016. City council meetings and seats. Available from: <<http://www.hel.fi/www/Helsinki/en/administration/decision/council/seats/>>.
- City of Vancouver, 2006. Trent Berry. Biomass permit analysis. City of Vancouver, Vancouver, BC.
- Clapp, C.E., Allmaras, R.R., Layese, M.F., Linden, D.R., Dowdy, R.H., 2000. Soil organic carbon and ¹³C abundance as related to tillage, crop residue, and nitrogen fertilization under continuous corn management in Minnesota. *Soil and Tillage Research* 55, 127–142.
- CLCV (National consumer protection association), 2017. Tarif, contrats, gouvernance Il faut reprendre en main le chauffage urbain. Available from: <http://www.clcv.org/images/CLCV/DP_chauffage_urbain_copy_copy_copy_copy_copy.pdf> [in French].

- CNNC (Chinese National Nuclear Corporation), 2017. CNNC launches pool-type low-temperature heating reactor. 2017-12-12. Available from: <http://en.cnncc.com.cn/2017-12/12/c_118604.htm>.
- Colmenar-Santos, A., Rosales-Asensio, E., Borge-Diez, D., Collado-Fernández, E., 2016. Evaluation of the cost of using power plant reject heat in low-temperature district heating and cooling networks. *Applied Energy* 162, 892–907.
- Colmenar-Santos, A., Rosales-Asensio, E., Borge-Diez, D., Mur-Pérez, F., 2015. Cogeneration and district heating networks: Measures to remove institutional and financial barriers that restrict their joint use in the EU-28. *Energy* 85, 403–414.
- Commissariat Général du Plan, 2005. Révision du taux d'actualisation des investissements publics. Report directed by Danial Lebègue. Available from: <http://www.documentation.eaufrance.fr/entrepotsOAI/OIEAU/44/223176/223176_doc.pdf> [in French].
- Communauté Urbaine de Dunkerque (Dunkirk Conurbation Committee), 2015. Plan Air Climat Energie Territorial 2015-2021. Available from: <https://www.communaute-urbaine-dunkerque.fr/fileadmin/documents/rapports/Plan_Air_Climat_Energie_Territorial_2015-2021_cud.pdf> [in French].
- Communauté urbaine de Dunkerque, 2016. Opportunités et stratégies de valorisation de la chaleur industrielle fatale . Available from: <http://atee.fr/sites/default/files/11_-_cud_-_f.mabille_-_oportunitr_stratrgie.pdf> [in French].
- Comte, A., 1853. The positive philosophy of Auguste Comte. Freely translated and condensed by Harriet Martineau with an introduction of Frederic Harrison. Batoche books, Kitchener 2000 Edition. In three Volumes. Volume 1 available from: <<https://socialsciences.mcmaster.ca/econ/ugcm/3ll3/comte/Philosophy1.pdf>>
- Connolly, D., Lund, H., Mathiesen, B.V., Werner, S., Möller, B., Persson, U., Boermans, T., Trier, D., Østergaard, P.A., Nielsen, S., 2014. Heat Roadmap Europe: Combining district heating with heat savings to decarbonise the EU energy system. *Energy Policy* 65, 475–489.
- Core Cities, 2013. Core Cities Growth Prospectus Policies Step 6: Power Up the Cities. Core Cities.
- CRE (French energy regulation commission), 2013. Analyse des coûts de production et de commercialisation d'EDF dans le cadre des tarifs réglementés de vente d'électricité. Available from: <<http://www.cre.fr/documents/publications/rapports-thematiques/analyse-des-couts-de-production-et-de-commercialisation-d-edf>> [in French].
- CRE, 2014. La contribution au service public de l'électricité (CSPE) : mécanisme, historique et prospective. Available from: <<http://www.cre.fr/documents/publications/rapports-thematiques/rapport-sur-la-cspe-mecanisme-historique-et-prospective>> [in French].
- CRE, 2016a. Les marchés de gros de l'électricité, du gaz naturel et du CO₂. 2nd trimestre 2016. Available from: <<http://www.cre.fr/marches/observatoire-des-marches#section2>> [in French].
- CRE, 2016b. Les marchés de détail de l'électricité et du gaz naturel. 2nd trimestre 2016 (Data on 30/06/2016). Available from: <<http://www.cre.fr/marches/observatoire-des-marches#section1>> [in French].
- Cuce, P.M., Cuce, E., 2017. Toward cost-effective and energy-efficient heat recovery systems in buildings: Thermal performance monitoring. *Energy* 137, 487–494.
- Dalkia (Groupe EDF), 2015. Energie Grand Littoral. Réseau de chauffage urbain. Compte-rendu technique et financier. Exercice 2015. Available from: <https://www.communaute-urbaine-dunkerque.fr/fileadmin/documents/rapports/Reseau_de_chaleur_-_compte-rendu_d_activite_2015.pdf> [in French].
- Dalla Rosa, A., Christensen, J.E., 2011. Low-energy district heating in energy-efficient building areas. *Energy* 36, 6890–6899.
- Dalla Rosa, A., Boulter, R., Church, K., Svendsen, S., 2012. District heating (DH) network design and operation toward a system-wide methodology for optimizing renewable energy solutions (SMORES) in Canada: a case study. *Energy* 45, 960–074.

General References

- Dalla Rosa, A., Li, H., Svendsen, S., Werner, S., Persson, U., Ruehling, K., Felsmann, C., Crane, M., Burzynski, R., Bevilacqua, C., 2014. Toward 4th Generation District Heating: Experience and Potential of Low-Temperature District Heating.
- Dalmaso, A., 2008. Le projet Thermos (1975-1981) ou l'échec de « l'atome au coin du feu. Colloque Nucléaire et développement régional, Tours, CEHMVI, Fondation EDF, 17-18 décembre 2008. [in French].
- DBDH (Danish DH association), 2014. Mapping of Polish district heating market. Available from: <https://dbdh.dk/download/member_contries/poland/mapping%20poland.pdf>.
- DEA (Danish Energy Agency), 2013. Technology Data for Energy Plants Individual Heating Plants and Energy Transport. Original version (2013). Available from: <https://ens.dk/sites/ens.dk/files/Analyser/old_technology_data_for_individual_heating_plants_and_energy_transport_aug2016.pdf>.
- DEA, 2016a. Technology Data for Energy Plants Updated chapters, August 2016. Available from: <https://ens.dk/sites/ens.dk/files/Analyser/update_-_technology_data_catalogue_for_energy_plants_-_aug_2016.pdf>.
- DEA, 2016b. Technology Data for Energy Plants. Generation of Electricity and District Heating, Energy Storage and Energy Carrier Generation and Conversion. Available from: <https://ens.dk/sites/ens.dk/files/Analyser/teknologikatalog_august_2016_08082016.pdf>.
- DEA, 2016c. Technology Data for Individual Heating Plants and Energy Transport. Updated chapters, August 2016. Available from: <https://ens.dk/sites/ens.dk/files/Analyser/technology_catalogue_individual_heating_plants_energy_transport_aug16.pdf>.
- DECC (Department of Energy and Climate Change), 2012. District Heating - Heat Metering Cost Benefit Analysis.
- DECC, 2013a. Summary evidence on District Heating Networks in the UK. Available from: <https://www.gov.uk/government/uploads/system/uploads/attachment_data/file/212565/summary_evidence_district_heating_networks_uk.pdf>.
- DECC, 2013b. Research into barriers to deployment of district heating networks. Available from: <<https://www.cse.org.uk/downloads/reports-and-publications/policy/community-energy/insulation-and-heating/planning/renewables/research-into-barriers-to-deployment-of-district-heating-networks.pdf>>.
- Decentralized energy, 2017. Chinese firm to develop nuclear district heating plant. Available from: <<http://www.decentralized-energy.com/articles/2017/12/chinese-firm-to-develop-nuclear-district-heating-plant.html>>.
- Delmastro, C., Mutani, G., Schranz, L., 2015. Advantages of Coupling a Woody Biomass Cogeneration Plant with a District Heating Network for a Sustainable Built Environment: A Case Study in Luserna San Giovanni (Torino, Italy). Energy Procedia, 6th International Building Physics Conference, IBPC 2015 78, 794–799.
- Dick, W.A., Blevins, R.L., Frye, W.W., Peters, S.E., Christenson, D.R., Pierce, F.J., Vitosh, M.L., 1998. Impacts of agricultural management practices on C sequestration in forest-derived soils of the eastern Corn Belt. Soil and Tillage Research 47, 235–244.
- Difs, K., Danestig, M., Trygg, L., 2009. Increased use of district heating in industrial processes – Impacts on heat load duration. Applied Energy 86, 2327–2334.
- Dincer, I., Dost, S., 1996. A perspective on thermal energy storage systems for solar energy applications. Int. J. Energy Res. 20, 547–557.
- Dincer, I., Rosen, M., 2011. Thermal energy storage: systems and applications (2nd ed.), John Wiley & Sons.
- Direction Générale du Trésor (French financial authority), 2013. Livre blanc sur le financement de la transition écologique. Directed by Dron, D. Direction Générale du Trésor, Commissariat général au développement durable [in French].
- Decision Deck Consortium, 2018. DIVIZ, workbench to design, execute and share complex MCDA algorithms and experiments. Available from: <<https://www.diviz.org/>>.

General References

- Duna Center Therm Kft (Paks DH operator), 2016. Paks Város Környezeti állapotértékelése 2016 (Paks City Environmental status assessment 2016). Available from: <http://www.paks.hu/res/kornyezeti_allapotertekeles_2016.pdf> [in Hungarian].
- Easterby-Smith, M., Thorpe, R., Jackson, P., 2015. Management and Business Research. Fourth ed. Sage Publishing.
- EC (European Commission), 2008. NACE rev. 2. Statistical Classification of Economic Activities in the European Community, Rev. 2 (2008). Available from: <http://ec.europa.eu/eurostat/ramon/nomenclatures/index.cfm?TargetUrl=LST_NOM_DTL&StrNom=NACE_REV2&StrLanguageCode=EN&IntPcKey=&StrLayoutCode=HIERARCHIC>.
- EC, 2011. Commission staff working paper. Impact assessment. Energy roadmap 2050. COM (2011) 885 final {SEC (2011) 1566 final; SEC (2011) 1569 final}.
- EC, 2012a. Background Report on EU27 District Heating and Cooling Potentials, Barriers, Best Practice and Measures of Promotion. Available from: <<https://setis.ec.europa.eu/publications/jrc-setis-reports/background-report-eu-27-district-heating-and-cooling-potentials-0>>.
- EC, 2012b. Ecodesign and energy labelling - Air conditioners and comfort fans. Commission regulation (EU) No 206/2012 of 6 March 2012 implementing Directive 2009/125/EC of the European Parliament and of the Council with regard to ecodesign requirements for air conditioners and comfort fans OJ L 72, 10.3.2012.
- EC, 2013. EU energy, transport and GHG emissions. Trends to 2050. Reference scenario 2013.
- EC, 2014a. Special Eurobarometer 416: Attitudes of European Citizens towards the Environment. Available from: <http://ec.europa.eu/public_opinion/archives/ebs/ebs_416_en.pdf>.
- EC, 2014b. European Energy Security Strategy. COM (2014) 0330 final. Available from: <<http://eur-lex.europa.eu/legal-content/EN/ALL/?uri=CELEX:52014DC0330&qid=1407855611566>>.
- EC, 2014c. Guide to Cost-Benefit Analysis of Investment Projects for Cohesion Policy 2014-2020.
- EC, 2014d. State of play on the sustainability of solid and gaseous biomass used for electricity, heating and cooling in the EU. Brussels, 28.7.2014 SWD(2014) 259 final. Available from: <https://ec.europa.eu/energy/sites/ener/files/2014_biomass_state_of_play_.pdf>.
- EC, 2015a. Strategic Energy Technology Plan (SET-Plan). Available from: <<http://ec.europa.eu/energy/en/topics/technology-and-innovation/strategic-energy-technology-plan>>.
- EC, 2015b. Advanced Reactor for Cogeneration of Heat & Electricity. Available from: <<http://www.archer-project.eu/>>.
- EC, 2016a. Communication from the Commission to the European Parliament, the Council, the European Economic and Social Committee and the Committee of the Regions on an EU Strategy for Heating and Cooling. Available from: <https://ec.europa.eu/energy/sites/ener/files/documents/1_EN_autre_document_travail_service_part1_v6_0.pdf>.
- EC, 2016b. Energy in Buildings. Available from: <<https://ec.europa.eu/energy/en/topics/energy-efficiency/buildings>>.
- EC, 2016c. Communication from the Commission to the European Parliament, the Council, the European Economic and Social Committee and the Committee of the Regions on an EU Strategy for Heating and Cooling. Available from: <<http://eur-lex.europa.eu/legal-content/ES/TXT/?uri=CELEX:52016SC0024>>.
- EC, 2016d. Communication from the Commission to the European Parliament, the council, the European Economic and Social Committee and the Committee of the Regions. An EU Strategy on Heating and Cooling. Available from: <https://ec.europa.eu/energy/sites/ener/files/documents/1_EN_ACT_part1_v14.pdf>.
- EC, 2016e. Annexes to the Proposal for a Directive of the European Parliament and the Council on the promotion of the use of energy from renewable sources (recast). Available from: <<http://eur-lex.europa.eu/legal-content/EN/ALL/?uri=COM%3A2016%3A767%3AFIN>>.
- EC, 2016f. Efficient district heating and cooling systems in the EU. Case studies analysis, replicable key success factors and potential policy implications. Available from:

General References

- <http://publications.jrc.ec.europa.eu/repository/bitstream/JRC104437/study%20on%20efficiency%20dhc%20systems%20in%20the%20eu%20-dec2016_final%20-%20public%20report6.pdf>.
- EC, 2017. Photovoltaic geographical information system. Available from: <http://re.jrc.ec.europa.eu/pvg_tools/en/tools.html#MR>.
- Economidou, M., Lautsen, J., Strong, D., Zinetti, S., 2011. Europe' s buildings under the microscope: A country-by-country review of the energy performance of buildings. Available from: <http://bpie.eu/wp-content/uploads/2015/10/HR_EU_B_under_microscope_study.pdf>.
- Eduskunta (Parliament of Finland), 2009. The law regulates energy companies' energy services, including informing obligations and energy efficiency. Act No. 1211/2009 (Laki energiamarkkinoilla toimivien yritysten energiatehokkuuspalveluista).
- EEA (European Environment Agency), 2009. Water resources across Europe — confronting water scarcity and drought.
- EEA, 2011. CO2 electricity per kWh. Available from: <https://www.eea.europa.eu/data-and-maps/figures/co2-electricity-g-per-kwh/co2-per-electricity-kwh-fig-1_2010_qa.xls>.
- EEA, 2012. Air quality in Europe – 2012 report. Available from: <<https://www.eea.europa.eu/publications/air-quality-in-europe-2012>>.
- EEA, 2013. Progress on energy efficiency in Europe. Available from: <<https://www.eea.europa.eu/data-and-maps/indicators/progress-on-energy-efficiency-in-europe/assessment>>.
- Energiategollisuus, 2013. Kaukolämpöjohtojen suunnittelu- ja rakentamisohjeet Suositus L11/2013. Available from: <https://energia.fi/files/825/SuositusL11_2013_KI-johtojen_suunnittelu_ja_rakentamisohjeet.pdf> [in Finnish].
- Energimyndigheten (Swedish Energy Agency), 2015. Energy in Sweden.
- ENERGINET (Danish energy company), 2012. Technology data for energy plants. Generation of Electricity and District Heating, Energy Storage and Energy Carrier Generation and Conversion. Available from: <https://www.energinet.dk/SiteCollectionDocuments/Danske%20dokumenter/Forskning/Technology_data_for_energy_plants.pdf>.
- Energy efficiency watch, 2013. Energy efficiency in Europe/Country report: Finland. Available from: <http://www.energy-efficiency-watch.org/fileadmin/eew_documents/Documents/EEW2/Finland.pdf>.
- Enertech, 2010. Notes techniques et réflexions . Coûts des premières rénovations « basse consommation » en France Perspectives. Available from: <<http://www.enertech.fr/modules/catalogue/pdf/73/Couts%20renovation%20basse%20consommation.pdf>> [in French].
- ENTRANZE, 2014. Policies to ENforce the TRAnstition to Nearly Zero Energy building in the EU27. Available from: <<http://www.entranze-scenario.enerdata.eu/site/>>.
- ENTRANZE, 2017a. Policies to ENforce the TRAnstition to Nearly Zero Energy building in the EU27. Research project co-funded by the European Commission. Breakdown of dwelling stock by energy used for space heating (at normal climate). Data for 2008. Available from: <<http://www.entranze.enerdata.eu/share-of-dwellings-with-biomass-systems.html#/share-of-dwellings-connected-to-district-heating.html>>.
- ENTRANZE, 2017b. Policies to ENforce the TRAnstition to Nearly Zero Energy building in the EU27. Research project co-funded by the European Commission. Total unit consumption per m2 in non-residential (at normal climate). Data for 2008. Available from: <<http://www.entranze.enerdata.eu/total-unit-consumption-per-m2-in-non-residential-at-normal-climate.html>>.
- ESD, 2005. Sustainable energy communities and sustainable development: conclusions and recommendations. Wiltshire: ESD Ltd.
- Esen, H., Inalli, M., Esen, M., 2006. Technoeconomic appraisal of a ground source heat pump system for a heating season in eastern Turkey. Energy Conversion and Management 47, 1281–1297.

General References

- Esen, H., Inalli, M., Esen, M., 2007. A techno-economic comparison of ground-coupled and air-coupled heat pump system for space cooling. *Building and Environment* 42, 1955–1965.
- Esen, M., Yuksel, T., 2013. Experimental evaluation of using various renewable energy sources for heating a greenhouse. *Energy and Buildings* 65, 340–351.
- ETI (Energy Technology Institute), M., 2015. The role for nuclear within a low carbon energy system. Energy Technology Institute (ETI). Available from: <<http://www.eti.co.uk/the-role-for-nuclear-within-a-low-carbon-energy-system/>>.
- ETI, 2016. System Requirements for Alternative Nuclear Technologies - Phase 3. Technical assessment of SMR heat extraction for district heat networks. Available from: <<http://www.eti.co.uk/library/system-requirements-for-alternative-nuclear-technologies-phase-3>>.
- ETSAP (Energy Technology Systems Analysis Programme), 2013. District Heating. Available from: <http://iea-etsap.org/E-TechDS/PDF/E16_DistrHeat_EA_Final_Jan2013_GSOK.pdf>.
- Euroheat & Power, 2006. Ecoheatcool - Reducing Europe's consumption of fossil fuels for heating and cooling.
- Euroheat & Power, 2015a. District Heating and Cooling country by country Survey 2015. Available from: <<http://www.euroheat.org/wp-content/uploads/2016/03/2015-Country-by-country-Statistics-Overview.pdf>>.
- Euroheat & Power, 2015b. Country by country survey of district heating and cooling. 2015 statistics. Available from: <<http://euroheat.org/Statistics-69.aspx>>.
- EUROPAIRS, 2009. FP7 End User Requirement for Process Heat Applications With Innovative Reactors for Sustainable Energy Supply (EUROPAIRS). Available from: <http://cordis.europa.eu/project/rcn/94416_en.html>.
- European Parliament, 2003. Directive 2002/91/EC. On the Energy Performance of Buildings.
- European Parliament, 2009. Directive 2009/28/EC on the promotion of the use of energy from renewable sources and amending and subsequently repealing Directives 2001/77/EC and 2003/30/EC.
- European Parliament, 2010. Directive 2010/31/EU of the European Parliament and of the Council of 19 May 2010 on the energy performance of buildings (recast).
- European Parliament, 2012. Directive 2012/27/EU of the European Parliament and of the Council of 25 October 2012 on energy efficiency, amending Directives 2009/125/EC and 2010/30/EU and repealing Directives 2004/8/EC and 2006/32/EC.
- European Parliament, 2015. Directive (EU) 2015/2193 of the European Parliament and of the Council of 25 November 2015 on the limitation of emissions of certain pollutants into the air from medium combustion plants (MCP Directive).
- Eurostat, 2015. Urban Audit 2011-2014. Database. Luxembourg. Available from: <<http://ec.europa.eu/eurostat/web/gisco/geodata/reference-data/administrative-units-statistical-units/urban-audit>>. [Data collected for core cities].
- Eurostat, 2016a. Natural gas price statistics. Natural gas prices for industrial consumers. Available from: <[http://ec.europa.eu/eurostat/statistics-explained/index.php/File:Natural_gas_prices_for_industrial_consumers,_comparison_between_2015s2-2014s2_\(NAT_kWh\).png](http://ec.europa.eu/eurostat/statistics-explained/index.php/File:Natural_gas_prices_for_industrial_consumers,_comparison_between_2015s2-2014s2_(NAT_kWh).png)>.
- Eurostat, 2016b. Electricity price statistics. Available from: <http://ec.europa.eu/eurostat/statistics-explained/index.php/Electricity_price_statistics>.
- Evans, J.S., Wolff, S.K., Phonboon, K., Levy, J.I., Smith, K.R., 2002. Exposure efficiency: an idea whose time has come? *Chemosphere* 49, 1075–1091.
- Fang, H., Xia, J., Jiang, Y., 2015. Key issues and solutions in a district heating system using low-grade industrial waste heat. *Energy* 86, 589–602.
- Fan, Y.-T., Zhang, Y.-H., Zhang, S.-F., Hou, H.-W., Ren, B.-Z., 2006. Efficient conversion of wheat straw wastes into biohydrogen gas by cow dung compost. *Bioresource Technology* 97, 500–505.
- Fawcett, S.E., Jones, S.L., Fawcett, A.M., 2012. Supply chain trust: The catalyst for collaborative innovation. *Business Horizons* 55, 163–178.

General References

- Finnish Energy, 2016. District heating in Finland 2015. Available from: <https://energia.fi/en/current_issues_and_material_bank/material_bank/district_heating_statistics.html>.
- Fischer, L.-B., Newig, J., 2016. Importance of Actors and Agency in Sustainability Transitions: A Systematic Exploration of the Literature. *Sustainability* 8, 476.
- Florio, M., 2014. *Applied Welfare Economics: Cost-Benefit Analysis of Projects and Policies*, 1 edition. ed. Routledge, New York.
- Flyvbjerg, B., 2009. Optimism and misrepresentation in early project development. In: *Making Essential Choices with Scant Information: Front-End Decision Making in Major Projects*. Terry Williams, Knut Samset, and Kjell Sunnevag, eds. 147–148.
- Flyvbjerg, B., 2016. *The Oxford Handbook of Megaproject Management*. Terry Williams, Knut Samset, and Kjell Sunnevag, eds.
- Fonseca, J.N.B., Oliveira Panão, M.J.N., 2017. Monte Carlo housing stock model to predict the energy performance indicators. *Energy and Buildings* 152, 503–515.
- Fortum Power and Heat Oy, 2009. Application for a Decision-in-Principle Concerning the Construction of a Nuclear Power Plant Unit - Loviisa 3.
- Fortum, 2013. Nuclear District Heating Plans from Loviisa to Helsinki Metropolitan Area. Presentation by Harri Tuomisto. Available from: <https://www.oecd-neo.org/ndd/workshops/nucogen/presentations/3_Tuomisto_Nuclear-District-Heating-Plans.pdf>.
- Foskolos, K., Brogli, R., 1991. Prospects of SMSNR development in Switzerland and the influence of the evolution of district heating networks. *Energy, High-temperature Helium Gas-cooled Nuclear reactors: Past Experience Current Status and Future Prospects* 16, 573–581.
- Frederiksen, S., Werner, S., 1993. *Fjärrvärme – teori, teknik och funktion (District Heating – theory, technology and function)*. Studentlitteratur, Lund.
- Frederiksen, S., Werner, S., 2013. *District heating and cooling*. Lund Studentlitteratur.
- Frischknecht, R., Rebitzer, G., 2005. The ecoinvent database system: a comprehensive web-based LCA database. *Journal of Cleaner Production, Life Cycle Assessment* 13, 1337–1343.
- Fröling, M., Bengtsson, H., Ramnäs, O., 2006. Environmental performance of district heating in suburban areas compared with heat pump and pellets furnace, in: *Chalmers Publication Library (CPL)*. Presented at the 10th International Symposium on District Heating and Cooling, September 3-5, 2006, Hanover, Germany.
- Fütterer, M.A., Carlsson, J., de Groot, S., Deffrennes, M., Bredimas, A., 2014. European energy policy and the potential impact of HTR and nuclear cogeneration. *Nuclear Engineering and Design, SI : HTR 2012* 271, 73–78.
- Gabrielli, R., Castrataro, P., Del Medico, F., Di Palo, M., Lenzo, B., 2014. Levelized Cost of Heat for Linear Fresnel Concentrated Solar Systems. *Energy Procedia* 49, 1340–1349.
- García-Gutiérrez, A., Hernández, A.F., Martínez, J.I., Ceceñas, M., Ovando, R., Canchola, I., 2015. Hydraulic model and steam flow numerical simulation of the Cerro Prieto geothermal field, Mexico, pipeline network. *Applied Thermal Engineering* 75, 1229–1243.
- Geels, F., Raven, R., 2006. Non-linearity and Expectations in Niche-Development Trajectories: Ups and Downs in Dutch Biogas Development (1973–2003). *Technology Analysis & Strategic Management* 18, 375–392.
- GEN energia d.o.o, 2016. Socio-economic Aspect of Cogeneration in Krško NPP. Available from: <<https://www.iaea.org/NuclearPower/Downloadable/Meetings/2016/2016-11-21-11-23-NPES/02-SLOVENIA-DEBELAK.pdf>>.
- Georgopoulou, E., Sarafidis, Y., Diakoulaki, D., 1998. Design and implementation of a group DSS for sustaining renewable energies exploitation. *European Journal of Operational Research* 109, 483–500.
- Ghafghazi, S., Sowlati, T., Sokhansanj, S., Melin, S., 2010. A multicriteria approach to evaluate district heating system options. *Applied Energy* 87, 1134–1140.

General References

- Ghafghazi, S., Sokhansanj, S., Sowlati, T., S., Bi, X., Melin, S., 2011a. Life cycle assessment of base-load heat sources for district heating system options. *Int J Life Cycle Assess* 16, 212–223.
- Ghafghazi, S., Sowlati, T., Sokhansanj, S., Bi, X., Melin, S., 2011b. Particulate matter emissions from combustion of wood in district heating applications. *Renewable and Sustainable Energy Reviews* 15, 3019–3028.
- Gilliams, S., Raymaekers, D., Muys, B., Orshoven, J.V., 2005. Comparing multiple criteria decision methods to extend a geographical information system on afforestation. *Computers and Electronics in Agriculture, Decision Support Systems for Forest Management* 49, 142–158.
- Gils, H.C., Cofala, J., Wagner, F., Schöpp, W., 2013. GIS-based assessment of the district heating potential in the USA. *Energy* 58, 318–329.
- Ginley, D.S., Cahen, D., 2011. *Fundamentals of Materials for Energy and Environmental Sustainability*. Cambridge University Press.
- Giraud, G., 2014. How Dependent is Growth from Primary Energy ? Output Energy Elasticity in 50 Countries (1970-2011). Available from: <<https://www.parisschoolofeconomics.eu/IMG/pdf/article-pse-medde-juin2014-giraud-kahraman.pdf>>.
- GISTEMP Team, 2016. GISS Surface Temperature Analysis (GISTEMP). NASA Goddard Institute for Space Studies. Available from: <<https://data.giss.nasa.gov/gistemp/>>.
- Gliedt, T., Hoicka, C.E., Jackson, N., 2018. Innovation intermediaries accelerating environmental sustainability transitions. *Journal of Cleaner Production* 174, 1247–1261.
- Goletsis, Y., Psarras, J., Samouilidis, J.-E., 2003. Project Ranking in the Armenian Energy Sector Using a Multicriteria Method for Groups. *Annals of Operations Research* 120, 135–157.
- Gollier, C., 2011. Le calcul du risque dans les investissements publics. Available from: <<http://www.ladocumentationfrancaise.fr/var/storage/rapports-publics/114000605.pdf>> [in French].
- Goodfellow, M.J., Williams, H.R., Azapagic, A., 2011. Nuclear renaissance, public perception and design criteria: An exploratory review. *Energy Policy, Sustainability of biofuels* 39, 6199–6210.
- Grand Paris Sud, 2017. Grand Paris Sud Energie positive : vers un chauffage urbain propre et moins cher dès le 1er janvier 2017. Communiqué de presse. Available from: <https://publidata-prod.s3.amazonaws.com/production/documents/documents/000/000/303/original/Chauffage_urbain_grand_paris_sud.pdf?1484729133> [in French].
- Greene, S.R., Flanagan, G.F., Borole, A.P., 2009. Integration of Biorefineries and Nuclear Cogeneration Power Plants - a Preliminary Analysis (No. ORNL/TM-2008/102). Oak Ridge National Laboratory (ORNL).
- Greenhalgh, C., Azapagic, A., 2009. Review of drivers and barriers for nuclear power in the UK. *Environmental Science & Policy* 12, 1052–1067.
- Gronlund, C.J., Humbert, S., Shaked, S., O'Neill, M.S., Jolliet, O., 2015. Characterizing the burden of disease of particulate matter for life cycle impact assessment. *Air Qual Atmos Health* 8, 29–46.
- Groth, T., Scholtens, B., 2016. A comparison of cost-benefit analysis of biomass and natural gas CHP projects in Denmark and the Netherlands. *Renewable Energy* 86, 1095–1102.
- Haberl, H., Sprinz, D., Bonazountas, M., Cocco, P., Desaubies, Y., Henze, M., Hertel, O., Johnson, R.K., Kastrup, U., Laconte, P., Lange, E., Novak, P., Paavola, J., Reenberg, A., van den Hove, S., Vermeire, T., Wadhams, P., Searchinger, T., 2012. Correcting a fundamental error in greenhouse gas accounting related to bioenergy. *Energy Policy* 45, 18–23.
- Hache, E., Leboullenger, D., Mignon, V., 2017. Beyond average energy consumption in the French residential housing market: A household classification approach. *Energy Policy* 107, 82–95.
- Hahne, E., 2000. The ITW solar heating system: an oldtimer fully in action. *Solar Energy, Large Scale Solar Heating* 69, 469–493.
- Haralambopoulos, D.A., Polatidis, H., 2003. Renewable energy projects: structuring a multi-criteria group decision-making framework. *Renewable Energy* 28, 961–973.

- Hasanbeigi, A., Harrell, G., Schreck, B., Monga, P., 2016. Moving beyond equipment and to systems optimization: techno-economic analysis of energy efficiency potentials in industrial steam systems in China. *Journal of Cleaner Production* 120, 53–63.
- HAS Centre for Energy Research, 2016. Socio-economic aspects of nuclear cogeneration development in the region of Paks. Available from: <<https://www.iaea.org/NuclearPower/Downloadable/Meetings/2016/2016-11-21-11-23-NPES/03-HUNGARY-BORCSOK.pdf>>.
- Hatchuel, A., Masson, P.L., Weil, B., 2011. Teaching innovative design reasoning: How concept-knowledge theory can help overcome fixation effects. *Artificial Intelligence for Engineering Design, Analysis and Manufacturing* 25, 77–92.
- Hawkey, D., Webb, J., 2012. Multi-level governance of socio-technical innovation: the case of district heating in the UK. Contribution to the Jean Monnet International Workshop, Copenhagen Business School.
- Hayashi, M., Hughes, L., 2013. The Fukushima nuclear accident and its effect on global energy security. *Energy Policy* 59, 102–111.
- Hayter, C.S., Link, A.N., 2015. On the economic impact of university proof of concept centers. *J Technol Transf* 40, 178–183.
- Heath, G.A., Nazaroff, W.W., 2007. Intake-to-delivered-energy ratios for central station and distributed electricity generation in California. *Atmospheric Environment* 41, 9159–9172.
- Heat Network Partnership for Scotland, 2015. District Heating Strategy Support: Proposal for HNP support for Local Authorities. HNP.
- Heat Roadmap Europe, 2015. Heat Roadmap Europe 2050. Research project co-funded by the European Commission. Peta, the Pan-European Thermal Atlas: renewable energy. Available from: <<http://maps.heatroadmap.eu/maps/31157/Renewable-Resources-Map-for-EU28?preview=true#>>.
- Hein, A.M., Jankovic, M., Feng, W., Farel, R., Yune, J.H., Yannou, B., 2017. Stakeholder power in industrial symbioses: A stakeholder value network approach. *Journal of Cleaner Production* 148, 923–933.
- Heiselberg, P., Brohus, H., Hesselholt, A., Rasmussen, H., Seinre, E., Thomas, S., 2009. Application of sensitivity analysis in design of sustainable buildings. *Renewable Energy, Special Issue: Building and Urban Sustainability* 34, 2030–2036.
- Hekkert, M.P., Suurs, R.A.A., Negro, S.O., Kuhlmann, S., Smits, R.E.H.M., 2007. Functions of innovation systems: A new approach for analysing technological change. *Technological Forecasting and Social Change* 74, 413–432.
- Helen Ltd, 2015a. Energy Production in Helsinki. Available from: <<https://www.helen.fi/en/helen-oy/about-us/energy-production/>>.
- Helen Ltd, 2015b. Nuclear District Heating. Private communication.
- Hellström, M., Ruuska, I., Wikström, K., Jåfs, D., 2013. Project governance and path creation in the early stages of Finnish nuclear power projects. *International Journal of Project Management* 31, 712–723.
- Hendricks, A.M., Wagner, J.E., Volk, T.A., Newman, D.H., Brown, T.R., 2016. A cost-effective evaluation of biomass district heating in rural communities. *Applied Energy* 162, 561–569.
- Henttonen, T., Paananen, P., 2009. Nuclear Combined Heat and Power - Analyses of Hot Water Pipeline Breaks in a Service Tunnel with APROS Simulation Software. Available from: <http://www.apros.fi/filebank/119-Conference_paper%3A_Loviisa_3_Nuclear_CHP_ENC2010.pdf>.
- Hesaraki, A., Holmberg, S., Haghighat, F., 2015. Seasonal thermal energy storage with heat pumps and low temperatures in building projects—A comparative review. *Renewable and Sustainable Energy Reviews* 43, 1199–1213.
- Hirsch, P., Grochowski, M., Duzinkiewicz, K., 2015. Pipeline System for Heat Transportation from Nuclear Power Plant – an Optimizing Approach. Faculty of Electrical and Control Engineering, Gdańsk University of Technology.

General References

- Hirsch, P., Duzinkiewicz, K., Grochowski, M., Piotrowski, R., 2016. Two-phase optimizing approach to design assessments of long distance heat transportation for CHP systems. *Applied Energy* 182, 164–176.
- Hirsch, P., Duzinkiewicz, K., Grochowski, M., 2017. Multicriteria optimization approach to design and operation of district heating supply system over its life cycle. Presented at the E3S Web of Conferences.
- Hobbs, B.F., Horn, G.T., 1997. Building public confidence in energy planning: a multimethod MCDM approach to demand-side planning at BC gas. *Energy Policy, Model-based policy analysis* 25, 357–375.
- Hodson, M., Marvin, S., 2010. Can cities shape socio-technical transitions and how would we know if they were? *Research Policy, Special Section on Innovation and Sustainability Transitions* 39, 477–485.
- Holtmark, B., 2012. Harvesting in boreal forests and the biofuel carbon debt. *Climatic Change* 112, 415–428.
- Hondeman, H., 2000. Electrical compression cooling versus absorption cooling – a comparison, IEA Heat pump Centre Newsletter Volume 18, no. 4/2000. Available from: <etkhpcorderapi.extweb.sp.se/api/file/35>.
- Howells, J., 2006. Intermediation and the role of intermediaries in innovation. *Research Policy* 35, 715–728.
- Huang, S.K., Kuo, L., Chou, K.-L., 2016. The applicability of marginal abatement cost approach: A comprehensive review. *Journal of Cleaner Production* 127, 59–71.
- Hugo, A., 2008. Computer simulation and life cycle analysis of a seasonal thermal storage system in a residential building. Available from: <<https://spectrum.library.concordia.ca/976234/>> (masters). Concordia University.
- Huisingh, D., Zhang, Z., Moore, J.C., Qiao, Q., Li, Q., 2015. Recent advances in carbon emissions reduction: policies, technologies, monitoring, assessment and modeling. *Journal of Cleaner Production, Carbon Emissions Reduction: Policies, Technologies, Monitoring, Assessment and Modeling* 103, 1–12.
- Humbert, S., Marshall, J.D., Shaked, S., Spadaro, J.V., Nishioka, Y., Preiss, P., McKone, T.E., Horvath, A., Jolliet, O., 2011. Intake Fraction for Particulate Matter: Recommendations for Life Cycle Impact Assessment. *Environ. Sci. Technol.* 45, 4808–4816.
- IAEA (International Atomic Energy Agency), 1997. Design approaches for heating reactors. IAEA-TECDOC-965.
- IAEA, 2003. Market Potential for Non-electric Applications of Nuclear Energy. STI/DOC/010/410.
- IAEA, 2009. Fuel ethanol production using nuclear steam. Contribution of Forsberg, C., Rosembloom, S. and Black, R. to the International conference on non-electric applications of nuclear power: Seawater desalination, hydrogen production and other industrial applications. IAEA-CN-152.
- IAEA, 2016a. Desalination Thermodynamic Optimization Program (DE-TOP). Available from: <https://www.iaea.org/NuclearPower/NEA_Desalination/index.html>.
- IAEA, 2016b. Technical Meeting on the Socio-Economic Aspects of Nuclear Cogeneration. Available from: <<https://www.iaea.org/NuclearPower/Meetings/2016/2016-11-21-11-23-NPTDS.html>>.
- IAEA, 2017a. Opportunities for Cogeneration with Nuclear Energy. IAEA Nuclear Energy Series No. NP-T-4.1. Available from: <<http://www-pub.iaea.org/books/iaeabooks/10877/Opportunities-for-Cogeneration-with-Nuclear-Energy>>.
- IAEA, 2017b. Nuclear power reactors in the world. IAEA-RDS-2/37.
- IEA (International Energy Agency), 2011. Technology roadmap energy-efficient buildings: heating and cooling equipment. Tech rep.
- IEA, 2014. Status Report on District Heating in IEA countries. Prepared for the International Energy Agency (IEA) Bioenergy Task 32 and the Swiss Federal Office of Energy. Available from: <http://www.ieabcc.nl/publications/IEA_Task32_DHS_Status_Report.pdf>.

General References

- IEA, 2015. Energy Balances of OECD countries.
- IEA, 2016. CO2 Emissions from Fuel Consumption. 2016 World Edition.
- IEA, 2017a. World Energy Outlook.
- IEA, 2017b. Energy Technology Perspectives 2017, OECD/IEA, Paris.
- IEA, 2017c. Projected Costs of Generating Electricity. 2017 Editions.
- IEEP (Institute for European Environmental Policy), 2008. Potential impacts of desalination development on energy consumption. Available from: <<http://ec.europa.eu/environment/water/quantity/pdf/desalination.pdf>>.
- Immonen, S., Vuori, S., 1978. Cost/benefit analysis of district heat transmission distance from a nuclear power plant. *Annals of Nuclear Energy* 5, 179–184.
- INAPG (Institut Nationale Agronomique de Paris-Grignon), 2006. Valorisation énergétique des biomasses agricoles en Pays d’Aunis. Etude réalisée par les étudiants de 2ème année de l’institut nationale agronomique Paris-Grignon. Available from: <<https://tice.agroparistech.fr/coursenligne/courses/INIP/document/INIP/inipespv06/projets/Paille.pdf>> [in French].
- Inkinen, T., Suorsa, K., 2010. Intermediaries in Regional Innovation Systems: High-Technology Enterprise Survey from Northern Finland. *European Planning Studies* 18, 169–187.
- INSEE (French National Institution for Statistics and Economics Studies), Région Nord-Pas-de-Calais, 2009. Se loger en Nord-Pas-de-Calais - Les parcours résidentiels se transforment 1992-2006. Available from: <<https://www.insee.fr/fr/statistiques/1379099>> [in French]. Profils 93.
- INSEE, 2014a. Les consommations d’énergie dans l’industrie en 2014. Enquête annuelle sur les consommations d’énergie dans l’industrie (EACEI). Achats et consommation en unité propre, valeur d’achat et prix moyens des produits énergétiques. Available from: <<https://www.insee.fr/fr/statistiques/1912290?sommaire=1912292#titre-bloc-11>> [in French].
- INSEE, 2014b. Logements en France. Available from: <<https://www.insee.fr/fr/statistiques/3137421>> [in French].
- INSEE, 2016. ESANE. Élaboration des statistiques annuelles d’entreprise. Available from: <<https://www.insee.fr/fr/metadonnees/definition/c1700>> [in French].
- Inspection Générale des Finances (French general inspection of finances), 2017. Revue de dépenses. Aides à la rénovation énergétique des logements privés. Available from: <<https://www.actu-environnement.com/media/pdf/news-29861-rapport-IFG-CGEDD-aides-publiques-renovations-energetiques.pdf>> [in French].
- Intelligent Energy Europe Programme, 2015. Energy Efficiency Trends and Policies in the EU an analysis based on the ODYSSEE and MURE databases. Available from: <<http://www.odyssee-mure.eu/publications/br/synthesis-energy-efficiency-trends-policies.pdf>>.
- IPCC (Intergovernmental Panel on Climate Change), 2006. Guidelines for National Greenhouse Gas Inventories, Volume 2 Energy.
- IPCC, 2012. Renewable Energy Sources and Climate Change Mitigation. Special Report of the Intergovernmental Panel on Climate Change.
- IPCC, 2014. The fifth assessment report. Available from: <<https://www.ipcc.ch/report/ar5/>>.
- IRDES (Institut de recherche et documentation en économie de la santé), 2011. Données de cadrage: Indicateurs d’état de santé. Available from: <<http://www.irdes.fr/EspaceEnseignement/ChiffresGraphiques/Cadrage/IndicateursEtatSant e/EsperanceVie.htm>> [in French].
- ISNP (International School on Nuclear Power), 2014. Safety aspects related to deploying nuclear cogeneration for district heating: Case Helsinki. Contribution of Harri Tuomisto.
- Ivner, J., Broberg Viklund, S., 2015. Effect of the use of industrial excess heat in district heating on greenhouse gas emissions: A systems perspective. *Resources, Conservation and Recycling* 100, 81–87.

General References

- Jaber, J.O., Jaber, Q.M., Sawalha, S.A., Mohsen, M.S., 2008. Evaluation of conventional and renewable energy sources for space heating in the household sector. *Renewable and Sustainable Energy Reviews* 12, 278–289.
- Jacobsen, N.B., 2006. Industrial symbiosis in Kalundborg, Denmark: A quantitative assessment of economic and environmental aspects. *Journal of Industrial Ecology* 10, 239–255.
- Jakubcionis, M., Carlsson, J., 2017. Estimation of European Union residential sector space cooling potential. *Energy Policy* 101, 225–235.
- Jami, A.A.N., Walsh, P.R., 2014. The role of public participation in identifying stakeholder synergies in wind power project development: The case study of Ontario, Canada. *Renewable Energy* 68, 194–202.
- Jaskólski, M., Reński, A., Duzinkiewicz, K., Kaczmarek-Kacprzak, A., 2014. Profitability criteria of partial cogeneration in nuclear power plant. *Rynek Energii*.
- Jaskólski, M., Reński, A., Minkiewicz, T., 2017. Thermodynamic and economic analysis of nuclear power unit operating in partial cogeneration mode to produce electricity and district heat. *Energy* 141, 2470–2483.
- Jasserand, F., Lavergne, J.-G., 2016. Initial Economic Appraisal of Nuclear District Heating in France. *EPJ Nuclear Sci. Technol.* 2, 39.
- Jensen, P.D., 2016. The role of geospatial industrial diversity in the facilitation of regional industrial symbiosis. *Resources, Conservation and Recycling* 107, 92–103.
- Kaivosoja, T., Jalava, P.I., Lamberg, H., Virén, A., Tapanainen, M., Torvela, T., Tapper, U., Sippula, O., Tissari, J., Hillamo, R., Hirvonen, M.R., Jokiniemi, J., 2013. Comparison of emissions and toxicological properties of fine particles from wood and oil boilers in small (20-25 kW) and medium (5-10 MW) scale. *Atmospheric Environment* 77, 193–201.
- Kaklauskas, A., Zavadskas, E.K., Raslanas, S., 2005. Multivariant design and multiple criteria analysis of building refurbishments. *Energy and Buildings* 37, 361–372.
- Kalafatis, S.E., Grace, A., Gibbons, E., 2015. Making climate science accessible in Toledo: The linked boundary chain approach. *Climate Risk Management, Boundary Organisations* 9, 30–40.
- Karagiannis, I.C., Soldatos, P.G., 2008. Water desalination cost literature: review and assessment. *Desalination, European Desalination Society and Center for Research and Technology Hellas (CERTH), Sani Resort 22–25 April 2007, Halkidiki, Greece* European Desalination Society and Center for Research and Technology Hellas (CERTH), Sani Resort 223, 448–456.
- Karschin, I., Geldermann, J., 2015. Efficient cogeneration and district heating systems in bioenergy villages: an optimization approach. *Journal of Cleaner Production* 104, 305–314.
- Kenis, A., Bono, F., Mathijs, E., 2016. Unravelling the (post-)political in Transition Management: Interrogating Pathways towards Sustainable Change. *Journal of Environmental Policy & Planning* 18, 568–584.
- Kesicki, F., Strachan, N., 2011. Marginal abatement cost (MAC) curves: confronting theory and practice. *Environmental Science & Policy* 14, 1195–1204.
- Kessides, I.N., 2012. The future of the nuclear industry reconsidered: Risks, uncertainties, and continued promise. *Energy Policy* 48, 185–208.
- Keynes, J.M., 1921. *A Treatise on Probability*, Londres, McMillan (2e éd., 1948).
- Keynes, J.M., 1936. *The General Theory of Employment, Interest, and Money*, Paperback ed.
- Kim, Y., Kim, M., Kim, W., 2013. Effect of the Fukushima nuclear disaster on global public acceptance of nuclear energy. *Energy Policy* 61, 822–828.
- Kivimaa, P., Kern, F., 2016. Creative destruction or mere niche support? Innovation policy mixes for sustainability transitions. *Research Policy* 45, 205–217.
- Kivimaa, P., Boon, W., Antikainen, R., 2017. Commercialising university inventions for sustainability—a case study of (non-)intermediating “cleantech” at Aalto University. *Sci Public Policy* 44, 631–644.
- Kjeang, A.E., Venkatesh, G., Ståhl, M., Palm, J., 2017. Energy consulting services in the information age - literature review. *Energ Sustain Soc* 7, 30.

General References

- Kjellsson, E., Hellström, G., Perers, B., 2010. Optimization of systems with the combination of ground-source heat pump and solar collectors in dwellings. *Energy*, 7th International Conference on Sustainable Energy Technologies 35, 2667–2673.
- Klerkx, L., Leeuwis, C., 2008. Balancing multiple interests: Embedding innovation intermediation in the agricultural knowledge infrastructure. *Technovation* 28, 364–378.
- Klewitz, J., Zeyen, A., Hansen, E.G., 2012. Intermediaries driving eco-innovation in SMEs: A qualitative investigation. *European Journal of Innovation Management* 15, 442–467.
- Kontu, K., Rinne, S., Olkkonen, V., Lahdelma, R., Salminen, P., 2015. Multicriteria evaluation of heating choices for a new sustainable residential area. *Energy and Buildings* 93, 169–179.
- Korhonen, J., 2001. Co-production of heat and power: an anchor tenant of a regional industrial ecosystem. *Journal of Cleaner Production* 9, 509–517.
- Küçüksayraç, E., Keskin, D., Brezet, H., 2015. Intermediaries and innovation support in the design for sustainability field: cases from the Netherlands, Turkey and the United Kingdom. *Journal of Cleaner Production* 101, 38–48.
- Kuznetsov, Y.N., Khrilev, L.S., Brailov, V.P., 2008a. The technical and economic principles and lines of development of nuclear district heating cogeneration. *Therm Eng* 55: 939-46.
- Kuznetsov, Y.N., Khrilev, L.S., Brailov, V.P., Livshits, I.M., Smirnov, I.A., Svetlov, K.S. 2008b. An analysis of technical and economic indicators characterizing the development of nuclear cogeneration stations in the Northwestern region. *Therm Eng* 55: 913-25.
- Kwak, D.-H., Binns, M., Kim, J.-K., 2014. Integrated design and optimization of technologies for utilizing low grade heat in process industries. *Applied Energy* 131, 307–322.
- Lamberg, H., 2014. Small-scale pellet boiler emissions. Characterization and comparison to other combustion units. Reports Series in Aerol Science N°156. University of Eastern Finland, Kupio.
- Lanahan, M., Tabares-Velasco, P.C., 2017. Seasonal Thermal-Energy Storage: A Critical Review on BTES Systems, Modeling, and System Design for Higher System Efficiency. *Energies* 10, 743.
- Langer, K., Decker, T., Menrad, K., 2017. Public participation in wind energy projects located in Germany: Which form of participation is the key to acceptance? *Renewable Energy* 112, 63–73.
- Laurichesse, S., Avérous, L., 2014. Chemical modification of lignins: Towards biobased polymers. *Progress in Polymer Science, Topical Issue on Biomaterials* 39, 1266–1290.
- Leurent, M., 2015. Pas de croissance soutenable sans innovations financière - La cogénération nucléaire, une innovation d'importance stratégique pour la transition écologique. *Entreprendre & Innover* 25, 75–85.
- Leurent, M., Cany, C., 2016. A comprehensive taxonomy of nuclear non-electric markets: Application to the market perspectives for France. 39th annual conference of the International Association for Energy Economics (IAEE) on Energy, expectations and uncertainties.
- Leurent, M., Jasserand, F., Locatelli, G., Palm, J., Rämä, M., Trianni, A., 2017. Driving forces and obstacles to nuclear cogeneration in Europe: Lessons learnt from Finland. *Energy Policy* 107, 138–150.
- Leurent, M., Da Costa, P., Jasserand, F., Rämä, M., Persson, U., 2018a. Cost and climate savings through nuclear district heating in a French urban area. *Energy Policy* 115, 616–630.
- Leurent, M., Da Costa, P., Rämä, M., Persson, U., Jasserand, F., 2018b. Cost-benefit analysis of district heating systems using heat from nuclear plants in seven European countries. *Energy* 149, 454–472.
- Leurent, M., Da Costa, P., Sylvestre, S., Berthélémy, M., 2018c. Feasibility assessment of the use of nuclear plant-sourced steam for French factories considering spatial configuration into consideration. *Journal of Cleaner Production*, Accepted Manuscript.
- Lewtas, J., 2007. Air pollution combustion emissions: Characterization of causative agents and mechanisms associated with cancer, reproductive, and cardiovascular effects. *Mutation Research/Reviews in Mutation Research, The Sources and Potential Hazards of Mutagens in Complex Environmental Matrices - Part II* 636, 95–133.

- Li, H., Svendsen, S., 2012. Energy and exergy analysis of low temperature district heating network. *Energy, The 24th International Conference on Efficiency, Cost, Optimization, Simulation and Environmental Impact of Energy, ECOS 2011* 45, 237–246.
- Li, H., Wang, S.J., 2014. Challenges in Smart Low-temperature District Heating Development. *Energy Procedia* 61, 1472–1475.
- Liu, W., Zhang, Z., Xie, X., Yu, Z., von Gadow, K., Xu, J., Zhao, S., Yang, Y., 2017. Analysis of the Global Warming Potential of Biogenic CO₂ Emission in Life Cycle Assessments. *Sci Rep* 7.
- Locatelli, G., Mancini, M., 2012. Looking back to see the future: building nuclear power plants in Europe. *Construction Management and Economics* 30, 623–637.
- Locatelli, G., 2013. Generation IV nuclear reactors: Current status and future prospects. *Energy Policy* 61, 1503–1520.
- Locatelli, G., Bingham, C., Mancini, M., 2014. Small modular reactors: A comprehensive overview of their economics and strategic aspects. *Progress in Nuclear Energy* 73, 75–85.
- Locatelli, G., Boarin, S., Pellegrino, F., Ricotti, M.E., 2015. Load following with Small Modular Reactors (SMR): A real options analysis. *Energy* 80, 41–54.
- Locatelli, G., Fiordaliso, A., Boarin, S., Ricotti, M.E., 2017. Cogeneration: An option to facilitate load following in Small Modular Reactors. *Progress in Nuclear Energy* 97, 153–161.
- Lockie, D., Sonnenfeld, D., 2013. *Routledge International Handbook of Social and Environmental Change*, Routledge. Fisher (Eds).
- Loiseaux, B., Safa, H., Tamain, B., 2016. La cogénération nucléaire dans la production d'électricité. *Revue Générale Nucléaire* 6 Nov-Déc. 2016.
- Loorbach, D., Rotmans, J., 2010. The practice of transition management: Examples and lessons from four distinct cases. *Futures* 42, 237–246.
- Lund, H., Werner, S., Wiltshire, R., Svendsen, S., Thorsen, J.E., Hvelplund, F., Mathiesen, B.V., 2014a. 4th Generation District Heating (4GDH). *Energy* 68, 1–11.
- Lund, H., Werner, S., Wiltshire, R., Svendsen, S., Thorsen, J.E., Hvelplund, F., Mathiesen, B.V., 2014b. 4th Generation District Heating (4GDH): Integrating smart thermal grids into future sustainable energy systems. *Energy* 68, 1–11.
- Lund, H., Arler, F., Østergaard, P.A., Hvelplund, F., Connolly, D., Mathiesen, B.V., Karnøe, P., 2017. Simulation versus Optimisation: Theoretical Positions in Energy System Modelling. *Energies* 10, 840.
- Lund, R., Ilic, D.D., Trygg, L., 2016. Socioeconomic potential for introducing large-scale heat pumps in district heating in Denmark. *Journal of Cleaner Production* 139, 219–229.
- Madlener, R., 2007. Innovation diffusion, public policy, and local initiative: The case of wood-fuelled district heating systems in Austria. *Energy Policy* 35, 1992–2008.
- Maes, T., Van Eetvelde, G., De Ras, E., Block, C., Pisman, A., Verhofstede, B., Vandendriessche, F., Vandeveld, L., 2011. Energy management on industrial parks in Flanders. *Renewable and Sustainable Energy Reviews* 15, 1988–2005.
- Magistrát města České Budějovice (Municipal Authority of České Budějovice), 2016. Územní Energetická Koncepce Statutárního Města České Budějovice (Territorial Energy Concept of the Statutory City of České Budějovice). Available from: <<http://www.c-budejovice.cz/cz/magistrat/odborny/osvs/aktuality/Documents/%C3%9AEK%20%C4%8CB%20final%202016.pdf>> [in Czech].
- Magnusson, D., 2010. Between municipal and regional planning: the development of regional district heating systems in Stockholm from 1978 to 2010. *Local Environ* 16, 319–37.
- Maizi, N., Assoumou, E., 2014. Future prospects for nuclear power in France. *Applied Energy* 136, 849–859.
- Mansilla, C., Sigurvinsson, J., Bontemps, A., Maréchal, A., Werkoff, F., 2007. Heat management for hydrogen production by high temperature steam electrolysis. *Energy, ECOS 05. 18th International Conference on Efficiency, Cost, Optimization, Simulation, and Environmental Impact of Energy Systems* 32, 423–430.

General References

- Ma, Q., Luo, L., Wang, R.Z., Sauce, G., 2009. A review on transportation of heat energy over long distance: Exploratory development. *Renewable and Sustainable Energy Reviews* 13, 1532–1540.
- Mari, C., 2014. Hedging electricity price volatility using nuclear power. *Applied Energy* 113, 615–621.
- Martin, M., Eklund, M., 2011. Improving the environmental performance of biofuels with industrial symbiosis. *Biomass and Bioenergy* 35, 1747–1755.
- Matschoss, K., Heiskanen, E., 2017. Making it experimental in several ways: The work of intermediaries in raising the ambition level in local climate initiatives. *Journal of Cleaner Production, Experimentation for climate change solutions* 169, 85–93.
- Mattes, J., Huber, A., Koehrsen, J., 2015. Energy transitions in small-scale regions – What we can learn from a regional innovation systems perspective. *Energy Policy* 78, 255–264.
- Matthews, R., Sokka, L., Soimakallio, S., Mortimer, N., Rix, J., Schelhaas, M.-J., Jenkis, T., Hogan, G., Mackie, E., Morris, A., Randle, T., 2014. Review of literature on biogenic carbon and life cycle assessment of forest bioenergy. Final Task 1 report, DG ENER project, “Carbon impacts of biomass consumed in the EU”. Available from: <https://ec.europa.eu/energy/sites/ener/files/2014_biomass_forest_research_report_.pdf>.
- Mazdiyasi, O., AghaKouchak, A., Davis, S.J., Madadgar, S., Mehran, A., Ragno, E., Sadegh, M., Sengupta, A., Ghosh, S., Dhanya, C.T., Niknejad, M., 2017. Increasing probability of mortality during Indian heat waves. *Science Advances* 3, e1700066.
- McDaniel, B., Kosanovic, D., 2016. Modeling of combined heat and power plant performance with seasonal thermal energy storage. *Journal of Energy Storage* 7, 13–23.
- MEEDDAT, 2008. Direction générale de l'énergie et du climat. Programmation pluriannuelle des investissements de production de chaleur, Période 2009 – 2020 [in French].
- Meleo, L., 2014. On the determinants of industrial competitiveness: The European Union emission trading scheme and the Italian paper industry. *Energy Policy* 74, 535–546.
- Miller, R., Hobbes, B., 2009. The Complexity of Decision-Making in Large Projects with Multiple Partners: Be Prepared to Change. In: *Making Essential Choices with Scant Information: Front-End Decision Making in Major Projects*. Terry Williams, Knut Samset, and Kjell Sunnevig, eds. pp. 375–389.
- Ministère de l'action et des comptes publics (French Ministry of actions and of public accountability), 2017. IR - Crédit d'impôt pour la transition énergétique - Nature des dépenses éligibles au crédit d'impôt. Available from: <<http://bofip.impots.gouv.fr/bofip/3889-PGP.html?identifiant=BOI-IR-RICI-280-10-30>> [in French].
- Ministère de la transition écologique et solidaire (French ministry of the united and eco-friendly transition), 1997. Arrêté du 25/07/97 relatif aux prescriptions générales applicables aux installations classées pour la protection de l'environnement soumises à déclaration sous la rubrique n° 2910 : Combustion. Available from: <https://aida.ineris.fr/consultation_document/5683> [in French].
- Ministère de la transition écologique et solidaire, 2016. Observations et Statistiques. Secteur Résidentiel-Tertiaire. Available from: <<http://www.statistiques.developpement-durable.gouv.fr/energie-climat/s/consommations-secteur-residentiel-tertiaire.html>> [in French].
- Ministère de l'écologie, du développement durable et de l'énergie (French Ministry of Ecology, Sustainable development and Energy), 2014. Ministère de l'écologie, du développement durable et de l'énergie, 2014. Application de l'article 14.5 de la directive 2002/27/EU sur la valorisation de la chaleur fatale industrielle via des réseaux de chaleur. Décret n° 2014-1363 du 14 Novembre 2014.
- Ministère de l'écologie, du développement durable et de l'énergie, 2015. Consommations énergétiques des ménages en 2012. Available from: <http://www.statistiques.developpement-durable.gouv.fr/fileadmin/documents/Produits_editoriaux/Publications/Chiffres_et_statistiq>

- ues/2015/chiffres-stats645-conso-energetiques-des-menages2012-juin2015.pdf> [in French]. Chiffres et Statistiques 645.
- Ministère de l'environnement, de l'énergie et de la mer (French Ministry of the Environment, Energy and Seas), 2014a. Application of the article 14.5 of the Directive 2012/27/UE with regards to the connexion of utilities generating excess heat and district heating networks. Décret n° 2014-1363 of the 14th of November 2014 [in French], 2014-1363.
- Ministère de l'environnement, de l'énergie et de la mer, 2014b. Le Fonds Chaleur. Available from: <<http://www.developpement-durable.gouv.fr/Presentation-generale,25027.html>> [in French].
- Ministère de l'environnement, de l'énergie et de la mer, 2015. Loi relative à la transition énergétique pour la croissance verte (TECV). Available from: <<https://www.legifrance.gouv.fr/affichTexte.do?cidTexte=JORFTEXT000031044385&categorieLien=id>> [in French].
- Ministère de l'environnement, de l'énergie et de la mer, 2016a. L'accès régulé à l'électricité nucléaire historique (ARENH). Available from: <<http://www.developpement-durable.gouv.fr/Le-prix-de-l-ARENH.html>> [in French].
- Ministère de l'environnement, de l'énergie et de la mer, 2016b. Programmation pluriannuelle de l'énergie. Available from: <<http://www.developpement-durable.gouv.fr/Programmation-pluriannuelle-de-l,48569.html>> [in French].
- Ministère de l'environnement, de l'énergie et de la mer, 2017. Chiffres clés du climat. France et Monde. Editions 2017. Available from: <http://www.statistiques.developpement-durable.gouv.fr/fileadmin/documents/Produits_editoriaux/Publications/Datalab/2016/chiffres-cles-du-climat-edition2017-2016-12-05-fr.pdf> [in French].
- Ministerstvo Průmyslu A Obchodu (Czech Ministry of Industry and Trade), 2015. Assessment of the potential for high-efficiency combined heat and power generation and efficient district heating and cooling for the Czech Republic. Available from: <https://ec.europa.eu/energy/sites/ener/files/documents/cz_report_eed_art_141_en.pdf>.
- Ministerstwo Energii (Polish Ministry of Energy), 2016. Economic impact of possible large LWR cogeneration in Poland. Available from: <<https://www.iaea.org/NuclearPower/Downloadable/Meetings/2016/2016-11-21-11-23-NPES/06-POLAND-SAWICKI.pdf>>.
- Ministerstwo Gospodarki (Polish Ministry of the Economy), 2014. Polish Nuclear Power Programme. Available from: <<http://www.paa.gov.pl/sites/default/files/PPEJ%20eng.2014.pdf>>.
- Misra, B.M., 2007. Seawater desalination using nuclear heat/electricity — Prospects and challenges. *Desalination* 205, 269–278.
- Mohanraj, M., Belyayev, Y., Jayaraj, S., Kaltayev, A., 2017. Research and developments on solar assisted compression heat pump systems – A comprehensive review (Part-B: Applications). *Renewable and Sustainable Energy Reviews*.
- Mora, C., Dousset, B., Caldwell, I.R., Powell, F.E., Geronimo, R.C., Bielecki, C.R., Counsell, C.W.W., Dietrich, B.S., Johnston, E.T., Louis, L.V., Lucas, M.P., McKenzie, M.M., Shea, A.G., Tseng, H., Giambelluca, B.W., Leon, L.R., 2017. Global risk of deadly heat. *Nature Climate Change* 7, 501–506.
- Mróz, T.M., 2008. Planning of community heating systems modernization and development. *Applied Thermal Engineering* 28, 1844–1852.
- NC2I, 2015a. Nuclear Cogeneration Industrial Initiative (NC2i). Available from: <<http://www.snetp.eu/nc2i/>>.
- NC2I, 2015b. CHP and High Temperature Reactors. Contribution of R. Arnold to the NC2I Conference, CDMA Brussels.
- NC2I, 2015c. Experience Feedback from Nuclear Cogeneration. Contribution of C. Auriault, M.A. Fütterer, O. Baudrand to the NC2I Conference, CDMA Brussels.
- NEA (Nuclear Energy Agency), 2011. Current Status, Technical Feasibility and Economics of Small Nuclear Reactors. Organisation for Economic Co-operation and Development (OECD).

General References

- Available from: <<https://www.oecd-nea.org/ndd/reports/2011/current-status-small-reactors.pdf>>.
- NEA, 2015. Ad hoc Expert Group of the Nuclear Energy Agency on the Role and Economics of Nuclear Co-generation in a Low-carbon Energy Future (COGEN-2015). Available from: <<http://www.oecd-nea.org/ndd/groups/cogen.html>>.
- NEA, 2016. Nuclear Energy Data. Données sur l'énergie nucléaire. Available from: <<https://www.oecd-nea.org/ndd/pubs/2016/7300-ned-2016.pdf>>.
- NEA, 2018. On the Role and Economics of Nuclear Cogeneration in a Low Carbon Energy Future. In Press.
- NERI (National Environmental Research Institute), 2010. Emissions from decentralised CHP plants 2007. NERI Technical Report no. 786. Available from: <<http://www.dmu.dk/Pub/FR786.pdf>>.
- NETNUC, 2011. Contribution of Auterinen, I., Kangas, P. and Koukkari, P. to the New Type Nuclear Reactors 2008–2011 Final Report. bioNuclear Refinery – A Concept for Integration of Nuclear Heat and Biorefineries.
- Nielsen, K., 2003. Thermal energy storage: a state-of-art, a report within the research program Smart Energy-Efficient Buildings at NTNU and SINTEF 2002–2006.
- Nielsen, S., Möller, B., 2013. GIS based analysis of future district heating potential in Denmark. *Energy* 57, 458–468.
- Nielsen, S., 2014. A geographic method for high resolution spatial heat planning. *Energy* 67, 351–362.
- Nijkamp, P., Rietveld, P., Voogd, H., 1990. Multicriteria evaluation in physical planning. North-Holland: Amsterdam.
- Nisan, S., Dardour, S., 2007. Economic evaluation of nuclear desalination systems. *Desalination* 205, 231–242.
- NISP (National Industrial Symbiosis Project), 2008. Potential uses of waste heat from a proposed new power station at Blyth. Report by Terra Infirma for the National Industrial Symbiosis Project (NISP).
- NNL (National Nuclear Laboratory), 2014. Small Modular Reactors (SMR) – Feasibility Study, NNL report. Available from: <<http://www.nnl.co.uk/media/1627/smr-feasibility-study-december-2014.pdf>>.
- Nordell, B., 2000. Large-scale thermal energy storage. WinterCities' 2000, Energy and Environment, Lulea, Sweden. Available from: <<http://large.stanford.edu/courses/2013/ph240/lim1/docs/nordell.pdf>>.
- Novo, A.V., Bayon, J.R., Castro-Fresno, D., Rodriguez-Hernandez, J., 2010. Review of seasonal heat storage in large basins: Water tanks and gravel–water pits. *Applied Energy* 87, 390–397.
- Nuytten, T., Claessens, B., Paredis, K., Van Bael, J., Six, D., 2013. Flexibility of a combined heat and power system with thermal energy storage for district heating. *Applied Energy* 104, 583–591.
- Odell, J.S., 2001. Case Study Methods in International Political Economy. *International Studies Perspectives* 2, 161 – 176.
- Olkkonen, V., Syri, S., 2016. Spatial and temporal variations of marginal electricity generation: the case of the Finnish, Nordic, and European energy systems up to 2030. *Journal of Cleaner Production* 126, 515–525.
- OPEC (Polish DH operator), 2016. Infrastruktura OPEC w Wejherowie (OPEC Infrastructures in Wejherowo). Available from: <<https://opecgdy.com.pl/dla-klienta/podlacz-sie-do-sieci/rozwijamy-sie-w-kazdym-kierunku/wejherowo/>> [in Polish].
- OPEC, 2017. OPEC Sp. z o.o z prestiżowym Godłem „Teraz Polska”! (press informations). Available from: <<https://opecgdy.com.pl/biuro-prasowe/informacje-prasowe/>> [in Polish].
- OREE (French association of companies and local municipalities promoting circular economy), 2015. Le recueil des démarches d'écologie territoriale. Available from: <<http://www.oree.org/ecologie-industrielle-territoriale/presentation.html>> [in French].
- Orhan, M.F., Babu, B.S., 2015. Investigation of an integrated hydrogen production system based on nuclear and renewable energy sources: Comparative evaluation of hydrogen production options with a regenerative fuel cell system. *Energy* 88, 801–820.

- Oxera, 2009. The cost of capital for heat distribution and supply: final report. The Hague: Energiekamer eds. Available from: <http://www.acm.nl/download/documenten/nma/Oxera-Cost_of_capital_for_heat_Final.pdf>.
- Paananen, P., Henttonen, T., 2009. Investigations of a Long-Distance 1000 MW Heat Transport System with APROS Simulation Software. Contribution to the 20th International Conference on Structural Mechanics in Reactor Technology (SMiRT 20).
- Pahl-Wostl, C., 2015. The Role of Institutions, Actors and Social Networks in Societal Change, in: Water Governance in the Face of Global Change, Water Governance - Concepts, Methods, and Practice. Springer, Cham, pp. 51–83.
- Palm, J., Thollander, P., 2010. An interdisciplinary perspective on industrial energy efficiency. *Applied Energy* 87, 3255–3261.
- Parajuli, R., Løkke, S., Østergaard, P.A., Knudsen, M.T., Schmidt, J.H., Dalgaard, T., 2014. Life Cycle Assessment of district heat production in a straw fired CHP plant. *Biomass and Bioenergy* 68, 115–134.
- Pavlov, G., Olesen, B., 2012. Thermal energy storage — a review of concepts and systems for heating and cooling applications in buildings: Part 1—Seasonal storage in the ground. *HVAC&R Res*; 18:515–38.
- Pearce, D., Atkinson, G., Mourato, S., 2006. Cost-Benefit Analysis and the Environment: Recent Developments Organisation for Economic Co-operation and Development (OECD).
- Persson, U., Werner, S., 2011. Heat distribution and the future competitiveness of district heating. *Applied Energy* 88, 568–576.
- Persson, U., Möller, B., Werner, S., 2014. Heat Roadmap Europe: Identifying strategic heat synergy regions. *Energy Policy* 74, 663–681.
- Persson, U., Münster, M., 2016. Current and future prospects for heat recovery from waste in European district heating systems: A literature and data review. *Energy, Special issue on Smart Energy Systems and 4th Generation District Heating* 110, 116–128.
- Peters, M., Fudge, S., Wade, J., 2013. Local authority perspectives on energy governance and delivery in the UK: a thematic assessment of enabling and restricting factors. University of Surrey, Centre for Environmental Strategy Working Paper 01/13.
- Petrov, O., Bi, X., Lau, A., 2015. Impact assessment of biomass-based district heating systems in densely populated communities. Part I: Dynamic intake fraction methodology. *Atmospheric Environment* 115, 70–78.
- Peupliers de France (French poplar association), 2017. Associations des peupliers Nord-Pas-de-Calais-Picardie. Available from: <<http://www.peupliersdefrance.org/n/association-peuplier-nord-pas-de-calais-picardie/n:1124>> [in French].
- Pierrès, N.L., Luo, L., Berthiaud, J., Mazet, N., n.d. Heat transportation from the Bugey power plant. *International Journal of Energy Research* 33, 135–143.
- Pikas, E., Kurnitski, J., Thalfeldt, M., Koskela, L., 2017. Cost-benefit analysis of nZEB energy efficiency strategies with on-site photovoltaic generation. *Energy* 128, 291–301.
- Pingoud, K., Ekholm, T., Savolainen, I., 2012. Global warming potential factors and warming payback time as climate indicators of forest biomass use. *Mitig Adapt Strateg Glob Change* 17, 369–386.
- Pope, C.A., Burnett, R.T., Thun, M.J., Calle, E.E., Krewski, D., Ito, K., Thurston, G.D., 2002. Lung cancer, cardiopulmonary mortality, and long-term exposure to fine particulate air pollution. *JAMA* 287, 1132–1141.
- Popovski, E., Fleiter, T., Steinbach, J., Aydemir, A., Büchele, R., Kranzl, L., Hummel, M., Münster, M., Amer-Allam, S.B., Petrovic, S., 2017. Cost-effectiveness of large-scale heat pumps in DH networks: a simulation model for a case study in Germany. Participation of the Progress Heat project to the 3rd International Conference on Smart Energy Systems and 4th Generation District Heating. Copenhagen, Sept. 2017. Available from: <http://www.4dh.eu/images/3__Eftim_Popovski.pdf>.

- Poredos, A., Kitanovski, A., 2011. District heating and cooling for efficient energy supply. In: 2011 International conference on electrical and control engineering (ICECE 2011), Yichang, China, September 16–18, 2011, p. 5238–41.
- Praetorius, B., Martiskainen, M., Sauter, R., Watson, J., 2010. Technological innovation systems for microgeneration in the UK and Germany – a functional analysis: Technology Analysis & Strategic Management: Vol 22, No 6.
- Puikkonen, I., 2010. Cooperative Mankala-Companies – the Acceptability of the company form in EC Competition Law. *Helsinki Law Review*, 1 139–156.
- Pyrko, J., Darby, S., 2011. Conditions of energy efficient behaviour—a comparative study between Sweden and the UK. *Energy Efficiency* 4, 393–408.
- QGIS, 2017. Geographical Information system (GIS). Open source software. Available from: <<http://www.qgis.org/fr/site/>>.
- Rad, F.M., Fung, A.S., 2016. Solar community heating and cooling system with borehole thermal energy storage – Review of systems. *Renewable and Sustainable Energy Reviews* 60, 1550–1561.
- Rämä, M., Sipilä, K., 2017. Transition to low temperature distribution in existing systems. *Energy Procedia*, 15th International Symposium on District Heating and Cooling, DHC15-2016, 4-7 September 2016, Seoul, South Korea 116, 58–68.
- Rämä, M., 2018. Flexible nuclear cogeneration. *Lettre I-Tésé* 33. Spring 2018. Available from: <http://itese.cea.fr/fr/Publications/Lettreltese/Lettre_itese_33/files/04_Lettr_itese_printemps_2018_Eclairages_Flexible_nuclear_cogen.pdf>.
- Ramanathan, R., Ganesh, L.S., 1995. Energy resource allocation incorporating qualitative and quantitative criteria: An integrated model using goal programming and AHP. *Socio-Economic Planning Sciences* 29, 197–218.
- Raskin, P., Gleick, P.H., Kirshen, P., Pontius, R.G.J., Strzepek, K., 1997. Comprehensive assessment of the freshwater resources of the world. Stockholm Environmental Institute, Sweden. Document prepared for the fifth session of the United Nations Commission on Sustainable Development, 1997.
- Raven, R., 2007. Co-evolution of waste and electricity regimes: Multi-regime dynamics in the Netherlands (1969–2003). *Energy Policy* 35, 2197–2208.
- Raven, R., Verbong, G.P.J., 2009. Boundary crossing innovations: Case studies from the energy domain. *Technology in Society* 31, 85–93.
- Région Hauts-de-France (French northern region), 2017. La troisième révolution en Hauts-de-France. Available from: <<http://rev3.fr/>> [in French].
- Reidhav, C., Werner, S., 2008. Profitability of sparse district heating. *Applied Energy* 85, 867–877.
- Reuss, M., Beck, M., Müller, J.P., 1997. Design of a seasonal thermal energy storage in the ground. *Solar Energy*, Selected Proceeding of ISES 1995: Solar World Congress. Part III 59, 247–257.
- Rezaie, B., Rosen, M.A., 2012. District heating and cooling: Review of technology and potential enhancements. *Applied Energy*, (1) Green Energy; (2) Special Section from papers presented at the 2nd International Energy 2030 Conf 93, 2–10.
- Risom, L., Møller, P., Loft, S., 2005. Oxidative stress-induced DNA damage by particulate air pollution. *Mutation Research/Fundamental and Molecular Mechanisms of Mutagenesis, Linking Toxicology to Epidemiology: Biomarkers and New Technologies* 592, 119–137.
- Rogers, J.C., Simmons, E.A., Convery, I., Weatherall, A., 2012. Social impacts of community renewable energy projects: findings from a woodfuel case study. *Energy Policy* 42, 239–247.
- Rowinski, M.K., White, T.J., Zhao, J., 2015. Small and Medium sized Reactors (SMR): A review of technology. *Renewable and Sustainable Energy Reviews* 44, 643–656.
- RTE (French power network operator), 2018. Bilan électrique français 2017. Available from: <<http://bilan-electrique-2017.rte-france.com/>>.
- Ruth, M.F., Zinaman, O.R., Antkowiak, M., Boardman, R.D., Cherry, R.S., Bazilian, M.D., 2014. Nuclear-renewable hybrid energy systems: Opportunities, interconnexions, and needs. *Energy Conversion and Management* 78, 684–694.

- Ruuska, I., Ahola, T., Artto, K., Locatelli, G., Mancini, M., 2011. A new governance approach for multi-firm projects: Lessons from Olkiluoto 3 and Flamanville 3 nuclear power plant projects. *International Journal of Project Management* 29, 647–660.
- Safa, H., 2012. Heat recovery from nuclear power plants. *International Journal of Electrical Power & Energy Systems* 42, 553–559.
- Safa, H., 2017. The Impact of Energy on Global Economy. *International Journal of Energy Economics and Policy* 7, 287–295.
- Sainati, T., Locatelli, G., Brookes, N., 2015. Small Modular Reactors: Licensing constraints and the way forward. *Energy* 82, 1092–1095.
- Sanderson, J., 2012. Risk, uncertainty and governance in megaprojects: A critical discussion of alternative explanations. *International Journal of Project Management* 30, 432–443.
- Santos, F.M., Eisenhardt, K.M., 2009. Constructing Markets and Shaping Boundaries: Entrepreneurial Power in Nascent Fields. *The Academy of Management Journal* 52, 643–671.
- Sardi, J., Mithulananthan, N., Gallagher, M., Hung, D.Q., 2017. Multiple community energy storage planning in distribution networks using a cost-benefit analysis. *Applied Energy* 190, 453–463.
- Sayegh, M.A., Danielewicz, J., Nannou, T., Miniewicz, M., Jadwiszczak, P., Piekarska, K., Jouhara, H., 2017. Trends of European research and development in district heating technologies. *Renewable and Sustainable Energy Reviews* 68, 1183–1192.
- Scamman, D., Newborough, M., 2016. Using surplus nuclear power for hydrogen mobility and power-to-gas in France. *International Journal of Hydrogen Energy* 41, 10080–10089.
- Schmidt, D., Kallert, A., Blesl, M., Svendsen, S., Li, H., Nord, N., Sipilä, K., 2017. Low Temperature District Heating for Future Energy Systems. *Energy Procedia*, 15th International Symposium on District Heating and Cooling, DHC15-2016, 4-7 September 2016, Seoul, South Korea 116, 26–38.
- Schmidt, T., Mangold, D., Müller-Steinhagen, H., 2004. Central solar heating plants with seasonal storage in Germany. *Solar Energy, Solar World Congress 2001* 76, 165–174.
- Schot, J., Geels, F.W., 2008. Strategic niche management and sustainable innovation journeys: theory, findings, research agenda, and policy. *Technology Analysis & Strategic Management* 20, 537–554.
- Schulze, E.-D., Körner, C., Law, B.E., Haberl, H., Luysaert, S., 2012. Large-scale bioenergy from additional harvest of forest biomass is neither sustainable nor greenhouse gas neutral. *Glob. Change Biol. Bioenergy* 4, 611–616.
- SDH (Solar District Heating), 2012. Solar District Heating Guidelines. Solar collectors. Available from: <http://solar-district-heating.eu/Portals/0/Factsheets/SDH-WP3_FS-7-1_SolarCollectors_version3.pdf>.
- SDH, 2013. SUNSTORE4 Tool. Available from: <<http://sunstore4.eu/use-results/sunstore4-tool/>>.
- Searchinger, T.D., Hamburg, S.P., Melillo, J., Chameides, W., Havlik, P., Kammen, D.M., Likens, G.E., Lubowski, R.N., Obersteiner, M., Oppenheimer, M., Robertson, G.P., Schlesinger, W.H., Tilman, G.D., 2009. Fixing a Critical Climate Accounting Error. *Science* 326, 527–528.
- Seck, G.S., Guerassimoff, G., Maïzi, N., 2015. Heat recovery using heat pumps in non-energy intensive industry: Are Energy Saving Certificates a solution for the food and drink industry in France? *Applied Energy* 156, 374–389.
- Sengers, F., Wieczorek, A.J., Raven, R., 2016. Experimenting for sustainability transitions: A systematic literature review. *Technological Forecasting and Social Change*.
- Sernhed, K., Jönsson, M., 2017. Risk management for maintenance of district heating networks. *Energy Procedia*, 15th International Symposium on District Heating and Cooling, DHC15-2016, 4-7 September 2016, Seoul, South Korea 116, 381–393.
- SFEN (French nuclear energy association), 2018. Le nucléaire français dans le système énergétique européen. Scénarios basés sur le modèle PRIME pour la SFEN. Available from: <http://www.sfen.org/sites/default/files/public/atoms/files/le_nucleaire_francais_dans_le_système_energetique_europeen_-_sfen_-_ppe.pdf> [in French].

General References

- Shi, H., Chertow, M., Song, Y., 2010. Developing country experience with eco-industrial parks: a case study of the Tianjin Economic-Technological Development Area in China. *Journal of Cleaner Production* 18, 191–199.
- Short, W., Daniel, J., Holt, T., 1995. *A Manual for the Economic Evaluation of Energy Efficiency and Renewable Energy Technologies*. NREL/TP-462-5173/.
- Sibbitt, B., McClenahan, D., Djebbar, R., Thornton, J., Wong, B., Carriere, J., Kokko, J., 2012. The Performance of a High Solar Fraction Seasonal Storage District Heating System – Five Years of Operation. *Energy Procedia*, 1st International Conference on Solar Heating and Cooling for Buildings and Industry (SHC 2012) 30, 856–865.
- Sieg, J.H., Wallin, M.W., von Krogh, G., 2010. *Managerial Challenges in Open Innovation: A Study of Innovation Intermediation in the Chemical Industry* (SSRN Scholarly Paper No. ID 1602201). Social Science Research Network, Rochester, NY.
- Silverman, D., 2013. *Doing Qualitative Research: A Practical Handbook*. Sage Publishing. Fourth ed.
- Smil, V., 2010. *Energy Transitions: History, Requirements, Prospects*. Praeger publishing.
- Smirnov, I.A., Svetlov, K.S., Khrilev, L.S., 2008. Selecting main technical solutions for heat supply systems equipped with nuclear cogeneration stations. *Therm Eng* 55: 939-46.
- Smith, A., Voß, J.-P., Grin, J., 2010. Innovation studies and sustainability transitions: The allure of the multi-level perspective and its challenges. *Research Policy*, Special Section on Innovation and Sustainability Transitions 39, 435–448.
- SNCU (French National Union for District Heating), 2017. *Enquête annuelle sur les réseaux de chaleur et de froid. Rapport 2017. Chiffres 2016. Edition nationale*. Available from: <<https://www.actu-environnement.com/media/pdf/news-29857-enquete-sncu-2017.pdf>> [In French].
- Soares, N., Bastos, J., Pereira, L.D., Soares, A., Amaral, A.R., Asadi, E., Rodrigues, E., Lamas, F.B., Monteiro, H., Lopes, M.A.R., Gaspar, A.R., 2017. A review on current advances in the energy and environmental performance of buildings towards a more sustainable built environment. *Renewable and Sustainable Energy Reviews* 77, 845–860.
- Socaciu, L.G., 2012. THERMAL ENERGY STORAGE: AN OVERVIEW. *ACTA TECHNICA NAPOCENSIS - Series: APPLIED MATHEMATICS, MECHANICS, and ENGINEERING* 55.
- Song, J., Li, H., Wallin, F., 2017. Cost Comparison Between District Heating and Alternatives During the Price Model Restructuring Process. *Energy Procedia*, 8th International Conference on Applied Energy, ICAE2016, 8-11 October 2016, Beijing, China 105, 3922–3927.
- Sorgulu, F., Dincer, I., 2017. Cost evaluation of two potential nuclear power plants for hydrogen production. *International Journal of Hydrogen Energy*.
- Sorrell, S., Schleich, J., Scott, S., O'Malley, E., Trace, F., Boede, U., Ostertag, A., Radgen, P., 2000. *Reducing barriers to energy efficiency in public and private Organisations*. Brighton: Science Policy Research Unit - University of Sussex.
- Sovacool, B.K., Cooper, C.J., 2013. *The Governance of Energy Megaprojects: Politics, Hubris and Energy Security*.
- Sovacool, B.K., 2014. What are we doing here? Analyzing fifteen years of energy scholarship and proposing a social science research agenda. *Energy Research & Social Science* 1, 1–29.
- Statistical office of the Republic of Slovenia, 2011. *Development of detailed statistics on energy consumption in households. Final Report*. Available from: <https://ec.europa.eu/eurostat/cros/system/files/SECH_final_report_Slovenia.pdf>.
- Statistics Finland, 2015. *Production of electricity and heat*. Available from: <http://www.stat.fi/til/salatuo/index_en.html>.
- Stern, N., 2006. *Stern Review: The Economy of Climate Changes*. Cambridge University Presse Publishing.
- Stiglitz, J., Amartya, S., Fitoussi, J.-P., 2009. *Report by the Commission on the Measurement of Economic Performance and Social Progress (CMEPSP)*. Available from: <http://library.bsl.org.au/jspui/bitstream/1/1267/1/Measurement_of_economic_performance_and_social_progress.pdf>.

General References

- STRATEGO, 2015a. Enhanced Heating and Cooling Plans to Quantify the Impact of Increased Energy Efficiency in EU Member States Translating the Heat Roadmap Europe Methodology to Member State Level.
- STRATEGO, 2015b. The fourth version of the fourth Pan-European Thermal Atlas. Peta 4_v1.0. Available from: < <http://www.heatroadmap.eu/maps.php>>.
- STUK (Finnish Radiation and Nuclear Safety Authority), 2009. Preliminary Safety Assessment of the Fennovoima Oy Nuclear Power Plant Project. Available from: <https://www.stuk.fi/documents/88234/148256/STUK-Fennovoima_preliminarysafetyassessment_letter.pdf/2b9012c5-0d9a-4253-8efd-c2070fdc2cb7>.
- Stuttgart University, 2011. Seasonal Thermal Storage. State of the Art and Future Aspects. Available from: <http://www.rhc-platform.org/fileadmin/Events/4_-_Kerskes_seasonal_TES.pdf>.
- SUSEN (SUStainable ENergy), 2015. Sustainable energy project. Research centre Řež. Available from: <<http://www.snetp.eu/wp-content/uploads/2015/06/SUSEN-project.pdf>>.
- Svensson, I.-L., Moshfegh, B., 2011. System analysis in a European perspective of new industrial cooling supply in a CHP system. *Applied Energy* 88, 5164–5172.
- TEM (Finnish Ministry of Employment and the Economy), 2011. Nuclear Energy in Finland.
- TEM, 2013. National Energy and Climate Strategy (Kansallinen energia- ja ilmastostrategia).
- TEM, 2014. Energy Efficiency Agreements in Finland 2008–2016 (Energiatehokkuussopimukset suomessa).
- Terziotti, L.T., Sweet, M.L., McLeskey, J.T., 2012. Modeling seasonal solar thermal energy storage in a large urban residential building using TRNSYS 16. *Energy and Buildings* 45, 28–31.
- Thatcher, A., Vasconcelos, A.C., Ellis, D., 2015. An investigation into the impact of information behaviour on information failure: The Fukushima Daiichi nuclear power disaster. *International Journal of Information Management* 35, 57–63.
- Thollander, P., Palm, J., Rohdi, P., 2010. Categorizing Barriers to Energy Efficiency – an Interdisciplinary Perspective, in: Palm, J. (Ed.), *Energy Efficiency*. Sciyo.
- Togawa, T., Fujita, T., Dong, L., Fujii, M., Ooba, M., 2014. Feasibility assessment of the use of power plant-sourced waste heat for plant factory heating considering spatial configuration. *Journal of Cleaner Production* 81, 60–69.
- Trygg, L., Amiri, S., 2007. European perspective on absorption cooling in a combined heat and power system – A case study of energy utility and industries in Sweden. *Applied Energy* 84, 1319–1337.
- Tudor, T., Adam, E., Bates, M., 2007. Drivers and limitations for the successful development and functioning of EIPs (eco-industrial parks): A literature review. *Ecological Economics* 61, 199–207.
- Ueda, K., Togano, Y., Shimoda, Y., 2009. Energy conservation effects of heat source systems for business use by advanced centrifugal chillers. *ASHRAE Trans* 2009; 115(00012505):640–53.
- UFC-Que Choisir (French association for consumer's protection), 2016. Rénovation énergétique. Des artisans du bâtiment qui n'ont toujours pas fait leur transition génétique pour répondre à la transition énergétique. Available from: < <https://www.quechoisir.org/action-ufc-que-choisir-renovation-energetique-performance-zero-des-professionnels-n23361/>> [in French].
- UNDP (United Nations Development Programme), 2012. Transforming on-grid renewable energy markets: A review of UNDP-GEF support for feed-in tariffs and related price and market-access instruments.
- Unternährer, J., Moret, S., Joost, S., Maréchal, F., 2017. Spatial clustering for district heating integration in urban energy systems: Application to geothermal energy. *Applied Energy* 190, 749–763.
- Upham, P., Jones, C., 2012. Don't lock me in: Public opinion on the prospective use of waste process heat for district heating. *Applied Energy*, Special issue on Thermal Energy Management in the Process Industries 89, 21–29.

General References

- U.S. Environmental Protection Agency, 2010. Quantitative Risk Assessment for Particulate Matter. Office of Air and Radiation, Office of Air Quality Planning and Standards, Health and Environmental Impacts Division, U.S. Environmental Protection Agency; Research Triangle Park, NC 27711.
- Uxc (Ux consulting company), 2013. SMR market outlook and deployment prospects. Presentation of Uxc at the 4th annual Platts SMR conference. Available from: <<https://www.uxc.com/smr/documents/UxC%20Hinze-Platts%20SMR%202013-05-29.pdf>>.
- Van de Graaf, T., Sovacool, B.K., 2014. Thinking big: Politics, progress, and security in the management of Asian and European energy megaprojects. *Energy Policy* 74, 16–27.
- van Lente, H., Hekkert, M., Smits, R., van Waveren, B., 2003. Roles of Systemic Intermediaries in Transition Processes. *Int. J. Innov. Mgt.* 07, 247–279.
- Verfondern, K., 2013. Overview of Nuclear Cogeneration in High-Temperature Industrial Process Heat Applications. OECD-IAEA Workshop, April 4-5, 2013, Paris. Available from: <https://www.oecd-nea.org/ndd/workshops/nucogen/presentations/15_Verfondern_2013-OECD-IAEA-Workshop.pdf>.
- Viaséva (French association for the promotion of district and cooling networks), 2016. *Annuaire des réseaux de chaleur et de froid*. Available from: <<http://reseaux.viaseva.com/>> [in french].
- Viaseva, 2017. *L'annuaire des réseaux de chaleur et de froid*. Edition 2016/2017. Available from: <<http://viaseva.org/wp-content/uploads/2017/07/Annuaire-2016-2017.pdf>> [in French].
- Viessmann GmbH, 2009. Technical guide. Solar thermal systems. Available from: https://www.viessmann.co.uk/content/dam/vi-brands/UK/PDFs/Brochures/Technical%20Guide%20Solar%20Thermal%20Systems_05-2009_GB.pdf/_jcr_content/renditions/original.media_file.download_attachment.file/Technical%20Guide%20Solar%20Thermal%20Systems_05-2009_GB.pdf.
- Visschers, V.H.M., Wallquist, L., 2013. Nuclear power before and after Fukushima: The relations between acceptance, ambivalence and knowledge. *Journal of Environmental Psychology* 36, 77–86.
- VTT (Technical Research Center of Finland), 2005. Pienhiukkaspäästöt ja niiden vähentämismahdollisuudet Suomessa. Available from: <<http://www.vtt.fi/inf/pdf/tiedotteet/2005/T2300.pdf>> [in Finnish].
- VTT, 2016. Properties of indigenous fuels in Finland. Available from: <<http://www.vtt.fi/inf/pdf/technology/2016/T272.pdf>>.
- Wallner, H.P., 1999. Towards sustainable development of industry: networking, complexity and eco-clusters. *Journal of Cleaner Production* 7, 49–58.
- Wang, H., Wang, H., Zhu, T., Deng, W., 2017. A novel model for steam transportation considering drainage loss in pipeline networks. *Applied Energy* 188, 178–189.
- Wang, J.-J., Yang, D.-L., 2007. Using a hybrid multi-criteria decision aid method for information systems outsourcing. *Computers & Operations Research, Operations Research and Outsourcing* 34, 3691–3700.
- Wang, W.-C., 2016. Techno-economic analysis of a bio-refinery process for producing Hydro-processed Renewable Jet fuel from *Jatropha*. *Renewable Energy* 95, 63–73.
- Wang, Y., Silva, V., Lopez-Botet-Zulueta, M., 2016. Impact of high penetration of variable renewable generation on frequency dynamics in the continental Europe interconnected system. *IET Renewable Power Generation* 10, 10–16.
- Warren, R., Price, J., Graham, E., Forstenhaeusler, N., VanDerWal, J., 2018. The projected effect on insects, vertebrates, and plants of limiting global warming to 1.5°C rather than 2°C. *Science* 360, 791–795.
- Webb, J., 2015. Improvising innovation in UK urban district heating: The convergence of social and environmental agendas in Aberdeen. *Energy Policy* 78, 265–272.
- Weber, L., 1997. Some reflections on barriers to the efficient use of energy. *Energy Policy* 25, 833–835.

General References

- Werner, S., 2016. European district heating price series. Report no. 2016:316 Energiforsk-Fjärrsyn. Available from: <<https://energiforskmedia.blob.core.windows.net/media/21926/european-district-heating-price-series-energiforskrapport-2016-316.pdf>>.
- Werner, S., 2017a. International review of district heating and cooling. *Energy* 137, 617–631.
- Werner, S., 2017b. International review of district heating and cooling. *Energy* In press, 1–15.
- Wittmayer, J.M., Avelino, F., van Steenbergen, F., Loorbach, D., 2017. Actor roles in transition: Insights from sociological perspectives. *Environmental Innovation and Societal Transitions* 24, 45–56.
- World Nuclear Association, 2017. Nuclear Power in Finland. Available from: <<http://www.world-nuclear.org/information-library/country-profiles/countries-a-f/finland.aspx>>.
- Xiaohua, W., Zhenmin, F., 2002. Sustainable development of rural energy and its appraising system in China. *Renewable and Sustainable Energy Reviews* 6, 395–404.
- Xu, J., Wang, R.Z., Li, Y., 2014. A review of available technologies for seasonal thermal energy storage. *Solar Energy* 103, 610–638.
- Yi, L., Xiao-Bai, C., Chun-Yan, W., 2011. Monte Carlo Simulation of Energy Distribution of Radiation Field. *Procedia Engineering, CEIS 2011* 15, 3299–3307.
- Yin, R., 2014. *Case Study Research: Design and Methods*. Sage Publishing. Fifth ed.
- Yoshiyuki, S., Kuniharu, Y., Minoru, M., 2001. Combined Heat and Power System Using Waste Heat from Refuse Incinerator with Considering Monthly Change of Heat Demand. *Transactions of the Society of Heating, Air-Conditioning and Sanitary Engineers of Japan* 27–35.
- Zaubrecher, B.S., Arning, K., Falke, T., Ziefle, M., 2016. No pipes in my backyard? *Energy Research & Social Science* 14, 90–101.
- Zhang, H., Dong, L., Li, H., Fujita, T., Ohnishi, S., Tang, Q., 2013. Analysis of low-carbon industrial symbiosis technology for carbon mitigation in a Chinese iron/steel industrial park: A case study with carbon flow analysis. *Energy Policy* 61, 1400–1411.
- Zvingilaite, E., 2013. Modelling energy savings in the Danish building sector combined with internalisation of health related externalities in a heat and power system optimisation model. *Energy Policy, Special section: Long Run Transitions to Sustainable Economic Structures in the European Union and Beyond* 55, 57–72.

List of Figures

Figure 1.1	<i>Temperature ranges of heat applications and types of nuclear plants</i>	18
Figure 1.2	<i>Benchmarking of recent SMR market studies (2035 time horizon)</i>	20
Figure 1.3	<i>Climatological degree-days in Europe for the time period 1981-2000 with an effective indoor temperature of 17°C and a threshold temperature of 13°C</i>	21
Figure 1.4	<i>Heat supplied into all DH systems in the EU according to four heat supply methods, 2014</i>	23
Figure 1.5	<i>Percentage of the population served by DH systems</i>	23
Figure 1.6	<i>Impact of increased buildings efficiency on the competitiveness of DH systems</i>	25
Figure 1.7	<i>Illustration of the concept of 4th Generation District Heating in comparison to the previous three generations</i>	26
Figure 1.8	<i>Evolution of heat losses (GWh_{th}) and network length (km) of the Helsinki DH network between 1982 and 2013</i>	27
Figure 1.9	<i>Estimated future need for replacement of two different types of district heating pipes in Vattenfall's grid in Uppsala</i>	27
Figure 1.10	<i>Mapping of NCHP experiences and projects in Europe</i>	28
Figure 1.11	<i>Schematic showing equipment within the nuclear plant boundary to achieve heat extraction for DH</i>	30
Figure I.2.1	<i>Final energy consumption for space heating and domestic hot water in the EU per energy source, 2012 (%)</i>	51

List of Figures

Figure I.2.2	<i>Heat supplied to all DH systems in the EU categorised into four heat supply methods, 2014</i>	51
Figure I.2.3	Heat supplied to all DH systems in the current EU according to original energy supply sources used, 2014	52
Figure I.2.4	<i>The 12 nuclear sites considered for the CBA of DH + NCHP systems</i>	53
Figure I.2.5	<i>The structure of the techno-economic model used to estimate the costs and GHG emissions of DH + NCHP systems</i>	57
Figure I.2.6	<i>Locations used to model DH networks in the Chapter (4 cases over 15). The DH network boundaries are indicated by the dashed lines</i>	58
Figure I.2.7	<i>Heat load profile used to assess the maximal thermal capacity of NCHP</i>	60
Figure I.2.8	<i>Estimated 2030 heat demand and linear heat density of the modelled DH networks</i>	65
Figure I.2.9	<i>LCOH breakdown of DH + NCHP systems considering 25% connexion rates</i>	68
Figure I.2.10	<i>Payback period of DH + NCHP systems for three different DH prices and 25% connexion rates</i>	69
Figure I.2.11	<i>IRR for three different DH prices and 25% connexion rates</i>	70
Figure I.2.12	<i>LCOH as a function of the distance from the NCHP to the city considering a 25% connexion rate</i>	71
Figure I.2.13	<i>NPV as a function of the GHG tax considering a 25% connexion rate and a DH price of €65/MWh_{th}</i>	72
Figure I.2.14	<i>LCOH as a function of the connexion rate</i>	73
Figure I.2.15	<i>Marginal GHG abatement cost as a function of the connexion rate considering a DH price of €65/MWh_{th}</i>	74

List of Figures

Figure I.2.16	<i>Sensitivity analysis for the Dunkirk DH + NCHP system with a 50% connexion rate</i>	76
Figure I.2.17	<i>Sensitivity analysis for the London DH + NCHP system with a 25% connexion rate</i>	77
Figure I.3.1	<i>Existing and modelled DH areas in the Dunkirk conurbation committee</i>	95
Figure I.3.2	<i>Sketch of the heat pump cycle with components</i>	99
Figure I.3.3	<i>Practical COP values of compression HP heating water up to 60 (Max. COP) or 90 (Min. COP) °C</i>	100
Figure I.3.4	<i>Principle of energy flows in a solar collector</i>	104
Figure I.3.5	<i>Illustration of a solar DH system with BTES</i>	106
Figure I.3.6	<i>Illustration of a PTES</i>	108
Figure I.3.7	<i>A floor standing medium size condensing gas boiler for apartment blocks</i>	110
Figure I.3.8	<i>Illustration of air to water HP</i>	112
Figure I.3.9	<i>Illustration of brine to water HP</i>	113
Figure I.3.10	<i>Collection efficiency of conventional gas cleaning technologies</i>	116
Figure I.3.11	<i>Impact of increased buildings efficiency on the competitiveness of DH systems</i>	124
Figure I.3.12	<i>Overnight investment cost of heating systems (millions euros)</i>	131

List of Figures

Figure I.3.13	<i>LCOH breakdown of the DH + NCHP system</i>	133
Figure I.3.14	<i>LCOH breakdown of the DH + NEH + HP system</i>	133
Figure I.3.15	<i>LCOH breakdown of the DH + Water to Water HP system</i>	134
Figure I.3.16	<i>LCOH breakdown of DH + Biomass HOB systems</i>	134
Figure I.3.17	<i>LCOH breakdown of DH + Solar collectors + STES systems</i>	135
Figure I.3.18	<i>LCOH breakdown of individual condensing gas boilers</i>	135
Figure I.3.19	<i>LCOH breakdown of individual electric heaters</i>	135
Figure I.3.20	<i>LCOH breakdown of individual HP</i>	136
Figure I.3.21	<i>Investment and O&M components of LCOH heating systems</i>	136
Figure I.3.22	<i>LCOH as a function of electricity prices, ceteris paribus</i>	137
Figure I.3.23	<i>LCOH as a function of natural gas prices, ceteris paribus</i>	137
Figure I.3.24	<i>LCOH as a function of discount rates, ceteris paribus</i>	138
Figure I.3.25	<i>LCOH as a function of operational lifetimes, ceteris paribus</i>	138
Figure I.3.26	<i>LCOH of heating systems considering energy price scenario shown in Table I.3.36</i>	140

List of Figures

Figure I.3.27	<i>Payback periods of DH systems considering the energy scenario '2015' and three different DH price to final consumer</i>	141
Figure I.3.28	<i>NPV of DH systems considering the energy scenario '2015' and three different DH price to final consumer</i>	142
Figure I.3.29	<i>DALY as a function of GHG emissions</i>	145
Figure I.3.30	<i>Maximum amount (% of total investment) of public subsidies that heating systems could get</i>	146
Figure I.3.31	<i>LCOH of heating systems when the maximum amount of public subsidies (see Figure I.3.30) is obtained</i>	147
Figure I.3.32	<i>LCOH as functions of CO₂ taxation (direct emissions)</i>	148
Figure I.3.33	<i>LCOH as functions of GHG taxation (direct and lifecycle emissions)</i>	148
Figure I.3.34	<i>LCOH increase when accounting for the social cost of air pollutants</i>	149
Figure I.3.35	<i>LCOH as functions of human life pricing</i>	150
Figure I.3.36	<i>Comparison of the levelised cost of renovation with the levelised cost of heating systems, considering a discount rate of 3.5%</i>	151
Figure I.3.37	<i>Comparison of the levelised cost of renovation with the levelised cost of heating systems, considering a discount rate of 0%</i>	152
Figure I.3.38	<i>Levelised costs as function of direct and lifecycle CO₂ price, considering a 0% discount rate</i>	152
Figure I.3.39	<i>LCOH of heating systems designed to supply shallowly renovated buildings</i>	154
Figure I.3.40	<i>LCOH of heating systems designed to supply completely renovated buildings</i>	154

List of Figures

Figure I.3.A.1	<i>LCOH comparison when the power losses due to heat generation with the NCHP can be compensated by increasing the load factor of the plant</i>	166
Figure I.3.A.2	<i>Direct and indirect CO₂ emissions of heating systems when the power losses due to heat generation with the NCHP can be compensated by increasing the load factor of the plant</i>	166
Figure I.4.1	<i>Structure of the regional energy analytical model and system boundaries</i>	174
Figure I.4.2	<i>Spatial mapping of nuclear sites and factories studied</i>	180
Figure I.4.3	<i>Subsectoral distribution of heat consumption below 250°C and of corresponding factories</i>	181
Figure I.4.4	<i>Spatial distribution of heat consumption below 250°C</i>	181
Figure I.4.5	<i>Relationships between distance and cost of steam in IS complexes 1 and 2</i>	183
Figure II.5.1	<i>Heat transportation system routing from the Loviisa 3 NDH unit to the Helsinki metropolitan area, about 80 km long</i>	199
Figure II.5.2	<i>Current configuration of stakeholders involved in the Loviisa NPP and the Helsinki metropolitan area DH networks</i>	200
Figure II.5.3	<i>Obstacles to the Loviisa 3 Nuclear District Heating projects as perceived by Fortum respondents (10 out of 27)</i>	203
Figure II.5.4	<i>Obstacles to the Loviisa 3 Nuclear District Heating project as perceived by VTT respondents (17 out of 27)</i>	203
Figure II.5.5	<i>Theoretical project governance of a sustainable Loviisa 3 NDH project</i>	205
Figure II.5.6	<i>Importance of physical constraints on the Loviisa 3 NDH project, as perceived by individuals from Fortum and VTT respectively</i>	207
Figure II.6.1	<i>Existing and modelled DH systems in the Dunkirk conurbation committee</i>	225

List of Figures

Figure III.7.1	<i>Major heat markets for nuclear plants in France</i>	251
Figure III.7.2	<i>The evolution of the French nuclear capacity if no new reactor is built</i>	253
Figure III.7.3	<i>Spatial mapping of the DH potential in France according to the three linear heat density ranges</i>	258
Figure III.7.4	<i>DH potential by region based on the 2015 heat demand. Potential DH heat consumption (TWh_{th}/a) and DH share in the total heat demand (%) for three ranges of linear heat density</i>	259
Figure III.7.5	<i>Number of agglomerations and average size of agglomerations (km^2) corresponding to the DH potential identified in Figure III.7.4</i>	259
Figure III.7.6	<i>Global DH potential in France. Left: DH potential based on the 2015 heat demand. Right: DH potential when the 2015 heat demand is uniformly reduced by 50%</i>	260
Figure III.7.7	<i>Example of built-up areas with the heat density (GWh_{th}/km^2) but different DH pipe length (m)</i>	262
Figure III.7.8	<i>Evolution of the energy sources used for residential and commercial space and water heating</i>	263
Figure III.7.9	<i>LCOH of the DH + NCHP systems projected in Table III.7.3</i>	266
Figure III.7.10	<i>The development of the Stockholm DH systems from 1978 to 2010</i>	266
Figure III.7.11	<i>The development of the Helsinki DH systems from 1982 to 2013</i>	268
Figure III.7.12	<i>Projected evolution of the energy sources used for DH in France towards 2050</i>	268
Figure III.8.1	<i>Diagram describing the three stages of the development process in a technology push approach</i>	278
Figure III.8.2	<i>MLP framework for the development of innovative systems: Intermediaries as agents for stimulating transitions</i>	280

List of Figures

Figure III.8.3 *Organisation chart of a non-integrated energy cluster* 286

Figure III.8.4 *Organisation chart of a Mankala energy cluster* 287

List of Tables

Table 1.1	<i>Heating sources in European residential buildings</i>	22
Table 1.2	<i>Comprehensive presentation of the plan followed by the Ph.D Report</i>	37
Table I.2.1	<i>Description of the 15 DH + NCHP systems evaluated in this Chapter and references to previous studies</i>	55
Table I.2.2	<i>Country-specific parameters used to evaluate the linear heat density ($MWh_{th}/m.a$) of DH systems</i>	59
Table I.2.3	<i>Direct and lifecycle GHG specific emissions of studied sources of energy</i>	64
Table I.2.4	<i>Estimated and empirical parameters for the countries and urban areas under investigation</i>	66
Table I.2.5	<i>Comparison of DH + NCHP systems according to different criteria</i>	75
Table I.2.B.1	<i>Initial capital costs and investment periods of DH + NCHP systems in the base case</i>	88
Table I.2.C.1	<i>Parameters relative to the efficiency of DH + NCHP systems and the operational and maintenance (O&M) costs</i>	89
Table I.2.D.1	<i>Technical lifetime of technologies comprised in DH + NCHP systems</i>	90
Table I.3.1	<i>Heating systems and building envelopes studied in Chapter 3</i>	93
Table I.3.2	<i>Distribution of the construction period and specific heat consumption of buildings in the Dunkirk conurbation committee</i>	97

List of Tables

Table I.3.3	<i>Capital cost of DH pipelines (€) in Dunkirk as a function of pipes diameter (mm). Data provided by Dalkia in 2017</i>	98
Table I.3.4	<i>Parameter values used to model electric compression HP for DH systems. Values projected towards 2030</i>	100
Table I.3.5	<i>Parameter values used to model biomass HOB towards 2030</i>	102
Table I.3.6	<i>Parameter values used to model solar collectors towards 2030</i>	104
Table I.3.7	<i>Parameter values used to model BTES towards 2030</i>	107
Table I.3.8	<i>Parameter values used to model PTES towards 2030</i>	108
Table I.3.9	<i>Parameter values used to model individual natural gas condensing boilers towards 2030</i>	110
Table I.3.10	<i>Parameter values used to model individual electric heaters towards 2030</i>	111
Table I.3.11	<i>Parameter values used to model individual air-to-water HP</i>	112
Table I.3.12	<i>Parameter values used to model brine-to-water HP</i>	113
Table I.3.13	<i>Direct CO₂ emission factors specific to the studied sources of energy</i>	114
Table I.3.14	<i>Indirect CO₂ emission factors specific to the studied sources of energy</i>	114
Table I.3.15	<i>Air pollution emission factors, i.e. amount of air pollutants rejected in air (g/MWh_{th})</i>	116
Table I.3.16	<i>Social costs of air pollutants (euros per ton of pollutant emitted)</i>	117

List of Tables

Table I.3.17	<i>Effect factors of PM_{2,5}</i>	117
Table I.3.18	<i>Comprehensive description of the assumptions made to assess the intake fractions of the heating systems in the case of the Dunkirk conurbation committee</i>	118
Table I.3.19	<i>Upper values of public subsidies for DH systems</i>	120
Table I.3.20	<i>Upper values of tax credits for individual heating systems</i>	120
Table I.3.21	<i>Average cost of retrofitting buildings and average efficiency gains associated, for three category of buildings age</i>	122
Table I.3.22	<i>Main changes affecting the DH modelled area (see Figure I.3.1) when renovating buildings</i>	123
Table I.3.23	<i>Parameter values used to evaluate DH heat losses of a network designed to operate at lower temperatures than the existing DH system</i>	125
Table I.3.24	<i>Parameter values relative to DH distribution and peak-load systems that are modified when supplying lower temperatures</i>	126
Table I.3.25	<i>Parameter values relative to NCHP system that are modified when supplying lower temperatures</i>	126
Table I.3.26	<i>Parameter values relative to NEH + HP that are modified when supplying lower temperatures</i>	127
Table I.3.27	<i>Parameter values relative to water to water HP that are modified when supplying lower temperatures</i>	127
Table I.3.28	<i>Parameter values relative to biomass HOB that are modified when supplying lower temperatures</i>	128
Table I.3.29	<i>Parameter values relative to solar DH systems that are modified when supplying lower temperatures</i>	128
Table I.3.30	<i>Parameter values relative to natural gas condensing boilers that are modified when supplying lower temperatures</i>	129

List of Tables

Table I.3.31	<i>Parameter values relative to electric heaters that are modified when supplying lower temperatures</i>	129
Table I.3.32	<i>Parameter values relative to air to water HP that are modified when supplying lower temperatures</i>	129
Table I.3.33	<i>Parameter values relative to brine to water HP that are modified when supplying lower temperatures</i>	129
Table I.3.34	<i>Main technical parameters of DH systems dimensioned to supply the existing building stock of the DH modelled area shown in Figure I.3.1 of Section 3</i>	130
Table I.3.35	<i>Energy price used in the '2015 scenario'</i>	132
Table I.3.36	<i>Energy price scenario considered in Section 5.1.1.3</i>	139
Table I.3.37	<i>Non-economic indicators characterizing the heating systems</i>	144
Table I.3.38	<i>DH distribution systems designed to satisfy buildings with different energy performances</i>	153
Table I.4.1	<i>Experience of industrial use of steam sourced from nuclear plants</i>	169
Table I.4.2	<i>Direct and lifecycle CO₂ emission factors of energy sources</i>	171
Table I.4.3	<i>Industrial subsectors suitable for the integration of IS complexes</i>	178
Table I.4.4	<i>Theoretical IS complexes assessed</i>	182
Table II.5.1	<i>Worldwide experiences in nuclear district heating</i>	197
Table II.5.2	<i>Mains arguments exposed by Fortum and Helen respectively when addressing nuclear district heating for the Helsinki area</i>	205

List of Tables

Table II.5.A.1	<i>Details of the semi-structured interviews</i>	218
Table II.6.1	<i>Alternatives/criteria matrix</i>	228
Table II.6.2	<i>Criteria weights considered in Scenario I</i>	231
Table II.6.3	<i>Criteria weights considered in Scenario II</i>	233
Table II.6.4	<i>Ranking of alternatives for each stakeholder based on PROMETHEE II</i>	234
Table II.6.A.1	<i>Questionnaire shared in order to extract stakeholder preferences</i>	244
Table II.6.B.1	<i>Stakeholder' comments when answering the questionnaire shown in Appendix II.6.A.1</i>	245
Table II.6.C.1	<i>Direct and lifecycle GHG emissions</i>	246
Table III.7.1	<i>Population, heat demand and average specific heat demand by regions</i>	256
Table III.7.2	<i>Existing DH networks by region</i>	261
Table III.7.3	<i>Prospective scenario considering the deployment of eight DH + NCHP projects in France</i>	265
Table III.7.4	<i>Prospective scenario considering the deployment of industrial complexes using 250°C steam from nuclear plants in France</i>	270
Table III.8.1	<i>Actors that could be involved in the revolt and remember processes surrounding the development of heat production with nuclear plants in France</i>	282
Table III.8.2	<i>Actions that could be led by intermediaries to nurture niche experiment</i>	282

Titre : Les centrales nucléaires comme une option pour aider à décarboner les secteurs de la chaleur Européens et Français ? Une analyse prospective tehnico-économique.

Mots clés : Cogénération, Energie nucléaire, Economie, Réseaux de chaleur, Eco-parcs industriels

Résumé : La thèse étudie le rôle que les centrales nucléaires pourraient jouer dans la décarbonisation des secteurs du chauffage en Europe et en France. Un réacteur nucléaire est d'abord une source de chaleur à longue durée de vie qui peut produire de l'électricité grâce à un turboalternateur. Mais il peut également être utilisé en mode cogénération en produisant à la fois de l'électricité et de la chaleur. Cette option présente plusieurs avantages dont celui de fournir une chaleur exempte d'émissions de gaz à effet de serre (GES) et celui d'offrir de la flexibilité au réseau électrique.

Aujourd'hui, l'exploitation la plus courante des centrales nucléaires est la fourniture exclusive d'électricité. Cependant, cela entraîne le rejet dans l'environnement de grandes quantités de chaleur issues de la conversion en électricité. Le transfert d'une partie de cette chaleur aux puits industriels ou aux systèmes de chauffage urbain à proximité réduirait la consommation de combustibles fossiles et les émissions de GES. Si cette chaleur venait en substitution de combustibles fossiles importés, cela permettrait également d'améliorer l'indépendance énergétique, favorisant ainsi la stabilité des prix à long terme.

Title: Nuclear plants as an option to help decarbonising the European and French heat sectors? A techno-economic prospective analysis.

Keywords: Cogeneration, Nuclear energy, Economics, District heating, Eco-industrial parks

Abstract: The Ph.D. Thesis studies the role that nuclear plants could play in decarbonizing the European and French heating sectors. A nuclear power plant is basically a thermal plant that convert the nuclear heat into electricity using a turboalternator. But it could also be used in a cogeneration mode producing simultaneously power and heat. The latter offers many advantages including the low carbon profile and the ability to provide flexibility to the power grid.

The most widely spread operation of nuclear plants today is electricity only production, which imply the dumping into the environment a large amount of heat that has not been converted to electricity. Transferring part of this heat to nearby industrial sinks or district heating systems would reduce fossil fuel consumption and greenhouse gases emissions. If this heat is replacing imported fossil-fuels that would also improve energy self-sufficiency, favouring long-term price stability.