



HAL
open science

Non-asymptotic method estimation and applications for fractional order systems

Xing Wei

► **To cite this version:**

Xing Wei. Non-asymptotic method estimation and applications for fractional order systems. Other. Institut National des Sciences Appliquées - Centre Val de Loire, 2017. English. NNT : 2017ISAB0003 . tel-01897436

HAL Id: tel-01897436

<https://theses.hal.science/tel-01897436>

Submitted on 17 Oct 2018

HAL is a multi-disciplinary open access archive for the deposit and dissemination of scientific research documents, whether they are published or not. The documents may come from teaching and research institutions in France or abroad, or from public or private research centers.

L'archive ouverte pluridisciplinaire **HAL**, est destinée au dépôt et à la diffusion de documents scientifiques de niveau recherche, publiés ou non, émanant des établissements d'enseignement et de recherche français ou étrangers, des laboratoires publics ou privés.

ÉCOLE DOCTORALE MIPTIS

LABORATOIRE : PRISME

THÈSE présentée par :

Xing WEI

soutenue le : **23 Novembre 2017**

pour obtenir le grade de : **Docteur de l'INSA Centre Val de Loire**

Discipline : **Automatique**

Non-asymptotic method estimation and applications for fractional order systems

RAPPORTEURS :

Taous-Meriem LALEG-KIRATI

Associate Professor, King Abdullah University of Science and Technology

Pierre MELCHIOR

Maître de conférences HdR, Université de Bordeaux

JURY :

Taous-Meriem LALEG-KIRATI

Associate Professor, King Abdullah University of Science and Technology

Pierre MELCHIOR

Maître de conférences HDR, Université de Bordeaux

Maïtine BERGOUNIOUX

Professeur, Université d'Orléans, Présidente du jury

Frédéric KRATZ

Professeur, INSA Centre Val de Loire

Olivier GIBARU

Professeur, École Nationale des Arts et Métiers

Gang ZHENG

Chargé de recherche HDR, INRIA-Lille Nord Europe

Dayan LIU

Maître de conférences, INSA Centre Val de Loire, Encadrant

Driss BOUTAT

Professeur, INSA Centre Val de Loire, Directeur de thèse

Abstract

This thesis aims to design non-asymptotic and robust estimators for a class of fractional order linear systems in noisy environment. It deals with a class of commensurate fractional order linear systems modeled by the so-called pseudo-state space representation with unknown initial conditions. It also assumed that linear systems under study can be transformed into the Brunovsky's observable canonical form. Firstly, the pseudo-state of the considered systems is estimated. For this purpose, the Brunovsky's observable canonical form is transformed into a fractional order linear differential equation involving the initial values of the fractional sequential derivatives of the output. Then, using the modulating functions method, the former initial values and the fractional derivatives with commensurate orders of the output are given by algebraic integral formulae in a recursive way. Thereby, they are used to calculate the pseudo-state in the continuous noise-free case. Moreover, to perform this estimation, it provides an algorithm to build the required modulating functions. Secondly, inspired by the modulating functions method developed for pseudo-state estimation, an operator based algebraic method is introduced to estimate the fractional derivative with an arbitrary fractional order of the output. This operator is applied to cancel the former initial values and then enables to estimate the desired fractional derivative by a new algebraic formula using a recursive way. Thirdly, the pseudo-state estimator and the fractional order differentiator are studied in discrete noisy case. Each of them contains a numerical error due to the used numerical integration method, and the noise error contribution due to a class of stochastic processes. In particular, it provides an analysis to decrease noise contribution by means of an error bound that enables to select the optimal degrees of the modulating functions at each instant. Then, several numerical examples are given to highlight the accuracy, the robustness and the non-asymptotic property of the proposed estimators. Moreover, the comparisons to some existing methods and a new fractional order \mathcal{H}_∞ -like observer are shown. Finally, conclusions are outlined with some perspectives.

Index Terms: Fractional order linear systems, Pseudo-state space representation, Modulating functions method, Algebraic method, Non-asymptotic and robust estimation, Pseudo-state estimator, Fractional order differentiators, Initial condition estimator, Fractional order Luenberger-like observer, Fractional order \mathcal{H}_∞ -like observer, Fractional order Legendre differentiator.

Résumé étendu en français

Cette thèse vise à concevoir des estimateurs non-asymptotiques et robustes pour les systèmes linéaires d'ordre fractionnaire commensurable dans un environnement bruité. Elle traite une classe des systèmes linéaires d'ordre fractionnaire modélisées par la dite pseudo représentation d'état avec des conditions initiales inconnues. Elle suppose également que les systèmes étudiés ici peuvent être transformés sous la forme canonique observable de Brunovsky. Pour estimer le pseudo-état, la forme précédente est transformée en une équation différentielle linéaire d'ordre fractionnaire en prenant en compte les valeurs initiales des dérivées fractionnaires séquentielles de la sortie. Ensuite, en utilisant la méthode des fonctions modulatrices, les valeurs initiales précédentes et les dérivées fractionnaires avec des ordres commensurables de la sortie sont données par des formules algébriques avec des intégrales à l'aide d'une méthode récursive. Ainsi, ces formules sont utilisées pour calculer le pseudo-état dans le cas continu sans bruit. En outre, elle fournit un algorithme pour construire les fonctions modulatrices requises à l'accomplissement de l'estimation. Deuxièmement, inspirée par la méthode des fonctions modulatrices développée pour l'estimation de pseudo-état, une méthode algébrique basée sur un opérateur est introduite pour estimer la dérivée fractionnaire avec un ordre quelconque de la sortie pour les systèmes considérés. Cet opérateur sert à annuler les valeurs initiales non désirées, puis permet d'estimer la dérivée fractionnaire souhaitée par une nouvelle formule algébrique à l'aide d'une méthode récursive. Troisièmement, l'estimateur du pseudo-état et le différentiateur d'ordre fractionnaire obtenus précédemment sont étudiés respectivement dans le cas discret et bruité. Chacun d'entre eux contient une erreur numérique due à la méthode d'intégration numérique utilisée et une autre due au bruit. En particulier, elle fournit une analyse pour diminuer la contribution du bruit au moyen d'une majoration d'erreur qui permet de sélectionner les degrés optimaux des fonctions modulatrices à chaque instant. Ensuite, des exemples numériques sont donnés pour mettre en évidence la précision, la robustesse et la propriété non-asymptotique des estimateurs proposés. En outre, les comparaisons avec certaines méthodes existantes et avec un nouvel observateur d'ordre fractionnaire de type \mathcal{H}_∞ sont montrées. Enfin, elle donne des conclusions et des perspectives.

Mots clés : Systèmes linéaires d'ordre fractionnaire, Pseudo représentation d'état, Méthode des fonctions modulatrices, Méthode algébrique, Estimation non-asymptotique et robuste, Estimateur de pseudo-état, Différentiateurs d'ordre fractionnaire, Estimateur de conditions initiales, Observateur d'ordre fractionnaire de type Leuenberger, Observateur d'ordre fractionnaire de type de \mathcal{H}_∞ , Différentiateur de Legendre d'ordre fractionnaire.

Acknowledgements

The PhD work presented in this thesis was supported by the Central Region of France, and has been carried out within the PRISME (Pluridisciplinaire de Recherche en Ingénierie des Systèmes, Mécanique et Énergétique) laboratory at INSA Centre Val de Loire Campus of Bourges

Firstly, I would like to thank my advisor Prof. Driss Boutat and supervisor Dr. Dayan Liu, for the great opportunities, for their high level of guidance, for their patience, for broadening my vision in research and other things in daily life.

I would like to express my sincere gratitude to Laleg-Kirati Taous-Meriem and Melchior Pierre who have kindly accepted the invitation to be the reviewers of my PhD thesis. My heartfelt thanks are dedicated to Prof. Maitine BERGOUNIOUX, Frédéric KRATZ, Prof. Olivier GIBARU and Dr. Gang ZHENG, for their kind acceptance to be the members of my PhD Committee.

Thank you to all my colleagues working in the same place, with whom I know I am not fighting alone in research world. I would especially like to mention Antoine FERREIRA, Omar TAHRI, Adel HAFIANE, Arnaud PARIS, Toufik AGGAB, Bassem CHIEB, Julien THUILLIER, Bainan LIU, Ruipeng CHEN, Lifei WANG, Tingting ZHANG and Yanqiao WEI.

I would like to thank all the support staffs. Especially for Marylene VALLEE, Nathalie MACHU, Karine COTTANCIN, Laura GUILLET and Laure SPINA.

I would like to thank all my friends in France for their friendships and supports.

Last, but certainly not the least, many thanks to my mother's choice of studying in France, thank you to all my family for the sacrifices they had to make in order to allow me to pursue my studies in France. Thank you for my wife years of companionship that I always believe in love. All the family's love is the source of strength let me stronger.

Since there are too many people helped me during this period, please forgive me for not listing more.

List of publications

Journals

[1] **Xing Wei**, Da-Yan Liu, and Driss Boutat, “Non-asymptotic pseudo-state estimation for a class of fractional order linear systems,” *IEEE Transactions on Automatic Control*, vol. 62, no. 3, pp. 1150–1164, 2017, Impact Factor: 4.27.

Under review:

[2] **Xing Wei**, Da-Yan Liu, Driss Boutat, and Yi-Ming Chen, “Algebraic fractional order differentiator based on the pseudo-state space representation,” *IEEE Transactions on Automatic Control*.

International Conferences

[3] **Xing Wei**, Da-Yan Liu, Driss Boutat, Hao-Ran Liu, and Ya-Qian Li, “Modulating functions-based fractional order differentiator for fractional order linear systems with a biased output,” in *20th IFAC World Congress, 2017*.

[4] Yan-Qiao Wei, **Xing Wei**, Da-Yan Liu, and Driss Boutat, “Robust estimation for the fractional integral and derivative of the output for a class of fractional order linear systems,” in *Control Conference (CCC), 2017 36th Chinese*.

[5] **Xing Wei**, Da-Yan Liu, and Driss Boutat, “Extension of modulating functions method to pseudo-state estimation for fractional order linear systems,” in *Control Conference (CCC), 2016 35th Chinese*, pp. 10469–10474, TCCT, 2016.

[6] **Xing Wei**, Da-Yan Liu, and Driss Boutat, “A new model-based fractional order differentiator with application to fractional order pid controllers,” in *2015 54th IEEE Conference on Decision and Control (CDC)*, pp. 3718–3723, IEEE, 2015.

[7] **Xing Wei**, Da-Yan Liu, and Driss Boutat, “Caputo fractional derivative estimation for a class of signals satisfying a linear differential equation,” in *Control Conference (CCC), 2015 34th Chinese*, pp. 4598–4603, IEEE, 2015.

Contents

0.1	List of Figures	8
1	General Introduction	1
1.1	Getting started	1
1.2	Introduction	2
1.3	Motivations and objectives of the thesis	4
1.4	Outline	6
2	Fractional calculus and fractional order systems	7
2.1	Some useful functions and Laplace transform	7
2.2	Definitions and properties of fractional calculus	11
2.3	Commensurate fractional order linear systems	19
2.4	Fractional order controllers	32
2.5	Conclusions	34
3	Modulating functions method	35
3.1	Introduction	35
3.2	Modulating functions method for integer order linear systems	37
3.3	Fractional order differentiator for integer order linear systems	44
3.4	Numerical results	53
3.5	Conclusions	59
4	Non-asymptotic pseudo-state estimator	61
4.1	Introduction	61
4.2	Problem formulation	63
4.3	Main results	67
4.4	Simulation results	83
4.5	Conclusions	92
5	Non-asymptotic fractional order differentiator	93
5.1	Introduction	93
5.2	Algebraic fractional order differentiator	95

5.3	Simulation results	107
5.4	Conclusions	114
6	General conclusions and perspectives	115
6.1	Conclusions	115
6.2	Future works	117
Annexes		I
A	Appendix: different properties of Modulating functions	III
A	Reference	VII

0.1 List of Figures

2.1	The variation of the Gamma function.	8
2.2	Riemann-Liouville definition case $x(t) = \frac{1}{t^{1-\alpha}} E_{\alpha,\alpha}(t^\alpha A)$ with $\alpha = 0.1, 0.5, 0.9, 1$	23
2.3	Caputo definition case $x(t) = E_\alpha(t^\alpha A)x(0)$ with $\alpha = 0.1, 0.5, 0.9, 1$	23
2.4	Caputo definition case: $x(t) = E_\alpha(t^\alpha A)x(0)$ with $\alpha = 0.1$ and $A = -0.1, -1, -8, -20$	24
2.5	Riemann surface for $w = s^{1/4}$	25
2.6	The evaluation contour Γ_0	26
2.7	$ \arg(\lambda) = \frac{\pi}{4}$	27
2.8	$ \arg(\lambda) > \alpha\pi$	27
2.9	$\arg(\lambda) = \pi$	28
2.10	$ \arg(\lambda) < \frac{\alpha\pi}{2}$	28
2.11	$\frac{\alpha\pi}{2} < \arg(\lambda) < \alpha\pi$	29
2.12	Block diagram of a closed-loop system with a fractional order $PI^\lambda D^\mu$ controller.	32
2.13	Classical PID controllers and fractional order $PI^\lambda D^\mu$ controllers.	33
3.1	Classic modulating functions	38
3.2	Example 1: Open-loop case.	56
3.3	Example 2: Closed-loop case.	57
3.4	Example 3: Sinusoidal signal case	58
4.1	Example: Output of the linear system defined in (4.109)-(4.110), and its discrete noisy observation corrupted by a zero-mean white Gaussian noise with SNR= 20 dB.	88
4.2	Noise error and noise error bound for the estimation of $D_t^{\frac{1}{2}}y$	89

4.3	Estimation of $D_t^{\frac{1}{2}} y$ obtained by the proposed method (resp. the Grünwald-Letnikov scheme) in the discrete noisy case (resp. noise-free case), and estimations of $\left[D_t^{-\frac{1}{2}} \left\{ \mathcal{D}_t^{\frac{k}{2}} y(t) \right\} \right]_{t=0}$, for $k = 0, 1, 2$	90
4.4	Estimations of x_1 obtained by the proposed estimator and the fractional order Luenberger-like observer and \mathcal{H}_∞ -like observer in the discrete noisy case, and the ones obtained by the Grünwald-Letnikov scheme in the discrete noise-free case.	91
5.1	Repartition of the orders: ν_0, \dots, ν_d	103
5.2	Example 5.2 The output and its discrete noisy observation.	108
5.3	Example 5.2 The variation of the noise error bound given in (5.43) with $m = 2, \dots, 10$	108
5.4	Example 5.2 Estimations and estimation errors obtained by the proposed method and the fractional order Legendre differentiator	109
5.5	Example 5.3 The output and its discrete noisy observation of a fractional electrical circuit model.	111
5.6	Example 5.3 The variation of the noise error bound given in (5.43) with $m = 2, \dots, 10$	111
5.7	Example 5.3 The numerical calculations obtained by the Grünwald-Letnikov scheme in discrete noise-free case and the estimations obtained by the proposed method in the discrete noisy case.	112
5.8	Example 5.3 Estimations and estimation errors obtained by the proposed method and the modulating functions method [1].	113

List of Symbols

\mathbb{N}	the set of natural numbers
\mathbb{Z}	the set of integers
\mathbb{R}	the set of real numbers
\mathbb{C}	the set of complex numbers
$(\cdot)^*$	the set of non-zero numbers
$(\cdot)_+$	the set of positive numbers
$(\cdot)_-$	the set of negative numbers
$\Re(\cdot)$	the real part of a complex number
$\Im(\cdot)$	the imaginary part of a complex number
$\lfloor \cdot \rfloor$	the floor function
$\lceil \cdot \rceil$	the ceiling function
$\Gamma(\cdot)$	the Gamma function
$B(\cdot, \cdot)$	the Beta function
$E_\alpha(\cdot)$	one parameter Mittag-Leffler function
$E_{\alpha, \alpha}(\cdot)$	two-parameter Mittag-Leffler function
$E_{\alpha, \beta}^Y(\cdot)$	three-parameter Mittag-Leffler function
$\delta_{in}(\cdot)$	the Kronecker delta function
$D_{a,t}^{-\alpha}\{\cdot\}$	the Riemann-Liouville fractional integral operator
$D_{a,t}^\alpha\{\cdot\}$	the Riemann-Liouville fractional derivative operator
$D_t^\alpha\{\cdot\}$	the Riemann-Liouville fractional derivative operator start from 0
$\mathcal{D}_{a,t}^{k\alpha}\{\cdot\}$	the Riemann-Liouville fractional sequential derivative operator
${}^C D_{a,t}^\alpha\{\cdot\}$	the Caputo fractional derivative operator

${}^C D_{t,b}^\alpha \{ \cdot \}$ the right-sided Caputo fractional derivative operator

${}^{GL} D_{a,t}^\alpha \{ \cdot \}$ the Grünwald-Letnikov fractional derivative operator

$D^\alpha \{ \cdot \}$ the Riemann-Liouville or the Caputo fractional derivative operator start from 0

Chapter 1

General Introduction

1.1 Getting started

Before starting this thesis, let us briefly answer the following three basic questions.

1.1.1 What is fractional calculus?

Fractional calculus is a branch of mathematical analysis, where the integer orders in the integral and differentiation operators are extended to real numbers or complex numbers, and which develops the properties of the classical calculus.

1.1.2 Why do we use fractional calculus?

When we try to describe the real world, the fractional characteristic is more conventional and rational than the integer one. The fractional calculus is an extension of the classical one. Due to the existence of massive non-integer properties in nature, fractional order systems are more suitable to describe them [8, 9, 10, 11].

1.1.3 How can we use fractional calculus?

Thanks to the development of computer science, more and more applications of fractional calculus appear in many science and engineering fields such as economics[12], physics [9], biology[13, 14, 15], chemistry[16], automatic control [8, 10, 17], etc. Among these applications, the classical integral and differentiation operators are usually replaced by the fractional order ones, such that the non-standard dynamical behaviors can be characterized with long memory or with hereditary effects.

1.2 Introduction

1.2.1 History and applications of fractional calculus

Fractional calculus is an old mathematical subject flowing with young blood. It was born in 1695 during the communications between L'Hôpital and Leibniz. Some interesting questions and answers can be found in their letters:

- Leibniz: *"Can the meaning of derivatives with integer order be generalized to derivatives with non-integer orders?"*
- L'Hôpital: *"What if the order will be 1/2?"*
- Leibniz: *"It will lead to a paradox, from which one day useful consequences will be drawn."*

Since then, fractional calculus was studied and developed by many famous mathematicians during more than 300 years. Readers can refer to [18, 19, 20] for more details on the history of fractional calculus. Now, fractional calculus has been becoming very useful in many scientific and engineering fields, such as:

- automatic control [10, 21, 22],
- robotics [23],
- electrical engineering [24, 25, 26],
- signal and image processing [27],
- physics [9],
- chemistry [28],
- mechanic [29, 30],
- biology [13, 14, 15, 31],
- economics [32],
- rheology [33, 34, 35, 36],
- earthquakes [37],
- etc.

Among all these domains, an important research topic is on fractional order systems and controllers in automatic control. In the following section, let us recall some famous groups and their outstanding works in the world. As the list is long, there are risks to forget some works to cite.

1.2.2 Some research groups

There are many well-known researchers and research groups in the world, who work on fraction order systems and controllers, such as Machado [38, 39], Ortigueira [40], Trigeassou [41, 42] etc. However, we can not enumerate all of them. Here, we introduce some stars in this domain.

One of the most celebrated group in France is the CRONE team [43, 44]. CRONE is the French abbreviation for *Commande robuste d'ordre non entier* with the meaning of non-integer order robust control. "*We live in a 2.3-dimensional world, which is larger than the surface but smaller than the volume*" -Alain Oustaloup. This brilliant sentence opened my door to fractional palace when I was a Master student at University Bordeaux 1. This team is formed by Oustaloup, Sabatier, Melchior, Lanusse, Malti et al. The CRONE Toolbox is one of the earliest Matlab Toolbox for fractional order control [17]. The book [11] summarizes the work of the CRONE team such as the stability of fractional order systems, different generations of CRONE control and the \mathcal{H}_∞ control. Further more, some fractional order applications have been implemented like suspension CRONE [29, 30].

The contribution of Igor Podlubny's group has been widely recognized. The book of Podlubny [21] is one of the most cited publication in fractional calculus domain. The proposed fractional order $PI^\lambda D^\mu$ controllers are used to improve the performance of systems [8]. He demonstrated the better response of this type of controllers comparing to the classical PID controllers. A frequency domain approach using the fractional order $PI^\lambda D^\mu$ controllers was also studied [45]. The implementation of these controllers is presented by an approach to the design of analogue circuits [46].

Yangquan Chen's group is one of the leading contributors to the research field of fractional order systems and controllers. Their research interests include both theoretical and practical issues, such as the Impulse Response Invariant Discretization (IRID) method for approximating the fractional differential operators [47, 48], the flat-phase tuning rule based on the iso-damping property [49, 50], the control of hard-disc drive servos [51], and the flight control of unmanned arial vehicles [52]. These monographs [10, 53] are good tools to be familiar with fractional order systems and controllers.

1.3 Motivations and objectives of the thesis

During the past decades, fractional order systems and controllers have been applied to improve performance and robustness properties in control design, for example, to increase of the stability margin [8, 54, 55, 56].

On the one hand, there exist two linear models for fractional order systems: the fractional order differential equation model and the one with the pseudo-state space representation. For the systems which can be transformed into the Brunovsky's observable canonical form, these two models are equivalent in the case with zero initial conditions [1]. Due to the non-locality of the fractional derivative operator, the real-state of a fractional order system can be divided into two parts: the pseudo-state and an initialization function. However, for some applications, the knowledge of pseudo-state is enough to understand the behavior of a studied fractional order system [55, 57]. As for integer order linear systems, the design of pseudo-state estimators for fractional order linear systems is also important in automatic control. Indeed, for cost and technological reasons, the pseudo-state can not always be measured. Moreover, the estimation normally requires the measurements which are usually noisy. Existing pseudo-state observers for fractional order systems are often extensions of the ones for integer order systems, which usually converge asymptotically. However, estimations with fast convergence in finite-time are required to achieve the control objective in numerous applications [58]. Consequently, non-asymptotic and robust pseudo-state estimators are useful for fractional order systems.

On the other hand, for a studied system whatever integer order or fractional order, when dealing with the problem of output regulation such as the stabilization of the output, a fractional order controller can be designed using the fractional derivatives of the output [59]. For example, when designing a fractional order $PI^\lambda D^\mu$ controller, the fractional derivative of the output needs to be estimated using its discrete noisy observation, whose order can be arbitrary [21]. Consequently, non-asymptotic and robust fractional order differentiators are useful for fractional order systems and controllers.

When designing a fractional order differentiator, the accuracy and the robustness to noise effect need be considered. Based on these criteria, various robust fractional order differentiators have been proposed in the frequency domain [60, 61, 62, 63] and in the time domain [62, 64, 65, 66, 67]. They can be divided into two classes: fractional order model-free differentiators [60, 61, 64, 66] and fractional order model-based differentiators [62, 63, 67]. The first class of fractional order differentiators are obtained by truncating the analytical expression. Hence, they contain truncated errors even in noise free case, which reduce the accuracy of the differentiators. It was shown in [66] that the truncated term error can be significantly reduced by admitting a time-delay. The second class of fractional order differentiators are obtained from the differential equa-

tions of considered signals. They do not introduce any truncated errors [62, 63, 67]. Recall that the latter model-based differentiators were obtained by applying two recent non-asymptotic methods: the algebraic parametric estimation method working in the frequency domain [68] and the modulating functions method working in the time domain [64, 69, 70], which exhibit good robustness properties with respect to corrupting noises, even if the statistical properties of the noises are unknown [71, 72]. These differentiators were exactly given by algebraic integral formulae which can be considered as a low-pass filter. Hence, they are non-asymptotic and robust. However, they are not applicable for the systems modeled by the pseudo-state space representation.

Bearing the previous ideas in mind, the objectives of this thesis are to design non-asymptotic and robust pseudo-state estimators and fractional order differentiators for a class of fractional order linear systems modeled by the pseudo-state space representation with unknown initial conditions.

Finally, remark that most of the modeling and analysis on fractional order systems and controllers were done in the frequency domain. However, the works in this thesis will be directly carried out in the time domain.

1.4 Outline

This thesis summarizes my PhD work from 2014-2017, which is organized as follows.

Chapter 2 presents some useful definitions and properties on fractional calculus, and some fundamental results on fractional order systems.

Chapter 3 recalls the ideas of the modulating functions method on parameter identification and derivative estimation for integer order linear systems via simple examples. Then, it is explained how to apply the modulating functions method to design fractional order differentiators for integer order linear systems in several cases by constructing different types of modulating functions.

The main contributions of this thesis are given in Chapter 4 and Chapter 5, where a class of commensurate fractional order linear systems modeled by the pseudo-state space representation with unknown initial conditions are considered. It is assumed that these systems can be transformed into the Brunovsky's observable canonical form.

Chapter 4 is devoted to estimating the pseudo-state of the considered systems. By applying the modulating functions method, both the initial values of sequential fractional derivatives and the commensurate fractional order derivatives of the output are exactly given by algebraic integral formulae using a recursive way, which are used to calculate the pseudo-state in continuous noise-free case. Moreover, it is shown how to construct the required modulating functions.

Chapter 5 is inspired by the modulating functions method developed in Chapter 4, where an operator-based algebraic method is introduced to estimate the fractional derivative with an arbitrary order of the output for the considered systems. The designed operator is applied to eliminate the undesired initial values and to calculate the desired fractional derivative by a new algebraic formula using a recursive way.

Both the estimators obtained in Chapter 4 and Chapter 5 are studied in discrete noisy case. In particular, the noise error contribution is analyzed, where an error bound useful for the selection of design parameter is provided. Then, numerical examples are given to illustrate the accuracy, the robustness and the non-asymptotic property of the proposed estimators, where some comparisons to other methods are shown.

Finally, conclusions are outlined in Chapter 6 with some perspectives.

Chapter 2

Fractional calculus and fractional order systems

Résumé en français

Dans ce chapitre, on rappelle quelques éléments importants du calcul fractionnaire : les différentes définitions de la dérivation fractionnaire dans l'espace-temps ainsi qu'à l'aide de la transformée de Laplace. Puis, nous introduisons quelques propriétés fondamentales des systèmes d'ordre fractionnaire telles que la stabilité, la propriété de la dimension infinie, l'observabilité et la contrôlabilité. Enfin, certains contrôleurs de commande d'ordre fractionnaire sont présentés.

2.1 Some useful functions and Laplace transform

In this section, we will introduce some fundamental functions which play an important role in fractional calculus.

2.1.1 Gamma Function

Like the factorial operator which plays an indispensable role in the classical calculus, the Gamma function is one of the most fundamental tools in fractional calculus. It was first introduced by the famous mathematician Leonhard Euler as a natural extension of the factorial operator from positive integers to real numbers [73].

Definition 2.1 [74] *The Gamma function is defined by: $\forall x \in \mathbb{C}^* \setminus \mathbb{Z}_-$,*

$$\Gamma(x) = \int_0^{\infty} t^{x-1} e^{-t} dt. \quad (2.1)$$

The variation of the Gamma function is illustrated in Fig. 2.1, where the non-positive integers represent its poles.

Some useful properties of the Gamma function can be given as follows [74]:

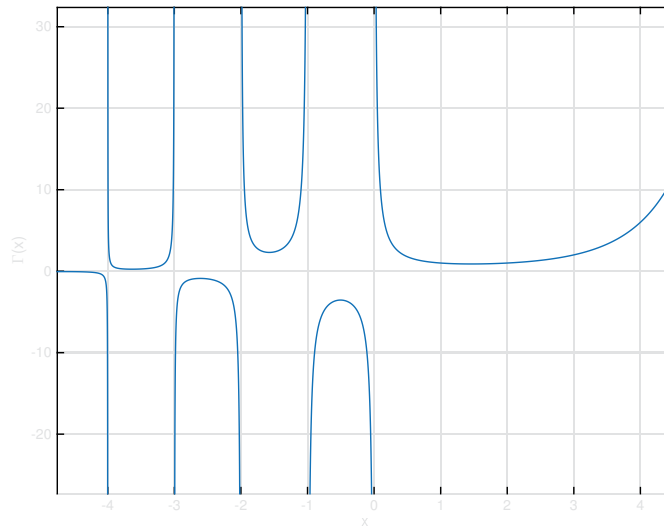

Figure 2.1: The variation of the Gamma function.

- $\Gamma(1) = 1$,
- $\forall x \in \mathbb{R}_+^*$, $\Gamma(x+1) = x\Gamma(x)$,
- $\forall z \in \mathbb{R} \setminus \mathbb{Z}$, $\Gamma(1-z)\Gamma(z) = \frac{\pi}{\sin(\pi z)}$.

Hence, it yields:

- $\forall n \in \mathbb{N}$, $\Gamma(n+1) = n!$,
- $\Gamma(0.5) = \sqrt{\pi}$.

2.1.2 Beta function

The Beta function is another important function which occurs in fractional calculus. This function is related to the Gamma function and defined as follows.

Definition 2.2 [75] *The Beta function is defined by: $\forall x, y \in \mathbb{C}$ with $\Re(x) > 0$ and $\Re(y) > 0$,*

$$B(x, y) = \int_0^1 t^{x-1} (1-t)^{y-1} dt. \quad (2.2)$$

This functions have the following properties:

- $B(x, y) = B(y, x)$,
- $B(x, y) = \frac{\Gamma(x)\Gamma(y)}{\Gamma(x+y)}$.

2.1.3 Mittag-Leffler functions

The exponential function is an important function in the classical calculus. There exist several types of Mittag-Leffler functions in the fractional case [76]. The one-parameter Mittag-Leffler function is the generalization of the exponential function, which is defined as follows.

Definition 2.3 [21] Let $\alpha \in \mathbb{C}$ with $\Re(\alpha) > 0$, then the one-parameter Mittag-Leffler function defined by: $\forall z \in \mathbb{C}$,

$$E_{\alpha}(z) = \sum_{k=0}^{\infty} \frac{z^k}{\Gamma(\alpha k + 1)}. \quad (2.3)$$

The two-parameter Mittag-Leffler function introduced by Agarwal [77] is the most popular and widely applicable in fractional calculus.

Definition 2.4 [77] Let $\alpha, \beta \in \mathbb{C}$ with $\Re(\alpha) > 0$ and $\Re(\beta) > 0$, then the two-parameter Mittag-Leffler function defined by: $\forall z \in \mathbb{C}$,

$$E_{\alpha, \beta}(z) = \sum_{k=0}^{\infty} \frac{z^k}{\Gamma(\alpha k + \beta)}. \quad (2.4)$$

Some times, a more generalized Mittag-Leffler function with three parameters is needed.

Definition 2.5 [78] Let $\alpha, \beta, \gamma \in \mathbb{C}$ with $\Re(\alpha) > 0$, $\Re(\beta) > 0$ and $\Re(\gamma) > 0$, then the three-parameter Mittag-Leffler function defined by: $\forall z \in \mathbb{C}$,

$$E_{\alpha, \beta}^{\gamma}(z) = \sum_{k=0}^{\infty} \frac{\Gamma(k + \gamma)}{\Gamma(\gamma) k!} \frac{z^k}{\Gamma(\alpha k + \beta)}. \quad (2.5)$$

These types Mittag-Leffler functions are sufficient in this thesis. Hence, we do not need more general functions. In particular, by taking $z = 0$, we get:

$$E_{\alpha, \beta}(0) = E_{\alpha, \beta}^{\gamma}(0) = \frac{1}{\Gamma(\beta)}. \quad (2.6)$$

Moreover, by taking some special values to the parameters α and β , we obtain the following well-known classical functions [21]:

- $E_{1,1}(z) = e^z$,
- $E_{2,1}(z) = \frac{e^z - 1}{z}$,
- $E_{2,1}(z^2) = \cosh(z) = \frac{e^z + e^{-z}}{2}$,
- $E_{2,2}(z^2) = \frac{\sinh(z)}{z} = \frac{e^z - e^{-z}}{2z}$,
- $E_{\alpha,1}(z) = E_{\alpha}(z)$.

2.1.4 Laplace transform

Finally, let us introduce the well-known Laplace transform which can be used to analyze the stability of systems in the frequency domain.

Definition 2.6 [21] *The Laplace transform of a function f denoted by F is defined as follows: $\forall s \in \mathbb{C}$,*

$$F(s) := \mathcal{L}\{f(t)\}(s) = \int_0^{\infty} e^{-st} f(t) dt, \quad (2.7)$$

where s is the variable in the frequency domain, and f is a causal function, i.e. $\forall t < 0$, $f(t) = 0$.

Then, we give the Laplace transform of some useful functions in the following table.

Frequency domain	Time domain
$\frac{1}{s^\alpha}$	$\frac{t^{\alpha-1}}{\Gamma(\alpha)}$
$\frac{1}{s+a}$	e^{-at}
$s^{\alpha-\beta}(s^\alpha \pm A)^{-1}$	$\frac{1}{t^{1-\beta}} E_{\alpha,\beta}(\mp t^\alpha A)$
$\sum_{k=0}^{\infty} \frac{\Gamma(m+1)}{\Gamma(k\alpha + \beta) s^{m+1}}$	$E_{\alpha,\beta}(t) = \sum_{k=0}^{\infty} \frac{t^k}{\Gamma(k\alpha + \beta)}$
$\frac{s^\alpha}{s(s^\alpha - a)}$	$E_\alpha(at^\alpha) = \sum_{k=0}^{\infty} \frac{a^k t^{k\alpha}}{\Gamma(k\alpha + 1)}$
$\frac{s^{\alpha-1}}{s^\alpha \mp \lambda}, \Re(s) > \lambda ^{\frac{1}{\alpha}}$	$E_{\alpha,1}(\pm \lambda t^\alpha)$
$\frac{s^{\alpha\gamma-\beta}}{(s^\alpha + a)^\gamma}$	$t^{\beta-1} E_{\alpha,\beta}^\gamma(-at^\alpha)$

Table 2.1: Laplace transform of some useful functions.

2.2 Definitions and properties of fractional calculus

There exist several definitions for fractional derivatives, among which the Riemann-Liouville one [58, 79, 80, 81] and the Caputo one [82, 83] are usually considered in control field. There also exists the Grünwald-Letnikov one [84] which coincides with the Riemann-Liouville one in many cases[21]. All these fractional derivatives will be introduced in this section.

Physical and geometric interpretations of fractional derivatives can be found in [85] and the references cited therein. Moreover, the physical meaning to initial conditions with the Riemann-Liouville fractional derivative was explained in [86].

Through this section, let $I = [a, b] \subset \mathbb{R}$, $\alpha \in \mathbb{R}_+$, and $l = [\alpha]$, where $[\alpha]$ (resp. $\lceil \alpha \rceil$) denotes the smallest (resp. largest) integer greater than or equal to α . Then, all the definitions given in this section can be found in [21, 87].

2.2.1 Riemann-Liouville fractional integrals and derivatives

Let us begin this subsection by the following definition.

Definition 2.7 *The Riemann-Liouville fractional integral of a function f is defined as follows: $\forall t > a$,*

$$\begin{cases} D_{a,t}^0 f(t) & := f(t), \\ D_{a,t}^{-\alpha} f(t) & := \frac{1}{\Gamma(\alpha)} \int_a^t (t-\tau)^{\alpha-1} f(\tau) d\tau. \end{cases} \quad (2.8)$$

Remark that if f is continuous for $t \geq 0$, we have $\lim_{\alpha \rightarrow 0} D_{a,t}^{-\alpha} f(t) = D_{a,t}^0 f(t) = f(t)$ [21].

By taking integer numbers in (2.8), we can obtain the following Cauchy formula: $\forall n \in \mathbb{N}^*$,

$$D_{a,t}^{-n} f(t) = \frac{1}{(n-1)!} \int_a^t (t-\tau)^{n-1} f(\tau) d\tau, \quad (2.9)$$

which refers to the n^{th} order integral from a to t .

The Riemann-Liouville fractional integral of f can also be interpreted as the convolution product of $\frac{t^{\alpha-1}}{\Gamma(\alpha)}$ and $f: \forall t > a$,

$$D_{a,t}^{-\alpha} f(t) = x_{[a,+\infty[} \frac{t^{\alpha-1}}{\Gamma(\alpha)} * f(t), \quad (2.10)$$

where $*$ stands for the convolution product, $\frac{t^{\alpha-1}}{\Gamma(\alpha)}$ is usually called the kernel of fractional integral operator, where $x_{[a,+\infty[}$ is indicator function of the interval $[a, +\infty[$. Thus, the function is assumed to be 0 for $t < a$ (causality). Thus, the Laplace transform of the Riemann-Liouville fractional integral can be obtained as follows:

$$\mathcal{L} \{D_{a,t}^{-\alpha} f(t)\}(s) = \mathcal{L} \left\{ \frac{t^{\alpha-1}}{\Gamma(\alpha)} * f(t) \right\}(s) = \frac{1}{s^\alpha} F(s). \quad (2.11)$$

2.2. Definitions and properties of fractional calculus

Based on the Riemann-Liouville fractional integrals, the fractional derivatives can be defined by applying the integer order derivative operator.

Definition 2.8 *The Riemann-Liouville fractional derivative of a function f is defined as follows: $\forall t > a$,*

$$D_{a,t}^{\alpha} f(t) := \frac{d^l}{dt^l} \left\{ D_{a,t}^{\alpha-l} f(t) \right\}. \quad (2.12)$$

Remark 2.1 *According to (2.11), if $0 < \alpha < 1$, the Riemann-Liouville fractional integrals are defined by improper integrals. Thus, if $l \neq \alpha$, the Riemann-Liouville fractional derivatives are also defined by improper integrals.*

Then, some useful properties on Riemann-Liouville fractional integrals and derivatives are recalled in the following lemmas.

Lemma 2.1 [21] *The Laplace transform of the Riemann-Liouville fractional derivative of f is given by:*

$$\mathcal{L} \{ D_{a,t}^{\alpha} f(t) \} (s) = s^{\alpha} F(s) - \sum_{k=0}^{l-1} \left[D_{a,t}^{\alpha-k-1} f(t) \right]_{t=a} s^k. \quad (2.13)$$

Lemma 2.2 [74] **Fractional Leibniz formulae:** *Let $\alpha \in \mathbb{R}_+$ and $m \in \mathbb{N}$. Then, the following formulas hold:*

$$D_{a,t}^{-\alpha} \{ t^m f(t) \} = \sum_{k=0}^m (-1)^k \binom{m}{k} \frac{\Gamma(\alpha+k)}{\Gamma(\alpha)} t^{m-k} D_{a,t}^{-\alpha-k} f(t), \quad (2.14)$$

$$D_{a,t}^{\alpha} \{ t^m f(t) \} = \sum_{k=0}^{\alpha_m} \binom{\alpha}{k} \frac{m!}{(m-k)!} t^{m-k} D_{a,t}^{\alpha-k} f(t), \quad (2.15)$$

where $\alpha_m \leq m$ is defined as follows:

$$\alpha_m = \begin{cases} \alpha, & \text{if } \alpha \in \mathbb{N}^*, \text{ and } \alpha \leq m, \\ m, & \text{else.} \end{cases} \quad (2.16)$$

Lemma 2.3 [21] **Additive index laws:** *Let $\alpha \in \mathbb{R}_+$, and $\beta \in \mathbb{R}$. Then, the following formulae hold:*

$$D_{a,t}^{\beta} \{ D_{a,t}^{-\alpha} f(t) \} = D_{a,t}^{\beta-\alpha} f(t), \quad (2.17)$$

$$D_{a,t}^{\beta} \{ D_{a,t}^{\alpha} f(t) \} = D_{a,t}^{\beta+\alpha} f(t) - \Psi_{\beta,\alpha} \{ f(t) \}, \quad (2.18)$$

where $\Psi_{\beta,\alpha} \{ f(t) \}$ is a decreasing function of t and defined as follows:

$$\Psi_{\beta,\alpha} \{ f(t) \} := \sum_{i=1}^{[\alpha]} c_{\beta,i} (t-a)^{-\beta-i} \left[D_{a,t}^{\alpha-i} f(t) \right]_{t=a} \quad (2.19)$$

with

$$c_{\beta,i} = \begin{cases} 0, & \text{if } \beta \in \mathbb{Z}, \\ \frac{1}{\Gamma(1-\beta-i)}, & \text{else.} \end{cases} \quad (2.20)$$

Remark 2.2 According to the behavior of f at $t = a$, the initial values of the Riemann-Liouville fractional derivatives of f can be equal to zero, infinity, or a fixed value. (see [21] for more details).

Now, let us consider the case with zero initial conditions.

Lemma 2.4 [21] Assume that f satisfies the flowing condition:

- (\hat{C}_1) : f is $(l-1)$ -times continuously differentiable on I and $f^{(l)}$ is integrable on I .

Then, the following two conditions are equivalent:

- (\hat{C}_2) : $f^{(i)}(a) = 0$, for $i = 0, \dots, l-1$,
- (\hat{C}_3) : $[D_{a,t}^\alpha f(t)]_{t=a} = 0$ with $l-1 < \alpha < l$.

Moreover, if (\hat{C}_2) or (\hat{C}_3) holds, we have: $\forall \gamma \in \mathbb{R}$ with $\gamma \leq \alpha$,

$$[D_{a,t}^\gamma f(t)]_{t=a} = 0. \quad (2.21)$$

Based on the Riemann-Liouville fractional derivative, we define a new kind of fractional derivatives.

Definition 2.9 Let $k \in \mathbb{N}$, the Riemann-Liouville fractional sequential derivative of a function f is defined as follows: $\forall t > a$,

$$\mathcal{D}_{a,t}^{k\alpha} f(t) := \begin{cases} f(t), & \text{for } k = 0, \\ D_{a,t}^\alpha \left\{ \mathcal{D}_{a,t}^{(k-1)\alpha} f(t) \right\}, & \text{for } k \geq 1. \end{cases} \quad (2.22)$$

Remark that $\mathcal{D}_{a,t}^{k\alpha} f$ and $D_{a,t}^{k\alpha} f$ are two different kinds of derivatives, the relation between them is given in the following lemma which is the first important result obtained in this thesis.

Lemma 2.5 The Riemann-Liouville fractional integral and derivative of a fractional sequential derivative can be given as follows: $\forall \beta \in \mathbb{R}, \forall k \in \mathbb{N}^*$,

$$D_{a,t}^\beta \left\{ \mathcal{D}_{a,t}^{k\alpha} f(t) \right\} = D_{a,t}^{\beta+k\alpha} f(t) - \Phi_{\beta,k,\alpha} \{f(t)\}, \quad (2.23)$$

where

$$\Phi_{\beta,k,\alpha}\{f(t)\} := \sum_{j=1}^k \Psi_{\beta+(j-1)\alpha,\alpha}\left\{\mathcal{D}_{a,t}^{(k-j)\alpha}f(t)\right\}, \quad (2.24)$$

where $\Psi_{\beta+(j-1)\alpha,\alpha}\left\{\mathcal{D}_{a,t}^{(k-j)\alpha}f(t)\right\}$ can be given by (2.19).

Moreover, we have: $\forall k \geq 2$,

$$\mathcal{D}_{a,t}^{k\alpha}f(t) = D_{a,t}^{k\alpha}f(t) - \Phi_{\alpha,(k-1),\alpha}\{f(t)\}. \quad (2.25)$$

Proof. This lemma is proven by induction.

Step 1. Initial step: According to (2.16), (2.23) holds for $k = 1$.

Step 2. Inductive step: Assume (2.23) holds for $k \geq 1$. Then, we have:

$$\begin{aligned} D_{a,t}^{\beta}\left\{\mathcal{D}_{a,t}^{(k+1)\alpha}f(t)\right\} &= D_{a,t}^{\beta}\left\{\mathcal{D}_{a,t}^{k\alpha}\{D_{a,t}^{\alpha}f(t)\}\right\} \\ &= D_{a,t}^{\beta+k\alpha}\{D_{a,t}^{\alpha}f(t)\} - \Phi_{\beta,k,\alpha}\{D_{a,t}^{\alpha}f(t)\}, \end{aligned} \quad (2.26)$$

where

$$\Phi_{\beta,k,\alpha}\{D_{a,t}^{\alpha}f(t)\} = \sum_{j=1}^k \Psi_{\beta+(j-1)\alpha,\alpha}\left\{\mathcal{D}_{a,t}^{(k+1-j)\alpha}f(t)\right\}. \quad (2.27)$$

By applying (2.18), we get:

$$D_{a,t}^{\beta+k\alpha}\{D_{a,t}^{\alpha}f(t)\} = D_{a,t}^{\beta+(k+1)\alpha}f(t) - \Psi_{\beta+k\alpha,\alpha}\{f(t)\}. \quad (2.28)$$

From (2.26)-(2.28), we get:

$$D_{a,t}^{\beta}\left\{\mathcal{D}_{a,t}^{(k+1)\alpha}f(t)\right\} = D_{a,t}^{\beta+(k+1)\alpha}f(t) - \Phi_{\beta,k+1,\alpha}\{f(t)\}. \quad (2.29)$$

Thus, (2.23) also holds for $k + 1$. Consequently, (2.23) holds for any integer larger than 1. Finally, (2.25) can be obtained by substituting β and k by α and $k - 1$ in (2.23), respectively. \blacksquare

In order to simplify the presentation of this thesis, $D_t^{\alpha}f$ (resp. $\mathcal{D}_t^{k\alpha}f$) will be referred to $D_{a,t}^{\alpha}f$ (resp. $\mathcal{D}_{a,t}^{k\alpha}f$) with $a = 0$ in the sequel.

2.2.2 Caputo fractional derivatives

Different from the Riemann-Liouville fractional derivative, the Caputo fractional derivative is defined by taking the the Riemann-Liouville fractional integral of an integer order derivative.

Definition 2.10 *The Caputo fractional derivative of f is defined as follows:*

$\forall t \in]a, +\infty[$,

$${}^C D_{a,t}^{\alpha}f(t) := \frac{1}{\Gamma(l-\alpha)} \int_a^t (t-\tau)^{l-\alpha-1} f^{(l)}(\tau) d\tau. \quad (2.30)$$

The upper-left index C in ${}^C D_{a,t}^\alpha f$ is used to distinguish from the Riemann-Liouville fractional derivative. The relationship between these two fractional derivatives are established in the following formulae.

- If $-1 < \alpha < 0$, then $l = 0$. We have:

$$D_{a,t}^\alpha f(t) = {}^C D_{a,t}^\alpha f(t). \quad (2.31)$$

- If $\alpha \in \mathbb{R}_+ \setminus \mathbb{N}$, then $l \in \mathbb{N}^*$. We have [21]:

$${}^C D_{a,t}^\alpha f(t) = D_{a,t}^\alpha f(t) - \sum_{i=0}^{l-1} \frac{(t-a)^{i-\alpha}}{\Gamma(i+1-\alpha)} f^{(i)}(a). \quad (2.32)$$

Remark that (2.32) can also be obtained by applying the additive index law given in (2.16).

Then, we have the following property.

Lemma 2.6 [21] *The Laplace transform of the Caputo fractional derivative of f is given by:*

$$\mathcal{L}\{{}^C D_{a,t}^\alpha f(t)\}(s) = s^\alpha F(s) - \sum_{k=0}^{l-1} f^{(k)}(a) s^{\alpha-k-1}. \quad (2.33)$$

Consequently, different from the Laplace transform of the Riemann-Liouville fractional derivative, the one of the Caputo fractional derivative contains the integer order derivatives initial values.

In this thesis, the following right-sided Caputo fractional derivative is widely used, which is different from the Caputo fractional derivative defined in (2.30) by distinguishing the lower and upper limits of the integration.

Definition 2.11 *The right-sided Caputo fractional derivative of f is defined as follows:*
 $\forall t \in]-\infty, b[$,

$${}^C D_{t,b}^\alpha f(t) := \frac{(-1)^l}{\Gamma(l-\alpha)} \int_t^b (\tau-t)^{l-\alpha-1} f^{(l)}(\tau) d\tau. \quad (2.34)$$

Remark that if $\alpha \in \mathbb{N}^*$, then we have: ${}^C D_{t,b}^\alpha f(t) = (-1)^\alpha f^{(\alpha)}(t)$ [87].

Using the right-sided Caputo fractional derivative, the following fractional order integration by parts formulae are given, which are indispensable tools in this thesis.

Lemma 2.7 [88] *For any interval $[a, t] \subset I$, the following formulae hold:*

$$\int_a^t g(\tau) D_{a,\tau}^{-\alpha} f(\tau) d\tau = \int_a^t {}^C D_{\tau,t}^{-\alpha} g(\tau) f(\tau) d\tau, \quad (2.35)$$

$$\int_a^t g(\tau) D_{a,\tau}^\alpha f(\tau) d\tau = \int_a^t {}^C D_{\tau,t}^\alpha g(\tau) f(\tau) d\tau + \sum_{k=0}^{l-1} (-1)^k \left[g^{(k)}(\tau) D_{a,\tau}^{\alpha-1-k} f(\tau) \right]_{\tau=a}^{\tau=t}. \quad (2.36)$$

2.2.3 Grünwald-Letnikov fractional derivative

Let us introduce the last fractional derivative which is useful in this thesis.

Definition 2.12 *The Grünwald-Letnikov fractional derivative of a function f is given by: $\forall t > a$,*

$${}^{\text{GL}}D_{a,t}^{\alpha} f(t) := \lim_{h \rightarrow 0} h^{-\alpha} \sum_{j=0}^{\lceil \frac{t-a}{h} \rceil} (-1)^j \binom{\alpha}{j} f(t - jh), \quad (2.37)$$

where $\binom{\alpha}{j} = \frac{\Gamma(\alpha + 1)}{\Gamma(\alpha + 1 - j) j!}$ is the generalized binomial coefficient.

Then, the relation between the Riemann-Liouville and Grünwald-Letnikov fractional derivatives is given in the following lemma.

Lemma 2.8 [21] *If f satisfies the condition (\hat{C}_1) given in Lemma 2.3. Then, for every $0 < \gamma < l$ the Riemann-Liouville fractional derivative $D_{a,t}^{\gamma} f$ exists and coincides with the Grünwald-Letnikov fractional derivative ${}^{\text{GL}}D_{a,t}^{\gamma} f$.*

Thanks to the previous lemma, the Grünwald-Letnikov scheme is usually used to approximate the Riemann-Liouville fractional integrals and derivatives in discrete case [10, 21], which is given by $\forall \alpha \in \mathbb{R}$,

$$D_{a,t}^{\alpha} y(t) \approx \frac{1}{T_s^{\alpha}} \sum_{j=0}^{\lceil \frac{t-a}{T_s} \rceil} w_j^{(\alpha)} y(t - jT_s), \quad (2.38)$$

where T_s is the sampling period of the discrete data, and the binomial coefficients can be recursively calculated as follows:

$$\begin{cases} w_0^{(\alpha)} = 1, & \text{if } j = 0, \\ w_j^{(\alpha)} = \left(1 - \frac{\alpha+1}{j}\right) w_{j-1}^{(\alpha)}, & \text{else.} \end{cases} \quad (2.39)$$

The Grünwald-Letnikov scheme is the extension of the finite difference scheme is efficient in noisy free case [10]. However, it is highly sensible to noises.

2.2.4 Fractional derivatives of some usual functions

Different from the integer order derivatives, the fractional derivative of a function usually can not be analytically calculated. In this subsection, the fractional derivatives of some usual functions are given.

Fractional derivatives of a constant

According to Definition 2.9, the Caputo fractional derivative of a constant is equal to 0. However, using (2.10) the Riemann-Liouville fractional derivative of a constant C is given by:

$$D_{a,t}^{\alpha} C = C \frac{(t-a)^{-\alpha}}{\Gamma(1-\alpha)}. \quad (2.40)$$

Power functions

The Riemann-Liouville fractional derivative of the power function $(t-a)^{\nu}$ with $\nu > -1$ is given by [21]:

$$D_{a,t}^{\alpha} (t-a)^{\nu} = \frac{\Gamma(\nu+1)}{\Gamma(\nu-\alpha+1)} (t-a)^{\nu-\alpha}. \quad (2.41)$$

Trigonometric functions

The Riemann-Liouville fractional derivatives of the sine and cosine functions are given by [74]:

$$D_t^{\alpha} \sin(\omega t) = \frac{\omega t^{1-\alpha}}{\Gamma(2-\alpha)} {}_1F_2 \left(1; \frac{1}{2}(2-\alpha), \frac{1}{2}(3-\alpha); -\frac{1}{4}\omega^2 t^2 \right), \quad (2.42)$$

$$D_t^{\alpha} \cos(\omega t) = \frac{t^{-\alpha}}{\Gamma(1-\alpha)} {}_1F_2 \left(1; \frac{1}{2}(1-\alpha), \frac{1}{2}(2-\alpha); -\frac{1}{4}\omega^2 t^2 \right), \quad (2.43)$$

where ${}_1F_2$ is the generalized hypergeometric function.

There exists a second way to calculate the Riemann-Liouville fractional derivatives of the ordinary trigonometric functions, which is given in the following form with the aide of rotation matrix [89]:

$$\begin{pmatrix} D_t^{\alpha} \sin(t) \\ D_t^{\alpha} \cos(t) \end{pmatrix} = \begin{pmatrix} \cos(\alpha \frac{\pi}{2}) & \sin(\alpha \frac{\pi}{2}) \\ -\sin(\alpha \frac{\pi}{2}) & \cos(\alpha \frac{\pi}{2}) \end{pmatrix} \begin{pmatrix} \sin_{\alpha}(t) \\ \cos_{\alpha}(t) \end{pmatrix}, \quad (2.44)$$

where $\sin_{\alpha}(t)$ and $\cos_{\alpha}(t)$ are the generalized trigonometric functions which are given by [89]:

$$\sin_{\alpha}(t) = \sum_{k=0}^{\infty} \frac{t^{k-\alpha}}{\Gamma(k+1-\alpha)} \sin \left[(k-\alpha) \frac{\pi}{2} \right], \quad (2.45)$$

$$\cos_{\alpha}(t) = \sum_{k=0}^{\infty} \frac{t^{k-\alpha}}{\Gamma(k+1-\alpha)} \cos \left[(k-\alpha) \frac{\pi}{2} \right]. \quad (2.46)$$

It is simple to verify that if $\alpha = 1$, then they become the sine and cosine functions.

Remark that the characteristics of these generalized trigonometric functions are different from the traditional ones, since their integer order derivatives are aperiodic functions:

$$D_t^1 \sin_\alpha t = \cos_\alpha t - \frac{\sin\left(\alpha \frac{\pi}{2}\right)}{\Gamma(-\alpha) t^{\alpha+1}}, \quad (2.47)$$

$$D_t^1 \cos_\alpha t = -\sin_\alpha t + \frac{\cos\left(\alpha \frac{\pi}{2}\right)}{\Gamma(-\alpha) t^{\alpha+1}}. \quad (2.48)$$

Right-sided Caputo fractional derivatives of a polynomial

Finally, let us give the right-sided Caputo fractional derivatives of a polynomial as well as its integral in the following lemma. These results will be very useful in thesis.

Lemma 2.9 [6] *For $-1 < \alpha \in \mathbb{R} \setminus \mathbb{N}$ with $l-1 < \alpha < l \in \mathbb{N}$, the right-sided Caputo fractional derivative of a polynomial t^n with $n \in \mathbb{N}$ is given on $] -\infty, b]$ by:*

$${}^C D_{t,b}^\alpha \{t^n\} = \begin{cases} 0, & \text{if } \alpha > n, \\ \frac{(-1)^l}{\Gamma(l-\alpha)} \frac{n!}{(n-l)!} \sum_{i=0}^{n-l} \binom{n-l}{i} \frac{t^{n-l-i} (b-t)^{i+l-\alpha}}{i+l-\alpha}, & \text{else,} \end{cases} \quad (2.49)$$

Moreover, if $\alpha < n$, the following formula holds:

$$\int_a^b {}^C D_{t,b}^\alpha \{t^n\} dt = \frac{(-1)^l}{\Gamma(l-\alpha)} \frac{n!}{(n-l)!} \sum_{i=0}^{n-l} \binom{n-l}{i} \sum_{k=0}^{n-l-i} \binom{n-l-i}{k} \times \frac{a^{n-l-i-k} (b-a)^{k+i+l-\alpha+1} B(k+1, i+l-\alpha+1)}{i+l-\alpha}. \quad (2.50)$$

2.3 Commensurate fractional order linear systems

There is an increasing interest in fractional order systems due to not only their novelty but also their practical applications [90, 91, 92]. This work only invests in the commensurate fractional order linear systems which are modeled by a fractional order linear differential equation and the pseudo-state space presentation, respectively. In this section, some important properties are recalled.

In order to simplify the presentation, the notation D^α is used in this section to refer both the Riemann-Liouville fractional derivative $D_{a,t}^\alpha$ and the Caputo fractional derivative ${}^C D_{a,t}^\alpha$ with $a = 0$.

2.3.1 Fractional order linear differential equation model

A general fractional order linear differential equation has the following form [21]: $\forall t \geq 0$,

$$\begin{aligned} a_N D^{\alpha_N} y(t) + a_{N-1} D^{\alpha_{N-1}} y(t) + \dots + a_0 D^{\alpha_0} y(t) = \\ b_M D^{\beta_M} u(t) + b_{M-1} D^{\beta_{M-1}} u(t) + \dots + b_0 D^{\beta_0} u(t). \end{aligned} \quad (2.51)$$

where $a_i \in \mathbb{R}$, $\alpha_i \in \mathbb{R}_+$, for $i = 0, \dots, N$, $b_j \in \mathbb{R}$, $\beta_j \in \mathbb{R}_+$, for $j = 0, \dots, M$, u and y are the input and output, respectively.

If all the orders of the fractional order derivation are integer multiples of a base order $\alpha \in \mathbb{R}_+$ in (2.51), then the differential equation is called commensurate order, and defined by: $\forall t \geq 0$,

$$\sum_{i=0}^N a_i D^{i\alpha} y(t) = \sum_{j=0}^M b_j D^{j\alpha} u(t), \quad (2.52)$$

where $\alpha_i = i\alpha$ for $i = 0, \dots, N$, and $\beta_j = j\alpha$ for $j = 0, \dots, M$.

If there is no special statement in this section, the fractional order system means commensurate fractional order linear systems in the sequel.

2.3.2 Pseudo-state space presentation model

Within this framework, the following fractional order linear system is also considered:

$$D^\alpha x = Ax + Bu, \quad (2.53)$$

$$y = Cx, \quad (2.54)$$

on $I \subset \mathbb{R}_+ \cup \{0\}$, where $\alpha \in \mathbb{R}$, $A \in \mathbb{R}^{N \times N}$, $B \in \mathbb{R}^{N \times 1}$, $C \in \mathbb{R}^{1 \times N}$, $D^\alpha x = (D^\alpha x_1, \dots, D^\alpha x_N)^T$, $x \in \mathbb{R}^N$ is the pseudo-state column vector with unknown initial values, $y \in \mathbb{R}$ and $u \in \mathbb{R}$ are the output and the input, respectively. In order to guarantee the stability of the considered fractional order system, it is assumed that $0 < \alpha < 2$ [93]. For discrete fractional order state-space systems, some analysis can be found in [94, 95].

Remark 2.3 *Since the fractional derivative is an hereditary operator, i.e. a nonlocal operator, both the knowledge of the vector x at a moment and its past are required to predict the behavior of a fractional order system. In fact, the real-state of a fractional order system can be divided into two parts: the pseudo-state and an initialization function [57, 96, 97, 98]. That is why x is referred to the pseudo-state in the literature.*

It will be shown in Chapter 4 that the pseudo-state space presentation model and the fractional order linear differential equation model are equivalent for a class of fractional order linear systems with zero initial conditions.

2.3.3 Solutions using Laplace transform

In this subsection, we calculate the solution of (2.53) in the case of $B = 0$ using the Laplace transform method.

By applying the Laplace transform to (2.53), we get:

$$\mathcal{L}\{D^\alpha x(t)\}(s) = AX(s), \quad (2.55)$$

where X is the Laplace transform of x . Then, by applying Lemma 2.1 and Lemma 2.5, the following cases need to be distinguished:

- if $0 < \alpha \leq 1$, then
 - in the case with the Riemann-Liouville fractional derivative, we get:

$$X(s) = (s^\alpha I - A)^{-1} D_t^{\alpha-1} [x(t)]_{t=0}, \quad (2.56)$$

- in the case with the Caputo fractional derivative, we obtain:

$$X(s) = s^{\alpha-1} (s^\alpha I - A)^{-1} x(0); \quad (2.57)$$

- if $1 < \alpha < 2$, then
 - in the case with the Riemann-Liouville fractional derivative, we get:

$$X(s) = (s^\alpha I - A)^{-1} (D_t^{\alpha-1} [x(t)]_{t=0} + sD^{\alpha-2} [x(t)]_{t=0}), \quad (2.58)$$

- in the case with the Caputo fractional derivative, we obtain:

$$X(s) = s^{\alpha-1} (s^\alpha I - A)^{-1} (s^{\alpha-1} x(0) + s^{\alpha-2} D^1 x(0)). \quad (2.59)$$

Then, the solutions in each can be computed by using the inverse Laplace transform given in Tab. 2.1:

- in the case with the Riemann-Liouville fractional derivative, we get:

- if $0 < \alpha \leq 1$, then

$$x(t) = \frac{1}{t^{1-\alpha}} E_{\alpha,\alpha}(t^\alpha A) D_t^{\alpha-1} [x(t)]_{t=0}, \quad (2.60)$$

- if $1 < \alpha < 2$, then

$$x(t) = \frac{1}{t^{1-\alpha}} E_{\alpha,\alpha}(t^\alpha A) D_t^{\alpha-1} [x(t)]_{t=0} + \frac{1}{t^{2-\alpha}} E_{\alpha,\alpha-1}(t^\alpha A) D^{\alpha-2} [x(t)]_{t=0}. \quad (2.61)$$

- in the case with the Caputo fractional derivative, we get:

- if $0 < \alpha \leq 1$, then

$$x(t) = E_\alpha(t^\alpha A)x(0), \quad (2.62)$$

where $E_{\alpha,1} = E_\alpha$,

- if $1 < \alpha < 2$, then

$$x(t) = E_\alpha(t^\alpha A)x(0) + tE_{\alpha,2}(t^\alpha A)\dot{x}(0). \quad (2.63)$$

Remark 2.4 According to Remark 2.2, the value of $D_t^{\alpha-1} [x(t)]_{t=0}$ in (2.60) can be be equal to zero, infinity, or a fixed value.

- If $D_t^{\alpha-1} [x(t)]_{t=0}$ is infinity, then x is also infinity in (2.60).
- If $D_t^{\alpha-1} [x(t)]_{t=0} = 0$, then $x(t) = 0$ everywhere in (2.60).
- If $D_t^{\alpha-1} [x(t)]_{t=0} = C$ with $C \in \mathbb{R}^*$, then using (2.60) and (2.6), we get:

$$\Gamma(\alpha) \lim_{t \rightarrow 0} (t^{1-\alpha} x(t)) = D_t^{\alpha-1} [x(t)]_{t=0} = C. \quad (2.64)$$

Therefore, then behavior of x in the neighbourhood of 0 must be of the form $\frac{C}{\Gamma(\alpha)} t^{\alpha-1}$.

2.3.4 Stability of commensurate fractional order linear systems

This subsection deals with stability conditions of fractional order linear dynamical systems. Moreover, it provides examples that show the damping behaviors of such systems. In order to determine the stability conditions of the system defined in (2.53)-(2.54), the following definitions and theorems are needed.

Definition 2.13 [99] *The zero solution of a fractional order system $D^\alpha x(t) = f(t, x)$ is said to be stable, if for any initial conditions $x(0) \in \mathbb{R}^n$, there exists $\delta \in \mathbb{R}_+$ such that any solution $x(t)$ of the system satisfies $\|x(t)\| < \delta$ for all $t > 0$. Further, the zero solution of the system is said to be asymptotically stable, if in addition to being stable, $\|x(t)\| \rightarrow 0$ as $t \rightarrow \infty$.*

Consider the following integer order linear system:

$$\dot{x}(t) = Ax(t), \quad (2.65)$$

whose solution is $x(t) = e^{tA}x(0)$. It is well-known that this system is stable if $|\arg(\text{eig}(A))| \geq \frac{\pi}{2}$. Further, if $|\arg(\text{eig}(A))| > \frac{\pi}{2}$, the system is said to be asymptotically stable.

Before stating the characterization of the fractional order stability, let us show the behavior of a fractional order system. Let us consider the following fractional order system:

$$D^\alpha x(t) = Ax(t), \quad (2.66)$$

where $0 < \alpha < 1$. According to (2.60) and (2.62), we have:

- for Caputo fractional derivative: $x(t) = E_\alpha(t^\alpha A)x(0)$,
- for Riemann-Liouville fractional derivative: $x(t) = \frac{1}{t^{1-\alpha}} E_{\alpha,\alpha}(t^\alpha A) D_t^{\alpha-1} [x(t)]_{t=0}$.

By taking different values of α , the variations of x are shown in Figure 2.2 and Figure 2.3, where $A = -1$.

It is important to note that for small α , we have a sort of damping. We can choose a matrix A with $A < 0$ and $\|A\|$ big enough to overcome this phenomena which is shown in Figure 2.4.

Now, let us introduce the fractional version of the asymptotic stability.

Theorem 2.1 [100] *The commensurate fractional order linear system defined in (2.66) is asymptotic stable if the following condition fulfils:*

$$|\arg(\text{eig}(A))| > \alpha \frac{\pi}{2}, \quad (2.67)$$

where $\text{eig}(A)$ represents the eigenvalues of the matrix A .

For the integer order linear system defined in (2.65), the condition (2.67) means that the real parts of all the eigenvalues of A are negative. Hence, as $x(t) = e^{tA}x(0)$, we have $\|x(t)\| \leq Me^{-\lambda_{\min}t}$, which goes to 0 as $t \rightarrow \infty$. In this case, the asymptotic stability is exponential. This kind of exponential stability cannot be used to characterize the asymptotic stability of fractional systems. Some new definitions should be introduced.

$t^{-\alpha}$ stability

The $t^{-\alpha}$ stability can be used to refer to the asymptotic stability of fractional order systems.

Definition 2.14 [101] *The trajectory $x(t) = 0$ of the system defined in (2.66) is $t^{-\alpha}$ asymptotically stable if the system is uniformly asymptotically stable and if there exist $N \in \mathbb{R}_+$ and $b \in \mathbb{R}$ such that: $\forall t > t_0$,*

$$\|x(t)\| \leq N(t - b)^{-\alpha}, \quad (2.68)$$

where $t_0 = 0$ is the initial time.

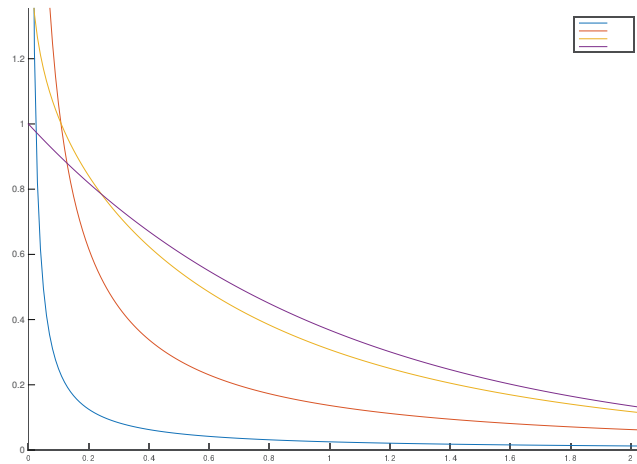

Figure 2.2: Riemann-Liouville definition case $x(t) = \frac{1}{t^{1-\alpha}} E_{\alpha,\alpha}(t^\alpha A)$ with $\alpha = 0.1, 0.5, 0.9, 1$.

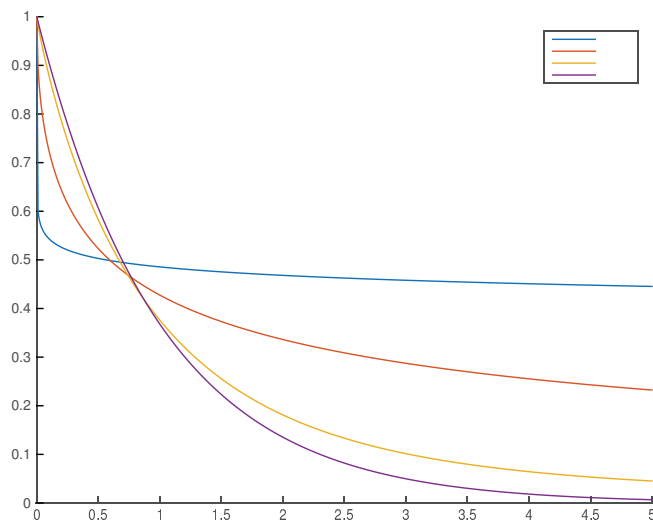

Figure 2.3: Caputo definition case $x(t) = E_\alpha(t^\alpha A)x(0)$ with $\alpha = 0.1, 0.5, 0.9, 1$.

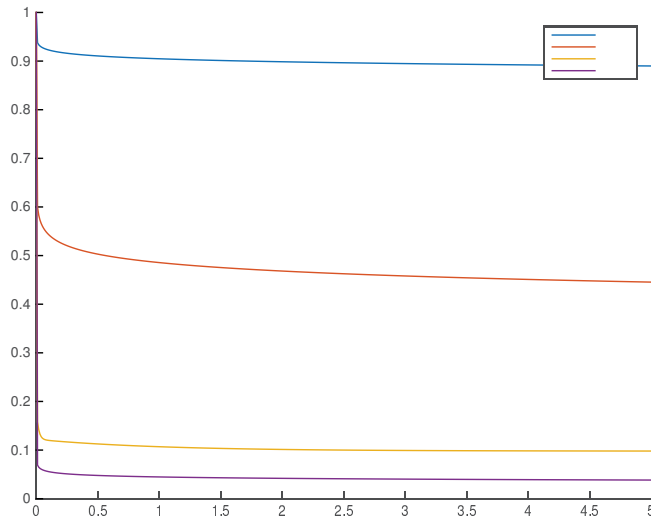

Figure 2.4: Caputo definition case: $x(t) = E_{\alpha}(t^{\alpha}A)x(0)$ with $\alpha = 0.1$ and $A = -0.1, -1, -8, -20$.

Mittag-Leffler stability

By using the Lyapunov direct method, the stability of the fractional order system defined in (2.66) can be determined, which is associated with the Mittag-Leffler stability.

Definition 2.15 [102] *The solution of the system defined in (2.66) is said to be Mittag-Leffler stable if there exist $\lambda, b \in \mathbb{R}_+$ and a locally Lipschitz function m such that*

$$\|x(t)\| \leq (m(x_0)E_{\alpha}(-\lambda(t-t_0)^{\alpha}))^b, \quad (2.69)$$

where $x_0 = x(t_0)$ with $t_0 = 0$ being the initial time, $m(0) = 0$ and $m(x) \geq 0$.

Examples: some behaviors of fractional order systems

Consider a fractional order system with the following transfer function:

$$G(s) = \frac{1}{s^{2\alpha} + \mu s^{\alpha} + \nu}, \quad (2.70)$$

where $\alpha = \frac{1}{q}$, $q \in \mathbb{N}^*$, $\mu, \nu \in \mathbb{R}$. s^{α} is a multi-valued function which admits q sheets of the Riemann surface given by [103]:

$$s = |s|e^{j\phi}, \quad -\pi + 2k\pi < \phi < \pi + 2k\pi, \quad k = 0, 1, 2, \dots, q-1. \quad (2.71)$$

The case with $k = 0$ is called the principal sheet that $-\pi < \theta < \pi$. The regions of the plane $w = s^{\alpha}$ can be defined by:

$$w = |w|e^{j\theta}, \quad -\alpha\pi + 2k\alpha\pi < \theta < \alpha\pi + 2k\alpha\pi. \quad (2.72)$$

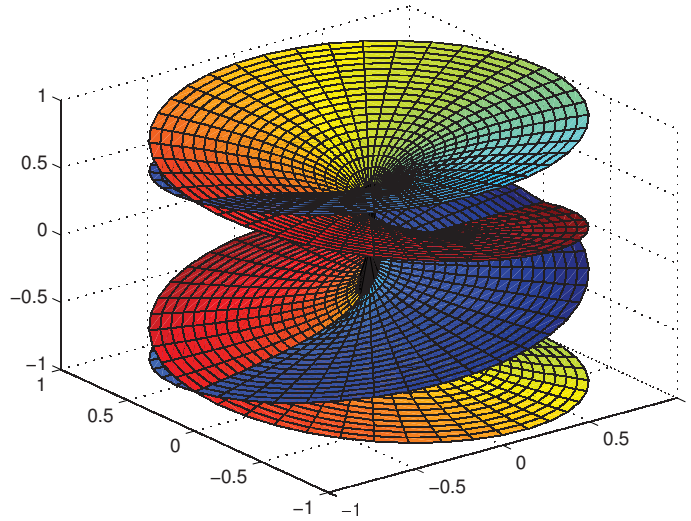
 Figure 2.5: Riemann surface for $w = s^{1/4}$.

In practice, we only work on the principal sheet [10]. Therefore, we only consider the poles of the equation given in (2.70) (roots of the denominator) that lie with the principal sheet. Only the roots that are in the principal sheet of the Riemann surface have influence on the different dynamics: damped oscillation, oscillation of constant amplitude, oscillation of increasing amplitude with monotonic growth.

For example, consider the following equation:

$$s^{2\alpha} + \mu s^\alpha + \nu = 0, \quad (2.73)$$

the solutions are given by

$$w = s^\alpha = \frac{-\mu \pm \sqrt{\mu^2 - 4\nu}}{2}. \quad (2.74)$$

If we suppose $\lambda = \frac{-\mu \pm \sqrt{\mu^2 - 4\nu}}{2}$, then we have:

$$s = b^{\frac{1}{\alpha}} = |b|^{\frac{1}{\alpha}} \angle \frac{\arg(b) + 2k\pi}{\alpha}, \quad (2.75)$$

where $k \in \mathbb{N}$, and only the roots satisfying the condition:

$$\left| \frac{\arg(b) + 2k\pi}{\alpha} \right| < \pi \quad (2.76)$$

are on the principal sheet.

2.3. Commensurate fractional order linear systems

Example: (2.70) with $\alpha = \frac{1}{2}$

By taking $\alpha = \frac{1}{2}$ in (2.70), we get:

$$G(s) = \frac{1}{s^{2(\frac{1}{2})} + \mu s^{\frac{1}{2}} + \nu}. \quad (2.77)$$

If we evaluate the function with $\lambda = s^{\frac{1}{2}}$, then we have:

$$G(\lambda) = \frac{1}{\lambda^2 + \mu\lambda + \nu} \quad (2.78)$$

along the curve Γ_0 which is a simple closed contour oriented in counter clockwise direction in defined by

$$\Gamma_0 = \Gamma_1 \cup \Gamma_2 \cup \Gamma_3, \quad (2.79)$$

where

$$\begin{aligned} \Gamma_1 : \arg(\lambda) &= -\frac{\pi}{4}, \\ \Gamma_2 : \lambda &= |\lambda|e^{j\phi}, -\frac{\pi}{4} < \phi < \frac{\pi}{4}, \\ \Gamma_3 : \arg(\lambda) &= \frac{\pi}{4}, \end{aligned} \quad (2.80)$$

with $\lambda \in \mathbb{R}^*$ (see Figure 2.6).

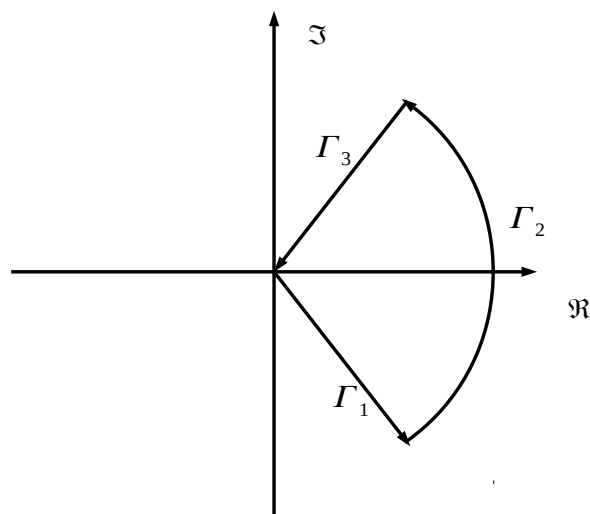

Figure 2.6: The evaluation contour Γ_0 .

The roots of the characteristic equation can be obtained from the following polynomial:

$$P(\lambda) = \lambda^2 + \mu\lambda + \nu, \quad (2.81)$$

whose roots are $\lambda_{1,2} = \frac{-\mu \pm \sqrt{\mu^2 - 4\nu}}{2}$. Thus, $s_{1,2}$ are the roots of the denominator of $G(s)$:

$$s_{1,2} = (\lambda_{1,2})^\alpha. \quad (2.82)$$

The transient response depends on the roots of the characteristic equation, which has several different cases [10].

- There are roots in the Riemann principal sheet, located in $\Re(s) > 0$ and $\Im(s) \neq 0$. In this case, the response is a oscillatory function with a constant amplitude when $t \rightarrow \infty$. For example, as shown in Figure 2.7 with $\mu = -1$ and $\nu = 0.5$.

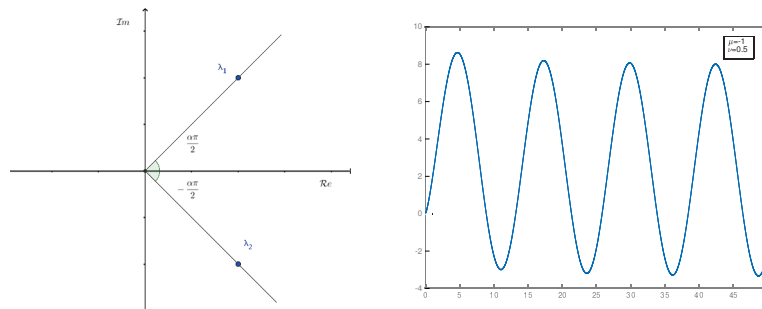

Figure 2.7: $|\arg(\lambda)| = \frac{\pi}{4}$.

- There are roots in the Riemann principal sheet, located in $\Re(s) < 0$ and $\Im(s) \neq 0$. The response is a monotonically increasing function. For example, as showed in Figure 2.8 with $\mu = 1$ and $\nu = 1$.

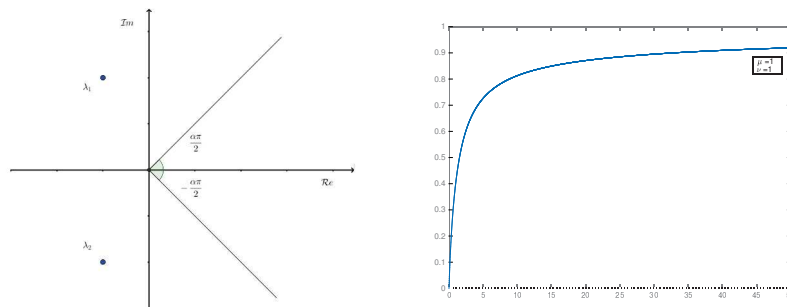

Figure 2.8: $|\arg(\lambda)| > \alpha\pi$.

2.3. Commensurate fractional order linear systems

- There are no roots in the Riemann principal sheet which located in the negative real axe. In this case, the response is a oscillatory function with a constant amplitude when $t \rightarrow \infty$. For example, as shown in Figure 2.9 with $\mu = 2$ and $\nu = 1$.

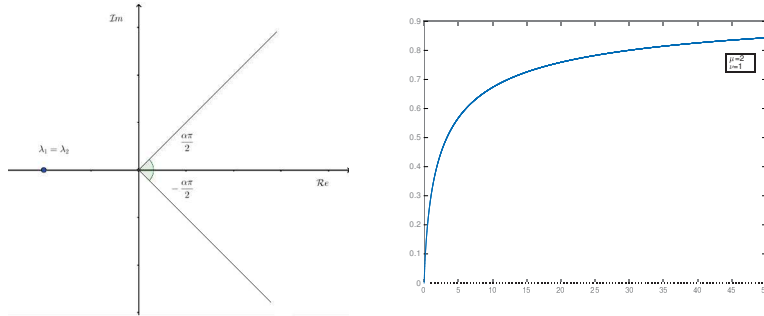

Figure 2.9: $\arg(\lambda) = \pi$.

- There are roots in the Riemann principal sheet, located in $\Re(s) > 0$ and $\Im(s) \neq 0$. In this case, the response is a oscillatory function with a increasing amplitude. For example, as shown in Figure 2.10 with $\mu = -\sqrt{3}$ and $\nu = 1$.

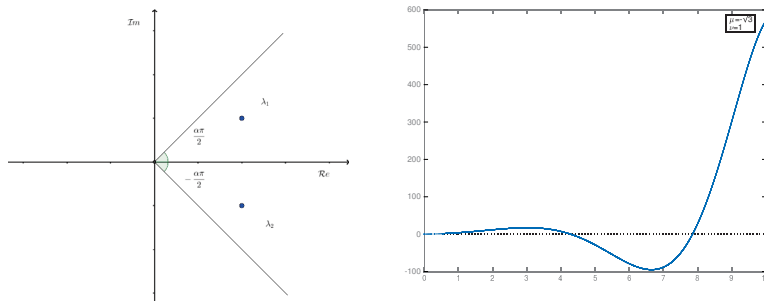
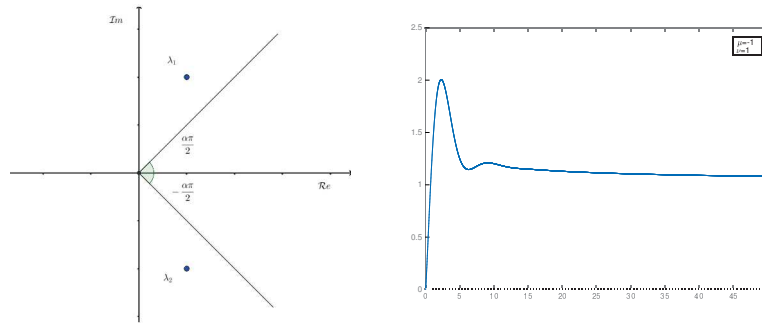

Figure 2.10: $|\arg(\lambda)| < \frac{\alpha\pi}{2}$.

- There are roots in the Riemann principal sheet. In this case, the response is a oscillatory function with a decreasing amplitude. For example, as shown in Figure 2.11 with $\mu = -1$ and $\nu = 1$.

 Figure 2.11: $\frac{\alpha\pi}{2} < |\arg(\lambda)| < \alpha\pi$.

2.3.5 Infinite dimension property of fractional order systems

This subsection presents a state space presentation for fractional order systems, which involves a classical integer order linear model and a model described by a parabolic equation. This representation is based on the decomposition of the impulse response of a fractional order system into an exponential part and an aperiodic part. The decomposition of the impulse response appears in the literature since the in [104]. Such representation makes it possible to show the real state of a fractional order system, which is of infinite dimension (see [55, 105] for more detail).

The impulse response of a fractional order system with the following transfer function:

$$G(s) = \frac{1}{s^\gamma - a}, \quad (2.83)$$

where $\gamma, a \in \mathbb{R}_+$ with $0 < \gamma < 2$, can be written by [106]:

$$y(t) = \int_0^t \frac{1}{a^\gamma} \sum_{i=1}^k p_i e^{(t-\tau)p_i} u(\tau) d\tau + \int_0^t \frac{\sin(\gamma\pi)}{\pi} \left(\int_0^\infty \frac{x^\gamma e^{-(t-\tau)x}}{a^2 - 2ax^\gamma \cos(\gamma x) + x^{2\gamma}} dx \right) u(\tau) d\tau, \quad (2.84)$$

where u is the input, y is the output, and p_i for $i = 1, \dots, k$ are the poles defined by $p_i = |p_i| e^{j\theta_i}$ with

$$\begin{cases} |p_i| = (|\lambda_i|)^{\frac{1}{n}}, \\ \theta_i = \frac{\arg(\lambda_i)}{n} + \frac{2i\pi}{n}, \\ -\frac{n}{2} - \frac{\arg(\lambda_i)}{2\pi} < k < \frac{n}{2} - \frac{\arg(\lambda_i)}{2\pi}, \end{cases} \quad (2.85)$$

λ_i represents the s^n poles of $G(s)$.

The difference between a fractional order system and an integer order system is the second part in (2.84), which is caused by the Branch point. Therefore, the equation in (2.85) provides conditions on the poles to lie with the principal sheet of Riemann

surface. These poles enable to write the first part of (2.84) as in the integer order case where sine, cosine and exponential functions are mixed.

If we interchange the integral in the second part of (2.85), then it becomes:

$$\int_0^\infty \frac{x^\gamma w(t, x)}{a^2 - 2ax^\gamma \cos(\gamma x) + x^{2\gamma}} dx, \quad (2.86)$$

where,

$$w(t, x) = \int_0^t e^{-(t-\tau)x} u(\tau) d\tau. \quad (2.87)$$

Then, by taking the time derivative of the w , we obtain:

$$\dot{w}(t, x) = -xw(t, x) + u(t). \quad (2.88)$$

Consequently, the state space representation of system $G(s) = \frac{1}{s^\gamma - a}$ can be written as a diffusive representation [105, 107, 108]:

$$\begin{pmatrix} \dot{w}_1(t) \\ \vdots \\ \dot{w}_k(t) \\ \dot{w}(t, x) \end{pmatrix} = \begin{pmatrix} p_1 & & (0) \\ & \ddots & \\ & & p_k \\ (0) & & -x \end{pmatrix} \begin{pmatrix} w_1(t) \\ \vdots \\ w_k(t) \\ w(t, x) \end{pmatrix} + \begin{pmatrix} 1 \\ \vdots \\ 1 \\ 1 \end{pmatrix} u(t), \quad (2.89)$$

$$y(t) = y_1(t) + y_2(t)$$

$$= \begin{pmatrix} \frac{p_1}{a^\gamma} & \dots & \frac{p_k}{a^\gamma} \end{pmatrix} \begin{pmatrix} w_1(t) \\ \vdots \\ w_k(t) \end{pmatrix} + \frac{\sin(\gamma\pi)}{\pi} \int_0^\infty \frac{x^\gamma w(t, x)}{a^2 - 2ax^\gamma \cos(\gamma x) + x^{2\gamma}} dx. \quad (2.90)$$

2.3.6 Another explication of infinity dimension property

In this subsection, some demonstration is provided to describe the infinite dimension property of the fractional order derivative operator in the case of $0 < \alpha < 1$ [109].

Let us start with Definition 2.1 of the Gamma function:

$$\Gamma(\alpha) = \int_0^\infty x^{\alpha-1} e^{-x} dx. \quad (2.91)$$

By taking the following change of variables $x \rightarrow zt$ with $t \in \mathbb{R}_+$ in (2.91), we get:

$$t^{-\alpha} = \frac{1}{\Gamma(\alpha)} \int_0^\infty z^{\alpha-1} e^{-zt} dz. \quad (2.92)$$

Then, by taking the Laplace transform to the two sides of (2.91) and by interchanging the order of the integrations with respect to z and t , we get:

$$\frac{\Gamma(1-\alpha)}{s^{1-\alpha}} = \frac{1}{\Gamma(\alpha)} \int_0^\infty \frac{z^{\alpha-1}}{s+z} dz. \quad (2.93)$$

Hence, we get:

$$s^{\alpha-1} = \frac{1}{\Gamma(\alpha)\Gamma(1-\alpha)} \int_0^{\infty} \frac{z^{\alpha-1}}{s+z} dz. \quad (2.94)$$

Finally, by taking the following change of variables $z \rightarrow \frac{1}{\tau}$ with $\tau \in \mathbb{R}_+$, we obtain:

$$s^{\alpha} = \frac{1}{\Gamma(\alpha)\Gamma(1-\alpha)} \int_0^{\infty} -\tau^{-\alpha} \left(\frac{\tau s}{\tau s + 1} \right) \frac{d\tau}{\tau}. \quad (2.95)$$

Consequently, it can be seen that the fractional integrator $s^{\alpha-1}$ and the fractional operator s^{α} are expressed in terms of an integral of low-pass filters and high-pass filters, respectively [15]. Thus, the fractional order operator can be regarded as infinite dimension.

2.3.7 Observability and controllability of commensurate fractional order linear systems

This subsection reviews two results on the controllability and observability of fractional order systems.

Theorem 2.2 [110] *The system defined by (2.53)-(2.54) is observable if the observability matrix is of full rank:*

$$\text{rank} \begin{pmatrix} C \\ CA \\ \vdots \\ CA^{N-1} \end{pmatrix} = N. \quad (2.96)$$

Theorem 2.3 [110] *The system defined by (2.53)-(2.54) is controllable if the controllability matrix is of full rank:*

$$\text{rank} \begin{pmatrix} A & AB & A^2B & \dots & A^{N-1}B \end{pmatrix} = N. \quad (2.97)$$

2.4 Fractional order controllers

This section introduces different types of controllers, where fractional integrals and derivatives are applied in control design.

2.4.1 Fractional order $PI^\lambda D^\mu$ controllers

PID (Proportional-Integral-Derivative) controllers are the most famous and widely applied controller in industrial production. As the extension of classical PID controllers, fractional order PID controllers, denoted by $PI^\lambda D^\mu$, are widely used both for integer order and fractional order systems [21, 111], which are with the following form:

$$u(t) = K_p e(t) + K_i D^{-\lambda} e(t) + K_d D^\mu e(t), \quad (\lambda, \mu > 0), \quad (2.98)$$

where K_p , K_i and K_d are proportional, integral and derivative gains, respectively, e is the regulation error, $D^{-\lambda} e$ and $D^\mu e$ are the fractional integral and derivative of e , respectively.

The transfer function of such controllers is with the following form:

$$G_c(s) = \frac{U(s)}{E(s)} = K_p + K_i s^{-\lambda} + K_d s^\mu, \quad (2.99)$$

which can be realized in Fig. 2.12.

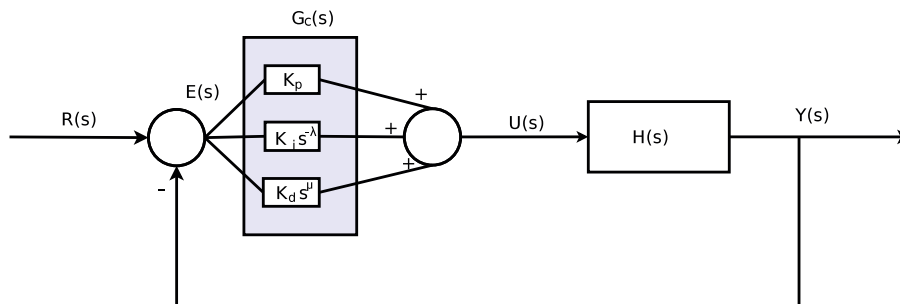

Figure 2.12: Block diagram of a closed-loop system with a fractional order $PI^\lambda D^\mu$ controller.

Since the fractional order $PI^\lambda D^\mu$ controllers have two more parameters λ and μ than the classical PID controllers, the use of such controllers can enhance the performance and the robustness of the controlled system. In particular, by taking $\lambda = \mu = 1$, we obtain the classical PID controllers. The relation between them is shown in Fig. 2.13[10].

The parameter tuning of these controllers has been well discussed in the literature [112, 113, 114], for example, the Ziegler-Nichols method [115, 116].

2.4.2 Other typical fractional order controllers

There also exist other types of fractional order controllers in the literature, such as (see [10, 11, 117] for detailed introduction):

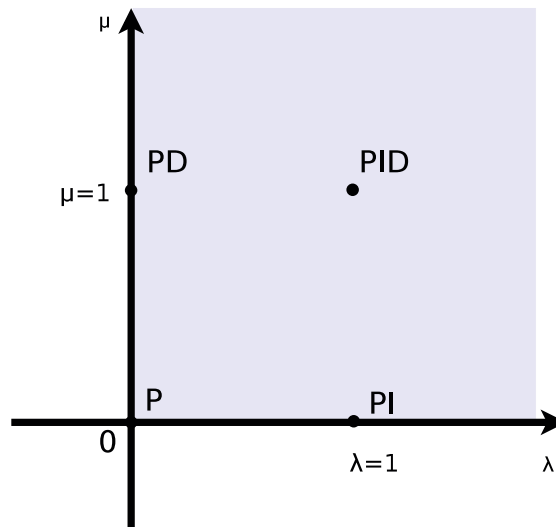

Figure 2.13: Classical PID controllers and fractional order $PI^\lambda D^\mu$ controllers.

- **CRONE controllers** [104]: this kind of controllers are developed by the CRONE group, an exhaustive overview of these controllers can be found in [11] with examples that can be reworked using the CRONE toolbox.
- **TID (Tilt-Integral-Derivative) controllers** [117, 118, 119]: compared to conventional fractional order $PI^\lambda D^\mu$ controllers, the kind of controllers have the following advantages: simpler tuning, better disturbance rejection ratio, and smaller effects of plant parameter variations on closed loop response.
- **Lead-lag compensators** [120, 121]: the objective of this kind of controllers is to develop a auto-tune method for fractional order $PI^\lambda D^\mu$ controllers.
- **Observer based fractional order controllers** [122, 123, 124]: the pseudo-state estimated by a fractional order observer is used to design such kind of controllers.

2.5 Conclusions

In this chapter, some important functions on fractional calculus were firstly recalled, as well as the Laplace transform. Then, different kinds of fractional derivatives were introduced with useful properties. Some fundamental properties on fractional order systems were reviewed, such the stability, the infinity dimension property, observability and controllability. Finally, some fractional order controllers were presented.

Chapter 3

Modulating functions method

Résumé en français

Dans ce chapitre, nous introduisons tout d'abord l'idée d'estimation des paramètres d'une équation différentielle ainsi que des différentes dérivées entières de sa sortie à l'aide des dites fonctions modulatrices. Dans ce travail, nous adaptons cette technique pour estimer les dérivées fractionnaires de la sortie (la mesure) avec ou sans bruit. Pour ce faire, nous multiplions l'équation différentielle par des fonctions modulatrices que nous construisons, puis nous utilisons une intégration par parties d'ordre fractionnaire pour aboutir au résultat désiré. Enfin, un différentiateur est proposé et appliqué pour concevoir un PID d'ordre fractionnaire pour un système linéaire d'ordre entier dans des exemples numériques.

3.1 Introduction

In many practical engineering situations, on the one hand, there always exist some non-measurable variables and parameters for cost and technological reasons, on the other hand, the measured variables and parameters usually contain noises. In order to overcome these problems, different kinds of robust estimation methods have been developed [125, 126, 127, 128, 129, 130]. Moreover, sometimes non-asymptotic estimation with fast convergence in finite-time is required in online applications [58, 59, 131, 132, 133]. Among existing non-asymptotic methods, the modulating functions method originally introduced by Shinbrot [134] has been widely used to estimate unknown parameters for linear and non-linear continuous time systems [135, 136, 137], systems modeled by partial differential equations [138], and noisy sinusoidal signals [139, 140, 141]. The application on parameter estimation of this method is based on the linear differential equation of a measurable signal. The idea is to transform the linear differential equation into a set of algebraic integral equations by applying the following basic steps:

- choose a set of modulating functions,
- multiply each modulating function to the linear differential equation,
- integrate the obtained equation over an interval with a finite length,
- apply the integration by parts formula to shift the derivative operations from the measurable signal to the multiplied modulating functions, where the undesired boundary values are eliminated by the properties of modulating functions,
- replace the measurable signal by its measured observation in the obtained algebraic integral equations,
- solve the linear system of the algebraic integral equations which are linear with respect to the unknown parameters.

Thus, parameter estimators are exactly given by algebraic integral formulae involving the measured noisy signal, which can be considered as a low-pass filter. A detailed example will be given later in this chapter. Consequently, the modulating functions method has the following advantages:

- exact algebraic formulation using integral formulae of the noisy signal,
- non-asymptotic and fast estimation using a sliding integration window with a finite length;
- no need of initial conditions,
- without calculating the derivatives of the noisy signal,
- good robustness with respect to corrupting noises without the need of knowing in priori their statistical properties (see [71, 72] for more theoretical details).

There also exists another robust and non-asymptotic method which is the algebraic parametric estimation method originally introduced by by Fliess and Sira-Ramirez for linear identification [68]. Different to the modulating functions method which is applied in the time domain, the algebraic parametric estimation method is applied in the frequency domain. However, these two methods have the same previously mentioned advantages. Consequently, the algebraic parametric estimation method has been widely extended to various problems in signal processing [62, 63, 142, 143, 144, 145, 146, 147]. In several cases, the modulating functions method can be considered as a generalization of the algebraic parametric estimation method via working in the time domain [148]. However, when tackling a complex problem, we can first be inspired by

the algebraic parametric estimation method via working in the frequency domain. Indeed, the modulating functions method has been extended to fractional order linear identification [149], integer order and fractional order differentiators for integer order linear systems [67, 150].

In this chapter, the ideas of the modulating functions method on parameter identification and derivative estimation for integer order linear systems are recalled via simple examples. Then, it is shown how to apply the modulating functions method to design fractional order differentiators for integer order linear systems in several cases by constructing different types of modulating functions. Moreover, it is shown how to construct the required modulating functions.

3.2 Modulating functions method for integer order linear systems

In this section, the idea of the classical modulating functions method for linear identification is explained via simple examples. Then, it is shown how to generalize this method to design integer order differentiators for integer order linear systems.

3.2.1 Linear identification

Before introducing the modulating functions method, the definition of the classical modulating functions is recalled.

Definition 3.1 [135] *Let $[a, b] \subset \mathbb{R}$, $N \in \mathbb{N}^*$, and g be a function satisfying the following properties: for $k = 0, 1, \dots, N - 1$,*

$$(P_1): g \in \mathcal{C}^N([a, b]),$$

$$(P_2): g^{(k)}(a) = 0,$$

$$(P_3): g^{(k)}(b) = 0.$$

Then, g is called a N^{th} order modulating function on $[a, b]$.

There exist several kinds of modulating functions in the literature, such as polynomial modulating functions [138, 141], Walsh modulating functions [151], Hermite modulating functions [152, 153], Fourier modulating functions [136, 154, 155], and spline-type modulating functions [139, 140, 156, 157]. For example, a N^{th} order polynomial modulating function can be defined on $[a, b]$ as follows: $\forall t \in [a, b]$,

$$g_{n,m}(t) = (t - a)^{N+n}(t - b)^{N+m}, \quad (3.1)$$

3.2. Modulating functions method for integer order linear systems

where $n, m \in \mathbb{N}$. Indeed, it is easy to verify that $g_{n,m}^{(k)}(a) = g_{n,m}^{(k)}(b) = 0$, for $k = 0, 1, \dots, N-1$. By taking different values of n and m , the curves of $g_{n,m}$ is shown in Figure 3.1, where $a = 0, b = 2, N = 3, n = 0, m = 0, 1, 2$.

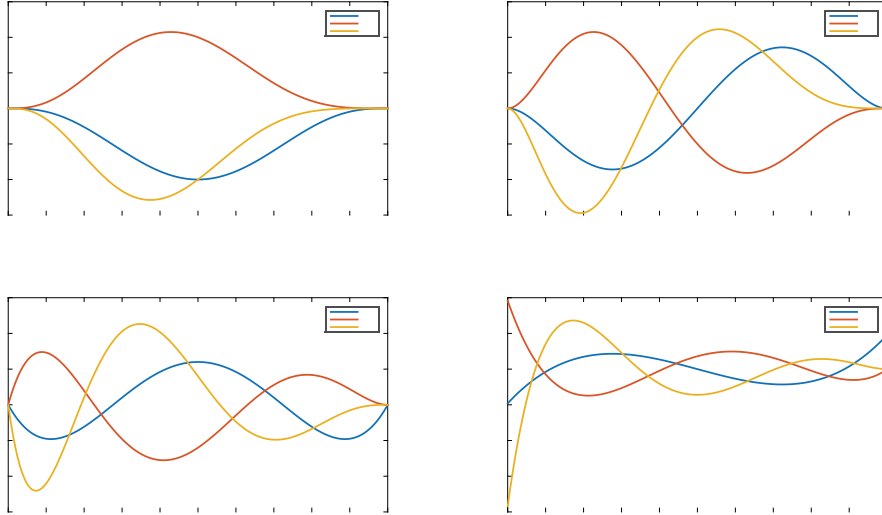

Figure 3.1: Classic modulating functions

When applying the modulating functions method, the integration by parts formula is always needed. The fractional order integration by parts formula is introduced in Lemma 2.7, which can be given in the integer order case as follows:

$$\int_a^b g(t) f^{(n)}(t) dt = (-1)^n \int_a^b g^{(n)}(t) f(t) dt + \sum_{k=0}^{n-1} (-1)^k \left[g^{(k)}(t) f^{(n-1-k)}(t) \right]_a^b, \quad (3.2)$$

where $f, g \in \mathcal{C}^n(\mathbb{R})$ with $n \in \mathbb{N}^*$.

Now, let us explain how to apply the classical modulating functions method for linear identification in the following example.

Example 3.1 Consider the following third order linear system: $\forall t \in [a, b] \subset \mathbb{R}$,

$$\ddot{a}_3 y(t) + a_2 \ddot{y}(t) + a_1 \dot{y}(t) + a_0 y(t) = u(t), \quad (3.3)$$

where y, u are the output, input respectively. It is assumed that $a_3 = 1$, and a_0, a_1, a_2 are unknown to be estimated using y and u . Then, the following steps are needed:

Step 1. Modulating functions: Take 3 third order modulating functions on $[a, b]$: g_n , for $n = 0, 1, 2$.

Step 2. Multiplication and Integration: By multiplying both sides of (3.3) by g_n and integrating from a to b , we get: for $n = 0, 1, 2$,

$$\int_a^b (g_n(\tau) \ddot{y}(\tau) + a_2 g_n(\tau) \dot{y}(\tau) + a_1 g_n(\tau) y(\tau) + a_0 g_n(\tau) y(\tau)) d\tau = \int_a^b g_n(\tau) u(\tau) d\tau. \quad (3.4)$$

Step 3. Integration by parts: By applying the integration by parts formula given in (3.2) to (3.4), we obtain: for $n = 0, 1, 2$,

$$S_n(b) - S_n(a) + \sum_{i=0}^3 (-1)^i a_i \int_a^b g_n^{(i)}(\tau) y(\tau) d\tau = \int_a^b g_n(\tau) u(\tau) d\tau, \quad (3.5)$$

where $S_n(a) = \sum_{i=1}^3 a_i \sum_{k=0}^{i-1} (-1)^k g_n^{(k)}(a) y^{(i-1-k)}(a)$ and $S_n(b) = \sum_{i=1}^3 a_i \sum_{k=0}^{i-1} (-1)^k g_n^{(k)}(b) y^{(i-1-k)}(b)$ contain all the boundary values.

Step 4. Elimination of undesired boundary values: Thanks to the properties of g_n , we get $S_n(a) = S_n(b) = 0$. Hence, (3.5) becomes: for $n = 0, 1, 2$,

$$\sum_{i=0}^3 (-1)^i a_i \int_a^b g_n^{(i)}(\tau) y(\tau) d\tau = \int_a^b g_n(\tau) u(\tau) d\tau. \quad (3.6)$$

Thus, 3 algebraic integral equations are obtained, which are linear with respect to a_0 , a_1 and a_2 .

Step 5. Resolution of a linear system: According to (3.6), the following linear system is obtained:

$$\begin{pmatrix} \int_a^b g_0(\tau) y(\tau) d\tau & -\int_a^b \dot{g}_0(\tau) y(\tau) d\tau & \int_a^b \ddot{g}_0(\tau) y(\tau) d\tau \\ \int_a^b g_1(\tau) y(\tau) d\tau & -\int_a^b \dot{g}_1(\tau) y(\tau) d\tau & \int_a^b \ddot{g}_1(\tau) y(\tau) d\tau \\ \int_a^b g_2(\tau) y(\tau) d\tau & -\int_a^b \dot{g}_2(\tau) y(\tau) d\tau & \int_a^b \ddot{g}_2(\tau) y(\tau) d\tau \end{pmatrix} \times \begin{pmatrix} a_0 \\ a_1 \\ a_2 \end{pmatrix} = \begin{pmatrix} \int_a^b g_0(\tau) u(\tau) d\tau + \int_a^b \ddot{g}_0(\tau) y(\tau) d\tau \\ \int_a^b g_1(\tau) u(\tau) d\tau + \int_a^b \ddot{g}_1(\tau) y(\tau) d\tau \\ \int_a^b g_2(\tau) u(\tau) d\tau + \int_a^b \ddot{g}_2(\tau) y(\tau) d\tau \end{pmatrix}. \quad (3.7)$$

Consequently, algebraic integral formulae can be obtained for the unknown parameters by solving (3.10), where y will be replaced by its noisy observation.

Remark 3.1 More modulating functions can be taken in Example 3.1, then more algebraic integral equations will be obtained. Then, the linear system can be solved by applying the least square method in **Step 5**.

Remark 3.2 For each $t \in]a, b]$, a sliding integration window over $[t - h, t]$ can be used in Example 3.1 by taking $a = t - h$ and $b = t$ such that $[t - h, t] \subset [a, b]$.

3.2.2 Integer order differentiators

The classical modulating functions method presented in Subsection 3.2.1 was used for parameter estimation by many researchers. Recently, it has been originally generalized

to estimate the derivatives of the output for integer order linear time-varying systems with unknown inputs in [150]. In this subsection, the idea of this generalized modulating functions method is explained.

Inspired by Example 3.1 in Subsection 3.2.1, if $S_n(a)$ or $S_n(b)$ is kept in Step 4, then the unknown boundary values can be obtained. For this purpose, several kinds of generalized modulating functions can be introduced.

Definition 3.2 Let $[a, b] \subset \mathbb{R}$, $N \in \mathbb{N}^*$. If a function g only satisfies (P_1) and (P_2) (resp. (P_1) and (P_3)), then g is called a N^{th} order left-sided (resp. right-sided) modulating function on $[a, b]$.

Thanks to Definition 3.2, the integer order derivatives of the output for the system given in (3.3) can be estimated.

Example 3.2 Consider the following third order linear system: $\forall t \in [a, b] \subset \mathbb{R}$,

$$\ddot{a}_3 y(t) + a_2 \dot{y}(t) + a_1 \dot{y}(t) + a_0 y(t) = u(t), \quad (3.8)$$

where y, u are the output, input respectively. It is assumed that $a_3 = 1$, and a_0, a_1, a_2 are known. Then, y, \dot{y} and \ddot{y} can be estimated by applying the following steps:

Steps 1-3.: By replacing the classical modulating functions used in Steps 1-3 in Example 3.1 by 3 third order left-sided modulating functions on $[a, t]$: g_n for $n = 0, 1, 2$, (3.5) becomes: $\forall t \in]a, b]$,

$$S_n(t) - S_n(a) + \sum_{i=0}^3 (-1)^i a_i \int_a^t g_n^{(i)}(\tau) y(\tau) d\tau = \int_a^t g_n(\tau) u(\tau) d\tau, \quad (3.9)$$

where $S_n(t) = \sum_{i=1}^3 a_i \sum_{k=0}^{i-1} (-1)^k g_n^{(k)}(t) y^{(i-1-k)}(t)$ contains the derivative values of y .

Step 4. Elimination of undesired boundary values at $t = a$: Thanks to the properties of g_n , we get $S_n(a) = 0$. Hence, (3.9) becomes: for $n = 0, 1, 2, \forall t \in]a, b]$,

$$S_n(t) + \sum_{i=0}^3 (-1)^i a_i \int_a^t g_n^{(i)}(\tau) y(\tau) d\tau = \int_a^t g_n(\tau) u(\tau) d\tau. \quad (3.10)$$

Thus, 3 algebraic integral equations are obtained, which contain $y(t), \dot{y}(t)$ and $\ddot{y}(t)$.

Step 5. Resolution of a linear system: Let us present all the terms in the double sum in $S_n(t)$ in the following matrix: for $n = 0, 1, 2, \forall t \in]a, b]$,

$$M_n(t) = \begin{pmatrix} a_1 g_n(t) y(t) & a_2 g_n(t) \dot{y}(t) & a_3 g_n(t) \ddot{y}(t) \\ 0 & -a_2 \dot{g}_n(t) y(t) & -a_3 \dot{g}_n(t) \dot{y}(t) \\ 0 & 0 & a_3 \ddot{g}_n(t) y(t) \end{pmatrix}. \quad (3.11)$$

By regrouping the terms containing $y^{(i)}(t)$ in (3.11) for $i = 0, 1, 2$, we get: for $n = 0, 1, 2$,

$$S_n(t) = \sum_{i=0}^2 G_{i,n}(t) y^{(i)}(t), \quad (3.12)$$

where we define:

$$G_{i,n}(t) = \sum_{k=0}^{2-i} (-1)^k a_{i+1+k} g_n^{(k)}(t). \quad (3.13)$$

Then, according to (3.10) and (3.12), the following linear system is obtained: $\forall t \in]a, b[$,

$$\begin{pmatrix} G_{0,0}(t) & G_{1,0}(t) & G_{2,0}(t) \\ G_{0,1}(t) & G_{1,1}(t) & G_{2,1}(t) \\ G_{0,2}(t) & G_{1,2}(t) & G_{2,2}(t) \end{pmatrix} \times \begin{pmatrix} y(t) \\ \dot{y}(t) \\ \ddot{y}(t) \end{pmatrix} = \begin{pmatrix} \int_a^t g_0(\tau) u(\tau) d\tau - \sum_{i=0}^3 (-1)^i a_i \int_a^t g_0^{(i)}(\tau) y(\tau) d\tau \\ \int_a^t g_1(\tau) u(\tau) d\tau - \sum_{i=0}^3 (-1)^i a_i \int_a^t g_1^{(i)}(\tau) y(\tau) d\tau \\ \int_a^t g_2(\tau) u(\tau) d\tau - \sum_{i=0}^3 (-1)^i a_i \int_a^t g_2^{(i)}(\tau) y(\tau) d\tau \end{pmatrix}. \quad (3.14)$$

Consequently, if the matrix in (3.14) is invertible, then algebraic integral formulae can be obtained for the derivative values $y(t)$, $\dot{y}(t)$ and $\ddot{y}(t)$ by solving (3.14), where y will be replaced by its noisy observation.

Step 6. Triangular matrix case: Remark that if g_n for $n = 0, 1, 2$, satisfy the following property: for $k = 0, 1, 2, \forall t \in]a, b[$,

$$g_n^{(k)}(t) =, \quad (3.15)$$

where δ_{kn} is the Kronecker delta function defined as follows: $\delta_{kn} = 1$ if $k = n$, $\delta_{kn} = 0$ else, then the matrix in (3.14) becomes triangular as follows:

$$\begin{pmatrix} a_1 & a_2 & a_3 \\ -a_2 & -a_3 & 0 \\ a_3 & 0 & 0 \end{pmatrix}, \quad (3.16)$$

with $a_3 = 1$. Then, by solving (3.14) $y^{(n)}(t)$ for $n = 0, 1, 2$ are given algebraic integral

formulae using a recursive way: $\forall t \in]a, b]$,

$$y(t) = \int_a^t g_2(\tau) u(\tau) d\tau - \sum_{i=0}^3 (-1)^i a_i \int_a^t g_2^{(i)}(\tau) y(\tau) d\tau, \quad (3.17)$$

$$\dot{y}(t) = - \int_a^t g_1(\tau) u(\tau) d\tau + \sum_{i=0}^3 (-1)^i a_i \int_a^t g_1^{(i)}(\tau) y(\tau) d\tau - a_2 y(t), \quad (3.18)$$

$$\ddot{y}(t) = \int_a^t g_0(\tau) u(\tau) d\tau - \sum_{i=0}^3 (-1)^i a_i \int_a^t g_0^{(i)}(\tau) y(\tau) d\tau - (a_1 y(t) + a_2 \dot{y}(t)). \quad (3.19)$$

Step 7. Identical matrix case: Remark that the matrix in (3.14) can be identical, if g_n for $n = 0, 1, 2$, satisfy the following property: for $i = 0, 1, 2, \forall t \in]a, b]$,

$$G_{i,n}(t) = \delta_{in}. \quad (3.20)$$

Then, $y^{(n)}(t)$ for $n = 0, 1, 2$ are directly given algebraic integral formulae as follows: $\forall t \in]a, b]$,

$$y^{(n)}(t) = \int_a^t g_n(\tau) u(\tau) d\tau - \sum_{i=0}^3 (-1)^i a_i \int_a^t g_n^{(i)}(\tau) y(\tau) d\tau. \quad (3.21)$$

Remark 3.3 Similar to Remark 3.2, Example 3.2 can also be improved by using a sliding integration window over $[t - h, t]$, where the lower integration bound a is replaced by $t - h$.

Remark 3.4 If we take 3 third order right-sided modulating functions on $[a, t]$: g_n for $n = 0, 1, 2$ in Example 3.2, then the initial values $y^{(n)}(a)$ for $n = 0, 1, 2$, can also be given by algebraic integral formulae by two ways.

Recursive estimators: If the modulating functions g_n satisfy the following property: for $k = 0, 1, 2$,

$$g_n^{(k)}(a) = \delta_{kn}, \quad (3.22)$$

then $y^{(n)}(a)$ for $n = 0, 1, 2$ are given by the following recursive way:

$$y(a) = - \int_a^t g_2(\tau) u(\tau) d\tau + \sum_{i=0}^3 (-1)^i a_i \int_a^t g_2^{(i)}(\tau) y(\tau) d\tau, \quad (3.23)$$

$$\dot{y}(a) = \int_a^t g_1(\tau) u(\tau) d\tau - \sum_{i=0}^3 (-1)^i a_i \int_a^t g_1^{(i)}(\tau) y(\tau) d\tau - a_2 y(a), \quad (3.24)$$

$$\ddot{y}(a) = - \int_a^t g_0(\tau) u(\tau) d\tau + \sum_{i=0}^3 (-1)^i a_i \int_a^t g_0^{(i)}(\tau) y(\tau) d\tau - (a_1 y(a) + a_2 \dot{y}(a)). \quad (3.25)$$

Independent estimators: If the modulating functions g_n satisfy the following property: for $i = 0, 1, 2$,

$$G_{i,n}(a) = \delta_{in}, \quad (3.26)$$

where $G_{i,n}(a)$ can be obtained by taking $t = a$ in (3.13), then $y^{(n)}(a)$ for $n = 0, 1, 2$, are independently given as follows:

$$y^{(n)}(a) = - \int_a^t g_n(\tau) u(\tau) d\tau + \sum_{i=0}^3 (-1)^i a_i \int_a^t g_n^{(i)}(\tau) y(\tau) d\tau. \quad (3.27)$$

Consequently, it can be seen that the core ideas of the derivative estimation method presented in Example 3.2 are to transform the differential equation into an integral equation, where conditions are designed for the modulating functions to eliminate the undesired terms and keep the desired ones. In the next section, these ideas will be generalized for designing fractional order differentiators.

3.3 Fractional order differentiator for integer order linear systems

In the previous section, it is shown how to generalize the modulating functions method to design integer order differentiators for integer order linear systems. The method was also extended to design fractional order differentiators for integer order linear systems in [67]. In this section, the idea will be explained and developed by considering three cases, where the contributions of can be summarized as follows:

- Fractional order differentiators are proposed for the output with an unknown bias in zero initial conditions case [6].
- The Caputo fractional derivatives of the signals satisfying a linear differential equation are estimated [7].
- The construction of the modulating functions is improved with respect to [67].

3.3.1 Problem formulation

Let us consider the following integer order linear system:

$$\sum_{i=0}^N a_i y^{(i)}(t) = u(t) \quad (3.28)$$

on $I = [a, b] \subset \mathbb{R}$, where $N \in \mathbb{N}^*$, $a_N \in \mathbb{R}^*$, $a_i \in \mathbb{R}$ for $i = 0, \dots, N-1$, are assumed known. Moreover, y and u are the output and the input, respectively. The objective of this section is to estimate the fractional order derivative with an arbitrary order of y in noisy environment. The idea is to generalize the modulating functions method developed in Example 3.2 to design two kinds of fractional order differentiators: the recursive ones and the independent ones.

Firstly, we define two new kinds of modulating functions, where the conditions given in (3.15) and (3.20) are given in a general case, respectively.

Definition 3.3 Let $[a, b] \subset \mathbb{R}$, $N \in \mathbb{N}^*$, $n \in \{0, \dots, l-1\}$, and g be a N^{th} order left-sided modulating function satisfying the following property: for $k = 0, 1, \dots, N-1$,

$$(P_4): g^{(k)}(b) = \delta_{kn}.$$

Then, g is called a $(N, n)^{th}$ order modulating function on $[a, b]$.

Definition 3.4 Let $[a, b] \subset \mathbb{R}$, $N \in \mathbb{N}^*$, $n \in \{0, \dots, N-1\}$, $a_i \in \mathbb{R}$ for $i = 0, 1, \dots, N-1$, and g be a N^{th} order left-sided modulating function satisfying the following property: for $i = 0, 1, \dots, N-1$,

$$(P_5): G_i(b) = \delta_{in}, \text{ where } G_i(b) = \sum_{k=0}^{N-1-i} (-1)^k a_{i+1+k} g^{(k)}(b).$$

Then, g is called a mixed $(N, n)^{th}$ order left-sided modulating function on $[a, b]$.

Secondly, in order to apply the generalized functions method to design fractional order differentiators, an intuitive idea is to transform the integer order linear differential equation given in (3.28) into a fractional order one. For this purpose, let us take $D_{a,t}^{-\beta}$ to (3.28) with $\beta \in]0, 1]$, and then apply the additive index law giving in Lemma 2.3, the following lemma can be obtained.

Lemma 3.1 [67] *Let $\beta \in]0, 1]$, then the integer order linear differential equation given in (3.28) can be transformed as follows: $\forall t \in I$,*

$$\sum_{i=0}^N a_i D_{a,t}^{i-\beta} y(t) = D_{a,t}^{-\beta} u(t) + \sum_{i=1}^N a_i \sum_{j=0}^{i-1} \Psi_{-\beta,j} \{y(t)\}, \quad (3.29)$$

where $\Psi_{-\beta,j} \{y(t)\}$ can be given by (2.19).

Now, inspired by the ideas on derivative estimation explained in Example 3.2, algebraic integral formulae will be given in several cases without considering the noise in the following subsections. Indeed, the corresponding differentiators can be obtained by replacing y by its noisy observation in the obtained formulae. In the next subsection, the cases with zero initial conditions are firstly considered.

3.3.2 Fractional order differentiators with zero initial conditions

In this subsection, we assume that the integer order linear system defined in (3.28) satisfy the following conditions:

$$y^{(i)}(a) = 0, \text{ for } i = 0, \dots, N-1. \quad (3.30)$$

Then, the following theorem is given.

Theorem 3.1 *Let y be the output of the linear system defined in (3.28) under the conditions (3.30). For $t \in]a, b]$, let g_n be a set of functions satisfying (P_1) and (P_4) on $[a, t]$, for $n = 0, \dots, N-1$. Let $\alpha \in]-1, N-1] \subset \mathbb{R}$ with $l = \lceil \alpha \rceil$, there exists $\beta \in [0, 1[$ such that $\beta = l - \alpha$. Then, $D_{a,t}^\alpha y(t)$ with $\alpha = l - \beta$ can be calculated by a recursive way as follows:*

- if $l = 0$, then

$$D_{a,t}^\alpha y(t) = F_0 \left(u(\tau), y(\tau), \left\{ {}^C D_{\tau,t}^{i-\beta} g_{N-1}(\tau) \right\}_{i=0}^N \right), \quad (3.31)$$

- if $l \geq 1$, then

$$D_{a,t}^\alpha y(t) = F_l \left(u(\tau), y(\tau), \left\{ {}^C D_{\tau,t}^{i-\beta} g_{N-1-l}(\tau) \right\}_{i=0}^N, \left\{ D_{a,t}^{i-\beta} y(t) \right\}_{i=0}^{l-1} \right), \quad (3.32)$$

where the operators F_k for $k = 0, 1, \dots, N-1$ are defined by:

$$F_0 \left(u(\tau), y(\tau), \left\{ {}^C D_{\tau,t}^{i-\beta} g_{N-1}(\tau) \right\}_{i=0}^N \right) =: \frac{(-1)^{N-1}}{a_N} \left(\int_a^t {}^C D_{\tau,t}^{-\beta} g_{N-1}(\tau) u(\tau) d\tau - \sum_{i=0}^N a_i \int_a^t {}^C D_{\tau,t}^{i-\beta} g_{N-1}(\tau) y(\tau) d\tau \right), \quad (3.33)$$

and for $k = 1, 2, \dots, N-1$,

$$F_k \left(u(\tau), y(\tau), \left\{ {}^C D_{\tau,t}^{i-\beta} g_{N-1-k}(\tau) \right\}_{i=0}^N, \left\{ D_{a,t}^{i-\beta} y(t) \right\}_{i=0}^{k-1} \right) =: \frac{(-1)^{N-1-k}}{a_N} \int_a^t {}^C D_{\tau,t}^{-\beta} g_{N-1-k}(\tau) u(\tau) d\tau - \sum_{i=0}^{k-1} \frac{a_{i+N-k}}{a_N} D_{a,t}^{i-\beta} y(t) - \frac{(-1)^{N-1-k}}{a_N} \sum_{i=0}^N a_i \int_a^t {}^C D_{\tau,t}^{i-\beta} g_{N-1-k}(\tau) y(\tau) d\tau. \quad (3.34)$$

Proof. Similar to Example 3.2, this proof needs the following steps.

Step 1. Multiplication and integration: By multiplying both sides of (3.29) by g_n and integrating from a to t , we obtain: for $n = 0, \dots, N-1, \forall t \in]a, b]$,

$$\sum_{i=0}^N a_i \int_a^t g_n(\tau) D_{a,\tau}^{i-\beta} y(\tau) d\tau = \int_a^t g_n(\tau) D_{a,\tau}^{-\beta} u(\tau) d\tau. \quad (3.35)$$

Step 2. Fractional order integration by parts: By applying the fractional order integration by parts formula given in Lemma 2.7, we get: for $n = 0, \dots, N-1, \forall t \in]a, b]$,

$$\int_a^t {}^C D_{\tau,t}^{-\beta} g_n(\tau) u(\tau) d\tau = \sum_{i=0}^N a_i \int_a^t {}^C D_{\tau,t}^{i-\beta} g_n(\tau) y(\tau) d\tau + S_n(t) - S_n(a), \quad (3.36)$$

where $S_n(\tau) = \sum_{i=1}^N a_i \sum_{k=0}^{i-1} (-1)^k g_n^{(k)}(\tau) D_{a,t}^{i-\beta-1-k} y(\tau)$ for $\tau = a, t$. Then, in order to better illustrate the derivative values in $S_n(t)$, they are presented in the following matrices: for $n = 0, \dots, N-1$,

$$M_n(t) = \begin{pmatrix} a_1 g_n^{(0)}(t) D_{a,t}^{-\beta} y(t) & a_2 g_n^{(0)}(t) D_{a,t}^{1-\beta} y(t) & \cdots & a_N g_n^{(0)}(t) D_{a,t}^{N-1-\beta} y(t) \\ 0 & -a_2 g_n^{(1)}(t) D_{a,t}^{-\beta} y(t) & \cdots & -a_N g_n^{(1)}(t) D_{a,t}^{N-2-\beta} y(t) \\ 0 & 0 & \cdots & (-1)^2 a_N g_n^{(2)}(t) D_{a,t}^{N-3-\beta} y(t) \\ \vdots & \vdots & \ddots & \vdots \\ 0 & 0 & \cdots & (-1)^{N-1} a_N g_n^{(N-1)}(t) D_{a,t}^{-\beta} y(t) \end{pmatrix}. \quad (3.37)$$

Step 3. Elimination of all the undesired initial values: Under the zero initial conditions given in (3.30), according Lemma 2.4, we have: $\left[D_{a,\tau}^{i-\beta} y(\tau) \right]_{\tau=a} = 0$ for $i = 0, \dots, N-1$. Hence, it yields $S_n(a) = 0$.

Step 4. Calculation of the boundary values at $\tau = t$: Thanks to (P₄), all the rows in (3.37) are equal to 0, except the $(n + 1)^{th}$ one. Thus, (3.36) becomes: for $n = 0, \dots, N - 1$, $\forall t \in]a, b]$,

$$\int_a^t {}^C D_{\tau,t}^{-\beta} g_n(\tau) u(\tau) d\tau = \sum_{i=0}^N a_i \int_a^t {}^C D_{\tau,t}^{i-\beta} g_n(\tau) y(\tau) d\tau + (-1)^n \sum_{i=n+1}^N a_i D_{a,t}^{i-n-1-\beta} y(t). \quad (3.38)$$

Hence, according to (3.38), we have: for $n = N - 1$,

$$D_{a,t}^{-\beta} y(t) = \frac{(-1)^{N-1}}{a_N} \left(\int_a^t {}^C D_{\tau,t}^{-\beta} g_{N-1}(\tau) u(\tau) d\tau - \sum_{i=0}^N a_i \int_a^t {}^C D_{\tau,t}^{i-\beta} g_{N-1}(\tau) y(\tau) d\tau \right), \quad (3.39)$$

and for $n = N - 2, N - 3, \dots, 0$,

$$\begin{aligned} D_{a,t}^{N-n-1-\beta} y(t) &= \frac{(-1)^n}{a_N} \int_a^t {}^C D_{\tau,t}^{-\beta} g_n(\tau) u(\tau) d\tau - \sum_{i=n+1}^{N-1} \frac{a_i}{a_N} D_{a,t}^{i-n-1-\beta} y(t) \\ &\quad - \frac{(-1)^n}{a_N} \sum_{i=0}^N a_i \int_a^t {}^C D_{\tau,t}^{i-\beta} g_n(\tau) y(\tau) d\tau. \end{aligned} \quad (3.40)$$

Finally, this proof can be completed by applying a change of indices $n \rightarrow N - 1 - k$. ■

Remark 3.5 *If the order α of the desired fractional derivative is larger than $N - 1$, then in order to apply Theorem 3.1 we need to differentiate the equation given in (3.28) $([\alpha] - N + 1)$ times.*

It is previously mentioned there exists several kinds of modulating functions in the literatures [135]. Unlike classical integer order derivatives, the fractional derivatives of the existing modulating functions usually cannot be formally calculated. For this reason, we consider polynomials whose right-sided Caputo fractional derivatives can be formally calculated using Lemma 2.9. Moreover, inspired by the algebraic parametric method [158, 159], these polynomials are easy to construct to fulfill the required properties.

Proposition 3.1 *Let $[a, t] \subset \mathbb{R}$, $m, n \in \mathbb{N}$, $N \in \mathbb{N}^*$ with $n \leq N - 1 \leq m$, and g_n be a polynomial with the following form:*

$$g_n(\tau) = \sum_{i=0}^{N-1} c_i t^{n-m-i} \tau^{m+i}. \quad (3.41)$$

If the coefficient vector $(c_0, \dots, c_{N-1})^T$ is the solution of the following system:

$$A_m \begin{pmatrix} c_0 \\ \vdots \\ c_{N-1} \end{pmatrix} = I_n, \quad (3.42)$$

3.3. Fractional order differentiator for integer order linear systems

where for $j = 0, \dots, N-1$, $I_n(j) = \delta_{jn}$, and for $i, j = 0, \dots, N-1$,

$$A_m(j, i) = \frac{(m+i)!}{(m+i-j)!}, \quad (3.43)$$

then g_n satisfies (P₁) and (P₄) on $[a, t]$.

Proof. Since g_n is a polynomial, it satisfies (P₁). By calculating the j^{th} order derivative of g_n , for $j = 0, \dots, N-1$, we obtain:

$$g_n^{(j)}(\tau) = \sum_{i=0}^{N-1} c_i \frac{(m+i)!}{(m+i-j)!} t^{n-m-i} \tau^{m+i-j}. \quad (3.44)$$

Hence, we get:

$$g_n^{(j)}(t) = t^{n-j} \sum_{i=0}^{N-1} c_i \frac{(m+i)!}{(m+i-j)!}. \quad (3.45)$$

Finally, if $(c_0, \dots, c_{N-1})^T$ is the solution of the system (3.42), then g_n also satisfies (P₄). Thus, this proof is completed. ■

Remark 3.6 m is a design parameter in the constructed modulating functions. The role of t^{n-m-i} is to make the matrix A_m be independent to t such that the coefficient vector $(c_0, \dots, c_{N-1})^T$ does not depend on t . Hence, this coefficient vector can be obtained by solving the linear system (3.42) once for every t .

We can see in Theorem 3.1 that the fractional derivatives of y are simultaneously calculated in a recursive way. If we use (P₅) as done in Example 3.2, these fractional derivatives can be independently calculated.

Theorem 3.2 Let y be the output of the linear system defined in (3.28) under the conditions (3.30). Let $\alpha \in]-1, N-1[\subset \mathbb{R}$ with $l = \lceil \alpha \rceil$, there exists $\beta \in [0, 1[$ such that $\beta = l - \alpha$. For $t \in]a, b]$, let g_l be a function satisfying (P₁) and (P₅) with $l = n$ on $[a, t]$. Then, $D_{a,t}^\alpha y(t)$ with $\alpha = l - \beta$ can be independently calculated as follows:

$$D_{a,t}^\alpha y(t) = \int_a^t {}^C D_{\tau,t}^{-\beta} g_l(\tau) u(\tau) d\tau - \sum_{i=0}^N a_i \int_a^t {}^C D_{\tau,t}^{i-\beta} g_l(\tau) y(\tau) d\tau. \quad (3.46)$$

Proof. This proof is similar to the one of Theorem 3.1. Using (3.37), the terms in the double sum in $S_l(t)$ can be regrouped as follows:

$$S_l(t) = \sum_{j=0}^{N-1} G_{j,l}(t) D_{a,t}^{j-\beta} y(t), \quad (3.47)$$

where $G_{j,l}(t) = \sum_{k=0}^{N-1-j} (-1)^k a_{j+1+k} g_l^{(k)}(t)$. Hence, if g_l satisfies (P₅) with $l = n$, this proof can be completed by using (3.36) where $S_l(a) = 0$. ■

By using a similar way as done in Proposition 3.1, the required functions in Theorem 3.2 can be constructed in the following proposition.

Proposition 3.2 Let $[a, t] \subset \mathbb{R}$, $m, n \in \mathbb{N}$, $N \in \mathbb{N}^*$ with $n \leq N - 1 \leq m$, and g_n be a polynomial with the following form:

$$g_n(\tau) = \sum_{i=0}^{N-1} d_i \tau^{m+i}. \quad (3.48)$$

If the coefficient vector $(d_0, \dots, d_{N-1})^T$ is the solution of the following system:

$$\mathbf{B}_m \begin{pmatrix} d_0 \\ \vdots \\ d_{N-1} \end{pmatrix} = \mathbf{I}_n, \quad (3.49)$$

where for $j = 0, \dots, N - 1$, $\mathbf{I}_n(j) = \delta_{jn}$, and for $i, j = 0, \dots, N - 1$,

$$\mathbf{B}_m(j, i) = \sum_{k=0}^{N-1-j} (-1)^k a_{j+1+k} \frac{(m+i)!}{(m+i-k)!} t^{m+i-k}, \quad (3.50)$$

then g_n satisfies the properties (P₁) and (P₅) on $[a, t]$.

Polynomial type modulating functions are constructed in Proposition 3.1 (resp. Proposition 3.2), according to Lemma 2.9 and the definition domain of m , it can be deduce that all the integrals involving u and y in (3.33)–(3.34) (resp. in (3.46)) are proper. Consequently, unlike the improper integral in Definition 2.11, the Riemann-Liouville fractional derivatives of y are exactly given by proper integral formulae in Theorem 3.1 and Theorem 3.2, which do not contain any source of errors in continuous noise free case.

Now, let us assume that the output y of the linear system defined by (3.28) contains an unknown constant bias: $\forall t \in \mathbb{I}$,

$$y_\delta(t) = y(t) + \delta, \quad (3.51)$$

where $\delta \in \mathbb{R}^*$ is the unknown bias. In order to cope with this situation, the following proposition is given.

Proposition 3.3 Under the same hypotheses given in Theorem 3.1 (resp. Theorem 3.2), we assume that the used modulating functions g_n also satisfy the following property:

$$(P_6): \sum_{i=0}^N a_i \int_a^t {}^C D_{\tau,t}^{i-\beta} g_n(\tau) d\tau = 0.$$

Then, by replacing y by y_δ in (3.33)–(3.34) (resp. (3.46)), the algebraic integral formulae for $D_{a,t}^\alpha y(t)$ still hold.

Proof. This proof can be completed by adding the following step in the proof of Theorem 3.1 and Theorem 3.2 respectively:

New Step. Elimination of the unknown bias: If g_n satisfies (P_6) , then we get:

$$\sum_{i=0}^N a_i \int_a^t {}^C D_{\tau,t}^{i-\beta} g_n(\tau) y_\delta(\tau) d\tau = \sum_{i=0}^N a_i \int_a^t {}^C D_{\tau,t}^{i-\beta} g_n(\tau) y(\tau) d\tau. \quad (3.52)$$

Hence, the error due to the unknown bias δ is eliminated. ■

Let us recall that the modulating functions constructed in Proposition 3.1 (resp. Proposition 3.2) contain N coefficients which are determined such at the N conditions required in (P_4) (resp. (P_5)) fulfil. Thus, since a new condition should be fulfilled in (P_6) , the required modulating functions can be constructed by increasing one coefficient, *i.e.* by increasing the degree of the polynomials. Hence, one more 0 is added in I_n , and the dimension of A_m (resp. B_m) is increased from (N, N) to $(N + 1, N + 1)$ where the new row of A_m (resp. B_m) is given by: for $i = 0, \dots, N$,

$$A_m(N, i) = t^{n-m-i} \sum_{k=0}^N a_k \int_a^t {}^C D_{\tau,t}^{k-\beta} \tau^{m+i} d\tau, \quad (3.53)$$

$$B_m(N, i) = \sum_{k=0}^N a_k \int_a^t {}^C D_{\tau,t}^{k-\beta} \tau^{m+i} d\tau, \quad (3.54)$$

where $\int_a^t {}^C D_{\tau,t}^{i-\beta} \{\tau^{m+j}\} d\tau$ can be given by (2.50).

In this subsection, the initial conditions are assumed to be zero. In the next subsection, unknown initial conditions will be considered, which can be non-zero.

3.3.3 Fractional order differentiators with unknown initial conditions

From now on, the unknown initial conditions $y^i(a)$ for $i = 0, \dots, N-1$ will be considered for the integer order linear system defined in (3.28), which can be non-zero. Similar to the previous subsection, the modulating functions method will be applied to (3.29). Different from the previous subsection, due to the unknown initial conditions, $\Psi_{-\beta,j}\{y(t)\}$ and $S_n(a)$ given in (3.36) should also be eliminated. Then, the following proposition is given.

Proposition 3.4 [67] *Under the same hypotheses given in Theorem 3.1 (resp. Theorem 3.2), we assume that the used modulating functions g_n also satisfy (P_2) and the following property: for $i = 1, 2, \dots, N$,*

$$(P_7) : \int_a^t (\tau - a)^{\beta-i} g_n(\tau) d\tau = 0.$$

Then, the algebraic integral formulae for $D_{a,t}^\alpha y(t)$ still hold in the case with unknown initial conditions.

Proof. The objective of this proof is to eliminate the undesired terms due to the unknown initial conditions in the proofs of Theorem 3.1 and Theorem 3.2. Firstly, thanks to (P₇), we obtain: $\int_a^t g_n(\tau) \Psi_{-\beta, j}\{y(\tau)\} d\tau = 0$. Hence, the equation given in (3.35) holds in non-zero conditions case. Secondly, thanks to (P₂), we get: $S_n(a) = 0$ in (3.36). Consequently, the rest of the proofs of Theorem 3.1 and Theorem 3.2 also holds. Thus, this proof is completed. ■

According to Proposition 3.4, a set of $(N, n)^{th}$ order modulating functions (resp. a mixed $(N, n)^{th}$ order modulating function) satisfying (P₇) on $[a, t]$ are (resp. is) required in Theorem 3.1 (resp. Theorem 3.2). Inspired by Proposition 3.1 and Proposition 3.2, these modulating functions are constructed in the following two propositions.

Proposition 3.5 *Let $[a, t] \subset \mathbb{R}$, $m, n \in \mathbb{N}$, $N \in \mathbb{N}^*$ with $n \leq N - 1 < m$, and g_n be a polynomial with the following form:*

$$g_n(\tau) = \sum_{i=0}^{2N-1} c_i (t-a)^{n-m-i} (\tau-a)^{m+i}. \quad (3.55)$$

If the coefficient vector $(c_0, \dots, c_{2N-1})^T$ is the solution of the following system:

$$A_m \begin{pmatrix} c_0 \\ \vdots \\ c_{2N-1} \end{pmatrix} = I_n, \quad (3.56)$$

where for $j = 0, \dots, 2N - 1$, $I_n(j) = \delta_{jn}$, and for $i = 0, \dots, 2N - 1$,

$$A_m(j, i) = \begin{cases} \frac{(m+i)!}{(m+i-j)!}, & \text{for } j = 0, \dots, N-1, \\ \frac{1}{m+i+\beta-j+N}, & \text{for } j = N, \dots, 2N-1, \end{cases} \quad (3.57)$$

then g_n is a $(N, n)^{th}$ order modulating function satisfying (P₇) on $[a, t]$.

Proof. Since g_n is a polynomial, it satisfies (P₁). Then, by calculating the j^{th} order derivative of g_n , for $j = 0, \dots, N - 1$, we obtain:

$$g_n^{(j)}(\tau) = \sum_{i=0}^{2N-1} c_i \frac{(m+i)!}{(m+i-j)!} (t-a)^{n-m-i} (\tau-a)^{m+i-j}. \quad (3.58)$$

Since $m > N - 1$, g_n satisfies (P₂). Moreover, we have:

$$g_n^{(j)}(t) = (t-a)^{n-j} \sum_{i=0}^{2N-1} c_i \frac{(m+i)!}{(m+i-j)!}. \quad (3.59)$$

3.3. Fractional order differentiator for integer order linear systems

Then, we calculate the following integral: for $j = 1, \dots, N$,

$$\int_a^t (\tau - a)^{\beta-j} g_n(\tau) d\tau = (t - a)^{n+\beta-j+1} \sum_{i=0}^{2N-1} c_i \frac{1}{m+i+\beta-j+1}. \quad (3.60)$$

Finally, according to (3.58) and (3.60) if $(c_0, \dots, c_{2N-1})^T$ is the solution of the system (3.56), then g_n also satisfies (P₄) and (P₇) on $[a, t]$. Thus, this proof is completed. ■

Consequently, similar to Proposition 3.1, the coefficient vector $(c_0, \dots, c_{2N-1})^T$ is independent to t . Similar to Proposition 3.5, the following proposition can be obtained.

Proposition 3.6 [67] *Let $[a, t] \subset \mathbb{R}$, $n, m \in \mathbb{N}$, $N \in \mathbb{N}^*$ with $n \leq N-1 < m$, and g_n be a polynomial with the following form:*

$$g_n(\tau) = \sum_{i=0}^{2N-1} d_i (\tau - a)^{m+i}. \quad (3.61)$$

If the coefficient vector $(d_0, \dots, d_{2N-1})^T$ is the solution of the following system:

$$B_m \begin{pmatrix} d_0 \\ \vdots \\ d_{2N-1} \end{pmatrix} = I_n, \quad (3.62)$$

where for $j = 0, \dots, 2N-1$, $I_n(j) = \delta_{jn}$, and for $i = 0, \dots, 2N-1$,

$$B_m(j, i) = \begin{cases} \sum_{k=0}^{N-1-j} (-1)^k a_{j+1+k} \frac{(m+i)!}{(m+i-k)!} (t-a)^{m+i-k}, & \text{for } j = 0, \dots, N-1, \\ \frac{1}{m+i+\beta-j+N} (t-a)^{m+i+\beta-j+N}, & \text{for } j = N, \dots, 2N-1, \end{cases} \quad (3.63)$$

then g_n is a mixed $(N, n)^{th}$ order modulating function satisfying (P₇) on $[a, t]$.

3.4 Numerical results

In order to illustrate the accuracy and robustness with respect to corrupting noises of the modulating functions method presented in Section 3.2 and Section 3.3, numerical examples are given in this section by considering two cases:

- the initial conditions are assumed to be zero and the output observation contains an unknown bias [6],
- the initial conditions are assumed to be non-zero [7].

For this purpose, the independent differentiators designed in Section 3.3 will be applied in discrete noisy case, where the output is replaced by its noisy observation in the integrals in the formula and the trapezoidal numerical integration method is applied to approximate these integrals.

3.4.1 Case of zero initial conditions and an unknown bias

In this subsection, two third order linear systems with zero initial conditions are considered by taking $N = 3$ in (3.28) and (3.30). The objective is estimate $D_{a,t}^\alpha y$ by considering the following noisy output observation: $\forall t \in I$,

$$y^\ominus(t) = y(t) + \omega(t) + \delta, \quad (3.64)$$

where ω is a corrupting noise, and $\delta \in \mathbb{R}^*$ is an unknown constant bias.

Example 1. Open-loop case In this example, the following linear system is considered: $\forall t \in [0, 10]$,

$$y^{(3)}(t) + 2y^{(2)}(t) + 2y^{(1)}(t) + y(t) = u(t), \quad (3.65)$$

where $u(t) = \sin(3t)$. It is assumed that $y(t_j) = y(t_j) + \omega(t_j) + 0.1$, where $t_j = jT_s$ with $T_s = 0.001$, and the noise $\{\omega(t_j)\}$ is simulated from a zero-mean white Gaussian *iid* sequence with $\text{Var}[\omega(t_j)] = 0.124$. The value of the variance is adjusted such that the signal-to-noise ratio $\text{SNR} = 10 \log_{10} \left(\frac{\sum |y^\ominus(t_i)|^2}{\sum |\omega(t_i)|^2} \right)$ is equal to $\text{SNR} = 15\text{dB}$ (see [160]) for this well known concept in signal processing). The original output and the biased noisy output are shown in Figure 3.2(a). $D_{0,t}^{0.85} y$ is estimated in this discrete noisy case by the differentiator proposed in Theorem 3.2 and Proposition 3.2 by considering (P₆). Moreover, the design parameter m is set to 3 in Proposition 3.2 and (3.54) for the modulating function. Since the fractional derivatives of y can not be analytically calculated, the Grünwald-Letnikov scheme given in (2.38)-(2.39) is applied in noise free case to verify the estimated result. Recall that this scheme is only efficient in noise free case and is not robust against noises. Hence, the estimation obtained by the Grünwald-Letnikov scheme is considered as the original one. Finally, the obtained estimation is shown in Figure 3.2(b).

Example 2. Closed-loop case In this example, the following system is considered [161]:
 $\forall t \in [0, 10]$,

$$y^{(3)}(t) + 7y^{(2)}(t) + 12y^{(1)}(t) = u(t), \quad (3.66)$$

where a $PI^\lambda D^\mu$ controller $u(t) = K_p e(t) + K_i D_{0,t}^{-\lambda} e(t) + K_d D_{0,t}^\mu e(t)$ is applied to this system. This controller u is realized as follows: $K_p = 42.458$, $K_i = 87.2733$, $K_d = 53.1352$, $\lambda = 0.85030$, $\mu = 0.9623$ and $e(t) = r(t) - y(t)$ with r being a reference. It is assumed that $y^\ominus(t_j) = y(t_j) + \omega(t_j)$, where $T_s = 10^{-3}$, and $\{\omega(t_j)\}$ is simulated from a Poisson *iid* sequence with $E[\omega(t_j)] = \text{Var}[\omega(t_j)] = 0.05$. In order to design u , $D_{0,t_j}^{-\lambda} y(t_j)$ and $D_{0,t_j}^\mu y(t_j)$ are estimated by applying the same differentiator to the previous example with $m = 3$ and the Grünwald-Letnikov scheme in the noise case, respectively. The obtained outputs and the designed controllers are shown in Figure 3.3(a) and Figure 3.3(b), respectively. It can be seen in Figure 3.3(a) that the noise error contribution obtained by the Grünwald-Letnikov scheme is much larger than the one obtained by the proposed differentiator. Moreover, it can be seen in Figure 3.3(b) that the proposed differentiator can cope with the bias term.

3.4.2 Case of non-zero initial conditions

In this section, it will be shown that the differentiators designed in Section 3.3 can also be applied to estimate the Caputo fractional derivatives of a signal satisfying a linear differential equation [7].

Example 3. Sinusoidal signal Let us consider the following sinusoidal signal: $\forall t \in I \subset \mathbb{R}$,

$$y(t) = A \sin(\omega t + \phi), \quad (3.67)$$

where $A = 3$, $\omega = 5$, and $\phi = 0.85$. Hence, y satisfies the following harmonic oscillator equation: $\forall t \in I$,

$$\ddot{y}(t) + \omega^2 \dot{y}(t) = 0. \quad (3.68)$$

The Riemann-Liouville fractional derivatives of y can be given using the expansion of y and the linearity of the Riemann-Liouville fractional derivatives [21]:

$$D_t^\alpha y(t) = A \cos \phi D_t^\alpha \sin(\omega t) + A \sin \phi D_t^\alpha \cos(\omega t)$$

where $D_t^\alpha \sin(\omega t)$ and $D_t^\alpha \cos(\omega t)$ are given by (2.42)-(2.43). Moreover, the Caputo fractional derivatives of y can be obtained using (2.32).

Assumed that $y^\ominus(t_i) = y(t_i) + \omega(t_i)$ is a discrete noisy observation with $I = [0, 10]$ and $T_s = 0.001$, where the noise $\{\omega(t_i)\}$ is simulated from a zero-mean white Gaussian *iid* sequence, and the variance is adjusted such that SNR= 20 dB. The discrete signal y and its noisy observation y^\ominus are shown in Figure 3.4(a), where $\text{Var}[\omega(t_i)] = 0.215^2$.

The 0.85th order Caputo fractional derivative of y will be estimated on $[0.85, 10]$. Firstly, according to (2.32) $y(0)$ needs to be estimated. For this, the estimator obtained in (3.27) is applied. The used modulating function can be constructed using a similar way as done in Proposition 3.2 where τ^{m+i} is replaced by $(\tau - t)^{m+i}$. The obtained relative estimation error for $y(0)$ is shown in Figure 3.4(b), where $m = 5$. Secondly, the Riemann-Liouville fractional derivative $D_{0,t}^{0.85} y$ is estimated by the differentiator proposed in Theorem 3.2 and Proposition 3.4 by considering (P₇). The design parameter m is set to 5 in Proposition 3.6 for the used modulating function. Finally, the estimated derivative is shown in Figure 3.4(c).

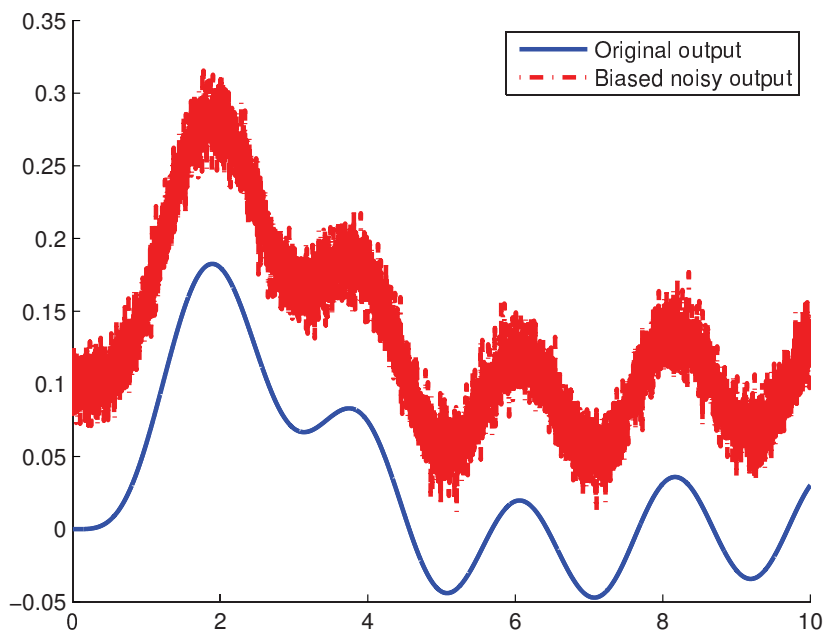

(a) Original output and Biased noisy output.

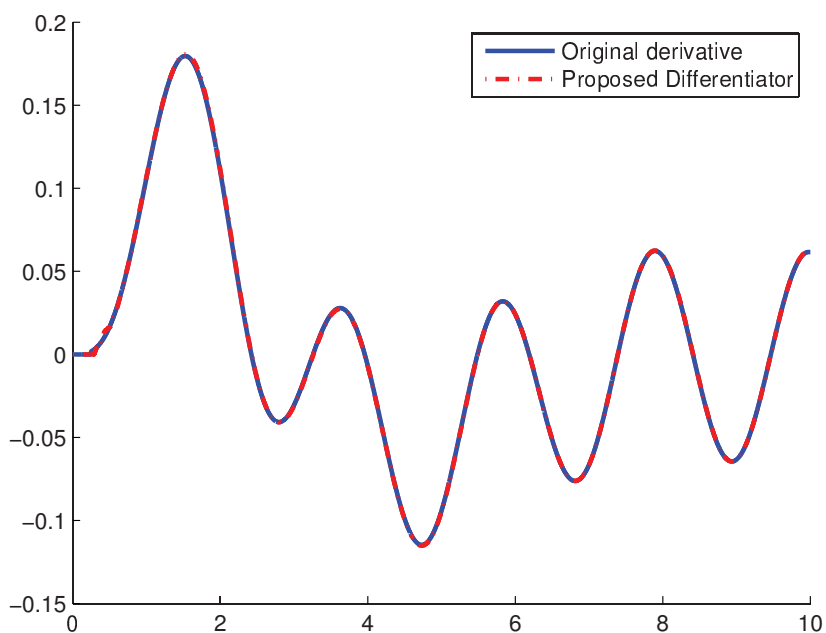

(b) Original 0.85^{th} order fractional derivative and its estimation.

Figure 3.2: Example 1: Open-loop case.

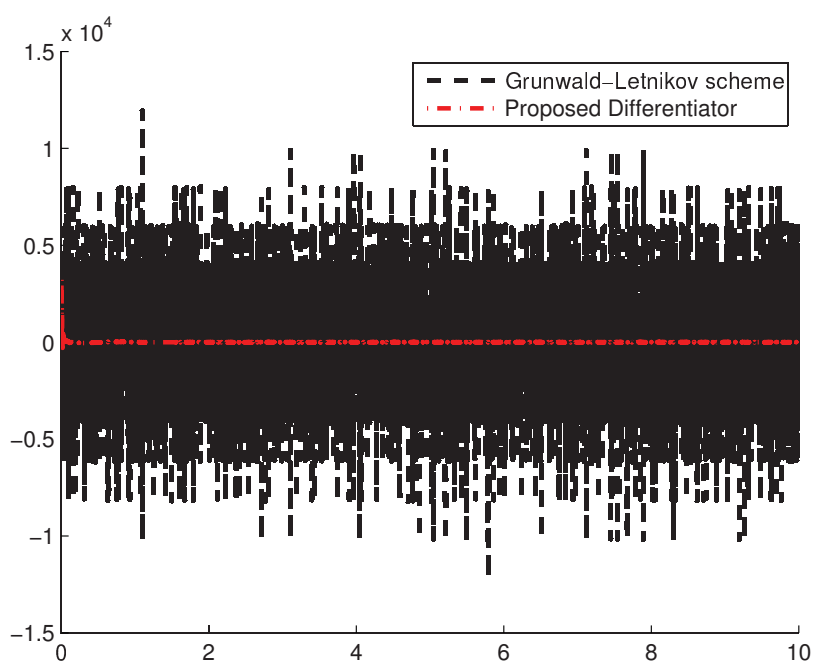
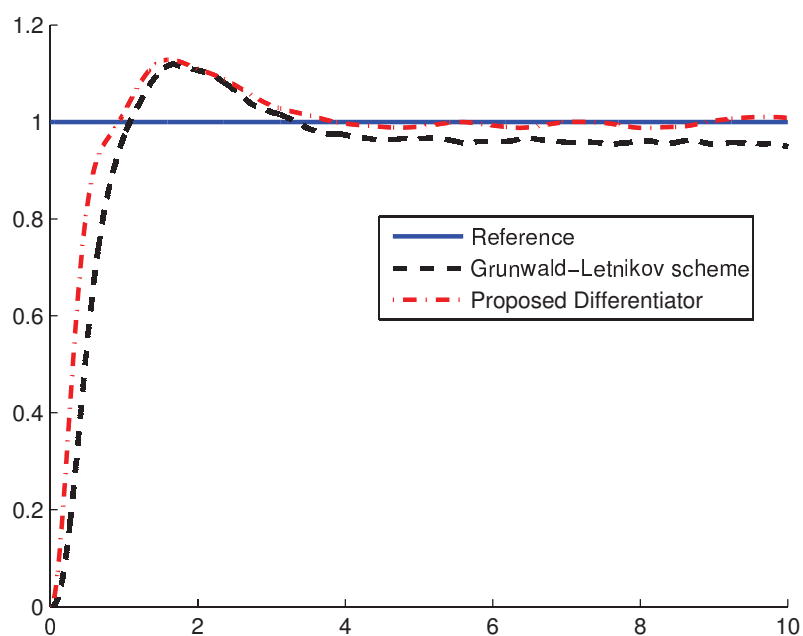
(a) Designed $PI^\lambda D^\mu$ controllers.

(b) Obtained outputs by two methods.

Figure 3.3: Example 2: Closed-loop case.

3.4. Numerical results

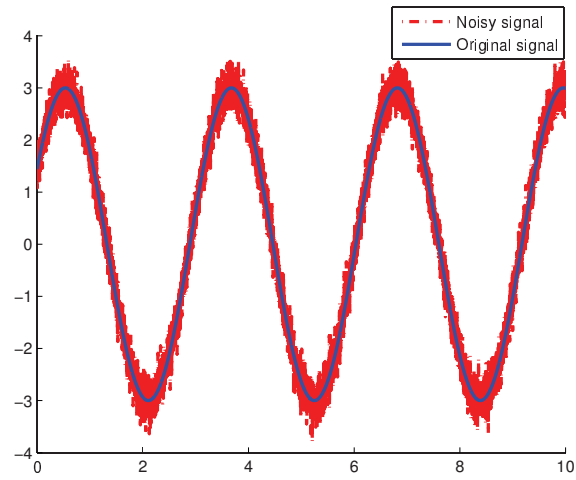

(a) Sinusoidal signal and its noisy observation.

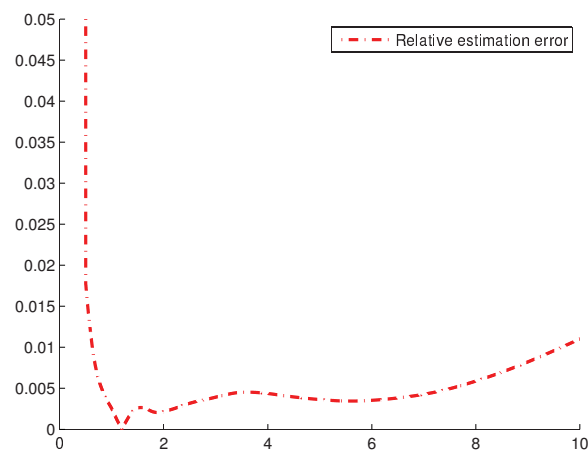

(b) Relative estimation error for initial condition $y(0)$.

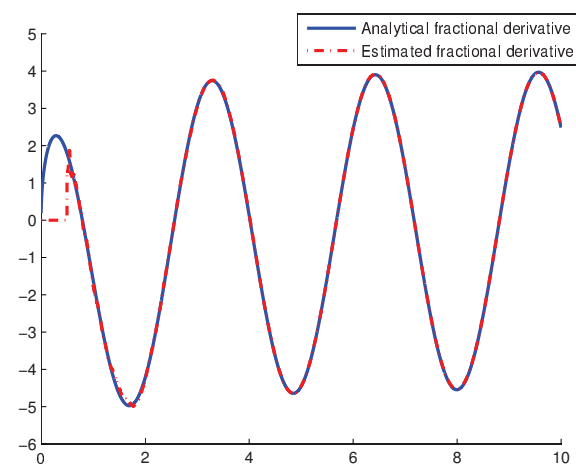

(c) Analytical Caputo derivative and its estimation.

Figure 3.4: Example 3: Sinusoidal signal case

3.5 Conclusions

In this chapter, the idea of the classical modulating functions on parameter estimation was explained: we transform the studied differential equation into an integral equation. Then, it was shown that by changing the properties of the modulating functions, this method can also be applied to estimate the integer order derivatives and the initial conditions of the output for a class of integer order linear systems. By transforming the studied integer order linear differential equation into a fractional order one, and thanks to the fractional order integration by parts formulae, the modulating functions method was extended to design two kinds of fractional order differentiators in three cases. The first case with zero initial conditions was a direct extension of the integer order case. The unknown bias in the second case was eliminated by an additional property on the modulating functions. Hence, the obtained differentiators can cope with a class of non zero-mean noises. Similarly, by adding more properties, the undesired terms were eliminated in the third case with non-zero initial conditions case. All the used properties are listed in Annexe A. In order to construct the required modulating functions, polynomial were considered which can easily be determined by solving linear systems. Finally, a proposed differentiator was applied to design a fractional order $PI^\lambda D^\mu$ controller for an integer order linear system in numerical examples. Moreover, the Caputo fractional derivative of a sinusoidal signal was also estimated. Indeed, the obtained fractional order differentiators can be applied for the signals satisfying an integer order linear differential equation. The basic ideas of the modulating functions were explained in this chapter, which will be applied in the next chapter for fractional order linear systems.

3.5. Conclusions

Chapter 4

Non-asymptotic pseudo-state estimator

Résumé en français

Dans ce chapitre, nous concevons un estimateur non-asymptotique du pseudo-état pour une classe de systèmes linéaires d'ordre fractionnaire commensurable qui peuvent être transformés sous la forme canonique observable de Brunovsky avec des conditions initiales inconnues. Dans un premier temps, cette forme canonique est exprimée par une équation différentielle entraînant des valeurs initiales de dérivées fractionnaires séquentielles de la sortie. Ensuite, nous mettons en évidence deux algorithmes récursifs qui donnent des formules algébriques intégrales pour calculer ces conditions initiales et les dérivées fractionnaires de la sortie à l'aide de deux familles de fonctions modulatrices. Ces formules permettent d'estimer le pseudo-état en temps fini. Dans le cas discret et bruité, l'estimateur du pseudo-état contient deux types d'erreurs : une erreur numérique due à la méthode d'intégration numérique utilisée et une autre due au bruit. En particulier, une analyse est fournie pour diminuer la contribution du bruit au moyen d'une majoration d'erreur qui permet de sélectionner les degrés optimaux des fonctions modulatrices à chaque instant. Enfin, les comparaisons avec certaines méthodes existantes et avec un nouvel observateur d'ordre fractionnaire de type \mathcal{H}_∞ sont montrées.

4.1 Introduction

Fractional order systems and controllers have been applied to improve performance and robustness properties in control design [21, 54, 58, 66, 162, 163, 164]. Due to the nonlocality of the fractional derivative operator, the real-state of a fractional order system can be divided into two parts: the pseudo-state and an initialization function [57, 96, 97, 98]. However, for some applications, the knowledge of pseudo-state is enough to understand the behavior of a studied fractional order system [55]. As for integer order linear systems, the design of pseudo-state estimators for fractional order

linear systems is also important in automatic control. Indeed, for cost and technological reasons, the pseudo-state can not always be measured. Existing pseudo-state observers for fractional order systems are often extensions of the ones for integer order systems [124, 165, 166, 167], which usually converge asymptotically. However, sometimes fast convergence in finite-time is required in online applications, [131, 132, 133]. Consequently, non-asymptotic pseudo-state estimators are useful for fractional order systems.

The aim of this chapter is to apply the modulating functions method to design a non-asymptotic (with convergence in finite-time) and robust (against corrupting noises) pseudo-state estimator for a class of fractional order linear systems which can be transformed into the Brunovsky's observable canonical form of pseudo-state space representation with unknown initial conditions. The contributions of this chapter can be summarized as follows:

1. The transformation between the pseudo-state space representation and the fractional order differential equation is given without the knowledge of initial conditions.
2. The initial values of the fractional sequential derivatives and the fractional derivatives of the output are exactly given by algebraic integral formulae using a recursive way, which permit us to calculate the pseudo-state of the system.
3. The choice of the design parameter is studied by providing a noise error bound.
4. A new fractional order \mathcal{H}_∞ -like observer is designed in order to compare with the proposed non-asymptotic pseudo-state estimator.

4.2 Problem formulation

From now on, the following fractional order linear system is considered:

$$D_t^\alpha x = Ax + Bu, \quad (4.1)$$

$$y = Cx, \quad (4.2)$$

on $I \subset \mathbb{R}_+ \cup \{0\}$, where $0 < \alpha < 2$, $A \in \mathbb{R}^{N \times N}$, $B \in \mathbb{R}^{N \times 1}$, $C \in \mathbb{R}^{1 \times N}$, $D_t^\alpha x = (D_t^\alpha x_1, \dots, D_t^\alpha x_N)^T$ with $\alpha = \frac{p}{q}$, $p, q, N \in \mathbb{N}^*$, $x \in \mathbb{R}^N$ is the pseudo-state column vector with unknown initial values, $y \in \mathbb{R}$ and $u \in \mathbb{R}$ are the output and the input, respectively. Moreover, the following conditions are assumed to be fulfilled:

$$(C_1): \text{rank} \begin{pmatrix} C \\ CA \\ \vdots \\ CA^{N-1} \end{pmatrix} = N,$$

$$(C_2): CB = CAB = \dots = CA^{N-2}B = 0,$$

$$(C_3): CA^{N-1}B \neq 0.$$

Remark that it was mentioned in [57] that if the Caputo fractional derivative is used to describe a fractional system, the infinite dimension property is lost at initial time but exists elsewhere, which is not physically consistent. For this reason, the Riemann-Liouville fractional derivative is considered in (4.1)-(4.2).

The objective of this chapter is to estimate the pseudo-state x in noisy environment. For this purpose, the system defined by (4.1)-(4.2) firstly needs to be transformed into the well-known Brunovsky's observable canonical form [10]. Under this form, the system can be represented by a fractional order differential equation, based on which the modulating function method will be applied.

Lemma 4.1 *By taking the following change of coordinates*

$$z = M_1 x, \quad (4.3)$$

where

$$M_1 = \begin{pmatrix} CA^{N-1} + \sum_{i=1}^{N-1} a_i CA^{i-1} \\ \vdots \\ CA^{N-j} + \sum_{i=j}^{N-1} a_i CA^{i-j} \\ \vdots \\ CA + a_{N-1}C \\ C \end{pmatrix}, \quad (4.4)$$

and $a_i \in \mathbb{R}$, for $i = 0, \dots, N-1$, are coefficients of the characteristic polynomial of A , the system defined by (4.1)-(4.2) satisfying conditions (C₂) – (C₃) can be transformed into the following Brunovsky's observable canonical form of pseudo-state space representation:

$$D_t^\alpha z = \hat{A}z + \hat{B}u, \quad (4.5)$$

$$y = \hat{C}z, \quad (4.6)$$

where $\hat{B} = [CA^{N-1}B, 0, \dots, 0]^T \in \mathbb{R}^{N \times 1}$, $\hat{C} = [0, \dots, 0, 1] \in \mathbb{R}^{1 \times N}$,

$$\hat{A} = \begin{pmatrix} 0 & 0 & \cdots & 0 & 0 & -a_0 \\ 1 & 0 & \cdots & 0 & 0 & -a_1 \\ 0 & 1 & \cdots & 0 & 0 & -a_2 \\ \vdots & \vdots & \ddots & \vdots & \vdots & \vdots \\ 0 & 0 & \cdots & 1 & 0 & -a_{N-2} \\ 0 & 0 & \cdots & 0 & 1 & -a_{N-1} \end{pmatrix}. \quad (4.7)$$

Proof. Using (4.1) and (4.3), we obtain: for $j = 1, \dots, N-1$,

$$\begin{aligned} D_t^\alpha z_j &= CA^{N-j} D_t^\alpha x + \sum_{i=j}^{N-1} a_i CA^{i-j} D_t^\alpha x \\ &= CA^{N-j} (Ax + Bu) + \sum_{i=j}^{N-1} a_i CA^{i-j} (Ax + Bu) \\ &= CA^{N-j+1} x + CA^{N-j} Bu + \sum_{i=j}^{N-1} a_i CA^{i-j+1} x \\ &\quad + \sum_{i=j}^{N-1} a_i CA^{i-j} Bu, \end{aligned} \quad (4.8)$$

and

$$D_t^\alpha z_N = CD_t^\alpha x = C(Ax + Bu) = CAx + CBu. \quad (4.9)$$

Thanks to (C₂), (4.8) becomes:

- if $j = 1$, then

$$D_t^\alpha z_j = CA^N x + CA^{N-1} Bu + \sum_{i=1}^{N-1} a_i CA^i x, \quad (4.10)$$

- if $2 \leq j \leq N-1$, then

$$\begin{aligned} D_t^\alpha z_j &= CA^{N-j+1} x + \sum_{i=j}^{N-1} a_i CA^{i-j+1} x \\ &= z_{j-1} - a_{j-1} Cx = z_{j-1} - a_{j-1} z_N, \end{aligned} \quad (4.11)$$

and (4.9) becomes:

$$D_t^\alpha z_N = CAx = z_{N-1} - a_{N-1} Cx = z_{N-1} - a_{N-1} z_N. \quad (4.12)$$

By applying (C₃) and the Cayley-Hamilton theorem that states: $A^N + \sum_{i=0}^{N-1} a_i A^i = 0$ to (4.10), we get:

$$D_t^\alpha z_1 = CA^{N-1} Bu - a_0 Cx = CA^{N-1} Bu - a_0 z_N. \quad (4.13)$$

Finally, since $y = Cx = z_N$, (4.6) is obtained. ■

Remark 4.1 *The Brunovsky's observable canonical form given in (4.5)-(4.6), which is similar to the one of ordinary integer order systems, is only associated to the pseudo-state space representation. It is not available for the real-state space representation, which is of infinite dimension (see [11] for more details).*

Secondly, the Brunovsky's observable canonical form of pseudo-state space representation defined by (4.5)-(4.6) can be expressed by a fractional order linear differential equation in the following lemma.

Lemma 4.2 *The system defined by (4.5)-(4.6) can be written into the following form on I:*

$$\sum_{i=0}^N a_i \mathcal{D}_t^{\alpha_i} y(t) = CA^{N-1} Bu(t), \quad (4.14)$$

where $a_N = 1$, and $\alpha_i = i\alpha = \frac{p}{q}i$, for $i = 0, \dots, N$. Moreover, we have:

$$\begin{pmatrix} z_1 \\ \vdots \\ z_{N-1} \\ z_N \end{pmatrix} = M_2 \begin{pmatrix} y \\ \mathcal{D}_t^\alpha y \\ \vdots \\ \mathcal{D}_t^{(N-1)\alpha} y \end{pmatrix}, \quad (4.15)$$

4.2. Problem formulation

where

$$M_2 = \begin{pmatrix} a_1 & a_2 & a_3 & \cdots & a_{N-1} & 1 \\ \vdots & \vdots & \vdots & \ddots & \vdots & \vdots \\ a_{N-1} & 1 & 0 & \cdots & 0 & 0 \\ 1 & 0 & 0 & \cdots & 0 & 0 \end{pmatrix}. \quad (4.16)$$

Proof. Using (4.5)-(4.7), we get: $CA^{N-1}Bu = D_t^\alpha z_1 + a_0 y$, and

$$\begin{pmatrix} z_1 \\ \vdots \\ z_{N-j} \\ \vdots \\ z_{N-1} \\ z_N \end{pmatrix} = \begin{pmatrix} D_t^\alpha z_2 + a_1 y \\ \vdots \\ D_t^\alpha z_{N-j+1} + a_{N-j} y \\ \vdots \\ D_t^\alpha z_N + a_{N-1} y \\ y \end{pmatrix}. \quad (4.17)$$

Then, the following equation is proven by induction: for $j = 1, \dots, N-1$,

$$z_{N-j} = \mathcal{D}_t^{j\alpha} y + \sum_{i=1}^j a_{N-i} \mathcal{D}_t^{(j-i)\alpha} y, \quad (4.18)$$

which is equivalent to (4.15) with $z_N = y$.

Step 1. Initial step: According to (4.17), (4.18) holds for $j = 1$.

Step 2. Inductive step: Assume (4.18) holds for $j = 1, \dots, k$ with $1 \leq k \leq N-2$. Then, we have:

$$z_{N-k} = \mathcal{D}_t^{k\alpha} y + \sum_{i=1}^k a_{N-i} \mathcal{D}_t^{(k-i)\alpha} y. \quad (4.19)$$

Using (4.17) and (4.19), we obtain:

$$\begin{aligned} & z_{N-k-1} \\ &= D_t^\alpha z_{N-k} + a_{N-k-1} y \\ &= \mathcal{D}_t^\alpha \left\{ \mathcal{D}_t^{k\alpha} y \right\} + \sum_{i=1}^k a_{N-i} \mathcal{D}_t^\alpha \left\{ \mathcal{D}_t^{(k-i)\alpha} y \right\} + a_{N-k-1} y \\ &= \mathcal{D}_t^{(k+1)\alpha} y + \sum_{i=1}^{k+1} a_{N-i} \mathcal{D}_t^{(k+1-i)\alpha} y. \end{aligned} \quad (4.20)$$

Hence, (4.18) also holds for $k+1$. Consequently, (4.18) holds for all $j \in \{1, \dots, N-1\}$.

Thus, we have:

$$\begin{aligned} D_t^\alpha z_1 &= D_t^\alpha \left\{ \mathcal{D}_t^{(N-1)\alpha} y \right\} + \sum_{i=1}^{N-1} a_{N-i} D_t^\alpha \left\{ \mathcal{D}_t^{(N-1-i)\alpha} y \right\} \\ &= \mathcal{D}_t^{N\alpha} y + \sum_{i=1}^{N-1} a_{N-i} \mathcal{D}_t^{(N-i)\alpha} y. \end{aligned} \quad (4.21)$$

Finally, (4.14) can be obtained using $CA^{N-1}Bu = D_t^\alpha z_1 + a_0 y$. ■

If condition (C₁) is fulfilled, the matrix M_1 defined in (4.4) is invertible. Consequently, by applying Lemma 4.1 and Lemma 4.2, the following lemma can be obtained.

Lemma 4.3 *The pseudo-state variables of the system defined by (4.1)-(4.2) satisfying conditions (C₁) – (C₃) can be written as linear combinations of the fractional sequential derivatives of the output y :*

$$x = M_1^{-1} M_2 \begin{pmatrix} y \\ \mathcal{D}_t^\alpha y \\ \vdots \\ \mathcal{D}_t^{(N-1)\alpha} y \end{pmatrix}, \quad (4.22)$$

where M_1 and M_2 are defined in (4.4) and (4.16), respectively.

Consequently, if the fractional sequential derivatives of the output y are estimated, the pseudo-state x can be estimated using Lemma 4.3. For this purpose, according to Lemma 2.2, the fractional derivatives of y and the initial values of the fractional sequential derivatives of y should be estimated. Inspired by this idea, a non-asymptotic pseudo-state estimator is constructed in the next section.

4.3 Main results

In this section, the modulating functions method will be applied to design a non-asymptotic pseudo-state estimator for the system defined by (4.1)-(4.2) satisfying (C₁)–(C₃). Before giving this main result, let us explain the originality of the ideas in the following example.

Example 4.1 *Let us assume $\alpha = \frac{1}{2}$ and $N = 3$ in (4.1)-(4.2). Then, according to Lemma 4.2, we have: $\forall t \in I$,*

$$\sum_{i=0}^3 a_i \mathcal{D}_t^{\alpha_i} y(t) = \hat{u}(t), \quad (4.23)$$

where $\hat{u} = CA^2Bu$. Moreover, according to Lemma 4.3, we have:

$$x = M_1^{-1} M_2 \begin{pmatrix} y \\ \mathcal{D}_t^\alpha y \\ \mathcal{D}_t^{2\alpha} y \end{pmatrix}. \quad (4.24)$$

By applying the additive index law for fractional sequential derivatives given in Lemma 2.2, we get: $\forall t \in I$,

$$\mathcal{D}_t^{2\alpha} y(t) = \dot{y}(t) - \frac{1}{\Gamma(-\frac{1}{2})} t^{-\frac{3}{2}} \left[D_t^{-\frac{1}{2}} y(t) \right]_{t=0}. \quad (4.25)$$

Consequently, if y , $\mathcal{D}_t^{\frac{1}{2}} y = D_t^{\frac{1}{2}} y$, \dot{y} and $\left[D_t^{-\frac{1}{2}} y(t) \right]_{t=0}$ are estimated, the pseudo-state x can be estimated. Thus, both the fractional derivatives and the initial values need to be estimated.

Algebraic integral formulae for fractional order initial values

By applying the modulating functions methods, algebraic integral formulae will be given for the fractional order initial values.

Step 1. Construction of differential equations: By applying Lemma 2.2, the fractional order differential equation obtained in (4.23) with fractional sequential derivatives is transformed as follows:

$$\sum_{i=0}^3 a_i D_\tau^{\frac{i}{2}} y(\tau) = \hat{u}(\tau) + \frac{\tau^{-\frac{3}{2}}}{\Gamma(-\frac{1}{2})} (a_2 d_0 + d_1), \quad (4.26)$$

where $d_0 = \left[D_\tau^{-\frac{1}{2}} y(\tau) \right]_{\tau=0}$ and $d_1 = \left[D_\tau^{-\frac{1}{2}} \left\{ D_\tau^{\frac{1}{2}} y(\tau) \right\} \right]_{\tau=0}$.

Remark that (4.26) is not enough to separately calculate d_0 and d_1 by the modulating functions method. Hence, we take $D_\tau^{-\frac{1}{2}}$ to (4.23) to construct a new equation. Then, by applying Lemma 2.2, we get:

$$\sum_{i=0}^3 a_i D_\tau^{\frac{i-1}{2}} y(\tau) = D_\tau^{-\frac{1}{2}} \hat{u}(\tau) + \frac{\tau^{-\frac{3}{2}}}{\Gamma(-\frac{1}{2})} d_0 + \frac{\tau^{-\frac{1}{2}}}{\Gamma(\frac{1}{2})} (a_1 d_0 + a_2 d_1 + d_2), \quad (4.27)$$

where $d_2 = \left[D_\tau^{-\frac{1}{2}} \left\{ D_\tau^{\frac{1}{2}} \left\{ D_\tau^{\frac{1}{2}} y(\tau) \right\} \right\} \right]_{\tau=0}$.

Step 2. Multiplication and integration: Let us take two functions h_1 and h_3 satisfying the following property: for $n, j = 1, 3$,

$$\int_0^t h_n(\tau) \tau^{-\frac{j}{2}} d\tau = \delta_{nj}. \quad (4.28)$$

Then, by multiplying h_n to (4.26)–(4.27) and integrating from 0 to t , we get:

$$\sum_{i=0}^3 a_i \int_0^t h_3(\tau) D_\tau^{\frac{i}{2}} y(\tau) d\tau = \int_0^t h_3(\tau) \hat{u}(\tau) d\tau + \frac{a_2 d_0 + d_1}{\Gamma(-\frac{1}{2})}, \quad (4.29)$$

$$\sum_{i=0}^3 a_i \int_0^t h_3(\tau) D_\tau^{\frac{i-1}{2}} y(\tau) d\tau = \int_0^t h_3(\tau) D_\tau^{-\frac{1}{2}} \hat{u}(\tau) d\tau + \frac{d_0}{\Gamma(-\frac{1}{2})}, \quad (4.30)$$

$$\sum_{i=0}^3 a_i \int_0^t h_1(\tau) D_\tau^{\frac{i-1}{2}} y(\tau) d\tau = \int_0^t h_1(\tau) D_\tau^{-\frac{1}{2}} \hat{u}(\tau) d\tau + \frac{a_1 d_0 + a_2 d_1 + d_2}{\Gamma(\frac{1}{2})}. \quad (4.31)$$

Step 3. Successive fractional integration by parts: Moreover, if h_n for $n = 1, 3$, are second order modulating functions on $[0, t]$ satisfying (4.28), then by applying the fractional integration by parts given in Lemma 2.7 to (4.29)-(4.31), we get:

$$\sum_{i=0}^3 a_i \int_0^t D_{\tau,t}^{\frac{i}{2}} h_3(\tau) y(\tau) d\tau = \int_0^t h_3(\tau) \hat{u}(\tau) d\tau + \frac{a_2 d_0 + d_1}{\Gamma(-\frac{1}{2})}, \quad (4.32)$$

$$\sum_{i=0}^3 a_i \int_0^t D_{\tau,t}^{\frac{i-1}{2}} h_3(\tau) y(\tau) d\tau = \int_0^t D_{\tau,t}^{-\frac{1}{2}} h_3(\tau) \hat{u}(\tau) d\tau + \frac{d_0}{\Gamma(-\frac{1}{2})}, \quad (4.33)$$

$$\sum_{i=0}^3 a_i \int_0^t D_{\tau,t}^{\frac{i-1}{2}} h_1(\tau) y(\tau) d\tau = \int_0^t D_{\tau,t}^{-\frac{1}{2}} h_1(\tau) \hat{u}(\tau) d\tau + \frac{a_1 d_0 + a_2 d_1 + d_2}{\Gamma(\frac{1}{2})}, \quad (4.34)$$

where all the boundary conditions are eliminated using (P₂)-(P₃).

Step 4. Recursive algorithm: Finally, the unknown initial values can be recursively given by solving the following linear system:

$$\begin{pmatrix} \frac{1}{\Gamma(\frac{1}{2})} & \frac{a_2}{\Gamma(\frac{1}{2})} & \frac{a_1}{\Gamma(\frac{1}{2})} \\ 0 & \frac{1}{\Gamma(-\frac{1}{2})} & \frac{a_2}{\Gamma(-\frac{1}{2})} \\ 0 & 0 & \frac{1}{\Gamma(-\frac{1}{2})} \end{pmatrix} \begin{pmatrix} \left[D_{\tau}^{-\frac{1}{2}} \left\{ D_{\tau}^{\frac{1}{2}} \left\{ D_{\tau}^{\frac{1}{2}} y(\tau) \right\} \right\} \right]_{\tau=0} \\ \left[D_{\tau}^{-\frac{1}{2}} \left\{ D_{\tau}^{\frac{1}{2}} y(\tau) \right\} \right]_{\tau=0} \\ \left[D_{\tau}^{-\frac{1}{2}} y(\tau) \right]_{\tau=0} \end{pmatrix} = \begin{pmatrix} \sum_{i=0}^3 a_i \int_0^t D_{\tau,t}^{\frac{i-1}{2}} h_1(\tau) y(\tau) d\tau - \int_0^t D_{\tau,t}^{-\frac{1}{2}} h_1(\tau) \hat{u}(\tau) d\tau \\ \sum_{i=0}^3 a_i \int_0^t D_{\tau,t}^{\frac{i}{2}} h_3(\tau) y(\tau) d\tau - \int_0^t h_3(\tau) \hat{u}(\tau) d\tau \\ \sum_{i=0}^3 a_i \int_0^t D_{\tau,t}^{\frac{i-1}{2}} h_3(\tau) y(\tau) d\tau - \int_0^t D_{\tau,t}^{-\frac{1}{2}} h_3(\tau) \hat{u}(\tau) d\tau \end{pmatrix}. \quad (4.35)$$

Algebraic integral formulae for fractional derivatives

Now, using a similar ways as done in Section 3.3, algebraic integral formulae will be given for the fractional derivatives by applying the modulating functions methods.

Step 1. Construction of differential equations: Let us consider (4.26)-(4.27). In particular, according to (4.27), we have:

$$\begin{aligned} \dot{y} = & -a_2 D_{\tau}^{\frac{1}{2}} y(\tau) - a_1 y(\tau) - a_0 D_{\tau}^{-\frac{1}{2}} y(\tau) + D_{\tau}^{-\frac{1}{2}} \hat{u}(\tau) \\ & + \frac{\tau^{-\frac{3}{2}}}{\Gamma(-\frac{1}{2})} d_0 + \frac{\tau^{-\frac{1}{2}}}{\Gamma(\frac{1}{2})} (a_1 d_0 + a_2 d_1 + d_2). \end{aligned} \quad (4.36)$$

Step 2. Multiplication and integration: Consider two functions g_n for $n = 0, 1$, which satisfy the following property: $\forall j \in \{1, 3\}$,

$$\int_0^t g(\tau) \tau^{-\frac{j}{2}} d\tau = 0. \quad (4.37)$$

4.3. Main results

Then, by multiply g_n to (4.26)–(4.27) and integrating from 0 to t , we get: for $n = 0, 1$,

$$\sum_{i=0}^3 a_i \int_0^t g_n(\tau) D_{\tau}^{\frac{i}{2}} y(\tau) d\tau = \int_0^t g_n(\tau) \hat{u}(\tau) d\tau, \quad (4.38)$$

$$\sum_{i=0}^3 a_i \int_0^t g_n(\tau) D_{\tau}^{\frac{i-1}{2}} y(\tau) d\tau = \int_0^t g_n(\tau) D_{\tau}^{-\frac{1}{2}} \hat{u}(\tau) d\tau. \quad (4.39)$$

Step 3. Successive fractional integration by parts: If $g_n(0) = \dot{g}_n(0) = 0$ for $n = 0, 1$, i.e. g_n satisfy (P_2) , by applying fractional integration by parts to (4.38)–(4.39), we get:

$$\sum_{i=0}^3 a_i \int_0^t D_{\tau,t}^{\frac{i}{2}} g_n(\tau) y(\tau) d\tau = \int_0^t g_n(\tau) \hat{u}(\tau) d\tau - g_n(t) \left(D_t^{\frac{1}{2}} y(t) + a_2 y(t) \right) + \dot{g}_n(t) D_t^{-\frac{1}{2}} y(t), \quad (4.40)$$

$$\sum_{i=0}^3 a_i \int_0^t D_{\tau,t}^{\frac{i-1}{2}} g_n(\tau) y(\tau) d\tau = \int_0^t D_{\tau,t}^{-\frac{1}{2}} g_n(\tau) \hat{u}(\tau) d\tau - g_n(t) \left(y(t) + a_2 D_t^{-\frac{1}{2}} y(t) \right). \quad (4.41)$$

Step 4. Construction of new equations: Furthermore, if g_n satisfy (P_4) for $n = 0, 1$, i.e. g_n for $n = 0, 1$ are $(2, n)^{th}$ order modulating functions on $[0, t]$ satisfying (4.37), (4.40)–(4.41) become:

$$\begin{aligned} \sum_{i=0}^3 a_i \int_0^t D_{\tau,t}^{\frac{i}{2}} g_0(\tau) y(\tau) d\tau &= \int_0^t g_0(\tau) \hat{u}(\tau) d\tau - D_t^{\frac{1}{2}} y(t) - a_2 y(t), \\ \sum_{i=0}^3 a_i \int_0^t D_{\tau,t}^{\frac{i}{2}} g_1(\tau) y(\tau) d\tau &= \int_0^t g_1(\tau) \hat{u}(\tau) d\tau + D_t^{-\frac{1}{2}} y(t), \\ \sum_{i=0}^3 a_i \int_0^t D_{\tau,t}^{\frac{i-1}{2}} g_0(\tau) y(\tau) d\tau &= \int_0^t D_{\tau,t}^{-\frac{1}{2}} g_0(\tau) \hat{u}(\tau) d\tau - y(t) - a_2 D_t^{-\frac{1}{2}} y(t). \end{aligned}$$

Step 5. Recursive algorithm: Finally, the unknown fractional derivative values can be recursively given by solving the following linear system:

$$\begin{pmatrix} -1 & -a_2 & 0 \\ 0 & 1 & a_2 \\ 0 & 0 & 1 \end{pmatrix} \begin{pmatrix} D_t^{\frac{1}{2}} y(t) \\ y(t) \\ D_t^{-\frac{1}{2}} y(t) \end{pmatrix} = \begin{pmatrix} \sum_{i=0}^3 a_i \int_0^t D_{\tau,t}^{\frac{i}{2}} g_0(\tau) y(\tau) d\tau - \int_0^t g_0(\tau) \hat{u}(\tau) d\tau \\ \sum_{i=0}^3 a_i \int_0^t D_{\tau,t}^{\frac{i-1}{2}} g_0(\tau) y(\tau) d\tau - \int_0^t D_{\tau,t}^{-\frac{1}{2}} g_0(\tau) \hat{u}(\tau) d\tau \\ \sum_{i=0}^3 a_i \int_0^t D_{\tau,t}^{\frac{i}{2}} g_1(\tau) y(\tau) d\tau - \int_0^t g_1(\tau) \hat{u}(\tau) d\tau \end{pmatrix}. \quad (4.42)$$

In the next subsection, the ideas explained in the previous example will be developed in a general case. Before doing so, let us define the following useful set: for

$j \in \{0, \dots, q-1\}$ and $0 < \alpha < 2$,

$$\Phi_j := \begin{cases} \left\{ (j', i') \in \mathbb{N}^2; 1 \leq i' \leq \lceil \alpha \rceil, 1 \leq j' \leq N-1, \frac{j}{q} - j'\alpha - i' \notin \mathbb{Z} \right\}, & \text{if } j=0, \\ \left\{ (j', i') \in \mathbb{N}^2; 1 \leq i' \leq \lceil \alpha \rceil, 0 \leq j' \leq N-1, \frac{j}{q} - j'\alpha - i' \notin \mathbb{Z} \right\}, & \text{else.} \end{cases} \quad (4.43)$$

Remark that it can be verify that $\forall j' \in \{0, \dots, N-1\}, i' \in \{1, \lceil \alpha \rceil\}, \exists j \in \{0, \dots, q-1\}$ such that $(j', i') \in \Phi_j$.

4.3.1 Algebraic formulae in continuous noise-free case

Now, we are ready to present the mains results of this chapter. Firstly, the initial values of the fractional sequential derivatives of y are calculated by algebraic formulae in the following theorem.

Theorem 4.1 [1] For $j \in \{0, \dots, q-1\}$, $(n, k) \in \Phi_j$, and for $t \in \mathbb{I}$, let $h_{j,n,k}$ be a set of $(\lceil \frac{Np-j}{q} \rceil)^{th}$ order modulating functions on $[0, t]$ satisfying the following property: $\forall (j', i') \in \Phi_j$,

$$(P_8): \int_0^t h_{j,n,k}(\tau) \tau^{\frac{j}{q} - j'\alpha - i'} d\tau = \begin{cases} 1, & \text{if } (n, k) = (j', i'), \\ 0, & \text{else.} \end{cases}$$

Then, the initial values of the fractional sequential derivatives of the output of the system defined by (4.1)–(4.2) satisfying conditions (C₁) – (C₃) can be obtained by a recursive way as follows: for $j \in \{0, \dots, q-1\}$,

- $\forall (N-1, k) \in \Phi_j$,

$$\begin{aligned} \left[D_{\tau}^{\alpha-k} y(\tau) \right]_{\tau=0} &= \frac{1}{c_{\frac{-j}{q} + (N-1)\alpha, k}} \sum_{i=0}^N a_i \int_0^t {}^C D_{\tau, t}^{i\alpha - \frac{j}{q}} h_{j, N-1, k}(\tau) y(\tau) d\tau \\ &\quad - \frac{1}{c_{\frac{-j}{q} + (N-1)\alpha, k}} \int_0^t {}^C D_{\tau, t}^{\frac{-j}{q}} h_{j, N-1, k}(\tau) \hat{u}(\tau) d\tau, \end{aligned} \quad (4.44)$$

- $\forall (n, k) \in \Phi_j$ with $n \in \{0, \dots, N-2\}$,

$$\begin{aligned} \left[D_{\tau}^{\alpha-k} \left\{ \mathcal{D}_{\tau}^{(N-n-1)\alpha} y(\tau) \right\} \right]_{\tau=0} &= \frac{1}{c_{\frac{-j}{q} + n\alpha, k}} \sum_{i=0}^N a_i \int_0^t {}^C D_{\tau, t}^{i\alpha - \frac{j}{q}} h_{j, n, k}(\tau) y(\tau) d\tau \\ &\quad - \frac{1}{c_{\frac{-j}{q} + n\alpha, k}} \int_0^t {}^C D_{\tau, t}^{\frac{-j}{q}} h_{j, n, k}(\tau) \hat{u}(\tau) d\tau - \sum_{i=n+1}^{N-1} a_i \left[D_{\tau}^{\alpha-k} \left\{ \mathcal{D}_{\tau}^{(i-n-1)\alpha} y(\tau) \right\} \right]_{\tau=0}, \end{aligned} \quad (4.45)$$

where $\frac{1}{c_{\frac{-j}{q} + n\alpha, k}} = \Gamma(1 + \frac{j}{q} - n\alpha - k)$ is given by (2.20).

4.3. Main results

Proof. According to Lemma 4.1 and Lemma 4.2, the system defined by (4.1)–(4.2) can be transformed into (4.14) using conditions (C₁) – (C₃), based on which this proof requires the following steps.

Step 1. Construction of equations: By applying D_{τ}^{-j} to (4.14), for $j = 0, \dots, q - 1$, we get:

$$\sum_{i=0}^N a_i D_{\tau}^{-j} \left\{ \mathcal{D}_{\tau}^{i\alpha} y(\tau) \right\} = D_{\tau}^{-j} \hat{u}(\tau). \quad (4.46)$$

Then, by applying Lemma 2.5 to (4.46), we get: for $j = 0$,

$$\sum_{i=0}^N a_i D_{\tau}^{i\alpha} y(\tau) = \hat{u}(\tau) + \sum_{i=2}^N a_i \phi_{\alpha, i-1, \alpha} \{y(\tau)\}, \quad (4.47)$$

and for $j = 1, \dots, q - 1$,

$$\sum_{i=0}^N a_i D_{\tau}^{i\alpha - \frac{j}{q}} y(\tau) = D_{\tau}^{-j} \hat{u}(\tau) + \sum_{i=1}^N a_i \phi_{\frac{-j}{q}, i, \alpha} \{y(\tau)\}. \quad (4.48)$$

Step 2. Multiplication and integration: Multiply both sides of (4.47) and (4.48) by $h_{j,n,k}$, and integrate from 0 to t . It yields: for $j = 0$,

$$\sum_{i=0}^N a_i \int_0^t h_{j,n,k}(\tau) D_{\tau}^{i\alpha} y(\tau) d\tau = \int_0^t h_{j,n,k}(\tau) \hat{u}(\tau) d\tau + \sum_{i=2}^N a_i \int_0^t h_{j,n,k}(\tau) \phi_{\alpha, i-1, \alpha} \{y(\tau)\} d\tau, \quad (4.49)$$

and for $j = 1, \dots, q - 1$,

$$\sum_{i=0}^N a_i \int_0^t h_{j,n,k}(\tau) D_{\tau}^{i\alpha - \frac{j}{q}} y(\tau) d\tau = \int_0^t h_{j,n,k}(\tau) D_{\tau}^{-j} \hat{u}(\tau) d\tau + \sum_{i=1}^N a_i \int_0^t h_{j,n,k}(\tau) \phi_{\frac{-j}{q}, i, \alpha} \{y(\tau)\} d\tau. \quad (4.50)$$

Step 3. Successive integration by parts: By applying Lemma 2.7 to (4.49) and (4.50), we get: for $j = 0$,

$$\sum_{i=2}^N a_i \int_0^t h_{j,n,k}(\tau) \phi_{\alpha, i-1, \alpha} \{y(\tau)\} d\tau = \sum_{i=0}^N a_i \int_0^t {}^C D_{\tau, t}^{i\alpha} h_{j,n,k}(\tau) y(\tau) d\tau - \int_0^t h_{j,n,k}(\tau) \hat{u}(\tau) d\tau, \quad (4.51)$$

and for $j = 1, \dots, q - 1$,

$$\sum_{i=1}^N a_i \int_0^t h_{j,n,k}(\tau) \phi_{\frac{-j}{q}, i, \alpha} \{y(\tau)\} d\tau = \sum_{i=0}^N a_i \int_0^t {}^C D_{\tau, t}^{i\alpha - \frac{j}{q}} h_{j,n,k}(\tau) y(\tau) d\tau - \int_0^t {}^C D_{\tau, t}^{-\frac{j}{q}} h_{j,n,k}(\tau) \hat{u}(\tau) d\tau, \quad (4.52)$$

where all the boundary conditions are eliminated using (P₂) – (P₃).

Step 4. Recursive algorithm: By applying Lemma 2.5 and (2.19), we get:

$$\begin{aligned} \sum_{i=2}^N a_i \Phi_{\alpha, i-1, \alpha} \{y(\tau)\} &= \sum_{i=2}^N a_i \sum_{j'=1}^{i-1} \Psi_{j', \alpha, \alpha} \left\{ \mathcal{D}_{\tau}^{(i-1-j')\alpha} y(\tau) \right\} \\ &= \sum_{i=2}^N a_i \sum_{j'=1}^{i-1} \sum_{i'=1}^{[\alpha]} c_{j', \alpha, i'} \tau^{-j'\alpha-i'} \times \left[D_{\tau}^{\alpha-i'} \left\{ \mathcal{D}_{\tau}^{(i-1-j')\alpha} y(\tau) \right\} \right]_{\tau=0}. \end{aligned} \quad (4.53)$$

Then, regrouping terms in (4.53) gives:

$$\sum_{i=2}^N a_i \Phi_{\alpha, i-1, \alpha} \{y(\tau)\} = \sum_{i'=1}^{[\alpha]} \sum_{j'=1}^{N-1} c_{j', \alpha, i'} \tau^{-j'\alpha-i'} \times \left(\sum_{i=j'+1}^N a_i \left[D_{\tau}^{\alpha-i'} \left\{ \mathcal{D}_{\tau}^{(i-1-j')\alpha} y(\tau) \right\} \right]_{\tau=0} \right). \quad (4.54)$$

Similarly, we get: for $j = 1, \dots, q-1$,

$$\sum_{i=1}^N a_i \Phi_{\frac{-j}{q}, i, \alpha} \{y(\tau)\} = \sum_{i'=1}^{[\alpha]} \sum_{j'=0}^{N-1} c_{\frac{-j}{q}+j', \alpha, i'} \tau^{\frac{j}{q}-j'\alpha-i'} \times \left(\sum_{i=j'+1}^N a_i \left[D_{\tau}^{\alpha-i'} \left\{ \mathcal{D}_{\tau}^{(i-j'-1)\alpha} y(\tau) \right\} \right]_{\tau=0} \right). \quad (4.55)$$

Thanks to (4.43) and (P₈), using (4.53) and (4.55), (4.51) and (4.52) become: $\forall (n, k) \in \Phi_j$ with $n = 1, \dots, N-1$ and $j \in \{0, \dots, q-1\}$,

$$\begin{aligned} c_{\frac{-j}{q}+n\alpha, k} \sum_{i=n+1}^N a_i \left[D_{\tau}^{\alpha-k} \left\{ \mathcal{D}_{\tau}^{(i-n-1)\alpha} y(\tau) \right\} \right]_{\tau=0} &= \sum_{i=0}^N a_i \int_0^t {}^C D_{\tau, t}^{\alpha-\frac{j}{q}} h_{j, n, k}(\tau) y(\tau) d\tau \\ &\quad - \int_0^t {}^C D_{\tau, t}^{\frac{-j}{q}} h_{j, n, k}(\tau) \hat{u}(\tau) d\tau, \end{aligned} \quad (4.56)$$

and $\forall (0, k) \in \Phi_j$ with $j \in \{1, \dots, q-1\}$,

$$\begin{aligned} c_{\frac{-j}{q}, k} \sum_{i=1}^N a_i \left[D_{\tau}^{\alpha-k} \left\{ \mathcal{D}_{\tau}^{(i-1)\alpha} y(\tau) \right\} \right]_{\tau=0} &= \sum_{i=0}^N a_i \int_0^t {}^C D_{\tau, t}^{\alpha-\frac{j}{q}} h_{j, 0, k}(\tau) y(\tau) d\tau \\ &\quad - \int_0^t {}^C D_{\tau, t}^{\frac{-j}{q}} h_{j, 0, k}(\tau) \hat{u}(\tau) d\tau, \end{aligned} \quad (4.57)$$

where according to (2.20), $c_{\frac{-j}{q}+n\alpha, k} \neq 0$. Hence, using (4.56) and (4.57), (4.44) and (4.45) are obtained. Thus, this proof is completed. \blacksquare

Secondly, algebraic formulae are given in the following theorem to calculate the fractional derivatives of the output y .

Theorem 4.2 [1] For $j \in \{0, \dots, q-1\}$ and $n \in \{0, \dots, \lceil \frac{Np-j}{q} \rceil - 1\}$, there exists $d = Np - j - nq$ with $d \in \{1, \dots, Np\}$. For $t \in I$, let $g_{j, n}$ be a set of $(\lceil \frac{Np-j}{q} \rceil, n)^{th}$ order modulating functions on $[0, t]$ satisfying the following property:

$$(P_9): \forall (j', i') \in \Phi_j, \int_0^t g_{j, n}(\tau) \tau^{\frac{j}{q}-j'\alpha-i'} d\tau = 0.$$

4.3. Main results

Then, the fractional derivative $D_t^{\frac{d-q}{q}} y$ ($1 \leq d \leq Np$) of the output of the system defined by (4.1)–(4.2) satisfying conditions (C₁)–(C₃) can be obtained by a recursive way as follows:

- if $d = 1$, then

$$D_t^{\frac{d-q}{q}} y(t) = H_1 \left(\hat{u}(\tau), y(\tau), \left\{ {}^C D_{\tau,t}^{\frac{i'-j}{q}} g_{j,n}(\tau) \right\}_{i'=0}^{Np} \right), \quad (4.58)$$

- if $2 \leq d \leq Np$, then

$$D_t^{\frac{d-q}{q}} y(t) = H_d \left(\hat{u}(\tau), y(\tau), \left\{ {}^C D_{\tau,t}^{\frac{i'-j}{q}} g_{j,n}(\tau) \right\}_{i'=0}^{Np}, \left\{ D_t^{\frac{i'-q}{q}} y(t) \right\}_{i'=1}^{d-1} \right), \quad (4.59)$$

where the operators H_d for $d = 1, \dots, Np$ are defined by:

$$\begin{aligned} H_1 \left(\hat{u}(\tau), y(\tau), \left\{ {}^C D_{\tau,t}^{\frac{i'-j}{q}} g_{j,n}(\tau) \right\}_{i'=0}^{Np} \right) = \\ (-1)^n \int_0^t {}^C D_{\tau,t}^{\frac{-j}{q}} g_{j,n}(\tau) \hat{u}(\tau) d\tau + (-1)^{n+1} \sum_{i'=0}^{Np} \hat{a}_{i'} \int_0^t {}^C D_{\tau,t}^{\frac{i'-j}{q}} g_{j,n}(\tau) y(\tau) d\tau, \end{aligned} \quad (4.60)$$

and for $d = 2, \dots, Np$,

$$\begin{aligned} H_d \left(\hat{u}(\tau), y(\tau), \left\{ {}^C D_{\tau,t}^{\frac{i'-j}{q}} g_{j,n}(\tau) \right\}_{i'=0}^{Np}, \left\{ D_t^{\frac{i'-q}{q}} y(t) \right\}_{i'=1}^{d-1} \right) = \\ (-1)^n \int_0^t {}^C D_{\tau,t}^{\frac{-j}{q}} g_{j,n}(\tau) \hat{u}(\tau) d\tau + (-1)^{n+1} \sum_{i'=0}^{Np} \hat{a}_{i'} \int_0^t {}^C D_{\tau,t}^{\frac{i'-j}{q}} g_{j,n}(\tau) y(\tau) d\tau \\ - \sum_{i'=1}^{d-1} \hat{a}_{i'+Np-d} D_t^{\frac{i'-q}{q}} y(t). \end{aligned} \quad (4.61)$$

Moreover, $\hat{u} = CA^{N-1}Bu$, and $\hat{a}_{i'}$ are defined as follows:

$$\hat{a}_{i'} = \begin{cases} a_i, & \text{if } \exists i \in \{0, \dots, N\} \text{ such that } i' = ip, \\ 0, & \text{else.} \end{cases} \quad (4.62)$$

Proof. This proof is similar to the one of Theorem 4.1, and requires the following steps based on (4.47) and (4.48). T

Step 1. Multiplication and integration: Multiply both sides of (4.47) and (4.48) by $g_{j,n}$ for $n = 0, \dots, \lceil \frac{Np-j}{q} \rceil - 1$, and integrate from 0 to t . It yields: for $j = 0$,

$$\sum_{i=0}^N a_i \int_0^t g_{j,n}(\tau) D_\tau^{i\alpha} y(\tau) d\tau = \int_0^t g_{j,n}(\tau) \hat{u}(\tau) d\tau + \sum_{i=2}^N a_i \int_0^t g_{j,n}(\tau) \Phi_{\alpha, i-1, \alpha} \{y(\tau)\} d\tau, \quad (4.63)$$

and for $j = 1, \dots, q - 1$,

$$\sum_{i=0}^N a_i \int_0^t g_{j,n}(\tau) D_{\tau}^{i\alpha - \frac{j}{q}} y(\tau) d\tau = \int_0^t g_{j,n}(\tau) D_{\tau}^{\frac{-j}{q}} \hat{u}(\tau) d\tau + \sum_{i=1}^N a_i \int_0^t g_{j,n}(\tau) \phi_{\frac{-j}{q}, i, \alpha} \{y(\tau)\} d\tau. \quad (4.64)$$

Step 2. Elimination of undesired terms: According to (4.53), (4.55), and thanks to (P₉), the orders of the power functions in the integrals containing $\phi_{\alpha, i-1, \alpha} \{y(\tau)\}$ and $\phi_{\frac{-j}{q}, i, \alpha} \{y(\tau)\}$ in (4.63) and (4.64) can be eliminated. Thus, (4.63) and (4.64) become: for $j = 0, \dots, q-1$,

$$\sum_{i=0}^N a_i \int_0^t g_{j,n}(\tau) D_{\tau}^{i\alpha - \frac{j}{q}} y(\tau) d\tau = \int_0^t g_{j,n}(\tau) D_{\tau}^{\frac{-j}{q}} \hat{u}(\tau) d\tau. \quad (4.65)$$

Then, (4.65) can be written into the following form: for $j = 0, \dots, q - 1$,

$$\sum_{i'=0}^{Np} \hat{a}_{i'} \int_0^t g_{j,n}(\tau) D_{\tau}^{\frac{i'-j}{q}} y(\tau) d\tau = \int_0^t g_{j,n}(\tau) D_{\tau}^{\frac{-j}{q}} \hat{u}(\tau) d\tau. \quad (4.66)$$

Step 3. Successive integration by parts: By applying Lemma 2.7 to (4.66), we get:

$$\begin{aligned} \int_0^t {}^C D_{\tau,t}^{\frac{-j}{q}} g_{j,n}(\tau) \hat{u}(\tau) d\tau &= \sum_{i'=0}^{Np} \hat{a}_{i'} \int_0^t {}^C D_{\tau,t}^{\frac{i'-j}{q}} g_{j,n}(\tau) y(\tau) d\tau \\ &+ \sum_{i'=j+1}^{Np} \hat{a}_{i'} \sum_{k=0}^{\lceil \frac{i'-j}{q} \rceil - 1} (-1)^k g_{j,n}^{(k)}(t) D_t^{\frac{i'-j}{q} - 1 - k} y(t), \end{aligned} \quad (4.67)$$

where all the initial conditions are eliminated using (P₂). Moreover, there is no boundary values when $i' \leq j$.

Step 4. Elimination of undesired boundary values: By regrouping the terms in the double sum in (4.67), we get:

$$\sum_{i'=j+1}^{Np} \hat{a}_{i'} \sum_{k=0}^{\lceil \frac{i'-j}{q} \rceil - 1} (-1)^k g_{j,n}^{(k)}(t) D_t^{\frac{i'-j}{q} - 1 - k} y(t) = \sum_{k=0}^{\lceil \frac{Np-j}{q} \rceil - 1} \sum_{i'=j+kq+1}^{Np} \hat{a}_{i'} (-1)^k g_{j,n}^{(k)}(t) D_t^{\frac{i'-j}{q} - 1 - k} y(t). \quad (4.68)$$

Since $g_{j,n}$ satisfies (P₄), using (4.67) and (4.68) gives:

$$\int_0^t {}^C D_{\tau,t}^{\frac{-j}{q}} g_{j,n}(\tau) \hat{u}(\tau) d\tau = \sum_{i'=0}^{Np} \hat{a}_{i'} \int_0^t {}^C D_{\tau,t}^{\frac{i'-j}{q}} g_{j,n}(\tau) y(\tau) d\tau + (-1)^n \sum_{i'=j+nq+1}^{Np} \hat{a}_{i'} D_t^{\frac{i'-j}{q} - 1 - n} y(t). \quad (4.69)$$

Step 5. Recursive algorithm: According to (4.69), the following recursive algorithm is obtained:

4.3. Main results

- If $j + nq + 1 = Np$, i.e. $d = Np - j - nq = 1$,

$$D_t^{\frac{1-q}{q}} y(t) = (-1)^{-n} \int_0^t {}^C D_{\tau,t}^{\frac{-j}{q}} g_{j,n}(\tau) \hat{u}(\tau) d\tau - (-1)^{-n} \sum_{i'=0}^{Np} \hat{a}_{i'} \int_0^t {}^C D_{\tau,t}^{\frac{i'-j}{q}} g_{j,n}(\tau) y(\tau) d\tau. \quad (4.70)$$

- If $1 \leq j + nq + 1 \leq Np - 1$, i.e. $2 \leq d \leq Np$,

$$\begin{aligned} D_t^{\frac{d-q}{q}} y(t) &= (-1)^{-n} \int_0^t {}^C D_{\tau,t}^{\frac{-j}{q}} g_{j,n}(\tau) \hat{u}(\tau) d\tau - (-1)^{-n} \sum_{i'=0}^{Np} \hat{a}_{i'} \int_0^t {}^C D_{\tau,t}^{\frac{i'-j}{q}} g_{j,n}(\tau) y(\tau) d\tau \\ &\quad - \sum_{i'=j+nq+1}^{Np-1} \hat{a}_{i'} D_t^{\frac{i'-j}{q}-1-n} y(t) \\ &= (-1)^n \int_0^t {}^C D_{\tau,t}^{\frac{-j}{q}} g_{j,n}(\tau) \hat{u}(\tau) d\tau + (-1)^{n+1} \sum_{i'=0}^{Np} \hat{a}_{i'} \int_0^t {}^C D_{\tau,t}^{\frac{i'-j}{q}} g_{j,n}(\tau) y(\tau) d\tau \\ &\quad - \sum_{i'=1}^{d-1} \hat{a}_{i'+j+nq} D_t^{\frac{i'-q}{q}} y(t). \end{aligned} \quad (4.71)$$

Thus, this proof is completed. ■

Finally, the following corollary is deduced from Theorem 4.1 and Theorem 4.2.

Corollary 4.1 *Under the same hypotheses given in Theorem 4.1 and Theorem 4.2, the following fractional derivatives of the output y can be obtained by a recursive way: for $j = 1, \dots, q-1$,*

$$D_t^{N\alpha - \frac{j}{q}} y(t) = D_t^{\frac{-j}{q}} \hat{u}(t) - \sum_{i=0}^{N-1} a_i D_t^{i\alpha - \frac{j}{q}} y(t) + \sum_{i=1}^N a_i \Phi_{\frac{-j}{q}, i, \alpha} \{y(t)\}, \quad (4.72)$$

and

$$D_t^{N\alpha} y(t) = \hat{u}(t) - \sum_{i=0}^{N-1} a_i D_t^{i\alpha} y(t) + \sum_{i=2}^N a_i \Phi_{\alpha, i-1, \alpha} \{y(t)\}, \quad (4.73)$$

where $\sum_{i=1}^N a_i \Phi_{\frac{-j}{q}, i, \alpha} \{y(t)\}$ (resp. $\sum_{i=2}^N a_i \Phi_{\alpha, i-1, \alpha} \{y(t)\}$) can be given by (4.55) (resp. (4.54))

and Theorem 4.1, $D_t^{\frac{d-q}{q}} y(t)$, for $d = 1, \dots, Np$, are given by Theorem 4.2.

Proof. This proof can be given using (4.47) and (4.48). ■

In order to apply the initial value estimator proposed in Theorem 4.1, the following algorithm is required:

Function [D] = Estimator ($[a_0, \dots, a_N], p, q, u, y, t$),

$D = \left([D_{\tau}^{\alpha-k} y(\tau)]_{\tau=0}, \dots, [D_{\tau}^{\alpha-k} \{ \mathcal{D}_{\tau}^{(N-1)\alpha} y(\tau) \}]_{\tau=0} \right)^T$. This algorithm contains the following two steps:

Step 1. For each $n \in \{0, \dots, N-1\}$, $k \in \{1, [\alpha]\}$, find $j \in \{0, \dots, q-1\}$ such that $(n, k) \in \Phi_j$. Then, the integrals involving u and y obtained in (4.44) and (4.45) are calculated. In particular, $[D_t^{\alpha-k} y(\tau)]_{\tau=0}$ is obtained for $n = N-1$.

Step 2. For $n = 0, \dots, N-2$, $[D_t^{\alpha-k} \{ \mathcal{D}_t^{(N-n-1)\alpha} y(\tau) \}]_{\tau=0}$ can be given using a recursive way by (4.45).

Similarly, in order to apply the fractional order differentiator proposed in Theorem 4.2 and Corollary 4.1, the following algorithm is required:

Function [D] = Differentiator ($[a_0, \dots, a_N], p, q, u, y, t$),

where $D = \left(D_t^{\frac{1-q}{q}} y(t), \dots, D_t^{\frac{Np}{q}} y(t) \right)^T$. It contains the following three steps:

Step 1. In this step, all the integrals involving u and y obtained in (4.60) and (4.61) are calculated, for $j = 0, \dots, q-1$ and $n = 0, \dots, \lceil \frac{Np-j}{q} \rceil - 1$.

Step 2. In this step, the values of $D_t^{\frac{d-q}{q}} y(t)$ are calculated, for $d = 1, \dots, Np$. Since $d = Np - j - nq$, the key point is to find the corresponding j and n . According to the proof of Theorem 4.2, q equations are constructed in (4.66). For each equation, the orders of the fractional derivatives of y are given in the first row of Table 4.1, for $j \in \{0, \dots, q-1\}$. Moreover, the orders of all the boundary values obtained in (4.67) are given in the other rows of Table 4.1, where $k+1$ represents the times of integration by parts applied to each equation. According to the properties of $g_{j,n}$, only the boundary values at $\tau = t$ in the row where $n = k$ are kept. In this row, the value of the fractional derivative of y , i.e. $D_t^{\frac{d-q}{q}} y(t)$, whose order is given in the last column, is calculated using the values of the fractional derivatives of y whose orders are given in the other columns.

Consequently, this step begins with finding a j such that $\frac{1}{q} - 1 = \frac{Np-j}{q} - \lceil \frac{Np-j}{q} \rceil$. Then, $D_t^{\frac{1-q}{q}} y(t)$ is given by (4.60) with $n = \lceil \frac{Np-j}{q} \rceil - 1$. Hence, $D_t^{\frac{d-q}{q}} y(t)$ for $d = 2, \dots, Np$, can be given using a recursive way by (4.61), where the values of j and n are taken as follows: if $j > 0$, then $j = j - 1$, else $j = q - 1$ and $n = n - 1$.

Step 3. In this step, the values of $D_t^{\frac{Np-j}{q}} y(t)$ are calculated using (4.72), for $j = 0, 1, \dots, q-1$,

where the values of $D_t^{\frac{i'-j}{q}} y(t)$ for $i' = 0, \dots, Np-1$, are previously calculated, $\phi_{\frac{-j}{q}, i, \alpha} \{y(t)\}$ and $\phi_{\alpha, i-1, \alpha} \{y(t)\}$ can be obtained using the previous algorithm and Lemma 2.5.

Inspired by Proposition 3.5, the modulating functions required in Theorem 4.1 and Theorem 4.2 are constructed in the following proposition.

Proposition 4.1 Let $t \in \mathbb{R}_+$, $0 < \alpha < 2$, $j, m, M \in \mathbb{N}$, $q, N \in \mathbb{N}^*$, $L = \lceil N\alpha - \frac{j}{q} \rceil$, where $0 \leq j \leq q-1$, $m > (N-1)\alpha + \lceil \alpha \rceil - \frac{j}{q}$, and g_j be a polynomial with the following form: $\forall \tau \in [0, t]$,

$$g_j(\tau) = \sum_{i=0}^{N'+L-1} c_i t^{M-m-i} \tau^{m+i}, \quad (4.74)$$

4.3. Main results

j^{th} Equation	$\frac{-j}{q} \dots 0$	$\frac{1}{q} \dots 1$	$1 + \frac{1}{q} \dots$	\dots	$\frac{Np-j}{q}$
$k = 0$		$\frac{1}{q} - 1 \dots 0$	$\frac{1}{q} \dots$	\dots	$\frac{Np-j}{q} - 1$
$k = 1$			$\frac{1}{q} - 1 \dots$	\dots	$\frac{Np-j}{q} - 2$
\vdots			\ddots	\ddots	\vdots
$k = \lceil \frac{Np-j}{q} \rceil - 1$				$\frac{1}{q} - 1 \dots$	$\frac{Np-j}{q} - \lceil \frac{Np-j}{q} \rceil$

Table 4.1: Orders of the fractional derivatives of y in (4.66) and (4.67).

where $N' = \text{card}(\Phi_j)$, Φ_j is defined in (5.22), and the coefficient vector $(c_0, \dots, c_{N'+L-1})^T$ is the solution of the following system:

$$B_m \begin{pmatrix} c_0 \\ \vdots \\ c_{N'+L-1} \end{pmatrix} = b_n, \quad (4.75)$$

where $b_n \in \mathbb{R}^{N'+L}$ and $B_m \in \mathbb{R}^{(N'+L) \times (N'+L)}$ is defined as follows: for $i = 0, \dots, N' + L - 1$, for $(j', i') \in \Phi_j$,

$$B_m(k', i) = \begin{cases} \frac{(m+i)!}{(m+i-k')!}, & \text{for } k' = 0, \dots, L-1, \\ \frac{1}{m+i+\frac{j}{q}-j'\alpha-i'+1}, & \text{for } k' = L, \dots, N'+L-1. \end{cases} \quad (4.76)$$

• Let $(n, k) \in \Phi_j$, if $M = n\alpha + k - \frac{j}{q} - 1$ b_n is defined as follows: for $k' = 0, \dots, L-1$, $b_n(k') = 0$, and for $k' = L, \dots, N'+L-1$, for $(j', i') \in \Phi_j$,

$$b_n(k') = \begin{cases} 1, & \text{if } (j', i') = (n, k), \\ 0, & \text{else.} \end{cases} \quad (4.77)$$

Then, g_j is a L^{th} order modulating function on $[0, t]$ satisfying (P₈).

• If $M = n$ with $0 \leq n \leq L-1$, and b_n is defined as follows: for $k' = 0, \dots, N'+L-1$,

$$b_n(k') = \delta_{k'n}, \quad (4.78)$$

then g_j is a $(L, n)^{th}$ order modulating function on $[0, t]$ satisfying (P₉).

Proof. Since g_j is a polynomial, $g_{j,n} \in \mathcal{C}^{L-1}([0, t])$, i.e. (P₁) is fulfilled. On the one hand, by calculating the $(k')^{th}$ order derivative of g_j , for $k' = 0, \dots, L-1$, we obtain: $\forall \tau \in [0, t]$,

$$g_j^{(k')}(\tau) = \sum_{i=0}^{N'+L-1} c_i \frac{(m+i)!}{(m+i-k')!} t^{M-m-i} \tau^{m+i-k'}. \quad (4.79)$$

Since $m > (N - 1)\alpha + [\alpha] - \frac{j}{q} \geq L - 1$, $g_j^{(k')}(0) = 0$, *i.e.* (P₂) is fulfilled. Moreover, we have:

$$g_j^{(k')}(t) = t^{M-k'} \sum_{i=0}^{N'+L-1} c_i \frac{(m+i)!}{(m+i-k')!}. \quad (4.80)$$

On the other hand, the definition domain of m guarantees the convergence of the following improper integral. Hence, we get:

$$\int_0^t g_j(\tau) \tau^{\frac{j}{q}-j'\alpha-i'} d\tau = \sum_{i=0}^{N'+L-1} c_i \frac{t^{M+\frac{j}{q}-j'\alpha-i'+1}}{m+i+\frac{j}{q}-j'\alpha-i'+1}. \quad (4.81)$$

Consequently, using (4.80)–(4.81) and by solving the system (4.75), this proof can be completed. ■

Remark that m is a design parameter in (4.74). It will be shown how to choose this parameter latter.

Remark 4.2 According to (4.76) –(4.78), the coefficient vector c is independent of the time t . Thus, in order to construct the modulating functions, the system given in (4.75) only needs to solve once for every t . This result improves the construction of the modulating functions proposed in [1].

Polynomial type modulating functions are constructed in Proposition 4.1, according to Lemma 2.9 and the definition domain of m , it can be deduce that all the integrals involving u and y in (4.44) and (4.45) (resp. in (4.60) and (4.61)) are proper. In this case, on the one hand, $[D_\tau^{\alpha-k} y(\tau)]_{\tau=0}$ (resp. $D_t^{\frac{1-q}{q}} y(t)$) is given by a proper integral formula in (4.44) (resp. in (4.60)). Then, $[D_\tau^{\alpha-k} \{ \mathcal{D}_\tau^{(N-n-1)\alpha} y(\tau) \}]_{\tau=0}$ (resp. $D_t^{\frac{d-q}{q}} y(t)$) calculated using a recursive way by (4.45) for $n = 0, \dots, N-2$ (resp. by (4.61) for $d = 2, \dots, Np$), are also given by proper integral formulae. On the other hand, $D_t^{\frac{Np-j}{q}} y(t)$ for $j = 0, 1, \dots, q-1$, are given by the Riemann-Liouville integrals of u in (4.72), which can be formally or numerically calculated. Thus, the algebraic integral formulae for the initial values of the fractional sequential derivatives of the output (resp. for the fractional derivatives of the output) can be written as follows:

$$D = \int_0^t Q(\tau) y(\tau) d\tau + \int_0^t P_m u(\tau) d\tau, \quad (4.82)$$

where D refers to $[D_\tau^{\alpha-k} \{ \mathcal{D}_\tau^{(N-n-1)\alpha} y(\tau) \}]_{\tau=0}$ with $n \in \{0, \dots, N-1\}$ and $k \in \{1, [\alpha]\}$ (resp. to $D_t^{\frac{j}{q}} y(t)$ with $j \in \{1-q, \dots, Np\}$), Q and P_m denote the corresponding functions in the integrals involving y and u , respectively. Consequently, according to Lemma 2.5, the fractional sequential derivatives of the output y can be calculated by algebraic integral formulae. Then, the pseudo-state can also be obtained using Lemma 4.3. Remark

that these formulae do not contain any source of errors in continuous noise-free case, and can provide non-asymptotic estimations in finite-time without knowing the initial conditions of the considered system. Moreover, the proper integrals of y can be considered as a low-pass filter in noisy cases [71]. In the next subsection, a pseudo-state estimator is introduced in discrete noisy cases.

4.3.2 Non-asymptotic pseudo-state estimator in discrete noisy case

From now on, let y^ω be a discrete noisy observation of y on $I = [0, h]$:

$$y^\omega(t_i) = y(t_i) + \omega(t_i), \quad (4.83)$$

where $t_i = iT_s$, for $i = 0, 1, \dots, M$, with an equidistant sampling period $T_s = \frac{h}{M}$. Moreover, the noise $\{\omega(t), t \in I\}$ is assumed to be a continuous stochastic process satisfying the following conditions:

(C₄) : for any $s, t \in I$, $s \neq t$, $\omega(s)$ and $\omega(t)$ are independent,

(C₅) : the mean value function of $\{\omega(t), t \in I\}$ denoted by $\mathbb{E}[\cdot]$ is equal to zero,

(C₆) : the variance function of $\{\omega(t), t \in I\}$ denoted by $\text{Var}[\cdot]$ is bounded on I ,
i.e. $\exists \delta \in \mathbb{R}_+, \forall t \in I, \text{Var}[\omega(t)] \leq \delta$.

Note that a zero-mean white Gaussian noise satisfies these conditions.

In order to estimate the fractional sequential derivatives of y using y^ω , the integral formulae given in Theorem 4.1 and Theorem 4.2 need to be performed in the discrete case. For this purpose, a numerical integration method is applied to approximate the integrals. Denote the integral involving y in (4.82) as follows:

$$I_Q^y(t) := \int_0^t Q(\tau) y(\tau) d\tau. \quad (4.84)$$

Hence, I_Q^y can be approximated in the discrete case by:

$$I_Q^{y,t_i} := T_s \sum_{j=0}^i w_j Q(t_j) y(t_j), \quad (4.85)$$

where $0 \leq w_j \in \mathbb{R}$ are the weights for a given numerical integration method. Then, using the discrete noisy observation y^ω , we get:

$$I_Q^{y^\omega,t_i} = I_Q^{y,t_i} + e_Q^{\omega,t_i}, \quad (4.86)$$

where $e_Q^{\omega,t_i} := T_s \sum_{j=0}^i w_j Q(t_j) \omega(t_j)$. Thus, the integral I_Q^y is subject to two sources of errors:

- the numerical error due to the numerical integration method;
- the noise error contribution e_Q^{ω, t_i} .

Similarly, it can be deduced that the integrals involving u in Theorem 4.1 and Theorem 4.2 only contain numerical errors in the discrete case. Consequently, a pseudo-state estimator is proposed, which contains numerical errors and noise error contributions in the discrete noisy case. It is well known that the numerical errors due to a numerical integration method converge to 0 when $T_s \rightarrow 0$ [168]. In the following proposition, it is shown that the convergence in mean square of the noise error contributions when $T_s \rightarrow 0$.

Proposition 4.2 [1] *Let $\{\omega(t_i)\}$ be a sequence of $\{\omega(t), t \in \mathbb{I}\}$ with an equidistant sampling period T_s , where $\{\omega(t), t \in \mathbb{I}\}$ is a continuous stochastic process satisfying conditions (C₄) – (C₆). Assume that $Q \in \mathcal{L}^2([0, t])$, then we have:*

$$\mathbb{E} \left[\left(e_Q^{\omega, t_i} \right)^2 \right] \xrightarrow{T_s \rightarrow 0} 0, \quad (4.87)$$

where e_Q^{ω, t_i} is given by (4.86).

The proof of the previous proposition can be obtained using a similar way to Proposition 4 in [62]. In fact, using (C₄), (C₅) and (C₆) we obtain: $\mathbb{E}[e_Q^{\omega, i}] = 0$ and

$$\mathbb{E} \left[\left(e_Q^{\omega, i} \right)^2 \right] = \text{Var} \left[e_Q^{\omega, i} \right] \leq T_s \delta \left(T_s \sum_{j=0}^i w_j^2 Q^2(t_j) \right). \quad (4.88)$$

Hence, if $Q \in \mathcal{L}^2([a, t])$, the convergence in (4.87) can be obtained. A similar result has been shown using non-standard analysis in [71, 72]. Consequently, both the numerical errors due to a numerical integration method and the noise error contributions in the proposed pseudo-state estimator can be reduced by decreasing the sampling period T_s . However, if the computations are performed on a finite precision numerical machine, there are also round-off errors [169]. Hence, the infinite reduction of T_s would not lead to arbitrary reduction of estimation errors, since the round-off errors would become too large at some points.

When the sampling period is set, on the one hand the numerical errors can be bounded by the well-known error bounds for numerical integration methods [168], on the other hand the noise error contribution e_Q^{ω, t_i} satisfying $\mathbb{E}[e_Q^{\omega, t_i}] = 0$ can be bounded using the Bienaymé-Chebyshev inequality:

$$\forall \gamma \in \mathbb{R}_+, \Pr \left(\left| e_Q^{\omega, t_i} \right| < \gamma \left(\text{Var}[e_Q^{\omega, t_i}] \right)^{\frac{1}{2}} \right) > 1 - \frac{1}{\gamma^2}, \quad (4.89)$$

i.e. the probability for $|e_Q^{\omega, t_i}|$ to be smaller than $\gamma \left(\text{Var}[e_Q^{\omega, t_i}] \right)^{\frac{1}{2}}$ is larger than $1 - \frac{1}{\gamma^2}$. Thus, the following error bound is deduced from (4.88) and (4.89):

$$|e_Q^{\omega, t_i}|^{p_\gamma} < \gamma T_s \left(\delta \sum_{j=0}^i w_j^2 Q^2(t_j) \right)^{\frac{1}{2}}, \quad (4.90)$$

where $a <^{p_\gamma} b$ means that the probability for a real number b to be larger than another real number a is equal to p_γ with $p_\gamma > 1 - \frac{1}{\gamma^2}$. Remark that the value of p_γ can be given by the probability density function of the considered noise ω . In particular, if ω is a white Gaussian noise, according to the three-sigma rule, we have:

$$|e_Q^{\omega, t_i}|^{p_\gamma} \leq \gamma T_s \left(\delta \sum_{j=0}^i w_j^2 Q^2(t_j) \right)^{\frac{1}{2}}, \quad (4.91)$$

where $p_1 = 68.26\%$, $p_2 = 95.44\%$ and $p_3 = 99.73\%$, for $\gamma = 1, 2, 3$, respectively.

Thanks to the probability properties of the mean value and the variance functions, and the Bienaymé-Chebyshev inequality, the noise error bound obtained in (4.90) is sharp, especially in white Gaussian noise cases. Since it depends on the design parameter m , the study of the influence of m on this error bound is useful to deduce the influence of m on the noise error contribution. Consequently, at each t_i the noise error contribution can be reduced by choosing the value of m which minimizes the noise error bound at t_i .

Remark 4.3 *If the parameters N , α and a_i for $i = 0, \dots, N$ are known in a studied system, the selection of the design parameter m can be done offline by fixing the desired initial value (resp. the desired fractional derivative), T_s and the used numerical integration method, without the knowledge on u , y and the noise level δ . Indeed, the idea of setting m is to choose the value of m which minimizes the noise error bound obtained in (4.90). Since this bound is linear with respect to $\gamma \delta^{\frac{1}{2}} T_s$, the optimal value of m is independent of $\gamma \delta^{\frac{1}{2}} T_s$ and only depends on the weights w_j and the values of $Q_m(t_j)$. Hence, if the desired initial value (resp. the desired fractional derivative) is fixed, Q_m can be calculated in an offline work, so is the error bound.*

In order to reduce the noise error contributions, the error bound obtained in (4.90) will be applied to choose the design parameter m for the modulating functions constructed in Proposition 4.1.

4.4 Simulation results

In this section, the accuracy and the robustness with respect to corrupting noises of the proposed non-asymptotic pseudo-state estimator will be shown by comparing with fractional order observers. For this purpose, the pseudo-state of the system defined by (4.1)–(4.2) satisfying conditions (C₁) – (C₃) will be estimated using the noisy output defined in (4.83). Thus, the following model is considered:

$$D_t^\alpha x = Ax + Bu, \quad (4.92)$$

$$y^\omega = Cx + D_\omega \omega, \quad (4.93)$$

where $D_\omega = 1$. Based on (4.92)-(4.93), two kinds of fractional order observers are designed in the two following subsections.

4.4.1 Fractional order Luenberger-like observer

The well-known Luenberger observer is widely applied for integer order systems [165]. This observer can be extended for fractional order systems as follows [11]:

$$D_t^\alpha \hat{x} = A\hat{x} + Bu + \eta, \quad (4.94)$$

$$\hat{y} = C\hat{x}, \quad (4.95)$$

$$\eta = L(y^\omega - \hat{y}), \quad (4.96)$$

where \hat{x} is the pseudo-state estimation, and L is the observer gain. In order to get a good compromise between the convergence speed and the sensitivity to noises, L is set using a classical eigenvalues placement technique in this chapter.

4.4.2 Fractional order \mathcal{H}_∞ -like observer

\mathcal{H}_∞ observer is another useful integer order observer, where the observer gain is obtained using the \mathcal{H}_∞ -optimization technique. In this subsection, the \mathcal{H}_∞ observer proposed in [170] for lipschitz integer order nonlinear systems is adapted to design a new \mathcal{H}_∞ -like observer for fractional order linear systems.

Firstly, the following fractional order dynamical observer is proposed:

$$D_t^\alpha \hat{x} = A\hat{x} + Bu + \eta, \quad (4.97)$$

$$\hat{y} = C\hat{x}, \quad (4.98)$$

$$D_t^\alpha \varepsilon = A_F \varepsilon + B_F v, \quad (4.99)$$

$$\eta = C_F \varepsilon + D_F v, \quad (4.100)$$

where ε is an auxiliary pseudo-state, η is obtained by the dynamical system (4.99)-(4.100) with $v = y^\omega - \hat{y}$. It can be seen that if $A_F = B_F = C_F = 0$ and $D_F = L$, (4.94)-(4.96)

is deduced from (4.97)-(4.100). In this case, a fractional order \mathcal{H}_∞ -like observer is designed in [171].

Secondly, the matrix $F = \begin{pmatrix} A_F & B_F \\ C_F & D_F \end{pmatrix}$ needs to be determined. By subtracting (4.97)-(4.98) from (4.92)-(4.93) and using (4.99)-(4.100), the following system is obtained:

$$\begin{pmatrix} D_t^\alpha e \\ D_t^\alpha \varepsilon \end{pmatrix} = A_L \begin{pmatrix} e \\ \varepsilon \end{pmatrix} + B_L \omega, \quad (4.101)$$

$$e = C_L \begin{pmatrix} e \\ \varepsilon \end{pmatrix} + D_L \omega, \quad (4.102)$$

where $e = x - \hat{x}$, $A_L = \begin{pmatrix} A - D_F C & -C_F \\ B_F C & A_F \end{pmatrix}$, $B_L = \begin{pmatrix} -D_F D_\omega \\ B_F D_\omega \end{pmatrix}$, $C_L = (I \ 0)$ and $D_L = 0$.

Then, the matrix F is calculated such that:

- the matrix A_L is stable,
- the error e is robust against the noise ω , *i.e.* the \mathcal{L}_2 -gain of the system (4.101)-(4.102) is bounded:

$$\|G_{e\omega}\|_\infty := \sup_{\omega \in \mathbb{R}} \sigma(G_{e\omega}(j\omega)) \leq \bar{\gamma}, \quad (4.103)$$

where $G_{e\omega}$ is the transfer function of the system (4.101)-(4.102), $\sigma(\cdot)$ denotes the maximum singular value of the matrix $G_{e\omega}$, and $\bar{\gamma} \in \mathbb{R}_+$.

It is shown in [172] that the two previous conditions are fulfilled if there exists a symmetric positive definite matrix X_L such that the following Linear Matrix Inequality (LMI) holds:

$$\begin{pmatrix} \beta A_L^* X_L + \beta^* X_L A_L & X_L B_L & \beta C_L^* \\ B_L^* X_L & -\bar{\gamma}^2 I & D_L^* \\ \beta^* C_L & D_L & -I \end{pmatrix} < 0, \quad (4.104)$$

where $\beta = e^{(\alpha-1)j\frac{\pi}{2}}$, $\beta^* = e^{(1-\alpha)j\frac{\pi}{2}}$, and J^* denotes the complex conjugate of a complex matrix J . Hence, if X_L is known, F can be obtained by solving (4.104) using LMI tools [173, 174]. However, X_L is unknown and (4.104) is not jointly affine in X_L and F. In order to overcome this problem, a solution is proposed as done in [175].

By denoting $\bar{A} = \begin{pmatrix} A & 0 \\ 0 & 0 \end{pmatrix}$, $\bar{B} = \begin{pmatrix} 0 & -I \\ I & 0 \end{pmatrix}$, $\bar{C} = \begin{pmatrix} 0 & I \\ C & 0 \end{pmatrix}$, $\bar{D} = \begin{pmatrix} 0 \\ D_{\omega} \end{pmatrix}$, $\bar{C} = (I \ 0)$, we obtain: $A_L = \bar{A} + \bar{B}\bar{F}\bar{C}$, $B_L = \bar{B}\bar{F}\bar{D}$, $C_L = \bar{C}$ and $D_L = 0$. Thus, (4.104) is transformed into the following LMI:

$$H_{X_L} + Q^* F^* P_{X_L} + P_{X_L}^* F Q < 0, \quad (4.105)$$

where $Q = (\beta^* \bar{C}, \bar{D}, 0)$, $P_{X_L} = (\bar{B}^* X_L, 0, 0)$, and

$$H_{X_L} = \begin{pmatrix} \beta \bar{A}^* X_L + \beta^* X_L \bar{A} & 0 & \beta \bar{C}^* \\ 0 & -\bar{\gamma}^2 I & 0 \\ \beta^* \bar{C} & 0 & -I \end{pmatrix}. \quad (4.106)$$

Finally, using the algorithm proposed in [175], F can be obtained by solving (4.105).

4.4.3 Example: Fractional electrical circuit model

Some numerical results are presented in this subsection by considering a fractional electrical circuit model introduced in [176]. Other kinds of fractional circuit elements have been used to model biological tissues in [109].

Let us consider the electrical circuit presented in Figure 4.1(a), where G_k for $k = 0, \dots, N$, are conductances, C_j for $j = 1, \dots, N$, are capacitances, and u is a source. Then, this electrical circuit can be modeled by the following fractional order pseudo-state space representation (see [176] for more details):

$$D_t^\alpha x = Ax + Bu, \quad (4.107)$$

where

$$A = \begin{pmatrix} -\frac{G_1 G - G_1^2}{C_1 G} & \frac{G_1 G_2}{C_1 G} & \dots & \frac{G_1 G_N}{C_1 G} \\ \frac{G_2 G_1}{C_2 G} & -\frac{G_2 G - G_2^2}{C_2 G} & \dots & \frac{G_2 G_N}{C_2 G} \\ \vdots & \vdots & \ddots & \vdots \\ \frac{G_N G_1}{C_N G} & \frac{G_N G_2}{C_N G} & \dots & -\frac{G_N G - G_N^2}{C_N G} \end{pmatrix} \quad (4.108)$$

and $B = \left(\frac{G_0 G_1}{C_1 G}, \frac{G_0 G_2}{C_2 G}, \dots, \frac{G_0 G_N}{C_N G} \right)^T$ with $G = \sum_{k=0}^N G_k$.

In this example, the following system is considered:

$$D_t^\alpha x = Ax + Bu, \quad (4.109)$$

$$y = Cx, \quad (4.110)$$

where $\alpha = \frac{1}{2}$, $N = 3$, $C = (-1, 0, 1)$, $B = (0, 1, 0)^T$, and

$$A = \begin{pmatrix} 11 & 1 & -11 \\ 6 & 0 & -6 \\ 18 & 1 & -17 \end{pmatrix}. \quad (4.111)$$

It can be verified that this system satisfies conditions $(C_1) - (C_3)$.

It is mentioned in Remark 2.3 that due to the hereditary property of the fractional derivative operator, the real-state of a fractional order system depends on not only the pseudo-state but also an initialization function which is also called a history function [57, 97]. Without considering the history function, the uniqueness of the state cannot be guaranteed. Consequently, the initialization problem is an important concept for fractional order systems [101, 177]. There also exists an approach based on the infinite dimensional representation, which is equivalent to the one based on the history function [178]. In this example, using a similar way as done in [80, 179, 180], the initialization of the considered fractional order system is realized as follows:

- The system is at rest on $] -\infty, -2[$.
- A constant input $u(t) = 0.5$ is applied on $[-2, 0]$. Then, a history function of x is generated by solving (4.109) using the Grünwald-Letnikov scheme given in (2.38)-(2.39), where we get: $x(0) = (0.2362, 0.5324, 0.2719)^T$.
- $u(t) = \sin(5t)$ is applied on $]0, 5]$. Then, the output is obtained by solving (4.109)-(4.110) using the Grünwald-Letnikov scheme.

Assume that $y^\omega(t_i) = y(t_i) + \sigma\omega(t_i)$ is the noisy observation of the output y on $I = [0, 5]$, where $t_i = iT_s$ with $T_s = 0.0005$, the noise $\{\omega(t_i)\}$ is simulated from a zero-mean white Gaussian *iid* sequence, and the value of σ is adjusted such that SNR = 20 dB. The output and the associated noisy output are shown in Figure 4.1(b), where the output is obtained by solving (4.1)-(4.2) using the Grünwald-Letnikov scheme.

We are going to estimate the pseudo-state x using the discrete noisy output. For this purpose, the non-asymptotic pseudo-state estimator proposed in Section 4.3.1 is applied, where the used modulating functions are constructed in Proposition 4.1, and the trapezoidal numerical integration method is considered.

According to Lemma 4.3, $\mathcal{D}_t^{\frac{k}{2}} y$ for $k = 0, 1, 2$, need to be estimated. Hence, according to Lemma 2.5 and Corollary 4.1, $D_t^{\frac{k}{2}} y$ and $\left[D_t^{-\frac{1}{2}} \left\{ \mathcal{D}_t^{\frac{k}{2}} y(t) \right\} \right]_{t=0}$, for $k = 0, 1, 2$, also need to be estimated using Theorem 4.1 and Theorem 4.2. Firstly, the choice of the design parameter m is studied using the noise error bound obtained in (4.91) with $\gamma = 3$. According to Proposition 4.1, $m \geq 2$. Then, by taking different values of m , the variation

of the noise error bound for $D_t^{\frac{1}{2}}y$ is shown in Figure 4.2(a). Hence, the influence of m on the noise error contribution can be deduced. Thus, in order to reduce the noise error contribution, the following values of m are chosen: $m = 2$ for $t_i \in [T_s, 0.4]$, and $m = 14$ for $t_i \in [0.4 + T_s, 5]$. Secondly, the estimated $D_t^{\frac{1}{2}}y$ is shown in Figure 4.3(a). Since the analytical Riemann-Liouville fractional derivatives of the output are unknown, the estimation obtained by the Grünwald-Letnikov scheme in the noise-free case is also given to verify the estimation obtained by the proposed method. The associated absolute noise error for $D_t^{\frac{1}{2}}y$ is shown in Figure 4.2(b), where the corresponding noise error bound is also given. Using a similar way, y , \dot{y} and $\left[D_t^{-\frac{1}{2}} \left\{ \mathcal{D}_t^{\frac{k}{2}} y(t) \right\} \right]_{t=0}$, for $k = 0, 1, 2$, can also be estimated. The estimations of the latter are shown in Figure 4.3(b), which are obtained by taking $m = 2$. According to the error analysis given in Subsection 4.3.2, these estimations can be improved by reducing the sampling period. Moreover, since $\phi_{-\frac{1}{2}, k, \frac{1}{2}} \{y(t)\}$ is decreasing with respect to t , the role of $\left[D_t^{-\frac{1}{2}} \left\{ \mathcal{D}_t^{\frac{k}{2}} y(t) \right\} \right]_{t=0}$ becomes less important when t becomes larger.

Finally, the obtained estimations of x_1 are shown in Figure 4.4, where the non-asymptotic property and the robustness of the proposed estimator can be distinguished by comparing with the fractional order Luenberger-like observer and the fractional order \mathcal{H}_∞ -like observer designed in Subsection 4.4.2. The initial value $\hat{x}_0 = (1, 2, 3)^T$ is used for these observers. Then, two different gains are chosen for the fractional order Luenberger-like observer. The first gain is chosen by taking the eigenvalues to be 1.5 times greater than the ones of the system in order to guaranty the robustness against the noise. The obtained estimation is shown in Figure 4.4(a). The second gain is chosen by taking the eigenvalues to be 4 times greater than the ones of the system in order to improve the convergence speed, which produces larger noise error contribution. The absolute error between the obtained estimation and the one calculated by the Grünwald-Letnikov scheme in noise-free case is shown in Figure 4.4(b), as well as the ones obtained by the fractional order \mathcal{H}_∞ -like observer and the proposed pseudo-state estimator.

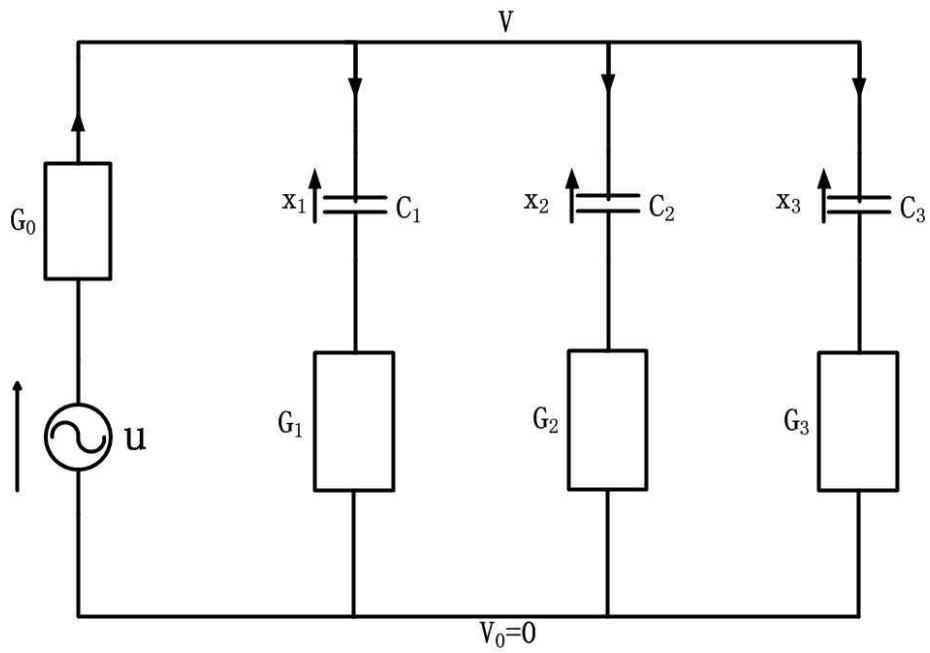

(a) Fractional electrical circuit model.

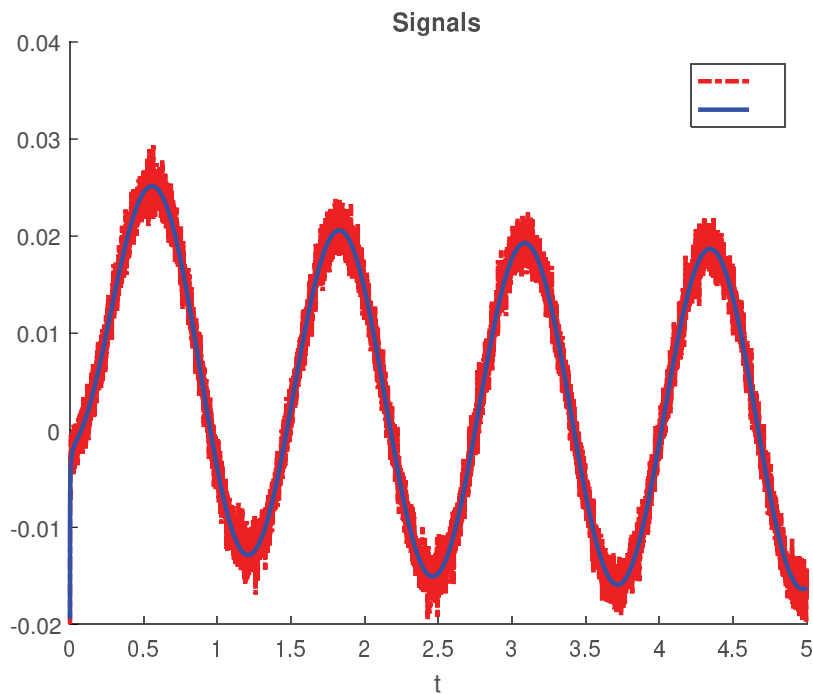

(b) Output y and its discrete noisy observation.

Figure 4.1: Example: Output of the linear system defined in (4.109)-(4.110), and its discrete noisy observation corrupted by a zero-mean white Gaussian noise with SNR = 20 dB.

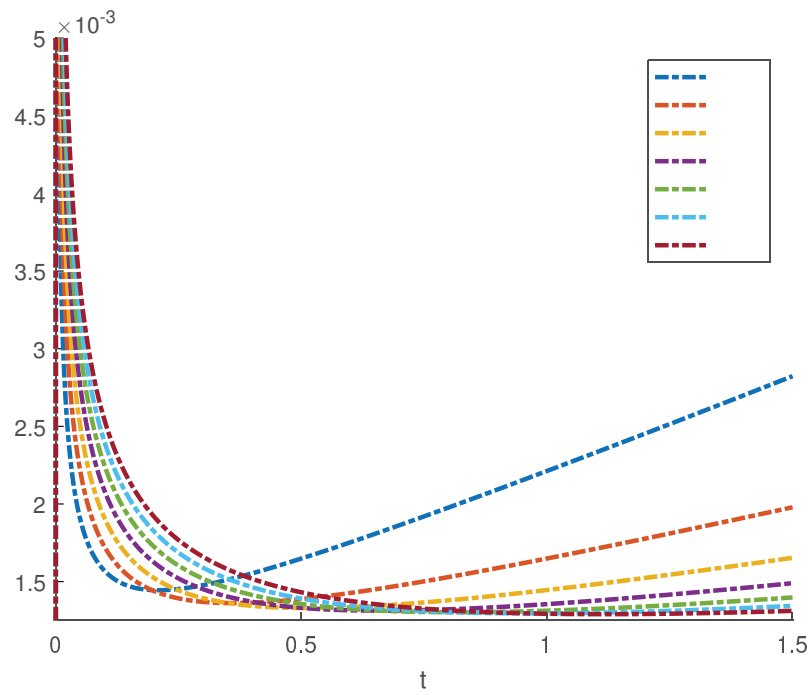

(a) Variation of the noise error bound.

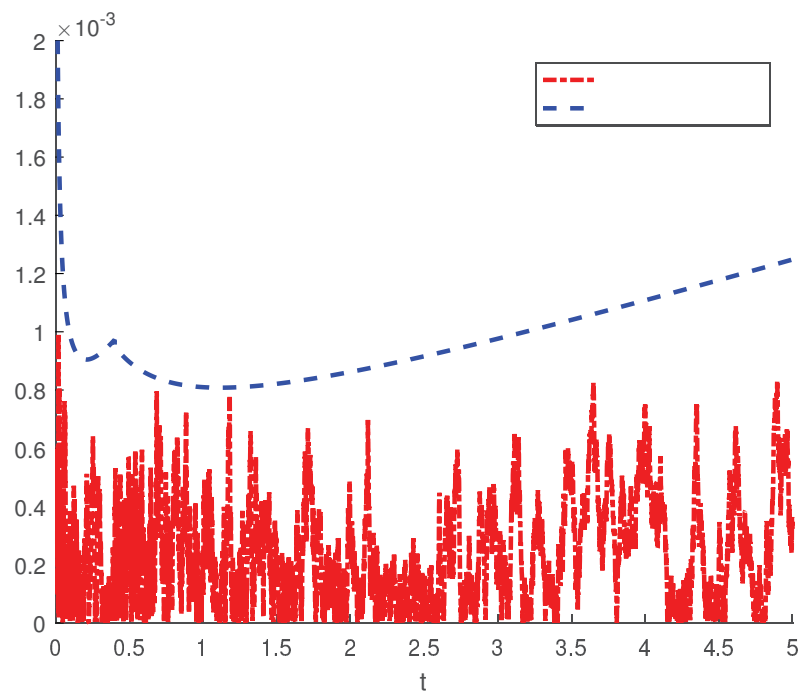

(b) Noise error and the corresponding noise error bound.

Figure 4.2: Noise error and noise error bound for the estimation of $D_t^{\frac{1}{2}}y$.

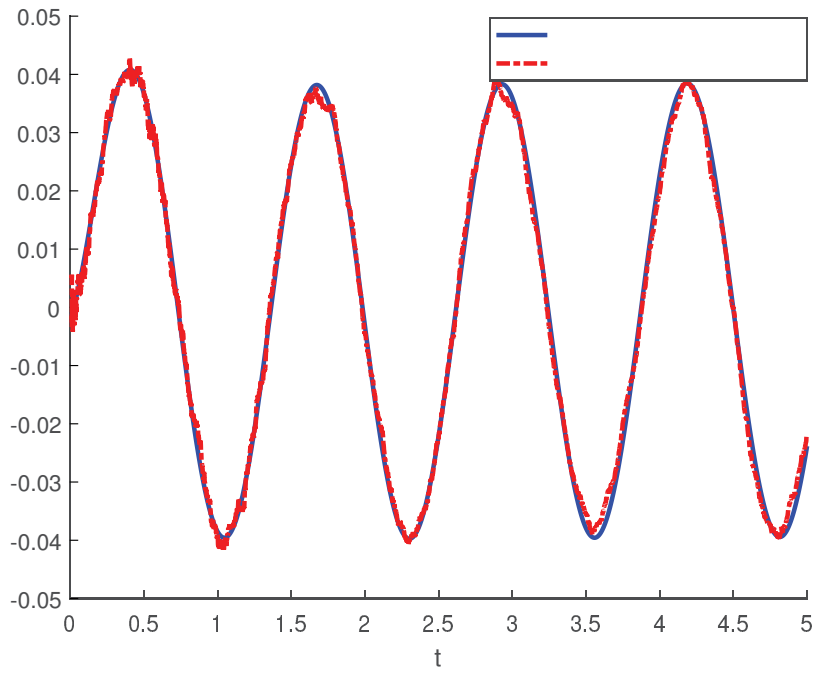

(a) Estimations of $D_t^{\frac{1}{2}} y$.

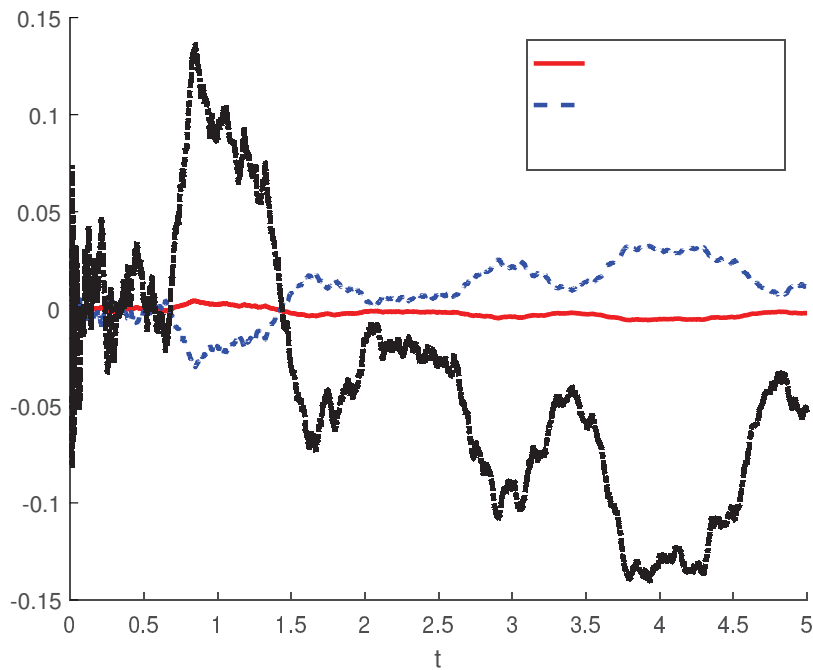

(b) Estimations of the initial values of the fractional sequential derivatives.

Figure 4.3: Estimation of $D_t^{\frac{1}{2}} y$ obtained by the proposed method (resp. the Grünwald-Letnikov scheme) in the discrete noisy case (resp. noise-free case), and estimations of $\left[D_t^{-\frac{1}{2}} \left\{ \mathcal{D}_t^{\frac{k}{2}} y(t) \right\} \right]_{t=0}$, for $k=0,1,2$.

(a) Estimations of x_1 .(b) Absolute estimation errors of x_1 .

Figure 4.4: Estimations of x_1 obtained by the proposed estimator and the fractional order Luenberger-like observer and \mathcal{H}_∞ -like observer in the discrete noisy case, and the ones obtained by the Grünwald-Letnikov scheme in the discrete noise-free case.

4.5 Conclusions

In this chapter, a non-asymptotic pseudo-state estimator was constructed for a class of commensurate fractional order linear systems which can be transformed into the Brunovsky's observable canonical form of pseudo-state space representation with unknown initial conditions. Firstly, this form was expressed by a set of fractional order linear differential equations involving the initial values of the fractional sequential derivatives of the output, based on which the modulating functions method was applied. Then, algebraic integral formulae were exactly obtained for the former initial values and the commensurate fractional order derivatives of the output by a recursive way, where the required modulating functions were constructed. These formulae were used to calculate the pseudo-state of the system, which can provide estimations in finite-time. Secondly, the pseudo-state estimator was studied in discrete noisy case, which contains the numerical error due to a used numerical integration method, and the noise error contribution due to a class of stochastic processes. The convergence in mean square of the noise error contribution was shown when the sampling period tends to zero. Moreover, a noise error bound was provided, which can help us to choose the design parameter in order to reduce the noise error contribution. Finally, numerical examples were given to show the efficiency of the proposed pseudo-state estimator, where some comparisons with the fractional order Luenberger-like observer and a new fractional order \mathcal{H}_∞ -like observer were studied.

Chapter 5

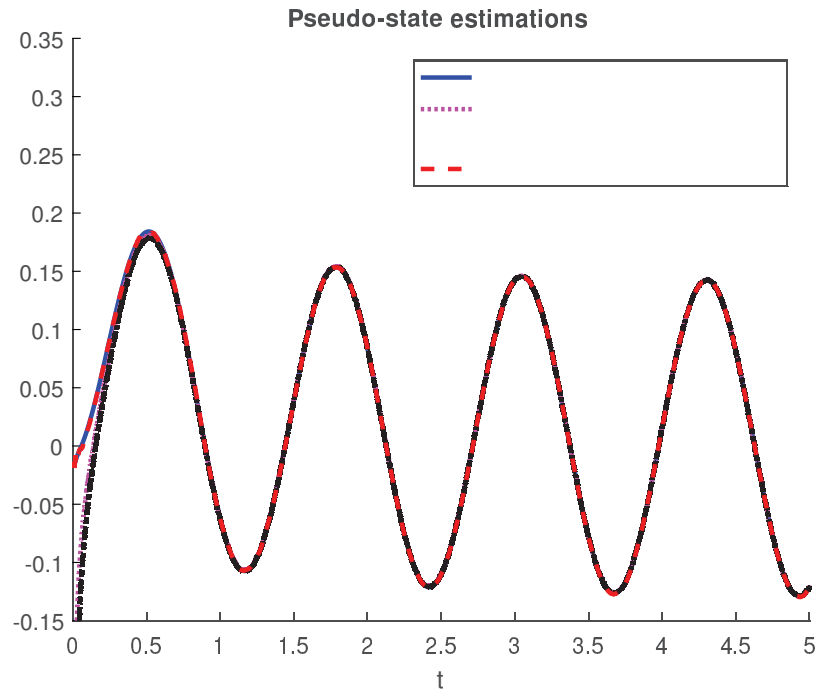
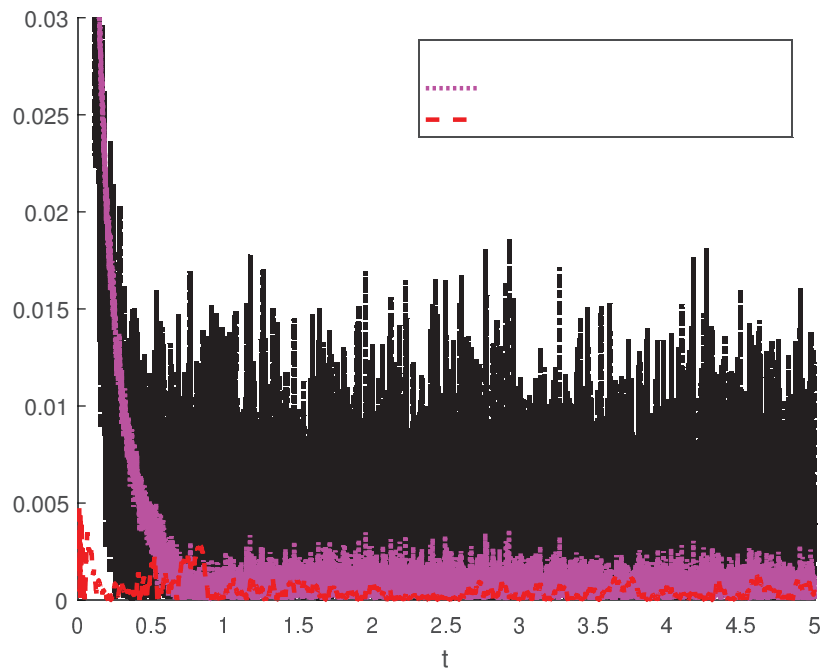
Non-asymptotic fractional order differentiator

Résumé en français

Dans ce chapitre, nous introduisons un nouveau différentiateur algébrique et robuste. Il permet d'estimer la dérivée fractionnaire d'ordre quelconque de la sortie à la fois pour les systèmes modélisés par la pseudo représentation d'état et ceux modélisés par une équation différentielle d'ordre fractionnaire avec des conditions initiales inconnues. Comme dans toute cette thèse, c'est un estimateur non-asymptotique qui donne des estimations en temps fini. Puis, il est introduit dans le cas discret et bruité. Enfin, nous donnons des résultats numériques afin de montrer la précision et la robustesse du différentiateur d'ordre fractionnaire proposé.

5.1 Introduction

Fractional order systems and controllers have been applied to improve performance and robustness properties in control design [8, 54, 55, 56], where the fractional derivatives of the output usually need to be estimated from its discrete noisy observation. An interesting research topic concerns with designing robust fractional order differentiators with convergence in finite-time. It is shown in Chapter 3 how to apply the modulating functions method to estimate the fractional derivative of the output with an arbitrary order for a class of integer order linear systems. In Chapter 4, this method is developed to estimate the commensurate order fractional derivatives of the output for a class of fractional order linear systems modeled by the pseudo-state space representation. In particular, the obtained differentiators can also be applied for the systems modeled by a fractional order linear differential equation. Recently, the algebraic parametric estimation method has been applied for the former systems to estimate the fractional derivative of the output with an arbitrary order [63]. However, the obtained

differentiator is not applicable to the systems modeled by the pseudo-state space representation.

Having these ideas in mind, the objective of this chapter is to introduce a new algebraic fractional order differentiator which has the following advantages similar to the ones designed in Chapter 3, Chapter 4 and [63]:

- it is accurate, robust against corrupting noises, non-asymptotic with estimations in finite-time, and without knowing the initial conditions.

Moreover, it also has the following advantages:

- it can be applied to estimate the fractional derivative of the output with an arbitrary order both for the systems modeled by the pseudo-state space representation and the ones modeled by a fractional order linear differential equation.

For this purpose, inspired both by the algebraic parametric estimation method and the modulating functions method, a new operator based algebraic method is introduced. The operator can transform the considered system into a fractional order integral equation by eliminating all the unknown initial conditions. Then, based on the obtained equation, the desired fractional derivative can be given using a recursive way.

5.2 Algebraic fractional order differentiator

The main results of this chapter will be given in this section in continuous noise-free case and discrete noisy cases, respectively.

5.2.1 Problem formulation

As done in Chapter 4, the following fractional order linear system is considered:

$$D_t^\alpha x = Ax + Bu, \quad (5.1)$$

$$y = Cx, \quad (5.2)$$

on $I \subset \mathbb{R}_+ \cup \{0\}$, where $0 < \alpha < 2$, $A \in \mathbb{R}^{N \times N}$, $B \in \mathbb{R}^{N \times 1}$, $C \in \mathbb{R}^{1 \times N}$, $D_t^\alpha x = (D_t^\alpha x_1, \dots, D_t^\alpha x_N)^T$ with $\alpha = \frac{p}{q}$, $p, q, N \in \mathbb{N}^*$, $x \in \mathbb{R}^N$ is the pseudo-state column vector with unknown initial values, $y \in \mathbb{R}$ and $u \in \mathbb{R}$ are the output and the input, respectively. Without loss of generality, p is assumed to be equal to 1 in the sequel. Moreover, the following conditions are assumed to be fulfilled:

$$(C_1): CB = CAB = \dots = CA^{N-2}B = 0,$$

$$(C_2): CA^{N-1}B \neq 0.$$

The objective of this chapter is to non-asymptotically estimate the fractional derivative of the output y with an arbitrary order. As mentioned in Remark 2.1, the Riemann-Liouville fractional derivatives of y are defined by taking the integer order derivatives of fractional improper integrals. Unlike Definition 2.8, a new algebraic formula involving proper integrals of y will be proposed in continuous noise-free case in the next subsection. This new formula can cope with the noisy observation of y in discrete noisy cases.

5.2.2 Algebraic formulas in continuous noise-free case

Before giving the main results of this chapter, the following example is devoted to explaining the originality of the proposed idea.

Example 5.1 *Let us consider the following fractional order linear system:*

$$\forall t \geq 0, D_t^{\frac{1}{2}} y(t) + y(t) = u(t), \quad (5.3)$$

$$y(0) = 0. \quad (5.4)$$

We will express $D_t^{-\frac{1}{2}} y$, y , $D_t^{\frac{1}{2}} y$ and \dot{y} by means of proper integrals of y (which are robust against corrupting noises) and a part involving u , the fractional integrals and derivatives of u . For this purpose, the following steps are required.

5.2. Algebraic fractional order differentiator

Step 1: Fractional integration. According to Remark 2.1, $D_t^{-\frac{1}{2}} y$ is defined by an improper integral. Hence, it needs to be calculated. For this, it is enough to apply D_t^{-1} to (5.3) and use the additive law given in (2.18) with the zero initial condition given in (5.4). Thus, we obtain:

$$D_t^{-\frac{1}{2}} y(t) = -D_t^{-1} y(t) + D_t^{-1} u(t). \quad (5.5)$$

Then, successive fractional differentiations will be applied to (5.5).

Step 2: Fractional differentiation. By applying $D_t^{\frac{1}{2}}$ to (5.5) and using the additive law given in (2.17), we get:

$$y(t) = -D_t^{-\frac{1}{2}} y(t) + D_t^{-\frac{1}{2}} u(t). \quad (5.6)$$

Step 3: Recursive way. Using (5.6) and the express of $D_t^{-\frac{1}{2}} y$ obtained in (5.5), we obtain:

$$y(t) = D_t^{-1} y(t) - D_t^{-1} u(t) + D_t^{-\frac{1}{2}} u(t). \quad (5.7)$$

Similarly, by applying D_t^1 and $D_t^{\frac{3}{2}}$ to (5.5) respectively, we can get using a recursive way:

$$D_t^{\frac{1}{2}} y(t) = -D_t^{-1} y(t) + D_t^{-1} u(t) - D_t^{-\frac{1}{2}} u(t) + u(t), \quad (5.8)$$

$$\dot{y}(t) = D_t^{-1} y(t) - D_t^{-1} u(t) + D_t^{-\frac{1}{2}} u(t) - u(t) + D_t^{\frac{1}{2}} u(t). \quad (5.9)$$

Obviously, in order to apply the method proposed in Example 5.1 to the system defined by (5.1)-(5.2), the following three problems should be solved, where Problem 2 and Problem 3 are due to unknown initial conditions.

Problem 1: System model. As shown in Example 5.1, the proposed method is based on a fractional order differential equation. Consequently, the pseudo-state space representation given in (5.1)-(5.2) firstly needs to be transformed into a fractional order differential equation. Thus, the following result is given.

Proposition 5.1 [1] *The system defined by (5.1)-(5.2) satisfying conditions (C₁)-(C₂) can be transformed into the following form:*

$$\sum_{i=0}^N a_i D_t^{\alpha_i} y(t) = \hat{u}(t) + b \sum_{i=2}^N a_i \Phi_{i,\alpha} \{y(t)\}, \quad (5.10)$$

where $b = 1$, $a_N = 1$, $a_i \in \mathbb{R}$, for $i = 0, \dots, N-1$, are coefficients of the characteristic polynomial of A , $\alpha_i = i\alpha$ for $i = 0, \dots, N$, $\hat{u} = CA^{N-1}Bu$, and $\Phi_{i,\alpha} \{y(t)\}$ is given by (2.24).

Remark 5.1 By taking $b = 0$ in (5.10), the fractional order differential equation model can be deduced for a class of fractional order linear systems. Consequently, according to Lemma 2.4 and (2.24) this model is equivalent to the pseudo-state space representation model defined by (5.1)-(5.2) in the case of zero initial conditions.

Problem 2: Unknown initial conditions. Inspired by Example 5.1, the fractional order differential equation obtained in (5.10) should be transformed into a fractional order integral equation. A simple way is to integrate the equation using the additive index law given in (2.18). However, if the initial conditions are non-zero, this law can produce additional undesired terms in the obtained integral equation. Unlike the additive index law given in (2.18), a formula which does not involve initial conditions will be introduced in Proposition 5.2. To achieve this, firstly the following definition is given.

Definition 5.1 Let $\beta \in \mathbb{R}_+ \cup \{0\}$, $l, m \in \mathbb{N}$, the following operator is defined for a function $f: \forall t \in \mathbb{R}_+$,

$$I\Gamma_m^{\beta,l}\{f\} := D_t^{-(\beta+l)} \{t^m f(t)\}. \quad (5.11)$$

Secondly, the following useful function is defined: $\forall n \in \mathbb{Z}$,

$$\begin{aligned} I_{m,l,n}^{\alpha,\beta} \{f(t)\} := & \beta \sum_{k=1}^m (-1)^k \binom{m}{k} \frac{\Gamma(\beta+k)}{\Gamma(\beta+1)} t^{m-k+n} D_t^{\alpha-l-\beta-k} f(t) \\ & + l_0 \sum_{j=1}^l \sum_{k=0}^{m-j} \binom{l}{j} \frac{(-1)^{j+k} m!}{k!(m-j-k)!} \frac{\Gamma(\beta+j+k)}{\Gamma(\beta+j)} t^{m-j-k+n} D_t^{\alpha-l-\beta-j-k} f(t), \end{aligned} \quad (5.12)$$

where $l_0 = 0$ if $l = 0$, $l_0 = 1$ else.

Proposition 5.2 [2] Let $I\Gamma_m^{\beta,l}$ be the operator defined by (5.11). Then, $\forall \alpha \in \mathbb{R}_+ \cup \{0\}$, by taking $l = [\alpha]$ with $l \leq m$ we have:

$$I\Gamma_m^{\beta,l} \{D_t^\alpha f(t)\} = t^m D_t^{\alpha-l-\beta} f(t) + I_{m,l,0}^{\alpha,\beta} \{f(t)\}, \quad (5.13)$$

where $I_{m,l,0}^{\alpha,\beta} \{f(t)\}$ is given by (5.12) with $n = 0$.

Proof. According to Definition 2.7 and Definition 2.8, we have: $\forall t \in \mathbb{R}_+$,

$$D_t^{-(\beta+l)} \{t^m D_t^\alpha f(t)\} = \int_0^t g_t(\tau) \frac{d^l}{d\tau^l} \{D_\tau^{\alpha-l} f(\tau)\} d\tau, \quad (5.14)$$

where $g_t(\tau) = \frac{(t-\tau)^{\beta+l-1} \tau^m}{\Gamma(\beta+l)}$. If $\alpha = l = 0$, (5.13) can be obtained using Lemma 2.2. If $\alpha > 0$, by applying l times integration by parts formula to (5.14), we get: $\forall t \in \mathbb{R}_+$,

$$D_t^{-(\beta+l)} \{t^m D_t^\alpha f(t)\} = (-1)^l \int_0^t g_t^{(l)}(\tau) D_\tau^{\alpha-l} f(\tau) d\tau + \sum_{k=0}^{l-1} (-1)^k \left[g_t^{(k)}(\tau) D_\tau^{\alpha-1-k} f(\tau) \right]_0^t, \quad (5.15)$$

where for $k = 0, \dots, l$,

$$g_t^{(k)}(\tau) = \sum_{j=\delta_0}^k \binom{k}{j} \frac{(-1)^{k-j} m!}{\Gamma(\beta+l-k+j)(m-j)!} (t-\tau)^{\beta+l-1-k+j} \tau^{m-j} \quad (5.16)$$

5.2. Algebraic fractional order differentiator

where $\delta_0 = 1$ if $\beta + l - k = 0$, $\delta_0 = 0$ else. Then, two cases are considered.

• First case $\beta > 0$: In this case, since $m \geq l$, we get: $g_t^{(k)}(0) = g_t^{(k)}(t) = 0$ for $k = 0, \dots, l-1$. Hence, using (5.15), (5.16) becomes: $\forall t \in \mathbb{R}_+$,

$$\begin{aligned} D_t^{-(\beta+l)} \{t^m D_t^\alpha f(t)\} &= (-1)^l \int_0^t g_t^{(l)}(\tau) D_\tau^{\alpha-l} f(\tau) d\tau \\ &= \sum_{j=0}^l \binom{l}{j} \frac{(-1)^j m!}{\Gamma(\beta+j)(m-j)!} \int_0^t (t-\tau)^{\beta-1+j} \tau^{m-j} D_\tau^{\alpha-l} f(\tau) d\tau \quad (5.17) \\ &= \sum_{j=0}^l \binom{l}{j} \frac{(-1)^j m!}{(m-j)!} D_t^{-(\beta+j)} \{t^{m-j} D_t^{\alpha-l} f(t)\}. \end{aligned}$$

By applying Lemma 2.3 and the additive law given in (2.17) to (5.17), we get: $\forall t \in \mathbb{R}_+$,

$$\begin{aligned} D_t^{-(\beta+l)} \{t^m D_t^\alpha f(t)\} &= \sum_{j=0}^l \binom{l}{j} \frac{(-1)^j m!}{(m-j)!} \sum_{k=0}^{m-j} (-1)^k \binom{m-j}{k} \frac{\Gamma(\beta+j+k)}{\Gamma(\beta+j)} t^{m-j-k} D_t^{\alpha-l-\beta-j-k} f(t) \\ &= \sum_{j=0}^l \sum_{k=0}^{m-j} \binom{l}{j} \frac{(-1)^{j+k} m!}{k!(m-j-k)!} \frac{\Gamma(\beta+j+k)}{\Gamma(\beta+j)} t^{m-j-k} D_t^{\alpha-l-\beta-j-k} f(t) \quad (5.18) \\ &= t^m D_t^{\alpha-l-\beta} f(t) + \sum_{k=1}^m (-1)^k \binom{m}{k} \frac{\Gamma(\beta+k)}{\Gamma(\beta)} t^{m-k} D_t^{\alpha-l-\beta-k} f(t) \\ &\quad + \sum_{j=1}^l \sum_{k=0}^{m-j} \binom{l}{j} \frac{(-1)^{j+k} m!}{k!(m-j-k)!} \frac{\Gamma(\beta+j+k)}{\Gamma(\beta+j)} t^{m-j-k} D_t^{\alpha-l-\beta-j-k} f(t). \end{aligned}$$

• Second case $\beta = 0$: In this case, $g_t^{(l-1)}(t) \neq 0$. Hence, using (5.16), (5.15) becomes: $\forall t \in \mathbb{R}_+$,

$$D_t^{-l} \{t^m D_t^\alpha f(t)\} = t^m D_t^{\alpha-l} f(t) + (-1)^l \int_0^t g_t^{(l)}(\tau) D_\tau^{\alpha-l} f(\tau) d\tau. \quad (5.19)$$

Finally, similar to the first case, this proof can be completed by applying Lemma 2.3, the additive law given in (2.17) and using (5.19). ■

Remark 5.2 According to (5.15)-(5.16), the role of t^m with $l \leq m$ is devoted to eliminating the unknown initial conditions in (5.15). Hence, if the initial conditions are equal to 0, the design parameter m can be set to any positive integer number.

Similar to (5.18), by applying Lemma 2.3, the additive law given in (2.17) and using (5.12), the following lemma can be obtained.

Lemma 5.1 [2] Let $n \in \mathbb{N}$, we have: $\forall \gamma \in \mathbb{R}_+ \cup \{0\}$,

$$\begin{aligned} D_t^\gamma \left\{ I_{m,l,n}^{\alpha,\beta} \{f(t)\} \right\} = & \beta \sum_{k=1}^m (-1)^k \binom{m}{k} \frac{\Gamma(\beta+k)}{\Gamma(\beta+1)} \sum_{k'=0}^{\gamma_{m-k+n}} \binom{\gamma}{k'} \frac{(m-k+n)!}{(m-k+n-k')!} t^{m-k+n-k'} D_t^{\gamma-k'+\alpha-l-\beta-k} f(t) \\ & + I_0 \sum_{j=1}^l \sum_{k=0}^{m-j} \binom{l}{j} \frac{(-1)^{j+k} m!}{k!(m-j-k)!} \frac{\Gamma(\beta+j+k)}{\Gamma(\beta+j)} \times \\ & \sum_{k'=0}^{\gamma_{m-j-k+n}} \binom{\gamma}{k'} \frac{(m-j-k+n)!}{(m-j-k+n-k')!} t^{m-j-k+n-k'} D_t^{\gamma-k'+\alpha-l-\beta-j-k} f(t), \end{aligned} \quad (5.20)$$

where γ_{m-k+n} and $\gamma_{m-j-k+n}$ are given by (2.16).

Remark 5.3 Let $n_f, n_l \in \mathbb{R}$ and $s \in \mathbb{R}_+$, the following set is defined:

$$\mathcal{S}_{n_f, n_l, s} := \{n_f, n_f - s, \dots, n_l\}, \quad (5.21)$$

which contains all real numbers varying from n_f to n_l with a common difference s . Consequently, according to (5.12) and (5.20), it can be verified that the orders of $D_t^{\alpha-l-\beta-k} f$ in $I_{m,l,n}^{\alpha,\beta} \{f(t)\}$ belong to $\mathcal{S}_{\alpha-l-\beta-1, \alpha-l-\beta-m, 1}$ and the ones of $D_t^{\gamma-k'+\alpha-l-\beta-j-k} f$ in $D_t^\gamma \left\{ I_{m,l,n}^{\alpha,\beta} \{f(t)\} \right\}$ belong to $\mathcal{S}_{\gamma+\alpha-l-\beta-1, \gamma+\alpha-l-\beta-m-n, 1}$.

Problem 3: Undesired term. Different from the fractional order differential equation given in (5.3), the one obtained in (5.10) contains the undesired term $\sum_{i=2}^N a_i \Phi_{i,\alpha} \{y(t)\}$ involving unknown initial conditions (see (2.19)). It is shown in the following proposition that by taking a combination of operators given by (5.11), this undesired term can be annihilated. Before doing this, the following notation is useful:

$$\Phi := \{j' \in \mathbb{N}^*; 1 \leq j' \leq N-1, j' \alpha \notin \mathbb{N}^*\} \quad (5.22)$$

with $N' = \text{card}(\Phi)$.

Proposition 5.3 [2] Let $\beta \in \mathbb{R}_+ \cup \{0\}$, $l, m \in \mathbb{N}$, the following operator is defined: $\forall t \in \mathbb{R}_+$,

$$\Pi_{m,N'}^{\beta,l} := \sum_{i'=0}^{N'} c_{i'} t^{N'-i'} \Pi_{m+i'}^{\beta,l}, \quad (5.23)$$

where $\Pi_{m+i'}^{\beta,l}$ is defined by (5.11). If $\beta + l > 0$ and $m > (N-1)\alpha$, we have:

$$\Pi_{m,N'}^{\beta,l} \left\{ \sum_{i=2}^N a_i \Phi_{i,\alpha} \{y(t)\} \right\} = 0, \quad (5.24)$$

5.2. Algebraic fractional order differentiator

where the coefficient vector $c = (c_0, \dots, c_{N'})^T$ is the solution of the following system:

$$B_m(c_0, \dots, c_{N'})^T = (0, \dots, 0, 1)^T, \quad (5.25)$$

where $B_m \in \mathbb{R}^{(N'+1) \times (N'+1)}$ is defined as follows: for $i' = 0, \dots, N'$ and for $j' \in \Phi$,

$$B_m(k', i') = \begin{cases} \frac{\Gamma(m + i' - j'\alpha)}{\Gamma(\beta + l + m + i' - j'\alpha)}, & \text{for } k' = 0, \dots, N' - 1, \\ 1, & \text{for } k' = N'. \end{cases} \quad (5.26)$$

Proof. Using (2.24) and (2.19), we get:

$$\sum_{i=2}^N a_i \Phi_{i,\alpha} \{y(t)\} = \sum_{i=2}^N a_i \sum_{j'=1}^{i-1} c_{j'\alpha,1} t^{-j'\alpha-1} \left[D_t^{\alpha-1} \left\{ \mathcal{D}_t^{(i-1-j')\alpha} y(t) \right\} \right]_{t=0}, \quad (5.27)$$

where $\alpha = \frac{1}{q}$ and $c_{j'\alpha,1} \neq 0$ for $j' \in \Phi$. Then, by applying the following change of variables: $\tau \rightarrow t\tau$, we get:

$$\begin{aligned} \Pi_{m,N'}^{\beta,l} \left\{ t^{-j'\alpha-1} \right\} &= \frac{1}{\Gamma(\beta + l)} \sum_{i'=0}^{N'} c_{i'} t^{N'-i'} \int_0^t (t - \tau)^{\beta+l-1} \tau^{m+i'-j'\alpha-1} d\tau \\ &= \frac{t^{\beta+l+m+N'-j'\alpha-1}}{\Gamma(\beta + l)} \sum_{i'=0}^{N'} c_{i'} \int_0^1 (1 - \tau)^{\beta+l-1} \tau^{m+i'-j'\alpha-1} d\tau. \end{aligned} \quad (5.28)$$

Hence, if $\beta + l > 0$ and $m > (N - 1)\alpha$, by using the Beta function $B(\cdot, \cdot)$ defined in Definition 2.2, we obtain: for $j' \in \Phi$,

$$\begin{aligned} \Pi_{m,N'}^{\beta,l} \left\{ t^{-j'\alpha-1} \right\} &= \frac{t^{\beta+l+m+N'-j'\alpha-1}}{\Gamma(\beta + l)} \sum_{i'=0}^{N'} c_{i'} B(\beta + l, m + i' - j'\alpha) \\ &= t^{\beta+l+m+N'-j'\alpha-1} \sum_{i'=0}^{N'} c_{i'} \frac{\Gamma(m + i' - j'\alpha)}{\Gamma(\beta + l + m + i' - j'\alpha)}. \end{aligned} \quad (5.29)$$

Consequently, by taking the vector c as the solution of the system given in (5.25), the result in (5.24) is fulfilled. Thus, this proof is completed. \blacksquare

Remark 5.4 According to (5.25) and (5.26), the coefficient vector c is independent of the time t . Thus, in order to construct $\Pi_{m,N'}^{\beta,l}$ the system given in (5.25) only needs to solve once for every t .

Thanks to Proposition 5.2, the fractional order differential equation obtained in (5.10) can be transformed into a fractional order integral equation. Then, according to Remark 2.1 and similar to Example 5.1, the fractional integral of y with an order belonging to $] - 1, -1 + \frac{1}{q}]$ should first be deduced from the integral equation. Then, by differentiating this integral equation, the fractional derivative of y with an arbitrary order can be given using a recursive way. Now, we are ready to state the first main result of this chapter.

Theorem 5.1 [2] *By applying the operator $\Pi_{m,N'}^{\beta_N, l_N}$ defined by (5.23) to the fractional order differential equation obtained in (5.10), where $l_i = [\alpha_i]$ for $i = 0, \dots, N$, $m \in \mathbb{N}^*$ is a design parameter with $m \geq l_N$, $\beta_N = \bar{\beta} + \alpha_N - l_N + 1 - \frac{1}{q}$ with $\bar{\beta} \in [0, \frac{1}{q}]$, $D_t^{\nu_d} y$ with $\nu_d = -1 + \frac{1+d}{q} - \bar{\beta}$ and $d \in \mathbb{N}$ can be given on $]0, h]$ as follows:*

$$\begin{aligned} D_t^{\nu_0} y(t) &= D_t^{-l_N - \beta_N} \hat{u}(t) + \sum_{i'=0}^{N'} c_{i'} I_{m+i', 0, -m-i'}^{0, \beta_N + l_N} \{\hat{u}(t)\} \\ &\quad - \sum_{i=0}^{N-1} a_i D_t^{\alpha_i - l_N - \beta_N} y(t) - \sum_{i'=0}^{N'} c_{i'} \sum_{i=0}^N a_i I_{m+i', l_i, -m-i'}^{\alpha_i, \beta_N + l_N - l_i} \{y(t)\}, \end{aligned} \quad (5.30)$$

then by induction for $d \in \mathbb{N}^*$,

$$\begin{aligned} D_t^{\nu_d} y(t) &= - \sum_{k=1}^{\left(\frac{d}{q}\right)_{m+N'}} \binom{\frac{d}{q}}{k} \frac{(m+N')!}{(m+N'-k)!} \frac{1}{t^k} D_t^{\frac{d}{q} - k + \alpha_N - l_N - \beta_N} y(t) \\ &\quad + \sum_{k=0}^{\left(\frac{d}{q}\right)_{m+N'}} \binom{\frac{d}{q}}{k} \frac{(m+N')!}{(m+N'-k)!} \frac{1}{t^k} D_t^{\frac{d}{q} - k - l_N - \beta_N} \hat{u}(t) + \frac{1}{t^{m+N'}} \sum_{i'=0}^{N'} c_{i'} D_t^{\frac{d}{q}} \left\{ I_{m+i', 0, N'-i'}^{0, \beta_N + l_N} \{\hat{u}(t)\} \right\} \\ &\quad - \sum_{i=0}^{N-1} a_i \sum_{k=0}^{\left(\frac{d}{q}\right)_{m+N'}} \binom{\frac{d}{q}}{k} \frac{(m+N')!}{(m+N'-k)!} \frac{1}{t^k} D_t^{\frac{d}{q} - k + \alpha_i - l_N - \beta_N} y(t) \\ &\quad - \frac{1}{t^{m+N'}} \sum_{i'=0}^{N'} c_{i'} \sum_{i=0}^N a_i D_t^{\frac{d}{q}} \left\{ I_{m+i', l_i, N'-i'}^{\alpha_i, \beta_N + l_N - l_i} \{y(t)\} \right\}, \end{aligned} \quad (5.31)$$

where $\binom{\frac{d}{q}}{m+N'}$ is given by (2.16), $I_{m+i', 0, -m-i'}^{0, \beta_N + l_N} \{\hat{u}(t)\}$ and $I_{m+i', l_i, -m-i'}^{\alpha_i, \beta_N + l_N - l_i} \{y(t)\}$ are given by (5.12), $D_t^{\frac{d}{q}} \left\{ I_{m+i', 0, N'-i'}^{0, \beta_N + l_N} \{\hat{u}(t)\} \right\}$ and $D_t^{\frac{d}{q}} \left\{ I_{m+i', l_i, N'-i'}^{\alpha_i, \beta_N + l_N - l_i} \{y(t)\} \right\}$ are given by (5.20).

Proof. This proof requires the following steps.

Step 1: Application of constructed operator. Let us apply the operator $\Pi_{m,N'}^{\beta_N, l_N}$ defined by (5.23) to (5.10). Then, using Proposition 5.3, we get:

$$\sum_{i=0}^N a_i \sum_{i'=0}^{N'} c_{i'} t^{N'-i'} D_t^{-(\beta_N + l_N)} \left\{ t^{m+i'} D_t^{\alpha_i} y(t) \right\} = \sum_{i'=0}^{N'} c_{i'} t^{N'-i'} D_t^{-(\beta_N + l_N)} \left\{ t^{m+i'} \hat{u}(t) \right\}. \quad (5.32)$$

Step 2: Transformation to an integral equation. By applying Proposition 5.2, we get: for $i = 0, \dots, N$, and for $i' = 0, \dots, N'$,

$$D_t^{-(\beta_N + l_N - l_i) - l_i} \left\{ t^{m+i'} D_t^{\alpha_i} y(t) \right\} = t^{m+i'} D_t^{\alpha_i - l_N - \beta_N} y(t) + I_{m+i', l_i, 0}^{\alpha_i, \beta_N + l_N - l_i} \{y(t)\}, \quad (5.33)$$

and

$$D_t^{-(\beta_N + l_N)} \left\{ t^{m+i'} \hat{u}(t) \right\} = t^{m+i'} D_t^{-l_N - \beta_N} \hat{u}(t) + I_{m+i', 0, 0}^{0, \beta_N + l_N} \{\hat{u}(t)\}. \quad (5.34)$$

Hence, the following fractional order integral equation is obtained using (5.32)-(5.34)

and the relation $\sum_{i'=0}^{N'} c_{i'} = 1$:

$$\begin{aligned} t^{m+N'} a_N D_t^{\alpha_N - l_N - \beta_N} y(t) &= t^{m+N'} D_t^{-l_N - \beta_N} \hat{u}(t) + \sum_{i'=0}^{N'} c_{i'} I_{m+i', 0, N'-i'}^{0, \beta_N + l_N} \{\hat{u}(t)\} \\ &- t^{m+N'} \sum_{i=0}^{N-1} a_i D_t^{\alpha_i - l_N - \beta_N} y(t) - \sum_{i'=0}^{N'} c_{i'} \sum_{i=0}^N a_i I_{m+i', l_i, N'-i'}^{\alpha_i, \beta_N + l_N - l_i} \{y(t)\}. \end{aligned} \quad (5.35)$$

Thus, (5.30) can be deduced using $a_N = 1$.

Step 3: Successive fractional differentiations. By applying $D_t^{\frac{d}{q}}$ with $d \in \mathbb{N}^*$ to (5.35), since $c_{i'}$ are constant, we get:

$$\begin{aligned} D_t^{\frac{d}{q}} \left\{ t^{m+N'} D_t^{\alpha_N - l_N - \beta_N} y(t) \right\} &= D_t^{\frac{d}{q}} \left\{ t^{m+N'} D_t^{-l_N - \beta_N} \hat{u}(t) \right\} + \sum_{i'=0}^{N'} c_{i'} D_t^{\frac{d}{q}} \left\{ I_{m+i', 0, N'-i'}^{0, \beta_N + l_N} \{\hat{u}(t)\} \right\} \\ &- D_t^{\frac{d}{q}} \left\{ t^{m+N'} \sum_{i=0}^{N-1} a_i D_t^{\alpha_i - l_N - \beta_N} y(t) \right\} - \sum_{i'=0}^{N'} c_{i'} \sum_{i=0}^N a_i D_t^{\frac{d}{q}} \left\{ I_{m+i', l_i, N'-i'}^{\alpha_i, \beta_N + l_N - l_i} \{y(t)\} \right\}. \end{aligned} \quad (5.36)$$

Consequently, this proof can be completed by applying Lemma 2.2 and using (5.20). ■

Remark 5.5 By taking $\bar{\beta} = 0$ in Theorem 5.1, (5.31) can give the commensurate order fractional derivatives of the output, as done in Chapter 4. However, the differentiator proposed in Chapter 4 cannot estimate the fractional derivative of y with an arbitrary order.

Remark 5.6 According to Remark 5.1, Theorem 5.1 can also be applied for the systems modeled by a fractional order differential equation. In this case, we can take the coefficient vector $c = 1$ with $N' = 0$. Consequently, the results obtained in this chapter are more general than the ones obtained in [62, 181].

Thanks to Theorem 5.1, the Riemann-Liouville fractional derivative of y with an arbitrary order can be given by (5.31). Indeed, $\forall \alpha^* \in \mathbb{R}_+$, there exists $d \in \mathbb{N}^*$ and $\bar{\beta} \in [0, \frac{1}{q}]$ such that $\alpha^* = -1 + \frac{1+d}{q} - \bar{\beta} = \nu_d \in]-1 + \frac{d}{q}, -1 + \frac{1+d}{q}]$, where $D_t^{\nu_d} y$ with $\nu_{d'} = \nu_d - \frac{d-d'}{q}$ for $d' = d-1, \dots, 0$, needs to be firstly calculated (see Figure 5.1).

Moreover, $\forall d \in \mathbb{N}$, $D_t^{\nu_d} y$ is exactly given by proper integrals of y and a part involving \hat{u} using a recursive way. Indeed, according to Remark 5.3, we have:

- for $d = 0$, on the one hand, the part involving \hat{u} in (5.30) is a combination of the fractional integrals of \hat{u} whose orders belong to $\mathcal{S}_{\nu_0 - \alpha_N, \nu_0 - \alpha_N - m - N', 1}$ with $\nu_0 - \alpha_N \leq -1$. On the other hand, $I_{m+i', l_i, -m-i'}^{\alpha_i, \beta_N + l_N - l_i} \{y(t)\}$ contains the fractional integrals of y whose orders belong to $\mathcal{S}_{\nu_0 + \alpha_i - \alpha_N - 1, \nu_0 + \alpha_i - \alpha_N - m - i', 1}$. Thus, the part involving y in (5.30) is a combination of the fractional integrals of y whose orders belong to $\mathcal{S}_{\nu_0 - \frac{1}{q}, \nu_0 - \alpha_N - m - N', \frac{1}{q}}$. Since $\nu_0 - \frac{1}{q} = -1 - \bar{\beta} \leq -1$, according to Remark 2.1, these integrals are proper.

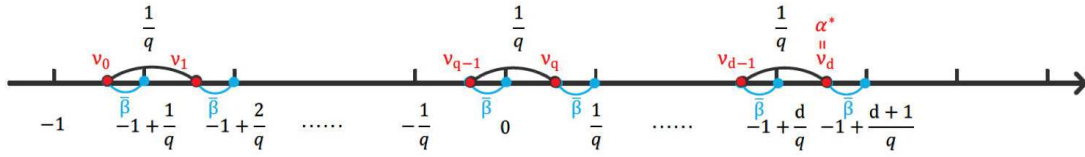
 Figure 5.1: Repartition of the orders: v_0, \dots, v_d .

• for $d \in \mathbb{N}^*$, on the one hand, the part involving \hat{u} in (5.31) is a combination of the fractional integrals and derivatives of \hat{u} whose orders belong to $\mathcal{S}_{v_d - \alpha_N, v_d - \alpha_N - m - N', 1}$, where three cases should be considered:

1. if $v_d - \alpha_N \leq -1$, this part only contains proper fractional integrals of \hat{u} ,
2. if $-1 < v_d - \alpha_N < 0$, this part contains fractional integrals of \hat{u} , which are improper,
3. if $v_d - \alpha_N \geq 0$, this part contains \hat{u} and its fractional derivatives.

On the other hand, the part involving y in (5.31) is a combination of the fractional integrals and derivatives of y whose orders belong to $\mathcal{S}_{v_{d-1}, v_d - \alpha_N - m - N', \frac{1}{q}}$, where $D_t^{v_{d'}} y$ with $v_{d'} = v_d - \frac{d-d'}{q}$ for $d' = d-1, \dots, 0$, are previously given by proper integrals of y and a part involving \hat{u} .

Thus, by grouping the integrals of y , $D_t^{v_d} y$ can be given by an algebraic formula as follows:

$$D_t^{v_d} y(t) = \int_0^t W_m(\tau) y(\tau) d\tau + U_m(t), \quad (5.37)$$

where U_m denotes the part involving \hat{u} , and W_m denotes the combination of the associated functions in the proper integrals of y . It can be seen that W_m depends not only on m , but also on t, v_d, N, α and a_i for $i = 0, \dots, N$.

Consequently, the Riemann-Liouville fractional derivative of y with an arbitrary order is exactly given by a new algebraic formula in Theorem 5.1, *i.e.* it does not contain any source of errors in continuous noise-free case, and can provide non-asymptotic estimations in finite-time without knowing the initial conditions of the considered system. Moreover, the proper integrals of y can be considered as a low-pass filter in noisy cases [71, 72]. In the next subsection, a digital fractional order differentiator is introduced in discrete noisy cases.

5.2.3 Digital fractional order differentiator in discrete noisy cases

From now on, the framework will be given in a noisy environment. Let y^ω be a discrete noisy observation of y on $I = [0, h] \subset \mathbb{R}_+$:

$$y^\omega(t_i) = y(t_i) + \omega(t_i), \quad (5.38)$$

where $t_i = iT_s$, for $i = 0, 1, \dots, M$, with an equidistant sampling period $T_s = \frac{h}{M}$, and ω is a noise.

According to (5.37), the formula of $D_t^{\nu_d} y$ contains two parts: the one given by a proper integral of y , and the other one involving \hat{u} . In order to estimate the Riemann-Liouville fractional derivatives of y in discrete noisy cases, $D_t^{\nu_d} y$ is approximated by the following digital fractional order differentiator: for $i = 1, \dots, M$,

$$D_m^{\nu_d} y^\omega(t_i) := T_s \sum_{j=0}^i w_j W_m(t_j) y^\omega(t_j) + \tilde{U}_m(t_i), \quad (5.39)$$

where $w_i \in \mathbb{R}_+$ are the weights of a given numerical integration method. According to the analysis in previous subsection, $\tilde{U}_m(t_i)$ is calculated in the following way:

- the fractional integrals of \hat{u} of order larger than 1 are calculated using a numerical integration method;
- the fractional integrals of \hat{u} of order strictly smaller than 1 and the fractional derivatives of \hat{u} are numerically calculated using the Grünwald-Letnikov scheme given in (5.1)-(5.2).

Consequently, the digital fractional order differentiator $D_m^{\nu_d} y^\omega(t_i)$ can be used to estimate the Riemann-Liouville fractional derivative $D_t^{\nu_d} y$ for any $\nu_d \in \mathbb{R}_+^*$, where y is the output of the fractional order linear system defined by (5.1)-(5.2). It contains three sources of errors:

- the numerical error due to the numerical integration method used to approximate the proper integral involving y ;
- the noise error contribution of the following form:

$$e_m^\omega(t_i) := T_s \sum_{j=0}^i w_j W_m(t_j) \omega(t_j); \quad (5.40)$$

- the numerical errors in $\tilde{U}_m(t_i)$, which are due to a numerical integration method and the Grünwald-Letnikov scheme, respectively.

Firstly, it is well known that the numerical errors due to the numerical integration method converge to 0 when $T_s \rightarrow 0$ [168]. Secondly, as shown previously, the Grünwald-Letnikov scheme is used to approximate $D_t^\alpha \hat{u}$ with $-1 < \alpha$ in the calculation of $\tilde{U}_m(t_i)$. It is shown in [92] that in the case of $-1 < \alpha < 0$ (resp. $\alpha > 0$), if \hat{u} is continuous on I (resp. \hat{u} is $[\alpha]$ -times continuously differentiable on I), the produced numerical error converges to 0 when $T_s \rightarrow 0$. Thirdly, using a similar way as done in Chapter 4, it can be shown that the noise error contribution $e_m^\ominus(t_i)$ converges to 0 in mean square when $T_s \rightarrow 0$, if the noise $\{\omega(t), t \in I\}$ is assumed to be a continuous stochastic process satisfying the conditions (C₄) – (C₆). Consequently, both the numerical errors and the noise error contribution can be reduced in the proposed digital fractional order differentiator by decreasing the sampling period T_s .

When the sampling period is set, by applying (C₄)–(C₆) and the properties of the mean value and the variance functions to (5.40), we get:

$$\mathbb{E}[e_m^\ominus(t_i)] = 0, \quad (5.41)$$

$$\text{Var}[e_m^\ominus(t_i)] \leq \delta T_s^2 \sum_{j=0}^i w_j^2 W_m^2(t_j). \quad (5.42)$$

Hence, similar to Chapter 4, by using the Bienaymé-Chebyshev inequality and (5.42) the following error bound can be obtained:

$$|e_m^\ominus(t_i)| \stackrel{p_\gamma}{<} \gamma \delta^{\frac{1}{2}} T_s \left(\sum_{j=0}^i w_j^2 W_m^2(t_j) \right)^{\frac{1}{2}}, \quad (5.43)$$

where $a \stackrel{p_\gamma}{<} b$ means that the probability for a real number b to be larger than another real number a is equal to p_γ with $1 - \frac{1}{\gamma^2} < p_\gamma < 1$.

Finally, according to the previous analysis, the following algorithm is required to realize the proposed differentiator $D_m^{\vee d} y^\ominus(t_i)$, which is devoted to applying Proposition 5.3, Theorem 5.1, and contains the following steps:

- Step 1.** using (5.22), find N' ;
- Step 2.** using N' and Proposition 5.3, find the coefficient vector $c = (c_0, \dots, c_{N'})^T$;
- Step 3.** find $\bar{\beta} \in [0, \frac{1}{q}[$ and d such that $v_d = -1 + \frac{1+d}{q} - \bar{\beta}$;
- Step 4.** using $\bar{\beta}$, N' and c , calculate $D_t^{\vee 0} y$ by (5.30), where all the integrals $D_t^{-\alpha} y$ and $D_t^{-\alpha} \hat{u}$ are proper with $\alpha \geq 1$, and calculated using a numerical integration method;
- Step 5.** using d , $\bar{\beta}$, N' and c , calculate $D_t^{\vee d'} y$ by (5.31), for $d' = 1, \dots, d$ in a loop. For each d' , the fractional integrals and derivatives $D_t^{-\alpha} y$ (resp. $D_t^{-\alpha} u$) in the expression of $D_t^{\vee d'} y$ are calculated as follows:

5.2. Algebraic fractional order differentiator

- if $\alpha \geq 1$, they are calculated using the numerical integration method;
- otherwise they are previously calculated (resp. calculated using the Grünwald-Letnikov scheme).

5.3 Simulation results

In order to show the accuracy and the robustness of the proposed fractional order differentiator, some numerical results are presented in this section.

Example 5.2 *In most cases, neither the output of a fractional order linear system nor its fractional derivatives can be analytically calculated. In order to obtain the exact value of the sought fractional derivative, the following academic model is considered in this example: $\forall t \in]0, 30]$,*

$$\sum_{i=0}^4 a_i D_t^{\frac{i}{3}} y(t) = \hat{u}(t) + t^{-\frac{4}{3}} + t^{-\frac{5}{3}}, \quad (5.44)$$

where $a_i = 1$ for $i = 0, \dots, 4$, $\hat{u}(t) = \sum_{i=0}^4 a_i D_t^{\frac{i}{3}} y(t)$, $y(t) = y_1(t) + y_2(t)$, $y_1(t) = \sin(\omega_1 t)$ and $y_2(t) = \cos(\omega_2 t)$ with $\omega_1 = 1.2$ and $\omega_2 = 0.6$. The analytical Riemann-Liouville fractional derivatives of y_1 and y_2 can be given by [74] (2.42)-(2.43).

$D_t^{\frac{1}{2}} y$ will be estimated in the discrete noisy case with $t_i = iT_s \in I = [0, 30]$, $T_s = 0.01$, for $i = 0, \dots, 3000$, and $y^\circledast(t_i) = y(t_i) + \delta\omega(t_i)$, where the noise $\{\omega(t_i)\}$ is simulated from a zero-mean white Gaussian iid sequence, and the value of δ is adjusted such that $\text{SNR} = 15$ dB. The original output y and the discrete noisy output y^\circledast are shown in Figure 5.2. Then, the fractional order differentiator proposed in (5.39) is applied, where the trapezoidal numerical integration method is considered.

Firstly, it is shown how to choose the value of the design parameter m using the noise error bound obtained in (5.43) with $\gamma = 2$. Since the value of ν_d is set in Theorem 5.1 with $\nu_d = \frac{1}{2}$ and $\bar{\beta} = \frac{2}{3} - \frac{1}{2}$, the expression of $D_t^{\frac{1}{2}} y$ can be obtained. Thus, the expression of W_m can be deduced in (5.37). Then, by taking different values of m , the values of the error bound obtained in (5.43) can be calculated at each t_i for $i = 2, \dots, 3000$. Using such a way, the variation with respect to m of the noise error bound can be observed in Figure 5.3. According to Figure 5.3, the influence of m on the noise error contribution can be deduced. Hence, in order to reduce the noise error contribution, the following values of m are chosen: $m = 2$ for $t_i \in [2T_s, 13]$, and $m = 10$ for $t_i \in [13 + T_s, 30]$.

Secondly, in order to compare with the proposed method, the fractional order Legendre differentiator proposed in [62] is applied. The latter is a model-free differentiator and obtained by a polynomial approximation method. Hence, it contains a truncated term error which can be significantly reduced by admitting a time-delay. Consequently, this differentiator depends on two design parameters: the order of the used polynomial N and the time-delay ϑ . According to the analysis done in [62], the design parameters are set in this example as follows: $\vartheta = 0.8$, $N = 6$ for $t_i \in [0.9, 8]$, $N = 12$ for $t_i \in [8 + T_s, 18]$, and $N = 20$ for $t_i \in [18 + T_s, 30]$.

Finally, the obtained estimations of $D_t^{\frac{1}{2}} y$ are shown in Figure 5.4(a). It can be seen

5.3. Simulation results

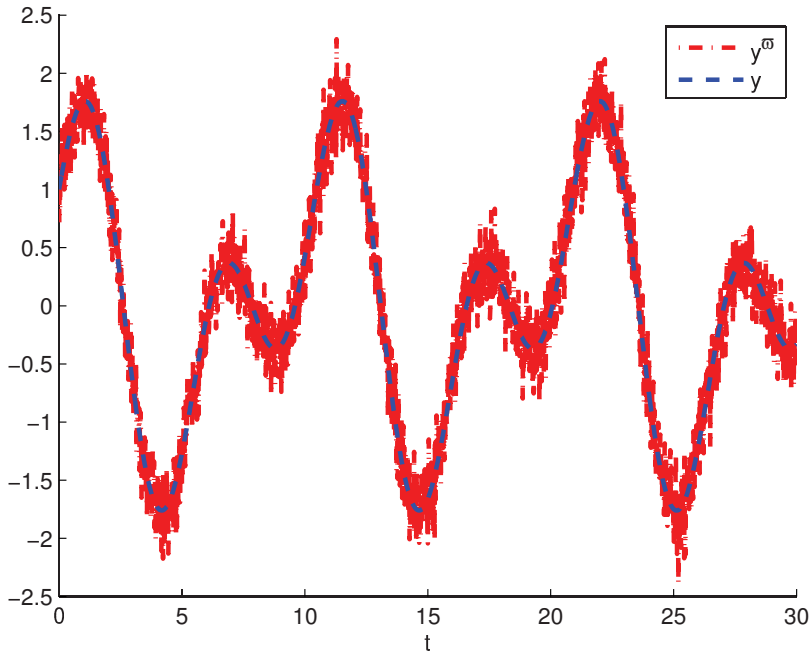

Figure 5.2: Example 5.2 The output and its discrete noisy observation.

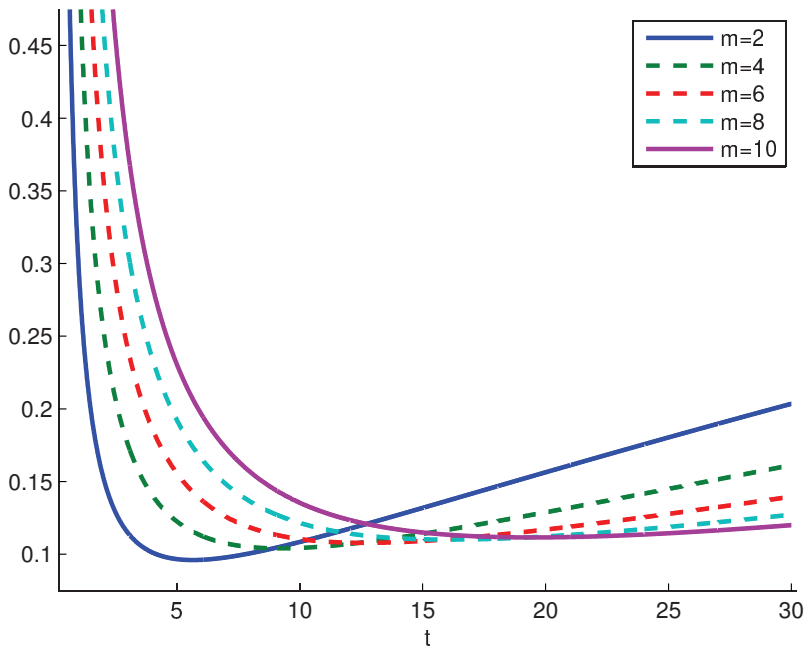

Figure 5.3: Example 5.2 The variation of the noise error bound given in (5.43) with $m = 2, \dots, 10$.

(a) Estimations of $D_t^{\frac{1}{2}} y$.(b) Absolute estimation errors of $D_t^{\frac{1}{2}} y$.

Figure 5.4: Example 5.2 Estimations and estimation errors obtained by the proposed method and the fractional order Legendre differentiator .

that different from the fractional order Legendre differentiator the proposed differentiator does not produce a time-delay. The reason is that the proposed method is based on the system model. Moreover, the corresponding absolute estimation errors are shown in Figure 5.4(b), where the one for the fractional order Legendre differentiator is obtained by shifting the estimation to avoid the time-delay. The latter principally contains the amplitude error (in vertical direction) and the noise error contribution.

Example 5.3 In this example, the system defined in (4.109)–(4.110) is considered with the same initialization.

Assume that $y^\ominus(t_i) = y(t_i) + \sigma\omega(t_i)$ is the noisy observation of the output y on $I = [0, 5]$, where $t_i = iT_s$ with $T_s = 0.001$, and $\{\sigma\omega(t_i)\}$ is a zero-mean white Gaussian noise with $\text{SNR} = 22$ dB. The output and the associated noisy output are shown in Figure 5.5.

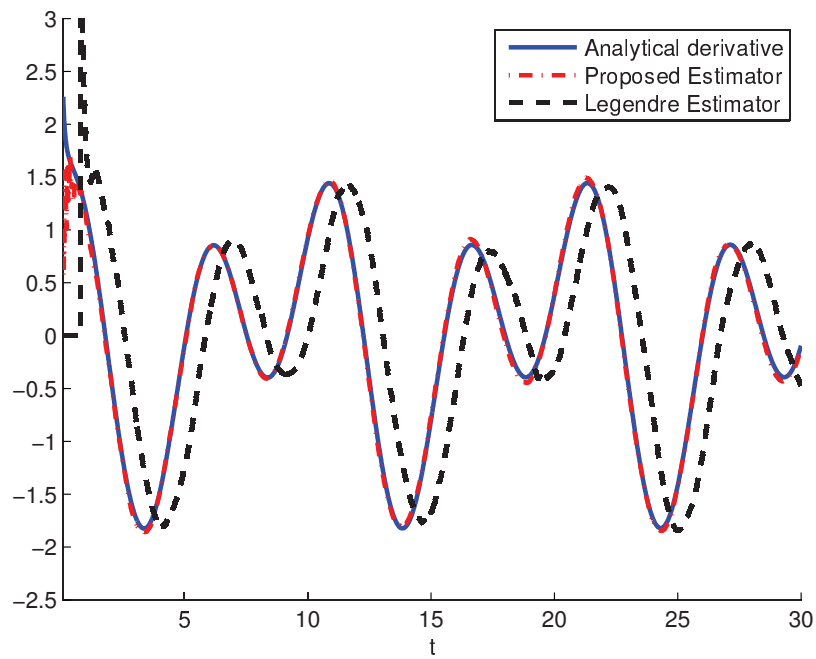
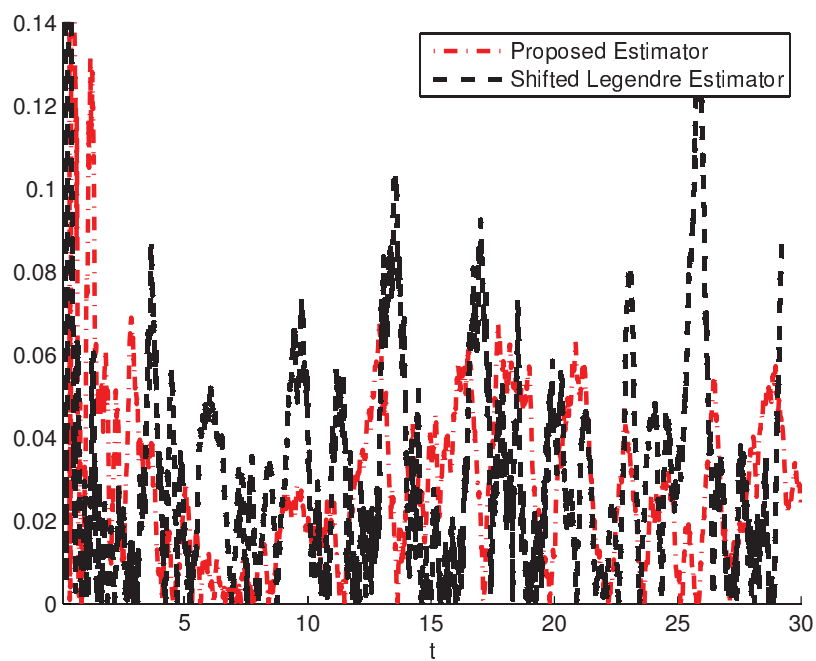
Firstly, using a similar way as done in Example 1, the design parameter m needs to be set. For this purpose, $D_t^{0.3}y$ is considered as an example. Then, the values of the corresponding error bound are calculated at each t_i for $i = 2, \dots, 5000$, and the variation with respect to m is shown in Figure 5.6. Hence, according to Figure 5.6, the following values of m are chosen: $m = 2$ for $t_i \in [2T_s, 0.3]$, and $m = 10$ for $t_i \in [0.3 + T_s, 5]$.

Secondly, since the analytical Riemann-Liouville fractional derivatives of the output are unknown, the Grünwald-Letnikov scheme is applied in the noise-free case to verify the efficiency of the proposed fractional order differentiator.

Thirdly, the obtained estimation of $D_t^{0.3}y$ is shown in Figure 5.7(a). Moreover, by applying the recursive way proposed in Theorem 5.1, $D_t^{0.8}y$ is also estimated using the previous design parameter values. The obtained estimation is shown in Figure 5.7(b).

Finally, recall that the advantages of the proposed differentiator with respect to the one obtained in Chapter 4 is stated in Remark 5.5. In particular, the latter cannot be used to estimate $D_t^{0.3}y$ and $D_t^{0.8}y$ for the considered system. In order to compare further these two differentiators, they are both applied to estimate $D_t^{0.5}y$, where $m = 2$ for $t_i \in [2T_s, 0.4]$, and $m = 14$ for $t_i \in [0.4 + T_s, 5]$. The obtained results and the related noise error contributions are shown in Figure 5.8. Consequently, it can be seen that both methods give good results and the noise error produced by the proposed differentiator is a little smaller. In fact, the idea of both differentiators is to use an integral involving a designed function to reduce the noise effect in y . Since these two differentiators are constructed by two different methods, the designed functions are different. As shown previously, the designed function is W_m for the proposed method. Moreover, since these designed functions can be calculated offline, as well as the ones associated to u , the algorithm of each differentiator can be realized only using two scalar products of vectors in online applications.

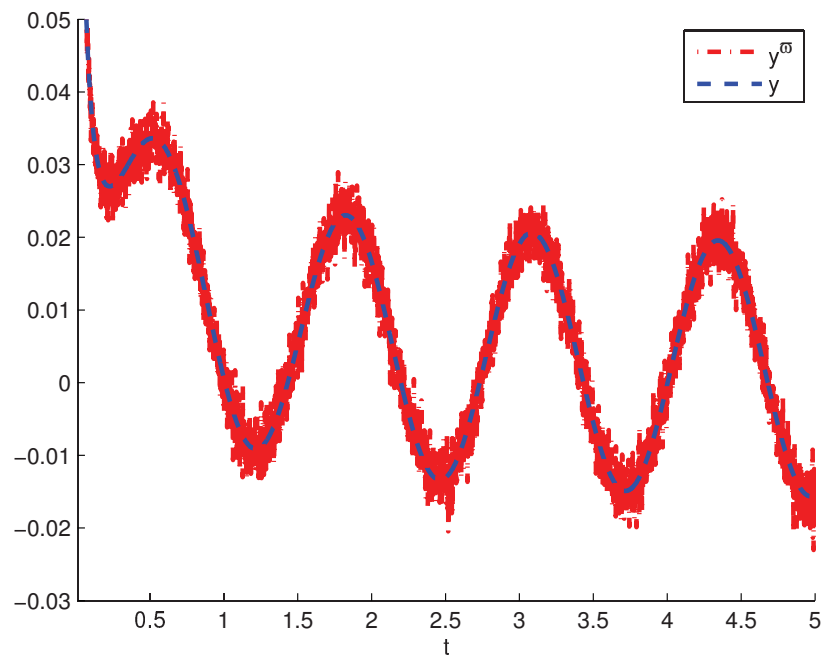

Figure 5.5: Example 5.3 The output and its discrete noisy observation of a fractional electrical circuit model.

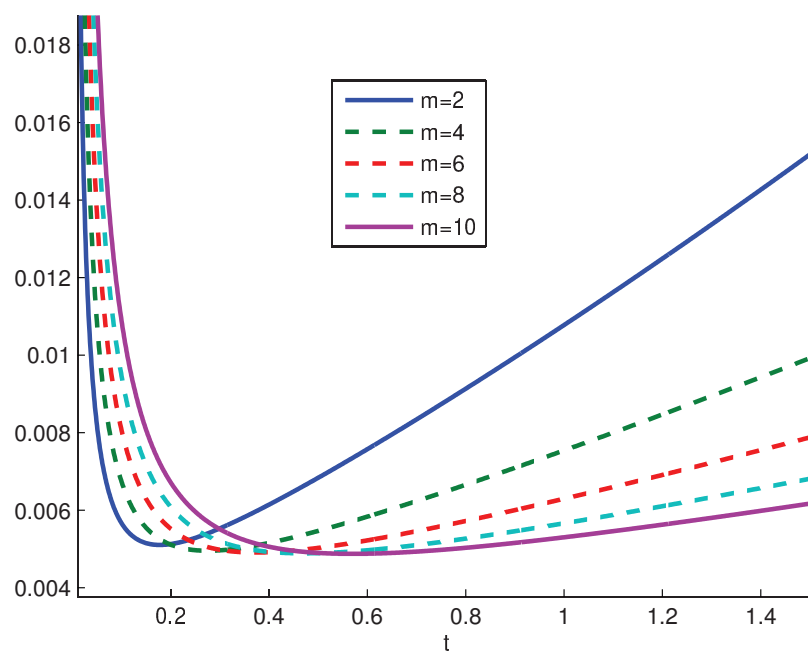
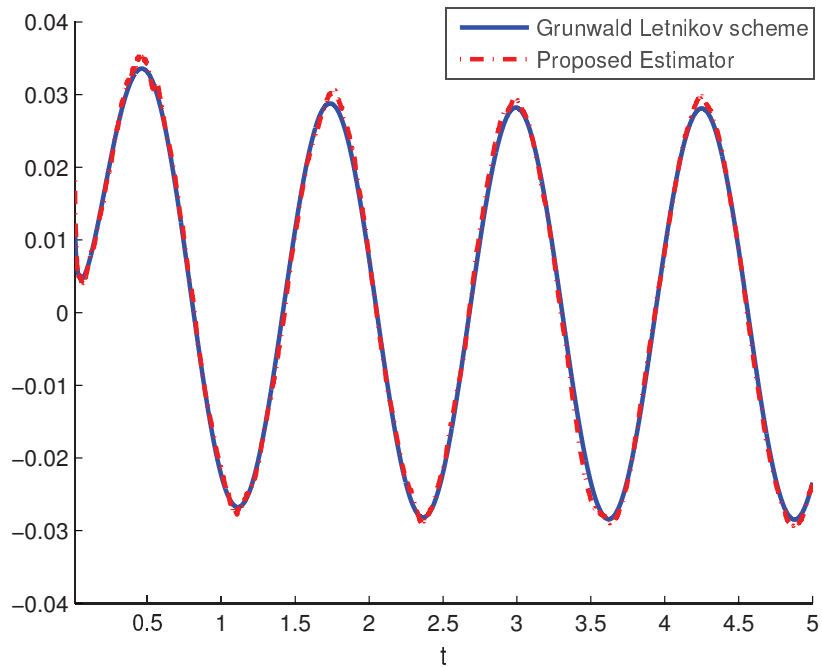
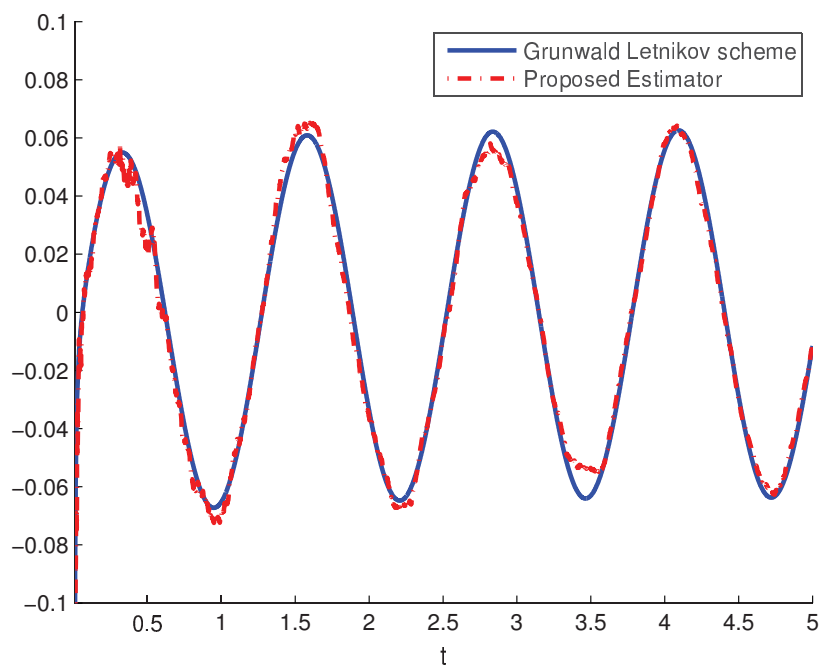

Figure 5.6: Example 5.3 The variation of the noise error bound given in (5.43) with $m = 2, \dots, 10$.

5.3. Simulation results



(a) Estimations of $D_t^{0.3}y$.



(b) Estimations of $D_t^{0.8}y$.

Figure 5.7: Example 5.3 The numerical calculations obtained by the Grünwald-Letnikov scheme in discrete noise-free case and the estimations obtained by the proposed method in the discrete noisy case.

(a) Estimations of $D_t^{\frac{1}{2}} y$.(b) Absolute noise errors of $D_t^{\frac{1}{2}} y$.

Figure 5.8: Example 5.3 Estimations and estimation errors obtained by the proposed method and the modulating functions method [1].

5.4 Conclusions

In this chapter, a new algebraic and robust fractional order model-based differentiator was proposed. It can be applied to estimate the fractional derivative of the output with an arbitrary order both for the systems modeled by the pseudo-state space representation and the ones modeled by a fractional order differential equation without knowing the initial conditions. Firstly, by applying a designed operator, the considered system was transformed into a fractional order integral equation, where all the unknown initial conditions were eliminated. Then, based on the obtained equation, the desired fractional derivative was exactly given by a new algebraic formula using a recursive way. This formula does not contain any source of errors in continuous noise-free case. Hence, it can provide estimations in finite-time. Secondly, a digital fractional order differentiator was introduced in discrete noisy cases. Finally, numerical results were given to show the accuracy and the robustness of the proposed fractional order differentiator.

Chapter 6

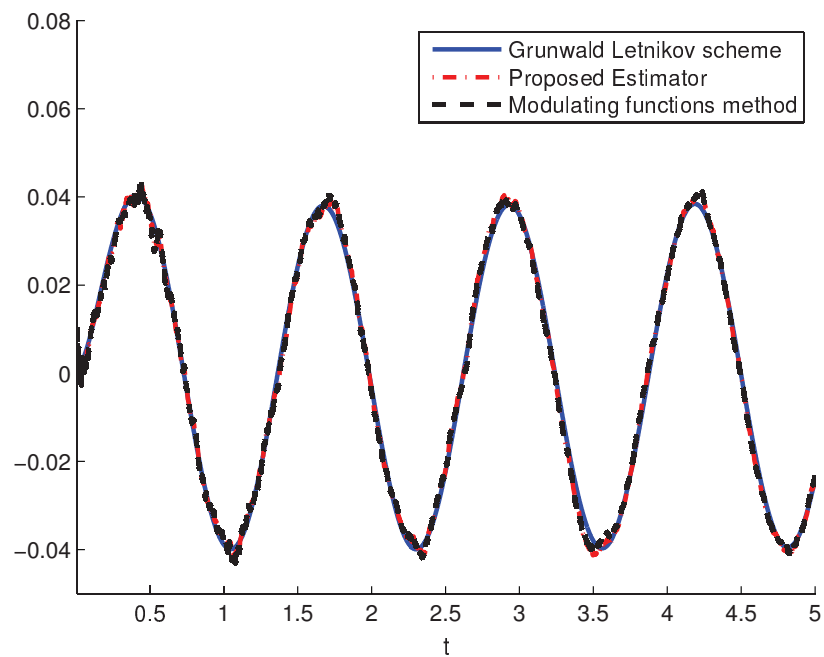
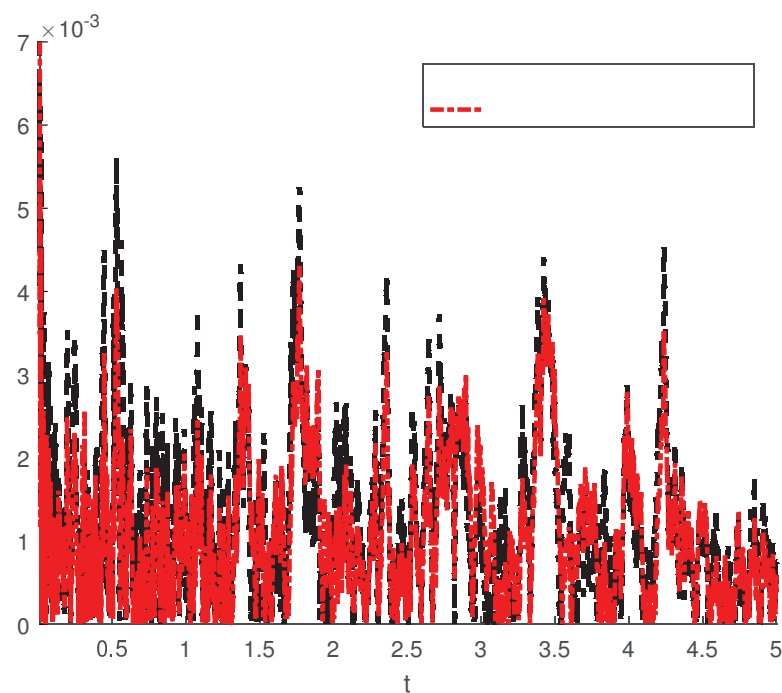
General conclusions and perspectives

6.1 Conclusions

This PhD thesis was devoted to estimating the pseudo-state and the fractional derivative of the output with an arbitrary order for a class of commensurate fractional order linear systems which can be transformed into the Brunovsky's observable canonical form of pseudo-state space representation with unknown initial conditions. For this purpose, two algebraic non-asymptotic methods were developed, which exhibits good robustness properties with respect to corrupting noises.

Firstly, the ideas of modulating functions method on parameter identification and derivative estimation for integer order linear systems were recalled in Chapter 3 via simple examples: we transform the studied differential equation into an integral equation by applying the integration by parts formula, where the desired boundary values such as the derivative values or the initial conditions, can be kept thanks to the property of the modulating functions and the undesired ones can also be eliminated. Then, it was explained how to extend the method to estimate the fractional derivatives of the output of the studied integer order linear system: we transform the studied integer order differential equation into a fractional order one, and we apply the fractional order integration by parts formulae. By changing the properties of the modulating functions, it was shown that this method can cope with different situations: the cases of zero initial conditions with a bias or not, and the case of non-zero initial conditions. All the used properties are listed in Annexe A. The basic ideas on the construction of the required modulating functions were also given: we used polynomials and we find the unknown coefficients by solving linear systems. Finally, a proposed differentiator was applied to design a fractional order $PI^\lambda D^\mu$ controller for an integer order linear system in numerical examples. Moreover, it was shown that the obtained fractional order differentiators can be applied for the signals satisfying an integer order linear differential equation.

6.1. Conclusions

Secondly, based on the ideas explained in Chapter 3, a non-asymptotic pseudo-state estimator was constructed for the studied systems. In order to apply the modulating functions method, the studied system was transformed into a set of fractional order linear differential equations involving the initial values of the fractional sequential derivatives of the output. Then, algebraic integral formulae were exactly obtained for the former initial values and the commensurate fractional order derivatives of the output by a recursive way, where the required modulating functions were constructed. These formulae were used to calculate the pseudo-state of the system in continuous noise free case, which can provide estimations with convergence in finite-time. In this chapter, a new fractional order \mathcal{H}_∞ -like observer was also designed.

Thirdly, inspired by the modulating functions method developed in Chapter 4, an operator-based algebraic method was introduced in Chapter 5 to estimate the fractional derivative with an arbitrary order of the output for the considered systems. The designed operator was applied to eliminate the fractional sequential derivative initial values involved in the obtained fractional order linear differential equation and to calculate the desired fractional derivative by a new algebraic formula using a recursive way. In particular, this method can also be applied for the fractional order systems modeled by a commensurate fractional order linear differential equation.

Fourthly, both the estimators obtained in Chapter 4 and Chapter 5 were studied in discrete noisy case, each of which contains the numerical error due to a used numerical integration method, and the noise error contribution due to a class of stochastic processes. In particular, the noise error contribution was analyzed, where an error bound useful for the selection of design parameter was provided. Then, numerical examples were given to illustrate the accuracy, the robustness and the non asymptotic property of the proposed estimators, where some comparisons to other methods are shown.

Finally, let us outline in the following table the recent works on the applications of the modulating functions methods in different situations.

		$y^{(n)}$	$D^{\frac{p}{q}} y$	$D^\alpha y$	x	C.I.
IOLDE	C.I. = 0+bias		[6]		X	X
	C.I. $\neq 0$	[150]	[62, 67]		X	[7]
FOLDE	C.I. = 0+bias		[3]		X	X
	C.I. $\neq 0$		*		X	NY
PSSP	C.I. = 0	[5]		NY	[5]	X
	C.I. $\neq 0$	[1]		[2, 4]	[1]	[1]

where IOLDE (resp. FOLDE) refers to the systems modeled by an integer order (resp.

a fractional order) linear differential equation, PSSP refers to the systems modeled by the pseudo-state space representation, C.I. refers to initial conditions, y is the output, x is the pseudo-state, $y^{(n)}$ is the integer order derivative of y , $D^{\frac{p}{q}}y$ is the commensurate fractional order derivative of y , $D^\alpha y$ is the fractional derivative of y with an arbitrary order, X means the situation is not applicable, and NY means the situation is not considered yet. * this situation has been considered by the algebraic parametric estimation method [63]. Remark that the estimators obtained in the PSSP case can also be applied for the FOLDE case.

6.2 Future works

Fractional calculus is promising in the domain of automatic control. Based on the results obtained in this thesis, several perspectives should be considered:

- Extend the modulating functions method to the fractional order systems with tim-delay.
- Extend the modulating functions method to fractional order nonlinear systems.
- Extend the modulating functions method to fractional order partial differential equation systems.

Annexes

Appendix A

Appendix: different properties of Modulating functions

Classic modulating function : Let $[a, b] \subset \mathbb{R}$, $N \in \mathbb{N}^*$, and g be a function satisfying the following properties: for $k = 0, 1, \dots, N - 1$,

$$(P_1): g \in \mathcal{C}^N([a, b]).$$

$$(P_2): g^{(k)}(a) = 0.$$

$$(P_3): g^{(k)}(b) = 0.$$

Generalized modulating functions:

$$(P_4): g_n^{(k)}(b) = \delta_{kn}.$$

$$(P_5): G_i(b) = \delta_{in}, \text{ where } G_i(b) = \sum_{k=0}^{N-1-i} (-1)^k a_{i+1+k} g^{(k)}(b).$$

$$(P_6): \sum_{i=0}^N a_i \int_a^t {}^C D_{\tau, t}^{i-\beta} g_n(\tau) d\tau = 0.$$

$$(P_7): \int_a^t (\tau - a)^{\beta-i} g_n(\tau) d\tau = 0.$$

$$(P_8): \int_0^t h_{j,n,k}(\tau) \tau^{\frac{j}{q}-j'\alpha-i'} d\tau = \begin{cases} 1, & \text{if } (n, k) = (j', i'), \\ 0, & \text{else.} \end{cases}$$

$$(P_9): \forall (j', i') \in \Phi_j, \int_0^t g_{j,n}(\tau) \tau^{\frac{j}{q}-j'\alpha-i'} d\tau = 0.$$

Résumé étendu en français

Cette thèse a été consacrée à estimer le pseudo-état et la dérivée fractionnaire de la sortie avec un ordre quelconque pour une classe de systèmes linéaires d'ordre fractionnaire commensurable qui peuvent être transformés sous la forme canonique observable de Brunovsky avec des conditions initiales inconnues. A cet effet, deux méthodes algébriques non-asymptotiques ont été développées, qui présentent de bonnes propriétés de robustesse par rapport aux bruits. Premièrement, les idées de la méthode des fonctions modulatrices sur l'identification des paramètres et l'estimation des dérivées pour les systèmes linéaires d'ordre entier ont été rappelées au Chapitre 3 à l'aide des exemples simples: nous transformons l'équation différentielle étudiée en une équation intégrale en appliquant la formule d'intégration par parties, où les valeurs aux bords souhaitées telles que les valeurs des dérivées ou les conditions initiales, peuvent être conservées grâce aux propriétés des fonctions modulatrices et des valeurs non désirées peuvent également être éliminées. Alors, il a été expliqué comment étendre la méthode pour estimer les dérivées fractionnaires de la sortie du système linéaire d'ordre entier étudié: nous transformons l'équation différentielle étudiée en une équation différentielle d'ordre fractionnaire, et nous appliquons la formule de l'intégration par parties d'ordre fractionnaire. En changeant les propriétés des fonctions modulatrices, il a été montré que cette méthode peut être appliquée aux situations différentes: les cas de conditions initiales nulles avec ou sans biais, et le cas avec des conditions initiales non nulles. Toutes les propriétés utilisées ont été énumérées dans Annexe A. Les idées de base sur la construction des fonctions modulatrices requises ont également été données: nous utilisons des polynômes et nous trouvons les coefficients inconnus en résolvant des systèmes linéaires. Enfin, un différentiateur proposé a été appliqué pour concevoir un contrôleur PID d'ordre fractionnaire pour un système linéaire d'ordre entier dans des exemples numériques. De plus, il a été montré que les différentiateurs d'ordre fractionnaire obtenus peuvent être appliqués aux signaux satisfaisant une équation différentielle linéaire d'ordre entier.

Deuxièmement, basé sur les idées exposées au Chapitre 3, un estimateur non-asymptotique de pseudo-état a été construit pour les systèmes d'ordre fractionnaire étudiés au Chapitre 4. Afin d'appliquer la méthode des fonctions modulatrices, le système étudié a été transformé en un ensemble des équations différentielles linéaires d'ordre fractionnaire impliquant les valeurs initiales des dérivées fractionnaires séquentielles de la sortie. Ensuite, des formules intégrales algébriques ont été obtenues pour les valeurs initiales précédentes et les dérivées fractionnaires commensurables de la sortie d'une manière récursive, où les fonctions modulatrices nécessaires ont été construites. Ces formules ont été utilisées pour calculer le pseudo-état du système en continu cas

sans bruit, qui peuvent fournir des estimations en temps fini. Dans ce chapitre, un nouvel observateur d'ordre fractionnaire de type \mathcal{H}_∞ a également été conçu.

Troisièmement, inspirée par la méthode des fonctions modulatrices développée au Chapitre 4, une méthode algébrique basée sur un opérateur a été introduite au Chapitre 5 pour estimer la dérivée fractionnaire avec un ordre quelconque de la sortie pour les systèmes considérés. Le opérateur conçu a été appliqué pour éliminer les valeurs initiales des dérivées fractionnaires séquentielles impliquées dans l'équation différentielle linéaire d'ordre fractionnaire obtenu et pour calculer la dérivée fractionnaire désirée par une nouvelle formule algébrique utilisant un algorithme récursive. En particulier, cette méthode peut également être appliquée aux systèmes d'ordre fractionnaire modélisés par une équation différentielle linéaire d'ordre fractionnaire commensurable.

Quatrièmement, les deux estimateurs obtenus au Chapitre 4 et au Chapitre 5 ont été étudiés dans le cas discret et bruité, dont chacun contient l'erreur numérique due à la méthode d'intégration numérique utilisée, et l'erreur de bruit due à une classe de processus stochastiques. En particulier, l'erreur de bruit a été analysée, où une majoration d'erreur liée pour la sélection du paramètre de conception a été fournie. Ensuite, des exemples numériques ont été donnés pour illustrer la précision, la robustesse et la propriété non-asymptotique des estimateurs proposés, où certaines comparaisons avec d'autres méthodes sont montrées.



A Reference

- [1] X. Wei, D.-Y. Liu, and D. Boutat, “Non-asymptotic pseudo-state estimation for a class of fractional order linear systems,” *IEEE Transactions on Automatic Control*, vol. 62, no. 3, pp. 1150–1164, 2017. 5, 9, 4, 71, 73, 79, 81, 96, 113, 116
- [2] X. Wei, D.-Y. Liu, D. Boutat, and Y.-M. Chen, “Algebraic fractional order differentiator based on the pseudo-state space representation,” *IEEE Transactions on Automatic Control*, 2018. 5, 97, 99, 101, 116
- [3] X. Wei, D.-Y. Liu, D. Boutat, H.-R. Liu, and Y.-Q. Li, “Modulating functions-based fractional order differentiator for fractional order linear systems with a biased output,” in *2017, 20th IFAC World Congress*, 2017. 5, 116
- [4] Y.-Q. Wei, X. Wei, D.-Y. Liu, and D. Boutat, “Robust estimation for the fractional integral and derivative of the output for a class of fractional order linear systems,” in *Control Conference (CCC), 2017 36th Chinese*, 2017. 5, 116
- [5] X. Wei, D.-Y. Liu, and D. Boutat, “Extension of modulating functions method to pseudo-state estimation for fractional order linear systems,” in *Control Conference (CCC), 2016 35th Chinese*, pp. 10469–10474, IEEE, 2016. 5, 116
- [6] X. Wei, D.-Y. Liu, and D. Boutat, “A new model-based fractional order differentiator with application to fractional order pid controllers,” in *2015 54th IEEE Conference on Decision and Control (CDC)*, pp. 3718–3723, IEEE, 2015. 5, 18, 44, 53, 116
- [7] X. Wei, D.-Y. Liu, and D. Boutat, “Caputo fractional derivative estimation for a class of signals satisfying a linear differential equation,” in *Control Conference (CCC), 2015 34th Chinese*, pp. 4598–4603, IEEE, 2015. 5, 44, 53, 54, 116
- [8] I. Podlubny, “Fractional-order systems and $\pi/\sup/spl \lambda//d/\sup/spl \mu//$ -controllers,” *IEEE Transactions on automatic control*, vol. 44, no. 1, pp. 208–214, 1999. 1, 3, 4, 93
- [9] R. Hilfer, *Applications of fractional calculus in physics*. World Scientific, 2000. 1, 2
- [10] C. A. Monje, Y. Chen, B. M. Vinagre, D. Xue, and V. Feliu-Batlle, *Fractional-order systems and controls: fundamentals and applications*. Springer Science & Business Media, 2010. 1, 2, 3, 16, 25, 27, 32, 63
- [11] J. Sabatier, P. Lanusse, P. Melchior, and A. Oustaloup, “Fractional order differentiation and robust control design,” 1, 3, 32, 33, 65, 83

- [12] E. Scalas, “The application of continuous-time random walks in finance and economics,” *Physica A: Statistical Mechanics and its Applications*, vol. 362, no. 2, pp. 225–239, 2006. 1
- [13] C. Ionescu, R. De Keyser, J. Sabatier, A. Oustaloup, and F. Levron, “Low frequency constant-phase behavior in the respiratory impedance,” *Biomedical Signal Processing and Control*, vol. 6, no. 2, pp. 197–208, 2011. 1, 2
- [14] C. Ionescu, J. T. Machado, and R. De Keyser, “Fractional-order impulse response of the respiratory system,” *Computers & Mathematics with Applications*, vol. 62, no. 3, pp. 845–854, 2011. 1, 2
- [15] R. L. Magin, *Fractional calculus in bioengineering*. Begell House Redding, 2006. 1, 2, 31
- [16] K. B. Oldham, “Signal-independent electroanalytical method,” *Analytical Chemistry*, vol. 44, no. 1, pp. 196–198, 1972. 1
- [17] A. Oustaloup, B. Mathieu, and P. Lanusse, “The crone control of resonant plants: application to a flexible transmission,” *European Journal of control*, vol. 1, no. 2, pp. 113–121, 1995. 1, 3
- [18] K. Oldham and J. Spanier, *The fractional calculus theory and applications of differentiation and integration to arbitrary order*, vol. 111. Elsevier, 1974. 2
- [19] I. Podlubny, “Fractional-order systems and fractional-order controllers,” *Institute of Experimental Physics, Slovak Academy of Sciences, Kosice*, vol. 12, no. 3, pp. 1–18, 1994. 2
- [20] J. T. Machado, A. M. Galhano, and J. J. Trujillo, “Science metrics on fractional calculus development since 1966,” *Fractional Calculus and Applied Analysis*, vol. 16, no. 2, pp. 479–500, 2013. 2
- [21] I. Podlubny, *Fractional differential equations: an introduction to fractional derivatives, fractional differential equations, to methods of their solution and some of their applications*, vol. 198. Academic press, 1998. 2, 3, 4, 9, 10, 11, 12, 13, 15, 16, 17, 19, 32, 54, 61
- [22] R. Caponetto, G. Dongola, L. Fortuna, and I. Petráš, “Modeling and control applications,” 2010. 2
- [23] M. Ö. Efe, “Fractional fuzzy adaptive sliding-mode control of a 2-dof direct-drive robot arm,” *IEEE Transactions on Systems, Man, and Cybernetics, Part B (Cybernetics)*, vol. 38, no. 6, pp. 1561–1570, 2008. 2

-
- [24] J. Tenreiro Machado and A. M. Galhano, "Fractional order inductive phenomena based on the skin effect," *Nonlinear Dynamics*, vol. 68, no. 1, pp. 107–115, 2012. 2
- [25] J. Xu, C. C. Mi, B. Cao, and J. Cao, "A new method to estimate the state of charge of lithium-ion batteries based on the battery impedance model," *Journal of power sources*, vol. 233, pp. 277–284, 2013. 2
- [26] W. Mitkowski and P. Skruch, "Fractional-order models of the supercapacitors in the form of rc ladder networks," *Bulletin of The Polish Academy of Sciences: Technical Sciences*, vol. 61, no. 3, pp. 581–587, 2013. 2
- [27] Y.-M. Chen, Y.-Q. Wei, D.-Y. Liu, D. Boutat, and X.-K. Chen, "Variable-order fractional numerical differentiation for noisy signals by wavelet denoising," *Journal of Computational Physics*, vol. 311, pp. 338–347, 2016. 2
- [28] S. Kumar, H. Kocak, and A. Yildirim, "A fractional model of gas dynamics equations and its analytical approximate solution using laplace transform," *Zeitschrift für Naturforschung A*, vol. 67, no. 6-7, pp. 389–396, 2012. 2
- [29] A. Oustaloup, X. Moreau, and M. Nouillant, "The crone suspension," *Control Engineering Practice*, vol. 4, no. 8, pp. 1101–1108, 1996. 2, 3
- [30] X. Moreau, *La dérivation non entière en isolation vibratoire et son application dans le domaine de l'automobile. La suspension CRONE: du concept à la réalisation*. PhD thesis, 1995. 2, 3
- [31] T. J. Freeborn, "A survey of fractional-order circuit models for biology and biomedicine," *IEEE Journal on Emerging and Selected Topics in Circuits and Systems*, vol. 3, no. 3, pp. 416–424, 2013. 2
- [32] R. T. Baillie, "Long memory processes and fractional integration in econometrics," *Journal of econometrics*, vol. 73, no. 1, pp. 5–59, 1996. 2
- [33] R. Metzler, W. Schick, H.-G. Kilian, and T. F. Nonnenmacher, "Relaxation in filled polymers: A fractional calculus approach," *The Journal of Chemical Physics*, vol. 103, no. 16, pp. 7180–7186, 1995. 2
- [34] H. Schiessel, R. Metzler, A. Blumen, and T. Nonnenmacher, "Generalized viscoelastic models: their fractional equations with solutions," *Journal of physics A: Mathematical and General*, vol. 28, no. 23, p. 6567, 1995. 2
- [35] R. L. Bagley and P. J. Torvik, "On the fractional calculus model of viscoelastic behavior," *Journal of Rheology*, vol. 30, no. 1, pp. 133–155, 1986. 2

- [36] F. Mainardi, *Fractional calculus and waves in linear viscoelasticity: an introduction to mathematical models*. World Scientific, 2010. 2
- [37] C. G. Koh and J. M. Kelly, “Application of fractional derivatives to seismic analysis of base-isolated models,” *Earthquake engineering & structural dynamics*, vol. 19, no. 2, pp. 229–241, 1990. 2
- [38] J. T. Machado, V. Kiryakova, and F. Mainardi, “Recent history of fractional calculus,” *Communications in Nonlinear Science and Numerical Simulation*, vol. 16, no. 3, pp. 1140–1153, 2011. 3
- [39] J. A. T. Machado, F. Mainardi, V. Kiryakova, and T. Atanacković, “Fractional calculus: D’où venons-nous? que sommes-nous? où allons-nous?,” *Fractional Calculus and Applied Analysis*, vol. 19, no. 5, pp. 1074–1104, 2016. 3
- [40] M. D. Ortigueira and J. T. Machado, “Fractional signal processing and applications,” 2003. 3
- [41] J.-C. Trigeassou, N. Maamri, J. Sabatier, and A. Oustaloup, “A lyapunov approach to the stability of fractional differential equations,” *Signal Processing*, vol. 91, no. 3, pp. 437–445, 2011. 3
- [42] J.-C. Trigeassou, N. Maamri, and A. Oustaloup, “Lyapunov stability of commensurate fractional order systems: a physical interpretation,” *Journal of Computational and Nonlinear Dynamics*, vol. 11, no. 5, p. 051007, 2016. 3
- [43] CRONE, *Home page of CRONE*. University of Bordeaux, IMS Laboratory (CRONE Team), CNRS, UMR 5218, 351 cours de la Libération, 33405 Talence, France., Apr. 2017. <https://www.ims-bordeaux.fr/fr/recherche/groupe-recherche/45-automatique/crone/28-CRONE>. 3
- [44] A. Oustaloup, P. Melchior, P. Lanusse, O. Cois, and F. Dancla, “The crone toolbox for matlab,” in *Computer-Aided Control System Design, 2000. CACSD 2000. IEEE International Symposium on*, pp. 190–195, IEEE, 2000. 3
- [45] B. M. Vinagre, I. Podlubny, L. Dorcak, and V. Feliu, “On fractional pid controllers: a frequency domain approach,” in *Proceedings of IFAC Workshop on Digital Control-PID’00, Terrassa, Spain*, pp. 53–58, 2000. 3
- [46] I. Podlubny, I. Petraš, B. M. Vinagre, P. O’leary, and L. Dorčák, “Analogue realizations of fractional-order controllers,” *Nonlinear dynamics*, vol. 29, no. 1, pp. 281–296, 2002. 3

-
- [47] Y. Li, H. Sheng, and Y. Chen, “Analytical impulse response of a fractional second order filter and its impulse response invariant discretization,” *Signal Processing*, vol. 91, no. 3, pp. 498–507, 2011. 3
- [48] Y. Q. Chen and K. L. Moore, “Discretization schemes for fractional-order differentiators and integrators,” *IEEE Transactions on Circuits and Systems I: Fundamental Theory and Applications*, vol. 49, no. 3, pp. 363–367, 2002. 3
- [49] Y. Chen and K. L. Moore, “Relay feedback tuning of robust pid controllers with iso-damping property,” *IEEE Transactions on Systems, Man, and Cybernetics, Part B (Cybernetics)*, vol. 35, no. 1, pp. 23–31, 2005. 3
- [50] H. Li, Y. Luo, and Y. Chen, “A fractional order proportional and derivative (fopd) motion controller: tuning rule and experiments,” *IEEE Transactions on control systems technology*, vol. 18, no. 2, pp. 516–520, 2010. 3
- [51] Y. Luo, T. Zhang, B. Lee, C. Kang, and Y. Chen, “Fractional-order proportional derivative controller synthesis and implementation for hard-disk-drive servo system,” *IEEE Transactions on Control Systems Technology*, vol. 22, no. 1, pp. 281–289, 2014. 3
- [52] J. I. Suárez, B. M. Vinagre, A. Calderón, C. Monje, and Y. Chen, “Using fractional calculus for lateral and longitudinal control of autonomous vehicles,” in *International Conference on Computer Aided Systems Theory*, pp. 337–348, Springer, 2003. 3
- [53] Y. Luo and Y. Chen, *Fractional order motion controls*. John Wiley & Sons, 2012. 3
- [54] A. Oustaloup, J. Sabatier, and P. Lanusse, “From fractal robustness to the crone control,” *FCAA*, vol. 2, no. 1, pp. 1–30, 1999. 4, 61, 93
- [55] J. Sabatier, C. Farges, M. Merveillaut, and L. Feneteau, “On observability and pseudo state estimation of fractional order systems,” *European journal of control*, vol. 18, no. 3, pp. 260–271, 2012. 4, 29, 61, 93
- [56] M. K. Bouafoura and N. B. Braiek, “ $\text{P}\lambda\text{d}\mu$ controller design for integer and fractional plants using piecewise orthogonal functions,” *Communications in Non-linear Science and Numerical Simulation*, vol. 15, no. 5, pp. 1267–1278, 2010. 4, 93
- [57] J. Sabatier, C. Farges, and J.-C. Trigeassou, “Fractional systems state space description: some wrong ideas and proposed solutions,” *Journal of Vibration and Control*, vol. 20, no. 7, pp. 1076–1084, 2014. 4, 20, 61, 63, 86

- [58] S. Kamal, A. Raman, and B. Bandyopadhyay, “Finite-time stabilization of fractional order uncertain chain of integrator: an integral sliding mode approach,” *IEEE Transactions on Automatic Control*, vol. 58, no. 6, pp. 1597–1602, 2013. 4, 11, 35, 61
- [59] B. Bandyopadhyay and S. Kamal, *Stabilization and control of fractional order systems: a sliding mode approach*, vol. 317. Springer, 2015. 4, 35
- [60] J. T. Machado, “Calculation of fractional derivatives of noisy data with genetic algorithms,” *Nonlinear Dynamics*, vol. 57, no. 1-2, pp. 253–260, 2009. 4
- [61] J. T. Machado, “Exploiting sensor redundancy for the calculation of fractional derivatives in the presence of noise,” *Signal Processing*, vol. 92, no. 1, pp. 204–209, 2012. 4
- [62] D.-Y. Liu, Y. Tian, D. Boutat, and T.-M. Laleg-Kirati, “An algebraic fractional order differentiator for a class of signals satisfying a linear differential equation,” *Signal Processing*, vol. 116, pp. 78–90, 2015. 4, 5, 36, 81, 102, 107, 116
- [63] D.-Y. Liu, G. Zheng, D. Boutat, and H.-R. Liu, “Non-asymptotic fractional order differentiator for a class of fractional order linear systems,” *Automatica*, 2017. 4, 5, 36, 93, 94, 117
- [64] D. Chen, Y. Chen, and D. Xue, “Digital fractional order savitzky-golay differentiator,” *IEEE Transactions on Circuits and Systems II: Express Briefs*, vol. 58, no. 11, pp. 758–762, 2011. 4, 5
- [65] A. Pisano, D. Nesi, E. Usai, and M. R. Rapaic, “Nonlinear discrete-time algorithm for fractional derivatives computation with application to $\pi\lambda d\mu$ controller implementation,” *IFAC Proceedings Volumes*, vol. 46, no. 1, pp. 887–892, 2013. 4
- [66] D.-Y. Liu, O. GIBARU, W. Perruquetti, and T.-M. Laleg-Kirati, “Fractional order differentiation by integration and error analysis in noisy environment,” *IEEE Transactions on Automatic Control*, vol. 60, no. 11, pp. 2945–2960, 2015. 4, 61
- [67] D.-Y. Liu and T.-M. Laleg-Kirati, “Robust fractional order differentiators using generalized modulating functions method,” *Signal Processing*, vol. 107, pp. 395–406, 2014. 4, 5, 37, 44, 45, 50, 52, 116
- [68] M. Fliess and H. Sira-Ramírez, “An algebraic framework for linear identification,” *ESAIM: Control, Optimisation and Calculus of Variations*, vol. 9, pp. 151–168, 2003. 5, 36

-
- [69] D.-Y. Liu, O. GIBARU, W. Perruquetti, and T.-M. Laleg-Kirati, "Fractional order differentiation by integration with jacobi polynomials," in *2012 IEEE 51st IEEE Conference on Decision and Control (CDC)*, pp. 624–629, IEEE, 2012. 5
- [70] D. Liu, T. Laleg-Kirati, O. GIBARU, and W. Perruquetti, "Fractional order numerical differentiation with b-spline functions," in *The International Conference on Fractional Signals and Systems 2013*, 2013. 5
- [71] M. Fliess, "Analyse non standard du bruit," *Comptes Rendus Mathematique*, vol. 342, no. 10, pp. 797–802, 2006. 5, 36, 80, 81, 103
- [72] M. Fliess, "Critique du rapport signal \a bruit en communications num\eriques—questioning the signal to noise ratio in digital communications," *arXiv preprint arXiv:0808.3712*, 2008. 5, 36, 81, 103
- [73] P. J. Davis, "Leonhard euler's integral: A historical profile of the gamma function: In memoriam: Milton abramowitz," *The American Mathematical Monthly*, vol. 66, no. 10, pp. 849–869, 1959. 7
- [74] K. S. Miller and B. Ross, "An introduction to the fractional calculus and fractional differential equations," 1993. 7, 12, 17, 107
- [75] M. Abramowitz, I. A. Stegun, *et al.*, "Handbook of mathematical functions," *Applied mathematics series*, vol. 55, no. 62, p. 39, 1966. 8
- [76] G. Mittag-Leffler, "Sur la nouvelle fonction $e_x(x)$," *CR Acad. Sci. Paris*, vol. 137, no. 2, pp. 554–558, 1903. 9
- [77] R. Agarwal, "A propos d'une note de m. pierre humbert," *CR Acad. Sci. Paris*, vol. 236, no. 21, pp. 2031–2032, 1953. 9
- [78] A. Shukla and J. Prajapati, "On a generalization of mittag-leffler function and its properties," *Journal of Mathematical Analysis and Applications*, vol. 336, no. 2, pp. 797–811, 2007. 9
- [79] S. Victor, P. Melchior, J. Lévine, and A. Oustaloup, "Flatness for linear fractional systems with application to a thermal system," *Automatica*, vol. 57, pp. 213–221, 2015. 11
- [80] S. Ibrir and M. Bettayeb, "New sufficient conditions for observer-based control of fractional-order uncertain systems," *Automatica*, vol. 59, pp. 216–223, 2015. 11, 86

- [81] S. Djennoune and M. Bettayeb, “Optimal synergetic control for fractional-order systems,” *Automatica*, vol. 49, no. 7, pp. 2243–2249, 2013. 11
- [82] X. Tang, Y. Shi, and L.-L. Wang, “A new framework for solving fractional optimal control problems using fractional pseudospectral methods,” *Automatica*, vol. 78, pp. 333–340, 2017. 11
- [83] W. Yu, Y. Li, G. Wen, X. Yu, and J. Cao, “Observer design for tracking consensus in second-order multi-agent systems: Fractional order less than two,” *IEEE Transactions on Automatic Control*, vol. 62, no. 2, pp. 894–900, 2017. 11
- [84] S. Abrashov, R. Malti, M. Moze, X. Moreau, F. Aioun, and F. Guillemard, “Simple and robust experiment design for system identification using fractional models,” *IEEE Transactions on Automatic Control*, 2016. 11
- [85] V. E. Tarasov, “Geometric interpretation of fractional-order derivative,” *Fractional Calculus and Applied Analysis*, vol. 19, no. 5, pp. 1200–1221, 2016. 11
- [86] N. Heymans and I. Podlubny, “Physical interpretation of initial conditions for fractional differential equations with riemann-liouville fractional derivatives,” *Rheologica Acta*, vol. 45, no. 5, pp. 765–771, 2006. 11
- [87] A. A. Kilbas, H. M. Srivastava, and J. J. Trujillo, “Theory and applications of fractional differential equations,” 2006. 11, 15
- [88] I. Podlubny and Y. Chen, “Adjoint fractional differential expressions and operators,” in *Proceedings of the ASME 2007 International Design Engineering Technical Conferences & Computers and Information in Engineering Conference IDETC/CIE*, pp. 4–7, 2007. 15
- [89] M. Bologna, “Short introduction to fractional calculus,” *Lecture Notes*, pp. 41–54, 2005. 17
- [90] V. Namias, “The fractional order fourier transform and its application to quantum mechanics,” *IMA Journal of Applied Mathematics*, vol. 25, no. 3, pp. 241–265, 1980. 19
- [91] R. L. Bagley and P. Torvik, “A theoretical basis for the application of fractional calculus to viscoelasticity,” *Journal of Rheology*, vol. 27, no. 3, pp. 201–210, 1983. 19
- [92] K. Diethelm, *The analysis of fractional differential equations: An application-oriented exposition using differential operators of Caputo type*. Springer, 2010. 19, 105

-
- [93] S. Victor, R. Malti, H. Garnier, and A. Oustaloup, "Parameter and differentiation order estimation in fractional models," *Automatica*, vol. 49, no. 4, pp. 926–935, 2013. 19
- [94] A. Dzieliński and D. Sierociuk, "Stability of discrete fractional order state-space systems," *Journal of Vibration and Control*, vol. 14, no. 9-10, pp. 1543–1556, 2008. 19
- [95] D. Sierociuk and A. Dzieliński, "Fractional kalman filter algorithm for the states, parameters and order of fractional system estimation," *International Journal of Applied Mathematics and Computer Science*, vol. 16, pp. 129–140, 2006. 19
- [96] C. F. Lorenzo and T. T. Hartley, "Initialization in fractional order systems," in *Control Conference (ECC), 2001 European*, pp. 1471–1476, IEEE, 2001. 20, 61
- [97] T. T. Hartley and C. F. Lorenzo, "Dynamics and control of initialized fractional-order systems," *Nonlinear Dynamics*, vol. 29, no. 1-4, pp. 201–233, 2002. 20, 61, 86
- [98] C. Farges, M. Moze, and J. Sabatier, "Pseudo-state feedback stabilization of commensurate fractional order systems," *Automatica*, vol. 46, no. 10, pp. 1730–1734, 2010. 20, 61
- [99] C. Li and F. Zhang, "A survey on the stability of fractional differential equations," *The European Physical Journal-Special Topics*, vol. 193, no. 1, pp. 27–47, 2011. 21
- [100] D. Matignon, "Stability results for fractional differential equations with applications to control processing," in *Computational engineering in systems applications*, vol. 2, pp. 963–968, Citeseer, 1996. 22
- [101] J. Sabatier, M. Moze, and C. Farges, "Lmi stability conditions for fractional order systems," *Computers & Mathematics with Applications*, vol. 59, no. 5, pp. 1594–1609, 2010. 22, 86
- [102] Y. Li, Y. Chen, and I. Podlubny, "Stability of fractional-order nonlinear dynamic systems: Lyapunov direct method and generalized mittag-leffler stability," *Computers & Mathematics with Applications*, vol. 59, no. 5, pp. 1810–1821, 2010. 24
- [103] H. M. Farkas and I. Kra, "Riemann surfaces," in *Riemann surfaces*, pp. 9–31, Springer, 1992. 24
- [104] A. Oustaloup and P. Coiffet, *Systèmes asservis linéaires d'ordre fractionnaire: théorie et pratique: par Alain Oustaloup*. Masson, 1983. 29, 33

- [105] G. Montseny, “Diffusive representation of pseudo-differential time-operators,” 1998. 29, 30
- [106] J. Sabatier, M. Merveillaut, R. Malti, and A. Oustaloup, “How to impose physically coherent initial conditions to a fractional system?,” *Communications in Nonlinear Science and Numerical Simulation*, vol. 15, no. 5, pp. 1318–1326, 2010. 29
- [107] D. Matignon, “Stability properties for generalized fractional differential systems,” in *ESAIM: proceedings*, vol. 5, pp. 145–158, EDP Sciences, 1998. 30
- [108] G. Montseny, *Représentation diffusive*. Hermès science publications, 2005. 30
- [109] R. L. Magin, “Fractional calculus models of complex dynamics in biological tissues,” *Computers & Mathematics with Applications*, vol. 59, no. 5, pp. 1586–1593, 2010. 30, 85
- [110] D. Matignon and B. d’Andréa Novel, “Some results on controllability and observability of finite-dimensional fractional differential systems,” in *Computational engineering in systems applications*, vol. 2, pp. 952–956, Citeseer, 1996. 31
- [111] V. Badri and M. S. Tavazoei, “On tuning fractional order [proportional–derivative] controllers for a class of fractional order systems,” *Automatica*, vol. 49, no. 7, pp. 2297–2301, 2013. 32
- [112] M. Zhuang and D. Atherton, “Automatic tuning of optimum pid controllers,” in *IEE Proceedings D (Control Theory and Applications)*, vol. 140, pp. 216–224, IET, 1993. 32
- [113] K. J. Åström and T. Hägglund, *PID controllers: theory, design, and tuning*, vol. 2. Isa Research Triangle Park, NC, 1995. 32
- [114] K. J. Åström and T. Hägglund, *Advanced PID control*. ISA-The Instrumentation, Systems and Automation Society, 2006. 32
- [115] J. G. Ziegler and N. B. Nichols, “Optimum settings for automatic controllers,” *trans. ASME*, vol. 64, no. 11, 1942. 32
- [116] K. J. Åström and T. Hägglund, “Revisiting the ziegler–nichols step response method for pid control,” *Journal of process control*, vol. 14, no. 6, pp. 635–650, 2004. 32
- [117] D. Xue and Y. Chen, “A comparative introduction of four fractional order controllers,” in *Intelligent Control and Automation, 2002. Proceedings of the 4th World Congress on*, vol. 4, pp. 3228–3235, IEEE, 2002. 32, 33

-
- [118] B. J. Lurie, “Three-parameter tunable tilt-integral-derivative (tid) controller,” Dec. 6 1994. US Patent 5,371,670. 33
- [119] M. Asadollahi, H. Dehghani, *et al.*, “Excitation control of a synchronous generator using a novel fractional-order controller,” *IET Generation, Transmission & Distribution*, vol. 9, no. 15, pp. 2255–2260, 2015. 33
- [120] H.-F. Raynaud and A. Zergamoh, “State-space representation for fractional order controllers,” *Automatica*, vol. 36, no. 7, pp. 1017–1021, 2000. 33
- [121] C. A. Monje, B. M. Vinagre, A. J. Calderon, V. Feliu, and Y. Chen, “Auto-tuning of fractional lead-lag compensators,” *IFAC Proceedings Volumes*, vol. 38, no. 1, pp. 319–324, 2005. 33
- [122] D. Matignon and B. d’Andrea Novel, “Observer-based controllers for fractional differential systems,” in *Decision and Control, 1997., Proceedings of the 36th IEEE Conference on*, vol. 5, pp. 4967–4972, IEEE, 1997. 33
- [123] K. Zhou, J. C. Doyle, K. Glover, *et al.*, *Robust and optimal control*, vol. 40. Prentice hall New Jersey, 1996. 33
- [124] Y.-H. Lan, H.-X. Huang, and Y. Zhou, “Observer-based robust control of $a(1 \leq a < 2)$ fractional-order uncertain systems: a linear matrix inequality approach,” *IET control theory & applications*, vol. 6, no. 2, pp. 229–234, 2012. 33, 62
- [125] M. Fliess, M. Mboup, H. Mounier, and H. Sira-Ramirez, “Questioning some paradigms of signal processing via concrete examples,” in *Algebraic Methods in Flatness, Signal Processing and State Estimation*, pp. pp–1, Editorial Lagares, 2003. 35
- [126] M. Fliess, C. Join, M. Mboup, and H. Sira-Ramirez, “Compression différentielle de transitoires bruités,” *Comptes Rendus Mathématique*, vol. 339, no. 11, pp. 821–826, 2004. 35
- [127] M. Mboup, “Parameter estimation for signals described by differential equations,” *Applicable Analysis*, vol. 88, no. 1, pp. 29–52, 2009. 35
- [128] G. Pin, M. Lovera, A. Assalone, and T. Parisini, “Kernel-based non-asymptotic state estimation for linear continuous-time systems,” in *American Control Conference (ACC), 2013*, pp. 3123–3128, IEEE, 2013. 35

- [129] G. Pin, A. Assalone, M. Lovera, and T. Parisini, “Non-asymptotic kernel-based parametric estimation of continuous-time linear systems,” *IEEE Transactions on Automatic Control*, vol. 61, no. 2, pp. 360–373, 2016. 35
- [130] G. Pin, B. Chen, and T. Parisini, “Robust finite-time estimation of biased sinusoidal signals: A volterra operators approach,” *Automatica*, vol. 77, pp. 120–132, 2017. 35
- [131] R. Delpoux, R. Béarée, A. Olabi, and O. Gibaru, “Toward on-line robot vibratory modes estimation,” in *American Control Conference (ACC), 2014*, pp. 4385–4390, IEEE, 2014. 35, 62
- [132] Q. Guo, W. Perruquetti, and D. Efimov, “Universal robust adaptive control of robot manipulators using real time estimation,” *IFAC-PapersOnLine*, vol. 48, no. 11, pp. 499–504, 2015. 35, 62
- [133] M. N. Mahyuddin, S. G. Khan, and G. Herrmann, “A novel robust adaptive control algorithm with finite-time online parameter estimation of a humanoid robot arm,” *Robotics and Autonomous Systems*, vol. 62, no. 3, pp. 294–305, 2014. 35, 62
- [134] M. Shinbrot, “On the analysis of linear and nonlinear dynamic systems from transient-response data, national advisory committee for aeronautics naca,” tech. rep., Technical Note 3288, Washington, 1954. 35
- [135] H. Preisig and D. Rippin, “Theory and application of the modulating function method—i. review and theory of the method and theory of the spline-type modulating functions,” *Computers & chemical engineering*, vol. 17, no. 1, pp. 1–16, 1993. 35, 37, 47
- [136] T. B. Co and S. Ungarala, “Batch scheme recursive parameter estimation of continuous-time systems using the modulating functions method,” *Automatica*, vol. 33, no. 6, pp. 1185–1191, 1997. 35, 37
- [137] H. Unbehauen and G. Rao, “A review of identification in continuous-time systems,” *Annual reviews in Control*, vol. 22, pp. 145–171, 1998. 35
- [138] S. Asiri and T.-M. Laleg-Kirati, “Modulating functions-based method for parameters and source estimation in one-dimensional partial differential equations,” *Inverse Problems in Science and Engineering*, pp. 1–25, 2016. 35, 37
- [139] G. Fedele, C. Picardi, and D. Sgro, “A power electrical signal tracking strategy based on the modulating functions method,” *IEEE Transactions on Industrial Electronics*, vol. 56, no. 10, pp. 4079–4087, 2009. 35, 37

-
- [140] G. Fedele and L. Coluccio, "A recursive scheme for frequency estimation using the modulating functions method," *Applied Mathematics and Computation*, vol. 216, no. 5, pp. 1393–1400, 2010. 35, 37
- [141] D.-Y. Liu, O. Gibaru, and W. Perruquetti, "Parameters estimation of a noisy sinusoidal signal with time-varying amplitude," in *19th Mediterranean Conference on Control and Automation, 2011*, 2011. 35, 37
- [142] A. Neves, M. Mboup, and M. Fliess, "An algebraic receiver for full response cpm demodulation," in *Telecommunications Symposium, 2006 International*, pp. 387–392, IEEE, 2006. 36
- [143] A. Neves, M. D. Miranda, and M. Mboup, "Algebraic parameter estimation of damped exponentials," in *Signal Processing Conference, 2007 15th European*, pp. 965–969, IEEE, 2007. 36
- [144] J. R. Trapero, H. Sira-Ramírez, and V. F. Batlle, "An algebraic frequency estimator for a biased and noisy sinusoidal signal," *Signal Processing*, vol. 87, no. 6, pp. 1188–1201, 2007. 36
- [145] J. R. Trapero, H. Sira-Ramírez, and V. F. Batlle, "A fast on-line frequency estimator of lightly damped vibrations in flexible structures," *Journal of sound and vibration*, vol. 307, no. 1, pp. 365–378, 2007. 36
- [146] J. R. Trapero, H. Sira-Ramírez, and V. Feliu Batlle, "On the algebraic identification of the frequencies, amplitudes and phases of two sinusoidal signals from their noisy sum," *International Journal of Control*, vol. 81, no. 3, pp. 507–518, 2008. 36
- [147] D.-Y. Liu, O. Gibaru, W. Perruquetti, M. Fliess, and M. Mboup, "An error analysis in the algebraic estimation of a noisy sinusoidal signal," in *16th Mediterranean Conference on Control and Automation*, 2008. 36
- [148] D. Liu, *Analyse d'erreurs d'estimateurs des dérivées de signaux bruités et applications*. PhD thesis, Lille 1, 2011. 36
- [149] D.-Y. Liu, T.-M. Laleg-Kirati, O. Gibaru, and W. Perruquetti, "Identification of fractional order systems using modulating functions method," in *The American Control Conference 2013*, 2013. 37
- [150] D.-Y. Liu, T.-M. Laleg-Kirati, W. Perruquetti, and O. Gibaru, "Non-asymptotic state estimation for a class of linear time-varying systems with unknown inputs," *IFAC Proceedings Volumes*, vol. 47, no. 3, pp. 3732–3738, 2014. 37, 40, 116

- [151] G. P. Rao and K. Palanisamy, "Improved algorithms for parameter identification in continuous systems via walsh functions," in *IEE Proceedings D-Control Theory and Applications*, vol. 130, p. 9, IET, 1983. 37
- [152] J. Jordan and N. Paterson, "A modulating-function method for on-line fault detection (machinery health monitoring)," *Journal of Physics E: Scientific Instruments*, vol. 19, no. 9, p. 681, 1986. 37
- [153] J. Jordan, S. Jalali-Naini, and R. Mackie, "System identification with hermite modulating functions," in *IEE Proceedings D-Control Theory and Applications*, vol. 137, pp. 87–93, IET, 1990. 37
- [154] A. Pearson and F. Lee, "On the identification of polynomial input-output differential systems," *IEEE Transactions on Automatic Control*, vol. 30, no. 8, pp. 778–782, 1985. 37
- [155] S. Ungarala and T. B. Co, "Time-varying system identification using modulating functions and spline models with application to bio-processes," *Computers & Chemical Engineering*, vol. 24, no. 12, pp. 2739–2753, 2000. 37
- [156] L. Coluccio, A. Eisinberg, G. Fedele, C. Picardi, and D. Sgro, "Modulating functions method plus sogi scheme for signal tracking," in *Industrial Electronics, 2008. ISIE 2008. IEEE International Symposium on*, pp. 854–859, IEEE, 2008. 37
- [157] G. P. Rao and L. Sivakumar, "Identification of deterministic time-lag systems," *IEEE Transactions on Automatic Control*, vol. 21, no. 4, pp. 527–529, 1976. 37
- [158] Y. Tian, T. Floquet, and W. Perruquetti, "Fast state estimation in linear time-varying systems: an algebraic approach," in *Decision and Control, 2008. CDC 2008. 47th IEEE Conference on*, pp. 2539–2544, IEEE, 2008. 47
- [159] Y. Tian, T. Floquet, and W. Perruquetti, "Fast state estimation in linear time-invariant systems: an algebraic approach," in *Control and Automation, 2008 16th Mediterranean Conference on*, pp. 350–355, IEEE, 2008. 47
- [160] S. Haykin and B. Van Veen, *Signals and systems*. John Wiley & Sons, 2007. 53
- [161] C. Yeroglu and N. Tan, "Note on fractional-order proportional–integral–differential controller design," *IET control theory & applications*, vol. 5, no. 17, pp. 1978–1989, 2011. 54
- [162] V. Pommier, J. Sabatier, P. Lanusse, and A. Oustaloup, "Crone control of a nonlinear hydraulic actuator," *Control Engineering Practice*, vol. 10, no. 4, pp. 391–402, 2002. 61

-
- [163] F. Hu and W. Q. Zhu, "Stabilization of quasi integrable hamiltonian systems with fractional derivative damping by using fractional optimal control," *IEEE Transactions on Automatic Control*, vol. 58, no. 11, pp. 2968–2973, 2013. 61
- [164] C. Yin, Y. Chen, and S.-m. Zhong, "Fractional-order sliding mode based extremum seeking control of a class of nonlinear systems," *Automatica*, vol. 50, no. 12, pp. 3173–3181, 2014. 61
- [165] D. Luenberger, "Observers for multivariable systems," *IEEE Transactions on Automatic Control*, vol. 11, no. 2, pp. 190–197, 1966. 62, 83
- [166] A. Dzieliński and D. Sierociuk, "Observer for discrete fractional order state-space systems," *IFAC Proceedings Volumes*, vol. 39, no. 11, pp. 511–516, 2006. 62
- [167] I. N'doye, M. Zasadzinski, M. Darouach, and N.-E. Radhy, "Observer-based control for fractional-order continuous-time systems," in *Decision and Control, 2009 held jointly with the 2009 28th Chinese Control Conference. CDC/CCC 2009. Proceedings of the 48th IEEE Conference on*, pp. 1932–1937, IEEE, 2009. 62
- [168] A. Ralston, "A first course in numerical analysis," 1965. 81, 105
- [169] R. Butt, *Introduction to Numerical Analysis Using MATLAB®*. Jones & Bartlett Learning, 2009. 81
- [170] A. M. Pertew, H. J. Marquez, and Q. Zhao, "H/sub/spl infin//observer design for lipschitz nonlinear systems," *IEEE Transactions on Automatic Control*, vol. 51, no. 7, pp. 1211–1216, 2006. 83
- [171] Y. Boukal, M. Darouach, M. Zasadzinski, and N.-E. Radhy, " h_∞ observer design for linear fractional-order systems in time and frequency domains," in *Control Conference (ECC), 2014 European*, pp. 2975–2980, IEEE, 2014. 84
- [172] M. Moze, J. Sabatier, and A. Oustaloup, "On bounded real lemma for fractional systems," *IFAC Proceedings Volumes*, vol. 41, no. 2, pp. 15267–15272, 2008. 84
- [173] M. Grant, S. Boyd, and Y. Ye, "Cvx: Matlab software for disciplined convex programming," 2008. 84
- [174] J. Lofberg, "Yalmip: A toolbox for modeling and optimization in matlab," in *Computer Aided Control Systems Design, 2004 IEEE International Symposium on*, pp. 284–289, IEEE, 2004. 84
- [175] S.-C. Lee, Y. Li, Y. Chen, and H.-S. Ahn, " h_∞ and sliding mode observers for linear time-invariant fractional-order dynamic systems with initial memory effect,"

- Journal of Dynamic Systems, Measurement, and Control*, vol. 136, no. 5, p. 051022, 2014. 84, 85
- [176] T. Kaczorek and K. Rogowski, *Fractional linear systems and electrical circuits*. Springer, 2015. 85
- [177] M. D. Ortigueira and F. J. Coito, “System initial conditions vs derivative initial conditions,” *Computers & Mathematics with Applications*, vol. 59, no. 5, pp. 1782–1789, 2010. 86
- [178] T. T. Hartley, C. F. Lorenzo, J.-C. Trigeassou, and N. Maamri, “Equivalence of history-function based and infinite-dimensional-state initializations for fractional-order operators,” *Journal of Computational and Nonlinear Dynamics*, vol. 8, no. 4, p. 041014, 2013. 86
- [179] Y. Boukal, M. Darouach, M. Zasadzinski, and N.-E. Radhy, “Robust h_∞ observer-based control of fractional-order systems with gain parametrization,” *IEEE Transactions on Automatic Control*, 2017. 86
- [180] Z. Belkhatir and T. M. Laleg-Kirati, “High-order sliding mode observer for fractional commensurate linear systems with unknown input,” *Automatica*, vol. 82, pp. 209–217, 2017. 86
- [181] D.-Y. Liu, O. Ghibaru, and W. Perruquetti, “Synthesis on a class of algebraic differentiators and application to nonlinear observation,” in *Control Conference (CCC), 2014 33rd Chinese*, pp. 2592–2599, IEEE, 2014. 102

Méthodes d'estimation non-asymptotiques des systèmes d'ordre fractionnaire et applications

Résumé :

Cette thèse vise à concevoir des estimateurs non-asymptotiques et robustes pour les systèmes linéaires d'ordre fractionnaire commensurable dans un environnement bruité. Elle traite une classe des systèmes linéaires d'ordre fractionnaire modélisés par la dite pseudo représentation d'état avec des conditions initiales inconnues. Elle suppose également que les systèmes étudiés ici peuvent être transformés sous la forme canonique observable de Brunovsky. Pour estimer le pseudo-état, la forme précédente est transformée en une équation différentielle linéaire d'ordre fractionnaire en prenant en compte les valeurs initiales des dérivées fractionnaires séquentielles de la sortie. Ensuite, en utilisant la méthode des fonctions modultrices, les valeurs initiales précédentes et les dérivées fractionnaires avec des ordres commensurables de la sortie sont données par des formules algébriques avec des intégrales à l'aide d'une méthode récursive. Ainsi, ces formules sont utilisées pour calculer le pseudo-état dans le cas continu sans bruit. En outre, elle fournit un algorithme pour construire les fonctions modultrices requises à l'accomplissement de l'estimation. Deuxièmement, inspirée par la méthode des fonctions modultrices développée pour l'estimation de pseudo-état, une méthode algébrique basée sur un opérateur est introduite pour estimer la dérivée fractionnaire avec un ordre quelconque de la sortie pour les systèmes considérés. Cet opérateur sert à annuler les valeurs initiales non désirées, puis permet d'estimer la dérivée fractionnaire souhaitée par une nouvelle formule algébrique à l'aide d'une méthode récursive. Troisièmement, l'estimateur du pseudo-état et le différentiateur d'ordre fractionnaire obtenus précédemment sont étudiés respectivement dans le cas discret et bruité. Chacun d'entre eux contient une erreur numérique due à la méthode d'intégration numérique utilisée et une autre due au bruit. En particulier, elle fournit une analyse pour diminuer la contribution du bruit au moyen d'une majoration d'erreur qui permet de sélectionner les degrés optimaux des fonctions modultrices à chaque instant. Ensuite, des exemples numériques sont donnés pour mettre en évidence la précision, la robustesse et la propriété non-asymptotique des estimateurs proposés. En outre, les comparaisons avec certaines méthodes existantes et avec un nouvel observateur d'ordre fractionnaire de type \mathcal{H}_∞ sont montrées. Enfin, elle donne des conclusions et des perspectives.

Mots clés : Systèmes linéaires d'ordre fractionnaire, Pseudo représentation d'état, Méthode des fonctions modultrices, Méthode algébrique, Estimation non-asymptotique et robuste, Estimateur de pseudo-état, Différentiateurs d'ordre fractionnaire, Estimateur de conditions initiales, Observateur d'ordre fractionnaire de type Leuenberger, Observateur d'ordre fractionnaire de type de \mathcal{H}_∞ , Différentiateur de Legendre d'ordre fractionnaire.

Non-asymptotic method estimation and applications for fractional order systems

Abstract :

This thesis aims to design non-asymptotic and robust estimators for a class of fractional order linear systems in noisy environment. It deals with a class of commensurate fractional order linear systems modeled by the so-called pseudo-state space representation with unknown initial conditions. It also assumed that linear systems under study can be transformed into the Brunovsky's observable canonical form. Firstly, the pseudo-state of the considered systems is estimated. For this purpose, the Brunovsky's observable canonical form is transformed into a fractional order linear differential equation involving the initial values of the fractional sequential derivatives of the output. Then, using the modulating functions method, the former initial values and the fractional derivatives with commensurate orders of the output are given by algebraic integral formulae in a recursive way. Thereby, they are used to calculate the pseudo-state in the continuous noise-free case. Moreover, to perform this estimation, it provides an algorithm to build the required modulating functions. Secondly, inspired by the modulating functions method developed for pseudo-state estimation, an operator based algebraic method is introduced to estimate the fractional derivative with an arbitrary fractional order of the output. This operator is applied to cancel the former initial values and then enables to estimate the desired fractional derivative by a new algebraic formula using a recursive way. Thirdly, the pseudo-state estimator and the fractional order differentiator are studied in discrete noisy case. Each of them contains a numerical error due to the used numerical integration method, and the noise error contribution due to a class of stochastic processes. In particular, it provides an analysis to decrease noise contribution by means of an error bound that enables to select the optimal degrees of the modulating functions at each instant. Then, several numerical examples are given to highlight the accuracy, the robustness and the non-asymptotic property of the proposed estimators. Moreover, the comparisons to some existing methods and a new fractional order \mathcal{H}_∞ -like observer are shown. Finally, conclusions are outlined with some perspectives.

Index Terms: Fractional order linear systems, Pseudo-state space representation, Modulating functions method, Algebraic method, Non-asymptotic and robust estimation, Pseudo-state estimator, Fractional order differentiators, Initial condition estimator, Fractional order Luenberger-like observer, Fractional order \mathcal{H}_∞ -like observer, Fractional order Legendre differentiator.