



**HAL**  
open science

## A piecewise-affine approach to nonlinear performance

Sergio Waitman

► **To cite this version:**

Sergio Waitman. A piecewise-affine approach to nonlinear performance. Other. Université de Lyon, 2018. English. NNT: 2018LYSEC017 . tel-01917511

**HAL Id: tel-01917511**

**<https://theses.hal.science/tel-01917511>**

Submitted on 9 Nov 2018

**HAL** is a multi-disciplinary open access archive for the deposit and dissemination of scientific research documents, whether they are published or not. The documents may come from teaching and research institutions in France or abroad, or from public or private research centers.

L'archive ouverte pluridisciplinaire **HAL**, est destinée au dépôt et à la diffusion de documents scientifiques de niveau recherche, publiés ou non, émanant des établissements d'enseignement et de recherche français ou étrangers, des laboratoires publics ou privés.



ÉCOLE  
**CENTRALE** LYON

N° d'ordre NNT : 2017LYSEC017

**THÈSE DE DOCTORAT DE L'UNIVERSITÉ DE LYON**

opérée au sein de

**l'École Centrale de Lyon**

Spécialité: “**Automatique**”

préparée dans le laboratoire **Ampère**

dans le cadre de l'École Doctorale EEA de Lyon (**ED160**)

par : **Sérgio Waitman**

---

# **A piecewise-affine approach to nonlinear performance**

---

*Soutenue publiquement le 25 Juillet 2018 devant le jury composé de :*

Président	M. Dimitri Peaucelle	Directeur de Recherche CNRS, LAAS, Toulouse
Rapporteur	M. Alexandre Trofino	Professeur, UFSC, Florianópolis, Brésil
Rapporteur	M. Marc Jungers	Directeur de Recherche CNRS, CRAN, Nancy
Examinatrice	Mme. Safta de Hillerin	Docteur, Ingénieur, Airbus Group MBDA, Paris
Encadrant	M. Laurent Bako	Maître de Conférences, École Centrale de Lyon
Encadrant	M. Paolo Massioni	Maître de Conférences, INSA de Lyon
Directeur de thèse	M. Gérard Scorletti	Professeur des Universités, École Centrale de Lyon



To my wife and best friend.



*“Assaz o senhor sabe: a gente quer passar um rio a nado, e passa; mas vai dar na outra banda é num ponto muito mais embaixo, bem diverso do em que primeiro se pensou. Viver nem não é muito perigoso?”*

*“You know how it is: a person wants to swim across a river and does, but comes out on the other side at a point lower down, not at all where he expected. Isn't life really a dangerous business?”*

---

JOÃO GUIMARÃES ROSA  
*Grande Sertão: Veredas*



# Acknowledgments

This thesis is the result of almost 4 years of work in the Laboratoire Ampère, at Ecole Centrale de Lyon, even if remotely during the last year. I would like to take the time to acknowledge all of those who made it possible.

My first appreciation goes to my supervisor, Prof. Gérard Scorletti, for believing in me since I was a young undergraduate student who needed help to find an internship in automatic control. His belief in my potential, together with his great pedagogy and patience, is what helped me to make up my mind, repack all my things and come back for another French adventure. I thank him for all of the explanations, the help with the mind-bending proofs and the extensive professional and personal support he provided me as my supervisor.

I was very lucky to have Dr. Laurent Bako and Dr. Paolo Massioni as co-advisors of this thesis. I thank Laurent for his friendship, for our long (and, sometimes, late) discussions, and for his encouragement and advice in my times of need. It is fair to say that a great deal of the rigor in the proofs contained in this manuscript come from his thoroughness, for which I am also deeply grateful. I thank Paolo for pushing and believing in me, and for providing invaluable help with the numerous numerical examples I wrestled with during my thesis. Numerical issues were not lacking, and it would have been much harder to cope without his help. On a different side, but not less important, I thank him for the friendship and for introducing me to the wonder that is *panzerotti*.

It was a great honor for me to have Prof. Alexandre Trofino and Dr. Marc Jungers as reporters of this thesis. Their invaluable remarks and suggestions have helped improve quite a bit the quality of the final version of this manuscript. I specially thank Prof. Trofino for coming all the way from Brazil to be present in my defense. I am also grateful to Dr. Dimitri Peaucelle for giving me the pleasure of accepting to be the president of the thesis committee. Last, but not least, I thank Dr. Safta de Hillerin for also taking part in the thesis committee, even while committed to a much nobler labor.

My time spent in Lyon would not have been as pleasant without the company of the many colleagues with whom I had the pleasure to work. A special appreciation goes to all those who shared the great *salle Poitou* with me, including, but not limited to, “Frenchois” Tavernier, (Han) Zhao Li, Khaled Laib, Samuel Eke and Debu Ghosh. Thank you also to Arthur for reminding me of long forgotten Brazilian sayings. The day-to-day company of all the colleagues at Laboratoire Ampère was also greatly appreciated. Thank you all for your company and for the laughs we had together. To Marie-Christine and Edith goes a big thank you for their kindness and patience when helping me navigate the bureaucracy of French higher education. Finally, a special thanks to Alice for the joyful conversations early in the morning, such a nice way of starting the day.

I was able to start and conclude this thesis due to my love for the field of automatic control. This was imbued in me during my undergraduate years, mostly due to the chance of being around great researchers and educators. I thank Mrs. Cathérine Musy-Bassot for giving me my first ever class in linear control theory, and for the support she provided me as my tutor. I also give effusive thanks to Dr. Carsten Döll for accepting and believing in my application for a very interesting internship at Onera, and also for the support and the friendship that remained afterwards. Finally, all my gratitude to Dr. Grace Deaecto and Prof. José C. Geromel for



accepting to supervise my final undergraduate project. It was a very enriching experience, not only for everything that I learned from them, but also for the chance of being around such outstanding persons and researchers.

I must also thank Dr. Andrés Marcos for kindly understanding my situation as a “postdoc” without a “doc”. The freedom he provided me during my year as a double agent was greatly appreciated, and is what made it possible for me to accomplish the writing of this thesis.

None of the work reported here would have existed if it wasn’t for the support provided by my beloved mother, Marta, who always put myself and my brother above everything else. It was her love and hard work that allowed me to get where I am today, and for that I am eternally grateful. My gratitude extends to my brother Pedro for enduring some hardships by my side. A special thank you to my “new” parents, Bete and Oswaldo, and my “new” aunt Grazia for all the assistance and encouragement they have always so kindly showed me. Finally, a big thank you to everyone in my family (by birth or by marriage) for everything they have ever done, and for all the love and care they have provided me with. I am ever so lucky for having such amazing people in my life.

Last but foremost, I express my deepest gratitude to my wife, Juliana, for putting up with all the strains of this process, and for all the love and relentless support she has gifted me during our 8 years together. This adventure only started because she accepted to come back to France side by side with me, and it would not have been possible without her generous help, her wonderful company and her radiant smile. Now that she starts her PhD, I hope to be able to repay everything with all the interest she is due.

# Abstract

When dealing with nonlinear systems, regular notions of stability are not enough to ensure an appropriate behavior when dealing with problems such as tracking, synchronization and observer design. Incremental stability has been proposed as a tool to deal with such problems and ensure that the system presents relevant qualitative behavior. However, as it is often the case with nonlinear systems, the complexity of the analysis leads engineers to search for relaxations, which introduce conservatism. In this thesis, we focus on the incremental stability of a specific class of systems, namely piecewise-affine systems, which could provide a valuable tool for approaching the incremental stability of more general dynamical systems.

Piecewise-affine systems have a partitioned state space, in each region of which the dynamics are governed by an affine differential equation. They can represent systems containing piecewise-affine nonlinearities, as well as serve as approximations of more general nonlinear systems. More importantly, their description is relatively close to that of linear systems, allowing us to obtain analysis conditions expressed as linear matrix inequalities that can be efficiently handled numerically by existing solvers.

In the first part of this memoir, we review the literature on the analysis of piecewise-affine systems using Lyapunov and dissipativity techniques. We then propose new conditions for the analysis of incremental  $\mathcal{L}_2$ -gain and incremental asymptotic stability of piecewise-affine systems expressed as linear matrix inequalities. These conditions are shown to be less conservative than previous results and illustrated through numerical examples.

In the second part, we consider the case of uncertain piecewise-affine systems represented as the interconnection between a nominal system and a structured uncertainty block. Using graph separation theory, we propose conditions that extend the framework of integral quadratic constraints to consider the case when the nominal system is piecewise affine, both in the non-incremental and incremental cases. Through dissipativity theory, these conditions are then expressed as linear matrix inequalities.

Finally, the third part of this memoir is devoted to the analysis of uncertain Lur'e-type nonlinear systems. We develop a new approximation technique allowing to equivalently rewrite such systems as uncertain piecewise-affine systems connected with the approximation error. The proposed approach ensures that the approximation error is Lipschitz continuous with a guaranteed pre-specified upper bound on the Lipschitz constant. This enables us to use the aforementioned techniques to analyze more general classes of nonlinear systems.

**Keywords:** Performance analysis; nonlinear systems; piecewise-affine systems; incremental stability; robustness; graph separation; integral quadratic constraints.



# Résumé

Lorsqu'on fait face à des systèmes non linéaires, les notions classiques de stabilité ne suffisent pas à garantir un comportement approprié vis-à-vis de problématiques telles que le suivi de trajectoires, la synchronisation et la conception d'observateurs. La stabilité incrémentale a été proposée en tant qu'outil permettant de traiter de tels problèmes et de garantir que le système présente des comportements qualitatifs pertinents. Cependant, comme c'est souvent le cas avec les systèmes non linéaires, la complexité de l'analyse conduit les ingénieurs à rechercher des relaxations, ce qui introduit du conservatisme. Dans cette thèse, nous nous intéressons à la stabilité incrémentale d'une classe spécifique de systèmes, à savoir les systèmes affines par morceaux, qui pourraient fournir un outil avantageux pour aborder la stabilité incrémentale de systèmes dynamiques plus génériques.

Les systèmes affines par morceaux ont un espace d'états partitionné, et sa dynamique dans chaque région est régie par une équation différentielle affine. Ils peuvent représenter des systèmes contenant des non linéarités affines par morceaux, ainsi que servir comme des approximations de systèmes non linéaires plus génériques. Ce qui est plus important, leur description est relativement proche de celle des systèmes linéaires, ce qui permet d'obtenir des conditions d'analyse exprimées comme des inégalités matricielles linéaires qui peuvent être traitées numériquement de façon efficace par des solveurs existants.

Dans la première partie de ce document de thèse, nous passons en revue la littérature sur l'analyse des systèmes affines par morceaux en utilisant des techniques de Lyapunov et la dissipativité. Nous proposons ensuite de nouvelles conditions pour l'analyse du gain  $\mathcal{L}_2$  incrémental et la stabilité asymptotique incrémentale des systèmes affines par morceaux exprimés en tant qu'inégalités matricielles linéaires. Ces conditions sont montrées être moins conservatives que les résultats précédents et sont illustrées par des exemples numériques.

Dans la deuxième partie, nous considérons le cas des systèmes affines par morceaux incertains représentés comme l'interconnexion entre un système nominal et un bloc d'incertitude structuré. En utilisant la théorie de la séparation des graphes, nous proposons des conditions qui étendent le cadre des contraintes quadratiques intégrales afin de considérer le cas où le système nominal est affine par morceaux, à la fois dans les cas non incrémental et incrémental. Via la théorie de la dissipativité, ces conditions sont ensuite exprimées en tant qu'inégalités matricielles linéaires.

Finalement, la troisième partie de ce document de thèse est consacrée à l'analyse de systèmes non linéaires de Lur'e incertains. Nous développons une nouvelle technique d'approximation permettant de réécrire ces systèmes de façon équivalente comme des systèmes affines par morceaux incertains connectés avec l'erreur d'approximation. L'approche proposée garantit que l'erreur d'approximation est Lipschitz continue avec la garantie d'une borne supérieure prédéterminée sur la constante de Lipschitz. Cela nous permet d'utiliser les techniques susmentionnées pour analyser des classes plus génériques de systèmes non linéaires.

**Mots-clés :** Analyse de la performance ; systèmes non-linéaires ; systèmes affines par morceaux ; stabilité incrémentale ; robustesse ; séparation des graphes ; contraintes intégrales quadratiques.



# Resumo

Em se tratando de sistemas não-lineares, as noções clássicas de estabilidade não são suficientes para garantir um comportamento adequado quando se lida com problemas como rastreamento, sincronização e concepção de observadores. A estabilidade incremental foi proposta como uma ferramenta para tratar tais problemas e garantir que o sistema apresente um comportamento qualitativo relevante. Entretanto, como frequentemente observado em sistemas não lineares, a complexidade da análise leva engenheiros a procurar relaxamentos, o que introduz conservadorismo. Neste trabalho, nos interessamos à estabilidade incremental de uma classe específica de sistemas, a saber sistemas afins por setores, o que poderia fornecer uma ferramenta valiosa para a abordagem da estabilidade incremental de sistemas dinâmicos mais gerais.

Sistemas afins por setores possuem um espaço de estados particionado, e sua dinâmica em cada região é governada por uma equação diferencial afim. Eles podem representar sistemas contendo não-linearidades afins por setores, assim como servir de aproximações de sistemas não lineares mais gerais. Sobretudo, sua descrição é relativamente próxima a de sistemas lineares, o que permite obter condições de análise expressas como desigualdades matriciais lineares que podem ser tratadas de maneira eficaz através de algoritmos numéricos.

Na primeira parte deste documento de tese, realizamos uma revisão da literatura sobre a análise de sistemas afins por setores por meio de técnicas de Lyapunov e dissipatividade. Em seguida, propomos novas condições para a análise do ganho  $\mathcal{L}_2$  incremental e estabilidade assintótica incremental de sistemas afins por setores expressos como desigualdades matriciais lineares. Estas condições são mostradas serem menos conservadoras que os resultados anteriores e ilustradas através de exemplos numéricos.

Na segunda parte, consideramos o caso de sistemas afins por setores incertos, representados como a interconexão entre um sistema nominal e um bloco de incerteza estruturado. Usando a teoria de separação de gráficos, propomos condições que estendem o quadro de restrições integrais quadráticas de modo a considerar um sistema nominal afim por setores, tanto no caso não-incremental quanto incremental. Através da teoria da dissipatividade, essas condições são então expressas como desigualdades matriciais lineares.

Finalmente, a terceira parte deste trabalho é dedicada à análise de sistemas não-lineares do tipo Lur'e incertos. Desenvolvemos uma nova técnica de aproximação que permite reescrever esses sistemas de forma equivalente como sistemas afins por setores incertos conectados ao erro de aproximação. A abordagem proposta assegura que o erro de aproximação é Lipschitz contínuo com a garantia de um limite superior pré-especificado sobre a constante de Lipschitz. Isso permite o uso das técnicas previamente mencionadas para a análise de classes mais gerais de sistemas não-lineares.

**Palavras-chave:** Análise de performance; sistemas não-lineares; sistemas afins por setores; estabilidade incremental; robustez; separação de gráficos; restrições integrais quadráticas.



# Contents

<b>Acknowledgments</b>	<b>vii</b>
<b>Abstract</b>	<b>ix</b>
<b>Résumé</b>	<b>xi</b>
<b>Resumo</b>	<b>xiii</b>
<b>Contents</b>	<b>xv</b>
<b>Notations</b>	<b>xix</b>
<b>1 Introduction</b>	<b>1</b>
1.1 Context and motivations . . . . .	1
1.1.1 Incremental stability . . . . .	1
1.1.2 Piecewise-affine systems . . . . .	3
1.2 Scope and contributions . . . . .	5
1.3 Structure of the memoir . . . . .	6
1.4 Publications . . . . .	8
<b>2 Analysis of piecewise-affine systems</b>	<b>9</b>
2.1 Introduction . . . . .	9
2.2 Piecewise-affine systems . . . . .	10
2.2.1 Behavior of piecewise-affine systems . . . . .	12
2.3 Analysis of dynamical systems . . . . .	17
2.3.1 Input-output characterizations and performance assessment . . . . .	17
2.3.2 State space and stability . . . . .	18
2.4 Stability and performance assessment . . . . .	19
2.4.1 Dissipativity analysis . . . . .	19
2.4.2 Lyapunov stability . . . . .	22
2.4.3 Construction of storage functions and Lyapunov functions . . . . .	25
2.5 Study of LTI systems . . . . .	26
2.5.1 $\mathcal{L}_2$ -gain stability . . . . .	27
2.5.2 Exponential stability . . . . .	27
2.5.3 Incremental stability . . . . .	28
2.6 Stability and performance of PWA systems . . . . .	30
2.6.1 Analysis with quadratic functions . . . . .	34
2.6.2 Analysis with piecewise-quadratic functions . . . . .	38
2.7 Incremental stability and performance of PWA systems . . . . .	41
2.7.1 Analysis with quadratic functions . . . . .	42
2.8 Conclusion . . . . .	43
<b>3 Contribution to the incremental stability analysis of piecewise-affine systems</b>	<b>45</b>



3.1	Introduction . . . . .	45
3.2	Analysis with piecewise-quadratic functions . . . . .	45
3.2.1	Incremental $\mathcal{L}_2$ -gain stability . . . . .	48
3.2.2	Incremental asymptotic stability . . . . .	49
3.3	Comments on the computation of piecewise-quadratic functions for incremental stability . . . . .	49
3.4	Analysis using SOS techniques . . . . .	51
3.4.1	Polynomials and convex optimization . . . . .	51
3.4.2	Analysis with polynomial functions . . . . .	54
3.4.3	Analysis with piecewise-polynomial functions . . . . .	57
3.5	Numerical examples . . . . .	59
3.6	Conclusion . . . . .	62
<b>4</b>	<b>Analysis of uncertain piecewise-affine systems</b>	<b>65</b>
4.1	Introduction . . . . .	65
4.2	Uncertain piecewise-affine systems . . . . .	66
4.2.1	Robust stability . . . . .	68
4.2.2	Robust performance . . . . .	71
4.3	Graph separation . . . . .	72
4.4	Robust stability and performance of nonlinear feedback systems . . . . .	75
4.4.1	Robust stability . . . . .	75
4.4.2	Robust performance . . . . .	77
4.4.3	Construction of multipliers . . . . .	79
4.4.4	Multiplier parametrization . . . . .	86
4.4.5	Dissipativity approach . . . . .	89
4.4.6	Application to piecewise-affine systems . . . . .	93
4.5	Robust incremental stability and performance of nonlinear feedback systems . . . . .	99
4.5.1	Robust incremental stability . . . . .	99
4.5.2	Robust incremental performance . . . . .	100
4.5.3	Multipliers for incremental stability . . . . .	101
4.5.4	Dissipativity approach . . . . .	101
4.5.5	Application to piecewise-affine systems . . . . .	103
4.6	Numerical examples . . . . .	107
4.7	Relation with classic IQC approach . . . . .	110
4.8	Conclusion . . . . .	113
<b>5</b>	<b>Analysis of uncertain Lur'e systems</b>	<b>115</b>
5.1	Introduction . . . . .	115
5.2	Uncertain Lur'e systems . . . . .	116
5.3	Proposed approach . . . . .	116
5.4	Lipschitz approximation of static nonlinearities . . . . .	120
5.4.1	Scalar case . . . . .	120
5.4.2	General case . . . . .	123
5.5	Numerical examples . . . . .	124
5.6	Conclusion . . . . .	130
<b>6</b>	<b>Conclusion and perspectives</b>	<b>131</b>

6.1	Summary of contributions . . . . .	131
6.2	Open problems and perspectives for future research . . . . .	132
<b>A</b>	<b>The circle criterion</b>	<b>135</b>
A.1	Introduction . . . . .	135
A.2	Circle criterion . . . . .	135
A.3	Incremental circle criterion . . . . .	138
A.4	Circle criterion and integral quadratic constraints . . . . .	139
<b>B</b>	<b>Proofs</b>	<b>143</b>
B.1	Proofs from Chapter 2 . . . . .	143
B.2	Proofs from Chapter 3 . . . . .	151
B.3	Proofs from Chapter 4 . . . . .	153
<b>C</b>	<b>Une approche affine par morceaux de la performance non-linéaire</b>	<b>169</b>
C.1	Introduction . . . . .	169
C.2	Analyse des systèmes affines par morceaux . . . . .	170
C.2.1	Introduction . . . . .	170
C.2.2	Systèmes affines par morceaux . . . . .	170
C.2.3	Analyse des systèmes dynamiques . . . . .	171
C.2.4	Evaluation de la stabilité et de la performance . . . . .	173
C.2.5	Stabilité et performance de systèmes PWA . . . . .	176
C.2.6	Stabilité et performance incrémentale des systèmes PWA . . . . .	179
C.3	Contribution à l'analyse de la stabilité incrémentale des systèmes affines par morceaux . . . . .	180
C.3.1	Introduction . . . . .	180
C.3.2	Polynômes et optimisation convexe . . . . .	180
C.3.3	Analyse avec des fonctions polynomiales par morceaux . . . . .	182
C.4	Analyse des systèmes affines par morceaux incertains . . . . .	186
C.4.1	Introduction . . . . .	186
C.4.2	Systèmes affines par morceaux incertains . . . . .	187
C.4.3	Séparation des graphes . . . . .	191
C.4.4	Stabilité et performance robuste des systèmes non-linéaires en boucle . . . . .	193
C.4.5	Stabilité et performance incrémentale robuste des systèmes non-linéaires en boucle . . . . .	206
C.5	Analyse des systèmes de Lur'e incertains . . . . .	212
C.5.1	Introduction . . . . .	212
C.5.2	Systèmes de Lur'e incertains . . . . .	213
C.5.3	Approche proposée . . . . .	214
C.5.4	Approximation Lipschitz de non-linéarités statiques . . . . .	215
	<b>Bibliography</b>	<b>217</b>



# Notations

## Acronyms

IQC	Integral quadratic constraint
LFT	Linear fractional transformation
LMI	Linear matrix inequality
LPV	Linear parameter-varying
LTI	Linear time-invariant
MIMO	Multiple-input multiple-output
ODE	Ordinary differential equation
PDI	Partial differential inequality
PWA	Piecewise-affine
SISO	Single-input single-output
SOS	Sum of squares

## List of symbols

$\mathbb{R}$	The set of real numbers.
$\mathbb{R}_+$	The set of nonnegative real numbers, i.e. $\mathbb{R}_+ = [0, \infty)$ .
$\overline{\mathbb{R}}$	Extended real line, i.e. $\overline{\mathbb{R}} := \mathbb{R} \cup \{-\infty\} \cup \{+\infty\}$ .
$\overline{\mathbb{R}}_+$	Extended half-line of nonnegative reals, i.e. $\overline{\mathbb{R}}_+ := \mathbb{R}_+ \cup \{+\infty\}$ .
$j$	Imaginary unit, i.e. $j^2 = -1$ .
$\mathbb{C}^0$	Extended imaginary axis $j\overline{\mathbb{R}}$ .
$\mathbb{C}^+$	Open right-half complex plane.
$\overline{\mathbb{C}}^+$	Closed right-half complex plane, i.e. $\overline{\mathbb{C}}^+ = \mathbb{C}^0 \cup \mathbb{C}^+$ .
$\mathbb{C}^-$	Open left-half complex plane.
$\overline{\mathbb{C}}^-$	Closed left-half complex plane, i.e. $\overline{\mathbb{C}}^- = \mathbb{C}^0 \cup \mathbb{C}^-$ .
$A^T$	The transpose of $A$ .
$a \cdot b$	The scalar product between vectors $a$ and $b$ , i.e. $a \cdot b = a^T b$ .
$ \cdot $	The Euclidean norm on $\mathbb{R}^n$ given by $ x  := \sqrt{x^T x}$ .

$\ \cdot\ $	The operator norm between two Euclidean spaces, i.e. $\ A\  = \sup_{\substack{x \in \mathbb{R}^n \\  x =1}}  Ax $ .
$I_n$	Identity matrix of size $n$ .
$0_{m \times n}$	Zero matrix of dimension $m \times n$ .
$\mathbb{S}^n$	The set of real symmetric matrices of dimension $n \times n$ , i.e. $\mathbb{S}^n = \{A \in \mathbb{R}^{n \times n} \mid A^\top = A\}$ .
$\text{col}(A, B)$	Columnwise concatenation of two matrices $A$ and $B$ of compatible dimensions, i.e. $\text{col}(A, B) = \begin{bmatrix} A \\ B \end{bmatrix}$ .
$\text{diag}_i$	Block diagonal concatenation of a finite ordered list of elements indexed by $i$ , i.e. $\text{diag}_i(A_i) = \text{diag}(A_1, \dots, A_n)$ .
$\succeq$	For a vector $v = (v_1, \dots, v_n)$ , $v \succ 0$ (resp. $v \succeq 0$ ) is equivalent to the componentwise inequality $v_i > 0$ (resp. $v_i \geq 0$ ), $\forall i \in \{1, \dots, n\}$ . For a matrix $A \in \mathbb{S}^n$ , $A \succ 0$ (resp. $A \succeq 0$ ) denotes that $A$ is positive definite (resp. semi-definite).
$G(j\omega)^*$	The Hermitian conjugate of $G(j\omega)$ , defined by $G(j\omega)^* := G(-j\omega)^\top$ .
$\hat{x}$	The Fourier transform of $x$ .
$\mathcal{RL}_\infty^{l \times m}$	Space of real-rational and proper transfer function matrices of dimension $l \times m$ without poles on the extended imaginary axis $\mathbb{C}^0$ .
$\mathcal{RH}_\infty^{l \times m}$	Subset of $\mathcal{RL}_\infty^{l \times m}$ consisting of transfer function matrices without poles on the closed right-half plane $\overline{\mathbb{C}^+}$ .
$\mathcal{K}$	Class of continuous and strictly increasing functions $\alpha : \mathbb{R}_+ \rightarrow \mathbb{R}_+$ for which $\alpha(0) = 0$ .
$\mathcal{K}_\infty$	Class of functions in $\mathcal{K}$ which are unbounded ( $\mathcal{K}_\infty \subset \mathcal{K}$ ).
$\mathcal{KL}$	Class of continuous functions $\beta : \mathbb{R}_+ \times \mathbb{R}_+ \rightarrow \mathbb{R}_+$ so that for any fixed $t \geq 0$ , $\beta(\cdot, t) \in \mathcal{K}$ and, for any fixed $s$ , $\beta(s, \cdot)$ is decreasing with $\lim_{t \rightarrow \infty} \beta(s, t) = 0$ .
$\mathcal{C}[a, b]$	Set of continuous functions from $[a, b] \subseteq \mathbb{R}$ into $\mathbb{R}$ .
$\mathcal{C}^1(\mathbb{R})$	Set of continuously differentiable real scalar functions.
$\text{Sect}(\kappa_1, \kappa_2)$	Sector containing a nonlinearity or a SISO operator.
$\text{Sect}_\Delta(\kappa_1, \kappa_2)$	Incremental sector containing a nonlinearity or a SISO operator.
$\Sigma$	Nonlinear dynamical system.
$\phi$	The state transition map defined from $\mathcal{T} \times \mathcal{T} \times X \times \mathcal{W}$ , such that $x = \phi(t, t_0, x_0, w)$ is the state $x \in X$ attained at instant $t$ when the system is driven from $x_0 \in X$ at the instant $t_0$ by the input $w$ .

$\mathbb{I}$	The identity operator from a vector space into itself, i.e. $\mathbb{I}(x) = x$ .
$P_T$	Truncation operator at time $T$ .
$\mathcal{W}$	Input space of a nonlinear operator.
$\mathcal{W}_e$	Extended input space of a nonlinear operator, i.e. $\mathcal{W}_e = \{w : \mathbb{R}_+ \rightarrow \mathbb{R}^{n_w} \mid P_T w \in \mathcal{W}, \forall T \geq 0\}$ .
$\mathcal{Z}$	Output space of a nonlinear operator.
$\mathcal{Z}_e$	Extended output space of a nonlinear operator, i.e. $\mathcal{Z}_e = \{z : \mathbb{R}_+ \rightarrow \mathbb{R}^{n_z} \mid P_T z \in \mathcal{Z}, \forall T \geq 0\}$ .
$\mathcal{L}_2^n(\mathcal{T})$	Space of square integrable $\mathbb{R}^n$ -valued functions on $\mathcal{T}$ .
$\mathcal{L}_{2e}^n(\mathcal{T})$	Space of $\mathbb{R}^n$ -valued functions on $\mathcal{T}$ whose truncation is square integrable.
$\ \Sigma\ _2$	The $\mathcal{L}_2$ -gain of $\Sigma$ , i.e. $\sup_{w \in \mathcal{L}_{2e}^{n_w}(\mathbb{R}_+)} \frac{\ \Sigma(w)\ _2}{\ w\ _2}$ .
$\ \Sigma\ _{\Delta 2}$	The incremental $\mathcal{L}_2$ -gain of $\Sigma$ , i.e. $\sup_{\substack{w, \tilde{w} \in \mathcal{L}_{2e}^{n_w}(\mathbb{R}_+) \\ w \neq \tilde{w}}} \frac{\ \Sigma(w) - \Sigma(\tilde{w})\ _2}{\ w - \tilde{w}\ _2}$ .
$\ \cdot\ _T$	Truncated norm in a normed function space, i.e. $\ x\ _T = \ P_T x\ $ .
$\ \cdot\ _2$	The $\mathcal{L}_2$ norm of a signal, i.e. $\ x\ _2 = \left( \int_0^\infty  x(t) ^2 dt \right)^{\frac{1}{2}}$ .
$\ \cdot\ _{2,T}$	The truncated $\mathcal{L}_2$ norm of a signal at time $T$ , i.e. $\ x\ _{2,T} = \ P_T x\ _2$ .
$\mathbb{R}[x]$	Ring of polynomials in $x$ with coefficients in $\mathbb{R}$ .
$SOS[x]$	Subset of polynomials in $\mathbb{R}[x]$ that are sums of squares.
$\binom{n}{k}$	Binomial coefficient defined as $\binom{n}{k} := \frac{n!}{k!(n-k)!}$ .
$\chi_d(x)$	Vector in $\mathbb{R}^{\varrho(n,d)}$ containing all monomials in $x$ of degree less than or equal to $d$ .
$\varrho(n,d)$	Number of monomials in $x \in \mathbb{R}^n$ of degree less than or equal to $d$ .
$\mathcal{Q}(n,d)$	Null space of the map that associates to every matrix $Q \in \mathbb{S}^{\varrho(n,d)}$ a polynomial $\chi_d^\top Q \chi_d$ in $\mathbb{R}[x]$ .
$\iota(n,d)$	Dimension of the set $\mathcal{Q}(n,d)$ .
$\varrho_w(n,d,n_w)$	Dimension of the vector $w \otimes \chi_{d-1}$ , for $w \in \mathbb{R}^{n_w}$ and $\chi_{d-1} \in \mathbb{R}^{\varrho(n,d-1)}$ .
$\mathcal{R}(n,d,n_w)$	Null space of the map that associates to every matrix $R \in \mathbb{S}^{\varrho_w(n,d,n_w)}$ a polynomial $\bar{\chi}_w^\top R \bar{\chi}_w$ in $\mathbb{R}[\text{col}(x,w)]$ .
$\iota_w(n,d,n_w)$	Dimension of the set $\mathcal{R}(n,d,n_w)$ .



---

# Introduction

## 1.1 Context and motivations

The analysis of systems described by linear time-invariant (LTI) dynamics has been extensively treated in the literature. The methods pertaining to linear systems are for the most part well-known and have been successfully employed by researchers and engineers in a vast array of fields and applications. These results are sufficient when the behavior of the system can be reasonably described by LTI models, i.e. nonlinear and time-varying effects are negligible. This hypothesis might become unrealistic when dealing with systems operating under harsh conditions and stringent performance constraints. In such cases, the nonlinearities must be taken into account explicitly, and analysis should be performed in a nonlinear model representing the relevant behavior of the system.

While in the linear case much could be said about the system by simply assessing stability, nonlinear systems present more complex behavior such as local stability and multiple equilibrium points, existence of limit cycles, non-harmonic response to sinusoidal inputs, chaotic behavior, and so forth. Then, when dealing with problems involving nonlinear systems for which specific qualitative behaviors are needed, such as tracking, synchronization, observer synthesis, etc., a stronger notion of stability is needed. For this reason, we consider the concept of *incremental stability*.

### 1.1.1 Incremental stability

Incremental stability concerns the requirement that every pair of trajectories of the system converges to each other. This is much stronger than the simpler requirement of asymptotic convergence to an equilibrium point, and as a result ensures that the system is more “well-behaved”. The concept of incremental stability has been around for some time, and has been recently gaining more widespread attention due to the properties it ensures for nonlinear systems. As it is the case with non-incremental properties, its origins are also divided into two different frameworks: input-output and state-space.

Concerning the former, the first results concerning incremental stability can be traced back to the works of Zames in the Sixties. In the article [187], he introduced the *maximum incremental amplification* as a particular notion of operator gain. This gain is nothing other than the Lipschitz constant of the operator from the input space into the output space. The motivation for this choice comes from the use of fixed point theorems to establish the existence



and uniqueness of the signals flowing through a feedback loop. In his seminal papers [188, 189], Zames defined the stability of feedback loops using boundedness and continuity of the underlying operator. Stability could then be assessed by analyzing the incremental gain of the systems in the interconnection. This leads to a simple interpretation: small perturbations of the input should lead to small perturbations in the output. In the reference book by Willems [177], Lipschitz continuity plays a central role in the study of nonlinear feedback systems. Nevertheless, in the subsequent years, continuity (incremental stability) would be somewhat neglected in favor of boundedness (stability), perhaps due to its higher complexity. More recently, a new light was shed on incremental finite-gain stability due to the pioneering works by Fromion in his PhD thesis [51], where it was used as a tool for robust analysis of nonlinear systems [59]. The author proposed the connection between the incremental gain property and the celebrated dissipativity framework by Willems [180] in [51, 56]. Moreover, using appropriate notions of observability and reachability, he was able to derive some of the first results on the behavior of the trajectories of incrementally stable systems and the connection with Lyapunov theory [51, 52, 56–58]. The notion of incremental gain was also extended in some new directions, see e.g. the generalized incremental gain [29] and differential stability [62]. In parallel to these concepts are the notions of incremental [188] and differential passivity [50].

In the state-space framework, some first results were proposed by Yoshizawa [185] and LaSalle and Lefschetz [97, 98] in the early Sixties, extending results by Trefftz and Reissig dating back to the Twenties [98]. The authors were interested in the convergence of trajectories of forced systems to unique periodic motions, and referred to this property as *extreme stability*. They established results based on the construction of Lyapunov functions for the stability of an augmented system, consisting of two copies of the original, with respect to the diagonal set where both states are equal. Around the same time, similar results were obtained in the Soviet Union by Demidovich [124], also using Lyapunov arguments together with conditions involving the Jacobian of the system. In the late Nineties and early 2000s, in addition to the works by Fromion, the appearance of three papers revitalized the interest in incremental state-space stability. The first, by Lohmiller and Slotine [105], proposed the notion of *contraction* using considerations on the differential of the system across regions of the state space. This approach is closely related to Riemannian geometry, and can be seen as an extension of the results by Demidovich by considering non-constant Riemannian metrics (see [87] for historical remarks). It has subsequently been connected with Lyapunov theory [49] and control synthesis [107], to name a few. The second paper, by Angeli [5], provides necessary and sufficient conditions for incremental asymptotic stability based on the construction of an incremental Lyapunov function. It also extends the framework of input-to-state stability [160] by defining its incremental counterpart, also characterized by means of a Lyapunov dissipation function. A variant of this result was proposed in [186] by considering coordinate independent versions of the aforementioned results. Finally, the third paper by Pavlov et al. [124] brought the results of Demidovich to the attention of the western community and formalized the notion of *convergent dynamics*. The connection between convergence and incremental asymptotic stability was studied in [55, 145].

In common between the input-output and state-space points of view is the fact that incremental notions of stability ensure some interesting qualitative behaviors. Broadly speaking, incrementally stable systems have been shown to have a unique asymptotically stable constant (respectively  $T$ -periodic) trajectory in response to a constant (respectively  $T$ -periodic) input, asymptotic independence of initial conditions (similar to the fading memory property [16])

and unicity of the steady state [5, 52, 105, 126].

Due to these important properties, Fromion proposed the use of the incremental  $\mathcal{L}_2$ -gain as an extension of the celebrated  $H_\infty$  control techniques into the nonlinear framework [51, 56, 60]. The weighted  $H_\infty$  norm has been proposed as a way to formalize performance and robustness constraints as an optimization problem by Zames [190]. It has found great success in the analysis of LTI systems due to its power to generalize known frequency-domain techniques from single-input single-output (SISO) systems into the more general class of multiple-input multiple-output (MIMO), thus allowing us to deal with desensitization, tracking and disturbance rejection problems [155]. Desoer and Wang [35] discussed how these properties of feedback systems could be treated in a nonlinear context. Based on this formulation, Fromion has shown that the weighted incremental  $\mathcal{L}_2$ -gain can be used to ensure the same performance constraints on nonlinear feedback systems [51, 56, 60]. This approach brings together quantitative specification of performance via appropriate weighting functions and the qualitative interesting behavior of incrementally stable systems.

The implementation of this approach is directly connected to the possibility of computing the incremental  $\mathcal{L}_2$ -gain for general classes of systems. Romanchuk and James [142] proposed necessary and sufficient conditions for incremental  $\mathcal{L}_2$ -gain stability based on dissipativity. The conditions rely on finding a solution of a Hamilton-Jacobi-Bellman inequality [79]. This is a problem of infinite dimension involving a partial differential inequality (PDI), and hence can be very difficult to solve in the general case. Numerical procedures to find approximate solutions of this problem exist [80], but seem to be impractical for systems of increased complexity and size. Hence, if one needs to assess incremental  $\mathcal{L}_2$ -gain stability efficiently, there is a need to relax the constraints of the problem to rewrite it in a different form. One possible way of doing so is by introducing a finite parametrization of the infinite dimensional functional problem, and then computing an upper bound on the incremental  $\mathcal{L}_2$ -gain. In this vein, the notion of quadratic incremental stability was introduced in [59]. In this approach, incremental  $\mathcal{L}_2$ -gain stability is ensured via the  $\mathcal{L}_2$ -gain stability of the time-varying linearizations of the system around every possible trajectory. This time-varying linearized representation is embedded in a linear parameter-varying (LPV) model represented as a linear fractional transformation (LFT). In this way, usual tools from LPV theory can be used to analyze the system efficiently. The drawback of methods based on relaxed conditions is the addition of *conservatism*: the computed upper bound may be too far from the real incremental  $\mathcal{L}_2$ -gain of the original system. There seems to be a tradeoff between complexity and conservatism in the analysis of nonlinear systems, and it is important to be able to adjust the balance towards more precision (less conservatism) when needed, even with the price of some added complexity. It is in this context that we have chosen to turn our attention to the class of nonlinear systems having a piecewise-affine (PWA) representation.

### 1.1.2 Piecewise-affine systems

Piecewise-affine systems are nonlinear systems whose dynamics are governed by piecewise-affine equations, i.e. their state space is partitioned in different regions, in each of which the dynamics are governed by an affine time-invariant differential equation. Due to the commutation between different dynamics in different regions, piecewise-affine systems can also be seen as a special class of hybrid system [64]. This class of systems is of great interest both from a theoretical and practical points of view due to three concurring factors: 1) it exactly represents systems made of the interconnection of LTI dynamics with piecewise-

affine static nonlinearities, such as saturations, relays, dead zones, friction models, which are virtually ubiquitous in applied control; 2) piecewise-affine systems serve as an approximation to more complex nonlinear systems; 3) although their behavior may be quite complex, their description remain quite close to that of LTI systems, so that some of the classic analysis results of linear systems can be transposed. Namely, due to its regional affine description, it is possible to obtain analysis conditions written as linear matrix inequalities (LMI) [18]. Such conditions constitute semidefinite programming optimization problems, for which efficient solvers exist.

The analysis of piecewise-affine systems from the control standpoint dates back to the Eighties [10, 129, 157], even though this class of systems had already been used to model electronic circuits containing nonlinear components in the Seventies [81, 120]. In the papers [85, 133], Johansson and Rantzer proposed sufficient conditions for the construction of continuous piecewise-quadratic Lyapunov and storage functions, which allowed to greatly reduce the conservatism when compared to results obtained with single quadratic functions. The key element in their results is the use of the  $\mathcal{S}$ -procedure, which allowed them to write LMIs for each region, thus rendering the analysis local. Their results sparked a wide range of new results from analysis [4, 82, 113, 149] to synthesis [135, 140, 148], to cite but a few.

There have been results in the literature concerning the analysis of incremental stability properties of piecewise-affine systems. In [143], Romanchuk and Smith studied the incremental  $\mathcal{L}_2$ -gain stability of piecewise-affine systems by constructing quadratic storage functions. In the framework of convergent systems, Pavlov et al. [125] propose conditions for incremental stability by constructing a quadratic incremental Lyapunov function. Both of these results rely on the construction of global quadratic incremental Lyapunov and storage functions by means of semidefinite programs. Morinaga et al. [114] have proposed conditions for incremental  $\mathcal{L}_2$ -gain stability using piecewise-quadratic storage functions in the same vein as the results by Johansson and Rantzer. Nevertheless, it is uncertain as to whether an example of system can be found that satisfies the conditions proposed in this paper.

Even though the analysis of piecewise-affine systems has flourished in the past years, most of the results were obtained with the underlying assumption that the piecewise-affine model gives a perfect description of the dynamical system. Unfortunately, this is never the case, as the model is but a simplified representation of the real physical system. In certain cases, a disregard of this uncertainty inherent to the model might lead to a disconnection between the results of the analysis and the actual behavior of the system [147]. This observation has led to the development of robust control methods, where the focus of the analysis is on *robustness*, i.e. the capability of retaining stability and performance in the presence of uncertainty. At the center of this approach is the notion of uncertain models, which are in fact an ensemble of models supposed to contain the real system. Then, by guaranteeing stability and performance of the uncertain model, we are ensuring that the actual system will have these properties.

There have been some results on the stability analysis of uncertain piecewise-affine systems, in the non-incremental case [14, 44, 76]. These results are based on the construction of Lyapunov functions and rely on a polytopic representation of the uncertain system. The drawback of this representation is that it only allows the description of parametric uncertainties. Among the body of results proposed in the robust control literature, we can find a different form of representation that is capable of describing much more general classes of uncertainties: the LFT. This representation is given by the interconnection of a nominal system and an uncertainty block. There exists a range of results concerning stability and performance analysis in the case where the nominal system is LTI, among which we may

cite  $\mu$ -analysis and integral quadratic constraints (IQC), to name a few. To the best of our knowledge, there has been no results in the literature extending these approaches to the case where the nominal system is described by piecewise-affine dynamics.

In view of this discussion, in the next section we consider the scope of this memoir and highlight its main contributions.

## 1.2 Scope and contributions

In this thesis, we aim to assess stability and performance of piecewise-affine systems, both in nominal and robust settings. Our focus is on incremental stability properties, but we revisit some results in the literature concerning the non-incremental case as both analysis standpoints are strongly connected. In doing so, we also obtain new results for robust stability and performance analysis of uncertain piecewise-affine systems in the non-incremental case. Since the analysis of non-incremental properties tends to be more straightforward (both from a conceptual and computational points of view), its study may be seen as a starting point before considering the incremental case. More precisely, we aim to address the following problems:

1. Most of the results about incremental stability of piecewise-affine systems were obtained using quadratic incremental Lyapunov/storage functions [125, 143]. The authors of [114] developed an approach for the construction of piecewise-quadratic functions, but were unable to produce an example of such a function. Would it be possible to go beyond simple quadratic functions for the analysis of piecewise-affine systems?
2. There have been results in the literature concerning the robust analysis of piecewise-affine systems with polytopic uncertainties [14, 44, 76]. Would it be possible to extend the analysis to consider more general classes of uncertainties, both in the non-incremental and incremental cases?
3. Piecewise-affine systems have been used as approximations for more general nonlinear systems as a means to obtain more tractable analysis conditions. Could we develop an approximation technique of static nonlinearities, specifically tailored for incremental analysis, so that we could extend the analysis to Lur'e-type nonlinear systems?

These problems are considered in this order and incrementally, meaning that each step builds up on the results of the previous problems. We begin by considering the analysis of nominal piecewise-affine systems, where we propose a new approach to the construction of piecewise-quadratic and piecewise-polynomial incremental Lyapunov/storage functions for incremental stability and performance. The computation of these functions is parametrized by a set of linear matrix inequalities, which constitute a semidefinite programming optimization problem for which efficient solvers are available.

These first results serve as a basis for the analysis of robust stability and performance in the presence of uncertainties. Using graph separation theory and dissipativity, together with the framework of integral quadratic constraints, we propose new results allowing robust analysis of stability and performance of piecewise-affine systems with general classes of uncertainties. In doing so, we propose a new version of the classic sector stability criterion, by Safonov [146], both in the non-incremental and incremental cases. We use a new and simpler

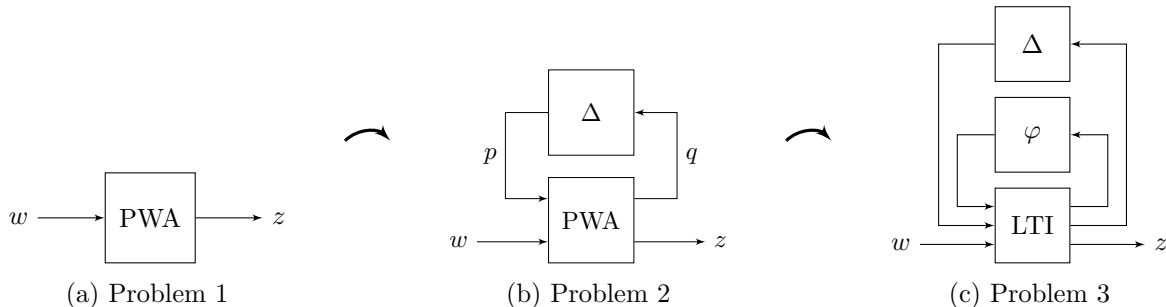

FIGURE 1.1 – Problems considered in this memoir.

proof technique that allows us to remove a restrictive hypothesis on the original formulation, thus achieving a seamless extension from (incremental) stability to the formulation of (incremental) performance problems. This approach provides new interesting results both in the non-incremental and incremental cases.

Finally, we tackle the analysis of uncertain Lur'e systems. We develop an approximation technique to transform these systems into uncertain piecewise-affine systems. This new approximation method allows us to minimize the Lipschitz constant of the approximation error, which can be seen as a minimization of the magnitude of the error, in an incremental sense. This progression is illustrated in Figure 1.1.

The analysis of nonlinear systems, whether it be in the non-incremental or incremental case, suffers from excessive complexity in the general case. Necessary and sufficient conditions for stability and performance of nonlinear systems are generally difficult to verify. The traditional route to deal with this limitation is to search for relaxations that allow us to rewrite the problem in a new form that we know how to solve efficiently. In this process, we trade the necessity of the conditions for computation efficiency. Since the analysis tools become only sufficient, the results might become conservative. One of the ultimate goals of this memoir is to provide results in which this tradeoff between complexity and conservatism can be adjusted. This is at the heart of our approximation technique. The precision of the approximation is directly connected to the number of regions of the piecewise-affine approximating function. Hence, by adjusting the approximation precision, we are able to shift the tradeoff between complexity and conservatism in the desired direction. This idea is illustrated in Figure 1.2.

All the numerical examples presented in this memoir were developed in the Matlab software. We have used the parser YALMIP [104] to write the semidefinite programming problems, which were solved using the solvers SeDuMi [163] and MOSEK [115]. Additionally, we have used the toolbox by Paolo Massioni (developed in the framework of [13, 108]) to write the optimization problems associated to the sum-of-squares techniques in Chapters 3 and 5.

### 1.3 Structure of the memoir

The core of this thesis is divided into 4 chapters, which are described next.

**Chapter 2** We begin by introducing the definition of piecewise-affine systems, the object at the heart of the methods proposed in this thesis. We discuss its representation, as well as its main features and characteristic behaviors. Afterwards, we present the stability and performance notions that we aim to assess in these systems, namely asymptotic stability and

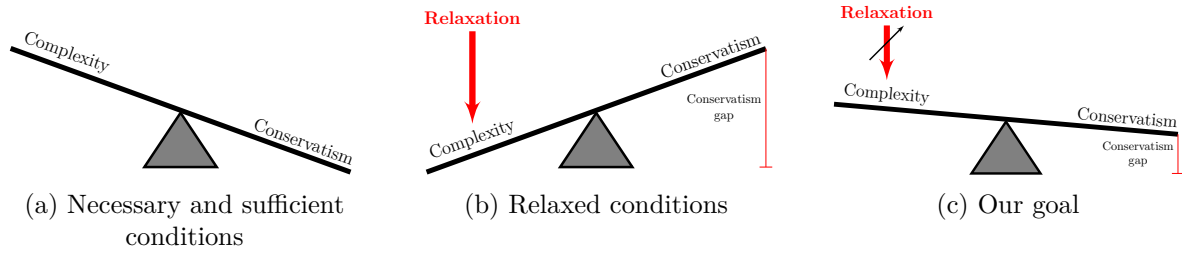

FIGURE 1.2 – One of the goals of this memoir is to provide results where the tradeoff between complexity and conservatism can be adjusted.

$\mathcal{L}_2$ -gain stability, both in their standard and incremental versions. Following this, we discuss the functional methods we shall use to achieve it. After a brief recall on how these methods are applied to LTI systems to obtain conditions expressed as LMIs, we review the literature concerning the analysis of piecewise-affine systems.

**Chapter 3** After all the relevant concepts have been defined in the previous chapter, we present some new results concerning the analysis of incremental asymptotic stability and incremental  $\mathcal{L}_2$ -gain stability. At first, we consider the construction of piecewise-quadratic incremental Lyapunov functions and storage functions, extending the classic approach for piecewise-affine systems. After a discussion on the limitations of this approach, we increase the degrees of freedom in the analysis by considering polynomial and piecewise-polynomial incremental Lyapunov functions and storage functions. A numerical example is presented that illustrates the approach.

**Chapter 4** In this chapter, we consider the case when the piecewise-affine system is not perfectly known. This is done by considering that the system is represented by a family of models that should include the real system. This family of models is represented as the interconnection between a known piecewise-affine system and an unknown block  $\Delta$ . We then introduce some concepts of robust stability and performance, and recall the notion of graph separation that we shall use to study them. The separation is obtained by means of integral quadratic constraints in the time domain, which allows us to propose a new formulation for the sector stability criterion using dynamic filters, and thus conclude on robust (incremental) stability and performance. This allows a simpler proof and an homogeneous treatment of both stability and performance. These conditions are reinterpreted in terms of dissipativity and then applied to the case of uncertain piecewise-affine systems. Once again, a numeric example is presented to illustrate the approach.

**Chapter 5** Finally, we consider the analysis of Lur'e-type uncertain nonlinear systems. We introduce the method of Lipschitz approximation to obtain a piecewise-affine function approximating a given memoryless nonlinearity. We then discuss how this approximation can be used to equivalently represent Lur'e systems as the interconnection of an uncertain piecewise-affine system and the approximation error. Using this representation, the analysis techniques presented in the last chapter can be employed to assess robust stability and performance with potentially less conservative results. The chapter is closed with a numerical example of the performance analysis of an uncertain Lur'e system.

## 1.4 Publications

Peer-reviewed conference papers:

- **S. Waitman**, P. Massioni, L. Bako, G. Scorletti and V. Fromion. Incremental  $\mathcal{L}_2$ -gain analysis of piecewise-affine systems using piecewise quadratic storage functions. *Proceedings of the 55th IEEE Conference on Decision and Control*, pages 1334–1339, Dec 2016. doi: [10.1109/CDC.2016.7798451](https://doi.org/10.1109/CDC.2016.7798451).
- **S. Waitman**, L. Bako, P. Massioni, G. Scorletti and V. Fromion. Incremental stability of Lur’e systems through piecewise-affine approximations. *Proceedings of the 20th IFAC World Congress*, pages 1673–1679, Jul 2017. doi: [10.1016/j.ifacol.2017.08.491](https://doi.org/10.1016/j.ifacol.2017.08.491)

Journal article (under review):

- **S. Waitman**, P. Massioni, L. Bako and G. Scorletti. Incremental analysis of piecewise-affine systems with efficient methods. *Automatica* (submitted).

---

# Analysis of piecewise-affine systems

## 2.1 Introduction

This chapter is devoted to a synthetic introduction of piecewise-affine systems, unifying different results from the literature in a homogeneous presentation. We discuss their mathematical description as dynamical systems, as well as the important features and behaviors that are of interest when dealing with them. We shall also present the stability and performance properties that we seek to study in such systems, as well as a review of how these problems have been dealt with in recent years.

The interest in piecewise-affine systems, i.e. nonlinear systems described by piecewise-affine differential equations, is not new (see [83, Chapter 1] for a thorough historical review). It was the application of piecewise-affine equations to model nonlinear electronic components [81, 120] that first attracted attention to problems such as efficient representation of piecewise-affine functions [30, 88] and approximation of nonlinear mappings [21, 168]. Some initial efforts on the qualitative analysis of piecewise-affine systems were attempted by Sontag [157] and Pettit [129]. It is fair to say that the interest in piecewise-affine system by the control community has greatly increased after the important papers by Johansson and Rantzer [85, 133]. The authors proposed new results for stability and performance analysis of piecewise-affine systems by constructing piecewise-quadratic Lyapunov and storage functions. This was achieved by making use of the  $\mathcal{S}$ -procedure to take into account the regional description of PWA systems. Several extensions of these results were subsequently proposed, enabling to consider systems with regional descriptions depending on the input [32, 113], systems with polytopic uncertainty [14, 44, 76], as well as stabilization problems [70, 139, 140], to name a few. The original approach to stability and performance analysis of piecewise-affine systems by Johansson and Rantzer serves as a basis for the results proposed in this memoir for the analysis of incremental stability properties.

The chapter is organized as follows: in Section 2.2 we formally introduce the concept of piecewise-affine systems, and state some of its characteristics and behavior. Section 2.3 defines the stability and performance properties that we aim to assess for nonlinear systems. Following that, Section 2.4 describes the classical approach taken in this memoir for the study of these properties. Section 2.5 is devoted to a review of the application of these techniques on LTI systems. Finally, the study of non-incremental as well as incremental stability and performance properties of piecewise-affine systems is presented in Sections 2.6 and 2.7, respectively.



## 2.2 Piecewise-affine systems

Piecewise-affine systems can be seen as a special class of nonlinear systems. Let us consider a nonlinear autonomous dynamical system  $\Sigma : \mathcal{W}_e \rightarrow \mathcal{Z}_e$  with a state space representation given by

$$z = \Sigma(w) \begin{cases} \dot{x}(t) = f(x(t), w(t)) \\ z(t) = h(x(t), w(t)) \\ x(0) = x_0 \end{cases} \quad (2.1)$$

where  $x(t) \in X \subseteq \mathbb{R}^n$  is the state,  $w \in \mathcal{W}_e$  is the input taking values in  $W = \mathbb{R}^{n_w}$ ,  $z \in \mathcal{Z}_e$  is the output taking values in  $Z = \mathbb{R}^{n_z}$  and  $x_0$  is the initial condition. In this memoir we are interested in nonlinear systems defined from  $\mathcal{W}_e = \mathcal{L}_{2e}^{n_w}(\mathbb{R}_+)$  into  $\mathcal{L}_{2e}^{n_z}(\mathbb{R}_+)$ . The functions  $f : \mathbb{R}^n \times \mathbb{R}^{n_w} \rightarrow \mathbb{R}^n$  and  $h : \mathbb{R}^n \times \mathbb{R}^{n_w} \rightarrow \mathbb{R}^{n_z}$  are called the drift map and output map, respectively.

Piecewise-affine systems are nonlinear systems whose state evolution is governed by a set of affine equations, each valid in a different region of the state space. They are then described by piecewise differential equations, and are represented as follows:

$$\begin{cases} \dot{x}(t) = A_i x(t) + a_i + B_i w(t) \\ z(t) = C_i x(t) + c_i + D_i w(t) \\ x(0) = x_0 \end{cases} \quad \text{for } x(t) \in X_i \quad (2.2)$$

where  $A_i \in \mathbb{R}^{n \times n}$ ,  $a_i \in \mathbb{R}^n$ ,  $B_i \in \mathbb{R}^{n \times n_w}$ ,  $C_i \in \mathbb{R}^{n_z \times n}$ ,  $c_i \in \mathbb{R}^{n_z}$  and  $D_i \in \mathbb{R}^{n_z \times n_w}$ , for  $i \in \mathcal{I} := \{1, \dots, N\}$ . We shall denote  $\mathcal{I}_0 \subseteq \mathcal{I}$  the set containing all  $i$  such that  $0 \in X_i$ . The regions  $X_i$ , for  $i \in \mathcal{I}$ , are closed convex polyhedral sets, and may be unbounded. Each face of the polyhedron  $X_i$  is in a hyperplane that divides  $X$  into two regions. Let

$$\mathcal{G}_{i,k} := \{x \in X \mid G_{i,k}x + g_{i,k} \geq 0\} \quad (2.3)$$

be a half-plane defined by the  $k$ -th face of the polyhedron. The region  $X_i$  is then characterized by the intersection of all  $\mathcal{G}_{i,k}$ , i.e

$$X_i = \bigcap_k \mathcal{G}_{i,k} = \{x \in X \mid G_i x + g_i \succeq 0\}, \quad (2.4)$$

where

$$G_i := \begin{bmatrix} G_{i,1} \\ \vdots \\ G_{i,l_i} \end{bmatrix} \quad g_i := \begin{bmatrix} g_{i,1} \\ \vdots \\ g_{i,l_i} \end{bmatrix} \quad (2.5)$$

and  $l_i$  is the number of faces of  $X_i$ . The sign  $\succeq$  denotes that every component of the vector  $G_i x + g_i$  must be positive. The regions  $X_i$  have non-empty and pairwise disjoint interiors and are such that  $\bigcup_{i \in \mathcal{I}} X_i = X$ . Then,  $\{X_i\}_{i \in \mathcal{I}}$  constitutes a finite partition of  $X$ . From the geometry of  $X_i$ , the intersection  $X_i \cap X_j$  between two different regions is always contained in a hyperplane. Let us denote by  $E_{ij}^\top \in \mathbb{R}^n$  and  $e_{ij} \in \mathbb{R}$  the vector and scalar such that

$$X_i \cap X_j \subseteq \{x \in X \mid E_{ij}x + e_{ij} = 0\}. \quad (2.6)$$

The polyhedral partition is illustrated in Figure 2.1.

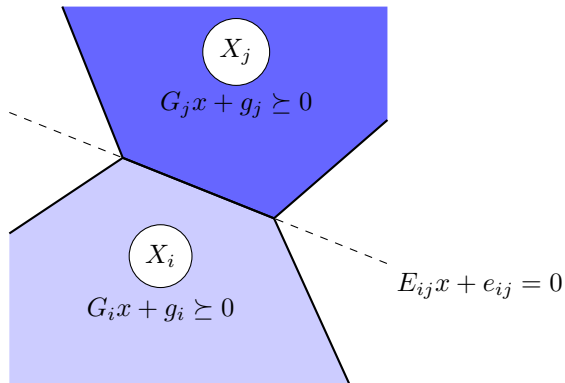

FIGURE 2.1 – Polytopic partition of the state space

Piecewise-affine systems arise naturally when dealing with static piecewise-affine nonlinearities, such as saturations, relays and dead-zones. They serve also as approximations of more complex nonlinear systems, for example those containing smooth separable nonlinearities. They have attracted a considerable attention from the control community in the last years. One reason for this is the fact that their description is very close to that of LTI systems. This allows us to efficiently transpose several results from classic control theory, such as Lyapunov stability, computation of the  $\mathcal{L}_2$ -gain, etc. [83].

As a special case of nonlinear systems, piecewise-affine systems can present a wide range of behaviors that are not found within LTI models. We can mention the presence of multiple isolated equilibrium points [70, 83], non-unique steady states [125], limit cycles [89], among others. This shows that, despite having a somewhat “simple” description, piecewise-affine systems are indeed nonlinear systems presenting a rich variety of pure nonlinear behaviors.

Due to the connection between the continuous dynamics inside each region of the state space partition and the switching of dynamics when the trajectory crosses a boundary, piecewise-affine systems can be considered as a special class of *hybrid systems*, i.e. systems presenting concurrent continuous and discrete dynamics [64, 100, 106]. One way to represent hybrid systems is as a finite collection of *continuous dynamics*  $\{f_i\}_{i \in \mathcal{I}}$ , with  $f_i : \mathbb{R}^n \times \mathbb{R}^{n_w} \rightarrow \mathbb{R}^n$ ,  $\forall i \in \mathcal{I}$  and  $\mathcal{I} \subseteq \mathbb{N}$ , and a *switching function*  $\sigma : \mathbb{R} \times \mathbb{R}^n \times \mathbb{R}^{n_w} \rightarrow \mathcal{I}$  that selects which subsystem is active at each time  $t$ :

$$\dot{x}(t) = f_{i(t)}(x(t), w(t)), \quad \text{with } i(t) = \sigma(t, x(t), w(t)) \quad (2.7)$$

where  $x(t) \in \mathbb{R}^n$  is the state and  $w(t) \in \mathbb{R}^{n_w}$  is the input. The switching function  $\sigma$  can be time-dependent and/or state-dependent and/or input-dependent. In the case when the switching function is seen as a piecewise-continuous function of time, and we neglect the details about the discrete behavior, we speak of *switched systems* [100].

Piecewise-affine systems are the subclass of hybrid systems for which the continuous dynamics are given by affine functions  $f_i(x, w) = A_i x + a_i + B_i w$ . Additionally, the switching function  $\sigma$  does not depend explicitly on time. This means that the switching occurs as a function of the state  $x$  and/or the input  $w$ . In this memoir we shall focus on piecewise-affine systems whose switching depends only on the state space partition  $\{X_i\}_{i \in \mathcal{I}}$ .

Due to its regional representation, the piecewise-affine system (2.2) is at the intersection between hybrid systems and nonlinear systems, see Figure 2.2. Thus, in addition to the

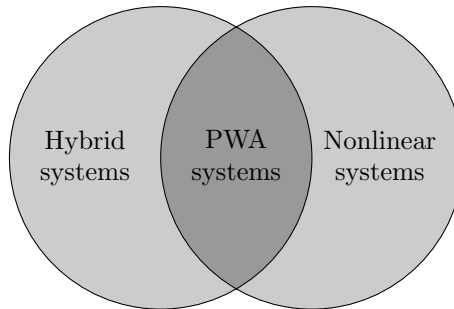

FIGURE 2.2 – Piecewise-affine systems are special cases of hybrid and nonlinear systems

aforementioned phenomena that are typical of nonlinear systems, piecewise-affine systems may also present some behaviors related to hybrid systems.

### 2.2.1 Behavior of piecewise-affine systems

The behavior of hybrid systems is heavily characterized by the interplay between its continuous and discrete dynamics. That is why, for example, a hybrid system consisting only of stable continuous dynamics may be unstable, and unstable dynamics may give rise to a stable hybrid system by means of judicious switching. As a special class of hybrid systems, piecewise-affine systems present some phenomena that are characteristic of these systems, and which must be accounted for. One such behavior that can be pathological in the framework of this thesis is the presence of *Zeno behavior*.

Zeno behavior is characterized by the occurrence of infinite region transitions in a bounded time interval. As with the original Zeno paradoxes, Zeno behavior can be hard to visualize intuitively. In order to better understand this phenomenon, let us consider the following definition of switching times and dwell-time of the piecewise-affine system.

#### DEFINITION 2.1 (Switching time and dwell-time)

We denote  $\{\tau_i\}_{i \in \mathbb{N}}$  the sequence of switching times of (2.2), i.e. the time instants when the solution to (2.2) passes from one region to another.

The dwell-time, usually denoted  $\tau_d$  is defined as the lower bound on the time the solution spends on each region, i.e.  $\tau_{i+1} - \tau_i \geq \tau_d$ , for all  $i$ . ┘

We then have the following definition of Zeno behavior, adapted from [1, 20, 78]. The input  $w$  is taken to belong to  $\mathcal{L}_{2e}^{nw}(\mathbb{R}_+)$ , since this is the class of inputs in which we are interested in this memoir.

#### DEFINITION 2.2 (Zeno behavior)

The system (2.2) is said to present Zeno behavior if for some  $x_0$  and some  $w \in \mathcal{L}_{2e}^{nw}(\mathbb{R}_+)$  there exists a finite constant  $\tau_\infty$  such that

$$\lim_{i \rightarrow \infty} \tau_i = \sum_{i=0}^{\infty} (\tau_{i+1} - \tau_i) = \tau_\infty. \quad (2.8)$$

The time instant  $\tau_\infty$  is called the Zeno accumulation time. Zeno behavior can be split into two more specific categories:

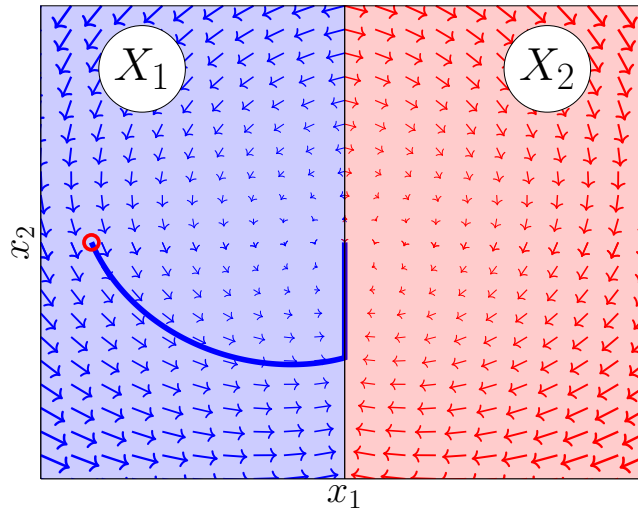

FIGURE 2.3 – Sliding mode trajectory.

**Chattering Zero:** *If there exists a finite  $i^*$  such that  $\tau_{i+1} - \tau_i = 0$  for all  $i \geq i^*$ .*

**Genuine Zero:** *If  $\tau_{i+1} - \tau_i > 0$  for all  $i \in \mathbb{N}$ .* ┘

Chattering Zero behavior takes place when the vector fields of two neighboring regions  $X_i$  and  $X_j$  are opposed to each other along the common boundary, see Figure 2.3. In this case, the trajectory cannot be continued in any region, and slides along the boundary, so that the dwell-time is zero. For this reason, Chattering Zero behavior is also referred to as *sliding mode dynamics*. When evolving along the sliding surface, the trajectory is not a solution of any of the subsystems in (2.2). Instead, the dynamics in the boundary are given by a convex combination of the dynamics associated with each region. To cope with such phenomena, there would be a need to use a notion of trajectory that incorporates these behaviors. A natural trajectory concept when dealing with hybrid systems is Filippov solutions [47].

Genuine Zero behavior is characterized by a strictly increasing sequence of switching times, and is somewhat more complex to characterize and to detect. A classic example of genuine Zero behavior is the bouncing ball, where the bouncing frequency tends to infinity when the accumulation time is approached [1].

In the framework of this thesis, we are interested in piecewise-affine systems that serve as a representation of well-posed nonlinear systems. For this reason, Zero behavior represents unwanted dynamics of the piecewise-affine system. As introduced in the previous section, we shall be interested in constructing piecewise-affine systems that are approximations of Lur'e systems, i.e. interconnections of linear systems and memoryless nonlinearities<sup>1</sup>. The nonlinearity in these systems is in general *well-behaved*, meaning that it can be assumed to be continuous, differentiable, and even (locally) Lipschitz continuous in most cases. This means that the solution to the underlying nonlinear system exists and is unique. It is natural then to expect that the approximated piecewise-affine system inherits these properties, which conflicts with the presence of Zero behavior. In view of this, we shall make the following assumption.

<sup>1</sup>Please refer to Chapter 5 for a formal definition of Lur'e system.

## ASSUMPTION 2.3

The PWA system (2.2) does not present Zeno behavior.  $\lrcorner$

A sufficient condition to ensure the non-existence of sliding modes is the Lipschitz continuity of the right-hand side of the differential equation in (2.2). The following lemma, adapted from [125], ensures continuity, which in turn implies Lipschitz continuity in view of Proposition 2.6, to be stated below.

## LEMMA 2.4

Consider the piecewise-affine function  $f_{\text{PWA}} : \mathbb{R}^n \times \mathbb{R}^{n_w} \rightarrow \mathbb{R}^n$  defined by  $f_{\text{PWA}}(x, w) = A_i x + a_i + B_i w$  for  $x \in X_i$ , with  $\{X_i\}_{i \in \mathcal{I}}$  forming a polyhedral partition of  $\mathbb{R}^n$ . Then,  $f_{\text{PWA}}$  is continuous if and only if  $B_i = B_j =: B$ ,  $\forall i, j \in \mathcal{I}$  and for any two cells  $X_i$  and  $X_j$  having a common boundary  $X_i \cap X_j \subseteq \{x \in X \mid E_{ij}x + e_{ij} = 0\}$  the corresponding matrices  $A_i$  and  $A_j$  and the vectors  $a_i$  and  $a_j$  satisfy

$$\begin{aligned} gE_{ij} &= A_i - A_j \\ ge_{ij} &= a_i - a_j \end{aligned} \tag{2.9}$$

for some vector  $g \in \mathbb{R}^n$ .  $\lrcorner$

Due to the special structure of piecewise-affine functions, it turns out that continuity directly implies Lipschitz continuity. To see this, let us first introduce the following proposition, which is a standard result concerning the analysis of piecewise-affine functions [143, 152].

## PROPOSITION 2.5

Let  $f_{\text{PWA}}(x) := A_i x + a_i$ , for  $x \in X_i$ , be a continuous piecewise-affine function, i.e.  $A_i x + a_i = A_j x + a_j$  for every  $x \in X_i \cap X_j$ , and such that  $\{X_i\}_{i \in \mathcal{I}}$  forms a finite polyhedral partition of  $\mathbb{R}^n$ . Then there exists  $\lambda \in \mathbb{R}^N$  with every component  $\lambda_i \geq 0$  and  $\sum_{i=1}^N \lambda_i = 1$  such that

$$f_{\text{PWA}}(x) - f_{\text{PWA}}(\tilde{x}) = \sum_{i=1}^N \lambda_i A_i (x - \tilde{x}) \tag{2.10}$$

for every  $x, \tilde{x} \in X$ .  $\lrcorner$

## PROOF

The case  $x, \tilde{x} \in X_i$  is trivial. Let us consider the case where  $x \in X_i$  and  $\tilde{x} \in X_j$ , for  $i \neq j$ . There exists a segment joining  $x$  and  $\tilde{x}$ , and we denote the elements of this line as  $\xi(\lambda) = (1 - \lambda)x + \lambda\tilde{x}$ , for  $\lambda \in [0, 1]$ . Since the partition is finite, this segment passes through  $r$  regions, and then there exist  $r + 1$  points  $\xi_0, \dots, \xi_r$ , with  $\xi_0 = x$ ,  $\xi_r = \tilde{x}$ , so that each  $\xi_\ell$ , for  $\ell \in \{1, \dots, r - 1\}$ , lies in the intersection between two regions, see Figure 2.4. From the geometry of the partition  $\{X_i\}_{i \in \mathcal{I}}$ , each portion of the segment that belongs to a specific region  $X_i$  is either a singleton, a closed interval, or empty. Let  $\sigma : \{1, \dots, r\} \rightarrow \mathcal{I}$  be such that  $\xi_\ell \in X_{\sigma(\ell)} \cap X_{\sigma(\ell+1)}$ , for  $\ell \in \{1, \dots, r - 1\}$ . We can then define  $\hat{\lambda}_\ell$ , for  $\ell \in \{0, \dots, r\}$ , as the value of  $\lambda$  for which  $\xi(\lambda) = \xi_\ell$ , i.e.  $\xi_\ell = (1 - \hat{\lambda}_\ell)x + \hat{\lambda}_\ell\tilde{x}$ . We can see that the values of  $\hat{\lambda}_\ell$  are such that  $0 = \lambda_0 < \lambda_1 < \dots < \lambda_r = 1$ . Continuity ensures that  $A_{\sigma(\ell)}\xi_\ell + a_{\sigma(\ell)} =$

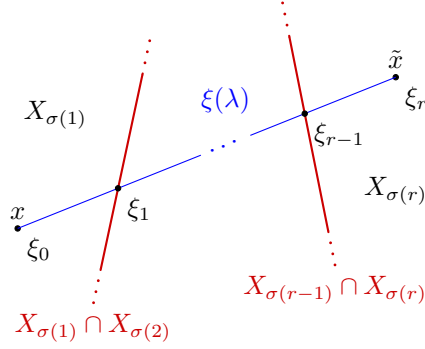
FIGURE 2.4 – Representation of the line segment connecting  $x$  and  $\tilde{x}$ .

$A_{\sigma(\ell+1)}\xi_{\ell+1} + a_{\sigma(\ell+1)}$ . We may then write

$$\begin{aligned}
f_{\text{PWA}}(x) - f_{\text{PWA}}(\tilde{x}) &= A_i x + a_i - A_j \tilde{x} - a_j \\
&= A_{\sigma(1)}\xi_0 + a_{\sigma(1)} - (A_{\sigma(1)}\xi_1 + a_{\sigma(1)}) + (A_{\sigma(2)}\xi_1 + a_{\sigma(2)}) - \cdots \\
&\quad \cdots - (A_{\sigma(r)}\xi_r + a_{\sigma(r)}) \\
&= A_{\sigma(1)}(\xi_0 - \xi_1) + \cdots + A_{\sigma(r)}(\xi_{r-1} - \xi_r) \\
&= \sum_{\ell=1}^r A_{\sigma(\ell)}(\xi_{\ell-1} - \xi_\ell) \\
&= \sum_{\ell=1}^r A_{\sigma(\ell)}((1 - \hat{\lambda}_{\ell-1})x + \hat{\lambda}_{\ell-1}\tilde{x} - (1 - \hat{\lambda}_\ell)x - \hat{\lambda}_\ell\tilde{x}) \\
&= \sum_{\ell=1}^r (\hat{\lambda}_\ell - \hat{\lambda}_{\ell-1})A_{\sigma(\ell)}(x - \tilde{x}). \tag{2.11}
\end{aligned}$$

Let us define  $\lambda_\ell := (\hat{\lambda}_\ell - \hat{\lambda}_{\ell-1})$ . Then, we have that every  $\lambda_\ell \geq 0$  and also

$$\sum_{\ell=1}^r \lambda_\ell = \sum_{\ell=1}^r (\hat{\lambda}_\ell - \hat{\lambda}_{\ell-1}) = \hat{\lambda}_r - \hat{\lambda}_0 = 1. \tag{2.12}$$

Substitution in (2.11), with the assignment of the value  $\lambda_i = 0$  for every  $i$  such that the line segment  $\xi(\lambda)$  does not cross  $X_i$ , yields the desired result. This concludes the proof.  $\blacksquare$

Using the above result, we can now state the following proposition showing that Lipschitz continuity of piecewise-affine functions is a direct consequence of continuity and finiteness of the state partition.

**PROPOSITION 2.6**

*If the piecewise-affine function  $f_{\text{PWA}}(x, w) = A_i x + a_i + Bw$ , for  $x \in X_i$ , is continuous with respect to  $x$ , then it is also globally Lipschitz continuous with respect to  $x$  and  $w$ .  $\lrcorner$*

**PROOF**

We need to show that there exist  $L_x$  and  $L_w$  such that

$$|f_{\text{PWA}}(x, u) - f_{\text{PWA}}(\tilde{x}, \tilde{u})| \leq L_x |x - \tilde{x}| + L_w |u - \tilde{u}| \tag{2.13}$$

Using Proposition 2.5, we can write

$$\begin{aligned}
|f_{\text{PWA}}(x, u) - f_{\text{PWA}}(\tilde{x}, \tilde{u})| &= \left| \sum_{i=1}^N \lambda_i A_i(x - \tilde{x}) + B(w - \tilde{w}) \right| \\
&\leq \left| \sum_{i=1}^N \lambda_i A_i(x - \tilde{x}) \right| + |B(w - \tilde{w})| \\
&\leq \max_{i \in \mathcal{I}} \{\|A_i\|\} |(x - \tilde{x})| + \|B\| |w - \tilde{w}| \\
&=: L_x |(x - \tilde{x})| + L_w |w - \tilde{w}|,
\end{aligned}$$

where the last equality comes from the fact that the state partition is finite and matrices  $A_i$ ,  $\forall i \in \mathcal{I}$ , and  $B$  are bounded. This proves the claim.  $\blacksquare$

In view of Lemma 2.4 and Proposition 2.6, we see that global Lipschitz continuity of piecewise-affine systems is not a hard property to be satisfied, as it is directly implied by continuity. In this sense, Assumption 2.3 is not too strong with respect to the presence of sliding modes.

In the case of discontinuous right-hand side, it might be difficult to ensure non-existence of sliding modes in the general case (see e.g. [83]). It is possible to obtain conditions for stability in the presence of sliding modes, see e.g. [83, Section 4.8] and [37], but this path is not followed in this memoir, due to the reasons mentioned above. Genuine Zeno behavior is somewhat more complicated to exclude. [167] states that no Zeno behavior exist in the case where the right-hand side of the ordinary differential equation (ODE) is continuous and the input is piecewise real-analytic. [92] extends the results to ensure non-existence of Zeno behavior when the right-hand side of the ODE is continuous and the input is left/right-analytic.

In the absence of Zeno behavior, we can use the concept of Carathéodory solution as a definition of trajectory for the piecewise-affine system (2.2) [83]. For a recall of the definition of absolute continuity, we refer the reader to [136, p. 50].

#### DEFINITION 2.7 (Trajectory)

Let  $x(t) \in \bigcup_{i \in \mathcal{I}} X_i$  be an absolutely continuous function. We say that  $x(t)$  is a trajectory of system (2.2) on  $[t_0, t_f]$  if, for almost all  $t \in [t_0, t_f]$ , the equation  $\dot{x}(t) = A_i x(t) + a_i + B_i w(t)$  holds for all  $i \in \mathcal{I}$  with  $x(t) \in X_i$ .  $\lrcorner$

We shall be interested in the operator  $\Sigma_{\text{PWA}}$  mapping  $\mathcal{L}_{2e}^{n_w}(\mathbb{R}_+)$  into  $\mathcal{L}_{2e}^{n_z}(\mathbb{R}_+)$ , presenting a piecewise-affine state representation:

$$z = \Sigma_{\text{PWA}}(w) \begin{cases} \dot{x}(t) = A_i x(t) + a_i + B_i w(t) \\ z(t) = C_i x(t) + c_i + D w(t) \\ x(0) = x_0 \end{cases} \quad \text{for } x(t) \in X_i \quad (2.14)$$

Let us remark that we have fixed  $D$  in (2.14) to be a constant, i.e. it does not depend on the regional description. This shall be important for the feasibility of the proposed conditions for incremental  $\mathcal{L}_2$ -gain stability, as it will become clear from the discussion in Chapter 3.

We make the following additional assumption.

#### ASSUMPTION 2.8

For any  $i \in \mathcal{I}_0$ ,  $a_i = 0$  and  $c_i = 0$ .  $\lrcorner$

This assumption ensures that  $x = 0$  is an equilibrium point of (2.14) with zero input and zero output. This is done as our purpose is to assess performance of control systems, meaning systems in closed loop that are conceived to follow some reference input or reject exogenous perturbations, but when left at rest should stay at this state.

## 2.3 Analysis of dynamical systems

In this section we shall define the stability and performance concepts that we aim to assess.

### 2.3.1 Input-output characterizations and performance assessment

We shall be interested in characterizing *performance* of the nonlinear system (2.1). Performance can be characterized via a certain measure of the output of the system with respect to the corresponding input. We refer to these as the *performance channels* of the system  $\Sigma$ , since the measurement of performance is obtained from the dynamics between these two signals. The input channel may represent a reference signal, disturbance or noise, for example, while the output might be a desired signal that gives information on the behavior of the system, such as the tracking error, control effort and so forth.

Let us begin with the notion of  $\mathcal{L}_2$ -gain, which is characterized by an energetic ratio between input and output.

#### DEFINITION 2.9 ( $\mathcal{L}_2$ -gain stability)

The system  $\Sigma : \mathcal{L}_{2e}^{n_w}(\mathbb{R}_+) \rightarrow \mathcal{L}_{2e}^{n_z}(\mathbb{R}_+)$  in (2.1) is said to be  $\mathcal{L}_2$ -gain stable if there exists  $0 < \gamma < \infty$  such that for all  $w \in \mathcal{L}_2^{n_w}(\mathbb{R}_+)$  we have

$$\int_0^\infty |z(t)|^2 dt \leq \gamma^2 \int_0^\infty |w(t)|^2 dt \quad (2.15)$$

for  $z = \Sigma(w)$  with initial state  $x_0 = 0$ . We define the  $\mathcal{L}_2$ -gain of  $\Sigma$  as the smallest  $\gamma$  for which (2.15) holds, and we denote it  $\|\Sigma\|_{\mathcal{L}_2}$ .

It is interesting to note that the definition of  $\mathcal{L}_2$ -gain stability used here concerns systems with zero initial condition. The gain is then a measure of the impact of the input on the output of the system initially at rest. It is possible to take initial conditions into account by considering them as an input to the system. A different approach would be to consider the addition of a bias to the above definition to account for transient behavior due to initial conditions (see e.g. [171, 175]).

A stronger input-output property of dynamical systems is that of *incremental  $\mathcal{L}_2$ -gain stability*. In this case we are interested in the energetic ratio between the difference of any two inputs and the corresponding outputs, as it is made clear in the next definition.

#### DEFINITION 2.10 (Incremental $\mathcal{L}_2$ -gain stability)

The system  $\Sigma : \mathcal{L}_{2e}^{n_w}(\mathbb{R}_+) \rightarrow \mathcal{L}_{2e}^{n_z}(\mathbb{R}_+)$  in (2.1) is said to be incrementally  $\mathcal{L}_2$ -gain stable if it is  $\mathcal{L}_2$ -gain stable and there exists  $0 < \eta < \infty$  such that for all  $w, \tilde{w} \in \mathcal{L}_2^{n_w}(\mathbb{R}_+)$  we have

$$\int_0^\infty |z(t) - \tilde{z}(t)|^2 dt \leq \eta^2 \int_0^\infty |w(t) - \tilde{w}(t)|^2 dt \quad (2.16)$$



for  $z = \Sigma(w)$  and  $\tilde{z} = \Sigma(\tilde{w})$  with the same initial condition  $x_0$ . We define the incremental  $\mathcal{L}_2$ -gain of  $\Sigma$  as the smallest  $\eta$  for which (2.16) holds, and we denote it  $\|\Sigma\|_{\Delta_2}$ .

For more general dynamical operators defined on more generic signal spaces, this property is often simply called continuity (see e.g. [178, 187]). This provides the simple interpretation that a continuous system is that for which a small perturbation of the input yields a small perturbation on the corresponding output.

In contrast with Definition 2.9, the initial conditions  $x_0, \tilde{x}_0$ , associated respectively with the trajectories  $z = \Sigma(w)$  and  $\tilde{z} = \Sigma(\tilde{w})$ , can be non zero. However, they are required to be the same. The idea is similar to what was discussed above: the incremental  $\mathcal{L}_2$ -gain is a measure of the impact of two different inputs on the system starting at the same state. In this case, there is no transient due to initial conditions, as both systems begin at the same starting point. We also note that, given Assumption 2.8, incremental  $\mathcal{L}_2$ -gain stability implies  $\mathcal{L}_2$ -gain stability of (2.14).

### 2.3.2 State space and stability

In section 2.3.1 we saw how input-output characterizations allow us to tackle the problem of performance assessment. Another way to analyze dynamical systems is to study the behavior of the state. One might be interested in checking stability of a given equilibrium point, or the asymptotic behavior when time goes to infinity. Concerning incremental stability, the interest is in the behavior of every state trajectory with respect to each other. In this section we present the concepts of internal stability that are used throughout the memoir. We begin by recalling the definition of asymptotic stability.

#### DEFINITION 2.11 (Asymptotic and exponential stability)

We say that system (2.1) is asymptotically stable if there exists a function  $\beta$  of class  $\mathcal{KL}$  so that for all  $x_0 \in X$  and all  $t \geq 0$  the following holds

$$|x(t)| \leq \beta(|x_0|, t) \quad (2.17)$$

with  $x(t) = \phi(t, 0, x_0, 0)$ . If there exist  $d, \lambda > 0$  such that  $\beta(r, t) \leq de^{-\lambda t}r$ , the system is said to be exponentially stable. If  $X = \mathbb{R}^n$ , the system is said to be globally asymptotically (exponentially) stable.  $\lrcorner$

#### REMARK 2.12

The definition of asymptotic stability using the comparison function terminology in (2.17) is equivalent to the traditional  $\varepsilon$ - $\delta$  definition, see e.g. [103, Proposition 2.5].  $\lrcorner$

As an internal stability notion, asymptotic stability is a stability property of unforced systems. It concerns the response of the system to different initial conditions in the absence of inputs.

Incremental notions of asymptotic stability are concerned with the convergence of every trajectory, independent of the initial condition. In this sense, it can be related to the fading memory property, which is understood as an asymptotic independence of initial conditions [16]. The following definition of asymptotic incremental stability is adapted from [6].

**DEFINITION 2.13 (Incremental asymptotic and exponential stability)**

We say that system (2.1) is incrementally asymptotically stable if there exists a function  $\beta$  of class  $\mathcal{KL}$  so that for all  $x_0, \tilde{x}_0 \in X$  and all  $t \geq 0$  the following holds

$$|x(t) - \tilde{x}(t)| \leq \beta(|x_0 - \tilde{x}_0|, t) \quad (2.18)$$

with  $x(t) = \phi(t, 0, x_0, w)$  and  $\tilde{x}(t) = \phi(t, 0, \tilde{x}_0, w)$  for any  $w \in \mathcal{L}_{2e}^{n_w}(\mathbb{R}_+)$ . If there exist  $d, \lambda > 0$  such that  $\beta(r, t) \leq de^{-\lambda t}r$ , the system is said to be incrementally exponentially stable. If  $X = \mathbb{R}^n$ , the system is said to be incrementally globally asymptotically (exponentially) stable.  $\square$

It is interesting to note that in the definition of the incremental  $\mathcal{L}_2$ -gain, we compared the behavior of the system in response to different inputs, but stemming from the same initial condition. In the case of incremental asymptotic stability, we are concerned with the behavior of two trajectories stemming from different initial conditions and under the same input. It is clear that the first is an input-output characterization, while the second is interested with qualitative behavior of the state. As seen in Definition 2.10, the input characteristic of interest for incremental stability is the difference between the two inputs  $|w - \tilde{w}|$ . In this sense, incremental asymptotic stability is indeed an “internal stability” notion, since, from the point of view of incremental stability, the input is “null” (since  $w = \tilde{w}$ ). The signal  $w$  in Definition 2.13 can then be seen as a time-varying parameter, or a disturbance [6].

## 2.4 Stability and performance assessment

In this section we review classic tools in the analysis of dynamical systems: dissipativity and Lyapunov stability. They will allow us to obtain tractable conditions to perform analysis on piecewise-affine systems.

### 2.4.1 Dissipativity analysis

Input-output properties characterize the interaction between the internal behavior of a dynamical system and its environment. This is at the heart of the dissipativity theory introduced by Willems [180, 181], connecting state space and input-output characterizations via the notions of *supply rate* and *storage function*.

Let us call *supply rate* a function  $\varpi$  from  $W \times Z$  into  $\mathbb{R}$ . We suppose that  $\varpi$  is locally absolutely integrable, i.e. for all  $t_1 \geq t_0 \geq 0$ ,  $w \in \mathcal{L}_{2e}^{n_w}(\mathbb{R}_+)$  and  $z \in \mathcal{L}_{2e}^{n_z}(\mathbb{R}_+)$ , it satisfies

$$\int_{t_0}^{t_1} |\varpi(w(t), z(t))| dt < \infty. \quad (2.19)$$

The supply rate is a generalization of the energy flow between the system and exterior elements. The energy that enters the system can be stored, augmenting its internal energy, or dissipated. To account for the stored energy, we introduce the storage function, so that the notion of dissipative systems can be defined as follows.

**DEFINITION 2.14 (Dissipative system)**

A dynamical system  $\Sigma : \mathcal{W}_e \rightarrow \mathcal{Z}_e$  is said to be dissipative with respect to the supply rate  $\varpi : W \times Z \rightarrow \mathbb{R}$  if there exists a nonnegative function  $S : X \rightarrow \mathbb{R}_+$ , called the storage

function, such that for all  $t_1, t_0 \in \mathbb{R}_+$ ,  $t_1 \geq t_0$ , and  $w \in \mathcal{W}_e$ ,

$$S(x(t_1)) - S(x(t_0)) \leq \int_{t_0}^{t_1} \varpi(w(t), z(t)) dt \quad (2.20)$$

where  $x(t_1) = \phi(t_1, t_0, x(t_0), w)$  and  $z = \Sigma(w)$ . In the case where  $S$  is differentiable, the dissipation inequality (2.20) can be written as

$$\nabla S(x) \cdot f(x, w) - \varpi(w, z) \leq 0 \quad (2.21)$$

for all  $w \in \mathcal{W}_e$ . ┘

Inequality (2.20) implies that the generalized energy stored in the system in any future time  $t_1$  cannot be greater than the sum of the generalized energy at a given time  $t_0$  and the energy supplied between these two time instants, i.e. no internal creation of “energy” is possible [171]. In this sense, they can be seen as a generalization of internally stable systems to the input-output framework.

The storage function  $S$  is not unique, and it is readily seen from (2.20) that if  $S_1$  and  $S_2$  are both storage functions, then their convex combination also is. There is a lower bound to the continuum of storage functions, which is given by the *available storage*.

#### DEFINITION 2.15 (Available storage)

The available storage of system (2.1) with supply rate  $\varpi$  is the function from  $X$  to  $\overline{\mathbb{R}}_+$  defined by

$$S_a(x_0) := \sup_{\substack{T \geq 0 \\ w \in \mathcal{W}}} \left\{ - \int_0^T \varpi(w(\tau), z(\tau)) d\tau \mid \begin{array}{l} (w, x, z) \text{ satisfy (2.1)} \\ \text{with } x(0) = x_0 \end{array} \right\} \quad (2.22) \quad \text{┘}$$

From its definition, we see that the available storage at some point  $x$  is the maximum energy that may be extracted from the system starting from this point. The available storage is an important function and shall prove a useful theoretical tool in the remaining of this section. A first result, taken from [180], shows that finiteness of the available storage is equivalent to dissipativity. A proof is provided in appendix B.1.

#### LEMMA 2.16

Let  $S_a$  be the available storage for system (2.1).  $S_a$  is finite for all  $x \in X$  if and only if  $\Sigma$  is dissipative with respect to  $\varpi$ . In this case,  $S_a$  is itself a possible storage function, and for any other storage function  $S$  it holds that  $0 \leq S_a \leq S$ . ┘

This result shows how the available storage can be used to assess dissipativity of a dynamical system.

Dissipativity theory is an important tool in the assessment of input-output characteristics. In fact, it can be shown that input-output stability, in the sense of finite  $\mathcal{L}_2$ -gain, passivity or any other input-output characterization, is equivalent to an appropriate notion of dissipativity. As expected, the supply rate is the key to specialize dissipativity into these particular cases. Before stating this result, we need to provide a definition of reachability of the state space of a dynamical system. This is needed since the storage function is defined in the entire state space, and then equivalence between dissipativity and input-output stability should come through the fact that a storage function exists and is defined for every state.

**DEFINITION 2.17 (Reachability)**

The state space of  $\Sigma : \mathcal{W}_e \rightarrow \mathcal{Z}_e$  is said to be reachable from  $x_0$  if given any  $x \in X$  and  $t \geq 0$ , there exist  $w \in \mathcal{W}_e$  and  $T_r \geq 0$  such that  $x = \phi(t, t - T_r, x_0, w)$ . We say that  $\Sigma$  is reachable if its state space is reachable from every  $x_0 \in X$ .  $\lrcorner$

Simply put, reachability means that for any pair  $(x_0, x)$  in the state space, there exists a valid input that drives the system from  $x_0$  to  $x$ .

The following is a standard result in dissipativity theory, see e.g. [71] and [171, Remark 3.1.11]. A proof is provided in Appendix B.1.

**THEOREM 2.18**

Let  $\Sigma : \mathcal{W}_e \rightarrow \mathcal{Z}_e$  be a time invariant dynamical system, with a state-space reachable from  $x_0$ . Then, the following two statements are equivalent:

(i) for every  $T \geq 0$  and every  $w \in \mathcal{W}_e$ , we have

$$\int_0^T \varpi(w(t), z(t)) dt \geq 0 \quad (2.23)$$

where  $z = \Sigma(w)$  and  $x(0) = x_0$ .

(ii)  $\Sigma$  is dissipative with respect to the supply rate  $\varpi$ , and there exists a storage function normalized at  $S(x_0)$ , i.e.  $S(x_0) = 0$ .

If the state space is not assumed to be reachable from  $x_0$ , the implication (ii)  $\Rightarrow$  (i) remains true.  $\lrcorner$

The power of Theorem 2.18 becomes clear when it is specialized to a given input-output property. In this memoir, we shall be interested in characterizing  $\mathcal{L}_2$ -gain stability and incremental  $\mathcal{L}_2$ -gain stability, as previously defined. Concerning the former, the following result is immediate.

**COROLLARY 2.19**

Let  $\Sigma : \mathcal{L}_{2e}^{nw}(\mathbb{R}_+) \rightarrow \mathcal{L}_{2e}^{nz}(\mathbb{R}_+)$  be a time-invariant dynamical system defined by (2.1), with  $x_0 = 0$  and a state-space reachable from the origin. Then,  $\Sigma$  is  $\mathcal{L}_2$ -gain stable if and only if it is dissipative with respect to the supply rate

$$\varpi(w, z) = \gamma^2 |w|^2 - |z|^2. \quad (2.24)$$

Using Corollary 2.19, the assessment of  $\mathcal{L}_2$ -gain stability of a dynamical system is replaced by the assessment of dissipativity with respect to the supply rate (2.24).

We now turn our attention to the study of the incremental  $\mathcal{L}_2$ -gain. As seen in the previous section, incremental stability properties are concerned with the behavior of every trajectory of the system with respect to one another. In order to be able to compare two different trajectories of system (2.1), we introduce the fictitious augmented system  $\bar{\Sigma} : \mathcal{L}_{2e}^{nw}(\mathbb{R}_+) \times \mathcal{L}_{2e}^{nw}(\mathbb{R}_+) \rightarrow \mathcal{L}_{2e}^{nz}(\mathbb{R}_+)$ .

$$\bar{z} = \bar{\Sigma}(w, \tilde{w}) \begin{cases} \dot{x}(t) = f(x(t), w(t)) \\ \dot{\tilde{x}}(t) = f(\tilde{x}(t), \tilde{w}(t)) \\ \bar{z}(t) = h(x(t), w(t)) - h(\tilde{x}(t), \tilde{w}(t)) \\ x(0) = x_0 \\ \tilde{x}(0) = \tilde{x}_0 \end{cases} \quad (2.25)$$

We note that  $\bar{\Sigma}(w, \tilde{w}) := \Sigma(w) - \Sigma(\tilde{w})$ . The state space of the augmented system, or simply the augmented state space, is denoted  $\bar{X}$  and is equal to the Cartesian product of the original state space, i.e.  $\bar{X} := X \times X$ .

It is possible to study the incremental  $\mathcal{L}_2$ -gain stability of system (2.1) through the dissipativity analysis of the augmented system (2.25) [56, 142]. For this, we shall consider a storage function defined on the augmented state space  $\bar{S} : \bar{X} \rightarrow \mathbb{R}_+$ . We shall write  $\bar{S}(x, \tilde{x})$  instead of  $\bar{S}(\text{col}(x, \tilde{x}))$  to improve readability, but it should be clear that  $\bar{S}$  is a storage function for the augmented system, and thus is a function of the augmented state vector  $\text{col}(x, \tilde{x})$ .

#### COROLLARY 2.20

Let  $\Sigma : \mathcal{L}_{2e}^{nw}(\mathbb{R}_+) \rightarrow \mathcal{L}_{2e}^{nz}(\mathbb{R}_+)$  be a time-invariant dynamical system defined by (2.1), with a state-space reachable from  $x_0$ . Then,  $\Sigma$  is incrementally  $\mathcal{L}_2$ -gain stable if and only if the augmented system  $\bar{\Sigma}$  defined by (2.25) with  $x_0 = \tilde{x}_0$  is dissipative with respect to the supply rate

$$\bar{\omega}(w, \tilde{w}, \bar{z}) = \eta^2 |w - \tilde{w}|^2 - |\bar{z}|^2 \quad (2.26)$$

and there exists a storage function  $\bar{S} : \bar{X} \rightarrow \mathbb{R}_+$  such that  $\bar{S}(x, x) = 0$  for every  $x \in X$ .  $\lrcorner$

#### REMARK 2.21

While the above corollary is a direct consequence of Theorem 2.18, the fact that the storage function is null on the diagonal set  $X_{\mathcal{D}} = \{\xi \in \bar{X} \mid \exists x \in X : \xi = \text{col}(x, x)\}$  might deserve some clarification. Let us recall that in the definition of the incremental  $\mathcal{L}_2$ -gain, the initial state of both trajectories is taken to be same, i.e.  $x_0 = \tilde{x}_0$ . Then, from Theorem 2.18, the storage function  $\bar{S}$  is normalized on  $\xi_0 := \text{col}(x_0, x_0)$ , meaning that  $\bar{S}(x_0, x_0) = 0$ . Since every state  $x \in X$  is assumed to be reachable from  $x_0$ , there exists an input  $w \in \mathcal{L}_{2e}^{nw}(\mathbb{R}_+)$  such that  $x = \phi(t, 0, x_0, w)$  for some  $t \geq 0$ . Choosing  $\tilde{w} = w$ , it is clear that  $\bar{z} \equiv 0$ . Then, using the dissipation inequality (2.20), we have

$$\bar{S}(x, x) \leq \bar{S}(x_0, x_0). \quad (2.27)$$

Nonnegativity of the storage function and the fact that  $\bar{S}(x_0, x_0) = 0$  yields that  $\bar{S}(x, x) = 0$ . Since  $x$  was arbitrary, this must be true for every  $x \in X$ .  $\lrcorner$

### 2.4.2 Lyapunov stability

Assessment of asymptotic stability can be done by applying Lyapunov's second method. This approach has played a central role in system theory, and has been extended to the analysis of discrete-time systems, stochastic systems, switched systems, to name a few. The following theorem presents a version of the classic Lyapunov stability theorem where differentiability of the Lyapunov function is not assumed. It is essentially contained in [159, Section 6], see also [95, Section 3.1].

## THEOREM 2.22

System (2.1) is asymptotically stable as in Definition 2.11 if there exist a continuous function  $V : X \rightarrow \mathbb{R}_+$ , called a Lyapunov function, and  $\mathcal{K}_\infty$  functions  $\alpha_1$  and  $\alpha_2$  such that

$$\alpha_1(|x|) \leq V(x) \leq \alpha_2(|x|) \quad (2.28)$$

and along any trajectory  $x$ , starting from  $x_0$ ,  $V$  satisfies for any  $t \geq 0$

$$V(x(t)) - V(x_0) \leq - \int_0^t \rho(|x(\tau)|) d\tau \quad (2.29)$$

with  $x(t) = \phi(t, 0, x_0, 0)$  and  $\rho$  a positive definite function.  $\lrcorner$

## REMARK 2.23

The constraint (2.29) can be shown to be equivalent to the more traditional requirement that the time derivative of  $V$  be negative along trajectories of the system, see e.g. the discussion in [159, Section 6].  $\lrcorner$

In certain cases, the asymptotic behavior of the trajectories may be characterized in a stronger manner. Instead of assessing asymptotic stability, the next theorem gives conditions under which the origin is exponentially stable. This is a classic result in system theory, see e.g. [175, Theorem 62] and also the proof of Theorem 2.27, to be stated below.

## THEOREM 2.24

If the conditions in Theorem 2.22 are satisfied with  $\alpha_i(r) = \sigma_i |r|^2$ , with  $\sigma_i > 0$  for  $i \in \{1, 2\}$ , and  $\rho(r) = \sigma_3 |r|^2$  with  $\sigma_3 > 0$ , then system (2.14) is exponentially stable.  $\lrcorner$

Parallel to the study of the incremental  $\mathcal{L}_2$ -gain, incremental asymptotic stability can also be connected to the study of the augmented system (2.25). In this case, we fix  $\tilde{w} = w$ , since we are only interested in the convergence of trajectories due to different initial conditions. Let us define the diagonal set

$$X_{\mathcal{D}} = \{\xi \in \overline{X} \mid \exists x \in X : \xi = \text{col}(x, x)\}. \quad (2.30)$$

Let  $|\xi|_{\mathcal{D}} := \inf_{y \in X_{\mathcal{D}}} |\xi - y|$  denote the distance of the point  $\xi$  to the set  $X_{\mathcal{D}}$ . The next proposition is taken from [6].

## PROPOSITION 2.25

The incremental asymptotic stability of system (2.1) is equivalent to the asymptotic stability of (2.25) with respect to the diagonal set  $X_{\mathcal{D}}$ .  $\lrcorner$

## PROOF

We shall show that the distance between an arbitrary  $\xi = \text{col}(x, \tilde{x})$  and the set  $X_{\mathcal{D}}$  is proportional to the Euclidean distance between  $x$  and  $\tilde{x}$ . Let us note that

$$\begin{aligned} |\xi|_{\mathcal{D}}^2 &= \left( \inf_{y \in X_{\mathcal{D}}} |\xi - y| \right)^2 \\ &= \inf_{y \in X_{\mathcal{D}}} |\xi - y|^2 \\ &= \inf_{z \in \mathbb{R}^n} |x - z|^2 + |\tilde{x} - z|^2 \end{aligned} \quad (2.31)$$

The function  $f(z) = |x - z|^2 + |\tilde{x} - z|^2$  is strictly convex and differentiable, and hence attains its minimum when its gradient is null. Since  $\nabla f(z) = -2(x + \tilde{x} - 2z)$ , the minimum is attained when  $z = (x + \tilde{x})/2$ . Substitution in (2.31) yields

$$|\xi|_{\mathcal{D}}^2 = 2 \left| \frac{x - \tilde{x}}{2} \right|^2, \quad (2.32)$$

and then

$$|\xi|_{\mathcal{D}} = \frac{1}{\sqrt{2}} |x - \tilde{x}|. \quad (2.33)$$

Hence, inequality (2.18) can be rewritten as  $|\xi|_{\mathcal{D}} \leq \hat{\beta}(|\xi_0|_{\mathcal{D}}, t)$ , with  $\hat{\beta}(\cdot, t) := \frac{1}{\sqrt{2}}\beta(\sqrt{2}(\cdot), t)$  which is valid for all  $\xi_0 \in \mathbb{R}^{2n}$  and all  $t \geq 0$ , thus concluding the proof. ■

Some of the first studies on incremental stability using Lyapunov theory were done by Yoshizawa (see e.g. [185, Section 4.15]) and La Salle (see e.g. [97, Section 4.26]) in the sixties. They referred to this property as *extreme stability*. Starting from an input-output point-of-view, and using dissipativity arguments, Fromion established similar results [52]. He proposed that incrementally  $\mathcal{L}_2$ -gain stable systems satisfying certain observability and reachability constraints have the property of *stability of the unperturbed motion*, which can be connected with Definition 2.13. Angeli proposed an extension of Lyapunov techniques to the analysis of incremental asymptotic stability and incremental input-to-state stability [6]. He provided a necessary and sufficient characterization of global incremental asymptotic stability in terms of the existence of a Lyapunov-like function. In view of the fact that Definition 2.13 is concerned with local stability, and the inputs belong to a subset of  $\mathcal{L}_{2e}^{nw}(\mathbb{R}_+)$ , instead of being any essentially bounded function of time as in [6], we present the following theorem as a sufficient condition for incremental asymptotic stability.

#### THEOREM 2.26

*System (2.14) is incrementally asymptotically stable as in Definition 2.13 if there exist a continuous function  $\bar{V} : \bar{X} \rightarrow \mathbb{R}_+$  and  $\mathcal{K}_\infty$  functions  $\alpha_1$  and  $\alpha_2$  such that*

$$\alpha_1(|x - \tilde{x}|) \leq \bar{V}(x, \tilde{x}) \leq \alpha_2(|x - \tilde{x}|) \quad (2.34)$$

*and along any two trajectories  $x, \tilde{x}$ , starting respectively from  $x_0$  and  $\tilde{x}_0$  under input  $w \in \mathcal{L}_{2e}^{nw}(\mathbb{R}_+)$ ,  $\bar{V}$  satisfies for any  $t \geq 0$*

$$\bar{V}(x(t), \tilde{x}(t)) - \bar{V}(x_0, \tilde{x}_0) \leq - \int_0^t \rho(|x(\tau) - \tilde{x}(\tau)|) d\tau \quad (2.35)$$

*with  $x(t) = \phi(t, 0, x_0, w)$ ,  $\tilde{x}(t) = \phi(t, 0, \tilde{x}_0, w)$  and  $\rho$  a positive definite function. A function  $\bar{V}$  satisfying the above properties is called an incremental Lyapunov function. ┘*

As it was done for asymptotic stability, the incremental Lyapunov function is not supposed to be differentiable. This detail is of importance in the construction of the Lyapunov and incremental Lyapunov functions for piecewise-affine systems, where differentiability is a delicate matter. This will be further discussed in Section 2.6.

For completeness, the following theorem is provided concerning the characterization of incremental exponential stability. Its proof follows a classic discretization approach adapted from [166, Theorem 2] and given in Appendix B.1.

## THEOREM 2.27

If the conditions in Theorem 2.26 are satisfied with  $\alpha_i(r) = \sigma_i |r|^2$ , with  $\sigma_i > 0$  for  $i \in \{1, 2, 3\}$ , then system (2.14) is incrementally exponentially stable.  $\lrcorner$

### 2.4.3 Construction of storage functions and Lyapunov functions

In the previous sections, the analysis of input-output and state space characterizations of stability and performance have been recast as the problem of finding appropriate storage functions and Lyapunov functions. In this section we review how these results can be used to systematically perform stability and performance analysis.

Let us consider the assessment of  $\mathcal{L}_2$ -gain. Corollary 2.19 states the equivalence between  $\mathcal{L}_2$ -gain stability and dissipativity with respect to the storage function (2.24). Then, to conclude on  $\mathcal{L}_2$ -gain stability, it suffices to find a nonnegative storage function  $S$  such that the dissipation inequality (2.20) is satisfied. In the case of LTI systems, this can be easily done, as we shall see in Section 2.5.1. On the other hand, when dealing with nonlinear systems the problem becomes much harder. In fact, apart from being nonnegative and respecting the dissipation inequality, not much else is known about the storage function. Additional information may be obtained from characterizations of observability and reachability of the state space (see e.g. [52, 57, 58, 71–73, 179]). Assuming that the storage function is differentiable,  $\mathcal{L}_2$ -gain stability would then be ensured by the existence of a storage function such that [180]

$$\sup_{w \in W} \left\{ \nabla S(x) \cdot f(x, w) - \gamma^2 |w|^2 + |z|^2 \right\} \leq 0. \quad (2.36)$$

This nonlinear partial differential inequality is known as a *Hamilton-Jacobi-Bellman* (HJB) inequality, due to its relation with the Hamilton-Jacobi-Bellman equation from optimal control theory (see e.g. [101]). James [79] showed that the above inequality, taken in a weak sense, becomes a necessary and sufficient condition for  $\mathcal{L}_2$ -gain stability if its solutions are understood in the viscosity sense. In this case, no a priori condition is made on the differentiability of the storage function. Solving the HJB inequality explicitly can prove to be a very difficult problem in the general case of nonlinear systems. James and Yuliar proposed a method to compute a numerical solution based on discretization of the HJB inequality built using the finite difference method [80]. This allows us to compute a range containing the actual  $\mathcal{L}_2$ -gain of the system. However, this technique becomes impractical when systems of increased order and complexity are considered.

Analogous conclusions can be made in the stability case. For academic low-order systems, Lyapunov functions can be found by intuition and experience. When complexity and size augment, this approach can be ruled out as practically infeasible.

Another angle of attack must then be taken if we aim to obtain efficient conditions allowing to systematically tackle a large class of systems. The classic approach is to restrain the storage functions considered down to a certain class of functions  $\mathcal{S}$ . A parametrization of this class then allows us to recast  $\mathcal{L}_2$ -gain assessment as an optimization problem:

$$\begin{aligned} & \text{minimize} && \gamma \\ & \text{subject to} && \nabla S(x) \cdot f(x, w) - \gamma^2 |w|^2 + |z|^2 \leq 0, \forall x \in X, \forall w \in W \\ & && S(x) \geq 0, \forall x \in X \\ & && \gamma > 0 \\ & && S \in \mathcal{S} \end{aligned} \quad (2.37)$$



The idea is to choose a parametrization such that this problem is convex, mostly involving constraints written as linear matrix inequalities. In this way, we can make use of interior-point algorithms [118] to find a solution rather efficiently. Since an a priori structure is chosen for the storage function, there might be a gap between the value of  $\gamma$  found after minimization and the true  $\mathcal{L}_2$ -gain of the system. That is, the results become *conservative*.

As it shall be seen in the next section, analysis of LTI systems can be carried out by searching for quadratic storage and Lyapunov functions without adding conservatism. For this reason, the choice  $\mathcal{S} = \{S : X \rightarrow \mathbb{R}_+ \mid S(x) = x^\top P x, \text{ with } P \succeq 0\}$  seems to be a natural first step when dealing with nonlinear systems. However, as it shall be seen in the sequel, the choice of quadratic storage functions may prove too restrictive. This may lead to inconclusive analysis, when the optimization problem is infeasible, or to excessive conservatism, when the gap between  $\gamma$  and the actual  $\mathcal{L}_2$ -gain is larger than the desired accuracy.

In this memoir, we propose to construct storage and Lyapunov functions for the study of incremental stability properties having a more flexible pre-defined structure. We extend some results from the literature to propose the construction of piecewise-quadratic and piecewise-polynomial storage and Lyapunov functions. After considering the analysis of LTI systems in the next section, we formally introduce the class of piecewise-affine systems and a range of tools for stability and performance analysis.

## 2.5 Study of LTI systems

In this section the analysis tools presented in the previous sections are applied for stability and performance assessment of linear time invariant systems. The goal is to motivate the approach that will be taken to analyze piecewise-affine systems in Section 2.6. Among the important features that we aim to reuse in the analysis of piecewise-affine systems is the possibility to recast stability and performance assessment as an optimization problem constrained by linear matrix inequalities.

Let us consider the linear time-invariant system possessing a minimal state space representation given by:

$$z = \Sigma_{\text{LTI}}(w) \begin{cases} \dot{x}(t) = Ax(t) + Bw(t) \\ z(t) = Cx(t) + Dw(t) \\ x(0) = x_0 \end{cases} \quad (2.38)$$

where  $x(t) \in \mathbb{R}^n$  is the state,  $w \in \mathcal{L}_{2e}^{n_w}(\mathbb{R}_+)$  is the input taking values in  $W = \mathbb{R}^{n_w}$ , and  $z \in \mathcal{L}_{2e}^{n_z}(\mathbb{R}_+)$  is the output taking values in  $Z = \mathbb{R}^{n_z}$ . The associated transfer function between  $w$  and  $z$  is defined as  $H(s) := C(sI - A)^{-1}B + D$ , where  $s$  is the complex Laplace variable.

In the following sections we propose to analyze system (2.38) through the construction of quadratic storage and Lyapunov functions of the form:

$$S(x) = V(x) = x^\top P x. \quad (2.39)$$

We shall recall that analysis of LTI systems using quadratic Lyapunov and storage functions yields necessary and sufficient conditions for stability and performance.

### 2.5.1 $\mathcal{L}_2$ -gain stability

We begin by studying  $\mathcal{L}_2$ -gain stability of the LTI system (2.38). The following is a classic result in control theory, and is known as the *bounded real lemma* [18, Section 2.7.3].

THEOREM 2.28

The system (2.38) is  $\mathcal{L}_2$ -gain stable and has an  $\mathcal{L}_2$ -gain inferior to  $\gamma$  if and only if there exists a symmetric matrix  $P \in \mathbb{S}^n$  such that

$$\begin{cases} P \succeq 0 \\ \begin{bmatrix} A^\top P + PA + C^\top C & PB + C^\top D \\ \bullet & D^\top D - \gamma^2 I_p \end{bmatrix} \preceq 0 \end{cases} \quad (2.40)$$

PROOF

( $\Leftarrow$ ) Assume there exists a matrix  $P$  satisfying (2.40). Let us multiply the second inequality in (2.40) on the right by  $\text{col}(x, w)$  and on the left by  $\text{col}(x, w)^\top$  to obtain

$$2x^\top P(Ax + Bw) + (Cx + Dw)^\top (Cx + Dw) - \gamma^2 w^\top w \leq 0 \quad (2.41)$$

Let us define  $S(x) := x^\top P x$  to be a candidate storage function.  $S$  is nonnegative due to the first inequality in (2.40). Using (2.38) and the fact that  $\nabla S(x) = 2Px$  yields

$$\nabla S(x) \cdot (Ax + Bw) + z^\top z - \gamma^2 w^\top w \leq 0 \quad (2.42)$$

Hence,  $S$  is a storage function and system (2.38) is dissipative with respect to the supply rate (2.24), and application of Corollary 2.19 concludes the proof of sufficiency.

( $\Rightarrow$ ) The proof of necessity is related to the theory of infinite horizon Linear Quadratic optimal control (see e.g. [101, 177]).  $\blacksquare$

Condition (2.40) is composed of linear matrix inequalities on the variables  $P$  and  $\gamma^2$ , and can thus be efficiently solved. In order to compute the  $\mathcal{L}_2$ -gain of (2.38), it suffices to minimize over  $\gamma^2$ . This is a convex optimization problem, and then the result is guaranteed to be the global minimum. Since condition (2.40) is necessary and sufficient for  $\mathcal{L}_2$ -gain stability, it turns out that the computed value of  $\gamma$  is the true value of the  $\mathcal{L}_2$ -gain of (2.38).

### 2.5.2 Exponential stability

In this section we study exponential stability properties of linear time-invariant systems. These results are now common knowledge in system theory, and can be traced back to the first results of Lyapunov concerning the stability of dynamical systems (see e.g. [18, Section 2.5.2] or [91, Theorems 4.5 and 4.6]).

THEOREM 2.29

The system (2.38) is exponentially stable if and only if there exists a symmetric matrix  $P \in \mathbb{S}^n$  such that

$$\begin{cases} P \succ 0 \\ A^\top P + PA \prec 0 \end{cases} \quad (2.43)$$

PROOF

Assume that there exists a matrix  $P$  satisfying (2.43). Let  $V(x) := x^\top P x$  be a Lyapunov function candidate. The first inequality in (2.43) ensures that

$$\sigma_1 |x|^2 \leq V(x) \leq \sigma_2 |x|^2, \quad \text{for every } x \in X, \quad (2.44)$$

where  $\sigma_1$  and  $\sigma_2$  denote the smallest and greatest eigenvalue of  $P$ , respectively, and then  $V$  respects (2.28).

The time derivative of  $V$  along trajectories of the system is given by  $\dot{V}(x) = x^\top (A^\top P + PA)x$ . We remark that the second constraint in (2.43) is equivalent to the existence of  $\varepsilon > 0$  such that  $A^\top P + PA \preceq -\varepsilon I_n$ . Then we have  $\dot{V}(x) \leq -\varepsilon |x|^2$ . Integration from 0 to  $t$  yields (2.29). Hence,  $V$  is a Lyapunov function satisfying the conditions in Theorem 2.24, and then system (2.38) is globally exponentially stable.

( $\Rightarrow$ ) The proof of necessity can be found in classical control theory references, such as [91].  $\blacksquare$

REMARK 2.30

*When dealing with LTI systems, input-output and internal stability properties can be shown to be equivalent, provided we require the system to be observable. Indeed, condition (2.40) implies that there exists some  $P = P^\top$  such that  $P \succeq 0$  and  $A^\top P + PA + C^\top C \preceq 0$ . If the pair  $(C, A)$  is observable, it can be shown that  $P \succ 0$  and such that (2.43) is satisfied.  $\lrcorner$*

### 2.5.3 Incremental stability

We consider now incremental stability properties of linear time-invariant systems. We shall see that this class of systems is very special, since incremental performance and stability is automatically ensured by their non-incremental counterparts.

PROPOSITION 2.31

*The linear system (2.38) is incrementally  $\mathcal{L}_2$ -gain stable if and only if it is  $\mathcal{L}_2$ -gain stable. In this case, its incremental  $\mathcal{L}_2$ -gain coincides with its  $\mathcal{L}_2$ -gain.  $\lrcorner$*

PROOF

( $\Rightarrow$ ) Assume the system is incrementally  $\mathcal{L}_2$ -gain stable, and let  $x_0 = \tilde{x}_0 = 0$ . Since  $\Sigma_{\text{LTI}}(0) = 0$ , taking  $\tilde{w} \equiv 0$  in (2.16) yields that (2.38) is  $\mathcal{L}_2$ -gain stable with an  $\mathcal{L}_2$ -gain  $\gamma$  such that  $\gamma \leq \eta$ .

( $\Leftarrow$ ) Assume the system is  $\mathcal{L}_2$ -gain stable. Let  $w = w_1 - w_2$ , with  $w_1, w_2 \in \mathcal{L}_2^{nw}(\mathbb{R}_+)$ . Clearly,  $w \in \mathcal{L}_2^{nw}(\mathbb{R}_+)$ . Since the system is  $\mathcal{L}_2$ -gain stable, there exist  $\gamma \geq 0$  such that

$$\int_0^\infty |z(t)|^2 dt \leq \gamma^2 \int_0^\infty |w(t)|^2 dt = \gamma^2 \int_0^\infty |w_1(t) - w_2(t)|^2 dt \quad (2.45)$$

where  $z = \Sigma_{\text{LTI}}(w)$ . From linearity of the system,  $z = z_1 - z_2$ , where  $z_1 = \Sigma_{\text{LTI}}(w_1)$  and  $z_2 = \Sigma_{\text{LTI}}(w_2)$ . This yields

$$\int_0^\infty |z_1(t) - z_2(t)|^2 dt \leq \gamma^2 \int_0^\infty |w_1(t) - w_2(t)|^2 dt \quad (2.46)$$

Then the system is incrementally  $\mathcal{L}_2$ -gain stable with an incremental  $\mathcal{L}_2$ -gain  $\eta$  such that  $\eta \leq \gamma$ .

From both relations between  $\gamma$  and  $\eta$ , we conclude that  $\gamma = \eta$ , and thus the  $\mathcal{L}_2$ -gain of the system coincides with its incremental  $\mathcal{L}_2$ -gain. This concludes the proof. ■

Regarding incremental exponential stability, the following similar result is straightforwardly obtained.

PROPOSITION 2.32

*The linear system (2.38) is incrementally asymptotically stable if and only if it is asymptotically stable.* ┘

PROOF

( $\Rightarrow$ ) Assume the system is incrementally asymptotically stable. The implication then follows directly from Definition 2.13, with  $w = 0$  and  $\tilde{x}_0 = 0$ .

( $\Leftarrow$ ) Assume the system is asymptotically stable. The implication is then a simple consequence of the linearity of the state representation. Indeed,

$$\dot{x} - \dot{\tilde{x}} = Ax + Bw - (A\tilde{x} + Bw) = A(x - \tilde{x}). \quad (2.47)$$

Hence, if (2.38) is asymptotically stable,  $A$  is Hurwitz and then  $x - \tilde{x}$  goes asymptotically to zero. ■

Similar to the study of  $\mathcal{L}_2$ -gain and asymptotic stability, analysis of incremental properties of LTI systems can be carried out via an appropriate quadratic function. As usual, we make use of an auxiliary augmented system to study incremental stability. Given the linear description in (2.38), the augmented system (2.25) becomes:

$$\bar{z} = \bar{\Sigma}_{\text{LTI}}(\text{col}(w, \tilde{w})) \begin{cases} \dot{x}(t) = Ax(t) + Bw(t) \\ \dot{\tilde{x}}(t) = A\tilde{x}(t) + B\tilde{w}(t) \\ \bar{z}(t) = C(x(t) - \tilde{x}(t)) + D(w(t) - \tilde{w}(t)) \\ x(0) = x_0 \\ \tilde{x}(0) = \tilde{x}_0 \end{cases} \quad (2.48)$$

Incremental stability is concerned with the relative behavior of each possible trajectory of the system, and thus it would seem natural to propose a quadratic storage/Lyapunov function of the form:

$$\bar{S}(x, \tilde{x}) = \bar{V}(x, \tilde{x}) = (x - \tilde{x})^\top P(x - \tilde{x}) \quad (2.49)$$

For  $P \succeq 0$ , this function is obviously nonnegative and such that  $S(x, x) = 0$ , for every  $x \in \mathbb{R}^n$ , making it a proper storage function candidate according to Corollary 2.20. If  $P \succ 0$ , it is also strictly positive whenever  $x \neq \tilde{x}$ , and directly satisfies the norm bounds (2.34) with quadratic functions, where  $\sigma_1$  and  $\sigma_2$  given by the minimum and maximum eigenvalue of  $P$ , respectively. Development of the conditions in Corollary 2.20 and Theorem 2.26 straightforwardly yields the LMI constraints in Theorems 2.28 and 2.29, respectively, due to the linearity of the augmented system description (2.48). This comes as no surprise, as we saw that asymptotic stability and  $\mathcal{L}_2$ -gain stability are equivalent to their incremental counterparts for LTI systems.

## 2.6 Stability and performance of PWA systems

We now present a literature review of some results concerning the analysis of piecewise-affine systems using dissipativity and Lyapunov theory, as presented in the last section. Tables 2.1 and 2.2 present an overview of some references that have treated these problems. As we can see, quite a few studies have been dedicated to the study of these systems with this approach, with different classes of Lyapunov and storage functions. Also, we may notice that the results dealing with incremental stability are rather scarce, and are mostly based on the use of quadratic storage functions and incremental Lyapunov functions.

TABLE 2.1 – References on asymptotic/exponential stability of PWA systems

Property	Q	PWQ		PWA	P	PWP		CT/DT
		Cont.	Disc.			Cont.	Disc.	
A/ES	[70, 74, 83–85, 149]	[3, 44, 77, 83, 85, 113, 133, 149, 164]	[127, 128]	[15, 83, 93, 94, 119]	[121, 130, 149]	[4, 121, 130, 182]		CT
		[32, 43]	[43, 46, 68, 112]	[94]		[182]		DT
Inc. A/ES	[125, 170]							CT
								DT

A/ES stands for asymptotic and/or exponential stability. Classes of Lyapunov function: quadratic (Q), piecewise-quadratic (PWQ), piecewise-affine (PWA), polynomial (P) and piecewise-polynomial (PWP). PWQ and PWP functions are divided into continuous and discontinuous ones. References are also split according to whether they deal with systems in continuous (CT) or discrete time (DT).

Some authors have also approached the problem of stability analysis of piecewise-affine systems from a different point of view, i.e. without using dissipativity or Lyapunov theory. For example, the authors of [67] propose an extension of Poincaré maps for the analysis of piecewise-linear systems. It is based on the construction of so-called *Surface Lyapunov functions*, i.e. Lyapunov functions defined only on the switching surfaces. With these functions, it is possible to establish whether the trajectory is approaching the origin each time it crosses a switching surface. The authors of [12] study the stability of piecewise-affine systems as a verification problem. They propose a method to check if a given set of initial conditions eventually attains some given set close to the origin or a set of very large states. In the reference [138], stability of closed-loop piecewise-affine systems is assessed via considerations on invariant sets and appropriate control action. Another approach, somewhat closer to the one pursued in this memoir, was investigated in [38, 48]. The authors generalize the notion of *contraction* [105] to a class of non-differentiable systems, including piecewise-affine systems.

TABLE 2.2 – References on  $\mathcal{L}_2$ -gain stability of PWA systems

Property	Q	PWQ		PWA	P	PWP		CT/DT
		Cont.	Disc.			Cont.	Disc.	
$\mathcal{L}_2$ -gain	[34, 70]	[34, 44, 70, 99, 113, 133]						CT
		[32, 33]						DT
Inc.	[143]	[114]						CT
$\mathcal{L}_2$ -gain								DT

See Table 2.1 for definitions.

Since contraction is a differential property, i.e. it deals with the differential inclusion obtained by differentiating the system along its trajectories, this approach requires a regularization phase to “smooth” the PWA system.

In this section, we shall present a series of results concerning the analysis of piecewise-affine systems. We review some of the results that can be found in the literature concerning performance and stability analysis of this class of systems, and present some new results developed in the framework of this thesis. The goal is to provide tools to efficiently analyze piecewise-affine system both from an input-output and from a state space point of view. The route we take to approach this problem can be seen as an extension of the classic approach for LTI systems. In the end, we aim to obtain conditions expressed as linear matrix inequalities allowing the construction of appropriate storage/Lyapunov functions.

In Section 2.5, we saw how LMIs emerged from the positivity (or negativity) of quadratic forms coming from the application of dissipativity and Lyapunov theory. Due to the affine terms in the piecewise-affine description (2.14), we will deal with the problem of assessing positivity (or negativity) of quadratic functions containing affine and constant terms. The following lemma shows that these constraints can also be transformed into LMIs, and a proof is provided in Appendix B.1.

LEMMA 2.33

The quadratic function  $\sigma$  defined as

$$\sigma(x) := \begin{bmatrix} x \\ 1 \end{bmatrix}^T \begin{bmatrix} P & q \\ \bullet & r \end{bmatrix} \begin{bmatrix} x \\ 1 \end{bmatrix} \quad (2.50)$$

is nonnegative for all  $x \in \mathbb{R}^n$  if and only if

$$\begin{bmatrix} P & q \\ \bullet & r \end{bmatrix} \succeq 0. \quad (2.51)$$

┘

## REMARK 2.34

In the above lemma, it is important to note that the equivalence does not hold for strict inequalities. Nevertheless, positive-definiteness of (2.51) is a sufficient condition for positivity of  $\sigma$ .  $\lrcorner$

The above lemma shows how constraints described by quadratic functions can be studied via LMIs. This is a key step in providing efficient techniques for the construction of storage/Lyapunov functions.

When analyzing piecewise-affine systems, we shall have to check whether some inequality involving quadratic functions is satisfied by the system. However, due to the regional representation of piecewise-affine systems (2.14), this generally translates into verifying whether a quadratic function  $\sigma$  satisfies  $\sigma(x) \geq 0$  for every  $x \in X_i$ . Direct transcription of such a constraint as an LMI would require that  $\sigma(x) \geq 0$  for every  $x \in \mathbb{R}^n$ . This can be an excessively conservative requirement, since it means that inequalities pertaining to the dynamics in a specific region of the state space would need to be verified globally. To overcome this problem, we need to be able to verify positivity of quadratic functions restrained to some spatial region. One way to do so is to use the so-called  $\mathcal{S}$ -procedure. This powerful result was largely studied by Yakubovich (see e.g. [183]) and has its roots in the study of absolute stability. The following version of the  $\mathcal{S}$ -procedure is taken from [18].

LEMMA 2.35 ( $\mathcal{S}$ -procedure)

The quadratic function  $\sigma_0(x) := x^\top Qx + 2q^\top x + r$  is nonnegative for all  $x$  such that  $\sigma_i(x) := x^\top T_i x + 2u_i^\top x + v_i \geq 0$ ,  $i \in \{1, \dots, k\}$ , if there exist nonnegative constants  $\tau_i$  such that

$$\begin{bmatrix} Q & q \\ q^\top & r \end{bmatrix} - \sum_{i=1}^k \tau_i \begin{bmatrix} T_i & u_i \\ u_i^\top & v_i \end{bmatrix} \succeq 0 \quad (2.52)$$

The converse is true if  $k = 1$ .  $\lrcorner$

The  $\mathcal{S}$ -procedure is crucial to the analysis of piecewise-affine systems. It allows us to transform local requirements for each subsystem into global constraints that we can verify using semidefinite programming with less conservatism. It is also the tool that will allow us to go further than what could be achieved using simple quadratic storage/Lyapunov functions. All that is needed is to find a way to describe the fact that  $x \in X_i$  using a quadratic function inequality of the type  $\sigma_i(x) \geq 0$ . We consider next some of the techniques in the literature to achieve this goal.

 **$\mathcal{S}$ -procedure for polyhedral regions proposed by [70]**

Hassibi and Boyd [70] propose the construction of  $\mathcal{S}$ -procedure terms in the case when  $0 \in \text{int}(X_i)$ , for some  $i \in \mathcal{I}_0$  (i.e.  $\mathcal{I}_0$  is a singleton). Let  $i \in \mathcal{I} \setminus \mathcal{I}_0$ , and  $G_{i,k}$  and  $g_{i,k}$  be the  $k$ -th row of  $G_i$  and  $g_i$ , respectively, for  $k = 1, \dots, l_i$ . From (2.3), the constraint  $G_{i,k}x + g_{i,k} \geq 0$  represents one of the half-planes that contain  $X_i$ . This constraint may be seen as a degenerated quadratic form:

$$\begin{aligned} G_{i,k}x + g_{i,k} \geq 0 &\Leftrightarrow \begin{bmatrix} x \\ 1 \end{bmatrix}^\top \begin{bmatrix} 0_n & 0_{n \times 1} \\ G_{i,k} & g_{i,k} \end{bmatrix} \begin{bmatrix} x \\ 1 \end{bmatrix} \geq 0 \\ &\Leftrightarrow \begin{bmatrix} x \\ 1 \end{bmatrix}^\top \left( \begin{bmatrix} 0_n & 0_{n \times 1} \\ G_{i,k} & g_{i,k} \end{bmatrix} + \begin{bmatrix} 0_n & (G_{i,k})^\top \\ 0_{1 \times n} & (g_{i,k})^\top \end{bmatrix} \right) \begin{bmatrix} x \\ 1 \end{bmatrix} \geq 0 \end{aligned} \quad (2.53)$$

We may write

$$\sum_k^{l_i} \tau_{i,k} \left( \begin{bmatrix} 0_n & 0_{n \times 1} \\ G_{i,k} & g_{i,k} \end{bmatrix} + \begin{bmatrix} 0_n & (G_{i,k})^\top \\ 0_{1 \times n} & (g_{i,k})^\top \end{bmatrix} \right) = \begin{bmatrix} 0 & G_i^\top u_i \\ u_i^\top G_i & g_i^\top u_i + u_i^\top g_i \end{bmatrix} \quad (2.54)$$

where  $u_i = \text{col}(\tau_{i,1}, \dots, \tau_{i,l_i})$ , with  $\tau_i \geq 0$ . Let the inequality to be satisfied be denoted as  $x^\top M x \geq 0$ , for all  $x \in X_i$ . The application of the  $\mathcal{S}$ -procedure (2.52) then gives

$$\exists u_i \text{ such that } M - \begin{bmatrix} 0 & G_i^\top u_i \\ u_i^\top G_i & g_i^\top u_i + u_i^\top g_i \end{bmatrix} \succeq 0 \Rightarrow x^\top M x \geq 0, \text{ for } x \in X_i \quad (2.55)$$

### $\mathcal{S}$ -procedure for polyhedral regions proposed by [84]

In [84], Johansson and Rantzer propose to construct  $\mathcal{S}$ -procedure terms allowing us to contemplate also the case where the origin belongs to the boundary of some regions. For this, we construct a set of matrices  $E_i \in \mathbb{R}^{l_i \times n}$  and  $e_i \in \mathbb{R}^{l_i}$ , for  $i \in \mathcal{I}$ , called *cell boundings* from the cell identifiers using the following algorithm [83].

#### ALGORITHM 2.36

Let  $\{X_i\}_{i \in \mathcal{I}}$  be a polyhedral partition with associated cell identifiers  $G_i$  and  $g_i$ . The corresponding cell boundings can be computed as follows:

- if  $i \in \mathcal{I}_0$ , then  $\begin{bmatrix} E_i & e_i \end{bmatrix}$  is obtained by deleting all rows of  $\begin{bmatrix} G_i & g_i \end{bmatrix}$  whose last entry is non-zero.
- if  $i \in \mathcal{I} \setminus \mathcal{I}_0$  and  $X_i$  is unbounded, then  $\begin{bmatrix} E_i & e_i \end{bmatrix}$  is obtained by augmenting  $\begin{bmatrix} G_i & g_i \end{bmatrix}$  with the row  $\begin{bmatrix} 0_{1 \times n} & 1 \end{bmatrix}$ .
- if  $i \in \mathcal{I} \setminus \mathcal{I}_0$  and  $X_i$  is bounded, then  $\begin{bmatrix} E_i & e_i \end{bmatrix} = \begin{bmatrix} G_i & g_i \end{bmatrix}$ . ┘

We remark that Algorithm 2.36 ensures that  $e_i = 0$  for  $i \in \mathcal{I}_0$ . This will be important for the construction of piecewise-quadratic functions, as it shall be discussed in Section 2.6.2.

Let  $U_i \in \mathbb{S}^{l_i}$  be a matrix such that  $u_{ii} = 0, \forall i \in \{1, \dots, l_i\}$  and  $u_{ij} \geq 0, \forall i \neq j$ . Then, the constraint  $E_i x + e_i \succeq 0$  implies that

$$\begin{bmatrix} x \\ 1 \end{bmatrix}^\top \begin{bmatrix} E_i & e_i \end{bmatrix}^\top U_i \begin{bmatrix} E_i & e_i \end{bmatrix} \begin{bmatrix} x \\ 1 \end{bmatrix} \geq 0 \quad (2.56)$$

Let  $E_i^j$  and  $e_i^j$  be the  $j$ -th row of  $E_i$  and  $e_i$ , respectively, for  $j = 1, \dots, l_i$ . We note that

$$\begin{bmatrix} E_i & e_i \end{bmatrix}^\top U_i \begin{bmatrix} E_i & e_i \end{bmatrix} = \sum_{j,k} u_{jk} \begin{bmatrix} E_i^j & e_i^j \end{bmatrix} \begin{bmatrix} E_i^k & e_i^k \end{bmatrix}^\top \quad (2.57)$$

The application of the  $\mathcal{S}$ -procedure (2.52) then gives

$$\exists U_i \text{ such that } M - \begin{bmatrix} E_i & e_i \end{bmatrix}^\top U_i \begin{bmatrix} E_i & e_i \end{bmatrix} \succeq 0 \Rightarrow x^\top M x \geq 0, \text{ for } x \in X_i \quad (2.58)$$

In (2.54) and (2.57), we remark that both  $\mathcal{S}$ -procedure terms correspond to a sum of quadratic functions. More specifically, each hyperplane bounding the polyhedral region  $X_i$



gives rise to a quadratic function. Thus, the application of the  $\mathcal{S}$ -procedure to the analysis of piecewise-affine systems is conservative in general. However, this conservatism is counterbalanced by the flexibility inherent to piecewise-quadratic functions.

Another way of constructing  $\mathcal{S}$ -procedure terms was proposed in [70], based on the construction of ellipsoidal outer approximations of every region  $X_i$ . However, this is only possible when the regions are bounded or degenerate ellipsoids (such as a slab, for example). For this reason, in this memoir we shall focus on  $\mathcal{S}$ -procedure terms obtained directly from the polyhedral description of  $X_i$ .

The procedure in the second item of Algorithm 2.36 can be generalized to all regions  $X_i$ ,  $i \in \mathcal{I} \setminus \mathcal{I}_0$ , not only those that are unbounded. This amounts to adding  $\mathcal{S}$ -procedure terms as those proposed in [70]. Indeed, let

$$\hat{U}_i = \begin{bmatrix} U_i & u_i \\ u_i^\top & 0 \end{bmatrix} \quad (2.59)$$

for some vector  $u_i \succeq 0$ . Then we have

$$\begin{aligned} \begin{bmatrix} E_i & e_i \end{bmatrix}^\top \hat{U}_i \begin{bmatrix} E_i & e_i \end{bmatrix} &= \begin{bmatrix} G_i & g_i \\ 0 & 1 \end{bmatrix}^\top \hat{U}_i \begin{bmatrix} G_i & g_i \\ 0 & 1 \end{bmatrix} \\ &= \begin{bmatrix} G_i^\top U_i G_i & G_i^\top U_i g_i + G_i^\top u_i \\ g_i^\top U_i G_i + u_i^\top G_i & g_i^\top U_i g_i + g_i^\top u_i + u_i^\top g_i \end{bmatrix} \\ &= \begin{bmatrix} G_i & g_i \end{bmatrix}^\top U_i \begin{bmatrix} G_i & g_i \end{bmatrix} + \begin{bmatrix} 0 & G_i^\top u_i \\ u_i^\top G_i & g_i^\top u_i + u_i^\top g_i \end{bmatrix} \end{aligned} \quad (2.60)$$

as stated. This yields  $\mathcal{S}$ -procedure terms that are more general and thus potentially less conservative.

We have now all the ingredients to tackle the analysis of piecewise-affine systems. We present methods allowing to extend the approach used for LTI systems, using convex optimization tools to efficiently analyze performance and stability of this class of systems. We begin by reviewing the analysis of non-incremental properties using quadratic storage/Lyapunov functions. Contrary to the linear case, this approach no longer yields necessary and sufficient conditions. As it turns out, quadratic functions can sometimes be too restrictive, as it will become clear after some examples are treated. This is due to the fact that quadratic functions do not offer the flexibility that is needed to describe the invariant sets of the nonlinear system. To go further, it would be needed to consider storage/Lyapunov functions that take into account the regional description of the piecewise-affine system.

The seminal paper [84] by Johansson and Rantzer proposed conditions for stability analysis of piecewise-affine systems using *continuous piecewise-quadratic* Lyapunov functions. These are much more flexible than single quadratic functions, and hence yield less conservative results when analyzing piecewise-affine systems. Making use of the  $\mathcal{S}$ -procedure, the stability problem can be transformed in a set of LMIs that can be efficiently solved.

### 2.6.1 Analysis with quadratic functions

In this section we consider performance and stability analysis of piecewise-affine systems using quadratic storage/Lyapunov functions of the form (2.39).

**$\mathcal{L}_2$ -gain stability**

We begin by considering the computation of an upper bound to the  $\mathcal{L}_2$ -gain of piecewise-affine systems. The following result is adapted from [70].

**THEOREM 2.37**

Consider the piecewise-affine system (2.14). If there exist a symmetric matrix  $P \in \mathbb{S}^n$  and symmetric matrices  $W_i \in \mathbb{S}^{l_i}$  with nonnegative coefficients and zero diagonal such that

$$\left\{ \begin{array}{l} P \succeq 0 \\ \left[ \begin{array}{cc} A_i^\top P + PA_i + C_i^\top C_i + E_i^\top W_i E_i & PB_i + C_i^\top D \\ \bullet & D^\top D - \gamma^2 I_p \end{array} \right] \preceq 0 & \text{for } i \in \mathcal{I}_0 \\ \left[ \begin{array}{ccc} \left( \begin{array}{c} A_i^\top P + PA_i + \\ C_i^\top C_i + E_i^\top W_i E_i \end{array} \right) & \left( \begin{array}{c} Pa_i + C_i^\top c_i + \\ E_i^\top W_i e_i \end{array} \right) & PB_i + C_i^\top D \\ \bullet & c_i^\top c_i + e_i^\top W_i e_i & c_i^\top D \\ \bullet & \bullet & D^\top D - \gamma^2 I_p \end{array} \right] \preceq 0 & \text{for } i \in \mathcal{I} \setminus \mathcal{I}_0 \end{array} \right. \quad (2.61)$$

are satisfied, then

- (i) the piecewise-affine system (2.14) is  $\mathcal{L}_2$ -gain stable.
- (ii) it has an  $\mathcal{L}_2$ -gain less than or equal to  $\gamma$ .
- (iii) it is dissipative with respect to the supply rate given by (2.24).
- (iv)  $S$  given by (2.39) is a storage function for it. ┘

**PROOF**

According to Corollary 2.19, the  $\mathcal{L}_2$ -gain of (2.14) is less than or equal to  $\gamma$  if the system is dissipative with respect to the supply rate (2.24). We will show that the LMIs (2.61) allow the construction of a nonnegative quadratic storage function  $S$  of structure given by (2.39) such that the above condition is met.

Let  $S(x) = x^\top P x$  be a candidate storage function. The first inequality in (2.61) ensures that  $S(x) \geq 0$ , for every  $x \in X$ .

It remains to show that the dissipation inequality (2.20) is respected with the supply rate given by (2.24). Since  $S$  is differentiable, with  $\dot{S}(x, w) = 2x^\top P(A_i x + a_i + B_i w)$ , the differential dissipation inequality (2.21) gives

$$2x^\top P(A_i x + a_i + B_i w) + z^\top z - \gamma^2 w^\top w \leq 0, \quad \text{for } x \in X_i \quad (2.62)$$

The above inequality must be verified in every region  $X_i$ . If  $W_i$  is a matrix with nonnegative coefficients,  $x \in X_i$  implies that  $(E_i x + e_i)^\top U_i (E_i x + e_i) \geq 0$ . Application of the  $\mathcal{S}$ -procedure allows us to state that (2.62) is ensured if

$$2x^\top P(A_i x + a_i + B_i w) + (E_i x + e_i)^\top W_i (E_i x + e_i) + z^\top z - \gamma^2 w^\top w \leq 0 \quad (2.63)$$

for all  $x \in \mathbb{R}^n$  and all  $w \in W$ . By recalling that  $z = (C_i x + c_i + Dw)$ , the above inequality can be rewritten as

$$\begin{bmatrix} x \\ 1 \\ w \end{bmatrix}^\top \begin{bmatrix} \left( \begin{array}{c} A_i^\top P + PA_i + \\ C_i^\top C_i + E_i^\top W_i E_i \end{array} \right) & \left( \begin{array}{c} Pa_i + C_i^\top c_i + \\ E_i^\top W_i e_i \\ c_i^\top c_i + e_i^\top W_i e_i \end{array} \right) & PB_i + C_i^\top D \\ \bullet & \bullet & c_i^\top D \\ \bullet & \bullet & D^\top D - \gamma^2 I_p \end{bmatrix} \begin{bmatrix} x \\ 1 \\ w \end{bmatrix} \leq 0 \quad (2.64)$$

which is ensured by the last inequality in (2.61). For  $i \in \mathcal{I}_0$ , we have that  $a_i = 0$  and  $c_i = 0$  by Assumption 2.8, and  $e_i = 0$  by Algorithm 2.36, so that we obtain

$$\begin{bmatrix} x \\ w \end{bmatrix}^\top \begin{bmatrix} A_i^\top P + PA_i + C_i^\top C_i + E_i^\top W_i E_i & PB_i + C_i^\top D \\ \bullet & D^\top D - \gamma^2 I_p \end{bmatrix} \begin{bmatrix} x \\ w \end{bmatrix} \leq 0 \quad (2.65)$$

which is ensured by the second inequality in (2.61). This concludes the proof.  $\blacksquare$

Let us remark that conditions (2.61) would be unfeasible without the addition of  $\mathcal{S}$ -procedure terms in the case where  $c_i \neq 0$  for some  $i \in \mathcal{I} \setminus \mathcal{I}_0$ . Indeed, this would mean that there would be a positive diagonal term in matrix that needs to be negative semidefinite, which is a contradiction. In the special case where  $a_i = 0$  and  $c_i = 0$  for every  $i \in \mathcal{I}$ , we have what we call piecewise-linear systems. In this case, it is possible to analyze performance of the system using quadratic storage functions without the application of the  $\mathcal{S}$ -procedure. This is stated in the following theorem, whose proof is omitted as it is a simple adaptation of Theorem 2.37.

#### THEOREM 2.38

Let system (2.14) be such that  $a_i = 0$  and  $c_i = 0$  for every  $i \in \mathcal{I}$ . If there exists a symmetric matrix  $P \in \mathbb{S}^n$  such that

$$\begin{cases} P \succeq 0 \\ \left[ \begin{array}{cc} A_i^\top P + PA_i + C_i^\top C_i & PB_i + C_i^\top D \\ \bullet & D^\top D - \eta^2 I_p \end{array} \right] \preceq 0 \quad \text{for } i \in \mathcal{I} \end{cases} \quad (2.66)$$

are satisfied, then statements (i)–(iv) in Theorem 2.37 hold true.  $\lrcorner$

We remark that the conditions in Theorem 2.38 do not take into account the regional description of the piecewise-linear system, thus making the analysis potentially more conservative. On the positive side, it lends itself to the analysis of more general hybrid systems made up of the same subsystems, such as switched systems for example.

### Exponential stability

We now consider the stability analysis of piecewise-affine systems using quadratic Lyapunov functions. The following result is adapted from [70].

## THEOREM 2.39

If there exist a symmetric matrix  $P \in \mathbb{S}^n$  and symmetric matrices  $W_i \in \mathbb{S}^{l_i}$  with nonnegative coefficients and zero diagonal such that

$$\begin{cases} P \succ 0 \\ A_i^\top P + PA_i + E_i^\top W_i E_i \prec 0 & \text{for } i \in \mathcal{I}_0 \\ \begin{bmatrix} A_i^\top P + PA_i + E_i^\top W_i E_i & Pa_i + E_i^\top W_i e_i \\ \bullet & e_i^\top W_i e_i \end{bmatrix} \prec 0 & \text{for } i \in \mathcal{I} \setminus \mathcal{I}_0 \end{cases} \quad (2.67)$$

are satisfied, then the piecewise-affine system (2.14) is exponentially stable.  $\lrcorner$

## PROOF

According to Theorem 2.24, the PWA system (2.14) is exponentially stable if there exists a Lyapunov function respecting the conditions (2.28)–(2.29), with  $\alpha_1, \alpha_2$  and  $\rho$  being quadratic functions. We will show that the LMIs (2.67) allow the construction of a quadratic Lyapunov function  $V$ .

Let  $V(x) = x^\top P x$  be a candidate Lyapunov function. The first inequality in (2.67) ensures that

$$\sigma_1 |x|^2 \leq V(x) \leq \sigma_2 |x|^2, \quad \text{for every } x \in X, \quad (2.68)$$

where  $\sigma_1$  and  $\sigma_2$  denote the smallest and greatest eigenvalue of  $P$ , respectively, and then  $V$  respects (2.28) with quadratic functions  $\alpha_1$  and  $\alpha_2$ .

It remains to show that  $V$  is decreasing along unforced solutions of (2.14).  $V$  is a differentiable function of  $x$ , with  $\dot{V}(x) = 2x^\top P(A_i x + a_i)$ , for  $x \in X_i$ . If  $W_i$  is a matrix with nonnegative coefficients,  $x \in X_i$  implies that  $(E_i x + e_i)^\top W_i (E_i x + e_i) \geq 0$ . Application of the  $\mathcal{S}$ -procedure allows us to state that (2.29) is ensured if

$$2x^\top P_i(A_i x + a_i) + (E_i x + e_i)^\top W_i (E_i x + e_i) < 0 \quad (2.69)$$

for all non-zero  $x \in \mathbb{R}^n$ . The above inequality can be rewritten as

$$\begin{bmatrix} x \\ 1 \end{bmatrix}^\top \begin{bmatrix} A_i^\top P + PA_i + E_i^\top W_i E_i & Pa_i + E_i^\top W_i e_i \\ \bullet & e_i^\top W_i e_i \end{bmatrix} \begin{bmatrix} x \\ 1 \end{bmatrix} < 0 \quad (2.70)$$

which is ensured by the last inequality in (2.67). Since the inequality is strict, there exist  $\sigma_{3,i} > 0$ , for  $i \in \mathcal{I}$ , such that

$$\begin{bmatrix} A_i^\top P + PA_i + E_i^\top W_i E_i & Pa_i + E_i^\top W_i e_i \\ \bullet & e_i^\top W_i e_i \end{bmatrix} \preceq -\sigma_{3,i} \begin{bmatrix} I_n & 0 \\ 0 & 0 \end{bmatrix} \quad (2.71)$$

For  $i \in \mathcal{I}_0$ , we have that  $a_i = 0$  by Assumption 2.8, and  $e_i = 0$  by Algorithm 2.36, so that we obtain

$$x^\top (A_i^\top P + PA_i + E_i^\top W_i E_i) x < 0 \quad (2.72)$$

which is ensured by the second inequality in (2.67). Similarly, since the inequality is strict, we have that

$$A_i^\top P + PA_i + E_i^\top W_i E_i \preceq -\sigma_{3,i} I_n \quad (2.73)$$

Taking  $\sigma_3 := \min_{i \in \mathcal{I}} \sigma_{3,i}$ , we conclude that  $\dot{V}(x) \leq -\sigma_3 |x|^2$ , for all  $x \in X$ . Integration from 0 to  $t$  yields (2.29) with  $\alpha_3$  quadratic. This concludes the proof.  $\blacksquare$

Similarly to the discussion after Theorem 2.37, the conditions of Theorem 2.39 would be unfeasible without the addition of  $\mathcal{S}$ -procedure terms in the case where  $a_i \neq 0$  for some  $i \in \mathcal{I} \setminus \mathcal{I}_0$ . Once again, in the case of piecewise-linear systems, it is possible to cast the analysis of exponential stability of piecewise-linear systems as LMIs without the use of the  $\mathcal{S}$ -procedure, with the drawback of a potential increase in conservatism. The following result is taken from [85], and again the proof is omitted for being a simple adaptation of Theorem 2.39.

**THEOREM 2.40**

Let system (2.14) be such that  $a_i = 0$  and  $c_i = 0$  for every  $i \in \mathcal{I}$ . If there exists a symmetric matrix  $P \in \mathbb{S}^n$  such that

$$\begin{cases} P \succ 0 \\ A_i^\top P + PA_i \prec 0 \quad \text{for } i \in \mathcal{I} \end{cases} \quad (2.74)$$

are satisfied, then the piecewise-affine system (2.14) is exponentially stable.  $\lrcorner$

### 2.6.2 Analysis with piecewise-quadratic functions

In section 2.6.1 we presented the analysis of piecewise-affine systems using quadratic storage/Lyapunov functions. The advantages of this approach were highlighted through some examples, as well as one of its flaws: conservatism. In this section, following the paper [84], we propose analysis techniques based on the construction of continuous piecewise-quadratic storage/Lyapunov functions of the form:

$$S(x) = V(x) = \begin{bmatrix} x \\ 1 \end{bmatrix}^\top \begin{bmatrix} P_i & q_i \\ \bullet & r_i \end{bmatrix} \begin{bmatrix} x \\ 1 \end{bmatrix}, \quad \text{for } x \in X_i \quad (2.75)$$

Since the Lyapunov function and storage function should be zero at the origin, we have that  $r_i = 0$ , for all  $i \in \mathcal{I}_0$ . We then also choose  $q_i$  to be zero whenever  $i \in \mathcal{I}_0$ , so that the piecewise-quadratic function behaves as a quadratic function close to the origin [83, 85]. This will allow us to find scalars  $\sigma_2 > \sigma_1 > 0$  such that  $\sigma_1 |x|^2 \leq V(x) \leq \sigma_2 |x|^2$ , which will be useful in establishing exponential stability. We then obtain the following structure.

$$S(x) = V(x) = \begin{cases} x^\top P_i x & \text{for } x \in X_i, i \in \mathcal{I}_0 \\ \begin{bmatrix} x \\ 1 \end{bmatrix}^\top \begin{bmatrix} P_i & q_i \\ \bullet & r_i \end{bmatrix} \begin{bmatrix} x \\ 1 \end{bmatrix} & \text{for } x \in X_i, i \in \mathcal{I} \setminus \mathcal{I}_0 \end{cases} \quad (2.76)$$

In order to ensure continuity of (2.76), we shall use the following version of the Finsler lemma. A proof is provided in Appendix B.1.

**LEMMA 2.41**

Let  $Q \in \mathbb{S}^n$  and  $V \in \mathbb{R}^{k \times n}$ , with  $k < n$  and  $\text{rank}(V) = k$ , and let  $V^\perp$  denote a matrix whose columns span the null space of  $V$ . Then the following statements are equivalent:

- (i)  $x^\top Q x = 0$  for all  $x$  such that  $Vx = 0$ .
- (ii)  $(V^\perp)^\top Q V^\perp = 0$ .
- (iii)  $Q + KV + V^\top K^\top = 0$ , for some matrix  $K \in \mathbb{R}^{n \times k}$ .  $\lrcorner$

The equivalence between items (i) and (ii) is immediate from the definition of  $V^\perp$ . The proof of the equivalence between (ii) and (iii) can be found in [2, Lemma 3.4].

For (2.76) to be continuous, we need that

$$\begin{bmatrix} x \\ 1 \end{bmatrix}^\top \begin{bmatrix} P_i & q_i \\ \bullet & r_i \end{bmatrix} \begin{bmatrix} x \\ 1 \end{bmatrix} = \begin{bmatrix} x \\ 1 \end{bmatrix}^\top \begin{bmatrix} P_j & q_j \\ \bullet & r_j \end{bmatrix} \begin{bmatrix} x \\ 1 \end{bmatrix}, \quad \forall x \in X_i \cap X_j. \quad (2.77)$$

Now, since the intersection  $X_i \cap X_j$  is contained in the hyperplane described by

$$\begin{bmatrix} E_{ij} & e_{ij} \end{bmatrix} \begin{bmatrix} x \\ 1 \end{bmatrix} = 0, \quad (2.78)$$

the equivalence between items (i) and (iii) allows us to say that (2.76) is continuous if and only if there exist matrices  $L_{ij} \in \mathbb{R}^{(2n+1) \times 1}$  such that

$$\begin{bmatrix} P_i & q_i \\ \bullet & r_i \end{bmatrix} = \begin{bmatrix} P_j & q_j \\ \bullet & r_j \end{bmatrix} + L_{ij} \begin{bmatrix} E_{ij} & e_{ij} \end{bmatrix} + \begin{bmatrix} E_{ij}^\top \\ e_{ij} \end{bmatrix} L_{ij}^\top, \quad \forall (i, j) \in \mathcal{I}^2 \text{ s.t. } X_i \cap X_j \neq \emptyset. \quad (2.79)$$

### $\mathcal{L}_2$ -gain stability

We begin by stating the following result, adapted from [133]. The proof is given in Appendix B.1.

#### THEOREM 2.42

Consider the piecewise-affine system (2.14). If there exist symmetric matrices  $P_i \in \mathbb{S}^n$ , vectors  $q_i \in \mathbb{R}^n$  scalars  $r_i \in \mathbb{R}$ , symmetric matrices  $U_i, W_i \in \mathbb{S}^l$  with nonnegative coefficients and zero diagonal and vectors  $L_{ijkl} \in \mathbb{R}^{n+1}$  such that

$$\begin{cases} P_i - E_i^\top U_i E_i \succeq 0 \\ \begin{bmatrix} A_i^\top P_i + P_i A_i + C_i^\top C_i + E_i^\top W_i E_i & P_i B_i + C_i^\top D \\ \bullet & D^\top D - \gamma^2 I_p \end{bmatrix} \preceq 0 \end{cases} \quad \text{for } i \in \mathcal{I}_0 \quad (2.80)$$

$$\begin{cases} \begin{bmatrix} P_i - E_i^\top U_i E_i & q_i - E_i^\top U_i e_i \\ \bullet & r_i - e_i^\top U_i e_i \end{bmatrix} \succeq 0 \\ \begin{bmatrix} \begin{pmatrix} A_i^\top P_i + P_i A_i + \\ C_i^\top C_i + \\ E_i^\top W_i E_i \end{pmatrix} & \begin{pmatrix} P_i a_i + A_i^\top q_i + \\ C_i^\top c_i + \\ E_i^\top W_i e_i \end{pmatrix} & P_i B_i + C_i^\top D \\ \bullet & \begin{pmatrix} 2q_i^\top a_i + \\ c_i^\top c_i + e_i^\top W_i e_i \end{pmatrix} & c_i^\top D \\ \bullet & \bullet & D^\top D - \gamma^2 I_p \end{bmatrix} \preceq 0 \end{cases} \quad \text{for } i \in \mathcal{I} \setminus \mathcal{I}_0 \quad (2.81)$$

$$\begin{bmatrix} P_i & q_i \\ \bullet & r_i \end{bmatrix} = \begin{bmatrix} P_j & q_j \\ \bullet & r_j \end{bmatrix} + L_{ij} \begin{bmatrix} E_{ij} & e_{ij} \end{bmatrix} + \begin{bmatrix} E_{ij} & e_{ij} \end{bmatrix}^\top L_{ij}^\top \quad \begin{array}{l} \text{for } (i, j) \in \mathcal{I} \times \mathcal{I} \\ \text{s.t. } X_i \cap X_j \neq \emptyset \end{array} \quad (2.82)$$

with  $q_i = 0$  and  $r_i = 0$  for  $i \in \mathcal{I}_0$ , are satisfied, then

- (i) the piecewise-affine system (2.14) is  $\mathcal{L}_2$ -gain stable.
- (ii) it has an  $\mathcal{L}_2$ -gain less than or equal to  $\gamma$ .
- (iii) it is dissipative with respect to the supply rate given by (2.24).
- (iv)  $S$  given by (2.76) is a storage function. ┘

### Exponential stability

We proceed now to the analysis of the exponential stability of piecewise-affine systems using piecewise-quadratic Lyapunov functions. As discussed in the beginning of Section 2.6.2, the choice of the structure (2.76) for the Lyapunov function is capital in establishing the existence of a quadratic function  $\alpha_2$  satisfying (2.28). The following result is adapted from [85], and a proof is provided in Appendix B.1.

#### THEOREM 2.43

Consider the piecewise-affine system (2.14). If there exist symmetric matrices  $P_i \in \mathbb{S}^n$ , vectors  $q_i \in \mathbb{R}^n$ , scalars  $r_i \in \mathbb{R}$ , symmetric matrices  $U_i, W_i \in \mathbb{S}^l$  with nonnegative coefficients and zero diagonal and vectors  $L_{ijkl} \in \mathbb{R}^{n+1}$  such that

$$\begin{cases} P_i - E_i^\top U_i E_i \succ 0 \\ A_i^\top P_i + P_i A_i + E_i^\top W_i E_i \prec 0 \end{cases} \quad \text{for } i \in \mathcal{I}_0 \quad (2.83)$$

$$\begin{cases} \begin{bmatrix} P_i - E_i^\top U_i E_i & q_i - E_i^\top U_i e_i \\ \bullet & r_i - e_i^\top U_i e_i \end{bmatrix} \succ 0 \\ \begin{bmatrix} A_i^\top P_i + P_i A_i + E_i^\top W_i E_i & P_i a_i + A_i^\top q_i + E_i^\top W_i e_i \\ \bullet & 2q_i^\top a_i + e_i^\top W_i e_i \end{bmatrix} \prec 0 \end{cases} \quad \text{for } i \in \mathcal{I} \setminus \mathcal{I}_0 \quad (2.84)$$

$$\begin{bmatrix} P_i & q_i \\ \bullet & r_i \end{bmatrix} = \begin{bmatrix} P_j & q_j \\ \bullet & r_j \end{bmatrix} + L_{ij} \begin{bmatrix} E_{ij} & e_{ij} \end{bmatrix} + \begin{bmatrix} E_{ij} & e_{ij} \end{bmatrix}^\top L_{ij}^\top \quad \text{for } (i, j) \in \mathcal{I} \times \mathcal{I} \quad (2.85)$$

s.t.  $X_i \cap X_j \neq \emptyset$

with  $q_i = 0$  and  $r_i = 0$  for  $i \in \mathcal{I}_0$ , are satisfied, then the piecewise-affine system (2.14) is exponentially stable. ┘

Let us now consider a numerical example of the construction of piecewise-quadratic Lyapunov functions for piecewise-affine systems using Theorem 2.43.

#### EXAMPLE 2.44

Let us consider the following two-dimensional bimodal system

$$\dot{x}(t) = \begin{cases} A_1 x(t) & \text{for } x_1 \leq 0 \\ A_2 x(t) & \text{for } x_1 \geq 0 \end{cases} \quad (2.86)$$

with

$$A_1 = \begin{bmatrix} 0 & 1 \\ -0.01 & -2 \end{bmatrix} \quad A_2 = \begin{bmatrix} 0 & 1 \\ -6 & -2 \end{bmatrix} \quad (2.87)$$

┘

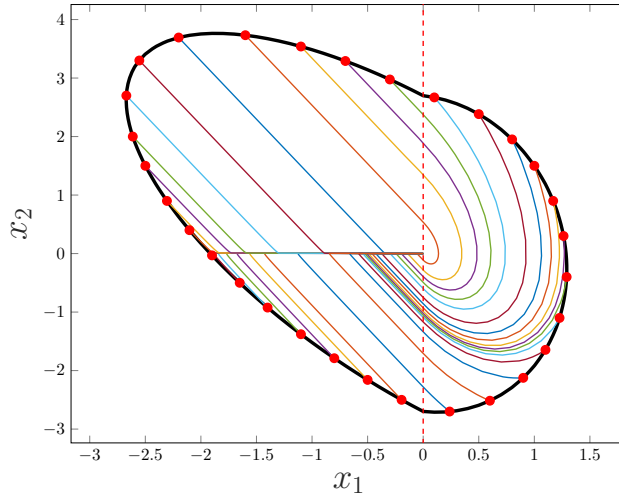

FIGURE 2.5 – A level curve of the piecewise-quadratic Lyapunov function obtained in Example 3.13, along with some trajectories of the PWA system.

We would like to verify whether this system is exponentially stable. Application of Theorem 2.39 is inconclusive, as no quadratic Lyapunov function was found for this system. Using Theorem 2.43, a piecewise-quadratic Lyapunov function can be found. A level curve of this Lyapunov function is presented in Figure 2.5 (in black), along with some trajectories of the PWA system (colored lines) stemming from different initial conditions (red dots). The dashed line marks the boundary between  $X_1$  and  $X_2$ . We verify that the level curve defines an invariant set for this system, as all trajectories starting at the boundary remain inside the delimited region.

## 2.7 Incremental stability and performance of PWA systems

Having presented some results concerning asymptotic stability and  $\mathcal{L}_2$ -gain stability of piecewise-affine systems, we now consider the analysis of incremental stability. The majority of the literature concerns the use of quadratic storage and incremental Lyapunov functions (see e.g. [54, 59, 143]), and we review how such functions can be used with PWA systems.

As discussed in Section 2.4, when studying incremental properties it is usual to consider the augmented system defined in (2.25). When the underlying nonlinear system is given by a piecewise-affine description, we obtain the following representation:

$$\bar{z} = \bar{\Sigma}_{\text{PWA}}(\bar{w}) \begin{cases} \dot{\bar{x}}(t) = \bar{A}_{ij}\bar{x}(t) + \bar{B}_{ij}\bar{w}(t) \\ \bar{z}(t) = \bar{C}_{ij}\bar{x}(t) + \bar{D}\bar{w}(t) \\ \bar{x}(0) = \bar{x}_0 \end{cases} \quad \text{for } \bar{x}(t) \in X_{ij} \quad (2.88)$$

where  $\bar{x} = \text{col}(x, \tilde{x}, 1)$ ,  $\bar{w} = \text{col}(w, \tilde{w})$ , and

$$\begin{aligned} \bar{A}_{ij} &= \begin{bmatrix} A_i & 0 & a_i \\ 0 & A_j & a_j \\ 0 & 0 & 0 \end{bmatrix} & \bar{B}_{ij} &= \begin{bmatrix} B_i & 0 \\ 0 & B_j \\ 0 & 0 \end{bmatrix} \\ \bar{C}_{ij} &= \begin{bmatrix} C_i & -C_j & c_i - c_j \end{bmatrix} & \bar{D} &= \begin{bmatrix} D & -D \end{bmatrix} \end{aligned} \quad (2.89)$$



Regions  $X_{ij}$  are defined as  $X_{ij} = \{\bar{x} = \text{col}(x, \tilde{x}, 1) \mid x \in X_i \text{ and } \tilde{x} \in X_j\}$ . Each region  $X_{ij}$  is described by  $X_{ij} = \{\bar{x} \in \bar{X} \times \{1\} \mid \bar{G}_{ij}\bar{x} \succeq 0\}$  where  $\bar{G}_{ij} \in \mathbb{R}^{l_{ij} \times (2n+1)}$  is given by

$$\bar{G}_{ij} = \begin{bmatrix} G_i & 0 & g_i \\ 0 & G_j & g_j \end{bmatrix} \quad (2.90)$$

with  $l_{ij} := l_i + l_j$ .

Analogously to the state partition  $\{X_i\}_{i \in \mathcal{I}}$  of system  $\Sigma_{\text{PWA}}$ , the intersection between any two regions  $X_{ij}$  and  $X_{kl}$  of  $\bar{\Sigma}_{\text{PWA}}$  is either empty or contained in the hyperplane given by

$$X_{ij} \cap X_{kl} \subseteq \{\bar{x} \in \bar{X} \times \{1\} \mid \bar{E}_{ijkl}\bar{x} = 0\} \quad (2.91)$$

In order to study the incremental asymptotic stability of (2.14), it is useful to specialize the augmented system (2.88) to the case when  $w = \tilde{w}$ , and then we have a single vector input  $w$ . Using the fact that  $w = \tilde{w}$ , the augmented system (2.88) may be rewritten as

$$\bar{z} = \bar{\Sigma}_{\text{PWA}}(w) \begin{cases} \dot{\bar{x}}(t) = \bar{A}_{ij}\bar{x}(t) + \bar{F}_{ij}w(t) \\ \bar{z}(t) = \bar{C}_{ij}\bar{x}(t) \\ \bar{x}(0) = \bar{x}_0 \end{cases} \quad \text{for } \bar{x}(t) \in X_{ij} \quad (2.92)$$

with  $\bar{F}_{ij}$  given by

$$\bar{F}_{ij} = \begin{bmatrix} B_i \\ B_j \\ 0 \end{bmatrix}. \quad (2.93)$$

### 2.7.1 Analysis with quadratic functions

We now consider the assessment of incremental stability using quadratic functions. In the next chapter, we shall see how these results can be made less conservative through the use of a broader class of storage functions and incremental Lyapunov functions, such as piecewise-quadratic and polynomial ones.

#### Incremental $\mathcal{L}_2$ -gain stability

Suppose that the piecewise-affine system (2.14) has continuous drift and output map, i.e. the functions  $A_i x + a_i + Bw$  and  $C_i x + c_i + Dw$  satisfy the conditions in Lemma 2.4. Then, the following theorem, proposed by Romanchuk and Smith [143], can be applied. A proof is provided in Appendix B.1.

#### THEOREM 2.45

*Assume the PWA system (2.14) is such that its drift and output map satisfy the conditions in Lemma 2.4. If there exists a symmetric matrix  $P \in \mathbb{S}^n$  such that*

$$\begin{cases} P \succ 0 \\ \begin{bmatrix} A_i^\top P + P A_i + C_i^\top C_i & P B + C_i^\top D \\ \bullet & D^\top D - \eta^2 I_p \end{bmatrix} \prec 0 \quad \text{for } i \in \mathcal{I} \end{cases} \quad (2.94)$$

*are satisfied, then*

- (i) the piecewise-affine system (2.14) is incrementally  $\mathcal{L}_2$ -gain stable.
- (ii) it has an incremental  $\mathcal{L}_2$ -gain less than or equal to  $\eta$ .
- (iii) the augmented system (2.88) is dissipative with respect to the supply rate (2.26).
- (iv)  $\bar{S}$  given by (2.49) is a storage function for the augmented system.  $\lrcorner$

### Incremental asymptotic stability

In the case of piecewise-affine systems with continuous drift, the assessment of incremental asymptotic stability can also be done by searching for a quadratic incremental Lyapunov function having the structure (2.49). This is done in the following theorem, whose proof is reported in Appendix B.1.

#### THEOREM 2.46

Assume the PWA system (2.14) is such that its drift satisfies the conditions in Lemma 2.4. If there exist a symmetric matrix  $P \in \mathbb{S}^n$  such that

$$\begin{cases} P \succ 0 \\ A_i^\top P + PA_i \prec 0 \quad \text{for } i \in \mathcal{I} \end{cases} \quad (2.95)$$

are satisfied, then the piecewise-affine system (2.14) is incrementally exponentially stable.  $\lrcorner$

## 2.8 Conclusion

In this chapter we have defined the main object of analysis of this memoir: piecewise-affine systems. We have seen that these systems are able to represent a wide range of nonlinear phenomena, despite their somewhat simple description. We have also presented the methodology that we shall use to analyze such systems, namely using dissipativity and Lyapunov theory. The review of the literature that followed allows us to understand how these systems have been dealt with by the control community. The most important aspect is how the use of the  $\mathcal{S}$ -procedure allows us to profit from the regional description of piecewise-affine systems and propose the construction of piecewise-defined storage functions and Lyapunov functions. The analysis can then be cast as an LMI optimization problem, that we know how to solve efficiently and systematically. This will pave the way for the establishment of the new analysis results that we propose in the next chapter. By doing so, we are able to take incremental stability analysis some steps further from what could be done using quadratic functions.



---

# Contribution to the incremental stability analysis of piecewise-affine systems

## 3.1 Introduction

In Chapter 2, we presented a formal definition of piecewise-affine systems, as well as the analysis tools that we shall use to study them. This chapter presents some new results developed in the framework of this thesis. They consist of new analysis methods for the assessment of incremental stability properties of piecewise-affine systems, based on the construction of piecewise-quadratic and piecewise-polynomial functions. The goal is to go beyond simple quadratic functions for incremental stability assessment, thus reducing the conservatism.

Section 3.2 begins by presenting piecewise-quadratic functions based on the state partition of the augmented system. Indeed, these functions are extensions of the ones proposed by Johansson and Rantzer [85, 133], and propose LMI-constrained optimization problems allowing their construction. In Section 3.3, we provide some comments on the shortcomings of these results, which lead us to Section 3.4, where we extend the analysis using polynomial functions and sum-of-squares (SOS) techniques. Finally, Section 3.5 contains some numerical examples illustrating the proposed results.

## 3.2 Analysis with piecewise-quadratic functions

A first attempt to use piecewise-quadratic storage/Lyapunov functions for the analysis of incremental properties was provided by Morinaga et al. in [114]. Despite displaying some of the key ingredients, the approach proposed by the authors presented some shortcomings that make it too conservative. The approach presented in this section was developed in the framework of this thesis, and provides efficient conditions for the incremental performance and stability analysis of piecewise-affine systems using piecewise-quadratic storage/Lyapunov functions.

Due to the fact that incremental properties are concerned with how each trajectory behaves relatively to one another, it might seem natural to consider incremental storage/Lyapunov functions that are a function of the difference of the state:  $\bar{S}(x, \tilde{x}) = S(x - \tilde{x})$ , for some

function  $S : \mathbb{R}^n \rightarrow \mathbb{R}_+$ , as was the case with the quadratic function (2.49). However, it turns out that this choice is too restrictive in general. To see that, let us consider the following lemma, taken from [7].

LEMMA 3.1

Let  $\bar{V} : \mathbb{R}^n \times \mathbb{R}^n \rightarrow \mathbb{R}_+$  be a global incremental Lyapunov function for system  $\dot{x} = f(x)$  of the form  $\bar{V}(x, \tilde{x}) = V(x - \tilde{x})$  for some function  $V : \mathbb{R}^n \rightarrow \mathbb{R}_+$ . Then  $V$  is a global Lyapunov function such that  $V(x) = V(-x)$  for all  $x \in \mathbb{R}^n$ .  $\lrcorner$

Lemma 3.1 states that whenever a system is incrementally asymptotically stable and admits an incremental Lyapunov function that is of the type  $W(x - \tilde{x})$ , it also admits a global Lyapunov function that presents rotational symmetry about the origin. It is clear that this is not the general case when dealing with general nonlinear systems. Using these arguments, [7] showed that there exist incrementally asymptotically stable systems for which no incremental Lyapunov function of the form  $V(x - \tilde{x})$  may exist.

Going back to the augmented system (2.25), a more general proposal is to consider quadratic functions of the augmented state  $\text{col}(x, \tilde{x})$ . Based on the piecewise-affine augmented system (2.88), we propose the construction of storage/Lyapunov functions presenting the following continuous piecewise-quadratic structure:

$$\bar{S}(x, \tilde{x}) = \bar{V}(x, \tilde{x}) = \bar{x}^\top \bar{P}_{ij} \bar{x} \quad \text{for } \bar{x} \in X_{ij} \quad (3.1)$$

On the grounds of Corollary 2.20 and Remark 2.21, as well as Theorem 2.26, the storage/Lyapunov functions must be such that  $\bar{S}(x, x) = \bar{V}(x, x) = 0$ , for every  $x \in X$ . The next proposition shows that this constraint implies a particular structure on the storage/Lyapunov function in regions containing the diagonal set  $X_{\mathcal{D}}$ .

PROPOSITION 3.2

Let  $\bar{S} : \bar{X} \rightarrow \mathbb{R}_+$  be a piecewise-quadratic function given by  $\bar{S}(x, \tilde{x}) = \bar{x}^\top \bar{P}_{ij} \bar{x}$  for  $\bar{x} \in X_{ij}$ , where  $X_{ij}$  are the regions defined in Section 2.7. If  $\bar{S}$  is nonnegative and such that  $\bar{S}(x, x) = 0$  for all  $x \in X$ , then on regions  $X_{ii}$ ,  $\bar{S}$  must be of the form  $\bar{S}(x, \tilde{x}) = (x - \tilde{x})^\top P_i (x - \tilde{x})$ .  $\lrcorner$

PROOF

Let us denote

$$\bar{P}_{ij} = \begin{bmatrix} P_{ij}^{11} & P_{ij}^{12} & q_{ij}^1 \\ \bullet & P_{ij}^{22} & q_{ij}^2 \\ \bullet & \bullet & r_{ij} \end{bmatrix} \quad (3.2)$$

We have that  $\bar{S}(x, x) = 0$ , for all  $x \in X$ . Then, in regions  $X_{ii}$  we have

$$\bar{S}(x, x) = x^\top \left( P_{ii}^{11} + 2P_{ii}^{12} + P_{ii}^{22} \right) x + 2 \left( q_{ii}^1 + q_{ii}^2 \right)^\top x + r_{ii} = 0 \quad (3.3)$$

for all  $x \in X_i$ , which implies that

$$P_{ii}^{12} = -\frac{1}{2} \left( P_{ii}^{11} + P_{ii}^{22} \right) \quad (3.4)$$

$$q_{ii}^1 = -q_{ii}^2 =: q_{ii} \quad (3.5)$$

$$r_{ii} = 0 \quad (3.6)$$

The function  $\bar{S}$  can then be rewritten as

$$\bar{S}(x, \tilde{x}) = (x - \tilde{x})^\top P_{ii}^{22}(x - \tilde{x}) + x^\top Q(x - \tilde{x}) + 2q_{ii}^\top(x - \tilde{x}) \quad (3.7)$$

for  $\bar{x} \in X_{ii}$ , with  $Q = P_{ii}^{11} - P_{ii}^{22}$ .

Since regions  $X_i$  have non-empty interiors, the vector given by  $x - \tilde{x}$  for  $x, \tilde{x} \in X_i$  can take any direction on  $\mathbb{R}^n$ . Based on this fact, we can take  $x, \tilde{x}_1, \tilde{x}_2 \in X_i$  such that  $x - \tilde{x}_1 = \alpha\xi$  and  $x - \tilde{x}_2 = -\alpha\xi$ , for  $\alpha > 0$  and some  $\xi \in \mathbb{R}^n$ . We can then write

$$\begin{aligned} \bar{S}(x, \tilde{x}_1) &= \alpha^2 \xi^\top P_{ii}^{22} \xi + \alpha(x^\top Q \xi + 2q_{ii}^\top \xi) \geq 0 \\ \bar{S}(x, \tilde{x}_2) &= \alpha^2 \xi^\top P_{ii}^{22} \xi - \alpha(x^\top Q \xi + 2q_{ii}^\top \xi) \geq 0 \end{aligned} \quad (3.8)$$

For  $|\xi| \rightarrow 0$ , the quadratic term becomes negligible and the sign is dominated by the remaining term. Since  $\bar{S}$  is nonnegative and  $\alpha > 0$ , we must have  $x^\top Q \xi = -2q_{ii}^\top \xi$ ,  $\forall \xi \in \mathbb{R}^n$  and  $\forall x \in X_i$ . Since  $\xi$  is an arbitrary vector in  $\mathbb{R}^n$ , there exists an  $n \times n$  matrix  $\Xi$  of full rank so that  $(Qx + 2q_{ii})^\top \xi = 0$  implies  $(Qx + 2q_{ii})^\top \Xi = 0$  and then

$$Qx = -2q_{ii}, \quad \forall x \in \text{int}(X_i) \quad (3.9)$$

Every vector  $x \in \text{int}(X_i)$  can be written as  $x = x_0 + (x - x_0) = x_0 + \alpha\xi$ , for some  $x_0 \in X_i$ ,  $\alpha > 0$  and  $\xi \in \mathbb{R}^n$ . Substituting in (3.9), we get  $Qx_0 + \alpha Q\xi = -2q_{ii}$ . Using (3.9) yields  $\alpha Q\xi = 0$ . Since  $\xi$  can take any direction, this requires that the null space of  $Q$  be of dimension  $n$ , which implies  $Q = 0$ . Therefore,  $P_{ii}^{11} = P_{ii}^{22} =: P_i$  and  $q_{ii} = 0$ , and function  $\bar{S}$  becomes

$$\bar{S}(x, \tilde{x}) = (x - \tilde{x})^\top P_i(x - \tilde{x}) \quad \text{for } x, \tilde{x} \in X_i \quad (3.10)$$

which concludes the proof.  $\blacksquare$

For convenience, let us define  $\bar{P}_{ii}$  as the matrix

$$\bar{P}_{ii} := \begin{bmatrix} P_i & -P_i & 0 \\ -P_i & P_i & 0 \\ 0 & 0 & 0 \end{bmatrix}. \quad (3.11)$$

Using the above result, the piecewise-quadratic storage/Lyapunov function (3.1) becomes:

$$\bar{S}(x, \tilde{x}) = \bar{V}(x, \tilde{x}) = \begin{cases} (x - \tilde{x})^\top P_i(x - \tilde{x}) & \text{for } \bar{x} \in X_{ii} \\ \bar{x}^\top \bar{P}_{ij} \bar{x} & \text{for } \bar{x} \in X_{ij}, i \neq j \end{cases} \quad (3.12)$$

It is interesting to note the resemblance between the above piecewise-quadratic function and the one used for  $\mathcal{L}_2$ -gain and asymptotic stability analysis, given by (2.76). In the latter, a special structure is induced in some regions by the presence of the origin and the fact that  $S(0) = 0$ . The origin represents a state of minimum energy, an equilibrium towards which the system shall asymptotically converge. When considering incremental stability properties, the origin is replaced by the diagonal set  $X_{\mathcal{D}}$  of the augmented state space, which is evidenced by the fact that  $\bar{S}(x, x) = 0$ , for every  $x \in X$ . As a final note, let us fix  $\tilde{x}_0 = 0$  and  $\tilde{w} = 0$  on (2.88). This implies that  $\tilde{x}(t) \equiv 0$ , for every  $t \in \mathbb{R}_+$ . Let  $X_{j_0}$  be a region containing the origin in its interior (i.e.  $\mathcal{I}_0 = \{j_0\}$ ) and then so does  $\tilde{x}$ . Then, we can write

$$\bar{S}(x, 0) = \begin{cases} x^\top P_i x & \text{for } \bar{x} \in X_{ij_0}, i \in \mathcal{I}_0 \\ \begin{bmatrix} x \\ 0 \\ 1 \end{bmatrix}^\top \bar{P}_{ij_0} \begin{bmatrix} x \\ 0 \\ 1 \end{bmatrix} & \text{for } \bar{x} \in X_{ij_0}, i \in \mathcal{I} \setminus \mathcal{I}_0 \end{cases} \quad (3.13)$$

Then, removing the unused columns and rows of  $\bar{P}_{ij_0}$  and dropping the  $j_0$  index, we obtain that  $\bar{S}(x, 0) = S(x)$ . In this sense, the proposed piecewise-quadratic storage/Lyapunov function can be seen as a direct extension of the piecewise-quadratic function proposed by Johansson and Rantzer to the framework of incremental stability.

### 3.2.1 Incremental $\mathcal{L}_2$ -gain stability

We begin by proposing the following theorem concerning the incremental  $\mathcal{L}_2$ -gain analysis of piecewise-affine systems. The proof is in Appendix B.2, and follows the same approach used in Chapter 2.

#### THEOREM 3.3

If there exist symmetric matrices  $P_i \in \mathbb{S}^n$  and  $\bar{P}_{ij} \in \mathbb{S}^{2n+1}$ , symmetric matrices  $U_{ij}, W_{ij} \in \mathbb{S}^{l_{ij}}$  with nonnegative coefficients and zero diagonal and matrices  $L_{ijkl} \in \mathbb{R}^{2n+1}$  such that

$$\begin{cases} P_i \succeq 0 \\ \begin{bmatrix} A_i^\top P_i + P_i A_i + C_i^\top C_i & P_i B_i + C_i^\top D \\ \bullet & D^\top D - \eta^2 I_{n_w} \end{bmatrix} \preceq 0 \end{cases} \quad \text{for } i \in \mathcal{I} \quad (3.14)$$

$$\begin{cases} \bar{P}_{ij} - \bar{G}_{ij}^\top U_{ij} \bar{G}_{ij} \succeq 0 \\ \begin{bmatrix} \bar{A}_{ij}^\top \bar{P}_{ij} + \bar{P}_{ij} \bar{A}_{ij} + \bar{C}_{ij}^\top \bar{C}_{ij} + \bar{G}_{ij}^\top W_{ij} \bar{G}_{ij} & \bar{P}_{ij} \bar{B}_{ij} + \bar{C}_{ij}^\top \bar{D} \\ \bullet & \bar{D}^\top \bar{D} - \eta^2 \bar{I}_{n_w} \end{bmatrix} \preceq 0 \end{cases} \quad \begin{array}{l} \text{for } (i, j) \in \mathcal{I}^2, \\ i \neq j \end{array} \quad (3.15)$$

$$\bar{P}_{ij} = \bar{P}_{kl} + L_{ijkl} \bar{E}_{ijkl} + \bar{E}_{ijkl}^\top L_{ijkl}^\top \quad \begin{array}{l} \text{for } (i, j), (k, l), \\ X_{ij} \cap X_{kl} \neq \emptyset \end{array} \quad (3.16)$$

are satisfied, then

- (i) the piecewise-affine system (2.14) is incrementally  $\mathcal{L}_2$ -gain stable;
- (ii) it has an incremental  $\mathcal{L}_2$ -gain less than or equal to  $\eta$ ;
- (iii) the augmented system (2.88) is dissipative with respect to the supply rate (2.26);
- (iv)  $\bar{S}$  given by (3.12) is a storage function for the augmented system.  $\lrcorner$

We note that inequality (3.15) would not be feasible for systems with matrix  $D$  depending on the regional partition. Indeed, suppose matrix  $\bar{D}$  of the augmented system (2.88) was replaced by

$$\bar{D}_{ij} = \begin{bmatrix} D_i & -D_j \end{bmatrix} \quad (3.17)$$

In this way, the lower right block of (3.15) would become  $\bar{D}_{ij}^\top \bar{D}_{ij} - \eta^2 \bar{I}_p$ . Using the change of variables

$$\begin{bmatrix} w \\ \tilde{w} \end{bmatrix} = \frac{1}{2} \begin{bmatrix} I_p & I_p \\ -I_p & I_p \end{bmatrix} \begin{bmatrix} w - \tilde{w} \\ w + \tilde{w} \end{bmatrix} \quad (3.18)$$

on this block yields the matrix

$$\frac{1}{4} \begin{bmatrix} (D_i + D_j)^\top (D_i + D_j) - \eta^2 I_p & (D_i + D_j)^\top (D_i - D_j) \\ (D_i - D_j)^\top (D_i + D_j) & (D_i - D_j)^\top (D_i - D_j) \end{bmatrix} \quad (3.19)$$

The lower right diagonal block must be negative semidefinite for the inequalities to be feasible, and hence  $D_i = D_j$ . This explains why in the last chapter we have made the assumption that the direct feedthrough term  $D$  does not depend on the regional partition.

### 3.2.2 Incremental asymptotic stability

We now turn our attention to the assessment of incremental exponential stability of piecewise-affine systems using piecewise-quadratic incremental Lyapunov functions. We propose the following theorem, whose proof is also presented in Appendix B.2.

THEOREM 3.4

If there exist symmetric matrices  $P_i \in \mathbb{S}^n$  and  $\bar{P}_{ij} \in \mathbb{S}^{2n+1}$ , symmetric matrices  $U_{ij}$ ,  $R_{ij}$ ,  $W_{ij} \in \mathbb{S}^{l_{ij}}$  with nonnegative coefficients and zero diagonal, vectors  $L_{ijkl} \in \mathbb{R}^{2n+1}$  and  $\sigma_1, \sigma_2, \sigma_3$  strictly positive such that

$$\begin{cases} P_i - \sigma_1 I_n \succeq 0 \\ P_i - \sigma_2 I_n \preceq 0 \\ A_i^\top P_i + P_i A_i + \sigma_3 I_n \preceq 0 \end{cases} \quad \text{for } i \in \mathcal{I} \quad (3.20)$$

$$\begin{cases} \bar{P}_{ij} - \sigma_1 \bar{J}_n - \bar{G}_{ij}^\top U_{ij} \bar{G}_{ij} \succeq 0 \\ \bar{P}_{ij} - \sigma_2 \bar{J}_n + \bar{G}_{ij}^\top R_{ij} \bar{G}_{ij} \preceq 0 \\ \bar{A}_{ij}^\top \bar{P}_{ij} + \bar{P}_{ij} \bar{A}_{ij} + \sigma_3 \bar{J}_n + \bar{G}_{ij}^\top W_{ij} \bar{G}_{ij} \preceq 0 \\ \bar{P}_{ij} \bar{F}_{ij} = 0 \end{cases} \quad \text{for } (i, j) \in \mathcal{I}^2, i \neq j \quad (3.21)$$

$$\bar{P}_{ij} = \bar{P}_{kl} + L_{ijkl} \bar{E}_{ijkl} + \bar{E}_{ijkl}^\top L_{ijkl}^\top \quad \text{for } (i, j), (k, l), \quad (3.22)$$

$$X_{ij} \cap X_{kl} \neq \emptyset$$

are satisfied, then the piecewise-affine system (2.14) is incrementally exponentially stable.  $\lrcorner$

### 3.3 Comments on the computation of piecewise-quadratic functions for incremental stability

In this section, we consider the application of the results in the previous section concerning the computation of piecewise-quadratic functions for incremental stability. Let us begin with a simple example of a scalar system.

EXAMPLE 3.5

Let us consider the linear system described by the transfer function  $H(s) = (s + 3)/(s + 1)$  that is negatively fed back with a saturated linear gain  $\varphi$  given by

$$\varphi(y) = \begin{cases} h \operatorname{sign}(y) & |y| > \frac{h}{k} \\ ky & |y| \leq \frac{h}{k} \end{cases} \quad (3.23)$$

The closed loop system is represented in Figure 3.1. It admits a PWA representation given by

$$\begin{array}{lll} A_1 = -1 & A_2 = -\frac{3k+1}{k+1} & A_3 = -1 \\ a_1 = -2h & a_2 = 0 & a_3 = 2h \end{array} \quad (3.24)$$



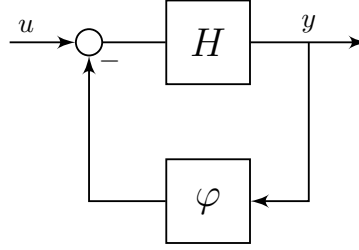

FIGURE 3.1 – Block diagram of the closed-loop system considered in Example 3.5

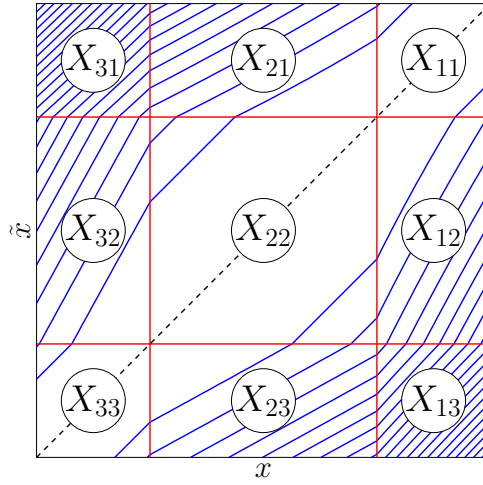

FIGURE 3.2 – Contour plot of the incremental Lyapunov function for the augmented system in Example 3.5 illustrating its piecewise-quadratic structure

and  $B_i = 2$ ,  $C_i = 1$ ,  $c_i = 0$ , for all  $i \in \mathcal{I}$ , and  $D = 1$ . For  $h = 5$  and  $k = 1$ , applying Theorem 3.4, one can find a continuous piecewise-quadratic incremental Lyapunov function  $\bar{V}$  that ensures global incremental asymptotic stability, which is given by the matrices

$$\begin{aligned}
 \bar{P}_{11} &= \begin{bmatrix} 5.1993 & -5.1993 & 0 \\ -5.1993 & 5.1993 & 0 \\ 0 & 0 & 0 \end{bmatrix} & \bar{P}_{12} &= \begin{bmatrix} 5.1993 & -3.5709 & -12.2131 \\ -3.5709 & 1.8971 & 12.5529 \\ -12.2131 & 12.5529 & -2.5482 \end{bmatrix} & \bar{P}_{13} &= \begin{bmatrix} 5.1993 & -5.4991 & -26.6745 \\ -5.4991 & 5.1993 & 35.6129 \\ -26.6745 & 35.6129 & 157.6066 \end{bmatrix} \\
 \bar{P}_{21} &= \begin{bmatrix} 1.8971 & -3.5709 & 12.5529 \\ -3.5709 & 5.1993 & -12.2131 \\ 12.5529 & -12.2131 & -2.5482 \end{bmatrix} & \bar{P}_{22} &= \begin{bmatrix} 1.8971 & -1.8971 & 0 \\ -1.8971 & 1.8971 & 0 \\ 0 & 0 & 0 \end{bmatrix} & \bar{P}_{23} &= \begin{bmatrix} 1.8971 & -2.9750 & -8.0837 \\ -2.9750 & 5.1993 & 16.6823 \\ -8.0837 & 16.6823 & 64.4895 \end{bmatrix} \\
 \bar{P}_{31} &= \begin{bmatrix} 5.1993 & -5.4991 & 35.6129 \\ -5.4991 & 5.1993 & -26.6745 \\ 35.6129 & -26.6745 & 157.6066 \end{bmatrix} & \bar{P}_{32} &= \begin{bmatrix} 5.1993 & -2.9750 & 16.6823 \\ -2.9750 & 1.8971 & -8.0837 \\ 16.6823 & -8.0837 & 64.4895 \end{bmatrix} & \bar{P}_{33} &= \begin{bmatrix} 5.1993 & -5.1993 & 0 \\ -5.1993 & 5.1993 & 0 \\ 0 & 0 & 0 \end{bmatrix}
 \end{aligned} \tag{3.25}$$

Figure 3.2 presents the contour plot of  $\bar{V}$ , where we can see it is indeed a piecewise-quadratic function of  $\bar{x}$ . ┘

This simple example of a scalar system allows us to validate the methods proposed in Section 3.2. However, concerning the case of systems of dimension greater than 1, we have not been able to find an example where it was possible to construct genuine piecewise-quadratic functions, i.e. with different  $\bar{P}_{ij}$  in each region  $X_{ij}$ . Concerning closed-loop systems consisting

on the interconnection between an LTI system and a memoryless nonlinearity, in the case where the conditions of the incremental circle criterion are satisfied (see e.g. [188, 189]), it can be shown that there exists a quadratic incremental Lyapunov function [176]. In this case, the LMIs in Theorems 3.3 and 3.4 are feasible, but the computed storage function and incremental Lyapunov function are quadratic. However, when the conditions of the incremental circle criterion are not satisfied, we could not find an example leading to a piecewise-quadratic function.

One reason for this might come from the continuity constraints between each augmented region  $X_{ij}$ . To see this, let us consider the linear change of variables given by

$$\delta\bar{x} := \begin{bmatrix} x - \tilde{x} \\ x + \tilde{x} \\ 1 \end{bmatrix} = \begin{bmatrix} I & -I & 0 \\ I & I & 0 \\ 0 & 0 & 1 \end{bmatrix} \begin{bmatrix} x \\ \tilde{x} \\ 1 \end{bmatrix} =: T_\delta^{-1}\bar{x}. \quad (3.26)$$

Using this coordinate transformation, the matrices  $\bar{P}_{ij}$  and  $\bar{P}_{ii}$  (recall its special structure in (3.11) due to Proposition 3.2) are transformed into

$$\tilde{P}_{ij} := T_\delta^\top \bar{P}_{ij} T_\delta = \begin{bmatrix} \tilde{P}_{ij}^{11} & \tilde{P}_{ij}^{12} & \tilde{q}_{ij}^1 \\ \bullet & \tilde{P}_{ij}^{22} & \tilde{q}_{ij}^2 \\ \bullet & \bullet & \tilde{r}_{ij} \end{bmatrix} \quad \text{and} \quad \tilde{P}_{ii} := T_\delta^\top \bar{P}_{ii} T_\delta = \begin{bmatrix} P_i & 0 & 0 \\ \bullet & 0 & 0 \\ \bullet & \bullet & 0 \end{bmatrix}. \quad (3.27)$$

As we can see, the restriction to quadratic functions on  $x - \tilde{x}$  on the diagonal regions  $X_{ii}$  forces the majority of the terms in the matrix  $\tilde{P}_{ii}$  to be zero, while  $\tilde{P}_{ij}$  can be a full-block matrix. Nonetheless, the overall piecewise-quadratic function must be continuous at every cell boundary. Geometrically, this means that at the intersection  $X_{ij} \cap X_{ii}$ , we must ensure the continuity between the ellipsoids defined by  $\mathcal{E}_{ij} = \{\bar{x} \in \mathbb{R}^{2n+1} \mid \bar{x}^\top \tilde{P}_{ij} \bar{x} \leq 1\}$  and  $\mathcal{E}_{ii} = \{\bar{x} \in \mathbb{R}^{2n+1} \mid \bar{x}^\top \tilde{P}_{ii} \bar{x} \leq 1\}$  to construct an invariant region. However, the ellipsoid  $\mathcal{E}_{ii}$  is degenerated, since it only bounds  $x - \tilde{x}$ , while  $x + \tilde{x}$  may be arbitrarily large. We believe that requiring continuity between both ellipsoids at the intersection, while also ensuring that both are invariant ellipsoids in their respective regions, is a requirement that may be too strong. This might explain why no piecewise-quadratic storage function or incremental Lyapunov function could be found for systems of dimension greater than 1. This complements the work in [114], where the authors were also not able to produce an example of piecewise-quadratic storage function for incremental  $\mathcal{L}_2$ -gain stability of piecewise-affine systems.

To overcome this problem, we turn our attention to higher order polynomial functions in the next section, thus increasing the degrees of freedom for the construction of the desired storage function and incremental Lyapunov function.

### 3.4 Analysis using SOS techniques

In this section we consider the use of polynomial functions for the assessment of incremental stability properties. We begin by recalling some concepts about polynomials and sum of squares representation, and present the main results in Sections 3.4.2 and 3.4.3.

#### 3.4.1 Polynomials and convex optimization

A monomial is a function  $v : \mathbb{R}^n \rightarrow \mathbb{R}$  such that  $v(x) = cx^a$ , where  $c \in \mathbb{R}$  is a coefficient and  $a \in \mathbb{N}^n$  is a multi-index, i.e.  $x^a = x_1^{a_1} \cdots x_n^{a_n}$ . The degree of  $v$  is given by  $|a| = \sum_{i=1}^n a_i$ . A

polynomial  $p : \mathbb{R}^n \rightarrow \mathbb{R}$  is a finite sum of monomials  $v_1, v_2, \dots$  with finite degree. The degree of the polynomial is the largest degree of its monomials. In what follows,  $\mathbb{R}[x]$  denotes the ring of polynomials in  $x \in \mathbb{R}^n$  with coefficients in  $\mathbb{R}$ .

We shall be interested in constructing nonnegative polynomials to be used as storage functions and Lyapunov functions. It can be shown that, in general, testing global nonnegativity of polynomials is NP-hard, see e.g. [122, 123]. For this reason, we turn our attention to a special class of polynomials, namely those that can be represented as *sums of squares*. The next definition is adapted from [26, 121].

**DEFINITION 3.6 (Sum-of-squares polynomials)**

For  $x \in \mathbb{R}^n$ , the polynomial  $p \in \mathbb{R}[x]$  is a *sum of squares (SOS)* if there exist some polynomials  $p_i(x)$ ,  $i = 1, \dots, M$  such that

$$p(x) = \sum_{i=1}^M p_i^2(x) \quad (3.28)$$

In this case we say that  $p \in \text{SOS}[x]$ .

It is clear that SOS polynomials are nonnegative. It can be shown that, in the general case, not all nonnegative polynomials are SOS (see e.g. [26, Theorem 2] for a characterization of when there is equivalence between nonnegativity and the existence of an SOS description). However, even if the existence of an SOS decomposition is not equivalent to nonnegativity, this representation is quite important, as the test of whether or not a polynomial is SOS can be cast into a convex optimization problem constrained by linear matrix inequalities. To see this, let  $\chi_d(x)$  denote a vector containing all monomials in  $x \in \mathbb{R}^n$  of degree less than or equal to  $d$ . With the addition of a fictitious nonnegative term  $a_0$  to the multi-index  $a$ , all such monomials can be written as  $v(x) = 1^{a_0} x_1^{a_1} \dots x_n^{a_n}$ , with

$$\sum_{i=0}^n a_i = d. \quad (3.29)$$

The number of monomials  $v$  with degree less than or equal to  $d$  is then equal to the number of distinguishable solutions to (3.29), which is given by  $\varrho(n, d)$  [42, Section II.5], with

$$\varrho(n, d) = \binom{n+d}{d}. \quad (3.30)$$

Hence, the vector  $\chi_d(x)$  takes values in  $\mathbb{R}^{\varrho(n,d)}$ . A polynomial  $p$  of degree less than or equal to  $d$  can then be written as

$$p(x) = \mathcal{O}^\top \chi_d(x). \quad (3.31)$$

for some  $\mathcal{O} \in \mathbb{R}^{\varrho(n,d)}$ , and a polynomial  $p$  of degree less than or equal to  $2d$  can be written as

$$p(x) = \chi_d(x)^\top \mathcal{P} \chi_d(x) \quad (3.32)$$

for some  $\mathcal{P} \in \mathbb{S}^{\varrho(n,d)}$ . In what follows we drop the dependence of  $\chi_d$  on  $x$  to ease the notation. Due to the interdependence between the different elements of  $\chi_d$  (for example,  $x^2 = x \cdot x = x^2 \cdot 1$ ), the representation (3.32) is not unique. Let us define the set

$$\mathcal{Q}(n, d) := \{Q \in \mathbb{S}^{\varrho(n,d)} \mid \chi_d^\top Q \chi_d = 0, \forall x \in \mathbb{R}^n\}. \quad (3.33)$$

Then,  $\mathcal{Q}(n, d)$  is the null space of the map that associates to every matrix  $Q \in \mathbb{S}^{\varrho(n, d)}$  a polynomial  $\chi_d^\top Q \chi_d$  in  $\mathbb{R}[x]$ . Let  $\{Q_\ell^{n, d}\}_{\ell=1, \dots, \iota(n, d)}$  be a basis of  $\mathcal{Q}(n, d)$ , where  $\iota(n, d)$  is given by

$$\iota(n, d) = \frac{1}{2} \varrho(n, d) (\varrho(n, d) + 1) - \varrho(n, 2d). \quad (3.34)$$

We call  $Q_\ell^{n, d}$  the slack matrices associated with the representation of polynomials of degree  $d$  in  $x \in \mathbb{R}^n$ . The first term in the above right-hand side represents the number of independent terms in a symmetric matrix belonging to  $\mathbb{S}^{\varrho(n, d)}$ , and the second is the number of distinct monomials in the polynomial representation  $\chi_d^\top Q \chi_d$ , for some  $Q \in \mathbb{S}^{\varrho(n, d)}$ . Then,  $\iota(n, d)$  represents the number of redundant terms in the representation  $\chi_d^\top Q \chi_d$ . A method to construct the basis  $\{Q_\ell^{n, d}\}_{\ell=1, \dots, \iota(n, d)}$  is given in [27, Table 4]. Finally,  $Q^{n, d}(\tau)$  denotes a linear parametrization of  $\mathcal{Q}(n, d)$ , i.e.  $Q^{n, d}(\tau) = \sum_{\ell=1}^{\iota(n, d)} \tau_\ell Q_\ell^{n, d}$ , for  $\tau \in \mathbb{R}^{\iota(n, d)}$ . Then, the following result may be stated [26, 122].

**THEOREM 3.7**

Let  $p \in \mathbb{R}[x]$  be a polynomial of degree  $2d$  in  $x \in \mathbb{R}^n$  and let  $\mathcal{P} \in \mathbb{S}^{\varrho(n, d)}$  be such that  $p(x) = \chi_d^\top \mathcal{P} \chi_d$ . Then,  $p \in \text{SOS}[x]$  if and only if there exist  $\tau \in \mathbb{R}^{\iota(n, d)}$  such that

$$\mathcal{P} + Q^{n, d}(\tau) \succeq 0. \quad (3.35)$$

┘

Condition (3.35) is an LMI feasibility problem on  $\tau$ , and hence testing whether a polynomial is SOS can be done by solving a convex optimization problem.

As we have seen in the previous chapter, in order to be able to analyse piecewise-affine systems we need to use the  $\mathcal{S}$ -procedure to go from the constrained inequalities for every region to LMIs. Using polynomial functions, the approach remains the same, but we are able to consider a more flexible application of the  $\mathcal{S}$ -procedure using a key result in real algebraic geometry: the *Positivstellensatz* (see [26, 122, 123] for its statement and details). It provides a way to certify whether a given set, defined by polynomial equations and inequalities, is empty, and can be used as a test for constrained positivity of polynomials. In this sense, it can be relaxed to provide a generalization of the  $\mathcal{S}$ -procedure, as it should become clear after the following lemma (adapted from [26, 121]).

**LEMMA 3.8**

The polynomial function  $f_0 \in \mathbb{R}[x]$  is nonnegative for all  $x$  such that  $f_k(x) \geq 0$ , where  $f_k \in \mathbb{R}[x]$ ,  $k = 1, \dots, M$ , if there exist polynomials  $g_k \in \text{SOS}[x]$  such that

$$f_0(x) - \sum_{k=1}^M g_k(x) f_k(x) \in \text{SOS}[x], \quad \forall x \in \mathbb{R}^n \quad (3.36)$$

┘

From (3.36), it is clear why Lemma 3.8 can be seen as a generalization of the  $\mathcal{S}$ -procedure, since by taking  $g$  to be a nonnegative scalar and  $f_i$  to be quadratic functions, we recover Lemma 2.35.

### 3.4.2 Analysis with polynomial functions

In this section we shall see how we can use sum of squares polynomials together with convex optimization to assess incremental stability. More precisely, we shall propose sufficient conditions for the construction of polynomial incremental storage and Lyapunov functions satisfying the conditions in Corollary 2.20 (page 22) and Theorem 2.26 (page 24), respectively.

As a first step, we begin by considering the construction of a global polynomial function of degree  $2d$  given by

$$\bar{S}(x, \tilde{x}) = \bar{V}(x, \tilde{x}) = \chi_d(\bar{x})^\top \mathcal{P} \chi_d(\bar{x}) \quad (3.37)$$

where  $\chi_d(\bar{x})$  is a vector of monomials in  $\bar{x}$  of degree less than or equal to  $d$ . We shall again drop the dependence of  $\chi_d$  on  $\bar{x}$  for the sake of notation.

As we did in the previous chapter and in Section 3.2, we aim to rewrite the dissipativity inequality, as well as the incremental Lyapunov inequality in Theorem 2.26, into quadratic inequalities that we can verify via LMI optimization. In the case of polynomial functions, we shall obtain quadratic inequalities on the vector of monomials  $\chi_d$ . In order to consider dissipativity properties, we need to be able to take the inputs into account. This means that we need to devise a way of producing a quadratic function that leads to an LMI containing the vector of monomials  $\chi_d$  as well as some vector containing the inputs. Following the approach in [28], we define  $\bar{w}_\chi := \bar{w} \otimes \chi_{d-1}$ , where  $\bar{w} = \text{col}(w, \tilde{w})$  and  $\otimes$  is the Kronecker product. The vector  $\bar{\chi}_{\bar{w}} := \text{col}(\chi_d, \bar{w}_\chi)$  is of dimension  $\varrho_w(2n, d, 2n_w)$ , where  $\varrho_w$  is defined as

$$\varrho_w(n, d, n_w) := \varrho(n, d) + n_w \varrho(n, d-1). \quad (3.38)$$

In order to obtain quadratic inequalities on  $\chi_d$  and  $\bar{w}_\chi$ , we shall rewrite the dynamics of the augmented system in terms of these variables. For this, let us consider matrices  $\mathcal{A}_{ij} \in \mathbb{R}^{\varrho(2n, d) \times \varrho(2n, d)}$  and  $\mathcal{B}_{ij} \in \mathbb{R}^{\varrho(2n, d) \times \varrho_w(2n, d, 2n_w)}$  implicitly defined by

$$\dot{\chi}_d = \frac{\partial \chi_d}{\partial \bar{x}} (\bar{A}_{ij} \bar{x} + \bar{B}_{ij} \bar{w}) =: \mathcal{A}_{ij} \chi_d + \mathcal{B}_{ij} \bar{w}_\chi, \quad \text{for } \bar{x} \in X_{ij}. \quad (3.39)$$

Consider the polynomial (3.37). Its derivative can then be written as

$$\begin{aligned} \dot{\bar{S}} &= 2\chi_d^\top \mathcal{P} \dot{\chi}_d = 2\chi_d^\top \mathcal{P} (\mathcal{A}_{ij} \chi_d + \mathcal{B}_{ij} \bar{w}_\chi) = \begin{bmatrix} \chi_d \\ \bar{w}_\chi \end{bmatrix}^\top \begin{bmatrix} \mathcal{A}_{ij}^\top \mathcal{P} + \mathcal{P} \mathcal{A}_{ij} & \mathcal{P} \mathcal{B}_{ij} \\ \bullet & 0 \end{bmatrix} \begin{bmatrix} \chi_d \\ \bar{w}_\chi \end{bmatrix} \\ &= \bar{\chi}_{\bar{w}}^\top \begin{bmatrix} \mathcal{A}_{ij}^\top \mathcal{P} + \mathcal{P} \mathcal{A}_{ij} & \mathcal{P} \mathcal{B}_{ij} \\ \bullet & 0 \end{bmatrix} \bar{\chi}_{\bar{w}}. \end{aligned} \quad (3.40)$$

We obtain a quadratic function on the vector  $\bar{\chi}_{\bar{w}}$ . As it happened with the vector of monomials  $\chi_d$ , the quadratic representation of a polynomial with respect to the vector  $\bar{\chi}_{\bar{w}}$  is not unique. Let us define the set

$$\mathcal{R}(n, d, n_w) := \left\{ R \in \mathbb{S}^{\varrho_w(n, d, n_w)} \mid \chi_w^\top R \chi_w = 0, \text{ with } \chi_w = \text{col}(\chi_d(x), w_\chi), \forall x \in \mathbb{R}^n, \forall w \in \mathbb{R}^{n_w} \right\}. \quad (3.41)$$

Let  $\{R_\ell^{n,d,n_w}\}_{\ell=1,\dots,\iota_w(n,d,n_w)}$  be a basis of  $\mathcal{R}(n,d,n_w)$ , where  $\iota_w(n,d,n_w)$  is the number of slack matrices  $R_\ell^{n,d,n_w}$ , and is given by [27]:

$$\iota_w(n,d,n_w) = \frac{1}{2}\varrho_w(n,d,n_w)(\varrho_w(n,d,n_w) + 1) - \left( \varrho(n,2d) + n_w\varrho(n,2d-1) + \frac{n_w(n_w+1)}{2}\varrho(n,2d-2) \right). \quad (3.42)$$

Finally, let us take  $R^{n,d,n_w}(\tau)$  to be a linear parametrization of the set  $\mathcal{R}(n,d,n_w)$ , i.e.  $R^{n,d,n_w}(\tau) = \sum_{\ell=1}^{\iota_w(n,d,n_w)} \tau_\ell R_\ell^{n,d,n_w}$ , for  $\tau \in \mathbb{R}^{\iota_w(n,d,n_w)}$ . By doing this, we have that a sufficient condition to ensure the nonpositivity of  $\dot{S}$  is the existence of  $\mathcal{P} \in \mathbb{S}^{\varrho(2n,d)}$  and  $\tau \in \mathbb{R}^{\iota_w(n,d,n_w)}$  such that

$$\begin{bmatrix} \mathcal{A}_{ij}^\top \mathcal{P} + \mathcal{P} \mathcal{A}_{ij} & \mathcal{P} \mathcal{B}_{ij} \\ \bullet & 0 \end{bmatrix} + R^{2n,d,2n_w}(\tau) \preceq 0. \quad (3.43)$$

In order to assess dissipativity, we also need to rewrite the supply rate (2.26) as a quadratic function on  $\bar{\chi}_{\bar{w}}$ . Proceeding similarly to the previous discussion, let us define matrices  $\mathcal{C}_{ij} \in \mathbb{R}^{n_z \times \varrho(2n,d)}$  and  $\mathcal{D} \in \mathbb{R}^{n_z \times \varrho_w(2n,d,2n_w)}$  such that

$$\bar{z} = \bar{\mathcal{C}}_{ij} \bar{x} + \bar{\mathcal{D}} \bar{w} =: \mathcal{C}_{ij} \chi_d + \mathcal{D} \bar{w}_\chi. \quad (3.44)$$

and also the matrix  $M_\eta \in \mathbb{S}^{\varrho_w(2n,d,2n_w)}$  such that

$$\eta^2 |w - \tilde{w}|^2 =: \bar{w}_\chi^\top M_\eta \bar{w}_\chi. \quad (3.45)$$

In this way, the supply rate (2.26) can be written as the quadratic function

$$\bar{\omega}(w, \tilde{w}, \bar{z}) = \bar{\chi}_{\bar{w}}^\top \begin{bmatrix} -\mathcal{C}_{ij}^\top \mathcal{C}_{ij} & -\mathcal{C}_{ij}^\top \mathcal{D} \\ \bullet & M_\eta - \mathcal{D}^\top \mathcal{D} \end{bmatrix} \bar{\chi}_{\bar{w}}. \quad (3.46)$$

By doing this, we have the ingredients to write the dissipativity condition  $\dot{S} - \bar{\omega} \leq 0$  as a quadratic function of  $\bar{\chi}_{\bar{w}}$ , for which we can test nonnegativity using LMI optimization.

Let us define some notations concerning the use of the extended  $\mathcal{S}$ -procedure as stated in Lemma 3.8. In our case,  $f_0(\bar{x}) \geq 0$  denotes the polynomial inequality that we are trying to satisfy, namely the nonnegativity of the storage function or incremental Lyapunov function and the nonpositivity of their respective derivatives. Then, the constraint functions  $f_i$  are given in each region by each hyperplane defining the augmented region  $X_{ij}$ , i.e. each row of the constraint  $\bar{\mathcal{G}}_{ij} \bar{x} \succeq 0$ . Let  $\bar{\mathcal{G}}_{ij,k}$  denote the  $k$ -th row of  $\bar{\mathcal{G}}_{ij}$ , and let us define  $\mathcal{T}_{ij} \in \mathbb{S}^{\varrho(2n,d)}$  as the matrix such that

$$g_{ij,1}(\bar{x}) \bar{\mathcal{G}}_{ij,1} \bar{x} + \dots + g_{ij,l_{ij}}(\bar{x}) \bar{\mathcal{G}}_{ij,l_{ij}} \bar{x} =: \chi_d^\top \mathcal{T}_{ij} \chi_d. \quad (3.47)$$

Since  $\bar{\mathcal{G}}_{ij,k} \bar{x}$  is an affine function of  $\bar{x}$ , we may choose polynomials  $g_{ij,k}$  of degree up to  $2d-1$ . Let us also define  $\mathcal{G}_{ij,k} \in \mathbb{S}^{\varrho(2n,d)}$  as the matrix such that

$$g_{ij,k}(\bar{x}) =: \chi_d^\top \mathcal{G}_{ij,k} \chi_d. \quad (3.48)$$

Then, if  $f_0(\bar{x}) = \chi_d^\top F_0 \chi_d$ , the conditions on Lemma 3.8 become

$$\begin{cases} F_0 + Q^{2n,d}(\tau) - \mathcal{T}_{ij} \succeq 0 \\ \mathcal{G}_{ij,k} + Q^{2n,d}(\nu_{ij,k}) \succeq 0, \quad \text{for } k = 1, \dots, l_{ij} \end{cases}. \quad (3.49)$$

As we have seen in Corollary 2.20 and Theorem 2.26, the storage function and incremental Lyapunov function must be such that  $\bar{S}(x, x) = \bar{V}(x, x) = 0$ , for every  $x \in X$ . In order to ensure this, let  $\delta\chi_d := \chi_d(\delta\bar{x})$ , where  $\delta\bar{x} = \text{col}(x - \tilde{x}, x + \tilde{x})$ , and let  $T \in \mathbb{R}^{\varrho(2n,d) \times \varrho(2n,d)}$  be such that  $\chi_d = T\delta\chi_d$ . Let us define  $\delta\bar{x}^0 = \text{col}(0, 2x)$ , i.e. the case when  $x = \tilde{x}$ , and then  $\delta\chi_d^0 := \chi_d(\delta\bar{x}^0)$ . If  $\bar{V}(x, \tilde{x}) = \chi_d^\top \mathcal{P} \chi_d$ , the constraint  $\bar{V}(x, x) = 0$  for every  $x \in X$  then means that  $(\delta\chi_d^0)^\top T^\top \mathcal{P} T \delta\chi_d^0 = 0$ , for every  $\delta\chi_d^0$  generated by every  $x \in X$ . Let  $\mathcal{Z} \in \mathbb{R}^{\varrho(2n,d) \times \varrho(2n,d)}$  be a matrix such that  $\delta\chi_d^0 = \mathcal{Z} \delta\chi_d$ . Then,  $\mathcal{Z}$  generates all  $\delta\chi_d$  with  $x = \tilde{x}$ . Let  $Z$  be an orthogonal basis of  $\text{range}(\mathcal{Z})$ . Then, to ensure that  $\bar{V}(x, x) = 0$ , for every  $x \in \mathbb{R}^n$ , we must have that  $Z^\top T^\top \mathcal{P} T Z = 0$ . It is interesting to note that, contrary to the case of quadratic functions presented in Section 2.7 (see also Proposition 3.2, page 46), the fact that the incremental storage/Lyapunov function must be zero on the diagonal set  $X_{\mathcal{D}}$  does not necessarily imply that it can be rewritten as a function of  $(x - \tilde{x})$ .

We now have all we need to consider the analysis of incremental  $\mathcal{L}_2$ -gain stability and incremental asymptotic stability using global polynomial functions to represent Lyapunov or storage functions, as we will see in the next sections. As the conditions we propose are based on the same arguments as before, namely the construction of incremental storage functions and incremental Lyapunov functions, we do not present the proofs of the next theorems. They can be obtained by simple adaptations of the arguments in the proofs of the theorems in Chapter 2.

### Incremental $\mathcal{L}_2$ -gain stability

We begin by considering the case of incremental  $\mathcal{L}_2$ -gain stability, through the computation of a common polynomial storage function for the augmented system satisfying the corresponding dissipation inequality.

#### THEOREM 3.9

If there exist a symmetric matrix  $\mathcal{P} \in \mathbb{S}^{\varrho(2n,d)}$ , as well as  $\mathcal{T}_{ij} \in \mathbb{S}^{\varrho(2n,d)}$  and  $\mathcal{G}_{ij} \in \mathbb{S}^{\varrho(2n,d)}$  defined respectively by (3.47) and (3.48), vectors  $\tau_{ij} \in \mathbb{R}^{\iota(2n,d)}$ ,  $\nu_{ij,k} \in \mathbb{R}^{\iota(2n,d)}$ , for  $k \in \{1, \dots, l_{ij}\}$  and  $\mu_{ij} \in \mathbb{R}^{\iota_w(2n,d,2n_w)}$ , a matrix  $M_\eta$ , as defined in (3.45), such that

$$\mathcal{P} + Q^{2n,d}(\tau_{ij}) \succeq 0 \quad (3.50)$$

$$\left\{ \begin{array}{l} \left[ \begin{array}{c|c} \mathcal{A}_{ij}^\top \mathcal{P} + \mathcal{P} \mathcal{A}_{ij} + & \mathcal{P} \mathcal{B}_{ij} + \mathcal{C}_{ij}^\top \mathcal{D} \\ \mathcal{C}_{ij}^\top \mathcal{C}_{ij} + \mathcal{T}_{ij} & \\ \hline \bullet & \mathcal{D}^\top \mathcal{D} - M_\eta \end{array} \right] + R^{2n,d,2n_w}(\mu_{ij}) \preceq 0 & \text{for } (i, j) \in \mathcal{I}^2 \\ \mathcal{G}_{ij,k} + Q^{2n,d}(\nu_{ij,k}) \succeq 0, & \text{for } k = 1, \dots, l_{ij} \end{array} \right. \quad (3.51)$$

$$Z^\top T^\top \mathcal{P} T Z = 0 \quad (3.52)$$

are satisfied, then

- (i) the piecewise-affine system (2.14) is incrementally  $\mathcal{L}_2$ -gain stable;
- (ii) it has an incremental  $\mathcal{L}_2$ -gain less than or equal to  $\eta$ ;
- (iii) the augmented system (2.88) is dissipative with respect to the supply rate (2.26);
- (iv)  $\bar{S}$  given by (3.37) is a storage function for the augmented system. ┘

It should be noted that, due to the symmetry in the description of the augmented system (2.88), the conditions in the above theorem could be tested only over the subset  $\mathcal{I}_S \subset \mathcal{I}^2$  defined as  $\mathcal{I}_S := \{(i, j) \in \mathcal{I}^2 \mid i \geq j\}$ , with the remaining being obtained by symmetry.

### Incremental asymptotic stability

Since we are dealing with polynomial incremental Lyapunov functions, we need to consider bounds  $\alpha_1$ ,  $\alpha_2$  and  $\rho$  in Theorem 2.26 that are of polynomial form. We may choose

$$\alpha_k(|x - \tilde{x}|) = \sigma_{k,1} |x - \tilde{x}|^2 + \dots + \sigma_{k,d} |x - \tilde{x}|^{2d} =: \chi_d^\top M_{\alpha_k} \chi_d \quad (3.53)$$

for  $k \in \{1, 2, 3\}$ , where  $\sigma_{k,i}$  are positive scalars and  $\rho = \alpha_3$ . These functions clearly belong to class  $\mathcal{K}_\infty$ , as they are positive and strictly increasing over  $\mathbb{R}_+ \setminus \{0\}$ , and such that  $\alpha_k(0) = 0$ .

As seen in Section 2.7, to study the incremental asymptotic stability of (2.14), we defined the augmented system (2.92) by fixing  $\tilde{w} = w$ . Let us then define  $w \otimes \chi_{d-1} =: w_\chi \in \mathbb{R}^{l_w(2n,d,n_w)}$ , and let  $\mathcal{F}_{ij} \in \mathbb{R}^{q(2n,d) \times q_w(2n,d,n_w)}$  be the matrix implicitly defined by

$$\frac{\partial \chi_d}{\partial \bar{x}} \bar{F}_{ij} w =: \mathcal{F}_{ij} w_\chi, \quad (3.54)$$

where  $\bar{F}_{ij}$  is the matrix defined by (2.93). It is then possible to state the following result.

#### THEOREM 3.10

*If there exist a symmetric matrix  $\mathcal{P} \in \mathbb{S}^{q(2n,d)}$ , as well as  $\mathcal{T}_{ij} \in \mathbb{S}^{q(2n,d)}$  and  $\mathcal{G}_{ij} \in \mathbb{S}^{q(2n,d)}$  defined respectively by (3.47) and (3.48); vectors  $\tau_{ij,k} \in \mathbb{R}^{l(2n,d)}$ , for  $k \in \{1, 2, 3\}$  and  $\nu_{ij} \in \mathbb{R}^{l(2n,d)}$ ; matrices  $M_{\alpha_k}$ , for  $k \in \{1, 2, 3\}$ , as defined in (3.53), such that*

$$\mathcal{P} + Q^{2n,d}(\tau_{ij,1}) - M_{\alpha_1} \succeq 0 \quad (3.55)$$

$$\mathcal{P} + Q^{2n,d}(\tau_{ij,2}) - M_{\alpha_2} \preceq 0 \quad (3.56)$$

$$\begin{cases} \mathcal{A}_{ij}^\top \mathcal{P} + \mathcal{P} \mathcal{A}_{ij} + M_{\alpha_3} + Q^{2n,d}(\tau_{ij,3}) + \mathcal{T}_{ij} \preceq 0 \\ \mathcal{G}_{ij} + Q^{2n,d}(\nu_{ij}) \succeq 0, \quad \text{for } k = 1, \dots, l_{ij} \\ \mathcal{P} \mathcal{F}_{ij} = 0 \end{cases} \quad \text{for } (i, j) \in \mathcal{I}^2 \quad (3.57)$$

$$Z^\top T^\top \mathcal{P} T Z = 0 \quad (3.58)$$

*are satisfied, then the piecewise-affine system (2.14) is incrementally asymptotically stable.  $\square$*

### 3.4.3 Analysis with piecewise-polynomial functions

We now consider continuous piecewise-polynomial functions composed of polynomials of degree  $2d$  given by:

$$\bar{S}(x, \tilde{x}) = \bar{V}(x, \tilde{x}) = \chi_d(\bar{x})^\top \mathcal{P}_{ij} \chi_d(\bar{x}), \quad \text{for } \bar{x} \in X_{ij}, \quad (3.59)$$

where  $\chi_d(\bar{x})$  is a vector of monomials in  $\bar{x}$  of degree less than or equal to  $d$ . As usual, the dependence on  $\bar{x}$  is dropped in what follows.

To ensure continuity of (3.59), we need to extend the results presented in Section 3.2 to the case of polynomial functions. The equality constraint  $\bar{E}_{ijkl} \bar{x} = 0$  can be extended to the vector of monomials  $\chi_d$ , i.e. we want to find  $\mathcal{E}_{ijkl}$  such that  $\bar{E}_{ijkl} \bar{x} = 0$  implies  $\mathcal{E}_{ijkl} \chi_d = 0$ .



This matrix can be obtained by extending the constraint  $\overline{E}_{ijkl}\bar{x} = 0$  with the multiplication of a vector of monomials of reduced order, i.e.  $\mathcal{E}_{ijkl}$  is implicitly defined by:

$$\chi_{d-1}\overline{E}_{ijkl}\bar{x} =: \mathcal{E}_{ijkl}\chi_d = 0, \quad (3.60)$$

where  $\mathcal{E}_{ijkl} \in \mathbb{R}^{\varrho(2n,d-1) \times \varrho(2n,d)}$ . Then, using the same approach taken in the construction of (2.79), the associated continuity constraint becomes

$$P_{ij} = P_{kl} + L_{ijkl}\mathcal{E}_{ijkl} + \mathcal{E}_{ijkl}^\top L_{ijkl}^\top + Q^{2n,d}(\tau) \quad (3.61)$$

with  $L_{ijkl} \in \mathbb{R}^{\varrho(2n,d) \times \varrho(2n,d-1)}$ , and where we introduce  $Q^{2n,d}(\tau)$  to take into account the non-uniqueness of the polynomial representation.

In the next sections we propose some results establishing new methods for the construction of piecewise-polynomial functions for incremental stability assessment. Again, the proofs are omitted since they follow the same approach as the proofs in the previous chapter.

### Incremental $\mathcal{L}_2$ -gain stability

We continue with the study of the incremental  $\mathcal{L}_2$ -gain of piecewise-affine systems, this time using piecewise-polynomial incremental storage functions. Let us consider the following theorem.

#### THEOREM 3.11

If there exist symmetric matrices  $\mathcal{P}_{ij} \in \mathbb{S}^{\varrho(2n,d)}$ , as well as  $\mathcal{T}_{ij,r} \in \mathbb{S}^{\varrho(2n,d)}$  and  $\mathcal{G}_{ij,r,k} \in \mathbb{S}^{\varrho(2n,d)}$  defined respectively by (3.47) and (3.48) for  $r \in \{1, 2\}$  and  $k \in \{1, \dots, l_{ij}\}$ , vectors  $\tau_{ij} \in \mathbb{R}^{\varrho(2n,d)}$  and  $\nu_{ij,r,k} \in \mathbb{R}^{\varrho(2n,d)}$ , for  $r \in \{1, 2\}$  and  $k \in \{1, \dots, l_{ij}\}$ ,  $\mu_{ij} \in \mathbb{R}^{\varrho(2n,d,2n_w)}$  and  $\vartheta_{ijkl} \in \mathbb{R}^{\varrho(2n,d)}$ , a matrix  $M_\eta$ , as defined in (3.45) and matrices  $L_{ijkl} \in \mathbb{R}^{\varrho(2n,d) \times \varrho(2n,d-1)}$  such that

$$\left\{ \begin{array}{l} \mathcal{P}_{ij} + Q^{2n,d}(\tau_{ij}) - \mathcal{T}_{ij,1} \succeq 0 \\ \left[ \begin{array}{c|c} \mathcal{A}_{ij}^\top \mathcal{P}_{ij} + \mathcal{P}_{ij} \mathcal{A}_{ij} + & \mathcal{P}_{ij} \mathcal{B}_{ij} + \mathcal{C}_{ij}^\top \mathcal{D} \\ \mathcal{C}_{ij}^\top \mathcal{C}_{ij} + \mathcal{T}_{ij,2} & \\ \hline & \mathcal{D}^\top \mathcal{D} - M_\eta \end{array} \right] + R^{2n,d,2n_w}(\mu_{ij}) \preceq 0 \\ \left\{ \begin{array}{l} \mathcal{G}_{ij,1,k} + Q^{2n,d}(\nu_{ij,1,k}) \succeq 0 \\ \mathcal{G}_{ij,2,k} + Q^{2n,d}(\nu_{ij,2,k}) \succeq 0 \end{array} \right., \text{ for } k = 1, \dots, l_{ij} \end{array} \right. \quad \text{for } (i, j) \in \mathcal{I}^2 \quad (3.62)$$

$$Z^\top T^\top \mathcal{P}_{ii} T Z = 0 \quad \text{for } i \in \mathcal{I} \quad (3.63)$$

$$P_{ij} = P_{kl} + L_{ijkl}\mathcal{E}_{ijkl} + \mathcal{E}_{ijkl}^\top L_{ijkl}^\top + Q^{2n,d}(\vartheta_{ijkl}) \quad \text{for } (i, j), (k, l), \quad (3.64)$$

$$X_{ij} \cap X_{kl} \neq \emptyset$$

are satisfied, then

- (i) the piecewise-affine system (2.14) is incrementally  $\mathcal{L}_2$ -gain stable;
- (ii) it has an incremental  $\mathcal{L}_2$ -gain less than or equal to  $\eta$ ;
- (iii) the augmented system (2.88) is dissipative with respect to the supply rate (2.26);
- (iv)  $\overline{S}$  given by (3.59) is a storage function for the augmented system.  $\lrcorner$

### Incremental asymptotic stability

We now consider the analysis of incremental asymptotic stability of piecewise-affine systems. We propose conditions allowing the construction of piecewise-polynomial incremental Lyapunov functions. This is done in the next theorem.

#### THEOREM 3.12

If there exist symmetric matrices  $\mathcal{P}_{ij} \in \mathbb{S}^{\varrho(2n,d)}$ , as well as  $\mathcal{T}_{ij,r} \in \mathbb{S}^{\varrho(2n,d)}$  and  $\mathcal{G}_{ij,r,k} \in \mathbb{S}^{\varrho(2n,d)}$  defined respectively by (3.47) and (3.48), for  $r \in \{1, 2, 3\}$  and  $k \in \{1, \dots, l_{ij}\}$ , vectors  $\tau_{ij,r} \in \mathbb{R}^{\varrho(2n,d)}$  and  $\nu_{ij,r,k} \in \mathbb{R}^{\varrho(2n,d)}$ , for  $r \in \{1, 2, 3\}$  and  $k \in \{1, \dots, l_{ij}\}$ , and  $\vartheta_{ijkl} \in \mathbb{R}^{\varrho(2n,d)}$ , matrices  $M_{\alpha_r}$ , for  $r \in \{1, 2, 3\}$ , as defined in (3.53) and matrices  $L_{ijkl} \in \mathbb{R}^{\varrho(2n,d) \times \varrho(2n,d-1)}$  such that

$$\begin{cases} \mathcal{P}_{ij} + Q^{2n,d}(\tau_{ij,1}) - M_{\alpha_1} - \mathcal{T}_{ij,1} \succeq 0 \\ \mathcal{P}_{ij} + Q^{2n,d}(\tau_{ij,2}) - M_{\alpha_2} + \mathcal{T}_{ij,2} \preceq 0 \\ \mathcal{A}_{ij}^\top \mathcal{P}_{ij} + \mathcal{P}_{ij} \mathcal{A}_{ij} + Q^{2n,d}(\tau_{ij,3}) + M_{\alpha_3} + \mathcal{T}_{ij,3} \preceq 0 \\ \begin{cases} \mathcal{G}_{ij,1,k} + Q^{2n,d}(\nu_{ij,1,k}) \succeq 0 \\ \mathcal{G}_{ij,2,k} + Q^{2n,d}(\nu_{ij,2,k}) \succeq 0 \\ \mathcal{G}_{ij,3,k} + Q^{2n,d}(\nu_{ij,3,k}) \succeq 0 \end{cases} & \text{for } k = 1, \dots, l_{ij} \\ \mathcal{P}_{ij} \mathcal{F}_{ij} = 0 \end{cases} \quad \text{for } (i, j) \in \mathcal{I}^2 \quad (3.65)$$

$$Z^\top T^\top \mathcal{P}_{ii} Z T = 0 \quad \text{for } i \in \mathcal{I} \quad (3.66)$$

$$\begin{aligned} \mathcal{P}_{ij} &= \mathcal{P}_{kl} + L_{ijkl} \mathcal{E}_{ijkl} + \mathcal{E}_{ijkl}^\top L_{ijkl}^\top + Q^{2n,d}(\vartheta_{ijkl}) & \text{for } (i, j), (k, l), \\ & & X_{ij} \cap X_{kl} \neq \emptyset \end{aligned} \quad (3.67)$$

are satisfied, then the piecewise-affine system (2.14) is incrementally asymptotically stable.  $\lrcorner$

## 3.5 Numerical examples

In this section we consider some numerical examples illustrating the application of the techniques presented in the last sections.

#### EXAMPLE 3.13

Let us consider the two-dimensional bimodal system given by

$$\dot{x}(t) = \begin{cases} A_1 x(t) + B_1 w(t) & \text{for } x_1 \leq 0 \\ A_2 x(t) + B_2 w(t) & \text{for } x_1 > 0 \end{cases} \quad (3.68)$$

with

$$A_1 = \begin{bmatrix} 0 & 1 \\ -1 & -2 \end{bmatrix} \quad A_2 = \begin{bmatrix} 0 & 1 \\ -11 & -2 \end{bmatrix} \quad (3.69)$$

and  $B_i = \text{col}(0, 1)$ . This system can also be represented as the interconnection of the LTI system

$$\left[ \begin{array}{cc|c} A & B & 0 \\ C & D & 1 \\ \hline & & 0 \end{array} \right] \quad (3.70)$$

with the nonlinearity  $\varphi$  given by

$$\varphi(q) = \begin{cases} 0.5q, & \text{for } q \leq 0 \\ 10.5q, & \text{for } q > 0 \end{cases} \quad (3.71)$$

through a negative feedback.

We are interested in assessing the incremental asymptotic stability of this system using the results presented in this memoir. It can be shown that the conditions for the incremental circle criterion are not respected by this system, which would suggest that no quadratic incremental Lyapunov function exists. Since the conditions in Theorem 2.46 correspond to those of the incremental circle criterion (see Appendix A), they cannot be satisfied. It remains to check whether we can use the results presented in this chapter to construct a piecewise-quadratic or piecewise-polynomial incremental Lyapunov function. We were unable to construct a piecewise-quadratic incremental Lyapunov function for this system, as the conditions in Theorem 2.43 were infeasible in this case. For this reason, we turn to the construction of polynomial functions. In view of the increase in the size of the representation (3.59) with the increase of the polynomial order, a natural first choice is to pick  $d = 2$  to construct a single 4-th order polynomial incremental Lyapunov function using Theorem 3.10. This has once again proven unfruitful, reason why we turn to the construction of 4-th order piecewise-polynomial functions. By using the conditions in Theorem 3.12, we were able to construct a piecewise-polynomial incremental Lyapunov function given by (3.59), with bounding functions  $\alpha_1$ ,  $\alpha_2$  and  $\alpha_3$  given by

$$\begin{aligned} \alpha_1(|x - \tilde{x}|) &= 0.5346 |x - \tilde{x}|^2 + 0.0475 |x - \tilde{x}|^4 \\ \alpha_2(|x - \tilde{x}|) &= 56.6597 |x - \tilde{x}|^2 + 16.7061 |x - \tilde{x}|^4 \\ \alpha_3(|x - \tilde{x}|) &= 0.3644 |x - \tilde{x}|^2 + 0.1825 |x - \tilde{x}|^4. \end{aligned} \quad (3.72)$$

A sample trajectory with an arbitrary couple of initial conditions is shown in Figure 3.3, together with the evolution of the incremental Lyapunov function and its derivative. We can see that the function is decreasing along trajectories of the system, as expected.

Figure 3.4 shows  $\bar{V}$  and its derivative for 100 different initial conditions chosen randomly. We may see that  $\bar{V}$  is positive definite, with a strictly negative derivative, which shows that it is indeed an incremental Lyapunov function.

Figure 3.5 shows the level curves of the intersection of  $\bar{V}$  with the plane  $x - \tilde{x}$ , for some fixed values of  $x + \tilde{x}$ . It shows that  $\bar{V}$  is indeed positive definite with respect to the diagonal set  $X_{\mathcal{D}}$ , i.e. the manifold where  $x = \tilde{x}$ , and hence  $x - \tilde{x} = 0$ .

Figure 3.6 shows also some intersections of  $\bar{V}$ , now with the plane  $x_1 - \tilde{x}_1$  for some fixed values of  $x_2 = \tilde{x}_2$ . It is clear from this figure that the incremental Lyapunov function is dependent on the regional description of the piecewise-affine system, i.e. of the fact that  $x_1$  and  $\tilde{x}_1$  are positive or negative. Comparing this result with the piecewise-quadratic function obtained in Example 3.5 (see Figure 3.2), we see that the piecewise-polynomial function allows for a more “smooth” transition between each region. This is of course due to the increased degrees of freedom it provides for the incremental Lyapunov function.

#### EXAMPLE 3.14

In this example we consider the same bimodal system used in the previous example, with  $C_i = \begin{bmatrix} 1 & 0 \end{bmatrix}$  and  $D = 0$ . We want to compute an upper bound to the incremental  $\mathcal{L}_2$ -gain of

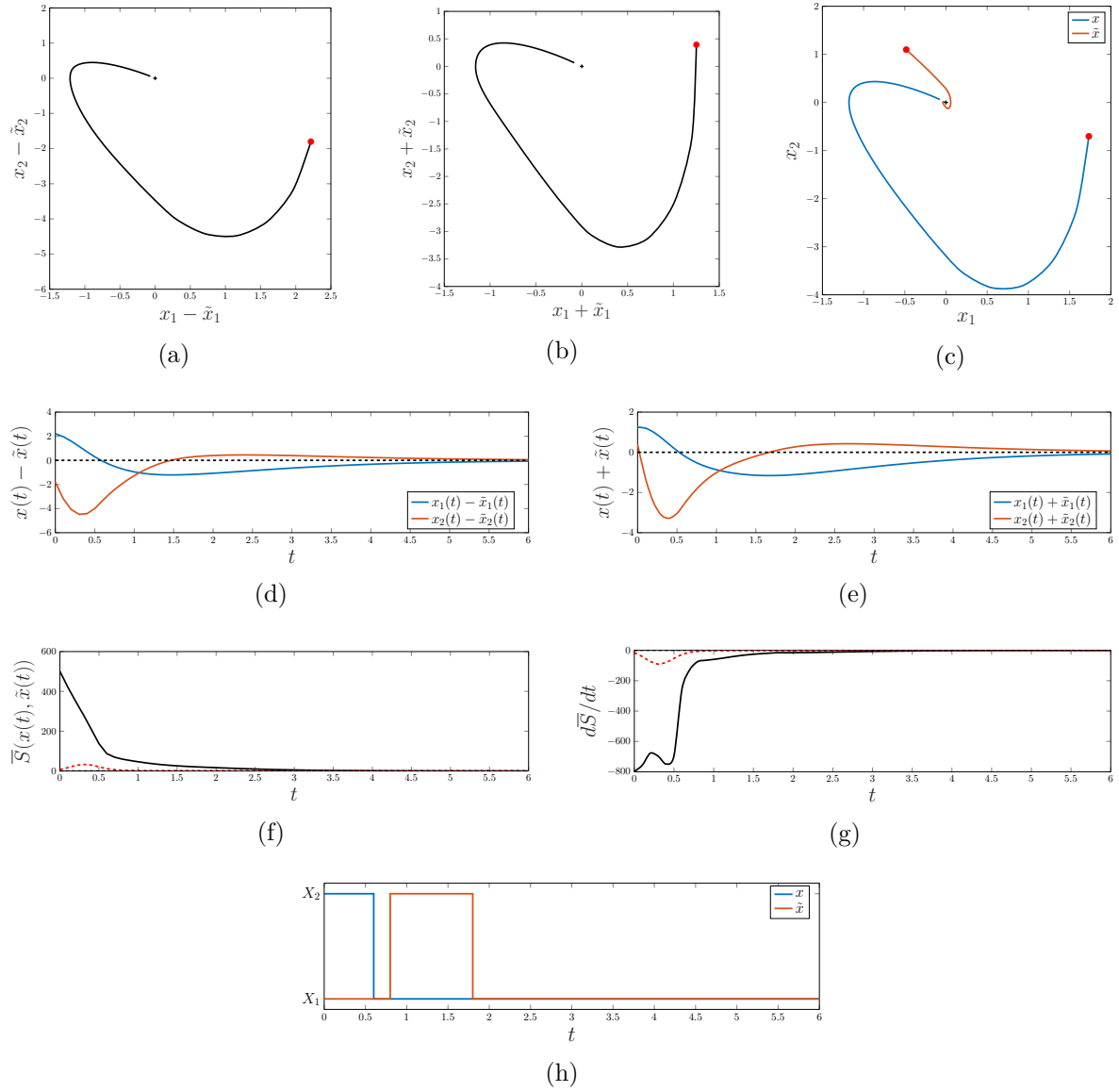

FIGURE 3.3 – A sample trajectory of the augmented system in Example 3.13. (a) Projection over the  $x - \tilde{x}$  plane. (b) Projection over the  $x + \tilde{x}$  plane. (c) Trajectories  $x$  and  $\tilde{x}$ . (d) Time evolution of  $x - \tilde{x}$ . (e) Time evolution of  $x + \tilde{x}$ . (f) Time evolution of the incremental Lyapunov function  $\bar{V}$  (black) and of the lower bound  $\alpha_1$  (red). (g) Time evolution of the derivative of  $\bar{V}$  (black) and of the upper bound  $\alpha_3$  (red). (h) Region  $X_i$  occupied by  $x$  and  $\tilde{x}$  over time.

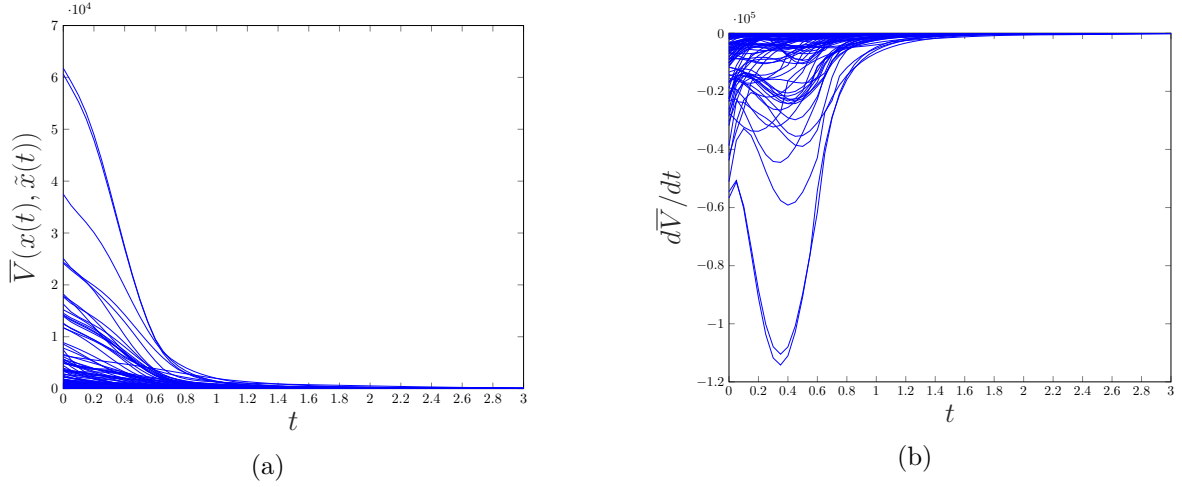

FIGURE 3.4 – Plots of (a) the incremental Lyapunov function and (b) its derivative in Example 3.13.

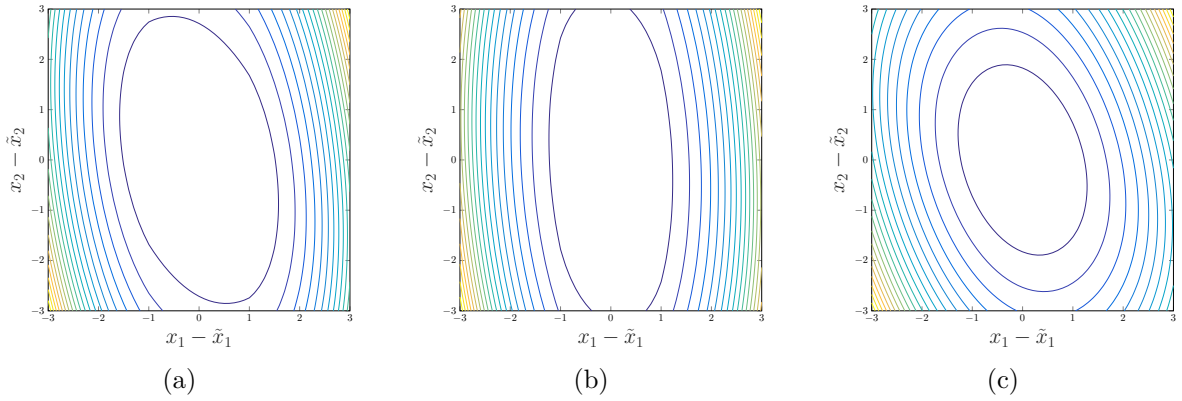

FIGURE 3.5 – Level curves of the intersections of  $\bar{V}$  with the plane  $(x_1 - \tilde{x}_1)$ - $(x_2 - \tilde{x}_2)$  for:  
 (a)  $x_1 + \tilde{x}_1 = -1$ ,  $x_2 + \tilde{x}_2 = -3$ . (b)  $x_1 + \tilde{x}_1 = 1$ ,  $x_2 + \tilde{x}_2 = 1$ . (c)  $x_1 + \tilde{x}_1 = -3$ ,  
 $x_2 + \tilde{x}_2 = -3$ .

this system. As seen in the previous example, the incremental circle criterion is not respected, so we cannot hope to find a quadratic storage function. The search for a piecewise-quadratic storage function is also fruitless, so we apply Theorem 3.11, which allows us to compute a piecewise-polynomial storage function and an upper bound on the incremental  $\mathcal{L}_2$ -gain of  $\eta = 6.6778$ .  $\lrcorner$

### 3.6 Conclusion

In this chapter we have presented new methods for the assessment of incremental stability properties of piecewise-affine systems. We begun by refining the results in [114] to propose a method of analysis using piecewise-quadratic functions that can be seen as the direct extension of the results by Johansson and Rantzer [85, 133]. This approach having proven unsuccessful, we moved one step further with the proposal of polynomial and piecewise-polynomial functions

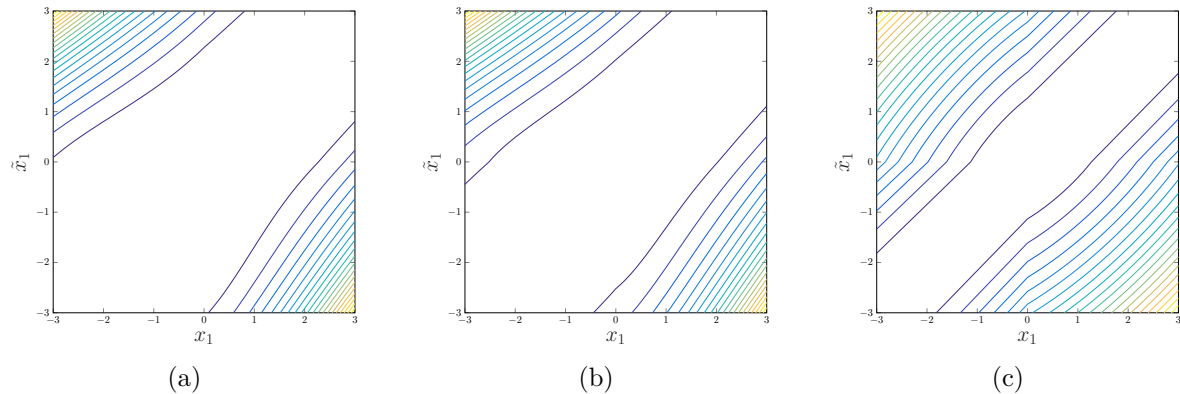

FIGURE 3.6 – Level curves of the intersections of  $\bar{V}$  with the plane  $x_1\text{-}\tilde{x}_1$  for: (a)  $x_2 = \tilde{x}_2 = 0$ . (b)  $x_2 = \tilde{x}_2 = 3$ . (c)  $x_2 = \tilde{x}_2 = 30$ .

TABLE 3.1 – Values of  $\varrho_w$  for some choices of  $n$  and  $n_w$  with  $d = 2$  (left) and  $d = 3$  (right).

$\varrho_w(2n, d, 2n_w)$	$n = 1$		$n = 2$		$n = 3$		$n = 4$		$n = 5$	
$n_w = 1$	12	22	25	65	42	140	63	255	88	418
$n_w = 2$	18	34	35	95	56	196	81	345	110	550
$n_w = 3$	24	46	45	125	70	252	99	435	132	682

using sum-of-squares techniques. With the help of some examples, we have shown that this approach can be successfully applied for the analysis of incremental properties of piecewise-affine systems. To the best of our knowledge, these are the first results allowing the assessment of incremental stability of PWA systems taking advantage of their regional description. We are then able to construct storage functions and incremental Lyapunov functions that are more general than single quadratic ones. In this sense, we have gone beyond the results of Romanchuk [143] and Morinaga et al. [114].

It should be noted that, as seen in Example 3.13, the constructed polynomial functions can be quite complicated, and involve solving LMI optimization problems of increased complexity. Indeed, in Example 3.14, for a second order system ( $n = 2$ ) with a scalar input ( $n_w = 1$ ), we are led to deal with LMIs of size  $\varrho_w(2n, d, 2n_w) = 25$ . In Table 3.1, we present some values of  $\varrho_w$ , where we can see that the size of the problem may become rather large. For now, this seems to be the price to pay for reduced conservatism in the incremental analysis of piecewise-affine systems, when there is a need to go beyond the results obtained with quadratic functions. This of course also ratifies the fact that incremental stability is a strong property for nonlinear systems, and it may be necessary to increase the complexity of the analysis methods in order to reduce the conservatism.



---

# Analysis of uncertain piecewise-affine systems

## 4.1 Introduction

Chapters 2 and 3 were devoted to the introduction of piecewise-affine systems and the analysis tools that form the basis for this memoir. Underlying this approach is the hypothesis that the piecewise-affine model is an accurate representation of the corresponding physical system. However, between a system and its model there is always a gap, whose importance depends on the resources spent to obtain it. Additionally, a model may be used to represent a batch of systems, which are produced using real machinery presenting variability of output. Hence, between the model and the actual physical system, there is the notion of *uncertainty*.

In order to deal with uncertainty, we need to ensure that the system is robust, i.e. performs as it should in the face of expected variability. This is achieved by devising a model for the uncertainty, and taking it into account explicitly during analysis. The focal point of this chapter is to apply this methodology for the analysis of uncertain piecewise-affine systems.

Preliminary work on the robust analysis of piecewise-affine systems has been reported in [90, 141]. In the former, the author considers robustness with respect to noise disturbances using robust simulation. In the latter, the author considers the case of uncertainty in the dynamics as well as in the definition of the polyhedral regions, and studies the qualitative behavior at each face of the polyhedra. Some previous work on the quantitative analysis of uncertain piecewise-affine systems has been reported in [44, 193]. The authors consider systems described by uncertain matrices, and propose conditions for analysis using LMIs. Related results are also presented in [83, Section 4.7], where the analysis of piecewise-affine differential inclusions is considered. These can be seen to represent uncertain systems with polytopic description. Piecewise-affine systems with polytopic uncertainties are also studied in [14] by means of homogeneous polynomial Lyapunov functions. In this memoir, we have chosen to pursue an approach intimately connected with the classical and general results of robust control. By doing so, we are able to build upon the extensive robust control literature and propose new methods that can deal with a rather general class of robust stability problems. The uncertainties are modeled by an operator  $\Delta$ , which may represent unknown dynamics, uncertain or time-varying parameters, delays, nonlinearities, and so forth. We then propose an extension of the celebrated Integral Quadratic Constraints (IQC) framework [111] to address the class of uncertain piecewise-affine systems, by means of graph separation theory.



In order to avoid confusion, we shall refer to this new approach as PWA/IQC, and use LTI/IQC to refer to the classic results in [111].

The chapter is organized as follows. Section 4.2 introduces the models of uncertain piecewise-affine systems that will be considered in this memoir, as well as some definitions of robust stability and performance. In Section 4.3, we recall some notions of graph separation theory. These will be used in Section 4.4 to propose efficient conditions for robust analysis of stability and performance of piecewise-affine systems. Then, in Section 4.5, this approach is extended to the analysis of incremental stability and performance. Section 4.6 presents a numerical example that illustrates the use of the techniques of this chapter. Finally, Section 4.7 provides a connection between the approach used in this memoir and the classical LTI/IQC results.

## 4.2 Uncertain piecewise-affine systems

In the robust control literature, it is standard to represent uncertain systems in a feedback structure, where the uncertainties are isolated from the nominal system. This allows us to deal with generic classes of uncertain systems in a unified manner. Based on this, let us introduce the following description of an uncertain piecewise-affine system.

$$\begin{cases} \dot{x}(t) = A_i x(t) + a_i + B_{p,i} p(t) \\ q(t) = C_{q,i} x(t) + c_{q,i} + D_{qp} p(t) \\ x(0) = x_0 \\ p(t) = (\Delta(q))(t) \end{cases} \quad \text{for } x(t) \in X_i \quad (4.1)$$

where  $A_i \in \mathbb{R}^{n \times n}$ ,  $a_i \in \mathbb{R}^n$ ,  $B_{p,i} \in \mathbb{R}^{n \times n_p}$ ,  $C_{q,i} \in \mathbb{R}^{n_q \times n}$ ,  $c_{q,i} \in \mathbb{R}^{n_q}$ , for  $i \in \mathcal{I} := \{1, \dots, N\}$ , and  $D_{qp} \in \mathbb{R}^{n_q \times n_p}$ . We shall again denote  $\mathcal{I}_0 \subseteq \mathcal{I}$  the set containing all  $i$  such that  $0 \in X_i$ . The regions  $X_i$ , for  $i \in \mathcal{I}$ , are closed convex polyhedral sets defined as in (2.4). The intersection between each pair of regions is defined by (2.6). For details about this description, please refer to Section 2.2.

The uncertainty is represented by a causal and (incrementally) bounded operator  $\Delta$  from  $\mathcal{L}_{2e}^{n_q}(\mathbb{R}_+)$  into  $\mathcal{L}_{2e}^{n_p}(\mathbb{R}_+)$ . It can represent a wide variety of elements, such as uncertain parameters and unmodeled dynamics, or any combination of these. It can also represent static nonlinearities and other “troublesome” components, such as delays and time-varying components (see e.g. [111, 174]). As its name indicates, the uncertain block  $\Delta$  is not known precisely. However, it can be characterized as belonging to general sets of uncertainties, denoted  $\mathbf{\Delta}$  and  $\overline{\mathbf{\Delta}}$  and defined below. In this sense, the description (4.1) is an abuse of notation, as it should read “there exists  $\Delta \in \mathbf{\Delta}$  such that (4.1)”. We make the assumption that  $\Delta$  and the piecewise-affine system are unbiased, i.e.  $\Delta(0) = 0$  and, for any  $i \in \mathcal{I}_0$ , we have  $a_i = 0$  and  $c_{q,i} = 0$ . This ensures that the uncertainty has no effect on the system at rest, i.e. it cannot drive the system out of its equilibrium point by itself. It is usual that  $\Delta$  represents a normalized uncertainty on a given nominal system, which is obtained when  $\Delta = 0$ . We shall thus ensure that 0 belongs to the uncertainty sets  $\mathbf{\Delta}$  and  $\overline{\mathbf{\Delta}}$ . We proceed now to a definition of both sets of uncertainties.

DEFINITION 4.1 (Uncertainty set  $\Delta$ )

The uncertainty set  $\Delta$  is a subset of the bounded operators mapping  $\mathcal{L}_{2e}^{n_q}(\mathbb{R}_+)$  into  $\mathcal{L}_{2e}^{n_p}(\mathbb{R}_+)$ , and is defined by

$$\Delta := \left\{ \Delta \left| \begin{array}{l} \Delta = \text{diag} \left( \text{diag}_i \left( \delta_{I,i} I_{n_{I,i}} \right), \text{diag}_j \left( \Delta_{I,j} \right), \text{diag}_k \left( \delta_{V,k} I_{n_{V,k}} \right), \text{diag}_l \left( \Delta_{V,l} \right) \right), \\ \|\Delta\|_2 \leq 1, \Delta(0) = 0 \end{array} \right. \right\} \quad (4.2)$$

where

- $\{\delta_{I,i}\}_{i=1,\dots,m_I}$  are time-invariant real parametric uncertainties: each  $\delta_{I,i}$  is repeated  $n_{I,i}$  times in the uncertain block;
- $\{\Delta_{I,j}\}_{j=1,\dots,M_I}$  are LTI dynamic uncertainties from  $\mathcal{L}_{2e}^{N_{I,j}}(\mathbb{R}_+)$  into  $\mathcal{L}_{2e}^{N_{I,j}}(\mathbb{R}_+)$ ;
- $\{\delta_{V,k}\}_{k=1,\dots,m_V}$  are time-varying real parametric uncertainties: each  $\delta_{V,k}$  is repeated  $n_{V,k}$  times in the uncertain block;
- $\{\Delta_{V,l}\}_{l=1,\dots,M_V}$  are nonlinear or time-varying dynamic uncertainties from  $\mathcal{L}_{2e}^{n_{V,l}}(\mathbb{R}_+)$  into  $\mathcal{L}_{2e}^{n_{V,l}}(\mathbb{R}_+)$ ;

and  $n_q = n_p = m_I + M_I + m_V + M_V$ . ┘

DEFINITION 4.2 (Uncertainty set  $\overline{\Delta}$ )

The uncertainty set  $\overline{\Delta}$  is a subset of the incrementally bounded operators mapping  $\mathcal{L}_{2e}^{n_q}(\mathbb{R}_+)$  into  $\mathcal{L}_{2e}^{n_p}(\mathbb{R}_+)$ , and is defined analogously to  $\Delta$  in Definition 4.1, with the  $\mathcal{L}_2$  norm replaced by the incremental  $\mathcal{L}_2$  norm. ┘

The first three classes of uncertainties contained in  $\Delta$  and  $\overline{\Delta}$  are equivalent. The only difference arises in the last class, where  $\mathcal{L}_2$ -gain stability is replaced by incremental  $\mathcal{L}_2$ -gain stability. It is clear that  $\overline{\Delta} \subseteq \Delta$ , since the condition  $\Delta(0) = 0$  implies that every incrementally  $\mathcal{L}_2$ -gain stable  $\Delta$  is also  $\mathcal{L}_2$ -gain stable. In the case when  $M_V = 0$ , the sets  $\Delta$  and  $\overline{\Delta}$  coincide. The structured uncertainty  $\Delta$  is represented in Figure 4.1.

We are also interested in assessing robust input-output performance of uncertain piecewise-affine systems. For this, let us introduce the following piecewise-affine system containing the performance input channel  $w$  and output  $z$  (see discussion on Section 2.3.1, page 17).

$$z = \Sigma_{\text{PWA}}^{\Delta}(w) \begin{cases} \dot{x}(t) = A_i x(t) + a_i + B_{p,i} p(t) + B_{w,i} w(t) \\ q(t) = C_{q,i} x(t) + c_{q,i} + D_{qp} p(t) + D_{qw} w(t) \quad \text{for } x(t) \in X_i \\ z(t) = C_{z,i} x(t) + c_{z,i} + D_{zp} p(t) + D_{zw} w(t) \\ x(0) = x_0 \\ p(t) = (\Delta(q))(t) \end{cases} \quad (4.3)$$

where  $A_i \in \mathbb{R}^{n \times n}$ ,  $a_i \in \mathbb{R}^n$ ,  $B_{p,i} \in \mathbb{R}^{n \times n_p}$ ,  $B_{w,i} \in \mathbb{R}^{n \times n_w}$ ,  $C_{q,i} \in \mathbb{R}^{n_q \times n}$ ,  $c_{q,i} \in \mathbb{R}^{n_q}$ ,  $C_{z,i} \in \mathbb{R}^{n_z \times n}$ ,  $c_{z,i} \in \mathbb{R}^{n_z}$ , for  $i \in \mathcal{I} := \{1, \dots, N\}$ , and  $D_{qp} \in \mathbb{R}^{n_q \times n_p}$ ,  $D_{qw} \in \mathbb{R}^{n_q \times n_w}$ ,  $D_{zp} \in \mathbb{R}^{n_z \times n_p}$  and  $D_{zw} \in \mathbb{R}^{n_z \times n_w}$ .

Due to the uncertain nature of  $\Delta$ , we need to study the stability and performance of systems (4.1) and (4.3) for every  $\Delta \in \Delta$ . Compared to the last two chapters, where we analyzed asymptotic stability and performance of a well-described system, we are now confronted to a

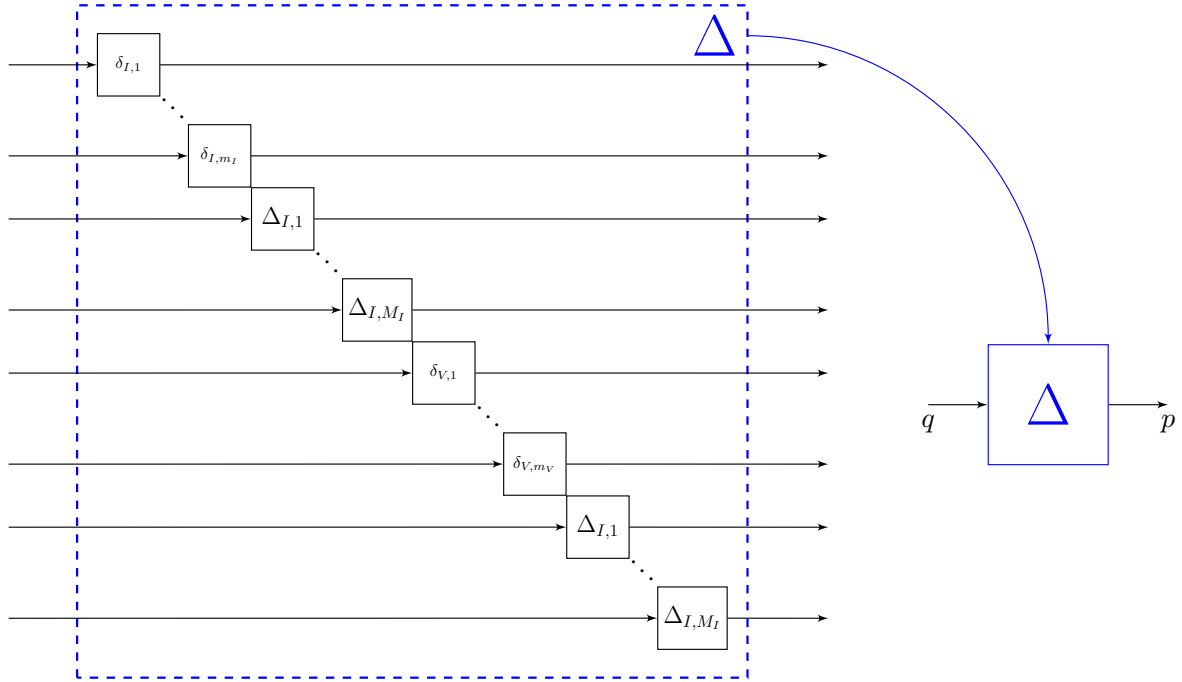
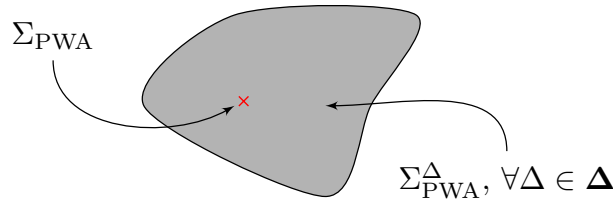
FIGURE 4.1 – Structure of the uncertainties belonging to sets  $\Delta$  and  $\bar{\Delta}$ .FIGURE 4.2 – Set of models parametrized by the uncertainty block  $\Delta$ 

continuum of models generated by taking every possible  $\Delta \in \Delta$ . This is represented in Figure 4.2. For this reason, we refer to the notion of *robustness*, i.e. the property that stability and/or performance is maintained for *every* uncertainty in the given set  $\Delta$ . In Sections 4.2.1 and 4.2.2 we shall introduce proper definitions of robust stability and robust performance.

#### 4.2.1 Robust stability

Our goal is to study the stability of (4.1) and the performance of (4.3) with uncertainties belonging to the sets  $\Delta$  and  $\bar{\Delta}$ . In this section we recall some key definitions concerning robustness and analysis of interconnected systems. It will serve as a basis for the results presented in the next sections.

Let us consider the following feedback system, illustrated in Figure 4.3:

$$\begin{cases} q = G(p) + q_{\text{in}} \\ p = \Delta(q) + p_{\text{in}} \end{cases} \quad (4.4)$$

We shall denote system (4.4) as  $(G, \Delta)$ .

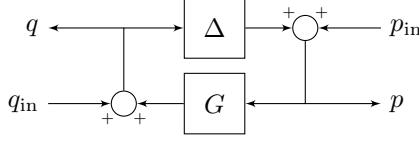
FIGURE 4.3 – Feedback interconnection  $(G, \Delta)$ .

Following [151], let us define the interconnection map  $\ell_G(\Delta)$ , mapping  $\mathcal{L}_{2e}^{(n_q+n_p)}(\mathbb{R}_+)$  into  $\mathcal{L}_{2e}^{(n_q+n_p)}(\mathbb{R}_+)$ , such that

$$\begin{bmatrix} q_{\text{in}} \\ p_{\text{in}} \end{bmatrix} = \ell_G(\Delta) \left( \begin{bmatrix} q \\ p \end{bmatrix} \right) := \begin{bmatrix} q - G(p) \\ p - \Delta(q) \end{bmatrix}. \quad (4.5)$$

We note that the notation  $\ell_G(\Delta)$  indicates that  $G$  (the nominal system) is fixed, and  $\Delta$  is any possible uncertainty in  $\mathbf{\Delta}$  or  $\overline{\mathbf{\Delta}}$ .

One important characteristic of feedback interconnections such as the one in (4.4) is that of *well-posedness*. In this context, well-posedness means that the signals exchanged in the feedback loop are well-defined functions of time, and depend causally on the external inputs. For the systems considered in this memoir, well-posedness is directly connected to the existence and uniqueness of solutions of the differential equations describing the feedback loop. The following definition is adapted from [111, 172, 174].

**DEFINITION 4.3 (Well-posedness)**

*We say that the feedback interconnection  $(G, \Delta)$  is well-posed if the map  $\ell_G(\Delta)$  defined by (4.5) has a causal inverse on  $\mathcal{L}_{2e}^{(n_q+n_p)}(\mathbb{R}_+)$ , i.e. if the map  $\ell_G(\Delta)^{-1}$  is well-defined and causal.  $\square$*

Well-posedness is a necessary property to ensure that the model represents an actual physical system. It expresses that the feedback system is able to serve as an adequate representation of the real processes being modeled [178]. In Chapter 2, we have discussed the well-posedness of piecewise-affine systems. Conditions for well-posedness of feedback systems can be found for example in [178, Section 4.3]. As the author suggests, most of these conditions are based on the limitation of the feedthrough gain of the closed-loop, i.e. requiring that algebraic loops can be uniquely solved.

Now that we have defined well-posedness of  $(G, \Delta)$ , we may propose a definition concerning the stability of the closed-loop system. First, let us consider the following definition of boundedness and finite-gain stability [146]. Let us introduce the truncated norm  $\|x\|_T$  defined as  $\|x\|_T = \|P_T x\|$ , where  $P_T$  is the truncation operator such that

$$P_T x(t) = \begin{cases} x(t), & \text{for } t \leq T \\ 0, & \text{otherwise.} \end{cases} \quad (4.6)$$

**DEFINITION 4.4 (Boundedness and finite-gain stability)**

*Let  $\mathcal{X}_e$  and  $\mathcal{Y}_e$  be extended normed spaces, and let  $F$  be a map from  $\mathcal{X}_e$  into  $\mathcal{Y}_e$ . If there exists a continuous increasing function  $\phi$  mapping  $\mathbb{R}_+$  into itself such that for all  $x \in \mathcal{X}_e$  and all  $T \geq 0$  we have*

$$\|F(x)\|_T \leq \phi(\|x\|_T), \quad (4.7)$$

then  $F$  is said to be bounded. If  $\phi \in \mathcal{K}$ , we say that  $F$  is bounded without bias. If  $\phi$  is linear, we say that  $F$  is finite-gain stable.

If there exists a continuous increasing function  $\phi$  mapping  $\mathbb{R}_+$  into itself such that for all  $x, \tilde{x} \in \mathcal{X}_e$  and all  $T \geq 0$  we have

$$\|F(x) - F(\tilde{x})\|_T \leq \phi(\|x - \tilde{x}\|_T), \quad (4.8)$$

then  $F$  is said to be incrementally bounded. If  $\phi \in \mathcal{K}$ , we say that  $F$  is incrementally bounded without bias. If  $\phi$  is linear, we say that  $F$  is incrementally finite-gain stable.  $\lrcorner$

The stability of  $(G, \Delta)$  can then be obtained by requiring well-posedness of the feedback interconnection as well as finite-gain stability of the closed-loop map between the external inputs and the internal signals. The following definition is again adapted from [111, 172, 174].

**DEFINITION 4.5 (Stability of the feedback interconnection)**

The feedback interconnection  $(G, \Delta)$  is stable if it is well-posed and if the map  $(q_{\text{in}}, p_{\text{in}}) \mapsto (q, p)$  is  $\mathcal{L}_2$ -gain stable in the sense of Definition 2.9, i.e. there exists  $c > 0$  such that

$$\|q\|_2^2 + \|p\|_2^2 \leq c^2 \left( \|q_{\text{in}}\|_2^2 + \|p_{\text{in}}\|_2^2 \right). \quad (4.9)$$

In Definition 4.5, well-posedness is considered as a condition for stability. This is done following the classic approach in the literature of Integral Quadratic Constraints, see e.g. [86, 111, 174], as well as [177]. Another possibility would be to decouple the problem, defining stability independently of well-posedness, such as in [146, 188].

Parallel to Definition 4.5, let us state the following definition concerning incremental stability of feedback loops.

**DEFINITION 4.6 (Incremental stability of the feedback interconnection)**

The feedback interconnection  $(G, \Delta)$  is incrementally stable if it is well-posed and if the map  $(q_{\text{in}}, p_{\text{in}}) \mapsto (q, p)$  is incrementally  $\mathcal{L}_2$ -gain stable in the sense of Definition 2.10, i.e. there exists  $\bar{c} > 0$  such that

$$\|q - \tilde{q}\|_2^2 + \|p - \tilde{p}\|_2^2 \leq \bar{c}^2 \left( \|q_{\text{in}} - \tilde{q}_{\text{in}}\|_2^2 + \|p_{\text{in}} - \tilde{p}_{\text{in}}\|_2^2 \right). \quad (4.10)$$

Definitions 4.5 and 4.6 concern the stability of the feedback interconnection  $(G, \Delta)$ . However,  $\Delta$  represents an uncertainty, and thus is not known a priori. All that is known is that it belongs to sets  $\mathbf{\Delta}$  and  $\overline{\mathbf{\Delta}}$ . Then, instead of trying to establish stability for a particular interconnection  $(G, \Delta)$ , we are interested in proving stability for every  $\Delta \in \mathbf{\Delta}$ . This means that stability should be robust with respect to the sets of uncertainties  $\mathbf{\Delta}$  and  $\overline{\mathbf{\Delta}}$ , as it is made precise in the following definitions.

**DEFINITION 4.7 (Robust stability)**

The feedback interconnection  $(G, \Delta)$  is robustly stable with respect to  $\mathbf{\Delta}$  if it is stable for every  $\Delta \in \mathbf{\Delta}$ .  $\lrcorner$

A similar definition may be proposed concerning incremental stability.

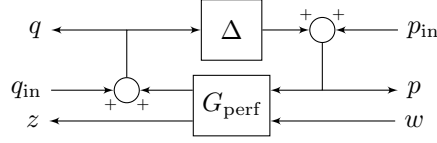
FIGURE 4.4 – Feedback interconnection  $(G_{\text{perf}}, \Delta)$ .**DEFINITION 4.8 (Robust incremental stability)**

The feedback interconnection  $(G, \Delta)$  is robustly incrementally stable with respect to  $\overline{\Delta}$  if it is incrementally stable for every  $\Delta \in \overline{\Delta}$ .  $\lrcorner$

Simply put, robust notions of stability and incremental stability mean that no uncertainty in the sets  $\Delta$  or  $\overline{\Delta}$  can destabilize the nominal system  $G$ , which is originally (incrementally) stable. This is done by ensuring that, for every  $\Delta$  in  $\Delta$  or  $\overline{\Delta}$ , the internal signals are well-defined and (incrementally) bounded functions of time.

**4.2.2 Robust performance**

In addition to robust stability of uncertain systems, we are also interested in ensuring robust performance. As we did in Chapters 2 and 3, we will characterize performance by means of an upper bound on the  $\mathcal{L}_2$ -gain or incremental  $\mathcal{L}_2$ -gain between the performance input and output channels  $w$  and  $z$ . For this, let us consider the following feedback interconnection, obtained as a direct extension of (4.4) and represented in Figure 4.4.

$$\begin{cases} q = G_{\text{perf},q}(p, w) + q_{\text{in}} \\ p = \Delta(q) + p_{\text{in}} \\ z = G_{\text{perf},z}(p, w). \end{cases} \quad (4.11)$$

The first and last equations in (4.11) can be equivalently written as  $(r, z) = G_{\text{perf}}(p, w)$ , with  $G_{\text{perf}}(p, w) := \begin{bmatrix} G_{\text{perf},q}(p, w) \\ G_{\text{perf},z}(p, w) \end{bmatrix}$  and  $q = r + q_{\text{in}}$ . We choose the former expression to be consistent with the definition in (4.4), but both are used throughout this memoir. We shall denote the interconnection (4.11) as  $(G_{\text{perf}}, \Delta)$ .

As we did for the feedback loop (4.4), we need to define the interconnection map  $\ell_{G_{\text{perf}}}(\Delta)$  mapping the outputs of (4.11) to the respective inputs. In order to do so, let us introduce a fictitious auxiliary signal  $w_{\text{aux}}$  so that  $w_{\text{aux}} = w$ . We may now define  $\ell_{G_{\text{perf}}}(\Delta)$  as the mapping from  $\mathcal{L}_{2e}^{(n_q+n_w+n_p)}(\mathbb{R}_+)$  into  $\mathcal{L}_{2e}^{(n_q+n_w+n_p)}(\mathbb{R}_+)$ , such that

$$\begin{bmatrix} q_{\text{in}} \\ w \\ p_{\text{in}} \end{bmatrix} = \ell_{G_{\text{perf}}}(\Delta) \left( \begin{bmatrix} q \\ w_{\text{aux}} \\ p \end{bmatrix} \right) := \begin{bmatrix} q - G_{\text{perf},q}(p, w_{\text{aux}}) \\ w_{\text{aux}} \\ p - \Delta(q) \end{bmatrix}. \quad (4.12)$$

Then, the interconnection (4.11) is well-posed if  $\ell_{G_{\text{perf}}}(\Delta)^{-1}$  is well-defined and causal.

We are interested in characterizing performance from  $w$  to  $z$  for the uncertain system (4.3). As we did previously, we consider an upper bound on the  $\mathcal{L}_2$ -gain and/or the incremental  $\mathcal{L}_2$ -gain as the measure of performance. Following Definition 2.9, we introduce the following notion of robust  $\mathcal{L}_2$ -gain stability.

**DEFINITION 4.9 (Robust  $\mathcal{L}_2$ -gain stability)**

The feedback interconnection  $(G_{\text{perf}}, \Delta)$  is said to be robustly  $\mathcal{L}_2$ -gain stable with respect to  $\Delta$  if it is robustly stable with respect to this class of uncertainties and every trajectory of (4.11) satisfies

$$\|z\|_2 \leq \gamma \|w\|_2. \quad (4.13)$$

In this case, we say that the  $\mathcal{L}_2$ -gain of  $(G_{\text{perf}}, \Delta)$  is less than or equal to  $\gamma$ .  $\lrcorner$

Once again, this definition can be extended to the case of incremental  $\mathcal{L}_2$ -gain stability.

**DEFINITION 4.10 (Robust incremental  $\mathcal{L}_2$ -gain stability)**

The feedback interconnection  $(G_{\text{perf}}, \Delta)$  is said to be robustly incrementally  $\mathcal{L}_2$ -gain stable with respect to  $\Delta$  if it is robustly incrementally stable with respect to this class of uncertainties and every couple of trajectories of (4.11) satisfies

$$\|z - \tilde{z}\|_2 \leq \eta \|w - \tilde{w}\|_2. \quad (4.14)$$

In this case, we say that the incremental  $\mathcal{L}_2$ -gain of  $(G_{\text{perf}}, \Delta)$  is less than or equal to  $\eta$ .  $\lrcorner$

Several techniques exist in the literature to analyze robust stability and performance of feedback systems. Those include small-gain theorems (see e.g. [188, Theorem 1] or [36, Theorem 3.2.1]), passivity theorems (such as [188, Theorem 3] or [36, Theorem 5.5.1]) and integral quadratic constraints [111], among others. In this memoir, we choose to pursue a more general approach, that can be specialized into the aforementioned notions: graph separation.

### 4.3 Graph separation

The graph separation theory was proposed by Safonov in his seminal work [146]. His goal was to provide a more general framework and extend the results of Zames concerning the stability of feedback systems satisfying complementary conic relations.

Let us begin by defining what we mean by the graph of a dynamical operator [146].

**DEFINITION 4.11 (Graph and inverse graph)**

If  $G$  is a mapping of points  $x \in \mathcal{X}_e$  into points  $G(x) \in \mathcal{Y}_e$ , then the graph of  $G$  is the relation

$$\mathcal{G}_G := \{(x, y) \in \mathcal{X}_e \times \mathcal{Y}_e \mid x \in \mathcal{X}_e \text{ and } y = G(x)\}. \quad (4.15)$$

Similarly, the inverse graph of  $G$  is defined as

$$\mathcal{G}_G^I := \{(y, x) \in \mathcal{Y}_e \times \mathcal{X}_e \mid x \in \mathcal{X}_e \text{ and } y = G(x)\}. \quad (4.16)$$

From Definition 4.11, we see that  $(x, y) \in \mathcal{G}_G$  is equivalent to  $(y, x) \in \mathcal{G}_G^I$ . It is often the case that the graph of an operator is influenced by an external input, which could be used to represent disturbances or initial conditions, for example. Let us denote this external input by  $u$ , belonging to the extended space  $\mathcal{U}_e$ . We may then define the graph  $\mathcal{G}_G[u]$  as the set of points  $(x, y) \in \mathcal{X}_e \times \mathcal{Y}_e$  such that  $x \in \mathcal{X}_e$  and  $y = G[u](x)$ . The inverse graph  $\mathcal{G}_G^I[u]$  is defined similarly. The corresponding system is represented in Figure 4.5. The dissymmetry between  $u$  and  $x$  in the notation  $y = G[u](x)$  is reminiscent of the fact that  $G[u]$  is taken

FIGURE 4.5 – Perturbed system  $G$ .

FIGURE 4.6 – Feedback interconnection (4.17).

to be a nonlinear relation in [146]. This means that there is no notion of precedence or causality between  $x$  and  $y$ . In this way, stability analysis is decoupled from the necessity of well-posedness and causality of the feedback system. However, in this memoir, it will be assumed that the system  $G$  is always described by a well-defined dynamic operator.

Let us consider the analysis of a feedback interconnection such as that in Figure 4.6, that can be represented by

$$\begin{cases} (x, y) \in \mathcal{G}_G[u] \\ (x, y) \in \mathcal{G}_H^I[v] \end{cases} \quad (4.17)$$

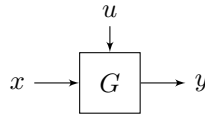
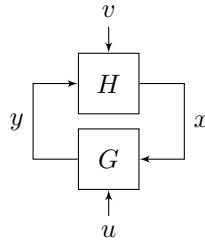
where  $u \in \mathcal{U}_e$  and  $v \in \mathcal{V}_e$  are disturbance inputs,  $x \in \mathcal{X}_e$  and  $y \in \mathcal{Y}_e$  are the outputs,  $\mathcal{G}_G[u] \subset \mathcal{X}_e \times \mathcal{Y}_e$  and  $\mathcal{G}_H^I[v] \subset \mathcal{X}_e \times \mathcal{Y}_e$  are nonlinear relations which are dependent on the respective disturbance inputs, and  $\mathcal{U}_e, \mathcal{V}_e, \mathcal{X}_e, \mathcal{Y}_e$  are extended normed spaces.

As its name suggests, analysis via graph separation is performed by establishing a topological separation between the graphs of  $G$  and  $H$  in the product space  $\mathcal{X}_e \times \mathcal{Y}_e$ . This is the idea behind the stability conditions involving conic sectors in [188]. In our case, the separation will be established via the construction of an appropriate functional from  $\mathcal{X}_e \times \mathcal{Y}_e$  into  $\mathbb{R}$ . Before stating the result, let us define some auxiliary notation. We shall use  $\|(x, y)\|$  to denote

$$\|(x, y)\| = \left\| \begin{bmatrix} x \\ y \end{bmatrix} \right\| = \left( \|x\|^2 + \|y\|^2 \right)^{\frac{1}{2}}. \quad (4.18)$$

The stability result can then be stated in the following Theorem [146].

**THEOREM 4.12**

Suppose that there exists for every  $T \geq 0$  a functional  $d_T : \mathcal{X}_e \times \mathcal{Y}_e \rightarrow \mathbb{R}$  such that

(i) for every  $T \geq 0$  and every  $(x, y) \in \mathcal{G}_G[u]$  we have

$$d_T(x, y) \geq \phi_1(\|(x, y)\|_T) - \phi_2(\|u\|_T); \quad (4.19)$$

(ii) for every  $T \geq 0$  and every  $(x, y) \in \mathcal{G}_H^I[v]$  we have

$$d_T(x, y) \leq \phi_3(\|v\|_T); \quad (4.20)$$



where  $\phi_i : \mathbb{R}_+ \rightarrow \mathbb{R}_+$ , for  $i \in \{1, 2, 3\}$ , are continuous increasing functions and where  $\phi_1 \in \mathcal{K}_\infty$ . Then, the system (4.17) is bounded. If, additionally, the  $\phi_i$  ( $i \in \{2, 3\}$ ) are all in class  $\mathcal{K}$ , then (4.17) is bounded without bias. If, furthermore, the  $\phi_i$  ( $i \in \{1, 2, 3\}$ ) are all linear, then (4.17) is finite-gain stable.  $\lrcorner$

The proof of the above result is rather simple, and can be found in the original text [146]. A simple interpretation is that the functional  $d_T$  divides the space  $\mathcal{X}_e \times \mathcal{Y}_e$  into two regions, one containing the graph of  $G$  and another containing that of  $H$ . When both inputs  $u$  and  $v$  are zero, the conditions in Theorem 4.12 ensure that the only possible solution to the unperturbed system is  $(x, y) = (0, 0)$ . When the inputs are non-zero, an intersection between both sets appears, and thus existence of non-zero solutions is possible. These solutions are guaranteed to remain bounded with respect to the corresponding inputs, and stability is obtained.

An interesting aspect of Theorem 4.12 is that it allows the assessment of stability of the interconnection based on considerations over each system in open-loop. The connecting element is simply the separator  $d_T$ , which delimits the subspaces that should contain each graph.

Due to its simplicity, Theorem 4.12 can be easily transposed to the case of incremental stability. This is done in the next theorem, for which a proof is provided for completeness.

#### THEOREM 4.13

Suppose that there exists for every  $T \geq 0$  a functional  $d_T : \mathcal{X}_e \times \mathcal{Y}_e \rightarrow \mathbb{R}$  such that

(i) for every  $T \geq 0$ , every  $(x, y) \in \mathcal{G}_G[u]$  and every  $(\tilde{x}, \tilde{y}) \in \mathcal{G}_G[\tilde{u}]$  we have

$$d_T(x - \tilde{x}, y - \tilde{y}) \geq \phi_1(\|(x - \tilde{x}, y - \tilde{y})\|_T) - \phi_2(\|u - \tilde{u}\|_T). \quad (4.21)$$

(ii) for every  $T \geq 0$ , every  $(x, y) \in \mathcal{G}_H^I[v]$  and every  $(\tilde{x}, \tilde{y}) \in \mathcal{G}_H^I[\tilde{v}]$  we have

$$d_T(x - \tilde{x}, y - \tilde{y}) \leq \phi_3(\|v - \tilde{v}\|_T). \quad (4.22)$$

where  $\phi_i : \mathbb{R}_+ \rightarrow \mathbb{R}_+$ , for  $i \in \{1, 2, 3\}$ , are continuous increasing functions and where  $\phi_1 \in \mathcal{K}_\infty$ . Then, the system (4.17) is incrementally bounded. If, additionally, the  $\phi_i$  ( $i \in \{2, 3\}$ ) are all in class  $\mathcal{K}$ , then (4.17) is incrementally bounded without bias. If, furthermore, the  $\phi_i$  ( $i \in \{1, 2, 3\}$ ) are all linear, then (4.17) is incrementally finite-gain stable.  $\lrcorner$

#### PROOF

Let  $(x, y) \in \mathcal{G}_G[u] \cap \mathcal{G}_H^I[v]$ . Then

$$\phi_1(\|(x - \tilde{x}, y - \tilde{y})\|_T) - \phi_2(\|u - \tilde{u}\|_T) \leq d_T(x - \tilde{x}, y - \tilde{y}) \leq \phi_3(\|v - \tilde{v}\|_T). \quad (4.23)$$

Since  $\phi_1 \in \mathcal{K}_\infty$ , we may write

$$\begin{aligned} \|(x - \tilde{x}, y - \tilde{y})\|_T &\leq \phi_1^{-1}\left(\phi_2(\|u - \tilde{u}\|_T) + \phi_3(\|v - \tilde{v}\|_T)\right) \\ &\leq \phi_1^{-1}\left(\phi_2(\|(u - \tilde{u}, v - \tilde{v})\|_T) + \phi_3(\|(u - \tilde{u}, v - \tilde{v})\|_T)\right) \\ &=: \phi_4(\|(u - \tilde{u}, v - \tilde{v})\|_T). \end{aligned} \quad (4.24)$$

Since  $\phi_2$  and  $\phi_3$  are continuous and increasing functions,  $\phi_4$  is also continuous and increasing, and thus system (4.17) is incrementally bounded. If, in addition,  $\phi_2$  and  $\phi_3$  belong to class  $\mathcal{K}$ , so does  $\phi_4$ , and then (4.17) is incrementally bounded without bias. Finally, if  $\phi_i$  ( $i \in \{1, 2, 3\}$ ) are all linear, so is  $\phi_4$ , and the system (4.17) is incrementally finite-gain stable.  $\blacksquare$

Classic results such as small-gain, passivity and even Lyapunov theory, as well as their incremental counterparts, can be seen as specialized versions of Theorems 4.12 and 4.13 (see e.g. [146]). As it was discussed in Chapter 2 concerning dissipativity and Lyapunov stability, in order to be able to use Theorems 4.12 and 4.13 we have to construct an appropriate functional  $d_T$  and functions  $\phi_i$ . In this memoir, we follow an approach based on the use of Integral Quadratic Constraints (IQCs), as it will be detailed in Sections 4.4 and 4.5.

## 4.4 Robust stability and performance of nonlinear feedback systems

In this section we shall consider a method of constructing the functional  $d_T$  needed in the graph separation theorems. For this, we shall use IQCs constraining the input and output of systems  $G$  and  $\Delta$ . Differently from what has now become known as integral quadratic constraints in the control theory literature (see e.g. [111, 154, 174]), we consider integrals in the time domain, from 0 to  $T$ , for every  $T \geq 0$ . It is interesting to note that some of the first results containing explicit use of IQCs, due to Yakubovich, also considered constraints in the time domain (e.g. see discussion in [22]). As it will be discussed in Section 4.4.3, this may limit the choice of available IQCs, but it comes with the advantage of allowing us to deal rather naturally with the case when the nominal systems  $G$  is nonlinear. This will be of importance when trying to assess stability and performance, as we are dealing with piecewise-affine systems, which are obviously nonlinear. For a discussion of the relation between the approach presented here and the classic view on IQCs, please refer to Section 4.7.

### 4.4.1 Robust stability

Before stating the main result of this section, let us introduce some preliminary concepts. Let  $\Pi$  denote a complex rational matrix function in  $\mathcal{RL}_\infty^{(n_q+n_p) \times (n_q+n_p)}$ , which is partitioned as

$$\Pi(j\omega) = \begin{bmatrix} \Pi_{11}(j\omega) & \Pi_{12}(j\omega) \\ \Pi_{12}(j\omega)^* & \Pi_{22}(j\omega) \end{bmatrix}, \quad (4.25)$$

with frequency  $\omega \in \overline{\mathbb{R}}$ ,  $\Pi_{11}(j\omega) \in \mathbb{C}^{n_q \times n_q}$  and  $\Pi_{22}(j\omega) \in \mathbb{C}^{n_p \times n_p}$ . The operator  $\Pi$  is frequently referred to as the *multiplier*. This denomination is rooted in the classic multiplier theory, see e.g. the discussion in [86, Section 1.6]. More details about the structure and properties of these multipliers will be provided in Sections 4.4.3 and 4.4.4.

Let us begin by proposing the following theorem concerning robust stability, which is an adaptation of [146, Theorem 2.2]. A proof is included in Appendix B.3.

#### THEOREM 4.14

Let  $G : \mathcal{L}_{2e}^{n_p}(\mathbb{R}_+) \rightarrow \mathcal{L}_{2e}^{n_q}(\mathbb{R}_+)$  be a causal and  $\mathcal{L}_2$ -gain stable system, and let  $\Delta$  be the uncertainty set defined in Definition 4.1. Let  $\Psi \in \mathcal{RH}_\infty^{n_y \times (n_q+n_p)}$  and  $M \in \mathbb{S}^{n_y}$  be such that  $\Pi(j\omega) := \Psi(j\omega)^* M \Psi(j\omega)$  satisfies  $\Pi_{11} \succeq \varepsilon_\Pi I_{n_q}$  and  $\Pi_{22} \preceq -\varepsilon_\Pi I_{n_p}$ , for some  $\varepsilon_\Pi > 0$ . Assume that:

- (i) The feedback interconnection  $(G, \Delta)$  is well-posed for every  $\Delta \in \Delta$ .

(ii) The following time-domain IQC is satisfied

$$\int_0^T y_\Delta(t)^\top M y_\Delta(t) dt \geq 0, \quad \forall T \geq 0, \forall \Delta \in \mathbf{\Delta}, \forall q \in \mathcal{L}_{2e}^{n_q}(\mathbb{R}_+) \quad (4.26)$$

$$\text{with } y_\Delta = \Psi \begin{bmatrix} \mathbb{I} \\ \Delta \end{bmatrix} (q).$$

(iii) There exists  $\varepsilon > 0$  such that the following time-domain IQC is satisfied

$$\int_0^T y_G(t)^\top M y_G(t) dt \leq -\varepsilon \|p\|_{2,T}^2, \quad \forall T \geq 0, \forall p \in \mathcal{L}_{2e}^{n_p}(\mathbb{R}_+) \quad (4.27)$$

$$\text{with } y_G = \Psi \begin{bmatrix} G \\ \mathbb{I} \end{bmatrix} (p).$$

Then, the feedback interconnection  $(G, \Delta)$  is robustly stable with respect to  $\mathbf{\Delta}$ .  $\lrcorner$

When condition (ii) in the above theorem is satisfied, we say that every uncertainty  $\Delta$  in the set  $\mathbf{\Delta}$  satisfy the IQC defined by  $(M, \Psi)$ . The separation ensured by the integral quadratic constraints allows us to conclude on the  $\mathcal{L}_2$ -gain stability of every possible trajectory of the feedback interconnection. Then, with the added assumption on well-posedness, we can conclude on the robust stability of  $(G, \Delta)$ .

The condition on the definiteness of  $\Pi_{11}$  and  $\Pi_{22}$  might seem arbitrary at this point. Nonetheless, as we shall discuss in Section 4.4.3, this condition will be capital in allowing the use of frequency-dependent dynamic multipliers in the time domain. Moreover, the condition is not too restrictive, and will be satisfied by all of the multipliers considered in this memoir. Additionally, this assumption allows us to propose a proof of Theorem 4.14 (and also of the subsequent theorems for stability and performance) that is simpler than the original proof of [146, Theorem 2.2].

It is interesting to note that the disturbance inputs  $p_{\text{in}}$  and  $q_{\text{in}}$  do not appear in the conditions of Theorem 4.14. Stability is hence concluded based on independent considerations on each undisturbed open-loop system.

Theorem 4.14 can be seen as an extension of Zames' results on sectors conditions [188], by enabling us to consider dynamic conic sectors via the filter  $\Psi$ . To see this, assume for example, that  $n_q = n_p$ . Then, by taking  $\Psi = I_{2n_q}$  and

$$M = \begin{bmatrix} -2abI_{n_q} & (a+b)I_{n_q} \\ (a+b)I_{n_q} & -2I_{n_q} \end{bmatrix}, \quad (4.28)$$

we see that condition (ii) in Theorem 4.14 is equivalent to saying that  $\Delta$  is inside the sector  $\text{Sect}(a, b)$ , while condition (iii) ensures that  $G$  is strictly outside the complementary sector (see [188, Section 4]).

The addition of the filter  $\Psi$  can be seen as a generalization of the traditional approach of stability assessment using multipliers [19, 189, 191]. Instead of trying to establish the topological separation of the graphs of  $G$  and  $\Delta$  directly, we use the filter  $\Psi$  to create the fictitious signals  $y_\Delta$  and  $y_G$ , which are then used in the IQC. This is akin to performing a loop transformation, with the goal to obtain stability conditions that are more general, thus leading to possibly less conservative analysis.

### 4.4.2 Robust performance

Having established robust stability in the previous section, we now turn our attention to the study of performance of uncertain systems. In this memoir, we consider the  $\mathcal{L}_2$ -gain and the incremental  $\mathcal{L}_2$ -gain as measures of performance of the closed-loop system. The goal of this section is to propose an extension to Theorem 4.14 allowing the assessment of robust stability and robust  $\mathcal{L}_2$ -gain stability concurrently. For this, we shall represent the performance measure as an integral quadratic constraint. Let us note that the  $\mathcal{L}_2$ -gain constraint (2.15) can be equivalently represented as

$$\begin{aligned} \int_0^\infty |z(t)|^2 - \gamma^2 |w(t)|^2 dt &= \int_0^\infty \begin{bmatrix} z(t) \\ w(t) \end{bmatrix}^\top \begin{bmatrix} I_{n_z} & 0 \\ 0 & -\gamma^2 I_{n_w} \end{bmatrix} \begin{bmatrix} z(t) \\ w(t) \end{bmatrix} dt \\ &= \int_0^\infty \begin{bmatrix} z(t) \\ w(t) \end{bmatrix}^\top M_p \begin{bmatrix} z(t) \\ w(t) \end{bmatrix} dt \\ &\leq 0, \end{aligned} \quad (4.29)$$

with

$$M_p := \begin{bmatrix} I_{n_z} & 0 \\ 0 & -\gamma^2 I_{n_w} \end{bmatrix}. \quad (4.30)$$

For causal systems, it is well known that  $\mathcal{L}_2$ -gain stability implies boundedness in truncated time (see e.g. [177, Theorem 2.1] or [175, Lemma 6.2.11]). Then, if the closed-loop system is robustly  $\mathcal{L}_2$ -gain stable, it means that

$$\int_0^T \begin{bmatrix} z(t) \\ w(t) \end{bmatrix}^\top M_p \begin{bmatrix} z(t) \\ w(t) \end{bmatrix} dt \leq 0, \quad \forall T \geq 0. \quad (4.31)$$

The idea is then to incorporate the above inequality into an integral constraint like (4.27), in order to assess performance alongside stability.

Let us define some auxiliary notation before stating the main result in this section. We define  $\Upsilon : \mathcal{L}_{2e}^{n_p}(\mathbb{R}_+) \times \mathcal{L}_{2e}^{n_w}(\mathbb{R}_+) \rightarrow \mathcal{L}_{2e}^{n_q}(\mathbb{R}_+) \times \mathcal{L}_{2e}^{n_p}(\mathbb{R}_+) \times \mathcal{L}_{2e}^{n_z}(\mathbb{R}_+) \times \mathcal{L}_{2e}^{n_w}(\mathbb{R}_+)$  as the map

$$\begin{bmatrix} q \\ p \\ z \\ w \end{bmatrix} = \Upsilon \left( \begin{bmatrix} p \\ w \end{bmatrix} \right) := \begin{bmatrix} G_{\text{perf},q} \\ \mathbb{I} & 0 \\ G_{\text{perf},z} \\ 0 & \mathbb{I} \end{bmatrix} \begin{bmatrix} p \\ w \end{bmatrix}, \quad (4.32)$$

i.e.  $(q, p, z, w) = \Upsilon(p, w)$ , with  $(q, z) = G_{\text{perf}}(p, w)$ .

We propose the following result, which is again based on [146, Theorem 2.2]. A proof can be found in Appendix B.3.

#### THEOREM 4.15

Let  $G_{\text{perf}} : \mathcal{L}_{2e}^{n_p}(\mathbb{R}_+) \times \mathcal{L}_{2e}^{n_w}(\mathbb{R}_+) \rightarrow \mathcal{L}_{2e}^{n_q}(\mathbb{R}_+) \times \mathcal{L}_{2e}^{n_z}(\mathbb{R}_+)$  be a causal and  $\mathcal{L}_2$ -gain stable system, and let  $\Delta$  be the uncertainty set defined in Definition 4.1. Let  $\Psi \in \mathcal{RH}_\infty^{n_y \times (n_q + n_p)}$  and  $M \in \mathbb{S}^{n_y}$  be such that  $\Pi(j\omega) := \Psi(j\omega)^* M \Psi(j\omega)$  satisfies  $\Pi_{11} \succeq \varepsilon_\Pi I_{n_q}$  and  $\Pi_{22} \preceq -\varepsilon_\Pi I_{n_p}$ , for some  $\varepsilon_\Pi > 0$ . Let  $M_p \in \mathbb{S}^{n_z + n_w}$  be the matrix defined in (4.30) and let  $\Upsilon$  be the map defined in (4.32). Assume that:

(i) The feedback interconnection of  $(G_{\text{perf}}, \Delta)$  is well-posed.

(ii) The following time-domain IQC is satisfied

$$\int_0^T y_\Delta(t)^\top M y_\Delta(t) dt \geq 0, \quad \forall T \geq 0, \forall \Delta \in \mathbf{\Delta}, \forall q \in \mathcal{L}_{2e}^{n_q}(\mathbb{R}_+) \quad (4.33)$$

$$\text{with } y_\Delta = \Psi \begin{bmatrix} \mathbb{I} \\ \Delta \end{bmatrix} (q).$$

(iii) There exists  $\varepsilon > 0$  such that the following time-domain IQC is satisfied

$$\int_0^T y_G(t)^\top \begin{bmatrix} M & 0 \\ 0 & M_p \end{bmatrix} y_G(t) dt \leq -\varepsilon \left\| \begin{bmatrix} p \\ w \end{bmatrix} \right\|_{2,T}^2, \quad \forall T \geq 0, \forall p \in \mathcal{L}_{2e}^{n_p}(\mathbb{R}_+), \forall w \in \mathcal{L}_{2e}^{n_w}(\mathbb{R}_+) \quad (4.34)$$

$$\text{with } y_G = \text{diag}(\Psi, I_{n_z+n_w}) \Upsilon(p, w).$$

Then, the feedback interconnection  $(G_{\text{perf}}, \Delta)$  is robustly  $\mathcal{L}_2$ -gain stable with respect to  $\mathbf{\Delta}$ , with an  $\mathcal{L}_2$ -gain less than or equal to  $\gamma$ .  $\lrcorner$

In Theorems 4.14 and 4.15, the assessment of stability and performance has been divided into two parts. The reasoning behind this approach is to encapsulate in the uncertain block  $\Delta$  all the troublesome components of the system at hand (such as uncertain parameters, unmodeled dynamics, nonlinearities, delays, etc.), and use  $G_{\text{perf}}$  to represent the “nominal” system, which is generally “well-behaved” (in the sense that all troublesome components have been isolated in the  $\Delta$  block) and well-known. The analysis is then subdivided into two complementary problems:

1. Find  $(M, \Psi)$  for which we know that (4.26) (resp. (4.33)) is satisfied for  $\Delta \in \mathbf{\Delta}$ .
2. Check whether (4.27) (resp. (4.34)) is satisfied for  $G$  (resp.  $G_{\text{perf}}$ ).

In general, the choice of the multiplier  $(M, \Psi)$  is not unique. Instead, it is taken to belong to a class of multipliers depending on the structure of  $\mathbf{\Delta}$ . This is discussed in the next section, where we present a catalog of multipliers for the uncertainties considered in this memoir.

The class of multipliers for a given structured uncertainty is generally a subset of the functional space of rational complex matrix functions. The search for an appropriate multiplier would then lead to an optimization problem of infinite dimension. To overcome this difficulty, we shall consider a parametrization of  $(M, \Psi)$  using a fixed finite basis of rational functions. In this way, the search for a suitable multiplier becomes a problem of finite dimension. This will be the subject of Section 4.4.4.

Finally, problem number 2 requires verifying that the time-domain IQC is satisfied by the system, given the specified parametrization of the multiplier  $(M, \Psi)$ . In our case, we are dealing with piecewise-affine systems. Our goal is to propose analysis conditions that can be efficiently solved using convex optimization. From the discussion presented in Chapter 2, we know that we can use dissipativity theory in conjunction with piecewise-quadratic and/or piecewise-polynomial storage functions to propose sufficient conditions for stability and performance of the uncertain system. The details of this approach will be made clear in Sections 4.4.5 and 4.4.6.

### 4.4.3 Construction of multipliers

In Sections 4.4.1 and 4.4.2, we have provided two results allowing assessment of robust stability and performance of uncertain systems. Theorems 4.14 and 4.15 use dynamic sectors defined by  $M$  and  $\Psi$  to ensure the topological separation between the graphs of the nominal system and the uncertainty. In order to apply these results, one must then be able to construct appropriate dynamic multipliers  $(M, \Psi)$ . In this section, we present how this can be done.

It is instructive to illustrate the approach to obtain these multipliers via a simple example. Let  $\Delta$  in (4.2) be such that  $M_I = m_V = M_V = 0$  and  $m_I = 1$ , with some positive  $n_{I,1} = n_q = n_p$ . In this case,  $\Delta$  contains only a single real parametric uncertainty, i.e.  $p = \Delta(q) = \delta q$ , with  $\delta \in \mathbb{R}$  and  $|\delta| \leq 1$ . Using the information on the gain bound on  $\Delta$ , a first proposition of multiplier is to take  $\Psi = I$  and

$$M = \begin{bmatrix} \xi I_{n_q} & 0 \\ 0 & -\xi I_{n_p} \end{bmatrix}, \quad (4.35)$$

for some  $\xi > 0$ . Then,  $y_\Delta = \text{col}(q, p)$ , and constraint (4.27) implies that

$$\int_0^T \begin{bmatrix} q(t) \\ p(t) \end{bmatrix}^\top M \begin{bmatrix} q(t) \\ p(t) \end{bmatrix} dt = \int_0^T \xi |q(t)|^2 - \xi |p(t)|^2 dt \geq 0, \quad (4.36)$$

since  $|p(t)| = |\delta q(t)| \leq |q(t)|$ , due to  $|\delta| \leq 1$ .

Using the multiplier  $(M, I)$  defined above, in conjunction with Theorem 4.14, would yield a version of the small-gain theorem. In order to go beyond this, we would need to compute dynamic multipliers  $(M, \Psi)$ . However, doing so in the time domain may prove too complicated, since it would require to explicitly take into consideration the convolution integral connecting  $y_\Delta$  to  $q$  and  $p$ .

Following the standard procedure on linear systems theory, we transpose the analysis into the frequency domain, where the convolution product becomes a simple multiplication. To do so, let  $q \in \mathcal{L}_2^{n_q}(\mathbb{R}_+)$ . Then, by hypothesis,  $p = \Delta(q) \in \mathcal{L}_2^{n_p}(\mathbb{R}_+)$ . Since  $\Psi$  is assumed to belong to  $\mathcal{RH}_\infty^{n_y \times (n_q + n_p)}$ ,  $y_\Delta$  is also bounded. We may then take the limit when  $T \rightarrow \infty$  in (4.26) to obtain

$$\int_0^\infty y_\Delta(t)^\top M y_\Delta(t) dt \geq 0, \quad \forall \Delta \in \Delta, \forall q \in \mathcal{L}_2^{n_q}(\mathbb{R}_+). \quad (4.37)$$

Using Parseval's equality (also referred to as Plancherel's theorem, see [144, Theorem 9.13]), together with the fact that  $\hat{y}_\Delta(j\omega) = \Psi(j\omega) \text{col}(\hat{q}(j\omega), \hat{p}(j\omega))$ , we have that

$$\int_{-\infty}^\infty \begin{bmatrix} \hat{q}(j\omega) \\ \hat{p}(j\omega) \end{bmatrix}^* \Psi(j\omega)^* M \Psi(j\omega) \begin{bmatrix} \hat{q}(j\omega) \\ \hat{p}(j\omega) \end{bmatrix} dt \geq 0, \quad \forall \Delta \in \Delta, \forall q \in \mathcal{L}_2^{n_q}(\mathbb{R}_+). \quad (4.38)$$

Let us define the frequency-dependent multiplier  $\Pi(j\omega) := \Psi(j\omega)^* M \Psi(j\omega)$ . We shall refer to  $(M, \Psi)$  as a factorization of  $\Pi$ . Since the filter  $\Psi$  belongs to  $\mathcal{RH}_\infty^{n_y \times (n_q + n_p)}$ ,  $\Pi$  is an Hermitian multiplier in  $\mathcal{RL}_\infty^{(n_q + n_p) \times (n_q + n_p)}$ , i.e.  $\Pi(j\omega)^* = \Pi(j\omega)$  and  $\sup_{\omega \in \mathbb{R}} \bar{\sigma}(\Pi(j\omega)) < \infty$ .

We are now interested in finding a class of multipliers  $\Pi$  such that (4.38) is satisfied by all  $\Delta \in \Delta$ . We shall use the fact that  $\Delta(q) = \delta q$ , with  $\delta$  being a scalar, to derive a class of multipliers for this uncertainty. Let  $T(\omega_0) \in \mathbb{C}^{n_q \times n_q}$  be an invertible complex matrix. Then, since  $\delta$  is a scalar, we have that  $T(\omega_0)\delta = \delta T(\omega_0)$ , and hence  $\delta = T(\omega_0)^{-1}\delta T(\omega_0)$ . We

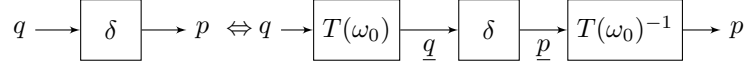
FIGURE 4.7 – Equivalent representation of uncertainty  $\Delta(q) = \delta q$ .

introduce the notation  $\underline{q} = T(\omega_0)q$  and  $\underline{p} = T(\omega_0)p$ , and obtain the equivalent uncertainty in Figure 4.7. Then, for any  $\omega_0 \in \mathbb{R}$ ,  $|\delta| \leq 1$  implies that

$$\hat{p}(j\omega_0)^* T(\omega_0)^* T(\omega_0) \hat{p}(j\omega_0) = \underline{\hat{p}}(j\omega)^* \underline{\hat{p}}(j\omega_0) \leq \underline{\hat{q}}(j\omega_0)^* \underline{\hat{q}}(j\omega_0) = \hat{q}(j\omega_0)^* T(\omega_0)^* T(\omega_0) \hat{q}(j\omega_0), \quad (4.39)$$

which can be rewritten as

$$\begin{bmatrix} \hat{q}(j\omega_0) \\ \hat{p}(j\omega_0) \end{bmatrix}^* \begin{bmatrix} T(\omega_0)^* T(\omega_0) & 0 \\ 0 & -T(\omega_0)^* T(\omega_0) \end{bmatrix} \begin{bmatrix} \hat{q}(j\omega_0) \\ \hat{p}(j\omega_0) \end{bmatrix} \geq 0. \quad (4.40)$$

Let us define  $X_D(j\omega_0) := T(\omega_0)^* T(\omega_0)$ , so that  $X_D(j\omega) = X_D(j\omega)^* \succ 0$ . It thus follows from (4.40) that

$$\begin{bmatrix} \hat{q}(j\omega) \\ \hat{p}(j\omega) \end{bmatrix}^* \begin{bmatrix} X_D(j\omega) & 0 \\ 0 & -X_D(j\omega) \end{bmatrix} \begin{bmatrix} \hat{q}(j\omega) \\ \hat{p}(j\omega) \end{bmatrix} \geq 0, \quad \forall \omega \in \overline{\mathbb{R}}. \quad (4.41)$$

Integration from  $-\infty$  up to  $+\infty$  shows that the multiplier  $\Pi = \text{diag}(X_D, -X_D)$ , with any Hermitian and positive-definite  $X_D$ , is indeed a valid multiplier for this class of uncertainties.

We can go one step further in the construction of more general multipliers for this class of uncertainties, by using the fact that  $\delta$  is real. Indeed, if we denote  $\bar{\delta}$  the complex conjugate of  $\delta$ , this means that  $\bar{\bar{\delta}} = \delta$ , which implies that

$$\hat{p}(j\omega)^* \hat{q}(j\omega) = \hat{q}(j\omega)^* \bar{\delta} \hat{q}(j\omega) = \hat{q}(j\omega)^* \delta \hat{q}(j\omega) = \hat{q}(j\omega)^* \hat{p}(j\omega) \quad (4.42)$$

and hence that

$$\begin{bmatrix} \hat{q}(j\omega) \\ \hat{p}(j\omega) \end{bmatrix}^* \begin{bmatrix} 0 & I_{n_q} \\ -I_{n_q} & 0 \end{bmatrix} \begin{bmatrix} \hat{q}(j\omega) \\ \hat{p}(j\omega) \end{bmatrix} = 0, \quad \forall \omega \in \overline{\mathbb{R}}. \quad (4.43)$$

Let us replace  $I_{n_q}$  and  $-I_{n_q}$  by a skew-Hermitian complex operator  $X_G$  and its conjugate transpose, respectively. We then have

$$\begin{aligned} \begin{bmatrix} \hat{q}(j\omega) \\ \hat{p}(j\omega) \end{bmatrix}^* \begin{bmatrix} 0 & X_G(j\omega) \\ X_G(j\omega)^* & 0 \end{bmatrix} \begin{bmatrix} \hat{q}(j\omega) \\ \hat{p}(j\omega) \end{bmatrix} &= \hat{p}(j\omega)^* X_G(j\omega) \hat{q}(j\omega) + \hat{q}(j\omega)^* X_G(j\omega)^* \hat{p}(j\omega) \\ &= \hat{q}(j\omega)^* \bar{\delta} X_G(j\omega) \hat{q}(j\omega) + \hat{q}(j\omega)^* X_G(j\omega)^* \delta \hat{q}(j\omega) \\ &= \delta \hat{q}(j\omega)^* (X_G(j\omega) + X_G(j\omega)^*) \hat{q}(j\omega) \\ &= 0, \quad \forall \omega \in \overline{\mathbb{R}}, \end{aligned} \quad (4.44)$$

since  $X_G(j\omega)^* = -X_G(j\omega)$ . Adding (4.44) to (4.41), we conclude that

$$\begin{bmatrix} \hat{q}(j\omega) \\ \hat{p}(j\omega) \end{bmatrix}^* \begin{bmatrix} X_D(j\omega) & X_G(j\omega) \\ X_G(j\omega)^* & -X_D(j\omega) \end{bmatrix} \begin{bmatrix} \hat{q}(j\omega) \\ \hat{p}(j\omega) \end{bmatrix} \geq 0, \quad \forall \omega \in \overline{\mathbb{R}}, \quad (4.45)$$

for every  $X_D = X_D^* \succ 0$  and every  $X_G = -X_G^*$ . Integration over  $\omega$  from  $-\infty$  to  $+\infty$  yields that this is a valid multiplier for  $\Delta$ . The approach used in the construction of the above

TABLE 4.1 – Catalog of multipliers  $\Pi$ 

Uncertainty $\Delta$	Multiplier $\Pi(j\omega)$
Constant real repeated scalar $p(t) = \delta_I q(t)$ , $ \delta_I  \leq 1$	$\begin{bmatrix} X_D(j\omega) & X_G(j\omega) \\ X_G(j\omega)^* & -X_D(j\omega) \end{bmatrix}$ , with $\begin{cases} X_D(j\omega) = X_D(j\omega)^* \succ 0 \\ X_G(j\omega) = -X_G(j\omega)^* \end{cases}$
LTI dynamic uncertainty $\hat{p}(j\omega) = \Delta_I(j\omega)\hat{q}(j\omega)$ , $\ \Delta_I\ _2 \leq 1$	$\begin{bmatrix} x_D(j\omega)I_{n_q} & 0 \\ 0 & -x_D(j\omega)I_{n_p} \end{bmatrix}$ , with $x_D(j\omega) \succ 0$
Time-varying real repeated scalar $p(t) = \delta_V(t)q(t)$ , $ \delta_V(t)  \leq 1, \forall t \geq 0$	$\begin{bmatrix} X_D & X_G \\ X_G^T & -X_D \end{bmatrix}$ , with $\begin{cases} X_D = X_D^T \succ 0 \\ X_G = -X_G^T \end{cases}$
General dynamic uncertainty $p = \Delta_V(q)$ , $\ \Delta_V\ _2 \leq 1$	$\begin{bmatrix} x_D I_{n_q} & 0 \\ 0 & -x_D I_{n_p} \end{bmatrix}$ , with $x_D > 0$
Memoryless nonlinearity in the sector $\text{Sect}(\kappa_1, \kappa_2)$ , with $\kappa_1 \leq 0 \leq \kappa_2$ $p = -\varphi(q)$ , $\kappa_1 \leq \varphi(q)/q \leq \kappa_2$	$\begin{bmatrix} -2\kappa_1\kappa_2 & -(\kappa_1 + \kappa_2) \\ -(\kappa_1 + \kappa_2) & -2 \end{bmatrix}$

multiplier is at the heart of the computation of upper bounds on the structured singular value for  $\mu$ -analysis [39, 41], and the operators  $X_D$  and  $X_G$  are generally referred to as D and G scalings, respectively (see e.g. [40]).

Via this exposition of the simple case of a single real uncertain parameter, we can see how analysis on the frequency domain allows us to obtain multipliers  $\Pi$  in a much more straightforward manner than it would have been possible in the time domain. In Table 4.1, we provide a catalog of multipliers that are valid for the class of uncertainties  $\Delta$ , as well as a multiplier for memoryless nonlinearities in a sector. This multiplier is connected to the celebrated circle criterion, see Appendix A, and will be used in Example 4.36 by the end of this chapter.

An extensive list of frequency-dependent multipliers for a wide class of uncertainties can be found in the literature, see e.g. [111, 174]. Some are known in the control community for a long time, such as those coming from the vast literature on absolute stability. One could mention conditions concerning memoryless nonlinearities in a sector (circle criterion) [111, 189], Popov's criterion [19, 96] and Zames-Falb multipliers [24, 191].

It is possible that a given uncertainty  $\Delta$  satisfies integral quadratic constraints defined by more than one multiplier  $\Pi$ . The next lemma, taken from [111], provides a way to take advantage of this.

LEMMA 4.16

*Let  $\Delta$  satisfy the IQCs defined by multipliers  $\Pi_i$ , for  $i = 1, \dots, r$ . Then it also satisfies the IQC given by the multiplier  $\Pi$  defined by the conic combination  $\Pi := \sum_{i=1}^r \lambda_i \Pi_i$ , with  $\lambda_i \geq 0$ .*

Using the multiplier  $\Pi$  given in Lemma 4.16 can provide more degrees of freedom when testing condition (4.27). Indeed, there might exist some combination of  $\{\lambda_i\}_{i=1, \dots, r}$  such that (4.27) can be satisfied even when this is not the case for each separate  $\Pi_i$ .

The uncertainty set  $\Delta$  is composed of structured uncertainties. As we have seen, each type of uncertainty in  $\Delta$  satisfies an IQC with a multiplier in Table 4.1. These IQCs can



be easily grouped into a single one for the overall uncertainty  $\Delta$ , as explained in the next lemma [174].

LEMMA 4.17

Let  $\Delta_i$  satisfy the IQC given by multiplier  $\Pi_i$ , for  $i = 1, \dots, r$  and let  $\Pi_i$  be partitioned as

$$\Pi_i(j\omega) = \begin{bmatrix} \Pi_{11}^i(j\omega) & \Pi_{12}^i(j\omega) \\ \Pi_{12}^i(j\omega)^* & \Pi_{22}^i(j\omega) \end{bmatrix} \quad (4.46)$$

according to the dimensions of the input and output of  $\Delta_i$ . Then, the structured operator defined as  $\Delta := \text{diag}(\Delta_1, \dots, \Delta_r)$  satisfies the IQC defined by the multiplier

$$\Pi := \begin{bmatrix} \text{diag}(\Pi_{11}^1, \dots, \Pi_{11}^r) & \text{diag}(\Pi_{12}^1, \dots, \Pi_{12}^r) \\ \text{diag}(\Pi_{12}^1, \dots, \Pi_{12}^r)^* & \text{diag}(\Pi_{22}^1, \dots, \Pi_{22}^r) \end{bmatrix}. \quad (4.47)$$

With the help of the above results, we are able to construct an overall multiplier  $\Pi$  so that every  $\Delta \in \mathbf{\Delta}$  satisfies the corresponding IQC. Having constructed  $\Pi$ , we now need to revert back to time domain, as the integral quadratic constraints that we need to verify are expressed in time. We know that any multiplier  $\Pi \in \mathcal{RL}_\infty^{n_q+n_p}$  can be factorized as  $\Pi = \Psi^* M \Psi$ , where  $M \in \mathbb{S}^{n_y}$  and  $\Psi \in \mathcal{RH}_\infty^{n_y \times (n_q+n_p)}$  [154]. In this case, we say that  $(M, \Psi)$  is a factorization of  $\Pi$ . This factorization is not unique, and we will see that the existence of a particular choice of  $(M, \Psi)$  will be capital in establishing the result in the time domain.

Assume that  $\Psi$  admits a state space representation given by

$$\begin{cases} \dot{\psi}(t) = A_\psi \psi(t) + B_{\psi q} q(t) + B_{\psi p} p(t) \\ y(t) = C_\psi \psi(t) + D_{\psi q} q(t) + D_{\psi p} p(t) \\ \psi(0) = 0, \end{cases} \quad (4.48)$$

and let us define

$$\hat{y}(j\omega) := \Psi(j\omega) \begin{bmatrix} \hat{q}(j\omega) \\ \hat{p}(j\omega) \end{bmatrix} \quad (4.49)$$

for signals  $q \in \mathcal{L}_2^{n_q}(\mathbb{R}_+)$  and  $p \in \mathcal{L}_2^{n_p}(\mathbb{R}_+)$ . Then, for all  $p = \Delta(q)$ , (4.38) may be rewritten as

$$\int_{-\infty}^{\infty} \hat{y}(j\omega)^* M \hat{y}(j\omega) d\omega \geq 0. \quad (4.50)$$

At the beginning of this section, we have used Parseval's equality to go from time to the frequency domain. We now use this result again in the opposite direction to obtain

$$\int_0^\infty y(t)^\top M y(t) dt \geq 0, \quad (4.51)$$

where  $y$  is the output of the LTI system (4.48), see Figure 4.8. From this we see that, if  $(M, \Psi)$  is a factorization of  $\Pi$ , the IQC (4.38) is satisfied if and only if  $y$  defined as in (4.49), satisfies (4.51).

Condition (ii) in Theorem 4.14, which ultimately comes from the graph separation Theorem 4.12, requires that (4.51) be satisfied not only from 0 to  $\infty$ , but from 0 to  $T$ , for every  $T \geq 0$ . However, from the above reasoning, using frequency-dependent multipliers only ensures (via Parseval's theorem) that the constraint is satisfied for  $T \rightarrow \infty$ . In general, (4.51)

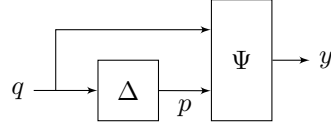

FIGURE 4.8 – Filtered uncertainty.

does not imply that the integral between 0 and arbitrary  $T$  is nonnegative. As it has been shown in [154], this implication depends on the particular factorization  $(M, \Psi)$  of  $\Pi$ . For this reason, let us introduce the following definition of *soft and hard factorizations* [23, 154].

**DEFINITION 4.18 (Soft and hard factorizations)**

Let the multiplier  $\Pi \in \mathcal{RL}_\infty^{(n_q+n_p) \times (n_q+n_p)}$  be factorized as  $\Pi = \Psi^* M \Psi$ , where  $M \in \mathbb{S}^{n_z}$  and  $\Psi \in \mathcal{RH}_\infty^{n_z \times (n_q+n_p)}$ . Then,  $(M, \Psi)$  is said to be a

1. soft factorization of  $\Pi$  if, for any bounded causal operator  $\Delta$  satisfying the IQC defined by  $\Pi$ , the following inequality holds

$$\int_0^\infty y_\Delta(t)^\top M y_\Delta(t) dt \geq 0 \quad (4.52)$$

for all  $q \in \mathcal{L}_2^{n_q}(\mathbb{R}_+)$ , with  $y_\Delta = \Psi \begin{bmatrix} \Pi \\ \Delta \end{bmatrix} (q)$ .

2. hard factorization of  $\Pi$  if, for any bounded causal operator  $\Delta$  satisfying the IQC defined by  $\Pi$ , the following inequality holds

$$\int_0^T y_\Delta(t)^\top M y_\Delta(t) dt \geq 0 \quad (4.53)$$

for all  $T \geq 0$  and all  $q \in \mathcal{L}_{2e}^{n_q}(\mathbb{R}_+)$ , with  $y_\Delta$  defined as above.  $\lrcorner$

Hard factorizations ensure that the integral inequality (4.51) remains true in truncated time. It is clear that hard factorizations are also soft, while the converse is not true in general. The discussion about soft and hard factorizations is also valid for the IQC in condition (iii) of Theorem 4.14. Let us then introduce the notion of *doubly-hard factorization*, proposed in [23].

**DEFINITION 4.19 (Doubly-hard factorization)**

Let the multiplier  $\Pi \in \mathcal{RL}_\infty^{(n_q+n_p) \times (n_q+n_p)}$  be factorized as  $\Pi = \Psi^* M \Psi$ , where  $M \in \mathbb{S}^{n_y}$  and  $\Psi \in \mathcal{RH}_\infty^{n_y \times (n_q+n_p)}$ . Then  $(M, \Psi)$  is said to be a doubly-hard factorization of  $\Pi$  if for any two bounded causal operators  $\Delta_1$  and  $\Delta_2$ , the following two conditions hold:

1. The IQC condition

$$\int_{-\infty}^\infty \begin{bmatrix} \hat{q}(j\omega) \\ \hat{p}(j\omega) \end{bmatrix}^* \Pi(j\omega) \begin{bmatrix} \hat{q}(j\omega) \\ \hat{p}(j\omega) \end{bmatrix} d\omega \geq 0, \quad \forall q \in \mathcal{L}_{2e}^{n_q}(\mathbb{R}_+) \quad (4.54)$$

with  $p = \Delta_1(q)$ , implies that

$$\int_0^T y_{\Delta_1}(t)^\top M y_{\Delta_1}(t) dt \geq 0, \quad \forall T \geq 0, \forall q \in \mathcal{L}_{2e}^{n_q}(\mathbb{R}_+) \quad (4.55)$$

with  $y_{\Delta_1} = \Psi \begin{bmatrix} \mathbb{I} \\ \Delta_1 \end{bmatrix} (q)$ .

2. The IQC condition

$$\int_{-\infty}^{\infty} \begin{bmatrix} \hat{q}(j\omega) \\ \hat{p}(j\omega) \end{bmatrix}^* \Pi(j\omega) \begin{bmatrix} \hat{q}(j\omega) \\ \hat{p}(j\omega) \end{bmatrix} d\omega \leq -\varepsilon \|p\|_2^2, \quad \forall p \in \mathcal{L}_{2e}^{n_p}(\mathbb{R}_+) \quad (4.56)$$

with  $q = \Delta_2(p)$ , implies that

$$\int_0^T y_{\Delta_2}(t)^\top M y_{\Delta_2}(t) dt \leq -\varepsilon \|p\|_{2,T}^2, \quad \forall T \geq 0, \forall p \in \mathcal{L}_{2e}^{n_p}(\mathbb{R}_+) \quad (4.57)$$

with  $y_{\Delta_2} = \Psi \begin{bmatrix} \Delta_2 \\ \mathbb{I} \end{bmatrix} (p)$ . ┘

It is clear that a hard factorization is also a soft factorization, while the converse is not true in general. It is interesting to note that factorizations are not unique, and the same multiplier can have factorizations that are only soft and others that are hard and soft (see e.g. the numerical example in [23, Section 5]). For rational and bounded multipliers  $\Pi \in \mathcal{RH}_\infty^{(n_q+n_p) \times (n_q+n_p)}$ , soft factorizations always exist [111, 154] and also [31]. However, some classes of multipliers may not admit hard factorizations, as the discussion in [111, Section 4] indicates. The notion of hard factorizations of multipliers is fairly new in the literature [22, 23, 154], and an exact characterization of the existence of such factorizations seems to be an open problem. In order to use frequency-dependent multipliers in the time-domain, we have to ensure that they admit a doubly-hard factorization, so that the integral quadratic constraints in Theorems 4.14 and 4.15 can be satisfied in truncated time. The question is thus what are sufficient conditions for a given multiplier to admit a hard factorization. To answer this question, let us focus our attention on a special class of multipliers, called *positive-negative multipliers* [22].

**DEFINITION 4.20 (Positive-negative multipliers)**

Let  $\Pi \in \mathcal{RH}_\infty^{(n_q+n_p) \times (n_q+n_p)}$  be partitioned as

$$\Pi(j\omega) = \begin{bmatrix} \Pi_{11}(j\omega) & \Pi_{12}(j\omega) \\ \Pi_{12}(j\omega)^* & \Pi_{22}(j\omega) \end{bmatrix}. \quad (4.58)$$

Then,  $\Pi$  is said to be a positive-negative multiplier if there exists  $\varepsilon_\Pi > 0$  such that  $\Pi_{11} \succeq \varepsilon_\Pi I_{n_q}$  and  $\Pi_{22} \preceq -\varepsilon_\Pi I_{n_p}$ . ┘

Let us note that, since (4.38) must be satisfied for every  $\Delta \in \mathbf{\Delta}$ , the fact that  $0 \in \mathbf{\Delta}$  implies that  $\Pi_{11} \succeq 0$ . This can be strengthened via the following lemma. For a proof, see [23].

**LEMMA 4.21**

If conditions (4.54) and (4.56) are satisfied, and  $\Delta_2$  is  $\mathcal{L}_2$ -gain stable, then both conditions are also satisfied when the multiplier  $\Pi$  is replaced by  $\bar{\Pi}$ , defined as

$$\bar{\Pi}(j\omega) := \begin{bmatrix} \Pi_{11}(j\omega) + \varepsilon_1 I_{n_q} & \Pi_{12}(j\omega) \\ \Pi_{12}(j\omega)^* & \Pi_{22}(j\omega) \end{bmatrix}, \quad (4.59)$$

with  $\varepsilon_1 = \varepsilon / (2 \|\Delta_2\|_2^2) > 0$ , where  $\varepsilon$  is the constant in (4.56). ┘

Lemma 4.21 shows that we can assume  $\Pi_{11}(j\omega) \succeq \varepsilon_{\Pi} I_{n_q}$  without loss of generality. Then, the only possible source of conservatism in restricting our attention to positive-negative multipliers comes from the constraint  $\Pi_{22}(j\omega) \preceq -\varepsilon_{\Pi} I_{n_p}$ . That being said, a rather large class of uncertainties may be represented by integral quadratic constraints defined by positive-negative multipliers. Namely, all multipliers presented in Table 4.1 fall into this category.

In order to establish that positive-negative multipliers admit a hard factorization, we shall use a special type of canonical factorization [154].

**DEFINITION 4.22 (J-spectral factorization)**

$(J, \Psi_J)$  is said to be a J-spectral factorization of  $\Pi \in \mathcal{RH}_{\infty}^{(n_q+n_p) \times (n_q+n_p)}$  if  $\Pi = \Psi_J^* J \Psi_J$ ,  $J = \text{diag}(I_{n_q}, -I_{n_p})$  and  $\Psi_J, \Psi_J^{-1} \in \mathcal{RH}_{\infty}^{(n_q+n_p) \times (n_q+n_p)}$ . ┘

For a discussion about canonical factorizations of integral quadratic constraints for robust stability, please refer to [65, 66]. The following lemma, adapted from [154, Lemma 4], provides a connection between positive-negative multipliers and J-spectral factorizations.

**LEMMA 4.23**

Let  $\Pi = \Pi^* \in \mathcal{RL}_{\infty}^{(n_q+n_p) \times (n_q+n_p)}$ . If  $\Pi$  is positive-negative, then  $\Pi$  admits a J-spectral factorization  $(J, \Psi_J)$ . ┘

Finally, the next lemma, taken from [23, Theorem 2], gives conditions under which a given factorization  $(M, \Psi)$  of a positive-negative multiplier is doubly-hard.

**LEMMA 4.24**

Given a positive-negative multiplier  $\Pi \in \mathcal{RL}_{\infty}^{(n_q+n_p) \times (n_q+n_p)}$ , the factorization  $(M, \Psi)$  is doubly-hard if  $\Psi, \Psi^{-1} \in \mathcal{RH}_{\infty}^{n_y \times (n_q+n_p)}$ . ┘

Lemma 4.23 states that positive-negative multipliers always admit a J-spectral factorization. This factorization is then shown to be doubly-hard through Lemma 4.24. Figure 4.9 summarizes this chain of implications. From these results, we see that it is possible to use the multipliers in Table 4.1 to define the IQCs in truncated time in condition (ii) from Theorems 4.14 and 4.15. All that is left to assess stability and performance is to verify whether or not condition (iii) in the aforementioned theorems is satisfied.

The approach presented in this section and in Section 4.4.5 is similar to the results presented in [22], namely Corollary V.8. Factorizations with a stable and inversely stable filter  $\Psi$  were used to propose a dissipativity-based proof of the classic IQC theorem by Megretski and Rantzer, see [154, 172]. The stable invertibility of  $\Psi$  allows us to uniquely connect the trajectories of the system  $\Psi \text{col}(G, \mathbb{I})$  and the signals being exchanged in the feedback interconnection  $(G, \Delta)$ . A generalization of the notions of soft/hard factorizations of multipliers is presented by Megretski in [110]. The author proposes conditions under which a factorization ensures that a related integral quadratic constraint is also valid in truncated time.

In this section, we have discussed how to use frequency-dependent multipliers to assess stability in the time domain. In the next section we shall see how to parametrize these multipliers in order to be able to compute them numerically via convex optimization.

$$\begin{aligned}
& \int_{-\infty}^{\infty} \begin{bmatrix} \hat{q}(j\omega) \\ \hat{p}(j\omega) \end{bmatrix}^* \Pi(j\omega) \begin{bmatrix} \hat{q}(j\omega) \\ \hat{p}(j\omega) \end{bmatrix} d\omega \geq 0 \\
& \quad \begin{array}{c} \Uparrow \text{Parseval's equality} \\ \Downarrow \text{soft factorization} \end{array} \\
& \int_0^{\infty} y(t)^\top M y(t) dt \geq 0, \quad \text{with } y = \Psi \left( \begin{bmatrix} q \\ p \end{bmatrix} \right) \\
& \quad \Downarrow \text{Positive-negative multiplier} \\
& \quad \quad \quad \text{(Lemma 4.23)} \\
& \int_0^{\infty} y(t)^\top J y(t) dt \geq 0, \quad \text{with } y = \Psi_J \left( \begin{bmatrix} q \\ p \end{bmatrix} \right) \\
& \quad \Downarrow \Psi_J, \Psi_J^{-1} \in \mathcal{RH}_{\infty}^{n_y \times (n_q + n_p)} \\
& \quad \quad \quad \text{(Lemma 4.24)} \\
& \int_0^T y(t)^\top J y(t) dt \geq 0, \quad \forall T \geq 0, \quad \text{with } y = \Psi_J \left( \begin{bmatrix} q \\ p \end{bmatrix} \right)
\end{aligned}$$

FIGURE 4.9 – Summary of the discussion on hard factorizations in Section 4.4.3.

#### 4.4.4 Multiplier parametrization

In the previous section, we have seen how to obtain a class of multipliers for every kind of uncertainty in the structured block  $\Delta \in \mathbf{\Delta}$ , and the results are catalogued in Table 4.1. In the case of time-invariant uncertainties  $\delta_I$  and  $\Delta_I$ , the multipliers presented in the first two rows of Table 4.1 are a subset of the functional space  $\mathcal{RH}_{\infty}^{(n_q+n_p) \times (n_q+n_p)}$ , which is of infinite dimension. Then, if we are to propose conditions to assess stability and performance based on numerical procedures using convex optimization, we have to use a certain parametrization of  $(M, \Psi)$  (and then also of  $\Pi$ ).

Let us denote by  $W$  a given operator in  $\mathcal{RH}_{\infty}^{k \times k}$ . We shall restrict  $W$  to belong to the set of proper rational transfer functions of order  $\ell$ . The fixed order will allow us to construct  $W$  using linear combinations of the elements of a basis of finite dimension. We shall also fix the denominator of  $W$  as the scalar function  $d(s) = s^\ell + d_{\ell-1}s^{\ell-1} + \dots + d_0$ , with roots in  $\mathbb{C}^-$ . Then,  $W$  can be represented as

$$W(j\omega) = \frac{N(j\omega)}{d(j\omega)^* d(j\omega)}, \quad (4.60)$$

where  $N : \mathbb{C} \rightarrow \mathbb{C}^{k \times k}$  is a matrix of  $\ell$ -th order polynomial functions with real coefficients. Let us fix a basis for  $N$  by defining the vector function  $B_\ell : \mathbb{C} \rightarrow \mathbb{C}^{\ell+1}$  as

$$B_\ell(s) = \begin{bmatrix} 1 \\ s \\ \vdots \\ s^\ell \end{bmatrix}. \quad (4.61)$$

Then,  $N$  can be parametrized as  $N(j\omega) = (B_\ell(j\omega) \otimes I_k)^* M (B_\ell(j\omega) \otimes I_k)$ , where  $M \in \mathbb{S}^{k(\ell+1)}$

is a coefficient matrix. Using this description,  $W$  can be represented as

$$\begin{aligned} W(j\omega) &= \left( \frac{B_\ell(j\omega)}{d(j\omega)} \otimes I_k \right)^* M \left( \frac{B_\ell(j\omega)}{d(j\omega)} \otimes I_k \right) \\ &=: \Psi_b(j\omega)^* M \Psi_b(j\omega), \end{aligned} \quad (4.62)$$

with  $\Psi_b$  the basis for  $W$ . The parametrization clearly depends on  $d$  and on the order  $\ell$  of the basis. Unfortunately, there is no direct method for defining any one of the two. Concerning the order, the standard procedure is to start at  $\ell = 0$  and augment it if needed. One possible way of choosing the pole locations of  $d(s)$  is to look at the Bode diagram of the system, and to choose poles near to the frequencies where the effect of the multiplier might be needed. This is an ad hoc solution, whose success depends on the expertise of the engineer performing the analysis. An alternative would be to consider a denominator given by  $d(s) = (s + \rho)^\ell$  and proceed to do a line-search for  $\rho > 0$  [174, Remark 5]. The choice proposed here for the basis  $\Psi_b$  is evidently not unique. Some other possibilities are suggested in [174].

The operator  $W$  represents the operators  $X_D$ ,  $X_G$  and  $x_D$ , presented in Table 4.1. All that is left is then to define a set  $\mathbf{M}$  such that every  $M \in \mathbf{M}$  yields an operator satisfying the constraints in Table 4.1. Let us again consider the case of a single parametric uncertainty to illustrate the approach. As we have seen in Section 4.4.3, this kind of uncertainty satisfies the IQC defined by the multiplier

$$\Pi(j\omega) = \begin{bmatrix} X_D(j\omega) & X_G(j\omega) \\ X_G(j\omega)^* & -X_D(j\omega) \end{bmatrix}, \quad (4.63)$$

with  $X_D = X_D^* \succ 0$  and  $X_G = -X_G^*$ . Using the parametrization defined above, we may write

$$\begin{aligned} X_D(j\omega) &= \left( \frac{B_\ell(j\omega)}{d(j\omega)} \otimes I_k \right)^* M_D \left( \frac{B_\ell(j\omega)}{d(j\omega)} \otimes I_k \right) \\ X_G(j\omega) &= \left( \frac{B_\ell(j\omega)}{d(j\omega)} \otimes I_k \right)^* M_G \left( \frac{B_\ell(j\omega)}{d(j\omega)} \otimes I_k \right). \end{aligned} \quad (4.64)$$

Let  $\mathbf{M}_D$  and  $\mathbf{M}_G$  be sets of matrices such that  $M_D \in \mathbf{M}_D$  ensures that  $X_D$  is Hermitian and positive-definite,  $M_G \in \mathbf{M}_G$  ensures that  $X_G$  is skew-Hermitian. The structural constraints  $X_D = X_D^*$  and  $X_G = -X_G^*$  can be ensured without loss of generality by a parametrization of the matrices  $M_D$  and  $M_G$  [153]. Let us define the matrix  $Y \in \mathbb{R}^{k(\ell+1) \times k(\ell+1)}$  given by

$$Y := \begin{bmatrix} D_0 + L_0 + U_0 & \frac{1}{2}D_1 + U_1 & \cdots & \cdots & \frac{1}{2}D_\ell + U_\ell \\ -\frac{1}{2}D_1 - L_1 & 0 & \cdots & 0 & \frac{1}{2}D_{\ell+1} + U_{\ell+1} \\ \vdots & \vdots & \ddots & \vdots & \vdots \\ (-1)^{\ell-1} \left( \frac{1}{2}D_{\ell-1} + L_{\ell-1} \right) & 0 & \cdots & 0 & \frac{1}{2}D_{2\ell-1} + U_{2\ell-1} \\ (-1)^\ell \left( \frac{1}{2}D_\ell + L_\ell \right) & (-1)^{\ell+1} \left( \frac{1}{2}D_{\ell+1} + L_{\ell+1} \right) & \cdots & \cdots & D_{2\ell} + L_{2\ell} + U_{2\ell} \end{bmatrix}, \quad (4.65)$$

where  $D_i$  are diagonal matrices,  $U_i$  are upper triangular matrices and  $L_i$  are lower triangular matrices in  $\mathbb{R}^{k \times k}$ , for  $i \in \{0, \dots, 2\ell\}$ . Then, if  $M_D = Y$ , with  $D_{2i-1} = 0$ ,  $L_{2i-1} = -U_{2i-1}^\top$  and  $L_{2i} = U_{2i}^\top$ , for all  $i \in \{1, \dots, \ell\}$ , we have that  $X_D$  defined in (4.64) is Hermitian. On the other hand, if  $M_G = Y$ , with  $D_{2i} = 0$ ,  $L_{2i} = -U_{2i}^\top$  and  $L_{2i-1} = U_{2i-1}^\top$ , for all  $i \in \{1, \dots, \ell\}$ , we have that  $X_G$  defined in (4.64) is skew-Hermitian.

It remains to ensure that  $X_D$  is a positive-definite operator. For this, we shall make use of a key result in control theory: the Kalman-Yakubovich-Popov lemma (or KYP lemma, for short). The KYP lemma concerns the equivalence between a frequency domain criterion and a related linear matrix inequality. The following version of the KYP lemma is taken from [132].

LEMMA 4.25

Given  $A \in \mathbb{R}^{n \times n}$ ,  $B \in \mathbb{R}^{n \times m}$ ,  $Q \in \mathbb{S}^{n+m}$ , with  $\det(j\omega I - A) \neq 0$  for  $\omega \in \overline{\mathbb{R}}$ , the following two statements are equivalent:

(i) The following Frequency Domain Inequality (FDI) is satisfied

$$\begin{bmatrix} (j\omega I - A)^{-1}B \\ I \end{bmatrix}^* Q \begin{bmatrix} (j\omega I - A)^{-1}B \\ I \end{bmatrix} \prec 0, \quad \forall \omega \in \overline{\mathbb{R}}. \quad (4.66)$$

(ii) There exists a symmetric matrix  $P \in \mathbb{S}^n$  such that the following LMI is satisfied

$$\begin{bmatrix} A^\top P + PA & PB \\ B^\top P & 0 \end{bmatrix} + Q \prec 0. \quad (4.67)$$

The corresponding equivalence persists to hold for non-strict inequalities if, in addition,  $(A, B)$  is controllable.  $\lrcorner$

The KYP lemma is a fundamental result that links an infinite-dimensional constraint in the frequency domain with a corresponding linear matrix inequality. Important in numerous applications, it is yet another result stemming from the study of absolute stability in the sixties [69, 132].

Let  $(B_\ell(s)/d(s) \otimes I_k)$  admit the minimal state space representation given by  $(A, B, C, D)$ . The constraint  $X_D \succ 0$  may then be rewritten as

$$(C(j\omega - A)^{-1}B + D)^*(-M_D)(C(j\omega - A)^{-1}B + D) \prec 0, \quad \forall \omega \in \overline{\mathbb{R}}. \quad (4.68)$$

Using the KYP lemma, the above constraint is equivalent to the existence of  $P = P^\top$  such that

$$\begin{bmatrix} A^\top P + PA & B^\top P \\ \bullet & 0 \end{bmatrix} - \begin{bmatrix} C & D \end{bmatrix}^\top M_D \begin{bmatrix} C & D \end{bmatrix} \prec 0 \quad (4.69)$$

Using this, we may define  $\mathbf{M}_D$  as the set

$$\mathbf{M}_D := \left\{ M_D \in \mathbb{S}^{n_q(\ell+1)} \left| \begin{array}{l} \exists P = P^\top \text{ s.t. (4.69), with } M_D = Y \text{ as defined} \\ \text{in (4.65), with } D_{2i-1} = 0, L_{2i-1} = -U_{2i-1}^\top \\ \text{and } L_{2i} = U_{2i}^\top, \text{ for all } i \in \{1, \dots, \ell\} \end{array} \right. \right\}. \quad (4.70)$$

From the discussion above, we may also define the set  $\mathbf{M}_G$  as

$$\mathbf{M}_G := \left\{ M_G \in \mathbb{R}^{n_q(\ell+1) \times n_q(\ell+1)} \left| \begin{array}{l} M_G = Y \text{ as defined in (4.65), with } D_{2i} = 0, L_{2i} = -U_{2i}^\top \\ \text{and } L_{2i-1} = U_{2i-1}^\top, \text{ for all } i \in \{1, \dots, \ell\} \end{array} \right. \right\}. \quad (4.71)$$

After this discussion, it becomes clear why the denominator  $d(s)$  is chosen a priori and fixed. Indeed, it is well-known that the denominator  $d(s)$  is given by  $\det(sI_n - A)$ . Then, to

have  $d$  as a variable in the optimization problem would mean to consider the dynamic matrix  $A$  as variable. Looking at inequality (4.69), we see that this would lead to a bilinear matrix inequality, which is a nonlinear and non-convex constraint.

The multiplier  $\Pi$  for parametric uncertainties may then be parametrized as  $\Pi \in \mathbf{\Pi}$ , where

$$\mathbf{\Pi} := \{\Pi \in \mathcal{RL}_{\infty}^{2n_q \times 2n_q} \mid \Pi = \Psi_b^* M \Psi_b, M \in \mathbf{M}\}, \quad (4.72)$$

where  $\Psi_b \in \mathcal{RH}_{\infty}^{2n_q(\ell+1) \times (n_q+n_p)}$  is given by

$$\Psi_b(j\omega) := \text{diag} \left( \left( \frac{B_{\ell}(j\omega)}{d(j\omega)} \otimes I_{n_q} \right), \left( \frac{B_{\ell}(j\omega)}{d(j\omega)} \otimes I_{n_q} \right) \right), \quad (4.73)$$

and

$$\mathbf{M} := \left\{ M \in \mathbb{S}^{2n_q(\ell+1)} \mid M = \begin{bmatrix} M_D & M_G \\ \bullet & -M_D \end{bmatrix}, M_D \in \mathbf{M}_D, M_G \in \mathbf{M}_G \right\}. \quad (4.74)$$

Following the same reasoning, the class of multipliers for uncertain LTI dynamics (second row in Table 4.1) can also be defined as in (4.72), where  $\Psi_b \in \mathcal{RH}_{\infty}^{(n_q+n_p)(\ell+1) \times (n_q+n_p)}$  is given by

$$\Psi_b(j\omega) := \text{diag} \left( \left( \frac{B_{\ell}(j\omega)}{d(j\omega)} \otimes I_{n_q} \right), \left( \frac{B_{\ell}(j\omega)}{d(j\omega)} \otimes I_{n_p} \right) \right), \quad (4.75)$$

and

$$\mathbf{M} := \left\{ M \in \mathbb{S}^{(n_q+n_p)(\ell+1)} \mid M = \begin{bmatrix} m_D \otimes I_{n_q} & 0 \\ \bullet & -m_D \otimes I_{n_p} \end{bmatrix}, m_D \in \mathbf{m}_D \right\}, \quad (4.76)$$

with

$$\mathbf{m}_D := \left\{ m_D \in \mathbb{S}^{\ell+1} \mid \exists P = P^{\top} \text{ s.t. } \begin{bmatrix} A^{\top}P + PA & B^{\top}P \\ \bullet & 0 \end{bmatrix} - [C \ D]^{\top} m_D [C \ D] \prec 0 \right\}, \quad (4.77)$$

where  $(A, B, C, D)$  is a minimal state space representation of  $B_{\ell}(s)/d(s)$ .

We may update Table 4.1 with respect to the parametrization introduced in this section. This is done in Table 4.2, where the different classes  $\mathbf{\Pi}$  are defined.

#### 4.4.5 Dissipativity approach

In Sections 4.4.3 and 4.4.4, we have discussed how to construct and parametrize multipliers  $\Pi$  for some classes of uncertainties. These multipliers are used in Theorems 4.14 and 4.15 to establish a separation of the graphs of the uncertain block  $\Delta$  and the system  $G$ . With the results in Section 4.4.3, we have a catalog of multipliers that define valid IQCs for the desired class of uncertainties. This means that, using the multipliers in Table 4.1, we ensure that the uncertainty satisfies the corresponding IQC. Then, all that is left to conclude on the stability and performance of the uncertain system is to verify whether the complementary IQC is satisfied by the system  $G$ . As we have hinted before, since we are dealing with nonlinear systems  $G$ , the proposed approach to verify this is by means of dissipativity theory, introduced in Chapter 2.



TABLE 4.2 – Catalog of parametrizations for the multipliers in Table 4.1

Uncertainty $\Delta$	Parametrization $\Psi_b^* M \Psi_b$
Constant real repeated scalar $p(t) = \delta_I q(t)$ , $ \delta_I  \leq 1$	$\Psi_b$ defined in (4.73) $M \in \mathbf{M}$ , with $\mathbf{M}$ defined in (4.74)
LTI dynamic uncertainties $\hat{p}(j\omega) = \Delta_I(j\omega)\hat{q}(j\omega)$ , $\ \Delta_I\ _2 \leq 1$	$\Psi_b$ defined in (4.75) $M \in \mathbf{M}$ , with $\mathbf{M}$ defined in (4.76)
Time-varying real repeated scalar $p(t) = \delta_V(t)q(t)$ , $ \delta_V(t)  \leq 1, \forall t \geq 0$	$\Psi_b = I_{2n_q}$ $M = \begin{bmatrix} X_D & X_G \\ X_G^* & -X_D \end{bmatrix}$ , with $\begin{cases} X_D = X_D^T \succ 0 \\ X_G = -X_G^T \end{cases}$
General dynamic uncertainties $p = \Delta_V(q)$ , $\ \Delta_V\ _2 \leq 1$	$\Psi_b = I_{n_q+n_p}$ $M = \begin{bmatrix} x_D I_{n_q} & 0 \\ 0 & -x_D I_{n_p} \end{bmatrix}$ , with $x_D > 0$
Memoryless nonlinearity in the sector $\text{Sect}(\kappa_1, \kappa_2)$ , with $\kappa_1 \leq 0 \leq \kappa_2$ $p = -\varphi(q)$ , $\kappa_1 \leq \varphi(q)/q \leq \kappa_2$	$\Psi_b = I_{n_q+n_p}$ $M = \begin{bmatrix} -2\kappa_1\kappa_2 & -(\kappa_1 + \kappa_2) \\ -(\kappa_1 + \kappa_2) & -2 \end{bmatrix}$

Let us note that (4.27) can be rewritten as

$$\begin{aligned}
-\int_0^T y_G(t)^\top M y_G(t) dt - \varepsilon \|p\|_{2,T}^2 &= -\int_0^T \left( y_G(t)^\top M y_G(t) + \varepsilon |p(t)|^2 \right) dt \\
&= -\int_0^T \begin{bmatrix} y_G(t) \\ p(t) \end{bmatrix}^\top \begin{bmatrix} M & 0 \\ 0 & \varepsilon I_{n_p} \end{bmatrix} \begin{bmatrix} y_G(t) \\ p(t) \end{bmatrix} dt \\
&= \int_0^T \varpi(p(t), y_G(t)) dt \geq 0, \quad \forall p \in \mathcal{L}_{2e}^{n_p}(\mathbb{R}_+), \forall T \geq 0,
\end{aligned} \tag{4.78}$$

with

$$\varpi(p, y_G) := - \begin{bmatrix} y_G \\ p \end{bmatrix}^\top \begin{bmatrix} M & 0 \\ 0 & \varepsilon I_{n_p} \end{bmatrix} \begin{bmatrix} y_G \\ p \end{bmatrix}, \tag{4.79}$$

and where  $y_G = \Psi \begin{bmatrix} G \\ \mathbb{I} \end{bmatrix} (p)$ .

Let us recall that Theorem 2.18 provided a connection between an integral inequality concerning the input and output signals of an operator and dissipativity. Then, considering the integral relation (4.78), we use this result to propose the following corollary.

#### COROLLARY 4.26

Let  $G : \mathcal{L}_{2e}^{n_p}(\mathbb{R}_+) \rightarrow \mathcal{L}_{2e}^{n_q}(\mathbb{R}_+)$  be a causal and  $\mathcal{L}_2$ -gain stable system, and let  $\Delta$  be the set of uncertainties defined in Definition 4.1. Let  $\Pi \in \mathcal{R}\mathcal{L}_{\infty}^{(n_q+n_p) \times (n_q+n_p)}$  be a multiplier factorized as  $\Pi = \Psi_b^* M \Psi_b$ , with  $\Psi_b \in \mathcal{R}\mathcal{H}_{\infty}^{n_y \times (n_q+n_p)}$ , and  $M \in \mathbf{M}$ , as defined in Table 4.2. Assume that:

(i) The feedback interconnection  $(G, \Delta)$  is well-posed for all  $\Delta \in \mathbf{\Delta}$ .

(ii) The filtered system  $\Psi_b \begin{bmatrix} G \\ \mathbb{I} \end{bmatrix}$  is dissipative with respect to the supply rate  $\varpi$  defined in (4.79).

Then, the feedback interconnection  $(G, \Delta)$  is robustly stable with respect to  $\mathbf{\Delta}$ .  $\lrcorner$

#### PROOF

Condition (ii) ensures that

$$\int_0^T \begin{bmatrix} y_G(t) \\ p(t) \end{bmatrix}^\top \begin{bmatrix} M & 0 \\ 0 & \varepsilon I_{n_p} \end{bmatrix} \begin{bmatrix} y_G(t) \\ p(t) \end{bmatrix} dt \leq 0, \quad \forall T \geq 0, \forall p \in \mathcal{L}_{2\varepsilon}^{n_p}(\mathbb{R}_+), \quad (4.80)$$

where  $y_G = \Psi_b \begin{bmatrix} G \\ \mathbb{I} \end{bmatrix} (p)$ . Let  $p$  be in  $\mathcal{L}_2^{n_p}(\mathbb{R}_+)$ . Since  $\Psi_b \begin{bmatrix} G \\ \mathbb{I} \end{bmatrix}$  is bounded,  $y_G \in \mathcal{L}_2^{n_y}(\mathbb{R}_+)$ . We may then take the limit when  $T \rightarrow \infty$ , and use Parseval's equality to write

$$\int_{-\infty}^{\infty} \begin{bmatrix} \hat{q}(j\omega) \\ \hat{p}(j\omega) \end{bmatrix}^* \Pi(j\omega) \begin{bmatrix} \hat{q}(j\omega) \\ \hat{p}(j\omega) \end{bmatrix} dt \leq -\varepsilon \|p\|_2^2, \quad \forall p \in \mathcal{L}_2^{n_p}(\mathbb{R}_+), q = G(p). \quad (4.81)$$

By taking  $\Pi$  from the parametrizations in Table 4.2, we ensure that  $\Pi$  is a positive-negative multiplier and such that the IQC defined by  $\Pi$  is satisfied by every  $\Delta \in \mathbf{\Delta}$ . Then, Lemmas 4.23 and 4.24 ensure that  $\Pi$  admits a doubly-hard factorization. Together with (4.81) and assumption (i), this ensures that the conditions in Theorem 4.14 are satisfied. The proof is thus concluded.  $\blacksquare$

It is interesting to note that, by choosing an adequate multiplier in Table 4.1 (with the respective parametrization in Table 4.2), we ensure a priori that the IQC defined by  $\Pi$  is satisfied by every  $\Delta \in \mathbf{\Delta}$ . It also ensures that  $\Pi$  is a positive-negative multiplier, which is important when going from the frequency into the time domain. Additionally, well-posedness is a basic requirement when the uncertain system is supposed to represent a real physical system, and is thus naturally assumed to be true. Then, to use Corollary 4.26, all that remains is to assess dissipativity of the filtered system  $\Psi \text{col}(G, \mathbb{I})$ .

The exact same reasoning can be applied to robust performance assessment via Theorem 4.15. Let us note that (4.34) can be rewritten as

$$\begin{aligned} & - \int_0^T y_G(t)^\top \begin{bmatrix} M & 0 \\ 0 & M_p \end{bmatrix} y_G(t) dt - \varepsilon \left\| \begin{bmatrix} p \\ w \end{bmatrix} \right\|_{2,T}^2 \\ & = - \int_0^T \left( y_G(t)^\top \begin{bmatrix} M & 0 \\ 0 & M_p \end{bmatrix} y_G(t) + \varepsilon \left\| \begin{bmatrix} p(t) \\ w(t) \end{bmatrix} \right\|^2 \right) dt \\ & = - \int_0^T \begin{bmatrix} y_G(t) \\ p(t) \\ w(t) \end{bmatrix}^\top \begin{bmatrix} M & 0 & 0 \\ 0 & M_p & 0 \\ 0 & 0 & \varepsilon I_{n_p+n_w} \end{bmatrix} \begin{bmatrix} y_G(t) \\ p(t) \\ w(t) \end{bmatrix} dt \\ & = \int_0^T \varpi(p(t), w(t), y_G(t)) dt \geq 0 \end{aligned} \quad (4.82)$$

for every  $T \geq 0$ , every  $p \in \mathcal{L}_{2e}^{n_p}(\mathbb{R}_+)$  and every  $w \in \mathcal{L}_{2e}^{n_w}(\mathbb{R}_+)$ , with

$$\varpi(p, w, y_G) := - \begin{bmatrix} y_G \\ p \\ w \end{bmatrix}^\top \left[ \begin{array}{cc|c} M & 0 & 0 \\ 0 & M_p & 0 \\ \hline 0 & 0 & \varepsilon I_{n_p+n_w} \end{array} \right] \begin{bmatrix} y_G \\ p \\ w \end{bmatrix}, \quad (4.83)$$

and where  $y_G = \text{diag}(\Psi, I_{n_z+n_w})\Upsilon(p, w)$ , with  $\Upsilon$  defined in (4.32).

Using again dissipativity through Theorem 2.18, let us state the following corollary to Theorem 4.15.

#### COROLLARY 4.27

Let  $G_{\text{perf}} : \mathcal{L}_{2e}^{n_p}(\mathbb{R}_+) \times \mathcal{L}_{2e}^{n_w}(\mathbb{R}_+) \rightarrow \mathcal{L}_{2e}^{n_q}(\mathbb{R}_+) \times \mathcal{L}_{2e}^{n_z}(\mathbb{R}_+)$  be a causal and  $\mathcal{L}_2$ -gain stable system, and let  $\Delta$  be the set of uncertainties defined in Definition 4.1. Let  $\Pi \in \mathcal{RL}_\infty^{(n_q+n_p) \times (n_q+n_p)}$  be a multiplier factorized as  $\Pi = \Psi_b^* M \Psi_b$ , with  $\Psi_b \in \mathcal{RH}_\infty^{n_y \times (n_q+n_p)}$ , and  $M \in \mathbf{M}$ , as defined in Table 4.2, and let  $M_p \in \mathbb{S}^{n_z+n_w}$  be the matrix defined in (4.30). Finally, let  $\Upsilon$  be the map defined in (4.32). Assume that:

- (i) the feedback interconnection of  $G_{\text{perf}}$  and  $\Delta$  is well-posed for all  $\Delta \in \Delta$ ;
- (ii) the filtered system  $\text{diag}(\Psi_b, I_{n_z+n_w})\Upsilon$ , is dissipative with respect to the supply rate  $\varpi$  defined in (4.83).

Then, the feedback interconnection of  $(G_{\text{perf}}, \Delta)$  is robustly  $\mathcal{L}_2$ -gain stable with respect to  $\Delta$ , with an  $\mathcal{L}_2$ -gain less than or equal to  $\gamma$ .  $\square$

#### PROOF

Condition (ii) ensures that

$$\int_0^T \begin{bmatrix} y_G(t) \\ p(t) \\ w(t) \end{bmatrix}^\top \left[ \begin{array}{cc|c} M & 0 & 0 \\ 0 & M_p & 0 \\ \hline 0 & 0 & \varepsilon I_{n_p+n_w} \end{array} \right] \begin{bmatrix} y_G(t) \\ p(t) \\ w(t) \end{bmatrix} dt \leq 0, \quad \forall T \geq 0, \forall p \in \mathcal{L}_{2e}^{n_p}(\mathbb{R}_+), \quad (4.84)$$

$$\forall w \in \mathcal{L}_{2e}^{n_w}(\mathbb{R}_+),$$

where  $y_G = \text{diag}(\Psi_b, I_{n_z+n_w})\Upsilon(p, w)$ . Let  $p$  be in  $\mathcal{L}_2^{n_p}(\mathbb{R}_+)$  and  $w \in \mathcal{L}_2^{n_w}(\mathbb{R}_+)$ . Since  $\text{diag}(\Psi_b, I_{n_z+n_w})\Upsilon$  is bounded,  $y_G \in \mathcal{L}_2^{n_y+n_z+n_w}(\mathbb{R}_+)$ . We may then take the limit when  $T \rightarrow \infty$ , and use Parseval's equality to write

$$\int_{-\infty}^{\infty} \begin{bmatrix} \hat{q}(j\omega) \\ \hat{p}(j\omega) \\ \hat{z}(j\omega) \\ \hat{w}(j\omega) \end{bmatrix}^* \left[ \begin{array}{cc|c} \Pi(j\omega) & 0 & \\ \hline 0 & M_p & \end{array} \right] \begin{bmatrix} \hat{q}(j\omega) \\ \hat{p}(j\omega) \\ \hat{z}(j\omega) \\ \hat{w}(j\omega) \end{bmatrix} dt \leq -\varepsilon \left\| \begin{bmatrix} p \\ w \end{bmatrix} \right\|_2^2, \quad \forall p \in \mathcal{L}_2^{n_p}(\mathbb{R}_+), \forall w \in \mathcal{L}_2^{n_w}(\mathbb{R}_+), \quad (4.85)$$

$$(q, z) = G_{\text{perf}}(p, w)$$

By taking  $\Pi$  from the parametrizations in Table 4.2, we ensure that  $\Pi$  is a positive-negative multiplier and such that the IQC defined by  $\Pi$  is satisfied by every  $\Delta \in \Delta$ . Then, Lemmas 4.23 and 4.24 ensure that  $\Pi$  admits a doubly-hard factorization. Together with (4.85) and assumption (i), this ensures that the conditions in Theorem 4.15 are satisfied. The proof is thus concluded.  $\blacksquare$

Corollaries 4.26 and 4.27 are the culmination of the results introduced in Chapter 2 and in the previous sections of the present chapter. They bring together the graph separation theory approach, the factorization techniques for constructing and parametrizing the multipliers  $(M, \Psi)$  as well as the dissipativity theory used to verify whether or not the conditions may be satisfied. They provide us with all the foundation we need to be able to propose analysis techniques for robust stability and performance assessment of uncertain piecewise-affine systems.

#### 4.4.6 Application to piecewise-affine systems

In this section, we consider the application of Corollaries 4.26 and 4.27 to the analysis of uncertain piecewise-affine systems. We shall again provide sufficient conditions for stability and performance assessment, in the same vein as the results proposed in Chapter 2. Namely, we propose convex optimization problems based on linear matrix inequalities allowing the construction of piecewise-quadratic storage functions. These conditions can be tested via semi-definite programming very efficiently, as we will illustrate in Section 4.6.

##### Robust stability

Let us begin by considering the problem of robust stability of uncertain piecewise-affine systems. The nominal system  $G$  will then be taken to be the piecewise-affine system  $G_{\text{PWA}}$ , given by:

$$q = G_{\text{PWA}}(p) \begin{cases} \dot{x}_G(t) = A_i x_G(t) + a_i + B_{p,i} p(t) \\ q(t) = C_{q,i} x_G(t) + c_{q,i} + D_{qp} p(t) \\ x_G(0) = 0 \end{cases} \quad \text{for } x_G(t) \in X_i \quad (4.86)$$

with  $x_G(t) \in \mathbb{R}^n$ ,  $p(t) \in \mathbb{R}^{n_p}$  and  $q(t) \in \mathbb{R}^{n_q}$ .

Our goal is to establish dissipativity of the filtered system  $\Psi \text{col}(G_{\text{PWA}}, \mathbb{I})$ . We recall that the filter  $\Psi$  has the minimal state space representation (4.48). The filtered system can then be written as the following piecewise-affine system:

$$y_G = \left( \Psi \begin{bmatrix} G_{\text{PWA}} \\ \mathbb{I} \end{bmatrix} \right) (p) \begin{cases} \dot{x}(t) = \hat{A}_i x(t) + \hat{a}_i + \hat{B}_i p(t) \\ y_G(t) = \hat{C}_i x(t) + \hat{c}_i + \hat{D} p(t) \\ x(0) = 0 \end{cases} \quad \text{for } x(t) \in \hat{X}_i \quad (4.87)$$

where  $x = \text{col}(x_G, \psi)$  and

$$\begin{aligned} \hat{A}_i &= \begin{bmatrix} A_i & 0 \\ B_{\psi q} C_{q,i} & A_\psi \end{bmatrix} & \hat{a}_i &= \begin{bmatrix} a_i \\ B_{\psi q} c_{q,i} \end{bmatrix} & \hat{B}_i &= \begin{bmatrix} B_{p,i} \\ B_{\psi p} + B_{\psi q} D_{qp} \end{bmatrix} \\ \hat{C}_i &= \begin{bmatrix} D_{\psi q} C_{q,i} & C_\psi \end{bmatrix} & \hat{c}_i &= D_{\psi q} c_{q,i} & \hat{D} &= D_{\psi p} + D_{\psi q} D_{qp}. \end{aligned} \quad (4.88)$$

Let us recall that the regions  $X_i$ , for  $i \in \mathcal{I} := \{1, \dots, N\}$ , are closed convex polyhedral sets defined by

$$X_i = \{x_G \in X \mid G_i x_G + g_i \succeq 0\} \quad (4.89)$$

with non-empty and pairwise disjoint interiors such that  $\bigcup_{i \in \mathcal{I}} X_i = X$ . From the geometry of  $X_i$ , the intersection  $X_i \cap X_j$  between two different regions is always contained in a hyperplane. We again denote by  $E_{ij}^\top \in \mathbb{R}^n$  and  $e_{ij} \in \mathbb{R}$  the vectors and scalars such that

$$X_i \cap X_j \subseteq \{x_G \in X \mid E_{ij}x_G + e_{ij} = 0\}. \quad (4.90)$$

Let us denote by  $\hat{X} = X \times \mathbb{R}^\ell$  the state space of the filtered system. The partition  $\{\hat{X}_i\}_{i=1, \dots, N}$  is induced by the original partition of  $X$ . Hence, we can define  $\hat{X}_i := \{x \in \hat{X} \mid x = \text{col}(x_G, \psi), x_G \in X_i\}$ . By defining the matrices

$$\hat{G}_i = \begin{bmatrix} G_i & 0 \end{bmatrix} \quad \hat{g}_i = g_i, \quad (4.91)$$

the region  $\hat{X}_i$  can be equivalently defined as

$$\hat{X}_i = \{x \in \hat{X} \mid \hat{G}_i x + \hat{g}_i \succeq 0\} \quad (4.92)$$

Likewise, the intersection between any two regions  $\hat{X}_i$  and  $\hat{X}_j$  is contained in the hyperplane given by

$$\hat{X}_i \cap \hat{X}_j \subseteq \left\{x \in \hat{X} \mid \hat{E}_{ij}x + \hat{e}_{ij} = 0\right\}, \quad (4.93)$$

where the matrix  $\hat{E}_{ij}$  and the scalar  $\hat{e}_{ij}$  are given by

$$\hat{E}_{ij} = \begin{bmatrix} E_{ij} & 0 \end{bmatrix} \quad \hat{e}_{ij} = e_{ij}. \quad (4.94)$$

As we have done in Chapter 2, we use Algorithm 2.36 to construct the cell boundings  $\hat{E}_i$  and  $\hat{e}_i$  from the cell identifiers  $\hat{G}_i$  and  $\hat{g}_i$ .

We aim to assess dissipativity of the filtered system by constructing a piecewise-quadratic storage function given by

$$S(x) = \begin{cases} x^\top P_i x & \text{for } x \in \hat{X}_i, i \in \mathcal{I}_0 \\ \begin{bmatrix} x \\ 1 \end{bmatrix}^\top \begin{bmatrix} P_i & q_i \\ \bullet & r_i \end{bmatrix} \begin{bmatrix} x \\ 1 \end{bmatrix} & \text{for } x \in \hat{X}_i, i \in \mathcal{I} \setminus \mathcal{I}_0 \end{cases} \quad (4.95)$$

Based on the piecewise-affine representation of the filtered system presented above, we propose the following theorem that specializes Corollary 4.26 to the case of piecewise-affine systems with piecewise-quadratic storage functions.

#### THEOREM 4.28

Let  $\Pi \in \mathcal{R}\mathcal{L}_\infty^{(n_q+n_p) \times (n_q+n_p)}$  be a multiplier factorized as  $\Pi = \Psi_b^* M \Psi_b$ , with the basis  $\Psi_b \in \mathcal{R}\mathcal{H}_\infty^{n_y \times (n_q+n_p)}$  and  $M \in \mathbf{M}$  as defined in Table 4.2. Let the filtered PWA system  $\Psi_b \text{col}(G_{\text{PWA}}, \mathbb{I})$  be defined as in (4.87)–(4.88). Suppose that the interconnection  $(G_{\text{PWA}}, \Delta)$  is well-posed for every  $\Delta \in \mathbf{\Delta}$ . If there exist symmetric matrices  $P_i \in \mathbb{S}^n$ , vectors  $q_i \in \mathbb{R}^n$ , scalars  $r_i \in \mathbb{R}$ , symmetric matrices  $U_i, W_i \in \mathbb{S}^{l_i}$  with nonnegative coefficients and zero diagonal, and vectors  $L_{ijkl} \in \mathbb{R}^{n+1}$  such that

$$\begin{cases} P_i \succeq 0 \\ \begin{bmatrix} \hat{A}_i^\top P_i + P_i \hat{A}_i & P_i \hat{B}_i \\ \hat{B}_i^\top P_i & 0 \end{bmatrix} + \begin{bmatrix} \hat{C}_i & \hat{D} \\ 0 & I_{n_p} \end{bmatrix}^\top \begin{bmatrix} M & 0 \\ 0 & \varepsilon I_{n_p} \end{bmatrix} \begin{bmatrix} \hat{C}_i & \hat{D} \\ 0 & I_{n_p} \end{bmatrix} \preceq 0 \end{cases} \quad \text{for } i \in \mathcal{I}_0 \quad (4.96)$$

$$\left\{ \begin{array}{l} \left[ \begin{array}{cc} P_i - \hat{E}_i^\top U_i \hat{E}_i & q_i - \hat{E}_i^\top U_i \hat{e}_i \\ \bullet & r_i - \hat{e}_i^\top U_i \hat{e}_i \end{array} \right] \succeq 0 \\ \left[ \begin{array}{cc} \left( \begin{array}{c} \hat{A}_i^\top P_i + P_i \hat{A}_i + \\ \hat{E}_i^\top W_i \hat{E}_i \end{array} \right) & \left( \begin{array}{c} P_i \hat{a}_i + \hat{A}_i^\top q_i + \\ \hat{E}_i^\top W_i \hat{e}_i \\ (2q_i^\top \hat{a}_i + \\ + \hat{e}_i^\top W_i \hat{e}_i) \end{array} \right) & P_i \hat{B}_i \\ \bullet & 0 \\ \bullet & 0 \end{array} \right] + \\ + \left[ \begin{array}{ccc} \hat{C}_i & \hat{c}_i & \hat{D} \\ 0 & 0 & I_{n_p} \end{array} \right]^\top \left[ \begin{array}{cc} M & 0 \\ 0 & \varepsilon I_{n_p} \end{array} \right] \left[ \begin{array}{ccc} \hat{C}_i & \hat{c}_i & \hat{D} \\ 0 & 0 & I_{n_p} \end{array} \right] \preceq 0 \end{array} \right. \quad \text{for } i \in \mathcal{I} \setminus \mathcal{I}_0 \quad (4.97)$$

$$\left[ \begin{array}{cc} P_i & q_i \\ \bullet & r_i \end{array} \right] = \left[ \begin{array}{cc} P_j & q_j \\ \bullet & r_j \end{array} \right] + L_{ij} \left[ \begin{array}{cc} \hat{E}_{ij} & \hat{e}_{ij} \end{array} \right] + \left[ \begin{array}{cc} \hat{E}_{ij} & \hat{e}_{ij} \end{array} \right]^\top L_{ij}^\top \quad \text{for } (i, j) \quad (4.98)$$

s.t.  $X_i \cap X_j \neq \emptyset$

where we define  $q_i = 0$  and  $r_i = 0$  for  $i \in \mathcal{I}_0$ . Then, the uncertain PWA system (4.1) is robustly stable with respect to  $\Delta$ .  $\square$

PROOF

We shall prove that the conditions in Theorem 4.28 allow us to construct a continuous piecewise-quadratic storage function having the structure (4.95) so that the filtered system (4.87) is dissipative with respect to the supply rate (4.79). Then, all the conditions in Corollary 4.26 are satisfied, and we conclude that the uncertain PWA system (4.1) is robustly stable with respect to  $\Delta$ .

The proofs of continuity and nonnegativity of  $S$  follow in the same lines as the proofs in Chapter 2, and are thus omitted. We focus then on establishing the dissipation inequality. *Dissipation inequality* - Let us show that the storage function  $S$  respects a dissipation inequality given by the supply rate (4.79). The last inequality in (4.97), post and pre multiplied by  $\text{col}(x, 1, p)^\top$  and  $\text{col}(x, 1, p)$ , implies that

$$\begin{aligned} & \left[ \begin{array}{c} x \\ 1 \end{array} \right]^\top \left[ \begin{array}{cc} P_i & q_i \\ \bullet & r_i \end{array} \right] \left[ \begin{array}{c} (\hat{A}_i x + \hat{a}_i + \hat{B}_i p) \\ 0 \end{array} \right] + \left[ \begin{array}{c} (\hat{A}_i x + \hat{a}_i + \hat{B}_i p) \\ 0 \end{array} \right]^\top \left[ \begin{array}{cc} P_i & q_i \\ \bullet & r_i \end{array} \right] \left[ \begin{array}{c} x \\ 1 \end{array} \right] + \\ & \left[ \begin{array}{c} (\hat{C}_i x + \hat{c}_i + \hat{D} p) \\ p \end{array} \right]^\top \left[ \begin{array}{cc} M & 0 \\ 0 & \varepsilon I_{n_p} \end{array} \right] \left[ \begin{array}{c} (\hat{C}_i x + \hat{c}_i + \hat{D} p) \\ p \end{array} \right] \leq -(\hat{E}_i x + \hat{e}_i)^\top W_i (\hat{E}_i x + \hat{e}_i). \end{aligned} \quad (4.99)$$

Since  $W_i$  is composed of nonnegative coefficients, the right-hand side of the previous inequality is nonpositive whenever  $x \in X_i$ . This implies that

$$\begin{aligned} & \left[ \begin{array}{c} x \\ 1 \end{array} \right]^\top \left[ \begin{array}{cc} P_i & q_i \\ \bullet & r_i \end{array} \right] \left[ \begin{array}{c} (\hat{A}_i x + \hat{a}_i + \hat{B}_i p) \\ 0 \end{array} \right] + \left[ \begin{array}{c} (\hat{A}_i x + \hat{a}_i + \hat{B}_i p) \\ 0 \end{array} \right]^\top \left[ \begin{array}{cc} P_i & q_i \\ \bullet & r_i \end{array} \right] \left[ \begin{array}{c} x \\ 1 \end{array} \right] + \\ & \left[ \begin{array}{c} (\hat{C}_i x + \hat{c}_i + \hat{D} p) \\ p \end{array} \right]^\top \left[ \begin{array}{cc} M & 0 \\ 0 & \varepsilon I_{n_p} \end{array} \right] \left[ \begin{array}{c} (\hat{C}_i x + \hat{c}_i + \hat{D} p) \\ p \end{array} \right] \leq 0 \end{aligned} \quad (4.100)$$

for all  $p \in \mathbb{R}^{n_p}$  and all  $x \in X_i$ . Let  $t_a$  and  $t_b$  be two time instants such that the state trajectory of system (4.87) remains in  $X_i$  on the interval  $[t_a, t_b]$ . By recalling that  $\dot{x} = \hat{A}_i x + \hat{a}_i + \hat{B}_i p$  and  $y_G = \hat{C}_i x + \hat{c}_i + \hat{D} p$ , and integrating from  $t_a$  to  $t_b$  along trajectories of (4.87), we have

$$\left[ \begin{array}{c} x(t_b) \\ 1 \end{array} \right]^\top \left[ \begin{array}{cc} P_i & q_i \\ \bullet & r_i \end{array} \right] \left[ \begin{array}{c} x(t_b) \\ 1 \end{array} \right] - \left[ \begin{array}{c} x(t_a) \\ 1 \end{array} \right]^\top \left[ \begin{array}{cc} P_i & q_i \\ \bullet & r_i \end{array} \right] \left[ \begin{array}{c} x(t_a) \\ 1 \end{array} \right] - \int_{t_a}^{t_b} \varpi(p(t), y_G(t)) dt \leq 0, \quad (4.101)$$

where  $\varpi$  is the supply rate defined in (4.79). The same reasoning can be applied to the last inequality in (4.96), post and pre multiplying by  $\text{col}(x, p)^\top$  and  $\text{col}(x, p)$ , which yields

$$x(t_b)^\top P_i x(t_b) - x(t_a)^\top P_i x(t_a) - \int_{t_a}^{t_b} \varpi(p(t), y_G(t)) dt \leq 0. \quad (4.102)$$

We note that the first terms in (4.101) and (4.102) represent the storage function (4.95). Let us consider a trajectory  $x(\tau)$ ,  $\forall \tau \in [0, T]$ . The time  $T$  can be decomposed as  $T = T - t_{in,n} + \sum_{k=0}^{n-1} (t_{out,k} - t_{in,k})$ , with  $t_{out,k} = t_{in,k+1}$  and  $t_{in,0} = 0$ , so that during each time interval  $[t_{in,k}, t_{out,k}]$  the trajectory stays in a given region. Then, replacing  $t_a$  by  $t_{in,k}$  and  $t_b$  by  $t_{out,k}$  in (4.101) and (4.102), adding up to  $n$  for every region  $X_i$  crossed, and using the continuity of  $S$  yields

$$S(x(T)) - S(x(0)) \leq \int_0^T \varpi(p(t), y_G(t)) dt, \quad \forall T \geq 0. \quad (4.103)$$

Hence, the filtered system (4.87) is dissipative with respect to the supply rate (4.79). Thus, condition (ii) in Corollary 4.26 is satisfied. Since condition (i) is satisfied by assumption, we conclude that the uncertain PWA system (4.1) is robustly stable with respect to  $\Delta$ . ■

It is interesting to note that in the case when  $N = 1$  (i.e. the piecewise-affine system  $G_{\text{PWA}}$  reduces to an LTI system  $G$ ), we recover the classic conditions in [111]. Indeed, when  $N = 1$ , the conditions in Theorem 4.28 become simply

$$\begin{cases} P \succeq 0 \\ \begin{bmatrix} \hat{A}^\top P + P \hat{A} & P \hat{B} \\ \hat{B}^\top P & 0 \end{bmatrix} + \begin{bmatrix} \hat{C} & \hat{D} \\ 0 & I_{n_p} \end{bmatrix}^\top \begin{bmatrix} M & 0 \\ 0 & \varepsilon I_{n_p} \end{bmatrix} \begin{bmatrix} \hat{C} & \hat{D} \\ 0 & I_{n_p} \end{bmatrix} \preceq 0. \end{cases} \quad (4.104)$$

When these conditions are satisfied, we may use the KYP lemma (Lemma 4.25, page 88) to rewrite the second inequality as

$$\begin{bmatrix} (j\omega - \hat{A})^{-1} \hat{B} \\ I_{n_p} \end{bmatrix}^* \begin{bmatrix} \hat{C} & \hat{D} \\ 0 & I_{n_p} \end{bmatrix}^\top \begin{bmatrix} M & 0 \\ 0 & \varepsilon I_{n_p} \end{bmatrix} \begin{bmatrix} \hat{C} & \hat{D} \\ 0 & I_{n_p} \end{bmatrix} \begin{bmatrix} (j\omega - \hat{A})^{-1} \hat{B} \\ I_{n_p} \end{bmatrix} \preceq 0, \quad \forall \omega \in \overline{\mathbb{R}}, \quad (4.105)$$

which is equivalent to

$$\left( \hat{C}(j\omega - \hat{A})^{-1} \hat{B} + \hat{D} \right)^* M \left( \hat{C}(j\omega - \hat{A})^{-1} \hat{B} + \hat{D} \right) \preceq -\varepsilon I_{n_p}, \quad \forall \omega \in \overline{\mathbb{R}}. \quad (4.106)$$

Since  $\hat{C}(j\omega - \hat{A})^{-1} \hat{B} + \hat{D}$  is precisely the transfer function of the filtered system  $\Psi \text{col}(G, \mathbb{I})$ , we may rewrite the above, with some abuse of notation, as

$$\begin{bmatrix} G(j\omega) \\ I_{n_p} \end{bmatrix}^* \Pi(j\omega) \begin{bmatrix} G(j\omega) \\ I_{n_p} \end{bmatrix} \preceq -\varepsilon I_{n_p}, \quad \forall \omega \in \overline{\mathbb{R}}, \quad (4.107)$$

where  $\Pi(j\omega) = \Psi(j\omega)^* M \Psi(j\omega)$ . The above frequency-domain inequality is simply the classic IQC condition proposed by Megretski and Rantzer [111] (see Section 4.7 for a discussion about these results and their connection with the approach proposed in this thesis). As a final note, we remark that, since  $(M, \Psi)$  is a doubly-hard factorization of  $\Pi$ , the constraint  $P \succeq 0$  is not restrictive, as per [154] and the discussion in Section 4.4.3. Based on the above discussion, we may say that the approach we propose is an extension of the classic LTI/IQC approach to the class of uncertain piecewise-affine systems.

### Robust performance

We now consider the problem of robust performance of uncertain piecewise-affine systems. Due to the presence of the performance channels  $w$  and  $z$ , we consider the piecewise-affine system  $G_{\text{PWA}}$  given by:

$$\begin{bmatrix} q \\ z \end{bmatrix} = G_{\text{PWA}} \left( \begin{bmatrix} p \\ w \end{bmatrix} \right) \begin{cases} \dot{x}(t) = A_i x_G(t) + a_i + B_{p,i} p(t) + B_{w,i} w(t) \\ q(t) = C_{q,i} x_G(t) + c_{q,i} + D_{qp} p(t) + D_{qw} w(t) \\ z(t) = C_{z,i} x_G(t) + c_{z,i} + D_{zp} p(t) + D_{zw} w(t) \\ x_G(0) = 0 \end{cases} \text{ for } x_G(t) \in X_i \quad (4.108)$$

Let  $\Upsilon_{\text{PWA}}$  be defined analogously to  $\Upsilon$  in (4.32), i.e.  $(q, p, z, w) = \Upsilon_{\text{PWA}}(p, w)$ , with  $(q, z) = G_{\text{PWA}}(p, w)$ . In order to analyze performance through Corollary 4.27, we need to assess dissipativity of the filtered system  $\text{diag}(\Psi, I_{n_z+n_w})\Upsilon_{\text{PWA}}$ . This system can be written as the following piecewise-affine system

$$y_G = \begin{bmatrix} \Psi & 0 \\ 0 & I_{n_z+n_w} \end{bmatrix} \Upsilon_{\text{PWA}} \left( \begin{bmatrix} p \\ w \end{bmatrix} \right) \begin{cases} \dot{x}(t) = \hat{A}_i x(t) + \hat{a}_i + \hat{B}_i u(t) \\ y_G(t) = \hat{C}_i x(t) + \hat{c}_i + \hat{D} u(t) \\ x(0) = 0 \end{cases} \text{ for } x(t) \in X_i \quad (4.109)$$

where  $x = \text{col}(x_G, \psi)$ ,  $u = \text{col}(p, w)$  and

$$\begin{aligned} \hat{A}_i &= \begin{bmatrix} A_i & 0 \\ B_{\psi q} C_{q,i} & A_{\psi} \end{bmatrix} & \hat{a}_i &= \begin{bmatrix} a_i \\ B_{\psi q} c_{q,i} \end{bmatrix} & \hat{B}_i &= \begin{bmatrix} B_{p,i} & B_{w,i} \\ (B_{\psi p} + B_{\psi q} D_{qp}) & B_{\psi q} D_{qw} \end{bmatrix} \\ \hat{C}_i &= \begin{bmatrix} D_{\psi q} C_{q,i} & C_{\psi} \\ C_{z,i} & 0 \\ 0 & 0 \end{bmatrix} & \hat{c}_i &= \begin{bmatrix} D_{\psi q} c_{q,i} \\ c_{z,i} \\ 0 \end{bmatrix} & \hat{D} &= \begin{bmatrix} (D_{\psi p} + D_{\psi q} D_{qp}) & D_{\psi q} D_{qw} \\ D_{zp} & D_{zw} \\ 0 & I_{n_w} \end{bmatrix} \end{aligned} \quad (4.110)$$

Following the discussion and the definitions provided in Section 4.4.1, we propose the next theorem for performance assessment of uncertain piecewise-affine systems. It is again based on the construction of piecewise-quadratic storage functions via a convex optimization problem based on linear matrix inequalities. The proof follows the exact same approach as the proof of Theorem 4.28, and is thus omitted.

#### THEOREM 4.29

Let  $\Pi \in \mathcal{RL}_{\infty}^{(n_q+n_p) \times (n_q+n_p)}$  be a multiplier factorized as  $\Pi = \Psi_b^* M \Psi_b$ , with the basis  $\Psi_b \in \mathcal{RH}_{\infty}^{n_y \times (n_q+n_p)}$  and  $M \in \mathbf{M}$  as defined in Table 4.2, and let  $M_p$  be the matrix defined in (4.30). Let the filtered PWA system  $\text{diag}(\Psi_b, I_{n_z+n_w})\Upsilon_{\text{PWA}}$  be defined as in (4.109)–(4.110). Suppose the interconnection  $(G_{\text{PWA}}, \Delta)$  is well-posed for every  $\Delta \in \mathbf{\Delta}$ . If there exist symmetric matrices  $P_i \in \mathbb{S}^n$ , vectors  $q_i \in \mathbb{R}^n$ , scalars  $r_i \in \mathbb{R}$ , symmetric matrices  $U_i, W_i \in \mathbb{S}^{l_i}$  with nonnegative coefficients and zero diagonal, and vectors  $L_{ijkl} \in \mathbb{R}^{n+1}$  such that

$$\begin{cases} P_i \succeq 0 \\ \begin{bmatrix} \hat{A}_i^T P_i + P_i \hat{A}_i & P_i \hat{B}_i \\ \hat{B}_i^T P_i & 0 \end{bmatrix} + \begin{bmatrix} \hat{C}_i & \hat{D} \\ 0 & I_{n_p+n_w} \end{bmatrix}^T \hat{M}_p \begin{bmatrix} \hat{C}_i & \hat{D} \\ 0 & I_{n_p+n_w} \end{bmatrix} \preceq 0 \end{cases} \text{ for } i \in \mathcal{I}_0 \quad (4.111)$$



$$\left\{ \begin{array}{l} \left[ \begin{array}{cc} P_i - \hat{E}_i^\top U_i \hat{E}_i & q_i - \hat{E}_i^\top U_i \hat{e}_i \\ \bullet & r_i - \hat{e}_i^\top U_i \hat{e}_i \end{array} \right] \succeq 0 \\ \left[ \begin{array}{cc} \left( \begin{array}{c} \hat{A}_i^\top P_i + P_i \hat{A}_i + \\ \hat{E}_i^\top W_i \hat{E}_i \end{array} \right) & \left( \begin{array}{c} P_i \hat{a}_i + \hat{A}_i^\top q_i + \\ \hat{E}_i^\top W_i \hat{e}_i \end{array} \right) & P_i \hat{B}_i \\ \bullet & \left( \begin{array}{c} 2q_i^\top \hat{a}_i + \\ \hat{e}_i^\top W_i \hat{e}_i \end{array} \right) & 0 \\ \bullet & \bullet & 0 \end{array} \right] + \\ + \left[ \begin{array}{ccc} \hat{C}_i & \hat{c}_i & \hat{D} \\ 0 & 0 & I_{n_p+n_w} \end{array} \right]^\top \hat{M}_p \left[ \begin{array}{ccc} \hat{C}_i & \hat{c}_i & \hat{D} \\ 0 & 0 & I_{n_p+n_w} \end{array} \right] \preceq 0 \end{array} \right. \quad \text{for } i \in \mathcal{I} \setminus \mathcal{I}_0 \quad (4.112)$$

$$\left[ \begin{array}{cc} P_i & q_i \\ \bullet & r_i \end{array} \right] = \left[ \begin{array}{cc} P_j & q_j \\ \bullet & r_j \end{array} \right] + L_{ij} \left[ \begin{array}{cc} \hat{E}_{ij} & \hat{e}_{ij} \end{array} \right] + \left[ \begin{array}{cc} \hat{E}_{ij} & \hat{e}_{ij} \end{array} \right]^\top L_{ij}^\top \quad \text{for } (i, j) \\ \text{s.t. } X_i \cap X_j \neq \emptyset \quad (4.113)$$

where we define  $q_i = 0$  and  $r_i = 0$  for  $i \in \mathcal{I}_0$ , and with

$$\hat{M}_p := \left[ \begin{array}{cc|c} M & 0 & 0 \\ 0 & M_p & 0 \\ 0 & 0 & \varepsilon I_{n_p+n_w} \end{array} \right], \quad (4.114)$$

then the uncertain PWA system (4.3) is robustly  $\mathcal{L}_2$ -gain stable with respect to  $\Delta$ , with an  $\mathcal{L}_2$ -gain less than or equal to  $\gamma$ .  $\lrcorner$

It is interesting to note that by removing the uncertainty  $\Delta$  (i.e. taking  $n_p = n_q = 0$ ), the LMI conditions in Theorem 4.29 reduce to the conditions of Theorem 2.42. Indeed, in this case the filtered system  $\text{diag}(\Psi_b, I_{n_z+n_w})\Upsilon_{\text{PWA}}$  becomes simply  $\text{col}(G_{\text{PWA}}, \mathbb{I})$ , which admits a piecewise-affine representation with matrices

$$\begin{aligned} \hat{A}_i &= A_i & \hat{a}_i &= a_i & \hat{B}_i &= B_i \\ \hat{C}_i &= \begin{bmatrix} C_{z,i} \\ 0 \end{bmatrix} & \hat{c}_i &= \begin{bmatrix} c_{z,i} \\ 0 \end{bmatrix} & \hat{D} &= \begin{bmatrix} D_{zw} \\ I_{n_w} \end{bmatrix}. \end{aligned} \quad (4.115)$$

Then, looking at (4.34), we have that

$$\left[ \begin{array}{ccc} \hat{C}_i & \hat{c}_i & \hat{D} \\ 0 & 0 & I_{n_w} \end{array} \right]^\top \hat{M}_p \left[ \begin{array}{ccc} \hat{C}_i & \hat{c}_i & \hat{D} \\ 0 & 0 & I_{n_w} \end{array} \right] = \left[ \begin{array}{ccc} C_{z,i}^\top C_{z,i} & C_{z,i}^\top c_{z,i} & C_{z,i}^\top D_{zw} \\ \bullet & c_{z,i}^\top c_{z,i} & c_{z,i}^\top D \\ \bullet & \bullet & D^\top D - (\gamma^2 - \varepsilon) I_{n_z} \end{array} \right]. \quad (4.116)$$

Since we no longer need to ensure the strict separation of the graphs between the system and the uncertainty, we may take  $\varepsilon = 0$ , which allows us to recover the conditions in Theorem 2.42.

As we have discussed in the end of Section 4.4.6, in the case when  $N = 1$  and the piecewise-affine system reduces to an LTI system, it is possible to obtain frequency-domain constraints for robust performance akin to the classic IQC approach [174]. The arguments for this claim are strictly the same as in the previous section, and thus the details are omitted.

## 4.5 Robust incremental stability and performance of nonlinear feedback systems

In Section 4.4, we have considered the problems of assessing stability and performance of uncertain piecewise-affine systems. We have shown how graph separation theory could be used to deal with these problems, with the help of integral quadratic constraints in the time domain. Finally, we have proposed sufficient conditions for the analysis of the class of uncertain piecewise-affine systems using linear matrix inequalities.

In this section, we follow a parallel route, considering instead the problems of incremental stability and performance. The results are somewhat similar to those obtained in the previous section, but the question of incremental stability using integral quadratic constraints is relatively less studied than their non-incremental counterparts. For this reason, we shall introduce in this section some extensions of the analysis techniques used previously, providing the proofs when necessary.

### 4.5.1 Robust incremental stability

We begin with an extension of Theorem 4.14 to the case of robust incremental stability. For completeness, the proof of the following theorem is reported to Appendix B.3. It is again based on the proof of [146, Theorem 2.2] and also on [151, Theorem 7.15], and a proof is provided in Appendix B.3.

THEOREM 4.30

Let  $G : \mathcal{L}_{2e}^{n_p}(\mathbb{R}_+) \rightarrow \mathcal{L}_{2e}^{n_q}(\mathbb{R}_+)$  be a causal and incrementally bounded system, and let  $\overline{\Delta}$  be the uncertainty set defined in Definition 4.2. Let  $\Psi \in \mathcal{RH}_{\infty}^{n_y \times (n_q + n_p)}$  and  $M \in \mathbb{S}^{n_y}$  be such that  $\Pi(j\omega) := \Psi(j\omega)^* M \Psi(j\omega)$  satisfies  $\Pi_{11} \succeq \varepsilon_{\Pi} I_{n_q}$  and  $\Pi_{22} \preceq -\varepsilon_{\Pi} I_{n_p}$ , for some  $\varepsilon_{\Pi} > 0$ . Assume that:

(i) the following time-domain IQC is satisfied

$$\int_0^T \bar{y}_{\Delta}(t)^{\top} M \bar{y}_{\Delta}(t) dt \geq 0, \quad \forall T \geq 0, \forall \Delta \in \overline{\Delta}, \forall q, \tilde{q} \in \mathcal{L}_{2e}^{n_q}(\mathbb{R}_+) \quad (4.117)$$

$$\text{with } \bar{y}_{\Delta} = \Psi \begin{bmatrix} \mathbb{I} & -\mathbb{I} \\ \Delta & -\Delta \end{bmatrix} (q, \tilde{q}).$$

(ii) there exists  $\varepsilon > 0$  such that the following time-domain IQC is satisfied

$$\int_0^T \bar{y}_G(t)^{\top} M \bar{y}_G(t) dt \leq -\varepsilon \|p - \tilde{p}\|_{2,T}^2, \quad \forall T \geq 0, \forall p, \tilde{p} \in \mathcal{L}_{2e}^{n_p}(\mathbb{R}_+) \quad (4.118)$$

$$\text{with } \bar{y}_G = \Psi \begin{bmatrix} G & -G \\ \mathbb{I} & -\mathbb{I} \end{bmatrix} (p, \tilde{p}).$$

Then, the feedback interconnection  $(G, \Delta)$  is robustly incrementally stable with respect to  $\overline{\Delta}$ .  $\lrcorner$

One interesting aspect of Theorem 4.30 (in comparison with Theorem 4.14) is that the condition requiring well-posedness of the feedback interconnection  $(G, \Delta)$  is no longer required. This is due to well-posedness being implied by conditions (i) and (ii), as it becomes clear from the proof in Appendix B.3.

### 4.5.2 Robust incremental performance

As we have stated before, we shall use the incremental  $\mathcal{L}_2$ -gain as the measure of performance. Let us note that the incremental  $\mathcal{L}_2$ -gain constraint (2.16) can be equivalently represented as

$$\begin{aligned} \int_0^\infty |z(t) - \tilde{z}(t)|^2 - \eta^2 |w(t) - \tilde{w}(t)|^2 dt &= \int_0^\infty \begin{bmatrix} z(t) - \tilde{z}(t) \\ w(t) - \tilde{w}(t) \end{bmatrix}^\top \begin{bmatrix} I_{n_z} & 0 \\ 0 & -\eta^2 I_{n_w} \end{bmatrix} \begin{bmatrix} z(t) - \tilde{z}(t) \\ w(t) - \tilde{w}(t) \end{bmatrix} dt \\ &= \int_0^\infty \begin{bmatrix} z(t) - \tilde{z}(t) \\ w(t) - \tilde{w}(t) \end{bmatrix}^\top \overline{M}_p \begin{bmatrix} z(t) - \tilde{z}(t) \\ w(t) - \tilde{w}(t) \end{bmatrix} dt \\ &\leq 0, \end{aligned} \quad (4.119)$$

with

$$\overline{M}_p := \begin{bmatrix} I_{n_z} & 0 \\ 0 & -\eta^2 I_{n_w} \end{bmatrix}. \quad (4.120)$$

Let us define  $\overline{\Upsilon}$  as the map from  $\mathcal{L}_{2e}^{n_p}(\mathbb{R}_+) \times \mathcal{L}_{2e}^{n_w}(\mathbb{R}_+) \times \mathcal{L}_{2e}^{n_p}(\mathbb{R}_+) \times \mathcal{L}_{2e}^{n_w}(\mathbb{R}_+)$  into  $\mathcal{L}_{2e}^{n_q}(\mathbb{R}_+) \times \mathcal{L}_{2e}^{n_p}(\mathbb{R}_+) \times \mathcal{L}_{2e}^{n_z}(\mathbb{R}_+) \times \mathcal{L}_{2e}^{n_w}(\mathbb{R}_+)$  given by

$$\begin{bmatrix} q - \tilde{q} \\ p - \tilde{p} \\ z - \tilde{z} \\ w - \tilde{w} \end{bmatrix} = \overline{\Upsilon} \left( \begin{bmatrix} p \\ w \\ \tilde{p} \\ \tilde{w} \end{bmatrix} \right) := \left[ \begin{array}{cc|cc} G_{\text{perf},q} & -G_{\text{perf},q} & & \\ \hline \mathbb{I} & 0 & -\mathbb{I} & 0 \\ G_{\text{perf},z} & -G_{\text{perf},z} & & \\ \hline 0 & \mathbb{I} & 0 & -\mathbb{I} \end{array} \right] \begin{bmatrix} p \\ w \\ \tilde{p} \\ \tilde{w} \end{bmatrix}, \quad (4.121)$$

i.e.  $(q - \tilde{q}, p - \tilde{p}, z - \tilde{z}, w - \tilde{w}) = \Upsilon(p, w, \tilde{p}, \tilde{w})$ , with  $(q, z) = G_{\text{perf}}(p, w)$  and  $(\tilde{q}, \tilde{z}) = G_{\text{perf}}(\tilde{p}, \tilde{w})$ .

We may now propose the following theorem concerning the assessment of incremental  $\mathcal{L}_2$ -gain stability of uncertain systems using graph separation arguments.

#### THEOREM 4.31

Let  $G_{\text{perf}} : \mathcal{L}_{2e}^{n_p}(\mathbb{R}_+) \times \mathcal{L}_{2e}^{n_w}(\mathbb{R}_+) \rightarrow \mathcal{L}_{2e}^{n_q}(\mathbb{R}_+) \times \mathcal{L}_{2e}^{n_z}(\mathbb{R}_+)$  be a causal and incrementally  $\mathcal{L}_2$ -gain stable system, and let  $\overline{\Delta}$  be the uncertainty set defined in Definition 4.2. Let  $\Psi \in \mathcal{RH}_\infty^{n_y \times (n_q + n_p)}$  and  $M \in \mathbb{S}^{n_y}$  be such that  $\Pi(j\omega) := \Psi(j\omega)^* M \Psi(j\omega)$  satisfies  $\Pi_{11} \succeq \varepsilon_\Pi I_{n_q}$  and  $\Pi_{22} \preceq -\varepsilon_\Pi I_{n_p}$ , for some  $\varepsilon_\Pi > 0$ . Let  $\overline{M}_p \in \mathbb{S}^{n_z + n_w}$  be the matrix defined in (4.120), and let  $\overline{\Upsilon}$  be the map defined in (4.121). Assume that:

(i) The following time-domain IQC is satisfied

$$\int_0^T \overline{y}_\Delta(t)^\top M \overline{y}_\Delta(t) dt \geq 0, \quad \forall T \geq 0, \forall \Delta \in \overline{\Delta}, \forall q, \tilde{q} \in \mathcal{L}_{2e}^{n_q}(\mathbb{R}_+) \quad (4.122)$$

$$\text{with } \overline{y}_\Delta = \Psi \begin{bmatrix} \mathbb{I} & -\mathbb{I} \\ \Delta & -\Delta \end{bmatrix} (q, \tilde{q}).$$

(ii) There exists  $\varepsilon > 0$  such that the following time-domain IQC is satisfied

$$\int_0^T \overline{y}_G(t)^\top \begin{bmatrix} M & 0 \\ 0 & \overline{M}_p \end{bmatrix} \overline{y}_G(t) dt \leq -\varepsilon \left\| \begin{bmatrix} p - \tilde{p} \\ w - \tilde{w} \end{bmatrix} \right\|_{2,T}^2, \quad \forall T \geq 0, \forall p, \tilde{p} \in \mathcal{L}_{2e}^{n_p}(\mathbb{R}_+) \quad (4.123)$$

$$\forall w, \tilde{w} \in \mathcal{L}_{2e}^{n_w}(\mathbb{R}_+),$$

$$\text{with } \overline{y}_G = \text{diag}(\Psi, I_{n_z + n_w}) \overline{\Upsilon}(p, w, \tilde{p}, \tilde{w}).$$

Then, the feedback interconnection  $(G_{\text{perf}}, \overline{\Delta})$  is robustly incrementally  $\mathcal{L}_2$ -gain stable with respect to  $\overline{\Delta}$ , with an incremental  $\mathcal{L}_2$ -gain less than or equal to  $\eta$ .  $\square$

### 4.5.3 Multipliers for incremental stability

In Sections 4.5.1 and 4.5.2, we have proposed conditions to assess robust incremental stability and performance of uncertain systems. Those conditions were obtained by using dynamic sector conditions to construct a quadratic separator, allowing us to conclude on the basis of Theorem 4.13. As we did in Section 4.4.3 for the case of non-incremental analysis, we consider in this section how to construct multipliers  $\Pi$  defining valid incremental integral quadratic constraints for the uncertainties in the set  $\overline{\Delta}$ .

Let us first recall that the three first categories of uncertainties in the sets  $\Delta$  and  $\overline{\Delta}$  are the same. This is the case since boundedness of  $\Delta$  defined by multiplication by a (time-invariant or time-varying) scalar or stable LTI dynamics imply incremental boundedness. Concerning the fourth case, i.e. general dynamic uncertainties with bounded incremental  $\mathcal{L}_2$ -gain, the same multiplier used for the class of dynamic uncertainties with bounded  $\mathcal{L}_2$ -gain can be used. Indeed, let  $\Delta$  be such that  $\|\Delta\|_{\Delta 2} \leq 1$ . This means that  $\|p - \tilde{p}\|_2^2 \leq \|q - \tilde{q}\|_2^2$ , with  $p = \Delta(q)$  and  $\tilde{p} = \Delta(\tilde{q})$ . Multiplication by  $x_D > 0$  then yields that  $x_D \|p - \tilde{p}\|_2^2 \leq x_D \|q - \tilde{q}\|_2^2$ , which can be rewritten as

$$\int_{-\infty}^{\infty} \begin{bmatrix} q - \tilde{q} \\ p - \tilde{p} \end{bmatrix}^* \begin{bmatrix} x_D I_{n_p} & 0 \\ 0 & -x_D I_{n_q} \end{bmatrix} \begin{bmatrix} q - \tilde{q} \\ p - \tilde{p} \end{bmatrix} d\omega \geq 0. \quad (4.124)$$

Finally, the multiplier in the last row can also be used for nonlinearities in the incremental sector  $\text{Sect}_{\Delta}(\kappa_1, \kappa_2)$ , see discussion in Appendix A. Thus, we can analyze robust incremental stability and performance using the multipliers defined in Table 4.1, with the respective parametrizations given in Table 4.2.

As it was discussed in Section 4.4.3, when the uncertainty set  $\Delta$  contains memoryless nonlinearities in a sector, it is possible to reduce the conservatism of the robust stability analysis by considering frequency-dependent multipliers such as Zames-Falb or Popov multipliers. However, in the case of robust incremental stability, it has been shown in [53, 96] that these multipliers cannot be used to ensure incremental stability. Therefore, if one aims to reduce the conservatism of the analysis of systems containing memoryless nonlinearities, another path should be taken. One possible procedure is to try to reduce the sector containing the nonlinearity, by incorporating some part of it in the nominal system  $G$ . This idea is at the heart of the motivations for this thesis, and shall be further discussed in Chapter 5.

### 4.5.4 Dissipativity approach

We now turn our attention to the characterization of the incremental graph of the nominal system  $G$ . We mirror the approach and the presentation in Section 4.4.5, and we show how to achieve this using dissipativity theory.

Let us note that (4.118) can be rewritten as

$$\begin{aligned} - \int_0^T \bar{y}_G(t)^\top M \bar{y}_G(t) dt - \varepsilon \|p - \tilde{p}\|_{2,T}^2 &= - \int_0^T \left( \bar{y}_G(t)^\top M \bar{y}_G(t) + \varepsilon |p(t) - \tilde{p}(t)|^2 \right) dt \\ &= - \int_0^T \begin{bmatrix} \bar{y}_G(t) \\ p(t) - \tilde{p}(t) \end{bmatrix}^\top \begin{bmatrix} M & 0 \\ 0 & \varepsilon I_{n_p} \end{bmatrix} \begin{bmatrix} \bar{y}_G(t) \\ p(t) - \tilde{p}(t) \end{bmatrix} dt \\ &= \int_0^T \overline{\omega}(p(t), \tilde{p}(t), \bar{y}_G(t)) dt \geq 0, \quad \forall T \geq 0 \\ &\quad \forall p, \tilde{p} \in \mathcal{L}_{2e}^{n_p}(\mathbb{R}_+), \end{aligned} \quad (4.125)$$

with

$$\overline{\omega}(p, \tilde{p}, \bar{y}_G) := - \begin{bmatrix} \bar{y}_G \\ p - \tilde{p} \end{bmatrix}^\top \begin{bmatrix} M & 0 \\ 0 & \varepsilon I_{n_p} \end{bmatrix} \begin{bmatrix} \bar{y}_G \\ p - \tilde{p} \end{bmatrix}, \quad (4.126)$$

and where  $\bar{y}_G = \Psi \begin{bmatrix} G & -G \\ \mathbb{I} & -\mathbb{I} \end{bmatrix} (p, \tilde{p})$ .

As we did in Section 4.4.5, we shall again use dissipativity and Theorem 2.18 to propose the following corollary to Theorem 4.14. The proof is omitted, as it essentially follows the same route taken in the proof of Corollary 4.26.

COROLLARY 4.32

Let  $G : \mathcal{L}_{2e}^{n_p}(\mathbb{R}_+) \rightarrow \mathcal{L}_{2e}^{n_q}(\mathbb{R}_+)$  be a causal and incrementally  $\mathcal{L}_2$ -gain stable system, and let  $\overline{\Delta}$  be the uncertainty set defined in Definition 4.2. Let  $\Pi \in \mathcal{RL}_\infty^{(n_q+n_p) \times (n_q+n_p)}$  be factorized as  $\Pi = \Psi_b^* M \Psi_b$ , with  $\Psi_b \in \mathcal{RH}_\infty^{n_y \times (n_q+n_p)}$ , and  $M \in \mathbf{M}$ , as defined in Table 4.2. Assume that the filtered augmented system  $\Psi_b \begin{bmatrix} G & -G \\ \mathbb{I} & -\mathbb{I} \end{bmatrix}$  is dissipative with respect to the supply rate  $\overline{\omega}$  defined in (4.126). Then, the feedback interconnection  $(G, \Delta)$  is robustly incrementally stable with respect to  $\overline{\Delta}$ .  $\lrcorner$

As it was previously discussed, by choosing an appropriate set of multipliers  $\Pi$ , all we need to do to assess robust incremental stability through Corollary 4.32 is to assess dissipativity of the filtered augmented system  $\Psi \begin{bmatrix} G & -G \\ \mathbb{I} & -\mathbb{I} \end{bmatrix}$ .

We may use the same reasoning employed in Remark 2.21, page 22, to obtain some information on the structure of the storage function  $\overline{S}(x, \tilde{x}, \psi)$  for the filtered augmented system. Indeed, by taking the initial states  $x_0 = \tilde{x}_0 = 0$ , as well as  $\psi(0) = 0$ , the storage function for the filtered augmented system is normalized as  $\overline{S}(0, 0, 0) = 0$ . Then, by applying the same input  $p = \tilde{p} \in \mathcal{L}_{2e}^{n_p}(\mathbb{R}_+)$ , we have that  $G(p) - G(\tilde{p}) = 0$  and  $p - \tilde{p} = 0$ , which means that no input is fed to  $\Psi$ , and hence the filter states satisfy  $\psi(T) = 0$  for all  $T \geq 0$ . This in turn means that

$$\int_0^T \overline{\omega}(p(t), \tilde{p}(t), \bar{y}_G(t)) dt = 0, \quad \forall T \geq 0. \quad (4.127)$$

The dissipation inequality then implies that  $\overline{S}(x(T), x(T), 0) \leq \overline{S}(x_0, \tilde{x}_0, 0) = 0$ . Since  $\overline{S}$  is nonnegative, we conclude that  $\overline{S}(x, x, 0) = 0$ , for all  $x \in X$  reachable from the origin.

Let us note that (4.123) can be rewritten as

$$- \int_0^T \bar{y}_G(t)^\top \begin{bmatrix} M & 0 \\ 0 & \overline{M}_p \end{bmatrix} \bar{y}_G(t) dt - \varepsilon \left\| \begin{bmatrix} p - \tilde{p} \\ w - \tilde{w} \end{bmatrix} \right\|_{2,T}^2 \quad (4.128)$$

$$\begin{aligned} &= - \int_0^T \left( \bar{y}_G(t)^\top \begin{bmatrix} M & 0 \\ 0 & \overline{M}_p \end{bmatrix} \bar{y}_G(t) + \varepsilon \left\| \begin{bmatrix} p(t) - \tilde{p}(t) \\ w(t) - \tilde{w}(t) \end{bmatrix} \right\|^2 \right) dt \\ &= - \int_0^T \begin{bmatrix} \bar{y}_G(t) \\ p(t) - \tilde{p}(t) \\ w(t) - \tilde{w}(t) \end{bmatrix}^\top \begin{bmatrix} M & 0 & 0 \\ 0 & \overline{M}_p & 0 \\ 0 & 0 & \varepsilon I_{n_z+n_w} \end{bmatrix} \begin{bmatrix} \bar{y}_G(t) \\ p(t) - \tilde{p}(t) \\ w(t) - \tilde{w}(t) \end{bmatrix} dt \\ &= \int_0^T \overline{\omega}(p(t), \tilde{p}(t), w(t), \tilde{w}(t), \bar{y}_G(t)) dt \geq 0 \end{aligned} \quad (4.129)$$

for every  $T \geq 0$ , every  $p, \tilde{p} \in \mathcal{L}_{2e}^{n_p}(\mathbb{R}_+)$  and every  $w, \tilde{w} \in \mathcal{L}_{2e}^{n_w}(\mathbb{R}_+)$ , with

$$\varpi(p, \tilde{p}, w, \tilde{w}, \bar{y}_G) := - \begin{bmatrix} \bar{y}_G \\ p - \tilde{p} \\ w - \tilde{w} \end{bmatrix}^\top \left[ \begin{array}{cc|c} M & 0 & 0 \\ 0 & \bar{M}_p & 0 \\ \hline 0 & 0 & \varepsilon I_{n_z+n_w} \end{array} \right] \begin{bmatrix} \bar{y}_G \\ p - \tilde{p} \\ w - \tilde{w} \end{bmatrix}, \quad (4.130)$$

and where  $\bar{y}_G = \text{diag}(\Psi, I_{n_z+n_w})\bar{\Upsilon}(p, w, \tilde{p}, \tilde{w})$ , with  $\bar{\Upsilon}$  defined in 4.121.

Using again dissipativity and Theorem 2.18, we propose the following corollary to Theorem 4.31. The proof shall once again be omitted for being an adaptation of the proof of Corollary 4.27.

**COROLLARY 4.33**

Let  $G_{\text{perf}} : \mathcal{L}_{2e}^{n_p}(\mathbb{R}_+) \times \mathcal{L}_{2e}^{n_w}(\mathbb{R}_+) \rightarrow \mathcal{L}_{2e}^{n_q}(\mathbb{R}_+) \times \mathcal{L}_{2e}^{n_z}(\mathbb{R}_+)$  be a causal and incrementally  $\mathcal{L}_2$ -gain stable system, and let  $\bar{\Delta}$  be the uncertainty set defined in Definition 4.2. Let  $\Pi \in \mathcal{RH}_\infty^{(n_q+n_p) \times (n_q+n_p)}$  be a multiplier factorized as  $\Pi = \Psi_b^* M \Psi_b$ , with  $\Psi_b \in \mathcal{RH}_\infty^{n_y \times (n_q+n_p)}$ , and  $M \in \mathbf{M}$ , as defined in Table 4.2, and let  $\bar{M}_p \in \mathbb{S}^{n_z+n_w}$  be the matrix defined in (4.120). Finally, let  $\bar{\Upsilon}$  be the map defined in (4.121). Assume that the filtered augmented system  $\text{diag}(\Psi_b, I_{n_z+n_w})\bar{\Upsilon}$ , is dissipative with respect to the supply rate  $\varpi$  defined in (4.83). Then, the feedback interconnection of  $(G_{\text{perf}}, \bar{\Delta})$  is robustly incrementally  $\mathcal{L}_2$ -gain stable with respect to  $\bar{\Delta}$ , with an incremental  $\mathcal{L}_2$ -gain less than or equal to  $\eta$ .  $\square$

**4.5.5 Application to piecewise-affine systems**

In this section we consider the application of Corollaries 4.32 and 4.33 to the special case of piecewise-affine systems. Following the approach in Section 4.4.6, we shall benefit from the piecewise-affine description of the system to propose sufficient conditions to construct storage functions using convex optimization. In view of the discussion presented in Chapter 3, we shall focus straight away on conditions allowing the construction of piecewise-polynomial storage functions.

**Robust incremental stability**

We begin by considering the analysis of robust stability of uncertain piecewise-affine systems. The nominal system  $G$  will again be taken to be the piecewise-affine system  $G_{\text{PWA}}$  given in (4.86).

Our goal is to assess dissipativity of the filtered augmented system  $\Psi_b \begin{bmatrix} G_{\text{PWA}} & -G_{\text{PWA}} \\ \mathbb{I} & -\mathbb{I} \end{bmatrix}$  with respect to the supply rate (4.126), where the filter  $\Psi_b$  has the minimal state space representation (4.48). The filtered augmented system can then be written as the following piecewise-affine system:

$$\bar{y}_G = \left( \Psi_b \begin{bmatrix} G_{\text{PWA}} & -G_{\text{PWA}} \\ \mathbb{I} & -\mathbb{I} \end{bmatrix} \right) \left( \begin{bmatrix} p \\ \tilde{p} \end{bmatrix} \right) \begin{cases} \dot{\bar{x}}(t) = \bar{A}_{ij}\bar{x}(t) + \bar{B}_{ij}\bar{p}(t) \\ \bar{y}_G(t) = \bar{C}_{ij}\bar{x}(t) + \bar{D}\bar{p}(t) \\ \bar{x}(0) = 0 \end{cases} \text{ for } x(t) \in X_{ij} \quad (4.131)$$

where  $\bar{x} = \text{col}(x_G, \tilde{x}_G, \psi, 1)$ ,  $\bar{p} = \text{col}(p, \tilde{p})$  and

$$\begin{aligned} \bar{A}_{ij} &= \begin{bmatrix} A_i & 0 & 0 & a_i \\ 0 & A_j & 0 & a_j \\ B_{\psi q} C_{q,i} & -B_{\psi q} C_{q,j} & A_\psi & B_{\psi q}(c_{q,i} - c_{q,j}) \\ 0 & 0 & 0 & 0 \end{bmatrix} & \bar{B}_{ij} &= \begin{bmatrix} B_{p,i} & 0 \\ 0 & B_{p,j} \\ (B_{\psi p} + B_{\psi q} D_{qp}) & -(B_{\psi p} + B_{\psi q} D_{qp}) \\ 0 & 0 \end{bmatrix} \\ \bar{C}_{ij} &= \begin{bmatrix} D_{\psi q} C_{q,i} & -D_{\psi q} C_{q,j} & C_\psi & D_{\psi q}(c_{q,i} - c_{q,j}) \end{bmatrix} & \bar{D} &= \begin{bmatrix} (D_{\psi p} + D_{\psi q} D_{qp}) & -(D_{\psi p} + D_{\psi q} D_{qp}) \end{bmatrix}. \end{aligned} \quad (4.132)$$

In view of the discussion about the augmented regions  $X_{ij}$  presented in Section 2.7 and the technical details presented in Section 4.4.6, the augmented region  $X_{ij}$  can be defined as

$$X_{ij} = \{\bar{x} \in X \times X \times \mathbb{R}^\ell \times \{1\} \mid \bar{G}_{ij} \bar{x} \succeq 0\}, \quad (4.133)$$

where

$$\bar{G}_{ij} := \begin{bmatrix} G_i & 0 & 0 & g_i \\ 0 & G_j & 0 & g_j \end{bmatrix}. \quad (4.134)$$

Similarly, the intersection between any two adjacent augmented regions  $X_{ij}$  and  $X_{kl}$  is contained in the hyperplane defined by the matrix  $\bar{E}_{ijkl}$ , i.e.

$$X_{ij} \cap X_{kl} \subseteq \{\bar{x} \in X \times X \times \mathbb{R}^\ell \times \{1\} \mid \bar{E}_{ijkl} \bar{x} = 0\}. \quad (4.135)$$

As we did in Chapter 3, we aim to use sum-of-squares techniques to be able to construct piecewise-polynomial storage functions to verify dissipativity of the augmented system (4.131). We consider storage functions given by piecewise-polynomials of degree less than or equal to  $d$  given by

$$\bar{S}(\bar{x}) = \chi_d(\bar{x})^\top \mathcal{P}_{ij} \chi_d(\bar{x}), \quad \text{for } \bar{x} \in X_{ij}, \quad (4.136)$$

with  $\chi_d(\bar{x}) \in \mathbb{R}^{\varrho(2n+\ell,d)}$ . From this point onward the dependence on  $\bar{x}$  is dropped to ease the notation. We shall also define  $\bar{p}_\chi := \bar{p} \otimes \chi_{d-1}$ , with  $\bar{p} = \text{col}(p, \tilde{p})$ , similarly to what was presented in Section 3.4, in order to write the dissipation inequality as a quadratic function of the vector  $\bar{\chi}_\bar{p} := \text{col}(\chi_d, \bar{p}_\chi)$ .

Let the matrices  $\mathcal{A}_{ij} \in \mathbb{R}^{\varrho(2n,d) \times \varrho(2n,d)}$ ,  $\mathcal{B}_{ij} \in \mathbb{R}^{\varrho(2n,d) \times \varrho_w(2n,d,2n_p)}$ ,  $\mathcal{C}_{ij} \in \mathbb{R}^{n_y \times \varrho(2n,d)}$  and  $\mathcal{D} \in \mathbb{R}^{n_y \times \varrho_w(2n,d,2n_p)}$  be such that (see Section 3.4 for details)

$$\begin{aligned} \dot{\chi}_d &= \frac{\partial \chi_d}{\partial \bar{x}} (\bar{A}_{ij} \bar{x} + \bar{B}_{ij} \bar{p}) =: \mathcal{A}_{ij} \chi_d + \mathcal{B}_{ij} \bar{p}_\chi \\ \bar{y}_G &= \bar{C}_{ij} \bar{x} + \bar{D} \bar{p} =: \mathcal{C}_{ij} \chi_d + \mathcal{D} \bar{p}_\chi. \end{aligned} \quad (4.137)$$

In order to use the generalization of the  $\mathcal{S}$ -procedure as in Lemma 3.8, let us recall some notations defined in Section 3.4 (for details, please refer to the discussion in page 53). Let  $\bar{G}_{ij,k}$  denote the  $k$ -th row of  $\bar{G}_{ij}$ , and let us define  $\mathcal{T}_{ij} \in \mathbb{S}^{\varrho(2n+\ell,d)}$  as the matrix such that

$$g_{ij,1}(\bar{x}) \bar{G}_{ij,1} \bar{x} + \cdots + g_{ij,l_{ij}}(\bar{x}) \bar{G}_{ij,l_{ij}} \bar{x} =: \chi_d^\top \mathcal{T}_{ij} \chi_d. \quad (4.138)$$

Since  $\bar{G}_{ij,k} \bar{x}$  is an affine function of  $\bar{x}$ , we may choose polynomials  $g_{ij,k}$  of degree up to  $2d-1$ . Let us also define  $\mathcal{G}_{ij,k} \in \mathbb{S}^{\varrho(2n+\ell,d)}$  as the matrix such that

$$g_{ij,k}(\bar{x}) =: \chi_d^\top \mathcal{G}_{ij,k} \chi_d. \quad (4.139)$$

As we have discussed in Section 4.5.4, the storage function we aim to construct is such that  $\bar{S}(x, x, 0) = 0$ , for all  $x \in X$ . Using the same arguments we used in Section 3.4, page 56, we may construct matrices  $Z$  and  $T$  such that the constraint  $Z^\top T^\top \mathcal{P}_{ii} T Z = 0$ , for all  $i \in \mathcal{I}$ , ensures the desired structure on  $\bar{S}$ .

Finally, the supply rate (4.126) can be written as the quadratic function

$$\bar{\omega}(p, \tilde{p}, \bar{y}_G) := - \begin{bmatrix} \chi_d \\ \bar{p}_\chi \end{bmatrix}^\top \begin{bmatrix} \mathcal{C}_{ij}^\top M \mathcal{C}_{ij} & \mathcal{C}_{ij} M \mathcal{D} \\ \bullet & \mathcal{D}^\top M \mathcal{D} + \varepsilon M_1 \end{bmatrix} \begin{bmatrix} \chi_d \\ \bar{p}_\chi \end{bmatrix}, \quad (4.140)$$

with  $M_1 \in \mathbb{S}^{\varrho_w(2n+\ell, d, 2n_p)}$  the matrix such that

$$|p - \tilde{p}|^2 =: \bar{p}_\chi^\top M_1 \bar{p}_\chi. \quad (4.141)$$

We now propose the following theorem, allowing us to assess robust incremental stability of the filtered augmented system (4.131) by constructing piecewise-polynomial storage functions via convex optimization.

**THEOREM 4.34**

Let  $\Pi \in \mathcal{R}\mathcal{L}_\infty^{(n_q+n_p) \times (n_q+n_p)}$  be a positive-negative multiplier so that every  $\Delta \in \bar{\Delta}$  satisfy the incremental IQC defined by  $\Pi$ . Let  $\Pi$  be factorized as  $\Pi = \Psi_b^* M \Psi_b$ , with  $\Psi_b \in \mathcal{R}\mathcal{H}_\infty^{n_y \times (n_q+n_p)}$ , and  $M \in \mathbf{M}$ , as defined in Table 4.2. Let the filtered PWA system  $\Psi \begin{bmatrix} G_{\text{PWA}} & -G_{\text{PWA}} \\ \mathbb{I} & -\mathbb{I} \end{bmatrix}$  be defined as in (4.131)–(4.132). If there exist symmetric matrices  $\mathcal{P}_{ij} \in \mathbb{S}^{\varrho(2n+\ell, d)}$ , as well as matrices  $\mathcal{T}_{ij,r} \in \mathbb{S}^{\varrho(2n+\ell, d)}$  and  $\mathcal{G}_{ij,r,k} \in \mathbb{S}^{\varrho(2n+\ell, d)}$  defined respectively by (4.138) and (4.139) for  $r \in \{1, 2\}$  and  $k \in \{1, \dots, l_{ij}\}$ , vectors  $\tau_{ij} \in \mathbb{R}^{\iota(2n+\ell, d)}$  and  $\nu_{ij,r,k} \in \mathbb{R}^{\iota(2n+\ell, d)}$ , for  $r \in \{1, 2\}$  and  $k \in \{1, \dots, l_{ij}\}$ ,  $\mu_{ij} \in \mathbb{R}^{\iota_w(2n+\ell, d, 2n_p)}$  and  $\vartheta_{ijkl} \in \mathbb{R}^{\iota(2n+\ell, d)}$ , a matrix  $M_1$ , as defined in (4.141) and matrices  $L_{ijkl} \in \mathbb{R}^{\varrho(2n+\ell, d) \times \varrho(2n+\ell, d-1)}$  such that

$$\left\{ \begin{array}{l} \mathcal{P}_{ij} + Q^{2n+\ell, d}(\tau_{ij}) - \mathcal{T}_{ij,1} \succeq 0 \\ \left[ \begin{array}{c|c} \mathcal{A}_{ij}^\top \mathcal{P}_{ij} + \mathcal{P}_{ij} \mathcal{A}_{ij} + & \mathcal{P}_{ij} \mathcal{B}_{ij} + \mathcal{C}_{ij}^\top M \mathcal{D} \\ \mathcal{C}_{ij}^\top M \mathcal{C}_{ij} + \mathcal{T}_{ij,2} & \\ \bullet & \mathcal{D}^\top M \mathcal{D} + \varepsilon M_1 \end{array} \right] + R^{2n+\ell, d, 2n_p}(\mu_{ij}) \preceq 0 \\ \left\{ \begin{array}{l} \mathcal{G}_{ij,1,k} + Q^{2n+\ell, d}(\nu_{ij,1,k}) \succeq 0 \\ \mathcal{G}_{ij,2,k} + Q^{2n+\ell, d}(\nu_{ij,2,k}) \succeq 0 \end{array} \right., \quad \text{for } k = 1, \dots, l_{ij} \end{array} \right. \quad \text{for } (i, j) \in \mathcal{I}^2 \quad (4.142)$$

$$Z^\top T^\top \mathcal{P}_{ii} T Z = 0 \quad \text{for } i \in \mathcal{I} \quad (4.143)$$

$$\mathcal{P}_{ij} = \mathcal{P}_{kl} + L_{ijkl} \mathcal{E}_{ijkl} + \mathcal{E}_{ijkl}^\top L_{ijkl}^\top + Q^{2n+\ell, d}(\vartheta_{ijkl}) \quad \begin{array}{l} \text{for } (i, j), (k, l), \\ X_{ij} \cap X_{kl} \neq \emptyset \end{array} \quad (4.144)$$

then the uncertain PWA system (4.1) is robustly incrementally stable with respect to  $\bar{\Delta}$ .  $\square$

**Robust incremental performance**

Finally, let us consider the problem of robust incremental performance of uncertain piecewise-affine systems. Let  $G_{\text{PWA}}$  be given by (4.108), and let  $\bar{\Upsilon}_{\text{PWA}}$  be defined analogously to



$\bar{\Upsilon}$  in (4.121), i.e.  $(q - \tilde{q}, p - \tilde{p}, z - \tilde{z}, w - \tilde{w}) = \bar{\Upsilon}_{\text{PWA}}(p, w, \tilde{p}, \tilde{w})$ , with  $(q, z) = G_{\text{PWA}}(p, w)$  and  $(\tilde{q}, \tilde{z}) = G_{\text{PWA}}(\tilde{p}, \tilde{w})$ . In order to analyze incremental performance through Corollary 4.33, we need to assess dissipativity of the piecewise-affine filtered augmented system given by

$$\bar{y}_G = \begin{bmatrix} \Psi & 0 \\ 0 & I_{n_z+n_w} \end{bmatrix} \bar{\Upsilon}_{\text{PWA}} \begin{pmatrix} p \\ w \\ \tilde{p} \\ \tilde{w} \end{pmatrix} \begin{cases} \dot{\bar{x}}(t) = \bar{A}_{ij}\bar{x}(t) + \bar{B}_{ij}\bar{u} \\ \bar{y}_G(t) = \bar{C}_{ij}\bar{x}(t) + \bar{D}\bar{u} \\ \bar{x}(0) = 0 \end{cases} \text{ for } \bar{x}(t) \in X_{ij} \quad (4.145)$$

where  $\bar{x} = \text{col}(x_G, \tilde{x}_G, \psi, 1)$ ,  $\bar{u} = \text{col}(p, w, \tilde{p}, \tilde{w})$ , and

$$\bar{A}_{ij} = \begin{bmatrix} A_i & 0 & 0 & a_i \\ 0 & A_j & 0 & a_j \\ B_{\psi q}C_{q,i} & -B_{\psi q}C_{q,j} & A_\psi & B_{\psi q}(c_{q,i} - c_{q,j}) \\ 0 & 0 & 0 & 0 \end{bmatrix} \quad (4.146)$$

$$\bar{B}_{ij} = \begin{bmatrix} B_{p,i} & B_{w,i} & 0 & 0 \\ 0 & 0 & B_{p,j} & B_{w,j} \\ (B_{\psi p} + B_{\psi q}D_{qp}) & B_{\psi q}D_{qw} & -(B_{\psi p} + B_{\psi q}D_{qp}) & -B_{\psi q}D_{qw} \\ 0 & 0 & 0 & 0 \end{bmatrix}$$

and

$$\bar{C}_{ij} = \begin{bmatrix} D_{\psi q}C_{q,i} & -D_{\psi q}C_{q,j} & C_\psi & D_{\psi q}(c_{q,i} - c_{q,j}) \\ C_{z,i} & -C_{z,j} & 0 & (c_{z,i} - c_{z,j}) \\ 0 & 0 & 0 & 0 \end{bmatrix} \quad (4.147)$$

$$\bar{D} = \begin{bmatrix} (D_{\psi p} + D_{\psi q}D_{qp}) & D_{\psi q}D_{qw} & -(D_{\psi p} + D_{\psi q}D_{qp}) & -D_{\psi q}D_{qw} \\ D_{zp} & D_{zw} & -D_{zp} & -D_{zw} \\ 0 & I_{n_w} & 0 & -I_{n_w} \end{bmatrix}$$

We are again aiming to construct piecewise-polynomial storage functions having the structure (4.136). As we did previously, we shall define  $\bar{u}_\chi := \bar{u} \otimes \chi_{d-1}$  in order to write the dissipation inequality as a quadratic function of the vector  $\bar{\chi}_{\bar{u}} := \text{col}(\chi_d, \bar{u}_\chi)$ . Let the matrices  $\mathcal{A}_{ij} \in \mathbb{R}^{\varrho(2n+\ell,d) \times \varrho(2n+\ell,d)}$ ,  $\mathcal{B}_{ij} \in \mathbb{R}^{\varrho(2n+\ell,d) \times \varrho_w(2n+\ell,d,2(n_p+n_w))}$ ,  $\mathcal{C}_{ij} \in \mathbb{R}^{n_y \times \varrho(2n+\ell,d)}$  and  $\mathcal{D} \in \mathbb{R}^{n_y \times \varrho_w(2n+\ell,d,2(n_p+n_w))}$  be such that

$$\dot{\chi}_d = \frac{\partial \chi_d}{\partial \bar{x}} (\bar{A}_{ij}\bar{x} + \bar{B}_{ij}\bar{u}) =: \mathcal{A}_{ij}\chi_d + \mathcal{B}_{ij}\bar{u}_\chi \quad (4.148)$$

$$\bar{y}_G = \bar{C}_{ij}\bar{x} + \bar{D}\bar{u} =: \mathcal{C}_{ij}\chi_d + \mathcal{D}\bar{u}_\chi.$$

Using this notation, the supply rate (4.130) can be rewritten as a quadratic function of  $\bar{\chi}_{\bar{u}}$ :

$$\varpi(p, \tilde{p}, w, \tilde{w}, \bar{y}_G) := - \begin{bmatrix} \chi_d \\ \bar{u}_\chi \end{bmatrix}^\top \begin{bmatrix} \mathcal{C}_{ij}^\top \bar{M} \mathcal{C}_{ij} & \mathcal{C}_{ij}^\top \bar{M} \mathcal{D} \\ \bullet & \mathcal{D}^\top \bar{M} \mathcal{D} + \varepsilon \bar{M}_1 \end{bmatrix} \begin{bmatrix} \chi_d \\ \bar{u}_\chi \end{bmatrix}, \quad (4.149)$$

where

$$\bar{M} := \begin{bmatrix} M & 0 \\ 0 & \bar{M}_p \end{bmatrix}, \quad (4.150)$$

and  $M_1 \in \mathbb{S}^{\varrho_w(2n+\ell,d,2(n_p+n_w))}$  is the matrix such that

$$\left\| \begin{bmatrix} p - \tilde{p} \\ w - \tilde{w} \end{bmatrix} \right\|^2 =: \bar{u}_\chi^\top \bar{M}_1 \bar{u}_\chi. \quad (4.151)$$

After these preliminary definitions, we are able to state the following result providing sufficient conditions to assess robust incremental  $\mathcal{L}_2$ -gain stability of uncertain piecewise-affine systems.

**THEOREM 4.35**

Let  $\Pi \in \mathcal{RL}_\infty^{(n_q+n_p) \times (n_q+n_p)}$  be a positive-negative multiplier so that every  $\Delta \in \overline{\Delta}$  satisfy the incremental IQC defined by  $\Pi$ . Let  $\Pi$  be factorized as  $\Pi = \Psi_b^* M \Psi_b$ , with  $\Psi_b \in \mathcal{RH}_\infty^{n_y \times (n_q+n_p)}$ , and  $M \in \mathbf{M}$ , as defined in Table 4.2. Let  $\overline{M}$  be the matrix defined in (4.150), with  $\overline{M}_p$  be the matrix defined in (4.120). Let the filtered PWA system  $\text{diag}(\Psi, I_{n_z+n_w}) \overline{\Upsilon}_{\text{PWA}}$  be defined as in (4.145)–(4.147). If there exist symmetric matrices  $\mathcal{P}_{ij} \in \mathbb{S}^{\varrho(2n+\ell,d)}$ , as well as matrices  $\mathcal{T}_{ij,r} \in \mathbb{S}^{\varrho(2n+\ell,d)}$  and  $\mathcal{G}_{ij,r,k} \in \mathbb{S}^{\varrho(2n+\ell,d)}$  defined respectively by (4.138) and (4.139) for  $r \in \{1, 2\}$  and  $k \in \{1, \dots, l_{ij}\}$ , vectors  $\tau_{ij} \in \mathbb{R}^{\iota(2n+\ell,d)}$  and  $\nu_{ij,r,k} \in \mathbb{R}^{\iota(2n+\ell,d)}$ , for  $r \in \{1, 2\}$  and  $k \in \{1, \dots, l_{ij}\}$ ,  $\mu_{ij} \in \mathbb{R}^{\iota_w(2n+\ell,d,2n_p)}$  and  $\vartheta_{ijkl} \in \mathbb{R}^{\iota(2n+\ell,d)}$ , a matrix  $M_1$ , as defined in (4.141) and matrices  $L_{ijkl} \in \mathbb{R}^{\varrho(2n+\ell,d) \times \varrho(2n+\ell,d-1)}$  such that

$$\left\{ \begin{array}{l} \mathcal{P}_{ij} + Q^{2n+\ell,d}(\tau_{ij}) - \mathcal{T}_{ij,1} \succeq 0 \\ \left[ \begin{array}{c|c} \mathcal{A}_{ij}^\top \mathcal{P}_{ij} + \mathcal{P}_{ij} \mathcal{A}_{ij} + & \mathcal{P}_{ij} \mathcal{B}_{ij} + \mathcal{C}_{ij}^\top \overline{M} \mathcal{D} \\ \mathcal{C}_{ij}^\top \overline{M} \mathcal{C}_{ij} + \mathcal{T}_{ij,2} & \\ \hline & \mathcal{D}^\top \overline{M} \mathcal{D} + \varepsilon \overline{M}_1 \end{array} \right] + R^{2n+\ell,d,2(n_p+n_w)}(\mu_{ij}) \preceq 0 \\ \bullet \\ \left\{ \begin{array}{l} \mathcal{G}_{ij,1,k} + Q^{2n+\ell,d}(\nu_{ij,1,k}) \succeq 0 \\ \mathcal{G}_{ij,2,k} + Q^{2n+\ell,d}(\nu_{ij,2,k}) \succeq 0 \end{array} \right., \quad \text{for } k = 1, \dots, l_{ij} \end{array} \right. \quad \text{for } (i, j) \in \mathcal{I}^2 \quad (4.152)$$

$$Z^\top T^\top \mathcal{P}_{ii} T Z = 0 \quad \text{for } i \in \mathcal{I} \quad (4.153)$$

$$\begin{aligned} \mathcal{P}_{ij} &= \mathcal{P}_{kl} + L_{ijkl} \mathcal{E}_{ijkl} + \mathcal{E}_{ijkl}^\top L_{ijkl}^\top + Q^{2n+\ell,d}(\vartheta_{ijkl}) \\ &\quad X_{ij} \cap X_{kl} \neq \emptyset \end{aligned} \quad \text{for } (i, j), (k, l), \quad (4.154)$$

then the uncertain PWA system (4.3) is robustly incrementally  $\mathcal{L}_2$ -gain stable with respect to  $\overline{\Delta}$ , with an incremental  $\mathcal{L}_2$ -gain less than or equal to  $\eta$ .  $\lrcorner$

As we discussed in Section 4.4.6, by removing the uncertainty  $\Delta$ , we recover the conditions for assessing the incremental  $\mathcal{L}_2$ -gain of nominal piecewise-affine systems given in Theorem 3.11.

## 4.6 Numerical examples

In this section we consider a numerical example illustrating how the PWA/IQC approach can be used to assess robust performance of uncertain piecewise-affine systems.

**EXAMPLE 4.36**

This example is inspired by the nonlinear PI controller of [54]. Let us consider the closed-loop system in Figure 4.11. It represents a controlled system, where the objective is to ensure

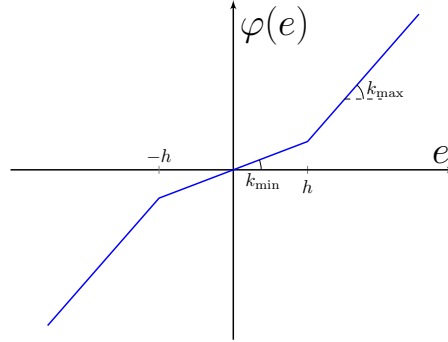
FIGURE 4.10 – Piecewise-affine nonlinearity  $\varphi$  in Example 4.36.

rejection of output disturbances while limiting the control output due to measurement noise. The LTI system  $H$  is described by the transfer function

$$H(s) = \frac{k_0(s + 0.55)(s + 1.5)}{s(s + 0.2)(s + 0.9)(s + 5)}, \quad (4.155)$$

with  $k_0 = 23.4$ .

The block  $\phi$  represents a static piecewise-affine nonlinearity, represented in Figure 4.10, and given by the continuous function

$$\phi(e) = \begin{cases} k_{\max}e + (k_{\min} - k_{\max})h \operatorname{sign}(e) & |e| > h \\ k_{\min}e & |e| \leq h, \end{cases} \quad (4.156)$$

where  $h = 0.2$ ,  $k_{\min} = 0.5$  and  $k_{\max} = 1.5$ .

The goal of this nonlinearity is to act as a variable controller gain for the system, in view of the conflicting objectives of disturbance rejection and noise attenuation. When the output is far from zero due to a perturbation, the gain  $k_{\max}$  ensures that adequate control action is used to bring the system back to the origin. When it gets close to the desired value, the gain switches to  $k_{\min}$  to limit the bandwidth and provide improved noise attenuation.

The weighting function  $W_d$  is given by

$$W_d(s) = \frac{1}{s + 0.0001}, \quad (4.157)$$

and is used to ensure a rejection bandwidth of 1 rad/s.

The system presents an inverse multiplicative parametric uncertainty at the input, given by  $\delta$  and normalizing factors  $k_b$  and  $k_v$ . This uncertainty represents an unknown gain, and allows us to ensure a given gain margin on the system. In the present example, we choose a gain margin of 3 dB, which yields  $k_v = 0.1710$  and  $k_b = 1.1710$ .

Our goal is to assess robust performance of the system in Figure 4.11 by computing an upper bound on the  $\mathcal{L}_2$ -gain between  $d$  and  $y$ . We begin by applying the traditional LTI/IQC approach of [111], thus considering both  $\delta$  and  $\phi$  as uncertainties. As a preliminary step, we use the circle criterion to analyze the nominal stability of the system. Analysis of the Nyquist plot of  $k_b H$  shows that the circle criterion is respected, see Figure 4.12. This means that stability can be assessed via LTI/IQC with a static multiplier (for a discussion about the circle criterion, see Appendix A). This in turn suggests that performance of the nominal

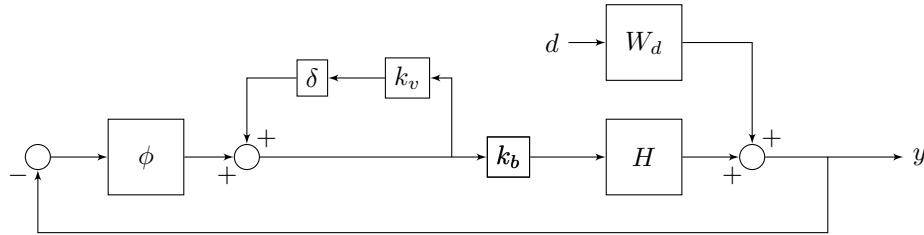
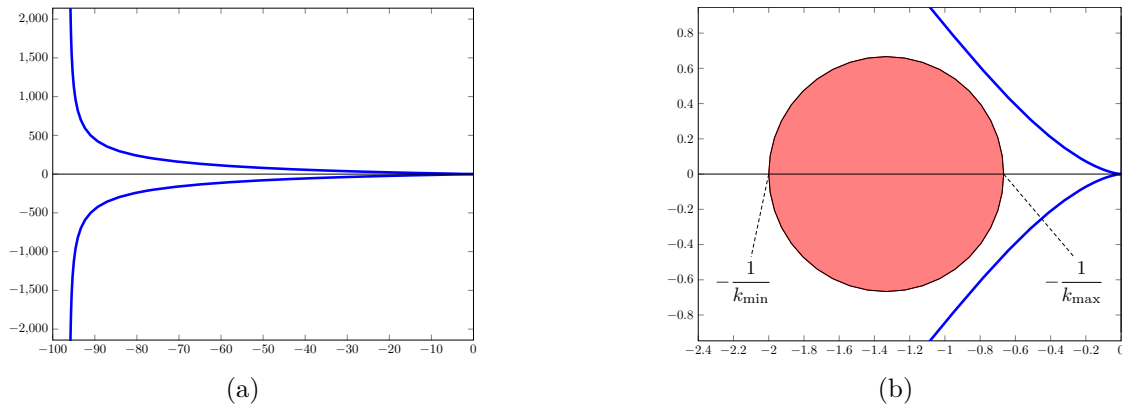

FIGURE 4.11 – Block diagram of the closed-loop system in Example 4.36.

FIGURE 4.12 – Nyquist plot of  $k_b H$ , with  $k_0 = 23.4$ , and application of the circle criterion (a) and zoom in (b) for the system in Example 4.36.

system could be assessed using a static multiplier for  $\phi$ , even though the results might be very conservative. Based on these considerations, we choose to assess robust performance using a frequency-dependent multiplier for the uncertainty  $\delta$  given by the DG-scaling (first row in Table 4.2), as well as a static multiplier for the nonlinearity  $\phi$  (last row in Table 4.2). Choosing a parametrization  $\Psi_b$  of order 2, robust performance analysis with the LTI/IQC approach (see Theorem 4.40 in Section 4.7) yields an upper bound on the  $\mathcal{L}_2$ -gain from  $d$  to  $y$  of 2.0647.

By noticing that  $\phi$  is a piecewise-affine nonlinearity, we see that the closed-loop system could be represented as an uncertain piecewise-affine system. By doing this, we may use the PWA/IQC approach (Theorem 4.29) to assess robust performance using dissipativity and piecewise-quadratic storage functions. With this method, we compute an upper bound on the  $\mathcal{L}_2$ -gain from  $d$  to  $y$  of 0.95362, a reduction of 53.81% with respect to LTI/IQC.

Let us now consider the case where the LTI system  $H$  is given by (4.155), this time with  $k_0 = 70.2$ . The Nyquist plot of this new system is provided in Figure 4.13, where we can see that the circle criterion is no longer respected. This could indicate that the classic LTI/IQC approach with static multipliers might not be enough to assess robust performance of this system. Indeed, by applying Theorem 4.40, the LMI conditions are found to be infeasible. On the other hand, by applying Theorem 4.29, we are able to compute an upper bound of 2.3351 on the  $\mathcal{L}_2$ -gain from  $d$  to  $y$ . These results are gathered in Table 4.3.

This example illustrates how the PWA/IQC approach to robust performance of nonlinear systems can be less conservative than the traditional LTI/IQC approach. In some cases, it can give results where traditional approaches fail, and can provide tighter performance measures.  $\square$

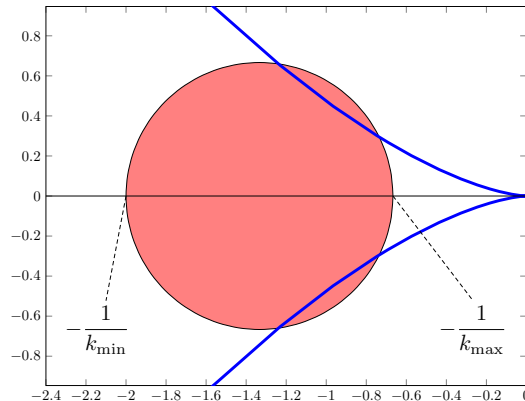

FIGURE 4.13 – Zoom over the Nyquist plot of  $k_b H$ , with  $k_0 = 70.2$ , and application of the circle criterion for the system in Example 4.36.

TABLE 4.3 – Comparison between the results obtained with the LTI/IQC and PWA/IQC approaches in Example 4.36.

$\gamma$	LTI/IQC	PWA/IQC
$k_0 = 23.4$	2.0647	0.95362
$k_0 = 70.2$	–	2.3351

## 4.7 Relation with classic IQC approach

The results presented in this section are based on the establishment of the separation between the graphs of the nominal system  $G$  and of the uncertainty  $\Delta$ , in the lines of the work developed by Safonov in [146]. The separation was obtained through the use of multipliers, which constitute a type of dynamical sector condition, extending some classical results proposed by Zames in the Sixties [188, 189]. Using these multipliers, we obtained the separation between both graphs by means of integral quadratic constraints in the time domain.

Integral quadratic constraints have been known in the control community for a long time, and can be traced back to the works on absolute stability in the Sixties (see e.g. [22, 184] and references therein). Traditionally, they are expressed as integrals in the frequency domain. This is mostly due to two concurring factors. Firstly, as we discussed in Section 4.4.3, working in the frequency domain allows us to turn convolution products in simple algebraic multiplication. This makes it easier to propose multipliers  $\Pi$  for given classes of uncertainties. Secondly, conditions on the frequency domain for SISO systems could be verified graphically by means of a Nyquist plot, which was of importance in a time when numerical computation was far from being as widespread as it is today.

It is fair to say that the works by Megretski and Rantzer [111] did a great deal to bring together and homogenize the somewhat large literature concerning integral quadratic constraints and frequency multipliers. Additionally, the possibility of using the KYP lemma to recast the stability test as an optimization problem with LMI constraints meant that stability could be assessed rather efficiently. The success was such that, in today's jargon, the term "IQC" is naturally understood to mean a frequency constraint like (4.38). In this section, we shall present some connections between the results presented in this chapter and the classic

IQC approach.

Using IQCs in the frequency domain, Theorem 4.14 could be rewritten in the following form, adapted from [134, Theorem 2] and [151, Theorem 7.13] to be consistent with the presentation in this memoir.

**THEOREM 4.37**

Let  $G : \mathcal{L}_{2e}^{n_p}(\mathbb{R}_+) \rightarrow \mathcal{L}_{2e}^{n_q}(\mathbb{R}_+)$  and  $\Delta : \mathcal{L}_{2e}^{n_q}(\mathbb{R}_+) \rightarrow \mathcal{L}_{2e}^{n_p}(\mathbb{R}_+)$  be bounded causal operators, and let  $\Pi \in \mathcal{R}\mathcal{L}_{\infty}^{(n_q+n_p) \times (n_q+n_p)}$ . Assume that:

- (i) for every  $\Delta \in \mathbf{\Delta}$ , the interconnection  $(G, \Delta)$  is well-posed.
- (ii) for every  $\Delta \in \mathbf{\Delta}$ , the IQC defined by  $\Pi$  is satisfied.
- (iii) there exists  $\varepsilon > 0$  such that

$$\int_{-\infty}^{\infty} \begin{bmatrix} \hat{q}(j\omega) \\ \hat{p}(j\omega) \end{bmatrix}^* \Pi(j\omega) \begin{bmatrix} \hat{q}(j\omega) \\ \hat{p}(j\omega) \end{bmatrix} d\omega \leq -\varepsilon \|p\|_2^2, \quad \forall p \in \mathcal{L}_2^{n_p}(\mathbb{R}_+), \quad (4.158)$$

with  $q = G(p)$ .

Then, the feedback interconnection  $(G, \Delta)$  is robustly stable with respect to  $\mathbf{\Delta}$ . ┘

**REMARK 4.38**

If the multiplier  $\Pi$  used in Theorem 4.37 admits a doubly-hard factorization  $(M, \Psi)$ , then we immediately recover Theorem 4.14. ┘

In order to use Theorem 4.37 to study stability of uncertain systems, we would need to verify whether (4.158) is satisfied. Since this condition is in the frequency domain, we cannot use dissipativity to test it, especially since  $\Pi$  may be a non-causal multiplier that does not admit a hard factorization. Hence, checking (4.158) might prove a complicated task when dealing with nonlinear systems  $G$ . However, in the case where  $G$  is linear, the analysis can be greatly simplified. Indeed, when  $G$  is linear, the frequency component  $\hat{q}(j\omega)$  depends only on the transfer function of  $G$  and the Fourier transform of  $p$  in the same frequency  $\omega$ , i.e.  $\hat{q}(j\omega) = G(j\omega)\hat{p}(j\omega)$ . Then, (4.158) becomes

$$\int_{-\infty}^{\infty} \hat{p}(j\omega)^* \begin{bmatrix} G(j\omega) \\ I_{n_p} \end{bmatrix}^* \Pi(j\omega) \begin{bmatrix} G(j\omega) \\ I_{n_p} \end{bmatrix} \hat{p}(j\omega) d\omega \leq -\varepsilon \|p\|_2^2, \quad \forall p \in \mathcal{L}_2^{n_p}(\mathbb{R}_+). \quad (4.159)$$

We may then use [109, Theorem 3.1] to show that (4.159) is equivalent to

$$\begin{bmatrix} G(j\omega) \\ I_{n_p} \end{bmatrix}^* \Pi(j\omega) \begin{bmatrix} G(j\omega) \\ I_{n_p} \end{bmatrix} \leq -\varepsilon I_{n_p}, \quad \text{for almost all } \omega \in \mathbb{R}. \quad (4.160)$$

This gives rise to the celebrated IQC theorem by Megretski and Rantzer [111], presented here with a focus on robust stability.

**THEOREM 4.39**

Let  $G \in \mathcal{R}\mathcal{H}_{\infty}^{(n_q \times n_p)}$ , and let  $\Delta : \mathcal{L}_{2e}^{n_q}(\mathbb{R}_+) \rightarrow \mathcal{L}_{2e}^{n_p}(\mathbb{R}_+)$  be a bounded causal operator belonging to  $\mathbf{\Delta}$ . Assume that:

- (i) for every  $\Delta \in \mathbf{\Delta}$ , the interconnection  $(G, \Delta)$  is well-posed.
- (ii) for every  $\Delta \in \mathbf{\Delta}$ , the IQC defined by  $\Pi$  is satisfied.
- (iii) there exists  $\varepsilon > 0$  such that

$$\begin{bmatrix} G(j\omega) \\ I_{n_p} \end{bmatrix}^* \Pi(j\omega) \begin{bmatrix} G(j\omega) \\ I_{n_p} \end{bmatrix} \leq -\varepsilon I_{n_p}, \quad \forall \omega \in \mathbb{R}. \quad (4.161)$$

Then, the feedback interconnection  $(G, \Delta)$  is robustly stable with respect to  $\mathbf{\Delta}$ .  $\lrcorner$

Constraint (4.161) is a frequency domain inequality, and leads to a convex optimization problem of infinite dimension due to the need to test it for every  $\omega \in \mathbb{R}$ . This can be overcome in two different ways. Firstly, using a parametrization for  $\Pi$  such as those presented in Section 4.4.4, one could use the KYP Lemma (Lemma 4.25) to obtain an equivalent linear matrix inequality, which could be efficiently solved via semidefinite programming. Another way to approach the problem, reminiscent of the approach used in  $\mu$ -analysis, would be to discretize the frequency domain, and then solve (4.161) for every point of the grid.

Similar results can be established concerning robust performance. When  $G_{\text{perf}}$  is an LTI system, it can be represented by the transfer matrix

$$G_{\text{perf}}(s) = \begin{bmatrix} G_{qp}(s) & G_{qw}(s) \\ G_{zp}(s) & G_{zw}(s) \end{bmatrix} \quad (4.162)$$

In this case, the feedback interconnection (4.11) can be represented by

$$\begin{cases} q = G_{qp}p + G_{qw}w + q_{\text{in}} \\ p = \Delta(q) + p_{\text{in}} \\ z = G_{zp}p + G_{zw}w \end{cases} \quad (4.163)$$

We may then propose the following theorem, which can be found e.g. in [174].

#### THEOREM 4.40

Let  $G_{\text{perf}} \in \mathcal{RH}_{\infty}^{(n_q+n_z) \times (n_p+n_w)}$  be partitioned as in (4.162), and let  $\Delta : \mathcal{L}_{2e}^{n_q}(\mathbb{R}_+) \rightarrow \mathcal{L}_{2e}^{n_p}(\mathbb{R}_+)$  be a bounded causal operator belonging to  $\mathbf{\Delta}$ . Let  $M_p$  be the matrix defined in (4.30). Assume that:

- (i) for every  $\Delta \in \mathbf{\Delta}$ , the interconnection  $(G_{\text{perf}}, \Delta)$  is well-posed.
- (ii) for every  $\Delta \in \mathbf{\Delta}$ , the IQC defined by  $\Pi$  is satisfied.
- (iii) there exists  $\varepsilon > 0$  such that

$$\begin{bmatrix} G_{qp}(j\omega) & G_{qw}(j\omega) \\ I_{n_p} & 0 \\ G_{zp}(j\omega) & G_{zw}(j\omega) \\ 0 & I_{n_w} \end{bmatrix}^* \begin{bmatrix} \Pi(j\omega) & 0 \\ 0 & M_p \end{bmatrix} \begin{bmatrix} G_{qp}(j\omega) & G_{qw}(j\omega) \\ I_{n_p} & 0 \\ G_{zp}(j\omega) & G_{zw}(j\omega) \\ 0 & I_{n_w} \end{bmatrix} \leq -\varepsilon I_{n_p+n_w}, \quad \forall \omega \in \mathbb{R}. \quad (4.164)$$

Then, the feedback interconnection  $(G_{\text{perf}}, \Delta)$  is robustly  $\mathcal{L}_2$ -gain stable with respect to  $\mathbf{\Delta}$ , with an  $\mathcal{L}_2$ -gain inferior to  $\gamma$ .  $\lrcorner$

Equivalent versions of Theorems 4.39 and 4.40 for robust incremental stability and performance can readily be obtained by simply changing the uncertainty set from  $\Delta$  to  $\overline{\Delta}$ , and requiring that every  $\Delta \in \overline{\Delta}$  satisfy an incremental version of the IQC, i.e.

$$\int_{-\infty}^{\infty} \begin{bmatrix} \hat{q}(j\omega) - \tilde{\hat{q}}(j\omega) \\ \hat{p}(j\omega) - \tilde{\hat{p}}(j\omega) \end{bmatrix}^* \Pi(j\omega) \begin{bmatrix} \hat{q}(j\omega) - \tilde{\hat{q}}(j\omega) \\ \hat{p}(j\omega) - \tilde{\hat{p}}(j\omega) \end{bmatrix} d\omega \geq 0, \quad \forall q, \tilde{q} \in \mathcal{L}_2^{n_q}(\mathbb{R}_+), \quad (4.165)$$

with  $p = \Delta(q)$  and  $\tilde{p} = \Delta(\tilde{q})$ . However, the IQC condition over  $G$  (i.e. condition (iii) in Theorems 4.39 and 4.40) remains unchanged. This is due to the fact that linearity implies that if  $G$  satisfies a given IQC, it also satisfies its incremental counterpart. This can be simply seen by post and pre multiplying (4.161) with  $(\hat{p}(j\omega) - \tilde{\hat{p}}(j\omega))$  and  $(\hat{p}(j\omega) - \tilde{\hat{p}}(j\omega))^*$ , respectively, and integrating over  $\mathbb{C}^0$ .

One of the main advantages of using frequency-domain IQCs is that the stability test can be promptly recast as an LMI-constrained optimization problem, after the parametrization of the multiplier  $\Pi$  and application of the KYP lemma. In this way, it leads to computationally tractable conditions that can be solved rather efficiently. However, as we have seen, this advantage can only be efficiently leveraged in the case when  $G$  is linear. This might lead to conservative analysis in case the original uncertain system contains nonlinearities, which must be pushed into the  $\Delta$  block. One way to reduce the conservatism in the case of memoryless nonlinearities is to consider additional classes of multipliers, such as Popov and Zames-Falb ones. However, as it was discussed in Section 4.5.3, these multipliers cannot be used to assess robust incremental stability. Hence, it would appear that one does not lose much by using time-domain IQCs in the incremental case, while gaining the flexibility provided by dissipativity analysis with sufficiently general classes of storage functions.

## 4.8 Conclusion

In this chapter we have considered the analysis of uncertain piecewise-affine systems. Conditions for stability and performance, as well as their incremental counterparts, were obtained by establishing the separation of the graphs of the nominal system and of the uncertainty. The separation is ensured by integral quadratic constraints in the time domain, as opposed to most of the results following the celebrated paper by Megretski and Rantzer [111]. In order to be able to use IQCs with dynamic multipliers in the time domain, special attention must be given to the existence of doubly-hard factorizations of these multipliers. However, by doing so, we are allowed to use the powerful tools provided by dissipativity theory in the case when the nominal system is not linear time-invariant. Building upon the results in Chapters 2 and 3, we have proposed conditions to analyze uncertain piecewise-affine systems using piecewise-quadratic and piecewise-polynomial storage functions.

The results in this chapter can be seen as an extension of analysis using integral quadratic constraints to the case of piecewise-affine systems. A first step in this direction was done in [83, Chapter 5], where robustness analysis is performed via the small-gain theorem. To the best of our knowledge, this is the first time integral quadratic constraints have been formally applied to piecewise-affine systems, even in the non-incremental case. Our results might allow us to conclude on robust (incremental) stability and performance even when quadratic functions fail. The approach was shown to be numerically viable with an example representing a realistic application of a nonlinear controller, and the reduction in conservatism was evidenced with the computation of an upper bound on the  $\mathcal{L}_2$ -gain which was more than



50% smaller than the one obtained with the classic LTI/IQC approach. This validates the interest of the approach and motivates us to continue working in this area.

We would like to highlight that the formulation of the theorems on (incremental) stability and analysis based on time-domain IQCs (Theorems 4.14, 4.15, 4.30 and 4.31) used in this chapter are of independent interest. The proof technique that we employed allowed us to remove the condition on the boundedness of the graphs of  $G$  and  $\Delta$  with respect to the external inputs that was present in the original result by Safonov [146, Theorem 2.2], as well as in the subsequent article by Teel [165, Corollary 5.1]. This condition is trivially satisfied when the disturbance inputs enter the system additively, but may be hard to verify for more general settings. This is of special interest when considering performance, as the input  $w$  (as well as  $\tilde{w}$  in the incremental case) does not enter the feedback loop additively. We have achieved this by establishing the proofs using considerations on the norm of the filtered internal signals, in a small-gain-like fashion, instead of using inner product arguments, which was made possible by the use of J-spectral factorizations of the frequency-dependent multipliers. The price to be paid is the restriction to positive-negative multipliers, for which we know that a J-spectral factorization exists.

It should be noted that the techniques presented in this chapter are not restricted to the analysis of PWA systems. Both of the main tools used to establish the results, graph separation and dissipativity, are rather general and applicable to general classes of nonlinear systems. The bottleneck is the existence of techniques allowing the construction of storage functions using efficient methods, such as we did for the special class of piecewise-affine systems.

As a final note, we would like to remark that the stability concept adopted in this chapter comes from the theory of feedback systems based on input-output considerations. It is then based on the boundedness of the signals being transmitted in the feedback loop, instead of on conditions on the asymptotic behavior of the state of the closed-loop system. Asymptotic stability could be studied with the addition of observability and reachability constraints for both  $G$  and  $\Delta$ , in the likes of [52, 57, 71, 73, 177]. However, in view of the dissipativity arguments introduced in Sections 4.4.5 and 4.5.4, it should not be too difficult to impose some extra conditions on the storage function to make sure it is also an (incremental) Lyapunov function, so that we could conclude on the robust (incremental) asymptotic stability of the closed-loop system. Nevertheless, it should be noted that the case where  $\Delta$  is a dynamic operator requires special attention, since then the (incremental) Lyapunov function would have to depend on the states of both  $G$  and  $\Delta$ .

---

# Analysis of uncertain Lur'e systems

## 5.1 Introduction

In the previous chapters we have presented analysis methods to assess nominal and robust (incremental) stability and performance of piecewise-affine systems. One could wonder whether these techniques could also be used to address the case of nonlinear systems with smooth nonlinearities. This problem is addressed in this chapter.

Nonlinear systems consisting of the interconnection between an LTI system and memoryless nonlinearities are known as *Lur'e systems*. This is due to the proposition of the so-called *Lur'e problem of absolute stability*, by Lur'e and Postnikov in the 1940s (see e.g. [102] for a discussion and historical perspective in English). The problem, which attracted and continues to attract several researchers in control theory, consisted in determining conditions under which the interconnection was stable, i.e. its trajectories went asymptotically to zero. This topic sparked many new and interesting discoveries, such as the circle criterion [188, 189] (see also Appendix A), the Popov criterion (see e.g. [36, 91]) and the Kalman-Yakubovich-Popov lemma (Lemma 4.25) [69, 132], to name but a few.

The circle criterion proposes sufficient conditions to analyze systems containing nonlinearities belonging to a sector. In this sense, the nonlinearity can be seen as a bounded perturbation on the linear dynamics of the system. The description via sector bounds yields stability results that tend to be quite conservative, as the sector gives a very crude representation of the nonlinear operator. For stability analysis, an attempt to reduce the conservatism was made by transforming the feedback loop via the addition of so-called *Popov-Zames-Falb frequency-dependent multipliers* [189, 191]. However, it turns out that this approach is not applicable when incremental stability is considered [96]. Fromion and Safonov showed that there exist Lur'e nonlinear systems for which multiplier-based analysis ensures finite-gain stability, but which are not incrementally stable [53]. On the other hand, necessary and sufficient conditions for incremental stability of Lur'e systems were proposed in [61], but with the drawback of being NP-hard.

Part of the great interest in Lur'e systems stems from its practical universality. Indeed, a great number of systems can be represented in this form, including feedback systems with saturated actuators, systems with friction, dead-zones, etc. This motivates the study of such systems and the search for less conservative analysis techniques. In order to achieve this, we propose to compute piecewise-affine approximations of the memoryless nonlinearity. This allows us to rewrite the system as the feedback interconnection of a piecewise-affine system

and a nonlinearity which is *smaller* than the original one, in the sense of its Lipschitz constant.

The idea of using piecewise-affine functions to approximate more complex nonlinear functions is in itself not new, and is at the heart of some of the first uses of piecewise-affine descriptions in circuit theory, see e.g. [81, 120]. Some new results in this area were proposed in [9, 25, 192], where the authors propose some different gridding methods for the computation of the approximation.

In this chapter, we shall focus on the analysis of incremental stability properties. In view of our specific needs, we develop a novel approximation technique, called *Lipschitz approximation*, allowing us to guarantee a given upper bound on the Lipschitz constant of the approximation error. The obtained uncertain piecewise-affine system can then be analyzed using the tools in Chapter 4. A first draft of this idea was present in [169], where a linear approximation of a nonlinearity is computed with the goal of minimizing the incremental sector of the approximation error.

This chapter is organized as follows. Section 5.2 presents the uncertain Lur'e system that we want to analyze. Then, in Section 5.3, we introduce the analysis approach proposed. Section 5.4 presents the Lipschitz approximation technique in the case of scalar and multivariable nonlinearities. Finally, Section 5.5 brings a numerical example illustrating the ideas presented in this chapter, and a conclusion is given in Section 5.6.

## 5.2 Uncertain Lur'e systems

In this chapter we are interested in the analysis of uncertain Lur'e type nonlinear systems, represented in Figure 5.1 and given by

$$z = \Sigma^\Delta(w) \begin{cases} \dot{x}(t) = Ax(t) + B_p p(t) + B_u u(t) + B_w w(t) \\ q(t) = C_q x(t) + D_{qp} p(t) + D_{qu} u(t) + D_{qw} w(t) \\ z(t) = C_z x(t) + D_{zp} p(t) + D_{zu} u(t) + D_{zw} w(t) \\ v(t) = C_v x(t) + D_{vp} p(t) + D_{vu} u(t) + D_{vw} w(t) \\ u(t) = -\varphi(v(t)) \\ p(t) = (\Delta(q))(t) \end{cases} \quad (5.1)$$

where  $A \in \mathbb{R}^{n \times n}$ ,  $B_p \in \mathbb{R}^{n \times n_p}$ ,  $B_u \in \mathbb{R}^{n \times n_u}$ ,  $B_w \in \mathbb{R}^{n \times n_w}$ ,  $C_q \in \mathbb{R}^{n_q \times n}$ ,  $D_{qp} \in \mathbb{R}^{n_q \times n_p}$ ,  $D_{qu} \in \mathbb{R}^{n_q \times n_u}$ ,  $D_{qw} \in \mathbb{R}^{n_q \times n_w}$ ,  $C_z \in \mathbb{R}^{n_z \times n}$ ,  $D_{zp} \in \mathbb{R}^{n_z \times n_p}$ ,  $D_{zu} \in \mathbb{R}^{n_z \times n_u}$ ,  $D_{zw} \in \mathbb{R}^{n_z \times n_w}$ ,  $C_v \in \mathbb{R}^{n_v \times n}$ ,  $D_{vp} \in \mathbb{R}^{n_v \times n_p}$ ,  $D_{vu} \in \mathbb{R}^{n_v \times n_u}$ ,  $D_{vw} \in \mathbb{R}^{n_v \times n_w}$ ,  $\Delta$  from  $\mathcal{L}_{2e}^{n_q}(\mathbb{R}_+)$  into  $\mathcal{L}_{2e}^{n_p}(\mathbb{R}_+)$  is a causal and bounded operator representing the uncertainty, and  $\varphi : \mathbb{R}^{n_v} \rightarrow \mathbb{R}^{n_u}$  is a given memoryless Lipschitz nonlinearity satisfying  $\varphi(0) = 0$ . We assume that the system is defined globally, i.e.  $X = \mathbb{R}^n$ .

We shall once again consider uncertainties  $\Delta$  belonging to the uncertainty set  $\bar{\Delta}$  defined in Definition 4.2, page 67, with the only difference being that static nonlinearities are regrouped in  $\varphi$ .

## 5.3 Proposed approach

The traditional method to assess incremental stability of uncertain Lur'e systems (5.1) is to consider  $\varphi$  as an uncertainty and use the LTI/IQC approach with a static multiplier for the nonlinearity, as in Table 4.1. In the nominal case, i.e. when  $\Delta = 0$ , this yields the

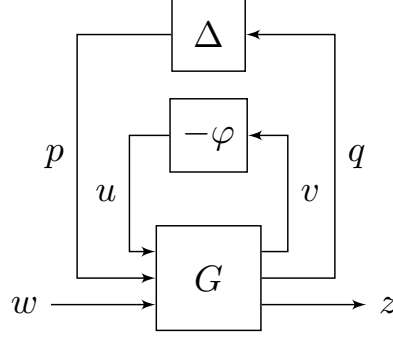

FIGURE 5.1 – Representation of the uncertain Lur'e system defined in (5.1).

conditions of the incremental circle criterion (see e.g. [59, 189] as well as Appendix A). This involves embedding the nonlinearity  $\varphi$  in an incremental sector  $\text{Sect}_\Delta(K_1, K_2)$ , i.e. finding  $K_1 := \text{diag}(\kappa_{1,1}, \dots, \kappa_{1,n_v})$  and  $K_2 := \text{diag}(\kappa_{2,1}, \dots, \kappa_{2,n_v})$  such that

$$((\varphi(v) - \varphi(\tilde{v})) - K_1(v - \tilde{v}))^\top ((\varphi(v) - \varphi(\tilde{v})) - K_2(v - \tilde{v})) \leq 0, \text{ for all } v, \tilde{v} \in \mathbb{R}^{n_v}. \quad (5.2)$$

It is clear that a Lipschitz nonlinearity  $\varphi$ , with Lipschitz constant  $L_\varphi$ , belongs to the incremental sector  $\text{Sect}_\Delta(-L_\varphi I_{n_v}, L_\varphi I_{n_v})$ . The incremental circle criterion gives conditions to assess incremental stability of *every* nonlinearity inside an incremental sector. By doing so, we obtain tractable conditions to perform the analysis, but at the price of some conservatism. This is due to the fact that, in general, incremental sector conditions provide a crude description of  $\varphi$ . The aim of this chapter is to propose a new description of system (5.1) so that we can reduce the conservatism of the analysis. This new description shall be based on rewriting the uncertain Lur'e system with the help of piecewise-affine systems. We propose computing a piecewise-affine approximation  $\varphi_{\text{PWA}}$  of the nonlinearity  $\varphi$ , so that (5.1) is transformed into the interconnection of a PWA system with the approximation error:

$$z = \Sigma_{\text{PWA}, \epsilon}^\Delta(w) \begin{cases} \dot{x}(t) = A_i x(t) + a_i + B_{p,i} p(t) + B_{u,i} u_\epsilon(t) + B_{w,i} w(t) \\ q(t) = C_{q,i} x(t) + c_{q,i} + D_{qp,i} p(t) + D_{qu,i} u_\epsilon(t) + D_{qw,i} w(t) \\ z(t) = C_{z,i} x(t) + c_{z,i} + D_{zp,i} p(t) + D_{zu,i} u_\epsilon(t) + D_{zw,i} w(t) \\ v(t) = C_{v,i} x(t) + c_{v,i} + D_{vp,i} p(t) + D_{vu,i} u_\epsilon(t) + D_{vw,i} w(t) \\ u_\epsilon(t) = -\epsilon(v(t)) \\ p(t) = (\Delta(q))(t) \end{cases} \text{ for } x(t) \in X_i \quad (5.3)$$

We shall refer to (5.3) as a *PWA Lur'e system*. We remark that it is equivalent to (4.1), where the block  $\Delta$  could also include the nonlinearity  $\varphi$ . The fact that it is separated from  $\Delta$  in this chapter is due to the fact that (5.3) will be obtained via an approximation of (5.1). We make the assumption that the approximation error  $\epsilon$  is Lipschitz with Lipschitz constant  $L_\epsilon$ . The regions  $X_i$ , for  $i \in \mathcal{I} := \{1, \dots, N\}$ , are closed convex polyhedral sets  $X_i = \{x \in X \mid G_i x + g_i \succeq 0\}$  with non-empty and pairwise disjoint interiors such that  $\bigcup_{i \in \mathcal{I}} X_i = X$ . Then,  $\{X_i\}_{i \in \mathcal{I}}$  constitutes a finite partition of  $X$ . From the geometry of  $X_i$ , the intersection  $X_i \cap X_j$  between two different regions is always contained in a hyperplane, i.e.  $X_i \cap X_j \subseteq \{x \in X \mid E_{ij} x + e_{ij} = 0\}$ . The approach is illustrated in Fig. 5.2, and formalized in the next proposition.

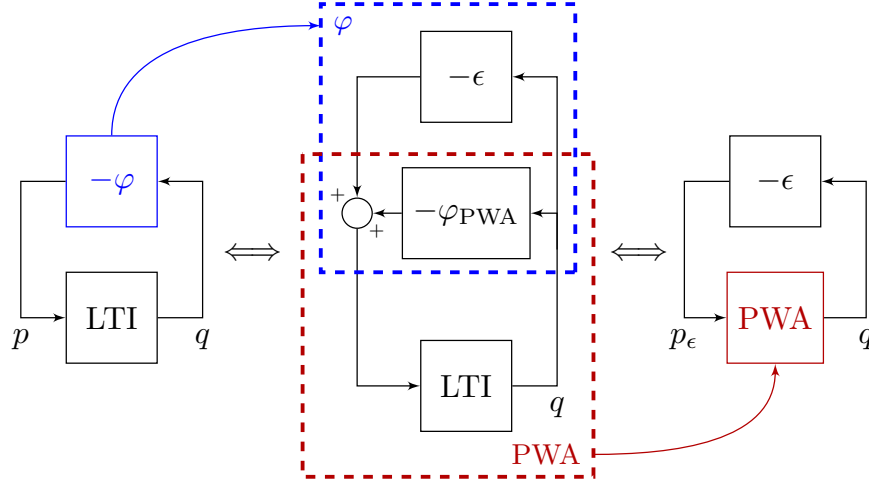

FIGURE 5.2 – Block diagram illustrating the approach proposed in this chapter (the performance channels  $w$  and  $z$ , as well as the uncertainty  $\Delta$ , are omitted for clarity).

#### PROPOSITION 5.1

Let  $\mathcal{R}_i \subset \mathbb{R}^{n_v}$ ,  $i \in \mathcal{I} = \{1, \dots, N\}$ , be non-empty convex polyhedral regions with pairwise disjoint interiors, such that  $\{\mathcal{R}_i\}_{i \in \mathcal{I}}$  forms a partition of  $\mathbb{R}^{n_v}$ . Let the nonlinearity  $\varphi$  in (5.1) be decomposed as  $\varphi(v) = \varphi_{\text{PWA}}(v) + \epsilon(v)$ , with  $\varphi_{\text{PWA}}$  a piecewise-affine function given by  $\varphi_{\text{PWA}}(v) = r_i v + s_i$ , for  $q \in \mathcal{R}_i$ , with  $r_i \in \mathbb{R}^{n_u \times n_v}$  and  $s_i \in \mathbb{R}^{n_u}$ . Then, the Lur'e system (5.1), with  $D_{vp} = 0$ ,  $D_{vu} = 0$  and  $D_{vw} = 0$ , is equivalent to the PWA Lur'e system (5.3), with  $\epsilon(v) := \varphi(v) - \varphi_{\text{PWA}}(v)$ , and

$$\begin{aligned}
 A_i &= (A - B_u r_i C_v) & a_i &= -B_u s_i & B_{p,i} &= B_p & B_{u,i} &= B_u & B_{w,i} &= B_w \\
 C_{q,i} &= (C_q - D_{qu} r_i C_v) & c_{q,i} &= -D_{qu} s_i & D_{qp,i} &= D_{qp} & D_{qu,i} &= D_{qu} & D_{qw,i} &= D_{qw} \\
 C_{z,i} &= (C_z - D_{zu} r_i C_v) & c_{z,i} &= -D_{zu} s_i & D_{zp,i} &= D_{zp} & D_{zu,i} &= D_{zu} & D_{zw,i} &= D_{zw} \\
 C_{v,i} &= C_v & c_{v,i} &= 0 & D_{vp,i} &= 0 & D_{vu,i} &= 0 & D_{vw,i} &= 0
 \end{aligned} \tag{5.4}$$

and  $X_i = \{x \in X \mid C_v x \in \mathcal{R}_i\}$ . ┘

#### PROOF

The proof follows after straightforward manipulations. Indeed, it suffices to replace  $\varphi(v)$  by the sum  $\varphi_{\text{PWA}}(v) + \epsilon(v)$ . Then, using the fact that  $\varphi_{\text{PWA}}(v) = r_i v + s_i = r_i C_v x + s_i$ , the nonlinear system (5.1) may be rewritten as (5.3), with the systems matrices defined by (5.4). ■

In Proposition 5.1, we consider the case where the direct terms  $D_{vp}$ ,  $D_{vu}$  and  $D_{vw}$  are zero. This is due to the fact that non-zero matrices would lead to a piecewise-affine system whose regional description would depend on the inputs  $p$ ,  $u_\epsilon$  and  $w$ . As we have discussed in Chapter 2, in this memoir we focus our attention in piecewise-affine system whose regional description depends uniquely on the state. It would be possible to consider the former, in the likes of the results presented in [113, 143], at the expense of some added complexity.

The regions  $X_i$  are defined as  $X_i = \{x \in X \mid C_v x \in \mathcal{R}_i\}$ , i.e. as the preimage of  $\mathcal{R}_i$  under the linear transformation defined by  $C_v$ . Since  $\mathcal{R}_i$  are closed convex polyhedra, this means that so are  $X_i$ , see [137, Theorem 19.3] as well as [158]. It is easy to see that the regions  $X_i$  defined

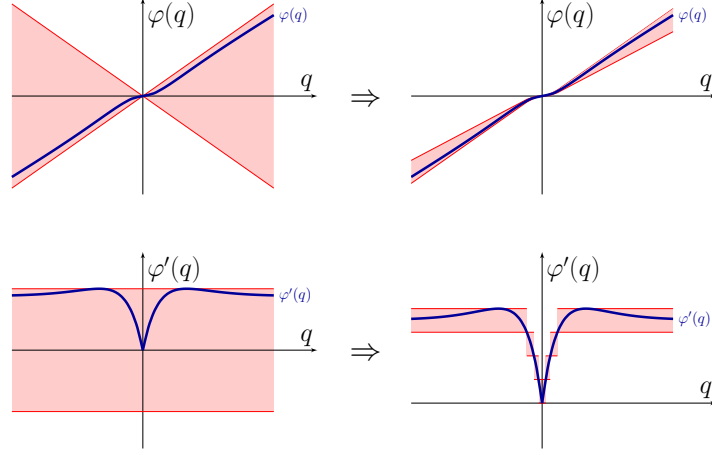

FIGURE 5.3 – Comparison between the sectors describing the nonlinearity  $\varphi$  for the incremental circle criterion (left) and the piecewise-affine approach (right).

in this way have pairwise disjoint interiors. Indeed, if there exists  $x \in \text{int}(X_i) \cap \text{int}(X_j)$ , this means that  $C_v x$  belongs to both  $\text{int}(\mathcal{R}_i)$  and  $\text{int}(\mathcal{R}_j)$ , which is impossible since  $\{\mathcal{R}_i\}_{i \in \mathcal{I}}$  is a partition of  $\mathbb{R}^{n_v}$ . Now, for  $\{X_i\}_{i \in \mathcal{I}}$  to be a partition of  $X$ , we need that  $\bigcup_i X_i = X$ . Since  $X = \mathbb{R}^n$ , we clearly have that  $\bigcup_i X_i \subseteq X$ . Suppose that there exist  $x \in X$  such that  $x \notin \bigcup_i X_i$ . This means that  $\mathbb{R}^{n_v} \ni C_v x \notin \mathcal{R}_i$ , for any  $i \in \mathcal{I}$ , which is once again impossible since  $\{\mathcal{R}_i\}_{i \in \mathcal{I}}$  is a partition of  $\mathbb{R}^{n_v}$ . We then conclude that  $\{X_i\}_{i \in \mathcal{I}}$  is indeed a partition of  $X$ .

By performing analysis on (5.3), we replace the test for every nonlinearity  $\varphi \in \{\varphi \mid \varphi \in \text{Sect}_{\Delta}(-L_{\varphi}I_{n_u}, L_{\varphi}I_{n_u})\}$  by the test for every  $\varphi \in \{\varphi \mid \varphi = \varphi_{\text{PWA}} + \epsilon, \text{ with } \epsilon \in \text{Sect}_{\Delta}(-L_{\epsilon}I_{n_u}, L_{\epsilon}I_{n_u})\}$ . As we are able to control the approximation error through the refinement of  $\varphi_{\text{PWA}}$  (and thus to control  $L_{\epsilon}$ ), this allows us to obtain a PWA Lur'e system whose nonlinearity is described by much tighter sector bounds (see Fig. 5.3). Hence, the analysis provides potentially less conservative results for the incremental analysis of Lur'e systems. The approach is presented in the next algorithm.

#### ALGORITHM 5.2

Given an uncertain Lur'e system (5.1) with a memoryless Lipschitz nonlinearity  $\varphi$  and zero direct transfer matrices  $D_{vp}$ ,  $D_{vu}$  and  $D_{vw}$ :

1. Compute a piecewise-affine approximation  $\varphi_{\text{PWA}}$  so that  $\epsilon = \varphi - \varphi_{\text{PWA}}$  is Lipschitz, with a Lipschitz constant  $L_{\epsilon}$  smaller than a given upper bound  $L_{\text{ref}}$ .
2. Use Proposition 5.1 to construct an equivalent PWA Lur'e system (5.3) from (5.1).
3. Assess incremental robust stability and performance of (5.3) using the results in Section 4.5, and, if positive, conclude on the robust incremental stability and performance of (5.1).  $\lrcorner$

In order to use Algorithm 5.2, we need to be able to compute a piecewise-affine approximation of  $\varphi$  that ensures an upper bound on the Lipschitz constant of the approximation error. In the next section we provide some insights on how this can be achieved.

## 5.4 Lipschitz approximation of static nonlinearities

Piecewise-affine functions are a natural choice for the approximation of scalar nonlinearities. Indeed, the next theorem, taken from [156, Theorem 4.7.2], states that it is always possible to approximate a continuous function with a piecewise-affine one so that the pointwise approximation error is less than some desired value.

### THEOREM 5.3

Given any  $\varphi \in \mathcal{C}[a, b]$  and any  $\varepsilon > 0$ , there exists a continuous piecewise-affine function  $\varphi_{\text{PWA}, \varepsilon} : [a, b] \rightarrow \mathbb{R}$  such that

$$|\varphi(v) - \varphi_{\text{PWA}, \varepsilon}(v)| < \varepsilon \quad \forall v \in [a, b]. \quad (5.5)$$

┘

This result motivates the choice of piecewise-affine functions as approximation functions. Several results exist in the literature concerning the computation of piecewise-affine approximations. The first and most simple approach is to use a uniform grid of the domain and compute a piecewise-affine function that interpolates  $\varphi$  on each vertex (see e.g. [8, 120, 162]). Although very simple, this strategy may lead to piecewise-affine functions with a high number of regions. In [25], the authors propose a strategy to minimize this issue, by taking into account the curvature of  $\varphi$ . Also in this vein, the authors in [9] propose a new method based on the uniform partition of the image, inspired by the concept of Lebesgue integration. An alternative iterative strategy is proposed in [192], where successive steps are taken to refine the partition and achieve a smaller approximation error.

The references presented above are interested in computing piecewise-affine approximations that minimize the approximation in the sense of the pointwise distance between  $\varphi$  and the computed approximation. However, in view of the application of Algorithm 5.2, our goal is to compute a piecewise-affine approximation such that the approximation error is Lipschitz, and respects a given bound on the Lipschitz constant. We shall refer to this approach as *Lipschitz approximation*.

### 5.4.1 Scalar case

Let us first consider the scalar case  $\varphi : \mathbb{R} \rightarrow \mathbb{R}$ . We begin by recalling a well-known fact connecting Lipschitz continuity with boundedness of the derivative. This is a basic result of real analysis found in standard textbooks such as [161].

#### LEMMA 5.4

Let  $f : \mathbb{R} \rightarrow \mathbb{R}$  be a memoryless nonlinearity. Then, both statements are equivalent:

- (i)  $f$  is Lipschitz continuous, with Lipschitz constant  $L$ , i.e.  $|f(v) - f(\tilde{v})| \leq L|v - \tilde{v}|$ , for all  $v, \tilde{v} \in \mathbb{R}$ .
- (ii)  $f$  is absolutely continuous and the derivative  $f'$  is bounded almost everywhere by  $L$ , i.e.  $|f'(v)| \leq L$ , for almost all  $v \in \mathbb{R}$ . ┘

The above lemma is central to the development of the approximation technique presented in this section. As we will see in the following, it will allow us to arrive at simple conditions for the construction of  $\varphi_{\text{PWA}}$  based on its derivative. As an additional benefit, working with

the derivative  $\epsilon'(v)$  instead of with the difference  $\epsilon(v) - \epsilon(\tilde{v})$  avoids the need of dealing with every combination of the regions of  $\varphi_{\text{PWA}}$ .

Let us define  $\Phi(N)$  as the set of piecewise-affine functions  $\varphi_{\text{PWA}} : \mathbb{R} \rightarrow \mathbb{R}$  defined on a partition of size  $N$ . That is,  $\Phi(N)$  is the set of piecewise-affine functions for which there exists a partition  $\{\mathcal{R}_i\}_{i \in \mathcal{I}}$  of  $\mathbb{R}$ , with  $|\mathcal{I}| = N$ . Then, there are  $(r_i, s_i) \in \mathbb{R}^2$  such that  $\varphi_{\text{PWA}}(v) = r_i v + s_i$ , for  $v \in \mathcal{R}_i$ , where  $i \in \mathcal{I} = \{1, \dots, N\}$ . Since  $\varphi$  is continuous and  $\epsilon$  is Lipschitz continuous,  $\varphi_{\text{PWA}}$  must be continuous. This implies that

$$r_i v + s_i = r_j v + s_j, \quad \forall v \in \mathcal{R}_i \cap \mathcal{R}_j. \quad (5.6)$$

We also fix  $\varphi_{\text{PWA}}(0) = 0$ , so that for any  $i$  such that  $v = 0 \in \mathcal{R}_i$ , we have  $s_i = 0$ . We shall make the following assumption on the nonlinearity  $\varphi$ .

ASSUMPTION 5.5

*The memoryless nonlinearity  $\varphi$  is continuously differentiable, i.e.  $\varphi \in \mathcal{C}^1(\mathbb{R})$ , and asymptotically affine, i.e. there exist constants  $k_1, k_2 \in \mathbb{R}$  such that  $\lim_{v \rightarrow -\infty} |\varphi'(v) - k_1| = 0$  and  $\lim_{v \rightarrow \infty} |\varphi'(v) - k_2| = 0$ .*

Assumption 5.5 ensures that we are able to construct an approximation  $\varphi_{\text{PWA}}$  with a finite partition (with  $N < \infty$ ) on a unbounded domain like  $\mathbb{R}$ . We are interested in finding  $\varphi_{\text{PWA}}$  that best approximates  $\varphi$ . We shall measure the approximation error by its Lipschitz constant, i.e., by its incremental gain. This may be formalized as

$$\begin{aligned} & \underset{\varphi_{\text{PWA}} \in \Phi(N)}{\text{minimize}} && L_\epsilon \\ & \text{subject to} && |\epsilon(v) - \epsilon(\tilde{v})| \leq L_\epsilon |v - \tilde{v}| \\ & && v, \tilde{v} \in \mathbb{R}, \end{aligned} \quad (5.7)$$

where  $\epsilon(v) = \varphi(v) - \varphi_{\text{PWA}}(v)$ .

As we refine the partition  $\{\mathcal{R}_i\}_{i \in \mathcal{I}}$ , by choosing a larger  $N$ , the approximation error decreases, while the complexity of  $\varphi_{\text{PWA}}$  increases. This indicates a trade-off between the accuracy of the description and the complexity of the analysis. We shall search for a value of  $N$  ensuring a given upper bound  $L_{\text{ref}}$  on the Lipschitz constant of the approximation error. The next proposition gives a method to obtain  $\varphi_{\text{PWA}}$  respecting the desired upper bound on the approximation.

PROPOSITION 5.6

*Let  $\varphi$  be a function satisfying Assumption 5.5. Let  $L_{\text{ref}} > 0$ , and let  $\{\mathcal{R}_i\}_{i \in \mathcal{I}}$ , with  $\mathcal{I} = \{1, \dots, N\}$ , be a partition of  $\mathbb{R}$  obtained by a uniform division of the image of  $\varphi'$  under  $\mathbb{R}$ , i.e.  $l(\varphi'(\mathcal{R}_i)) = l(\varphi'(\mathcal{R}_j))$ , for all  $i, j \in \mathcal{I}$ , where  $l(\cdot)$  denotes the length of an interval. Also, let  $r_i = (\sup_{v \in \text{int}(\mathcal{R}_i)} \varphi'(v) + \inf_{v \in \text{int}(\mathcal{R}_i)} \varphi'(v))/2$  and  $s_i$  be chosen to ensure continuity of  $\varphi_{\text{PWA}}$ , i.e. so that (5.6) is satisfied for all pairs  $(i, j)$  such that  $\mathcal{R}_i \cap \mathcal{R}_j \neq \emptyset$ . Then, by choosing  $N$  such that  $l(\varphi'(\mathcal{R}_i)) \leq 2L_{\text{ref}}$ , the obtained approximation  $\varphi_{\text{PWA}}$  ensures that  $\epsilon$  is Lipschitz with a Lipschitz constant  $L_\epsilon \leq L_{\text{ref}}$ .  $\lrcorner$*

PROOF

We first show that the proposed partition method ensures the desired upper bound on the derivative of the error  $\epsilon$ . We then use Lemma 5.4 to conclude on the Lipschitz continuity of  $\epsilon$ .



We recall that  $\epsilon'(v) = \varphi'(v) - r_i$ , for all  $v \in \text{int}(\mathcal{R}_i)$ . Let us denote  $L_i$  the smallest positive scalar bounding the derivative  $\epsilon'(v)$  for all  $v \in \mathcal{R}_i$ , i.e. such that  $\sup_{v \in \text{int}(\mathcal{R}_i)} |\epsilon'(v)| \leq L_i$ . By choosing  $r_i = (\sup_{v \in \text{int}(\mathcal{R}_i)} \varphi'(v) + \inf_{v \in \text{int}(\mathcal{R}_i)} \varphi'(v))/2$ , we ensure that  $L_i = \ell(\varphi'(\mathcal{R}_i))/2$ . Since  $\varphi$  is Lipschitz continuous, its derivative is bounded on  $\mathbb{R}$ . Then, we can use the proposed partition so that the image of  $\varphi'$  under  $\mathbb{R}$  is uniformly divided, and we have  $L_i = \ell(\varphi'(\mathcal{R}_i))/2 \leq L_{\text{ref}}$ ,  $\forall i \in \mathcal{I}$ .

Let us note that  $\epsilon$  is the difference between a Lipschitz function ( $\varphi$ ) and a continuous piecewise-affine function ( $\varphi_{\text{PWA}}$ ), which is absolutely continuous. Then, by defining  $L_\epsilon = L_i$  and using Lemma 5.4, we have that  $|\epsilon(v) - \epsilon(\tilde{v})| \leq L_\epsilon |v - \tilde{v}|$ , for all  $v, \tilde{v} \in \mathbb{R}$ , with  $L_\epsilon \leq L_{\text{ref}}$ , which concludes the proof. ■

The regions  $\mathcal{R}_i = [v_i, v_{i+1}]$  can be defined by solving scalar nonlinear equations, which can be done by standard techniques such as the bisection method. We remark that, since  $\varphi$  is asymptotically linear, the leftmost and rightmost regions  $\mathcal{R}_i$  may be unbounded.

One could wonder whether the partition method in Proposition 5.6 gives the optimal solution to (5.7). It turns out that this is true, provided that  $\varphi$  satisfies some additional assumptions, as stated in the following.

ASSUMPTION 5.7

*The memoryless nonlinearity  $\varphi$  is odd, monotone, and so that  $\varphi'$  is nondecreasing on  $\mathbb{R}_+$ .* ◻

PROPOSITION 5.8

*Let  $\varphi$  be a nonlinear function respecting Assumptions 5.5 and 5.7. Then, the partition method described in Proposition 5.6 yields  $\varphi_{\text{PWA}}$  that is the optimal solution to (5.7).* ◻

PROOF

Due to  $\varphi$  being odd, we can focus on  $\mathbb{R}_+$  and obtain the remaining by symmetry. Let  $\{\mathcal{R}_i\}_{i \in \mathcal{I}}$  be an arbitrary partition of  $\mathbb{R}_+$ , with  $\mathcal{I} = \{0, \dots, m\}$ . Also, let  $L_i > 0$  be as in the proof of Proposition 5.6. Then, by taking  $L_\epsilon := \max_{i \in \mathcal{I}} L_i$ , we have that  $|\epsilon'(v)| \leq L_\epsilon$ , for almost all  $v \in \mathbb{R}_+$ . It is clear that, for each region, the choice of  $r_i$  that minimizes  $L_i$  is given by  $r_i = (\sup_{v \in \text{int}(\mathcal{R}_i)} \varphi'(v) + \inf_{v \in \text{int}(\mathcal{R}_i)} \varphi'(v))/2$ . In this case, we have  $L_i = (\sup_{v \in \text{int}(\mathcal{R}_i)} \varphi'(v) - \inf_{v \in \text{int}(\mathcal{R}_i)} \varphi'(v))/2$ . As  $\varphi$  is Lipschitz,  $\varphi'$  is bounded on  $\mathbb{R}_+$ . Since the derivative  $\varphi'$  is continuous and nondecreasing on  $\mathbb{R}_+$ , we have

$$\begin{aligned} \sum_{i=0}^m L_i &= \sum_{i=0}^m \frac{\sup_{v \in \text{int}(\mathcal{R}_i)} \varphi'(v) - \inf_{v \in \text{int}(\mathcal{R}_i)} \varphi'(v)}{2} \\ &= \frac{\ell(\varphi'(\mathbb{R}_+))}{2}. \end{aligned} \quad (5.8)$$

From this, we are interested in minimizing  $L_\epsilon = \max_{i \in \mathcal{I}} L_i$ , subject to  $L_i \geq 0$  and  $\sum_{i=0}^m L_i = \ell(\varphi'(\mathbb{R}_+))/2$ . The minimum is obtained when all  $L_i$  have the same value, which is obtained by taking a partition such that the image of  $\varphi'$  under  $\mathbb{R}_+$  is uniformly divided. This yields  $L_\epsilon = \ell(\varphi'(\mathbb{R}_+))/(2(m+1))$ . Then, proceeding as in Proposition 5.6, we conclude that  $\varphi_{\text{PWA}}$  obtained by this method ensures that  $|\epsilon(v) - \epsilon(\tilde{v})| \leq L_\epsilon |v - \tilde{v}|$ , for all  $v, \tilde{v} \in \mathbb{R}$ , with  $L_\epsilon$  minimal. ■

Despite the fact that Problem (5.7) is non-convex due to the need to define the partition  $\{\mathcal{R}_i\}_{i \in \mathcal{I}}$ , Proposition 5.8 shows that, in the case where  $\varphi$  satisfies Assumption 5.7, the optimal

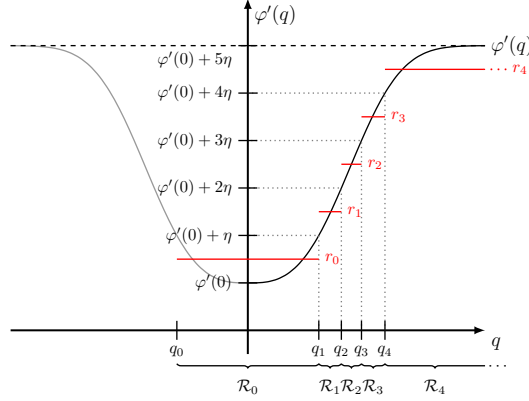

FIGURE 5.4 – Partitioning strategy presented in Proposition 5.8, based on the uniform division of the image of  $\varphi'$  under  $\mathbb{R}$ .

solution is known and quite easy to compute. The partitioning strategy is illustrated in Figure 5.4. In this case, we may explicitly compute  $N$  such that the error bound is guaranteed to be inferior to  $L_{\text{ref}}$ , as stated in the next proposition.

PROPOSITION 5.9

Let  $\varphi$  be a nonlinearity satisfying Assumptions 5.5 and 5.7. Let  $L_{\text{ref}} > 0$  be the desired upper bound on the Lipschitz constant of the approximation error. Let  $\lceil \cdot \rceil$  denote the ceiling function. Then, if

$$m = \left\lceil \frac{\ell(\varphi'(\mathbb{R}_+))}{2L_{\text{ref}}} \right\rceil - 1 > 0, \quad (5.9)$$

with  $N := 2m + 1$ , and  $\varphi_{\text{PWA}}$  is obtained by the method in Proposition 5.8, then the approximation error  $\epsilon$  is Lipschitz with a Lipschitz constant  $L_\epsilon \leq L_{\text{ref}}$ .  $\square$

PROOF

This is a simple consequence of the fact that the partitioning strategy presented in Proposition 5.8 ensures that  $L_\epsilon = \ell(\varphi'(\mathbb{R}_+))/(2(m + 1))$ .  $\blacksquare$

With the techniques presented in this section and Chapter 4, we have all the tools to apply Algorithm 5.2 to the study of the robust incremental stability and performance of Lur'e systems (5.1). This shall be illustrated in section 5.5 with a numerical example.

### 5.4.2 General case

Let us now consider the case of multivariable  $\varphi : \mathbb{R}^{n_v} \rightarrow \mathbb{R}^{n_u}$ . In this setting, Lemma 5.4 can be generalized as follows (see e.g. [75]).

LEMMA 5.10

Let  $f : \mathbb{R}^n \rightarrow \mathbb{R}^m$  be a memoryless nonlinearity. Then, both statements are equivalent:

- (i)  $f$  is Lipschitz continuous, with Lipschitz constant  $L$ , i.e.  $|f(v) - f(\tilde{v})| \leq L|v - \tilde{v}|$ , for all  $v, \tilde{v} \in \mathbb{R}^n$ .

(ii)  $f$  is weakly differentiable, and the norm of the Jacobian matrix  $J_f$  is essentially bounded by  $L$ , i.e.  $\|J_f(v)\| \leq L$ , for almost all  $v \in \mathbb{R}^n$ .  $\lrcorner$

In the multivariable case, it would be much more complicated to obtain conditions such as those obtained for scalar nonlinearities. Indeed, it appears to be difficult to generalize the adopted approach of uniformly partitioning the image of  $\varphi'$ . Other strategies should be considered in this case.

Let us note that the norm in item (ii) of Lemma 5.10 is the operator norm, i.e.

$$\|J_f(v)\| = \sup_{\substack{h \in \mathbb{R}^{n_v} \\ |h|=1}} \{|J_f(v)h|\}. \quad (5.10)$$

Since we have chosen to endow both  $\mathbb{R}^{n_v}$  and  $\mathbb{R}^{n_u}$  with the Euclidean norm, the operator norm can be explicitly computed as (see e.g. [17, Section A.1.5])

$$\|J_f(v)\| = \sigma_{\max}(J_f(v)) = \sqrt{\lambda_{\max}(J_f(v)^\top J_f(v))}, \quad (5.11)$$

where  $\sigma_{\max}$  and  $\lambda_{\max}$  denote the maximum singular value and the maximum eigenvalue, respectively. Using this, the bound in item (ii) can be equivalently rewritten as

$$J_f(v)^\top J_f(v) - L^2 I_{n_v} \preceq 0, \quad \text{for almost all } v \in \mathbb{R}^{n_v}. \quad (5.12)$$

Let us consider the case where  $\varphi$  is a polynomial nonlinearity from  $\mathbb{R}^{n_v}$  into  $\mathbb{R}^{n_u}$ . Then, using a uniform grid on a compact set  $\mathcal{V} \subset \mathbb{R}^{n_v}$ , it would be possible to use (5.12) together with the SOS tools presented in Section 3.4 to obtain a convex optimization problem allowing the computation of a suitable  $\varphi_{\text{PWA}}$ .

## 5.5 Numerical examples

In this section we consider some numerical examples of the application of the Lipschitz approximation technique and the analysis of robust incremental stability of an uncertain Lur'e system.

### EXAMPLE 5.11

Let us consider a SISO Lipschitz nonlinearity  $\varphi : \mathbb{R} \rightarrow \mathbb{R}$  given by:

$$\varphi(v) = kv \left(1 - e^{-\lambda|v|}\right), \quad (5.13)$$

with  $k = 5.5$  and  $\lambda = 2$ . We are interested in computing a piecewise-affine approximation of  $\varphi$  using the Lipschitz approximation technique presented in the previous section. In Figure 5.5 are plotted both  $\varphi$  and its derivative, and we can see that it is continuously differentiable and asymptotically affine, thus satisfying Assumption 5.5. This means that we are able to compute a piecewise-affine approximation that is valid globally and such that the approximation error is Lipschitz constant. Using the technique in Proposition 5.6 with  $L_{\text{ref}} = 1$ , we obtain an approximation  $\varphi_{\text{PWA}}$  with  $N = 7$  regions. Both  $\varphi$  and  $\varphi_{\text{PWA}}$  together with their respective derivatives are represented in Figure 5.6. The computed piecewise-affine approximation is such that the Lipschitz constant of the approximation error  $\epsilon$  is  $L_\epsilon = 0.7805$ . The derivative of the approximation error is represented in Figure 5.7, where we see that it is indeed essentially bounded by  $L_\epsilon$ .  $\lrcorner$

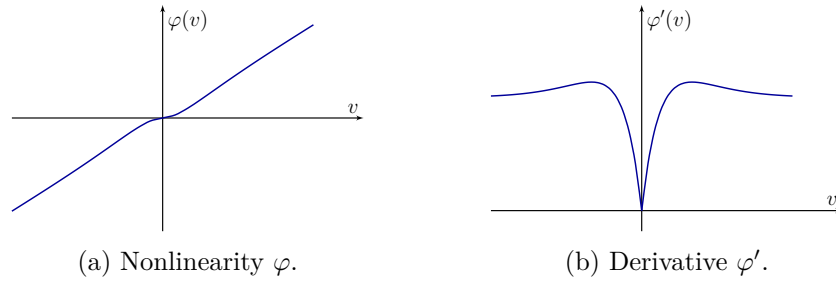
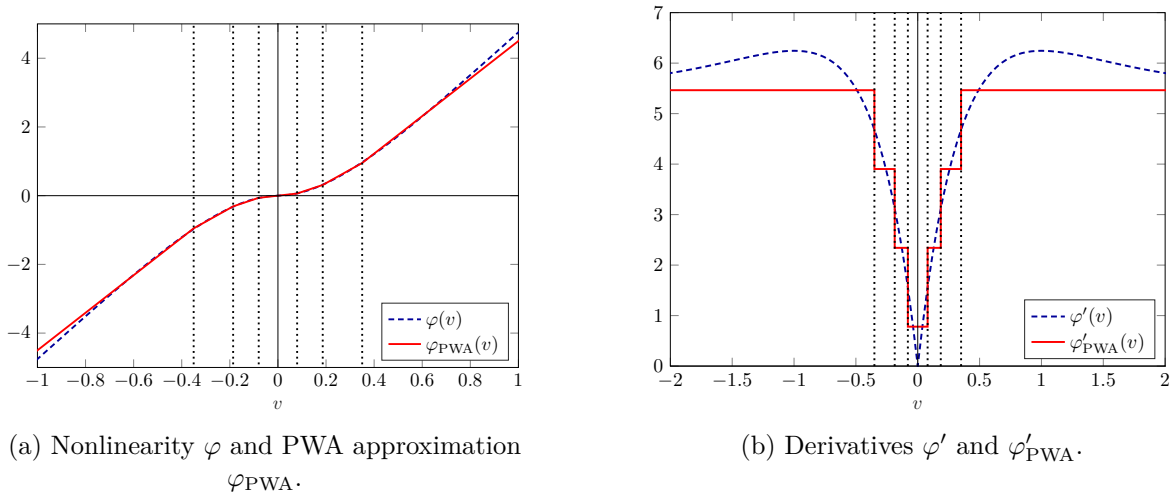
FIGURE 5.5 – Nonlinearity  $\varphi$  considered in Example 5.11 together with its derivative.FIGURE 5.6 – Nonlinearity  $\varphi$  and piecewise-affine approximation  $\varphi_{\text{PWA}}$  computed in Example 5.11.

## EXAMPLE 5.12

Let us consider the case of the nonlinearity  $\varphi$  represented in Figure 5.8 and given by:

$$\varphi(v) = \begin{cases} \frac{k_0}{3}v^3 & \text{for } |v| \leq 1 \\ k_0v - \frac{2k_0}{3}\text{sign}(v) & \text{for } |v| > 1. \end{cases} \quad (5.14)$$

We are once again interested in computing a piecewise-affine approximation of  $\varphi$  by minimizing the Lipschitz constant of the approximation error. Figure 5.8b represents the derivative of  $\varphi$ , where we see that the conditions in Assumption 5.5 are satisfied. We are then able to use Proposition 5.6 to compute a global piecewise-affine approximation. Moreover, this nonlinearity also satisfies Assumption 5.7, and then, according to Proposition 5.8, the technique described in Proposition 5.6 yields the optimal solution to the approximation problem (5.7). Finally, using Proposition 5.9, we are able to compute a priori the number of regions needed to obtain a given bound  $L_{\text{ref}}$  on the Lipschitz constant of the approximation error  $L_\epsilon$ . This is illustrated in Table 5.1, where some values of  $L_{\text{ref}}$  are considered together with the corresponding  $L_\epsilon$  and  $N$ , for  $k_0 = 6$ .

Let us consider the approximation obtained with  $L_{\text{ref}} = 1$ , with  $N = 5$  regions and an approximation error having a Lipschitz constant of  $L_\epsilon = 1$ . The approximating function  $\varphi_{\text{PWA}}$  computed for these values is shown in Figure 5.9, and the derivative of the approximation error

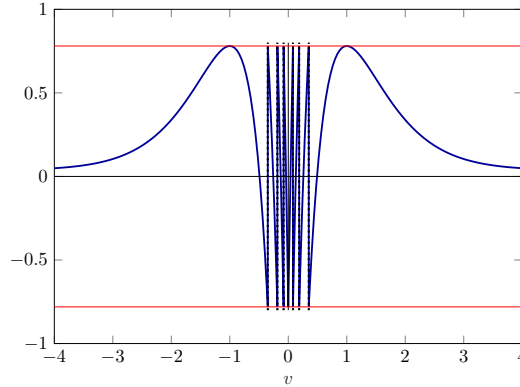
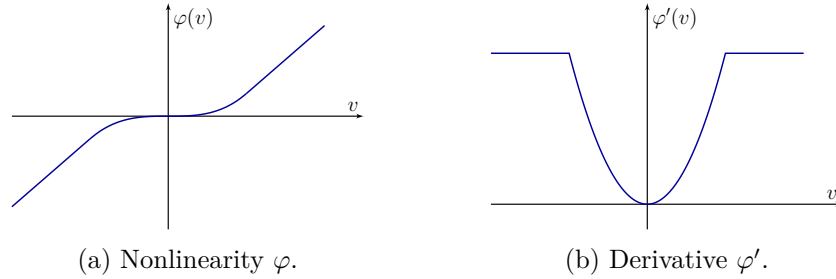

FIGURE 5.7 – Derivative of the approximation error  $\epsilon$  due to the PWA approximation computed in Example 5.11. The red lines indicate the bound  $\mathcal{L}_\epsilon = 0.7805$



(a) Nonlinearity  $\varphi$ .

(b) Derivative  $\varphi'$ .

FIGURE 5.8 – Nonlinearity  $\varphi$  considered in Example 5.12 together with its derivative.

TABLE 5.1 – Lipschitz constant  $L_\epsilon$  of the approximation error  $\epsilon$  with respect to the number of regions  $N$  corresponding to the desired approximation accuracy  $L_{\text{ref}}$  for the nonlinearity in Example 5.12 with  $k_0 = 6$ .

$L_{\text{ref}}$	$L_\epsilon$	$N$
2	1.5	3
1	1	5
0.8	0.75	7
0.7	0.6	9
0.55	0.5	11
0.45	0.42857	13
0.4	0.375	15
0.35	0.33333	17

is shown in Figure 5.10. Looking at Figure 5.9a, we see that the pointwise distance between  $\varphi$  and  $\varphi_{\text{PWA}}$  is not small. This is not surprising, though, as the approximation was obtained as a solution to an optimization problem whose objective is to minimize the Lipschitz constant of the approximation error, and not the pointwise distance. This observation illustrates the fact that the approximation technique presented in this chapter is quite different from some of the other results in the literature, such as those in [9, 25, 192].  $\lrcorner$

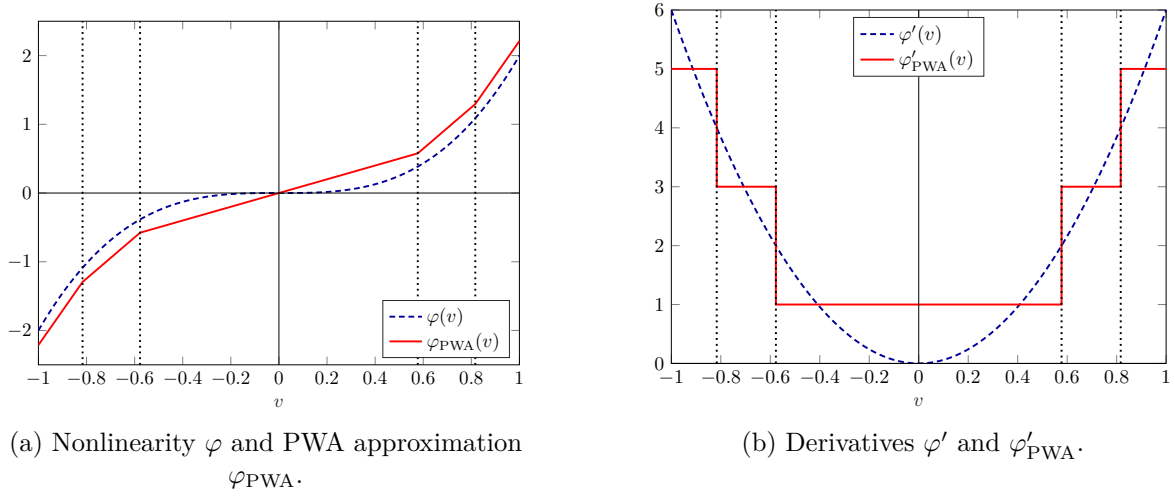

FIGURE 5.9 – Nonlinearity  $\varphi$  and piecewise-affine approximation  $\varphi_{\text{PWA}}$  computed in Example 5.12.

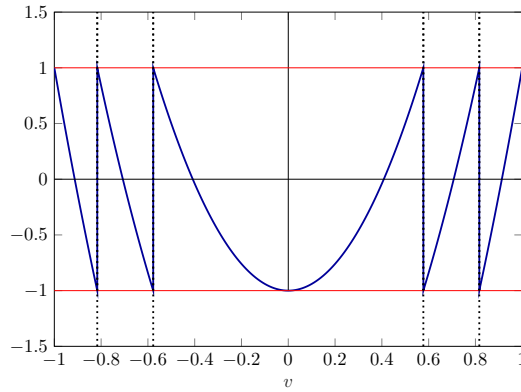

FIGURE 5.10 – Derivative of the approximation error  $\epsilon$  due to the PWA approximation computed in Example 5.12. The red lines indicate the bound  $L_\epsilon = 1$ .

EXAMPLE 5.13

We now consider an example of the use of the approximation technique to compute the incremental  $\mathcal{L}_2$ -gain of a nonlinear system. For this, let us consider the system represented in Figure 5.11a. The linear system  $H$  is given by

$$\left[ \begin{array}{c|c} A & B \\ \hline C & D \end{array} \right] = \left[ \begin{array}{cc|c} -1 & 0 & 1 \\ 3 & -2 & 0 \\ \hline 0 & 1 & 0 \\ 1 & 0 & 0 \end{array} \right]. \quad (5.15)$$

The nonlinearity  $\varphi$  is the one in Example 5.12, given by (5.14) with  $k_0 = 5$ . The weight  $W_d$  is given by

$$W_d(s) = 4838.7 \frac{s + 2}{s + 10000}, \quad (5.16)$$

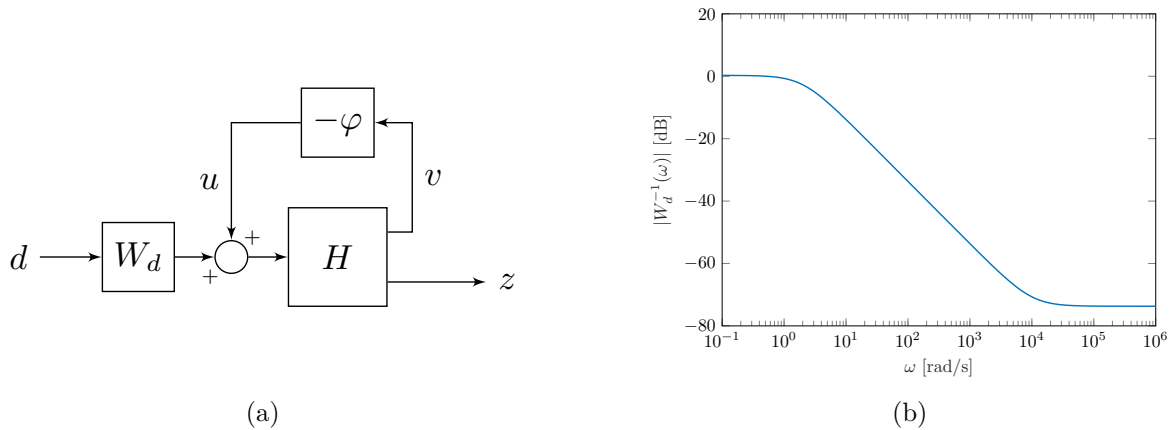

FIGURE 5.11 – (a) Lur'e system analyzed in Example 5.13 and (b) Bode plot of  $W_d^{-1}(j\omega)$  showing its low-pass behavior.

and the frequency response of its inverse is shown in Figure 5.11b, where we can see that it ensures attenuation of high-frequency disturbances  $d$ .

The interconnected system without the weight  $W_d$  can be shown to be globally asymptotically stable<sup>1</sup>. In Figure 5.12a are plotted some trajectories (colored lines) stemming from several initial conditions (red dots) on a level curve of a piecewise-quadratic Lyapunov function (black curve). The red dashed lines indicate the partitioning of the state space that is induced by the piecewise description of  $\varphi$ . Figure 5.12b shows the response of this system with different initial conditions and two different inputs given by

$$d_1(t) = \begin{cases} +15 & \text{for } 0 \leq t < 4 \\ 4f_{\text{sq}}(0.4\pi t) & \text{for } t \geq 4 \end{cases} \quad \text{and} \quad d_2(t) = \begin{cases} -15 & \text{for } 0 \leq t < 4 \\ 4f_{\text{sq}}(0.4\pi t) & \text{for } t \geq 4, \end{cases} \quad (5.17)$$

where  $f_{\text{sq}}(0.4\pi t) = \text{sign}(\sin(0.4\pi t))$  is a square wave function of period 5 s. We can see that the trajectories converge towards a pair of constant values corresponding to each input in the first 4 seconds, independently of the initial condition. Then, after 4 seconds, all trajectories converge to the same steady state driven by the square wave function, with a period of 5 seconds. This behavior suggests that the system is indeed incrementally stable, and we would like to assess incremental performance via the weight  $W_d$ .

We are interested in computing an upper bound on the incremental  $\mathcal{L}_2$ -gain from  $d$  to  $z$ . The nonlinearity  $\varphi$  is in the incremental sector  $\text{Sect}_\Delta(0, 5)$ , and we can then use the LTI/IQC approach with the multiplier in the last row of Table 4.2. Using the incremental version of Theorem 4.40, we obtain an upper bound  $\eta = 7.7654$  on the incremental  $\mathcal{L}_2$ -gain.

As we have discussed in Example 5.12, this nonlinearity satisfies Assumptions 5.5 and 5.7, and we are able to compute a global piecewise-affine approximation  $\varphi_{\text{PWA}}$ . We note that the direct terms  $D_{vu}$ ,  $D_{vp}$  and  $D_{vw}$  for this system are null, and we can thus use Proposition 5.1 to rewrite the Lur'e system as an uncertain PWA Lur'e system together with an incrementally bounded approximation error. Using  $L_{\text{ref}} = 1.5$ , we obtain an approximation with  $N = 3$  regions and  $L_\epsilon = 1.25$ , which means that the approximation error lies in the

<sup>1</sup>This can be done by using a piecewise-affine approximation of  $\varphi$  and adapting Theorem 4.28 to make sure that the computed storage function is also a Lyapunov function for the system with zero input, as we have discussed in the conclusion of Chapter 4. The details are omitted here as this is not the scope of this example.

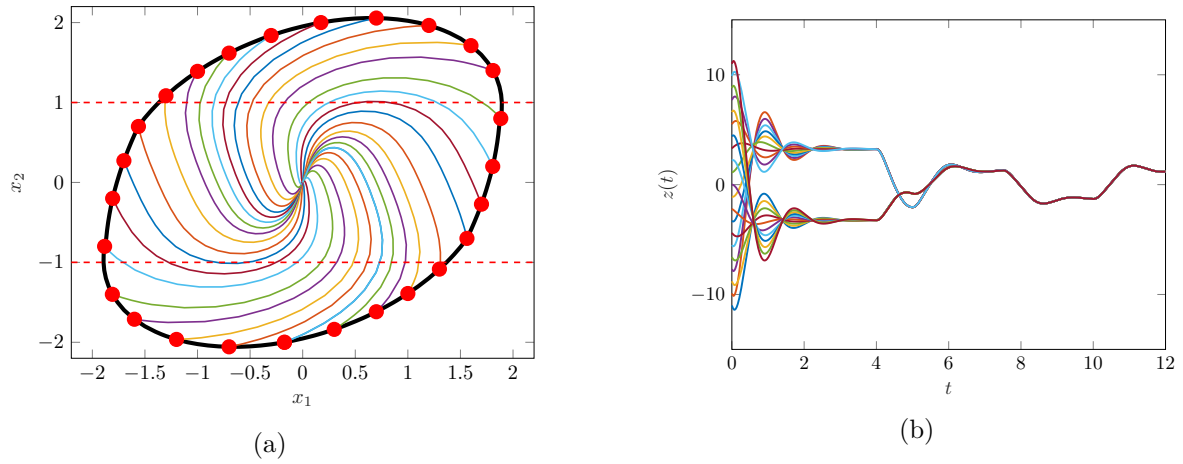

FIGURE 5.12 – Simulation of the system in Example 5.13 in the case of (a) different initial conditions with zero input and (b) different initial conditions with nonzero inputs in (5.17).

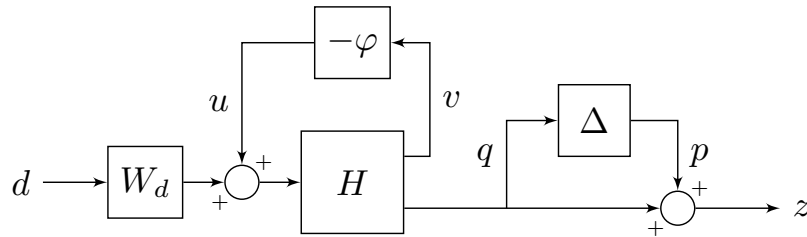

FIGURE 5.13 – Uncertain Lur'e system analyzed in Example 5.13.

sector  $\text{Sect}_{\Delta}(-L_{\epsilon}, L_{\epsilon})$ . Then, we apply Theorem 4.35 once again using the multiplier in the last row of Table 4.2, and obtain an upper bound  $\eta = 1.8404$  on the incremental  $\mathcal{L}_2$ -gain, a reduction of  $\approx 76\%$  with respect to the result obtained by LTI/IQC.

Let us now consider the case where there are possible unmodeled dynamics acting at the output  $z$ . We represent this uncertainty as a direct multiplicative uncertainty  $\Delta$  given by a scalar LTI with an  $\mathcal{L}_2$ -gain less than or equal to 0.5, as in Figure 5.13. We may once again use the LTI/IQC approach, using the multiplier in the last row of Table 4.2 for the nonlinearity  $\varphi$  and the one in the second row for the uncertainty  $\Delta$ . For this, we choose a parametrization of second-order multipliers ( $\ell = 2$ ) with denominator  $(s + 1)(s + 10)$ , as discussed in Section 4.4.4. For this configuration, the conditions in Theorem 4.40 prove unfeasible, and we cannot conclude. Increasing the order of the multiplier to  $\ell = 3$  with the denominator  $(s + 1)(s + 10)(s + 100)$  yields the same inconclusive result. Turning to the PWA/IQC approach, with the second-order multiplier for the uncertainty  $\Delta$ , application of Theorem 4.35 yields an upper bound of  $\eta = 2.902$ , with the computed second-order multiplier for the uncertainty  $\Delta$  given by

$$\Pi(j\omega) = \begin{bmatrix} m_D(j\omega) & 0 \\ 0 & -m_D(j\omega) \end{bmatrix}, \quad (5.18)$$

with

$$m_D(j\omega) = \frac{66.706(s^2 - 2.717s + 5.596)(s^2 + 2.717s + 5.596)}{(s - 10)(s + 10)(s - 1)(s + 1)}. \quad (5.19)$$



TABLE 5.2 – Comparison of LTI/IQC and PWA/IQC approaches for the computation of an upper bound to the  $\mathcal{L}_2$ -gain ( $\gamma$ ) and incremental  $\mathcal{L}_2$ -gain ( $\eta$ ) of the system in Example 5.13 in the nominal and robust cases.

$\gamma/\eta$	LTI/IQC	PWA/IQC ( $\gamma$ )	PWA/IQC ( $\eta$ )
nominal	7.7654	1.8403	1.8404
robust	–	2.3757	2.9020

As we have discussed, since  $\varphi(0) = 0$ , the computed approximation also ensures that the approximation error  $\epsilon$  lies in the (non-incremental) sector  $\text{Sect}(-L_\epsilon, L_\epsilon)$ . By noticing that  $\varphi$  also lies in the (non-incremental) sector  $\text{Sect}(0, 5)$ , the results presented above are also valid for the computation of an upper bound on the  $\mathcal{L}_2$ -gain, i.e. the LTI/IQC approach yields the same results in the incremental and non-incremental case. We are then able to proceed exactly as above to compare the results of the LTI/IQC and PWA/IQC approaches on the computation of an upper bound on the (non-incremental)  $\mathcal{L}_2$ -gain from  $d$  to  $z$ . These results are summarized in Table 5.2.

This example illustrates how the use of piecewise-approximations together with the proposed PWA/IQC approach is able to reduce the conservatism of the analysis of incremental and non-incremental stability properties of uncertain Lur'e systems.  $\lrcorner$

## 5.6 Conclusion

In this chapter we have proposed a simple yet powerful new approach to the robust incremental analysis of nonlinear Lur'e systems. Our technique is based on the computation of piecewise-affine approximations of memoryless nonlinearities and the subsequent reformulation of the original system into a piecewise-affine Lur'e system. By doing so, we are able to use the tools presented in Chapter 4 to analyze the system and hopefully achieve less conservative results. This is of increased importance in the case of incremental stability, as we have seen that we are not allowed to use frequency-dependent multipliers for memoryless nonlinearities.

We have proposed the Lipschitz approximation technique to obtain suitable piecewise-affine functions minimizing the Lipschitz constant of the approximation error. Although the approximation technique is rather simple, it allows us to guarantee a given upper bound on the obtained Lipschitz constant. To the best of our knowledge, this technique is a new result of independent interest.

It should be noted that, while we have chosen to focus on incremental stability, the techniques in this chapter also apply to the robust stability and performance analysis in the non-incremental case. Namely, since  $\varphi_{\text{PWA}}$  is chosen to satisfy  $\varphi_{\text{PWA}}(0) = 0$ , the obtained bound on the Lipschitz constant is also a bound on the gain of the approximation error, i.e.  $|\epsilon(v)| \leq L_\epsilon |v|$ . Using this, it becomes possible to assess robust stability and performance of the uncertain piecewise-affine system using the results in Section 4.4.

This chapter is the culmination of all the results presented in the previous ones. It synthesizes the approach proposed in this thesis: to seek for an alternative and more suitable representation of a problem, one with which we know how to perform analysis efficiently and where the trade-off between conservatism and complexity is adjustable.

---

# Conclusion and perspectives

## 6.1 Summary of contributions

In this memoir we have considered the analysis of incremental stability properties of uncertain nonlinear systems. With the goal of obtaining tractable numerical conditions, we have focused our approach on systems with a piecewise-affine representation. This representation is interesting for two main reasons. Firstly, it can represent nonlinear systems containing a wide range of nonlinearities that permeate the field of applied control, such as saturations, dead-zones, relays, friction, etc. Secondly, its regional description is sufficiently close to that of linear systems to allow for a relatively straightforward extension of some classic analysis results. Namely, it is possible to cast the search for Lyapunov and storage functions as a semi-definite programming problem constrained by linear matrix inequalities, for which efficient solvers are available. Building upon these previous results, we have proposed extensions for the analysis of incremental stability properties of nominal and uncertain piecewise-affine systems.

In Chapter 2, we have introduced the class of piecewise-affine systems as well as the relevant definitions of stability and performance that we adopted. Afterwards, we have presented some of the main results in the literature concerning the analysis of piecewise-affine systems. An effort was made to homogenize the presentation of the different results in view of the approach taken in this memoir.

Chapter 3 introduces new results on the analysis of incremental stability properties of piecewise-affine systems. We proposed an extension of the classic results by Johansson and Rantzer [83, 85, 133], and formulated conditions for the construction of incremental Lyapunov and storage functions having a piecewise-quadratic structure. However, as it was the case in [114], we were not able to exhibit a legitimate piecewise-quadratic function in the case of systems of order superior to one. This has led us to search for functions with additional degrees of freedom, and we considered the case of polynomial and piecewise-polynomial functions through the use of sum-of-squares techniques. By doing so, we were able to go beyond quadratic functions, which potentially leads to reduced conservatism, although not without some increase in complexity.

The analysis of uncertain piecewise-affine systems is considered in Chapter 4. We have chosen to pursue an approach that allows for a direct extension of classic results in robust control, such as the small-gain theorem, passivity and  $\mu$ -analysis, to mention a few. It is based on the union between two classic results, graph separation and dissipativity, together with

more recent results concerning integral quadratic constraints in the time domain [22, 154]. Before addressing the analysis of robust incremental stability and performance of piecewise-affine systems, we have considered the non-incremental case. In doing so, we have extended the traditional IQC approach of Megretski and Rantzer [111] to the case of uncertain piecewise-affine systems. To the best of our knowledge, this is the first time this extension has been formally treated.

Finally, Chapter 5 introduces a methodology for the analysis of uncertain Lur'e systems. It is based on the approximation of the memoryless nonlinearity by a piecewise-affine function, which in turn allows us to rewrite the system as an uncertain piecewise-affine system. We have proposed a novel approximation technique, named Lipschitz approximation, to obtain a piecewise-affine function that guarantees an upper bound on the Lipschitz constant of the approximation error.

The initial idea at the beginning of this PhD was to extend the results by Johansson and Rantzer [85, 133] to the analysis of incremental stability properties, by proposing conditions for the construction of piecewise-quadratic incremental Lyapunov/storage functions. However, we were not able to produce an example where we were able to construct such functions, and so we turned our attention to polynomial and piecewise-polynomial functions. Unfortunately, this leads to optimization problems of greater complexity. Together with the fact that we are proposing conditions on an augmented system that contains twice the number of states of the original system, this restricts the analysis to low-dimensional systems. Nevertheless, to the best of our knowledge, this memoir presents the first results allowing to systematically compute incremental Lyapunov and storage functions that are not quadratic functions of the form  $(x - \tilde{x})^T P(x - \tilde{x})$  using convex optimization. Our results allow us to draw conclusions in the case where no quadratic function can be found, as we have illustrated with Examples 3.13 and 3.14.

Our approach to the robust analysis of uncertain piecewise-affine systems using dissipativity arguments opens some perspectives for new research topics, as we discuss in the next section. It is based on the application of graph separation theory to the class of piecewise-affine systems. We have considered uncertain systems that depend rationally on the uncertainty, represented by the interconnection of a nominal system and a structured uncertainty  $\Delta$ . This allows us to deal with general classes of uncertainties, such as unknown parameters, unmodeled dynamics, uncertain delays, nonlinearities and so forth. The analysis can then be carried out using a catalogue of multipliers, see e.g. [111].

## 6.2 Open problems and perspectives for future research

Let us conclude by considering some open questions that remain to be addressed by the end of this memoir. We also indicate possible new lines of research stemming from the results obtained in this work.

### Existence of piecewise-quadratic incremental Lyapunov and storage functions

As we have discussed in Chapter 3, we were not able to produce an example of incrementally stable piecewise-affine system for which the conditions proposed allow the computation of a strict piecewise-quadratic function (i.e. not a simple quadratic one). This result is in accordance with the discussion presented in [114], where the authors were also unable to present such a case. It seems to be an interesting question whether there exist piecewise-quadratic functions for incremental stability, or, in the negative case, how to prove it.

**Application of the results for robust stability and performance to different classes of systems**

The approach we used in Chapter 4 was based on graph separation, which is a rather general result that can be applied in a variety of settings. The establishment of the topological separation was obtained using integral quadratic constraints in the time domain together with dissipativity. We then considered the specific case of piecewise-affine systems with piecewise-quadratic and piecewise-polynomial storage functions. However, due to the generality of the approach, it could be applied to other classes of systems without great difficulty. The bottleneck is always the possibility of parametrizing the space of possible storage functions in such a way as to allow the use of convex optimization for an efficient solution.

**Extension of dissipativity results**

The analysis of robust stability and performance with dissipativity arguments opens some interesting possibilities. Indeed, as we have discussed in Chapter 4, with straightforward adaptations it would be possible to modify the constraints of Corollary 4.26 (and then, consequently, also those of Theorem 4.28 in the case of piecewise-affine systems) to make sure that the computed storage function is also a Lyapunov function ensuring asymptotic stability. In the same vein, it would be possible to modify and extend the results in some different directions. One possibility would be to consider the obtention of robust estimates of regions of attraction, extending the results in [82]. It would also be possible to extend the novel results obtained in the recent paper [13] for the so-called robust simulation to the case of uncertain nonlinear (or piecewise-affine) systems. In this memoir we have focused on the  $\mathcal{L}_2$ -gain and incremental  $\mathcal{L}_2$ -gain as performance measures, but it would also be possible to consider more general performance indicators such as the ones presented in [174], for example.

**Synthesis problem**

In this thesis we have focused on the analysis of stability and performance, both in the traditional and incremental sense. It would be interesting to investigate whether any of the developments of this thesis could be used to obtain new results for the synthesis of robust controllers for piecewise-affine systems or Lur'e systems. The synthesis of piecewise-affine static state-feedback and dynamic output-feedback controllers has been reported in the literature, see e.g. [45, 116, 131, 135, 139, 140, 148] and references therein. The synthesis of output-feedback controllers ensuring incremental stability properties has also been studied in [170]. It is well-known that the synthesis of piecewise-affine controllers using piecewise-quadratic control Lyapunov functions yields bilinear matrix inequalities, which configures an optimization problem that is hard to solve globally [140]. It could be interesting to investigate whether it would be possible to develop some sort of generalization of the classic  $DK$ -iteration approach [151, 155, 173]. This would allow us to synthesize a robust controller for piecewise-affine systems taking advantage explicitly of the multiplier theory in the presence of structured uncertainties.



# The circle criterion

## A.1 Introduction

In this appendix we consider a key result in the control literature: the circle criterion. This important stability criterion provides sufficient conditions under which the interconnection between an LTI system and a memoryless nonlinearity is exponentially (incrementally) stable. Its origins are intimately tied with the so-called Lur'e problem of absolute stability [102].

The circle criterion has been found independently by several different authors, such as Zames [188, 189], Sandberg [150] and Narendra and Goldwyn [117]. The first two arrived at the result using input-output considerations of stability, while the last authors used Lyapunov arguments. It is interesting to note that both approaches were to be connected through the use of the KYP lemma some time later [176].

One of the main features of this result is that the conditions for stability of the interconnection are based on considerations over the open-loop behavior of the nonlinearity and the LTI system. This feature would become an important starting point to the development of important results in robust control, such as graph separation [146] and integral quadratic constraints [111]. The broad reach of the circle criterion is mostly due to two factors: (1) the conditions on the nonlinearity are simple, and (2) the conditions on the LTI system are expressed in terms of graphical conditions over its Nyquist plot. The latter was of great importance in the sixties and seventies, when there was no widespread access to numerical solvers for convex optimization.

## A.2 Circle criterion

Let us consider the nonlinear system in Figure A.1, which is given by

$$z = \Sigma(w) \begin{cases} \dot{x}(t) = Ax(t) + B_u u(t) + B_w w(t) \\ z(t) = C_z x(t) + D_{zu} u(t) + D_{zw} w(t) \\ v(t) = C_v x(t) + D_{vu} u(t) + D_{vw} w(t) \\ u(t) = -\varphi(t, v(t)) \end{cases} \quad (\text{A.1})$$

where  $A \in \mathbb{R}^{n \times n}$ ,  $B_u \in \mathbb{R}^{n \times n_u}$ ,  $B_w \in \mathbb{R}^{n \times n_w}$ ,  $C_q \in \mathbb{R}^{n_q \times n}$ ,  $C_z \in \mathbb{R}^{n_z \times n}$ ,  $D_{zu} \in \mathbb{R}^{n_z \times n_u}$ ,  $D_{zw} \in \mathbb{R}^{n_z \times n_w}$ ,  $C_v \in \mathbb{R}^{n_v \times n}$ ,  $D_{vu} \in \mathbb{R}^{n_v \times n_u}$ ,  $D_{vw} \in \mathbb{R}^{n_v \times n_w}$  and  $\varphi : \mathbb{R}_+ \times \mathbb{R}^{n_v} \rightarrow \mathbb{R}^{n_u}$  is a given memoryless (possibly time-varying) Lipschitz nonlinearity with  $\varphi(t, 0) = 0$ , for all

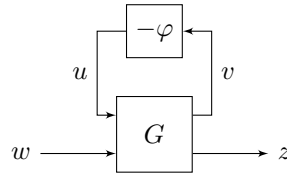

FIGURE A.1 – Lur'e system described by (A.1).

$t \geq 0$ . In what follows, we suppose that  $n_u = n_v = 1$ , i.e.  $\varphi$  is a scalar nonlinearity. The generalization of the results to the multivariable case can be found in [91]. We also assume that the pair  $(A, B_u)$  is controllable and  $(A, C_v)$  is observable.

The conditions on  $\varphi$  imply that the origin is an equilibrium point of the unforced system (A.1) (i.e. when  $w = 0$ ). The problem of absolute stability consists in finding sufficient conditions under which the origin is a globally asymptotically stable equilibrium point. The circle criterion is one of the most widespread tools for the assessment of absolute stability. Prior to its statement, let us introduce some new concepts.

**DEFINITION A.1 (Sector)**

The nonlinearity  $\varphi : \mathbb{R}_+ \times \mathbb{R} \rightarrow \mathbb{R}$  is said to belong to the sector  $\text{Sect}(\kappa_1, \kappa_2)$  if the inequality

$$(\varphi(t, v) - \kappa_1 v)(\varphi(t, v) - \kappa_2 v) \leq 0 \quad (\text{A.2})$$

is satisfied for every  $t \geq 0$  and every  $v \in \mathbb{R}$ . It is said to be outside the sector  $\text{Sect}(\kappa_1, \kappa_2)$  if (A.2) holds with the sign reversed. If the inequality signs are strict for every  $v$ ,  $\varphi$  is said to be strictly inside (outside) the sector.  $\lrcorner$

Inequality (A.2) is equivalent to

$$\kappa_1 \leq \frac{\varphi(t, v)}{v} \leq \kappa_2 \quad (\text{A.3})$$

for every  $t \geq 0$  and every  $v \in \mathbb{R} \setminus \{0\}$ . This means that, for every  $v \neq 0$ , the line joining the point  $(v, \varphi(t, v))$  and the origin is always in the sector defined by the linear functions  $\kappa_1 v$  and  $\kappa_2 v$ , see Figure A.2.

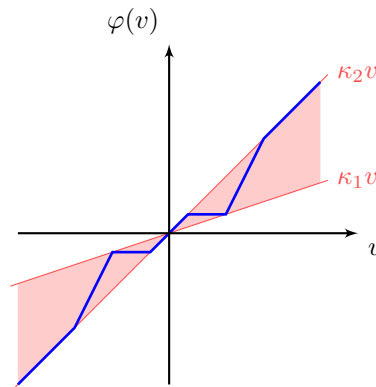
FIGURE A.2 – Sector  $\text{Sect}(\kappa_1, \kappa_2)$  containing a given piecewise-affine nonlinearity.

Before stating the main theorem, let us introduce the concept of *positive real* transfer functions [63].

**DEFINITION A.2 (Positive realness)**

The transfer function  $G(s) : \mathbb{C} \rightarrow \mathbb{C}$  is positive real if it is Hurwitz stable (i.e. all its poles have strictly negative real part) and

$$\operatorname{Re}(G(j\omega)) \geq 0, \forall \omega \in \mathbb{R} \quad (\text{A.4})$$

If the inequality is strict,  $G(s)$  is said to be strictly positive real. ┘

It can be shown that a positive real transfer function describes a passive system, while strict positive realness is equivalent to strict passivity [91]. We may now state the celebrated circle criterion. It provides sufficient conditions to assess stability of the Lur'e system (A.1) in the case where the nonlinearity  $\varphi$  is contained in a given sector.

The next theorem is taken from [91].

**THEOREM A.3 (Circle criterion)**

Let  $G(s) = C_v(sI - A)^{-1}B_u + D_vu$ . Suppose that the nonlinearity  $\varphi$  belongs to the sector  $\text{Sect}(\kappa_1, \kappa_2)$ . Then, system (A.1) with  $w = 0$  is exponentially stable if

$$\mathcal{Z}(s) := \frac{1 + \kappa_2 G(s)}{1 + \kappa_1 G(s)} \quad (\text{A.5})$$

is strictly positive real. ┘

There is a geometric interpretation to the condition that  $\mathcal{Z}(s)$  is strictly positive real. Let us consider the case where  $\kappa_1 > 0$ . We may verify that  $\operatorname{Re}(\mathcal{Z}(j\omega)) > 0$  can be written as

$$1 + (\kappa_1 + \kappa_2) \operatorname{Re}(G(j\omega)) + \kappa_1 \kappa_2 \operatorname{Re}(G(j\omega))^2 + \kappa_1 \kappa_2 \operatorname{Im}(G(j\omega))^2 > 0 \quad (\text{A.6})$$

which after some algebraic manipulations can be factorized as

$$\left( \operatorname{Re}(G(j\omega)) + \frac{\kappa_1 + \kappa_2}{2\kappa_1 \kappa_2} \right)^2 + \operatorname{Im}(G(j\omega))^2 > \left( \frac{\kappa_1 - \kappa_2}{2\kappa_1 \kappa_2} \right)^2 \quad (\text{A.7})$$

This inequality defines exactly the region outside the circle indicated in Figure A.3a, which explains why Theorem A.3 is known as the circle criterion.

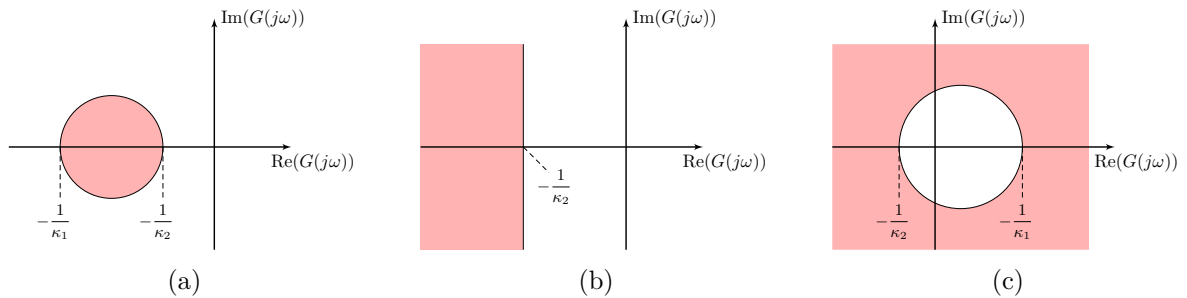

FIGURE A.3 – Graphical representation of the circle criterion when (a)  $\kappa_1 > 0$ , (b)  $\kappa_1 = 0$  and (c)  $\kappa_1 < 0$ . The area in red represents the critical region.



If  $\varphi$  belongs to sector  $\text{Sect}(0, \kappa_2)$ , the circle degenerates to a rectangular region. Actually, fixing  $\kappa_2$  and making  $\kappa_1 \rightarrow 0$ , the radius of the circle tends to infinity, see Figure A.3b. In this case, system (A.1) is exponentially stable if

$$\text{Re}(G(j\omega)) > -1/\kappa, \quad \forall \omega \in \mathbb{R} \quad (\text{A.8})$$

Proceeding similarly in the case where  $\kappa_1 < 0$ , we obtain

$$\left( \text{Re}(G(j\omega)) + \frac{\kappa_1 + \kappa_2}{2\kappa_1\kappa_2} \right)^2 + \text{Im}(G(j\omega))^2 < \left( \frac{\kappa_1 - \kappa_2}{2\kappa_1\kappa_2} \right)^2, \quad (\text{A.9})$$

which defines the region inside the circle with center at  $-\frac{1}{2} \left( \frac{1}{\kappa_1} + \frac{1}{\kappa_2} \right)$  and radius  $\frac{1}{2} \left( \frac{1}{\kappa_2} - \frac{1}{\kappa_1} \right)$ , see Figure A.3c.

The proof of Theorem A.3 is based on the use of the KYP lemma (Lemma 4.25, page 88) and the construction of a quadratic Lyapunov function  $V(x) = x^\top P x$  (see [91, Theorem 7.1]). We may then state the following result.

LEMMA A.4

*When the conditions of Theorem A.3 are satisfied, there exists a quadratic Lyapunov function  $V(x) = x^\top P x$ , with  $P \succ 0$  satisfying the conditions in Theorem 2.24.*  $\lrcorner$

### A.3 Incremental circle criterion

We may now consider an analogous result, but concerning incremental stability. We begin by defining the *incremental sector*.

DEFINITION A.5 (**Incremental sector**)

*The nonlinearity  $\varphi : \mathbb{R}_+ \times \mathbb{R} \rightarrow \mathbb{R}$  is said to belong to the incremental sector  $\text{Sect}_\Delta(\kappa_1, \kappa_2)$  if the inequality*

$$((\varphi(t, v) - \varphi(t, \tilde{v})) - \kappa_1(v - \tilde{v}))((\varphi(t, v) - \varphi(t, \tilde{v})) - \kappa_2(v - \tilde{v})) \leq 0 \quad (\text{A.10})$$

*is satisfied for every  $t \geq 0$  and every  $v, \tilde{v} \in \mathbb{R}$ . It is said to be outside the incremental sector  $\text{Sect}_\Delta(\kappa_1, \kappa_2)$  if (A.10) holds with the sign reversed. If the inequality signs are strict for every  $v, \tilde{v}$ ,  $\varphi$  is said to be strictly inside (outside) the incremental sector.*  $\lrcorner$

Condition (A.10) is equivalent to

$$\kappa_1 \leq \frac{\varphi(t, v) - \varphi(t, \tilde{v})}{v - \tilde{v}} \leq \kappa_2 \quad (\text{A.11})$$

for every  $t \geq 0$  and every  $v, \tilde{v} \in \mathbb{R}$ , with  $v \neq \tilde{v}$ . In the case where  $\varphi$  is differentiable, it is also equivalent to

$$\kappa_1 \leq \frac{d\varphi(t, v)}{dv} \leq \kappa_2 \quad (\text{A.12})$$

for every  $t \geq 0$  and every  $v \in \mathbb{R}$ .

Due to the fact that  $\varphi(t, 0) = 0$  for every  $t \geq 0$ , it can be seen that if  $\varphi \in \text{Sect}_\Delta(\kappa_1, \kappa_2)$ , then  $\varphi \in \text{Sect}(\kappa_1, \kappa_2)$ . The converse is not true in general, and in some cases the incremental

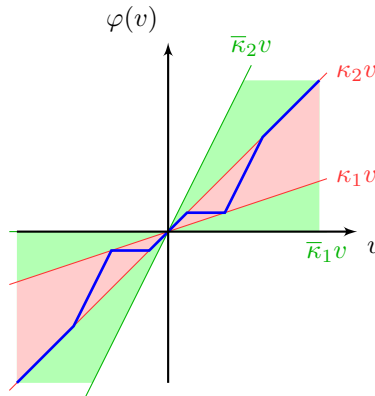

FIGURE A.4 – Sector  $\text{Sect}(\kappa_1, \kappa_2)$  and incremental sector  $\text{Sect}_\Delta(\bar{\kappa}_1, \bar{\kappa}_2)$  containing a given piecewise-affine nonlinearity.

sector may be much larger than the regular one. Indeed, (A.12) shows that the incremental sector  $\text{Sect}_\Delta(\kappa_1, \kappa_2)$  must contain the nonlinearity  $\varphi$  as well as its derivative, see Figure A.4.

We may now state the *incremental circle criterion*, which comes as a simple adaptation of Theorem A.3.

#### THEOREM A.6 (Incremental circle criterion)

Let  $G(s) = C_v(sI - A)^{-1}B_u + D_v u$ . Suppose that the nonlinearity  $\varphi$  belongs to the incremental sector  $\text{Sect}_\Delta(\kappa_1, \kappa_2)$ . Then, system (A.1) is exponentially incrementally stable if

$$\mathcal{Z}(s) := \frac{1 + \kappa_2 G(s)}{1 + \kappa_1 G(s)} \quad (\text{A.13})$$

is strictly positive real. ┘

The proof of this theorem follows from the proof of [91, Theorem 7.1], and is based on the application of KYP lemma and the construction of a quadratic incremental Lyapunov function  $V(x, \tilde{x}) = (x - \tilde{x})^\top P(x - \tilde{x})$ , with  $P \succ 0$ . This leads to the following result.

#### LEMMA A.7

When the conditions of Theorem A.6 are satisfied, there exists a quadratic incremental Lyapunov function  $V(x, \tilde{x}) = (x - \tilde{x})^\top P(x - \tilde{x})$ , with  $P \succ 0$  satisfying the conditions in Theorem 2.27. ┘

## A.4 Circle criterion and integral quadratic constraints

Based on the sector containing the nonlinearity, the circle criterion defines a critical region on the complex plane where the Nyquist plot of the transfer function  $G(s)$  cannot enter. In this approach, the nonlinearity  $\varphi$  is seen as an uncertain parameter that can vary between predefined bounds. In this sense, the application of the circle criterion can be seen from the point of view of robust control, with the LTI system  $G$  representing the nominal system that is perturbed by the nonlinearity  $\varphi$ .

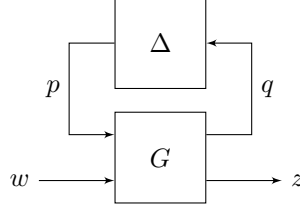
FIGURE A.5 –  $G$ - $\Delta$  structure.

Let us look closer at the implications of the robust control approach to the circle criterion. As it is exposed in Chapter 4, in this framework the uncertain system is normally decoupled into two interconnected elements. In general, all troublesome components of the system (nonlinearities, time-varying components, infinite dimension dynamics, uncertainties, etc.) are grouped in a  $\Delta$  block. The remaining LTI components are grouped in a  $G$  block, and we obtain an uncertain representation, see Figure A.5.

As it has been discussed in Chapter 4, stability of the interconnected system may be assessed by establishing the separation between the graphs of  $G$  and  $\Delta$ . One way of doing so is by constructing separators through integral quadratic constraints, as it was stated in Theorems 4.14 (page 75) and 4.30 (page 99).

We shall illustrate the approach of constructing these separators via the application of the circle criterion. Let us note that the constraint (A.2) can be represented in an equivalent manner:

$$\frac{1}{2} \begin{bmatrix} q \\ -\varphi(q) \end{bmatrix} \begin{bmatrix} -2\kappa_1\kappa_2 & -(\kappa_1 + \kappa_2) \\ -(\kappa_1 + \kappa_2) & -2 \end{bmatrix} \begin{bmatrix} q \\ -\varphi(q) \end{bmatrix} \geq 0, \quad \forall q \in \mathbb{R}^p, \quad (\text{A.14})$$

where the minus sign is due to the negative feedback in (A.1). Since  $\varphi$  is a memoryless nonlinearity, this is equivalent to

$$\int_0^\infty \frac{1}{2} \begin{bmatrix} q(t) \\ -\varphi(q(t)) \end{bmatrix} \begin{bmatrix} -2\kappa_1\kappa_2 & -(\kappa_1 + \kappa_2) \\ -(\kappa_1 + \kappa_2) & -2 \end{bmatrix} \begin{bmatrix} q(t) \\ -\varphi(q(t)) \end{bmatrix} dt \geq 0 \quad (\text{A.15})$$

for any signal  $q \in \mathcal{L}_{2e}^{n_q}(\mathbb{R}_+)$ . To see that the circle criterion ensures the inverse relation for  $G$ , let us first recall the following definition of sector for operators, taken from [189].

**DEFINITION A.8 (Sector for SISO operators)**

The operator  $G : \mathcal{L}_{2e}(\mathbb{R}_+) \rightarrow \mathcal{L}_{2e}(\mathbb{R}_+)$  is said to be inside the sector  $\text{Sect}(\kappa_1, \kappa_2)$ , if

$$\langle (G(p) - \kappa_1 p), (G(p) - \kappa_2 p) \rangle_{2,T} \leq 0, \quad \forall T \geq 0, \forall p \in \mathcal{L}_{2e}^{n_p}(\mathbb{R}_+). \quad (\text{A.16})$$

It is said to be inside the incremental sector  $\text{Sect}_\Delta(\kappa_1, \kappa_2)$  if

$$\langle (G(p) - G(\tilde{p}) - \kappa_1(p - \tilde{p})), (G(p) - G(\tilde{p}) - \kappa_2(p - \tilde{p})) \rangle_{2,T} \leq 0, \quad \forall T \geq 0, \forall p, \tilde{p} \in \mathcal{L}_{2e}^{n_p}(\mathbb{R}_+). \quad (\text{A.17})$$

It is said to be positive if

$$\langle p, G(p) \rangle_{2,T} \leq 0, \quad \forall T \geq 0, \forall p \in \mathcal{L}_{2e}^{n_p}(\mathbb{R}_+). \quad (\text{A.18})$$

It is said to be incrementally positive if

$$\langle (p - \tilde{p}), (G(p) - G(\tilde{p})) \rangle_{2,T} \leq 0, \quad \forall T \geq 0, \forall p, \tilde{p} \in \mathcal{L}_{2e}^{n_p}(\mathbb{R}_+). \quad (\text{A.19})$$

The notions of outside and strict follow analogously to Definitions A.1 and A.5.  $\lrcorner$

The relation between the circle criterion and the previous definition is given by the following lemma, extracted from [189]. With some abuse of notation, we use the same notation for the operator and its transfer function.

LEMMA A.9

Let  $G$  be a linear SISO operator, and let  $c$  and  $r \geq 0$  be real constants.

- (i) If  $G(s)$  satisfies the inequality  $|G(j\omega) - c| \geq r$ , for all  $\omega \in \mathbb{R}$ , and if the Nyquist diagram of  $G(s)$  does not encircle the point  $c$ , then  $G$  is outside the incremental sector  $\text{Sect}_\Delta(c - r, c + r)$ .
- (ii) If  $G(s)$  is such that  $\text{Re}\{G(j\omega)\} \geq 0$ , for all  $\omega \in \mathbb{R}$ , then  $G$  is incrementally positive.
- (iii) If  $G(s)$  satisfies the inequality  $|G(j\omega) - c| \leq r$ , for all  $\omega \in \mathbb{R}$ , then  $G$  is inside the incremental sector  $\text{Sect}_\Delta(c - r, c + r)$ . ┘

Let us take the case  $\kappa_1 > 0$ . Then, the circle criterion states that the closed-loop system is stable if the Nyquist plot of  $G(s)$  is strictly outside the critical region defined by the circle passing through  $-1/\kappa_1$  and  $-1/\kappa_2$ . According to Lemma A.9, this is equivalent to  $G$  being outside the sector  $\text{Sect}(-1/\kappa_1 - \delta, -1/\kappa_2 + \delta)$ , for some  $\delta > 0$ , which can be equivalently written as

$$\int_0^T \frac{1}{2} \begin{bmatrix} q(t) \\ p(t) \end{bmatrix} \begin{bmatrix} -2\kappa_1\kappa_2 & -(\kappa_1 + \kappa_2) \\ -(\kappa_1 + \kappa_2) & -2 \end{bmatrix} \begin{bmatrix} q(t) \\ p(t) \end{bmatrix} dt \leq -\varepsilon \|p\|_{2,T}^2, \quad \forall T \geq 0, \quad (\text{A.20})$$

for all  $p \in \mathcal{L}_{2e}^{n_p}(\mathbb{R}_+)$ , where  $q = G(p)$  and  $\varepsilon = \delta^2\kappa_1\kappa_2 + \delta(\kappa_2 - \kappa_1) > 0$ .

A completely equivalent approach could be used with the incremental sector and the incremental circle criterion, arriving at similar results. This shows how both versions of the circle criterion may be seen from the viewpoint of topological separation. However, if the circle criterion is used to assess stability of Lur'e systems feedback through a specific and known nonlinearity  $\varphi$ , the analysis may be too conservative. This is due to the fact that the sector description is a rather crude representation of the nonlinearity, and the circle criterion then handles a class of systems that is much larger than the original one. Another way of saying this is that the critical region in the complex plane might be much bigger than it needed to be.

In some special cases, e.g. when  $\varphi$  is monotone or odd monotone, the conservatism can be reduced via the utilization of so-called *frequency-dependent multipliers* [19, 189, 191]. This involves adding new elements to the feedback loop to obtain an equivalent system, and then performing the analysis on the modified loop, hoping that the multiplier “pulls” the system away from the critical region.



# Proofs

## B.1 Proofs from Chapter 2

### PROOF OF LEMMA 2.16

We first prove the equivalence assertion, and then show that the available storage constitutes a lower bound to every storage function.

( $\Rightarrow$ ) We first note that  $S_a(x) \geq 0$ , for every  $x \in X$ , since it is the supremum of a set containing zero (by taking  $T = 0$ ). We then show that  $S_a$  satisfies the dissipation inequality (2.20), and is itself a storage function. Since  $S_a$  is an optimal cost function, we can apply the *Principle of Optimality* (see e.g. [11, 101]) to see that

$$S_a(x_0) \geq - \int_0^t \varpi(w(\tau), z(\tau)) d\tau + \sup \left\{ - \int_t^{t+T} \varpi(w(\tau), z(\tau)) d\tau \right\} \quad (\text{B.1})$$

where the supremum is taken over all  $w \in \mathcal{W}_e$  and all  $T \geq 0$ . Since  $\Sigma$  is time-invariant, the rightmost term in the above inequality is nothing other than the available storage at  $x(t) = \phi(t, 0, x_0, w)$ , which shows that the available storage is indeed a storage function and thus that (2.1) is dissipative with respect to  $\varpi$ .

( $\Leftarrow$ ) From the dissipation inequality (2.20), we have

$$\begin{aligned} S(x_0) &\geq - \int_0^t \varpi(w(t), z(t)) dt + S(x(t)) \\ &\geq - \int_0^t \varpi(w(t), z(t)) dt \end{aligned} \quad (\text{B.2})$$

for every  $t \geq 0$ , and every  $w \in \mathcal{W}$ . Then

$$S(x_0) \geq \sup \left\{ - \int_0^T \varpi(w(t), z(t)) dt \mid \begin{array}{l} T \geq 0, (w, x, z) \text{ satisfy (2.1)} \\ \text{with } x(0) = x_0 \text{ and } w \in \mathcal{W}_e \end{array} \right\} = S_a(x_0) \quad (\text{B.3})$$

From the above inequality, we see that  $S_a$  is finite, and also that it is a lower bound to the storage function  $S$ . ■

## PROOF OF THEOREM 2.18

(i)  $\Rightarrow$  (ii) From the definition (2.22) and (2.23), the available storage is such that  $S_a(x_0) \leq 0$ . On the other hand,  $S_a(x_0)$  is the supremum of a set containing zero, obtained when  $T = 0$ . Then,  $S_a(x_0) \geq 0$  and we conclude that  $S_a(x_0) = 0$ .

Since  $S_a$  is an optimal cost function, we can apply the Principle of optimality to see that

$$S_a(x_0) \geq - \int_0^t \varpi(w(\tau), z(\tau)) d\tau + \sup \left\{ - \int_t^{t+T} \varpi(w(\tau), z(\tau)) d\tau \right\} \quad (\text{B.4})$$

where the supremum is taken over all  $w \in \mathcal{W}$  and all  $T \geq 0$ . Since  $\Sigma$  is time-invariant, the second term on the right-hand side is equivalent to  $S_a(x)$ , with  $x = \phi(t, 0, x_0, w)$ . Using the fact that  $S_a(x_0) = 0$ , we may then write

$$S_a(x) \leq \int_0^t \varpi(w(t), z(t)) dt. \quad (\text{B.5})$$

The right-hand side is bounded since  $\varpi$  is absolutely integrable, hence  $S_a$  is finite for every  $x$  reachable from  $x_0$ . Since the state space of  $\Sigma$  is reachable from  $x_0$  by hypothesis,  $S_a$  is well defined and finite for all  $x \in X$ . Then, according to Lemma 2.16, the system is dissipative with respect to the supply rate  $\varpi$ .

(ii)  $\Rightarrow$  (i) From the dissipation inequality (2.20), we have

$$S(x_0) + \int_0^T \varpi(w(t), z(t)) dt \geq S(x(T)) \geq 0 \quad (\text{B.6})$$

where the last inequality comes from the nonnegativity of the storage function. Since  $S(x_0) = 0$ , the desired result is obtained, for every  $T \geq 0$  and every  $w \in \mathcal{W}_e$ .  $\blacksquare$

## PROOF OF THEOREM 2.27

Let us first note that (2.35) implies that  $V$  is non-increasing along trajectories of the system, so that we have

$$\sigma_1 |x(t) - \tilde{x}(t)|^2 \leq \bar{V}(x(t), \tilde{x}(t)) \leq \bar{V}(x_0, \tilde{x}_0) \leq \sigma_2 |x_0 - \tilde{x}_0|^2, \quad (\text{B.7})$$

and then

$$|x(t) - \tilde{x}(t)| \leq \rho |x_0 - \tilde{x}_0|, \quad (\text{B.8})$$

with  $\rho := \sqrt{\sigma_2/\sigma_1} > 1$ . Additionally, it implies that

$$\int_0^T \sigma_3 |x(\tau) - \tilde{x}(\tau)|^2 d\tau \leq \bar{V}(x(t), \tilde{x}(t)) + \int_0^T \sigma_3 |x(\tau) - \tilde{x}(\tau)|^2 d\tau \leq \bar{V}(x_0, \tilde{x}_0) \leq \sigma_2 |x_0 - \tilde{x}_0|^2 \quad (\text{B.9})$$

for all  $t \geq 0$ , where the last inequality comes from (2.34). Taking the limit when  $t \rightarrow \infty$  yields

$$\int_0^\infty |x(t) - \tilde{x}(t)|^2 dt \leq \kappa |x_0 - \tilde{x}_0|^2, \quad (\text{B.10})$$

with  $\kappa := \sigma_2/\sigma_3$ . Let us define  $T := \rho^2\kappa/\mu^2$ , for some  $\mu \in (0, 1)$ . We claim that for all  $x_0, \tilde{x}_0 \in \mathbb{R}^n$  and all  $w \in \mathcal{W}$  we have

$$|x(T) - \tilde{x}(T)| \leq \mu |x_0 - \tilde{x}_0|. \quad (\text{B.11})$$

To see this, we proceed by contradiction. Let us note that it is sufficient to show that  $|x(T) - \tilde{x}(T)| \leq (\mu/\rho) |x_0 - \tilde{x}_0|$ , since  $\mu/\rho < \mu$ . Suppose there exist  $x_0, \tilde{x}_0 \in \mathbb{R}^n$  and  $w \in \mathcal{W}$  such that

$$|x(T) - \tilde{x}(T)| > \frac{\mu}{\rho} |x_0 - \tilde{x}_0|. \quad (\text{B.12})$$

Then, we have

$$\int_0^\infty |x(t) - \tilde{x}(t)|^2 dt \geq \int_0^T |x(t) - \tilde{x}(t)|^2 dt \geq \frac{\mu^2 T}{\rho^2} |x_0 - \tilde{x}_0|^2 = \kappa |x_0 - \tilde{x}_0|^2, \quad (\text{B.13})$$

which contradicts (B.10). Let us define  $\lambda := -(1/T) \ln \mu$ . Then, using (B.8) for  $\tau \in [0, T]$ , we have

$$|x(\tau) - \tilde{x}(\tau)| \leq \rho |x_0 - \tilde{x}_0| = \frac{\rho}{\mu} |x_0 - \tilde{x}_0| \mu = \frac{\rho}{\mu} |x_0 - \tilde{x}_0| e^{-\lambda T} \leq \frac{\rho}{\mu} |x_0 - \tilde{x}_0| e^{-\lambda \tau}. \quad (\text{B.14})$$

Let  $N$  be the largest integer such that  $t - NT \geq 0$ . Recursive application of (B.11) yields

$$|x(t) - \tilde{x}(t)| \leq \mu^N |x(t - NT) - \tilde{x}(t - NT)|. \quad (\text{B.15})$$

Then, noting that  $t - NT < T$ , we can use (B.14) to write

$$|x(t) - \tilde{x}(t)| \leq \mu^N \frac{\rho}{\mu} |x_0 - \tilde{x}_0| e^{-\lambda(t-NT)} = \mu^N e^{\lambda NT} \frac{\rho}{\mu} |x_0 - \tilde{x}_0| e^{-\lambda t} = \frac{\rho}{\mu} |x_0 - \tilde{x}_0| e^{-\lambda t}, \quad (\text{B.16})$$

where we used the fact that, for  $N \geq 1$ , we have that  $e^{-\lambda NT} = \mu^N$ . Hence, for all  $t \geq 0$ , we have that  $|x(t) - \tilde{x}(t)| \leq (\rho/\mu) |x_0 - \tilde{x}_0| e^{-\lambda t}$ , which concludes the proof.  $\blacksquare$

### PROOF OF LEMMA 2.33

The sufficient part is a direct consequence of the positive-semidefiniteness of the coefficient matrix. We shall prove necessity by contradiction. Suppose that the implication is not true, i.e. the coefficient matrix is not positive-semidefinite. Then, there exist  $y \in \mathbb{R}^{n+1}$  such that

$$y^\top \begin{bmatrix} P & q \\ \bullet & r \end{bmatrix} y < 0. \quad (\text{B.17})$$

Let us distinguish between two cases. First, suppose that  $y_{n+1} \neq 0$ . Then, by dividing (B.17) by  $y_{n+1}^2$ , we obtain

$$\begin{bmatrix} z/y_{n+1} \\ 1 \end{bmatrix}^\top \begin{bmatrix} P & q \\ \bullet & r \end{bmatrix} \begin{bmatrix} z/y_{n+1} \\ 1 \end{bmatrix} < 0, \quad (\text{B.18})$$

with  $z := \text{col}(y_1, \dots, y_n)$ , which is in contradiction with the initial hypothesis.



Let us now suppose that  $y_{n+1} = 0$ . Then, we have

$$y^\top \begin{bmatrix} P & q \\ \bullet & r \end{bmatrix} y = z^\top Pz < 0, \quad (\text{B.19})$$

On the other hand, we have that  $x^\top Px + 2q^\top x + r \geq 0$ , for all  $x \in \mathbb{R}^n$ . When  $|x|$  becomes large, the sign of the quadratic function above is dominated by the quadratic term  $x^\top Px$ . This implies that for the above inequality to be true for all  $x \in \mathbb{R}^n$ , we must have  $P \succeq 0$ . Inequality (B.19) then constitutes a contradiction, and this proves the claim.  $\blacksquare$

#### PROOF OF LEMMA 2.41

(i)  $\Rightarrow$  (ii): All vectors  $x$  such that  $Vx = 0$  can be written as  $x = V^\perp z$ , for some  $z \in \mathbb{R}^{n-k}$ . Then, we have that

$$x^\top Qx = z^\top (V^\perp)^\top QV^\perp z = 0, \quad \forall z \in \mathbb{R}^{n-k}, \quad (\text{B.20})$$

which implies that  $(V^\perp)^\top QV^\perp = 0$ .

(ii)  $\Rightarrow$  (i): Left and right multiplication by  $z^\top$  and  $z$ , respectively, yields  $z^\top (V^\perp)^\top QV^\perp z = 0$ , which implies that

$$x^\top Qx = 0, \quad \forall x = V^\perp z. \quad (\text{B.21})$$

Since  $V^\perp$  spans the null space of  $V$  this means that  $x^\top Qx = 0$  for all  $x$  such that  $Vx = 0$ .

(iii)  $\Rightarrow$  (ii): Left and right multiplication by  $(V^\perp)^\top$  and  $V^\perp$ , respectively, together with the fact that  $VV^\perp = 0$ , yields  $(V^\perp)^\top QV^\perp = 0$ .

(ii)  $\Rightarrow$  (iii): Let  $Y \in \mathbb{R}^{n \times k}$  be such that the matrix  $\begin{bmatrix} V^\perp & Y \end{bmatrix}$  is square and non-singular. Then,  $Q + KV + V^\top K^\top = 0$  if and only if  $\begin{bmatrix} V^\perp & Y \end{bmatrix}^\top (Q + KV + V^\top K^\top) \begin{bmatrix} V^\perp & Y \end{bmatrix} = 0$ . By assumption, we have that  $(V^\perp)^\top QV^\perp = 0$ , so that the above is equivalent to

$$\begin{bmatrix} 0 & (V^\perp)^\top QY \\ \bullet & Y^\top QY \end{bmatrix} + \begin{bmatrix} (V^\perp)^\top \\ Y^\top \end{bmatrix} K \begin{bmatrix} 0 & VY \end{bmatrix} + \begin{bmatrix} 0 \\ Y^\top V^\top \end{bmatrix} K^\top \begin{bmatrix} V^\perp & Y \end{bmatrix} = 0. \quad (\text{B.22})$$

Since  $V$  is full-rank, and  $\begin{bmatrix} V^\perp & Y \end{bmatrix}$  is non-singular, we have that

$$\text{rank}(V) = \text{rank}\left(V \begin{bmatrix} V^\perp & Y \end{bmatrix}\right) = \text{rank}\left(\begin{bmatrix} 0 & VY \end{bmatrix}\right) = \text{rank}(VY) = k. \quad (\text{B.23})$$

This means that the matrix  $VY \in \mathbb{R}^{k \times k}$  is non-singular. Let us then choose

$$K = \begin{bmatrix} (V^\perp)^\top \\ Y^\top \end{bmatrix}^{-1} \begin{bmatrix} X_1 \\ X_2 \end{bmatrix} (VY)^{-1}, \quad (\text{B.24})$$

for some matrices  $X_1 \in \mathbb{R}^{(n-k) \times k}$  and  $X_2 \in \mathbb{R}^{k \times k}$ . Replacing the above in (B.22), we obtain

$$\begin{bmatrix} 0 & (V^\perp)^\top QY + X_1 \\ \bullet & Y^\top QY + X_2 + X_2^\top \end{bmatrix} = 0. \quad (\text{B.25})$$

Then, by choosing  $X_1 = -(V^\perp)^\top QY$  and  $X_2 = -\frac{1}{2}Y^\top QY$ , the result follows.  $\blacksquare$

## PROOF OF THEOREM 2.42

According to Corollary 2.19, the  $\mathcal{L}_2$ -gain of (2.14) is less than or equal to  $\gamma$  if the system is dissipative with respect to the supply rate (2.24). We will show that the LMIs (2.80), (2.81) and the matrix equality (2.82) allow the construction of a continuous nonnegative piecewise-quadratic storage function  $S$  of structure given by (2.76) such that the above condition is met.

*Continuity* - We first show that  $S$  is a continuous function of  $x$ . This is clearly the case inside every cell, so we just need to show continuity on the boundaries. From (2.6),  $E_{ij}x + e_{ij} = 0$  for all  $x \in X_j \cap X_i$ , then (2.82) implies that  $x^\top P_i x + 2q_i^\top x + r_i = x^\top P_j x + 2q_j^\top x + r_j$  for  $x \in X_i \cap X_j$  and hence that  $S$  is continuous.

*Nonnegativity* - We now show that  $S$  is a nonnegative function. The first inequality in (2.81), post and pre multiplied respectively by  $\text{col}(x, 1)$  and  $\text{col}(x, 1)^\top$ , implies that  $x^\top P_i x + 2q_i^\top x + r_i \geq (E_i x + e_i)^\top U_i (E_i x + e_i)$ . Since  $U_i$  is composed of nonnegative coefficients, the right-hand side of the previous inequality is nonnegative whenever  $x \in X_i$ . This implies that

$$x^\top P_i x + 2q_i^\top x + r_i \geq 0 \quad \text{for } x \in X_i, \quad \forall i \in \mathcal{I} \setminus \mathcal{I}_0 \quad (\text{B.26})$$

The first inequality in (2.80) implies that  $S(x) \geq 0$  for all  $x \in X_i$  with  $i \in \mathcal{I}_0$ . With (B.26), this guarantees that

$$S(x) \geq 0, \quad \forall x \in X \quad (\text{B.27})$$

*Dissipation inequality* - We now show that the storage function respects the dissipation constraint (2.20). Using the same arguments as before, the last inequality in (2.81), post and pre multiplied by  $\text{col}(x, 1, w)^\top$  and  $\text{col}(x, 1, w)$ , implies that

$$\begin{aligned} \begin{bmatrix} x \\ 1 \end{bmatrix}^\top \begin{bmatrix} P_i & q_i \\ \bullet & r_i \end{bmatrix} \begin{bmatrix} (A_i x + a_i + B_i w) \\ 0 \end{bmatrix} + \begin{bmatrix} (A_i x + a_i + B_i w) \\ 0 \end{bmatrix}^\top \begin{bmatrix} P_i & q_i \\ \bullet & r_i \end{bmatrix} \begin{bmatrix} x \\ 1 \end{bmatrix} + \\ (C_i x + c_i + Dw)^\top (C_i x + c_i + Dw) - \gamma^2 w^\top w \leq 0 \end{aligned} \quad (\text{B.28})$$

for all  $w \in W$  and all  $x \in X_i$ . Let  $t_a$  and  $t_b$  be two time instants such that the state trajectory of system (2.14) remains in  $X_i$  on the interval  $[t_a, t_b]$ . By noticing that  $\dot{x} = A_i x + a_i + B_i w$ , and integrating from  $t_a$  to  $t_b$  along a trajectory of (2.14), we have

$$\begin{aligned} \begin{bmatrix} x(t_b) \\ 1 \end{bmatrix}^\top \begin{bmatrix} P_i & q_i \\ \bullet & r_i \end{bmatrix} \begin{bmatrix} x(t_b) \\ 1 \end{bmatrix} - \begin{bmatrix} x(t_a) \\ 1 \end{bmatrix}^\top \begin{bmatrix} P_i & q_i \\ \bullet & r_i \end{bmatrix} \begin{bmatrix} x(t_a) \\ 1 \end{bmatrix} + \int_{t_a}^{t_b} |z(\tau)|^2 d\tau - \gamma^2 \int_{t_a}^{t_b} |w(\tau)|^2 d\tau \leq 0 \end{aligned} \quad (\text{B.29})$$

The same reasoning can be applied to the last inequality in (2.80), post and pre multiplied by  $\text{col}(x, w)^\top$  and  $\text{col}(x, w)$ , which yields

$$x(t_b)^\top P_i x(t_b) - x(t_a)^\top P_i x(t_a) + \int_{t_a}^{t_b} |z(\tau)|^2 d\tau - \gamma^2 \int_{t_a}^{t_b} |w(\tau)|^2 d\tau \leq 0. \quad (\text{B.30})$$

We note that the first terms in (B.29) and (B.30) represent the storage function (2.76). Let us consider a trajectory  $x(t)$ ,  $\forall t \in [t_0, t_1]$ , with  $t_0 \geq 0$ . The time  $t_1$  can be decomposed as  $t_1 = t_1 - t_{in,q} + \sum_{k=0}^{q-1} (t_{out,k} - t_{in,k})$ , with  $t_{out,k} = t_{in,k+1}$  and  $t_{in,0} = t_0$ , so that during each time interval  $[t_{in,k}, t_{out,k}]$  the trajectory stays in a given region. Then, replacing  $t_a$  by  $t_{in,k}$

and  $t_b$  by  $t_{out,k}$  in (B.29) and (B.30), adding up to  $q$  for every region  $X_i$  traversed, and using the continuity of  $S$  yields

$$S(x(t_1)) - S(x(t_0)) + \int_{t_0}^{t_1} |z(\tau)|^2 d\tau - \gamma^2 \int_{t_0}^{t_1} |w(\tau)|^2 d\tau \leq 0 \quad (\text{B.31})$$

From (2.20), this shows that  $S$  is a storage function such that the system  $\Sigma_{\text{PWA}}$  is dissipative with respect to the supply rate (2.24). Corollary 2.19 thus implies that  $\Sigma_{\text{PWA}}$  has an  $\mathcal{L}_2$ -gain less than or equal to  $\gamma$ , which concludes the proof. ■

### PROOF OF THEOREM 2.43

According to Theorem 2.24, the system (2.14) is exponentially stable if there exists a Lyapunov function respecting the conditions 2.28–2.29 with  $\alpha_1, \alpha_2$  and  $\rho$  being quadratic functions. We will show that the LMIs (2.83)–(2.85) allow the construction of a continuous piecewise-quadratic Lyapunov function  $V$  having the same structure as  $S$  in (2.76).

*Continuity* - We first show that  $V$  is a continuous function of  $x$ . This is clearly the case inside every cell, so we just need to show continuity on the boundaries. From (2.6),  $E_{ij}x + e_{ij} = 0$  for all  $x \in X_j \cap X_i$ , then (2.85) implies that  $x^\top P_i x + 2q_i^\top x + r_i = x^\top P_j x + 2q_j^\top x + r_j$  for  $x \in X_i \cap X_j$  and hence that  $V$  is continuous.

*Positive definiteness* - We now show that  $V$  is a positive definite function. The first inequality in (2.84) being strict, it implies the existence of  $\sigma_{1,i} > 0$  such that

$$\begin{bmatrix} P_i - E_i^\top U_i E_i & q_i - E_i^\top U_i e_i \\ \bullet & r_i - e_i^\top U_i e_i \end{bmatrix} \succeq \sigma_{1,i} \begin{bmatrix} I_n & 0 \\ 0 & 0 \end{bmatrix}. \quad (\text{B.32})$$

This inequality, post and pre multiplied respectively by  $\text{col}(x, 1)$  and  $\text{col}(x, 1)^\top$ , implies that  $x^\top P_i x + 2q_i^\top x + r_i - \sigma_{1,i} |x|^2 \geq (E_i x + e_i)^\top U_i (E_i x + e_i)$ . Since  $U_i$  is composed of nonnegative coefficients, the right-hand side of the previous inequality is nonnegative whenever  $x \in X_i$ . This implies that

$$x^\top P_i x + 2q_i^\top x + r_i \geq \sigma_{1,i} |x|^2 \quad \text{for } x \in X_i, \quad i \in \mathcal{I} \setminus \mathcal{I}_0. \quad (\text{B.33})$$

Similarly, the first inequality in (2.83) implies that  $V(x) \geq \sigma_{1,i} |x|^2$  for all  $x \in X_i$ , with  $i \in \mathcal{I}_0$ . With (B.33), and defining  $\sigma_1 := \min_{i \in \mathcal{I}} \sigma_{1,i}$ , this guarantees that

$$V(x) \geq \sigma_1 |x|^2, \quad \forall x \in X \quad (\text{B.34})$$

Since the Lyapunov function candidate is continuous and such that  $q_i = 0$  and  $r_i = 0$  for  $i \in \mathcal{I}_0$ , there exist  $\sigma_2 > 0$  such that

$$V(x) \leq \sigma_2 |x|^2, \quad \forall x \in X \quad (\text{B.35})$$

*Lyapunov function decay* - We now show that the function  $V$  is decreasing along the trajectories of the system. Using the same arguments as before, the last inequality in (2.84), post and pre multiplied by  $\text{col}(x, 1)^\top$  and  $\text{col}(x, 1)$ , implies that

$$\begin{bmatrix} x \\ 1 \end{bmatrix}^\top \begin{bmatrix} P_i & q_i \\ \bullet & r_i \end{bmatrix} \begin{bmatrix} (A_i x + a_i + B_i w) \\ 0 \end{bmatrix} + \begin{bmatrix} (A_i x + a_i + B_i w) \\ 0 \end{bmatrix}^\top \begin{bmatrix} P_i & q_i \\ \bullet & r_i \end{bmatrix} \begin{bmatrix} x \\ 1 \end{bmatrix} \leq -\sigma_{3,i} |x|^2 \quad (\text{B.36})$$

for all  $x \in X_i$ . Let  $t_a$  and  $t_b$  be two time instants such that the state trajectory of system (2.14) remains in  $X_i$  on the interval  $[t_a, t_b]$ . By noticing that  $\dot{x} = A_i x + a_i + B_i w$ , and integrating from  $t_a$  to  $t_b$  along a trajectory of (2.14), we have

$$\begin{bmatrix} x(t_b) \\ 1 \end{bmatrix}^\top \begin{bmatrix} P_i & q_i \\ \bullet & r_i \end{bmatrix} \begin{bmatrix} x(t_b) \\ 1 \end{bmatrix} - \begin{bmatrix} x(t_a) \\ 1 \end{bmatrix}^\top \begin{bmatrix} P_i & q_i \\ \bullet & r_i \end{bmatrix} \begin{bmatrix} x(t_a) \\ 1 \end{bmatrix} < - \int_{t_a}^{t_b} \sigma_{3,i} |x|^2 dt. \quad (\text{B.37})$$

The same reasoning can be applied to the last inequality in (2.83), post and pre multiplying by  $x^\top$  and  $x$ , which yields

$$x(t_b)^\top P_i x(t_b) - x(t_a)^\top P_i x(t_a) < - \int_{t_a}^{t_b} \sigma_{3,i} |x|^2 dt. \quad (\text{B.38})$$

We note that the first terms on the left-hand side of in (B.37) and (B.38) represent the Lyapunov function having the same structure as (2.76). Let us consider a trajectory  $x(t)$ ,  $\forall t \in [t_0, t_1]$ , with  $t_0 \geq 0$ . The time  $t_1$  can be decomposed as  $t_1 = t_0 - t_{in,q} + \sum_{k=0}^{q-1} (t_{out,k} - t_{in,k})$ , with  $t_{out,k} = t_{in,k+1}$  and  $t_{in,0} = t_0$ , so that during each time interval  $[t_{in,k}, t_{out,k}]$  the trajectory stays in a given region. Let us define  $\sigma_3 := \min_{i \in \mathcal{I}} \sigma_{3,i}$ . Then, replacing  $t_a$  by  $t_{in,k}$  and  $t_b$  by  $t_{out,k}$  in (B.37) and (B.38), adding up to  $q$  for every region  $X_i$  traversed, and using the continuity of  $V$  yields

$$V(x(t_1)) - V(x(t_0)) < - \int_{t_0}^{t_1} \sigma_3 |x|^2 dt \quad (\text{B.39})$$

for every  $t_1 \geq t_0$ . Hence, the function  $V$  respects (2.29), with  $\alpha_3$  quadratic. This shows that  $V$  is a Lyapunov function, and thus system (2.14) is exponentially stable.  $\blacksquare$

#### PROOF OF THEOREM 2.45

According to Corollary 2.20, the incremental  $\mathcal{L}_2$ -gain of (2.14) is less than or equal to  $\eta$  if the augmented system (2.88) is dissipative with respect to the supply rate (2.26). We will show that the LMIs (2.94) allow the construction of a nonnegative quadratic storage function  $\bar{S}$  of structure given by (2.49) such that the above condition is met.

Let  $\bar{S}(x, \tilde{x}) = (x - \tilde{x})^\top P(x - \tilde{x})$  be a candidate storage function. The first inequality in (2.94) ensures that  $\bar{S}(x, \tilde{x}) \geq 0$ , for every  $x, \tilde{x} \in X$ .

It remains to show that the dissipation inequality (2.20) is respected with the supply rate given by (2.26). Since  $\bar{S}$  is differentiable, with  $\dot{\bar{S}}(x, \tilde{x}, w, \tilde{w}) = 2(x - \tilde{x})^\top P(A_i x + a_i + Bw - (A_j \tilde{x} + a_j + B\tilde{w}))$  for  $\bar{x} \in X_{ij}$ , the differential dissipation inequality (2.21) gives

$$2(x - \tilde{x})^\top P(A_i x + a_i + Bw - (A_j \tilde{x} + a_j + B\tilde{w})) + |\bar{z}|^2 - \eta^2 |(w - \tilde{w})|^2 \leq 0, \quad \text{for } x \in X_i, \tilde{x} \in X_j. \quad (\text{B.40})$$

We recall from (2.88) that  $\bar{z} = C_i x + c_i + Dw - (C_j \tilde{x} + c_j + D\tilde{w})$ , for  $x \in X_i$  and  $\tilde{x} \in X_j$ . Substitution in the previous inequality yields

$$2(x - \tilde{x})^\top P(A_i x + a_i + Bw - (A_j \tilde{x} + a_j + B\tilde{w})) + |C_i x + c_i + Dw - (C_j \tilde{x} + c_j + D\tilde{w})|^2 - \eta^2 |(w - \tilde{w})|^2 \leq 0, \quad \text{for } x \in X_i, \tilde{x} \in X_j. \quad (\text{B.41})$$

Application of Proposition 2.5 allows us to rewrite the inequality as

$$\sum_{i=1}^N \lambda_i \left( 2(x - \tilde{x})^\top P(A_i(x - \tilde{x}) + B(w - \tilde{w})) - \eta^2 |(w - \tilde{w})|^2 \right) + \left| \sum_{i=1}^N \lambda_i (C_i(x - \tilde{x}) + D(w - \tilde{w})) \right|^2 \leq 0. \quad (\text{B.42})$$

Let us consider the last term in the previous inequality. Application of the triangle inequality yields

$$\left| \sum_{i=1}^N \lambda_i (C_i(x - \tilde{x}) + D(w - \tilde{w})) \right|^2 \leq \left( \sum_{i=1}^N \lambda_i \left| (C_i(x - \tilde{x}) + D(w - \tilde{w})) \right| \right)^2 \quad (\text{B.43})$$

By the convexity of the quadratic function, we can apply Jensen's inequality [17, Section 3.1.8] and convexity of the quadratic function, we obtain

$$\left( \sum_{i=1}^N \lambda_i \left| (C_i(x - \tilde{x}) + D(w - \tilde{w})) \right| \right)^2 \leq \sum_{i=1}^N \lambda_i \left| (C_i(x - \tilde{x}) + D(w - \tilde{w})) \right|^2. \quad (\text{B.44})$$

With these results, the left-hand side of (B.42) is less than or equal to

$$\sum_{i=1}^N \lambda_i \left( 2(x - \tilde{x})^\top P(A_i(x - \tilde{x}) + B(w - \tilde{w})) + |C_i(x - \tilde{x}) + D(w - \tilde{w})|^2 - \eta^2 |(w - \tilde{w})|^2 \right) \quad (\text{B.45})$$

which can be rewritten as

$$\sum_{i=1}^N \lambda_i \left( \begin{bmatrix} x - \tilde{x} \\ w - \tilde{w} \end{bmatrix}^\top \begin{bmatrix} A_i^\top P + PA_i & PB + C_i^\top D \\ \bullet & D^\top D - \eta^2 I_p \end{bmatrix} \begin{bmatrix} x - \tilde{x} \\ w - \tilde{w} \end{bmatrix} \right). \quad (\text{B.46})$$

The above is negative whenever the last inequality in (2.94) is satisfied. This means that the dissipation inequality is satisfied and then that (2.14) is incrementally  $\mathcal{L}_2$ -gain stable, with an incremental  $\mathcal{L}_2$ -gain less than or equal to  $\eta$ .  $\blacksquare$

#### PROOF OF THEOREM 2.46

According to Theorem 2.26, the system (2.14) is incrementally asymptotically stable if there exists an incremental Lyapunov function respecting the conditions (2.34) and (2.35). We will show that the LMIs (2.95) allow the construction of a quadratic incremental Lyapunov function  $\bar{V}$ .

Let  $\bar{V}(x, \tilde{x}) = (x - \tilde{x})^\top P(x - \tilde{x})$  be a candidate incremental Lyapunov function. The first inequality in (2.95) ensures that

$$\sigma_1 |x - \tilde{x}|^2 \leq \bar{V}(x, \tilde{x}) \leq \sigma_2 |x - \tilde{x}|^2, \quad \text{for every } x, \tilde{x} \in X, \quad (\text{B.47})$$

where  $\sigma_1$  and  $\sigma_2$  denote the smallest and greatest eigenvalue of  $P$ , respectively.

It remains to show that the inequality (2.35) is respected for some positive definite function  $\rho$ . Since  $\bar{V}$  is differentiable, with  $\dot{\bar{V}} = 2(x - \tilde{x})^\top P(A_i x + a_i + Bw - (A_j \tilde{x} + a_j + Bw)) = 2(x - \tilde{x})^\top P(A_i x + a_i + (A_j \tilde{x} + a_j))$ , application of Proposition 2.5 allows us to write

$$\dot{\bar{V}}(x, \tilde{x}) = \sum_{i=1}^N \lambda_i \left( 2(x - \tilde{x})^\top P A_i (x - \tilde{x}) \right), \quad (\text{B.48})$$

which can be rewritten as

$$\dot{\bar{V}}(x, \tilde{x}) = \sum_{i=1}^N \lambda_i \left( (x - \tilde{x})^\top (A_i^\top P + P A_i) (x - \tilde{x}) \right) \quad (\text{B.49})$$

Then, if the second inequality in (2.95) is satisfied for every  $i \in \mathcal{I}$ , there exists  $\sigma_3 > 0$  such that

$$\dot{\bar{V}}(x, \tilde{x}) \leq - \sum_{i=1}^N \lambda_i \sigma_3 |x - \tilde{x}|^2 = -\sigma_3 |x - \tilde{x}|^2 \quad (\text{B.50})$$

Integration from 0 to  $t$  yields

$$\bar{V}(x(t), \tilde{x}(t)) - \bar{V}(x_0, \tilde{x}_0) \leq - \int_0^t \sigma_3 |x(\tau) - \tilde{x}(\tau)|^2 d\tau. \quad (\text{B.51})$$

Then  $\bar{V}$  respects the conditions in Theorem 2.27, and is then an incremental Lyapunov function. This proves that system (2.14) is incrementally exponentially stable.  $\blacksquare$

## B.2 Proofs from Chapter 3

### PROOF OF THEOREM 3.3

According to Corollary 2.20, the incremental  $\mathcal{L}_2$ -gain of (2.14) is less than or equal to  $\eta$  if the augmented system (2.88) is dissipative with respect to the supply rate (2.26). We will show that the LMIs (3.14), (3.15) and the matrix equality (3.16) allow the construction of a continuous nonnegative piecewise-quadratic storage function  $\bar{S}$  of structure given by (3.12) such that the above condition is met.

*Continuity* - We first show that  $\bar{S}$  is a continuous function of  $\bar{x}$ . This is clearly the case inside every cell, so we just need to show continuity on the boundaries. From (2.91),  $\bar{E}_{ijkl}\bar{x} = 0$  for all  $\bar{x} \in X_{ij} \cap X_{kl}$ , then (3.16) implies that  $\bar{x}^\top \bar{P}_{ij} \bar{x} = \bar{x}^\top \bar{P}_{kl} \bar{x}$  for  $\bar{x} \in X_{ij} \cap X_{kl}$  and hence that  $\bar{S}$  is continuous.

*Nonnegativity* - We now show that  $\bar{S}$  is a nonnegative function. The first inequality in (3.15), post and pre multiplied respectively by  $\bar{x}$  and  $\bar{x}^\top$ , implies that  $\bar{x}^\top \bar{P}_{ij} \bar{x} \geq \bar{x}^\top \bar{G}_{ij}^\top U_{ij} \bar{G}_{ij} \bar{x}$ . Since  $U_{ij}$  is composed of nonnegative coefficients, the right-hand side of the previous inequality is nonnegative whenever  $\bar{x} \in X_{ij}$ . This implies that

$$\bar{x}^\top \bar{P}_{ij} \bar{x} \geq 0 \quad \text{for } \bar{x} \in X_{ij} \quad (\text{B.52})$$

The first inequality in (3.14) implies that  $\bar{S}(x, \tilde{x}) \geq 0$  for all  $\bar{x} \in X_{ii}$ . With (B.52), this guarantees that

$$\bar{S}(x, \tilde{x}) \geq 0, \quad \forall x, \tilde{x} \in X \quad (\text{B.53})$$

*Dissipation inequality* - We now show that the storage function respects the dissipation constraint (2.20). Using the same arguments as before, the last inequality in (3.15), post and pre multiplied by  $\text{col}(\bar{x}, \bar{w})^\top$  and  $\text{col}(\bar{x}, \bar{w})$ , implies that

$$\bar{x}^\top \bar{P}_{ij} (\bar{A}_{ij} \bar{x} + \bar{B}_{ij} \bar{w}) + (\bar{A}_{ij} \bar{x} + \bar{B}_{ij} \bar{w})^\top \bar{P}_{ij} \bar{x} + (\bar{C}_{ij} \bar{x} + \bar{D} \bar{w})^\top (\bar{C}_{ij} \bar{x} + \bar{D} \bar{w}) - \eta^2 \bar{w}^\top \bar{I}_{n_w} \bar{w} \leq 0 \quad (\text{B.54})$$

for all  $\bar{w} \in W \times W$  and all  $\bar{x} \in X_{ij}$ . Let  $t_a$  and  $t_b$  be two time instants such that the state trajectory of system (2.88) remains in  $X_{ij}$  on the interval  $[t_a, t_b]$ . By noticing that  $\dot{\bar{x}} = \bar{A}_{ij} \bar{x} + \bar{B}_{ij} \bar{w}$ , and integrating from  $t_a$  to  $t_b$  along a trajectory of (2.88), we have

$$\bar{x}(t_b)^\top \bar{P}_{ij} \bar{x}(t_b) - \bar{x}(t_a)^\top \bar{P}_{ij} \bar{x}(t_a) + \int_{t_a}^{t_b} |z(\tau) - \tilde{z}(\tau)|^2 d\tau - \eta^2 \int_{t_a}^{t_b} |w(\tau) - \tilde{w}(\tau)|^2 d\tau \leq 0 \quad (\text{B.55})$$

The same reasoning can be applied to the last inequality in (3.14), post and pre multiplying by  $\text{col}(x - \tilde{x}, w - \tilde{w})^\top$  and  $\text{col}(x - \tilde{x}, w - \tilde{w})$ , which yields

$$(x(t_b) - \tilde{x}(t_b))^\top P_i (x(t_b) - \tilde{x}(t_b)) - (x(t_a) - \tilde{x}(t_a))^\top P_i (x(t_a) - \tilde{x}(t_a)) + \int_{t_a}^{t_b} |z(\tau) - \tilde{z}(\tau)|^2 d\tau - \eta^2 \int_{t_a}^{t_b} |w(\tau) - \tilde{w}(\tau)|^2 d\tau \leq 0 \quad (\text{B.56})$$

We note that the first terms in (B.55) and (B.56) represent the storage function (3.12). Let us consider a trajectory  $\bar{x}(t)$ ,  $\forall t \in [t_0, t_1]$ , with  $t_0 \geq 0$ . The time  $t_1$  can be decomposed as  $t_1 = t_1 - t_{in,q} + \sum_{k=0}^{q-1} (t_{out,k} - t_{in,k})$ , with  $t_{out,k} = t_{in,k+1}$  and  $t_{in,0} = t_0$ , so that during each time interval  $[t_{in,k}, t_{out,k}]$  the trajectory stays in a given region. Then, replacing  $t_a$  by  $t_{in,k}$  and  $t_b$  by  $t_{out,k}$  in (B.55) and (B.56), adding up to  $q$  for every region  $X_{ij}$  crossed, and using the continuity of  $\bar{S}$  yields

$$\bar{S}(x(t_1), \tilde{x}(t_1)) - \bar{S}(x(t_0), \tilde{x}(t_0)) + \int_{t_0}^{t_1} |z(\tau) - \tilde{z}(\tau)|^2 d\tau - \eta^2 \int_{t_0}^{t_1} |w(\tau) - \tilde{w}(\tau)|^2 d\tau \leq 0. \quad (\text{B.57})$$

From (2.20), this shows that  $\bar{S}$  is a storage function such that the augmented system  $\bar{\Sigma}_{\text{PWA}}$  is dissipative with respect to the supply rate (2.26). Corollary 2.20 thus implies that  $\Sigma_{\text{PWA}}$  has an incremental  $\mathcal{L}_2$ -gain less than or equal to  $\eta$ , which concludes the proof.  $\blacksquare$

#### PROOF OF THEOREM 3.4

We shall demonstrate that the above conditions allow us to build a continuous piecewise-quadratic incremental Lyapunov function  $V$ , given by the same structure as  $\bar{S}$  in (3.12), which is shown to respect the conditions in Theorem 2.27. This allows us to prove incremental exponential stability of (2.14).

*Continuity* - Follows exactly as in Theorem 3.3.

*Norm bounds* - The first inequality in (3.21), post and pre multiplied respectively by  $\bar{x}$  and  $\bar{x}^\top$ , implies that  $\bar{x}^\top \bar{P}_{ij} \bar{x} - \sigma_1 |x - \tilde{x}|^2 \geq \bar{x}^\top \bar{G}_{ij}^\top U_{ij} \bar{G}_{ij} \bar{x}$ . Since  $U_{ij}$  is composed of nonnegative coefficients, the right-hand side of the previous inequality is nonnegative whenever  $\bar{x} \in X_{ij}$ . This implies that

$$\bar{x}^\top \bar{P}_{ij} \bar{x} \geq \sigma_1 |x - \tilde{x}|^2, \quad \text{for } \bar{x} \in X_{ij}. \quad (\text{B.58})$$

The first inequality in (3.20) implies that  $V(x, \tilde{x}) \geq \sigma_1 |x - \tilde{x}|^2$  for all  $\bar{x} \in X_{ii}$ . Together with (B.58), this guarantees that

$$V(x, \tilde{x}) \geq \sigma_1 |x - \tilde{x}|^2, \quad \forall x, \tilde{x} \in X. \quad (\text{B.59})$$

Proceeding exactly as before, the second inequalities in (3.20) and (3.21) imply that

$$V(x, \tilde{x}) \leq \sigma_2 |x - \tilde{x}|^2, \quad \forall x, \tilde{x} \in X. \quad (\text{B.60})$$

Inequalities (B.59) and (B.60) imply that the continuous piecewise-quadratic function  $V$  is such that

$$\sigma_1 |x - \tilde{x}|^2 \leq V(x, \tilde{x}) \leq \sigma_2 |x - \tilde{x}|^2 \quad (\text{B.61})$$

*Exponential decay* - We now show that the function  $V$  decays exponentially and conclude on the incremental exponential stability. Using the same arguments as before, the third inequality in (3.21), post and pre multiplied by  $\bar{x}^\top$  and  $\bar{x}$ , implies that

$$\bar{x}^\top \bar{P}_{ij} \bar{A}_{ij} \bar{x} + \bar{x}^\top \bar{A}_{ij}^\top \bar{P}_{ij} \bar{x} \leq -\sigma_3 |x - \tilde{x}|^2 \quad (\text{B.62})$$

for all  $\bar{x} \in X_{ij}$ . From the equality in (3.21), and using the fact that  $\dot{\bar{x}} = \bar{A}_{ij} \bar{x} + \bar{F}_{ij} u$ , we may write

$$\bar{x}^\top \bar{P}_{ij} \dot{\bar{x}} + \dot{\bar{x}}^\top \bar{P}_{ij} \bar{x} \leq -\sigma_3 |x - \tilde{x}|^2. \quad (\text{B.63})$$

In the interior of each region  $X_{ij}$ ,  $V$  is differentiable and such that  $\dot{V}(x, \tilde{x})$  is equal to the left-hand side of the previous inequality. Let  $t_a$  and  $t_b$  be two time instants such that the state trajectory of system (2.92) remains in  $X_{ij}$  on the interval  $[t_a, t_b]$ . Integrating from  $t_a$  to  $t_b$  along trajectories of (2.92), we have

$$V(x(t_b), \tilde{x}(t_b)) - V(x(t_a), \tilde{x}(t_a)) \leq - \int_{t_a}^{t_b} \sigma_3 |x(t) - \tilde{x}(t)|^2 dt. \quad (\text{B.64})$$

The same reasoning can be applied to the last inequality in (3.20). Let us consider two trajectories  $x(t) = \phi(t, 0, x_0, u)$  and  $\tilde{x}(t) = \phi(t, 0, \tilde{x}_0, u)$ , for  $u \in \mathcal{L}_{2e}^{nw}(\mathbb{R}_+)$ . The time  $t$  can be decomposed as  $t = t - t_{in,q} + \sum_{k=0}^{q-1} (t_{out,k} - t_{in,k})$ , with  $t_{out,k} = t_{in,k+1}$  and  $t_{in,0} = 0$ , so that during each time interval  $[t_{in,k}, t_{out,k}]$  the trajectory stays in a given region. Then, replacing  $t_a$  by  $t_{in,k}$  and  $t_b$  by  $t_{out,k}$  in (B.64), adding up to  $q$  for every region  $X_{ij}$  crossed, and using continuity yields

$$V(x(t), \tilde{x}(t)) - V(x_0, \tilde{x}_0) \leq - \int_0^t \sigma_3 |x(\tau) - \tilde{x}(\tau)|^2 d\tau, \quad (\text{B.65})$$

which concludes the proof. ■

## B.3 Proofs from Chapter 4

Before stating the proofs of Chapter 4, let us introduce the following lemma, which will be used in what follows.



LEMMA B.1

Let  $p \in \mathcal{L}_{2e}^{n_p}(\mathbb{R}_+)$ , and let  $\theta_1$  and  $\theta_2$  be two bounded causal operators from  $\mathcal{L}_{2e}^{n_p}(\mathbb{R}_+)$  into itself, i.e. there exist positive scalars  $\gamma_1$  and  $\gamma_2$  such that

$$\begin{aligned}\|\theta_1(p)\|_{2,T} &\leq \gamma_1 \|p\|_{2,T} \\ \|\theta_2(p)\|_{2,T} &\leq \gamma_2 \|p\|_{2,T}.\end{aligned}\tag{B.66}$$

If there exists  $\varepsilon > 0$  such that

$$\|\theta_1(p)\|_{2,T}^2 - \|\theta_2(p)\|_{2,T}^2 \leq -\varepsilon \|p\|_{2,T}^2, \quad \forall T \geq 0,\tag{B.67}$$

then there exists  $\tilde{\varepsilon} > 0$  such that

$$\|\theta_1(p)\|_{2,T} - \|\theta_2(p)\|_{2,T} \leq -\tilde{\varepsilon} \|p\|_{2,T}, \quad \forall T \geq 0.\tag{B.68}$$

┘

PROOF

When  $p = 0$ , inequality (B.68) is trivially satisfied. We shall consider the case when  $p \neq 0$ . Let us begin by rewriting

$$\|\theta_1(p)\|_{2,T}^2 - \|\theta_2(p)\|_{2,T}^2 = (\|\theta_1(p)\|_{2,T} - \|\theta_2(p)\|_{2,T})(\|\theta_1(p)\|_{2,T} + \|\theta_2(p)\|_{2,T}).\tag{B.69}$$

Inequality (B.67) implies that  $\|\theta_2(p)\|_{2,T} \geq \sqrt{\varepsilon} \|p\|_{2,T}$ , so that  $\|\theta_1(p)\|_{2,T} + \|\theta_2(p)\|_{2,T} > 0$  when  $p \neq 0$ . Using this, (B.67) can be rewritten as

$$\|\theta_1(p)\|_{2,T} - \|\theta_2(p)\|_{2,T} \leq -\frac{\varepsilon}{\|\theta_1(p)\|_{2,T} + \|\theta_2(p)\|_{2,T}} \|p\|_{2,T}^2.\tag{B.70}$$

Using the gain bounds in (B.66) and defining  $\gamma = \gamma_1 + \gamma_2$ , we have that  $\|\theta_1(p)\|_{2,T} + \|\theta_2(p)\|_{2,T} \leq \gamma \|p\|_{2,T}$ , which yields

$$-\frac{1}{\|\theta_1(p)\|_{2,T} + \|\theta_2(p)\|_{2,T}} \leq -\frac{1}{\gamma \|p\|_{2,T}}.\tag{B.71}$$

Using the above inequality, (B.70) becomes

$$\|\theta_1(p)\|_{2,T} - \|\theta_2(p)\|_{2,T} \leq -\frac{\varepsilon}{\gamma} \|p\|_{2,T},\tag{B.72}$$

which concludes the proof. ■

PROOF OF THEOREM 4.14

We shall prove this theorem by showing that inequalities (4.26) and (4.27) ensure a topological separation between the inverse graph of  $G$  and the graph of  $\Delta$ , so that stability can be concluded on the grounds of Theorem 4.12.

Firstly, we use the fact that  $\Pi$  is positive-negative to rewrite conditions (4.26) and (4.27) in a new form. Since  $\Delta$  and  $\Psi$  are bounded, the integral in (4.26) is well-defined when  $T \rightarrow \infty$ . Using Parseval's equality, we may write

$$\int_{-\infty}^{\infty} \begin{bmatrix} \hat{q}(j\omega) \\ \hat{p}(j\omega) \end{bmatrix}^* \Pi(j\omega) \begin{bmatrix} \hat{q}(j\omega) \\ \hat{p}(j\omega) \end{bmatrix} d\omega \geq 0. \quad (\text{B.73})$$

Since  $\Pi$  is positive-negative, Lemma 4.23 ensures that it admits a J-spectral factorization. According to Lemma 4.24, this factorization is doubly-hard. This means that

$$\int_0^T y_{\Delta}(t)^{\top} J y_{\Delta}(t) dt \geq 0, \quad \forall T \geq 0, \forall \Delta \in \mathbf{\Delta}, \forall q \in \mathcal{L}_{2e}^{n_q}(\mathbb{R}_+), \quad (\text{B.74})$$

where  $y_{\Delta} = \Psi_J \begin{bmatrix} \mathbb{I} \\ \Delta \end{bmatrix} (q)$ ,  $J = \text{diag}(I_{n_q}, -I_{n_p})$ , and  $\Pi(j\omega) = \Psi_J(j\omega)^* J \Psi_J(j\omega)$ . The same reasoning can be applied to inequality (4.27).

Let us recall that the feedback system is described by

$$\begin{cases} q = q_{\text{in}} + G(p) \\ p = p_{\text{in}} + \Delta(q). \end{cases} \quad (\text{B.75})$$

We begin by considering the inverse graph of  $G$  through (4.27). Let us define

$$\Psi_J = \begin{bmatrix} \phi_{11} & \phi_{12} \\ \phi_{21} & \phi_{22} \end{bmatrix}, \quad (\text{B.76})$$

and then note that (4.27) can be rewritten as

$$\int_0^T \Psi_J \begin{pmatrix} u \\ v \end{pmatrix} (t)^{\top} J \Psi_J \begin{pmatrix} u \\ v \end{pmatrix} (t) dt \leq -\varepsilon \|v\|_{2,T}^2, \quad (\text{B.77})$$

for every  $T \geq 0$  and every  $v \in \mathcal{L}_{2e}^{n_p}(\mathbb{R}_+)$ , with  $u = G(v)$ . Using (B.76) and the fact that  $J = \text{diag}(I_{n_q}, -I_{n_p})$ , the above inequality can be rewritten as

$$\|\phi_{11}u + \phi_{12}v\|_{2,T}^2 - \|\phi_{21}u + \phi_{22}v\|_{2,T}^2 \leq -\varepsilon \|v\|_{2,T}^2. \quad (\text{B.78})$$

We know that  $q = q_{\text{in}} + G(p)$ . Then, in the above inequality, we have  $u = q - q_{\text{in}} = G(p)$  and  $v = p$ . Let us define  $\theta_1(p) := \phi_{11}G(p) + \phi_{12}p$  and  $\theta_2(p) := \phi_{21}G(p) + \phi_{22}p$ . Then, we have that

$$\begin{aligned} \|\theta_i(p)\|_{2,T} &= \|\phi_{i1}G(p) + \phi_{i2}p\|_{2,T} \\ &\leq (\|\phi_{i1}\|_2 \|G\|_2 + \|\phi_{i2}\|_2) \|p\|_{2,T} \\ &=: \gamma_i \|p\|_{2,T} \end{aligned} \quad (\text{B.79})$$

for  $i = \{1, 2\}$ . From this, we see that all of the conditions in Lemma B.1 are satisfied, and then there exists  $\tilde{\varepsilon} > 0$  such that

$$\|\phi_{11}(q - q_{\text{in}}) + \phi_{12}p\|_{2,T} - \|\phi_{21}(q - q_{\text{in}}) + \phi_{22}p\|_{2,T} \leq -\tilde{\varepsilon} \|p\|_{2,T}. \quad (\text{B.80})$$

Using the reverse triangle inequality, we have that

$$\|\phi_{11}(q - q_{\text{in}}) + \phi_{12}p\|_{2,T} \geq \|\phi_{11}q + \phi_{12}p\|_{2,T} - \|\phi_{11}q_{\text{in}}\|_{2,T}. \quad (\text{B.81})$$

In the same way, the triangle inequality ensures that

$$\|\phi_{21}(q - q_{\text{in}}) + \phi_{22}p\|_{2,T} \leq \|\phi_{21}q + \phi_{22}p\|_{2,T} + \|\phi_{21}q_{\text{in}}\|_{2,T}, \quad (\text{B.82})$$

which yields

$$-\|\phi_{21}(q - q_{\text{in}}) + \phi_{22}p\|_{2,T} \geq -\|\phi_{21}q + \phi_{22}p\|_{2,T} - \|\phi_{21}q_{\text{in}}\|_{2,T}. \quad (\text{B.83})$$

We then obtain that

$$\|\phi_{11}q + \phi_{12}p\|_{2,T} - \|\phi_{21}q + \phi_{22}p\|_{2,T} - \|\phi_{11}q_{\text{in}}\|_{2,T} - \|\phi_{21}q_{\text{in}}\|_{2,T} \leq -\tilde{\varepsilon}\|p\|_{2,T}. \quad (\text{B.84})$$

Let us note that, using the  $\mathcal{L}_2$ -gain stability of  $G$  and the reverse triangle inequality, we have

$$\|q\|_{2,T} - \|q_{\text{in}}\|_{2,T} \leq \|q - q_{\text{in}}\|_{2,T} \leq \|G\|_2 \|p\|_{2,T}, \quad (\text{B.85})$$

and then

$$\|q\|_{2,T} \leq \|G\|_2 \|p\|_{2,T} + \|q_{\text{in}}\|_{2,T}. \quad (\text{B.86})$$

Using the above inequality and the fact that, for  $a, b \geq 0$ ,  $\sqrt{a+b} \leq \sqrt{a} + \sqrt{b}$ , we may write

$$\begin{aligned} \|(p, q)\|_{2,T} &= \left(\|p\|_{2,T}^2 + \|q\|_{2,T}^2\right)^{\frac{1}{2}} \leq \|p\|_{2,T} + \|q\|_{2,T} \\ &\leq (1 + \|G\|_2) \|p\|_{2,T} + \|q_{\text{in}}\|_{2,T}, \end{aligned} \quad (\text{B.87})$$

which yields

$$\|p\|_{2,T} \geq \frac{1}{(1 + \|G\|_2)} \left(\|(p, q)\|_{2,T} - \|q_{\text{in}}\|_{2,T}\right). \quad (\text{B.88})$$

Then, we have

$$-\tilde{\varepsilon}\|p\|_{2,T} \leq -\bar{\varepsilon}_1 \left(\|(p, q)\|_{2,T} - \|q_{\text{in}}\|_{2,T}\right), \quad (\text{B.89})$$

where

$$\bar{\varepsilon}_1 := \frac{\tilde{\varepsilon}}{(1 + \|G\|_2)} \quad (\text{B.90})$$

is a positive scalar. Replacing (B.89) back into (B.84), and using the fact that  $\phi_{11}, \phi_{21} \in \mathcal{RH}_\infty$  yields

$$-\|\phi_{11}q + \phi_{12}p\|_{2,T} + \|\phi_{21}q + \phi_{22}p\|_{2,T} \geq \bar{\varepsilon}_1 \|(p, q)\|_{2,T} - \bar{\varepsilon}_2 \|q_{\text{in}}\|_{2,T}, \quad (\text{B.91})$$

where  $\bar{\varepsilon}_2 := \bar{\varepsilon}_1 + \|\phi_{11}\|_2 + \|\phi_{21}\|_2 > 0$ .

We shall now look at the graph of  $\Delta$ . We proceed in a similar manner as before with respect to inequality (4.26). As we did before, we rewrite it as

$$\|\phi_{11}u + \phi_{12}v\|_{2,T}^2 - \|\phi_{21}u + \phi_{22}v\|_{2,T}^2 \geq 0. \quad (\text{B.92})$$

We know that  $p = p_{\text{in}} + \Delta(q)$ . We may then replace  $u = q$  and  $v = p - p_{\text{in}}$  in the above inequality and take the square root to obtain

$$\|\phi_{11}q + \phi_{12}(p - p_{\text{in}})\|_{2,T} - \|\phi_{21}q + \phi_{22}(p - p_{\text{in}})\|_{2,T} \geq 0. \quad (\text{B.93})$$

Using the triangle inequality, we have that

$$\|\phi_{11}q + \phi_{12}(p - p_{\text{in}})\|_{2,T} \leq \|\phi_{11}q + \phi_{12}p\|_{2,T} + \|\phi_{12}p_{\text{in}}\|_{2,T}. \quad (\text{B.94})$$

Now, using the reverse triangle inequality, we may write

$$\|\phi_{21}q + \phi_{22}(p - p_{\text{in}})\|_{2,T} \geq \|\phi_{21}q + \phi_{22}p\|_{2,T} - \|\phi_{22}p_{\text{in}}\|_{2,T}, \quad (\text{B.95})$$

and then

$$-\|\phi_{21}q + \phi_{22}(p - p_{\text{in}})\|_{2,T} \leq -\|\phi_{21}q + \phi_{22}p\|_{2,T} + \|\phi_{22}p_{\text{in}}\|_{2,T}. \quad (\text{B.96})$$

We then obtain that

$$\|\phi_{11}q + \phi_{12}p\|_{2,T} - \|\phi_{21}q + \phi_{22}p\|_{2,T} + \|\phi_{12}p_{\text{in}}\|_{2,T} + \|\phi_{22}p_{\text{in}}\|_{2,T} \geq 0, \quad (\text{B.97})$$

which, using the fact that  $\phi_{12}, \phi_{22} \in \mathcal{RH}_\infty$ , can be rewritten as

$$\begin{aligned} -\|\phi_{11}q + \phi_{12}p\|_{2,T} + \|\phi_{21}q + \phi_{22}p\|_{2,T} &\leq \|\phi_{12}p_{\text{in}}\|_{2,T} + \|\phi_{22}p_{\text{in}}\|_{2,T} \\ &\leq \bar{\varepsilon}_3 \|p_{\text{in}}\|_{2,T}, \end{aligned} \quad (\text{B.98})$$

with  $\bar{\varepsilon}_3 := \|\phi_{12}\|_2 + \|\phi_{22}\|_2 > 0$ . Let us define the functions

$$d_T(p, q) := -\|\phi_{11}q + \phi_{12}p\|_{2,T} + \|\phi_{21}q + \phi_{22}p\|_{2,T}, \quad (\text{B.99})$$

$\phi_1(r) := \bar{\varepsilon}_1 r$ ,  $\phi_2(r) := \bar{\varepsilon}_2 r$  and  $\phi_3(r) := \bar{\varepsilon}_3 r$ . Then, the conditions in Theorem 4.12 are satisfied with linear functions  $\phi_i$ , for  $i = \{1, 2, 3\}$ . Together with the well-posedness assumption, this ensures that the closed-loop system is stable for every  $\Delta \in \mathbf{\Delta}$ , and hence robustly stable with respect to  $\mathbf{\Delta}$ .  $\blacksquare$

### PROOF OF THEOREM 4.15

We shall prove this theorem in two steps. We begin by showing that inequalities (4.33) and (4.34) ensure a topological separation between the inverse graph of  $G_{\text{perf}}$  and the graph of  $\Delta$ , so that robust stability can be concluded on the grounds of Theorem 4.12. Then, we show that stability of the closed loop together with (4.34) ensures  $\mathcal{L}_2$ -gain stability of the closed-loop system, with an upper bound on the  $\mathcal{L}_2$ -gain given by  $\gamma$ .

Robust stability:

Using the same arguments as in the proof of Theorem 4.14, we have that (4.33) can be rewritten as

$$\int_0^T y_\Delta(t)^\top J y_\Delta(t) dt \geq 0, \quad \forall T \geq 0, \forall \Delta \in \mathbf{\Delta}, \forall q \in \mathcal{L}_{2e}^{n_q}(\mathbb{R}_+), \quad (\text{B.100})$$

where  $y_\Delta = \Psi_J \begin{bmatrix} \mathbb{I} \\ \Delta \end{bmatrix} (q)$ ,  $J = \text{diag}(I_{n_q}, -I_{n_p})$ , and  $\Pi(j\omega) = \Psi_J(j\omega)^* J \Psi_J(j\omega)$ . The same reasoning can be applied to (4.34).

Let us recall that the feedback loop is described by the equations

$$\begin{cases} q = q_{\text{in}} + G_{\text{perf},q}(p, w) \\ p = p_{\text{in}} + \Delta(q) \\ z = G_{\text{perf},z}(p, w). \end{cases} \quad (\text{B.101})$$

We begin by considering the inverse graph of  $G_{\text{perf}}$  through (4.34). Let us define

$$\Psi_J = \begin{bmatrix} \phi_{11} & \phi_{12} \\ \phi_{21} & \phi_{22} \end{bmatrix}, \quad (\text{B.102})$$

and then note that (4.34) can be rewritten as

$$\int_0^T \Psi_J \begin{pmatrix} u \\ v \end{pmatrix} (t)^\top J \Psi_J \begin{pmatrix} u \\ v \end{pmatrix} (t) dt + \|z\|_{2,T}^2 - \gamma^2 \|w\|_{2,T}^2 \leq -\varepsilon \|(v, w)\|_{2,T}^2, \quad (\text{B.103})$$

for every  $T \geq 0$ , every  $v \in \mathcal{L}_{2e}^{n_p}(\mathbb{R}_+)$ , every  $w \in \mathcal{L}_{2e}^{n_w}(\mathbb{R}_+)$ , with  $u = G_{\text{perf},q}(v, w)$  and  $z = G_{\text{perf},z}(v, w)$ . Using (B.102) and the facts that  $J = \text{diag}(I_{n_q}, -I_{n_p})$  and  $\|z\|_{2,T}^2 \geq 0$ , the above inequality can be rewritten as

$$\|\phi_{11}u + \phi_{12}v\|_{2,T}^2 - \|\phi_{21}u + \phi_{22}v\|_{2,T}^2 - \gamma^2 \|w\|_{2,T}^2 \leq -\varepsilon \|(v, w)\|_{2,T}^2, \quad (\text{B.104})$$

which can in turn be put into the following form

$$\|\phi_{11}u + \phi_{12}v\|_{2,T}^2 - \|(\phi_{21}u + \phi_{22}v, \gamma w)\|_{2,T}^2 \leq -\varepsilon \|(v, w)\|_{2,T}^2. \quad (\text{B.105})$$

We know that  $q = q_{\text{in}} + G_{\text{perf},q}(p, w)$ . Then, in the above inequality, we have  $u = q - q_{\text{in}} = G_{\text{perf},q}(p, w)$  and  $v = p$ . Let us define  $\theta_1(p, w) := \phi_{11}G_{\text{perf},q}(p, w) + \phi_{12}p$  and  $\theta_2(p, w) := \text{col}(\phi_{21}G_{\text{perf},q}(p, w) + \phi_{22}p, \gamma w)$ . Then, we have that

$$\begin{aligned} \|\theta_1(p, w)\|_{2,T} &= \|\phi_{11}G_{\text{perf},q}(p, w) + \phi_{12}p\|_{2,T} \\ &\leq \|\phi_{11}G_{\text{perf},q}\|_2 \|(p, w)\|_{2,T} + \|\phi_{12}\|_2 \|p\|_{2,T} \\ &\leq (\|\phi_{11}\|_2 \|G_{\text{perf},q}\|_2 + \|\phi_{12}\|_2) \|(p, w)\|_{2,T} \\ &=: \gamma_1 \|(p, w)\|_{2,T} \end{aligned} \quad (\text{B.106})$$

and

$$\begin{aligned} \|\theta_2(p, w)\|_{2,T} &= \|(\phi_{11}G_{\text{perf},q}(p, w) + \phi_{12}p, \gamma w)\|_{2,T} \\ &= \left( \|\phi_{11}G_{\text{perf},q}(p, w) + \phi_{12}p\|_{2,T}^2 + \|\gamma w\|_{2,T}^2 \right)^{\frac{1}{2}} \\ &\leq \|\phi_{11}G_{\text{perf},q}(p, w) + \phi_{12}p\|_{2,T} + \|\gamma w\|_{2,T} \\ &\leq \|\phi_{11}G_{\text{perf},q}\|_2 \|(p, w)\|_{2,T} + \|\phi_{12}\|_2 \|p\|_{2,T} + \gamma \|w\|_{2,T} \\ &\leq (\|\phi_{11}\|_2 \|G_{\text{perf},q}\|_2 + \|\phi_{12}\|_2 + \gamma) \|(p, w)\|_{2,T} \\ &=: \gamma_2 \|(p, w)\|_{2,T}. \end{aligned} \quad (\text{B.107})$$

From this, we see that all of the conditions in Lemma B.1 are satisfied, and then there exists  $\tilde{\varepsilon} > 0$  such that

$$\|\phi_{11}(q - q_{\text{in}}) + \phi_{12}p\|_{2,T} - \|(\phi_{21}(q - q_{\text{in}}) + \phi_{22}p, \gamma w)\|_{2,T} \leq -\tilde{\varepsilon} \|(p, w)\|_{2,T}, \quad (\text{B.108})$$

which, using the fact that for  $a, b \geq 0$ ,  $\sqrt{a+b} \leq \sqrt{a} + \sqrt{b}$ , is equivalent to

$$\|\phi_{11}(q - q_{\text{in}}) + \phi_{12}p\|_{2,T} - \|\phi_{21}(q - q_{\text{in}}) + \phi_{22}p\|_{2,T} \leq -\tilde{\varepsilon} \|(p, w)\|_{2,T} + \gamma \|w\|_{2,T}. \quad (\text{B.109})$$

Using the reverse triangle inequality, we have that

$$\|\phi_{11}(q - q_{\text{in}}) + \phi_{12}p\|_{2,T} \geq \|\phi_{11}q + \phi_{12}p\|_{2,T} - \|\phi_{11}q_{\text{in}}\|_{2,T}. \quad (\text{B.110})$$

In the same way, the triangle inequality ensures that

$$\|\phi_{21}(q - q_{\text{in}}) + \phi_{22}p\|_{2,T} \leq \|\phi_{21}q + \phi_{22}p\|_{2,T} + \|\phi_{21}q_{\text{in}}\|_{2,T}, \quad (\text{B.111})$$

which yields

$$-\|\phi_{21}(q - q_{\text{in}}) + \phi_{22}p\|_{2,T} \geq -\|\phi_{21}q + \phi_{22}p\|_{2,T} - \|\phi_{21}q_{\text{in}}\|_{2,T}. \quad (\text{B.112})$$

We then obtain that

$$\|\phi_{11}q + \phi_{12}p\|_{2,T} - \|\phi_{21}q + \phi_{22}p\|_{2,T} - \|\phi_{11}q_{\text{in}}\|_{2,T} - \|\phi_{21}q_{\text{in}}\|_{2,T} \leq -\tilde{\varepsilon} \|(p, w)\|_{2,T} + \gamma \|w\|_{2,T}. \quad (\text{B.113})$$

Let us note that, using the  $\mathcal{L}_2$ -gain stability of  $G_{\text{perf}}$  and the reverse triangle inequality, we have

$$\begin{aligned} \|q\|_{2,T} - \|q_{\text{in}}\|_{2,T} &\leq \|q - q_{\text{in}}\|_{2,T} \leq \|G_{\text{perf},q}\|_2 \|(p, w)\|_{2,T} \\ &\leq \|G_{\text{perf},q}\|_2 (\|p\|_{2,T} + \|w\|_{2,T}) \end{aligned} \quad (\text{B.114})$$

and then

$$\|q\|_{2,T} \leq \|G_{\text{perf},q}\|_2 (\|p\|_{2,T} + \|w\|_{2,T}) + \|q_{\text{in}}\|_{2,T}. \quad (\text{B.115})$$

Using the above inequality, we may write

$$\begin{aligned} \|(p, q)\|_{2,T} &= \left( \|p\|_{2,T}^2 + \|q\|_{2,T}^2 \right)^{\frac{1}{2}} \leq \|p\|_{2,T} + \|q\|_{2,T} \\ &\leq (1 + \|G_{\text{perf},q}\|_2) \|p\|_{2,T} + \|G_{\text{perf},q}\|_2 \|w\|_{2,T} + \|q_{\text{in}}\|_{2,T}, \end{aligned} \quad (\text{B.116})$$

which yields

$$\|p\|_{2,T} \geq \frac{1}{(1 + \|G_{\text{perf},q}\|_2)} \left( \|(p, q)\|_{2,T} - \|G_{\text{perf},q}\|_2 \|w\|_{2,T} - \|q_{\text{in}}\|_{2,T} \right). \quad (\text{B.117})$$

Then, we have

$$\begin{aligned} -\tilde{\varepsilon} \|(p, w)\|_{2,T} &= -\tilde{\varepsilon} \left( \|p\|_{2,T}^2 + \|w\|_{2,T}^2 \right)^{\frac{1}{2}} \leq -\tilde{\varepsilon} (\|p\|_{2,T} + \|w\|_{2,T}) \\ &\leq -\bar{\varepsilon}_1 \left( \|(p, q)\|_{2,T} + \|w\|_{2,T} - \|q_{\text{in}}\|_{2,T} \right), \end{aligned} \quad (\text{B.118})$$

where

$$\bar{\varepsilon}_1 := \frac{\tilde{\varepsilon}}{(1 + \|G_{\text{perf},q}\|_2)} \quad (\text{B.119})$$

is a positive scalar. Replacing (B.118) back into (B.113), and using the fact that  $\phi_{11}, \phi_{21} \in \mathcal{RH}_\infty$  yields

$$\|\phi_{11}q + \phi_{12}p\|_{2,T} - \|\phi_{21}q + \phi_{22}p\|_{2,T} \leq -\bar{\varepsilon}_1 \|(p, q)\|_{2,T} + \bar{\varepsilon}_2 \|w\|_{2,T} + \bar{\varepsilon}_3 \|q_{\text{in}}\|_{2,T}, \quad (\text{B.120})$$

where

$$\begin{aligned} \bar{\varepsilon}_2 &:= \gamma - \bar{\varepsilon}_1 \\ \bar{\varepsilon}_3 &:= \bar{\varepsilon}_1 + \|\phi_{11}\|_2 + \|\phi_{21}\|_2 \end{aligned} \quad (\text{B.121})$$

are positive scalars ( $\bar{\varepsilon}_1$  can be made as small as needed by taking  $\tilde{\varepsilon}$  small enough). We then have that

$$\begin{aligned} -\|\phi_{11}q + \phi_{12}p\|_{2,T} + \|\phi_{21}q + \phi_{22}p\|_{2,T} &\geq \bar{\varepsilon}_1 \|(p, q)\|_{2,T} - \bar{\varepsilon}_2 \|w\|_{2,T} - \bar{\varepsilon}_3 \|q_{\text{in}}\|_{2,T} \\ &\geq \bar{\varepsilon}_1 \|(p, q)\|_{2,T} - \bar{\varepsilon}_4 \|(q_{\text{in}}, w)\|_{2,T}, \end{aligned} \quad (\text{B.122})$$

with  $\bar{\varepsilon}_4 := \bar{\varepsilon}_2 + \bar{\varepsilon}_3 > 0$ .

Let us now consider the graph of  $\Delta$ . Following the same steps as in the proof of Theorem 4.14, we obtain

$$-\|\phi_{11}q + \phi_{12}p\|_{2,T} + \|\phi_{21}q + \phi_{22}p\|_{2,T} \leq \bar{\varepsilon}_5 \|p_{\text{in}}\|_{2,T} \quad (\text{B.123})$$

with  $\bar{\varepsilon}_5 := \|\phi_{12}\|_2 + \|\phi_{22}\|_2 > 0$ . Let us define the functions

$$d_T(p, q) := -\|\phi_{11}q + \phi_{12}p\|_{2,T} + \|\phi_{21}q + \phi_{22}p\|_{2,T}, \quad (\text{B.124})$$

$\phi_1(r) := \bar{\varepsilon}_1 r$ ,  $\phi_2(r) := \bar{\varepsilon}_4 r$  and  $\phi_3(r) := \bar{\varepsilon}_5 r$ . Then, the conditions in Theorem 4.12 are satisfied with linear functions  $\phi_i$ , for  $i = \{1, 2, 3\}$ . Together with the well-posedness assumption, this ensures that the closed-loop system is stable for every  $\Delta \in \mathbf{\Delta}$ , and hence robustly stable with respect to  $\mathbf{\Delta}$ .

Robust performance:

For performance analysis, we consider the case of zero inputs  $q_{\text{in}}$  and  $p_{\text{in}}$ . Then, (4.34) can be rewritten as

$$\int_0^T y(t)^\top M y(t) dt + \|z\|_{2,T}^2 - \gamma^2 \|w\|_{2,T}^2 \leq -\varepsilon \|(p, w)\|_{2,T}^2, \quad (\text{B.125})$$

where  $y = \Psi \begin{bmatrix} G_{\text{perf},q} \\ \mathbb{I} & 0 \end{bmatrix} (p, w) = \Psi \begin{bmatrix} q \\ p \end{bmatrix} = y_\Delta$ . Then, using (4.33), we have that

$$\|z\|_{2,T}^2 \leq \gamma^2 \|w\|_{2,T}^2 \quad (\text{B.126})$$

so that the uncertain system is  $\mathcal{L}_2$ -gain stable for every  $\Delta \in \mathbf{\Delta}$ . It is then robustly  $\mathcal{L}_2$ -gain stable with respect to  $\mathbf{\Delta}$ , and has an  $\mathcal{L}_2$ -gain less than or equal to  $\gamma$ .  $\blacksquare$

### PROOF OF THEOREM 4.30

We prove this theorem by showing that inequalities (4.117) and (4.118) ensure the incremental topological separation between the inverse graph of  $G$  and the graph of  $\Delta$  along with well-posedness of the feedback interconnection, so that incremental stability can be concluded on the grounds of Theorem 4.13.

We begin by proving the incremental separation of the graphs of  $G$  and  $\Delta \in \overline{\mathbf{\Delta}}$ . Using the same arguments as in the proof of Theorem 4.14, we have that (4.117) can be rewritten as

$$\int_0^T \bar{y}_\Delta(t)^\top J \bar{y}_\Delta(t) dt \geq 0, \quad \forall T \geq 0, \forall \Delta \in \overline{\mathbf{\Delta}}, \forall q, \tilde{q} \in \mathcal{L}_{2e}^{n_q}(\mathbb{R}_+), \quad (\text{B.127})$$

where  $\bar{y}_\Delta = \Psi_J \begin{bmatrix} \mathbb{I} & -\mathbb{I} \\ \Delta & -\Delta \end{bmatrix} (q, \tilde{q})$ ,  $J = \text{diag}(I_{n_q}, -I_{n_p})$ , and  $\Pi(j\omega) = \Psi_J(j\omega)^* J \Psi_J(j\omega)$ . Once again, the same reasoning can be applied to (4.118).

Let us recall that the feedback system is described by

$$\begin{cases} q = q_{\text{in}} + G(p) \\ p = p_{\text{in}} + \Delta(q). \end{cases} \quad (\text{B.128})$$

We begin by considering the incremental graph of  $G$  through (4.118). Let us define

$$\Psi_J = \begin{bmatrix} \phi_{11} & \phi_{12} \\ \phi_{21} & \phi_{22} \end{bmatrix}, \quad (\text{B.129})$$

and then note that (4.118) can be rewritten as

$$\int_0^T \Psi_J \begin{pmatrix} u - \tilde{u} \\ v - \tilde{v} \end{pmatrix} (t)^\top J \Psi_J \begin{pmatrix} u - \tilde{u} \\ v - \tilde{v} \end{pmatrix} (t) dt \leq -\varepsilon \|v - \tilde{v}\|_{2,T}^2, \quad (\text{B.130})$$

for every  $T \geq 0$  and every  $v, \tilde{v} \in \mathcal{L}_{2e}^{n_p}(\mathbb{R}_+)$ , with  $u = G(v)$  and  $\tilde{u} = G(\tilde{v})$ . Using (B.129) and the fact that  $J = \text{diag}(I_{n_q}, -I_{n_p})$ , the above inequality can be rewritten as

$$\|\phi_{11}(u - \tilde{u}) + \phi_{12}(v - \tilde{v})\|_{2,T}^2 - \|\phi_{21}(u - \tilde{u}) + \phi_{22}(v - \tilde{v})\|_{2,T}^2 \leq -\varepsilon \|v - \tilde{v}\|_{2,T}^2. \quad (\text{B.131})$$

We know that  $q = q_{\text{in}} + G(p)$  and  $\tilde{q} = \tilde{q}_{\text{in}} + G(\tilde{p})$ . Then, in the above inequality, we have  $u = q - q_{\text{in}} = G(p)$ ,  $\tilde{u} = \tilde{q} - \tilde{q}_{\text{in}} = G(\tilde{p})$ ,  $v = p$  and  $\tilde{v} = \tilde{p}$ . For the sake of compactness of notation, let us introduce  $\delta_p := p - \tilde{p}$ ,  $\delta_q := q - \tilde{q}$ , and so forth. Let us define  $\theta_1(p, \tilde{p}) := \phi_{11}(G(p) - G(\tilde{p})) + \phi_{12}\delta_p$  and  $\theta_2(p, \tilde{p}) := \phi_{21}(G(p) - G(\tilde{p})) + \phi_{22}\delta_p$ . Then, we have that

$$\begin{aligned} \|\theta_i(p, \tilde{p})\|_{2,T} &= \|\phi_{i1}(G(p) - G(\tilde{p})) + \phi_{i2}\delta_p\|_{2,T} \\ &\leq (\|\phi_{i1}\|_2 \|G\|_{\Delta 2} + \|\phi_{i2}\|_2) \|\delta_p\|_{2,T} \\ &=: \gamma_i \|\delta_p\|_{2,T} \end{aligned} \quad (\text{B.132})$$

for  $i = \{1, 2\}$ . From this, we see that all of the conditions in Lemma B.1 are satisfied, and then there exists  $\tilde{\varepsilon} > 0$  such that

$$\|\phi_{11}(\delta_q - \delta_{q_{\text{in}}}) + \phi_{12}\delta_p\|_{2,T} - \|\phi_{21}(\delta_q - \delta_{q_{\text{in}}}) + \phi_{22}\delta_p\|_{2,T} \leq -\tilde{\varepsilon} \|\delta_p\|_{2,T}. \quad (\text{B.133})$$

Following the same steps as in the proof of Theorem 4.14, we obtain that

$$-\|\phi_{11}\delta_q + \phi_{12}\delta_p\|_{2,T} + \|\phi_{21}\delta_q + \phi_{22}\delta_p\|_{2,T} \geq \bar{\varepsilon}_1 \|(\delta_p, \delta_q)\|_{2,T} - \bar{\varepsilon}_2 \|\delta_{q_{\text{in}}}\|_{2,T}, \quad (\text{B.134})$$

where

$$\bar{\varepsilon}_1 = \frac{\tilde{\varepsilon}}{(1 + \|G\|_{\Delta 2})} \quad \bar{\varepsilon}_2 := \bar{\varepsilon}_1 + \|\phi_{11}\|_2 + \|\phi_{21}\|_2 \quad (\text{B.135})$$

are positive scalars.

We shall now look at the incremental graph of  $\Delta$ . Using again the same arguments as in the proof of Theorem 4.14, we obtain

$$-\|\phi_{11}\delta_q + \phi_{12}\delta_p\|_{2,T} + \|\phi_{21}\delta_q + \phi_{22}\delta_p\|_{2,T} \leq \bar{\varepsilon}_3 \|\delta_{p_{\text{in}}}\|_{2,T}, \quad (\text{B.136})$$



with  $\bar{\varepsilon}_3 := (\|\phi_{12}\|_2 + \|\phi_{22}\|_2) > 0$ . Let us define the functions

$$d_T(\delta_p, \delta_q) := -\|\phi_{11}\delta_q + \phi_{12}\delta_p\|_{2,T} + \|\phi_{21}\delta_q + \phi_{22}\delta_p\|_{2,T}, \quad (\text{B.137})$$

$\phi_1(r) := \bar{\varepsilon}_1 r$ ,  $\phi_2(r) := \bar{\varepsilon}_2 r$  and  $\phi_3(r) := \bar{\varepsilon}_3 r$ . Then, the conditions in Theorem 4.13 are satisfied with linear functions  $\phi_i$ , for  $i = \{1, 2, 3\}$ . This means that there exists  $c > 0$  such that, whenever the signals  $p, \tilde{p}, q, \tilde{q}$  exist and are uniquely defined, we have

$$\|(q, p) - (\tilde{q}, \tilde{p})\|_2^2 \leq c^2 \|(q_{\text{in}}, p_{\text{in}}) - (\tilde{q}_{\text{in}}, \tilde{p}_{\text{in}})\|_2^2. \quad (\text{B.138})$$

We now have to show that the feedback interconnection  $(G, \Delta)$  is well-posed for every  $\Delta \in \bar{\mathbf{\Delta}}$ , i.e. that the operator  $\ell_G[\Delta]^{-1}$  is well-defined for every  $\Delta \in \bar{\mathbf{\Delta}}$ . Let us first note that the definition of  $\bar{\mathbf{\Delta}}$  (Definition 4.2, page 67) implies that if  $\Delta \in \bar{\mathbf{\Delta}}$ , then  $\tau\Delta \in \bar{\mathbf{\Delta}}$ , for every  $\tau \in [0, 1]$ . We shall prove that if  $\ell_G[\tau_0\Delta]^{-1}$  is well-defined for some  $\tau_0$ , then that is also the case for every  $\tau \in [\tau_0, \tau_0 + \bar{\delta}]$ , for  $\bar{\delta} < 1/(c\|\Delta\|_{\Delta_2})$ . In order to show that  $\ell_G[\tau\Delta]^{-1}$  is well-defined, we need to show that to each  $(q_{\text{in}}, p_{\text{in}}) \in \mathcal{L}_2^{(n_q+n_p)}(\mathbb{R}_+)$  corresponds a unique  $(q, p)$  such that  $\ell_G[\tau\Delta](q, p) = (q_{\text{in}}, p_{\text{in}})$ . This equality may be rewritten as  $\ell_G[\tau\Delta](q, p) + \ell_G[\tau_0\Delta](q, p) - \ell_G[\tau_0\Delta](q, p) = (q_{\text{in}}, p_{\text{in}})$ , which implies, since  $\ell_G[\tau_0\Delta]^{-1}$  is supposed well-defined, that

$$\begin{aligned} \begin{bmatrix} q \\ p \end{bmatrix} &= \ell_G[\tau_0\Delta]^{-1} \left( \begin{bmatrix} q_{\text{in}} \\ p_{\text{in}} \end{bmatrix} - \ell_G[\tau\Delta] \left( \begin{bmatrix} q \\ p \end{bmatrix} \right) + \ell_G[\tau_0\Delta] \left( \begin{bmatrix} q \\ p \end{bmatrix} \right) \right) \\ &= \ell_G[\tau_0\Delta]^{-1} \left( \begin{bmatrix} q_{\text{in}} \\ p_{\text{in}} \end{bmatrix} - \begin{bmatrix} q - G(p) \\ p - \tau\Delta(q) \end{bmatrix} + \begin{bmatrix} q - G(p) \\ p - \tau_0\Delta(q) \end{bmatrix} \right) \\ &= \ell_G[\tau_0\Delta]^{-1} \left( \begin{bmatrix} q_{\text{in}} \\ p_{\text{in}} \end{bmatrix} + \begin{bmatrix} 0 \\ (\tau - \tau_0)\Delta(q) \end{bmatrix} \right) \\ &=: T_{(q_{\text{in}}, p_{\text{in}})} \left( \begin{bmatrix} q \\ p \end{bmatrix} \right) \end{aligned} \quad (\text{B.139})$$

Since  $\Delta$  is incrementally bounded and such that  $\Delta(0) = 0$ , it is also bounded. This also implies that  $\ell_G[\tau_0\Delta](0) = 0$ , which in turn means that  $\ell_G[\tau_0\Delta]^{-1}(0) = 0$ . Then, (B.138) with  $(\tilde{q}_{\text{in}}, \tilde{p}_{\text{in}}) = 0$  implies that  $\|\ell_G[\tau_0\Delta]^{-1}\|_2 \leq c$ . This shows that  $T$  maps  $\mathcal{L}_2^{(n_q+n_p)}(\mathbb{R}_+)$  into itself, and we recall that  $\mathcal{L}_2^{(n_q+n_p)}(\mathbb{R}_+)$  is a Banach space. We may then use Banach's fixed point theorem [91, Theorem B.1] to conclude that if  $T_{(q_{\text{in}}, p_{\text{in}})}$  is a contraction, i.e. if  $\|T_{(q_{\text{in}}, p_{\text{in}})}(q, p) - T_{(q_{\text{in}}, p_{\text{in}})}(\tilde{q}, \tilde{p})\|_2 \leq \rho \|(q, p) - (\tilde{q}, \tilde{p})\|_2$  for every  $(q, p), (\tilde{q}, \tilde{p}) \in \mathcal{L}_2^{(n_q+n_p)}(\mathbb{R}_+)$  and  $0 \leq \rho < 1$ , then there exists a unique  $(q, p)$  such that  $T(q, p) = (q, p)$ . Let us see that

$$\begin{aligned} \left\| T_{(q_{\text{in}}, p_{\text{in}})} \left( \begin{bmatrix} q \\ p \end{bmatrix} \right) - T_{(q_{\text{in}}, p_{\text{in}})} \left( \begin{bmatrix} \tilde{q} \\ \tilde{p} \end{bmatrix} \right) \right\|_2 &= \left\| \ell_G[\tau_0\Delta]^{-1} \left( \begin{bmatrix} q_{\text{in}} \\ p_{\text{in}} \end{bmatrix} + \begin{bmatrix} 0 \\ (\tau - \tau_0)\Delta(q) \end{bmatrix} \right) \right. \\ &\quad \left. - \ell_G[\tau_0\Delta]^{-1} \left( \begin{bmatrix} q_{\text{in}} \\ p_{\text{in}} \end{bmatrix} + \begin{bmatrix} 0 \\ (\tau - \tau_0)\Delta(\tilde{q}) \end{bmatrix} \right) \right\|_2 \\ &\leq c \left\| \begin{bmatrix} q_{\text{in}} \\ p_{\text{in}} \end{bmatrix} + \begin{bmatrix} 0 \\ (\tau - \tau_0)\Delta(q) \end{bmatrix} - \begin{bmatrix} q_{\text{in}} \\ p_{\text{in}} \end{bmatrix} - \begin{bmatrix} 0 \\ (\tau - \tau_0)\Delta(\tilde{q}) \end{bmatrix} \right\|_2 \\ &= c \|(\tau - \tau_0)(\Delta(q) - \Delta(\tilde{q}))\|_2 \\ &\leq c |\tau - \tau_0| \|\Delta\|_{\Delta_2} \|q - \tilde{q}\|_2 \\ &\leq c |\tau - \tau_0| \|\Delta\|_{\Delta_2} \|(q, p) - (\tilde{q}, \tilde{p})\|_2 \end{aligned} \quad (\text{B.140})$$

From (B.140) we see that, for all  $\tau > \tau_0$  such that  $c|\tau - \tau_0| \|\Delta\|_{\Delta_2} < 1$ ,  $T$  has a unique fixed point such that  $T(q, p) = (q, p)$ , which means that  $\ell_G[\tau\Delta]^{-1}$  is well-defined for every  $\tau \in [0, 1] \cap [\tau_0, \tau_0 + \bar{\delta}]$ , with  $\bar{\delta} < 1/(c\|\Delta\|_2)$ . Then, if  $\ell_G[\tau_0\Delta]^{-1}$  is well-defined for some  $\tau_0 \in [0, 1]$ , it is also for every  $\tau \in [0, 1] \cap [\tau_0, \tau_0 + \bar{\delta}]$ .

Now, suppose that  $\ell_G[\tau_0\Delta]^{-1}$  is causal. Let us note that, using the causality of  $\Delta$ , we may write

$$\begin{aligned} P_T \left( \begin{bmatrix} q_{\text{in}} \\ p_{\text{in}} \end{bmatrix} + \begin{bmatrix} 0 \\ (\tau - \tau_0)\Delta(q) \end{bmatrix} \right) &= P_T \left( \begin{bmatrix} P_T q_{\text{in}} \\ P_T p_{\text{in}} \end{bmatrix} + \begin{bmatrix} 0 \\ (\tau - \tau_0)\Delta(q) \end{bmatrix} \right) \\ &= P_T \left( \begin{bmatrix} P_T q_{\text{in}} \\ P_T p_{\text{in}} \end{bmatrix} + \begin{bmatrix} 0 \\ (\tau - \tau_0)\Delta(P_T q) \end{bmatrix} \right) \\ &= P_T \left( \begin{bmatrix} q_{\text{in}} \\ p_{\text{in}} \end{bmatrix} + \begin{bmatrix} 0 \\ (\tau - \tau_0)\Delta(P_T q) \end{bmatrix} \right). \end{aligned} \quad (\text{B.141})$$

Using this, we can show that the mapping  $T$  defined in (B.139) satisfies

$$P_T T_{(q_{\text{in}}, p_{\text{in}})}(q, p) = P_T T_{(P_T q_{\text{in}}, P_T p_{\text{in}})}(q, p) = P_T T_{(q_{\text{in}}, p_{\text{in}})}(P_T q, P_T p). \quad (\text{B.142})$$

Let  $(q_1, p_1) = \ell_G[\tau\Delta]^{-1}(P_T q_{\text{in}}, P_T p_{\text{in}})$ . Then, according to B.139, we have that  $(q_1, p_1)$  satisfies  $(q_1, p_1) = T_{(P_T q_{\text{in}}, P_T p_{\text{in}})}(q_1, p_1)$ . Using B.142, we may write

$$P_T(q_1, p_1) = P_T T_{(P_T q_{\text{in}}, P_T p_{\text{in}})}(q_1, p_1) = P_T T_{(q_{\text{in}}, p_{\text{in}})}(P_T q_1, P_T p_1). \quad (\text{B.143})$$

Now let  $(q_2, p_2) = \ell_G[\tau\Delta]^{-1}(q_{\text{in}}, p_{\text{in}})$ , which again means that  $(q_2, p_2) = T_{(q_{\text{in}}, p_{\text{in}})}(q_2, p_2)$ . Then,

$$P_T(q_2, p_2) = P_T T_{(q_{\text{in}}, p_{\text{in}})}(q_2, p_2) = P_T T_{(q_{\text{in}}, p_{\text{in}})}(P_T q_2, P_T p_2). \quad (\text{B.144})$$

It is not hard to show that  $\|P_T\|_{\Delta_2} \leq 1$ , which implies that if  $T_{(q_{\text{in}}, p_{\text{in}})}$  is a contraction, then so is  $P_T T_{(q_{\text{in}}, p_{\text{in}})}$ . We have shown above that  $T_{(q_{\text{in}}, p_{\text{in}})}$  is a contraction for every  $\tau > \tau_0$  such that  $c|\tau - \tau_0| \|\Delta\|_{\Delta_2} < 1$ . In this case, using again Banach's fixed point theorem, there exists a unique  $P_T(q, p)$  such that  $P_T(q, p) = P_T T_{(q_{\text{in}}, p_{\text{in}})}(P_T q, P_T p)$ . This in turn means that  $P_T(q_1, p_1) = P_T(q_2, p_2)$ , which implies that  $P_T \ell[\tau\Delta]^{-1}(P_T q_{\text{in}}, P_T p_{\text{in}}) = P_T \ell[\tau\Delta]^{-1}(q_{\text{in}}, p_{\text{in}})$ , and hence that  $\ell[\tau\Delta]^{-1}$  is causal for every  $\tau \in [0, 1] \cap [\tau_0, \tau_0 + \bar{\delta}]$ .

To conclude, we note that  $\ell_G[0]^{-1}$  is clearly well-posed, and is given by  $\ell_G[0]^{-1}(q_{\text{in}}, p_{\text{in}}) = (G(p_{\text{in}}) + q_{\text{in}}, p_{\text{in}})$ . Then, using the argument above for  $\tau_0 = 0, \delta, \dots, k\delta$ , for  $k$  sufficiently large, we conclude by induction that the feedback interconnection  $(G, \Delta)$  is well-posed for every  $\Delta \in \bar{\Delta}$ . Together with (B.138), this implies that  $(G, \Delta)$  is robustly incrementally stable with respect to  $\bar{\Delta}$ , which concludes the proof.  $\blacksquare$

### PROOF OF THEOREM 4.31

We shall prove this theorem in two steps. We begin by showing that inequalities (4.122) and (4.123) ensure an incremental topological separation between the inverse graph of  $G_{\text{perf}}$  and the graph of  $\Delta$ , as well as well-posedness of the feedback interconnection, so that robust incremental stability can be concluded on the grounds of Theorem 4.12. Then, we show that robust incremental stability of the closed loop together with (4.123) ensures incremental

$\mathcal{L}_2$ -gain stability of the closed-loop system, with an upper bound on the incremental  $\mathcal{L}_2$ -gain given by  $\eta$ .

Robust incremental stability:

We begin by proving the incremental separation of the graphs of  $G_{\text{perf}}$  and  $\Delta \in \overline{\Delta}$ . Using the same arguments as in the proof of Theorem 4.14, we have that (4.122) can be rewritten as

$$\int_0^T \bar{y}_\Delta(t)^\top J \bar{y}_\Delta(t) dt \geq 0, \quad \forall T \geq 0, \forall \Delta \in \overline{\Delta}, \forall q, \tilde{q} \in \mathcal{L}_{2e}^{n_q}(\mathbb{R}_+), \quad (\text{B.145})$$

where  $\bar{y}_\Delta = \Psi_J \begin{bmatrix} \mathbb{I} & -\mathbb{I} \\ \Delta & -\Delta \end{bmatrix} (q, \tilde{q})$ ,  $J = \text{diag}(I_{n_q}, -I_{n_p})$ , and  $\Pi(j\omega) = \Psi_J(j\omega)^* J \Psi_J(j\omega)$ . Once again, the same reasoning can be applied to (4.123).

Let us recall that the feedback loop is described by the equations

$$\begin{cases} q = q_{\text{in}} + G_{\text{perf},q}(p, w) \\ p = p_{\text{in}} + \Delta(q) \\ z = G_{\text{perf},z}(p, w). \end{cases} \quad (\text{B.146})$$

We begin by considering the graph of  $G_{\text{perf}}$  through (4.123). For the sake of notation, let us introduce  $\delta_p := p - \tilde{p}$ ,  $\delta_q := q - \tilde{q}$ , and so forth. Let us define

$$\Psi_J = \begin{bmatrix} \phi_{11} & \phi_{12} \\ \phi_{21} & \phi_{22} \end{bmatrix}, \quad (\text{B.147})$$

and then note that (4.123) can be rewritten as

$$\int_0^T \Psi_J \begin{pmatrix} \delta_u \\ \delta_v \end{pmatrix} (t)^\top J \Psi_J \begin{pmatrix} \delta_u \\ \delta_v \end{pmatrix} (t) dt + \|\delta_z\|_{2,T}^2 - \eta^2 \|\delta_w\|_{2,T}^2 \leq -\varepsilon \|(\delta_v, \delta_w)\|_{2,T}^2, \quad (\text{B.148})$$

for every  $T \geq 0$ , every  $v, \tilde{v} \in \mathcal{L}_{2e}^{n_p}(\mathbb{R}_+)$ , every  $w, \tilde{w} \in \mathcal{L}_{2e}^{n_w}(\mathbb{R}_+)$ , with  $u = G_{\text{perf},q}(v, w)$ ,  $\tilde{u} = G_{\text{perf},q}(\tilde{v}, \tilde{w})$ ,  $z = G_{\text{perf},z}(v, w)$  and  $\tilde{z} = G_{\text{perf},z}(\tilde{v}, \tilde{w})$ . Using (B.147) and the facts that  $J = \text{diag}(I_{n_q}, -I_{n_p})$  and  $\|\delta_z\|_{2,T}^2 \geq 0$ , the above inequality can be rewritten as

$$\|\phi_{11}\delta_u + \phi_{12}\delta_v\|_{2,T}^2 - \|\phi_{21}\delta_u + \phi_{22}\delta_v\|_{2,T}^2 - \eta^2 \|\delta_w\|_{2,T}^2 \leq -\varepsilon \|(\delta_v, \delta_w)\|_{2,T}^2, \quad (\text{B.149})$$

which can in turn be put into the following form

$$\|\phi_{11}\delta_u + \phi_{12}\delta_v\|_{2,T}^2 - \|(\phi_{21}\delta_u + \phi_{22}\delta_v, \eta\delta_w)\|_{2,T}^2 \leq -\varepsilon \|(\delta_v, \delta_w)\|_{2,T}^2. \quad (\text{B.150})$$

We know that  $q = q_{\text{in}} + G_{\text{perf},q}(p, w)$  and  $\tilde{q} = \tilde{q}_{\text{in}} + G_{\text{perf},q}(\tilde{p}, \tilde{w})$ . Then, in the above inequality, we have  $\delta_u = u - \tilde{u} = (q - q_{\text{in}}) - (\tilde{q} - \tilde{q}_{\text{in}}) = G_{\text{perf},q}(p, w) - G_{\text{perf},q}(\tilde{p}, \tilde{w})$  and  $\delta_v = v - \tilde{v} = p - \tilde{p}$ . Let us define  $\theta_1(p, \tilde{p}, w, \tilde{w}) := \phi_{11}(G_{\text{perf},q}(p, w) - G_{\text{perf},q}(\tilde{p}, \tilde{w})) + \phi_{12}\delta_p$  and  $\theta_2(p, \tilde{p}, w, \tilde{w}) := \text{col}(\phi_{21}(G_{\text{perf},q}(p, w) - G_{\text{perf},q}(\tilde{p}, \tilde{w})) + \phi_{22}\delta_p, \gamma\delta_w)$ . Then, we have that

$$\begin{aligned} \|\theta_1(p, \tilde{p}, w, \tilde{w})\|_{2,T} &= \|\phi_{11}(G_{\text{perf},q}(p, w) - G_{\text{perf},q}(\tilde{p}, \tilde{w})) + \phi_{12}\delta_p\|_{2,T} \\ &\leq \|\phi_{11}\|_2 \|G_{\text{perf},q}\|_{\Delta_2} \|(\delta_p, \delta_w)\|_{2,T} + \|\phi_{12}\|_2 \|\delta_p\|_{2,T} \\ &\leq (\|\phi_{11}\|_2 \|G_{\text{perf},q}\|_{\Delta_2} + \|\phi_{12}\|_2) \|(\delta_p, \delta_w)\|_{2,T} \\ &=: \gamma_1 \|(\delta_p, \delta_w)\|_{2,T} \end{aligned} \quad (\text{B.151})$$

and

$$\begin{aligned}
\|\theta_2(p, \tilde{p}, w, \tilde{w})\|_{2,T} &= \|(\phi_{11}(G_{\text{perf},q}(p, w) - G_{\text{perf},q}(\tilde{p}, \tilde{w})) + \phi_{12}\delta_p, \eta\delta_w)\|_{2,T} \\
&= \left( \|(\phi_{11}(G_{\text{perf},q}(p, w) - G_{\text{perf},q}(\tilde{p}, \tilde{w})) + \phi_{12}\delta_p\|_{2,T}^2 + \|\eta\delta_w\|_{2,T}^2 \right)^{\frac{1}{2}} \\
&\leq \|\phi_{11}(G_{\text{perf},q}(p, w) - G_{\text{perf},q}(\tilde{p}, \tilde{w})) + \phi_{12}\delta_p\|_{2,T} + \|\eta\delta_w\|_{2,T} \quad (\text{B.152}) \\
&\leq \|\phi_{11}\|_2 \|G_{\text{perf},q}\|_{\Delta_2} \|(\delta_p, \delta_w)\|_{2,T} + \|\phi_{12}\|_2 \|\delta_p\|_{2,T} + \eta \|\delta_w\|_{2,T} \\
&\leq (\|\phi_{11}\|_2 \|G_{\text{perf},q}\|_{\Delta_2} + \|\phi_{12}\|_2 + \eta) \|(\delta_p, \delta_w)\|_{2,T} \\
&=: \gamma_2 \|(\delta_p, \delta_w)\|_{2,T}.
\end{aligned}$$

From this, we see that all of the conditions in Lemma B.1 are satisfied, and then there exists  $\tilde{\varepsilon} > 0$  such that

$$\|\phi_{11}(\delta_q - \delta_{q_{\text{in}}}) + \phi_{12}\delta_p\|_{2,T} - \|(\phi_{21}(\delta_q - \delta_{q_{\text{in}}}) + \phi_{22}\delta_p, \eta\delta_w)\|_{2,T} \leq -\tilde{\varepsilon} \|(\delta_p, \delta_w)\|_{2,T}, \quad (\text{B.153})$$

which, using the fact that for  $a, b \geq 0$ ,  $\sqrt{a+b} \leq \sqrt{a} + \sqrt{b}$ , is equivalent to

$$\|\phi_{11}(\delta_q - \delta_{q_{\text{in}}}) + \phi_{12}\delta_p\|_{2,T} - \|\phi_{21}(\delta_q - \delta_{q_{\text{in}}}) + \phi_{22}\delta_p\|_{2,T} \leq -\tilde{\varepsilon} \|(\delta_p, \delta_w)\|_{2,T} + \eta \|\delta_w\|_{2,T}. \quad (\text{B.154})$$

Using the reverse triangle inequality, we have that

$$\|\phi_{11}(\delta_q - \delta_{q_{\text{in}}}) + \phi_{12}\delta_p\|_{2,T} \geq \|\phi_{11}\delta_q + \phi_{12}\delta_p\|_{2,T} - \|\phi_{11}\delta_{q_{\text{in}}}\|_{2,T}. \quad (\text{B.155})$$

In the same way, the triangle inequality ensures that

$$\|\phi_{21}(\delta_q - \delta_{q_{\text{in}}}) + \phi_{22}\delta_p\|_{2,T} \leq \|\phi_{21}\delta_q + \phi_{22}\delta_p\|_{2,T} + \|\phi_{21}\delta_{q_{\text{in}}}\|_{2,T}, \quad (\text{B.156})$$

which yields

$$-\|\phi_{21}(\delta_q - \delta_{q_{\text{in}}}) + \phi_{22}\delta_p\|_{2,T} \geq -\|\phi_{21}\delta_q + \phi_{22}\delta_p\|_{2,T} - \|\phi_{21}\delta_{q_{\text{in}}}\|_{2,T}. \quad (\text{B.157})$$

We then obtain that

$$\begin{aligned}
\|\phi_{11}\delta_q + \phi_{12}\delta_p\|_{2,T} - \|\phi_{21}\delta_q + \phi_{22}\delta_p\|_{2,T} - \|\phi_{11}\delta_{q_{\text{in}}}\|_{2,T} - \|\phi_{21}\delta_{q_{\text{in}}}\|_{2,T} \\
\leq -\tilde{\varepsilon} \|(\delta_p, \delta_w)\|_{2,T} + \eta \|\delta_w\|_{2,T}. \quad (\text{B.158})
\end{aligned}$$

Let us note that, using the incremental  $\mathcal{L}_2$ -gain stability of  $G_{\text{perf}}$  and the reverse triangle inequality, we have

$$\begin{aligned}
\|\delta_q\|_{2,T} - \|\delta_{q_{\text{in}}}\|_{2,T} &\leq \|\delta_q - \delta_{q_{\text{in}}}\|_{2,T} \leq \|G_{\text{perf},q}\|_{\Delta_2} \|(\delta_p, \delta_w)\|_{2,T} \\
&\leq \|G_{\text{perf},q}\|_{\Delta_2} (\|\delta_p\|_{2,T} + \|\delta_w\|_{2,T}) \quad (\text{B.159})
\end{aligned}$$

and then

$$\|\delta_q\|_{2,T} \leq \|G_{\text{perf},q}\|_{\Delta_2} (\|\delta_p\|_{2,T} + \|\delta_w\|_{2,T}) + \|\delta_{q_{\text{in}}}\|_{2,T}. \quad (\text{B.160})$$

Using the above inequality, we may write

$$\begin{aligned}
\|(\delta_p, \delta_q)\|_{2,T} &= \left( \|\delta_p\|_{2,T}^2 + \|\delta_q\|_{2,T}^2 \right)^{\frac{1}{2}} \leq \|\delta_p\|_{2,T} + \|\delta_q\|_{2,T} \\
&\leq (1 + \|G_{\text{perf},q}\|_{\Delta_2}) \|\delta_p\|_{2,T} + \|G_{\text{perf},q}\|_{\Delta_2} \|\delta_w\|_{2,T} \\
&\quad + \|\delta_{q_{\text{in}}}\|_{2,T}, \quad (\text{B.161})
\end{aligned}$$

which yields

$$\|\delta_p\|_{2,T} \geq \frac{1}{(1 + \|G_{\text{perf},q}\|_{\Delta 2})} \left( \|(\delta_p, \delta_q)\|_{2,T} - \|G_{\text{perf},q}\|_{\Delta 2} \|\delta_w\|_{2,T} - \|\delta_{q_{\text{in}}}\|_{2,T} \right). \quad (\text{B.162})$$

Then, we have

$$\begin{aligned} -\tilde{\varepsilon} \|(\delta_p, \delta_w)\|_{2,T} &= -\tilde{\varepsilon} \left( \|\delta_p\|_{2,T}^2 + \|\delta_w\|_{2,T}^2 \right)^{\frac{1}{2}} \leq -\tilde{\varepsilon} \left( \|\delta_p\|_{2,T} + \|\delta_w\|_{2,T} \right) \\ &\leq -\bar{\varepsilon}_1 \left( \|(\delta_p, \delta_q)\|_{2,T} + \|\delta_w\|_{2,T} - \|\delta_{q_{\text{in}}}\|_{2,T} \right), \end{aligned} \quad (\text{B.163})$$

where

$$\bar{\varepsilon}_1 := \frac{\tilde{\varepsilon}}{(1 + \|G_{\text{perf},q}\|_{\Delta 2})} \quad (\text{B.164})$$

is a positive scalar. Replacing (B.163) back into (B.158), and using the fact that  $\phi_{11}, \phi_{21} \in \mathcal{RH}_\infty$  yields

$$\|\phi_{11}\delta_q + \phi_{12}\delta_p\|_{2,T} - \|\phi_{21}\delta_q + \phi_{22}\delta_p\|_{2,T} \leq -\bar{\varepsilon}_1 \|(\delta_p, \delta_q)\|_{2,T} + \bar{\varepsilon}_2 \|\delta_w\|_{2,T} + \bar{\varepsilon}_3 \|\delta_{q_{\text{in}}}\|_{2,T}, \quad (\text{B.165})$$

where

$$\begin{aligned} \bar{\varepsilon}_2 &:= \eta - \bar{\varepsilon}_1 \\ \bar{\varepsilon}_3 &:= \bar{\varepsilon}_1 + \|\phi_{11}\|_2 + \|\phi_{21}\|_2 \end{aligned} \quad (\text{B.166})$$

are positive scalars ( $\bar{\varepsilon}_1$  can be made as small as needed by taking  $\tilde{\varepsilon}$  small enough). We then have that

$$\begin{aligned} -\|\phi_{11}\delta_q + \phi_{12}\delta_p\|_{2,T} + \|\phi_{21}\delta_q + \phi_{22}\delta_p\|_{2,T} &\geq \bar{\varepsilon}_1 \|(\delta_p, \delta_q)\|_{2,T} - \bar{\varepsilon}_2 \|\delta_w\|_{2,T} - \bar{\varepsilon}_3 \|\delta_{q_{\text{in}}}\|_{2,T} \\ &\geq \bar{\varepsilon}_1 \|(\delta_p, \delta_q)\|_{2,T} - \bar{\varepsilon}_4 \|(\delta_{q_{\text{in}}}, \delta_w)\|_{2,T}, \end{aligned} \quad (\text{B.167})$$

with  $\bar{\varepsilon}_4 := \bar{\varepsilon}_2 + \bar{\varepsilon}_3 > 0$ .

Let us now consider the graph of  $\Delta$ . Following the same steps as in the proof of Theorem 4.14, we obtain

$$-\|\phi_{11}\delta_q + \phi_{12}\delta_p\|_{2,T} + \|\phi_{21}\delta_q + \phi_{22}\delta_p\|_{2,T} \leq \bar{\varepsilon}_5 \|\delta_{p_{\text{in}}}\|_{2,T} \quad (\text{B.168})$$

with  $\bar{\varepsilon}_5 := \|\phi_{12}\|_2 + \|\phi_{22}\|_2 > 0$ . Let us define the functions

$$d_T(p, q) := -\|\phi_{11}\delta_q + \phi_{12}\delta_p\|_{2,T} + \|\phi_{21}\delta_q + \phi_{22}\delta_p\|_{2,T}, \quad (\text{B.169})$$

$\phi_1(r) := \bar{\varepsilon}_1 r$ ,  $\phi_2(r) := \bar{\varepsilon}_4 r$  and  $\phi_3(r) := \bar{\varepsilon}_5 r$ . Then, the conditions in Theorem 4.13 are satisfied with linear functions  $\phi_i$ , for  $i = \{1, 2, 3\}$ . This means that there exists  $c > 0$  such that, whenever the signals  $p, \tilde{p}, q, \tilde{q}$  exist and are uniquely defined, we have

$$\|(q, p) - (\tilde{q}, \tilde{p})\|_2^2 \leq c^2 \|(q_{\text{in}}, p_{\text{in}}) - (\tilde{q}_{\text{in}}, \tilde{p}_{\text{in}})\|_2^2. \quad (\text{B.170})$$

We now have to show that the feedback interconnection  $(G_{\text{perf}}, \Delta)$  is well-posed for every  $\Delta \in \overline{\Delta}$ , i.e. that the operator  $\ell_{G_{\text{perf}}}[\Delta]^{-1}$  is well-defined and causal for every  $\Delta \in \overline{\Delta}$ . The proof of this fact follows exactly like in the proof of Theorem 4.30, and the details are thus

omitted. Together with (B.170), this implies that  $(G_{\text{perf}}, \Delta)$  is robustly incrementally stable with respect to  $\overline{\Delta}$ .

Robust incremental performance:

For performance analysis, we consider the case of zero inputs  $q_{\text{in}}$ ,  $\tilde{q}_{\text{in}}$ ,  $p_{\text{in}}$  and  $\tilde{p}_{\text{in}}$ . In this case, (4.123) can be rewritten as

$$\int_0^T \bar{y}(t)^\top M \bar{y}(t) dt + \|z - \tilde{z}\|_{2,T}^2 - \eta^2 \|w - \tilde{w}\|_{2,T}^2 \leq -\varepsilon \|(p - \tilde{p}, w - \tilde{w})\|_{2,T}^2, \quad (\text{B.171})$$

where

$$\bar{y} = \Psi \left[ \begin{array}{c|c} G_{\text{perf},q} & -G_{\text{perf},q} \\ \hline \mathbb{I} & 0 \\ \hline -\mathbb{I} & 0 \end{array} \right] (p, w, \tilde{p}, \tilde{w}) = \Psi \begin{bmatrix} q - \tilde{q} \\ p - \tilde{p} \end{bmatrix} = \bar{y}_\Delta. \quad (\text{B.172})$$

Then, using (4.122), we have that

$$\|z - \tilde{z}\|_{2,T}^2 \leq \eta^2 \|w - \tilde{w}\|_{2,T}^2 \quad (\text{B.173})$$

so that the uncertain system is incrementally  $\mathcal{L}_2$ -gain stable for every  $\Delta \in \overline{\Delta}$ . It is then robustly incrementally  $\mathcal{L}_2$ -gain stable with respect to  $\overline{\Delta}$ , and has an incremental  $\mathcal{L}_2$ -gain less than or equal to  $\eta$ .  $\blacksquare$



# Une approche affine par morceaux de la performance non-linéaire

## C.1 Introduction

Dans ce mémoire nous considérons l'analyse des systèmes affines par morceaux (*piecewise-affine* en anglais, d'où l'acronyme PWA). Ces systèmes ont attiré beaucoup d'attention de la part de la communauté d'automatique, surtout après l'apparition des articles [84, 133]. Ils servent à représenter des systèmes contenant des saturations, des zones mortes, des relais, parmi d'autres. En plus, ils peuvent être considérés comme des approximations de systèmes non-linéaires plus génériques. L'analyse de cette classe de systèmes met à profit le fait que leur description est assez proche de celle des systèmes linéaires temps-invariants (LTI), ce qui permet d'adapter certains résultats portant sur ces systèmes aux systèmes PWA. Surtout, il est possible d'établir des résultats d'analyse écrits comme des inégalités matricielles linéaires (*linear matrix inequalities* en anglais, d'où l'acronyme LMI), que l'on sait résoudre de façon efficace.

Nous nous intéressons ici à l'analyse des propriétés de stabilité incrémentale des systèmes PWA. La stabilité incrémentale concerne la convergence de toute paire de trajectoires du système l'une vers l'autre, au lieu de vers un point d'équilibre. Cette notion plus forte de stabilité nous permet de garantir que le système possède certains comportements qualitatifs tels que l'unicité du régime permanent et l'indépendance des conditions initiales. Ces propriétés sont très intéressantes quand on fait face à des problèmes d'asservissement, de synchronisation et d'observation, par exemple. Cela est à la base des résultats proposés par Fromion, qui utilise le  $\mathcal{L}_2$ -gain incrémental pour étendre l'analyse avec la norme  $H_\infty$  pondérée au cas des systèmes non-linéaires [51, 59]. Nous partons de ces développements pour proposer de nouveaux résultats pour l'analyse de la stabilité incrémentale des systèmes PWA.

Un modèle ne peut jamais être une représentation exacte du système qu'il est censé représenter. Cet écart entre le modèle et la réalité peut avoir un impact sur la validité de l'analyse, et pour faire face à cela nous considérons la notion de robustesse. Grosso modo, la robustesse est la capacité du système à garder la stabilité et la performance en présence d'incertitudes. De façon à garantir la robustesse, nous considérons l'analyse des systèmes PWA incertains, c'est-à-dire, contenant un modèle explicite de l'incertitude. Pour ce faire, nous utilisons la séparation des graphes pour étendre l'analyse avec des contraintes quadratiques intégrales (*integral quadratic constraints* en anglais, d'où l'acronyme IQC) au cadre des systèmes PWA.



Finalement, nous considérons comment obtenir des systèmes PWA qui servent d'approximation à des systèmes non-linéaires de Lur'e. Nous développons une technique d'approximation adaptée à l'analyse des propriétés incrémentales et nous discutons de comment elle peut être mise en œuvre en pratique.

## C.2 Analyse des systèmes affines par morceaux

### C.2.1 Introduction

Ce chapitre est consacré à l'introduction des systèmes affines par morceaux. Nous présentons également les propriétés de stabilité et de performance que nous cherchons à étudier dans de tels systèmes, ainsi que la façon dont ces problèmes ont été traités ces dernières années.

L'intérêt pour les systèmes affines par morceaux de la part de la communauté d'Automatique a considérablement augmenté après les articles de Johansson et Rantzer [85, 133]. Les auteurs ont proposé de nouveaux résultats pour l'analyse de la stabilité et de la performance des systèmes affines par morceaux en construisant des fonctions de Lyapunov et de stockage quadratiques par morceaux. Ceci a été réalisé en utilisant la  $\mathcal{S}$ -procédure pour prendre en compte la description régionale des systèmes PWA. L'approche originale de Johansson et Rantzer sert de base aux résultats proposés dans ce mémoire.

### C.2.2 Systèmes affines par morceaux

Les systèmes affines par morceaux sont des systèmes non-linéaires dont l'évolution de l'état est régie par un ensemble d'équations affines, chacune valable dans une région différente de l'espace d'états. Nous nous intéresserons à l'opérateur  $\Sigma_{\text{PWA}}$  de  $\mathcal{L}_{2e}^{n_w}(\mathbb{R}_+)$  dans  $\mathcal{L}_{2e}^{n_z}(\mathbb{R}_+)$ , présentant une représentation d'état affine par morceaux :

$$z = \Sigma_{\text{PWA}}(w) \begin{cases} \dot{x}(t) = A_i x(t) + a_i + B_i w(t) \\ z(t) = C_i x(t) + c_i + D w(t) \\ x(0) = x_0 \end{cases} \quad \text{for } x(t) \in X_i \quad (\text{C.1})$$

où  $A_i \in \mathbb{R}^{n \times n}$ ,  $a_i \in \mathbb{R}^n$ ,  $B_i \in \mathbb{R}^{n \times n_w}$ ,  $C_i \in \mathbb{R}^{n_z \times n}$ ,  $c_i \in \mathbb{R}^{n_z}$  et  $D_i \in \mathbb{R}^{n_z \times n_w}$ , pour  $i \in \mathcal{I} := \{1, \dots, N\}$ . On notera  $\mathcal{I}_0 \subseteq \mathcal{I}$  l'ensemble contenant tout  $i$  tel que  $0 \in X_i$ . Les régions  $X_i$ , pour  $i \in \mathcal{I}$ , sont des ensembles polyédriques convexes fermés et peuvent être non bornées. Chaque face du polyèdre  $X_i$  est dans un hyperplan qui divise  $X$  en deux régions. Soit

$$\mathcal{G}_{i,k} := \{x \in X \mid G_{i,k}x + g_{i,k} \geq 0\} \quad (\text{C.2})$$

un demi-plan défini par la  $k$ -ième face du polyèdre. La région  $X_i$  est alors caractérisée par l'intersection de tout  $\mathcal{G}_{i,k}$ , i.e

$$X_i = \bigcap_k \mathcal{G}_{i,k} = \{x \in X \mid G_i x + g_i \succeq 0\}, \quad (\text{C.3})$$

où

$$G_i := \begin{bmatrix} G_{i,1} \\ \vdots \\ G_{i,l_i} \end{bmatrix} \quad g_i := \begin{bmatrix} g_{i,1} \\ \vdots \\ g_{i,l_i} \end{bmatrix} \quad (\text{C.4})$$

et  $l_i$  est le nombre de faces de  $X_i$ . Le signe  $\succeq$  indique que chaque composante du vecteur  $G_i x + g_i$  doit être positive. Les régions  $X_i$  ont des intérieurs non vides et disjoints deux-à-deux, et sont telles que  $\bigcup_{i \in \mathcal{I}} X_i = X$ .  $\{X_i\}_{i \in \mathcal{I}}$  constitue alors une partition finie de  $X$ . À partir de la géométrie de  $X_i$ , l'intersection  $X_i \cap X_j$  entre deux régions différentes est toujours contenue dans un hyperplan. Notons  $E_{ij}^\top \in \mathbb{R}^n$  et  $e_{ij} \in \mathbb{R}$  le vecteur et le scalaire tels que

$$X_i \cap X_j \subseteq \{x \in X \mid E_{ij} x + e_{ij} = 0\}. \quad (\text{C.5})$$

La partition polyédrique est illustrée sur la Figure C.1.

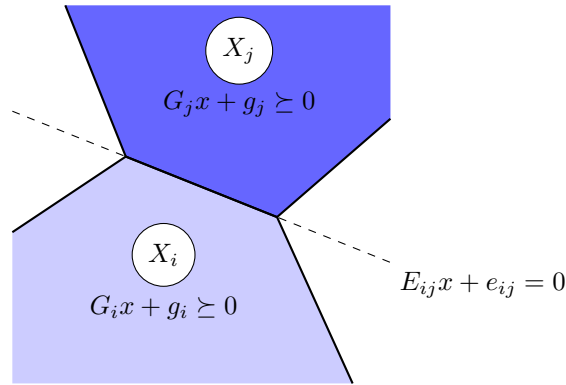

FIGURE C.1 – Partition polytopique de l'espace d'état

Dans le cadre de cette thèse, nous nous intéressons aux systèmes affines par morceaux qui représentent des systèmes non-linéaires bien posés. Pour cette raison, on ne va pas s'intéresser à des comportements pathologiques tels que les modes glissants ou le phénomène de Zénon (pour plus de détails, veuillez consulter la Section 2.6 et les références y mentionnées). Compte tenu de cela, nous ferons l'hypothèse suivante.

#### HYPOTHÈSE C.1

*Le système PWA (C.1) ne présente pas de modes glissants ni de phénomène de Zénon.* ┘

Nous faisons l'hypothèse supplémentaire suivante.

#### HYPOTHÈSE C.2

*Pour tout  $i \in \mathcal{I}_0$ ,  $a_i = 0$  et  $c_i = 0$ .* ┘

Cette hypothèse garantit que  $x = 0$  est un point d'équilibre de (C.1) avec une entrée nulle et une sortie nulle. Ceci est fait car notre but est d'évaluer la performance des systèmes de contrôle, c'est-à-dire des systèmes en boucle fermée conçus pour suivre certaines entrées de référence ou rejeter des perturbations exogènes, mais qui doivent rester en repos quand non excités.

### C.2.3 Analyse des systèmes dynamiques

Dans cette section on définira les notions de stabilité et performance que l'on envisage d'évaluer.

### Caractérisations entrée-sortie et évaluation de la performance

On s'intéressera à évaluer la *performance* des systèmes affines par morceaux. La performance est caractérisée par une certaine mesure de la sortie du système par rapport à l'entrée. Commençons par la notion de  $\mathcal{L}_2$ -gain, qui est caractérisée par un rapport énergétique entre l'entrée et la sortie.

#### DÉFINITION C.3 ( $\mathcal{L}_2$ -gain stability)

Le système  $\Sigma_{\text{PWA}} : \mathcal{L}_{2e}^{n_w}(\mathbb{R}_+) \rightarrow \mathcal{L}_{2z}^{n_z}(\mathbb{R}_+)$  dans (C.1) est dit être  $\mathcal{L}_2$ -gain stable s'il existe  $0 < \gamma < \infty$  tel que pour tout  $w \in \mathcal{L}_2^{n_w}(\mathbb{R}_+)$  nous avons

$$\int_0^\infty |z(t)|^2 dt \leq \gamma^2 \int_0^\infty |w(t)|^2 dt \quad (\text{C.6})$$

pour  $z = \Sigma_{\text{PWA}}(w)$  avec l'état initial  $x_0 = 0$ . Nous définissons le  $\mathcal{L}_2$ -gain de  $\Sigma_{\text{PWA}}$  comme le plus petit  $\gamma$  pour lequel (C.6) est valide, et nous le notons  $\|\Sigma_{\text{PWA}}\|_{\mathcal{L}_2}$ .  $\lrcorner$

Une propriété entrée-sortie plus forte des systèmes dynamiques est celle de la *stabilité  $\mathcal{L}_2$ -gain incrémental*. Dans ce cas, nous nous intéressons au rapport énergétique entre la différence de deux entrées et les sorties correspondantes, comme dans la définition suivante.

#### DÉFINITION C.4 (Stabilité $\mathcal{L}_2$ -gain incrémental)

Le système  $\Sigma_{\text{PWA}} : \mathcal{L}_{2e}^{n_w}(\mathbb{R}_+) \rightarrow \mathcal{L}_{2z}^{n_z}(\mathbb{R}_+)$  dans (C.1) est dit *incrémentalement  $\mathcal{L}_2$ -gain stable* s'il est  $\mathcal{L}_2$ -gain stable et s'il existe  $0 < \eta < \infty$  tel que pour tout  $w, \tilde{w} \in \mathcal{L}_2^{n_w}(\mathbb{R}_+)$  nous avons

$$\int_0^\infty |z(t) - \tilde{z}(t)|^2 dt \leq \eta^2 \int_0^\infty |w(t) - \tilde{w}(t)|^2 dt \quad (\text{C.7})$$

pour  $z = \Sigma_{\text{PWA}}(w)$  et  $\tilde{z} = \Sigma_{\text{PWA}}(\tilde{w})$  avec la même condition initiale  $x_0$ . Nous définissons le  $\mathcal{L}_2$ -gain incrémental de  $\Sigma_{\text{PWA}}$  comme le plus petit  $\eta$  pour lequel (C.7) est valide, et nous le notons  $\|\Sigma_{\text{PWA}}\|_{\Delta_2}$ .  $\lrcorner$

### Espace d'états et stabilité

Dans la Section C.2.3, nous avons vu comment les caractérisations entrées-sorties nous permettent d'aborder le problème de l'évaluation de la performance des systèmes dynamiques. Une autre façon d'analyser ces systèmes est d'étudier le comportement de l'état. Il pourrait être intéressant de vérifier la stabilité d'un point d'équilibre donné, ou le comportement asymptotique lorsque le temps tend vers l'infini. Concernant la stabilité incrémental, l'intérêt réside dans le comportement de chaque trajectoire d'état l'une par rapport à l'autre. Dans cette section, nous présentons les concepts de stabilité utilisés dans tout ce mémoire.

Les notions incrémentales de stabilité asymptotique concernent la convergence de chaque trajectoire, indépendante de la condition initiale. La définition suivante de la stabilité incrémental asymptotique est adaptée de [6].

#### DÉFINITION C.5 (Stabilité incrémental asymptotique et exponentielle)

On dit que le système (C.1) est *incrémental asymptotiquement stable* s'il existe une fonction  $\beta$  de classe  $\mathcal{KL}$  de sorte que pour tout  $x_0, \tilde{x}_0 \in X$  et tout  $t \geq 0$ , nous avons

$$|x(t) - \tilde{x}(t)| \leq \beta(|x_0 - \tilde{x}_0|, t) \quad (\text{C.8})$$

avec  $x(t) = \phi(t, 0, x_0, w)$  et  $\tilde{x}(t) = \phi(t, 0, \tilde{x}_0, w)$ , pour tout  $w \in \mathcal{L}_{2e}^{n_w}(\mathbb{R}_+)$ . S'il existe  $d, \lambda > 0$  tel que  $\beta(r, t) \leq de^{-\lambda t}r$ , on dit que le système est *incrémentalement exponentiellement stable*. Si  $X = \mathbb{R}^n$ , le système est dit *incrémentalement globalement asymptotiquement (exponentiellement) stable*.  $\lrcorner$

### C.2.4 Evaluation de la stabilité et de la performance

Dans cette section, nous passons en revue des outils classiques pour l'analyse des systèmes dynamiques : la dissipativité et la stabilité de Lyapunov. Ils nous permettront d'obtenir des conditions traitables pour effectuer des analyses sur des systèmes affines par morceaux.

#### Analyse de la dissipativité

Les propriétés entrée-sortie caractérisent l'interaction entre le comportement interne d'un système dynamique et son environnement. Ceci est au cœur de la théorie de la dissipativité introduite par Willems [180, 181], reliant l'espace d'états à des caractérisations entrée-sortie via les notions de *taux d'échange* et *fonction de stockage*.

Appelons *taux d'échange* une fonction absolument intégrable  $\varpi$  de  $W \times Z$  dans  $\mathbb{R}$ .

Le taux d'échange est une généralisation du flux d'énergie entre le système et des éléments extérieurs. L'énergie qui entre dans le système peut être stockée, augmentant son énergie interne, ou dissipée. Pour rendre compte de l'énergie stockée, nous introduisons la fonction de stockage, de sorte que la notion de systèmes dissipatifs peut être définie comme suit.

#### DÉFINITION C.6 (Système dissipatif)

Un système dynamique  $\Sigma_{\text{PWA}} : \mathcal{W}_e \rightarrow \mathcal{Z}_e$  est dit *dissipatif par rapport au taux d'échange*  $\varpi : W \times Z \rightarrow \mathbb{R}$  s'il existe une fonction non négative  $S : X \rightarrow \mathbb{R}_+$ , appelée *fonction de stockage*, telle que pour tout  $t_1, t_0 \in \mathbb{R}_+$ ,  $t_1 \geq t_0$ , et  $w \in \mathcal{W}_e$ ,

$$S(x(t_1)) - S(x(t_0)) \leq \int_{t_0}^{t_1} \varpi(w(t), z(t)) dt \quad (\text{C.9})$$

où  $x(t_1) = \phi(t_1, t_0, x(t_0), w)$  et  $z = \Sigma_{\text{PWA}}(w)$ . Dans le cas où  $S$  est différentiable, l'inégalité de dissipativité (C.9) peut s'écrire comme

$$\nabla S(x) \cdot f(x, w) - \varpi(w, z) \leq 0 \quad (\text{C.10})$$

pour tout  $w \in \mathcal{W}_e$ .  $\lrcorner$

L'inégalité (C.9) implique que l'énergie généralisée stockée dans le système dans un temps futur  $t_1$  ne peut pas être supérieure à la somme de l'énergie généralisée à un instant donné  $t_0$  et l'énergie fournie entre ces deux instants, i.e. aucune création interne « d'énergie » est possible [171].

Ce qui suit est un résultat standard dans la théorie de la dissipativité, voir par exemple [71] et [171, Remark 3.1.11].

#### THÉORÈME C.7

Soit  $\Sigma_{\text{PWA}} : \mathcal{W}_e \rightarrow \mathcal{Z}_e$  un système dynamique temps-invariant, avec un espace d'état atteignable depuis  $x_0$ . Alors, les deux déclarations suivantes sont équivalentes :

(i) pour chaque  $T \geq 0$  et chaque  $w \in \mathcal{W}_e$ , nous avons

$$\int_0^T \varpi(w(t), z(t)) dt \geq 0 \quad (\text{C.11})$$

où  $z = \Sigma_{\text{PWA}}(w)$  et  $x(0) = x_0$ .

(ii)  $\Sigma_{\text{PWA}}$  est dissipatif par rapport au taux d'échange  $\varpi$ , et il existe une fonction de stockage normalisée à  $S(x_0)$ , c'est-à-dire  $S(x_0) = 0$ .

Si l'espace d'état n'est pas supposé être atteignable depuis  $x_0$ , l'implication (ii)  $\Rightarrow$  (i) reste vraie.  $\lrcorner$

La puissance du Théorème C.7 devient claire quand il est spécialisé pour une propriété d'entrée-sortie donnée. Dans ce mémoire, nous nous intéresserons à la caractérisation de la stabilité  $\mathcal{L}_2$ -gain et de la stabilité  $\mathcal{L}_2$ -gain incrémentale, comme défini précédemment. Concernant la première, le résultat suivant est immédiat.

#### COROLLAIRE C.8

Soit  $\Sigma_{\text{PWA}} : \mathcal{L}_{2e}^{n_w}(\mathbb{R}_+) \rightarrow \mathcal{L}_{2e}^{n_z}(\mathbb{R}_+)$  un système dynamique temps-invariant défini par (C.1), avec  $x_0 = 0$  et un espace d'état atteignable depuis l'origine. Alors,  $\Sigma_{\text{PWA}}$  est  $\mathcal{L}_2$ -gain stable si et seulement si il est dissipatif par rapport au taux d'échange

$$\varpi(w, z) = \gamma^2 |w|^2 - |z|^2. \quad (\text{C.12})$$

En utilisant le Corollaire C.8, l'évaluation de la stabilité  $\mathcal{L}_2$ -gain d'un système dynamique est remplacée par l'évaluation de la dissipativité par rapport au taux d'échange (C.12).

Nous portons notre attention maintenant sur l'étude du  $\mathcal{L}_2$ -gain incrémental. Comme nous l'avons vu dans la section précédente, les propriétés de stabilité incrémentale concernent le comportement de chaque trajectoire du système les unes par rapport aux autres. Afin de pouvoir comparer deux trajectoires différentes du système (C.1), nous introduisons le système augmenté fictif  $\bar{\Sigma}_{\text{PWA}} : \mathcal{L}_{2e}^{n_w}(\mathbb{R}_+) \times \mathcal{L}_{2e}^{n_w}(\mathbb{R}_+) \rightarrow \mathcal{L}_{2e}^{n_z}(\mathbb{R}_+)$ .

$$\bar{z} = \bar{\Sigma}_{\text{PWA}}(\bar{w}) \begin{cases} \dot{\bar{x}}(t) = \bar{A}_{ij}\bar{x}(t) + \bar{B}_{ij}\bar{w}(t) \\ \bar{z}(t) = \bar{C}_{ij}\bar{x}(t) + \bar{D}\bar{w}(t) \\ \bar{x}(0) = \bar{x}_0 \end{cases} \quad \text{pour } \bar{x}(t) \in X_{ij} \quad (\text{C.13})$$

où  $\bar{x} = \text{col}(x, \tilde{x}, 1)$ ,  $\bar{w} = \text{col}(w, \tilde{w})$ , et

$$\begin{aligned} \bar{A}_{ij} &= \begin{bmatrix} A_i & 0 & a_i \\ 0 & A_j & a_j \\ 0 & 0 & 0 \end{bmatrix} & \bar{B}_{ij} &= \begin{bmatrix} B_i & 0 \\ 0 & B_j \\ 0 & 0 \end{bmatrix} \\ \bar{C}_{ij} &= \begin{bmatrix} C_i & -C_j & c_i - c_j \end{bmatrix} & \bar{D} &= \begin{bmatrix} D & -D \end{bmatrix} \end{aligned} \quad (\text{C.14})$$

Nous notons que  $\bar{\Sigma}(w, \tilde{w}) := \Sigma_{\text{PWA}}(w) - \Sigma_{\text{PWA}}(\tilde{w})$ . L'espace d'état du système augmenté, ou simplement l'espace d'état augmenté, est noté  $\bar{X}$  et est égal au produit cartésien de l'espace d'état original, c'est-à-dire  $\bar{X} := X \times X$ . Les régions  $X_{ij}$  sont définies comme  $X_{ij} = \{\bar{x} =$

$\text{col}(x, \tilde{x}, 1) \mid x \in X_i \text{ and } \tilde{x} \in X_j$ . Chaque région  $X_{ij}$  est décrite par  $X_{ij} = \{\bar{x} \in \bar{X} \times \{1\} \mid \bar{G}_{ij}\bar{x} \succeq 0\}$  où  $\bar{G}_{ij} \in \mathbb{R}^{l_{ij} \times (2n+1)}$  est donné par

$$\bar{G}_{ij} = \begin{bmatrix} G_i & 0 & g_i \\ 0 & G_j & g_j \end{bmatrix} \quad (\text{C.15})$$

avec  $l_{ij} := l_i + l_j$ .

Analogue à la partition d'état  $\{X_i\}_{i \in \mathcal{I}}$  du système  $\Sigma_{\text{PWA}}$ , l'intersection entre deux régions  $X_{ij}$  et  $X_{kl}$  de  $\bar{\Sigma}_{\text{PWA}}$  est soit vide soit contenue dans l'hyperplan donné par

$$X_{ij} \cap X_{kl} \subseteq \left\{ \bar{x} \in \bar{X} \times \{1\} \mid \bar{E}_{ijkl}\bar{x} = 0 \right\} \quad (\text{C.16})$$

Il est possible d'étudier la stabilité  $\mathcal{L}_2$ -gain incrémental du système (C.1) à travers l'analyse de dissipativité du système augmenté (C.13) [56, 142]. Pour cela, nous allons considérer une fonction de stockage définie sur l'espace d'état augmenté  $\bar{S} : \bar{X} \rightarrow \mathbb{R}_+$ . Nous écrirons  $\bar{S}(x, \tilde{x})$  au lieu de  $\bar{S}(\text{col}(x, \tilde{x}))$  pour favoriser la lisibilité, mais il devrait être clair que  $\bar{S}$  est une fonction de stockage pour le système augmenté, et est donc une fonction du vecteur d'état augmenté  $\text{col}(x, \tilde{x})$ .

#### COROLLAIRE C.9

Soit  $\Sigma_{\text{PWA}} : \mathcal{L}_{2e}^{n_w}(\mathbb{R}_+) \rightarrow \mathcal{L}_{2e}^{n_z}(\mathbb{R}_+)$  un système dynamique temps-invariant défini par (C.1), avec un espace d'état accessible depuis  $x_0$ . Alors,  $\Sigma_{\text{PWA}}$  est incrémentalement  $\mathcal{L}_2$ -gain stable si et seulement si le système augmenté  $\bar{\Sigma}_{\text{PWA}}$  défini par (C.13), avec  $x_0 = \tilde{x}_0$ , est dissipatif par rapport au taux d'échange

$$\bar{\omega}(w, \tilde{w}, \bar{z}) = \eta^2 |w - \tilde{w}|^2 - |\bar{z}|^2 \quad (\text{C.17})$$

et il existe une fonction de stockage  $\bar{S} : \bar{X} \rightarrow \mathbb{R}_+$  telle que  $\bar{S}(x, x) = 0$  pour tout  $x \in X$ .  $\square$

### Stabilité de Lyapunov

L'évaluation de la stabilité asymptotique peut être faite en appliquant la deuxième méthode de Lyapunov. Cette approche a joué un rôle central dans la théorie des systèmes et a été étendue à l'analyse des systèmes à temps discret, des systèmes stochastiques, des systèmes commutés, pour n'en nommer que quelques-uns.

Parallèlement à l'étude du  $\mathcal{L}_2$ -gain incrémental, la stabilité asymptotique incrémentale peut aussi être reliée à l'étude du système augmenté (C.13). Dans ce cas, nous fixons  $\tilde{w} = w$ , puisque nous ne sommes intéressés que par la convergence des trajectoires due à des conditions initiales différentes. Le théorème suivant est adapté de [6].

#### THÉORÈME C.10

Le système (C.1) est incrémentalement exponentiellement stable comme dans la définition C.5 s'il existe une fonction continue  $\bar{V} : \bar{X} \rightarrow \mathbb{R}_+$  et des scalaires positifs  $\sigma_1, \sigma_2$  et  $\sigma_3$  tels que

$$\sigma_1 |x - \tilde{x}|^2 \leq \bar{V}(x, \tilde{x}) \leq \sigma_2 |x - \tilde{x}|^2 \quad (\text{C.18})$$

et le long de n'importe quelles deux trajectoires  $x, \tilde{x}$ , en partant respectivement de  $x_0$  et  $\tilde{x}_0$  sous l'entrée  $w \in \mathcal{L}_{2e}^{n_w}(\mathbb{R}_+)$ ,  $\bar{V}$  satisfait pour tout  $t \geq 0$

$$\bar{V}(x(t), \tilde{x}(t)) - \bar{V}(x_0, \tilde{x}_0) \leq - \int_0^t \sigma_3 |x - \tilde{x}|^2 d\tau \quad (\text{C.19})$$

avec  $x(t) = \phi(t, 0, x_0, w)$  et  $\tilde{x}(t) = \phi(t, 0, \tilde{x}_0, w)$ . Une fonction  $\bar{V}$  satisfaisant les propriétés ci-dessus est appelée une fonction de Lyapunov incrémentale .  $\lrcorner$

D'après les résultats sur les sections précédentes, on peut conclure sur la stabilité et sur la performance en construisant des fonctions de Lyapunov et des fonctions de stockage, respectivement. Dans le cas général, la recherche de telles fonctions s'avère un problème de dimension infinie, et est donc assez difficile à résoudre. Dans le cadre de ce mémoire, nous choisissons de poursuivre une approche basé sur la paramétrisation de ces fonctions avec une base finie. Cela rend le problème de dimension finie et nous permet d'utiliser des outils de l'optimisation convexe pour résoudre le problème de façon systématique et efficace. Comme une structure a priori est choisie, il peut y avoir un écart entre les résultats de l'analyse et le système, i.e. les résultats deviennent *conservatifs*. Dans ce mémoire, nous proposons de construire des fonctions de stockage et de Lyapunov pour l'étude des propriétés de stabilité incrémentale ayant une structure prédéfinie plus flexible que les résultats de la littérature, comme nous allons voir par la suite. Nous étendons quelques résultats de la littérature pour proposer la construction de fonctions de stockage et de fonctions de Lyapunov quadratiques par morceaux et polynomiales par morceaux.

### C.2.5 Stabilité et performance de systèmes PWA

Nous présentons maintenant quelques résultats de la littérature concernant l'analyse des systèmes affines par morceaux en utilisant la dissipativité et la théorie de Lyapunov, comme présenté dans la dernière section.

Pour étudier la stabilité et la performance des systèmes affines par morceaux, nous devons être en mesure de vérifier la positivité de fonctions quadratiques restreintes à une région spatiale. Une façon de le faire est d'utiliser la  $\mathcal{S}$ -procédure. La version suivante de la  $\mathcal{S}$ -procédure provient de [18].

#### LEMME C.11 ( $\mathcal{S}$ -procédure)

La fonction quadratique  $\sigma_0(x) := x^\top Qx + 2q^\top x + r$  est non négative pour tout  $x$  tel que  $\sigma_i(x) := x^\top T_i x + 2u_i^\top x + v_i \geq 0$ ,  $i \in \{1, \dots, k\}$ , s'il existe des constantes non-négatives  $\tau_i$  telles que

$$\begin{bmatrix} Q & q \\ q^\top & r \end{bmatrix} - \sum_{i=1}^k \tau_i \begin{bmatrix} T_i & u_i \\ u_i^\top & v_i \end{bmatrix} \succeq 0 \quad (\text{C.20})$$

L'inverse est vrai si  $k = 1$ .  $\lrcorner$

La  $\mathcal{S}$ -procédure est cruciale pour l'analyse des systèmes affines par morceaux. Elle nous permet de transformer les exigences locales pour chaque sous-système en contraintes globales que nous pouvons vérifier en utilisant de la programmation semi-définie avec moins de conservatisme. C'est aussi l'outil qui nous permettra d'aller plus loin que ce qui pourrait être réalisé en utilisant des fonctions de stockage/Lyapunov quadratiques. Tout ce qui est nécessaire est de trouver un moyen de décrire le fait que  $x \in X_i$  en utilisant une inégalité de quadratique du type  $\sigma_i(x) \geq 0$ . Pour ce faire, Johansson [84] propose l'approche suivante : soit  $U_i \in \mathbb{S}^{l_i}$  une matrice symétrique avec des coefficients positifs et zéro sur la diagonale. Alors,  $x \in X_i$  implique que  $x^\top E_i^\top U_i E_i x \geq 0$ , où  $E_i$  sont des matrices construites à partir de  $G_i$  en suivant [83, Algorithmme A.1].

Suivant l'article [84], nous proposons des techniques d'analyse basées sur la construction de fonctions de stockage/Lyapunov continues quadratiques par morceaux de la forme :

$$S(x) = V(x) = \begin{cases} x^\top P_i x & \text{for } x \in X_i, i \in \mathcal{I}_0 \\ \begin{bmatrix} x \\ 1 \end{bmatrix}^\top \begin{bmatrix} P_i & q_i \\ \bullet & r_i \end{bmatrix} \begin{bmatrix} x \\ 1 \end{bmatrix} & \text{for } x \in X_i, i \in \mathcal{I} \setminus \mathcal{I}_0 \end{cases} \quad (\text{C.21})$$

Afin d'assurer la continuité de (C.21), nous utiliserons la version suivante du lemme de Finsler.

LEMME C.12

Soit  $Q \in \mathbb{S}^n$  et  $V \in \mathbb{R}^{k \times n}$ , avec  $k < n$  et  $\text{rank}(V) = k$ , et soit  $V^\perp$  une matrice dont les colonnes couvrent le noyau de  $V$ . Alors les énoncés suivants sont équivalents :

- (i)  $x^\top Q x = 0$  pour tout  $x$  tel que  $Vx = 0$ .
- (ii)  $(V^\perp)^\top Q V^\perp = 0$ .
- (iii)  $Q + KV + V^\top K^\top = 0$ , pour une matrice  $K \in \mathbb{R}^{n \times k}$ . ┘

Pour que (C.21) soit continue, nous avons besoin de que

$$\begin{bmatrix} x \\ 1 \end{bmatrix}^\top \begin{bmatrix} P_i & q_i \\ \bullet & r_i \end{bmatrix} \begin{bmatrix} x \\ 1 \end{bmatrix} = \begin{bmatrix} x \\ 1 \end{bmatrix}^\top \begin{bmatrix} P_j & q_j \\ \bullet & r_j \end{bmatrix} \begin{bmatrix} x \\ 1 \end{bmatrix}, \quad \forall x \in X_i \cap X_j. \quad (\text{C.22})$$

Maintenant, puisque l'intersection  $X_i \cap X_j$  est contenue dans l'hyperplan décrit par

$$\begin{bmatrix} E_{ij} & e_{ij} \end{bmatrix} \begin{bmatrix} x \\ 1 \end{bmatrix} = 0, \quad (\text{C.23})$$

l'équivalence entre (i) et (iii) nous permet de dire que (C.21) est continue si et seulement s'il existe des matrices  $L_{ij} \in \mathbb{R}^{(2n+1) \times 1}$  telles que

$$\begin{bmatrix} P_i & q_i \\ \bullet & r_i \end{bmatrix} = \begin{bmatrix} P_j & q_j \\ \bullet & r_j \end{bmatrix} + L_{ij} \begin{bmatrix} E_{ij} & e_{ij} \end{bmatrix} + \begin{bmatrix} E_{ij}^\top \\ e_{ij} \end{bmatrix} L_{ij}^\top, \quad \forall (i, j) \in \mathcal{I}^2 \text{ t.q. } X_i \cap X_j \neq \emptyset. \quad (\text{C.24})$$

### Stabilité $\mathcal{L}_2$ -gain

Nous commençons par énoncer le résultat suivant, adapté de [133].

THÉORÈME C.13

Considérons le système affine par morceaux (C.1). S'il existe des matrices symétriques  $P_i \in \mathbb{S}^n$ , des vecteurs  $q_i \in \mathbb{R}^n$ , des scalaires  $r_i \in \mathbb{R}$ , des matrices symétriques  $U_i, W_i \in \mathbb{S}^{l_i}$  avec des



coefficients non négatifs et zéro sur la diagonale et des vecteurs  $L_{ijkl} \in \mathbb{R}^{n+1}$  tels que

$$\begin{cases} P_i - E_i^\top U_i E_i \succeq 0 \\ \left[ \begin{array}{cc} A_i^\top P_i + P_i A_i + C_i^\top C_i + E_i^\top W_i E_i & P_i B_i + C_i^\top D \\ \bullet & D^\top D - \gamma^2 I_p \end{array} \right] \preceq 0 \end{cases} \quad \text{pour } i \in \mathcal{I}_0 \quad (\text{C.25})$$

$$\begin{cases} \left[ \begin{array}{cc} P_i - E_i^\top U_i E_i & q_i - E_i^\top U_i e_i \\ \bullet & r_i - e_i^\top U_i e_i \end{array} \right] \succeq 0 \\ \left[ \begin{array}{cc} \left( \begin{array}{c} A_i^\top P_i + P_i A_i + \\ C_i^\top C_i + \\ E_i^\top W_i E_i \end{array} \right) & \left( \begin{array}{c} P_i a_i + A_i^\top q_i + \\ C_i^\top c_i + \\ E_i^\top W_i e_i \end{array} \right) & P_i B_i + C_i^\top D \\ \bullet & \left( \begin{array}{c} 2q_i^\top a_i + \\ c_i^\top c_i + e_i^\top W_i e_i \end{array} \right) & c_i^\top D \\ \bullet & \bullet & D^\top D - \gamma^2 I_p \end{array} \right] \preceq 0 \end{cases} \quad \text{pour } i \in \mathcal{I} \setminus \mathcal{I}_0 \quad (\text{C.26})$$

$$\begin{bmatrix} P_i & q_i \\ \bullet & r_i \end{bmatrix} = \begin{bmatrix} P_j & q_j \\ \bullet & r_j \end{bmatrix} + L_{ij} \begin{bmatrix} E_{ij} & e_{ij} \end{bmatrix} + \begin{bmatrix} E_{ij} & e_{ij} \end{bmatrix}^\top L_{ij}^\top \quad \text{pour } (i, j) \in \mathcal{I} \times \mathcal{I} \\ \text{t.q. } X_i \cap X_j \neq \emptyset \quad (\text{C.27})$$

avec  $q_i = 0$  et  $r_i = 0$  pour  $i \in \mathcal{I}_0$ , sont satisfaits, alors

- (i) le système affine par morceaux (C.1) est  $\mathcal{L}_2$ -gain stable ;
- (ii) il a un  $\mathcal{L}_2$ -gain inférieur ou égal à  $\gamma$  ;
- (iii) il est dissipatif par rapport au taux d'échange donné par (C.12) ;
- (iv)  $S$  donné par (C.21) est une fonction de stockage. ┘

### Stabilité exponentielle

Nous procédons maintenant à l'analyse de la stabilité exponentielle des systèmes affines par morceaux à l'aide de fonctions de Lyapunov quadratiques par morceaux. Le résultat suivant est adapté de [85].

#### THÉORÈME C.14

Considérons le système affine par morceaux (C.1). S'il existe des matrices symétriques  $P_i \in \mathbb{S}^n$ , des vecteurs  $q_i \in \mathbb{R}^n$ , des scalaires  $r_i \in \mathbb{R}$ , des matrices symétriques  $U_i, W_i \in \mathbb{S}^{l_i}$  avec des coefficients non négatifs et zéro sur la diagonale et des vecteurs  $L_{ijkl} \in \mathbb{R}^{n+1}$  tels que

$$\begin{cases} P_i - E_i^\top U_i E_i \succ 0 \\ A_i^\top P_i + P_i A_i + E_i^\top W_i E_i \prec 0 \end{cases} \quad \text{pour } i \in \mathcal{I}_0 \quad (\text{C.28})$$

$$\begin{cases} \left[ \begin{array}{cc} P_i - E_i^\top U_i E_i & q_i - E_i^\top U_i e_i \\ \bullet & r_i - e_i^\top U_i e_i \end{array} \right] \succ 0 \\ \left[ \begin{array}{cc} A_i^\top P_i + P_i A_i + E_i^\top W_i E_i & P_i a_i + A_i^\top q_i + E_i^\top W_i e_i \\ \bullet & 2q_i^\top a_i + e_i^\top W_i e_i \end{array} \right] \prec 0 \end{cases} \quad \text{pour } i \in \mathcal{I} \setminus \mathcal{I}_0 \quad (\text{C.29})$$

$$\begin{bmatrix} P_i & q_i \\ \bullet & r_i \end{bmatrix} = \begin{bmatrix} P_j & q_j \\ \bullet & r_j \end{bmatrix} + L_{ij} \begin{bmatrix} E_{ij} & e_{ij} \end{bmatrix} + \begin{bmatrix} E_{ij} & e_{ij} \end{bmatrix}^\top L_{ij}^\top \quad \begin{array}{l} \text{pour } (i, j) \in \mathcal{I} \times \mathcal{I} \\ \text{t.q. } X_i \cap X_j \neq \emptyset \end{array} \quad (\text{C.30})$$

avec  $q_i = 0$  et  $r_i = 0$  pour  $i \in \mathcal{I}_0$ , sont satisfaits, alors le système affine par morceaux (C.1) est exponentiellement stable.  $\lrcorner$

### C.2.6 Stabilité et performance incrémentale des systèmes PWA

Après avoir présenté quelques résultats concernant la stabilité asymptotique et la stabilité  $\mathcal{L}_2$ -gain des systèmes affines par morceaux, nous considérons maintenant le cas de l'évaluation de la stabilité incrémentale. La majorité de la littérature concerne l'utilisation de fonctions de stockage et de fonctions de Lyapunov incrémentales quadratiques (voir par exemple [54, 59, 143]), et nous verrons comment ces fonctions peuvent être utilisées dans le cadre de systèmes affines par morceaux.

Comme discuté dans la Section C.2.4, lors de l'étude des propriétés incrémentales, il est habituel de considérer le système augmenté défini dans (C.13). Les résultats dans la littérature proposent des méthodes d'analyse basées sur la construction de fonctions de stockage/de Lyapunov incrémentales quadratiques ayant la structure suivante :

$$\bar{S}(x, \tilde{x}) = \bar{V}(x, \tilde{x}) = (x - \tilde{x})^\top P (x - \tilde{x}). \quad (\text{C.31})$$

Afin d'étudier la stabilité asymptotique incrémentale de (C.1), il est utile de spécialiser le système augmenté (C.13) dans le cas où  $w = \tilde{w}$ , nous avons alors une entrée vectorielle unique  $w$ . En utilisant le fait que  $w = \tilde{w}$ , le système augmenté (C.13) peut être réécrit comme

$$\bar{z} = \bar{\Sigma}_{\text{PWA}}(w) \begin{cases} \dot{\bar{x}}(t) = \bar{A}_{ij}\bar{x}(t) + \bar{F}_{ij}w(t) \\ \bar{z}(t) = \bar{C}_{ij}\bar{x}(t) \\ \bar{x}(0) = \bar{x}_0 \end{cases} \quad \text{pour } \bar{x}(t) \in X_{ij} \quad (\text{C.32})$$

avec  $\bar{F}_{ij}$  donné par

$$\bar{F}_{ij} = \begin{bmatrix} B_i \\ B_j \\ 0 \end{bmatrix}. \quad (\text{C.33})$$

#### Stabilité $\mathcal{L}_2$ -gain incrémentale

Supposons que les fonctions  $A_i x + a_i + Bw$  et  $C_i x + c_i + Dw$  dans la description du système (C.1) soient continues. Alors, le théorème suivant, proposé par Romanchuk et Smith [143], peut être appliqué.

#### THÉORÈME C.15

Supposons que le système PWA (C.1) soit tel  $A_i x + a_i + Bw$  et  $C_i x + c_i + Dw$  soient continues. S'il existe une matrice symétrique  $P \in \mathbb{S}^n$  telle que

$$\begin{cases} P \succ 0 \\ \begin{bmatrix} A_i^\top P + P A_i + C_i^\top C_i & P B + C_i^\top D \\ \bullet & D^\top D - \eta^2 I_p \end{bmatrix} \prec 0 \end{cases} \quad \text{pour } i \in \mathcal{I} \quad (\text{C.34})$$

sont satisfaites, alors

- (i) le système affine par morceaux (C.1) est incrémentalement  $\mathcal{L}_2$ -gain stable ;
- (ii) il a un  $\mathcal{L}_2$ -gain incrémental inférieur ou égal à  $\eta$  ;
- (iii) le système augmenté (C.13) est dissipatif par rapport à au taux d'échange (C.17) ;
- (iv)  $\bar{S}$  donnée par (C.31) est une fonction de stockage pour le système augmenté ; ┘

### Stabilité asymptotique incrémentale

Dans le cas des systèmes affines par morceaux continus, l'évaluation de la stabilité asymptotique incrémentale peut également être faite en recherchant une fonction de Lyapunov incrémentale quadratique ayant la structure (C.31). Ceci est fait dans le théorème suivant.

#### THÉORÈME C.16

Supposons que le système (C.1) soit continu. S'il existe une matrice symétrique  $P \in \mathbb{S}^n$  telle que

$$\begin{cases} P \succ 0 \\ A_i^\top P + P A_i \prec 0 \quad \text{pour } i \in \mathcal{I} \end{cases} \quad (\text{C.35})$$

sont satisfaites, alors le système affine par morceaux (C.1) est incrémentalement exponentiellement stable. ┘

## C.3 Contribution à l'analyse de la stabilité incrémentale des systèmes affines par morceaux

### C.3.1 Introduction

Dans la Section C.2, nous avons présenté une définition formelle des systèmes affines par morceaux, ainsi que les outils d'analyse que nous utiliserons pour les étudier. Cette section présente de nouveaux résultats développés dans le cadre de cette thèse. Ils consistent en de nouvelles méthodes d'analyse pour l'évaluation des propriétés de stabilité incrémentale des systèmes affines par morceaux. Dans un premier temps, nous avons considéré des fonctions quadratiques par morceaux de façon à étendre les résultats de la littérature, de façon similaire aux résultats présentés dans [114]. Malheureusement, de la même façon que les auteurs, nous n'avons pas été capables de construire de telles fonctions sur des exemples numériques. Pour cette raison, nous nous sommes tournés vers les fonctions polynomiales par morceaux. L'objectif est d'aller au-delà des fonctions quadratiques simples pour l'évaluation de la stabilité incrémentale, de façon à réduire le conservatisme.

### C.3.2 Polynômes et optimisation convexe

Un monôme est une fonction  $v : \mathbb{R}^n \rightarrow \mathbb{R}$  telle que  $v(x) = cx^a$ , où  $c \in \mathbb{R}$  est un coefficient et  $a \in \mathbb{N}^n$  est un multi-index, c'est-à-dire  $x^a = x_1^{a_1} \cdots x_n^{a_n}$ . Le degré de  $v$  est donné par  $|a| = \sum_{i=1}^n a_i$ . Un polynôme  $p : \mathbb{R}^n \rightarrow \mathbb{R}$  est une somme finie de monômes  $v_1, v_2, \dots$  avec un degré fini. Le degré du polynôme est le plus grand degré de ses monômes. Dans ce qui suit,  $\mathbb{R}[x]$  dénote l'anneau de polynômes dans  $x \in \mathbb{R}^n$  avec des coefficients dans  $\mathbb{R}$ .

Nous nous intéresserons à la construction de polynômes non négatifs pour les utiliser comme des fonctions de stockage et des fonctions de Lyapunov incrémentales. On peut montrer que, en général, tester la non-négativité globale des polynômes est NP-difficile, voir par exemple [122, 123]. Pour cette raison, nous portons notre attention sur une classe spéciale de polynômes, à savoir ceux qui peuvent être représentés comme une *somme de carrés*. La définition suivante est adaptée de [26, 121].

**DÉFINITION C.17 (Polynômes sommes de carrés)**

Pour  $x \in \mathbb{R}^n$ , le polynôme  $p \in \mathbb{R}[x]$  est une somme de carrés (SOS) s'il existe des polynômes  $p_i(x)$ ,  $i = 1, \dots, M$  tels que

$$p(x) = \sum_{i=1}^M p_i^2(x) \quad (\text{C.36})$$

Dans ce cas, nous disons que  $p \in \text{SOS}[x]$ . ┘

Il est clair que les polynômes SOS sont non négatifs. On peut montrer que, dans le cas général, tous les polynômes non négatifs ne sont pas des SOS. Cependant, même si l'existence d'une décomposition SOS n'est pas équivalente à la non-négativité, cette représentation est assez importante, car le test si un polynôme admet une description SOS peut être transformé en un problème d'optimisation convexe contraint par des inégalités matricielles linéaires. Pour le voir, soit  $\chi_d(x)$  un vecteur contenant tous les monômes en  $x \in \mathbb{R}^n$  de degré inférieur ou égal à  $d$ . Ce vecteur prend des valeurs dans  $\mathbb{R}^{\varrho(n,d)}$ , où

$$\varrho(n, d) = \binom{n+d}{d}. \quad (\text{C.37})$$

Alors, un polynôme  $p$  de degré inférieur ou égal à  $d$  peut être écrit comme

$$p(x) = \mathcal{O}^\top \chi_d(x) \quad (\text{C.38})$$

avec  $\mathcal{O} \in \mathbb{R}^{\varrho(n,d)}$ , et un polynôme  $p$  de degré inférieur ou égal à  $2d$  peut être écrit comme

$$p(x) = \chi_d(x)^\top \mathcal{P} \chi_d(x) \quad (\text{C.39})$$

avec  $\mathcal{P} \in \mathbb{S}^{\varrho(n,d)}$ . Dans ce qui suit, nous laissons tomber la dépendance de  $\chi_d$  en  $x$  pour faciliter la notation. En raison de l'interdépendance entre les différents éléments de  $\chi_d$  (par exemple,  $x^2 = x \cdot x = x^2 \cdot 1$ ), la représentation (C.39) n'est pas unique. Définissons l'ensemble

$$\mathcal{Q}(n, d) := \{Q \in \mathbb{S}^{\varrho(n,d)} \mid \chi_d^\top Q \chi_d = 0, \forall x \in \mathbb{R}^n\}. \quad (\text{C.40})$$

Alors,  $\mathcal{Q}(n, d)$  est le noyau de l'application qui associe à chaque matrice  $Q \in \mathbb{S}^{\varrho(n,d)}$  un polynôme  $\chi_d^\top Q \chi_d$  dans  $\mathbb{R}[x]$ . Soit  $\{Q_\ell^{n,d}\}_{\ell=1, \dots, \iota(n,d)}$  une base de  $\mathcal{Q}(n, d)$ , où  $\iota(n, d)$  est donné par

$$\iota(n, d) = \frac{1}{2} \varrho(n, d) (\varrho(n, d) + 1) - \varrho(n, 2d). \quad (\text{C.41})$$

Nous appelons  $Q_\ell^{n,d}$  les matrices de slack associées à la représentation de polynômes de degré  $d$  dans  $x \in \mathbb{R}^n$ . Le premier terme à droite de l'égalité ci-dessus représente le nombre de termes indépendants dans une matrice symétrique appartenant à  $\mathbb{S}^{\varrho(n,d)}$ , et le second est le nombre de monômes distincts dans la représentation polynomiale  $\chi_d^\top Q \chi_d$ , avec  $Q \in \mathbb{S}^{\varrho(n,d)}$ . Alors,  $\iota(n, d)$

représente le nombre de termes redondants dans la représentation  $\chi_d^\top Q \chi_d$ . Enfin,  $Q^{n,d}(\tau)$  note une paramétrisation linéaire de  $\mathcal{Q}(n, d)$ , i.e.  $Q^{n,d}(\tau) = \sum_{\ell=1}^{\iota(n,d)} \tau_\ell Q_\ell^{n,d}$ , pour  $\tau \in \mathbb{R}^{\iota(n,d)}$ . Ensuite, le résultat suivant peut être indiqué [26, 122].

THÉORÈME C.18

Soit  $p \in \mathbb{R}[x]$  un polynôme de degré  $2d$  dans  $x \in \mathbb{R}^n$  et soit  $\mathcal{P} \in \mathbb{S}^{e(n,d)}$  tel que  $p(x) = \chi_d^\top \mathcal{P} \chi_d$ . Alors,  $p \in \text{SOS}[x]$  si et seulement s'il existe  $\tau \in \mathbb{R}^{\iota(n,d)}$  tel que

$$\mathcal{P} + Q^{n,d}(\tau) \succeq 0. \quad (\text{C.42})$$

┘

La condition (C.42) est un problème de faisabilité LMI sur la variable  $\tau$ , et donc le test si un polynôme est SOS peut être fait en résolvant un problème d'optimisation convexe.

Comme nous l'avons vu dans le chapitre précédent, pour pouvoir analyser les systèmes affines par morceaux, nous devons utiliser la  $\mathcal{S}$ -procédure pour passer des contraintes dans chaque région à des LMIs. En utilisant des fonctions polynomiales, l'approche reste la même, mais nous sommes en mesure d'envisager une application plus flexible de la  $\mathcal{S}$ -procédure.

LEMME C.19

La fonction polynomiale  $f_0 \in \mathbb{R}[x]$  est non négative pour tout  $x$  tel que  $f_k(x) \geq 0$ , où  $f_k \in \mathbb{R}[x]$ ,  $k = 1, \dots, M$ , s'il existe des polynômes  $g_k \in \text{SOS}[x]$  tels que

$$f_0(x) - \sum_{k=1}^M g_k(x) f_k(x) \in \text{SOS}[x], \quad \forall x \in \mathbb{R}^n \quad (\text{C.43})$$

┘

De (C.43), il est clair pourquoi le Lemme C.19 peut être vu comme une généralisation de la  $\mathcal{S}$ -procédure, car en prenant  $g$  comme un scalaire non négatif et  $f_i$  comme des fonctions quadratiques, nous retrouvons le Lemme C.11.

### C.3.3 Analyse avec des fonctions polynomiales par morceaux

Nous considérons maintenant des fonctions polynomiales par morceaux continues composées de polynômes de degré  $2d$  donnés par :

$$\bar{S}(x, \tilde{x}) = \bar{V}(x, \tilde{x}) = \chi_d(\bar{x})^\top \mathcal{P}_{ij} \chi_d(\bar{x}), \quad \text{pour } \bar{x} \in X_{ij}, \quad (\text{C.44})$$

où  $\chi_d(\bar{x})$  est un vecteur de monômes de  $\bar{x}$  de degré inférieur ou égal à  $d$ . Comme précédemment, la dépendance sur  $\tilde{x}$  est supprimée dans ce qui suit.

Nous envisageons de réécrire l'inégalité de dissipativité, ainsi que l'inégalité de la fonction de Lyapunov incrémentale dans le Théorème C.10, comme des inégalités quadratiques que nous pouvons vérifier avec de l'optimisation LMI. Dans le cas des fonctions polynomiales par morceaux, nous obtiendrons des inégalités quadratiques sur le vecteur de monômes  $\chi_d$ . Afin de pouvoir considérer des propriétés de dissipativité, nous devons être capables de prendre en compte les entrées. Cela signifie que nous devons concevoir un moyen de produire une fonction quadratique qui mène à une LMI contenant le vecteur de monômes  $\chi_d$  ainsi qu'un vecteur contenant les entrées. D'après l'approche [28], nous définissons  $\bar{w}_\chi := \bar{w} \otimes \chi_{d-1}$ , où

$\bar{w} = \text{col}(w, \tilde{w})$  et  $\otimes$  est le produit de Kronecker. Le vecteur  $\bar{\chi}_w := \text{col}(\chi_d, \bar{w}_\chi)$  est de dimension  $\varrho_w(2n, d, 2n_w)$ , où  $\varrho_w$  est défini comme

$$\varrho_w(n, d, n_w) := \varrho(n, d) + n_w \varrho(n, d - 1). \quad (\text{C.45})$$

Afin d'obtenir des inégalités quadratiques dans  $\chi_d$  et  $\bar{w}_\chi$ , nous devons réécrire les dynamiques du système augmenté en terme de ces variables. Pour ce faire, considérons des matrices  $\mathcal{A}_{ij} \in \mathbb{R}^{\varrho(2n, d) \times \varrho(2n, d)}$  et  $\mathcal{B}_{ij} \in \mathbb{R}^{\varrho(2n, d) \times \varrho_w(2n, d, 2n_w)}$  définies implicitement par

$$\dot{\chi}_d = \frac{\partial \chi_d}{\partial \bar{x}} (\bar{A}_{ij} \bar{x} + \bar{B}_{ij} \bar{w}) =: \mathcal{A}_{ij} \chi_d + \mathcal{B}_{ij} \bar{w}_\chi, \quad \text{pour } \bar{x} \in X_{ij}. \quad (\text{C.46})$$

Considérons le polynôme (C.44). Sa dérivée, pour  $\bar{x} \in X_{ij}$ , peut être écrite comme

$$\begin{aligned} \dot{\bar{S}} &= 2\chi_d^\top \mathcal{P}_{ij} \dot{\chi}_d = 2\chi_d^\top \mathcal{P}_{ij} (\mathcal{A}_{ij} \chi_d + \mathcal{B}_{ij} \bar{w}_\chi) = \begin{bmatrix} \chi_d \\ \bar{w}_\chi \end{bmatrix}^\top \begin{bmatrix} \mathcal{A}_{ij}^\top \mathcal{P} + \mathcal{P} \mathcal{A}_{ij} & \mathcal{P} \mathcal{B}_{ij} \\ \bullet & 0 \end{bmatrix} \begin{bmatrix} \chi_d \\ \bar{w}_\chi \end{bmatrix} \\ &= \bar{\chi}_w^\top \begin{bmatrix} \mathcal{A}_{ij}^\top \mathcal{P}_{ij} + \mathcal{P}_{ij} \mathcal{A}_{ij} & \mathcal{P}_{ij} \mathcal{B}_{ij} \\ \bullet & 0 \end{bmatrix} \bar{\chi}_w. \end{aligned} \quad (\text{C.47})$$

Nous obtenons une fonction quadratique en  $\bar{\chi}_w$ . Comme il était le cas pour le vecteur de monômes  $\chi_d$ , la représentation quadratique d'un polynôme en  $\bar{\chi}_w$  n'est pas unique. Définissons l'ensemble

$$\mathcal{R}(n, d, n_w) := \left\{ R \in \mathbb{S}^{\varrho_w(n, d, n_w)} \mid \begin{array}{l} \chi_w^\top R \chi_w = 0, \text{ with } \chi_w = \text{col}(\chi_d(x), w_\chi), \\ \forall x \in \mathbb{R}^n, \forall w \in \mathbb{R}^{n_w} \end{array} \right\}. \quad (\text{C.48})$$

Soit  $\{R_\ell^{n, d, n_w}\}_{\ell=1, \dots, \iota_w(n, d, n_w)}$  une base de  $\mathcal{R}(n, d, n_w)$ , où  $\iota_w(n, d, n_w)$  est le nombre de matrices de slack  $R_\ell^{n, d, n_w}$ , et est donné par [27] :

$$\begin{aligned} \iota_w(n, d, n_w) &= \frac{1}{2} \varrho_w(n, d, n_w) (\varrho_w(n, d, n_w) + 1) - \\ &\quad \left( \varrho(n, 2d) + n_w \varrho(n, 2d - 1) + \frac{n_w(n_w + 1)}{2} \varrho(n, 2d - 2) \right). \end{aligned} \quad (\text{C.49})$$

Finalement, soit  $R^{n, d, n_w}(\tau)$  une paramétrisation linéaire de l'ensemble  $\mathcal{R}(n, d, n_w)$ , c'est-à-dire  $R^{n, d, n_w}(\tau) = \sum_{\ell=1}^{\iota_w(n, d, n_w)} \tau_\ell R_\ell^{n, d, n_w}$ , pour  $\tau \in \mathbb{R}^{\iota_w(n, d, n_w)}$ . Avec cela, nous avons qu'une condition suffisant pour assurer la non positivité de  $\dot{\bar{S}}$  est l'existence de  $\mathcal{P} \in \mathbb{S}^{\varrho(2n, d)}$  t  $\tau \in \mathbb{R}^{\iota_w(n, d, n_w)}$  tels que

$$\begin{bmatrix} \mathcal{A}_{ij}^\top \mathcal{P} + \mathcal{P} \mathcal{A}_{ij} & \mathcal{P} \mathcal{B}_{ij} \\ \bullet & 0 \end{bmatrix} + R^{2n, d, 2n_w}(\tau) \preceq 0. \quad (\text{C.50})$$

Pour évaluer la dissipativité, nous avons besoin aussi de réécrire le taux d'échange (C.17) comme une fonction quadratique en  $\bar{\chi}_w$ . Comme nous avons fait précédemment, définissons des matrices  $\mathcal{C}_{ij} \in \mathbb{R}^{n_z \times \varrho(2n, d)}$  et  $\mathcal{D} \in \mathbb{R}^{n_z \times \varrho_w(2n, d, 2n_w)}$  telles que

$$\bar{z} = \bar{\mathcal{C}}_{ij} \bar{x} + \bar{\mathcal{D}} \bar{w} =: \mathcal{C}_{ij} \chi_d + \mathcal{D} \bar{w}_\chi. \quad (\text{C.51})$$

et aussi la matrice  $M_\eta \in \mathbb{S}^{\varrho_w(2n, d, 2n_w)}$  telle que

$$\eta^2 |w - \tilde{w}|^2 =: \bar{w}_\chi^\top M_\eta \bar{w}_\chi. \quad (\text{C.52})$$

De cette façon, le taux d'échange (C.17) peut être écrit comme la fonction quadratique

$$\overline{\omega}(w, \tilde{w}, \bar{z}) = \bar{\chi}_w^\top \begin{bmatrix} -\mathcal{C}_{ij}^\top \mathcal{C}_{ij} & -\mathcal{C}_{ij}^\top \mathcal{D} \\ \bullet & M_\eta - \mathcal{D}^\top \mathcal{D} \end{bmatrix} \bar{\chi}_w. \quad (\text{C.53})$$

Avec cela, nous avons les ingrédients pour écrire la condition de dissipativité  $\bar{S} - \overline{\omega} \leq 0$  comme une fonction quadratique en  $\bar{\chi}_w$ , dont nous pouvons tester la non négativité avec de l'optimisation LMI.

Définissons quelques notations concernant l'utilisation de la  $\mathcal{S}$ -procédure étendue comme indiqué dans le Lemme C.19. Dans notre cas,  $f_0(\bar{x}) \geq 0$  désigne l'inégalité polynomiale que nous voulons satisfaire, à savoir la non négativité de la fonction de stockage ou de la fonction de Lyapunov incrémentale et la non positivité des respectives dérivées. Alors, les contraintes  $f_i$  sont données dans chaque région par chaque hyperplan qui définit la région augmenté  $X_{ij}$ , i.e. chaque ligne de la contrainte  $\overline{G}_{ij}\bar{x} \succeq 0$ . Soit  $\overline{G}_{ij,k}$  la  $k$ -ième ligne de  $\overline{G}_{ij}$ , et définissons  $\mathcal{T}_{ij} \in \mathbb{S}^{\rho(2n,d)}$  comme la matrice telle que

$$g_{ij,1}(\bar{x})\overline{G}_{ij,1}\bar{x} + \dots + g_{ij,l_{ij}}(\bar{x})\overline{G}_{ij,l_{ij}}\bar{x} =: \chi_d^\top \mathcal{T}_{ij} \chi_d. \quad (\text{C.54})$$

Comme  $\overline{G}_{ij,k}\bar{x}$  est une fonction affine de  $\bar{x}$ , nous pouvons choisir des polynômes  $g_{ij,k}$  d'ordre jusqu'à  $2d - 1$ . Définissons aussi  $\mathcal{G}_{ij,k} \in \mathbb{S}^{\rho(2n,d)}$  comme la matrice telle que

$$g_{ij,k}(\bar{x}) =: \chi_d^\top \mathcal{G}_{ij,k} \chi_d. \quad (\text{C.55})$$

Alors, si  $f_0(\bar{x}) = \chi_d^\top F_0 \chi_d$ , les conditions du Lemme C.19 deviennent

$$\begin{cases} F_0 + Q^{2n,d}(\tau) - \mathcal{T}_{ij} \succeq 0 \\ \mathcal{G}_{ij,k} + Q^{2n,d}(\nu_{ij,k}) \succeq 0, \quad \text{pour } k = 1, \dots, l_{ij} \end{cases}. \quad (\text{C.56})$$

Comme nous avons vu dans le Corollaire C.9 et dans le Théorème C.10, la fonction de stockage et la fonction de Lyapunov incrémentale doivent être telles que  $\bar{S}(x, x) = \bar{V}(x, x) = 0$ , pour tout  $x \in X$ . Pour assurer cela, soit  $\delta\chi_d := \chi_d(\delta\bar{x})$ , où  $\delta\bar{x} = \text{col}(x - \tilde{x}, x + \tilde{x})$ , et soit  $T \in \mathbb{S}^{\rho(2n,d)}$  tels que  $\chi_d = T\delta\chi_d$ . Définissons  $\delta\bar{x}^0 = \text{col}(0, 2x)$ , i.e. le cas quand  $x = \tilde{x}$ , et alors  $\delta\chi_d^0 := \chi_d(\delta\bar{x}^0)$ . Si  $V(x, \tilde{x}) = \chi_d^\top \mathcal{P} \chi_d$ , alors la contrainte  $V(x, x) = 0$  pour tout  $x \in X$  signifie que  $(\delta\chi_d^0)^\top T^\top \mathcal{P} T \delta\chi_d^0 = 0$ , pour tout  $\delta\chi_d^0$  généré par tout  $x \in X$ . Soit  $\mathcal{Z} \in \mathbb{R}^{\rho(2n,d) \times \rho(2n,d)}$  une matrice telle que  $\delta\chi_d^0 = \mathcal{Z}\delta\chi_d$ . Alors,  $\mathcal{Z}$  génère tout  $\delta\chi_d$  avec  $x = \tilde{x}$ . Soit  $Z$  une base orthogonale de  $\text{range}(\mathcal{Z})$ . Alors, pour garantir que  $V(x, x) = 0$ , pour tout  $x \in \mathbb{R}^n$ , nous devons avoir  $Z^\top T^\top \mathcal{P} T Z = 0$ .

Considérons maintenant comment assurer la continuité de la fonction (C.44). La contrainte d'égalité  $\overline{E}_{ijkl}\bar{x} = 0$  peut être étendue au vecteur des monômes  $\chi_d$ , c'est-à-dire nous voulons trouver  $\mathcal{E}_{ijkl}$  tel que  $\overline{E}_{ijkl}\bar{x} = 0$  implique  $\mathcal{E}_{ijkl}\chi_d = 0$ . Cette matrice peut être obtenue en étendant la contrainte  $\overline{E}_{ijkl}\bar{x} = 0$  avec la multiplication d'un vecteur de monômes d'ordre réduit, c'est-à-dire  $\mathcal{E}_{ijkl}$  est implicitement défini par :

$$\chi_{d-1} \overline{E}_{ijkl} \bar{x} =: \mathcal{E}_{ijkl} \chi_d = 0, \quad (\text{C.57})$$

où  $\mathcal{E}_{ijkl} \in \mathbb{R}^{\rho(2n,d-1) \times \rho(2n,d)}$ . Ensuite, en utilisant la même approche que dans la construction de (C.24), la contrainte de continuité associée devient

$$P_{ij} = P_{kl} + L_{ijkl} \mathcal{E}_{ijkl} + \mathcal{E}_{ijkl}^\top L_{ijkl}^\top + Q^{2n,d}(\tau) \quad (\text{C.58})$$

avec  $L_{ijkl} \in \mathbb{R}^{\varrho(2n,d) \times \varrho(2n,d-1)}$ , et où nous introduisons  $Q^{2n,d}(\tau)$  pour prendre en compte la non-unicité de la représentation polynomiale.

Dans les sections suivantes, nous proposons quelques résultats établissant de nouvelles méthodes pour la construction de fonctions polynomiales par morceaux pour l'évaluation de la stabilité incrémentale. Les preuves sont omises puisqu'elles suivent la même approche que les preuves du chapitre précédent.

### Stabilité $\mathcal{L}_2$ -gain incrémental

Nous commençons avec l'étude du  $\mathcal{L}_2$ -gain incrémental des systèmes affines par morceaux avec des fonctions de stockage polynomiales par morceaux. Considérons le théorème suivant.

#### THÉORÈME C.20

*S'il existe des matrices symétriques  $\mathcal{P}_{ij} \in \mathbb{S}^{\varrho(2n,d)}$ , ainsi que  $\mathcal{T}_{ij,r} \in \mathbb{S}^{\varrho(2n,d)}$  et  $\mathcal{G}_{ij,r,k} \in \mathbb{S}^{\varrho(2n,d)}$  définis respectivement par (C.54) et (C.55) pour  $r \in \{1, 2\}$  et  $k \in \{1, \dots, l_{ij}\}$ , des vecteurs  $\tau_{ij} \in \mathbb{R}^{\varrho(2n,d)}$  et  $\nu_{ij,r,k} \in \mathbb{R}^{\varrho(2n,d)}$ , pour  $r \in \{1, 2\}$  et  $k \in \{1, \dots, l_{ij}\}$ ,  $\mu_{ij} \in \mathbb{R}^{\varrho_w(2n,d,2n_w)}$  et  $\vartheta_{ijkl} \in \mathbb{R}^{\varrho(2n,d)}$ , une matrice  $M_\eta$ , comme défini dans (C.52) et des matrices  $L_{ijkl} \in \mathbb{R}^{\varrho(2n,d) \times \varrho(2n,d-1)}$  tels que*

$$\left\{ \begin{array}{l} \mathcal{P}_{ij} + Q^{2n,d}(\tau_{ij}) - \mathcal{T}_{ij,1} \succeq 0 \\ \left[ \begin{array}{c|c} \mathcal{A}_{ij}^\top \mathcal{P}_{ij} + \mathcal{P}_{ij} \mathcal{A}_{ij} + & \mathcal{P}_{ij} \mathcal{B}_{ij} + \mathcal{C}_{ij}^\top \mathcal{D} \\ \mathcal{C}_{ij}^\top \mathcal{C}_{ij} + \mathcal{T}_{ij,2} & \\ \hline \bullet & \mathcal{D}^\top \mathcal{D} - M_\eta \end{array} \right] + R^{2n,d,2n_w}(\mu_{ij}) \preceq 0 \\ \left\{ \begin{array}{l} \mathcal{G}_{ij,1,k} + Q^{2n,d}(\nu_{ij,1,k}) \succeq 0 \\ \mathcal{G}_{ij,2,k} + Q^{2n,d}(\nu_{ij,2,k}) \succeq 0 \end{array} \right., \text{ for } k = 1, \dots, l_{ij} \end{array} \right. \quad \text{pour } (i, j) \in \mathcal{I}^2 \quad (\text{C.59})$$

$$Z^\top T^\top \mathcal{P}_{ii} T Z = 0 \quad \text{for } i \in \mathcal{I} \quad (\text{C.60})$$

$$\mathcal{P}_{ij} = \mathcal{P}_{kl} + L_{ijkl} \mathcal{E}_{ijkl} + \mathcal{E}_{ijkl}^\top L_{ijkl}^\top + Q^{2n,d}(\vartheta_{ijkl}) \quad \text{pour } (i, j), (k, l), \quad (\text{C.61}) \\ X_{ij} \cap X_{kl} \neq \emptyset$$

sont satisfaits, alors

- (i) le système affine par morceaux (C.1) est incrémentalement  $\mathcal{L}_2$ -gain stable ;
- (ii) il a un  $\mathcal{L}_2$ -gain incrémental inférieur ou égal à  $\eta$  ;
- (iii) le système augmenté (C.13) est dissipatif par rapport au taux d'échange (C.17) ;
- (iv)  $\bar{S}$  donné par (C.44) est une fonction de stockage pour le système augmenté.  $\lrcorner$

### Stabilité asymptotique incrémentale

Nous considérons maintenant l'analyse de la stabilité asymptotique incrémentale des systèmes affines par morceaux.

Comme nous considérons des fonctions de Lyapunov incrémentales polynomiales par morceaux, nous devons considérer des bornes  $\alpha_1$ ,  $\alpha_2$  et  $\rho$  dans le Théorème C.10 qui sont elles aussi polynomiales. Nous pouvons choisir

$$\alpha_k(|x - \tilde{x}|) = \sigma_{k,1} |x - \tilde{x}|^2 + \dots + \sigma_{k,d} |x - \tilde{x}|^{2d} =: \chi_d^\top M_{\alpha_k} \chi_d \quad (\text{C.62})$$



pour  $k \in \{1, 2, 3\}$ , où  $\sigma_{k,i}$  sont des scalaires positifs et  $\rho = \alpha_3$ . Ces fonctions appartiennent à la classe  $\mathcal{K}_\infty$ , vue qu'elles sont positives et strictement croissantes sur  $\mathbb{R}_+ \setminus \{0\}$ , et telles que  $\alpha_k(0) = 0$ .

Définissons  $w \otimes \chi_{d-1} =: w_\chi \in \mathbb{R}^{l_w(2n,d,n_w)}$ , et soit  $\mathcal{F}_{ij} \in \mathbb{R}^{\varrho(2n,d) \times \varrho_w(2n,d,n_w)}$  la matrice implicitement définie par

$$\frac{\partial \chi_d}{\partial \bar{x}} \bar{F}_{ij} w =: \mathcal{F}_{ij} w_\chi, \quad (\text{C.63})$$

où  $\bar{F}_{ij}$  est la matrice définie par (C.33).

Nous proposons des conditions permettant la construction de fonctions de Lyapunov incrémentales polynomiales par morceaux. Ceci est fait dans le prochain théorème.

#### THÉORÈME C.21

*S'il existe des matrices symétriques  $\mathcal{P}_{ij} \in \mathbb{S}^{\varrho(2n,d)}$ , ainsi que  $\mathcal{T}_{ij,r} \in \mathbb{S}^{\varrho(2n,d)}$  et  $\mathcal{G}_{ij,r,k} \in \mathbb{S}^{\varrho(2n,d)}$  définis respectivement par (C.54) et (C.55), pour  $r \in \{1, 2, 3\}$  et  $k \in \{1, \dots, l_{ij}\}$ , des vecteurs  $\tau_{ij,r} \in \mathbb{R}^{l(2n,d)}$  et  $\nu_{ij,r,k} \in \mathbb{R}^{l(2n,d)}$ , pour  $r \in \{1, 2, 3\}$  et  $k \in \{1, \dots, l_{ij}\}$ , et  $\vartheta_{ijkl} \in \mathbb{R}^{l(2n,d)}$ , des matrices  $M_{\alpha_r}$ , pour  $r \in \{1, 2, 3\}$ , comme défini dans (C.62) et des matrices  $L_{ijkl} \in \mathbb{R}^{\varrho(2n,d) \times \varrho(2n,d-1)}$  tels que*

$$\begin{cases} \mathcal{P}_{ij} + Q^{2n,d}(\tau_{ij,1}) - M_{\alpha_1} - \mathcal{T}_{ij,1} \succeq 0 \\ \mathcal{P}_{ij} + Q^{2n,d}(\tau_{ij,2}) - M_{\alpha_2} + \mathcal{T}_{ij,2} \preceq 0 \\ \mathcal{A}_{ij}^\top \mathcal{P}_{ij} + \mathcal{P}_{ij} \mathcal{A}_{ij} + Q^{2n,d}(\tau_{ij,3}) + M_{\alpha_3} + \mathcal{T}_{ij,3} \preceq 0 \\ \begin{cases} \mathcal{G}_{ij,1,k} + Q^{2n,d}(\nu_{ij,1,k}) \succeq 0 \\ \mathcal{G}_{ij,2,k} + Q^{2n,d}(\nu_{ij,2,k}) \succeq 0 \\ \mathcal{G}_{ij,3,k} + Q^{2n,d}(\nu_{ij,3,k}) \succeq 0 \end{cases} & \text{pour } (i,j) \in \mathcal{I}^2 \\ \mathcal{P}_{ij} \mathcal{F}_{ij} = 0 \end{cases} \quad (\text{C.64})$$

$$Z^\top T^\top \mathcal{P}_i Z T = 0 \quad \text{pour } i \in \mathcal{I} \quad (\text{C.65})$$

$$\mathcal{P}_{ij} = \mathcal{P}_{kl} + L_{ijkl} \mathcal{E}_{ijkl} + \mathcal{E}_{ijkl}^\top L_{ijkl}^\top + Q^{2n,d}(\vartheta_{ijkl}) \quad \begin{matrix} \text{pour } (i,j), (k,l), \\ X_{ij} \cap X_{kl} \neq \emptyset \end{matrix} \quad (\text{C.66})$$

sont satisfaites, alors le système affine par morceaux (C.1) est incrémentalement asymptotiquement stable.  $\lrcorner$

## C.4 Analyse des systèmes affines par morceaux incertains

### C.4.1 Introduction

Les Sections C.2 et C.3 ont été consacrées à l'introduction des systèmes affines par morceaux et des outils d'analyse qui forment la base de ce mémoire. Cette approche repose sur l'hypothèse que le modèle affine par morceaux est une représentation précise du système physique correspondant. Cependant, entre un système et son modèle il y a toujours un écart, dont l'importance dépend des ressources dépensées pour l'obtenir. En outre, un modèle peut être utilisé pour représenter un lot de systèmes, qui sont produits à l'aide de machines réelles présentant de la variabilité. Donc, entre le modèle et le système physique actuel, il y a la notion d'*incertitude*. Pour faire face à l'incertitude, nous devons nous assurer que le système est robuste, c'est-à-dire qu'il fonctionne comme il le devrait face à la variabilité attendue.

Ceci est réalisé en concevant un modèle pour l'incertitude, et en le prenant en compte explicitement pendant l'analyse. Le point focal de cette section est d'appliquer cette méthodologie pour l'analyse de systèmes affines par morceaux incertains. Dans ce mémoire, nous avons choisi de poursuivre une approche intimement liée aux résultats classiques et généraux de la commande robuste. De cette façon, nous sommes en mesure de profiter de la littérature sur la commande robuste et de proposer de nouvelles méthodes qui peuvent traiter une classe plutôt générale de problèmes de stabilité robuste. Les incertitudes sont modélisées par un opérateur  $\Delta$ , qui peut représenter des dynamiques inconnues, des paramètres incertains ou variant dans le temps, des retards, des non-linéarités, etc. Nous proposons ensuite une extension du célèbre cadre des contraintes quadratiques intégrales (*integral quadratic constraints* en anglais, d'où l'acronyme IQC) [111] pour aborder la classe des systèmes affines par morceaux incertains, au moyen de la théorie de la séparation des graphes. Afin d'éviter toute confusion, nous nous référons à cette nouvelle approche comme PWA/IQC, et utilisons LTI/IQC pour se référer aux résultats classiques dans [111].

### C.4.2 Systèmes affines par morceaux incertains

Dans la littérature sur la commande robuste, il est courant de représenter des systèmes incertains par une boucle de rétroaction, où les incertitudes sont isolées du système nominal. Cela nous permet de traiter de manière unifiée des classes génériques de systèmes incertains. Sur cette base, introduisons la description suivante d'un système affine par morceaux incertain.

$$\begin{cases} \dot{x}(t) = A_i x(t) + a_i + B_{p,i} p(t) \\ q(t) = C_{q,i} x(t) + c_{q,i} + D_{qp} p(t) \\ x(0) = x_0 \\ p(t) = (\Delta(q))(t) \end{cases} \quad \text{pour } x(t) \in X_i \quad (\text{C.67})$$

où  $A_i \in \mathbb{R}^{n \times n}$ ,  $a_i \in \mathbb{R}^n$ ,  $B_{p,i} \in \mathbb{R}^{n \times n_p}$ ,  $C_{q,i} \in \mathbb{R}^{n_q \times n}$ ,  $c_{q,i} \in \mathbb{R}^{n_q}$ , pour  $i \in \mathcal{I} := \{1, \dots, N\}$ , et  $D_{qp} \in \mathbb{R}^{n_q \times n_p}$ . On notera toujours  $\mathcal{I}_0 \subseteq \mathcal{I}$  l'ensemble contenant tout  $i$  tel que  $0 \in X_i$ . Les régions  $X_i$ , pour  $i \in \mathcal{I}$ , sont des ensembles polyédriques convexes fermés définis comme dans (2.4). L'intersection entre chaque paire de régions est définie par (2.6). Pour plus d'informations sur cette description, reportez-vous à la Section C.2.2.

L'incertitude est représentée par un opérateur causal et (incrémentalement) borné  $\Delta$  de  $\mathcal{L}_{2e}^{n_q}(\mathbb{R}_+)$  dans  $\mathcal{L}_{2e}^{n_p}(\mathbb{R}_+)$ . Il peut représenter une grande variété d'éléments, tels que des paramètres incertains et des dynamiques non modélisées. Il peut également représenter des non-linéarités statiques et d'autres composants « gênants », tels que des retards et des composants variant dans le temps (voir par exemple [111, 174]). Comme son nom l'indique, le bloc incertain  $\Delta$  n'est pas connu avec précision. Cependant, il peut être caractérisé comme appartenant à des ensembles généraux d'incertitudes, notés  $\mathbf{\Delta}$  et  $\overline{\mathbf{\Delta}}$  et définis ci-dessous. Dans ce sens, la description (4.1) est un abus de notation, car elle devrait lire « il existe  $\Delta \in \mathbf{\Delta}$  tel que (4.1) ». Nous faisons l'hypothèse que  $\Delta$  et le système affine par morceaux sont sans biais, i.e.  $\Delta(0) = 0$  et, pour tout  $i \in \mathcal{I}_0$ , nous avons  $a_i = 0$  et  $c_{q,i} = 0$ . Cela garantit que l'incertitude n'a aucun effet sur le système au repos, c'est-à-dire qu'elle ne peut pas faire sortir le système de son point d'équilibre par lui-même. Il est habituel que  $\Delta$  représente une incertitude normalisée sur un système nominal donné, qui est obtenue lorsque  $\Delta = 0$ . Nous ferons ainsi en sorte que 0 appartienne aux ensembles d'incertitudes  $\mathbf{\Delta}$  et  $\overline{\mathbf{\Delta}}$ . Nous passons maintenant à une définition des ces deux ensembles.

DÉFINITION C.22 (**Ensemble d'incertitudes  $\Delta$** )

L'ensemble d'incertitudes  $\Delta$  est un sous-ensemble des opérateurs bornés de  $\mathcal{L}_{2e}^{n_q}(\mathbb{R}_+)$  dans  $\mathcal{L}_{2e}^{n_p}(\mathbb{R}_+)$ , et est défini par

$$\Delta := \left\{ \Delta \left| \begin{array}{l} \Delta = \text{diag} \left( \text{diag}_i \left( \delta_{I,i} I_{n_{I,i}} \right), \text{diag}_j \left( \Delta_{I,j} \right), \text{diag}_k \left( \delta_{V,k} I_{n_{V,k}} \right), \text{diag}_l \left( \Delta_{V,l} \right) \right), \\ \|\Delta\|_2 \leq 1, \Delta(0) = 0 \end{array} \right. \right\} \quad (\text{C.68})$$

où

- $\{\delta_{I,i}\}_{i=1,\dots,m_I}$  sont des incertitudes paramétriques réelles invariantes dans le temps : chaque  $\delta_{I,i}$  est répété  $n_{I,i}$  fois dans le bloc incertain ;
- $\{\Delta_{I,j}\}_{j=1,\dots,M_I}$  sont des incertitudes dynamiques LTI de  $\mathcal{L}_{2e}^{N_{I,j}}(\mathbb{R}_+)$  dans  $\mathcal{L}_{2e}^{N_{I,j}}(\mathbb{R}_+)$  ;
- $\{\delta_{V,k}\}_{k=1,\dots,m_V}$  sont des incertitudes paramétriques réelles variant dans le temps : chaque  $\delta_{V,k}$  est répété  $n_{V,k}$  fois dans le bloc incertain ;
- $\{\Delta_{V,l}\}_{l=1,\dots,M_V}$  sont des incertitudes dynamiques non linéaires ou variant dans le temps à partir de  $\mathcal{L}_{2e}^{n_{V,l}}(\mathbb{R}_+)$  dans  $\mathcal{L}_{2e}^{n_{V,l}}(\mathbb{R}_+)$  ;

and  $n_q = n_p = m_I + M_I + m_V + M_V$ . ┘

DÉFINITION C.23 (**Ensemble d'incertitudes  $\bar{\Delta}$** )

L'ensemble d'incertitudes  $\bar{\Delta}$  est un sous-ensemble des opérateurs incrémentalement bornés de  $\mathcal{L}_{2e}^{n_q}(\mathbb{R}_+)$  dans  $\mathcal{L}_{2e}^{n_p}(\mathbb{R}_+)$ , et est défini de façon analogue à  $\Delta$  dans Définition C.22, avec la norme  $\mathcal{L}_2$  remplacée par la norme  $\mathcal{L}_2$  incrémentale. ┘

Nous nous intéressons également à l'évaluation des performances robustes d'entrée-sortie de systèmes affines par morceaux incertains. Pour cela, introduisons le système affine par morceaux suivant contenant le canal d'entrée de performance  $w$  et la sortie  $z$ .

$$z = \Sigma_{\text{PWA}}^{\Delta}(w) \begin{cases} \dot{x}(t) = A_i x(t) + a_i + B_{p,i} p(t) + B_{w,i} w(t) \\ q(t) = C_{q,i} x(t) + c_{q,i} + D_{qp} p(t) + D_{qw} w(t) \quad \text{pour } x(t) \in X_i \\ z(t) = C_{z,i} x(t) + c_{z,i} + D_{zp} p(t) + D_{zw} w(t) \\ x(0) = x_0 \\ p(t) = (\Delta(q))(t) \end{cases} \quad (\text{C.69})$$

où  $A_i \in \mathbb{R}^{n \times n}$ ,  $a_i \in \mathbb{R}^n$ ,  $B_{p,i} \in \mathbb{R}^{n \times n_p}$ ,  $B_{w,i} \in \mathbb{R}^{n \times n_w}$ ,  $C_{q,i} \in \mathbb{R}^{n_q \times n}$ ,  $c_{q,i} \in \mathbb{R}^{n_q}$ ,  $C_{z,i} \in \mathbb{R}^{n_z \times n}$ ,  $c_{z,i} \in \mathbb{R}^{n_z}$ , pour  $i \in \mathcal{I} := \{1, \dots, N\}$ , et  $D_{qp} \in \mathbb{R}^{n_q \times n_p}$ ,  $D_{qw} \in \mathbb{R}^{n_q \times n_w}$ ,  $D_{zp} \in \mathbb{R}^{n_z \times n_p}$  et  $D_{zw} \in \mathbb{R}^{n_z \times n_w}$ .

En raison de la nature incertaine de  $\Delta$ , nous devons étudier la stabilité et les performances des systèmes (4.1) et (4.3) pour tout  $\Delta \in \Delta$ . Comparé aux deux derniers chapitres, où nous avons analysé la stabilité asymptotique et la performance d'un système bien décrit, nous sommes maintenant confrontés à un continuum de modèles générés en prenant chaque possible  $\Delta \in \Delta$ . Pour cette raison, nous faisons appel à la notion de *robustesse*, c'est-à-dire la propriété que la stabilité et/ou la performance sont maintenues pour toute incertitude dans l'ensemble donné  $\Delta$ . Dans les Sections C.4.2 et C.4.2, nous introduirons des définitions précises de stabilité et de performance robustes.

**Stabilité robuste**

Notre objectif est d'étudier la stabilité de (C.67) et les performances de (C.69) avec des incertitudes appartenant aux ensembles  $\Delta$  et  $\overline{\Delta}$ . Considérons le système en boucle suivant

$$\begin{cases} q = G(p) + q_{\text{in}} \\ p = \Delta(q) + p_{\text{in}} \end{cases} \quad (\text{C.70})$$

On notera le système (C.70) comme  $(G, \Delta)$ .

Une caractéristique importante des boucles de rétroaction comme celle de (C.70) est la *bien-posé*. La définition suivante est adaptée de [111, 172, 174].

**DÉFINITION C.24 (Bien-posé)**

*Nous disons que l'interconnexion de retour  $(G, \Delta)$  est bien posée si pour chaque perturbation  $q_{\text{in}} \in \mathcal{L}_{2e}^{n_q}(\mathbb{R}_+)$  et  $p_{\text{in}} \in \mathcal{L}_{2e}^{n_p}(\mathbb{R}_+)$  il existe unique  $q \in \mathcal{L}_{2e}^{n_q}(\mathbb{R}_+)$  et  $p \in \mathcal{L}_{2e}^{n_p}(\mathbb{R}_+)$  satisfaisant (C.70) et dépendant de  $q_{\text{in}}$  de  $p_{\text{in}}$  de façon causale.*  $\lrcorner$

Le bien-posé est une propriété nécessaire pour s'assurer que le modèle représente un système physique réel. Nous pouvons maintenant proposer une définition concernant la stabilité du système en boucle. D'abord, considérons la définition suivante de la bornitude et de la stabilité avec gain fini [146].

**DÉFINITION C.25 (Bornitude et stabilité avec gain fini)**

*Soit  $\mathcal{X}_e$  et  $\mathcal{Y}_e$  des espaces normés étendus, et soit  $F$  un opérateur de  $\mathcal{X}_e$  en  $\mathcal{Y}_e$ . S'il existe une fonction croissante continue  $\phi$  de  $\mathbb{R}_+$  dans lui-même tel que pour tout  $x \in \mathcal{X}_e$  et tout  $T \geq 0$  nous avons*

$$\|F(x)\|_T \leq \phi(\|x\|_T), \quad (\text{C.71})$$

*alors  $F$  est dit borné. Si  $\phi \in \mathcal{K}$ , on dit que  $F$  est borné sans biais. Si  $\phi$  est linéaire, on dit que  $F$  est stable avec gain fini.*

*S'il existe une fonction croissante continue  $\phi$  de  $\mathbb{R}_+$  dans lui-même tel que pour tout  $x, \tilde{x} \in \mathcal{X}_e$  et tout  $T \geq 0$  nous avons*

$$\|F(x) - F(\tilde{x})\|_T \leq \phi(\|x - \tilde{x}\|_T), \quad (\text{C.72})$$

*alors  $F$  est dit incrémentalement borné. Si  $\phi \in \mathcal{K}$ , on dit que  $F$  est incrémentalement borné sans biais. Si  $\phi$  est linéaire, on dit que  $F$  est incrémentalement stable avec gain fini.*  $\lrcorner$

La stabilité de  $(G, \Delta)$  peut alors être obtenue en exigeant que l'interconnexion en boucle soit bien posée et que l'opérateur reliant les entrées externes aux signaux internes soit stable avec gain fini. La définition suivante est de nouveau adaptée de [111, 172, 174].

**DÉFINITION C.26 (Stabilité de l'interconnexion en boucle)**

*L'interconnexion en boucle  $(G, \Delta)$  est stable si elle est bien posée et si l'opérateur  $(q_{\text{in}}, p_{\text{in}}) \mapsto (q, p)$  est  $\mathcal{L}_2$ -gain stable dans le sens de la Définition C.3, i.e. il existe  $c > 0$  tel que*

$$\|q\|_2^2 + \|p\|_2^2 \leq c^2 \left( \|q_{\text{in}}\|_2^2 + \|p_{\text{in}}\|_2^2 \right). \quad (\text{C.73})$$

$\lrcorner$

Parallèlement à la Définition C.26, indiquons la définition suivante concernant la stabilité incrémentale des boucles de rétroaction.

**DÉFINITION C.27 (Stabilité incrémentale de l'interconnexion en boucle)**

L'interconnexion en boucle  $(G, \Delta)$  est incrémentalement stable si elle est bien posée et si l'opérateur  $(q_{\text{in}}, p_{\text{in}}) \mapsto (q, p)$  est incrémentalement  $\mathcal{L}_2$ -gain stable dans le sens de la Définition C.4, i.e. il existe  $\bar{c} > 0$  tel que

$$\|q - \tilde{q}\|_2^2 + \|p - \tilde{p}\|_2^2 \leq \bar{c}^2 \left( \|q_{\text{in}} - \tilde{q}_{\text{in}}\|_2^2 + \|p_{\text{in}} - \tilde{p}_{\text{in}}\|_2^2 \right). \quad (\text{C.74})$$

┘

Les Définitions C.26 et C.27 concernent la stabilité de l'interconnexion en boucle  $(G, \Delta)$ . Cependant,  $\Delta$  représente une incertitude, et n'est donc pas connu a priori. Tout ce que l'on sait, c'est qu'il appartient aux ensembles  $\Delta$  et  $\overline{\Delta}$ . Alors, au lieu d'essayer d'établir la stabilité pour une interconnexion particulière  $(G, \Delta)$ , nous cherchons à prouver la stabilité pour *tout*  $\Delta \in \Delta$ . Cela signifie que la stabilité devrait être *robuste* par rapport aux ensembles d'incertitudes  $\Delta$  et  $\overline{\Delta}$ , comme cela est précisé dans les définitions suivantes.

**DÉFINITION C.28 (Stabilité robuste)**

L'interconnexion en boucle  $(G, \Delta)$  est robustement stable par rapport à  $\Delta$  si elle est stable pour tout  $\Delta \in \Delta$ .

┘

Une définition similaire peut être proposée concernant la stabilité incrémentale.

**DÉFINITION C.29 (Stabilité incrémentale robuste)**

L'interconnexion de retour  $(G, \Delta)$  est robustement incrémentalement stable par rapport à  $\overline{\Delta}$  si elle est incrémentalement stable pour tout  $\Delta \in \overline{\Delta}$ .

┘

Autrement dit, les notions robustes de stabilité et de stabilité incrémentale signifient qu'aucune incertitude dans les ensembles  $\Delta$  ou  $\overline{\Delta}$  ne peut déstabiliser le système nominal  $G$ , qui est initialement (incrémentalement) stable. Ceci est fait en s'assurant que, pour chaque  $\Delta$  dans  $\Delta$  ou  $\overline{\Delta}$ , les signaux internes sont des fonctions bien définies et (incrémentalement) bornés dans le temps.

**Performance robuste**

En plus de la stabilité robuste des systèmes incertains, nous sommes également intéressés à assurer la performance robuste. Comme nous l'avons fait dans les Sections C.2 et C.3, nous caractériserons la performances au moyen d'une borne supérieure sur le  $\mathcal{L}_2$ -gain ou le  $\mathcal{L}_2$ -gain incrémental entre les canaux d'entrée et de sortie de performance  $w$  et  $z$ . Pour cela, considérons l'interconnexion en boucle suivante, obtenue comme une extension directe de (C.70).

$$\begin{cases} q = G_{\text{perf},q}(p, w) + q_{\text{in}} \\ p = \Delta(q) + p_{\text{in}} \\ z = G_{\text{perf},z}(p, w). \end{cases} \quad (\text{C.75})$$

On notera l'interconnexion (C.75) comme  $(G_{\text{perf}}, \Delta)$ .

Nous cherchons à caractériser la performance entre  $w$  et  $z$  pour le système incertain (C.69). Suivant la Définition C.3, nous introduisons la notion suivante de stabilité  $\mathcal{L}_2$ -gain robuste.

**DÉFINITION C.30 (Stabilité  $\mathcal{L}_2$ -gain robuste)**

L'interconnexion en boucle  $(G_{\text{perf}}, \Delta)$  est dite robustement  $\mathcal{L}_2$ -gain stable par rapport à  $\Delta$  si elle est robustement stable par rapport à cette classe d'incertitudes et si toute trajectoire de (C.75) satisfait

$$\|z\|_2 \leq \gamma \|w\|_2. \quad (\text{C.76})$$

Dans ce cas, nous disons que le  $\mathcal{L}_2$ -gain de  $(G_{\text{perf}}, \Delta)$  est inférieur ou égal à  $\gamma$ .  $\lrcorner$

Encore une fois, cette définition peut être étendue au cas de la stabilité  $\mathcal{L}_2$ -gain incrémentale.

**DÉFINITION C.31 (Stabilité  $\mathcal{L}_2$ -gain incrémentale robuste)**

L'interconnexion en bouclé  $(G_{\text{perf}}, \Delta)$  est dite robustement incrémentalement  $\mathcal{L}_2$ -gain stable par rapport à  $\overline{\Delta}$  si elle est robustement incrémentalement stable par rapport à cette classe d'incertitudes et si tout paire de trajectoires de (C.75) satisfait

$$\|z - \tilde{z}\|_2 \leq \eta \|w - \tilde{w}\|_2. \quad (\text{C.77})$$

Dans ce cas, nous disons que le  $\mathcal{L}_2$ -gain incrémental de  $(G_{\text{perf}}, \Delta)$  est inférieur ou égal à  $\eta$ .  $\lrcorner$

Dans ce document, nous choisissons de poursuivre une approche basée sur la séparation des graphes pour étudier la stabilité et la performance robustes, comme on décrit dans la prochaine section.

**C.4.3 Séparation des graphes**

La théorie de la séparation des graphes a été proposée par Safonov dans son ouvrage [146]. Commençons par définir ce que nous entendons par le graphe d'un opérateur dynamique [146].

**DÉFINITION C.32 (Graphe et graphe inverse)**

Si  $G$  est un opérateur qui relie  $x \in \mathcal{X}_e$  à  $G(x) \in \mathcal{Y}_e$ , alors le graphe de  $G$  est la relation

$$\mathcal{G}_G := \{(x, y) \in \mathcal{X}_e \times \mathcal{Y}_e \mid x \in \mathcal{X}_e \text{ et } y = G(x)\}. \quad (\text{C.78})$$

De même, le graphe inverse de  $G$  est défini comme

$$\mathcal{G}_G^I := \{(y, x) \in \mathcal{Y}_e \times \mathcal{X}_e \mid x \in \mathcal{X}_e \text{ et } y = G(x)\}. \quad (\text{C.79})$$

Il arrive souvent que le graphe d'un opérateur soit influencé par une entrée externe, qui pourrait être utilisée pour représenter des perturbations ou des conditions initiales, par exemple. Notons cette entrée externe par  $u$ , appartenant à l'espace étendu  $\mathcal{U}_e$ . On peut alors définir le graphe  $\mathcal{G}_G[u]$  comme l'ensemble des points  $(x, y) \in \mathcal{X}_e \times \mathcal{Y}_e$  tels que  $x \in \mathcal{X}_e$  et  $y = G[u](x)$ . Le graphe inverse  $\mathcal{G}_G^I[u]$  est défini de manière similaire.

Considérons l'analyse d'une interconnexion en boucle telle que celle de la Figure C.2, qui peut être représentée par

$$\begin{cases} (x, y) \in \mathcal{G}_G[u] \\ (x, y) \in \mathcal{G}_H^I[v] \end{cases} \quad (\text{C.80})$$

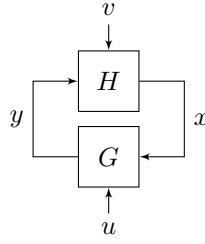

FIGURE C.2 – Interconnexion en boucle (C.80).

où  $u \in \mathcal{U}_e$  et  $v \in \mathcal{V}_e$  sont des entrées de perturbation,  $x \in \mathcal{X}_e$  et  $y \in \mathcal{Y}_e$  sont les sorties,  $\mathcal{G}_G[u] \subset \mathcal{X}_e \times \mathcal{Y}_e$  et  $\mathcal{G}_H^I[v] \subset \mathcal{X}_e \times \mathcal{Y}_e$  sont des relations non-linéaires qui dépendent des entrées de perturbation respectives, et  $\mathcal{U}_e, \mathcal{V}_e, \mathcal{X}_e, \mathcal{Y}_e$  sont des espaces normés étendus.

Le résultat de stabilité peut alors être énoncé dans le Théorème suivant [146].

THÉORÈME C.33

Supposons qu'il existe pour chaque  $T \geq 0$  une fonction  $d_T : \mathcal{X}_e \times \mathcal{Y}_e \rightarrow \mathbb{R}$  telle que

(i) pour chaque  $T \geq 0$  et chaque  $(x, y) \in \mathcal{G}_G[u]$  nous avons

$$d_T(x, y) \geq \phi_1(\|(x, y)\|_T) - \phi_2(\|u\|_T); \quad (\text{C.81})$$

(ii) pour chaque  $T \geq 0$  et chaque  $(x, y) \in \mathcal{G}_H^I[v]$  nous avons

$$d_T(x, y) \leq \phi_3(\|v\|_T); \quad (\text{C.82})$$

où  $\phi_i : \mathbb{R}_+ \rightarrow \mathbb{R}_+$ , pour  $i \in \{1, 2, 3\}$ , sont des fonctions croissantes continues et où  $\phi_1 \in \mathcal{K}_\infty$ . Alors, le système (C.80) est borné. Si, de plus, les  $\phi_i$  ( $i \in \{2, 3\}$ ) sont tous de classe  $\mathcal{K}$ , alors (C.80) est borné sans biais. Si, de plus, les  $\phi_i$  ( $i \in \{1, 2, 3\}$ ) sont tous linéaires, alors (C.80) est stable avec gain fini.  $\lrcorner$

Du fait de sa simplicité, le Théorème C.33 peut être facilement transposé au cas de la stabilité incrémentale.

THÉORÈME C.34

Supposons qu'il existe pour chaque  $T \geq 0$  une fonction  $d_T : \mathcal{X}_e \times \mathcal{Y}_e \rightarrow \mathbb{R}$  telle que

(i) pour chaque  $T \geq 0$ , chaque  $(x, y) \in \mathcal{G}_G[u]$  et chaque  $(\tilde{x}, \tilde{y}) \in \mathcal{G}_G[\tilde{u}]$  nous avons

$$d_T(x - \tilde{x}, y - \tilde{y}) \geq \phi_1(\|(x - \tilde{x}, y - \tilde{y})\|_T) - \phi_2(\|u - \tilde{u}\|_T). \quad (\text{C.83})$$

(ii) pour chaque  $T \geq 0$ , chaque  $(x, y) \in \mathcal{G}_H^I[v]$  et chaque  $(\tilde{x}, \tilde{y}) \in \mathcal{G}_H^I[\tilde{v}]$  nous avons

$$d_T(x - \tilde{x}, y - \tilde{y}) \leq \phi_3(\|v - \tilde{v}\|_T). \quad (\text{C.84})$$

où  $\phi_i : \mathbb{R}_+ \rightarrow \mathbb{R}_+$ , pour  $i \in \{1, 2, 3\}$ , sont des fonctions croissantes continues et où  $\phi_1 \in \mathcal{K}_\infty$ . Alors, le système (C.80) est incrémentalement borné. Si, de plus, les  $\phi_i$  ( $i \in \{2, 3\}$ ) sont tous de classe  $\mathcal{K}$ , alors (C.80) est incrémentalement borné sans biais. Si, de plus, les  $\phi_i$  ( $i \in \{1, 2, 3\}$ ) sont tous linéaires, alors (C.80) est incrémentalement stable avec gain fini.  $\lrcorner$

Comme il a été discuté dans la Section C.2 concernant la dissipativité et la stabilité de Lyapunov, afin de pouvoir utiliser les Théorèmes C.33 et C.34 nous devons construire la fonctionnelle  $d_T$  et des fonctions  $\phi_i$  appropriées. Dans ce document, nous suivons une approche basée sur l'utilisation de Contraintes Quadratiques Intégrales (Integral Quadratic Constraints en anglais, d'où l'acronyme IQC), comme cela sera détaillé dans les Sections C.4.4 et C.4.5.

#### C.4.4 Stabilité et performance robuste des systèmes non-linéaires en boucle

Dans cette section, nous allons considérer une méthode de construction de la fonctionnelle  $d_T$  nécessaire dans les théorèmes de séparation de graphes. Pour cela, nous utiliserons des IQCs qui contraignent l'entrée et la sortie des systèmes  $G$  and  $\Delta$ . Différemment de ce qui est maintenant connu sous le nom de contraintes quadratiques intégrales dans la littérature d'automatique (voir par exemple [111, 154, 174]), nous considérons des intégrales dans le domaine temporel de 0 to  $T$ , pour tout  $T \geq 0$ . Comme nous le verrons dans la Section C.4.4, Ce choix peut limiter le choix des IQCs disponibles, mais il a l'avantage de nous permettre de traiter de façon naturelle le cas où les systèmes nominaux  $G$  sont non-linéaires. Cela sera important pour évaluer la stabilité et la performance, car il s'agit de systèmes affines par morceaux, qui sont évidemment non-linéaires.

##### Stabilité robuste

Avant d'énoncer le résultat principal de cette section, introduisons quelques concepts préliminaires. Soit  $\Pi$  une fonction matricielle rationnelle complexe dans  $\mathcal{RL}_\infty^{(n_q+n_p) \times (n_q+n_p)}$ , qui est partitionnée en

$$\Pi(j\omega) = \begin{bmatrix} \Pi_{11}(j\omega) & \Pi_{12}(j\omega) \\ \Pi_{12}(j\omega)^* & \Pi_{22}(j\omega) \end{bmatrix}, \quad (\text{C.85})$$

avec fréquence  $\omega \in \overline{\mathbb{R}}$ ,  $\Pi_{11}(j\omega) \in \mathbb{C}^{n_q \times n_q}$  et  $\Pi_{22}(j\omega) \in \mathbb{C}^{n_p \times n_p}$ . L'opérateur  $\Pi$  est souvent appelé le *multiplieur*. Commençons par proposer le théorème suivant concernant la stabilité robuste, qui est une adaptation de [146, Theorem 2.2].

##### THÉORÈME C.35

Soit  $G : \mathcal{L}_{2e}^{n_p}(\mathbb{R}_+) \rightarrow \mathcal{L}_{2e}^{n_q}(\mathbb{R}_+)$  un système causal et  $\mathcal{L}_2$ -gain stable, et soit  $\Delta$  l'ensemble d'incertitudes défini dans la Définition C.22. Soit  $\Psi \in \mathcal{RH}_\infty^{n_y \times (n_q+n_p)}$  et  $M \in \mathbb{S}^{n_y}$  tels que  $\Pi(j\omega) := \Psi(j\omega)^* M \Psi(j\omega)$  satisfait  $\Pi_{11} \succeq \varepsilon_\Pi I_{n_q}$  et  $\Pi_{22} \preceq -\varepsilon_\Pi I_{n_p}$ , pour  $\varepsilon_\Pi > 0$ . Supposons que :

- (i) L'interconnexion en boucle  $(G, \Delta)$  est bien posée pour tout  $\Delta \in \Delta$ .
- (ii) L'IQC temporelle suivant est satisfaite

$$\int_0^T y_\Delta(t)^\top M y_\Delta(t) dt \geq 0, \quad \forall T \geq 0, \forall \Delta \in \Delta, \forall q \in \mathcal{L}_{2e}^{n_q}(\mathbb{R}_+) \quad (\text{C.86})$$

$$\text{avec } y_\Delta = \Psi \begin{bmatrix} \mathbb{I} \\ \Delta \end{bmatrix} (q).$$



(iii) Il existe  $\varepsilon > 0$  de telle sorte que l'IQC temporelle suivante est satisfaite

$$\int_0^T y_G(t)^\top M y_G(t) dt \leq -\varepsilon \|p\|_{2,T}^2, \quad \forall T \geq 0, \forall p \in \mathcal{L}_{2e}^{n_p}(\mathbb{R}_+) \quad (\text{C.87})$$

$$\text{avec } y_G = \Psi \begin{bmatrix} G \\ \mathbb{I} \end{bmatrix} (p).$$

Alors, l'interconnexion en boucle  $(G, \Delta)$  est robustement stable par rapport à  $\Delta$ .  $\lrcorner$

Lorsque la condition (ii) dans le théorème ci-dessus est satisfaite, on dit que toute incertitude  $\Delta$  dans l'ensemble  $\Delta$  satisfait l'IQC défini par  $(M, \Psi)$ . La séparation assurée par les contraintes quadratiques intégrales nous permet de conclure sur la stabilité  $\mathcal{L}_2$ -gain de toute trajectoire possible de l'interconnexion en boucle. Ensuite, avec l'hypothèse supplémentaire sur le bien-posé, nous pouvons conclure sur la stabilité robuste de  $(G, \Delta)$ .

### Performance robuste

Le but de cette section est de proposer une extension du Théorème C.35 permettant l'évaluation simultanée de la stabilité robuste et de la stabilité  $\mathcal{L}_2$ -gain robuste. Pour cela, nous représenterons la mesure de la performance comme une contrainte quadratique intégrale. Notons que la contrainte du  $\mathcal{L}_2$ -gain (C.6) peut être représentée de façon équivalente comme

$$\int_0^\infty \begin{bmatrix} z(t) \\ w(t) \end{bmatrix}^\top M_p \begin{bmatrix} z(t) \\ w(t) \end{bmatrix} dt \leq 0, \quad (\text{C.88})$$

avec

$$M_p := \begin{bmatrix} I_{n_z} & 0 \\ 0 & -\gamma^2 I_{n_w} \end{bmatrix}. \quad (\text{C.89})$$

Alors, si le système en boucle fermée est robustement  $\mathcal{L}_2$ -gain stable, cela signifie que

$$\int_0^T \begin{bmatrix} z(t) \\ w(t) \end{bmatrix}^\top M_p \begin{bmatrix} z(t) \\ w(t) \end{bmatrix} dt \leq 0, \quad \forall T \geq 0. \quad (\text{C.90})$$

L'idée est alors d'incorporer l'inégalité ci-dessus dans une contrainte intégrale comme (C.87), afin d'évaluer les performances parallèlement à la stabilité.

Nous définissons  $\Upsilon : \mathcal{L}_{2e}^{n_p}(\mathbb{R}_+) \times \mathcal{L}_{2e}^{n_w}(\mathbb{R}_+) \rightarrow \mathcal{L}_{2e}^{n_q}(\mathbb{R}_+) \times \mathcal{L}_{2e}^{n_p}(\mathbb{R}_+) \times \mathcal{L}_{2e}^{n_z}(\mathbb{R}_+) \times \mathcal{L}_{2e}^{n_w}(\mathbb{R}_+)$  comme

$$\begin{bmatrix} q \\ p \\ z \\ w \end{bmatrix} = \Upsilon \left( \begin{bmatrix} p \\ w \end{bmatrix} \right) := \begin{bmatrix} G_{\text{perf},q} \\ \mathbb{I} & 0 \\ G_{\text{perf},z} \\ 0 & \mathbb{I} \end{bmatrix} \left( \begin{bmatrix} p \\ w \end{bmatrix} \right), \quad (\text{C.91})$$

i.e.  $(q, p, z, w) = \Upsilon(p, w)$ , avec  $(q, z) = G_{\text{perf}}(p, w)$ .

Nous proposons le résultat suivant, toujours basé sur [146, Theorem 2.2].

## THÉORÈME C.36

Soit  $G_{\text{perf}} : \mathcal{L}_{2e}^{n_p}(\mathbb{R}_+) \times \mathcal{L}_{2e}^{n_w}(\mathbb{R}_+) \rightarrow \mathcal{L}_{2e}^{n_q}(\mathbb{R}_+) \times \mathcal{L}_{2e}^{n_z}(\mathbb{R}_+)$  un système causal et  $\mathcal{L}_2$ -gain stable, et soit  $\Delta$  l'ensemble d'incertitudes défini dans la Définition C.22. Soit  $\Psi \in \mathcal{RH}_{\infty}^{n_y \times (n_q + n_p)}$  et  $M \in \mathbb{S}^{n_y}$  tels que  $\Pi(j\omega) := \Psi(j\omega)^* M \Psi(j\omega)$  satisfait  $\Pi_{11} \succeq \varepsilon_{\Pi} I_{n_q}$  et  $\Pi_{22} \preceq -\varepsilon_{\Pi} I_{n_p}$ , pour  $\varepsilon_{\Pi} > 0$ . Soit  $M_p \in \mathbb{S}^{n_z + n_w}$  la matrice définie dans (C.89) et soit  $\Upsilon$  défini dans (C.91). Supposons que :

(i) L'interconnexion en boucle  $(G_{\text{perf}}, \Delta)$  est bien posée.

(ii) L'IQC temporelle suivante est satisfaite

$$\int_0^T y_{\Delta}(t)^{\top} M y_{\Delta}(t) dt \geq 0, \quad \forall T \geq 0, \forall \Delta \in \Delta, \forall q \in \mathcal{L}_{2e}^{n_q}(\mathbb{R}_+) \quad (\text{C.92})$$

$$\text{avec } y_{\Delta} = \Psi \begin{bmatrix} \mathbb{I} \\ \Delta \end{bmatrix} (q).$$

(iii) Il existe  $\varepsilon > 0$  de telle sorte que l'IQC temporelle suivante est satisfaite

$$\int_0^T y_G(t)^{\top} \begin{bmatrix} M & 0 \\ 0 & M_p \end{bmatrix} y_G(t) dt \leq -\varepsilon \left\| \begin{bmatrix} p \\ w \end{bmatrix} \right\|_{2,T}^2, \quad \forall T \geq 0, \forall p \in \mathcal{L}_{2e}^{n_p}(\mathbb{R}_+), \forall w \in \mathcal{L}_{2e}^{n_w}(\mathbb{R}_+) \quad (\text{C.93})$$

$$\text{avec } y_G = \text{diag}(\Psi, I_{n_z + n_w}) \Upsilon(p, w).$$

Alors, l'interconnexion en boucle  $(G_{\text{perf}}, \Delta)$  est robustement  $\mathcal{L}_2$ -gain stable par rapport à  $\Delta$ , avec un  $\mathcal{L}_2$ -gain inférieur ou égal à  $\gamma$ .  $\lrcorner$

Dans les Théorèmes C.35 et C.36, l'évaluation de la stabilité et de la performance robuste a été divisée en deux parties. Le raisonnement derrière cette approche est d'encapsuler dans le bloc incertain  $\Delta$  tous les composants gênants du système (tels que les paramètres incertains, les dynamiques non modélisées, les non-linéarités, les retards, etc.), et d'utiliser  $G_{\text{perf}}$  pour représenter le système « nominal », qui est généralement « bien comporté » (dans le sens où tous les composants gênants ont été isolés dans le bloc  $\Delta$ ) et bien connu. L'analyse est ensuite subdivisée en deux problèmes complémentaires :

1. Trouver  $(M, \Psi)$  pour lequel on sait que (C.86) (resp. (C.92)) est satisfait pour  $\Delta \in \Delta$ .
2. Evaluer si (C.87) (resp. (C.93)) est satisfait pour  $G$  (resp.  $G_{\text{perf}}$ ).

En général, le choix du multiplicateur  $(M, \Psi)$  n'est pas unique. En fait, il est choisi dans une classe de multiplicateurs en fonction de la structure de  $\Delta$ . Ceci est discuté dans la section suivante, où nous présentons un catalogue de multiplicateurs pour les incertitudes considérées dans ce mémoire.

Enfin, le problème numéro 2 nécessite de vérifier que l'IQC temporelle est satisfaite par le système, étant donné la paramétrisation du multiplicateur  $(M, \Psi)$ . Dans notre cas, nous avons affaire à des systèmes affines par morceaux. Notre objectif est de proposer des conditions d'analyse qui peuvent être efficacement résolues grâce à l'optimisation convexe, comme nous verrons par la suite.

TABLE C.1 – Catalogue de multipliers II

Incertitude $\Delta$	Multiplieur $\Pi(j\omega)$
Scalaire réel constant répété $p(t) = \delta_I q(t),  \delta_I  \leq 1$	$\begin{bmatrix} X_D(j\omega) & X_G(j\omega) \\ X_G(j\omega)^* & -X_D(j\omega) \end{bmatrix}$ , avec $\begin{cases} X_D(j\omega) = X_D(j\omega)^* \succ 0 \\ X_G(j\omega) = -X_G(j\omega)^* \end{cases}$
Incertitude dynamique LTI $\hat{p}(j\omega) = \Delta_I(j\omega)\hat{q}(j\omega), \ \Delta_I\ _2 \leq 1$	$\begin{bmatrix} x_D(j\omega)I_{n_q} & 0 \\ 0 & -x_D(j\omega)I_{n_p} \end{bmatrix}$ , avec $x_D(j\omega) \succ 0$
Scalaire réel variant dans le temps répété $p(t) = \delta_V(t)q(t),  \delta_V(t)  \leq 1, \forall t \geq 0$	$\begin{bmatrix} X_D & X_G \\ X_G^\top & -X_D \end{bmatrix}$ , avec $\begin{cases} X_D = X_D^\top \succ 0 \\ X_G = -X_G^\top \end{cases}$
Incertitude dynamique générale $p = \Delta_V(q), \ \Delta_V\ _2 \leq 1$	$\begin{bmatrix} x_D I_{n_q} & 0 \\ 0 & -x_D I_{n_p} \end{bmatrix}$ , avec $x_D > 0$
Non-linéarité sans mémoire dans le secteur $\text{Sect}(\kappa_1, \kappa_2)$ , avec $\kappa_1 \leq 0 \leq \kappa_2$ $p = -\varphi(q), \kappa_1 \leq \varphi(q)/q \leq \kappa_2$	$\begin{bmatrix} -2\kappa_1\kappa_2 & -(\kappa_1 + \kappa_2) \\ -(\kappa_1 + \kappa_2) & -2 \end{bmatrix}$

### Multipliers pour la stabilité robuste

Dans la Table C.1 nous fournissons un catalogue de multipliers valables pour la classe d'incertitudes  $\Delta$ , ainsi qu'un multiplieur pour les non-linéarités sans mémoire dans un secteur. Une liste étendue de multipliers dépendants de la fréquence pour une large classe d'incertitudes peut être trouvée dans la littérature, voir par exemple [111, 174].

Les multipliers dans la Table C.1 sont exprimés dans le domaine fréquentiel, alors que les IQCs que nous devons vérifier ont été écrites dans le domaine temporel. Nous savons que tout multiplieur  $\Pi \in \mathcal{RL}_\infty^{n_q+n_p}$  peut être factorisé comme  $\Pi = \Psi^* M \Psi$ , où  $M \in \mathbb{S}^{n_y}$  et  $\Psi \in \mathcal{RH}_\infty^{n_y \times (n_q+n_p)}$  [154]. Dans ce cas, nous disons que  $(M, \Psi)$  est une factorisation de  $\Pi$ . Cette factorisation n'est pas unique, et nous verrons que l'existence d'un choix particulier de  $(M, \Psi)$  sera capitale dans l'établissement du résultat dans le domaine temporel. Supposons que  $\Psi$  admet une représentation d'espace d'état donnée par

$$\begin{cases} \dot{\psi}(t) = A_\psi \psi(t) + B_{\psi q} q(t) + B_{\psi p} p(t) \\ y(t) = C_\psi \psi(t) + D_{\psi q} q(t) + D_{\psi p} p(t) \\ \psi(0) = 0, \end{cases} \quad (\text{C.94})$$

et définissons

$$\hat{y}(j\omega) := \Psi(j\omega) \begin{bmatrix} \hat{q}(j\omega) \\ \hat{p}(j\omega) \end{bmatrix} \quad (\text{C.95})$$

pour les signaux  $q \in \mathcal{L}_2^{n_q}(\mathbb{R}_+)$  et  $p \in \mathcal{L}_2^{n_p}(\mathbb{R}_+)$ . Alors, pour tout  $p = \Delta(q)$ , l'IQC fréquentielle

$$\int_{-\infty}^{\infty} \begin{bmatrix} \hat{q}(j\omega) \\ \hat{p}(j\omega) \end{bmatrix}^* \Pi(j\omega) \begin{bmatrix} \hat{q}(j\omega) \\ \hat{p}(j\omega) \end{bmatrix} d\omega \geq 0 \quad (\text{C.96})$$

peut être réécrite à l'aide de l'égalité de Parseval comme

$$\int_0^{\infty} y(t)^\top M y(t) dt \geq 0, \quad (\text{C.97})$$

où  $y$  est la sortie du système LTI (C.94). De ceci nous avons que, si  $(M, \Psi)$  est une factorisation de  $\Pi$ , l'IQC (C.96) est satisfaite si et seulement si  $y$ , défini comme dans (C.95), satisfait (C.97).

La condition (ii) dans le Théorème C.35 requiert que (C.97) soit satisfaite non seulement de 0 à  $\infty$ , mais de 0 à  $T$ , pour tout  $T \geq 0$ . Cependant, d'après le raisonnement ci-dessus, l'utilisation de multipliers dépendants de la fréquence assure seulement (via l'égalité de Parseval) que la contrainte est satisfaite pour  $T \rightarrow \infty$ . En général, (C.97) n'implique pas que l'intégrale entre 0 et  $T$  arbitraire est non négative. Comme cela a été montré dans [154], cette implication dépend de la factorisation  $(M, \Psi)$  de  $\Pi$ .

Introduisons la notion de *factorisation doublement dure*, proposée dans [23].

**DÉFINITION C.37 (Factorisation doublement dure)**

Soit le multiplicateur  $\Pi \in \mathcal{R}\mathcal{L}_{\infty}^{(n_q+n_p) \times (n_q+n_p)}$  factorisé comme  $\Pi = \Psi^* M \Psi$ , où  $M \in \mathbb{S}^{n_y}$  et  $\Psi \in \mathcal{R}\mathcal{H}_{\infty}^{n_y \times (n_q+n_p)}$ . Alors  $(M, \Psi)$  est dit être une factorisation doublement dure de  $\Pi$  si pour deux opérateurs causaux bornés  $\Delta_1$  et  $\Delta_2$ , les deux conditions suivantes sont vérifiées :

1. L'IQC

$$\int_{-\infty}^{\infty} \begin{bmatrix} \hat{q}(j\omega) \\ \hat{p}(j\omega) \end{bmatrix}^* \Pi(j\omega) \begin{bmatrix} \hat{q}(j\omega) \\ \hat{p}(j\omega) \end{bmatrix} d\omega \geq 0, \quad \forall q \in \mathcal{L}_{2e}^{n_q}(\mathbb{R}_+) \quad (\text{C.98})$$

avec  $p = \Delta_1(q)$ , implique que

$$\int_0^T y_{\Delta_1}(t)^{\top} M y_{\Delta_1}(t) dt \geq 0, \quad \forall T \geq 0, \forall q \in \mathcal{L}_{2e}^{n_q}(\mathbb{R}_+) \quad (\text{C.99})$$

$$\text{avec } y_{\Delta_1} = \Psi \begin{bmatrix} \mathbb{I} \\ \Delta_1 \end{bmatrix} (q).$$

2. L'IQC

$$\int_{-\infty}^{\infty} \begin{bmatrix} \hat{q}(j\omega) \\ \hat{p}(j\omega) \end{bmatrix}^* \Pi(j\omega) \begin{bmatrix} \hat{q}(j\omega) \\ \hat{p}(j\omega) \end{bmatrix} d\omega \leq -\varepsilon \|p\|_2^2, \quad \forall p \in \mathcal{L}_{2e}^{n_p}(\mathbb{R}_+) \quad (\text{C.100})$$

avec  $q = \Delta_2(p)$ , implique que

$$\int_0^T y_{\Delta_2}(t)^{\top} M y_{\Delta_2}(t) dt \leq -\varepsilon \|p\|_{2,T}^2, \quad \forall T \geq 0, \forall p \in \mathcal{L}_{2e}^{n_p}(\mathbb{R}_+) \quad (\text{C.101})$$

$$\text{avec } y_{\Delta_2} = \Psi \begin{bmatrix} \Delta_2 \\ \mathbb{I} \end{bmatrix} (p). \quad \lrcorner$$

Afin d'utiliser des multipliers dépendants de la fréquence dans le domaine temporel, nous devons nous assurer qu'ils admettent une factorisation doublement dure, de sorte que les IQCs dans les Théorèmes C.35 et C.36 peuvent être satisfaites. La question est donc de savoir quelles sont les conditions suffisantes pour qu'un multiplicateur donné admette une factorisation dure. Pour répondre à cette question, concentrons-nous sur une classe particulière de multipliers, appelés *multipliers positifs-négatifs* [22].

DÉFINITION C.38 (**Multiplieurs positifs-négatifs**)

Soit  $\Pi \in \mathcal{RH}_\infty^{(n_q+n_p) \times (n_q+n_p)}$  partitionné comme

$$\Pi(j\omega) = \begin{bmatrix} \Pi_{11}(j\omega) & \Pi_{12}(j\omega) \\ \Pi_{12}(j\omega)^* & \Pi_{22}(j\omega) \end{bmatrix}. \quad (\text{C.102})$$

Alors,  $\Pi$  est appelé un multiplieur positif-négatif s'il existe  $\varepsilon_\Pi > 0$  tel que  $\Pi_{11} \succeq \varepsilon_\Pi I_{n_q}$  et  $\Pi_{22} \preceq -\varepsilon_\Pi I_{n_p}$ . ┘

Une classe considérable d'incertitudes peut être représentée par des contraintes quadratiques intégrales définies par des multiplieurs positif-négatif. A savoir, tous les multiplieurs présentés dans la Table C.1 sont dans cette catégorie.

Le prochain résultat, pris de [23], donne un lien entre les multiplieurs positifs-négatifs et les factorisations doublement dures.

LEMME C.39

Soit  $\Pi = \Pi^* \in \mathcal{RL}_\infty^{(n_q+n_p) \times (n_q+n_p)}$ . Si  $\Pi$  est positif-négatif, alors  $\Pi$  admet une factorisation doublement dure. ┘

A partir de ce résultat, nous voyons qu'il est possible d'utiliser les multiplieurs dans la Table C.1 pour définir les IQCs dans la condition (ii) des Théorèmes C.35 et C.36. Tout ce qui reste pour évaluer la stabilité et la performance est de vérifier si la condition (iii) dans les théorèmes mentionnés ci-dessus est satisfaite. Dans la section suivante, nous verrons comment paramétrer les multiplieurs afin de pouvoir les calculer numériquement via l'optimisation convexe.

**Paramétrisation des multiplieurs**

Dans la section précédente, nous avons vu comment obtenir une classe de multiplieurs pour chaque type d'incertitude dans le bloc structuré  $\Delta \in \mathbf{\Delta}$ , et les résultats sont catalogués dans la Table C.1.

Dans le cas des incertitudes invariantes dans le temps  $\delta_I$  et  $\Delta_I$ , les multiplieurs présentés dans les deux premières lignes de la Table C.1 sont un sous-ensemble de l'espace fonctionnel  $\mathcal{RL}_\infty^{(n_q+n_p) \times (n_q+n_p)}$ , qui est de dimension infinie. Alors, si nous voulons proposer des conditions pour évaluer la stabilité et la performance sur la base de procédures numériques utilisant l'optimisation convexe, nous devons utiliser une certaine paramétrisation de  $\Pi$ .

Notons  $W$  un opérateur donné dans  $\mathcal{RL}_\infty^{k \times k}$ . Nous choisissons  $W$  dans l'ensemble des fonctions de transfert rationnelles propres d'ordre  $\ell$ . L'ordre fixe nous permettra de construire  $W$  en utilisant des combinaisons linéaires des éléments d'une base de dimension finie. Nous allons aussi fixer le dénominateur de  $W$  comme la fonction scalaire  $d(s) = s^\ell + d_{\ell-1}s^{\ell-1} + \dots + d_0$ , avec des racines dans  $\mathbb{C}^-$ . Dans ce cas,  $W$  peut être représenté comme

$$W(j\omega) = \frac{N(j\omega)}{d(j\omega)^*d(j\omega)}, \quad (\text{C.103})$$

où  $N : \mathbb{C} \rightarrow \mathbb{C}^{k \times k}$  est une matrice de fonctions polynomiales avec coefficients réels d'ordre  $\ell$ . Fixons une base pour  $N$  en définissant la fonction vectorielle  $B_\ell : \mathbb{C} \rightarrow \mathbb{C}^{\ell+1}$  comme

$$B_\ell(s) = \begin{bmatrix} 1 \\ s \\ \vdots \\ s^\ell \end{bmatrix}. \quad (\text{C.104})$$

Alors,  $N$  peut être paramétré comme  $N(j\omega) = (B_\ell(j\omega) \otimes I_k)^* M (B_\ell(j\omega) \otimes I_k)$ , où  $M \in \mathbb{S}^{k(\ell+1)}$  est une matrice de coefficients. En utilisant cette description,  $W$  peut être représenté comme

$$\begin{aligned} W(j\omega) &= \left( \frac{B_\ell(j\omega)}{d(j\omega)} \otimes I_k \right)^* M \left( \frac{B_\ell(j\omega)}{d(j\omega)} \otimes I_k \right) \\ &=: \Psi_b(j\omega)^* M \Psi_b(j\omega), \end{aligned} \quad (\text{C.105})$$

avec  $\Psi_b$  la base de  $W$ . La paramétrisation dépend clairement de  $d$  et de l'ordre  $\ell$  de la base.

L'opérateur  $W$  représente les opérateurs  $X_D$ ,  $X_G$  et  $x_D$ , présentés dans la Table C.1. Tout ce qui reste est alors de définir un ensemble  $\mathbf{M}$  tel que chaque  $M \in \mathbf{M}$  donne un opérateur satisfaisant les contraintes de la Table C.1. Considérons le cas d'une incertitude paramétrique unique pour illustrer l'approche. Comme nous l'avons vu dans la Section C.4.4, ce type d'incertitude satisfait l'IQC défini par le multiplicateur

$$\Pi(j\omega) = \begin{bmatrix} X_D(j\omega) & X_G(j\omega) \\ X_G(j\omega)^* & -X_D(j\omega) \end{bmatrix}, \quad (\text{C.106})$$

avec  $X_D = X_D^* \succ 0$  et  $X_G = -X_G^*$ . En utilisant la paramétrisation définie ci-dessus, nous pouvons écrire

$$\begin{aligned} X_D(j\omega) &= \left( \frac{B_\ell(j\omega)}{d(j\omega)} \otimes I_k \right)^* M_D \left( \frac{B_\ell(j\omega)}{d(j\omega)} \otimes I_k \right) \\ X_G(j\omega) &= \left( \frac{B_\ell(j\omega)}{d(j\omega)} \otimes I_k \right)^* M_G \left( \frac{B_\ell(j\omega)}{d(j\omega)} \otimes I_k \right). \end{aligned} \quad (\text{C.107})$$

Soit  $\mathbf{M}_D$  et  $\mathbf{M}_G$  des ensembles de matrices tels que  $M_D \in \mathbf{M}_D$  assure que  $X_D$  est Hermitien et positif-défini,  $M_G \in \mathbf{M}_G$  assure que  $X_G$  est antihermitienne. Les contraintes structurelles  $X_D = X_D^*$  et  $X_G = -X_G^*$  peuvent être assurées sans perte de généralité par une paramétrisation des matrices  $M_D$  et  $M_G$  [153]. Il reste à s'assurer que  $X_D$  est un opérateur défini-positif. Pour cela, nous utiliserons un résultat clé de l'automatique : le lemme de Kalman-Yakubovich-Popov (ou lemme KYP, pour faire court). Le lemme KYP concerne l'équivalence entre un critère dans le domaine fréquentiel et une LMI associée. La version suivante du lemme KYP provient de [132].

LEMME C.40

Étant donnés  $A \in \mathbb{R}^{n \times n}$ ,  $B \in \mathbb{R}^{n \times m}$ ,  $Q \in \mathbb{S}^{n+m}$ , avec  $\det(j\omega I - A) \neq 0$  pour  $\omega \in \overline{\mathbb{R}}$ , les deux affirmations suivantes sont équivalentes :

(i) L'inégalité fréquentielle suivante est satisfaite

$$\begin{bmatrix} (j\omega I - A)^{-1} B \\ I \end{bmatrix}^* Q \begin{bmatrix} (j\omega I - A)^{-1} B \\ I \end{bmatrix} \prec 0, \quad \forall \omega \in \overline{\mathbb{R}}. \quad (\text{C.108})$$

(ii) Il existe une matrice symétrique  $P \in \mathbb{S}^n$  telle que la LMI suivante est satisfaite

$$\begin{bmatrix} A^\top P + PA & PB \\ B^\top P & 0 \end{bmatrix} + Q \prec 0. \quad (\text{C.109})$$

L'équivalence correspondante est aussi valable pour des inégalités non strictes si, de plus, le paire  $(A, B)$  est contrôlable.  $\square$

Soit  $(A, B, C, D)$  une représentation minimale dans l'espace d'état de  $(B_\ell(s)/d(s) \otimes I_k)$ . La contrainte  $X_D \succ 0$  peut alors être réécrite comme

$$(C(j\omega - A)^{-1}B + D)^*(-M_D)(C(j\omega - A)^{-1}B + D) \prec 0, \quad \forall \omega \in \overline{\mathbb{R}}. \quad (\text{C.110})$$

En utilisant le lemme KYP, la contrainte ci-dessus est équivalente à l'existence de  $P = P^\top$  telle que

$$\begin{bmatrix} A^\top P + PA & B^\top P \\ \bullet & 0 \end{bmatrix} - [C \ D]^\top M_D [C \ D] \prec 0 \quad (\text{C.111})$$

Avec ceci, nous pouvons définir  $\mathbf{M}_D$  comme l'ensemble

$$\mathbf{M}_D := \left\{ M_D \in \mathbb{S}^{n_q(\ell+1)} \mid \exists P = P^\top \text{ s.t. (4.69), with } M_G \text{ ayant la structure dans [153]} \right\}. \quad (\text{C.112})$$

De la discussion ci-dessus, nous pouvons également définir l'ensemble  $\mathbf{M}_G$  comme

$$\mathbf{M}_G := \left\{ M_G \in \mathbb{R}^{n_q(\ell+1) \times n_q(\ell+1)} \mid M_G \text{ ayant la structure dans [153]} \right\}. \quad (\text{C.113})$$

Le multiplicateur  $\Pi$  pour les incertitudes paramétriques peut alors être paramétré comme  $\Pi \in \mathbf{\Pi}$ , avec

$$\mathbf{\Pi} := \{ \Pi \in \mathcal{RL}_\infty^{2n_q \times 2n_q} \mid \Pi = \Psi_b^* M \Psi_b, M \in \mathbf{M} \}, \quad (\text{C.114})$$

et où  $\Psi_b \in \mathcal{RH}_\infty^{2n_q(\ell+1) \times (n_q+n_p)}$  est donné par

$$\Psi_b(j\omega) := \text{diag} \left( \left( \frac{B_\ell(j\omega)}{d(j\omega)} \otimes I_{n_q} \right), \left( \frac{B_\ell(j\omega)}{d(j\omega)} \otimes I_{n_q} \right) \right), \quad (\text{C.115})$$

et

$$\mathbf{M} := \left\{ M \in \mathbb{S}^{2n_q(\ell+1)} \mid M = \begin{bmatrix} M_D & M_G \\ \bullet & -M_D \end{bmatrix}, M_D \in \mathbf{M}_D, M_G \in \mathbf{M}_G \right\}. \quad (\text{C.116})$$

Suivant le même raisonnement, la classe des multiplicateurs pour les incertitudes dynamiques LTI (deuxième ligne de la Table C.1) peut être aussi définie comme dans (C.114), avec  $\Psi_b \in \mathcal{RH}_\infty^{(n_q+n_p)(\ell+1) \times (n_q+n_p)}$  donné par

$$\Psi_b(j\omega) := \text{diag} \left( \left( \frac{B_\ell(j\omega)}{d(j\omega)} \otimes I_{n_q} \right), \left( \frac{B_\ell(j\omega)}{d(j\omega)} \otimes I_{n_p} \right) \right), \quad (\text{C.117})$$

et

$$\mathbf{M} := \left\{ M \in \mathbb{S}^{(n_q+n_p)(\ell+1)} \mid M = \begin{bmatrix} m_D \otimes I_{n_q} & 0 \\ \bullet & -m_D \otimes I_{n_p} \end{bmatrix}, m_D \in \mathbf{m}_D \right\}, \quad (\text{C.118})$$

avec

$$\mathbf{m}_D := \left\{ m_D \in \mathbb{S}^{\ell+1} \left| \exists P = P^\top \text{ s.t. } \begin{bmatrix} A^\top P + PA & B^\top P \\ \bullet & 0 \end{bmatrix} - [C \ D]^\top m_D [C \ D] \prec 0 \right. \right\}, \quad (\text{C.119})$$

où  $(A, B, C, D)$  est une représentation minimale dans l'espace d'états de  $B_\ell(s)/d(s)$ .

Nous pouvons mettre à jour la Table C.1 par rapport à la paramétrisation introduite dans cette section. Ceci est fait dans la Table C.2, où les différentes classes  $\mathbf{\Pi}$  sont définies.

TABLE C.2 – Catalogue des paramétrisations pour les multipliers dans la Table C.1

Incertitude $\Delta$	Paramétrisation $\Psi_b^* M \Psi_b$
Scalaire réel constant répété $p(t) = \delta_I q(t),  \delta_I  \leq 1$	$\Psi_b$ défini dans (C.115) $M \in \mathbf{M}$ , avec $\mathbf{M}$ défini dans (C.116)
Incertitude dynamique LTI $\hat{p}(j\omega) = \Delta_I(j\omega)\hat{q}(j\omega), \ \Delta_I\ _2 \leq 1$	$\Psi_b$ défini dans (C.117) $M \in \mathbf{M}$ , avec $\mathbf{M}$ défini dans (C.118)
Scalaire réel variant dans le temps répété $p(t) = \delta_V(t)q(t),  \delta_V(t)  \leq 1, \forall t \geq 0$	$\Psi_b = I_{2n_q}$ $M = \begin{bmatrix} X_D & X_G \\ X_G^* & -X_D \end{bmatrix}$ , avec $\begin{cases} X_D = X_D^\top \succ 0 \\ X_G = -X_G^\top \end{cases}$
Incertitude dynamique générale $p = \Delta_V(q), \ \Delta_V\ _2 \leq 1$	$\Psi_b = I_{n_q+n_p}$ $M = \begin{bmatrix} x_D I_{n_q} & 0 \\ 0 & -x_D I_{n_p} \end{bmatrix}$ , avec $x_D > 0$
Non-linéarité sans mémoire dans le secteur $\text{Sect}(\kappa_1, \kappa_2)$ , avec $\kappa_1 \leq 0 \leq \kappa_2$ $p = -\varphi(q), \kappa_1 \leq \varphi(q)/q \leq \kappa_2$	$\Psi_b = I_{n_q+n_p}$ $M = \begin{bmatrix} -2\kappa_1\kappa_2 & -(\kappa_1 + \kappa_2) \\ -(\kappa_1 + \kappa_2) & -2 \end{bmatrix}$

### Approche par dissipativité

Avec les résultats de la Section C.4.4 nous avons un catalogue de multipliers qui définissent des IQCs valides pour la classe d'incertitudes considérée. Alors, tout ce qui reste à conclure sur la stabilité et la performance du système incertain est de vérifier si l'IQC complémentaire est satisfaite par le système  $G$ . Comme nous l'avons déjà fait remarquer, puisque nous traitons des systèmes non linéaires  $G$ , l'approche proposée pour vérifier cela est au moyen de la théorie de la dissipativité, introduite dans la Section C.2.

Notons que (C.87) peut être réécrit comme

$$\int_0^T \varpi(p(t), y_G(t)) dt \geq 0, \quad \forall p \in \mathcal{L}_{2e}^{n_p}(\mathbb{R}_+), \forall T \geq 0, \quad (\text{C.120})$$

avec

$$\varpi(p, y_G) := - \begin{bmatrix} y_G \\ p \end{bmatrix}^\top \begin{bmatrix} M & 0 \\ 0 & \varepsilon I_{n_p} \end{bmatrix} \begin{bmatrix} y_G \\ p \end{bmatrix} \text{ et } y_G = \Psi \begin{bmatrix} G \\ \mathbb{I} \end{bmatrix} (p). \quad (\text{C.121})$$

Rappelons que le Théorème C.7 a fourni une connexion entre une inégalité intégrale concernant les signaux d'entrée et de sortie d'un opérateur et la dissipativité. Alors, en considérant la relation intégrale (C.120), nous utilisons ce résultat pour proposer le corollaire suivant.



COROLLAIRE C.41

Soit  $G : \mathcal{L}_{2e}^{n_p}(\mathbb{R}_+) \rightarrow \mathcal{L}_{2e}^{n_q}(\mathbb{R}_+)$  un système causal et  $\mathcal{L}_2$ -gain stable, et soit  $\Delta$  l'ensemble des incertitudes défini dans la Définition C.22. Soit  $\Pi \in \mathcal{RL}_{\infty}^{(n_q+n_p) \times (n_q+n_p)}$  un multiplicateur factorisé comme  $\Pi = \Psi_b^* M \Psi_b$ , avec  $\Psi_b \in \mathcal{RH}_{\infty}^{n_y \times (n_q+n_p)}$ , et  $M \in \mathbf{M}$ , comme défini dans la Table C.2. Supposons que :

(i) L'interconnexion en boucle  $(G, \Delta)$  est bien posée pour tout  $\Delta \in \Delta$ .

(ii) Le système filtré  $\Psi_b \begin{bmatrix} G \\ \mathbb{I} \end{bmatrix}$  est dissipatif par rapport au taux d'échange  $\varpi$ , comme défini dans (C.121).

Alors, l'interconnexion en boucle  $(G, \Delta)$  est robustement stable par rapport à  $\Delta$ .  $\lrcorner$

Il est intéressant de noter qu'en choisissant un multiplicateur adéquat dans la Table C.1, on assure a priori que l'IQC définie par  $\Pi$  est satisfaite pour chaque  $\Delta \in \Delta$ . Cela garantit également que  $\Pi$  est un multiplicateur positif-négatif, ce qui est important lorsqu'on passe du domaine fréquentiel au temporel. De plus, le bien-posé est une exigence fondamentale lorsque le système incertain est censé représenter un système physique réel, et est donc naturellement supposé être vrai. Donc, pour utiliser le Corollaire C.41, il ne reste plus qu'à évaluer la dissipativité du système filtré  $\Psi \text{col}(G, \mathbb{I})$ .

Le même raisonnement peut être appliqué à l'évaluation de la performance robuste via le Théorème C.36.

COROLLAIRE C.42

Soit  $G_{\text{perf}} : \mathcal{L}_{2e}^{n_p}(\mathbb{R}_+) \times \mathcal{L}_{2e}^{n_w}(\mathbb{R}_+) \rightarrow \mathcal{L}_{2e}^{n_q}(\mathbb{R}_+) \times \mathcal{L}_{2e}^{n_z}(\mathbb{R}_+)$  un système causal et  $\mathcal{L}_2$ -gain stable, et soit  $\Delta$  l'ensemble des incertitudes défini dans la Définition C.22. Soit  $\Pi \in \mathcal{RL}_{\infty}^{(n_q+n_p) \times (n_q+n_p)}$  un multiplicateur factorisé comme  $\Pi = \Psi_b^* M \Psi_b$ , avec  $\Psi_b \in \mathcal{RH}_{\infty}^{n_y \times (n_q+n_p)}$ , et  $M \in \mathbf{M}$ , comme défini dans la Table C.2, et  $M_p \in \mathbb{S}^{n_z+n_w}$  la matrice définie dans (C.89). Enfin, soit  $\Upsilon$  comme définie dans (C.91). Supposons que :

(i) l'interconnexion en boucle  $(G_{\text{perf}}, \Delta)$  est bien posée pour tout  $\Delta \in \Delta$  ;

(ii) le système filtré  $\text{diag}(\Psi_b, I_{n_z+n_w})\Upsilon$ , est dissipatif par rapport au taux d'échange  $\varpi$  défini par

$$\varpi(p, w, y_G) := - \begin{bmatrix} y_G \\ p \\ w \end{bmatrix}^{\top} \left[ \begin{array}{cc|c} M & 0 & 0 \\ 0 & M_p & 0 \\ \hline 0 & 0 & \varepsilon I_{n_p+n_w} \end{array} \right] \begin{bmatrix} y_G \\ p \\ w \end{bmatrix}, \quad (\text{C.122})$$

Alors, l'interconnexion en boucle  $(G_{\text{perf}}, \Delta)$  est robustement  $\mathcal{L}_2$ -gain stable par rapport à  $\Delta$ , avec un  $\mathcal{L}_2$ -gain inférieur ou égal à  $\gamma$ .  $\lrcorner$

Nous considérons maintenant comment appliquer les résultats ci-dessus aux systèmes affines par morceaux.

**Application à des systèmes affines par morceaux**

Dans cette section, nous considérons l'application des Corollaires C.41 et C.42 à l'analyse des systèmes affines par morceaux incertains.

**Stabilité robuste**

Commençons par considérer le problème de la stabilité robuste des systèmes affines par morceaux incertains. Le système nominal  $G$  sera alors considéré comme le système affine par morceaux  $G_{\text{PWA}}$ , donné par :

$$q = G_{\text{PWA}}(p) \begin{cases} \dot{x}_G(t) = A_i x_G(t) + a_i + B_{p,i} p(t) \\ q(t) = C_{q,i} x_G(t) + c_{q,i} + D_{qp} p(t) \\ x_G(0) = 0 \end{cases} \text{ pour } x_G(t) \in X_i \quad (\text{C.123})$$

avec  $x_G(t) \in \mathbb{R}^n$ ,  $p(t) \in \mathbb{R}^{n_p}$  et  $q(t) \in \mathbb{R}^{n_q}$ .

Notre objectif est d'établir la dissipativité du système filtré  $\Psi \text{col}(G_{\text{PWA}}, \mathbb{I})$ . Nous rappelons que le filtre  $\Psi$  a la représentation minimale (C.94). Le système filtré peut alors être écrit comme le système affine par morceaux suivant :

$$y_G = \left( \Psi \begin{bmatrix} G_{\text{PWA}} \\ \mathbb{I} \end{bmatrix} \right) (p) \begin{cases} \dot{x}(t) = \hat{A}_i x(t) + \hat{a}_i + \hat{B}_i p(t) \\ y_G(t) = \hat{C}_i x(t) + \hat{c}_i + \hat{D} p(t) \\ x(0) = 0 \end{cases} \text{ pour } x(t) \in \hat{X}_i \quad (\text{C.124})$$

où  $x = \text{col}(x_G, \psi)$ .

Rappelons que les régions  $X_i$ , pour  $i \in \mathcal{I} := \{1, \dots, N\}$ , sont des ensembles polyédriques convexes fermés définis par

$$X_i = \{x_G \in X \mid G_i x_G + g_i \succeq 0\} \quad (\text{C.125})$$

avec des intérieurs non vides disjoints deux à deux tels que  $\bigcup_{i \in \mathcal{I}} X_i = X$ . A partir de la géométrie de  $X_i$ , l'intersection  $X_i \cap X_j$  entre deux régions différentes est toujours contenue dans un hyperplan. On note à nouveau  $E_{ij}^T \in \mathbb{R}^n$  et  $e_{ij} \in \mathbb{R}$  les vecteurs et les scalaires tels que

$$X_i \cap X_j \subseteq \{x_G \in X \mid E_{ij} x_G + e_{ij} = 0\}. \quad (\text{C.126})$$

Notons par  $\hat{X} = X \times \mathbb{R}^\ell$  l'espace d'état du système filtré. La partition  $\{\hat{X}_i\}_{i=1, \dots, N}$  est induite par la partition d'origine de  $X$ . Par conséquent, nous pouvons définir  $\hat{X}_i := \{x \in \hat{X} \mid x = \text{col}(x_G, \psi), x_G \in X_i\}$ . En définissant les matrices

$$\hat{G}_i = \begin{bmatrix} G_i & 0 \end{bmatrix} \quad \hat{g}_i = g_i, \quad (\text{C.127})$$

la région  $\hat{X}_i$  peut être définie de manière équivalente

$$\hat{X}_i = \{x \in \hat{X} \mid \hat{G}_i x + \hat{g}_i \succeq 0\} \quad (\text{C.128})$$

De même, l'intersection entre deux régions  $\hat{X}_i$  et  $\hat{X}_j$  est contenu dans l'hyperplan donné par

$$\hat{X}_i \cap \hat{X}_j \subseteq \left\{ x \in \hat{X} \mid \hat{E}_{ij} x + \hat{e}_{ij} = 0 \right\}, \quad (\text{C.129})$$

où la matrice  $\hat{E}_{ij}$  et le scalaire  $\hat{e}_{ij}$  sont donnés par

$$\hat{E}_{ij} = \begin{bmatrix} E_{ij} & 0 \end{bmatrix} \quad \hat{e}_{ij} = e_{ij}. \quad (\text{C.130})$$

Nous cherchons à évaluer la dissipativité du système filtré en construisant une fonction de stockage quadratique par morceaux donnée par

$$S(x) = \begin{cases} x^\top P_i x & \text{for } x \in \hat{X}_i, i \in \mathcal{I}_0 \\ \begin{bmatrix} x \\ 1 \end{bmatrix}^\top \begin{bmatrix} P_i & q_i \\ \bullet & r_i \end{bmatrix} \begin{bmatrix} x \\ 1 \end{bmatrix} & \text{for } x \in \hat{X}_i, i \in \mathcal{I} \setminus \mathcal{I}_0 \end{cases} \quad (\text{C.131})$$

Basé sur la représentation affine par morceaux du système filtré présenté ci-dessus, nous proposons le théorème suivant qui spécialise le Corollaire C.41 au cas des systèmes affines par morceaux avec des fonctions de stockage quadratique par morceaux.

THÉORÈME C.43

Soit  $\Pi \in \mathcal{RL}_\infty^{(n_q+n_p) \times (n_q+n_p)}$  un multiplicateur factorisé comme  $\Pi = \Psi_b^* M \Psi_b$ , avec la base  $\Psi_b \in \mathcal{RH}_\infty^{n_y \times (n_q+n_p)}$  et  $M \in \mathbf{M}$  comme défini dans la Table C.2. Soit le système PWA filtré  $\Psi_b \text{col}(G_{\text{PWA}}, \mathbb{I})$  défini comme dans (C.124). Supposons que l'interconnexion  $(G_{\text{PWA}}, \Delta)$  est bien posée pour chaque  $\Delta \in \mathbf{\Delta}$ . S'il existe des matrices symétriques  $P_i \in \mathbb{S}^n$ , des vecteurs  $q_i \in \mathbb{R}^n$ , des scalaires  $r_i \in \mathbb{R}$ , des matrices symétriques  $U_i, W_i \in \mathbb{S}^{l_i}$  avec des coefficients non négatifs et zéro sur la diagonale, et des vecteurs  $L_{ijkl} \in \mathbb{R}^{n+1}$  tels que

$$\begin{cases} P_i \succeq 0 \\ \begin{bmatrix} \hat{A}_i^\top P_i + P_i \hat{A}_i & P_i \hat{B}_i \\ \hat{B}_i^\top P_i & 0 \end{bmatrix} + \begin{bmatrix} \hat{C}_i & \hat{D} \\ 0 & I_{n_p} \end{bmatrix}^\top \begin{bmatrix} M & 0 \\ 0 & \varepsilon I_{n_p} \end{bmatrix} \begin{bmatrix} \hat{C}_i & \hat{D} \\ 0 & I_{n_p} \end{bmatrix} \preceq 0 \end{cases} \quad \text{pour } i \in \mathcal{I}_0 \quad (\text{C.132})$$

$$\begin{cases} \begin{bmatrix} P_i - \hat{E}_i^\top U_i \hat{E}_i & q_i - \hat{E}_i^\top U_i \hat{e}_i \\ \bullet & r_i - \hat{e}_i^\top U_i \hat{e}_i \end{bmatrix} \succeq 0 \\ \begin{bmatrix} \left( \hat{A}_i^\top P_i + P_i \hat{A}_i + \right) & \left( P_i \hat{a}_i + \hat{A}_i^\top q_i + \right) & P_i \hat{B}_i \\ \left( \hat{E}_i^\top W_i \hat{E}_i \right) & \left( \hat{E}_i^\top W_i \hat{e}_i \right) & 0 \\ \bullet & \left( 2q_i^\top \hat{a}_i + \right) & 0 \\ \bullet & \left( + \hat{e}_i^\top W_i \hat{e}_i \right) & 0 \end{bmatrix} + \\ + \begin{bmatrix} \hat{C}_i & \hat{c}_i & \hat{D} \\ 0 & 0 & I_{n_p} \end{bmatrix}^\top \begin{bmatrix} M & 0 \\ 0 & \varepsilon I_{n_p} \end{bmatrix} \begin{bmatrix} \hat{C}_i & \hat{c}_i & \hat{D} \\ 0 & 0 & I_{n_p} \end{bmatrix} \preceq 0 \end{cases} \quad \text{pour } i \in \mathcal{I} \setminus \mathcal{I}_0 \quad (\text{C.133})$$

$$\begin{bmatrix} P_i & q_i \\ \bullet & r_i \end{bmatrix} = \begin{bmatrix} P_j & q_j \\ \bullet & r_j \end{bmatrix} + L_{ij} \begin{bmatrix} \hat{E}_{ij} & \hat{e}_{ij} \end{bmatrix} + \begin{bmatrix} \hat{E}_{ij} & \hat{e}_{ij} \end{bmatrix}^\top L_{ij}^\top \quad \begin{array}{l} \text{pour } (i, j) \\ \text{s.t. } X_i \cap X_j \neq \emptyset \end{array} \quad (\text{C.134})$$

où nous définissons  $q_i = 0$  et  $r_i = 0$  pour  $i \in \mathcal{I}_0$ . Alors, le système PWA incertain (C.67) est robustement stable par rapport à  $\mathbf{\Delta}$ .  $\square$

Performance robuste

Nous considérons maintenant la performance robuste des systèmes affines par morceaux incertains. En raison de la présence des signaux de performance  $w$  et  $z$ , nous considérons le

système affine par morceaux  $G_{\text{PWA}}$  donné par :

$$\begin{bmatrix} q \\ z \end{bmatrix} = G_{\text{PWA}} \left( \begin{bmatrix} p \\ w \end{bmatrix} \right) \begin{cases} \dot{x}(t) = A_i x_G(t) + a_i + B_{p,i} p(t) + B_{w,i} w(t) \\ q(t) = C_{q,i} x_G(t) + c_{q,i} + D_{qp} p(t) + D_{qw} w(t) \\ z(t) = C_{z,i} x_G(t) + c_{z,i} + D_{zp} p(t) + D_{zw} w(t) \\ x_G(0) = 0 \end{cases} \text{ pour } x_G(t) \in X_i \quad (\text{C.135})$$

Soit  $\Upsilon_{\text{PWA}}$  défini de façon analogue à  $\Upsilon$  dans (C.91), i.e.  $(q, p, z, w) = \Upsilon_{\text{PWA}}(p, w)$ , avec  $(q, z) = G_{\text{PWA}}(p, w)$ . Afin d'analyser les performances via le Corollaire C.42, nous devons évaluer la dissipativité du système filtré  $\text{diag}(\Psi, I_{n_z+n_w})\Upsilon_{\text{PWA}}$ . Ce système peut être écrit comme le système affine par morceaux suivant

$$y_G = \begin{bmatrix} \Psi & 0 \\ 0 & I_{n_z+n_w} \end{bmatrix} \Upsilon_{\text{PWA}} \left( \begin{bmatrix} p \\ w \end{bmatrix} \right) \begin{cases} \dot{x}(t) = \hat{A}_i x(t) + \hat{a}_i + \hat{B}_i u(t) \\ y_G(t) = \hat{C}_i x(t) + \hat{c}_i + \hat{D} u(t) \\ x(0) = 0 \end{cases} \text{ pour } x(t) \in X_i \quad (\text{C.136})$$

où  $x = \text{col}(x_G, \psi)$ ,  $u = \text{col}(p, w)$ .

Après la discussion et les définitions fournies dans la Section C.4.4, nous proposons le théorème suivant pour l'évaluation de la performance des systèmes affines par morceaux incertains.

#### THÉORÈME C.44

Soit  $\Pi \in \mathcal{RL}_{\infty}^{(n_q+n_p) \times (n_q+n_p)}$  un multiplieur factorisé comme  $\Pi = \Psi_b^* M \Psi_b$ , avec la base  $\Psi_b \in \mathcal{RH}_{\infty}^{n_y \times (n_q+n_p)}$  et  $M \in \mathbf{M}$  comme défini dans la Table C.2, et soit  $M_p$  la matrice définie dans (C.89). Soit le système PWA filtré  $\text{diag}(\Psi_b, I_{n_z+n_w})\Upsilon_{\text{PWA}}$  défini comme dans (C.136). Supposons que l'interconnexion  $(G_{\text{PWA}}, \Delta)$  est bien posée pour tout  $\Delta \in \Delta$ . S'il existe des matrices symétriques  $P_i \in \mathbb{S}^n$ , des vecteurs  $q_i \in \mathbb{R}^n$ , des scalaires  $r_i \in \mathbb{R}$ , des matrices symétriques  $U_i, W_i \in \mathbb{S}^{l_i}$  avec des coefficients non négatifs et zéro sur la diagonale, et des vecteurs  $L_{ijkl} \in \mathbb{R}^{n+1}$  tels que

$$\begin{cases} P_i \succeq 0 \\ \begin{bmatrix} \hat{A}_i^T P_i + P_i \hat{A}_i & P_i \hat{B}_i \\ \hat{B}_i^T P_i & 0 \end{bmatrix} + \begin{bmatrix} \hat{C}_i & \hat{D} \\ 0 & I_{n_p+n_w} \end{bmatrix}^T \hat{M}_p \begin{bmatrix} \hat{C}_i & \hat{D} \\ 0 & I_{n_p+n_w} \end{bmatrix} \preceq 0 \end{cases} \text{ pour } i \in \mathcal{I}_0 \quad (\text{C.137})$$

$$\begin{cases} \begin{bmatrix} P_i - \hat{E}_i^T U_i \hat{E}_i & q_i - \hat{E}_i^T U_i \hat{e}_i \\ \bullet & r_i - \hat{e}_i^T U_i \hat{e}_i \end{bmatrix} \succeq 0 \\ \begin{bmatrix} \left( \hat{A}_i^T P_i + P_i \hat{A}_i + \right) & \left( P_i \hat{a}_i + \hat{A}_i^T q_i + \right) & P_i \hat{B}_i \\ \hat{E}_i^T W_i \hat{E}_i & \hat{E}_i^T W_i \hat{e}_i & \\ \bullet & \left( 2q_i^T \hat{a}_i + \right) & 0 \\ \bullet & \hat{e}_i^T W_i \hat{e}_i & 0 \end{bmatrix} + \\ + \begin{bmatrix} \hat{C}_i & \hat{c}_i & \hat{D} \\ 0 & 0 & I_{n_p+n_w} \end{bmatrix}^T \hat{M}_p \begin{bmatrix} \hat{C}_i & \hat{c}_i & \hat{D} \\ 0 & 0 & I_{n_p+n_w} \end{bmatrix} \preceq 0 \end{cases} \text{ pour } i \in \mathcal{I} \setminus \mathcal{I}_0 \quad (\text{C.138})$$

$$\begin{bmatrix} P_i & q_i \\ \bullet & r_i \end{bmatrix} = \begin{bmatrix} P_j & q_j \\ \bullet & r_j \end{bmatrix} + L_{ij} \begin{bmatrix} \hat{E}_{ij} & \hat{e}_{ij} \end{bmatrix} + \begin{bmatrix} \hat{E}_{ij} & \hat{e}_{ij} \end{bmatrix}^\top L_{ij}^\top \quad \text{pour } (i, j) \\ \text{s.t. } X_i \cap X_j \neq \emptyset \quad \text{(C.139)}$$

où nous définissons  $q_i = 0$  et  $r_i = 0$  pour  $i \in \mathcal{I}_0$ , et avec

$$\hat{M}_p := \left[ \begin{array}{cc|c} M & 0 & 0 \\ 0 & M_p & 0 \\ \hline 0 & 0 & \varepsilon I_{n_p+n_w} \end{array} \right], \quad \text{(C.140)}$$

alors le système PWA incertain (C.69) est robustement  $\mathcal{L}_2$ -gain stable par rapport à  $\Delta$ , avec un  $\mathcal{L}_2$ -gain inférieur ou égal à  $\gamma$ .  $\lrcorner$

#### C.4.5 Stabilité et performance incrémentale robuste des systèmes non-linéaires en boucle

Dans cette section, nous suivons une route parallèle à celle de la Section C.4.4, en considérant plutôt les problèmes de stabilité et de performance incrémentales.

##### Stabilité incrémentale robuste

Nous commençons par une extension du Théorème C.35 au cas de stabilité incrémentale robuste.

##### THÉORÈME C.45

Soit  $G : \mathcal{L}_{2e}^{n_p}(\mathbb{R}_+) \rightarrow \mathcal{L}_{2e}^{n_q}(\mathbb{R}_+)$  un système causal et incrémentalement borné, et soit  $\overline{\Delta}$  l'ensemble d'incertitudes défini dans la Définition C.23. Soit  $\Psi \in \mathcal{RH}_\infty^{n_y \times (n_q+n_p)}$  et  $M \in \mathbb{S}^{n_y}$  tels que  $\Pi(j\omega) := \Psi(j\omega)^* M \Psi(j\omega)$  satisfait  $\Pi_{11} \succeq \varepsilon_\Pi I_{n_q}$  et  $\Pi_{22} \preceq -\varepsilon_\Pi I_{n_p}$ , pour  $\varepsilon_\Pi > 0$ . Supposons que :

(i) l'IQC temporelle suivante est satisfaite

$$\int_0^T \bar{y}_\Delta(t)^\top M \bar{y}_\Delta(t) dt \geq 0, \quad \forall T \geq 0, \forall \Delta \in \overline{\Delta}, \forall q, \tilde{q} \in \mathcal{L}_{2e}^{n_q}(\mathbb{R}_+) \quad \text{(C.141)}$$

$$\text{avec } \bar{y}_\Delta = \Psi \begin{bmatrix} \mathbb{I} & -\mathbb{I} \\ \Delta & -\Delta \end{bmatrix} (q, \tilde{q}).$$

(ii) il existe  $\varepsilon > 0$  de telle sorte que l'IQC temporelle suivante est satisfaite

$$\int_0^T \bar{y}_G(t)^\top M \bar{y}_G(t) dt \leq -\varepsilon \|p - \tilde{p}\|_{2,T}^2, \quad \forall T \geq 0, \forall p, \tilde{p} \in \mathcal{L}_{2e}^{n_p}(\mathbb{R}_+) \quad \text{(C.142)}$$

$$\text{avec } \bar{y}_G = \Psi \begin{bmatrix} G & -G \\ \mathbb{I} & -\mathbb{I} \end{bmatrix} (p, \tilde{p}).$$

Alors, l'interconnexion en boucle  $(G, \Delta)$  est robustement incrémentalement stable par rapport à  $\overline{\Delta}$ .  $\lrcorner$

Un aspect intéressant du Théorème C.45 (en comparaison avec le Théorème C.35) est que la condition exigeant le bien posé de l'interconnexion en boucle  $(G, \Delta)$  n'est plus nécessaire. Cela est dû au fait que le bien posé est impliqué par les conditions (i) et (ii).

### Performance incrémentale robuste

Nous portons maintenant notre attention sur le cas de la performance incrémentale robuste. Comme nous l'avons déjà dit, nous utiliserons le  $\mathcal{L}_2$ -gain incrémental comme mesure de la performance du système incertain. Notons que la contrainte sur le  $\mathcal{L}_2$ -gain incrémental (C.7) peut être représentée de manière équivalente comme

$$\int_0^\infty \begin{bmatrix} z(t) - \tilde{z}(t) \\ w(t) - \tilde{w}(t) \end{bmatrix}^\top \bar{M}_p \begin{bmatrix} z(t) - \tilde{z}(t) \\ w(t) - \tilde{w}(t) \end{bmatrix} dt \leq 0, \quad (\text{C.143})$$

avec

$$\bar{M}_p := \begin{bmatrix} I_{n_z} & 0 \\ 0 & -\eta^2 I_{n_w} \end{bmatrix}. \quad (\text{C.144})$$

Définissons  $\bar{\Upsilon}$  l'opérateur de  $\mathcal{L}_{2e}^{n_p}(\mathbb{R}_+) \times \mathcal{L}_{2e}^{n_w}(\mathbb{R}_+) \times \mathcal{L}_{2e}^{n_p}(\mathbb{R}_+) \times \mathcal{L}_{2e}^{n_w}(\mathbb{R}_+)$  dans  $\mathcal{L}_{2e}^{n_q}(\mathbb{R}_+) \times \mathcal{L}_{2e}^{n_p}(\mathbb{R}_+) \times \mathcal{L}_{2e}^{n_z}(\mathbb{R}_+) \times \mathcal{L}_{2e}^{n_w}(\mathbb{R}_+)$  donné par

$$\begin{bmatrix} q - \tilde{q} \\ p - \tilde{p} \\ z - \tilde{z} \\ w - \tilde{w} \end{bmatrix} = \bar{\Upsilon} \left( \begin{bmatrix} p \\ w \\ \tilde{p} \\ \tilde{w} \end{bmatrix} \right) := \begin{bmatrix} G_{\text{perf},q} & -G_{\text{perf},q} \\ \mathbb{I} & 0 \\ G_{\text{perf},z} & -G_{\text{perf},z} \\ 0 & \mathbb{I} \end{bmatrix} \begin{bmatrix} p \\ w \\ \tilde{p} \\ \tilde{w} \end{bmatrix}, \quad (\text{C.145})$$

i.e.  $(q - \tilde{q}, p - \tilde{p}, z - \tilde{z}, w - \tilde{w}) = \Upsilon(p, w, \tilde{p}, \tilde{w})$ , avec  $(q, z) = G_{\text{perf}}(p, w)$  et  $(\tilde{q}, \tilde{z}) = G_{\text{perf}}(\tilde{p}, \tilde{w})$ .

Nous pouvons maintenant proposer le théorème suivant concernant l'évaluation de la stabilité  $\mathcal{L}_2$ -gain incrémental de systèmes incertains en utilisant des arguments de séparation de graphes.

#### THÉORÈME C.46

Soit  $G_{\text{perf}} : \mathcal{L}_{2e}^{n_p}(\mathbb{R}_+) \times \mathcal{L}_{2e}^{n_w}(\mathbb{R}_+) \rightarrow \mathcal{L}_{2e}^{n_q}(\mathbb{R}_+) \times \mathcal{L}_{2e}^{n_z}(\mathbb{R}_+)$  un système causal et incrémentalement  $\mathcal{L}_2$ -gain stable, et soit  $\Delta$  l'ensemble d'incertitudes défini dans la Définition C.23. Soit  $\Psi \in \mathcal{RH}_\infty^{n_y \times (n_q + n_p)}$  et  $M \in \mathbb{S}^{n_y}$  tels que  $\Pi(j\omega) := \Psi(j\omega)^* M \Psi(j\omega)$  satisfait  $\Pi_{11} \succeq \varepsilon_\Pi I_{n_q}$  et  $\Pi_{22} \preceq -\varepsilon_\Pi I_{n_p}$ , pour  $\varepsilon_\Pi > 0$ . Soit  $\bar{M}_p \in \mathbb{S}^{n_z + n_w}$  la matrice définie dans (C.144), et soit  $\bar{\Upsilon}$  défini dans (C.145). Supposons que :

(i) L'IQC temporelle suivante est satisfaite

$$\int_0^T \bar{y}_\Delta(t)^\top M \bar{y}_\Delta(t) dt \geq 0, \quad \forall T \geq 0, \forall \Delta \in \bar{\Delta}, \forall q, \tilde{q} \in \mathcal{L}_{2e}^{n_q}(\mathbb{R}_+) \quad (\text{C.146})$$

$$\text{avec } \bar{y}_\Delta = \Psi \begin{bmatrix} \mathbb{I} & -\mathbb{I} \\ \Delta & -\Delta \end{bmatrix} (q, \tilde{q}).$$

(ii) Il existe  $\varepsilon > 0$  de telle sorte que l'IQC temporelle suivante est satisfaite

$$\int_0^T \bar{y}_G(t)^\top \begin{bmatrix} M & 0 \\ 0 & \bar{M}_p \end{bmatrix} \bar{y}_G(t) dt \leq -\varepsilon \left\| \begin{bmatrix} p - \tilde{p} \\ w - \tilde{w} \end{bmatrix} \right\|_{2,T}^2, \quad \forall T \geq 0, \forall p, \tilde{p} \in \mathcal{L}_{2e}^{n_p}(\mathbb{R}_+) \quad (\text{C.147})$$

$$\text{avec } \bar{y}_G = \text{diag}(\Psi, I_{n_z + n_w}) \bar{\Upsilon}(p, w, \tilde{p}, \tilde{w}).$$

Alors, l'interconnexion en boucle  $(G_{\text{perf}}, \Delta)$  est robustement incrémentalement  $\mathcal{L}_2$ -gain stable par rapport à  $\bar{\Delta}$ , avec un  $\mathcal{L}_2$ -gain incrémental inférieur ou égal à  $\eta$ .  $\square$

### Multiplieurs pour la stabilité incrémentale

Comme nous l'avons fait dans la Section C.4.4 pour le cas de l'analyse non incrémentale, nous considérons dans cette section comment construire des multiplieurs  $\Pi$  définissant des IQCs valides pour les incertitudes de l'ensemble  $\overline{\Delta}$ .

Rappelons d'abord que les trois premières catégories d'incertitudes dans les ensembles  $\Delta$  et  $\overline{\Delta}$  sont identiques. C'est le cas puisque la bornitude de  $\Delta$  défini par la multiplication par un scalaire ou par une dynamique LTI stable implique la bornitude incrémentale. En ce qui concerne le quatrième cas, c'est-à-dire les incertitudes dynamiques générales avec  $\mathcal{L}_2$ -gain incrémental borné, le même multiplieur utilisé pour la classe des incertitudes dynamiques avec  $\mathcal{L}_2$ -gain borné peut être utilisé. Enfin, le multiplieur de la dernière ligne peut également être utilisé pour les non-linéarités dans le secteur incrémental  $\text{Sect}_\Delta(\kappa_1, \kappa_2)$ , voir la discussion dans l'Annexe A. Ainsi, nous pouvons analyser la stabilité et la performance incrémentales robustes en utilisant les multiplieurs définis dans la Table C.1, avec les paramétrisations respectives données dans la Table C.2.

### Approche par dissipativité

Comme nous l'avons fait dans la Section C.4.4 nous utiliserons à nouveau la dissipativité et le Théorème C.7 pour proposer le corollaire suivant au Théorème C.35.

COROLLAIRE C.47

Soit  $G : \mathcal{L}_{2e}^{n_p}(\mathbb{R}_+) \rightarrow \mathcal{L}_{2e}^{n_q}(\mathbb{R}_+)$  un système causal et incrémentalement  $\mathcal{L}_2$ -gain stable, et soit  $\overline{\Delta}$  l'ensemble d'incertitudes défini dans la Définition C.23. Soit  $\Pi \in \mathcal{RL}_\infty^{(n_q+n_p) \times (n_q+n_p)}$  factorisé comme  $\Pi = \Psi_b^* M \Psi_b$ , avec  $\Psi_b \in \mathcal{RH}_\infty^{n_y \times (n_q+n_p)}$ , et  $M \in \mathbf{M}$ , comme défini dans la Table C.2. Supposons que le système augmenté filtré  $\Psi_b \begin{bmatrix} G & -G \\ \mathbb{I} & -\mathbb{I} \end{bmatrix}$  est dissipatif par rapport au taux d'échange  $\overline{\varpi}$  défini par :

$$\overline{\varpi}(p, \tilde{p}, \bar{y}_G) := - \begin{bmatrix} \bar{y}_G \\ p - \tilde{p} \end{bmatrix}^\top \begin{bmatrix} M & 0 \\ 0 & \varepsilon I_{n_p} \end{bmatrix} \begin{bmatrix} \bar{y}_G \\ p - \tilde{p} \end{bmatrix}. \quad (\text{C.148})$$

Alors, l'interconnexion en boucle  $(G, \Delta)$  est robustement incrémentalement stable par rapport à  $\overline{\Delta}$ . ┘

En utilisant à nouveau la dissipativité et le Théorème C.7, nous proposons le corollaire suivant au Théorème C.46.

COROLLAIRE C.48

Soit  $G_{\text{perf}} : \mathcal{L}_{2e}^{n_p}(\mathbb{R}_+) \times \mathcal{L}_{2e}^{n_w}(\mathbb{R}_+) \rightarrow \mathcal{L}_{2e}^{n_q}(\mathbb{R}_+) \times \mathcal{L}_{2e}^{n_z}(\mathbb{R}_+)$  un système causal et incrémentalement  $\mathcal{L}_2$ -gain stable, et soit  $\overline{\Delta}$  l'ensemble d'incertitudes défini dans la Définition C.23. Soit  $\Pi \in \mathcal{RL}_\infty^{(n_q+n_p) \times (n_q+n_p)}$  un multiplieur factorisé comme  $\Pi = \Psi_b^* M \Psi_b$ , avec  $\Psi_b \in \mathcal{RH}_\infty^{n_y \times (n_q+n_p)}$ , et  $M \in \mathbf{M}$ , comme défini dans la Table C.2, et soit  $\overline{M}_p \in \mathbb{S}^{n_z+n_w}$  la matrice définie dans (C.144). Enfin, soit  $\overline{\Upsilon}$  défini dans (C.145). Supposons que le système augmenté filtré  $\text{diag}(\Psi_b, I_{n_z+n_w}) \overline{\Upsilon}$  est dissipatif par rapport au taux d'échange  $\varpi$  défini par

$$\varpi(p, \tilde{p}, w, \tilde{w}, \bar{y}_G) := - \begin{bmatrix} \bar{y}_G \\ p - \tilde{p} \\ w - \tilde{w} \end{bmatrix}^\top \begin{bmatrix} M & 0 & 0 \\ 0 & \overline{M}_p & 0 \\ 0 & 0 & \varepsilon I_{n_z+n_w} \end{bmatrix} \begin{bmatrix} \bar{y}_G \\ p - \tilde{p} \\ w - \tilde{w} \end{bmatrix}. \quad (\text{C.149})$$

Alors, l'interconnexion en boucle  $(G_{\text{perf}}, \Delta)$  est robustement incrémentalement  $\mathcal{L}_2$ -gain stable par rapport à  $\overline{\Delta}$ , avec un  $\mathcal{L}_2$ -gain incrémental inférieur ou égal à  $\eta$ .  $\lrcorner$

### Application à des systèmes affines par morceaux

Dans cette section, nous considérons l'application des Corollaires C.47 et C.48 au cas particulier des systèmes affines par morceaux.

#### Stabilité incrémentale robuste

Nous commençons par considérer l'analyse de la stabilité incrémentale robuste des systèmes affines par morceaux incertains. Le système nominal  $G$  sera à nouveau considéré comme le système affine par morceaux  $G_{\text{PWA}}$  donné par (C.123).

Notre objectif est d'évaluer la dissipativité du système augmenté filtré donné comme  $\Psi_b \begin{bmatrix} G_{\text{PWA}} & -G_{\text{PWA}} \\ \mathbb{I} & -\mathbb{I} \end{bmatrix}$  par rapport au taux d'échange (C.148), où le filtre  $\Psi_b$  a la représentation minimale (C.94). Le système augmenté filtré peut alors être écrit comme le système affine par morceaux suivant :

$$\bar{y}_G = \left( \Psi_b \begin{bmatrix} G_{\text{PWA}} & -G_{\text{PWA}} \\ \mathbb{I} & -\mathbb{I} \end{bmatrix} \right) \left( \begin{bmatrix} p \\ \tilde{p} \end{bmatrix} \right) \begin{cases} \dot{\bar{x}}(t) = \bar{A}_{ij}\bar{x}(t) + \bar{B}_{ij}\bar{p}(t) \\ \bar{y}_G(t) = \bar{C}_{ij}\bar{x}(t) + \bar{D}\bar{p}(t) \\ \bar{x}(0) = 0 \end{cases} \quad \text{pour } x(t) \in X_{ij} \quad (\text{C.150})$$

où  $\bar{x} = \text{col}(x_G, \tilde{x}_G, \psi, 1)$ ,  $\bar{p} = \text{col}(p, \tilde{p})$ .

La région augmentée  $X_{ij}$  peut être définie comme

$$X_{ij} = \{ \bar{x} \in X \times X \times \mathbb{R}^\ell \times \{1\} \mid \bar{G}_{ij}\bar{x} \succeq 0 \}, \quad (\text{C.151})$$

où

$$\bar{G}_{ij} := \begin{bmatrix} G_i & 0 & 0 & g_i \\ 0 & G_j & 0 & g_j \end{bmatrix}. \quad (\text{C.152})$$

De même, l'intersection entre deux régions augmentées adjacentes  $X_{ij}$  et  $X_{kl}$  est contenue dans l'hyperplan défini par la matrice  $\bar{E}_{ijkl}$ , c'est à dire

$$X_{ij} \cap X_{kl} \subseteq \{ \bar{x} \in X \times X \times \mathbb{R}^\ell \times \{1\} \mid \bar{E}_{ijkl}\bar{x} = 0 \}. \quad (\text{C.153})$$

Comme nous l'avons fait dans la Section C.3, nous cherchons à utiliser des techniques SOS pour construire des fonctions de stockage polynomiales par morceaux afin de vérifier la dissipativité du système augmenté (C.150). Nous considérons les fonctions de stockage polynomiales par morceaux de degré inférieur ou égal à  $d$  données par

$$\bar{S}(\bar{x}) = \chi_d(\bar{x})^\top \mathcal{P}_{ij} \chi_d(\bar{x}), \quad \text{for } \bar{x} \in X_{ij}, \quad (\text{C.154})$$

avec  $\chi_d(\bar{x}) \in \mathbb{R}^{\varrho(2n+\ell, d)}$ . À partir de ce point, la dépendance sur  $\bar{x}$  est supprimée pour faciliter la notation. Nous allons également définir  $\bar{p}_\chi := \bar{p} \otimes \chi_{d-1}$ , avec  $\bar{p} = \text{col}(p, \tilde{p})$ , similaire à ce qui a été présenté dans la Section C.3, afin d'écrire l'inégalité de dissipativité comme une fonction quadratique du vecteur  $\bar{\chi}_{\bar{p}} := \text{col}(\chi_d, \bar{p}_\chi)$ .



Définissons les matrices  $\mathcal{A}_{ij} \in \mathbb{R}^{\varrho(2n,d) \times \varrho(2n,d)}$ ,  $\mathcal{B}_{ij} \in \mathbb{R}^{\varrho(2n,d) \times \varrho_w(2n,d,2n_p)}$ ,  $\mathcal{C}_{ij} \in \mathbb{R}^{n_y \times \varrho(2n,d)}$  et  $\mathcal{D} \in \mathbb{R}^{n_y \times \varrho_w(2n,d,2n_p)}$  telles que (voir la Section C.3 pour plus de détails)

$$\begin{aligned}\dot{\chi}_d &= \frac{\partial \chi_d}{\partial \bar{x}} (\bar{A}_{ij} \bar{x} + \bar{B}_{ij} \bar{p}) =: \mathcal{A}_{ij} \chi_d + \mathcal{B}_{ij} \bar{p}_\chi \\ \bar{y}_G &= \bar{C}_{ij} \bar{x} + \bar{D} \bar{p} =: \mathcal{C}_{ij} \chi_d + \mathcal{D} \bar{p}_\chi.\end{aligned}\tag{C.155}$$

Afin d'utiliser la généralisation de la  $\mathcal{S}$ -procédure comme dans le Lemme C.19, rappelons quelques notations définies dans la Section C.3 (pour plus de détails, veuillez vous référer à la discussion dans la page 182). Soit  $\bar{G}_{ij,k}$  la  $k$ -ième ligne de  $\bar{G}_{ij}$ , et définissons  $\mathcal{T}_{ij} \in \mathbb{S}^{\varrho(2n+\ell,d)}$  comme la matrice telle que

$$g_{ij,1}(\bar{x}) \bar{G}_{ij,1} \bar{x} + \dots + g_{ij,l_{ij}}(\bar{x}) \bar{G}_{ij,l_{ij}} \bar{x} =: \chi_d^\top \mathcal{T}_{ij} \chi_d.\tag{C.156}$$

Puisque  $\bar{G}_{ij,k} \bar{x}$  est une fonction affine de  $\bar{x}$ , on peut choisir des polynômes  $g_{ij,k}$  de degré jusqu'à  $2d - 1$ . Définissons aussi  $\mathcal{G}_{ij,k} \in \mathbb{S}^{\varrho(2n+\ell,d)}$  comme la matrice telle que

$$g_{ij,k}(\bar{x}) =: \chi_d^\top \mathcal{G}_{ij,k} \chi_d.\tag{C.157}$$

Comme nous l'avons discuté dans la Section C.4.5, la fonction de stockage que nous visons à construire est telle que  $\bar{S}(x, x, 0) = 0$ , pour tout  $x \in X$ . En utilisant les mêmes arguments que nous avons utilisés dans la Section C.3, page 184, on peut construire des matrices  $Z$  et  $T$  telles que la contrainte  $Z^\top T^\top \mathcal{P}_i T Z = 0$ , pour  $i \in \mathcal{I}$ , assure la structure souhaitée sur  $\bar{S}$ .

Finalement, le taux d'échange (C.148) peut être écrit comme la fonction quadratique

$$\bar{\omega}(p, \tilde{p}, \bar{y}_G) := - \begin{bmatrix} \chi_d \\ \bar{p}_\chi \end{bmatrix}^\top \begin{bmatrix} \mathcal{C}_{ij}^\top M \mathcal{C}_{ij} & \mathcal{C}_{ij} M \mathcal{D} \\ \bullet & \mathcal{D}^\top M \mathcal{D} + \varepsilon M_1 \end{bmatrix} \begin{bmatrix} \chi_d \\ \bar{p}_\chi \end{bmatrix},\tag{C.158}$$

avec  $M_1 \in \mathbb{S}^{\varrho_w(2n+\ell,d,2n_p)}$  la matrice telle que

$$|p - \tilde{p}|^2 =: \bar{p}_\chi^\top M_1 \bar{p}_\chi.\tag{C.159}$$

Nous proposons maintenant le théorème suivant, qui nous permet d'évaluer la stabilité incrémentale robuste du système augmenté filtré (C.150) en construisant des fonctions de stockage polynomiales par morceaux via l'optimisation convexe.

#### THÉORÈME C.49

Soit  $\Pi \in \mathcal{R}\mathcal{L}_\infty^{(n_q+n_p) \times (n_q+n_p)}$  un multiplicateur positif-négatif de sorte que chaque  $\Delta \in \bar{\Delta}$  satisfait l'IQC incrémentale définie par  $\Pi$ . Soit  $\Pi$  factorisé comme  $\Pi = \Psi_b^* M \Psi_b$ , avec  $\Psi_b \in \mathcal{R}\mathcal{H}_\infty^{n_y \times (n_q+n_p)}$ , et  $M \in \mathbf{M}$ , comme défini dans la Table C.2. Soit le système PWA filtré défini dans (C.150). S'il existe des matrices symétriques  $\mathcal{P}_{ij} \in \mathbb{S}^{\varrho(2n+\ell,d)}$ , ainsi que des matrices  $\mathcal{T}_{ij,r} \in \mathbb{S}^{\varrho(2n+\ell,d)}$  et  $\mathcal{G}_{ij,r,k} \in \mathbb{S}^{\varrho(2n+\ell,d)}$  définies respectivement par (C.156) et (C.157) pour  $r \in \{1, 2\}$  et  $k \in \{1, \dots, l_{ij}\}$ , des vecteurs  $\tau_{ij} \in \mathbb{R}^{\varrho(2n+\ell,d)}$  et  $\nu_{ij,r,k} \in \mathbb{R}^{\varrho(2n+\ell,d)}$ , pour  $r \in \{1, 2\}$  et  $k \in \{1, \dots, l_{ij}\}$ ,  $\mu_{ij} \in \mathbb{R}^{\varrho_w(2n+\ell,d,2n_p)}$  et  $\vartheta_{ijkl} \in \mathbb{R}^{\varrho(2n+\ell,d)}$ , une matrice  $M_1$ , tel que défini

dans (C.159) et des matrices  $L_{ijkl} \in \mathbb{R}^{\varrho(2n+\ell,d) \times \varrho(2n+\ell,d-1)}$  tels que

$$\left\{ \begin{array}{l} \mathcal{P}_{ij} + Q^{2n+\ell,d}(\tau_{ij}) - \mathcal{T}_{ij,1} \succeq 0 \\ \left[ \begin{array}{c|c} \mathcal{A}_{ij}^\top \mathcal{P}_{ij} + \mathcal{P}_{ij} \mathcal{A}_{ij} + & \mathcal{P}_{ij} \mathcal{B}_{ij} + \mathcal{C}_{ij}^\top M \mathcal{D} \\ \mathcal{C}_{ij}^\top M \mathcal{C}_{ij} + \mathcal{T}_{ij,2} & \mathcal{D}^\top M \mathcal{D} + \varepsilon M_1 \end{array} \right] + R^{2n+\ell,d,2n_p}(\mu_{ij}) \preceq 0 \\ \bullet & \mathcal{D}^\top M \mathcal{D} + \varepsilon M_1 \end{array} \right. \quad \text{pour } (i, j) \in \mathcal{I}^2$$

$$\left\{ \begin{array}{l} \mathcal{G}_{ij,1,k} + Q^{2n+\ell,d}(\nu_{ij,1,k}) \succeq 0 \\ \mathcal{G}_{ij,2,k} + Q^{2n+\ell,d}(\nu_{ij,2,k}) \succeq 0 \end{array} \right., \quad \text{for } k = 1, \dots, l_{ij}$$
(C.160)

$$Z^\top T^\top \mathcal{P}_{ii} T Z = 0 \quad \text{pour } i \in \mathcal{I} \quad \text{(C.161)}$$

$$\mathcal{P}_{ij} = \mathcal{P}_{kl} + L_{ijkl} \mathcal{E}_{ijkl} + \mathcal{E}_{ijkl}^\top L_{ijkl}^\top + Q^{2n+\ell,d}(\vartheta_{ijkl}) \quad \text{pour } (i, j), (k, l),$$

$$X_{ij} \cap X_{kl} \neq \emptyset \quad \text{(C.162)}$$

alors le système PWA incertain (C.67) est robustement incrémentalement stable par rapport à  $\bar{\Delta}$ .  $\lrcorner$

### Performance incrémentale robuste

Enfin, considérons le problème de la performance incrémentale robuste des systèmes affines par morceaux incertains. Soit  $G_{\text{PWA}}$  donné par (C.135), et soit  $\bar{\Upsilon}_{\text{PWA}}$  défini de manière analogue à  $\bar{\Upsilon}$  dans (C.145), i.e.  $(q - \tilde{q}, p - \tilde{p}, z - \tilde{z}, w - \tilde{w}) = \bar{\Upsilon}_{\text{PWA}}(p, w, \tilde{p}, \tilde{w})$ , avec  $(q, z) = G_{\text{PWA}}(p, w)$  and  $(\tilde{q}, \tilde{z}) = G_{\text{PWA}}(\tilde{p}, \tilde{w})$ . Afin d'évaluer la performance incrémentale à travers le Corollaire C.48, nous devons évaluer la dissipativité du système augmentée affine par morceaux donné par

$$\bar{y}_G = \begin{bmatrix} \Psi & 0 \\ 0 & I_{n_z+n_w} \end{bmatrix} \bar{\Upsilon}_{\text{PWA}} \left( \begin{bmatrix} p \\ w \\ \tilde{p} \\ \tilde{w} \end{bmatrix} \right) \left\{ \begin{array}{l} \dot{\bar{x}}(t) = \bar{A}_{ij} \bar{x}(t) + \bar{B}_{ij} \bar{u} \\ \bar{y}_G(t) = \bar{C}_{ij} \bar{x}(t) + \bar{D} \bar{u} \\ \bar{x}(0) = 0 \end{array} \right. \quad \text{pour } \bar{x}(t) \in X_{ij} \quad \text{(C.163)}$$

où  $\bar{x} = \text{col}(x_G, \tilde{x}_G, \psi, 1)$ ,  $\bar{u} = \text{col}(p, w, \tilde{p}, \tilde{w})$ .

Nous visons à nouveau à construire des fonctions de stockage polynomiales par morceaux ayant la structure (C.154). Comme nous l'avons fait précédemment, nous définirons  $\bar{u}_\chi := \bar{u} \otimes \chi_{d-1}$  afin d'écrire l'inégalité de dissipativité comme une fonction quadratique du vecteur  $\bar{\chi}_\bar{u} := \text{col}(\chi_d, \bar{u}_\chi)$ . Soient les matrices  $\mathcal{A}_{ij} \in \mathbb{R}^{\varrho(2n+\ell,d) \times \varrho(2n+\ell,d)}$ ,  $\mathcal{B}_{ij} \in \mathbb{R}^{\varrho(2n+\ell,d) \times \varrho_w(2n+\ell,d,2(n_p+n_w))}$ ,  $\mathcal{C}_{ij} \in \mathbb{R}^{n_y \times \varrho(2n+\ell,d)}$  et  $\mathcal{D} \in \mathbb{R}^{n_y \times \varrho_w(2n+\ell,d,2(n_p+n_w))}$  telles que

$$\dot{\chi}_d = \frac{\partial \chi_d}{\partial \bar{x}} (\bar{A}_{ij} \bar{x} + \bar{B}_{ij} \bar{u}) =: \mathcal{A}_{ij} \chi_d + \mathcal{B}_{ij} \bar{u}_\chi$$

$$\bar{y}_G = \bar{C}_{ij} \bar{x} + \bar{D} \bar{u} =: \mathcal{C}_{ij} \chi_d + \mathcal{D} \bar{u}_\chi \quad \text{(C.164)}$$

En utilisant cette notation, le taux d'échange (4.130) peut être réécrit comme une fonction quadratique de  $\bar{\chi}_\bar{u}$  :

$$\varpi(p, \tilde{p}, w, \tilde{w}, \bar{y}_G) := - \begin{bmatrix} \chi_d \\ \bar{u}_\chi \end{bmatrix}^\top \begin{bmatrix} \mathcal{C}_{ij}^\top \bar{M} \mathcal{C}_{ij} & \mathcal{C}_{ij}^\top \bar{M} \mathcal{D} \\ \bullet & \mathcal{D}^\top \bar{M} \mathcal{D} + \varepsilon \bar{M}_1 \end{bmatrix} \begin{bmatrix} \chi_d \\ \bar{u}_\chi \end{bmatrix}, \quad \text{(C.165)}$$

où

$$\overline{M} := \begin{bmatrix} M & 0 \\ 0 & \overline{M}_p \end{bmatrix}, \quad (\text{C.166})$$

et  $M_1 \in \mathbb{S}^{\varrho_w(2n+\ell, d, 2(n_p+n_w))}$  est la matrice telle que

$$\left\| \begin{bmatrix} p - \tilde{p} \\ w - \tilde{w} \end{bmatrix} \right\|^2 =: \bar{u}_\chi^\top \overline{M}_1 \bar{u}_\chi. \quad (\text{C.167})$$

Après ces définitions préliminaires, nous sommes en mesure d'énoncer le résultat suivant qui fournit des conditions suffisantes pour évaluer la stabilité  $\mathcal{L}_2$ -gain incrémentale robuste des systèmes affines par morceaux incertains.

#### THÉORÈME C.50

Soit  $\Pi \in \mathcal{RL}_\infty^{(n_q+n_p) \times (n_q+n_p)}$  un multiplicateur positif-négatif de sorte que chaque  $\Delta \in \overline{\Delta}$  satisfait l'IQC incrémentale définie par  $\Pi$ . Soit  $\Pi$  factorisé comme  $\Pi = \Psi_b^* M \Psi_b$ , avec  $\Psi_b \in \mathcal{RH}_\infty^{n_y \times (n_q+n_p)}$ , et  $M \in \mathbf{M}$ , tel que défini dans la Table C.2. Soit  $\overline{M}$  la matrice définie dans (C.166), avec  $\overline{M}_p$  la matrice définie dans (C.144). Soit le système PWA filtré défini comme dans (C.163). S'il existe des matrices symétriques  $\mathcal{P}_{ij} \in \mathbb{S}^{\varrho(2n+\ell, d)}$ , ainsi que des matrices  $\mathcal{T}_{ij,r} \in \mathbb{S}^{\varrho(2n+\ell, d)}$  et  $\mathcal{G}_{ij,r,k} \in \mathbb{S}^{\varrho(2n+\ell, d)}$  définies respectivement par (C.156) et (C.157) pour  $r \in \{1, 2\}$  et  $k \in \{1, \dots, l_{ij}\}$ , des vecteurs  $\tau_{ij} \in \mathbb{R}^{\varrho(2n+\ell, d)}$  et  $\nu_{ij,r,k} \in \mathbb{R}^{\varrho(2n+\ell, d)}$ , pour  $r \in \{1, 2\}$  et  $k \in \{1, \dots, l_{ij}\}$ ,  $\mu_{ij} \in \mathbb{R}^{\varrho_w(2n+\ell, d, 2n_p)}$  et  $\vartheta_{ijkl} \in \mathbb{R}^{\varrho(2n+\ell, d)}$ , une matrice  $M_1$ , tel que défini dans (C.159) et des matrices  $L_{ijkl} \in \mathbb{R}^{\varrho(2n+\ell, d) \times \varrho(2n+\ell, d-1)}$  tels que

$$\left\{ \begin{array}{l} \mathcal{P}_{ij} + Q^{2n+\ell, d}(\tau_{ij}) - \mathcal{T}_{ij,1} \succeq 0 \\ \left[ \begin{array}{c|c} \mathcal{A}_{ij}^\top \mathcal{P}_{ij} + \mathcal{P}_{ij} \mathcal{A}_{ij} + & \mathcal{P}_{ij} \mathcal{B}_{ij} + \mathcal{C}_{ij}^\top \overline{M} \mathcal{D} \\ \mathcal{C}_{ij}^\top \overline{M} \mathcal{C}_{ij} + \mathcal{T}_{ij,2} & \text{---} \\ \bullet & \mathcal{D}^\top \overline{M} \mathcal{D} + \varepsilon \overline{M}_1 \end{array} \right] + R^{2n+\ell, d, 2(n_p+n_w)}(\mu_{ij}) \preceq 0 \\ \left\{ \begin{array}{l} \mathcal{G}_{ij,1,k} + Q^{2n+\ell, d}(\nu_{ij,1,k}) \succeq 0 \\ \mathcal{G}_{ij,2,k} + Q^{2n+\ell, d}(\nu_{ij,2,k}) \succeq 0 \end{array} \right., \text{ for } k = 1, \dots, l_{ij} \end{array} \right. \quad \text{pour } (i, j) \in \mathcal{I}^2 \quad (\text{C.168})$$

$$Z^\top T^\top \mathcal{P}_{ii} T Z = 0 \quad \text{pour } i \in \mathcal{I} \quad (\text{C.169})$$

$$\mathcal{P}_{ij} = \mathcal{P}_{kl} + L_{ijkl} \mathcal{E}_{ijkl} + \mathcal{E}_{ijkl}^\top L_{ijkl}^\top + Q^{2n+\ell, d}(\vartheta_{ijkl}) \quad \text{pour } (i, j), (k, l), \\ X_{ij} \cap X_{kl} \neq \emptyset \quad (\text{C.170})$$

alors le système PWA incertain (C.69) est robustement incrémentalement  $\mathcal{L}_2$ -gain stable par rapport à  $\overline{\Delta}$ , avec un  $\mathcal{L}_2$ -gain incrémental inférieur ou égal à  $\eta$ .  $\square$

## C.5 Analyse des systèmes de Lur'e incertains

### C.5.1 Introduction

Dans les chapitres précédents, nous avons présenté des méthodes d'analyse pour évaluer la stabilité et la performance (incrémentales) nominale et robuste des systèmes affines par morceaux. On peut se demander si ces techniques pourraient également être utilisées pour traiter

le cas des systèmes non-linéaires avec des non linéarités lisses. Ce problème est traité dans cette section. Les systèmes non-linéaires consistant en l'interconnexion entre un système LTI et des non-linéarités sans mémoire sont connus sous le nom de *systèmes de Lur'e*.

Le critère du cercle propose des conditions suffisantes pour analyser des systèmes contenant des non-linéarités appartenant à un secteur. En ce sens, la non-linéarité peut être vue comme une perturbation bornée de la dynamique linéaire du système. La description via des secteurs bornés donne des résultats de stabilité qui tendent à être assez conservatifs, car le secteur donne une représentation très grossière de l'opérateur non linéaire. Pour l'analyse de la stabilité, une tentative de réduire le conservatisme a été faite en transformant la boucle de rétroaction par l'addition des *multiplieurs fréquentiels de Popov-Zames-Falb* [189, 191]. Cependant, il s'avère que cette approche n'est pas applicable lorsque la stabilité incrémentale est considérée [96]. D'autre part, des conditions nécessaires et suffisantes pour la stabilité incrémentale des systèmes de Lur'e ont été proposées dans [61], mais avec l'inconvénient d'être NP-difficile.

Une partie du grand intérêt pour les systèmes Lur'e provient de son universalité pratique. En effet, un grand nombre de systèmes peuvent être représentés sous cette forme, y compris des systèmes de rétroaction avec des actionneurs saturés, des systèmes avec friction, des zones mortes, etc. Cela motive l'étude de tels systèmes et la recherche de techniques d'analyse moins conservatives. Pour ce faire, nous proposons de calculer des approximations affines par morceaux de la non-linéarité sans mémoire. Cela nous permet de réécrire le système comme l'interconnexion entre un système affine par morceaux et une non-linéarité qui est *plus petite* que celle d'origine, dans le sens de sa constante de Lipschitz.

Dans cette section, nous allons nous concentrer sur l'analyse des propriétés de stabilité incrémentale. Au vu de nos besoins spécifiques, nous développons une nouvelle technique d'approximation, appelée *approximation Lipschitz*, permettant de garantir une borne supérieure donnée sur la constante de Lipschitz de l'erreur d'approximation. Le système affine par morceaux incertain obtenu peut ensuite être analysé en utilisant les outils de la Section C.4.

### C.5.2 Systèmes de Lur'e incertains

Dans cette section nous nous intéressons à l'analyse des systèmes non-linéaires de type Lur'e incertains, représentés dans la Figure C.3 et donnés par

$$z = \Sigma^\Delta(w) \begin{cases} \dot{x}(t) = Ax(t) + B_p p(t) + B_u u(t) + B_w w(t) \\ q(t) = C_q x(t) + D_{qp} p(t) + D_{qu} u(t) + D_{qw} w(t) \\ z(t) = C_z x(t) + D_{zp} p(t) + D_{zu} u(t) + D_{zw} w(t) \\ v(t) = C_v x(t) + D_{vp} p(t) + D_{vu} u(t) + D_{vw} w(t) \\ u(t) = -\varphi(v(t)) \\ p(t) = (\Delta(q))(t) \end{cases} \quad (\text{C.171})$$

où  $A \in \mathbb{R}^{n \times n}$ ,  $B_p \in \mathbb{R}^{n \times n_p}$ ,  $B_u \in \mathbb{R}^{n \times n_u}$ ,  $B_w \in \mathbb{R}^{n \times n_w}$ ,  $C_q \in \mathbb{R}^{n_q \times n}$ ,  $D_{qp} \in \mathbb{R}^{n_q \times n_p}$ ,  $D_{qu} \in \mathbb{R}^{n_q \times n_u}$ ,  $D_{qw} \in \mathbb{R}^{n_q \times n_w}$ ,  $C_z \in \mathbb{R}^{n_z \times n}$ ,  $D_{zp} \in \mathbb{R}^{n_z \times n_p}$ ,  $D_{zu} \in \mathbb{R}^{n_z \times n_u}$ ,  $D_{zw} \in \mathbb{R}^{n_z \times n_w}$ ,  $C_v \in \mathbb{R}^{n_v \times n}$ ,  $D_{vp} \in \mathbb{R}^{n_v \times n_p}$ ,  $D_{vu} \in \mathbb{R}^{n_v \times n_u}$ ,  $D_{vw} \in \mathbb{R}^{n_v \times n_w}$ ,  $\Delta : \mathcal{L}_{2e}^{n_q}(\mathbb{R}_+) \rightarrow \mathcal{L}_{2e}^{n_p}(\mathbb{R}_+)$  est un opérateur causal et borné représentant l'incertitude, et  $\varphi : \mathbb{R}^{n_v} \rightarrow \mathbb{R}^{n_u}$  est une non-linéarité Lipschitz continue sans mémoire donnée satisfaisant  $\varphi(0) = 0$ . Nous supposons que le système est défini globalement, c'est-à-dire  $X = \mathbb{R}^n$ . On considèrera à nouveau des incertitudes  $\Delta$

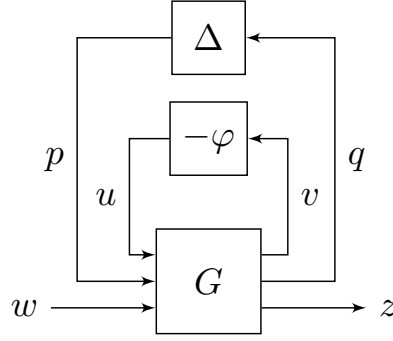

FIGURE C.3 – Représentation du système de Lur'e incertain défini dans (C.171).

appartenant à l'ensemble d'incertitudes  $\bar{\Delta}$  défini dans Définition C.23, page 188, avec la seule différence que les non-linéarités statiques sont regroupés dans  $\varphi$ .

### C.5.3 Approche proposée

Le but de cette section est de proposer une nouvelle description du système (C.171) afin de pouvoir réduire le conservatisme de l'analyse. Cette nouvelle description doit être basée sur la réécriture du système incertain de Lur'e à l'aide de systèmes affines par morceaux. Nous proposons de calculer une approximation affine par morceaux  $\varphi_{\text{PWA}}$  de la non-linéarité  $\varphi$ , de sorte que (C.171) soit transformé en l'interconnexion d'un système PWA avec l'erreur d'approximation :

$$z = \Sigma_{\text{PWA}, \epsilon}^{\Delta}(w) \begin{cases} \dot{x}(t) = A_i x(t) + a_i + B_{p,i} p(t) + B_{u,i} u_{\epsilon}(t) + B_{w,i} w(t) \\ q(t) = C_{q,i} x(t) + c_{q,i} + D_{qp,i} p(t) + D_{qu,i} u_{\epsilon}(t) + D_{qw,i} w(t) \\ z(t) = C_{z,i} x(t) + c_{z,i} + D_{zp,i} p(t) + D_{zu,i} u_{\epsilon}(t) + D_{zw,i} w(t) \\ v(t) = C_{v,i} x(t) + c_{v,i} + D_{vp,i} p(t) + D_{vu,i} u_{\epsilon}(t) + D_{vw,i} w(t) \\ u_{\epsilon}(t) = -\epsilon(v(t)) \\ p(t) = (\Delta(q))(t) \end{cases} \text{ pour } x(t) \in X_i \quad (\text{C.172})$$

Nous appellerons (C.172) un *système PWA de Lur'e incertain*. Nous faisons l'hypothèse que l'erreur d'approximation  $\epsilon$  est Lipschitz continu avec constante de Lipschitz  $L_{\epsilon}$ . Les régions  $X_i$ , pour  $i \in \mathcal{I} := \{1, \dots, N\}$ , sont des ensembles polyédriques convexes fermés  $X_i = \{x \in X \mid G_i x + g_i \succeq 0\}$  avec des intérieurs disjoints deux-à-deux et non vides tels que  $\bigcup_{i \in \mathcal{I}} X_i = X$ . Alors,  $\{X_i\}_{i \in \mathcal{I}}$  constitue une partition finie de  $X$ . A partir de la géométrie de  $X_i$ , l'intersection  $X_i \cap X_j$  entre deux régions différentes est toujours contenue dans un hyperplan, c'est-à-dire  $X_i \cap X_j \subseteq \{x \in X \mid E_{ij} x + e_{ij} = 0\}$ . L'approche est illustrée dans la Figure C.4 et détaillé dans l'Algorithme C.51.

#### ALGORITHME C.51

Étant donné un système incertain de Lur'e (C.171) avec une non-linéarité Lipschitz continue  $\varphi$  et des matrices de transfert direct  $D_{vp}$ ,  $D_{vu}$  and  $D_{vw}$  nulles :

1. Trouver une approximation affine par morceaux  $\varphi_{\text{PWA}}$  de sorte que  $\epsilon = \varphi - \varphi_{\text{PWA}}$  soit Lipschitz continu, avec une constante de Lipschitz  $L_{\epsilon}$  plus petite qu'une borne supérieure donnée  $L_{\text{ref}}$ .

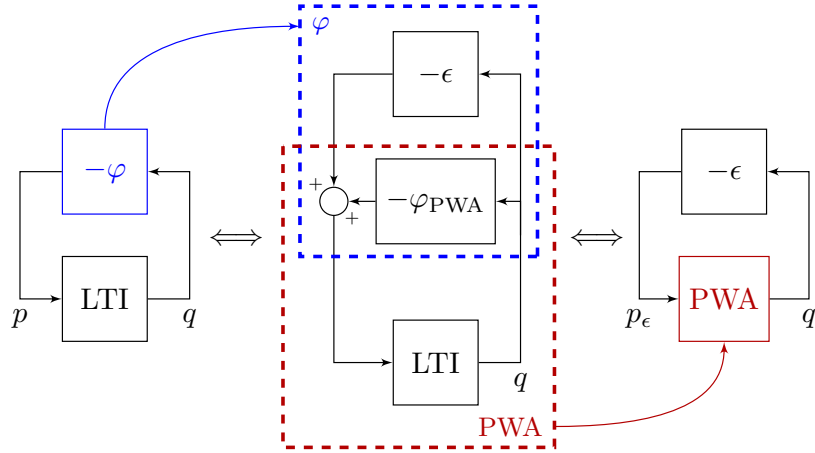

FIGURE C.4 – Diagramme illustrant l’approche proposée dans ce chapitre (les signaux de performance  $w$  et  $z$ , ainsi que l’incertitude  $\Delta$ , sont omis pour plus de clarté).

2. Construire un système PWA de Lur’e équivalent (C.172) à partir de (C.171).
3. Évaluer la stabilité et la performance incrémentale robuste de (C.172) en utilisant les résultats de la Section C.4.5, et, dans le cas positif, conclure sur la stabilité et la performance incrémentale robuste de (C.171). ┘

Pour utiliser l’Algorithme C.51, nous devons être capables de calculer une approximation affine par morceaux de  $\varphi$  qui assure une borne supérieure sur la constante de Lipschitz de l’erreur d’approximation. Cela est traité dans la section suivante.

#### C.5.4 Approximation Lipschitz de non-linéarités statiques

Plusieurs résultats existent dans la littérature concernant l’approximation avec des fonctions affines par morceaux, voir par exemple [8, 9, 25, 120, 162, 192]. Le travail reporté dans ces références s’intéresse au calcul d’approximations affines par morceaux qui minimisent l’erreur d’approximation dans le sens de la distance ponctuelle entre  $\varphi$  et  $\varphi_{\text{PWA}}$ . Cependant, en vue de l’application de l’Algorithme C.51, notre but est de calculer une approximation affine par morceaux telle que l’erreur d’approximation est Lipschitz, et respecte une borne donnée sur la constante de Lipschitz. Nous appellerons cette approche *approximation Lipschitz*.

Considérons le cas scalaire  $\varphi : \mathbb{R} \rightarrow \mathbb{R}$  (le cas multivariable est discuté dans la version en anglais, voir Section 5.4.2). Nous commençons par rappeler un fait bien connu reliant la continuité de Lipschitz avec la bornitude de la dérivée [161].

LEMME C.52

Soit  $f : \mathbb{R} \rightarrow \mathbb{R}$  une non-linéarité sans mémoire. Alors, les deux affirmations sont équivalentes :

- (i)  $f$  est Lipschitz continue, avec une constante de Lipschitz  $L$ , c’est-à-dire  $|f(v) - f(\tilde{v})| \leq L|v - \tilde{v}|$ , pour tout  $v, \tilde{v} \in \mathbb{R}$ .
- (ii)  $f$  est absolument continue et la dérivée  $f'$  est bornée presque partout par  $L$ , c’est-à-dire  $|f'(v)| \leq L$ , pour presque tous les  $v \in \mathbb{R}$ . ┘

Définissons  $\Phi(N)$  l'ensemble de fonctions affines par morceaux  $\varphi_{\text{PWA}} : \mathbb{R} \rightarrow \mathbb{R}$  définies dans une partition de taille  $N$ . Alors, il existe  $(r_i, s_i) \in \mathbb{R}^2$  tels que  $\varphi_{\text{PWA}}(v) = r_i v + s_i$ , pour  $v \in \mathcal{R}_i$ , où  $i \in \mathcal{I} = \{1, \dots, N\}$ . Comme  $\varphi$  est continue et  $\epsilon$  est Lipschitz continue,  $\varphi_{\text{PWA}}$  doit être continue. Cela implique que

$$r_i v + s_i = r_j v + s_j, \quad \forall v \in \mathcal{R}_i \cap \mathcal{R}_j. \quad (\text{C.173})$$

Nous fixons aussi  $\varphi_{\text{PWA}}(0) = 0$ , de sorte que pour tout  $i$  tel que  $v = 0 \in \mathcal{R}_i$ , nous avons  $s_i = 0$ . Nous ferons l'hypothèse suivante sur la non-linéarité  $\varphi$ .

HYPOTHÈSE C.53

*La non-linéarité sans mémoire  $\varphi$  est continuellement différentiable, c'est-à-dire  $\varphi \in \mathcal{C}^1(\mathbb{R})$ , et est asymptotiquement affine, c'est-à-dire qu'il existe des constantes  $k_1, k_2 \in \mathbb{R}$  telles que  $\lim_{v \rightarrow -\infty} |\varphi'(v) - k_1| = 0$  et  $\lim_{v \rightarrow \infty} |\varphi'(v) - k_2| = 0$ .*  $\lrcorner$

L'Hypothèse C.53 assure que nous sommes capables de construire une approximation  $\varphi_{\text{PWA}}$  avec une partition finie (avec  $N < \infty$ ) sur un domaine non borné comme  $\mathbb{R}$ . Nous cherchons à trouver  $\varphi_{\text{PWA}}$  qui se rapproche le plus de  $\varphi$ . Nous mesurerons l'erreur d'approximation par sa constante de Lipschitz, c'est-à-dire par son gain incrémental. Cela peut être formalisé comme

$$\begin{aligned} & \underset{\varphi_{\text{PWA}} \in \Phi(N)}{\text{minimiser}} && L_\epsilon \\ & \text{contraint par} && |\epsilon(v) - \epsilon(\tilde{v})| \leq L_\epsilon |v - \tilde{v}| \\ & && v, \tilde{v} \in \mathbb{R}, \end{aligned} \quad (\text{C.174})$$

où  $\epsilon(v) = \varphi(v) - \varphi_{\text{PWA}}(v)$ .

Quand on raffine la partition  $\{\mathcal{R}_i\}_{i \in \mathcal{I}}$ , en choisissant un plus grand  $N$ , l'erreur d'approximation diminue, tandis que la complexité de  $\varphi_{\text{PWA}}$  augmente. Cela indique un compromis entre l'exactitude de la description et la complexité de l'analyse. Nous chercherons une valeur de  $N$  assurant une limite supérieure donnée  $L_{\text{ref}}$  sur la constante de Lipschitz de l'erreur d'approximation. La proposition suivante donne une méthode pour obtenir  $\varphi_{\text{PWA}}$  en respectant la limite supérieure désirée pour l'approximation.

PROPOSITION C.54

*Soit  $\varphi$  une fonction qui satisfait l'Hypothèse C.53. Soit  $L_{\text{ref}} > 0$ , et soit  $\{\mathcal{R}_i\}_{i \in \mathcal{I}}$ , avec  $\mathcal{I} = \{1, \dots, N\}$ , une partition de  $\mathbb{R}$  obtenue par une division uniforme de l'image de  $\varphi'$  sous  $\mathbb{R}$ , i.e.  $l(\varphi'(\mathcal{R}_i)) = l(\varphi'(\mathcal{R}_j))$ , pour tous  $i, j \in \mathcal{I}$ , où  $l(\cdot)$  indique la longueur d'un intervalle. Soit  $r_i = (\sup_{v \in \text{int}(\mathcal{R}_i)} \varphi'(v) + \inf_{v \in \text{int}(\mathcal{R}_i)} \varphi'(v))/2$  et  $s_i$  choisi pour assurer la continuité de  $\varphi_{\text{PWA}}$ , i.e. de sorte que  $r_i v + s_i = r_j v + s_j$  soit satisfait pour toutes les paires  $(i, j)$  telles que  $\mathcal{R}_i \cap \mathcal{R}_j \neq \emptyset$ . Alors, en choisissant  $N$  tel que  $l(\varphi'(\mathcal{R}_i)) \leq 2L_{\text{ref}}$ , l'approximation obtenue  $\varphi_{\text{PWA}}$  assure que  $\epsilon$  est Lipschitz continu avec une constante de Lipschitz  $L_\epsilon \leq L_{\text{ref}}$ .*  $\lrcorner$

# Bibliography

- [1] A. D. Ames and S. Sastry. Characterization of Zeno behavior in hybrid systems using homological methods. In *Proceedings of the American Control Conference*, volume 2, pages 1160–1165, 2005. doi: [10.1109/ACC.2005.1470118](https://doi.org/10.1109/ACC.2005.1470118).
- [2] O. Ameer. *Commande et stabilité des systèmes commutés : Application Fluid Power*. PhD thesis, Université de Lyon, Lyon, France, 2015. URL [http://bibli.ec-lyon.fr/exl-doc/TH\\_T2458\\_oameur.pdf](http://bibli.ec-lyon.fr/exl-doc/TH_T2458_oameur.pdf). (in French).
- [3] O. Ameer, P. Massioni, G. Scorletti, X. Brun, and M. Smaoui. A piecewise-affine approach to the analysis of non-linear control laws for pneumatic systems. In *Proceedings of the 53rd IEEE Conference on Decision and Control*, pages 15–17, 2014. doi: [10.1109/CDC.2014.7040005](https://doi.org/10.1109/CDC.2014.7040005).
- [4] O. Ameer, P. Massioni, G. Scorletti, X. Brun, and M. Smaoui. Lyapunov stability analysis of switching controllers in presence of sliding modes and parametric uncertainties with application to pneumatic systems. *IEEE Transactions on Control Systems Technology*, 24(6):1953–1964, 2016. doi: [10.1109/TCST.2016.2529964](https://doi.org/10.1109/TCST.2016.2529964).
- [5] D. Angeli. A Lyapunov approach to incremental stability. In *Proceedings of the 39th IEEE Conference on Decision and Control*, volume 3, pages 2947–2952, 2000. doi: [10.1109/CDC.2000.914265](https://doi.org/10.1109/CDC.2000.914265).
- [6] D. Angeli. A Lyapunov approach to incremental stability properties. *IEEE Transactions on Automatic Control*, 47(3):410–421, 2002. doi: [10.1109/9.989067](https://doi.org/10.1109/9.989067).
- [7] D. Angeli. Further results on incremental input-to-state stability. *IEEE Transactions on Automatic Control*, 54(6):1386–1391, 2009. doi: [10.1109/TAC.2009.2015561](https://doi.org/10.1109/TAC.2009.2015561).
- [8] E. Asarin, T. Dang, and A. Girard. Hybridization methods for the analysis of nonlinear systems. *Acta Informatica*, 43(7):451–476, 2007. doi: [10.1007/s00236-006-0035-7](https://doi.org/10.1007/s00236-006-0035-7).
- [9] S. Azuma, J. Imura, and T. Sugie. Lebesgue piecewise affine approximation of non-linear systems. *Nonlinear Analysis: Hybrid Systems*, 4(1):92–102, 2010. doi: [10.1016/j.nahs.2009.08.003](https://doi.org/10.1016/j.nahs.2009.08.003).
- [10] S. P. Banks and S. A. Khathur. Structure and control of piecewise-linear systems. *International Journal of Control*, 50(2):667–686, 1989. doi: [10.1080/00207178908953388](https://doi.org/10.1080/00207178908953388).
- [11] R. Bellman. *Dynamic Programming*. Princeton University Press, 1957.



- [12] A. Bemporad, F. D. Torrisi, and M. Morari. Optimization-based verification and stability characterization of piecewise affine and hybrid systems. In N. Lynch and B. H. Krogh, editors, *Hybrid Systems: Computation and Control*, pages 45–58. Springer Berlin Heidelberg, Berlin, Heidelberg, 2000. doi: [10.1007/3-540-46430-1\\_8](https://doi.org/10.1007/3-540-46430-1_8).
- [13] H. Ben-Talha, P. Massioni, and G. Scorletti. Robust simulation of continuous-time systems with rational dynamics. *International Journal of Robust and Nonlinear Control*, 27(16):3097–3108, 2017. doi: [10.1002/rnc.3728](https://doi.org/10.1002/rnc.3728).
- [14] A. BenAbdallah, M. A. Hammami, and J. Kallel. Robust stability of uncertain piecewise-linear systems: LMI approach. *Nonlinear Dynamics*, 63(1):183–192, 2011. doi: [10.1007/s11071-010-9795-2](https://doi.org/10.1007/s11071-010-9795-2).
- [15] F. Blanchini. Nonquadratic Lyapunov functions for robust control. *Automatica*, 31(3):451–461, 1995. doi: [10.1016/0005-1098\(94\)00133-4](https://doi.org/10.1016/0005-1098(94)00133-4).
- [16] S. Boyd and L. O. Chua. Fading memory and the problem of approximating nonlinear operators with Volterra series. *IEEE Transactions on Circuits and Systems*, 32(11):1150–1161, 1985. doi: [10.1109/TCS.1985.1085649](https://doi.org/10.1109/TCS.1985.1085649).
- [17] S. Boyd and L. Vandenberghe. *Convex Optimization*. Cambridge University Press, 2004. doi: [10.1017/CBO9780511804441](https://doi.org/10.1017/CBO9780511804441).
- [18] S. Boyd, L. El Ghaoui, E. Feron, and V. Balakrishnan. *Linear Matrix Inequalities in System and Control Theory*, volume 15 of *SIAM studies in applied mathematics*. Society for Industrial and Applied Mathematics, 1994. doi: [10.1137/1.9781611970777](https://doi.org/10.1137/1.9781611970777).
- [19] R. W. Brockett and J. L. Willems. Frequency domain stability criteria — Part I. *IEEE Transactions on Automatic Control*, 10(3):255–261, 1965. doi: [10.1109/TAC.1965.1098143](https://doi.org/10.1109/TAC.1965.1098143).
- [20] K. Camlibel. Well-posed bimodal piecewise linear systems do not exhibit Zeno behavior. In *Proceedings of the 17th IFAC World Congress*, pages 7973–7978, Seoul, Korea, 2008. doi: [10.3182/20080706-5-KR-1001.01347](https://doi.org/10.3182/20080706-5-KR-1001.01347).
- [21] A. Cantoni. Optimal curve fitting with piecewise linear functions. *IEEE Transactions on Computers*, C-20(1):59–67, 1971. doi: [10.1109/T-C.1971.223082](https://doi.org/10.1109/T-C.1971.223082).
- [22] J. Carrasco and P. Seiler. Integral quadratic constraint theorem: A topological separation approach. In *Proceedings of the 54th IEEE Conference on Decision and Control*, pages 5701–5706, 2015. doi: [10.1109/CDC.2015.7403114](https://doi.org/10.1109/CDC.2015.7403114).
- [23] J. Carrasco and P. Seiler. Conditions for the equivalence between IQC and graph separation stability results. *International Journal of Control*, pages 1–8, 2018. doi: [10.1080/00207179.2018.1465205](https://doi.org/10.1080/00207179.2018.1465205).
- [24] J. Carrasco, M. C. Turner, and W. P. Heath. Zames-Falb multipliers for absolute stability: From O’Shea’s contribution to convex searches. *European Journal of Control*, 28(Supplement C):1–19, 2016. doi: [10.1016/j.ejcon.2015.10.003](https://doi.org/10.1016/j.ejcon.2015.10.003).

- [25] S. Casselman and L. Rodrigues. A new methodology for piecewise affine models using Voronoi partitions. In *Proceedings of the joint 48th IEEE Conference on Decision and Control and 28th Chinese Control Conference*, pages 3920–3925, 2009. doi: [10.1109/CDC.2009.5400928](https://doi.org/10.1109/CDC.2009.5400928).
- [26] G. Chesi. LMI techniques for optimization over polynomials in control: A survey. *IEEE Transactions on Automatic Control*, 55(11):2500–2510, 2010. doi: [10.1109/TAC.2010.2046926](https://doi.org/10.1109/TAC.2010.2046926).
- [27] G. Chesi, A. Garulli, A. Tesi, and A. Vicino. Homogeneous polynomial Lyapunov functions for robust stability analysis of LFR systems. Technical report, Università di Siena, Siena, Italy, 2002. URL [http://www.dii.unisi.it/~garulli/opt\\_papers.html](http://www.dii.unisi.it/~garulli/opt_papers.html).
- [28] G. Chesi, A. Garulli, A. Tesi, and A. Vicino. Robust analysis of LFR systems through homogeneous polynomial Lyapunov functions. *IEEE Transactions on Automatic Control*, 49(7):1211–1215, 2004. doi: [10.1109/TAC.2004.831152](https://doi.org/10.1109/TAC.2004.831152).
- [29] Y. Chitour, W. Liu, and E. Sontag. On the continuity and incremental-gain properties of certain saturated linear feedback loops. *International Journal of Robust and Nonlinear Control*, 5(5):413–440, 1995. doi: [10.1002/rnc.4590050505](https://doi.org/10.1002/rnc.4590050505).
- [30] L. O. Chua and S. M. Kang. Section-wise piecewise-linear functions: Canonical representation, properties, and applications. *Proceedings of the IEEE*, 65(6):915–929, 1977. doi: [10.1109/PROC.1977.10589](https://doi.org/10.1109/PROC.1977.10589).
- [31] D. J. Clements. A state-space approach to indefinite spectral factorization. *SIAM Journal on Matrix Analysis and Applications*, 21(3):743–767, 2000. doi: [10.1137/S0895479897324469](https://doi.org/10.1137/S0895479897324469).
- [32] F. A. Cuzzola and M. Morari. A generalized approach for analysis and control of discrete-time piecewise affine and hybrid systems. In M. D. D. Benedetto and A. Sangiovanni-Vincentelli, editors, *Hybrid Systems: Computation and Control*, volume 2034 of *Lecture Notes in Computer Science*, pages 189–203. Springer, 2001. doi: [10.1007/3-540-45351-2\\_18](https://doi.org/10.1007/3-540-45351-2_18).
- [33] F. A. Cuzzola and M. Morari. An lmi approach for  $H_\infty$  analysis and control of discrete-time piecewise affine systems. *International Journal of Control*, 75(16–17):1293–1301, 2002. doi: [10.1080/0020717021000023726](https://doi.org/10.1080/0020717021000023726).
- [34] D. Dai, T. Hu, A. R. Teel, and L. Zaccarian. Piecewise-quadratic Lyapunov functions for systems with deadzones or saturations. *Systems & Control Letters*, 58(5):365–371, 2009. doi: [10.1016/j.sysconle.2009.01.003](https://doi.org/10.1016/j.sysconle.2009.01.003).
- [35] C. Desoer and Y.-T. Wang. Foundations of feedback theory for nonlinear dynamical systems. *IEEE Transactions on Circuits and Systems*, 27(2):104–123, 1980. doi: [10.1109/TCS.1980.1084787](https://doi.org/10.1109/TCS.1980.1084787).
- [36] C. A. Desoer and M. Vidyasagar. *Feedback Systems: Input-Output Properties*. SIAM, 2009.

- [37] T. Dezuo, L. Rodrigues, and A. Trofino. Stability analysis of piecewise affine systems with sliding modes. In *Proceedings of the American Control Conference*, pages 2005–2010, Portland, USA, 2014. doi: [10.1109/ACC.2014.6859071](https://doi.org/10.1109/ACC.2014.6859071).
- [38] M. di Bernardo, D. Liuzza, and G. Russo. Contraction analysis for a class of nondifferentiable systems with applications to stability and network synchronization. *SIAM Journal on Control and Optimization*, 52(5):3203–3227, 2014. doi: [10.1137/120883001](https://doi.org/10.1137/120883001).
- [39] J. Doyle. Analysis of feedback systems with structured uncertainties. *IEE Proceedings D - Control Theory and Applications*, 129(6):242–250, 1982. doi: [10.1049/ip-d.1982.0053](https://doi.org/10.1049/ip-d.1982.0053).
- [40] Y. Ebihara. An elementary proof for the exactness of (D, G) scaling. In *Proceedings of the American Control Conference*, pages 2433–2438, 2009. doi: [10.1109/ACC.2009.5159874](https://doi.org/10.1109/ACC.2009.5159874).
- [41] M. K. H. Fan, A. L. Tits, and J. C. Doyle. Robustness in the presence of mixed parametric uncertainty and unmodeled dynamics. *IEEE Transactions on Automatic Control*, 36(1):25–38, 1991. doi: [10.1109/9.62265](https://doi.org/10.1109/9.62265).
- [42] W. Feller. *An Introduction to Probability Theory and Its Applications*. Wiley Series in Probability and Mathematical Statistics. John John Wiley & Sons, Ltd., third edition, 1968.
- [43] G. Feng. Stability analysis of piecewise discrete-time linear systems. *IEEE Transactions on Automatic Control*, 47(7):1108–1112, 2002. doi: [10.1109/TAC.2002.800666](https://doi.org/10.1109/TAC.2002.800666).
- [44] G. Feng. Controller design and analysis of uncertain piecewise-linear systems. *IEEE Transactions on Circuits and Systems I: Fundamental Theory and Applications*, 49(2):224–232, 2002. doi: [10.1109/81.983869](https://doi.org/10.1109/81.983869).
- [45] G. Ferrari-Trecate, F. A. Cuzzola, D. Mignone, and M. Morari. Analysis and control with performance of piecewise affine and hybrid systems. In *Proceedings of the American Control Conference*, volume 1, pages 200–205, 2001. doi: [10.1109/ACC.2001.945542](https://doi.org/10.1109/ACC.2001.945542).
- [46] G. Ferrari-Trecate, F. A. Cuzzola, D. Mignone, and M. Morari. Analysis of discrete-time piecewise affine and hybrid systems. *Automatica*, 38(12):2139 – 2146, 2002. doi: [10.1016/S0005-1098\(02\)00142-5](https://doi.org/10.1016/S0005-1098(02)00142-5).
- [47] A. F. Filippov. *Differential Equations with Discontinuous Righthand Sides*, volume 18 of *Soviet Series*. Springer, 1988. doi: [10.1007/978-94-015-7793-9](https://doi.org/10.1007/978-94-015-7793-9).
- [48] D. Fiore, S. J. Hogan, and M. di Bernardo. Contraction analysis of switched systems via regularization. *Automatica*, 73(Supplement C):279–288, 2016. doi: [10.1016/j.automatica.2016.06.028](https://doi.org/10.1016/j.automatica.2016.06.028).
- [49] F. Forni and R. Sepulchre. A differential Lyapunov framework for contraction analysis. *IEEE Transactions on Automatic Control*, 59(3):614–628, 2014. doi: [10.1109/tac.2013.2285771](https://doi.org/10.1109/tac.2013.2285771).
- [50] F. Forni, R. Sepulchre, and A. van der Schaft. On differential passivity of physical systems. In *Proceedings of the 52nd IEEE Conference on Decision and Control*, pages 6580–6585. IEEE, 2013. doi: [10.1109/CDC.2013.6760930](https://doi.org/10.1109/CDC.2013.6760930).

- [51] V. Fromion. *Une approche incrémentale de la robustesse non linéaire ; application au domaine de l'aéronautique*. PhD thesis, Université de Paris Sud Orsay, 1995. (in French).
- [52] V. Fromion. Some results on the behavior of Lipschitz continuous systems. In *Proceedings of the European Control Conference*, pages 2011–2016, 1997.
- [53] V. Fromion and M. G. Safonov. Popov-Zames-Falb multipliers and continuity of the input/output map. In *Proceedings of the 6th IFAC Symposium on Nonlinear Control Systems*, Stuttgart, Germany, 2004.
- [54] V. Fromion and G. Scorletti. Performance and robustness analysis of nonlinear closed loop systems using  $\mu_{\text{nl}}$  analysis: applications to nonlinear PI controllers. In *Proceedings of the 41st IEEE Conference on Decision and Control*, volume 3, pages 2480–2485, 2002. doi: [10.1109/CDC.2002.1184208](https://doi.org/10.1109/CDC.2002.1184208).
- [55] V. Fromion and G. Scorletti. Connecting nonlinear incremental Lyapunov stability with the linearizations Lyapunov stability. In *Proceedings of the 44th IEEE Conference on Decision and Control*, pages 4736–4741. IEEE, 2005. doi: [10.1109/CDC.2005.1582910](https://doi.org/10.1109/CDC.2005.1582910).
- [56] V. Fromion, S. Monaco, and D. Normand-Cyrot. A possible extension of  $H_{\infty}$  control to the nonlinear context. In *Proceedings of the 34th IEEE Conference on Decision and Control*, volume 2, pages 975–980 vol.2, 1995. doi: [10.1109/CDC.1995.480212](https://doi.org/10.1109/CDC.1995.480212).
- [57] V. Fromion, S. Monaco, and D. Normand-Cyrot. Asymptotic properties of incrementally stable systems. *IEEE Transactions on Automatic Control*, 41(5):721–723, 1996. doi: [10.1109/9.489210](https://doi.org/10.1109/9.489210).
- [58] V. Fromion, S. Monaco, and D. Normand-Cyrot. A link between input-output stability and Lyapunov stability. *Systems & Control Letters*, 27(4):243–248, 1996. doi: [10.1016/0167-6911\(95\)00046-1](https://doi.org/10.1016/0167-6911(95)00046-1).
- [59] V. Fromion, G. Scorletti, and G. Ferreres. Nonlinear performance of a PI controlled missile: an explanation. *International Journal of Robust and Nonlinear Control*, 9(8):485–518, 1999. doi: [10.1002/\(SICI\)1099-1239\(19990715\)9:8<485::AID-RNC417>3.0.CO;2-4](https://doi.org/10.1002/(SICI)1099-1239(19990715)9:8<485::AID-RNC417>3.0.CO;2-4).
- [60] V. Fromion, S. Monaco, and D. Normand-Cyrot. The weighted incremental norm approach: from linear to nonlinear  $H_{\infty}$  control. *Automatica*, 37(10):1585–1592, 2001. doi: [10.1016/S0005-1098\(01\)00106-6](https://doi.org/10.1016/S0005-1098(01)00106-6).
- [61] V. Fromion, M. G. Safonov, and G. Scorletti. Necessary and sufficient conditions for Lur'e system incremental stability. In *European Control Conference (ECC), 2003*, pages 71–76, 2003.
- [62] T. T. Georgiou. Differential stability and robust control of nonlinear systems. *Mathematics of Control, Signals and Systems*, 6(4):289–306, 1993. doi: [10.1007/BF01211498](https://doi.org/10.1007/BF01211498).
- [63] J. C. Geromel and R. H. Korogui. *Controle Linear de Sistemas Dinâmicos*. Editora Blucher, São Paulo, SP, 2011. (in Portuguese).
- [64] R. Goebel, R. G. Sanfelice, and A. R. Teel. *Hybrid Dynamical Systems: Modeling, Stability, and Robustness*. Princeton University Press, 2012.

- [65] K.-C. Goh. Structure and factorization of quadratic constraints for robustness analysis. In *Proceedings of the 35th IEEE Conference on Decision and Control*, volume 4, pages 4649–4654, 1996. doi: [10.1109/CDC.1996.577607](https://doi.org/10.1109/CDC.1996.577607).
- [66] K.-C. Goh and M. G. Safonov. Robust analysis, sectors, and quadratic functionals. In *Proceedings of the 34th IEEE Conference on Decision and Control*, volume 2, pages 1988–1993, 1995. doi: [10.1109/CDC.1995.480638](https://doi.org/10.1109/CDC.1995.480638).
- [67] J. M. Gonçalves, A. Megretski, and M. A. Dahleh. Global analysis of piecewise linear systems using impact maps and surface Lyapunov functions. *IEEE Transactions on Automatic Control*, 48(12):2089–2106, 2003. doi: [10.1109/TAC.2003.820061](https://doi.org/10.1109/TAC.2003.820061).
- [68] P. Grieder, M. Liithi, P. A. Parrilo, and M. Morari. Stability & feasibility of constrained receding horizon control. In *Proceedings of the European Control Conference*, pages 701–706, Cambridge, UK, 2003.
- [69] S. V. Gusev and A. L. Likhtarnikov. Kalman-Popov-Yakubovich lemma and the S-procedure: A historical essay. *Automation and Remote Control*, 67(11):1768–1810, 2006. doi: [10.1134/S000511790611004X](https://doi.org/10.1134/S000511790611004X).
- [70] A. Hassibi and S. Boyd. Quadratic stabilization and control of piecewise-linear systems. In *Proceedings of the American Control Conference*, volume 6, pages 3659–3664, 1998. doi: [10.1109/ACC.1998.703296](https://doi.org/10.1109/ACC.1998.703296).
- [71] D. J. Hill and P. J. Moylan. The stability of nonlinear dissipative systems. *IEEE Transactions on Automatic Control*, 21(5):708–711, 1976. doi: [10.1109/TAC.1976.1101352](https://doi.org/10.1109/TAC.1976.1101352).
- [72] D. J. Hill and P. J. Moylan. Dissipative dynamical systems: Basic input-output and state properties. *Journal of the Franklin Institute*, 309(5):327 – 357, 1980. doi: [10.1016/0016-0032\(80\)90026-5](https://doi.org/10.1016/0016-0032(80)90026-5).
- [73] D. J. Hill and P. J. Moylan. Connections between finite-gain and asymptotic stability. *IEEE Transactions on Automatic Control*, 25(5):931–936, 1980. doi: [10.1109/TAC.1980.1102463](https://doi.org/10.1109/TAC.1980.1102463).
- [74] T. Hu, A. R. Teel, and L. Zaccarian. Stability and performance for saturated systems via quadratic and nonquadratic Lyapunov functions. *IEEE Transactions on Automatic Control*, 51(11):1770–1786, 2006. doi: [10.1109/TAC.2006.884942](https://doi.org/10.1109/TAC.2006.884942).
- [75] J. K. Hunter. Notes on partial differential equations. Lecture Notes, Department of Mathematics, University of California at Davis, 2014. URL [https://www.math.ucdavis.edu/~hunter/pdes/pde\\_notes.pdf](https://www.math.ucdavis.edu/~hunter/pdes/pde_notes.pdf).
- [76] R. Iervolino, F. Vasca, and L. Iannelli. A cone-copositive approach for the stability of piecewise linear differential inclusions. In *Proceedings of the joint 50th IEEE Conference on Decision and Control and European Control Conference*, pages 1062–1067, 2011. doi: [10.1109/CDC.2011.6160752](https://doi.org/10.1109/CDC.2011.6160752).
- [77] R. Iervolino, D. Tangredi, and F. Vasca. Lyapunov stability for piecewise affine systems via cone-copositivity. *Automatica*, 81:22–29, 2017. doi: [10.1016/j.automatica.2017.03.011](https://doi.org/10.1016/j.automatica.2017.03.011).

- [78] J. Imura and A. van der Schaft. Characterization of well-posedness of piecewise-linear systems. *IEEE Transactions on Automatic Control*, 45(9):1600–1619, 2000. doi: [10.1109/9.880612](https://doi.org/10.1109/9.880612).
- [79] M. R. James. A partial differential inequality for dissipative nonlinear systems. *Systems & Control Letters*, 21(4):315–320, 1993. doi: [10.1016/0167-6911\(93\)90074-G](https://doi.org/10.1016/0167-6911(93)90074-G).
- [80] M. R. James and S. Yuliar. Numerical approximation of the  $H_\infty$  norm for nonlinear systems. *Automatica*, 31(8):1075–1086, 1995. doi: [10.1016/0005-1098\(94\)00161-B](https://doi.org/10.1016/0005-1098(94)00161-B).
- [81] M. Jeh Chien and E. S. Kuh. Solving nonlinear resistive networks using piecewise-linear analysis and simplicial subdivision. *IEEE Transactions on Circuits and Systems*, 24(6):305–317, 1977. doi: [10.1109/TCS.1977.1084349](https://doi.org/10.1109/TCS.1977.1084349).
- [82] M. Johansson. Piecewise quadratic estimates of domains of attraction for linear systems with saturation. In *Proceedings of the 15th IFAC World Congress*, pages 187–192, Barcelona, Spain, 2002. doi: [10.3182/20020721-6-ES-1901.00281](https://doi.org/10.3182/20020721-6-ES-1901.00281).
- [83] M. Johansson. *Piecewise Linear Control Systems: A Computational Approach*, volume 284 of *Lecture Notes in Control and Information Sciences*. Springer, 2003. doi: [10.1007/3-540-36801-9](https://doi.org/10.1007/3-540-36801-9).
- [84] M. Johansson and A. Rantzer. On the computation of piecewise quadratic Lyapunov functions. In *Proceedings of the 36th IEEE Conference on Decision and Control*, volume 4, pages 3515–3520, 1997. doi: [10.1109/CDC.1997.652393](https://doi.org/10.1109/CDC.1997.652393).
- [85] M. Johansson and A. Rantzer. Computation of piecewise quadratic Lyapunov functions for hybrid systems. *IEEE Transactions on Automatic Control*, 43(4):555–559, 1998. doi: [10.1109/9.664157](https://doi.org/10.1109/9.664157).
- [86] U. Jönsson. *Robustness Analysis of Uncertain and Nonlinear Systems*. PhD thesis, Department of Automatic Control, Lund Institute of Technology, Lund, Sweden, 1996. URL <http://portal.research.lu.se/portal/files/4661414/8840257.pdf>.
- [87] J. Jouffroy. Some ancestors of contraction analysis. In *Proceedings of the 44th IEEE Conference on Decision and Control*, pages 5450–5455, 2005. doi: [10.1109/CDC.2005.1583029](https://doi.org/10.1109/CDC.2005.1583029).
- [88] P. Julián, A. Desages, and O. Agamennoni. High-level canonical piecewise linear representation using a simplicial partition. *IEEE Transactions on Circuits and Systems I: Fundamental Theory and Applications*, 46(4):463–480, 1999. doi: [10.1109/81.754847](https://doi.org/10.1109/81.754847).
- [89] T. Kai and R. Masuda. Limit cycle synthesis of multi-modal and 2-dimensional piecewise affine systems. *Mathematical and Computer Modelling*, 55(3):505–516, 2012. doi: [10.1016/j.mcm.2011.08.028](https://doi.org/10.1016/j.mcm.2011.08.028).
- [90] M. Kantner. Robust stability of piecewise linear discrete time systems. In *Proceedings of the American Control Conference*, volume 2, pages 1241–1245, 1997. doi: [10.1109/ACC.1997.609732](https://doi.org/10.1109/ACC.1997.609732).
- [91] H. K. Khalil. *Nonlinear Systems*. Prentice Hall, third edition, 2002.

- [92] K. A. Khan and P. I. Barton. Switching behavior of solutions of ordinary differential equations with abs-factorable right-hand sides. *Systems & Control Letters*, 84:27–34, 2015. doi: [10.1016/j.sysconle.2015.07.007](https://doi.org/10.1016/j.sysconle.2015.07.007).
- [93] H. Kiendl and J. Rüger. Stability analysis of fuzzy control systems using facet functions. *Fuzzy Sets and Systems*, 70(2):275–285, 1995. doi: [10.1016/0165-0114\(94\)00222-S](https://doi.org/10.1016/0165-0114(94)00222-S).
- [94] X. D. Koutsoukos and P. J. Antsaklis. Characterization of stabilizing switching sequences in switched linear systems using piecewise linear Lyapunov functions. In M. D. D. Benedetto and A. Sangiovanni-Vincentelli, editors, *Hybrid Systems: Computation and Control*, volume 2034 of *Lecture Notes in Computer Science*, pages 347–360. Springer, 2001. doi: [10.1007/3-540-45351-2\\_29](https://doi.org/10.1007/3-540-45351-2_29).
- [95] M. Krichman and E. D. Sontag. Characterizations of detectability notions in terms of discontinuous dissipation functions. *International Journal of Control*, 75(12):882–900, 2002. doi: [10.1080/00207170210141842](https://doi.org/10.1080/00207170210141842).
- [96] V. V. Kulkarni and M. G. Safonov. Incremental positivity nonpreservation by stability multipliers. *IEEE Transactions on Automatic Control*, 47(1):173–177, 2002. doi: [10.1109/9.981740](https://doi.org/10.1109/9.981740).
- [97] J. La Salle and S. Lefschetz. *Stability by Lyapunov’s Second Method with Applications*. Academic Press, 1961.
- [98] J. P. LaSalle. A study of synchronous asymptotic stability. *Annals of Mathematics*, 65(3):571–581, 1957. doi: [10.2307/1970065](https://doi.org/10.2307/1970065).
- [99] Y. Li and Z. Lin. Stability and performance analysis of saturated systems via partitioning of the virtual input space. *Automatica*, 53:85–93, 2015. doi: [10.1016/j.automatica.2014.12.033](https://doi.org/10.1016/j.automatica.2014.12.033).
- [100] D. Liberzon. *Switching in Systems and Control*. Systems & Control: Foundations & Applications. Springer Science+Business Media, 2003. doi: [10.1007/978-1-4612-0017-8](https://doi.org/10.1007/978-1-4612-0017-8).
- [101] D. Liberzon. *Calculus of Variations and Optimal Control Theory: A Concise Introduction*. Princeton University Press, 2011.
- [102] M. R. Liberzon. Essays on the absolute stability theory. *Automation and Remote Control*, 67(10):1610–1644, 2006. doi: [10.1134/S0005117906100043](https://doi.org/10.1134/S0005117906100043).
- [103] Y. Lin, E. D. Sontag, and Y. Wang. A smooth converse Lyapunov theorem for robust stability. *SIAM Journal on Control and Optimization*, 34(1):124–160, 1996. doi: [10.1137/S0363012993259981](https://doi.org/10.1137/S0363012993259981).
- [104] J. Löfberg. YALMIP : A toolbox for modeling and optimization in MATLAB. In *Computer Aided Control Systems Design, 2004 IEEE International Symposium on*, Taipei, Taiwan, 2004. doi: [10.1109/CACSD.2004.1393890](https://doi.org/10.1109/CACSD.2004.1393890).
- [105] W. Lohmiller and J.-J. E. Slotine. On contraction analysis for non-linear systems. *Automatica*, 34(6):683–696, 1998. doi: [10.1016/S0005-1098\(98\)00019-3](https://doi.org/10.1016/S0005-1098(98)00019-3).

- [106] J. Lunze and F. Lamnabhi-Lagarrigue, editors. *Handbook of Hybrid Systems Control: Theory, Tools, Applications*. Cambridge University Press, 2009.
- [107] I. R. Manchester and J. J. E. Slotine. Control contraction metrics: Convex and intrinsic criteria for nonlinear feedback design. *IEEE Transactions on Automatic Control*, 62(6): 3046–3053, 2017. doi: [10.1109/TAC.2017.2668380](https://doi.org/10.1109/TAC.2017.2668380).
- [108] P. Massioni and G. Scorletti. Guaranteed systematic simulation of discrete-time systems defined by polynomial expressions via convex relaxations. *International Journal of Robust and Nonlinear Control*, 28(3):1062–1073, 2018. doi: [10.1002/rnc.3920](https://doi.org/10.1002/rnc.3920).
- [109] A. Megretski and S. Treil. Power distribution inequalities in optimization and robustness of uncertain systems. *Journal of Mathematical Systems, Estimation, and Control*, 3(3): 301–319, 1993.
- [110] A. Megretski. KYP lemma for non-strict inequalities and the associated minimax theorem, 2010. arXiv preprint [arXiv:1008.2552](https://arxiv.org/abs/1008.2552).
- [111] A. Megretski and A. Rantzer. System analysis via integral quadratic constraints. *IEEE Transactions on Automatic Control*, 42(6):819–830, 1997. doi: [10.1109/9.587335](https://doi.org/10.1109/9.587335).
- [112] D. Mignone, G. Ferrari-Trecate, and M. Morari. Stability and stabilization of piecewise affine and hybrid systems: an LMI approach. In *Proceedings of the 39th IEEE Conference on Decision and Control*, volume 1, pages 504–509, Sydney, Australia, 2000. doi: [10.1109/CDC.2000.912814](https://doi.org/10.1109/CDC.2000.912814).
- [113] E. Morinaga and K. Hirata. An  $L_2$ -gain analysis of piecewise affine systems by piecewise quadratic storage functions. In *Proceedings of the American Control Conference*, volume 6, pages 5176–5181, Boston, USA, 2004.
- [114] E. Morinaga, K. Hirata, and Y. Ohta. Performance analysis of control systems with input constraints via piecewise quadratic storage functions. *Asian Journal of Control*, 6(1):34–45, 2004. doi: [10.1111/j.1934-6093.2004.tb00182.x](https://doi.org/10.1111/j.1934-6093.2004.tb00182.x).
- [115] MOSEK ApS. *The MOSEK optimization toolbox for MATLAB manual. Version 7.1 (Revision 28)*, 2015. URL <http://docs.mosek.com/7.1/toolbox/index.html>.
- [116] E. F. Mulder and M. V. Kothare. Synthesis of stabilizing anti-windup controllers using piecewise quadratic Lyapunov functions. In *Proceedings of the American Control Conference*, volume 5, pages 3239–3243, 2000. doi: [10.1109/ACC.2000.879163](https://doi.org/10.1109/ACC.2000.879163).
- [117] K. Narendra and R. Goldwyn. A geometrical criterion for the stability of certain nonlinear nonautonomous systems. *IEEE Transactions on Circuit Theory*, 11(3):406–408, 1964. doi: [10.1109/TCT.1964.1082320](https://doi.org/10.1109/TCT.1964.1082320).
- [118] Y. Nesterov and A. Nemirovskii. *Interior-Point Polynomial Algorithms in Convex Programming*, volume 13 of *SIAM Studies in Applied and Numerical Mathematics*. Society for Industrial and Applied Mathematics, 1994. doi: [10.1137/1.9781611970791](https://doi.org/10.1137/1.9781611970791).
- [119] Y. Ohta, H. Imanishi, L. Gong, and H. Haneda. Computer generated Lyapunov functions for a class of nonlinear systems. *IEEE Transactions on Circuits and Systems I: Fundamental Theory and Applications*, 40(5):343–354, 1993. doi: [10.1109/81.232578](https://doi.org/10.1109/81.232578).



- [120] T. Ohtsuki and N. Yoshida. DC analysis of nonlinear networks based on generalized piecewise-linear characterization. *IEEE Transactions on Circuit Theory*, 18(1):146–152, 1971. doi: [10.1109/TCT.1971.1083226](https://doi.org/10.1109/TCT.1971.1083226).
- [121] A. Papachristodoulou and S. Prajna. A tutorial on sum of squares techniques for systems analysis. In *Proceedings of the American Control Conference*, volume 4, pages 2686–2700, Portland, USA, 2005. doi: [10.1109/ACC.2005.1470374](https://doi.org/10.1109/ACC.2005.1470374).
- [122] P. A. Parrilo. *Structured Semidefinite Programs and Semialgebraic Geometry Methods in Robustness and Optimization*. PhD thesis, California Institute of Technology, Pasadena, California, 2000. URL <http://resolver.caltech.edu/CaltechETD:etd-05062004-055516>.
- [123] P. A. Parrilo. Semidefinite programming relaxations for semialgebraic problems. *Mathematical Programming*, 96(2):293–320, 2003. doi: [10.1007/s10107-003-0387-5](https://doi.org/10.1007/s10107-003-0387-5).
- [124] A. Pavlov, A. Pogromsky, N. van de Wouw, and H. Nijmeijer. Convergent dynamics, a tribute to Boris Pavlovich Demidovich. *Systems & Control Letters*, 52(3–4):257 – 261, 2004. doi: [10.1016/j.sysconle.2004.02.003](https://doi.org/10.1016/j.sysconle.2004.02.003).
- [125] A. Pavlov, A. Pogromsky, N. van de Wouw, and H. Nijmeijer. On convergence properties of piecewise affine systems. *International Journal of Control*, 80(8):1233–1247, 2007. doi: [10.1080/00207170701261978](https://doi.org/10.1080/00207170701261978).
- [126] A. V. Pavlov, N. van de Wouw, and H. Nijmeijer. *Uniform Output Regulation of Nonlinear Systems - A Convergent Dynamics Approach*. Systems & Control: Foundations & Applications. Birkhäuser Basel, first edition, 2006. doi: [10.1007/0-8176-4465-2](https://doi.org/10.1007/0-8176-4465-2).
- [127] S. Pettersson and B. Lennartson. LMI for stability and robustness of hybrid systems. In *Proceedings of the American Control Conference*, volume 3, pages 1714–1718, Albuquerque, USA, 1997. doi: [10.1109/ACC.1997.610877](https://doi.org/10.1109/ACC.1997.610877).
- [128] S. Pettersson and B. Lennartson. Exponential stability of hybrid systems using piecewise quadratic Lyapunov functions resulting in LMIs. In *Proceedings of the 14th IFAC World Congress*, pages 103–108, Beijing, China, 1999.
- [129] N. B. O. L. Pettit and P. E. Wellstead. Analyzing piecewise linear dynamical systems. *IEEE Control Systems*, 15(5):43–50, 1995. doi: [10.1109/37.466263](https://doi.org/10.1109/37.466263).
- [130] S. Prajna and A. Papachristodoulou. Analysis of switched and hybrid systems - beyond piecewise quadratic methods. In *Proceedings of the American Control Conference*, volume 4, pages 2779–2784, Denver, USA, 2003. doi: [10.1109/ACC.2003.1243743](https://doi.org/10.1109/ACC.2003.1243743).
- [131] J. Qiu, G. Feng, and H. Gao. Approaches to robust  $H_\infty$  static output feedback control of discrete-time piecewise-affine systems with norm-bounded uncertainties. *International Journal of Robust and Nonlinear Control*, 21(7):790–814, 2011. doi: [10.1002/rnc.1627](https://doi.org/10.1002/rnc.1627).
- [132] A. Rantzer. On the Kalman-Yakubovich-Popov lemma. *Systems & Control Letters*, 28(1):7–10, 1996. doi: [10.1016/0167-6911\(95\)00063-1](https://doi.org/10.1016/0167-6911(95)00063-1).
- [133] A. Rantzer and M. Johansson. Piecewise linear quadratic optimal control. *IEEE Transactions on Automatic Control*, 45(4):629–637, 2000. doi: [10.1109/9.847100](https://doi.org/10.1109/9.847100).

- [134] A. Rantzer and A. Megretski. System analysis via integral quadratic constraints – part II. Technical Report ISRN LUTFD2/TFRT—7559—SE, Department of Automatic Control, Lund University, Sweden, 1997. URL <http://www.control.lth.se/documents/1997/ran+meg97t.pdf>.
- [135] J. Richter, W. Heemels, N. van de Wouw, and J. Lunze. Reconfigurable control of piecewise affine systems with actuator and sensor faults: Stability and tracking. *Automatica*, 47(4):678–691, 2011. doi: [10.1016/j.automatica.2011.01.048](https://doi.org/10.1016/j.automatica.2011.01.048).
- [136] F. Riesz and B. Sz.-Nagy. *Functional Analysis*. Blackie & Son Limited, 1955.
- [137] R. T. Rockafellar. *Convex Analysis*, volume 28 of *Princeton Mathematical Series*. Princeton University Press, 1970.
- [138] L. Rodrigues. Stability analysis of piecewise-affine systems using controlled invariant sets. *Systems & Control Letters*, 53(2):157–169, 2004. doi: [10.1016/j.sysconle.2004.04.001](https://doi.org/10.1016/j.sysconle.2004.04.001).
- [139] L. Rodrigues and S. Boyd. Piecewise-affine state feedback for piecewise-affine slab systems using convex optimization. *Systems & Control Letters*, 54(9):835 – 853, 2005. doi: [10.1016/j.sysconle.2005.01.002](https://doi.org/10.1016/j.sysconle.2005.01.002).
- [140] L. Rodrigues and J. P. How. Observer-based control of piecewise-affine systems. *International Journal of Control*, 76(5):459–477, 2003. doi: [10.1080/0020717031000091432](https://doi.org/10.1080/0020717031000091432).
- [141] J. Roll. Robust verification of piecewise affine systems. In *Proceedings of the 15th IFAC World Congress*, pages 369–374, Barcelona, Spain, 2002. doi: [10.3182/20020721-6-ES-1901.00223](https://doi.org/10.3182/20020721-6-ES-1901.00223).
- [142] B. G. Romanchuk and M. R. James. Characterization of the  $L_p$  incremental gain for nonlinear systems. In *Proceedings of the 35th IEEE Conference on Decision and Control*, volume 3, pages 3270–3275, 1996. doi: [10.1109/CDC.1996.573646](https://doi.org/10.1109/CDC.1996.573646).
- [143] B. G. Romanchuk and M. C. Smith. Incremental gain analysis of piecewise linear systems and application to the antiwindup problem. *Automatica*, 35(7):1275 – 1283, 1999. doi: [10.1016/S0005-1098\(99\)00023-0](https://doi.org/10.1016/S0005-1098(99)00023-0).
- [144] W. Rudin. *Real and Complex Analysis*. Mathematics series. McGraw-Hill, third edition, 1987.
- [145] B. S. Rüffer, N. van de Wouw, and M. Mueller. Convergent systems vs. incremental stability. *Systems & Control Letters*, 62(3):277 – 285, 2013. doi: [10.1016/j.sysconle.2012.11.015](https://doi.org/10.1016/j.sysconle.2012.11.015).
- [146] M. G. Safonov. *Stability and Robustness of Multivariable Feedback Systems*. Number 3 in Signal Processing, Optimization, and Control. MIT Press, 1980.
- [147] M. G. Safonov. Origins of robust control: Early history and future speculations. *Annual Reviews in Control*, 36(2):173–181, 2012. doi: [10.1016/j.arcontrol.2012.09.001](https://doi.org/10.1016/j.arcontrol.2012.09.001).

- [148] B. Samadi and L. Rodrigues. Extension of local linear controllers to global piecewise affine controllers for uncertain non-linear systems. *International Journal of Systems Science*, 39(9):867–879, 2008. doi: [10.1080/00207720802184683](https://doi.org/10.1080/00207720802184683).
- [149] B. Samadi and L. Rodrigues. A unified dissipativity approach for stability analysis of piecewise smooth systems. *Automatica*, 47(12):2735 – 2742, 2011. doi: [10.1016/j.automatica.2011.09.018](https://doi.org/10.1016/j.automatica.2011.09.018).
- [150] I. W. Sandberg. A frequency-domain condition for the stability of feedback systems containing a single time-varying nonlinear element. *The Bell System Technical Journal*, 43(4):1601–1608, 1964. doi: [10.1002/j.1538-7305.1964.tb04100.x](https://doi.org/10.1002/j.1538-7305.1964.tb04100.x).
- [151] C. W. Scherer and S. Weiland. Linear matrix inequalities in control. Lecture notes, 2004. URL <http://www.dsc.tudelft.nl/~cscherer/lmi/notes05.pdf>.
- [152] S. Scholtes. *Introduction to Piecewise Differentiable Equations*. SpringerBriefs in Optimization. Springer-Verlag New York, first edition, 2012. doi: [10.1007/978-1-4614-4340-7](https://doi.org/10.1007/978-1-4614-4340-7).
- [153] G. Scorletti and V. Fromion. Further results on the design of robust  $H_\infty$  feedforward controllers and filters. In *Proceedings of the 45th IEEE Conference on Decision and Control*, pages 3560–3565, 2006. doi: [10.1109/CDC.2006.377469](https://doi.org/10.1109/CDC.2006.377469).
- [154] P. Seiler. Stability analysis with dissipation inequalities and integral quadratic constraints. *IEEE Transactions on Automatic Control*, 60(6):1704–1709, 2015. doi: [10.1109/TAC.2014.2361004](https://doi.org/10.1109/TAC.2014.2361004).
- [155] S. Skogestad and I. Postlethwaite. *Multivariable Feedback Control: Analysis and Design*. Wiley, 2005.
- [156] H. H. Sohrab. *Basic Real Analysis*. Springer New York, 2003. doi: [10.1007/978-1-4939-1841-6](https://doi.org/10.1007/978-1-4939-1841-6).
- [157] E. D. Sontag. Nonlinear regulation: The piecewise linear approach. *IEEE Transactions on Automatic Control*, 26(2):346–358, 1981. doi: [10.1109/TAC.1981.1102596](https://doi.org/10.1109/TAC.1981.1102596).
- [158] E. D. Sontag. Remarks on piecewise-linear algebra. *Pacific Journal of Mathematics*, 98(1):183–201, 1982. doi: [10.2140/pjm.1982.98.183](https://doi.org/10.2140/pjm.1982.98.183).
- [159] E. D. Sontag. Smooth stabilization implies coprime factorization. *IEEE Transactions on Automatic Control*, 34(4):435–443, 1989. doi: [10.1109/9.28018](https://doi.org/10.1109/9.28018).
- [160] E. D. Sontag. Input to state stability: Basic concepts and results. In P. Nistri and G. Stefani, editors, *Nonlinear and Optimal Control Theory*, volume 1932 of *Lecture Notes in Mathematics*, pages 163–220. Springer Berlin Heidelberg, 2008. doi: [10.1007/978-3-540-77653-6\\_3](https://doi.org/10.1007/978-3-540-77653-6_3).
- [161] E. M. Stein and R. Shakarchi. *Real Analysis: Measure Theory, Integration, and Hilbert Spaces*, volume 3 of *Princeton Lectures in Analysis*. Princeton University Press, 2005.

- [162] M. Storace and O. De Feo. Piecewise-linear approximation of nonlinear dynamical systems. *IEEE Transactions on Circuits and Systems I: Regular Papers*, 51(4):830–842, 2004. doi: [10.1109/TCSI.2004.823664](https://doi.org/10.1109/TCSI.2004.823664).
- [163] J. F. Sturm. Using SeDuMi 1.02, a MATLAB toolbox for optimization over symmetric cones. *Optimization Methods and Software*, 11(1-4):625–653, 1999. doi: [10.1080/10556789908805766](https://doi.org/10.1080/10556789908805766).
- [164] Z. Sun. Stability of piecewise linear systems revisited. *Annual Reviews in Control*, 34(2):221–231, 2010. doi: [10.1016/j.arcontrol.2010.08.003](https://doi.org/10.1016/j.arcontrol.2010.08.003).
- [165] A. R. Teel. On graphs, conic relations, and input-output stability of nonlinear feedback systems. *IEEE Transactions on Automatic Control*, 41(5):702–709, 1996. doi: [10.1109/9.489206](https://doi.org/10.1109/9.489206).
- [166] A. Teel, E. Panteley, and A. Loria. Integral characterizations of uniform asymptotic and exponential stability with applications. *Mathematics of Control, Signals and Systems*, 15(3):177–201, 2002. doi: [10.1007/s004980200007](https://doi.org/10.1007/s004980200007).
- [167] L. Q. Thuan. Non-Zenoness of piecewise affine dynamical systems and affine complementarity systems with inputs. *Control Theory and Technology*, 12(1):35–47, 2014. doi: [10.1007/s11768-014-0074-5](https://doi.org/10.1007/s11768-014-0074-5).
- [168] I. Tomek. Two algorithms for piecewise-linear continuous approximation of functions of one variable. *IEEE Transactions on Computers*, C-23(4):445–448, 1974. doi: [10.1109/T-C.1974.223961](https://doi.org/10.1109/T-C.1974.223961).
- [169] D. Valsamis and J. Gray. The circle criterion as a special case of an  $L_p$  criterion. *IEEE Transactions on Automatic Control*, 32(3):263–266, 1987. doi: [10.1109/TAC.1987.1104584](https://doi.org/10.1109/TAC.1987.1104584).
- [170] N. van de Wouw and A. Pavlov. Tracking and synchronisation for a class of PWA systems. *Automatica*, 44(11):2909–2915, 2008. doi: [10.1016/j.automat.2008.04.015](https://doi.org/10.1016/j.automat.2008.04.015).
- [171] A. J. van der Schaft.  *$\mathcal{L}_2$ -Gain and Passivity Techniques in Nonlinear Control*. Communications and Control Engineering. Springer-Verlag London, second edition, 2000. doi: [10.1007/978-1-4471-0507-7](https://doi.org/10.1007/978-1-4471-0507-7).
- [172] J. Veenman and C. W. Scherer. Stability analysis with integral quadratic constraints: A dissipativity based proof. In *Proceedings of the 52nd IEEE Conference on Decision and Control*, pages 3770–3775, 2013. doi: [10.1109/CDC.2013.6760464](https://doi.org/10.1109/CDC.2013.6760464).
- [173] J. Veenman and C. W. Scherer. IQC-synthesis with general dynamic multipliers. *International Journal of Robust and Nonlinear Control*, 24(17):3027–3056, 2014. doi: [10.1002/rnc.3042](https://doi.org/10.1002/rnc.3042).
- [174] J. Veenman, C. W. Scherer, and H. Köroğlu. Robust stability and performance analysis based on integral quadratic constraints. *European Journal of Control*, 31:1–32, 2016. doi: [10.1016/j.ejcon.2016.04.004](https://doi.org/10.1016/j.ejcon.2016.04.004).
- [175] M. Vidyasagar. *Nonlinear Systems Analysis*. Englewood Cliffs: Prentice Hall, second edition, 1993.

- [176] J. L. Willems. The circle criterion and quadratic Lyapunov functions for stability analysis. *IEEE Transactions on Automatic Control*, 18(2):184–184, 1973. doi: [10.1109/TAC.1973.1100260](https://doi.org/10.1109/TAC.1973.1100260).
- [177] J. C. Willems. Least squares stationary optimal control and the algebraic Riccati equation. *IEEE Transactions on Automatic Control*, 16(6):621–634, 1971. doi: [10.1109/TAC.1971.1099831](https://doi.org/10.1109/TAC.1971.1099831).
- [178] J. C. Willems. *The analysis of feedback systems*, volume 62 of *Research Monographs*. M.I.T. Press, Cambridge, Massachusetts, 1971.
- [179] J. C. Willems. The generation of Lyapunov functions for input-output stable systems. *SIAM Journal on Control*, 9(1):105–134, 1971. doi: [10.1137/0309009](https://doi.org/10.1137/0309009).
- [180] J. C. Willems. Dissipative dynamical systems — Part I: General theory. *Archive for Rational Mechanics and Analysis*, 45(5):321–351, 1972. doi: [10.1007/BF00276493](https://doi.org/10.1007/BF00276493).
- [181] J. C. Willems. Dissipative dynamical systems — Part II: Linear systems with quadratic supply rates. *Archive for Rational Mechanics and Analysis*, 45(5):352–393, 1972. doi: [10.1007/BF00276494](https://doi.org/10.1007/BF00276494).
- [182] J. Xu and L. Xie. Homogeneous polynomial Lyapunov functions for piecewise affine systems. In *Proceedings of the American Control Conference*, pages 581–586, Portland, USA, 2005. doi: [10.1109/ACC.2005.1470019](https://doi.org/10.1109/ACC.2005.1470019).
- [183] V. A. Yakubovich. The  $\mathcal{S}$ -procedure in nonlinear control theory. *Vestnik Leningrad University*, 1:62–77, 1971.
- [184] V. A. Yakubovich. Necessity in quadratic criterion for absolute stability. *International Journal of Robust and Nonlinear Control*, 10(11-12):889–907, 2000. doi: [10.1002/1099-1239\(200009/10\)10:11/12<889::AID-RNC531>3.0.CO;2-X](https://doi.org/10.1002/1099-1239(200009/10)10:11/12<889::AID-RNC531>3.0.CO;2-X).
- [185] T. Yoshizawa. *Stability Theory By Lyapunov's Second Method*, volume 9. The Mathematical Society of Japan, 1966.
- [186] M. Zamani and R. Majumdar. A Lyapunov approach in incremental stability. In *Proceedings of the joint 50th IEEE Conference on Decision and Control and European Control Conference*, pages 302–307, 2011. doi: [10.1109/CDC.2011.6160735](https://doi.org/10.1109/CDC.2011.6160735).
- [187] G. Zames. Functional analysis applied to nonlinear feedback systems. *IEEE Transactions on Circuit Theory*, 10(3):392–404, 1963. doi: [10.1109/TCT.1963.1082162](https://doi.org/10.1109/TCT.1963.1082162).
- [188] G. Zames. On the input-output stability of time-varying nonlinear feedback systems — Part I: Conditions derived using concepts of loop gain, conicity, and positivity. *IEEE Transactions on Automatic Control*, 11(2):228–238, 1966. doi: [10.1109/TAC.1966.1098316](https://doi.org/10.1109/TAC.1966.1098316).
- [189] G. Zames. On the input-output stability of time-varying nonlinear feedback systems — Part II: Conditions involving circles in the frequency plane and sector nonlinearities. *IEEE Transactions on Automatic Control*, 11(3):465–476, 1966. doi: [10.1109/TAC.1966.1098356](https://doi.org/10.1109/TAC.1966.1098356).

- [190] G. Zames. Feedback and optimal sensitivity: Model reference transformations, multiplicative seminorms, and approximate inverses. *IEEE Transactions on Automatic Control*, 26(2):301–320, 1981. doi: [10.1109/TAC.1981.1102603](https://doi.org/10.1109/TAC.1981.1102603).
- [191] G. Zames and P. L. Falb. Stability conditions for systems with monotone and slope-restricted nonlinearities. *SIAM Journal on Control*, 6(1):89–108, 1968. doi: [10.1137/0306007](https://doi.org/10.1137/0306007).
- [192] A. Zavieh and L. Rodrigues. Intersection-based piecewise affine approximation of nonlinear systems. In *Proceedings of the 21st Mediterranean Conference on Control Automation*, pages 640–645, 2013. doi: [10.1109/MED.2013.6608790](https://doi.org/10.1109/MED.2013.6608790).
- [193] J. Zhang and W. Tang. Output feedback  $H_\infty$  control for uncertain piecewise linear systems. *Journal of Dynamical and Control Systems*, 14(1):121–144, 2008. doi: [10.1007/s10883-007-9030-8](https://doi.org/10.1007/s10883-007-9030-8).