



HAL
open science

Role of the Histamine Releasing Factor (HRF) in Plasmodium parasite transmission and disease pathogenesis

Claudia Demarta-Gatsi

► **To cite this version:**

Claudia Demarta-Gatsi. Role of the Histamine Releasing Factor (HRF) in Plasmodium parasite transmission and disease pathogenesis. Parasitology. Université Pierre et Marie Curie - Paris VI, 2016. English. NNT: 2016PA066403 . tel-01933730

HAL Id: tel-01933730

<https://theses.hal.science/tel-01933730v1>

Submitted on 24 Nov 2018

HAL is a multi-disciplinary open access archive for the deposit and dissemination of scientific research documents, whether they are published or not. The documents may come from teaching and research institutions in France or abroad, or from public or private research centers.

L'archive ouverte pluridisciplinaire **HAL**, est destinée au dépôt et à la diffusion de documents scientifiques de niveau recherche, publiés ou non, émanant des établissements d'enseignement et de recherche français ou étrangers, des laboratoires publics ou privés.



Université Pierre et Marie Curie

Ecole doctorale Complexité du Vivant

Biologie des Interactions Hôte-Parasite

**Role of the Histamine Releasing Factor (HRF) in *Plasmodium*
parasite transmission and disease pathogenesis**

Claudia DEMARTA-GATSI

Thèse de doctorat de Immunologie-Parasitologie

Dirigée par Dr. Salah MECHERI

Présentée et soutenue publiquement le 22 novembre 2016

Devant un jury composé de :

Pr. Dominique MAZIER

Pr. Marita TROYE BLOMBERG

Dr. Frédéric TANGY

Dr. Nicolas BLANCHARD

Dr. Salah MECHERI

Président du jury

Rapporteur

Rapporteur

Examineur

Directeur de thèse

Alla mia nonna Cecchina perché ci sei sempre stata, anche ora,

Al mio amico tedesco che fin dall'inizio sei al mio fianco,

E in fine alla mia mamma e al mio papà – ci siamo arrivati insieme.

« La science, comme la poésie, se trouve,
on le sait, à un pas de la folie. »

Alexandre Yersin

Summary

Summary	1
Acknowledgements	2-4
Table of contents	5-6
List of Figures	7
List of Tables	7
Abbreviations	8-9
Resumé en Française	10-16
General Introduction	17-58
Histamine Releasing Factor	72-59
Objective	73
Results	74-75
Supplementary Results	76-86
Discussion	87-107
Bibliography	108-136

Acknowledgements

Almost four years have passed from the start of my thesis and many things have changed. Not only my scientific knowledge has been improved but I also developed new job skills such as identifying problems and solving them. This thesis represents not only my work at the keyboard, but it is a milestone after more than three years of work at the Institut Pasteur and specifically within the BIHP Unit. My experience has been nothing short of amazing. I have been given unique opportunities and I have taken advantage of them. This includes working with incredible scientists of all levels and participating at many lectures that enabled my achievements as a scientist. The content of this thesis represents the lessons learnt from the study of malaria disease based on the creation of a special tool: Genetically Attenuated Parasites (GAPs). This work is the result of many experiences I have encountered and of different people I wish to thank.

First and foremost I would like to express my sincere gratitude to my advisor, **Dr. Salah Mecheri**, for the continuous support during my Ph.D training and related research, for his patience, motivation, and immense knowledge. His guidance helped me throughout the time of my research and writing of this thesis (a hard moment!). I remember he used to say something like " we arrive in the morning and you're already here, we go home at night and we leave you behind us, it is as if you had a bed camp here!, this is " to encourage me to go home and to relax". I couldn't have imagined having a better advisor and mentor for my Ph.D training.

Similar, deep gratitude goes to our **TONTON Roger** who welcomed me to the lab and introduced me to mouse experiments showing me all the secrets of the profession and tried to turn my passion for the dissection of the mosquitoes that was never born! I really need to thank you for coming early at 6 a.m. to start mouse dissections and stay all day long with me spending hours in front of the FACS machine laughing because our eyelids grew heavy closed; we really built a good work team and, even if you didn't like it, a speedy work team.

My gratitude to **The Helmut Horten Foundation** for their financial support which allowed me to benefit from this experience and to strengthen my scientific knowledge.

I would also like to thank my committee members, **Pr. Dominique Mazier, Pr. Marita Troye Blomberg, Pr. Frédéric Tangy** and **Dr. Nicolas Blanchard** for being part of my thesis committee even at hardship. I also want to thank you for letting my defence be an enjoyable moment, and for your brilliant comments and suggestions, many thanks to you.

Special mention goes to **Pr. Artur Scherf** who gave me the opportunity to be hosted in his laboratory and who always tackled me with puzzling questions.

I am grateful to **Dr. Robert Menard** and **Dr. Shruthi Vembar** for the help in developing my writings tools, to **Sabine Tiberge** who provided me with a fantastic lab training in IFA and sporozoite infections, to **Dr. Sylvie Garcia** and **Dr. Rogerio Amino** who were available whenever I needed their advices in various fields, and **Pierre-Henri Commere** for his kind help with FACS sorting.

To my friends in every corner of the world, starting for the ones who stay at home **Noemi, David, Ariella, Paki, Elisabetta, Anna, Flora, Nina, Kim, Giona, Augustin, Tugba, Messina twins, Andrea & Cindy**, and the one who was there when I needed him the most, **Alessandro**. Their unconditional support has been essential all these years. The ones who I left somewhere **Bridget, sister Immaculate and sister Carla, Simon, Julius, Meck, Sheila, Colin, Kevin, Blessing, Paul, Karanjia** and all the others who always remember me what is really important and give me the strength to fight for them. And all the good people who I have met during these years and who helped me to keep smile on my face. **Irina** for the blabla between one experiment and the other or in the animal facility, **Raquel** for the lunch times and the discovery of Paris, **Laura** for the help in French language and culture, **Carmen** who was an amazing friend but left so quickly, **Shuai** for a lot of things starting from blabla and ending with running moments, **Doro** for the running and walking moments, **Shruthi** for the picnic and advices, **Anne** - with you, French Administration was not so hard anymore-, **Malika** for animating the lab, **Sara** for the Swiss meals and the photography weekends, **Patricia** for the scientific advices, **Laura-Ines-Memo** for the amazing time spending with you during the month-long vaccinology course, the Swiss-Italian and the South American culture are finally not so far, **Carolie-Alexander-Gopaul and iGEM students** for the evenings at the Institut Pasteur trying to develop the Plasticure project and for the wonderful trip to Boston.

Finally, I want to thank **Anthony** because without you things would be harder, thank you for the cappuccino breaks, for the swimming and running times; at the end you become more fanatic than me but also thanks for always listening to and enduring me, weekends spent in the laboratory were not so long in your company.

A special THANKS to my family. Words cannot express how grateful I am to my **mother Rita**, and **father Marco** for all of the sacrifices that you've made on my behalf. Your prayer for me was what sustained me thus far. *Non avete mai mollato la presa nonostante qualche volta, a causa di una testa assai dura, ho dato i numeri. Per le domeniche mattina a fare matematica e le gare di francese contro il papi, che alla fine mi hanno servito. Per le ore in colonna tra Agno-Caslano con la mamma dopo le mie lunghe sedute in piscina e per la compagnia durante i nostri viaggi in giro per il mondo.* To my **sister Valeria** who is so different from me but in the end we are not so different. *Perché questa tesi ci ha avvicinato un po di più, senza di te starei ancora cercando di dare una forma alla tesi!*

At the end, I would like to express appreciation to my beloved **husband Nico** who fought with me for our survival in France, who always pushed me beyond my limits because he believes in me more than myself, and was always my support in the moments when there was no one to answer my queries.

THANKS TO ALL, Claudia

Table of contents

1. GENERAL INTRODUCTION

1.1 MALARIA	17
1.2 HISTORY OF MALARIA	17
1.2.1 THE ORIGIN	17
1.2.2 MALARIA IN THE ANCIENT WORLD	18
1.2.3 SCIENTIFIC DISCOVERIES	19
1.3 DISTRIBUTION AND IMPACT	20
1.4 PARASITES AND DISEASES	21
1.4.1 MALARIA PARASITES	21
1.4.2 RODENT MALARIA PARASITES (ANIMAL MODELS IN EXPERIMENTAL MALARIA)	23
1.4.3 MALARIA GENOME	24
1.4.4 LIFE CYCLE	25
1.4.4.1 Mosquito host	26
1.4.4.2 Pre-erythrocytic phase	27
1.4.4.3 Erythrocytic phase	28
1.5 MALARIA PATHOGENESIS	30
1.5.1 ASYMPTOMATIC MALARIA	30
1.5.2 UNCOMPLICATED MALARIA	31
1.5.3 SEVERE MALARIA	32
1.5.3.1 Severe Malaria Anaemia (SMA)	33
1.5.3.2 Cerebral Malaria (CM)	34
1.6 MALARIA PROTECTIVE IMMUNITY	38
1.6.1 INNATE IMMUNITY	39
1.6.2 ADAPTIVE IMMUNITY	42
1.6.2.1 Cellular immunity	43
1.6.2.2 Humoral immunity	47
1.7 MALARIA TREATMENT	50
1.7.1 ANTIMALARIAL CHEMOTHERAPY	51
1.7.2 MALARIA VACCINE	51
1.7.2.1 Subunit approach	52
1.7.2.2 Whole organism approach	54

2. HISTAMINE RELEASING FACTOR

2.1 HISTAMINE RELEASING FACTOR (HRF)	59
2.1.1 HRF STRUCTURE	61
2.1.2 HRF SECRETION	63
2.1.3 HRF DIMERIZATION	64
2.2 ROLE OF PLASMODIUM HRF DURING MALARIA INFECTION	65
2.2.1 CONSEQUENCES OF HISTAMINE RELEASE	66
2.2.2 ARTEMISININ CHEMO-RESISTANCE	69
2.2.3 CALCIUM BINDING AND SELF-INTERACTION WITH MALARIA HRF	70
2.2.4 B CELL INHIBITION BY MALARIA HRF	70
2.2.5 BASOPHILS ACTIVATION BY MALARIA HRF	70
2.3 Comparative characteristics of mammal HRF and Plasmodium HRF	71

3.OBJECTIVE

3.1 SCOPE OF THE THESIS	73
--------------------------------	-----------

4. RESULTS

4.1 ARTICLE I	74
4.2 ARTICLE II	75

5. SUPPLEMENTARY RESULTS

5.1 HRF IS IMPORTANT FOR P. BERGHEI PRE-ERYTHROCYTIC AND ERYTHROCYTIC INFECTION	76
5.2 PATTERN OF CYTOKINES ASSOCIATED WITH PbNK65-HRFΔ INDUCED PROTECTION	76
5.3 AUGMENTED CD11B+ CELLS DURING HRFΔ PbNK65 INFECTION	78
5.4 PROTECTION CONFERRED BY MUTANT PARASITES IS DEPENDENT ON EFFECTOR CD4+ CELLS	79
5.5 PROTECTION INDUCED BY PbNK65-HRFΔ PARASITES IS ASSOCIATED WITH DOWN-REGULATION OF PD-1 ON T CELLS	81
5.6 PRIOR EXPOSURE TO WT PARASITE FOLLOWED BY DRUG TREATMENT DOES NOT HAMPER PbNK65-HRFΔ-INDUCED PARASITE CLEARANCE AND IMMUNE PROTECTION	83
5.7 PbNK65-HRFΔ PARASITE-INDUCED PROTECTION IS ASSOCIATED WITH AN INCREASED NUMBER OF CENTRAL AND EFFECTOR MEMORY B CELLS	85

6. DISCUSSION	87
----------------------	-----------

7. BIBLIOGRAPHY	108
------------------------	------------

List of Figures

FIGURE 1: GLOBAL DISTRIBUTION OF MALARIA.	21
FIGURE 2: PHYLOGENETIC RELATIONSHIPS AMONG <i>PLASMODIUM</i> SPECIES.	22
FIGURE 3: PHYLOGENETIC TREE DEMONSTRATING THE PUTATIVE RELATIONSHIPS BETWEEN THE MAJOR TYPES OF EUKARYOTIC ORGANISMS.	25
FIGURE 4: SCHEMATIC REPRESENTATION OF THE <i>PLASMODIUM</i> LIFE CYCLE.	26
FIGURE 5: SCHEMATIC REPRESENTATION OF THE DIFFERENT STAGES OF <i>P. FALCIPARUM</i> DEVELOPMENT IN ERYTHROCYTE.	29
FIGURE 6: POTENTIAL MECHANISM OF MALARIA-INDUCED FEVER.	32
FIGURE 7: SCHEMATIC REPRESENTATION OF MECHANISMS INVOLVED IN THE DEVELOPMENT OF CM.	37
FIGURE 8: PATTERN OF <i>P. FALCIPARUM</i> INFECTION OUTCOME WITH AGE IN A MALARIA ENDEMIC POPULATION.	38
FIGURE 9: IFN- γ PRODUCERS AND THEIR ACTIVATION.	41
FIGURE 10: LINKING INNATE AND ADAPTIVE IMMUNITY TO BLOOD-STAGE MALARIA.	43
FIGURE 11: MALARIA VACCINE CANDIDATE ANTIGENS.	53
FIGURE 12: LIVER STAGES OF ARREST FOR RADIATION-ATTENUATED SPOROZOITES (RAS), GENETICALLY ATTENUATED PARASITES (GAP), AND WILD TYPE SPOROZOITES WITH CHEMOPROPHYLAXIS (CPS).	56
FIGURE 13: HISTAMINE RELEASING FACTOR (HRF).	61
FIGURE 14: HRF STRUCTURE OF <i>S. POMBE</i> AND <i>P. KNOWLESII</i>	63
FIGURE 15: MECHANISM OF SECRETION AND HYPOTHETICAL MODIFICATION OF HRF.	65
FIGURE 16: IGE/FC ϵ RI COMPLEX AND PARASITE HRF REPRESENT TWO MECHANISMS BY WHICH HISTAMINE RELEASE IS TRIGGERED FROM ITS CELLULAR STORES DURING MALARIA INFECTION.	67
FIGURE 17: MARKED DIFFERENCES IN PARASITAEMIA BETWEEN WT AND <i>HRFΔ</i> <i>PBNK65</i> -INFECTED MICE IN BLOOD STAGE DEVELOPMENT.	76
FIGURE 18: IMMUNE RESPONSE GENES ARE DIFFERENTIALLY REGULATED BY WT AND <i>HRFΔ</i> PARASITES.	77
FIGURE 19: CYTOKINE PRODUCTION BY BLOOD-STAGE WT AND <i>HRFΔ</i> <i>PBNK65</i> INFECTION.	78
FIGURE 20: INNATE IMMUNE CELLS ARE ACTIVATED IN THE SPLEEN AND LIVER AFTER MALARIA INFECTION.	79
FIGURE 21: INFLUENCE OF CD4 ⁺ OR CD8 ⁺ T CELLS DEPLETION ON PARASITE DEVELOPMENT IN PROTECTED MICE.	80
FIGURE 22: PROTECTION INDUCED BY <i>HRFΔ</i> <i>PBNK65</i> PARASITES IS ASSOCIATED WITH REDUCED INDUCTION OF PD1 ⁺ CD8 ⁺ CD62L ⁻ AND PD1 ⁺ CD4 ⁺ CD62L ⁻ CELLS IN SPLEEN.	82
FIGURE 23: DRUG TREATMENT DOES NOT AFFECT THE DEVELOPMENT OF LONG-LASTING PROTECTION AFTER INFECTION WITH HRF-DEFICIENT BLOOD STAGE PARASITES.	84
FIGURE 24: FREQUENCY OF MEMORY B CELLS IN <i>PBNK65-HRFΔ</i> PROTECTED MICE.	86
FIGURE 25: HYPOTHESIS: UNDERSTANDING MALARIA PATHOGENESIS ASSOCIATED WITH <i>PLASMODIUM</i> INFECTION AND ALLERGIC INFLAMMATION SHARE COMMON SIGNALLING PATHWAYS.	88
FIGURE 26: HYPOTHETICAL MECHANISMS INDUCED BY <i>PBNK65-HRFΔ</i> PARASITES INVOLVED IN PARASITE KILLING AND DEVELOPMENT OF PROTECTIVE IMMUNITY.	104

List of Tables

TABLE 1 – BLOOD STAGE GAPS AND THEIR CHARACTERISTICS.	58
TABLE 2 – HRF CHARACTERISTICS.	58

Abbreviations

Ab	Antibody
ADCC	Antibody-dependent cellular cytotoxicity
ADCI	Antibody-dependent cellular inhibition
AID	Activation-induced cytidine deaminase
AMA	Apical membrane protein
APC	Antigen presenting cell
BBB	Blood-brain barrier
CD	Cluster of differentiation
CM	Cerebral malaria
COX	Cyclooxygenase
CS	Circumsporozoite
CSP	Chemoprophylaxis
DC	Dendritic cell
ECM	Experimental cerebral malaria
EMP	Erythrocyte membrane protein
GAP	Genetically attenuated parasite
GPI	Glycosylphosphatidylinositol
HDC	Histidine decarboxylase
HRF	Histamine releasing factor
<i>hrf</i>Δ	Genetically HRF-deficient parasites
ICAM	Intracellular adhesion molecule
IFA	Immune fluorescence assay
IFN	Interferon
Ig	Immunoglobulin
LAP	Live attenuated parasite
IL	Interlukin
IRBCs	Infected red blood cells
LAG	Lymphocyte-activation gene
MIF	Macrophage migration inhibitory factor

MIP	Macrophage inflammatory protein
MSP	Merozoite surface protein
NK	Natural killer
NKT	Natural killer T
NO	Nitric oxide
PAMPs	Pathogen-associated molecular patterns
PD	Programmed death
PD-L	Programmed death ligand
p.i.	Post infection
PRRs	Pattern-recognition receptors
PV	Parasitophorous vacuole
RAS	Radiation-attenuated sporozite
RBCs	Red blood cells
SERA	Serin repeat antigen
SMA	Severe malarial anaemia
TCR	T cell receptor
Th	T helper cell
TLR	Toll like receptor
TNF	Tumor necrosis factor
TSAP	Tumor suppressor activated pathway
uRBCs	Uninfected red blood cells
VCAM	Vascular cellular adhesion molecule Plamsodium
<i>P.</i>	<i>Plasmodium</i>
<i>Pf</i>	<i>P. falciparum</i>
<i>Pb</i>	<i>P. berghei</i>
<i>Pc</i>	<i>P. chabaudi</i>
<i>Py</i>	<i>P. yoelii</i>
<i>Pv</i>	<i>P. vinckei</i>
kDa	Kilo Dalton
Å	Ångström

Résumé en Française

Au seuil du troisième millénaire, le paludisme constitue et demeure un problème majeur de santé publique. Avec le sida (VIH) et la tuberculose, le paludisme fait partie des trois maladies infectieuses les plus mortelles au monde. Bien qu'en diminution, il s'agit de la maladie parasitaire la plus dévastatrice car elle concerne 95 pays, avec environ la moitié de la population mondiale exposée au risque d'infection. En 2015, les estimations font état d'environ 500'000 décès en Afrique sub-saharienne dont 65% étant des enfants de moins de 5 ans (WHO, 2015). Outre son impact sanitaire, dans les régions hautement endémiques, le paludisme représente un sérieux obstacle au développement socio-économique avec une diminution de près de 1,3% du produit intérieur brut (Sachs and Malaney, 2002). Si la maladie est essentiellement retrouvée dans la plupart des régions tropicales et subtropicales de la planète, avec un risque particulièrement élevé en Afrique, des cas d'importation ont également été recensés en Europe.

Le paludisme est dû à une infection par un protozoaire intracellulaire du genre *Plasmodium*, transmis entre individus par la piqûre de certaines espèces de moustique femelles du genre *Anopheles*. Dans la nature il existe plus de 250 espèces de *Plasmodium*, mais seulement cinq espèces infectent naturellement l'homme (*Plasmodium malariae*, *P. vivax*, *P. ovale*, *P. knowlesi* et *P. falciparum*), dont *P. falciparum* est responsable de la majorité des décès et des formes cliniques sévères du paludisme. D'autres espèces plasmodiales qui infectent les singes (par exemple *P. knowlesi*, *P. cynomolgi*, etc.) ou les rongeurs (*P. yoelii*, *P. berghei*, *P. chabaudi* et *P. vinckei*) sont étudiées comme modèles expérimentaux.

Le cycle de vie de l'agent causal du paludisme est complexe et implique un hôte intermédiaire vertébré et un hôte définitif (vecteur). Chez l'hôte vertébré, l'infection par *Plasmodium* débute avec la phase pré-érythrocytaire au cours de laquelle la forme sporozoïte déposée dans la peau par le moustique rejoint le foie *via* la circulation sanguine afin de se différencier en une forme infectant les globules rouges. Lors de sa phase érythrocytaire, le parasite s'engage dans un cycle de maturation et multiplication, c'est alors que les symptômes de la maladie vont apparaître. Les premiers symptômes (fièvre, maux de tête, frissons et vomissements) apparaissent au bout de 10 à 15 jours après la piqûre de

moustique infectante. Dans des cas plus graves, la maladie peut se développer en neuropaludisme (NP) où les érythrocytes infectés ainsi que des leucocytes sont séquestrés au niveau des veinules post-capillaires du cerveau. Les patients atteints de cette forme sévère de la maladie présentent des taux élevés de cytokines pro-inflammatoires (IFN γ , TNF α , IL-1, IL-6) dans de nombreux tissus (Perlmann et al., 1999; Stevenson and Riley, 2004).

Le diagnostic peut se faire par évaluation de la parasitémie au microscope ou l'utilisation de tests de diagnostic rapide. Le traitement de choix pour le paludisme réside en une association médicamenteuse contenant de l'artémisinine. Mais au cours des dernières années, l'augmentation des phénomènes de résistance associés à l'utilisation d'antipaludiques de synthèse a conduit à réexaminer les stratégies de lutte pour réduire la mortalité, la morbidité et la transmission vectorielle imputées à la maladie. Dans ce contexte, la mise au point d'un vaccin contre le paludisme est l'approche la plus prometteuse pour parvenir à contrôler de manière significative le paludisme, en particulier en Afrique, où l'habitat écologique est tel que le contrôle des moustiques est difficile, voire impossible à réaliser. En outre, le programme de vaccination lancé par l'Organisation Mondiale de la Santé (OMS) en 1974 a démontré que le contrôle des principales maladies infectieuses est réalisable à l'échelle mondiale grâce aux vaccins. Actuellement, aucun vaccin contre le paludisme n'existe sur le marché. La complexité du parasite qui inclut trois stades de développement (stade pré-érythrocytaire, stade sanguin asexué et stade sanguin sexué) chez l'homme et le choix d'un antigène capable d'induire une réponse immunitaire durable sont des obstacles à la sélection des cibles vaccinales. En effet, plusieurs milliers de protéines (plus des glucides et des lipides) sont synthétisées par les parasites au cours de l'infection. Ces composés peuvent servir de cibles antigéniques pour deux types de réponses immunitaires: humorale avec la sécrétion d'anticorps (IgG) contre les parasites et cellulaire avec l'activation des cellules T qui peuvent attaquer les cellules infectées et stimuler la production d'anticorps. De plus, de nombreuses protéines antigéniques varient entre les différentes souches de *Plasmodium* pendant l'infection. Pour rendre les choses encore plus complexes, le parasite peut également commuter la sélection de protéines qui apparaissent à la surface des globules rouges infectés et échapper ainsi aux anticorps de l'hôte. Le paludisme, par conséquent, constitue un défi complexe pour le système immunitaire humain

et la compréhension des mécanismes régissant la pathogénèse et les réponses immunitaires de l'hôte contre les parasites *Plasmodium* représente un défi majeur. Dans ce contexte, un vaccin efficace peut sembler utopique, malgré le fait qu'une immunité naturelle est de facto développée au fil des ans chez les personnes constamment exposées au parasite.

Des études récentes suggèrent une forte relation entre susceptibilité au paludisme de forme sévère et réponse de type allergique. En effet, des niveaux plasmatiques et tissulaires élevés d'histamine, un amine vaso-active connue pour ses propriétés pro-inflammatoires et immuno-régulatrices, ont été associés à la sévérité de la maladie chez l'homme infecté par *P. falciparum* et dans de nombreux modèles animaux (MacDonald et al., 1995). Récemment, notre laboratoire a mis en évidence le rôle crucial de l'histamine dans la pathogénèse de la maladie chez le rongeur (Beghdadi et al., 2008). L'utilisation de souris traitées avec des antihistaminiques ou génétiquement déficientes en histamine ont montré une résistance au NP, suggérant un rôle important de la voie de signalisation de l'histamine pendant l'infection palustre (Beghdadi et al., 2008). Cette résistance est caractérisée par une préservation de l'intégrité de la barrière hémato-encéphalique avec une diminution de l'expression d'ICAM-1 par les cellules endothéliales et une absence de séquestration d'érythrocytes infectés et d'adhésion de leucocytes au niveau des vaisseaux sanguins cérébraux (Beghdadi et al., 2008). Au cours de l'infection, l'histamine peut être libérée par les basophiles et les mastocytes via le complexe IgE-FcεRI (Perlmann et al., 1999) ou via l'activation des cellules par le facteur de libération de l'histamine (HRF), une protéine ubiquitaire multifonctionnelle hautement conservée chez les eucaryotes (Bommer and Thiele, 2004a), y compris *Plasmodium* (MacDonald et al., 2001). Impliquée dans la réversion tumorale et dans l'allergie, HRF a également été décrite comme cible d'antipaludiques tels que l'artémisinine (Bhisutthibhan et al., 1998). En outre, une étude réalisée au Mali a montré qu'une concentration élevée de la protéine parasitaire HRF dans le sérum est liée au développement d'une forme sévère de paludisme, mettant ainsi en évidence l'importance de cette protéine dans le développement de la maladie (MacDonald et al., 2001). D'après les observations précédentes, il est raisonnable de postuler que la libération d'histamine induite par le parasite depuis son entrée dans la peau de l'hôte suivie par son développement dans le foie et, finalement, dans le sang périphérique, peut contribuer au développement des propriétés pathogènes du parasite en modulant la réponse immunitaire de l'hôte.

Pour évaluer l'importance de la protéine parasitaire HRF pendant le développement de la réponse immunitaire et son impact sur la sévérité de la maladie associée à la production d'histamine, il était nécessaire de générer des lignées de parasite déficientes en *hrf*. Contrairement à la souris chez qui la délétion du gène est létale au stade embryonnaire, chez *P. berghei* (*Pb*), nous avons réussi à générer deux parasites murins déficients pour la protéine HRF (*hrf* Δ): *PbANKA* GFP et *PbNK65* GFP, une souche mortelle du paludisme murin qui, contrairement à *PbANKA*, n'engendre pas de NP, mais provoque une forte anémie et nous permet de suivre la réponse immunitaire sur une plus longue période.

Tout d'abord nous avons étudié le rôle de la protéine parasitaire pendant le cycle de vie et surtout dans le développement du parasite chez le moustique en déterminant par qRT-PCR ou par comptage le nombre de parasites (ookinète et sporozoïtes) au cours du temps. Les résultats obtenus ont démontré que la délétion du gène *hrf* chez *Plasmodium* n'affecte pas le développement du parasite en soi, ce qui signifie que la suppression n'est pas létale pour le parasite. En outre, nous avons observé que la mutation ne montre aucune anomalie significative dans la motilité et dans la formation des formes exo-érythrocytaires *in vitro* et dans la traversée cellulaire *in vivo*.

Les souris infectées avec des sporozoïtes *PbANKA-hrf* Δ ont montré une diminution de la fréquence du NP associée à un retard de deux jours entre l'apparition des formes sanguines de *PbANKA-hrf* Δ par rapport à *PbANKA* WT. L'absence de *Plasmodium* HRF induit une diminution de la sévérité de la maladie, ainsi qu'une anomalie au niveau du développement des parasites mutants pendant le stade hépatique qui est associée à une augmentation précoce systémique d'IL-6 (Mathieu et al., 2015), une cytokine qui inhibe fortement le développement des stades hépatiques du *Plasmodium* (Pied et al., 1991). L'effet inhibiteur de *PbHRF* sur la production de IL-6 induite par LPS souligne le rôle spécifique et l'effet direct de la protéine parasitaire HRF dans l'inhibition d'une cytokine qui présente une activité antiparasitaire (Mathieu et al., 2015). De plus l'augmentation de la population des cellules B dans le foie des souris infectées par des parasites mutants reflète la possibilité que la protéine *Plasmodium* HRF puisse interférer avec la mémoire des lymphocytes B et désactiver le développement des cellules B, possiblement via l'induction d'apoptose.

Après cette première observation, les parasites *PbNK65-hrfΔ* ont été utilisés pour étudier le rôle de HRF dans la pathogénèse. L'infection par les parasites *PbNK65-hrfΔ* est caractérisée par l'élimination du parasite au 12^{ème} jour après l'infection qui conduit à une protection de longue durée et au développement d'une mémoire immunitaire. Contrairement à l'infection par le parasite de type sauvage, la souche atténuée induit une immunité contre différentes souches de *Plasmodium* et aussi contre les différents stades. D'ailleurs, nos données ont montré le rôle protecteur joué par les cellules B et T sachant que les souris dépourvues de ces lymphocytes ont été incapables de contrôler le développement du parasite dans le sang. En outre, nous avons observé que l'absence de la protéine HRF augmente la survie des cellules T par l'inhibition de l'expression du récepteur "programmed cell death 1 (PD1)" sur des cellules de type CD4⁺ et CD8⁺. La production de cytokines telles que l'IL-12 et IL-6 sont également augmentée chez les souris infectées par *PbNK65-hrfΔ* et chez les souris déficientes en IL-6, nous avons observé une augmentation de la parasitémie ce qui suggère un rôle important de l'IL-6 dans le contrôle du développement du parasite. Il a été rapporté que l'IL-6 favorise la prolifération des cellules B ainsi que la différenciation et la sécrétion d'anticorps. Avec cette information à l'esprit nous avons testé si des anticorps spécifiques (IgG) pour les antigènes du parasite ont été produits chez les souris protégées. Les analyses sur le sérum de ces souris ont montré qu'en effet la réponse immunitaire contre *PbNK65 WT* ou d'autres souches de *Plasmodium* est associée à la production d'anticorps spécifiques IgG2c qui reconnaissent des protéines de *Plasmodium* telles que MSP-1, MSP-8, SERA-1, et SERA-2 de façon spécifique. De plus, ces protéines de *Plasmodium* sont connues pour susciter des anticorps associés à la protection chez les personnes vivant dans les zones endémiques (Banic et al., 1998; Okech et al., 2001) et ont déjà été présentées comme des possibles candidats vaccins. En outre, l'importance des anticorps dans la protection contre le paludisme a été clairement démontrée par des études cliniques où le transfert passif de sérum hyper-immunisé ou d'Ig purifiées d'adultes asymptomatiques aux enfants malades peut modifier le cours de l'infection en réduisant la parasitémie et les symptômes cliniques (Bouharoun-Tayoun et al., 1990; Cohen et al., 1961). Enfin, pour déterminer si les anticorps IgG induits par les parasites *PbNK65-hrfΔ* peuvent être des biomarqueurs à l'exposition aux parasites ou constituent des corrélats de protection stérile, des anticorps purifiés provenant de souris protégées ont été transférés passivement à des souris naïves, infectées par la suite

avec des parasites *PbNK65* WT. Les souris traitées avec des IgG purifiées à partir d'individus protégés ont développé une parasitémie moindre que les souris non traitées, ce qui suggère une activité anti parasitaire partielle mais significative des anticorps IgG protecteurs. Cela nous a conduit à suggérer que le transfert de cellules CD11b⁺ ayant acquis une fonction phagocytaire plus accrue à partir de souris protégées par *PbNK65-hrfΔ* serait nécessaire et suffisant pour protéger les souris naïves d'une infection par le parasite sauvage. En conséquence, nous avons réalisé des expériences de transfert adoptif de cellules CD11b⁺, obtenues à partir de souris sauvages ou de souris protégées par *PbNK65-hrfΔ*, suivi d'une infection avec des parasites WT.

Le transfert de cellules CD11b⁺ à partir de souris protégées par *PbNK65-hrfΔ*, mais pas de souris naïves, protège les souris receveuses contre des infections avec le parasite sauvage. Les résultats obtenus suggèrent que les anticorps sécrétés sont importants pour l'immunité protectrice à *P. berghei*, mais l'absence apparente de protection complète suggère que ces anticorps doivent agir avec des cellules effectrices CD11b⁺ FcγR⁺ "amorçées" telles que les monocytes, les macrophages, les cellules NK et d'autres qui existent chez les souris infectées par des parasites *hrfΔ*, mais pas chez les souris naïves. A l'appui des résultats obtenus, plusieurs études *in vitro* ont indiqué la pertinence biologique des sous-classes de FcγRII et IgG dans la résistance au parasite en montrant l'importance du mécanisme "antibody-dependent cellular inhibition (ADCI)" lors de la protection contre *P. falciparum* en phase sanguine (Bouharoun-Tayoun et al., 1990; Bouharoun-Tayoun et al., 1995; Druilhe and Perignon, 1994; Shi et al., 1999; Zhou et al., 2015). En outre, des études humaines ont également montré l'implication de FcγR à engendrer une puissante immunité antipaludique (McIntosh et al., 2007).

Dans ce travail nous avons démontré que le ciblage précis d'un gène du parasite responsable de la régulation des processus inflammatoires, dans ce cas précis en modulant la voie de signalisation de l'histamine au niveau de l'hôte vertébré, se révèle être une stratégie clé pour le déverrouillage du système immunitaire protecteur de l'hôte induisant une diminution de la charge parasitaire et de la pathogénicité. Ces travaux ont contribué à décrypter les liens entre l'inflammation en général, et de type allergique en particulier, et le pouvoir pathogène du parasite. Cela nous permet d'émettre l'hypothèse que les individus atopiques/allergiques

sont à risque vis-à-vis du paludisme. Cela revient à aborder la prise en charge du paludisme en prenant en compte la susceptibilité des individus aux pathologies allergiques. Ainsi une prise en charge thérapeutique originale pourrait consister à proposer des combinaisons médicamenteuses, incluant des antipaludiques et des anti-histaminiques. D'autre part les mécanismes immunologiques révélés par l'action de notre mutant HRF conduisent à proposer cet outil comme un nouveau GAP (Genetically Attenuated Parasite) à portée vaccinale visant le développement d'une protection durable.

General Introduction

1.1 MALARIA

Malaria, sometimes called the "King of Diseases", is a terrible disease, one of humankind's oldest and deadliest parasitic diseases in the world. It is caused by protozoan parasites (a group of single-celled microorganisms) belonging to the genus *Plasmodium* that infects humans, birds, reptiles, and other mammals through the intermediary of an infected female mosquito vector of the genus *Anopheles*.

Today half of the world's population is at risk. It hits the young, the poor and the vulnerable the hardest. A farmer sick for just some weeks has a huge consequence when his crops go to waste and his family goes hungry. This is happening to families around the world, causing untold misery and hampering development. In the last two decades of the 20th century the number of malaria cases worldwide seems to be increasing due to appearance of resistance phenomena associated with synthetic antimalarial drugs in use. Under this condition, identification and functional characterisation of key parasite and host proteins involved in this multi-system disorder with many similarities with the sepsis syndromes are a major challenge of the post-genomic era of *Plasmodium* research.

1.2 HISTORY OF MALARIA

1.2.1 The origin

Phylogenetic analyses of Apicomplexa genome sequences suggest that the genus *Plasmodium* evolved around 130 million years ago (Escalante and Ayala, 1995), before the dinosaurs extension. These ancestral malaria parasites were characterized by the two-host life cycle involving blood-feeding Dipterans and land vertebrates (Carter and Mendis, 2002). Mitochondrial genome sequences studies suggest that malaria may have affected human beings ever since the emergence of *Homo sapiens* 200,000 years ago (Jongwutiwes et al., 2005).

The climatic and ecological changes associated with an early and stable development of agriculture in sub-Saharan Africa with the loss of the forest cover beginning around 8,000 to 10,000 years ago contributed to the transmission of malaria in humans (Coluzzi, 1961; Joy et al., 2003). The forest agriculture development with culture of crops, including breaking up

the soil and clearing the forest cover created new breeding conditions that favoured the reproduction of *Anopheles* mosquitoes that could have accelerated the transmission of *Plasmodium* species among forest-dwelling agriculturalists was pivotal to the subsequent evolution and history of human malaria (Carter and Mendis, 2002; Coluzzi, 1961).

1.2.2 Malaria in the ancient world

The illness is probably from Africa and followed human migrations toward the Mediterranean coasts, to India and Southeast Asia. In the past, malaria was frequent in the Pontines swamps, around Rome and its name has derived from a medieval Italian term “mal’aria” (born in Venezia, in 1571) or bad air.

The first traces of malaria seem back to ancient Egypt, as evidenced by cases of splenomegaly (Ruffer, 1913) and presence of specific *Plasmodium falciparum* (*P. falciparum*) genes such as apical membrane antigen (*ama*) 1 and merozoite surface protein (*msp*) 1 found in 2010 by DNA amplification and sequencing performed on bone samples from the Egyptian Pharaoh Tutankhamon mummified in 1324 B.C at the age of 19 years (Hawass et al., 2010).

Historical records of ancient civilizations (Sumerians, Assyrians, Babylonians, Chinese, Egyptians and Indians) report testimonials, in medical and religious texts, of the presence of seasonal or intermittent fevers that attest the antiquity of the malaria. But at this time the malarial fevers were attributed to demons or to different gods (Crotti, 2005). The Chinese classical medical book Huang Di Nei Jing (the Canon of Medicine), edited in 2007 B.C by the Emperor Huang Ti, describes enlargement of spleen connected with different types of fever. In this document three malaria symptoms (headache, chills, and fever) are represented in the form of three demons: one with a hammer, one with a pail of cold water and one with a stone (Crotti, 2005).

At the end of the fifth century B.C in Greece, Hippocrates (460-377 B.C) attributes the origin of the various diseases to natural causes related to climatic and environmental conditions. In the Hippocrates corpus, he reported the occurrence of seasonal fevers characterized by fever peaks recurring every 48 or 72 hours and associated with rigors, cold and hot spells, profuse perspiration and splenomegaly (Cunha and Cunha, 2008).

In Italy, during the Roman Empire (circa 50 B.C to 400 A.D), malaria was excluded for several centuries, by drainage, husbandry, and building development. New episodes of malaria appeared with the decline of Empire. The presence and the disappearance of malaria have been associated with corresponding rising and falling agricultural and economic prosperity. This behavior, still observable, reflects the dependence of malaria on prevailing human activity and life-style.

All the medical knowledge acquired during the Roman Empire was lost and the malaria fevers returned to be confused with other common fevers. This situation was the cause of the spread of malaria in the cooler countries, Central and Eastern Europe. Around the sixteenth century, with the first colonization, malaria was widespread in the Americas.

1.2.3 Scientific discoveries

The scientific studies on malaria made their first significant advance the 6 November 1880 when a French military doctor in Algeria, Alphonse Laveran (Nobel prize 1907), discovered the malarial parasites by studying, under a microscope, the blood of patients not treated with quinine (natural alkaloid from the bark of a Peruvian tree, the tree of china). Due to the movement of the observed parasite, Laveran named the parasite *Oscillaria malariae*.

But the confirmation of an association between malaria and parasites occurred only in the late nineteenth century with the Italians Angelo Celli, Ettore Marchiafava and Camillo Golgi (Nobel Prize 1906). The first two described how malaria parasites, which they called *Plasmodium*, grow and multiply within the red blood cells before lysing the host cell to infect fresh erythrocytes and Golgi linked the onset of intermittent fever with the destruction of red blood cells and the spread of parasites into the blood (Ferroni et al., 2012). At the same time, morphological differences of the various agents responsible for fever were identified and *P. falciparum* was individualized as the species responsible for fatal cases of malaria (Ferroni et al., 2012). These findings allowed the description of malaria parasite life cycle stages in human blood.

While Golgi described the intra-erythrocyte parasite multiplication, Sir Ronald Ross (Nobel prize 1902), a medical officer in the British Colonial Medical Service, identified in the gut of infected mosquitoes *Plasmodium sp.* oocysts that broke and release sporozoites that

migrated to the mosquitoes salivary glands, highlighting the role of mosquitoes in malaria transmission. This discovery allowed Giambattista Grassi in collaboration with Amico Bignami and Giuseppe Bastianelli to identify the specific species of mosquito responsible for malaria transmission to humans (Ferroni et al., 2012). They showed that the mosquitoes belonging to the genus

Anopheles were the specific carriers of malaria in Italy, and described the development of the *Plasmodium* in the mosquito (Ferroni et al., 2012). To confirm these results Sir Patrick Manson, a Scottish physician working in London (where there was no *P. falciparum*), exposed his son and one of his colleagues to the infected mosquitoes coming from Italy confirming previous observations.

In 1948, Shortt and Garnham showed that the cyst-like bodies (schizonte), filled with thousands of merozoites, are formed in the liver of a rhesus monkey that had been bitten by infected mosquitoes (Cox, 2010). Henceforth, the life cycle of the parasite was fully known.

With the development of the scientific techniques it was possible to initiate the genome sequencing of the *P. falciparum* and *Anopheles gambiae* in 1996 and 1998, respectively. The published results (Gardner et al., 2002a; Winzerling and Pham, 2006) made possible different studies on parasite biology and entomology in order to promote new strategies destined to control the malaria such as diagnoses, medicines and vaccines.

1.3 DISTRIBUTION AND IMPACT

Despite the rise in the knowledge gained on *Plasmodium* parasites and the tremendous efforts to control this disease, malaria remains one of the most deadly infectious diseases in the world with a particularly devastating effect in Africa, where over 90% of deaths due to malaria occur (Fig.1). The endemic areas are mostly found in tropical and subtropical regions at an altitude below 1800 meters. Malaria infects not only in Sub-Saharan Africa, but also in Asia, Latin America, Middle East and even some areas of Europe are at risk (Fig.1).

According to the World Health Organisation, estimated 214 million cases leading to 438,000 deaths were reported in 2015, among the poorest populations in the world (WHO, 2015). The same year, 65% of deaths occur in children under 5 years of age in Africa.

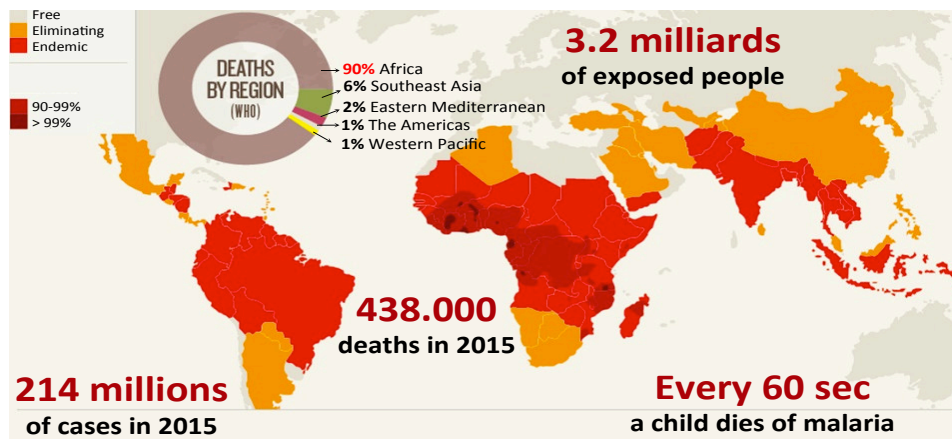

Figure 1: Global distribution of Malaria. (Shetty, 2012)

In highly endemic areas, in addition to an enormous amount of human pain, malaria plays a critical role in the socio-economic development (working and education days lost, costs of health care, and loss of investment and tourism), especially in the widespread regions. The morbidity and mortality constitute a serious obstacle to socio-economic development with a decrease of nearly 1.3% in the gross domestic product of countries (Sachs and Malaney, 2002).

Moreover, in recent years there was a return of malaria in countries where it had been eradicated in the past. This return may be the result of factors such as increasing insecticide-resistance in the vector, increasing multiple drug resistance in the parasite, increasing of large population migrations, increasing of the world proportion climatically suitable for transmission (global warming) (Nabi and Qader, 2009) and increasing of tourism between non-endemic and endemic countries (Moorthy and Hill, 2002).

1.4 PARASITES AND DISEASES

1.4.1 Malaria parasites

Malaria parasites are members of the genus *Plasmodium*, belonging to the Apicomplexa family a monophyletic group composed of at least 6000 species (Levine, 1988; Morrison, 2009), the majority of which have an obligatory intracellular lifestyle. The phylum contains other parasites that are important causative agents of human and animal diseases, such as

Toxoplasma and *Cryptosporidium* (Beck et al., 2009). In nature there are over 250 species of *Plasmodium* (Fig. 2), but only five species naturally infect humans: *P. falciparum*, *P. vivax*, *P. ovale*, *P. malariae*, and sometimes *P. knowlesi*. The five species differ by clinical criteria, their geographic distribution and their ability to develop resistance to antimalarial drugs. *P. vivax* is the most prevalent world-wide in most countries outside of sub-Saharan Africa, and *P. falciparum* is the most dangerous and virulent species, which is associated with severe complications such as cerebral malaria, renal failure and pulmonary affection leading to death. The other human malaria species can cause acute, severe illness but mortality rates are low. The last species, *P. knowlesi*, has been recently added to the list, originally a malaria parasite of long-tailed macaque monkeys, which has jumped the species barrier and can naturally infect humans (Daneshvar et al., 2009; Singh et al., 2004).

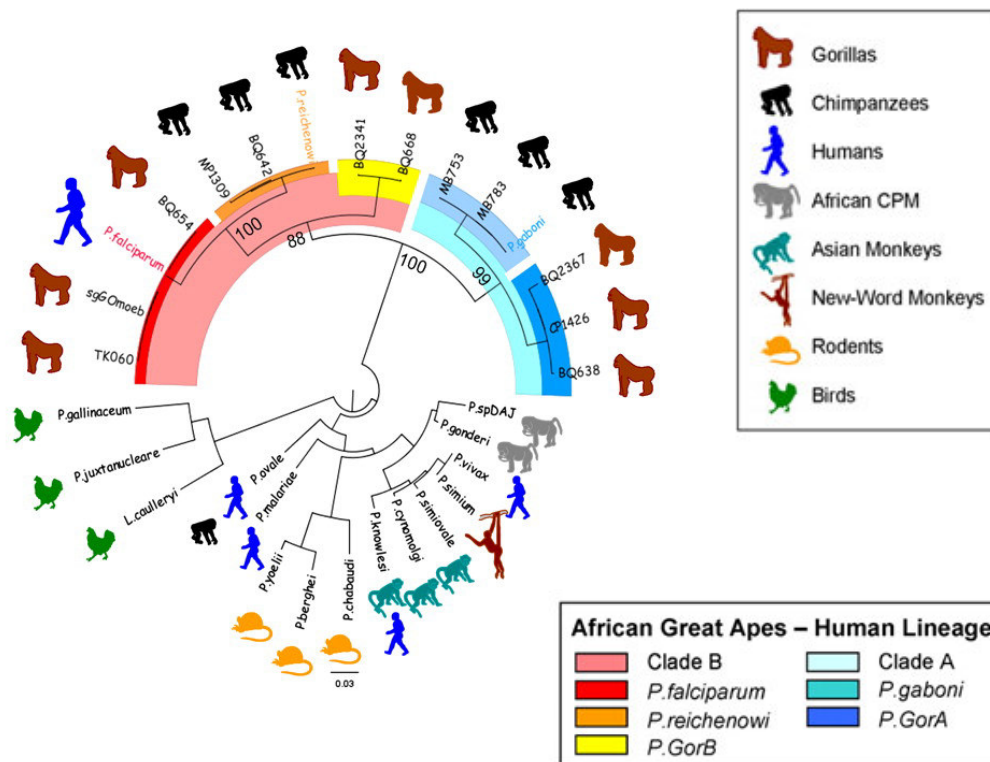

Figure 2: Phylogenetic relationships among *Plasmodium* species (Prugnolle et al., 2010).

1.4.2 Rodent malaria parasites (animal models in experimental malaria)

Rodent malaria parasites are mostly used to study experimentally the development of the disease to understand how parasites adjust traits during infections in response to changes in the host environment to maximise their fitness and escape the host immune response.

Rodent malaria parasites were discovered in Central Africa (Cameroon, Central African Republic, Congo, Democratic Republic of the Congo and Nigeria) between 1948 and 1974.

During this period, four species – *P. berghei* (*Pb*), *P. vinckei* (*Pv*), *P. chabaudi* (*Pc*) and *P. Yoelii* (*Py*) – were described, encompassing 13 sub-species of various strains (e.g. *Pb* ANKA and *Pb* NK65) (Ramiro et al., 2012). Like all mammalian malaria parasites, they undergo several rounds of asexual replication in the vertebrate host and sexual reproduction in *Anopheline* mosquitoes. All four rodent malaria parasites are known to be infective to mice by blood inoculation and by mosquito transmission with some differences in the susceptibility to laboratory animals. Infections caused by parasites such as *P. berghei*, and some strains of *P. vinckei* (*Pv vinckei*), *P. yoelii* (*Py* YM, *Py* XL) and *P. chabaudi* (*Pc* CB) cause lethal infections in mice, whereas infections with some strains of *P. yoelii* (*Py* 17XNL), *P. chabaudi* (*Pc chabaudi* AS, *Pc adami*) and *P. vinckei* (*Pv petterei*) are cleared after the initial acute parasitaemia (Wykes and Good, 2009). Moreover, *P. berghei* and *P. yoelii* have a marked predilection to invade reticulocytes with a relatively asynchronous development in laboratory rodents whereas *P. vinckei* and *P. chabaudi* invade both immature and mature RBCs populations showing a synchronous development during the blood stage (Wykes and Good, 2009). These differences are due to some changes in morphology, developmental time and size of different stages and iso-enzymes that influence host-parasite interactions.

Consequently, there is no single model that reflects exactly infections in humans, but taken together, different systems could provide valuable informations on the mechanisms of immunity and immunopathogenesis. Lethal infections are better suited for testing putative vaccine candidates and also examining the efficacy and safety of antimalarial drugs. Non-lethal infections have been used as best models to investigate the mechanism of acquired immunity. For example, *Pb* ANKA and *Py* 17X, in C57BL/6J mice are used as experimental models to study the development of cerebral malaria (CM) (Sanni et al., 2002; Wykes and

Good, 2009), and *Pc chabaudi* or *Py* 17XNL are usually used to explore immune response mechanisms. Moreover, *P. yoelii* is used to compare two strains (non-lethal 17XNL and lethal YM) with vastly different pathogenicity to deduce which factors may contribute to more serious malaria infections.

1.4.3 Malaria Genome

The recently available sequence of the *P. falciparum* (clone 3D7) genome provides powerful information for understanding resistance mechanisms and opens exciting new avenues for drug and vaccine development (Arav-Boger and Shapiro, 2005).

In addition to *P. falciparum*, other genome sequences of *Plasmodium* parasites have been published. The rodent malaria *Py* 17XNL clone (Carlton et al., 2002), *Pb* ANKA clone and *Pc* AS clone (Hall et al., 2005), the human malaria *P. vivax* Salvador 1 (Sal 1) strain (Carlton et al., 2008) and the human/simian malaria *P. knowlesi* H strain (Pain et al., 2008).

Comparative analysis of the available *Plasmodium* genomes revealed that they are all haploid and composed of 22.8 megabases distributed among 14 chromosomes that vary from approximately 0.643 to 3.29 megabases. A remarkable feature is its base composition that varies among the different species, with the *P. falciparum* and rodent genomes extremely A + T rich (80.6% on average and close to 90% in introns and intergenic regions in *P. falciparum* (Gardner et al., 2002a; Winzeler, 2008) in contrast with the more G + C rich *P. knowlesi* and *P. vivax* genomes (37.5% and 42.3%, respectively) (Carlton et al., 2008; Pain et al., 2008).

Gene research identified around 5000-6000 protein-encoding genes and, about 60% (approximately two-thirds) of the predicted proteins appear to be unique to this organism and another 5% presents significant similarities to proteins of other organisms (Plouffe et al., 2008; Ward et al., 2004). The two-thirds of the proteins have poor similarities to proteins of other organisms indicating a great evolutionary distance between *Plasmodium* and other eukaryotes (Fig.3) (Gardner et al., 2002a).

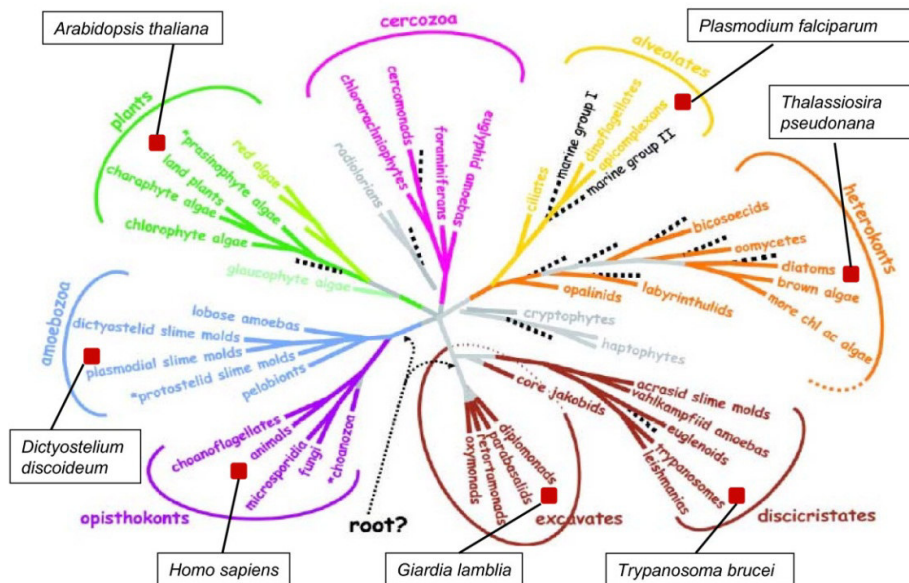

Figure 3: Phylogenetic tree demonstrating the putative relationships between the major types of eukaryotic organisms (Ward et al., 2004).

The evolutionary distance between the host (human) and the parasite proteins makes the use of inhibitors or genetic modifications, targeting the parasite, more interesting since they do not disturb the human protein and allow the development of new anti-malarial drugs or vaccines that target only the parasite vital functions without any influence on the host.

1.4.4 Life cycle

Malaria parasites have a complex life cycle which involves more than one host, an invertebrate primary host and a vertebrate secondary host (Fig. 4). The cycle can be divided into three main steps: (i) the **mosquito phase** characterized by sexual and asexual multiplications allowing the formation of sporozoites (12-14 days) (ii) the **pre-erythrocytic phase** (2-14 days) characterized by an asymptomatic asexual multiplication of the parasite in the liver of the vertebrate host and the (iii) the **erythrocytic phase** (48-72h) where the parasite undergoes an asexual multiplication within red blood cells leading to the symptoms of the disease.

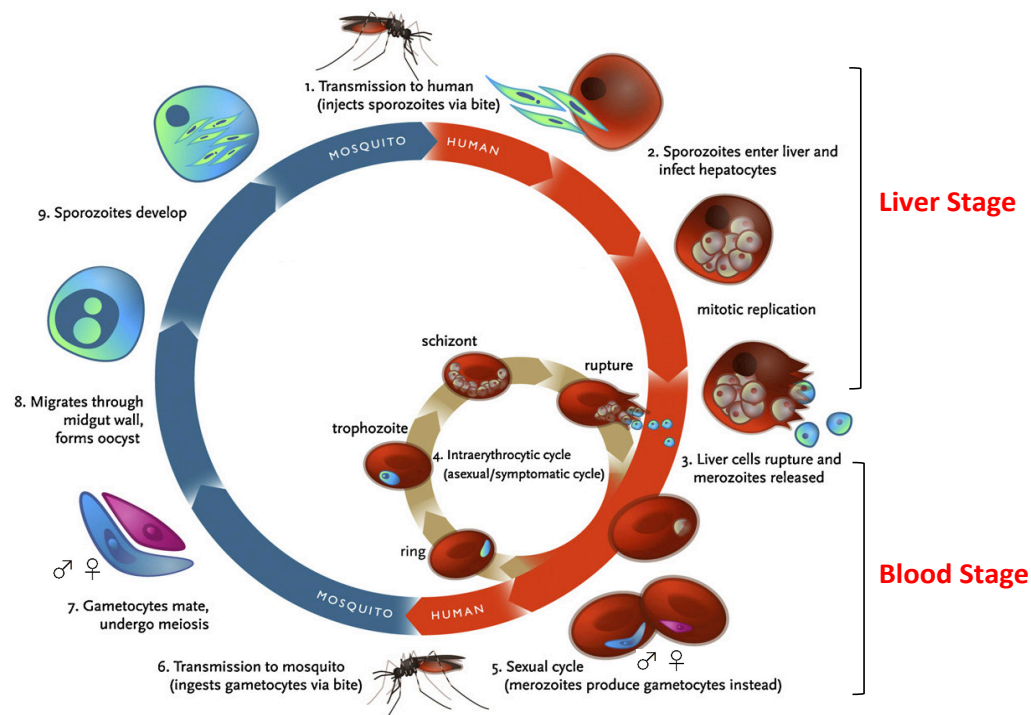

Figure 4: Schematic representation of the *Plasmodium* life cycle. The cycle consists of asexual development phase in the vertebrate host (liver and erythrocytic stages) and one sexual development phase inside the mosquito hosts (Klein, 2013).

1.4.4.1 Mosquito host

During a blood meal when a female *Anopheles* mosquito bites an infected host, it ingests mature male and female gametocytes (Kappe et al., 2010). As soon as the gametocytes are in the tract of the insect, triggered by the temperature drop and by chemicals (Billker et al., 1998), they escape from their surrounding erythrocyte membrane. In the midgut the gametocytes undergo gametogenesis, resulting in the development of female gametocyte into macrogametes while the male gametocyte undergoes exflagellation whereby it develops into eight flagella called microgametes. The male and female gametes fuse together (sexual reproduction) to form a diploid zygote that undergoes meiotic nuclear division and develops into a motile form, called ookinete, which penetrates the midgut epithelium and forms oocysts on the outer surface. Within the oocyst the parasite undergoes several rounds of asexual replication (sporogony) producing thousands sporozoites, elongate slightly curved cells approximately 10 μm long with a central nucleus and apical organelles (Schrevel et al., 2008). Rupture of the mature oocyst releases the sporozoites into the hemocoel (body cavity) of the mosquito. The sporozoites migrate to and

invade the salivary glands, thus completing the life cycle (Aly et al., 2009) for onward transmission, ready to be delivered to the skin of the host during mosquito bite (Zhang et al., 2010).

1.4.4.2 Pre-erythrocytic phase

This obligatory hepatic phase is the only classically described life cycle of the parasite where the parasite development requires invasion of nucleated host cells. Upon mosquito injection of motile salivary gland sporozoites into the human dermis, most of them start migrating in the cutaneous tissues and enter into the blood stream or the lymphatic system (Amino et al., 2006). In mice, around 50% of the inoculated parasites remain in the skin where ~10% can initiate development and lead to the production of new infectious parasites inside skin cells (Gueirard et al., 2010). Another 15% enter lymphatic vessels and reach the proximal draining lymph node where the parasites are eventually degraded. Finally, the remaining 35% invade bloodstream by entering capillaries in a process that usually lasts less than a minute (Amino et al., 2006) after the sporozoite deposition in the skin, but it can extend to hours. Once in the circulation, sporozoites migrate passively to the liver sinusoids where they migrate along the endothelial cell layer and cross the sinusoidal barrier. The parasite traverses different cells, including Kupffer cells and several hepatocytes, before settling and establishing a parasitophorous vacuole (PV) derived from the host-cell membrane (Frevert et al., 2005; Mota et al., 2001) which is rapidly remodelled by parasite proteins (Bano et al., 2007). Once the PV vacuole is established the parasite start to develop (Frevert et al., 2005) via a process of asexual multiplication, called hepatic merogony, which leads to the generation of hundreds or thousands of uninucleated merozoites contained vesicles called merozoites. After the lysis of the hepatocytes the merozoites are carried away in the circulation and finally reach the pulmonary vasculature where they break releasing hepatic merozoites in the blood.

Infections of *P. vivax* and *P. ovale* differ from the other types of malaria in that some sporozoites may develop into a dormant forms termed hypnozoites. Under this form the parasite can remain in the liver and relapses months or even years after the primary infection.

1.4.4.3 Erythrocytic phase

Red blood cells (RBCs) are the 'central stage' for the asexual development of the malaria parasite. Within RBCs, repeated cycles of parasitic development occur with precise periodicity. Once release in the blood, hepatic merozoites invade healthy erythrocytes by an active and rapid process, accomplished within 30 seconds of initial attachment to the erythrocyte surface minimizing the parasite surface antigens exposure, thereby protecting these parasite forms from the host immune response (Cowman and Crabb, 2006; Greenwood et al., 2008) (Fig. 5A). This invasion is a process which depends on successive major events: (i) initial weak attachment of merozoite to the erythrocyte surface by random collision mediated by MSP-1 and MSP-9 co-ligand complex that binds erythrocyte membrane transport glycoprotein (Gaur et al., 2004), (ii) reorientation of the merozoite mediated by AMA-1 (Mitchell et al., 2004) and creation of a distinctive tight junction between the apical end of the parasite and the erythrocyte followed by protein and lipid material secretion, and (iii) starting of the invagination process that involves direct interactions of parasite ligands at the apical end with erythrocyte receptors (Gaur et al., 2004). Formation of an invasive pit with the tight junction moving along the surface of merozoite as it penetrates into the erythrocyte, closing of the invasion pit on the erythrocyte membrane and isolation of the parasite within PV in the erythrocyte cytoplasm. At this point the parasite develops (asexual replication) through a change of its morphology (stages) inside the PV (Fig. 5C):

- Ring stage (0–24 hours),
- Trophozoite stage (24–36 hours)
- Schizont stage (40–48 hours)

At the end of the cycle the infected RBCs (iRBCs) lyse and release around 16-32 new merozoites that in turn will infect new RBCs. After several rounds of erythrocytic schizogony, some merozoites differentiate into the extracellular sexual stage gametocytes which develop into male and female gametocytes and are taken by mosquitoes during the blood meal.

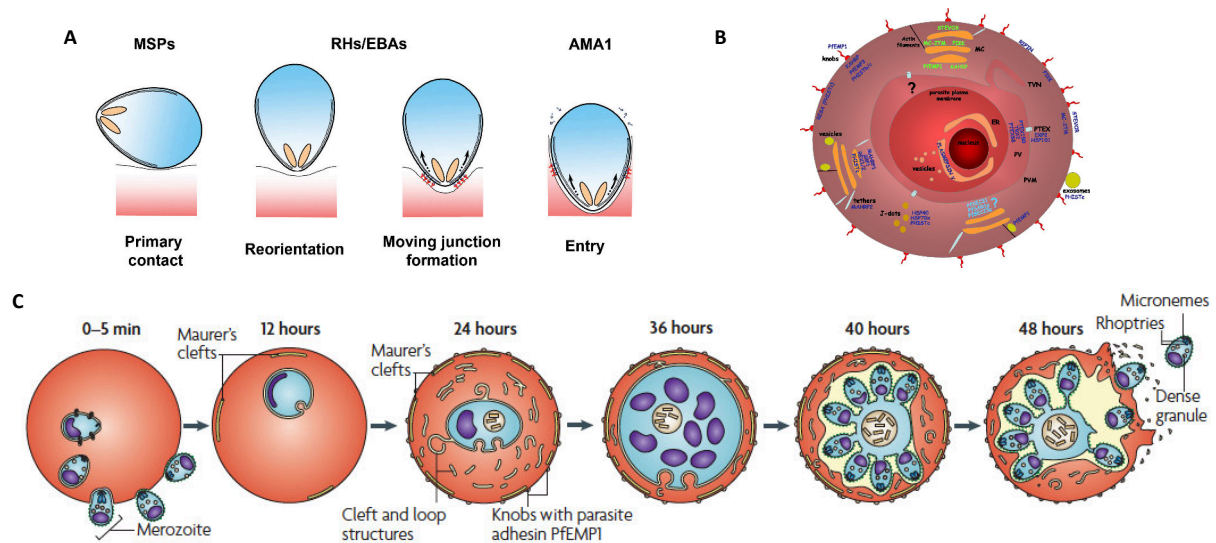

Figure 5: Schematic representation of the different stages of *P. falciparum* development in erythrocyte. (A) Major morphological changes occur during the merozoite invasion of erythrocytes. Initial weak attachment followed by reorientation, formation of tight junction and secretion of apical organelle contents and invagination (Wright and Rayner, 2014). (B) Cellular modifications occurring during parasite growth in the host erythrocyte and confirmed locations of exported proteins within the export. Protein names in dark blue indicate resident proteins of that organelle, names in green indicate transient location, and names in light blue indicate proteins, the of which location has not been confirmed. Abbreviations: ER, endoplasmic reticulum; MC, Maurer's clefts; PVM, parasitophorous vacuolar membrane; TVN, tubular-vesicular network (Mundwiler-Pachlatko and Beck, 2013). (C) Parasite development process. Merozoite attach and RBCs invasion (0-5min). The parasite develops in a parasitophorous vacuole (PV) through the ring (0–24 hours), trophozoite (24–36 hours) and schizont stages (40–48 hours). In mature-stage (>24 h) news membrane-bound structures appear in RBC (Knobs, Maurer's clefts, etc.). After approximately 48 hours there are the infected RBC lyse and 16–32 daughter merozoites are released (Maier et al., 2009).

One of the *Plasmodium* unique features is the ability to remodelling the host erythrocyte in order to overcome the lack of standard biosynthetic pathways and intracellular organelles in the RBCs that create obstacles for the parasites fast-growing. During the ring stage the major nutrient is the hemoglobin that is ingested into a food vacuole and degraded to obtain amino acids utilized for protein biosynthesis. The remaining toxic heme is converted into harmless hemozoin (malaria pigment) by heme polymerase and sequestered (Coronado et al., 2014). As the parasite grows and multiplies within the cell there is a dramatic expansion of the surface area through the formation of a tubulovesicular network and the parasite exports a variety of proteins to the erythrocyte cytoplasm and cell surface remodeling the RBCs structure (Fig. 5B). These exported proteins have functions in cytoadherence (such as *falciparum* erythrocyte membrane protein 1 (PfEMP-1)), nutrient acquisition and evasion of the host immune response (Charpian and Przyborski, 2008; Winzeler, 2008).

1.5 MALARIA PATHOGENESIS

Malaria pathogenesis is caused by the asexual multiplication of parasites in erythrocytes. The severity and the incubation period of the symptoms vary depending on the species of *Plasmodium* that causes the parasitosis. The red blood cells destruction leads to fever and flu-like symptoms, such as chills, headache, muscle aches, nausea, vomiting and diarrhea. These symptoms usually appear 10-15 days after being bitten. The disease can progress extremely rapidly and if it is not treated quickly with effective drugs, the parasite burden continues to increase and severe malaria may occur. However, symptoms can sometimes appear after weeks or months in patients who have not been appropriately treated. In epidemic region in people who have recently survived an infection, re-infection typically causes milder or no symptoms (uncomplicated malaria) but this partial resistance disappears over months to years if there is no on-going exposure to malaria.

1.5.1 Asymptomatic malaria

In areas of high malaria transmission, *P. falciparum* infections are characterized by persistence of low levels of chronic parasitaemia in the blood stream without manifestation of any clinical symptoms in adult patients (Hamad et al., 2000). These persistent or repeated “asymptomatic” infections allow the development of a natural acquired partial immunity, which controls but not completely eliminate the infection (Doolan et al., 2009). Moreover, microscopic diagnosis is often challenged by very low parasite density and individuals who are not treated with antimalarials remain reservoirs of gametocyte for perpetuating the malaria transmission cycle (Bousema et al., 2004).

During pregnancy, malaria infection is usually asymptomatic associated with placental sequestration of parasite and significant reduction of maternal haemoglobin level (Leke et al., 1999; Matangila et al., 2014) particularly in primigravidae (Ndyomugenyi and Magnussen, 1999). It is only during subsequent pregnancies that they acquire a form of pregnancy-associated immunity (Rowe and Kyes, 2004).

1.5.2 Uncomplicated malaria

Malaria infection usually results in an uncomplicated, mild febrile disease in which intermittent episodes of fever and peaks of parasitemia are controlled by the body's immune defences and eventually eliminated. Nevertheless, clinical symptoms and signs of malaria infection are not specific and shared with other febrile diseases as viral or bacterial diseases and precise analysis, as blood smear or rapid diagnostic test, are necessary to confirm malaria infection. Moreover, the presence of hepatosplenomegaly, thrombocytopenia and anaemia are clearly associated with malaria, particularly in children (Grobusch and Kremsner, 2005; White et al., 2014).

The clinical features have been attributed to the release of numerous known and unknown substances, such as red cell membrane products, hemozoin pigment (Sherry et al., 1995), and other toxin factors including parasite-specific glycosylphosphatidylinositol (GPI) (Schofield et al., 1996; Schumann, 2007) into the blood. These products, in particular the GPI, are potent stimulators of cytokines and inflammatory mediators synthesis by macrophages and endothelial cells (Gazzinelli et al., 2014), such as tumor necrosis factor (TNF), interferon (IFN)- γ , interleukin (IL)-1 β , macrophage inflammatory proteins (MIP)-1 α and MIP-1 β (Sherry et al., 1995), and nitric oxide (NO) (Gazzinelli et al., 2014). Additionally, the plasmodial DNA is highly proinflammatory and able to induce cytokinemia and fever. Hemozoin internalizes the DNA that is recognized by the toll-like receptor (TLR)-9 and activate the synthesis of pro-inflammatory cytokines. Cyclooxygenase (COX)-2 release upregulates the production of prostaglandins and leads to fever (Schumann, 2007) (Fig. 6).

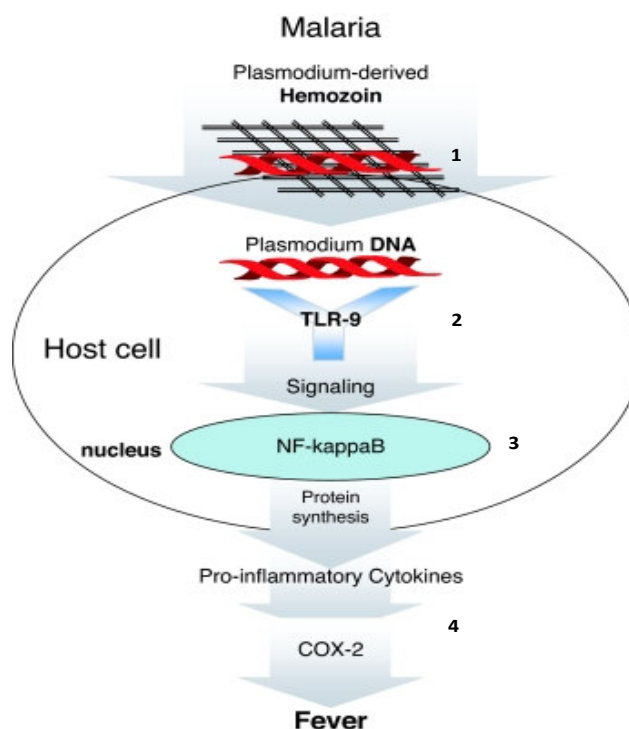

Figure 6: Potential mechanism of malaria-induced fever. (1) Hemozoin presents or internalizes plasmodial DNA. (2) TLR9 recognizes plasmodial DNA and initiates the innate immune response. (3) NF-kappaB activated pro-inflammatory cytokines induce COX-2. (4) COX-2 upregulates prostaglandins leading to a change in the set-point of the thermoregulatory center (fever). (Schumann, 2007)

1.5.3 Severe malaria

The progression of the infection results in progressive and dramatic modification of RBCs that can worsen into severe malaria responsible for a broad spectrum of clinical features accompanying *P. falciparum* infection. Nevertheless in the recent years, several cases of severe infection and even deaths have been reported in non-*falciparum* infections such as *P. vivax* (Naing et al., 2014) and *P. knowlesi* (Cox-Singh et al., 2010; Rajahram et al., 2016) infections.

The manifestations of severe *falciparum* malaria depend on age (Dondorp et al., 2008). In infants and young children the development of metabolic acidosis (respiratory distress), cerebral malaria (CM) and severe malarial anaemia (SMA) are the major complications causing high mortality (Gazzinelli et al., 2014; Schofield and Grau, 2005). In non-immune adults only a minority of infections become severe with the involvement of single-organ, multiple-organ or systemic impairment. Multiple complications could occur in an individual

at the same time and can develop rapidly and progress to death within hours or days if appropriate treatment is not provided in time.

1.5.3.1 Severe Malaria Anaemia (SMA)

Anemia is a common manifestation of all types of malaria, especially in children and during pregnancy, and is globally the leading cause of malaria related to mortality and morbidity. The pathophysiological processes in SMA can include a number of distinct, as well as overlapping features, such as the rupture of infected and uninfected RBCs (Dondorp et al., 1999), splenic sequestration of RBCs (Buffet et al., 2009), impaired erythropoiesis and dyserythropoiesis (Abdalla et al., 1980; Dormer et al., 1983; Kurtzhals et al., 1997; Perkins et al., 2011), co-infections with bacteria (Were et al., 2011), virus (ex. HIV-1) (Davenport et al., 2010) or hookworm (Price et al., 2001; Stoltzfus et al., 2000).

The spleen uptake of infected, altered or uninfected RBCs (uRBCs) is responsible for the clearance of those cells by the phagocytic cells such as monocytes, macrophages and neutrophils due to adherence of malarial IgG or complement binding to their surface (Haldar and Mohandas, 2009). The elimination of uRBCs may also occur by antibody-dependent cell-mediated cytotoxicity (ADCC). In confirmation of this hypothesis, recent studies have detected on the surface of ring stage iRBCs membrane as well as in uRBCs *P. falciparum* rhoptry protein 2 (Sterkers et al., 2007). Moreover, the impaired erythropoiesis due to the involvement of cytokines and other mediators of inflammation (such as hemozoin) causes SMA. The dysregulation of the innate immune response due to the phagocytosis of the malarial pigment hemozoin by effector cells such as neutrophils, macrophages and monocytes down-regulate IL-12 levels, associated with a decreased production of IFN- γ and IFN- α , through an IL-10-dependent mechanism allowing the development of the parasite and SMA (Haldar and Mohandas, 2009; Keller et al., 2006). Increased circulating levels of TNF, IL-6, IL-1b, IL-1RA, MIP-1 α , MIP-1 β are observed in sick children as well as prostaglandin E, NO, macrophage migration inhibitory factor (MIF), chemokine (C-C motif) ligand 5 (CCL5 or RANTES) and stem cells growth factor suppression. Further, in children with SMA, reduced NO production promotes ineffective parasite killing and may suppress, in the bone marrow, the erythropoiesis (Haldar and Mohandas, 2009). Recent studies in mice using

P. chabaudi AS have highlighted the important role of the Th2 cytokine IL-4 in erythropoiesis suppression (Thawani et al., 2009).

1.5.3.2 Cerebral Malaria (CM)

Cerebral malaria (CM) due to *P. falciparum* parasites sequestration in the brain is the most striking severe malaria syndrome characterized by gradual neurological disorders (Idro et al., 2005) starting from prostration, loss of consciousness, convulsions that occur in one third of the cases and progressive paralysis leading to coma even with appropriate medical intervention (Lovegrove et al., 2008). Disorders develop in 1% of patients infected with *P. falciparum* which cause a mortality rate of 20-30% among infected people, while more than 10% of survivors present neurological sequelae such as spasticity, ataxia, hemiplegia and blindness (Armah et al., 2007). Furthermore, numerous differences exist between paediatric and adult CM. Epidemiological data show that in endemic areas severe malaria is a complication almost exclusively associated with infancy. However, CM does not occur in children upon first infection, but after one or several infections (Artavanis-Tsakonas et al., 2003).

The immunopathogenesis of cerebral pathology in both human CM and experimental cerebral malaria (ECM) is a complicated series of inter-related events involving multiple organs, parasite and host immune factors over a period of some 5-10 days. Several mechanisms, which fall under three major hypotheses (Polimeni and Prato, 2014) are supported today to explain the CM pathogenesis: 1) the mechanical theory, 2) the permeability theory, and 3) the immunological theory.

The mechanical theory proposes that CM pathology is as a result of mechanical obstruction of cerebral microvasculature by iRBCs due to their impaired deformability (Coltel et al., 2004) or cytoadherence to receptors expressed on endothelial cell surfaces (Fig. 7A) (Miller et al., 2002), causing flow perturbations and hypoxia of the surrounding brain parenchyma (Turner, 1997) and increased lactate production due to anaerobic glycolysis (Planche et al., 2005). The cytoadherent properties increased in mature parasites (trophozoites, older schizonts) is associated with the expression on iRBCs surface of parasite proteins, such as PfEMP-1, that interact with specific host receptors in the microvascular endothelium,

including intracellular adhesion molecule-1 (ICAM-1), vascular cellular adhesion molecule-1 (VCAM-1), thrombospondin, CD36, and E-elastin (Polimeni and Prato, 2014). Other phenomena such as rosetting (Kaul et al., 1991), characterized by iRBCs forming a flower-like cluster around a uRBCs, clumping a cluster of iRBCs and platelets (Cox and McConkey, 2010; Pain et al., 2001), and decreased deformability of the iRBCs further increase the clogging of the microcirculation (Fig. 7A).

The permeability theory highlights the importance of the blood-brain barrier (BBB) alterations, caused by secondary signalling events activated by sequestered iRBCs, that allow toxic compounds to enter the brain and cause neurological dysfunction (Gitau and Newton, 2005; Hunt et al., 2006). Vascular permeability is found to be mildly increased and associated with cerebral edema in several animal models, however, in human no definite evidence of cerebral edema has been found on imaging studies (Medana and Turner, 2006). A correlation between malaria disease severity and the role of histamine, a vaso-active amine, has also been demonstrated in *P. falciparum* infections; with a markedly increased brain uptake of histidine in infected children that would favour an elevated brain level of histamine (Enwonwu et al., 1999). Accordingly, increased levels in plasma and tissue histamine have been associated with disease severity in human *P. falciparum* infections (Enwonwu et al., 2000). Moreover, our laboratory has highlighted the crucial role of histamine in the pathogenesis of the disease in mice. Mice deficient in histamine due to disruption of the histidine decarboxylase gene ($HDC^{-/-}$) or treated with antihistamines or deficient for the H1 and H2 receptors of histamine are more resistant to ECM, suggesting a harmful role of histamine pathway signalling through these receptors (Beghdadi et al., 2008). The involvement of histamine in the severity of the disease was confirmed by the absence of neuropathology observed in histamine-deficient mice. This resistance is characterized by the preservation of the integrity of the BBB with a decrease in the expression of ICAM-1 by endothelial cells and the absence of sequestration of iRBCs or adhesion of leukocytes to the cerebral blood vessels (Beghdadi et al., 2008).

The immunological theory, based on animal testing and poorly established, suggests that host factors such as cytokines and chemokines can enter the brain parenchyma after increased BBB permeability and aggravate pathological consequences. Curiously, in contrast

to other encephalitis-causing pathogens, such as *Trypanosoma* spp. or *Toxoplasma gondii* (Elsheikha and Khan, 2010), *P. falciparum* appears to remain in the vascular space without entering the brain parenchyma. Murine and human studies, during the development of CM, have demonstrated the recruitment of leukocytes and platelets in the cerebral microvasculature, caused by the production of local toxins from the sequestered iRBCs, followed by an exaggerated immune response through excessive release of pro-inflammatory cytokines (IL-1, IL-6, IL-12, TNF- α , IFN- γ , lymptoxine, and NO) (Hunt and Grau, 2003; Jain et al., 2013; Schofield and Grau, 2005) and microparticles (Jain et al., 2013). The cellular recruitment is a series of steps, in a first time neutrophils and monocytes via chemotaxis migrate to the brain where they bind to the brain endothelium and stimulate more chemokine and cytokine production (Renia et al., 2006). Furthermore, in mice studies, depletion of neutrophils that contribute to the brain lesions and are important source of cytokines and chemokines, prevents the development of CM by downregulation of the expression of T helper (Th)1 cytokines and monocyte sequestration (Schofield and Grau, 2005). In contrast to mice, neutrophil contribution to CM is unknown in humans. Several days post-infection (p.i.), after neutrophils and monocytes recruitment in the brain, naïve T cells fully primed by spleen CD11c^{high}CD8⁺DCs (Piva et al., 2012) upregulates chemokinereceptor CXCR3 on CD8⁺ T cells (deWalick et al., 2007; Miyakoda et al., 2008), influenced by IFN- γ derived from NK cells, and migrate to the brain in a full assault of the BBB representing the central component of ECM immunopathogenesis also responsible for severe symptoms and mortality. CD8⁺ T cells accumulate within the cerebral vessels, recognise and kill endothelial cells presenting parasite antigen by MHC I on their surface (Monso-Hinard et al., 1997) and initiate BBB tight junction disruption by promoting the central nervous system vascular permeability under neuroinflammatory conditions (Fig. 7B). Additionally mice studies shown that depletion of CD8⁺ T cell at both early and late infection prevents ECM pathology (Belnoue et al., 2002; Hermsen et al., 1997; Yanez et al., 1996).

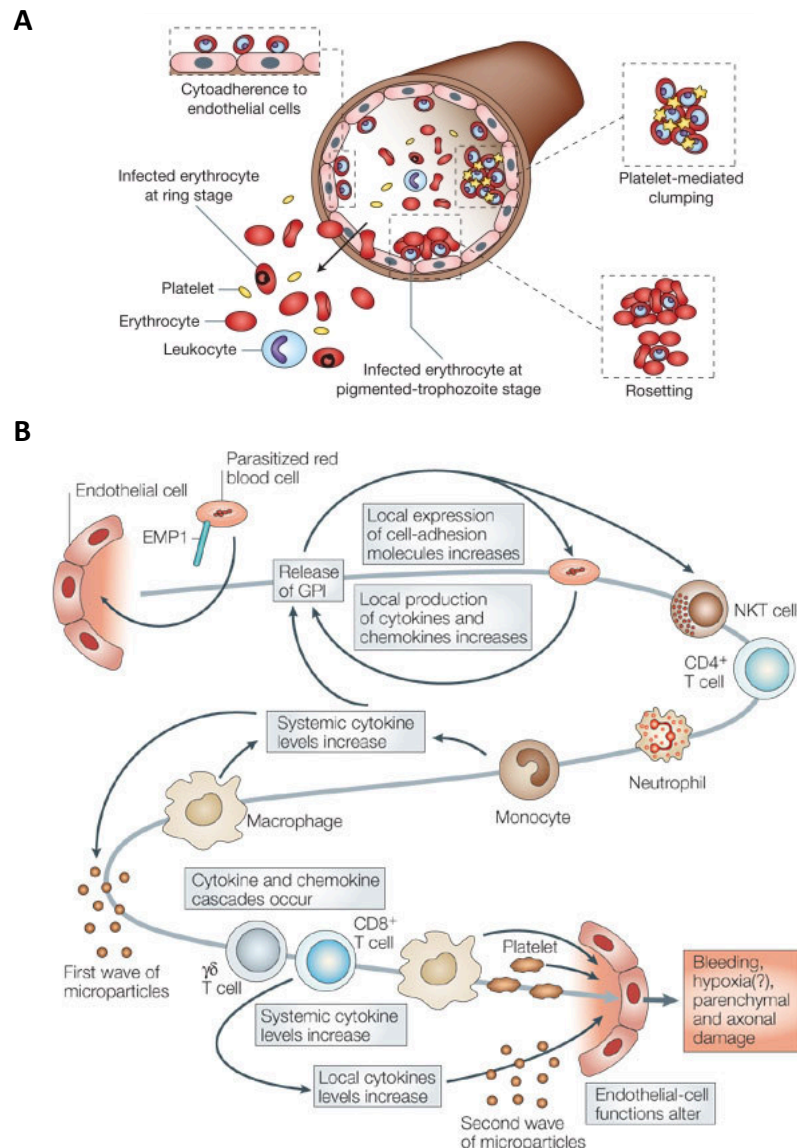

Figure 7: Schematic representation of mechanisms involved in the development of CM. (A) Schematic representation of the adhesion properties of *P. falciparum* iRBCs to different host cells. The iRBCs mature forms have the ability to bind to a range of host cells, such as endothelium, uRBCs (rosetting) and platelets (platelet-mediated clumping)(Rowe et al., 2009). (B) Schematic representation of severe malarial disease events. iRBCs adherence to receptors expressed by brain microvascular endothelial cells is followed by merozoites releasing. The release of parasite GPI induces an inflammatory response. A local acute-phase response then occurs, which involves activation of the endothelium and local production of cytokines and chemokines resulting in upregulation of expression of cell-adhesion molecules by endothelial cells. GPI can also function as a ligand for CD1d-restricted natural killer T (NKT) cells, leading to their activation. Activated NKT cells can regulate the differentiation and activation of CD4⁺ T cells into Th1 or Th2 cells. In addition, chemokines recruit monocytes and activate neutrophils. Recruited monocytes can then differentiate into macrophages and become arrested in brain microvessels. Macrophages can also be activated by GPI, a process that is amplified by IFN- γ . Local activated macrophages produce more chemokines amplifying the infiltration of cells, sequestration of iRBCs and release of microparticles. After several more cycles, $\gamma\delta$ T cells and CD8⁺ T cells might become involved, releasing more chemokines and cytokines both systemically and locally and possibly inducing perforin-mediated lesions in the endothelium. Together with locally arrested macrophages, platelets are sequestered and participate in altering endothelial-cell functions. More microparticles of platelet, endothelial-cell and monocyte origin are released, which leads to the dissemination of pro-inflammatory and pro-coagulant effects. Finally, damage to the endothelium, with possible perivascular haemorrhage, axonal injury, and neurotransmitter and metabolic changes, can ensue. (Schofield and Grau, 2005).

1.6 MALARIA PROTECTIVE IMMUNITY

In 1980, Bruce-Chwatt wrote, “malaria immunity may be defined as the state of resistance to the infection brought about by all those processes involved in parasite destroying or by limiting their multiplication” (Bruce-Chwatt, 1980). Immunity to malaria is complex, and is essentially both species and stage specific. The multi-stage nature of the *Plasmodium* life cycle, the differential and specific expression of genes at each stage, and the predominantly intracellular lifestyle of the parasite pose challenges to the ability of the vertebrate host to mount an effective defense (Ferreira et al., 2004). Other factors, including the age and genetic background of the host, pregnancy, nutritional status and co-infection, also influence the development of antimalarial immunity (Baird, 1995; Doolan et al., 2009). In humans, various types of acquired or adaptive immunity against plasmodia have been defined (Fig. 8)(Doolan et al., 2009):

- Antidisease immunity, rapidly acquired and results in reduced mortality or severe clinical disease.
- Antiparasite immunity, slowly acquired confers protection against parasitemia by affecting the parasites density and the attendant risk of severe disease (Marsh and Snow, 1997).
- Premunition, phenomenon that describes the asymptomatic status observed in adults with high degree of immune responsiveness together with the nearly permanent presence of relatively low densities of parasite (Sergent, 1935).

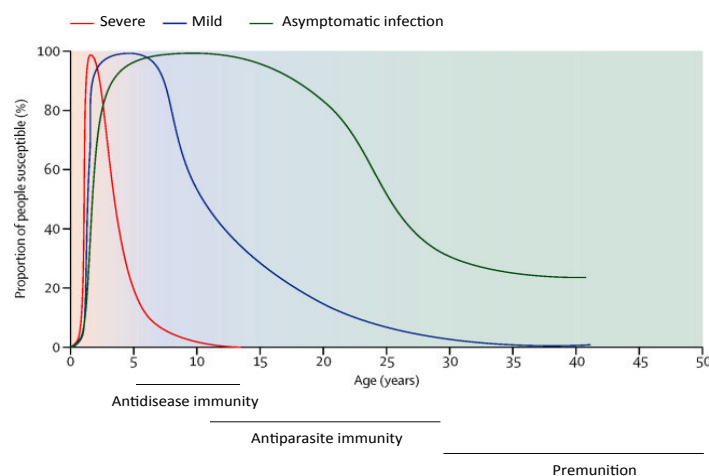

Figure 8: Pattern of *P. falciparum* infection outcome with age in a malaria endemic population. Asymptomatic infection (green), mild disease (febrile episodes caused by malaria; blue) and severe or life-threatening disease (red) (White et al., 2014).

In malaria endemic areas the inhabitants are usually infected repeatedly with malaria parasites and acquired immunity gradually. Sterilizing immunity against infections is never fully achieved. A general trend of increased serological response is seen with age, this is probably due to cumulative exposure over time to various parasite antigens. Acquisition of immunity appears to be sequential, with the ability to limit parasite growth and multiplication, followed by essentially complete protection against severe and then mild clinical disease, and culminating with partial protection against infection. Maintenance of this malaria immunity is dependent on persistent sub-clinical infection and is lost when people leave malaria-endemic areas.

1.6.1 Innate immunity

Animal and human studies have highlighted the importance of innate immune mechanisms to limit the initial phase of parasite replication, controlling the first wave of parasitemia and allowing the host to develop specific adaptive responses that will be able to clear the infection (Molineaux et al., 2002; Stevenson and Riley, 2004). The initial trigger of the innate immune response is the activation of different cell types including dendritic cells (DCs), monocytes/macrophages, natural killer (NK) cells, natural killer T (NKT) cells, and $\gamma\delta$ T cells resulting in the production of different factors among which several inflammatory mediators in particular cytokines and chemokines (Stanisic et al., 2013). This early inflammatory response is involved in various effector mechanisms such as parasite phagocytic clearance through the production of reactive oxygen and nitrogen species, and secretion of anti-microbial peptides, that all aim at destroying the parasites.

The production of inflammatory cytokines is controlled by the type of interactions between host cells and parasite. The innate immune system recognizes *Plasmodium* components (such as hemozoin, CpG-containing DNA motifs bound to hemozoin or AT-rich DNA motif), known as pathogen-associated molecular patterns (PAMPs), via a limited number of pattern-recognition receptors (PRRs). These receptors include the TLRs family that recognize parasite molecules (Coban et al., 2007) or hemozoin (Coban et al., 2005) and cell surface receptors such as CD36 (Stevenson and Riley, 2004), a co-receptor for TLR2 (Langhorne et al., 2008). The strongest evidence of the importance of these interactions comes from mouse models,

specifically *P. berghei*, *P. yoelii* and *P. chabaudi*. *In vitro* studies show the capacity of *Plasmodium* GPI- anchored molecules to activate and stimulate the production of pro-inflammatory cytokines (TNF- α and IL-1) and NO from mice and human macrophages through TLR2 and TLR4 (Krishnegowda et al., 2005; Nebl et al., 2005; Schofield and Hackett, 1993). In early infection activation of DCs via TLRs appears to cause inflammatory cytokines, IL-12, release from T cells in mice (Perry et al., 2004) and IL-12 production by NK cells in appropriate dose has been shown to be useful in induction of protective immunity during *P. chabaudi* infection (Stevenson et al., 1995). However, TLR-MyD88-mediated IL-12 production, during blood stage infection with *P. berghei* in mice, was shown to be associated with perforin-dependent liver injury (Adachi et al., 2001). Recently, the role of the CD36 receptor was shown to be involved in opsonin-independent phagocytosis of *P. falciparum* iRBCs by monocytes from non-immune individuals (Serghides et al., 2003). Moreover, the *in vitro* binding of *P. falciparum* iRBCs to CD36 on the surface of host LPS-activated DCs induces the secretion of IL-10 rather than IL-12 and reduces their ability to activate T cells in an allogeneic mixed lymphocyte reaction or to activate memory CD4⁺ T cells (Urban et al., 1999).

Another important cytokine implicated in the early inflammatory response and essential for controlling the initial wave of parasitaemia in mice is IFN- γ release by NK cells and $\gamma\delta$ ⁺ T cell that strongly expanded during the early phases of malaria infection (Fig. 9) (Hensmann and Kwiatkowski, 2001; Inoue et al., 2013; Stevenson and Riley, 2004), and enhances phagocyte activity, resulting in the elimination of extracellular parasites. Indeed, IFN- γ deletion during *P. chabaudi* infection led to impaired cytokine responses, uncontrolled parasitemia and increased mortality (Favre et al., 1997; Su and Stevenson, 2000). Additionally, IL-12p40 subunit deficiency in resistant mice reduced IFN- γ induction and increased mortality (Su and Stevenson, 2002), while administration of recombinant IL-12 to susceptible mice enhanced IFN- γ production, parasite control, and survival (Stevenson et al., 1995).

A study of *P. falciparum* infection showed that IFN- γ is produced in major quantities by $\gamma\delta$ T cells in contrast to NK cells in response to iRBCs before and after *P. falciparum* infection (Teirlinck et al., 2011). Moreover, IFN- γ -producing responses of malaria antigen-specific $\gamma\delta$ T cells were shown to be important for the development of a protective immunity against *P.*

falciparum infection in Papua New Guinea children (D'Ombrain et al., 2008). In contrast, several *in vitro* culture studies demonstrated the rapid production of IFN- γ by NK cells in response to malaria infection *via* IL-12 and IL-18 signalling from antigen-presenting cells (APCs) (Micallef et al., 1996; Okamoto et al., 1999). Additionally, different studies showed that IFN- γ is also produced by DCs (Suzue et al., 2003) and is important for priming lymphocytes, nevertheless it not clear if IFN- γ production from DCs enhances protective immunity against *Plasmodium* infection.

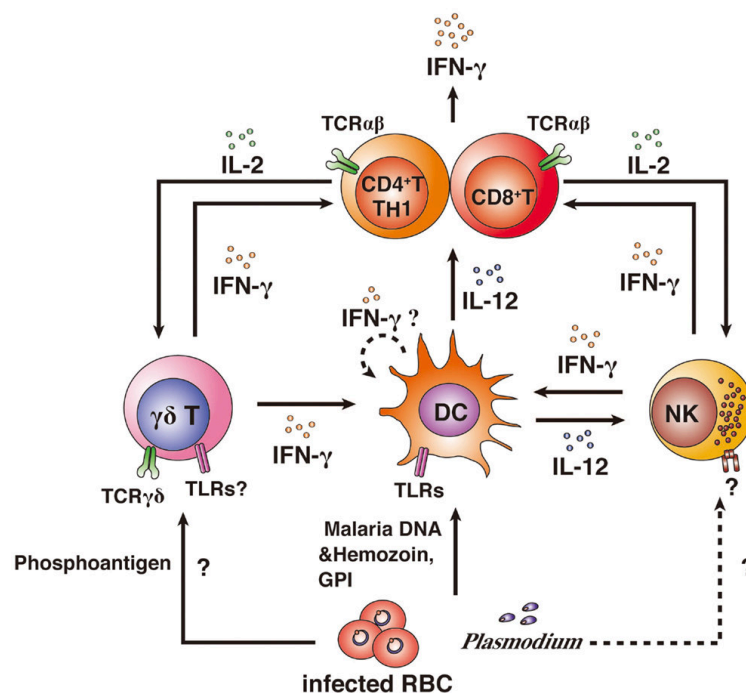

Figure 9: IFN- γ producers and their activation. *Plasmodium* antigens are recognized by innate immune cells ($\gamma\beta$ T cells, DCs and NK cells) via PPRs (TLRs and TCR) expressed on cells surface and activate the cells to produce IFN- γ . Moreover, IL-12 production and the antigen presentation from activated DCs strong activate the $\alpha\beta$ T cells leading to high IFN- γ production. Furthermore, activated $\alpha\beta$ T cells produce IL-2, resulting in the proliferation of $\gamma\beta$ T cells and NK cells and $\alpha\beta$ T cells themselves. IL-12 can also activate NK cells. (Inoue et al., 2013)

Liver stage production of IFN- γ , capable to inhibit parasite growth *in vitro* hepatocyte cultures, seems to be mediated by NKT cells (Pied et al., 2000). Furthermore, during *P. yoelii* low-doses blood infection in nude mice liver NKT cells are required for partial protection, and adoptive transfer of these cells was able to passively transfer resistance to naïve mice (Mannoor et al., 2002; Schmiege et al., 2003). In addition, it has been reported that NKT cells are capable to regulate IgG antibody responses against *P. falciparum* GPI protein of pre-

erythrocytic parasites (Hansen et al., 2003). Nevertheless, additional investigations are required because other reports have shown the opposite (Schmiege et al., 2003).

The role of neutrophil activation in the host response to *P. falciparum* needs further clarification. Host resistance to malarial infection is not classically attributed to a neutrophil response (Stevenson and Riley, 2004). However, examining gene-expression profiles in whole blood from Kenyan children, a cluster associated with neutrophil activity, including absolute neutrophil count and neutrophil-related gene expression was identified (Griffiths et al., 2005). A significant increase in parasite gene-expression intensity corresponded to a significant increase in neutrophil count in subjects who had acute malaria as compared to convalescent subjects. Indeed, it has been observed that neutrophils have been linked with acute malaria (Ladhani et al., 2002).

1.6.2 Adaptive immunity

The parasite-mediated innate inflammatory immune response is the first step of the induction of the subsequent adaptive response responsible for the effector mechanisms against pathogens and ultimately leading to the memory response (Fig. 10). However, during malaria infection long-term memory (central memory) doesn't exist because continued exposure to malarial antigens is needed for: (i) the generation of effector memory cells and (ii) the persistence of memory and effector cells. The underlying mechanisms and antigenic specificity of protective immunity against malaria parasite are not well understood. The acquired anti-malaria immunity has been demonstrated to be strain and stage specific, with some cross reactivity

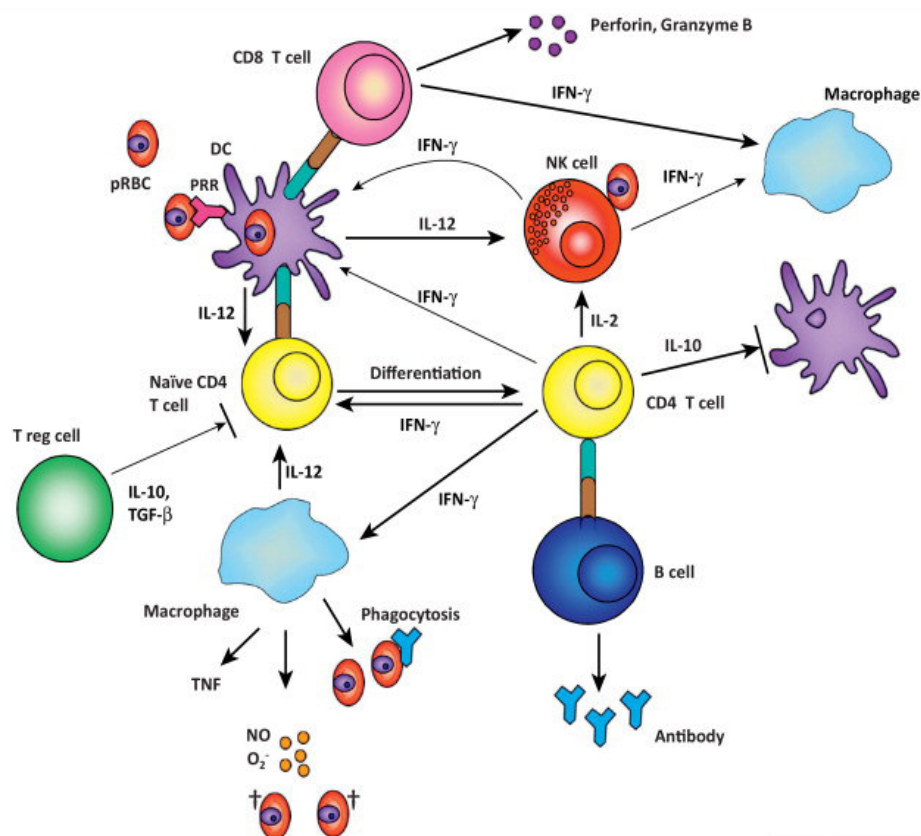

Figure 10: Linking innate and adaptive immunity to blood-stage malaria. In response to parasite ligands recognized by pattern-recognition receptors (PRRs), such as Toll-like receptors (TLRs) and CD36, or inflammatory cytokines, such as interferon- γ (IFN- γ), dendritic cells (DCs) mature and migrate to the spleen. Maturation of DCs is associated with the up regulation of IL-12 secretion, and antigen presentation to CD4⁺ T cells. DCs can also cross-present antigen to CD8⁺ T cells. IL-12 activates natural killer (NK) cells to produce IFN- γ and promote adaptive and humoral immune responses via antibody subclass switching. IFN- γ production by NK cells, CD8⁺ T cells, and differentiated CD4⁺ T cells primes antigen presenting cells to produce cytokines and chemokines, further assists DC maturation, and also activates macrophages, resulting in phagocytosis and killing of parasites via the production of nitric oxide and reactive oxygen intermediates. CD4⁺ T cells can also produce IL-10, which can induce apoptosis of DCs. Once activated, macrophages can also participate in antigen

1.6.2.1 Cellular immunity

Control of asexual stages depends on both humoral and cellular immune response mechanisms. Nevertheless, the acquisition and maintenance of protective immunity is largely both CD4⁺ and CD8⁺ T cell dependent (Troye-Blomberg et al., 1994). In fact depletion of T cells in animal models does not allow recovery from infections and reconstitution with T cells from immune donors of severe combined immunodeficient mice suppress *P. chabaudi adami* growth suggesting that T cells contribute to immunity (van der Heyde et al., 1994). In contrast, animals unable to make antibodies recover normally from some primary infections

with *P. chabaudi* and when rescued by chemotherapy from other species of malaria parasite develop lasting, nonsterile immunity (Langhorne et al., 1998; von der Weid et al., 1996).

The most important cells implicated in regulating the human immune responses to asexual blood stages of *P. falciparum* are CD4⁺ T cells. These cells are polarized to make some defined cytokine response and provide help to the humoral component. Activation of malaria-specific $\alpha\beta$ TCR⁺ CD4⁺ T cells can be initiated soon after the antigen presentation by APCs (Bruna-Romero and Rodriguez, 2001; Chemtai et al., 1984). The role of CD4⁺ T cells was observed in *in vitro* experiments in which CD4⁺ T cells from malaria exposed individuals respond to a diversity of *P. falciparum* antigens by proliferation or by production of IFN- γ or IL-4 (Troye-Blomberg et al., 1990). The T cell production of IL-4 instead of IFN- γ was correlated to Abs levels in exposed individuals (Troye-Blomberg et al., 1990). While the production of IL-4 is typically observed at the end of the acute phase characterized by a Th2 response, the production of IFN- γ is predominant in the early acute *P. chabaudi* infection highlighting a Th1 response involved in the activation of mononuclear and polymorphonuclear leukocytes which phagocytose or lyse iRBCs (Kharazmi and Jepsen, 1984; Orago and Facer, 1991). This high production of IFN- γ declines as the parasitemia decreases, and is replaced by IL-4 and IL-10 production (Taylor-Robinson, 2002; Taylor-Robinson and Phillips, 1994). Moreover, activation of Th2 cells in the early acute phase of *P. chabaudi* infection in susceptible A/J mice results in a severe and lethal course of malaria (Stevenson and Tam, 1993). In human infection with *P. falciparum*, the shift from a Th2 response to a more pronounced Th1 response is associated with the resolution of infection (Winkler et al., 1998). These results show that both Th1 and Th2 cells are involved in protective immunity against blood stage malaria, at different times of infection and maybe according to localization.

Infective dose and kinetics also appears to be important and influence Th1/Th2 response in malaria. The increase in inoculum size in susceptible A/J mice leads to fulminating parasitaemia associated with elevated Th2 responses (Taylor-Robinson and Phillips, 1998). In murine model infected with *P. chabaudi*, changes over time of the ability of splenic DCs (CD11c⁺CD8⁺ or CD11c⁺CD8⁻) to present antigens to CD4⁺ T cells was observed. High mortality in CD8⁺DCs population followed by an increase in the number of CD8⁻DCs

responsible to induce IL-4 and IL-10 production from MSP-1-specific T cells was observed in coincidence with the Th1 to Th2 switch during the immune response to the pathogen (Sponaas et al., 2006).

Although CD4⁺ T cells are critical for protection against malaria, at the same time they could play a role in the development of lethal complications. The depletion of CD4⁺ T cells before the infection with *P. berghei* can prevent the convulsions due to ECM (Hermsen et al., 1998).

While CD4⁺ T cells are important during the blood stage, available evidence indicates that MHC class 1-restricted CD8⁺ T cells, with a cytotoxic potential, seem to have important effector functions in pre-erythrocytic immunity (Crompton et al., 2014; Nardin and Nussenzweig, 1993) and contribute to protection against severe malaria (Aidoo and Udhayakumar, 2000; Hill et al., 1991). In animal model, CD8⁺ T cell were shown to directly lyse the infected hepatocytes and destroy intracellular parasite via an IFN- γ - dependent mechanism (Tse et al., 2011). Nevertheless, this CD8⁺ T cells response appears to be dependent on CD4⁺ T cells and the persistence of parasite antigens (Cockburn et al., 2010; Overstreet et al., 2011). Moreover, It has been proposed that CD8⁺ T cells may regulate immunosuppression in acute malaria and down-modulate inflammatory responses. Nevertheless, no available evidence for a protective role of CD8⁺ T cells against *P. falciparum* blood stage has been reported. This is supported by the fact that RBC do not express classical MHC class I molecules, hence lacking the antigen processing machinery, suggesting that RBC do not represent a target for CD8⁺ T cells. However, in contrast to the MHC-restricted $\alpha\beta$ T cells, the MHC-unrestricted $\gamma\delta$ T cells may have a direct cytotoxic potential on the asexual blood stages of malaria parasites, as demonstrated by their inhibitory activity in *P. falciparum* cultures (Troye-Blomberg et al., 1999b).

Despite the important role of T cells in the development of anti-malaria immunity, some mechanisms are opposed to its effectiveness. In rodent models the development of memory CD4⁺ T cells during malaria infection occurs but this memory decays over time in the absence of re-infection. Indeed, mice infected with a chronic *P. chabaudi* are more protected in absence of anti-malaria drug treatment than treated mice suggesting that the persistence of the parasite was necessary for the establishment of the immunity. These non-treated mice

presented enhanced Th1 response compared to those treated with drug (Stephens and Langhorne, 2010; Stephens et al., 2011). In humans Th1 memory responses gradually decline in the absence of infection, whereas central memory IL-10 regulatory responses were maintained (Wipasa et al., 2011).

Moreover, in chronic diseases it was shown that repeated antigen stimulation through the T cell antigen receptor drives the sustained expression of T cell inhibitory receptors, including programmed death 1 (PD-1; also known as PDCD1) and lymphocyte-activation gene 3 (LAG3), on virus-specific CD8⁺ T cells (Ishida et al., 1992). Transcriptional changes that negatively regulate proliferation and the expression of pro-inflammatory cytokines by virus-specific CD8⁺ T cells are induced (Barber et al., 2006; Blackburn et al., 2009). Recently it was reported that in mice, infection with nonlethal *P. yoelii* parasites drives specific T cell dysfunction called exhaustion (Butler et al., 2012). Therapeutic blockade of PD-1 ligand (PD-L1) and the inhibitory receptor LAG3 in mice demonstrated a restoration of CD4⁺ T cells and B cell responses resulting in enhanced parasite control, even in chronically infected mice, suggesting that regulatory pathways may also promote chronicity of infection (Butler et al., 2012; Horne-Debets et al., 2013; Stanisic et al., 2013). The combined blocking of PD-L1 and LAG3 was also associated with increased numbers of CD4⁺ T_{FH} cells and germinal center B cells resulting in higher Abs titres which contribute to a better control of blood stage malaria (Butler et al., 2012). Recently, studies using a PD1-KO mouse model infected chronically with *P. chabaudi* confirmed the importance of PD1 and highlighted the important role of CD8⁺ T cells in the development of a long-term protection against murine malaria. In fact, depletion of CD8⁺ T cells during a secondary infection in PD1-KO mice results in the development of the parasite in the blood stage, the opposite is observed with CD4⁺ T cell depletion (Horne-Debets et al., 2016). Furthermore, *P. falciparum*-infected children present higher expression of the inhibitory receptor PD-1 associated with T cell dysfunction (Butler et al., 2012), and the increased frequency of CD4⁺ T cells expressing PD-1 alone and in combination with LAG-3 appeared to be driven by persistent *P. falciparum* exposure (Illingworth et al., 2013).

1.6.2.2 Humoral immunity

The role of Abs in malaria protective immunity is not completely understood. However different anti-parasite effector functions have been attributed to the strong Abs responses reported during the infection: (i) the inhibition of the invasion of hepatocytes and erythrocytes, (ii) the inhibition of the cytoadherence, (iii) the complement-mediated opsonization of iRBCs, and (iv) monocyte-dependent antibody-mediated cellular cytotoxicity (ADCC) and monocyte-dependent antibody-mediated cellular inhibition (ADCI) (Perlmann and Troye-Blomberg, 2002).

The importance of antibodies in protection against malaria has been clearly shown by clinical studies where passive transfer of hyper-immune serum or purified Igs from asymptomatic adults to sick children can modify the course of infection by reducing parasitaemias and clinical diseases (Bouharoun-Tayoun et al., 1990; Cohen et al., 1961). Moreover, until 6 month of age children remain remarkably resistant to *P. falciparum* and *P. vivax* infection. This protection has been associated with maternally derived immunoglobulin G (IgG) antibodies (Logie et al., 1973), acquired by the fetus *in utero* through the passage of Abs across the placenta by an active receptor-mediated transport system (hFcRn) (Ellinger and Fuchs, 2012; Malek et al., 1996). During breastfeeding, infant protection may be associated with parasite growth-inhibitory factors such as lactoferrin and secretory IgA found in maternal milk. As observed in humans in animal models the passive immunization with mAbs (Quinn and Wyler, 1979; Siddiqui et al., 1987), adoptive transfer of B cells (Langhorne et al., 1998) and increased susceptibility of B-cell-deficient hosts (von der Weid et al., 1996) have highlighted the important role of antibodies in malaria immune response.

However, the protection obtained *in vivo* studies with passive transfer of Igs is lost around 10 months after the Abs treatment (Cohen et al., 1961). *In vitro*, clinically effective Igs obtained from the sera of *P. falciparum* immune adults had no detectable inhibitory effect on either parasite invasion or growth, but was shown to suppress the parasite growth in cooperation with human monocytes in an antibody-dependent cellular inhibition (ADCI) assay (Bouharoun-Tayoun et al., 1990). Additional studies in humans and squirrel monkeys have shown that opsonic or cytophilic antibodies (IgG1 and IgG3 in humans) are associated with

the protective effect of the Abs (Bouharoun-Tayoun and Druilhe, 1992; Groux and Gysin, 1990; Shi et al., 1999). At this point cooperation between cells of the immune system and Abs appears to be crucial in parasite elimination and acquired protective immunity.

The elimination of the parasite through an Abs-cell complex is mediated by the capture of Abs on the surface of cells via Fc γ Rs receptors that bind the Fc part of the Ab, while the Fab part of the Ab is bound to antigens on the surface of either merozoites (Bouharoun-Tayoun et al., 1990) or late infected erythrocytes (Gysin et al., 1993) enhancing their phagocytosis by immune cells (neutrophils, monocytes and macrophages) and making parasites available for clearance by the spleen (David et al., 1983; Del Portillo et al., 2012), thus protecting against CM (Carlson et al., 1990). Different Abs with a protective function are produced (IgG, IgM and IgE) but in clinically immune individuals the predominance of the cytophilic IgG1 and IgG3 subclasses has been associated with either lower parasitaemia or a lower risk of malaria attack (Bouharoun-Tayoun et al., 1995). The non-cytophilic IgG4, present in low doses in immune individuals, may inhibit effector mechanisms by competing with cytophilic Ab and are considered nonprotective (Aucan et al., 2000; Garraud et al., 2003; Leoratti et al., 2008). In contrast, recent data suggest that, under certain circumstances, the non-cytophilic IgG2 could be correlated with protection in individuals. This protection is due to a rare mutation on the allele encoding an Fc γ RIIa that can bind IgG2 (Aucan et al., 2000). Moreover, highest levels of IgG1, IgG2 and IgG3 Abs were observed in individuals with asymptomatic and uncomplicated malaria infection, while high levels of IgG4, IgM and IgE Abs were predominant among individuals with complicated malaria infection in individuals naturally exposed to malaria living in different regions of Brazil (Leoratti et al., 2008).

Although many functions have been attributed to IgM Abs in infectious diseases, no specific function has been ascribed to this class of Abs during malaria infection. However, it was observed that natural non-specific IgM bind to the surface of some *P. falciparum* infected erythrocytes via the Fc, and this was shown to correlate with severe malaria in laboratory strains and field isolates (Ghumra et al., 2008; Rowe et al., 2002). Therefore, the understanding of the role of non-immune IgM and its contribution to the development of a protective immunity needs further investigation.

While the role of IgG subclasses has been characterized in some detail, there is some controversy as to the role of specific IgE Abs and whether they serve to protect against the disease or to make the illness more severe (Desowitz, 1989; Perlmann et al., 1994; Troye-Blomberg et al., 1999a). Elevated levels of IgE and anti-plasmodial IgE Abs were observed in human and experimental malaria infections (Desowitz et al., 1993; Helmbj et al., 1996; Perlmann et al., 1994). The induction of IgE Abs reflects a switch in the CD4⁺ T helper cells, from Th1 to Th2, due to repeated exposures to the parasite (Perlmann et al., 1994). However, the rise in IgE levels is controlled by a variety of environmental and genetic factors (Perlmann et al., 1994). IgE bind to high-affinity receptors (FcεRI) on mast cells and basophils as well as to low-affinity receptors (FcεRII/CD23) expressed on the surface of B cells, activated macrophages and eosinophils amongst other cell types (Stone et al., 2010). Cross-linking of receptor bound IgE by the antigens triggers the release of pharmacologically active substances from mast cells and basophils, including histamine, leukotrienes and peptides attracting neutrophils and eosinophils.

Some studies conducted in endemic areas suggest that IgE could play a role in the pathogenesis of malaria. Increased levels of IgE were found in individuals suffering from severe malaria in comparison to uncomplicated malaria (Perlmann et al., 1994; Perlmann et al., 1997; Perlmann et al., 2000; Seka-Seka et al., 2004). Furthermore, immunohistological studies on brain sections revealed the presence of IgE deposits in brain microvessels and on infected erythrocytes from cerebral malaria patients as well as in placentas infected with *P. falciparum* (Maeno et al., 2000; Maeno et al., 1993). Additionally, the expression of high levels of IgE during cerebral *P. falciparum* infection was related to the deepness of the coma (Maeno et al., 2000). *In vitro* studies using malaria patient's sera showed high levels of TNF-α, known to contribute to pathogenesis of CM (Clark et al., 1991), from activated monocytes. In contrast, *P. falciparum* specific IgE in the form of immune complexes, with either antigen aggregates or with IgG anti-IgE autoantibodies, crosslink the CD23 receptor expressed on monocytes which results in TNF-α and NO production (Elghazali et al., 1997; Perlmann et al., 1999). The CD23/NO pathway is believed to play a protective role during the development of malaria pathogenesis by down regulating the expression of ICAM-1 and decreasing iRBCs cytoadherence (Pino et al., 2004). However, it has been shown in Thai patients that during

severe malaria the release of CD23 from the cell surface giving rise to increased sCD23 levels in plasma was higher compared to uncomplicated and asymptomatic malaria (Kumsiri et al., 2016). Indeed, the amount of sCD23 correlates with disease severity (Rujeni et al., 2013; Vouldoukis et al., 2011) and is recognized as an important indicator of disease progression (Schwarzmeier et al., 2005) in other diseases. In the opposite, several findings have demonstrated that high levels of IgE increase with age in parallel with the acquisition of immunity (Desowitz et al., 1993; Maeno et al., 1993) and in the non-comatose patients compared to comatose patients (Calissano et al., 2003). In support of these results studies on the Fulani group, known to be less susceptible to malaria infections, showed a correlation between the decrease of infected cells with the increase of anti-malaria IgG and IgE levels (Farouk et al., 2005). In Tanzania, elevated anti-malaria IgE were associated with the reduction of the subsequent malaria attacks risk (Bereczky et al., 2004).

The impact of malaria parasite on B cells and subsequently on Abs production and in maintenance of B cell memory in individuals chronically re-infected with *P. falciparum* was highlighted during epidemiological studies in malaria endemic areas where atypical memory B cells were reported to be significantly expanded in *Pf*-exposed Malian adults and children. In chronically infected asymptomatic children the number of these atypical MBCs was higher compared with uninfected children, suggesting that the chronic presence of the parasite may drive expansion of these distinct MBCs (Weiss et al., 2009).

Protective immunity against malaria appears to result in a delicate balance, temporally and spatially regulated, between an appropriate innate immunity able to drive a quick Th1 response for the control of the parasite density followed by a Th2 response avoiding Th1-mediated deleterious effects, and maintaining the long term protection against parasite rise.

1.7 MALARIA TREATMENT

Public health efforts to combat malaria take the three-pronged approach of insecticide-treated bed nets, case management of malaria illness and preventative treatment. Despite the intensive efforts over the years to reduce the malaria burden the situation has gradually worsened in the recent years with the increase in resistance phenomena associated with synthetic antimalarial drugs (Ashley et al., 2014; Packard, 2014) and insecticides in use

(Brown, 1958) in addition to the economic instability of affected countries and the lack of infrastructure required to instigate these public health measures *en masse*. For this reason, to further combat the disease, researchers and politicians need to invest in a combination of both traditional and new public health interventions by revising antimalarial drugs and strategy policies. This may take the form of developing new drugs and insecticides, along with novel approaches such as transgenic mosquitoes resistant to malaria parasites and new vaccine design.

Another important aspect, indispensable to prevent the over-medication and avoid the development of resistance, is the development of a reliable diagnostic test. Unfortunately in the past the diagnostic was based on clinical symptoms and sometimes associated to a microscopic examination of a drop of peripheral blood. In recent years new diagnostic techniques have been developed as the rapid diagnostic test based on the identification of three different types of *Plasmodium* antigens (histidine-rich protein 2, *Plasmodium* lactate dehydrogenase and aldolase) (Moody, 2002).

1.7.1 Antimalarial chemotherapy

Several drugs are available to kill the malaria parasite. They can be differentiated into 5 categories: the quinolines, the hydroxynaphthoquinones, the antifolates, the antibiotics not antifolates, and the artemisinin derivatives, depending on their activity on different stages of the parasite life cycle or by their mechanism of action (Arav-Boger and Shapiro, 2005). Antimalarials have been known for a long time but their mode of action has still not been completely elucidated. The commonly used were chloroquine, which inhibits haemoglobin digestion, and sulfadoxine or pyrimethamine that inhibit enzymes in the parasite folate synthesis pathway. With the development and spread of drug resistance to chloroquine and the antifolate drugs alkylating agents, such as artemisinin, are becoming more widely used.

1.7.2 Malaria Vaccine

Over the years one of the greatest challenges in the malaria eradication program has been the development of an effective and safe vaccine. Studies on malaria vaccine started in the 1960 with the first immunization of mice with irradiated sporozoites, but despite the

persistent efforts, the lifelong sacrifice from dedicated physicians and scientists, and the investment of hundreds of millions of dollars, the malaria vaccine has remained elusive.

Development of an effective vaccine seems to be a daunting task, due to the complexity of *Plasmodium* biology (Gardner et al., 2002a; Scherf et al., 2008) which allows the parasite to escape the host immune system following different mechanisms. Additionally, natural infection with malaria does not induce immune protection in fact only partially effective immunity is acquired after repeated and prolonged exposures to malaria parasite over several years and is short-lived and highly stage- and strain-specific (Langhorne et al., 2008; Stevenson and Riley, 2004).

In spite the evidence that an effective malaria vaccine should be possible, numerous challenges need to be overcome. Essentially two main strategies for malaria vaccine development, targeting the different phases of the parasite's life cycle, are currently being pursued, largely in parallel: (i) the subunit approach, and (ii) the whole organism approach.

1.7.2.1 Subunit approach

The first peptide-based candidate vaccine tested extensively in endemic areas was the SPf66 developed in Colombia and appeared to be effective in South America (Patarroyo et al., 1987). Unfortunately, field efficacy trials in Africa and Asia failed to demonstrate protection.

In 1982 the identification of the circumsporozoite (CS) protein as the major component of the sporozoite coat has promoted the development of a sporozoite vaccine. The RTS,S/AS, a recombinant protein that fuses a part of the *P. falciparum* CS protein with the hepatitis B surface antigen (Proietti and Doolan, 2014), is the most advanced subunit vaccine in development. RTS,S/AS induces antibodies and T cell function that are believed to diminish the capacity of the malaria parasite to infect, survive, and develop in the human liver. However, due to the low vaccine efficacy or cover (around 30%) and the development of only a partial protection that is lost about two years after vaccination, alternative strategies need to be considered (Agnandji et al., 2012; Agnandji et al., 2011; RTS, 2015). Moreover, the RTS,S/AS candidate has been tested only in the Africa continent with no data obtained from outside the continent while it should be effective worldwide.

Other vaccine candidates have been developed (Fig. 11) such as MSP-1 or 2 and AMA-1, targeting the asexual blood-stage, both tested in clinical trials still the lack of clear efficacy (McCarthy et al., 2011; Ogutu et al., 2009; Sagara et al., 2009). Different approaches have been used to make the immune response and the protection more efficient, such as the conjugation of *Plasmodium* antigens to an immunogenic carrier protein (Que et al., 1988) or the generation of chimeric proteins comprising domains of two or more vaccine candidates (Malkin et al., 2008) (ex. PfCP2.9, comprising domain III of the apical membrane antigen AMA1 and the C terminal epidermal growth factor-like domains of the merozoite surface protein MSP1), without any positive result. Although it has been shown that several *Plasmodium* antigens can induce some degree of protection in laboratory animal models and induce antibody response able to inhibit *P. falciparum* development *in vitro* (Richards and Beeson, 2009), the antigenic complexity of the parasite is an obstacle of greater importance in the development of an efficient subunit vaccine and contributes to some disillusionment with the recombinant protein subunit approach.

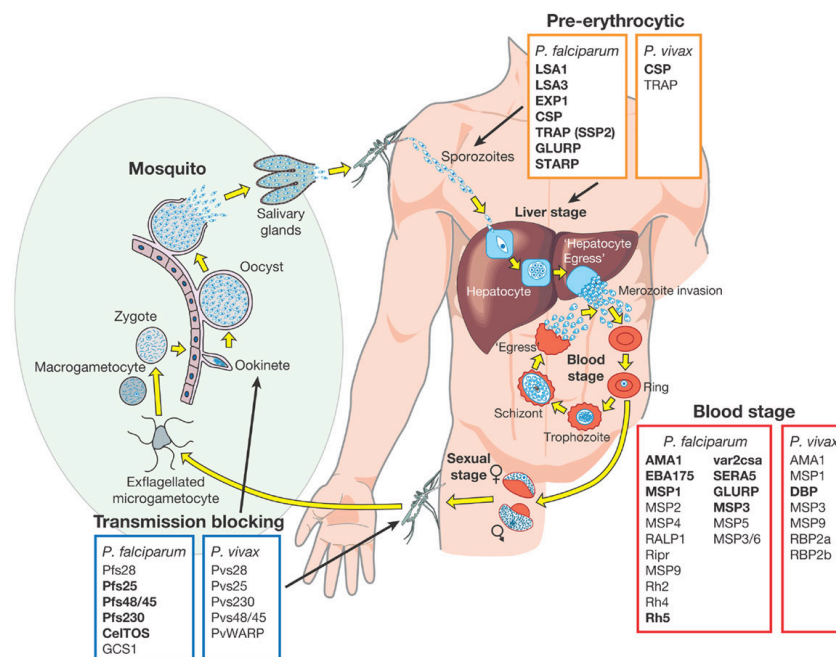

Figure 11: Malaria vaccine candidate antigens. List of *P. falciparum* and *P. vivax* candidate antigens indicated the category of malaria vaccine being developed and the life cycle stage targeted. Antigens evaluated in pre-clinical trials or have entered at least Phase I clinical trials, according to WHO malaria vaccine rainbow tables, are indicated in bold. (Barry and Arnott, 2014)

1.7.2.2 Whole organism approach

In recent years the use of live attenuated parasites (LAPs) as vaccines due to their ability to induce sterile long-lasting immunity has become popular. The advantage of whole-parasite vaccines is to induce immune response to a broad range of parasite antigens, and thus potentially more protective. The necessity of using viable parasite for whole parasite immunization has become evident because protection cannot be induced by heat-killed sporozoites, which are unable to invade and develop in the liver (Alger and Harant, 1976).

The first LAP appeared in 1967 when Ruth Nussenzweig and co-workers showed the necessity to use whole parasite for complete immunization using radiation-attenuated sporozoites (RAS) (Vanderberg et al., 1969). In mice RAS, whose attenuation is based on multiple random DNA breaks, shows an arrest in the earliest phase of liver-stage, causing no blood infection and conferring sterile, protective immunity against subsequent challenge with wild type sporozoites (Suhrbier et al., 1990; Vanderberg et al., 1969) over at least 10 months (Hoffman et al., 2002). Mice studies carried out to understand the mechanism involved during the immune response highlighted the role of CD8⁺ T cells (Schofield et al., 1987; Weiss et al., 1988) and sporozoite-specific antibodies against the major surface protein CSP (Doolan and Hoffman, 2000). Interestingly, recent studies have shown the possible implication of CD4⁺ T cells and IFN- γ in protection (Oliveira et al., 2008). Moreover, it is known that activation of CD8⁺ T cells is followed by the production of IFN- γ , which in turn provokes the secretion of IL-12, responsible for stimulating NK cells to produce more IFN- γ in a positive feedback loop (Yazdani et al., 2006). This causes the activation of the NO pathway, which induces the killing of the infected hepatocyte (Doolan and Hoffman, 1999; Doolan and Hoffman, 2000). Consistently, humans immunized by the bite of irradiated *P. falciparum* infected mosquitoes were effectively protected from subsequent challenges with homologous and heterologous infectious *P. falciparum* sporozoites (efficacy > 90%) (Hoffman et al., 2002; Vanderberg et al., 1969). Given the high levels of protection achieved by irradiated sporozoites in many malaria models the development of *P. falciparum* RAS vaccine, called PfSPZ, was proposed by Stephen Hoffman (Sanaria) and is actually tested in a

Phase I clinical study with encouraging results (100% protection after challenge) (Richie et al., 2015; Seder et al., 2013).

Although this vaccine presents some safety problem as the efficacy of the irradiated sporozoites that depend on the number of irradiated sporozoites injected (> 100,000 RAS (Luke and Hoffman, 2003)) and on the precise irradiation dose; up to 200 Gray can confer complete protection (Chattopadhyay et al., 2009), less doses allow the parasite to complete the liver stage development and cause blood stage infection, higher doses completely inactivate the sporozoites resulting in no significant protection (Silvie et al., 2002; Suhrbier et al., 1990). In addition to challenges of manufacturing and delivering a viable cryopreserved whole parasite vaccine, it remains to solve the limit of mass-production of vaccines using the sporozoites stage. Besides, animal studies show that several higher doses are needed to protect mice with cryopreserved irradiated sporozoites as compared to fresh ones, demonstrating that the cryopreservation might inactivate the sporozoites (Epstein et al., 2011).

Another approach has been possible with the availability of the whole *Plasmodium* genome sequences (Carlton et al., 2002; Gardner et al., 2002a; Gardner et al., 2002b) and the advancement of gene manipulation technologies (de Koning-Ward et al., 2000; Menard and Nussenzweig, 2000; Thathy and Menard, 2002) which has led to the individualization of genes essential for parasite survival at distinct points during its life cycle. Genetically arrested parasites (GAP) generated by targeted gene deletion(s) designed to arrest at specific points of liver-stage development (Fig. 12) (Butler et al., 2011; Mueller et al., 2005a; Mueller et al., 2005b; van Dijk et al., 2005) were able to successfully invade the liver but arrest prior to liver stage maturity, generating complete protective immunity against wild type sporozoite challenge in a manner comparable to radiation attenuated sporozoites (Butler et al., 2011; Khan et al., 2012; Mueller et al., 2005b). This immune response is mediated by MHC class I-dependent IFN- γ producing CD8⁺ T cells (Jobe et al., 2007; Mueller et al., 2007), which results in sterile protracted protection (Jobe et al., 2007; Wang et al., 2009) against sporozoite challenge in rodent models. Moreover, a late-blocked liver-stage GAPs have been shown to induce superior protective immunity against sporozoite challenge in outbred mice compared to both early-blocked liver-stage GAP and RAS vaccine (Butler et

al., 2011; Nganou-Makamdop and Sauerwein, 2013). Similar transgenic parasites have been produced in *P. falciparum* and studied in clinical assays. Unfortunately the first clinic study showed considerable but incomplete attenuation (Spring et al., 2013), indicating that complete attenuation of the parasite in humans remains challenging (Bijker et al., 2015).

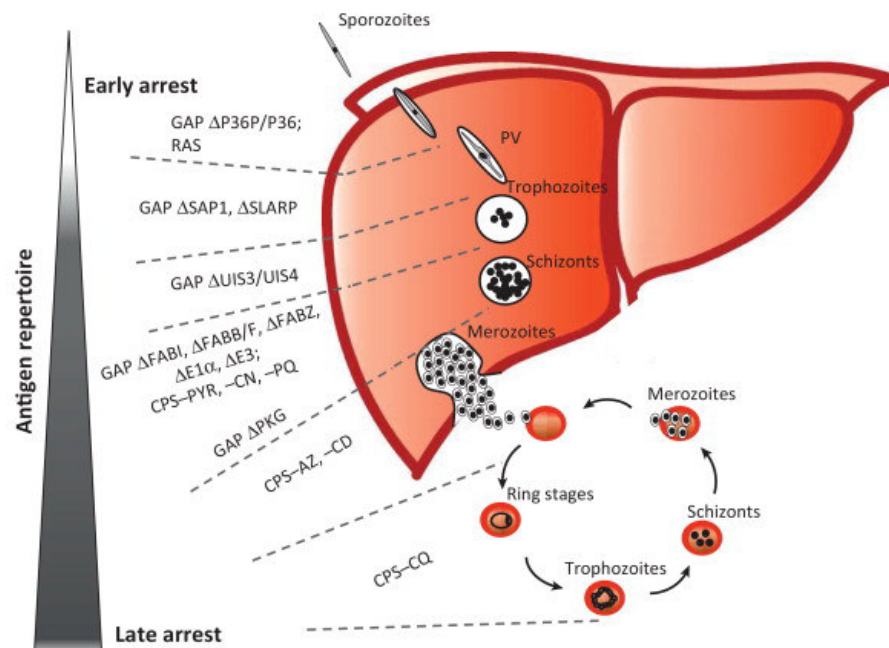

Figure 12: Liver stages of arrest for radiation-attenuated sporozoites (RAS), genetically attenuated parasites (GAP), and wild type sporozoites with chemoprophylaxis (CPS). Shortly after entry, sporozoites form a parasitophorous vacuole (PV) for further development into liver trophozoites, schizonts, and eventually merozoites. Release of merozoites marks the end of the liver stage and the start of blood-stage infection. GAPS are produced by deletion of selected parasite genes (Δ). Both RAS and the GAP Δ P36p/P36, Δ SAP1, Δ SLARP arrest early in the liver before completion or remodeling of the PV. Development into intermediate stages is observed for the GAP (Δ UIS3/UIS4, Δ E1 α , Δ E3, Δ FABI, Δ FABB/F, Δ FABZ, and Δ PKG), and the CPS-PYR (pyrimethamine), -CN (centanamycin) and -PQ (primaquine). Later liver-stage arrest is observed for CPS-AZ (azithromycin) and CD (clindamycin). Blood-stage exposure occurs only for CPS-CQ (chloroquine) where the latest parasite arrest is observed (Nganou-Makamdop and Sauerwein, 2013).

More recently, the development of blood-stage GAPs (Table 1) as the *P. yoelii* lacking purine nucleoside phosphorylase (Ting et al., 2008) or nucleoside transporter 1 (Aly et al., 2010) and *P. berghei* ANKA lacking plasmepsin-4 (Spaccapelo et al., 2010) where shown to attenuate the parasite development in the blood stage, resulted in long-lasting protection against sporozoite and iRBCs re-infection respectively.

Alternative strategies have been developed by combining wild type sporozoite immunizations with drugs acting at various stages of parasite life cycle. Several treatments have been tested as primaquine (liver stages elimination) (Putrianti et al., 2009), chloroquine (blood stages elimination) (Belnoue et al., 2004; White, 1997), clindamycin and azithromycin (targeting the apicoplast resulting in non-infectious merozoites) (Friesen et al., 2010). David Pombo and co-workers demonstrated that different challenges of low doses of live blood-stages wild type parasites treated early by appropriate drug treatment could induce a strong cell-mediated immunity to the same strain of malaria parasite in human adults (Belnoue et al., 2004). These results were confirmed in murine models where was highlighted the need of three and more repeated malaria infections followed by drug treatment to obtain semi-immune mice (Bao et al., 2013; Bao et al., 2015; Evans et al., 2006). The fact that the infection and the acquisition of immunity are thereby the result of natural wild type infection, as opposed to the attenuated infection induced by GAPs or RAS, the use of this model seems to be difficult in endemic areas where drug resistance is high and the majority of people have already had malaria episodes with the development of an humoral or cellular response.

The pathogenesis of malaria is complex, and development of pathogenesis depends on the parasite species that cause infection and the immune status of the infected host. While current blood stage sub-unit preparations have not yielded any protection in field trials (Proietti and Doolan, 2014; White et al., 2014), live attenuated parasites appear to confer significantly broader and more lasting protection. However, the development of an adequate and effective vaccine definitely requires well and detailed understanding of the mechanisms underlying natural immunity to malaria associated with all environmental cultural, society and territorial parameters that can be found among the different populations living in endemic areas.

			PROTECTION			IMMUNE RESPONSE				
	Mouse	Development/ Phenotype	Protectio n (time)	Cross stage	Cross strain	Cytokines	T/B cell	Ab/ Protectio n	FcyR ⁺ /Protecti on	Ref.
<i>Py</i> YM <i>Δpnp</i>	BALB/c Swiss	Slow/ CLEARENCE (D15)	YES (5 m)	<i>Py</i> 17XNL	<i>Py</i> 17XNL	ND	ND/ND	ND	ND	(Ting et al., 2008)
<i>Py</i> 17XNL <i>Δnt1</i>	BALB/c Swiss C57BL/ 6	Very slow/ CLEARENCE (D15)	YES (3 m)	<i>Py</i> YM	<i>Py</i> YM <i>Pb</i> ANKA	ND	YES/YES	ND	ND	(Aly et al., 2010)
<i>Py</i> YM <i>Δsera2</i>	BALB/c	Normal/ CLEARENCE (D28-30)	ND	ND	ND	ND	ND/ND	ND	ND	(Hua ng et al., 2013)
<i>Pb</i> ANKA <i>Δnt1</i>	C57BL/ 6	Normal and no ECM/ CLEARENCE (D90)	YES	ND	ND	ND	ND/ND	IgG/ND	ND	(Niik ura et al.,
<i>Pb</i> ANKA <i>Δpm4</i>	BALB/c	Slow/ CLEARENCE (D25)	YES (1 y)	ND	<i>Pb</i> ANKA <i>Py</i> 17XNL	ND	ND/ND	IgG/YES	ND	(Spa ccap elo et
<i>Pb</i> ANKA <i>Δpm4</i>	C57BL/ 6	Slow no ECM/ 20% CLEARENCE (D25)	ND	ND	ND	ND	ND/ND	ND	ND	(Spa ccap elo et
<i>Pb</i> ANKA <i>Δmps7</i>	C57BL/ 6	Slow and no ECM/ Death at D18-22	ND	ND	ND	ND	ND/ND	ND	ND	(Spa ccap elo et
<i>Pb</i> ANKA <i>Δpm4Δmps7</i>	BALB/c C57BL/ 6 CD1	Slow and no ECM/ CLEARENCE (D25, D12,	YES	ND	<i>Pb</i> ANKA <i>Py</i> 17XNL	ND	YES/YES	ND	ND	(Spa ccap elo et
<i>Pb</i> ANKA <i>Δhmgb2</i>	C57BL/ 6	Slow and no ECM/ Death at D20- 25	ND	ND	ND	↓ TNF-α, IL-10 and IL-6	Brain: ↓CD 4 and CD8 /ND	ND	ND	(Briq uet et al.,
<i>Pb</i> NK65 <i>Δhmgb2</i>	C57BL/ 6	Normal/ CLEARENCE (D15)	ND	ND	ND	ND	ND/ND	ND	ND	(Briq uet et al.,
<i>Pb</i> ANKA <i>Δhfr</i>	C57BL/ 6	Slow and no ECM/ Death at D20-25	ND	ND	ND	↑IL-6	ND/(Liver) ↑ B cell	ND	ND	(Mat hieu et al.,
<i>Pb</i> NK65 <i>Δhrf</i>	C57BL/ 6	Normal/ CLEARENCE (D12-15)	YES (1 y)	<i>Pb</i> NK65 <i>Pb</i> ANKA	<i>Pb</i> ANKA <i>Py</i> YM	↑ IL-12, IL-23, IFN- γ and IL-6	YES (↓PD1)/Y ES	IgG, IgG2a/ Partial	CD11b ⁺ /Y ES	(De mart a- Gatsi et
<i>Pb</i> ANKA <i>Δsb1</i>	C57BL/ 6 BALB/c	Slow and no ECM/ Death at D32- 45	ND	ND	ND	ND	ND/ND	ND	ND	(De Niz et al.,
<i>Pb</i> ANKA <i>Δmhrp1a</i>	C57BL/ 6 BALB/c	Slow and no ECM/ Death at D25- 38	ND	ND	ND	ND	ND/ND	ND	ND	(De Niz et al.,
<i>Pb</i> ANKA <i>Δptex88</i> (iKD)	C57BL/ 6	Slow and no ECM/ Death at D?	ND	ND	ND	↑IL-6 (serum)	ND/ND	ND	ND	(Chis holm et al.,
<i>Pb</i> ANKA <i>Δptex88</i>	C57BL/ 6	Slow and no ECM/ Death at D?	ND	ND	ND	ND	ND/ND	ND	ND	(Mat z et al., 2015)

Table 1 – Blood stage GAPs and their characteristics.

Histamine Releasing Factor

2.1 HISTAMINE RELEASING FACTOR (HRF)

Discovered in the 1980s the histamine releasing factor (HRF) protein, also known as translationally controlled tumour protein (TCTP), P23/21, Q23 or fortilin is a housekeeping protein, highly conserved in many organisms, ranging from unicellular, yeast, plants to vertebrates including all *Plasmodium* parasite species with both intracellular and extracellular functions (Fig. 13).

At first, the synthesis of HRF was shown to be regulated at the translational level, based on the fact that the cDNA cloned from a mouse tumour cell line, and derived from an abundant mRNA found to mainly exist as messenger ribonucleoprotein (mRNP) particles was unable to interact with translational apparatus within the cells (Chitpatima et al., 1988). Later, it was shown that the protein could also be regulated at the level of transcription (Bohm et al., 1991; Chung et al., 2000).

Recently HRF has attracted the attention of an increasing number of researchers due to its strong regulation in response to a wide range of extracellular stimuli effecting calcium concentrations both intracellular and within endoplasmic reticulum (Xu et al., 1999). A series of recent reports highlighted the importance of HRF in different intracellular functions including the cell cycle progression (Gachet et al., 1999; Yarm, 2002), apoptosis inhibition (Amson et al., 2012; Li et al., 2001; Liu et al., 2005; Rho et al., 2011) and malignant transformation of a variety of cell types (Li et al., 2001; Tuynder et al., 2002).

Accordingly, multiple studies have implicated the protein in the regulation of growth and proliferation as well as in the control of organ size. Complete gene knockout of HRF in drosophila (Hsu et al., 2007) and mice (Chen et al., 2007; Koide et al., 2009) provided genetic evidence that it plays a critical role in the normal proliferation and survival of embryonic fibroblasts. Moreover, different cellular proteins involved in cell growth have been reported to interact with HRF, including tubulin (Gachet et al., 1999), elongation factor eEF1A and its guanine nucleotide exchange factor eEF1B β (Cans et al., 2003; Langdon et al., 2004), Mcl-1 (Li et al., 2001; Liu et al., 2005), TSAP6 (Amzallag et al., 2004) and Na,K-ATPase (Jung et al., 2004).

A series of publications have highlighted the role of HRF in anti-apoptotic activities since a decrease at the protein levels leads to apoptosis or reversion of malignant phenotypes (Amson et al., 2012; Li et al., 2001; Liu et al., 2005; Rho et al., 2011). In tumor cells the expression of HRF is upregulated while during reversion of cells from the malignant phenotype the HRF levels are considerably reduced. Consistently, the inhibition of HRF expression, by anti-sense cDNA or small interfering RNA molecules, results in the suppression of the malignant phenotype (Tuynder et al., 2002).

The extracellular function of HRF presents a cytokine-like activity leading to the release of histamine from mast cells and basophils via IgE antibody-mediated mechanisms during late-phase acute allergy. Moreover, investigations of the actions of HRF on the immune response first indicated that the human recombinant HRF (HrHRF) induces the secretion of histamine, IL-4 and IL-13 from basophils (Schroeder et al., 1997) and IL-8 from eosinophils (Bheekha-Escura et al., 2000) from a subset of allergic donors in a IgE-dependent and IgE-independent manner. Recombinant murine HRF was found to stimulate B cell proliferation in a dose-dependent manner (*in vitro* and *in vivo*) (Kang et al., 2001) and the HrHRF was found to modulate cytokine release from peripheral blood T cells (PBTs) by inhibition of IL-2 and IL-13 secretion, but not IFN- γ (Vonakis et al., 2003).

Unfortunately so far no connection has been made between the extracellular functions of HRF with the variety of intracellular processes attributed to the protein family and many intracellular and extracellular functions that have been ascribed to HRF seem to be contradictory. Therefore overall functions of HRF still remained to be elucidated.

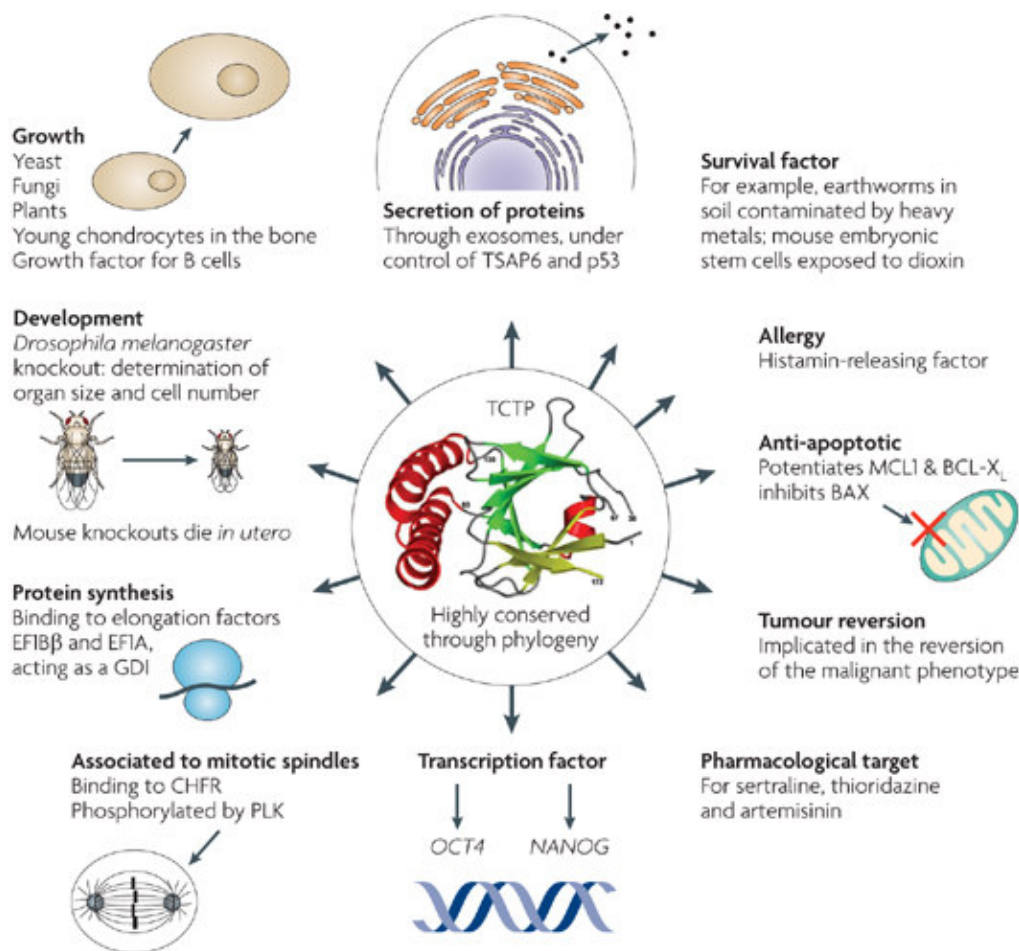

Figure 13: Histamine Releasing Factor (HRF), is secreted through exosomes that are regulated by TSAP6 and p53. *hrf* is a key gene in the process of tumour reversion and a pharmacological target for sertraline, thioridazine and artemisinin. Well conserved through phylogeny as a pro-survival, growth-stimulating and anti-apoptotic factor, it is also a transcription factor for *OCT4*. HRF binds to CHFR and to elongation factor eEF1A and eEF1B β , leading to roles during mitosis and in protein synthesis, respectively. GDI, GDP dissociation inhibitor. (Telerman and Amson, 2009)

2.1.1 HRF structure

The translationally controlled tumor protein consists of 170 amino acids in average and has a mean weight of 18-23 kDa.

Bioinformatic analysis was performed to investigate the sequence and predicted structure of the HRFs from many species (Hinojosa-Moya et al., 2008). Extensive sequence analysis revealed that most species, including malaria parasites, have only a single *hrf* gene. Mammals appear to harbour more *hrf* genes (eg. in mouse genome seven *hrf* genes were identified) (Fiucci et al., 2003). Additionally, no similarity to other proteins or functional domains was discovered, so the protein was listed as a ‘family’ on its own in the databases.

Elucidation of the HRF structure, resolved by NMR spectroscopy and X-ray crystallography, demonstrated that the HRF molecule consists of three distinct domains, the core β -sheet domain, a α -helical domain and a flexible loop structure (Fig. 14) (Thaw et al., 2001). Additional analysis confirmed that this principal structure is highly conserved through phylogeny over a long period of evolution supporting the hypothesis that HRF plays an important role in the cellular physiological functions (Bini et al., 1997; Bommer and Thiele, 2004b; Thaw et al., 2001). Moreover, the sequence alignment demonstrates that 9% of HRF amino acids are absolutely conserved (Bommer and Thiele, 2004b). The invariant residues are largely clustered on one side of the β -strand domain indicating that this side is important for interaction. In fact, three conserved amino acids (Glu12, Leu74 and Glu134) which form a binding surface for G protein interaction are localized in this domain suggests a possible role for HRF in proliferation and growth (Hinojosa-Moya et al., 2008). The other major domains, the flexible loop and the helical domain, are specific for HRF. The flexible loop is predominantly hydrophilic containing a highly conserved area named HRF1. The α -helical domain is characterized by a tubulin-binding region (Gachet et al., 1999) and a Ca^{2+} -binding area (Kim et al., 2000). However, the calcium-binding domain position is controversial. Additionally detailed studies localized the domain in the residues N131, Q132 and D150, located in the β -stranded core domain close to the connection with the α -helical domain (Feng et al., 2007) or in the residues E58 and E60 located in the floppy loop (Graidist et al., 2007).

Interestingly, 3D structure of *P. knowlesi* an extra α -helix segment, which in other HRFs correspond to a β -sheet, is present and could potentially interfere with G protein interactions (Fig. 14) (Hinojosa-Moya et al., 2008).

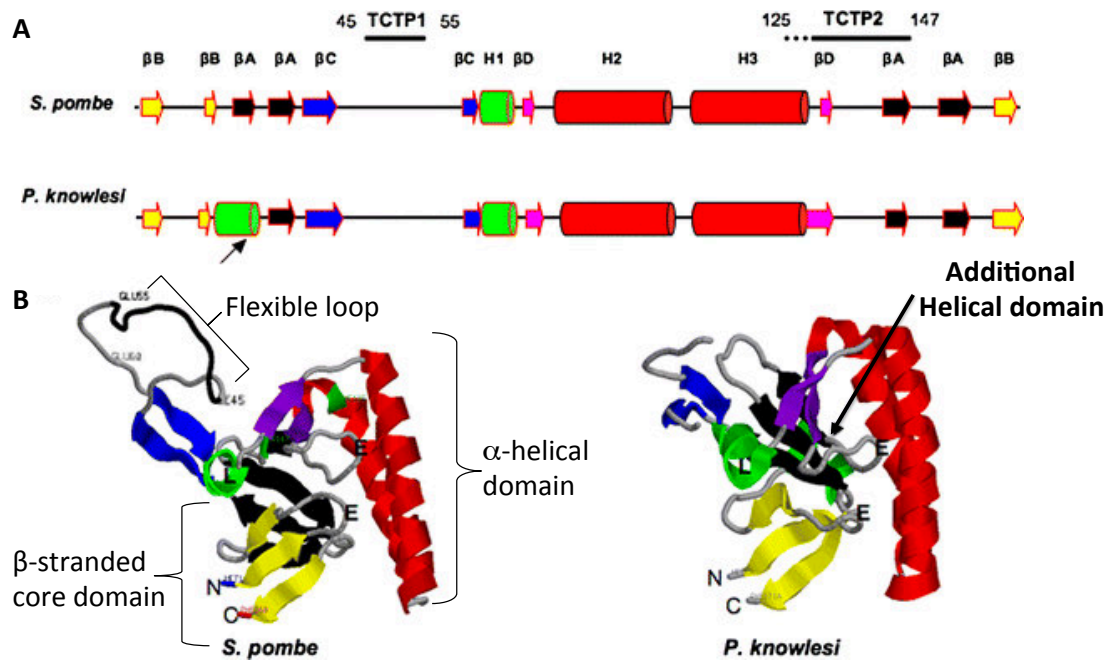

Figure 14: HRF structure of *S. Pombe* and *P. knowlesi*. (A) Two- and (B) three dimensional structure. The arrow indicated the additional α -helix from residue 22 to 30 in *P. knowlesi*, which replaces a β -sheet in the orthologous *S. Pombe*. Note that in the 3D structure the torsion induced by the α -helix instigates the resulting protrusion exhibited by the two β -sheets. (Hinojosa-Moya et al., 2008)

2.1.2 HRF secretion

It has been reported that HRF protein lacks the NH_2 -terminus signal and no precursor protein has been described suggesting that HRF secretion proceeded via an endoplasmic reticulum/Golgi-independent or nonclassical pathway (Muesch et al., 1990). Interestingly, immune fluorescence assay (IFA) analysis shows a partially co-localisation of HRF with tumour suppressor activated pathway-6 (TSAP6, a p53-regulated gene) in vesicular-like structures at the plasma and nuclear membranes (Amzallag et al., 2004). Furthermore, the overexpression of TSAP6 considerably enhanced the secretion of both endogenous and exogenous HRF in epithelial cells as well as in hematopoietic cell lines (Amzallag et al., 2004). More importantly, these studies show that the TSAP6 gene product could facilitate the secretion of HRF in exosomes (Fig. 15) (Amzallag et al., 2004). Exosomes are nanovesicles (50-150nm in diameter) of cup shape appearance originating from large multivesicular endosomes containing nucleic acids, proteins, lipid rafts and exposed phosphatidylserine (They et al., 2009) that induce phenotypic changes in the recipient cells (Raposo and Stoorvogel, 2013). Due to their stability, exosomes protect their cargo against degradation

and denaturation in the extracellular environment. Moreover, they play an important role in many biological processes including pathogen spread: various pathogens utilize the exosomal pathway to facilitate their survival and propagation, including transfer of virulence factors to host target cells (Feng et al., 2013; Ramakrishnaiah et al., 2013).

Recently, another pathway that proposes the involvement of H, K-ATPase was used to describe HRF secretion (Fig. 15) (Kim et al., 2013). A screening of possible HRF secretion inhibitors show that proton pumps inhibitors modulated the protein export. Indeed, the use of omeprazole and pantoprazole, two peptic ulcer drugs, block HRF secretion from HEK293 and U937 cells in a concentration-dependant fashion, corroborated by the observation that H, K-ATPase inhibitor ameliorated the allergic symptoms.

2.1.3 HRF dimerization

The comparison of basophil histamine releasing abilities of mouse recombinant HRF (MrHRF), human recombinant (HrHRF), HRF from nasal lavages, and HRF from supernatants of peripheral blood mononuclear cells (PBMC) cultures have shown that recombinant HRF were less active than the native HRF purified from the biological fluids. Dimerization of HRF seems to be essential for its cytokine-like activity, as the cytokine-releasing activity of extracellular HRF is generated only when the NH₂-terminal is truncated allowing the dimerization via the formation of an intermolecular disulfide bond (Kim et al., 2009). Moreover, dimerized form of the protein was found in sera in allergic patients and bronchoalveolar lavage fluids from airway-inflamed mice (Kim et al., 2013; Kim et al., 2009). Subsequent studies suggested that allergic status might affect the normal biochemistry composition and physiology of the cellular environment, leading to posttranslational modification of the protein, and the activation of inflammatory cells that promote the late phase reaction. Three possible contributors were described: (i) proteolytic enzymes which catalysed the truncation of the NH₂-terminus, (ii) oxidants responsible for the formation of intermolecular disulfure bonds, and (iii) HRF-reactive IgE that possibly confer autoantigen activity (Kim et al., 2013)(Fig. 15).

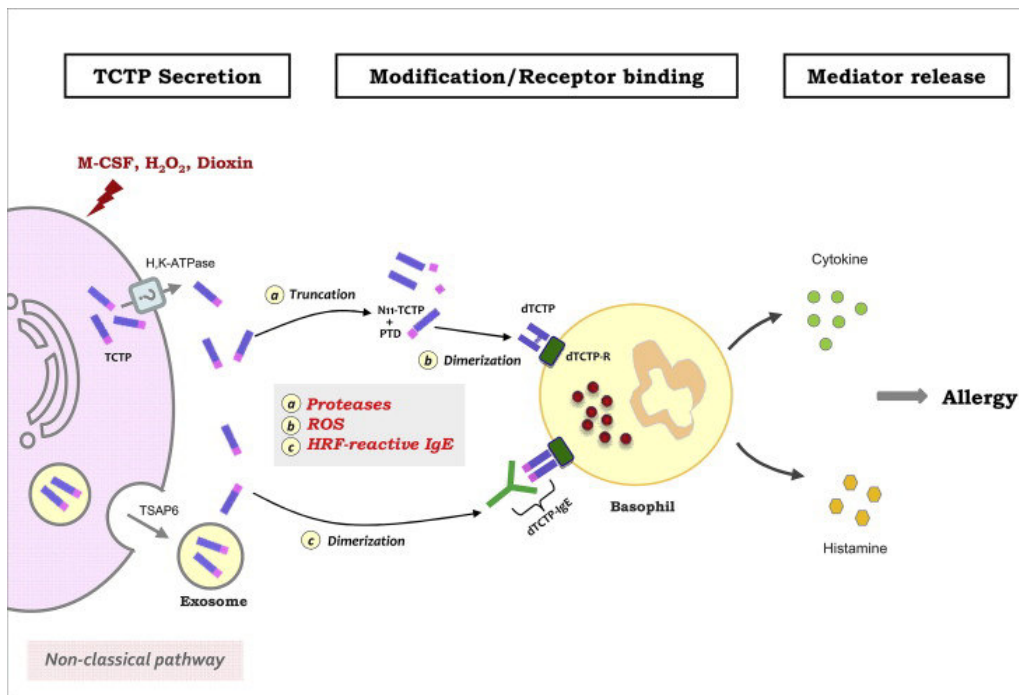

Figure 15: Mechanism of secretion and hypothetical modification of HRF. Secretion of HRF is enhanced by hydrogen peroxide, M-CSF, dioxin, and so forth during late phase allergic inflammation. HRF is secreted outside of cells through H,K-ATPase- or TSAP6-mediated non-classical pathway and undergoes posttranslational modification. (a) Processing of secreted full-length HRF by proteolytic enzyme releases truncated HRF (N11TCTP) and short-length N-terminal fragments (PTD). (b) Oxidants can form an intermolecular disulfide linkage between two of HRF that produces the dimerized HRF (dTCTP). (c) Alternatively, HRF can cross-react with IgE which dimerize the intact HRF (dHRF-IgE) by connecting a HRF monomer with an other HRF monomer. Active structure of HRF now can bind to its specific receptor (dHRF-R) to stimulate the mediator release from basophils. In addition to dHRF-R, subset of IgE can serve as a receptor for HRF dimer in FcεRI-expressing cells. Since these modifications might be possible at inflamed site, extracellular HRF will affect around cells only during the late phase or chronic allergic inflammation. (Kim et al., 2013)

2.2 ROLE OF *PLASMODIUM* HRF DURING MALARIA INFECTION

Evidence of *P. falciparum* HRF (*Pf*HRF) secretion was observed in *in vitro* cultures and in malaria infected individuals. Trophozoite stage culture supernatants of *P. falciparum* contained $87 \pm 21 \mu\text{g}$ of *Pf*HRF per 10^9 iRBCs, while schizont stage culture supernatants contained $44 \pm 6 \mu\text{g}$ of *Pf*HRF per 10^9 iRBCs. Therefore around half of the total parasite HRF was released during schizogony (MacDonald et al., 2001). *Pf*HRF has been identified in the serum of mildly ($0.6 \mu\text{g}/\text{mL}$) and severely ($1.4 \mu\text{g}/\text{mL}$) *P. falciparum* infected Malawian children (Janse et al., 2006; MacDonald et al., 2001). There was no correlation between percentage parasitemia of infected individuals and serum *Pf*HRF levels, suggesting that the parasite protein might have local rather than systemic effects.

At the amino acid level, *Pf*HRF is highly homologous to mammalian protein by sharing 33% identity and 54% similarity with human HRF. Molecular mass of recombinant *Plasmodium* HRF molecules is between 20 and 23 kDa for the monomeric form and around 45 kDa for the dimeric form (Bhisutthibhan and Meshnick, 2001). Sequence homology between HRF molecules is very high between different species of *Plasmodium* parasites. It was found that *P. falciparum* share 88% identity and 97% similarity in HRF amino acids sequence with *P. yoelli* (Walker et al., 2000) and 90% identity with *P. chabaudi* HRF. Additionally, comparisons of HRF amino acid sequence of *P. chabaudi* with that of *P. yoelli* and *P. berghei* orthologues show amino acid identities of 97 and 98%, respectively (Afonso et al., 2006). IFA and immunoelectron microscopy with immunogold labelling have allowed the localization of intracellular *Pf*TCTP within the cytoplasm, the haem-rich food vacuole and the host or parasite-derived membranes surrounding the parasite (Bhisutthibhan and Meshnick, 2001; Bhisutthibhan et al., 1999).

2.2.1 Consequences of histamine release

Generation of histamine-releasing activity was observed in cultured peripheral blood mononuclear cells and their supernatants which were able to induce the release of histamine from basophils (Thuesen et al., 1979). Several studies have attempted to chemically characterize the new cytokine that induce the release of histamine from basophils. In 1995, HRF was found and purified from the nasal, skin blister, and bronchoalveolar lavage fluids during late-stage allergic reaction, implicating HRF in the late-phase allergic reactions (MacDonald et al., 1987; MacDonald et al., 1995). Other studies reported the implication of HRF in promoting the allergic inflammation in the skin and lung from mouse models of asthma and allergy. Furthermore, Ig-interacting HRF peptides, shown to block HRF-Ig interactions *in vitro*, inhibited IgE-HRF-induced mast cell-dependent inflammation *in vivo* (Kashiwakura et al., 2012). Collectively, these studies indicate that HRF has pro-inflammatory features during allergic reactions. At first this release was thought to be the consequence of physical interaction between HRF and IgE on the surface of the responding basophils (MacDonald et al., 1987). However, some evidences suggested that the interaction with IgE may not be required for cell activation mediated by human recombinant HRF and that the protein exerts its activity independently of IgE through a human

recombinant HRF-specific activation pathway other than through FcεRI (Schroeder et al., 1997).

Recent studies suggest a strong relationship between clinical susceptibility to malaria and severe allergic-type responses (Demeure et al., 2005; Griffiths et al., 2005; Sakuntabhai et al., 2008). As previously demonstrated in the laboratory, this allergic-type response starts immediately after the mosquito bite by the intermediary of mosquito saliva which exerts immunomodulatory effects through induction of mast cell degranulation, in the absence of IgE Abs, affecting the maturation of adjacent DCs, which fail to ultimately elicit fully activated effector T cells (Demeure et al., 2005). Additionally, *Plasmodium* infection in a murine model of malaria, upon mosquito bite and saliva inoculation, potentiates the pathogenesis via dysregulation of immune signalling and reduction in the recruitment of key inflammatory cells into the inoculation site perturbing the early antiparasite immune response and effecting downstream disease development (Fig. 16) (Schneider et al., 2011).

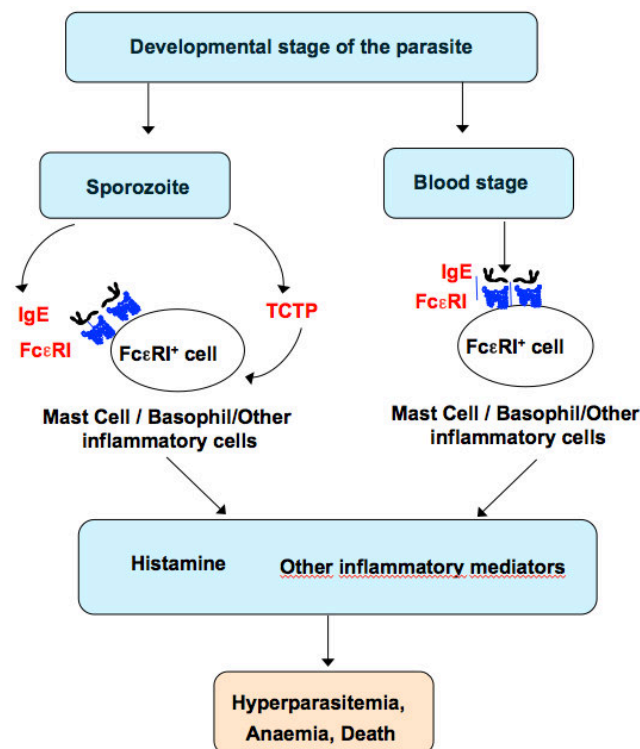

Figure 16: IgE/FcεRI complex and parasite HRF represent two mechanisms by which histamine release is triggered from its cellular stores during malaria infection. Histamine is continuously released into host body starting from the beginning of the infection which allows the development of ECM.

High levels of histamine, a major product of allergic responses derived from basophils and mast cells in plasma and tissue, have been associated with the severity of the disease in humans infected with *P. falciparum* and in many animal models (Enwonwu et al., 2000; MacDonald et al., 1995; Maegraith and Fletcher, 1972; Srichaikul et al., 1976). In addition, during parasitic infection in human and mouse model, higher levels of IgE, which bind to basophils and mast cells and trigger histamine release, are associated with the severity of the disease (MacDonald et al., 2001; Porcherie et al., 2011; Schroeder et al., 1997).

Elevated histamine synthesis (*in situ*) within the brain mediated by the histidine decarboxylase enzyme was five-fold more elevated in plasma of infected children with *P. falciparum* compared with uninfected controls (Enwonwu et al., 2000). Moreover, the proinflammatory activities via histamine signalling pathway was previously demonstrated in the laboratory to be crucial for the development of ECM pathologies and symptoms exhibited in rodent malaria models. Mice treated with antihistamines or deficient for the H1 and H2 receptors were found more resistant to ECM after infection with *P. berghei* ANKA sporozoites (Beghdadi et al., 2008) than untreated or wild type mice respectively. Similar results were obtained in HDC^{-/-} mice, not able to synthesize histamine, infected either with *P. berghei* ANKA iRBCs or sporozoites. This indicated that histamine is produced during all stages of infection and is involved in late stage of pathogenesis (Fig. 16). During the later phase of infection, particularly during the blood stage of parasite development, histamine can be elicited by *Plasmodium* HRF. Parasite HRF has been found in plasma of patients infected with *P. falciparum* and was shown to trigger histamine release from basophils and IL-8 secretion from eosinophils (MacDonald et al., 2001). Significantly elevated plasma histamine concentrations by *Plasmodium* HRF could assist the parasite by inducing vasodilation and increased expression of endothelial adhesion factors such as thrombomodulin, to which *P. falciparum*-infected erythrocytes adhere (MacDonald et al., 2001). These results show that the existence of a parasite protein able to stimulate host histamine secretion can amplify the host inflammatory response, via histamine signalling and highlight a possible strategy developed by the parasite to create conditions advantageous for its own survival and persistence.

2.2.2 Artemisinin chemo-resistance

The artemisinin removes quickly the parasites and eliminates the symptoms associated with malaria by reducing the carriage of the transmission stages. All the artemisinin drugs have activity throughout the asexual intra-erythrocytic stage, also having effect on young gametocytes. However, their mode of action is not completely clear (Klonis et al., 2011). Some researchers agree that artemisinin might interact with intraparasitic haem as well as other parasite proteins (Meshnick, 2002; Robert et al., 2002). Consistently, artemisinin and its derivatives are inactive against the RC strain of *P. berghei*, which doesn't produce hemozoin (Meshnick, 2002). This hypothesis supposes that artemisinin is activated by intraparasitic heme into a carbon-centred free radicals mediated by the decomposition of the artemisinin endoperoxide bridge. The carbon-centred free radicals then act as alkylating agents for specific parasite proteins (Meshnick, 2002). The hypothesis that *Plasmodium* HRF might be a possible drug target for artemisinin comes from the reaction of *Plasmodium* HRF with radio labelled dihydroartemisinin ($[^3\text{H}]\text{DHA}$) both *in vitro* in the presence of hemin, and in intact infected erythrocytes. Scatchard analysis showed that two hemin-binding sites of modest affinity existed on parasite HRF (Bhisutthibhan et al., 1998). Additionally, $[^3\text{H}]\text{DHA}$ adducts could be immunoprecipitated using anti-HRF antibodies. Overexpression of *Plasmodium* HRF at the protein level in artemisinin-resistant parasites of *P. yoelii* is consistent with this hypothesis (Walker et al., 2000).

The three-dimensional structure of *Pf*HRF created using the nuclear magnetic resonance structure of the *S. pombe* HRF as a template was used to study the interactions between artemisinin, heme and *Pf*HPF. The center of the peroxide bond of artemisinin was docked within a short distance of 2.6 Å from the iron of the heme, in the same way the center of heme-activated artemisinin (C4-radical) was docked on the *Pf*TCTP sulfur of Cys14 within a distance of 2.48 Å suggesting the possibility of alkylation having occurred (Chae et al., 2006). To confirm this modelling previous study had shown that blocking the single cysteine of *Pf*TCTP reduced artemisinin binding by 67% (Bhisutthibhan et al., 1998).

2.2.3 Calcium binding and self-interaction with malaria HRF

High-affinity binding of HRF to calcium was previously demonstrated from both human and trypanosome (Haghighat and Ruben, 1992; Xu et al., 1999). Depletion of endoplasmic reticulum levels of calcium up-regulates HRF transcription, while an increase in cytosolic calcium up-regulates HRF translation showing that HRF expression is regulated by calcium at both transcription and post-transcriptional level (Xu et al., 1999).

The primary sequence of *Pf*TCTP lacks a calcium-binding motif; but calcium-binding properties have been demonstrated by *Pf*HRF migration and PVDF membrane transfer followed by calcium (^{45}Ca) incubation or by SDS-PAGE gel migration of recombinant *Pf*HRF in presence of calcium (Bhisutthibhan et al., 1999).

2.2.4 B cell inhibition by malaria HRF

Structural analysis of *P. knowlesi* HRF and human HRF shows some variations, particularly for the presence in *P. knowlesi* of an extra α -helix near the GTPase binding pocket while in human HRF is a β -strand. This difference causes a more general structural distortion in the putative G-protein binding pocket suggesting that *Plasmodium* HRF may act as a dominant negative mutant in the host, as it could potentially block the action of B cells due to its proposed inability to bind G proteins (Hinojosa-Moya et al., 2008). Recently it was shown that recombinant *Pf*HRF has a lower B cell stimulatory effect compared to recombinant human HRF. In addition, splenic B cells were shown to incorporate more efficiently and faster the parasite protein than the human one (Calderon-Perez et al., 2014). This result indicated that *Plasmodium* HRF could interfere with the action of the host HRF by inhibiting B cell responses allowing the parasite to escape the immune response. However, additional work is required to confirm these results.

2.2.5 Basophils activation by malaria HRF

Field studies in Senegal had shown an association between high levels of *Pf*HRF in the peripheral blood circulation and basophils activation. At the same time it was observed that a decrease of basophils in the peripheral blood circulation is associated with the severity of symptoms (Pelleau et al., 2012). A significant accumulation of basophils in the spleen during

malaria was similarly observed in the mouse model during *P. chabaudi* AS infection (Poorafshar et al., 2000). Moreover, activation of basophils leads to IL-4 production that might play a crucial role in the initiation of Th2 responses, that when activated too early during the infection, increases host susceptibility to malaria disease. However, in this case also additional studies are required to understand whether basophils have a protective or deleterious effect during the development of pathogenesis.

2.3 Comparative characteristics of mammal HRF and Plasmodium HRF

Many intracellular and extracellular functions have been ascribed to mammal HRF (Table 2) (Bommer and Thiele, 2004b). Many of the functions that have been determined for HRF are unrelated, and some seem to be contradictory. An overall function of HRF has yet to be determined, and much is left to be learned.

Moreover, despite this broad knowledge on mammal HRF, little is known about Plasmodium HRF (Table 2) and the structural differences observed suggest that the parasite protein may have different if not opposite biological functions than the human HRF, especially in influencing the biological responses of immune cells. For this reason, during this work we want to study and identify the possible effects of *Plasmodium* HRF on the host immune response and their implication in the development of disease pathogenesis.

	Mammal HRF	<i>Plasmodium</i> HRF	Ref.
Biological function			
Calcium binding	YES	YES	(Xu et al., 1999), (Bhisutthibhan et al., 1999)
Growth and development	YES (<i>hrf</i> ^{-/-} mouse lethal)	NO	(Chen et al., 2007; Hsu et al., 2007; Koide et al., 2009; Tuynder et al., 2002), (Mathieu et al., 2015)
Tubulin binding activity	YES	ND	(Gachet et al., 1999)
Chaperon activity	YES	ND	(Cans et al., 2003)
Anti-apoptotic	YES	ND	(Amson et al., 2012; Li et al., 2001; Liu et al., 2005; Rho et al., 2011)
Tumour reversion	YES	ND	(Li et al., 2001; Tuynder et al., 2002)
Pharmacological target	YES	YES	(Tuynder et al., 2004), (Bhisutthibhan et al., 1998)
Histamine release	YES (from basophils)	YES (from basophils and mast cells?)	(MacDonald et al., 1987; MacDonald et al., 1995; Thueson et al., 1979), (Briquet et al., 2015; MacDonald et al., 2001)
Cytokines release	YES (IL-4, IL-13 from basophils and IL-8 from eosinophils)	YES (IL-8 from eosinophils)	(Bheekha-Escura et al., 2000; Schroeder et al., 1997), (MacDonald et al., 2001)
B cell	YES (Proliferation-Stimulation)	YES (Inhibition of proliferation)	(Mathieu et al., 2015), (Calderon-Perez et al., 2014)
T cell	YES (Inhibition of IL2 and IL13 secretion)	ND	(Vonakis et al., 2003).
Other Characteristics			
Copy nb of <i>hrf</i> genes	Several copies	Only one copy	(Fiucci et al., 2003)
Structure	YES	YES	(Hinojosa-Moya et al., 2008; Thaw et al., 2001), (Hinojosa-Moya et al., 2008)
Secretion	Exosomes or H,K-ATPase channel	ND	(Amzallag et al., 2004; Kim et al., 2013)
Active form	Dimer	ND	(Kim et al., 2013; Kim et al., 2009)

Table2 – HRF characteristics.

Objective

3. SCOPE OF THE THESIS

The purpose of this thesis was to assess the importance of *Plasmodium* HRF in the modulation of immune mechanisms during malaria infection and evaluate whether its expression is associated with the severity of malaria disease.

Specific Aims

Our specific objectives were as follows

- Design and generation of HRF-deficient parasites (*hrf* Δ) in a *P. berghei*-GFP ANKA and NK65-GFP strains by homologous recombination
- The proof of concept that the HRF protein plays a role in malaria pathogenesis
- To assess whether mutant parasites show an altered phenotype that may ultimately cause a sterile immunity
- Characterize the cellular and molecular alterations induced by the presence or the absence of HRF and the immune mechanisms by which the *hrf* gene modulates the immune response

In the present thesis, the methodological part has been omitted since it is described in detail in the enclosed articles.

Results

4.1 ARTICLE I

***Plasmodium berghei* histamine-releasing factor favours liver-stage development via inhibition of IL-6 production and associates with a severe outcome of disease.**

In this work we were interested in the role of the *P. berghei* HRF protein during malaria infection since it could affect the immune responses of the host *in vivo*, at least through its potential to induce secretion of histamine and to contribute to the pathogenesis of cerebral malaria. To characterize the role of *Plasmodium* HRF in parasite transmission, development and disease pathogenesis, HRF-deficient *P. berghei* ANKA (*PbANKA-hrfΔ*) parasites were generated. The parasite ability to induce ECM was studied comparing mice infected with either WT or mutant *PbANKA-hrfΔ* parasites. Parasitemia, survival rates, and immunological monitoring were all used to establish the mutant phenotype.

Highlights

- Identification of *hrf* as a gene playing a role during parasite development in pre-erythrocytic stages. The development of *PbANKA-hrfΔ* parasite was specifically inhibited during liver stage development *in vivo*, resulting in reduction of merozoites numbers initially released in the blood, and an extension of the time between sporozoite injection and blood stage development.
- The prolonged liver-stage development influenced the clinical outcome of infection by decreasing the frequency of ECM and by increasing the survival rate.
- Impairment in the development of *PbANKA-hrfΔ* parasite in liver stages was associated with an early rise in liver and systemic IL-6 that in case of WT parasite infection was directly inhibited by *Plasmodium* HRF production.
- Increase in B-cell population in the liver of mice infected with mutant parasites at 40 h p.i. in association with early rise of IL-6 reflects the possibility that the HRF molecule could interfere with B-cell memory.

Plasmodium berghei histamine-releasing factor favours liver-stage development via inhibition of IL-6 production and associates with a severe outcome of disease

Cédric Mathieu,^{1,2†} Claudia Demarta-Gatsi,^{1,2†} Adeline Porcherie,^{1,2} Sara Brega,³ Sabine Thiberge,³ Karine Ronce,^{1,2} Leanna Smith,^{1,2} Roger Peronet,^{1,2} Rogerio Amino,³ Robert Ménard³ and Salaheddine Mécheri^{1,2*}

¹Institut Pasteur, Unité de Biologie des Interactions Hôte Parasites, Paris F-75015, France.

²Centre National de la Recherche Scientifique, Unité de Recherche Associée 2581, CEDEX 15, Paris F-75724, France.

³Institut Pasteur, Unité de Biologie et Génétique du Paludisme, Paris F-75015, France.

Summary

Plasmodium spp., which causes malaria, produces a histamine-releasing factor (HRF), an orthologue of mammalian HRF. Histamine-releasing factor produced by erythrocytic stages of the parasite is thought to play a role in the pathogenesis of severe malaria. Here, we show in a rodent model that HRF is not important during the erythrocytic but pre-erythrocytic phase of infection, which mainly consists in the transformation in the liver of the mosquito-injected parasite form into the erythrocyte-infecting form. Development of *P. berghei* ANKA cl15cy1 liver stages lacking HRF is impaired and associated with an early rise in systemic IL-6, a cytokine that strongly suppresses development of *Plasmodium* liver stages. The defect is rescued by injection of anti-IL-6 antibodies or infection in IL-6-deficient mice and parasite HRF is sufficient to decrease IL-6 synthesis, indicating a direct role of parasite HRF in reducing host IL-6. The target cells modulated by HRF for IL-6 production at early time points during liver infection are neutrophils. Parasite HRF is thus used to down-regulate a cytokine with anti-parasite

activity. Our data also highlight the link between a prolonged transition from liver to blood-stage infection and reduced incidence of experimental cerebral malaria.

Introduction

Histamine-releasing factor (HRF), originally classified as a tumour protein (translationally controlled tumour protein, TCTP) in mouse erythroleukemia, is found in a wide range of eukaryotes including yeast, plants and animals. The name TCTP was coined as a consequence of cDNA cloning from a human mammary carcinoma and based on the fact that TCTP is regulated at the translational level. Histamine-releasing factor/TCTP was first described as P21, Q23 and P23 by different groups and the mouse and human cDNA were cloned in the late eighties (Chitpatima *et al.*, 1988; Gross *et al.*, 1989). HRF plays many different functions and is involved in many physiological processes such as cell proliferation, stress and heat shock responses, and cell death. As an intracellular product, HRF has a calcium- and tubulin-binding properties and has been shown to transiently associate with microtubules during cell cycle (Gachet *et al.*, 1999). As a calcium-binding protein, HRF was found to be up-regulated in response to a loss of calcium homeostasis, which could be part of a role of HRF in general stress response (Xu *et al.*, 1999). HRF was shown to be associated with prostate, breast and colon cancers (Chung *et al.*, 2000; Vercoutter-Edouart *et al.*, 2001; Arcuri *et al.*, 2004), which is consistent with its anti-apoptotic activity (Zhang *et al.*, 2002). This was supported by the capacity of HRF to interact with the B-cell lymphoma-extra large (Zhang *et al.*, 2002; Yang *et al.*, 2005; Fenner *et al.*, 2010; Rid *et al.*, 2010) and to antagonize bax dimerization (Susini *et al.*, 2008) and to control the stability of the tumour suppressor p53 (Rho *et al.*, 2011). As a secreted product, HRF has immuno-modulatory roles. In humans, HRF induces the release of histamine and modulates cytokine secretion from basophils, eosinophils and T-cells. Histamine-releasing factor stimulates eosinophils to produce IL-8 (Bheekha-Escura *et al.*, 2000), induces

Received 17 September, 2014; revised 11 October, 2014; accepted 15 October, 2014. *For correspondence. E-mail smecheri@pasteur.fr; Tel. (+33) 14568 8245, Fax: (+33) 14438 9521

[†]These two authors contributed equally.

secretion of IL-4 and IL-13 from basophils (MacDonald *et al.*, 1995; Schroeder *et al.*, 1997) and inhibits IL-2, IL-4 and IL-13 production from stimulated primary T-cells (Vonakis *et al.*, 2003). Recently, HRF was found to have an inflammatory role in mouse models of asthma and allergy and to exist as a dimer bound to a subset of IgE and IgG antibodies, suggesting the possibility for HRF to cross-link IgE on the surface of basophils and mast cells (Kashiwakura *et al.*, 2012).

HRF is also expressed by a number of eukaryotic parasites, including *Plasmodium*, the causative agent of malaria. Malaria is the most deadly parasitic disease worldwide, causing almost a million deaths each year. The symptoms of the disease are due to the multiplication of the parasite inside host erythrocytes. Infection starts by an asymptomatic phase, during which the highly motile parasite form injected by mosquitoes reaches the liver, invades hepatocytes and multiplies into the erythrocyte-infecting parasite form. The latter, once released into the bloodstream, invades erythrocytes and initiates the clinical phase of infection, consisting in repeated cycles of parasite multiplication inside erythrocytes. A severe complication of the erythrocytic phase of malaria infection is cerebral malaria (CM), a syndrome caused by the cytoadherence of infected erythrocytes to endothelial cells in brain capillaries, the release of inflammatory cytokines and chemokines and the accumulation of activated CD8⁺ T-cells.

Plasmodium HRF, which has a high homology to human HRF (their amino acid sequences are 33% identical and 54% similar) and similar activity (MacDonald *et al.*, 2001), has been proposed to play an important role during the erythrocytic phase of malarial infection. *Plasmodium falciparum* HRF was detected in the plasma of malarial patients in Malawi (MacDonald *et al.*, 2001) and in higher concentration in patients with severe malaria in Senegal (Pelleau *et al.*, 2012). Increased levels of plasma histamine have been associated with disease severity during *P. falciparum* infection as well as in animal models of malaria (Maegraith and Fletcher, 1972; Srichaikul *et al.*, 1976; Bhattacharya *et al.*, 1988; Enwonwu *et al.*, 2000). Accordingly, CM does not develop in histamine-free, histidine decarboxylase-deficient mice (Beghdadi *et al.*, 2008). Therefore, parasite HRF is thought to play a role in malaria pathogenesis, at least in part through its action on histamine.

Although the contribution of cytokines and other inflammatory molecules during malarial erythrocytic infection is extensively studied, still little is known about host factors that control *Plasmodium* development in the liver. Work in rodents and cultured hepatocytes showed that several host cytokines strongly inhibit parasite development inside hepatocytes, including IFN- γ , TNF- α , IL-1 and IL-6 (Schofield *et al.*, 1987; Maheshwari, 1990; Pied *et al.*,

1992; Vreden *et al.*, 1992). Both TNF- α -induced (Vreden *et al.*, 1992) and IL-1-induced (Nussler *et al.*, 1991) inhibitions of liver-stage development are mediated by IL-6. In contrast, recombinant IL-6 is sufficient to reduce liver-stage development inside cultured hepatocytes in the absence of non-parenchymal cells (Pied *et al.*, 1992) and exerts its action throughout liver-stage maturation (Nussler *et al.*, 1991). One of the mechanisms by which IL-6 might control parasite liver infection is by regulating iron homeostasis through hepcidin (Nemeth *et al.*, 2004), which limits *Plasmodium* development inside hepatocytes (Portugal *et al.*, 2011).

In this work, we investigated the role of HRF in *P. berghei*, a rodent-infecting species of *Plasmodium* that can be cycled *in vivo*. We found that HRF has no contribution during the erythrocytic phase of infection, but plays an important role during the pre-erythrocytic phase of infection in the liver by decreasing IL-6.

Results

HRF is important for P. berghei pre-erythrocytic infection

To test the role of HRF in *P. berghei*, we replaced in erythrocytic stages of a GFP-expressing *P. berghei* ANKA clone (Ishino *et al.*, 2006) the entire coding sequence of *PbHRF* (PBANKA_111050) by the *hDHFR* selectable marker (Supporting Information Fig. S1). Three clones were selected from independent transfection experiments, called HRF Δ 1–3, which were verified to harbour the expected *HRF* null-mutant locus by PCR (Supporting Information Fig. S1A–C), and by Southern blot analysis (Supporting Information Fig. S1D). Blood stages of the wild type (WT) and of the three mutant clones exhibited similar growth rates in the blood of C57BL/6 mice, as measured by Fluorescence-activated cell sorter (FACS) analysis during exponential growth (Fig. 1A). When similar numbers of erythrocytes infected with HRF Δ 1 or WT parasites were injected in mice, a similar proportion of mice (>90%) succumbed to CM in the two groups, with similar kinetics (Fig. 1B). Similar results were obtained with HRF Δ 2 and HRF Δ 3 parasites (not shown). We conclude that HRF is not essential for *P. berghei* blood stages.

To test pre-erythrocytic stage infectivity, sporozoites were inoculated into mice by mosquito bite (Fig. 1C and D), intradermal (ID, Fig. 1E) or intravenous (IV, Fig. 1F) injection and emergence of blood-stage parasites monitored by FACS. Only 40% to 50% of animals became infected after injection of HRF Δ 1 sporozoites when 100% animals were infected after injection of WT parasites (Fig. 6B). Animals became patent with HRF Δ 1 blood-stage parasites on average 2 to 3 days after the WT following infection by mosquito bites (Fig. 1C, insert) or inoculation of isolated sporozoites (Fig. 1E and F),

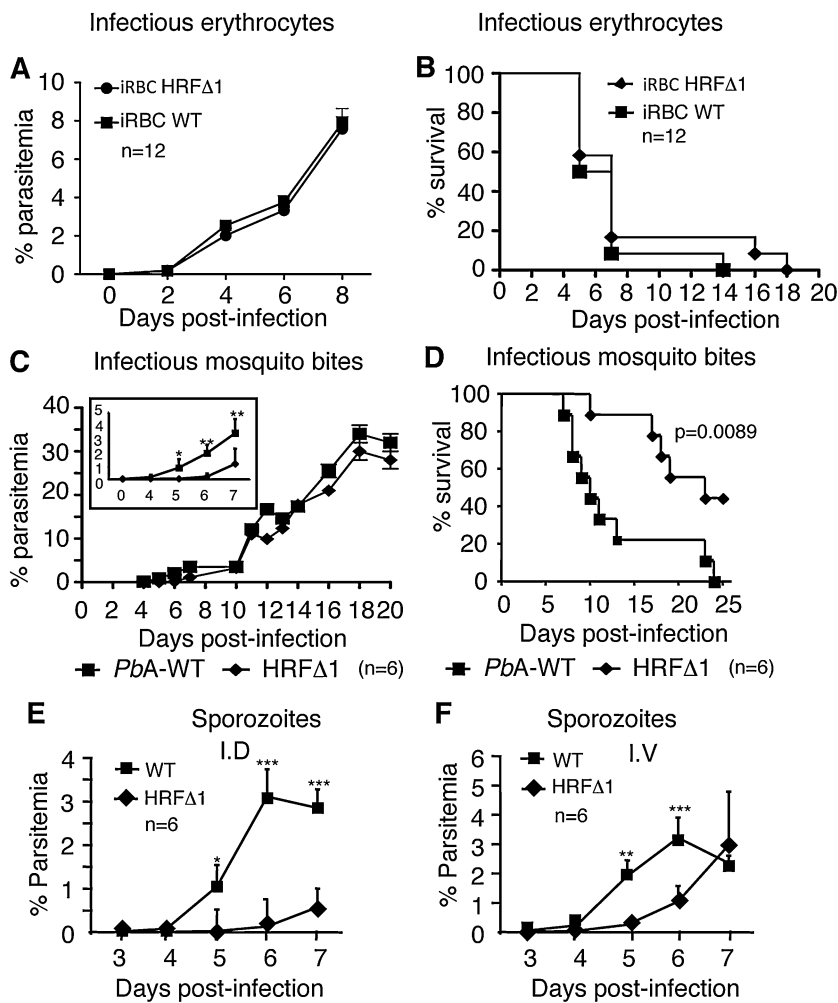

Fig. 1. Marked differences in parasitaemia between WT and HRF Δ 1 *Pb* ANKA-infected mice are observed only at the pre-erythrocytic stage. C57BL/6 mice (12 mice per group) were infected with 10^6 WT or HRF Δ 1 *Pb* ANKA-infected RBCs (A, B) or via bites of 10 mosquitoes (C, D), or inoculated with 10 000 isolated sporozoites ID (E), or IV (F). In C, D, E, and F panels, as 50% of mice did not show parasitaemia, only six mice per group were shown. Kaplan–Meier survival plots (log-rank test) and parasitaemia (Mann–Whitney test; * $P < 0.028$; ** $P < 0.007$; *** $P < 0.002$) were recorded over time. Results are from three independent experiments.

corresponding to a 100- to 1000-fold decrease in infectivity of mutant parasites (day of patency 4 and 6 for WT and HRF Δ 1-infected mice, respectively, Fig. 1C; day of patency 4 and 6 for WT and HRF Δ 1-infected mice, respectively, Fig. 1E; day of patency 3 and 5 for WT and HRF Δ 1-infected mice, respectively, Fig. 1F). Similar results were obtained with clones HRF Δ 2 and HRF Δ 3 (Supporting Information Fig. S2A and B). As expected, the delayed development of the mutant in the liver greatly decreased its ability to induce CM after sporozoite inoculation, as already reported for other mutants with a developmental block in the liver (Butler *et al.*, 2011) and in humans after RTS,S (repeat and T-cell epitope in the circumsporozoite protein (CSP) of *Plasmodium falciparum* malaria parasite and a viral envelope protein of the hepatitis B virus, HBsAg) immunization (Heppner *et al.*, 2005). Indeed while 100% C57BL/6 mice developed CM on day 7 or 8 after WT sporozoite inoculation by mosquito bite, only 10% of the mice inoculated with HRF Δ 1 sporozoites showed signs of neuropathology (Fig. 1D). Similar CM resistant pheno-

type was observed in C57BL/6 mice infected by intravenous injection of isolated sporozoites (Supporting Information Fig. S2). We conclude that in *P. berghei* HRF is crucial for the pre-erythrocytic, but not erythrocytic phase of infection.

HRF is produced by sporozoites and liver stages

To detect HRF in *P. berghei* pre-erythrocytic stages, specific antibodies were generated by rabbit immunization with recombinant *P. berghei* HRF protein (*Pb*HRF). Expression of HRF by WT sporozoites was assessed by immunofluorescence assay (IFA), which showed a diffuse staining pattern suggesting a cytoplasmic localization (Fig. 2A). In contrast, no detectable HRF could be seen in HRF Δ 1 parasites (Fig. 2A). Expression of HRF in parasitized hepatocytes was assessed by incubating cultured HepG2 hepatoma cells with WT or HRF Δ 1 sporozoites. After 48 h, HRF was detected specifically in fixed/permeabilized cells infected with WT, not HRF Δ 1, parasites (Fig. 2B). Staining of WT and mutant sporozoites, as

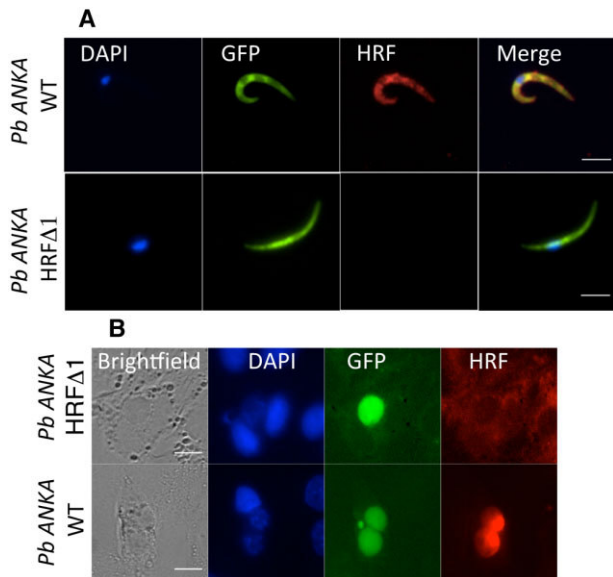

Fig. 2. Detection of HRF protein in pre-erythrocytic stages. **A.** Immunofluorescent detection of HRF in fixed WT and HRF Δ 1 GFP-tagged sporozoites. Representative images are shown for anti-HRF antibody together with bright-field images and DAPI stained nuclei. Scale bar 10 μ m. **B.** Intracellular staining for detection of HRF within hepatocytes was performed by incubating HepG2 cells with WT or HRF Δ 1 sporozoites at MOI of 1:1 for 48 h. Cells were fixed and stained with anti-HRF rabbit IgG antibodies followed by Alexafluor 568-labelled donkey anti-rabbit IgG antibodies. Experiments were replicated twice with similar results. Scale bar, 10 μ m.

well as HepG2 cultures harbouring WT or mutant parasites, with only secondary antibodies were negative.

HRF is important for liver-stage development in vivo

In vitro, HRF Δ 1 sporozoites did not display any detectable defect in gliding motility (Supporting Information Fig. S3A–C), host cell traversal (Supporting Information Fig. S3F) or host cell invasion of HepG2 cells (Supporting Information Fig. S3D and E). HRF Δ 1 and WT developed indistinguishably inside HepG2 cells into exo-erythrocytic forms (EEF, liver stages; Supporting Information Fig. S3G). Therefore, HRF does not appear to be important for a basic parasite developmental step detectable *in vitro*. After transmission to mosquitoes, WT and HRF Δ 1–3 parasites generated similar numbers of sporozoites in the insect salivary glands. Indeed, at day 20 following parasite passage into female mosquitoes, similar prevalence of mosquito infection and similar numbers of HRF Δ 1 and WT sporozoites per infected mosquito salivary gland were counted (Supporting Information Fig. S3H), indicating that HRF was dispensable for parasite development inside mosquitoes.

We then tested whether HRF might play a role during sporozoite progression *in vivo* using a putative vasodilatory effect of histamine. A potential role of HRF in facilitating sporozoite passage across the liver sinusoidal endothelium to reach hepatocytes was addressed by intravital imaging. Mice were injected IV with a 1:1 mixture of GFP⁺ HRF Δ 1 and RFP⁺ control *P. berghei* sporozoites and sporozoites present in the parenchyma were counted after 3 h, when sporozoite motility has ceased. As shown in Fig. 3A and B, sporozoites of each type crossed the sinusoidal barrier with similar efficacy. We next tested whether HRF might help sporozoites penetrate blood capillaries in the skin and thus exit the skin. For this, sporozoites were injected IV or ID and parasite loads in the liver were compared by quantitative real-time polymerase chain reaction (qRT-PCR) at 40 hpi, when individual liver stages have initiated nuclear division (Fig. 3C). The HRF Δ 1 parasite load was 3.7- and 3.3-fold smaller than that of the WT after IV and ID injections respectively (Fig. 3C). This indicated that the mutant is not more impaired compared with WT after ID than IV injection, i.e. that the mutant is not impaired in exiting the skin. Clones HRF Δ 2 and HRF Δ 3 gave similar results (Fig. 3D).

To analyse liver-stage development *in vivo*, mice were injected with sporozoites IV and liver samples collected at 40, 96 or 144 hpi were subjected to qRT-PCR analysis of parasite LISP1 RNA (Fig. 3E). At 40 hpi, the HRF Δ 1 parasite load was ~2.5 times lower than that of the WT. At 96 hpi, WT parasites were undetectable, as expected from the release of merozoites from liver stages starting ~55 hpi, while the amounts of HRF Δ 1 parasites had risen to levels similar to those of the WT at 40 hpi. At 144 hpi, both WT and HRF Δ 1 parasites were undetectable in the liver. Therefore, RT-PCR analysis in the liver indicated a > 48 h delay in the completion of the pre-erythrocytic phase. In parallel, as expected, blood smears and FACS analysis detected WT parasites 2 days earlier than HRF Δ 1 parasites (Fig. 3F).

Lack of HRF increases IL-6 production in the infected liver

Since HRF is important for liver-stage development specifically *in vivo*, we assessed the levels of various molecules of the host immune system during parasite liver infection (Fig. 4). Liver samples from naïve C57BL/6 mice and mice infected with WT or HRF Δ 1 parasites were harvested at various hpi and host gene expression measured by RT-qPCR. Strikingly, at 40 hpi, the transcripts for IL-6 were the sole among those tested that were differentially expressed between infections with WT and HRF Δ 1 parasites, being increased fivefold in HRF Δ 1-infected liver samples. At 96 and 144 hpi, the levels of transcripts for MIP-1 β , MIP-2, ICAM-1, TNF- α and IFN- γ were all higher

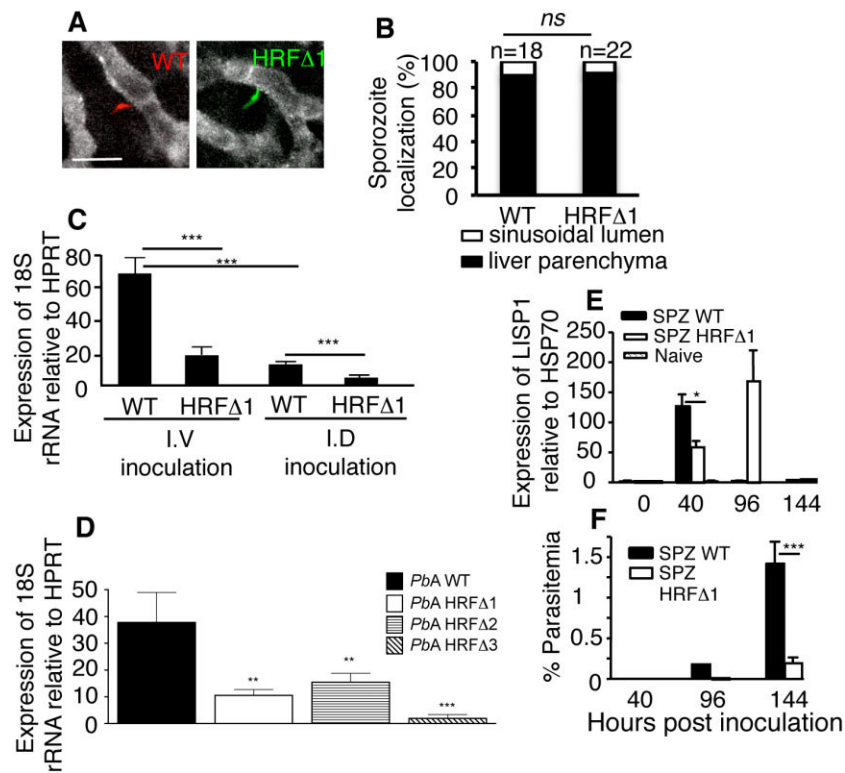

Fig. 3. Comparison of the liver infection by the WT and HRFΔ1 parasites.

A, B. 5×10^5 WT and HRFΔ1 sporozoites were injected together in the tail vein of C57BL/6 mice to compare the parasite ability to cross the sinusoidal barrier. WT and mutant parasites were imaged in the liver of the same infected mice at 3 h post-inoculation.

A. Representative intravital confocal images of WT (red) and HRFΔ1 sporozoites (green) that invaded the liver parenchyma at 3 h post-inoculation. The liver parenchyma (black) is delineated by the liver sinusoids (white), which are labelled by the IV injection of Alexa Fluor 647 BSA. Scale bar, 20 μ m.

B. Percentage of sporozoites that invaded the liver parenchyma (black bar) or not (white bar) after 3 h post-inoculation. Similar numbers of parasites were detected in the imaged area ($n = 18$ WT sporozoites, $n = 22$ HRFΔ1 sporozoites).

C. Role of HRF in infectivity of pre-erythrocytic stages of the parasite. Forty hours after inoculation of C57BL/6J Rj mice IV or ID with 10 000 WT or HRFΔ1 sporozoites, livers were isolated and total RNA extracted. Parasite loads were determined using real-time RT-PCR by measuring *P. berghei* 18S rRNA. Gene mRNA expression was normalized to the endogenous control gene HPRT. Data are presented as the means \pm SD ($n = 5$) from two independent experiments. $***0.02 < P < 0.004$ (Kruskal–Wallis multiple comparison test).

D. Comparative development of independent HRF mutant clones. Analysis of the three mutant clones was performed as in E. Data are presented as the means \pm SD from two independent experiments. For statistics, $n = 5$, $**P < 0.01$, $***P < 0.001$ according to the Kruskal–Wallis test.

E, F. Groups of C57BL/6 mice were injected IV with 10 000 GFP-WT or GFP-HRFΔ1 sporozoites and livers and blood were collected at indicated time points. Parasite loads in the liver were assessed by measuring parasite LISP1 mRNA by real-time RT-PCR (E). Gene mRNA expression was normalized to the parasite control gene HSP70. Data are presented as the means \pm SD from six individual values. $*P < 0.01$. In parallel, parasitaemia (F) was determined and means \pm SD from six individual values are shown. Significant differences were obtained using The Kruskal–Wallis multiple comparison test ($*P = 0.02$, $***P < 0.002$). Shown are data from two distinct experiments (E, F).

in response to WT compared with HRFΔ1 parasites (Fig. 4), while the levels of IL-6 transcripts had reverted and reached higher levels in WT-infected livers. Transcripts for IL-4, IL-5 and IL-13 were not detectable both in WT and HRFΔ1 parasites. To verify specificity of the IL-6 increase in HRFΔ1-infected livers, we tested *P. berghei* ANKA parasites lacking the *p36* gene, previously shown to be rapidly blocked in development after hepatocyte invasion (van Dijk *et al.*, 2005; Ishino *et al.*, 2005; Labaied *et al.*, 2007). After IV injection of 10 000 p36Δ sporozoites into C57BL/6 mice, RT-PCR at 40 h post-infection confirmed the arrested development of the mutant in the liver (Fig. 4H). In addition to the abortive intrahepatocytic

development, p36Δ parasites did not up-regulate IL-6 (Fig. 4I), confirming that the latter was not a mere consequence of parasite developmental arrest in the liver but indeed the consequence of the absence of HRF.

To characterize the IL-6-producing cells regulated by HRF, C57BL/6 mice were inoculated IV with WT or HRFΔ1 sporozoites and, 40 h later, cells were harvested from the liver and characterized for IL-6 production. For this, liver cells gated on CD45⁺ IL-6⁺ cells were subsequently labelled for various leukocyte markers. As shown in Supporting Information Fig. S4A, a higher proportion of liver cells producing IL-6 upon infection with HRFΔ1 parasites compared with WT parasites were confined to Ly6G⁺,

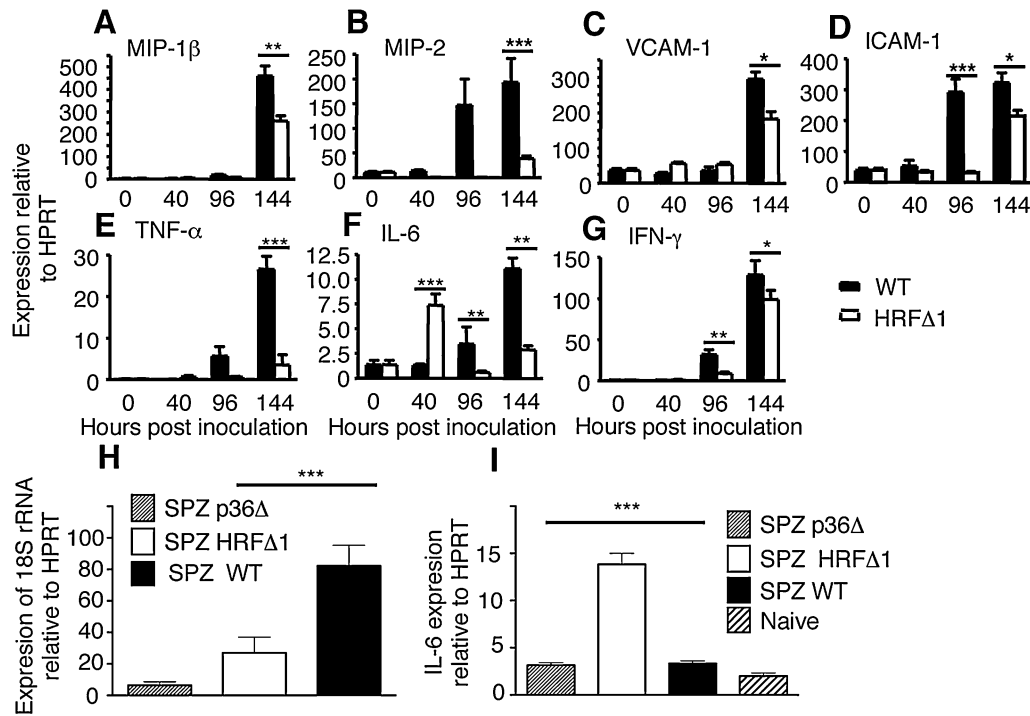

Fig. 4. Immune response genes are differentially regulated by WT and HRFΔ1 parasites. Transcription of the immune response genes including MIP-1β (A), MIP-2 (B), VCAM-1 (C), ICAM-1 (D), TNF-α (E), IL-6 (F) and IFN-γ (G) in the liver ($n = 6$ per group) at different time points post-infection as evaluated by real-time RT-PCR. mRNA expression was normalized relative to HPRT expression for each mouse strain. The asterisk indicates that differences are significant (Mann–Whitney test, $0.01 < P < 0.05$), double asterisk indicates that these values are significantly different (Mann–Whitney test, $0.005 < P < 0.01$) and triple asterisk indicates that differences are significant (Mann–Whitney test, $0.001 < P < 0.007$). (H) C57BL/6 mice (6/group) were inoculated with 10 000 WT, HRFΔ1 or p36Δ sporozoites. Forty hours later, livers were isolated and total RNA extracted. Parasite load was determined by using primers specific for the *P. berghei* 18S rRNA by real-time RT-PCR, which expression was normalized relative to HPRT expression. (I) IL-6 expression was determined in the same liver samples using real-time RT-PCR by measuring IL-6 mRNA. Triple asterisk indicates that differences are significant (Mann–Whitney test, $0.003 < P < 0.01$).

7/4⁺, CD11b⁺ and CD11c⁺ cells, presumably neutrophils and inflammatory monocytes. At early time point of infection (40 h post-infection), gated Ly6G⁺, 7/4⁺ double-positive neutrophils (R2) were twice more frequent in mice infected with HRFΔ1 compared with WT parasites (Supporting Information Fig. S4B). Further characterization within this gate of neutrophils expressing IL-6 showed higher mean fluorescence intensity for HRFΔ1 parasites (1200) than those induced by WT parasites (800) (Supporting Information Fig. S4B). Other cells potentially expressing IL-6 including CD4, CD8, B-cells and macrophages were apparently not regulated by HRF (Supporting Information Fig. S4A). These data support the view that HRF modulation of IL-6 at early time points during liver infection may involve neutrophils.

HRF impact on host cell recruitment in the infected liver

We then analysed host cell recruitment in livers infected with HRFΔ1 or WT parasites (Fig. 5). Innate immunity-associated leukocytes such as neutrophils, eosinophils, monocytes, macrophages, NK cells and adaptive

immunity-related leukocytes such as CD4⁺, CD8⁺ and B-cells were investigated. Leukocyte populations in the livers of C57BL/6 mice were collected from 40 hpi to 4 days post-injection (dpi) after IV injection of HRFΔ1 or WT sporozoites. At 40 hpi, 3.5- to 4-fold more CD19⁺/B220⁺ cells, likely B-cells, were found in mice infected with HRFΔ1 parasites and, conversely, twofold fewer NK1.1⁺ cells than in mice infected with WT parasites. At 4 dpi, WT infection was associated with higher numbers of CD8⁺, CD11b⁺, Ly6-G⁺ (neutrophils) and CD11c⁺ CD11b⁺ dendritic cells. Other leukocyte populations including CD4⁺, eosinophils, basophils and macrophages were similarly affected during WT and HRFΔ1 infections.

Since the 40 h time point appears to be the critical point for events distinctly elicited by the HRFΔ1 parasite, namely increased B-cell number, we examined whether activation markers on leukocytes were modulated as well. To test whether distinct activation phenotypes could serve a cellular marker for HRFΔ1 infection in the liver, leukocytes were analysed for their level of CD62L expression, a key adhesion molecule that is expressed on the surface of most circulating leukocytes, including lymphocytes,

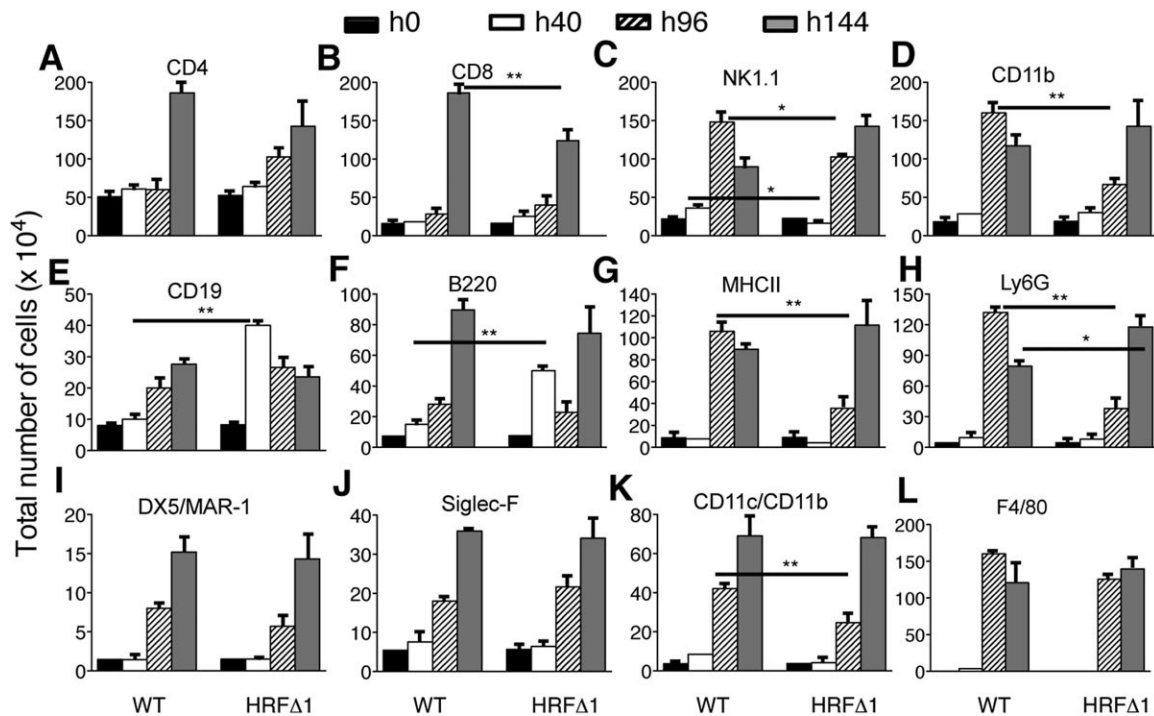

Fig. 5. Leukocyte patterns are differentially regulated by WT and HRFΔ1 parasites. At indicated time points post-infection, livers from C57BL/6 mice infected with 10 000 GFP-WT or GFP-HRFΔ1 sporozoites of *Pb* ANKA strain ($n = 6$ per group) were taken and leukocytes associated with liver tissue were analysed by using the following leukocyte markers: CD4 (A), CD8 (B), NK1.1 (C), CD11b (D), CD19 (E), B220 (F), MHCII (G), Ly6G (H), DX5/MAR-1 (I), Siglec-F (J), CD11c/CD11b (K) and F4/80 (L). Data are expressed as number of cells. The asterisk indicates that differences are significant (Mann–Whitney test, $0.018 < P < 0.05$), double asterisk indicates that these values are significantly different (Mann–Whitney test, $0.008 < P < 0.025$). Values represent the mean \pm SD of two experiments.

neutrophils, monocytes, eosinophils and basophils and is down-regulated on activated leukocytes. As shown in Supporting Information Fig. S5, we determined the proportion of various subsets of leukocytes including B-cells ($B220^+$, $CD19^+$), $CD4^+$, $CD8^+$, NK cells and $Ly6G^+$ (neutrophils) that express low levels of CD62L among $CD45^+$ cells taken 40 h after infection from the liver of naïve mice or mice inoculated with WT or with HRFΔ1 parasites. Regardless of the parasite used, only B-cells ($B220^+$ $CD62L^{low}$ and $CD19^+$ $CD62L^{low}$) were found to be slightly activated compared with naïve mice. $CD4$, $CD8$, NK cells and neutrophils were not affected by any parasite. MHC class II expression used as an activation marker for dendritic cells ($CD11c^+$ MHC class II^{high}) was also found to be indistinctly up-regulated by both parasites. We infer from this analysis that the slightly increased proportion of activated B-cells and dendritic cells in the liver at early time points is independent from HRF, and that the only HRF-specific effect is the increase in the B-cell number.

To assess whether B-cells contributed to impaired infection by HRFΔ1 parasites, B-cell-deficient mice were inoculated IV with 10 000 WT or HRFΔ1 sporozoites, and the parasite load and IL-6 gene expression were exam-

ined at 40 hpi. Data showed, similarly to WT C57BL/6 mice, a ~3-fold reduced parasite load for the mutant parasite compared with the WT in B-cell-deficient mice (Supporting Information Fig. S6A). The IL-6 gene was also up-regulated in B-cell-deficient mice infected with HRFΔ1 sporozoites (Supporting Information Fig. S6B). Mortality rates caused by WT and HRFΔ1 sporozoites were similar in B-cell-deficient and WT mice (Supporting Information Fig. S6C), and the absence of CM induced by HRFΔ1 sporozoites was also observed in B-cell-deficient mice. These data suggested that B-cells were not involved in the HRFΔ1 parasite developmental block in the liver.

The mutant phenotype is rescued by decreasing IL-6 levels

To test whether the impaired HRFΔ1 liver-stage growth *in vivo* might be caused by increased IL-6, we attempted to rescue the phenotype of the mutant by decreasing IL-6 amounts. Mice received anti-IL-6 antibodies IV, were injected IV 24 h later with HRFΔ1 sporozoites, and parasite loads in the liver were measured at 40 hpi by qRT-PCR. Anti-IL-6 antibodies increased the HRFΔ1 load in the liver ~2.5-fold (Fig. 6A), thus largely rescuing the

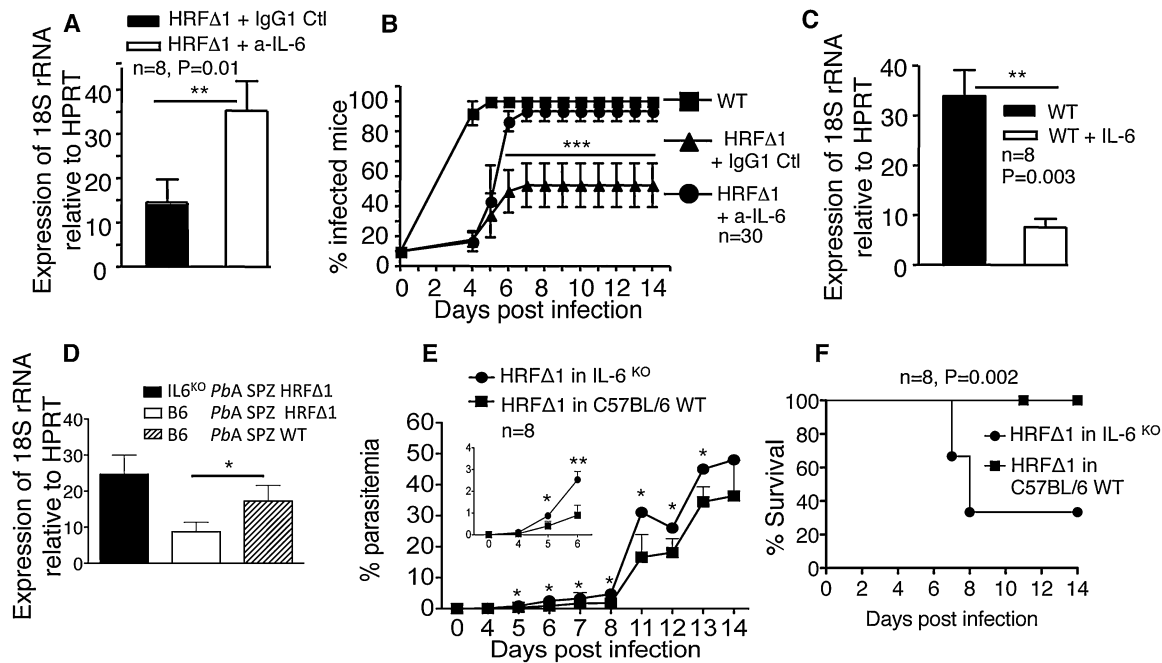

Fig. 6. HRF Δ 1-mediated regulation of IL-6 expression in the liver is critical for parasite development. C57BL/6 mice were infected with 10 000 WT GFP-HRF Δ 1 sporozoites in the presence of rat anti-mouse IL-6 mAbs or normal rat IgG1 as control (A) or with GFP-WT sporozoites treated or not with 5 μ g of rHuIL-6 (C), and 40 h later parasite loads in the liver were assessed by measuring parasite 18S rRNA by real-time RT-PCR, which expression was normalized relative to HPRT expression. Data are presented as the means \pm SD from one representative experiment out of two ($n=8$). Double asterisk indicates that differences are significant (Mann-Whitney test: $0.01 < P < 0.03$). (B) Mice were treated as in A, but were followed for parasitaemia and the proportion of mice developing blood-stage parasites were determined (Mann-Whitney test; $***P=0.006$). (D) C57BL/6 or IL-6 KO mice were inoculated IV with 10 000 GFP HRF Δ 1 sporozoites. As control, C57BL/6 mice were inoculated with 10 000 WT sporozoites. Forty hours later, livers were isolated and total RNA extracted. Parasite load was determined by using primers specific for the *P. berghei* 18S rRNA. mRNA expression measured by real-time PCR was normalized to the endogenous control gene HPRT. Data are presented as the means \pm SD from two independent experiments ($n=5$, *Mann-Whitney test, $P=0.028$). (E) C57BL/6 or IL-6 KO mice were infected IV with 10 000 GFP HRF Δ 1 sporozoites and parasitaemia (Mann-Whitney test; $*P=0.032$, $**P=0.009$) and (F) survival rates (log-rank test) were followed over time.

defective phenotype. Moreover, while only 40% of the mice infected with 10^4 HRF Δ 1 sporozoites became blood-stage patent (Fig. 6B, triangles), all mice infected similarly and pretreated with anti-IL-6 antibodies developed blood-stage parasites (Fig. 6B, closed circles). Conversely, when WT sporozoites were injected IV into mice immediately before human recombinant IL-6 (5 μ g per mouse), WT parasite loads in the liver decreased \sim 4-fold at 40 hpi (Fig. 6C). As controls and to see whether IL-6 treatment affects liver parasite load in HRF Δ 1-infected mice, mice infected with HRF Δ 1 plus/minus IL-6 displayed the same liver parasite load (Supporting Information Fig. S7A). To assess whether treatment with exogenous IL-6 would affect endogenous liver IL-6 mRNA expression, HRF Δ 1-infected mice displayed similar IL-6 mRNA expression in IL-6-treated and untreated mice (Supporting Information Fig. S7B).

Next, experiments were conducted in IL-6-knockout (IL-6 KO) C57BL/6 mice. First, sporozoites were injected IV into mice and parasite loads in the liver assessed by RT-PCR. While the liver load of HRF Δ 1 parasites was lower than that

of the WT in WT C57BL/6 mice, the load of HRF Δ 1 parasites in IL-6 KO mice was higher than in WT mice and similar to that of WT parasites in WT mice (Fig. 6D). Second, pre-patent periods of liver-stage development of HRF Δ 1 parasites were assessed in IL-6 KO and WT mice. Figure 6E shows that HRF Δ 1 parasites developed at a higher rate in IL-6-deficient mice than in WT recipients, reverting to a fully complemented phenotype. The control experiment which consists of inoculation of 10 000 SPZ of WT or HRF Δ 1 *PbANKA* parasites in IL-6 KO mice shows that the phenotype of the mutant parasite in IL-6 KO mice is not completely rescued; however, the delay in the patent period is reduced as compared with the WT parasite (1 day instead of 2 to 3 days in WT mice, day of patency 3, and 4 for WT and HRF Δ 1-infected IL-6 KO mice, respectively; Supporting Information Fig. S7C) but the mortality caused by HRF Δ 1 parasites is re-established as 5 mice died out of 7 as compared with no death in WT mice (shown in Fig. 6F). Also the death rate is not significantly different than those IL-6 KO mice infected with *PbANKA* WT parasites (6 mice died out of 7; Supporting Information Fig. S7C).

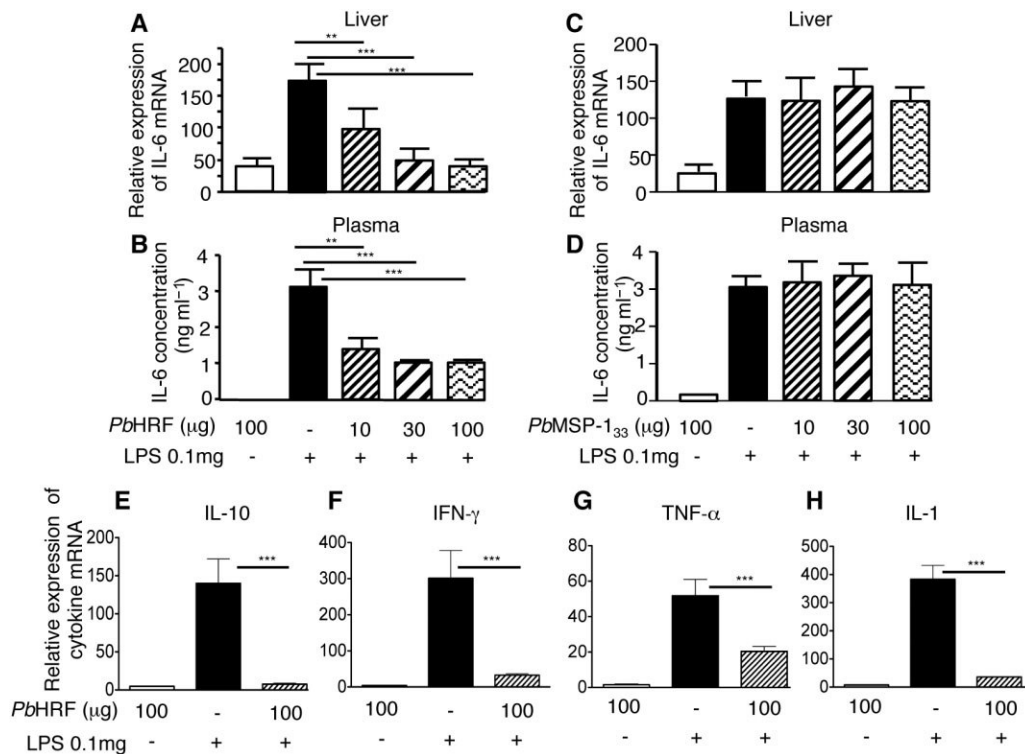

Fig. 7. Capacity of the recombinant HRF to down-modulate LPS-induced IL6- and other cytokine-mRNA expression and protein synthesis. C57BL/6 mice were injected i.v with the indicated doses of recombinant *Pb* ANKA HRF (A and B) or with recombinant *PbMSP1₃₃* (panels C and D) 15 min prior to the administration of 0.1 mg of LPS. Two hours later, livers were harvested and processed for IL-6 mRNA transcript analysis by RT-PCR (A, C) and in parallel plasma were tested for IL-6 content by ELISA (B, D). As control, HRF was injected alone at 0.1 mg per mouse (far left bar). In the same experimental setting, mRNA transcripts for IL-6, IL-10, IFN- γ , TNF- α and IL-1 (E-H) were measured in mice injected with LPS alone, HRF alone, or in combination. One representative analysis out of 2 is shown and the means \pm SD of values obtained in three mice. For statistics in all graphs, ** $P < 0.05 < 0.01$, *** $P < 0.001$ according to the Kruskal–Wallis test.

Last, we compared the ability of sporozoites to induce CM in WT and IL-6^{ko} mice. HRF Δ 1 sporozoites injected IV did not induce CM in WT mice, whereas 70% of IL-6^{ko} mice developed CM (Fig. 6F), similar to the CM frequency caused by WT parasites in WT mice infected via infectious mosquito bites (Fig. 1D). Similar results were obtained with HRF Δ 2 and HRF Δ 3 parasites. Together, these data indicate that the phenotype caused by lack of HRF in the parasite is mainly, if not only, due to IL-6 overexpression in the host.

HRF is sufficient to decrease IL-6 production

We then tested whether HRF directly affected the production of IL-6 in the liver and systemically in the mouse. For this, recombinant *P. berghei* HRF (*PbHRF*) was expressed in pRSETA plasmid, with an N-terminal his tag and purified/collected from *Escherichia coli* BL21 strain. Mice were injected IV with various doses of recombinant *PbHRF* prior to the administration of 0.1 mg of Lipopolysaccharide (LPS), a known IL-6 inducer, and 2 h later IL-6 mRNA expression and plasma levels of IL-6 were determined by RT-qPCR and ELISA respectively.

IL-6 expression was down-regulated both at the mRNA (Fig. 7A) and protein levels (Fig. 7B) by HRF, in a dose-dependent manner. As a control, we tested the ability of another parasite protein, merozoite surface protein 1 fragment 33 (*PbMSP1₃₃*), to modulate IL-6 production in the same conditions. *MSP1₃₃* had no inhibitory effect on the levels of LPS-induced IL-6 mRNA (Fig. 7C) or IL-6 protein (Fig. 7D). Therefore, the differential regulation of IL-6 in the liver in response to infections with WT and HRF Δ parasites can be directly ascribed to HRF itself. The mRNA transcripts for IL-10, IFN- γ , TNF- α and IL-1 (Fig. 7E–H) were also inhibited by the co-injection of HRF, while those for IL-4, IL-5 and IL-13 remained undetectable in mice treated with LPS alone or LPS combined with HRF.

HRF is detected in the extracellular environment in the liver and in the blood

The phenotype of the mutant predicted that HRF would be secreted by the liver stage of the parasite. To test this, the supernatant of 24 h cultures of HepG2 cells harbouring WT parasites was collected and analysed by immunoblot

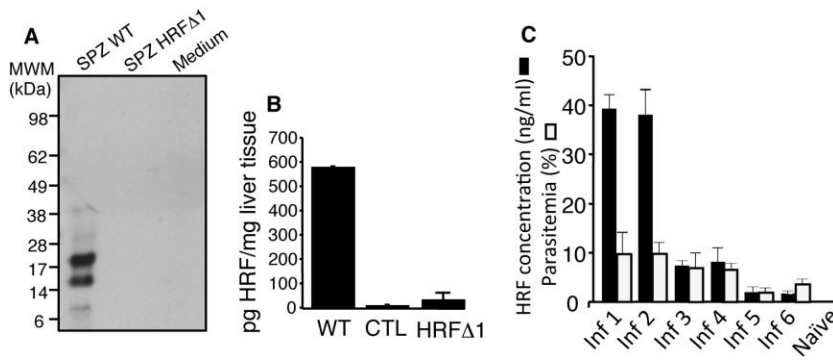

Fig. 8. Detection and quantification of HRF protein in various biological fluids.

A. Supernatants from HepG2 cells cultured in the presence of WT, HRFΔ1 sporozoites, or in the absence of parasite were immunolabelled with anti-HRF antibody.

B. Presence of HRF was measured in the liver extract of mice infected with 10^5 WT sporozoite at 40 h post-infection by using ELISA.

C. The level of HRF in plasma of infected mice with WT and HRFΔ1 (not shown) was measured along with parasitaemia. One representative experiment among three are shown.

using anti-HRF antibody (Fig. 8A). The presence of HRF (22 000 Da molecular weight) was detected, as well as other bands at around 15 000 and 7000 molecular weights, likely representing fragments from the native protein. No signal was detected in supernatants from HepG2 cells containing HRFΔ1 parasites or uninfected HepG2 cells (Fig. 8A). To confirm that HRF was produced by liver-stage parasites *in vivo*, liver extracts obtained 40 h post-infection with WT sporozoites were tested for the presence of HRF. As shown in Fig. 8B, HRF was detected in liver extracts. To assess whether HRF is present in the plasma of infected mice during the blood phase of infection, we measured HRF in the plasma of mice with various levels of parasitaemia. In order to correlate the level of parasitaemia with the amount of circulating HRF, selected sera from two mice with 10% parasitaemia (day 7 post-infection), two mice with 7% parasitaemia (day 5 post-infection) and two mice with 3% parasitaemia (day 3 post-infection) were examined for their content of HRF using a quantitative ELISA assay. As shown in Fig. 8C, HRF was present in the plasma and appeared to correlate with the parasite load in the blood. HRF was not detected in the plasma of mice infected with HRFΔ1 parasites.

Discussion

This work shows that, in rodents, plasmodial HRF is involved in the pre-erythrocytic phase of malarial infection. Given the high (97%) similarity between *P. falciparum* and *P. berghei* HRF, it is likely that the same applies in humans. Histamine-releasing factor was not involved in the erythrocytic phase of infection in rodents, including in the development of CM. This, however, does not exclude a role for HRF in severe *P. falciparum* malaria in humans. It was striking to observe that deletion of *hrf/tctp* gene was not lethal for *Plasmodium* parasites in contrast to the loss of *hrf* expression in mice which results in increased spontaneous apoptosis during embryogenesis (Susini *et al.*, 2008). Therefore, in mice, HRF is regarded as both a key intracellular anti-apoptotic regula-

tor beside other functions and as a secreted protein exerting extracellular biological functions. A possible explanation for the lack of lethality of HRFΔ mutants we obtained in our laboratory is that *Plasmodium* parasites have preferentially selected extracellular functions rather than essential intracellular functions of HRF for a better fitness within infected hosts.

The HRF mutant was specifically inhibited during liver-stage development *in vivo*. *In vitro*, mutant development was normal in cultured hepatocytes and, *in vivo*, the mutant was not significantly impaired in leaving the skin and reaching the blood, or in leaving the blood and reaching hepatocytes. In the liver, mutant development was slowed though not blocked, as shown by qRT-PCR analysis of parasite amounts over time. However, the impaired development of HRF mutant liver stages *in vivo* is likely to induce some parasite death, as suggested by intravital imaging studies. This resulted in a 10^2 - to 10^3 -fold reduction in the numbers of merozoites initially released in the blood, and an extension of the time between sporozoite injection and a threshold of parasitaemia. This prolonged liver-stage development influenced the clinical outcome of a parasite infection by decreasing the frequency of CM. A link between expression of ECM in susceptible C57BL/6 mice and a lengthy development period of parasite in the liver was already suggested by other *P. berghei* parasites deficient in apicoplast protein important for liver merozoite formation (PALM) (*palm*), which displayed a strong impairment in liver merozoite formation with a severe delay in blood-stage infection and a reduced incidence of ECM (Haussig *et al.*, 2011). Our data strengthen the wider concept that the efficiency of pre-erythrocytic infection controls CM occurrence during erythrocytic infection.

Like other pathogens, *Plasmodium* must fine-tune activation/inhibition of host immune effector cells to ensure host survival and parasite dissemination. However, few examples exist in the literature describing particular pathogen genes that manipulate specific host immune response pathways, in particular *Plasmodium*-associated genes regulating specific host cytokine

responses. Three lines of evidence indicate that the mutant defect is mainly caused by increased IL-6 in the infected host. (i) IL-6 increase in the mutant-infected liver was the earliest detectable difference with WT among the tested factors, while the earliest cellular difference was an increase in B-cell counts in the mutant, in line with the B-cell-activating activity of IL-6. (ii) The mutant defect was complemented by decreasing IL-6 levels in the host, using injection of anti-IL6 antibodies in WT mice or infection in IL-6^{ko} mice. (iii) Recombinant HRF was sufficient to inhibit LPS-induced IL-6 production in the liver and release in the circulation. Therefore, although HRF might still have other targets than IL-6, the defective phenotype of the mutant appears to be largely caused by unrepressed IL-6.

How the parasite controls IL-6 expression via HRF remains unclear. During the initial phase of the liver development, the main target of IL-6-producing cells appears to be neutrophils, in which IL-6 production was enhanced by the HRF Δ 1 parasite. Consistent with this finding, IL-6 was previously found in murine neutrophils as a pre-stored protein, which makes it readily available upon stimulation (Terebuh *et al.*, 1992). Evidence that HRF is able to directly prevent or inhibit IL-6 production was provided by the direct inhibitory effect of HRF on LPS-induced cytokine production. At the same time, B-cells increase in number, perhaps as a result of increased IL-6 production. The interplay between neutrophils and B-cells via IL-6 may represent the mechanism by which the delayed development of the mutant parasite occurs. Such an interplay between neutrophils and B-cells has been recently elegantly demonstrated by the discovery of a B-helper neutrophil population whereby splenic neutrophils can function as professional helper cells for marginal zone B-cells, leading to the generation of affinity-matured antibodies (Puga *et al.*, 2012). However, using B-cell-deficient C57BL/6 *mu*MT mice, homozygous for the *Ighm*^{tm1Cgn} targeted mutation, the phenotype of the mutant was similar in B-cell-deficient and WT mice. This suggests that B-cells are not involved in protection during infection with HRF Δ 1 parasites.

Both the sporozoite and the intracellular liver stage produce HRF (Fig. 2). The extracellular sporozoite might secrete HRF during gliding motility and/or the liver stage might export HRF through the PVM and out of the infected cell. Here, we showed that HRF from *Plasmodium berghei* was secreted by infected HepG2 cells in the culture supernatant and *in vivo* in the liver of infected mice (Fig. 8). Histamine-releasing factor secretion by liver stages might occur via exosomes. In the human embryonic kidney 293T cells, HRF was found secreted via a non-classical route and exosomes (Amzallag *et al.*, 2004). Immunofluorescence and immunoelectron microscopy studies on *P. falciparum* show that some of the malarial HRF is present in the food vacuole membranes,

where it is in proximity to the heme-rich food vacuole (Bhisutthibhan *et al.*, 1999).

Whether mammalian and malarial HRF, despite their high (54%) similarity, have similar targets and modes of action remains uncertain. Mammalian HRF was reported to act on basophils, eosinophils and B-cells (Macdonald, 2012). Interestingly, HRF was reported to increase IL-6 production from B-cells. Examination of immune cells at early time point, 40 h post-infection, indicated a unique association between the absence of HRF expression and an increased accumulation of B-cells. One of the characteristic features in malaria infection is the induction of short-lived B-cell memory. It has been shown that malaria parasites interfere with the immune response by disabling B-cell development, possibly undergoing apoptosis (Wykes *et al.*, 2005). In light of these findings, increased B-cell population in the liver of mice infected with mutant parasites reflects the possibility that the HRF molecule could interfere with B-cell memory. In support of this observation, early rise in IL-6 induction, a B-cell-activating and anti-apoptotic cytokine, at 40 h post-infection was induced by mutant parasites. *Plasmodium falciparum* HRF stimulates histamine release from basophils and IL-8 secretion from eosinophils *in vitro* (Bheekha-Escura *et al.*, 2000; MacDonald *et al.*, 2001). We showed here that *P. berghei* HRF is sufficient to decrease IL-6 production in the liver. Numerous cell types produce IL-6 in the liver, including T-cells, macrophages, endothelial cells and hepatocytes themselves, where it eventually exerts its anti-parasite effect. Clearly, HRF does not affect the levels of IL-6 only, as co-injection of HRF with LPS down-regulates other pro-inflammatory cytokines like IFN- γ , TNF- α and IL-1. More work is needed to understand the mode of action of malarial HRF.

Few molecules of malaria parasites have been shown to counteract host innate immunity. In early liver stages, the major sporozoite surface protein called circumsporozoite protein translocates into the hepatocyte cytosol and nucleus, where it outcompetes NF- κ B nuclear import and suppresses hundreds of genes involved in the host inflammatory response. Another parasite product, the migration inhibitory factor (MIF) orthologue of mammalian MIF, was shown to increase inflammatory cytokine production during the blood phase of infection in rodents and to induce antigen-experienced CD4 T-cells to develop into short-lived effector cells rather than into memory cells, causing decreased CD4 T-cell recall responses to homologous parasites (Sun *et al.*, 2012). However, parasites lacking MIF were shown to have no growth defect throughout the parasite life cycle in *P. berghei* (Augustijn *et al.*, 2007) or a growth defect during liver-stage development in *P. yoelii* (Miller *et al.*, 2012) although in this latter case, the causes of MIF-deficient liver-stage attenuation were not investigated.

In conclusion, *Plasmodium* HRF is the first secreted parasite molecule that is found to down-regulate host cytokines, in particular IL-6, which inhibits the development of the *Plasmodium* liver stage. The importance of the contribution of HRF to *Plasmodium* liver-stage development makes it an attractive target for intervention strategies, given its secreted nature and diffuse action a target of antibody-mediated immunity.

Experimental procedures

Ethics statement

All animal care and experiments described in the present study involving mice were conducted at the Institut Pasteur, approved by the 'Direction Départementale des Services Vétérinaires' de Paris, France (Permit Number N° 75-066 issued on September 14, 2009) and performed in compliance with institutional guidelines and European regulations (http://ec.europa.eu/environment/chemical?s/lab_animals/home_en.htm). A statement of compliance with the French Government's ethical and animal experiment regulations was issued by the Ministère de l'Enseignement Supérieur et de la Recherche under the number 00218.01.

Mice

Seven- to eight-week-old female C57BL/6J Rj mice were purchased from Charles River Laboratories. The IL-6^{KO} mice have been backcrossed 10 times on C57BL/6 mice from the Jackson Laboratory. To make sure the background of IL-6^{KO} mice does not alter at least the course of infection and disease in our ECM model, comparable survival rates and parasitaemia are shown between IL-6^{KO} mice and C57BL/6J Rj used as WT control in this study. C57BL/6 *mu*MT mice, homozygous for the *Ighm*^{tm1Cgn} targeted mutation and lacking mature B-cells were obtained from The Jackson Laboratory, Bar Harbor, ME, USA.

Parasites

Mice were inoculated with red blood cells (RBCs) infected with either GFP-transgenic *P. berghei* ANKA (MRA-867) or HRFΔ1 *PbANKA* parasites. In a few control experiments, HRFΔ2 and HRFΔ3 *PbANKA* parasites were used. The *P. berghei* deficient for the *Pbs36* gene (van Dijk *et al.*, 2005; Ishino *et al.*, 2005; Labaied *et al.*, 2007), the disruption of which was previously found to nearly abolish sporozoite infectivity in the mammalian liver host was kindly provided by Dr. T. Ishino (Department of Medical Zoology, Mie University School of Medicine, Edobashi, Tsu, Japan).

Murine model of ECM

Six- to eight-week-old C57BL/6 mice were inoculated with 10⁵ RBCs infected with *PbANKA* or their knockout counterparts. Parasites, before every experiment, were reactivated by previous passage in C57BL/6 mice. Parasitaemia was determined by flow cytometry and the results expressed in percentage of pRBCs.

C57BL/6 mice infected with *PbANKA* or HRFΔ *PbANKA* were monitored for clinical symptoms of ECM: hemi- or paraplegia, deviation of the head, tendency to roll over on stimulation, ataxia and convulsions.

Quantification of parasite loads in the liver

C57BL/6J Rj mice were injected IV or ID with 10 000 WT or HRFΔ1 sporozoites. Forty hours later, livers were isolated and total RNA extracted. Parasite load was determined by using primers specific for the *P. berghei* 18S rRNA (forward: 5'-AAGCATTAAATAAAGCGAATACATCCTTAC-3' and reverse: 5'-GGAGATTGGTTTTGACGTTTATGTG-3'). Gene mRNA expression measured by real-time RT-PCR is normalized to the endogenous control gene HPRT.

For kinetic studies spanning 6 days after sporozoite inoculation, groups of C57BL/6J Rj mice were injected IV with 10 000 GFP-WT or GFP-HRFΔ1 sporozoites and livers were collected at indicated time points. To avoid possible contamination of liver stages by blood-stage parasites, we decided to use LISP1 as a specific marker for late stage liver merozoites. Parasite loads in the liver were assessed by measuring parasite LISP1 mRNA by real-time RT-PCR. Gene mRNA expression was normalized to the parasite control gene HSP70.

Detection and quantification of HRF

A plasmid containing the DNA encoding for the *PbNK65* HRF was obtained from Kim Taylor (RMIT University, Australia). *PbHRF* plasmid was in pRSET A (Life Technologies Paisley, United Kingdom), with an N-terminal his tag and *E. coli* BL21 was used for expression. Bacteria grew in a 10 ml overnight preculture in LB medium with 100 μg ml⁻¹ ampicillin, and we then inoculated 500 μl of LB with 1–2% of the preculture. The culture was kept at 37°C for ~ 3 h until the OD at 600 nm was ~ 0.5. The expression was then induced for 3 h with 1 mM IPTG. We used freeze/thaw cycles and lysozyme to lyse the bacteria, followed by filtration through a 0.2 μm syringe filter. Purification was performed by using the Profinity resin from Bio-Rad (Marnes-la-Coquette, France). Endotoxin was removed by passing HRF solution on Detoxi-Gel Endotoxin Removing Gel column (Thermo Fisher Scientific, Brebières, France). The recombinant protein (100 μg) was injected intradermally into the back skin of a rabbit in the presence of complete Freund's adjuvant followed by two booster injections in the presence of incomplete Freund's adjuvant. Rabbit IgG antibodies were isolated using a protein A column as an immunoabsorbent. For intracellular detection of HRF, isolated sporozoites were washed in phosphate buffered saline (PBS) buffer and resuspended in fixation/permeabilization solution (BD Pharmingen) in the presence of anti-HRF rabbit antibodies for 20 min at 4°C. Fixed/permeabilized sporozoites were resuspended in Perm/Wash buffer and incubated with Allophycocyanin (APC)-anti-rabbit antibodies before flow cytometric analysis. A total of 4 × 10⁵ living cells were analysed using a four-colour FACSCalibur flow cytometer with ProCellQuest software (BD Biosciences, Mountain View, CA, USA). *In vivo* production of HRF by hepatic merozoites was demonstrated by ID inoculation of 100 000 sporozoite to C57BL/6 mice, and 40 h post-infection liver extracts were made. Quantitative determination of HRF in the

liver and in the plasma was performed by using quantitative ELISA sandwich using anti-HRF rabbit antibody as capture and a range of concentrations of recombinant HRF for the titration curve and the same rabbit antibody labelled with horse radish peroxidase for detection. Liver extract from naïve mice was used as negative control.

Western blot

Supernatant samples (14 µl) of HepG2 cells cultured in the presence of sporozoites were loaded onto 4–12% pre-cast gel gradients (Bolt Bis-Tris Plus; Life Technologies, Carlsbad, CA, USA). Gels were placed in the Novex Bolt Mini Gel system (Life Technologies). At the completion of SDS-PAGE, the gel was washed in distilled water and assembled with the iBlot Gel Transfer Stacks (Life Technologies). At the completion of the Western transfer, the membrane was removed from the sandwich and was incubated in blocking solution for 1 h, shaking (5% milk solution in PBS tween 0.01%), then incubated with the rabbit anti-HRF antibody in diluent solution overnight shaking at 4°C.

The membrane was washed three times with PBS tween 0.01% shaking for 10 min, and then incubated in biotinylated-goat anti-rabbit antibody (Life Technologies) for 1 h, shaking at room temperature. The membrane was washed three times in PBS tween for 10 min shaking, and then was incubated with HRPO-streptavidine for 1 h at room temperature. After several washings, the membrane was incubated in a solution of Supersignal West Pico Chemiluminescent substrate (Thermo Scientific, Rockford, IL, USA) in the dark. The blot was recorded either by scanning the image or by photography.

Sporozoite development in HepG2 cells and intracellular detection of HRF

HepG2 cells ($3\text{--}4 \times 10^4$ per well) were plated in eight-well chamber slides (Lab-Tek® Chamber Slide™) and cultured overnight in DMEM + GlutaMAX-I media (Gibco) supplemented with 10% heat inactivated FBS (Fetal Bovine Serum, Gibco) at 37°C in the presence of 5% CO₂. Wild type and/or mutant purified *P. berghei* salivary gland sporozoites were used for HepG2 infection at a ratio of 1:1 (parasite/cells) for 48 h, at 37°C, 5% CO₂ in the presence of PSN (penicillin-streptomycin-neomycin solution, Sigma). The *Pb*HRF was detected by immunofluorescence staining as described above.

HepG2 cells fixation and permeabilization was done with 4% paraformaldehyde + 0.1% triton or acetone 1:1 mix, and blocked with 1% gelatin from porcine skin (Sigma) for 30 min at RT. Thereafter, cells were incubated with anti-HRF rabbit antibodies (diluted 1:500) at 4°C overnight, and then incubated with Alexa Fluor® 568 donkey anti-rabbit IgG (Life Technologies; diluted 1:500) and 0.02 mg/ml 4', 6-diamidino-2-phenylindole (DAPI) for nuclear staining for 30 min at RT. The presence of *Pb*HRF was detected under the fluorescence microscope. Similar IFA was performed to detect HRF in sporozoites.

Flow cytometric analysis of liver leukocytes

Liver cells obtained after various periods of time after infection were stained for FACS analysis according to standard protocols in cold PBS containing 2% Fetal calf serum (FCS) and 0.01%

sodium azide (FACS buffer) with the following Abs: APC-labelled CD4, phycoerythrin (PE)-labelled anti-CD8, Fluorescein isothiocyanate (FITC)-labelled anti-F4/80 antibody, and PE-labelled anti-Ly6G antibody, Alexa Fluor 647-labelled anti-B220, APC-anti-NK1.1 antibodies. Red blood cells were eliminated using cell lysis buffer, and cells were washed in FACS buffer. A total of 4×10^5 living cells were analysed using a four-colour FACSCalibur flow cytometer with ProCellQuest software (BD Biosciences, Mountain View, California).

Cytokine and chemokine quantification in the liver

Cytokine and chemokine expression in the liver taken at different periods of time after infection was analysed by the real-time RT-qPCR. RNA utilized for these assays was isolated by means of a two-step extraction process. First, livers were surgically removed from mice as previously described and placed immediately in RNAlater at 4°C overnight. After RNAlater infused the samples, it was removed and samples were maintained at –80°C until processing. Livers were thawed in 1 ml of Trizol and subjected to bead disruption in a polytron three times from 2 min at a setting of 30 cycles per second. Samples were spun at high speed (10 000× g) for 3 min to remove debris and lipids. Half of the sample was transferred to a new tube and mixed with 500 µl of Trizol reagent by vortexing. Following this step, RNA extraction proceeded according to manufacturer's protocol. Precipitated RNA was resuspended in 100 µl of RNase-free water. The second step of this extraction was followed by Qiagen's protocol for RNA clean-up including steps for removal of protein and DNA (Qiagen RNeasy Kit). Samples were eluted with 50 µl of RNase-free water and quality and quantity assured by photospectroscopy. Real-time RT-qPCR utilized various primer-probe sets and standard Taqman protocols (Applied Biosystems).

Assessment of cell traversal

To determine the ability of sporozoites to traverse host cells, a standard cell traversal assay was used. GFP-labelled WT and HRFΔ1 sporozoites, isolated from *Anopheles stephensi* mosquito salivary glands, were incubated with human HepG2 cells, grown in 24-well plates in the presence of rhodamine dextran. After 3 h, the cells were washed with PBS/1% FCS, fixed and analysed by FACS using a BD Bioscience FACSCalibur flow cytometer. Percentage of traversed HepG2 cells was labelled with rhodamine dextran.

Intravital microscopy and development of EEF

Freshly isolated WT or HRFΔ1 sporozoites were resuspended in Ringer's solution containing 1% FBS, and allowed to glide on glass-bottom dishes (MatTek Corp., Ashland, MA, USA) precoated with 2% FCS. Video microscopy was conducted using a Zeiss Axiovert equipped with phase-contrast and epifluorescence microscopy. Time-lapse images and videos were collected under low-light illumination with a Hamamatsu ORCA ER camera (Hamamatsu Photonics KK, Hamamatsu, Japan). Videos were recorded digitally at approximately eight frames per second. Colours represent different frames from a time-lapse movie.

Development of EEF of HRFΔ1 as compared with WT *Pb* ANKA sporozoites was assessed by plating HepG2 cells (10^5 in

1 ml) in 8-well Labtek chamber slides for 24 or 48 h, respectively, in the presence of 2.5×10^4 genetically GFP tagged WT or HRF Δ 1 sporozoites. Cells were examined with a fluorescence microscope. Exo-erythrocytic forms in each well were counted and expressed as EEFs \pm SD of duplicate wells. Exo-erythrocytic forms were counted randomly and expressed as number of EEF per field.

In vivo treatment with IL-6 and anti-IL-6 antibodies

C57BL/6 mice were injected IV with 5 μ g of human recombinant IL-6 (kindly provided by Barbara Willi, Novartis Pharma AG, Basel, Switzerland) in 200 μ l of sterile PBS 15 min before sporozoite inoculation. To neutralize endogenous IL-6, recipient mice were injected IV with 1 mg per mouse of anti-IL-6 (rat anti-mIL-6 IgG1 MP5-32C11 kindly provided by Dr Paola Minoprio, Institut Pasteur, Paris), or with 1 mg per mouse of isotype control (rat IgG1), 1 day prior to sporozoite inoculation. The rat anti-mouse IL-6 neutralizing mAb is a very potent and specific antagonist of mouse IL-6 bioactivity.

Determination of IL-6 in the plasma of infected mice was performed using ELISA kit assays according to the manufacturer's instructions (BD Biosciences, San Diego, CA, USA).

Statistical analysis

Significant differences in survival were evaluated by generation of Kaplan–Meier plots and log-rank analysis. $P < 0.05$ was considered statistically significant. For parasitaemia, after verification using a Jarque–Bera test, our data did not follow normal distribution, and thus, when differences between groups of mice were to be compared at a given time point, the Mann–Whitney test was performed with significance set at $P < 0.05$.

Acknowledgements

We thank Peter Smooker and Kim Taylor (Department of Biotechnology and Environmental Biology, RMIT University, Bundoora, Australia) for providing *P. berghei* HRF plasmid. We are grateful to Barbara Willi, Novartis Pharma AG, Basel, Switzerland, and Lionel Apetoh, Dr Lionel Apetoh (INSERM U866, Dijon, France) for providing human recombinant IL-6 and IL-6^{KO} mice respectively. We thank CEPIA (Centre d'élevage, de production et d'infection des anophèles, Institut Pasteur) for providing anophèles mosquitoes. We also thank the Helmut Horten Foundation for the financial support provided to CDG.

References

Amzallag, A., Passer, B.J., Allanic, D., Segura, E., Théry, C., Goud, B., *et al.* (2004) TSAP6 facilitates the secretion of translationally controlled tumour protein/histamine-releasing factor via a nonclassical pathway. *J Biol Chem* **279**: 46104–46122.

Arcuri, F., Papa, S., Carducci, A., Romagnoli, R., Liberatori, S., Riparbelli, M.G., *et al.* (2004) Translationally controlled tumor protein (TCTP) in the human prostate and prostate cancer cells: expression, distribution, and calcium binding activity. *Prostate* **60**: 130–140.

Augustijn, K.D., Kleemann, R., Thompson, J., Kooistra, T., Crawford, C.E., Reece, S.E., *et al.* (2007) Functional characterization of the *Plasmodium falciparum* and *P. berghei* homologues of macrophage migration inhibitory factor. *Infect Immun* **75**: 1116–1128.

Beghdadi, W., Porcherie, A., Schneider, B.S., Dubayle, D., Peronet, R., Huerre, M., *et al.* (2008) Inhibition of histamine-mediated signaling confers significant protection against severe malaria in mouse models of disease. *J Exp Med* **205**: 395–408.

Bhattacharya, U., Roy, S., Kar, P.K., Sarangi, B., and Lahiri, S.C. (1988) Histamine & kinin system in experimental malaria. *Indian J Med Res* **88**: 558–563.

Bheekha-Escura, R., MacGlashan, D.W., Langdon, J.M., and MacDonald, S.M. (2000) Human recombinant histamine-releasing factor activates human eosinophils and the eosinophilic cell line, AML14-3D10. *Blood* **96**: 2191–2198.

Bhisutthibhan, J., Philbert, M.A., Fujioka, H., Aikawa, M., and Meshnick, S.R. (1999) The *Plasmodium falciparum* translationally controlled tumor protein: subcellular localization and calcium binding. *Eur J Cell Biol* **78**: 665–670.

Butler, N.S., Schmidt, N.W., Vaughan, A.M., Aly, A.S., Kappe, S.H., and Harty, J.T. (2011) Superior antimalarial immunity after vaccination with late liver stage-arresting genetically attenuated parasites. *Cell Host Microbe* **9**: 451–462.

Chitpatima, S.T., Makrides, S., Bandyopadhyay, R., and Brawerman, G. (1988) Nucleotide sequence of a major messenger RNA for a 21 kilodalton polypeptide that is under translational control in mouse tumour cells. *Nucleic Acids Res* **16**: 2350.

Chung, S., Kim, M., Choi, W., Chung, J., and Lee, K. (2000) Expression of translationally controlled tumor protein mRNA in human colon cancer. *Cancer Lett* **156**: 185–190.

van Dijk, M.R., Douradinha, B., Franke-Fayard, B., Heussler, V., van Dooren, M.W., van Schaijk, B., *et al.* (2005) Genetically attenuated, P36p-deficient malarial sporozoites induce protective immunity and apoptosis of infected liver cells. *Proc Natl Acad Sci USA* **102**: 12194–12199.

Enwonwu, C.O., Afolabi, B.M., Salako, L.O., Idigbe, E.O., and Bashirelah, N. (2000) Increased plasma levels of histidine and histamine in falciparum malaria: relevance to severity of infection. *J Neural Transm* **107**: 1273–1287.

Fenner, B.J., Scannell, M., and Prehn, J.H. (2010) Expanding the substantial interactome of NEMO using protein microarrays. *PLoS ONE* **5**: e8799.

Gachet, Y., Tournier, S., Lee, M., Lazaris-Karatzas, A., Poulton, T., and Bommer, U.A. (1999) The growth-related, translationally controlled protein P23 has properties of a tubulin binding protein and associates transiently with microtubules during the cell cycle. *J Cell Sci* **112** (Part 8): 1257–1271.

Gross, B., Gaestel, M., Boehm, H., and Bielka, H. (1989) cDNA sequence coding for a translationally controlled human tumour protein. *Nucleic Acids Res* **17**: 8367.

Haussig, J.M., Matuschewski, K., and Kooij, T.W. (2011) Inactivation of a *Plasmodium apicoplast* protein attenuates formation of liver merozoites. *Mol Microbiol* **81**: 1511–1525.

Heppner, D.G., Jr, Kester, K.E., Ockenhouse, C.F., Tornieporth, N., Ofori, O., Lyon, J.A., *et al.* (2005) Towards an RTS,S-based, multi-stage, multi-antigen vaccine

- against falciparum malaria: progress at the Walter Reed Army Institute of Research. *Vaccine* **23**: 2243–2250.
- Ishino, T., Chinzei, Y., and Yuda, M. (2005) Two proteins with 6-cys motifs are required for malarial parasites to commit to infection of the hepatocyte. *Mol Microbiol* **58**: 1264–1275.
- Ishino, T., Orito, Y., Chinzei, Y., and Yuda, M. (2006) A calcium-dependent protein kinase regulates Plasmodium ookinete access to the midgut epithelial cell. *Mol Microbiol* **59**: 1175–1184.
- Kashiwakura, J.C., Ando, T., Matsumoto, K., Kimura, M., Kitaura, J., Matho, M.H., et al. (2012) Histamine-releasing factor has a proinflammatory role in mouse models of asthma and allergy. *J Clin Invest* **122**: 218–228.
- Labaid, M., Harupa, A., Dumpit, R.F., Coppens, I., Mikolajczak, S.A., and Kappe, S.H. (2007) Plasmodium yoelii sporozoites with simultaneous deletion of P52 and P36 are completely attenuated and confer sterile immunity against infection. *Infect Immun* **75**: 3758–3768.
- Macdonald, S.M. (2012) Potential role of histamine releasing factor (HRF) as a therapeutic target for treating asthma and allergy. *J Asthma Allergy* **5**: 51–59.
- MacDonald, S.M., Rafnar, T., Langdon, J., and Lichtenstein, L.M. (1995) Molecular identification of an IgE-dependent histamine-releasing factor. *Science* **269**: 688–690.
- MacDonald, S.M., Bhisutthibhan, J., Shapiro, T.A., Rogerson, S.J., Taylor, T.E., Tembo, M., et al. (2001) Immune mimicry in malaria: Plasmodium falciparum secretes a functional histamine-releasing factor homolog *in vitro* and *in vivo*. *Proc Natl Acad Sci USA* **98**: 10829–10832.
- Maegraith, B., and Fletcher, A. (1972) The pathogenesis of mammalian malaria. *Adv Parasitol* **10**: 49–75.
- Maheshwari, R.K. (1990) The role of cytokines in malaria infection. *Bull World Health Organ* **68** (Suppl.): 138–144.
- Miller, J.L., Harupa, A., Kappe, S.H., and Mikolajczak, S.A. (2012) Plasmodium yoelii macrophage migration inhibitory factor is necessary for efficient liver-stage development. *Infect Immun* **80**: 1399–1407.
- Nemeth, E., Rivera, S., Gabayan, V., Keller, C., Taudorf, S., Pedersen, B.K., and Ganz, T. (2004) IL-6 mediates hypoferrremia of inflammation by inducing the synthesis of the iron regulatory hormone hepcidin. *J Clin Invest* **113**: 1271–1276.
- Nussler, A., Drapier, J.C., Renia, L., Pied, S., Miltgen, F., Gentilini, M., and Mazier, D. (1991) L-arginine-dependent destruction of intrahepatic malaria parasites in response to tumor necrosis factor and/or interleukin 6 stimulation. *Eur J Immunol* **21**: 227–230.
- Pelleau, S., Diop, S., Dia Badiane, M., Vitte, J., Beguin, P., Nato, F., et al. (2012) Enhanced basophil reactivities during severe malaria and their relationship with the Plasmodium falciparum histamine-releasing factor translationally controlled tumor protein. *Infect Immun* **80**: 2963–2970.
- Pied, S., Civas, A., Berlot-Picard, F., Renia, L., Miltgen, F., Gentilini, M., et al. (1992) IL-6 induced by IL-1 inhibits malaria pre-erythrocytic stages but its secretion is down-regulated by the parasite. *J Immunol* **148**: 197–201.
- Portugal, S., Drakesmith, H., and Mota, M.M. (2011) Superinfection in malaria: plasmodium shows its iron will. *EMBO Rep* **12**: 1233–1242.
- Puga, I., Cols, M., Barra, C.M., He, B., Cassis, L., Gentile, M., et al. (2012) B cell-helper neutrophils stimulate the diversification and production of immunoglobulin in the marginal zone of the spleen. *Nat Immunol* **13**: 170–180.
- Rho, S.B., Lee, J.H., Park, M.S., Byun, H.J., Kang, S., Seo, S.S., et al. (2011) Anti-apoptotic protein TCTP controls the stability of the tumor suppressor p53. *FEBS Lett* **585**: 29–35.
- Rid, R., Onder, K., Trost, A., Bauer, J., Hintner, H., Ritter, M., et al. (2010) H₂O₂-dependent translocation of TCTP into the nucleus enables its interaction with VDR in human keratinocytes: TCTP as a further module in calcitriol signalling. *J Steroid Biochem Mol Biol* **118**: 29–40.
- Schofield, L., Ferreira, A., Altszuler, R., Nussenzweig, V., and Nussenzweig, R.S. (1987) Interferon-gamma inhibits the intrahepatocytic development of malaria parasites *in vitro*. *J Immunol* **139**: 2020–2025.
- Schroeder, J.T., Lichtenstein, L.M., and MacDonald, S.M. (1997) Recombinant histamine-releasing factor enhances IgE-dependent IL-4 and IL-13 secretion by human basophils. *J Immunol* **159**: 447–452.
- Srichaikul, T., Archararit, N., Siriasawakul, T., and Viriyapanich, T. (1976) Histamine changes in Plasmodium falciparum malaria. *Trans R Soc Trop Med Hyg* **70**: 36–38.
- Sun, T., Holowka, T., Song, Y., Zierow, S., Leng, L., Chen, Y., et al. (2012) A Plasmodium-encoded cytokine suppresses T-cell immunity during malaria. *Proc Natl Acad Sci USA* **109**: E2117–E2126.
- Susini, L., Besse, S., Duflaut, D., Lespagnol, A., Beekman, C., Fiucci, G., et al. (2008) TCTP protects from apoptotic cell death by antagonizing bax function. *Cell Death Differ* **15**: 1211–1220.
- Terebuh, P.D., Otterness, I.G., Strieter, R.M., Lincoln, P.M., Danforth, J.M., Kunkel, S.L., and Chensue, S.W. (1992) Biologic and immunohistochemical analysis of interleukin-6 expression *in vivo*. Constitutive and induced expression in murine polymorphonuclear and mononuclear phagocytes. *Am J Pathol* **140**: 649–657.
- Vercoutter-Edouart, A.S., Czeszak, X., Crepin, M., Lemoine, J., Boilly, B., Le Bourhis, X., et al. (2001) Proteomic detection of changes in protein synthesis induced by fibroblast growth factor-2 in MCF-7 human breast cancer cells. *Exp Cell Res* **262**: 59–68.
- Vonakis, B.M., Sora, R., Langdon, J.M., Casolaro, V., and MacDonald, S.M. (2003) Inhibition of cytokine gene transcription by the human recombinant histamine-releasing factor in human T lymphocytes. *J Immunol* **171**: 3742–3750.
- Vreden, S.G., van den Broek, M.F., Oettinger, M.C., Verhave, J.P., Meuwissen, J.H., and Sauerwein, R.W. (1992) Cytokines inhibit the development of liver schizonts of the malaria parasite Plasmodium berghei *in vivo*. *Eur J Immunol* **22**: 2271–2275.
- Wykes, M.N., Zhou, Y.H., Liu, X.Q., and Good, M.F. (2005) Plasmodium yoelii can ablate vaccine-induced long-term protection in mice. *J Immunol* **175**: 2510–2516.

- Xu, A., Bellamy, A.R., and Taylor, J.A. (1999) Expression of translationally controlled tumour protein is regulated by calcium at both the transcriptional and translational level. *Biochem J* **342**: 683–689.
- Yang, Y., Yang, F., Xiong, Z., Yan, Y., Wang, X., Nishino, M., *et al.* (2005) An N-terminal region of translationally controlled tumor protein is required for its antiapoptotic activity. *Oncogene* **24**: 4778–4788.
- Zhang, D., Li, F., Weidner, D., Mnjoyan, Z.H., and Fujise, K. (2002) Physical and functional interaction between myeloid cell leukemia 1 protein (MCL1) and Fortilin. The potential role of MCL1 as a fortilin chaperone. *J Biol Chem* **277**: 37430–37438.

Supporting information

Additional Supporting Information may be found in the online version of this article at the publisher's web-site:

Fig. S1. Disruption of the *PbHRF* gene. Schematic representation of the strategy utilized to knock out the *PbHRF* gene via double-crossover homologous recombination. Red lines represent regions of homology for recombination. Integration of the targeting sequence disrupt the HRF-coding sequence and replace it by drug resistance (*hDHFR*) marker. Specific PCR primers indicated genomic integration of the *hDHFR* targeting vector (within the *hrf/tctp* locus) within the *PbANKA* clone. A, B and C primers were used for PCR analysis. The amplicons are diagnostic for lane 1, wild-type locus; lane 2, integrated plasmid; lane 3, H₂O. (A) Band sizes corresponding to 2681 bp in lane 2 indicated the integration of the plasmid (*hDHFR* cassette (1600 bp) and 5' (487 bp) and 3' (594 bp) *PbHRF* UTRs). A PCR product of 1760 bp in lane 1 indicated wild-type locus. (B) In lane 2 a PCR product of 700 bp indicated the HRFΔ1 mutant. (C) PCR product of 1100 bp indicated the HRFΔ1 mutant. (D) Southern blot analysis of the *PbWT* and *PbHRFΔ1* mutant locus in *PbANKA* parasites. Genomic DNA was cleaved with EcoRV, transferred and probed with a HRF probe. The sizes of the bands are indicated in blue in locus representation. Line 1 represents the WT locus (1840 bp), whereas line 2 represents the genomic integration of the *hDHFR* targeting vector (2780 bp).

Fig. S2. Assessment of the phenotype of additional HRF-deficient clones. C57BL/6 mice were inoculated with 10 000 isolated WT or HRFΔ2 or HRFΔ3 *PbANKA*. (A) Parasitaemia (Mann–Whitney test; **P* < 0.02; ****P* < 0.001) and (B) Kaplan–Meier survival plots (log-rank test) were recorded over time. Results are from two independent experiments.

Fig. S3. Comparable gliding locomotion capacity, EEF formation, cell traversal ability and *in vivo* cycling of WT and HRFΔ1 *PbANKA* sporozoites. (A, B) Circular sporozoite motility of WT and HRFΔ1 *PbANKA* parasites expressing GFP fluorescence images of WT and HRFΔ1 sporozoites was tracked on glass cover slides. Individual frames are 2 s apart. The rings indicate the maximum intensity projection over 30 frames showing sporozoite gliding motility (arrows) or passive floating parasites (stars). (C) Percentage of gliding parasites expressed as a ratio between ring forms and total parasites, WT (54% ± 8), HRFΔ1 (48.8% ± 12). (D, E) Comparison of exoerythrocytic forms between cultured GFP-WT and GFP-HRFΔ1 *PbANKA* sporozoites on HepG2 cells for 24 h. EEFs in each well were counted and expressed as EEFs plus SD of duplicate wells.

EEFs were counted randomly and expressed as number of EEF per field. No significant difference was observed at both 24 and 48 h of culture. (F) Cell traversal was determined by counting wounded HepG2 cells labelled with rhodamine dextran and incubated with WT or HRFΔ1 sporozoites. Percentage of positive cells was determined by FACS analysis. Results shown are from two experiments. (G) Quantification of hepatic merozoites (EEFs) numbered on HepG2 cells cultured in the presence of WT or HRFΔ1 merozoites. Results shown are from two experiments. (H) HRFΔ1 parasites cycle normally between the anophel and the vertebrate host. Cages of 200 WT *PbANKA* or HRFΔ1 *PbANKA*-infected *Anopheles stephensi* female mosquitoes showing GFP-labelled sporozoites in their salivary glands were counted at day 20 post-blood feeding on infected C57BL/6 mice. Prevalence of infected mosquitoes was expressed as a ratio between positive ones and total mosquitoes. Sporozoites were extracted from salivary glands of 10 mosquitoes and counted. The number of sporozoites was expressed as per pair of salivary glands.

Fig. S4. HRFΔ1 sporozoites preferentially modulate the frequency and the magnitude of IL-6-producing neutrophils. C57BL/6 mice were inoculated IV with 10 000 isolated from WT or HRFΔ1 *PbANKA* parasites. (A) Liver leukocytes, taken 40 h post-infection, were gated on CD45⁺ cells and stained with anti-Ly6G-PE, anti-7/4-FITC, anti-CD11b-FITC, anti-CD11c-PE, anti-CD4-FITC, anti-CD8-PE, anti-B220-FITC, anti-F4/80-PECy5 and anti-IL-6-Alexa647. Indicated numbers show the proportion in this gate of various cell subsets expressing IL-6. (B) Proportion and mean fluorescence intensity of gated Ly6G⁺ 7/4⁺ neutrophils (R2) were determined for IL-6 expression in liver cells from WT and HRFΔ1 *PbANKA*-infected mice. Shown data are representative of one mouse out of three.

Fig. S5. Regulation of activation markers on leukocytes is independent of HRF at early time points of infection. C57BL/6 mice were inoculated IV with 10 000 isolated from WT or HRFΔ1 *PbANKA* parasites. Liver leukocytes, taken 40 h post-infection, were gated on CD45⁺ cells and stained with anti-Ly6G-PE, anti-CD19-FITC, anti-CD4-FITC, anti-CD8-PE, anti-B220-FITC combined with anti-CD62L as an activation marker and with anti-CD11c-PE combined with anti-MHC class II as an activation marker for these cells. Results are expressed as the % of respective cell markers and CD62L^{low} expression or MHC class II^{high} expression. Values are expressed as means ± SD obtained in three mice. For statistics in all graphs, **P* < 0.05 < 0.01, according to the Kruskal–Wallis test.

Fig. S6. B-cells are not involved in protection during infection with HRFΔ1 parasites. (A, B) C57BL/6 and B-cell-deficient muMT mice were inoculated IV with 10 000 sporozoites from WT or HRFΔ1 *PbANKA* parasites. Livers were taken 40 h after infection and total RNA extracted. Parasite loads and IL-6 expression were determined using real-time RT-PCR by measuring *P. berghei* 18S rRNA and IL-6 mRNA respectively. Gene expression was normalized to the endogenous control gene HPRT. Data are presented as the means ± SD (*n* = 5) from two independent experiments and whenever indicated, differences with the respective control groups were significant (Mann–Whitney test; **P* = 0.022, ***P* = 0.008). (C) Kaplan–Meier survival plots (log-rank test) were followed over time (*P* < 0.0004).

Fig. S7. Relationship between IL-6 and the reversibility of the phenotype of HRFΔ1 parasites. (A, B) effect of exogenous delivery of IL-6 on liver parasite load and IL-6 mRNA expression.

C57BL/6 mice were inoculated IV with 10 000 sporozoites from WT or HRF Δ 1 *Pb* ANKA parasites. Livers were taken 40 h after infection and total RNA extracted. Parasite loads and IL-6 expression were determined using real-time RT-PCR by measuring *P. berghei* 18S rRNA and IL-6 mRNA respectively. Gene expression was normalized to the endogenous control gene HPRT. Values are expressed as means \pm SD obtained in five mice. (C) Rescue of the phenotype of HRF Δ 1 *Pb* ANKA parasite

in IL-6^{KO} mice. IL-6^{KO} mice (seven mice per group) were infected IV with 10 000 GFP *Pb* ANKA WT or *Pb* ANKA HRF Δ 1 sporozoites and parasitaemia (Mann–Whitney test; * P = 0.02, ** P = 0.007) and survival rates (log-rank test) were followed over time.

Table S1. List of the oligonucleotides used for PCR of wild-type and recombinant parasites.

Appendix S1. Supporting experimental procedures.

Figure S1

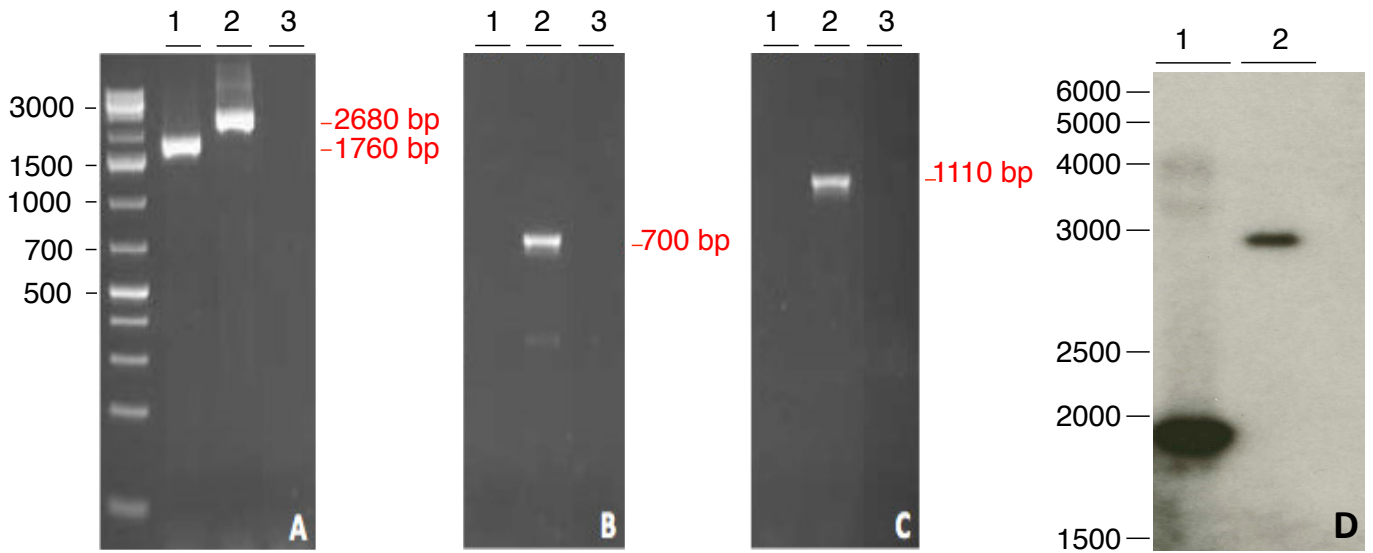
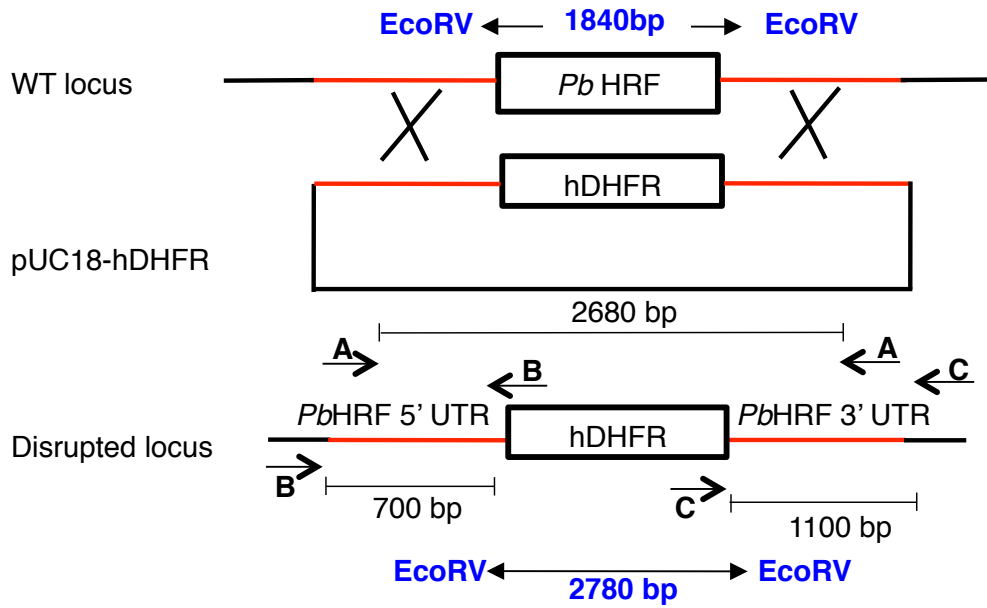

Figure S2

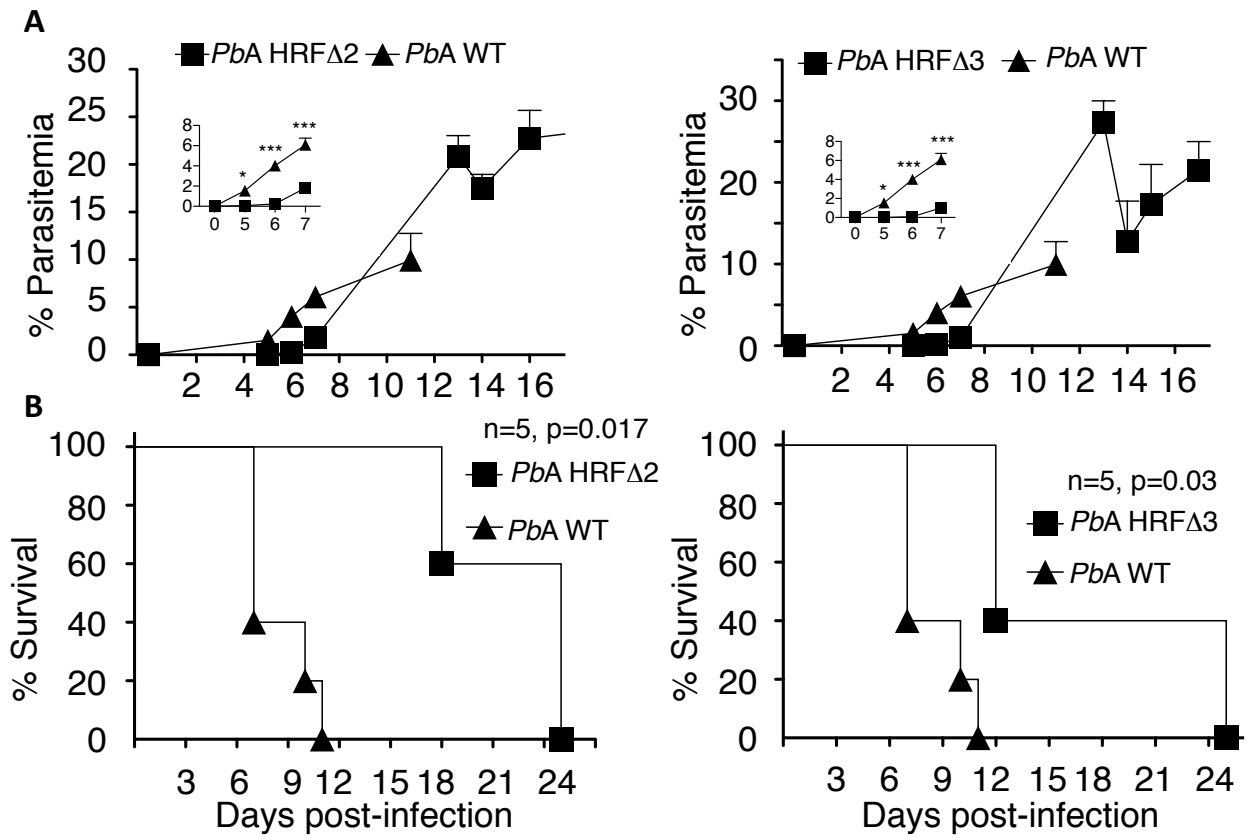

Figure S3

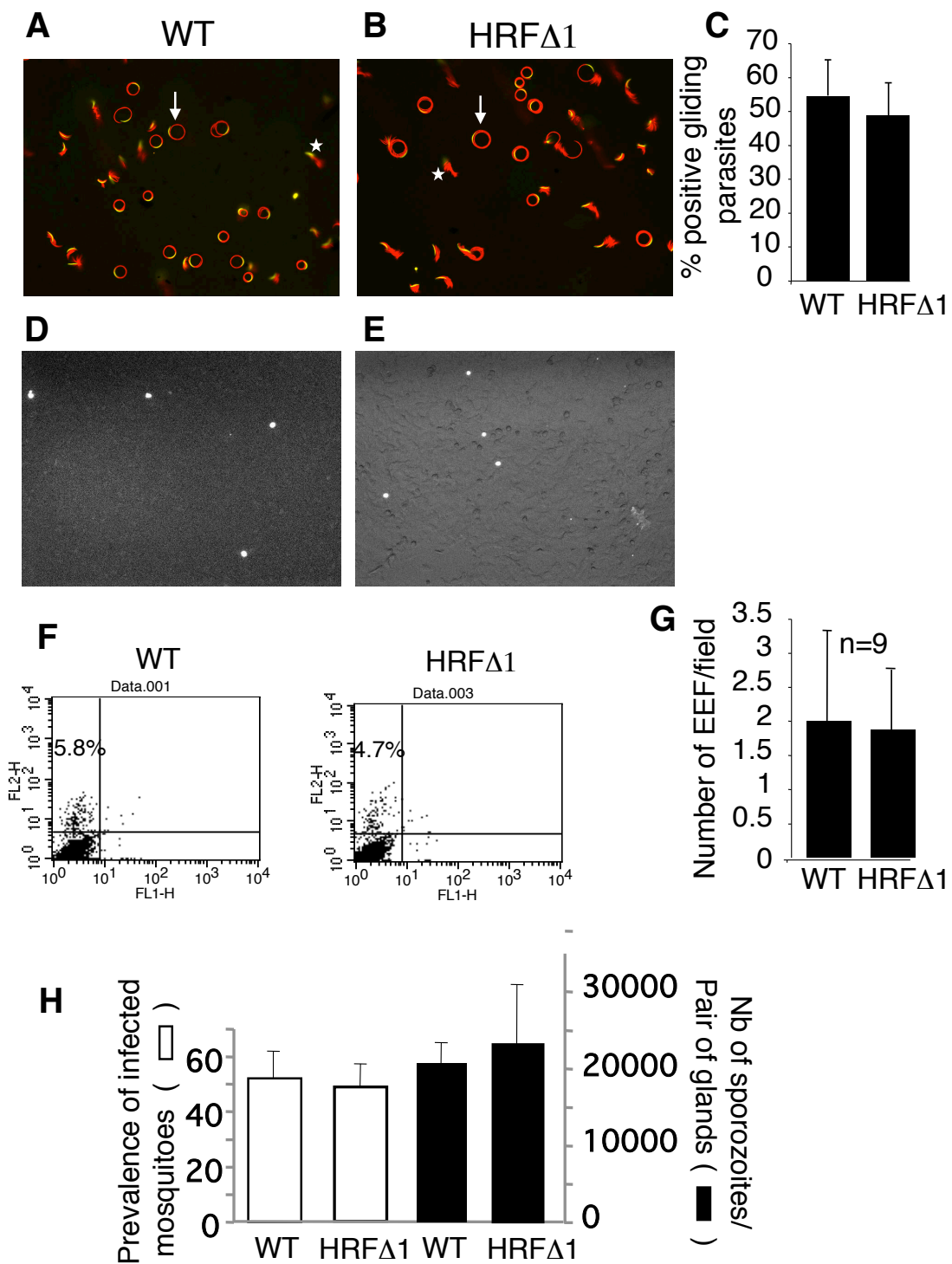

Figure S4

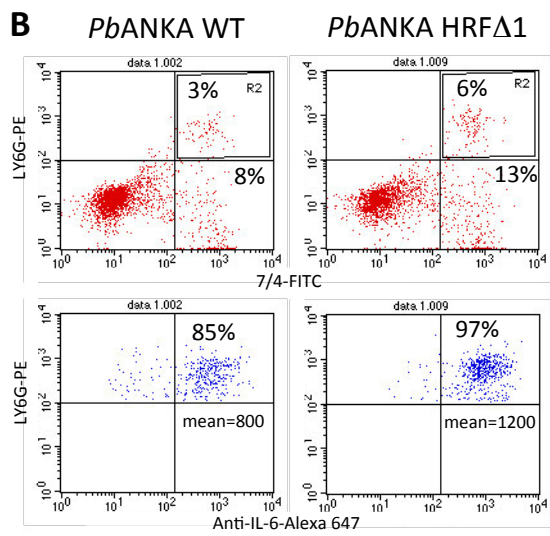
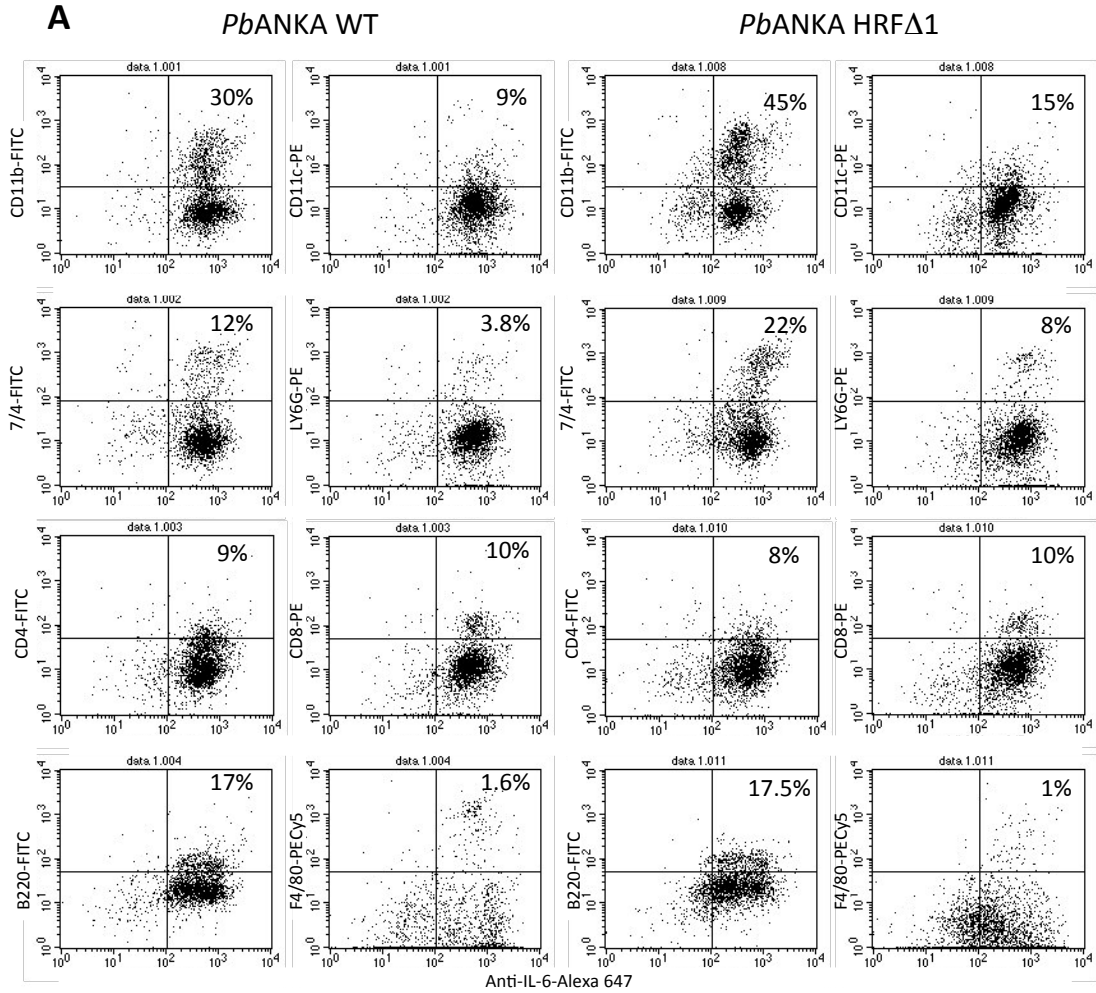

Figure S5

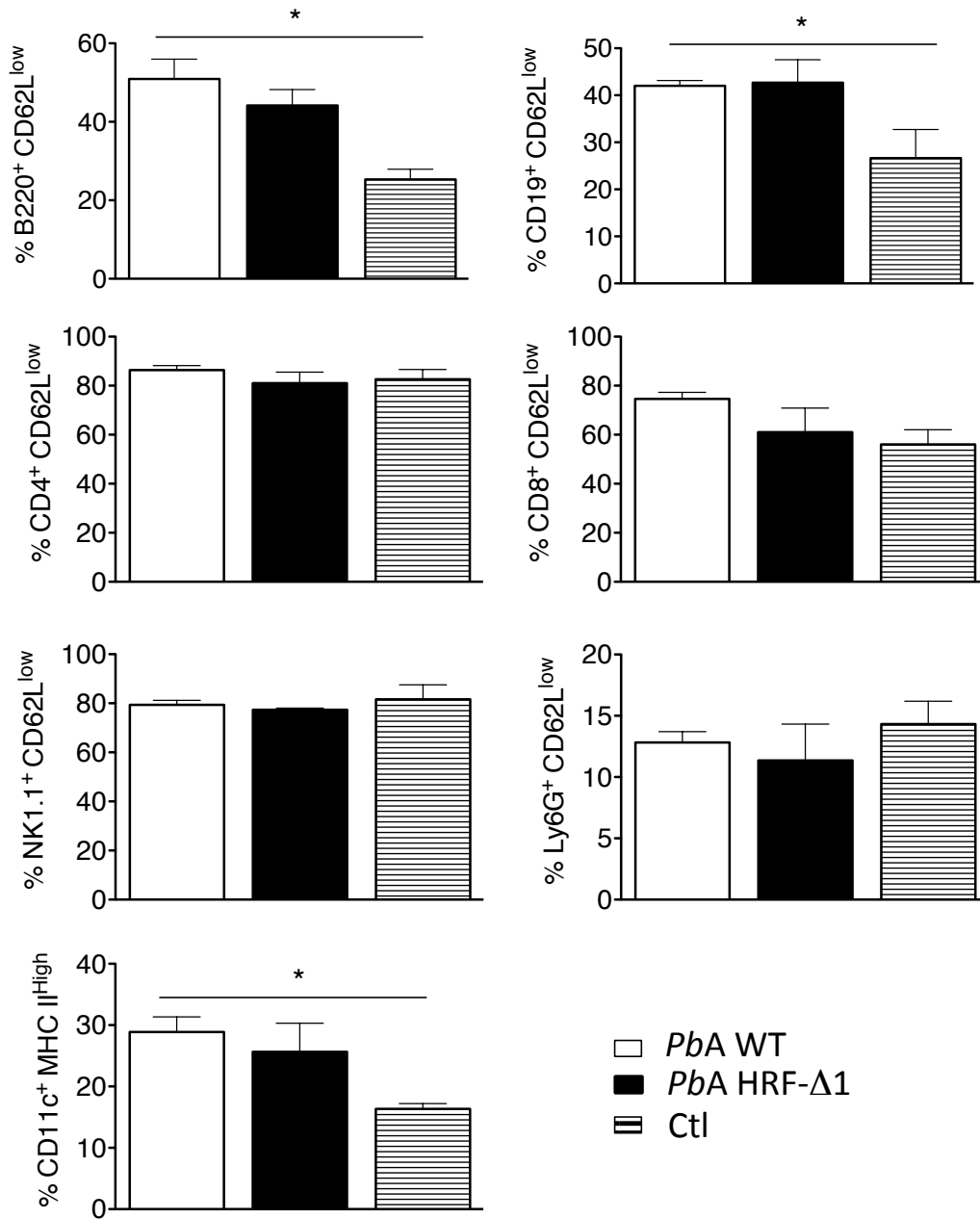

Figure S6

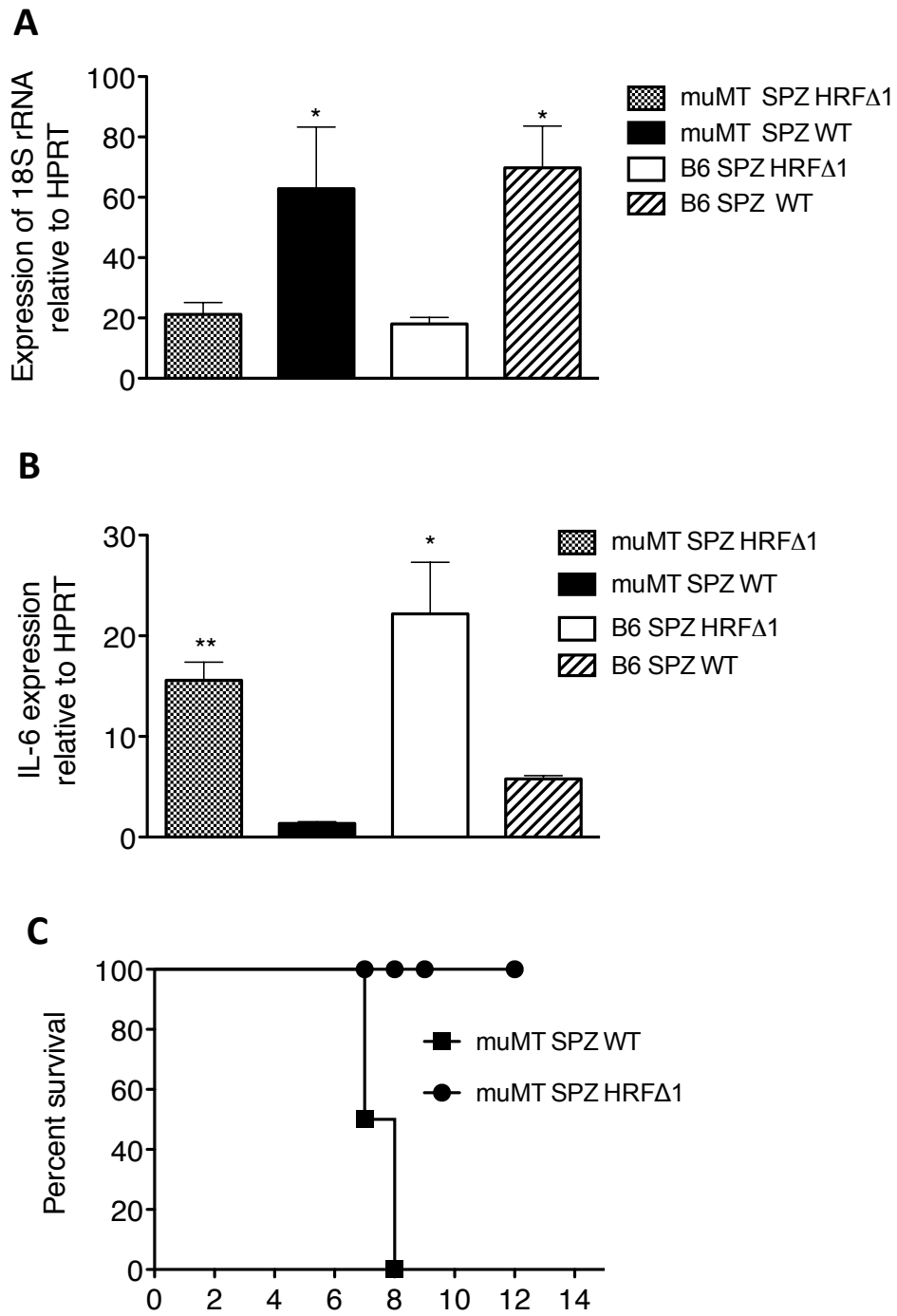

Figure S7

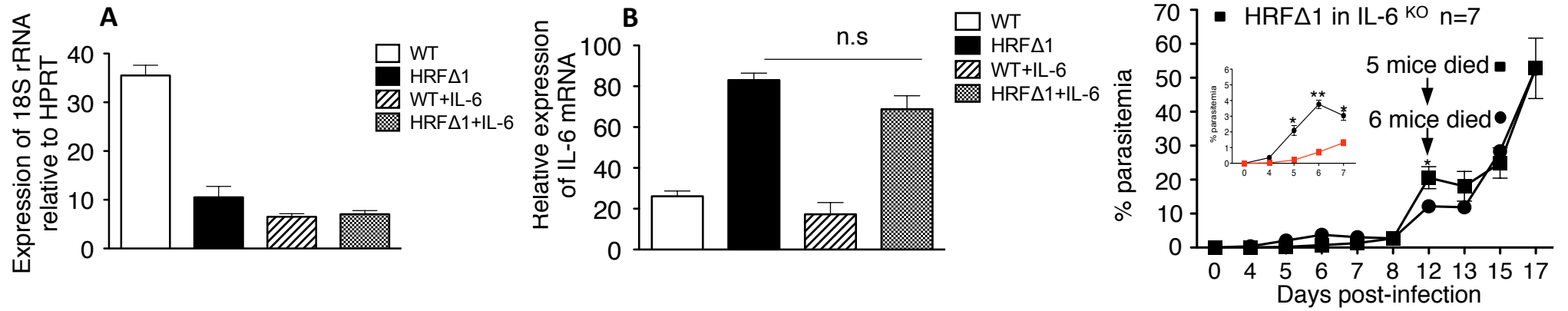

Table S1

List of the oligonucleotides used for PCR of wild-type and recombinant parasites

Apal-5'UTR-PbHRF-F	5'- cgcgggcccgcgattattaccgtgtca -3'
PstI-5'UTR-PbHRF-R	5'- cgctgcagggcttatgcaagtatcgaaca -3'
KpnI-3'UTR-PbHRF-F	5'- cgcggtaccttgctacatgacgcataaacc -3'
EcoRI-3'UTR-PbHRF-R	5'- cgcaattctgtgaaatcgacaatgttttgg -3'
PbHRF -5'anal-F	5'- gcgatacaaaacaatttattcagc -3'
PbHRF -3'anal-R	5'- cgcaagatatcagagctttca -3'
hDHFR 3'-F	5'- tgtgtctcttcaatgattcataaatagttgg -3'
hDHFR 5'-R	5'- tgcttgaggggtgagcatttaaagc -3'
PbHRF-5'orf-F	5'- ccatttgaaatgcggaat -3'
PbHRF-3'orf-R	5'- ttttcttcaataaaccatctga -3'

4.2 ARTICLE II

Protection against malaria in mice is induced by blood stage-arresting histamine-releasing factor (HRF)–deficient parasites.

In this work the attention was focused on the role and the possible immune mechanisms modulated by *Plasmodium* HRF during *P. berghei* NK65 infections using a mutant parasite where *hrf* gene was deleted (*PbNK65-hrfΔ*). Instead of using *PbANKA* which causes a rapid death of infected mice around day 7-8 p.i., we introduced the same mutation in a distinct lethal strain of parasite, *PbNK65*, which causes severe anemia and death around day 20-25 p.i., allowing the tracking of anti-blood stage immune responses over a relatively extended period of time.

Highlights

- Identification of *hrf* as a gene which deletion confers to the lethal parasite strain *PbNK65* an attenuated virulence and the ability to induce a long lasting protection and immune memory against homologous and heterologous strains of parasites.
- Elevated IL-6 production in the absence of HRF expression is key in establishing parasite clearance and acquisition of sterile immunity.
- In an effort to identify the cellular source of IL-6 that was negatively regulated by HRF, examination by intracellular cell staining showed that Ly6G⁺ and CD11c⁺ cells are the main targets.
- Furthermore, our data showed the immunological role played by B and T cell as mice lacking these lymphocytes were unable to control the infection.
- Absence of the HRF protein increased the survival of T cells by the down-regulation of PD1 expression in both CD4⁺ and CD8⁺ T cells and the production of specific anti-parasite antibodies that recognized multiple *Pb* antigens.
- Parasite antigen-specific antibodies and FcγR⁺ CD11b⁺ cells play an important part in mutant-induced protection.

Protection against malaria in mice is induced by blood stage–arresting *histamine-releasing factor (HRF)*–deficient parasites

Claudia Demarta-Gatsi,¹ Leanna Smith,¹ Sabine Thiberge,² Roger Peronet,¹ Pierre-Henri Commere,³ Mariette Matondo,⁴ Lionel Apetoh,⁶ Pierre Bruhns,⁵ Robert Ménard,² and Salaheddine Mécheri¹

¹Unité de Biologie des Interactions Hôte Parasites, Centre National de la Recherche Scientifique ERL9195, Institut National de la Santé et de la Recherche Médicale U1201, ²Unité de Biologie et Génétique du Paludisme, ³Imagopole, ⁴Spectrométrie de Masse Structurale et Protéomique, and ⁵Anticorps en Thérapie et Pathologie, Institut National de la Santé et de la Recherche Médicale U1222, Institut Pasteur, F-75015 Paris, France

⁶Institut National de la Santé et de la Recherche Médicale U866, Université Bourgogne Franche-Comté et Centre Georges François Leclerc, 21000 Dijon, France

Although most vaccines against blood stage malaria in development today use subunit preparations, live attenuated parasites confer significantly broader and more lasting protection. In recent years, *Plasmodium* genetically attenuated parasites (GAPs) have been generated in rodent models that cause self-resolving blood stage infections and induce strong protection. All such GAPs generated so far bear mutations in housekeeping genes important for parasite development in red blood cells. In this study, using a *Plasmodium berghei* model compatible with tracking anti-blood stage immune responses over time, we report a novel blood stage GAP that lacks a secreted factor related to histamine-releasing factor (HRF). Lack of HRF causes an IL-6 increase, which boosts T and B cell responses to resolve infection and leave a cross-stage, cross-species, and lasting immunity. Mutant-induced protection involves a combination of antiparasite IgG2c antibodies and FcγR⁺ CD11b⁺ cell phagocytes, especially neutrophils, which are sufficient to confer protection. This immune-boosting GAP highlights an important role of opsonized parasite-mediated phagocytosis, which may be central to protection induced by all self-resolving blood stage GAP infections.

Live attenuated parasites, in particular genetically attenuated parasites (GAPs), are increasingly being considered as vaccines against malaria. Preerythrocytic GAPs fail to develop in the liver, whereas blood stage GAPs cause abortive infections in the blood. In both cases, GAP infection induces solid protection against challenge.

The notion that attenuated blood stage parasites can confer protection originated in early studies using irradiated parasites (Waki et al., 1982; Miyagami et al., 1987). More recently, it was found that infecting individuals with low doses of *Plasmodium falciparum*–infected RBCs (iRBCs) followed by rapid curative treatment induced strong cell-mediated immunity and durable protection against challenge (Pombo et al., 2002). Subsequently, blood stage GAPs were generated in rodent parasites, targeting genes involved in the purine salvage pathway in *Plasmodium yoelii* (Ting et al., 2008; Aly et al., 2010) or genes encoding a protease involved in hemoglobin degradation (Spaccapelo et al., 2010) and a merozoite surface protein involved in adhesion to RBCs (Spaccapelo et al., 2011) in *Plasmodium berghei*. These GAPs multiply suboptimally in the blood and cause infections that eventually self-resolve. Notably, abortive GAP-induced infections confer lasting protection against challenge with blood stages or

mosquito transmission stages and depend on both cellular and humoral immunity (Ting et al., 2008; Aly et al., 2010).

Recently, we described the crucial role of histamine-releasing factor (HRF), also known as translationally controlled tumor protein, during development of *P. berghei* ANKA (*PbANKA*) in the host liver (Mathieu et al., 2015). In vivo development of *HRF*–deficient *PbANKA* parasites is severely impaired in the liver, caused by elevated levels of IL-6 (Pied et al., 1991). To test whether HRF might also modulate blood stage multiplication, we deleted the *HRF*–encoding gene in *P. berghei* NK65 (*PbNK65*). *PbANKA* induces cerebral malaria in susceptible mice, with lesions starting at day 5 postinfection (p.i.) and mice dying from day 7–8 p.i. (Beghdadi et al., 2008), which precludes studies on adaptive immunity. In contrast, *PbNK65* does not cause cerebral malaria but hyperparasitemia, leading to mouse death by severe anemia around day 25 p.i. It thus provides an opportunity to track immune responses against blood stage parasites over a longer period of time.

RESULTS AND DISCUSSION

Deletion of the *hrf* gene in *PbNK65* parasites causes abortive blood stage development

We generated *hrf* knockout *PbNK65* parasites (*PbNK65-hrfΔ*) by replacing the coding sequence of *pbhrf* (PBA

Correspondence to Salaheddine Mécheri: smecheri@pasteur.fr

Abbreviations used: APC, allo phyco cyanine; DTR, diphtheria toxin receptor; FA, formic acid; GAP, genetically attenuated parasite; gDNA, genomic DNA; hDHFR, human dihydrofolate reductase; HPRT, hypoxanthine phosphoribosyltransferase; HRF, histamine-releasing factor; iRBC, infected RBC; p.i., postinfection; qPCR, quantitative PCR; UTR, untranslated.

© 2016 Demarta-Gatsi et al. This article is distributed under the terms of an Attribution–Noncommercial–Share Alike–No Mirror Sites license for the first six months after the publication date (see <http://www.rupress.org/terms>). After six months it is available under a Creative Commons License (Attribution–Noncommercial–Share Alike 3.0 Unported license, as described at <http://creativecommons.org/licenses/by-nc-sa/3.0/>).

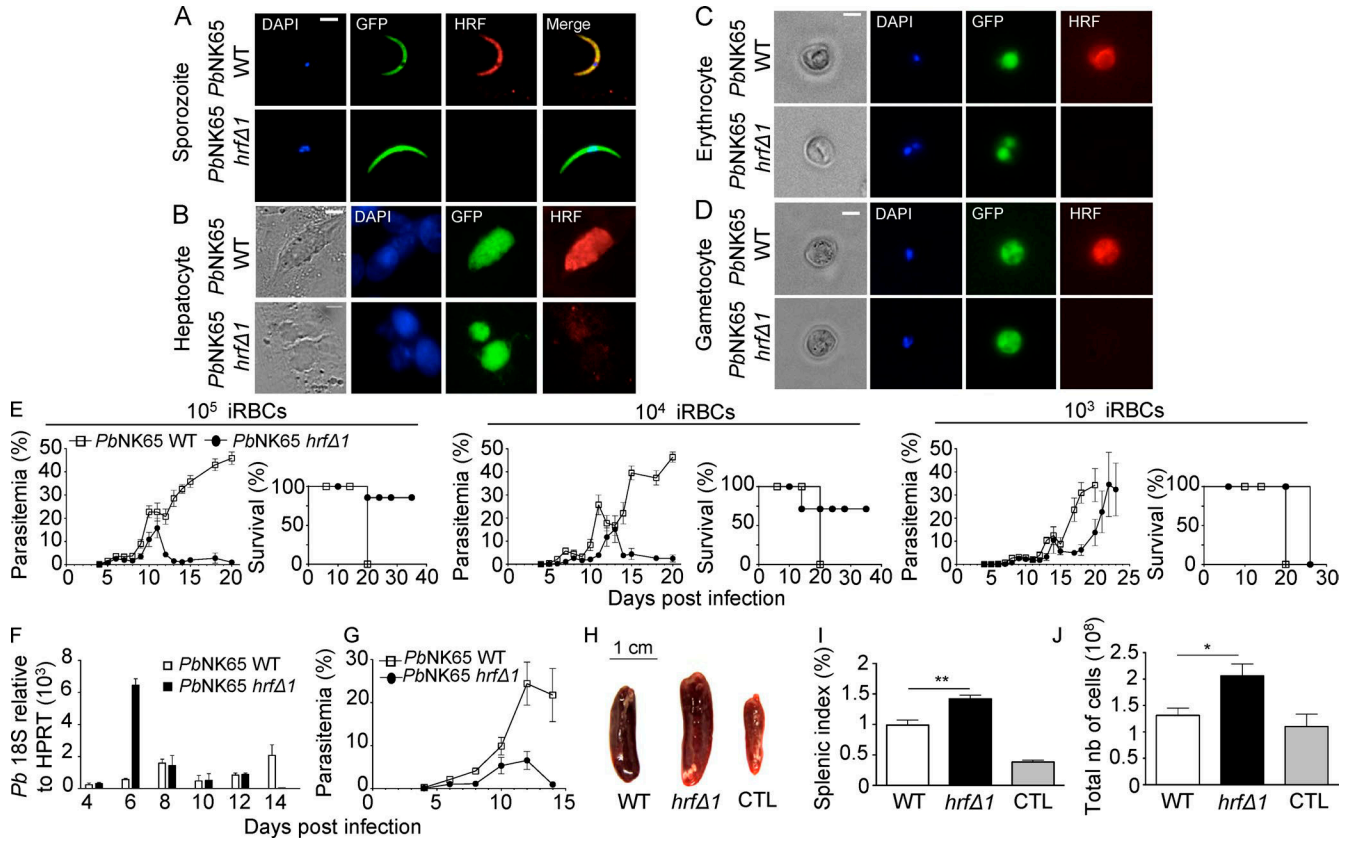

Figure 1. *Pb*HRF protein expression and phenotype of mutant parasites. (A–D) Anti-HRF-based immunofluorescence (red) was used to detect HRF in GFP-expressing WT or *PbNK65-hrfΔ1* sporozoites (A), liver stages obtained 48 h p.i. of HepG2 cells with sporozoites at a multiplicity of infection of 1:1 (B), infected erythrocytes (C), and gametocytes (D). Nuclear DNA stained with DAPI and phase-contrast images are shown. (A–D) Bars, 6 μ m. (E) Blood stage parasitemia and survival of C57BL/6 mice (Kaplan–Meier survival plots) after i.p. injection of 10^5 , 10^4 , and 10^3 WT or *PbNK65-hrfΔ1*-infected iRBCs measured over several days. (F and G) The kinetics of parasite load in the spleen of WT or *PbNK65-hrfΔ1*-infected mice was determined by RT-qPCR analysis of *P. berghei* 18S rRNA expression relative to mouse HPRT mRNA levels (F) or flow cytometric analysis of parasitemia (G). (H) Spleen size of WT or *PbNK65-hrfΔ1*-infected mice at day 6 p.i. (I and J) Splenic index (I) and total cell number (J) were compared at day 6 p.i. between mice infected with 10^5 WT and *PbNK65-hrfΔ1* iRBCs. Control: splenic index and cell number from naive mice. Error bars, SEM. Data are representative of three (A–D and H–J), six (E), and two (F and G) independent experiments with five to six mice per group. *, $P = 0.029$; **, $P = 0.003$; Mann–Whitney test. CTL, control; nb, number.

NKA_111050; UniProt accession no. A0A077XCV2) with the human dihydrofolate reductase (*hDHFR*)–selectable marker in a GFP-expressing *PbNK65* strain (Fig. S1 A). Two clones, *PbNK65-hrfΔ1* and 2, were selected from independent transfection experiments and verified to harbor the mutant locus by PCR (Fig. S1, B–D) and Southern blot analysis (Fig. S1 E). Using specific rabbit antibodies against recombinant *Pb*HRF (Mathieu et al., 2015), the protein was found to be expressed at all *Plasmodium* stages tested and to localize to the cytoplasm (Fig. 1, A–D), consistent with previous studies in human cells and *PbANKA* parasites (Bhisutthibhan et al., 1999; Mathieu et al., 2015). HRF was not detected in *PbNK65-hrfΔ1* parasites (Fig. 1, A–D), confirming both antibody specificity and successful gene knockout.

To assess the effect of *pbhrf* deletion on parasite blood stage development, C57BL/6 mice were infected i.p. with 10^5 , 10^4 , or 10^3 WT or *PbNK65-hrfΔ1*-infected

iRBCs, and parasite growth was monitored by flow cytometry. In mice infected with WT parasites, parasitemia increased steadily, resulting in severe malaria and death at approximately day 20 p.i. When using 10^5 or 10^4 infectious doses, *PbNK65-hrfΔ1* parasites multiplied like WT until day 10 p.i., reaching parasitemia of $\sim 20\%$, and were cleared from mice at day 13 or 14 p.i., respectively. Mouse survival rate after injection of 10^4 or 10^5 *PbNK65-hrfΔ1* parasites was $\sim 90\%$ and $\sim 70\%$, respectively. Notably, injection of 10^3 *PbNK65-hrfΔ1* parasites did not lead to parasite clearance or mouse survival. Infection with *PbNK65-hrfΔ2*, a second clone, gave similar results (Fig. S1, F and G). We concluded that infection with parasites lacking HRF can self-resolve and that parasite clearance depends on the initial parasite load and/or time to threshold parasitemia. Further experiments were performed after injection of 10^5 *PbNK65-hrfΔ1* parasites.

To determine whether clearance of mutant parasites from the circulation could be caused by parasite retention in the spleen, the parasite load in this organ was measured by RT-quantitative PCR (RT-qPCR). After a dramatic re-entention of *PbNK65-hrfΔ1* parasites at day 6, parasites were no longer detected in the spleen at day 14 (Fig. 1 F), indicating that parasite clearance was not caused by retention in the spleen (Fig. 1 G). Moreover, macroscopic examination showed a more important splenomegaly at day 6 in *PbNK65-hrfΔ1*-infected mice than in WT-infected mice, suggesting leukocyte infiltration in the mutant-infected spleen (Fig. 1, H–J).

IL-6, B cells, and T cells are critical for inhibition of *PbNK65-hrfΔ* blood stage growth

Because HRF-deficient *PbANKA* sporozoites induce IL-6 production in the liver during preerythrocytic infection (Mathieu et al., 2015), we compared IL-6 levels in mouse spleens 6 d p.i. with WT or *PbNK65-hrfΔ1* iRBCs. Levels of IL-6 mRNA and plasmatic IL-6 protein were higher in *PbNK65-hrfΔ1*-infected mice than in WT-infected mice (Fig. 2, A and B). Given that recombinant *PbHRF* protein is sufficient to down-regulate IL-6 expression in vivo (Mathieu et al., 2015), we tested whether clearance of mutant parasites was the consequence of elevated IL-6 by infecting IL-6^{KO} mice with mutant parasites. Mutant parasites developed normally in and eventually killed IL-6^{KO} mice (Fig. 2 C), phenocopying WT parasite behavior in WT mice (Fig. 1 E). We concluded that increased IL-6 accounts for mutant parasite clearance.

Immunostaining with leukocyte surface markers and anti-IL-6 antibodies of cells collected from the spleen at days 6 and 20 p.i. identified IL-6-producing cells as Ly6G⁺ neutrophils at day 6 and both Ly6G⁺ neutrophils and CD11c⁺ DCs at day 20 (Fig. 2 D). Depletion of neutrophils (Fig. S2, A and B) or DCs (Fig. S2, C and D) in mutant-infected mice reduced splenomegaly (Fig. S2, E, F, H, and I) and cell counts (Fig. S2, G and J) compared with nondepleted mice, confirming the contribution of neutrophils and DCs in the splenomegaly caused by mutant infection.

IL-6 is known to regulate the acute phase of the immune response and major B and T cell functions (Kishimoto et al., 1992; Barton, 1997). To test whether B or T cells were involved in self-resolution of mutant infection, we infected mice lacking B cells (μ S^{KO}) or T cells (CD3^{KO}) with WT or *PbNK65-hrfΔ1* parasites and monitored parasite development. B cell- or T cell-deficient mice were unable to control *PbNK65-hrfΔ1* blood stage multiplication and died with kinetics similar to WT mice infected with WT parasites (Fig. 2, E and F). The importance of T cells was confirmed by the normal multiplication of the mutant parasite upon mouse treatment of previously protected mice with anti-CD3 antibody (Fig. 2 G and Fig. S2 K). This indicated that B and T lymphocytes contributed to the clearance of mutant parasites.

PbNK65-hrfΔ1 infection confers lasting protection in a species- and stage-transcendent manner

To determine whether resolved *PbNK65-hrfΔ1* parasite infection might confer protection against challenge, mutant-infected mice were challenged with 10⁵ WT *PbNK65* iRBCs at days 20, 35, 68, 168, and 396 p.i. Mice were protected in all cases, displaying no detectable parasitemia at any time point, and survived for more than a year (Fig. 3 A). Mice challenged at days 20 and 23 p.i. with 10⁵ RBCs infected with virulent *P. berghei* ANKA (Fig. 3 B) or *P. yoelii* YM (Fig. 3 C), respectively, were also protected and did not develop parasitemia. Next, we asked whether mutant-infected mice were also protected against a challenge with WT *PbNK65* sporozoites, the mosquito-transmitted parasite stage. Sporozoite challenge did not result in detectable blood stage infection (Fig. 3 D), and parasite genes were not detected in the blood by PCR (not depicted). To ascertain that protection indeed targeted preerythrocytic stages and not just emerging blood stage development, the livers of mice challenged with sporozoites were analyzed by RT-qPCR 40 h after sporozoite inoculation. As shown in Fig. 3 E, the parasite load was significantly lower in the liver of *PbNK65-hrfΔ1*-protected mice compared with control mice. A similar protection was observed against heterologous *P. berghei* ANKA (Fig. 3 F) and *P. yoelii* YM (Fig. 3 G) sporozoite challenge. Therefore, infection with HRF-deficient blood stage *PbNK65* parasites induces long-lasting protection against malaria in a species- and stage-transcendent manner.

Mutant-induced immunity involves *Plasmodium*-specific IgG2c antibodies

To assess whether antibodies were involved in the anti-*PbNK65-hrfΔ1* response, anti-parasite-specific antibodies of various isotypes were quantified by ELISA in sera of mice 15 d p.i. with WT or *PbNK65-hrfΔ1* parasites. As shown in Fig. 4 A, mice infected with *PbNK65-hrfΔ1* produced higher levels of IgG antibodies than mice infected with WT parasites, essentially belonging to the IgG2c subclass and to a lesser extent to the IgG3 subclass (Fig. 4 A). Next, as shown by Western blot analysis of extracts from WT blood stages (Fig. 4 B), these antibodies recognized multiple *P. berghei* antigens in contrast to sera from WT *PbNK65*-infected mice or from naive mice (Fig. 4 B). Interestingly, the IgG2c isotype, expressed in C57BL/6 mice in which the IgG2a heavy chain is deleted, is known to be the predominant isotype generated in antiviral antibody responses (Coutelier et al., 1987) and the most efficient IgG subclass for antipathogen FcR-mediated effector functions (Nimmerjahn and Ravetch, 2005). In most experimental mouse malaria models, parasite-specific antibodies have been shown to be predominantly skewed toward the IgG2c isotype (Ndungu et al., 2009).

Immunoprecipitation of *P. berghei* blood stage proteins with the IgG antibodies from mutant-infected mice and mass spectrometry of the immunoprecipitate revealed five *P. berghei* proteins targeted by the protective IgG response (Fig. S3, A and B). These included the vaccine candidates merozoite surface protein 1

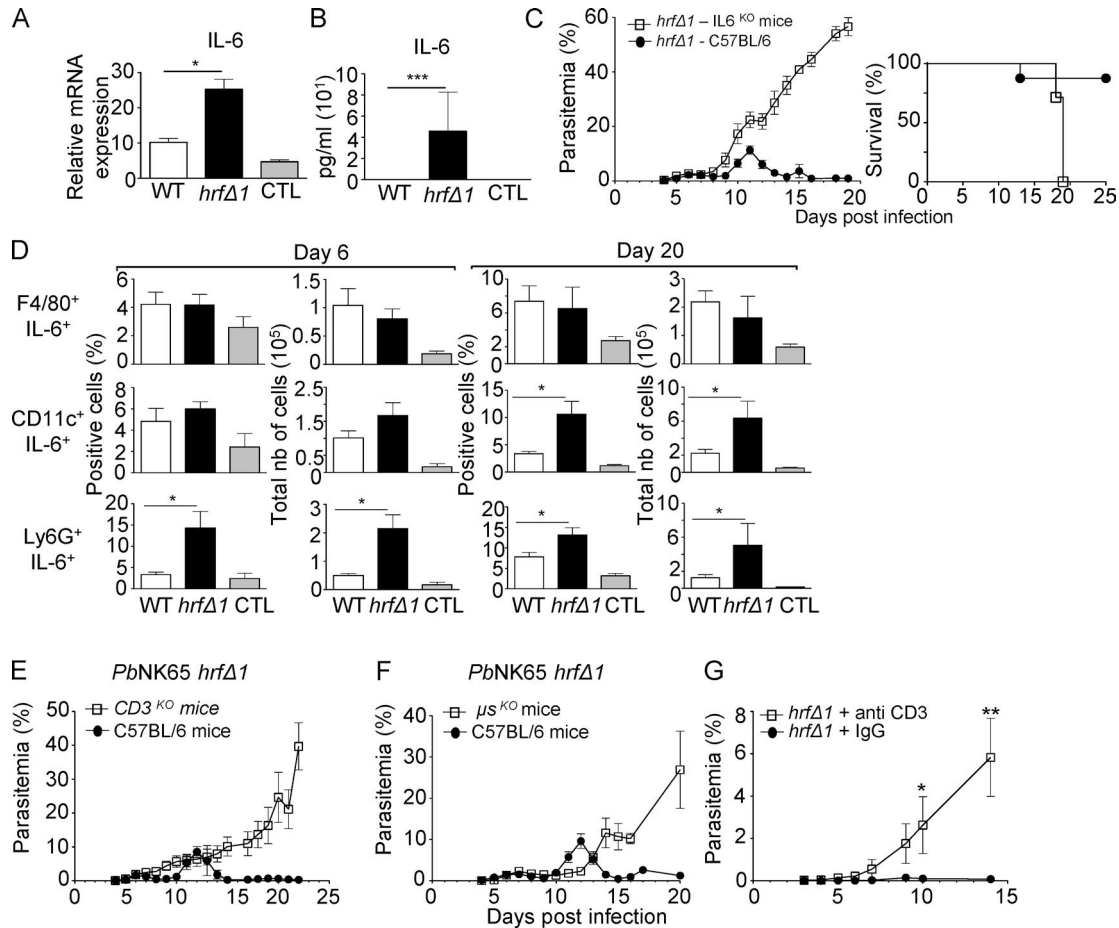

Figure 2. IL-6 expression by neutrophils and DCs and T and B cells are essential for the clearance of *PbNK65-hrfΔ1* parasites. (A and B) mRNA levels (RT-qPCR) normalized to HPRT of IL-6 in the spleen (A) and in the serum (ELISA; B) measured at day 6 p.i. from WT or *PbNK65-hrfΔ1*-infected mice. Control (CTL): mRNA and sera from naive mice. (C) WT or IL-6^{KO} C57BL/6 mice were infected i.p. with 10⁵ *PbNK65-hrfΔ1* iRBCs. Parasitemia and mouse survival (Kaplan-Meier survival plots: log-rank test; $P = 0.0046$) were followed over time. (D) Frequency and absolute numbers (nb) of IL-6-expressing splenic macrophages, DCs, and neutrophils at day 6 and day 20 p.i. from mice (five per group) infected with 10⁵ WT or *PbNK65-hrfΔ1* iRBCs or from naive mice (CTL). (E and F) WT or T cell-deficient (E) or B cell-deficient (F) C57BL/6 mice were infected i.p. with 10⁵ *PbNK65-hrfΔ1* iRBCs, and parasitemia was followed over time. (G) Protected mice were treated with IgG or with anti-CD3–depleting antibody 1 d prior to a challenge with WT parasites followed by two booster injections of anti-CD3 at days 1 and 3 after challenge. Error bars, SEM. Data are representative of four (A and B), three (C and E–G), and two (D) independent experiments with five to seven mice per group. *, $0.0028 < P < 0.046$; **, $P = 0.019$; ***, $P = 0.0097$; Mann-Whitney test.

(MSP1), serine repeat antigen 1 (SERA1), and SERA2 (Bodescot et al., 2004; Putrianti et al., 2010; Alaro et al., 2013). As shown by immunoblots (Fig. S3 C) and ELISA (Fig. S3 D), only sera from protected mice recognized the recombinant MSP1–33 antigen.

Next, to test whether IgG antibodies may mediate parasite clearance via FcR γ -expressing cells, WT or FcR γ ^{KO} C57BL/6 mice were infected with *PbNK65-hrfΔ1* parasites. As shown in Fig. 4 C, in contrast to WT mice, FcR γ ^{KO} mice were unable to eliminate *PbNK65-hrfΔ1* parasites and phenocopied WT mice infected with WT parasites.

Antibodies and CD11b⁺ cells from mutant-infected mice mediate protective immunity

Finally, to assess what immune effectors are important for protection, we performed passive transfer experi-

ments. First, antibodies purified from protected mice were transferred to naive mice before challenge with WT *PbNK65* parasites. As shown in Fig. 4 D, parasitemia was lower in mice treated with IgG from protected mice than in normal IgG-treated mice, suggesting that antibodies alone provide partial but significant protective activity (Fig. 4 D).

Last, we asked whether CD11b⁺ cells such as phagocytic leukocytes from *PbNK65-hrfΔ1*-protected mice might be sufficient to protect naive mice from WT infection. WT C57BL/6 mice with adoptively transferred CD11b⁺ cells from naive or *PbNK65-hrfΔ1*-infected mice at day 15 p.i. were challenged with 10⁵ WT parasites. As shown in Fig. 4 E, transfer of CD11b⁺ cells from mutant-infected, but not naive, mice efficiently protected against infection. Collectively, these data suggest that

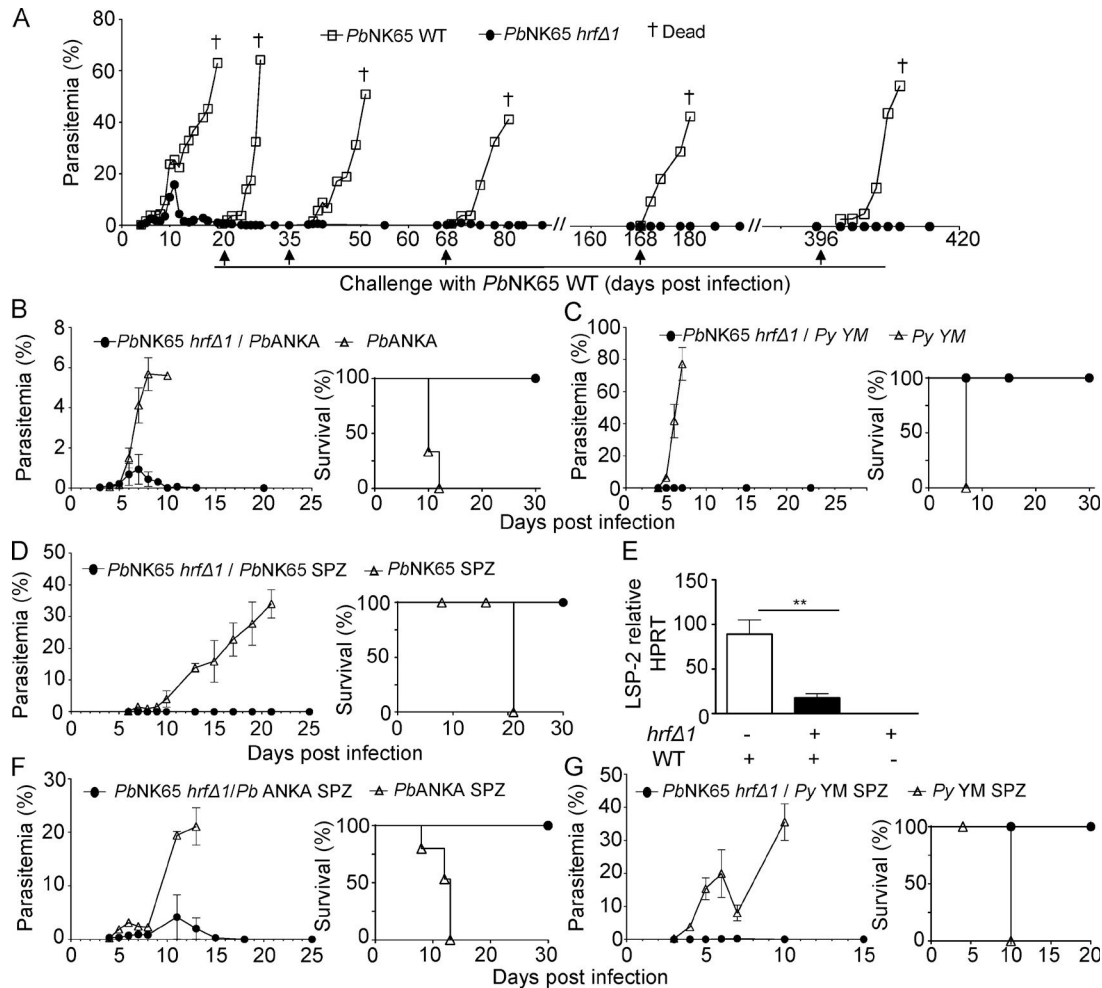

Figure 3. Infection with HRF-deficient blood stage parasites ensures long-lasting cross-species and cross-stage protection. (A) *PbNK65-hrfΔ1*-protected mice were challenged with 10^5 WT *PbNK65* iRBCs at the indicated time points where control naive mice were also infected with 10^5 WT *PbNK65* iRBCs. (B–D) Parasitemia and survival were measured over time. Parasitemia and Kaplan-Meier survival plots of *PbNK65-hrfΔ1*-protected mice challenged with 10^5 *PbANKA* (log-rank test; $P = 0.0027$; B) or *P. yoelii* YM (log-rank test; $P = 0.0047$; C) iRBCs at day 20 and day 23 p.i., respectively, or with 10^4 GFP-expressing WT *PbNK65* sporozoites (log-rank test; $P = 0.0047$) at day 36 p.i. (D). (E) Intrahepatic parasite development in experimental and control mice from D was assessed by RT-qPCR analysis of the liver stage-specific LSP-2 marker at 40 h p.i. of sporozoites. (F and G) *PbNK65-hrfΔ1*-protected mice were challenged with 10^4 *PbANKA* (F) or *P. yoelii* YM (G) sporozoites at day 25 p.i., and parasitemia and survival (log-rank test; $P = 0.0082$) were determined over time. Naive mice infected on the same day with *PbANKA* (F) or with *P. yoelii* YM (G) sporozoites were used as controls. Error bars, SEM. Data are representative of two (A) and three (B–G) independent experiments with four to eight mice per group. **, $P = 0.015$; Mann-Whitney test. *Py*, *P. yoelii*; SPZ, sporozoites.

parasite antigen-specific antibodies and $Fc\gamma R^+ CD11b^+$ cells play an important part in mutant-induced protection.

This study shows that abortive blood stage infection leading to lasting protection can be achieved not just by impairing parasite intracellular growth, but also by enhancing protective immune responses. Indeed, lack of HRF and an increase in IL-6 do not affect parasite growth per se because *PbNK65-hrfΔ1* blood stages multiply normally in mice until day 10. Rather, IL-6, which is involved in B and T cell differentiation, boosts antiparasite adaptive responses that clear parasites. Like with previously reported blood stage GAPs that induce abortive infections, the protective response to *PbNK65-hrfΔ1* parasites is both solid, conferring cross-stage and cross-species

immunity, and durable. We found that the protective response relies on the combination of antiparasite IgG2c antibodies and $Fc\gamma R^+ CD11b^+$ phagocytic cells, in particular neutrophils, which are sufficient for solid protection. Interestingly, the discovery of a B helper neutrophil population in the spleen that can act as professional helper cells for marginal zone B cells (Puga et al., 2012) highlights a neutrophil–B cell interplay that may be critical for B cell differentiation into antibody-producing plasma cells and may also contribute to inhibition of the well-known *Plasmodium* capacity to induce short-lived B cell memory (Wykes et al., 2005). Opsonic phagocytosis was also described as a protective mechanism induced by the plasmeprin-4-deficient mutant (Spaccapelo et al., 2010). Whether

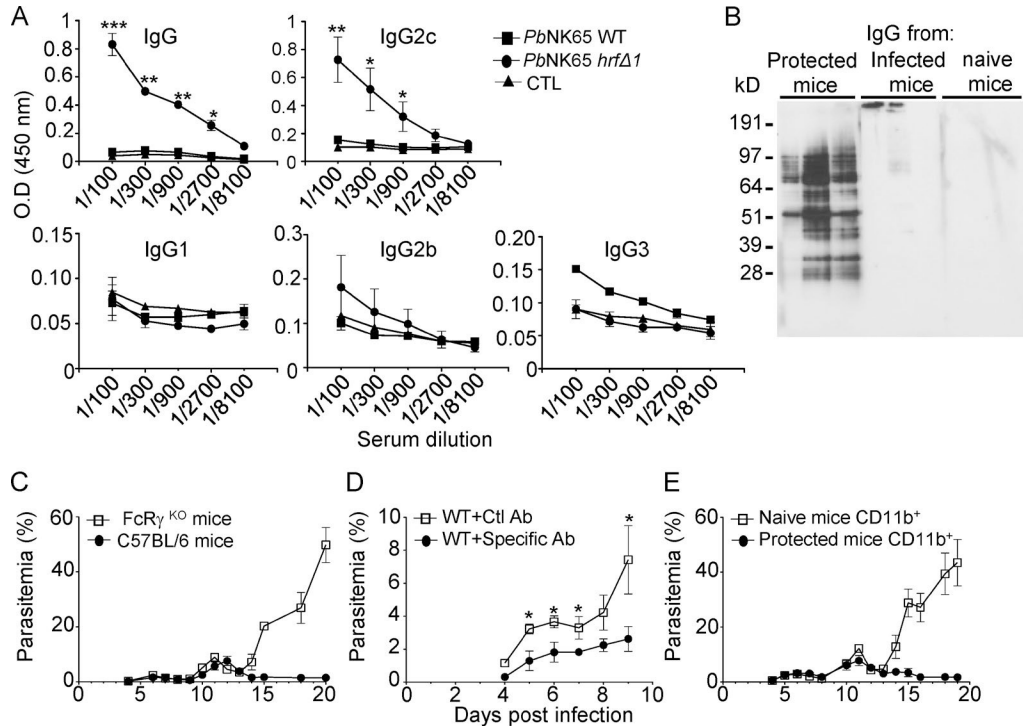

Figure 4. *Pbnk65-hrfΔ*-induced immunity is T and B cell dependent and involves the secretion of *Plasmodium*-specific IgG2c antibodies. (A) ELISA detection and quantification of antiparasite-specific antibodies of various isotypes in mouse sera at day 20 p.i. with WT or *Pbnk65-hrfΔ1* parasites. Control (CTL): sera from naive mice. (B) Separated total protein extracts from WT *Pbnk65* iRBCs were incubated with the IgG fraction from three independent mice infected with either *Pbnk65-hrfΔ1* or WT parasites at day 20 p.i. or with normal mouse IgG. (C) C57BL/6 or *FcγR^{KO}* mice were infected i.p. with 10^5 *Pbnk65-hrfΔ1* iRBCs, and parasitemia was followed over time. (D) Purified IgG antibodies from *Pbnk65-hrfΔ1*-protected mice or from naive mice were injected i.p. 1 d before and 1 d after infection with 10^5 WT *Pbnk65* iRBCs, and parasitemia was recorded over time. Ab, antibody; Ctl, control. (E) Sorted CD11b⁺ cells from naive or *Pbnk65-hrfΔ1*-protected mice were transferred into WT C57BL/6 mice and immediately infected with 10^5 WT *Pbnk65* iRBCs. Parasitemia was recorded over time. Error bars, SEM. Data are representative of three (A–D) and two (E) independent experiments with five to seven mice per group. *, $0.019 < P < 0.03$; **, $0.0079 < P < 0.01$; ***, $P = 0.0002$; Mann-Whitney test.

this represents the essential protective mechanism common to all self-resolving infections remains to be determined. Finally, although not formally demonstrated in our work, the contribution of parasite-specific CD8⁺ cells to self-resolution cannot be precluded and awaits further investigation.

MATERIALS AND METHODS

Ethics statements. All experiments involving mice were conducted at Institut Pasteur, approved by the Direction Départementale des Services Vétérinaires de Paris, France (permit number N° 75–066 issued on September 14, 2009), and performed in compliance with institutional guidelines and European regulations. A statement of compliance with the French government's ethical and animal experiment regulations was issued by the Ministère de l'Enseignement Supérieur et de la Recherche under the number 00218.01.

Rodents. 5–8-wk-old WT female C57BL/6J Rj and Swiss Webster (SW) mice were purchased from the Janvier laboratory. Transgenic T cell-deficient (*CD3^{KO}*), B cell-deficient (secretory μ chain [μ s^{KO}]), Fc γ receptor-deficient (*FcγR^{KO}*),

and IL-6^{KO} mice strains were provided by B. Ryffel (Institut Pasteur, Paris, France), J.M. Cavillon (Institut Pasteur), P. Bruhns (Institut Pasteur), and L. Apetoh (Institut National de la Santé et de la Recherche Médicale U866, Dijon, France), respectively. CD11c-DTR (diphtheria toxin receptor)-GFP mice (Jung et al., 2002) have been used to explore the role of DCs in controlling parasite development. Transgenic mice have all been backcrossed 10 times on C57BL/6 mice from The Jackson Laboratory.

Parasites. Mice were inoculated with RBCs infected with either *P. berghei* (*Pb*) NK65 WT or mutant (*hrfΔ*) GFP-transgenic parasites. In a few control experiments, mice were infected with *P. yoelii* YM or *Pb* ANKA-GFP iRBCs, or with *Pbnk65* or *PbANKA* GFP-transgenic sporozoites collected from salivary glands of infected *Anopheles stephensi*. Mosquitoes were provided by the CEPIA (Centre d'élevage, de production et d'infection des anophèles, Institut Pasteur).

Mouse infections and immunization with blood stages. Cryopreserved *P. berghei* parasites were passaged once through SW

mice before being used to infect experimental animals. Mice were infected with blood stages of either GFP-transgenic *PbNK65*, *PbNK65-hrfΔ1*, or *PbNK65-hrfΔ2* parasites by injecting 10^5 , 10^4 , or 10^3 iRBCs i.p. After injection, blood samples were taken daily from the tail, and parasitemia was assessed by flow cytometry. If mice did not develop parasites after challenge, they were recorded as completely protected.

Splenic index. Spleens from uninfected and infected mice were harvested at day 6 p.i. with WT or *PbNK65-hrfΔ1* parasites. The splenic index for each individual mouse was calculated as follows: spleen weight (mg)/body weight (mg) \times 100.

Sporozoite development in HepG2 cells. HepG2 cells ($2-3 \times 10^4$ /well) were plated in 8-well chamber slides (Lab-Tek) and cultured overnight in DMEM + GlutaMAX-I media (Gibco) supplemented with 10% heat-inactivated FBS (Gibco) at 37°C in the presence of 5% CO₂. WT or mutant purified *P. berghei* salivary gland sporozoites were used for HepG2 infection at a ratio of 1:1 (parasite/cells) for 36 h at 37°C with 5% CO₂ in the presence of penicillin–streptomycin–neomycin solution (Sigma-Aldrich). *PbHRF* was detected by immunofluorescence staining as described in the next paragraph.

Immunofluorescence assays for the intracellular detection of HRF. Fixation and permeabilization of sporozoites, infected HepG2 cells, iRBCs, and purified gametocytes were performed using 4% paraformaldehyde and 0.1% Triton X-100 and blocked with 1–3% gelatin from porcine skin (Sigma-Aldrich). Thereafter, cells were incubated with specific rabbit anti-HRF antibodies (diluted 1:500; Mathieu et al., 2015) and then incubated with Alexa Fluor 568–conjugated secondary antibodies (diluted 1:500; Thermo Fisher Scientific) and 0.02 mg/ml DAPI for nuclear staining. The expression of *PbHRF* was detected using a fluorescence microscope (AxioVert 200; ZEISS).

Preparation of total RNA and RT-qPCR analysis of mRNA. The spleens and livers of C57BL/6J mice infected with WT or *PbNK65-hrfΔ1* parasites were surgically removed 40 h p.i. or at day 2, 4, 6, 8, 10, 12, 14, and 20 p.i., respectively. Total RNAs were extracted from the spleen as well as from liver samples using the guanidinium-thiocyanate-phenol-chloroform method (all from Invitrogen). RNA was thereafter reverse transcribed by PCR (temperature profile: 65°C for 5 min, 42°C for 50 min, and 70°C for 15 min) using 100 U of SuperScript II reverse transcriptase (Invitrogen), 40 U RNase inhibitor, and 2 μ M oligo(dT) 18S rRNA primer (Eurofins MWG Operon) per sample. The expression levels of diverse transcripts were analyzed by real-time RT-qPCR using Power SYBR green PCR master mix (Applied Biosystems) and various primer sets (Table S1). All reactions were performed in a real-time PCR machine (temperature profile: 50°C for 2 min, 95°C for 10 min, 40 cycles of 15 s at 95°C, and 60°C for 1 min; ABI PRISM 7000 Sequence Detection System; Ap-

plied Biosystems). The relative abundance of parasite and cytokine rRNA in the spleen was calculated using the ΔC_t method and expressed as $2^{-\Delta C_t}$. The mouse hypoxanthine phosphoribosyltransferase (HPRT) gene was used as an internal control for the variation in input RNA amounts. A no-template control was included to ensure that there was no cross-contamination during sample preparation.

Flow cytometry analysis of spleen leukocytes. Spleens were mechanically disrupted in 2 ml PBS, and cells were filtered through a 70-mm strainer (BD). Erythrocytes were lysed using Gey's solution for 5 min on ice and washed twice in PBS. Single-cell suspensions were stained for FACS analysis according to standard protocols in cold PBS containing 2% FCS and 0.01% sodium azide (FACS buffer) with the following antibodies: PE-labeled anti-CD4, PE-Cy5-labeled anti-CD45, allo phyco cyanine (APC)-labeled anti-CD8, FITC-labeled anti-CD11b, APC-labeled anti-CD11c, APC-labeled anti-Ly6G, PE-Cy5-labeled anti-F4/80, and PE-labeled anti-IL-6 antibodies (all antibodies from BD). A total of 5×10^5 living cells were analyzed using a four-color flow cytometer (FACSCalibur; BD) and ProCellQuest software (BD).

In vivo cell depletion. For neutrophil depletion, C57BL/6 mice were injected with 500 μ g of a rat anti-mouse neutrophil (clone NIMP-R14) provided by G. Milon (Institut Pasteur) at day 2 and day 4 p.i. with *PbNK65-hrfΔ1*. For systemic DC depletion, CD11c-DTR-GFP transgenic mice were injected i.p. with 5.2 ng/g body weight diphtheria toxin (Sigma-Aldrich) in PBS at days 2 and 4 p.i. with *PbNK65-hrfΔ1*. To determine whether CD3 plays a role in the antiparasitic memory response developed by protected mice, cell-specific depletion experiments were performed. C57BL/6J Rj-protected mice were injected i.p. with 20 μ g anti-CD3 (clone 145-2C11) Armenian hamster IgG (eBioscience) 24 h before the infection with *PbNK65* WT and 48 h p.i. The cell depletion was followed and confirmed by flow cytometry. Before the infection and every day p.i., 10 μ l of blood was collected from the tip of the mouse tail and analyzed to confirm neutrophil, DC, and CD3 cell depletion by FACS analysis.

Detection of specific IgG antibodies and IL-6 cytokine in the serum of infected mice. To detect parasite-specific antibodies, protein extracts from blood stages obtained by saponin lysis (0.1%) of parasite pellets were sonicated in lysis buffer (10 mM Tris, pH 7.4, 150 mM NaCl, 0.02% NaN₃, 20 mM MgCl₂, 1% Triton X-100, and complex protease inhibitors) and centrifuged (10,000 g for 30 min at 4°C). The total amount of proteins in the supernatant was measured using a Bio-Rad Laboratories protein assay. 96-well plates (Nunc-immunoplate; Thermo Fisher Scientific) were coated with 2 μ g/ml *PbNK65* WT protein extracts in carbonate buffer, pH 9.6, for 2 h at 37°C and then saturated with 1% (wt/vol) BSA (Sigma-Aldrich). Serum samples were assayed using serial dilutions and incubated for 2 h at 37°C. Specific binding was detected

using HRP-conjugated goat anti-mouse secondary antibody (diluted 1:2,000; Cell Signaling Technology) followed by the addition of *o*-phenylenediamine dihydrochloride substrate (Sigma-Aldrich). HCl 1N was used to block the reaction. The optical density was read at 490–630 nm. Each sample was tested against nonimmune serum and PBS as background controls. Amounts of IL-6 in the serum were analyzed following the instructions provided by the ELISA kits supplier (BD).

Western blotting. 20 μ g *PbNK65* WT protein extract from asexual blood stages were separated by SDS-PAGE (4–12% Bis-Tris gels; BOLT mini gel system; Thermo Fisher Scientific) and transferred onto a polyvinylidene fluoride membrane (iBLOT system; Thermo Fisher Scientific). Sera from uninfected, WT, or *PbNK65-hrf Δ 1* mice were added (1:1,000 dilution) and incubated overnight at 4°C. After washing the membrane with PBS + Tween 20 (Sigma-Aldrich), polyclonal anti-mouse IgGs (1:20,000; P0260; Dako) were added, and specific bands were visualized with the SuperSignal West Pico kit (Thermo Fisher Scientific) according to the manufacturer's instructions.

Adoptive transfer of IgG-specific antibodies and CD11b-positive cells. C57BL/6J mice were infected with either WT or *PbNK65-hrf Δ 1* parasites as described in the previous paragraph. Specific IgGs and CD11b⁺ cells were obtained from challenged protected mice at day 15 p.i. Immune sera were collected, and the IgG fraction was purified on an immunoabsorbent protein G–Sepharose column (BioVision). 100 μ g IgGs was transferred i.p. into naive mice 24 h before WT *PbNK65* iRBC infection. Mice were then given 100 μ g of antibody on days 3 and 6 p.i. Single-cell suspension of CD11b⁺ cells was obtained from naive or *PbNK65-hrf Δ 1*-infected mice by FACs sorting of spleen and bone marrow cells stained with FITC-labeled anti-CD11b. Each mouse received intravenous injections of 2.5×10^6 CD11b⁺ cells 1 h after WT *PbNK65* iRBC infection.

Generation and cloning of *PbNK65-hrf Δ* parasites. For construction of the targeting vector for *pbhrf* disruption (*PbHRF*; plasmid provided by P. Smooker and K. Taylor, RMIT University, Bundoora, Australia), DNA fragments corresponding to the 5' untranslated (UTR) and 3'UTR regions of the *pbhrf* gene were amplified by PCR using *P. berghei* NK65 genomic DNA (gDNA) as a template. These primers (Table S2) were tailed with restriction sites for *ApaI*, *PstI*, *KpnI*, and *EcoRI* to facilitate cloning into either side of the *hDHFR* cassette (de Koning-Ward et al., 2000) in pUC18 backbone. The targeting construct was integrated into the *pbhrf* gene locus by double crossover recombination, resulting in the disruption of *pbhrf* and conferring WR99210 or pyrimethamine resistance. Transfection into a GFP-*PbNK65* parasite strain and selection of recombinant parasite clones were performed as previously described (Janse et al., 2006). In brief, after overnight culture (37°C with 10% O₂ and 5% CO₂ at 90 rpm) of

the blood of infected animals, mature schizonts were purified using a Nycodenz gradient and collected at room temperature. The electroporation mix was composed of 10^7 – 10^8 merozoites resuspended in 50 μ l and 100 μ l of human T cell Nucleofector solution (Amaxa) and 5 μ l DNA (containing 5 μ g of digested DNA in water). Parasites were electroporated using the U33 program of the Nucleofector electroporator (Amaxa) and immediately resuspended in PBS and injected intravenously into 3-wk-old female SW mice. Recipient mice were treated with 0.07 mg/ml pyrimethamine in drinking water or with 6 mg/kg WR99210 by subcutaneous injections, starting 24 h after electroporation. At day 6 after electroporation, the emerging parasite population was collected, gDNA was extracted, and genomic integration of the *hDHFR* cassette (within the *pbhrf* locus of GFP-*PbNK65* transfectants) was confirmed using specific PCR primers: (a) *Apa*-5'UTR *PbHRF*-F and *EcoRI*-3'UTR *PbHRF*-R, (b) *HRF5'*-F and *hDHFR5'*-R, and (c) *HRF3'*-R and *hDHFR3'*-F. The first pair of primers (*Apa*-5'UTR *PbHRF*-F and *EcoRI*-3'UTR *PbHRF*-R) amplified gDNA encompassed by the *ApaI* and *EcoRI* restriction sites and inclusive of the *pbhrf* 5' and 3'UTRs. A PCR product of 2,681 bp was indicative of *hrf Δ* , whereas a PCR product of 1,760 bp denoted a WT genotype. The second pair of primers (*HRF5'*-F and *hDHFR5'*-R) amplified DNA outside the *hDHFR* insert (inclusive of the 5'UTR *PbHRF*) and within the 5' region of the *hDHFR* cassette, respectively. A PCR product of 700 bp indicated a *hrf Δ* clone, whereas absence of a band denoted a WT genotype. The third pair of primers (*hDHFR3'*-F and *HRF3'*-R) amplified gDNA within the 3' region of the *hDHFR* cassette and outside the *hDHFR* insert (inclusive of the 3'UTR *pbhrf*), respectively. A PCR product of 1,100 bp indicated a *hrf Δ* clone, whereas absence of a band indicated a WT genotype.

Statistical analysis. All data were analyzed using Prism 5.0 software (GraphPad Software). Unpaired data between two groups at a specific time point were analyzed by a Mann-Whitney test for nonparametric analysis when data did not fit a Gaussian distribution. A *p*-value <0.05 was considered to be statistically significant. All experiments were replicated several times as indicated in the figure legends.

Southern blotting. gDNA was obtained as follows: parasite pellets obtained by saponin lysis of iRBCs were resuspended in PBS and treated with 150 μ g/ml proteinase K and 2% SDS at 55°C for 20 min. The DNA was isolated from the parasite pellet using the DNeasy blood and tissue kit (QIAGEN). The DNA was digested with *EcoRV* and probed with an *hrf* probe.

Mass spectrometry analysis, database search, protein identification, and statistical analysis. After the immunoprecipitation, proteins were solubilized in denaturation buffer (10 mM Tris, pH 8, and 8 M urea). Proteins were reduced, alkylated, and digested with trypsin. Tryptic peptides were analyzed by

nano LC-MS/MS (liquid chromatography coupled with tandem mass spectrometry) using a chromatograph (EASY-nLC 1000; Thermo Fisher Scientific) coupled to a mass spectrometer (Q Exactive Orbitrap). About 1 µg of each sample (dissolved in 0.1% formic acid [FA]) was loaded at 250 nl/min on a homemade C18 50-cm capillary column picotip silica emitter tip (75-µm diameter filled with 1.9 µm Reprosil-Pur Basic C18-HD resin [Dr. Maisch GmbH]) equilibrated in solvent A (0.1% FA). The peptides were eluted using a two-slopes gradient of solvent B (0.1% FA in acetonitrile) from 2–30% in 90 min and from 30–80% in 60 min at a 250-nl/min flow rate (total length of the chromatographic run was 180 min). The mass spectrometer (Q Exactive Orbitrap; Thermo Fisher Scientific) was operated in data-dependent acquisition mode with XCalibur software (version 2.2; Thermo Fisher Scientific). Survey scan MSs were acquired in the Orbitrap on the 300–1,800-m/z range with the resolution set to a value of 70,000 at m/z = 400 in profile mode (automatic gain control target at 1E6). The 20 most intense ions per survey scan were selected for higher energy collisional dissociation fragmentation (NCE 28), and the resulting fragments were analyzed in the mass spectrometer at 17,500 resolution (m/z of 400). Isolation of parent ion was fixed at 2.5 m/z, and the underfill ratio was fixed at 0.1%. Dynamic exclusion was used within 20 s. Each sample was prepared in triplicate.

Data were searched using MaxQuant (version 1.4.1.2; with the Andromeda search engine) against the *Plasmodium berghei* database (22,006 entries). The following search parameters were applied. Carbamidomethylation of cysteines was set as a fixed modification. Oxidation of methionine and protein N-terminal acetylation were set as variable modifications. The mass tolerances in MS and MS/MS were set to 10 parts per million for each, respectively. Two peptides were required for protein identification and quantitation. Peptides and proteins identified with a false discovery rate <0.01% were considered as valid identification. Statistical analysis of the data was performed using Perseus, R package, MSstat, and internal tools. Two sample Student's *t* tests were used to identify significantly regulated proteins between two groups. The results were visualized on volcano plots.

Immunoprecipitation. Immunoprecipitation of *Pb* proteins from parasite extracts was performed using the Pierce Direct immunoprecipitation kit (Thermo Fisher Scientific). Before immunoprecipitation, 10 µg of purified IgG antibodies from the serum of protected, infected, and naive mice was directly immobilized onto an agarose support (AminoLink Plus Resin) using a short coupling protocol. 500–700 µg of parasite extracts was incubated with the immobilized antibody to form the immune complex with gentle end-over-end mixing overnight at 4°C. To remove nonbound material, beads were washed three times with wash buffer, and a low pH elution buffer was used to dissociate the bound antigen from the an-

tibody. Immunoprecipitated proteins were then used for mass spectrometry analysis.

Online supplemental material. Fig. S1 shows disruption of the *pbhrf* gene in *Pb*NK65 parasites. Fig. S2 shows assessment of leukocyte depletion and the role of neutrophils and DCs in the occurrence of splenomegaly. Fig. S3 shows identification of immune sera-derived immunoprecipitated proteins. Table S1 contains a list of oligonucleotides used for RT-qPCR analyses. Table S2 contains a list of oligonucleotides used for PCR of WT and recombinant parasites. Online supplemental material is available at <http://www.jem.org/cgi/content/full/jem.20151976/DC1>.

ACKNOWLEDGMENTS

We thank Peter Smooker and Kim Taylor for providing *P. berghei* HRF plasmid the CEP IA for providing *A. stephensi*, Shruthi Vembar for her thorough revision of the manuscript, and Veronique Houdel for her technical assistance for mass spectrometry.

This work was funded by an Institut Pasteur grant to S. Mécheri. C. Demartagatsi is supported by a predoctoral fellowship from the Helmut Horten Foundation.

The authors declare no competing financial interests.

Submitted: 18 December 2015

Accepted: 26 May 2016

REFERENCES

- Alaro, J.R., A. Partridge, K. Miura, A. Diouf, A.M. Lopez, E. Angov, C.A. Long, and J.M. Burns Jr. 2013. A chimeric *Plasmodium falciparum* merozoite surface protein vaccine induces high titers of parasite growth inhibitory antibodies. *Infect. Immun.* 81:3843–3854. <http://dx.doi.org/10.1128/IAI.00522-13>
- Aly, A.S., M.J. Downie, C.B. Mamoun, and S.H. Kappe. 2010. Subpatent infection with nucleoside transporter 1-deficient *Plasmodium* blood stage parasites confers sterile protection against lethal malaria in mice. *Cell. Microbiol.* 12:930–938. <http://dx.doi.org/10.1111/j.1462-5822.2010.01441.x>
- Barton, B.E. 1997. IL-6: insights into novel biological activities. *Clin. Immunol. Immunopathol.* 85:16–20. <http://dx.doi.org/10.1006/clin.1997.4420>
- Beghdadi, W., A. Porcherie, B.S. Schneider, D. Dubayle, R. Peronet, M. Huerre, T. Watanabe, H. Ohtsu, J. Louis, and S. Mécheri. 2008. Inhibition of histamine-mediated signaling confers significant protection against severe malaria in mouse models of disease. *J. Exp. Med.* 205:395–408. <http://dx.doi.org/10.1084/jem.20071548>
- Bhisuthibhan, J., M.A. Philbert, H. Fujioka, M. Aikawa, and S.R. Meshnick. 1999. The *Plasmodium falciparum* translationally controlled tumor protein: subcellular localization and calcium binding. *Eur. J. Cell Biol.* 78:665–670. [http://dx.doi.org/10.1016/S0171-9335\(99\)80052-1](http://dx.doi.org/10.1016/S0171-9335(99)80052-1)
- Bodescot, M., O. Silvie, A. Siau, P. Refour, P. Pino, J.F. Franetich, L. Hammoun, R. Sauerwein, and D. Mazier. 2004. Transcription status of vaccine candidate genes of *Plasmodium falciparum* during the hepatic phase of its life cycle. *Parasitol. Res.* 92:449–452. <http://dx.doi.org/10.1007/s00436-003-1061-9>
- Coutelier, J.P., J.T. van der Logt, F.W. Heessen, G. Warnier, and J. Van Snick. 1987. IgG2a restriction of murine antibodies elicited by viral infections. *J. Exp. Med.* 165:64–69. <http://dx.doi.org/10.1084/jem.165.1.64>
- de Koning-Ward, T.F., D.A. Fidock, V. Thathy, R. Menard, R.M. van Spaendonk, A.P. Waters, and C.J. Janse. 2000. The selectable marker human dihydrofolate reductase enables sequential genetic manipulation of the *Plasmodium berghei* genome. *Mol. Biochem. Parasitol.* 106:199–212. [http://dx.doi.org/10.1016/S0166-6851\(99\)00189-9](http://dx.doi.org/10.1016/S0166-6851(99)00189-9)

- Janse, C.J., J. Ramesar, and A.P. Waters. 2006. High-efficiency transfection and drug selection of genetically transformed blood stages of the rodent malaria parasite *Plasmodium berghei*. *Nat. Protoc.* 1:346–356. <http://dx.doi.org/10.1038/nprot.2006.53>
- Jung, S., D. Unutmaz, P. Wong, G. Sano, K. De los Santos, T. Sparwasser, S. Wu, S. Vuthoori, K. Ko, F. Zavala, et al. 2002. In vivo depletion of CD11c⁺ dendritic cells abrogates priming of CD8⁺ T cells by exogenous cell-associated antigens. *Immunity*. 17:211–220. [http://dx.doi.org/10.1016/S1074-7613\(02\)00365-5](http://dx.doi.org/10.1016/S1074-7613(02)00365-5)
- Kishimoto, T., S. Akira, and T. Taga. 1992. Interleukin-6 and its receptor: a paradigm for cytokines. *Science*. 258:593–597. <http://dx.doi.org/10.1126/science.1411569>
- Mathieu, C., C. Demarta-Gatsi, A. Porcherie, S. Brega, S. Thiberge, K. Ronce, L. Smith, R. Peronet, R. Amino, R. Ménard, and S. Mécheri. 2015. *Plasmodium berghei* histamine-releasing factor favours liver-stage development via inhibition of IL-6 production and associates with a severe outcome of disease. *Cell. Microbiol.* 17:542–558. <http://dx.doi.org/10.1111/cmi.12382>
- Miyagami, T., I. Igarashi, and M. Suzuki. 1987. *Plasmodium berghei*: long lasting immunity induced by a permanent attenuated mutant. *Zentralbl. Bakteriol. Mikrobiol. Hyg. [A]*. 264:502–512.
- Ndungu, F.M., E.T. Cadman, J. Coulcher, E. Nduati, E. Couper, D.W. Macdonald, D. Ng, and J. Langhorne. 2009. Functional memory B cells and long-lived plasma cells are generated after a single *Plasmodium chabaudi* infection in mice. *PLoS Pathog.* 5:e1000690. <http://dx.doi.org/10.1371/journal.ppat.1000690>
- Nimmerjahn, F., and J.V. Ravetch. 2005. Divergent immunoglobulin g subclass activity through selective Fc receptor binding. *Science*. 310:1510–1512. <http://dx.doi.org/10.1126/science.1118948>
- Pied, S., L. Rénia, A. Nüssler, F. Miltgen, and D. Mazier. 1991. Inhibitory activity of IL-6 on malaria hepatic stages. *Parasite Immunol.* 13:211–217. <http://dx.doi.org/10.1111/j.1365-3024.1991.tb00276.x>
- Pombo, D.J., G. Lawrence, C. Hirunpetcharat, C. Rzepczyk, M. Bryden, N. Cloonan, K. Anderson, Y. Mahakunkijcharoen, L.B. Martin, D. Wilson, et al. 2002. Immunity to malaria after administration of ultra-low doses of red cells infected with *Plasmodium falciparum*. *Lancet*. 360:610–617. [http://dx.doi.org/10.1016/S0140-6736\(02\)09784-2](http://dx.doi.org/10.1016/S0140-6736(02)09784-2)
- Puga, I., M. Cols, C.M. Barra, B. He, L. Cassis, M. Gentile, L. Comerma, A. Chorny, M. Shan, W. Xu, et al. 2012. B cell-helper neutrophils stimulate the diversification and production of immunoglobulin in the marginal zone of the spleen. *Nat. Immunol.* 13:170–180. <http://dx.doi.org/10.1038/ni.2194>
- Putrianti, E.D., A. Schmidt-Christensen, I. Arnold, V.T. Heussler, K. Matuschewski, and O. Silvie. 2010. The *Plasmodium* serine-type SERA proteases display distinct expression patterns and non-essential in vivo roles during life cycle progression of the malaria parasite. *Cell. Microbiol.* 12:725–739. <http://dx.doi.org/10.1111/j.1462-5822.2009.01419.x>
- Spaccapelo, R., C.J. Janse, S. Caterbi, B. Franke-Fayard, J.A. Bonilla, L.M. Syphard, M. Di Cristina, T. Dottorini, A. Savarino, A. Cassone, et al. 2010. Plasmepsin 4-deficient *Plasmodium berghei* are virulence attenuated and induce protective immunity against experimental malaria. *Am. J. Pathol.* 176:205–217. <http://dx.doi.org/10.2353/ajpath.2010.090504>
- Spaccapelo, R., E. Aime, S. Caterbi, P. Arcidiacono, B. Capuccini, M. Di Cristina, T. Dottorini, M. Rende, F. Bistoni, and A. Crisanti. 2011. Disruption of plasmepsin-4 and merozoites surface protein-7 genes in *Plasmodium berghei* induces combined virulence-attenuated phenotype. *Sci. Rep.* 1:39. <http://dx.doi.org/10.1038/srep00039>
- Ting, L.M., M. Gissot, A. Coppi, P. Sinnis, and K. Kim. 2008. Attenuated *Plasmodium yoelii* lacking purine nucleoside phosphorylase confer protective immunity. *Nat. Med.* 14:954–958. <http://dx.doi.org/10.1038/nm.1867>
- Waki, S., J. Tamura, M. Imanaka, S. Ishikawa, and M. Suzuki. 1982. *Plasmodium berghei*: isolation and maintenance of an irradiation attenuated strain in the nude mouse. *Exp. Parasitol.* 53:335–340. [http://dx.doi.org/10.1016/0014-4894\(82\)90076-5](http://dx.doi.org/10.1016/0014-4894(82)90076-5)
- Wykes, M.N., Y.H. Zhou, X.Q. Liu, and M.F. Good. 2005. *Plasmodium yoelii* can ablate vaccine-induced long-term protection in mice. *J. Immunol.* 175:2510–2516. <http://dx.doi.org/10.4049/jimmunol.175.4.2510>

SUPPLEMENTAL MATERIAL

Demarta-Gatsi et al., <http://www.jem.org/cgi/content/full/jem.20151976/DC1>

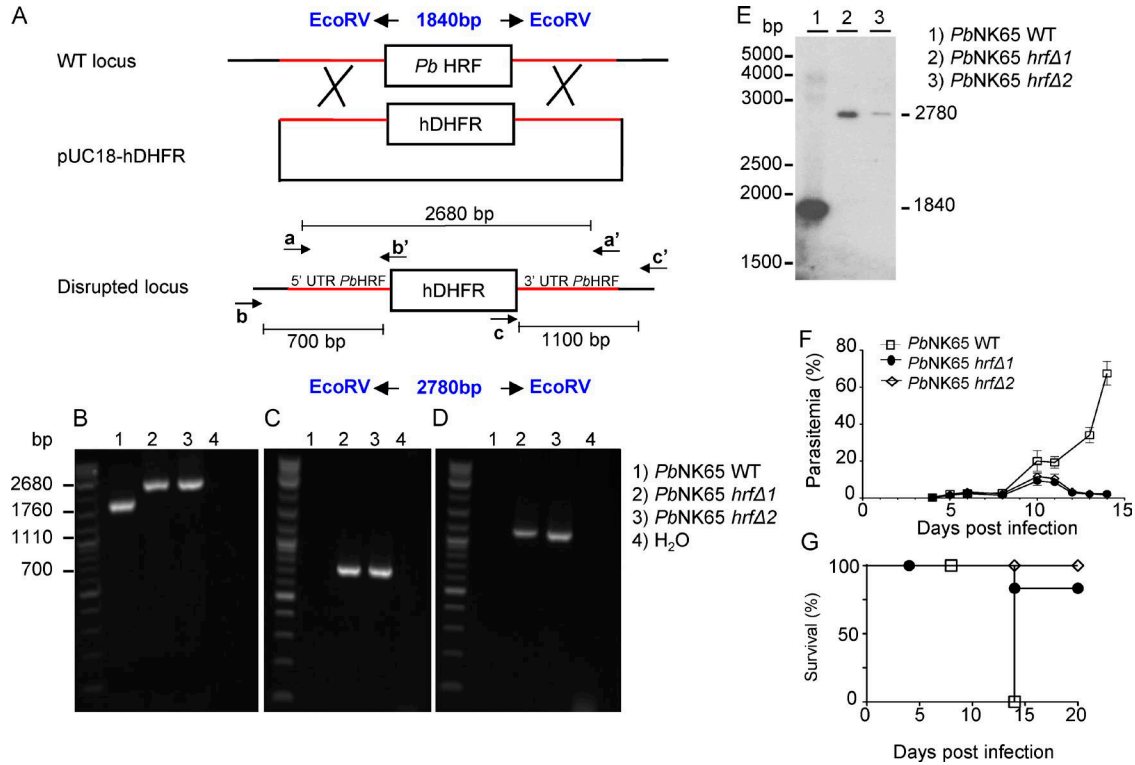

Figure S1. **Disruption of the *pbhfrf* gene in *PbNK65* parasites.** (A) Schematic representation of the strategy used to delete the *pbhfrf* open reading frame in *PbNK65* parasites using double-crossover homologous recombination. Red lines represent regions of homology. Successful recombination disrupts the HRF-coding sequence and replaces it with the drug resistance marker *hDHFR*. (B–D) Specific PCR primers (Table S2) were used to assess genomic integration of *hDHFR* in *PbNK65-hrfΔ* clones. The primers used for PCR analysis include a + a' (B), b + b' (C), and c + c' (D), with gDNA from the following: lane 1, WT parasites; lane 2, *hrfΔ* clone 1; lane 3, *hrfΔ* clone 2; and lane 4, H₂O. (E) Southern blot analysis of the *pbhfrf* locus in *PbNK65* WT, *PbNK65 hrfΔ1*, and *PbNK65 hrfΔ2* mutant locus in *PbNK65* parasites. WT locus = 1,840 bp, whereas *hDHFR* insertion = 2,780 bp. (F and G) C57BL/6 mice were inoculated with either 10⁵ GFP-expressing WT, *PbNK65-hrfΔ1*, or *PbNK65-hrfΔ2* iRBCs, and parasitemia (F) or survival (Kaplan-Meier survival plots; log-rank test; n = 11; P = 0.007; G) was followed over time. Error bars, SEM. Experiments were replicated three times.

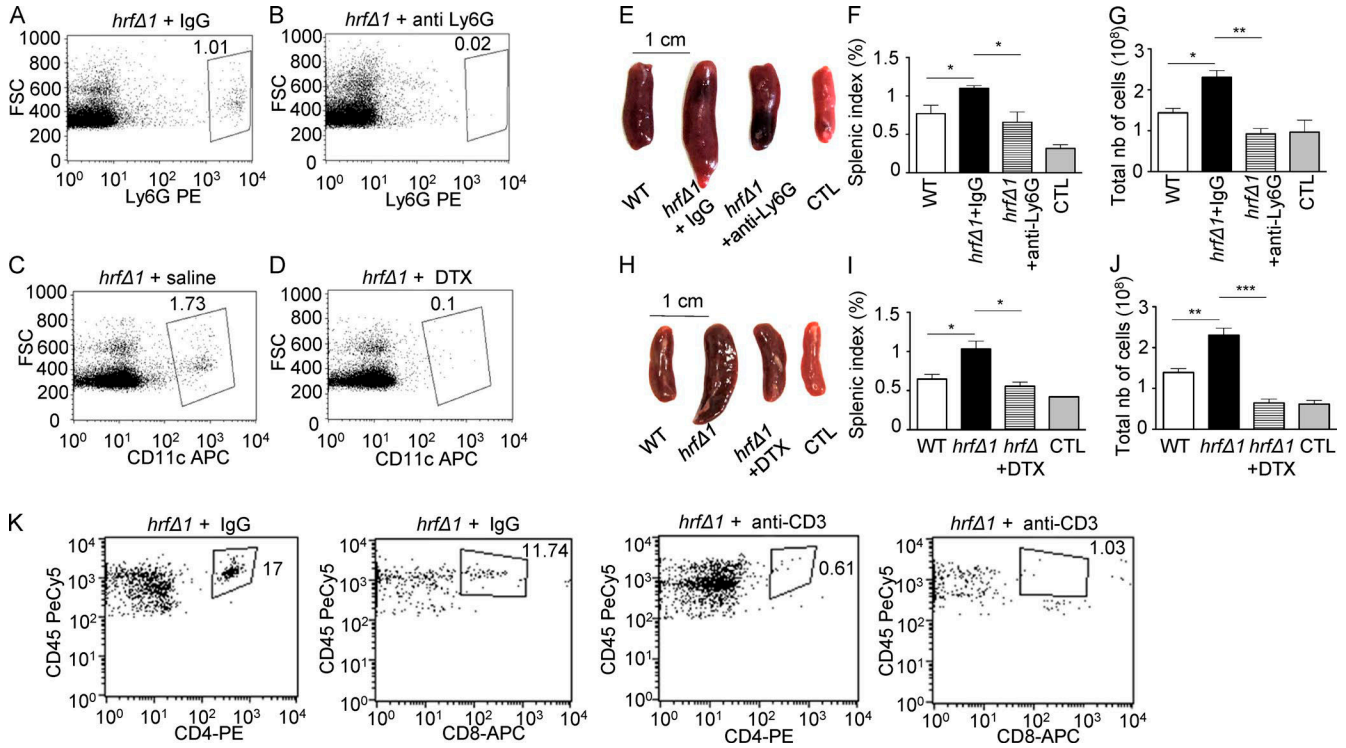

Figure S2. **Assessment of leukocyte depletion and role of neutrophils and DCs in the occurrence of splenomegaly.** (A and B) In vivo depletion of neutrophils using antineutrophil antibody (B) or normal IgG (A) was assessed by measuring at day 6 p.i. the percentage of residual Ly6G⁺ neutrophils in spleens by FACS analysis. (C and D) Depletion of DCs was performed by injection of diphtheria toxin (DTX; D) or saline (C) into CD11c-DTR-GFP mice, and at day 6 p.i., the percentage of CD11c⁺ cells was determined in spleens by FACS analysis. (E–J) Comparison at day 6 p.i. of splenic indexes and total number of leukocytes in WT and *PbNK65-hrfΔ1*-infected mice untreated or depleted of neutrophils (E–G) or DCs (H–J). (K) Control of T cell depletion (Fig. 2 G): protected mice received anti-CD3-depleting antibody 1 d before a challenge with WT parasites followed by two booster injections of anti-CD3 at days 1 and 3 after challenge with *PbNK65* WT parasites. T cell depletion efficiency was assessed by FACS analysis using anti-CD4-PE or anti-CD8-APC in blood samples from protected mice that were challenged at day 15 p.i. with *PbNK65* WT parasites. Analysis was performed 10 d after challenge. Error bars, SEM. Data are representative of two independent experiments with five to six mice per group. *, $P = 0.028$; **, $P = 0.015$; ***, $P = 0.009$; Mann-Whitney test. CTL, control; FSC, forward side scatter; nb, number.

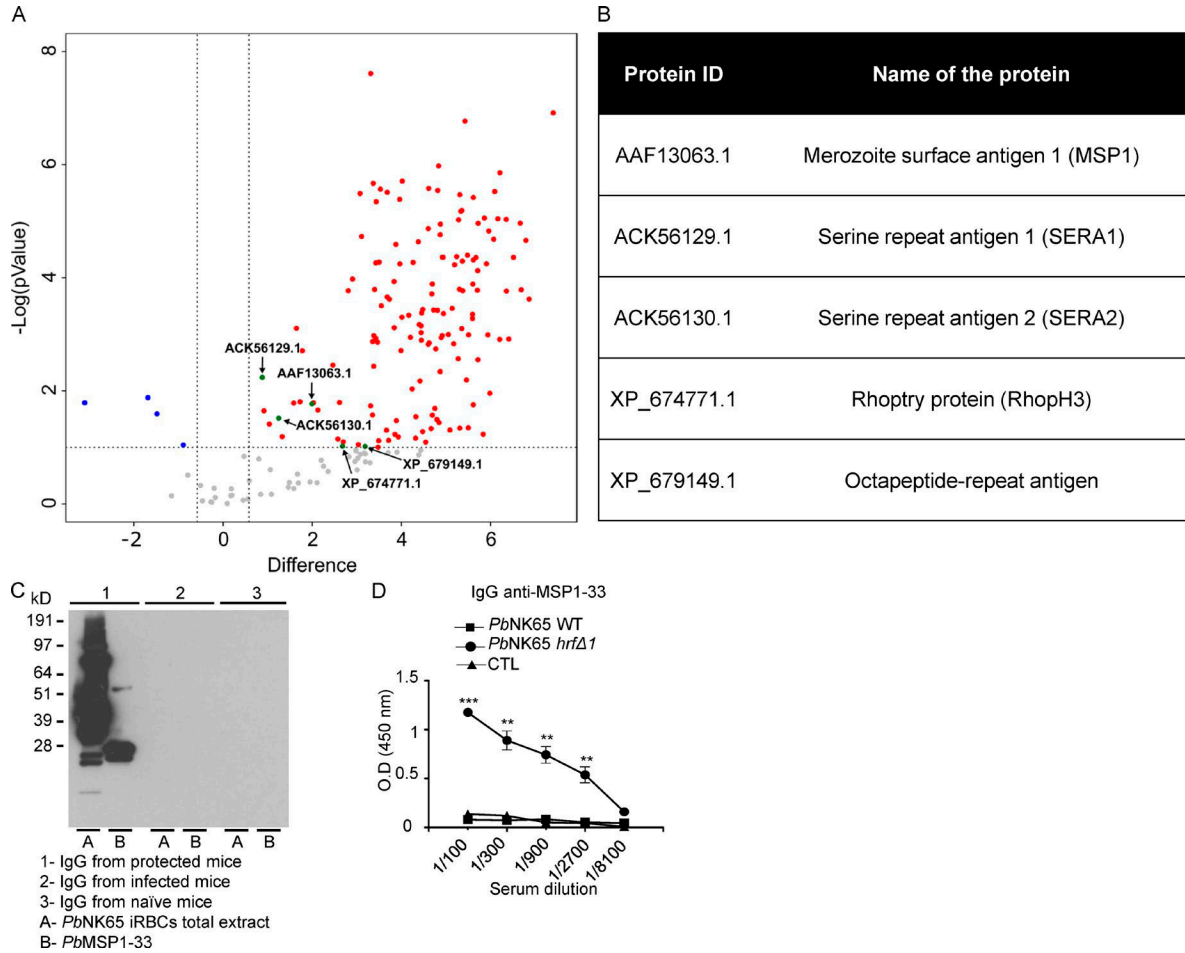

Figure S3. **Identification of immune sera-derived immunoprecipitated proteins.** (A–D) *P. berghei* antigens recognized specifically by IgGs from *PbNK65-hrfΔ1*-protected mice serum were identified by mass spectrometry. (A) Volcano plot representing results of the immunoprecipitated proteins of *PbNK65* parasite extract. This plot is colored such that those points having a fold change <1.5 are shown in gray, points >1.5 are in red, and points <1.5 are in blue. Green and red dots display both large-magnitude fold changes (x axis) as well as high statistical significance ($-\log_{10}$ of p-value, y axis). The dashed black line shows where $P = 0.05$, with points above the line having $P < 0.05$ and points below the line having $P > 0.05$. Statistical analysis was performed on triplicate samples. (B) Selected proteins for further validation are in green in A, and they are reported in the table. (C and D) Evidence that protected sera actually recognize the green dot, GenBank accession no. AAF13063.1 identified as MSP1 protein was assessed by using a recombinant *PbMSP1-33* protein by immunoblotting (C) and by ELISA (D). Error bars, SEM. Experiments were replicated three times (six mice per group). **, $0.02 < P < 0.028$; ***, $P = 0.0002$; Mann-Whitney test. CTL, control.

Table S1. List of oligonucleotides used for RT-qPCR analyses

Primer	Forward / Reverse	Sequence (5'-3')
<i>Pb</i> 18S	Forward	ATTAATCTTGAACGAGGAATGGCT
	Reverse	TCAATCGGTAGGAGCGACG
<i>Pb</i> LSP2	Forward	GCCAAATGCTAAACCTAATG
	Reverse	TGGTTTGTATTGTATGCAC
<i>Pb</i> HSP70	Forward	TGCAGCTAATCAAATC
	Reverse	ACTTCAATTTGTGGAACACC
mu IL-23	Forward	CCACCAGGACTCAAGGACAACA
	Reverse	GCAGGCTCCCTTTGAAGA
mu EB13	Forward	CAGAGTGCAATGCCATGCTCC
	Reverse	GCCACACCGAGCCTGTAAGT
mu IL-12p35	Forward	TACTAGAGAGACTTCTTCCACAACAAGAG
	Reverse	GATTCTGAAGTGCTGCGTTGAT
mu IL-12p40	Forward	GGAAGCACGGCAGCAGAATA
	Reverse	AACTTGAGGGAGAAGTAGGAATGG
mu IFN- γ	Forward	AAAGGATGCATTTCATGAGTATTGC
	Reverse	CGCTTCTGAGGCTGGATT
mu IL-6	Forward	AAAGAAATGATGGATGCTACCAAAC
	Reverse	CTTGTTATCTTTAAGTTGTTCTTCAT G TACTC
mu IL-10	Forward	GCGGCTGTCATCGATTTCTC
	Reverse	GACACCTTGGTCTTGGAGCTTATTAA
mu HPRT	Forward	CTGGTGAAGGACCTCTCG
	Reverse	TGAAGTACTCATTATAGTCAAGGGCA

Table S2. List of oligonucleotides used for PCR of WT and recombinant parasites

Oligonucleotide	Sequence (5'-3')
Apal-5'UTR- <i>Pb</i> HRF-F (a)	CGCGGGCCCGCGCATTATTACCGTTGTCA
PstI-5'UTR- <i>Pb</i> HRF-R	CGCCTGCAGGGCTTATGCAAGTATCGAACAA
KpnI-3'UTR- <i>Pb</i> HRF-F	CGCGGTACCTTGCTACATGACGCATAAACC
EcoRI-3'UTR- <i>Pb</i> HRF-R (a')	CGCGAATTCTGTGAAATCGACAATGTTTTGG
<i>HRF5'</i> -F (b)	GCGATACAACAATTTATTCAGC
<i>HRF3'</i> -R (c')	CGCAAGATATCAGAGCTTTTCA
<i>hDHFR3'</i> -F (c)	TGTTGTCTCTTCAATGATTCATAAATAGTTGG
<i>hDHFR5'</i> -R (b')	TGCTTTGAGGGGTGAGCATTTAAAGC
<i>Pb</i> HRF-5'orf-F	CCATTTGGAATGCGGAAT
<i>Pb</i> HRF-3'orf-R	TTTTTCTTCAAATAAACCATCTGA

Bold letters refer to the oligonucleotide's position in Fig. S1 (A and B).

Supplementary Results

5.1 HRF is important for *P. berghei* pre-erythrocytic and erythrocytic infection

Similar to previous studies performed on *PbANKA* strain, we examined the contribution of *Plasmodium* HRF to the phenotype of *PbNK65* both at the level of the pre-erythrocytic phase and at the blood stage. As depicted in Fig. 17A, mice inoculated with *PbNK65-hrfΔ* sporozoites showed an initial delayed development of the parasite followed by a complete clearance during blood stage at around day 17 p.i., in a similar way as the parasite was inoculated with iRBCs (Fig. 17B). Since similar phenotypes were obtained with both sporozoites and iRBCs, the follow-up investigation was carried out using iRBCs to explore the mechanisms by which HRF shapes the immune response.

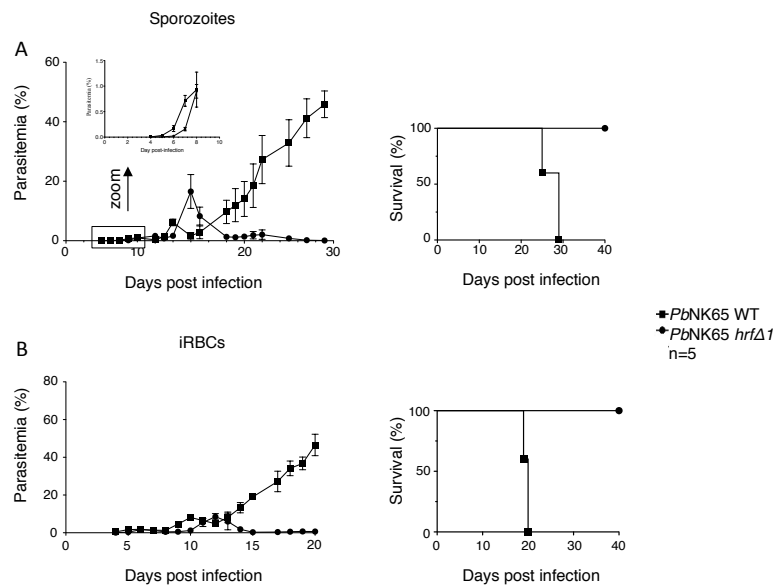

Figure 17: Marked differences in parasitaemia between WT and *hrfΔ* *PbNK65*-infected mice in blood stage development. Blood stage parasitemia and survival (Kaplan-Meier survival plots) of C57BL/6 mice infected WT or *hrfΔ* *PbNK65* parasites (A) i.v. with 1000 isolated sporozoites or (B) i.p. with 10^5 iRBCs. Error bars, SEM. Data are representative of two independent experiments with 5 mice per group. (Following methods already described in the previous article (Demarta-Gatsi et al., 2016)).

5.2 Pattern of cytokines associated with *PbNK65-hrfΔ* induced protection

It is known from previous studies that both $CD4^+$ and $CD8^+$ T cells play a central role in the elimination of blood-stage malaria parasites through the release of cytokines that activate other effector cells such as NK cells, macrophages and dendritic cells. In addition, Th1

cytokines IL-12, IFN- γ , and TNF- α , were shown to confer immunity against blood-stage *Plasmodium* infection (Perlmann and Troye-Blomberg, 2002). To examine whether the infection of C57BL/6 mice with either the WT or *hrf* Δ *PbNK65* parasite induces a particular set of cytokines, we first examined the mRNA expression of a variety of cytokines by RT-PCR in the spleen of infected mice. Spleens were analyzed at various time intervals, starting from day 2 until day 14, post infection (Fig. 18A).

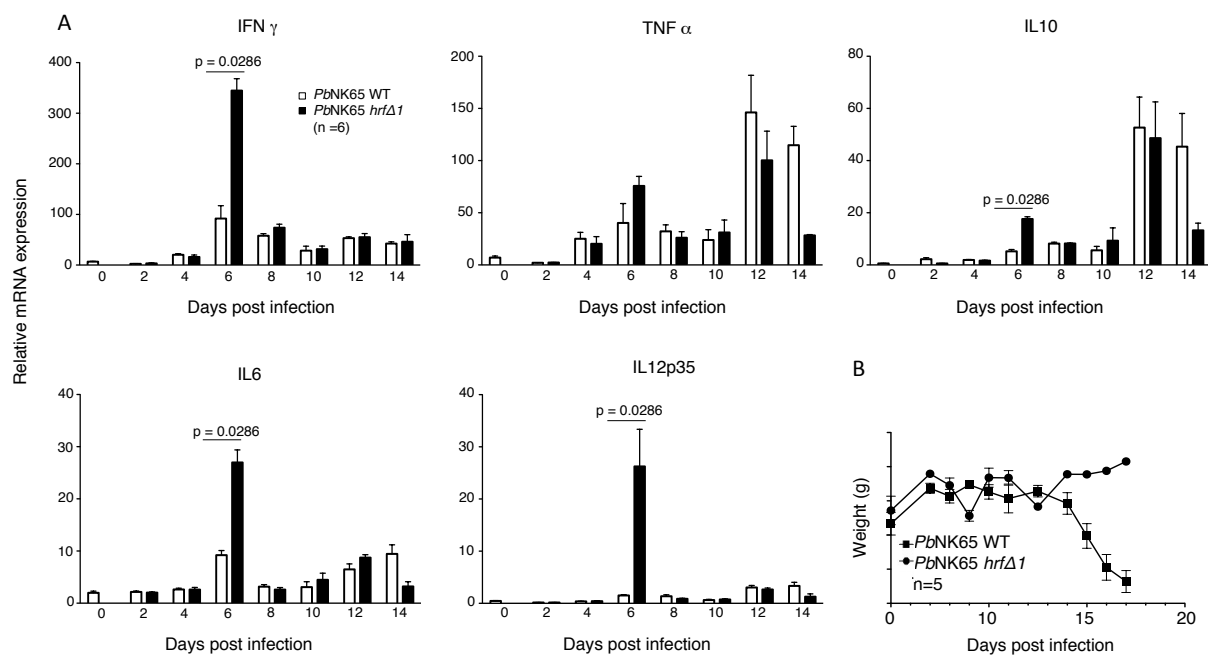

Figure 18: Immune response genes are differentially regulated by WT and *hrf* Δ 1 parasites. (A) mRNA levels (RT-qPCR) normalized to HPRT of cytokine production in spleen cells measured at different time points p.i., each 2 days from day 2 to day 14 p.i., from WT or *PbNK65-hrf* Δ infected mice. Error bars, SEM. Data are representative of two independent experiments with 5 mice per group. (Following methods already described in the previous article (Demarta-Gatsi et al., 2016). (B) Determination of body weight during infection. C57BL/6 mice were inoculated with either 10^5 GFP-WT or *hrf* Δ iRBCs and the weight was measured over time. (Following methods already described in the previous article (Demarta-Gatsi et al., 2016)).

Analyzed samples showed that IL-23, EBI-3 (IL-27 beta subunit), IL-12p40, IL-12p35, IFN- γ , IL-6, and IL-10 mRNA expressions were all higher in *PbNK65-hrf* Δ infected mice as compared to mice infected with WT parasites at day-6 p.i. (Fig. 19A, B). Higher levels of IFN-g, IL-12p70, and IL-6, as measured by ELISA, were confirmed in the plasma *PbNK65-hrf* Δ infected mice as compared to WT parasite-infected mice (Fig. 19C). This burst of pro-inflammatory cytokines induced by *PbNK65-hrf* Δ parasites was followed by a significant loss of weight at day 8 p.i. (Fig. 18B), which resulted first in the decrease of the parasitemia (Fig. 17B) followed by the

normalization of the weight a few days later (day 10 p.i.). The loss of weight from day 4 to day 8 represented 10% of the weight of control mice at the same age. In contrast, mice infected with WT parasites did not show any loss of weight until day 8 where this was continuously decreasing until the death of the mice (Fig. 17B). Mice that were infected with WT parasites displayed a delayed peak of TNF- α , IL-10 and IL-6 at day 12-14 post infection which in addition to high parasitemia may be associated to a drastic loss of body weight in these mice starting from day 14 (Fig. 18B).

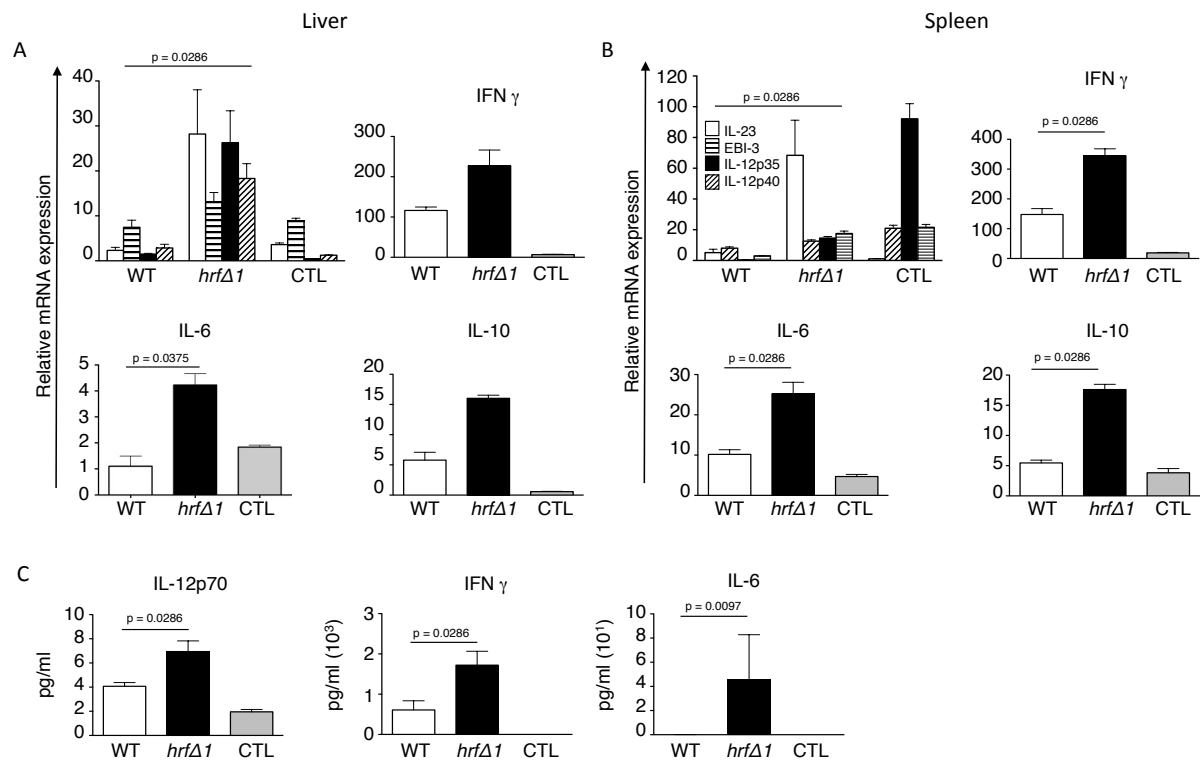

Figure 19: Cytokine production by blood-stage WT and *hrfΔ* *PbNK65* infection. A, B and C) mRNA levels (RT-qPCR) normalized to HPRT of cytokine production in liver cells (A), in spleen cells (B) and in the serum (ELISA) (C) measured at day 6 p.i. from WT or *PbNK65-hrfΔ* infected mice. CTL: mRNA and sera from naive mice. Error bars, SEM. Data are representative of four (A,B and C) independent experiments with 5 mice per group. (Following methods already described in the previous article (Demarta-Gatsi et al., 2016)).

5.3 Augmented CD11b⁺ cells during *PbNK65-hrfΔ* infection

Detailed analyses of two organs (spleen and liver) mainly characterized by high parasitemia following malaria infection show differences in the innate immune cell activation (Fig. 20). As compared to the *PbNK65* WT infected spleen, we observed an increase in the total number of F4/80⁺ macrophages and CD11c⁺ CD11b⁺ dendritic cells in the *PbNK65-hrfΔ* infected spleen

(Fig. 20B), whereas we found the opposite in the infected liver (Fig. 20A). In addition, we observed no differences in the percentage and total number of Ly6G⁺ neutrophils between WT and *hrfΔ PbNK65*-infected spleens but increased number of neutrophils in the *PbNK65* WT infected liver as compared to the *PbNK65-hrfΔ* infected liver. Taken together, these data suggest organ-specific innate cell activation after malaria infection.

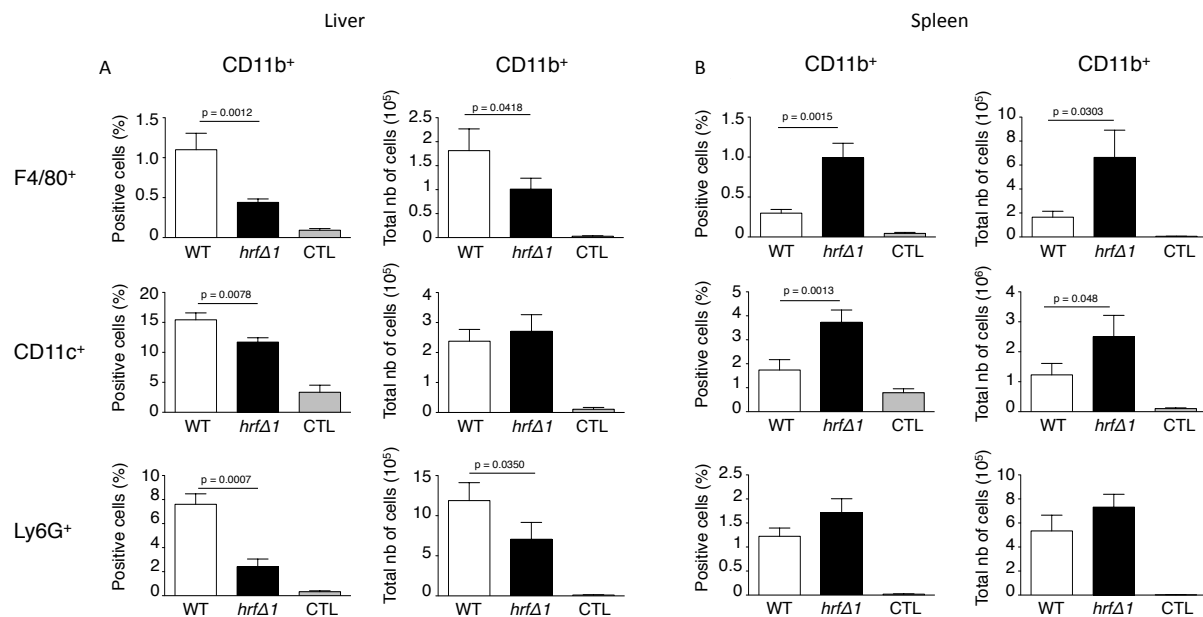

Figure 20: Innate immune cells are activated in the spleen and liver after malaria infection. (A) Liver analysis show increased levels of innate immune cells in mice infected with WT *PbNK65* parasites. (B) Spleen analysis show increased levels of innate immune cells in mice infected with *PbNK65-hrfΔ* parasites. CTL: spleen from naive mice. Error bars, SEM. Data are representative of three independent experiments with 9 mice per group. (Following methods already described in the previous article (Demarta-Gatsi et al., 2016)).

5.4 Protection conferred by mutant parasites is dependent on effector CD4⁺ T cells.

In order to show that the protection induced by *PbNK65-hrfΔ* parasites is dependent on effector CD8⁺ or CD4⁺ T cells, protected mice were treated with normal mouse IgG, anti-CD8 or with anti-CD4 depleting antibody. The dose of each antibody used was set to 20 mg for anti-CD8 (clone 53-6.7, Armenian hamster IgG, eBioscience) and 100 mg for anti-CD4 (clone GK1.5). The different blood cell populations were monitored by flow cytometry 24h after intravenous injection. Mice were challenged with 10⁵ iRBCs of WT *PbNK65* parasites and both parasite growth and cells depletion efficacy were monitored daily by flow cytometry in blood samples (Fig. 21). The results confirmed the specific reduction of CD8⁺ or CD4⁺ T cells

in animals injected with anti-CD8 and anti-CD4 respectively. Interestingly, the measurement of parasitemia indicated a loss of parasite control upon treatment of protected mice with anti-CD4 antibody but not with anti-CD8 antibody. WT parasite-challenged mice treated with control IgG remained parasite free. This suggests that the activation of effector CD4⁺ T lymphocytes but not CD8⁺ are indispensable for clearance of malaria infection in long term immune protection. These results are further supported by previous studies in animal models where depletion or adoptive transfer of the different T cell populations highlighted the important role of CD4⁺ T cells in the development of protective immunity against blood stages (Taylor-Robinson, 2002; van der Heyde et al., 1997).

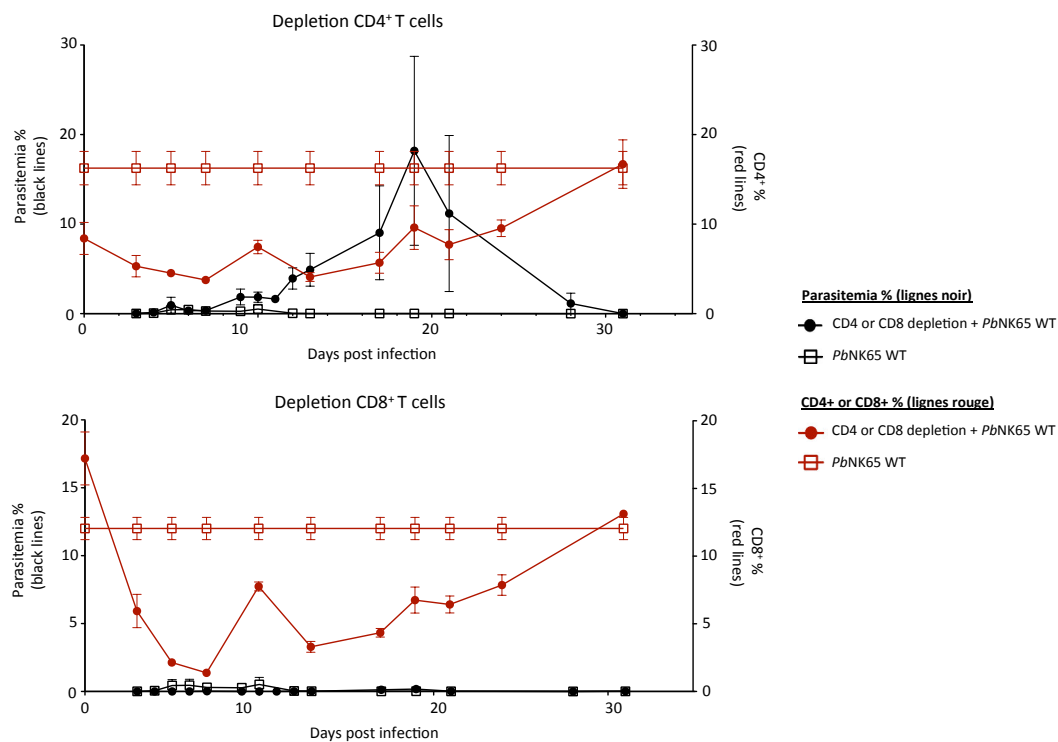

Figure 21: Influence of CD4⁺ or CD8⁺ T cells depletion on parasite development in protected mice. Protected mice were treated either with IgG or with anti-CD4-depletion Abs or anti-CD8-depletion Abs one day prior to a challenge with WT parasites followed by two booster injections of anti-CD4 and anti-CD8 at days 1 and 3 after challenge. Error bars, SEM. Data are representative of two independent experiments with 5 mice per group. (Following methods already described in the previous article (Demarta-Gatsi et al., 2016)).

5.5 Protection induced by *PbNK65-hrfΔ* parasites is associated with down-regulation of PD-1 on T cells

As previously observed, mice lacking T cells were unable to control the parasitemia of *PbNK65-hrfΔ* infected mice, suggesting that the activation of T lymphocytes may be indispensable for immune memory against malaria infection. In order to better characterize the molecular signatures of the T cell response and given that chronic malaria infection results in an increased frequency of T cells expressing surface markers of exhaustion such as programmed cell death-1 (PD-1) (Butler et al., 2012), we asked whether the self-resolving nature of *PbNK65-hrfΔ* infection could be correlated to a change in PD-1 expression on the surface of effector T cells. When we analyzed PD-1 expression by flow cytometry at day 6 and day 20 p.i. (Fig. 22A, B), we observed that WT parasites induced a high proportion of PD1⁺CD4⁺ and PD1⁺CD8⁺ T cells in the spleen hinting at T cell exhaustion. In contrast, *PbNK65-hrfΔ* parasites induced two-fold fewer PD1⁺ CD4⁺ and PD1⁺ CD8⁺ T cells at day 6 p.i. as compared to WT parasites, with this number decreasing to basal levels found in uninfected mice at day 20 p.i. (Fig. 22A). We further correlated PD-1 expression to the activation status of T cells using the cell surface marker CD62L: low or undetectable levels of surface CD62L are indicative of T cell activation and effector function (Oehen and Brduscha-Riem, 1998). At day 6 p.i. we observed in WT parasite-infected mice, 65% and 70% of activated CD4⁺CD62L⁻ and CD8⁺CD62L⁻ T cells, respectively, were PD-1⁺ whereas only 40% of activated CD4⁺CD62L⁻ and CD8⁺CD62L⁻ T cells were positive for PD-1⁺ in mice infected with *PbNK65-hrfΔ* parasites (Fig. 22B). The number of PD-1⁺ activated T cells further decreased at day 20 p.i. in *PbNK65-hrfΔ*-infected mice, resetting to the basal levels found in uninfected mice (Fig. 22A, B). To investigate whether *rPbHRF* can directly modulate the expression of PD-1 on the surface of T cells, naïve mice were injected with 100 μg of *rPbHRF* or BSA as a negative control and 48 h later, PD-1 surface expression examined. We observed an upregulation of PD-1 on CD4⁺ and CD8⁺ T cells surface (Fig. 22C) and on activated CD4⁺ CD62L⁻ and CD8⁺ CD62L⁻ T cells (Fig. 22D) induced by the *rPbHRF*. Taken together, these data demonstrate that infection with *PbNK65* parasites expressing *PbHRF* is associated with an increased proportion of PD-1⁺ T cells in mice, indicative of T cell exhaustion.

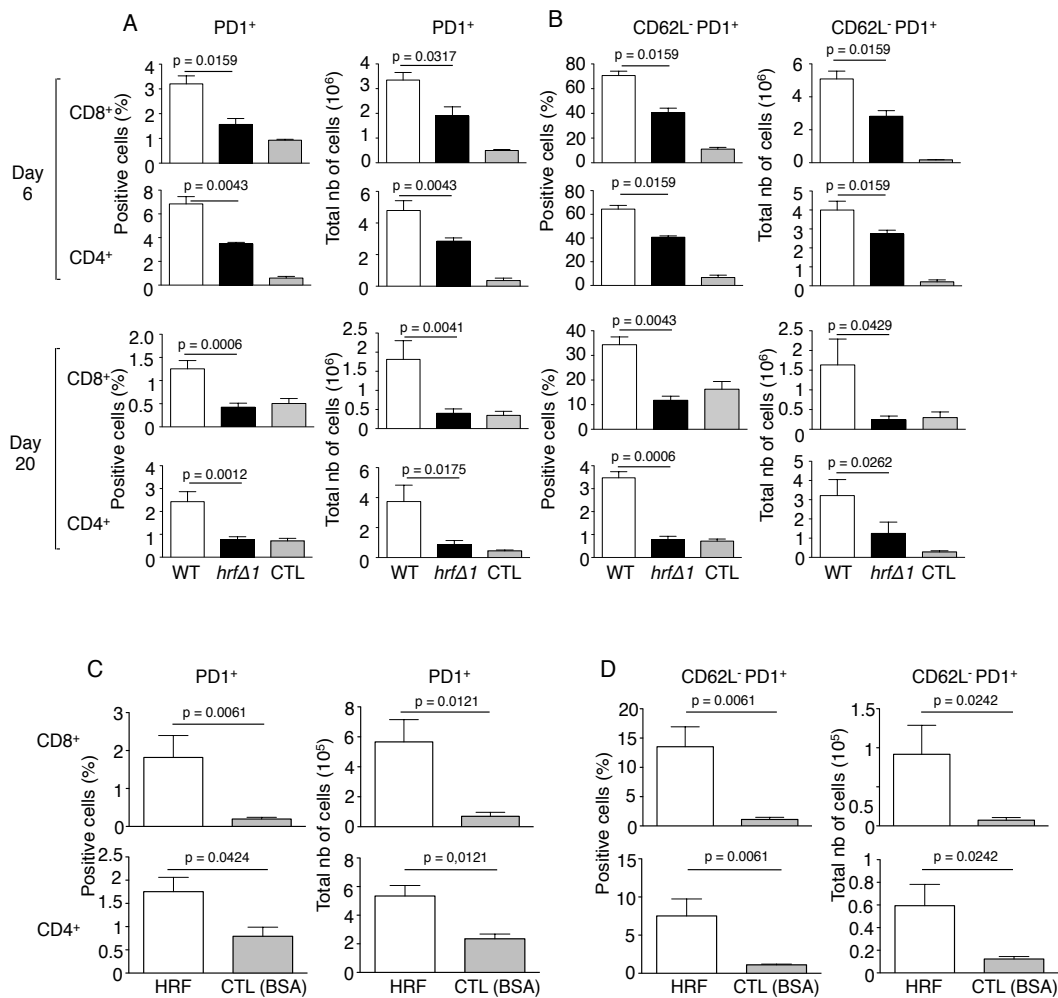

Figure 22: Protection induced by *hrfΔ* *PbNK65* parasites is associated with reduced induction of PD1⁺CD8⁺CD62L⁻ and PD1⁺CD4⁺CD62L⁻ cells in spleen. (A) Representative frequency and absolute number of CD8⁺PD1⁺ and CD4⁺PD1⁺ splenic leukocytes at day 6 and day 20 p.i. with either 10⁵ GFP-WT or *hrfΔ* iRBCs. (B) Representative frequency and absolute number of CD8⁺CD62L⁻ and CD4⁺CD62L⁻ splenic leukocytes expressing the PD1 receptor at day 6 and day 20 post infection with either 10⁵ GFP-WT or *hrfΔ* iRBCs. (C) Representative frequency and absolute number of CD8⁺PD1⁺ and CD4⁺PD1⁺ splenic leukocytes 48h after *Pb* recombinant HRF administration (IV). (D) Representative frequency and absolute number of CD8⁺CD62L⁺ and CD4⁺CD62L⁺ splenic leukocytes expressing the PD1 receptor 48h after *Pb* recombinant HRF administration (IV). Error bars, SEM. Data are representative of three (A,B) and two (C,D) independent experiments with 5 and 8 mice per group. (Following methods already described in a previous article (Demarta-Gatsi et al., 2016)).

5.6 Prior exposure to WT parasite followed by drug treatment does not hamper *PbNK65-hrfΔ*-induced parasite clearance and immune protection

Results obtained from mice infected firstly with *PbNK65-hrfΔ* parasites and, upon the complete clearance of *PbNK65-hrfΔ* parasites, with either *PbNK65*, *PbANKA* or *PyYM* WT parasites demonstrated that the sterile protection conferred by this GAP is long-lasting in a species- and stage-transcendent manner. In real field conditions, such GAP delivery would only be given to individuals who had been previously infected with WT parasites and drug treated. In endemic areas pre-exposure to WT parasites followed by antimalarial chemotherapy could induce epigenetic marks that may negatively influence anti-parasite immunity. In this situation the protective effect induced by the *PbNK65-hrfΔ* mutant will not be effective. The question is to assess whether these individuals who had been exposed to WT parasites and drug cured will be equally efficiently protected following *PbNK65-hrfΔ* infection as in naïve mice. To address this issue, mice were first infected with 10^5 *PbNK65* WT iRBCs, and when parasitemia reached around 2%, were treated for three consecutive days with 6 mg/kg WR99210 by subcutaneous injections. Once the parasites were completely eliminated from the blood stream, at day 19 p.i., mice were infected either with 10^5 WT or with *PbNK65-hrfΔ* parasites iRBCs (Fig. 23). We observed that in the group of mice which have received WT parasites, parasites develop normally and the mice died around day 20 p.i.. In contrast mice, which received *PbNK65-hrfΔ* parasites, show a slow development of parasites which were ultimately eliminated around day 15 p.i. from peripheral blood circulation. To assess whether one single infection with the mutant parasite was enough to develop a long-lasting immune response, as we previously observed without the use of drugs, mice which received WT parasites followed by *PbNK65-hrfΔ* parasites were infected with 10^5 WT iRBCs 4 weeks after the elimination of the mutant parasite from the blood circulation (Fig. 23). A control group, which has been neither infected nor treated by antimalarial drugs, was infected at the same time with 10^5 WT iRBCs. As obtained with WT parasite challenges in protected mice without drug treatment, infection with *PbNK65-hrfΔ* parasites allows the development of a long-lasting immune protection despite a prior drug

treatment. This result shows that a primary infection with WT parasites followed by a drug cure does not hamper the efficacy of NK65-*hrf* Δ -induced protection.

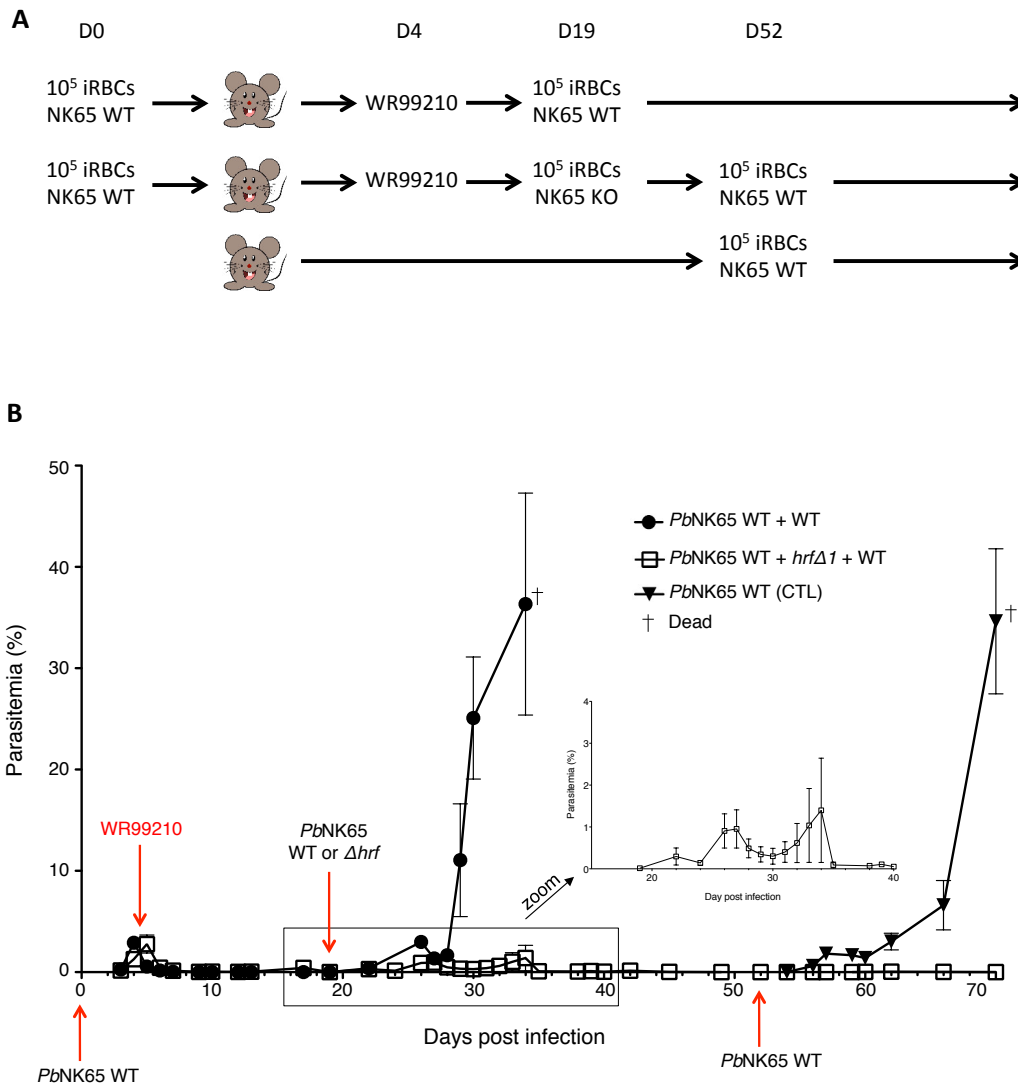

Figure 23: Drug treatment does not affect the development of long-lasting protection after infection with HRF-deficient blood stage parasites. (A) Protocol used to infect and to treat mice. (B) Blood stage parasitemia of C57BL/6 mice after i.p. injection of 10^5 WT iRBCs and treated at day 4 p.i. with 6 mg/kg WR99210 by subcutaneous injections. At day 19 p.i. infection of mice with either with 10^5 iRBCs WT or *PbNK65-hrf* Δ iRBCs. Mice group infected with *PbNK65-hrf* Δ parasites were subsequently, at day 52 p.i., infected with 10^5 WT iRBCs. Error bars, SEM. Data are representative of three independent experiments with 5 mice per group. (Following methods already described in a previous article (Demarta-Gatsi et al., 2016)).

5.7 *PbNK65-hrfΔ* parasite-induced protection is associated with an increased number of central and effector memory B cells

The observation that *hrfΔ* *PbNK65* infected mice eliminate the parasite while they acquire a long lasting immune memory and high anti-parasite IgG Abs titers prompted us to analyse the generation of central and memory B cells. The germinal centers are the main sites where somatic hypermutations and class switch recombination occur. During the immune response, B cells express the activation-induced cytidine deaminase (AID) enzyme which acts on Ig gene loci to enhance antibody production and B cell functions. To visualize activated AID transcription in B cells, AID/YFP Tg mice were used, in which memory B cells containing populations can be divided into “central” memory (AID/YFP⁺CD19⁺IgM⁺IgG) and “effector” memory (AID/YFP⁺CD19⁺IgM⁻IgG⁺) B cells. In order to investigate the generation of the immunological memory during *Plasmodium* infections AID/YFP Tg mice were infected i.p with 10⁵ iRBCs of either WT or *hrfΔ* *PbNK65* parasites. At day 15 p.i., mice were killed and spleen B cell populations analysed by flow cytometry (Fig. 24). From our preliminary data we observe a significant difference in the memory B cells between mice infected with either WT or *hrfΔ* *PbNK65* parasites. Additionally, characterization of memory B cells populations show also significant difference in both effector and central memory B cells between the two populations of mice. As compared to the WT *PbNK65*-infected spleen, we observed an increase in the total number of CD19⁺AID/YFP⁺ memory B cells and its population (IgM⁻IgG⁺ or IgM⁺IgG⁻) in the *hrfΔ* *PbNK65*-infected spleen. These preliminary results reinforce the hypothesis that the B cells are important in the immune response developed in C57BL/6 mice against the *PbNK65-hrfΔ* parasites. We can assume that the effector memory cells developed during the first infection with the *PbNK65-hrfΔ* parasites are important for the maintenance of the immune response during a long period of time, in fact challenges of protected mice with WT parasites show that the parasite is eliminated by the immune system immediately without allowing him to develop.

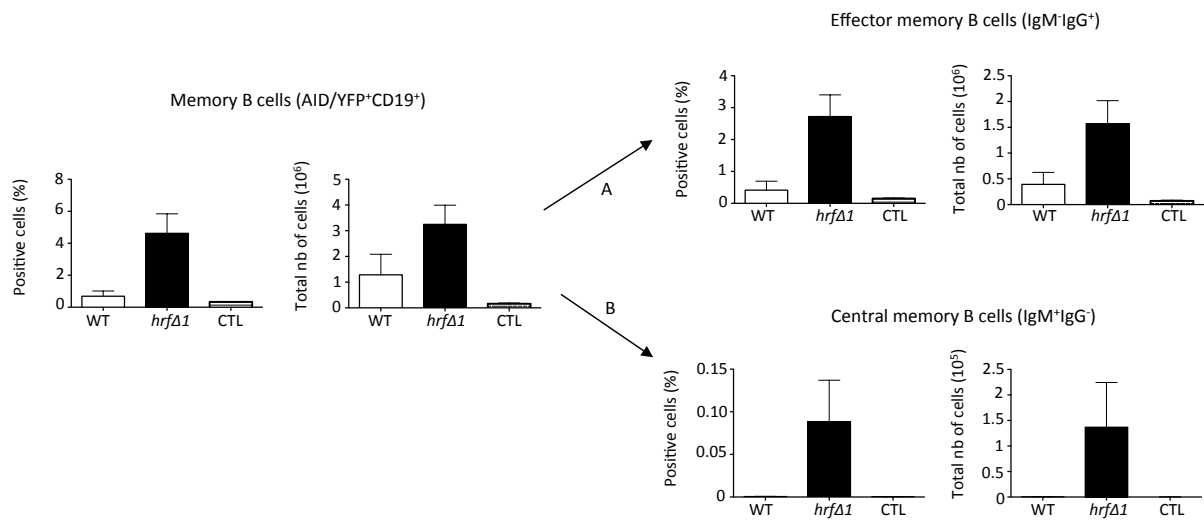

Figure 24: Frequency of memory B cells in *PbNK65-hrfΔ* protected mice. Representative frequency and absolute number of AID/YFP⁺CD19⁺ memory B cells splenic leukocytes at day 15 p.i. with either 10⁵ GFP-WT or *hrfΔ* iRBCs. (A) Representative frequency and absolute number of AID/YFP⁺CD19⁺ memory B cells splenic leukocytes expressing IgM⁺IgG⁺ at day 15 p.i. (B) Representative frequency and absolute number of AID/YFP⁺CD19⁺ memory B cells splenic leukocytes expressing IgM⁺IgG⁻ at day 15 p.i. Error bars, SEM. Data are representative of two independent experiments with 4 mice per group. (Following methods already described in a previous article (Demarta-Gatsi et al., 2016)).

Discussion

In spite of continued efforts to control the disease, malaria remains a major health problem in many regions of the world, especially sub-Saharan Africa, and new ways to control or eradicate the disease are urgently needed. Development of an effective malaria vaccine, that could greatly improve global public health by enhancing a rapid and protective immune response that completely eliminates the infection, would provide a better way of alleviating malaria. But scientists have different point of view on the best lines of research to pursue. Despite the large number of successful vaccines in use today for different diseases (such as polio, tetanus, measles, smallpox or pertussis) the development of malaria vaccine still remains a challenge for scientists. Malaria vaccine research involves the combination of vaccinology, immunology and parasitology (malariology) and there are few established theoretical principles in this field to serve as guidelines. Moreover, the differences between *Plasmodium* strains, the persistence of infection for months and the capacity of the parasite to both evade and disable the immune system by a variety of mechanisms are the major problems encountered for the development of a vaccine.

Understanding malaria pathogenesis may find its way in the investigation of possible common pathways with allergic inflammation.

Since the beginning of the humanity, the parasite has learned to live and co-evolve with the human immune system. This co-evolution has been performed through a myriad of complex mechanisms that ultimately result in the inability of the immune system to eliminate the parasite and to mediate resistance to subsequent infections. An important part in the development of an effective malaria vaccine is the understanding of the mechanisms developed by the parasite to escape the immune response or the natural immunity to malaria developed by the host. A way to address the mechanisms involved in the pathogenesis of a disease is to find out if the disease in question does not share signalling pathways associated with other pathologies. Following this line of thought we hypothesised that the *Plasmodium* parasite turns to its advantage the mechanisms involved in the allergic inflammatory response (Fig. 25).

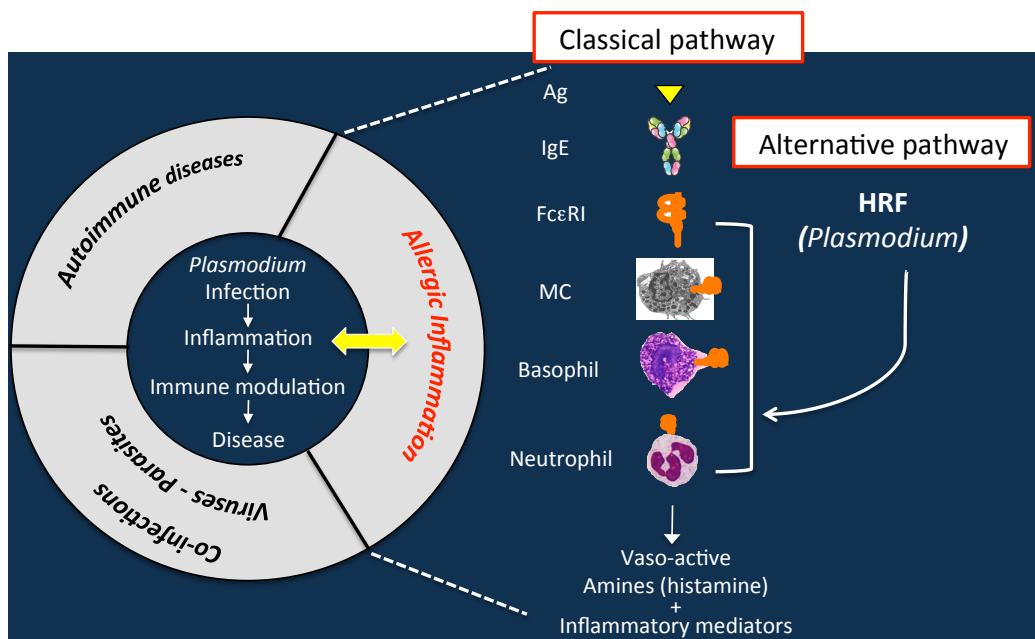

Figure 25: Hypothesis: understanding malaria pathogenesis associated with *Plasmodium* infection and allergic inflammation share common signalling pathways. The figure displays three major known pathologies: autoimmune diseases, infections diseases, and allergic responses. Indirect evidence from immuno-epidemiological studies support that an association exist between malaria pathogenesis and mechanisms involving IgE-mediated inflammatory responses. This latter consist of classical pathway which starts with the binding of antigen (Ag)-specific IgE Abs to FcεRI expressed on various leukocytes (mast cells, basophils, and neutrophils), and upon aggregation, cells will release histamine and other inflammatory mediators. Beside this classical pathway, alternative pathway independent from IgE/ FcεRI complexes, are also able to trigger mediator release. One of the prototypes IgE-independent triggers is the histamine releasing factor (HRF).

Several studies conducted in endemic areas in humans suggest a strong relationship between clinical susceptibility to malaria and severe allergic-type responses (Demeure et al., 2005; Griffiths et al., 2005; Sakuntabhai et al., 2008). Indeed, the contribution of host genetic factors to the risk of severe outcome was highlighted in different studies during *P. falciparum* infection in African populations. Large scale genetic studies in Senegal revealed that several chromosome regions were linked to clinical malaria, and 12q21-q23 and 5q31-33 associated with parasite density, evoked have been previously found to be associated to atopic disease or related phenotypes (Flori et al., 2003; Iyengar et al., 2001; Rihet et al., 1998; Sakuntabhai et al., 2008). Link between parasite density and the region on chromosome 5q31, previously found to be significantly linked to malaria parasite density and involved in the control of immunity to *P. falciparum* blood stage, have been shown to be associated to asthma/atopy related traits and to elevated IgE levels (Bouzigon et al., 2010;

Flori et al., 2003; Iyengar et al., 2001; Rihet et al., 1998; Sakuntabhai et al., 2008). Previous studies highlighted the importance of this region in immune regulation by its linkage to plasma IgE levels (Marsh et al., 1994; Meyers et al., 1994), bronchial hyper responsiveness, and to *Schistosoma mansoni* infection intensity (Postma et al., 1995) in humans and with resistance to *P. chabaudi* in mice (Hernandez-Valladares et al., 2004). The 5q31–33 region encodes for several genes mostly Th2 cytokines (IL-3, IL-4, IL-5, IL-9, IL-13) which are responsible for the differentiation of B cells that generate IgE, but also the Th1 cytokine IL-12B and other immunologically active genes such as interferon regulatory factor-1 which are strong candidates for controlling the outcome of malaria infection. The 13q13-q22 and 12q21-q23 regions contain genes, namely *PHF1153* and *STAT6*, known to increase total serum IgE levels (Chen and Khurana Hershey, 2007). Moreover, the IL-4, IL-13 and *STAT6* pathways have been reported to be associated with IgE and asthma. The role of IL-4 in regulating the antibody response induced by *Plasmodium* parasite was studied using different approaches. Genetic studies on IL4 T/C single nucleotide polymorphism (SNP) in Mali (Vafa et al., 2009; Vafa et al., 2007) and in Burkina Faso (Verra et al., 2004) have highlighted the importance of the IgE antibodies induced by IL-4 pathway. Higher parasite prevalence in asymptomatic Fulani population, known to be naturally less susceptible to malarial infections than their sympatric neighbours, was correlated with the T allele, suggesting that CT genotype carriers are less successful in clearing the infection as compared to the CC genotype carriers (Vafa et al., 2007). Additionally, an increased level of IgE in the T allele group was associated to the presence of malaria parasites (Vafa et al., 2009). Burkina Faso studies in non-Fulani children correlated CT genotype carriers with higher total IgE levels with severe malaria compared to uncomplicated malaria (Verra et al., 2004).

Elevated plasma levels of IgE and anti-plasmodial IgE Abs which bind to basophils and mast cells have been associated with severity to *P. falciparum* infections in adults and children living in malaria endemic areas in different African and Asian countries (Perlmann et al., 1994; Perlmann et al., 1999; Troye-Blomberg et al., 1999a). Indeed, IgE levels were reduced amongst patients with uncomplicated malaria in comparison to those suffering from severe malaria (Seka-Seka et al., 2004) and high IgE levels were found during cerebral *P. falciparum* malaria related to the deepness of the coma compared to uncomplicated malaria

(Luty et al., 1994; Maeno et al., 2000). In a more recent study, total IgE levels tended to be higher in uncomplicated malaria than in severe cases, while the levels of *P. falciparum*-specific IgE in severe forms were higher than those found in the uncomplicated cases of the disease (Kumsiri et al., 2016), suggesting that parasite-specific IgE Abs may contribute to the severity of the disease.

During the allergic inflammatory response, the IgE Abs bind to the high-affinity receptor FcεRI and the formation of the antigen-IgE-FcεRI complex activates the cells and stimulates the release of inflammatory mediators such as histamine (Fig. 25). Release of pro-inflammatory mediators involved in allergic inflammation in the host is one of the events occurring during malaria infection (Mecheri, 2012). Significantly elevated plasma histamine concentrations, derived from basophils and mast cells (MacDonald et al., 2001), in comparison to uninfected controls ($P < 0.01$) correlate with systemic *P. falciparum* disease complications within infected children (Bhattacharya et al., 1988; Enwonwu et al., 2000; Srichaikul et al., 1976). A study conducted in a hyperendemic area of malaria in Southwest Nigeria, where chloroquine and amodiaquine treatment failed, demonstrated that treatment of children with a combination of amodiaquine or chloroquine or pyrimethamine/sulfadoxine plus chlorpheniramine, a histamine receptor type 1 antagonist reversed chloroquine resistance *in vitro* (Basco and Le Bras, 1994), and enhanced the drug efficacy *in vivo* (Sowunmi et al., 2001; Sowunmi et al., 2007; Sowunmi et al., 1997; Sowunmi et al., 1998a; Sowunmi et al., 1998b). In addition a clinical drug library screen using existing drugs for previously unknown activities identifies the non-sedating anti-histamine astemizole as an antimalarial agent able to inhibit the proliferation of three *P. falciparum* strains (3D7, Dd2 and ItG) (Chong et al., 2006). These findings strongly suggest that histamine, a major product of the allergic inflammatory cascade, plays a prominent role in malaria pathogenesis.

Moreover, a mouse model for human atopic disease (NC/Jic) was found to be susceptible to *P. yoelii* infections compared to WT mice (Ohno et al., 2001). The *Pymr* (*P. yoelii* malaria resistance) locus, able to control host survival and parasitemia after infection, was mapped on chromosome 9. In *P. chadaudi* infection, the *char1* locus (*P. chadaudi* resistance locus 1)

responsible to control host survival and peak parasitemia was mapped to the same region. Interestingly, the loci of atopic disease susceptibility (quantitative trait locus of *derm1*) on chromosome 9 are mapped exceptionally close to genes (*char1* and *pymr*) mediating parasitemia control (Kohara et al., 2001; Sakuntabhai et al., 2008). This concept has been further supported by several *in vivo* studies carried out in human and mice. Thus, atopic dermatitis in children is linked with a higher prevalence of clinical malaria attacks in Ethiopia (Haileamlak et al., 2005). In our laboratory, using a mouse model, we highlighted the crucial role of histamine in the pathogenesis of malaria disease. Firstly, by demonstrating that the allergic-type response, by the intermediary of mosquito saliva, starts immediately after the mosquito bite perturbing the early anti-parasite immune response and affecting downstream disease development (Demeure et al., 2005; Schneider et al., 2011). Secondly, by showing the importance of histamine release during malaria infection and its consequences. Indeed, mice treated with antihistamines or deficient for the H1 and H2 receptors for histamine were more resistant to ECM (Beghdadi et al., 2008). Moreover, the disruption of IgE or the α chain of Fc ϵ RI led to the resistance to the development of ECM after infection with *PbANKA* indicating a pathological role of IgE that acts via Fc ϵ RI to promote disease development. This study identified, in mice, neutrophils and eosinophils as alternative Fc ϵ RI-expressing cell types having a disease enhancing capacity. Although Fc ϵ RI α is essentially absent in naive mouse neutrophils, the receptor was shown to be induced during *Plasmodium* infection (Porcherie et al., 2011). The transfer of Fc ϵ RI⁺, but not Fc ϵ RI⁻, neutrophils to the otherwise resistant Fc ϵ RI- α -KO mice conferred ECM susceptibility highlighting the implication of Fc ϵ RI⁺ neutrophils in malaria pathogenesis (Porcherie et al., 2011). Altogether, these findings demonstrate that components of the allergic cascade including IgE, Fc ϵ RI, histamine and the newly identified Fc ϵ RI-positive neutrophil population, are intimately associated with severe forms of malaria disease. This may have practical consequences on the management of malaria disease by introducing novel anti-allergic therapeutic approaches used individually or in combination with classical anti-malarial chemotherapy.

Recent studies have documented the importance of an alternative mechanism, independent of the classical pathway implicating the IgE-Fc ϵ RI complex during histamine release, where

cells are directly activated by a *Plasmodium*-derived protein called Histamine Releasing Factor (HRF) (MacDonald et al., 2001)(Fig. 25). Additionally, high levels of *Pf*HRF have been detected in the serum of mildly and severely *P. falciparum* infected Malawian children (Janse et al., 2006; MacDonald et al., 2001).

Considering these observations, we chose to provide a comprehensive description of the role of *Plasmodium* HRF during the parasite development in the host liver and during blood stages infection. To do so, we investigated (1) the influence of the *Plasmodium* HRF to modulate the immune mechanisms during malaria infection and (2) whether its expression was associated with the severity of malaria disease. For this, we generated a genetically HRF-deficient parasites (*hrf* Δ) firstly in *P. berghei* ANKA-GFP parasites and later in *P. berghei* NK65-GFP parasites, and we assessed the impact of this mutation both on the host immune response and on the severity of the resulting malaria disease. Knowing that the loss of *hrf* expression in mice results in increased spontaneous apoptosis and death during embryogenesis, we analysed the development of mutant parasites during the whole life cycle by determining by qRT-PCR or by counting the number of parasites over time. We found that the deletion of the *hrf* gene did not affect the parasite development per se, meaning that the deletion was not lethal for the parasite.

Inoculation of *Pb*ANKA WT or *hrf* Δ sporozoites was implemented either via intravenous or intradermic injection, ensuring that a consistent number of sporozoites enters mouse circulatory system, or via mosquito bite. The later involves saliva effects, that include anti-platelet, anti-coagulant, vasodilatory and anti-platelet mediators and was shown to induce more likely a development into blood stage parasitemias than their intravenous inoculated counterparts. We also studied the influence of HRF in the development of the parasite during direct injection of RBCs previously infected with WT or HRF mutant parasites in mice. Our results showed that infection with sporozoites was characterized by a delay in blood stage development of mutant parasites as compared to *Pb*ANKA WT parasites. This delayed development resulted in clinical immunity but without sterile immunity.

Sporozoite infectious capacities are dependent on three characteristics: host cell traversal, host cell invasion and gliding motility, all critical for parasite proceeding development within

the liver. Therefore, cell traversal assay was done to deduce a potential role of *Plasmodium* HRF in mediating sporozoite locomotive capacities. Incubation of hepatic cells (HepG2) with *PbANKA* WT or *hrfΔ* sporozoites *in vitro* did not display any detectable defect in gliding motility or host cell traversal and invasion. A comparative qualitative analysis between *PbANKA* WT and *hrfΔ* parasite gliding properties was also observed via intravital (*in vivo*) microscopy. Injection of *PbANKA* WT and *hrfΔ* sporozoites in the tail vein was performed to compare the parasite ability to cross the sinusoidal barrier. The number of moving sporozoites and respective percentage within the liver parenchyma did not show any reduced gliding motility in mutant parasites compared to WT parasites, confirming the previous *in vitro* results and demonstrated that HRF is not important during the entry into hepatocytes. However, the impaired development of HRF mutant liver stages *in vivo* is likely to induce some parasite death, as suggested by intravital imaging studies. This resulted in a 10^2 - to 10^3 -fold reduction in the numbers of merozoites initially released in the blood, and an extension of the time between sporozoite injection and detectable parasitaemia. This prolonged liver-stage development influenced the clinical outcome of infection by decreasing the frequency of ECM as was observed in mice infection by mosquito bite sporozoite inoculation. Indeed, in these conditions, 100% of the mice that received *PbANKA* WT parasites develop ECM and died on day 7 or 8 p.i., while only 10% of mice infected with *PbANKA-hrfΔ* parasites showed signs of cerebral complications.

These first results, using *PbANKA* strain, demonstrated the importance of the *Plasmodium* HRF during malaria infection and the development of the pathogenesis of cerebral malaria. In order to confirm and consolidate our results on the role of *Plasmodium* HRF in parasite and pathogenesis development we decided to extend these observations to a murine parasite strain *PbNK65*, which causes a lethal infection in C57BL/6 mice that is less acute than *PbANKA*, and anemia and mortality occur within 20-25 days p.i. allowing us to explore the immune mechanisms in more detail over a longer period of time. Mice infection with *PbNK65* WT or *hrfΔ* sporozoites shown, as previously observed with *PbANKA*, a delay in blood stage parasite development between mutant and WT parasite confirming a prolonged liver-stage development of *Plasmodium hrfΔ*. Moreover, infection with *PbNK65-hrfΔ* sporozoites results at day 17 p.i. in complete blood stage clearance of the parasite, in

contrast to *PbANKA-hrfΔ* sporozoite infection that despite the development of a clinical immunity (no ECM) the parasite develops normally without being eliminated at the blood stage. More interestingly, differently from what was observed during *PbANKA-hrfΔ* iRBCs infection where there was no difference between WT and mutant parasite development and pathology, the infection course with the *PbNK65-hrfΔ* iRBCs gave rise to a particular phenotype characterized by an initial growth similar to that of the WT parasite, followed by a clearance of the parasite at day 12 p.i.. This phenotype was reminiscent of an infection with the WT *P. chabaudi chabaudi* parasite strain, which mimics a similar pattern of an initial growth followed (around day 12) by a tight control of the parasite. This phenotype was well documented in terms of the mechanisms involved in the anti-parasite immune response. Indeed, parasite elimination was preceded by a Th1 response with a marked IFN- γ production during acute infection followed by a switch to a Th2 response crucial for the total clearance of the parasite (Muxel et al., 2011).

HRF, a key regulator of IL-6 production: a prototype example of how a parasite gene product directly modulates host cytokine responses (Fig. 26).

A more detailed analysis showed that the impairment in the development of *PbANKA-hrfΔ* parasites in liver stages was associated with an early rise in systemic IL-6 at 40 hours post infection from neutrophils and inflammatory monocytes. The importance of IL-6 was confirmed by injection of anti-IL-6 antibodies or infection in IL-6-deficient mice during *PbANKA-hrfΔ* infection that rescue WT phenotype. In parallel, injection of human recombinant IL-6 in mice infected with *PbANKA* WT parasite shows a decrease in parasite load in the liver. Additionally, we demonstrated the inhibitory effect of HRF on LPS-induced IL-6 cytokine production confirming a direct role of parasite HRF in the down-regulation of anti-parasite cytokines. Previous studies have shown that in addition to the cellular mechanisms involving both CD8⁺ and CD4⁺ T cells (Crispe, 2014; Van Braeckel-Budimir and Harty, 2014), the production of type I IFN responses (Haque and Engwerda, 2014; Liehl et al., 2014) has an important role in parasite killing within hepatocytes. Additionally, IL-6 with IL-1 and TNF- α have been involved in induction of acute phase proteins in the liver (Gabay and Kushner, 1999; Gauldie et al., 1987; Gruys et al., 2005; Heinrich et al., 1990; Ramadori et al., 1988), some of which being known to interfere with malaria parasite development or the

outcome of disease (Aggrey et al., 2013; Pied et al., 1989). Consistently, addition of recombinant IL-6 during *P. yoelii* infection in *in vitro* hepatic cultures resulted in a specific dose-dependent inhibition of parasite development exerting its action during both the early phase of infection and during the subsequent maturation of the schizonts. These observations support the hypothesis that production of IL-6 during liver stage could be important for the outcome of the disease (Nussler et al., 1991; Pied et al., 1991). Consistent with these reports, our data also highlight the link between the early rise of IL-6 induction and the B-cell-activation at 40 h p.i. induced by mutant parasites. One of the features in malaria infection is the induction of short-lived B-cell memory resulting in the short-lived nature of many anti-malarial antibody responses (Dorfman et al., 2005) and the increase of the frequency and absolute number of apoptotic cells (T cells, B cells, and macrophages) in spleen (Helmsby et al., 2000). Accordingly, studies using lethal *P. yoelii* YM infection have reported that malaria parasites interfere with the immune response by disabling B-cell differentiation, possibly by inducing apoptosis (Wykes et al., 2005). In our murine malaria model, the increase in B-cell population in the liver of mice infected with mutant parasites reflects the possibility that the HRF molecule could interfere with B-cell function and memory possibly via the down-regulation of IL-6 production. Despite the observation that recombinant murine HRF stimulates proliferation and increased serum Abs production in splenic B cells both *in vivo* and *in vitro* (Kang et al., 2001), recent studies have shown that *Plasmodium* HRF could inhibit B cell functions. Indeed murine splenic B cells were shown to incorporate more efficiently and faster the parasite protein than the human ones, indicating that *Plasmodium* HRF could be responsible for the altered immune response, thus allowing the parasite to escape the immune response (Calderon-Perez et al., 2014). This result is supported by structural studies on *Plasmodium* HRF, highlighting some differences between parasite and mammalian protein structure, which could impact the functionality of the protein (Hinojosa-Moya et al., 2008).

Interestingly, the production of IL-6 observed in mice infected with the *hrfΔ PbNK65* parasite confirms what was previously observed with *PbANKA-hrfΔ* where IL-6 strongly suppressed the liver-stage development. More importantly, in the *PbNK65* model, the elevated IL-6 production during blood stage in the absence of HRF expression seems to be important in

establishing parasite clearance and acquisition of sterile immunity during *PbNK65-hrfΔ* infection. Based on two main observations: first, a marked upregulation of IL-6 expression induced by *PbNK65-hrfΔ* parasites found in spleen and plasma at day 6 p.i. as compared to WT parasites, and second, a normal development of *hrfΔ* parasites and acquisition of the WT phenotype when the mutant parasites were inoculated to the IL6^{-KO} mice allow us to conclude that the IL-6 pathway, a component of innate immunity, plays a central role in controlling *PbNK65-hrfΔ* blood stage parasitemia. In support of our findings, Prakash and colleagues, by studying the clusters of cytokines that determine the severity of the disease during *P. falciparum* infection in endemic areas of central India showed that the induction of serum IL-6 was inversely correlated with the disease severity (Prakash et al., 2006). In addition, co-infection with *Schistosoma mansoni* followed by *P. knowlesi* in baboons showed that animals with chronic schistosomiasis were protected from severe malaria by an increase of IL-6 levels compared to animals not infected with (Nyakundi et al., 2016). In an effort to identify the cellular source of IL-6 during *PbNK65-hrfΔ* infection that was negatively regulated by HRF, examination by intracellular cell staining flow cytometry analysis showed that neutrophils are the main cell targets. Nonetheless, how IL-6 affects parasite growth inside erythrocytes, and the contribution of other cytokines such as IL-12 or TNF- α to the deficient growth of the *PbNK65-hrfΔ* mutant parasite, remain open questions. IL-6 is a cytokine with well-defined pro- and anti-inflammatory properties. Among the biological activities, IL-6 plays a role in T cell stimulation (Tormo et al., 2012), B cell proliferation and differentiation (Hirano et al., 1986), monocytes/macrophages differentiation (Chomarat et al., 2000) and neutrophils activation (Borish et al., 1989). Additionally, IL-6 deficiency can lead to dysfunctional innate and adaptive immunity against many infections (Hoge et al., 2013; van der Poll et al., 1997). For example, IL-6 was shown to play a protective role in many bacterial, viral and fungal infections (Imanishi, 2000). Consistently, IL-6-deficient mice are significantly more susceptible to some fungal infections like candida (Basu et al., 2008) and herpes simplex virus type 1 infections. In this later infection, IL-6 ensures survival of infected mice, but does not substantively affect herpes simplex virus replication (LeBlanc et al., 1999).

HRF mutant parasite infection is associated with potent effector immune mechanisms (Fig. 26).

The reasons for the abortive infection and subsequent protection by *PbNK65-hrfΔ* parasites are likely multifactorial. Analysis of cytokine levels at early time points (day 6 p.i) indicated an increase of several pro-inflammatory cytokines, such as IL-12 cytokine family including IL-12p35, IL-12p40, IL-23, and Ebi3, IFN- γ and IL-6, in the spleen, liver and plasma of *PbNK65-hrfΔ*-infected mice indicating the development of a Th1 response at early time points following infection. In support of our results, administration of IL-12 antibody to mice infected with *P. chabaudi chabaudi* AS resulted in the elimination of the parasite with an increased cell numbers of NK and CD4⁺ T cells that enhance IFN- γ production (Mohan et al., 1997). A similar mechanism operates in a distinct experimental model where administration of recombinant IL-12 before inoculation of rhesus monkeys with *P. cynomolgi* provides 100% protection through an IFN- γ -dependent antiplasmodial mechanism (Hoffman et al., 1997). A parallel can be made in the human situation since during *P. falciparum* infection, children with mild malaria infection have higher levels of plasma IL-12 than children with severe malaria infection, and the levels of IL-12 are inversely correlated with parasitemia and numbers of malaria pigment-containing neutrophils (Luty et al., 2000; Perkins et al., 2000; Prakash et al., 2006). Additionally, an increase in IL-12 levels during the acute phase of uncomplicated *P. falciparum* malaria is thought to reflect an early and effective immune response regulated by proinflammatory Th1 cytokines (Prakash et al., 2006). Furthermore, IL-12 production by macrophages in response to infection mediates resistance to *Trypanosoma cruzi* (Aliberti et al., 1996). Studies regarding strategies toward cancer immunotherapy showed that optimal target-cell clearance required DC support and IL-12 production allowing the development of CD4⁺ cytotoxic T lymphocytes (Nelles et al., 2014). Knowing that in cancer cells the IL-12 production is almost non-existent and that the HRF is implicated in cancer development (Li et al., 2001; Tuynder et al., 2002), assumption can be made that HRF maybe responsible for the inhibition of IL-12 production, function that during malaria infection allows the parasite to escape the initial immune response.

Some evidence suggests that IFN- γ have a protective role during malaria infections. Indeed, enhanced IFN- γ protective immunity was observed during *P. chabaudi* and *P. yoelii* 17XL

infection in IFN- γ -deficient mice where absence of cytokine production increases the severity of the infection resulting in death or require additional time for the resolution of the infection in comparison to WT mice (van der Heyde et al., 1997). Mice infected with *P. chabaudi* and treated with neutralizing anti-IFN- γ Ab failed to suppress acute infection developing high levels of parasitemia and administration of IFN- γ to intact C57BL/6 mice slightly decreased and partially delayed parasitemia (Meding et al., 1990). In humans, the protective capacity of IFN- γ during malaria infections appears to be related to the timing of IFN- γ production. Early appearance of IFN- γ after infection is correlated in humans and animal models with protection against the development of clinical symptoms of malaria as CM (D'Ombra et al., 2008; Villegas-Mendez et al., 2012). The Fulani ethnic group in Mali present elevated levels of IFN- γ suggesting a protective role for IFN- γ against malaria (McCall et al., 2010; Prakash et al., 2006). Moreover, IFN- γ is a key mediator of inflammatory immune responses induced primarily by IL-12 and its secretion is essential for control of intracellular pathogens (such as *Mycobacterium tuberculosis* or *Listeria*) and tumours. Indeed, it was demonstrated that during Ebola infection, a disease that at the beginning of the infection present the same symptoms of malaria, the administration of IFN- γ in mice profoundly inhibits Ebola virus infection of macrophages reducing morbidity and serum viral titres (Rhein et al., 2015). Once adaptive immunity is initiated IFN- γ secreted by CD4⁺ T cells is critical for optimal activation of cytotoxic CD8⁺ T cells (Janssen et al., 2003), induction of B cell class-switching to the cytophilic IgG2a antibodies (Su and Stevenson, 2000; Xu and Zhang, 2005) and induction of inflammatory monocytes in bone marrow that migrate into spleen (Sponaas et al., 2009) or expression of a number of proteins such as Fc γ RI on macrophage surface enhancing their phagocytic abilities (Waddell et al., 2010), all of which perform vital roles in the control of *Plasmodium* infection.

At day 6 p.i. analysis also show that the parasite load in the spleen was higher in mice infected with *PbNK65-hrf Δ* parasite than the ones infected with WT parasite. Moreover, macroscopic examination of spleens showed a splenomegaly in mice infected with *PbNK65-hrf Δ* confirmed by quantitative cell analysis. The importance of the spleen in elimination of parasites and in the development of the immune response during malaria infection was demonstrated in different studies both in humans and in experimental murine models.

Several studies in the African population showed that an enlarged spleen was more frequently seen among the Fulani compared to the Dogon (Bereczky et al., 2006; Greenwood et al., 1987; Oomen et al., 1979). Indeed, during acute *P. falciparum* infection patients with splenomegaly accelerate the clearance of iRBCs compared to patients with normal spleen sizes (Looareesuwan et al., 1987) and splenectomised patients show an increase in parasitemia (Bachmann et al., 2009), demonstrating the crucial role of spleen in parasite clearance. It is known that the first lines of defence against blood stage in spleen are the red pulp macrophages and the splenic marginal zones DCs able to capture malaria antigens and activate T cells. During *P. chabaudi* infection two population of DCs responsible for the activation of CD4⁺ T cells in spleen with different kinetics. At the beginning of the infection splenic CD8⁺ DCs cells or macrophages through the production of IL-12 induce the proliferation of CD4⁺ T cells and their production of IFN- γ (Th1 response) (Ing and Stevenson, 2009; Sam and Stevenson, 1999a; Sam and Stevenson, 1999b). The switch of the immune response from Th1 to Th2 starts at the peak of infection when CD8⁺ DCs cells undergo apoptosis in the spleen and CD8⁻ DCs cells activated CD4⁺ T cells to produce IL-4 and IL-10 (Helmby et al., 2000; Sponaas et al., 2009). These mechanisms allow the generation of a robust splenic immune response to the parasite, including prominent germinal centre formation and generation of a long-lived memory B and CD4⁺ T cell responses as well as long-lived plasma cells and protective antibodies (Del Portillo et al., 2012).

Additionally, we show that immunological effectors are required to clear *PbNK65-hrf Δ* parasites and induce protection. In concordance with findings on previous protective blood stage mutants (Aly et al., 2010; Spaccapelo et al., 2011), *PbNK65-hrf Δ* -induced protection was T cell- and B cell-dependent, with the involvement of two types of effectors. Indeed, this mutant parasite developed normally in T- and B-cell deficient mice. By reflexion, these findings raise the question why WT parasites develop normally within the host environment without being cleared. Two key findings were presented in the present work: first, no trace of anti-parasite antibodies could be detected at any time of the infection course with the WT parasite and the B cell compartment seems to be completely non functional, and second, a significant proportion of CD4⁺ CD62L⁻ and CD8⁺ CD62L⁻ cells, which are memory effector T cells, have their surface PD-1 expression upregulated during infection with WT parasites in

contrast to *hrfΔ* parasites. These two combined mechanisms may explain why the WT parasite remains unaffected by the host immune system.

During *PbNK65-hrfΔ* infection antibodies of the IgG2c subclass were dramatically increased in *PbNK65-hrfΔ*-infected mice. A clear evidence of the association of parasite clearance and the subsequent sterile immunity was provided by the strong antigen-specific antibody response demonstrated by immunoblot and by ELISA assays. Among these antigens, MSP-1, MSP-8, SERA-1, and SERA-2 which are known to elicit antibodies associated with protection in people living in malaria-endemic areas (Banic et al., 1998; Okech et al., 2001) were identified by mass spectrometry. Moreover, BALB/c mice infected with *P. Yoelii* YM-*sera2Δ* but not SERA-1 mutant parasites, showed a clearance of the parasite at day 28-30 p.i. compared to the lethal WT parasite which killed mice within 6-8 days indicating that SERA2 during malaria infection is an important antigen and that its inhibition or blocking could help parasite elimination (Huang et al., 2013). In contrast, in a distinct murine model of malaria using NMRI mice (originally from Swiss strain but maintained as an inbred strain), namely during infection with *P. berghei*, SERA1 and SERA2 seem not to play a vital role *in vivo*, since loss-of-function parasite lines progressed normally through the parasite life cycle (Putrianti et al., 2010). These murine models highlight inconsistencies regarding the GAP phenotypes depending both on the parasite and the mouse strain. In order to gain more insight into the role of genes of potential interest, novel studies must be carried out to design GAPs using the same parasite line tested in the same mouse strain. We found that secreted antibodies from *PbNK65-hrfΔ* protected mice were able to reduce parasitemia following a passive transfer to naïve mice but were not able to completely clear the infection. In addition $Fc\gamma R^{-/-}$ mice were unable to clear infection by mutant parasites and $CD11b^{+}$ cells, most likely macrophages and dendritic cells, were necessary and sufficient for adoptive transfer of immunity. These results suggest that secreted antibodies are important for the protective immunity to *P. berghei* but the apparent lack of complete protection suggests that these antibodies need to act in concert with “primed” $Fc\gamma R^{+}$ effector cells such as monocytes, macrophages, NK cells, and others that are existing in *hrfΔ* parasites-infected but not in naive mice. This picture of antibody-dependent cellular cytotoxicity involved in protection was earlier reported in the case of the plasmepsin-4-deficient mutant (Spaccapelo et al.,

2010) and in host resistance to blood stage *P. berghei* XAT infection (Yoneto et al., 2001). *In vivo* experiments using rodent malaria parasites transgenic for *P. falciparum* MSP1₁₉ in mice also transgenic for human Fc-receptors (FcRs) after three i.p. inoculations of functional humans anti-MSP1₁₉ IgG1 Abs effectively suppressed a lethal blood stage challenge with *P. berghei*. In contrast in non transgenic mice, human anti-MSP1₁₉ IgG1 Abs were not protective suggesting that FcγRI recruitment is crucial for parasite elimination (McIntosh et al., 2007). Several *in vitro* studies have indicated the biologic relevance of the FcγRII and IgG subclasses in resistance to high-density parasitemia by showing the importance of ADCI mechanism during protection against blood-stage *P. falciparum* parasitemia (Bouharoun-Tayoun et al., 1990; Bouharoun-Tayoun et al., 1995; Druilhe and Perignon, 1994; Shi et al., 1999; Zhou et al., 2015). The ADCI function is triggered by the binding of the IgG-merozoite complex to monocytes via the FcγRII receptor (Bouharoun-Tayoun et al., 1995), and correlates with malaria-specific IgG (Bouharoun-Tayoun and Druilhe, 1992; Shi et al., 1999). Human studies also showed the capacity of FcγR to mediate potent antimalarial immunity (McIntosh et al., 2007). Studies on the Fulani population demonstrate a relation between FcγRs polymorphisms and susceptibility to malaria, which is associated with higher antibody levels (Cherif et al., 2016; Modiano et al., 1996). A recent study on the allelic frequencies of rs396991 (FCGR3A) and rs3933769 (FCGR2C) between the Fulani and Dogon populations in Mali revealed differences in these allelic frequencies suggesting that the genes may contribute to the interethnic variability in malaria susceptibility seen among the Fulani and their sympatric neighbours. For example, the rs396991 mutant allele occurs at a higher frequency in the Dogon, who are more susceptible to malaria relative to Fulani, suggesting that this SNP may play a role in malaria pathogenesis (Cherif et al., 2016). However, further studies will be needed to determine the possible roles of these SNPs in malaria pathogenesis. Additionally, a study performed in Kenyan infants, residing in an area of high malaria transmission, provides evidence that genetic polymorphism of FcγRIIIa is associated with protection against high-density *P. falciparum*. Indeed, infants with FcγRIIIa-Arg/Arg131 genotype, which binds IgG1 or IgG3 Abs, were less likely to have repeated high-density *P. falciparum* infections during the first year of life suggesting a protective effect of this FcγRIIIa genotype. Moreover, the study showed that infants with FcγRIIIa-His/Arg131 genotype were

at greater risk for high-density *P. falciparum* infection compared to infants who were at low risk (Shi et al., 2001). The clinical importance of FcγRIIIa polymorphism has been evaluated during encapsulated bacterial infections where FcγRIIIa-His/His131 genotype was associated to protection, whereas the poorly IgG2-binding allotype FcγRIIIa-Arg/Arg131 was associated with increased susceptibility to these pathogens (Musser et al., 1990; Platonov et al., 1998; Yee et al., 2000).

One of the characteristic features of malaria infection is the inability to generate an acquired protective immunity suggesting that memory T cells develop inadequately or their maintenance is not assured. Using our mutant strain of parasite, we observed a dramatic difference with the WT parasites in modulating the expression of PD-1 on the surface of both CD4⁺ and CD8⁺ T cells. PD1 and its ligand PD-L1/PD-L2 belong to the family of immune checkpoint proteins that act as co-inhibitory factors transmitting an inhibitory signal into the T cell, which reduces cytokine production and suppresses T-cell proliferation (Day et al., 2006; Hofmeyer et al., 2011; Wherry, 2011). The PD1/PD-L1 pathway represents an adaptive immune resistance mechanism that is exerted by tumour cells in response to endogenous anti-tumour activity. Moreover, T cells exhaustion by upregulation of PD1 expression of cell surfaces was described in humans in the context of chronic viral infection such as HIV and hepatitis (B and C) (El-Far et al., 2008; Kim and Ahmed, 2010; Wherry, 2011). Interruption of PD1/PD-L1 binding, with monoclonal antibodies against PD1 and PD-L1, has shown to rescue tumours and HIV-infected cells from this state of anergy or 'exhaustion' (Porichis and Kaufmann, 2012; Swaika et al., 2015). Examining the expression of PD-1, an inhibitory receptor expressed on T cells, we found that throughout the infection period starting from day 6 p.i., the absence of HRF was associated with a significantly reduced expression of this receptor. This suggests that this marker, found early during infection (day 6 p.i.) and lasted throughout the infection period (day 20 p.i.), may have an influence on both clearance of primary infection and induction of lasting protection. Moreover using the *P. berghei* recombinant HRF protein we demonstrated the direct involvement of HRF in the upregulation of PD-1 receptor. Interestingly, an involvement of PD-1 in malaria blood stage control has already been reported: in *P. falciparum* infections, higher expression of PD-1 was associated with T cell dysfunction and the blockade of PD-1 ligand in a murine model of

infection rapidly cleared blood-stage malaria in a B- and T- cell dependent manner resulting in enhanced parasite control (Butler et al., 2012). In the *P. chabaudii* rodent model of chronic blood stage infection (Good et al., 2013), parasite-specific protective CD8⁺ T cells undergo significant PD-1-dependent exhaustion (up to 95% reduction), which exacerbates acute blood stage infection and drives chronic disease. A parallel that can be made with our results is that our mutant parasite allows a rapid clearance of the parasite, a down-regulation of PD-1 expression and the establishment of a long lasting memory which are all dependent on both B and T cells.

After confirming the importance of T cell responses during parasite clearance such as helper function for B cells to produce Abs that are essential for parasite clearance or production of cytokines able to amplify the phagocytosis and the parasitocidal response of the innate immune system, we wanted to determine the importance of T cells for the maintaining of the immune response and to identify which population of T cells are implicated in the memory. Depletion of CD4 or CD8 T cells in protected mice followed by *PbNK65* WT re-infection showed no differences in parasitemia in the control group and in CD8 depleted mice. In contrast, all of CD4 depleted mice had detectable parasitemia (until 30%) indicating the contribution of CD4⁺ T cells to long term immunity. Studies performed in both mice and humans have shown the importance of CD4⁺ T cells in parasite-specific memory (Brake et al., 1988; Vinetz et al., 1990). Depletion of CD4⁺ or CD8⁺ T cells in mice during *P. yoelii* 17X infection and adoptive transfer into a naïve mice showed that mice which received CD8⁺ T cells failed to control the infection in contrast to mice which received CD4⁺ T cells which were able to control the infection, suggesting that CD8⁺ T cells are not responsible for blood-stage immunity (Vinetz et al., 1990). Additionally, parasite-specific memory CD4⁺T cells were found in the blood of human volunteers deliberately exposed to very low doses of malaria parasites with very few or no parasite-specific antibodies (Pombo et al., 2002; Roestenberg et al., 2009).

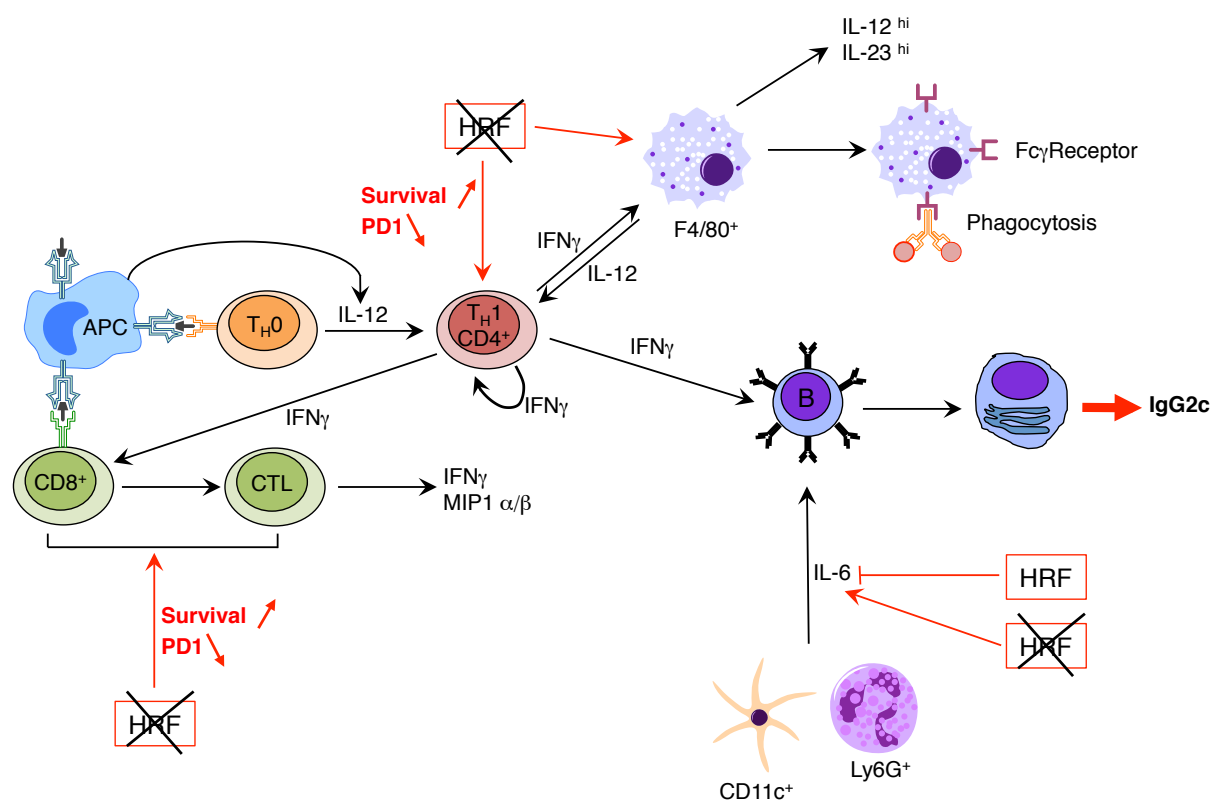

Figure 26: Hypothetical mechanisms induced by *PbNK65-hrf Δ* parasites involved in parasite killing and development of protective immunity. Parasite Ag presentation to both $CD4^+$ and $CD8^+$ T cells by APC cells. IL-12 production which polarizes activated $CD4^+$ T cells toward Th1 response. $CD4^+$ helper T cells through the production of IFN- γ induce three types of cellular events; (1) activation of $CD8^+$ cytotoxic T cells and their production of IFN- γ , (2) activation of macrophages that increase Fc γ R expression on their surface and the production of other cytokines, and (3) the Ig switching of B cells, previously activated by IL-6, to produce IgG2c Abs. These Abs promote ADCl of iRBCs by Fc γ R expressing macrophages. Elimination of *Plasmodium* HRF exerts its inhibitory effects at 3 levels; (1) decrease of $CD4^+$ and $CD8^+$ T cell survival due to the increase on PD1 expression, (2) decrease of spleen macrophage number, and (3) inhibition of IL-6 production with subsequent reduction in B cell proliferation and abrogation of ADCl.

HRF mutant parasites as vaccine candidates

The use of whole parasites to induce protection against malaria blood stage infection has a long history of inventive approaches. Early studies in the 1940s using *P. knowlesi* or *P. falciparum* infection in monkeys showed that high doses of killed parasites along with complete Freund's adjuvant provided protection against blood stage challenge (Pombo et al., 2002). In the 1980s, radiation-attenuated derivatives of *P. berghei* or *P. yoelii* blood stage parasites which initiate self-resolving infections in immuno-competent hosts, were found to be protective (Miyagami et al., 1987; Waki et al., 1982). Nevertheless, production and use of this live attenuated parasite presents different problems such as the large scale production

and the maintaining of the efficacy after storage. More recent work has demonstrated that in humans, repeated infections that were initiated by ultra-low doses of *P. falciparum* and rapidly cured by appropriate drug treatment, induced protective immunity. The resulting protection was associated with CD4⁺ and CD8⁺ T cell proliferative responses (Fell et al., 1994), nitric oxide synthase activity and IFN- γ production, but did not appear to involve parasite-specific antibodies (Pombo et al., 2002). Likewise, low doses of killed *P. falciparum*-infected red blood cells in the adjuvant CpG-ODN demonstrated strong protective efficacy, mainly dependent on CD4⁺ T cells, IFN- γ and NO (Pinzon-Charry et al., 2010). Nonetheless, human studies are highly regimented and require the use of rodent and ape models for initial validation.

Given the advances in genetic manipulation techniques for rodent malaria parasites, the identification of GAP vaccines against infections by pre-erythrocytic and blood stage malaria infections has become more feasible. Some of the pre-erythrocytic GAP studies have been extended to human malaria parasites: for example, in 2013, *P. falciparum* $\Delta p52\Delta p36$ GAPs, that arrest in pre-erythrocytic stages, were tested in human adult volunteers (Spring et al., 2013); and they conferred partial protection, similar to the equivalent murine model *P. berghei* GAP *Pb* $\Delta p52\Delta p36$ (Annoura et al., 2014). However, few candidates for blood stage GAP vaccines have been explored. For example, *P. yoelii* lacking genes involved in the purine salvage pathway (Aly et al., 2010; Ting et al., 2008) or *P. berghei* lacking an aspartic protease, plasmepsin-4, involved in hemoglobin degradation (Spaccapelo et al., 2010) and a merozoite surface protein 7 (Spaccapelo et al., 2011) displayed various degrees of attenuation, from limited peak parasitemia to delayed blood stage growth. Crucially, all these mutants generated self-resolving infections that induced strong and lasting immunity. Protection was effective against both erythrocytic and pre-erythrocytic stages of the parasite as well as across *Plasmodium* species (Aly et al., 2010; Spaccapelo et al., 2011; Spaccapelo et al., 2010), and lasted up to at least one year (Spaccapelo et al., 2010). Moreover, both antibodies and T cells (Aly et al., 2010), as well as antibody-dependent cellular cytotoxicity in which antibodies function by enhancing clearance of infected erythrocytes by splenic macrophages (Spaccapelo et al., 2011; Spaccapelo et al., 2010), were shown to be involved in protection. Interestingly, *P. berghei* plasmepsin-4 KO parasites were shown to be more rapidly cleared

and induced stronger protective immunity than WT parasites treated by pyrimethamine (Spaccapelo et al., 2010). Taken together with our observations, we conclude that regardless of the specific effect of the genetic mutation, self-resolving, protective blood stage GAPs induce similar immune responses that are B- and T-cell dependent (Aly et al., 2010; this work) and rely on opsonized phagocytosis (Spacapello et al., 2010; this work). Importantly, this protection is stage-transcendent against homologous and heterologous challenges. In contrast there are no evidence of heterologous protection using liver stage GAPs. Furthermore, it was shown that *Plasmodium* blood stage infection can suppress, through modulation of DCs maturation and their capacity to activate CD8⁺ T cell responses against the liver stage, inhibiting the establishment of a protective response during the liver stage leaving the host susceptible for the next infection (Ocana-Morgner et al., 2003).

Overall, we speculate that early during blood stage infection, protective mechanisms are induced by low amounts of parasites, which might be progressively overwhelmed, and possibly replaced by inhibitory immune mechanisms caused by further parasite multiplication. The balance between protective and inhibitory mechanisms might depend on peak parasitemia (*i.e.*, parasite load), or more importantly, on the parasite growth rate after the initial antigen stimulation in the host. One can then assume that any genetic modification that causes a growth defect would tip the balance towards protective mechanisms, resulting in parasite clearance before inhibitory mechanisms can be fully engaged. We further propose that PD-1 expression might constitute a crucial marker of protective vs. inhibitory responses and needs to be further exploited for both antimalarial drug and vaccine design. Future work should continue to dissect the different protective mechanisms induced by self-resolving blood stage GAP infections, with an emphasis to develop an effective multi-stage malaria vaccine. In order to achieve this aim it would be interesting to compare, using the same murine *Plasmodium* strain, the phenotypes of all the blood stage GAPs developed until now. This first step could help for the choice of a second mutation in order to develop a double mutant parasite maybe more performing in the development of the immune response. The last step in the vaccine development will be the construction of a *P. falciparum* mutant parasite, for example *Pf3D7-hrfΔ* and the assessment of mutation on the parasite viability.

Beside the whole parasite vaccine approach, we could also propose to use *Plasmodium* HRF as a subunit vaccine since anti-*Plasmodium* HRF Abs may mimic *Plasmodium-hrf* Δ induced protection. Nevertheless, the evidence does not support this hypothesis. First, we cannot hide the high sequence homology that exists between the human and the parasite HRF protein, even if structural differences have been highlighted. It cannot be excluded that this homology might generate cross-reactive Abs against human HRF, thus causing autoimmune reactions. Second, a recent study showed that immunization of mice with *Plasmodium* HRF resulted in a weak protective capacity against malaria infections (Taylor et al., 2015). Taken together these observations strongly support the fact that, at least in the case of HRF, whole organism approach should be used to generate sterile immunity.

Bibliography

Bibliography

- Abdalla, S., D.J. Weatherall, S.N. Wickramasinghe, and M. Hughes. 1980. The anaemia of *P. falciparum* malaria. *British journal of haematology* 46:171-183.
- Adachi, K., H. Tsutsui, S. Kashiwamura, E. Seki, H. Nakano, O. Takeuchi, K. Takeda, K. Okumura, L. Van Kaer, H. Okamura, S. Akira, and K. Nakanishi. 2001. Plasmodium berghei infection in mice induces liver injury by an IL-12- and toll-like receptor/myeloid differentiation factor 88-dependent mechanism. *Journal of immunology (Baltimore, Md. : 1950)* 167:5928-5934.
- Afonso, A., P. Hunt, S. Cheesman, A.C. Alves, C.V. Cunha, V. do Rosario, and P. Cravo. 2006. Malaria parasites can develop stable resistance to artemisinin but lack mutations in candidate genes *atp6* (encoding the sarcoplasmic and endoplasmic reticulum Ca²⁺ ATPase), *tctp*, *mdr1*, and *cg10*. *Antimicrobial agents and chemotherapy* 50:480-489.
- Aggrey, A.A., K. Srivastava, S. Ture, D.J. Field, and C.N. Morrell. 2013. Platelet induction of the acute-phase response is protective in murine experimental cerebral malaria. *Journal of immunology (Baltimore, Md. : 1950)* 190:4685-4691.
- Agnandji, S.T., B. Lell, J.F. Fernandes, B.P. Abossolo, B.G. Methogo, A.L. Kabwende, A.A. Adegnika, B. Mordmuller, S. Issifou, P.G. Kremsner, J. Sacarlal, P. Aide, M. Lanaspá, J.J. Aponte, S. Machevo, S. Acacio, H. Bulo, B. Sigauque, E. Macete, P. Alonso, S. Abdulla, N. Salim, R. Minja, M. Mpina, S. Ahmed, A.M. Ali, A.T. Mtoro, A.S. Hamad, P. Mutani, M. Tanner, H. Tinto, U. D'Alessandro, H. Sorgho, I. Valea, B. Bihoun, I. Guiraud, B. Kabore, O. Sombie, R.T. Guiguemde, J.B. Ouedraogo, M.J. Hamel, S. Kariuki, M. Oneko, C. Odero, K. Otieno, N. Awino, M. McMorro, V. Muturi-Kioi, K.F. Laserson, L. Slutsker, W. Otieno, L. Otieno, N. Otsyula, S. Gondi, A. Otieno, V. Owira, E. Oguk, G. Odongo, J.B. Woods, B. Ogutu, P. Njuguna, R. Chilengi, P. Akoo, C. Kerubo, C. Maingi, T. Lang, A. Olotu, P. Bejon, K. Marsh, G. Mwambingu, S. Owusu-Agyei, K.P. Asante, K. Osei-Kwakye, O. Boahen, D. Dosoo, I. Asante, G. Adjei, E. Kwara, D. Chandramohan, B. Greenwood, J. Lusingu, S. Gesase, A. Malabeja, O. Abdul, C. Mahende, E. Liheluka, L. Malle, M. Lemnge, T.G. Theander, C. Drakeley, D. Ansong, T. Agbenyega, S. Adjei, H.O. Boateng, T. Rettig, J. Bawa, J. Sylverken, D. Sambian, A. Sarfo, A. Agyekum, F. Martinson, I. Hoffman, T. Mvalo, P. Kamthunzi, R. Nkomo, T. Tembo, G. Tegha, M. Tsidya, J. Kilembe, C. Chawinga, W.R. Ballou, J. Cohen, Y. Guerra, E. Jongert, D. Lapierre, A. Leach, M. Lievens, O. Ofori-Anyinam, A. Olivier, J. Vekemans, T. Carter, D. Kaslow, D. Leboulloux, C. Loucq, A. Radford, B. Savarese, D. Schellenberg, M. Sillman, and P. Vansadia. 2012. A phase 3 trial of RTS,S/AS01 malaria vaccine in African infants. *The New England journal of medicine* 367:2284-2295.
- Agnandji, S.T., B. Lell, S.S. Soulanoudjingar, J.F. Fernandes, B.P. Abossolo, C. Conzelmann, B.G. Methogo, Y. Doucka, A. Flamen, B. Mordmuller, S. Issifou, P.G. Kremsner, J. Sacarlal, P. Aide, M. Lanaspá, J.J. Aponte, A. Nhamuave, D. Quelhas, Q. Bassat, S. Mandjate, E. Macete, P. Alonso, S. Abdulla, N. Salim, O. Juma, M. Shomari, K. Shubis, F. Machera, A.S. Hamad, R. Minja, A. Mtoro, A. Sykes, S. Ahmed, A.M. Urassa, A.M. Ali, G. Mwangoka, M. Tanner, H. Tinto, U. D'Alessandro, H. Sorgho, I. Valea, M.C. Tahita, W. Kabore, S. Ouedraogo, Y. Sandrine, R.T. Guiguemde, J.B. Ouedraogo, M.J. Hamel, S. Kariuki, C. Odero, M. Oneko, K. Otieno, N. Awino, J. Omoto, J. Williamson, V. Muturi-Kioi, K.F. Laserson, L. Slutsker, W. Otieno, L. Otieno, O. Nekoye, S. Gondi, A. Otieno, B. Ogutu, R. Wasuna, V. Owira, D. Jones, A.A. Onyango, P. Njuguna, R. Chilengi, P. Akoo, C. Kerubo, J. Gitaka, C. Maingi, T. Lang, A. Olotu, B. Tsofa, P. Bejon, N. Peshu, K. Marsh, S. Owusu-Agyei, K.P. Asante, K. Osei-Kwakye, O. Boahen, S. Ayamba, K. Kayan, R. Owusu-Ofori, D. Dosoo, I. Asante, G. Adjei, G. Adjei, D. Chandramohan, B. Greenwood, J. Lusingu, S. Gesase, A. Malabeja, O. Abdul, H. Kilavo, C. Mahende, E. Liheluka, M. Lemnge, T. Theander, C. Drakeley, D. Ansong, T. Agbenyega, S. Adjei, H.O. Boateng, T. Rettig, J. Bawa, J. Sylverken, D. Sambian, A. Agyekum, L. Owusu, F. Martinson, I. Hoffman, T. Mvalo, P. Kamthunzi, R. Nkomo, A. Msika, A. Jumbe, N. Chome, D. Nyakuipa, J. Chintedza, W.R. Ballou, M. Bruls, J. Cohen, Y. Guerra, E. Jongert, D. Lapierre, A. Leach, M. Lievens, O. Ofori-Anyinam, J. Vekemans, T.

- Carter, D. Leboulleux, C. Loucq, A. Radford, B. Savarese, D. Schellenberg, M. Sillman, and P. Vansadia. 2011. First results of phase 3 trial of RTS,S/AS01 malaria vaccine in African children. *The New England journal of medicine* 365:1863-1875.
- Aidoo, M., and V. Udhayakumar. 2000. Field studies of cytotoxic T lymphocytes in malaria infections: implications for malaria vaccine development. *Parasitology today (Personal ed.)* 16:50-56.
- Alger, N.E., and J. Harant. 1976. Plasmodium berghei: heat-treated sporozoite vaccination of mice. *Experimental parasitology* 40:261-268.
- Aliberti, J.C., M.A. Cardoso, G.A. Martins, R.T. Gazzinelli, L.Q. Vieira, and J.S. Silva. 1996. Interleukin-12 mediates resistance to Trypanosoma cruzi in mice and is produced by murine macrophages in response to live trypomastigotes. *Infection and immunity* 64:1961-1967.
- Aly, A.S., M.J. Downie, C.B. Mamoun, and S.H. Kappe. 2010. Subpatent infection with nucleoside transporter 1-deficient Plasmodium blood stage parasites confers sterile protection against lethal malaria in mice. *Cellular microbiology* 12:930-938.
- Aly, A.S., A.M. Vaughan, and S.H. Kappe. 2009. Malaria parasite development in the mosquito and infection of the mammalian host. *Annual review of microbiology* 63:195-221.
- Amino, R., S. Thiberge, B. Martin, S. Celli, S. Shorte, F. Frischknecht, and R. Menard. 2006. Quantitative imaging of Plasmodium transmission from mosquito to mammal. *Nature medicine* 12:220-224.
- Amson, R., S. Pece, A. Lespagnol, R. Vyas, G. Mazzarol, D. Tosoni, I. Colaluca, G. Viale, S. Rodrigues-Ferreira, J. Wynendaele, O. Chaloin, J. Hoebeke, J.C. Marine, P.P. Di Fiore, and A. Telerman. 2012. Reciprocal repression between P53 and TCTP. *Nature medicine* 18:91-99.
- Amzallag, N., B.J. Passer, D. Allanic, E. Segura, C. Thery, B. Goud, R. Amson, and A. Telerman. 2004. TSAP6 facilitates the secretion of translationally controlled tumor protein/histamine-releasing factor via a nonclassical pathway. *The Journal of biological chemistry* 279:46104-46112.
- Annoura, T., B.C. van Schaijk, I.H. Ploemen, M. Sajid, J.W. Lin, M.W. Vos, A.G. Dinmohamed, D.K. Inaoka, S.R. Rijpma, G.J. van Gemert, S. Chevalley-Maurel, S.M. Kielbasa, F. Scheltinga, B. Franke-Fayard, O. Klop, C.C. Hermsen, K. Kita, A. Gego, J.F. Franetich, D. Mazier, S.L. Hoffman, C.J. Janse, R.W. Sauerwein, and S.M. Khan. 2014. Two Plasmodium 6-Cys family-related proteins have distinct and critical roles in liver-stage development. *FASEB journal : official publication of the Federation of American Societies for Experimental Biology* 28:2158-2170.
- Arav-Boger, R., and T.A. Shapiro. 2005. Molecular mechanisms of resistance in antimalarial chemotherapy: the unmet challenge. *Annual review of pharmacology and toxicology* 45:565-585.
- Armah, H.B., N.O. Wilson, B.Y. Sarfo, M.D. Powell, V.C. Bond, W. Anderson, A.A. Adjei, R.K. Gyasi, Y. Tettey, E.K. Wiredu, J.E. Tongren, V. Udhayakumar, and J.K. Stiles. 2007. Cerebrospinal fluid and serum biomarkers of cerebral malaria mortality in Ghanaian children. *Malaria journal* 6:147.
- Artavanis-Tsakonas, K., J.E. Tongren, and E.M. Riley. 2003. The war between the malaria parasite and the immune system: immunity, immunoregulation and immunopathology. *Clinical and experimental immunology* 133:145-152.
- Ashley, E.A., M. Dhorda, R.M. Fairhurst, C. Amaratunga, P. Lim, S. Suon, S. Sreng, J.M. Anderson, S. Mao, B. Sam, C. Sopha, C.M. Chuor, C. Nguon, S. Sovannaroeth, S. Pukrittayakamee, P. Jittamala, K. Chotivanich, K. Chutasmit, C. Suchatsoonthorn, R. Runcharoen, T.T. Hien, N.T. Thuy-Nhien, N.V. Thanh, N.H. Phu, Y. Htut, K.T. Han, K.H. Aye, O.A. Mokuolu, R.R. Olaosebikan, O.O. Folaranmi, M. Mayxay, M. Khanthavong, B. Hongvanthong, P.N. Newton, M.A. Onyamboko, C.I. Fanello, A.K. Tshefu, N. Mishra, N. Valecha, A.P. Phyto, F. Nosten, P. Yi, R. Tripura, S. Borrmann, M. Bashraheil, J. Peshu, M.A. Faiz, A. Ghose, M.A. Hossain, R. Samad, M.R. Rahman, M.M. Hasan, A. Islam, O. Miotto, R. Amato, B. MacInnis, J. Stalker, D.P. Kwiatkowski, Z. Bozdech, A. Jeeyapant, P.Y. Cheah, T. Sakulthaew, J. Chalk, B. Intharabut, K. Silamut, S.J. Lee, B. Vihokhern, C. Kunasol, M. Imwong, J. Tarning, W.J.

- Taylor, S. Yeung, C.J. Woodrow, J.A. Flegg, D. Das, J. Smith, M. Venkatesan, C.V. Plowe, K. Stepniewska, P.J. Guerin, A.M. Dondorp, N.P. Day, N.J. White, and C. Tracking Resistance to Artemisinin. 2014. Spread of artemisinin resistance in *Plasmodium falciparum* malaria. *The New England journal of medicine* 371:411-423.
- Aucan, C., Y. Traore, F. Tall, B. Nacro, T. Traore-Leroux, F. Fumoux, and P. Rihet. 2000. High immunoglobulin G2 (IgG2) and low IgG4 levels are associated with human resistance to *Plasmodium falciparum* malaria. *Infection and immunity* 68:1252-1258.
- Bachmann, A., C. Esser, M. Petter, S. Predehl, V. von Kalckreuth, S. Schmiedel, I. Bruchhaus, and E. Tannich. 2009. Absence of erythrocyte sequestration and lack of multicopy gene family expression in *Plasmodium falciparum* from a splenectomized malaria patient. *PloS one* 4:e7459.
- Baird, J.K. 1995. Host age as a determinant of naturally acquired immunity to *Plasmodium falciparum*. *Parasitology today (Personal ed.)* 11:105-111.
- Banic, D.M., J. de Oliveira-Ferreira, L.R. Pratt-Riccio, V. Conseil, D. Goncalves, R.R. Fialho, H. Gras-Masse, C.T. Daniel-Ribeiro, and D. Camus. 1998. Immune response and lack of immune response to *Plasmodium falciparum* P126 antigen and its amino-terminal repeat in malaria-infected humans. *The American journal of tropical medicine and hygiene* 58:768-774.
- Bano, N., J.D. Romano, B. Jayabalasingham, and I. Coppens. 2007. Cellular interactions of *Plasmodium* liver stage with its host mammalian cell. *International journal for parasitology* 37:1329-1341.
- Bao, L.Q., N.T. Huy, M. Kikuchi, T. Yanagi, M. Senba, M.N. Shuaibu, K. Honma, K. Yui, and K. Hirayama. 2013. CD19(+) B cells confer protection against experimental cerebral malaria in semi-immune rodent model. *PloS one* 8:e64836.
- Bao, L.Q., D.M. Nhi, N.T. Huy, M. Kikuchi, T. Yanagi, S. Hamano, and K. Hirayama. 2015. Splenic CD11c+ cells derived from semi-immune mice protect naive mice against experimental cerebral malaria. *Malaria journal* 14:23.
- Barber, D.L., E.J. Wherry, D. Masopust, B. Zhu, J.P. Allison, A.H. Sharpe, G.J. Freeman, and R. Ahmed. 2006. Restoring function in exhausted CD8 T cells during chronic viral infection. *Nature* 439:682-687.
- Barry, A.E., and A. Arnott. 2014. Strategies for designing and monitoring malaria vaccines targeting diverse antigens. *Frontiers in immunology* 5:359.
- Basco, L.K., and J. Le Bras. 1994. In vitro reversal of chloroquine resistance with chlorpheniramine against African isolates of *Plasmodium falciparum*. *Japanese journal of medical science & biology* 47:59-63.
- Basu, S., C. Quilici, H.H. Zhang, D. Grail, and A.R. Dunn. 2008. Mice lacking both G-CSF and IL-6 are more susceptible to *Candida albicans* infection: critical role of neutrophils in defense against *Candida albicans*. *Growth factors (Chur, Switzerland)* 26:23-34.
- Beck, H.P., D. Blake, M.L. Darde, I. Felger, S. Pedraza-Diaz, J. Regidor-Cerrillo, M. Gomez-Bautista, L.M. Ortega-Mora, L. Putignani, B. Shiels, A. Tait, and W. Weir. 2009. Molecular approaches to diversity of populations of apicomplexan parasites. *International journal for parasitology* 39:175-189.
- Beghdadi, W., A. Porcherie, B.S. Schneider, D. Dubayle, R. Peronet, M. Huerre, T. Watanabe, H. Ohtsu, J. Louis, and S. Mecheri. 2008. Inhibition of histamine-mediated signaling confers significant protection against severe malaria in mouse models of disease. *The Journal of experimental medicine* 205:395-408.
- Belnoue, E., F.T. Costa, T. Frankenberg, A.M. Vigario, T. Voza, N. Leroy, M.M. Rodrigues, I. Landau, G. Snounou, and L. Renia. 2004. Protective T cell immunity against malaria liver stage after vaccination with live sporozoites under chloroquine treatment. *Journal of immunology (Baltimore, Md. : 1950)* 172:2487-2495.
- Belnoue, E., M. Kayibanda, A.M. Vigario, J.C. Deschemin, N. van Rooijen, M. Viguier, G. Snounou, and L. Renia. 2002. On the pathogenic role of brain-sequestered alphabeta CD8+ T cells in experimental cerebral malaria. *Journal of immunology (Baltimore, Md. : 1950)* 169:6369-6375.

- Berezcky, S., A. Dolo, B. Maiga, M. Hayano, F. Granath, S.M. Montgomery, M. Daou, C. Arama, M. Troye-Blomberg, O.K. Doumbo, and A. Farnert. 2006. Spleen enlargement and genetic diversity of *Plasmodium falciparum* infection in two ethnic groups with different malaria susceptibility in Mali, West Africa. *Transactions of the Royal Society of Tropical Medicine and Hygiene* 100:248-257.
- Berezcky, S., S.M. Montgomery, M. Troye-Blomberg, I. Rooth, M.A. Shaw, and A. Farnert. 2004. Elevated anti-malarial IgE in asymptomatic individuals is associated with reduced risk for subsequent clinical malaria. *International journal for parasitology* 34:935-942.
- Bhattacharya, U., S. Roy, P.K. Kar, B. Sarangi, and S.C. Lahiri. 1988. Histamine & kinin system in experimental malaria. *The Indian journal of medical research* 88:558-563.
- Bheekha-Escura, R., D.W. MacGlashan, J.M. Langdon, and S.M. MacDonald. 2000. Human recombinant histamine-releasing factor activates human eosinophils and the eosinophilic cell line, AML14-3D10. *Blood* 96:2191-2198.
- Bhisutthibhan, J., and S.R. Meshnick. 2001. Immunoprecipitation of [(3)H]dihydroartemisinin translationally controlled tumor protein (TCTP) adducts from *Plasmodium falciparum*-infected erythrocytes by using anti-TCTP antibodies. *Antimicrobial agents and chemotherapy* 45:2397-2399.
- Bhisutthibhan, J., X.Q. Pan, P.A. Hossler, D.J. Walker, C.A. Yowell, J. Carlton, J.B. Dame, and S.R. Meshnick. 1998. The *Plasmodium falciparum* translationally controlled tumor protein homolog and its reaction with the antimalarial drug artemisinin. *The Journal of biological chemistry* 273:16192-16198.
- Bhisutthibhan, J., M.A. Philbert, H. Fujioka, M. Aikawa, and S.R. Meshnick. 1999. The *Plasmodium falciparum* translationally controlled tumor protein: subcellular localization and calcium binding. *European journal of cell biology* 78:665-670.
- Bijker, E.M., S. Borrmann, S.H. Kappe, B. Mordmuller, B.K. Sack, and S.M. Khan. 2015. Novel approaches to whole sporozoite vaccination against malaria. *Vaccine* 33:7462-7468.
- Billker, O., V. Lindo, M. Panico, A.E. Etienne, T. Paxton, A. Dell, M. Rogers, R.E. Sinden, and H.R. Morris. 1998. Identification of xanthurenic acid as the putative inducer of malaria development in the mosquito. *Nature* 392:289-292.
- Bini, L., H. Heid, S. Liberatori, G. Geier, V. Pallini, and R. Zwillig. 1997. Two-dimensional gel electrophoresis of *Caenorhabditis elegans* homogenates and identification of protein spots by microsequencing. *Electrophoresis* 18:557-562.
- Blackburn, S.D., H. Shin, W.N. Haining, T. Zou, C.J. Workman, A. Polley, M.R. Betts, G.J. Freeman, D.A. Vignali, and E.J. Wherry. 2009. Coregulation of CD8+ T cell exhaustion by multiple inhibitory receptors during chronic viral infection. *Nature immunology* 10:29-37.
- Bohm, H., B. Gross, M. Gaestel, U.A. Bommer, G. Ryffel, and H. Bielka. 1991. The 5'-untranslated region of p23 mRNA from the Ehrlich ascites tumor is involved in translation control of the growth related protein p23. *Biomedica biochimica acta* 50:1193-1203.
- Bommer, U.-A., and B.-J. Thiele. 2004a. The translationally controlled tumour protein (TCTP). *The international journal of biochemistry & cell biology* 36:379-385.
- Bommer, U.A., and B.J. Thiele. 2004b. The translationally controlled tumour protein (TCTP). *The international journal of biochemistry & cell biology* 36:379-385.
- Borish, L., R. Rosenbaum, L. Albury, and S. Clark. 1989. Activation of neutrophils by recombinant interleukin 6. *Cellular immunology* 121:280-289.
- Bouharoun-Tayoun, H., P. Attanath, A. Sabchareon, T. Chongsuphajaisiddhi, and P. Druilhe. 1990. Antibodies that protect humans against *Plasmodium falciparum* blood stages do not on their own inhibit parasite growth and invasion in vitro, but act in cooperation with monocytes. *The Journal of experimental medicine* 172:1633-1641.
- Bouharoun-Tayoun, H., and P. Druilhe. 1992. *Plasmodium falciparum* malaria: evidence for an isotype imbalance which may be responsible for delayed acquisition of protective immunity. *Infection and immunity* 60:1473-1481.

- Bouharoun-Tayoun, H., C. Oeuvray, F. Lunel, and P. Druilhe. 1995. Mechanisms underlying the monocyte-mediated antibody-dependent killing of *Plasmodium falciparum* asexual blood stages. *The Journal of experimental medicine* 182:409-418.
- Bousema, J.T., L.C. Gouagna, C.J. Drakeley, A.M. Meutstege, B.A. Okech, I.N. Akim, J.C. Beier, J.I. Githure, and R.W. Sauerwein. 2004. *Plasmodium falciparum* gametocyte carriage in asymptomatic children in western Kenya. *Malaria journal* 3:18.
- Bouzigon, E., P. Forabosco, G.H. Koppelman, W.O. Cookson, M.H. Dizier, D.L. Duffy, D.M. Evans, M.A. Ferreira, J. Kere, T. Laitinen, G. Malerba, D.A. Meyers, M. Moffatt, N.G. Martin, M.Y. Ng, P.F. Pignatti, M. Wjst, F. Kauffmann, F. Demenais, and C.M. Lewis. 2010. Meta-analysis of 20 genome-wide linkage studies evidenced new regions linked to asthma and atopy. *European journal of human genetics : EJHG* 18:700-706.
- Brake, D.A., C.A. Long, and W.P. Weidanz. 1988. Adoptive protection against *Plasmodium chabaudi* adami malaria in athymic nude mice by a cloned T cell line. *Journal of immunology (Baltimore, Md. : 1950)* 140:1989-1993.
- Briquet, S., N. Lawson-Hogban, B. Boisson, M.P. Soares, R. Peronet, L. Smith, R. Menard, M. Huerre, S. Mecheri, and C. Vaquero. 2015. Disruption of Parasite *hmgb2* Gene Attenuates *Plasmodium berghei* ANKA Pathogenicity. *Infection and immunity* 83:2771-2784.
- Brown, A.W. 1958. The insecticide-resistance problem: a review of developments in 1956 and 1957. *Bulletin of the World Health Organization* 18:309-321.
- Bruce-Chwatt, L.J. 1980. Essential malariology. *William Heinemann Medical Books Ltd., London, United Kingdom.* 354:
- Bruna-Romero, O., and A. Rodriguez. 2001. Dendritic cells can initiate protective immune responses against malaria. *Infection and immunity* 69:5173-5176.
- Buffet, P.A., I. Safeukui, G. Milon, O. Mercereau-Puijalon, and P.H. David. 2009. Retention of erythrocytes in the spleen: a double-edged process in human malaria. *Current opinion in hematology* 16:157-164.
- Butler, N.S., J. Moebius, L.L. Pewe, B. Traore, O.K. Doumbo, L.T. Tygrett, T.J. Waldschmidt, P.D. Crompton, and J.T. Harty. 2012. Therapeutic blockade of PD-L1 and LAG-3 rapidly clears established blood-stage *Plasmodium* infection. *Nature immunology* 13:188-195.
- Butler, N.S., N.W. Schmidt, A.M. Vaughan, A.S. Aly, S.H. Kappe, and J.T. Harty. 2011. Superior antimalarial immunity after vaccination with late liver stage-arresting genetically attenuated parasites. *Cell host & microbe* 9:451-462.
- Calderon-Perez, B., B. Xoconostle-Cazares, R. Lira-Carmona, R. Hernandez-Rivas, J. Ortega-Lopez, and R. Ruiz-Medrano. 2014. The *Plasmodium falciparum* translationally controlled tumor protein (TCTP) is incorporated more efficiently into B cells than its human homologue. *PLoS one* 9:e85514.
- Calissano, C., D. Modiano, B.S. Sirima, A. Konate, I. Sanou, A. Sawadogo, H. Perlmann, M. Troye-Blomberg, and P. Perlmann. 2003. IgE antibodies to *Plasmodium falciparum* and severity of malaria in children of one ethnic group living in Burkina Faso. *The American journal of tropical medicine and hygiene* 69:31-35.
- Cans, C., B.J. Passer, V. Shalak, V. Nancy-Portebois, V. Crible, N. Amzallag, D. Allanic, R. Tufino, M. Argentini, D. Moras, G. Fiucci, B. Goud, M. Mirande, R. Amson, and A. Telerman. 2003. Translationally controlled tumor protein acts as a guanine nucleotide dissociation inhibitor on the translation elongation factor eEF1A. *Proceedings of the National Academy of Sciences of the United States of America* 100:13892-13897.
- Carlson, J., G. Holmquist, D.W. Taylor, P. Perlmann, and M. Wahlgren. 1990. Antibodies to a histidine-rich protein (PfHRP1) disrupt spontaneously formed *Plasmodium falciparum* erythrocyte rosettes. *Proceedings of the National Academy of Sciences of the United States of America* 87:2511-2515.
- Carlton, J.M., J.H. Adams, J.C. Silva, S.L. Bidwell, H. Lorenzi, E. Caler, J. Crabtree, S.V. Angiuoli, E.F. Merino, P. Amedeo, Q. Cheng, R.M. Coulson, B.S. Crabb, H.A. Del Portillo, K. Essien, T.V. Feldblyum, C. Fernandez-Becerra, P.R. Gilson, A.H. Gueye, X. Guo, S. Kang'a, T.W. Kooij, M. Korsinczky, E.V. Meyer, V. Nene, I. Paulsen, O. White, S.A. Ralph, Q. Ren, T.J.

- Sargeant, S.L. Salzberg, C.J. Stoeckert, S.A. Sullivan, M.M. Yamamoto, S.L. Hoffman, J.R. Wortman, M.J. Gardner, M.R. Galinski, J.W. Barnwell, and C.M. Fraser-Liggett. 2008. Comparative genomics of the neglected human malaria parasite *Plasmodium vivax*. *Nature* 455:757-763.
- Carlton, J.M., S.V. Angiuoli, B.B. Suh, T.W. Kooij, M. Peretea, J.C. Silva, M.D. Ermolaeva, J.E. Allen, J.D. Selengut, H.L. Koo, J.D. Peterson, M. Pop, D.S. Kosack, M.F. Shumway, S.L. Bidwell, S.J. Shallom, S.E. van Aken, S.B. Riedmuller, T.V. Feldblyum, J.K. Cho, J. Quackenbush, M. Sedegah, A. Shoaibi, L.M. Cummings, L. Florens, J.R. Yates, J.D. Raine, R.E. Sinden, M.A. Harris, D.A. Cunningham, P.R. Preiser, L.W. Bergman, A.B. Vaidya, L.H. van Lin, C.J. Janse, A.P. Waters, H.O. Smith, O.R. White, S.L. Salzberg, J.C. Venter, C.M. Fraser, S.L. Hoffman, M.J. Gardner, and D.J. Carucci. 2002. Genome sequence and comparative analysis of the model rodent malaria parasite *Plasmodium yoelii yoelii*. *Nature* 419:512-519.
- Carter, R., and K.N. Mendis. 2002. Evolutionary and historical aspects of the burden of malaria. *Clinical microbiology reviews* 15:564-594.
- Chae, J., I. Choi, and C. Kim. 2006. Homology modeling and molecular docking study of translationally controlled tumor protein and artemisinin. *Archives of pharmacal research* 29:50-58.
- Charpian, S., and J.M. Przyborski. 2008. Protein transport across the parasitophorous vacuole of *Plasmodium falciparum*: into the great wide open. *Traffic* 9:157-165.
- Chattopadhyay, R., S. Conteh, M. Li, E.R. James, J.E. Epstein, and S.L. Hoffman. 2009. The Effects of radiation on the safety and protective efficacy of an attenuated *Plasmodium yoelii* sporozoite malaria vaccine. *Vaccine* 27:3675-3680.
- Chemtai, A.K., C. Hamers-Casterman, R. Hamers, and P. De Baetselier. 1984. T cell-mediated immunity in murine malaria. II. Induction of protective immunity to *P. chabaudi* by antigen-fed macrophages and antigen-educated lymphocytes. *Parasite immunology* 6:469-480.
- Chen, S.H., P.S. Wu, C.H. Chou, Y.T. Yan, H. Liu, S.Y. Weng, and H.F. Yang-Yen. 2007. A knockout mouse approach reveals that TCTP functions as an essential factor for cell proliferation and survival in a tissue- or cell type-specific manner. *Molecular biology of the cell* 18:2525-2532.
- Chen, W., and G.K. Khurana Hershey. 2007. Signal transducer and activator of transcription signals in allergic disease. *The Journal of allergy and clinical immunology* 119:529-541; quiz 542-523.
- Cherif, M., D. Amoako-Sakyi, A. Dolo, J.O. Pearson, B. Gyan, D. Obiri-Yeboah, I. Nebie, S.B. Sirima, O. Doumbo, M. Troye-Blomberg, and M. Bakary. 2016. Distribution of FcγR3 gene polymorphisms among two sympatric populations in Mali: differing allele frequencies, associations with malariometric indices and implications for genetic susceptibility to malaria. *Malaria journal* 15:29.
- Chisholm, S.A., E. McHugh, R. Lundie, M.W. Dixon, S. Ghosh, M. O'Keefe, L. Tilley, M. Kalanon, and T.F. de Koning-Ward. 2016. Contrasting Inducible Knockdown of the Auxiliary PTEX Component PTEX88 in *P. falciparum* and *P. berghei* Unmasks a Role in Parasite Virulence. *PLoS one* 11:e0149296.
- Chitpatima, S.T., S. Makrides, R. Bandyopadhyay, and G. Brawerman. 1988. Nucleotide sequence of a major messenger RNA for a 21 kilodalton polypeptide that is under translational control in mouse tumor cells. *Nucleic acids research* 16:2350.
- Chomarat, P., J. Banchereau, J. Davoust, and A.K. Palucka. 2000. IL-6 switches the differentiation of monocytes from dendritic cells to macrophages. *Nature immunology* 1:510-514.
- Chong, C.R., X. Chen, L. Shi, J.O. Liu, and D.J. Sullivan, Jr. 2006. A clinical drug library screen identifies astemizole as an antimalarial agent. *Nature chemical biology* 2:415-416.
- Chung, S., M. Kim, W. Choi, J. Chung, and K. Lee. 2000. Expression of translationally controlled tumor protein mRNA in human colon cancer. *Cancer letters* 156:185-190.
- Clark, I.A., K.A. Rockett, and W.B. Cowden. 1991. Proposed link between cytokines, nitric oxide and human cerebral malaria. *Parasitology today (Personal ed.)* 7:205-207.

- Coban, C., K.J. Ishii, T. Kawai, H. Hemmi, S. Sato, S. Uematsu, M. Yamamoto, O. Takeuchi, S. Itagaki, N. Kumar, T. Horii, and S. Akira. 2005. Toll-like receptor 9 mediates innate immune activation by the malaria pigment hemozoin. *The Journal of experimental medicine* 201:19-25.
- Coban, C., K.J. Ishii, S. Uematsu, N. Arisue, S. Sato, M. Yamamoto, T. Kawai, O. Takeuchi, H. Hisaeda, T. Horii, and S. Akira. 2007. Pathological role of Toll-like receptor signaling in cerebral malaria. *International immunology* 19:67-79.
- Cockburn, I.A., Y.C. Chen, M.G. Overstreet, J.R. Lees, N. van Rooijen, D.L. Farber, and F. Zavala. 2010. Prolonged antigen presentation is required for optimal CD8+ T cell responses against malaria liver stage parasites. *PLoS pathogens* 6:e1000877.
- Cohen, S., G.I. Mc, and S. Carrington. 1961. Gamma-globulin and acquired immunity to human malaria. *Nature* 192:733-737.
- Coltel, N., V. Combes, N.H. Hunt, and G.E. Grau. 2004. Cerebral malaria -- a neurovascular pathology with many riddles still to be solved. *Current neurovascular research* 1:91-110.
- Coluzzi, A. 1961. [The eradication of malaria. A world-wide challenge]. *Annali della sanita pubblica* 22:241-253.
- Coronado, L.M., C.T. Nadovich, and C. Spadafora. 2014. Malarial hemozoin: from target to tool. *Biochimica et biophysica acta* 1840:2032-2041.
- Cowman, A.F., and B.S. Crabb. 2006. Invasion of red blood cells by malaria parasites. *Cell* 124:755-766.
- Cox, D., and S. McConkey. 2010. The role of platelets in the pathogenesis of cerebral malaria. *Cellular and molecular life sciences : CMLS* 67:557-568.
- Cox, F.E. 2010. History of the discovery of the malaria parasites and their vectors. *Parasites & vectors* 3:5.
- Cox-Singh, J., J. Hiu, S.B. Lucas, P.C. Divis, M. Zulkarnaen, P. Chandran, K.T. Wong, P. Adem, S.R. Zaki, B. Singh, and S. Krishna. 2010. Severe malaria - a case of fatal Plasmodium knowlesi infection with post-mortem findings: a case report. *Malaria journal* 9:10.
- Crispe, I.N. 2014. APC licensing and CD4+T cell help in liver-stage malaria. *Frontiers in microbiology* 5:617.
- Crompton, P.D., J. Moebius, S. Portugal, M. Waisberg, G. Hart, L.S. Garver, L.H. Miller, C. Barillas-Mury, and S.K. Pierce. 2014. Malaria immunity in man and mosquito: insights into unsolved mysteries of a deadly infectious disease. *Annual review of immunology* 32:157-187.
- Crotti, D. 2005. [A history of Malaria from and for a popular point of view]. *Le infezioni in medicina : rivista periodica di eziologia, epidemiologia, diagnostica, clinica e terapia delle patologie infettive* 13:265-270.
- Cunha, C.B., and B.A. Cunha. 2008. Brief history of the clinical diagnosis of malaria: from Hippocrates to Osler. *Journal of vector borne diseases* 45:194-199.
- D'Ombrian, M.C., L.J. Robinson, D.I. Stanistic, J. Taraika, N. Bernard, P. Michon, I. Mueller, and L. Schofield. 2008. Association of early interferon-gamma production with immunity to clinical malaria: a longitudinal study among Papua New Guinean children. *Clinical infectious diseases : an official publication of the Infectious Diseases Society of America* 47:1380-1387.
- Daneshvar, C., T.M. Davis, J. Cox-Singh, M.Z. Rafa'ee, S.K. Zakaria, P.C. Divis, and B. Singh. 2009. Clinical and laboratory features of human Plasmodium knowlesi infection. *Clinical infectious diseases : an official publication of the Infectious Diseases Society of America* 49:852-860.
- Davenport, G.C., C. Ouma, J.B. Hittner, T. Were, Y. Ouma, J.M. Ong'echa, and D.J. Perkins. 2010. Hematological predictors of increased severe anemia in Kenyan children coinfecting with Plasmodium falciparum and HIV-1. *American journal of hematology* 85:227-233.
- David, P.H., M. Hommel, L.H. Miller, I.J. Udeinya, and L.D. Oligino. 1983. Parasite sequestration in Plasmodium falciparum malaria: spleen and antibody modulation of cytoadherence of infected erythrocytes. *Proceedings of the National Academy of Sciences of the United States of America* 80:5075-5079.
- Day, C.L., D.E. Kaufmann, P. Kiepiela, J.A. Brown, E.S. Moodley, S. Reddy, E.W. Mackey, J.D. Miller, A.J. Leslie, C. DePierres, Z. Mncube, J. Duraiswamy, B. Zhu, Q. Eichbaum, M.

- Altfeld, E.J. Wherry, H.M. Coovadia, P.J. Goulder, P. Klenerman, R. Ahmed, G.J. Freeman, and B.D. Walker. 2006. PD-1 expression on HIV-specific T cells is associated with T-cell exhaustion and disease progression. *Nature* 443:350-354.
- de Koning-Ward, T.F., C.J. Janse, and A.P. Waters. 2000. The development of genetic tools for dissecting the biology of malaria parasites. *Annual review of microbiology* 54:157-185.
- De Niz, M., A.K. Ullrich, A. Heiber, A. Blancke Soares, C. Pick, R. Lyck, D. Keller, G. Kaiser, M. Prado, S. Flemming, H. Del Portillo, C.J. Janse, V. Heussler, and T. Spielmann. 2016. The machinery underlying malaria parasite virulence is conserved between rodent and human malaria parasites. *Nature communications* 7:11659.
- Del Portillo, H.A., M. Ferrer, T. Brugat, L. Martin-Jaular, J. Langhorne, and M.V. Lacerda. 2012. The role of the spleen in malaria. *Cellular microbiology* 14:343-355.
- Demarta-Gatsi, C., L. Smith, and S. Thiberge. 2016. Protection against malaria in mice is induced by blood stage-arresting histamine-releasing factor (HRF)-deficient parasites. 213:1419-1428.
- Demeure, C.E., K. Brahimi, F. Hacini, F. Marchand, R. Peronet, M. Huerre, P. St-Mezard, J.F. Nicolas, P. Brey, G. Delespesse, and S. Mecheri. 2005. Anopheles mosquito bites activate cutaneous mast cells leading to a local inflammatory response and lymph node hyperplasia. *Journal of immunology (Baltimore, Md. : 1950)* 174:3932-3940.
- Desowitz, R.S. 1989. Plasmodium-specific immunoglobulin E in sera from an area of holoendemic malaria. *Transactions of the Royal Society of Tropical Medicine and Hygiene* 83:478-479.
- Desowitz, R.S., J. Elm, and M.P. Alpers. 1993. Plasmodium falciparum-specific immunoglobulin G (IgG), IgM, and IgE antibodies in paired maternal-cord sera from east Sepik Province, Papua New Guinea. *Infection and immunity* 61:988-993.
- deWalick, S., F.H. Amante, K.A. McSweeney, L.M. Randall, A.C. Stanley, A. Haque, R.D. Kuns, K.P. MacDonald, G.R. Hill, and C.R. Engwerda. 2007. Cutting edge: conventional dendritic cells are the critical APC required for the induction of experimental cerebral malaria. *Journal of immunology (Baltimore, Md. : 1950)* 178:6033-6037.
- Dondorp, A.M., B.J. Angus, K. Chotivanich, K. Silamut, R. Ruangveerayuth, M.R. Hardeman, P.A. Kager, J. Vreeken, and N.J. White. 1999. Red blood cell deformability as a predictor of anemia in severe falciparum malaria. *The American journal of tropical medicine and hygiene* 60:733-737.
- Dondorp, A.M., S.J. Lee, M.A. Faiz, S. Mishra, R. Price, E. Tjitra, M. Than, Y. Htut, S. Mohanty, E.B. Yunus, R. Rahman, F. Nosten, N.M. Anstey, N.P. Day, and N.J. White. 2008. The relationship between age and the manifestations of and mortality associated with severe malaria. *Clinical infectious diseases : an official publication of the Infectious Diseases Society of America* 47:151-157.
- Doolan, D.L., C. Dobano, and J.K. Baird. 2009. Acquired immunity to malaria. *Clinical microbiology reviews* 22:13-36, Table of Contents.
- Doolan, D.L., and S.L. Hoffman. 1999. IL-12 and NK cells are required for antigen-specific adaptive immunity against malaria initiated by CD8+ T cells in the Plasmodium yoelii model. *Journal of immunology (Baltimore, Md. : 1950)* 163:884-892.
- Doolan, D.L., and S.L. Hoffman. 2000. The complexity of protective immunity against liver-stage malaria. *Journal of immunology (Baltimore, Md. : 1950)* 165:1453-1462.
- Dorfman, J.R., P. Bejon, F.M. Ndungu, J. Langhorne, M.M. Kortok, B.S. Lowe, T.W. Mwangi, T.N. Williams, and K. Marsh. 2005. B cell memory to 3 Plasmodium falciparum blood-stage antigens in a malaria-endemic area. *The Journal of infectious diseases* 191:1623-1630.
- Dormer, P., M. Dietrich, P. Kern, and R.D. Horstmann. 1983. Ineffective erythropoiesis in acute human P. falciparum malaria. *Blut* 46:279-288.
- Druilhe, P., and J.L. Perignon. 1994. Mechanisms of defense against P. falciparum asexual blood stages in humans. *Immunology letters* 41:115-120.
- El-Far, M., R. Halwani, E. Said, L. Trautmann, M. Doroudchi, L. Janbazian, S. Fonseca, J. van Grevenynghe, B. Yassine-Diab, R.P. Sekaly, and E.K. Haddad. 2008. T-cell exhaustion in HIV infection. *Current HIV/AIDS reports* 5:13-19.

- Elghazali, G., H. Perlmann, A.S. Rutta, P. Perlmann, and M. Troye-Blomberg. 1997. Elevated plasma levels of IgE in Plasmodium falciparum-primed individuals reflect an increased ratio of IL-4 to interferon-gamma (IFN-gamma)-producing cells. *Clinical and experimental immunology* 109:84-89.
- Ellinger, I., and R. Fuchs. 2012. HFcRn-mediated transplacental immunoglobulin G transport: protection of and threat to the human fetus and newborn. *Wiener medizinische Wochenschrift (1946)* 162:207-213.
- Elsheikha, H.M., and N.A. Khan. 2010. Protozoa traversal of the blood-brain barrier to invade the central nervous system. *FEMS microbiology reviews* 34:532-553.
- Enwonwu, C.O., B.M. Afolabi, L.A. Salako, E.O. Idigbe, H. al-Hassan, and R.A. Rabi. 1999. Hyperphenylalaninaemia in children with falciparum malaria. *QJM : monthly journal of the Association of Physicians* 92:495-503.
- Enwonwu, C.O., B.M. Afolabi, L.O. Salako, E.O. Idigbe, and N. Bashirelah. 2000. Increased plasma levels of histidine and histamine in falciparum malaria: relevance to severity of infection. *Journal of neural transmission (Vienna, Austria : 1996)* 107:1273-1287.
- Epstein, J.E., K. Tewari, K.E. Lyke, B.K. Sim, P.F. Billingsley, M.B. Laurens, A. Gunasekera, S. Chakravarty, E.R. James, M. Sedegah, A. Richman, S. Velmurugan, S. Reyes, M. Li, K. Tucker, A. Ahumada, A.J. Ruben, T. Li, R. Stafford, A.G. Eappen, C. Tamminga, J.W. Bennett, C.F. Ockenhouse, J.R. Murphy, J. Komisar, N. Thomas, M. Loyevsky, A. Birkett, C.V. Plowe, C. Loucq, R. Edelman, T.L. Richie, R.A. Seder, and S.L. Hoffman. 2011. Live attenuated malaria vaccine designed to protect through hepatic CD8(+) T cell immunity. *Science (New York, N.Y.)* 334:475-480.
- Escalante, A.A., and F.J. Ayala. 1995. Evolutionary origin of Plasmodium and other Apicomplexa based on rRNA genes. *Proceedings of the National Academy of Sciences of the United States of America* 92:5793-5797.
- Evans, K.J., D.S. Hansen, N. van Rooijen, L.A. Buckingham, and L. Schofield. 2006. Severe malarial anemia of low parasite burden in rodent models results from accelerated clearance of uninfected erythrocytes. *Blood* 107:1192-1199.
- Farouk, S.E., A. Dolo, S. Berezky, B. Kouriba, B. Maiga, A. Farnert, H. Perlmann, M. Hayano, S.M. Montgomery, O.K. Doumbo, and M. Troye-Blomberg. 2005. Different antibody- and cytokine-mediated responses to Plasmodium falciparum parasite in two sympatric ethnic tribes living in Mali. *Microbes and infection / Institut Pasteur* 7:110-117.
- Favre, N., B. Ryffel, G. Bordmann, and W. Rudin. 1997. The course of Plasmodium chabaudi chabaudi infections in interferon-gamma receptor deficient mice. *Parasite immunology* 19:375-383.
- Fell, A.H., J. Currier, and M.F. Good. 1994. Inhibition of Plasmodium falciparum growth in vitro by CD4+ and CD8+ T cells from non-exposed donors. *Parasite immunology* 16:579-586.
- Feng, Y., D. Liu, H. Yao, and J. Wang. 2007. Solution structure and mapping of a very weak calcium-binding site of human translationally controlled tumor protein by NMR. *Archives of biochemistry and biophysics* 467:48-57.
- Feng, Z., L. Hensley, K.L. McKnight, F. Hu, V. Madden, L. Ping, S.H. Jeong, C. Walker, R.E. Lanford, and S.M. Lemon. 2013. A pathogenic picornavirus acquires an envelope by hijacking cellular membranes. *Nature* 496:367-371.
- Ferreira, M.U., M. da Silva Nunes, and G. Wunderlich. 2004. Antigenic diversity and immune evasion by malaria parasites. *Clinical and diagnostic laboratory immunology* 11:987-995.
- Ferroni, E., T. Jefferson, and G. Gachelin. 2012. Angelo Celli and research on the prevention of malaria in Italy a century ago. *Journal of the Royal Society of Medicine* 105:35-40.
- Fiucci, G., A. Lespagnol, P. Stumptner-Cuvelette, S. Beaucourt, D. Duflaut, L. Susini, R. Amson, and A. Telerman. 2003. Genomic organization and expression of mouse Tpt1 gene. *Genomics* 81:570-578.
- Flori, L., B. Kumulungui, C. Aucan, C. Esnault, A.S. Traore, F. Fumoux, and P. Rihet. 2003. Linkage and association between Plasmodium falciparum blood infection levels and chromosome 5q31-q33. *Genes and immunity* 4:265-268.

- Frevert, U., S. Engelmann, S. Zougbede, J. Stange, B. Ng, K. Matuschewski, L. Liebes, and H. Yee. 2005. Intravital observation of *Plasmodium berghei* sporozoite infection of the liver. *PLoS biology* 3:e192.
- Friesen, J., O. Silvie, E.D. Putrianti, J.C. Hafalla, K. Matuschewski, and S. Borrmann. 2010. Natural immunization against malaria: causal prophylaxis with antibiotics. *Science translational medicine* 2:40ra49.
- Gabay, C., and I. Kushner. 1999. Acute-phase proteins and other systemic responses to inflammation. *The New England journal of medicine* 340:448-454.
- Gachet, Y., S. Tournier, M. Lee, A. Lazaris-Karatzas, T. Poulton, and U.A. Bommer. 1999. The growth-related, translationally controlled protein P23 has properties of a tubulin binding protein and associates transiently with microtubules during the cell cycle. *Journal of cell science* 112 (Pt 8):1257-1271.
- Gardner, M.J., N. Hall, E. Fung, O. White, M. Berriman, R.W. Hyman, J.M. Carlton, A. Pain, K.E. Nelson, S. Bowman, I.T. Paulsen, K. James, J.A. Eisen, K. Rutherford, S.L. Salzberg, A. Craig, S. Kyes, M.S. Chan, V. Nene, S.J. Shallom, B. Suh, J. Peterson, S. Angiuoli, M. Pertea, J. Allen, J. Selengut, D. Haft, M.W. Mather, A.B. Vaidya, D.M. Martin, A.H. Fairlamb, M.J. Fraunholz, D.S. Roos, S.A. Ralph, G.I. McFadden, L.M. Cummings, G.M. Subramanian, C. Mungall, J.C. Venter, D.J. Carucci, S.L. Hoffman, C. Newbold, R.W. Davis, C.M. Fraser, and B. Barrell. 2002a. Genome sequence of the human malaria parasite *Plasmodium falciparum*. *Nature* 419:498-511.
- Gardner, M.J., S.J. Shallom, J.M. Carlton, S.L. Salzberg, V. Nene, A. Shoaibi, A. Ciecko, J. Lynn, M. Rizzo, B. Weaver, B. Jarrahi, M. Brenner, B. Parvizi, L. Tallon, A. Moazzez, D. Granger, C. Fujii, C. Hansen, J. Pederson, T. Feldblyum, J. Peterson, B. Suh, S. Angiuoli, M. Pertea, J. Allen, J. Selengut, O. White, L.M. Cummings, H.O. Smith, M.D. Adams, J.C. Venter, D.J. Carucci, S.L. Hoffman, and C.M. Fraser. 2002b. Sequence of *Plasmodium falciparum* chromosomes 2, 10, 11 and 14. *Nature* 419:531-534.
- Garraud, O., S. Mahanty, and R. Perraut. 2003. Malaria-specific antibody subclasses in immune individuals: a key source of information for vaccine design. *Trends in immunology* 24:30-35.
- Gauldie, J., C. Richards, D. Harnish, P. Lansdorp, and H. Baumann. 1987. Interferon beta 2/B-cell stimulatory factor type 2 shares identity with monocyte-derived hepatocyte-stimulating factor and regulates the major acute phase protein response in liver cells. *Proceedings of the National Academy of Sciences of the United States of America* 84:7251-7255.
- Gaur, D., D.C. Mayer, and L.H. Miller. 2004. Parasite ligand-host receptor interactions during invasion of erythrocytes by *Plasmodium* merozoites. *International journal for parasitology* 34:1413-1429.
- Gazzinelli, R.T., P. Kalantari, K.A. Fitzgerald, and D.T. Golenbock. 2014. Innate sensing of malaria parasites. *Nature reviews. Immunology* 14:744-757.
- Ghumra, A., J.P. Semblat, R.S. McIntosh, A. Raza, I.B. Rasmussen, R. Braathen, F.E. Johansen, I. Sandlie, P.K. Mongini, J.A. Rowe, and R.J. Pleass. 2008. Identification of residues in the Cmu4 domain of polymeric IgM essential for interaction with *Plasmodium falciparum* erythrocyte membrane protein 1 (PfEMP1). *Journal of immunology (Baltimore, Md. : 1950)* 181:1988-2000.
- Gitau, E.N., and C.R. Newton. 2005. Review Article: blood-brain barrier in falciparum malaria. *Tropical medicine & international health : TM & IH* 10:285-292.
- Good, M.F., J.M. Reiman, I.B. Rodriguez, K. Ito, S.K. Yanow, I.M. El-Deeb, M.R. Batzloff, D.I. Stanisic, C. Engwerda, T. Spithill, S.L. Hoffman, M. Lee, and V. McPhun. 2013. Cross-species malaria immunity induced by chemically attenuated parasites. *The Journal of clinical investigation*
- Graidist, P., M. Yazawa, M. Tonganunt, A. Nakatomi, C.C. Lin, J.Y. Chang, A. Phongdara, and K. Fujise. 2007. Fortilin binds Ca²⁺ and blocks Ca²⁺-dependent apoptosis in vivo. *The Biochemical journal* 408:181-191.

- Greenwood, B.M., D.A. Fidock, D.E. Kyle, S.H. Kappe, P.L. Alonso, F.H. Collins, and P.E. Duffy. 2008. Malaria: progress, perils, and prospects for eradication. *The Journal of clinical investigation* 118:1266-1276.
- Greenwood, B.M., F. Groenendaal, A.K. Bradley, A.M. Greenwood, F. Shenton, S. Tulloch, and R. Hayes. 1987. Ethnic differences in the prevalence of splenomegaly and malaria in The Gambia. *Annals of tropical medicine and parasitology* 81:345-354.
- Griffiths, M.J., M.J. Shafi, S.J. Popper, C.A. Hemingway, M.M. Kortok, A. Wathen, K.A. Rockett, R. Mott, M. Levin, C.R. Newton, K. Marsh, D.A. Relman, and D.P. Kwiatkowski. 2005. Genomewide analysis of the host response to malaria in Kenyan children. *The Journal of infectious diseases* 191:1599-1611.
- Grobusch, M.P., and P.G. Kremsner. 2005. Uncomplicated malaria. *Current topics in microbiology and immunology* 295:83-104.
- Groux, H., and J. Gysin. 1990. Opsonization as an effector mechanism in human protection against asexual blood stages of *Plasmodium falciparum*: functional role of IgG subclasses. *Research in immunology* 141:529-542.
- Gruys, E., M.J. Toussaint, T.A. Niewold, and S.J. Koopmans. 2005. Acute phase reaction and acute phase proteins. *Journal of Zhejiang University. Science. B* 6:1045-1056.
- Gueirard, P., J. Tavares, S. Thiberge, F. Bernex, T. Ishino, G. Milon, B. Franke-Fayard, C.J. Janse, R. Menard, and R. Amino. 2010. Development of the malaria parasite in the skin of the mammalian host. *Proceedings of the National Academy of Sciences of the United States of America* 107:18640-18645.
- Gysin, J., S. Gavoille, D. Mattei, A. Scherf, S. Bonnefoy, O. Mercereau-Puijalon, T. Feldmann, J. Kun, B. Muller-Hill, and L. Pereira da Silva. 1993. In vitro phagocytosis inhibition assay for the screening of potential candidate antigens for sub-unit vaccines against the asexual blood stage of *Plasmodium falciparum*. *Journal of immunological methods* 159:209-219.
- Haghighat, N.G., and L. Ruben. 1992. Purification of novel calcium binding proteins from *Trypanosoma brucei*: properties of 22-, 24- and 38-kilodalton proteins. *Molecular and biochemical parasitology* 51:99-110.
- Haileamlak, A., D. Dagoye, H. Williams, A.J. Venn, R. Hubbard, J. Britton, and S.A. Lewis. 2005. Early life risk factors for atopic dermatitis in Ethiopian children. *The Journal of allergy and clinical immunology* 115:370-376.
- Haldar, K., and N. Mohandas. 2009. Malaria, erythrocytic infection, and anemia. *Hematology / the Education Program of the American Society of Hematology. American Society of Hematology. Education Program* 87-93.
- Hall, N., M. Karras, J.D. Raine, J.M. Carlton, T.W. Kooij, M. Berriman, L. Florens, C.S. Janssen, A. Pain, G.K. Christophides, K. James, K. Rutherford, B. Harris, D. Harris, C. Churcher, M.A. Quail, D. Ormond, J. Doggett, H.E. Trueman, J. Mendoza, S.L. Bidwell, M.A. Rajandream, D.J. Carucci, J.R. Yates, 3rd, F.C. Kafatos, C.J. Janse, B. Barrell, C.M. Turner, A.P. Waters, and R.E. Sinden. 2005. A comprehensive survey of the *Plasmodium* life cycle by genomic, transcriptomic, and proteomic analyses. *Science (New York, N.Y.)* 307:82-86.
- Hamad, A.A., I.M. El Hassan, A.A. El Khalifa, G.I. Ahmed, S.A. Abdelrahim, T.G. Theander, and D.E. Arnot. 2000. Chronic *Plasmodium falciparum* infections in an area of low intensity malaria transmission in the Sudan. *Parasitology* 120 (Pt 5):447-456.
- Hansen, D.S., M.A. Siomos, T. De Koning-Ward, L. Buckingham, B.S. Crabb, and L. Schofield. 2003. CD1d-restricted NKT cells contribute to malarial splenomegaly and enhance parasite-specific antibody responses. *European journal of immunology* 33:2588-2598.
- Haque, A., and C. Engwerda. 2014. Hepatocytes break the silence during liver-stage malaria. *Nature medicine* 20:17-19.
- Hawass, Z., Y.Z. Gad, S. Ismail, R. Khairat, D. Fathalla, N. Hasan, A. Ahmed, H. Elleithy, M. Ball, F. Gaballah, S. Wasef, M. Fateen, H. Amer, P. Gostner, A. Selim, A. Zink, and C.M. Pusch. 2010. Ancestry and pathology in King Tutankhamun's family. *Jama* 303:638-647.
- Heinrich, P.C., J.V. Castell, and T. Andus. 1990. Interleukin-6 and the acute phase response. *The Biochemical journal* 265:621-636.

- Helmbj, H., G. Jonsson, and M. Troye-Blomberg. 2000. Cellular changes and apoptosis in the spleens and peripheral blood of mice infected with blood-stage *Plasmodium chabaudi chabaudi* AS. *Infection and immunity* 68:1485-1490.
- Helmbj, H., H. Perlmann, M. Troye-Blomberg, and P. Perlmann. 1996. Immunoglobulin E elevation in *Plasmodium chabaudi* malaria. *Infection and immunity* 64:1432-1433.
- Hensmann, M., and D. Kwiatkowski. 2001. Cellular basis of early cytokine response to *Plasmodium falciparum*. *Infection and immunity* 69:2364-2371.
- Hermsen, C., T. van de Wiel, E. Mommers, R. Sauerwein, and W. Eling. 1997. Depletion of CD4+ or CD8+ T-cells prevents *Plasmodium berghei* induced cerebral malaria in end-stage disease. *Parasitology* 114 (Pt 1):7-12.
- Hermsen, C.C., E. Mommers, T. van de Wiel, R.W. Sauerwein, and W.M. Eling. 1998. Convulsions due to increased permeability of the blood-brain barrier in experimental cerebral malaria can be prevented by splenectomy or anti-T cell treatment. *The Journal of infectious diseases* 178:1225-1227.
- Hernandez-Valladares, M., P. Rihet, O.K. ole-MoiYoi, and F.A. Iraqi. 2004. Mapping of a new quantitative trait locus for resistance to malaria in mice by a comparative mapping approach with human Chromosome 5q31-q33. *Immunogenetics* 56:115-117.
- Hill, A.V., C.E. Allsopp, D. Kwiatkowski, N.M. Anstey, P. Twumasi, P.A. Rowe, S. Bennett, D. Brewster, A.J. McMichael, and B.M. Greenwood. 1991. Common west African HLA antigens are associated with protection from severe malaria. *Nature* 352:595-600.
- Hinojosa-Moya, J., B. Xoconostle-Cazares, E. Piedra-Ibarra, A. Mendez-Tenorio, W.J. Lucas, and R. Ruiz-Medrano. 2008. Phylogenetic and structural analysis of translationally controlled tumor proteins. *Journal of molecular evolution* 66:472-483.
- Hirano, T., K. Yasukawa, H. Harada, T. Taga, Y. Watanabe, T. Matsuda, S. Kashiwamura, K. Nakajima, K. Koyama, A. Iwamatsu, and et al. 1986. Complementary DNA for a novel human interleukin (BSF-2) that induces B lymphocytes to produce immunoglobulin. *Nature* 324:73-76.
- Hoffman, S.L., J.M. Crutcher, S.K. Puri, A.A. Ansari, F. Villinger, E.D. Franke, P.P. Singh, F. Finkelman, M.K. Gately, G.P. Dutta, and M. Sedegah. 1997. Sterile protection of monkeys against malaria after administration of interleukin-12. *Nature medicine* 3:80-83.
- Hoffman, S.L., L.M. Goh, T.C. Luke, I. Schneider, T.P. Le, D.L. Doolan, J. Sacci, P. de la Vega, M. Dowler, C. Paul, D.M. Gordon, J.A. Stoute, L.W. Church, M. Sedegah, D.G. Heppner, W.R. Ballou, and T.L. Richie. 2002. Protection of humans against malaria by immunization with radiation-attenuated *Plasmodium falciparum* sporozoites. *The Journal of infectious diseases* 185:1155-1164.
- Hofmeyer, K.A., H. Jeon, and X. Zang. 2011. The PD-1/PD-L1 (B7-H1) pathway in chronic infection-induced cytotoxic T lymphocyte exhaustion. *Journal of biomedicine & biotechnology* 2011:451694.
- Hoge, J., I. Yan, N. Janner, V. Schumacher, A. Chalaris, O.M. Steinmetz, D.R. Engel, J. Scheller, S. Rose-John, and H.W. Mittrucker. 2013. IL-6 controls the innate immune response against *Listeria monocytogenes* via classical IL-6 signaling. *Journal of immunology (Baltimore, Md. : 1950)* 190:703-711.
- Horne-Debets, J.M., R. Faleiro, D.S. Karunarathne, X.Q. Liu, K.E. Lineburg, C.M. Poh, G.M. Grotenbreg, G.R. Hill, K.P. MacDonald, M.F. Good, L. Renia, R. Ahmed, A.H. Sharpe, and M.N. Wykes. 2013. PD-1 dependent exhaustion of CD8+ T cells drives chronic malaria. *Cell reports* 5:1204-1213.
- Horne-Debets, J.M., D.S. Karunarathne, R.J. Faleiro, C.M. Poh, L. Renia, and M.N. Wykes. 2016. Mice lacking Programmed cell death-1 show a role for CD8(+) T cells in long-term immunity against blood-stage malaria. *Scientific reports* 6:26210.
- Hsu, Y.C., J.J. Chern, Y. Cai, M. Liu, and K.W. Choi. 2007. *Drosophila* TCTP is essential for growth and proliferation through regulation of dRheb GTPase. *Nature* 445:785-788.
- Huang, X., K. Liew, O. Natalang, A. Siau, N. Zhang, and P.R. Preiser. 2013. The role of serine-type serine repeat antigen in *Plasmodium yoelii* blood stage development. *PloS one* 8:e60723.

- Hunt, N.H., J. Golenser, T. Chan-Ling, S. Parekh, C. Rae, S. Potter, I.M. Medana, J. Miu, and H.J. Ball. 2006. Immunopathogenesis of cerebral malaria. *International journal for parasitology* 36:569-582.
- Hunt, N.H., and G.E. Grau. 2003. Cytokines: accelerators and brakes in the pathogenesis of cerebral malaria. *Trends in immunology* 24:491-499.
- Idro, R., E. Bitarakwate, S. Tumwesigire, and C.C. John. 2005. Clinical manifestations of severe malaria in the highlands of southwestern Uganda. *The American journal of tropical medicine and hygiene* 72:561-567.
- Illingworth, J., N.S. Butler, S. Roetynck, J. Mwacharo, S.K. Pierce, P. Bejon, P.D. Crompton, K. Marsh, and F.M. Ndungu. 2013. Chronic exposure to *Plasmodium falciparum* is associated with phenotypic evidence of B and T cell exhaustion. *Journal of immunology (Baltimore, Md. : 1950)* 190:1038-1047.
- Imanishi, J. 2000. Expression of cytokines in bacterial and viral infections and their biochemical aspects. *Journal of biochemistry* 127:525-530.
- Ing, R., and M.M. Stevenson. 2009. Dendritic cell and NK cell reciprocal cross talk promotes gamma interferon-dependent immunity to blood-stage *Plasmodium chabaudi* AS infection in mice. *Infection and immunity* 77:770-782.
- Inoue, S., M. Niikura, S. Mineo, and F. Kobayashi. 2013. Roles of IFN-gamma and gammadelta T Cells in Protective Immunity Against Blood-Stage Malaria. *Frontiers in immunology* 4:258.
- Ishida, Y., Y. Agata, K. Shibahara, and T. Honjo. 1992. Induced expression of PD-1, a novel member of the immunoglobulin gene superfamily, upon programmed cell death. *The EMBO journal* 11:3887-3895.
- Iyengar, S.K., K.B. Jacobs, and L.J. Palmer. 2001. Improved evidence for linkage on 6p and 5p with retrospective pooling of data from three asthma genome screens. *Genetic epidemiology* 21 Suppl 1:S130-135.
- Jain, K., S. Sood, and K. Gowthamarajan. 2013. Modulation of cerebral malaria by curcumin as an adjunctive therapy. *The Brazilian journal of infectious diseases : an official publication of the Brazilian Society of Infectious Diseases* 17:579-591.
- Janse, C.J., J. Ramesar, and A.P. Waters. 2006. High-efficiency transfection and drug selection of genetically transformed blood stages of the rodent malaria parasite *Plasmodium berghei*. *Nature protocols* 1:346-356.
- Janssen, E.M., E.E. Lemmens, T. Wolfe, U. Christen, M.G. von Herrath, and S.P. Schoenberger. 2003. CD4+ T cells are required for secondary expansion and memory in CD8+ T lymphocytes. *Nature* 421:852-856.
- Jobe, O., J. Lumsden, A.K. Mueller, J. Williams, H. Silva-Rivera, S.H. Kappe, R.J. Schwenk, K. Matuschewski, and U. Krzych. 2007. Genetically attenuated *Plasmodium berghei* liver stages induce sterile protracted protection that is mediated by major histocompatibility complex Class I-dependent interferon-gamma-producing CD8+ T cells. *The Journal of infectious diseases* 196:599-607.
- Jongwutiwes, S., C. Putaporntip, T. Iwasaki, M.U. Ferreira, H. Kanbara, and A.L. Hughes. 2005. Mitochondrial genome sequences support ancient population expansion in *Plasmodium vivax*. *Molecular biology and evolution* 22:1733-1739.
- Joy, D.A., X. Feng, J. Mu, T. Furuya, K. Chotivanich, A.U. Krettli, M. Ho, A. Wang, N.J. White, E. Suh, P. Beerli, and X.Z. Su. 2003. Early origin and recent expansion of *Plasmodium falciparum*. *Science (New York, N.Y.)* 300:318-321.
- Jung, J., M. Kim, M.J. Kim, J. Kim, J. Moon, J.S. Lim, M. Kim, and K. Lee. 2004. Translationally controlled tumor protein interacts with the third cytoplasmic domain of Na,K-ATPase alpha subunit and inhibits the pump activity in HeLa cells. *The Journal of biological chemistry* 279:49868-49875.
- Kang, H.S., M.J. Lee, H. Song, S.H. Han, Y.M. Kim, J.Y. Im, and I. Choi. 2001. Molecular identification of IgE-dependent histamine-releasing factor as a B cell growth factor. *Journal of immunology (Baltimore, Md. : 1950)* 166:6545-6554.

- Kappe, S.H., A.M. Vaughan, J.A. Boddey, and A.F. Cowman. 2010. That was then but this is now: malaria research in the time of an eradication agenda. *Science* 328:862-866.
- Kashiwakura, J.C., T. Ando, K. Matsumoto, M. Kimura, J. Kitaura, M.H. Matho, D.M. Zajonc, T. Ozeki, C. Ra, S.M. MacDonald, R.P. Siraganian, D.H. Broide, Y. Kawakami, and T. Kawakami. 2012. Histamine-releasing factor has a proinflammatory role in mouse models of asthma and allergy. *The Journal of clinical investigation* 122:218-228.
- Kaul, D.K., E.F. Roth, Jr., R.L. Nagel, R.J. Howard, and S.M. Handunnetti. 1991. Rosetting of Plasmodium falciparum-infected red blood cells with uninfected red blood cells enhances microvascular obstruction under flow conditions. *Blood* 78:812-819.
- Keller, C.C., O. Yamo, C. Ouma, J.M. Ong'echa, D. Ounah, J.B. Hittner, J.M. Vulule, and D.J. Perkins. 2006. Acquisition of hemozoin by monocytes down-regulates interleukin-12 p40 (IL-12p40) transcripts and circulating IL-12p70 through an IL-10-dependent mechanism: in vivo and in vitro findings in severe malarial anemia. *Infection and immunity* 74:5249-5260.
- Khan, S.M., C.J. Janse, S.H. Kappe, and S.A. Mikolajczak. 2012. Genetic engineering of attenuated malaria parasites for vaccination. *Current opinion in biotechnology* 23:908-916.
- Kharazmi, A., and S. Jepsen. 1984. Enhanced inhibition of in vitro multiplication of Plasmodium falciparum by stimulated human polymorphonuclear leucocytes. *Clinical and experimental immunology* 57:287-292.
- Kim, M., Y. Jung, K. Lee, and C. Kim. 2000. Identification of the calcium binding sites in translationally controlled tumor protein. *Archives of pharmacal research* 23:633-636.
- Kim, M., J. Maeng, and K. Lee. 2013. Dimerization of TCTP and its clinical implications for allergy. *Biochimie* 95:659-666.
- Kim, M., H.J. Min, H.Y. Won, H. Park, J.C. Lee, H.W. Park, J. Chung, E.S. Hwang, and K. Lee. 2009. Dimerization of translationally controlled tumor protein is essential for its cytokine-like activity. *PLoS one* 4:e6464.
- Kim, P.S., and R. Ahmed. 2010. Features of responding T cells in cancer and chronic infection. *Current opinion in immunology* 22:223-230.
- Klein, E.Y. 2013. Antimalarial drug resistance: a review of the biology and strategies to delay emergence and spread. *International journal of antimicrobial agents* 41:311-317.
- Klonis, N., M.P. Crespo-Ortiz, I. Bottova, N. Abu-Bakar, S. Kenny, P.J. Rosenthal, and L. Tilley. 2011. Artemisinin activity against Plasmodium falciparum requires hemoglobin uptake and digestion. *Proceedings of the National Academy of Sciences of the United States of America* 108:11405-11410.
- Kohara, Y., K. Tanabe, K. Matsuoka, N. Kanda, H. Matsuda, H. Karasuyama, and H. Yonekawa. 2001. A major determinant quantitative-trait locus responsible for atopic dermatitis-like skin lesions in NC/Nga mice is located on Chromosome 9. *Immunogenetics* 53:15-21.
- Koide, Y., T. Kiyota, M. Tonganunt, D. Pinkaew, Z. Liu, Y. Kato, N. Hutadilok-Towatana, A. Phongdara, and K. Fujise. 2009. Embryonic lethality of fortilin-null mutant mice by BMP-pathway overactivation. *Biochimica et biophysica acta* 1790:326-338.
- Krishnegowda, G., A.M. Hajjar, J. Zhu, E.J. Douglass, S. Uematsu, S. Akira, A.S. Woods, and D.C. Gowda. 2005. Induction of proinflammatory responses in macrophages by the glycosylphosphatidylinositols of Plasmodium falciparum: cell signaling receptors, glycosylphosphatidylinositol (GPI) structural requirement, and regulation of GPI activity. *The Journal of biological chemistry* 280:8606-8616.
- Kumsiri, R., M. Troye-Blomberg, K. Pattanapanyasat, S. Krudsood, and Y. Maneerat. 2016. IgE low affinity receptor (CD23) expression, Plasmodium falciparum specific IgE and tumor necrosis factor-alpha production in Thai uncomplicated and severe falciparum malaria patients. *Acta tropica* 154:25-33.
- Kurtzhals, J.A., O. Rodrigues, M. Addae, J.O. Commey, F.K. Nkrumah, and L. Hviid. 1997. Reversible suppression of bone marrow response to erythropoietin in Plasmodium falciparum malaria. *British journal of haematology* 97:169-174.

- Ladhani, S., B. Lowe, A.O. Cole, K. Kowuondo, and C.R. Newton. 2002. Changes in white blood cells and platelets in children with falciparum malaria: relationship to disease outcome. *British journal of haematology* 119:839-847.
- Langdon, J.M., B.M. Vonakis, and S.M. MacDonald. 2004. Identification of the interaction between the human recombinant histamine releasing factor/translationally controlled tumor protein and elongation factor-1 delta (also known as eElongation factor-1B beta). *Biochimica et biophysica acta* 1688:232-236.
- Langhorne, J., C. Cross, E. Seixas, C. Li, and T. von der Weid. 1998. A role for B cells in the development of T cell helper function in a malaria infection in mice. *Proceedings of the National Academy of Sciences of the United States of America* 95:1730-1734.
- Langhorne, J., F.M. Ndungu, A.M. Sponaas, and K. Marsh. 2008. Immunity to malaria: more questions than answers. *Nature immunology* 9:725-732.
- LeBlanc, R.A., L. Pesnicak, E.S. Cabral, M. Godleski, and S.E. Straus. 1999. Lack of interleukin-6 (IL-6) enhances susceptibility to infection but does not alter latency or reactivation of herpes simplex virus type 1 in IL-6 knockout mice. *Journal of virology* 73:8145-8151.
- Leke, R.F., R.R. Djokam, R. Mbu, R.J. Leke, J. Fogako, R. Megnekou, S. Metenou, G. Sama, Y. Zhou, T. Cadigan, M. Parra, and D.W. Taylor. 1999. Detection of the Plasmodium falciparum antigen histidine-rich protein 2 in blood of pregnant women: implications for diagnosing placental malaria. *Journal of clinical microbiology* 37:2992-2996.
- Leoratti, F.M., R.R. Durlacher, M.V. Lacerda, M.G. Alecrim, A.W. Ferreira, M.C. Sanchez, and S.L. Moraes. 2008. Pattern of humoral immune response to Plasmodium falciparum blood stages in individuals presenting different clinical expressions of malaria. *Malaria journal* 7:186.
- Levine, N.D. 1988. Progress in taxonomy of the Apicomplexan protozoa. *The Journal of protozoology* 35:518-520.
- Li, F., D. Zhang, and K. Fujise. 2001. Characterization of fortilin, a novel antiapoptotic protein. *The Journal of biological chemistry* 276:47542-47549.
- Liehl, P., V. Zuzarte-Luis, J. Chan, T. Zillinger, F. Baptista, D. Carapau, M. Konert, K.K. Hanson, C. Carret, C. Lassnig, M. Muller, U. Kalinke, M. Saeed, A.F. Chora, D.T. Golenbock, B. Strobl, M. Prudencio, L.P. Coelho, S.H. Kappe, and G. Superti-Furga. 2014. Host-cell sensors for Plasmodium activate innate immunity against liver-stage infection. 20:47-53.
- Liu, H., H.W. Peng, Y.S. Cheng, H.S. Yuan, and H.F. Yang-Yen. 2005. Stabilization and enhancement of the antiapoptotic activity of mcl-1 by TCTP. *Molecular and cellular biology* 25:3117-3126.
- Logie, D.E., I.A. McGregor, D.S. Rowe, and W.Z. Billewicz. 1973. Plasma immunoglobulin concentrations in mothers and newborn children with special reference to placental malaria: Studies in the Gambia, Nigeria, and Switzerland. *Bulletin of the World Health Organization* 49:547-554.
- Looareesuwan, S., M. Ho, Y. Wattanagoon, N.J. White, D.A. Warrell, D. Bunnag, T. Harinasuta, and D.J. Wyler. 1987. Dynamic alteration in splenic function during acute falciparum malaria. *The New England journal of medicine* 317:675-679.
- Lovegrove, F.E., S.A. Gharib, L. Pena-Castillo, S.N. Patel, J.T. Ruzinski, T.R. Hughes, W.C. Liles, and K.C. Kain. 2008. Parasite burden and CD36-mediated sequestration are determinants of acute lung injury in an experimental malaria model. *PLoS pathogens* 4:e1000068.
- Luke, T.C., and S.L. Hoffman. 2003. Rationale and plans for developing a non-replicating, metabolically active, radiation-attenuated Plasmodium falciparum sporozoite vaccine. *The Journal of experimental biology* 206:3803-3808.
- Luty, A.J., J. Mayombo, F. Lekoulou, and R. Mshana. 1994. Immunologic responses to soluble exoantigens of Plasmodium falciparum in Gabonese children exposed to continuous intense infection. *The American journal of tropical medicine and hygiene* 51:720-729.
- Luty, A.J., D.J. Perkins, B. Lell, R. Schmidt-Ott, L.G. Lehman, D. Luckner, B. Greve, P. Matousek, K. Herbich, D. Schmid, J.B. Weinberg, and P.G. Kremsner. 2000. Low interleukin-12 activity in severe Plasmodium falciparum malaria. *Infection and immunity* 68:3909-3915.

- MacDonald, S.M., J. Bhisutthibhan, T.A. Shapiro, S.J. Rogerson, T.E. Taylor, M. Tembo, J.M. Langdon, and S.R. Meshnick. 2001. Immune mimicry in malaria: Plasmodium falciparum secretes a functional histamine-releasing factor homolog in vitro and in vivo. *Proceedings of the National Academy of Sciences of the United States of America* 98:10829-10832.
- MacDonald, S.M., L.M. Lichtenstein, D. Proud, M. Plaut, R.M. Naclerio, D.W. MacGlashan, and A. Kagey-Sobotka. 1987. Studies of IgE-dependent histamine releasing factors: heterogeneity of IgE. *Journal of immunology (Baltimore, Md. : 1950)* 139:506-512.
- MacDonald, S.M., T. Rafnar, J. Langdon, and L.M. Lichtenstein. 1995. Molecular identification of an IgE-dependent histamine-releasing factor. *Science (New York, N.Y.)* 269:688-690.
- Maegraith, B., and A. Fletcher. 1972. The pathogenesis of mammalian malaria. *Advances in parasitology* 10:49-75.
- Maeno, Y., P. Perlmann, PerlmannH, Y. Kusuhara, K. Taniguchi, T. Nakabayashi, K. Win, S. Looareesuwan, and M. Aikawa. 2000. IgE deposition in brain microvessels and on parasitized erythrocytes from cerebral malaria patients. *The American journal of tropical medicine and hygiene* 63:128-132.
- Maeno, Y., R.W. Steketee, T. Nagatake, T. Tegoshi, R.S. Desowitz, J.J. Wirima, and M. Aikawa. 1993. Immunoglobulin complex deposits in Plasmodium falciparum-infected placentas from Malawi and Papua New Guinea. *The American journal of tropical medicine and hygiene* 49:574-580.
- Maier, A.G., B.M. Cooke, A.F. Cowman, and L. Tilley. 2009. Malaria parasite proteins that remodel the host erythrocyte. *Nat Rev Microbiol* 7:341-354.
- Malek, A., R. Sager, P. Kuhn, K.H. Nicolaides, and H. Schneider. 1996. Evolution of maternofetal transport of immunoglobulins during human pregnancy. *American journal of reproductive immunology (New York, N.Y. : 1989)* 36:248-255.
- Malkin, E., J. Hu, Z. Li, Z. Chen, X. Bi, Z. Reed, F. Dubovsky, J. Liu, Q. Wang, X. Pan, T. Chen, B. Giersing, Y. Xu, X. Kang, J. Gu, Q. Shen, K. Tucker, E. Tierney, W. Pan, C. Long, and Z. Cao. 2008. A phase 1 trial of PfCP2.9: an AMA1/MSP1 chimeric recombinant protein vaccine for Plasmodium falciparum malaria. *Vaccine* 26:6864-6873.
- Mannoor, M.K., R.C. Halder, S.R. Morshed, A. Ariyasinghe, H.Y. Bakir, H. Kawamura, H. Watanabe, H. Sekikawa, and T. Abo. 2002. Essential role of extrathymic T cells in protection against malaria. *Journal of immunology (Baltimore, Md. : 1950)* 169:301-306.
- Marsh, D.G., J.D. Neely, D.R. Breazeale, B. Ghosh, L.R. Freidhoff, E. Ehrlich-Kautzky, C. Schou, G. Krishnaswamy, and T.H. Beaty. 1994. Linkage analysis of IL4 and other chromosome 5q31.1 markers and total serum immunoglobulin E concentrations. *Science (New York, N.Y.)* 264:1152-1156.
- Marsh, K., and R.W. Snow. 1997. Host-parasite interaction and morbidity in malaria endemic areas. *Philosophical transactions of the Royal Society of London. Series B, Biological sciences* 352:1385-1394.
- Matangila, J.R., J. Lufuluabo, A.L. Ibalanky, R.A. Inocencio da Luz, P. Lutumba, and J.P. Van Geertruyden. 2014. Asymptomatic Plasmodium falciparum infection is associated with anaemia in pregnancy and can be more cost-effectively detected by rapid diagnostic test than by microscopy in Kinshasa, Democratic Republic of the Congo. *Malaria journal* 13:132.
- Mathieu, C., C. Demarta-Gatsi, A. Porcherie, S. Brega, S. Thiberge, K. Ronce, L. Smith, R. Peronet, R. Amino, R. Menard, and S. Mecheri. 2015. Plasmodium berghei histamine-releasing factor favours liver-stage development via inhibition of IL-6 production and associates with a severe outcome of disease. *Cellular microbiology* 17:542-558.
- Matz, J.M., A. Ingmundson, J. Costa Nunes, W. Stenzel, K. Matuschewski, and T.W. Kooij. 2015. In Vivo Function of PTEX88 in Malaria Parasite Sequestration and Virulence. 14:528-534.
- McCall, M.B., J. Hopman, M. Daou, B. Maiga, V. Dara, I. Ploemen, K. Nganou-Makamdop, A. Niangaly, Y. Tolo, C. Arama, J.T. Bousema, J.W. van der Meer, A.J. van der Ven, M. Troye-Blomberg, A. Dolo, O.K. Doumbo, and R.W. Sauerwein. 2010. Early interferon-gamma response against Plasmodium falciparum correlates with interethnic differences in

- susceptibility to parasitemia between sympatric Fulani and Dogon in Mali. *The Journal of infectious diseases* 201:142-152.
- McCarthy, J.S., J. Marjason, S. Elliott, P. Fahey, G. Bang, E. Malkin, E. Tierney, H. Aked-Hurditch, C. Adda, N. Cross, J.S. Richards, F.J. Fowkes, M.J. Boyle, C. Long, P. Druilhe, J.G. Beeson, and R.F. Anders. 2011. A phase 1 trial of MSP2-C1, a blood-stage malaria vaccine containing 2 isoforms of MSP2 formulated with Montanide(R) ISA 720. *PloS one* 6:e24413.
- McIntosh, R.S., J. Shi, R.M. Jennings, J.C. Chappel, T.F. de Koning-Ward, T. Smith, J. Green, M. van Egmond, J.H. Leusen, M. Lazarou, J. van de Winkel, T.S. Jones, B.S. Crabb, A.A. Holder, and R.J. Pleass. 2007. The importance of human FcγRI in mediating protection to malaria. *PLoS pathogens* 3:e72.
- Mecheri, S. 2012. Contribution of allergic inflammatory response to the pathogenesis of malaria disease. *Biochimica et biophysica acta* 1822:49-56.
- Medana, I.M., and G.D. Turner. 2006. Human cerebral malaria and the blood-brain barrier. *International journal for parasitology* 36:555-568.
- Meding, S.J., S.C. Cheng, B. Simon-Haarhaus, and J. Langhorne. 1990. Role of gamma interferon during infection with *Plasmodium chabaudi chabaudi*. *Infection and immunity* 58:3671-3678.
- Menard, R., and V. Nussenzweig. 2000. Structure-function analysis of malaria proteins by gene targeting. *Parasitology today (Personal ed.)* 16:222-224.
- Meshnick, S.R. 2002. Artemisinin: mechanisms of action, resistance and toxicity. *International journal for parasitology* 32:1655-1660.
- Meyers, D.A., D.S. Postma, C.I. Panhuysen, J. Xu, P.J. Amelung, R.C. Levitt, and E.R. Bleeker. 1994. Evidence for a locus regulating total serum IgE levels mapping to chromosome 5. *Genomics* 23:464-470.
- Micallef, M.J., T. Ohtsuki, K. Kohno, F. Tanabe, S. Ushio, M. Namba, T. Tanimoto, K. Torigoe, M. Fujii, M. Ikeda, S. Fukuda, and M. Kurimoto. 1996. Interferon-gamma-inducing factor enhances T helper 1 cytokine production by stimulated human T cells: synergism with interleukin-12 for interferon-gamma production. *European journal of immunology* 26:1647-1651.
- Miller, L.H., D.I. Baruch, K. Marsh, and O.K. Doumbo. 2002. The pathogenic basis of malaria. *Nature* 415:673-679.
- Mitchell, G.H., A.W. Thomas, G. Margos, A.R. Dlugowski, and L.H. Bannister. 2004. Apical membrane antigen 1, a major malaria vaccine candidate, mediates the close attachment of invasive merozoites to host red blood cells. *Infection and immunity* 72:154-158.
- Miyagami, T., I. Igarashi, and M. Suzuki. 1987. *Plasmodium berghei*: long lasting immunity induced by a permanent attenuated mutant. *Zentralblatt für Bakteriologie, Mikrobiologie, und Hygiene. Series A, Medical microbiology, infectious diseases, virology, parasitology* 264:502-512.
- Miyakoda, M., D. Kimura, M. Yuda, Y. Chinzei, Y. Shibata, K. Honma, and K. Yui. 2008. Malaria-specific and nonspecific activation of CD8⁺ T cells during blood stage of *Plasmodium berghei* infection. *Journal of immunology (Baltimore, Md. : 1950)* 181:1420-1428.
- Modiano, D., V. Petrarca, B.S. Sirima, I. Nebie, D. Diallo, F. Esposito, and M. Coluzzi. 1996. Different response to *Plasmodium falciparum* malaria in west African sympatric ethnic groups. *Proceedings of the National Academy of Sciences of the United States of America* 93:13206-13211.
- Mohan, K., P. Moulin, and M.M. Stevenson. 1997. Natural killer cell cytokine production, not cytotoxicity, contributes to resistance against blood-stage *Plasmodium chabaudi* AS infection. *Journal of immunology (Baltimore, Md. : 1950)* 159:4990-4998.
- Molineaux, L., M. Trauble, W.E. Collins, G.M. Jeffery, and K. Dietz. 2002. Malaria therapy reinoculation data suggest individual variation of an innate immune response and independent acquisition of antiparasitic and antitoxic immunities. *Transactions of the Royal Society of Tropical Medicine and Hygiene* 96:205-209.
- Monso-Hinard, C., J.N. Lou, C. Behr, P. Juillard, and G.E. Grau. 1997. Expression of major histocompatibility complex antigens on mouse brain microvascular endothelial cells in relation to susceptibility to cerebral malaria. *Immunology* 92:53-59.

- Moody, A. 2002. Rapid diagnostic tests for malaria parasites. *Clinical microbiology reviews* 15:66-78.
- Moorthy, V., and A.V. Hill. 2002. Malaria vaccines. *Br Med Bull* 62:59-72.
- Morrison, D.A. 2009. Evolution of the Apicomplexa: where are we now? *Trends in parasitology* 25:375-382.
- Mota, M.M., G. Pradel, J.P. Vanderberg, J.C. Hafalla, U. Frevert, R.S. Nussenzweig, V. Nussenzweig, and A. Rodriguez. 2001. Migration of Plasmodium sporozoites through cells before infection. *Science (New York, N.Y.)* 291:141-144.
- Mueller, A.K., N. Camargo, K. Kaiser, C. Andorfer, U. Frevert, K. Matuschewski, and S.H. Kappe. 2005a. Plasmodium liver stage developmental arrest by depletion of a protein at the parasite-host interface. *Proceedings of the National Academy of Sciences of the United States of America* 102:3022-3027.
- Mueller, A.K., M. Deckert, K. Heiss, K. Goetz, K. Matuschewski, and D. Schluter. 2007. Genetically attenuated Plasmodium berghei liver stages persist and elicit sterile protection primarily via CD8 T cells. *The American journal of pathology* 171:107-115.
- Mueller, A.K., M. Labaied, S.H. Kappe, and K. Matuschewski. 2005b. Genetically modified Plasmodium parasites as a protective experimental malaria vaccine. *Nature* 433:164-167.
- Muesch, A., E. Hartmann, K. Rohde, A. Rubartelli, R. Sitia, and T.A. Rapoport. 1990. A novel pathway for secretory proteins? *Trends in biochemical sciences* 15:86-88.
- Mundwiler-Pachlatko, E., and H.P. Beck. 2013. Maurer's clefts, the enigma of Plasmodium falciparum. *Proceedings of the National Academy of Sciences of the United States of America* 110:19987-19994.
- Musser, J.M., J.S. Kroll, D.M. Granoff, E.R. Moxon, B.R. Brodeur, J. Campos, H. Dabernat, W. Frederiksen, J. Hamel, G. Hammond, and et al. 1990. Global genetic structure and molecular epidemiology of encapsulated Haemophilus influenzae. *Reviews of infectious diseases* 12:75-111.
- Muxel, S.M., A.P. Freitas do Rosario, C.A. Zago, S.I. Castillo-Mendez, L.R. Sardinha, S.M. Rodriguez-Malaga, N.O. Camara, J.M. Alvarez, and M.R. Lima. 2011. The spleen CD4+ T cell response to blood-stage Plasmodium chabaudi malaria develops in two phases characterized by different properties. *PloS one* 6:e22434.
- Nabi, S., and S. Qader. 2009. Is Global Warming likely to cause an increased incidence of Malaria? *The Libyan journal of medicine* 4:18-22.
- Naing, C., M.A. Whittaker, V. Nyunt Wai, and J.W. Mak. 2014. Is Plasmodium vivax malaria a severe malaria?: a systematic review and meta-analysis. *PLoS neglected tropical diseases* 8:e3071.
- Nardin, E.H., and R.S. Nussenzweig. 1993. T cell responses to pre-erythrocytic stages of malaria: role in protection and vaccine development against pre-erythrocytic stages. *Annual review of immunology* 11:687-727.
- Ndyomugenyi, R., and P. Magnussen. 1999. Anaemia in pregnancy: Plasmodium falciparum infection is an important cause in primigravidae in Hoima district, western Uganda. *Annals of tropical medicine and parasitology* 93:457-465.
- Nebl, T., M.J. De Veer, and L. Schofield. 2005. Stimulation of innate immune responses by malarial glycosylphosphatidylinositol via pattern recognition receptors. *Parasitology* 130 Suppl:S45-62.
- Nelles, M.E., J.M. Moreau, C.L. Furlonger, A. Berger, J.A. Medin, and C.J. Paige. 2014. Murine splenic CD4(+) T cells, induced by innate immune cell interactions and secreted factors, develop antileukemia cytotoxicity. *Cancer immunology research* 2:1113-1124.
- Nganou-Makamdop, K., and R.W. Sauerwein. 2013. Liver or blood-stage arrest during malaria sporozoite immunization: the later the better? *Trends in parasitology* 29:304-310.
- Niikura, M., S. Inoue, S. Mineo, Y. Yamada, I. Kaneko, S. Iwanaga, M. Yuda, and F. Kobayashi. 2013. Experimental cerebral malaria is suppressed by disruption of nucleoside transporter 1 but not purine nucleoside phosphorylase. *Biochemical and biophysical research communications* 432:504-508.
- Nussler, A., S. Pied, J. Goma, L. Renia, F. Miltgen, G.E. Grau, and D. Mazier. 1991. TNF inhibits malaria hepatic stages in vitro via synthesis of IL-6. *International immunology* 3:317-321.

- Nyakundi, R.K., O. Nyamongo, J. Maamun, M. Akinyi, I. Mulei, I.O. Farah, D. Blankenship, B. Grimberg, J. Hau, I. Malhotra, H. Ozwara, C.L. King, and T.M. Kariuki. 2016. Protective Effect of Chronic Schistosomiasis in Baboons Coinfected with *Schistosoma mansoni* and *Plasmodium knowlesi*. *Infection and immunity* 84:1320-1330.
- Ocana-Morgner, C., M.M. Mota, and A. Rodriguez. 2003. Malaria blood stage suppression of liver stage immunity by dendritic cells. *The Journal of experimental medicine* 197:143-151.
- Oehen, S., and K. Brduscha-Riem. 1998. Differentiation of naive CTL to effector and memory CTL: correlation of effector function with phenotype and cell division. *Journal of immunology (Baltimore, Md. : 1950)* 161:5338-5346.
- Ogutu, B.R., O.J. Apollo, D. McKinney, W. Okoth, J. Siangla, F. Dubovsky, K. Tucker, J.N. Waitumbi, C. Diggs, J. Wittes, E. Malkin, A. Leach, L.A. Soisson, J.B. Milman, L. Otieno, C.A. Holland, M. Polhemus, S.A. Remich, C.F. Ockenhouse, J. Cohen, W.R. Ballou, S.K. Martin, E. Angov, V.A. Stewart, J.A. Lyon, D.G. Heppner, and M.R. Withers. 2009. Blood stage malaria vaccine eliciting high antigen-specific antibody concentrations confers no protection to young children in Western Kenya. *PloS one* 4:e4708.
- Ohno, T., A. Ishih, Y. Kohara, H. Yonekawa, M. Terada, and M. Nishimura. 2001. Chromosomal mapping of the host resistance locus to rodent malaria (*Plasmodium yoelii*) infection in mice. *Immunogenetics* 53:736-740.
- Okamoto, I., K. Kohno, T. Tanimoto, H. Ikegami, and M. Kurimoto. 1999. Development of CD8+ effector T cells is differentially regulated by IL-18 and IL-12. *Journal of immunology (Baltimore, Md. : 1950)* 162:3202-3211.
- Okech, B.A., A. Nalunkuma, D. Okello, X.L. Pang, K. Suzue, J. Li, T. Horii, and T.G. Egwang. 2001. Natural human immunoglobulin G subclass responses to *Plasmodium falciparum* serine repeat antigen in Uganda. *The American journal of tropical medicine and hygiene* 65:912-917.
- Oliveira, G.A., K.A. Kumar, J.M. Calvo-Calle, C. Othoro, D. Altszuler, V. Nussenzweig, and E.H. Nardin. 2008. Class II-restricted protective immunity induced by malaria sporozoites. *Infection and immunity* 76:1200-1206.
- Oomen, J.M., J.H. Meuwissen, and W. Gemert. 1979. Differences in blood status of three ethnic groups inhabiting the same locality in Northern Nigeria. Anaemia, splenomegaly and associated causes. *Tropical and geographical medicine* 31:587-606.
- Orago, A.S., and C.A. Facer. 1991. Cytotoxicity of human natural killer (NK) cell subsets for *Plasmodium falciparum* erythrocytic schizonts: stimulation by cytokines and inhibition by neomycin. *Clinical and experimental immunology* 86:22-29.
- Overstreet, M.G., Y.C. Chen, I.A. Cockburn, S.W. Tse, and F. Zavala. 2011. CD4+ T cells modulate expansion and survival but not functional properties of effector and memory CD8+ T cells induced by malaria sporozoites. *PloS one* 6:e15948.
- Packard, R.M. 2014. The origins of antimalarial-drug resistance. *The New England journal of medicine* 371:397-399.
- Pain, A., U. Bohme, A.E. Berry, K. Mungall, R.D. Finn, A.P. Jackson, T. Mourier, J. Mistry, E.M. Pasini, M.A. Aslett, S. Balasubramaniam, K. Borgwardt, K. Brooks, C. Carret, T.J. Carver, I. Cherevach, T. Chillingworth, T.G. Clark, M.R. Galinski, N. Hall, D. Harper, D. Harris, H. Hauser, A. Ivens, C.S. Janssen, T. Keane, N. Larke, S. Lapp, M. Marti, S. Moule, I.M. Meyer, D. Ormond, N. Peters, M. Sanders, S. Sanders, T.J. Sargeant, M. Simmonds, F. Smith, R. Squares, S. Thurston, A.R. Tivey, D. Walker, B. White, E. Zuiderwijk, C. Churcher, M.A. Quail, A.F. Cowman, C.M. Turner, M.A. Rajandream, C.H. Kocken, A.W. Thomas, C.I. Newbold, B.G. Barrell, and M. Berriman. 2008. The genome of the simian and human malaria parasite *Plasmodium knowlesi*. *Nature* 455:799-803.
- Pain, A., D.J. Ferguson, O. Kai, B.C. Urban, B. Lowe, K. Marsh, and D.J. Roberts. 2001. Platelet-mediated clumping of *Plasmodium falciparum*-infected erythrocytes is a common adhesive phenotype and is associated with severe malaria. *Proceedings of the National Academy of Sciences of the United States of America* 98:1805-1810.

- Patarroyo, M.E., P. Romero, M.L. Torres, P. Clavijo, A. Moreno, A. Martinez, R. Rodriguez, F. Guzman, and E. Cabezas. 1987. Induction of protective immunity against experimental infection with malaria using synthetic peptides. *Nature* 328:629-632.
- Pelleau, S., S. Diop, M. Dia Badiane, J. Vitte, P. Beguin, F. Nato, B.M. Diop, P. Bongrand, D. Parzy, and R. Jambou. 2012. Enhanced basophil reactivities during severe malaria and their relationship with the Plasmodium falciparum histamine-releasing factor translationally controlled tumor protein. *Infection and immunity* 80:2963-2970.
- Perkins, D.J., J.B. Weinberg, and P.G. Kremsner. 2000. Reduced interleukin-12 and transforming growth factor-beta1 in severe childhood malaria: relationship of cytokine balance with disease severity. *The Journal of infectious diseases* 182:988-992.
- Perkins, D.J., T. Were, G.C. Davenport, P. Kempaiah, J.B. Hittner, and J.M. Ong'echa. 2011. Severe malarial anemia: innate immunity and pathogenesis. *International journal of biological sciences* 7:1427-1442.
- Perlmann, H., H. Helmbj, M. Hagstedt, J. Carlson, P.H. Larsson, M. Troye-Blomberg, and P. Perlmann. 1994. IgE elevation and IgE anti-malarial antibodies in Plasmodium falciparum malaria: association of high IgE levels with cerebral malaria. *Clinical and experimental immunology* 97:284-292.
- Perlmann, P., H. Perlmann, G. ElGhazali, and M.T. Blomberg. 1999. IgE and tumor necrosis factor in malaria infection. *Immunology letters* 65:29-33.
- Perlmann, P., H. Perlmann, B.W. Flyg, M. Hagstedt, G. Elghazali, S. Worku, V. Fernandez, A.S. Rutta, and M. Troye-Blomberg. 1997. Immunoglobulin E, a pathogenic factor in Plasmodium falciparum malaria. *Infection and immunity* 65:116-121.
- Perlmann, P., H. Perlmann, S. Looareesuwan, S. Krudsood, S. Kano, Y. Matsumoto, G. Brittenham, M. Troye-Blomberg, and M. Aikawa. 2000. Contrasting functions of IgG and IgE antimalarial antibodies in uncomplicated and severe Plasmodium falciparum malaria. *The American journal of tropical medicine and hygiene* 62:373-377.
- Perlmann, P., and M. Troye-Blomberg. 2002. Malaria and the immune system in humans. *Chemical immunology* 80:229-242.
- Perry, J.A., A. Rush, R.J. Wilson, C.S. Olver, and A.C. Avery. 2004. Dendritic cells from malaria-infected mice are fully functional APC. *Journal of immunology (Baltimore, Md. : 1950)* 172:475-482.
- Pied, S., A. Nussler, M. Pontent, F. Miltgen, H. Matile, P.H. Lambert, and D. Mazier. 1989. C-reactive protein protects against preerythrocytic stages of malaria. *Infection and immunity* 57:278-282.
- Pied, S., L. Renia, A. Nussler, F. Miltgen, and D. Mazier. 1991. Inhibitory activity of IL-6 on malaria hepatic stages. *Parasite immunology* 13:211-217.
- Pied, S., J. Roland, A. Louise, D. Voegtler, V. Soulard, D. Mazier, and P.A. Cazenave. 2000. Liver CD4-CD8- NK1.1+ TCR alpha beta intermediate cells increase during experimental malaria infection and are able to exhibit inhibitory activity against the parasite liver stage in vitro. *Journal of immunology (Baltimore, Md. : 1950)* 164:1463-1469.
- Pino, P., I. Vouldoukis, N. Dugas, M. Conti, J. Nitcheu, B. Traore, M. Danis, B. Dugas, and D. Mazier. 2004. Induction of the CD23/nitric oxide pathway in endothelial cells downregulates ICAM-1 expression and decreases cytoadherence of Plasmodium falciparum-infected erythrocytes. *Cellular microbiology* 6:839-848.
- Pinzon-Charry, A., V. McPhun, V. Kienzle, C. Hirunpetcharat, C. Engwerda, J. McCarthy, and M.F. Good. 2010. Low doses of killed parasite in CpG elicit vigorous CD4+ T cell responses against blood-stage malaria in mice. *The Journal of clinical investigation* 120:2967-2978.
- Piva, L., P. Tetlak, C. Claser, K. Karjalainen, L. Renia, and C. Ruedl. 2012. Cutting edge: Clec9A+ dendritic cells mediate the development of experimental cerebral malaria. *Journal of immunology (Baltimore, Md. : 1950)* 189:1128-1132.
- Planche, T., A. Dzeing, E. Ngou-Milama, M. Kombila, and P.W. Stacpoole. 2005. Metabolic complications of severe malaria. *Current topics in microbiology and immunology* 295:105-136.

- Platonov, A.E., G.A. Shipulin, I.V. Vershinina, J. Dankert, J.G. van de Winkel, and E.J. Kuijper. 1998. Association of human Fc gamma RIIa (CD32) polymorphism with susceptibility to and severity of meningococcal disease. *Clinical infectious diseases : an official publication of the Infectious Diseases Society of America* 27:746-750.
- Plouffe, D., A. Brinker, C. McNamara, K. Henson, N. Kato, K. Kuhlen, A. Nagle, F. Adrian, J.T. Matzen, P. Anderson, T.G. Nam, N.S. Gray, A. Chatterjee, J. Janes, S.F. Yan, R. Trager, J.S. Caldwell, P.G. Schultz, Y. Zhou, and E.A. Winzeler. 2008. In silico activity profiling reveals the mechanism of action of antimalarials discovered in a high-throughput screen. *Proc Natl Acad Sci U S A* 105:9059-9064.
- Polimeni, M., and M. Prato. 2014. Host matrix metalloproteinases in cerebral malaria: new kids on the block against blood-brain barrier integrity? *Fluids and barriers of the CNS* 11:1.
- Pombo, D.J., G. Lawrence, C. Hirunpetcharat, C. Rzepczyk, M. Bryden, N. Cloonan, K. Anderson, Y. Mahakunkijcharoen, L.B. Martin, D. Wilson, S. Elliott, S. Elliott, D.P. Eisen, J.B. Weinberg, A. Saul, and M.F. Good. 2002. Immunity to malaria after administration of ultra-low doses of red cells infected with *Plasmodium falciparum*. *The Lancet* 360:610-617.
- Poorafshar, M., H. Helmbj, M. Troye-Blomberg, and L. Hellman. 2000. MMCP-8, the first lineage-specific differentiation marker for mouse basophils. Elevated numbers of potent IL-4-producing and MMCP-8-positive cells in spleens of malaria-infected mice. *European journal of immunology* 30:2660-2668.
- Porcherie, A., C. Mathieu, R. Peronet, E. Schneider, J. Claver, P.H. Commere, H. Kiefer-Biasizzo, H. Karasuyama, G. Milon, M. Dy, J.P. Kinet, J. Louis, U. Blank, and S. Mecheri. 2011. Critical role of the neutrophil-associated high-affinity receptor for IgE in the pathogenesis of experimental cerebral malaria. *The Journal of experimental medicine* 208:2225-2236.
- Porichis, F., and D.E. Kaufmann. 2012. Role of PD-1 in HIV pathogenesis and as target for therapy. *Current HIV/AIDS reports* 9:81-90.
- Postma, D.S., E.R. Bleeker, P.J. Amelung, K.J. Holroyd, J. Xu, C.I. Panhuysen, D.A. Meyers, and R.C. Levitt. 1995. Genetic susceptibility to asthma--bronchial hyperresponsiveness coinherited with a major gene for atopy. *The New England journal of medicine* 333:894-900.
- Prakash, D., C. Fesel, R. Jain, P.A. Cazenave, G.C. Mishra, and S. Pied. 2006. Clusters of cytokines determine malaria severity in *Plasmodium falciparum*-infected patients from endemic areas of Central India. *The Journal of infectious diseases* 194:198-207.
- Price, R.N., J.A. Simpson, F. Nosten, C. Luxemburger, L. Hkijjaroen, F. ter Kuile, T. Chongsuphajaisiddhi, and N.J. White. 2001. Factors contributing to anemia after uncomplicated *falciparum* malaria. *The American journal of tropical medicine and hygiene* 65:614-622.
- Proietti, C., and D.L. Doolan. 2014. The case for a rational genome-based vaccine against malaria. *Frontiers in microbiology* 5:741.
- Prugnolle, F., P. Durand, C. Neel, B. Ollomo, F.J. Ayala, C. Arnathau, L. Etienne, E. Mpoudi-Ngole, D. Nkoghe, E. Leroy, E. Delaporte, M. Peeters, and F. Renaud. 2010. African great apes are natural hosts of multiple related malaria species, including *Plasmodium falciparum*. *Proceedings of the National Academy of Sciences of the United States of America* 107:1458-1463.
- Putrianti, E.D., A. Schmidt-Christensen, I. Arnold, V.T. Heussler, K. Matuschewski, and O. Silvie. 2010. The *Plasmodium* serine-type SERA proteases display distinct expression patterns and non-essential in vivo roles during life cycle progression of the malaria parasite. *Cellular microbiology* 12:725-739.
- Putrianti, E.D., O. Silvie, M. Kordes, S. Borrmann, and K. Matuschewski. 2009. Vaccine-like immunity against malaria by repeated causal-prophylactic treatment of liver-stage *Plasmodium* parasites. *The Journal of infectious diseases* 199:899-903.
- Que, J.U., S.J. Cryz, Jr., R. Ballou, E. Furer, M. Gross, J. Young, G.F. Wasserman, L.A. Loomis, and J.C. Sadoff. 1988. Effect of carrier selection on immunogenicity of protein conjugate vaccines against *Plasmodium falciparum* circumsporozoites. *Infection and immunity* 56:2645-2649.

- Quinn, T.C., and D.J. Wyler. 1979. Mechanisms of action of hyperimmune serum in mediating protective immunity to rodent malaria (*Plasmodium berghei*). *Journal of immunology (Baltimore, Md. : 1950)* 123:2245-2249.
- Rajahram, G.S., B.E. Barber, T. William, M.J. Grigg, J. Menon, T.W. Yeo, and N.M. Anstey. 2016. Falling *Plasmodium knowlesi* Malaria Death Rate among Adults despite Rising Incidence, Sabah, Malaysia, 2010-2014. *Emerging infectious diseases* 22:41-48.
- Ramadori, G., J. Van Damme, H. Rieder, and K.H. Meyer zum Buschenfelde. 1988. Interleukin 6, the third mediator of acute-phase reaction, modulates hepatic protein synthesis in human and mouse. Comparison with interleukin 1 beta and tumor necrosis factor-alpha. *European journal of immunology* 18:1259-1264.
- Ramakrishnaiah, V., C. Thumann, I. Fofana, F. Habersetzer, Q. Pan, P.E. de Ruiter, R. Willemsen, J.A. Demmers, V. Stalin Raj, G. Jenster, J. Kwekkeboom, H.W. Tilanus, B.L. Haagmans, T.F. Baumert, and L.J. van der Laan. 2013. Exosome-mediated transmission of hepatitis C virus between human hepatoma Huh7.5 cells. *Proceedings of the National Academy of Sciences of the United States of America* 110:13109-13113.
- Ramiro, R.S., S.E. Reece, and D.J. Obbard. 2012. Molecular evolution and phylogenetics of rodent malaria parasites. *BMC evolutionary biology* 12:219.
- Raposo, G., and W. Stoorvogel. 2013. Extracellular vesicles: exosomes, microvesicles, and friends. *The Journal of cell biology* 200:373-383.
- Renia, L., S.M. Potter, M. Mauduit, D.S. Rosa, M. Kayibanda, J.C. Deschemin, G. Snounou, and A.C. Gruner. 2006. Pathogenic T cells in cerebral malaria. *International journal for parasitology* 36:547-554.
- Rhein, B.A., L.S. Powers, K. Rogers, M. Anantpadma, B.K. Singh, Y. Sakurai, T. Bair, C. Miller-Hunt, P. Sinn, R.A. Davey, M.M. Monick, and W. Maury. 2015. Interferon-gamma Inhibits Ebola Virus Infection. *PLoS pathogens* 11:e1005263.
- Rho, S.B., J.H. Lee, M.S. Park, H.J. Byun, S. Kang, S.S. Seo, J.Y. Kim, and S.Y. Park. 2011. Anti-apoptotic protein TCTP controls the stability of the tumor suppressor p53. *FEBS letters* 585:29-35.
- Richards, J.S., and J.G. Beeson. 2009. The future for blood-stage vaccines against malaria. *Immunology and cell biology* 87:377-390.
- Richie, T.L., P.F. Billingsley, B.K. Sim, E.R. James, S. Chakravarty, J.E. Epstein, K.E. Lyke, B. Mordmuller, P. Alonso, P.E. Duffy, O.K. Doumbo, R.W. Sauerwein, M. Tanner, S. Abdulla, P.G. Kremsner, R.A. Seder, and S.L. Hoffman. 2015. Progress with *Plasmodium falciparum* sporozoite (PfSPZ)-based malaria vaccines. *Vaccine* 33:7452-7461.
- Rihet, P., Y. Traore, L. Abel, C. Aucan, T. Traore-Leroux, and F. Fumoux. 1998. Malaria in humans: *Plasmodium falciparum* blood infection levels are linked to chromosome 5q31-q33. *American journal of human genetics* 63:498-505.
- Robert, A., Y. Coppel, and B. Meunier. 2002. Alkylation of heme by the antimalarial drug artemisinin. *Chemical communications (Cambridge, England)* 414-415.
- Roestenberg, M., M. McCall, J. Hopman, J. Wiersma, A.J. Luty, G.J. van Gemert, M. van de Vegte-Bolmer, B. van Schaijk, K. Teelen, T. Arens, L. Spaarman, Q. de Mast, W. Roeffen, G. Snounou, L. Renia, A. van der Ven, C.C. Hermsen, and R. Sauerwein. 2009. Protection against a malaria challenge by sporozoite inoculation. *The New England journal of medicine* 361:468-477.
- Rowe, J.A., A. Claessens, R.A. Corrigan, and M. Arman. 2009. Adhesion of *Plasmodium falciparum*-infected erythrocytes to human cells: molecular mechanisms and therapeutic implications. *Expert reviews in molecular medicine* 11:e16.
- Rowe, J.A., and S.A. Kyes. 2004. The role of *Plasmodium falciparum* var genes in malaria in pregnancy. *Molecular microbiology* 53:1011-1019.
- Rowe, J.A., J. Shafi, O.K. Kai, K. Marsh, and A. Raza. 2002. Nonimmune IgM, but not IgG binds to the surface of *Plasmodium falciparum*-infected erythrocytes and correlates with rosetting and severe malaria. *The American journal of tropical medicine and hygiene* 66:692-699.

- RTS, S.C.T.P. 2015. Efficacy and safety of RTS,S/AS01 malaria vaccine with or without a booster dose in infants and children in Africa: final results of a phase 3, individually randomised, controlled trial. *Lancet* 386:31-45.
- Ruffer, M.A. 1913. Studies in palæopathology in Egypt. *The Journal of Pathology and Bacteriology* 18:149-162.
- Rujeni, N., N. Nausch, N. Midzi, R. Gwisai, T. Mduluzi, D.W. Taylor, and F. Mutapi. 2013. Soluble CD23 levels are inversely associated with atopy and parasite-specific IgE levels but not with polyclonal IgE levels in people exposed to helminth infection. *International archives of allergy and immunology* 161:333-341.
- Sachs, J., and P. Malaney. 2002. The economic and social burden of malaria. *Nature* 415:680-685.
- Sagara, I., A. Dicko, R.D. Ellis, M.P. Fay, S.I. Diawara, M.H. Assadou, M.S. Sissoko, M. Kone, A.I. Diallo, R. Saye, M.A. Guindo, O. Kante, M.B. Niambele, K. Miura, G.E. Mullen, M. Pierce, L.B. Martin, A. Dolo, D.A. Diallo, O.K. Doumbo, L.H. Miller, and A. Saul. 2009. A randomized controlled phase 2 trial of the blood stage AMA1-C1/Alhydrogel malaria vaccine in children in Mali. *Vaccine* 27:3090-3098.
- Sakuntabhai, A., R. Ndiaye, I. Casademont, C. Peerapittayamongkol, C. Rogier, P. Tortevoye, A. Tall, R. Paul, C. Turbpaiboon, W. Phimpraphi, J.F. Trape, A. Spiegel, S. Heath, O. Mercereau-Puijalon, A. Dieye, and C. Julier. 2008. Genetic determination and linkage mapping of Plasmodium falciparum malaria related traits in Senegal. *PLoS one* 3:e2000.
- Sam, H., and M.M. Stevenson. 1999a. Early IL-12 p70, but not p40, production by splenic macrophages correlates with host resistance to blood-stage Plasmodium chabaudi AS malaria. *Clinical and experimental immunology* 117:343-349.
- Sam, H., and M.M. Stevenson. 1999b. In vivo IL-12 production and IL-12 receptors beta1 and beta2 mRNA expression in the spleen are differentially up-regulated in resistant B6 and susceptible A/J mice during early blood-stage Plasmodium chabaudi AS malaria. *Journal of immunology (Baltimore, Md. : 1950)* 162:1582-1589.
- Sanni, L.A., L.F. Fonseca, and J. Langhorne. 2002. Mouse models for erythrocytic-stage malaria. *Methods in molecular medicine* 72:57-76.
- Scherf, A., J.J. Lopez-Rubio, and L. Riviere. 2008. Antigenic variation in Plasmodium falciparum. *Annual review of microbiology* 62:445-470.
- Schmieg, J., G. Gonzalez-Aseguinolaza, and M. Tsuji. 2003. The role of natural killer T cells and other T cell subsets against infection by the pre-erythrocytic stages of malaria parasites. *Microbes and infection / Institut Pasteur* 5:499-506.
- Schneider, B.S., C. Mathieu, R. Peronet, and S. Mecheri. 2011. Anopheles stephensi saliva enhances progression of cerebral malaria in a murine model. *Vector borne and zoonotic diseases (Larchmont, N.Y.)* 11:423-432.
- Schofield, L., and G.E. Grau. 2005. Immunological processes in malaria pathogenesis. *Nature reviews. Immunology* 5:722-735.
- Schofield, L., and F. Hackett. 1993. Signal transduction in host cells by a glycosylphosphatidylinositol toxin of malaria parasites. *The Journal of experimental medicine* 177:145-153.
- Schofield, L., S. Novakovic, P. Gerold, R.T. Schwarz, M.J. McConville, and S.D. Tachado. 1996. Glycosylphosphatidylinositol toxin of Plasmodium up-regulates intercellular adhesion molecule-1, vascular cell adhesion molecule-1, and E-selectin expression in vascular endothelial cells and increases leukocyte and parasite cytoadherence via tyrosine kinase-dependent signal transduction. *Journal of immunology (Baltimore, Md. : 1950)* 156:1886-1896.
- Schofield, L., J. Villaquiran, A. Ferreira, H. Schellekens, R. Nussenzweig, and V. Nussenzweig. 1987. Gamma interferon, CD8+ T cells and antibodies required for immunity to malaria sporozoites. *Nature* 330:664-666.
- Schrevel, J., G. Asfaux-Foucher, J.M. Hopkins, V. Robert, C. Bourgoignie, G. Prensier, and L.H. Bannister. 2008. Vesicle trafficking during sporozoite development in Plasmodium berghei: ultrastructural evidence for a novel trafficking mechanism. *Parasitology* 135:1-12.

- Schroeder, J.T., L.M. Lichtenstein, and S.M. MacDonald. 1997. Recombinant histamine-releasing factor enhances IgE-dependent IL-4 and IL-13 secretion by human basophils. *Journal of immunology (Baltimore, Md. : 1950)* 159:447-452.
- Schumann, R.R. 2007. Malarial fever: hemozoin is involved but Toll-free. *Proceedings of the National Academy of Sciences of the United States of America* 104:1743-1744.
- Schwarzmeier, J.D., R. Hubmann, M. Duchler, U. Jager, and M. Shehata. 2005. Regulation of CD23 expression by Notch2 in B-cell chronic lymphocytic leukemia. *Leukemia & lymphoma* 46:157-165.
- Seder, R.A., L.J. Chang, M.E. Enama, K.L. Zephir, U.N. Sarwar, I.J. Gordon, L.A. Holman, E.R. James, P.F. Billingsley, A. Gunasekera, A. Richman, S. Chakravarty, A. Manoj, S. Velmurugan, M. Li, A.J. Ruben, T. Li, A.G. Eappen, R.E. Stafford, S.H. Plummer, C.S. Hendel, L. Novik, P.J. Costner, F.H. Mendoza, J.G. Saunders, M.C. Nason, J.H. Richardson, J. Murphy, S.A. Davidson, T.L. Richie, M. Sedegah, A. Sutamihardja, G.A. Fahle, K.E. Lyke, M.B. Laurens, M. Roederer, K. Tewari, J.E. Epstein, B.K. Sim, J.E. Ledgerwood, B.S. Graham, and S.L. Hoffman. 2013. Protection against malaria by intravenous immunization with a nonreplicating sporozoite vaccine. *Science (New York, N.Y.)* 341:1359-1365.
- Seka-Seka, J., Y. Brouh, A.C. Yapo-Crezoit, and N.H. Atseye. 2004. The role of serum immunoglobulin E in the pathogenesis of Plasmodium falciparum malaria in Ivorian children. *Scandinavian journal of immunology* 59:228-230.
- Sergent, E., and L. Parrot. . 1935. L'immunité, la prémunition et la résistance innée. . *Arch. Inst. Pasteur Algerie* 13:279-319.
- Serghides, L., T.G. Smith, S.N. Patel, and K.C. Kain. 2003. CD36 and malaria: friends or foes? *Trends in parasitology* 19:461-469.
- Sherry, B.A., G. Alava, K.J. Tracey, J. Martiney, A. Cerami, and A.F. Slater. 1995. Malaria-specific metabolite hemozoin mediates the release of several potent endogenous pyrogens (TNF, MIP-1 alpha, and MIP-1 beta) in vitro, and altered thermoregulation in vivo. *Journal of inflammation* 45:85-96.
- Shetty, P. 2012. The numbers game. *Nature* 484:S14-15.
- Shi, Y.P., B.L. Nahlen, S. Kariuki, K.B. Urdahl, P.D. McElroy, J.M. Roberts, and A.A. Lal. 2001. Fcgamma receptor IIa (CD32) polymorphism is associated with protection of infants against high-density Plasmodium falciparum infection. VII. Asembo Bay Cohort Project. *The Journal of infectious diseases* 184:107-111.
- Shi, Y.P., V. Udhayakumar, A.J. Oloo, B.L. Nahlen, and A.A. Lal. 1999. Differential effect and interaction of monocytes, hyperimmune sera, and immunoglobulin G on the growth of asexual stage Plasmodium falciparum parasites. *The American journal of tropical medicine and hygiene* 60:135-141.
- Siddiqui, W.A., L.Q. Tam, K.J. Kramer, G.S. Hui, S.E. Case, K.M. Yamaga, S.P. Chang, E.B. Chan, and S.C. Kan. 1987. Merozoite surface coat precursor protein completely protects Aotus monkeys against Plasmodium falciparum malaria. *Proceedings of the National Academy of Sciences of the United States of America* 84:3014-3018.
- Silvie, O., J.P. Semblat, J.F. Franetich, L. Hannoun, W. Eling, and D. Mazier. 2002. Effects of irradiation on Plasmodium falciparum sporozoite hepatic development: implications for the design of pre-erythrocytic malaria vaccines. *Parasite immunology* 24:221-223.
- Singh, B., L. Kim Sung, A. Matusop, A. Radhakrishnan, S.S. Shamsul, J. Cox-Singh, A. Thomas, and D.J. Conway. 2004. A large focus of naturally acquired Plasmodium knowlesi infections in human beings. *Lancet* 363:1017-1024.
- Sowunmi, A., A.I. Ayede, A.G. Falade, V.N. Ndikum, C.O. Sowunmi, A.A. Adedeji, C.O. Falade, T.C. Happi, and A.M. Oduola. 2001. Randomized comparison of chloroquine and amodiaquine in the treatment of acute, uncomplicated, Plasmodium falciparum malaria in children. *Annals of tropical medicine and parasitology* 95:549-558.
- Sowunmi, A., G.O. Gbotosho, C.T. Happi, A.A. Adedeji, O.M. Bolaji, F.A. Fehintola, B.A. Fateye, and A.M. Oduola. 2007. Enhancement of the antimalarial efficacy of amodiaquine by chlorpheniramine in vivo. *Memorias do Instituto Oswaldo Cruz* 102:417-419.

- Sowunmi, A., A.M. Oduola, O.A. Ogundahunsi, C.O. Falade, G.O. Gbotosho, and L.A. Salako. 1997. Enhanced efficacy of chloroquine-chlorpheniramine combination in acute uncomplicated falciparum malaria in children. *Transactions of the Royal Society of Tropical Medicine and Hygiene* 91:63-67.
- Sowunmi, A., A.M. Oduola, O.A. Ogundahunsi, and L.A. Salako. 1998a. Comparative efficacy of chloroquine plus chlorpheniramine and pyrimethamine/sulfadoxine in acute uncomplicated falciparum malaria in Nigerian children. *Transactions of the Royal Society of Tropical Medicine and Hygiene* 92:77-81.
- Sowunmi, A., A.M. Oduola, O.A. Ogundahunsi, and L.A. Salako. 1998b. Enhancement of the antimalarial effect of chloroquine by chloropheniramine in vivo. *Tropical medicine & international health : TM & IH* 3:177-183.
- Spaccapelo, R., E. Aime, S. Caterbi, P. Arcidiacono, B. Capuccini, M. Di Cristina, T. Dottorini, M. Rende, F. Bistoni, and A. Crisanti. 2011. Disruption of plasmepsin-4 and merozoites surface protein-7 genes in *Plasmodium berghei* induces combined virulence-attenuated phenotype. *Scientific reports* 1:39.
- Spaccapelo, R., C.J. Janse, S. Caterbi, B. Franke-Fayard, J.A. Bonilla, L.M. Syphard, M. Di Cristina, T. Dottorini, A. Savarino, A. Cassone, F. Bistoni, A.P. Waters, J.B. Dame, and A. Crisanti. 2010. Plasmepsin 4-deficient *Plasmodium berghei* are virulence attenuated and induce protective immunity against experimental malaria. *The American journal of pathology* 176:205-217.
- Sponaas, A.M., E.T. Cadman, C. Voisine, V. Harrison, A. Boonstra, A. O'Garra, and J. Langhorne. 2006. Malaria infection changes the ability of splenic dendritic cell populations to stimulate antigen-specific T cells. *The Journal of experimental medicine* 203:1427-1433.
- Sponaas, A.M., A.P. Freitas do Rosario, C. Voisine, B. Mastelic, J. Thompson, S. Koernig, W. Jarra, L. Renia, M. Mauduit, A.J. Potocnik, and J. Langhorne. 2009. Migrating monocytes recruited to the spleen play an important role in control of blood stage malaria. *Blood* 114:5522-5531.
- Spring, M., J. Murphy, R. Nielsen, M. Dowler, J.W. Bennett, S. Zarlino, J. Williams, P. de la Vega, L. Ware, J. Komisar, M. Polhemus, T.L. Richie, J. Epstein, C. Tamminga, I. Chuang, N. Richie, M. O'Neil, D.G. Heppner, J. Healer, M. O'Neill, H. Smithers, O.C. Finney, S.A. Mikolajczak, R. Wang, A. Cowman, C. Ockenhouse, U. Krzych, and S.H. Kappe. 2013. First-in-human evaluation of genetically attenuated *Plasmodium falciparum* sporozoites administered by bite of *Anopheles* mosquitoes to adult volunteers. *Vaccine* 31:4975-4983.
- Srichaikul, T., N. Archararit, T. Siriasawakul, and T. Viriyapanich. 1976. Histamine changes in *Plasmodium falciparum* malaria. *Transactions of the Royal Society of Tropical Medicine and Hygiene* 70:36-38.
- Stanisic, D.I., A.E. Barry, and M.F. Good. 2013. Escaping the immune system: How the malaria parasite makes vaccine development a challenge. *Trends in parasitology* 29:612-622.
- Stephens, R., and J. Langhorne. 2010. Effector memory Th1 CD4 T cells are maintained in a mouse model of chronic malaria. *PLoS pathogens* 6:e1001208.
- Stephens, R., B. Seddon, and J. Langhorne. 2011. Homeostatic proliferation and IL-7R alpha expression do not correlate with enhanced T cell proliferation and protection in chronic mouse malaria. *PloS one* 6:e26686.
- Sterkers, Y., C. Scheidig, M. da Rocha, C. Lepolard, J. Gysin, and A. Scherf. 2007. Members of the low-molecular-mass rhoptry protein complex of *Plasmodium falciparum* bind to the surface of normal erythrocytes. *The Journal of infectious diseases* 196:617-621.
- Stevenson, M.M., and E.M. Riley. 2004. Innate immunity to malaria. *Nature reviews. Immunology* 4:169-180.
- Stevenson, M.M., and M.F. Tam. 1993. Differential induction of helper T cell subsets during blood-stage *Plasmodium chabaudi* AS infection in resistant and susceptible mice. *Clinical and experimental immunology* 92:77-83.
- Stevenson, M.M., M.F. Tam, S.F. Wolf, and A. Sher. 1995. IL-12-induced protection against blood-stage *Plasmodium chabaudi* AS requires IFN-gamma and TNF-alpha and occurs via a nitric oxide-dependent mechanism. *Journal of immunology (Baltimore, Md. : 1950)* 155:2545-2556.

- Stoltzfus, R.J., H.M. Chwaya, A. Montresor, M. Albonico, L. Savioli, and J.M. Tielsch. 2000. Malaria, hookworms and recent fever are related to anemia and iron status indicators in 0- to 5-y old Zanzibari children and these relationships change with age. *The Journal of nutrition* 130:1724-1733.
- Stone, K.D., C. Prussin, and D.D. Metcalfe. 2010. IgE, mast cells, basophils, and eosinophils. *The Journal of allergy and clinical immunology* 125:S73-80.
- Su, Z., and M.M. Stevenson. 2000. Central role of endogenous gamma interferon in protective immunity against blood-stage Plasmodium chabaudi AS infection. *Infection and immunity* 68:4399-4406.
- Su, Z., and M.M. Stevenson. 2002. IL-12 is required for antibody-mediated protective immunity against blood-stage Plasmodium chabaudi AS malaria infection in mice. *Journal of immunology (Baltimore, Md. : 1950)* 168:1348-1355.
- Suhrbier, A., L.A. Winger, E. Castellano, and R.E. Sinden. 1990. Survival and antigenic profile of irradiated malarial sporozoites in infected liver cells. *Infection and immunity* 58:2834-2839.
- Suzue, K., T. Asai, T. Takeuchi, and S. Koyasu. 2003. In vivo role of IFN-gamma produced by antigen-presenting cells in early host defense against intracellular pathogens. *European journal of immunology* 33:2666-2675.
- Swaika, A., W.A. Hammond, and R.W. Joseph. 2015. Current state of anti-PD-L1 and anti-PD-1 agents in cancer therapy. *Molecular immunology* 67:4-17.
- Taylor, K.J., T.T. Van, S.M. MacDonald, S.R. Meshnick, R.T. Fernley, I.G. Macreadie, and P.M. Smooker. 2015. Immunization of mice with Plasmodium TCTP delays establishment of Plasmodium infection. *Parasite immunology* 37:23-31.
- Taylor-Robinson, A.W. 2002. A model of development of acquired immunity to malaria in humans living under endemic conditions. *Medical hypotheses* 58:148-156.
- Taylor-Robinson, A.W., and R.S. Phillips. 1994. B cells are required for the switch from Th1- to Th2-regulated immune responses to Plasmodium chabaudi chabaudi infection. *Infection and immunity* 62:2490-2498.
- Taylor-Robinson, A.W., and R.S. Phillips. 1998. Infective dose modulates the balance between Th1- and Th2-regulated immune responses during blood-stage malaria infection. *Scandinavian journal of immunology* 48:527-534.
- Teirlinck, A.C., M.B. McCall, M. Roestenberg, A. Scholzen, R. Woestenenk, Q. de Mast, A.J. van der Ven, C.C. Hermsen, A.J. Luty, and R.W. Sauerwein. 2011. Longevity and composition of cellular immune responses following experimental Plasmodium falciparum malaria infection in humans. *PLoS pathogens* 7:e1002389.
- Telerman, A., and R. Amson. 2009. The molecular programme of tumour reversion: the steps beyond malignant transformation. *Nature reviews. Cancer* 9:206-216.
- Thathy, V., and R. Menard. 2002. Gene targeting in Plasmodium berghei. *Methods in molecular medicine* 72:317-331.
- Thaw, P., N.J. Baxter, A.M. Hounslow, C. Price, J.P. Waltho, and C.J. Craven. 2001. Structure of TCTP reveals unexpected relationship with guanine nucleotide-free chaperones. *Nature structural biology* 8:701-704.
- Thawani, N., M. Tam, and M.M. Stevenson. 2009. STAT6-mediated suppression of erythropoiesis in an experimental model of malarial anemia. *Haematologica* 94:195-204.
- Thery, C., M. Ostrowski, and E. Segura. 2009. Membrane vesicles as conveyors of immune responses. *Nature reviews. Immunology* 9:581-593.
- Thuesen, D.O., L.S. Speck, M.A. Lett-Brown, and J.A. Grant. 1979. Histamine-releasing activity (HRA). I. Production by mitogen- or antigen-stimulated human mononuclear cells. *Journal of immunology (Baltimore, Md. : 1950)* 123:626-632.
- Ting, L.M., M. Gissot, A. Coppi, P. Sinnis, and K. Kim. 2008. Attenuated Plasmodium yoelii lacking purine nucleoside phosphorylase confer protective immunity. *Nature medicine* 14:954-958.
- Tormo, A.J., M.C. Letellier, M. Sharma, G. Elson, S. Crabe, and J.F. Gauchat. 2012. IL-6 activates STAT5 in T cells. *Cytokine* 60:575-582.

- Troye-Blomberg, M., K. Berzins, and P. Perlmann. 1994. T-cell control of immunity to the asexual blood stages of the malaria parasite. *Critical reviews in immunology* 14:131-155.
- Troye-Blomberg, M., P. Perlmann, L. Mincheva Nilsson, and H. Perlmann. 1999a. Immune regulation of protection and pathogenesis in Plasmodium falciparum malaria. *Parassitologia* 41:131-138.
- Troye-Blomberg, M., E.M. Riley, L. Kabilan, M. Holmberg, H. Perlmann, U. Andersson, C.H. Heusser, and P. Perlmann. 1990. Production by activated human T cells of interleukin 4 but not interferon-gamma is associated with elevated levels of serum antibodies to activating malaria antigens. *Proceedings of the National Academy of Sciences of the United States of America* 87:5484-5488.
- Troye-Blomberg, M., S. Worku, P. Tangteerawatana, R. Jamshaid, K. Soderstrom, G. Elghazali, L. Moretta, M. Hammarstrom, and L. Mincheva-Nilsson. 1999b. Human gamma delta T cells that inhibit the in vitro growth of the asexual blood stages of the Plasmodium falciparum parasite express cytolytic and proinflammatory molecules. *Scandinavian journal of immunology* 50:642-650.
- Tse, S.W., A.J. Radtke, and F. Zavala. 2011. Induction and maintenance of protective CD8+ T cells against malaria liver stages: implications for vaccine development. *Memorias do Instituto Oswaldo Cruz* 106 Suppl 1:172-178.
- Turner, G. 1997. Cerebral malaria. *Brain pathology (Zurich, Switzerland)* 7:569-582.
- Tuynder, M., G. Fiucci, S. Prieur, A. Lespagnol, A. Geant, S. Beaucourt, D. Duflaut, S. Besse, L. Susini, J. Cavarelli, D. Moras, R. Amson, and A. Telerman. 2004. Translationally controlled tumor protein is a target of tumor reversion. *Proceedings of the National Academy of Sciences of the United States of America* 101:15364-15369.
- Tuynder, M., L. Susini, S. Prieur, S. Besse, G. Fiucci, R. Amson, and A. Telerman. 2002. Biological models and genes of tumor reversion: cellular reprogramming through tpt1/TCTP and SIAH-1. *Proceedings of the National Academy of Sciences of the United States of America* 99:14976-14981.
- Urban, B.C., D.J. Ferguson, A. Pain, N. Willcox, M. Plebanski, J.M. Austyn, and D.J. Roberts. 1999. Plasmodium falciparum-infected erythrocytes modulate the maturation of dendritic cells. *Nature* 400:73-77.
- Vafa, M., E. Israelsson, B. Maiga, A. Dolo, O.K. Doumbo, and M. Troye-Blomberg. 2009. Relationship between immunoglobulin isotype response to Plasmodium falciparum blood stage antigens and parasitological indexes as well as splenomegaly in sympatric ethnic groups living in Mali. *Acta tropica* 109:12-16.
- Vafa, M., B. Maiga, K. Berzins, M. Hayano, S. Bereczky, A. Dolo, M. Daou, C. Arama, B. Kouriba, A. Farnert, O.K. Doumbo, and M. Troye-Blomberg. 2007. Associations between the IL-4 -590 T allele and Plasmodium falciparum infection prevalence in asymptomatic Fulani of Mali. *Microbes and infection / Institut Pasteur* 9:1043-1048.
- Van Braeckel-Budimir, N., and J.T. Harty. 2014. CD8 T-cell-mediated protection against liver-stage malaria: lessons from a mouse model. *Frontiers in microbiology* 5:272.
- van der Heyde, H.C., D. Huszar, C. Woodhouse, D.D. Manning, and W.P. Weidanz. 1994. The resolution of acute malaria in a definitive model of B cell deficiency, the JHD mouse. *Journal of immunology (Baltimore, Md. : 1950)* 152:4557-4562.
- van der Heyde, H.C., B. Pepper, J. Batchelder, F. Cigel, and W.P. Weidanz. 1997. The time course of selected malarial infections in cytokine-deficient mice. *Experimental parasitology* 85:206-213.
- van der Poll, T., C.V. Keogh, X. Guirao, W.A. Buurman, M. Kopf, and S.F. Lowry. 1997. Interleukin-6 gene-deficient mice show impaired defense against pneumococcal pneumonia. *The Journal of infectious diseases* 176:439-444.
- van Dijk, M.R., B. Douradinha, B. Franke-Fayard, V. Heussler, M.W. van Dooren, B. van Schaijk, G.J. van Gemert, R.W. Sauerwein, M.M. Mota, A.P. Waters, and C.J. Janse. 2005. Genetically attenuated, P36p-deficient malarial sporozoites induce protective immunity and apoptosis of infected liver cells. *Proceedings of the National Academy of Sciences of the United States of America* 102:12194-12199.

- Vanderberg, J., R. Nussenzweig, and H. Most. 1969. Protective immunity produced by the injection of x-irradiated sporozoites of *Plasmodium berghei*. V. In vitro effects of immune serum on sporozoites. *Military medicine* 134:1183-1190.
- Verra, F., G. Luoni, C. Calissano, M. Troye-Blomberg, P. Perlmann, H. Perlmann, B. Arca, B.S. Sirima, A. Konate, M. Coluzzi, D. Kwiatkowski, and D. Modiano. 2004. IL4-589C/T polymorphism and IgE levels in severe malaria. *Acta tropica* 90:205-209.
- Villegas-Mendez, A., R. Greig, T.N. Shaw, J.B. de Souza, E. Gwyer Findlay, J.S. Stumhofer, J.C. Hafalla, D.G. Blount, C.A. Hunter, E.M. Riley, and K.N. Couper. 2012. IFN-gamma-producing CD4+ T cells promote experimental cerebral malaria by modulating CD8+ T cell accumulation within the brain. *Journal of immunology (Baltimore, Md. : 1950)* 189:968-979.
- Vinetz, J.M., S. Kumar, M.F. Good, B.J. Fowlkes, J.A. Berzofsky, and L.H. Miller. 1990. Adoptive transfer of CD8+ T cells from immune animals does not transfer immunity to blood stage *Plasmodium yoelii* malaria. *Journal of immunology (Baltimore, Md. : 1950)* 144:1069-1074.
- von der Weid, T., N. Honarvar, and J. Langhorne. 1996. Gene-targeted mice lacking B cells are unable to eliminate a blood stage malaria infection. *Journal of immunology (Baltimore, Md. : 1950)* 156:2510-2516.
- Vonakis, B.M., R. Sora, J.M. Langdon, V. Casolaro, and S.M. MacDonald. 2003. Inhibition of cytokine gene transcription by the human recombinant histamine-releasing factor in human T lymphocytes. *Journal of immunology (Baltimore, Md. : 1950)* 171:3742-3750.
- Vouldoukis, I., D. Mazier, D. Moynet, D. Thiolat, D. Malvy, and M.D. Mossalayi. 2011. IgE mediates killing of intracellular *Toxoplasma gondii* by human macrophages through CD23-dependent, interleukin-10 sensitive pathway. *PloS one* 6:e18289.
- Waddell, S.J., S.J. Popper, K.H. Rubins, M.J. Griffiths, P.O. Brown, M. Levin, and D.A. Relman. 2010. Dissecting interferon-induced transcriptional programs in human peripheral blood cells. *PloS one* 5:e9753.
- Waki, S., J. Tamura, M. Imanaka, S. Ishikawa, and M. Suzuki. 1982. *Plasmodium berghei*: isolation and maintenance of an irradiation attenuated strain in the nude mouse. *Experimental parasitology* 53:335-340.
- Walker, D.J., J.L. Pitsch, M.M. Peng, B.L. Robinson, W. Peters, J. Bhisutthibhan, and S.R. Meshnick. 2000. Mechanisms of artemisinin resistance in the rodent malaria pathogen *Plasmodium yoelii*. *Antimicrobial agents and chemotherapy* 44:344-347.
- Wang, R., J.D. Smith, and S.H. Kappe. 2009. Advances and challenges in malaria vaccine development. *Expert reviews in molecular medicine* 11:e39.
- Ward, P., L. Equinet, J. Packer, and C. Doerig. 2004. Protein kinases of the human malaria parasite *Plasmodium falciparum*: the kinome of a divergent eukaryote. *BMC Genomics* 5:79.
- Weiss, G.E., P.D. Crompton, S. Li, L.A. Walsh, S. Moir, B. Traore, K. Kayentao, A. Ongoiba, O.K. Doumbo, and S.K. Pierce. 2009. Atypical memory B cells are greatly expanded in individuals living in a malaria-endemic area. *Journal of immunology (Baltimore, Md. : 1950)* 183:2176-2182.
- Weiss, W.R., M. Sedegah, R.L. Beaudoin, L.H. Miller, and M.F. Good. 1988. CD8+ T cells (cytotoxic/suppressors) are required for protection in mice immunized with malaria sporozoites. *Proceedings of the National Academy of Sciences of the United States of America* 85:573-576.
- Were, T., G.C. Davenport, J.B. Hittner, C. Ouma, J.M. Vulule, J.M. Ong'echa, and D.J. Perkins. 2011. Bacteremia in Kenyan children presenting with malaria. *Journal of clinical microbiology* 49:671-676.
- Wherry, E.J. 2011. T cell exhaustion. *Nature immunology* 12:492-499.
- White, N.J. 1997. Assessment of the pharmacodynamic properties of antimalarial drugs in vivo. *Antimicrobial agents and chemotherapy* 41:1413-1422.
- White, N.J., S. Pukrittayakamee, T.T. Hien, M.A. Faiz, O.A. Mokuolu, and A.M. Dondorp. 2014. Malaria. *Lancet* 383:723-735.
- WHO. 2015. World Malaria Report

- Winkler, S., M. Willheim, K. Baier, D. Schmid, A. Aichelburg, W. Graninger, and P.G. Kremsner. 1998. Reciprocal regulation of Th1- and Th2-cytokine-producing T cells during clearance of parasitemia in *Plasmodium falciparum* malaria. *Infection and immunity* 66:6040-6044.
- Winzeler, E.A. 2008. Malaria research in the post-genomic era. *Nature* 455:751-756.
- Winzerling, J.J., and D.Q. Pham. 2006. Iron metabolism in insect disease vectors: mining the *Anopheles gambiae* translated protein database. *Insect biochemistry and molecular biology* 36:310-321.
- Wipasa, J., L. Okell, S. Sakhachornphop, C. Suphavitai, K. Chawansuntati, W. Liewsaree, J.C. Hafalla, and E.M. Riley. 2011. Short-lived IFN-gamma effector responses, but long-lived IL-10 memory responses, to malaria in an area of low malaria endemicity. *PLoS pathogens* 7:e1001281.
- Wright, G.J., and J.C. Rayner. 2014. *Plasmodium falciparum* erythrocyte invasion: combining function with immune evasion. *PLoS pathogens* 10:e1003943.
- Wykes, M.N., and M.F. Good. 2009. What have we learnt from mouse models for the study of malaria? *European journal of immunology* 39:2004-2007.
- Wykes, M.N., Y.H. Zhou, X.Q. Liu, and M.F. Good. 2005. *Plasmodium yoelii* can ablate vaccine-induced long-term protection in mice. *Journal of immunology (Baltimore, Md. : 1950)* 175:2510-2516.
- Xu, A., A.R. Bellamy, and J.A. Taylor. 1999. Expression of translationally controlled tumour protein is regulated by calcium at both the transcriptional and post-transcriptional level. *The Biochemical journal* 342 Pt 3:683-689.
- Xu, W., and J.J. Zhang. 2005. Stat1-dependent synergistic activation of T-bet for IgG2a production during early stage of B cell activation. *Journal of immunology (Baltimore, Md. : 1950)* 175:7419-7424.
- Yanez, D.M., D.D. Manning, A.J. Cooley, W.P. Weidanz, and H.C. van der Heyde. 1996. Participation of lymphocyte subpopulations in the pathogenesis of experimental murine cerebral malaria. *Journal of immunology (Baltimore, Md. : 1950)* 157:1620-1624.
- Yarm, F.R. 2002. Plk phosphorylation regulates the microtubule-stabilizing protein TCTP. *Molecular and cellular biology* 22:6209-6221.
- Yazdani, S.S., P. Mukherjee, V.S. Chauhan, and C.E. Chitnis. 2006. Immune responses to asexual blood-stages of malaria parasites. *Current molecular medicine* 6:187-203.
- Yee, A.M., H.M. Phan, R. Zuniga, J.E. Salmon, and D.M. Musher. 2000. Association between Fc gamma RIIa-R131 allotype and bacteremic pneumococcal pneumonia. *Clinical infectious diseases : an official publication of the Infectious Diseases Society of America* 30:25-28.
- Yoneto, T., S. Waki, T. Takai, Y. Tagawa, Y. Iwakura, J. Mizuguchi, H. Nariuchi, and T. Yoshimoto. 2001. A critical role of Fc receptor-mediated antibody-dependent phagocytosis in the host resistance to blood-stage *Plasmodium berghei* XAT infection. *Journal of immunology (Baltimore, Md. : 1950)* 166:6236-6241.
- Zhang, M., C. Fennell, L. Ranford-Cartwright, R. Sakthivel, P. Gueirard, S. Meister, A. Caspi, C. Doerig, R.S. Nussenzweig, R. Tuteja, W.J. Sullivan, Jr., D.S. Roos, B.M. Fontoura, R. Menard, E.A. Winzeler, and V. Nussenzweig. 2010. The *Plasmodium* eukaryotic initiation factor-2alpha kinase IK2 controls the latency of sporozoites in the mosquito salivary glands. *J Exp Med* 207:1465-1474.
- Zhou, J., G. Feng, J. Beeson, P.M. Hogarth, S.J. Rogerson, Y. Yan, and A. Jaworowski. 2015. CD14(hi)CD16+ monocytes phagocytose antibody-opsonised *Plasmodium falciparum* infected erythrocytes more efficiently than other monocyte subsets, and require CD16 and complement to do so. *BMC medicine* 13:154.

Résumé:

Des études récentes suggèrent une forte relation entre susceptibilité au paludisme et réponse allergique. En effet, des niveaux élevés d'histamine plasmatique et tissulaire ont été associés à la sévérité de la maladie chez l'homme infecté par *P. falciparum* et dans de nombreux modèles animaux. Histamine releasing factor (HRF), une protéine pro-inflammatoire libérant l'histamine au cours des processus allergiques, est produite par le parasite au cours des infections palustres modérées et sévères, suggérant l'implication du HRF dans l'altération des réponses immunitaires et dans la pathogenèse. Les objectifs de ce travail consistaient à évaluer le rôle de la protéine parasitaire HRF dans le développement de la réponse immunitaire et à déterminer si son expression est associée à la sévérité de la maladie en étudiant deux parasites murins, *PbANKA* et *PbNK65*, déficients pour la protéine HRF (*hrfΔ*). Les souris infectées avec des sporozoïtes *PbANKA-hrfΔ* ont montré une diminution de la fréquence du neuropaludisme associée à un déficit du développement des parasites mutants au cours du stade hépatique et à une augmentation précoce systémique d'IL-6. En outre, l'infection par des parasites *PbNK65-hrfΔ* a confirmé l'importance de la protéine HRF dans la virulence du parasite. En effet, l'infection par les parasites *PbNK65-hrfΔ* est caractérisée par l'élimination du parasite qui conduit à une protection durable et au développement d'une mémoire immunitaire caractérisée par une augmentation d'IL-6, une diminution de l'expression de PD-1 sur les cellules T et une amélioration de la phagocytose dépendante des anticorps. La protéine HRF est le premier gène de parasite *Plasmodium* dont l'effet direct sur la réponse immunitaire de l'hôte est démontré.

Mots clés: *Plasmodium*, Histamine releasing factor, GAP, IL-6, immunité protectrice, vaccin

Abstract:

Recent findings have raised the hypothesis that clinical susceptibility to malaria may be related to allergy-type response. In human infection with *P. falciparum*, as well as in murine models of malaria, increased levels of histamine have been shown to be associated with disease severity. Histamine releasing factor (HRF), shown to be implicated in the release of pro-inflammatory histamine during late-phase allergy, was demonstrated to be produced by the parasite during mild and severe malaria infections suggesting that *Plasmodium* HRF may affect host immune responses and contributes to the pathogenesis. The objectives of this work were to evaluate the role of *Plasmodium* HRF in the development of the immune response and to determine whether its expression is associated with the severity of malaria disease by studying two HRF-deficient (*hrfΔ*) murine parasites (*PbANKA* and *PbNK65*). Infection with *PbANKA-hrfΔ* sporozoites showed a decrease in the frequency of ECM due to the impairment of the development of the mutant parasites in liver stages as a consequence of the up-regulation of IL-6. Infection with *PbNK65-hrfΔ* parasites confirmed the importance of HRF in enhancing the virulence of the parasite. Indeed, *PbNK65-hrfΔ* infection results in parasite clearance leading to a long-lasting protection and immune memory as reflected by an up-regulation of IL-6, a down-regulation of PD-1 expression on T cells and in the enhancement of Ab-mediated phagocytosis. HRF is the first parasite gene which directly modulates the host immune response.

Keywords: *Plasmodium*, Histamine releasing factor, GAP, IL-6, protective immunity, vaccine