



**HAL**  
open science

# Tat-independent lentivirus genomes for vaccination and host/pathogen interaction studies

Deepanwita Bose

► **To cite this version:**

Deepanwita Bose. Tat-independent lentivirus genomes for vaccination and host/pathogen interaction studies. Human health and pathology. Université Grenoble Alpes, 2017. English. NNT: 2017GREAV009 . tel-01938074

**HAL Id: tel-01938074**

**<https://theses.hal.science/tel-01938074>**

Submitted on 28 Nov 2018

**HAL** is a multi-disciplinary open access archive for the deposit and dissemination of scientific research documents, whether they are published or not. The documents may come from teaching and research institutions in France or abroad, or from public or private research centers.

L'archive ouverte pluridisciplinaire **HAL**, est destinée au dépôt et à la diffusion de documents scientifiques de niveau recherche, publiés ou non, émanant des établissements d'enseignement et de recherche français ou étrangers, des laboratoires publics ou privés.

## THÈSE

Pour obtenir le grade de

### **DOCTEUR DE LA COMMUNAUTÉ UNIVERSITÉ GRENOBLE ALPES**

Spécialité : **Virologie/Microbiologie/Immunologie**

Arrêté ministériel : 7 août 2006

Présentée par

**Deepanwita BOSE**

Thèse dirigée par **Dr. Yahia Chebloune**

préparée au sein du

**Laboratoire Pathogénèse et Vaccination Lentivirales (PAVAL  
Lab) dans l'École Doctorale Chimie & Sciences du Vivant  
(ED218)**

### **Tat-independent lentivirus genomes for vaccination and host/pathogen interaction studies.**

Thèse soutenue publiquement le **26 Janvier 2017**,  
devant le jury composé de :

**Dr. Giuseppe Bertoni**

Maitre de conférences, IVI, Bern, Suisse Rapporteur

**Pr. Francois Villinger**

Professeur, Director of New Iberia Research Center, USA, Rapporteur

**Pr. Philippe Sabatier**

Professeur à l'Université Grenoble Alpes, Président

**Dr. Yahia Chebloune**

Research Director, à l'Université Grenoble Alpes, Examineur

**Dr. Corinne Ronfort**

Chargé de recherche, Université Lyon I, Examineur



*"Dedicated to my Mom, Dad  
and Brother"*

## Acknowledgements

This thesis in its current form is a result of support, assistance, collaboration, critical inputs and guidance of several people and thus, I would sincerely thank each one of them.

Firstly, I would like to express my sincere gratitude to my mentor **Dr. Yahia Chebloune** for having his faith and confidence in me and accepting me in his research lab for doing a PhD. thesis. I am thankful to him for his support, encouragement and extraordinary guidance all through my graduate work. His insightful discussions and critical comments were an invaluable part in preparation of this thesis. I am grateful for his patience throughout the tribulations, errors, repeats and also the successes in the lab, the corrections in the redaction of the thesis. His mentorship greatly improved and enhanced my scientific grasp and outlook.

I would like to thank the members of my Committee:

Our collaborator **Pr. François Villinger**, Director of the New Iberia Research Center, for sharing his expertise in the field and providing invaluable time and suggestions with a lot of encouragement. I am also thankful to him for providing a platform for adapting the newly developed viruses that I developed in Grenoble. For performing these experiments and adapting the viruses, I would like to thank members of his team, specially **Dr. Chunxia Zhao** at the Yerkes National Primate Center, **Margot Lavy** at the New Iberia Research Center and other members of the lab working to adapt the viruses in vitro and in vivo.

**Dr. Giuseppe Bertoni**, for his invaluable time and expertise in the field and for being part of jury and reporter of the thesis.

**Dr. Corinne Ronfort**, for all her scientific wisdom providing valuable inputs during the thesis and for her patience, critical review and guidance throughout the correction of the thesis

**Pr. Phillipe Sabatier**, BioHealth Computing Director, for his professional excellence in providing constructive criticism and valuable inputs into the thesis.

**Dr. Catherine Lemaire**, for being part of my thesis committee and providing significant constructive criticisms, I would also like to thank her for allowing me free use of laboratory equipment in emergency situations. I also thank **Salima**, for her technical help during these visits to the LAPM, Jean Roget Institute.

I am thankful to **Dr. Jean Gagnon**, for his expertise and unwavering kindness, with valuable suggestions throughout my graduate studies and for his precious input for the redaction of my paper and thesis.

I am deeply grateful to my lab mates and colleagues **Maha, Simaa and Dimitri** for their help, motivation, support and encouragement during good and less good times. They were always around to discuss, and gave invaluable suggestions and technical help for which, I am more than grateful. They were a part of my day-to-day life in lab and I cannot imagine my three

## Acknowledgements

---

---

years of lab life without them. I want also to acknowledge the help of **Takfarinas**, who joined the lab recently for his help in English-French translation and his savviness in MS Word software.

I am also thankful and appreciate all other current and past members of the PAVAL team including previous students **Honorine, Mikael, Sara, Avika, Ivan, Amna, Nadia, Amandine, Margot, Vanessa, Kathia**, and technician **Abderrahim**. Special thanks to **Camille** for repeating some experiments of this thesis during her internship.

I also want to warmly thank **Gour, Monalisa, Ila, Sudha, Vikas, Vinodh, Lakshman, Bharat** from the Indian community in Grenoble for their homely, joyful gatherings with loads of food, fun and all their support and encouragements along with valuable inputs for living in the French system.

I am thankful for the financial support that I benefited from the Presidential Scholarship, University Grenoble Alpes for the years 2013-2016.

And I am thankful to my Parents and Brother in India for always being encouraging and supporting me in all my endeavors in life, and this thesis is dedicated to them.

**Tat-independent lentivirus genomes for vaccination and host/pathogen interaction studies.**

**Abstract in English**

Our lab has previously described the generation of a unique vaccine prototype against HIV-1/AIDS. It is a non-integrative lentivector DNA vaccine, tested in pilot studies in animal models of HIV vaccine. The non-human primate study showed protection of all 6/6 macaques and immune response correlates were composed of a variety of effector (EM) and central memory (CM) T cells. More importantly, they also contained high proliferating antigen specific cells containing a type of stem cell-like memory T cells (TSCM). Here in my thesis work, the specificity of the vaccine was enhanced further by switching the CXCR4 envelope of the vaccine to CCR5 tropic envelopes such as the clade B WARO obtained from a chronically infected patient and three transmitted/founder (T/F) HIV Clade C strains from Zambia. To improve the vaccine further, we developed new strategies to incorporate cytokine genes as molecular adjuvants able to enhance and sustain the newly elicited immune responses.

Since HIV-1 has developed multiple complex strategies to persist, the focus of the next part of my thesis was to develop tools to ease and better understand the underlying mechanisms of latency in infected memory CD4<sup>+</sup> T cells. Latently infected cells have integrated in their genomes the complete viral DNA sequences but viral genes are not expressed. One of the main mechanisms of this latency is the absence of Tat transactivation of the LTR promoter. A recent focus in the era of efficient highly active antiviral therapy (HAART) is the cure of infection by targeting the reservoir of latently infected cells. One of the obstacles faced, is a lack of primate lentivirus prototypes incapable of undergoing latency as an extreme infection model to allow for teasing apart the various mechanisms contributing to latency. We hypothesized that a replication-competent SHIV genome driven by Tat-independent constitutive-expression LTRs such as the one of the caprine arthritis encephalitis virus, CAEV, the natural lentivirus of goats, will be a valuable tool for such studies. We designed chimeric CAEV LTRs bearing terminal sequences of SIV at their extremities, and used them to drive the transcription of the complete genome of SHIV-KU2. The reverse transcription of such a genome generates double stranded viral DNA bearing SIV attachment sequences (*att*) used efficiently by SIV IN for provirus integration. The resulting construct termed SHIV-YCC is expected to generate a viral infection that will not undergo latency due to uncoupling from Tat activation. We found that cells transfected with the SHIV-YCC DNA produce SHIV proteins that assemble into infectious particles released from the producer cells. These virions are able to infect new target CD4<sup>+</sup> T cells both in primary PBMCs and in cell lines. SHIV-YCC passaged in macaques PBMCs increased virus replication and infectivity. SHIV-YCC is the first chimeric primate replication-competent lentivirus that constitutively expresses all viral proteins. This new model offers the possibility of studying the early events by which provirus undergoes latency and will serve as backbone for the construction of chimeric SHIVs with T/F CCR5 tropic HIV-1 envelopes more representative of early infecting isolates.

Another major focus of this thesis was the development of replication competent (Tat driven) SHIVs that also more closely represent new HIV infections in humans. There is a need for CCR5 tropic SHIVs that not only infect monkeys but also induce sustained viral load set-points and pathogenesis, as many of the current R5-tropic SHIVs tend to undergo spontaneous control *in vivo*. In an attempt to palliate this issue in this thesis, SHIV-AD-T/F-31 and SHIV-AD-T/F-18 were developed using the SHIV-AD8EO backbone, which is a recent clade B SHIV with promising replication kinetics *in vivo*. The *tat-env* region of SHIV-AD8EO was

exchanged with those of two HIV-1 clade C isolates: Z331T/F and Z3618T/F. These CCR5-tropic SHIVs will also provide tools to determine the mechanisms of latency/persistence when used in parallel with CAEV LTR chimeric constructs that are independent of the Tat/TAR transactivation. In addition, the replicative SHIV may provide invaluable reagents for testing HIV vaccines and microbicide efficacy in the macaque models.

**Keywords : HIV/SIV ; Tat ; CAEV ; CCR5 SHIV**

## Génomés de lentivirus Tat indépendants pour des études de vaccination et les interactions hôte / pathogène

### Abstract in French

Notre laboratoire a développé un prototype vaccinal unique contre le VIH-1 responsable du SIDA chez l'homme. C'est un lentivecteur ADN non-intégratif qui a été testé dans des études pilotes utilisant des modèles animaux. Une des études a montré la protection de tous les macaques (6/6) vaccinés et la réponse immunitaire qui corrèle avec cette protection était composée de cellules effectrices (EM) et des cellules T centrales mémoires (CM). Plus important encore, elle contenait également des cellules spécifiques des antigènes qui possèdent une haute capacité de prolifération contenant des cellules T mémoires de type cellules souches (TSCM). Un de mes objectifs durant le travail de cette thèse a été d'améliorer ce génome vaccinal en commutant son enveloppe dotée de tropisme CXCR4 contre des enveloppes à tropisme CCR5 de virus de clade B (WARO) obtenu à partir d'un patient infecté de façon chronique et de trois souches de VIH-1 de Clade C transmetteur fondateur (T/F) de patients Zambiens. Un second objectif a été d'améliorer le prototype vaccinal en modifiant son génome afin qu'il puisse incorporer des gènes de cytokines servants d'adjuvants moléculaires afin d'améliorer davantage son immunogénicité.

Etant donné que le lentivirus humain VIH-1 a développé plusieurs stratégies complexes pour persister chez l'homme, la seconde partie de ma thèse a été consacrée au développement d'outils pour faciliter l'étude et la compréhension des mécanismes impliqués dans la latence dans les cellules T CD4+ mémoires infectées. Les cellules infectées de façon latente possèdent des provirus entiers mais qui ne sont pas exprimés. Un des principaux mécanismes de cette latence est l'absence de transactivation par Tat du promoteur de la LTR 5'. Les développements récents de la thérapie antivirale hautement active (HAART) efficace pour contrôler les cellules infectées circulantes et dans les tissus, reste inefficace contre le réservoir composé de cellules infectées possédant des provirus latents. Un des obstacles pour développer des stratégies efficaces est l'absence de prototypes de lentivirus de primates appropriés, incapables d'induire la latence pour s'en servir comme modèle d'infection extrême qui permet d'étudier plus simplement les mécanismes qui contribuent à la latence. Notre hypothèse est qu'un génome SHIV répliatif dont l'expression du génome est sous le contrôle d'une LTR dotée de promoteur Tat-indépendant à expression constitutive telle que celle du virus de l'arthrite et de l'encéphalite de la chèvre, CAEV, le lentivirus naturel de la chèvre, constituera un outil précieux pour de telles études. Nous avons conçu des LTRs chimères de CAEV portant de courtes séquences des extrémités des LTRs du SIV qui permettent de créer la séquence d'attachement (*att*) spécifique du SIV et nous les avons utilisées pour contrôler l'expression du génome complet de SHIV-KU2. La construction résultante SHIV-YCC devrait générer un virus incapable de latence en absence de transactivation par Tat. Nous avons observé que les cellules transfectées avec le génome SHIV-YCC produisent des protéines SHIV qui s'assemblent en particules infectieuses excrétées des cellules. Les virions sont capables d'infecter les lymphocytes T CD4+ cibles tant dans les PBMC primaires que dans les lignées cellulaires. Le passage en série du virus dans les cellules mononucléées (PBMC) de macaques augmente la réplication et l'infectiosité du virus. SHIV-YCC est le premier



lentivirus chimérique répliatif de primates qui exprime de manière constitutive toutes les protéines virales. Ce nouveau modèle offre la possibilité d'étudier les événements précoces par lesquels le provirus subit une latence, en particulier lorsque le gène de l'enveloppe sera remplacé par celui des T / F CCR5 tropique VIH-1.

Un autre objectif majeur de cette thèse a été de développer des SHIVs répliatifs classiques qui imitent plus étroitement les étapes initiales de l'infection par le VIH-1 chez l'homme, les virus T/F. Il existe actuellement un besoin de SHIV à tropisme CCR5 qui non seulement infectent des singes mais aussi se répliquent à haute virémie et qui soient pathogènes. Dans le cadre du travail de cette thèse, les génomes SHIV-AD -T/F-31 et SHIV-AD-T/F-18 ont été développés à base du génome parental du SHIV-AD8EO. Ce SHIV a montré une bonne capacité répliative *in vivo*. La région des gènes *tat-env* du SHIV-AD8EO a été échangée avec celles des isolats Z331T/F et Z3618T/F du VIH-1 de clade C de patients Gambiens. Ces SHIVs à tropisme CCR5 constitueront également des outils précieux pour étudier les mécanismes de latence/persistance lorsqu'ils sont utilisés en parallèle avec des constructions chimériques dotées de LTR de CAEV qui sont indépendantes de la transactivation Tat/TAR typique pour le VIH/SIV. Ces SHIV répliatifs constitueront aussi des outils précieux pour les épreuves virulentes pour tester les efficacités de vaccins HIV et des microbicides.

**Mots-clés: VIH / SIV; Tat; CAEV; CCR5 SHIV**

## **Introduction**

A global pandemic occurred due to the emergence of Human Immunodeficiency Virus, (HIV) that has killed over 40 million during the past three decades by causing an Acquired Immunodeficiency Syndrome (AIDS). The complex properties of the life cycle of HIV, its ability to rapidly mutate and evade the immune responses, its interactions with the host's cell defenses and the variability of host antiviral defenses are some of the factors that make the studies of HIV pathogenesis and vaccinology difficult to conduct. The prospect of a preventive efficacious vaccine remains a formidable challenge. Therefore, there is a strong need for model systems with less complexity and wider accessibility to speed up the studies and develop safe and efficacious vaccines.

The main objectives of our lab are to develop novel chimeric lentivirus systems that will ease studies, help provide a better understanding the pathogenesis of lentiviruses and to develop a safe, durable and efficacious vaccine against HIV-1. One of the main mechanisms used by HIV-1 to cause persistent infection in infected humans is the regulation of provirus expression that goes from unexpressed genome in latently infected reservoir cells in resting memory T cells to active expression replication in activated CD4+ T cells. One of the key player in this latency/persistence/activation of provirus is the transcription transactivator viral Tat protein that interacts with the TAR sequence in the viral RNA genome. Our lab had previously developed a prototype single cycle non-integrative lentiviral simian/human immunodeficiency virus vector that constitutively expresses the viral proteins rather than *via* Tat/TAR transactivation. The work of this thesis contributes to the objectives of the lab by developing different unique molecular clones to study the pathogenesis and to enhance the efficacy of the vaccine constructs.

Chapter 1 is a review of the literature, which has been focused on various aspects of current HIV research, starting from the general overview of lentiviruses, their natural history and morphology. It further focuses in depth on HIV-1 immunology and strategies used to develop vaccine and the human vaccine trials undertaken until today. Chapter 1 also reviews in depth the latency/persistence aspects of HIV-1, by detailing the types of latency, mechanisms involved and models generated by different researchers to study

latency and prospects of disrupting latency. There is also a brief overview on CAEV and its biological and pathological properties. My published review at the end of the thesis “Comparative analysis of Tat-dependent and Tat-deficient natural lentiviruses” complements the review of the literature.

Chapter 2 describes in details the various materials and methodology used during the generation and testing of the unique molecular clones.

Chapter 3 contains the result section, which is subdivided into three different parts. The first part details the molecular clones developed for the enhancement of the vaccine efficacy. While the second and third parts detail the molecular clones developed to study HIV/SIV pathogenesis. All the constructs generated during this work are unique, original and they will be very helpful to dissect the pathogenesis of HIV-1 and to generate and test vaccines against HIV-1 in the future.

Chapter 4 comprises the Discussion, Prospects & Conclusions: This chapter discusses the main findings and gives a detailed account of the possible applications, experimental setups to study these unique molecular clones and their potential. At the end, there is a general conclusion.

---

---

**Table of Contents**

**Acknowledgements** ..... i

**Abstract in English**..... iii

**Abstract in French** ..... v

**Introduction**.....vii

**Table of Contents** .....ix

**List of Abbreviations**.....xvi

**Chapter 1- Review of Literature** ..... 1

    1.1    Lentiviruses of Human and Animals ..... 1

        1.1.1 Retroviruses..... 1

        1.1.2 Lentiviruses..... 2

        1.1.3 Timeline of Lentivirus discovery ..... 2

    1.2    Natural History of HIV-1 ..... 3

        1.2.1 Discovery of AIDS and the causative agent HIV ..... 3

        1.2.2 Epidemiology and Geographic distribution ..... 3

        1.2.3 HIV-1 Transmission ..... 4

        1.2.4 Transmitted Founder (T/F) virus ..... 4

        1.2.5 Tropism / Target cells ..... 5

        1.2.6 Pathogenesis ..... 5

    1.3    Structure and genetic organization of HIV-1..... 8

        1.3.1 Structure / Morphology of HIV virions ..... 8

        1.3.2 Genomic organization and proteins ..... 9

        1.3.3 Replication and virus life cycle ..... 11

        1.3.4 Cell factors interfering with HIV-1 replication..... 15

    1.4    HIV Immunology and Vaccination ..... 17

        1.4.1    Overview of HIV-1 Immunology

                1.4.1.1 HIV vs Innate immunity ..... 17

                1.4.1.2 The adaptive T cell response to HIV-1 ..... 18

                1.4.1.3 The antibody response ..... 19

                1.4.1.4 Obstacles to an efficient vaccine..... 19

                1.4.1.5 Goals of a successful vaccine..... 19

        1.4.2    Strategies used to develop HIV Vaccines ..... 20

                1.4.2.1 Live attenuated vaccines ..... 20

                Heat/chemical inactivated vaccines ..... 20

## Table of Contents

---

1.4.2.2 Subunit Vaccine .....	20
1.4.2.2.1 Recombinant Protein subunit vaccines .....	21
Virus like particle (VLPs) .....	21
1.4.2.2.2 Synthetic Peptide .....	21
1.4.2.3 DNA vaccine.....	22
1.4.2.4 Recombinant viral vector vaccines.....	22
1.4.3 Clinical Trials phase IIb and phase III trials .....	23
1.4.3.1 VAX003/VAX004 .....	23
1.4.3.2 Mrk/ STEP -HVTN502/ & HVTN503 –Phambili study .....	23
1.4.3.3 RV144 .....	23
1.4.3.4 HVTN505.....	23
1.4.4 Development of innovative HIV vaccines in our lab.....	24
1.4.5 Cytokines as adjuvants .....	25
1.5 SIV and SHIV as NHP models for HIV. ....	27
1.5.1 SIVs as challenge viruses .....	27
1.5.2 SHIVs as challenge viruses.....	27
1.5.3 The importance of a CCR5 tropic challenge virus.....	28
1.5.4 The need of novel development of a T/F CCR5 clade C envelop in a challenge virus.....	28
1.6 Antiretroviral drugs and HIV-1 Latency.....	29
1.6.1 ART- Antiretroviral drugs.....	29
1.6.2 Latency and Persistence .....	29
1.6.2.1 Pre-integration latency:.....	29
1.6.2.2 Post-integration latency: .....	30
1.6.2.3 Persistence .....	31
1.6.3 Mechanism of post integration latency .....	31
1.6.3.1 Integration site and orientation .....	31
1.6.3.2 Chromatin Remodeling.....	31
1.6.3.3 Host transcription factors and viral latency .....	32
1.6.3.4 Elongation factors and viral latency .....	34
1.6.3.5 Tat feedback and viral latency.....	35
1.6.3.6 Post transcriptional mechanism of latency-the micro RNA (miRNA).....	36
1.6.4 Reservoirs, types of cells and anatomical reservoirs .....	37
1.6.5 Current models to study latency .....	37
1.6.5.1 Primary cell models of latency .....	38

## Table of Contents

---

---

1.6.5.2 Humanized mouse models .....	38
1.6.5.3 Non-human primate (NHP) model .....	39
1.6.5.4 Experimental approach to detect the latently infected cells <i>in vivo</i> .....	39
1.6.5.4.1 Detecting the integrated HIV-1 DNA and Cell associated RNA .....	41
1.6.5.4.2 Detecting cells carrying the replication- competent virus/ Assay to measure the latent reservoir .....	41
1.6.6 Prospects for treatment of latency .....	44
1.6.6.1 ART intensification.....	44
1.6.6.2 Using transcriptional inhibitors to control the HIV-1 progression .....	44
1.6.6.3 Strategies to reactivate latent provirus from reservoirs (“Flushing out”/ “Shock and Kill”) 45	
1.6.6.4 Strategies based on the increasing apoptosis susceptibility .....	46
1.6.6.5 Other therapies targeting latency .....	46
1.6.6.6 Challenges in treatment of latency .....	46
1.7 Natural History of CAEV.....	47
1.7.1 Discovery and Epidemiology .....	47
1.7.2 Genomic Organization .....	48
1.7.3 Tropism & Target cells.....	48
1.7.4 Pathogenesis .....	48
<b>Chapter 2- Materials and Methods.....</b>	<b>49</b>
2.1 Materials.....	49
2.1.2 Plasmids.....	49
2.1.2.1 Cloning Vector .....	49
2.1.2.2 Infectious molecular plasmid genomes.....	49
2.1.3 Chemicals Buffers and Reagents. ....	51
2.1.3.1 Microbiology reagents.....	51
2.1.3.2 Bacterial Growth Media .....	51
2.1.3.3 LB Agar Plates .....	51
2.1.3.4 SOC Medium.....	51
2.1.3.5 Molecular Biology Reagents .....	51
2.1.3.5.1 Reagents for restriction enzyme digestions.....	51
2.1.3.5.2 Reagents for DNA modifications .....	51
2.1.3.5.3 Reagents for PCR .....	52
2.1.3.7 Buffers for Plasmid DNA isolation .....	52

## Table of Contents

---

---

2.2	Microbiology Methods.....	52
2.2.1	Growth and storage of bacterial strains.....	52
2.2.2	Transformation by heat shock method.....	53
2.2.2.1	Transformation protocol for JM109 and Stable -2 competent cells.....	53
2.2.2.2	Transformation protocol for dam-/dcm- Competent E. coli cells.....	53
2.2.3	Isolation of Plasmid DNA.....	53
2.2.3.1	Mini preparation of plasmid DNA (10-15 µg).....	53
2.2.3.2	Midi preparation of plasmid DNA (200-500 µg).....	54
2.2.4.	DNA Quantification.....	54
2.2.6	Extraction and Purification of PCR products / DNA from agarose gel.....	55
2.3	Molecular Biology and Cloning.....	55
2.3.1	Polymerase Chain Reaction (PCR).....	55
2.3.2	Restriction enzyme digestion.....	56
2.3.3.	DNA Modifications.....	57
2.3.3.1	Dephosphorylation of DNA 5'.....	57
2.3.3.2	Klenow.....	57
2.3.3.3	T4 DNA polymerase.....	57
2.3.4	Ligation.....	57
2.3.5	DNA precipitation by ethanol.....	57
2.3.6	DNA Sequencing.....	58
2.3.7	Oligonucleotides -Primers Used.....	58
2.3.7.1	Oligonucleotides used for PCR.....	58
2.3.7.2	Oligonucleotides for site directed mutation.....	59
2.3.7.3	Primers for whole genome sequencing of the CAL-SHIV-IN <sup>+</sup> .....	59
2.3.7.4	Primer pairs used for introducing restriction sites for cloning.....	60
2.4	Cell Culture.....	61
2.4.1	Media and Reagents.....	61
2.4.1.1	The media were purchased from Eurobio or Thermo Fisher Scientific.....	61
2.4.1.2	The antibiotics and supplements used were purchased from EuroBio.....	62
2.4.1.3	Transfection reagents:.....	62
2.4.1.4	X-gal staining solution:.....	62
2.4.1.5	PFA stock solution 20%.....	62
2.4.1.6	Giemsa-May-Grünwald staining reagents.....	62
2.4.2	Cell lines.....	62

## Table of Contents

---

2.4.3 Transfection of plasmid DNA into HEK-293T cells or TZM-bl cells.....	64
2.4.3.1 Liposome mediated transfection: .....	64
2.4.3.2 Calcium Phosphate mediated transfection .....	64
2.4.4 Infection of cell lines.....	64
2.4.5 TZM-bl and MGG stainings .....	65
2.4.6 Adaptation of viruses to cell lines (cell free and cell associated).....	65
2.4.7 Isolation; activation and infecting the PBMCs .....	65
2.4.8 Titration of viral stocks .....	66
2.4.9 Genomic DNA isolation .....	66
2.4.10 Quantitative analysis of SIV Gag p27 by ELISA .....	66
2.4.11 Virus harvest and storage.....	66
2.5 Cloning strategies used for Molecular virology.....	66
2.5.1 Construction of CAL-SHIV-IN <sup>+</sup> .....	66
2.5.1.1 Cloning of synthetic vif gene .....	67
2.5.1.2 Site directed mutagenesis to exchange the mutated vif.....	67
2.5.1.3 Introducing the polypurine tract (PPT) of CAEV.....	67
2.5.2 Construction of the SHIV-YCC.....	68
2.5.3 Construction of the CAL-SHIV-IN <sup>-</sup> .....	68
2.5.3.1 Construction of the CSH-DIN and introduction of an AgeI site and “Kozak” re-initiation spaced sequence .....	68
2.5.3.2 Construction steps to introduce functional vif and env .....	69
2.5.3.3 Construction of CSH-DIN-eGFP.....	69
2.5.3.4 Construction steps to introduce missing 60bp of <i>RNaseH</i> .....	69
2.5.3.5 Construction of CSH-DIN with the IRES eGFP (under construction).....	70
2.5.4 Construction of CSH-DIN with Transmitted/Founder (T/F) Env & WARO Env .....	70
2.5.5 Construction of SHIV-AD8EO with Transmitted/Founder Envelopes.....	71
2.5.6 Construction of the SHIV <sub>-KU2</sub> with WARO Envelope using Gibson Assembly .....	71
<b>Thesis Objectives.....</b>	<b>72</b>
<b>CHAPTER 3- RESULTS .....</b>	<b>74</b>
PART I- The CAL-SHIV-IN <sup>-</sup> Vaccine Construct and derivatives .....	74
3.1 The CAL-SHIV-IN <sup>-</sup> vaccine prototype .....	74
3.1.1 Construction of the CSH-DIN .....	74
3.1.1.1 Strategies and molecular construction of CSH-DIN vaccine.....	74
3.1.2 Construction of the CSH-DIN expressing eGFP.....	76



## Table of Contents

---

3.1.2.1 Introduction of eGFP coding sequences at the AgeI site .....	76
3.1.3 CSH-DIN constructs with T/F envelopes.....	77
3.1.3.1 Molecular biology and construction of the CSH-DIN with T/F envelopes.....	77
3.1.3.2 <i>In cellulo</i> studies of the CSH-DIN with T/F envelopes.....	78
3.1.3.2.1 The CSH-DIN-T/F-31, CSH-DIN-T/F-18, CSH-DIN-T/F-78, CSH-DIN-WARO vaccine prototypes produce single-cycle viruses .....	78
3.1.3.2.2 Tropism CSH-DIN-T/F-31, CSH-DIN-T/F-18, CSH-DIN-T/F-78, CSH-DIN-WARO studies on different cell lines .....	79
3.1.3.3 Quantification of Viral protein production (Gag p27 ELISA) .....	79
PART II- Novel replication-competent constructs.....	80
3.2. The replication competent chimeric lentiviruses with CAEV LTRs.....	81
Strategy 1: Construction and analysis of CAL-SHIV-IN <sup>+</sup> & CSH-INP constructs.....	81
Strategy 2: Construction and analysis of the SHIV-YCC construct.....	81
3.2.1. Strategy 1-Molecular biology and construction of the CAL-SHIV-IN <sup>+</sup> and CSH-INP .....	81
3.2.1.1 Strategy to develop the CAL-SHIV-IN <sup>+</sup> construct .....	81
a) The CAL-SHIV-IN <sup>+</sup> .....	81
b) CSH-INP .....	82
3.2.1.2 Checking of the CAL-SHIV-IN <sup>+</sup> .....	84
a) The CAL-SHIV-IN <sup>+</sup> .....	84
3.2.1.3 Site directed mutagenesis to obtain a correct <i>vif</i> gene .....	84
3.2.2 <i>In cellulo</i> studies of the replication competency of the CAL-SHIV-IN <sup>+</sup> and CSH-INP vectors. Production and infectivity of the viruses .....	85
The CAL-SHIV-IN <sup>+</sup> .....	85
3.2.3- Adaptation on different cell lines.....	87
3.2.4- Adaptation on monkey PBMCs .....	88
3.3- Strategy 2- Construction of the SHIV-YCC replication competent virus .....	90
3.3.1 <i>In cellulo</i> studies of the SHIV-YCC.....	92
3.3.1.1 Production of viruses and infection .....	92
3.3.1.2 Adaptation to different cell lines.....	93
3.3.1.3 Adaptation to monkey PBMCs .....	93
3.3.1.4. Quantification of Viral production .....	93
b) Real-Time Quantitative Reverse Transcription PCR.....	94
PART III- Novel SHIVs containing primary envelopes.....	94
3.4 SHIV-WARO .....	94
3.4.1 Constructions of the SHIV-KU2/WARO .....	94

## Table of Contents

---

---

3.4.2 Quantification of Gag p27 viral production.....	95
3.5 SHIV-AD8EO with T/F Clade C envelope & SHIV-KU2 with WARO envelope .....	96
3.5.1 Constructions of the SHIV-AD8EO-T/F .....	96
3.5.2 <i>In cellulo</i> studies of the SHIV-T/F.....	97
3.5.2.1 Transfection and infection .....	97
3.5.2.2 Tropism studies on different cell lines .....	97
<b>Chapter 4- Discussion and Future Prospects .....</b>	<b>99</b>
4.1 The Single Cycle Replication Competent Vaccine .....	99
4.1.1 Prospects for a Single Cycle Replication Competent Vaccine .....	101
4.2 The replication competent constructs to study host/virus interactions involved in latency and persistence the development of a SHIV for experimental infection studies. ....	103
a) CAL-SHIV-IN <sup>+</sup> .....	104
b) CSH-INP .....	105
c) SHIV-YCC .....	106
4.2.1 Prospects of the CSH-INP and SHIV-YCC replication competent constructs.....	106
4.3 SHIV-AD8EO with T/F Envelops .....	108
Prospects of the SHIV-AD8EO T/F .....	109
<b>Conclusion .....</b>	<b>110</b>
<b>APPENDIX .....</b>	<b>111</b>
<b>Thesis References.....</b>	<b>112</b>
<b>The Review- Comparative Analysis of Tat-Dependent and Tat-Deficient Natural Lentiviruses. ....</b>	<b>147</b>
<b>Bose, D.; Gagnon, J.; Chebloune, Y. Vet. Sci. 2015, 2, 293-348. ....</b>	<b>147</b>

## **List of Abbreviations**

AIDS -Acquired Immune Deficiency Syndrome  
AP1- activator protein-1  
ART- Anti-retroviral therapy  
APOBEC-3G- Apolipoprotein B mRNA-editing enzyme, catalytic polypeptide-like 3G  
BIV- Bovine immunodeficiency virus  
CIP- Calf Intestinal Phosphatase  
CA -Capsid  
CAEV-Caprine arthritis encephalitis virus  
CCR5 – C-C Chemokine receptor 5  
COUP: Chicken ovalbumin upstream promoter  
CTIP2 -COUP-Transcription factor Interacting Protein 2  
CBF-1-C-promoter binding factor-1  
CDK9-Cyclin dependent kinase 9  
CycT1-Cyclin T1  
CMV-Cytomegalovirus  
DCs -Dendritic cells  
DMSO -Dimethyl Sulfoxide  
DSIF-DRB sensitive inducing factor  
ERV-Endogenous retroviruses  
EIAV-Equine infectious anemia virus  
FBS-Fetal Bovine Serum  
FIV-Feline immunodeficiency viruses  
FIs-Fusion inhibitors  
HP1-Heterochromatin protein1  
HMBA-Hexamethylene bicetamide  
HAART- Highly active anti-retroviral drugs  
HDAC-Histone deacetylase  
HIV-1-Human immunodeficiency virus type-1  
HTLV-III-Human T Lymphotropic virus  
H3K9me3-Histone 3 lysine 9 trimethylation  
IN- Integrase  
INSTIs-Integrase inhibitors  
IFNs-Interferons  
IPTG -Isopropyl-beta-D-thiogalactopyranoside  
JDV-Jembrana Disease Virus  
LEDGF/p75-Lens Epithelium-derived Growth factor  
LB medium-Luria- Bertani medium  
LSD1-Lysine-specific demethylase  
M-CSF-Macrophage colony stimulating factor  
MVV-Maedi Visna Virus

## Abbreviations

---

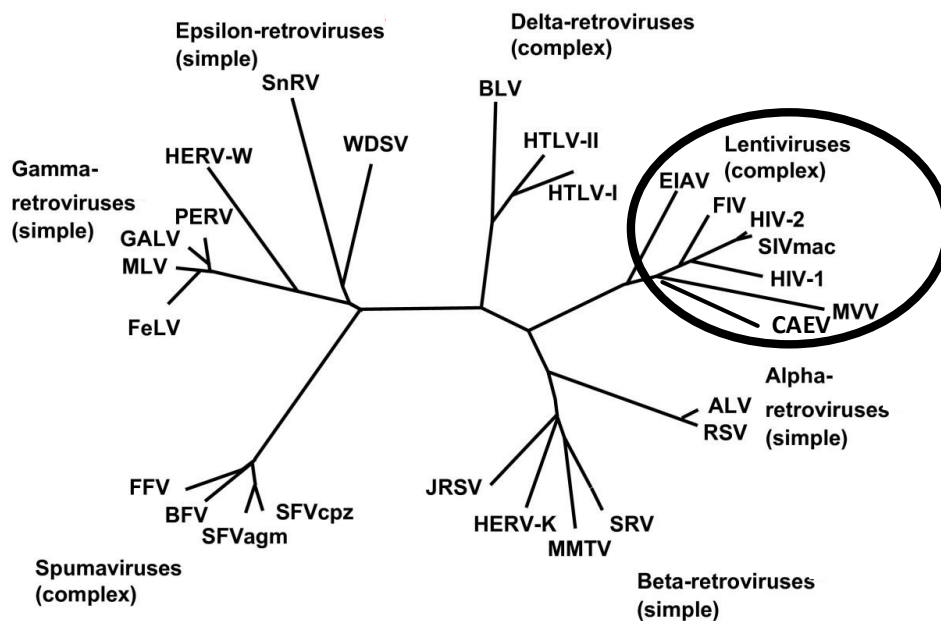
MPER -Membrane proximal external region  
mMQ H<sub>2</sub>O-Milli Q water  
MVA-Modified Vaccinia Ankara  
NK-Natural killer cells  
NELF-Negative elongation factor  
NTEF-Negative transcription elongation factor  
NHP-Non human primate  
NNRTIs-Non-nucleoside reverse transcriptase inhibitors  
NFAT-Nuclear factor of activated T cells  
NRTIs-Nucleoside reverse transcriptase inhibitors  
OvLV-Ovine Lentiviruses  
PAMPs-Pathogen associated molecular patterns  
PFA-Paraformaldehyde  
PHA-Phytohemagglutinin  
pDCs-Plasmacytoid Dendritic Cells  
PPT-PolyPurineTract  
PBLs-peripheral blood lymphocytes  
PBMC-peripheral blood mononuclear cells  
P-TEFb-Positive transcription elongation factor b  
PIC-Pre integration complex  
PR-Protease  
PIs-Protease inhibitors  
QVOA-Quantitative viral outgrowth assay  
RM-Rhesus macaque  
RNP -Ribonucleoprotein complex  
RRE -Rev Response Element  
RT- Reverse transcriptase  
SCID mice -Severe combined immunodeficient  
SHIV-Simian-human immunodeficiency virus  
SRLV-Small Ruminant LentiVruses  
SAMHD1-Sterile alpha motif and histidine/aspartic acid-domain containing protein  
TREX -Three prime repair exonuclease 1  
TILDA - Tat/Rev Induced Limiting Dilution Assay  
TLR-Toll-like receptors  
tRNA-Transfer RNA  
T/F-Transmitted Founder  
TRIM5 $\alpha$  -Tripartite motif protein 5-alpha  
TNFs -Tumor necrosis factor

## Chapter 1- Review of Literature

### 1.1 Lentiviruses of Human and Animals

#### 1.1.1 Retroviruses

*Retroviridae* are a family of small-enveloped RNA viruses that infect vertebrates. The viral genome is a positive strand RNA characterized by the presence of the virus-encoded enzymes reverse transcriptase (RT) and integrase (IN). These enzymes are key components for reverse transcription of RNA genome to double-stranded DNA and insure the integration into the host genome. The *Retroviridae* family has two subfamilies, the *Orthoretrovirinae* and the *Spumaretrovirinae*. In the subfamily *Orthoretrovirinae*, there are six genera: *Alpharetrovirus*, *Betaretrovirus*, *Deltaretrovirus*, *Gammaretrovirus*, *Epsilonretrovirus*, and *Lentivirus*. While in the *Spumaretrovirinae* subfamily there is only one genus *Spumavirus* as shown in the Figure 1.1.



**Figure 1.1:** Phylogenetic tree of the Retroviridae family. The figure is adapted from [1].

One cardinal property of the *Retroviridae* family is their capacity to insert their genomes irreversibly into that of the host, to insure productive replication and persistence of infection. Integration of retroviral genomes into the germline genome of vertebrates, leads to endogenous retroviruses (ERV) that are transmitted vertically to the offspring. The human genome comprises about 8% of its sequence originating from retroviruses. They are called Human endogenous retroviruses (HERVs) [1,2].

Other members of the *Retroviridae* family carry one or more oncogene that originated from the host cell genome [3]. The first identified retroviral oncogene was *src* from the Rous

sarcoma virus, a tumorigenic virus of chicken. Many other retroviral oncogenes such as *myc*, *ras*, *erbB* and *PI3K*, etc have been identified and found to be associated with cancer [3]. Delta retroviruses include the human T-cell lymphotropic viruses HTLV-I and HTLV-II which cause T-cell leukemia/lymphoma and a demyelinating disease called tropical spastic paraparesis in a relatively small percentage of infected humans.

### 1.1.2 Lentiviruses

Members of the lentivirus genus are characterized by slow progression of induced disease in infected hosts. This genus is of particular interest as it contains a variety of viruses, some of them are associated with increased virulence causing lethal immunodeficiency, but others are more attenuated and do not cause immunodeficiency.

The viruses that cause immunodeficiency are: Bovine immunodeficiency virus (BIV) and Jembrana Disease Virus (JDV) that infect cattle, Feline immunodeficiency viruses (FIV) which infect domestic and wild cats, Human immunodeficiency viruses type-1 (HIV-1) and type-2 (HIV-2) infecting humans, and a large number of viruses grouped under simian immunodeficiency viruses (SIV) which infect various species of monkeys. Lentiviruses that do not induce immunodeficiency are: Small Ruminant LentiViruses (SRLV) including the prototypic Maedi Visna Virus (MVV) or Ovine Lentiviruses (OvLV) that infects sheep and Caprine arthritis encephalitis virus (CAEV) that infects goats and finally Equine infectious anemia virus (EIAV) which infects and cause disease in equines.

There are many characteristics, which distinguish the non-immunodeficiency-inducer (SRLVs) lentiviruses from those responsible for immunodeficiency (HIV/SIVs) in their hosts. One of them is the simplicity of genome organization in SRLVs compared to that of HIV-1. The complex genome of HIV-1 encodes Gag, Pol and Env common to all retroviruses and in addition, it encodes six open reading frames, Tat and Rev are called regulatory proteins and Nef, Vpr, Vpu and Vif are called accessory proteins. While the SRLV genome encodes a single regulatory protein, Rev and two accessory proteins Vif and Vpr-like. The second main property of MVV, CAEV and EIAV is their inability to infect and cause depletion of CD4<sup>+</sup> T cells [4].

### 1.1.3 Timeline of Lentivirus discovery

Disease associated with EIA was first described in 1843 in France by Ligné [5]. It was associated with a “filterable agent” in 1904 [6], which made EIA the first animal disease to be associated with viruses [7]. The next description of disease associated with lentivirus infection, was in sheep reported by Mitchell in 1915 in South Africa and it was termed ovine progressive pneumonia and the virus was named ovine progressive pneumonia virus (OPPV) [8]. Later in 1923, Montana described the disease as chronic interstitial pneumonia causing wasting and death of affected sheep [9]. The appearance of MVV emerged in a local breed in Iceland after the import of asymptomatic Karakul rams from Germany in 1933[10]. This has resulted in large epidemics (1944-1952) ending by the slaughtering of hundreds of thousands

of affected animals to eradicate the disease, and since 1965 Iceland is free from the disease [10,11]. Disease associated with CAEV was reported in late 1950s in adult goats in Switzerland [12], and then in Germany [13]. Dr L. Cork has conducted extensive studies in 1970s in the USA to characterize the physiopathology of disease and isolate the pathogenic agent [14]. BIV was identified by C. Seger in 1969 while searching for the etiological agent Bovine Leukemia, BIV was isolated by Van Der Maaten, the initial R29 BIV isolates were described as visna-like virus due to the similarities to ovine lentiviruses [15].

## **1.2 Natural History of HIV-1**

### **1.2.1 Discovery of AIDS and the causative agent HIV**

HIV-1-induced Acquired Immune Deficiency Syndrome (AIDS) was clinically observed in 1979, when homosexual men in Los Angeles, CA in USA, were reported with rare tumors and opportunistic infections, like Kaposi sarcoma and pneumonia associated with *Pneumocystis carinii*, along with reduced CD4+ T lymphocytes [16,17]. HIV-1 was isolated by Montagnier and Barré-Sinoussi's lab at the Pasteur Institute in Paris in 1983, and was first named lymphadenopathy-associated virus (LAV). A separate research group led by Dr. Gallo also isolated the same virus in 1983 and named it as Human T Lymphotropic virus (HTLV-III); in 1986 the virus was renamed as HIV [18]. HIV-2 was isolated in 1986 from west Africa [19]

### **1.2.2 Epidemiology and Geographic distribution**

It is well established now that HIV-1 and HIV-2 are a result of zoonotic transmission of the pathogens from simians to humans. HIV-1 strains have their origin from SIVcpz of chimpanzees and SIVgor of gorillas and HIV-2 stems from SIVsmm of Sooty mangabey [20-22]. HIV-1 had been repetitively crossing the species barrier, causing infection and subsequent adaptation into human cells to ultimately emerge as highly replication-competent, transmissible virus strains [23,24]. The different independent cross species transmissions led to four phylogenetic lineages of HIV-1 (M, N, O and P). The naturally infected chimpanzees with SIVcpz from South Cameroon led to the cross species transmission of M and N groups of HIV-1 [25,26], while the west lowland SIVgor-infected gorillas were associated with the cross species transmission of the O group [27]. Groups N, O, and P are confined to West Africa while group M causes the worldwide pandemic. This group was further divided in subgroups, "clades" A-D, F-H, J and K. The clade C is dominant in Africa and India accounting for 56% of the overall people living with HIV worldwide (UNAIDS). Clade B dominates in Western Europe, America, Australia. However, circulation of recombinants of different subtypes has also been observed. HIV-2 is less transmissible and its induction of disease progresses slowly, it is confined to West Africa [24].

According to the 2015 World Health Organization (WHO) and United Nations Program reports on HIV/AIDS (UNAIDS), since the start of the epidemic, 71 million people have been infected, 34 million people have died and 36.9 million people are currently living with HIV.

Anti-retroviral therapy (ART) / highly active anti-retroviral therapy (HAART) are now been accessed by 17 million infected people.

The brunt of the epidemics is in sub Saharan Africa where one in every 20 adults (17.2 million) is living with HIV accounting for nearly 70% of the HIV burden worldwide. Additional geographic dissemination of HIV is as follows: Asia and Pacific (4.7 million), Eastern Europe and central Asia (1.0 million), Latin America and the Caribbean (1.8 million), Middle East and North Africa (190,000), Western and Central Africa (6.3 million), Western and Central Europe and North America (2.1 million) (Global AIDS update 2016). Sobering also are the observations that the rate of new infection (2.1 million worldwide) has not diminished in the last 3 years.

### **1.2.3 HIV-1 Transmission**

HIV is transmitted through exchange of contaminated (infected) body fluids such as blood, semen, vaginal fluids, rectal fluids, breast colostrum and milk. Mother to child transmission takes place primarily during delivery but also *in utero* and *via* post-natal breast feeding [28]. The risk of sexual transmission is correlated with the plasma viral load (number of HIV RNA virus copies per ml of plasma) of the donor. Every  $\log_{10}$  increase in viral load is associated with a 2.4x increase of risk of virus transmission [29]. Therefore, the risk is highest during the acute phase of infection when the viral loads are high and the host immune responses have not yet been elicited [30]. Many other factors can influence the transmission, like host factors that decrease or increase susceptibility to infection including but not limited to increased target cell availability due to mucosal inflammation, altered mucosal microbiota, physical barriers, and genetic make-up of the host (see section 1.3.4 for cell factors interfering with host replication). Of interest, while infected individuals produce a swarm of viruses with high genotypic and phenotypic diversities, its influence on transmission still remains unclear. The transmission across intact mucosal barriers is inherently inefficient, representing a viral selection bottleneck allowing only select most often single virus to efficiently transmit (see section 1.2.4) [31].

### **1.2.4 Transmitted Founder (T/F) virus**

During mucosal transmission, 80-90% of the heterosexual transmissions of HIV-1 are initiated with a single virus genotype selected during mucosal transmission to the recipient partner from the diverse swarm of viruses from the chronically infected donor [32]. This is characterized by a genetic bottleneck that selects a single viral variant transmitted/founder. The unifying characteristics of T/F viruses are the usage of CCR5 as the coreceptor and a predominance of shorter and less glycosylated Env proteins [32]. These viruses are also generally resistant to innate interferon- $\alpha$  response and have enhanced interaction with dendritic cells [31].



### 1.2.5 Tropism / Target cells

The primary target cells for HIV-1 are the CD4<sup>+</sup> T lymphocytes, expressing chemokine receptors CCR5 or CXCR4 used as co-receptors for HIV-1 entry. During the initial phases of infection, HIV-1 targets CD4<sup>+</sup> cells that express the CCR5 co-receptors [33] though passage of virus from antigen presenting cells such as dendritic cells to T cells may contribute to transmission. In addition to CD4 T cells, monocytes differentiated into macrophages in different organs (microglia in CNS; Kupffer cells in the liver, Gut associated macrophages of *lamina propria* in GIT, alveolar and interstitial macrophages in lungs) [34], dendritic cells (myeloid, Langerhans, plasmacytoid), epithelial cells, can also be targeted by the HIV-1. In the late stages of the infection, there is a switch in the co-receptor usage from CCR5 to CXCR4, resulting of HIV-1 productive replication mainly in CD4<sup>+</sup> T cells expressing the CXCR4 co-receptor [33].

*More detailed information about the HIV-1 tropism is covered in section 3.6 and section 5, of our published review enclosed at the end of this manuscript.*

### 1.2.6 Pathogenesis

The rate of disease progression after the initial infection depends on a number of host viral factor interactions. However, initially three phases of infection were considered: The first phase is the **acute primary infection** associated with transient flu-like illness and seroconversion; This phase is now further parsed in Fiebig stages I-VII [35]. The **second phase is a clinically “asymptomatic phase”** during which there is a balance between antiviral immune responses and viral replication characterized by a relatively stable level of viremia and chronic immune activation. **The third phase** in the absence of HAART corresponds to the development of **AIDS** with marked CD4 loss (<200/ul of blood) increased viral loads and opportunistic infections.

#### **Acute primary phase:**

The acute phase of the HIV-1 infection has been described [36]. Mucosal transmission studies in the female reproductive tract revealed that within 48 hrs, the virus has passed across the mucosal barrier and is found in the local draining lymph nodes [37]. Within 24-48 hrs of transmission of the founder virus, a rapid replication and then striking induction of inflammatory cytokines and chemokines (alpha interferon IL-15, inducible protein 10, tumor necrosis factor alpha and monocyte chemotactic protein 1 are observed with more protracted increases in levels of IL-6, IL-8, IL-18 and gamma interferon [38,39]. In this phase, the viral replication augments exponentially, with a production of up to 10 billion virions/day and the concentration of the HIV RNA can reach 10<sup>7</sup> copies/ml of plasma [40,41].

Within 4-7 days after infection there is a rapid depletion of at least 30%-60% of the mucosal memory CD4<sup>+</sup>T cells in macaques infected with SIV [42-44]. The gut associated lymphoid tissues (GALT) harbor 40-80% of all T cells in the body [45,46] and faces the brunt of the viral replication [47,48]; this site predominately contains memory CD4<sup>+</sup>/CCR5<sup>+</sup> T cells

[49,50]. Within 1-3 weeks of infection, clinical symptoms appear; they include headache, low to high grade fever, muscle ache, retro-orbital pain, swollen lymph nodes, macular erythematous rash involving trunk and later extremities. In acutely infected individuals pneumonitis, diarrhea, gastrointestinal complaints may occur [36]. This stage lasts around three weeks although lymphadenopathy, lethargy and malaise can persist longer than a month [36]. During the acute phase (Figure 1.2 A) the CD4 count decreases rapidly during the first 1-4 weeks and then reaches a set point. In case of intravenous transmission, the virus is disseminated rapidly in the body due to absence of any selective barrier. The virus seeds the thymus, spleen, peripheral lymphoid organs, and mucosal lymphoid tissues with peak of viremia at 10-14 days post infection.

Fiebig stages are important in classifying the acute HIV infection from stages I-VI which categorize patients based on the sequential gain in positive HIV-1 clinical diagnostic assays (viral RNA measurement, p24, p31 antigen measured by ELISA, HIV-1 specific antibodies detected by ELISA/western blot) figure 1.2 C.

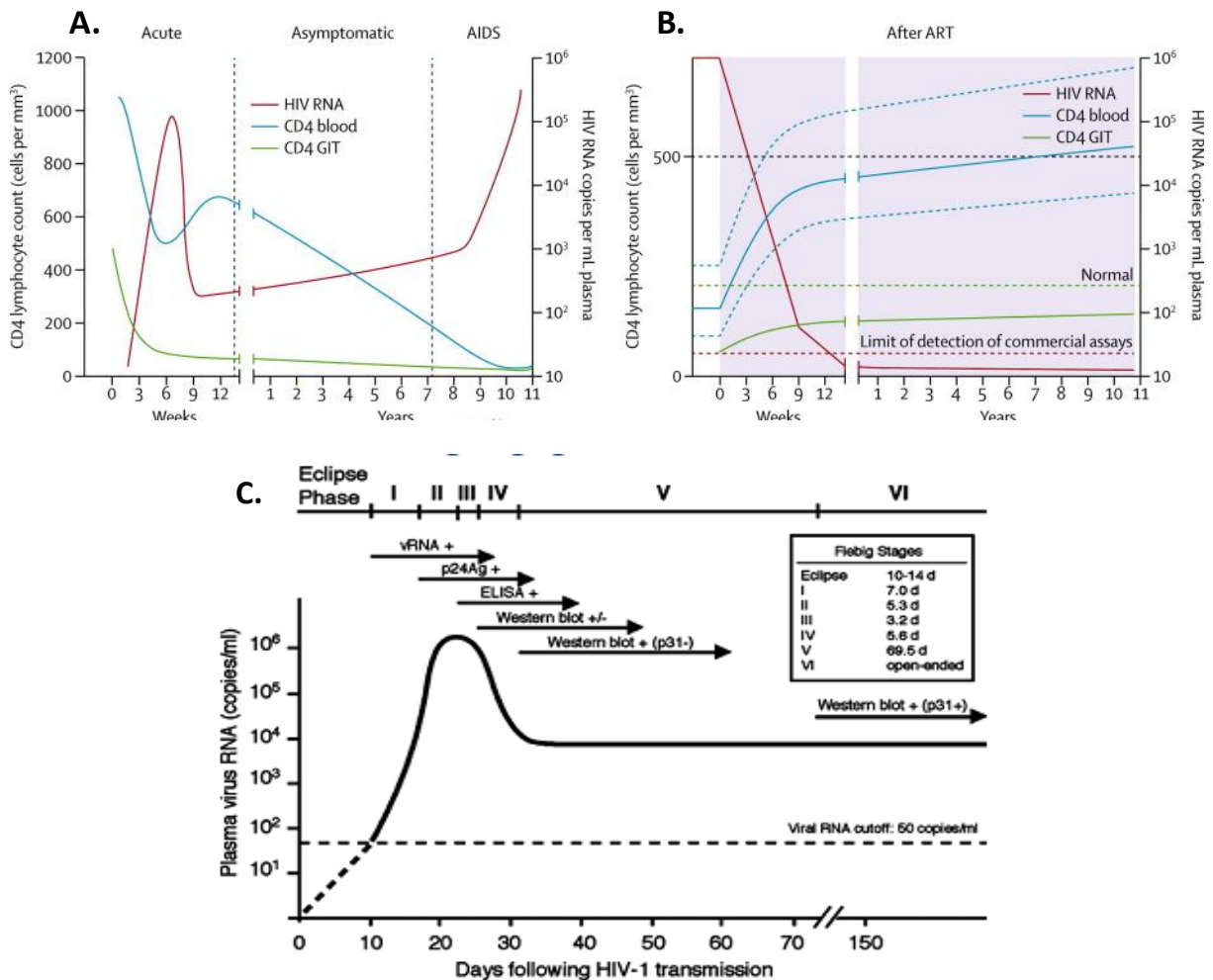


Figure 1.2. Natural history of HIV-1 infection in untreated (A) and changes after antiretroviral therapy (B) of infected individuals. Adapted from Lewin et al., 2014 [30] (C) Fiebig Staging of acute HIV-1 infection is a classification system used to divide the HIV-1 acute infection

phase into different clinical stages based on the stepwise gain in positivity for the detection of HIV-1 antigen and HIV specific antibody by diagnostics.

### **Asymptomatic phase / chronic infection**

Two to six months post infection a steady viral load set point is reached in plasma which represents a balance between the viral replication and the antiviral response. The CD4+T lymphocytes stabilize at around 350-800 cells/ $\mu$ l [51,52]. HIV-1 is active and multiplies in the body at this stage, although there may not be clinical manifestation of any disease, the virus can spread from an infected individual to others.

In the absence of HAART, the progression from asymptomatic phase to the full blown AIDS may vary from individual to individual according to their immunological profile.

### **AIDS**

Finally, the CD4 count progressively declines to below 200 cells/ $\mu$ l in a period of six to ten years when clinical manifestations of AIDS appear. These translate into several opportunistic diseases including Herpes zoster, oral hairy leukoplakia, idiopathic thrombocytopenic purpura, Kaposi sarcoma, pneumocystis carini pneumonia and others. Additional symptoms include peripheral neuropathy, HIV associated wasting, Herpes simplex infections, systemic fungal disease, HIV encephalopathy ending in death.

*More detailed information of the HIV-1 pathogenesis is covered in section 3.10 and section 4, of our published review that is attached at the end of the thesis.*

The great majority of patients undergoing first-line regimen of HAART with non-nucleoside reverse transcriptase inhibitors (NNRTIs) or a combination with protease inhibitors or integrase inhibitors, control the viral load to undetectable levels in plasma and a restoration of CD4+ T cells (Figure 1.2). The immunological profile in these patients is similar to the one in non-infected individuals. HAART substantially prolongs the life span of the patients; efficiently decreases virus transmission and has virtually eliminated the progression to AIDS. Second line regimen HAART is used on patients on whom the first-line regimen failed to have virus suppression. [53]. Careful evaluations of patients on HAART have shown that HAART does not resolve the chronic inflammation [54] and immune activation [55]. This has led to a host of novel, slow chronic progressive pathologies including dyslipidemia, cardiovascular disease, neurological disease (HIV-associated dementia) [56], liver disease [57] and have also accelerated aging.

### **HIV Immunological response profile**

There is a large amount of heterogeneity in the response to HIV infection and disease progression in HAART untreated infections, with the following general categories:

- a) Rapid progressors are patients that lose most of their CD4+T cells within less than two years, followed by the manifestation of AIDS. This group comprises individuals with unfavorable genetic backgrounds, the very young and the very old, as well as

individuals subject to other acute and/or chronic ailments that tend to hasten the HIV disease process.

- b) Intermediate progressors, are the large majority of patients which experience a highly variable but progressive loss of CD4+ T cells culminating in the development of AIDS defining illness about 5 to over 10 years post infection.
- c) Long-term non-progressors (LTNP) represent a minority of patients (~5%) who naturally achieve potent and durable, though not necessarily complete control of the viral replication. Plasma viral loads are generally undetectable in these patients and they maintain relatively high numbers of CD4 T cells even if these numbers slowly decrease over time. AIDS if any in these patients tend to take 20 years and more to develop [58,59].
- d) Finally an even smaller percentage of patients termed elite controllers manage to naturally suppress viral loads to levels that are not detectable in plasma for extended periods of time. These patients are not known to progress to AIDS. Recent studies show that in the elite controllers the conventional dendritic cells (cDC) have enhanced abilities to detect the cytosolic HIV-1 replication products, that result in effective IFN secretions [60].
- e) Though not properly infected, another interesting category of individuals are the highly exposed seronegative (HESN), who by all laboratory criteria remain uninfected in spite of repeated exposures. These subjects remain seronegative and viral RNA negative. The mechanisms underlying such phenotype are still puzzling though genetic make-up of the host can definitely contribute to resistance to infection such as the homozygous and heterozygous CCR5- $\Delta$ 32 alleles limiting access to the HIV co-receptor [61]. Approximately 1% the Caucasian population is homozygous for (CCR5- $\Delta$ 32) mutation while 15-20% are heterozygous [62]. Additional genetic correlates of resistance have recently been advanced such as the expression of p21<sup>WAF/CIP1</sup> RNA [63,64], the HIV-1 restriction factor Mx2 interfering with HIV integration [65]. Other studies have suggested that the stimulation of other responses such as those found in the Kenyan sex workers were able to mediate resistance to infection [66], though more work will be needed to fully delineate these various and other mechanisms contributing to this absence of HIV acquisition.

### 1.3 Structure and genetic organization of HIV-1

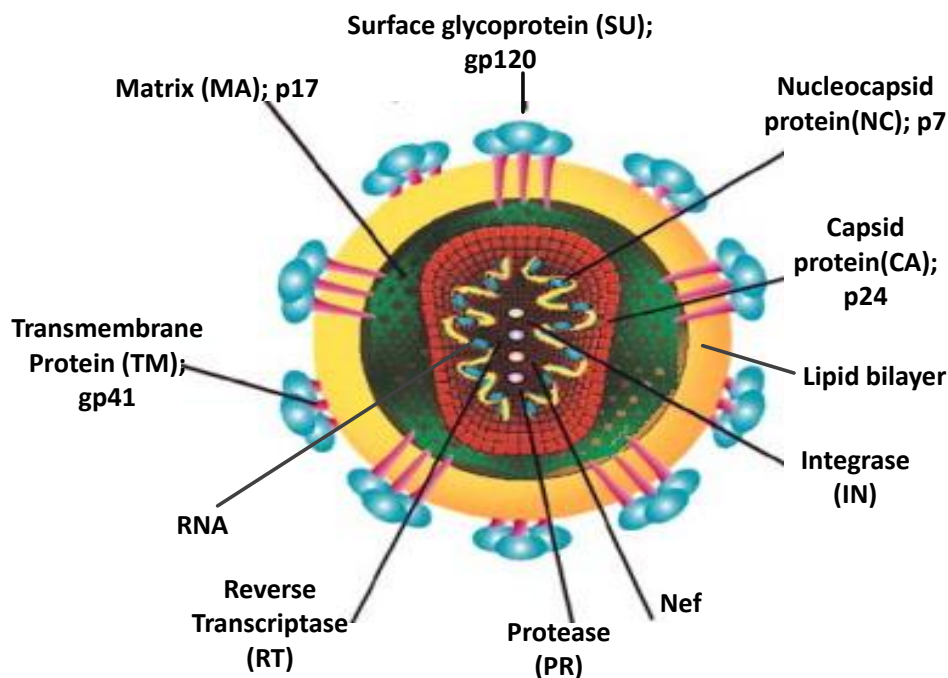
#### 1.3.1 Structure / Morphology of HIV virions

The HIV-1 virion has a spherical morphology 100-120 nm in diameter. It has a truncated cone shaped nucleocapsid (core) surrounded by a lipid bilayer membrane derived from the host cell membrane [67].

The core contains two 9.2 kb copies of the unspliced genomic RNA, with three viral enzymes [protease (PR), reverse transcriptase (RT), integrase (IN)] and viral proteins Vif, Vpr, Nef packaged into the virions with some cellular factors. Rev, Tat and Vpu do not appear to be packaged [68]. [The capsid core particle consists of 2000 copies of the capsid protein (CA, p24) and 2000 copies of nucleocapsid protein (NC, p7) stabilizing the ribonucleic complex (Figure 1.3)] . Surrounding the capsid core is the matrix shell containing around 2000 copies

of the matrix protein (MA, p17). The matrix protein is present at the inner surface of viral membrane[69].

The lipid bilayer contains 78 spikes of the viral envelope glycoproteins that consist of the surface glycoprotein (SU) gp120 and transmembrane (TM) gp41 proteins. SU molecules are exposed on the surface of the virion as trimmers anchored into the membrane via the gp41 transmembrane domain (TM.) The lipid bilayer also contains a vast array of host proteins, including MHC antigens, actin and ubiquitin [70,71] .



**Figure 1.3: Mature HIV-1 virion:** Shown are the surface glycoproteins (cyan), lipid bilayer (yellow), transmembrane protein (violet), matrix protein (green), capsid protein (red), two copies of RNA (yellow strands), along with the viral enzymes and proteins. (adapted from [68]).

### 1.3.2 Genomic organization and proteins

All replication-competent retrovirus genomes contain the classical *gag*, *pol* and *env* genes that encode the virus structural proteins and the viral enzymes. Genomes of lentiviruses further contain the regulatory genes *tat* and *rev* and the auxiliary genes *vif*, *nef*, *vpr* and *vpx* or *vpu*. The regulatory and auxiliary genes may differ depending of the nature of viruses as summarized in table 1.1. SIVmac has a *vpx* but no *vpu* gene (Figure 1.4). Similarly HIV-1 has a *vpu* gene but no *vpx* (Figure 1.4). Properties and functions of encoded viral proteins by these genes are summarized in table 1.2. SRLVs lack a regulatory gene, transactivation factor *tat*, the *tat* gene reported previously [72] was later defined as a *vpr* like factor. The genomes of SRLVs also do not contain *vpu*, *vpx* and *nef* genes.

More detailed information of the HIV-1 Genomic organization is covered in section 2 of our published review that is attached at the end of the thesis.

Table 1.1.- Comparison of different lentiviruses, with infecting host, whether causing/not causing immunodeficiency, viremic, lymphotropic or not and the genomic organization; adapted from [73].

Virus	Host	Immune deficiency	Disease	Lympho tropic	Viremia	Genomic Organization							
						rev	tat	vif	vpr	vpx	vpu	nef	Other ORF
MLV	Rodents	Yes	Yes	Yes	Yes								
HIV-1	Humans	Yes	Yes	Yes	Yes	√	√	√	√		√	√	
HIV-2	Humans	Mild	Mild	Yes	Yes	√	√	√	√	√		√	
SIVMAC	Monkeys	Yes	Yes	Yes	Yes	√	√	√	√	√		√	
SIVAGM	Monkeys	Yes	Yes	Yes	Yes	√	√	√	√			√	
FIV	Cats	Yes	Yes	Yes	Yes	√		√					A
EIAV	Horses	No	Yes	No	Yes, intermittent	√	√						S2
CAEV	Goats and sheep	No	Yes	No	Yes	√		√	√				
Visna virus	Sheep and goats	No	Yes	No	Yes	√		√	√				
BIV	Cattle	No	No	Yes	-	√	√	√					

### HIV-1 genome

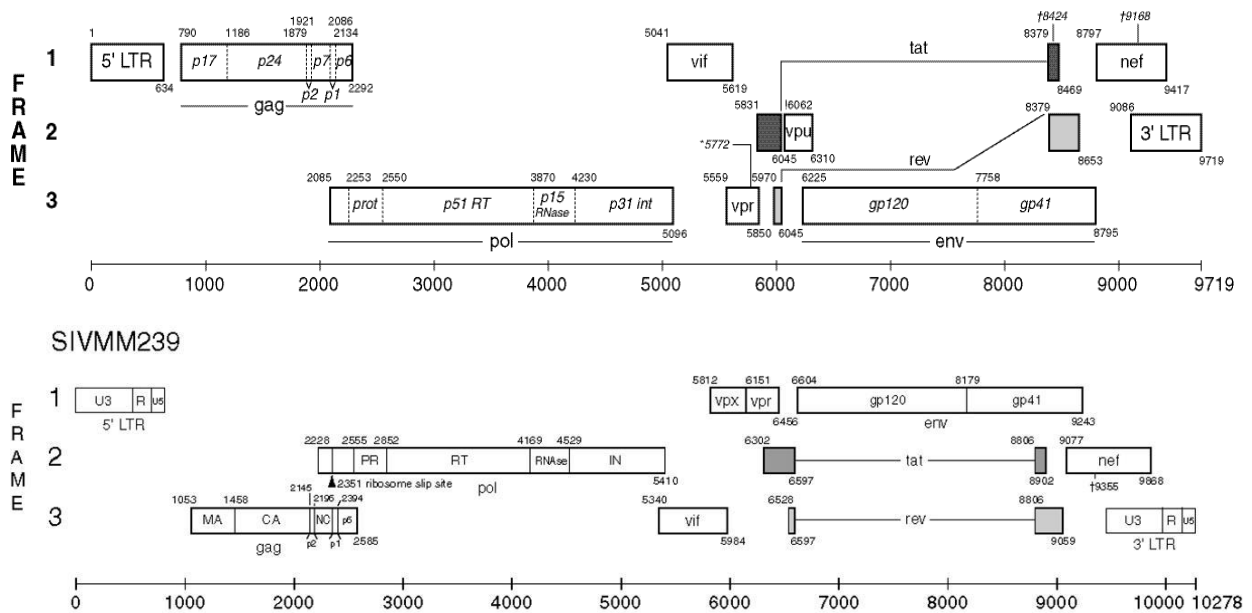


Figure 1.4. Genomic organization of HIV-1 and SIVmm239 viruses. Different open reading frames are shown as rectangles (adapted from Los Alamos).

Table 1.2. The HIV-1/SIV proteins function and localization. The table has been adapted from Los Alamos ([http://www.hiv.lanl.gov/content/sequence/HIV/COMPENDIUM/2015/sequence\\_2015.pdf](http://www.hiv.lanl.gov/content/sequence/HIV/COMPENDIUM/2015/sequence_2015.pdf)).

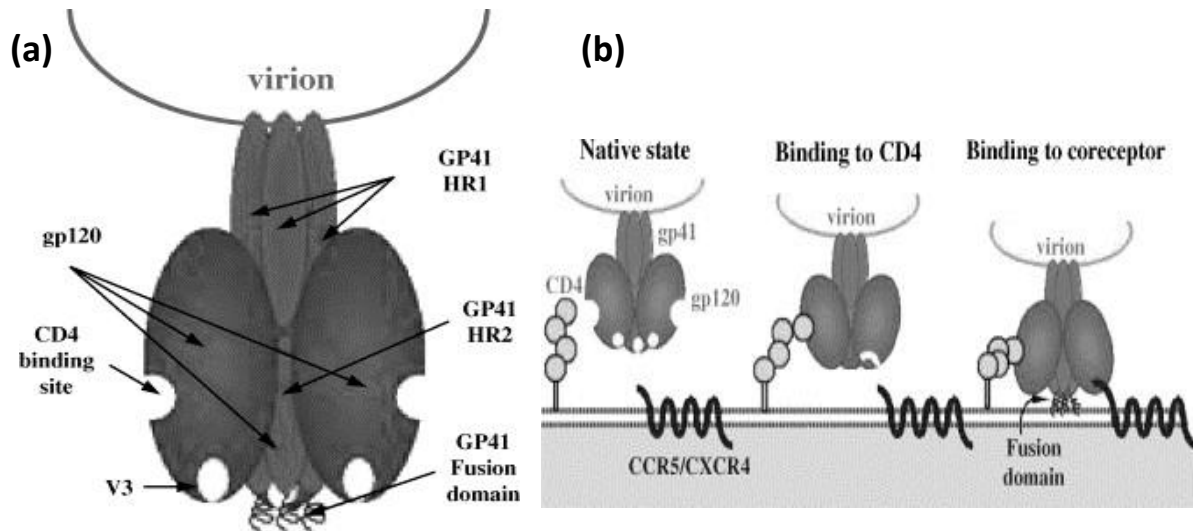
**1.3.3 Replication and virus life cycle**

<b>HIV/SIV viral proteins</b>			
<b>Name</b>	<b>Size</b>	<b>Function</b>	<b>Location</b>
Gag MA	p17	Membrane anchoring; Env interaction; nuclear transport of viral Core (myristoylated protein)	Virion
Gag CA	p24	Core capsid	Virion
Gag NC	p7	Nucleocapsid, binds RNA	Virion
	p6	Binds Vpr	Virion
Protease (PR)	p15	Gag/Pol cleavage and maturation	Virion
Reverse transcriptase (RT)	p66,p51	Reverse transcription	Virion
RNaseH		RNase H activity	Virion
Integrase (IN)		DNA provirus integration	Virion
Env	gp120/gp41	External viral glycoproteins bind to CD4 and chemokine co receptors	Plasma membrane, virion envelope
Tat	p16/p14	Viral transcriptional transactivator	Primarily in nucleolus, nucleus
Rev	p19	Binds RRE, inhibits viral RNA splicing, nuclear transport of RNA, stabilization and utilization factor (phosphoprotein)	Primarily in nucleolus, nucleus: shuttling between nucleolus and cytoplasm
Vif	p23	Viral infectivity factor, promotes minus strand viral DNA hypermutation	Cytoplasm, virion
Vpr	p10-15	Promotes nuclear localization of the preintegration complex, inhibits cell division and arrests infected cell in G2/M phase	Virion, nucleus (nuclear membrane)
Vpu	p16	Promotes extracellular release of viral particle, degrade CD4 in ER. (phospho protein in only in HIV-1 and SIVcpz)	Integral membrane protein
Nef	p27-p25	CD4 and Class-I MHC downregulation (myristoylated protein)	Plasma membrane, cytoplasm
Vpx	p12-16	Vpr homolog present in HIV-2 and SIVs , absent in HIV-1	Virion
Tev	p28	Tripartite tat-env-rev protein	Primarily in nucleolus, nucleus

The replication of HIV-1 can be divided into the early and late phases. The early or afferent phase begins with the recognition of the target cell by the virion until the integration of the proviral DNA into the host chromosomal DNA. The late or efferent phase begins with the transcription of viral RNA and expression of viral proteins from the integrated DNA until the maturation of budded particles into infectious virions [68].

**The Early Phase:** The HIV-1 envelope binds to target cells by using the CD4 as main receptor and CXCR4 or CCR5 as co-receptors (figure 1.5a). The gp120 surface glycoprotein of the virus interacts with the amino-terminal immunoglobulin domain of CD4 receptor on the cell membrane. This recognition induces a conformational change of the gp120 which allows

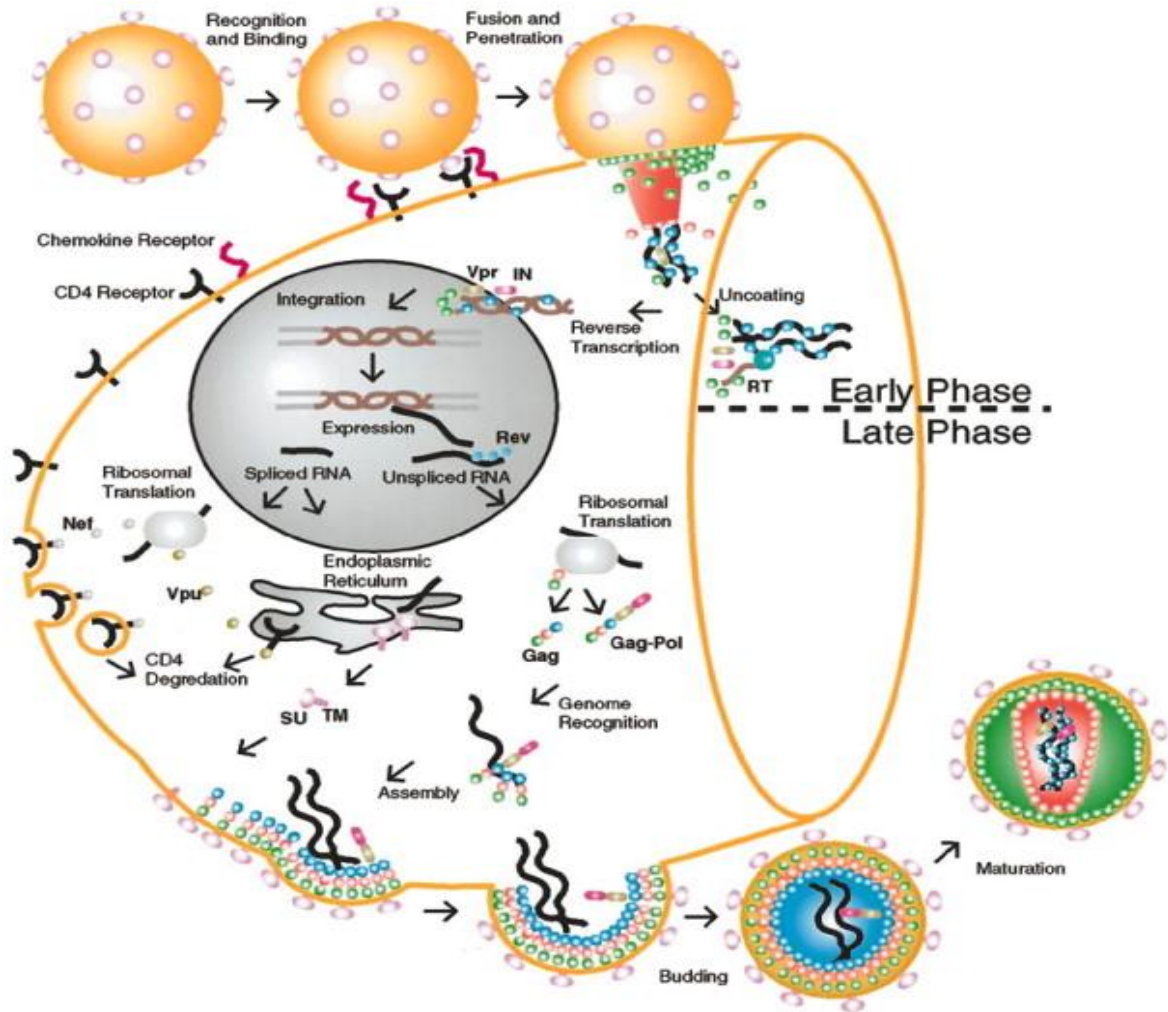
the chemokine receptor CXCR4 or CCR5 to bind to the gp120. This leads to additional conformational changes but now affecting the gp41 structure (figure 1.5 b) [74-77]. The HR1 and HR2 domain of gp41 interact together to form a stable six helix bundle that leads to the viral and cellular membranes fusion and entry of the viral core into the target cell [78].



**Figure 1.5.** (a) Schematic diagram of HIV-1 glycoproteins interaction with target cell receptor/coreceptors. The gp120 on the surface of the virion binds to the CD4-receptor and then to the coreceptor via their respective binding sites. The gp41 HR1 and HR2 have at their extremity the gp41 fusion domain. (b) represents the step by step schematic of the virion binding to the host cell membrane along with the conformational changes in each step (Figure adapted from [71])

After the internalization of the core in the host cell, uncoating takes place, though the exact mechanism for this process is not well known. However, the viral MA, Nef and Vif proteins are known to be involved in the uncoating process in association with cellular factors [79,80]. Concomitantly, the viral enzyme RT reverse transcribes the single stranded viral RNA into a double stranded DNA [79,80] (Figure 1.6). Vif is critical for this step as it counters the cellular antiviral proteins APOBEC3G that can scramble the copy process during reverse transcription [81,82].

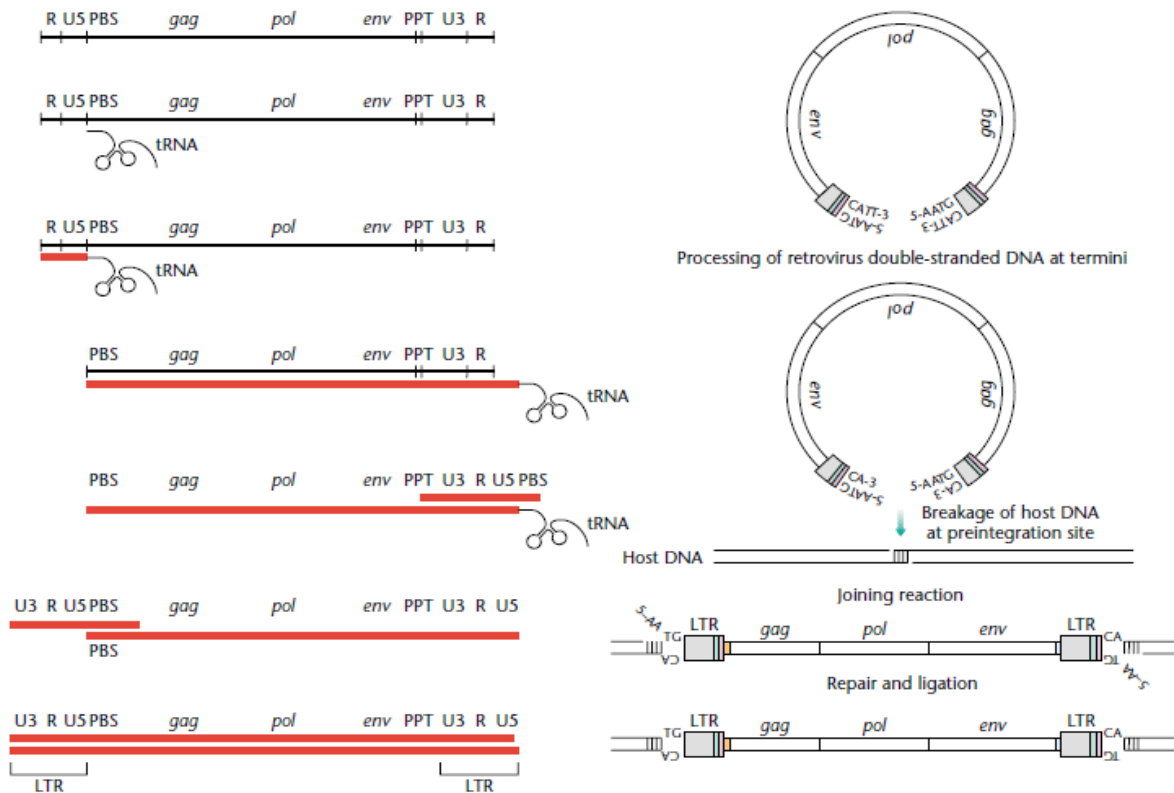




**Figure 1.6- Detailed HIV-1 replication cycle**-the early phase of the replication starts with the virus binding CD4 up to the integration, while the late phase starts from the transcription of the integrated DNA to the budding and maturation of infectious virions. Figure adapted from [68].

The reverse transcription results in the synthesis of the double-stranded viral DNA genome. The figure 1.7a illustrates the DNA synthesis steps. To produce the minus strand of DNA, first the transfer RNA (tRNA) binds to the primer binding site (PBS) in the LTR, the primer then extends to the 5' end of the viral RNA up to the integration site into the genome. The first significant jump takes place when the template shifts from the 5' end to the 3' end of the viral genome followed by elongation of the DNA minus strand up to the PBS. The RNA strand is digested by the RNase-H up to the PPT RNA sequence that is resistant to the RNase-H activity and serves as a primer for the initiation of the plus strand DNA synthesis towards the 3' end using the minus reverse transcribed DNA strand as a template and into the tRNA until the RT stops at the modified nucleotide at 19<sup>th</sup> position. The tRNA 3' sequence is a copy of the PBS sequence of the viral RNA. This leads to the second jump where the complementary sequence comprising the PBS initiates the elongation of the plus strand template, while the negative strand DNA copy also completes its elongation, resulting with a complete double stranded DNA copy of the original viral RNA [83]. Of note, the RT has no

proof reading capability which accounts for a high number of copy errors (one error every  $10^3$ - $10^4$  nucleotides) leading to HIV's ability to rapidly mutate.



**Figure 1.7: Reverse transcription and integration processes.** (a) the left diagram represents the reverse transcription steps. It starts with the attachment of the tRNA to the 5'LTR of the single strand RNA. The reverse transcriptase enzyme catalyses the single strand RNA (black) to the double strand DNA (red). (b) the image at the right represents the integration of the viral DNA into the host DNA (adapted from Pederson et al. [83]).

Once the double stranded DNA is synthesized, the next step is the translocation into the nucleus through nucleopores, via a transportation complex called the preintegration complex (PIC). The PIC includes IN, MA, RT and Vpr as well as cellular proteins from the host [84]. Vpr plays an important role in the nuclear localization of the PIC by connecting the PIC to the nuclear import machinery and arresting the growth of the infected cells at the G2 phase [85]. The viral DNA is then covalently integrated into the host DNA via the viral enzyme IN. The enzyme cleaves the special inverted repeat sequences at viral termini, the cleavage removes two nucleotides of 3' ends, the host DNA is cleaved with no preference, creating 5' overhangs of 4-6 nucleotides with staggered cuts [83] (Figure 1.7 b).

### Late Phase

Integrated ds-viral DNA is named the provirus. The late phase of viral replication cycle begins from provirus expression. The transcription of the provirus by the cell machinery generates the full genome unspliced RNA. From this, the splicing cell machinery generates the unspliced RNA and then multispliced RNAs. The unspliced, unspliced and multispliced

mRNA transcripts are transported out of nucleus for translation. The short spliced RNA coding for the regulatory proteins Tat, Rev and Nef migrate to the cytoplasm and are translated first [86]. Among the 3 proteins Nef is the most abundant. However, once Tat is produced in adequate amounts, it translocates to the nucleus and binds to its target TAR in the R region of the 5' LTR. This markedly promotes the transcriptional of unspliced full length viral RNA [80,87] which is transported to the cytoplasm by a mechanisms depending on the activity of Rev protein. Rev binds as an oligomer to the target Rev Response Element sequence (RRE) of both the nascent unspliced and the unispliced mRNAs and therefore facilitates their transport through the nuclear membrane, thus saving the mRNA from further splicing and degradation and allowing them to be translated in the cytoplasm [88]. Thus, Rev plays a critical role, both in the initial transport of highly spliced mRNAs (for basal the initial production of Tat, Rev and Nef) and in later stage transportation of the singly spliced (Env, Vpu, Vif, Vpr) and unspliced (Gag-Pol) mRNAs [89,90].

The *env* gene is translated as a gp160 precursor protein that is glycosylated in the endoplasmic reticulum. The non-covalantly associated (TM-SU)<sub>3</sub> trimeric glycoprotein complex is produced by post translational modifications in ER and Golgi bodies. These heterogenously glycosylated TM-SU trimers are translocated near the membrane for viral assembly. Since Env and CD4 are both synthesized in the ER and CD4 inhibits translocation of Env to the cell membrane, it is important for viral production that CD4 is removed not only from the ER but also from the cell surface. The viral proteins Nef and Vpu are involved in degrading and downregulating the CD4 molecule. Nef downregulates the CD4 from the cell surface and induces the degradation of both CD4, MHC class I and MHC class II [91]. Vpu is involved in the degradation of the CD4 in the ER [92] and allows the gp160 to translocate to the cell membrane for maturation.

Gag and Gag-Pol polyproteins migrate to the cell membrane. There is assembly of viral proteins with Env containing cell membranes before the budding. The immature viral core consists of Gag-Pol polyprotein, viral enzymes, full size genomic RNA, tRNA<sup>Lys3</sup> primer and cellular components [93-95]. The immature viral complex buds through the cell membrane producing immature virions. Budding activates PR to proteolytically cleave the Gag-Pol p55 into six structural proteins and further rearrangement of the MA, CA, NC for full maturation of the virus [89,96,97].

### **1.3.4 Cell factors interfering with HIV-1 replication**

There are a number of host cellular factors interfering with the HIV-1 replication, some are restricting HIV-1 at different stages of its replication cycle, while others enhance the HIV-1 replication. Table 1.3 compares the cellular factors interfering with the process of replication.

#### **1.3.4.1 Cellular factors restricting the HIV-1 at different stages of its replication cycle**

##### **1. APOBEC-3G**

Apolipoprotein B mRNA-editing enzyme, catalytic polypeptide-like 3G, known as CEM15 is a host enzyme which induces extensive dC to dU mutations in the viral minus strand during transcription resulting in an accumulation of G to A substitutions in the reverse transcribed plus strand of the viral DNA. These mutations terminate the viral cycle by introducing stop codons and frame shifts throughout the viral genome. The role of the viral protein Vif is critical at this stage, since it can effectively suppress the DNA editing enzyme APOBEC3G by impairing both its translation and intracellular stability [81,82,98-101].

## **2. TRIM-5 $\alpha$**

The tripartite motif-5alpha (TRIM-5 $\alpha$ ) is a host protein found in the cytoplasm which specifically recognizes and interacts with the capsid (CA) protein of the virus in a species specific manner and inhibits the process of viral uncoating. TRIM-5 $\alpha$ , has four domains (B-box 2 domain, RING domain, coiled coil domain and B30.2 domain) which are necessary for the retroviral restriction. The B30.2 domain determines the specificity of the restriction. TRIM-5 $\alpha$  is a novel target for antiviral therapeutics by modulating species specific innate resistance against specific retroviruses [102,103].

## **3. Tetherin (BST-2)**

Tetherin (BST-2) also known as BST2 or CD317 is an interferon-inducible membrane protein that restricts the virus replication by inhibiting the detachment of the virus from the cell. The HIV-1 group M, viral protein Vpu helps to overcome the restrictions imposed by tetherin [104]. For group O HIV isolates, Nef antagonizes tetherin [105].

## **4. SAMHD1**

A host cellular protein (sterile alpha motif and histidine/aspartic acid-domain containing protein). SAMHD1 restricts the infection of HIV-1 in DCs and myeloid cells by depleting the intracellular pool of deoxynucleoside triphosphates, but during infection with SIVsm and HIV-2, the viral protein Vpx is able to overcome the restrictions induced by SAMHD1 [105].

## **5. MX2**

IFN-induced human myxovirus resistance 2 (MX2) factor is a post-entry inhibitor of HIV-1 infection. MX2 expression reduces permissiveness to any lentiviruses. Inhibition occurs prior to (or during) reverse transcription and is manifested as the failure to accumulate viral cDNA in the nucleus. MX2 is a potent inhibitor of HIV-1 infection and effector of the IFN- $\alpha$  mediated resistance to HIV-1 infection. MX2 depletion results into reduced anti-HIV-1 potency of IFN- $\alpha$  [106].

### **1.3.4.2 Cellular factor enhancing the HIV-1 in different stages of its replication cycle TREX-1**

Three prime repair exonuclease 1 (TREX-1), is one of the cytosolic exonuclease, that helps HIV-1 infection by inhibiting the immune recognition, by suppressing the interferon response [107]. Recent studies have shown that knockdown of TREX-1 using CD4-AsiCs induces an expression of IFNs to HIV that delays viral infection in humanized mice [108].

## LEDGF/p75

Lens Epithelium-derived Growth factor (LEDGF/p75) is a host factor that facilitates the integration of HIV-1; LEDGF/p75 is required for the tethering of IN and targeting of the viral genome into the host chromatin [109]. Interestingly, in association with two proteins involved in the control of gene expression and chromatin structure (Spt6 and Iws1), LEDGF/p75 represses HIV expression in latently infected cells [110].

Table: 1.3. Host proteins that interact with HIV proteins or DNA and either restrict or promote HIV infection in human cells. APOBEC-3G=apolipoprotein B mRNA-editing enzyme-catalytic polypeptide-like-3G. TRIM=triptartite motif. SAM=sterile  $\alpha$  motif. HD1=histidine aspartic acid domain-containing protein 1. LEDGF=lens epithelium-derived growth factor (**Adapted from [30]** ).

Host proteins	Action	HIV target
APOBEC-3G	RNA editing protein	Vif
TRIM-5 $\alpha$	E3 ubiquitin ligase tripartite motif targets viral capsid	Capsid
Tetherin (BST-2)	Immunomodulatory membrane protein that inhibits virus budding	Vpu
SAMHD1	Hydrolyses dNTPs and restricts efficient reverse transcription of HIV	Vpx (Expressed by HIV-2 only)
TREX-1	Cytosolic exonuclease that inhibits the immune recognition of viral products such as HIV DNA	HIV DNA
LEDGF/p75	Brings HIV DNA in close proximity to chromatin	Integrase

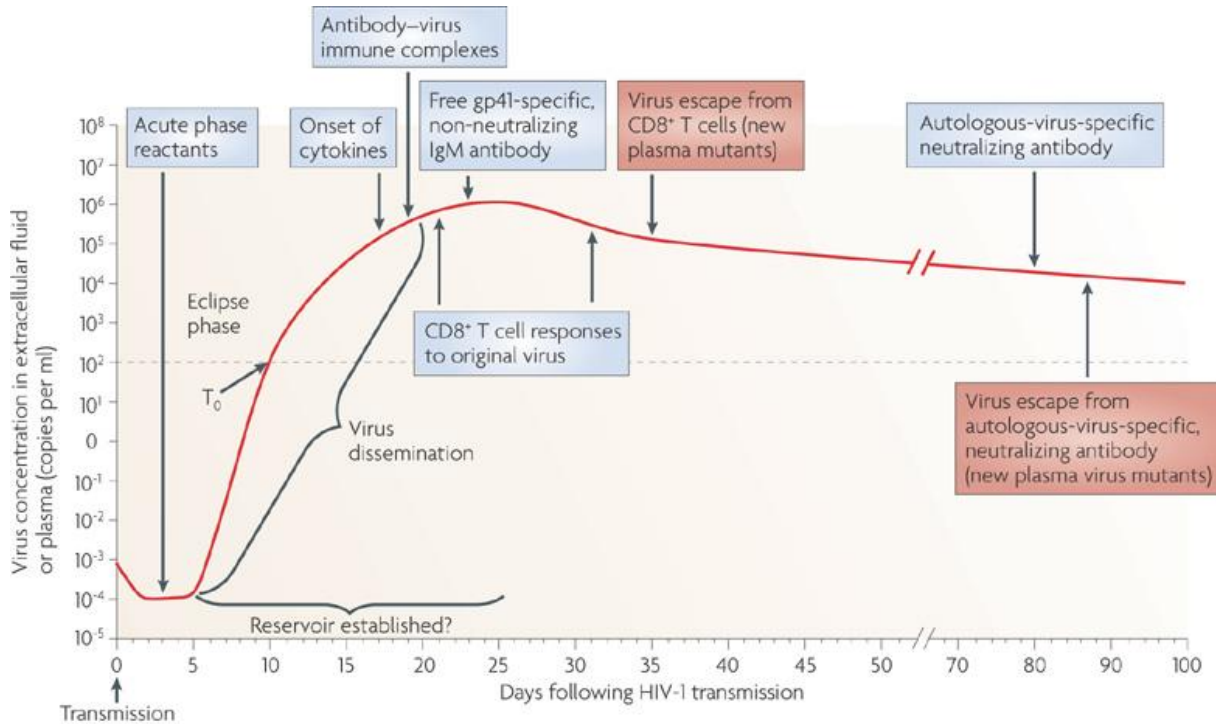
## 1.4 HIV Immunology and Vaccination

### 1.4.1 Overview of HIV-1 Immunology

#### 1.4.1.1 HIV vs Innate immunity

The main cell types implicated in innate immunity are the phagocytes monocytes, macrophages and dendritic cells (DCs), antigen-presenting DCs, cytolytic cells namely natural killer cells (NK) and neutrophils. The pathogen associated molecular patterns (PAMPs) are sensed by the pathogen recognition receptor (PRRs) of the host cells, thereby initiating the innate immune response; for example, the innate immune receptors toll-like receptors TLR7 and TLR8 are triggered by the viral ss-RNA resulting in activation of pDCs leading to release of high levels of interferons (IFNs) and tumor necrosis factor (TNFs) [111]. The IFNs activate the innate immune defenses, terminating the viral replication in infected cells [112]. The number of circulating DCs is rapidly reduced especially the plasmacytoid DCs (pDCs) due to the activation induced cell death and trafficking to the sites of infection such as the gut. IFN- $\alpha$  also enhances the adaptive immune response and mDCs elaborate proinflammatory factors such as IL-12 which will condition the nascent adaptive virus specific response. The NK and NKT cells can control HIV infection through cytolysis of

infected cell and releasing antiviral chemokines and cytokines [113] though the antigen non-specific pathway of NK activation via KIR receptor is in large part countered by the activity of Nef. HIV-1 infection significantly targets and kills memory CD4+T cells. However, many more CD4+ T cells die without being infected (bystander death) through a variety of mechanisms. In a recent report it was shown that many IFN stimulated genes, like IFI16 drive the inflammasome activation and induce inflammatory cell death of CD4+ T cells that are non-permissive to HIV infection via pyroptosis [114].



**Figure 1.8: kinetics of Innate and adaptive immune responses against HIV-1 infection.** The eclipse phase represents the period of time between the transmission and the first detectable systemic immune responses. At ( $T_0$ ) when the first virus is detected in plasma, there is also an onset of pro-inflammatory cytokines. As the plasma viremia increases, within 15-20 days, the first antibody-virus immune complexes are detected followed by antigen specific CD8+ T cell responses and gp41 specific non neutralizing IgM antibodies. While the early CD8+ T cell response to the infection is vigorous, HIV escape mutants develop rapidly with specific mutations in select epitopes recognized by CD8+ T cells. By day 80, autologous virus specific neutralizing antibodies are generated against which escape mutants are quickly and continuously produced too. The figure is adapted from McMichael et.al. [113].

#### 1.4.1.2 The adaptive T cell response to HIV-1

The first virus-specific CD8+T cell response appears within 1-2 weeks after the peak of viremia (Figure 1.8). The peak of CD8+T cell response correlates with a dramatic drop of the viral load in the blood and genetic variant viruses start to accumulate corresponding to escape mutants. At this time, the CD4+ T cells stop their rapid decline for a more protracted one for years. The initial T cell response is specific to the transmitted/founder Env and Nef antigens,

and in later stages the responses are mainly against conserved Env, Gag protein p24 and Pol antigens. The T cell responses tend to decline due to escape mutants and check point inhibitors mechanisms aiming to limit the proinflammatory damage due to chronic inflammation (PD-1, CTLA-4, TIM-3, TIGIT etc...) even as CD8+T cell responses adapt to recognize the new mutated epitopes leading to a relatively stable viral load set point [115].

#### **1.4.1.3 The antibody response**

While the first B cell response with immune complex appears eight days after initial infection the first neutralizing antibody response to autologous viruses develops slowly only by 12 weeks (Figure 1), but even at this stage, new neutralization escape mutant viruses have already developed leading to a constant effort by the immune system to catch-up with the virus [113]. HIV-specific IgM antibodies that appear in 13 days after infection are against gp41 and gp120, but they don't have neutralizing activity [116] (Figure 1). Only about 20% of infected patients develop neutralizing antibodies against heterologous viruses, years after the infection. These broadly neutralizing antibodies target conserved epitopes that the virus cannot mutate without losing fitness, though most of these epitopes are not easily accessible, either shielded through the structural folds or from an extensive glycan shield. Broadly neutralizing antibodies target epitopes from several different HIV env sites including the CD4 binding site, quaternary epitopes, glycosylation sites, V1/V2 variable regions, V3 on gp120 and the membrane proximal external region (MPER) on gp41.

#### **1.4.1.4 Obstacles to an efficient vaccine**

The main barriers to generate an efficient vaccine in three decades of research is due to the following issues: (i) HIV-1 is very diverse with different clades and its ability to rapidly mutate due to error prone reverse transcriptase and production of hybrids and circulating recombinant forms; (ii) Latency and creation of viral reservoirs in immune privileged sites; (iii) The rapid evasion by the virus from cellular and humoral immune responses. iv) The fact that HIV infects and kills activated CD4+T cells and in particular anti-HIV CD4+ T cells recruited to the site of infection; (v) Broadly specific antibody responses with neutralizing or other effector activity (ADCC, ADCVI, ...) take time to develop until significant immune erosion has occurred; (vi) Lack of optimized animal models.

#### **1.4.1.5 Goals of a successful vaccine**

A vaccine can be either prophylactic offering protection against acquisition and/or efficiently controls HIV replication following acquisition of the virus, e.g. via CD8+ T cells responses; Conversely, a therapeutic vaccine aims to elicit responses able to contain and inhibit virus replication or even cure the virus in already infected individuals. HIV vaccines aimed at preventing acquisition are largely predicated on the generation of humoral antibody responses able to block the infection at the mucosal surface, by a combination of neutralization, antibody dependent cellular cytotoxicity (ADCC), antibody dependent cell-mediated viral inhibition (ADCVI) and antibody mediated phagocytic activity. Additional relevant parameters of such approach are the relative quality of antibodies present on the mucosal

surfaces (isotype, secretory vs diffused, etc.). The other approach relies primarily on cellular defenses, to eliminate infected cells, such as CD8+ T cells but also effector antibody cellular responses to limit and contain the spread of the infection [117]. It is likely that the successful vaccine candidate will have to induce both humoral immunity that blocks infections and cell mediated responses that kills infected cells. Therapeutic vaccination in the context of HAART constitutes another recent avenue of cure research [118].

## **1.4.2 Strategies used to develop HIV Vaccines**

### **1.4.2.1 Live attenuated vaccines**

Live vaccines generally use an attenuated version of the pathogen to induce protective immune responses against infection with a virulent agent. This approach was widely successful for a number of vaccines such as small pox, measles, rubella, and polio. In addition, these vaccine generally are cheap to produce, require only low amounts of agent and therefore are very cost effective. However, these advantages come at the cost of safety, since reversion to virulence and/or recombination can occur. For HIV, live attenuated strains were proposed by introducing deletions in selected viral genes such as the regulatory gene nef. In fact blood transfusion from an Australian donor infected with HIV defective in Nef to several recipients led to longterm non progressor infections, though twenty years later, it was realized that the virus had not repaired Nef but developed compensatory mutations in other regions and resumed low level virus replication. In addition, while Nef deletion in SIV has provided the best and most protective immunization to date, it was shown to retain pathogenicity in newborn monkeys. [119]. Other prototypes of live-attenuated lentiviruses with various deletions in multiple genes have been tested, with various level of protective success [120], though the safety of the approach has remained unsolved. Thus, live-attenuated vaccine strategy was not considered safe for HIV vaccine development.

### **Heat/chemical inactivated vaccines**

Inactivated vaccines are made by growing a pathogen inactivated by various means. While these vaccines are generally considered safe, they require a lot more antigen, preparation work and are less immunogenic, triggering predominantly humoral responses. A whole-killed virus called Remune has been tested as a therapeutic adjunctive therapy in infected patients with modest results [121].

### **1.4.2.2 Subunit Vaccine**

With the development of biotechnology, subunits vaccines using recombinant proteins have become a prominent part of vaccine production (e.g. Hepatitis B vaccine). These vaccines are very safe since the pathogen they are supposed to protect against do not enter in the production of the vaccine and also provide an unlimited flexibility in their design, the creation of synthetic immunogenic compositions, strings of epitopes rather than proteins mimicking the native protein and more.



#### **1.4.2.2.1 Recombinant Protein subunit vaccines**

Recombinant DNA technology can be used to produce these antigens at low costs in microorganisms or plants in ways that allow for easy purification. The vaccines produced using this technology are termed “recombinant subunit vaccines”. For HIV subunit vaccines have focused on HIV Env glycoproteins gp120, gp160 or gp140 [122], Gag, Pol, Nef and Tat [123,124] [125] separately or in combinations and in the form of self assembling virus like particles. Another recent approach has been the creation of multi-epitope vaccines only, whereby epitopes recognized by T cells from a large percentage of the population (e.g. HLA-A2 restricted) are being aligned with spacer sequences to focus the response on the selected epitopes of the virus. The VAX003 and VAX004 (AIDSVAX) trials were based on recombinant gp120, and they failed to provide protection. Although these vaccines failed, these subunits are still used in prime/boost strategies; where the prime is delivered by a viral vectored vaccine, and the boost with the subunit vaccine aimed at amplifying humoral responses. For example, the RV144 comprised a vaccinia vectored prime and subunit protein boost [126]. A series of Env trimers (gp140) and scaffolds continue to be developed using recombinant technology to not only mimic the native conformation of the HIV env on the surface of virions and infected cells but also to expose select epitopes that may elicit broadly neutralizing immune responses (e.g. SOSIP scaffolds, 1VH8,) [127,128]. These recombinant protein scaffolds promote responses to the CD4 binding site, MPER, V1/V2, glycan V3 binding sites since bNAbs (PG9, PG16, 10E8 and others) can neutralize up to 80-96% of HIV isolates worldwide [129,130]. They have been successful in passive protection experiments in protecting monkeys against mucosal SHIV challenges [131]. However these scaffold and or subunit vaccines with the exception of poly-epitope vaccines are generally poor inducers of cellular immunity [132].

#### **Virus like particle (VLPs)**

VLPs are assembled viral proteins into virions lacking the virus genome; they induce strong immune responses. VLPs are promising vaccine technology produced in laboratories using the biotechnology tools. The main advantage of this type of vaccines is that viral proteins are in conformations mimicking viral infection. Since they lack genetic material, they are thought to be safer than inactivated, live-attenuated or recombinant virus vaccines [133]. VLPs present high density of B cell epitopes to induce potent antibody responses to antigens exposed in conformation similar to the infectious virus. In addition, VLPs contains intracellular T cell epitopes potentially inducing increased T cell responses. The main drawback of VLPs is that they incorporate plasma cell membrane against which there are inducing immune response against host cellular proteins [132].

#### **1.4.2.2.2 Synthetic Peptide**

Synthetic peptides and proteins as subunit vaccines are chemically synthesized and were used as immunogens to induce cellular and humoral immune responses. They require adjuvants for eliciting immune responses. The lipo-peptide HIV LIPO-5 vaccine had five long peptides in Gag, Pol, Nef regions with CD8+ and CD4+ epitopes coupled with a palmitoyl tail which induced CD8+ responses in two third of vaccinated subjects and CD4+ immune responses in half of the vaccinated subjects in its phase II trials [134]. But in further trials as a boost to an

ALVAC delivered prime immunization, HIV LIPO-5 did not induce cellular or humoral responses [135].

#### **1.4.2.3 DNA vaccine**

DNA vaccines are molecular genetic designs with antigen expressing genes under transcriptional control of eukaryotic promoters and transcription terminations signals. This recent technology is one of the most promising for development of vaccines of the future. Naked DNA vaccine is administered into muscles or skin with or without electroporation. Electroporation markedly enhances the uptake and subsequent expression of the DNA leading to high immune responses not only in murine but also in macaque models [136]. The vaccine can also be delivered encapsulated into other vehicles such as liposome formulations, nanoparticles for delivery. Intracellular DNA expression of protein antigens feed proteasomally degraded peptides into class I molecules for presentation to CD8+ T cells. The vaccine can express one or multiple antigens under a single or multiple promoters. DNA vaccines are safe and avoid the issue of pre-existing and/or induced immunity against the vector. Therefore, they can be used for multiple vaccinations against the same or different diseases. They are easy to produce in large scale, stable for transport at ambient temperatures for extended periods of time and highly flexible in their design [137]. These vaccines have also been shown to induce humoral and T cell responses (in influenza vaccine)[138] and can express more protein through addition of transcriptional element and codon optimization [137]. Several human trials are being conducted, using naked DNA vaccine, such as the HVTN505 vaccine comprising a prime/boost strategy. The prime vaccine was a DNA vector encoding Gag, Pol, Nef and Env while the boost was a recombinant Ad5 vector encoding Gag, Pol and Env. The HVTN505 and the Merck Ad5 vaccines directed at eliciting primarily T cell mediated responses did not show any efficacy, neither in preventing HIV acquisition nor in reducing viral loads [139-141].

One original therapeutic DNA vaccine aimed at producing VLPs was called DermaVir, since it was applied as a patch on the skin instead of an injection. The plasmid DNA in Dermavir expresses 15 processed HIV antigens and targets primarily Langerhans cells. Results showed expansion of existing and elicitation of novel T cell responses against Gag p17, p24, p15, Tat, Rev in infected patients [142]. Vector/boost regimen enhancement of the DermaVir vaccine with IL-7 or IL-15 showed that IL-15 expressed as a molecular adjuvant improved Gag specific effector memory T cell response [143].

#### **1.4.2.4 Recombinant viral vector vaccines**

Viral vectors are basically virus expression systems derived from attenuated and pathogenic viruses used for the intracellular expression of antigens as a method to deliver the immunogens. These can be designed to be replication-defective or replication-competent, with several modifications to eliminate their pathogenicity. The last phase III vaccine trials (STEP, Phambilli, RV144) in humans have used such vectors [126,139,140,144]. The main vectors being used were derived from adenoviruses (Ad5, Ad26 etc) [141,145], Pox viruses (canary pox, New York vaccinia virus (NYVAC)) [146-148], Modified Vaccinia Ankara (MVA), Herpes viruses such as Cytomegalovirus (CMV) [149] and alphaviruses (Table 1.4). Novel vaccines in development include a promising but intriguing CMV viral vector

expressing SIV proteins, (RhCMV/SIV) which has provided about 50% protection not only in preventive but also in therapeutic applications. The peculiarity of this vaccine is the induction of very broad repertoires of unconventional T cells: MHC class II restricted responses by CD8+ T cells. Moreover, the correlates of protection remain a mystery this far, since the investigators have not been able to differentiate immune responses shown in protected versus non-protected monkeys [149-151]. Last but not least, this viral vector is fully replicative and not attenuated, which will face significant safety hurdles to be tested in humans. In addition, the protection is not persistent since a second challenge of protected animals resulted in productive infection in some animals [152].

### **1.4.3 Clinical Trials phase IIb and phase III trials**

There have been more than two hundred clinical trials initiated in search of a vaccine with good efficacy, but only six of them advanced to the phase IIb and phase III level [132]. (Table 1.4)

#### **1.4.3.1 VAX003/VAX004**

AIDSVAX is the vaccine that has been used for the clinical trials VAX003 and VAX004. This vaccine is based on recombinant gp120 protein mainly tested on injection drug users and men who have sex with men (MSM). The two trials could not show vaccine efficacy and any effects on the prevention and acquisition of the virus [153,154].

#### **1.4.3.2 MrK/ STEP -HVTN502/ & HVTN503 –Phambili study**

STEP (HVTN502) and Phambili (HVTN 503) trials used a replication-defective Ad5 adenovirus vector expressing Gag, Pol and Nef that was designed to induce cell-mediated immune responses. The main disadvantage with some of human viruses and the rAd5 in particular is the presence of pre-existing immune responses in subjects due to previous exposure to the actual parent viruses. Both trials were stopped since results indicated that Ad5 seropositive uncircumcised men had modest increase in HIV infection. The trials also do not show any efficacy in protection from HIV infection [139,140]. The failure of the STEP [144] and Phambili [139] phase II-b MrK trials was mainly due to pre-existing immunity against Ad5 which not only lowered immune responses but seemed to cause enhanced susceptibility for the acquisition of HIV-1 infection [145].

#### **1.4.3.3 RV144**

Moderately encouraging results were obtained from the RV144 trial which was held in Thailand. The trial was conducted with the prime vaccine vector ALVAC-HIV (Sanofi Pasteur) which is a canarypox vector along with the boost which is recombinant gp120 protein (AIDSVAX B/E). The efficacy of the vaccine was reported to be 31.1% of exposed individuals that resisted to infection following exposure. The vaccine has induced binding but no neutralizing antibodies specific to Env in the plasma and also a primary CD4+ T cell response [146]. Genetic factors of infection-resistant vaccinees was also reported [155].

#### **1.4.3.4 HVTN505**

The HVTN trials used a vaccine prime and vaccine boost regime, the vaccine prime composed of plasmid DNA encoding clade B Gag/Pol/Nef while Env was from clade A,B,C

with the rAd5 vector, the epitopes of the Ad5 were changed from the previously used Ad5 to ensure safety issues of the vaccine. The rAd5 vector was substantially modified by deleting the E1/E4 and partial E3 genes to minimize the production of structural Ad5 proteins, yet this strategy did not enhance protection [156]. The trials showed no efficacy in preventing HIV acquisition nor in reducing viral load set points [141]. Table 1.4 summarizes the other factors of the trials.

Table 1.4: HIV-1 Vaccine Trials Phase IIb/III [132]

<b>Trials</b>	<b>VAX003</b>	<b>VAX004</b>	<b>STEP HVTN502</b>	<b>Phambili HVTN503</b>	<b>RV144</b>	<b>HVTN505</b>
<b>Product name</b>	AIDSVAX	AIDSVAX	MrK-Ad5	MrK-Ad5	ALVAC-HIV AIDSVAX	DNA /Ad5
<b>Clade</b>	B/E	B/E	B	B	B/E	A/B/C
<b>Phase</b>	III	III	IIb	IIb	III	IIb
<b>Antigen</b>	Recombinant gp120	Recombinant gp120	Gag, Pol, Nef	Gag, Pol, Nef	Prime- Gag, Pol and Env. Boost- Recombinant gp120	Gag, Pol, Nef and Env
<b>Vector</b>	Protein	Protein	Ad5	Ad5	Prime Canary Pox vector Boost: Protein	Prime DNA; Boost Ad5
<b>Immune response</b>	No efficiency	No efficiency	No efficiency, terminated due to safety concerns	No efficiency, terminated due to safety concerns	31.1% efficacy	No efficiency, terminated due to safety concerns
<b>Countries</b>	Canada, Netherlands, Puerto Rico, US	Thailand	Australia, Brazil, Canada, Dominican Republic, Haiti, Jamaica, Peru, Puerto Rico, USA	South Africa	Thailand	USA
<b>Number of volunteers</b>	5417	2546	3000	800	16402	2500
<b>Years</b>	1998-2003	1998-2003	2005-2007	2005-2007	2003-2009	2009-2013

Future human trials phase IIb are scheduled for HVTN702 in South Africa during November 2016-December 2020. It is a repeat of the RV144 with a prime ALVAC vaccine followed by a clade C gp120 boost adjuvanted with MF59. The trial is estimated to have 5400 volunteers. (<https://www.niaid.nih.gov/news/newsreleases/2016/Pages/HVTN702.aspx>)

#### 1.4.4 Development of innovative HIV vaccines in our lab

One of the main objectives in our lab is to develop an innovative HIV vaccine prototype that is safe, efficacious and providing long term protection to be used in humans.

The first generation vaccine developed was  $\Delta 4SHIV_{-KU2}$  based on the highly pathogenic SHIV<sub>-KU2</sub> from the genome of which the *rt*, *in*, *vif* genes and the 3'LTR were deleted. This latter was replaced with the SV40 poly A signal.  $\Delta 4SHIV_{-KU2}$  is a non-replicating and non-integrating DNA vaccine. When used in a single dose immunization, it has induced poly functional SHIV-specific T cell responses in mice and monkeys [157,158].

The next step in development of the vaccine was the replacement of the Tat-dependent 5' SIV LTR with Tat-independent constitutive CAEV LTR. This new vaccine prototype named CAL- $\Delta 4SHIV_{-KU2}$  has been shown to induce potent T-cell immune response in both mice and monkeys [159]. This gave the encouraging results that the replacement of the SIV 5'LTR with the CAEV Tat-independent LTRs. This construct induced HIV-specific CD8+ T cell response similar to those induced by  $\Delta 4SHIV_{-KU2}$ .

Thus, the next generation vaccine development in the lab was the CAL-SHIV-IN<sup>+</sup>, a vaccine based on SHIV<sub>-KU2</sub> genome that is delivered as DNA, which undergoes a single cycle of viral replication. In this new vaccine both SIV LTRs were replaced by CAEV LTRs which are Tat-independent and constitutive. This DNA vaccine indeed showed constitutive expression of all viral proteins in the genome which assembled as virions. These virions were then able to undergo a single replication cycle. Induced immune response both in mice and in macaques was increased and durable compared to  $\Delta 4SHIV_{-KU2}$  [159]

The vaccine induced central and effector memory T cell responses following a single immunization of mice that were shown to be long lasting in macaques [160,161] The vaccine induced also T cell precursors that have high proliferation capacity (PHPC) as evidenced by antigenic and homeostatic stimulation assay. In addition, the vaccine tends to elicit responses within the newly reported T memory stem cells (T<sub>SCM</sub> cells) (unpublished data). T<sub>SCM</sub> are long lived and self-renewing memory cells that are thought to be crucial for the maintenance of long term memory responses. These cells can survive for long periods of time in the absence of antigen, in contrast to T<sub>CM</sub> or T<sub>EM</sub> [162]. This type of response is very interesting since these immune cells have potential to differentiate and give rise to the different subsets of T<sub>CM</sub> or T<sub>EM</sub>. Therefore targeting of CD4+ and CD8+ T<sub>SCM</sub> are important parameters to follow when evaluating the immunogenicity of vaccine strategies [163].

#### **1.4.5 Cytokines as adjuvants**

While the effect of adjuvants has long been recognized, many come with undesired side effects and their use with DNA or vectors is not always possible or easy to control. The recent development of these vaccine technologies has pushed toward search of new adjuvants named molecular adjuvants. Since the classical adjuvants induce the production of cytokines that modulate the immune response, including cytokines as molecular adjuvants was thought to be an obvious choice for enhancing the immunogenicity of genetic vaccines. Many cytokines have been used as adjuvants or are in preclinical studies such as the granulocyte macrophage

colony stimulating factor (GM-CSF), interleukin 2 (IL-2), IL-4, IL-7, IL-12, IL-15, IL-18, IL-21 and tumor necrosis factor (TNF) among others. The two gamma chain signalling cytokines IL-7 and IL-15 are under current consideration for optimizing our DNA vaccine. These are required for the development and maintenance of memory T-cell responses [164].

IL-7 is produced by non-hematopoietic cells such as stromal and epithelial cells. This cytokine was found to be important for development of thymocytes and homeostasis of peripheral T cells. IL-7R is the receptor by which the cytokine interacts with the cells; it is a heterodimer of IL-7R $\alpha$  (CD127) and CD132 subunits. IL-7 is particularly important for driving the proliferative expansion and survival of naive T cells and central memory T cells [165]. These latter express high levels of CD127. Therefore IL-7 is associated with maintenance of high CD4 cell count. Absence of IL-7 results in a profound dysregulation of the T cell homeostasis. These properties raised interest in IL-7 as a strategy to boost de novo T cell production during HIV infection.

In contrast to IL-7, IL-15 regulates the homeostasis and activation of many cell types, including memory T cells (T<sub>M</sub>),  $\gamma\delta$  T cells, NK cells, invariant NKT cells, and lymphocytes in the gut-associated lymphoid tissues (GALT). Homozygote knockout mice bearing deletions either of the IL-15 coding sequences (IL-15<sup>-/-</sup>) or those encoding the receptor (IL-15R $\alpha$ <sup>-/-</sup>) manifest severe deficiencies in their T cell subsets. The receptor is a heterotrimer composed of IL-15R $\alpha$  (CD215), IL-2/15R $\beta$  (CD122), and CD132, though lower affinity receptors made of dimers may also respond. IL-15R $\alpha$  is expressed on antigen presenting cells (macrophages, monocytes, and dendritic cells). The binding of IL-15 to soluble IL-15R $\alpha$  enables the *trans* presentation to the CD122 and CD132 expressed at the surface of cells.

IL-7 and IL-15 in combination, have been reported to increase the number and function of natural killer cells, IL-7 via upregulation of the Fas ligand while IL-15 upregulates the tumor necrosis factor related apoptosis [166]. Moreover recent studies showed that IL-7 and IL-15 instruct the generation of human memory stem T cells from naive precursors, these cell types (TSCM) have been generated in vitro by using a cocktail of cytokines and co-stimulators [167].

The synergistic effect of the combination of IL-7 and IL-15 as vaccine adjuvants has not been investigated in details, but appears promising. The studies done by Wang et al. used molecular adjuvants IL-6 and boosted with either IL-7 or IL-15 which resulted in the enhancement of cellular and humoral immune responses, maturation of dendritic cells (DCs) and macrophages, and a higher frequency of CD4<sup>+</sup> T<sub>M</sub> [168]. Similar results from Lisziewicz et. al., demonstrated that DermaVir formulated with HIV-1 Gag protein in the presence IL-15-encoding plasmid significantly enhanced Gag-specific central memory T-cells [143]. Previous study by Mackall et al. confirm the adjuvant activity of IL-15 and demonstrate that IL-7 serves as a potent vaccine adjuvant that broadens immunity by augmenting responses to subdominant antigens and improving the survival of the CD8<sup>+</sup> T cell memory pool [169]. Thus the concomitant expression of IL-15 and/or IL-7 cytokine adjuvants with HIV antigens in the existing vaccine is expected to enhance the T cell immune responses along with the humoral responses specific to vaccine expressed antigens and would lead to augmented and effective durable antigen specific immune responses.

One of our specific aims in the vaccine project is to enhance the immunogenicity of our vaccine and the induced protection against pathogenic viruses. We chose a strategy that target and stimulate naive T cells to differentiate into a variety of memory T cells associated with long term survival by adding cytokines.

### **1.5 SIV and SHIV as NHP models for HIV.**

There is an inability of HIV to replicate in macaque cells. This is mainly due to the restriction factors TRIM5 $\alpha$  and APOBEC3G. This led to the development of SIV and SHIV NHP models for HIV.

#### **1.5.1 SIVs as challenge viruses**

SIVsmm and SIVmac have a *vpx* gene while they lack a *vpu* gene which is present in HIV-1 genome. The genomic organization and the overlapping of the ORFs are different in HIV-1 and HIV-2/SIVsmm/SIVmac [115]. SIVmac251 and SIVsmE660 are the commonly used as challenge viruses with stocks that are not derived from molecular clones. On the other hand, a variety of infectious pathogenic molecular clones have been derived mainly from biological pathogenic isolates, such as SIVmac239 and SIVsmE543-3. Since there is a genetic lineage difference between the SIVmac239 and the SIVsmE543-3, these are used at times as heterologous challenge to evaluate protection induced by immunogens from the other strain, though genes other than *env* and *nef* are fairly conserved [135,170]. However, SIVsmE660 and potentially its molecular clone SIVsmE543-3 come with additional limitations as challenge stocks. Rhesus macaque with select TRIM5 $\alpha$  allele combinations can present variable levels of susceptibility to disease progression and potentially virus acquisition as well [171]. SIV uses CCR5 as a co-receptor and rarely uses other receptors for infection [130]. HIV based vaccines investigating prevention of virus acquisition cannot be reliably tested on the SIV based models since the Env markedly differs from between HIV and SIV and SIVmac239 and 251 tend to be highly resistant to neutralization [172]. Other notable differences between SIV and HIV are some of the viral enzymes such as RT, and non-nucleosidic RT inhibitors are specific to HIV but inactive against SIV [173].

#### **1.5.2 SHIVs as challenge viruses**

The SIV macaque model has limitations that are mainly associated with marked heterogeneity of its *env* gene, relative to HIV. To address these limitations chimeric simian-human immunodeficiency viruses (SHIV) were developed generally with a SIVmac239 backbone while *tat*, *rev*, *vpu*, and *env* genes from HIV-1 are transplanted. The initial chimeric virus genome poorly replicated and needed *in vivo* passages in macaques to get adapted virus that replicates at high titers and became pathogenic in infected macaques [174-176]. The initial SHIVs were constructed with CXCR4-tropic HIV-1 Env [177,178]. Upon adaptation these

SHIVs tended to induce, a rapid depletion of the entire CD4+ T cell population in infected macaques, with rapidly ensuing disease within 3 months [132,134,177] which is not characteristic of most HIV infections and represent rather the end stage of infection in human. These have been used in studies investigating the lentiviral pathogenicity and antiviral immunity of the late stages of infection but the majority of the SHIV strains were derived from the clade B strain. However, the highest prevalence of HIV-1 is that of the subtype C, which is associated with the major epidemics in sub-Saharan Africa, India and China. HIV-1 subtype C is estimated to comprise of more than 50% of infections worldwide and it calls for efforts to develop a relevant animal model for evaluating AIDS candidate vaccines.

### **1.5.3 The importance of a CCR5 tropic challenge virus**

The mucosal transmission accounts for >90% of the HIV transmission. These mucosal transmissions invariably occur with CCR5-tropic virus strains, which use the CCR5 as co-receptor for entry into target cells. To better understand the lentivirus pathogenesis and to develop an effective vaccine, there is a need for lentivirus models and vaccines based on the genomes of clade C HIV that can be used in experimental infection and immunization in non-human primates during preclinical studies. These will help to better dissect the early events of virus entry into the body and engineer prototype vaccines that prevent virus entry. Thus, while chimeric SHIVs bearing CXCR4 tropic HIV envelopes have been helpful in studies to dissect the late stages of HIV-1-associated pathogenesis, these are not representative of early infecting virions [177,179] and hence of limited use to test vaccine protection. There was and still is a clear need for transmitted/founder R5-tropic strains of HIV [180,181]. Earlier efforts to develop R5 tropic SHIVs focused on switching the CXCR4 coreceptor usage of SHIV to CCR5 coreceptor usage by exchanging specific amino acids in the sequence of the third variable region (V3) loop of the env of SHIV89.6 clade B virus [182] or the complete sequence of the third variable region V3 [183]. Series of R5-tropic clade C SHIV like SHIV-1157ipd3N4[184], SHIV-2873Nip [185] and SHIV-1157ipEL-p were developed in Dr Ruprecht's Lab [185].

### **1.5.4 The need of novel development of a T/F CCR5 clade C envelop in a challenge virus**

During the mucosal transmission the studies demonstrate that 80-90% of the heterosexual transmissions are initiated with a single virus variant selected from the diverse swarm of virus from the chronically infected partner [186,187]. This is characterized by a bottleneck that selects for the productive infection by a single genetic transmitted/founder variant virus that will disseminate in the body. The characteristics of T/F virus Env are CCR5 tropism and a predominance of shorter and less glycosylated Env glycoproteins [188-190]. There have been reports of the SHIV with T/F envelopes of clade B, [191] and more recently clade C [192]. Ten viruses were developed with SHIV KB9 backbone and T/F clade C env obtained from South Africa. Among these only three viruses are mucosally transmitted exhibiting low Env reactivity and a Tier 2 neutralization sensitivity.

Recent studies conducted in Dr. Hunter's Lab, have focused on the isolation and characterization of R5-tropic clade C T/F HIV isolates from discordant couples in Zambia



[193]. These new T/F envelopes from these studies were used to replace the current SHIV-AD8EO envelopes since there is no documented report on development of an R5-tropic SHIV-C bearing the envelope of T/F HIVs to date. It was hypothesized that such particular envelopes may possess characteristics, allowing them to be preferentially acquired mucosally, and immune responses elicited by vaccines should be focused against such T/F determinants.

Thus another focus of this thesis was the development of replication competent T/F CCR5 SHIVs that more closely represent human HIV infections and T/F viruses. Currently there is a lack of CCR5 tropic SHIVs that not only infect monkeys but also induce sustained viral load set-points and pathogenesis. Although there have been research efforts to develop CCR5 tropic SHIV from the Env of a Zambian infant who turned out to be long term non-progressor (SHIV1157i) [194] and in another effort the *env* gene was derived from a rapid progressor (SHIV2873Ni). Currently there are only three infectious R5-tropic clade C T/F viruses available however they exhibit low Env reactivity and a Tier 2 neutralization sensitivity [192]. The improved SHIV-AD8EO constructs with T/F, if replicative in vivo, will provide invaluable tools for testing vaccines. Replication competent CCR5 tropic SHIVs will also provide comparative tools to determine the mechanisms of latency/persistence when used in parallel with CAEV LTR chimeric constructs that are independent of the Tat/TAR transactivation typical for HIV/SIV. Such tools and studies have direct relevance for the current ongoing studies aimed at curbing HIV.

## **1.6 Antiretroviral drugs and HIV-1 Latency**

### **1.6.1 ART- Antiretroviral drugs**

Development of antiretroviral drugs has nearly halved the mortality due to AIDS worldwide. It suppresses and reduces the viral load to undetectable levels within three months of the initiation of the treatment (Figure 1.2). Anti-retrovirals are a group of drugs that block the major steps of viral replication. Currently, six classes of antiretroviral agents are available 1) Nucleoside reverse transcriptase inhibitors (NRTIs), 2) Non-nucleoside reverse transcriptase inhibitors (NNRTIs), 3) Protease inhibitors (PIs), 4) Integrase inhibitors (INSTIs), 5) Fusion inhibitors (FIs), and 6) Chemokine receptor antagonists (CCR5 antagonists). The new drug regimens are less toxic; require less frequent dosage and they are more effective. The standard regimen combines two NRTIs with a NNRTIs or INSTIs or PIs. A lifelong treatment is thought to be necessary to keep the viral loads in check, antiretroviral therapy significantly reduces the viral load and also reduced the mortality but it is not sufficient to cure HIV-1 [30]. In general, once the antiretroviral drugs are stopped, the virus rebounds back within days or weeks, as viral replication resumes from the reservoirs of latently infected cells.

### **1.6.2 Latency and Persistence**

Latency can be classified as two types, the pre integration latency and post integration latency.

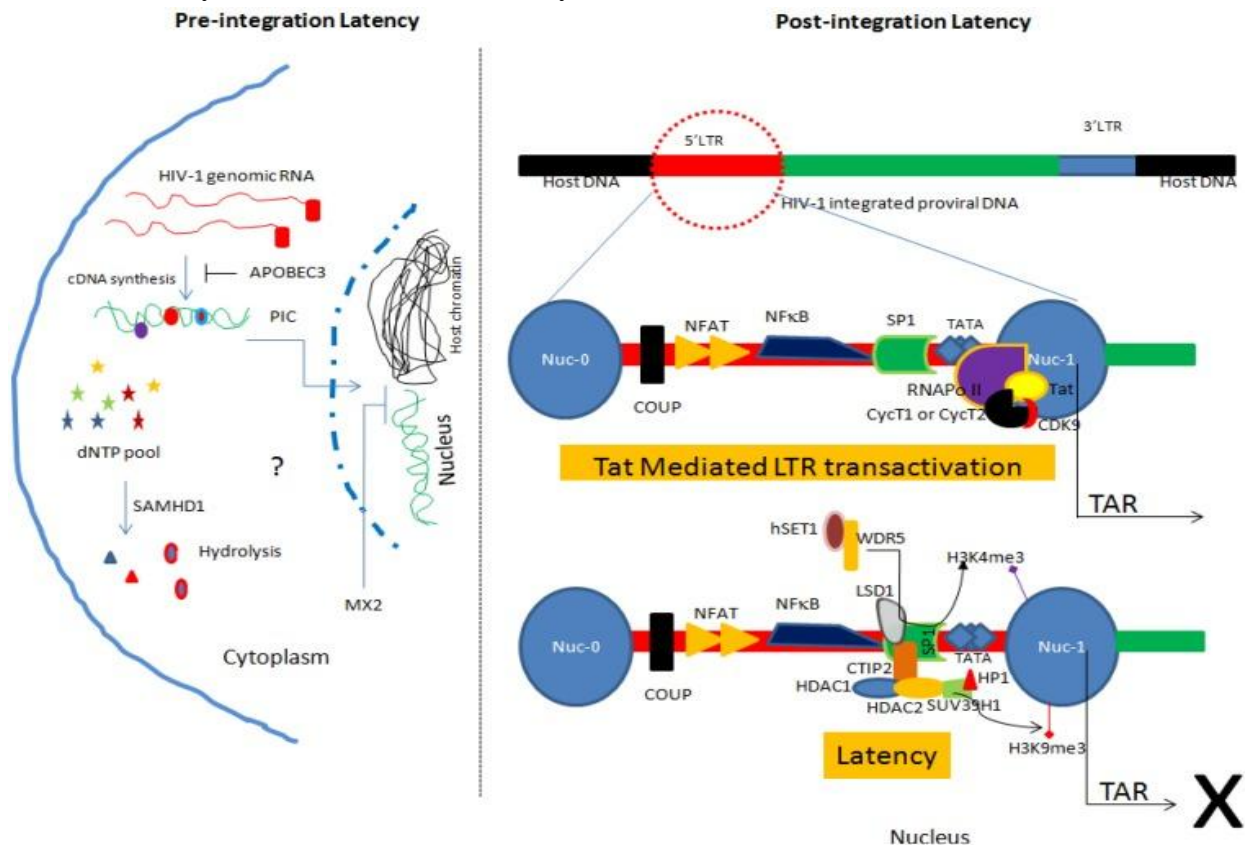
#### **1.6.2.1 Pre-integration latency:**

It is a state of latency where the viral DNA is not integrated into the host DNA. It occurs when the pre integration complex (PIC) comprised of the viral protein (IN, CA, MA, Vpr )

and dsDNA is transported into the nucleus but it does not integrate into host DNA. Pre integration latency's contribution to viral persistence is limited due to their very short half-lives of the DNA (1 day) [195]. Pre integration latency is characterized by poor reverse transcription and poor synthesis of proviral DNA. This can take place due to APOBEC-3G activity which induces hypermutation of DNA. On the other hand, the macrophages and monocytes this latency can contribute in formation of reservoirs [196,197] (figure 1.9). They can harbor large quantities of viral unintegrated DNA in circular form and remain stable up to two months in non-dividing macrophages [196,198]. Studies also show the important role played by Vpr in the viral infection of monocyte/macrophages but not in CD4+T cells [199]. Thus, these unintegrated circular episomal viral DNA contribute to the persistence and expression in non-dividing macrophages [197,200].

### 1.6.2.2 Post-integration latency:

Post-integration latency can be defined as a state of reversible, non-productive infection of individual cells. During latency, the HIV-1 provirus is integrated into the host's DNA but does not actively replicate and thus these types of infected cells are not targeted by the antiretroviral drugs, nor visible to the immune system. Latent reservoirs are established within a few days of the initial infection [201]. There are several potential cellular and anatomical reservoirs such as the CNS and male urogenital tract and most importantly the resting memory CD4+T cells with integrated HIV-1 DNA. The half-life of the latent reservoir is 44 months, which can be replenished through homeostatic proliferation [202]. It is estimated that an uninterrupted ART for 60 years is necessary to eradicate the latent reservoir [203]. There are  $>10^7$  latently infected T cells in the body [204].



**Figure 1.9: Pre-integration and post-integration latency in HIV-1.** The host factors

APOBEC3, SAMHD1 and Mx2 govern the pre-integration latency, Mx2 only relevant to macrophage and monocyte lineage. While the post-integration latency is due to epigenetic mechanisms, chromatin remodeling, host encoded miRNA and lack of Tat mediated reactivation. Adapted from Amit Kumar et al. [205].

### **1.6.2.3 Persistence**

The source of persistent viremia is most argued and is a result of various mechanisms. It is due mainly to failure of the immune system to clear out the infection due to slow, low level viral replication and in case of therapy to incomplete inhibition of replication in presence of ART [206,207]. The poorly accessed anatomical reservoirs or sanctuaries such as the nervous system [208], genitals, guts [209] and cellular reservoirs such as monocytes [210-212] and hematopoietic cell compartments are a source of persistence [213]. But it has been debated whether or not persistence is due to latency or due to ongoing viral replication [214]. The three memory CD4<sup>+</sup> T cell subsets associated with the persistence (central memory- T<sub>CM</sub>, transitional memory- T<sub>TM</sub>, effector memory- T<sub>EM</sub>) are distinct in their survival and functional and phenotypic properties [215]. T<sub>CM</sub> represent an ideal reservoir for the latent HIV, while T<sub>EM</sub> support the residual levels of viral replication during ART [202].

### **1.6.3 Mechanism of post integration latency**

HIV-1 latency is a multifactorial process involving a diversity of host cell and some viral factors. Several mechanisms lead to the post transcriptional latency such as site and orientation of provirus integration, epigenetic gene silencing, transcription gene silencing, post transcription gene silencing, suboptimal levels of viral transactivator Tat and presence of the microRNA (figure1.9).

#### **1.6.3.1 Integration site and orientation**

There are different regions in the DNA, the densely packed transcriptionally inactive heterochromatin and the loosely packed transcriptionally active region euchromatin. The insertion into heterochromatin enhances the latency. Studies have shown that the transcriptionally active HIV-1 proviral DNA binds into the euchromatin region [216-218]. In CD4<sup>+</sup> cells as well in the primary macrophages the HIV-1 integrates preferentially into the transcriptionally active regions. Transcriptional interference due to the orientation of the provirus relative to the host gene may also contribute to the latency [219]. If in the same orientation, the promoter occlusion can occur, which displaces the constitutively expressed transcription factors Sp1 binding to the viral promoter [220,221]. When the orientations are in opposite polarity, the collision of the RNA pol II complex from host and viral promoter leads to the premature termination of the transcription [220].

#### **1.6.3.2 Chromatin Remodeling**

The chromatin organization and reorganization influences gene expression and one of the mechanisms of HIV-1 latency is established through transcriptional gene silencing [222]. Table 1.5 summarizes the host factors involved in the chromatin modification and remodeling. In HIV-1 infected CD4<sup>+</sup> T cells as well as in monocyte/macrophage lineage cells the histone 3 lysine 9 trimethylation (H3K9me3), heterochromatin protein1 (HP1) and low histone acetylation role in heterochromatin formation and silencing of integrated HIV-1 is

well described [223-225]. The two nucleosomes nuc-0 and nuc-1 interact with the HIV-1 promoters and the transcription of the provirus becomes possible after the displacement of the nuc-1 [226]. The histone methyltransferase such as EZH2, G9a and SUV39H1 are involved in regulating transcription by inducing H3K9 and H3K27 methylations on lysine.

Table 1.5: Host factors involved in the (chromatin modification and chromatin remodeling) regulation of HIV proviral transcription adapted from [227]

<b>Factors</b>	<b>Description</b>
<b>Chromatin Modification</b>	
<b>HDACs</b>	Histone deacetylases HDAC1, HDAC2, and HDAC3 are each involved in establishment and maintenance of HIV latency.
<b>HATs</b>	The histone acetyltransferases p300/CBP and P/CAF reverse chromatin blocks and are recruited to the viral promoter by NF- $\kappa$ B and NFAT.
<b>SUV39H1</b>	Trimethylates histone H3 Lys9 (H3K9me3), an epigenetic marker of HIV latency.
<b>G9a</b>	Dimethylates histone H3 Lys9 (H3K9me2).
<b>EZH2</b>	Histone methyltransferase component of PRC2. Responsible for histone H3 Lys27 trimethylation (H3K27me3) found on silenced proviral templates.
<b>DNMT1</b>	Methylates CpG islands at the HIV LTR.
<b>Chromatin Remodeling</b>	
<b>BAF</b>	SWI/SNF chromatin remodeling complex which positions proviral Nuc-1 to repress transcription.
<b>PBAF</b>	Replaces BAF at the viral LTR to remodel Nuc-1 and enable transcription.

### 1.6.3.3 Host transcription factors and viral latency

HIV-1 transcription is dependent on host cell's factors for transcription. The promoter in the U3 sequence of the 5' LTR has several sites for binding of factors such as NF- $\kappa$ B, Nuclear factor of activated T cells (NFAT), activator protein-1 (AP-1) and SP-1. These factors are essential for transcription initiation. Some epigenetic restriction hampers these factors; also the limited availability of these factors causes restricted initiation and elongation. These factors work in harmony to regulate the transcription SP-1 recruits C-Myc to the 5' LTR, that recruit the histone deacetylase (HDAC) 1 which is responsible for chromatin remodeling and suppression of HIV-1 gene expression. Similarly the recruitment of HDACs and establishment of latency have been reported by factors like C-promoter binding factor-1 (CBF-1), COUP-TF interacting protein 2 (CTIP-2), YY1 and LSF [200,228-230] (Table 1.6). The role of CTIP-2 has been studied extensively and it has been reported in microglial cells

recruiting HDAC-1 and HDAC-2 at the 5'LTR. CTIP-2 also interacts with the SUV39H1 responsible for the methyl transferase of H3K9me-3 leading to recruitment of HP-1 to the 5'LTR that induces the heterochromatin formation and thus latency [231]. Lysine-specific demethylase (LSD-1) helps in recruiting CTIP-2 and hST-1/WDR-5 at Sp-1 resulting in increased tri-methylation of H3K-4 [232] (figure 1.8). In the resting cells transcription factor NFκB is in a complex with the homodimers p50/p50 which lacks the transcription domain, and represses transcription upon recruitment of HADC1[233]. In the activated T cell phosphorylation of IκB-α results in activation of the p50/RelA NFκB heterodimer through ubiquitination and degradation by proteasome resulting in the accumulation of the NFκB, that eventually displaces the p50/p50. The p50/RelA NFκB heterodimer stimulates the transcription through HATs that remodels Nuc-1[234].

Table 1.6: Host factors involved in the regulation of HIV proviral transcription [227]

<b>Factor or complex</b>	<b>Description</b>
<b>Initiation</b>	
<b>Sp1</b>	Required for assembly of the pre- initiation complex at the LTR TATA box. Co-operatively interacts with NF-κB p65/p50.
<b>TFIIH</b>	Component of the pre-initiation complex whose recruitment to the HIV LTR is NF-κB-dependent. Stimulates RNAPII to clear the promoter and initiate transcription.
<b>NF-κB (p65/p50)</b>	Central to the signal-dependent activation of HIV transcription initiation. Enables recruitment of histone acetyltransferases (HATs) to the LTR.
<b>NFAT</b>	Calcium-dependent activator of HIV transcription initiation. NFAT recognition sequences on the viral promoter overlap with NF-κB elements.
<b>AP-1</b>	Nuclear complex of c-fos and c-jun that is formed upon T-cell activation and can directly bind the HIV LTR and enhance NF-κB activity.
<b>Repression</b>	
<b>LSF/YY1</b>	Cooperative recruitment of LSF and YY1 to the LTR enables repression via recruitment of HDAC1.
<b>CBF-1</b>	CBF1 interacts with the LTR and represses proviral transcription by facilitating recruitment of HDAC1 and its co-repressor subunits CIR and mSin3A,
<b>p50/p50</b>	Binding of p50 homodimers to the κB elements permits recruitment of HDAC1.
<b>E2F1</b>	Can partner with p50 to bind κB elements and suppress transcription initiation, probably by recruiting BRD2.
<b>CTIP2</b>	Suppresses HIV transcription initiation in microglial cells in cooperation with COUP-TF and Sp1. Recently identified as a regulatory component of 7SK snRNP in T-cells.
<b>BRD2</b>	Present at the promoter of latent proviruses. Suppresses proviral transcription initiation, possibly through an interaction with E2F1.

### 1.6.3.4 Elongation factors and viral latency

The host factor, positive transcription elongation factor b (P-TEFb) is an important transcription elongation factor, which is a complex of cyclin T1 (CycT1) and cyclin dependent kinase 9 (CDK9) [235,236]. CDK9 starts a cascade of events where the CDK9 stimulates the serine 2 phosphorylation of the C terminal at the big subunit of RNA polymerase II (CTD) [235]. This leads to the phosphorylation of serine 5 by TFIIF at the C terminal domain, and also phosphorylation of negative transcription elongation factor (NTEF) consisting of DRB sensitive inducing factor (DSIF) and negative elongation factor (NELF) which results in removal of NELF and in productive full length transcription. Large catalytically repressed Ribonucleoprotein complex (RNP) consisting of 7SK RNA and 7SK binding proteins EXIM-1 or HEXIM-2, MEPCE, LARP7 represses the P-TEFb [237-240] (figure 1.10). The release of the P-TEFb from the HEXIM-2 is mediated by the hexamethylene bicetamide (HMBA) [241]. BrD4 can also extract P-TEFb from the 7SKsn RNP. In absence of or inadequate amount of any of the host elongation factors can lead to latency (Table 1.7) figure 1.9 B.

Table 1.7: Host factors involved in the elongation, co-transcriptional processing, P-TEFb regulation of HIV proviral transcription [227]

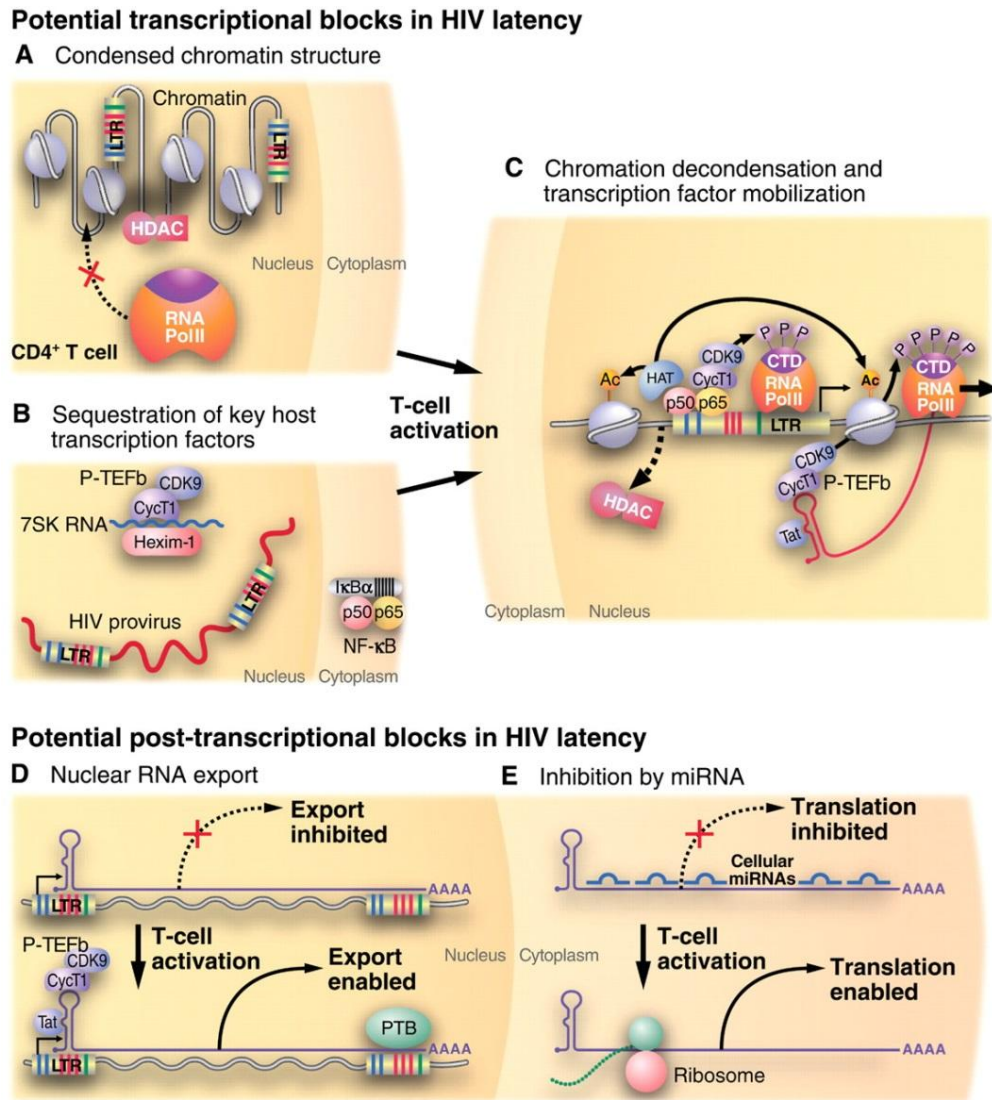
<b>Factors</b>		<b>Description</b>	
<b>Elongation</b>			
<b>P-TEFb</b>		Heterodimer of CDK9 and cyclin T1. Recruited by Tat to paused RNAPII at TAR RNA. Stimulates processive transcription by phosphorylating RNAPII, E subunit of NELF and hSpt5 subunit E subunit of NELF and hSpt5 subunit of DSIF.	
<b>Super Elongation Complex (SEC)</b>		AFF4 and AFF1 organize the assembly of Tat/P-TEFb into the SEC. ELL proteins of Tat/P-TEFb into the SEC. ELL proteins stimulate efficient elongation by preventing RNAPII pausing and backtracking. AF9 and ENL link the SEC to RNAPII.	
<b>Tat modifiers</b>		Histone modifying enzymes that regulate the trans-activating function of Tat by modifying its P-TEFb or Arg-rich RNA binding regions. These include P/CAF, SIRT1 and LSD1/CoREST.	
<b>Co-transcriptional processing</b>			
<b>SKIP</b>		Splicing factor that is recruited by Tat/P-TEFb to the HIV LTR. Associates with activated spliceosomes within the transcribed region of the proviral gene.	
<b>P-TEFb regulation</b>			
<b>7SK snRNP</b>		Provides an exchangeable pool of P-TEFb to support transcription of proviral and cellular genes. Contains 7SK snRNA, HEXIM, LARP7 and MEPCE.	
<b>CDK7</b>		Kinase component of TFIIF. Recently identified as the CDK9-activating kinase.	
<b>PPM1A</b>		Inactivates CDK9 via dephosphorylation of its activation loop.	
<b>BRD4</b>		Extracts P-TEFb from 7SK snRNP and directs it to cellular genes. Competes with Tat for P-TEFb binding.	

### 1.6.3.5 Tat feedback and viral latency

The HIV-1 RNA transcripts contain a trans-acting response element (TAR) at the 5' end. Viral protein Tat (a transactivation factor) plays an important role in transcription, it binds to TAR at the 5' end and directs P-TEFb to RNA polymerase II [242]. The P-TEFb which consists of catalytic subunit CDK9 and regulatory subunit CycT1, mediates and initiates the elongation stage as described in (section 1.4.3.4). In absence of Tat there is production of pre-maturely terminated short transcripts and eventually leads to latency.

Tat can be acetylated in the TAR binding domain at lysine 50 and 51 by CBP/p300 and GCN5 respectively [243]. The translation thus also depends on the acetylation state of Tat, it acts as a switch between the early phase and late phase of HIV-1 transcription elongation [243]. Tat interacts with the HATs and p300/CBP-associated factors (PCAF), which leads to the recruitment of the chromatin remodeling complex SWI/SNF/BAF. These complexes are necessary to de-compress the chromatin and allows the transcription elongation by displacing the restrictive nucleosomes [244-246]. The Tat can be de-acetylated by human sirtuin 1 (SIRT-1) [247]. Tat is also involved in the release of P-TEFb from the 7SK snRNP following Tat binding to RNA. This induces a RNA conformational change that competitively replaces the HEXIM1 from P-TEFb [248,249]. Thus, Tat is an important viral protein regulating the HIV-1 latency.

*More detailed information of the Molecular Biology of HIV-1 Latency with detailed figures is covered in (section 8), of our published review that is attached at the end of the thesis.*



**Figure 1.10: Proviral latency is a multi-factorial and result of multi-restrictions.** (A) Condensed chromatin structure limits the RNA polymerase to initiate the transcription, the condensed chromatin environment is due to the histone modifications, these histone modifications are due to recruitment of the HDACs by the transcription factors and LTR promoter. (B) In the resting CD4<sup>+</sup>T cells the important cellular factors for the transcription such as NF-κB, P-TFb-cycline complex are sequestered by inhibitors of nuclear factor IκB, HEXIM-7SK RNA respectively. (C) Once the T-cell is activated the HATs negates the effects of HDACs, the NF-κB can RNA Pol complex, the P-TEF-b is recruited as soon as there is production of Tat, this allows the provirus to escape from latency. (D) Potential post transcriptional block includes an inefficient transport of the multiply spliced mRNA which is relieved once the cellular activation is enhanced by expression of PTB. (E) The early expression of HIV mRNA is blocked by the cellular miRNAs, this reduces the production of Tat. Adapted from Richman et al. [250]

**1.6.3.6 Post transcriptional mechanism of latency-the micro RNA (miRNA).**



The miRNAs are 19-25 nucleotide of non-coding RNAs, which has a host antiviral defense mechanism, it interacts with the 3'UTR of target mRNAs and can regulate viral expression leading to the translational inhibition or mRNA degradation [251,252]. These processes can lead to and also maintain latency [253].

The nuclear enzyme Drosha and cytoplasmic enzyme Dicer contribute in the maturation of the miRNA. The miRNA silencing pathways are reported to involve in the viral replication and latency regulating the expression of the histone acetyltransferases Tat cofactor PCAF [254]. The miRNA (mir-198) can restrict HIV-1 replication via a strong downregulation of monocyte to macrophage differentiation by repressing the CycT1 expression [255]. Monocytes are less susceptible to the HIV-1 infection than the macrophages due to the presence of anti HIV miRNAs (miRNA-382, miRNA 223, miRNA 150, miRNA-28) [256]. In resting CD4+T lymphocyte miRNA-382, miRNA 223, miRNA 150, miRNA-28 and miRNA-125b target the mRNA of HIV-1 and suppress the translation. The miRNA thus inhibits the HIV-1 replication and induces latency.

#### **1.6.4 Reservoirs, types of cells and anatomical reservoirs**

Reservoirs are target cells and anatomical sites where the virus can persist without being cleared by the host's defense. For HIV-1, it is well established now that resting CD4+T cells are the main cellular reservoirs. Monocytes are also part of the reservoir even though the proportion of infected monocytes in the body seems lower than the CD4+ T cells, although it has to be kept in mind that the majority of reservoir studies have focused on blood while the vast majority of macrophages resides in tissues. Once monocytes are differentiated into tissue macrophages (dendritic cells, Langerhans cell in the epidermis, alveolar and interstitial macrophages in lungs, Kupffer cells in liver, osteoclasts in bones, microglia in CNS, perivascular macrophages, ordinary tissue macrophages), they replicate the virus and productively infected microglia and the Langerhans cells can persist in their anatomical site forming a reservoir [34,198,257]. A sanctuary is a type of anatomical reservoir that has only a limited accessibility for ART drugs (brain and testis). Compartments (compartmentalization) can be defined as anatomical sites where the virus isolates evolve as separate populations with limited transfer. The viral variants evolved in these sites are different from the pool. Yet it is not sure how much compartmentalization contributes to reservoirs [210].

*More detailed information of the Sites of Latent Reservoirs (cellular and anatomical) is covered in (section 9), of our published review that attached at the end of the thesis*

#### **1.6.5 Current models to study latency**

Models cannot recapitulate the complexity of the latent environment; nevertheless, it provides a platform to understand it.

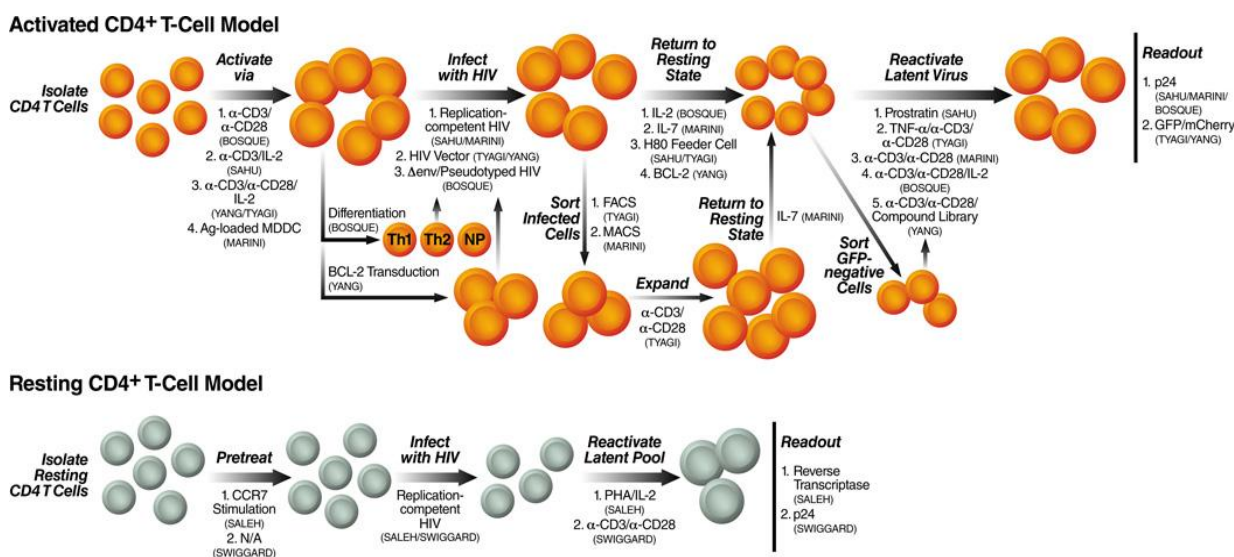
The T cell lines derived from the parental human CD4+ T cell Jurkat (J-Lat cell lines) and pro-monocyte clones (U1) were used for understanding of mechanisms of latency [258]. These artificially created cell lines have uniform copies of the integrated HIV-1 proviral DNA. The characteristic of these cells (due to immortalization changing the biology / "clonal"

making just one integration site in each cell) is not reflecting the wide diversity of latency in infected individuals.

### 1.6.5.1 Primary cell models of latency

Development of cell models to study latency is crucial for the test of potential drug candidates that could reverse the latency to productive replication stage. Cells models are easier cheaper and faster than the *in vivo* models.

Figure 1.11 and Table 1.8 summarize the commonly used primary cell models. Different strategies were used to establish the virus latency in different subsets of cells and with different viral strains. The primary cell models were developed using CD4<sup>+</sup> T cells from either HIV-1 negative donors in which latency was induced in vitro through different mechanisms; or from aviremic HIV-1 positive patient on HAART that are latently infected. Although the models are good tools, they fail to recapitulate all aspects of *in vivo* latency.



**Figure 1.11: Models for HIV latency in primary lymphocytes:** Different ways of establishment of HIV-1 latency in the primary activated or resting CD4<sup>+</sup>T cells are illustrated with the different mechanism for the activation and procedure to return it to the resting state and reactivating. Adapted from Shweta Hakre et.al [259].

### 1.6.5.2 Humanized mouse models

Mice humanized with human tissue/stem cells provide an alternative model to study the latency in vivo. The severe combined immunodeficient SCID mice transplanted with human fetal thymus and liver tissues SCID-hu (Thy/Liv) are one of the models used. CB17-SCID mice were used to study the latency and the action of the anti-HIV-1 immunotoxin to deplete the reservoir after IL-7 stimulation [111-113]. The NOD/SCID BLT mice designed by implanting human fetal hepatic and thymic tissue and transplanted with human CD34<sup>+</sup> hematopoietic stem cells reconstitutes mice with a functional human immune system in the periphery as well as in the mucosal tissues and therefore can be used for HIV-1 transmission/infection studies [114]. The next model is SCID-hu PBL mice developed by intraperitoneally injecting human peripheral blood leucocytes (PBLs) in SCID mice [260].

This model can survive for 6 months, secretes human antibodies and mount responses with human antibodies following immunization [261].

#### **1.6.5.3 Non-human primate (NHP) model**

The non-human primate models allow for studying virus/host interactions in many different organ systems. The NHP immune response is similar to that of human; however, the model is costly and more limited by ethical issues than the mouse models. The NHP model is used to study potential HAART treatment and the latent viruses in different anatomical locations. SIVs and recombinant SHIVs are used as challenge viruses.

#### **1.6.5.4 Experimental approach to detect the latently infected cells *in vivo***

Since latency is the barrier to a cure for HIV, it's important to primarily define the exact assay that can determine the latently infected cells, and activate expression of the integrated HIV-1 DNA. This will help to optimize the efficiency of HAART at curing infectious virus and infected cells following use of potential agents that can disrupt the latency. As Fig 1.11 illustrates the complex mix of CD4+ T cells that are isolated from the PBMCs. These CD4+ cells are in different differentiation, activation and infection stages. The initial step will be to purify the resting CD4+ T cells since the majority of latently infected cells are present in the resting CD4+ T cell compartment. This can be done by depleting all activated/differentiated T cells, since they express surface markers CD69, CD25 and HLA-DR during different stages of the kinetics. The group of cells remaining will be resting CD4+ T cells. And the replicating virus rescued from this group after activation is coming from the latently infected population [116].

Chapter 1- Review of Literature

Model	Phenotype of resting CD4+ T cell	HIV virus/ viral vector	Description on establishment of latency	Invitro stimulation	MOI	% of cells productively infected	% of cells latently infected	Read outs	Time to readout	Ref
<b>Activated CD4+ T cells</b>										
Sahu/Cloyd	T <sub>CM</sub>	Replication competent NL4-3	Naive cell stimulated with α-CD3 antibody+ IL2; culture on feeder cells(H80)	Yes	1-10	~ 80%	>5%		~ 2 months	[26 2]
Tayagi/Karn	T <sub>CM</sub>	Δagag/Δtat VSV-G pseudotyped GFP reporter	naive cell stimulated with α-CD3 α-CD28+IL2 antibody culture on feeder cells	Yes	-	~ 85%	20%	GFP	~ 2 months	[26 3]
Marini/Romerio	T <sub>CM</sub>	Replication competent NL4-3	DC activated cells cultured in IL-7	Yes	0.002	5-10%	2%	Measured by p24	~ 2 months	[26 4]
Bosque/Planelles	T <sub>CM</sub> / T <sub>EM</sub>	Δenv NL4-3	Naive cells activated with α-CD3 α-CD28+ IL2	Yes	50	3% NP,14.5% Th1, 3% Th2	45% NP,11% Th1, 40% Th2	Intracellular p24	~ 1 months	[26 5]
Yang/Silliciano	T <sub>EM</sub>	NL4-3 Δagag ΔvifΔvpr Δvpu Δenv-EGFP	Naive cells activated with α-CD3 α-CD28+ IL2;BCL-2 transduced cells are	Yes	<1.01	5-10%	1-3%	GFP	~ 4 months	[26 6]
<b>Resting CD4+ T cells</b>										
Swiggard / O'Doherty	Naive/ T <sub>CM</sub> / T <sub>EM</sub>	Replication competent NL4-3	Direct infection of the resting T cell	NO	22-150	1.3%	4.5%	P24	~ 1 week	[26 7,26 8]
Saleh/Lewin	Naive/ T <sub>CM</sub> / T <sub>EM</sub>	Replication competent NL4-3	CCR7 stimulation, exposed to CCL19 or CCL21and infected	YES	1	--	--	Concentration of RT	~ 2 - 3 weeks	[26 9]
Green	Naive/ T <sub>CM</sub> / T <sub>EM</sub>	NL4-3 Δnef/ luciferase	Primary resting CD4+T cells infected by spininoculation and cultured for 3 days.	NO			5-10%	luciferase	~ 1- 2 weeks	[27 0]
Spina	Naive/ T <sub>CM</sub> / T <sub>EM</sub>	Replication competent NL4-3	Resting CD4+T cells cocultured with productively infected cell and quiescent cell isolation.	NO			0.5-5%	Tat mRNA, intracellular p24	~ 1- 2 weeks	[27 1]
<b>Thymocyte model</b>										
Burke/Zack	Naive/ T <sub>CM</sub> / T <sub>EM</sub>	NL4-3 based mutated genes with reporter	Thymocytes infected and cultured in IL-2 ;IL4	YES					~ 1 week	[27 2]

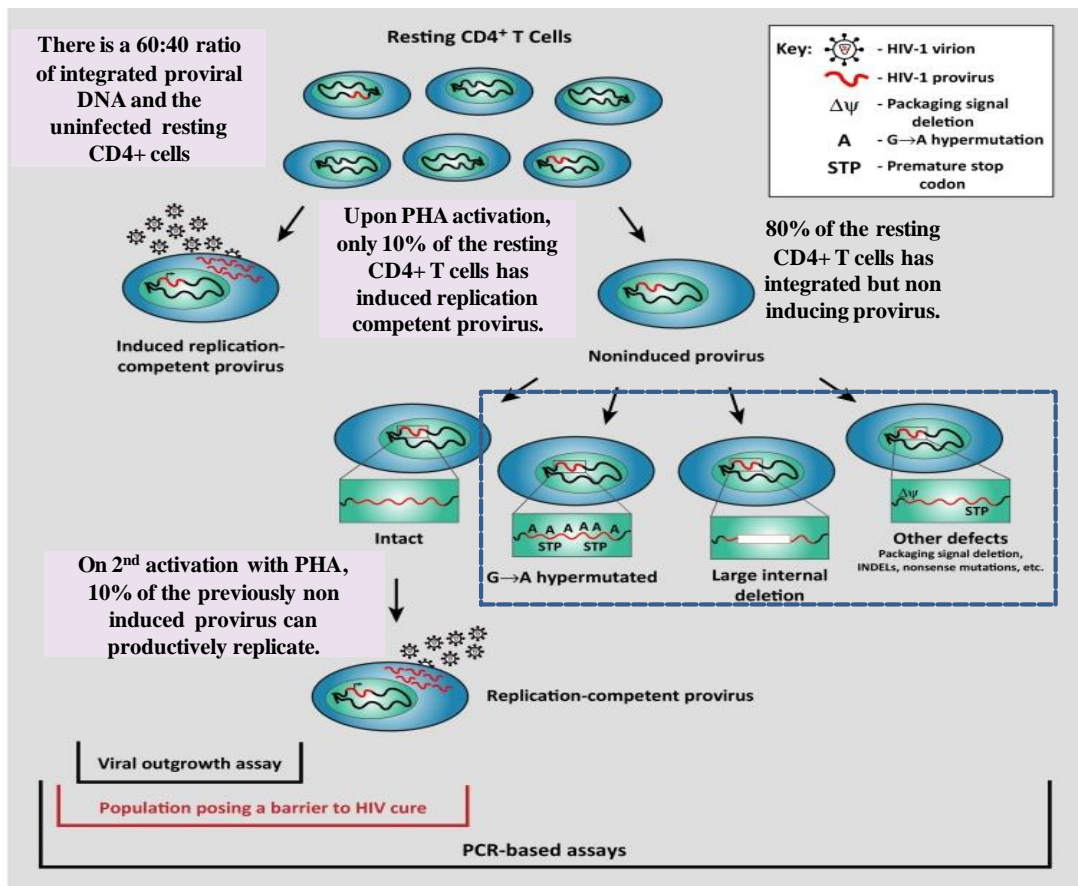
Table 1.8: Summary of commonly used primary cell models of latency adapted from [119,273,274].

#### **1.6.5.4.1 Detecting the integrated HIV-1 DNA and Cell associated RNA**

The PCR based technique to study the latent reservoir has been developed intensively in the last decade as a sensitive and quick assay. It can quantify the HIV DNA as total, integrated, or 2-LTR circles. Total HIV DNA (integrated and non-integrated) is measured by the qPCR (*Gag or Pol*) on the PBMCs or enriched CD4+T cells. A standard curve of the known copy number of viral DNA is then used to measure the number of infected cells. Alternative to qPCR is a droplet digital PCR (ddPCR) with improved precision and accuracy not requiring a standard curve. Integrated DNA is measured by using the *Alu* PCR method [136-138,144], which amplifies DNA that is located between a sequence of HIV *Gag* and an *Alu* element in the host DNA. Due to the variability of integration sites and the variable sizes of the amplicons technical adaptations are needed to detect all potential integration sites of proviruses [139,195]. Cell associated HIV RNAs are detected as multi-spliced, unspliced or unspliced mRNA [145,156,275]. They are measured either directly in PBMCs or in the enriched CD4+ T cells. The unspliced RNA (gag-pol) is abundant and easily detected with semi-nested or nested quantitative reverse transcription PCR (qRT-PCR) reviewed in [149,276].

#### **1.6.5.4.2 Detecting cells carrying the replication- competent virus/ Assay to measure the latent reservoir**

The importance of detecting the replication competent virus from the activated resting cells comes with the fact that most of the latently infected cells may have integrated a defective or inactivated DNA and there is a 100 fold difference in the molecular measurement between an integrated HIV-1 DNA and the fraction of cells that can produce replication competent virus [195] (Figure 1.12). These defective and inactivated DNA (due to the G-A mutation or mutations during reverse transcription) cannot be called latent since they are not in a reversible nonproductive state, thus an assay should focus on detecting cells which has replication competent virus rescued from resting CD4+ cells following the activation, reviewed in details in [277,278].



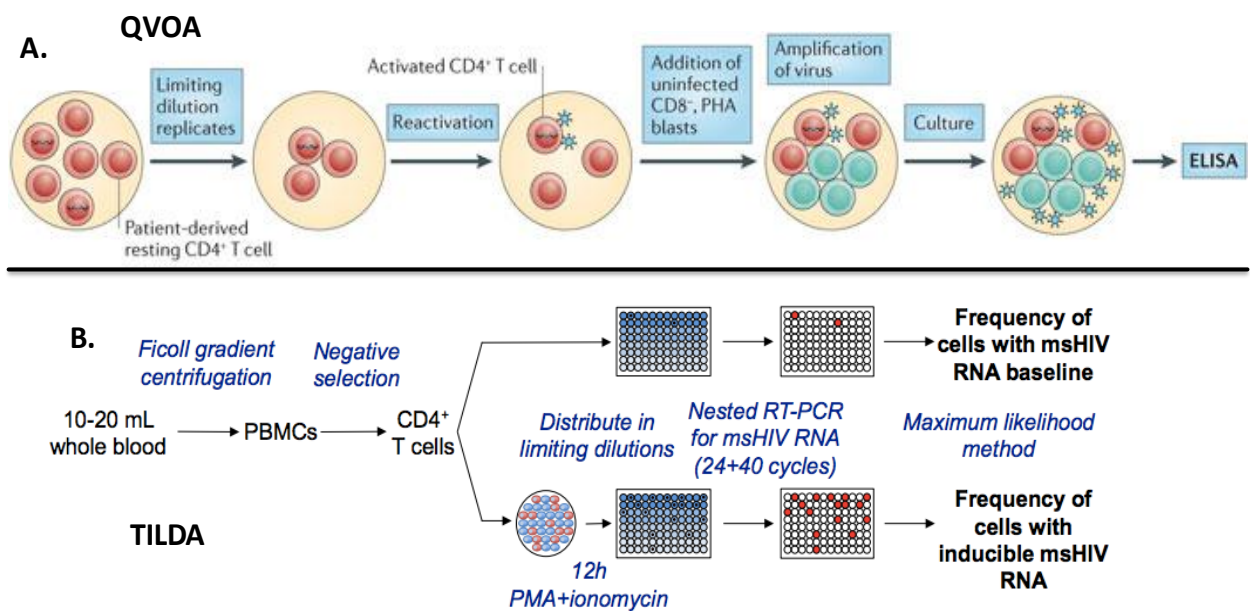
**Figure 1.12. Profile of proviruses in a resting CD4+T cells:** In the population of the resting CD4+ T cells there is a 60:40 ratio of integrated versus non-integrated viral DNA. Upon the first activation using PHA, only 10% of the resting CD4+ T cells will induce the replication of provirus (that infect other cells) while 80% are still non induced. Some of these 80% CD4+ T cells carrying a non-induced provirus contains an intact integrated proviral DNA while others has defects/deletions thus non replicative. Upon the second activation with PHA the portion of intact non-induced provirus (INPs) is activated and produces the replication competent virus. The entire population of integrated proviral DNA can be estimated with the PCR based assay, while the cell based viral outgrowth assay can detect the induced replication competent proviruses only. The barrier for a HIV cure is due to the induced replication of competent provirus and intact non induced replication competent virus, adapted from Bruner et.al., [277].

The most commonly and universally used technique designed to measure the infectious units per million (IUPM) in cell culture is illustrated in figure 1.13. In the quantitative viral outgrowth assay (QVOA), the serial dilution of purified CD4+ resting cells are activated with the mitogen phytohemagglutinin (PHA) and irradiated allogeneic PBMCs. This causes uniform activation of the cells and allows the expression of viral genes. The CD4+ lymphoblast from the normal donor are added to amplify the released virus. After 2-3 weeks viral growth is detected by p24 ELISA from each dilution. It is important to use an assay variance Poisson statistics to calculate the number of latently infected cells per million of resting cells. QVOA is slow, expensive and requires high number of cells. It may also under-

represent the true frequency of latent infection as the ‘intact non-induced provirus’ INPs are not recovered with a single activation as shown in figure 1.12 A., yet QVOA remains the most preponderant technique used to measure the HIV-1 latency and assess the virus eradication strategies.

**(Tat/rev Induced Limiting Dilution Assay - TILDA)**

This assay was described by the group of Dr. Chomont [279]. Advantages of this method over QVOA is that TIDLA requires less than a million cells, no RNA extraction needed and the assay can be completed in two days. As shown in the figure 1.13B, in the TILDA assay only 10 ml-20 ml of whole blood is used to harvest the PBMCs. CD4+T cells are separated and split into two plates of limited dilution samples. In plate two, PMA and ionomycin cocktail is used this stimulates the CD4+T cells. Nested RT- PCR is performed on both plates. The baseline is obtained from the first plate which gives the frequency of cells with the multiply spliced msHIV RNA. While plate two which was stimulated with PMA and ionomycin gives the frequency of cells with inducible msHIV RNA. This assay can be used as a screening assay to measure induction of HIV RNA in cells, TILDA would yield a reservoir size in between QVOA and qPCR on total viral DNA. This assay can be used as a screening assay to measure HIV RNA induction after treatment with putative latency-reversing agents.



**Figure 1.13 (A) : Quantitative viral outgrowth assay (QVOA):** this method is currently the most reliable and reproducible way to measure the replication competent but latent HIV-1. The latently infected resting CD4+ plated in serial dilutions are activated to reverse the latency. Virus is propagated in the PBMCs obtained from the uninfected donors. Adapted from [273]. **(B) (Tat/Rev Induced Limiting Dilution Assay - TILDA)** is used to measure the frequency of persistently infected cells in blood samples of virally suppressed individuals [279].

## **1.6.6 Prospects for treatment of latency**

### **1.6.6.1 ART intensification**

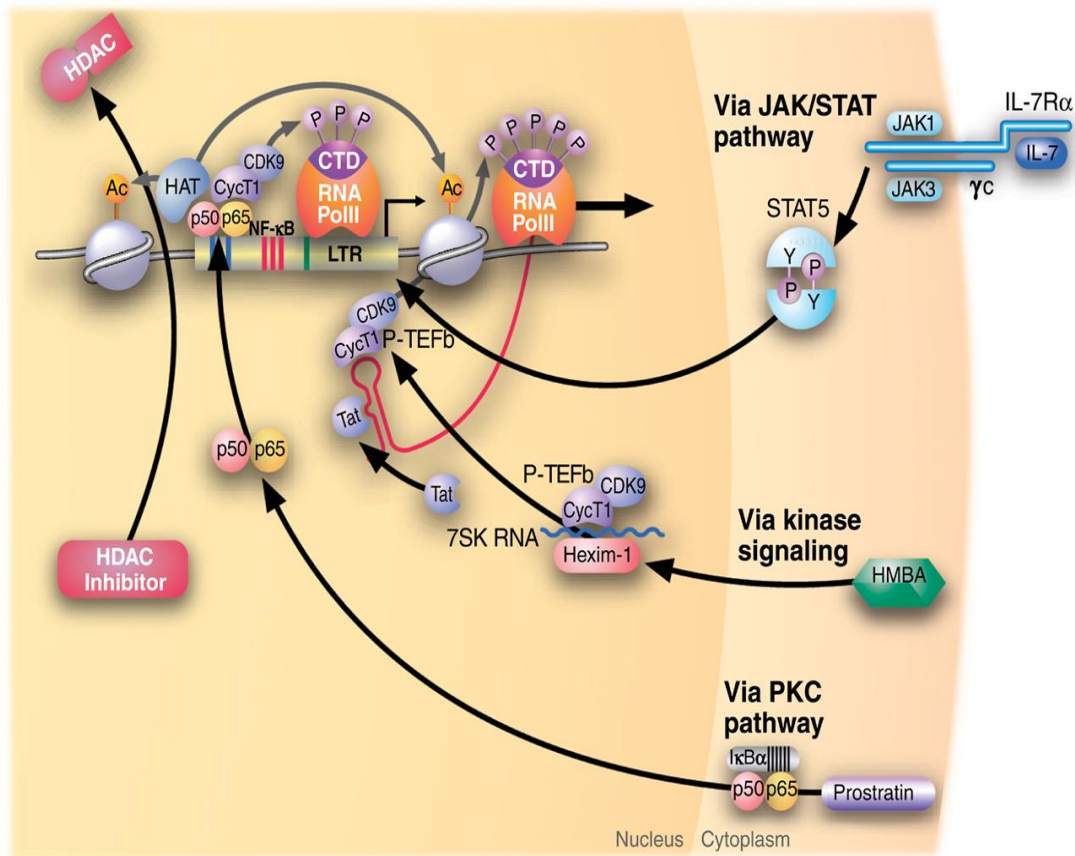
As discussed earlier, the HIV-1 reservoir produces low level of plasma RNA (few copies/ml) even during ART suggesting that the ART regime is not efficient enough. So the solution was to intensify ART with an objective to achieve complete suppression of residual viremia. These intensification of ART studies demonstrated that there was no further decrease in the residual viremia than already achieved by regular ART regimens. Thus, the current regimen can effectively control viremia to its maximal ability [280].

### **1.6.6.2 Using transcriptional inhibitors to control the HIV-1 progression**

Current ART drugs target the specific HIV-1 replication steps and the drugs target the envelope, reverse transcriptase, integrase and protease. HIV-1 transcription is a multifactorial process and additional drugs can be developed to target cellular cofactors of the transcription. Some transcription inhibitors are already described, such as C-terminally truncated STAT-5, Staf 50, prothymosin  $\alpha$  and thioredoxin reductase [281,282]. Several ideas around the control of viral expression in macrophages have been in focus. For instance, inhibition of NFAT5-LTR interaction by using siRNA can suppress viral replication in macrophages. Studies show that IL-10 is able to repress viral replication and transcription only in macrophages [283,284]. Another study about the repression of the viral replication by O-GlcNAcylation, an enhancing agent glycosamine in infected lymphocytes can be open options for metabolic treatment [285].

Further approaches based on the engineering of the transcription factors are also being developed as zinc finger proteins that bind to the HIV-1 LTR and represses the LTR activation. OKT-18 a zinc finger protein can reduce the replication by targeting the Tat induced LTR activity [286]. Zinc finger proteins can be further used to influence the epigenetic regulations.





**Figure 1.14 : Potential therapies to disrupt latent proviral HIV infection.** The condensed chromatin environment can be targeted by using HDAC inhibitors that may relieve repression by HDACs and may allow histone acetylation by HAT, this results in HIV expression via kinase signalling. In resting CD4+ T cells, the important cellular factors NF- $\kappa$ B, P-TFb-cyclin complex are sequestered; HMBA stimulates the release of P-TEFb from sequestration within a ribonucleoprotein complex containing HEXIM and 7SK snRNA (small nuclear RNA). While the transactivation factor Tat recruits P-TEFb to an HIV RNA structure (TAR) that allows phosphorylation and activation of RNA Pol II and other factors, leading to processive transcription. Protein kinase C (PKC)-mediated release of active NF- $\kappa$ B is stimulated through prostratin or bryostratin. Interleukin 7 (IL-7) can induce HIV expression from quiescent resting cells without global T cell activation, via the JAK/STAT5 signaling pathway. Adapted from [250]

### 1.6.6.3 Strategies to reactivate latent provirus from reservoirs (“Flushing out”/ “Shock and Kill”)

The main idea of this approach is to reactivate the latent proviruses and killing them together with infected cells via ART and/or apoptosis inducing agents. The preclinical studies have shown that activation involves many factors such as physical stimuli, chemical components (phorbol esters, histone deacetylase inhibitor [287], p-TEF-b activator, activating antibodies anti-CD3, IL2). Some of these protocols failed (the immunostimulation with IL-2) during clinical trials, as they tend to be toxic and directed primarily at the wrong T cell subset [288,289]. IL-7 was found to be able to reactivate HIV-1 provirus from latency through

JAK/STAT signaling pathway. This cytokine is also interesting as it increases TCR repertoire and proliferate both naive and memory T cells [290] (Figure 1.14).

HDAC and DNA methylation inhibitors are attractive means to induce activation of the HIV-1 reservoir. HIV promoter can be activated with the combination of TSA (an HDAC1) and TNF- $\alpha$  (NF- $\kappa$ B inducer), but due to the high toxicity of these factors, were not a part of clinical trials. HDAC inhibitor valproic acid could reportedly reduce but not eliminate the latent reservoir. Other HDACi metacept-1, metacept-3 and oxamflatin can promote the transcription in latently infected cells. Some protein kinase C (PKC) agonists like ingenols, prostratin (phorbol ester) are effective in activating the latent cells [291]. SAHA an HDACi can also reactivate the latent reservoirs [292] (Figure 1.14). Of importance though, recent studies show that these activators fail to reactivate the entire reservoir of latently infected resting CD4+ T cells.

#### **1.6.6.4 Strategies based on the increasing apoptosis susceptibility**

In the shock and kill approach the killing can be done with the specific agents that induce apoptosis like the AKT inhibitor factor Miltefosine targeting the long lived reservoirs, chemotherapeutic drug Imatibib induces apoptotic ability of the macrophages through inhibiting the pro-survival cytokine macrophage colony stimulating factor (M-CSF) [293].

#### **1.6.6.5 Other therapies targeting latency**

Immune based therapy targets to reactivate the latent cells using cytokines in combination to the agents that antagonize negative regulators of immune activation.

Reversing immune exhaustion by downregulating PD-1 also has prospects of treating latency [294].

Cell based therapy: HIV-1 specific CTLs stimulated by Gag have shown to be effective in clearing activated HIV-1 infected cells in the primary cell models of latency.

Gene therapy: in this type of strategies, the effector cells can be genetically engineered to increase the efficiency and redirect them to the target. The peripheral blood cells with molecularly cloned TCR redirect cells to the viral antigen.[295]

#### **1.6.6.6 Challenges in treatment of latency**

Although there has been considerable progress in targeting the latently infected cells, they have yet to achieve reactivation of the entire pool of latently infected cells and no eradication protocols tested during the preclinical and clinical trials have so far succeeded in preventing viral rebounds post ART interruption. The results obtained using single drugs are not encouraging, thus combination of drugs and approaches are needed. One of the challenges of these compounds is the level of toxicity at therapeutically effective doses. The use of the components for reactivation can also lead to the possible activation of endogenous retroelements [296,297]. The major challenge in evaluation and testing of new therapies is associated with an urgent need of developing models both *in vivo* and non-human primate models to represent the situation in the latently infected cells. There is also a need for universally employed and standardized methods for measuring the latently infected cells to

study the efficiency of the eradication methods. The challenge is also that since *in vivo*, the latently infected cells are one in million it is hard to study them in small amounts of blood samples to monitor the effect of therapeutic technique and most approaches do not yet address tissues [214].

---

## 1.7 Natural History of CAEV

### 1.7.1 Discovery and Epidemiology

CAEV and MVV are small ruminant lentiviruses (SRLV) which belong to the lentivirus genus and they affect goats and sheep respectively but also they cross the species barrier to infect and induce pathogenesis in either sheep or goat [298].

The history associated with SRLVs dates back to 1862 Texel, Netherlands, when Loman described it as “zwoegerziekte” in sheep. In 1915 Mitchell in South Africa first described disease associated with the lentivirus infection in sheep. Soon after in 1923, Marsh reported the chronic interstitial pneumonia that results in wasting and death in sheep [8,9].

In 1933 the asymptomatic Karakul rams from Germany were imported to Iceland to introduce a genetic diversity to the local breed. This was responsible for the major epidemic devastation that necessitated a large eradication program (slaughtering 100,000 sheep) that lasted for a decade to stop the fatal loss of local breeds. The infected animals developed severe degenerative disease characterized by pneumonia “maedi” and neuropathology “visna”. In 1939 Gislason described the symptoms in adult sheep. In 1960, Sigurdsson and Thormar demonstrated that “maedi” and “visna” are caused by same virus and therefore it has been named Maedi Visna virus (MVV) [11,127].

In the 1950s adult goats in Switzerland [12] and then in Germany [13] were reported with inflammations in joints and udder. The pathogenesis was studied by Linda Cork in the 1970s and they reported that adults were affected by arthritis and mastitis while the kids developed encephalitis [14]. The first virus isolations were reported from the joints of infected goats by Crawford et.al [299] and from the CNS of the encephalitic kids [125].

On the basis of the homology of the gag-pol sequences, the SRLVs are classified into five principle groups A-E. Group A comprises of South African ovine Maedi Visna virus and the ovine MVV-K1514 from Iceland. Group B comprises the CAEV Cork, with three subtypes. Group C comprises the viruses isolated from the goats from Norway. Group D comprises the virus isolated from goats from Switzerland and Spain. Group E comprises viruses isolated from goats of Northern Italy and Sardinia [298].

*More detailed information of the SRLVs discovery is covered in (section 3.5), of our published review attached at the end of the thesis.*

### **1.7.2 Genomic Organization**

SRLVs have a simpler genome organization than other lentiviruses in this genus. Their genome contains the three structural genes gag, pol and env, common to all replication-competent retroviruses. The gag gene expresses the proteins matrix protein (MA) p16, capsid protein (CA) p25, nucleocapsid (NC) p14. The pol gene encodes the viral enzymes reverse transcriptase (RT), integrase (IN), protease (PR) and deoxyuridine triphosphatase (dUTPase). The env gene encodes the gp38 transmembrane and gp135 surface glycoproteins. SRLVs also have accessory genes rev, vif and regulatory vpr-like coding genes [72,300].

CAEV lacks vpx, vpu, nef and tat that are well known to play important roles in increased virulence/pathogenicity in primate lentiviruses and therefore their absence correlates with natural attenuation of CAEV. The CAEV LTRs have a strong promoter that expresses viral genes constitutively independently of Tat regulation. A gene erroneously called Tat in SRLV due to its position and molecular weight was proven to function more like Vpr and does not play any role in transactivation [72,300]. Moreover studies had shown the constitutive LTRs as basis of natural attenuation of the virus leading to clearing of the infection in experimentally infected calves [301].

*More detailed information of the molecular mechanism of SRLV's Tat-independent transcription is covered in (section 8.2), of our published review attached at the end of the thesis.*

### **1.7.3 Tropism & Target cells**

SRLVs do not productively infect T cells nor directly kill these cells by mechanisms seen in primate lentiviruses; they do not induce immunodeficiency in their natural hosts following natural or experimental infections [301,302]. The receptor for CAEV is not yet defined, though mannose receptors have been proposed as potential entry receptors for CAEV. SRLVs are monocyte/macrophage tropic [303] and also infect microglia, astrocytes and oligodendrocytes [304].

*More detailed information of the SRLVs Tropism, cross species infection, transmission, viral dynamics, receptor usage, is covered in (section 3.6;3.7;3.8;3.9;5 respectively), of the published review, attached at the end of the thesis.*

### **1.7.4 Pathogenesis**

Less than 20% of CAEV infected goats show clinical symptoms after a long preclinical period and co-infections with other pathogens. Latently infected monocytes will differentiate into macrophages in different organs where they induce a pro inflammatory environment and damage tissues. The main clinical symptoms show arthritis and mastitis in adults and encephalitis in the kids.

*More detailed information of the SRLVs disease characterization and clinical pathogenesis is covered in (section 3.10 and 4 respectively of our published review attached at the end of the thesis.*

## Chapter 2- Materials and Methods

### 2.1 Materials

#### 2.1.1 Bacterial Strains

The bacterial strains used in the study are listed in Table 2.1. JM109 was used for all the transformations of the PCR products ligated into the pGEMT-easy plasmid. The Stable-2 strain was used to transform the final lentiviral whole genome, these competent cells have an *endA* mutation in the non-specific endonuclease I which eliminates non-specific endonuclease activity, resulting in improved plasmid preparations and integrity. Special *dam*<sup>-</sup>/*dcm*<sup>-</sup> competent *E. Coli* were used to abolish endogenous adenine methylation at GATC sequences (*dam*) or cytosine methylation at CCWGG sequences (*dcm*). These bacteria were used to propagate DNA for cleavage with methylation sensitive restriction enzymes (NruI)

**Table 2.1- List of the Bacterial strains used and their special features.**

Bacterial Strain	Genotype	Manufacturer
JM109	<i>endA1, recA1, gyrA96, thi, hsdR17</i> (rk – , mk +), <i>relA1, supE44, Δ(lac-proAB), [F', traD36, proAB, laqIq ZΔM15]</i>	Promega (L2001) (Lot-0000108457)
Stable-2	F- <i>mcrA Δ(mcrBC-hsdRMS-mrr) recA1 endA1 lon gyrA96 thi supE44 relA1 λ- Δ(lac-proAB)</i>	Invitrogen 10268019
<i>dam</i> <sup>-</sup> / <i>dcm</i> <sup>-</sup> Competent <i>E. coli</i>	<i>ara-14 leuB6 fhuA31 lacY1 tsx78 glnV44 galK2 galT22 mcrA dcm-6 hisG4 rfbD1 R(zgb210::Tn10) Tet<sup>S</sup>endA1 rspL136 (Str<sup>R</sup>) dam13::Tn9 (Cam<sup>R</sup>) xylA-5 mtl-1 thi-1 mcrB1 hsdR2</i>	New England Biolabs C2925I Lot 0491408

#### 2.1.2 Plasmids

##### 2.1.2.1 Cloning Vector

PCR amplified products were ligated into the cloning vector pGEMT-Easy (Promega) as intermediate clones. This cloning vector has T-overhangs for easy PCR cloning, along with the β-galactosidase-based blue/white selection of the recombinants. It has T7 and SP6 RNA polymerase promoters and a polylinker with a range of restriction enzyme sites to release the insert. See Appendix 1 for the map and the multiple cloning sites of the pGEMT-Easy.

##### 2.1.2.2 Infectious molecular plasmid genomes

###### i) SHIV-KU2

SHIV-KU2 is an infectious molecular chimeric virus in the genome of which *tat*, *rev*, *vpu*, and *env* genes are from HIV-1 (HXB2 strain), while LTRs, *gag*, *vif*, *vpr*, *vpx*, and *nef* genes are

from SIV (SIVmac239) as described in [305]. (GenBank database accession #[AY751799](#)). See Appendix 2 for the map.

**ii) CAL-SHIV-KU2**

The CAL-SHIV-KU2 was generated using classical molecular cloning techniques and PCR. The 5' and 3' SIV LTRs were removed from the genome of the infectious pathogenic SHIV-KU2 and replaced in with those of the goat lentivirus CAEV-CO strain (GenBank accession # [M33677](#)).

**Table 2.2: List of the vectors used along with the antibiotic resistance and information of the important genes and the source of availability.**

Vector	Resistance	Vector derivative	Genomic organization	Manufacturer
pGEMT-Easy vector system I	Ampicillin	pUC/M13	-T7 RNA polymerase transcription initiation site 1 multiple cloning region.-SP6 RNA polymerase promoter (-17 to +3) -SP6 RNA polymerase transcription initiation site . pUC/M13 -Reverse Sequencing -Primer binding site lacZ start codon 165 lac operator - β-lactamase coding region- phage f1 region, lac operon sequences 2821- pUC/M13.orward Sequencing Primer binding site T7 RNA polymerase promoter	Promega (A1360) Lot 0000125232
SHIV-KU2	Kanamycin	pET9 (Novagen, EMD Chemicals, San Diego, CA	tat,rev,vpu, env from HIV-HXB2; LTR, gag, vif, vpr, vpx, and nef from SIVmac239. GenBank data base accession # <a href="#">AY751799</a>	Donated by lab of, Narayan,O (USA)
CAL-SHIV-KU2	Kanamycin	pET9 (Novagen, EMD Chemicals, San Diego, CA	tat, rev,vpu, env from HIV-HXB2; gag, vif, vpr, vpx, and nef from SIVmac239 and LTRs from CAEV CO	Produced in lab of Chebloune, Y
SHIV-AD8EO	Ampicillin	pCR2.1 TOPO	gag, pol, vif, vpx, vpr, and nef genes from SIVmac239 and the first coding exons of the tat and rev genes plus the vpu and env genes (and associated second tat- and rev-coding exons) present in the HIV-1-derived CK15-3 [306]	Donated by Dr. Martin Malcolm NIH , USA
Z331T/F Z3618T/F Z6378T/F	Ampicillin	pBlue Script	GenBank-KR820323, KR820366, KR820393 full-length genome infectious	Donated by Dr.Eric Hunter

			molecular clones from an epidemiologically linked transmission pair [193,307]	Emory University, USA
--	--	--	---	-----------------------

### 2.1.3 Chemicals Buffers and Reagents.

#### 2.1.3.1 Microbiology reagents

Ampicillin (100 mg/ml stock in milli Q water (mMQ H<sub>2</sub>O), working concentration 100 µg/ml) (Roth-HP62.2)

Kanamycin (50 mg/ml stock in mMQ H<sub>2</sub>O, working concentration 50 µg/ml) (Euromedex-EU0420-A)

Isopropyl-beta-D-thiogalactopyranoside -IPTG(40 mg/ml stock in mMQ H<sub>2</sub>O, working concentration 40 µg/ml) (Euromedex-EU0008)

X-gal (40 mg/ml stock in mMQ H<sub>2</sub>O, working concentration 40 µg/ml) (Euromedex-EU0012)

#### 2.1.3.2 Bacterial Growth Media (Luria- Bertani- LB medium)

Standard formulation was used for propagation and culturing of *E. coli* as described by Sambrook et.al 1989 with tryptone 10 g/l, yeast extract 5 g/l, NaCl 5g/l; pH 7.0 ± 0.2. Molecular biology grade LB Broth (Lennox) (Ref-X964.3) was purchased from Carl Roth (as dried powder), 20 g of the powder was dissolved in 1 liter mMQ water and sterilized by autoclaving.

#### 2.1.3.3 LB Agar Plates

LB medium with 15 g/l bacteriological agar. Molecular biology grade LB Agar (Lennox) (Ref-X965.2) was purchased from Carl Roth (as dried powder), 35 g of the powder was dissolved in 1 liter of mMQ water and sterilized by autoclaving. Plates were prepared by pouring the LB agar at 55°C prior to adding the desired antibiotic.

#### 2.1.3.4 SOC Medium

Tryptone 20 g/l, 5 g/l yeast extract, 0.5 g/l NaCl, 10 ml 250 mM KCl (*prepared by dissolving 1.86 g of KCl in 100 ml mMQ water*), 5 ml of 2 M MgCl<sub>2</sub> (*prepared by dissolving 19 g of MgCl<sub>2</sub> in 90 ml mMQ water, adjusted the volume to 100 ml*). The medium was sterilized by autoclaving for 20 mins, and 18 ml of 20% filter sterilized glucose was added (*prepared by dissolving 4 g glucose in 20 ml mMQ water*).

Dimethyl Sulfoxide DMSO ACS grade (Ref. UD8050-05) was purchased from Euromedex.

#### 2.1.3.5 Molecular Biology Reagents

##### 2.1.3.5.1 Reagents for restriction enzyme digestions

The enzymes were purchased from New England Biolabs (NEB) and alternatively from Promega

##### 2.1.3.5.2 Reagents for DNA modifications;

Klenow (Ref: M0210S), T4 DNA Ligase (Ref: M0202S and Ref: M0202T), T4 DNA Polymerase (Ref: M0203S), calf alkaline intestinal phosphatase -CIP (Ref: M0290S) were also purchased from NEB.

#### **2.1.3.5.3 Reagents for PCR**

Taq Polymerase (Ref-01-01-01000), dNTP (100mM) (Ref: 02-21-00100) were purchased from Euromedex.

High Fidelity Taq Polymerase (Ref: PCR-204S) was purchased from Jena Bioscience

#### **2.1.3.6 Reagents for agarose gel electrophoresis.**

Standard agarose of high quality (Ref: 3810.4) was purchased from Roth. Agarose gel of (1%) was used to prepare the gels.

A stock solution of 50X TAE buffer was prepared by dissolving (242g Tris Base, 750 ml mMQ water, 100ml 0.5 M EDTA (prepared by dissolving 93.05g EDTA, 10.14g NaOH in 500 ml mMQ water), 57.1 ml Glacial Acetic acid—made up to 1000 ml). A dilution to 1X TAE in mMQ water was used for electrophoresis.

The 1kb DNA marker (#03B-1211) and the 100 bp DNA ladder (#03B-0712) were purchased from Euromedex which was diluted to 0.1µg/µl working dilution, 0.5µg of it was deposited in a well during gel electroporation.

The loading buffer 10X was prepared by mixing 0.25% bromophenol blue; 0.25% xylene cyanol FF ~ 50% glycerol at room temperature.

Ethidium Bromide (Ref: EU0070) ,was purchased from Euromedex and diluted in 1X TAE buffer to 1 mg/ml as working solution for staining DNA.

The high resolution Gel Doc XR + System from BioRad was used for imaging and detection along with the Image Lab 4.1 software for analysis.

#### **2.1.3.7 Buffers for Plasmid DNA isolation**

The supplied standard buffers provided in DNA isolation kits from Macherey-Nagel were used: NucleoSpin Plasmid EasyPure (Miniprep) (Ref: 740727.250 Lot: 15081004) NucleoBond Xtra Midi (Ref: 740410.50 Lot1511/010) (Midiprep) NucleoSpin Gel and PCR clean-up kit (Ref:740609.250 Lot-14021002).

## **2.2 Microbiology Methods.**

### **2.2.1 Growth and storage of bacterial strains.**

Bacterial cultures were handled according to microbiology sterile laboratory practices, all the glassware used were either sterile disposable or autoclaved and the heat labile solutions filter sterilized before being used. The bacteria were grown at 30-32°C, 250-350 rpm for 18-20 hrs (overnight) either on the LB plate (2.1.3.3) or LB media (2.1.3.2). Appropriate antibiotics



were used for the positive selection, (Ampicillin 100 µg/µl and Kanamycin 50 µg/µl). For longer storage, 10% DMSO was added dropwise to the bacteria in ice; the bacteria were then transferred to -80°C.

### **2.2.2 Transformation by heat shock method**

#### **2.2.2.1 Transformation protocol for JM109 and Stable -2 competent cells.**

The competent bacteria were thawed on ice. 10-100 ng of DNA were added to 40 µl of the competent bacteria. The mix was incubated in ice for 45 mins and then transferred in a water bath preheated at 42°C for a heat shock of 1.5 mins. The mix was transferred back to ice and 500 µl of SOC media (2.1.3.4) was added. Finally, the cells are placed in a shaking incubator for 1 hr and 30 mins before being plated on the pre-warmed LB agar plates supplemented with antibiotics and incubated overnight at 30 °C.

#### **2.2.2.2 Transformation protocol for dam-/dcm- Competent E. coli cells. (according to the manufacturer's protocol)**

Tubes of dam-/dcm- competent E. coli cells were thawed on ice until the last ice crystals disappeared. Then 50 µl of cells were carefully mixed and transferred into a transformation tube on ice, 1-5 µl containing 1 pg-100 ng of plasmid DNA were added to the cells and placed on ice for 30 minutes without mixing. Heat shock at 42°C for 30 seconds was done and the tubes were placed on ice for 5 minutes without mixing. 950 µl of room temperature SOC was added into the mixture. The tubes were transferred into an incubator at 37°C for 60 minutes with vigorous shaking (250 rpm). The selection LB plates were warmed to 37°C. Cells were mixed thoroughly by flicking and inverting the tube, 50-100 µl of bacteria was spread onto the selection plate and it was incubated overnight at 37°C.

### **2.2.3 Isolation of Plasmid DNA**

The plasmid DNA was isolated using the alkaline/SDS cell lysis method on either a silica membrane technology (minipreps) or by ion exchange chromatography membrane (midpreps) supplied either in NucleoSpin Plasmid EasyPure (Miniprep) (Ref: 740727.250 Lot: 15081004) or in the NucleoBond Xtra Midi (Ref:740410.50 Lot1511/010) Macherey-Nagel kits.

#### **2.2.3.1 Mini preparation of plasmid DNA (10-15 µg)**

The protocol of the mini-preparation was followed according to the manufacturer Macherey-Nagel's manual and supplied buffers were used.

Saturated bacterial culture of 2-4 ml was pelleted by micro-centrifuging for 30 sec at >12000 rpm. The supernatant is discarded and 150 µl of the resuspension buffer A1 supplemented with RNase is added, the pellet is re-suspended by vortexing, in this step RNAs get degraded by the RNase in the buffer. Lysis of bacteria was done by adding 250 µl of lysis buffer A2 and gently mixing by inverting the tubes 5 times. Tubes were incubated at room temperature for 2 mins. In the next step, 350 µl of neutralizing buffer A3 were added and the mixture invert to gently mix. The lysates were clarified following centrifugation at >12000 rpm for 3 mins. Clarified lysates were transferred into NucleoSpin Plasmid EasyPure columns and centrifuged at 2000 rpm for 30 sec. Supernatants were discarded and columns washed with

450  $\mu$ l of wash buffer AQ and then dried by centrifuging for 1 min at full speed >12000 rpm. The columns were transferred onto a 1.5ml fresh Eppendorf tube for elution and 50  $\mu$ l of the buffer AE were added and the column, incubated at room temperature 3-5mn before centrifugation at 12000 rpm, 1mn to elute the DNA.

### **2.2.3.2 Midi preparation of plasmid DNA (200-500 $\mu$ g)**

The protocol for the midi preparation of the plasmid DNA is similar to the miniprep described above, except that midiprep is a scale-up technique to produce larger quantity of plasmid DNA. The Macherey-Nagel's manual and supplied buffers were used.

The major difference between the miniprep and midiprep is the technology of the column used. In miniprep a silica membrane is used to bind the DNA that operates on centrifugation. The midi prep uses an ion exchange chromatography which is operated by gravity-flow instead of centrifugation. The volume of each buffer is uniformly increased. The bacterial culture of 500 ml is used to obtain a pellet, which is re-suspended in 8 ml of resuspension buffer supplemented with RNase by vortexing. Eight ml of cell lysis buffer were added and mixed gently by inverting the tubes five times and then incubated at room temperature for 5 min. Eight ml of neutralization buffer were added to neutralize the reaction and precipitate the proteins and chromosomal DNA. The clarified lysate is obtained by centrifuging the mix at 12000 rpm for 10 mins at 4°C. The NucleoBond Xtra column for midipreps were equilibrated by adding 12 ml of equilibration buffer under gravity flow. The clarified lysate is then loaded onto the column. The column is allowed to empty by gravity flow and then washed once with 5 ml equilibration buffer and followed by 8 ml wash buffer. The buffers were allowed to completely flow by gravity. A fresh collecting tube is placed before adding 5 ml of elusion buffer. The collected DNA was precipitated by adding 3.5 ml of isopropanol at room temperature and then centrifuged for 30 mins at 4°C at 14000 rpm. The supernatant was carefully discarded and the DNA pellet was washed with 70% ethanol at room temperature for 5-10 mins at 12000 rpm. The supernatant was discarded and the pellet was dried under sterile conditions. It was then reconstituted with 200  $\mu$ l of the sterile H<sub>2</sub>O.

The plasmid yield was determined by spectrophotometry (2.2.4). The integrity of the DNA was confirmed by agarose gel electrophoresis (2.2.5).

### **2.2.4. DNA Quantification**

The concentration of the double stranded (ds DNA) was quantified by using the spectrophotometer – Bio Photometer from Eppendorf at 260 nm absorbance wavelength. Purity of DNA was examined by evaluating the ratio of  $\lambda_{240}/260$  and  $\lambda_{280}/260$  that should not exceed 0.5.

### **2.2.5. Agarose gel electrophoresis**

The integrity of DNA was confirmed by electrophoresis profile following separation of DNA on 0.8-1.0% agarose gel. Agarose gel electrophoresis can be either preparative or analytic. Depending on the experiment, agarose gel electrophoresis was used for either separating only the DNA fragments or separating/purifying the fragments for cloning.

For preparing the 1% agarose gel, 1 g of agarose powder (2.1.3.6) was added to 100 ml 1X TAE buffer (2.1.3.6). The mix was gently dissolved and boiled in microwave for 1 min until fully melted. The agarose was subsequently cooled to approximately 60°C and poured into plastic molds with the appropriate number of wells in the comb (0.5 cm X 12 wells). The agarose was allowed to solidify and then transferred into the electrophoresis chamber filled with the 1X TAE buffer covering by 1-2 mm the surface of the gel. The samples were prepared with 1X TAE buffer and 2 µl of 10x loading dye in 20µl final volume. The samples were loaded along with the 0.5 µg of DNA marker (2.1.3.6). The electrophoresis was done at 75 V for 45 min. The gel was stained with ethidium bromide (1 mg/ml) for 10 min. The DNA bands were observed under UV with the BioRad Gel Doc XR+ system and analyzed using the Lab Image software.

### **2.2.6 Extraction and Purification of PCR products / DNA from agarose gel**

The PCR clean up and Gel extraction is done by the NucleoSpin Gel and PCR clean-up kit from Macherey-Nagel (2.1.3.7). In case of PCR product the DNA was mixed with the double amount of binding buffer NTI, while in case of agarose gel, the gel was cut, the DNA in agarose was then mixed with at least double the amount of buffer NTI, this mix was heated in water bath at 50°C for 5-10 mins to dissolve the gel. The mix is then transferred into the column of the NucleoSpin Gel and PCR clean-up kit that uses the silica membrane technology to bind the DNA in the presence of chaotropic salts, the fluid was forced through the membrane by centrifuging at 11000 rpm for 30 sec. The contaminants were removed by single wash step by adding 450 µl of wash buffer and centrifuging at 11000 rpm for 30 sec. The silica membrane was dried by centrifuging 1 min at 11000 rpm. In the final step, the purified DNA was eluted in fresh tubes by adding 20 µl of elution buffer, incubated at room temperature for 1 min; and centrifuged at 11000 rpm for 1 min.

## **2.3 Molecular Biology and Cloning**

### **2.3.1 Polymerase Chain Reaction (PCR)**

PCR technology was developed in 1980s by Kary Mullis. This technique not only amplifies and synthesizes exact copies of the target DNA fragments from the template DNA but also can induce specific mutations such as site directed mutagenesis, deletions or insertions. Thermostable Taq DNA polymerases extend the fragments during amplification while two specific primers of 20-50 bp bind to the 3' and 5' ends of the template DNA limiting the amplification of fragment. The PCR mix was prepared as shown in Tables 2.3 and 2.4. The PCR reaction proceeds in three steps. First step is the heat denaturation step that produces single strand DNA from double helices, the next step is the annealing of primers to each strand. Then elongation takes place where the polymerase binds at the 3' end from the primer and a complementary strand is generated. This process is repeated 35 times to amplify large amounts of DNA fragment. The different PCR programs used are elaborated in Table 2.5. Two different thermocycler were used for the PCR amplification. The plasmid DNA were amplified on a Peltier Thermo Cycler (PTC-200) MJ research, while the genomic DNA amplification was done in a separate thermocycler from VWR.

**Table 2.3:** The standard PCR reaction mix 50 $\mu$ l for each reaction is prepared in Eppendorf PCR tubes with the following reagents.

Reagents	
Plasmid DNA (10 ng/ $\mu$ l) OR Genomic DNA (500 ng)	1 $\mu$ l
Forward Primer (20 $\mu$ M)	1 $\mu$ l
Reverse Primer (20 $\mu$ M)	1 $\mu$ l
dNTPs (100mM)	1 $\mu$ l
Euromedix 10X buffer	5 $\mu$ l
MgCl <sub>2</sub> (2mM)	5 $\mu$ l
MQ H <sub>2</sub> O	35 $\mu$ l
Taq Polymerase (5U/ $\mu$ l)	1 $\mu$ l

**Table 2.4** For the high fidelity Taq polymerase the mix was prepared by using reagents from the kit (2.1.3.5).

Reagents	
Plasmid DNA (10 ng/ $\mu$ l) OR Genomic DNA (500 ng)	1 $\mu$ l
Forward Primer (20 $\mu$ M)	1 $\mu$ l
Reverse Primer(20 $\mu$ M)	1 $\mu$ l
dNTPs(100 $\mu$ M)	1 $\mu$ l
10X high fidelity buffer	5 $\mu$ l
MQ H <sub>2</sub> O	40 $\mu$ l
High fidelity Taq Polymerase (2.5U/ $\mu$ l)	1 $\mu$ l

**Table 2.5** The different PCR programs were developed for standardization and optimization of different set of primers.

Steps	Time	Temperature						
		Program 1	Program 2	Program 3	Program 4	Program 5	Gradient Program	
Initial Denaturation	5:00mins	94°C	94°C	94°C	94°C	94°C	94°C	
Denaturation	X35	0:30 sec	94°C	94°C	94°C	94°C	94°C	
Annealing		0:30 sec	50°C	52°C	52°C	56°C	56°C	46°C + 0.4°C per cycle
Elongation		1:00 min	56°C	56°C	58°C	62°C	62°C	68°C
Finishing Elongation	10:00mins	62°C	62°C	62°C	62°C	62°C	62°C	
Cooling	$\infty$	4°C	4°C	4°C	4°C	4°C	4°C	

### 2.3.2 Restriction enzyme digestion

The restriction enzymes are type I restriction endonucleases that target specific sequences on the DNA and cleave them resulting in either staggered (overhanging/ sticky ends) or blunt ends.

For characterization of the molecular clones, the plasmid DNAs were digested with commercial restriction enzymes from NEB with their recommended buffers at 37°C (few exceptional enzymes are optimal at 25°C or 65°C). The cocktail was prepared by mixing: 0.5  $\mu$ g DNA; recommended buffer; 4 U restriction enzyme; H<sub>2</sub>O variable followed by incubation

and migration on the agarose gel.

For preparation of the plasmid DNA (20 µg) and insert (50 µg) for development of a molecular constructs the reagents and incubation time were increased proportionally.

### **2.3.3. DNA Modifications**

#### **2.3.3.1 Dephosphorylation of DNA 5'**

To decrease the contamination by false positives clones during screening of colonies, the digested plasmid 5' ends were routinely dephosphorylated with Calf Intestinal Phosphatase (CIP). The CIP action avoids the plasmid recircularization on itself. In the study a mix of the digested plasmid DNA (20 µg) digested in cutsmart NEB buffer, H<sub>2</sub>O variable was made was first heat inactivated at 65°C for 15 mins; then 20 U of CIP was added and incubated at 37°C for 30 mins. The dephosphorylated DNA was finally purified on the NucleoSpin Macherey-Nagel column (2.1.3.7) or by ethanol precipitation (2.3.5).

#### **2.3.3.2 Klenow**

DNA polymerase I Large (Klenow) fragment is a polypeptide chain that lacks the 5'→3' exonuclease activity but retains the 5'→3' polymerase activities and 3'→5' exonuclease activity. The 3'→5' exonuclease activity is used to fill in the 3' overhangs to create the blunt ends. In the study Klenow was used to create blunt ends during cloning; the digested DNA (1-5µg), NEB buffer2; dNTP-1µl of 100µM; Klenow fragment (3'-5' exo) -20 U, H<sub>2</sub>O variable. The mix was incubated at 37°C for 30 min and the heat inactivated of the enzyme was done at 65°C for 15 mins. The DNA was later purified on the NucleoSpin Macherey-Nagel column (2.1.3.7) or ethanol precipitation (2.3.5).

#### **2.3.3.3 T4 DNA polymerase**

The activity of T4 DNA polymerase is opposite of that of the Klenow. T4 DNA polymerase has a 5'→3' exonuclease activity to fill the overhangs to create blunt ends. And it has a 3'→5' polymerase activity. In this study 20 U T4 DNA polymerase were used for 20 µg DNA along with the NEBuffer 2; 100 µM dNTP mix, H<sub>2</sub>O was incubated at 16°C for 30 min. Heat inactivation at 65°C for 15 min. The DNA was later purified on the NucleoSpin Macherey-Nagel column (2.1.3.7) or ethanol precipitation (2.3.5).

### **2.3.4 Ligation**

The ligation reaction requires an insert and a vector, the ligation takes place by the formation of a phosphodiester bond between the 5' phosphate of one molecule and 3' hydroxyl of another.

In the study a 20 µl mix was prepared with vector and insert in a 3:1 molar ratio; 0.5-1µl DNA ligase (400000 U/µl), 2 µl of 10X DNA ligase buffer and MQ H<sub>2</sub>O to make it up to 20 µl was added. The mix was incubated 16° C overnight.

#### **2.3.5 DNA precipitation by ethanol**

To obtain a purified DNA and to eliminate the salts from the reaction buffers ethanol precipitation is carried out. The final volume of the DNA mix was brought 0.5 M NaCl and

three volumes of 100% ethanol were added. The mix was incubated on ice for 30 mins and then centrifuged at 14000 rpm for 10 mins at room temperature. The supernatant was removed and the DNA pellet was air-dried at room temperature and then re-suspended in a required volume of mM<sub>Q</sub> H<sub>2</sub>O.

### 2.3.6 DNA Sequencing

All DNA sequencing was outsourced to Eurofins Genomics. Fifteen µl of plasmid DNA (50-100 ng/µl) was sent as recommended by Eurofins Genomics. The list of primers sent for sequencing is summarized in section 2.3.7.

### 2.3.7 Oligonucleotides -Primers Used

The oligomers were designed using serial cloner and the Vector NTi genomic softwares and synthesized by Eurofins Genomics or Sigma Aldrich. The following oligomers were used for PCR amplifications, genome sequencing, site-directed mutagenesis and for introducing restriction sites for molecular cloning.

#### 2.3.7.1 Oligonucleotides used for PCR

**Table 2.6-** The pair of primers used for the PCR amplification and the expected size of the PCR product

Primer pairs	Primers 5'-Sequence-3'	Expected size (bp)
YCN1(01-22)- CAEV LTR (forward) YCN4(480501)- CAEV LTR (reverse)	5'-GAATTCACTGTGAGACATGGGC-3' 5'-CTCAGGAGTCTCTCACTCTCC-3'	500
YCN2(39-59)- CAEV LTR (forward) YCN3(452-471)- CAEV LTR (reverse)	5'-CAAGCTAGGCCAAATTCCTG-3' 5'-CTGTTTCGGGCGCAGCTGC-3'	432
YCN5-(679-699) SIV GAG(forward) YCN9-(1268-1291) SIV GAG(reverse)	5'- GAGTGGGAGATGGGCGTGAG -3' 5'-CTGCATAGCCGCTTGATGGTCTC -3'	612
YCN 10-(4179-4200)CAEV INTEGRASE(forward) YCN12-(4855-4874) CAEV INTEGRASE (reverse)	5'-CCTCTGGCAGAGGAAGACCAC -3' 5'-CCACTCTCCTGATGTCCTC -3'	695
YCN11-(4248-4268) CAEV INTEGRASE (forward) YCN13-(4855-4874) CAEV INTEGRASE (reverse)	5'-CCAAGAACAGCAGCAGAAGAC -3' 5'-CCACAATTGGCTCCTTCCCC -3'	626
YCN18-(3857-3876)3'POL (forward) YCN19-(5083-5102)5' VIF (reverse)	5'- CACAGATAGGGGCAAAGAC-3' 5'- CGCTGCAGGTCCACCATGC-3'	1245
YCN24-SIV LTR(forward) YCN25-SIV LTR(reverse)	5'-CTGGAAGGGATTTATTACAG -3' 5'- CCAGGCGGCGGCTAGGAGA-3'	700
YCN26-SIV INTEGRASE (forward)	5'- GGCAGGCAGATGGCCTAT-3'	500

YCN27- SIV INTEGRASE (reverse)	5'-GTGGGAACTG CTATCCACCT -3'	
--------------------------------	------------------------------	--

### 2.3.7.2 Oligonucleotides for site directed mutation

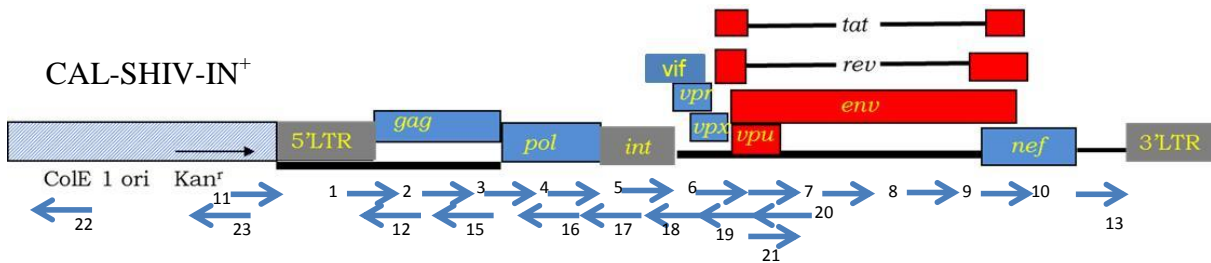
The primers for the site directed mutagenesis were designed and ordered from Sigma. The reverse primer has the BglIII restriction site marked in bold.

Forward primer 5'-GCCTCTGCAGTCGACGGG-3'

Reverse primer 5'-

TGTAGATCTTTAGTTTTATATTTTCAGATATTTTATGAGGCTATGCCACCTC-3'

### 2.3.7.3 Primers for whole genome sequencing of the CAL-SHIV-IN<sup>+</sup>



**Figure 2.1:** Location and sense of the primers binding region on the CAL-SHIV-IN<sup>+</sup> genome.

**Table 2.7 –** Primers used for sequencing and the region amplified.

S.no	Primers 5'-Sequence-3'	Sequenced Gene
CALSHIV int + 1	GGAGAACAAAGAAGGATGTC	SIV gag
CALSHIV int + 2	CCGGGACAGAAGGCTAGA	SIV gag + Protease
CALSHIV int + 3	CCATACAACACCCCAACA	SIV pol
CALSHIV int + 4	CACATACCAATGGAGTGAG	SIV pol
CALSHIV int + 5	GGAGAATCAGGGCAAG	SIV vif
CALSHIV int + 6	GCACCAGGTACCAAGCC	SIV vpx,vpr
CALSHIV int + 7	CAGTCAGACTCATCAAGC	HIV tat
CALSHIV int + 8	CAATGGAACAGGACC	HIV gp120
CALSHIV int + 9	GACGCTGACGGTACAGG	HIV gp41
CALSHIV int + 10	GGAGCTTGTAGAGCTATTC	SIV nef/ LTR CAEV 3'
CALSHIV int + 11	GATGCGCCAGAGTTGTTTC	LTR CAEV 5'
CALSHIV int +12	CCGTTGGGTCGTAGCCTAA(RC)	Reverse complement from Gag to 5' LTR
CALSHIV int + 13	GATCCAACCTCTGGCCTACACTT	End of nef till 3'LTR

<b>CALSHIV INT+ve 14</b>	GCCATACCACATTTGTAGAGG	After 3'LTR, into the Plasmid.
<b>CALSHIV INT+ve 15</b>	GCAACCTTCTGACAGTGCCT	Reverse complement gag
<b>CALSHIV INT+ve 16</b>	CATGGACCAAGGCCTA	Reverse complement gag
<b>CALSHIV INT+ve 17</b>	TTCCTGGCTCTGCATTA	Reverse complement pol
<b>CALSHIV INT+ve 18</b>	TGTCCACCACTGTTCCCAT	Reverse complement pol
<b>CALSHIV INT+ve 19</b>	GCCACTGTCTTCTGCT	Reverse complement vif
<b>CALSHIV INT+ve 20</b>	TCCATTATCATTCTCCCGCT	Reverse complement vpx-gp120
<b>CALSHIV INT+ve 21</b>	AATGCTCTCCCTGGTC	gp120
<b>CALSHIV INT+ve 22</b>	GGGCTTCCCATAACAATCG	Reverse complement plasmid
<b>CALSHIV INT+ve 23</b>	GGATAAGGCGCAGCG	Reverse complement plasmid

**2.3.7.4 Primer pairs used for introducing restriction sites for cloning.**

**Table 2.8** : Pair of primers used for molecular cloning, the expected size of the amplified fragment, the introduced restriction enzymes is marked in bold.

<b>Description</b>	<b>Primer pairs</b>	<b>Primers 5'-Sequence-3'</b>	<b>Expected size (bp)</b>
Primers to amplify the CAEV LTR with PPT for CSH-INP molecular clone	NotI - CA-PPT- (forward)	5' <b>GCGGCCG</b> CAAAAATAAAAAAAGAAAG GGTGGACTGTGAGACATGGGC-3'	550
	YCN 4 - CAEV LTR (reverse)	5'- CTCAGGAGTCTCTCACTCTCC-3'	
Primers to develop chimeric LTRs (SIV-CAEV) for SHIV-YCC molecular clone	Chim LTR CASI Fo	(5'-GAATTCTGGAAGGGATTTATTACAG TGCAAGAAGACATAGAATCTTTCCTG TGAGACATGG GCTAAAG AGG-3')	469
	Chim LTR CASI Re	(5'- AGGCGCCAATCTGCTAGGGATTTT CCTGCTTCGGTTTCCCGAGCCGCTCTGGTA TTGCACAG-3')	
Primers for introducing AgeI site in CALSHIN IN	END -RT-SIV-5P AgeI- END- RT- 3P	5'-ATTCCACTTACCAGTTGAGAAG-3' 5'- <b>TGACCGGT</b> GCTGGTACCCATGCTACATA-3'	400
	AgeI- BEG- VIF- 5P VIF-NOMOD-3P	5' - <b>ACACCGGT</b> GGAAAGGGGAAGGAGC-3' 5'- CATGAAGAGCGCTCGTTGG -3'	1000
Primers used	Forward Primer-		



for amplifying functional Vif and Env from SHIV <sub>-KU2</sub> and replace into CSH-DIN	AgeI Beg Vif Reverse primer Env	5'-ACACCGGTGGAAAGGGGAAGGAGC-3'  5'-CCTGAGGATTGCTTAAAGATTATTG-3'	2791
Primers used to amplify EGFP from pNL4-3d Env EGFP	pNL4-3 d env EGFP AgeI Forward---  pnl4-3 dEnv EGFP AgeI Reverse-	5'-GTACCGGTGCGCCACCATG-3'  5'-GACCGGTTACAGCTCGTC-3'	750
Primers used to amplify RNaseH from SHIV <sub>-KU2</sub>	Reverse- RNase 3P+AgeI  Forward- RNase 5P-XmnI	5'- GAATACCGGTTCTTTTACAATAC TATGGTATTTATCAAGTTCTTCTTGTGCTG GCTCTATCTTTTACAAGAAGAGAAC-3'  5'-GAACAGACTACTAATCAA C-3'	346
CSH-DIN-T/F-31	Fow Z331TFSphI  RevZ331TFNotI	5'-GAAGCATGCTGTAGAGCAAGA-3'  5'-GCGGCCGCGGAAAGTCCCTTCTG TGTC A-3'	3607
CSH-DIN-T/F-18	Fow Z331TFSphI  REV Z3618TFNotI	5'-GAAGCATGCTGTAGAGCAAGA-3'  5'-GCGGCCGCAGTCTCAGTC TTTGTACCAC-3'	3641
CSH-DIN-T/F-78	Fow Z3678TF BstBI  Rev Z3678TFNotI	5'-CCATTCGAAGATGCTAGATTAAT AATA3'  5'-GCGGCCGCTCCCTTCTG TGTCAGCAGTC-3'	4240
CSH-DIN- WARO	Fow-Tat+SphI    Rev Nef+NotI	5'-GAAGCATGCTGTAGAGCAAGAAAT GGAGCCCGTAGATC-3'    5'-CTGCGGCCGCTCAGCAGTTCTTGTAGT ACTCCGGATGCA-3'	3590

## 2.4 Cell Culture

### 2.4.1 Media and Reagents

#### 2.4.1.1 The media were purchased from Eurobio or Thermo Fisher Scientific.

MEM with salts of EARLE without L-glutamine, Liquid 1X (Ref: CM1MEM10-01; lot 614004). MEM DULBECCO (DMEM) with glucose 4,5 g/L, without L-glutamine with bicarbonate, Liquid 1X, (Ref :CM1DME60-01; Lot 609602 ). RPMI 1640 was purchased from GIBCO (Ref-21875-034 Lot726280), PBS buffer with Ca & Mg, Liquid 1X (Ref : CS1PBS00-01, Lot 252311) PBS buffer without Ca & Mg, Liquid 1X (Ref :ES1PBS01-01,Lot632410), Fetal Bovine Serum (FBS) (Ref : CVFSVF00-01, LotS51940-1879).

#### **2.4.1.2 The antibiotics and supplements used were purchased from EuroBio.**

Penicillin 10000 UI/Streptomycin 10 000 µg, Liquid (Ref : CABPES01-0U ,Lot 385917) ; G 418-sulphate solution (50 mg/ml); Gentamicin (Ref :CABGE400-0P,Lot421432) ; Puromycin (Ref: CABPUR00-6R); Solution Hygromycin B (50 mg/ml) (Ref: CABHYB00-0P) ; Sodium pyruvate (100 mM) 100X (Ref :CSTVAT00-0U,Lot 527323), Sodium Bicarbonate 7,0 % (Ref: CSTBIC00-0U,Lot 476503), Trypsin-EDTA (CEZTDA00-0U, Lot 579344), GlutaMAX from GIBCO (Ref :35050061); Lymphocyte separation medium  $d = 1,077$  (Ref: CMSMSL01-0U; Lot 632510)

#### **2.4.1.3 Transfection reagents:**

ExGen500 from Euromedex (Ref ET0250; Lot 151902/1426) was used. For Calcium phosphate transfection 2X HBS (8 g NaCl;0.2 g Na<sub>2</sub>HPO<sub>4</sub>.7H<sub>2</sub>O; 6.5 g HEPS) pH 7.0 was prepared in 500 ml then was aliquoted and stored at -20°C. 2M CaCl<sub>2</sub> was prepared by mixing 87.6g CaCl<sub>2</sub>.6H<sub>2</sub>O in 200ml distilled H<sub>2</sub>O, filter sterilized and stored in aliquots.

#### **2.4.1.4 X-gal staining solution:**

For preparing 250 ml of X-gal staining solution (0.41g K<sub>3</sub>Fe(CN)<sub>6</sub>, (5mM final); 0.525 g K<sub>4</sub>Fe(CN)<sub>6</sub>.3H<sub>2</sub>O (2mM final); 500 µl of 1M MgCl<sub>2</sub>, dissolved into 1XPBS 250 ml) stored in dark. 40 mg/ml of X-gal stock solution in DMSO was aliquoted and stored at -20°C.

**2.4.1.5 PFA stock solution 20%** was prepared by dissolving the 40 g paraformaldehyde (extra pure, DAC fixative, Roth Ref: 0335.3 ) into 150 ml of PBS 1X at 60°C, under magnetic stirring, pH was adjusted to 7.2-7.3, and the volume was adjusted up to 200 ml. (Hazardous fumes: the PFA has to be prepare under ventilated chemical hood). The stock was aliquoted and stored at -20°C.

#### **2.4.1.6 Giemsa-May-Grünwald staining reagents**

The ready to use staining solutions were purchased from Medion Diagnostics (Ref-130834) Diff-Quik I: Stain Solution I Contains Eosin Y (1.22 g/l) in phosphate buffer (pH 6.6) and 0.1% (w/v) sodium azide as preservative. Diff-Quik II: Stain Solution II contains Thiazine Dye (1.1 g/l) in phosphate buffer (pH 6.6). Diff-Quik Fix: fixative solution contains fast green (0.002 g/l) in Methanol.

#### **2.4.2 Cell lines**

The cell lines were obtained from the NIH (AIDS Reagent Program, NIAID), cells were cultured according to the recommended culture conditions. Table 2.9 has a detailed description of the cell lines used. The FBS used was heat inactivated at 56°C for 30 mins. Appropriate antibiotics were complemented with the media with final concentration of 0.05 U/ml penicillin and 0.05 µg/ml streptomycin. If absent from the media, Glutamine, (Glutamax) supplement was added to minimizes toxic ammonia build-up and improves cell viability and growth. Similarly if absent in the media, sodium bicarbonate buffer was added (3.7 g/L) ie 24.6 ml of 7.5% sodium bicarbonate solution for 500 ml of medium. Sodium pyruvate working concentration of 1 mM. The cells were cultured in an incubator at 5% CO<sub>2</sub> environment to maintain physiological pH, 37°C and high humidity.

**Table 2.9:** Detailed description of the NIH cell lines used, their propagation media, culture conditions and freezing media.

Cell Line/ NIH Ref: Number	Description	Special characteristics	Propagation Media	Culture conditions	Freeze Medium
<b>HEK-293T (Ref:103)</b>	Derived from primary human embryonic kidney cells	Used extensively for transfection	DMEM, 90%; fetal bovine serum, 10%.	5-10% CO <sub>2</sub> environment to maintain physiological pH	Propagation medium, 90%; DMSO, 10%.
<b>TZM-bl (Ref:8129)</b>	TZM-bl, is a HeLa cell line. stably expresses large amounts of CD4, CXCR4 and CCR5.	TZM-bl indicator cell line enables simple and quantitative analysis of HIV using either $\beta$ -gal or luciferase as a reporter.	DMEM (90%), 10% FBS, 100U of Penicillin and 0.1 mg/ml of Streptomycin.		50% FBS, 40% DMEM, 10% DMSO.
<b>M8166 (Ref:11395)</b>	human CD4+ cell line	Human T-lymphoblastoid cell with increased susceptibility to syncytia formation	RPMI 1640, 90%; FBS, 10%.		Propagation medium, 90%; DMSO, 10%.
<b>CEMx174 (Ref:272)</b>	Fusion product of human B cell line 721.174 and Human T lymphoblastoid cell line CEM.	They express both T and B cell markers, including CD4	Iscove's Modified Dulbecco's Medium, 90%; FBS, 10%. Also RPMI 1640, 90%; fetal bovine serum, 10%.		Propagation medium, 90%; DMSO, 10%.
<b>GHOST CCR5(Hi5) (Ref:3944)</b>	derived from HOS (human osteosarcoma) cells	Expresses CD4 and relatively high levels of CCR5. The Tat-dependent HIV-2 LTR-GFP construct produces GFP in response to infection.	High glucose DMEM, 90%; FBS, 10%. Supplement with 500 $\mu$ g/ml G418, 100 $\mu$ g/ml hygromycin, pen/strep, and 1 $\mu$ g/ml puromycin		FBS, 90%; DMSO, 10%.
<b>GHOST CXCR4 (Ref:3685)</b>	HOS (human osteosarcoma) cells	Expresses CD4 and CXCR4. The tat-dependent HIV-2 LTR-GFP construct produces GFP in response to	High glucose DMEM, 90%; FBS, 10%. Supplement with 500 $\mu$ g/ml G418, 100 $\mu$ g/ml hygromycin,		FBS, 90%; DMSO, 10%.

		infection.	pen/strep, and 1 µg/ml puromycin		
--	--	------------	--	--	--

### 2.4.3 Transfection of plasmid DNA into HEK-293T cells or TZM-bl cells.

#### 2.4.3.1 Liposome mediated transfection:

In this technique of transfection a liposome forming cationic lipid or non-lipid polymer is used. These lipids or polymers form liposomes that bind on DNA and merge with the cell membrane and thus transfer the DNA intracellularly. ExGene 500 (Euromedex) is a linear polyethylenimine used for transfection of eukaryotic cells even in the presence of serum and antibiotics.

TZM-bl or HEK-293T cells were seeded at density of  $5 \times 10^5$  cells/well in 6 well plates and incubated to form 70-80% confluent monolayers. At 24 hrs the culture media was replaced with 3 ml fresh media. In a fresh transfection polystyrene tube 350 µl of 150 mM NaCl and 5 µg of DNA were mixed and then 16.5 µl of ExGene 500 were added and mixed. The mix was incubated at room temperature for 35 mins. The mix was then added dropwise on the cells in the 6 well plates and then incubated at 37°C. After 24 hrs post-transfection the media is replaced with 2 ml fresh media. Virus released in the culture medium of the transfected cells 24 h later and for three consecutive days were collected, filtrated with 0.22 µm filter and stored at -80°C. (virus harvest and storage details in section 2.4.11).

#### 2.4.3.2 Calcium Phosphate mediated transfection

In this technique, DNA is precipitated with the calcium phosphate: DNA– calcium phosphate complex precipitates are inoculated on the cell monolayers and introduced in the cells by osmotic chock. The saline buffer HEPES is added which facilitates the precipitation.

As described before, TZM-bl or HEK-293T cells were seeded at density of  $5 \times 10^5$  cells/well in 6 wells plates and 24 h later the medium was replaced with 3 ml of fresh medium for transfection. In a fresh transfection polystyrene tube, 100 µl of Solution A (2X HBS) were added and in another tube 5 µg DNA (5 µl), 2M CaCl<sub>2</sub> (12.2 µl) and H<sub>2</sub>O (82.8 µl) were mixed corresponding to solution B. The latter was added dropwise in solution A while gently vortexing. The mix was incubated at room temperature for 5 mins and then added dropwise to the cells and the 6 wells plate was incubated at 37°C. After 24 h post transfection the media was replaced with 2ml fresh media. Virus released in the culture media of the transfected cells 24 h and for three consecutive days were collected, filtrated and stored at -80°C (virus harvest and storage details in section 2.4.11).

#### 2.4.4 Infection of cell lines

Virus was examined for infectivity using CEM<sub>x</sub>174 and M8166 cells ( $1 \times 10^5$  cells/well inoculated with 50 µl of virus collected from transfection) in a 24 well plate. To study the tropism of the new viruses, GHOST- Hi5 and GHOST- CXCR4 cell lines were infected ( $1 \times 10^5$  cells/well inoculated with 50 µl of virus stock from transfection) in a 24 well plate. The infectivity was also titrated on TZM-bl cells. Seventy two hrs post infection, TZM-bl cells were stained with X-gal to reveal the infected cells by blue color. The blue color originates from Tat activating the endogenous LTR/β-galactosidase expressing gene which

cleaves the X-gal substrate generating the blue color

#### **2.4.5 TZM-bl and MGG stainings**

##### **Staining of TZM-bl cells with X-gal to reveal the infected cells**

Infected cells were first washed twice with 1xPBS and fixed with 4% PFA diluted in 1xPBS and incubated 10 min at 4°C. Cells were then rinsed once with PBS containing 5 mM MgCl<sub>2</sub> and incubated in PBS containing 5 mM MgCl<sub>2</sub> for 10 min at 4°C. The X-Gal staining solution 1 mg/ml was prepared by diluting the X-gal stock solution- (40 mg/ml) in the X-gal staining solution (2.4.1.4). 500 µl of the staining solution was added on the cells and incubated at 37°C incubator for 1 hr without CO<sub>2</sub>. In the next step the cells stained blue were fixed in 4% PFA for 15 mins before washing in PBS and drying.

##### **May-Grünwald Giemsa (MGG) staining**

To observe the cytopathic effect, the cells were stained with the MGG. The adherent cells were washed once with PBS 1X, fixed with 4% PFA for 15 mins at 4°C. Cells were then washed with 1xPBS and covered with 500 µl of Diff-Quik Solution I and incubated at room temperature for 10 mins. The Diff-Quik Solution I was removed and replaced with 500 µl of Diff-Quik Solution II. Cells were incubated again 10 min at room temperature and then the Diff-Quik Solution II was discarded and the plate washed under tap water, dried and evaluated under the microscope.

#### **2.4.6 Adaptation of viruses to cell lines (cell free and cell associated)**

To examine whether the new viruses that we developed were replication competent, the M8166 and/or CEM<sub>x</sub>174 were inoculated with the virus stocks and passaged every 7 days by harvesting produced virus and inoculating fresh cells (cell free infection). To amplify the cell-associated virus, once cytopathic effect was observed, 500 µl of the infected cell culture were used to infect fresh cells. This type of infection facilitates better adaptation through cell to cell transmission as well as cell-free virus infections. All produced viral stocks were filtrated, stored at -80°C for further analyses. (virus harvest and storage details in section 2.4.11)

#### **2.4.7 Isolation; activation and infecting the PBMCs**

Primary human peripheral blood mononuclear cells (PBMCs) were isolated by the classical Ficoll-Hypaque density gradient separation technique [308]. PBMCs were activated using 5 µg/ml ConA during 3 days and then 50 IU of recombinant IL-2 for 48 h and then were inoculated with 100 µl of the viral stock.

Frozen rhesus macaque (RM) PBMCs were thawed and stimulated in RPMI1640 containing 20% FBS and supplemented with 5 µg/ml ConA during 3 days and then 50 IU of recombinant IL-2 for 48 hrs. Inoculation of cells with the virus was done using spinoculation at 2000 rpm for 1 h. Cells were resuspended in fresh 10% FBS/RPMI1640 supplemented with 50 IU/ml of recombinant IL-2. Virus stock were collected every 3-4 days and the media was replaced with fresh 10% FBS/RPMI1640 with 50 IU/ml IL-2.

#### **2.4.8 Titration of viral stocks**

Viral stocks were titrated by inoculating TZM-bl cells with serial dilutions of virus. Monolayers of TZM-bl were stained after 72 h post-infection (staining is reported in detail in section 2.4.5). The number of blue cells was counted to determine the blue forming units (pfu)/ml.

#### **2.4.9 Genomic DNA isolation**

Genomic DNA was isolated from mammalian cells using the proteolytic activity of proteinase K with alkaline SDS cell lysis method, and was isolated on a silica membrane technology. The kit from Macherey-Nagel, Genomic DNA Nucleo Spin Blood Quick Pure (Ref: 740569.250 Lot: 1404/001) was used as per manufacture's protocol.

The genomic DNA was isolated from infected  $1-5 \times 10^6$  cells, the cell pellet was suspended in 200  $\mu$ l of 1xPBS and supplemented with 25  $\mu$ l of proteinase K (25 mg/ml) were added. The mixture was supplemented with 200  $\mu$ l of lysis buffer and incubated at 70°C for 10-15 min. DNA was precipitated by addition of 210  $\mu$ l of (96%-100%) ethanol following homogenization by gentle vortexing. The lysate was loaded onto the Quick pure nucleo spin column and centrifuged for 1 min at 11000 rpm. The silica membrane was washed once with 500  $\mu$ l of wash buffer 1min at 11000 rpm. The column was dried by centrifuging it at 11000 rpm for 3 min. The highly pure DNA was then eluted from the column in a fresh tube in 50  $\mu$ l of elution buffer incubated 1 min and centrifuged 1 min at 11000 rpm.

#### **2.4.10 Quantitative analysis of SIV Gag p27 by ELISA**

Supernatants harvested from both transfected, passage 1 and passage 2 infected cells were analyzed for their SIV Gag p27 content. ELISA tests were performed using a commercial kit according to the manufacturer's instructions (XpressBio life science, MD, USA) (Ref: SK845 Lot: P2103). A standard curve was plotted for each assay and OD<sub>450</sub> values of tested samples were inserted to determine the concentrations of SIV Gag p27 (pg/ml). Values were used to generate the kinetics of SIV Gag p27 production.

#### **2.4.11 Virus harvest and storage**

Viruses were harvested and cleared either by filtration through a 0.22  $\mu$ m syringe filter or by centrifugation of the culture medium of infected cells for 10 min, 3000 rpm at 4°C. The virus stocks in the supernatant fluid was collected while the cell pellet was transferred back to the plate.

### **2.5 Cloning strategies used for Molecular virology**

#### **2.5.1 Construction of CAL-SHIV-IN<sup>+</sup>**

CAL-SHIV-IN<sup>+</sup> was present in the lab repository. This construct was not replication competent probably due to a defective vif gene; thus I had to fix this version to make it replication competent.

### **2.5.1.1 Cloning of synthetic vif gene**

A synthetic vif gene was designed, ordered from GeneCust (order number-G140035) and inserted into the pUC57 plasmid to facilitate subcloning. The pUC57-vif plasmid was double digested with BstBI and AvrII under standard conditions to release the vif gene fragment. It was then purified with the NucleoSpin Gel and PCR clean-up kit, and ligated (2.3.4) with the linearized CAL-SHIV-IN<sup>+</sup> double digested with BstBI/AvrII. The detailed strategy information is in the appendix 3. The ligated product was transformed (2.2.2.1) in JM109 competent cells and plated on LB agar plates containing 50 µg/ml ampicillin and incubated overnight at 32°C. DNAs isolated from transformed colonies were screened to select recombinant clones that have ligated the insert in the backbone of the vector. The sequence was verified, uncovering an additional mutation generated during cloning.

### **2.5.1.2 Site directed mutagenesis to exchange the mutated vif**

This construct was done in two steps. In step one, a pairs of primers were designed (2.3.7.2 and Table 2.8) to delete the additional mutation from the vif gene by site directed mutagenesis. The vif gene was amplified using a gradient PCR program as mentioned in Table 2.5. The amplified 651bp PCR fragment was ligated in the pGEM-T-easy and the ligated product was used to transform JM109 competent bacteria (2.2.2.1). One selected clone was amplified and was double digested with BglII and AvrII to release the 610 bp with suitable ends. In the second step this fragment was ligated (2.3.4) into the gel-purified pUC-57-vif construct that has been double digested with BglII and AvrII. The resulting product was used to transform JM109 and the colonies were screened. The clones were verified by sequencing the insert. The detailed strategy is presented in appendix 4.

In the next step the corrected vif was exchanged into the CAL-SHIV-IN<sup>+</sup> genome. For doing this, the pUC-57-vif construct was double digested with BstBI and AvrII to release the entire vif gene, this was gel purified and ligated with the gel purified CAL-SHIV-IN<sup>+</sup> genome double digested with BstBI and AvrII. The resulting products were used to transform JM109 and several colonies were screened. The DNA were amplified using the Midiprep (2.2.3.2). The integrity of the selected clones was verified for the insert by sequencing. The detailed strategy is presented in appendix 4. The final clone was also fully sequenced. Figure 2.1 shows the location and orientation of the primers along the CAL-SHIV-IN<sup>+</sup> genome. Table 2.7 enumerates the primers used for sequencing and the region amplified.

### **2.5.1.3 Introducing the polypurine tract (PPT) of CAEV**

A pair of primers (2.3.7.4 Table 2.8) and the gradient program mentioned in Table 2.5 were used to amplify the CAEV LTR along with CAEV PPT. The amplicon was thereafter ligated into the pGEMT-Easy, and the ligated plasmid was used to transform JM109 competent bacteria. A selected intermediate clone called pGEMT+CAEV LTR was digested with SpeI. This linearized fragment containing the PPT CAEV LTR was purified with the NucleoSpin Gel and PCR clean-up kit and was ligated to purified CAL-SHIV-IN<sup>+</sup> plasmid DNA double digested with SmaI and NruI. The ligations were used to transform JM109 and the colonies were screened and DNA was amplified using Midiprep (2.2.3.2). This final construct was named CSH-INP. The detailed strategy is presented in appendix 5.

### 2.5.2 Construction of the SHIV-YCC

The construction of the SHIV-YCC was a multistep process. In the first step, a pair of primers (2.3.7.4 Table 2.8) was used to amplify the 3' LTR of CAEV from the pBNL2LTR plasmid, (a lab construct bearing two CAEV LTRs). The LTR was amplified by PCR using a gradient program mentioned in Table 2.5, the amplified fragment contained a CAEV LTR with attachment sequences (*att*) recognized by SIV integrase. The amplified PCR fragment purified with NucleoSpin Gel and PCR clean-up kit was ligated into the pGEMT-Easy; the resulting ligations were transformed into JM109 and colonies were screened. Selected colonies were amplified and plasmid purified using Midiprep (2.2.3.2). The resulting construct was called pGEMT-Easy chimeric 3'LTR. In the second step, the LTRs were duplicated into the pGEMT-Easy chimeric 3'LTR. The CAEV LTR was removed from the pGEMT-Easy chimeric 3'LTR using EcoRI and NarI, and was ligated into the pGEMT-Easy chimeric LTRs linearized by HindIII, the ends were blunted using klenow. The resulting product was used to transform JM109 and the colonies were screened, DNAmplified using Midiprep (2.2.3.2). The resulting construct was named pGEMT-Easy chimeric 3'LTR and 5'LTR. In the next step, the SHIV-KU2 genome double digested with BsiEI and NarI was ligated into the pGEMT-Easy chimeric 3'LTR and 5'LTR double digested with NarI and SpeI. The resulting product was used to transform JM109 and the colonies were screened, amplified and the plasmid purified using Midiprep (2.2.3.2). The final construct was named SHIV-YCC. The SHIV-YCC construct has an SIV integrase while the LTRs are from CAEV with the *att* recognized by the SIV integrase. The detailed strategy is outlined in appendix 6.

### 2.5.3 Construction of the CAL-SHIV-IN<sup>-</sup>

The CAL-SHIV-IN<sup>-</sup> vaccine construct previously developed in the lab had been studied extensively in mice and monkeys [160,161]. The vaccine elicits persistent and specific central memory and effector memory CD8<sup>+</sup> and CD4<sup>+</sup> T cell responses. This construct has the genome of SHIV-KU2 whose SIV LTRs have been replaced by CAEV LTRs by classical molecular cloning techniques. The integrase was removed by double digestion with KpnI and AccI that flanked 314 bp of coding sequence from the 3' end of the pol gene [161].

#### 2.5.3.1 Construction of the CSH-DIN and introduction of an AgeI site and “Kozak” re-initiation spaced sequence

To introduce the molecular adjuvants coding sequences into the CAL-SHIV-IN<sup>-</sup> immunogenic vector, a new strategy was developed to modify the CAL-SHIV-IN<sup>-</sup> by removing 811 bp of the integrase gene by classic molecular cloning techniques. A 60 bp reinitiation spacer as defined by Kozak was introduced using PCR, along with a unique AgeI restriction site in the location of the genome where molecular adjuvants will be inserted.

This construct was a multistep process. The first step was to design the two set of primers that would amplify the end of reverse transcriptase (End RT) gene with AgeI restriction site and the other set of primer would amplify the beginning of vif (Beg Vif) with the Kozak sequence and the AgeI site. Table 2.8 shows the pairs of primers used. The PCR product was amplified by a gradient program mentioned in Table 2.5; the amplified fragments were ligated into the pGEMT-Easy. These constructs were called (pGEM-T-Easy End RT+AgeI) and (pGEM-T-Easy End BegVif+AgeI) respectively. The ligations were transformed into JM109, the



selected clones were amplified and the plasmid DNA was purified using Midiprep (2.2.3.2). In the next step, the (pGEM-T-Easy End RT+AgeI) plasmid DNA was double digested with ApaI and AgeI that released a 521 bp fragment with the end of RT from the plasmid. This fragment was purified with NucleoSpin Gel and PCR clean-up kit. The pGEM-T-Easy Beg *vif* + AgeI plasmid DNA was double digested with ApaI and AgeI, which released a fragment of 53 bp creating overhanging ends of ApaI and AgeI to which the previously purified 521 bp fragment of the end of RT was ligated (2.3.4). This molecular construct, named pGEM-T-Easy End RT/Vif+AgeI was double digested with XmnI and BstBI to release a 757 bp fragment, which was purified with NucleoSpin Gel and PCR clean-up kit. This fragment was ligated into the CAL-SHIV-KU2 double digested with XmnI and BstBI. The ligation was transformed into JM109, selected clones amplified and the plasmid purified using the Midiprep kit (2.2.3.2). This final molecular construct was named CSH-DIN. The detailed strategy is outlined in appendix 7.

### **2.5.3.2 Construction steps to introduce functional *vif* and *env***

The above CSH-DIN construct (2.5.3.1) was sequenced, which revealed mutations in *vif* and *env* genes generated during the multiple cloning steps. Thus, a two-step correction strategy was designed. First, PCR primers were designed to amplify the region from *vif* to *env* from SHIV-KU2 and then this fragment was replaced into the CSH-DIN. Table 2.8 lists the primers used to amplify the *vif* to *env* genes using a gradient amplification program mentioned in Table 2.5. The fragment was ligated into the pGEMT-Easy, this construct was called (pGEM-T-Easy+Vif+ Env+AgeI) and the ligation was used to transform JM109. The selected clones were amplified and the plasmid was purified by Midiprep (2.2.3.2). For the next step, the (pGEM-T-Easy+Vif+ Env+AgeI) plasmid DNA was double digested with NheI and AgeI and purified by NucleoSpin Gel and PCR clean-up kit. This fragment was ligated to the purified CSH-DIN plasmid, which was double digested by NheI and AgeI. The detailed strategy is outlined in appendix 8.

### **2.5.3.3 Construction of CSH-DIN-eGFP**

The eGFP gene was introduced into the CSH-DIN plasmid at the unique restriction site AgeI site, which is upstream of *vif* gene. The eGFP was amplified from pNL4-3d ENV plasmid DNA (obtained from NIH Ref:11100) with a pair of primers shown in Table 2.8. The PCR was performed using a gradient program as mentioned in Table 2.5, the amplified fragment was ligated into pGEMT-Easy. The ligation was then used to transform JM109. The selected clones were amplified and DNA was purified by Midiprep (2.2.3.2). This plasmid (pGEM-T-Easy +EGPF) was digested with AgeI, and the resulting fragment was purified and ligated to purified CAL-SHIV- IN<sup>-</sup> linearized by AgeI. The ligation was used to transform JM109, the selected clones amplified and the DNA was purified by Midiprep (2.2.3.2). This plasmid was called (CSH-DIN with corrected Vif+Env+EGFP). The detailed strategy is outlined in appendix 8.

### **2.5.3.4 Construction steps to introduce missing 60bp of *RNaseH***

The sequencing results of CSH-DIN with corrected Vif+Env+EGFP showed another mutation in the form of 60 bp missing in the RNaseH sequence, which required further repair via a two-step strategy. The first step was to design primers to amplify the RNaseH from SHIV-KU2. The

pair of primer used is listed in Table 2.8. The PCR was performed by a gradient program as mentioned in Table 2.5, the amplified fragment was then ligated to the pGEMT-Easy and the ligation was used to transform JM109. The colonies were screened and the selected clone was amplified. The plasmid was purified with a midi prep DNA and this clone was called (pGEM-T+RNaseH). This plasmid DNA was double digested with XmnI and AgeI. The fragment was purified (2.2.6) and ligated with the purified (CSH-DIN with corrected Vif+Env+EGFP) DNA double digested with the XmnI and AgeI enzyme. The ligation was used to transform JM109 and colonies were screened. The plasmid DNA was amplified by midiprep (2.2.3.2) and the construct was called (CSH-DIN with corrected Vif+Env+RNaseH+EGFP) or (**CSH-DIN-eGFP**). The detailed strategy is outlined in the appendix 9.

#### **2.5.3.5 Construction of CSH-DIN with the IRES eGFP (under construction)**

A pair of primers (5' IRES EGFP 5'- ACC GGT GTG AAT GCA TTA GGC GTA CGT CTC C-3')(3' IRES EGFP 5'-ACC GGT CTC ATC AAT GTA TCT TAT CAT GTC TGC TCG-3') were designed to amplify the IRES EGFP region from a relevant plasmid with AgeI restriction enzyme. The PCR was performed using a gradient program as mentioned in Table 2.5. The 1300 bp long amplified amplicon was ligated into the pGEM-T-easy. The ligation was transformed into JM109 competent cells. The colonies were screened and the selected construct was called pGEM-T-Easy IRES EGFP.

The pGEM-T-Easy IRES EGFP will be digested with AgeI, the resulting fragment will be purified on gel and ligated to purified (CSH-DIN-eGFP) digested with AgeI. The ligation will be used to transform STABL-2 competent cells and the colonies will be screened. The final construct will be called (CSH-DIN-IGFP).

#### **2.5.4 Construction of CSH-DIN with Transmitted/Founder (T/F) Env & WARO Env**

Three transmitted founder clade C- HIV-1 DNA plasmids were obtained from Dr. Eric Hunter's lab. Z331T/F (Genbank accession number KR820323), Z3618T/F (Genbank accession number KR820366), Z3678T/F (Genbank accession number KR820393) [193]. The WARO plasmid was obtained from the NIH (Ref: 12419).

#### **Construction of CSH-DIN-T/F-31, CSH-DIN-T/F-18, CSH-DIN-T/F-78, CSH-DIN-WARO**

A pair of primers was designed as mentioned in Table 2.8 to amplify the vpr-nef region of the CCR5 tropic HIV-1 clade C transmitted founder DNA. This fragment was amplified from the plasmid DNA of Z331T/F, Z3618T/F, Z3678T/F and WARO. The PCR amplification used a gradient program as mentioned in Table 2.5, the amplicon size obtained were 3607, 3641, 4240 and 3590 bp, respectively. These fragments were separately ligated into pGEMT-Easy. The ligations were used to transform JM109 competent cells and the colonies were screened and DNA was amplified using midipreps from the selected clones. The final constructs were called pGEMT-EasyZ331TF, pGEMT-EasyZ3618TF, pGEMT-EasyZ3678TF, pGEMT-EasyWARO.

pGEMT-EasyZ331TF, pGEMT-EasyZ3618TF, pGEMT-EasyWARO were double digested with SphI and NotI, the vpr-nef fragments were purified and ligated to the purified (CSH-DIN-eGFP) double digested with SphI and NotI. The ligations were used to transform JM109 competent cells and the colonies were screened and DNA is amplified using midipreps done

from the selected clones. The final constructs were called as CSH-DIN-T/F-31, CSH-DIN-T/F-18, CSH-DIN-WARO respectively. The detailed strategy is outlined in appendices 10A, 10B, 11B.

For development of the CSH-DIN-T/F-78, the pGEMT-EasyZ3678TF was double digested with BstBI and NotI, the fragments were purified and ligated to purified (CSH-DIN-eGFP) double digested with BstBI and NotI. The ligations were used to transform JM109 competent cells and the colonies were screened and midipreps were done from the selected clones. The final constructs were named CSH-DIN-T/F-78. The detailed strategy is outlined in appendix 11A.

### **2.5.5 Construction of SHIV-AD8EO with Transmitted/Founder Envelopes**

A CCR5 tropic pathogenic molecular clone SHIV-AD8EO [306] was developed in the lab of Dr. Malcolm Martin and was a generous gift from Dr. Villinger's lab, Louisiana, USA. To construct the SHIV-AD8EO with T/F envelopes, clade C HIV-1 were obtained from Dr. Eric Hunter's lab, Z331T/F (Genbank accession number KR820323), Z3618T/F (Genbank accession number KR820366). PCR primers (Fow-HIV-TaTZ331: 5'- AAG CAT GCT GAT TAA TTA GAG CAA GAA ATG GAT C-3'; RevHIVenvZ331SalI: 5'- GTC GAC TTA TTG CAA AGCTGC TTC-3') were designed with specific restriction enzymes (SphI/SalI) incorporated to amplify the tat-env genes from the T/F HIV clade C. The amplicon size obtained were ~ 3 Kb. These fragments were ligated into pGEMT-Easy. The ligations were used to transform JM109 competent cells and clones were screened. Selected clones were amplified and plasmid purified by midiprep. The constructs obtained were called pGEMT-Easy Z331TF for SHIV, and pGEMT-Easy Z3618TF for SHIV.

The pGEMT-Easy Z331TF for SHIV and pGEMT-Easy Z3618TF for SHIV, were each double digested with SphI and SalI. The fragments were gel purified and ligated to the purified SHIV-AD8EO double digested with SphI and SalI. The ligations were used to transform STABL-2 competent cells, the colonies were screened. Midipreps were done from selected clones and the final constructs were called SHIV-AD8-T/F-31 and SHIV-AD8-T/F-18. The detailed strategy is outlined in appendix 13.

### **2.5.6 Construction of the SHIV-KU2 with WARO Envelope using Gibson Assembly**

In an attempt to create a CCR5 tropic SHIV molecular clone in our lab, I developed a SHIV-KU2 with a WARO envelope. The pWARO was obtained from the NIH AIDS reagent program (Catalog number 12419) while SHIV-KU2 (GenBank AY751799.1) was from the lab. The Gibson method of assembly cloning was used to develop this construct. The first set of primers were designed for amplifying the WARO tat-env genes (FowTatSphIZ33 CGC CCT CTA GAA GCA TGC TGT AGA GCA AGA AAT GGA GCC AGT AG; RevEnvWARO GGA AAT AGC TCC ACC CAT TTT ATA GCA AAG CCC TTT CCA ) while the other set of primers was designed to amplify the SIV nef gene from SHIV-KU2 (FowNefWARO TGG AAA GGG CTT TGC TAT AAA ATG GGT GGA GCT ATT TCC; Rev pETCIIASHIV GCT TCC CAT ACA ATC GAT AGA TTG TCG CAG. A double digested SHIV-KU2 SphI and ClaI was purified. The two PCR amplicons and the digested vector was assembled at 50°C for 60 mins using Gibson assemble Master Mix kit from NEB catalog E2611S. The assembled products were transformed into NEB 5-alpha Competent E. coli (High efficiency). Colonies were screened and midiprep was done. The final construct was named as SHIV-KU2/WARO.

## **Thesis Objectives**

The long term objective of the PAVAL laboratory is, on one hand to develop a vaccine protecting against HIV-1 in humans and on the other hand, to develop new models that will help to better study HIV-1 associated pathogenesis and mechanisms of latency. Altogether, this will contribute to open the way for new studies and strategies for better understanding persistence mechanisms and fighting chronic infectious diseases.

My thesis work contributes to design molecular models (i) to study and understand HIV-1 pathogenesis and latency and (ii) to develop challenge viruses with a CCR5 transmitted/founder clade C envelope and further, improve the already existing vaccine prototype developed in the laboratory.

### **HIV-1 pathogenesis and latency**

As described earlier in (section 1.4.2, 1.4.3) latency is due to a very complex multi parameter interaction between viral and host cellular factors. Most of the models designed to study latency are designed around the cellular factors and study epigenetic regulations. There is no model developed to study the effects on latency in absence of requirement of the viral factors Tat. My thesis proposes a model based on SHIV that is independent of Tat transactivation of the LTRs as we switched the SIV LTRs to that of the CAEV, thus this model is hypothesized not to induce latency due to the Tat deficiency. Further, to make it replication competent we replaced the SIV integrase with the CAEV integrase. We generated two independent models, in the second model SHIV LTRs were replaced with CAEV LTRs and to make it replication competent, a SIV *att* sequence was added. Moreover, we propose to switch the Env, which is CXCR4 tropic to a CCR5 tropic Env to recapitulate the early stages of the infection.

The new viruses are studied for the replication kinetics, due to poor replication a prolonged adaptation step is carried initially in cell lines and then in primary monkey cells.

The model will be used to compare two viruses, one being susceptible to latency (with a Tat-dependent SIV-LTR), and the other not (CAEV LTR). This study will compare the percentage of cells undergoing latency in the two viruses (section 1.6.5.4.1 describes the experimental approach to detect the cell associated RNA). This will help to better understand latency and quantify the percentage of latency caused due to deficiency of Tat protein compared to the other factors of latency. This gives a platform to study in future the molecular insights of latency independent of Tat.

### **Challenge virus & Vaccine developments**

A pathogenic chimeric SHIV bearing the clade C HIV-1 Env that replicates efficiently in macaques is thought to be a relevant challenge of choice in animal models for evaluating HIV candidate vaccines and microbicides. Moreover a relevant model should target the initial infection stages, thus a CCR5-tropic transmitted/founder challenge virus is a superior model

In our lab the prototype vaccine CALSHIVIN<sup>™</sup> has been developed. The important innovation of this lentivector DNA vaccine compared to the existing DNA and lentivector vaccine is its ability to perform a single cycle of replication in the cells of the vaccinated host in absence of integration of the vaccine genome. This vaccine expresses the antigens only transiently in the vaccinated host and preferentially induces antigen-specific T cell responses that persist, and B cell responses that produce specific antibodies as well. A single immunization with this vaccine was shown to induce persistent multifunctional CD4<sup>+</sup> and CD8<sup>+</sup> T cell responses both in mouse and macaque models [160,161].

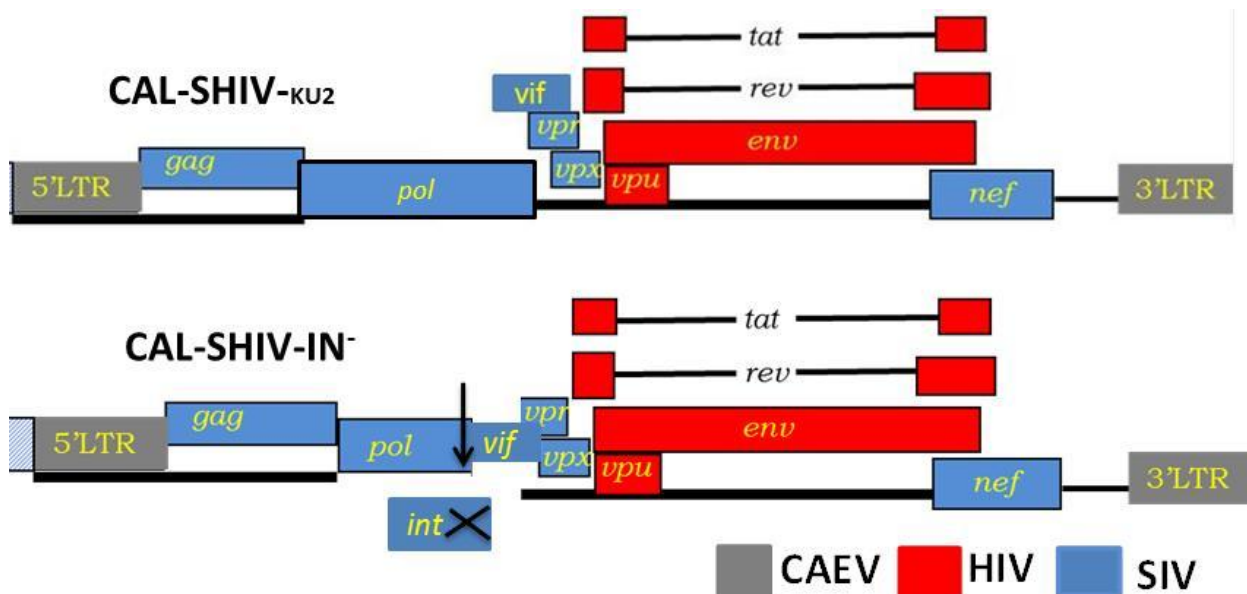
As a continuation of the lab objective to develop an optimized HIV lentivector DNA vaccine for use in human, my thesis work contributed both to the development of both vaccine prototypes and challenge viruses bearing CCR5-tropic T/F Env (Figure 2.2 (E)) as well as enhancing the immunogenicity of existing vaccine prototypes with molecular adjuvants (IL-7 and IL-15).

## CHAPTER 3- RESULTS

### PART I- The CAL-SHIV-IN<sup>-</sup> Vaccine Construct and derivatives

#### 3.1 The CAL-SHIV-IN<sup>-</sup> vaccine prototype

The single-cycle replication-competent vaccine construct (CAL-SHIV-IN<sup>-</sup>) is an HIV lentivector DNA vaccine prototype. This has been engineered in our lab by deleting a large portion (314 bp) of the integrase gene from the genome of the pathogenic SHIV-KU2 and replacing the Tat-dependent SIV LTRs with Tat-independent constitutive CAEV LTRs (figure 3.1). Our group has used this prototype to immunize both mice and cynomolgus monkeys with single doses of DNA vaccine [160,161]. Data from these studies have clearly demonstrated the generation of lasting antiviral responses as a balanced blend of central and effector memory T cells by this vaccine. While this immunization did not prevent the acquisition of the heterologous SIVmac251, it induced potent control of the steady state viremia, warranting further exploration of this safe approach. The next step was to modify the genome of this vaccine with the perspective to include molecular adjuvants to the construct to boost the immune responses while maintaining a balance of central and effector memory responses.



**Figure 3.1: Construction of CAL-SHIV-IN<sup>-</sup> from SHIV-KU2:** The CAL-SHIV-IN<sup>-</sup> vaccine was previously developed from the SHIV-KU2 by replacing the SIV LTRs with those of CAEV. The integrase gene was partially deleted by 314 bp of the integrase coding-sequences [161].

#### 3.1.1 Construction of the CSH-DIN

##### 3.1.1.1 Strategies and molecular construction of CSH-DIN vaccine

For the new *version* of the CAL-SHIV-IN<sup>-</sup> vaccine construct (named CSH-DIN, see section 2.5.3.1 for details), a larger fragment (811 bp) of the integrase gene was removed (from the end of the RNaseH sequence to the beginning of *vif* gene). This was achieved by using two different PCR amplifications and cloning steps. The first one (PCR 1) was used to amplify the end of the *RNase* coding sequences of *RT* and the second (PCR 2) was used to amplify the beginning of the *vif* gene (Figure 3.2). A unique restriction site (*Age*I) absent in the whole genome of the vaccine was added in both PCR products in order to ligate the fragments together and to use this unique site for further insertions. Along with the *Age*I site, a 61 bp specific spacer designed as recommended by Kozak et al. [309,310] was inserted upstream of the *vif* gene. In such a construct, we will be able to insert an additional gene in the *Age* I site and this latter will be translated by the re-initiation process of ribosome translation at the added spacer sequence after translation of the Gag-Pol precursor as previously described [311,312].

This construct will be used to insert (i) GFP coding sequences, to monitor the infection and its dissemination and or (ii) the coding sequences of several adjuvants (like IL-7 and IL-15), to enhance the immunogenicity and protective activity of the vaccine.

The resulting clones were verified using restriction enzymes and the selected clone (renamed CSH-DIN) was validated further by sequencing of the cloned region. Our data showed the successful incorporation of the unique *Age*I restriction site and of the spacer sequence for the re-initiation of transcription.

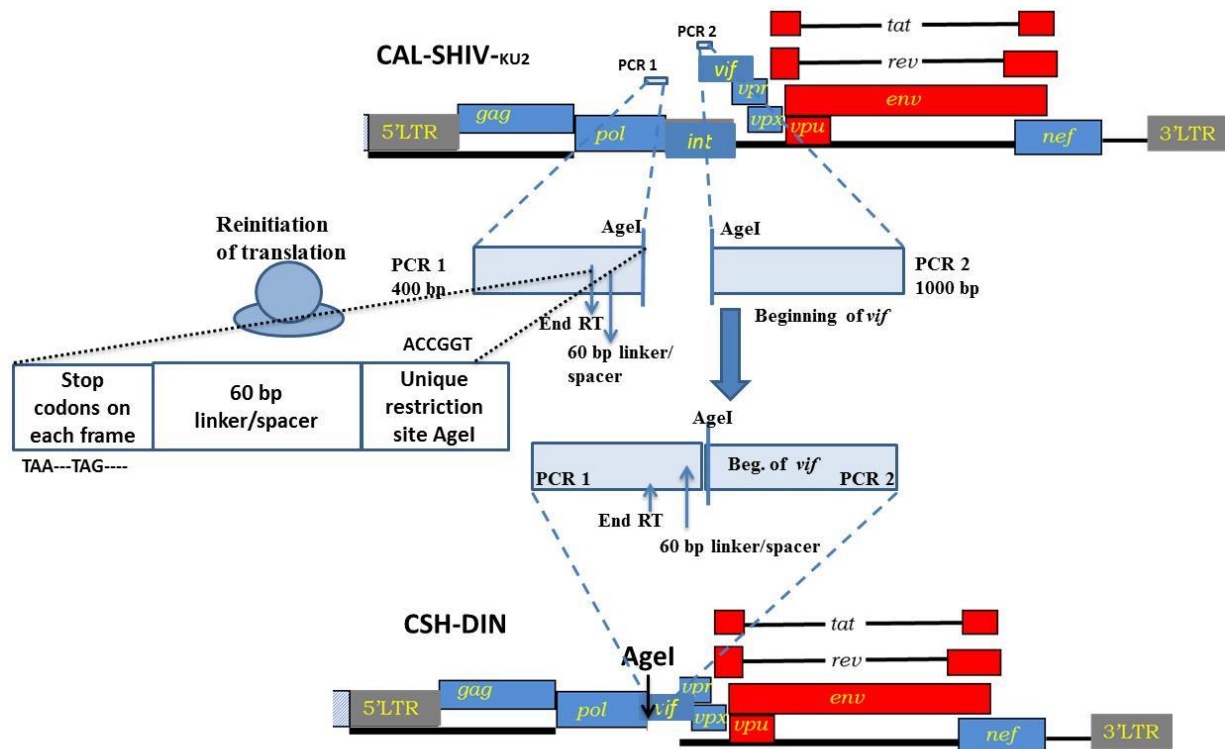


Figure 3.2: **Scheme of the CSH-DIN.** PCRs 1 and 2 were done to amplify the region at the end of the RNase sequence in the *Pol* gene and at the beginning of the *vif* gene. The resulting PCR products were digested and ligated at the AgeI site in order to join both ends without the integrase gene. This ligated PCR product was reinserted into the CAL-SHIV-KU2 genome to generate the CSH-DIN. Along with the amplified region, at the end of RNaseH, a spacer sequence and a unique restriction site AgeI were introduced.

The sequencing of *vif*, *env* and *RNaseH* coding sequences showed several mutations. Such mutations are frequently observed during the cloning and amplification of lentiviral sequences in bacteria and all mutations were corrected back to the original sequence as detailed in section 2.5.3.2 and 2.5.3.4. The final sequencing of the site of construction showed complete homology to the expected sequence.

### 3.1.2 Construction of the CSH-DIN expressing eGFP

*eGFP* was introduced into CSH-DIN following two parallel strategies. The first one by introducing the *eGFP* gene fused to a spacer sequence for re-initiation of transcription and the second one (under construction) by using the *eGFP* gene in frame with an internal ribosome entry site (IRES) for a full read-through, IRES *eGFP* was obtained.

#### 3.1.2.1 Introduction of eGFP coding sequences at the AgeI site

This construct will be used to tag the expression of the vaccine products both *in cellulo* and *in vivo*. *In cellulo*, we will comparatively measure the level of expression in different cell lines and primary cells to examine whether the CAEV LTRs are efficiently driving the antigen expression in all cell types. Introduction of this construct into mice will help to follow, *in vivo*, by imaging, the temporal and topographical expression of the vaccine in immunized mice. In this construct, the transcription of GFP is designed to be by reinitiation of transcription after the transcription of the *RNaseH* gene. This will also indicate how efficient the protein expression will be from this site both in cell culture and in the mouse model.

Thus, the eGFP coding sequences were introduced into the genome of CSH-DIN at the AgeI restriction site. The construction details to include the eGFP into the CSH-DIN are in section 2.5.3.3. Figure 3.3



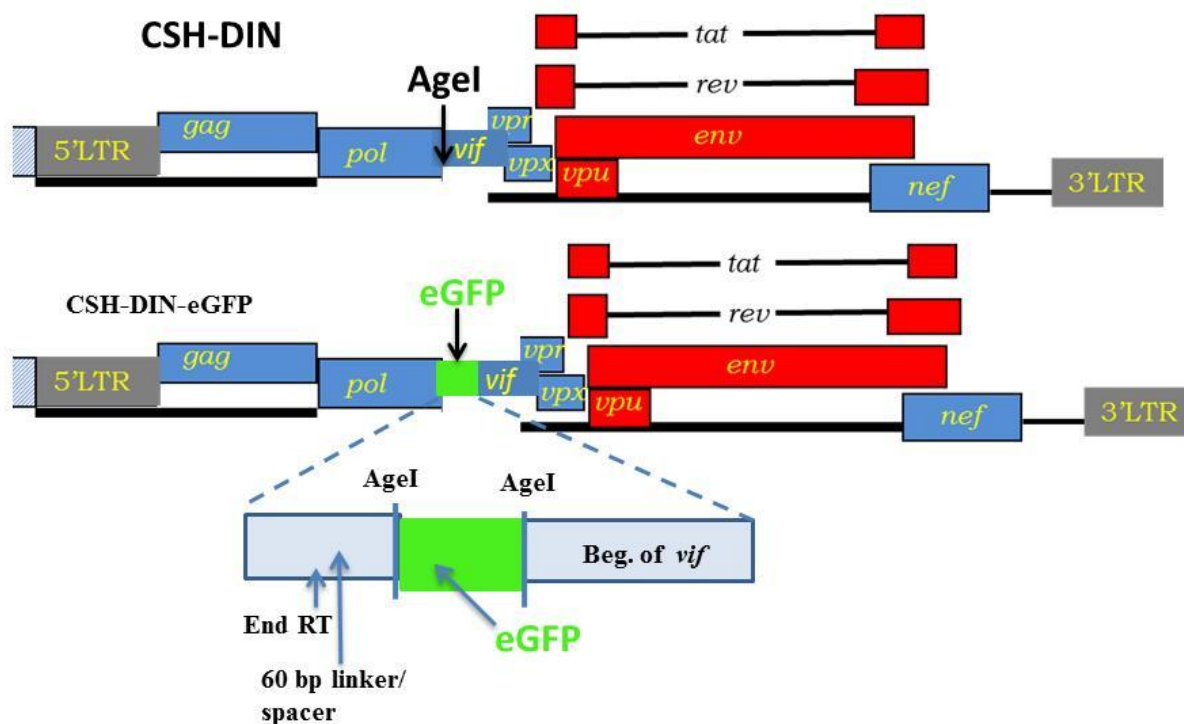


Figure 3.3 Scheme of the CSH-DIN-eGFP construct. The eGFP was inserted into the CSH-DIN construct at the AgeI unique restriction enzyme site.

The CSH-DIN -eGFP construct did not induce fluorescent cells *in cellulo* after transfection or infection and it was concluded that using the IRES based expression may be more efficient than the inserted spacer sequence. Altering the insertion site for the eGFP gene insertion might also be more efficient for its expression.

### 3.1.2.2 Construction of a CSH-DIN with an IRES-GFP

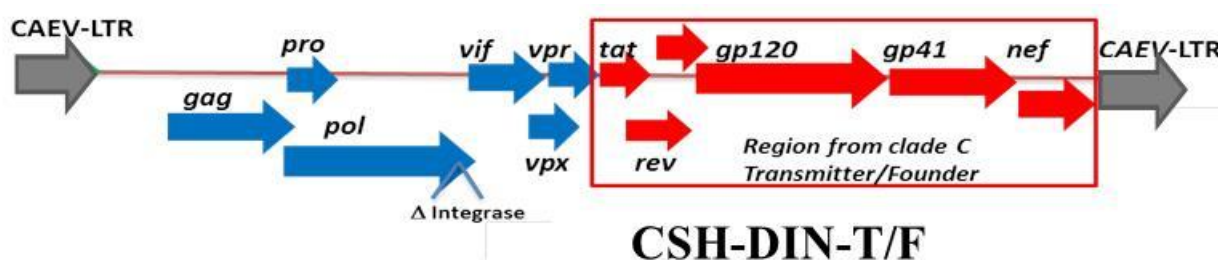
In order to study the dissemination kinetics of the vaccine in mice using imaging, an IRES eGFP would be incorporated into the CSH-DIN at the unique AgeI restriction site. The IRES eGFP was amplified using specific primers from the plasmid (pCI-Neo-LTR -HIV-1-TK-EMCV-GFP) and it will be introduced into the CSH-DIN at the AgeI unique site. The resulting construct will be named CSH-DIN-IGFP. Details of the construction are outlined in section 2.5.3.5. This molecular clone is still under construction.

### 3.1.3 CSH-DIN constructs with T/F envelopes

#### 3.1.3.1 Molecular biology and construction of the CSH-DIN with T/F envelopes

Recent data from the study of early infection of discordant couples have highlighted specific bottlenecks regarding envelope determinants for mucosal transmission. Thus, among the marked diversity of isolates circulating in the infected donors, only few often “Archived” isolates are found to transmit leading to a separate class of transmitted/founder (T/F) viruses that are able to both pass the mucosa and establish the initial foyer of infection. These T/F

viruses are generally CCR5 tropic, less heavily glycosylated and more susceptible to neutralization and therefore represent a relatively more narrow target for preventive vaccines. There is therefore a marked interest in the generation of both replication competent SHIV constructs and vaccine candidates targeted to T/F isolates. Using 3 distinct clade C envelopes of T/F obtained from discordant couples in Zambia [193]) were obtained from Dr. E Hunter (Emory University) and substituted to the original CXCR4 envelope of the CSH-DIN vaccine. A clade B vaccine construct was also developed using the WARO envelope isolated from a clinical HIV sample collected during chronic infection. The detailed constructions are outlined in section 2.5.4. These clones were sequenced and molecular characterization was done using various restriction enzymes. The sequencing results of the constructed substituted *env* confirmed the proper cloning for each of the 4 constructs. These clones were studied *in cellulo*.



**Figure 3.4: Vaccines with T/F clade C (Tat-Nef):** CSH-DIN-T/F-31, CSH-DIN-T/F-18, CSH-DIN-T/F-78, CSH-DIN-WARO were developed by replacing the CXCR4 clade B region of CSH-DIN (from *tat* to *nef*) with the CCR5 clade C (*tat-nef*) region of the Z331T/F, Z3618T/F, Z3678T/F, clade B WARO clones respectively by classical molecular biology techniques of cloning or PCR amplification.

### 3.1.3.2 *In cellulo* studies of the CSH-DIN with T/F envelopes

#### 3.1.3.2.1 The CSH-DIN-T/F-31, CSH-DIN-T/F-18, CSH-DIN-T/F-78, CSH-DIN-WARO vaccine prototypes produce single-cycle viruses

The plasmid DNA of CSH-DIN-T/F-31, CSH-DIN-T/F-18, CSH-DIN-T/F-78, CSH-DIN-WARO were transfected into HEK-293T cells to initiate a first round of virus replication and viral supernatants were collected on days 1, 4, 7, 10 post-transfection. Fractions of these collected samples were used to evaluate the Gag p27 levels produced by the cells.

In another set of experiment, HEK-293T transfected cells were co-cultured for 48 hrs post-transfection with TZM-bl cells (since these are indicator cells for infection *via* Tat transactivation to drive the endogenous LTR-βGal reporter). The X-gal staining of the monolayer after 72 hrs showed that a great majority (>50%) of the cells appeared blue. This result indicated that the virus has been transmitted from transfected cells to TZM-bl at least following cell-to-cell contact and probably by cell-free virus from passage 0.

Virus collected from day two post transfection of HEK-293T was also used to infect GHOST Hi5, GHOST CXCR4, M8166, CEMx174 and TZM-bl cells. The GHOST Hi5 (indicator cells) showed around 30% infection (cytopathogenic effect CPE and infected fluorescent

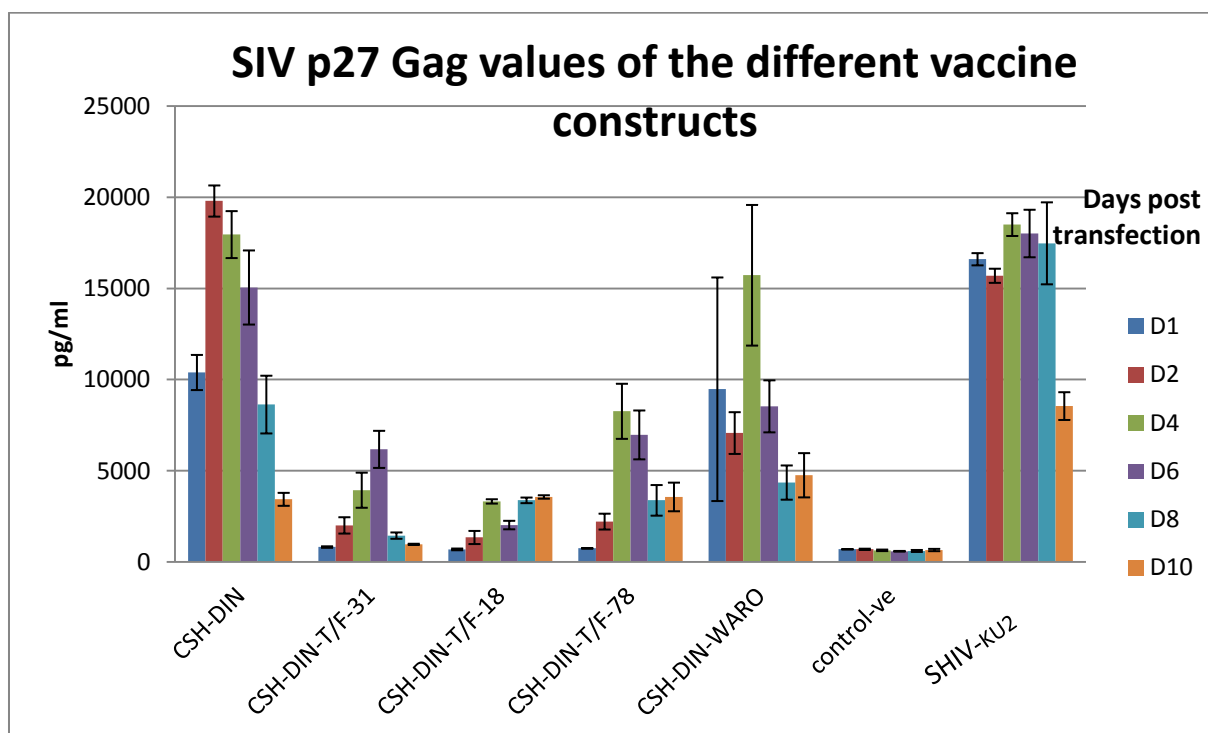
cells) after passage 1 infection, but none for passage 2 infection, confirming the single cycle property of the vaccine constructs.

#### **3.1.3.2.2 Tropism CSH-DIN-T/F-31, CSH-DIN-T/F-18, CSH-DIN-T/F-78, CSH-DIN-WARO studies on different cell lines**

The tropism of CSH-DIN-T/F-31, CSH-DIN-T/F-18, CSH-DIN-T/F-78, CSH-DIN-WARO was studied using GHOST Hi5, GHOST CXCR4, M8166 and CEM<sub>x</sub>174 cells. Day 2 virus supernatants (100 µl) from transfected HEK-293T cells were used to infect these different cell lines. The CSH-DIN-T/F-31, CSH-DIN-T/F-18, CSH-DIN-T/F-78, CSH-DIN-WARO showed around 30% GFP positive cells (infected cells) with the GHOST Hi5, while GHOST CXCR4 were negative. The positive control, the parental Z331T/F showed around 50% GFP positive GHOST Hi5 cells. There was no CPE observed after infection of M8166 cells. These data confirm that only GHOST Hi5 (which is CCR5+) were susceptible to infection by the new vaccine constructs while the parent SHIV-KU2 isolate was exclusively CXCR4 tropic.

#### **3.1.3.3 Quantification of Viral protein production (Gag p27 ELISA)**

The viral production of CSH-DIN, CSH-DIN-T/F-31, CSH-DIN-T/F-18, CSH-DIN-T/F-78, CSH-DIN-WARO was studied after transfection of HEK-293T cells in triplicates. The supernatants were collected on days 1, 2, 4, 6, 8 and 10 to study the dynamics of viral production via SIV Gag p27 ELISA. The SHIV-KU2 isolate was used as positive reference given its excellent replicative properties. As seen in Figure 3.5, replicate determinations showed only minor variations for a given isolate and time point. The CSH-DIN exhibited the highest Gag p27 values on day 2 post transfection, though relative to SHIV-KU2 this production gradually dropped over days 6, 8 and 10. The CSH-DIN-WARO replication was lower, but within the same overall range. However, the CSH-DIN-T/F-31, CSH-DIN-T/F-18 and CSH-DIN-T/F-78 showed markedly lower production of Gag p27 compared to CSH-DIN and SHIV-KU2. Since the same LTR promoter drives the expression in all these constructs, one has to hypothesize that the lower levels of viral protein production are due to differences of the envelope leading to lower efficiency of viral RNA transcription, since this assay excludes a reinfection of the HEK-293T cells. Clearly, the mechanisms underlying these differences remain to be fully elucidated, the only other reason for the lower production of Gag p27 may be due to unequal quality of the DNA used for the transfection in spite of similar quality control values.



**Figure 3.5: Quantification of Gag p27 in culture media of cells transfected with different vaccine constructs.** Five  $\mu\text{g}$  of CSH-DIN-T/F-31, CSH-DIN-T/F-18, CSH-DIN-T/F-78, CSH-DIN-WARO, plasmid DNA were transfected on HEK-293T cells in triplicates in parallel with the vaccine construct CSH-DIN, and replication competent SHIV-KU2. The supernatant fluid was collected on day 1, 2, 4, 6, 8 and 10; it was used to quantitate the production of Gag p27 antigen using ELISA. The standard deviation with the three sets of data (experiment done in triplicate) is indicated with the vertical bar.

## PART II- Novel replication-competent constructs

The pathogenesis of HIV infection, the dynamics of the viral reservoir and the mechanisms used by HIV-1 to undergo latency and reactivate from latency are not fully understood. One of the obstacles is the lack of proper models that help dissect these complex mechanisms. HIV-1 infects productively and replicates efficiently only in humans and great apes such as chimpanzee. The latter are protected and not longer accessible for experimentation. On another hand, the host/HIV-1 interactions are highly complex so that simpler derivative viruses with simpler interactions will be very helpful to dissect the underlying mechanisms. One of these goals is to better understand the mechanisms involved in HIV-1 latency. This is an important question as it is the basis for the development of strategies that will help eradicate viral reservoirs in infected patients treated with HAART. Thus, there is a need to develop lentivirus models that can/cannot undergo latency.

Our group designed the CAL-SHIV-IN<sup>+</sup> as a model of lentivirus that has the potential to not undergo latency in target infected cells because of the absence of Tat responsiveness and the transcriptional control of a constitutive promoter of the CAEV LTRs. Thus, the CAL-SHIV-IN<sup>+</sup> model, can be considered an extreme model of lentiviruses that lacks the possibility to undergo latency.

CAL-SHIV-IN<sup>+</sup> (that has constitutive promoter) and the parental Tat dependent SHIV-KU2 will help to evaluate the implications of whether the regulation of Tat transactivation is the key

mechanism that modulates HIV latency. This is also a valuable tool for studying the mechanisms of latency besides Tat transactivation. To evaluate the number of cells that underwent latency, the CAL-SHIV-IN<sup>+</sup> and SHIV-KU2 virus will be inoculated in parallel in ConA/IL-2-stimulated and non-stimulated CD8-depleted human and/or macaque PBMCs at a MOI=1 and 24 and 48 hours later, fractions of cells will be used to evaluate the proportion of cells having integrated the provirus by real-time PCR. In parallel, to phenotypically identify the cells that have been infected and those that are able to replicate the virus, fractions of infected cells will be stained with the surface markers CD3, CD4, CD95, CD62L, CD68, CD45RA and CD45R0 and intracellular SIV Gag mAbs and examined by flow cytometry.

### **3.2. The replication competent chimeric lentiviruses with CAEV LTRs**

To construct a chimeric replication-competent CAEV-SHIV-IN<sup>+</sup>, two strategies were developed:

#### **Strategy 1: Construction and analysis of CAL-SHIV-IN<sup>+</sup> & CSH-INP constructs**

The lab already developed a construct derived from the SHIV-KU2 genome in which the SIV LTRs have been replaced with those of CAEV. To render the construct replication competent, the SIV integrase gene was also removed and replaced with the CAEV integrase gene to match the CAEV *att* sequences of the LTRs. Since this construct wasn't replication competent, the vector was further improved by exchanging the SIV polypurine tract (ppt) with the CAEV ppt, thus developing the CSH-INP.

#### **Strategy 2: Construction and analysis of the SHIV-YCC construct.**

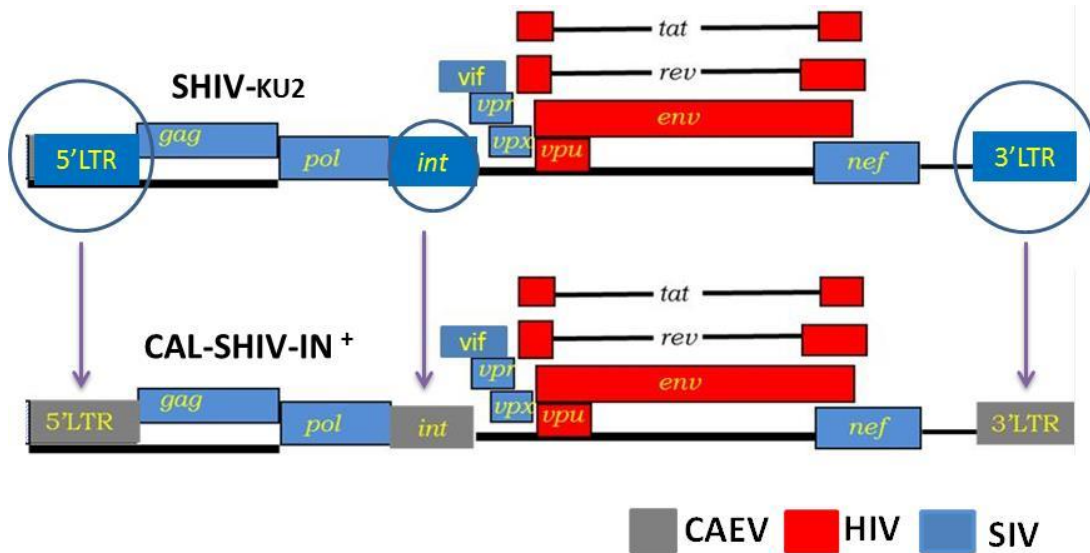
In this strategy, the SHIV-KU2 backbone was used and the SIV LTRs have been replaced with chimeric CAEV/SIV LTRs. Indeed, the ends of the CAEV LTRs have been modified to be recognized by the SIV IN, by incorporating 20 bp of U5 and U3 of the SIV LTRs (*att* sequences recognized by IN). This construct retains the integrase of SIV and theoretically should be fully replicative.

### **3.2.1. Strategy 1-Molecular biology and construction of the CAL-SHIV-IN<sup>+</sup> and CSH-INP**

#### **3.2.1.1 Strategy to develop the CAL-SHIV-IN<sup>+</sup> construct**

##### **a) The CAL-SHIV-IN<sup>+</sup>**

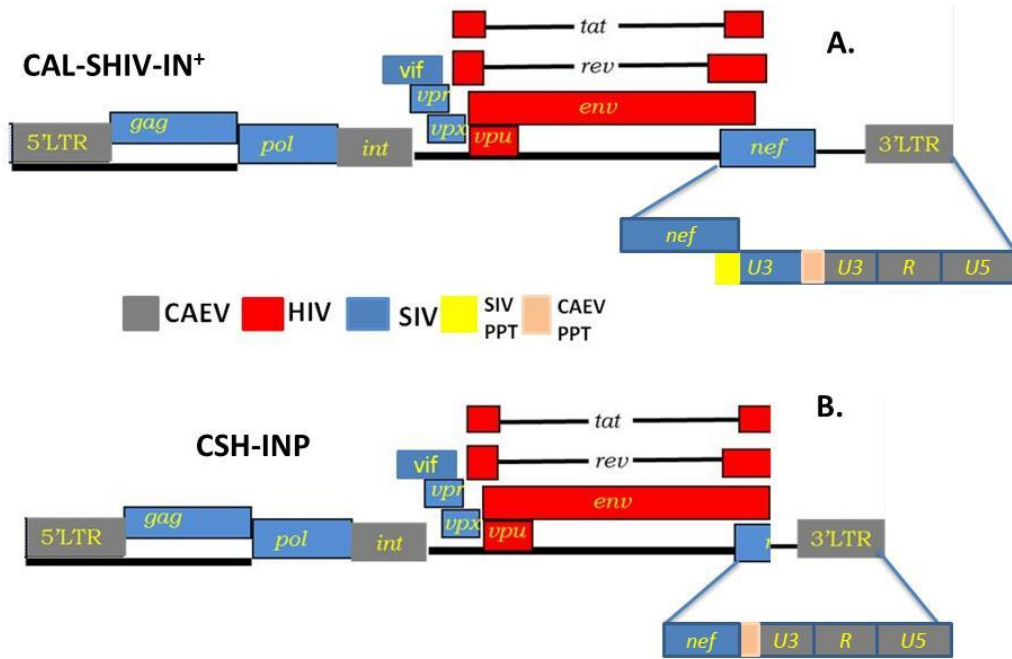
As mentioned previously, CAL-SHIV-IN<sup>+</sup> is a chimeric lentivector DNA, previously constructed in the lab. The physical map is shown in figure 3.6. The specific changes effected to the SHIV-KU2 genome to develop the CALSHIVIN<sup>+</sup> lentivector are indicated.



**Figure 3.6. Physical map showing specific changes on the SHIV-KU2 to obtain CAL-SHIV-IN<sup>+</sup>:** With the use of specific restriction enzymes and primers designed for PCR, the SIV LTRs and the SIV integrase gene were exchanged in the SHIV-KU2 construct with the CAEV LTRs and the CAEV integrase gene, respectively, to obtain the CAL-SHIV-IN<sup>+</sup> construct.

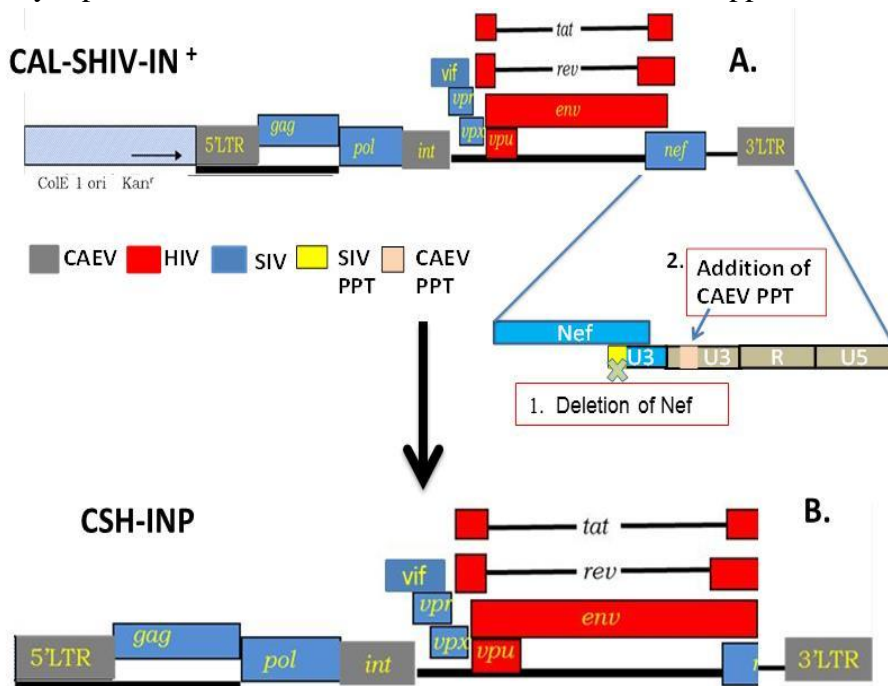
#### b) CSH-INP

According to the construction strategy for the CAL-SHIV-IN<sup>+</sup>, while the LTRs of SIV were switched with the LTRs of CAEV, the polypurine tract (ppt) of SIV located in the middle of the *nef* gene might not be functional to initiate the plus-strand DNA synthesis since it was far from the CAEV 3' LTR. Furthermore, this might lead to an unusual fusion of the remaining sequences of SIV U3 including the ppt that overlap with *nef* sequences, with CAEV U3 at the 3' LTR (Figure 3.7). This fusion might generate chimeric LTRs with non functional *att* sequence for CAEV IN.



**Figure 3.7 Physical map showing the differences in the CAL-SHIV-IN<sup>+</sup> to obtain CSH-INP:**  
 (A) The scheme shows the CAL-SHIV-IN<sup>+</sup> with the *nef*-3' LTR region. The region contains a SIV *nef* gene which has an overlapping region of SIV U3, fused with the 3'CAEV LTR. (B) The scheme is of the same region in the CSH-INP construct, where the *nef* gene is deleted to remove the SIV U3 region which was fused.

In the strategy shown in figure 3.8, for the sake of simplicity of the construction, the *nef* gene including the SIV ppt sequences was deleted and the CAEV ppt sequences were introduced upstream of the 3' U3 CAEV LTR. The CSH-INP lentivector construct should be theoretically fully replicative as it has the LTRs of CAEV with CAEV ppt and also integrase of CAEV.

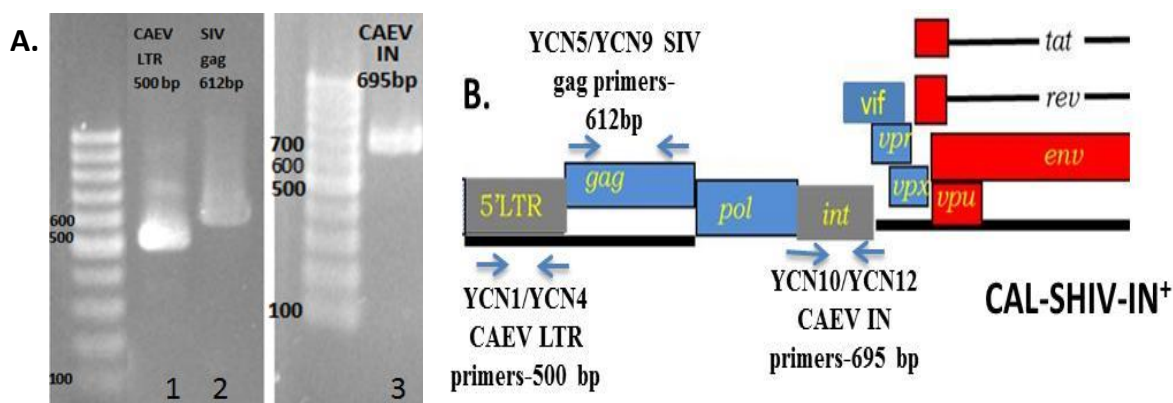


LEGEND??

### 3.2.1.2 Checking of the CAL-SHIV-IN<sup>+</sup>

#### a) The CAL-SHIV-IN<sup>+</sup>

PCR amplifications were conducted to verify the presence of the CAEV LTRs, the CAEV IN coding sequences as well as the SIV *gag* genes in the CAL-SHIV-IN<sup>+</sup> with primers YCN1/YCN4-CAEV LTR (500 bp); YCN5/YCN9- SIV *gag* (612 bp); YCN 10/YCN12 CAEV integrase (695 bp) (Table 2.6).(Figure 3.9)



**Figure 3.9: PCR analyses and position of primers.** (A) CAL-SHIV-IN<sup>+</sup> plasmid DNA was used to perform PCR reactions using the indicated primers: YCN1/YCN4 (lane 1) that amplifies a 500 bp product in CAEV LTRs, YCN5/YCN9 SIV (lane 2) that amplifies a 612 bp PCR product in the SIV *gag* sequences and YCN10/YCN12 (lane 3) that amplifies a 695 bp PCR product. PCR products were loaded and separated on a 1.5% agarose gel in parallel with a 100 bp ladder (on the left of each agarose gel). (B) Location of the primers used in the PCRs and expected size of the amplified products.

To examine the integrity of the genome within the area of replacement of the integrase gene we sequenced the region (800 bp from the end of CAEV IN into *Vif*). The analysis of sequence data showed an important mismatch in the *vif* gene that inactivates its function. *Vif* functions are important for counteracting the host antiviral factors by hijacking ubiquitin ligase factor and targeting APOBEC3G for degradation [150,151]. The *vif* gene was repaired by replacement of the entire gene obtained by synthesis (GeneCust). Details of this replacement are outlined in section (2.5.1.1.). The sequencing of the newly inserted *vif* coding sequences revealed the insertion of two additional CC leading to a shift in the reading frame and, consequently, to the synthesis of an incorrect *vif* protein.

#### 3.2.1.3 Site directed mutagenesis to obtain a correct *vif* gene

A set of PCR primers was designed as described in material methods section 2.3.7.2. to perform the site directed mutagenesis. The details of the construction are described in material methods section 2.5.1.2.



Vif Start Codon	Mutations leading to the change of open reading fram
ca tca aag att <b>atg</b> gag gag gaa aag agg tgg ata gca gtt ccc aca tgg agg ata ccg	
S K I M E E E K R W I A V P T W R I P	
gag agg tta gag agg tgg cat agc <b>ccc</b> tca taa aat atc tga aat ata aaa cta aag at	
E R L E R W H S P S * N I * N I K L K I	
c tac aaa agg ttt gct atg tgc ccc att tta agg tcg gat ggg cat ggt gga cct gca g	
Y K R F A M C P I L R S D G H G G P A A	
ca gag taa tct tcc cac tac agg aag gaa gcc att tag aag tac aag ggt att ggc att	
E * S S H Y R K E A I * K Y K G I G I	
tga cac cag aaa aag ggt ggc tca gta ctt atg cag tga gga taa cct ggt act c	
* H Q K K G G S V L M Q * G * P G T X	

**Figure 3.10:** The additional “CC” in the sequenced *vif* was observed. This mutation led to a change in the ORF.

Finally, whole genome sequencing was done (with primers indicated in the Table 2.7) and the area of the genome sequenced is illustrated in figure 2.1 of materials and methods section. The sequencing results were analyzed and confirmed the full coding of all genes as designed.

### 3.2.2 *In cellulo* studies of the replication competency of the CAL-SHIV-IN<sup>+</sup> and CSH-INP vectors . Production and infectivity of the viruses

#### The CAL-SHIV-IN<sup>+</sup>

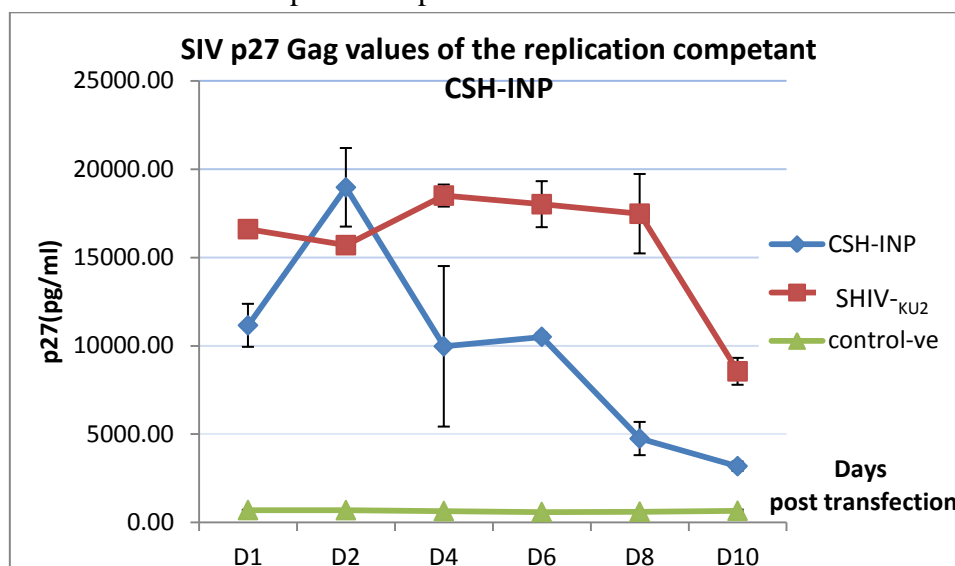
Plasmid DNA of CAL-SHIV-IN<sup>+</sup> was used to transfect HEK-293T cells and the culture media was harvested daily during 5 consecutive days. Infectious cytopathic virus in culture media samples was assayed on the CD4<sup>+</sup> T cell line M8166 that did not show any signs of infection with any of the samples. Thus, it was concluded that in the absence of ppt sequences linked directly to the U3 of CAEV 3’LTR, the CAL-SHIV-IN<sup>+</sup> was unable to accomplish proper reverse transcription that allows productive replication. Consequently, this construct was considered as replication incompetent.

#### The CSH-INP

To examine the capacity of the whole genome of CSH-INP chimera to express viral proteins, we directly transfected monolayers of TZM-bl indicator cells with the CSH-INP in parallel with the parental SHIV-KU2. X-Gal stained transfected TZM-bl cells showed high proportions of blue cells similar to the positive control SHIV-KU2, suggesting that the Tat protein was functionally expressed by the CSH-INP construct.

In a second experiment, HEK-293T cells were transfected with the CSH-INP plasmid DNA in triplicates. The virus released in the culture medium of transfected cells was collected on days 1, 2, 4, 6, 8, 10 and a Gag p27 SIV ELISA assay (Figure 3.11). The graph below shows that the CSH-INP p27 was produced to high levels on day 2 post transfection, but gradually decreased thereafter. By contrast, the positive control SHIV-KU2 maintained a high production

of p27 over the first 8 days of culture. These results suggest that the replication of the CSH-INP transduced virus reached a peak of replication but overall was transient.



**Figure 3.11: Evaluation of Gag p27 in the culture medium of transfected cells:** Five  $\mu\text{g}$  of CSH-INP plasmid DNA were transfected on HEK-293T cells in triplicates in parallel with SHIV-KU2 plasmid DNA used as a positive control and non-transfected cells were used as negative control. The supernatant fluids were collected on days 1, 2, 4, 6, 8 and 10 and used to quantitate the production of Gag p27 antigen using ELISA. The standard deviation for the three sets of data (experiment done in triplicate) is indicated with the vertical bar.

To examine the presence of infectious virus in the supernatant fluids of transfected HEK-293T cells, virus released in the culture medium of transfected cells collected during 3 consecutive days and stored at  $-80^{\circ}\text{C}$  was used for infectivity assays. A virus infectivity assay was performed in the CD4<sup>+</sup>/CXCR4<sup>+</sup> human T-lymphoblastoid M8166 cells with 100  $\mu\text{l}$  of the undiluted virus stock. While the positive control SHIV-KU2 showed the characteristic syncytia formations, there was no cytopathic effect (CPE) observed with any of the cultures inoculated with CSH-INP. These results were confirmed by infection of TZM-bl, which showed no evidence of Tat production from the CSH-INP. While in contrast, for cells inoculated with SHIV-KU2 positive control, the great majority >80% underwent blue coloration following X-Gal staining. Thus, it was inferred that CSH-INP transfection of HEK-293T did not result in the release of infectious virus.

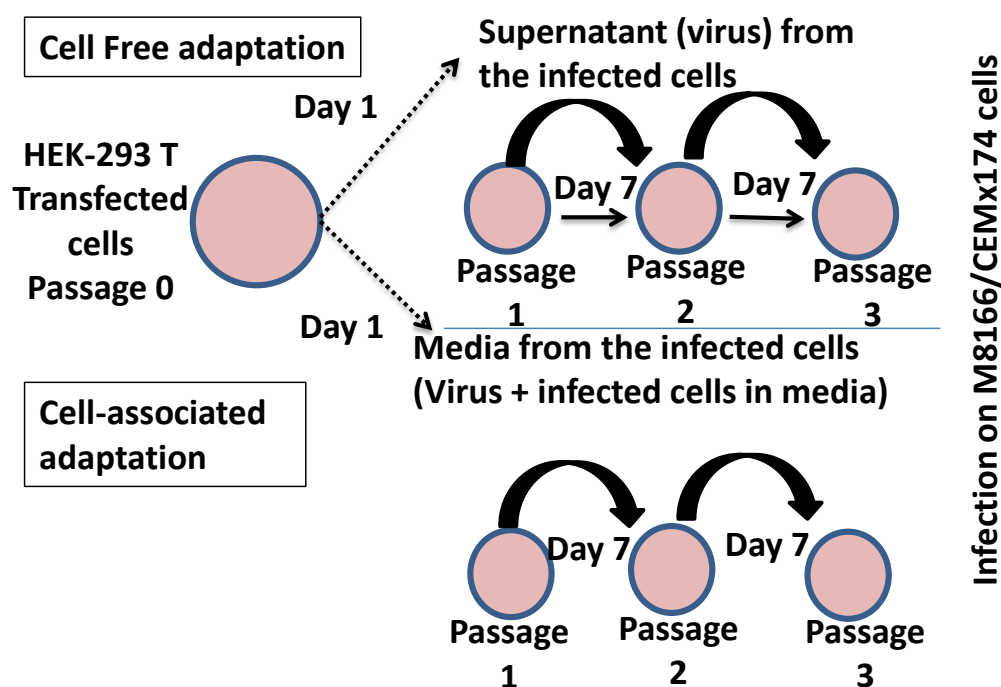
To examine whether HEK-293T transfected cells do produce viral particle that could be transmitted to the M8166 we performed cocultures of the two cells lines. In this case, CPE was observed in 25-30% of the cocultures of cells transfected with the CSH-INP, while greater than 50% underwent CPE in cocultures with the cells transfected SHIV-KU2 used as positive control. These results indicate that transfected HEK-293T cells do express mature viral Env glycoproteins that are exposed at their surface and following cell-to-cell contact, they induce fusion with non-transfected M8166 to generate syncytia.

Altogether, these data suggest that CSH-INP produces Gag p27 SIV, Tat and Env proteins in the transfected cells and in the culture medium. But, there was no evidence of production of infectious replication competent virus. One of the hypotheses is that the released virus needs adaptation in cultured cells to increase its infectivity and capacity of replication.

We decided to “adapt” the virus to different cell lines using successive passages. Adaptation would allow the virus to accumulate specific mutations necessary to productively infect cells.

### 3.2.3- Adaptation on different cell lines

To adapt virus to in vitro replication, serial passages on cultured cells were performed every week using the virus released in the culture medium or following co-cultures (Figure 3.12). The protocol of cell-free and cell-associated adaptation is detailed in section 2.4.6. The M8166 cell line was used for the adaptation of CSH-INP since it had the CXCR4 tropic SHIV-KU2 env. In addition, these cells readily exhibit CPE upon infection. CEMx174 is a second choice of cell line for adaptation due to its ability to produce the virus, at higher levels than the indicator cell lines, which is important for adaptation. The adaptation of CSH-INP to M8166 cells was pursued until passage 19 while the adaptation on CEMx174 cell line was done until passage 9. The relative adaptations were stopped after failing to detect evidence of virus present in the successive passages.



**Figure 3.12 Schematic representations of serial passages of virus for adaptation.** For the “Cell-free adaptation”, the supernatant harvested on day one post-transfection from HEK-293T cells transfected with CSH-INP plasmid DNA was used to inoculate M8166/CEMx174 cell cultures (passage 1). Seven days later, the supernatants from the infected M8166/CEMx174 cells were collected and 100  $\mu$ l of undiluted supernatant was deposited onto fresh M8166 and CEMx174 cells (passage 2). The process was repeated after 7 days in culture. For the “Cell-associated adaptation”, transfected cells were cocultured with M8166/CEMx174 cells at 24h post transfection and then non-

adherent cells in the culture medium were harvested at day 3 post co-culture and transferred into new well and grown for 4 more days. Culture medium containing cells was used to inoculate fresh cell cultures every seven days (passage 2, 3 ,....)

Genomic DNA of the infected cells was extracted from the frozen cell pellets obtained after 7 days in culture. DNA was used for PCR detection of the CAEV LTRs. Genomic DNA was extracted at passage 2, passage 10, passage 19 of infected M8166 cells while passage 1, passage 6, passage 8 genomic DNA was extracted from the infected CEM<sub>x</sub>174 cells and analyzed by PCR using primers CAEV LTRs YCN1/YCN. The CAEV LTRs were detected in passage 6 of CEM<sub>x</sub>174 cells while in M8166, it was detected only in passage 1. No positive amplification was detected in cells collected at later passages. These results suggested that limited virus replication occurred in CEM<sub>x</sub>174 cells at least but this replication did not augment due to adaptation but gradually decreased with every passage. One caveat to these studies is that the human cells lines used may not be appropriate for the adaptation of a new chimeric virus.

### **3.2.4- Adaptation on monkey PBMCs**

#### **Strategy of adaptation**

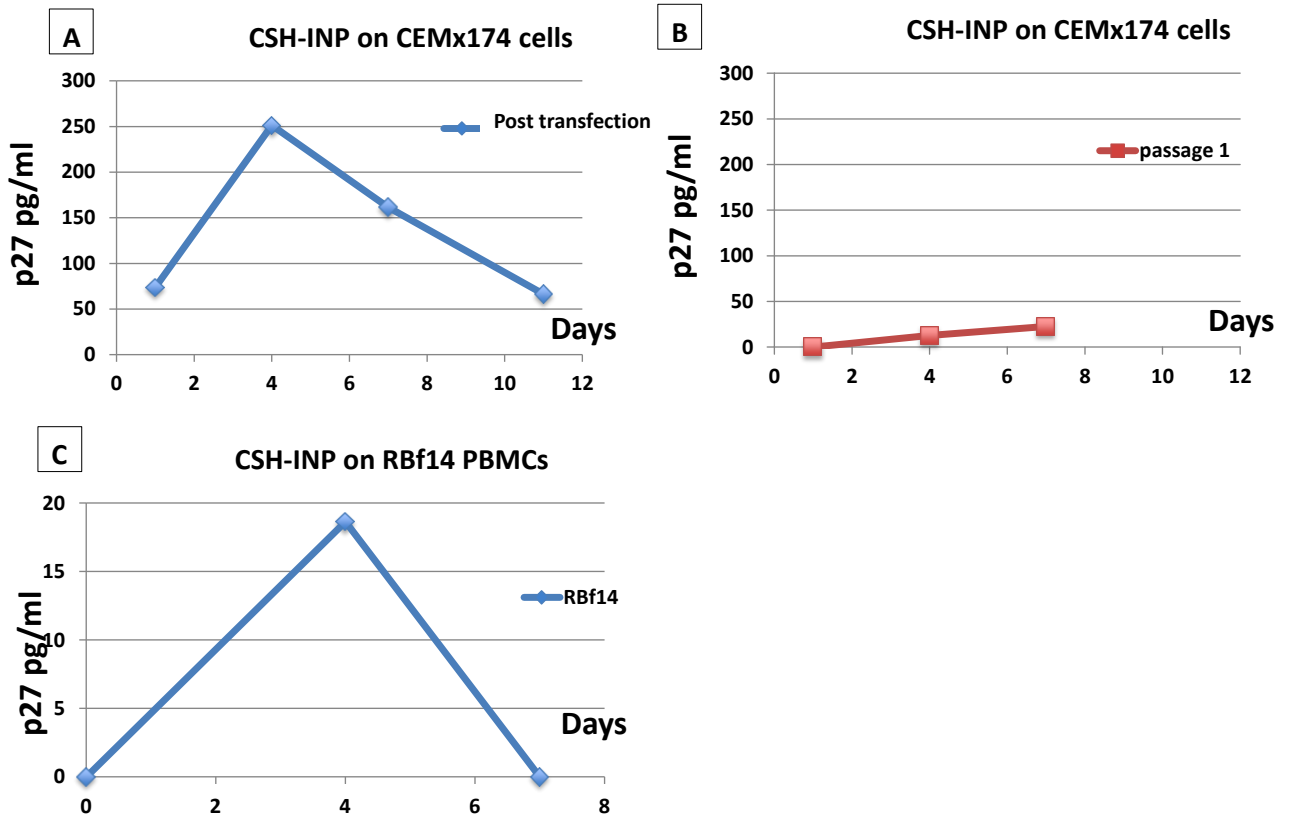
Since primary cells, such as rhesus macaques Peripheral Blood Mononuclear cells (PBMCs) represent heterogeneous cell lineages with a diversity of immune cells hypothesized to provide a more varied substrate for the adaptation of CSH-INP.

The CSH-INP plasmid DNA was sent to a collaborator's laboratory at Emory University, Atlanta USA, with ready access to monkey PBMCs.

The CSH-INP plasmid DNA was transfected into CEM<sub>x</sub>174 cells, viruses were collected on days 1, 4, 7, 9 and 11 post-transfection and assayed for Gag p27 using ELISA with undiluted samples. Passage 1 was performed on CEM<sub>x</sub>174 cells. The viruses were collected on days 1, 4, 7 and 11 and ELISA was used for Gag p27 quantification using undiluted samples (Figure 3.13A).

Though Gag p27 was very high after electroporation at day 4 post transfection, the amount of Gag p27 produced dropped overtime. The drop may be due to inability of the virus to replicate efficiently. In passage 1 (infection of CEM<sub>x</sub>174 cells from day four transfection supernatant fluid) virus were harvested, Gag p27 amount remained very low (<20 pg/ml) (Figure 3.13B). These data indicated that adaptation of this virus on the rhesus macaque PBMCs was necessary to increase its capacity of replication.

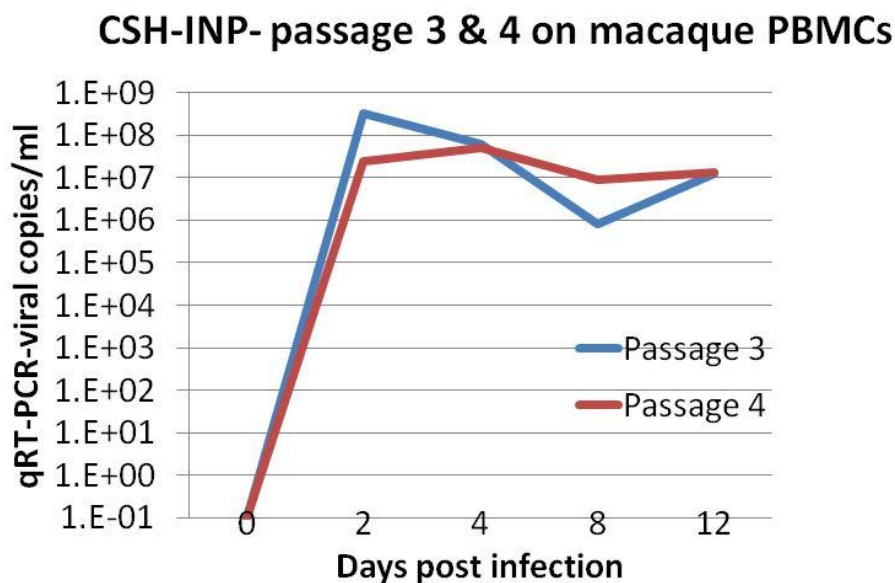
PBMCs were activated using 5µg/ml ConA and IL2-Fc for 48 hours and were then inoculated with 100 µl of the viral stock (transfected CEM<sub>x</sub>174 cells, collected on day 1). Passage 1 was done on rhesus macaques PBMCs (RBf14). Though Gag p27 was very high at day 4, the virus did not replicate on rhesus macaque PBMCs, and the Gag p27 amount remained very low. (< 20 pg/ml) (Figure 3.13 C).



**Figure 3.13. Infection of primary macaque PBMCs and CEMx174 cells with CSH-INP virus.** (A) CEMx174 cells were transfected with CSH-INP plasmid DNA and Gag p27 production was measured in the culture medium on days 1, 4, 7 and 9 and values are reported. Although p27 levels were high after electroporation on days 1 and 4, the Gag p27 levels declined thereafter. (B.) The culture medium of transfected cells harvested on day 4 were used to inoculate fresh CEMx174 and Gag p27 was measured by ELISA. Gag p27 levels were around 20 pg/ml suggesting that it needs adaptation (C) Culture medium of transfected cells on day 4 was used to inoculate CD8-depleted macaque PBMCs (RBF14) and Gag p27 was measured at days 1, 4 and 7 post-inoculation and values are reported in pg/ml. The p27 levels in the PBMC cultures dropped after day 4 in monkey RBF14 PBMCs.

### 1) Virus quantification by Quantitative Real Time Reverse Transcription PCR (qRT-PCR)

After several transfections and repeated passages on monkey PBMCs the virus could be adapted after 3-4 passages in tissue culture tubes, the tissue culture tube provide more contact between the virus and the cells compared to the tissue culture flasks and were made of polypropylene instead of polystyrene, which affects the attachment of macrophages. The Quantitative Reverse Transcription PCR (qRT-PCR) results showed high viral copy numbers of DNA over the period of 12 days, thus suggesting the virus was able to adapt (Figure 3.14).

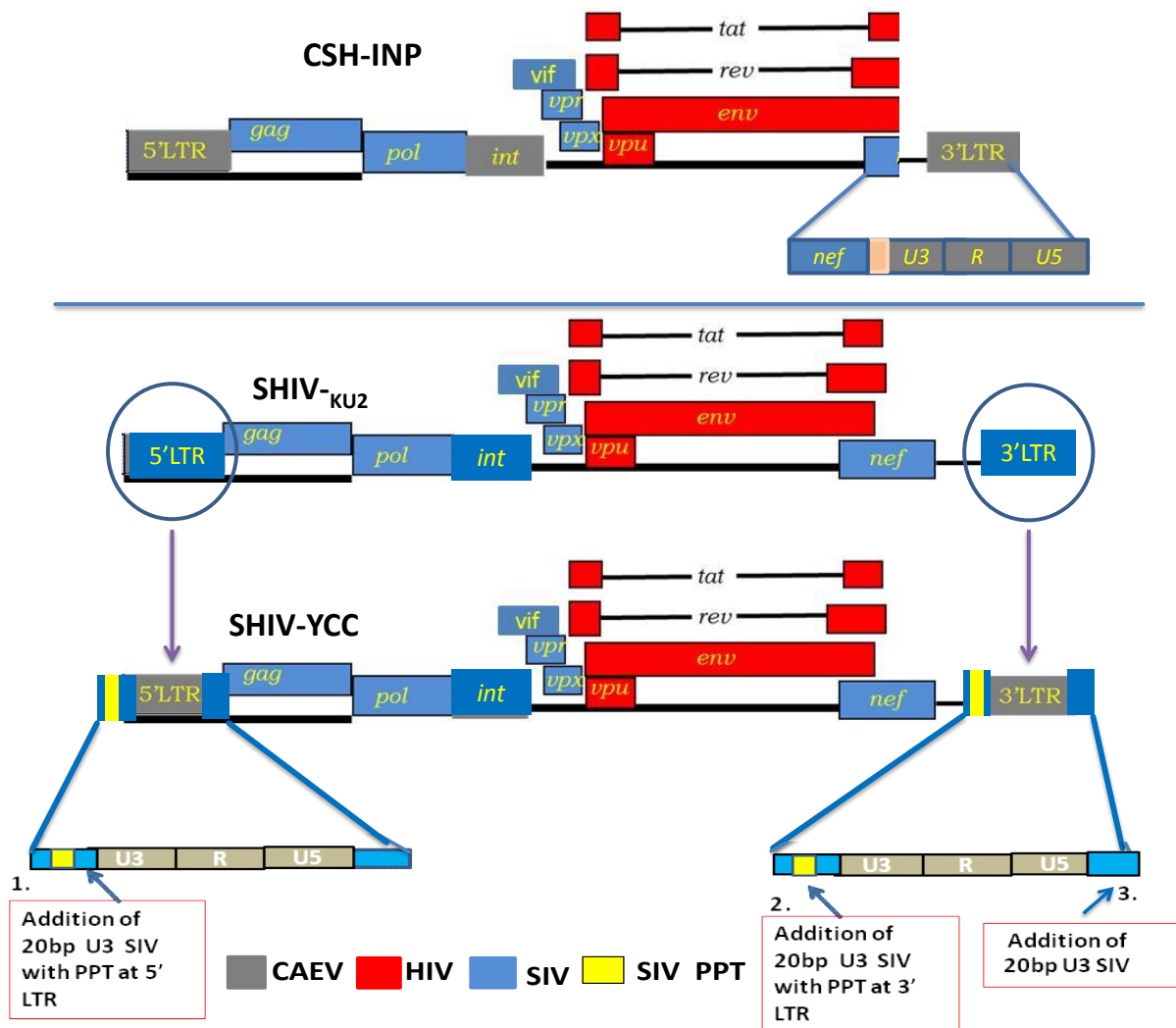


**Figure 3.14- Evaluation of virus production in infected macaque PBMCs:** In passage three and four the supernatant of day 4 from previous passages was used to infect fresh macaque PBMCs. RNA samples were isolated from 1 ml of culture medium, days 0, 2, 4, 8 and 12 were used for evaluation of viral copies using the qRT-PCR. In both passages 3 and 4, high viral copy numbers over the period of 12 days were observed, suggesting that the virus was adapting.

### 3.3- Strategy 2- Construction of the SHIV-YCC replication competent virus

In the second strategy to create replication competent viruses carrying the LTRs of CAEV (Figure 3.15), major changes were done to the SHIV-KU2 construct. The SIV LTRs of SHIV-KU2 DNA were replaced/exchanged with chimeric CAEV LTRs, which had 20 bp of U3 SIV and 20 bp of U5 SIV on both the 5' and 3' LTRs. This construct has the integrase of SIV and theoretically this construct should be fully replicative.

The major differences between the SHIV-YCC construct from the previous CAL-SHIV-IN<sup>+</sup> and the CSH-INP construct are 1) the integrase genes, SIV in SHIV-YCC and CAEV integrase in CSH-INP and 2) the incorporation of the *att* sequence necessary for integration in the SHIV-YCC, that makes this lentivector replication competent.



**Figure 3.15** Diagrams of the maps of SHIV-KU2, CSH-INP and SHIV-YCC chimera genomes. There were few modifications done on the SHIV-KU2 to develop the SHIV-YCC. SHIV-YCC has the LTRs of CAEV with 20 bp of each of SIV U3 and U5 at the extremities of both 3' and 5' CAEV LTRs. These contain the target attachment sequences recognized by the SIV IN to promote the provirus integration rendering this construct replication competent, at least in theory.

The cloning strategies involved PCR amplification of the CAEV LTRs with specific attachment sequences. Resulting PCR products were used to substitute the SIV LTRs using specific restriction enzymes. Section 2.5.2 of materials and methods has the detailed step of the construction. This construct was sequenced and characterized by restriction enzymes to confirm the integrity of the cloned regions.

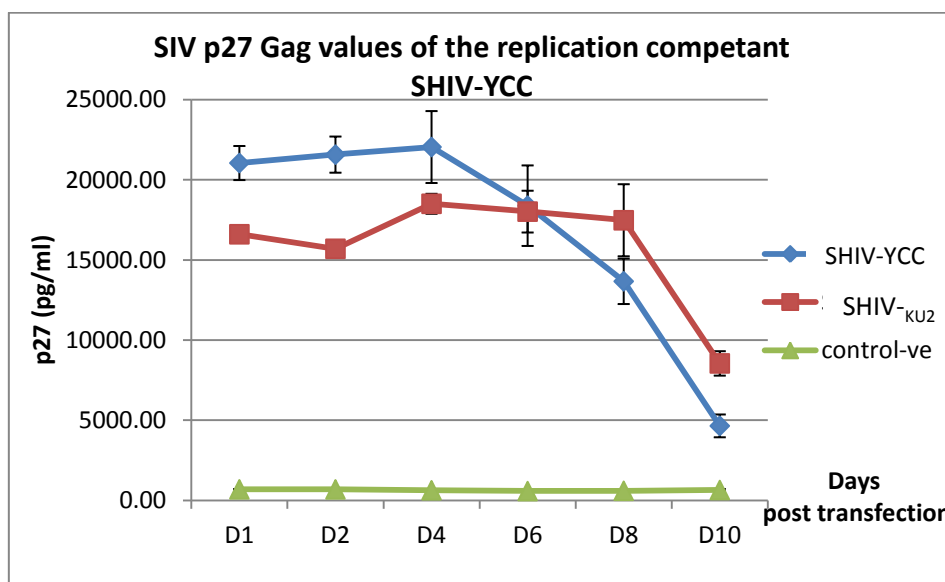
This construct was studied *in cellulo*.

### 3.3.1 *In cellulo* studies of the SHIV-YCC

#### 3.3.1.1 Production of viruses and infection

The SHIV-YCC plasmid DNA was transfected into HEK-293T cells and on day one post transfection, the supernatant fluid was used to inoculate M8166 cell cultures. Minimal numbers of CPE were observed for passages 1, 2 and 3 infections. Genomic DNA isolated from the M8166 passage 2 infection was used as a matrix to amplify the SIV gag, 5' and 3' chimeric LTRs. The amplicons were ligated to pGEM-T and sequenced. The sequencing results confirmed the LTRs in the plasmid construct were chimeric. The clones were tested by our collaborator's lab in Atlanta, and further adapted to monkey PBMCs and showed positives signs of productive replication.

Culture medium of HEK-293T cells transfected with the SHIV-YCC plasmid DNA collected on days 1, 2, 4, 6, 8 and 10 days post-transfection were used to quantify the SIV Gag p27 by ELISA. Values obtained were used to plot the graph shown in figure 3.16. Data shows that Gag p27 was produced at high levels on days 1, 2 and 4 post-transfection but gradually decreased over days 6, 8 and 10. While the positive control SHIV-KU2 produced slightly lower but uniform levels of Gag p27 from day 1-8, and dropping on day 10 post transfection. These results indicate that the SHIV-YCC DNA does express Gag p27 at high level but since these cells are not permissive to SHIV infection, the replication drops down after transient expression of the SHIV-YCC in transfected cells. Overall, these results confirmed similar growth properties for the SHIV-YCC and the control SHIV-KU2 at least after transfection.



**Figure 3.16: Evaluation of SHIV expression in transfected HEK-293T Cells:** SHIV-YCC plasmid DNA was transfected into HEK-293T cells in triplicates along with SHIV-KU2 as a positive control. The non-transfected cells were kept as negative control. The supernatants fluid were collected on days 1, 2, 4, 6, 8 and 10 to quantitate the production of Gag p27 antigen using ELISA. The standard deviation with the three sets of data (experiment done in triplicate) is indicated with the vertical bar.



### 3.3.1.2 Adaptation to different cell lines

The SHIV-YCC plasmid DNA was sent to a collaborator's lab at Emory University, Atlanta USA, to serially passage the virus on monkey PBMCs for adaptation of virus to replicate in primate primary cells and if successful, inoculate rhesus macaques.

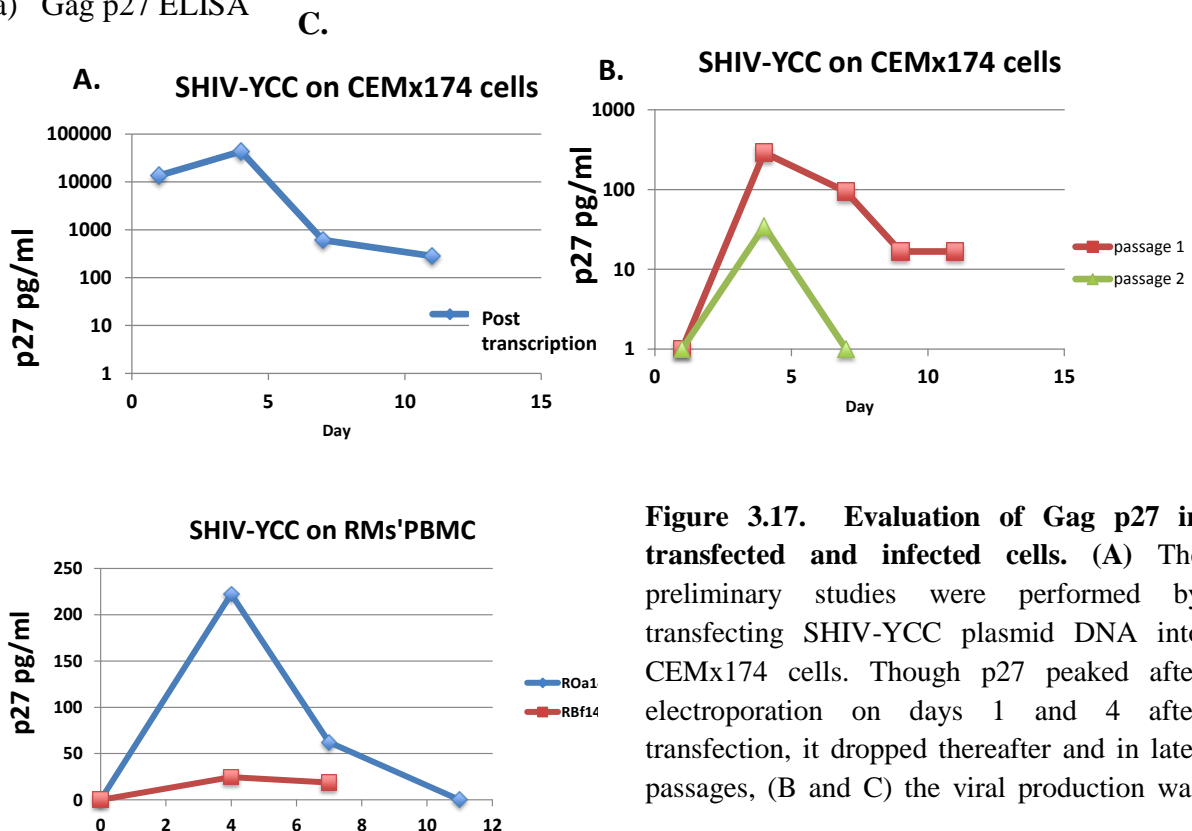
SHIV-YCC was transfected into CEMx174 cells and culture medium samples containing released viruses were collected on days 1, 4, 7, 9 and 11 and used in a Gag p27 ELISA, figure 3.17A. Passages 1 and 2 were then done in CEMx174 cells using the supernatants with the highest Gag p27 signals. The viruses collected on days 1, 4, 7 and 11 were evaluated for Gag p27 by ELISA. Values obtained were used to plot the graph in the figure 3.17B. Though the Gag p27 amount was very high in the culture medium of transfected cells at day 1 to 4, but the p27 amounts produced dropped with every passage and peaked on day 4. The drop may have been due to inability of the virus to replicate effectively. In passage 2, the p27 amount remained very low (<20 pg/ml) figure 3.17B.

### 3.3.1.3 Adaptation to monkey PBMCs

Activated macaque PBMCs were inoculated with 100  $\mu$ l of the viral stock of transfected CEMx174 cells collected 24 h post-transfection. Passages 1 and 2 were performed using PBMCs from two rhesus macaques and viral supernatants from transfected CEMx174 transfected cells. Though Gag p27 peaked on day 4, the virus did not undergo high replication activity in these two rhesus macaque PBMCs (Figure 3.17 C).

### 3.3.1.4. Quantification of Viral production

a) Gag p27 ELISA

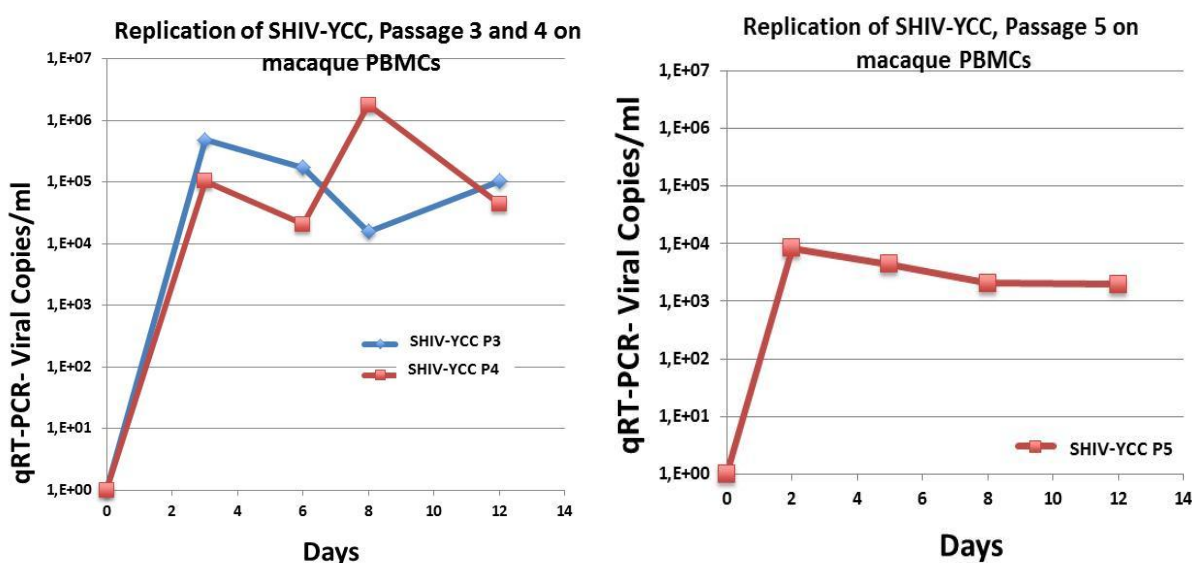


**Figure 3.17. Evaluation of Gag p27 in transfected and infected cells.** (A) The preliminary studies were performed by transfecting SHIV-YCC plasmid DNA into CEMx174 cells. Though p27 peaked after electroporation on days 1 and 4 after transfection, it dropped thereafter and in later passages, (B and C) the viral production was

even more limited, for both CEMx174 cells in passage 1 and 2 and RM PBMCs.

### b) Real-Time Quantitative Reverse Transcription PCR

Even though the Gag p27 production decreased following every passage, further passages were performed and the duration of culture of each passage were extended on macaque PBMCs. Virus production was monitored using the qRT-PCR to measure the released viral RNA in the culture medium of cell cultures during the successive passages. Interestingly using this new protocol, SHIV-YCC showed consistent release of viral RNA during passage 3-7 without major drops in production over 2 weeks of culture (Figure 3.18 A). These data suggest that viral replication/production required a prolonged culture time than used previously.



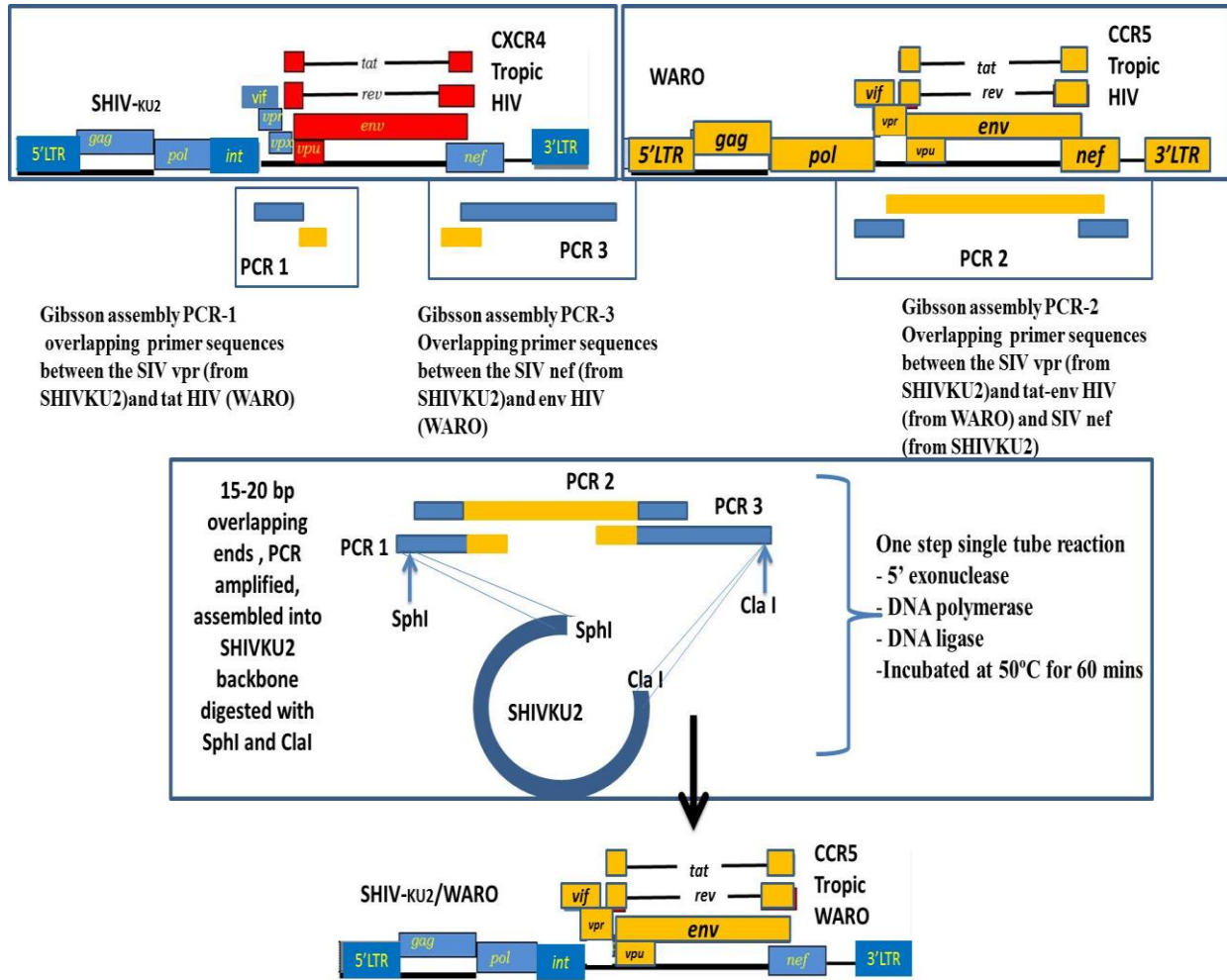
**Figure 3.18: Evaluation of RNA copies by qRT-PCR in culture medium from infected cells (A)** SHIV-YCC viral kinetics during passage in activated rhesus PBMCs. In passage three and four, the day 4 supernatant from previous passage was used to infect the fresh macaque PBMCs. RNA samples were isolated from 1 ml of culture medium on days 0, 2, 4, 8 and 12 and were used for evaluation of viral copies using the qRT-PCR. In both passages 3 and 4, high viral copy numbers were observed over the period of 12 days, suggesting that the virus was adapting. (B). In passage 5, the viral copies/ml was reduced. The viruses are being passaged further to continue the adaptation.

## PART III- Novel SHIVs containing primary envelopes.

### 3.4 SHIV-WARO

#### 3.4.1 Constructions of the SHIV-KU2/WARO

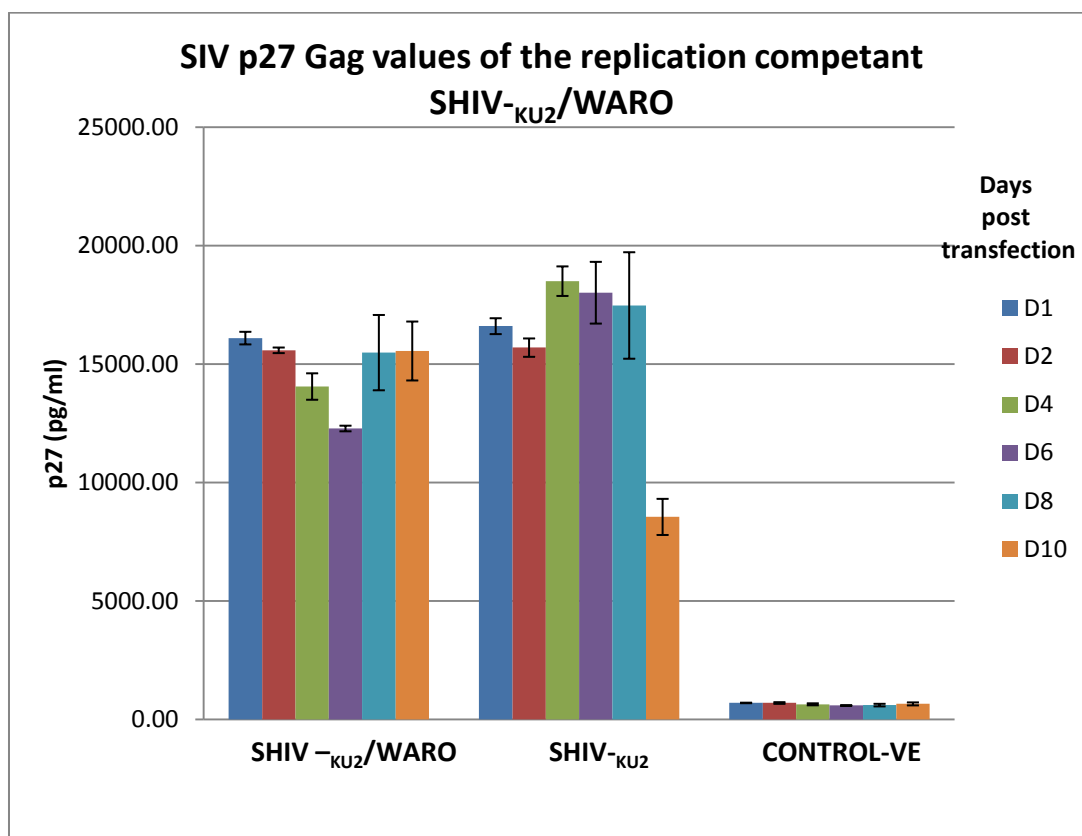
There was a need to generate novel CCR5 tropic SHIVs bearing primary envelopes that are more representative of *in vivo* early HIV isolates. The first such construct prepared in our lab used the SHIV-KU2 backbone in which the CCR5 the *tat*, *rev*, *vpu* and *env* genes sequence of HIV-1WARO, a clade B chronic isolate was introduced. Since unique restriction sites were lacking in SHIV-KU2, the Gibson assembly technique [313] was used to construct the SHIV\_KU2/WARO: More details of this construction are outlined in section 2.5.6 (Figure 3.19)



**Figure 3.19: Strategy to generate the SHIV-KU2/WARO construct.** The SHIV-KU2/WARO was prepared by Gibson assembly technique. Replacing the region from (Tat-Env) of SHIV-KU2 with the CCR5 clade B (Tat-Env) region of the molecular WARO construct. The first step used primers specific for the Tat-env region, amplicons were obtained from pWARO. Using another set of primers, the nef to pET region of SHIV-KU2 was amplified with part of the nef primer overlapping the env reverse primer. The two amplified fragments were substituted in a single reaction into the SHIV-KU2 digested with the SphI and ClaI.

### 3.4.2 Quantification of Gag p27 viral production

The supernatant fluid collected from HEK-293T cells transfected with SHIV-KU2/WARO plasmid DNA on day 1, 2, 4, 6 and 10 were used to quantify the production of viral Gag p27 by ELISA. SHIV-KU2 plasmid DNA was used as a positive control, and the non-transfected cells were kept as negative control. The p27 production of the SHIV-KU2/WARO was similar over the period of 10 days. The day 10 SHIV-KU2 p27 levels were 8 ng/ml compared to the SHIV-KU2/WARO which produced ~15 ng/ml on Day 8 and Day 10. The drop in SHIV-KU2 day 10 p27 value may be due to the increased death of the HEK-293T cells by 10 days thus lessening the production of p27 on day 10 post transfection. (Figure 20).



**Figure 3.20. Quantification of Gag p27 of replication competent SHIV-KU2/WARO:** SHIV-KU2/WARO plasmid DNA was transfected into HEK-293T cells in triplicates along with SHIV-KU2 as a positive control, while the negative control had no DNA for transfection. The supernatants were collected on days 1, 2, 4, 6, 8 and 10 to quantitate the production of Gag p27 antigen using ELISA. The standard deviations of the three sets of data (experiment done in triplicates) are indicated with the vertical bar.

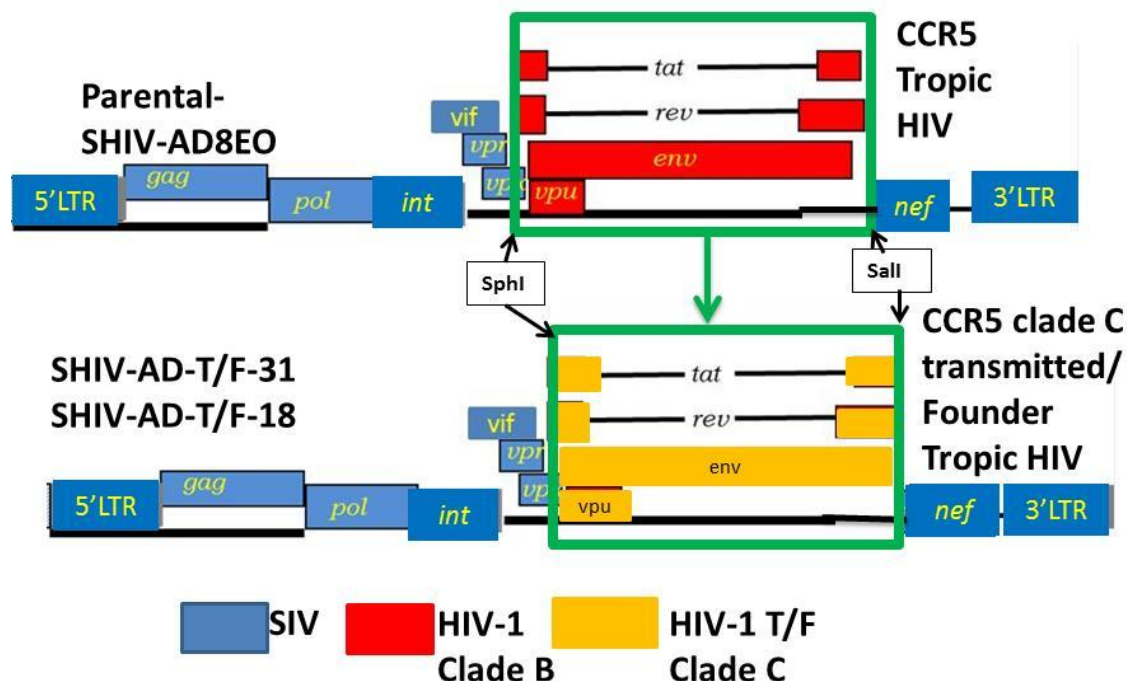
### 3.5 SHIV-AD8EO with T/F Clade C envelope & SHIV-KU2 with WARO envelope

#### 3.5.1 Constructions of the SHIV-AD8EO-T/F

To construct T/F SHIVs destined to become mucosal challenge stocks, the SHIV-AD8EO plasmid was obtained from Dr. M. Martin (NIH). Among CCR5 tropic SHIV isolates, the clade B SHIV-AD8EO has shown the most consistent virulence thus far (i.e. the least number of spontaneous controller monkeys) [306,314,315].

We used the SHIV-AD8EO as a backbone to remove the HIV *env* sequences and replace them with those of HIV-1 T/F Z331 and Z3618 to create SHIV-AD-T/F-31 and SHIV-AD-T/F-18 genomes. The construction involved PCR amplification of a fragment spanning *tat*, *rev*, *vpu*, *env* and *nef* from each of the HIV-1 T/F Z331 and T/F Z3618 infectious molecular clones and incorporating two unique SphI and SalI restriction sites in the primers used for cloning. The detailed strategy is outlined in material methods section 2.5.5 (Figure 3.15). The selected clones were sequenced across the inserted region. Examination of the sequencing results

showed a perfect match with the predicted sequences and therefore these clones were characterized and studied *in cellulo*.



**Figure 3.21: Schematic presentation of the maps of SHIV-AD8EO and derivatives SHIV-AD-T/F31 and SHIV-AD-T/F18.** The upper schematic represents the parental clade B SHIV-AD8EO from which the genes *tat*, *rev*, *vpu* and *env* were deleted using *SphI* and *Sall* enzymes. The lower schematic represents the SHIV-AD-T/F31 and SHIV-AD-T/F18 which were constructed by replacing the *tat-env* region of SHIV-AD8EO with the CCR5 clade C *tat-env* regions of HIV-1 Z331T/F and HIV-1 Z3618T/F, respectively.

### 3.5.2 *In cellulo* studies of the SHIV-T/F

#### 3.5.2.1 Transfection and infection

The plasmid DNA of the SHIV-AD-T/F-31 and SHIV-AD-T/F-18 were transfected in HEK-293T cells and GHOST Hi5 cells. The supernatants were collected from transfected HEK-293T cells on days 1, 2, 4, 6, 8 and 10 to quantify the viral Gag p27 protein. In parallel, the supernatants harvested on day 1 were used to inoculate GHOST Hi5, M8166 and GHOST X4 cell lines. The monolayers of transfected GHOST Hi5 cells showed green fluorescence expressing cells that were estimated to be around 30%, which is produced by the Tat-dependent HIV-2 LTR-GFP in response to infection. While the positive control SHIV-AD8EO could induce (50%) GFP positive cells.

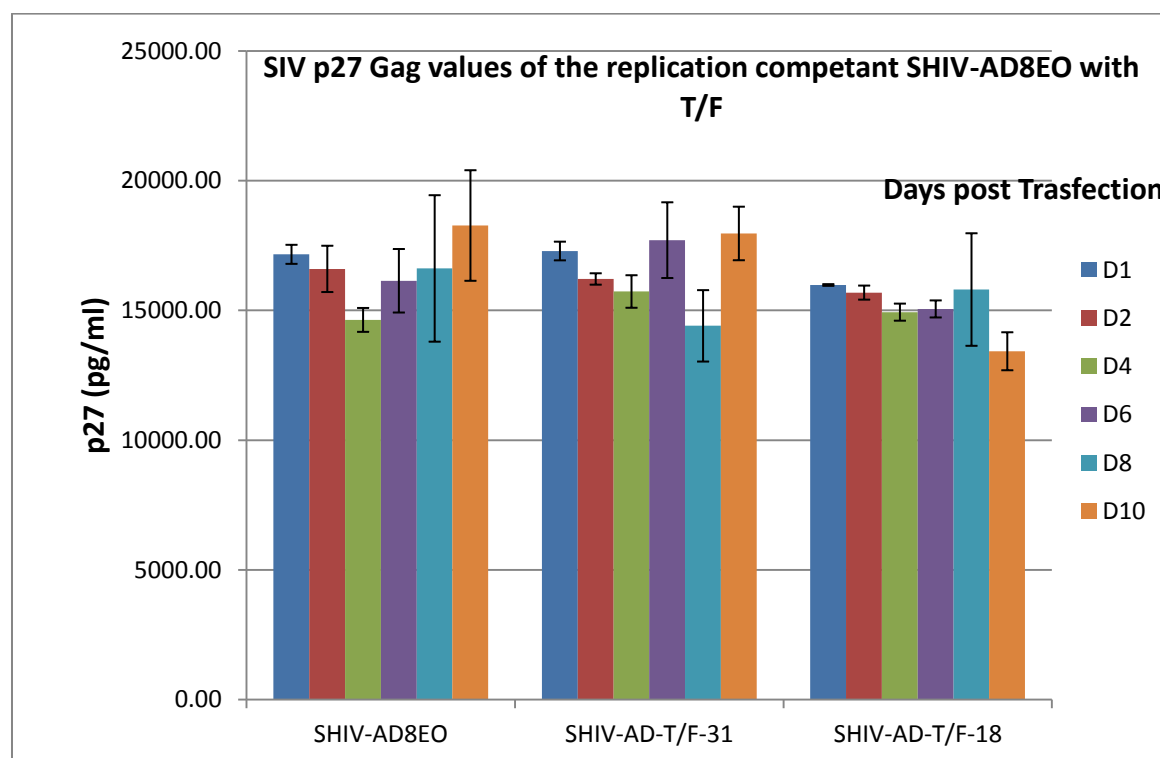
#### 3.5.2.2 Tropism studies on different cell lines

The supernatants harvested at 24 h post transfection of HEK-293T cells were used to inoculate GHOST Hi5, M8166 and CEMx174 to study the tropism. The M8166 cells did not show any of the characteristic syncytia of the cytopathic effects. While in contrast, GHOST Hi5 cells showed green fluorescent cells that were estimated at 10-15% compared to those in the SHIV-AD8EO positive control which were estimated to be around 20-30%. These results

helped to conclude that both SHIV-AD-T/F-31 and SHIV-AD-T/F-18 produced viruses are CCR5 tropic.

### 3.5.2.3 Quantification of viral production

The culture medium of HEK-293T cells transfected with SHIV-AD-T/F-31 and SHIV-AD-T/F-18 plasmid DNA collected on days 1, 2, 4, 6, 10 were used to quantify the Gag p27 released by ELISA. The parental SHIV-AD8EO was used as a positive control. The data reported in figure 3.20 show that both SHIV-AD-T/F-31 and SHIV-AD-T/F-18 produced similar high amount of Gag p27 like the parental over the 10 days.



**Figure 3.22: Evaluation of Gag p27 released by transfected cells with SHIV-AD-T/F genomes.** Five  $\mu\text{g}$  of SHIV-AD-T/F-31 and SHIV-AD-T/F-18 plasmid DNA were transfected into HEK-293T cells in triplicates along with parental SHIV-AD8EO used as a positive control. The supernatant fluids were collected on days 1, 2, 4, 6, 8 and 10 to quantitate the production of Gag p27 antigen using ELISA. The standard deviations of the three sets of data (experiment done in triplicate) are indicated with vertical bars.

## **Chapter 4- Discussion and Future Prospects**

The complex pathogenesis, host virus interaction, genome composition and evolution have made HIV-1 one of the most investigated viruses and difficult one to develop an effective vaccine against. HIV-1 was discovered more than three decades ago, and has since then infected more than 80 million (<http://www.unaids.org/en/resources/fact-sheet>) people globally. Despite very effective therapies that dramatically reduce the viremia in infected individuals, the pandemic is continuing all over the world with 1.2 million new infections and 1.1 million deaths yearly (UNAIDS). The prospect of a preventive efficacious vaccine remains a formidable challenge. While several clinical phase III trials in human have now been conducted, only RV144 comprising a Canarypox recombinant vector as prime and a recombinant gp120 protein as a boost, tested in Thailand has been shown to produce a low level of transient protection [153]. The classical vaccine design strategies have clearly failed to create immune barriers that can prevent virus acquisition and/or control the virus post infection. This is due to a combination of factors, the extensive variability of the antigens, difficulties for antibodies to reach the epitopes that are conserved across various isolates and complexity of the virus and target cell interactions. Other vaccines concepts based solely on humoral defenses or cell-mediated responses have failed; suggesting that a successful vaccine will need to elicit both cellular as well as humoral protective responses, establishing an initial barrier at the portal of entry but also antiviral control mechanisms should the virus succeed in bypassing the humoral barrier. The current vaccine efforts have by and large focused on prime/boost strategies using dual immunization strategies to achieve such dual type of responses that include variety of strategies, such as naked DNA recently enhanced by electroporation, a variety of recombinant viral vectors either single cycle (adeno, MVA, VSV etc.) or replicative (CMV) and a series of adjuvanted proteins and scaffolds [316-318]. While incremental progress has been achieved, none of these modalities are fully protective nor easy to translate into large-scale human vaccinations. The PAVAL laboratory where I conducted my graduate work has taken a different approach, based on the hypothesis that a safe lentiviral vaccine might hit multiple steps of HIV replication that would not be targeted by more classical vaccines, and thereby developed a prototype single-cycle non-integrative lentiviral simian/human immunodeficiency virus vector that is constitutively expressed rather than *via* Tat/TAR transactivation [72].

### **4.1 The Single Cycle Replication Competent Vaccine**

One of the main goals of our lab is developing an innovative HIV vaccine that has the ability to induce immune response that can control viral replication and protect from HIV-associated disease. To achieve this, the idea was to generate a vaccine that would induce immune responses similar to those established by live attenuated (e.g. *nef*-deleted) SIV [319] but at a much higher safety level, since attenuated lentiviruses have been shown to retain unacceptable levels of pathogenicity, especially in newborns [320,321]. This led to the development of the CAL-SHIV-IN<sup>-</sup> vaccine construct, which was based on the SHIV-KU2 viral genome, a recombinant highly virulent CXCR4 tropic recombinant virus [161]. The CAL-SHIV-IN<sup>-</sup> vaccine genome retained most of the SHIV-KU2 minus the SIV LTRs, which were replaced by

LTRs from CAEV and a deletion in the integrase gene that stably blocked this undesired function. This prototype developed in our lab is a lentivector DNA vaccine that has the property to undergo one cycle of replication in absence of integration following delivery as DNA. Immunization of cynomolgus macaques with a single dose of CAL-SHIV-IN<sup>-</sup> DNA lead to durable humoral and cellular responses including T<sub>SCM</sub> mediated SHIV responses detected 18 months post immunization [160] (manuscript in preparation). While the vaccine did not prevent rectal acquisition of the Env mismatched SIV, it did confer better control of the challenge virus (manuscript in preparation).

The uniqueness of this vaccine is to synergize the advantageous but not the drawback properties of both DNA and live-attenuated vaccines and also induction of VLPs that are involved in increased immunogenicity of the vaccine. The lack of integration of this vaccine genome disables the possibility of persistence and makes it safe. In addition, the switch of SIV LTRs to those of CAEV that induce constitutive expression and Tat-independent manner and are not recognized by HIV/SIV IN increases its efficacy and safety. The pilot experiment results obtained with this vaccine did however also indicate that improvements in the immunogenicity of the vaccine were likely necessary to make it more protective.

As a part of my PhD project, I attempted to enhance the vaccine further by 1) switching the CXCR4 envelope of CSH-DIN to primary CCR5 tropic envelopes such as the clade B WARO obtained from a chronically infected patient and a series of three transmitted/founder (T/F) HIV Clade C strains from Zambia [193]. This change of envelopes was important primarily for the generation of humoral and mucosal antibody responses able to recognize and contain the virus at the portal of entry. Indeed, T/F viruses have been found to undergo selective pressure from the passage which functions as an interesting bottleneck of transmission that can be targeted *via* vaccination. This change of envelopes is thought to be very significant for a vaccine because it helps to target the immune responses against epitopes that are specific to the T/F envelopes. Another important point about moving to clade C envelope is the fact that 56% of HIV infections worldwide are clade C related ([www.unaids.org](http://www.unaids.org)).

A second enhancement to the vaccine was to develop new strategies to incorporate molecular adjuvants able to enhance and sustain the newly elicited immune responses. This was achieved by modifying the backbone of the vaccine by creating a unique restriction site and introducing a spacer that will help incorporate genes like the GFP marker or molecular adjuvants into these vaccines. The molecular adjuvants selected were IL-7 and IL-15 due to their role in augmenting the responses of memory CD8<sup>+</sup> T cells, maturation of DCs, macrophages, NK cells, maintaining the naive T cell population and regulating T cell homeostasis [322]. The main goal of the adjuvants for this DNA vaccine is to further stimulate and enhance the proliferation of antigen-specific T lymphocytes. The use of these adjuvants may not be entirely novel, and they have shown increased induction of antigen specific responses in the context of other vaccine efforts and their congruent expression along with the antigen will ensure that their activity will benefit responses elicited by the immunization [316,323,324].



The existing CXCR4 tropic envelope of CSH-DIN was replaced with CCR5 tropic envelopes, the T/F CCR5 clade C envelopes from three full length infectious molecular clones derived from a Zambian cohort [193]. Envelopes from three selected T/F infectious molecular clones (Z331T/F, Z3618T/F, Z3678T/F) were successfully replaced into the CSH-DIN genome. Along with these T/F vaccine constructs, I also replaced the CXCR4-tropic HIV Env in CSH-DIN genome with the CCR5-tropic Env from an infectious molecular clone WARO that has a clade B CCR5 tropic envelope.

The in cellulo functional analyses of the four different vaccine constructs (WARO, Z331 T/F, Z3618 T/F, Z3678 T/F) demonstrated the integrity of the WARO and T/F envelopes in the newly developed vaccines. The tropism studies done on the different CCR5 and CXCR4 co-receptor expressing cell lines showed that the VLPs from the newly constructed vaccines maintained the CCR5 tropism. Moreover, these data provided the demonstration that all virus proteins were efficiently expressed and assembled into infectious particles able to infect the GHOST Hi5 and to transactivate the endogenous GFP by Tat and to cause fusion of cells by the fusion peptide on the Env glycoproteins. One surprising result among these comparisons were the differences in SIV Gag p27 production by the CSH-DIN-T/F-31, CSH-DIN-T/F-18, CSH-DIN-T/F-78, CSH-DIN-WARO constructs after transduction of HEK-293T which points to the various envelope differences regulating some step of the transcription which remains to be fully elucidated. Of note, the Gag p27 produced by CSH-DIN (KU2 envelope) was equivalent to the previous CAL-SHIV-IN<sup>-</sup> vaccine (~ 20ng/ml) [161].

The absence of infectious particles in the culture medium of GHOST Hi5 infected with the virus harvested from HEK-293T transfected cells has provided the demonstration that the vaccine constructs, like the parental construct, undergo only a single-cycle of replication.

#### **4.1.1 Prospects for a Single Cycle Replication Competent Vaccine**

High quality plasmid DNA extractions need to be produced and transfection experiments on HEK-293T cells repeated to evaluate and compare the production of SIV Gag p27 and titrate the infectious virus at the first round. The immunogenicity of these constructs can be tested in mouse models similar to the previous study conducted with the parental CAL-SHIV-IN<sup>-</sup> [160,161]. We anticipate a better humoral response to T/F envelopes upon use of the molecular adjuvants. The specific properties of the responses against the T/F antigens will be determined in comparison with those of the non-T/F CCR5-tropic vaccine CSH-DIN-WARO. In a study comparing the different envelopes' ability to induce neutralizing antibodies, T/F envelopes bound with higher affinity to MAb17b (a CCR5 co-receptor binding site antibody) and elicited low but potent broadly neutralizing antibody [325]. Therefore, we expect that the new vaccine prototypes will induce neutralizing and/or otherwise functional antibodies, which will improve the efficacy over the parental construct CAL-SHIV-IN<sup>-</sup> and potentially hold the virus off at the portal of entry.

The next step of the vaccine enhancement was the introduction of the IL-7 and IL-15 molecular adjuvants, this enhancement strategy has been previously described with IL-15 in DermaVir vaccine [143,326]. We hypothesized that coexpression of cytokine adjuvants with

vaccine antigens, rather than co-immunization, will create for each expressed vaccine an immunological niche that will favor the development and differentiation of a variety of memory types of responses. The difficulties in such approach are first to figure out the insertion site within the lentiviral genome if the replication steps of the lentivector constructs are to be maintained and also to ensure expression of the molecular adjuvant within the construct. Previously, successful introduction IL-5, IL-6, IL-12 were reported in *vpr*-deleted and *nef*-deleted regions of SHIVs [327-329]. But to achieve this in the CAL-SHIV-IN construct, since the deletion of the integrase was a desired trait of the construct, this step freed space to insert molecular adjuvants but did not guarantee its expression since the expression of the integrase in an internal part of the *pol* gene expression followed by specific cleavage inside of the virus particle. Rather than depends on this mechanism, a stop codon was inserted at the end of the *RNase*- coding sequence plus a 60 base pair spacer sequence for multicistronic reinitiation of translation of additional genes along with a unique restriction site upstream of the *vif* gene. A GFP reporter gene as well as cytokine genes will be inserted in this position with or without an IRES (internal ribosome entry sequence) to ensure the reinitiation of inserted genes.

To obtain a quick readout functional test for expression from this site, an eGFP gene was introduced first. Previously, successful introduction of eGFP has been reported at the C terminus of the matrix domain of the *gag* gene[330], in the *env* gene [331], and in another study the eGFP was fused to the N terminus of the HIV-1 *IN* [332]. Surprisingly the vaccine construct CSH-DIN- eGFP did not co-express the eGFP protein with viral proteins at the integrase deleted region. Many possible hypotheses could explain this defect of eGFP expression: 1) the chosen eGFP is not functional due to mutational event during the cloning steps; the sequencing of inserted gene and adjacent fragment didn't show any mutation that correlate with such defect. 2) The inserted spacer sequence is not functional for reinitiation of translation. The only recommendations for the spacer sequence to be functional are the lack of other ATG initiation codon other than the one of the expressed gene, the size that should be around 60vbp and stop codons in all three open reading frames; the sequencing results of our molecular clone confirmed the integrity of these sequences. 3) This region of the viral genome contains many splice acceptor sites that react with the major splice donor site upstream of *gag* coding sequences. One can consider that this latter is overreacting with sequences within GFP to remove at least part of the gene; RNA analysis by northern blot and/or RT PCR of viral transcript should provide the answer to this hypothesis.

Currently the CSH-DIN-IEGFP is under construction and we can expect this vaccine construct will co-express both eGFP and virus proteins providing proof that the location and the strategy are suitable for incorporation of the molecular adjuvants. Furthermore, the level of intensity of the eGFP will also provide indication on the efficacy of expression associated with this strategy/location.

An additional use of the CSH-IN-IEGFP, in the post thesis work will be to perform studies aiming to map the profile of vaccine protein expression *in vivo* through fluorescent imaging of the vaccinated mice models as previously shown in different studies [333,334]. Further, we will quantify the movement of the motile eGFP+ cells and evaluate the kinetics of the vaccine

expression at different time point intervals. This approach can be combined also with *ex vivo* analyses, whereby the fate of the vaccine proteins can be correlated with other immune markers, to CD8, CD4, CD3 and others to determine the early interactions, localization and expression of eGFP+ vaccine in different cell lineages.

The next prospect of the post-thesis work will be to include the molecular cytokines into the vaccine and study their effects on the efficacy of the vaccine in cell culture and in the mouse and macaque models.

#### **4.2 The replication competent constructs to study host/virus interactions involved in latency and persistence the development of a SHIV for experimental infection studies.**

A second major focus of this thesis was the development of replication competent SHIVs that represent more closely HIV infections in human with T/F viruses. There is currently a dearth of CCR5 tropic SHIVs that not only infect monkeys but also induce sustained viral load set-points and pathogenesis. The SHIV-KU2 while highly pathogenic is bearing a CXCR4 tropic Env and therefore poorly representative of early replicating HIV *in vivo*. These improved SHIV constructs, if proven to be replicative *in vivo* will provide invaluable tools for the field, testing vaccine and microbicide efficacy. However, for the purpose of the current studies, generating replication competent CCR5 tropic SHIVs will also provide comparative tools to determine the mechanisms of latency/persistence when used in parallel with CAEV LTR chimeric constructs that are independent of the Tat/TAR transactivation typical for HIV/SIV. Such tools and studies have direct relevance for the current ongoing studies aimed at curing HIV.

One of the main mechanisms used by HIV-1 to cause persistent infection in infected humans is the regulation of provirus expression that goes from unexpressed genome in latently infected reservoir cells to active expression replication in activated CD4+ T cells. One of the key player factors in this latency/persistence/activation of provirus is the transcription transactivator viral Tat protein that interacts with the TAR sequence in the viral genome. While the chimeric SHIV bearing the HIV-1 Env in the backbone of SIV helped extensively to study the tropism [335], pathogenicity [336] and immune responses [337] of HIV Env, both *in vitro* and in the non-human primate model, there was no attempt to develop replicative chimeric SHIVs with a Tat-independent constitutive promoter in the form of LTRs from any other Lentiviruses. Very limited studies have been developed with SIV or HIV genomes in which the LTR promoter was substituted with the constitutive CMV promoter [338,339]. However, since the replication of HIV-1 and CMV are very distinct and the viruses do not share much in their biology, target cell range or, pathogenesis, these recombinant viruses were not very helpful.

To study the latency/persistence, several latently infected cell lines (U1, ACH-2) have been developed and have been used to dissect the molecular basis of HIV-1 latency [340,341]. These early studies suggested that latency of HIV-1 is regulated by complex mutiparametric interactions of viral and host factors. Latency is enhanced if the viral DNA is integrated in

condensed chromatin or noncoding regions of the genomic DNA [230,263] which has led to the use of HDAC inhibitors as latency reactivating agents, SAHA, Vorinostat and Panobinostat in a strategy to flush out the reservoirs of latent virus under ART [342-344]. However, it appears clearly that these agents only achieve a partial reactivation of latent reservoirs [345]. Other attempts to revive latent virus attempt to activate the resting cells harboring the integrated provirus. This has been tried with TLR7 agonists or non oncogenic PKC activators such as prostratin and bryostatin [266,346-348]. The former, while clearly able to reactivate latent virus, has failed to markedly delay viral rebounds post ART interruption [349]. The PKC activators on the other hand are highly potent mitogens, which require rigorous testing prior to be allowed into humans whose viral loads are reasonably well controlled [346]. There is however, healthy skepticism within the field whether any strategy focused on activating the integrated yet transcriptionally silent viral promoter will succeed in functionally eliminating viral reservoirs. These studies however would benefit from additional models to better dissect the pathways that are relevant from those that are not, for HIV latency and reactivation.

To estimate these reservoirs, the current gold standard assay is the QVOA, which aims to measure the latent reservoir by assessing the number of resting CD4+T cells carrying replication-competent virus genome. There are limitations to this assay, it is labor intensive, time consuming, expensive, and requires 180-200ml of blood from HIV-1 positive and healthy individuals. A slight improvement to the drawbacks of QVOA was the MOLT/CCR5 viral outgrowth assay that reduces the need of high amounts of donor cells and the Murine Viral Outgrowth Assay that aims to avoid the underestimation of the reservoir. The PCR based assay to measure the latent reservoirs are overestimating the reservoir size three logs higher as it tends to measure the viral DNA irrespective of its intact or defective nature. The cell based QVOA underestimates the latent reservoir while the PCR based assays overestimates the viral reservoirs. The next generation assays measuring latent reservoirs closer to reality, they are, the tat/rev-induced limiting dilution assay (TILDA), the inducible cell-associated RNA expression in dilution (iCARED) assay and single molecule arrays (Simoa™, Quanterix Corporation, Lexington, MA, USA). TILDA is highly attractive alternative, as it requires only 10 ml of blood, is highly sensitive, does not need RNA extractions and the results are obtained in two days. TILDA measures the latent reservoir size in ART suppressed individuals. It measures the frequency of total CD4+ T cells that can produce viral tat/rev HIV-1 mRNA upon maximal cell activation. The latent reservoir size measured by TILDA is 48 times larger than QVOA but 6-27 times lower than the qPCR on total viral DNA [350].

#### **a) CAL-SHIV-IN<sup>+</sup>**

As a first chimera with constitutive LTR promoters, our lab developed CAL-SHIV-IN<sup>+</sup>; a primate lentivirus genome (SIV and HIV) whose gene expression is driven by the LTRs of the natural goat lentivirus, CAEV. These LTRs are totally independent from Tat transactivation and were shown to be active constitutively for the expression genes under their control, in all studied cell types [72]. In addition, the integrase gene of SIV was replaced by that of CAEV to obtain replication competent viruses.

The immediate goal of this lentivirus genome is to examine the impact of Tat on the regulation of latency/replication of primate lentiviruses and to evaluate the mechanisms specifically directing latency using a comparative model with closely related lentiviral constructs with Tat dependent vs Tat independent LTR side by side. This will be possible thanks to the availability of CAL-SHIV-IN<sup>+</sup> and the parental SHIV-KU2.

Since the attempts made by others in the lab to generate an infectious replication-competent virus stock using the plasmid DNA of CAL-SHIV-IN<sup>+</sup> were not successful, part of my work was to examine the integrity of the construct and to fix possible defects. After a series of modifications described in the material and methods and result sections, I developed the CSH-INP whose genome was sequenced and found to be conform to the theoretical sequences.

#### **b) CSH-INP**

Data from CSH-INP studies *in-cellulo* showed that co-culture of the M8166 cells with the transfected HEK-293T cells developed CPE of the non-adherent M8166 cells due to fusion of Env expressed by transfected cells. This provided the demonstration that the viral Env glycoproteins were correctly produced. In addition, the ELISA results of Gag p27 clearly showed a peak of p27 production on day 2 and a steady decline on this protein production at later time points post transfection. Since the infectivity assay on M8166 did not show indications of productive cytopathic infection, we sought that an adaptation to *in cellulo* replication in primate cells, is needed. Experimental adaptation has been reported previously and described as a step where the virus accumulate mutations needed to change the phenotype of non-syncytium inducing virus to syncytium inducing virus isolates [351-353]. Our first attempt of adaption model was using the human CD4<sup>+</sup> T cell lines, M8166 and CEMx174 for replication of CSH-INP as done by many groups previously [354-356]. After prolonged serial passages of the virus up to 19 passages, no sign of active replication was observed in M8166 and 8 passages in CEMx174, which was contradictory to the previously published results where the virus acquired mutations and adapted in long term passages in M8166 [354]. We concluded that these cells lines might not be suitable for adaptation and generation of CSH-INP virus. Our focus shifted towards adaptation using primary PBMCs as done in the literature by different groups [354,355]. Since PBMCs are composed of a mix of many mononuclear cell lineages: lymphocytes (T cells, B cells, NK cells) and monocyte/macrophages, there are many target cell types providing better opportunities to cause infection/adaption rather than in a single cell line. Dr. Villinger's group collaborated for the adaptation of the CSH-INP in primary PBMCs and the CD4<sup>+</sup> T cell line CEMx174. The adaptation was successful when infected cells were cultured in 5 ml tissue culture tubes instead of flask or 6 well plates. This probably provided more differentiation and activation of different cell types and more contact with various types of primary cells to the virus for adaptation (figure 3.14). Interestingly, after passage 3 and passage 4 of adaptation in PBMCs, the virus production reached 10<sup>6</sup>-10<sup>7</sup> viral copies per ml during all 12 days of culture. These results indicate that the virus was undergoing productive replication now in the primary cells.

Altogether, these results provide the demonstration that the chimeric lentivirus driven by the constitutive LTRs of the macrophage tropic CAEV and the integrase of this virus can productively replicate in primate mononuclear cells. This point is not trivial, since indeed,

CAEV does not replicate productively in goat CD4<sup>+</sup> T cells, and there is no indication in the literature that the LTRs of this virus are functionally active in T cells, there was no prior evidence that our chimeric virus driven by CAEV LTRs would undergo productive replication in primary T cell-derived cultures. In addition, since the IN is from CAEV, the data indicate that this indispensable enzyme for virus replication is functional. To be functional, IN has to be incorporated in virions as precursors where it is cleaved to release the mature functional enzyme during the infection of target cells. There was no prior evidence that the CAEV IN precursor would be incorporated into SHIV virions, nor matured properly or producing functional IN to support the replication of the chimeric virus. This new virus, although not fully characterized *in cellulo*, shows possible new ways to examine the mechanisms of replication of complicated primate lentiviruses.

### c) SHIV-YCC

In the second strategy to develop a replication competent virus with Tat independent CAEV LTRs, SHIV-YCC was constructed. This design was significantly different than the above one mentioned for the CSH-INP construction strategy. Since there was concern that CAEV IN would not be fully functional to support CSH-INP replication, here we conserved the SIV IN and modified the CAEV LTRs to allow for interaction with SIV IN. In SHIV-YCC the LTRs of the classic SHIV-KU2 were exchanged with the CAEV LTRs that bear the extremities of SIV LTRs that form the *att* sequence used by SIV IN for integration. Our primary *in cellulo* studies have provided evidence that the molecular clone was infectious since it showed CPE in infected M8166 both with the culture medium from transfection and from serial passage infections. The genomic DNA was extracted from passage two infected M8166 also showed the presence of proviral DNA with PCR with primers targeting the SIV gag, 5'LTR and 3'LTR. Consistently, the quantification of SIV Gag p27 SIV by ELISA using supernatants of transfected cells showed a high production and release of this protein.

SHIV-YCC was also sent to our collaborator, Dr. Villinger's group for adaption on the rhesus macaque PBMCs similar to CSH-INP. The passage 3 and passage 4 of the SHIV-YCC adaptation in monkey PBMCs showed  $10^5$ - $10^6$  viral RNA copies per ml, but the viral copies in passage 5 dropped to  $10^3$ - $10^4$  viral copies per ml. These data also provided the demonstration that this chimera is replicating in primary macaque cells and the SIV *att* sequence at the extremities of CAEV LTRs is being recognized by the SIV IN to promote provirus integration. Further passages did however restore replication but showed that cultures needed to be maintained beyond the classical 2 weeks of culture (data not shown). Passages of this virus are currently tested in 2 Indian rhesus macaques infected IV. The ability of the SHIV-YCC virus whose genome is driven by CAEV LTRs that have Tat-independent transcription to replicate in different cell type and whether or not it undergoes latency is yet to be studied.

#### 4.2.1 Prospects of the CSH-INP and SHIV-YCC replication competent constructs

It has been well established that latency/persistence of HIV/SIV is a complex interplay between the host and the viral proteins and viral genome [357]. Numerous cellular transcription proteins were identified as key factors for expression of HIV/SIV proviral

genomes in different cell types [235,236,358]. In contrast, only minimal cellular proteins were identified to interact with CAEV LTR promoter to activate the transcription (in U3 Multiple putative AP-1, AP-4, Ets-1, Stat-1 and TATA binding protein (TBP) sites, single AML(vis), GAS, IRF-1, NFAT and TAS sites.) [359,360] *as illustrated in detail in Figure 6 of our published review that is attached at the end of the thesis.* Since CAEV LTR was shown to be highly active in human and macaque cells [4,159] this indicates that the required factors for CAEV transcription are present and functional in primate cells and primate T cells. The examination will be initially focused on the cellular factors that are known to regulate HIV/SIV LTR promoters (Sp1, NF- $\kappa$ B, P-TEFb) and were not identified as regulators of CAEV LTR promoter. We will determine whether in the context of expression of HIV/SIV proteins these factors will interact with CAEV LTR promoter.

The first main objective of the CSH-INP and SHIV-YCC replication competent constructs is to examine whether or not these viruses driven by constitutive promoters retain the capability to undergo latency in resting memory CD4<sup>+</sup> T cells. The second is to comparatively investigate the host factors that control latency/persistence of the wild type HIV-1/ SIV with our novel chimera CSH-INP and SHIV-YCC that do not undergo latency. Indeed, a study by Dr. Weinberger's group that focused on a mathematical model with HIV feedback circuitry concluded that viral transactivation is possible without cellular activation, and that Tat feedback is sufficient to regulate latency [361].

The experiments will be conducted in parallel with CSH-INP, SHIV-YCC and the parental SHIV-KU2 on ConA/IL-2-stimulated and non-stimulated CD8-depleted human and/or macaque PBMCs that will be inoculated with the viruses at MOI=1 and sampled at 24 h intervals for analyses. The real-time PCR will indicate the proportion of cells having the provirus; the staining with anti-SIV Gag p27 will indicate the proportion of cells expressing the proteins. The phenotyping and functional analyses with combination of surface and intracellular antibodies (CD3, CD4, CD95, CD62L, CD68, CD45RA and CD45R0) using multiparametric flow cytometry, will allow for a delineation of the cells that are productively replicating the provirus from those that are not. We expect that the proportion of cells expressing the provirus will be higher with CSH-INP and SHIV-YCC than SHIV-KU2 infections. We expect that the difference in proportions between our chimera and the parental SHIV-KU2 correspond to the latently infected cells that we can isolate and study.

Next, it will be important to map the cellular factors that are involved in the latency/persistence independent of Tat that are difficult to segregate in the parental. This will be addressed using RNASeq based technologies and Fluidigm Biomark analyses that have been optimized for rhesus macaque cells [362]. Through transcriptomics, the expression of mRNA profiles in the cell population (latently infected, productively infected and uninfected) will be examined. Various models of latency have been developed from which sorted latently infected cells were used to isolate RNA that are used to perform transcriptomics [363-365]. In the case of the CSH-INP, SHIV-YCC and SHIV-KU2 a comparative transcriptomic analysis of cells infected with each of these viruses will establish profiles corresponding to latency

induction or the productive replication of the viruses. The microarray analysis will reveal profiles of upregulated and downregulated genes representing various functions (activation, proliferation, survival, gene expression, immune function, cell metabolism). These results may also lead into the delineation of novel biomarkers of latency as well as open novel insight into latency reversal agents and pathways that may be tested in HIV eradication attempts of the viral reservoirs. We will use both the NSG-SCID mouse and macaque models of HIV in this study SHIV<sub>-KU2</sub> to examine the eradication of the reservoir.

Further, the development of a CCR5 tropic SHIV-YCC and CSH-INP version of the model could decipher the initial stages of infection and gain more insights into the latency independent Tat transactivation.

### 4.3 SHIV-AD8EO with T/F Envelops

There is an urgent need for novel CCR5 tropic SHIVs bearing primary envelopes that are more representative of *in vivo* early HIV isolates, that are infectious and able to induce sustained level of viremia in monkey models to test vaccines and microbicides in mucosal challenges.

Envelope bearing SHIV constructs were developed initially in the mid nineties [178,305,366-368], though the initial choice for HIV Env were those of late CXCR4 tropic viruses. After *in vivo* passage, these viruses appeared very virulent, inducing rapid disease course with elimination of >95% CD4+ T cells after 2 weeks. However, it soon appeared also that protection against these viruses was more easily attainable [369] than against classical SIV infection and that the SHIVs did not correspond to early transmitted viruses that were almost uniformly CCR5 tropic. This was first answered by the Clade B SHIV-162 [370] or clade C SHIV [185]. While these later chimeric viruses retained their CCR5 tropism and infectious potential, many infected animals managed to control viremia to undetectable levels after few weeks of infection. This renders them unsuitable for measuring decrease of the chronic viral loads and/or reservoir eradication studies. This has led to a recent flurry of novel SHIV constructs that have been generated and tested.

While several groups have generated new clade C and other constructs, the replication kinetics or resistance to neutralization of these various isolates leaves room for improvement [184,185,194]. Recently, 10 SHIV constructs were developed with SHIV KB9 backbone and T/F clade C *env* obtained from South Africa. Among these, only three viruses are mucosally transmitted exhibiting low Env reactivity and a Tier 2 neutralization sensitivity [192]. We therefore used the best SHIV backbone, currently available, SHIV-AD8EO kindly provided by Dr. M. Martin (NIH), since this chimeric virus has shown the most consistent virulence among CCR5 tropic SHIVs thus far (i.e. the least number of spontaneous controller monkeys) [315,371]. However, SHIV-AD8EO bears a clade B chronic envelope, which is not representative of a large number of new infections. We therefore selected three CCR5 clade C T/F envelopes described and isolated from the Zambian cohort by lab of Dr. E. Hunter based on their *in vitro* replication kinetics [193]. While this by no means ensures high levels of replication *in vivo*, clone SHIV-AD8-T/F-31, one of the T/F envelopes shows that the Env residue 375 is mutated from serine to tyrosine a feature that has recently shown improved binding to macaque CD4 [372]. These clones also showed promising replication kinetics in HEK-293T cells and in CEM<sub>x</sub>174.



**Prospects of the SHIV-AD8EO T/F**

In term of pathogenesis, these unique tools will be very helpful to study the early events of host/virus interactions that positively select the T/F genotype for productive infection. Next, they will be passaged in activated primary macaque PBMCs, and if they found to be replicative, used to inoculate macaques and undergo passages in attempt to augment the virulence in macaques with the aim of developing Clade C T/F viral challenge stocks that are not only infectious but also able to generate sustained viremia in vivo.

Such viral stocks would be ideal to study the efficacy of vaccine prototypes at inducing protective immunity against virus acquisition/replication in macaques. The intent is to generate stocks that may be distributed to the NIH for use in experiments designed to test mucosal resistance to infection following vaccination or microbicide administration.

Finally, since it is thought that T/F viruses are those who seed the very early the reservoir, these SHIVs might help to develop targeted strategies to prevent them from establishing such type of infection in HIV recipients. Depending on their in vivo replication kinetics, these isolates may also provide reliable models of reservoir eradication that will allow for the testing of neutralizing and enhanced neutralizing antibodies and/or antibody dependent cytotoxicity effector antibodies as reservoir eradication strategies.

## **Conclusion**

The complex properties of the life cycle of HIV and SIV and their interactions with the host's cell components together with the limited accessibility of primates make the studies difficult to conduct in the natural models. Therefore, there is a strong need of model systems with less complexity and wider accessibility, to speed up the studies and development of safe and efficacious vaccines. The main objectives of our lab are to develop novel chimeric lentivirus systems that will ease these studies and help for better understanding the pathogenesis of lentiviruses and to develop a safe and efficacious vaccine against HIV-1. The work of this thesis contributes to these objectives by developing different unique molecular clones to study the pathogenesis and to enhance the efficacy of the vaccine constructs. This work represents a challenge since the manipulation of the full genome of lentiviruses is very difficult due to their instability in bacteria, which has led to multiple iterations and constructions to obtain the right constructs. However, this challenging work provided the opportunity to acquire solid expertise in lentivirus molecular virology that I hope to use in my post thesis work. All the constructs generated during this work are unique and I hope they will be helpful to dissect the pathogenesis of HIV-1 and to generate powerful vaccines against HIV-1 in the future. The data reported in this manuscript and discussed are very encouraging and already established some concept. I hope that the use of these constructs in the non-human primate model will provide more solid data that justify the time and the energy that I invested in these constructs.

**APPENDIX**

**The dissemination version of the thesis does not include the totality of the Appendix section for the reason of copyright.**

## Thesis References

1. Weiss, R.A. The discovery of endogenous retroviruses. *Retrovirology* **2006**, *3*, 67.
2. van der Kuyl, A.C. HIV infection and HERV expression: a review. *Retrovirology* **2012**, *9*, 6.
3. Vogt, P.K. Retroviral oncogenes: a historical primer. *Nat Rev Cancer* **2012**, *12*, 639-648.
4. Mselli-Lakhal, L.; Favier, C.; Leung, K.; Guiguen, F.; Grezel, D.; Miossec, P.; Mornex, J.F.; Narayan, O.; Querat, G.; Chebloune, Y. Lack of functional receptors is the only barrier that prevents caprine arthritis-encephalitis virus from infecting human cells. *Journal of virology* **2000**, *74*, 8343-8348.
5. M., L. Mémoire et observations sur une maladie de sang, connue sous le nom d'anémie hydrohémie, cachexie acquise du cheval. *Rec Med Vet Ec Alfort* **1843**, 30-45.
6. Vallée H, C.H. Sur la nature infectieuse de l'anémie du cheval. *C. R. Acad. Sci.* **1904**, *139*, 331–333.
7. Leroux, C.; Cadore, J.L.; Montelaro, R.C. Equine Infectious Anemia Virus (EIAV): what has HIV's country cousin got to tell us? *Vet Res* **2004**, *35*, 485-512.
8. Mitchell, D.T. Investigations into jaagziekte or chronic catarrhal pneumonia of sheep. *Dir. Vet. Educ. Res., Union of South Africa*, **1915**, p.585.
9. Marsh, H. Progressive pneumonia in sheep. *J. Am. Vet. Med. Assoc.* **1923**, *62*, 458-473.
10. Palsson, P.A. Maedi and visna in sheep. *Front Biol* **1976**, *44*, 17-43.
11. Palsson, P.A. Maedi-visna. *J Clin Pathol Suppl (R Coll Pathol)* **1972**, *6*, 115-120.
12. Stunzi, H.B.H., LeRoy HL, Leeman W. Endemische arthritis chronic a bei zeiegen. *Schw Arch Tier* **1959** *106*, 778-788.
13. Stavrou, D.; Deutschlander, N.; Dahme, E. Granulomatous encephalomyelitis in goats. *J Comp Pathol* **1969**, *79*, 393-396.
14. Cork, L.C.; Hadlow, W.J.; Crawford, T.B.; Gorham, J.R.; Piper, R.C. Infectious leukoencephalomyelitis of young goats. *The Journal of infectious diseases* **1974**, *129*, 134-141.
15. MJ, V.d.M. Isolation of a virus from cattle with persistent lymphocytosis *Journal of the National Cancer Institute* **1972**, *49*, 1649–1657.
16. Gottlieb, M.S. Pneumocystis pneumonia--Los Angeles. 1981. *Am J Public Health* **2006**, *96*, 980-981; discussion 982-983.
17. CfDC., C. Kaposi's sarcoma and Pneumocystis pneumonia among homosexual men--New York City and California. *MMWR Morbidity and mortality weekly report.* **1981**, *30*, 305-308.
18. Barre- Sinoussi, F.; Chermann, J.; Rey, F.; Nugeyre, M.; Chamaret, S.; Gruest, J.; Dauguet, C.; Axler, B.C.; Vezinet- Brun, F.; Rouzioux, C., *et al.* Isolation of a T-lymphotropic retrovirus from a patient at risk for acquired immune deficiency syndrome (AIDS). *Science.* **1983**, *220*, 868-871.
19. Clavel, F.; Guyader, M.; Guetard, D.; Salle, M.; Montagnier, L.; Alizon, M. Molecular cloning and polymorphism of the human immune deficiency virus type 2. *Nature* **1986**, *324*, 691-695.
20. Peeters, M.; Franssen, K.; Delaporte, E.; Van den Haesevelde, M.; Gershy-Damet, G.M.; Kestens, L.; van der Groen, G.; Piot, P. Isolation and characterization of a new chimpanzee lentivirus (simian immunodeficiency virus isolate cpz-ant) from a wild-captured chimpanzee. *AIDS* **1992**, *6*, 447-451.

21. Peeters, M.; Honore, C.; Huet, T.; Bedjabaga, L.; Ossari, S.; Bussi, P.; Cooper, R.W.; Delaporte, E. Isolation and partial characterization of an HIV-related virus occurring naturally in chimpanzees in Gabon. *AIDS* **1989**, *3*, 625-630.
22. Van Heuverswyn, F.; Li, Y.; Neel, C.; Bailes, E.; Keele, B.F.; Liu, W.; Loul, S.; Butel, C.; Liegeois, F.; Bienvenue, Y., *et al.* Human immunodeficiency viruses: SIV infection in wild gorillas. *Nature* **2006**, *444*, 164.
23. Plantier, J.C.; Leoz, M.; Dickerson, J.E.; De Oliveira, F.; Cordonnier, F.; Lemeé, V.; Damond, F.; Robertson, D.L.; Simon, F. A new human immunodeficiency virus derived from gorillas. *Nature medicine* **2009**, *15*, 871-872.
24. Sharp, P.M.; Hahn, B.H. Origins of HIV and the AIDS pandemic. *Cold Spring Harb Perspect Med* **2011**, *1*, a006841.
25. Delaugerre, C.; De Oliveira, F.; Lascoux-Combe, C.; Plantier, J.C.; Simon, F. HIV-1 group N: travelling beyond Cameroon. *Lancet* **2011**, *378*, 1894.
26. Vallari, A.; Holzmayer, V.; Harris, B.; Yamaguchi, J.; Ngansop, C.; Makamche, F.; Mbanya, D.; Kaptue, L.; Ndembi, N.; Gurtler, L., *et al.* Confirmation of putative HIV-1 group P in Cameroon. *Journal of virology* **2011**, *85*, 1403-1407.
27. D'Arc, M.; Ayoub, A.; Esteban, A.; Learn, G.H.; Boue, V.; Liegeois, F.; Etienne, L.; Tagg, N.; Leendertz, F.H.; Boesch, C., *et al.* Origin of the HIV-1 group O epidemic in western lowland gorillas. *Proceedings of the National Academy of Sciences of the United States of America* **2015**, *112*, E1343-1352.
28. Shaw, G.M.; Hunter, E. HIV transmission. *Cold Spring Harb Perspect Med* **2012**, *2*.
29. Quinn, T.C.; Wawer, M.J.; Sewankambo, N.; Serwadda, D.; Li, C.; Wabwire-Mangen, F.; Meehan, M.O.; Lutalo, T.; Gray, R.H. Viral load and heterosexual transmission of human immunodeficiency virus type 1. Rakai Project Study Group. *N Engl J Med* **2000**, *342*, 921-929.
30. Maartens, G.; Celum, C.; Lewin, S.R. HIV infection: epidemiology, pathogenesis, treatment, and prevention. *Lancet* **2014**, *384*, 258-271.
31. Parrish, N.F.; Gao, F.; Li, H.; Giorgi, E.E.; Barbian, H.J.; Parrish, E.H.; Zajic, L.; Iyer, S.S.; Decker, J.M.; Kumar, A., *et al.* Phenotypic properties of transmitted founder HIV-1. *Proceedings of the National Academy of Sciences of the United States of America* **2013**, *110*, 6626-6633.
32. Keele, B.F.; Giorgi, E.E.; Salazar-Gonzalez, J.F.; Decker, J.M.; Pham, K.T.; Salazar, M.G.; Sun, C.; Grayson, T.; Wang, S.; Li, H., *et al.* Identification and characterization of transmitted and early founder virus envelopes in primary HIV-1 infection. *Proceedings of the National Academy of Sciences of the United States of America* **2008**, *105*, 7552-7557.
33. Schuitemaker, H.; Koot, M.; Kootstra, N.A.; Dercksen, M.W.; de Goede, R.E.; van Steenwijk, R.P.; Lange, J.M.; Schattenkerk, J.K.; Miedema, F.; Tersmette, M. Biological phenotype of human immunodeficiency virus type 1 clones at different stages of infection: progression of disease is associated with a shift from monocytotropic to T-cell-tropic virus population. *Journal of virology* **1992**, *66*, 1354-1360.
34. Honeycutt, J.B.; Wahl, A.; Baker, C.; Spagnuolo, R.A.; Foster, J.; Zakharova, O.; Wietgreffe, S.; Caro-Vegas, C.; Madden, V.; Sharpe, G., *et al.* Macrophages sustain HIV replication in vivo independently of T cells. *The Journal of clinical investigation* **2016**.
35. Fiebig, E.W.; Wright, D.J.; Rawal, B.D.; Garrett, P.E.; Schumacher, R.T.; Peddada, L.; Heldebrant, C.; Smith, R.; Conrad, A.; Kleinman, S.H., *et al.* Dynamics of HIV viremia and antibody seroconversion in plasma donors: implications for diagnosis and staging of primary HIV infection. *AIDS* **2003**, *17*, 1871-1879.

36. Levy, J.A. Pathogenesis of human immunodeficiency virus infection. *Microbiol Rev* **1993**, *57*, 183-289.
37. Stieh, D.J.; Maric, D.; Kelley, Z.L.; Anderson, M.R.; Hattaway, H.Z.; Beilfuss, B.A.; Rothwangl, K.B.; Veazey, R.S.; Hope, T.J. Vaginal challenge with an SIV-based dual reporter system reveals that infection can occur throughout the upper and lower female reproductive tract. *PLoS pathogens* **2014**, *10*, e1004440.
38. Stacey, A.R.; Norris, P.J.; Qin, L.; Haygreen, E.A.; Taylor, E.; Heitman, J.; Lebedeva, M.; DeCamp, A.; Li, D.; Grove, D., *et al.* Induction of a striking systemic cytokine cascade prior to peak viremia in acute human immunodeficiency virus type 1 infection, in contrast to more modest and delayed responses in acute hepatitis B and C virus infections. *Journal of virology* **2009**, *83*, 3719-3733.
39. Keele, B.F. Identifying and characterizing recently transmitted viruses. *Current opinion in HIV and AIDS* **2010**, *5*, 327-334.
40. Piatak, M.; saag, M.; yang, L. High levels of HIV-1 in plasma during all stages of infection determined by competitive PCR. *Science*. **1993**, *259*, 1749-1754.
41. Daas, E.; Moudgil, T.; Meyer, R. Transient high levels of viremia in patients with primary human immunodeficiency virus type 1 infection. *N Engl J Med* **1991**, *324*, 961-964.
42. Mattapallil, J.; Douek, D.; Hill, B.; Nishimura Y; Martin M; M., R. Massive infection and loss of memory CD4+ T cells in multiple tissues during acute SIV infection. *Nature*. **2005**, *434*, 1093-1097.
43. Lackner, A.A.; Mohan, M.; Veazey, R.S. The Gastrointestinal Tract and AIDS Pathogenesis. *Gastroenterology* **2009**, *136*, 1966-1978.
44. Mattapallil, J.J.; Douek, D.C.; Hill, B.; Nishimura, Y.; Martin, M.; Roederer, M. Massive infection and loss of memory CD4+ T cells in multiple tissues during acute SIV infection. *Nature* **2005**, *434*, 1093-1097.
45. MacDonald, T.; Spencer, J. Lymphoid cells and tissues of the gastrointestinal tract. . *Heatley RH, ed. Gastrointestinal and hepatic immunology. Cambridge: Cambridge University Press* **1994**, 1-23.
46. Schieferdecker, H.; Ullrich, R.; Hirseland, H.; M., Z. T cell differentiation antigens on lymphocytes in the human intestinal lamina propria. *J Immunol*. **1992**, *149*, 2816-2822.
47. Dandekar, S. Pathogenesis of HIV in the Gastrointestinal tract. *Current HIV/AIDS Reports* **2007**, *4*, 10-15.
48. Veazey, R.S. Getting to the Guts of HIV Pathogenesis. *Journal of Experimental Medicine* **2004**, *200*, 697-700.
49. Brencley, J.; Schacker, T.; Ruff, L.; Price DA; Taylor JH; Beilman GJ; Nguyen PL; Khoruts A; Larson M; Haase AT, *et al.* CD4+T cell depletion during all stages of HIV disease occurs predominantly in the gastrointestinal tract. *J Exp Med*. **2004**, *200*, 749-759.
50. Veazey, R.S.; Marx, P.; Lackner, A. Importance of the state of activation and/or differentiation of CD4+ T cells in AIDS pathogenesis. *Trends Immunol* **2002**, *23*, 129.
51. Henrad, D.; Philips, J.; Muenz, L.; Blattner WA; Wiesner D; Eyster ME; JJ., G. Natural history of HIV-1 cell free viremia. *JAMA* **1995**, *274*, 554-558.
52. Jurriaans, S.; German, B.; Weverling, G.; Van Strijp D; Nara P; Coutinho R; Koot M; Schuitemaker H; J., G. The natural history of HIV-1 infection: Virus load and virus phenotype independent determinants of clinical course? *Virology*. **1994**, *204*, 223-233.
53. Espindola, M.S.; Lima, L.J.; Soares, L.S.; Cacemiro, M.C.; Zambuzi, F.A.; de Souza Gomes, M.; Amaral, L.R.; Bollela, V.R.; Martins-Filho, O.A.; Frantz, F.G.

- Dysregulated Immune Activation in Second-Line HAART HIV+ Patients Is Similar to That of Untreated Patients. *PloS one* **2015**, *10*, e0145261.
54. Deeks, S.G. HIV Infection, Inflammation, Immunosenescence, and Aging. *Annual Review of Medicine* **2011**, *62*, 141-155.
55. Brenchley, J.M.; Price, D.A.; Schacker, T.W.; Asher, T.E.; Silvestri, G.; Rao, S.; Kazzaz, Z.; Bornstein, E.; Lambotte, O.; Altmann, D., *et al.* Microbial translocation is a cause of systemic immune activation in chronic HIV infection. *Nature medicine* **2006**, *12*, 1365-1371.
56. Elbirt, D.; Mahlab-Guri, K.; Bezalel-Rosenberg, S.; Gill, H.; Attali, M.; Asher, I. HIV-associated neurocognitive disorders (HAND). *Isr Med Assoc J* **2015**, *17*, 54-59.
57. Almodovar, S. The complexity of HIV persistence and pathogenesis in the lung under antiretroviral therapy: challenges beyond AIDS. *Viral Immunol* **2014**, *27*, 186-199.
58. Lewthwaite, P.; Wilkins, E. Natural history of HIV/AIDS. *Medicine* **2005**, *33*, 10–13.
59. Lewthwaite, P.; Wilkins, E. Natural history of HIV/AIDS. *Medicine* **2009**, *37*, 333–337.
60. Martin-Gayo, E.; Buzon, M.J.; Ouyang, Z.; Hickman, T.; Cronin, J.; Pimenova, D.; Walker, B.D.; Lichterfeld, M.; Yu, X.G. Potent Cell-Intrinsic Immune Responses in Dendritic Cells Facilitate HIV-1-Specific T Cell Immunity in HIV-1 Elite Controllers. *PLoS pathogens* **2015**, *11*, e1004930.
61. Shearer, G.; Clerici, M. Historical perspective on HIV-exposed seronegative individuals: has nature done the experiment for us? *The Journal of infectious diseases* **2010**, *202 Suppl 3*, S329-332.
62. Novembre, J.; Galvani, A.P.; Slatkin, M. The geographic spread of the CCR5 Delta32 HIV-resistance allele. *PLoS Biol* **2005**, *3*, e339.
63. Guardo, A.C.; Ruiz-Riol, M.; Fernandez, E.; Maleno, M.J.; Bargallo, M.E.; Leon, A.; Climent, N.; Garcia, F.; Gatell, J.M.; Brander, C., *et al.* Detection of HIV-1-specific T-cell immune responses in highly HIV-exposed uninfected individuals by in-vitro dendritic cell co-culture. *AIDS* **2015**, *29*, 1309-1318.
64. Herbeck, J.; Ghorai, S.; Chen, L.; Rinaldo, C.R.; Margolick, J.B.; Detels, R.; Jacobson, L.; Wolinsky, S.; Mullins, J.I. p21(WAF1/CIP1) RNA expression in highly HIV-1 exposed, uninfected individuals. *PloS one* **2015**, *10*, e0119218.
65. Stein, D.R.; Shaw, S.Y.; McKinnon, L.R.; Abou, M.; McCorrister, S.J.; Westmacott, G.R.; Fowke, K.R.; Plummer, F.A.; Ball, T.B. Mx2 expression is associated with reduced susceptibility to HIV infection in highly exposed HIV seronegative Kenyan sex workers. *AIDS* **2015**, *29*, 35-41.
66. Kaul, R.; Rowland-Jones, S.L.; Kimani, J.; Dong, T.; Yang, H.B.; Kiama, P.; Rostron, T.; Njagi, E.; Bwayo, J.J.; MacDonald, K.S., *et al.* Late seroconversion in HIV-resistant Nairobi prostitutes despite pre-existing HIV-specific CD8+ responses. *The Journal of clinical investigation* **2001**, *107*, 341-349.
67. Arthur, L.O.; Bess, J.W., Jr.; Sowder, R.C., 2nd; Benveniste, R.E.; Mann, D.L.; Chermann, J.C.; Henderson, L.E. Cellular proteins bound to immunodeficiency viruses: implications for pathogenesis and vaccines. *Science* **1992**, *258*, 1935-1938.
68. Turner, B.G.; Summers, M.F. Structural biology of HIV. *J Mol Biol* **1999**, *285*, 1-32.
69. Ho, D.D.; Rota, T.; Hirsch, M. Infection of monocyte/macrophages by human T lymphotropic virus type III. *J Clin Invest.* **1986**, *77*, 1712-1715.
70. Montagnier L, C.F. Human immunodeficiency viruses. In: Webster RG, Granoff A, editors. *Encyclopedia of virology*, 2. London: Academic Press Ltd **1994**, p. 674–681.

71. Sierra, S.; Kupfer, B.; Kaiser, R. Basics of the virology of HIV-1 and its replication. *J Clin Virol* **2005**, *34*, 233-244.
72. Villet, S.; Faure, C.; Bouzar, B.A.; Morin, T.; Verdier, G.é.; Chebloune, Y.; Legras, C. Lack of trans-activation function for Maedi Visna virus and Caprine arthritis encephalitis virus Tat proteins. *Virology* **2003**, *307*, 317-327.
73. Miller, R.J.; Cairns, J.S.; Bridges, S.; Sarver, N. Human immunodeficiency virus and AIDS: insights from animal lentiviruses. *Journal of virology* **2000**, *74*, 7187-7195.
74. Clapham, P.R.; Weiss, R.A. Immunodeficiency viruses. Spoilt for choice of co-receptors. *Nature* **1997**, *388*, 230-231.
75. Doranz, B.J.; Rucker, J.; Yi, Y.; Smyth, R.J.; Samson, M.; Peiper, S.C.; Parmentier, M.; Collman, R.G.; Doms, R.W. A dual-tropic primary HIV-1 isolate that uses fusin and the beta-chemokine receptors CKR-5, CKR-3, and CKR-2b as fusion cofactors. *Cell* **1996**, *85*, 1149-1158.
76. Moore, J.P. Coreceptors: implications for HIV pathogenesis and therapy. *Science* **1997**, *276*, 51-52.
77. Clapham, P.R.; McKnight, A. Cell surface receptors, virus entry and tropism of primate lentiviruses. *The Journal of general virology* **2002**, *83*, 1809-1829.
78. Feng, Y.; Broder, C.C.; Kennedy, P.E.; Berger, E.A. HIV-1 entry cofactor: functional cDNA cloning of a seven-transmembrane, G protein-coupled receptor. *Science* **1996**, *272*, 872-877.
79. Hirsch MS, C.J. Human immunodeficiency viruses. *In: Fields, editor. Virology. 4th ed. Philadelphia: Lippincott-Raven Publishers; 1990*, 1953–1975.
80. Harrich, D.; Hooker, B. Mechanistic aspects of HIV-1 reverse transcription initiation. *Reviews in medical virology* **2002**, *12*, 31-45.
81. Kao, S.; Khan, M.A.; Miyagi, E.; Plishka, R.; Buckler-White, A.; Strebel, K. The human immunodeficiency virus type 1 Vif protein reduces intracellular expression and inhibits packaging of APOBEC3G (CEM15), a cellular inhibitor of virus infectivity. *Journal of virology* **2003**, *77*, 11398-11407.
82. Mariani, R.; Chen, D.; Schrofelbauer, B.; Navarro, F.; Konig, R.; Bollman, B.; Munk, C.; Nymark-McMahon, H.; Landau, N.R. Species-specific exclusion of APOBEC3G from HIV-1 virions by Vif. *Cell* **2003**, *114*, 21-31.
83. Pedersen, F.S.a.D., M. Retroviral Replication. . *eLS* **2006**. .
84. Miller, M.D.; Farnet, C.M.; Bushman, F.D. Human immunodeficiency virus type 1 preintegration complexes: studies of organization and composition. *Journal of virology* **1997**, *71*, 5382-5390.
85. Rogel, M.E.; Wu, L.I.; Emerman, M. The human immunodeficiency virus type 1 vpr gene prevents cell proliferation during chronic infection. *Journal of virology* **1995**, *69*, 882-888.
86. Jordan, A.; Defechereux, P.; Verdin, E. The site of HIV-1 integration in the human genome determines basal transcriptional activity and response to Tat transactivation. *The EMBO journal* **2001**, *20*, 1726-1738.
87. Harrich, D.; Hooker, C.W.; Parry, E. The human immunodeficiency virus type 1 TAR RNA upper stem-loop plays distinct roles in reverse transcription and RNA packaging. *Journal of virology* **2000**, *74*, 5639-5646.
88. Pollard, V.W.; Malim, M.H. The HIV-1 Rev protein. *Annu Rev Microbiol* **1998**, *52*, 491-532.
89. Briggs, J.A.; Wilk, T.; Welker, R.; Krausslich, H.G.; Fuller, S.D. Structural organization of authentic, mature HIV-1 virions and cores. *The EMBO journal* **2003**, *22*, 1707-1715.



90. Derdowski, A.; Ding, L.; Spearman, P. A novel fluorescence resonance energy transfer assay demonstrates that the human immunodeficiency virus type 1 Pr55Gag I domain mediates Gag-Gag interactions. *Journal of virology* **2004**, *78*, 1230-1242.
91. Hung, C.H.; Thomas, L.; Ruby, C.E.; Atkins, K.M.; Morris, N.P.; Knight, Z.A.; Scholz, I.; Barklis, E.; Weinberg, A.D.; Shokat, K.M., *et al.* HIV-1 Nef assembles a Src family kinase-ZAP-70/Syk-PI3K cascade to downregulate cell-surface MHC-I. *Cell host & microbe* **2007**, *1*, 121-133.
92. Willey, R.L.; Maldarelli, F.; Martin, M.A.; Strebel, K. Human immunodeficiency virus type 1 Vpu protein induces rapid degradation of CD4. *Journal of virology* **1992**, *66*, 7193-7200.
93. Zimmerman, C.; Klein, K.C.; Kiser, P.K.; Singh, A.R.; Firestein, B.L.; Riba, S.C.; Lingappa, J.R. Identification of a host protein essential for assembly of immature HIV-1 capsids. *Nature* **2002**, *415*, 88-92.
94. Greene, W.C.; Peterlin, B.M. Charting HIV's remarkable voyage through the cell: Basic science as a passport to future therapy. *Nature medicine* **2002**, *8*, 673-680.
95. De Guzman, R.N.; Wu, Z.R.; Stalling, C.C.; Pappalardo, L.; Borer, P.N.; Summers, M.F. Structure of the HIV-1 nucleocapsid protein bound to the SL3 psi-RNA recognition element. *Science* **1998**, *279*, 384-388.
96. Ehrlich, L.S.; Liu, T.; Scarlata, S.; Chu, B.; Carter, C.A. HIV-1 capsid protein forms spherical (immature-like) and tubular (mature-like) particles in vitro: structure switching by pH-induced conformational changes. *Biophys J* **2001**, *81*, 586-594.
97. Lanman, J.; Sexton, J.; Sakalian, M.; Prevelige, P.E., Jr. Kinetic analysis of the role of intersubunit interactions in human immunodeficiency virus type 1 capsid protein assembly in vitro. *Journal of virology* **2002**, *76*, 6900-6908.
98. Holmes, R.K.; Malim, M.H.; Bishop, K.N. APOBEC-mediated viral restriction: not simply editing? *Trends Biochem Sci* **2007**, *32*, 118-128.
99. Goila-Gaur, R.; Strebel, K. HIV-1 Vif, APOBEC, and intrinsic immunity. *Retrovirology* **2008**, *5*, 51.
100. Desimmie, B.A.; Delviks-Frankenberry, K.A.; Burdick, R.C.; Qi, D.; Izumi, T.; Pathak, V.K. Multiple APOBEC3 restriction factors for HIV-1 and one Vif to rule them all. *J Mol Biol* **2014**, *426*, 1220-1245.
101. Stopak, K.; de Noronha, C.; Yonemoto, W.; Greene, W.C. HIV-1 Vif blocks the antiviral activity of APOBEC3G by impairing both its translation and intracellular stability. *Mol Cell* **2003**, *12*, 591-601.
102. Zhang, J.; Ge, W.; Zhan, P.; De Clercq, E.; Liu, X. Retroviral restriction factors TRIM5alpha: therapeutic strategy to inhibit HIV-1 replication. *Curr Med Chem* **2011**, *18*, 2649-2654.
103. Nakayama, E.E.; Shioda, T. Impact of TRIM5alpha in vivo. *AIDS* **2015**, *29*, 1733-1743.
104. Neil, S.J.; Zang, T.; Bieniasz, P.D. Tetherin inhibits retrovirus release and is antagonized by HIV-1 Vpu. *Nature* **2008**, *451*, 425-430.
105. Serra-Moreno, R. The end of Nef's tether. *Trends in microbiology* **2014**, *22*, 662-664.
106. Goujon, C.; Moncorge, O.; Bauby, H.; Doyle, T.; Ward, C.C.; Schaller, T.; Hue, S.; Barclay, W.S.; Schulz, R.; Malim, M.H. Human MX2 is an interferon-induced post-entry inhibitor of HIV-1 infection. *Nature* **2013**, *502*, 559-562.
107. Yan, N.; Regalado-Magdos, A.D.; Stiggelbout, B.; Lee-Kirsch, M.A.; Lieberman, J. The cytosolic exonuclease TREX1 inhibits the innate immune response to human immunodeficiency virus type 1. *Nat Immunol* **2010**, *11*, 1005-1013.
108. Wheeler, L.A.; Trifonova, R.T.; Vrbanac, V.; Barteneva, N.S.; Liu, X.; Bollman, B.; Onofrey, L.; Mulik, S.; Ranjbar, S.; Luster, A.D., *et al.* TREX1 Knockdown Induces

- an Interferon Response to HIV that Delays Viral Infection in Humanized Mice. *Cell reports* **2016**, *15*, 1715-1727.
109. Christ, F.; Debyser, Z. The LEDGF/p75 integrase interaction, a novel target for anti-HIV therapy. *Virology* **2013**, *435*, 102-109.
110. Gerard, A.; Segeral, E.; Naughtin, M.; Abdouni, A.; Charmeteau, B.; Cheynier, R.; Rain, J.C.; Emiliani, S. The integrase cofactor LEDGF/p75 associates with Iws1 and Spt6 for postintegration silencing of HIV-1 gene expression in latently infected cells. *Cell host & microbe* **2015**, *17*, 107-117.
111. Iwasaki, A. Innate Immune Recognition of HIV-1. *Immunity* **2012**, *37*, 389-398.
112. Biasin, M.; Clerici, M.; Piacentini, L. Innate immunity in resistance to HIV infection. *The Journal of infectious diseases* **2010**, *202 Suppl 3*, S361-365.
113. McMichael, A.J.; Borrow, P.; Tomaras, G.D.; Goonetilleke, N.; Haynes, B.F. The immune response during acute HIV-1 infection: clues for vaccine development. *Nat Rev Immunol* **2010**, *10*, 11-23.
114. Altfeld, M.; Gale, M., Jr. Innate immunity against HIV-1 infection. *Nat Immunol* **2015**, *16*, 554-562.
115. Goonetilleke, N.; Liu, M.K.; Salazar-Gonzalez, J.F.; Ferrari, G.; Giorgi, E.; Gansov, V.V.; Keele, B.F.; Learn, G.H.; Turnbull, E.L.; Salazar, M.G., *et al.* The first T cell response to transmitted/founder virus contributes to the control of acute viremia in HIV-1 infection. *The Journal of experimental medicine* **2009**, *206*, 1253-1272.
116. Oxenius, A.; Fidler, S.; Brady, M.; Dawson, S.J.; Ruth, K.; Easterbrook, P.J.; Weber, J.N.; Phillips, R.E.; Price, D.A. Variable fate of virus-specific CD4(+) T cells during primary HIV-1 infection. *Eur J Immunol* **2001**, *31*, 3782-3788.
117. Esparza, J. A brief history of the global effort to develop a preventive HIV vaccine. *Vaccine* **2013**, *31*, 3502-3518.
118. Barry SM, M.L.A., Novak RM. Trial, Error, and Breakthrough: A Review of HIV Vaccine Development. . *J AIDS Clin Res* **2014**, *5*.
119. Whitney, J.B.; Ruprecht, R.M. Live attenuated HIV vaccines: pitfalls and prospects. *Curr Opin Infect Dis* **2004**, *17*, 17-26.
120. Shibata, R.; Siemon, C.; Czajak, S.C.; Desrosiers, R.C.; Martin, M.A. Live, attenuated simian immunodeficiency virus vaccines elicit potent resistance against a challenge with a human immunodeficiency virus type 1 chimeric virus. *Journal of virology* **1997**, *71*, 8141-8148.
121. Angel, J.B.; Routy, J.P.; Tremblay, C.; Ayers, D.; Woods, R.; Singer, J.; Bernard, N.; Kovacs, C.; Smaill, F.; Gurunathan, S., *et al.* A randomized controlled trial of HIV therapeutic vaccination using ALVAC with or without Remune. *AIDS* **2011**, *25*, 731-739.
122. Birx, D.L.; Loomis-Price, L.D.; Aronson, N.; Brundage, J.; Davis, C.; Deyton, L.; Garner, R.; Gordin, F.; Henry, D.; Holloway, W., *et al.* Efficacy testing of recombinant human immunodeficiency virus (HIV) gp160 as a therapeutic vaccine in early-stage HIV-1-infected volunteers. rgp160 Phase II Vaccine Investigators. *The Journal of infectious diseases* **2000**, *181*, 881-889.
123. Voss, G.; Manson, K.; Montefiori, D.; Watkins, D.I.; Heeney, J.; Wyand, M.; Cohen, J.; Bruck, C. Prevention of disease induced by a partially heterologous AIDS virus in rhesus monkeys by using an adjuvanted multicomponent protein vaccine. *Journal of virology* **2003**, *77*, 1049-1058.
124. Kelleher, A.D.; Roggensack, M.; Jaramillo, A.B.; Smith, D.E.; Walker, A.; Gow, I.; McMurchie, M.; Harris, J.; Patou, G.; Cooper, D.A. Safety and immunogenicity of a candidate therapeutic vaccine, p24 virus-like particle, combined with zidovudine, in

- asymptomatic subjects. Community HIV Research Network Investigators. *AIDS* **1998**, *12*, 175-182.
125. Finessi, V.; Nicoli, F.; Gallerani, E.; Sforza, F.; Sicurella, M.; Cafaro, A.; Caputo, A.; Ensoli, B.; Gavioli, R. Effects of different routes of administration on the immunogenicity of the Tat protein and a Tat-derived peptide. *Human vaccines & immunotherapeutics* **2015**, *11*, 1489-1493.
126. Montefiori, D.C.; Karnasuta, C.; Huang, Y.; Ahmed, H.; Gilbert, P.; de Souza, M.S.; McLinden, R.; Tovanabutra, S.; Laurence-Chenine, A.; Sanders-Buell, E., *et al.* Magnitude and breadth of the neutralizing antibody response in the RV144 and Vax003 HIV-1 vaccine efficacy trials. *The Journal of infectious diseases* **2012**, *206*, 431-441.
127. Kovacs, J.M.; Nkolola, J.P.; Peng, H.; Cheung, A.; Perry, J.; Miller, C.A.; Seaman, M.S.; Barouch, D.H.; Chen, B. HIV-1 envelope trimer elicits more potent neutralizing antibody responses than monomeric gp120. *Proceedings of the National Academy of Sciences of the United States of America* **2012**, *109*, 12111-12116.
128. Gorman, J.; Soto, C.; Yang, M.M.; Davenport, T.M.; Guttman, M.; Bailer, R.T.; Chambers, M.; Chuang, G.Y.; DeKosky, B.J.; Doria-Rose, N.A., *et al.* Structures of HIV-1 Env V1V2 with broadly neutralizing antibodies reveal commonalities that enable vaccine design. *Nature structural & molecular biology* **2016**, *23*, 81-90.
129. Huang, J.; Ofek, G.; Laub, L.; Louder, M.K.; Doria-Rose, N.A.; Longo, N.S.; Imamichi, H.; Bailer, R.T.; Chakrabarti, B.; Sharma, S.K., *et al.* Broad and potent neutralization of HIV-1 by a gp41-specific human antibody. *Nature* **2012**, *491*, 406-412.
130. Wu, X.; Yang, Z.Y.; Li, Y.; Hogerkorp, C.M.; Schief, W.R.; Seaman, M.S.; Zhou, T.; Schmidt, S.D.; Wu, L.; Xu, L., *et al.* Rational design of envelope identifies broadly neutralizing human monoclonal antibodies to HIV-1. *Science* **2010**, *329*, 856-861.
131. Moldt, B.; Rakasz, E.G.; Schultz, N.; Chan-Hui, P.Y.; Swiderek, K.; Weisgrau, K.L.; Piaskowski, S.M.; Bergman, Z.; Watkins, D.I.; Poignard, P., *et al.* Highly potent HIV-specific antibody neutralization in vitro translates into effective protection against mucosal SHIV challenge in vivo. *Proceedings of the National Academy of Sciences of the United States of America* **2012**, *109*, 18921-18925.
132. Rao, N. The Pursuit of a HIV Vaccine – Trials, Challenges and Strategies. . *J AIDS Clin Res* **2014**, *5*.
133. Zhao, C.; Ao, Z.; Yao, X. Current Advances in Virus-Like Particles as a Vaccination Approach against HIV Infection. *Vaccines* **2016**, *4*.
134. O'Connell, R.J.; Kim, J.H.; Corey, L.; Michael, N.L. Human immunodeficiency virus vaccine trials. *Cold Spring Harb Perspect Med* **2012**, *2*, a007351.
135. Frey, S.E.; Peiperl, L.; McElrath, M.J.; Kalams, S.; Goepfert, P.A.; Keefer, M.C.; Baden, L.R.; Lally, M.A.; Mayer, K.; Blattner, W.A., *et al.* Phase I/II randomized trial of safety and immunogenicity of LIPO-5 alone, ALVAC-HIV (vCP1452) alone, and ALVAC-HIV (vCP1452) prime/LIPO-5 boost in healthy, HIV-1-uninfected adult participants. *Clinical and vaccine immunology : CVI* **2014**, *21*, 1589-1599.
136. Martinon, F.; Kaldma, K.; Sikut, R.; Culina, S.; Romain, G.; Tuomela, M.; Adojaan, M.; Mannik, A.; Toots, U.; Kivisild, T., *et al.* Persistent immune responses induced by a human immunodeficiency virus DNA vaccine delivered in association with electroporation in the skin of nonhuman primates. *Hum Gene Ther* **2009**, *20*, 1291-1307.
137. Kutzler, M.A.; Weiner, D.B. DNA vaccines: ready for prime time? *Nat Rev Genet* **2008**, *9*, 776-788.

138. Ulmer, J.B.; Donnelly, J.J.; Parker, S.E.; Rhodes, G.H.; Felgner, P.L.; Dwarki, V.J.; Gromkowski, S.H.; Deck, R.R.; DeWitt, C.M.; Friedman, A., *et al.* Heterologous protection against influenza by injection of DNA encoding a viral protein. *Science* **1993**, *259*, 1745-1749.
139. Gray, G.; Buchbinder, S.; Duerr, A. Overview of STEP and Phambili trial results: two phase IIb test-of-concept studies investigating the efficacy of MRK adenovirus type 5 gag/pol/nef subtype B HIV vaccine. *Current opinion in HIV and AIDS* **2010**, *5*, 357-361.
140. Gray, G.E.; Allen, M.; Moodie, Z.; Churchyard, G.; Bekker, L.G.; Nchabeleng, M.; Mlisana, K.; Metch, B.; de Bruyn, G.; Latka, M.H., *et al.* Safety and efficacy of the HVTN 503/Phambili study of a clade-B-based HIV-1 vaccine in South Africa: a double-blind, randomised, placebo-controlled test-of-concept phase 2b study. *Lancet Infect Dis* **2011**, *11*, 507-515.
141. Hammer, S.M.; Sobieszczyk, M.E.; Janes, H.; Karuna, S.T.; Mulligan, M.J.; Grove, D.; Koblin, B.A.; Buchbinder, S.P.; Keefer, M.C.; Tomaras, G.D., *et al.* Efficacy trial of a DNA/rAd5 HIV-1 preventive vaccine. *N Engl J Med* **2013**, *369*, 2083-2092.
142. Lisziewicz, J.; Bakare, N.; Calarota, S.A.; Banhegyi, D.; Szlavik, J.; Ujhelyi, E.; Toke, E.R.; Molnar, L.; Lisziewicz, Z.; Autran, B., *et al.* Single DermaVir immunization: dose-dependent expansion of precursor/memory T cells against all HIV antigens in HIV-1 infected individuals. *PloS one* **2012**, *7*, e35416.
143. Calarota, S.A.; Dai, A.; Trocio, J.N.; Weiner, D.B.; Lori, F.; Lisziewicz, J. IL-15 as memory T-cell adjuvant for topical HIV-1 DermaVir vaccine. *Vaccine* **2008**, *26*, 5188-5195.
144. Buchbinder, S.P.; Mehrotra, D.V.; Duerr, A.; Fitzgerald, D.W.; Mogg, R.; Li, D.; Gilbert, P.B.; Lama, J.R.; Marmor, M.; Del Rio, C., *et al.* Efficacy assessment of a cell-mediated immunity HIV-1 vaccine (the Step Study): a double-blind, randomised, placebo-controlled, test-of-concept trial. *Lancet* **2008**, *372*, 1881-1893.
145. Hu, H.; Eller, M.A.; Zafar, S.; Zhou, Y.; Gu, M.; Wei, Z.; Currier, J.R.; Marovich, M.A.; Kibuuka, H.N.; Bailer, R.T., *et al.* Preferential infection of human Ad5-specific CD4 T cells by HIV in Ad5 naturally exposed and recombinant Ad5-HIV vaccinated individuals. *Proceedings of the National Academy of Sciences of the United States of America* **2014**, *111*, 13439-13444.
146. Rerks-Ngarm, S.; Pitisuttithum, P.; Nitayaphan, S.; Kaewkungwal, J.; Chiu, J.; Paris, R.; Premsri, N.; Namwat, C.; de Souza, M.; Adams, E., *et al.* Vaccination with ALVAC and AIDSVAX to prevent HIV-1 infection in Thailand. *N Engl J Med* **2009**, *361*, 2209-2220.
147. McElrath, M.J.; De Rosa, S.C.; Moodie, Z.; Dubey, S.; Kierstead, L.; Janes, H.; Defawe, O.D.; Carter, D.K.; Hural, J.; Akondy, R., *et al.* HIV-1 vaccine-induced immunity in the test-of-concept Step Study: a case-cohort analysis. *Lancet* **2008**, *372*, 1894-1905.
148. Harari, A.; Bart, P.A.; Stohr, W.; Tapia, G.; Garcia, M.; Medjitna-Rais, E.; Burnet, S.; Cellerai, C.; Erlwein, O.; Barber, T., *et al.* An HIV-1 clade C DNA prime, NYVAC boost vaccine regimen induces reliable, polyfunctional, and long-lasting T cell responses. *The Journal of experimental medicine* **2008**, *205*, 63-77.
149. Barouch, D.H.; Picker, L.J. Novel vaccine vectors for HIV-1. *Nature reviews. Microbiology* **2014**, *12*, 765-771.
150. Kaur, A.; Sanford, H.B.; Garry, D.; Lang, S.; Klumpp, S.A.; Watanabe, D.; Bronson, R.T.; Lifson, J.D.; Rosati, M.; Pavlakis, G.N., *et al.* Ability of herpes simplex virus vectors to boost immune responses to DNA vectors and to protect against challenge by simian immunodeficiency virus. *Virology* **2007**, *357*, 199-214.

151. Hansen, S.G.; Ford, J.C.; Lewis, M.S.; Ventura, A.B.; Hughes, C.M.; Coyne-Johnson, L.; Whizin, N.; Oswald, K.; Shoemaker, R.; Swanson, T., *et al.* Profound early control of highly pathogenic SIV by an effector memory T-cell vaccine. *Nature* **2011**, *473*, 523-527.
152. Selinger, C.; Strbo, N.; Gonzalez, L.; Aicher, L.; Weiss, J.M.; Law, G.L.; Palermo, R.E.; Vaccari, M.; Franchini, G.; Podack, E.R., *et al.* Multiple low-dose challenges in a rhesus macaque AIDS vaccine trial result in an evolving host response that affects protective outcome. *Clinical and vaccine immunology : CVI* **2014**, *21*, 1650-1660.
153. Pitisuttithum, P.; Gilbert, P.; Gurwith, M.; Heyward, W.; Martin, M.; van Griensven, F.; Hu, D.; Tappero, J.W.; Choopanya, K. Randomized, double-blind, placebo-controlled efficacy trial of a bivalent recombinant glycoprotein 120 HIV-1 vaccine among injection drug users in Bangkok, Thailand. *The Journal of infectious diseases* **2006**, *194*, 1661-1671.
154. Flynn, N.M.; Forthal, D.N.; Harro, C.D.; Judson, F.N.; Mayer, K.H.; Para, M.F. Placebo-controlled phase 3 trial of a recombinant glycoprotein 120 vaccine to prevent HIV-1 infection. *The Journal of infectious diseases* **2005**, *191*, 654-665.
155. Schwartz, J.L. Fcgbp - A Potential Viral Trap in RV144. *The open AIDS journal* **2014**, *8*, 21-24.
156. Day, T.A.; Kublin, J.G. Lessons learned from HIV vaccine clinical efficacy trials. *Current HIV research* **2013**, *11*, 441-449.
157. Arrode, G.; Hegde, R.; Mani, A.; Jin, Y.; Chebloune, Y.; Narayan, O. Phenotypic and functional analysis of immune CD8+ T cell responses induced by a single injection of a HIV DNA vaccine in mice. *J Immunol* **2007**, *178*, 2318-2327.
158. Arrode-Bruses, G.; Sheffer, D.; Hegde, R.; Dhillon, S.; Liu, Z.; Villinger, F.; Narayan, O.; Chebloune, Y. Characterization of T-cell responses in macaques immunized with a single dose of HIV DNA vaccine. *Journal of virology* **2010**, *84*, 1243-1253.
159. Arrode-Brusés, G.; Hegde, R.; Jin, Y.; Liu, Z.; Narayan, O.; Chebloune, Y. Immunogenicity of a lentiviral-based DNA vaccine driven by the 5'LTR of the naturally attenuated caprine arthritis encephalitis virus (CAEV) in mice and macaques. *Vaccine* **2012**, *30*, 2956-2962.
160. Arrode-Bruses, G.; Moussa, M.; Baccard-Longere, M.; Villinger, F.; Chebloune, Y. Long-term central and effector SHIV-specific memory T cell responses elicited after a single immunization with a novel lentivector DNA vaccine. *PloS one* **2014**, *9*, e110883.
161. Moussa, M.; Arrode-Bruses, G.; Manoylov, I.; Malogolovkin, A.; Mompelat, D.; Ishimwe, H.; Smaoune, A.; Ouzrout, B.; Gagnon, J.; Chebloune, Y. A novel non-integrative single-cycle chimeric HIV lentivector DNA vaccine. *Vaccine* **2015**, *33*, 2273-2282.
162. Gattinoni, L.; Lugli, E.; Ji, Y.; Pos, Z.; Paulos, C.M.; Quigley, M.F.; Almeida, J.R.; Gostick, E.; Yu, Z.; Carpenito, C., *et al.* A human memory T cell subset with stem cell-like properties. *Nature medicine* **2011**, *17*, 1290-1297.
163. Lugli, E.; Dominguez, M.H.; Gattinoni, L.; Chattopadhyay, P.K.; Bolton, D.L.; Song, K.; Klatt, N.R.; Brenchley, J.M.; Vaccari, M.; Gostick, E., *et al.* Superior T memory stem cell persistence supports long-lived T cell memory. *The Journal of clinical investigation* **2013**, *123*, 594-599.
164. Schluns, K.S.; Lefrancois, L. Cytokine control of memory T-cell development and survival. *Nat Rev Immunol* **2003**, *3*, 269-279.
165. Sportes, C.; Hakim, F.T.; Memon, S.A.; Zhang, H.; Chua, K.S.; Brown, M.R.; Fleisher, T.A.; Krumlauf, M.C.; Babb, R.R.; Chow, C.K., *et al.* Administration of

- rhIL-7 in humans increases in vivo TCR repertoire diversity by preferential expansion of naive T cell subsets. *The Journal of experimental medicine* **2008**, *205*, 1701-1714.
166. Lum, J.J.; Schneppele, D.J.; Nie, Z.; Sanchez-Dardon, J.; Mbisa, G.L.; Mihowich, J.; Hawley, N.; Narayan, S.; Kim, J.E.; Lynch, D.H., *et al.* Differential effects of interleukin-7 and interleukin-15 on NK cell anti-human immunodeficiency virus activity. *Journal of virology* **2004**, *78*, 6033-6042.
167. Cieri, N.; Camisa, B.; Cocchiarella, F.; Forcato, M.; Oliveira, G.; Provasi, E.; Bondanza, A.; Bordignon, C.; Peccatori, J.; Ciceri, F., *et al.* IL-7 and IL-15 instruct the generation of human memory stem T cells from naive precursors. *Blood* **2013**, *121*, 573-584.
168. Su, B.; Wang, J.; Zhao, G.; Wang, X.; Li, J.; Wang, B. Sequential administration of cytokine genes to enhance cellular immune responses and CD4 (+) T memory cells during DNA vaccination. *Human vaccines & immunotherapeutics* **2012**, *8*, 1659-1667.
169. Melchionda, F.; Fry, T.J.; Milliron, M.J.; McKirdy, M.A.; Tagaya, Y.; Mackall, C.L. Adjuvant IL-7 or IL-15 overcomes immunodominance and improves survival of the CD8+ memory cell pool. *The Journal of clinical investigation* **2005**, *115*, 1177-1187.
170. Wyand, M.S.; Manson, K.; Montefiori, D.C.; Lifson, J.D.; Johnson, R.P.; Desrosiers, R.C. Protection by live, attenuated simian immunodeficiency virus against heterologous challenge. *Journal of virology* **1999**, *73*, 8356-8363.
171. Reynolds, M.R.; Sacha, J.B.; Weiler, A.M.; Borchardt, G.J.; Glidden, C.E.; Sheppard, N.C.; Norante, F.A.; Castrovinci, P.A.; Harris, J.J.; Robertson, H.T., *et al.* The TRIM5{alpha} genotype of rhesus macaques affects acquisition of simian immunodeficiency virus SIVsmE660 infection after repeated limiting-dose intrarectal challenge. *Journal of virology* **2011**, *85*, 9637-9640.
172. Lopker, M.; Easlick, J.; Sterrett, S.; Decker, J.M.; Barbian, H.; Learn, G.; Keele, B.F.; Robinson, J.E.; Li, H.; Hahn, B.H., *et al.* Heterogeneity in neutralization sensitivities of viruses comprising the simian immunodeficiency virus SIVsmE660 isolate and vaccine challenge stock. *Journal of virology* **2013**, *87*, 5477-5492.
173. Buckheit, R.W., Jr.; Watson, K.; Fliakas-Boltz, V.; Russell, J.; Loftus, T.L.; Osterling, M.C.; Turpin, J.A.; Pallansch, L.A.; White, E.L.; Lee, J.W., *et al.* SJ-3366, a unique and highly potent nonnucleoside reverse transcriptase inhibitor of human immunodeficiency virus type 1 (HIV-1) that also inhibits HIV-2. *Antimicrobial agents and chemotherapy* **2001**, *45*, 393-400.
174. Shibata, R.; Kawamura, M.; Sakai, H.; Hayami, M.; Ishimoto, A.; Adachi, A. Generation of a chimeric human and simian immunodeficiency virus infectious to monkey peripheral blood mononuclear cells. *Journal of virology* **1991**, *65*, 3514-3520.
175. Stephens, E.B.; Mukherjee, S.; Sahni, M.; Zhuge, W.; Raghavan, R.; Singh, D.K.; Leung, K.; Atkinson, B.; Li, Z.; Joag, S.V., *et al.* A cell-free stock of simian-human immunodeficiency virus that causes AIDS in pig-tailed macaques has a limited number of amino acid substitutions in both SIVmac and HIV-1 regions of the genome and has offered cytotropism. *Virology* **1997**, *231*, 313-321.
176. Karlsson, G.B.; Halloran, M.; Li, J.; Park, I.W.; Gomila, R.; Reimann, K.A.; Axthelm, M.K.; Iliff, S.A.; Letvin, N.L.; Sodroski, J. Characterization of molecularly cloned simian-human immunodeficiency viruses causing rapid CD4+ lymphocyte depletion in rhesus monkeys. *Journal of virology* **1997**, *71*, 4218-4225.
177. Reimann, K.A.; Li, J.T.; Veazey, R.; Halloran, M.; Park, I.W.; Karlsson, G.B.; Sodroski, J.; Letvin, N.L. A chimeric simian/human immunodeficiency virus expressing a primary patient human immunodeficiency virus type 1 isolate env causes an AIDS-like disease after in vivo passage in rhesus monkeys. *Journal of virology* **1996**, *70*, 6922-6928.

- 
- 
178. Reimann, K.A.; Li, J.T.; Voss, G.; Lekutis, C.; Tenner-Racz, K.; Racz, P.; Lin, W.; Montefiori, D.C.; Lee-Parritz, D.E.; Lu, Y., *et al.* An env gene derived from a primary human immunodeficiency virus type 1 isolate confers high in vivo replicative capacity to a chimeric simian/human immunodeficiency virus in rhesus monkeys. *Journal of virology* **1996**, *70*, 3198-3206.
179. Sadjadpour, R.; Theodore, T.S.; Igarashi, T.; Donau, O.K.; Plishka, R.J.; Buckler-White, A.; Martin, M.A. Induction of disease by a molecularly cloned highly pathogenic simian immunodeficiency virus/human immunodeficiency virus chimera is multigenic. *Journal of virology* **2004**, *78*, 5513-5519.
180. Grivel, J.C.; Shattock, R.J.; Margolis, L.B. Selective transmission of R5 HIV-1 variants: where is the gatekeeper? *J Transl Med* **2011**, *9 Suppl 1*, S6.
181. Margolis, L.; Shattock, R. Selective transmission of CCR5-utilizing HIV-1: the 'gatekeeper' problem resolved? *Nature reviews. Microbiology* **2006**, *4*, 312-317.
182. Matsuda, K.; Inaba, K.; Fukazawa, Y.; Matsuyama, M.; Ibuki, K.; Horiike, M.; Saito, N.; Hayami, M.; Igarashi, T.; Miura, T. In vivo analysis of a new R5 tropic SHIV generated from the highly pathogenic SHIV-KS661, a derivative of SHIV-89.6. *Virology* **2010**, *399*, 134-143.
183. Ho, S.H.; Shek, L.; Gettie, A.; Blanchard, J.; Cheng-Mayer, C. V3 loop-determined coreceptor preference dictates the dynamics of CD4<sup>+</sup>-T-cell loss in simian-human immunodeficiency virus-infected macaques. *Journal of virology* **2005**, *79*, 12296-12303.
184. Song, R.J.; Chenine, A.L.; Rasmussen, R.A.; Ruprecht, C.R.; Mirshahidi, S.; Grisson, R.D.; Xu, W.; Whitney, J.B.; Goins, L.M.; Ong, H., *et al.* Molecularly cloned SHIV-1157ipd3N4: a highly replication-competent, mucosally transmissible R5 simian-human immunodeficiency virus encoding HIV clade C Env. *Journal of virology* **2006**, *80*, 8729-8738.
185. Siddappa, N.B.; Song, R.; Kramer, V.G.; Chenine, A.L.; Velu, V.; Ong, H.; Rasmussen, R.A.; Grisson, R.D.; Wood, C.; Zhang, H., *et al.* Neutralization-sensitive R5-tropic simian-human immunodeficiency virus SHIV-2873Nip, which carries env isolated from an infant with a recent HIV clade C infection. *Journal of virology* **2009**, *83*, 1422-1432.
186. Haaland, R.E.; Hawkins, P.A.; Salazar-Gonzalez, J.; Johnson, A.; Tichacek, A.; Karita, E.; Manigart, O.; Mulenga, J.; Keele, B.F.; Shaw, G.M., *et al.* Inflammatory genital infections mitigate a severe genetic bottleneck in heterosexual transmission of subtype A and C HIV-1. *PLoS pathogens* **2009**, *5*, e1000274.
187. Salazar-Gonzalez, J.F.; Salazar, M.G.; Keele, B.F.; Learn, G.H.; Giorgi, E.E.; Li, H.; Decker, J.M.; Wang, S.; Baalwa, J.; Kraus, M.H., *et al.* Genetic identity, biological phenotype, and evolutionary pathways of transmitted/founder viruses in acute and early HIV-1 infection. *The Journal of experimental medicine* **2009**, *206*, 1273-1289.
188. Gnanakaran, S.; Bhattacharya, T.; Daniels, M.; Keele, B.F.; Hraber, P.T.; Lapedes, A.S.; Shen, T.; Gaschen, B.; Krishnamoorthy, M.; Li, H., *et al.* Recurrent signature patterns in HIV-1 B clade envelope glycoproteins associated with either early or chronic infections. *PLoS pathogens* **2011**, *7*, e1002209.
189. Liu, Y.; Curlin, M.E.; Diem, K.; Zhao, H.; Ghosh, A.K.; Zhu, H.; Woodward, A.S.; Maenza, J.; Stevens, C.E.; Stekler, J., *et al.* Env length and N-linked glycosylation following transmission of human immunodeficiency virus Type 1 subtype B viruses. *Virology* **2008**, *374*, 229-233.
190. Chohan, B.; Lang, D.; Sagar, M.; Korber, B.; Lavreys, L.; Richardson, B.; Overbaugh, J. Selection for human immunodeficiency virus type 1 envelope glycosylation variants

- with shorter V1-V2 loop sequences occurs during transmission of certain genetic subtypes and may impact viral RNA levels. *Journal of virology* **2005**, *79*, 6528-6531.
191. Del Prete, G.Q.; Ailers, B.; Moldt, B.; Keele, B.F.; Estes, J.D.; Rodriguez, A.; Sampias, M.; Oswald, K.; Fast, R.; Trubey, C.M., *et al.* Selection of unadapted, pathogenic SHIVs encoding newly transmitted HIV-1 envelope proteins. *Cell host & microbe* **2014**, *16*, 412-418.
192. Asmal, M.; Luedemann, C.; Lavine, C.L.; Mach, L.V.; Balachandran, H.; Brinkley, C.; Denny, T.N.; Lewis, M.G.; Anderson, H.; Pal, R., *et al.* Infection of monkeys by simian-human immunodeficiency viruses with transmitted/founder clade C HIV-1 envelopes. *Virology* **2015**, *475*, 37-45.
193. Deymier, M.J.; Ende, Z.; Fenton-May, A.E.; Dilernia, D.A.; Kilembe, W.; Allen, S.A.; Borrow, P.; Hunter, E. Heterosexual Transmission of Subtype C HIV-1 Selects Consensus-Like Variants without Increased Replicative Capacity or Interferon-alpha Resistance. *PLoS pathogens* **2015**, *11*, e1005154.
194. Humbert, M.; Rasmussen, R.A.; Song, R.; Ong, H.; Sharma, P.; Chenine, A.L.; Kramer, V.G.; Siddappa, N.B.; Xu, W.; Else, J.G., *et al.* SHIV-1157i and passaged progeny viruses encoding R5 HIV-1 clade C env cause AIDS in rhesus monkeys. *Retrovirology* **2008**, *5*, 94.
195. Chun, T.W.; Carruth, L.; Finzi, D.; Shen, X.; DiGiuseppe, J.A.; Taylor, H.; Hermankova, M.; Chadwick, K.; Margolick, J.; Quinn, T.C., *et al.* Quantification of latent tissue reservoirs and total body viral load in HIV-1 infection. *Nature* **1997**, *387*, 183-188.
196. Gillim-Ross, L.; Cara, A.; Klotman, M.E. HIV-1 extrachromosomal 2-LTR circular DNA is long-lived in human macrophages. *Viral Immunol* **2005**, *18*, 190-196.
197. Kelly, J.; Beddall, M.H.; Yu, D.; Iyer, S.R.; Marsh, J.W.; Wu, Y. Human macrophages support persistent transcription from unintegrated HIV-1 DNA. *Virology* **2008**, *372*, 300-312.
198. Pang, S.; Koyanagi, Y.; Miles, S.; Wiley, C.; Vinters, H.V.; Chen, I.S. High levels of unintegrated HIV-1 DNA in brain tissue of AIDS dementia patients. *Nature* **1990**, *343*, 85-89.
199. Eckstein, D.A.; Sherman, M.P.; Penn, M.L.; Chin, P.S.; De Noronha, C.M.; Greene, W.C.; Goldsmith, M.A. HIV-1 Vpr enhances viral burden by facilitating infection of tissue macrophages but not nondividing CD4+ T cells. *The Journal of experimental medicine* **2001**, *194*, 1407-1419.
200. Le Douce, V.; Herbein, G.; Rohr, O.; Schwartz, C. Molecular mechanisms of HIV-1 persistence in the monocyte-macrophage lineage. *Retrovirology* **2010**, *7*, 32.
201. Chun, T.W.; Engel, D.; Berrey, M.M.; Shea, T.; Corey, L.; Fauci, A.S. Early establishment of a pool of latently infected, resting CD4(+) T cells during primary HIV-1 infection. *Proceedings of the National Academy of Sciences of the United States of America* **1998**, *95*, 8869-8873.
202. Chomont, N.; El-Far, M.; Ancuta, P.; Trautmann, L.; Procopio, F.A.; Yassine-Diab, B.; Boucher, G.; Boulassel, M.R.; Ghattas, G.; Brenchley, J.M., *et al.* HIV reservoir size and persistence are driven by T cell survival and homeostatic proliferation. *Nature medicine* **2009**, *15*, 893-900.
203. Pierson, T.; McArthur, J.; Siliciano, R.F. Reservoirs for HIV-1: mechanisms for viral persistence in the presence of antiviral immune responses and antiretroviral therapy. *Annu Rev Immunol* **2000**, *18*, 665-708.
204. Siliciano, J.D.; Kajdas, J.; Finzi, D.; Quinn, T.C.; Chadwick, K.; Margolick, J.B.; Kovacs, C.; Gange, S.J.; Siliciano, R.F. Long-term follow-up studies confirm the



- stability of the latent reservoir for HIV-1 in resting CD4+ T cells. *Nature medicine* **2003**, *9*, 727-728.
205. Kumar, A.; Abbas, W.; Herbein, G. HIV-1 latency in monocytes/macrophages. *Viruses* **2014**, *6*, 1837-1860.
206. Natarajan, V.; Bosche, M.; Metcalf, J.A.; Ward, D.J.; Lane, H.C.; Kovacs, J.A. HIV-1 replication in patients with undetectable plasma virus receiving HAART. Highly active antiretroviral therapy. *Lancet* **1999**, *353*, 119-120.
207. Ramratnam, B.; Mittler, J.E.; Zhang, L.; Boden, D.; Hurley, A.; Fang, F.; Macken, C.A.; Perelson, A.S.; Markowitz, M.; Ho, D.D. The decay of the latent reservoir of replication-competent HIV-1 is inversely correlated with the extent of residual viral replication during prolonged anti-retroviral therapy. *Nature medicine* **2000**, *6*, 82-85.
208. Gras, G.; Kaul, M. Molecular mechanisms of neuroinvasion by monocytes-macrophages in HIV-1 infection. *Retrovirology* **2010**, *7*, 30.
209. Chun, T.W.; Nickle, D.C.; Justement, J.S.; Meyers, J.H.; Roby, G.; Hallahan, C.W.; Kottlilil, S.; Moir, S.; Mican, J.M.; Mullins, J.I., *et al.* Persistence of HIV in gut-associated lymphoid tissue despite long-term antiretroviral therapy. *The Journal of infectious diseases* **2008**, *197*, 714-720.
210. Eisele, E.; Siliciano, Robert F. Redefining the Viral Reservoirs that Prevent HIV-1 Eradication. *Immunity* **2012**, *37*, 377-388.
211. Schragar, L.K.; D'Souza, M.P. Cellular and anatomical reservoirs of HIV-1 in patients receiving potent antiretroviral combination therapy. *JAMA* **1998**, *280*, 67-71.
212. Chun, T.W.; Davey, R.T., Jr.; Ostrowski, M.; Shawn Justement, J.; Engel, D.; Mullins, J.I.; Fauci, A.S. Relationship between pre-existing viral reservoirs and the re-emergence of plasma viremia after discontinuation of highly active anti-retroviral therapy. *Nature medicine* **2000**, *6*, 757-761.
213. Carter, C.C.; McNamara, L.A.; Onafuwa-Nuga, A.; Shackleton, M.; Riddell, J.t.; Bixby, D.; Savona, M.R.; Morrison, S.J.; Collins, K.L. HIV-1 utilizes the CXCR4 chemokine receptor to infect multipotent hematopoietic stem and progenitor cells. *Cell host & microbe* **2011**, *9*, 223-234.
214. Battistini, A.; Sgarbanti, M. HIV-1 Latency: An Update of Molecular Mechanisms and Therapeutic Strategies. *Viruses* **2014**, *6*, 1715-1758.
215. Sallusto, F.; Lenig, D.; Forster, R.; Lipp, M.; Lanzavecchia, A. Two subsets of memory T lymphocytes with distinct homing potentials and effector functions. *Nature* **1999**, *401*, 708-712.
216. Han, Y.; Lassen, K.; Monie, D.; Sedaghat, A.R.; Shimoji, S.; Liu, X.; Pierson, T.C.; Margolick, J.B.; Siliciano, R.F.; Siliciano, J.D. Resting CD4+ T cells from human immunodeficiency virus type 1 (HIV-1)-infected individuals carry integrated HIV-1 genomes within actively transcribed host genes. *Journal of virology* **2004**, *78*, 6122-6133.
217. Wu, X.; Li, Y.; Crise, B.; Burgess, S.M. Transcription start regions in the human genome are favored targets for MLV integration. *Science* **2003**, *300*, 1749-1751.
218. Taube, R.; Peterlin, M. Lost in Transcription: Molecular Mechanisms that Control HIV Latency. *Viruses* **2013**, *5*, 902-927.
219. Lenasi, T.; Contreras, X.; Peterlin, B.M. Transcriptional interference antagonizes proviral gene expression to promote HIV latency. *Cell host & microbe* **2008**, *4*, 123-133.
220. Han, Y.; Lin, Y.; An, W.; Xu, J.; yahg, H.; O'Connell, K.; Dordai, D.; Boeke, J.; Siliciano, J.D.; Siliciano, R.F. Orientation-dependent regulation of integrated HIV-1 expression by host gene transcriptional readthrough. *Cell Host Microbe*. **2008**, *4*, 134-146.

- 
- 
221. Greger, I.H.; Demarchi, F.; Giacca, M.; Proudfoot, N.J. Transcriptional interference perturbs the binding of Sp1 to the HIV-1 promoter. *Nucleic Acids Res* **1998**, *26*, 1294-1301.
  222. Easley, R.; Van Duyne, R.; Coley, W.; Guendel, I.; Dadgar, S.; Kehn-Hall, K.; Kashanchi, F. Chromatin dynamics associated with HIV-1 Tat-activated transcription. *Biochim Biophys Acta* **2010**, *1799*, 275-285.
  223. Verdin, E.; Paras, P., Jr.; Van Lint, C. Chromatin disruption in the promoter of human immunodeficiency virus type 1 during transcriptional activation. *The EMBO journal* **1993**, *12*, 3249-3259.
  224. Lusic, M.; Marcello, A.; Cereseto, A.; Giacca, M. Regulation of HIV-1 gene expression by histone acetylation and factor recruitment at the LTR promoter. *The EMBO journal* **2003**, *22*, 6550-6561.
  225. Van Lint, C. Role of chromatin in HIV-1 transcriptional regulation. *Adv Pharmacol* **2000**, *48*, 121-160.
  226. Van Lint, C.; Emiliani, S.; Ott, M.; Verdin, E. Transcriptional activation and chromatin remodeling of the HIV-1 promoter in response to histone acetylation. *The EMBO journal* **1996**, *15*, 1112-1120.
  227. Mbonye, U.; Karn, J. Transcriptional control of HIV latency: Cellular signaling pathways, epigenetics, happenstance and the hope for a cure. *Virology* **2014**, *454-455*, 328-339.
  228. Coull, J.J.; Romerio, F.; Sun, J.-M.; Volker, J.L.; Galvin, K.M.; Davie, J.R.; Shi, Y.; Hansen, U.; Margolis, D.M. The Human Factors YY1 and LSF Repress the Human Immunodeficiency Virus Type 1 Long Terminal Repeat via Recruitment of Histone Deacetylase 1. *Journal of virology* **2000**, *74*, 6790-6799.
  229. He, G.; Margolis, D.M. Counterregulation of chromatin deacetylation and histone deacetylase occupancy at the integrated promoter of human immunodeficiency virus type 1 (HIV-1) by the HIV-1 repressor YY1 and HIV-1 activator Tat. *Molecular and cellular biology* **2002**, *22*, 2965-2973.
  230. Tyagi, M.; Karn, J. CBF-1 promotes transcriptional silencing during the establishment of HIV-1 latency. *The EMBO journal* **2007**, *26*, 4985-4995.
  231. Marban, C.; Suzanne, S.; Dequiedt, F.; de Walque, S.; Redel, L.; Van Lint, C.; Aunis, D.; Rohr, O. Recruitment of chromatin-modifying enzymes by CTIP2 promotes HIV-1 transcriptional silencing. *The EMBO journal* **2007**, *26*, 412-423.
  232. Le Douce, V.; Colin, L.; Redel, L.; Cherrier, T.; Herbein, G.; Aunis, D.; Rohr, O.; Van Lint, C.; Schwartz, C. LSD1 cooperates with CTIP2 to promote HIV-1 transcriptional silencing. *Nucleic Acids Res* **2012**, *40*, 1904-1915.
  233. Williams, S.; Chen, L.; Kwon, C.; Ruiz-Jarabo, E.; Greene, W. NF- $\kappa$ B p50 promotes HIV latency through HDAC recruitment and repression of transcriptional initiation. *EMBO J.* **2006**, *25*, 139-149.
  234. Zhong, H.; May, M.J.; Jimi, E.; Ghosh, S. The phosphorylation status of nuclear NF- $\kappa$ B determines its association with CBP/p300 or HDAC-1. *Mol Cell* **2002**, *9*, 625-636.
  235. Kim, Y.K.; Bourgeois, C.F.; Isel, C.; Churcher, M.J.; Karn, J. Phosphorylation of the RNA polymerase II carboxyl-terminal domain by CDK9 is directly responsible for human immunodeficiency virus type 1 Tat-activated transcriptional elongation. *Molecular and cellular biology* **2002**, *22*, 4622-4637.
  236. Mbonye, U.R.; Gokulrangan, G.; Datt, M.; Dobrowolski, C.; Cooper, M.; Chance, M.R.; Karn, J. Phosphorylation of CDK9 at Ser175 enhances HIV transcription and is a marker of activated P-TEFb in CD4(+) T lymphocytes. *PLoS pathogens* **2013**, *9*, e1003338.

- 
- 
237. Barboric, M.; Kohoutek, J.; Price, J.P.; Blazek, D.; Price, D.H.; Peterlin, B.M. Interplay between 7SK snRNA and oppositely charged regions in HEXIM1 direct the inhibition of P-TEFb. *The EMBO journal* **2005**, *24*, 4291-4303.
238. Michels, A.A.; Fraldi, A.; Li, Q.; Adamson, T.E.; Bonnet, F.; Nguyen, V.T.; Sedore, S.C.; Price, J.P.; Price, D.H.; Lania, L., *et al.* Binding of the 7SK snRNA turns the HEXIM1 protein into a P-TEFb (CDK9/cyclin T) inhibitor. *The EMBO journal* **2004**, *23*, 2608-2619.
239. Yang, Z.; Zhu, Q.; Luo, K.; Zhou, Q. The 7SK small nuclear RNA inhibits the CDK9/cyclin T1 kinase to control transcription. *Nature* **2001**, *414*, 317-322.
240. Nguyen, V.T.; Kiss, T.; Michels, A.A.; Bensaude, O. 7SK small nuclear RNA binds to and inhibits the activity of CDK9/cyclin T complexes. *Nature* **2001**, *414*, 322-325.
241. Contreras, X.; Barboric, M.; Lenasi, T.; Peterlin, B.M. HMBA releases P-TEFb from HEXIM1 and 7SK snRNA via PI3K/Akt and activates HIV transcription. *PLoS pathogens* **2007**, *3*, 1459-1469.
242. Wei, P.; Garber, M.E.; Fang, S.M.; Fischer, W.H.; Jones, K.A. A novel CDK9-associated C-type cyclin interacts directly with HIV-1 Tat and mediates its high-affinity, loop-specific binding to TAR RNA. *Cell* **1998**, *92*, 451-462.
243. Ott, M.; Dorr, A.; Hetzer-Egger, C.; Kaehlcke, K.; Schnolzer, M.; Henklein, P.; Cole, P.; Zhou, M.-M.; Verdin, E. Tat acetylation: a regulatory switch between early and late phases in HIV transcription elongation. *Novartis Foundation Symposium* **2004**, *259*, 182-193; discussion 193-196, 223-225.
244. Mahmoudi, T.; Parra, M.; Vries, R.G.J.; Kauder, S.E.; Verrijzer, C.P.; Ott, M.; Verdin, E. The SWI/SNF Chromatin-remodeling Complex Is a Cofactor for Tat Transactivation of the HIV Promoter. *Journal of Biological Chemistry* **2006**, *281*, 19960-19968.
245. Dorr, A.; Kiermer, V.; Pedal, A.; Rackwitz, H.-R.; Henklein, P.; Schubert, U.; Zhou, M.-M.; Verdin, E.; Ott, M. Transcriptional synergy between Tat and PCAF is dependent on the binding of acetylated Tat to the PCAF bromodomain. *The EMBO journal* **2002**, *21*, 2715-2723.
246. Tréand, C.; du Chéné, I.; Brès, V.; Kiernan, R.; Benarous, R.; Benkirane, M.; Emiliani, S. Requirement for SWI/SNF chromatin-remodeling complex in Tat-mediated activation of the HIV-1 promoter. *The EMBO journal* **2006**, *25*, 1690-1699.
247. Pagans, S.; Pedal, A.; North, B.J.; Kaehlcke, K.; Marshall, B.L.; Dorr, A.; Hetzer-Egger, C.; Henklein, P.; Frye, R.; McBurney, M.W., *et al.* SIRT1 Regulates HIV Transcription via Tat Deacetylation. *PLoS Biology* **2005**, *3*, e41.
248. Muniz, L.; Egloff, S.; Ughy, B.; Jady, B.E.; Kiss, T. Controlling cellular P-TEFb activity by the HIV-1 transcriptional transactivator Tat. *PLoS pathogens* **2010**, *6*, e1001152.
249. Sedore, S.C.; Byers, S.A.; Biglione, S.; Price, J.P.; Maury, W.J.; Price, D.H. Manipulation of P-TEFb control machinery by HIV: recruitment of P-TEFb from the large form by Tat and binding of HEXIM1 to TAR. *Nucleic Acids Res* **2007**, *35*, 4347-4358.
250. Richman, D.D.; Margolis, D.M.; Delaney, M.; Greene, W.C.; Hazuda, D.; Pomerantz, R.J. The challenge of finding a cure for HIV infection. *Science* **2009**, *323*, 1304-1307.
251. Bartel, D.P. MicroRNAs: genomics, biogenesis, mechanism, and function. *Cell* **2004**, *116*, 281-297.
252. Yeung, M.L.; Benkirane, M.; Jeang, K.T. Small non-coding RNAs, mammalian cells, and viruses: regulatory interactions? *Retrovirology* **2007**, *4*, 74.
253. Kumar, A.; Jeang, K.T. Insights into cellular microRNAs and human immunodeficiency virus type 1 (HIV-1). *J Cell Physiol* **2008**, *216*, 327-331.

- 
- 
254. Triboulet, R.; Mari, B.; Lin, Y.L.; Chable-Bessia, C.; Bennasser, Y.; Lebrigand, K.; Cardinaud, B.; Maurin, T.; Barbry, P.; Baillat, V., *et al.* Suppression of microRNA-silencing pathway by HIV-1 during virus replication. *Science* **2007**, *315*, 1579-1582.
255. Sung, T.L.; Rice, A.P. miR-198 inhibits HIV-1 gene expression and replication in monocytes and its mechanism of action appears to involve repression of cyclin T1. *PLoS pathogens* **2009**, *5*, e1000263.
256. Wang, X.; Ye, L.; Hou, W.; Zhou, Y.; Wang, Y.J.; Metzger, D.S.; Ho, W.Z. Cellular microRNA expression correlates with susceptibility of monocytes/macrophages to HIV-1 infection. *Blood* **2009**, *113*, 671-674.
257. Davis, L.E.; Hjelle, B.L.; Miller, V.E.; Palmer, D.L.; Llewellyn, A.L.; Merlin, T.L.; Young, S.A.; Mills, R.G.; Wachsman, W.; Wiley, C.A. Early viral brain invasion in iatrogenic human immunodeficiency virus infection. *Neurology* **1992**, *42*, 1736-1739.
258. Jordan, A.; Bisgrove, D.; Verdin, E. HIV reproducibly establishes a latent infection after acute infection of T cells in vitro. *The EMBO journal* **2003**, *22*, 1868-1877.
259. Hakre, S.; Chavez, L.; Shirakawa, K.; Verdin, E. HIV latency: experimental systems and molecular models. *FEMS microbiology reviews* **2012**, *36*, 706-716.
260. Van Duyne, R.; Pedati, C.; Guendel, I.; Carpio, L.; Kehn-Hall, K.; Saifuddin, M.; Kashanchi, F. The utilization of humanized mouse models for the study of human retroviral infections. *Retrovirology* **2009**, *6*, 76.
261. Hatziioannou, T.; Evans, D.T. Animal models for HIV/AIDS research. *Nature reviews. Microbiology* **2012**, *10*, 852-867.
262. Sahu, G.K.; Lee, K.; Ji, J.; Braciale, V.; Baron, S.; Cloyd, M.W. A novel in vitro system to generate and study latently HIV-infected long-lived normal CD4+ T-lymphocytes. *Virology* **2006**, *355*, 127-137.
263. Tyagi, M.; Pearson, R.J.; Karn, J. Establishment of HIV latency in primary CD4+ cells is due to epigenetic transcriptional silencing and P-TEFb restriction. *Journal of virology* **2010**, *84*, 6425-6437.
264. Marini, A.; Harper, J.M.; Romerio, F. An in vitro system to model the establishment and reactivation of HIV-1 latency. *J Immunol* **2008**, *181*, 7713-7720.
265. Bosque, A.; Planelles, V. Induction of HIV-1 latency and reactivation in primary memory CD4+ T cells. *Blood* **2009**, *113*, 58-65.
266. Yang, H.C.; Xing, S.; Shan, L.; O'Connell, K.; Dinoso, J.; Shen, A.; Zhou, Y.; Shrum, C.K.; Han, Y.; Liu, J.O., *et al.* Small-molecule screening using a human primary cell model of HIV latency identifies compounds that reverse latency without cellular activation. *The Journal of clinical investigation* **2009**, *119*, 3473-3486.
267. Swiggard, W.J.; Baytop, C.; Yu, J.J.; Dai, J.; Li, C.; Schretzenmair, R.; Theodosopoulos, T.; O'Doherty, U. Human immunodeficiency virus type 1 can establish latent infection in resting CD4+ T cells in the absence of activating stimuli. *Journal of virology* **2005**, *79*, 14179-14188.
268. O'Doherty, U.; Swiggard, W.J.; Malim, M.H. Human immunodeficiency virus type 1 spinoculation enhances infection through virus binding. *Journal of virology* **2000**, *74*, 10074-10080.
269. Saleh, S.; Solomon, A.; Wightman, F.; Xhilaga, M.; Cameron, P.U.; Lewin, S.R. CCR7 ligands CCL19 and CCL21 increase permissiveness of resting memory CD4+ T cells to HIV-1 infection: a novel model of HIV-1 latency. *Blood* **2007**, *110*, 4161-4164.
270. Lassen, K.G.; Hebbeler, A.M.; Bhattacharyya, D.; Lobritz, M.A.; Greene, W.C. A flexible model of HIV-1 latency permitting evaluation of many primary CD4 T-cell reservoirs. *PloS one* **2012**, *7*, e30176.

271. Spina, C.A.; Anderson, J.; Archin, N.M.; Bosque, A.; Chan, J.; Famiglietti, M.; Greene, W.C.; Kashuba, A.; Lewin, S.R.; Margolis, D.M., *et al.* An in-depth comparison of latent HIV-1 reactivation in multiple cell model systems and resting CD4+ T cells from aviremic patients. *PLoS pathogens* **2013**, *9*, e1003834.
272. Burke, B.; Brown, H.J.; Marsden, M.D.; Bristol, G.; Vatakis, D.N.; Zack, J.A. Primary cell model for activation-inducible human immunodeficiency virus. *Journal of virology* **2007**, *81*, 7424-7434.
273. Archin, N.M.; Sung, J.M.; Garrido, C.; Soriano-Sarabia, N.; Margolis, D.M. Eradicating HIV-1 infection: seeking to clear a persistent pathogen. *Nature reviews. Microbiology* **2014**, *12*, 750-764.
274. Pace, M.J.; Agosto, L.; Graf, E.H.; O'Doherty, U. HIV reservoirs and latency models. *Virology* **2011**, *411*, 344-354.
275. Cillo, A.R.; Sobolewski, M.D.; Bosch, R.J.; Fyne, E.; Piatak, M., Jr.; Coffin, J.M.; Mellors, J.W. Quantification of HIV-1 latency reversal in resting CD4+ T cells from patients on suppressive antiretroviral therapy. *Proceedings of the National Academy of Sciences of the United States of America* **2014**, *111*, 7078-7083.
276. Kim, J.H.; Excler, J.L.; Michael, N.L. Lessons from the RV144 Thai phase III HIV-1 vaccine trial and the search for correlates of protection. *Annu Rev Med* **2015**, *66*, 423-437.
277. Bruner, K.M.; Hosmane, N.N.; Siliciano, R.F. Towards an HIV-1 cure: measuring the latent reservoir. *Trends in microbiology* **2015**, *23*, 192-203.
278. Massanella, M.; Richman, D.D. Measuring the latent reservoir in vivo. *The Journal of clinical investigation* **2016**, *126*, 464-472.
279. Procopio, F.A.; Fromentin, R.; Kulpa, D.A.; Brehm, J.H.; Bebin, A.G.; Strain, M.C.; Richman, D.D.; O'Doherty, U.; Palmer, S.; Hecht, F.M., *et al.* A Novel Assay to Measure the Magnitude of the Inducible Viral Reservoir in HIV-infected Individuals. *EBioMedicine* **2015**, *2*, 874-883.
280. Dinoso, J.B.; Kim, S.Y.; Wiegand, A.M.; Palmer, S.E.; Gange, S.J.; Cranmer, L.; O'Shea, A.; Callender, M.; Spivak, A.; Brennan, T., *et al.* Treatment intensification does not reduce residual HIV-1 viremia in patients on highly active antiretroviral therapy. *Proceedings of the National Academy of Sciences of the United States of America* **2009**, *106*, 9403-9408.
281. Crotti, A.; Lusic, M.; Lupo, R.; Lievens, P.M.; Liboi, E.; Della Chiara, G.; Tinelli, M.; Lazzarin, A.; Patterson, B.K.; Giacca, M., *et al.* Naturally occurring C-terminally truncated STAT5 is a negative regulator of HIV-1 expression. *Blood* **2007**, *109*, 5380-5389.
282. Mosoian, A.; Teixeira, A.; High, A.A.; Christian, R.E.; Hunt, D.F.; Shabanowitz, J.; Liu, X.; Klotman, M. Novel function of prothymosin alpha as a potent inhibitor of human immunodeficiency virus type 1 gene expression in primary macrophages. *Journal of virology* **2006**, *80*, 9200-9206.
283. Wang, Y.; Rice, A.P. Interleukin-10 inhibits HIV-1 LTR-directed gene expression in human macrophages through the induction of cyclin T1 proteolysis. *Virology* **2006**, *352*, 485-492.
284. Tanaka, N.; Hoshino, Y.; Gold, J.; Hoshino, S.; Martiniuk, F.; Kurata, T.; Pine, R.; Levy, D.; Rom, W.N.; Weiden, M. Interleukin-10 induces inhibitory C/EBPbeta through STAT-3 and represses HIV-1 transcription in macrophages. *Am J Respir Cell Mol Biol* **2005**, *33*, 406-411.
285. Jochmann, R.; Thurau, M.; Jung, S.; Hofmann, C.; Naschberger, E.; Kremmer, E.; Harrer, T.; Miller, M.; Schaft, N.; Sturzl, M. O-linked N-acetylglucosaminylation of

- Sp1 inhibits the human immunodeficiency virus type 1 promoter. *Journal of virology* **2009**, *83*, 3704-3718.
286. Buescher, J.L.; Duan, F.; Sun, J.; Price, R.W.; Ikezu, T. OTK18 levels in plasma and cerebrospinal fluid correlate with viral load and CD8 T-cells in normal and AIDS patients. *J Neuroimmune Pharmacol* **2008**, *3*, 230-235.
287. Savarino, A.; Mai, A.; Norelli, S.; El Daker, S.; Valente, S.; Rotili, D.; Altucci, L.; Palamara, A.T.; Garaci, E. "Shock and kill" effects of class I-selective histone deacetylase inhibitors in combination with the glutathione synthesis inhibitor buthionine sulfoximine in cell line models for HIV-1 quiescence. *Retrovirology* **2009**, *6*, 52.
288. Stellbrink, H.J.; van Lunzen, J.; Westby, M.; O'Sullivan, E.; Schneider, C.; Adam, A.; Weitner, L.; Kuhlmann, B.; Hoffmann, C.; Fenske, S., *et al.* Effects of interleukin-2 plus highly active antiretroviral therapy on HIV-1 replication and proviral DNA (COSMIC trial). *AIDS* **2002**, *16*, 1479-1487.
289. Prins, J.M.; Jurriaans, S.; van Praag, R.M.; Blaak, H.; van Rij, R.; Schellekens, P.T.; ten Berge, I.J.; Yong, S.L.; Fox, C.H.; Roos, M.T., *et al.* Immuno-activation with anti-CD3 and recombinant human IL-2 in HIV-1-infected patients on potent antiretroviral therapy. *AIDS* **1999**, *13*, 2405-2410.
290. Wang, F.X.; Xu, Y.; Sullivan, J.; Souder, E.; Argyris, E.G.; Acheampong, E.A.; Fisher, J.; Sierra, M.; Thomson, M.M.; Najera, R., *et al.* IL-7 is a potent and proviral strain-specific inducer of latent HIV-1 cellular reservoirs of infected individuals on virally suppressive HAART. *The Journal of clinical investigation* **2005**, *115*, 128-137.
291. Rullas, J.; Bermejo, M.; Garcia-Perez, J.; Beltan, M.; Gonzalez, N.; Hezareh, M.; Brown, S.J.; Alcamí, J. Prostratin induces HIV activation and downregulates HIV receptors in peripheral blood lymphocytes. *Antivir Ther* **2004**, *9*, 545-554.
292. Shan, L.; Deng, K.; Shroff, N.S.; Durand, C.M.; Rabi, S.A.; Yang, H.C.; Zhang, H.; Margolick, J.B.; Blankson, J.N.; Siliciano, R.F. Stimulation of HIV-1-specific cytolytic T lymphocytes facilitates elimination of latent viral reservoir after virus reactivation. *Immunity* **2012**, *36*, 491-501.
293. Swingler, S.; Mann, A.M.; Zhou, J.; Swingler, C.; Stevenson, M. Apoptotic killing of HIV-1-infected macrophages is subverted by the viral envelope glycoprotein. *PLoS pathogens* **2007**, *3*, 1281-1290.
294. Day, C.L.; Kaufmann, D.E.; Kiepiela, P.; Brown, J.A.; Moodley, E.S.; Reddy, S.; Mackey, E.W.; Miller, J.D.; Leslie, A.J.; DePierres, C., *et al.* PD-1 expression on HIV-specific T cells is associated with T-cell exhaustion and disease progression. *Nature* **2006**, *443*, 350-354.
295. Varela-Rohena, A.; Molloy, P.E.; Dunn, S.M.; Li, Y.; Suhoski, M.M.; Carroll, R.G.; Milicic, A.; Mahon, T.; Sutton, D.H.; Laugel, B., *et al.* Control of HIV-1 immune escape by CD8 T cells expressing enhanced T-cell receptor. *Nature medicine* **2008**, *14*, 1390-1395.
296. Maksakova, I.A.; Mager, D.L.; Reiss, D. Keeping active endogenous retroviral-like elements in check: the epigenetic perspective. *Cell Mol Life Sci* **2008**, *65*, 3329-3347.
297. Jern, P.; Coffin, J.M. Effects of retroviruses on host genome function. *Annu Rev Genet* **2008**, *42*, 709-732.
298. Minardi da Cruz, J.; Singh, D.; Lamara, A.; Chebloune, Y. Small Ruminant Lentiviruses (SRLVs) Break the Species Barrier to Acquire New Host Range. *Viruses* **2013**, *5*, 1867-1884.
299. Crawford, T.B.; Adams, D.S.; cheevers, W.; Cork, L.C. Chronic arthritis in goats caused by a retrovirus. *Science*. **1980**, *207*, 997-999.

300. Villet, S.; Bouzar, B.A.; Morin, T.; Verdier, G.; Legras, C.; Chebloune, Y. Maedi-Visna Virus and Caprine Arthritis Encephalitis Virus Genomes Encode a Vpr-Like but No Tat Protein. *Journal of virology* **2003**, *77*, 9632-9638.
301. Morin, T.; Guiguen, F.; Bouzar, B.A.; Villet, S.; Greenland, T.; Grezel, D.; Gounel, F.; Gallay, K.; Garnier, C.; Durand, J., *et al.* Clearance of a Productive Lentivirus Infection in Calves Experimentally Inoculated with Caprine Arthritis-Encephalitis Virus. *Journal of virology* **2003**, *77*, 6430-6437.
302. Gorrell, M.D.; Brandon, M.R.; Sheffer, D.; Adams, R.J.; Narayan, O. Ovine lentivirus is macrophagetropic and does not replicate productively in T lymphocytes. *Journal of virology* **1992**, *66*, 2679-2688.
303. Peluso, R.; Haase, A.; Stowring, L.; Edwards, M.; ventura, P. A Trojan Horse Mechanism for the spread of Visna virus in Monocytes. *Virology*. **1985**, *147*, 231-236.
304. Sanna, E.; Sanna, M.P.; Vitali, C.G.; Renzoni, G.; Sanna, L.; Spano, S.; Rossi, G.; Leoni, A. Proviral DNA in the brains of goats infected with caprine arthritis-encephalitis virus. *J Comp Pathol* **1999**, *121*, 271-276.
305. Liu, Z.Q.; Mukherjee, S.; Sahni, M.; McCormick-Davis, C.; Leung, K.; Li, Z.; Gattone, V.H., 2nd; Tian, C.; Doms, R.W.; Hoffman, T.L., *et al.* Derivation and biological characterization of a molecular clone of SHIV(KU-2) that causes AIDS, neurological disease, and renal disease in rhesus macaques. *Virology* **1999**, *260*, 295-307.
306. Shingai, M.; Donau, O.K.; Schmidt, S.D.; Gautam, R.; Plishka, R.J.; Buckler-White, A.; Sadjadpour, R.; Lee, W.R.; LaBranche, C.C.; Montefiori, D.C., *et al.* Most rhesus macaques infected with the CCR5-tropic SHIV(AD8) generate cross-reactive antibodies that neutralize multiple HIV-1 strains. *Proceedings of the National Academy of Sciences of the United States of America* **2012**, *109*, 19769-19774.
307. Deymier, M.J.; Claiborne, D.T.; Ende, Z.; Ratner, H.K.; Kilembe, W.; Allen, S.; Hunter, E. Particle infectivity of HIV-1 full-length genome infectious molecular clones in a subtype C heterosexual transmission pair following high fidelity amplification and unbiased cloning. *Virology* **2014**, *468-470*, 454-461.
308. Kierstead, L.S.; Dubey, S.; Meyer, B.; Tobery, T.W.; Mogg, R.; Fernandez, V.R.; Long, R.; Guan, L.; Gaunt, C.; Collins, K., *et al.* Enhanced rates and magnitude of immune responses detected against an HIV vaccine: effect of using an optimized process for isolating PBMC. *AIDS research and human retroviruses* **2007**, *23*, 86-92.
309. Kozak, M. A consideration of alternative models for the initiation of translation in eukaryotes. *Critical reviews in biochemistry and molecular biology* **1992**, *27*, 385-402.
310. Kozak, M. The scanning model for translation: an update. *The Journal of cell biology* **1989**, *108*, 229-241.
311. Morita, S.; Kojima, T.; Kitamura, T. Plat-E: an efficient and stable system for transient packaging of retroviruses. *Gene therapy* **2000**, *7*, 1063-1066.
312. Meyers, G. Characterization of the sequence element directing translation reinitiation in RNA of the calicivirus rabbit hemorrhagic disease virus. *Journal of virology* **2007**, *81*, 9623-9632.
313. Gibson, D.G. Programming biological operating systems: genome design, assembly and activation. *Nature methods* **2014**, *11*, 521-526.
314. Nishimura, Y.; Shingai, M.; Willey, R.; Sadjadpour, R.; Lee, W.R.; Brown, C.R.; Brenchley, J.M.; Buckler-White, A.; Petros, R.; Eckhaus, M., *et al.* Generation of the pathogenic R5-tropic simian/human immunodeficiency virus SHIVAD8 by serial passaging in rhesus macaques. *Journal of virology* **2010**, *84*, 4769-4781.

- 
- 
315. Gautam, R.; Nishimura, Y.; Lee, W.R.; Donau, O.; Buckler-White, A.; Shingai, M.; Sadjadpour, R.; Schmidt, S.D.; LaBranche, C.C.; Keele, B.F., *et al.* Pathogenicity and mucosal transmissibility of the R5-tropic simian/human immunodeficiency virus SHIV(AD8) in rhesus macaques: implications for use in vaccine studies. *Journal of virology* **2012**, *86*, 8516-8526.
  316. Gupta, S.; Clark, E.S.; Termini, J.M.; Boucher, J.; Kanagavelu, S.; LeBranche, C.C.; Abraham, S.; Montefiori, D.C.; Khan, W.N.; Stone, G.W. DNA vaccine molecular adjuvants SP-D-BAFF and SP-D-APRIL enhance anti-gp120 immune response and increase HIV-1 neutralizing antibody titers. *Journal of virology* **2015**, *89*, 4158-4169.
  317. Hanson, M.C.; Abraham, W.; Crespo, M.P.; Chen, S.H.; Liu, H.; Szeto, G.L.; Kim, M.; Reinherz, E.L.; Irvine, D.J. Liposomal vaccines incorporating molecular adjuvants and intrastructural T-cell help promote the immunogenicity of HIV membrane-proximal external region peptides. *Vaccine* **2015**, *33*, 861-868.
  318. Berzi, A.; Varga, N.; Sattin, S.; Antonazzo, P.; Biasin, M.; Cetin, I.; Trabattoni, D.; Bernardi, A.; Clerici, M. Pseudo-mannosylated DC-SIGN ligands as potential adjuvants for HIV vaccines. *Viruses* **2014**, *6*, 391-403.
  319. Johnson, R.P. Live attenuated AIDS vaccines: hazards and hopes. *Nature medicine* **1999**, *5*, 154-155.
  320. Baba, T.W.; Jeong, Y.S.; Pennick, D.; Bronson, R.; Greene, M.F.; Ruprecht, R.M. Pathogenicity of live, attenuated SIV after mucosal infection of neonatal macaques. *Science* **1995**, *267*, 1820-1825.
  321. Baba, T.W.; Liska, V.; Khimani, A.H.; Ray, N.B.; Dailey, P.J.; Penninck, D.; Bronson, R.; Greene, M.F.; McClure, H.M.; Martin, L.N., *et al.* Live attenuated, multiply deleted simian immunodeficiency virus causes AIDS in infant and adult macaques. *Nature medicine* **1999**, *5*, 194-203.
  322. Rubinstein, M.P.; Lind, N.A.; Purton, J.F.; Filippou, P.; Best, J.A.; McGhee, P.A.; Surh, C.D.; Goldrath, A.W. IL-7 and IL-15 differentially regulate CD8<sup>+</sup> T-cell subsets during contraction of the immune response. *Blood* **2008**, *112*, 3704-3712.
  323. Shedlock, D.J.; Tingey, C.; Mahadevan, L.; Hutnick, N.; Reuschel, E.L.; Kudchodkar, S.; Flingai, S.; Yan, J.; Kim, J.J.; Ugen, K.E., *et al.* Co-Administration of Molecular Adjuvants Expressing NF-Kappa B Subunit p65/RelA or Type-1 Transactivator T-bet Enhance Antigen Specific DNA Vaccine-Induced Immunity. *Vaccines* **2014**, *2*, 196-215.
  324. Dubie, R.A.; Maksaarekul, S.; Shacklett, B.L.; Lemongello, D.; Cole, K.S.; Villinger, F.; Blozis, S.A.; Luciw, P.A.; Sparger, E.E. Co-immunization with IL-15 enhances cellular immune responses induced by a vif-deleted simian immunodeficiency virus proviral DNA vaccine and confers partial protection against vaginal challenge with SIVmac251. *Virology* **2009**, *386*, 109-121.
  325. Liao, H.X.; Tsao, C.Y.; Alam, S.M.; Muldoon, M.; Vandergrift, N.; Ma, B.J.; Lu, X.; Sutherland, L.L.; Scarce, R.M.; Bowman, C., *et al.* Antigenicity and immunogenicity of transmitted/founder, consensus, and chronic envelope glycoproteins of human immunodeficiency virus type 1. *Journal of virology* **2013**, *87*, 4185-4201.
  326. Stevceva, L.; Moniuszko, M.; Ferrari, M.G. Utilizing IL-12, IL-15 and IL-7 as Mucosal Vaccine Adjuvants. *Letters in drug design & discovery* **2006**, *3*, 586-592.
  327. Kozыrev, I.L.; Miura, T.; Haga, T.; Kuwata, T.; Hayami, M. Construction of SIV/HIV-1 chimeric viruses having the IL-5 gene and determination of their ability to replicate and produce IL-5. *Archives of virology* **2001**, *146*, 1051-1062.
  328. Haga, T.; Kuwata, T.; Kozыrev, I.; Kwofie, T.B.; Hayami, M.; Miura, T. Construction of an SIV/HIV type 1 chimeric virus with the human interleukin 6 gene and its



- production of interleukin 6 in monkey and human cells. *AIDS research and human retroviruses* **2000**, *16*, 577-582.
329. Kuwata, T.; Miura, T.; Haga, T.; Kozyrev, I.; Hayami, M. Construction of chimeric simian and human immunodeficiency viruses that produce interleukin 12. *AIDS research and human retroviruses* **2000**, *16*, 465-470.
330. Muller, B.; Daecke, J.; Fackler, O.T.; Dittmar, M.T.; Zentgraf, H.; Krausslich, H.G. Construction and characterization of a fluorescently labeled infectious human immunodeficiency virus type 1 derivative. *Journal of virology* **2004**, *78*, 10803-10813.
331. Pang, S.; Yu, D.; An, D.S.; Baldwin, G.C.; Xie, Y.; Poon, B.; Chow, Y.H.; Park, N.H.; Chen, I.S. Human immunodeficiency virus Env-independent infection of human CD4(-) cells. *Journal of virology* **2000**, *74*, 10994-11000.
332. Plummers, W.; Cherepanov, P.; Schols, D.; De Clercq, E.; Debyser, Z. Nuclear localization of human immunodeficiency virus type 1 integrase expressed as a fusion protein with green fluorescent protein. *Virology* **1999**, *258*, 327-332.
333. Smith, T.R.; Schultheis, K.; Kiosses, W.B.; Amante, D.H.; Mendoza, J.M.; Stone, J.C.; McCoy, J.R.; Sardesai, N.Y.; Broderick, K.E. DNA vaccination strategy targets epidermal dendritic cells, initiating their migration and induction of a host immune response. *Mol Ther Methods Clin Dev* **2014**, *1*, 14054.
334. Cockburn, I.A.; Amino, R.; Kelemen, R.K.; Kuo, S.C.; Tse, S.W.; Radtke, A.; MacDaniel, L.; Ganusov, V.V.; Zavala, F.; Menard, R. In vivo imaging of CD8+ T cell-mediated elimination of malaria liver stages. *Proceedings of the National Academy of Sciences of the United States of America* **2013**, *110*, 9090-9095.
335. Stephens, E.B.; Liu, Z.Q.; Zhu, G.W.; Adany, I.; Joag, S.V.; Foresman, L.; Berman, N.E.; Narayan, O. Lymphocyte-tropic simian immunodeficiency virus causes persistent infection in the brains of rhesus monkeys. *Virology* **1995**, *213*, 600-614.
336. Gattone, V.H., 2nd; Tian, C.; Zhuge, W.; Sahni, M.; Narayan, O.; Stephens, E.B. SIV-associated nephropathy in rhesus macaques infected with lymphocyte-tropic SIVmac239. *AIDS research and human retroviruses* **1998**, *14*, 1163-1180.
337. Clements, J.E.; Montelaro, R.C.; Zink, M.C.; Amedee, A.M.; Miller, S.; Trichel, A.M.; Jagerski, B.; Hauer, D.; Martin, L.N.; Bohm, R.P., *et al.* Cross-protective immune responses induced in rhesus macaques by immunization with attenuated macrophage-tropic simian immunodeficiency virus. *Journal of virology* **1995**, *69*, 2737-2744.
338. Blancou, P.; Chenciner, N.; Ho Tsong Fang, R.; Monceaux, V.; Cumont, M.C.; Guetard, D.; Hurtrel, B.; Wain-Hobson, S. Simian immunodeficiency virus promoter exchange results in a highly attenuated strain that protects against uncloned challenge virus. *Journal of virology* **2004**, *78*, 1080-1092.
339. Mangeot, P.E.; Negre, D.; Dubois, B.; Winter, A.J.; Leissner, P.; Mehtali, M.; Kaiserlian, D.; Cosset, F.L.; Darlix, J.L. Development of minimal lentivirus vectors derived from simian immunodeficiency virus (SIVmac251) and their use for gene transfer into human dendritic cells. *Journal of virology* **2000**, *74*, 8307-8315.
340. Cannon, P.; Kim, S.H.; Ulich, C.; Kim, S. Analysis of Tat function in human immunodeficiency virus type 1-infected low-level-expression cell lines U1 and ACH-2. *Journal of virology* **1994**, *68*, 1993-1997.
341. Kitamura, K.; Zaki, S.R.; Greer, P.W.; Sinha, S.D.; Folks, T.M. Tumor necrosis factor-alpha induces circular forms of human immunodeficiency virus type-1 DNA in the persistently infected low-level expressing cell line, ACH-2. *Virus research* **1993**, *27*, 113-118.
342. Archin, N.M.; Liberty, A.L.; Kashuba, A.D.; Choudhary, S.K.; Kuruc, J.D.; Crooks, A.M.; Parker, D.C.; Anderson, E.M.; Kearney, M.F.; Strain, M.C., *et al.*

- Administration of vorinostat disrupts HIV-1 latency in patients on antiretroviral therapy. *Nature* **2012**, *487*, 482-485.
343. Matalon, S.; Rasmussen, T.A.; Dinarello, C.A. Histone deacetylase inhibitors for purging HIV-1 from the latent reservoir. *Mol Med* **2011**, *17*, 466-472.
344. Archin, N.M.; Keedy, K.S.; Espeseth, A.; Dang, H.; Hazuda, D.J.; Margolis, D.M. Expression of latent human immunodeficiency type 1 is induced by novel and selective histone deacetylase inhibitors. *AIDS* **2009**, *23*, 1799-1806.
345. Rasmussen, T.A.; Schmeltz Sogaard, O.; Brinkmann, C.; Wightman, F.; Lewin, S.R.; Melchjorsen, J.; Dinarello, C.; Ostergaard, L.; Tolstrup, M. Comparison of HDAC inhibitors in clinical development: effect on HIV production in latently infected cells and T-cell activation. *Human vaccines & immunotherapeutics* **2013**, *9*, 993-1001.
346. Jiang, G.; Dandekar, S. Targeting NF-kappaB signaling with protein kinase C agonists as an emerging strategy for combating HIV latency. *AIDS research and human retroviruses* **2015**, *31*, 4-12.
347. Stoszko, M.; De Crignis, E.; Rokx, C.; Khalid, M.M.; Lungu, C.; Palstra, R.J.; Kan, T.W.; Boucher, C.; Verbon, A.; Dykhuizen, E.C., *et al.* Small Molecule Inhibitors of BAF; A Promising Family of Compounds in HIV-1 Latency Reversal. *EBioMedicine* **2016**, *3*, 108-121.
348. Walker-Sperling, V.E.; Pohlmeier, C.W.; Tarwater, P.M.; Blankson, J.N. The Effect of Latency Reversal Agents on Primary CD8+ T Cells: Implications for Shock and Kill Strategies for Human Immunodeficiency Virus Eradication. *EBioMedicine* **2016**, *8*, 217-229.
349. Whitney, J.B.; Hill, A.L.; Sanisetty, S.; Penaloza-MacMaster, P.; Liu, J.; Shetty, M.; Parenteau, L.; Cabral, C.; Shields, J.; Blackmore, S., *et al.* Rapid seeding of the viral reservoir prior to SIV viraemia in rhesus monkeys. *Nature* **2014**, *512*, 74-77.
350. Hodel, F.; Patxot, M.; Snäkä, T.; Ciuffi, A. HIV-1 latent reservoir: size matters. *Future Virology* **2016**, *11*, 785-794.
351. Kim, E.Y.; Lorenzo-Redondo, R.; Little, S.J.; Chung, Y.S.; Phalora, P.K.; Maljkovic Berry, I.; Archer, J.; Penugonda, S.; Fischer, W.; Richman, D.D., *et al.* Human APOBEC3 induced mutation of human immunodeficiency virus type-1 contributes to adaptation and evolution in natural infection. *PLoS pathogens* **2014**, *10*, e1004281.
352. Herrera-Carrillo, E.; Paxton, W.A.; Berkhout, B. The search for a T cell line for testing novel antiviral strategies against HIV-1 isolates of diverse receptor tropism and subtype origin. *J Virol Methods* **2014**, *203*, 88-96.
353. Dejuicq, N.; Simmons, G.; Clapham, P.R. T-cell line adaptation of human immunodeficiency virus type 1 strain SF162: effects on envelope, vpu and macrophage-tropism. *The Journal of general virology* **2000**, *81*, 2899-2904.
354. Kwofie, T.; Miura, T. Increased Virus Replication and Cytotoxicity of Non-pathogenic Simian Human Immuno Deficiency Viruses-NM-3rN After Serial Passage in a Monkey-Derived Cell Line. *Annals of medical and health sciences research* **2013**, *3*, 55-61.
355. Akiyama, H.; Ishimatsu, M.; Miura, T.; Hayami, M.; Ido, E. Construction and infection of a new simian/human immunodeficiency chimeric virus (SHIV) containing the integrase gene of the human immunodeficiency virus type 1 genome and analysis of its adaptation to monkey cells. *Microbes and infection* **2008**, *10*, 531-539.
356. Akiyama, H.; Ido, E.; Akahata, W.; Kuwata, T.; Miura, T.; Hayami, M. Construction and in vivo infection of a new simian/human immunodeficiency virus chimera containing the reverse transcriptase gene and the 3' half of the genomic region of human immunodeficiency virus type 1. *The Journal of general virology* **2003**, *84*, 1663-1669.

- 
- 
357. Alexaki, A.; Liu, Y.; Wigdahl, B. Cellular reservoirs of HIV-1 and their role in viral persistence. *Current HIV research* **2008**, *6*, 388.
358. Jadowsky, J.K.; Wong, J.Y.; Graham, A.C.; Dobrowolski, C.; Devor, R.L.; Adams, M.D.; Fujinaga, K.; Karn, J. Negative elongation factor is required for the maintenance of proviral latency but does not induce promoter-proximal pausing of RNA polymerase II on the HIV long terminal repeat. *Molecular and cellular biology* **2014**, *34*, 1911-1928.
359. Juganaru, M.; Reina, R.; Grego, E.; Profiti, M.; Rosati, S. LTR promoter activity of SRLV genotype E, strain Roccaverano. *Veterinary research communications* **2010**, *34 Suppl 1*, S47-51.
360. Murphy, B.; McElliott, V.; Vapniarsky, N.; Oliver, A.; Rowe, J. Tissue tropism and promoter sequence variation in caprine arthritis encephalitis virus infected goats. *Virus research* **2010**, *151*, 177-184.
361. Razooky, B.S.; Pai, A.; Aull, K.; Rouzine, I.M.; Weinberger, L.S. A hardwired HIV latency program. *Cell* **2015**, *160*, 990-1001.
362. Billingsley, J.M.; Rajakumar, P.A.; Connole, M.A.; Salisch, N.C.; Adnan, S.; Kuzmichev, Y.V.; Hong, H.S.; Reeves, R.K.; Kang, H.J.; Li, W., *et al.* Characterization of CD8+ T cell differentiation following SIVDeltaneF vaccination by transcription factor expression profiling. *PLoS pathogens* **2015**, *11*, e1004740.
363. Iglesias-Ussel, M.; Marchionni, L.; Romerio, F. Isolation of microarray-quality RNA from primary human cells after intracellular immunostaining and fluorescence-activated cell sorting. *J Immunol Methods* **2013**, *391*, 22-30.
364. Evans, V.A.; Kumar, N.; Filali, A.; Procopio, F.A.; Yegorov, O.; Goulet, J.P.; Saleh, S.; Haddad, E.K.; da Fonseca Pereira, C.; Ellenberg, P.C., *et al.* Myeloid dendritic cells induce HIV-1 latency in non-proliferating CD4+ T cells. *PLoS pathogens* **2013**, *9*, e1003799.
365. Mohammadi, P.; di Iulio, J.; Munoz, M.; Martinez, R.; Bartha, I.; Cavassini, M.; Thorball, C.; Fellay, J.; Beerenwinkel, N.; Ciuffi, A., *et al.* Dynamics of HIV latency and reactivation in a primary CD4+ T cell model. *PLoS pathogens* **2014**, *10*, e1004156.
366. Luciw, P.A.; Pratt-Lowe, E.; Shaw, K.E.; Levy, J.A.; Cheng-Mayer, C. Persistent infection of rhesus macaques with T-cell-line-tropic and macrophage-tropic clones of simian/human immunodeficiency viruses (SHIV). *Proceedings of the National Academy of Sciences of the United States of America* **1995**, *92*, 7490-7494.
367. Luciw, P.A.; Mandell, C.P.; Himathongkham, S.; Li, J.; Low, T.A.; Schmidt, K.A.; Shaw, K.E.; Cheng-Mayer, C. Fatal immunopathogenesis by SIV/HIV-1 (SHIV) containing a variant form of the HIV-1SF33 env gene in juvenile and newborn rhesus macaques. *Virology* **1999**, *263*, 112-127.
368. Igarashi, T.; Endo, Y.; Englund, G.; Sadjadpour, R.; Matano, T.; Buckler, C.; Buckler-White, A.; Plishka, R.; Theodore, T.; Shibata, R., *et al.* Emergence of a highly pathogenic simian/human immunodeficiency virus in a rhesus macaque treated with anti-CD8 mAb during a primary infection with a nonpathogenic virus. *Proceedings of the National Academy of Sciences of the United States of America* **1999**, *96*, 14049-14054.
369. Feinberg, M.B.; Moore, J.P. AIDS vaccine models: challenging challenge viruses. *Nature medicine* **2002**, *8*, 207-210.
370. Harouse, J.M.; Gettie, A.; Tan, R.C.; Blanchard, J.; Cheng-Mayer, C. Distinct pathogenic sequela in rhesus macaques infected with CCR5 or CXCR4 utilizing SHIVs. *Science* **1999**, *284*, 816-819.

371. Shingai, M.; Donau, O.K.; Plishka, R.J.; Buckler-White, A.; Mascola, J.R.; Nabel, G.J.; Nason, M.C.; Montefiori, D.; Moldt, B.; Poignard, P., *et al.* Passive transfer of modest titers of potent and broadly neutralizing anti-HIV monoclonal antibodies block SHIV infection in macaques. *The Journal of experimental medicine* **2014**, *211*, 2061-2074.
372. Saen P O'Brien, A.E.S., Gregory Q. Del Prete, Christine M Fennessey, Carolyn Williamson et al. In *Rational design and in vivo selection of SHIVs encoding Transmitted/Founder subtype C HIV-1 envelopes*, 34 annual symposium on nonhuman primate models on AIDS Louisiana, 2016; Louisiana.

Le VIH-1 a été découvert depuis plus de trois décennies, dès-lors, il a infecté plus de 80 millions de personnes dans le monde. C'est toujours un défi de créer un vaccin thérapeutique qui peut induire une immunité protectrice. Les stratégies classiques de conception de vaccins n'ont pas réussi à créer un vaccin qui peut contrôler le virus et induire une immunité antivirale. Ceci est dû à la combinaison de facteurs tels que la variabilité des antigènes, la complexité du virus et des cellules cibles du virus ainsi que les difficultés à déclencher des bNAbs. Le vaccin efficace doit être capable d'induire non seulement l'immunité cellulaire, mais aussi l'immunité humorale. Le seul vaccin qui présente un résultat encourageant est le RV144 avec 31% d'efficacité. Il dispose d'un vecteur recombinant de Canarypox et un renforcement de protéine gp120.

### **Partie I - Le vaccin contre la réplication à cycle unique**

L'objectif principal de notre laboratoire dans le développement du vaccin est d'augmenter la capacité du vaccin à induire une réponse immunitaire capable de contrôler les charges virales et d'éliminer le virus. L'autre objectif est de développer le vaccin ADN qui soit sûr et aussi efficace que les virus atténués. Le vaccin actuel CAL-SHIV-IN<sup>7</sup> développé dans notre groupe couvre les caractéristiques mentionnées ci-dessus. Il est basé sur le génome lentiviral SHIV-KU2 complet qui peut maximiser le spectre antigénique et induire une réponse immunitaire contre plusieurs épitopes conformés pour produire les immunogènes lentiviraux qui amorcent également le TSCM (données non publiées). L'unicité de ce vaccin est sa capacité à avoir une réplication à cycle unique et également l'induction de VLP qui est impliquée dans l'augmentation de l'immunogénicité du vaccin. Ce vaccin n'est strictement pas intégratif donc sûr. Les LTR sont commutés vers CAEV qui sont constitutifs et Tat indépendants.

Dans le cadre de ma thèse de doctorat, j'ai encore amélioré le développement du vaccin en :

1)- transférant l'enveloppe CXCR4 de CSH-DIN à l'enveloppe CCR5 à partir des souches transmises / fondatrices (T / F) du clade C. Ce changement d'enveloppes est très significatif dans un vaccin car il développe la réponse immunitaire contre l'épitope de l'enveloppe T / F. Les virus avec enveloppe (T / F) sont les premiers variants du VIH-1 qui sont sélectionnés dans l'établissement l'infection initiale.

2) La deuxième amélioration du vaccin consistait en la mise au point de nouvelles stratégies pour incorporer les adjuvants moléculaires dans ces constructions vaccinales avec les enveloppes fondatrices de l'émetteur. Les adjuvants moléculaires sélectionnés sont les cytokines immunostimulantes IL-7 et IL-15 en raison de leur rôle dans l'augmentation des réponses des cellules T CD8 +, la maturation des DC, les macrophages, le maintien de la population de cellules T naïve et la régulation de l'homéostasie des lymphocytes T.

L'objectif principal de l'adjuvant pour ces vaccins ADN était de stimuler et de proliférer les lymphocytes T, bien qu'il puisse y avoir d'autres cytokines et adjuvants qui ont été développés

ces dernières années qui induisent l'immunité bNAbs ou antigène spécifique mais qui n'étaient pas intéressant pour le vaccin [ 6,7].

Pour la commutation de l'enveloppe tropique pour le CXCR4 existante de l'enveloppe CSH-DIN tropique pour le CCR5, on a utilisé les enveloppes CCR5 du clade C fondateur de l'émetteur à partir de trois clones moléculaires infectieux de longue durée dérivés des patients de la cohorte zambienne [8]. L'enveloppe du virus fondateur de l'émetteur (Z331 T/F, Z3618 T/F, Z3678 T/F) a été remplacée avec succès dans le CSH-DIN. Parallèlement à la construction du vaccin fondateur de l'émetteur, j'ai également développé le vaccin avec l'enveloppe CCR5 d'un virus moléculaire WARO qui ont une enveloppe tropicale CCR5.

L'analyse fonctionnelle de ces quatre vaccins différents est corrélée avec l'intégrité de l'enveloppe T/F dans les nouveaux vaccins. Les études de tropisme réalisées sur les différentes lignées cellulaires des co-récepteurs CCR5 et CXCR4 ont montré que la particule virale issue du vaccin nouvellement construit conservait le tropisme du co-récepteur CCR5 du T/F. Les cellules infectées par Ghost Hi 5 présentaient moins de 30% de fluorescence avec le vaccin CSH-DIN-T/F-31, CSH-DIN-T/F-18, CSH-DIN-T/F-78 50% fluorescent. De plus, l'expression de la protéine p27 de SIV Gag est conforme à la capacité du vaccin CSH-DIN - T/F-31, CSH-DIN-T/F-18, CSH-DIN-T/F-78, CSH-DIN-WARO à produire une protéine virale, moins par rapport au CSH-DIN en raison de la mauvaise qualité de l'ADN utilisé dans la transfection. La quantité de p27 par CSH-DIN était équivalente au précédent vaccin CAL-SHIV-IN (~ 20 ng / ml) [2].

Pour la démonstration de la réplication à cycle unique, le milieu de culture des cellules transduites a été inoculé (round1) passage1 sur les cellules Ghost Hi5, moins de 30% de cellules infectées par fluorescence ont été observées, alors que dans les infections de passage 2 (round 2) aucune cellule fluorescente infectée n'a été observée. Bien que l'ELISA sur la production de p27 de GIV de SIV détectée dans les milieux de culture de cellules U87 qui ont été inoculées avec les milieux de culture des cellules transfectées, le passage 1 (round 1) et le passage 2 ultérieur (round 2) était non concluant en raison de l'absence de témoins appropriés pour établir l'arrière-plan des seuils de positivité.

Même si certains résultats ne sont pas totalement concluants, ils fournissent l'analyse fonctionnelle de la construction du vaccin avec l'enveloppe T / F modifiée et le tropisme CCR5. Ces résultats démontrent également que le vaccin transfecté dans les cellules peut produire les particules virales qui peuvent se rassembler et montre une infectivité réussie des lignées cellulaires tropicales CRR5.

### **Perspectives de la Réplication à Cycle Unique Vaccine Compétente**

Ces constructions peuvent être testées dans les modèles de souris pour étudier l'immunogénicité et nous pouvons nous attendre à ce que ces constructions de vaccin induisent efficacement l'IFN- $\gamma$  produisant une réponse TIL spécifique à des antigènes SHIV en tant que CAL-SHIV-IN [1,2] parentale en plus de Des réponses spécifiques à l'antigène T / F. Bien que les antigènes T / F ne soient pas bien décrits, mais leurs propriétés phénotypiques

indiquent qu'ils ont une interaction plus élevée avec les cellules dendritiques et une forte résistance à l'IFN- $\alpha$  [9]. Dans une étude comparant la capacité de l'enveloppe différente à induire l'anticorps neutralisant, les enveloppes T / F se lient avec une affinité plus élevée au MAb17b et provoquent un anticorps faible mais puissant largement neutralisant [10]. On peut s'attendre à ce que le nouveau prototype de vaccin puisse induire un anticorps largement neutralisant qui améliorera l'efficacité par rapport à la construction parentale CAL-SHIV-IN qui ne pourrait pas induire d'anticorps neutralisants.

L'étape suivante de l'amélioration du vaccin consistait à développer la stratégie pour introduire les adjuvants moléculaires IL-7 et IL-15. Ainsi, une séquence de kozak pour réinitialiser les adjuvants moléculaires a été introduite en amont du gène vif, un site de restriction unique (AgeI) a également été ajouté avec lui. Un espaceur de 16 pb a également été introduit en aval du gène RNaseH.

Afin d'étudier la fonctionnalité de l'emplacement avant l'introduction des adjuvants, on a utilisé un EGFP à partir du pNL-4A Nef-EGFP. Le gène EGFP a été introduit en cet endroit en aval de la séquence kozak. De manière surprenante, la construction de vaccin CSH-IN-EGFP n'a pas exprimé les protéines EGFP. Il peut y avoir deux explications: d'abord, l'emplacement en aval de RNaseH et en amont de vif n'est pas un emplacement approprié pour une nouvelle incorporation de gène et une expression ultérieure pour des raisons inconnues. Et la deuxième raison pourrait être que la séquence de Kozak qui est impliquée dans l'initiation de la traduction d'une manière dépendante du capuchon n'a pas été en mesure d'améliorer l'EGFP en usage à cet endroit. Donc, pour écarter la deuxième raison et contourner la traduction dépendante du cap, l'IRES-EGFP semblait être une alternative appropriée. Les IRES sont des adaptations virales spéciales qui permettent de contourner la traduction dépendante du capuchon

Actuellement, le CSH-DIN-IGFP est en construction. Et on peut s'attendre à ce que la construction de vaccin CSH-DIN co-exprime EGFP qui nous donnera la preuve que l'emplacement est approprié pour l'incorporation des adjuvants moléculaires. En outre, l'intensité de l'EGFP permettra également de déterminer l'expression future des adjuvants moléculaires à cet endroit, même avant l'incorporation des adjuvants moléculaires dans le vaccin pour pouvoir être mesurée quantitativement par le test ELISA.

Dans la perspective de ce travail de thèse, d'autres études seront effectuées avec le CSH-IN-IEGFP, afin de démontrer le profil de migration du vaccin in vivo par fluorescence imagerie des modèles de souris vaccinées. L'imagerie révèle une protéine fluorescente verte distincte qui nous permettra de cartographier la migration inter-cellulaire du vaccin et d'étudier le transfert de gènes, l'interaction avec différents types cellulaires et l'expression comme précédemment montré dans différentes études [11,12].

En outre, nous quantifierons le mouvement des cellules EGFP + mobiles et découvrirons la cinétique du vaccin à différents intervalles de temps. La caractéristique la plus intéressante de l'outil d'imagerie in vivo est l'imagerie statique des souris anesthésiées avec des anticorps anti-

CD8 (ou anti CD4) anti-CD3 conjugués au PE et d'autres marqueurs pour déterminer l'interaction, la localisation et l'expression du vaccin EGFP + dans différents Sous-types de lymphocytes T.

L'un des objectifs majeurs est d'effectuer une cytométrie de flux polychromatique avec différents marqueurs définissant la lignée (CD4, CD8 et CD3) pour étudier les cellules T immunitaires spécifiques du VIH dans la population GFP + des splénocytes activés. Alors que l'analyse cytométrique en flux permettra également de révéler les cellules EGFP + dans les ganglions lymphatiques de drainage inguinal à différents intervalles de temps. En outre, les ganglions lymphatiques récoltés peuvent être utilisés pour une analyse histologique afin de détecter la GFP rapporteuse de la zone de cellules T du cortex.

L'approche mentionnée ci-dessus sera encore utilisée pour comparer et étudier les profils de migration et les cellules cibles du vaccin candidat avec des enveloppes différentes (CXCR4, CCR5 et T / F) avec un rapporteur EGFP.

La perspective suivante de la thèse sera d'inclure les cytokines moléculaires dans le vaccin et d'étudier ses effets sur l'efficacité du vaccin initialement en culture cellulaire et plus tard dans le modèle de souris et de singe.

## **Partie II - La construction compétente pour la réplication pour étudier la latence et le développement d'un virus de challenge basé sur SHIV avec une enveloppe T / F CCR5 de Clade C.**

L'un des principaux facteurs qui jouent un rôle déterminant important dans la latence / persistance est la transactivation de la transcription du génome du VIH / SIV par la protéine Tat. Il y a eu le développement de différentes lignées cellulaires clonales transformées infectées par le VIH-1 pour comprendre la base moléculaire de la latence du VIH-1. Ces premières études ont suggéré que la latence du VIH-1 est régulée par une interaction mutiparamétrique complexe entre le virus et les facteurs hôtes. En outre, il est amélioré si l'ADN viral est intégré dans la chromatine condensée ou les régions non codantes de l'ADN génomique. Dans le promoteur viral, il y a établissement d'un code histone suppressif qui stabilise l'état latent du provirus intégré. Plusieurs tentatives ont été faites pour épuiser thérapeutiquement les réserves latentes de VIH-1 sur la base de la compréhension des mécanismes moléculaires, la plupart de ces stratégies mettent l'accent sur l'activation du promoteur viral intégré mais transcriptionnellement silencieux. Cependant, ces études ne disposent pas d'un modèle lentivirus / animal adéquat.

### **A) CAL-SHIV-IN<sup>+</sup>**

Notre laboratoire a développé CAL-SHIV-IN<sup>+</sup> un nouveau génome de lentivirus de primates (SIV et HIV) qui sont conduits par les LTR du lentivirus naturel des chèvres, CAEV. Ces LTR sont totalement indépendants de Tat transactivation et se sont avérés être pleinement constitutive pour l'expression des gènes entraînés dans tous les types de cellules étudiées [13].



En outre, le gène de l'intégrase a été remplacé dans ces génomes par celui du CAEV pour obtenir des virus compétents pour la réplication.

Le but de ces constructions lentivectorales est de comprendre l'influence de la protéine Tat et le pourcentage de latence induite dans les modèles avec des LTR dépendantes de Tat et la comparer avec les LTR qui sont indépendantes de la transactivation de Tat. CAL-SHIV-IN<sup>+</sup> est un modèle unique qui est totalement indépendant de la transactivation Tat des LTR alors que SHIV<sub>KU2</sub> avec les LTR SIV classiques sont Tat dépendants pour la transactivation.

Dans cette thèse, j'ai commencé par l'analyse du lentivateur CAL-SHIV-IN<sup>+</sup> et j'ai séquencé la région autour du site de construction du gène de l'intégrase CAEV et rencontré des mésappariements et le changement d'ORF dans le vif. Et après quelques plus de débogage et le séquençage du génome entier, j'ai eu un CAL-SHIV-IN<sup>+</sup> mais cette construction n'était pas répliquative.

## **B) CSH-INP**

Afin de surmonter les limites du CAL-SHIV-IN<sup>+</sup> et de développer la version compétente de la réplication du lentivecteur, le PPT de CAEV manquant a été introduit et ainsi CSH-INP a été développé. Cette construction a été testée in-cellulo pour son infection, sa réplication et sa production d'antigène viral. Le test d'infectivité du virus sur différentes lignées cellulaires (M8166, TZM-bl) n'a pas produit l'effet cytopathique classique. Mais lors de la co-culture des cellules M8166 avec les cellules HEK293-T transfectées, le M8166 a montré le CPE dû à la fusion de l'enveloppe, ce qui montre que le peptide Env viral est produit. La production d'antigène viral à partir des cellules T HEK293-transfectées en triple testées le jour 1,2,4,6,8,10. Le pic de la production de p27 était le jour 2 et une baisse régulière de la production de p27 a été observée le jour

6,8,10. Tandis que le témoin positif SHIV<sub>KU2</sub> présentait un p27 valus élevé <15ng / ml pendant les jours 4,6,8 avant de chuter au jour 10 en raison de la perte de cellules HEK293T sur 10 jours. Les tests d'infectiosité sur M8166 n'ont pas montré d'infection productive, donc il y avait un besoin d'adaptation, l'adaptation expérimentale rapportée précédemment pourrait accumuler des mutations nécessaires aux cellules non-syncytium indiquant dans le syncytium [14-16]. Le modèle d'adaptation a été utilisé sur les lignées cellulaires M8166 et CEMX174 pour adapter le CSH-INP. Le virus ne présentait aucun signe d'adaptation sur le temps de 19 passages sur M8166 et de 8 passages sur CEMX174. Le centre de l'adaptation a été déplacé sur les cellules primaires PBMCs pour une adaptation réussie. Puisque les PBMC sont un mélange de lymphocytes (lymphocytes T, cellules B, cellules NK) monocytes et imite les principales cellules du système immunitaire impliquées dans la pathogenèse du VIH / SIV, les PBMC donnent au virus une meilleure opportunité d'adaptation plutôt qu'une seule lignée cellulaire. Le laboratoire du Dr Villinger a collaboré à l'adaptation du CSH-INP. Pour les adapter sur les PBMCs de macaque rhesus. Après plusieurs tentatives pour récupérer le virus dans différents passages, ils maintiennent finalement la culture d'adaptation dans 5 ml de tubes de culture tissulaire dans l'incubateur au lieu du flacon, ce qui a donné le virus plus de

contact aux cellules primaires pour l'adaptation (figure 3.14). Dans le passage 3 et le passage 4 d'adaptation sur les PBMC, on a observé que le virus pouvait produire 106-107 copies virales par ml et pouvait maintenir les numéros de copies virales stables pendant 12 jours. Montrant ainsi que les vecteurs compétents pour la réplication virale sont en train d'être adaptés de façon stable.

Ces résultats montrent un développement d'un lentivirus chimérique qui présente une stratégie compliquée avec les LTR de CAEV, l'intégrase de CAEV et le PPT de CAEV. La capacité de ce modèle unique développé à se reproduire de manière productive montre les nouvelles façons possibles de comprendre la réplication de lentivirus chimériques compliqués. En l'absence de SIV Ubox, mais en présence de PPT CAEV dans CSH-INP, les virus ne montrent aucun retard dans la capacité de réplication du virus après la transcription. Comme on peut le voir en l'absence de SIV Ubox les résultats de la recherche effectuée par le Dr Desrosiers où il a souligné l'élément séquence immédiatement en amont du tractus polypurine est essentielle pour la réplication des virus de l'immunodéficience simienne [17]. Dans CSH-INP, l'absence de Ubox n'a pas d'effet puisque les LTR et l'intégrase sont également échangées avec les LTR CAEV et l'intégrase CAEV. La capacité du virus CSH-INP avec le LTR de CAEV qui a une transcription indépendante de Tat et le temps qu'il ne subit pas de latence en absence de Tat est encore à étudier.

### **C) SHIV-YCC**

Dans la seconde stratégie pour développer le virus compétent pour la réplication avec des LTR de CAEV indépendants de Tat, le SHIV-YCC a été conçu. Cette conception était significativement différente de la stratégie mentionnée ci-dessus CSH-INP. Dans SHIV-YCC, les LTR du SHIV-KU2 classique ont été échangés avec les LTR de CAEV qui avaient la séquence att du SIV pour l'intégration. Les premières études de cellulose sur le virus ont été faites pour étudier l'infectiosité, la réplication et quantifier la production de protéines virales. Le test d'infectivité effectué sur M8166 a montré quelques effets cytopathiques cohérents sur les passages 1,2,3. L'ADN génomique a été extrait du passage 2 infecté M8166. La PCR a été effectuée avec des amorces ciblées sur le gag de SIV, 5'LTR et 3'LTR, I a trouvé le gag SIV amplifié et dans les séquences LTR amplifiées les LTR chimériques avec la séquence att de SIV ont été trouvés montrant que la réplication compétente SHIV-YCC Était présente dans le M81466 infecté dans les cellules infectées par le passage 2. En outre j'ai fait la quantification de la p27

En utilisant un ELISA test anti SIV Gag protéines. Le p27 a été quantifié à partir des surnageants cellulaires transfectés pendant la période de 10 jours (en triple). Les résultats montrent une production élevée de p27 ~ 20 ng/ml pendant les 4 premiers jours après transfection qui tombe à 18 ng/ml le jour 6 et Continue à tomber et le jour 10 la valeur p27 est d'environ 4 ng/ml. De même, le contrôle positif compétent pour la réplication SHIV-KU2 présente la même tendance à la production de p27. SHIV-YCC a également été envoyé à notre collaborateur, le laboratoire du Dr Villinger pour l'adaptation sur les PBMCs de macaque rhesus semblables à CSH-INP. Le

passage 3 et le passage 4 de l'adaptation de SHIV-YCC sur les PBMC ont montré 105-106 copies virales par ml, mais les copies virales dans le passage 5 sont tombées à 103-104 copies virales par ml. Ces résultats montrent que le virus est en train d'être adapté mais ils perdent l'infectivité et le modèle de réplication avec les passages. La capacité du virus SHIV-YCC avec LTR CAEV qui ont une transcription indépendante de Tat et le temps qu'il ne subit pas de latence en l'absence de Tat est encore à étudier.

### **Perspectives des constructions CSH-INP et SHIV-YCC compétentes pour la réplication**

Les principaux objectifs des constructions CSH-INP et de réplication SHIV-YCC sont d'étudier comparativement les facteurs hôtes qui contrôlent la latence / persistance du VIH-1 / SIV de type sauvage avec notre nouvelle chimère CSH-INP et SHIV-YCC qui ne subit pas de latence.

Ceci sera fait en examinant si CSH-INP et SHIV-YCC, et son SHIV-KU2 parental ont n'importe quel modèle différentiel d'expression de gène viral. Cela sera réalisé en inoculant le CSH-INP et le SHIV-YCC, et le virus SHIV-KU2 avec des PBMC humaines et / ou macaques non-stimulées et CDA-2 stimulées par ConA / IL-2 en parallèle à un MOI = 1 et 24h plus tard et tous les 24h La fraction sera utilisée pour évaluer par PCR en temps réel la proportion de cellules ayant le provirus. Les cellules infectées de façon latente auront le provirus mais ne les exprimeront pas. Pour identifier phénotypiquement les cellules infectées et répliquer le virus dans les PBMCs, les cellules infectées seront colorées avec la surface (CD3, CD4, CD95, CD62L, CD68, CD45RA et CD45R0) et les mAb intracellulaires SIV Gag et examinées par cytométrie en flux. Dans la cytométrie de flux, le passage sur les cellules activées CD3 + / CD4 + SIVGag + sera séparé des cellules non activées. Les cellules non activées seront en outre fermées pour séparer la population des cellules CD4 + au repos et des cellules T mémoire.

Nous supposons que si dans la transactivation dépendante de Tat, la population des cellules activées par rapport aux cellules non activées est de 60:40, et sur les 40% non activées (10% infectées de façon productive, 50% infectées de façon latente et 40% non infectées). -infectés) et lorsque ces cellules (10% infectées de manière productive, 50% infectées de façon latente). Dans le groupe (10% infecté + 50% infecté de façon latente), les résultats de la PCR doivent montrer un ADN intégré alors que la charge virale p27 et ARN sera faible, ce qui correspond à seulement 10% de cellules infectées car 50% restent latentes et ne produiront pas de ARN viral ou des protéines. Tandis que dans le groupe indépendant Tat des PBMCs, le groupe non activé de cellules sera (60% infecté de manière productive et 40% non infecté, pas de cellules infectées de façon latente en raison de Tat LTR constitutives). Dans le cas du groupe Tat indépendant, les résultats de la PCR indiquent 60% d'ADN intégré et les protéines p27 virales et la charge virale d'ARN correspondra également à 60% de cellules infectées.

Cette démonstration montrera que les constructions chimériques indépendantes de Tat ne subiront pas de latence par rapport à la SHIV-KU2 dépendante du tat.

La prochaine perspective importante sera de cartographier les facteurs cellulaires impliqués qui sont impliqués dans la latence / persistance indépendant Tat et non impliqués dans le parent. Ces dernières années, il ya eu un développement significatif de la technologie à base de micro-arrays et cela a permis d'effectuer une analyse génomique de l'expression de l'ARN. Grâce à la transcriptomique, l'expression de l'ARNm dans la population cellulaire (infectée latente, infectée, non infectée) peut être examinée. Différents groupes ont développé des modèles pour induire la latence et trié les cellules infectées latente pour isoler l'ARN pour effectuer la transcriptomique [18-20]. Dans le cas du CSH-INP, du SHIV-YCC et du SHIV-KU2 comme décrit précédemment, le virus sera inoculé avec des cellules PBMC humaines et / ou macaque non stimulées par ConA / IL-2 stimulées et non étirées par CD8. Les cellules infectées latent seront triées de chaque groupe (CSH-INP, SHIV-YCC et SHIV-KU2). L'ARN sera extrait des populations cellulaires des différents groupes (CSH-INP, SHIV-YCC et SHIV-KU2) et coloré avec le Cyn3 et le cyn5 (colorant pour échange) et utilisé pour l'analyse de microarray. L'analyse de microarray révélera l'expression régulée et régulée négativement de l'ARN pour les fonctions suivantes (Activation, prolifération, survie, expression génique, fonction immunitaire, métabolisme cellulaire). Ceci donnera une analyse transcriptome complète de cellules CD4 + infectées latentes des différents groupes ( CSH-INP, SHIV-YCC et SHIV-KU2). Ces résultats pourraient également conduire au développement de marqueurs spéciaux de latence. Cela permettra également de simuler et de développer des modèles biostatistiques de l'expression de ces facteurs dans les lignées cellulaires infectées de façon latente et d'évaluer les stratégies de retrait de la latence. En outre nous visons comme une perspective du travail sera de développer des modèles de la cinétique d'éradication du réservoir dans des modèles animaux. Nous utiliserons à la fois les modèles NSG-SCID de souris et de macaque du VIH dans cette étude pour examiner l'éradication du réservoir.

De plus, le développement d'une version tropique du modèle CCR5 SHIV-YCC et CSH-INP pourrait déchiffrer les étapes initiales de l'infection et plus de perspicacités sur la latence indépendante Tat transactivation.

### **Partie III- SHIV-AD8EO avec T / F Envelopes**

Le caractère unique des enveloppes T/ F clade C CCR5 décrites et isolées de la cohorte zambienne par le laboratoire du Dr Eric Hunter combiné au virus de la famille SHIV-AD8, SHIVAD8EO (tropique CCR5) développé par le laboratoire du Dr Martin Malcom nous donne un tropique CCR5 pathogène T / F SIV / VIH clone moléculaire. SHIV-AD-T/F-31 et SHIV-AD-T/F18 nous fournissent des outils uniques pour étudier la pathogenèse T / F, les événements précoces des interactions virus-hôte dans les modèles de macaque. Cet outil peut également être utilisé pour évaluer l'efficacité de la protection contre l'acquisition / réplication chez les macaques vaccinés avec les vaccins CSH-DIN- T/F-31, CSH-DIN-T/F-18, CSH-DIN-T/F-78 développés dans notre groupe.

Cette thèse présente la construction et la caractérisation des molécules pathologiques SHIV-AD-T/F-31 et SHIV-AD-T/F-18. Ces constructions ont l'épine dorsale du SHIV-AD8EO

et la région (Tat-Env) a été commutée avec la région (Tat-Env) Z331 T/F et Z3618 T/F. Ces constructions ont été séquencées pour vérifier la région d'insert. Ces constructions ont été étudiées en cellulo pour leur tropisme. Ces constructions ne infectent que les cellules Ghost Hi5 <30% (CCR5) et non M8166 (CXCR4) ont donc montré un tropisme CCR5 du T / F env, une évaluation supplémentaire peut être effectuée comme décrit dans les études de tropisme de T/F En outre.

La protéine virale p27SIV Gag a été quantifiée à partir des surnageants de cellules HEK293-T transfectés (Day1-10), la quantité de p27 produite avec le SHIV-AD-T/F-31 nouvellement construit et le SHIVAD-T/F-18 était similaire à celle du témoin positif du SHIV-AD8EO parental. Ces résultats montrent que nous avons développé un virus SHIVAD8EO avec T/F qui est CCR5 clade C.

D'autres études sont nécessaires pour déterminer la sensibilité à la neutralisation de ces nouvelles constructions CCR5 T/F SHIV-AD8EO.

### **Perspectives du SHIV-AD8EO T/F**

Ces outils uniques seront très utiles pour étudier les premiers événements d'interactions hôte / virus et l'efficacité de la protection contre l'acquisition / réplication chez les macaques vaccinés avec divers prototypes de vaccins. Les nouveaux SHIVs ont des éléments uniques qui seront très utiles pour des études fondamentales des événements initiaux Qui se produisent au cours des premiers stades de l'infection virale. Les SHIV portant des glycoprotéines d'enveloppe de T / F aideront à examiner quelles sont les propriétés associées à leur infection / réplication qui favorisent leurs sélections. De plus, ces virus sont des outils précieux pour des expériences de challenge afin d'évaluer l'efficacité des vaccins prototypes pour induire des réponses immunitaires qui abolissent ou réduisent leur transition. Enfin, puisqu'on pense que les virus T / F sont ceux qui commencent très tôt le réservoir, ces SHIV pourraient aider à développer des stratégies ciblées pour les empêcher d'établir ce type d'infection chez les personnes recevant le VIH.

### **Conclusion**

Les propriétés complexes du cycle de vie du VIH et du SIV et leurs interactions avec les cellules de l'hôte rendent les études difficiles à conduire dans les modèles naturels. Cela indique fortement la nécessité de développer de nouveaux systèmes de modèles simplifiés. Les principaux objectifs de notre laboratoire est de développer de nouveaux systèmes lentivirus chimériques qui faciliteront les études et aideront à mieux comprendre la pathogenèse des lentivirus d'une part et l'objectif du laboratoire est d'autre part est de développer un vaccin contre le VIH-1. Cette thèse représente un équilibre unique dans le développement de l'idée du laboratoire et le développement de différents clones moléculaires uniques pour étudier la pathogenèse et a également amélioré les constructions de vaccins. Cette thèse montre le moyen possible d'améliorer le CAL-SHIV-IN existant en échangeant l'enveloppe tropicale CXCR4 du vaccin à l'enveloppe T / F CCR5. En outre, le CSH-DIN a

été développé pour inclure les cytokines, CSH-DIN a donc la séquence kozak à incorporer avec le linker et un site de restriction unique où l'IL peut être incorporé.

Le développement de génomes de lentivirus chimériques (CSI-INP & SHIV-YCC) qui sont entraînés par les LTR du lentivirus naturellement atténué des chèvres, CAEV. Ces LTR constitutives sont indépendantes de Tat transactivation pour l'expression génique dans les génomes, indépendamment des types de cellules transduites. Ces génomes génétiquement modifiés ont été génétiquement modifiés, dans SHIV-YCC, dans lesquels j'ai introduit les séquences aux extrémités des LTR de CAEV, nécessaires pour réussir la transcription inverse et l'intégration. Bien qu'il y ait inclusion d'un PPTe de CAEV dans le CSH-INP pour réussir la transcription inverse et l'intégration. On s'attend à ce que ces deux constructions soient compétentes pour la réplication avec l'expression constitutive du génome viral dans tous les types de cellules transduites. Nous avons émis l'hypothèse que cette expression constitutive et la réplication virale se produiraient également dans les lymphocytes T CD4 + au repos dans lesquels l'infection par les lentivirus de primates subit une latence jusqu'à leur activation.

J'ai également développé des SHIV chimériques portant des glycoprotéines C CCR5-tropiques de clade C provenant de clones moléculaires infectieux soit d'un génome viral adapté au laboratoire (SHIV-WARO), soit d'un émetteur / fondateur SHIV-AD-T/F-31 et SHIV-AD-T/F-18. Ceux-ci seront très utiles pour déchiffrer les interactions hôtes-pathogènes au stade précoce chez les macaques, en plus de comprendre les caractéristiques T/F. Ces modèles seront également des outils utiles pour évaluer l'efficacité de la protection contre l'acquisition / réplication chez les macaques vaccinés avec les vaccins CSH-DIN-T/F-31, CSH-DIN-T/F-18, CSH-DIN-T/F-78 développés dans notre groupe.

**The Review- Comparative Analysis of Tat-Dependent and Tat-Deficient Natural Lentiviruses.**

**Bose, D.; Gagnon, J.; Chebloune, Y. Vet. Sci. 2015, 2, 293-348.**

Review

## Comparative Analysis of Tat-Dependent and Tat-Deficient Natural Lentiviruses

Deepanwita Bose, Jean Gagnon and Yahia Chebloune \*

Pathogénèse et Vaccination Lentivirales, PAVAL Lab., Université Joseph Fourier Grenoble 1, Bat. NanoBio2, 570 rue de la Chimie, BP 53, 38041, Grenoble Cedex 9, France;

E-Mails: deepanwita.bose@ujf-grenoble.fr (D.B.); jean.gagnon@ujf-grenoble.fr (J.G.)

\* Author to whom correspondence should be addressed; E-Mail: ychebloune@clermont.inra.fr; Tel.: +33-045-652-0866; Fax: +33-045-652-0852.

Academic Editors: Ellen (Liz) Sparger and Jane Sykes

Received: 29 June 2015 / Accepted: 24 August 2015 / Published: 29 September 2015

---

**Abstract:** The emergence of human immunodeficiency virus (HIV) causing acquired immunodeficiency syndrome (AIDS) in infected humans has resulted in a global pandemic that has killed millions. HIV-1 and HIV-2 belong to the lentivirus genus of the *Retroviridae* family. This genus also includes viruses that infect other vertebrate animals, among them caprine arthritis-encephalitis virus (CAEV) and Maedi-Visna virus (MVV), the prototypes of a heterogeneous group of viruses known as small ruminant lentiviruses (SRLVs), affecting both goat and sheep worldwide. Despite their long host-SRLV natural history, SRLVs were never found to be responsible for immunodeficiency in contrast to primate lentiviruses. SRLVs only replicate productively in monocytes/macrophages in infected animals but not in CD4+ T cells. The focus of this review is to examine and compare the biological and pathological properties of SRLVs as prototypic Tat-independent lentiviruses with HIV-1 as prototypic Tat-dependent lentiviruses. Results from this analysis will help to improve the understanding of why and how these two prototypic lentiviruses evolved in opposite directions in term of virulence and pathogenicity. Results may also help develop new strategies based on the attenuation of SRLVs to control the highly pathogenic HIV-1 in humans.

**Keywords:** Lentiviruses; HIV; CAEV; pathogenesis; Tat; latency

---



## 1. Background

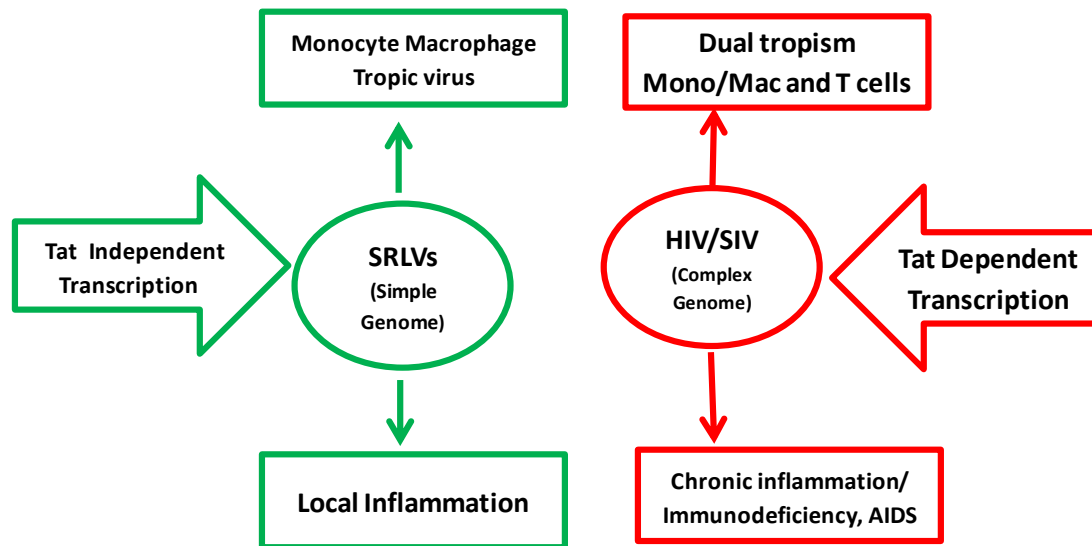
HIV type 1 and 2, like small ruminant lentiviruses SRLVs, belong to the lentivirus genus of the *Retroviridae* family. They are small single-stranded enveloped RNA viruses characterized by reverse transcription of their RNA into double-stranded DNA for their replication. Additional members of this genus are the simian immunodeficiency viruses (SIVs) which infect various species of monkeys, bovine immunodeficiency virus (BIV) which infects cattle, feline immunodeficiency (FIV) which infects domestic cats and a variety of wild felids, equine infectious anemia virus (EIAV) which infects horses, and the small ruminant lentiviruses (SRLVs) with the prototypic caprine arthritis encephalitis virus (CAEV) and Maedi Visna Virus (MVV) which infect mainly goats and sheep, respectively. It has been well established now that HIV-1 and HIV-2 arose in humans following recent zoonosis of SIVcpz from chimpanzees (*Pan troglodyte*), SIVgor from gorillas, and SIVsmm from Sooty mangabey macaques, respectively [1–3]. The viruses have repeatedly crossed the species barrier, caused infections, and adapted into human cells to become highly replication-competent and transmissible from human to human, resulting in increased pathogenesis in their new host.

Since the discovery of HIV-1 by Montagnier and Barré-Sinoussi's laboratory [4] over three decades ago, there have been nearly 80 million individuals infected and, prior to the development of efficient therapy, more than 35 million worldwide have progressed to AIDS and died from disease. Today there are over 35 million individuals living infected with HIV-1.

AIDS is characterized by low CD4<sup>+</sup> T cell counts (below 200 cells/ $\mu$ L), hemogram abnormalities, chronic immune activation, and the occurrence of opportunistic infections. AIDS is often preceded by the co-receptor usage shift of the virus from CCR5 (macrophage-tropic) expressed predominantly at the surface of memory CD4<sup>+</sup> T cells to CXCR4 (lymphocyte-tropic) at the surface of activated naïve CD4<sup>+</sup> T cells, leading to severe depletion of these cells and impaired regeneration of the immune system [5]. The molecular mechanisms responsible for the CCR5 to CXCR4 switch remain still to be determined.

MVV causing disease was intensely studied in Icelandic sheep following the import of Karakul Asian breed sheep from Germany in 1933 to genetically enrich local breeds. The sheep were quarantined and distributed to different places in Iceland. Within a span of few years, Icelandic sheep started showing signs of diseases, mostly lung (maedi) and CNS (visna) diseases [6,7]. CAEV causing disease was identified in the 1970s when caprine flocks showed neurological symptoms in kids and synovial arthritis in adults. In cell culture, MVV shows markedly more cytopathogenicity in infected monolayer cells than CAEV. The major tropism of MVV and CAEV is for macrophages and dendritic cells but not CD4<sup>+</sup> T cells *in vivo* [8,9]. Although HIV-1 also infects these cells, the virus replication occurs predominantly in CD4<sup>+</sup> T lymphocytes in infected humans. Thus, SRLVs only cause productive infection, inflammation, and chronic degenerative diseases in 20–50% of naturally infected animals; this affects the central nervous system, lungs, udder, and joints. In contrast, HIV-1 infection in humans is associated with impairment of the immune system in nearly 100% of infected individuals. In the absence of therapy, infected patients undergo progressive destruction of CD4<sup>+</sup> T lymphocytes, leading to AIDS and death due to opportunistic infections (Figure 1).

Here we will examine and compare the biological, pathological, and host/pathogen interactions in SRLVs of sheep and goats *versus* HIV-1/SIV of human and non-human primates.



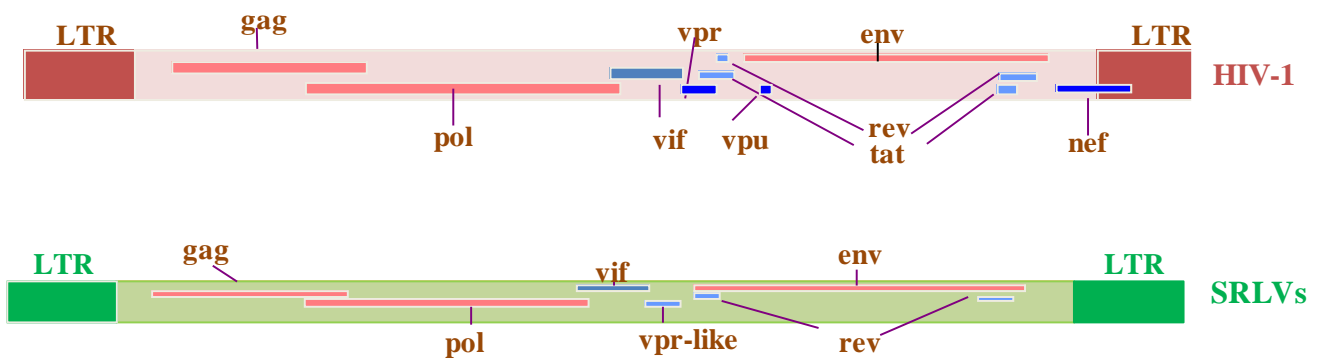
**Figure 1.** Comparison of SRLV and HIV-1 properties. SRLV replication is restricted to monocyte/macrophage cell lineage. HIV-1 can target both monocytes/macrophages and CD4+ T cells using CD4 as the main receptor and either CCR5 or CXCR4 as the co-receptor. The replication of HIV/SIV is highly dependent on Tat transactivation, while replication of SRLVs is fully independent and constitutive. The pathogenesis of SRLVs is characterized by local inflammatory diseases in target organs while HIV-1 induces chronic systemic inflammation and immunodeficiency leading to AIDS and multi-organ degenerative diseases.

## 2. Genome Organization of SRLVs and HIV-1

The HIV-1 genome contains the classical *gag*, *pol*, and *env* genes found in all replication-competent retroviruses. The genome has also three regulatory genes, *tat*, *rev* and *vif*, whose products are necessary for efficient replication, and three auxiliary genes, *nef*, *vpr* and *vpu*, whose products are involved in virus/host interactions and pathogenesis. The HIV-1 genome with its nine major genes is more complex than SRLV genomes which, in addition to *gag*, *pol* and *env*, contain only two regulatory *vif* and *rev* genes and one auxiliary gene called “*tat*”. The latter from here on will be referred to as *vpr*-like gene [10]. The low pathogenicity of SRLVs compared to HIV-1 can potentially be linked to the absence of proteins encoded by *nef*, *vpu*, and *tat* genes (Figure 2).

The HIV-1 *gag* gene produces a 55 kilodalton (kD) Gag precursor protein (Gag Pr-55) that is subsequently cleaved to generate the matrix p17, the capsid p24, the nucleocapsid p7 proteins, and the p6, which is critical for virus budding. The 160 kD Env glycoprotein precursor (gp160) is expressed from singly spliced viral mRNA and then is matured by cellular protease cleavage to generate the surface gp120 and transmembrane gp41 mature Env glycoproteins. The catalytic proteins are produced from a precursor protein encoded by the *pol* gene which, following cleavage, generates the protease (Pro p10), reverse transcriptase (RT p50), and integrase (IN p31). Proteases are known to play essential roles in many biological processes. They catalyze the hydrolysis of peptide bonds with high sequence selectivity and catalytic proficiency. HIV-1 protease, a member of the aspartic protease family, is a symmetrically assembled homodimer consisting of two identical subunits of 99 amino

acids. Both subunits are involved in the catalytic activity (through an aspartic acid at codon 25). It is responsible for the cleavage of Gag-Pol, where Gag and Pol can be released during budding. In the absence of functional protease the viral assembly is not impaired, but the resulting particles are non-infectious [11,12]. RT has two enzymatic activities, a DNA polymerase that can copy either a DNA or a RNA template, and a RNase H activity that removes RNA from the RNA/DNA intermediate. Two different domains of RT are implicated in these two activities and they cooperate to convert the genomic RNA into a double-stranded linear DNA. The resulting double-stranded viral DNA is then transported into the nucleus and integrated in the host genome by IN [14].



**Figure 2.** Genomic organization of HIV-1 and SRLV proviruses. Both genomes have the structural and enzyme *gag*, *pol*, and *env* genes (solid red bars), with LTRs at the 5' and 3' ends (solid brown and green rectangles in HIV-1 and SRLVs, respectively) common to all retroviruses. The six additional open reading frames (*vif*, *vpr*, *vpu*, *tat*, *rev*, and *nef*) that encode regulatory and accessory proteins are indicated (solid blue bars), while the SRLV genomes have only three additional open reading frames (*vif*, *vpr-like*, and *rev*) [13].

## 2.1. Virus-Encoded Regulatory Proteins

### 2.1.1. Regulatory Tat

Tat is a key protein that regulates positively the expression of all genome encoded proteins in some of the lentiviruses. Detailed description of Tat and Tat functions are discussed in Sections 2.3 and 2.4.

### 2.1.2. Regulatory Rev

Rev and Tat are expressed early during the initial phases of the replication cycle from multi-spliced RNA templates [15,16]. HIV-1 Rev is a 116-amino-acid phosphoprotein translated from fully spliced viral mRNA and encodes a protein that has four functional motifs. They include (i) a nuclear localization signal (NLS) directly interacting with importin- $\beta$  for the import of Rev to the nucleus; (ii) a RNA-binding domain (RBD) that specifically directs the interaction of Rev with the Rev response elements (RRE) sequence; (iii) sequences that mediate self-interactions of Rev-Rev ending with a complex formation with the RRE; and (iv) a C-terminal leucine-rich nuclear export signal (NES) that binds to the chromosomal region maintenance 1 (CRM1) for the nuclear export of unspliced and unspliced RNA [17–20].

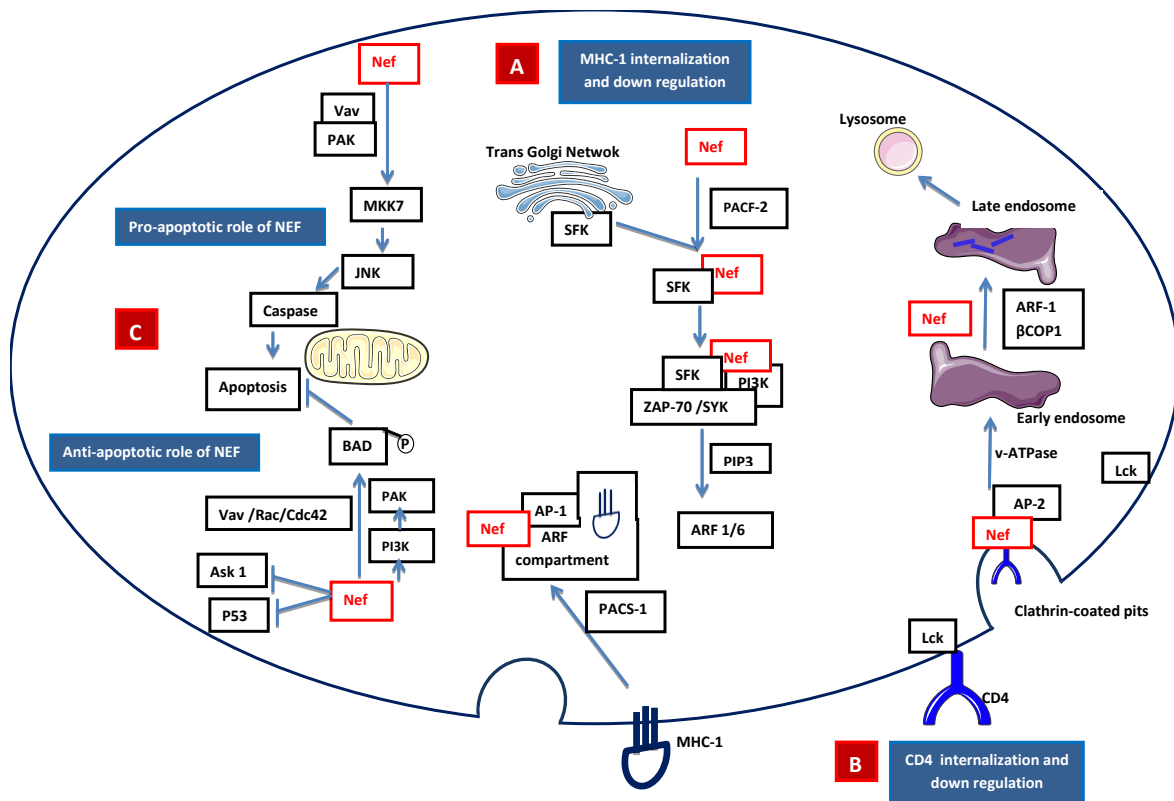
### 2.1.3. Regulatory Vif

Viral infectivity factor (Vif) is a 23 kD basic protein that is expressed in a Rev-dependent manner, largely localized in the cytoplasm of infected cells, and is essential for HIV-1 replication in lymphocytes and macrophages. Many studies using  $\Delta vif$  mutant genomes have demonstrated that these genotypes produce virions that are non-infectious, yet there is no difference in the protein or RNA contents of  $\Delta vif$  compared to the wild type [21–23]. The main role of Vif is to suppress the host antiviral defense mechanism involving the DNA editing enzyme APOBEC3G. Studies have demonstrated that Vif neutralizes the potent intracellular defense pathway of APOBEC3G that protects host cells from a retrovirus. Several members of the APOBEC family act on single-stranded DNA or RNA and they alter the nucleotide sequence through cytidine deamination, converting cytidine to uridine and thus providing an intrinsic immunity to the host [24], which is an edit-dependent process [25,26]. APOBEC inhibits the retrovirus by several mechanisms which are edit-independent processes as well [27].

## 2.2. Accessory Virus Gene Encoded Proteins

### 2.2.1 Accessory Nef

HIV-1 Nef is a 27 kD myristoylated protein that was initially thought to be a negative factor for virus replication and presents only in the intracellular compartment of infected cells. Later, Nef was found to have a positive effect on viral replication [28]. During HIV-1 infection, Nef down-regulates the surface expression of the CD4 and selective MHC class I receptors, thereby avoiding lytic HIV-1 superinfections and early elimination of HIV-1-infected cells by natural killer cells and cytotoxic T cells [29]. Nef induces internalization of MHC-I molecules that accumulate in the endosomal vesicles and are subsequently degraded. Nef also induces relocation of internalized MHC-I molecules from the cell surface to the transgolgi network (TGN) [30]. MHC-I down-regulation may involve clathrin adapter protein complex 1 (AP-1) or Src family kinase-ZAP70/Syk-PI3K cascade recruited by phosphofurin acidic cluster sorting protein 1 (PACS2) [31–33] (Figure 3A). Nef interacts with several downstream cascades and complexes, including the adaptor complex of clathrin-coated pits and the beta subunits of COP-I coatomer, to down-regulate CD4 [34]. The CD4-p56lck complex is disrupted by Nef, allowing for the internalization of CD4 and the diversion of internalized CD4 to the lysosomal pathway which results in its destruction through the phosphatidylinositol 3-kinase (PI3K) pathway [35] (Figure 3B). Nef is also found to be in the extracellular compartment, leading to interference with hematopoiesis, and its excretion may be associated with exosomes [36,37]. Nef also has an anti-apoptotic effect that promotes efficient viral replication [38] and pathogenesis. Nef activates NAK (PAK2) through guanine nucleotide exchange factor Vav and the small GTPase Rac1 and Cdc42. Nef-mediated activation of PAK involves PI3K, which acts upstream of PAK, and the Nef-associated PI3-PAK complex phosphorylates the pro-apoptotic Bad protein, thus blocking apoptosis [39,40] (Figure 3C).



**Figure 3.** Signaling model of Nef-mediated (A) apoptosis/anti-apoptosis, (B) down-regulation of expression of MHC class I molecules, and (C) down-regulation of the expression of CD4 molecules. **A. Internalization of MHC-I:** Nef accelerates the endocytosis of MHC class I molecules through PI3K-dependent activation of ADP ribosylation factor 6 (ARF6)-mediated endocytosis. First, the Nef binds PACS-2 and targets to the late Golgi/TGN; at the TGN, Nef binds and activates a TGN-localized SFK. The activated Nef–SFK complex, which leads to the signal transduction pathway recruiting and activating ZAP-70/Syk, then binds to a class I PI3K. The activated PI3K causes the accumulation of phosphatidylinositol-3,4,5-triphosphate (PtdInsP<sub>3</sub>) (PIP3) on the inner leaflet of the plasma membrane. PIP3 recruits the ARF6 guanine exchange factor (ARF6-GEF) to the plasma membrane. Nef mediates the internalization of MHC-I from the plasma membrane to an ARF-6 endosomal compartment. The endocytosed MHC-I forms a complex with Nef and AP-1 *via* phosphofurin acidic cluster sorting protein 1 (PACS1). **B. Internalization of CD4:** Lck disassociates from the cytoplasmic tail of CD4 and Nef is attached to the cytoplasmic tail of CD4 within clathrin-coated pits through the interaction of adaptor protein 2 (AP-2) and vacuolar ATPase (v-ATPase). This leads to the internalization of CD4 into the early endosome. During the formation of the late endosome, Nef interacts with βCOP1 and through ARF-1, which targets CD4 to the lysosomal degradation. **C. Apoptotic role of Nef:** Intrinsic Nef signals localized on plasma membrane activate MAP kinase kinase 7 (MKK7) and c-Jun N-terminal kinase (JNK) to induce caspase-dependent apoptosis, while the anti-apoptotic pathway is mediated by Fas cell surface death receptor (FAS) and tumor-necrosis factor receptor (TNFR) by inhibiting the apoptosis signal-regulating kinase (ASK1) and P53. Nef-mediated p21-activated kinase (PAK) activation involves PI3K, which acts upstream of PAK. Nef-associated PI3K and PAK phosphorylate the pro-apoptotic Bad protein to inactivate Bad, thus blocking the apoptosis mediated by BCL-2.

### 2.2.2. Accessory Vpr

Viral protein R (Vpr), a small basic protein (14 kDa) of 96 amino acids, is conserved in human (HIV-1 and HIV-2) and non-human (SIVs) lentiviruses. Vpr is mainly involved in the G2/M arrest of dividing cells [41–43], but it is also one of the virus protein members of the pre-integration complex that targets neo-synthesized double-stranded viral DNA to the nucleus, and it induces apoptosis and has some transactivation activity of HIV-1 long terminal repeats (LTR) [44]. The innate and cellular immunity of infected individuals is affected by the action of Vpr via the inhibition of IL-2 production and enhancement of glucocorticoid activity [45]. Vpr also triggers virus production by inducing TNF which activates HIV-1 expression and replication via the NFκB pathway. In the absence of Vpr, there is a delay in viral replication and disease progression as shown experimentally with SIVmac with mutated *vpr* [46,47].

Previously, several chimeric lentiviruses have been generated in our laboratory [48–50] by inserting the SIV *nef* and *vpr/vpx* genes separately or together in the infectious molecular genome of CAEV. All chimeras were found to be replication competent and showed increased cytopathicity in cell culture systems. The chimeric virus that has both *nef* and *vpx/vpr* genes was used along with the parental CAEV to inoculate newborn kids which were monitored for six months. The results showed that kids infected with this chimera have an increased persistence of viral replication in the blood mononuclear cells compared to kids infected with the wild-type CAEV. In addition, a persistent decrease in the proportion of circulating T cells was observed only in kids infected with the chimeric virus. Altogether, these data clearly provide the demonstration that the increased complexity of the CAEV viral genome is associated with the increased virulence of this virus.

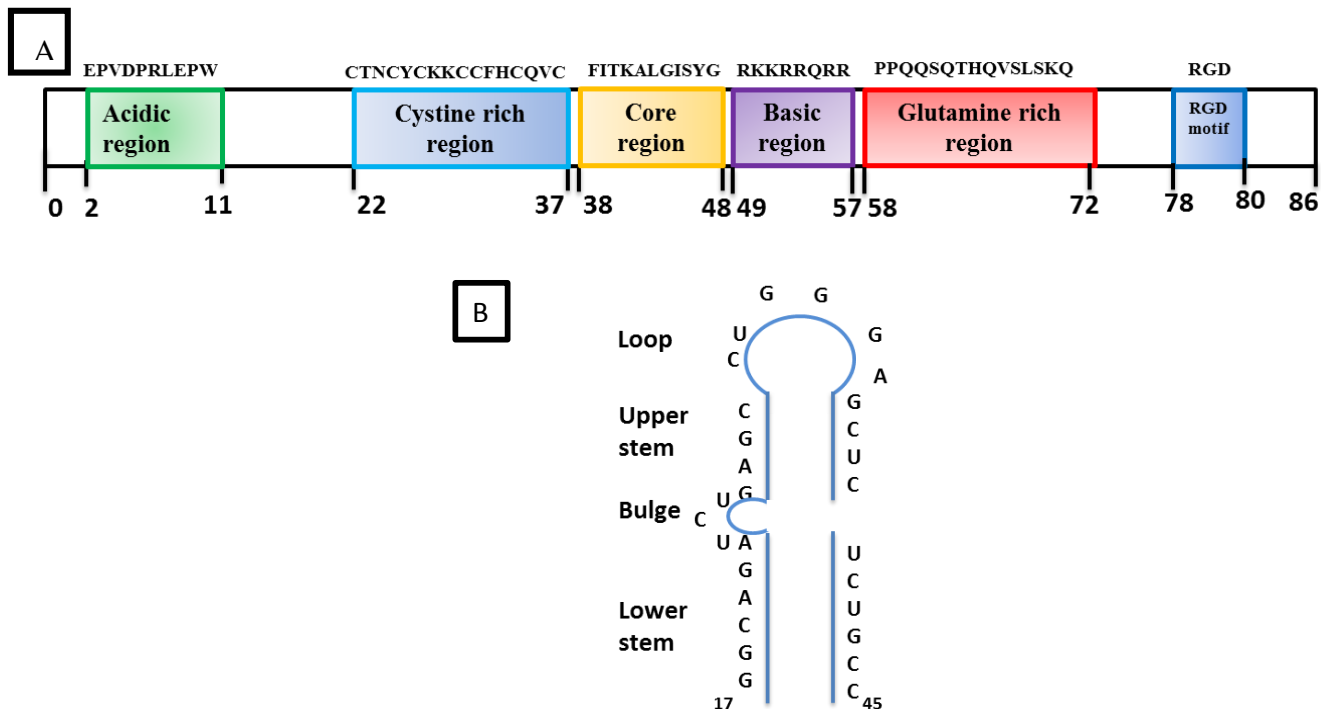
### 2.3. HIV Tat Protein

HIV-1 Tat is a 9–14 KD protein containing 86 amino acids encoded by two exons. It is one of the HIV-1 highly conserved proteins that is produced early in the HIV-1 infection. The first exon encodes the first 72 amino acids. Tat is subdivided into six functional domains (Figure 4A) including a proline and cysteine-rich N-terminal domain, a hydrophobic core, a basic region followed by a glutamine-rich region, and a C-terminal domain that contains a tripeptide RGD (Arg, Gly, Asp) [51–55]. In addition, there is a basic region called the protein transduction domain (PTD) which facilitates the trafficking of Tat through the plasma cell membrane. Thus, Tat can be found in the nuclear and cytosolic compartment of the cell as well as in the extracellular compartment. The primary function of Tat is to transactivate the promoter in the HIV-1 5'LTR for increased transcription of the proviral genome into full-length viral RNA [56].

### 2.4. Absence of SRLV Tat

Earlier studies suggested that SRLV genomes have *tat*-coding sequences upstream of the *env* gene. Furthermore, the encoded protein was found to be associated with high transactivation activity of the LTR promoter of SRLVs [57–59]. These data were not confirmed in the later studies and, in contrast, recent findings from our laboratory using more sophisticated and novel tools have proven that these proteins were associated with weak, if any, transactivation activities on their respective or heterologous

LTRs [60]. In addition, the nucleotide sequence of the open reading frame called *tat* does not produce a protein structurally or functionally comparable to primate lentivirus Tat [61]. Historically, this open reading frame located upstream of the *env* coding sequences in the genome of SRLVs has been named *tat* because of its position rather than its structure or function; as such, it appears a misnomer. Recent studies from our laboratory clearly demonstrated that this protein was associated with activities ascribed to HIV-1 Vpr and, therefore, this SRLV open reading frame was renamed Vpr-like [60–63].



**Figure 4.** Structural organization of Tat and TAR: **(A)** The boxes in different colors indicate the position of the six different domains in the amino acid sequence of HIV-1 Tat. The Basic region from 49–57 is required for RNA binding. **(B)** Schematic representation of the trans-activation response (TAR) stem-loop structure with its different regions and the bulge structure which is essential for the high-affinity binding of Tat. The minimal sequence element required for Tat-responsiveness is from residues 19–42.

### 3. Natural History of HIV-1 and SRLV

#### 3.1. Discovery of HIV-1

In 1981, AIDS was first recognized as a disease when homosexual men were reported with unusual opportunistic infections and malignancies. The principle causative agent of AIDS was a retrovirus now termed HIV-1, which was first discovered by Barré-Sinoussi *et al.* in the laboratory of Montagnier at the Pasteur Institute in Paris [4].

### 3.2. Cross-Species Infection from Monkeys to Human

HIV-1 is closely related to SIVs which have, on many occasions, jumped the species barrier from non-human primates to humans and spread successfully in the human population [64–67]. There are four phylogenetic lineage groups of HIV-1 (M, N, O, P) that were all thought to result from independent cross-species transmissions. It is now clearly established that cross-species transmission of the M and N groups of HIV-1 occurred from SIVcpz from naturally infected chimpanzees (*Pan troglodytes*) in South Cameroon, while a recent report indicated that O group originated following cross-species transmission from western lowland gorillas [68].

### 3.3. HIV Transmission in Humans

HIV-1 is generally transmitted through: (1) exchange of bodily fluids such as blood, semen, rectal fluids, vaginal fluids, breast colostrum, and milk from an infected person to recipient persons; (2) vertical transmission from mother to child either *in utero*, during delivery, or during post-natal breast feeding of colostrum or milk containing infected cells; (3) contaminated needle exchange during drug use or accidental iatrogenic exposure (reviewed in detail in [69]).

### 3.4. HIV Disease Progression

The rate of disease progression upon HIV-1 infection is variable and depends on host and viral factor interactions. The regular pattern of progression of HIV-1 infection has been found to be punctuated *in vivo* in three phases: 1) an acute primary infection associated with seroconversion and transient illness; 2) an asymptomatic phase during which the controlled virus continues to replicate, leading to a chronic immune activation; 3) a symptomatic phase during which the virus replicates to a higher titer. At this stage, the immune system is impaired and allows the proliferation of opportunistic infections [70].

### 3.5. First Descriptions of SRLV Infection

A disease that is now known to be associated with lentivirus infection in sheep was first described in South Africa by Mitchell in 1915 and termed as progressive pneumonia of sheep [71,72]. The next description was reported in sheep from Montana in 1923 with severe chronic interstitial pneumonia that resulted in wasting and, eventually, death of the affected animals [73]. In Iceland, about a decade later, “maedi”, a chronic form of pneumonia, emerged in a local breed of Icelandic sheep, progressing to a fatal form associated with important weight loss and shortness of breath [74]. There was also a neurological form of disease, “visna”, associated with paralysis and wasting that affected the Icelandic sheep during the next decade [72]. Epidemiological studies showed that the appearance of Maedi/Visna diseases began in a local breed of sheep after the import of asymptomatic Karakul rams from Germany in 1933. These lambs were imported for introducing genetic diversity because of the valuable Persian lamb skins of Karakul sheep for the Icelandic industry. An eradication program that lasted nearly a decade and in which all the sheep (over 100,000) in the affected areas were slaughtered was the only way to stop the fatal loss of the local breed [75]. During the following years, intensive studies were conducted for better understanding the Maedi and Visna diseases. Virological and



pathological studies under Dr. Bjorn Sigurdsson helped to conclude that a lentivirus was the etiologic agent responsible for both Maedi and Visna [6,7]. This was described as a “slow/low” virus that induces disease in infected sheep only years post-infection. Since then, the virus causing this type of infection in sheep was widely called “Maedi Visna Virus” (MVV) or ovine progressive pneumonia (OPPV) or ovine lentivirus (OvLV).

The pathological changes that are known to be attributed to the goat lentivirus infection CAEV were reported in the late 1950s in adult goats in Switzerland [76] and about a decade later in Germany [77]. Later, Linda Cork in the early 1970s described in detail the anatomic-pathological changes associated with this disease [78]. The first isolation of the etiologic agent was simultaneously reported from the joints of an arthritic goat [79] and from the CNS of an encephalitic kid [80]. Later, the virus was isolated from goats all over the world. All lentivirus isolates from sheep and goats are referred to now as Small Ruminant Lentiviruses (SRLVs).

### 3.6. Cellular Tropism *in Vivo* and *in Vitro*

The main cell types that support SRLV replication *in vivo* are those of the monocyte/macrophage cell lineage [8]. Unlike primate lentiviruses, SRLVs do not replicate productively in CD4<sup>+</sup> T lymphocytes [9]. The mechanisms underlying this restriction are still not well defined. *In vivo* in circulating monocytes, the viral DNA remains silent, not producing viral proteins and, thus, latently infected monocytes largely escape immune surveillance, providing for a Trojan horse mechanism [81]. Virus replication becomes productive only upon their differentiation into macrophages following their homing in tissues [82–84] in different organs [85]. SRLVs can infect cells other than monocytes/macrophages, including microglia, astrocytes, and oligodendrocytes [86,87]. In cell culture, SRLVs productively infect the goat synovial membrane cells, sheep choroid plexus cells [88,89], fibroblasts [90], and epithelial and endothelial cells [91]. Unlike primate lentiviruses, SRLVs do not use CD4, CCR5, and CXCR4 molecules as receptors/coreceptors for target cell infection. However, the receptor/coreceptor used by SRLVs are still not well identified.

HIV-1 infects predominantly the CD4<sup>+</sup> T cells following attachment to the principal CD4 receptor and either the CCR5 or CXCR4 co-receptor. Following the entry of HIV-1 in the human body, there is a bottle neck selection of a founder virus that predominantly uses the CCR5 as a co-receptor [92,93]. This is primarily expressed on the surface of memory CD4<sup>+</sup> T cells. The infection of such cells may lead either to productive HIV-1 replication and cell death via cytopathic effects or non-productive HIV-1 latently infected cells, depending on the activation dynamic of the host cells [94]. In addition to CD4<sup>+</sup> T lymphocytes, HIV-1 has the ability to infect myeloid cell lineages such as dendritic cells and monocytes/macrophages [95] both *in vitro* in cultured cells and *in vivo* in infected humans [96]. In blood, HIV-1 proviral DNA is detectable in less than 1% of the circulating monocytes [97–100]. However, monocytes disseminate to all tissues of the organism where they rapidly differentiate into specialized tissue-specific macrophages [101] and persist as infected cells for a long period of time. In addition to monocytes/macrophages, epithelial and endothelial cells and fibroblasts are susceptible to *in vitro* infection with varying levels of viral replication [10,91,102,103]. The other cell types susceptible to HIV-1 infection are dendritic cells (myeloid, Langerhans, and plasmacytoid) that are antigen-presenting cells which can be targets of HIV-1 infection [104–106]. Dendritic cells were found

to capture the virus through lectin-type receptors such as DC-specific ICAM-3-grabbing non-integrin (DC-SIGN) or sialic acid-binding Ig-like lectin 1 (SIGLEC-1), and act primarily as intermediates for virus transmission to T cells since HIV-1 replication in these lineages is limited [107–109].

### 3.7. Cross-Species Infection

Earlier experimental infections of sheep with the goat lentivirus (CAEV) and goats with ovine lentivirus (MVV) have provided the demonstration of the lack of species barrier for these viruses in sheep and goats [110]. Later, viruses genetically closer to CAEV were found in naturally infected sheep [111,112] and others genetically closer to MVV were found in naturally infected goats [113]. The experimental infection of mouflons [114] and calves [115] clearly demonstrated that the virus is capable of causing infection in a large variety of ruminants. The natural cross-species transmission of SRLVs in domestic and wild ruminants has been recently documented [116]; there is also evidence of mixed infections in field conditions with two closely related SRLVs. In addition, there have been descriptions of goats persistently infected with both CAEV and MVV and *vice versa* [117].

### 3.8. Natural SRLV Transmission

In adult sheep the virus is mainly transmitted by the respiratory route through the exchange of droplets when animals are housed in high density in closed facilities during the winter [118]. In newborn lambs and kids, the virus is transmitted mainly by consumption of virus-infected cells in the colostrum and milk from infected dams and female goats [119–121]. In early stages of small ruminant development, the gastrointestinal tract is porous, allowing infected cells to cross the epithelium barrier and invade lymph nodes and blood where they then cause infection of the peripheral blood mononuclear cells [122].

### 3.9. SRLV Viral Dynamics in Vivo

Unlike primate lentivirus infection, there are no defined phases of infection with SRLV [118,119,123]. Most infected animals remain lifelong seropositive following seroconversion and the virus is thought to cause lifelong persistence in the host monocytes where it can stay in a latent form. Following the differentiation of monocytes into macrophages in tissues, latent proviruses become transcriptionally active and productive of new infectious virus. The time between infection and seroconversion is greatly variable and can take more than two years [124]. Only a fraction of persistently seropositive animals remain productively infected and capable of transmitting the virus without showing any clinical symptoms of disease [79,118,125].

### 3.10. Acute Primary Infection, Disease Progression, and Characterization

The initial phase of HIV-1 infection in humans includes high activity of viral replication, virus genome mutagenesis, and cell death that lasts for two to eight weeks. During this stage, viral replication can produce up to 10 billion virions/day and the concentration of HIV-1 RNA in the plasma can exceed  $10^7$  copies/mL [126,127]. As mentioned earlier in section 3.6, the initial phase of infection of both SRLVs and HIV-1 targets monocyte/macrophage cell lineages but, unlike SRLVs,

HIV-1 also infects the CCR5+ CD4+ T cells where it mainly replicates in the gut-associated lymphoid tissues (GALT) early post-infection [128]. This productive replication is associated with the spread of the circulating virus throughout the body to establish the main reservoirs/sanctuaries of viruses in the lymphoid tissues, the central nervous system, and the genital tract [129]. The clinical symptoms during this stage can include fever, pharyngitis, lymphadenopathy, cough, rashes, myalgia, diarrhea, headache, nausea [130–132].

Following two to six months post-infection with HIV-1 in humans, a balance is reached between the rate of viral replication and induced antiviral immune defenses, leading to a steady level of viremia evaluated by HIV-1 RNA in the plasma [133–135]. The initial drop of CD4+ T lymphocytes stabilizes around 350–800 cells/ $\mu$ L, and this phase can be maintained or show progressive decline for years. This was initially considered as the asymptomatic phase. The progression towards symptomatic stages and AIDS varies greatly between infected individuals and is linked to host genetic factors and the reactivation of latent infections of other pathogens or new co-infections, but there are other potential environmental factors [136–139]. Disease progression in the absence of therapy can evolve in three distinct patterns; the normal progressors with a progressive loss of CD4+ T cells over six to eight years before developing AIDS, the rapid progressors whose loss of CD4+ T cells occurs within less than two years, and the long-term non-progressors in whom the CD4 count remains stable and the viral load is less than 50 copies/mL [140,141]. Although there is a tiny proportion of individuals, the elite controllers who, in absence of antiviral treatment, progress very slowly or do not progress, the vast majority of infected individuals (>95%) develop progressively typical HIV-1-associated pathogenesis [142,143]. The CD4+ T cell count progressively declines during approximately the eight years post-infection. Clinical manifestations are those associated with CDC category B symptomatic conditions such as Herpes zoster, oral Hairy leukoplakia, Listeriosis, Idiopathic thrombocytopenic purpura, Peripheral neuropathy, oropharyngeal Candidiasis, Bacillary angiomatosis, Kaposi sarcoma, HIV-associated idiopathic thrombocytopenic purpura, cervical intraepithelial neoplasia II-III, and lymphoid interstitial pneumonitis. With further disease progression and the decline of the CD4+ cell count below 200 cells/ $\mu$ L, the immune system further weakens and the individual shows susceptibility for CDC category C disease conditions such as *Pneumocystis jiroveci* pneumonia (pcp), mucocutaneous Herpes simplex, cryptosporidial/microsporidia diarrhea, esophageal candidiasis, extrapulmonary/military tuberculosis, HIV-associated wasting, and peripheral neuropathy [144–146]. The end-stage disease is generally associated with CD4 counts below 100 cells/ $\mu$ L and with systemic fungal diseases, symptomatic cytomegalovirus infection, and HIV encephalopathy, ending with the death of the infected patient. Such disease progression is, however, unlikely to occur in patients undergoing highly active antiretroviral therapy (HAART), which markedly controls viral replication to a barely detectable level and substantially prolongs the lifespan of infected patients. There is an increase of the CD4+ T cell count to around 800 cells/ $\mu$ L and there are no common opportunistic infections, but some patients develop degenerative diseases associated with persistent chronic inflammation in addition to the risk of virus rebound and the emergence of drug-resistant variants [114,147].

For SLRVs, after a long preclinical period lasting many years, animals may develop inflammatory symptoms characterized by arthritis and mastitis in adult goats and, in rare conditions, encephalitis in kids [80]. In some unique circumstances, CAEV-infected kids can also undergo CNS disease characterized by leukoencephalomyelitis in animals that are one to four months old [148]. This might

result from the synergistic effects of coinfections of CAEV with other pathogens, inducing local inflammation leading to permeabilization of the blood barrier and infiltration of CAEV-infected monocytes in the CNS. Animals can also develop chronic progressive arthritis with lympho-plasmocytic synovitis predominantly in adults [149].

In sheep, the symptoms are mainly in the lungs as a result of interstitial pneumonia, in the udder (mastitis), and the CNS (encephalitis) [6,116]. The clinical symptoms described by Sigurdsson *et al.* in 1957 appear mainly in adults, including weight loss, shortness of breath with progressive respiratory distress, and the enlargement of lungs. The progression of the disease to Visna, on the other hand, causes massive demyelination in the central nervous system associated with neuronal death, including in the spinal cord, leading to progressive paralysis of infected animals [7,150].

As mentioned previously in section 3.6, SRLVs do not replicate productively in T lymphocytes and both in early and late phases of infection there is no measurable depletion of CD4+ T lymphocytes in the periphery; therefore, infected animals do not undergo immunodeficiency. Moreover, unlike the cross-species infection of SIVs that has originated pathogenic persistent HIV-1 in humans, the experimental cross-species infection of adult mouflons and newborn calves with CAEV resulted in the productive infection of animals but did not result in the increased pathogenicity of virus. In mouflons, CAEV caused productive persistent infection [114] while, in contrast, in calves, it resulted in the diffusion of CAEV in target organs and transient replication, though, after four months, there was a total spontaneous clearance of all evidence of CAEV infection [115]. This provided the first demonstration that productive lentivirus experimental infection can be naturally cleared by the host's defenses. This last finding is promising for the development of new potential vaccine strategies to fight against lentivirus infections.

#### 4. Clinical Pathogenesis

HIV-1 mucosal transmission may occur through several sites including rectal, vaginal, and/or penile and oral mucosa. Rectal transmission is considered to be the easiest mucosal route for viral acquisition [151], where HIV-1 and HIV-infected cells transgress the epithelial layer via small breaks to cause systemic diffusion of the virus following the infection of numerous target CD4+/CCR5+ T lymphocytes. This transmission is thought to be established by one founder virus tropic for CD4+/CCR5+ T cells. This founder has enhanced interaction with dendritic cells and is resistant to the IFN- $\gamma$  host response [152]. Another mechanism highlighted for this route are M cells which produce mucus and form intraepithelial pockets that have CD4+ memory T cells and dendritic cells and promote the trans-epithelial transport of HIV-1 [153,154].

For vaginal transmission, extensive work is still ongoing to highlight the major target cells throughout the female reproductive tract (FRT). FRT is a strong barrier that effectively prevents the virus from transmission to germinal cells, so for virus entry it is likely that there is more than one site. The vagina and the ectocervix comprise multilayered epithelium, while the endocervix has only a single columnar epithelium layer [155]. In a recent rhesus macaque vaginal transmission model study, using a single round non-replicating SIV-based vector with dual marker genes, it was shown that the entire FRT including the vagina, ecto-, and endocervix, along with the ovaries and local draining lymph nodes, can contain vector transduced cells only 48 hours after inoculation. The results from this

study clearly suggest that virions quickly disseminate after the multisite entry of cells throughout the FRT with a preference for infection in squamous vaginal and ectocervical mucous. This study for the first time showed that even if the infection occurs primarily in vaginal and ectocervical tissue, it can spread as far as the ovaries and local draining lymph nodes [156].

Thereafter, the brunt of the viral replication has been found to be in immune cells of the gastrointestinal tract [157,158], named the gut-associated lymphoid tissue (GALT). GALT represents the most important lymphoid organ harboring 40–80% of all T cells in the body [159,160]. Importantly, this site predominantly contains memory CD4<sup>+</sup>/CCR5<sup>+</sup> T cells, expressing the major receptor and co-receptor for HIV-1 and SIV entry [161,162]. Infection in the GALT is extensive, reaching 60% of the mucosal memory CD4<sup>+</sup> T cells within days post-infection and the infected cells are rapidly eliminated [163,164].

Intravenous transmission of the virus is faster as there is no selective barrier between virus and target cells, and the virus rapidly disseminates to all lymphoid tissues including thymus, spleen, peripheral lymphoid organs, and mucosal lymphoid tissues, with a peak of viremia at 10–14 days post infection. The productive infection is observed within two weeks in the paracortex of the lymphoid sheath in the spleen, and in the thymus medulla. Like in the mucosal transmission, the main targets of the infection are memory CD4<sup>+</sup> T cells expressing the CCR5 receptor (reviewed in [165]).

As alluded above, progressive HIV-1 infection is associated with the progressive decrease of CD4<sup>+</sup> T cells both in number and in function, but also, as recently shown, with continuous chronic inflammation, is initiated by a burst of pro-inflammatory cytokines (reviewed in [166]). This is followed by the chronic presence of several pro-inflammatory factors, such as IL-6, TNF, and others, leading to early immune senescence and remodeling of lymphoid tissue [167].

In the CNS, the late stages of HIV-1 infection can be complicated by AIDS dementia complex or HIV-associated Dementia (HAD), which is a neurological syndrome characterized by abnormalities in cognition, motor performance, and behavior [168]. Invasion of the CNS occurs both by cell-free and cell-associated virus very early post-infection [169–171]. This occurs following virus and virus-infected cells crossing the blood-brain barrier using complex and multiple strategies [172]. Viral replication in the CNS relies predominantly on macrophages and microglia, often leading to multinucleated cells that are due to virus-induced cell fusion. The dementia is partially if not totally due to the inflammatory effect of the virus in the brain [173]. There is absence of productive infection in neurons and oligodendrocytes, while astrocytes may under select circumstances appear infected with limited contribution to viral replication. In the era of HAART, AIDS dementia complex has been largely eliminated but is replaced by more subtle motor and cognitive impairments regrouped under the term HIV-1 associated neurocognitive disorder (HAND), which is hypothesized to be caused by the low-grade chronic inflammation and neurotoxicity of select areas of the brain. The issue is often complicated by the poor penetration of many anti-retroviral drugs across the blood-brain barrier [174].

In SRLVs, the multiple routes of infection might influence the outcome of pathogenesis. Although the main route of SRLV transmission is thought to be through ingesting contaminated milk and colostrum containing infected cells, studies have shown that various cells in the female as well as male genital tracts are susceptible to permissive infection [175]. The main clinical disease is characterized by inflammatory lesions including infiltrates of lymphocytes, plasma cells, and macrophages into various regions of the central nervous system, joints, lungs, and the mammary glands [176–178].

The inflammation is fueled by infected cells expressing viral antigens promoting the local activation of immune cells. This sustained activation/inflammation causes tissue damage by cytokine-mediated amplification of antiviral immune responses leading to the damage of uninfected cells (bystander effect) in the affected tissue. In the CNS, the lesions are limited to the white matter and appear as focal discolored areas, which are prominent in the spinal cord [78,148,178]. Microscopic changes are observed in the white matter with perivascular cuffing and the accumulation of mononuclear cells. In all infected kids undergoing CNS disease, the spinal cord, especially the segments in the cervical and lumbosacral parts, is involved. The CNS inflammatory disease also comprises meningoencephalitis, microgliosis, and astrocytosis in different parts of the CNS, including the spinal cord [78,179]. Lesions are generally not seen in spinal ganglia, nerve roots, and peripheral nerves. In the joints, microscopic lesions include proliferative synovitis of the joints, tendon sheaths, and bursa. As the disease progresses, fibrosis, necrosis, and mineralization of synovial membranes and the enlargement of carpi become more evident [149]. The goats gradually exhibit a poor hair coat and lose weight to become cachectic. The clinical signs include lameness and atrophy of the muscles of the affected limb. In the lungs, pulmonary lesions may vary, depending on the severity of the infection, ranging from mild congestion and interstitial pneumonia to patchy interstitial pneumonia in affected goats [78]. The clinical signs include rapid shallow respiration and increased weight of lungs; tracheobronchial and mediastinal lymph nodes are generally enlarged. In sheep, lung lesions can progress to very severe interstitial pneumonia with massive infiltrates of mononuclear cells in the interstitium causing obstruction of alveoli, which may be associated with smooth muscle hyperplasia and fibrosis of the lungs [180]. This results in the progressive reduction of the respiratory volume and may cause the death of animals [181]. In the mammary glands of infected does and ewes, extensive intralobular infiltration of mostly lymphocytes and marked lymphoid hyperplasia adjacent to lactiferous ducts have been noted [123,182].

## 5. Receptor/Co-Receptor Usage

As mentioned previously in section 3.6, HIV-1 interacts with the cell surface CD4 receptor and a chemokine co-receptor molecule, which triggers the structural changes in gp120, resulting in movement of the variable loop and exposure of the co-receptor binding site. When the co-receptor binds, further structural changes take place mainly in gp41 which lead to fusion of the viral and cellular membranes and internalization of the virus capsid into the cell cytoplasm. There have been seven transmembrane receptors identified *in vitro* as co-receptors for HIV/SIV that support the infection of CD4+ cells [183]. However, *in vivo*, CCR5 and CXCR4 are the major co-receptors supporting the infection [184], and HIV-1 uses either one or both co-receptors for entry.

Receptor usage by SRLVs has been studied but, to date, no receptor/co-receptor mediating entry has been clearly and reproducibly identified. Studies have suggested the mannose receptor (MR) as a potential SRLV receptor either alone or in concert with another receptor. However, cells lacking MR can be infected, suggesting that at least other receptors may be used by the virus [185,186]. *In vivo*, SRLVs have tropism for and replicate essentially in cells of the monocyte/macrophage lineage and dendritic cells in various tissues [90,187].

Compartmentalization of viral replication and evolution has been observed in both HIV-1 [188–190] and the SRLVs [117,191], likely due to site-specific differences in immune selection. Conserved sequences in the hypervariable V3 region of HIV-1 Env have been identified and suggested to be determinant for virus entry of macrophage tropic strains; this region also determines the replication efficiency and cell tropism [192]. In SRLVs, the Env hypervariable region V4 is structurally and functionally similar to the V3 region of HIV-1 [193,194]. The variation in the Env V4 regions gives rise to the subpopulation of viruses that colonize different organs [193]. The diverse compartments of CNS and genital tracts contain unique HIV-1 variants that are clearly distinct from the ones found in blood and lymphatic tissues [195].

## 6. HAART in HIV-Infected Patients

HAART consists of combinations of drugs like nucleoside/nucleotide reverse transcriptase inhibitors, non-nucleoside reverse transcriptase inhibitors, fusion and entry inhibitors, protease inhibitors, and integrase inhibitors. According to the last UNAIDS 2014 report, there are 35 million HIV-1-infected individuals worldwide and nearly half of them (13.6 million) now have access to antiretroviral therapy. These treatments have significantly increased the life span of HIV-1-infected individuals and virtually eliminated numerous terminal comorbidities such as Kaposi sarcoma and other opportunistic infections. While an important breakthrough in the treatment of HIV-1, these drugs fail to fully eradicate the virus infection from the body of infected, treated individuals since numbers of latently infected CD4<sup>+</sup> T cells escape the treatment effects that are highly efficient only on cells productively replicating the provirus [196]. The discontinuation or interruption of HAART invariably results in the rebound of viremia from the latent reservoirs of HIV-1 [197,198]. Reservoirs of HIV-1 (estimated at 10<sup>5</sup>–10<sup>6</sup> cells) are established within the first few days of infection [199]. The reservoir sites include immune-privileged organs [200] with limited antiviral immune responses (CNS and testes) or organs separated from blood via anatomical barriers that limit the access of antiretroviral therapy [201,202].

## 7. Latency and Persistence

Lentiviruses have developed multiple complex strategies to persist in the infected hosts, inducing progressive chronic diseases. Among these strategies, there is the post-integration latency of the provirus involving various heterogeneous cellular and viral mechanisms regulating the balance transcriptional active/latent proviruses that are still not fully understood [203–206]. HIV-1-associated latency has been the most studied, particularly in the context of the HIV-1 cure after HAART treatment [207,208]. After virus entry and reverse transcription, HIV-1 double-stranded DNA can either stay episomal or become irreversibly integrated preferentially in transcriptionally active sites of the host's cell chromosomal DNA. However, a limited number of proviruses also integrate in transcriptionally inactive sites and remain transcriptionally silent in a state called viral latency. There are two main types of latency. The first is pre-integration latency in which viral DNA remains unintegrated located in the cytoplasm for a few days in the form of preintegration complex (PIC) and will eventually be degraded over time due to the cells' low metabolic rate. However, if the cell is activated before the decay of the PIC, it will then integrate and undergoes productive infection.

The second type is post-integration latency whereby proviral DNA integrated into the host genome remains transcriptionally silent. Several factors and mechanisms have been associated with post-integration latency. The most prevalent mechanisms of latency currently recognized are [203,209]:

- Absence of Tat, or non-functional transactivation activity of Tat [210].
- Epigenetic regulations/chromatin remodeling by post-transcriptional modifications (hypoacetylation or trimethylation) [211].
- Insufficient levels or lack of nuclear host transcription factors (SP1, NF- $\kappa$ B) [212,213].
- Expression of transcription factor complexes with negative regulatory activities (YY1, CBF-1/RBP, APOBEC3G) [214,215].
- Influence of integration sites and provirus orientation on HIV-1 transcription efficiency [216].
- Unproductive control of viral RNA splicing, due to absence of Rev and innate host antiviral processes [217].

The viral regulatory protein Tat is thought to be one of the major factors in the regulation of HIV-1 latency. The absence of Tat results in a repressive chromatin environment that blocks the elongation of transcription [218,219].

In SRLVs, the viral DNA can remain in transcriptionally silent until the circulating blood monocytes mature into macrophages after their localization in tissues. This mechanism is independent of Tat, since SRLV genomes lack the gene encoding this protein [60]. In HIV-1, the proviruses in monocytes could be associated with a minimal amount of viral proteins without active expression of the proviral genome, thereby escaping detection and killing by the immune system; however, like SRLV-infected monocytes, upon entry in various tissues their rapid maturation into tissue macrophages is associated with increased expression and the release of fully infectious viral particles [8,220]. In SRLVs, viral persistence is fueled mainly by the lack of or low-grade viral replication in infected circulating monocytes that disseminate productive replication of the virus in various tissues. However, SRLV replication in macrophages can be also restricted by a number of posttranscriptional blocks [103,221,222].

## 8. Molecular Biology of HIV-1 Latency

### 8.1. Molecular Mechanisms of the Transcription Involving Tat in HIV/SIV

To date, there is no identified viral negative factor that represses HIV-1 transcription to undergo latency. Factors that were thought to be negative regulators in initial studies were not confirmed in more recent studies. The transcription of HIV-1 is tightly controlled by powerful feedback mechanisms of viral and cellular factors that act like molecular switches to regulate the expression of HIV-1 RNA transcription. HIV-1 transcription comprises two phases: first, an initiation step, and then an elongation step. The core promoter region in the U3 region of the LTRs includes several important motifs for the binding of factors required for the transcription, including a TATA box element, three SP-1 sites, and an initiator element (Figure 5A) [223–226]. Each of these core promoter elements contributes to the binding of the initiation complex TFIID. During the initiation phase, several factors such as the TATA box binding protein (TBP) and TBP-associated factors (TAFs), which interact with the TATA box and



SP-1, are recruited by the promoter region to initiate the transcription complex [227]. A recent study shows the presence on an E-box motif (RBE1) within the core promoter that is implicated in transcriptional activation. RBE1 is a binding site for the RBF-2 transcription factor complex (USF1, USF2, and TFII-I), previously shown to bind an upstream viral element, RBE3. The results indicate that RBE1 is a *bona fide* RBF-2 binding site and that the RBE1 and RBE3 elements are necessary for mediating proper transcription from the HIV-1 LTR [228]. In another new study, it has been shown that CTGC motifs flanking the HIV-1 TATA box are required for Tat transactivation in living cells and the correct formation of pre-initiation complexes of HIV-1 (PICH); this complex contains the general transcription factor TFIIA that binds the HIV-1 core promoter formation *in vitro*. The binding of known core promoter binding proteins AP-4 and USF-1 was found to be dispensable for Tat function. The transcriptional response element (TAR) RNA prevented the stable binding of PICH-2. The impact of TAR on PICH-2 specifically required its bulge sequence, which is also known to interact with Tat [229]. A study by Jensen *et al.* using an *in vitro* model of a HIV Tat-mediated positive-feedback loop demonstrated that fluctuations in viral Tat-transactivating protein levels generate integration site-dependent, stochastically-driven phenotypes, in which infected cells randomly 'switch' between high and low expressing states in a manner that may be related to viral latency. Furthermore, in an extended model, they designed a forward genetic screen that systematically identifies the genetic elements in the HIV LTR promoter that modulate the fraction of genomic integration sites that specify 'switching' phenotypes. In this experiment, it has been shown that specific mutations in the core promoter regions, including Sp1 and TATA transcription factor binding sites, can increase the switching fraction several fold. Using the single-cell system experiments with computational modeling, they could further investigate the mechanism of switching-fraction enhancement for a selected Sp1 mutation. Altogether, these experiments demonstrated that mutations in the Sp1 site impaired not only Tat-induced transactivation of expression, but also the basal expression in the absence of Tat. Computational analysis demonstrated that the observed change in basal expression could contribute significantly to the observed increase in viral integrations that specify a switching phenotype, provided that the selected mutations affected Tat-mediated noise amplification differentially across genomic contexts [230].

Upstream of the core promoter region there is the regulatory region of HIV-1 LTR, which has binding sites for the cellular transcription factors nuclear factor of activated T-cells (NFAT), AP-1, p65/p50 nuclear factor kappa-light-chain-enhancer of activated B cells (NF- $\kappa$ B) and Signal Transducer and Activator of Transcription 5 (STAT5), which orchestrate HIV-1 expression. The enhancer region of the regulatory promoter region consists of the NF- $\kappa$ B binding site, which has been studied extensively. Any mutation in one or more core promoter sites or regulatory promoter elements or enhancer regions leads to strong impairment of both basal and Tat-dependent transcription [231–235]. The key factor in the initial stage of the transcription of the HIV-1 LTR promoter by RNA polymerase is the phosphorylation of the carboxyl terminal domain (CTD) [236]. The CTD phosphorylation renders the RNA polymerase highly processive. The phosphorylated polymerase, once cleared from the promoter region, is then able to transcribe through the TAR region [237] (Figure 5B).

The initial phase in the elongation of HIV-1 transcription produces a low-level of viral gene expression which is a result of the hypo-phosphorylated condition of RNA pol II and activity of the negative elongation factor, 5,6-dichloro-1-beta-D-ribofuranosyl-benzimidazole sensitivity-inducing

factor (DSIF), and negative elongation factor complex (NELF) [238–240]. This stage allows the initial production of small amounts of Tat, which plays an important role during the RNA Polymerase II elongation phase. Recent studies suggest that DSIF binds the elongation complex via association with the nascent transcript and subsequently recruits NELF [241,242]. In the case of the HIV-1 provirus, the recruitment of NELF may be further enhanced by the ability of NELF-E to bind directly to the TAR region of viral RNA [243] (Figure 5C). Unlike other transactivation factors, Tat does not bind to the DNA, but it interacts with the TAR element of the genomic viral RNA. TAR is a stem loop structure containing three nucleotide bulges (23–25 residues) and a loop of six nucleotides (30–35 residues) (Figure 4B). The bulge structure in TAR is the high affinity site for Tat binding [244]. During the elongation phase, which is a Tat dependent phase, Tat binds to TAR via its arginine-rich motif (ARM) and facilitates binding of the positive transcription elongation factor b (P-TEFb) [245,246], which is comprised of cyclin-dependent kinase 9 (Cdk9) and cyclin T1 [247–249]. The Bromo-domain protein 4 (Brd4) stimulates the kinase activity of P-TEFb for phosphorylation of the CTD of RNA polymerase II over basal levels. [250]. As a result, the HIV-1 transcription rate is enhanced several-hundred-fold, thereby producing a high level of viral gene transcripts [219,251] because P-TEFb phosphorylates subunits of the NELF and DSIF to release the RNA polymerase II activity preventing its pausing on the HIV-1 promoter [252,253] (Figure 5D,5E). For more details please refer to the following reviews on HIV-1 Tat transcription [206,209,254–263].

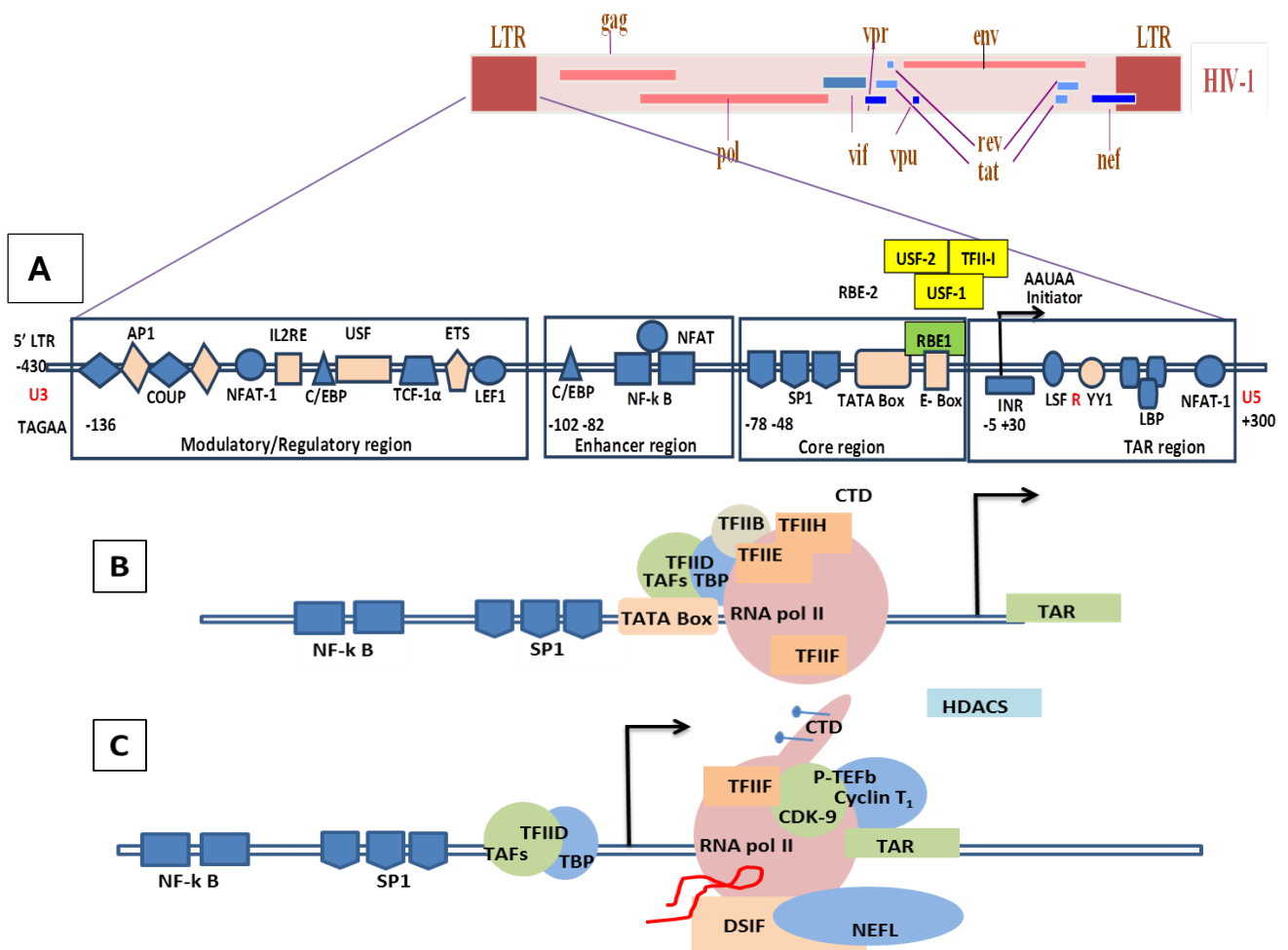
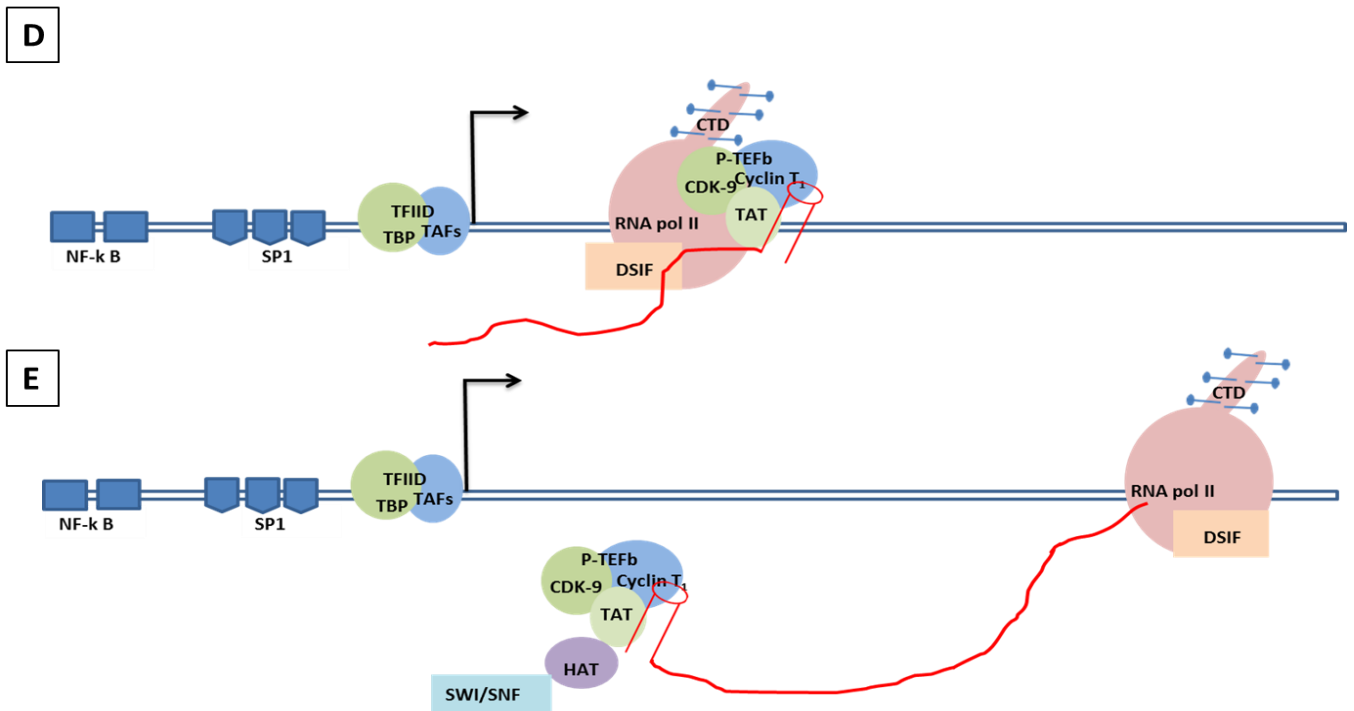


Figure 5. Cont.

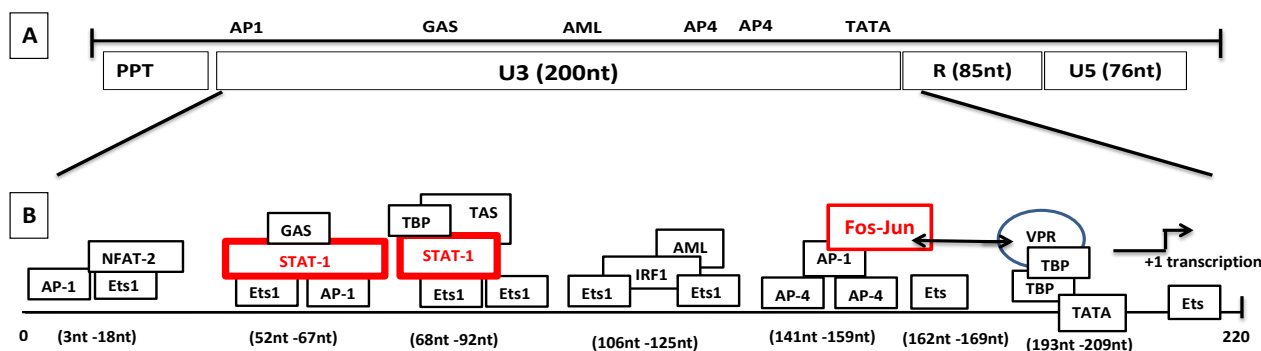


**Figure 5.** Genomic organization of HIV-1 and mechanisms of LTR transactivation. (A) The modulatory region consists of transcription factors such as COUP, AP1, NFAT-1, IL2RE, C/EBP, USF, TCF-1 $\alpha$ , ETS and LEF1. The enhancer region has the NF- $\kappa$ B and C/EBP, and the core region consists of three tandem SP1 sites and the TATA box and E-box to which RBE1 and RBE2 (USF1, USF2, TFII-I) binds. Downstream to the TATA box is the initiator element from the TAR region. A weak transcription starts at -430 at U3 with TAGAA and is enhanced at the downstream TAR region at the +1 AAUAA polyadenylation site. (Not all the transcription binding sites are shown here). (B) Initiation stage: the cellular transcription factors TAFs and TBP (TAFs + TBP + TFIID) are recruited which, along with the other components of the basal transcription, help in recruiting the RNA polymerase holoenzymes. The CDK7 kinase presents the CTD of the RNA polymerase in the TFIID phosphorylates. (C) The hypo-phosphorylated state of the CTD correlates with the low processivity of the RNA polymerase enzyme complex. Due to hypo-phosphorylation, and in absence of Tat, there is mainly production of short RNA. Furthermore, DSIF and NELF that bind to the RNA pol II inhibit the transcriptional elongation. (D) CDK9 phosphorylates the CTD and, along with cyclin T1, they produce the complex P-TEFb (positive transcription elongation factor b). TAT is recruited and binds to the bulge sequence of the TAR RNA. The hyper-phosphorylation of CTD is induced by the binding of the P-TEFb to the TAR, resulting in dissociation of DSIF and NELF. HATS and SWI/SNF, which induces acetylation of the nucleosomes, are recruited and remove any blocks due to epigenetic modification and support elongation. The acetylation of Tat creates a binding site for P300/CREB binding protein-associated factors (PCAF) which enhances the transcription elongation.

## 8.2. Molecular Mechanism of Tat-Independent Transcription in SRLVs

SRLV genomes lack both *tat*-coding sequences and its TAR target motif [60,61]. Earlier publications [58,264–267] reported interactions of LTR promoters with a protein called “Tat” (Vpr-Like) produced from an open reading frame whose position in SRLV genomes coincided with that of *tat*-coding sequences of primate lentiviruses. These publications reported the following findings:

- (1). Vpr-like protein mediates transcription activation of SRLV genomes and this is dependent on the presence of AP-1 and AP-4 sites located in the U3 region of SRLV LTRs. The proximal AP1 site to the MVV TATA box promoter is the most important for transcription, though SRLV Vpr-like protein does not bind the AP-1 site [264,268].
- (2). SRLV Vpr-like protein structure has three domains including: (a) an N-terminal acidic and hydrophobic domain, presumably the activator domain, which interacts with the TATA binding protein (TBP) *in vitro* [59,266]; (b) a central Leucine-rich domain that can interact with FOS-Jun-specific proteins in the AP-1 sites [266]; (c) a C-terminal Cysteine-rich domain which might direct protein dimerization. An interaction of the SRLV Vpr-like protein with the TBP from the TFIID complex was shown to bind to the TATA box via its activator domain, in addition to the proximal AP-1 binding to the Leucine-rich domain. These interactions allow a stabilization of protein complexes located at the viral promoter, and therefore induce an increase of viral gene transcription as illustrated in Figure 6.



**Figure 6.** Genomic organization of SRLVs and mechanism of LTR transactivation independent of Tat. (A) Various regions of the SRLV LTR are distinguished. (B) The transcriptional elements in U3 consist of TATA box, Ets-1, Stat-1, AP4, GAS, AML, NFAT-2, IRF-1, and AP-1 sites. The proposed transactivation pathway suggests that IFN- $\gamma$  activates STAT-1 phosphorylation. Phosphorylated homodimer binds to the gamma activation site (GAS) while tumor necrosis factor alpha (TNF- $\alpha$ ) activates the transcription by binding to the 17-nucleotide TNF-activated site (TAS) within the 70-nucleotide repeats. Vpr interacts with the Jun protein of the Fos-Jun complex bound to the AP-1 site and also interacts with the TATA box-binding proteins TBP, which interact with the TATA box.

Studies by Harmache *et al.* [269] showed that the *tat* gene of CAEV was fully dispensable for viral replication *in vitro* and *in vivo*. Three different infectious molecular clones of CAEV bearing three

distinct mutations in the *tat* gene were used in this study to compare the replication kinetics after transfection or infection of cultured goat synovial membrane cells and infection of blood-derived mononuclear cells or macrophages. The results showed that all mutants replicated at an efficiency similar to that of the wild type. The properties of wild type and *tat* mutant viruses were also compared *in vivo* by injecting the infectious molecular clones bearing the proviral DNAs directly into the joints of goats. Animals seroconverted between 27 and 70 days post-inoculation, and the CAEV mutant in *tat* was isolated from blood-derived macrophages, confirming that *tat* was dispensable for productive replication of CAEV *in vivo* as well.

Recent data clearly demonstrated that *tat*-encoded protein is not only structurally different, but also has no transactivation activity comparable to HIV/SIV Tat [60,61]. Further studies found instead that this protein was associated with functions similar to that of HIV-1 Vpr [61–63]. These studies compared the trans-activation activity exerted by MVV, CAEV, and HIV-1 Tat proteins in a variety of cell lines. The sub-cellular localization of MVV and CAEV Vpr-like protein was also investigated. None of the SRLV Vpr-like proteins tested induced the transactivation of SRLV or HIV-1 LTR promoters. Unlike HIV-1 Tat, the SRLV protein was found to be incorporated into the virions. The results also demonstrated that this lack of transactivation was not associated with the inability of this protein to enter the nucleus of expressing cells. The SRLV Vpr-like protein from the MVV strain, however, induced a very modest (two- to three-fold) upregulation of SRLV LTRs. However, in similar conditions, HIV-1 Tat *trans*-activated HIV-1 LTR over 60-fold [60,61].

The studies suggest that the primary role of the so-called Vpr-like protein in SRLV is not the transactivation of the LTR promoter similar to that of the primate lentiviruses HIV and SIV. Further studies demonstrated that this protein is structurally and functionally related to Vpr. The mechanism of transactivation with SRLV Vpr-like protein involves an interaction with Jun protein from the Fos/Jun complex bound to the AP-1 site located in viral LTR; this mechanism is functionally very close to the HIV-1 Vpr which it interacts with in the Sp1 located in viral LTR [61–63].

In the pursuit of exploration of other molecular pathways which lead to the consecutive transcription of the CAEV promoters and transcription factors, various studies were performed by Murphy *et al.* in the human monocytic U937 cell line expressing the SRLV genome. These studies suggested that the tumor necrosis factor alpha (TNF- $\alpha$ ) and granulocyte-macrophage colony stimulating factor (GM-CSF) activate the CAEV transcription. They used SP600125 to block the Jun N-terminal kinase (JNK) and the cells were subsequently treated with cytokines. SP600125 blocked the previously described transactivation pathway through AP-1 [270], yet the SRLV transactivation was observed. Therefore, they proved that the TNF- $\alpha$  and GM-CSF could induce the activation of CAEV promoter independent of AP-1. Furthermore, using a set of sequentially deleted mutants, they found that elements within the 70-bp repeat in the U3 region are involved in the activation by TNF- $\alpha$  [270]. In a similar work performed previously by Sepp *et al.*, they showed that the  $\gamma$ -interferon activation site (GAS) element from the 70-bp motif is adequate for the responsiveness to IFN- $\gamma$  using a heterologous minimal promoter. They also showed that the binding of the nuclear factor to the GAS element is inhibited by antibodies directed against the signal transducer and activator of transcription STAT1 (p91/84) [271]. In a later work reported by Murphy *et al.*, the authors identified a sequence of 17 nucleotides called TNF-activation site (TAS) which is located within the 70-bp repeat of the U3 region. They also found other sequences within the U3 region required for the IFN- $\gamma$  activation.

However, additional work is needed to establish whether STAT1 binding to the U3 site is involved in the activation of SRLV promoter through TNF- $\alpha$  and GM-CSF regulation.

Data from experiments in these two reports show that the TAS sequence in the SRLV LTRs is essential for TNF- $\alpha$  and IFN- $\gamma$  to activate STAT-1 phosphorylation and bind to GAS. The STAT-1 signaling pathway was shown to play an important role in the regulation of viral promoter activation through IFN- $\gamma$  [271,272] and GM-CSF [273]. It is also interesting to know that IFN- $\gamma$  leads to the activation of CAEV LTR through the STAT-1 signaling pathway [271] in monocytes, and STAT1 also plays an important role in the differentiation of monocytes to macrophages [274]. Interestingly, natural deletions in the U3 70-bp, *vrp*-like accessory gene and *dUTPase* resulted in highly attenuated genotype E strains of SRLV isolated in Italy [275]. Furthermore, the low pathogenicity and variable virulence can be also due to the deletions and/or mutations of the replication enhancer factors of the LTR, such as AP1, AML, TNF- $\alpha$ , and IFN- $\gamma$  responsive elements [276,277]. While in SRLV strains from sheep the viral promoter sequences in LTR were found to determine the cell tropism [278], those sequences of strains from goats were not [279,280]

In a serendipitous experiment of nature as quoted by Dr. Murphy, his group isolated SRLV (CAEV-MA) from the mammary glands and from the carpal synovium (CAEV-JT) of the same goat. Sequence analyses in viral promoters revealed that the CAEV MA had a rare loss of GAS that was replaced by 5'-ACTCGAGGGTCTAGGA-3' [281]. Earlier studies of SRLV-infected goats showed a heterogeneity of molecular clones with different promoters in different anatomical locations [279], but it was the first time that they found the rare mutation in the same goat. Using an assay based on  $\beta$ -galactosidase activity measurement, they found that the mean of basal promoter activity of CAEV-MA was inferior to that of CAEV-JT (mean OD of  $0.389 \pm 0.083$  vs. 0.007,  $p < .0001$ , respectively) [281].

### 8.3. Role of Epigenetics and Transcriptional Regulation Factors in Modulating HIV-1 Latency

In general, eukaryotic DNA that is not in a transcriptionally active form is tightly packaged around nucleosomes. Each nucleosome is composed of octamers of histone proteins having pairs of H2A, H2B, H3, and H4 molecules densely packed to form the chromatin. Any change in the structure of the chromatin markedly affects gene expression. The complex of DNA/histones undergoes various post-translational modifications like acetylation, methylation, and phosphorylation, leading to modifications of the structure of chromosomes [282–286]. Histone modifications also contribute to the transcriptional regulation by the transcriptionally active euchromatin or transcriptionally repressive region heterochromatin which inhibits the transcription.

The post-integrational event of HIV-1 provirus into the host genome is followed by interactions with two nucleosomes, nuc-1 and nuc-0, on the LTR region. The position of nuc-1 plays an important role in controlling gene expression [287,288]. The cellular transcription factors, such as Yin Yang-1 (YY1), LSF, c-Myc, Sp-1, and AP-4, recruit histone deacetylases HDACs to the HIV-1 promoter, leading to a block of the transcription activity leading to latency [215,289–294]. The classical NF- $\kappa$ B complex has two subunits, p50 and p65, and this heterodimer is a potent activator of transcription. However, p50 can also generate homodimers that repress HIV-1 transcription by recruiting the HDAC to

the LTR promoter. Knockdown experiments of p50 result in the reinitiation of RNA polymerase recruitment [293,295].

Histone acetyltransferases (HATs) such as E1A binding protein p300/CREB-binding protein (p300/CBP), P300/CBP-associated factor (PCAF), and GCN5 histone acetyltransferase may be recruited to the HIV-1 promoter. These HATs, which are critical for the acetylation of histone tails, interact with Tat, leading to recruitment of the chromatin remodeling complex SWI/SNF/BAF that opens/relaxes the chromatin and enables the transcription elongation by displacing restrictive nucleosomes [296–299].

There are also post-transcription modifications that are implicated in the regulation of Tat-induced latency [300]. Tat is necessary for sustained transcription of the HIV-1 LTR and suboptimal levels of Tat can lead to latency. Lack or minimal production of Tat can be due to the lack of cellular factors or due to mutations on the Tat/TAR axis. There are post-transcriptional modifications of Tat that control the interactions of Tat with P-TEFb and TAR. The dissociation of Tat from TAR and P-TEFb is due to the demethylation of Lysine 51 by Lysine-specific demethylase 1A (KDM1A/LSD1)/REST corepressor 1 (CoREST) and the acetylation of Lysine 50 mediated by Lysine acetyltransferase p300/KAT3B while, in contrast, Tat activity is enhanced by the methylation of Lysine 51 by Lysine methyltransferase SET7/9/KMT7 [301–305]. The transcriptional activity of pTEFb is reduced by acetylation of CDK9 of pTEFb, by the histone acetyltransferases hGCN5 and PCAF, leading to HIV-1 latency [306]. Moreover, efficient activity of Tat is dependent on the methylation of Lysine 51 by KMT7 that results in enhanced Tat binding to its target TAR in the 5' extremity of the genomic RNA. Acetylation of Tat by PCAF on Lysine 28 is essential for recruitment of pTEF at the 5' end of viral RNA for an efficient elongation of RNA transcription. Sirtuin-1, a specific Tat deacetylase, increases the amount of unacetylated Tat in number [296].

Histone methylation, another epigenetic modification, also plays a role in regulating the latency of HIV-1. The histone methyltransferases (HMTs) such as Enhancer of zeste homolog 2 (EZH2) and Euchromatic Histone-Lysine N-methyltransferase 2 (EHMT2), also known as G9a and Histone-Lysine N-methyltransferase (SUV39H1), are involved in regulating HIV-1 transcription by inducing H3 methylation at Lysine 9 (H3K9) and Lysine 27 (H3K27). The studies by Karn's group have demonstrated that EZH2 is a critical enzymatically active compound of the polycomb repressive complex 2 (PRC2), through which H3K27 trimethylation takes place [307]. The knock-out of EZH2 induces the loss of H3K27 trimethylation which leads to latency. SUV39H1 is an H3K9 methyltransferase that initiates the heterochromatin formation by interacting with HP1 and induces latency [204,308,309].

Further details on the epigenetic mechanism and post-translational modifications associated with HIV-1 latency and activation of transcription are reviewed in following [254,262,310–312].

#### 8.4. Latency and HIV Cure

Latently infected cells are defined as the cells containing the integrated HIV-1 DNA that are transcriptionally silent but retain the capacity to produce infectious virus upon activation. These latently infected cells reside in viral reservoirs in different anatomical locations. They consist of different cell types that have stable kinetic properties and allow persistent virus replication. In the

HAART era, most of the latently infected cells were abundantly found in the sanctuaries where the HAART drug penetration was limited. Theoretically, a cure can be either functional or sterilizing. A functional cure aims at permanent viral suppression following the interruption of therapy to levels that prevent immunodeficiency and transmission, while a sterilizing cure aims at the complete eradication of the viral population from the whole body [313].

Several therapeutic strategies to cure HIV-1 infection have been proposed, targeting the latently infected CD4<sup>+</sup> T cells (reviewed in [314–316]).

- Reactivation of latent virus while patient is on HAART using HDAC inhibitors, vorinostat (SAHA), valproic acid, [317] “non-oncogenic” phorbol ester (bryostatin, prostratin), and cytokine IL-7 [318]. Induction of viral replication of proviruses in cells from latent reservoirs and clearance is the most promising “Kick and kill” strategy.
- Excision and removal of the proviral DNA [319–321],

Strategies that aim to eradicate the virus without targeting latent reservoirs:

- Creation of HIV-1 resistant cells (SB 728-T) [322,323],
- Gene therapy (CCR5 $\Delta$ 32/ $\Delta$ 32) [324–326] and Elite suppressors (ESs) model [327,328],
- Reversal of immune exhaustion (PD-1 antibodies) [329],

#### The Unique Case of Possible Cure

The Berlin patient was infected with HIV-1 and was on ART for more than 11 years before being diagnosed with leukemia at age 40. The curative intervention included an acute myeloid leukemia (AML) intensive conditioning regimen, including chemotherapy, antithymocyte globulin, and total body irradiation, with allogeneic hematopoietic stem cell transplantation (HSCT) from a CCR5 D32 homozygous donor. These interventions have eliminated most of the patient’s immune cells, including latently infected cells, and engrafted cells could not be infected with residual virus if any remained. This patient is established “aviremic”, and even seven years after HSCT and extensive analyses, there is no HIV-1 detected [325,326,330]. With a similar HSCT procedure, two other patients, Boston patient 1 and Boston patient 2, were intervened by reduced intensity conditioning and allogeneic HSCT from CCR5 wild-type donor. They were on ART for 4.3 years and 2.6 years, respectively, after HSCT, but they had detected a rebound after 84 days and 225 days, respectively, after ART interruption [331,332].

A case of “functional cure” has been recently reported in the International AIDS Society’s 8th conference on HIV-1 pathogenesis, treatment, and prevention. Under the French Pediatric Cohort led by Dr. Asier Saez-Cirion, an ART treatment was initiated soon after the birth of a baby girl who continued the treatment for six years and then stopped. The young woman, now 18.5 years old, has been in remission for 12 years. The early antivirals might have limited and reduced the formation of the reservoirs and protected the immune system [333]. This is the only case so far with such a long remission in children. Earlier, the “Mississippi baby” who received an early postnatal ART became aviremic for a period of 24 months. However, after cessation of HAART at 18 months, a rebound was detected, thus suggesting that the early ART treatment in the infected infants did not completely eliminate the reservoirs [334]; however, new studies have proved otherwise. In another long-term



successful remission in the “VISCONTI cohort” study in adults, there are 14 post-treatment controllers (PTCs). They were initiated with the ART soon after infection and were on the treatment for at least three years before interruption. The study found that PTCs were able, after therapy interruption, to keep and in some cases further reduce a weak viral reservoir [335].

## 9. Sites of Latent Reservoirs

### 9.1. Cell Lineages

The primary cell targets of HIV-1 infections (discussed in detail in section 3.6) include the CD4+ T lymphocytes [336,337] and monocyte/macrophage lineages [338], while other cells were found to be capable of getting infected with HIV-1 including natural killer, CD8+, B and follicular dendritic cells.

#### 9.1.1. CD4+ T Lymphocytes

In normal conditions, the majority of the CD4+ T lymphocytes are not activated (naïve and resting memory cells comprising central memory T<sub>CM</sub> and transitional memory T<sub>M</sub>) [339]. Some studies have shown that non-activated CD4+ T cells can be permissive to HIV-1, and target naïve T cells might have a low level of CCR5 expression [340–342]. It is estimated that only approximately  $1 \times 10^7$  resting latently infected CD4+ T cells are present in blood and lymph nodes [343]. During HAART treatment, latent CD4+ reservoirs escape the efficient depletion of infected activated T cells and their progressive depletion occurs only slowly, depending on cell activation and cell death. The half-life of latently infected resting CD4+ T cells is estimated to be around 44 months [344] and, thus, mathematical modeling of eradication, assuming a constant rate of reactivation/elimination of the entire reservoir of  $10^6$  cells, would require 73 years [345,346]. Therefore, resting CD4+ T lymphocytes are considered the leading cell type in the HIV-1 reservoir [347]. SRLVs do not infect T lymphocytes productively or latently, therefore this cell lineage is not site of a SRLV reservoir.

#### 9.1.2. Monocytes and Macrophages

As such, monocytes/macrophages can act like a viral reservoir, some of which are immune-privileged sanctuaries such as the CNS where they mature into microglia, perivascular and meningeal macrophages, and choroid plexus [348]. Infected microglia and perivascular macrophages induce clinical pathogenesis of HIV-1-associated dementia [349]. In general, virus production from monocytes/macrophages is markedly lower than from the CD4+ T lymphocytes [101]. Nevertheless, in addition to truly silent reservoirs, these cells may support a continuous low level virus production throughout their life since, unlike T cells, they are less sensitive to cytopathic effects induced by virus infection [101]. Gut-associated macrophages of *lamina propria* differentiated from blood monocytes could represent an important HIV-1 reservoir [350,351]. The role of monocytes and macrophages is also reviewed in detail in the following reviews [312,352–354]. SRLV in sheep and goats would be an excellent model to specifically study the mechanisms involved in the latency associated with these cells in absence of that associated with the CD4+ T lymphocyte reservoir; unfortunately, there are only limited studies.

### 9.1.3. Dendritic Cells

Their potential implication as players in HIV-1 latency/reservoir was demonstrated by the mature myeloid dendritic cells located in the lymph nodes which can harbor and transmit virus shielded from immune recognition for extended periods of time [355]. There have been reports that SRLVs could also infect and replicate in dendritic cells, which may also play a role in virus dissemination into lymphoid tissues, but it seems to be of low significance [90,356].

## 9.2. Anatomical Reservoirs

Among the anatomical reservoirs for HIV-1 there are two main categories that deserve special attention: (i) immune-privileged sites in which antiviral effector mechanisms are inhibited and/or (ii) sites that are inaccessible or poorly accessible to drugs used in HAART. Examples of such reservoirs are the CNS, lymphoid organs, the genital tract, and lungs.

### 9.2.1. CNS

CNS is protected by the blood-brain barrier which is highly selective in the exchange between blood and the brain tissue compartments, thus creating an immunological micro-environment. The tight epithelium of the choroid plexus restricts the flow of the molecules and cells into the cerebrospinal fluid (CSF), thus creating an effective barrier which prevents the passage of most HAART drugs to the CNS. The HIV-1 reservoirs in the CNS are the microglia and, to a lesser extent, the cortical and basal ganglia-derived astrocytes in which HIV-1 DNA has been detected [357–359]. Microglia and perivascular macrophages produce neurotoxins and cellular factors that induce clinical pathogenesis of HIV-1-associated dementia [129,170,360,361].

In SRLVs, the endothelial cells of the vascular system of the CNS have been shown to facilitate viral entry into the CNS [10]. The virus in the CNS causes lesions and the obvious signs of meningitis along with the destruction of the myelin sheath [362]. Proviral DNA has been located in macrophages, microglial cells, astrocytes and oligodendrocytes, the ependymal epithelium, and the choroid plexus. Positive areas are also found in the spinal cord, in endothelial cells of small blood vessels of goats and kids naturally infected with SRLVs [87]. Apart from the Icelandic research, MVV is mostly associated with the pulmonary and mammary lesions, but the study done by Benavide's group described clinical cases in 12 Assaf sheep from Spain in which the CNS lesions were only confined to the spinal cord [363]. In another study on 64 sheep with natural SRLV-associated meningoencephalitis, they found lesions particularly in the cerebellar peduncles (non-suppurative meningoencephalitis), followed by the corpus callosum, hippocampus, and thoracic spinal cord [362]. These studies are cases of CNS alterations in sheep which are not the common pathogenesis currently seen in SRLV-infected flocks.

### 9.2.2. Lymphoid Organs

Lymphoid organs contain 98% of the lymphocytes in the body, and thus in patients treated with HAART, HIV-1 can be detected in all primary and secondary lymphoid tissues such as tonsils, bone marrow, GALT, spleen, lymph nodes, and thymus. The GALT is the tissue that contains the largest portion (40–60%) of lymphocyte populations and is also one of the largest reservoirs of

macrophages [364,365]. In infected individuals, the GALT generally has half- to one-log more HIV-1 RNA molecules than in the peripheral blood mononuclear cells (PBMC) [158,366]. This increase is mainly due to the constant presence of activated CD4+ T cells leading to replication of the viruses even during HAART. Thus, while not immunologically protected or necessarily preventing HAART access, the GALT serves as a reservoir by the sheer number of activated viral targets.

In SRLV-infected animals, provirus DNA was detected in classical peripheral lymphoid tissues (spleen, lymph nodes, thymus, bone marrow, PBMCs, and the lungs) of experimentally and chronically infected goats [102,367,368]. Although lymph nodes are considered an important viral reservoir, they do not appear to be sites of intense viral replication. Indeed, multi-spliced mRNA has not been shown to be present in samples from all goats, whereas un-spliced mRNA has been detected from lymph nodes, spleen, bone marrow, and /or PBMC [369].

### 9.2.3. Genital Tract

The genital tracts of both males and females are considered to be anatomical reservoirs. The testis in particular represents an immunologically privileged sanctuary of HIV-1, which additionally also restricts the accessibility of HAART drugs [370–373]. This may result in the presence of HIV-1-infected monocytes and T cells in seminiferous tubules and the interstitium of the testis, as well as in the semen [374]. Earlier works have reported HIV-1 infection of the spermatogonia, spermatocytes, spermatids, and residual germ layer [375–379]. In women, the viral replication is active in the submucosa of the cervix and HIV-1 has also been detected in the epithelial and stromal cells of the uterus, fallopian tubes, and ectocervix. HIV-1 DNA was found in cervicovaginal fluids, with cervical biopsies during HAART suggesting potential limited drug penetration [380–382].

Studies in SRLVs have clearly demonstrated that goat uterine epithelial cells are susceptible to SRLV infection *in vivo* [383]. Also, SRLV proviral DNA has been identified using PCR in tissues of the genital tract (uterus, oviduct, and ovary) [175] and *in vitro*, in granulosa cells, oviduct epithelial cells [384,385], and early goat embryo cells [386]. Recent studies also demonstrate that cells of the buck genital tract are targets of SRLV infection and are thus a potential reservoir that may shed infectious SRLV into the semen of infected animals [387–389]. The work conducted by Fieni's group demonstrated that the first four washes were sufficient to remove infectious CAEV and infected cells in the semen so that SRLV-free embryos can be produced by *in vitro* fertilization (IVF) using spermatozoa contaminated *in vitro* by SRLV [390].

### 9.2.4. Lungs and Kidney

HIV-1 is positively detected in alveolar macrophages, interstitial macrophages, and lymphocytes. Alveolar macrophages harbor HIV-1 even in patients under HAART with undetectable plasma viral loads, showing that they are a potential reservoir for the virus [391,392]. Additionally, phagocytosis and immune functions are impaired due to HIV-1 replication in macrophages, which increases the risk of lung infection with other pathogens [393]. The generally low levels of replication in alveolar macrophages and the presence of alveolar lymphocytes can be rapidly augmented in lungs due to inflammatory responses to opportunistic infections. In addition, HIV-1-infected individuals are

significantly more susceptible to long-term HIV-1-associated complications such as chronic obstructive pulmonary disease (COPD) [394] (reviewed in detail in [395]).

HIV-1 DNA and mRNA have been found in the renal globular and tubular epithelial cells of kidney, suggesting replication in renal tissues. Kidney biopsies have shown the presence of circularized viral DNA, suggesting active replication [396,397]. Recent studies showed increased evidence of the kidney as a potential reservoir where the virus is exchanged between interstitial T cells and renal tubule epithelial cells [398]. Using novel noninvasive tests designed for determining HIV-1 infection of the kidney allografts by measuring HIV-1 DNA and RNA levels in a patient's urine, it has been demonstrated that HIV-1 can be detected in kidney allografts after transplantation despite undetectable viremia, and this infection might influence the graft outcome [399]. Another study suggested that the HIV-1 persistence is reduced in the transplant recipient following the transplantation of the HIV-1 infected kidney [400].

Studies conducted by Ravazzolo *et al.* indicated the presence of SRLV provirus transcripts (both un-spliced and multi-spliced) in alveolar macrophages, confirming that the lungs represent an important site of virus replication [369,401,402]. Other studies also confirmed relatively high levels of genomic and sub-genomic viral RNAs in alveolar macrophages of infected goats [403]. In earlier studies, it was found that SRLV-infected sheep alveolar macrophages were able to stimulate CTL activity *in vitro* and were targets of these activated CTL [404]. In recent studies, the increased expression of chemoattractant chemokines (MCP-1 and IP-10) was linked to the inflamed lungs [50]. Some fatal infections show diffuse interstitial pneumonia characterized histologically by severe lymphoplasmacytic infiltrates with massive alveolar proteinosis, interstitial fibrosis, and type II pneumocyte hyperplasia [405].

## 10. Can SRLV Help to Develop Strategies to Control HIV-1?

SRLVs in infected sheep and goats do not cause immunodeficiency like HIV-1 does in HIV-1-infected humans. The reason why SRLVs did not evolve towards an immunodeficiency-inducing phenotype is not well understood. It has been established that SRLVs replicate only transiently in the periphery and replicate productively in macrophages but not in CD4<sup>+</sup> T cells in target tissues. Our group has demonstrated that SRLVs have Tat-independent constitutive LTR promoters [60]. We have also shown that SRLV infection in newborn calves results in a total clearance of the virus after four months of virus replication and diffusion in target tissues [115].

Taken together, these results helped to conclude that the constitutive expression of viral proteins by SRLV LTRs could have induced antigen-specific T cell responses that were associated with virus clearance. To test the hypothesis, our group has recently generated a chimeric genome, based on the former vaccine integration and replication-defective  $\Delta 4$ -SHIV<sub>KU2</sub> by replacing the 5' SIV LTR with that of CAEV ( $\Delta 4$ -SHIV-KU2 was derived from SHIV-KU2, from which the *rt*, *int*, *vif*, and the 3' LTR sequences were deleted). The replication- and integration-deficient lentivector DNA vaccine showed promising results by inducing potent immune responses both in mice and macaques [406].

These encouraging results led to the development of a further enhanced immunogenic chimeric lentivector DNA also based on the SHIV genome in which both 5' and 3' LTRs of SIV were replaced with those of CAEV. Additionally, the integrase was deleted, making it a safe, novel, non-integrative

one-cycle lentivector DNA vaccine that produces viral antigens and particles to stimulate the immune system in *in vivo* transfected cells. These viral particles can transduce target cells without integrating vaccine DNA into these cells, thereby expressing further viral proteins and thus amplifying the vaccine antigenicity. This lentivector induced high multifunctional persistent immune responses both in immunized mice and macaque models [406].

These data provide an encouraging perspective of use of CAEV for the development of innovative strategies for the generation of a safe and long-term effective vaccine that could control HIV-1 [407].

## 11. Conclusions

HIV-1, which causes AIDS, has been responsible for the infection of over 75 million people and the death of nearly 35 million people worldwide. SRLVs infect goats and sheep in flocks all over the world. The reason why these have not evolved to induce AIDS in their natural hosts in contrast to primate lentiviruses remains not well understood. Knowledge from SRLV studies was very helpful to understanding HIV-1 biopathology and host/pathogen interaction early after the discovery of the human lentivirus. However, during the last decades, there was no substantial effort to use the SRLV model for better understanding the complex host/pathogen interaction of primate lentiviruses. Comparative analyses of structural, functional, and pathogenesis differences between SRLVs and primate subgroups of lentiviruses might bring new insights that will help us better understanding the natural history of these viruses and help develop innovative tools to control them.

## Acknowledgments

We thank the National Institute of Health, AIDS Research and Reference Reagent Program for providing HIV and SIV overlapping peptides and cell lines.

We also thank the “Institut National de la Recherche Agronomique” (INRA), University Joseph Fourier and the “Agence Nationale de Recherche sur le SIDA” (ANRS) for supporting this work.

## Author Contributions

Yahia Chebloune had the original idea and conducted the design of the study. Deepanwita Bose performed the bibliographic study and the writing of the review. Jean Gagnon helped in the writing, discussion and proof reading.

## Conflicts of Interest

The authors declare no conflict of interest.

## References

1. Peeters, M.; Fransen, K.; Delaporte, E.; Van den Haesevelde, M.; Gershy-Damet, G.M.; Kestens, L.; van der Groen, G.; Piot, P. Isolation and characterization of a new chimpanzee lentivirus (simian immunodeficiency virus isolate cpz-ant) from a wild-captured chimpanzee. *AIDS* **1992**, *6*, 447–451.

2. Peeters, M.; Honore, C.; Huet, T.; Bedjabaga, L.; Ossari, S.; Bussi, P.; Cooper, R.W.; Delaporte, E. Isolation and partial characterization of an HIV-related virus occurring naturally in chimpanzees in Gabon. *AIDS* **1989**, *3*, 625–630.
3. Van Heuverswyn, F.; Li, Y.; Neel, C.; Bailes, E.; Keele, B.F.; Liu, W.; Loul, S.; Butel, C.; Liegeois, F.; Bienvenue, Y.; *et al.* Human immunodeficiency viruses: SIV infection in wild gorillas. *Nature* **2006**, doi:10.1038/444164a.
4. Barre-Sinoussi, F.; Chermann, J.; Rey, F.; Nugeyre, M.; Chamaret, S.; Gruest, J.; Dauguet, C.; Axler, B.C.; Vezinet- Brun, F.; Rouzioux, C.; *et al.* Isolation of a T-lymphotropic retrovirus from a patient at risk for acquired immune deficiency syndrome (AIDS). *Science* **1983**, *220*, 868–871.
5. Terzieva, V. Regulatory T Cells and HIV-1 Infection. *Viral Immunol.* **2008**, *21*, 285–292.
6. Sigurdsson, B.; Palsson, P.A. Visna of sheep; a slow, demyelinating infection. *Br. J. Exp. Pathol.* **1958**, *39*, 519–528.
7. Sigurdsson, B.; Palsson, P.A.; Tryggvaddottir, A. Transmission experiments with maedi. *J. Infect. Dis.* **1953**, *93*, 166–175.
8. Gendelman, H.E.; Narayan, O.; Kennedy-Stoskopf, S.; Kennedy, P.G.; Ghotbi, Z.; Clements, J.E.; Stanley, J.; Pezeshkpour, G. Tropism of sheep lentiviruses for monocytes: susceptibility to infection and virus gene expression increase during maturation of monocytes to macrophages. *J. Virol.* **1986**, *58*, 67–74.
9. Gorrell, M.D.; Brandon, M.R.; Sheffer, D.; Adams, R.J.; Narayan, O. Ovine lentivirus is macrophagetropic and does not replicate productively in T lymphocytes. *J. Virol.* **1992**, *66*, 2679–2688.
10. Clements, J.E.; Zink, M.C. Molecular biology and pathogenesis of animal lentivirus infections. *Clin. Microbiol. Rev.* **1996**, *9*, 100–117.
11. Fun, A.; Wensing, A.M.; Verheyen, J.; Nijhuis, M. Human immunodeficiency virus Gag and protease: Partners in resistance. *Retrovirology* **2012**, doi:10.1186/1742-4690-9-63.
12. Konvalinka, J.; Krausslich, H.G.; Muller, B. Retroviral proteases and their roles in virion maturation. *Virology* **2015**, *479–480*, 403–417.
13. Minardi da Cruz, J.; Singh, D.; Lamara, A.; Chebloune, Y. Small ruminant lentiviruses (SRLVs) break the species barrier to acquire new host range. *Viruses* **2013**, *5*, 1867–1884.
14. Sarafianos, S.G.; Marchand, B.; Das, K.; Himmel, D.M.; Parniak, M.A.; Hughes, S.H.; Arnold, E. Structure and function of HIV-1 reverse transcriptase: Molecular mechanisms of polymerization and inhibition. *J. Mol. Biol.* **2009**, *385*, 693–713.
15. Luciw, P. *Human Immunodeficiency Viruses and Their Replication*, 3rd ed.; Raven Press: Philadelphia, PA, USA, 1996; pp. 1881–1952.
16. Vaishnav, Y.; Wong-Staal, F. The Biochemistry of AIDS. *Annu. Rev. Biochem.* **1991**, *60*, 577–630.
17. Kalland, K.H.; Szilvay, A.M.; Brokstad, K.A.; Saetrevik, W.; Haukenes, G. The human immunodeficiency virus type 1 Rev protein shuttles between the cytoplasm and nuclear compartments. *Mol. Biol. Cell.* **1994**, *14*, 7436–7444.
18. Meyer, B.E.; Malim, M.H. The HIV-1 Rev trans-activator shuttles between the nucleus and the cytoplasm. *Genes Dev.* **1994**, *8*, 1538–1547.
19. Daly, T.J.; Cook, K.S.; Gray, G.S.; Maione, T.E.; Rusche, J.R. Specific binding of HIV-1 recombinant Rev protein to the Rev-responsive element *in vitro*. *Nature* **1989**, *342*, 816–819.

20. Fukuda, M.; Asano, S.; Nakamura, T.; Adachi, M.; Yoshida, M.; Yanagida, M.; Nishida, E. CRM1 is responsible for intracellular transport mediated by the nuclear export signal. *Nature* **1997**, *390*, 308–311.
21. Simon, J.H.; Malim, M.H. The human immunodeficiency virus type 1 Vif protein modulates the postpenetration stability of viral nucleoprotein complexes. *J. Virol.* **1996**, *70*, 5297–5305.
22. Fouchier, R.A.; Simon, J.H.; Jaffe, A.B.; Malim, M.H. Human immunodeficiency virus type 1 Vif does not influence expression or virion incorporation of gag-, pol-, and env-encoded proteins. *J. Virol.* **1996**, *70*, 8263–8269.
23. Simon, J.H.; Miller, D.L.; Fouchier, R.A.; Malim, M.H. Virion incorporation of human immunodeficiency virus type-1 Vif is determined by intracellular expression level and may not be necessary for function. *Virology* **1998**, *248*, 182–187.
24. Goila-Gaur, R.; Strebel, K. HIV-1 Vif, APOBEC, and intrinsic immunity. *Retrovirology* **2008**, doi:10.1186/1742-4690-5-51.
25. Sheehy, A.M.; Gaddis, N.C.; Choi, J.D.; Malim, M.H. Isolation of a human gene that inhibits HIV-1 infection and is suppressed by the viral Vif protein. *Nature* **2002**, *418*, 646–650.
26. Desimie, B.A.; Delviks-Frankenberry, K.A.; Burdick, R.C.; Qi, D.; Izumi, T.; Pathak, V.K. Multiple APOBEC3 restriction factors for HIV-1 and one Vif to rule them all. *J. Mol. Biol.* **2014**, *426*, 1220–1245.
27. Holmes, R.K.; Malim, M.H.; Bishop, K.N. APOBEC-mediated viral restriction: Not simply editing? *Trends Biochem. Sci.* **2007**, *32*, 118–128.
28. Kim, S.; Ikeuchi, K.; Byrn, R.; Groopman, J.; Baltimore, D. Lack of a negative influence on viral growth by the nef gene of human immunodeficiency virus type 1. *Proc. Natl. Acad. Sci. USA* **1989**, *86*, 9544–9548.
29. Pawlak, E.N.; Dikeakos, J.D. HIV-1 Nef: a master manipulator of the membrane trafficking machinery mediating immune evasion. *Biochim. Biophys. Acta* **2015**, *1850*, 733–741.
30. Piguet, V.; Wan, L.; Borel, C.; Mangasarian, A.; Demarex, N.; Thomas, G.; Trono, D. HIV-1 Nef protein binds to the cellular protein PACS-1 to downregulate class I major histocompatibility complexes. *Nat. Cell. Biol.* **2000**, *2*, 163–167.
31. Atkins, K.M.; Thomas, L.; Youker, R.T.; Harriff, M.J.; Pissani, F.; You, H.; Thomas, G. HIV-1 Nef binds PACS-2 to assemble a multikinase cascade that triggers major histocompatibility complex class I (MHC-I) down-regulation: analysis using short interfering RNA and knock-out mice. *J. Biol. Chem.* **2008**, *283*, 11772–11784.
32. Dikeakos, J.D.; Atkins, K.M.; Thomas, L.; Emert-Sedlak, L.; Byeon, I.J.; Jung, J.; Ahn, J.; Wortman, M.D.; Kukull, B.; Saito, M.; *et al.* Small molecule inhibition of HIV-1-induced MHC-I down-regulation identifies a temporally regulated switch in Nef action. *Mol. Biol. Cell.* **2010**, *21*, 3279–3292.
33. Hung, C.H.; Thomas, L.; Ruby, C.E.; Atkins, K.M.; Morris, N.P.; Knight, Z.A.; Scholz, I.; Barklis, E.; Weinberg, A.D.; Shokat, K.M.; *et al.* HIV-1 Nef assembles a Src family kinase-ZAP-70/Syk-PI3K cascade to downregulate cell-surface MHC-I. *Cell Host Microbe* **2007**, *1*, 121–133.
34. Schaefer, M.R.; Wonderlich, E.R.; Roeth, J.F.; Leonard, J.A.; Collins, K.L. HIV-1 Nef targets MHC-I and CD4 for degradation via a final common beta-COP-dependent pathway in T cells. *PLoS Pathog* **2008**, doi:10.1371/journal.ppat.1000131.

35. Swann, S.A.; Williams, M.; Story, C.M.; Bobbitt, K.R.; Fleis, R.; Collins, K.L. HIV-1 Nef blocks transport of MHC class I molecules to the cell surface via a PI 3-kinase-dependent pathway. *Virology* **2001**, *282*, 267–277.
36. Matthias, G.; Oliver, T.F.; Matija, P. Structure- function relationships in HIV-1 Nef. *EMBO Rep.* **2001**, *2*, 580–585.
37. Roth, W.W.; Khan, M.; Geleziunas, R.; Stringer, H.G.; Zuberi, J.A.; Greene, W.C.; Powell, M.; Bond, V.C. Functionally-impaired HIV-1 Nef alleles from a mother-child transmission pair. *Int. J. Mol. Sci.* **2002**, *3*, 1058–1072.
38. Jere, A.; Fujita, M.; Adachi, A.; Nomaguchi, M. Role of HIV-1 Nef protein for virus replication *in vitro*. *Microb. Infect.* **2010**, *12*, 65–70.
39. Fackler, O.; Lu, X.; Frost, J.; Geyer, M.; Jiang, B.; Luo, W.; Abo, A.; Alberts, A.; Peterlin, M. p21-activated kinase 1 plays a critical role in cellular activation by Nef. *Mol. Biol. Cell.* **2000**, *20*, 2619–2627.
40. Wolf, D.; Witte, V.; Laffert, B.; Blume, K.; Stromer, E.; Trapp, S.; d'Aloja, P.; Schurmann, A.; Baur, S. HIV-1 Nef associated PAK and PI3-kinases stimulate Akt-independent Bad-phosphorylation to induce anti-apoptotic signals. *Nat. Med.* **2001**, *7*, 1217–1224.
41. Groschel, B.; Bushman, F. Cell cycle arrest in G2/M promotes early steps of infection by human immunodeficiency virus. *J. Virol.* **2005**, *79*, 5695–5704.
42. Cohen, E.A. From arrest to escape: HIV-1 Vpr cuts a deal. *Cell Host Microbe* **2014**, *15*, 125–127.
43. Murakami, T.; Aida, Y. Visualizing Vpr-induced G2 arrest and apoptosis. *PloS ONE* **2014**, doi:10.1371/journal.pone.0086840.
44. Philippon, V.; Matsuda, Z.; Essex, M. Transactivation is a conserved function among primate lentivirus Vpr proteins but is not shared by Vpx. *J. Hum. Virol.* **1999**, *2*, 167–174.
45. Mirani, M.; Elenkov, I.; Volpi, S.; Hiroi, N.; Chrousos, G.; Kino, T. HIV-1 protein Vpr suppresses IL-12 production from human monocytes by enhancing glucocorticoid action: Potential implications of Vpr coactivator activity for the innate and cellular immunity deficits observed in HIV-1 infection. *J. Immunol.* **2002**, *169*, 6361–6368.
46. Hoch, J.; Lang, S.M.; Weeger, M.; Stahl-Hennig, C.; Coulibaly, C.; Dittmer, U.; Hunsmann, G.; Fuchs, D.; Muller, J.; Sopper, S.; *et al.* vpr deletion mutant of simian immunodeficiency virus induces AIDS in rhesus monkeys. *J. Virol.* **1995**, *69*, 4807–4813.
47. Lang, S.M.; Weeger, M.; Stahl-Hennig, C.; Coulibaly, C.; Hunsmann, G.; Muller, J.; Muller-Hermelink, H.; Fuchs, D.; Wachter, H.; Daniel, M.M.; *et al.* Importance of vpr for infection of rhesus monkeys with simian immunodeficiency virus. *J. Virol.* **1993**, *67*, 902–912.
48. Bouzar, A.B.; Guiguen, F.; Morin, T.; Villet, S.; Fornazero, C.; Garnier, C.; Gallay, K.; Gounel, F.; Favier, C.; Durand, J.; *et al.* Specific G2 arrest of caprine cells infected with a caprine arthritis encephalitis virus expressing vpr and vpx genes from simian immunodeficiency virus. *Virology* **2003**, *309*, 41–52.
49. Bouzar, A.B.; Villet, S.; Morin, T.; Rea, A.; Genestier, L.; Guiguen, F.; Garnier, C.; Mornex, J.F.; Narayan, O.; Chebloune, Y. Simian immunodeficiency virus Vpr/Vpx proteins kill bystander noninfected CD4+ T-lymphocytes by induction of apoptosis. *Virology* **2004**, *326*, 47–56.



50. Jin, Y.; Arrode-Brusés, G.; Halloway, N.; Narayan, O.; Chebloune, Y. Changes of biological properties and pathogenesis of CAEV chimeras expressing Nef and Vpx/Vpr accessory proteins in infected goats. *Retrovirology* **2009**, doi:10.1186/1742-4690-6-S2-P22.
51. Cullen, B.R. HIV-1 auxiliary proteins: Making connections in a dying cell. *Cell*. **1998**, *93*, 685–692.
52. Emerman, M.; Malim, M. HIV-1 regulatory/accessory genes: Key to unraveling viral and host cell biology. *Science* **1998**, *280*, 1880–1884.
53. Garcia, J.; Harrich, D.; Pearson, L.; Mitsuyasu, R.; Gaynor, R. Functional domains required for Tat-induced transcriptional activation of the HIV-1 long terminal repeats. *EMBO J.* **1988**, *7*, 3143–3147.
54. Hauber, J.; Malim, M.; Cullen, B.R. Mutational analysis of the conserved basic domain of human immunodeficiency virus Tat protein. *J. Virol.* **1989**, *63*, 1181–1187.
55. Tang, H.; Kuhen, K.; Wong-Staal, F. Lentivirus replication and regulation. *Annu. Rev. Genet.* **1999**, *33*, 133–170.
56. Arya, S.; Guo, C.; Josephs, S.; Wong-Staal, F. Trans-activator gene of human T-lymphotropic virus type III (HTLV-III). *Science* **1985**, *229*, 69–73.
57. Saltarelli, M.J.; Schoborg, R.; Gdovin, S.L.; Clements, J.E. The CAEV *tat* gene transactivates the viral LTR and is necessary for efficient viral replication. *Virology* **1993**, *197*, 35–44.
58. Neuveut, C.; Vigne, R.; Clements, J.E.; Sire, J. The visna transcriptional activator Tat: Effects on the viral LTR and on cellular genes. *Virology* **1993**, *197*, 236–244.
59. Carruth, L.M.; Hardwick, J.; Morse, B.A.; Clements, J.E. Visna virus Tat protein: a potent transcription factor with both activator and suppressor domains. *J. Virol.* **1994**, *68*, 6137–6146.
60. Villet, S.; Faure, C.; Bouzar, B.A.; Morin, T.; Verdier, G.; Chebloune, Y.; Legras, C. Lack of trans-activation function for Maedi Visna virus and Caprine arthritis encephalitis virus Tat proteins. *Virology* **2003**, *307*, 317–327.
61. Villet, S.; Bouzar, B.A.; Morin, T.; Verdier, G.; Legras, C.; Chebloune, Y. *Maedi-Visna* virus and caprine arthritis encephalitis virus genomes encode a Vpr-Like but No Tat protein. *J. Virol.* **2003**, *77*, 9632–9638.
62. Rea-Boutrois, A.; Villet, S.; Greenland, T.; Mehlen, P.; Chebloune, Y.; Verdier, G.; Legras-Lachuer, C. Small ruminant lentivirus Tat protein induces apoptosis in caprine cells *in vitro* by the intrinsic pathway. *Virology* **2009**, *383*, 93–102.
63. Rea-Boutrois, A.; Pontini, G.; Greenland, T.; Mehlen, P.; Chebloune, Y.; Verdier, G.; Legras-Lachuer, C. Caprine arthritis-encephalitis virus induces apoptosis in infected cells *in vitro* through the intrinsic pathway. *Virology* **2008**, *375*, 452–463.
64. Sharp, P.M.; Hahn, B.H. Origins of HIV and the AIDS pandemic. *Cold Spring Harb. Perspect. Med.* **2011**, doi:10.1101/cshperspect.a006841.
65. Delaugerre, C.; De Oliveira, F.; Lascoux-Combe, C.; Plantier, J.C.; Simon, F. HIV-1 group N: Travelling beyond Cameroon. *Lancet* **2011**, *378*, 1894.
66. Plantier, J.C.; Leoz, M.; Dickerson, J.E.; De Oliveira, F.; Cordonnier, F.; Lemee, V.; Damond, F.; Robertson, D.L.; Simon, F. A new human immunodeficiency virus derived from gorillas. *Nat. Med.* **2009**, *15*, 871–872.

67. Vallari, A.; Holzmayer, V.; Harris, B.; Yamaguchi, J.; Ngansop, C.; Makamche, F.; Mbanya, D.; Kaptue, L.; Ndembi, N.; Gurtler, L.; *et al.* Confirmation of putative HIV-1 group P in Cameroon. *J. Virol.* **2011**, *85*, 1403–1407.
68. D’Arc, M.; Ayouba, A.; Esteban, A.; Learn, G.H.; Boue, V.; Liegeois, F.; Etienne, L.; Tagg, N.; Leendertz, F.H.; Boesch, C.; *et al.* Origin of the HIV-1 group O epidemic in western lowland gorillas. *Proc. Natl. Acad. Sci. USA* **2015**, *112*, 1343–1352.
69. Shaw, G.M.; Hunter, E. HIV transmission. *Cold Spring Harb. Perspect. Med.* **2012**, doi:10.1101/cshperspect.a006965.
70. Touloumi, G.; Hatzakis, A. Natural history of HIV-1 infection. *Clin. Dermatol.* **2000**, *18*, 389–399.
71. Mitchell, D.T. *Investigations into Jaagziekte or Chronic Catarrhal Pneumonia of Sheep*. Directory Veterinary Education Research: Union of South Africa, UK, 1915; p.585.
72. Palsson, P.A. Maedi and visna in sheep. *Front. Biol.* **1976**, *44*, 17–43.
73. Marsh, H. Progressive pneumonia in sheep. *J. Am. Vet. Med. Assoc.* **1923**, *62*, 458–473.
74. Gislason, G. *Thaettir urn Indutning Bdfjar og Karak~Ilsjdkdbma.*; Icelandic Department of Agricultural Publication: Reykjavik, Iceland, 1947; pp. 235–254. (In Icelandic).
75. Palsson, P.A. Maedi-visna. *J. Clin. Pathol.* **1972**, *6*, 115–120.
76. Stunzi, H.; Buchi, H.F., LeRoy, H.L.; Leeman, W. Endemische arthritis chronic a bei zeiegen. *Schw. Arch. Tier.* **1959**, *106*, 778–788.
77. Stavrou, D.; Deutschlander, N.; Dahme, E. Granulomatous encephalomyelitis in goats. *J. Comp. Pathol.* **1969**, *79*, 393–396.
78. Cork, L.C.; Hadlow, W.J.; Crawford, T.B.; Gorham, J.R.; Piper, R.C. Infectious leukoencephalomyelitis of young goats. *J. Infect. Dis.* **1974**, *129*, 134–141.
79. Crawford, T.B.; Adams, D.S.; cheevers, W.; Cork, L.C. Chronic arthritis in goats caused by a retrovirus. *Science* **1980**, *207*, 997–999.
80. Narayan, O.; Clements, J.E.; Strandberg, J.D.; Cork, L.C.; Griffin, D.E. Biological characterization of the virus causing leukoencephalitis and arthritis in goats. *J. Gen. Virol.* **1980**, *50*, 69–79.
81. Peluso, R.; Haase, A.; Stowring, L.; Edwards, M.; ventura, P. A trojan hosre mechanism for the spread of visna virus in monocytes. *Virology* **1985**, *147*, 231–236.
82. Gendelman, H.E.; Narayan, O.; Molineaux, S.; Clements, J.E.; Ghotbi, Z. Slow, persistent replication of lentiviruses: role of tissue macrophages and macrophage precursors in bone marrow. *Proc. Natl. Acad. Sci. USA* **1985**, *82*, 7086–7090.
83. Lairmore, M.D.; Akita, G.Y.; Russell, H.I.; DeMartini, J.C. Replication and cytopathic effects of ovine lentivirus strains in alveolar macrophages correlate with *in vivo* pathogenicity. *J. Virol.* **1987**, *61*, 4038–4042.
84. Narayan, O.; Kennedy-Stoskopf, S.; Sheffer, D.; Griffin, D.E.; Clements, J.E. Activation of caprine arthritis-encephalitis virus expression during maturation of monocytes to macrophages. *Infect. Immun.* **1983**, *41*, 67–73.
85. Blacklaws, B.A. Small ruminant lentiviruses: immunopathogenesis of visna-maedi and caprine arthritis and encephalitis virus. *Comp. Immunol. Microbiol. Infect. Dis.* **2012**, *35*, 259–269.

86. Carrozza, M.L.; Mazzei, M.; Bandecchi, P.; Arispici, M.; Tolari, F. In situ PCR-associated immunohistochemistry identifies cell types harbouring the Maedi-Visna virus genome in tissue sections of sheep infected naturally. *J. Virol. Methods* **2003**, *107*, 121–127.
87. Sanna, E.; Sanna, M.P.; Vitali, C.G.; Renzoni, G.; Sanna, L.; Spano, S.; Rossi, G.; Leoni, A. Proviral DNA in the brains of goats infected with caprine arthritis-encephalitis virus. *J. Comp. Pathol.* **1999**, *121*, 271–276.
88. Pautrat, G.; Filippi, P. Evidence for the production of a fusion factor during *in vitro* infection of sheep choroid plexus cells by visna virus. *C. R. Seances Soc. Biol. Fil.* **1979**, *173*, 811–817.
89. Sihvonen, L.; Veijalainen, P. Kinetics of maedi virus production in sheep choroid plexus cells. *Vet. Microbiol.* **1981**, *6*, 1–8.
90. Ryan, S.; Tiley, L.; McConnell, I.; Blacklaws, B. Infection of dendritic cells by the Maedi-Visna lentivirus. *J. Virol.* **2000**, *74*, 10096–10103.
91. Lechat, E.; Milhau, N.; Brun, P.; Bellaton, C.; Greenland, T.; Mornex, J.F.; le Jan, C. Goat endothelial cells may be infected *in vitro* by transmigration of caprine arthritis-encephalitis virus-infected leucocytes. *Vet. Immunol. Immunopathol.* **2005**, *104*, 257–263.
92. Keele, B.F.; Giorgi, E.E.; Salazar-Gonzalez, J.F.; Decker, J.M.; Pham, K.T.; Salazar, M.G.; Sun, C.; Grayson, T.; Wang, S.; Li, H.; *et al.* Identification and characterization of transmitted and early founder virus envelopes in primary HIV-1 infection. *Proc. Natl. Acad. Sci. USA.* **2008**, *105*, 7552–7557.
93. Schuitemaker, H.; Koot, M.; Kootstra, N.A.; Dercksen, M.W.; de Goede, R.E.; van Steenwijk, R.P.; Lange, J.M.; Schattenkerk, J.K.; Miedema, F.; Tersmette, M. Biological phenotype of human immunodeficiency virus type 1 clones at different stages of infection: progression of disease is associated with a shift from monocytophagic to T-cell-tropic virus population. *J. Virol.* **1992**, *66*, 1354–1360.
94. McCune, J.M. The dynamics of CD4+ T-cell depletion in HIV disease. *Nature* **2001**, *410*, 974–979.
95. Khan, K.A.; Abbas, W.; Varin, A.; Kumar, A.; Di Martino, V.; Dichamp, I.; Herbein, G. HIV-1 Nef interacts with HCV Core, recruits TRAF2, TRAF5 and TRAF6, and stimulates HIV-1 replication in macrophages. *J. Innate Immun* **2013**, *5*, 639–656.
96. Brown, A.; Zhang, H.; Lopez, P.; Pardo, C.A.; Gartner, S. In vitro modeling of the HIV-1 macrophage reservoir. *J. Leukoc. Biol.* **2006**, *80*, 1127–1135.
97. Aquaro, S.; Calio, R.; Balzarini, J.; Bellocchi, M.; Garaci, E.; Perno, C. Macrophages and HIV infection: therapeutical approaches toward this strategic virus reservoir. *Antiviral Res.* **2002**, *55*, 209–225.
98. Crowe, S.; Zhu, T.; muller, W. The contribution of monocyte infection and trafficking to viral persistence, and maintenance of the viral reservoir in HIV infection. *J. Leukoc. Biol.* **2003**, *74*, 635–641.
99. Lambotte, O.; Taoufik, Y.; de Goer, M.; Wallon, C.; Goujard, C.; Delfraissy, J. Detection of infectious HIV in circulating monocytes from patients on prolonged highly active antiretroviral therapy. *J. Acquir. Immune Defic. Syndr.* **2000**, *23*, 114–119.

100. Zhu, T.; Muthui, D.; Holte, S.; Nickle, D.; Feng, F.; Brodie, S.; Hwangbo, Y.; Mullins, J.I.; Corey, L. Evidence for Human Immunodeficiency Virus Type 1 Replication In Vivo in CD14+ Monocytes and Its Potential Role as a Source of Virus in Patients on Highly Active Antiretroviral Therapy. *J. Virol.* **2002**, *76*, 707–716.
101. Le Douce, V.; Herbein, G.; Rohr, O.; Schwartz, C. Molecular mechanisms of HIV-1 persistence in the monocyte-macrophage lineage. *Retrovirology* **2010**, doi:10.1186/1742-4690-7-32.
102. Zink, M.C.; Yager, J.A.; Myers, J.D. Pathogenesis of caprine arthritis encephalitis virus. Cellular localization of viral transcripts in tissues of infected goats. *Am. J. Pathol.* **1990**, *136*, 843.
103. Clements, J.E.; Zink, M.C.; Narayan, O.; Gabuzda, D. Lentiviral infection of macrophages. *Immunol. Ser.* **1994**, *60*, 589–600.
104. Coleman, C.M.; Wu, L. HIV interactions with monocytes and dendritic cells: Viral latency and reservoirs. *Retrovirology* **2009**, doi:10.1186/1742-4690-6-51.
105. Lore, K.; Smed-sorensen, A.; Vasudevan, J.; Mascola, J.; Koup, R.A. Myeloid and plasmacytoid dendritic cells transfer HIV-1 preferentially to antigen-specific CD4+ T cells. *J. Exp. Med.* **2005**, *201*, 2023–2033.
106. Smed-Sørensen, A.; Loré K.; Vasudevan, J.; Louder, M.K.; Andersson, J.; Mascola, J.R.; Spetz, A.-L.; Koup, R.A. Differential susceptibility to human immunodeficiency virus type 1 infection of myeloid and plasmacytoid dendritic cells. *J. Virol.* **2005**, *79*, 8861–8869.
107. Burleigh, L.; Lozach, P.-Y.; Schiffer, C.; Staropoli, I.; Pezo, V.; Porrot, F.; Canque, B.; Virelizier, J.-L.; Arenzana-Seisdedos, F.; Amara, A. Infection of dendritic cells (DCs), not DC-SIGN-mediated internalization of human immunodeficiency virus, is required for long-term transfer of virus to T cells. *J. Virol.* **2006**, *80*, 2949–2957.
108. Geijtenbeek, T.B.; Kwon, D.S.; Torensma, R.; van Vliet, S.J.; van Duijnhoven, G.C.; Middel, J.; Cornelissen, I.L.; Nottet, H.S.; KewalRamani, V.N.; Littman, D.R.; *et al.* DC-SIGN, a dendritic cell-specific HIV-1-binding protein that enhances trans-infection of T cells. *Cell.* **2000**, *100*, 587–597.
109. Evans, V.A.; Kumar, N.; Filali, A.; Procopio, F.A.; Yegorov, O.; Goulet, J.P.; Saleh, S.; Haddad, E.K.; da Fonseca Pereira, C.; Ellenberg, P.C.; *et al.* Myeloid dendritic cells induce HIV-1 latency in non-proliferating CD4+ T cells. *PLoS Pathog.* **2013**, *9*, e1003799.
110. Banks, K.L.; Adams, D.S.; McGuire, T.C.; Carlson, J. Experimental infection of sheep by caprine arthritis-encephalitis virus and goats by progressive pneumonia virus. *Am. J. Vet. Res.* **1983**, *44*, 2307–2311.
111. Leroux, C.; Cruz, J.C.; Mornex, J.F. SRLVs: A genetic continuum of lentiviral species in sheep and goats with cumulative evidence of cross species transmission. *Curr. HIV Res.* **2010**, *8*, 94–100.
112. Karr, B.M.; Chebloune, Y.; Leung, K.; Narayan, O. Genetic characterization of two phenotypically distinct North American ovine lentiviruses and their possible origin from caprine arthritis-encephalitis virus. *Virology* **1996**, *225*, 1–10.
113. Shah, C.; Huder, J.B.; Boni, J.; Schonmann, M.; Muhlherr, J.; Lutz, H.; Schupbach, J. Direct evidence for natural transmission of small-ruminant lentiviruses of subtype A4 from goats to sheep and vice versa. *J. Virol.* **2004**, *78*, 7518–7522.

114. Guiguen, F.; Mselli-Lakhal, L.; Durand, J.; Du, J.; Favier, C.; Fornazero, C.; Grezel, D.; Balleydier, S.; Hausmann, E.; Chebloune, Y. Experimental infection of Mouflon-domestic sheep hybrids with caprine arthritis-encephalitis virus. *Am. J. Vet. Res.* **2000**, *61*, 456–461.
115. Morin, T.; Guiguen, F.; Bouzar, B.A.; Villet, S.; Greenland, T.; Grezel, D.; Gounel, F.; Gallay, K.; Garnier, C.; Durand, J.; *et al.* Clearance of a Productive Lentivirus Infection in Calves Experimentally Inoculated with Caprine Arthritis-Encephalitis Virus. *J. Virol.* **2003**, *77*, 6430–6437.
116. Erhouma, E.; Guiguen, F.; Chebloune, Y.; Gauthier, D.; Lakhal, L.M.; Greenland, T.; Mornex, J.F.; Leroux, C.; Alogninouwa, T. Small ruminant lentivirus proviral sequences from wild ibexes in contact with domestic goats. *J. Gen. Virol.* **2008**, *89*, 1478–1484.
117. Pisoni, G.; Bertoni, G.; Puricelli, M.; Maccalli, M.; Moroni, P. Demonstration of coinfection with and recombination by caprine arthritis-encephalitis virus and maedi-visna virus in naturally infected goats. *J. Virol.* **2007**, *81*, 4948–4955.
118. Adams, D.S.; Klevjer-Anderson, P.; Carlson, J.L.; McGuire, T.C.; Gorham, J.R. Transmission and control of caprine arthritis-encephalitis virus. *Am. J. Vet. Res.* **1983**, *44*, 1670–1675.
119. Knight, A.; Jokinen, M. Caprine arthritis-encephalitis. *Compend. Contin. Educ. Pract. Vet.* **1982**, *4*, 263–269.
120. Lloyd, S. Goat medicine and surgery. *Br. Vet. J.* **1982**, *138*, 70–85.
121. Sherman, D.M. CAE: Caprine arthritis encephalitis—a growing concern. *DGJ* **1983**, *61*, 93–95.
122. Preziuso, S.; Renzoni, G.; Allen, T.E.; Taccini, E.; Rossi, G.; DeMartini, J.C.; Braca, G. Colostral transmission of maedi visna virus: sites of viral entry in lambs born from experimentally infected ewes. *Vet. Microbiol.* **2004**, *104*, 157–164.
123. Cork, L.C.; Narayan, O.; Strandberg, J.; Clements, J.E.; Griffin, D. Viral leukoencephalomyelitis-arthritis of goats: Pathogenesis of the persistent viral infection. *J. Neuropath. Exp. Neur.* **1980**, doi:10.1186/1742-4690-6-51.
124. Rimstad, E.; East, N.E.; Torten, M.; Higgins, J.; DeRock, E.; Pedersen, N.C. Delayed seroconversion following naturally acquired caprine arthritis-encephalitis virus infection in goats. *Am. J. Vet. Res.* **1993**, *54*, 1858–1862.
125. Cork, L.C. Pathology and epidemiology of lentiviral infection of goats. *Maedi-Visna and Related Diseases*, Pétursson, G.; Hoff-Jørgensen, R. Eds.; Kluwer Academic Publishers; Dordrecht, The Netherlands, 1990; pp. 119–127.
126. Daas, E.; Moudgil, T.; Meyer, R. Transient high levels of viremia in patients with primary human immunodeficiency virus type 1 infection. *N. Engl. J. Med.* **1991**, *324*, 961–964.
127. Piatak, M.; saag, M.; yang, L. High levels of HIV-1 in plasma during all stages of infection determined by competitive PCR. *Science* **1993**, *259*, 1749–1754.
128. Mehandru, S.; Poles, M.A.; Tenner-Racz, K.; Horowitz, A.; Hurley, A.; Hogan, C.; Boden, D.; Racz, P.; Markowitz, M. Primary HIV-1 infection is associated with preferential depletion of CD4+ T lymphocytes from effector sites in the gastrointestinal tract. *J. Exp. Med.* **2004**, *200*, 761–770.
129. Saksena, N.; Potter, S. Reservoirs of HIV-1 *in vivo*: implications for antiretroviral therapy. *AIDS Rev.* **2003**, *5*, 3–18.
130. Busch, M.; El-Amad, Z.; Sheppard, H.; Ascher, M. Primary HIV-1 infection. *N. Engl. J. Med.* **1991**, *325*, 733–735.

131. Clark, S.; Saag, M.; Decker, W. High titers of cytopathic virus in plasma of patients with symptomatic primary infection. *N. Engl. J. Med.* **1991**, *324*, 954–960.
132. Tindall, B.; Cooper, D. Primary HIV infection: Host responses and intervention strategies. *AIDS* **1991**, *5*, 1–14.
133. Gupta, P.; Kingsley, L.; Armstrong, J.; Ding, M.; Cottrill, M.; Rinaldo, C. Enhanced expression of human immunodeficiency virus type 1 correlates with development of AIDS. *Virology* **1993**, *196*, 586–595.
134. Henrad, D.; Philips, J.; Muenz, L.; Blattner, W.A.; Wiesner, D.; Eyster, M.E. Natural history of HIV-1 cell free viremia. *J. Am. Med. Assoc.* **1995**, *274*, 554–558.
135. Jurriaans, S.; van German, B.; Weverling, G.J.; van Strijp, D.; Nara, P.; Coutinho, R.; Koot, M.; Schuitemaker, H.; Goudsmit, J. The natural history of HIV-1 infection: Virus load and virus phenotype independent determinants of clinical course? *Virology* **1994**, *204*, 223–233.
136. Cozzi-Lepri, A.; Sabin, C.; Tezzotti, P. Is there a general tendency for rate of CD4 lymphocyte count decline to speed up during HIV infection? Evidence from the Italian Seroconversion Study. *J. Infect. Dis.* **1997**, *175*, 775–780.
137. Lang, W.; Perkins, H.; Anderson, R.; Royce, R.; Jewell, N. Patterns of T lymphocyte changes with human immunodeficiency virus infection: From seroconversion to the development of AIDS. *J. Acquir. Immune Defic. Syndr.* **1989**, *2*, 63–69.
138. Phillips, A.N.; Lee, C.A.; Elford, J.; Janossy, G.; Timms, A.; Bofill, M.; Kernoff, P.B. Serial CD4 lymphocyte counts and development of AIDS. *Lancet* **1991**, *337*, 389–392.
139. Touloumi, G.; Hatzakis, A.; Rosenberg, P.S.; O'Brien, T.R.; Goedert, J.J. Effects of age at seroconversion and baseline HIV-RNA level on the loss of CD4 cells among persons with hemophilia. *AIDS* **1998**, *12*, 1691–1697.
140. Lewthwaite, P.; Wilkins, E. Natural history of HIV/AIDS. *Medicine* **2005**, *33*, 10–13.
141. Lewthwaite, P.; Wilkins, E. Natural history of HIV/AIDS. *Medicine* **2009**, *37*, 333–337.
142. Dean, M.; Carrington, M.; Winkler, C.; Huttley, G.A.; Smith, M.W.; Allikmets, R.; Goedert, J.J.; Buchbinder, S.P.; Vittinghoff, E.; Gomperts, E.; *et al.* Genetic restriction of HIV-1 infection and progression to AIDS by a deletion allele of the CKR5 structural gene. hemophilia growth and development study, multicenter AIDS cohort study, multicenter hemophilia cohort study, San Francisco city cohort, ALIVE study. *Science* **1996**, *273*, 1856–1862.
143. Al-Jabri, A.A. Mechanisms of host resistance against HIV infection and progression to AIDS. *Sultan Qaboos Univ. Med. J.* **2007**, *7*, 82–96.
144. Crowe, S.; Carlin, J.; Steward, K.; Lucas, C.R. Predictive value of CD4 lymphocyte numbers for the development of opportunistic infections and malignancies in HIV-infected persons. *J. Acquir. Immune Defic. Syndr.* **1991**, *4*, 770–776.
145. Hoover, D.R.; Rinaldo, C.; He, Y.; Phair, J.; Fahey, J.; Graham, N.M. Long-term survival without clinical AIDS after CD4+ cell fall below  $200 \times 10^6/L$ . *AIDS* **1995**, *9*, 145–152.
146. Mocroft, A.; Johnson, M.; Sabin, C.; Lipman, M.; Elford, J.; Emery, V.; Morcinek, J.; Youle, M.; Janossy, G.; Lee, C.A. Staging system for clinical AIDS patients. *Lancet* **1995**, *346*, 12–17.
147. Orenstein, R. *Presenting Syndromes of Human Immunodeficiency Virus*, Elsevier: Amsterdam, The Netherlands, 2002, pp. 1097–1102.

148. O'Sullivan, B.M.; Eaves, F.W.; Baxendell, S.A.; Rowan, K.J. Leucoencephalomyelitis of goat kids. *Aust. Vet. J.* **1978**, *54*, 479–483.
149. Adams, D.S.; Crawford, T.B.; Klevjer-Anderson, P. A pathogenetic study of the early connective tissue lesions of viral caprine arthritis-encephalitis. *Amer. J. Pathol.* **1980**, *99*, 257–278.
150. Sigurdsson, B.; Palsson, P.A. Visna of sheep. A slow demyelinating infection. *Brit. J. Exp. Pathol.* **1958**, *39*, 519–528.
151. Ruprecht, R.M.; Baba, T.W.; Liska, V.; Ray, N.B.; Martin, L.N.; Murphey-Corb, M.; Rizvi, T.A.; Bernacky, B.J.; Bernacky, M.E.; McClure, H.M.; *et al.* Oral transmission of primate lentiviruses. *J. Infect. Dis.* **1999**, *179*, 408–412.
152. Parrish, N.F.; Gao, F.; Li, H.; Giorgi, E.E.; Barbian, H.J.; Parrish, E.H.; Zajic, L.; Iyer, S.S.; Decker, J.M.; Kumar, A.; *et al.* Phenotypic properties of transmitted founder HIV-1. *Proc. Natl. Acad. Sci. USA* **2013**, *110*, 6626–6633.
153. Pope, M.; Betjes, M.; Romani, N.; Hirmand, H.; Cameron, P.; Hoffman, L.; Gezelter, S.; Schuler, G.; Steinman, R. Conjugates of dendritic cells and memory T lymphocytes from skin facilitate productive infection with HIV-1. *Cell*. **1994**, *78*, 389–398.
154. Neutra, M.; Frey, A.; Kraehenbuhl, J. Epithelial M cells: Gateways for mucosal infection and immunization. *Cell*. **1996**, *86*, 345–348.
155. Hladik, F.; Hope, T.J. HIV infection of the genital mucosa in women. *Curr. HIV/AIDS Rep.* **2009**, *6*, 20–28.
156. Stieh, D.J.; Maric, D.; Kelley, Z.L.; Anderson, M.R.; Hattaway, H.Z.; Beilfuss, B.A.; Rothwangl, K.B.; Veazey, R.S.; Hope, T.J. Vaginal challenge with an SIV-based dual reporter system reveals that infection can occur throughout the upper and lower female reproductive tract. *PLoS Pathog.* **2014**, doi:10.1371/journal.ppat.1004440.
157. Dandekar, S. Pathogenesis of HIV in the Gastrointestinal tract. *Curr HIV/AIDS Rep.* **2007**, *4*, 10–15.
158. Veazey, R.S. Getting to the Guts of HIV Pathogenesis. *J. Exp. Med.* **2004**, *200*, 697–700.
159. MacDonald, T.; Spencer, J. *Lymphoid cells and tissues of the gastrointestinal tract*. Cambridge University Press: Cambridge, UK, 1994; pp. 1–23.
160. Schieferdecker, H.; Ullrich, R.; Hirsland, H.; Zeitz, M. T cell differentiation antigens on lymphocytes in the human intestinal lamina propria. *J. Immunol.* **1992**, *149*, 2816–2822.
161. Brenchley, J.; Schacker, T.; Ruff, L.; Price, D.A.; Taylor, J.H.; Beilman, G.J.; Nguyen, P.L.; Khoruts, A.; Larson, M.; Haase, A.T.; *et al.* CD4+T cell depletion during all stages of HIV disease occurs predominantly in the gastrointestinal tract. *J. Exp. Med.* **2004**, *200*, 749–759.
162. Veazey, R.S.; Marx, P.; Lackner, A. Importance of the state of activation and/or differentiation of CD4+ T cells in AIDS pathogenesis. *Trends Immunol.* **2002**, *23*, 128–129.
163. Mattapallil, J.; Douek, D.; Hill, B.; Nishimura, Y.; Martin, M.; Roederer, M. Massive infection and loss of memory CD4+ T cells in multiple tissues during acute SIV infection. *Nature* **2005**, *434*, 1093–1097.
164. Lackner, A.A.; Mohan, M.; Veazey, R.S. The Gastrointestinal Tract and AIDS Pathogenesis. *Gastroenterology* **2009**, *136*, 1966–1978.
165. Lackner, A.A.; Lederman, M.M.; Rodriguez, B. HIV pathogenesis: The host. *Cold Spring Harb. Perspect. Med.* **2012**, doi:10.1101/cshperspect.a007005.

166. Katsikis, P.D.; Mueller, Y.M.; Villinger, F. The cytokine network of acute HIV Infection: A promising target for vaccines and therapy to reduce viral set-point? *PLoS Pathog.* **2011**, doi:10.1371/journal.ppat.1002055.
167. Deeks, S.G. HIV Infection, inflammation, immunosenescence, and aging. *Annu. Rev. Med.* **2011**, *62*, 141–155.
168. Elbirt, D.; Mahlab-Guri, K.; Bezalel-Rosenberg, S.; Gill, H.; Attali, M.; Asher, I. HIV-associated neurocognitive disorders (HAND). *Isr. Med. Assoc. J.* **2015**, *17*, 54–59.
169. Albright, A.V.; Soldan, S.S.; Gonzalez-Scarano, F. Pathogenesis of human immunodeficiency virus-induced neurological disease. *J. Neurovirol.* **2003**, *9*, 222–227.
170. Gonzalez-Scarano, F.; Martin-Garcia, J. The neuropathogenesis of AIDS. *Nat. Rev. Immunol.* **2005**, *5*, 69–81.
171. Kaul, M.; Lipton, S.A. Chemokines and activated macrophages in HIV gp120-induced neuronal apoptosis. *Proc. Natl. Acad. Sci. USA* **1999**, *96*, 8212–8216.
172. Lindl, K.A.; Marks, D.R.; Kolson, D.L.; Jordan-Sciutto, K.L. HIV-associated neurocognitive disorder: Pathogenesis and therapeutic opportunities. *J. Neuroimmune Pharmacol.* **2010**, *5*, 294–309.
173. Price, R.W.; Brew, B.; Sidtis, J.; Rosenblum, M.; Scheck, A.C.; Cleary, P. The brain in AIDS: Central nervous system HIV-1 infection and AIDS dementia complex. *Science* **1988**, *239*, 586–592.
174. Valcour, V.; Sithinamsuwan, P.; Letendre, S.; Ances, B. Pathogenesis of HIV in the Central Nervous System. *Curr. HIV/AIDS Rep.* **2011**, *8*, 54–61.
175. Fieni, F.; Rowe, J.; Van Hoosear, K.; Burucoa, C.; Oppenheim, S.; Anderson, G.; Murray, J.; BonDurant, R. Presence of caprine arthritis-encephalitis virus (CAEV) proviral DNA in genital tract tissues of superovulated dairy goat does. *Theriogenology* **2003**, *59*, 1515–1523.
176. Petursson, G.; Nathanson, N.; Georgsson, G.; Panitch, H.; Palsson, P.A. Pathogenesis of visna. Sequential virologic, serologic and pathologic studies. *Lab. Invest.* **1976**, *35*, 402–412.
177. Adams, D.S.; Crawford, T.B.; Klevjer-Anderson, P. A pathogenetic study of the early connective tissue lesions of viral caprine arthritis-encephalitis. *Am. J. Pathol.* **1980**, *99*, 257–278.
178. Narayan, O.; Cork, L.C. Lentiviral diseases of sheep and goats: Chronic pneumonia leukoencephalomyelitis and arthritis. *Rev. Infect. Dis.* **1985**, *7*, 89–98.
179. Cork, L.C.; Davis, W.C. Ultrastructural features of viral leukoencephalomyelitis of goats. *Lab. Invest.* **1975**, *32*, 359–365.
180. Ellis, T.M.; Robinson, W.F.; Wilcox, G.E. The pathology and aetiology of lung lesions in goats infected with caprine arthritis-encephalitis virus. *Aust. Vet. J.* **1988**, *65*, 69–73.
181. Sigurdsson, B.; Grimsson, H.; Palsson, P.A. Maedi, a chronic, progressive infection of sheep's lungs. *J. Infect. Dis.* **1952**, *90*, 233–241.
182. Cutlip, R.C.; Lehmkuhl, H.D.; Brogden, K.A.; Bolin, S.R. Mastitis associated with ovine progressive pneumonia virus infection in sheep. *Am. J. Vet. Res.* **1985**, *46*, 326–328.
183. Clapham, P.R.; McKnight, A. HIV-1 receptors and cell tropism. *Brit. Med. Bull.* **2001**, *58*, 43–59.
184. Michael, N. Host genetic influences on HIV-1 pathogenesis. *Curr. Opin. Immunol.* **1999**, *11*, 466–474.
185. Crespo, H.; Jáuregui, P.; Glaria, I.; Sanjose, L.; Polledo, L.; García-Marín, J.; Luján, L.; de Andrés, D.; Amorena, B.; Reina, R. Mannose receptor may be involved in small ruminant lentivirus pathogenesis. *Vet. Res.* **2012**, doi:10.1186/1297-9716-43-43.



186. Crespo, H.; Reina, R.; Glaria, I.; Ramírez, H.; de Andrés, X.; Járegui, P.; Luján, L.; Martínez-Pomares, L.; Amorena, B.; de Andrés, D. Identification of the ovine mannose receptor and its possible role in Visna/Maedi virus infection. *Vet. Res.* **2011**, doi:10.1186/1297-9716-42-28.
187. Narayan, O.; Wolinsky, J.; Clements, J.E.; Strandberg, J.; Griffin, D.; Cork, L.C. Slow virus replication: The role of macrophages in the persistence and expression of visna viruses of sheep and goats. *J. Gen. Virol.* **1982**, *59*, 345–356.
188. Chen, M.; Westmoreland, S.; Ryzhova, E.; Martin, G.J.; Soldan, S.; Lackner, A.A.; González-Scarano, F. Simian immunodeficiency virus envelope compartmentalizes in brain regions independent of neuropathology. *J. Neurovirol.* **2006**, *12*, 73–89.
189. Liu, P.; Hudson, L.; Tompkins, M.; Vahlenkamp, T.; Meeker, R. Compartmentalization and evolution of feline immunodeficiency virus between the central nervous system and periphery following intracerebroventricular or systemic inoculation. *J. Neurovirol.* **2006**, *12*, 307–321.
190. Zárate, S.; Kosakovsky, P.; Shapshak, F. Comparative study of methods for detecting sequence compartmentalization in human immunodeficiency virus type 1. *J. Virol.* **2007**, *81*, 6643–6651.
191. Ramirez, H.; Reina, R.; Bertolotti, L.; Cenoz, A.; Hernandez, M.; San Roman, B.; Glaria, I.; de Andrés, X.; Crespo, H.; Jauregui, P. Study of compartmentalization in the visna clinical form of small ruminant lentivirus infection in sheep. *BMC Vet. Res.* **2012**, doi:10.1186/1746-6148-8-249.
192. Korber, B.; Kunstman, K.; Patterson, B.; Furtado, M.; McEvilly, M.; Levy, R.; Wolinsky, S. Genetic differences between blood- and brain-derived viral sequences from human immunodeficiency virus type-1 infected patients: Evidence of conserved elements in the V3 region of the Envelope protein of brain-derived sequences. *J. Virol.* **1994**, *68*, 7467–7481.
193. Hotzel, I.; Cheevers, W. Sequence similarity between the envelope surface unit (SU) glycoproteins of primate and small ruminant lentiviruses. *Virus Res.* **2000**, *69*, 47–54.
194. Mwaengo, D.; Grant, R.; DeMartini, J.; Carlson, J. Envelope glycoprotein nucleotide sequence and genetic characterization of North American ovine lentiviruses. *Virology* **1997**, *238*, 135–144.
195. Blackard, J.T. HIV compartmentalization: a review on a clinically important phenomenon. *Curr HIV Res.* **2012**, *10*, 133–142.
196. Deeks, S.G.; Autran, B.; Berkhout, B.; Benkirane, M.; Cairns, S.; Chomont, N.; Chun, T.W.; Churchill, M.; di Mascio, M.; Katlama, C.; *et al.* Towards an HIV cure: A global scientific strategy. *Nat. Rev. Immunol.* **2012**, *12*, 607–614.
197. Deeks, S.G.; Wrin, T.; Liegler, T.; Hoh, R.; Hayden, M.; Barbour, J.D.; Hellmann, N.S.; Petropoulos, C.J.; McCune, J.M.; Hellerstein, M.K.; *et al.* Virologic and immunologic consequences of discontinuing combination antiretroviral-drug therapy in HIV-infected patients with detectable viremia. *New Engl. J. Med.* **2001**, *344*, 472–480.
198. Choudhary, S.K.; Rezk, N.L.; Ince, W.L.; Cheema, M.; Zhang, L.; Su, L.; Swanstrom, R.; Kashuba, A.D.; Margolis, D.M. Suppression of human immunodeficiency virus type 1 (HIV-1) viremia with reverse transcriptase and integrase inhibitors, CD4<sup>+</sup> T-cell recovery, and viral rebound upon interruption of therapy in a new model for HIV treatment in the humanized Rag2<sup>-/-</sup>γc<sup>-/-</sup> mouse. *J. Virol.* **2009**, *83*, 8254–8258.
199. Chun, T.W.; Engel, D.; Berrey, M.M.; Shea, T.; Corey, L.; Fauci, A.S. Early establishment of a pool of latently infected, resting CD4<sup>(+)</sup> T cells during primary HIV-1 infection. *Proc. Natl. Acad. Sci. USA* **1998**, *95*, 8869–8873.

200. Davis, L.E.; Hjelle, B.L.; Miller, V.E.; Palmer, D.L.; Llewellyn, A.L.; Merlin, T.L.; Young, S.A.; Mills, R.G.; Wachsman, W.; Wiley, C.A. Early viral brain invasion in iatrogenic human immunodeficiency virus infection. *Neurology* **1992**, *42*, 1736–1739.
201. Chun, T.-W.; Fauci, A.S. Latent reservoirs of HIV: obstacles to the eradication of virus. *Proc. Natl. Acad. Sci. USA* **1999**, *96*, 10958–10961.
202. Chun, T.-W.; Fauci, A.S. HIV reservoirs: pathogenesis and obstacles to viral eradication and cure. *AIDS* **2012**, *26*, 1261–1268.
203. Samuel, W.; Warner, G. Host factor regulating post integration latency of HIV. *Trends Microbiol.* **2005**, *13*, 137–139.
204. Du Ch  e I.; Basyuk, E.; Lin, Y.-L.; Triboulet, R.; Knezevich, A.; Chable-Bessia, C.; Mettling, C.; Baillat, V.; Reynes, J.; Corbeau, P.; *et al.* Suv39H1 and HP1 $\gamma$  are responsible for chromatin-mediated HIV-1 transcriptional silencing and post-integration latency. *EMBO J.* **2007**, *26*, 424–435.
205. Van Lint, C. Molecular control of HIV-1 postintegration latency: Implications for therapeutic strategies. *Retrovirology* **2012**, doi:10.1186/1742-4690-9-S1-I10.
206. Karn, J.; Stoltzfus, C.M. Transcriptional and posttranscriptional regulation of HIV-1 gene expression. *Cold Spring Harb. Perspect. Med.* **2012**, doi:10.1101/cshperspect. a006916.
207. Shan, L.; Siliciano, R.F. From reactivation of latent HIV-1 to elimination of the latent reservoir: The presence of multiple barriers to viral eradication. *Bioessays* **2013**, *35*, 544–552.
208. Siliciano, J.D.; Siliciano, R.F. Recent developments in the search for a cure for HIV-1 infection: Targeting the latent reservoir for HIV-1. *J. Allergy Clin. Immun.* **2014**, *134*, 12–19.
209. Lassen, K.; Han, Y.; Zhou, Y.; Siliciano, J.; Siliciano, R.F. The multifactorial nature of HIV-1 latency. *Trends Mol. Med.* **2004**, *10*, 525–531.
210. Zhou, Q.; Sharp, P. Novel mechanisms and factors for regulation by HIV-1 Tat. *EMBO J.* **1995**, *14*, 321–328.
211. Jordan, A.; Defechereux, P.; Verdin, E. The site of HIV-1 integration in the human genome determines basal transcriptional activity and response to Tat transactivation. *EMBO J.* **2001**, *20*, 1726–1738.
212. Osorio, A.A.; Munoz, A.; Torres-Romero, D.; Bedoya, L.M.; Perestelo, N.R.; Jimenez, I.A.; Alcamı, J.; Bazzocchi, I.L. Olean-18-ene triterpenoids from Celastraceae species inhibit HIV replication targeting NF- $\kappa$ B and Sp1 dependent transcription. *Eur. J. Med. Chem.* **2012**, *52*, 295–303.
213. Dandekar, D.H.; Ganesh, K.N.; Mitra, D. HIV-1 Tat directly binds to NF $\kappa$ B enhancer sequence: Role in viral and cellular gene expression. *Nucleic Acids Res.* **2004**, *32*, 1270–1278.
214. Margolis, D.M.; Somasundaran, M.; Green, M.R. Human transcription factor YY1 represses human immunodeficiency virus type 1 transcription and virion production. *J. Virol.* **1994**, *68*, 905–910.
215. Tyagi, M.; Karn, J. CBF-1 promotes transcriptional silencing during the establishment of HIV-1 latency. *EMBO J.* **2007**, *26*, 4985–4995.
216. Han, Y.; Lin, Y.; An, W.; Xu, J.; yahg, H.; O’Connell, K.; Dordai, D.; Boeke, J.; Siliciano, J.D.; Siliciano, R.F. Orientation-dependent regulation of integrated HIV-1 expression by host gene transcriptional readthrough. *Cell Host Microbe* **2008**, *4*, 134–146.

217. Powell, D.M.; Amaral, M.C.; Wu, J.Y.; Maniatis, T.; Greene, W.C. HIV Rev-dependent binding of SF2/ASF to the Rev response element: possible role in Rev-mediated inhibition of HIV RNA splicing. *Proc. Natl. Acad. Sci. USA* **1997**, *94*, 973–978.
218. Brady, J.; Kashanchi, F. Tat gets the “green” light on transcription initiation. *Retrovirology* **2005**, doi:10.1186/1742-4690-2-69.
219. Barboric, M.; Peterlin, B.M. A New Paradigm in Eukaryotic Biology: HIV Tat and the Control of Transcriptional Elongation. *PLoS Biol.* **2005**, doi:10.1371/journal.pbio.0030076.
220. Haase, A.; Stowring, L.; Narayan, O.; Griffin, D.; Price, D. Slow persistent infection caused by visna virus role of host restriction. *Science* **1977**, *195*, 175–177.
221. Thormar, H. *Physical, Chemical, Biological Properties of Visna Virus and Its Relationship to Other Animal Viruses*. In *Slow, Latent and Temperate Virus Infection*; The National Institute of Neurological Disorders and Blindness: Washington, DC, USA, 1966; pp. 335–340.
222. Thormar, H. Maedi-visna virus and its relationship to human immunodeficiency virus. *AIDS Rev.* **2005**, *7*, 233–245.
223. Pereira, L.A.; Bentley, K.; Peeters, A.; Churchill, M.J.; Deacon, N.J. A compilation of cellular transcription factor interactions with the HIV-1 LTR promoter. *Nucleic Acids Res.* **2000**, *28*, 663–668.
224. Gracia, J.; Harrich, D.; Soultanakis, E.; Wu, F.; Mitsuyasu, R.; Gaynor, R. Human immunodeficiency virus type 1 LTR TATA and TAR region sequences required for transcriptional regulation. *EMBO J.* **1989**, *8*, 765–778.
225. Harrich, D.; Gracia, J.; Mitsuyasu, R.; Gaynor, R. TAR independent activation of the human immunodeficiency virus in phorbol ester stimulated T lymphocytes. *EMBO J.* **1990**, *9*, 4417–4423.
226. Olsen, H.S.; Rosen, C. Contribution of the TATA motif to Tat-mediated transcriptional activation of the human immunodeficiency virus gene expression. *J. Virol.* **1992**, *66*, 5594–5597.
227. Danino, Y.M.; Even, D.; Ideses, D.; Juven-Gershon, T. The core promoter: At the heart of gene expression. *Biochim. Biophys. Acta* **2015**, *1849*, 1116–1131.
228. Dahabieh, M.S.; Ooms, M.; Malcolm, T.; Simon, V.; Sadowski, I. Identification and functional analysis of a second RBF-2 binding site within the HIV-1 promoter. *Virology* **2011**, *418*, 57–66.
229. Wilhelm, E.; Doyle, M.C.; Nzaramba, I.; Magdzinski, A.; Dumais, N.; Bell, B. CTGC motifs within the HIV core promoter specify Tat-responsive pre-initiation complexes. *Retrovirology* **2012**, doi:10.1186/1742-4690-9-62.
230. Miller-Jensen, K.; Skupsky, R.; Shah, P.S.; Arkin, A.P.; Schaffer, D.V. Genetic selection for context-dependent stochastic phenotypes: Sp1 and TATA mutations increase phenotypic noise in HIV-1 gene expression. *PLoS Comput. Biol.* **2013**, doi:10.1371/journal.pcbi.1003135.
231. Duverger, A.; Wolschendorf, F.; Zhang, M.; Wagner, F.; Hatcher, B.; Jones, J.; Cron, R.Q.; van der Sluis, R.M.; Jeeninga, R.E.; Berkhout, B.; *et al.* An AP-1 binding site in the enhancer/core element of the HIV-1 promoter controls the ability of HIV-1 to establish latent infection. *J. Virol.* **2013**, *87*, 2264–2277.
232. Duverger, A.; Jones, J.; May, J.; Bibollet-Ruche, F.; Wagner, F.A.; Cron, R.Q.; Kutsch, O. Determinants of the establishment of human immunodeficiency virus type 1 latency. *J. Virol.* **2009**, *83*, 3078–3093.

233. Jones, K.A.; Kadonaga, J.T.; Luciw, P.A.; Tjian, R. Activation of the AIDS retrovirus promoter by the cellular transcription factor, Sp1. *Science* **1986**, *232*, 755–759.
234. Rittner, K. The human immunodeficiency virus long terminal repeat includes a specialised initiator element which is required for Tat responsive transcription. *J. Mol. Biol.* **1995**, *248*, 562–580.
235. Ross, E.K.; Buckler-White, A.J.; Rabson, A.B.; Englund, G.; Martin, M.A. Contribution of NF- $\kappa$ B and Sp1 binding motifs to the replicative capacity of human immunodeficiency virus type 1: Distinct patterns of viral growth are determined by T-cell types. *J. Virol.* **1991**, *65*, 4350–4358.
236. Dahmus, M. Phosphorylation of C-terminal domain of RNA polymerase II. *Biochim. Biophys. Acta* **1995**, 171–182.
237. Kim, Y.K.; Bourgeois, C.F.; Isel, C.; Churcher, M.J.; Karn, J. Phosphorylation of the RNA polymerase II carboxyl-terminal domain by CDK9 is directly responsible for human immunodeficiency virus type 1 Tat-activated transcriptional elongation. *Mol. Biol. Cell.* **2002**, *22*, 4622–4637.
238. Guo, J.; Price, D.H. RNA polymerase II transcription elongation control. *Chem. Rev.* **2013**, *113*, 8583–8603.
239. Jadowsky, J.K.; Wong, J.Y.; Graham, A.C.; Dobrowolski, C.; Devor, R.L.; Adams, M.D.; Fujinaga, K.; Karn, J. Negative elongation factor is required for the maintenance of proviral latency but does not induce promoter-proximal pausing of RNA polymerase II on the HIV long terminal repeat. *Mol. Biol. Cell.* **2014**, *34*, 1911–1928.
240. Natarajan, M.; Schiralli Lester, G.M.; Lee, C.; Missra, A.; Wasserman, G.A.; Steffen, M.; Gilmour, D.S.; Henderson, A.J. Negative elongation factor (NELF) coordinates RNA polymerase II pausing, premature termination, and chromatin remodeling to regulate HIV transcription. *J. Biol. Chem.* **2013**, *288*, 25995–26003.
241. Cheng, B.; Price, D.H. Analysis of factor interactions with RNA polymerase II elongation complexes using a new electrophoretic mobility shift assay. *Nucleic Acids Res.* **2008**, *36*, e135.
242. Missra, A.; Gilmour, D.S. Interactions between DSIF (DRB sensitivity inducing factor), NELF (negative elongation factor), and the Drosophila RNA polymerase II transcription elongation complex. *Proc. Natl. Acad. Sci. USA* **2010**, *107*, 11301–11306.
243. Pagano, J.M.; Kwak, H.; Waters, C.T.; Sprouse, R.O.; White, B.S.; Ozer, A.; Szeto, K.; Shalloway, D.; Craighead, H.G.; Lis, J.T. Defining NELF-E RNA binding in HIV-1 and promoter-proximal pause regions. *PLoS Genet.* **2014**, doi:10.1371/journal.pgen.1004090.
244. Feng, S.; Holland, E.C. HIV-1 Tat trans-activation requires the loop sequence within tar. *Nature* **1988**, *334*, 165–167.
245. Gu, J.; Babayeva, N.D.; Suwa, Y.; Baranovskiy, A.G.; Price, D.H.; Tahirov, T.H. Crystal structure of HIV-1 Tat complexed with human P-TEFb and AFF4. *Cell. Cycle* **2014**, *13*, 1788–1797.
246. Herrmann, C.; Rice, A. Lentivirus Tat proteins specifically associate with a cellular protein-kinase, TAK, that hyperphosphorylates the carboxyl-terminal domain of the large subunit of RNA polymerase II: Candidate for a Tat cofactor. *J. Virol.* **1995**, *69*, 1612–1620.
247. Montanuy, I.; Torremocha, R.; Hernandez-Munain, C.; Sune, C. Promoter influences transcription elongation: TATA-box element mediates the assembly of processive transcription complexes responsive to cyclin-dependent kinase 9. *J. Biol. Chem.* **2008**, *283*, 7368–7378.

248. Wei, P.; Garber, M.E.; Fang, S.M.; Fischer, W.H.; Jones, K.A. A novel CDK9-associated C-type cyclin interacts directly with HIV-1 Tat and mediates its high-affinity, loop-specific binding to TAR RNA. *Cell* **1998**, *92*, 451–462.
249. Zhou, Q.; Li, T.; Price, D.H. RNA polymerase II elongation control. *Annu. Rev. Biochem.* **2012**, *81*, 119–143.
250. Itzen, F.; Greifenberg, A.K.; Bosken, C.A.; Geyer, M. Brd4 activates P-TEFb for RNA polymerase II CTD phosphorylation. *Nucleic Acids Res.* **2014**, *42*, 7577–7590.
251. Marshall, N.F.; Price, D. Control of formation of two distinct classes of RNA polymerase II elongation complexes. *Mol. Biol. Cell.* **1992**, *12*, 2078–2090.
252. Fujinaga, K. Dynamics of human immunodeficiency virus transcription: P-TEFb phosphorylates RD and dissociates negative effectors from the transactivation response element. *Mol. Biol. Cell.* **2004**, *24*, 787–795.
253. Mbonye, U.R.; Gokulrangan, G.; Datt, M.; Dobrowolski, C.; Cooper, M.; Chance, M.R.; Karn, J. Phosphorylation of CDK9 at Ser175 enhances HIV transcription and is a marker of activated P-TEFb in CD4(+) T lymphocytes. *PLoS Pathog.* **2013**, doi:10.1371/journal.ppat.1003338.
254. Battistini, A.; Sgarbanti, M. HIV-1 Latency: An Update of Molecular Mechanisms and Therapeutic Strategies. *Viruses* **2014**, *6*, 1715–1758.
255. Mbonye, U.; Karn, J. Transcriptional control of HIV latency: Cellular signaling pathways, epigenetics, happenstance and the hope for a cure. *Virology* **2014**, *454–455*, 328–339.
256. Karn, J. Tat, A Novel Regulator of HIV Transcription and Latency. In *HIV Sequence Compendium 2000*; Kuiken, C.M.F.; Foley, B.; Mellors, J.W.; Hahn, B.; Mullins, J.; Marx, P.; Wolinsky, S., Eds.; Theoretical Biology and Biophysics Group Los Alamos National Laboratory: Los Alamos, NM, USA, 2000; pp. 2–18.
257. Karn, J. Tackling Tat. *J. Mol. Biol.* **1999**, *293*, 235–254.
258. Siliciano, R.F.; Greene, W.C. HIV Latency. *Cold Spring Harb. Perspect. Med.* **2011**, doi:10.1101/cshperspect.a007096.
259. Strebel, K. Virus-host interactions: role of HIV proteins Vif, Tat, and Rev. *AIDS* **2003**, *17*, 25–34.
260. Taube, R.; Peterlin, M. Lost in Transcription: Molecular Mechanisms that Control HIV Latency. *Viruses* **2013**, *5*, 902–927.
261. Tyagi, M.; Bukrinsky, M. Human immunodeficiency virus (HIV) latency: The major hurdle in HIV eradication. *Mol. Med.* **2012**, *18*, 1096–1108.
262. Schiralli Lester, G.M.; Henderson, A.J. Mechanisms of HIV transcriptional regulation and their contribution to latency. *Mol. Biol. Int.* **2012**, *2012*, 1–11.
263. Ruelas, D.S.; Greene, W.C. An integrated overview of HIV-1 latency. *Cell* **2013**, *155*, 519–529.
264. Gdovin, S.; Clements, J.E. Molecular mechanisms of visna virus Tat: Identification of the targets for transcriptional activation and evidence for a post-transcriptional effect. *Virology* **1992**, *188*, 438–450.
265. Carruth, L.M.; Morse, B.A.; Clements, J.E. The leucine domain of the visna virus Tat protein mediates targeting to an AP-1 site in the viral long terminal repeat. *J. Virol.* **1996**, *70*, 4338–4344.
266. Morse, B.A.; Carruth, L.M.; Clements, J.E. Targeting of the visna virus Tat protein to AP-1 sites: Interactions with the bZIP domains of fos and jun *in vitro* and *in vivo*. *J. Virol.* **1999**, *73*, 37–45.

267. Barber, S.A.; Bruett, L.; Douglass, B.R.; Herbst, D.S.; Zink, M.C.; Clements, J.E. Visna virus-induced activation of MAPK is required for virus replication and correlates with virus-induced neuropathology. *J. Virol.* **2002**, *76*, 817–828.
268. Hess, J.L.; Small, J.; Clements, J.E. Sequences in the visna virus long terminal repeat that control transcriptional activity and respond to viral trans-activation: involvement of AP-1 sites in basal activity and trans-activation. *J. Virol.* **1989**, *63*, 3001–3015.
269. Harmache, A.; Vitu, C.; Russo, P.; Bouyac, M.; Hieblot, C.; Peveri, P.; Vigne, R.; Suzan, M. The caprine arthritis encephalitis virus tat gene is dispensable for efficient viral replication *in vitro* and *in vivo*. *J. Virol.* **1995**, *69*, 5445–5454.
270. Murphy, B.G.; Hotzel, I.; Jasmer, D.P.; Davis, W.C.; Knowles, D. TNFalpha and GM-CSF-induced activation of the CAEV promoter is independent of AP-1. *Virology* **2006**, *352*, 188–199.
271. Sepp, T.; Tong-Starksen, S.E. STAT1 pathway is involved in activation of caprine arthritis-encephalitis virus long terminal repeat in monocytes. *J. Virol.* **1997**, *71*, 771–777.
272. Guo, D.; Dunbar, J.D.; Yang, C.H.; Pfeffer, L.M.; Donner, D.B. Induction of Jak/STAT signaling by activation of the type 1 TNF receptor. *J. Immunol.* **1998**, *160*, 2742–2750.
273. Jackson, S.H.; Yu, C.R.; Mahdi, R.M.; Ebong, S.; Egwuagu, C.E. Dendritic cell maturation requires STAT1 and is under feedback regulation by suppressors of cytokine signaling. *J. Immunol.* **2004**, *172*, 2307–2315.
274. Coccia, E.M.; Del Russo, N.; Stellacci, E.; Testa, U.; Marziali, G.; Battistini, A. STAT1 activation during monocyte to macrophage maturation: role of adhesion molecules. *Int. Immunol.* **1999**, *11*, 1075–1083.
275. Reina, R.; Grego, E.; Bertolotti, L.; De Meneghi, D.; Rosati, S. Genome analysis of small-ruminant lentivirus genotype E: a caprine lentivirus with natural deletions of the dUTPase subunit, vpr-like accessory gene, and 70-base-pair repeat of the U3 region. *J. Virol.* **2009**, *83*, 1152–1155.
276. Barros, S.C.; Andresdottir, V.; Fevereiro, M. Cellular specificity and replication rate of Maedi Visna virus *in vitro* can be controlled by LTR sequences. *Arch. Virol.* **2005**, *150*, 201–213.
277. Oskarsson, T.; Hreggvidsdottir, H.S.; Agnarsdottir, G.; Matthiasdottir, S.; Ogmundsdottir, M.H.; Jonsson, S.R.; Georgsson, G.; Ingvarsson, S.; Andresson, O.S.; Andresdottir, V. Duplicated sequence motif in the long terminal repeat of maedi-visna virus extends cell tropism and is associated with neurovirulence. *J. Virol.* **2007**, *81*, 4052–4057.
278. Agnarsdottir, G.; Thorsteinsdottir, H.; Oskarsson, T.; Matthiasdottir, S.; Hafliadottir, B.S.; Andresson, O.S.; Andresdottir, V. The long terminal repeat is a determinant of cell tropism of maedi-visna virus. *J. Gen. Virol.* **2000**, *81*, 1901–1905.
279. Murphy, B.; McElliott, V.; Vapniarsky, N.; Oliver, A.; Rowe, J. Tissue tropism and promoter sequence variation in caprine arthritis encephalitis virus infected goats. *Virus Res.* **2010**, *151*, 177–184.
280. Adedeji, A.O.; Barr, B.; Gomez-Lucia, E.; Murphy, B. A polytropic caprine arthritis encephalitis virus promoter isolated from multiple tissues from a sheep with multisystemic lentivirus-associated inflammatory disease. *Viruses* **2013**, *5*, 2005–2018.
281. Murphy, B.; Hillman, C.; Castillo, D.; Vapniarsky, N.; Rowe, J. The presence or absence of the gamma-activated site determines IFN gamma-mediated transcriptional activation in CAEV

- promoters cloned from the mammary gland and joint synovium of a single CAEV-infected goat. *Virus Res.* **2012**, *163*, 537–545.
282. Mbonye, U.; Karn, J. Control of HIV latency by epigenetic and non-epigenetic mechanisms. *Curr. HIV Res.* **2011**, *9*, 554–567.
283. Narlikar, G.J.; Fan, H.-Y.; Kingston, R.E. Cooperation between complexes that regulate chromatin structure and transcription. *Cell.* **2002**, *108*, 475–487.
284. Wolffe, A. Nucleosome positioning and modification: chromatin structures that potentiate transcription. *Trends Biochem. Sci.* **1994**, *19*, 240–244.
285. Richman, D.D.; Margolis, D.M.; Delaney, M.; Greene, W.C.; Hazuda, D.; Pomerantz, R.J. The challenge of finding a cure for HIV infection. *Science* **2009**, *323*, 1304–1307.
286. Van Lint, C.; Emiliani, S.; Ott, M.; Verdin, E. Transcriptional activation and chromatin remodeling of the HIV-1 promoter in response to histone acetylation. *EMBO J.* **1996**, *15*, 1112–1120.
287. Verdin, E. DNase I-hypersensitive sites are associated with both long terminal repeats and with the intragenic enhancer of integrated human immunodeficiency virus type 1. *J. Virol.* **1991**, *65*, 6790–6799.
288. Verdin, E.; Paras, P., Jr.; Van Lint, C. Chromatin disruption in the promoter of human immunodeficiency virus type 1 during transcriptional activation. *EMBO J.* **1993**, *12*, 3249–3259.
289. Coull, J.J.; Romerio, F.; Sun, J.-M.; Volker, J.L.; Galvin, K.M.; Davie, J.R.; Shi, Y.; Hansen, U.; Margolis, D.M. The Human Factors YY1 and LSF Repress the Human Immunodeficiency Virus Type 1 Long Terminal Repeat via Recruitment of Histone Deacetylase 1. *J. Virol.* **2000**, *74*, 6790–6799.
290. Imai, K.; Okamoto, T. Transcriptional Repression of Human Immunodeficiency Virus Type 1 by AP-4. *J. Biol. Chem.* **2006**, *281*, 12495–12505.
291. Jiang, G.; Espeseth, A.; Hazuda, D.J.; Margolis, D.M. c-Myc and Sp1 contribute to proviral latency by recruiting histone deacetylase 1 to the human immunodeficiency virus type 1 promoter. *J. Virol.* **2007**, *81*, 10914–10923.
292. He, G.; Margolis, D.M. Counterregulation of chromatin deacetylation and histone deacetylase occupancy at the integrated promoter of human immunodeficiency virus type 1 (HIV-1) by the HIV-1 repressor YY1 and HIV-1 activator Tat. *Mol. Biol. Cell* **2002**, *22*, 2965–2973.
293. Williams, S.; Chen, L.; Kwon, C.; Ruiz-Jarabo, E.; Greene, W. NF- $\kappa$ B p50 promotes HIV latency through HDAC recruitment and repression of transcriptional initiation. *EMBO J.* **2006**, *25*, 139–149.
294. Keedy, K.S.; Archin, N.M.; Gates, A.T.; Espeseth, A.; Hazuda, D.J.; Margolis, D.M. A limited group of class I histone deacetylases acts to repress human immunodeficiency virus type 1 expression. *J. Virol.* **2009**, *83*, 4749–4756.
295. Nabel, G.; Baltimore, D. An inducible transcription factor activates expression of human immunodeficiency virus in T cells. *Nature* **1987**, *326*, 711–713.
296. Dorr, A.; Kiermer, V.; Pedal, A.; Rackwitz, H.-R.; Henklein, P.; Schubert, U.; Zhou, M.-M.; Verdin, E.; Ott, M. Transcriptional synergy between Tat and PCAF is dependent on the binding of acetylated Tat to the PCAF bromodomain. *EMBO J.* **2002**, *21*, 2715–2723.

297. Mahmoudi, T.; Parra, M.; Vries, R.G.J.; Kauder, S.E.; Verrijzer, C.P.; Ott, M.; Verdin, E. The SWI/SNF chromatin-remodeling complex is a cofactor for Tat transactivation of the HIV promoter. *J. Biol. Chem.* **2006**, *281*, 19960–19968.
298. Tréand, C.; du Chéné I.; Brès, V.; Kiernan, R.; Benarous, R.; Benkirane, M.; Emiliani, S. Requirement for SWI/SNF chromatin-remodeling complex in Tat-mediated activation of the HIV-1 promoter. *EMBO J.* **2006**, *25*, 1690–1699.
299. Agbottah, E.; Deng, L.; Dannenberg, L.O.; Pumfery, A.; Kashanchi, F. Effect of SWI/SNF chromatin remodeling complex on HIV-1 Tat activated transcription. *Retrovirology* **2006**, doi:10.1186/1742-4690-3-48.
300. Ott, M.; Geyer, M.; Zhou, Q. The control of HIV transcription: Keeping RNA Polymerase II on track. *Cell Host Microbe* **2011**, *10*, 426–435.
301. Col, E. The Histone Acetyltransferase, hGCN5, interacts with and acetylates the HIV transactivator, Tat. *J. Biol. Chem.* **2001**, *276*, 28179–28184.
302. Pagans, S.; Pedal, A.; North, B.J.; Kaehlcke, K.; Marshall, B.L.; Dorr, A.; Hetzer-Egger, C.; Henklein, P.; Frye, R.; McBurney, M.W.; *et al.* SIRT1 Regulates HIV Transcription via Tat Deacetylation. *PLoS Biol.* **2005**, doi:10.1371/journal.pbio.0030041.
303. Sakane, N.; Kwon, H.-S.; Pagans, S.; Kaehlcke, K.; Mizusawa, Y.; Kamada, M.; Lassen, K.G.; Chan, J.; Greene, W.C.; Schnolzer, M.; *et al.* Activation of HIV Transcription by the Viral Tat Protein Requires a Demethylation Step Mediated by Lysine-specific Demethylase 1 (LSD1/KDM1). *PLoS Pathog.* **2011**, doi: 10.1371/journal.ppat.1002184.
304. Ott, M.; Dorr, A.; Hetzer-Egger, C.; Kaehlcke, K.; Schnolzer, M.; Henklein, P.; Cole, P.; Zhou, M.-M.; Verdin, E. Tat acetylation: a regulatory switch between early and late phases in HIV transcription elongation. *Novartis Found. Symp.* **2004**, *259*, 182–193.
305. Pagans, S.; Kauder, S.E.; Kaehlcke, K.; Sakane, N.; Schroeder, S.; Dormeyer, W.; Trievel, R.C.; Verdin, E.; Schnolzer, M.; Ott, M. The Cellular lysine methyltransferase Set7/9-KMT7 binds HIV-1 TAR RNA, monomethylates the viral transactivator Tat, and enhances HIV transcription. *Cell. Host Microbe* **2010**, *7*, 234–244.
306. Sabo, A.; Lusic, M.; Cereseto, A.; Giacca, M. Acetylation of conserved lysines in the catalytic core of cyclin-dependent kinase 9 inhibits kinase activity and regulates transcription. *Mol. Biol. Cell.* **2008**, *28*, 2201–2212.
307. Friedman, J.; Cho, W.-K.; Chu, C.K.; Keedy, K.S.; Archin, N.M.; Margolis, D.M.; Karn, J. Epigenetic silencing of HIV-1 by the histone H3 lysine 27 methyltransferase enhancer of zeste 2. *J. Virol.* **2011**, *85*, 9078–9089.
308. Enderle, D.; Beisel, C.; Stadler, M.B.; Gerstung, M.; Athri, P.; Paro, R. Polycomb preferentially targets stalled promoters of coding and noncoding transcripts. *Genome Res.* **2011**, *21*, 216–226.
309. Imai, K.; Togami, H.; Okamoto, T. Involvement of Histone H3 Lysine 9 (H3K9) Methyltransferase G9a in the maintenance of HIV-1 latency and its reactivation by BIX01294. *J. Biol. Chem.* **2010**, *285*, 16538–16545.
310. Abbas, W.; Herbein, G. Molecular Understanding of HIV-1 Latency. *Adv. Virol.* **2012**, *2012*, 1–14.
311. Groen, J.; Morris, K. Chromatin, Non-Coding RNAs, and the Expression of HIV. *Viruses* **2013**, *5*, 1633–1645.



312. Kumar, A.; Abbas, W.; Herbein, G. HIV-1 latency in monocytes/macrophages. *Viruses* **2014**, *6*, 1837–1860.
313. Eisele, E.; Siliciano, R.F. Redefining the viral reservoirs that prevent HIV-1 eradication. *Immunity* **2012**, *37*, 377–388.
314. Rasmussen, T.A.; Tolstrup, M.; Winckelmann, A.; Ostergaard, L.; Sogaard, O.S. Eliminating the latent HIV reservoir by reactivation strategies: Advancing to clinical trials. *Hum. Vaccin. Immunother.* **2013**, *9*, 790–799.
315. Barton, K.M.; Burch, B.D.; Soriano-Sarabia, N.; Margolis, D.M. Prospects for treatment of latent HIV. *Clin. Pharmacol. Ther.* **2013**, *93*, 46–56.
316. Durand, C.M.; Blankson, J.N.; Siliciano, R.F. Developing strategies for HIV-1 eradication. *Trends Immunol.* **2012**, *33*, 554–562.
317. Archin, N.M.; Liberty, A.L.; Kashuba, A.D.; Choudhary, S.K.; Kuruc, J.D.; Crooks, A.M.; Parker, D.C.; Anderson, E.M.; Kearney, M.F.; Strain, M.C.; *et al.* Administration of vorinostat disrupts HIV-1 latency in patients on antiretroviral therapy. *Nature* **2012**, *487*, 482–485.
318. Levy, Y.; Sereti, I.; Tambussi, G.; Routy, J.P.; Lelievre, J.D.; Delfraissy, J.F.; Molina, J.M.; Fischl, M.; Goujard, C.; Rodriguez, B.; *et al.* Effects of recombinant human interleukin 7 on T-cell recovery and thymic output in HIV-infected patients receiving antiretroviral therapy: Results of a phase I/IIa randomized, placebo-controlled, multicenter study. *Clin. Infect. Dis.* **2012**, *55*, 291–300.
319. Strong, C.L.; Guerra, H.P.; Mathew, K.R.; Roy, N.; Simpson, L.R.; Schiller, M.R. Damaging the integrated HIV proviral DNA with TALENs. *PLoS ONE* **2015**, doi:10.1371/journal.pone.0125652.
320. Mariyanna, L.; Priyadarshini, P.; Hofmann-Sieber, H.; Kreptakies, M.; Walz, N.; Grundhoff, A.; Buchholz, F.; Hildt, E.; Hauber, J. Excision of HIV-1 proviral DNA by recombinant cell permeable tre-recombinase. *PLoS ONE* **2012**, doi:10.1371/journal.pone.0031576.
321. Sarkar, I.; Hauber, I.; Hauber, J.; Buchholz, F. HIV-1 proviral DNA excision using an evolved recombinase. *Science* **2007**, *316*, 1912–1915.
322. June, C. Introduction of Acquired CCR5 Deficiency with Zinc Finger Nuclease-Modified Autologous CD4 T Cells (SB-728-T) Correlates with Increases in CD4 Count and Effects on Viral Load in HIV-Infected Subjects. Proceedings of 19th Conference on Retroviruses and Opportunistic Infections, Seattle, USA, 5–8 March 2012.
323. Lalezari, J. A Single Infusion of Zinc Finger Nuclease CCR5 Modified Autologous CD4 T Cells (SB-728-T) Increases CD4 Counts and Leads to Decrease in HIV Proviral Load in an Aviremic HIV-Infected Subject. In Proceedings of 19th Conference on Retroviruses and Opportunistic Infections, Seattle, USA, 5–8 March 2012.
324. Allers, K.; Hutter, G.; Hofmann, J.; Loddenkemper, C.; Rieger, K.; Thiel, E.; Schneider, T. Evidence for the cure of HIV infection by CCR5Delta32/Delta32 stem cell transplantation. *Blood* **2011**, *117*, 2791–2799.
325. Hutter, G.; Ganepola, S. Eradication of HIV by transplantation of CCR5-deficient hematopoietic stem cells. *ScientificWorldJournal* **2011**, *11*, 1068–1076.

326. Hutter, G.; Nowak, D.; Mossner, M.; Ganepola, S.; Mussig, A.; Allers, K.; Schneider, T.; Hofmann, J.; Kucherer, C.; Blau, O.; *et al.* Long-term control of HIV by CCR5 Delta32/Delta32 stem-cell transplantation. *N. Engl. J. Med.* **2009**, *360*, 692–698.
327. Mens, H.; Kearney, M.; Wiegand, A.; Shao, W.; Schonning, K.; Gerstoft, J.; Obel, N.; Maldarelli, F.; Mellors, J.W.; Benfield, T.; *et al.* HIV-1 continues to replicate and evolve in patients with natural control of HIV infection. *J. Virol.* **2010**, *84*, 12971–12981.
328. O’Connell, K.A.; Brennan, T.P.; Bailey, J.R.; Ray, S.C.; Siliciano, R.F.; Blankson, J.N. Control of HIV-1 in elite suppressors despite ongoing replication and evolution in plasma virus. *J. Virol.* **2010**, *84*, 7018–7028.
329. Rosenblatt, J.; Glotzbecker, B.; Mills, H.; Vasir, B.; Tzachanis, D.; Levine, J.D.; Joyce, R.M.; Wellenstein, K.; Keefe, W.; Schickler, M.; *et al.* PD-1 blockade by CT-011, anti-PD-1 antibody, enhances *ex vivo* T-cell responses to autologous dendritic cell/myeloma fusion vaccine. *J. Immunother.* **2011**, *34*, 409–418.
330. Yukl, S.A.; Boritz, E.; Busch, M.; Bentsen, C.; Chun, T.W.; Douek, D.; Eisele, E.; Haase, A.; Ho, Y.C.; Hutter, G.; *et al.* Challenges in detecting HIV persistence during potentially curative interventions: a study of the Berlin patient. *PLoS Pathog.* **2013**, doi:10.1371/journal.ppat.1003347.
331. Henrich, T.J.; Hu, Z.; Li, J.Z.; Sciaranghella, G.; Busch, M.P.; Keating, S.M.; Gallien, S.; Lin, N.H.; Giguel, F.F.; Lavoie, L.; *et al.* Long-term reduction in peripheral blood HIV type 1 reservoirs following reduced-intensity conditioning allogeneic stem cell transplantation. *J. Infect. Dis.* **2013**, *207*, 1694–1702.
332. Henrich, T.J.; Hanhauser, .E., Sirignano, M.N.; Li, J.Z.; Lichterfeld, M.; Marty, F.M.; Armand, P.; Soiffer, R.J.; Altfeld, M.; Kuritzkes, D.R. HIV-1 Rebound Following Allogeneic Stem Cell Transplantation and Treatment Interruption. In Proceeding of 21st Conference on Retroviruses and Opportunistic Infections, Boston, MA, USA, 3–6 March, 2014.
333. Frange, P.; Avettand-Fenoel, A.F.V.; Bellaton, E.; Deschamps, D.; Angin, M.; Caillat-Zucman, S.G.; Peytavin, J.; Chenadec, L.; Warszawski, J.; Rouzioux, C.; Saez-Cirion, A.. HIV-1 Virological Remission for More Than 11 Years after Interruption of Early Initiated Antiretroviral Therapy in A Perinatally-Infected Child. In Proceedings of IAS 2015—8th IAS Conference on HIV Pathogenesis, Treatment and Prevention, Vancouver, Canada, 22 July **2015**.
334. Persaud, D.; Gay, H.; Ziemniak, C.; Chen, Y.H.; Piatak, M., Jr.; Chun, T.W.; Strain, M.; Richman, D.; Luzuriaga, K. Absence of detectable HIV-1 viremia after treatment cessation in an infant. *N. Engl. J. Med.* **2013**, *369*, 1828–1835.
335. Saez-Cirion, A.; Bacchus, C.; Hocqueloux, L.; Avettand-Fenoel, V.; Girault, I.; Lecuroux, C.; Potard, V.; Versmisse, P.; Melard, A.; Prazuck, T.; *et al.* Post-treatment HIV-1 controllers with a long-term virological remission after the interruption of early initiated antiretroviral therapy ANRS VISCONTI Study. *PLoS Pathog.* **2013**, doi:10.1371/journal.ppat.1003211.
336. Klatzmann, D.; Barre-Sinoussi, F.; Nugeyre, M. Selective tropism of lymphadenopathy associated virus (LAV) for helper-inducer T lymphocytes. *Science* **1984**, *225*, 59–63.
337. Klatzmann, D.; Champagne, E.; Chamaret, S.; Gruest, J.; Guetard, D.; Hercend, T.; Gluckman, J.C.; Montagnier, L. T-lymphocyte T4 molecule behaves as the receptor for human retrovirus LAV. *Nature* **1984**, *312*, 767–768.

338. Ho, D.D.; Rota, T.; Hirsch, M. Infection of monocyte/macrophages by human T lymphotropic virus type III. *J. Clin. Invest.* **1986**, *77*, 1712–1715.
339. Chomont, N.; El-Far, M.; Ancuta, P.; Trautmann, L.; Procopio, F.A.; Yassine-Diab, B.; Boucher, G.; Boulassel, M.R.; Ghattas, G.; Brenchley, J.M.; *et al.* HIV reservoir size and persistence are driven by T cell survival and homeostatic proliferation. *Nat. Med.* **2009**, *15*, 893–900.
340. Swiggard, W.J.; Baytop, C.; Yu, J.J.; Dai, J.; Li, C.; Schretzenmair, R.; Theodosopoulos, T.; O’Doherty, U. Human immunodeficiency virus type 1 can establish latent infection in resting CD4+ T cells in the absence of activating stimuli. *J. Virol.* **2005**, *79*, 14179–14188.
341. Chanel, C.; Staropoli, I.; Baleux, F.; Amara, A.; Valenzuela-Fernandez, A.; Virelizier, J.L.; Arenzana-Seisdedos, F.; Altmeyer, R. Low levels of co-receptor CCR5 are sufficient to permit HIV envelope-mediated fusion with resting CD4 T cells. *AIDS* **2002**, *16*, 2337–2340.
342. Eckstein, D.A.; Penn, M.L.; Korin, Y.D.; Scripture-Adams, D.D.; Zack, J.A.; Kreisberg, J.F.; Roederer, M.; Sherman, M.P.; Chin, P.S.; Goldsmith, M.A. HIV-1 actively replicates in naive CD4(+) T cells residing within human lymphoid tissues. *Immunity* **2001**, *15*, 671–682.
343. Chu, T.; Carruth, L.M.; Finzi, D. Quantification of latent tissue reservoirs and total body viral load in HIV-1 infection. *Nature* **1997**, *387*, 183–188.
344. Siliciano, J.D.; Kajdas, J.; Finzi, D.; Quinn, T.C.; Chadwick, K.; Margolick, J.B.; Kovacs, C.; Gange, S.J.; Siliciano, R.F. Long-term follow-up studies confirm the stability of the latent reservoir for HIV-1 in resting CD4+ T cells. *Nat. Med.* **2003**, *9*, 727–728.
345. Finzi, D.; Balnkson, J.; Siliciano, J. Latent infection of CD4+T cells provides a mechanism for life long persistence of HIV-1, even in patients on effective combination therapy. *Nat. Med.* **1999**, *5*, 512–517.
346. Siliciano, J.; Siliciano, R.F. Latency and viral persistence in HIV-1 infection. *J. Clin. Invest.* **2000**, *106*, 823–825.
347. Blankson, J.; Persaud, D.; Siliciano, R.F. The challenge of viral reservoirs in HIV-1 infection. *Annu. Rev. Med.* **2002**, *53*, 557–593.
348. Williams, K.C.; Hickey, W.F. Central nervous system damage, monocytes and macrophages, and neurological disorders in AIDS. *Annu. Rev. Neurosci.* **2002**, *25*, 537–562.
349. Garden, G.A. Microglia in human immunodeficiency virus-associated neurodegeneration. *Glia* **2002**, *40*, 240–251.
350. Smith, P.D.; Meng, G.; Salazar-Gonzalez, J.F.; Shaw, G.M. Macrophage HIV-1 infection and the gastrointestinal tract reservoir. *J. Leukoc. Biol.* **2003**, *74*, 642–649.
351. Shen, R.; Meng, G.; Ochsenbauer, C.; Clapham, P.R.; Grams, J.; Novak, L.; Kappes, J.C.; Smythies, L.E.; Smith, P.D. Stromal down-regulation of macrophage CD4/CCR5 expression and NF- $\kappa$ B activation mediates HIV-1 non-permissiveness in intestinal macrophages. *PLoS Pathog.* **2011**, doi:10.1371/journal.ppat.1002060.
352. Abbas, W.; Tariq, M.; Iqbal, M.; Kumar, A.; Herbein, G. Eradication of HIV-1 from the Macrophage Reservoir: An Uncertain Goal? *Viruses* **2015**, *7*, 1578–1598.
353. Alexaki, A.; Liu, Y.; Wigdahl, B. Cellular reservoirs of HIV-1 and their role in viral persistence. *Curr. HIV Res.* **2008**, *6*, 388–400.

354. Saksena, N.K.; Wang, B.; Zhou, L.; Soedjono, M.; Ho, Y.S.; Conceicao, V. HIV reservoirs *in vivo* and new strategies for possible eradication of HIV from the reservoir sites. *HIV/AIDS* **2010**, *2*, 103–122.
355. Haase, A.T.; Henry, K.; Zupancic, M. Quantitative image analysis of HIV-1 infection in lymphoid tissue. *Science* **1996**, *274*, 985–989.
356. Crespo, H.; Bertolotti, L.; Juganaru, M.; Galaria, I.; de Andres, D.; Amorena, B.; Rosati, S.; Reina, R. Small ruminant macrophage polarization may play a pivotal role on lentiviral infection. *Vet. Res.* **2013**, doi:10.1186/1297-9716-44-83.
357. Gray, L.R.; Roche, M.; Flynn, J.K.; Wesselingh, S.L.; Gorry, P.R.; Churchill, M.J. Is the central nervous system a reservoir of HIV-1? *Curr. Opin. HIV AIDS* **2014**, *9*, 552–558.
358. Churchill, M.; Nath, A. Where does HIV hide? A focus on the central nervous system. *Curr. Opin. HIV AIDS* **2013**, *8*, 165–169.
359. Williams, D.W.; Veenstra, M.; Gaskill, P.J.; Morgello, S.; Calderon, T.M.; Berman, J.W. Monocytes mediate HIV neuropathogenesis: mechanisms that contribute to HIV associated neurocognitive disorders. *Curr. HIV Res.* **2014**, *12*, 85–96.
360. Lawrence, D.; Major, E. HIV-1 and the brain: connections between HIV-1-associated dementia, neuropathology and neuroimmunology. *Microb. Infect.* **2002**, *4*, 301–308.
361. Hong, S.; Banks, W.A. Role of the immune system in HIV-associated neuroinflammation and neurocognitive implications. *Brain. Behav. Immun.* **2015**, *45*, 1–12.
362. Benavides, J.; Garcia-Pariente, C.; Fuertes, M.; Ferreras, M.C.; Garcia-Marin, J.F.; Juste, R.A.; Perez, V. Maedi-visna: the meningoencephalitis in naturally occurring cases. *J. Comp. Pathol.* **2009**, *140*, 1–11.
363. Benavides, J.; Fuertes, M.; Garcia-Pariente, C.; Ferreras, M.C.; Garcia Marin, J.F.; Perez, V. Natural cases of visna in sheep with myelitis as the sole lesion in the central nervous system. *J. Comp. Pathol.* **2006**, *134*, 219–230.
364. Yukl, S.A.; Gianella, S.; Sinclair, E.; Epling, L.; Li, Q.; Duan, L.; Choi, A.L.; Girling, V.; Ho, T.; Li, P.; *et al.* Differences in HIV burden and immune activation within the gut of HIV-positive patients receiving suppressive antiretroviral therapy. *J. Infect. Dis.* **2010**, *202*, 1553–1561.
365. Cerf-Bensussan, N.; Guy-Grand, D. Intestinal intraepithelial lymphocytes. *Gastroenterol. Clin. North. Am.* **1991**, *20*, 549–576.
366. Schneider, T.; Jahn, H.U.; Schmidt, W.; Riecken, E.O.; Zeitz, M.; Ullrich, R. Loss of CD4 T lymphocytes in patients infected with human immunodeficiency virus type 1 is more pronounced in the duodenal mucosa than in the peripheral blood. Berlin diarrhea/wasting syndrome study group. *Gut* **1995**, *37*, 524–529.
367. Olech, M.; Kubis, P.; Lipecka, C.; Junkuszew, A.; Gruszecki, T.M.; Kuźmak, J. Presence of specific antibodies and proviral DNA of small ruminant lentiviruses in lambs in their first weeks of life. *Bull. Vet. Inst. Pulawy* **2014**, *58*, 507–511.
368. Grossi, P.; Giudice, C.; Bertolotti, I.; Cioccarelli, G.; Brocchi, E.; Cammarata, G.; Gelmetti, D. Immunohistochemical detection of the p27 capsid protein of caprine arthritis-encephalitis virus (CAEV) in bone-marrow cells of seropositive goats. *J. Comp. Pathol.* **2005**, *133*, 197–200.
369. Ravazzolo, A.P.; Nenci, C.; Vogt, H.-R.; Waldvogel, A.; Obexer-Ruff, G.; Peterhans, E.; Bertoni, G. Viral load, organ distribution, histopathological lesions, and cytokine mRNA

- expression in goats infected with a molecular clone of the caprine arthritis encephalitis virus. *Virology* **2006**, *350*, 116–127.
370. Lambert-Niclot, S.; Tubiana, R.; Beaudoux, C.; Lefebvre, G.; Caby, F.; Bonmarchand, M.; Naouri, M.; Schubert, B.; Dommergues, M.; Calvez, V.; *et al.* Detection of HIV-1 RNA in seminal plasma samples from treated patients with undetectable HIV-1 RNA in blood plasma on a 2002–2011 survey. *AIDS* **2012**, *26*, 971–975.
371. Marcelin, A.G.; Tubiana, R.; Lambert-Niclot, S.; Lefebvre, G.; Dominguez, S.; Bonmarchand, M.; Vauthier-Brouzes, D.; Marguet, F.; Mousset-Simeon, N.; Peytavin, G.; *et al.* Detection of HIV-1 RNA in seminal plasma samples from treated patients with undetectable HIV-1 RNA in blood plasma. *AIDS* **2008**, *22*, 1677–1679.
372. Taylor, S.; Van Heeswijk, R.; Hoetelmans, R. Concentration of nevirapine, lamivudine and stavudine in semen of HIV-1 infected men. *AIDS* **2000**, 1979–1984.
373. Sheth, P.M.; Kovacs, C.; Kemal, K.S.; Jones, R.B.; Raboud, J.M.; Pilon, R.; la Porte, C.; Ostrowski, M.; Loutfy, M.; Burger, H.; *et al.* Persistent HIV RNA shedding in semen despite effective antiretroviral therapy. *AIDS* **2009**, *23*, 2050–2054.
374. Le Tortorec, A.; Dejudcq-Rainsford, N. HIV infection of the male genital tract—consequences for sexual transmission and reproduction. *Int. J. Androl.* **2010**, *33*, 98–108.
375. Dejudcq-Rainsford, N.; Jegou, B. Viruses in semen and male genital tissues—consequences for the reproductive system and therapeutic perspectives. *Curr. Pharm. Des.* **2004**, *10*, 557–575.
376. Lasheeb, A.S.; King, J.; Ball, J.K.; Curran, R.; Barratt, C.L.; Afnan, M.; Pillay, D. Semen characteristics in HIV-1 positive men and the effect of semen washing. *Genitourin. Med.* **1997**, *73*, 303–305.
377. Pudney, J.; Anderson, D. Orchitis and human immunodeficiency virus type 1 infected cells in reproductive tissues from men with the acquired immune deficiency syndrome. *Am. J. Pathol.* **1991**, *139*, 149–160.
378. Muciaccia, B.; Filippini, A.; Ziparo, E.; Colelli, F.; Baroni, C.D.; Stefanini, M. Testicular germ cells of HIV-seropositive asymptomatic men are infected by the virus. *J. Reprod. Immunol.* **1998**, *41*, 81–93.
379. Muciaccia, B.; Corallini, S.; Vicini, E.; Padula, F.; Gandini, L.; Liuzzi, G.; Lenzi, A.; Stefanini, M. HIV-1 viral DNA is present in ejaculated abnormal spermatozoa of seropositive subjects. *Hum. Reprod.* **2007**, *22*, 2868–2878.
380. Galvin, S.R.; Cohen, M.S. Genital tract reservoirs. *Curr. Opin. HIV AIDS* **2006**, *1*, 162–166.
381. Bull, M.E.; Learn, G.H.; McElhone, S.; Hitti, J.; Lockhart, D.; Holte, S.; Dragavon, J.; Coombs, R.W.; Mullins, J.I.; Frenkel, L.M. Monotypic human immunodeficiency virus type 1 genotypes across the uterine cervix and in blood suggest proliferation of cells with provirus. *J. Virol.* **2009**, *83*, 6020–6028.
382. Si-Mohamed, A.; Kazatchkine, M.D.; Heard, I.; Goujon, C.; Prazuck, T.; Aymard, G.; Cessot, G.; Kuo, Y.H.; Bernard, M.C.; Diquet, B.; *et al.* Selection of drug-resistant variants in the female genital tract of human immunodeficiency virus type 1-infected women receiving antiretroviral therapy. *J. Infect. Dis.* **2000**, *182*, 112–122.

383. Ali Al Ahmad, M.Z.; Dubreil, L.; Chatagnon, G.; Khayli, Z.; Theret, M.; Martignat, L.; Chebloune, Y.; Fieni, F. Goat uterine epithelial cells are susceptible to infection with Caprine Arthritis Encephalitis Virus (CAEV) *in vivo*. *Vet. Res.* **2012**, doi:10.1186/1297-9716-43-5.
384. Lamara, A.; Fieni, F.; Mselli-Lakhal, L.; Tainturier, D.; Chebloune, Y. Efficient replication of caprine arthritis-encephalitis virus in goat granulosa cells. *Virus Res.* **2001**, *79*, 165–172.
385. Lamara, A.; Fieni, F.; Mselli-Lakhal, L.; Tainturier, D.; Chebloune, Y. Epithelial cells from goat oviduct are highly permissive for productive infection with caprine arthritis-encephalitis virus (CAEV). *Virus Res.* **2002**, *87*, 69–77.
386. Ali Al Ahmad, M.Z.; Fieni, F.; Guiguen, F.; Larrat, M.; Pellerin, J.L.; Roux, C.; Chebloune, Y. Cultured early goat embryos and cells are susceptible to infection with caprine encephalitis virus. *Virology* **2006**, *353*, 307–315.
387. Lamara, A.; Fieni, F.; Chatagnon, G.; Larrat, M.; Dubreil, L.; Chebloune, Y. Caprine arthritis encephalitis virus (CAEV) replicates productively in cultured epididymal cells from goats. *Comp. Immunol. Microbiol. Infect. Dis.* **2013**, *36*, 397–404.
388. Ali Al Ahmad, M.Z.; Fieni, F.; Pellerin, J.L.; Guiguen, F.; Cherel, Y.; Chatagnon, G.; Bouzar, A.B.; Chebloune, Y. Detection of viral genomes of caprine arthritis-encephalitis virus (CAEV) in semen and in genital tract tissues of male goat. *Theriogenology* **2008**, *69*, 473–480.
389. Turchetti, A.P.; Paniago, J.J.; da Costa, L.F.; da Cruz, J.C.; Braz, G.F.; Gouveia, A.M.; Paixao, T.A.; Santos, R.L.; Heinemann, M.B. Distribution of caprine arthritis encephalitis virus provirus, RNA, and antigen in the reproductive tract of one naturally and seven experimentally infected bucks. *Theriogenology* **2013**, *80*, 933–939.
390. Fieni, F.; Pellerin, J.L.; Roux, C.; Poulin, N.; Baril, G.; Fatet, A.; Valas, S.; Chatagnon, G.; Mermillod, P.; Guignot, F. Can caprine arthritis encephalitis virus (CAEV) be transmitted by *in vitro* fertilization with experimentally infected sperm? *Theriogenology* **2012**, *77*, 644–651.
391. Alimohammadi, A.; Coker, R.; Miller, R.; Mitchell, D.; Williamson, J.; Clarke, J. Genotypic variants of HIV-1 from peripheral blood and lungs of AIDS patients. *AIDS* **1997**, *11*, 831–832.
392. White, N.; Israel-Biet, D.; coker, R.; Mitchell, D.; Weber, J.; Clarke, J. Different resistance mutations can be detected simultaneously in the blood and the lung of HIV-1 infected individuals on antiretroviral therapy. *J. Med. Virol.* **2004**, 352–357.
393. Cribbs, S.K.; Lennox, J.; Caliendo, A.M.; Brown, L.A.; Guidot, D.M. Healthy HIV-1-infected individuals on highly active antiretroviral therapy harbor HIV-1 in their alveolar macrophages. *AIDS Res. Hum. Retroviruses* **2015**, *31*, 64–70.
394. Almodovar, S. The complexity of HIV persistence and pathogenesis in the lung under antiretroviral therapy: challenges beyond AIDS. *Viral Immunol.* **2014**, *27*, 186–199.
395. Costiniuk, C.T.; Jenabian, M.A. The lungs as anatomical reservoirs of HIV infection. *Rev. Med. Virol.* **2014**, *24*, 35–54.
396. Bruggeman, L.; Ross, M.; Tanji, N. Renal epithelium is a previously unrecognized site of HIV-1 infection. *J. Am. Soc. Nephrol.* **2000**, 2079–2087.
397. Marras, D.; Bruggeman, L.; Gao, F. Replication and compartmentalization of HIV-1 in kidney epithelium of patients with HIV-associated nephropathy. *Nat. Med.* **2002**, 522–526.
398. Blasi, M.; Balakumaran, B.; Chen, P.; Negri, D.R.; Cara, A.; Chen, B.K.; Klotman, M.E. Renal epithelial cells produce and spread HIV-1 via T-cell contact. *AIDS* **2014**, *28*, 2345–2353.

399. Canaud, G.; Dejuq-Rainsford, N.; Avettand-Fenoel, V.; Viard, J.P.; Anglicheau, D.; Bienaime, F.; Muorah, M.; Galmiche, L.; Gribouval, O.; Noel, L.H.; *et al.* The kidney as a reservoir for HIV-1 after renal transplantation. *J. Am. Soc. Nephrol.* **2014**, *25*, 407–419.
400. Stock, P.G.; Barin, B.; Hatano, H.; Rogers, R.L.; Roland, M.E.; Lee, T.H.; Busch, M.; Deeks, S.G. Reduction of HIV persistence following transplantation in HIV-infected kidney transplant recipients. *Am. J. Transplant.* **2014**, *14*, 1136–1141.
401. McNeilly, T.N.; Baker, A.; Brown, J.K.; Collie, D.; Maclachlan, G.; Rhind, S.M.; Harkiss, G.D. Role of alveolar macrophages in respiratory transmission of visna/maedi virus. *J. Virol.* **2008**, *82*, 1526–1536.
402. McNeilly, T.N.; Tennant, P.; Lujan, L.; Perez, M.; Harkiss, G.D. Differential infection efficiencies of peripheral lung and tracheal tissues in sheep infected with Visna/maedi virus via the respiratory tract. *J. Gen. Virol.* **2007**, *88*, 670–679.
403. Zang, Z.; Watt, N.; Hopkins, J.; Harkiss, G.; Woodall, C. Quantitative analysis of Maedi Visna virus DNA load in peripheral blood monocytes and alveolar macrophages. *J. Virol. Methods* **2000**, 13–20.
404. Watt, N.J.; MacIntyre, N.; Collie, D.; Sargan, D.; McConnell, I. Phenotypic analysis of lymphocyte populations in the lungs and regional lymphoid tissue of sheep naturally infected with maedi visna virus. *Clin. Exp. Immunol.* **1992**, *90*, 204–208.
405. Patton, K.M.; Bildfell, R.J.; Anderson, M.L.; Cebra, C.K.; Valentine, B.A. Fatal Caprine arthritis encephalitis virus-like infection in 4 Rocky Mountain goats (*Oreamnos americanus*). *J. Vet. Diagn. Invest.* **2012**, *24*, 392–396.
406. Arrode-Brusés, G.; Hegde, R.; Jin, Y.; Liu, Z.; Narayan, O.; Chebloune, Y. Immunogenicity of a lentiviral-based DNA vaccine driven by the 5'LTR of the naturally attenuated caprine arthritis encephalitis virus (CAEV) in mice and macaques. *Vaccine* **2012**, *30*, 2956–2962.
407. Chebloune, Y.; Moussa, M.; Arrode-Bruses, G.; Gagnon, J. Cowpox helped against smallpox; will the goat lentivirus (Caprine Arthritis Encephalitis Virus) help against HIV-1? *AIDS Res. Hum. Retroviruses* **2015**, doi: 10.1089/aid.2015.0010.