



HAL
open science

Functional analysis of replication-competent primate lentivirus genomes driven by CAEV promoters: A new model to study latency and persistence

Simaa Ahmid

► To cite this version:

Simaa Ahmid. Functional analysis of replication-competent primate lentivirus genomes driven by CAEV promoters: A new model to study latency and persistence. Human health and pathology. Université Grenoble Alpes, 2017. English. NNT : 2017GREAV018 . tel-01938088

HAL Id: tel-01938088

<https://theses.hal.science/tel-01938088v1>

Submitted on 28 Nov 2018

HAL is a multi-disciplinary open access archive for the deposit and dissemination of scientific research documents, whether they are published or not. The documents may come from teaching and research institutions in France or abroad, or from public or private research centers.

L'archive ouverte pluridisciplinaire **HAL**, est destinée au dépôt et à la diffusion de documents scientifiques de niveau recherche, publiés ou non, émanant des établissements d'enseignement et de recherche français ou étrangers, des laboratoires publics ou privés.

THÈSE

Pour obtenir le grade de

DOCTEUR DE LA COMMUNAUTÉ UNIVERSITÉ GRENOBLE ALPES

Spécialité : **Virologie- Microbiologie-Immunologie**

Arrêté ministériel : 25 mai 2016

Présentée par : **Simaa AHMID**

Thèse dirigée par **Dr. Yahia CHEBLOUNE**

préparée au sein du :

Laboratoire Pathogénèse et Vaccination Lentivirales (PAVAL)

dans l'École Doctorale Chimie et Sciences du Vivant-Grenoble
EDCSV

**Analyse fonctionnelle de génomes lentiviraux de
primates répliatifs sous le contrôle des promoteurs du
lentivirus caprin CAEV : Modèle d'étude pour la
latence et persistance des lentivirus.**

Thèse soutenue publiquement le **10 avril 2017** devant le jury composé
de :

Prof. Christelle BRETON

Professor, Molecular Glycobiology Group, Directrice de l'École Doctorale
Chimie et Sciences du Vivant CERMAV-CNRS Université Grenoble Alpes
(Présidente du jury)

Dr. Catherine LEMAIRE-VIEILLE

Chargé de recherche, CNRS, Université Grenoble Alpes (Examineur)

Prof. François VILLINGER

Professeur, Université Lafayette, Louisiane (Rapporteur)

Prof. Michel PEPIN

Professeur de Microbiologie / Immunologie / Pathologie Infectieuse chez
VetAgroSup - Campus Vétérinaire de Lyon (Rapporteur)

Dr. Jean GAGNON

Directeur de recherche, Université Grenoble Alpes (Invité)



Acknowledgements



"SEIGNEUR, DONNE-MOI (TOUJOURS) PLUS DE SAVOIR"

"Oh, Lord, Enrich me with Knowledge"

I would like to thank Dr. Y. CHEBLOUNE for accepting me in his lab, supervision of this work, support and scientific advices.

I would like to thank Dr. J. GAGNON for his continuous support and scientific advices.

I would like to thank Prof. C. BRETON for her support

I would like to thank the members of my PhD committee and the members of this Jury.

I would like to thank all my teachers

I would like to thank my team members: Deepanwita BOSE, Dimitri MOMPÉLAT, Abderrahim LAHROUSSI, and all my friends

I would like to thank the French and Iraq authorities for the scholarship.

Dedication

To my parents (god bless their soul)

To my husband AHMED Anmar

To my daughter ALZAIDAN Noor and my son ALZAIDAN Yahya

To my sisters and my brother

To my town (Mosul) and my country IRAQ.

Abstract

Acquired Immuno-Deficiency Syndrome (AIDS) is a disease caused by immunodeficiency viruses in human (HIV-1) and some animal species. The virus is a small enveloped particle that has a single-strand RNA genome and belongs to the lentivirus genus that belongs to the *Retroviridae* family. In human the virus infects and replicates mainly in cells that express the CD4 on their surface. Since its apparition in human in 1982 the virus has infected around 80 million individuals worldwide and caused the death of nearly half of them. No vaccine exists but life expectancy of near half of HIV-1-infected individuals has been now prolonged due to extensive highly active antiretroviral therapy (HAART). Because of the complexity of the host/pathogen interactions that are associated with HIV-1 infection in human and non-human primate models, a simple model system is strongly needed to ease the studies aiming at better understanding the underlying mechanisms of increased pathogenesis of HIV-1 in human. A chimeric virus CAL-HIV-R1 was created in our laboratory by exchanging the long terminal repeats (LTRs) of HIV with those of CAEV, a caprine lentivirus. Because these CAEV LTRs have a constitutive promoter, which is independent of the trans-activator of transcription, we expect that this chimeric virus should not undergo latency in memory CD4⁺ T cells. To increase the potency of this chimera, serial passages on cultured human cells were performed. Besides its primary receptor, CD4, HIV needs to interact with another molecule as a co-receptor. Several infectious molecular clones of HIV-1 isolates pDNAs containing the complete proviral genomes were received from the NIH AIDS Reagent Program Repository. Three of these, namely pNL4-3, p89.6 and pWARO, were used to produce virus stocks following transfection in the human HEK-293T cell line and used to infect a variety of cell lines such as: 1) GHOST cells that were used to examine the tropism for the co-receptor that were X4, X4/R5 and R5 respectively; 2) M8166 a fusogenic indicator cell line to evaluate the replication competency, 3) TZM-bl to determine the infectivity titers of the viruses by scoring the blue cells enabled by infections. A vaccine based on a chimeric DNA vector, CAL-SHIV-IN⁺, has been developed in our laboratory and tested in macaques. A sero-neutralization assay was performed on sera of macaques, which had been vaccinated with this vector and challenged in parallel with control animals with a pathogenic virus. This assay was used to verify the presence of neutralizing antibodies, but, unfortunately none could be detected

Résumé

Le syndrome d'immunodéficience acquise (SIDA) est une maladie provoquée chez l'homme par le virus de l'immunodéficience humaine (VIH), un lentivirus à ARN monocaténaire qui infecte les cellules humaines qui expriment les CD4 à leur surface. Depuis son apparition en 1982 chez l'homme, il y a eu environ 80 millions d'individus infectés dans le monde et près de la moitié d'entre eux sont déjà décédés. Aucun vaccin n'existe actuellement mais l'espérance de vie d'un grand nombre de patients est maintenant prolongée grâce au développement et la disponibilité d'un traitement antirétroviral hautement actif (HAART en anglais). En raison de la complexité des interactions hôte/pathogène liées à l'infection par le VIH-1 chez l'homme et les modèles primates non-humains actuels, le développement d'un modèle plus simple est nécessaire pour étudier et mieux comprendre les mécanismes sous-jacents de l'augmentation de la pathogénèse du VIH-1 chez l'humain. Dans ce but, un virus chimérique CAL-HIV-R1 a été construit dans notre laboratoire en échangeant les longues séquences répétées terminales (LTR) du VIH par celles du CAEV, un lentivirus caprin. Parce que ces LTR de CAEV ont un promoteur constitutif qui est indépendant du trans-activateur de la transcription, ce virus chimérique ne devrait pas subir de latence dans les cellules T CD4+ mémoire. Pour rendre son efficacité répliquative plus performante, cette chimère a subi plusieurs passages successifs sur des cellules humaines en culture. En plus de la présence de son récepteur primaire, la protéine CD4, le VIH doit interagir avec une seconde molécule co-réceptrice pour entrer dans la cellule hôte. Des clones moléculaires infectieux contenant des génomes proviraux complets de plusieurs isolats de VIH-1 ont été reçus de la banque de produits "NIH AIDS Reagent Program Repository". Trois d'entre eux, à savoir pNL4-3, p89.6 et pWARO, ont été utilisés pour produire des stocks de virus après transfection des cellules de la lignée humaine HEK-293T et utilisés pour infecter d'autres lignées cellulaires telles que : 1) des cellules GHOST, utilisées pour examiner le tropisme des virus en fonction de leur utilisation des co-récepteurs et qui sont respectivement X4, X4/R5 et R5; 2) la lignée cellulaire M8166, utilisée comme cellules indicatrices du fait de ses propriétés fusogéniques, et qui sert à examiner les capacités de répliquaison et enfin, 3) la lignée cellulaire TZM-bl utilisée pour évaluer le titre infectieux des virus. Par ailleurs, un vaccin basé sur un vecteur ADN lentiviral chimérique, le CAL-SHIV-IN⁺, a été développé au laboratoire et testé chez des macaques. Dans le cadre de cette étude, un test de séro-neutralisation a été réalisé sur des échantillons de sérum des macaques vaccinés avec ce vecteur, et des animaux témoins, pour examiner la présence d'anticorps pouvant neutraliser le virus. Bien que des anticorps furent présents aucune capacité neutralisante n'a pu être détectée.

Abbreviations :

Ad5	Adenovirus serotype 5
AIDS	Acquired ImmunoDeficiency Syndrome
AM	Alveolar Macrophage
APC	Antigen Presenting Cell
APOBEC3G	Apolipoprotein B mRNA-editing enzyme catalytic polypeptide-like 3G
ART	Anti-Retroviral Therapy
BCFU	Blue Cell Forming Units
BIV	Bovine Immunodeficiency Virus
bNabs	Broadly Neutralizing Antibodies
BPS	Bovine Paraplegic Syndrome
BST-2	Bone marrow Stromal antigen 2 (tetherin)
CA	Capsid protein
CAEV	Caprine Arthritis Encephalitis Virus
CCR5	C-C Chemokine Receptor 5
CCR5-Δ32	CCR5 with gene deletion of 32 bp
CD4	Cluster of Differentiation 4
CMV	Cytomegalovirus
CNS	Central Nervous System
ConA	Concanavalin A
CPE	Cytopathic Effects
CSF	Cerebral Spinal Fluid
CXCR4	Chemokine C-X-C motif Receptor 4
DCs	Dendritic Cells
DMEM	Dulbecco's Modified Eagle's Medium
DMSO	Dimethyl Sulfoxide
DNA	Deoxyribonucleic Acid
dsDNA	Double-Stranded DNA
dscDNA	Double-Stranded Complementary DNA
EDTA	Ethylene Diamine Tetraacetic Acid
EIAV	Equine Infectious Anemia Virus
ELISA	Enzyme-Linked Immunosorbent Assay
Env	Envelope glycoproteins
FBS	Fetal Bovine Serum
FDA	Food and Drug Administration
FDCs	Follicular Dendritic Cells
FIV	Feline Immunodeficiency Virus
Gag	Group Antigens protein
GALT	Gut-Associated Lymphoid Tissue
Gp	Glycoprotein
HAART	Highly Active AntiRetroviral Therapy
HEK	Human Embryonic Kidney
HIV-1	Human Immunodeficiency Virus Type 1
HIV-2	Human Immunodeficiency Virus Type 2
HSPC	Hematopoietic Stem Cells
HTLV-III	Human T-Lymphotropic Virus Type III
ICTV	International Committee on Taxonomy of Viruses
IFN	Interferon

IN	Integrase
JDV	Jembrana Disease Virus
Lac Z	Lactose gene
LAV	Lymphadenopathy-Associated Virus
LB	Luria Broth medium
LTR	Long Terminal Repeat
MA	Matrix protein
MHC	Major Histocompatibility Complex
MOI	Multiplicity of Infection
mRNA	Messenger Ribonucleic Acid
M-tropic	Monocyte/Macrophage-tropic
MVA	Modified vaccinia virus Ankara
MVC	Maraviroc
MVV	Maedi Visna Virus
Mx2	Myxovirus resistance protein 2
NAbs	Neutralizing Antibodies
NC	Nucleocapsid protein
Nef	Negative Factor
NF-kB	Nuclear Factor of kappa light polypeptide gene enhancer in B-cell
NIAID	National Institute of Allergy and Infectious Diseases
NIH	National Institute of Health
NK	Natural Killer
NYVAC	New York attenuated vaccinia virus
OPPV	Ovine Progressive Pneumonia Virus
OWM	Old World Monkeys
PBS	Phosphate Buffered Saline
PFA	Paraformaldehyde
PFU	Plaque Forming Unit
PIC	Pre-Integration Complex
PLV	Puma Lentivirus
PMA	Phorbol Myristate Acetate
Pol	Polymerase
PPT	Poly Purine Tract
PR	Protease
PrEP	Pre-Exposure Prophylaxis
R5	HIV strains that bind to co-receptor CCR5
rAD5	Recombinant Adenovirus type 5
Rev	Regulator of Expression of Viral Proteins
RNA	Ribonucleic Acid
Rpm	Revolutions per minute
RPMI	Roswell Park Memorial Institute medium
RRE	Rev Response Element
RT	Reverse Transcriptase
RTC	Reverse Transcription Complex
SAIDS	Simian Acquired ImmunoDeficiency Syndrome
SAMHD1	Sterile α Motif and HD Domain-Containing Protein 1
SFC	Spot-Forming Cells (excreting IFN γ)
SHIV	Simian/Human Immunodeficiency Virus
SIV	Simian Immunodeficiency Virus
SIVcpz	SIV of Chimpanzees

SIVgor	SIV of Gorilla
SIVmac	SIV of Macaques
SIVsmm	SIV of Sooty Mangabeys
Sp1	Specificity Protein 1
SRLVs	Small Ruminant Lentivirus
ssRNA	Single Stranded Ribonucleic Acid
SU	Surface glycoprotein
TAE	Tris-Acetate-EDTA buffer
TAR	Trans-Activating Response element
Tat	Trans-Activator of Transcription
TCID ₅₀	Tissue Culture Infectious Dose 50%
Tetherin	Bone marrow Stromal antigen 2 (BST-2)
TF	Transmitted/Founder
TIGEF	T-Immortalized Goat Embryo Fibroblast
TM	Transmembrane glycoprotein
TMB	Tetramethylbenzidine
TNFR	Tumor Necrosis Factor Receptor
tRNA	Transfer Ribonucleic Acid
T-tropic	T-Lymphocytes tropic
U3/U5	Unique regions 3'/5' of LTR
V1/V2/V3	Variable regions of gp120
Vif	Viral Infectivity Factor
Vpr	Viral Protein R
Vpu	Viral Protein Unique
Vpx	Viral Protein X
VSV	Vesicular Stomatitis Virus
WHO	World Health Organization
X4	HIV strains that bind to co-receptor CXCR4
ZO-1	Zonula Occludens protein-1

List of Tables

<u>Table 1.</u> HIV vaccine efficacy trials.....	31
<u>Table 2.</u> List of cell lines used in this work.....	37
<u>Table 3.</u> Plasmids from the NIH AIDS Reagent Program Repository.....	46
<u>Table 4.</u> The tropism of viral clones.....	47
<u>Table 5.</u> Titration of viral stocks.....	51

List of Figures

<u>Figure 1.</u> Lentiviruses' taxonomy	3
<u>Figure 2.</u> Genome organizations of lentivirus.....	5
<u>Figure 3.</u> Physical maps of small ruminant and human lentivirus genomes.....	5
<u>Figure 4.</u> Simian origin of HIV-1 and HIV-2 in humans.....	8
<u>Figure 5.</u> Estimated number of people living with HIV in the world.....	10
<u>Figure 6.</u> Schematic representation of the structure and the genome of HIV virion.....	11
<u>Figure 7.</u> Schematic representation of 5' and 3'LTR regions.....	12
<u>Figure 8.</u> Schematic presentation of the reverse transcription process.....	14
<u>Figure 9.</u> Schematic representation of the env trimer interaction with target cells receptor....	15
<u>Figure 10.</u> Schematic presentation of Rev/RRE function in HIV-1 life cycle.....	19
<u>Figure 11.</u> Structure of the TAR region from the 5'LTR.....	21
<u>Figure 12.</u> Schematic representation HIV tropism.....	24
<u>Figure 13.</u> HIV-1 replication cycle.....	25
<u>Figure 14.</u> Latency in CD4+ T cells.....	27
<u>Figure 15.</u> Chimeric lentivector DNA vaccine CAL-SHIV-IN ⁻	32
<u>Figure 16.</u> Organization of CAL-HIV-R1 pDNA.....	43
<u>Figure 17.</u> Infectivity assay of selected HIV-1 strains on GHOST cells.....	48
<u>Figure 18.</u> TZM-bl titration of HIV-1.....	49
<u>Figure 19.</u> Synaptic study of replication in 174xCEM and M8166 cells.....	52
<u>Figure 20.</u> Adaptation by serial passages of CAL-HIV-R1.....	54
<u>Figure 21.</u> Sero-neutralization activity in serum of macaques challenged with SIVmac251.....	57

Table des matières

Acknowledgements	ii
Abstract	iii
Résumé	iv
Abbreviations :	v
List of Tables.....	viii
List of Figures	viii
I. Summary	1
II. Introduction.....	2
II.1. HIV/AIDS.....	2
II.1.1. Nomenclature.....	2
II.1.2. Classification of HIV	2
II.2. History of HIV	7
II.2.1. Origin of HIV-1 in humans.....	7
II.2.2. Human immunodeficiency virus type 2 (HIV-2):.....	8
II.3. HIV transmission	9
II.4.Epidemiology of HIV	9
II.5. Structure of the viral particle and HIV Gene Structure	10
II.5.1. Viral Enzymes:	12
II.5.2. Structural Proteins.....	15
II.5.3. Accessory and Regulatory Proteins	17
II.6. HIV receptors.....	22
II.6.1. CD4.....	22
II.6.2. CCR5	22
II.6.3. CXCR4	22
II.6.4. HIV cellular tropism	23
II.7. HIV life cycle	24
II.8. Latency	26
II.8.1. General mechanisms of latency	27
II.8.2. Cellular and Anatomical Reservoirs of HIV.....	28
II.9. HIV vaccines	29
II.10. General aims	32
II.10.1. Specific Aim of the PhD.....	34
III. Material and methods	35
III.1. Amplification of HIV-1 plasmid DNAs	35
III.2. Purification and control of plasmid DNA	35

III.3. Large-scale purification of plasmid DNA	36
III.4. Cell lines.....	37
III.5. Culture media	37
III.6. Thawing and freezing of cell lines	38
III.7. Cell maintenance	38
III.8. Transfection of HEK-293T cell line for production of viral stock.....	39
III.9. Viral stock titration on M8166	39
III.10. Viral stock titration on TZM-bl cell line	40
III.11. Determination of viral tropism	40
III.12. Kinetics of HIV-1 replication in permissive T cell lines.....	41
III.13. Sero-neutralization using TZM-bl X-gal assay	41
III.14. Sero-neutralization using ONE-Glo™ Luciferase assay	41
III.15. CAL-HIV-R1 plasmid preparation.....	42
III.16. Data interpretation.....	44
IV. Results and Discussion.....	45
IV.1. Tropism and infectivity	45
IV.1.1. Plasmids	45
IV.1.2. Tropism	47
IV.1.3. Infectivity	49
IV.1.4. Production of viral stocks.....	50
IV.2. Kinetics study of replication	51
IV.3. Study of the chimeric lentivirus CAL-HIV-R1	52
IV.3.1. Rationale and hypothesis.....	52
IV.3.2. Objective	53
IV.3.3. Strategy	53
IV.3.4. Adaptation.....	54
IV.4. Antibody responses induced by CAL-SHIV-IN ^r	55
V. Conclusions	59
VI. References	62
VII. Summary in French.....	86

I. Summary

Acquired Immuno-Deficiency Syndrome (AIDS) is a disease caused by immunodeficiency viruses in human (HIV-1) and some animal species. The virus is a small enveloped particle that has a single-strand RNA genome and belongs to the lentivirus genus that belongs to the *Retroviridae* family. In human the virus infects and replicates mainly in cells that express the CD4 on their surface. Since its apparition in human in 1982, the virus has infected around 80 million individuals worldwide and caused the death of nearly half of them. No vaccine exists but life expectancy of near half of HIV-1-infected individuals has been now prolonged due to extensive highly active antiretroviral therapy (HAART). Because of the complexity of the host/pathogen interactions that are associated with HIV-1 infection in human and non-human primate models, a simple model system is strongly needed to ease the studies aiming at better understanding the underlying mechanisms of increased pathogenesis of HIV-1 in human. A chimeric virus CAL-HIV-R1 was created in our laboratory by exchanging the long terminal repeats (LTRs) of HIV with those of CAEV, a caprine lentivirus. Because these CAEV LTRs have a constitutive promoter, which is independent of the trans-activator of transcription, we expect that this chimeric virus should not undergo latency in memory CD4⁺ T cells. To increase the potency of this chimera, serial passages on cultured human cells were performed. Besides its primary receptor, CD4, HIV needs to interact with another molecule as a co-receptor. Several infectious molecular clones of HIV-1 isolates pDNAs containing the complete proviral genomes were received from the NIH AIDS Reagent Program Repository. Three of these, namely pNL4-3, p89.6 and pWARO, were used to produce virus stocks following transfection in the human HEK-293T cell line and used to infect a variety of cell lines such as: 1) GHOST cells that were used to examine the tropism for the co-receptor that were X4, X4/R5 and R5 respectively; 2) M8166 a fusogenic indicator cell line to evaluate the replication competency, 3) TZM-bl to determine the infectivity titers of the viruses by scoring the blue cells enabled by infections. A vaccine based on a chimeric DNA vector, CAL-SHIV-IN⁻, has been developed in our laboratory and tested in macaques. A sero-neutralization assay was performed on sera of macaques, which had been vaccinated with this vector and challenged in parallel with control animals with a pathogenic virus. This assay was used to verify the presence of neutralizing antibodies, but, unfortunately none could be detected.

II. Introduction

II.1. HIV/AIDS.

II.1.1. Nomenclature

Acquired ImmunoDeficiency Syndrome (AIDS) induced by the human immunodeficiency virus type 1 (HIV-1) infection is one of the leading causes of death attributable to infectious diseases in adults and infants worldwide [1-2]. HIV infection induces a state of chronic immune activation that progressively erodes the immune defenses and severely depletes the CD4+ T cells, culminating in the development of AIDS, characterized by life threatening opportunistic infections [3]. The first report of AIDS was in June 1982 in conjunction with a clinical outbreak of *Pneumocystis pneumonia* among homosexual men, in the United States[4], though the virus at the origin of the syndrome was only isolated from a patient's lymph node in 1983 at the Pasteur Institute, as the first Lenti/retrovirus in human. While initially termed lymphadenopathy-associated virus (LAV) or human T-lymphotropic virus type III (HTLV-III) [5-6], the International Committee on Taxonomy of Viruses (ICTV) recommended its current identification as human immunodeficiency virus HIV in 1986 [7].

II.1.2. Classification of HIV

HIV is a single-stranded RNA-enveloped virus that belongs to the Lentivirus genus of the *Orthoretrovirinae* subfamily and the *Retroviridae* family (Figure 1). There are other lentiviruses of this genus that infect other vertebrates: Bovine immunodeficiency virus (BIV), Equine infectious anemia virus (EIAV), Feline immunodeficiency virus (FIV), Puma lentivirus of lion and puma (PLV), Maedi-visna virus (MVV) of sheep, Caprine arthritis encephalitis virus (CAEV) and a large variety of viruses in monkeys termed Simian immunodeficiency virus (SIV) [8-9].

II.1.2.1 *Retroviridae* family

Retroviruses are small enveloped RNA viruses that are found in many vertebrate animals such as birds, fish and mammals [10]. The diameter of a retroviral virion is approximately 80-100 nm [11]. The outer layer of the virus is a lipid bilayer originated from the host cell membrane [12]. It covers all the surface of the spherical capsid inside of which two single strand genomic RNA molecules of the virus are located. They are positive-sense and approximately contain 7-11 kb [13]. All replication-competent retroviral genomes have three structural genes called *gag*, *pol* and *env* which are enclosed between two long terminal repeats

(LTR) [14]. The (*gag*) gene encodes the matrix (MA), capsid (CA) and nucleocapsid (NC) proteins of the virus [15]. The (*pol*) gene encodes the protease (PR), reverse transcriptase (RT) and integrase (IN) [16]. The envelope (*env*) gene codes for the retroviral surface (SU) and transmembrane (TM) proteins [17].

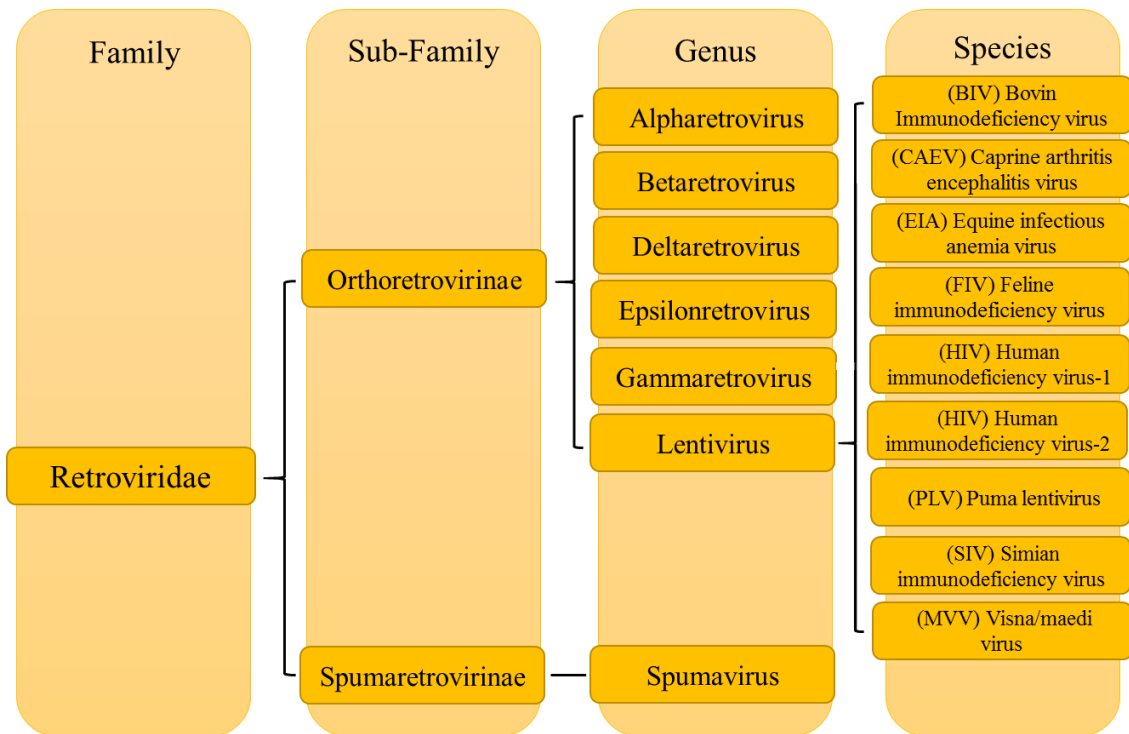

Figure 1. International Committee on Taxonomy of Viruses (ICTV) Lentiviruses' taxonomy (from [18]).

II.1.2.2. *Lentivirus of human and animals*

Lentiviruses infect humans and other mammalian animals in which they cause a long incubation period before inducing disease symptoms [19]. The bovine immunodeficiency virus (BIV) is the natural lentivirus that persistently infects cattle [20]. While BIV is not highly pathogenic in most of the cattle (*Bos Taurus*) raised in different part of the world. In contrast, the BIV variant, Jembrana Disease Virus (JDV) causes severe disease and death in a different breed of calves (*Bos Javanicus*) raised in Bali [21]. BIV genome organization resembles that of primate lentiviruses as shown in Figure 2. Like all lentivirus genomes, it includes the structural *gag* and *env*, the enzyme *pol* and the regulatory/accessory genes. These latter regulate the protein expression and the pathogenesis [22-23]. BIV causes persistent viral infection, lymphadenopathy, lymphocytosis, lesions in CNS, weakness and bovine paraplegic syndrome (BPS) [24-25].

II.1.2.3. Equine infectious anemia virus (EIAV)

EIAV is a lentivirus that causes infection in horses and induces chronic infectious diseases including recurrent anemia, weakness, thrombocytopenia and in rare cases encephalopathies [27]. Virus transmission occurs through infected cells in blood [28-29] by *Tabanus fuscicostatus* fly [30]. Vertical transmission of EIAV from infected mares to their foals occasionally causes abortion [31]. The virus does not induce immunodeficiency-like disease although there are multi-organ inflammatory disorders [32]. Tumor necrosis factor receptor (TNFR) has been identified as the primary EIAV receptor [33]. EIAV infects and replicates exclusively in the cells of the monocyte/macrophage lineage *in vivo* [34].

II.1.2.4. Feline Immunodeficiency Virus (FIV and PLV)

FIV is the natural lentivirus that infects domestic and a variety of wild cats, inducing an immunodeficiency syndrome in infected animals [35]. PLV is the puma lentivirus that is a variant of FIV infecting wild feline bobcats (*Lynx rufus*) and mountain lions (*Puma concolor*) [36]. Unlike FIV-infected cats, PLV-infected hosts do not undergo pathogenesis like many SIVs in their natural hosts [37]. FIV was first identified in 1986 in California [38]. The virus is tropic for T-cells and replicates in feline kidney cells *in vitro*, it is found in blood, CSF and saliva, but not in milk or colostrum. The initial phase of the disease is characterized by loss of appetite and weight, depression, fever, lymphadenopathy and neutropenia. The end stage of the disease includes loss of immune cells and proliferation of opportunistic infections that are associated with death of infected animals [39]. FIV uses the CXCR4, CCR3 and CCR5 chemokine receptors as entry receptors on mononuclear cells [40]. In contrast to primate lentiviruses FIV does not use the CD4 as primary receptor and CXCR4 is considered the primary receptor for entry in cells [41].

II.1.2.5. Ovine Lentivirus (OLV)

OLV is the natural lentivirus that was isolated from sheep and described as ovine progressive pneumonia virus (OPPV) [42], or Maedi Visna Virus (MVV). The pathological characteristics associated with OLV infections were reported in the beginning of the last century [43]. Following an introduction in 1933 of Karakul sheep in Iceland imported from Germany, two types of lethal disease syndromes were observed in local breed of sheep: Maedi (dyspnea “pneumonia”) and Visna (wasting). Both diseases were caused by a lentivirus called MVV [44].

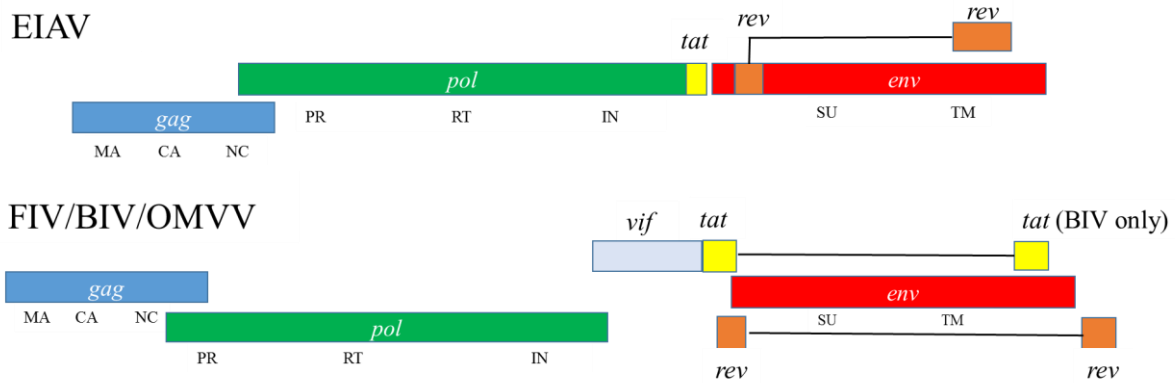

Figure 2. Genome organizations of lentivirus: equine (equine infectious anemia virus, EIAV), feline (feline immunodeficiency virus, FIV), bovine (bovine immunodeficiency virus, BIV), caprine/ovine (caprine arthritis encephalitis virus, CAEV, ovine maedi–visna virus, OMVV) (modified from [26]).

OLVs are macrophage-tropic lentiviruses that cause persistent infection in infected sheep and the virus does not productively infect T lymphocytes [43, 45]. Infected sheep develop interstitial progressive pneumonia, encephalitis, mastitis, arthritis and cachexia leading in some cases to death because of prolonged starvation [46-47]. Virus transmission occurs mainly *via* contaminated colostrum and milk from infected ewes to their newborn lambs [48].

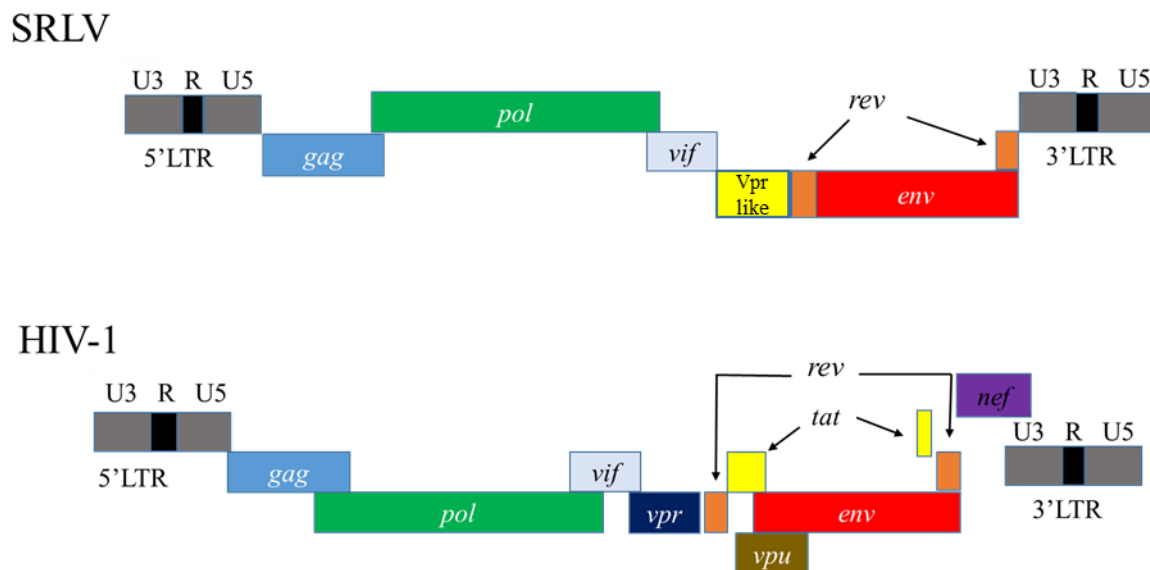

Figure 3. Physical maps of small ruminant and human lentivirus genomes (modified from [66]). The genomes contain in their extremities the 5' and 3' LTRs with the U3, R and U5 sequences that regulate the expression of structural and regulatory/accessory genes represented in different colors and whose names are indicated.

II.1.2.6. Caprine Arthritis-Encephalitis Virus (CAEV)

CAEV is the second member of the small ruminant lentivirus group that was initially reported in the late 1950s in Switzerland to be responsible of chronic arthritis in goats and then

years after it was associated disease in the central nervous system in CAEV-infected kids in Germany [49]. Later on in the mid-1970s, Cork and colleagues described the disease in the United States [50]. Later the virus was isolated from an adult goat suffering from chronic arthritis, and described to be a retrovirus member of the genus Lentivirus [51]. The virus was also simultaneously isolated from an encephalitis kid [52]. Like MVV in sheep, the productive replication of CAEV is restricted *in vivo* to the monocyte/macrophage cell lineage and this productive replication is dependent of the maturation of infected monocytes into macrophages [53-54]. Although CAEV infection is subclinical, a small number of animals develop disease syndromes including chronic polyarthritis in the joints and mastitis [55] but rarely encephalitis in adults, whereas infected kids under six months develop encephalitis [56]. Dams transmit CAEV to their kids *via* colostrum and milk [57-58]. The receptors and/or co-receptors of CAEV are still unknown. CAEV is unable to infect human cells and the lack of functional receptors is considered to be the main barrier that prevents CAEV from infecting human cells [59]. In primate lentiviruses the functions of trans activating protein Tat have been well studied. This protein is indispensable for the upregulation of transcription of the viral promoter in the LTR and allowing the elongation of the transcripts [60-61]. In small ruminant lentiviruses including CAEV, the LTR promoters were shown to induce virus expression constitutively and independent from Tat transactivation [62]. The open reading frame previously called Tat of CAEV and OLV/MVV does not encode a regulatory trans-activator protein of the LTR but rather for an accessory protein that is structurally and functionally close to Vpr of primate lentiviruses (Figure 3) [63-64]. In addition to Vpr-like, CAEV genome encodes Vif and Rev regulatory proteins and the three structural proteins of *gag*, *pol* and *env* genes common to all retroviruses [65]. *Vif* is necessary for effective *in vivo* virus replication and pathogenicity [66]. Rev trans-activation binds to Rev Response Element (RRE) an RNA structure [67]. The gene *rev* encodes Rev protein that is necessary for cytoplasmic transport of un-spliced and single spliced viral mRNA that are sequestered in nucleus [68].

II.1.2.7. Simian immunodeficiency virus SIV

This is a group of lentiviruses that infect a variety of species of non-human primates [69]. SIVs are thought to be an old natural lentivirus reservoir in non-human primates that has been the source of the spill over to human generating HIV-1 and HIV-2 [70-71]. SIVcpz from chimpanzees (*Pan troglodytes*) and SIVgor from gorilla were found to be at the origin of the cross species jumps to human generating HIV-1 [72-73], while SIVsmm from sooty mangabeys

(*Cercocebus atys*), generated HIV-2 [70]. SIVs are non-pathogenic in most of their own natural hosts species [74] despite high levels of virus replication [75-76]. The mechanisms by which these viruses remain non-pathogenic is unclear though several differences have been reported: a) Natural hosts of SIV appear to limit immune activation [77] and the production of type I IFN is limited to the early acute infection [78-79] which leads to b) an absence of chronic immune activation and c) normal gastrointestinal homeostasis. Additional intriguing findings include lower expression of CCR5 the SIV co-receptor on T cells [80], differential regulation of T cell anergy [81], differential regulation of $\alpha 4\beta 7$ on T cells [82] and a restriction of SIV replication to T cells *in vivo* [83]. Experimental infection of non-natural hosts such as macaque species with select isolates of SIVs has the ability to generate simian SAIDS with high levels of viremia, CD4 depletion, in particular depletion of mucosal CD4⁺ T cells [84], immune impairment, wasting and the occurrence of opportunistic infections [85]. Surprisingly, SIVs naturally infect only African Old World monkeys (OWM) and apes from sub-Saharan Africa, but SIVs have not been found in either Asian OWMs or New World monkeys [86].

II.2. History of HIV

It was believed that in 1960-1970, HIV-1 strains arrived in the USA from Congo. In an early AIDS study, a Canadian airline steward referred to as "Patient 0" was thought to be responsible for bringing HIV to North America [87]. However, data from a recent study indicate that this is not the case [88]. The first case of HIV was declared in 1981. The virus inducing AIDS was transmitted between homosexual men, who had begun dying of the disease [89].

II.2.1. Origin of HIV-1 in humans

HIV-1 is a zoonotic infectious pathogenic virus that arose from cross species infections of simian immunodeficiency viruses (SIVs) naturally existing in reservoirs that were identified to be in chimpanzees and gorillas. The subspecies *Pan Troglodytes* is the one naturally infected with SIVcpz and experimental infections of these animals has now demonstrated that both SIVcpz and HIV-1 infections can be associated with pathogenicity [90]. Genome detection and sequencing have established that the endemic SIVcpz strains that *P. t. troglodytes* is a natural reservoir of HIV-1 ancestor in Cameroon, where prevalence rates were found to be around 29 to 35%. Anti-SIV antibodies and viral genomes were detected in fecal and urine samples of wild chimpanzees [91-92]. Phylogenetic analyses of SIVcpz sequences obtained from various groups of chimpanzees have established that the infection has been present in this species for

over two centuries (Figure 4) [93]. HIV-1 is comprised of four viral lineages, termed groups M, N, O, and P. Each resulted from independent cross-species transmissions of SIVcpz and SIVgor [94]. The first group, M, originating from SIVcpz of Southern Cameroon is the cause of the worldwide HIV-1 pandemic. Three other groups were then discovered in Cameroon; in 1990, group O which represents less than 1% of global HIV-1 infections; in 1998, group N was identified in a mere 13 cases. Finally, in 2009, group P was discovered in France, in a woman and another person from Cameroon [93]. While HIV-1 group N is also from SIVcpz, the origin of group O has been recently demonstrated to be from gorilla (SIVgor) from central Cameroon and group P from SIVgor from southwestern Cameroon [95]. Previous studies have established that SIVgor arose from SIVcpz [96].

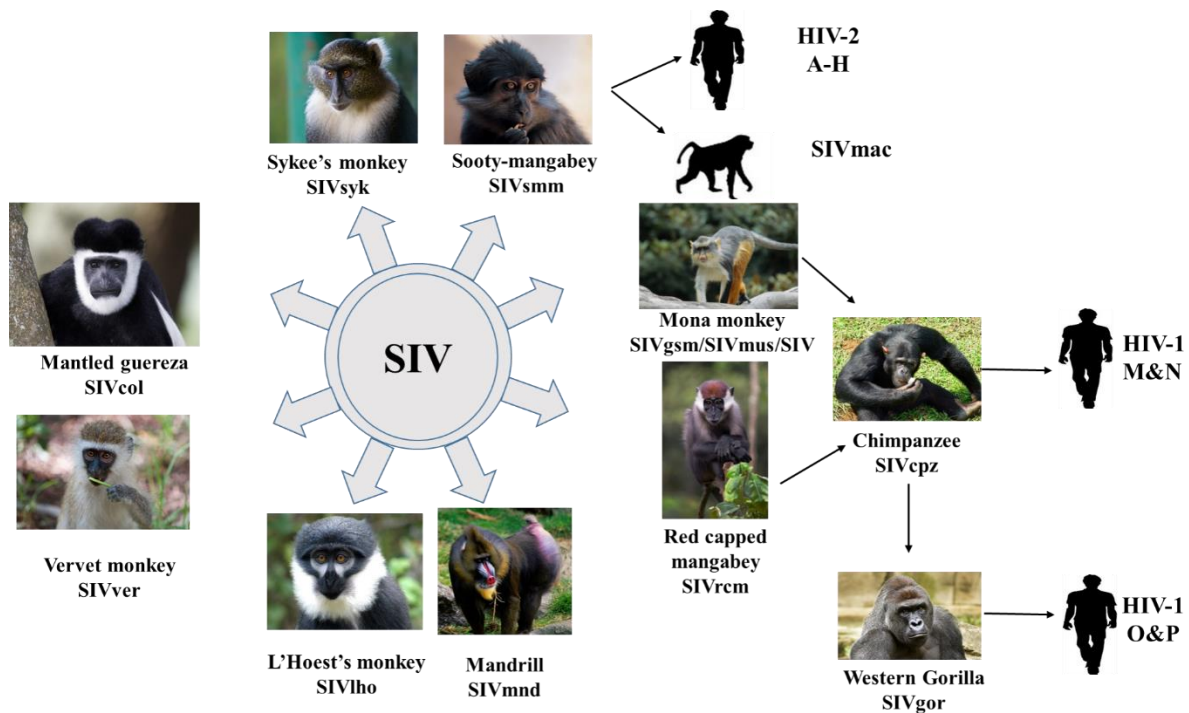

Figure 4. Simian virus (SIV) transmission is at the origin of the emergence of HIV-1 and HIV-2 in humans. Many kinds of SIV naturally infect non-human primates, each bearing the name of the host (i.e. SIVmac for macaques, SIVgor for gorillas) for which most of these viruses are non-pathogenic. However, the passage of these to another species of monkey or human leads to the emergence of AIDS-inducing viruses including pathogenic SIVmac in macaques as well as HIV-1 and HIV-2 infections in man [93].

II.2.2. Human immunodeficiency virus type 2 (HIV-2):

A second human retrovirus causing immunodeficiency emerged in the mid 1980's and was first found in a patient from a West African origin. The virus called HIV-2 has a genome structure similar to that of HIV-1, but with only about 40% nucleotide and amino acid sequence similarity. It was established that this virus has a different origin than HIV-1 and it emerged

from a zoonotic cross species infection from sooty mangabey monkeys (SIVsmm) to human [97-98]. HIV-2 is more commonly found in West Africa. In 1987, the first case in the United States was in a West African woman diagnosed with central nervous system toxoplasmosis [99]. There are eight HIV-2 groups: types A to H. Groups A and B are endemic in West Africa. Although HIV-2 is similar to HIV-1 in its genome organization and replication, it lacks the HIV-1 accessory *vpu* gene but encodes *vpx* [8] that facilitates the infection of resting CD4+ T cells, via degradation of Sterile Alpha Motif and HD domain-containing protein 1 (SAMHD1), the cell factor that prevent viral replication [100-101]. However in the absence of treatment, HIV-2 mediated progression to disease is slower than upon infection with HIV-1 and characterized with lower viral replication levels [102-103].

II.3. HIV transmission

HIV is transmitted through the exchange of body fluids from an infected to a non-infected person [104-105]. Fluids exchange during unprotected intercourse has been shown to be the most common route of HIV transmission [106]. However, HIV is also transmitted through injection with contaminated needles or syringes used by infected individuals for drug injection [107]. The efficiency of HIV transmission depends on the viral load and the virus type, and whether the infection is transmitted either directly into the blood or onto a mucous membrane [108]. Mother-to-child transmission from an infected mother to her baby during pregnancy, delivery, or via breast feeding [109] is also an important route of transmission particularly in children [110]. Throughout the breast-feeding period, the colostrum and breast milk contain a variety of HIV-infected cells including CD4+ T cells and mammary epithelial cells that are involved in virus transmission [111]. Other routes of HIV transmission include: receiving HIV contaminated blood or blood products [112], organ and tissue transplants [113] and accidental manipulation of infected products.

II.4. Epidemiology of HIV

Since the emergence of HIV-1 in human around 80 million individuals all over the world were infected, nearly half of them have already died and the other half is living with the virus [114-115]. The antiretroviral therapy (ART) helped not only HIV infected people to live longer, to have a better quality of life, but also to decrease the transmission from HIV-positive to HIV negative individuals. The great majority of HIV-infected individuals live in Sub Saharan Africa and the accessibility of ART to these low-income countries has significantly slowed HIV

diffusion (Figure 5). Many strategies were developed in developing countries, including male circumcision to slow down HIV-1 transmission [116], use of HAART during the pregnancy and after delivery decreased mother to child transmission [117]. In addition ART for pre-exposure prophylaxis (PrEP) was shown to decrease the risk of HIV acquisition [118].

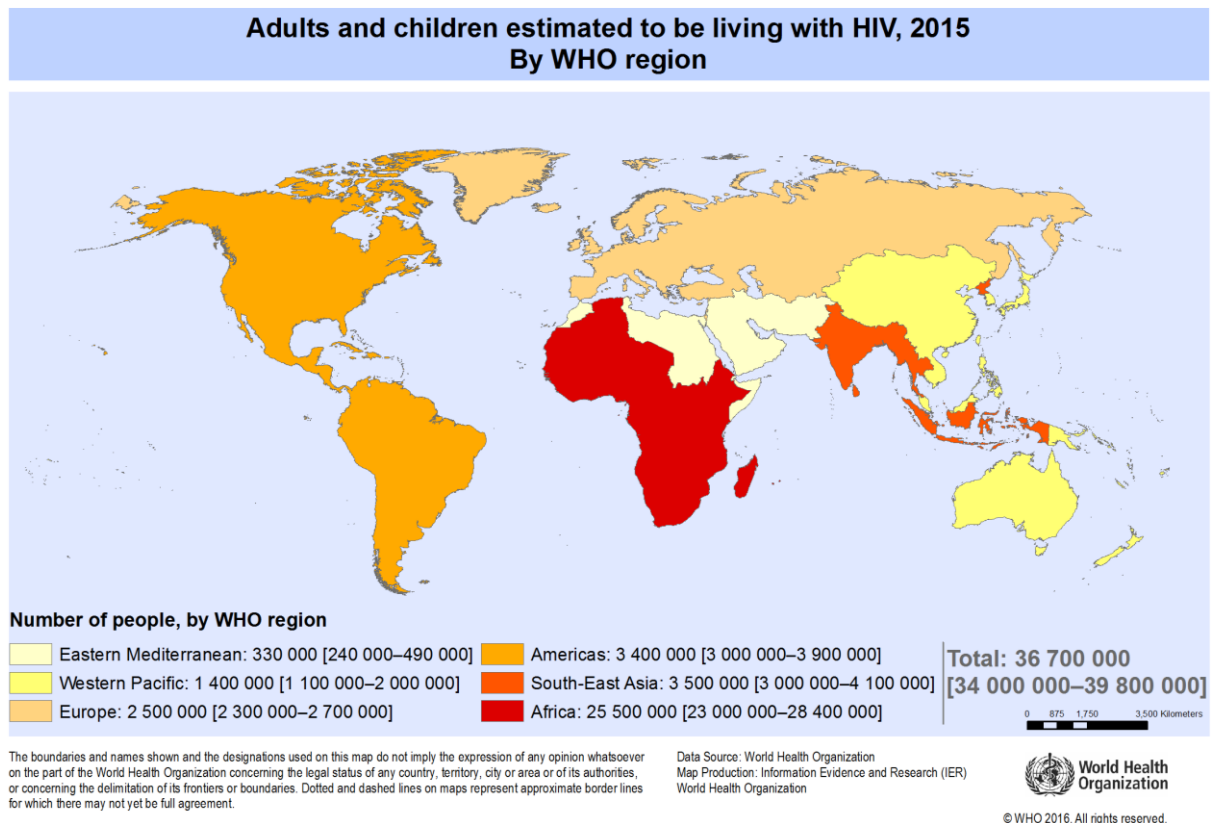

Figure 5. Estimated number of people living with HIV in the world (taken from WHO).

II.5. Structure of the viral particle and HIV Gene Structure

As shown in Figure 6A the HIV viral particle is roughly spherical and coated with a lipid bilayer derived from the host cell plasma membrane [119] when the newly formed virus particle buds from the cell. The viral *Env* glycoproteins inserted at the surface are produced as a precursor (gp160) [120], which is cleaved into the external surface gp120 (SU) and the trans-membrane gp41 (TM) [121]. Both proteins remain linked by non-covalent bonds and are assembled as a trimer at the surface of the viral particles. Immature virus particles also have an inner shell of Gag (Pr55) and Gag-Pol (Pr160) precursor group antigen polyproteins that are subsequently cleaved by protease into functional mature subunits (Figure 6B) [122].

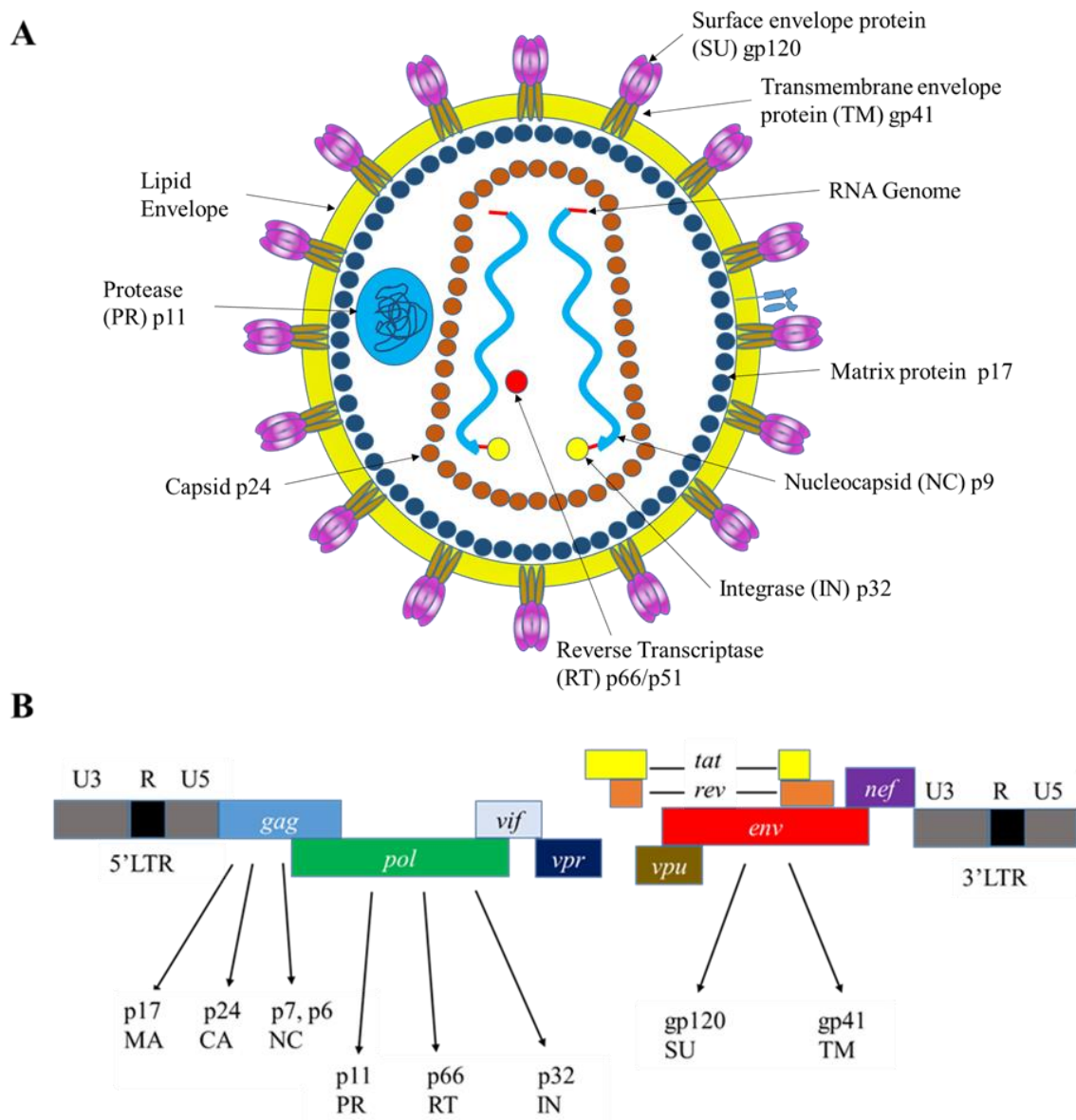

Figure 6. Schematic representation of (A) the structure and (B) the viral genome of HIV virion (modified from [123]).

The cleavage of Gag (Pr55) precursor generates four functional domains (Figure 6B):, the matrix protein (MA p17), capsid protein (CA p24), nucleocapsid proteins (NC p7 and p6) which closes the narrow end of the viral core [124] that contains two identical molecules of positive-sense strand genomic RNA [125]. The Gag-Pol (Pr160) precursor is subsequently cleaved to produce the viral enzymes (Figure 6B): protease (PR p10), reverse transcriptase (RT p66/p51), and integrase (IN p32). Immature PR is less sensitive to protease inhibitors than free mature PR enzyme [126].

Like all retroviruses, HIV encodes and incorporates into the virions enzymes that convert the single stranded viral RNA into double stranded DNA which irreversibly integrates

into the chromosomal DNA of infected cells [127]. The viral genome contains also regulatory and accessory genes (*tat*, *rev*, *nef*, *vif*, *vpr* and *vpu*) that express the virus regulatory and accessory proteins (Figure 6B). These proteins play determinant roles in the modulation of virus replication in infected cells and the pathogenesis in infected hosts.

In addition to these structure regulatory and accessory genes, the RNA also contains terminal sequences named long terminal repeat (LTR) (Figure 7). These are composed of the unique U3 region, the repeat R element and the U5 region flanked by the transactivation responsive element TAR and the primer-binding site in the 5'LTR. TAR is the target binding sequence required for Tat transactivation activity [128]. The 3'LTR on the other hand is preceded by the poly purine tract (PPT) [18]. This PPT segment is resistant to cleavage by ribonuclease H and it serves as primer for the synthesis of the second DNA strand [129]. The 5' LTR harbors a promoter region for the polymerase II complex that initiates transcription of the provirus, whereas the 3' LTR is needed for polyadenylation of the proviral mRNA and provides transcriptional termination [130].

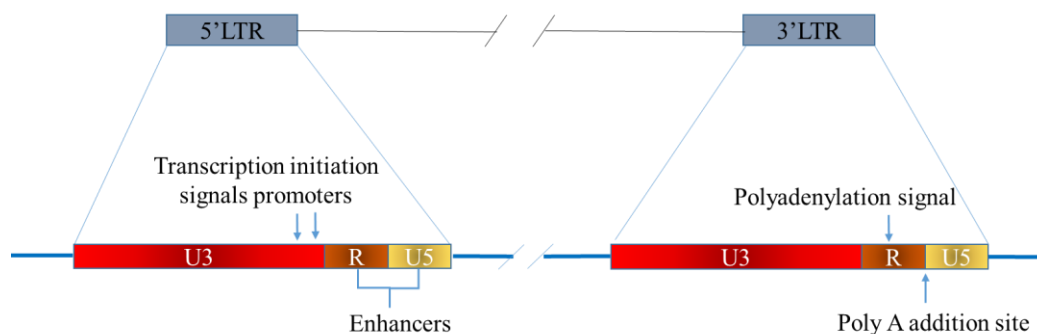

Figure 7. Schematic representation of regions of 5'LTR and 3'LTR which flank the proviral sequence [131].

II.5.1. Viral Enzymes:

The *pol* gene encodes a protein precursor of the three viral enzymes, which are the reverse transcriptase, the integrase and the protease. This precursor is cleaved by the auto processing of the protease.

II.5.1.1. Reverse transcriptase (RT)

This multifunctional enzyme contains two enzymatic activities [132]. HIV-1 RT is a heterodimer composed of two subunits of 66-kDa (p66) and 51-kDa (p51) derived from the Gag-Pol (Pr160) precursor protein. The p66 subunit is responsible for polymerase and RNase H activities and shows this activity also in the absence of the p51 subunit that serves as a structural support [133]. RT contains the DNA polymerase activity that can copy either a RNA or DNA template (Figure 8). It also has a RNase H activity that cleaves the DNA strand from the ssRNA template then degrades the RNA if the RNA is part of an RNA/DNA duplex [134]. The RT converts the +ssRNA genome of the virus into a double-stranded DNA (dsDNA) that can be integrated into the genome of the host cell [135]. Many drugs used currently to fight HIV infection target the activity of the RT.

II.5.1.2. Integrase (IN)

HIV-1 integrase is the enzyme that specifically and reproducibly integrates the HIV dsDNA into that of the host as a provirus. In the structure of IN one can distinguish three domains, the N-terminal domain which chelates zinc [136], the core domain which contains the enzymatic activity, and the C-terminal domain which nonspecifically binds to DNA [137]. In the cytoplasm of cells, IN binds to the extremities of the viral dsDNA at the specific sequences of the attachment site located in the U5 and U3 at the ends of the 5' and 3' LTR regions [138]. This action is mediated by a stable nucleoprotein complex, the two ends of the viral DNA are bridging by integrase making the synaptic complex [139]. Because of its N-terminal domain, HIV-1 IN exists under several forms: monomer, dimer and tetramer [140]. The enzyme undergoes two major catalytic activities: i) it processes the 3'-OH extremities of the viral genome, ii) it inserts the viral DNA molecule into the infected host cellular chromosomal DNA. Inserted DNA, called provirus, persists in the host cell serving as a template for viral gene transcription followed by translation of viral proteins that are assembled to produce new infectious virus particles [141]. As a reservoir, provirus can persist in a latent form lacking the expression of any of the viral protein, making it incredibly difficult to fight [142-143].

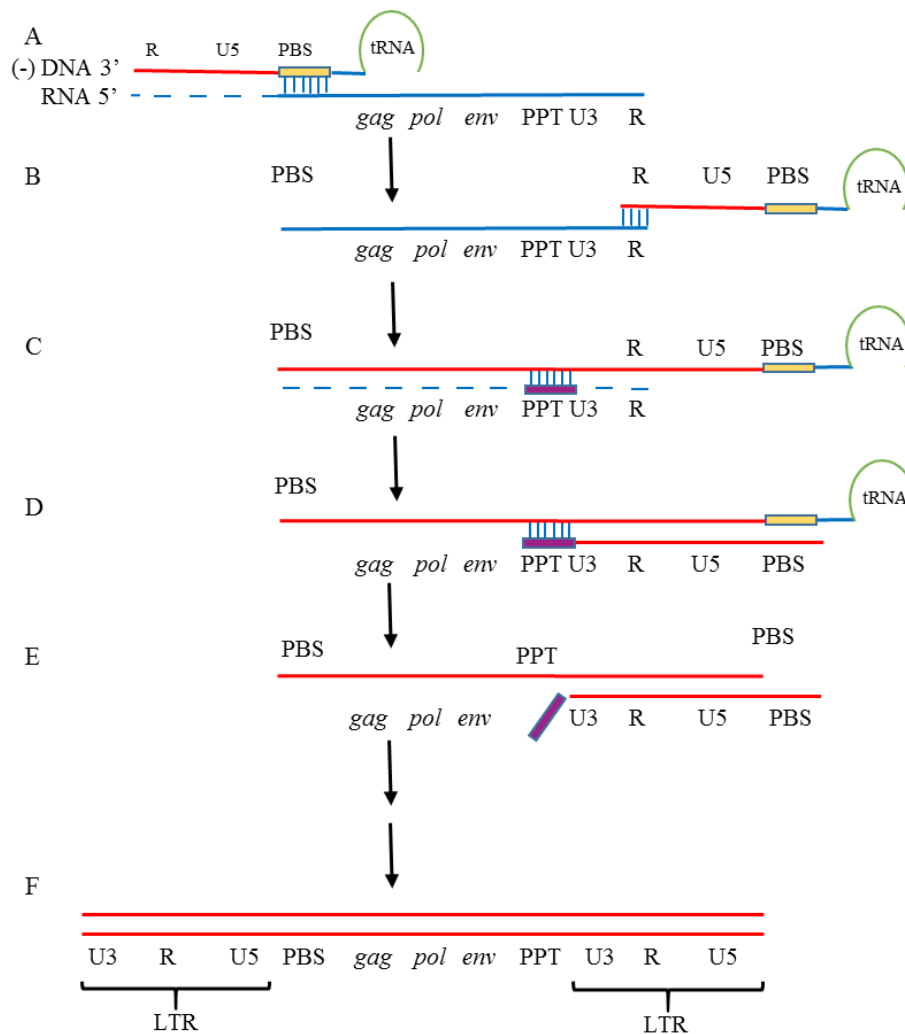

Figure 8. Schematic presentation of the process of reverse transcription. (A) Reverse transcription of RNA genome is initiated when the tRNA^{lys3} molecule binds to the primer binding site (PBS) on the 5' portion of the genome in order to begin DNA synthesis (in red). RT elongates the tRNA primer creating a single-stranded DNA (ssDNA). At the same time RNase H activity of RT degrades the 5' end of the genomic RNA to free the ssDNA. (B) The ssDNA transfers and re-associates with the repeat element (R) sequence at the 3' end of the viral genomic RNA. (C) Elongation of the ssDNA continues while the RNase H digests the RNA template, with the exception of the resistant polypurine tract (PPT). (D) The PPT sequence is used by the RT polymerase activity as primer to initiate the positive strand DNA. (E) After addition of several nucleotides, the RNase H removes the PPT primer. (F) The new +ssDNA is synthesized to the 5' end of the -ssDNA, thus creating a double linear DNA with LTRs [129].

II.5.1.3. Protease (PR)

The viral protease is encoded by the 5' end of the HIV *pol* gene of the virus to give a 11-kDa protein [144]. Dimerization of the polyprotein precursor Gag-Pol (Pr160) results in auto processing of the active protease [126]. In the mature virus, the protease exists as a symmetrical homodimer and the active site lies along the interface between the two identical subunits [145]. This proteolytic enzyme has an obligatory role in HIV life cycle for the post-translational processing of HIV precursor proteins and maturation of viral particles [146]. The activity of

this enzyme is also essential for virus infectivity because without an effective protease, HIV virions remain non-infectious [147]. Thus any mutation on functional domain or inhibition of protease activity leads to disruption of replication and propagation of virus to other cells [148]. This central role of PR made it an attractive target for anti-HIV drugs, thus specific protease inhibitors have been designed and are widely used to inhibit the protease [149].

II.5.2. Structural Proteins

II.5.2.1. Envelope glycoproteins (*Env*)

Envelope (*Env*) glycoproteins play a key role in HIV-1 diffusion of infection and pathogenicity [150]. The envelope glycoprotein precursor 160 kDa (gp160) encoded by the *env* gene from an unspliced RNA is cleaved by a cellular protease into two sub-units: the surface glycoprotein of 120 kDa (SU gp120) and the transmembrane glycoprotein of 41 kDa (TM gp41) [151]. Gp120 binds to the extracellular region of gp41 and is important for virus interaction with the main CD4 receptor at the surface of target cells [152]. Gp120 contains also co-receptor binding sites that determine the cell tropism of the virus [153].

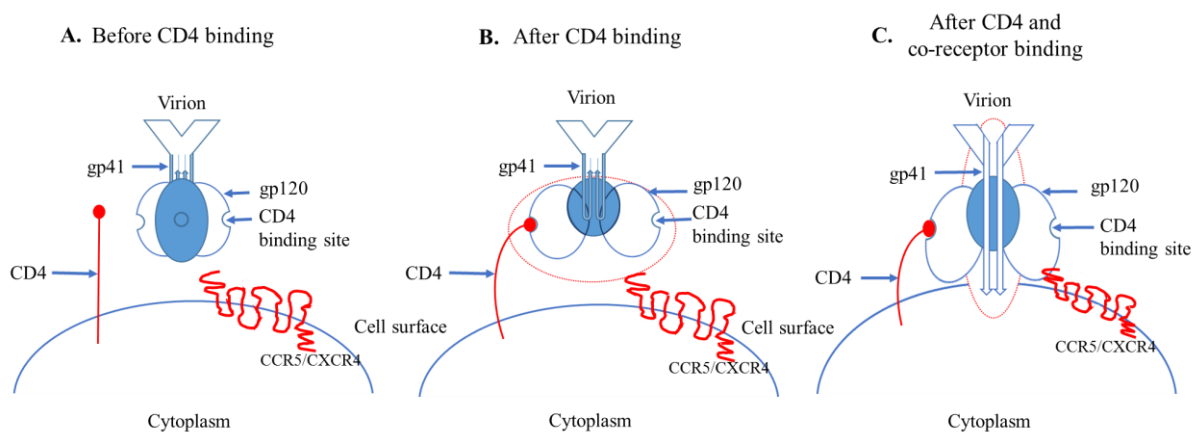

Figure 9. Schematic representation of the envelope glycoprotein trimer and interaction with receptors of target CD4+ cells (A) The target CD4+ cell and the virion with the gp120 and gp41 before binding; (B) The gp120 first bind to the CD4 receptor via its CD4 binding site and then to the co-receptor, either CCR5 or CXCR4; (C) following this double binding conformational changes in the gp41 lead to the fusion of lipid bilayer membranes of virus and target cell (adapted from [154]).

HIV-1 *Env* proteins are assembled as trimers that bind to cell-surface receptors CD4 on target cells and subsequently lead to conformational changes in the glycoproteins [155-156]. These changes involve shift in the V1 and V2 variable regions exposing the V3 region that then binds to the co-receptor (CXCR4 or CCR5). This last interaction induces conformational changes in gp41 and causes the exposure of the fusion peptide (Figure 9). This leads to the fusion of lipid

bilayer membranes of virus and target cell initiating the internalization of the capsid in the cytoplasm of infected host cell [157]. Gp120 is considered the primary target of the humoral immune response and specific neutralizing antibodies [158-159].

II.5.2.2. Group antigens (Gag)

Group antigen is the precursor of several major proteins: the matrix protein that lines the inside of the viral envelope, capsid and nucleocapsid proteins that are important for genomic RNA assembly and packaging (Figure 6).

Matrix (Ma) p17: This is a 17-kDa protein that originates from the cleavage of the amino-terminal portion of the Gag precursor, Gag Pr55 at the early stage of infection [160]. The protein is localized at the inner surface of the virion underneath the lipid bilayer membrane and has a multifunctional crucial role for virion assembly [161]. It participates to the import of the pre-integration complex (PIC) from the cytoplasm to the nucleus during the early stage of infection [162]. It transports also the precursor Gag (Pr55) to the plasma membrane for virus assembly [163].

Capsid (CA) p24: This is the major core protein of HIV that has a molecular weight of 24 kDa and is also derived from Gag (Pr55). The capsid is a cone shape structure composed of about 250 hexamers of p24 and exactly 12 pentamers of the same protein at both conical ends [164]. Inside the capsid, there are the two strands of genomic viral RNA, the nucleocapsid (NC) and all the enzymes necessary for replication [165]. The capsid p24 protein has been used as an antiviral specific target and for HIV vaccine development [166]. HIV-1 Gag p24 antigen is quantitatively the most abundant immunogenic element used for early stage diagnosis of HIV-1 infection by enzyme-linked immunosorbent assay (ELISA) in the plasma [167].

Nucleocapsid (NC) p7: HIV-1 NC is a small 7-kDa protein, derived from the precursors Gag (Pr55). NC sequence contains 55-amino acid with two zinc finger-binding domains. It is an RNA-binding protein which facilitates both RNA rearrangements [168] and reverse transcription [169]. The binding of NC with the viral RNA in the region of the psi (ψ) packaging sequence leads to the incorporation of genomic viral RNA (gRNA) into the newly formed HIV-1 particles [170]. For the initiation of the reverse transcription process, NC anneals the host cell tRNA^{Lys3} primer onto the primer binding site in the leader region of the genomic RNA [171].

p6: The HIV-1 p6 is the carboxy-terminal of the cleaved precursors Gag (Pr55). It is involved in the final separation step of nascent virions, where it facilitates virus release from the host cells [172]. Gag p6 has also been found to be phosphorylated during HIV-1 infection and this event may affect virus replication. Moreover, p6 mediates the incorporation of the viral Vpr protein into new HIV-1 viral particles [173].

II.5.3. Accessory and Regulatory Proteins

II.5.3.1. Viral protein U (*Vpu*):

"Viral Protein Unique" is an 81 amino acids phosphorylated HIV-encoded accessory protein with a molecular weight of 16 kDa. Vpu is a late viral protein expressed from a bicistronic mRNA that encodes also HIV-1 envelope glycoproteins [174-176]. This protein is almost unique to HIV-1 among primate immunodeficiency viruses. One of the major functions of Vpu is to prevent superinfection of infected cells by degrading the CD4 receptor, downregulating the newly synthesized CD4 receptor and major histocompatibility complex (MHC) class I *via* the endoplasmic reticulum proteasomal degradation pathway [177-178]. The second function of Vpu is at the level of efficient virus maturation by enhancement and regulation of the release of progeny virions from the external surface of infected host cells [179]. Vpu downregulates the antiviral factor bone marrow stromal antigen 2 (BST-2/tetherin), that prevents HIV-1 release from the cell surface, by interacting with tetherin to remove it from the plasma membrane [180].

II.5.3.2. Viral protein R (*Vpr*):

"Viral Protein R" is a late virus protein produced from a spliced mRNA that encodes the accessory genes expressing maturation proteins Vpu, Vpr and Vif proteins as well as Env glycoproteins [181]. Vpr contains 96 amino acids and has a molecular weight of 14-kDa. It is a virion-associated protein that has multiple functions on virus and infected cells [182]. In early stages of infection, Vpr is part of the complex of nuclear import that interacts with HIV-1 reverse-transcription and migration of pre-integration complex that transports the newly synthesized viral DNA genome from the cytoplasm into the nucleus [182-183]. In the pathogenesis of HIV-1 Vpr induces efficient replication of HIV-1 in non-dividing cells [184]. Vpr leads to cell arrest at the G2/M phase of cell division thereby inducing dysfunction and apoptosis of infected cells [185]. Lack of Vpr or mutated Vpr that leads to decreased function

is associated with a slow disease progression [186]. Other functions were ascribed to Vpr like modulation of the fidelity of viral reverse transcription and transactivation of the HIV-1 LTR promoter and cellular genes [187], induction of cellular differentiation [188] or its interaction with the p6 ensuring efficient Vpr packaging [189].

II.5.3.3. Viral infectivity factor (Vif):

Vif is a regulatory protein that is coded by all known lentivirus genomes of human and animals. HIV-1 Vif is a 23-kD protein. Vif is essential for viral fitness, pathogenicity, replication and productive infection in non-permissive cells mononuclear cells, macrophages. It is absolutely necessary for productive infection in primary CD4⁺ T lymphocytes and macrophages [190] where Vif interacts with the viral RNA and the NC for viral assembly and packaging into viral particles [191]. Vif degrades and inhibits the enzymatic activity of the cellular anti-viral enzyme apolipoprotein B mRNA-editing enzyme catalytic polypeptide-like 3G (APOBEC 3G) mainly but also other APOBEC-3 from the cytoplasm of infected cells, and packaging into virion [192-193]. APOBEC-3 family enzymes act as potent antiviral restriction factors to inhibit HIV-1 and other retroviruses [194].

II.5.3.4. Negative regulatory factor (Nef):

During the early stages of cell infection HIV-1 Nef is one of the first protein expressed from a multi-spliced mRNA [195]. Nef is a 27-kDa protein that has multiple functions both on virus life cycle and on host cells. Nef has multiple localizations, it is found both in the cytoplasm and nucleus compartments, and secreted in exosomes [196]. Although Nef-defective HIV-1 is replication competent, Nef is necessary for efficient virus replication and disease progression *in vivo* [197]. One of the main functions of Nef is to downregulate the expression of surface CD4 and Major Histocompatibility Complex-I molecules [198]. Nef enhances Gag localization at the cell membrane and viral particle assembly, and facilitates viral transfer from cell-to-cell [199]. Nef also enhances HIV-1 infection and replication in primary CD4⁺ T cells [200]. Nef is indispensable for progression to AIDS in HIV infected patients since individuals infected with nef-defective HIV-1 mutants do not progress to AIDS [201], as also demonstrated with the Sydney blood bank cohort [202].

II.5.3.5. Regulator expression of viral protein (Rev):

This is a small 13 kDa phosphoprotein expressed from a multiply spliced virus mRNA. Rev is a conserved regulatory protein that is essential for productive viral replication in HIV-1 but also all lentivirus genomes [203]. The protein is expressed from two exons producing the N-terminal and the C-terminal domains (Figure 10A). Initially during the early phase, the multi-spliced mRNA are exported from the nucleus to the cytoplasm by the same mechanism as cellular mRNA [204], where Rev as well as Tat and Nef are translated as early products. In the late phase Rev is essential and controls a critical step of export of unspliced and unspliced viral mRNA from the nucleus to the cytoplasm where they will be translated into structural and accessory proteins [205]. RRE, a segment present within the sequences of *env* gene, is the target binding site of Rev necessary for its function. This interaction generates the Rev-RRE complex that promotes the nuclear export of unspliced and unspliced viral mRNA to the cytoplasm (Figure 10B) [206-207].

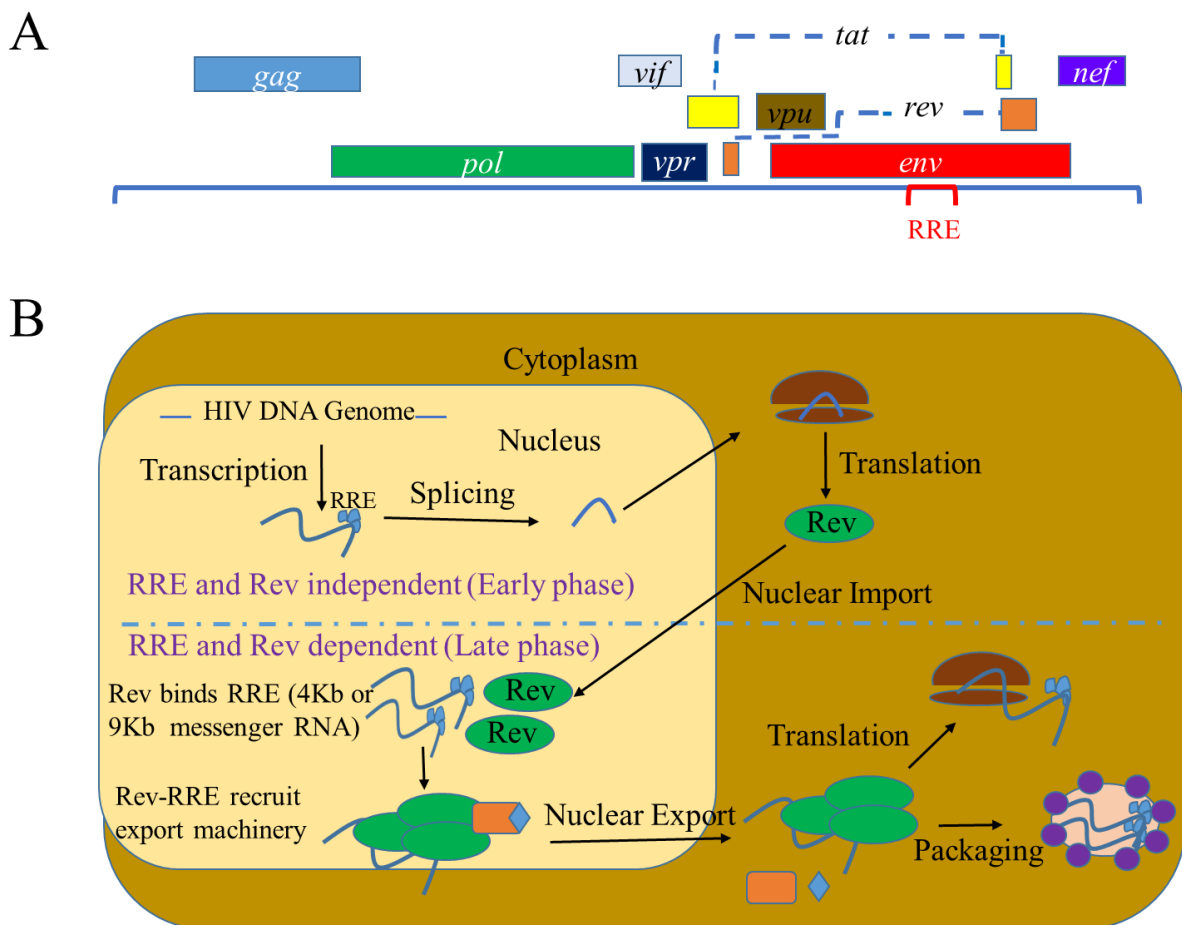

Figure 10. Schematic presentation of Rev/RRE function in HIV-1 life cycle. (A) Genome organization of HIV-1 showing the location of the RRE. (B) During the early phase of the cycle viral transcripts are exported in a Rev/RRE-independent manner. In the late phase, RRE interacts with Rev and the cellular nuclear-export machinery to transfer transcripts to the cytoplasm where they are translated or packaged into new virions [204].

II.5.3.6. Trans-activator of transcription (Tat)

HIV-1 *tat* gene expresses a regulatory protein that upregulates HIV genome transcription. Tat, which contains 86 aa with molecular weight of 14 kDa, is translated from two exons located upstream and within the *env* gene; the minor exon codes for 14 amino acids, while the major exon encodes 72 amino acids [208]. Tat is an essential virus protein in absence of which the viral genome lacks the capacity of expression. This protein is necessary for transcription initiation under control of HIV-1 long terminal repeat (LTR) and elongation of transcripts of viral genes [209]. HIV-1 DNA provirus transcription begins with cellular factors (NF- κ B, Sp1, the TATA box binding protein) and RNA polymerase II binding to the 5' LTR promoter region, forming a transcription complex that allows a low level of viral transcripts production, that then translates to Tat, one of the early viral proteins (Figure 11) [210]. Following the initiation of viral RNA transcription Tat binds to TAR hairpin located at the 5' end of viral RNA. This binding helps to increase transcription initiation and enhancement of viral gene expression by augmenting the transcription efficiency of the viral LTR promoter and highly enhances the efficiency of viral RNA transcription elongation by the cellular RNA polymerase II [211]. Deletion or mutated genomes in *tat* gene or in the Tat target TAR sequences dramatically decreases or cancels the transactivation activity of Tat and consequently the virus replication.

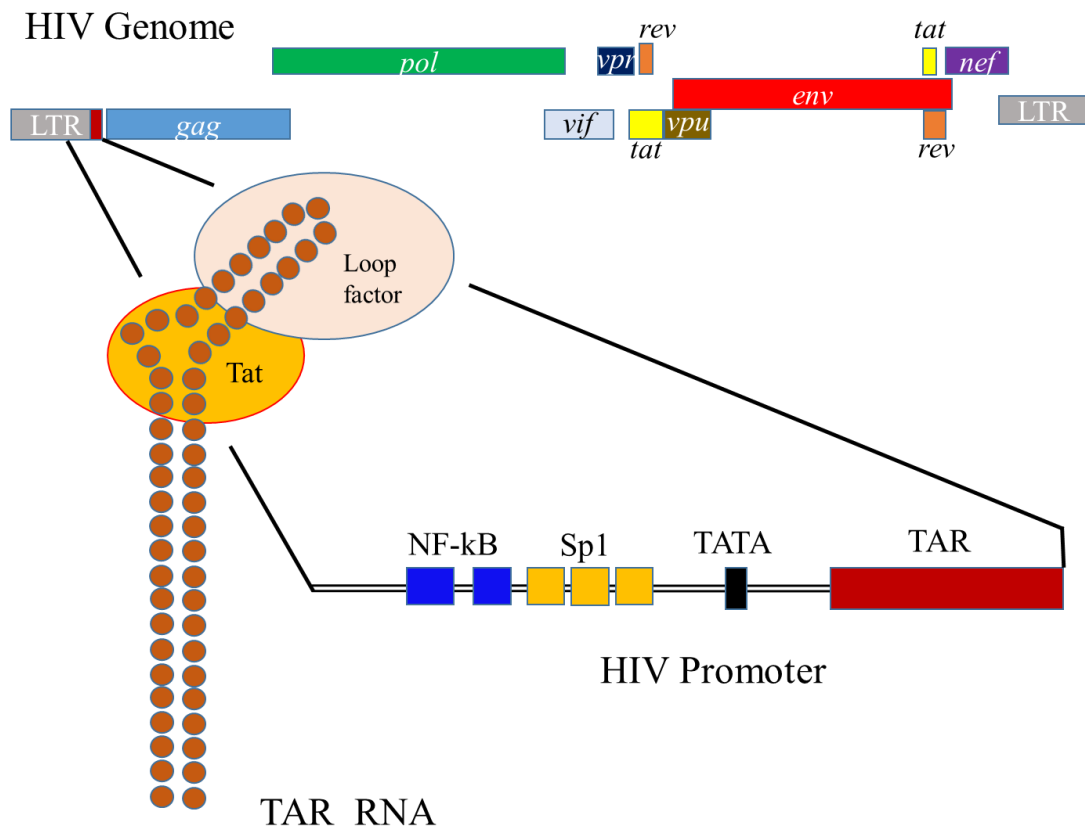

Figure 11. Structure of the TAR region from the 5'LTR. Upstream of the TATA box there are two NF-kB binding sites followed by three SP-1 binding sites. Downstream of the TATA box there is the TAR sequence that is critical for activation by the trans-activator Tat protein (adapted from [212]).

Tat also has a dual role in apoptosis regulation. Interestingly, Tat was previously described as an inducer of apoptosis, but further studies have demonstrated that Tat is also an inhibitor of apoptosis. However this inhibition of apoptosis is cell type and concentration (extracellular and intracellular) dependent [213]. HIV-1 infected cells release active soluble Tat [214] in the extracellular medium. This exogenous Tat acts as a soluble pro-apoptotic factor on neighboring non-infected cells [215]. In contrast, endogenous Tat protects HIV-infected T cells from undergoing apoptosis by up-regulating growth factors and anti-apoptotic proteins [216] that is the reason for the rare observation of apoptosis of HIV-1 infected cells. Also Tat promotes nuclear translocation of tight junction protein such as zonula occludens protein-1 (ZO-1) [217]. Tat upregulation of chemokines results in augmented chemo attraction for monocytes, macrophages and dendritic cells; in addition Tat induces upregulation of CCR5, CXCR4, and CCR3 expression on monocytes/macrophages and lymphocytes [218].

II.6. HIV receptors

II.6.1. CD4

CD4, the cluster of differentiation 4 receptor protein, was discovered in the late 1970s and it was then called leu-3 and T4 [219]. This cell-surface glycoprotein contains four immunoglobulin domains, a transmembrane hydrophobic segment and C terminal cytosolic part [220]. The glycoprotein is present on the surface of white blood cells, T helper cells, T lymphocytes, monocytes, macrophages and dendritic cells. CD4 receptor interacts directly with the major histocompatibility complex class II molecule (MHC class II) on the surface of the antigen-presenting cell (APC) and recognizes the foreign antigen, leading to T cell activation [221]. CD4 serves as a human immunodeficiency virus (HIV) essential receptor for entry into the host cell when its extracellular domain binds to gp120 the exterior protein of the envelope surface [222]. This receptor is found on the surface of T helper cells, at all stages of development, activation and function. Furthermore, after infection, the HIV accessory proteins VpU and Nef downregulate CD4, thus preventing superinfection of infected cells [223].

II.6.2. CCR5

CCR5, also known as CD195, is a seven transmembrane segments protein located at the surface of white blood cells where it acts as a receptor for chemokines [224]. CCR5 was identified as a major co-receptor for macrophage-tropic (M-tropic) viruses such as HIV that initially use CCR5 to enter and infect host cells [225]. CCR5 is predominantly expressed on T lymphocytes, macrophages, dendritic cells [226]. In certain individuals the CCR5 gene expresses a CCR5 co-receptor protein that contains a deletion of 32bp (CCR5- Δ 32) which prevents expression of the protein at the cell surface [227]. People that are homozygous for CCR5 Δ 32 are less susceptible to HIV infection, while for heterozygous people, the single copy of the mutated gene provides some protection against infection and makes the disease less severe if infection occurs [228].

II.6.3. CXCR4

CXCR4, also known as CD184, is another member of the chemokine receptor protein family. Like CCR5, the protein has seven transmembrane regions but is located on the surface of T cells [229]. This receptor, discovered in 1996, is expressed on leukocytes and hematopoietic cells such as endothelial and epithelial cells [230]. It serves as co-receptor for T-

tropic HIV infection into permissive cells. HIV strains with X4 tropism are typically found late in infection. Furthermore, AIDS is caused by both R5 and X4 strains, but the presence of X4 strain have been shown to accelerate depletion of CD4⁺T cells [231].

II.6.4. HIV cellular tropism

The main target cells of HIV infection and replication in infected hosts are the CD4⁺ T cells [232]. Although the great majority of these cells are T lymphocytes, monocyte/macrophage and dendritic cells are also important target of the virus [233]. ‘Viral tropism’ is the preference of the virus to bind with one co-receptor among the others co-receptors, in addition to CD4 the main receptor on the host cell surface [154]. Two subcategories of these target cells are distinguished: the CD4⁺ that co-express the CCR5 chemokine receptor (CD4⁺/CCR5) and those co-expressing the CXCR4 chemokine receptor (CD4⁺/CXCR4). Actually several HIV can also use other co-receptors such as CCR1, CCR2b, CCR3, CCR8, CCR9, CX3CR1/V28, STRL-33/BONZO/CXCR6, GPR1, GPR15/BOB, APJ, ChemR23, RDC1, and Leukotriene B4 receptor [154]. While the virus uses the CD4⁺/CCR5 cells localized mainly in the tissues to initiate the infection in the body and cause the chronic phase of the infection [234], in the late stages of infection (AIDS stage) the virus switches its tropism toward CD4⁺/CXCR4 T lymphocytes localized mainly in peripheral blood [235]. The great majority of CD4⁺/CCR5 T cells are localized in the gut-associated lymphoid tissue (GALT) [236] where the founder virus starts its replication prior to crossing the epithelium and migrating to the lymph nodes [237]. Heterosexual transmission of HIV-1 is initiated by a selected transmitter/founder (T/F) virus that generally uses the CCR5 as co-receptor [238]. This type of transmission acts as a genetic bottleneck selection of a single viral variant that replicates in the abundant CD4⁺/CCR5⁺ memory T lymphocytes of the GALT and then across the mucosa to disseminate in target organs of the body [239]. During the chronic infection, the swarm of viruses generated continuously by accumulation of mutations in the envelope use mainly the CD4/CCR5 receptor/co-receptor to replicate in the CD4⁺ cells [240]. After several years of chronic replication, there is a switch from the CCR5 co-receptor usage to two types of viruses: the dual tropic CXCR4/CCR5 and the CXCR4 tropic [241]. This emergence is a result of genetic variants that acquire amino acids in Env V3 loop that determine co-receptor usage [242].

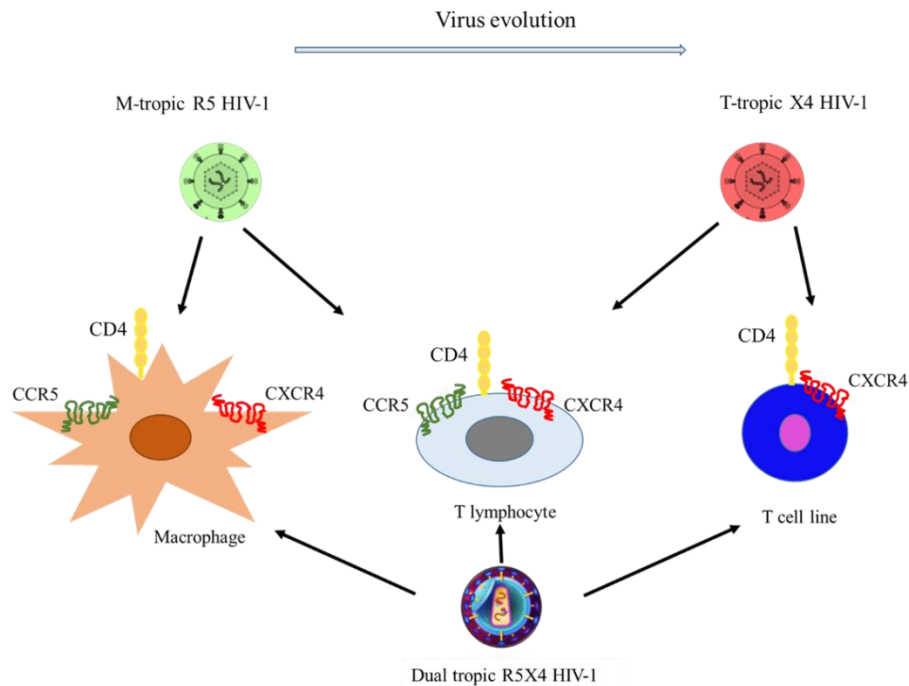

Figure 12. Schematic representation HIV cellular tropism. At the early acute phase of HIV infection, the transmitter/founder strains that initiate productive infection are R5-tropic strains that bind to CCR5 co-receptor on macrophages and T lymphocytes. During the late chronic phase of infection X4-tropic strains that bind to CXCR4 co-receptor on T lymphocytes and T cell line become more predominant. Dual tropic R5X4 viruses that can infect all CD4 cell lines also appear in the late chronic phase.

At the beginning of infection, while the CD4 count is still elevated, R5-tropic HIV is dominant. Almost 90% of infected patients have the HIV R5 strain [154]. However, as infection progresses and the CD4 count diminishes the X4 tropic virus becomes predominant [243]. The emergence of the X4 strain, more pathogenic than the R5, causes dramatic wipe out of activated naïve CD4+T cells both in the peripheral blood and in tissue. This results in the apparition of the clinical symptoms of AIDS (Figure 12). Some viruses show mixed tropism and are able to use both co-receptors CCR5 and CXCR4 to infect cells. These R5/X4 strains appear in the late-stage of infection [244]. Moreover, the majority of R5X4 strains prefer the CXCR4 co-receptor, as opposed to CCR5, to enter primary lymphocytes that express relatively low levels of CCR5 [245].

II.7. HIV life cycle

HIV receptor/co-receptor interaction leading to entry of the virion is the first step of HIV-1 replication cycle. This starts by the attachment of the viral gp120 SU protein with the CD4 molecule on the surface of a CD4+ target cells (Figure 13). This binding is followed by interaction with one of two co-receptors, either CCR5 or CXCR4, on the cell surface. This

second event induces a conformational change in the gp41 TM protein that allows the cellular membrane incorporated at the surface of the virus to fuse with the membrane of the target cell. After fusion, HIV introduces its content into the cell cytoplasm. The capsid with its components, ssRNA and viral enzymes, is internalized. The viral RT starts converting vssRNA into dsDNA [135]. This newly synthesized dsDNA interacts with the viral proteins MA, CA, NC, IN and Vpr to form the reverse transcription complex (RTC). RTC is then transformed into a pre-integration complex (PIC). This complex enters the cell nucleus via nuclear pores and IN integrates the viral DNA into active regions of the host cellular chromosomes. Thus this integrated DNA, called provirus, remains established for life. Once integrated, HIV can use host cell machinery to make new HIV proteins and HIV RNA that are moved to the surface of the cell and assemble into immature virions [246]. The newly formed noninfectious HIV buds out of the host cell taking some cell membrane and selected associated host proteins with it. Then the viral protease starts processing precursor proteins into individual proteins that combine to make a new infectious virus. Several steps essential for the replication cycle of HIV have been key targets of drug molecules aiming at inhibition of virus replication. The processes targeted are binding, fusion, reverse transcription, integration and maturation, as shown in Figure 13 [247].

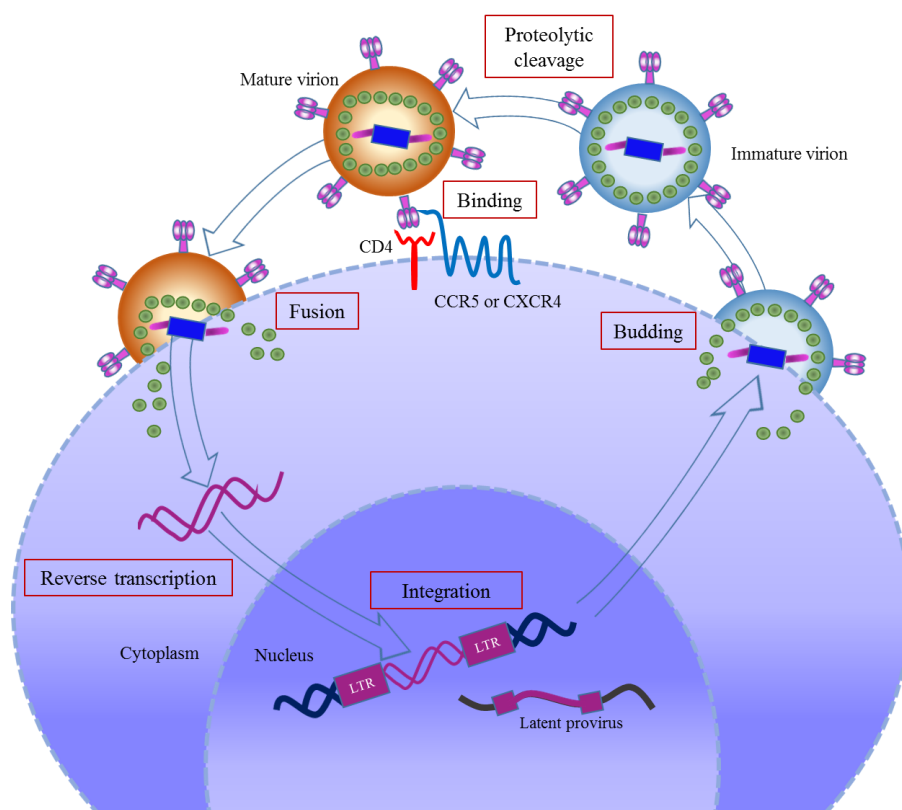

Figure 13. HIV-1 replication cycle. Key processes targeted by anti-HIV drugs are indicated in red boxes (adapted from [247]).

II.8. Latency

Viral latency is defined as dormant viral DNA in infected cells in which the provirus in chromosomal cellular DNA is not active for virus gene expression and replication. This results in the lack of detection of latently infected cells by the immune system and inability of ART to fully eliminate the infection [248], although the latently infected cells continue to proliferate [249].

The incubation period that includes the clinical latency is the long lag time, as much as ten years following the initial infection and development of AIDS. During the clinically asymptomatic latent stage of infection infected patients can transmit the virus recipients although with a lower efficacy than the initial phase or late AIDS phase associated with high viremia [250]. Although virus replicates and mutates during clinical latency.

Remarkably, HIV-1 latency is an uncommon event that occurs at a low frequency, such as one cell among 10^6 – 10^7 infected cells [251-252]. As previously mentioned, HIV-1 replicates productively in activated CD4+ T cells. Some of the infected CD4+T cells can revert-back to a resting memory state, which have a long life (Figure 14). These cells are non-permissive to viral gene expression; however, they allow viral persistence [253].

Latency is a complex process that involves both virus and cell components, but the full-mechanisms involved are not well understood. Because the virus depends on the cell machinery to replicate, latency of the virus can be caused by various limiting levels of cellular factors influencing transcription as well as low levels of Tat activity [254]. The cells control the latency when the infected cells transition from an active to a resting state. However, it was demonstrated that in absence of cellular activation, the presence of synthetic Tat is sufficient to reactivate expression of the latent virus [255].

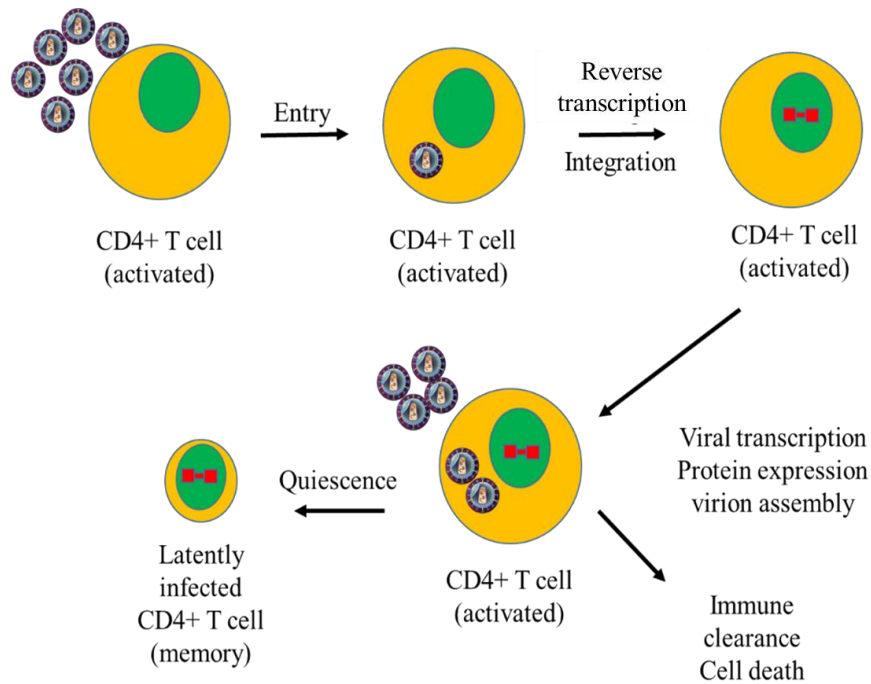

Figure 14. Latency in CD4+ T cells. In the early stage of infection, HIV enters CD4+ T cell and its genome is integrated into the host DNA. The activated infected T cells allow viral transcription, virion assembly and production of new virus particles able to propagate the infection. A small proportion of infected cells undergo transition from an active to a resting state contributing to the formation of the latent reservoir.

II.8.1. General mechanisms of latency

There are two types of latency known for HIV-1 infection: the pre-integration latency and the post-integration latency [256]. The pre-integration latency refers to the stage where virus in infected cells undergo all the early stages of virus replication to produce the double-stranded DNA but this latter fails to be integrated into host genome and is not expressed as extrachromosomal unit. This DNA will either be degraded or integrated later into the host cell chromatin [257]. After HIV-1 enters host cell, the genomic viral RNA is converted into double-stranded DNA by the reverse transcriptase, transported to the nucleus by the pre-integration complex and integrated in the genome of host cell as a provirus. Therefore, pre-integration latency may occasionally result from a defect of efficient reverse transcription activity, inhibition of RT, ineffective transfer of PIC from the cytoplasm to the nucleus or by defect of integration activity [258]. This type of pre-integration latency is very common in resting CD4+ T cells in untreated patients [259]. Pre-integration latency is influenced by interactions of host restriction factors (RFs) including APOBEC3 that induces hypermutations in HIV genome G to A [260]. To counteract this blocking activity to the virus replication, all lentiviruses including HIV and SIV express Vif protein that promotes APOBEC3 degradation [193].

Many cellular factors interfere with viral replication processes. Sterile alpha motif domain and HD domain-containing protein-1 (SAMHD1) is a cellular enzyme that has recently been discovered. This protein prevents HIV replication by depleting the pool of dNTPs available to the reverse transcriptase for viral DNA synthesis [261]. However, SIV_{mac}/HIV-2 express the Vpx protein which promotes SAMHD1 degradation, thus preventing decrease of dNTP concentration available for reverse transcription [262]. Myxovirus resistance protein 2 (Mx2) inhibits HIV-1 after reverse transcription and before proviral integration into the host genome, because Mx2 stimulate IFN production that is known to inhibit virus replication [263].

The most important mechanism of latency is the post-integration latency. Following transport of neosynthesised dsDNA by the pre-integration complex from the cytoplasm to the nucleus, viral DNA integrates into the host genome as a provirus. The pre-integration complex (PIC) consists of dsDNA, integrase (IN), reverse transcriptase (RT), matrix antigen (MA), viral protein R (Vpr) and some host proteins like the transportins [264]. Following transport from the cytoplasm to the nuclear pores, the viral DNA is translocated into the nucleus together with the virus IN which will catalyze viral DNA integration into the host cell genome. In some circumstances, in some cells the provirus stays dormant as a post-integration state of latency [265].

Insertion of proviral HIV-1 DNA into the heterochromatin region of host cell support the latency because it is densely packed and transcriptionally inactive [266]. Furthermore, HIV-1 latency is supported by several mechanisms implicating transcription factors and post-translational histone modifications enzymes [267]. Indeed histone deacetylases and histone methyltransferases have been shown to reinforce latency [268-269].

II.8.2. Cellular and Anatomical Reservoirs of HIV.

Viral latency establishes at the early stage during acute infection in two types of sanctuaries: cellular and anatomical [270]. There are many cell types involved in the persistence of HIV-1 reservoir, which remains the major barrier to HIV-1 cure. HIV-1 infected resting memory CD4⁺T cells that hold the provirus in latent stage represent the most important cellular reservoir [271]. Other cellular reservoirs of HIV are circulating infected monocytes that require to be differentiated into macrophages in tissues to activate virus replication [272-273]; hematopoietic stem cells (HSPC) in bone marrow that are precursor cells associated with self-renewal and differentiation; they are considered to be long-lived reservoirs [274]. Furthermore, dendritic cells (DCs) and follicular dendritic cells (FDCs) are important HIV reservoirs because

they have the ability to trap and store pathogens for long periods of time [275-276]. Other cell types like epithelial cells (renal, mucosa and cervix), skin fibroblasts, bone marrow [277] natural killer (NK) and memory stem cells [278] are also involved in latency and persistence of HIV-1.

There are anatomical tissues serving as sanctuary reservoir compartments for HIV-1. These tissues are immunologically protected and isolated by a barrier from the blood and the lymphoid systems so that drugs used for treatment can poorly or cannot penetrate or metabolize into active moieties [279]. Lymphoid organs, spleen, lymph nodes, and gut-associated lymphoid tissues (GALT) are major sites of viral replication [280]. Liver, kidney, and lungs, alveolar macrophages (AMs) in the respiratory tract are also suitable reservoirs for the virus as they are infected early by HIV [281]. In the central nervous system (CNS) cell types like mastocytes, astrocytes, and microglia are known to be infected. Microglia are brain resident macrophages that are more resistant to apoptosis induced by HIV-1. They are important stable hideouts for the virus, because of the long life span of macrophages compared to the short life of activated CD4+ T cells, especially in the late stage of viral infection when CD4+ T cells are largely depleted [282]. Furthermore, the blood–brain barrier limits the distribution of ART into the CNS [283]. The genital tract is also one of the sanctuaries of HIV-1. In the male genital tract, provirus DNA was detected in seminal cells [284]. The female reproductive tract is poorly permissive to ART so that elimination of provirus from the female genital tract is inefficient [285].

II.9. HIV vaccines

Since the discovery of HIV, many attempts to develop a safe, effective and durable vaccine have been tried. So far, HIV vaccine preparations, either preventive or therapeutic, have failed in part because of the complex biological properties of the virus [286]. Indeed, the life cycle of the virus is associated with genetic and antigenic variabilities that render the host adaptive immune response inefficient at controlling HIV infection [287]. In addition, the integration/latency of HIV DNA ensure the persistence of virus infection and hiding to avoid clearance by the immune system.

Several therapeutic or functional cure vaccines have been tested [288]. Some of these are based on whole virus as an immunogen in its native structure but inactivated to render it non-infectious [289]. One of these approaches uses inactivated HIV either by heat [290] or chemical [291] treatment for killing the whole virus used as immunogen. Although the killed

virus strategy is probably safe for human, it is no longer supported because of the low immunogenicity induced by this vaccine [292]. Neither heat nor chemical inactivation of HIV was found to be immunogenic enough to elicit immune responses capable of preventing HIV infection. In addition, this low immunogenicity requires adjuvants that are associated with undesirable effects [293]. The second approach is based on the use of a live-attenuated virus. Despite the encouraging initial results showing high levels of animal protection [294], the development of live attenuated HIV vaccine was not considered because of safety problems associated with this vaccine. The vaccine integrates in the host's genome and induces persistent replication. This is associated with reversion and emergence of new forms of pathogenic viruses in newborns and some of adults, as found in preclinical studies [295]. Other vaccines are based on proteins or peptide segments from the virus [296]. These immunogens consist either of recombinant native proteins, such as gp120 or gp41 from the viral surface or transmembrane respectively, or as fusion proteins such as gp140 [297].

Several HIV vaccine candidates follow a strategy consisting of viral vectors: here copies of HIV genes are inserted into an attenuated viral or bacterial vector. Thus, the vectors express HIV genes into the body in order to induce an immune response, because these vaccines can express different HIV antigens [298]. Several vaccine delivery vectors have been tested and used in clinical studies for a number of HIV vaccine preparations. As shown in Table 1, adenovirus serotype 5 (Ad5) has been used in the Step, the Phambili and HVTN505 trials, as well as canarypox virus (ALVAC) for the RV144 study. Other vectors have been tried such as modified vaccinia virus Ankara (MVA), New York attenuated vaccinia virus (NYVAC) [299], cytomegalovirus (CMV) [300] and vesicular stomatitis virus (VSV) [301]. The efficiency of this strategy still remains to be fully proven (Table 1). Recently, RV144 was improved to HVTN702 by changing env for that of clade C, which is predominant in Sub-Saharan Africa and the south East Asia. In addition, the Alum adjuvant was replaced with the safer MF59 adjuvant that uses squalene. The phase III clinical trial is currently been tested in South Africa [302].

Study	Vaccine	Composition	Location	Trail phase	Outcome
VAX003 (subtype B/E) VAX004 (subtype B/B)	AIDSVAX gp120	gp120s in Alum adjuvant.	Thailand drug user. US/Europe (MSM)	III	No efficacy No efficacy
HVTN502 (Step) HVTN503 (Phambili)	Ad5-Gag-Pol-Nef	rAD5-(gag/pol/nef) clade B	US South Africa	Iib	Harmful (increased infection in male)
HVTN505	DNA-Ad5-Env-Gag-Pol	Prime: DNA (gag/pol/nef) clade B, Envs clades A,B,C Boost: rAD5- (gag/pol) clade B, Envs clades A,B,C.	U.S.	Iib	No efficacy
RV144*	ALVAC-AIDSVAX (two vaccines)	Prime: ALVAC (vCP1521) vaccine (gag/pro/env)-canary pox vector Boost: AIDSVAX B/E gp120s in Alum	Thailand	III	31.2% protection

Table 1. HIV vaccine efficacy trials [300, 303]. * This phase III clinical trial is currently retested in South Africa.

Recombinant plasmid DNA vaccine is an innovative strategy that has been developed during these last decades using biotechnology tools. DNA vaccines are already used in veterinary vaccine strategies [304] and many trials are ongoing against human infectious diseases [305-306]. In HIV DNA vaccine strategies, the design of these vaccines allows essential HIV genes to express important antigens in order to eliciting protective immune responses. One such strategy has been developed by our laboratory. It was found that CAL-SHIV-IN- DNA vaccine was safe and stimulates both cellular and humoral immune responses in mouse and macaque models (Figure 15) [307-308]. All vaccinated macaques challenged with the heterologous SIVmac251 controlled this pathogenic virus.

Antibody and T cell immune responses against viral antigens appear quickly in human, following infection by HIV. Indeed, antibodies against viral proteins are detectable in serum within a few weeks post-infection and remain for life. In addition, antigen-specific CD8+ T cells appear early and can partly control virus replication. Within a few weeks, reduction of the viremia is observed, but unfortunately this cellular response does not persist. In normal humoral response, the antibodies produced can have non-neutralizing or neutralizing properties. Non-neutralizing antibodies can bind to the virus but will not necessarily prevent infection. However, they can reduce dissemination of infection by their action in a mechanism called antibody dependent cell-mediated cytotoxicity. Some non-neutralizing antibodies might even have opposite effects such as enhancing infection by facilitating entry through Fc receptors at the cell surface or block interaction with neutralizing antibodies. In contrast, neutralizing antibodies

are able to bind to the pathogens and block their entry into cells thus preventing infection of target cells, but these neutralizing antibodies are often strain specific. Interestingly, a minority of HIV infected individuals can develop, over time, broadly neutralizing antibodies (bNAb) that are capable of neutralizing multiple strains of HIV. These bNAbs have the potential to protect non-infected individuals as well as cure infected individuals; however, their development is difficult and represent a challenge.[309]. One aim of vaccine development is to induce production of bNAb in order to block virus infection at the entry, since passive immunization with such bNAbs in animal models of HIV transmission have shown complete prevention of infection.

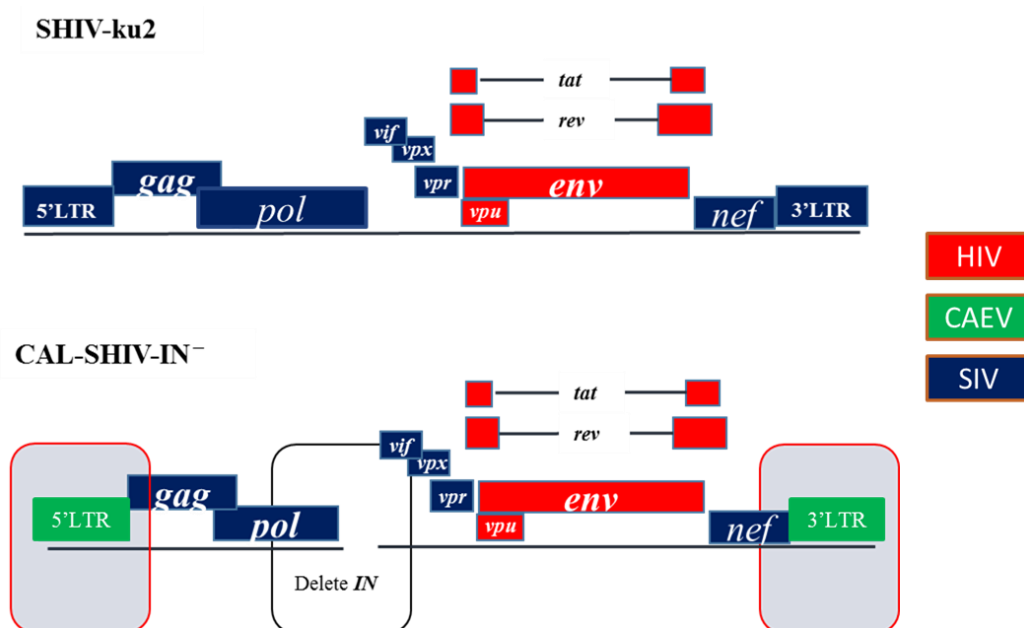

Figure 15. Chimeric lentivector DNA vaccine CAL-SHIV-IN⁻. This lentivector is based on SHIV-KU2 genome in the genetic background of SIVmac239. It is under the control of CAEV LTRs. The IN is deleted to prevent viral DNA from integration in host cell genome thus it undergoes a single cycle replication.

II.10. General aims

Altogether, these show clearly the complexity of the host/pathogen interactions that are associated with HIV-1 infection and the need of simpler model systems to dissect and better understand the underlying mechanisms of persistence and exacerbated pathogenesis. Since HIV-1 infection is restricted to human and the great apes, there is a lack of useful model for HIV-1 experimental infection to study direct HIV-1 induced pathogenesis and to evaluate the protective efficacy of HIV vaccine prototypes. The Simian/Human Immunodeficiency Virus (SHIV) has been developed as chimeric virus expressing both SIV and HIV genes to circumvent

the restrictions of HIV-1 in macaque cells, thereby creating a new model for HIV pathogenesis and vaccines [310-311]. The first SHIV genomes that have been developed were bearing the HIV-1 envelope of CXCR-4 tropic isolates into the backbone of SIVmac [312-313]. These chimeric genomes have provided the proof of the principle that these SHIVs do productively and persistently infect a variety of macaques [314]. However, since the virus genomes were bearing CXCR4 tropic envelopes from isolates that emerge at late stages of HIV infection associated with AIDS replicate preferentially in activated CD4+ T cells in the periphery, these SHIVs were found to induce rapid induction of late stage pathogenesis in macaques [315]. Indeed, infection of macaque with pathogenic CXCR4-tropic SHIV induces a rapid (2-3 weeks) loss of all CD4+ T cells. This helped to elucidate many of the mechanisms involved in HIV-1-induced depletion of CD4+ T cells both in the periphery and in tissues [316]. It helped also to test the efficacy of some vaccine prototypes [314]. However, these genomes failed to help dissect the early mechanisms of host pathogen interaction that are known to be initiated by R5-tropic viruses or to test the efficacy of vaccine prototypes against the acquisition/transmission of these viruses [317-318]. Moreover these CXCR4 SHIVs were found to be easy to neutralize and do not mimic the mucosal bottleneck selection associated with the transmitter/founders. Many efforts were then made and are ongoing to generate R5-tropic chimeric viruses that efficiently initiate the early stages of HIV-1 infection to dissect the early mechanisms and to evaluate the efficacy of vaccines prototypes to induce protective immunity that blocks the virus entry into target cells [319]. Although there are limited numbers of CCR5-tropic SHIVs that have been developed, most of these viruses are of the clade B that is not the most abundant and not bearing envelopes of transmitter/founders [320] with the exception of one [321].

On another hand, since HIV-1 has developed many strategies to undergo latency in a variety of target cell types in which expression of virus genome is blocked by both virus and cellular factors and mechanisms, these studies are very difficult to conduct with HIV-1. Therefore, there is a need of chimeric viruses that are unable to undergo latency or at least that use less complex mechanisms, for better understanding and developing more efficient drugs that will cure HIV-1 infection.

In this context, our lab has developed novel chimeric lentivirus genomes using properties from non-primate animal lentiviruses. Indeed, earlier studies from members of our lab have established that small ruminant lentivirus (SRLVs) genomes are driven by constitutive LTR promoters that are independent from Tat-transactivation [62, 322]. Furthermore, a gene of SRLVs first reported as *tat* was found to be a Vpr-like both at structural and functional levels [63]. Since these viruses were never associated with induction of immunodeficiency in their

hosts, even when they jump species in wildlife ruminant or in experimentally cross species infected animals, they were defined as naturally attenuated lentiviruses [322-323]. Members of our lab hypothesized that primate lentivirus genomes under transcriptional control of SRLV constitutive LTR promoters will cause infection, replication, latency, persistence and pathogenic properties different from the parental SIV. These properties will facilitate the studies of primate lentiviruses and the development of innovative vaccines against HIV-1. In this context, our lab has developed chimeric lentivector DNA vaccines under control of CAEV LTRs and has shown that they are immunogenic both in mouse and macaque models of HIV vaccines [307-308].

II.10.1. Specific Aim of the PhD

The main aim of this PhD project is to use the tools developed in our lab for studying the host HIV-1 interactions leading to the complex pathogenesis. In addition, we wanted to examine the humoral immune responses induced in macaques that have been vaccinated with a lentivector DNA vaccine and challenged with a heterologous pathogenic SIVmac.

III. Material and methods

III.1. Amplification of HIV-1 plasmid DNAs

This work was done mainly on fourteen HIV molecular clones received from the NIH AIDS Reagent Program Repository. These plasmids contain the complete or partial proviral genome of different isolates of HIV-1 with different properties. They have been isolated from different patients in various parts of the world. These infectious molecular clones are: pLAI.2, pLconsnefSN, p89.6, pNef-ER, pWCML249, pcDNA3.1SF2NefF195R, pZM249M, pSTCOR1, pWARO, pRGH-WT, pRGH-IntegraseD116A, pRGH-CMV- Δ CMV, pRGH-CMV- Δ U3, and pNL4-3. Each clone was transformed in *E.coli* JM109 competent bacteria as follows. In a 1.5 ml Eppendorf tube 45 μ l of *E.coli* competent bacteria (JM109, $>10^8$ CFU/ μ g of uncut plasmid DNA, Promega) were used for transformation with 5 μ l (containing one ng) of plasmid DNA. After incubation on ice for 30 min, a heat shock was performed by incubating the bacterial suspension at 42°C for 90 sec. Following addition of 800 μ l antibiotic-free LB, the sample was put in a shaker incubator at 32°C for 1.5-2 h then centrifuged 3 min /5000 rpm. Part of the supernatant (600 μ l) was removed and the pellet resuspended. Volumes of 150 μ l and 50 μ l were plated on separate Luria broth (LB) agar plates containing suitable antibiotic and incubated at 32°C for 24 h. Colonies were picked, transferred to 15 ml tubes that contained 5 ml LB with suitable antibiotic and incubated in a shaker incubator overnight at 32°C.

III.2. Purification and control of plasmid DNA

The pDNA from three clones for each of the fourteen molecular clones was purified by mini prep using NucleoSpin® Plasmid EasyPure Kit (MACHEREY-NAGEL) according to the manufacturer instructions. Briefly, bacteria from 1.5 ml of overnight culture with the adequate antibiotic were collected by centrifugation (11000 rpm for 30 sec) and resuspended into 150 μ l of the resuspension buffer A1 supplemented with RNase. Cell suspension were lysed by addition of 250 μ l of lysis buffer A2, the tubes inverted five times and then incubated for 5 min at RT. This lysis/denaturation step was stopped by adding 350 μ l of the neutralization buffer A3 and mixing thoroughly by inverting until the lysate turned “milky” colorless. The samples were cleared by centrifugation at 11000 rpm for 3-5 min. The DNA containing supernatant was loaded onto a NucleoSpin® Plasmid EasyPure column and centrifuged at 1000-2000 rpm for 30 sec. After washing with 450 μ l 70% ethanol solution corresponding to wash buffer AQ, the DNA was eluted with 50 μ l of elution buffer AE, by centrifugation at 11000 rpm for 1 min.

Each sample of DNA purified by mini prep was subjected to two selected digestions with restriction enzymes (BamHI and EcoRI) for characterization. Three samples (15 μ l) were used for each purified DNA: one is used as uncut control while two were digested with suitable enzymes as follows. In an Eppendorf tube containing the DNA, we added 2 μ l of 10x digestion buffer (different for the different enzymes), H₂O for a final volume of 19 μ l (2 μ l) and 1 μ l restriction enzyme. After incubation for one hour at 37⁰C (temperature differs for different enzymes), 4 μ l of loading buffer (8 ml Tris-Acetate-EDTA buffer (TAE), 1 ml glycerol and a 2 ml of bromophenol blue solution) are added and the total volume is loaded on 1% agarose gel in parallel with 1kb ladder marker DNA. The electrophoresis was performed at 100 volt for 30-60 min and bands were visualized following staining with ethidium bromide. To choose the bacteria that harbor the right clones, the band pattern obtained were compared with the theoretical maps provided by the NIH AIDS Reagent Program.

III.3. Large-scale purification of plasmid DNA

The chosen clones were grown overnight at 30-32⁰C in a shaker incubator in flasks containing 500-1000 ml of LB medium supplemented with the antibiotic. Bacterial cultures were harvested by centrifugation at 4500-6000 rpm for 15 min at 4⁰C. The cell pellets were resuspended in 8-16 ml (for midi prep) or 12-24 ml (for maxi prep) of resuspension buffer that contains RNase. Bacteria were lysed following addition of 8-16 ml (for midi) or 12-24 ml (for maxi) of lysing buffer, homogenized gently and incubated for 5 min at RT. Neutralization buffer was added (8-16 ml for midi or 12-24 ml for maxi), inverted three times and incubated on ice for 5 min, then centrifuged at 12000 rpm for 10 min at 4⁰C. The supernatants were filtrated gently on the NucleoBond[®] Xtra column filters previously equilibrated using buffer (15 ml for midi, 35 ml for maxi). After the NucleoBond[®]Xtra cotton pre-filter was washed with 5 ml (for midi) or 10 ml (for maxi) of filtration buffer, the pre-filter was discarded and 35 ml (for midi) or 90 ml (for maxi) of Endo wash buffer were added. The DNA was eluted with 5 ml (for midi) or 15 ml (for maxi) of elution buffer, precipitated with isopropyl alcohol (3.5 ml for midi, 10.5 ml for maxi) and collected by centrifugation at 15000 rpm for 30 min at RT. The DNA pellet was washed with 70% ethanol (2 ml for midi, 5 ml for maxi), centrifuged at 15000 for 10 min at RT and dried for 20-30 min. the DNA was solubilized in 200-800 μ l (for midi) or 400-1000 μ l (for maxi) of sterile H₂O. The DNA concentration was determined by spectrophotometry at 260 nm (see Table 3). The integrity and quality of each purified DNA by midi prep was evaluated using three selected endonuclease digestions with restriction enzymes (BamHI,

EcoRI and PstI) and non-digested and digested samples of DNAs were separated in 1% agarose gel.

III.4. Cell lines

Many cell lines were used in the study some of them are adherent others are non-adherent as shown in the Table below.

Cell line	Culture medium	Type	Description
HEK-293T	DMEM	Adherent	Human Embryonic Kidney cell line
TZM-bl	DMEM	Adherent	HeLa cell line with luciferase and β -galactosidase genes under the control of HIV-1 promoter. Indicator cells to visualize virus infection in neutralization assays
GHOST CCR5	DMEM	Adherent	Derived from human osteosarcoma cells, express CD4 and relatively high levels of CCR5
GHOST CXCR4	DMEM	Adherent	Derived from human osteosarcoma cells, express CD4 and CXCR4
M8166	RPMI 1640	Suspension	Highly susceptible and fusogenic human CD4+ T lymphocytic cells, express CXCR4
CEM _x 174	RPMI 1640	Suspension	Fusion product of human B cell line and human CD4+ T cell line CEM
U937	RPMI 1640	Suspension/ adherent	CD4+ promonocytic human cell line derived from an HIV-free individual. Cells can be differentiated into adherent macrophages in culture
TIGEF	DMEM	Adherent	T-immortalized goat embryo fibroblast cell line

Table 2. List of cell lines used in this work, originating from the NIH AIDS Research and Reference Reagent Program, Division of AIDS, NIAID, NIH.

III.5. Culture media

Fetal Bovine Serum (FBS) (Eurobio ^{AbCys} or Gibco®) was heat inactivated prior to use in cell growth medium. The bottle (500 ml) of FBS was transferred from -20°C freezer into 4°C

refrigerator to thaw overnight. After mixing by inversion, the serum was incubated for 30 min in a water bath at 56°C to inactivate heat-labile complement proteins, then cooled for 30 min at RT and stored at 4°C or frozen at -20°C. Dulbecco's Modified Eagle Medium (DMEM) containing 1.0 g/L glucose (Eurobio^{AbCys}) was supplemented with 10% FBS, 1% Penicillin/Streptomycin (Eurobio^{AbCys}), 1% L-Glutamine 200 mM (Eurobio^{AbCys}). Minimum Essential Media (MEM) (Eurobio^{AbCys}) was supplemented with 10% FBS, 1% Penicillin/Streptomycin and 1% L-Glutamine. Roswell Park Memorial Institute (RPMI 1640) medium (GibcoTM) was supplemented with 10% FBS.

III.6. Thawing and freezing of cell lines

The cryotubes (TM vial Nunc®) of frozen cells were transferred on ice from the liquid nitrogen container and then partially thawed by incubation into a 37°C water bath. After partial thawing the cell suspension, the outside of the vial was disinfected with 70% ethanol. Under a biological hood, the cell suspension was transferred into a 15 ml conical sterile centrifuge tube and the appropriate media was added drop wise into the cell suspension to dilute the freezing medium at least 5 times. After centrifugation at 1500 RPM for 5-10 minutes, the pellet was re-suspended into 5 ml complete culture medium and transferred into 25 cm² T flask and incubated for growth in a tissue culture incubator. For cryopreservation the cell suspension is enumerated and then centrifuged to remove the culture medium. The pellet of cells is re-suspended in FBS or freezing medium at the indicated concentration, transferred into 1-2 ml cryotubes and supplemented drop wise with 10% DMSO on ice. Cells were first placed in a -80°C for 24-48h in a freezing box prior to transfer into liquid nitrogen storage. The freezing protocol followed directions from the NIH AIDS Reagent Program.

III.7. Cell maintenance

Cell lines were grown using the appropriate culture medium in an incubator at 37°C in 5% CO₂. For adherent cell lines, passage was achieved by discarding the old media and washing the cells with PBS+2 mM EDTA, to remove any residual FBS media that block the trypsin action. Then cells were detached by treatment with Trypsin 0.025%/2 mM EDTA solution, such as 1 ml is used to cover the surface of a 25 cm² T flask, removed before cells start detaching and then the flask was incubated for 3-5 min at 37°C. After observation of cell detachment under the microscope, the flask was shaken to complete the detachment if necessary. Fresh culture medium with FBS was added to the cells and the resuspension was completed by

pipetting. Cells were centrifuged 1500 rpm/5 min, the pellet was re-suspended with suitable medium and cells were cultured at the required density depending on the flask size for example 10^6 cells in a 25 cm² T flask containing 5 ml of medium. For non-adherent cell lines, passage was performed by centrifuging the cells at 1500 rpm/5 min at RT. Then after discarding the old media, the cell pellet was re-suspended with complete suitable growth medium and seeded at the required density.

III.8. Transfection of HEK-293T cell line for production of viral stock

Transfection or delivery of plasmid DNA into eukaryotic HEK-293T cells was performed according to the manufacturer protocol using the cationic polymer polyethylene amine, ExGenTM500 (Euromedex, France). Briefly, 10^6 cells/well were seeded into 6-well plates in DMEM and incubated overnight in a tissue culture incubator. The next day, when the cell monolayer reaches approximately 80% confluency (i.e. the cells cover about 80% of the surface of the well) the medium was changed with 3 ml of fresh DMEM. The transfection mixture was prepared in a polystyrene tube, by mixing 350 μ l 150 mM NaCl with 5 μ g plasmid DNA and 16.5 μ l of ExGeneTM500 reagent. The mixture was incubated for 35 min at RT under gentle manual mixing from time to time and the transfection mixture was added drop wise into the 3 ml medium covering the HEK-293T cells and incubated. At 18-24 h post transfection, the medium was removed, the cell monolayer rinsed once with PBS and then cells were incubated in fresh 2 ml medium. The supernatant fluids were collected daily, for three successive days, filtrated (0.45) μ m and titrated on M8166 and/or TZM-bl cells, and stored at -80°C for further analyses.

III.9. Viral stock titration on M8166

M8166 cells, a highly fusogenic permissive human CD4+ T cell line, were used as indicator cells because they undergo development of typical giant multinucleated cells as cytopathic effect (CPE) upon infection. In order to quantify the amount of the virus causing CPE in 50% of inoculated cells (TCID₅₀/ml), 1×10^5 M8166 cells/well were seeded in a 24-well plate containing 400 μ l/well of RPMI. Viral dilutions were prepared as follows: Six tenfold dilutions of the viral stocks were inoculated on M8166 in quadruplicate. The plate was incubated in a humidified incubator at 37°C with 5% CO₂. After three days of incubation, the observation of development of cytopathic effect was started. If the fifth row have two well of

positive cytopathic effects (CPE), that reads as 10^5 TCID₅₀/ml and each one μ l of the viral stock have a 10^2 TCID₅₀.

III.10. Viral stock titration on TZM-bl cell line

The TZM-bl cell line was used as indicator to evaluate the titers of virus stock since infection of these cells enables the expression of Lac Z gene, producing β -galactosidase that generates blue cells in the presence of X-gal. The number of blue cells corresponds to the number of infectious viral particles capable of forming blue cell per unit volume called blue cell forming unit (BCFU). In order to achieve this, TZM-bl cells were seeded in 24-well plates at about 1×10^5 cells/well in 500 μ l of DMEM and grown overnight in an incubator. Next day the medium was changed and the monolayers were inoculated with virus in serial dilutions. After three to four days of incubation, monolayers of cells were stained in the plate with X-gal and observed for BCFU. Briefly, after washing the cell monolayer twice with PBS containing Ca and Mg, cells were fixed with 4% paraformaldehyde (PFA) for 5-10 min at 4°C, rinsed twice with PBS supplemented with 5 mM MgCl₂ and incubated for 10 minutes in this solution. Finally, 500 μ l of X-gal (1mg/ml, in DMSO eurobio^{AbCys}) were added to each well and the plate incubated for 1 hour at 37°C in a dry incubator. The number of infected cells, which appeared blue in each well were counted under the microscope. The number of BCFU/ml were calculated according to the dilution factors to determine the infectious titers. Graphic presentation of the data was done using Microsoft Excel.

III.11. Determination of viral tropism

GHOST CXCR4 and GHOST CCR5 cell lines were used to determine the tropism of the virus isolates [324]. GHOST cells (1×10^6 cells/well) were seeded in a 6-well plate containing 2 ml/well of DMEM and incubated overnight. The virus stocks corresponding to the supernatants of transfected HEK-293T with the plasmid DNA that were stored at -80°C were used to inoculate GHOST cell monolayers and incubated at least three days until the development of CPE and enabling of GFP expression were observed. The tropism is determined by the ability to infect cells with a specific co-receptor. In the case of pNL 4-3, pWARO and p89.6, the titer of the viruses was 10000 BCFU/ml, 2800 BCFU/ml and 12700 BCFU/ml respectively.

III.12. Kinetics of HIV-1 replication in permissive T cell lines

In order to study the kinetics of replication of pNL 4-3 and p89.6 viruses, M8166 and CEMx174 cell lines were inoculated at MOI 0.1 (1 virus /10 cells), thus 100µl of 10⁶ TCID₅₀/ml contain 100.000 viral particles used to infect 10⁶ cells in 1 ml of appropriate media. Then every day supernatant fluids were collected for eight successive days and kept at -80°C. Viruses in these supernatant fluids were titrated on TZM-bl for each time point. This experiment was performed in triplicate. Graphic presentation of the data was done using Microsoft Excel.

The viruses used in these studies were: SHIV-KU2 (GenBank data base accession # AY751799), SIVmac239 (# AY587015.1), NL4-3 (# AF324493), 89.6 (# U39362), WARO (5' half-genome sequences: KC312330–KC312366 / 3' half-genome sequences: KC312367–KC312398), STCOr1 (5' half-genome sequences: KC312399–KC312433 / 3' half-genome sequences: KC312434–KC312466), WCML249 (# AY445524), LAI.2.

III.13. Sero-neutralization using TZM-bl X-gal assay

To investigate the presence of the neutralizing antibodies in the serum of macaques that were vaccinated with the lentivector DNA vaccine and challenged with the pathogenic strain of SIVmac251, we used the TZM-bl X-gal assay. The analysis include six vaccinated and six control animals. The serum samples were already collected at a weekly time schedule and stored frozen. The sero-neutralization experiments were performed using the chimeric SHIV-KU2 with the envelope of HIV-1 and SIVmac239. Two dilutions (1/5 and 1/20) of serum samples were used in duplicate to assess the neutralizing activity of each serum. Suspensions of SHIV-KU2 and SIVmac239 for neutralization with macaques serum and SHIV-KU2 only for mouse sera, were prepared separately by mixing 50 µl of virus suspension with 50 µl of dilutions of (1/5 and 1/20) serum samples in DMEM free of FBS. After incubation for 1 h at 4°C, the mixtures were used to inoculate the TZM-bl cells in duplicate wells and incubated for 72 to 96 h in the humidified incubator at 37°C with 5% CO₂. The plates were stained with X-gal as described above prior to observation under photonic microscope and scoring of BCFU. Graphic presentation of the data was done using Microsoft Excel.

III.14. Sero-neutralization using ONE-Glo™ Luciferase assay

The ONE-Glo™ Luciferase Assay System provides a highly sensitive, robust, homogeneous assay for detection of firefly luciferase reporter gene expression in infected

mammalian cells. The procedure was identical to the sero-neutralization, using TZM-bl X-Gal assay, but without X-Gal staining. Instead, after removing the medium from the cell monolayers, cells were rinsed with PBS, lysed with 100 μ l of 1x Glo lysis buffer (Promega) at RT for five minutes with gentle shaking. Samples were transferred (50 μ l/sample) into a 96 wells plate (plate 96 W White solid F-Bot N-bind N) together with 50 μ l/well of 1x ONE-Glo™ Luciferase Assay substrate (Promega). After incubating for five min at RT, the luciferase activity was measured for 2 seconds using a luminometer (Berthold Technologies Centro LB 960). All values are reported as relative luminescence units.

III.15. CAL-HIV-R1 plasmid preparation

This chimeric plasmid is based on the genome of HIV-1 pNL4-3 infectious molecular clone where the two LTRs were replaced with those of CAEV that have a constitutive, tat-independent promoter. Using chimeric primers with HIV-1 and CAEV sequences, we amplified the chimeric LTR of CAEV having the extremities of HIV, PCR product was inserted in pGEMT easy to generate pHICA clone 4. Briefly, the development of CAL-HIV-R1 required five steps. The first step consisted in opening the pHICA clone 4. This plasmid was digested with HindII at the unique site in order to linearize the plasmid. For the second step, to isolate the CAEV LTR from the plasmid, another pHICA clone 4 was also double digested with EcoRI and NarI and the overhanging extremities were filled to blunt end with large fragment klenow polymerase. In the third step, the resulting fragment, which contains the CAEV LTR, was inserted into HindII site of linear pHICA clone 4 to generate pHICA-2LTR a plasmid containing two CAEV LTRs. In the fourth step, the LTRs from the HIV-1 pNL4-3 were removed by two consecutive digestions with BlnI and NarI that are located upstream the 3'LTR and downstream the 5'LTR. Finally, the plasmid prepared in step three that contains the two LTRs from CAEV and the plasmid prepared in step four containing pNL4-3 without its LTRs were ligated (Figure 16).

The ligated products were transformed into JM109 competent bacteria and selected colonies were analyzed by restriction enzyme digestion using EcoRI, HindIII, and PstI. The chosen clones that have the right digestion profiles were amplified in large scale and DNAs were isolated by midi-prep. Purified DNA (5 μ g each) was transfected in HEK-293T cells and the filtrated supernatants containing virus were stored in -80°C as viral stocks. Aliquots (100 μ l) were used to inoculate the permissive M8166 and CEMx174 cell cultures. Furthermore, these cell lines were used for viral adaptation that was performed by co-culturing with

transfected HEK-293T cells until appearance of CPE, i.e. fusion between M8166 indicator cells with transfected HEK-293T cells. Then the non-adherent M8166 and CEMx174 cells, were harvested, transferred to six-well plates and fresh cells were added. After CPE was clearly observed (three days), 1 ml of supernatant was kept at -80°C and fresh cells were added to the remaining cell suspension. This passage was performed 17 times. All collected supernatants kept at -80°C were titrated on TZM-bl, while pellets of cells used to extract the provirus genomic DNA. The presence of CAEV LTRs in these clones was confirmed by PCR on 1-2 μg of genomic DNA.

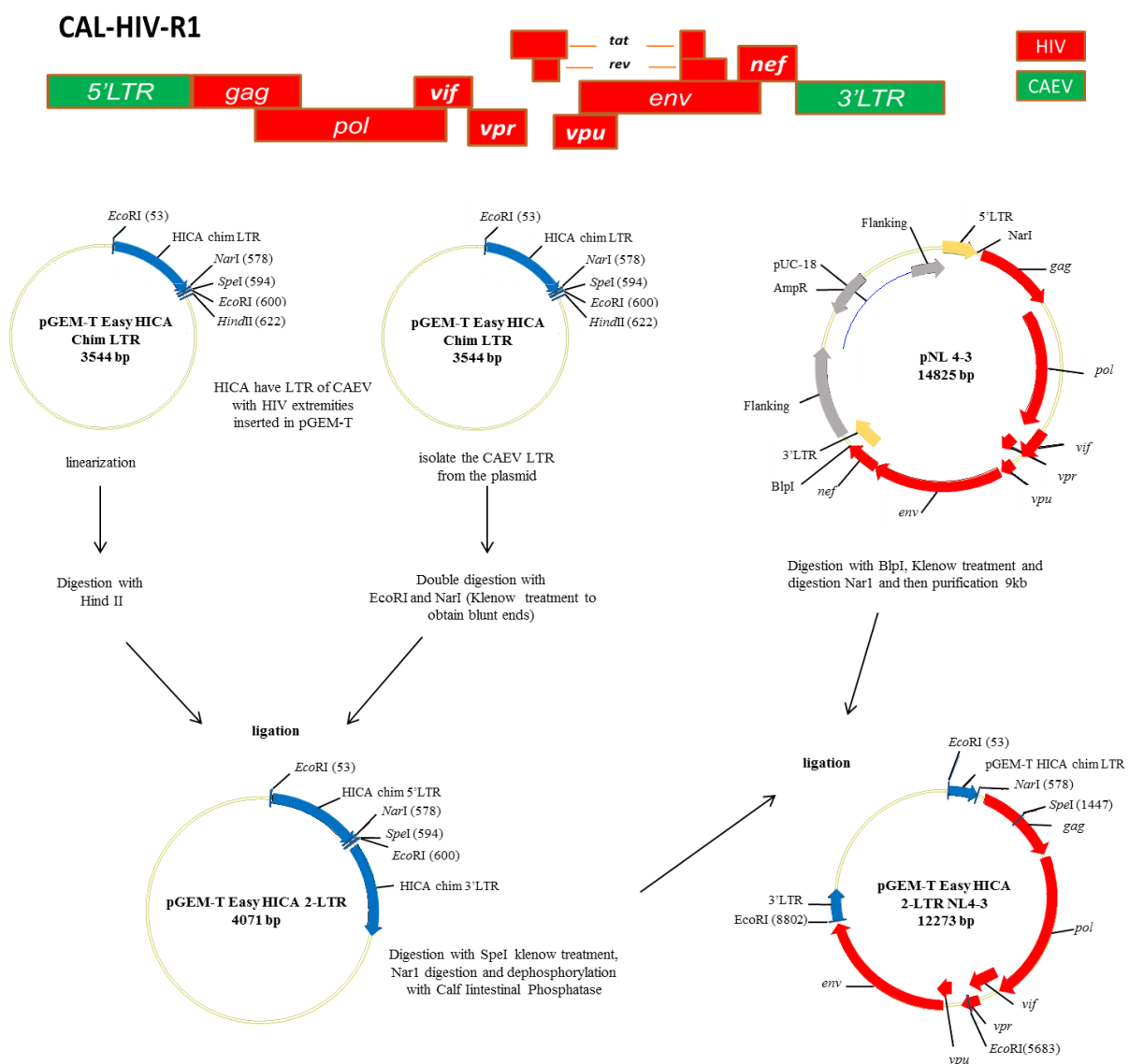

Figure 16. Organization of CAL-HIV-R1 pDNA. This plasmid contains all the genes of HIV-1 pNL4-3, but the LTRs were replaced by those of CAEV. The LTRs of CAEV have strong constitutive promoters. About 30 nucleotides of the termini of HIV LTRs were introduced in each side of CAEV LTRs. These short nucleotide sequences form the attachment site recognized by the HIV integrase to promote HIV-1 integration.

III.16. Data interpretation

Statistical analysis of the acquired data (mean and standard deviation) was performed using GraphPad Prism 5.0 software

IV. Results and Discussion

IV.1. Tropism and infectivity

IV.1.1. Plasmids

The aim of this part of the work was to prepare appropriate reagents and tools with a view to study the infectivity, the replication competence and the tropism properties of various HIV-1 strains in comparison with our chimeric CAL-HIV-R1 genome. For this, we ordered and received 14 clones from the NIH AIDS Reagent Program Repository as presented below and after a first analysis, the work concentrated on the three virus pNL4-3, p89.6, and WARO. Firstly, each one of the recombinant plasmid containing the viruses genomes of HIV-1 received from NIH was introduced into JM109 E. coli by transformation and then triplicates of each recombinant plasmid were screened by mini prep and for each plasmid, one clone was chosen and amplified as described in Materials and Methods. DNA extracted (midi prep) and quantification, three restriction enzymes (BamHI, EcoRI and PstI) were used for characterization. A brief description of the clones and the concentration of the DNA obtained is presented in Table 3.

All clones gave the expected bands after restriction enzyme digestions according to the theoretical maps. We chose to amplify six specific clones for further work: pNL4-3, pLAI.2, p89.6, pSTCOr1, pWCML249 and pWARO.

Analyses of infectivity and replication properties of selected molecular clones: The culture supernatant fluids of transfected HEK-293T cells with the six plasmid DNAs were analyzed by serial infection of M8166 cells and examination of virus replication. Cells infected with pNL4-3, pLAI.2, and p89.6 viruses developed clear CPE in each of the four rounds of infection, while pSTCOr1 produced only a weak CPE. In contrast, cells infected with pWCML249 and WARO showed no CPE on these indicator M8166 CD4+ T cells. Typical CPE appear as large cells with enlarged cytoplasm compartment housing numerous nuclei that can easily be detected by microscopy. CPE is an indication of lentivirus infection and correlates with the presence of virus production by infected cells, followed by cell depletion.

	Ref.	Name	Properties	DNA µg/µl
1.	2532	pLAI.2	Full-length replication competent, infectious, subtype B	0.74
2.	114	pNL 4-3	Full-length, replication and infection competent chimeric DNA laboratory adapted, infectious to a variety of cells as well as human T4 cells	3.8
3.	3297	pLconsnefSN.	Full-length consensus <i>nef</i> gene derived from 54 patient isolates	0.58
4.	3552	p89.6	Infectious molecular clone, highly cytopathic	0.58
5.	6454	pNef-ER	Full-length <i>nef</i> of NL4-3 and the estrogen receptor hormone-binding domain fused at the C terminus of <i>nef</i>	2.08
6.	10776	pWCML249	Infectious clone, subtype D/C, does not form syncytia <i>in vitro</i>	4,5
7.	11430	pcDNA3.1SF2NefF195R	Full-length <i>nef</i> gene, subtype B	1.68
8.	12416	pZM249M	Full-length replication competent, infectious, subtype C	2.5
9.	12417	pSTCOr1	Full-length replication competent, infectious, subtype B	0.78
10.	12419	pWARO	Full-length replication competent, infectious, subtype B	0.46
11.	12427	pRGH-WT	pLAI.2 based vector with a CMV-driven mCherry and a LTR-driven gag-iGFP markers, ΔEnv	0.64
12.	12428	pRGH-IntegraseD116A	pRGH-WT with inactive IN through D116A mutation	0.5
13.	12429	pRGH-CMV-ΔCMV	pRGH-WT, CMV promoter removed	1.34
14.	12430	pRGH-CMV-ΔU3	pRGH-WT, part of the U3 region (3' LTR) deleted, single cycle of replication	1.12

Table 3. Plasmids from the NIH AIDS Reagent Program Repository. All clones are Ampicillin resistant with the exception of clone #8 (pZM249M) which is Kanamycin resistant.

M8166 cells, which are a human T-lymphoblastoid cell line, are able to amplify HIV-1 at a good titer and have a high susceptibility to CPE syncytia formation [325]. The time needed to detect the presence of CPE will vary depending on the type of virus and host cell. Generally, M8166 cells infected with HIV-1 need three to six days to develop detectable CPE. In contrast, cells infected with herpes simplex virus show CPE after about 24 hours, while this phenotype is only visible after ten to thirty days in cells infected with cytomegalovirus [326].

IV.1.2. Tropism

HIV binds to the host cell through its envelope protein gp120. This protein first interacts with a main receptor, CD4, then with a co-receptor via its V3 loop at the protein surface. The tropism of the virus is defined by this co-receptor usage, either CCR5 or CXCR4 [327]. To verify the tropism of the viral strains chosen above, two GHOST cell lines bearing either CCR5 or CXCR4 co-receptors have been used to determine the tropism of the wild and mutated strains [328]. GHOST CCR5 expresses the co-receptor that binds R5-M-tropic viral strains and GHOST CXCR4 expresses the co-receptor that binds X4-T-tropic viral strains, at their cell surface. CCR5 co-receptor is present on macrophages, dendritic cells, microglial cells in brain and memory T cells, while CXCR4 co-receptor is present on naïve activated and effector CD4+ T cells [329].

The results obtained using these cell lines are shown in table 4. The data indicated that HIV-1 NL4-3 and LAI.2 have a tropism for X4, while WCML249, WARO and STCOr1 have a tropism for R5, and HIV-1 89.6 display dual tropism for R5/X4.

Viruses	NL4-3	LAI.2	89.6	WCML249	WARO	STCOr1
CPE on infected M8166	+ve	+ve	+ve	-ve	-ve	weak +ve
CPE on infected GHOST CXCR4	+ve	+ve	+ve	-ve	-ve	-ve
CPE on infected GHOST CCR5	-ve	-ve	+ve	+ve	+ve	+ve
Tropism	X4	X4	X4/R5	R5	R5	R5

Table 4. The tropism of viral clones.

During mucosal transmission of HIV-1, there is a bottleneck selection for a transmitter founder R5-tropic virus that initiates infection in the body. In the early stage of HIV-1, dissemination R5 strains are predominant, while in the late stage, tropism usually changes to include more X4 strains. Indeed the Food and Drug Administration (FDA) approved Maraviroc (MVC) as an entry inhibitor that binds to CCR5 co-receptors thus blocking entry of R5 HIV

strains by antagonism for the co-receptor. However, it was found that MVC was not able to block entry of HIV strains with X4-tropic or R5/X4 envelopes. So nowadays it is important to use a combination of drugs to block entry of other tropic strains [330].

Based on these results, three infectious molecular clones were selected to continue the study. Two molecular clones were mono-tropic for either CXCR4 (pNL4-3) or CCR5 (pWARO) and the third one was dual-tropic for both CXCR4 and CCR5 (p89.6), as shown in Figure 17.

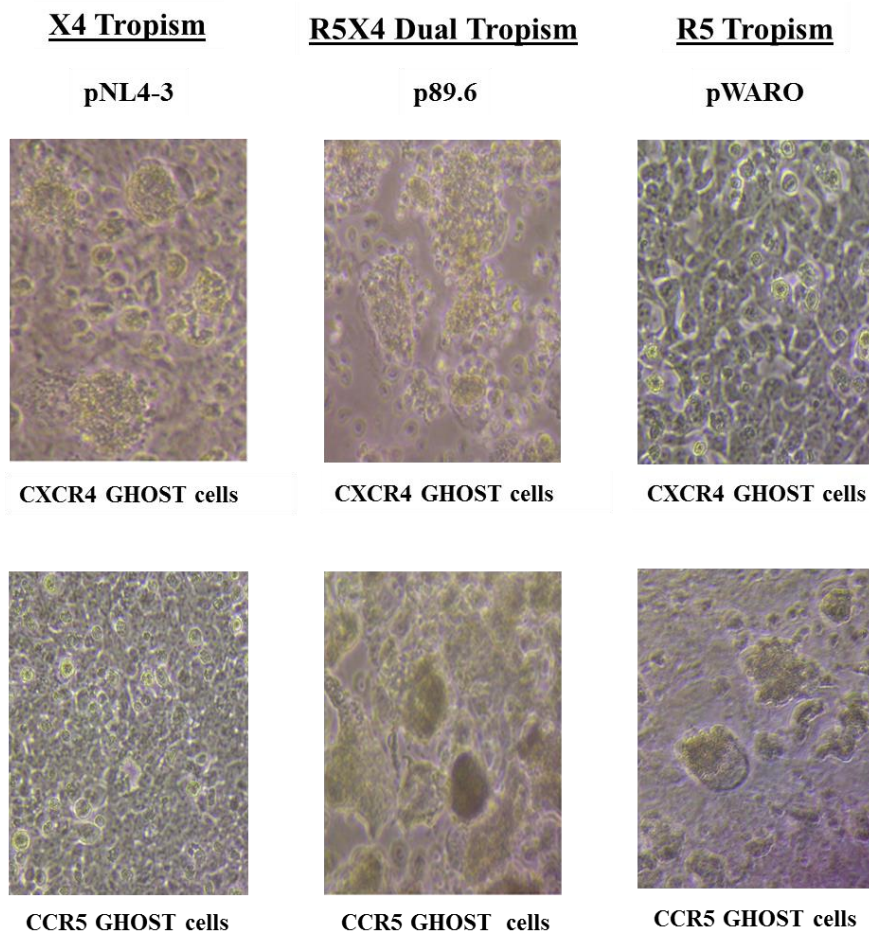

Figure 17. Infectivity assay of selected HIV-1 strains on GHOST cells using microscopy. Infectivity is detected by CPE identified by formation of multinucleated syncytial giant cells. The NL4-3 strain shows CPE in CXCR4 GHOST cells, but not in CCR5 GHOST cells; the 89.6 strain shows CPE in both CXCR4 and CCR5 GHOST cells; the WARO strain shows CPE only in CCR5 GHOST cells.

In order to maximize the treatment with ART it is best to assess the tropism of the infecting HIV strain in the patient. This is possible using the commercial Trofile assay (Monogram Biosciences), a phenotype and genotype test, but it is expensive, labor intensive and time consuming [331]. Instead, we used the two GHOST/CD4 cell lines, expressing CCR5 or CXCR4 that were infected separately with the HIV-1 viral strains. Then, depending on the

phenotype changes observed in these cells after 5-8 days post-inoculation, HIV-1 strains were classified into type R5, X4 or R5/X4 according to their ability to infect these indicator CD4+ cell lines. Another cell type could have been used such as described by Ceresola et al., where U87/CD4 /CCR5 or U87/CD4 /CXCR4 cell lines were utilized as indicator cells [332].

IV.1.3. Infectivity

In order to evaluate the efficacy of the viruses to assemble into infectious particles, HEK-293T cells were transfected with the three chosen clones and the supernatants were collected each day for three days. The supernatants were titrated on TZM-bl cells. The results shown in Figure 18 indicate that the two viruses pNL4-3 and p89.6 gave high titer, that increased with time. These titers were comparable to values obtained for SHIV-ku2 (50000 BCFU/ml). In contrast, WARO gave low titer of about 1000 BCFU/ml.

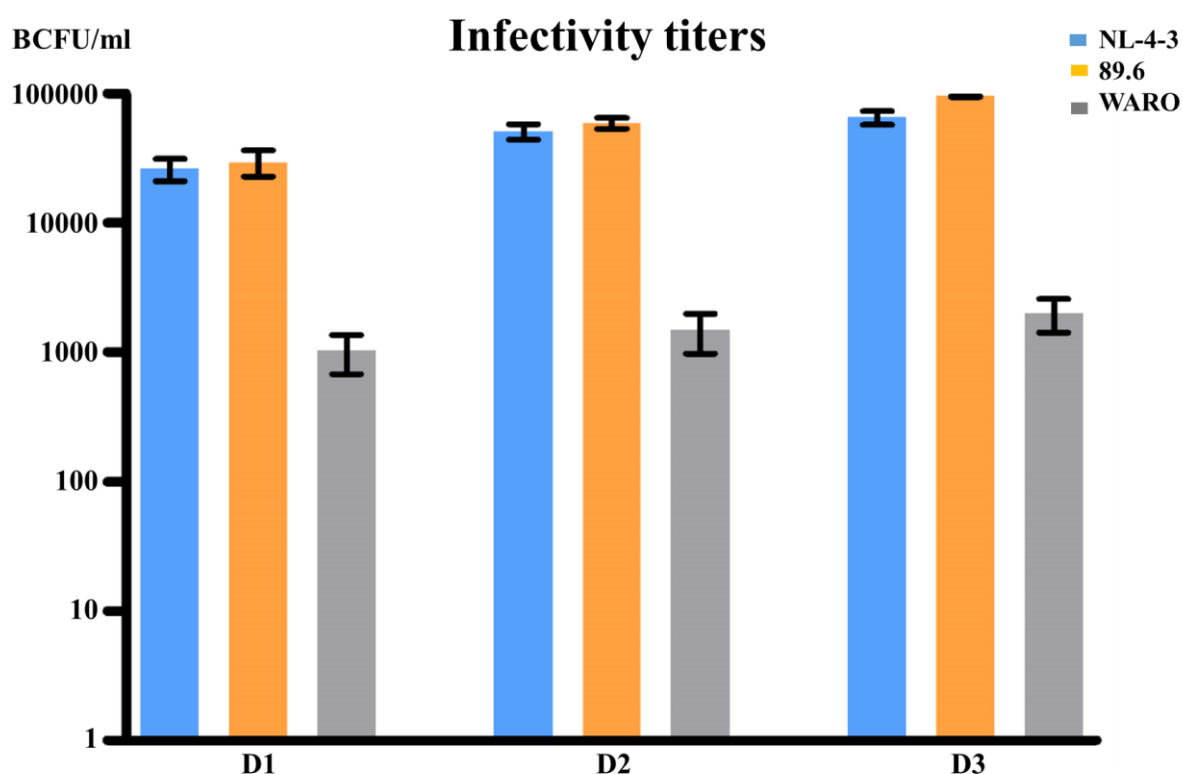

Figure 18. TZM-bl titration of HIV-1 stocks produced at day 1, day 2 and day 3 post transfection in HEK-293T cells.

Dilutions of virus stocks of NL-4-3, 89.6 and WARO produced in transfected HEK-293T cells and harvested at days 1, 2 and 3 post transfection were used to inoculate duplicate wells of TZM-bl monolayers in 24 wells plate. At 72 hours post-inoculation, cells were fixed and X-gal stained as described in Materials and Methods. After 2-8 hours, X Gal solution was

removed and cells rinsed with PBS and blue cell forming units scored, calculated/ml and used to plot the graph. Each virus stock was aliquoted, stored at -80°C [333-334].

Despite following the same protocol of transfection for all three strains, WARO always showed the lowest level of viral production. In addition, the production was followed during three days for all strains. As shown in Figure 17, HEK-293T production of NL4-3 and 89.6 increased during the three successive days, while WARO did not show any increase remaining very low compared with the other two strains. To overcome this problem we tried to inoculate the U937 cells that are known to express CCR5 co-receptors at high level on their surface. This monocytic cell line can be differentiated into macrophage using suitable concentrations of phorbol myristate acetate (PMA). Thus, the differentiated macrophage should replicate productively HIV, but the titration of WARO was still very weak. Therefore, dealing with U937 cell line to produce high enough titration of WARO was not pursued. A potential alternative would have been to use the MOLT T-lymphoblastoid cell line, because these cells express high level of both the CD4 receptor and the CCR5 co-receptor on their surface. It has been reported in the literature that when MOLT-4 cells are infected with R5 HIV-1 viral strains such as JR-FL or Ba-L, CPE was observed in the culture supernatants, indicating that this cell line might be better suited for R5 HIV-1 strain expression [335-336].

IV.1.4. Production of viral stocks

Because of the efficiency of M8166 cells, they were chosen to amplify and produce large stocks of infectious virus particles. Cells were infected for four days then the supernatants were removed and replaced with fresh medium that was also collected 24 h later. These supernatants were titrated on TZM-bl and M8166 cells to determine the BCFU/ml and HIV-1 TCID₅₀/ml respectively. The results obtained are shown in Table 5.

Time of collection of viruses	Titration on M8166 TCID₅₀/ml	Titration on TZM-bl BCFU/ml		Average BCFU/ml
NL4-3 SN (day 4)	10 ⁵	63800	52900	58350
NL4-3 SN (day 5)	10 ⁶	82000	87100	84550
89.6 SN (day 4)	10 ⁵	59800	66600	63200
89.6 SN (day 5)	10 ⁶	73000	78000	75500

Table 5. Results of titration of viral stocks.

IV.2. Kinetics study of replication

With a view to amplify the virus stocks from the two infectious clones HIV-1 NL4-3 and HIV-1 89.6, both CEMx174 and M8166 cell lines were inoculated with the viruses from transfected HEK-293T cells and the supernatant fluids from these two cell lines were harvested daily during one week. Samples of these virus stocks were used to inoculate TZM-bl cells and scored BCFU used to determine the infectious titers. The idea here was to determine which cells are more suitable for virus replication and at what time viral production is optimal. The results shown in Figure 19A and B clearly show that the production of infectious particles in M8166 cell line for both two viruses was higher than their production in CEMx174. Furthermore, the production of virus particles peaked at day four for the CEMx174 cells and at day five for the M8166 cells. Altogether, these results indicate that M8166 cells are better suited for our aim.

The viral production increased gradually until day four on CEMx174 cells or day five on M8166 cells due to the viral replication by infecting new target cells and transfer from cell to cell inducing CPE appearance and cell death at day seven. The viral infectivity of HIV-1 NL4-3 was higher than HIV-1 89.6, and the viral production from M8166 was higher than CEMx174. Despite the fact that the human T-lymphoblastoid cell line has previously been used to generate HIV-1 NL4-3 stock virus by transfection [337], we found that following infection with virus stock from transfected HEK-293T cells, the human M8166 CD4⁺ cell line produces this viral strain better than CEMx174. Although infected CEMx174 does not produce clear

CPE, unlike M8166, the results of virus infectivity analyzed on TZM-bl cells provided the demonstration that they are capable of viral production.

In this work, we used two cell lines while Cao et al. used many cell lines, M8166 and CEMx174 being among them, to identify the optimal T-cell lines for the HIV-1 replication. They also used MT-2 lymphoblasts that were produced by co-culturing normal human cord leukocytes with leukemic T-cells from a patient with adult T-cell leukemia [338]. PM1 T-lymphoid cells were derived from the neoplastic T-cell line Hut78; they have a unique susceptibility to several primary HIV-1 isolates [339]. They found that MT-2 and PM1 cells both supported high levels of virus replication of HIV-1 NL4-3 and NL4-3 Δ Vif, by measuring the viral replication using the TZM-bl cell system and measurement of β -Gal induction at day four post-infection [340].

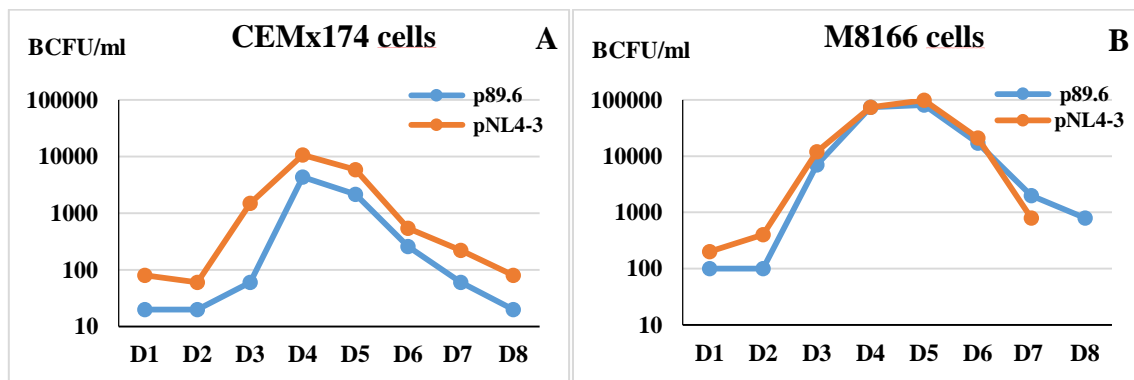

Figure 19. Synaptic study of replication in CEMx174 and M8166 cells. (A) CEMx174 and (B) M8166 cells were infected with NL4-3 or 89.6 viruses. Supernatants were collected every day for eight days and titrated on TZM-bl cells. Blue-cell forming units (BCFU/ml) were scored and values used to plot the graph.

IV.3. Study of the chimeric lentivirus CAL-HIV-R1

IV.3.1. Rationale and hypothesis

Because of the complexity of both host/pathogen interactions and pathogenesis induced by primate lentiviruses, the PAVAL laboratory has been developing new model systems of study that allow subsequent simplified analyses. One of these new tools is to create a chimeric replication-competent full HIV-1 genome in a plasmid DNA, CAL-HIV-R1 (Figure 15). This new chimeric lentiviral plasmid DNA, has been derived from the genome of pNL4-3 HIV-1 strain, genome in which the Tat-dependent LTRs have been removed and replaced with those of CAEV that are Tat-independent constitutive promoters-

Furthermore, a few nucleotides (about 30) from the LTRs of HIV have been kept and fused to CAEV LTRs in order to promote integration. These should allow the formation of the HIV-1 specific attachment sequence recognized by the HIV integrase that catalyzes dsDNA integration into cell genome. As a consequence, we should observe a constitutive expression of the virus in all infected cells.

Indeed, HIV infects human CD4⁺ T cells and monocyte-macrophage cell lineages both in cell culture and in infected individuals, eventually causing AIDS. Like all HIV strains, the HIV-1 pNL4-3 strain has LTRs that are dependent on Tat transactivation. In contrast, the caprine arthritis encephalitis virus, CAEV, a natural lentivirus pathogen of goats, has an *in vivo* tropism restricted to the monocyte/macrophage cell lineage. CAEV does not induce immunodeficiency in his host but leads to arthritis and mastitis in infected adults, and under some circumstances encephalitis in infected kids. The LTRs of CAEV have been shown to be independent from Tat transactivation since they have strong constitutive promoters. Furthermore, since the new CAL-HIV-R1 construct is derived from parental pNL4-3 HIV-1 strain, thus we expect tropism to be towards cells coexpressing the CD4 and the co-receptor CXCR4.

IV.3.2. Objective

The main goal of this work was to study the biological and cytopathological properties of this CAEV/HIV chimeric lentivirus DNA generated in the laboratory. More specifically, we wanted to look into the properties of replication and cytotoxicity associated with virus replication. Will this virus infect CD4 + T-lymphocyte bearing the CXCR4 co-receptor and replicate productively in these cells, as is the case with the parental viruses. The study should determine whether the replacement of LTRs is associated with a change in cell tropism, some modification of the kinetics of gene expression and/or an alteration or loss of the latency/persistence properties. The final aim is to be able to investigate potential modifications of the replication and biopathogenic properties of this viral construct in animal models.

IV.3.3. Strategy

The DNA of CAL-HIV-R1 was amplified from three clones (clone 9, 24 and 34). After purification of the plasmid, HEK-293T cells and the T-immortalized goat embryo fibroblast cell line (TIGEF) were transfected with this chimeric DNA in order to produce the virus, while TZM-bl cells were also transfected to verify that Tat is functional. The titration of transfected

HEK-293T cell supernatants were performed by inoculating TZM-bl cell monolayers. M8166 and CEMx174-T4 cells were co-cultured on transfected HEK-293T cells, and then harvested and used to perform serial passages by infecting M8166 to adapt the virus to the replication on these cells.

Tat of this chimeric virus is expressed and functional because blue cells were observed after staining the transfected TZM-bl cells. Surprisingly TIGEF was transfected with this chimera and although that this cell line is of goat origin and our construct contain CAEV LTRs, there was no viral production in the supernatant that was verified by infecting TZM-bl. Viral production of the transfected HEK-293T cells was also very weak as shown at day one in Figure 19. Thus, we decided to try adapting the chimeric virus by serial passages in M8166 cells co-cultured on transfected HEK-293T cells.

IV.3.4. Adaptation

As shown in Figure 20 titration of supernatants on TZM-bl cells indicates a small increase in virus production over the first ten passages but then it started to decrease again despite the daily addition of fresh M8166 cells.

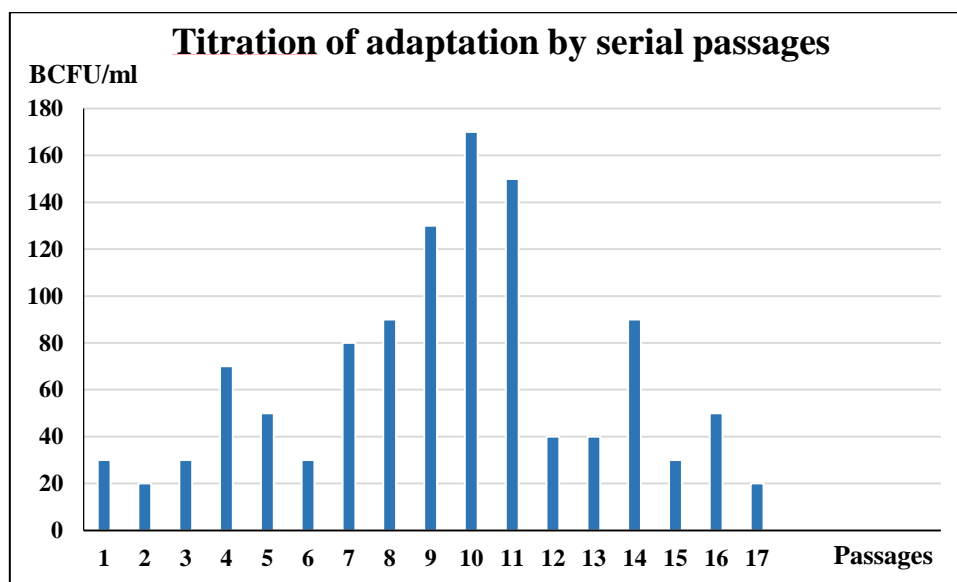

Figure 20. Adaptation by serial passages of CAL-HIV-R1 clone 24 co-cultured on M8166 cells. Supernatants collected after each passage (three days) were titrated using TZM-bl cells, blue-cell forming units (BCFU/ml) were scored and values used to plot the graph.

This was surprising, as increase of viral replication through adaptation performed by serial passages has been used before. One such example can be found in Kwofie and Miura

2013 [341], where the authors adapted the chimeric virus SHIV-NM-3rN to a monkey-derived cell line by 20 serial passages getting viral progeny able to replicate much better than HIV-1 NL4-3 from which the HIV-1 *env* gene originated and SIVmac239 parental viruses used as backbone. First, they serially passaged SHIV-NM-3rN on the M8166 cell line for about 20 passages. Second, the progeny was passed serially on HSC-F T cell line derived from Cynomolgus Monkey, originally immortalized by *Herpesvirus saimiri*, to increase the replication and cytotoxicity rates of SHIV in HSC-F cells. This evolution perhaps is due to the appearance of point mutations [341]. Another way for viral strain adaptation could also be performed in vivo by serial passages in animal model, as for example in monkeys [342].

IV.4. Antibody responses induced by CAL-SHIV-IN⁻

Beside the pathogenesis of HIV-1, PAVAL laboratory has focused for several years on the study of lentivirus vaccine vectors. A novel HIV-based lentivector DNA vaccine, CAL-SHIV-IN⁻, has recently been developed and tested in animal models. CAL-SHIV-IN⁻ encodes the complete genome of SHIV-KU2 without the integrase gene and both LTRs have been replaced with those of CAEV, a naturally attenuated goat lentivirus. In contrast to SIV or HIV, the CAEV LTRs present the advantage of having a constitutive promoter allowing a Tat independent gene expression.

When administered alone and in a single dose injection, this novel lentivector DNA can stimulate strong T-cell mediated and humoral immune responses against all antigens expressed by the vaccine. Indeed, in a recent study conducted in our laboratory, six cynomolgus macaques were vaccinated once with this DNA construct and were monitored longitudinally during 80 weeks for vaccine specific immune responses. Following this period, these six vaccinated macaques together with six control animals were challenged by the rectal mucosal route with repetitive low doses of a heterologous SIVmac251. Careful analysis of the peripheral blood cells and serum indicated the presence strong vaccine-specific cellular and humoral responses in all six vaccinated animals, and these responses were augmented following the injection of the challenge virus. In contrast, no response was observed in any of the control animals before the challenge, which induced classical seroconversion and antigen-specific T cell responses. Interestingly, all animals of the vaccinated group had lower viremia at one-week post infection and showed a lower peak of viremia than the non-vaccinated control animals. In addition, all vaccinated animals progressively controlled the challenge virus to barely detectable levels of viral genomes using the quantitative real-time RT-PCR. Altogether, these data enabled the

question whether the vaccinated animals have raised neutralized antibodies that could have participated in lowering the virus replication and the persistent control of viremia.

Because the presence of neutralizing antibodies blocks the virus at the entry portal and has been correlated with protection against HIV-1 infection and progression to AIDS, the goal of my study was to examine and evaluate whether among the antibodies elicited by this vaccine, there are those with neutralizing activity against HIV-1 and/or SIV. The neutralization activity was analyzed on serum samples from six immunized and six control animals. Samples were taken at 1, 22, 26, 30, 42 and 46 weeks post rectal challenge with SIVmac251. We used the TZM-bl/ β -Galactosidase assay by scoring the blue cell forming units (BCFU). As shown in Figure 21, no neutralizing antibody activity was detected during the entire time of experiment. Further, we used the TZM-bl/luciferase assay and this analysis gave also negative results confirming the β -Galactosidase results. The animals were euthanized shortly after week 46 in order to perform further pathological and histological analyses.

There are several types of binding antibody responses to envelope glycoproteins; non-neutralizing antibodies bind to Env but not with the trimer that is responsible of viral entry, while strain-specific neutralizing antibodies (NAb) and broadly neutralizing antibodies (bNAb) are able to bind to the native trimer gp Env [343].

In a previous study our laboratory proved the existence of antibodies both against Gag and Env induced in mice or macaques following immunization of animals with the HIV lentivector vaccine, CAL-SHIV-IN⁻ plasmid [307-308]. The main objective here was to examine whether injection of the replication competent challenge virus has activated development of the neutralizing antibodies against either antigens expressed by the DNA vaccine or those expressed by the challenge virus SIVmac251 strain. As shown in Figure 21, none of the serum samples from the vaccinated or from the control animals was found to have neutralizing activity against both virus stocks from the infectious molecular clones of SHIV-KU2 (the parental virus of the vaccine) and of SIVmac239 (a clone derived from SIVmac251). The lack of neutralizing activity was persistent during all 48 weeks post challenges in all animals. This absence of Nabs is perhaps linked to the short period of time (less than one year) of infection and the presence of these antibodies to develop needs more time post-infection. The second possibility is that the virus in all infected animals did not replicate persistently at very high titers enough to promote the emergence of such antibodies.

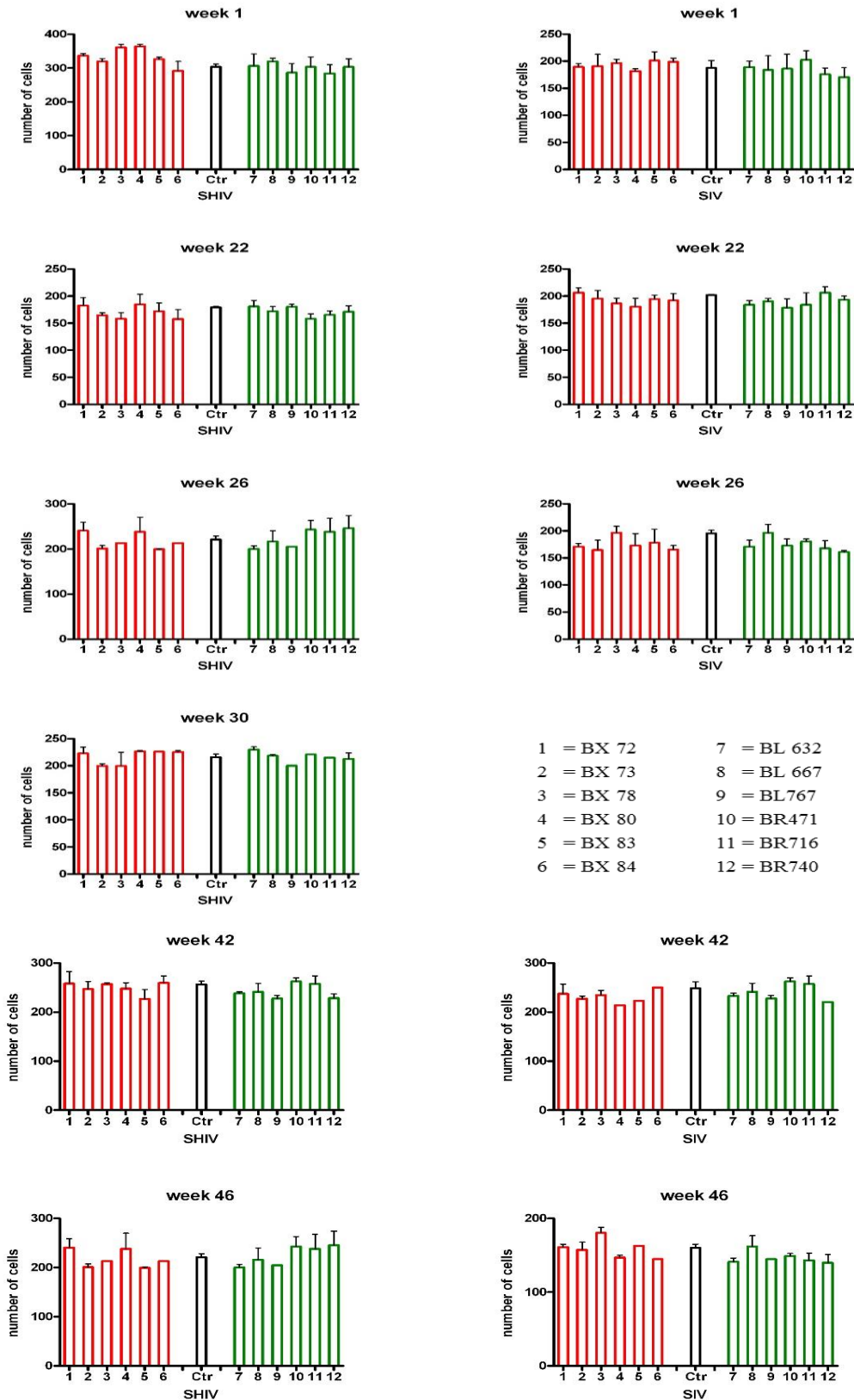

Figure 21. Evaluation of sero-neutralization activity in serum of macaques challenged with SIVmac 251. Serum samples from vaccinated animals (in red) and from control animals (in green) were taken at indicated weeks post infection with the challenge virus. Control with the challenge virus is shown in black. In the left side are the sero-neutralization against SHIV-KU2 and in the right side against SIVmac239. Values are numbers of blue cell forming units in each well.

If one looks back at the history of neutralizing antibodies in HIV infected patients, it appears that the initial neutralizing antibody response to this virus arises approximately 3 months, but can take years after transmission and this response is strain-specific [344]. The initial antibody response is restricted to the T/F virus and it induces viral escape. The newly generated virus mutants are resistant to neutralization by autologous plasma [345] and by the time NAbs to these new isolates appear the virus has again escaped. This interplay between antibodies and virus variants leads to accumulation of neutralizing antibodies that have poor activity or these latter are restricted to limited isolates in the great majority of patients (~80%). However in the remaining proportion (~20%) of patients the response induces antibodies with a wide neutralization breadth: broadly neutralizing antibodies, bNAbs [346-347] However, this takes about 2-4 years post-infection, therefore they don't have a strong effect on virus control. These bNAbs are often associated with high viral load, as detected by real-time RT-PCR, and low counts of CD4+ T cells [348]. In these individuals, the autologous plasma viruses are sensitive to NAb neutralization, where the targets of these Abs are frequently either the CD4bs or the V3 loop of HIV-1 Env [349]. Recently, there has been great interest in the use of bNAbs, isolated few years ago, for their notable therapeutic and prophylactic effectiveness in the animal models [343]. Indeed, passive infusion of broadly-neutralizing antibodies isolated from HIV-1-infected individuals were shown to be able to protect against SHIV acquisition in NHP models [350-351].

V. Conclusions

The aim of this project was to prepare appropriate reagents and tools for studying the host HIV-1 interactions leading to the complex pathogenesis. These reagents are needed to characterize various DNA constructs generated in our laboratory to study host/pathogen interactions. First, it was important to characterize properties of various HIV-1 strains by studying replication competence and tropism, and verifying infectivity of viral particles. Second work was performed to help prepare a new chimeric lentivirus that should not undergo latency target cells. Finally, humoral immune responses induced in vaccinated macaques challenged with a heterologous pathogenic SIVmac were analyzed.

Study of the replication competency

The replication competency of the X4- and R5/X4-tropic HIV-1 strains can be analyzed by infecting M8166 T4 cells serially for many rounds, where these cells can develop clearly visible CPE. However, the R5-tropic HIV-1 strains cannot replicate in M8166 cell line because the cells lack expression of the CCR5 co-receptor at their surface. R5-tropic HIV-1 strains can be studied by infecting cell line that coexpress both the main CD4 receptor and the CCR5 co-receptor at their surface, such as the adherent GHOST Hi5 or the non-adherent MOLT-4 cell line. While infection of GHOST Hi5 enables the expression of the endogenous GFP, infection of MOLT-4 induces typical CPE by forming large syncytia detectable by microscopy, which correlates with the productive replication of virus.

The tropism

From the above reported data, we conclude that there are three types of HIV viral strains (X4, R5, R5/X4) depending on their tropism. We were able to distinguish the properties of each strain by their ability to infect or not specific cell lines. Thus, the strain able to infect GHOST CCR5 is an HIV-1 R5-tropic strain, while the strain able to infect GHOST CXCR4 is an HIV-1 X4-tropic strain, and the strain capable of infecting both GHOST cell lines is an R5/X4-tropic strain. It is also possible to use the U87/CD4 /CCR5 or U87/CD4 /CXCR4 cell lines as indicator cells to study the tropism of HIV-1 strains.

Infectivity of viral particles

Two methods were used for viral titration: the TCID₅₀ was assessed using the M8166 cell line and the BCFU using the TZM-bl cell line. The presence of infectious virus can be

verified for all HIV-1 strains, either X4- or X4/R5- or even R5-tropic strain with TZM-bl cells, while M8166 cells are only useful for titration of X4-tropic and X4/R5-tropic HIV-1 strains, but not the R5-tropic HIV-1 strain. Thus, in order to determine the titers in TCID₅₀ of the R5-tropic strain, it is better to use the MOLT-4/CCR5 cell line, which is highly susceptible to R5-tropic HIV-1.

Viral amplification

The M8166 cell line is highly susceptible and therefore does replicate efficiently X4- and R5/X4-tropic HIV-1 strains, but much less efficiently the R5-tropic strains. In addition, in our hands using the monocyte U937 cell line to amplify R5-tropic HIV-1 strain was complicated and insufficient, because monocytes undergo latency when infected with HIV-1 and need to be differentiated into macrophages to productively replicate the virus. However, using PMA to perform this process, we could not measure the efficacy of differentiation of cells into macrophages and we did not obtain high virus production. Therefore, we concluded that it is better to use another cell line, such as MOLT-4/CCR5, which is highly permissive for R5-tropic HIV-1 replication, because cells of this line coexpress both CD4 and CCR5 receptors at high levels, and these non-adherent cells are highly susceptible to fusion and syncytium formation upon infection. There also exists a MOCHA-4/CXCR4/CCR5 cell line that is highly permissive for both X4- and R5-tropic HIV-1 strain replication. Although R5 HIV-1 is the major viral population transmitted by sexual intercourse and replicates during the asymptomatic stage in infected individuals, R5-tropic HIV-1 does not replicate efficiently *in vitro* in human T-cell lines and shows only weak cytopathogenicity [352].

Kinetic study of HIV-1 replication

The viral infectivity of the X4-tropic HIV-1 NL4-3 is higher than the X4/R5-dual tropic HIV-1 89.6 strains and the viral production in M8166 is higher than CEMx174. Day four had higher viral production of infected CEMx174, while day five had the higher viral production of infected M8166 cells for the two viral strains. The infection is more effective when many viral particles pass from the non-infected cell to the recipient non-infected target cell via viral synapses attacking the non-infected healthy cells, infecting them and leading to cell depletion. This cell-to-cell transmission can protect the viral particles from NABs [353-354].

Adaptation of chimeric virus *in vitro*

Adaptation of the chimeric virus CAL-HIV-R1 *in vitro* by serial passages on cell lines resulted only in a small and transient increase of viral production during the first ten passages. However, viral production did not continue and started to decrease. It might have been better to passage the chimeric virus *ex vivo* in human PBMCs [355] or bone marrow that have CXCR4 co-receptor [356] or CD34+ cord cells using *scid*-hu-Thy/Liv mice that produces human haematopoietic (CD34+) progenitor stem cells and mature human lymphocytes [357].

Neutralizing antibodies

Despite the fact that our experiment with infected macaques lasted 46 weeks, the presence of the NAbs was not detected in the collected serum of the challenged and control animals, even though production of antibodies against viral proteins was shown. Perhaps it would have been better to keep the animals for a longer time to verify the presence of these antibodies. Indeed, some HIV infected patients can produce bNAbs after 2-4 years. In our neutralizing assay, we used SIVmac239 while the strain used for the challenge was SIVmac251. The T/F SIVmac251 elicit NAbs after 5-8 months of infection, but in low titers. [358].

VI. References

1. Sobrino-Vegas, P.; Moreno, S.; Rubio, R.; Viciano, P.; Bernardino, J. I.; Blanco, J. R.; Bernal, E.; Asensi, V.; Pulido, F.; del Amo, J.; Hernando, V., Impact of late presentation of HIV infection on short-, mid- and long-term mortality and causes of death in a multicenter national cohort: 2004-2013. *J Infect* **2016**, *72* (5), 587-596.
2. Castilla, J.; Martinez de Aragon, M. V.; Gutierrez, A.; Llacer, A.; Belza, M. J.; Ruiz, C.; Perez de la Paz, J.; Noguer, I., Impact of human immunodeficiency virus infection on mortality among young men and women in Spain. *Int J Epidemiol* **1997**, *26* (6), 1346-1351.
3. Fevrier, M.; Dorgham, K.; Rebollo, A., CD4+ T cell depletion in human immunodeficiency virus (HIV) infection: role of apoptosis. *Viruses* **2011**, *3* (5), 586-612.
4. Robbins, K. E.; Lemey, P.; Pybus, O. G.; Jaffe, H. W.; Youngpairoj, A. S.; Brown, T. M.; Salemi, M.; Vandamme, A.-M.; Kalish, M. L., U.S. Human Immunodeficiency Virus Type 1 Epidemic: Date of Origin, Population History, and Characterization of Early Strains. *Journal of Virology* **2003**, *77* (11), 6359-6366.
5. Knolle, G., [Three names--one virus: HTLV-III/LAV/HIV]. *Die Quintessenz* **1987**, *38* (8), 1429-1430.
6. Rook, A. H.; Lane, H. C.; Folks, T.; McCoy, S.; Alter, H.; Fauci, A. S., Sera from HTLV-III/LAV antibody-positive individuals mediate antibody-dependent cellular cytotoxicity against HTLV-III/LAV-infected T cells. *The Journal of Immunology* **1987**, *138* (4), 1064-1067.
7. Nájera, R.; Herrera, M. I.; Andrés, R. d., Human Immunodeficiency Virus and Related Retroviruses. *Western Journal of Medicine* **1987**, *147* (6), 702-708.
8. Miller, R. J.; Cairns, J. S.; Bridges, S.; Sarver, N., Human Immunodeficiency Virus and AIDS: Insights from Animal Lentiviruses. *Journal of Virology* **2000**, *74* (16), 7187-7195.
9. Durand, S.; Cimarelli, A., The inside out of lentiviral vectors. *Viruses* **2011**, *3* (2), 132-159.
10. Hart, D.; Frerichs, G. N.; Rambaut, A.; Onions, D. E., Complete nucleotide sequence and transcriptional analysis of snakehead fish retrovirus. *Journal of Virology* **1996**, *70* (6), 3606-3616.
11. White, D. O., *Medical Virology*. Gulf Professional Publishing: 1994; p 626.
12. Chatterjea, M. N.; Shinde, R., *Textbook of Medical Biochemistry*. JP Medical Ltd: 2011; p 893.
13. Maclachlan, N. J.; Dubovi, E. J., *Fenner's Veterinary Virology*. Academic Press: 2010; p 530.
14. Clark, D. P.; Pazdernik, N. J., *Biotechnology: Academic Cell Update Edition*. Academic Press: 2011; p 768.
15. Sandrin, V.; Muriaux, D.; Darlix, J.-L.; Cosset, F.-L., Intracellular Trafficking of Gag and Env Proteins and Their Interactions Modulate Pseudotyping of Retroviruses. *Journal of Virology* **2004**, *78* (13), 7153-7164.
16. Dudley, D. M.; Bailey, A. L.; Mehta, S. H.; Hughes, A. L.; Kirk, G. D.; Westergaard, R. P.; O'Connor, D. H., Cross-clade simultaneous HIV drug resistance genotyping for reverse transcriptase, protease, and integrase inhibitor mutations by Illumina MiSeq. *Retrovirology* **2014**, *11* (1).
17. Nakagawa, S.; Bai, H.; Sakurai, T.; Nakaya, Y.; Konno, T.; Miyazawa, T.; Gojobori, T.; Imakawa, K., Dynamic Evolution of Endogenous Retrovirus-Derived Genes

- Expressed in Bovine Conceptuses during the Period of Placentation. *Genome Biology and Evolution* **2013**, 5 (2), 296-306.
18. Tomás, H. I. A.; Rodrigues, A. F.; Alves, P. M.; Coroadinha, A. S., Lentiviral Gene Therapy Vectors: Challenges and Future Directions, Gene Therapy - Tools and Potential Applications. In *Biochemistry, Genetics and Molecular Biology "Gene Therapy - Tools and Potential Applications"*, Martin, D. F., Ed. In Tech: 2013.
 19. Clements, J. E.; Zink, M. C., Molecular biology and pathogenesis of animal lentivirus infections. *Clinical Microbiology Reviews* **1996**, 9 (1), 100-117.
 20. Bhatia, S.; Patil, S. S.; Sood, R., Bovine immunodeficiency virus: a lentiviral infection. *Indian Journal of Virology* **2013**, 24 (3), 332-341.
 21. Desport, M.; Lewis, J., Jembrana disease virus: host responses, viral dynamics and disease control. *Current HIV Research* **2010**, 8 (1), 53-65.
 22. St-Louis, M.-C.; Cojocariu, M.; Archambault, D., The molecular biology of bovine immunodeficiency virus: a comparison with other lentiviruses. *Animal Health Research Reviews / Conference of Research Workers in Animal Diseases* **2004**, 5 (2), 125-143.
 23. Corredor, A. G.; St-Louis, M.-C.; Archambault, D., Molecular and biological aspects of the bovine immunodeficiency virus. *Current HIV Research* **2010**, 8 (1), 2-13.
 24. Carpenter, S.; Miller, L. D.; Alexandersen, S.; Whetstone, C. A.; VanDerMaaten, M. J.; Viuff, B.; Wannemuehler, Y.; Miller, J. M.; Roth, J. A., Characterization of early pathogenic effects after experimental infection of calves with bovine immunodeficiency-like virus. *Journal of Virology* **1992**, 66 (2), 1074-1083.
 25. Walder, R.; Kalvatchev, Z.; Tobin, G. J.; Barrios, M. N.; Garzaro, D. J.; Gonda, M. A., Possible role of bovine immunodeficiency virus in bovine paraplegic syndrome: evidence from immunochemical, virological and seroprevalence studies. *Research in Virology* **1995**, 146 (5), 313-323.
 26. Katzourakis, A.; Tristem, M.; Pybus, O. G.; Gifford, R. J., Discovery and analysis of the first endogenous lentivirus. *Proceedings of the National Academy of Sciences of the United States of America* **2007**, 104 (15), 6261-6265.
 27. Cook, R. F.; Leroux, C.; Issel, C. J., Equine infectious anemia and equine infectious anemia virus in 2013: A review. *Veterinary Microbiology* **2013**, 167 (1-2), 181-204.
 28. Kaiser, A.; Meier, H. P.; Straub, R.; Gerber, V., [Equine Infectious Anemia (EIA)]. *Schweizer Archiv Für Tierheilkunde* **2009**, 151 (4), 159-164.
 29. Bolfa, P.; Nolf, M.; Cadoré, J.-L.; Catoi, C.; Archer, F.; Dolmazon, C.; Mornex, J.-F.; Leroux, C., Interstitial lung disease associated with Equine Infectious Anemia Virus infection in horses. *Veterinary Research* **2013**, 44.
 30. Hawkins, J. A.; Adams, W. V., Jr.; Wilson, B. H.; Issel, C. J.; Roth, E. E., Transmission of equine infectious anemia virus by *Tabanus fuscicostatus*. *J Am Vet Med Assoc* **1976**, 168 (1), 63-64.
 31. Cruz, F.; Fores, P.; Ireland, J.; Moreno, M. A.; Newton, R., Freedom from equine infectious anaemia virus infection in Spanish Purebred horses. *Vet Rec Open* **2015**, 2 (1), e000074.
 32. Sellon, D. C.; Long, M., *Equine Infectious Diseases*. Elsevier Health Sciences: 2013; p 899.
 33. Lin, Y. Z.; Yang, F.; Zhang, S. Q.; Sun, L. K.; Wang, X. F.; Du, C.; Zhou, J. H., The soluble form of the EIAV receptor encoded by an alternative splicing variant inhibits EIAV infection of target cells. *PLoS ONE* **2013**, 8 (11), e79299.
 34. Oaks, J. L.; McGuire, T. C.; Ulibarri, C.; Crawford, T. B., Equine infectious anemia virus is found in tissue macrophages during subclinical infection. *Journal of Virology* **1998**, 72 (9), 7263-7269.

35. Abdusetir Cerfoglio, J. C.; González, S. A.; Affranchino, J. L., Structural elements in the Gag polyprotein of feline immunodeficiency virus involved in Gag self-association and assembly. *The Journal of General Virology* **2014**, *95* (Pt 9), 2050-2059.
36. Lee, J. S.; Bevins, S. N.; Serieys, L. E. K.; Vickers, W.; Logan, K. A.; Aldredge, M.; Boydston, E. E.; Lyren, L. M.; McBride, R.; Roelke-Parker, M.; Pecon-Slattey, J.; Troyer, J. L.; Riley, S. P.; Boyce, W. M.; Crooks, K. R.; VandeWoude, S., Evolution of Puma Lentivirus in Bobcats (*Lynx rufus*) and Mountain Lions (*Puma concolor*) in North America. *Journal of Virology* **2014**, *88* (14), 7727-7737.
37. VandeWoude, S.; Hageman, C. L.; Hoover, E. A., Domestic cats infected with lion or puma lentivirus develop anti-feline immunodeficiency virus immune responses. *Journal of Acquired Immune Deficiency Syndromes (1999)* **2003**, *34* (1), 20-31.
38. Pedersen, N. C.; Yamamoto, J. K.; Ishida, T.; Hansen, H., Feline immunodeficiency virus infection. *Veterinary Immunology and Immunopathology* **1989**, *21* (1), 111-129.
39. Yamamoto, J. K.; Sparger, E.; Ho, E. W.; Andersen, P. R.; O'Connor, T. P.; Mandell, C. P.; Lowenstine, L.; Munn, R.; Pedersen, N. C., Pathogenesis of experimentally induced feline immunodeficiency virus infection in cats. *Am J Vet Res* **1988**, *49* (8), 1246-1258.
40. Johnston, J. B.; Power, C., Feline immunodeficiency virus xenoinfection: the role of chemokine receptors and envelope diversity. *Journal of Virology* **2002**, *76* (8), 3626-3636.
41. Elder, J. H.; Lin, Y. C.; Fink, E.; Grant, C. K., Feline immunodeficiency virus (FIV) as a model for study of lentivirus infections: parallels with HIV. *Current HIV Research* **2010**, *8* (1), 73-80.
42. Thompson, J.; Ma, F.; Quinn, M.; Xiang, S. H., Genome-Wide Search for Host Association Factors during Ovine Progressive Pneumonia Virus Infection. *PLoS ONE* **2016**, *11* (3), e0150344.
43. Thormar, H., Maedi-visna virus and its relationship to human immunodeficiency virus. *AIDS reviews* **2005**, *7* (4), 233-245.
44. Fridriksdottir, V.; Gunnarsson, E.; Sigurdarson, S.; Gudmundsdottir, K. B., Paratuberculosis in Iceland: epidemiology and control measures, past and present. *Vet Microbiol* **2000**, *77* (3-4), 263-267.
45. Gorrell, M. D.; Brandon, M. R.; Sheffer, D.; Adams, R. J.; Narayan, O., Ovine lentivirus is macrophagetropic and does not replicate productively in T lymphocytes. *Journal of Virology* **1992**, *66* (5), 2679-2688.
46. White, S. N.; Mousel, M. R.; Reynolds, J. O.; Herrmann-Hoesing, L. M.; Knowles, D. P., Deletion variant near ZNF389 is associated with control of ovine lentivirus in multiple sheep flocks. *Animal Genetics* **2014**, *45* (2), 297-300.
47. Asadpour, R.; Paktinat, S.; Ghassemi, F.; Jafari, R., Study on Correlation of Maedi-Visna Virus (MVV) with Ovine Subclinical Mastitis in Iran. *Indian Journal of Microbiology* **2014**, *54* (2), 218-222.
48. Cutlip, R. C.; Lehmkuhl, H. D.; Schmerr, M. J.; Brogden, K. A., Ovine progressive pneumonia (maedi-visna) in sheep. *Veterinary Microbiology* **1988**, *17* (3), 237-250.
49. Stavrou, D.; Deutschländer, N.; Dahme, E., Granulomatous encephalomyelitis in goats. *J. Comp. Pathol.* **1969**, *79* (3), 393-396.
50. Cork, L. C.; Hadlow, W. J.; Crawford, T. B.; Gorham, J. R.; Piper, R. C., Infectious leukoencephalomyelitis of young goats. *J Infect Dis* **1974**, *129* (2), 134-141.
51. Crawford, T. B.; Adams, D. S.; Cheevers, W. P.; Cork, L. C., Chronic arthritis in goats caused by a retrovirus. *Science (New York, N.Y.)* **1980**, *207* (4434), 997-999.

52. Zink, M. C.; Yager, J. A.; Myers, J. D., Pathogenesis of caprine arthritis encephalitis virus. Cellular localization of viral transcripts in tissues of infected goats. *The American Journal of Pathology* **1990**, *136* (4), 843-854.
53. Zink, M. C.; Narayan, O.; Kennedy, P. G.; Clements, J. E., Pathogenesis of visna/maedi and caprine arthritis-encephalitis: new leads on the mechanism of restricted virus replication and persistent inflammation. *Veterinary Immunology and Immunopathology* **1987**, *15* (1-2), 167-180.
54. Chebloune, Y.; Karr, B.; Sheffer, D.; Leung, K.; Narayan, O., Variations in lentiviral gene expression in monocyte-derived macrophages from naturally infected sheep. *Journal of General Virology* **1996**, *77* (Pt 9), 2037-2051.
55. Balbin, M. M.; Belotindos, L. P.; Abes, N. S.; Mingala, C. N., Caprine arthritis encephalitis virus detection in blood by loop-mediated isothermal amplification (LAMP) assay targeting the proviral gag region. *Diagnostic Microbiology and Infectious Disease* **2014**, *79* (1), 37-42.
56. Chakraborty, S.; Kumar, A.; Tiwari, R.; Rahal, A.; Malik, Y.; Dhama, K.; Pal, A.; Prasad, M., Advances in Diagnosis of Respiratory Diseases of Small Ruminants. *Veterinary Medicine International* **2014**, *2014*.
57. Adams, D. S.; Klevjer-Anderson, P.; Carlson, J. L.; McGuire, T. C.; Gorham, J. R., Transmission and control of caprine arthritis-encephalitis virus. *American Journal of Veterinary Research* **1983**, *44* (9), 1670-1675.
58. L'Homme, Y.; Leboeuf, A.; Arsenault, J.; Fras, M., Identification and characterization of an emerging small ruminant lentivirus circulating recombinant form (CRF). *Virology* **2015**, *475*, 159-171.
59. Mselli-Lakhal, L.; Favier, C.; Leung, K.; Guiguen, F.; Grezel, D.; Miossec, P.; Mornex, J.-F.; Narayan, O.; Querat, G.; Chebloune, Y., Lack of Functional Receptors Is the Only Barrier That Prevents Caprine Arthritis-Encephalitis Virus from Infecting Human Cells. *Journal of Virology* **2000**, *74* (18), 8343-8348.
60. Gaynor, R. B., Regulation of HIV-1 gene expression by the transactivator protein Tat. *Curr Top Microbiol Immunol* **1995**, *193*, 51-77.
61. Lopez-Huertas, M. R.; Li, J.; Zafar, A.; Rodriguez-Mora, S.; Garcia-Dominguez, C.; Mateos, E.; Alcami, J.; Rao, S.; Coiras, M., PKC θ and HIV-1 Transcriptional Regulator Tat Co-exist at the LTR Promoter in CD4(+) T Cells. *Frontiers in Immunology* **2016**, *7*, 69.
62. Villet, S.; Faure, C.; Bouzar, B. A.; Morin, T.; Verdier, G.; Chebloune, Y.; Legras, C., Lack of trans-activation function for Maedi Visna virus and Caprine arthritis encephalitis virus Tat proteins. *Virology* **2003**, *307* (2), 317-327.
63. Villet, S.; Bouzar, B. A.; Morin, T.; Verdier, G.; Legras, C.; Chebloune, Y., Maedi-visna virus and caprine arthritis encephalitis virus genomes encode a Vpr-like but no Tat protein. *Journal of Virology* **2003**, *77* (17), 9632-9638.
64. Rea-Boutrois, A.; Villet, S.; Greenland, T.; Mehlen, P.; Chebloune, Y.; Verdier, G.; Legras-Lachuer, C., Small ruminant lentivirus Tat protein induces apoptosis in caprine cells in vitro by the intrinsic pathway. *Virology* **2009**, *383* (1), 93-102.
65. Padiernos, R. B. C.; Balbin, M. M.; Parayao, A. M.; Mingala, C. N., Molecular characterization of the gag gene of caprine arthritis encephalitis virus from goats in the Philippines. *Archives of Virology* **2015**, *160* (4), 969-978.
66. Stonos, N.; Wootton, S. K.; Karrow, N., Immunogenetics of small ruminant lentiviral infections. *Viruses* **2014**, *6* (8), 3311-3333.
67. Abelson, M. L.; Schoborg, R. V., Characterization of the caprine arthritis encephalitis virus (CAEV) rev N-terminal elements required for efficient interaction with the RRE. *Virus Res* **2003**, *92* (1), 23-35.

68. Schoborg, R. V., Analysis of caprine arthritis encephalitis virus (CAEV) temporal gene expression in infected cells. *Virus Res* **2002**, *90* (1-2), 37-46.
69. Locatelli, S.; Peeters, M., Cross-species transmission of simian retroviruses: how and why they could lead to the emergence of new diseases in the human population. *AIDS (London, England)* **2012**, *26* (6), 659-673.
70. Compton, A. A.; Malik, H. S.; Emerman, M., Host gene evolution traces the evolutionary history of ancient primate lentiviruses. *Philosophical Transactions of the Royal Society of London. Series B, Biological Sciences* **2013**, *368* (1626).
71. Mamede, J. I.; Sitbon, M.; Battini, J.-L.; Courgnaud, V., Heterogeneous susceptibility of circulating SIV isolate capsids to HIV-interacting factors. *Retrovirology* **2013**, *10*.
72. Sharp, P. M.; Shaw, G. M.; Hahn, B. H., Simian Immunodeficiency Virus Infection of Chimpanzees. *Journal of Virology* **2005**, *79* (7), 3891-3902.
73. D'Arc, M.; Ayoub, A.; Esteban, A.; Learn, G. H.; Boue, V.; Liegeois, F.; Etienne, L.; Tagg, N.; Leendertz, F. H.; Boesch, C.; Madinda, N. F.; Robbins, M. M.; Gray, M.; Cournil, A.; Ooms, M.; Letko, M.; Simon, V. A.; Sharp, P. M.; Hahn, B. H.; Delaporte, E.; Mpoudi Ngole, E.; Peeters, M., Origin of the HIV-1 group O epidemic in western lowland gorillas. *Proceedings of the National Academy of Sciences of the United States of America* **2015**, *112* (11), E1343-1352.
74. Kiene, M.; Marzi, A.; Urbanczyk, A.; Bertram, S.; Fisch, T.; Nehlmeier, I.; Gnirss, K.; Karsten, C. B.; Palesch, D.; Munch, J.; Chiodi, F.; Pohlmann, S.; Steffen, I., The role of the alternative coreceptor GPR15 in SIV tropism for human cells. *Virology* **2012**, *433* (1), 73-84.
75. Silvestri, G.; Sodora, D. L.; Koup, R. A.; Paiardini, M.; O'Neil, S. P.; McClure, H. M.; Staprans, S. I.; Feinberg, M. B., Nonpathogenic SIV infection of sooty mangabeys is characterized by limited bystander immunopathology despite chronic high-level viremia. *Immunity* **2003**, *18* (3), 441-452.
76. Klatt, N. R.; Silvestri, G.; Hirsch, V., Nonpathogenic Simian Immunodeficiency Virus Infections. *Cold Spring Harbor Perspectives in Medicine* **2012**, *2* (1).
77. Silvestri, G.; Fedanov, A.; Germon, S.; Kozyr, N.; Kaiser, W. J.; Garber, D. A.; McClure, H.; Feinberg, M. B.; Staprans, S. I., Divergent host responses during primary simian immunodeficiency virus SIVsm infection of natural sooty mangabey and nonnatural rhesus macaque hosts. *Journal of Virology* **2005**, *79* (7), 4043-4054.
78. Jacquelin, B.; Mayau, V.; Targat, B.; Liovat, A. S.; Kunkel, D.; Petitjean, G.; Dillies, M. A.; Roques, P.; Butor, C.; Silvestri, G.; Giavedoni, L. D.; Lebon, P.; Barre-Sinoussi, F.; Benecke, A.; Muller-Trutwin, M. C., Nonpathogenic SIV infection of African green monkeys induces a strong but rapidly controlled type I IFN response. *Journal of Clinical Investigation* **2009**, *119* (12), 3544-3555.
79. Jochems, S. P.; Petitjean, G.; Kunkel, D.; Liovat, A. S.; Ploquin, M. J.; Barre-Sinoussi, F.; Lebon, P.; Jacquelin, B.; Muller-Trutwin, M. C., Modulation of type I interferon-associated viral sensing during acute simian immunodeficiency virus infection in African green monkeys. *Journal of Virology* **2015**, *89* (1), 751-762.
80. Veazey, R.; Ling, B.; Pandrea, I.; McClure, H.; Lackner, A.; Marx, P., Decreased CCR5 expression on CD4+ T cells of SIV-infected sooty mangabeys. *AIDS Research and Human Retroviruses* **2003**, *19* (3), 227-233.
81. Bostik, P.; Noble, E. S.; Stephenson, S. T.; Villinger, F.; Ansari, A. A., CD4+ T cells from simian immunodeficiency virus disease-resistant sooty mangabeys produce more IL-2 than cells from disease-susceptible species: involvement of p300 and CREB at the proximal IL-2 promoter in IL-2 up-regulation. *The Journal of Immunology* **2007**, *178* (12), 7720-7729.

82. Byrareddy, S. N.; Sidell, N.; Arthos, J.; Cicala, C.; Zhao, C.; Little, D. M.; Dunbar, P.; Yang, G. X.; Pierzchalski, K.; Kane, M. A.; Mayne, A. E.; Song, B.; Soares, M. A.; Villinger, F.; Fauci, A. S.; Ansari, A. A., Species-specific differences in the expression and regulation of alpha4beta7 integrin in various nonhuman primates. *The Journal of Immunology* **2015**, *194* (12), 5968-5979.
83. Gordon, S. N.; Klatt, N. R.; Bosinger, S. E.; Brenchley, J. M.; Milush, J. M.; Engram, J. C.; Dunham, R. M.; Paiardini, M.; Klucking, S.; Danesh, A.; Strobert, E. A.; Apetrei, C.; Pandrea, I. V.; Kelvin, D.; Douek, D. C.; Staprans, S. I.; Sodora, D. L.; Silvestri, G., Severe depletion of mucosal CD4+ T cells in AIDS-free simian immunodeficiency virus-infected sooty mangabeys. *The Journal of Immunology* **2007**, *179* (5), 3026-3034.
84. Harris, L. D.; Tabb, B.; Sodora, D. L.; Paiardini, M.; Klatt, N. R.; Douek, D. C.; Silvestri, G.; Müller-Trutwin, M.; Vasile-Pandrea, I.; Apetrei, C.; Hirsch, V.; Lifson, J.; Brenchley, J. M.; Estes, J. D., Downregulation of Robust Acute Type I Interferon Responses Distinguishes Nonpathogenic Simian Immunodeficiency Virus (SIV) Infection of Natural Hosts from Pathogenic SIV Infection of Rhesus Macaques. *Journal of Virology* **2010**, *84* (15), 7886-7891.
85. O'Neil, S. P.; Suwyn, C.; Anderson, D. C.; Niedziela, G.; Bradley, J.; Novembre, F. J.; Herndon, J. G.; McClure, H. M., Correlation of acute humoral response with brain virus burden and survival time in pig-tailed macaques infected with the neurovirulent simian immunodeficiency virus SIVsmmFGb. *The American Journal of Pathology* **2004**, *164* (4), 1157-1172.
86. Lauck, M.; Switzer, W. M.; Sibley, S. D.; Hyeroba, D.; Tumukunde, A.; Weny, G.; Shankar, A.; Greene, J. M.; Ericson, A. J.; Zheng, H.; Ting, N.; Chapman, C. A.; Friedrich, T. C.; Goldberg, T. L.; O'Connor, D. H., Discovery and full genome characterization of a new SIV lineage infecting red-tailed guenons (*Cercopithecus ascanius schmidti*) in Kibale National Park, Uganda. *Retrovirology* **2014**, *11* (1).
87. McKay, R. A., "Patient Zero". *Bulletin of the History of Medicine* **2014**, 161-194.
88. Worobey, M.; Watts, T. D.; McKay, R. A.; Suchard, M. A.; Granade, T.; Teuwen, D. E.; Koblin, B. A.; Heneine, W.; Lemey, P.; Jaffe, H. W., 1970s and 'Patient 0' HIV-1 genomes illuminate early HIV/AIDS history in North America. *Nature* **2016**.
89. O'Leary, D., The syndemic of AIDS and STDS among MSM. *Linacre Q* **2014**, *81* (1), 12-37.
90. Souquiere, S.; Makuwa, M.; Salle, B.; Kazanji, M., New strain of simian immunodeficiency virus identified in wild-born chimpanzees from central Africa. *PLoS ONE* **2012**, *7* (9), e44298.
91. Keele, B. F.; Van Heuverswyn, F.; Li, Y.; Bailes, E.; Takehisa, J.; Santiago, M. L.; Bibollet-Ruche, F.; Chen, Y.; Wain, L. V.; Liegeois, F.; Loul, S.; Ngole, E. M.; Bienvenue, Y.; Delaporte, E.; Brookfield, J. F. Y.; Sharp, P. M.; Shaw, G. M.; Peeters, M.; Hahn, B. H., Chimpanzee Reservoirs of Pandemic and Nonpandemic HIV-1. *Science (New York, N.Y.)* **2006**, *313* (5786), 523-526.
92. Heeney, J. L.; Rutjens, E.; Verschoor, E. J.; Niphuis, H.; ten Haaf, P.; Rouse, S.; McClure, H.; Balla-Jhagjhoorsingh, S.; Bogers, W.; Salas, M.; Cobb, K.; Kestens, L.; Davis, D.; van der Groen, G.; Courgnaud, V.; Peeters, M.; Murthy, K. K., Transmission of Simian Immunodeficiency Virus SIVcpz and the Evolution of Infection in the Presence and Absence of Concurrent Human Immunodeficiency Virus Type 1 Infection in Chimpanzees. *Journal of Virology* **2006**, *80* (14), 7208-7218.
93. Sharp, P. M.; Hahn, B. H., Origins of HIV and the AIDS Pandemic. *Cold Spring Harbor Perspectives in Medicine* **2011**, *1* (1).
94. Boue, V.; Locatelli, S.; Boucher, F.; Ayoub, A.; Butel, C.; Esteban, A.; Okouga, A. P.; Ndougouet, A.; Motsch, P.; Le Flohic, G.; Ngari, P.; Prugnolle, F.; Ollomo, B.; Rouet,

- F.; Liegeois, F., High Rate of Simian Immunodeficiency Virus (SIV) Infections in Wild Chimpanzees in Northeastern Gabon. *Viruses* **2015**, *7* (9), 4997-5015.
95. D'arc, M.; Ayouba, A.; Esteban, A.; Learn, G. H.; Boué, V.; Liegeois, F.; Etienne, L.; Tagg, N.; Leendertz, F. H.; Boesch, C.; Madinda, N. F.; Robbins, M. M.; Gray, M.; Cournil, A.; Ooms, M.; Letko, M.; Simon, V. A.; Sharp, P. M.; Hahn, B. H.; Delaporte, E.; Ngole, E. M.; Peeters, M., Origin of the HIV-1 group O epidemic in western lowland gorillas. *Proceedings of the National Academy of Sciences* **2015**, *112* (11), E1343-E1352.
 96. Crawford, D. H., *Virus Hunt: The search for the origin of HIV/AIDs*. Oxford University Press: 2013; p 259.
 97. Santiago, M. L.; Range, F.; Keele, B. F.; Li, Y.; Bailes, E.; Bibollet-Ruche, F.; Fruteau, C.; Noë, R.; Peeters, M.; Brookfield, J. F. Y.; Shaw, G. M.; Sharp, P. M.; Hahn, B. H., Simian immunodeficiency virus infection in free-ranging sooty mangabeys (*Cercocebus atys atys*) from the Taï Forest, Côte d'Ivoire: implications for the origin of epidemic human immunodeficiency virus type 2. *Journal of Virology* **2005**, *79* (19), 12515-12527.
 98. Ayouba, A.; Akoua-Koffi, C.; Calvignac-Spencer, S.; Esteban, A.; Locatelli, S.; Li, H.; Li, Y.; Hahn, B. H.; Delaporte, E.; Leendertz, F. H.; Peeters, M., Evidence for continuing cross-species transmission of SIVsmm to humans: characterization of a new HIV-2 lineage in rural Côte d'Ivoire. *AIDS* **2013**, *27* (15), 2488-2491.
 99. Campbell-Yesufu, O. T.; Gandhi, R. T., Update on Human Immunodeficiency Virus (HIV)-2 Infection. *Clinical Infectious Diseases* **2011**, *52* (6), 780-787.
 100. Descours, B.; Cribier, A.; Chable-Bessia, C.; Ayinde, D.; Rice, G.; Crow, Y.; Yatim, A.; Schwartz, O.; Laguette, N.; Benkirane, M., SAMHD1 restricts HIV-1 reverse transcription in quiescent CD4(+) T-cells. *Retrovirology* **2012**, *9*, 87.
 101. Shingai, M.; Welbourn, S.; Brenchley, J. M.; Acharya, P.; Miyagi, E.; Plishka, R. J.; Buckler-White, A.; Kwong, P. D.; Nishimura, Y.; Strebel, K.; Martin, M. A., The Expression of Functional Vpx during Pathogenic SIVmac Infections of Rhesus Macaques Suppresses SAMHD1 in CD4+ Memory T Cells. *PLoS Pathog* **2015**, *11* (5), e1004928.
 102. Azevedo-Pereira, J. M.; Santos-Costa, Q.; Moniz-Pereira, J., HIV-2 infection and chemokine receptors usage - clues to reduced virulence of HIV-2. *Current HIV Research* **2005**, *3* (1), 3-16.
 103. Treviño, A.; Soriano, V.; Poveda, E.; Parra, P.; Cabezas, T.; Caballero, E.; Roc, L.; Rodríguez, C.; Eiros, J. M.; Lopez, M.; De Mendoza, C.; Group, H. I. V. S. S., HIV-2 viral tropism influences CD4+ T cell count regardless of viral load. *The Journal of Antimicrobial Chemotherapy* **2014**, *69* (8), 2191-2194.
 104. van der Graaf, M.; Diepersloot, R. J., Transmission of human immunodeficiency virus (HIV/HTLV-III/LAV): a review. *Infection* **1986**, *14* (5), 203-211.
 105. Choices, N. H. S. Can HIV be transmitted through oral sex (fellatio and cunnilingus)? - Health questions - NHS Choices.
<http://www.nhs.uk/chq/pages/3098.aspx?categoryid=118>
 106. Royce, R. A.; Seña, A.; Cates, W.; Cohen, M. S., Sexual Transmission of HIV. *New England Journal of Medicine* **1997**, *336* (15), 1072-1078.
 107. McCoy, C. B.; Metsch, L. R.; Chitwood, D. D.; Shapshak, P.; Comerford, S. T., Parenteral transmission of HIV among injection drug users: assessing the frequency of multiperson use of needles, syringes, cookers, cotton, and water. *Journal of Acquired Immune Deficiency Syndromes and Human Retrovirology: Official Publication of the International Retrovirology Association* **1998**, *18 Suppl 1*, S25-29.

108. Gray, R. H.; Wawer, M. J.; Brookmeyer, R.; Sewankambo, N. K.; Serwadda, D.; Wabwire-Mangen, F.; Lutalo, T.; Li, X.; vanCott, T.; Quinn, T. C., Probability of HIV-1 transmission per coital act in monogamous, heterosexual, HIV-1-discordant couples in Rakai, Uganda. *Lancet* **2001**, *357* (9263), 1149-1153.
109. Moodley, J.; Wennberg, J. L., HIV in pregnancy. *Current Opinion in Obstetrics & Gynecology* **2005**, *17* (2), 117-121.
110. Nkwo, P., Prevention of mother to child transmission of human immunodeficiency virus: the nigerian perspective. *Annals of Medical and Health Sciences Research* **2012**, *2* (1), 56-65.
111. Dorosko, S. M.; Connor, R. I., Primary human mammary epithelial cells endocytose HIV-1 and facilitate viral infection of CD4+ T lymphocytes. *Journal of Virology* **2010**, *84* (20), 10533-10542.
112. Desposito, F.; McSherry, G. D.; Oleske, J. M., Blood product acquired HIV infection in children. *Pediatric Annals* **1988**, *17* (5), 341-345.
113. Simonds, R. J., HIV transmission by organ and tissue transplantation. *AIDS (London, England)* **1993**, *7 Suppl 2*, S35-38.
114. Global-AIDS-update. Global AIDS update 2016.
http://www.who.int/hiv/pub/arv/global-AIDS-update-2016_en.pdf?ua=1.
115. Shafiee, H.; Wang, S.; Inci, F.; Toy, M.; Henrich, T. J.; Kuritzkes, D. R.; Demirci, U., Emerging Technologies for Point-of-Care Management of HIV Infection. *Annual Review of Medicine* **2015**, *66* (1), 387-405.
116. Gray, R.; Kigozi, G.; Kong, X.; Ssempiija, V.; Makumbi, F.; Watty, S.; Serwadda, D.; Nalugoda, F.; Sewenkambo, N. K.; Wawer, M. J., The effectiveness of male circumcision for HIV prevention and effects on risk behaviors in a posttrial follow-up study. *AIDS (London, England)* **2012**, *26* (5), 609-615.
117. Ngemu, E. K.; Khayeka-Wandabwa, C.; Kweka, E. J.; Choge, J. K.; Anino, E.; Oyoo-Okoth, E., Effectiveness of option B highly active antiretroviral therapy (HAART) prevention of mother-to-child transmission (PMTCT) in pregnant HIV women. *BMC Research Notes* **2014**, *7* (1).
118. McCormack, S.; Dunn, D. T.; Desai, M.; Dolling, D. I.; Gafos, M.; Gilson, R.; Sullivan, A. K.; Clarke, A.; Reeves, I.; Schembri, G.; Mackie, N.; Bowman, C.; Lacey, C. J.; Apea, V.; Brady, M.; Fox, J.; Taylor, S.; Antonucci, S.; Khoo, S. H.; Rooney, J.; Nardone, A.; Fisher, M.; McOwan, A.; Phillips, A. N.; Johnson, A. M.; Gazzard, B.; Gill, O. N., Pre-exposure prophylaxis to prevent the acquisition of HIV-1 infection (PROUD): effectiveness results from the pilot phase of a pragmatic open-label randomised trial. *Lancet* **2016**, *387* (10013), 53-60.
119. Aloia, R. C.; Tian, H.; Jensen, F. C., Lipid composition and fluidity of the human immunodeficiency virus envelope and host cell plasma membranes. *Proceedings of the National Academy of Sciences of the United States of America* **1993**, *90* (11), 5181-5185.
120. Schulz, T. F.; Jameson, B. A.; Lopalco, L.; Siccardi, A. G.; Weiss, R. A.; Moore, J. P., Conserved structural features in the interaction between retroviral surface and transmembrane glycoproteins? *AIDS Research and Human Retroviruses* **1992**, *8* (9), 1571-1580.
121. Barrie, K. A.; Perez, E. E.; Lamers, S. L.; Farmerie, W. G.; Dunn, B. M.; Sleasman, J. W.; Goodenow, M. M., Natural variation in HIV-1 protease, Gag p7 and p6, and protease cleavage sites within gag/pol polyproteins: amino acid substitutions in the absence of protease inhibitors in mothers and children infected by human immunodeficiency virus type 1. *Virology* **1996**, *219* (2), 407-416.

122. Speck, R. R.; Flexner, C.; Tian, C. J.; Yu, X. F., Comparison of human immunodeficiency virus type 1 Pr55(Gag) and Pr160(Gag-pol) processing intermediates that accumulate in primary and transformed cells treated with peptidic and nonpeptidic protease inhibitors. *Antimicrobial Agents and Chemotherapy* **2000**, *44* (5), 1397-1403.
123. Sakuma, T.; Barry, M. A.; Ikeda, Y., Lentiviral vectors: basic to translational. *Biochem J* **2012**, *443* (3), 603-618.
124. Abd El-Wahab, E. W.; Smyth, R. P.; Mailler, E.; Bernacchi, S.; Vivet-Boudou, V.; Hijnen, M.; Jossinet, F.; Mak, J.; Paillart, J. C.; Marquet, R., Specific recognition of the HIV-1 genomic RNA by the Gag precursor. *Nat Commun* **2014**, *5*, 4304.
125. Turner, B. G.; Summers, M. F., Structural biology of HIV. *Journal of Molecular Biology* **1999**, *285* (1), 1-32.
126. Pettit, S. C.; Everitt, L. E.; Choudhury, S.; Dunn, B. M.; Kaplan, A. H., Initial cleavage of the human immunodeficiency virus type 1 GagPol precursor by its activated protease occurs by an intramolecular mechanism. *Journal of Virology* **2004**, *78* (16), 8477-8485.
127. Fitzgerald, M. E.; Drohat, A. C., Studies of RNA/DNA Polypurine Tracts. *Chemistry & Biology* **2008**, *15* (3), 203-204.
128. Dingwall, C.; Ernberg, I.; Gait, M. J.; Green, S. M.; Heaphy, S.; Karn, J.; Lowe, A. D.; Singh, M.; Skinner, M. A.; Valerio, R., Human immunodeficiency virus 1 tat protein binds trans-activation-responsive region (TAR) RNA in vitro. *Proceedings of the National Academy of Sciences of the United States of America* **1989**, *86* (18), 6925-6929.
129. Sarafianos, S. G.; Das, K.; Tantillo, C.; Clark, A. D.; Ding, J.; Whitcomb, J. M.; Boyer, P. L.; Hughes, S. H.; Arnold, E., Crystal structure of HIV-1 reverse transcriptase in complex with a polypurine tract RNA:DNA. *The EMBO Journal* **2001**, *20* (6), 1449-1461.
130. Guntaka, R. V., Transcription termination and polyadenylation in retroviruses. *Microbiol Rev* **1993**, *57* (3), 511-521.
131. Gómez-Lucía, E.; Collado, V. M.; Miró, G.; Doménech, A., Effect of Type-I Interferon on Retroviruses. *Viruses* **2009**, *1* (3), 545-573.
132. Tachedjian, G.; Radzio, J.; Sluis-Cremer, N., Relationship between enzyme activity and dimeric structure of recombinant HIV-1 reverse transcriptase. *Proteins* **2005**, *60* (1), 5-13.
133. Mulky, A.; Kappes, J. C., Analysis of human immunodeficiency virus type 1 reverse transcriptase subunit structure/function in the context of infectious virions and human target cells. *Antimicrobial Agents and Chemotherapy* **2005**, *49* (9), 3762-3769.
134. Das, K.; Martinez, S. E.; Bandwar, R. P.; Arnold, E., Structures of HIV-1 RT-RNA/DNA ternary complexes with dATP and nevirapine reveal conformational flexibility of RNA/DNA: insights into requirements for RNase H cleavage. *Nucleic Acids Research* **2014**, *42* (12), 8125-8137.
135. Cimarelli, A.; Darlix, J. L., HIV-1 reverse transcription. *Methods in Molecular Biology (Clifton, N.J.)* **2014**, *1087*, 55-70.
136. Zheng, R.; Jenkins, T. M.; Craigie, R., Zinc folds the N-terminal domain of HIV-1 integrase, promotes multimerization, and enhances catalytic activity. *Proceedings of the National Academy of Sciences of the United States of America* **1996**, *93* (24), 13659-13664.
137. Chiu, T. K.; Davies, D. R., Structure and function of HIV-1 integrase. *Current Topics in Medicinal Chemistry* **2004**, *4* (9), 965-977.
138. Andrade, M. D.; Skalka, A. M., Retroviral Integrase: Then and Now. *Annu Rev Virol* **2015**, *2* (1), 241-264.

139. Li, M.; Ivanov, V.; Mizuuchi, M.; Mizuuchi, K.; Craigie, R., DNA requirements for assembly and stability of HIV-1 intasomes. *Protein Science: A Publication of the Protein Society* **2012**, *21* (2), 249-257.
140. Bojja, R. S.; Andrade, M. D.; Merkel, G.; Weigand, S.; Dunbrack, R. L.; Skalka, A. M., Architecture and assembly of HIV integrase multimers in the absence of DNA substrates. *The Journal of Biological Chemistry* **2013**, *288* (10), 7373-7386.
141. Delelis, O.; Carayon, K.; Saib, A.; Deprez, E.; Mouscadet, J. F., Integrase and integration: biochemical activities of HIV-1 integrase. *Retrovirology* **2008**, *5*, 114.
142. Chen, J. C. H.; Krucinski, J.; Miercke, L. J. W.; Finer-Moore, J. S.; Tang, A. H.; Leavitt, A. D.; Stroud, R. M., Crystal structure of the HIV-1 integrase catalytic core and C-terminal domains: A model for viral DNA binding. *Proceedings of the National Academy of Sciences* **2000**, *97* (15), 8233-8238.
143. Graf, E. H.; O'Doherty, U., Quantitation of integrated proviral DNA in viral reservoirs. *Current Opinion in HIV and AIDS* **2013**, *8* (2), 100-105.
144. Hoshikawa, N.; Kojima, A.; Yasuda, A.; Takayashiki, E.; Masuko, S.; Chiba, J.; Sata, T.; Kurata, T., Role of the gag and pol genes of human immunodeficiency virus in the morphogenesis and maturation of retrovirus-like particles expressed by recombinant vaccinia virus: an ultrastructural study. *The Journal of General Virology* **1991**, *72* (Pt 10), 2509-2517.
145. Wondrak, E. M.; Nashed, N. T.; Haber, M. T.; Jerina, D. M.; Louis, J. M., A Transient Precursor of the HIV-1 Protease ISOLATION, CHARACTERIZATION, AND KINETICS OF MATURATION. *Journal of Biological Chemistry* **1996**, *271* (8), 4477-4481.
146. Ashorn, P.; McQuade, T. J.; Thaisrivongs, S.; Tomasselli, A. G.; Tarpley, W. G.; Moss, B., An inhibitor of the protease blocks maturation of human and simian immunodeficiency viruses and spread of infection. *Proceedings of the National Academy of Sciences of the United States of America* **1990**, *87* (19), 7472-7476.
147. Kohl, N. E.; Emini, E. A.; Schleif, W. A.; Davis, L. J.; Heimbach, J. C.; Dixon, R. A.; Scolnick, E. M.; Sigal, I. S., Active human immunodeficiency virus protease is required for viral infectivity. *Proceedings of the National Academy of Sciences of the United States of America* **1988**, *85* (13), 4686-4690.
148. Titanji, B. K.; Aasa-Chapman, M.; Pillay, D.; Jolly, C., Protease inhibitors effectively block cell-to-cell spread of HIV-1 between T cells. *Retrovirology* **2013**, *10* (1).
149. Konvalinka, J.; Krausslich, H. G.; Muller, B., Retroviral proteases and their roles in virion maturation. *Virology* **2015**, *479-480*, 403-417.
150. Sattentau, Q. J., The role of the envelope glycoproteins in HIV-1 transmission and pathogenesis. *Perspectives in Drug Discovery and Design* **1996**, *5* (1), 1-16.
151. Binley, J. M.; Sanders, R. W.; Master, A.; Cayanan, C. S.; Wiley, C. L.; Schiffner, L.; Travis, B.; Kuhmann, S.; Burton, D. R.; Hu, S.-L.; Olson, W. C.; Moore, J. P., Enhancing the proteolytic maturation of human immunodeficiency virus type 1 envelope glycoproteins. *Journal of Virology* **2002**, *76* (6), 2606-2616.
152. Olshevsky, U.; Helseth, E.; Furman, C.; Li, J.; Haseltine, W.; Sodroski, J., Identification of individual human immunodeficiency virus type 1 gp120 amino acids important for CD4 receptor binding. *Journal of Virology* **1990**, *64* (12), 5701-5707.
153. Clapham, P. R.; McKnight, A., HIV-1 receptors and cell tropism. *Br Med Bull* **2001**, *58*, 43-59.
154. Balakrishna, L. S.; Kondapi, A. K., Role of Host Proteins in HIV-1 Early Replication In *Advances in Molecular Retrovirology*, Saxena, S. K., Ed. 2016.

155. Nguyen, D. G.; Hildreth, J. E. K., Involvement of macrophage mannose receptor in the binding and transmission of HIV by macrophages. *European Journal of Immunology* **2003**, *33* (2), 483-493.
156. Mao, Y.; Wang, L.; Gu, C.; Herschhorn, A.; Desormeaux, A.; Finzi, A.; Xiang, S. H.; Sodroski, J. G., Molecular architecture of the uncleaved HIV-1 envelope glycoprotein trimer. *Proceedings of the National Academy of Sciences of the United States of America* **2013**, *110* (30), 12438-12443.
157. Gallo, S. A.; Finnegan, C. M.; Viard, M.; Raviv, Y.; Dimitrov, A.; Rawat, S. S.; Puri, A.; Durell, S.; Blumenthal, R., The HIV Env-mediated fusion reaction. *Biochim Biophys Acta* **2003**, *1614* (1), 36-50.
158. Dey, B.; Svehla, K.; Xu, L.; Wycuff, D.; Zhou, T.; Voss, G.; Phogat, A.; Chakrabarti, B. K.; Li, Y.; Shaw, G.; Kwong, P. D.; Nabel, G. J.; Mascola, J. R.; Wyatt, R. T., Structure-based stabilization of HIV-1 gp120 enhances humoral immune responses to the induced co-receptor binding site. *PLoS Pathogens* **2009**, *5* (5).
159. Zolla-Pazner, S.; Cardozo, T., STRUCTURE-FUNCTION RELATIONSHIPS OF HIV-1 ENVELOPE SEQUENCE-VARIABLE REGIONS PROVIDE A PARADIGM FOR VACCINE DESIGN. *Nature reviews. Immunology* **2010**, *10* (7), 527-535.
160. Gozhenko, A. I., Intracellular Transport of HIV-1 Matrix Protein Associated with Viral RNA. *World Journal of AIDS* **2013**, *03* (01), 33-35.
161. Hearps, A. C.; Jans, D. A., Regulating the functions of the HIV-1 matrix protein. *AIDS Research and Human Retroviruses* **2007**, *23* (3), 341-346.
162. Levin, R.; Mhashilkar, A. M.; Dorfman, T.; Bukovsky, A.; Zani, C.; Bagley, J.; Hinkula, J.; Niedrig, M.; Albert, J.; Wahren, B.; Gattlinger, H. G.; Marasco, W. A., Inhibition of early and late events of the HIV-1 replication cycle by cytoplasmic Fab intrabodies against the matrix protein, p17. *Molecular Medicine* **1997**, *3* (2), 96-110.
163. Kyere, S. K.; Mercredi, P. Y.; Dong, X.; Spearman, P.; Summers, M. F., The HIV-1 matrix protein does not interact directly with the protein interactive domain of AP-3 δ . *Virus Research* **2012**, *169* (2), 411-414.
164. Pornillos, O.; Ganser-Pornillos, B. K.; Kelly, B. N.; Hua, Y.; Whitby, F. G.; Stout, C. D.; Sundquist, W. I.; Hill, C. P.; Yeager, M., X-Ray Structures of the Hexameric Building Block of the HIV Capsid. *Cell* **2009**, *137* (7), 1282-1292.
165. Sundquist, W. I.; Krusslich, H.-G., HIV-1 Assembly, Budding, and Maturation. *Cold Spring Harbor Perspectives in Medicine* **2012**, *2* (7).
166. Zhang, B.; Liu, D.; Bao, Z.; Chen, B.; Li, C.; Jiang, H.; Wang, X.; Mi, Z.; An, X.; Lu, J.; Tong, Y., High level soluble expression, one-step purification and characterization of HIV-1 p24 protein. *Virology Journal* **2011**, *8* (1).
167. Dong, H.; Liu, J.; Zhu, H.; Ou, C.-Y.; Xing, W.; Qiu, M.; Zhang, G.; Xiao, Y.; Yao, J.; Pan, P.; Jiang, Y., Two types of nanoparticle-based bio-barcode amplification assays to detect HIV-1 p24 antigen. *Virology Journal* **2012**, *9*.
168. Wu, H.; Mitra, M.; Naufer, M. N.; McCauley, M. J.; Gorelick, R. J.; Rouzina, I.; Musier-Forsyth, K.; Williams, M. C., Differential contribution of basic residues to HIV-1 nucleocapsid protein's nucleic acid chaperone function and retroviral replication. *Nucleic Acids Research* **2014**, *42* (4), 2525-2537.
169. Levin, J. G.; Mitra, M.; Mascarenhas, A.; Musier-Forsyth, K., Role of HIV-1 nucleocapsid protein in HIV-1 reverse transcription. *RNA Biology* **2010**, *7* (6), 754-774.
170. Webb, J. A.; Jones, C. P.; Parent, L. J.; Rouzina, I.; Musier-Forsyth, K., Distinct binding interactions of HIV-1 Gag to Psi and non-Psi RNAs: Implications for viral genomic RNA packaging. *RNA* **2013**, *19* (8), 1078-1088.
171. Chan, B.; Musier-Forsyth, K., The nucleocapsid protein specifically anneals tRNALys-3 onto a noncomplementary primer binding site within the HIV-1 RNA genome in vitro.

- Proceedings of the National Academy of Sciences of the United States of America* **1997**, *94* (25), 13530-13535.
172. Selig, L.; Pages, J. C.; Tanchou, V.; Prévéral, S.; Berlioz-Torrent, C.; Liu, L. X.; Erdtmann, L.; Darlix, J. L.; Benarous, R.; Benichou, S., Interaction with the p6 Domain of the Gag Precursor Mediates Incorporation into Virions of Vpr and Vpx Proteins from Primate Lentiviruses. *Journal of Virology* **1999**, *73* (1), 592-600.
 173. Kudoh, A.; Takahama, S.; Sawasaki, T.; Ode, H.; Yokoyama, M.; Okayama, A.; Ishikawa, A.; Miyakawa, K.; Matsunaga, S.; Kimura, H.; Sugiura, W.; Sato, H.; Hirano, H.; Ohno, S.; Yamamoto, N.; Ryo, A., The phosphorylation of HIV-1 Gag by atypical protein kinase C facilitates viral infectivity by promoting Vpr incorporation into virions. *Retrovirology* **2014**, *11*.
 174. Varthakavi, V.; Smith, R. M.; Bour, S. P.; Strebel, K.; Spearman, P., Viral protein U counteracts a human host cell restriction that inhibits HIV-1 particle production. *Proceedings of the National Academy of Sciences* **2003**, *100* (25), 15154-15159.
 175. Emeagwali, N.; Hildreth, J. E. K., Human immunodeficiency virus type 1 Vpu and cellular TASK proteins suppress transcription of unintegrated HIV-1 DNA. *Virology Journal* **2012**, *9*.
 176. Gonzalez, M. E., Vpu Protein: The Viroporin Encoded by HIV-1. *Viruses* **2015**, *7* (8), 4352-4368.
 177. Schubert, U.; Antón, L. C.; Bacík, I.; Cox, J. H.; Bour, S.; Bennink, J. R.; Orłowski, M.; Strebel, K.; Yewdell, J. W., CD4 glycoprotein degradation induced by human immunodeficiency virus type 1 Vpu protein requires the function of proteasomes and the ubiquitin-conjugating pathway. *Journal of Virology* **1998**, *72* (3), 2280-2288.
 178. Nomaguchi, M.; Fujita, M.; Adachi, A., Role of HIV-1 Vpu protein for virus spread and pathogenesis. *Microbes and Infection / Institut Pasteur* **2008**, *10* (9), 960-967.
 179. Ruiz, A.; Guatelli, J. C.; Stephens, E. B., The Vpu Protein: New Concepts in Virus Release and CD4 Down-Modulation. *Current HIV Research* **2010**, *8* (3), 240-252.
 180. Arias, J. F.; Iwabu, Y.; Tokunaga, K., Sites of action of HIV-1 Vpu in BST-2/tetherin downregulation. *Current HIV Research* **2012**, *10* (4), 283-291.
 181. Cavallari, I.; Rende, F.; D'Agostino, D. M.; Ciminale, V., Converging Strategies in Expression of Human Complex Retroviruses. *Viruses* **2011**, *3* (8), 1395-1414.
 182. Pandey, R. C.; Datta, D.; Mukerjee, R.; Srinivasan, A.; Mahalingam, S.; Sawaya, B. E., HIV-1 Vpr: a closer look at the multifunctional protein from the structural perspective. *Current HIV Research* **2009**, *7* (2), 114-128.
 183. Pirrone, V.; Mell, J.; Janto, B.; Wigdahl, B., Biomarkers of HIV Susceptibility and Disease Progression. *EBioMedicine* **2014**, *1* (2-3), 99-100.
 184. de Silva, S.; Planelles, V.; Wu, L., Differential Effects of Vpr on Single-cycle and Spreading HIV-1 Infections in CD4+ T-cells and Dendritic Cells. *PLoS ONE* **2012**, *7* (5).
 185. Zhao, R. Y.; Bukrinsky, M. I., HIV-1 accessory proteins: VpR. *Methods in Molecular Biology (Clifton, N.J.)* **2014**, *1087*, 125-134.
 186. Zhou, T.; Dang, Y.; Baker, J. J.; Zhou, J.; Zheng, Y.-H., Evidence for Vpr-dependent HIV-1 Replication in Human CD4+ CEM.NKR T-Cells. *Retrovirology* **2012**, *9*.
 187. Zhao, R. Y.; Li, G.; Bukrinsky, M. I., Vpr-host interactions during HIV-1 viral life cycle. *Journal Of Neuroimmune Pharmacology: The Official Journal Of The Society On Neuroimmune Pharmacology* **2011**, *6* (2), 216-229.
 188. Levy, D. N.; Fernandes, L. S.; Williams, W. V.; Weiner, D. B., Induction of cell differentiation by human immunodeficiency virus 1 vpr. *Cell* **1993**, *72* (4), 541-550.

189. Jenkins, Y.; Pornillos, O.; Rich, R. L.; Myszka, D. G.; Sundquist, W. I.; Malim, M. H., Biochemical Analyses of the Interactions between Human Immunodeficiency Virus Type 1 Vpr and p6Gag. *Journal of Virology* **2001**, *75* (21), 10537-10542.
190. Gabuzda, D. H.; Li, H.; Lawrence, K.; Vasir, B. S.; Crawford, K.; Langhoff, E., Essential role of vif in establishing productive HIV-1 infection in peripheral blood T lymphocytes and monocyte/macrophages. *Journal of Acquired Immune Deficiency Syndromes* **1994**, *7* (9), 908-915.
191. Schafer, A.; Bogerd, H. P.; Cullen, B. R., Specific packaging of APOBEC3G into HIV-1 virions is mediated by the nucleocapsid domain of the gag polyprotein precursor. *Virology* **2004**, *328* (2), 163-168.
192. Kao, S.; Miyagi, E.; Khan, M. A.; Takeuchi, H.; Opi, S.; Goila-Gaur, R.; Strebel, K., Production of infectious human immunodeficiency virus type 1 does not require depletion of APOBEC3G from virus-producing cells. *Retrovirology* **2004**, *1* (1).
193. Wang, Y.; Kinlock, B. L.; Shao, Q.; Turner, T. M.; Liu, B., HIV-1 Vif inhibits G to A hypermutations catalyzed by virus-encapsidated APOBEC3G to maintain HIV-1 infectivity. *Retrovirology* **2014**, *11* (1).
194. Apolonia, L.; Schulz, R.; Curk, T.; Rocha, P.; Swanson, C. M.; Schaller, T.; Ule, J.; Malim, M. H., Promiscuous RNA Binding Ensures Effective Encapsidation of APOBEC3 Proteins by HIV-1. *PLoS Pathogens* **2015**, *11* (1).
195. Landi, A.; Iannucci, V.; Nuffel, A. V.; Meuwissen, P.; Verhasselt, B., One Protein to Rule them All: Modulation of Cell Surface Receptors and Molecules by HIV Nef. *Current HIV Research* **2011**, *9* (7), 496-504.
196. Greenway, A. L.; McPhee, D. A.; Allen, K.; Johnstone, R.; Holloway, G.; Mills, J.; Azad, A.; Sankovich, S.; Lambert, P., Human Immunodeficiency Virus Type 1 Nef Binds to Tumor Suppressor p53 and Protects Cells against p53-Mediated Apoptosis. *Journal of Virology* **2002**, *76* (6), 2692-2702.
197. Rücker, E.; Grivel, J.-C.; Münch, J.; Kirchhoff, F.; Margolis, L., Vpr and Vpu Are Important for Efficient Human Immunodeficiency Virus Type 1 Replication and CD4+ T-Cell Depletion in Human Lymphoid Tissue Ex Vivo. *Journal of Virology* **2004**, *78* (22), 12689-12693.
198. Mann, J. K.; Chopera, D.; Omarjee, S.; Kuang, X. T.; Le, A. Q.; Anmole, G.; Danroth, R.; Mwimanzu, P.; Reddy, T.; Carlson, J.; Radebe, M.; Goulder, P. J. R.; Walker, B. D.; Abdool Karim, S.; Novitsky, V.; Williamson, C.; Brockman, M. A.; Brumme, Z. L.; Ndung'u, T., Nef-mediated down-regulation of CD4 and HLA class I in HIV-1 subtype C infection: association with disease progression and influence of immune pressure. *Virology* **2014**, *468-470*, 214-225.
199. Malbec, M.; Sourisseau, M.; Guivel-Benhassine, F.; Porrot, F.; Blanchet, F.; Schwartz, O.; Casartelli, N., HIV-1 Nef promotes the localization of Gag to the cell membrane and facilitates viral cell-to-cell transfer. *Retrovirology* **2013**, *10*.
200. Lundquist, C. A.; Zhou, J.; Aiken, C., Nef Stimulates Human Immunodeficiency Virus Type 1 Replication in Primary T Cells by Enhancing Virion-Associated gp120 Levels: Coreceptor-Dependent Requirement for Nef in Viral Replication. *Journal of Virology* **2004**, *78* (12), 6287-6296.
201. Tobiume, M.; Takahoko, M.; Yamada, T.; Tatsumi, M.; Iwamoto, A.; Matsuda, M., Inefficient enhancement of viral infectivity and CD4 downregulation by human immunodeficiency virus type 1 Nef from Japanese long-term nonprogressors. *Journal of Virology* **2002**, *76* (12), 5959-5965.
202. Learmont, J. C.; Geczy, A. F.; Mills, J.; Ashton, L. J.; Raynes-Greenow, C. H.; Garsia, R. J.; Dyer, W. B.; McIntyre, L.; Oelrichs, R. B.; Rhodes, D. I.; Deacon, N. J.; Sullivan, J. S., Immunologic and virologic status after 14 to 18 years of infection with an

- attenuated strain of HIV-1. A report from the Sydney Blood Bank Cohort. *N Engl J Med* **1999**, *340* (22), 1715-1722.
203. Richter, S. N.; Frasson, I.; Palù, G., Strategies for inhibiting function of HIV-1 accessory proteins: a necessary route to AIDS therapy? *Current Medicinal Chemistry* **2009**, *16* (3), 267-286.
 204. Fernandes, J.; Jayaraman, B.; Frankel, A., The HIV-1 Rev response element. *RNA Biology* **2012**, *9* (1), 6-11.
 205. Karn, J.; Stoltzfus, C. M., Transcriptional and posttranscriptional regulation of HIV-1 gene expression. *Cold Spring Harbor Perspectives in Medicine* **2012**, *2* (2), a006916.
 206. Lusvardi, S.; Sztuba-Solinska, J.; Purzycka, K. J.; Pauly, G. T.; Rausch, J. W.; Grice, S. F. J. L., The HIV-2 Rev-response element: determining secondary structure and defining folding intermediates. *Nucleic Acids Research* **2013**, *41* (13), 6637-6649.
 207. Jayaraman, B.; Crosby, D. C.; Homer, C.; Ribeiro, I.; Mavor, D.; Frankel, A. D., RNA-directed remodeling of the HIV-1 protein Rev orchestrates assembly of the Rev-Rev response element complex. *Elife* **2014**, *3*, e04120.
 208. Pugliese, A.; Vidotto, V.; Beltramo, T.; Petrini, S.; Torre, D., A review of HIV-1 Tat protein biological effects. *Cell Biochem Funct* **2005**, *23* (4), 223-227.
 209. Mann, D. A.; Frankel, A. D., Endocytosis and targeting of exogenous HIV-1 Tat protein. *The EMBO Journal* **1991**, *10* (7), 1733-1739.
 210. Paz, S.; Krainer, A. R.; Caputi, M., HIV-1 transcription is regulated by splicing factor SRSF1. *Nucleic Acids Research* **2014**, *42* (22), 13812-13823.
 211. Das, A. T.; Harwig, A.; Berkhout, B., The HIV-1 Tat Protein Has a Versatile Role in Activating Viral Transcription ∇ . *Journal of Virology* **2011**, *85* (18), 9506-9516.
 212. Karn, J., Tackling Tat. *Journal of Molecular Biology* **1999**, *293* (2), 235-254.
 213. Romani, B.; Engelbrecht, S.; Glashoff, R. H., Functions of Tat: the versatile protein of human immunodeficiency virus type 1. *Journal of General Virology* **2010**, *91* (Pt 1), 1-12.
 214. Huang, L.; Bosch, I.; Hofmann, W.; Sodroski, J.; Pardee, A. B., Tat protein induces human immunodeficiency virus type 1 (HIV-1) coreceptors and promotes infection with both macrophage-tropic and T-lymphotropic HIV-1 strains. *Journal of Virology* **1998**, *72* (11), 8952-8960.
 215. López-Huertas, M. R.; Mateos, E.; Sánchez Del Cojo, M.; Gómez-Esquer, F.; Díaz-Gil, G.; Rodríguez-Mora, S.; López, J. A.; Calvo, E.; López-Campos, G.; Alcamí, J.; Coiras, M., The presence of HIV-1 Tat protein second exon delays fas protein-mediated apoptosis in CD4⁺ T lymphocytes: a potential mechanism for persistent viral production. *The Journal of Biological Chemistry* **2013**, *288* (11), 7626-7644.
 216. McCloskey, T. W.; Ott, M.; Tribble, E.; Khan, S. A.; Teichberg, S.; Paul, M. O.; Pahwa, S.; Verdin, E.; Chirmule, N., Dual role of HIV Tat in regulation of apoptosis in T cells. *The Journal of Immunology* **1997**, *158* (2), 1014-1019.
 217. Zhong, Y.; Zhang, B.; Eum, S. Y.; Toborek, M., HIV-1 Tat triggers nuclear localization of ZO-1 via Rho signaling and cAMP response element-binding protein activation. *J Neurosci* **2012**, *32* (1), 143-150.
 218. Campbell, G. R.; Loret, E. P., What does the structure-function relationship of the HIV-1 Tat protein teach us about developing an AIDS vaccine? *Retrovirology* **2009**, *6* (1).
 219. Vignali, D. A., CD4 on the road to coreceptor status. *The Journal of Immunology* **2010**, *184* (11), 5933-5934.
 220. Freeman, M. M.; Seaman, M. S.; Rits-Volloch, S.; Hong, X.; Kao, C. Y.; Ho, D. D.; Chen, B., Crystal structure of HIV-1 primary receptor CD4 in complex with a potent antiviral antibody. *Structure* **2010**, *18* (12), 1632-1641.

221. Anderson, H. A.; Roche, P. A., MHC class II association with lipid rafts on the antigen presenting cell surface. *Biochim Biophys Acta* **2015**, *1853* (4), 775-780.
222. Dumas, F.; Preira, P.; Salome, L., Membrane organization of virus and target cell plays a role in HIV entry. *Biochimie* **2014**, *107 Pt A*, 22-27.
223. Sugden, S. M.; Bego, M. G.; Pham, T. N.; Cohen, E. A., Remodeling of the Host Cell Plasma Membrane by HIV-1 Nef and Vpu: A Strategy to Ensure Viral Fitness and Persistence. *Viruses* **2016**, *8* (3), 67.
224. Lopalco, L., CCR5: From Natural Resistance to a New Anti-HIV Strategy. *Viruses* **2010**, *2* (2), 574-600.
225. Berger, E. A.; Murphy, P. M.; Farber, J. M., Chemokine receptors as HIV-1 coreceptors: roles in viral entry, tropism, and disease. *Annu Rev Immunol* **1999**, *17*, 657-700.
226. Kedzierska, K.; Crowe, S. M., The role of monocytes and macrophages in the pathogenesis of HIV-1 infection. *Curr Med Chem* **2002**, *9* (21), 1893-1903.
227. Barmania, F.; Potgieter, M.; Pepper, M. S., Mutations in C-C chemokine receptor type 5 (CCR5) in South African individuals. *Int J Infect Dis* **2013**, *17* (12), e1148-1153.
228. Laurichesse, J. J.; Persoz, A.; Theodorou, I.; Rouzioux, C.; Delfraissy, J. F.; Meyer, L., Improved virological response to highly active antiretroviral therapy in HIV-1-infected patients carrying the CCR5 Delta32 deletion. *HIV Med* **2007**, *8* (4), 213-219.
229. Feng, Y.; Broder, C. C.; Kennedy, P. E.; Berger, E. A., HIV-1 entry cofactor: functional cDNA cloning of a seven-transmembrane, G protein-coupled receptor. *Science* **1996**, *272* (5263), 872-877.
230. Murdoch, C., CXCR4: chemokine receptor extraordinaire. *Immunological reviews* **2000**, *177*, 175-184.
231. Lin, N.; Gonzalez, O. A.; Registre, L.; Becerril, C.; Etemad, B.; Lu, H.; Wu, X.; Lockman, S.; Essex, M.; Moyo, S.; Kuritzkes, D. R.; Sagar, M., Humoral Immune Pressure Selects for HIV-1 CXC-chemokine Receptor 4-using Variants. *EBioMedicine* **2016**, *8*, 237-247.
232. Theze, J., [CD4 lymphocytes as targets and actors in the pathogenesis of HIV infection-therapeutic implications]. *Bull Acad Natl Med* **2008**, *192* (7), 1453-1466; discussion 1466-1458.
233. Verollet, C.; Le Cabec, V.; Maridonneau-Parini, I., HIV-1 Infection of T Lymphocytes and Macrophages Affects Their Migration via Nef. *Frontiers in Immunology* **2015**, *6*, 514.
234. Rottman, J. B.; Ganley, K. P.; Williams, K.; Wu, L.; Mackay, C. R.; Ringler, D. J., Cellular localization of the chemokine receptor CCR5. Correlation to cellular targets of HIV-1 infection. *The American Journal of Pathology* **1997**, *151* (5), 1341-1351.
235. Arasteh, K.; Stocker, H., Tropism switch in patients infected with HIV-1 and its clinical implications for the treatment with CCR5-receptor inhibitors. *Eur J Med Res* **2007**, *12* (9), 397-402.
236. Veazey, R. S.; Mansfield, K. G.; Tham, I. C.; Carville, A. C.; Shvetz, D. E.; Forand, A. E.; Lackner, A. A., Dynamics of CCR5 expression by CD4(+) T cells in lymphoid tissues during simian immunodeficiency virus infection. *Journal of Virology* **2000**, *74* (23), 11001-11007.
237. Barreto-de-Souza, V.; Arakelyan, A.; Margolis, L.; Vanpouille, C., HIV-1 vaginal transmission: cell-free or cell-associated virus? *Am J Reprod Immunol* **2014**, *71* (6), 589-599.
238. Keele, B. F.; Giorgi, E. E.; Salazar-Gonzalez, J. F.; Decker, J. M.; Pham, K. T.; Salazar, M. G.; Sun, C.; Grayson, T.; Wang, S.; Li, H.; Wei, X.; Jiang, C.; Kirchherr, J. L.; Gao, F.; Anderson, J. A.; Ping, L. H.; Swanstrom, R.; Tomaras, G. D.; Blattner, W. A.; Goepfert, P. A.; Kilby, J. M.; Saag, M. S.; Delwart, E. L.; Busch, M. P.; Cohen, M. S.;

- Montefiori, D. C.; Haynes, B. F.; Gaschen, B.; Athreya, G. S.; Lee, H. Y.; Wood, N.; Seoighe, C.; Perelson, A. S.; Bhattacharya, T.; Korber, B. T.; Hahn, B. H.; Shaw, G. M., Identification and characterization of transmitted and early founder virus envelopes in primary HIV-1 infection. *Proceedings of the National Academy of Sciences of the United States of America* **2008**, *105* (21), 7552-7557.
239. Joseph, S. B.; Swanstrom, R.; Kashuba, A. D.; Cohen, M. S., Bottlenecks in HIV-1 transmission: insights from the study of founder viruses. *Nature reviews. Microbiology* **2015**, *13* (7), 414-425.
240. Shen, H. S.; Yin, J.; Leng, F.; Teng, R. F.; Xu, C.; Xia, X. Y.; Pan, X. M., HIV coreceptor tropism determination and mutational pattern identification. *Sci Rep* **2016**, *6*, 21280.
241. Mortier, V.; Dauwe, K.; Vancoillie, L.; Staelens, D.; Van Wanzele, F.; Vogelaers, D.; Vandekerckhove, L.; Chalmet, K.; Verhofstede, C., Frequency and predictors of HIV-1 co-receptor switch in treatment naive patients. *PLoS ONE* **2013**, *8* (11), e80259.
242. White, E. J.; McColgan, B.; Kassaye, S.; Zijenah, L.; Katzenstein, D., Unusual five amino acid insert within subtype C HIV-1 envelope contributes to dual-tropism (X4R5). *AIDS* **2010**, *24* (7), 1063-1064.
243. Waters, L.; Mandalia, S.; Randell, P.; Wildfire, A.; Gazzard, B.; Moyle, G., The impact of HIV tropism on decreases in CD4 cell count, clinical progression, and subsequent response to a first antiretroviral therapy regimen. *Clinical Infectious Diseases: An Official Publication of the Infectious Diseases Society of America* **2008**, *46* (10), 1617-1623.
244. Mild, M.; Kvist, A.; Esbjornsson, J.; Karlsson, I.; Fenyo, E. M.; Medstrand, P., Differences in molecular evolution between switch (R5 to R5X4/X4-tropic) and non-switch (R5-tropic only) HIV-1 populations during infection. *Infect Genet Evol* **2010**, *10* (3), 356-364.
245. Yi, Y.; Shaheen, F.; Collman, R. G., Preferential use of CXCR4 by R5X4 human immunodeficiency virus type 1 isolates for infection of primary lymphocytes. *Journal of Virology* **2005**, *79* (3), 1480-1486.
246. Freed, E. O., HIV-1 assembly, release and maturation. *Nature reviews. Microbiology* **2015**, *13* (8), 484-496.
247. Volberding, P. A.; Deeks, S. G., Antiretroviral therapy and management of HIV infection. *Lancet* **2010**, *376* (9734), 49-62.
248. Ruelas, D. S.; Greene, W. C., An integrated overview of HIV-1 latency. *Cell* **2013**, *155* (3), 519-529.
249. Bosque, A.; Famiglietti, M.; Weyrich, A. S.; Goulston, C.; Planelles, V., Homeostatic proliferation fails to efficiently reactivate HIV-1 latently infected central memory CD4+ T cells. *PLoS Pathog* **2011**, *7* (10), e1002288.
250. Pasternak, A. O.; Lukashov, V. V.; Berkhout, B., Cell-associated HIV RNA: a dynamic biomarker of viral persistence. *Retrovirology* **2013**, *10*, 41.
251. Pierson, T.; Hoffman, T. L.; Blankson, J.; Finzi, D.; Chadwick, K.; Margolick, J. B.; Buck, C.; Siliciano, J. D.; Doms, R. W.; Siliciano, R. F., Characterization of chemokine receptor utilization of viruses in the latent reservoir for human immunodeficiency virus type 1. *Journal of Virology* **2000**, *74* (17), 7824-7833.
252. Tyagi, M.; Bukrinsky, M., Human Immunodeficiency Virus (HIV) Latency: The Major Hurdle in HIV Eradication. *Molecular Medicine* **2012**, *18* (1), 1096-1108.
253. Siliciano, R. F.; Greene, W. C., HIV Latency. *Cold Spring Harbor Perspectives in Medicine* **2011**, *1* (1).
254. Donahue, D. A.; Kuhl, B. D.; Sloan, R. D.; Wainberg, M. A., The viral protein Tat can inhibit the establishment of HIV-1 latency. *Journal of Virology* **2012**, *86* (6), 3253-3263.

255. Razooky, B. S.; Pai, A.; Aull, K.; Rouzine, I. M.; Weinberger, L. S., A Hardwired HIV Latency Program. *Cell* **2015**, *160* (5), 990-1001.
256. Lassen, K.; Han, Y.; Zhou, Y.; Siliciano, J.; Siliciano, R. F., The multifactorial nature of HIV-1 latency. *Trends Mol Med* **2004**, *10* (11), 525-531.
257. Cameron, P. U.; Saleh, S.; Sallmann, G.; Solomon, A.; Wightman, F.; Evans, V. A.; Boucher, G.; Haddad, E. K.; Sekaly, R.-P.; Harman, A. N.; Anderson, J. L.; Jones, K. L.; Mak, J.; Cunningham, A. L.; Jaworowski, A.; Lewin, S. R., Establishment of HIV-1 latency in resting CD4+ T cells depends on chemokine-induced changes in the actin cytoskeleton. *Proceedings of the National Academy of Sciences* **2010**, *107* (39), 16934-16939.
258. Lint, C. V.; Bouchat, S.; Marcello, A., HIV-1 transcription and latency: an update. *Retrovirology* **2013**, *10* (1).
259. Zhou, Y.; Zhang, H.; Siliciano, J. D.; Siliciano, R. F., Kinetics of Human Immunodeficiency Virus Type 1 Decay following Entry into Resting CD4+ T Cells. *Journal of Virology* **2005**, *79* (4), 2199-2210.
260. Armitage, A. E.; Deforche, K.; Chang, C.-h.; Wee, E.; Kramer, B.; Welch, J. J.; Gerstoft, J.; Fugger, L.; McMichael, A.; Rambaut, A.; Iversen, A. K. N., APOBEC3G-Induced Hypermutation of Human Immunodeficiency Virus Type-1 Is Typically a Discrete "All or Nothing" Phenomenon. *PLoS Genet* **2012**, *8* (3).
261. Amie, S. M.; Daly, M. B.; Noble, E.; Schinazi, R. F.; Bambara, R. A.; Kim, B., Anti-HIV host factor SAMHD1 regulates viral sensitivity to nucleoside reverse transcriptase inhibitors via modulation of cellular deoxyribonucleoside triphosphate (dNTP) levels. *The Journal of Biological Chemistry* **2013**, *288* (28), 20683-20691.
262. Reinhard, C.; Bottinelli, D.; Kim, B.; Luban, J., Vpx rescue of HIV-1 from the antiviral state in mature dendritic cells is independent of the intracellular deoxynucleotide concentration. *Retrovirology* **2014**, *11* (1), 1-18.
263. Busnadiego, I.; Kane, M.; Rihn, S. J.; Preugschas, H. F.; Hughes, J.; Blanco-Melo, D.; Strouvelle, V. P.; Zang, T. M.; Willett, B. J.; Boutell, C.; Bieniasz, P. D.; Wilson, S. J., Host and viral determinants of Mx2 antiretroviral activity. *Journal of Virology* **2014**, *88* (14), 7738-7752.
264. Matreyek, K. A.; Engelman, A., Viral and cellular requirements for the nuclear entry of retroviral preintegration nucleoprotein complexes. *Viruses* **2013**, *5* (10), 2483-2511.
265. Coiras, M.; Lopez-Huertas, M. R.; Perez-Olmeda, M.; Alcamí, J., Understanding HIV-1 latency provides clues for the eradication of long-term reservoirs. *Nature Reviews Microbiology* **2009**, *7* (11), 798-812.
266. Kumar, A.; Abbas, W.; Herbein, G., HIV-1 Latency in Monocytes/Macrophages. *Viruses* **2014**, *6* (4), 1837-1860.
267. Archin, N. M.; Sung, J. M.; Garrido, C.; Soriano-Sarabia, N.; Margolis, D. M., Eradicating HIV-1 infection: seeking to clear a persistent pathogen. *Nature reviews. Microbiology* **2014**, *12* (11), 750-764.
268. Friedman, J.; Cho, W. K.; Chu, C. K.; Keedy, K. S.; Archin, N. M.; Margolis, D. M.; Karn, J., Epigenetic silencing of HIV-1 by the histone H3 lysine 27 methyltransferase enhancer of Zeste 2. *Journal of Virology* **2011**, *85* (17), 9078-9089.
269. Mbonye, U.; Karn, J., Transcriptional control of HIV latency: cellular signaling pathways, epigenetics, happenstance and the hope for a cure. *Virology* **2014**, *454-455*, 328-339.
270. Ananworanich, J.; Dube, K.; Chomont, N., How does the timing of antiretroviral therapy initiation in acute infection affect HIV reservoirs? *Current Opinion in HIV and AIDS* **2015**, *10* (1), 18-28.

271. Jones, R. B.; Mueller, S.; O'Connor, R.; Rimpel, K.; Sloan, D. D.; Karel, D.; Wong, H. C.; Jeng, E. K.; Thomas, A. S.; Whitney, J. B.; Lim, S. Y.; Kovacs, C.; Benko, E.; Karandish, S.; Huang, S. H.; Buzon, M. J.; Lichterfeld, M.; Irrinki, A.; Murry, J. P.; Tsai, A.; Yu, H.; Geleziunas, R.; Trocha, A.; Ostrowski, M. A.; Irvine, D. J.; Walker, B. D., A Subset of Latency-Reversing Agents Expose HIV-Infected Resting CD4+ T-Cells to Recognition by Cytotoxic T-Lymphocytes. *PLoS Pathog* **2016**, *12* (4), e1005545.
272. Jayakumar, P.; Berger, I.; Autschbach, F.; Weinstein, M.; Funke, B.; Verdin, E.; Goldsmith, M. A.; Keppler, O. T., Tissue-resident macrophages are productively infected ex vivo by primary X4 isolates of human immunodeficiency virus type 1. *Journal of Virology* **2005**, *79* (8), 5220-5226.
273. Kumar, A.; Herbein, G., The macrophage: a therapeutic target in HIV-1 infection. *Molecular and Cellular Therapies* **2014**, *2* (1).
274. Zaikos, T. D.; Collins, K. L., Long-lived reservoirs of HIV-1. *Trends in Microbiology* **2014**, *22* (4), 173-175.
275. Coleman, C. M.; Wu, L., HIV interactions with monocytes and dendritic cells: viral latency and reservoirs. *Retrovirology* **2009**, *6*, 51.
276. Heesters, B. A.; Myers, R. C.; Carroll, M. C., Follicular dendritic cells: dynamic antigen libraries. *Nature Reviews Immunology* **2014**, *14* (7), 495-504.
277. Durand, C. M.; Ghiaur, G.; Siliciano, J. D.; Rabi, S. A.; Eisele, E. E.; Salgado, M.; Shan, L.; Lai, J. F.; Zhang, H.; Margolick, J.; Jones, R. J.; Gallant, J. E.; Ambinder, R. F.; Siliciano, R. F., HIV-1 DNA is detected in bone marrow populations containing CD4+ T cells but is not found in purified CD34+ hematopoietic progenitor cells in most patients on antiretroviral therapy. *J Infect Dis* **2012**, *205* (6), 1014-1018.
278. Flynn, J. K.; Gorry, P. R., Stem memory T cells (TSCM)—their role in cancer and HIV immunotherapies. *Clinical & Translational Immunology* **2014**, *3* (7).
279. Saksena, N. K.; Potter, S. J., Reservoirs of HIV-1 in vivo: implications for antiretroviral therapy. *AIDS reviews* **2003**, *5* (1), 3-18.
280. Chun, T. W.; Nickle, D. C.; Justement, J. S.; Meyers, J. H.; Roby, G.; Hallahan, C. W.; Kottlilil, S.; Moir, S.; Mican, J. M.; Mullins, J. I.; Ward, D. J.; Kovacs, J. A.; Mannon, P. J.; Fauci, A. S., Persistence of HIV in gut-associated lymphoid tissue despite long-term antiretroviral therapy. *J Infect Dis* **2008**, *197* (5), 714-720.
281. Jambo, K. C.; Banda, D. H.; Kankwatira, A. M.; Sukumar, N.; Allain, T. J.; Heyderman, R. S.; Russell, D. G.; Mwandumba, H. C., Small alveolar macrophages are infected preferentially by HIV and exhibit impaired phagocytic function. *Mucosal Immunol* **2014**, *7* (5), 1116-1126.
282. Abbas, W.; Tariq, M.; Iqbal, M.; Kumar, A.; Herbein, G., Eradication of HIV-1 from the macrophage reservoir: an uncertain goal? *Viruses* **2015**, *7* (4), 1578-1598.
283. Calcagno, A.; Simiele, M.; Alberione, M. C.; Bracchi, M.; Marinaro, L.; Ecclesia, S.; Di Perri, G.; D'Avolio, A.; Bonora, S., Cerebrospinal fluid inhibitory quotients of antiretroviral drugs in HIV-infected patients are associated with compartmental viral control. *Clinical Infectious Diseases: An Official Publication of the Infectious Diseases Society of America* **2015**, *60* (2), 311-317.
284. Zhang, H.; Dornadula, G.; Beumont, M.; Livornese, L., Jr.; Van Uitert, B.; Henning, K.; Pomerantz, R. J., Human immunodeficiency virus type 1 in the semen of men receiving highly active antiretroviral therapy. *N Engl J Med* **1998**, *339* (25), 1803-1809.
285. Cory, T. J.; Schacker, T. W.; Stevenson, M.; Fletcher, C. V., Overcoming pharmacologic sanctuaries. *Current Opinion in HIV and AIDS* **2013**, *8* (3), 190-195.

286. Voronin, Y.; Manrique, A.; Bernstein, A., The future of HIV vaccine research and the role of the Global HIV Vaccine Enterprise. *Current Opinion in HIV and AIDS* **2010**, *5* (5), 414-420.
287. Goudsmit, J.; Back, N. K.; Nara, P. L., Genomic diversity and antigenic variation of HIV-1: links between pathogenesis, epidemiology and vaccine development. *The FASEB Journal* **1991**, *5* (10), 2427-2436.
288. Garcia, F.; Leon, A.; Gatell, J. M.; Plana, M.; Gallart, T., Therapeutic vaccines against HIV infection. *Hum Vaccin Immunother* **2012**, *8* (5), 569-581.
289. Poon, B.; Hsu, J. F.; Gudeman, V.; Chen, I. S.; Grovit-Ferbas, K., Formaldehyde-treated, heat-inactivated virions with increased human immunodeficiency virus type 1 env can be used to induce high-titer neutralizing antibody responses. *Journal of Virology* **2005**, *79* (16), 10210-10217.
290. Gil, C.; Climent, N.; Garcia, F.; Hurtado, C.; Nieto-Marquez, S.; Leon, A.; Garcia, M. T.; Rovira, C.; Miralles, L.; Dalmau, J.; Pumarola, T.; Almela, M.; Martinez-Picado, J.; Lifson, J. D.; Zamora, L.; Miro, J. M.; Brander, C.; Clotet, B.; Gallart, T.; Gatell, J. M., Ex vivo production of autologous whole inactivated HIV-1 for clinical use in therapeutic vaccines. *Vaccine* **2011**, *29* (34), 5711-5724.
291. Grovit-Ferbas, K.; Hsu, J. F.; Ferbas, J.; Gudeman, V.; Chen, I. S., Enhanced binding of antibodies to neutralization epitopes following thermal and chemical inactivation of human immunodeficiency virus type 1. *Journal of Virology* **2000**, *74* (13), 5802-5809.
292. Sheppard, H. W., Inactivated- or killed-virus HIV/AIDS vaccines. *Curr Drug Targets Infect Disord* **2005**, *5* (2), 131-141.
293. Carter, D.; Reed, S. G., Role of adjuvants in modeling the immune response. *Current Opinion in HIV and AIDS* **2010**, *5* (5), 409-413.
294. Daniel, M. D.; Kirchhoff, F.; Czajak, S. C.; Sehgal, P. K.; Desrosiers, R. C., Protective effects of a live attenuated SIV vaccine with a deletion in the nef gene. *Science* **1992**, *258* (5090), 1938-1941.
295. Paul, W. E., Can the immune response control HIV infection? *Cell* **1995**, *82* (2), 177-182.
296. Yu, H. T.; Wang, J. Y.; Tian, D.; Wang, M. X.; Li, Y.; Yuan, L.; Chen, W. J.; Li, D.; Zhuang, M.; Ling, H., Comparison of the patterns of antibody recall responses to HIV-1 gp120 and hepatitis B surface antigen in immunized mice. *Vaccine* **2016**, *34* (50), 6276-6284.
297. Gong, Z.; Martin-Garcia, J. M.; Daskalova, S. M.; Craciunescu, F. M.; Song, L.; Dorner, K.; Hansen, D. T.; Yang, J. H.; LaBaer, J.; Hogue, B. G.; Mor, T. S.; Fromme, P., Biophysical Characterization of a Vaccine Candidate against HIV-1: The Transmembrane and Membrane Proximal Domains of HIV-1 gp41 as a Maltose Binding Protein Fusion. *PLoS ONE* **2015**, *10* (8), e0136507.
298. Excler, J. L.; Michael, N. L., Lessons from HIV-1 vaccine efficacy trials. *Current Opinion in HIV and AIDS* **2016**, *11* (6), 607-613.
299. Ondondo, B. O., The influence of delivery vectors on HIV vaccine efficacy. *Frontiers in Microbiology* **2014**, *5*, 439.
300. Barouch, D. H.; Picker, L. J., Novel vaccine vectors for HIV-1. *Nature reviews. Microbiology* **2014**, *12* (11), 765-771.
301. Clarke, D. K.; Hendry, R. M.; Singh, V.; Rose, J. K.; Seligman, S. J.; Klug, B.; Kochhar, S.; Mac, L. M.; Carbery, B.; Chen, R. T., Live virus vaccines based on a vesicular stomatitis virus (VSV) backbone: Standardized template with key considerations for a risk/benefit assessment. *Vaccine* **2016**, *34* (51), 6597-6609.
302. Gray, G. E.; Mayer, K. H.; Elizaga, M. L.; Bekker, L. G.; Allen, M.; Morris, L.; Montefiori, D.; De Rosa, S. C.; Sato, A.; Gu, N.; Tomaras, G. D.; Tucker, T.; Barnett,

- S. W.; Mkhize, N. N.; Shen, X.; Downing, K.; Williamson, C.; Pensiero, M.; Corey, L.; Williamson, A. L., Subtype C gp140 Vaccine Boosts Immune Responses Primed by the South African AIDS Vaccine Initiative DNA-C2 and MVA-C HIV Vaccines after More than a 2-Year Gap. *Clin Vaccine Immunol* **2016**, *23* (6), 496-506.
303. Haynes, B. F., New approaches to HIV vaccine development. *Curr Opin Immunol* **2015**, *35*, 39-47.
304. Holvold, L. B.; Myhr, A. I.; Dalmo, R. A., Strategies and hurdles using DNA vaccines to fish. *Vet Res* **2014**, *45*, 21.
305. Ingolotti, M.; Kawalekar, O.; Shedlock, D. J.; Muthumani, K.; Weiner, D. B., DNA vaccines for targeting bacterial infections. *Expert Rev Vaccines* **2010**, *9* (7), 747-763.
306. Saade, F.; Petrovsky, N., Technologies for enhanced efficacy of DNA vaccines. *Expert Rev Vaccines* **2012**, *11* (2), 189-209.
307. Arrode-Bruses, G.; Moussa, M.; Baccard-Longere, M.; Villinger, F.; Chebloune, Y., Long-term central and effector SHIV-specific memory T cell responses elicited after a single immunization with a novel lentivector DNA vaccine. *PLoS ONE* **2014**, *9* (10), e110883.
308. Moussa, M.; Arrode-Bruses, G.; Manoylov, I.; Malogolovkin, A.; Mompelat, D.; Ishimwe, H.; Smaoune, A.; Ouzrout, B.; Gagnon, J.; Chebloune, Y., A novel non-integrative single-cycle chimeric HIV lentivector DNA vaccine. *Vaccine* **2015**, *33* (19), 2273-2282.
309. Shin, S. Y., Recent update in HIV vaccine development. *Clin Exp Vaccine Res* **2016**, *5* (1), 6-11.
310. Shibata, R.; Adachi, A., SIV/HIV recombinants and their use in studying biological properties. *AIDS Research and Human Retroviruses* **1992**, *8* (3), 403-409.
311. Reimann, K. A.; Li, J. T.; Veazey, R.; Halloran, M.; Park, I. W.; Karlsson, G. B.; Sodroski, J.; Letvin, N. L., A chimeric simian/human immunodeficiency virus expressing a primary patient human immunodeficiency virus type 1 isolate env causes an AIDS-like disease after in vivo passage in rhesus monkeys. *Journal of Virology* **1996**, *70* (10), 6922-6928.
312. Li, J.; Lord, C. I.; Haseltine, W.; Letvin, N. L.; Sodroski, J., Infection of cynomolgus monkeys with a chimeric HIV-1/SIVmac virus that expresses the HIV-1 envelope glycoproteins. *J Acquir Immune Defic Syndr* **1992**, *5* (7), 639-646.
313. Joag, S. V.; Li, Z.; Foresman, L.; Stephens, E. B.; Zhao, L. J.; Adany, I.; Pinson, D. M.; McClure, H. M.; Narayan, O., Chimeric simian/human immunodeficiency virus that causes progressive loss of CD4+ T cells and AIDS in pig-tailed macaques. *Journal of Virology* **1996**, *70* (5), 3189-3197.
314. Lu, Y.; Salvato, M. S.; Pauza, C. D.; Li, J.; Sodroski, J.; Manson, K.; Wyand, M.; Letvin, N.; Jenkins, S.; Touzjian, N.; Chutkowski, C.; Kushner, N.; LeFaile, M.; Payne, L. G.; Roberts, B., Utility of SHIV for testing HIV-1 vaccine candidates in macaques. *J Acquir Immune Defic Syndr Hum Retrovirol* **1996**, *12* (2), 99-106.
315. Tasca, S.; Tsai, L.; Trunova, N.; Gettie, A.; Saifuddin, M.; Bohm, R.; Chakrabarti, L.; Cheng-Mayer, C., Induction of potent local cellular immunity with low dose X4 SHIV(SF33A) vaginal exposure. *Virology* **2007**, *367* (1), 196-211.
316. Nishimura, Y.; Brown, C. R.; Mattapallil, J. J.; Igarashi, T.; Buckler-White, A.; Lafont, B. A.; Hirsch, V. M.; Roederer, M.; Martin, M. A., Resting naive CD4+ T cells are massively infected and eliminated by X4-tropic simian-human immunodeficiency viruses in macaques. *Proceedings of the National Academy of Sciences of the United States of America* **2005**, *102* (22), 8000-8005.

317. Mumbauer, A.; Gettie, A.; Blanchard, J.; Cheng-Mayer, C., Efficient mucosal transmissibility but limited pathogenicity of R5 SHIV SF162P3N in Chinese-origin rhesus macaques. *J Acquir Immune Defic Syndr* **2013**, *62* (5), 496-504.
318. Ren, W.; Mumbauer, A.; Zhuang, K.; Harbison, C.; Knight, H.; Westmoreland, S.; Gettie, A.; Blanchard, J.; Cheng-Mayer, C., Mucosal transmissibility, disease induction and coreceptor switching of R5 SHIVSF162P3N molecular clones in rhesus macaques. *Retrovirology* **2013**, *10*, 9.
319. Nishimura, Y.; Shingai, M.; Willey, R.; Sadjadpour, R.; Lee, W. R.; Brown, C. R.; Brenchley, J. M.; Buckler-White, A.; Petros, R.; Eckhaus, M.; Hoffman, V.; Igarashi, T.; Martin, M. A., Generation of the pathogenic R5-tropic simian/human immunodeficiency virus SHIVAD8 by serial passaging in rhesus macaques. *Journal of Virology* **2010**, *84* (9), 4769-4781.
320. Harouse, J. M.; Gettie, A.; Tan, R. C.; Blanchard, J.; Cheng-Mayer, C., Distinct pathogenic sequela in rhesus macaques infected with CCR5 or CXCR4 utilizing SHIVs. *Science* **1999**, *284* (5415), 816-819.
321. Asmal, M.; Luedemann, C.; Lavine, C. L.; Mach, L. V.; Balachandran, H.; Brinkley, C.; Denny, T. N.; Lewis, M. G.; Anderson, H.; Pal, R.; Sok, D.; Le, K.; Pauthner, M.; Hahn, B. H.; Shaw, G. M.; Seaman, M. S.; Letvin, N. L.; Burton, D. R.; Sodroski, J. G.; Haynes, B. F.; Santra, S., Infection of monkeys by simian-human immunodeficiency viruses with transmitted/founder clade C HIV-1 envelopes. *Virology* **2015**, *475*, 37-45.
322. Minardi da Cruz, J. C.; Singh, D. K.; Lamara, A.; Chebloune, Y., Small ruminant lentiviruses (SRLVs) break the species barrier to acquire new host range. *Viruses* **2013**, *5* (7), 1867-1884.
323. Reina, R.; de Andres, D.; Amorena, B., Immunization against small ruminant lentiviruses. *Viruses* **2013**, *5* (8), 1948-1963.
324. Morner, A.; Bjorndal, A.; Albert, J.; Kewalramani, V. N.; Littman, D. R.; Inoue, R.; Thorstensson, R.; Fenyo, E. M.; Bjorling, E., Primary human immunodeficiency virus type 2 (HIV-2) isolates, like HIV-1 isolates, frequently use CCR5 but show promiscuity in coreceptor usage. *Journal of Virology* **1999**, *73* (3), 2343-2349.
325. Escarpe, P.; Zayek, N.; Chin, P.; Borellini, F.; Zufferey, R.; Veres, G.; Kiermer, V., Development of a sensitive assay for detection of replication-competent recombinant lentivirus in large-scale HIV-based vector preparations. *Mol Ther* **2003**, *8* (2), 332-341.
326. Hematian, A.; Sadeghifard, N.; Mohebi, R.; Taherikalani, M.; Nasrolahi, A.; Amraei, M.; Ghafourian, S., Traditional and Modern Cell Culture in Virus Diagnosis. *Osong Public Health Res Perspect* **2016**, *7* (2), 77-82.
327. Moore, J. P.; Kitchen, S. G.; Pugach, P.; Zack, J. A., The CCR5 and CXCR4 coreceptors--central to understanding the transmission and pathogenesis of human immunodeficiency virus type 1 infection. *AIDS Research and Human Retroviruses* **2004**, *20* (1), 111-126.
328. Polzer, S.; Dittmar, M. T.; Schmitz, H.; Schreiber, M., The N-linked glycan g15 within the V3 loop of the HIV-1 external glycoprotein gp120 affects coreceptor usage, cellular tropism, and neutralization. *Virology* **2002**, *304* (1), 70-80.
329. Dejuq, N.; Simmons, G.; Clapham, P. R., Expanded tropism of primary human immunodeficiency virus type 1 R5 strains to CD4(+) T-cell lines determined by the capacity to exploit low concentrations of CCR5. *Journal of Virology* **1999**, *73* (9), 7842-7847.
330. Woollard, S. M.; Kanmogne, G. D., Maraviroc: a review of its use in HIV infection and beyond. *Drug Des Devel Ther* **2015**, *9*, 5447-5468.
331. Arruda, L. B.; Araujo, M. L.; Martinez, M. L.; Gonzalez, C. R.; Duarte, A. J.; Coakley, E.; Lie, Y.; Casseb, J., Determination of viral tropism by genotyping and phenotyping

- assays in Brazilian HIV-1-infected patients. *Rev Inst Med Trop Sao Paulo* **2014**, *56* (4), 287-290.
332. Ceresola, E. R.; Nozza, S.; Sampaolo, M.; Pignataro, A. R.; Saita, D.; Ferrarese, R.; Ripa, M.; Deng, W.; Mullins, J. I.; Boeri, E.; Tambussi, G.; Toniolo, A.; Lazzarin, A.; Clementi, M.; Canducci, F., Performance of commonly used genotypic assays and comparison with phenotypic assays of HIV-1 coreceptor tropism in acutely HIV-1-infected patients. *J Antimicrob Chemother* **2015**, *70* (5), 1391-1395.
333. Wu, X.; Parast, A. B.; Richardson, B. A.; Nduati, R.; John-Stewart, G.; Mbori-Ngacha, D.; Rainwater, S. M.; Overbaugh, J., Neutralization escape variants of human immunodeficiency virus type 1 are transmitted from mother to infant. *Journal of Virology* **2006**, *80* (2), 835-844.
334. Jasinghe, V. J.; Peyrotte, E. A.; Meyers, A. F.; Gajanayaka, N.; Ball, T. B.; Sandstrom, P.; Lavigne, C., Human rElafin Inhibits HIV-1 Replication in Its Natural Target Cells. *Biores Open Access* **2013**, *2* (2), 128-137.
335. Baba, M.; Miyake, H.; Okamoto, M.; Iizawa, Y.; Okonogi, K., Establishment of a CCR5-expressing T-lymphoblastoid cell line highly susceptible to R5 HIV type 1. *AIDS Research and Human Retroviruses* **2000**, *16* (10), 935-941.
336. Dillon, S. M.; Lee, E. J.; Donovan, A. M.; Guo, K.; Harper, M. S.; Frank, D. N.; McCarter, M. D.; Santiago, M. L.; Wilson, C. C., Enhancement of HIV-1 infection and intestinal CD4+ T cell depletion ex vivo by gut microbes altered during chronic HIV-1 infection. *Retrovirology* **2016**, *13*, 5.
337. Rimsky, L. T.; Shugars, D. C.; Matthews, T. J., Determinants of human immunodeficiency virus type 1 resistance to gp41-derived inhibitory peptides. *Journal of Virology* **1998**, *72* (2), 986-993.
338. Harada, S.; Koyanagi, Y.; Yamamoto, N., Infection of HTLV-III/LAV in HTLV-I-carrying cells MT-2 and MT-4 and application in a plaque assay. *Science* **1985**, *229* (4713), 563-566.
339. Lusso, P.; Cocchi, F.; Balotta, C.; Markham, P. D.; Louie, A.; Farci, P.; Pal, R.; Gallo, R. C.; Reitz, M. S., Jr., Growth of macrophage-tropic and primary human immunodeficiency virus type 1 (HIV-1) isolates in a unique CD4+ T-cell clone (PM1): failure to downregulate CD4 and to interfere with cell-line-tropic HIV-1. *Journal of Virology* **1995**, *69* (6), 3712-3720.
340. Cao, J.; Isaacson, J.; Patick, A. K.; Blair, W. S., High-throughput human immunodeficiency virus type 1 (HIV-1) full replication assay that includes HIV-1 Vif as an antiviral target. *Antimicrobial Agents and Chemotherapy* **2005**, *49* (9), 3833-3841.
341. Kwofie, T.; Miura, T., Increased Virus Replication and Cytotoxicity of Non-pathogenic Simian Human Immuno Deficiency Viruses-NM-3rN After Serial Passage in a Monkey-Derived Cell Line. *Annals of Medical and Health Sciences Research* **2013**, *3* (1), 55-61.
342. Song, R. J.; Chenine, A. L.; Rasmussen, R. A.; Ruprecht, C. R.; Mirshahidi, S.; Grisson, R. D.; Xu, W.; Whitney, J. B.; Goins, L. M.; Ong, H.; Li, P. L.; Shai-Kobiler, E.; Wang, T.; McCann, C. M.; Zhang, H.; Wood, C.; Kankasa, C.; Secor, W. E.; McClure, H. M.; Strobert, E.; Else, J. G.; Ruprecht, R. M., Molecularly cloned SHIV-1157ipd3N4: a highly replication-competent, mucosally transmissible R5 simian-human immunodeficiency virus encoding HIV clade C Env. *Journal of Virology* **2006**, *80* (17), 8729-8738.
343. Burton, D. R.; Mascola, J. R., Antibody responses to envelope glycoproteins in HIV-1 infection. *Nat Immunol* **2015**, *16* (6), 571-576.
344. Gray, E. S.; Moore, P. L.; Choge, I. A.; Decker, J. M.; Bibollet-Ruche, F.; Li, H.; Leseka, N.; Treurnicht, F.; Mlisana, K.; Shaw, G. M.; Karim, S. S.; Williamson, C.;

- Morris, L., Neutralizing antibody responses in acute human immunodeficiency virus type 1 subtype C infection. *Journal of Virology* **2007**, *81* (12), 6187-6196.
345. Rong, R.; Li, B.; Lynch, R. M.; Haaland, R. E.; Murphy, M. K.; Mulenga, J.; Allen, S. A.; Pinter, A.; Shaw, G. M.; Hunter, E.; Robinson, J. E.; Gnanakaran, S.; Derdeyn, C. A., Escape from autologous neutralizing antibodies in acute/early subtype C HIV-1 infection requires multiple pathways. *PLoS Pathog* **2009**, *5* (9), e1000594.
346. Haynes, B. F.; McElrath, M. J., Progress in HIV-1 vaccine development. *Current Opinion in HIV and AIDS* **2013**, *8* (4), 326-332.
347. Ringe, R.; Bhattacharya, J., Preventive and therapeutic applications of neutralizing antibodies to Human Immunodeficiency Virus Type 1 (HIV-1). *Ther Adv Vaccines* **2013**, *1* (2), 67-80.
348. Landais, E.; Huang, X.; Havenar-Daughton, C.; Murrell, B.; Price, M. A.; Wickramasinghe, L.; Ramos, A.; Bian, C. B.; Simek, M.; Allen, S.; Karita, E.; Kilembe, W.; Lakhi, S.; Inambao, M.; Kamali, A.; Sanders, E. J.; Anzala, O.; Edward, V.; Bekker, L. G.; Tang, J.; Gilmour, J.; Kosakovsky-Pond, S. L.; Phung, P.; Wrin, T.; Crotty, S.; Godzik, A.; Poignard, P., Broadly Neutralizing Antibody Responses in a Large Longitudinal Sub-Saharan HIV Primary Infection Cohort. *PLoS Pathog* **2016**, *12* (1), e1005369.
349. Moody, M. A.; Gao, F.; Gurley, T. C.; Amos, J. D.; Kumar, A.; Hora, B.; Marshall, D. J.; Whitesides, J. F.; Xia, S. M.; Parks, R.; Lloyd, K. E.; Hwang, K. K.; Lu, X.; Bonsignori, M.; Finzi, A.; Vandergrift, N. A.; Alam, S. M.; Ferrari, G.; Shen, X.; Tomaras, G. D.; Kamanga, G.; Cohen, M. S.; Sam, N. E.; Kapiga, S.; Gray, E. S.; Tumba, N. L.; Morris, L.; Zolla-Pazner, S.; Gorny, M. K.; Mascola, J. R.; Hahn, B. H.; Shaw, G. M.; Sodroski, J. G.; Liao, H. X.; Montefiori, D. C.; Hraber, P. T.; Korber, B. T.; Haynes, B. F., Strain-Specific V3 and CD4 Binding Site Autologous HIV-1 Neutralizing Antibodies Select Neutralization-Resistant Viruses. *Cell Host & Microbe* **2015**, *18* (3), 354-362.
350. Baba, T. W.; Liska, V.; Hofmann-Lehmann, R.; Vlasak, J.; Xu, W.; Ayehunie, S.; Cavacini, L. A.; Posner, M. R.; Katinger, H.; Stiegler, G.; Bernacky, B. J.; Rizvi, T. A.; Schmidt, R.; Hill, L. R.; Keeling, M. E.; Lu, Y.; Wright, J. E.; Chou, T. C.; Ruprecht, R. M., Human neutralizing monoclonal antibodies of the IgG1 subtype protect against mucosal simian-human immunodeficiency virus infection. *Nature Medicine* **2000**, *6* (2), 200-206.
351. Hessel, A. J.; Hangartner, L.; Hunter, M.; Havenith, C. E.; Beurskens, F. J.; Bakker, J. M.; Lanigan, C. M.; Landucci, G.; Forthal, D. N.; Parren, P. W.; Marx, P. A.; Burton, D. R., Fc receptor but not complement binding is important in antibody protection against HIV. *Nature* **2007**, *449* (7158), 101-104.
352. Miyake, H.; Iizawa, Y.; Baba, M., Novel reporter T-cell line highly susceptible to both CCR5- and CXCR4-using human immunodeficiency virus type 1 and its application to drug susceptibility tests. *Journal of Clinical Microbiology* **2003**, *41* (6), 2515-2521.
353. Malbec, M.; Porrot, F.; Rua, R.; Horwitz, J.; Klein, F.; Halper-Stromberg, A.; Scheid, J. F.; Eden, C.; Mouquet, H.; Nussenzweig, M. C.; Schwartz, O., Broadly neutralizing antibodies that inhibit HIV-1 cell to cell transmission. *The Journal of Experimental Medicine* **2013**, *210* (13), 2813-2821.
354. Scharf, L.; Scheid, J. F.; Lee, J. H.; West, A. P., Jr.; Chen, C.; Gao, H.; Gnanapragasam, P. N.; Mares, R.; Seaman, M. S.; Ward, A. B.; Nussenzweig, M. C.; Bjorkman, P. J., Antibody 8ANC195 reveals a site of broad vulnerability on the HIV-1 envelope spike. *Cell Rep* **2014**, *7* (3), 785-795.

355. Zhang, Y. J.; Fredriksson, R.; McKeating, J. A.; Fenyo, E. M., Passage of HIV-1 molecular clones into different cell lines confers differential sensitivity to neutralization. *Virology* **1997**, *238* (2), 254-264.
356. Kortesisidis, A.; Zannettino, A.; Isenmann, S.; Shi, S.; Lapidot, T.; Gronthos, S., Stromal-derived factor-1 promotes the growth, survival, and development of human bone marrow stromal stem cells. *Blood* **2005**, *105* (10), 3793-3801.
357. Hatziioannou, T.; Evans, D. T., Animal models for HIV/AIDS research. *Nature reviews. Microbiology* **2012**, *10* (12), 852-867.
358. Yeh, W. W.; Rahman, I.; Hraber, P.; Coffey, R. T.; Nevidomskyte, D.; Giri, A.; Asmal, M.; Miljkovic, S.; Daniels, M.; Whitney, J. B.; Keele, B. F.; Hahn, B. H.; Korber, B. T.; Shaw, G. M.; Seaman, M. S.; Letvin, N. L., Autologous neutralizing antibodies to the transmitted/founder viruses emerge late after simian immunodeficiency virus SIVmac251 infection of rhesus monkeys. *Journal of Virology* **2010**, *84* (12), 6018-6032.

VII. Summary in French.

Le syndrome d'immunodéficience acquise (SIDA) est induit par le virus de l'immunodéficience humaine de type 1 (VIH-1). Le SIDA est une des principales causes de mortalité dans le monde. L'infection par le VIH-1 induit une activation immunitaire chronique entraînant une déplétion progressive des lymphocytes T CD4⁺ circulant et dans les organes, ce qui provoque le développement du SIDA. Ce dernier est caractérisé par l'apparition et la prolifération de pathogènes infectieux opportunistes. Les premières indications de cette maladie remontent au début des années 1980 avec l'identification de la prolifération de pneumocystose chez les homosexuels aux Etats Unis. En 1983, un retrovirus du genre lentivirus fut isolé par des chercheurs de l'Institut Pasteur à partir du ganglion lymphatique d'un patient. Ce virus associé à une lymphadénopathie fut initialement appelé virus T-lymphotrope humain de type III (ou HTLV-III en anglais). Cependant, en 1986, le Comité International de Taxonomie des Virus a recommandé le terme de VIH-1 pour ce virus responsable du SIDA.

Le VIH-1 appartient au genre *Lentivirus*, de la sous-famille des *Orthoretrovirinae* et de la famille des *Retroviridae*. En plus d'un second lentivirus VIH-2 chez l'homme, ce genre contient des virus qui infectent les plusieurs espèces de vertébrés. On trouve un groupe de virus de l'immunodéficience simienne (SIV) qui infectent plusieurs espèces de primates non-humains ; le virus de l'immunodéficience bovine (BIV) ; le virus de l'anémie infectieuse des équidés (EAIV) ; le virus de l'immunodéficience féline (FIV) : le lentivirus du puma (PLV), le virus maedi-visna du mouton (MVM), le virus de l'arthrite et de l'encéphalite caprine (CAEV). Ces deux derniers sont regroupés dans un sous-groupe appelé lentivirus des petits ruminants (SRLV pour small ruminant lentiviruses) et il a été établi que les SIVcpz et SIVgor ont franchi la barrière d'espèces, du chimpanzé et du gorille vers l'homme respectivement, générant le VIH-1. Le VIH-1 est constitué de quatre groupes : les groupes M et N résultent du virus de chimpanzé (SIVcpz) tandis que les groupes O et P dérivent du gorille (SIVgor). Le virus de l'immunodéficience humaine de type 2 (VIH-2) a d'abord été trouvé en Afrique de l'Ouest au milieu des années 1980. Le réservoir naturel de ce virus est chez le singe Mangabey couronné (SIVsmm) qui après passage et adaptation chez l'homme est devenu VIH-2. Le VIH-2 se répartit en huit groupes distincts typés de A à H. Le génome du VIH-2 est similaire à celui du VIH-1 dans son organisation et sa répllication, avec l'exception que le génome du VIH-2 porte un gène accessoire *vpx*, absent dans celui du VIH-1 et à l'inverse le gène *vpu*, présent dans le génome de VIH-1 est absent dans celui du VIH-2. La transmission interhumaine du VIH-1 s'effectue essentiellement lors, de rapports sexuels non protégés entre personnes infectées et non-

infectées, de l'injection de drogue avec des seringues/aiguilles souillées, de la transmission de la mère au nouveau-né lors de la naissance et l'allaitement et de la transfusion de sang contaminé. Depuis son apparition, environ 80 millions d'individus dans le monde entier ont été infectés par le VIH-1 : près de la moitié d'entre eux sont déjà décédés et l'autre moitié vit avec le virus. Cependant, les thérapies antirétrovirales récentes (ART) ont permis de réduire fortement la mortalité en permettant aux personnes infectées de survivre plus longtemps, mais aussi de réduire la transmission interhumaine.

Sur le plan structural, le VIH est un virus comportant deux molécules identiques d'ARN monocaténaire logées dans une capsidie sphérique, qui elle-même est entourée d'une bicouche lipidique externe provenant de la membrane de la cellule hôte. Le génome des rétrovirus réplicatifs porte au moins trois gènes dit de structure : *gag*, *pol* et *env* compris entre deux longues séquences répétées terminales (LTR). Les protéines de la capsidie sont codées par le gène *gag*, les glycoprotéines de l'enveloppe sont codées par le gène *env* et les enzymes virales de réplication sont codées par le gène *pol*. En plus de ces trois gènes, le génome du VIH-1 porte également des gènes régulateurs et accessoires (*tat*, *rev*, *nef*, *vif*, *vpr* et *vpu*) qui expriment des protéines qui régulent la réplication virale et la pathogénèse.

Cycle de réplication du VIH : L'entrée du virus dans la cellule cible commence par l'interaction de la glycoprotéine de surface SU du virus avec le récepteur membranaire CD4 de la cellule hôte. Cette première étape est suivie d'une seconde interaction avec un co-récepteur (CCR5 ou CXCR4) induisant des changements de conformation dans la glycoprotéine transmembranaire TM qui permettent de démasquer le peptide fusion de celle-ci qui permet au virus de fusionner sa membrane glycoprotéique avec la membrane de la cellule cible. La capsidie virale est alors internalisée dans le cytoplasme de la cellule infectée et la RT convertit l'ARN en un ADN double brins borné par des séquences répétées terminales : les LTRs. Cet ADN est transporté dans le noyau par le complexe de préintégration puis intégré par l'IN sous forme de provirus dans le génome cellulaire. Le provirus utilise la machinerie cellulaire pour la transcription et la traduction des gènes, produisant les protéines virales qui s'assemblent avec l'ARN viral et bourgeonnent hors de la cellule hôte et mûrent en particules infectieuses. Les principales étapes du cycle de réplication du VIH-1, représentent les cibles essentielles des médicaments développés pour combattre le virus. Un assemblage de ces médicaments est aujourd'hui à la base d'un traitement antirétroviral hautement actif (HAART en anglais) qui aide à la survie des patients infectés.

La molécule **CD4** est une glycoprotéine présente à la surface de certains globules blancs, tels que certains lymphocytes T, les monocytes, les macrophages et les cellules dendritiques. Ce récepteur CD4 interagit directement avec la molécule du complexe majeur d'histocompatibilité de classe II (MHC classe II) à la surface de la cellule présentatrice d'antigènes (CPA) pour la reconnaissance de l'antigène étranger, conduisant à l'activation des lymphocytes T. Le VIH-1 utilise cette molécule comme récepteur principal pour l'entrée dans la cellule cible. Les protéines virales Vpu et Nef exprimées par les cellules infectées diminuent la quantité de CD4 à la surface, empêchant ainsi la surinfection des cellules déjà infectées. En plus de ce récepteur principal le VIH-1 utilise des corécepteurs membranaires pour accomplir son entrée dans la cellule cible. Les co-récepteurs utilisés principalement par VIH-1 sont les récepteurs aux chimiokines : CCR5 et CXCR4. Le tropisme viral indique la préférence du virus à se lier à un des co-récepteurs de la cellule hôte. On distingue trois types de souches de VIH-1 : la R5-tropique utilise le co-récepteur CCR5, la X4-tropique utilise le co-récepteur CXCR4 et enfin la X4/R5-tropique utilise soit l'un soit l'autre co-récepteur. La souche de type R5, responsable de la dissémination de l'infection dans l'organisme est principalement trouvée au début d'infection, alors que les souches X4 ou R5/X4 apparaissent plus tardivement.

La **latence** définit l'ADN viral dormant dans les cellules infectées. Elle concerne une faible proportion ($1/10^6$ - 10^7) de cellules infectées, et a lieu soit avant l'intégration de l'ADN virale : latence pré-intégration, soit après l'intégration : latence post-intégration. Cette dernière est la plus fréquente. La latence s'établit au début de l'infection aiguë pour établir le réservoir. Le réservoir cellulaire le plus important est constitué de cellules T mémoires CD4+ qui maintiennent le provirus sous forme latente. Les monocytes, les macrophages, les cellules souches hématopoïétiques, et les cellules dendritiques contribuent également au réservoir cellulaire du VIH-1. De plus, le foie, le système nerveux central, les reins, les poumons et les organes génitaux représentent des tissus anatomiques sanctuaires pour le virus. Les organes lymphoïdes, la rate, les ganglions lymphatiques et le tissu lymphoïde associé au tube digestif (GALT en anglais) sont des sites majeurs de la réplication virale. Malheureusement, la barrière hémato-encéphalique limite l'entrée des agents utilisés dans le traitement HAART dans le système nerveux central. De même le tractus reproducteur féminin est peu permissif à ces agents et de ce fait il est donc difficile de purger complètement le virus de l'organisme.

Vaccins contre le VIH-1 : Depuis la découverte du VIH-1, des travaux très importants ont été réalisés pour développer un vaccin sûr, efficace et durable pour stopper le VIH. Mais jusqu'à présent, les stratégies et les prototypes vaccinaux contre le VIH ont conduit à des échecs répétés

à cause de la variabilité génétique du virus, de ses propriétés intégratives, de la latence et persistance mais aussi à ses capacités à échapper aux attaques du système immunitaire. Les premiers essais utilisant des préparations de virus inactivé ont été arrêtés à cause de leur faible immunogénicité ainsi que le risque de contamination avec du virus infectieux. Les protéines recombinantes ou les particules virales sans génome (VLPs) n'ont pas permis d'induire des réponses humorales soutenues et fonctionnellement actives qui protègent contre le virus infectieux. Par contre, les virus atténués obtenus par modification du génome ont montrés une immunogénicité augmentée et une protection accrue contre les virus pathogéniques chez les modèles animaux. Cependant, ils n'ont pu être utilisés chez l'homme à cause de la pathogénicité associé chez le nouveau-né et chez certains adultes. La vaccination avec l'ADN plasmidique est une stratégie innovante qui est conçue pour provoquer une réponse immunitaire cellulaire et/ou humorale protectrices contre les agents pathogènes. Cette approche sécuritaire est actuellement en cours d'essais cliniques contre plusieurs agents infectieux chez l'homme, mais il n'existe pas encore de vaccin homologué chez l'homme. Toutefois il existe quatre pDNA vaccins homologués dans le domaine vétérinaire.

Étude	Vaccin	Composition	Localisation	Phase de l'essai	Résultat
VAX003(sous-typeB/E) VAX004(sous-typeB/B)	SIDAVAX gp120	gp120s dans l'adjuvant d'alun.	Thaïlande (toxicomanes) États-Unis/Europe (HSH)	III	aucune efficacité aucune efficacité
HVTN502 (Etap) HVTN503 (Phambili)	Ad5-Gag-Pol-Nef	rAD5-(gag/pol/nef) clade B	États-Unis Afrique du Sud	Iib	nocif (augmentation de l'infection)
HVTN505	DNA-Ad5-Env-Gag-Pol	Prime: ADN (gag/pol/nef) clade B, Envs clades A,B,C Boost: rAD5- (gag/pol) clade B, Envs clades A,B,C	États-Unis.	Iib	aucune efficacité
RV144*	ALVAC-SIDAVAX (Deux vaccins)	Prime: ALVAC (vCP1521) vaccine (gag/pro/env)- vecteur canarypox Boost: SIDAVAX B/E gp120s à Alum	Thaïlande	III	31.2% de protection

Tableau 1. Récapitulatif des phases cliniques Iib et III conduites à ce jour. * Un essai similaire au RV144 est actuellement en cours en Afrique du sud.

L'ensemble des données accumulées durant ces décennies aboutissent à la conclusion qu'un vaccin contre VIH-1 qui protégerait contre l'acquisition du virus devrait induire la production d'anticorps dotés d'un large spectre de neutralisation (bNAbs). Les anticorps à large spectre de

neutralisation peuvent se développer naturellement chez une minorité de patients infectés par le VIH-1 après plusieurs années d'infection. Ces bNAbs ont le potentiel de protéger les individus non infectés contre l'acquisition des virus pathogéniques ainsi que de bloquer la propagation virale chez les individus infectés ; cependant leur développement pour une utilisation à large échelle chez l'homme reste un énorme challenge.

Les objectifs généraux : En raison de la complexité des interactions hôte/pathogène qui sont associées à l'infection par le VIH-1 chez l'hôte naturel et les modèles animaux actuels, un modèle plus simple est jugé nécessaire pour faciliter les études afin de mieux comprendre les mécanismes sous-jacents de la pathogenèse exacerbée chez l'homme. Etant donné que l'infection par le VIH-1 est restreinte à l'homme et aux grands singes, il n'existe pas de modèle animal simple et accessible pour conduire des études poussées en infection expérimentale. Un virus chimérique entre les génomes des virus d'immunodéficience simienne et humaine (SHIV) a été développé pour contourner les mécanismes de restriction liés à la réplication du VIH-1 dans les cellules de macaques. Ce virus chimérique exprime à la fois des gènes du SIV et du VIH-1, créant ainsi un nouveau modèle pour étudier la pathogenèse du VIH-1 et tester des vaccins chez des espèces de macaques qui sont reproduits en nombre dans les centres de primatologie. Le SHIV-KU2 utilisé dans notre laboratoire est un des prototypes de ces virus chimériques. Il produit les glycoprotéines d'enveloppe de type X4 du VIH-1 dans le génome du SIVmac, et par conséquent, l'infection de macaques avec ce type de SHIV induit très rapidement (2-3 semaines) la phase dite tardive de la pathogenèse du VIH-1 caractérisée par la déplétion quasi-totale des cellules T CD4+. Notre laboratoire travaille à développer des virus chimériques dotés du tropisme R5 qui devraient reproduire les premiers stades de l'infection par le VIH-1. Ces virus constitueraient des outils essentiels pour évaluer l'efficacité des prototypes de vaccins, mais aussi pour étudier les différentes propriétés répliquatives. En ce qui concerne la latence du VIH-1, l'expression du génome viral est bloquée par des interactions complexes de facteurs du virus et ceux de certaines cellules infectées. Cette complexité rend difficile l'étude des mécanismes impliqués pour développer des thérapies appropriées. Par conséquent il existe un réel besoin de créer des modèles dans lesquels le virus est incapable d'effectuer la phase de latence. Notre laboratoire a développé de nouveaux génomes chimériques de lentivirus utilisant une partie du génome de CAEV qui porte des LTRs dotés de promoteurs constitutifs qui sont indépendants de la transactivation par Tat.

L'objectif principal de ce projet de thèse est d'utiliser les outils développés dans notre laboratoire pour étudier les interactions hôte/VIH-1 qui, de l'infection conduisent à une

pathogénie complexe. Par ailleurs, nous voulions examiner la présence ou non de l'activité neutralisante dans les réponses immunitaires humorales induites chez les macaques vaccinés avec un lentivecteur à ADN et infectés au bout de 18 mois avec un virus d'épreuve SIVmac251 pathogène et hétérologue.

La stratégie du travail comporte la préparation d'outils appropriés pour étudier la capacité de réplication, le tropisme et le pouvoir infectieux de trois souches VIH-1 : VIH-1 pNL4-3, VIH-1 p89.6 et VIH-1 pWARO. Les ADNs plasmidiques portant les génomes complets de ces souches ont été produits puis utilisés pour produire et amplifier des stocks viraux pour réaliser une étude comparée avec notre génome chimérique CAL-VIH-R1. Ces trois souches ont été choisies parmi plus d'une dizaine de clones moléculaires infectieux obtenus de la base de données et de réactifs mis à disposition par le programme de réactifs SIDA du NIH. Les virus produits par transfection de cellules HEK-239T ont été utilisés pour examiner leurs propriétés répliquatives sur plusieurs lignées cellulaires.

Suite à l'infection des cellules T CD4⁺ de la lignée humaine M8166, les souches virales VIH-1 pNL4-3 et p89.6 ont induit des effets cytopathiques typiques après trois à six jours d'infection. Ces résultats indiquent que ces cellules ont été infectées par ces souches virales alors qu'au contraire aucun signe d'infection n'a été observé sur les cellules inoculées avec la souche virale VIH-1 WARO.

Pour caractériser d'avantage le tropisme de ces souches, nous avons utilisé des cellules indicatrices de type GHOST qui co-expriment le récepteur CD4 avec soit le co-récepteur CCR5 soit le CXCR4. Si des cellules GHOST exprimant le co-récepteur CCR5 sont infectées par une souche virale, ce virus est donc défini comme ayant un tropisme R5, et à l'inverse si des GHOST exprimant le co-récepteur CXCR4 sont infectées par une souche virale, celle-ci est alors définie comme ayant un tropisme X4. Quand une souche infecte les deux types cellulaires indifféremment elle est définie comme ayant un double tropisme X4/R5. Les virus VIH-1 NL4-3 et 89.6 ont causé des effets cytotoxiques sur les cellules GHOST CXCR4, et les souches VIH-1 WARO et 89.6 ont causé ces effets sur des cellules GHOST CCR5. Par conséquent, la souche VIH-1 NL4-3 est définie de tropisme X4, la souche WARO est définie de tropisme R5, tandis que la souche VIH-1 89.6 est définie de double tropisme R5 et X4.

Les titres infectieux des stocks viraux produits ont été évalués par inoculation de cellules TZM-bl et évaluation du nombre de cellules bleues induites par infection, ou par l'évaluation de la TCID₅₀/ml en utilisant la lignée cellulaire indicatrice M8166. Les résultats de ces analyses ont

montré que la production virale des souches VIH-1 NL4-3 et 89.6, contrairement à celle de la souche VIH-1 WARO, a augmenté progressivement au cours des trois premiers jours. Afin de préparer des stocks viraux, les cellules M8166 se sont avérées efficaces pour les souches VIH-1 NL4-3 et 89.6, tandis que pour la souche VIH-1 WARO nous avons utilisé la lignée humaine monocyttaire U-937, que nous avons différenciée en macrophages mais l'infection de cette dernière s'est montrée inefficace. Il serait donc préférable d'utiliser la lignée de cellules TCD4+/CCR5+ MOLT T pour résoudre ce problème.

Les études de la cinétique de réplication des souches VIH-1 NL4-3 et 89.6 ont été effectuées sur les cellules CEMx174 et M8166. Les surnageants des cellules infectées ont été recueillis tous les 24h pendant huit jours puis les titres infectieux ont été examinés sur des cellules TZM-bl. La production virale a augmenté progressivement jusqu'au quatrième jour sur les cellules CEMx174 et jusqu'au cinquième jour post infection sur les cellules M8166. La mortalité cellulaire est devenue très importante au septième jour. Le titre infectieux du VIH-1 NL4-3 a été trouvé supérieur à celui du VIH-1 89.6 et la production virale sur la lignée M8166 a été plus élevée que celle sur la lignée CEMx174.

Le génome ADN double-brins du **CAL-HIV-R1** comprend tous les gènes du génome du VIH-1 pNL4-3, cependant les LTRs ont été déléetées et remplacées par celles du CAEV. Ces LTR ont des promoteurs constitutifs qui expriment fortement les gènes qu'ils contrôlent. L'adaptation de la réplication virale par passages successifs du virus issu du clone moléculaire de CAL-HIV-R1 a été tentée sur des cellules de la lignée M8166, puis les surnageants ont été titrés en utilisant des cellules TZM-bl. Les résultats ont montré une légère augmentation de la production de virus au cours des dix premiers passages, mais ensuite la production virale a diminué.

Un dernier aspect du travail porte sur la détection et l'évaluation d'anticorps neutralisants dans les échantillons d'animaux vaccinés avec le lentivecteur CAL-SHIV-IN⁺ et non vaccinés, après infection avec un virus d'épreuve. Pour ce faire, des échantillons de sérum provenant d'animaux vaccinés et d'animaux témoins ont été prélevés à raison de plusieurs semaines après l'infection avec le virus d'épreuve SIVmac251. Les échantillons de sérum prélevés aux semaines 1, 22, 26, 30 42 et 46 post-infection avec le virus d'épreuve ont été testés pour leur capacité à neutraliser l'infection par séro-neutralisation réalisée contre les souches virales SHIV-KU2 et SIVmac239. Dans le temps imparti pour cette expérimentation animale, la présence d'anticorps

neutralisant n'a pu être mise en évidence bien qu'une étude parallèle ait démontré que tous les animaux avaient développé des réponses immunes cellulaires et humorales spécifiques.

L'ensemble de ce travail a permis de tester des méthodes et de valider des outils indispensables pour l'étude comparée des propriétés du nouvel virus chimérique dérivé du génome de VIH-1 : le CAL-HIV-IN⁺ construit au laboratoire et dont la conception permettrait une expression constitutive contrairement à l'expression Tat-dépendante du VIH-1.