



HAL
open science

Monitoring and advancing the circular economy transition: Circularity indicators and tools applied to the heavy vehicle industry

Michael Saidani

► **To cite this version:**

Michael Saidani. Monitoring and advancing the circular economy transition: Circularity indicators and tools applied to the heavy vehicle industry. Other. Université Paris Saclay (COMUE), 2018. English. NNT: 2018SACL071 . tel-01954809v2

HAL Id: tel-01954809

<https://theses.hal.science/tel-01954809v2>

Submitted on 23 Nov 2018

HAL is a multi-disciplinary open access archive for the deposit and dissemination of scientific research documents, whether they are published or not. The documents may come from teaching and research institutions in France or abroad, or from public or private research centers.

L'archive ouverte pluridisciplinaire **HAL**, est destinée au dépôt et à la diffusion de documents scientifiques de niveau recherche, publiés ou non, émanant des établissements d'enseignement et de recherche français ou étrangers, des laboratoires publics ou privés.

Monitoring and advancing the circular economy transition – Circularity indicators and tools applied to the heavy vehicle industry

Piloter et catalyser la transition vers une économie circulaire – Outils et indicateurs de circularité appliqués à l'industrie des véhicules lourds

Thèse de doctorat de l'Université Paris-Saclay
préparée à CentraleSupélec

École doctorale n°573 Interfaces : approches
interdisciplinaires, fondements, applications et innovation
Spécialité de doctorat: sciences et technologies industrielles

Thèse présentée et soutenue à Gif-sur-Yvette, le 11 octobre 2018, par

Michael Saidani

Composition du Jury (par ordre alphabétique) :

François Cluzel Maître de Conférences, CentraleSupélec	Co-encadrant
Pascal da Costa Maître de Conférences, CentraleSupélec	Examineur
Alissa Kendall Professor, University of California-Davis	Examineur
Yann Leroy Maître de Conférences, CentraleSupélec	Co-encadrant
Tim McAloone Professor, Technical University of Denmark	Rapporteur
Nicolas Perry Professeur des Universités, Arts et Métiers ParisTech	Président
Bernard Yannou Professeur des Universités, CentraleSupélec	Directeur de thèse
Peggy Zwolinski Professeur des Universités, Institut Polytechnique de Grenoble	Rapporteur

This page intentionally left blank.

To the only one who knows

-

To all the nights that never happened
and the days that don't exist

This page intentionally left blank.

Acknowledgements

From my thesis supervisors, the jury, to the researchers and industrialists I had the opportunity to discuss with all along this three-year research project, through my close relatives, many persons have been involved and contributed, in different ways, in the accomplishment of the present Ph.D. thesis. I paid a very particular attention to thank all of them in person, which I find more meaningful and personal.

Soundtrack of the thesis

Alex Turner et Jamie Cook étaient voisins à High Green, un quartier de Sheffield, et comme Alex, Jamie demanda une guitare électrique pour Noël en 2001. C'est à partir de là qu'ils décidèrent de former le groupe.

If you've a lesson to teach me, I'm listening, ready to learn
There's no one here to police me, I'm sinking in, until you return
If you've a lesson to teach me, don't deviate, don't be afraid
Without the last corner piece I can't calibrate, let's get it ingrained
Alex Turner, The Jeweller's Hands, Humbug, 2009

It might hibernate from time to time, and sink back into the swamp.
I think the cyclical nature of the universe in which it exists demands
it adheres to some of its rules. But it's always waiting there, just around the corner.
Ready to make its way back through the sludge and smash through the glass ceiling,
looking better than ever. Yeah, it seems like it's faded away sometimes,
but it will never die. And there's nothing you can do about it.
Alex Turner, Arctic Monkeys, BRIT Awards' Acceptance Speech, 2014

Take it easy for a little while, come and stay with us,
The Information-Action Ratio, is the place to go
I put a taqueria on the roof, it was well reviewed
Four stars out of five, and that's unheard of
Alex Turner, Four Out Of Five, Tranquility Base Hotel + Casino, 2018

Cook confia son étonnement lorsque Turner lui joua des démos. Mais au fur et à mesure qu'ils se comprirent, le piano et la guitare commencèrent à se répondre...

This page intentionally left blank.

Short biography

Michael Saidani is born on April 4th, 1991. Michael has a scientific background in Mechanical Engineering: he received his education from the “Grande Ecole” Ecole Normale Supérieure (ENS) de Cachan where he passed, in 2014, the “Agregation” of Engineering and Industrial Sciences. Then, he pursued his education at another top-tier French School, Ecole Centrale Paris, where he received with honors a research master degree in Design Engineering and Management in 2015. During his graduation, he had the opportunity to apply his knowledge and skills on the industrial ground, through projects (e.g. PY Innovation), internships (e.g. EDF) or collaborations (e.g. Manitou). Particularly, he successfully initiated, developed and implemented an eco-design approach in the industry during a 5-month internship in Switzerland at Liebherr Machines Bulle.

Michael started in September 2015 his Ph.D. thesis in the fields of circular economy and sustainability of heavy vehicles at CentraleSupélec, Université Paris-Saclay, within the Industrial Engineering Research Department headed by Professor Bernard Yannou. In parallel of his research project, he was involved in teaching assignments including mechanical engineering and innovation tutorial classes, an eco-design course, as well as supervision of several master internships. Also, during his Ph.D. period, he received a 6-month Fulbright scholarship to work in collaboration with the Industrial Ecology Program at UC Davis, under the supervision of Professor Alissa Kendall. Michael is member of the Design Society and has been elected to the EcoSD network (French network of eco-design researchers) board of directors as the young researchers’ representative.

He is passionate about watching and practicing sport, as well as listening and practicing music, being actively involved in activities outside of the academic realm. During his Ph.D. thesis, as a pastime, he enjoyed improving his running abilities by participating at several marathons (Paris, Liverpool) or half-marathons (Reykjavik, Dublin, Lille, Zurich) for fun, at a Parisian charity run (the 24-hour no finish line in 2018) and at shorter distance races for performance (e.g. second place at the 5k Labor Day Run in California, Davis in 2017). As a volunteer guitar teacher in a French association called “Music for All” (English translation for “Musique pour Tous”), he fostered the music access to children from disadvantage neighborhoods. Michael likes both doing research and teaching, with always in mind the desire to apply his talents positively on the ground to contribute effectively in building a more sustainable future.



This page intentionally left blank.

Résumé

Titre en français (French title) :

Piloter et catalyser la transition vers une économie circulaire - Outils et indicateurs de circularité appliqués à l'industrie des véhicules lourds

Résumé succinct (short summary in French) :

Cette thèse fournit des clés pour mesurer, améliorer et piloter la performance de circularité de produits industriels à différentes échelles d'implémentation de l'économie circulaire (micro, meso, macro). Plusieurs indicateurs de circularité y sont expérimentés au travers d'un cas d'étude industriel. Une analyse critique de ces indicateurs est effectuée aux regards du paradigme de l'économie circulaire et de leur intégration dans les pratiques industrielles de (re)conception et développement de produits et services. Dans le même temps, en réponse au nombre croissant d'indicateurs de circularité, de périmètres et d'ambitions inégales, une taxonomie d'indicateurs de circularité est proposée dans le but de clarifier le flou actuel autour de cette nébuleuse d'instruments de mesure. Cette classification ordonnée d'indicateurs est accompagnée de son outil informatique d'aide à la sélection afin de faciliter leurs usages appropriés. En s'appuyant sur les manques des indicateurs actuels pour évaluer le potentiel de circularité des produits industriels, un nouvel indicateur de circularité et son outil de calcul sont également développés et expérimentés, puis des recommandations pour la construction d'indicateurs futurs sont discutées. Bien que les indicateurs évoqués dans la thèse aient pour vocation à être utilisés pour tout type de secteur, l'industrie des véhicules lourds en est le cadre d'application. En effet, en l'absence de réglementation européenne sur la fin de vie de ces véhicules, il s'agit d'identifier, de questionner et de tester les leviers d'actions que cette industrie peut activer pour améliorer sa performance dans une perspective d'économie circulaire. Tout d'abord, les meilleures pratiques et les défis actuels de l'industrie des véhicules légers et des véhicules lourds sont mis en exergue au regard des quatre piliers fondamentaux de l'économie circulaire définis par la Fondation Ellen MacArthur (conception circulaire, nouveaux modèles d'affaires, logistique inversée, écosystème) et des quatre boucles principales du modèle circulaire (maintenance, réutilisation, reconditionnement, recyclage). Ces pratiques exemplaires sont synthétisées au sein d'une matrice de deux pages pour faciliter leur diffusion et adoption par les praticiens industriels désirant mettre en œuvre de tels modèles de circularité. Par la suite, une étude industrielle pilote a été menée avec un constructeur d'engins de manutention cherchant à développer son activité de reconditionnement d'engins en fin de vie. Inspiré par des investigations sur le terrain couplé à un état de l'art étendu, une modélisation multi-échelles – a) engin et composants clés, b) processus de démantèlement, c) filières de valorisation – a permis (i) de proposer et de valider une amélioration (en temps et en ressources) des opérations de démontage d'un point de vue organisationnel et technique, (ii) d'effectuer une analyse économique et environnementale des activités de démantèlement et de valorisation. Un premier outil d'aide à la décision a également été conçu pour accompagner l'industriel dans la valorisation optimale de son engin en fin de vie. Des réflexions sur la généralisation et transposition des approches développées à d'autres engins ou secteurs sont données, ainsi que des pistes de recherche prometteuses pour accomplir davantage la transition vers une économie circulaire – effective, efficiente et durable.

Mots-clés : Economie circulaire, indicateurs de circularité, gestion de la fin de vie, industrie des véhicules lourds, développement durable, génie industriel.

Résumé étendu (extended summary in French) :

Passer d'une économie linéaire – incarnée par la succession des verbes « extraire, fabriquer, distribuer, consommer, jeter » – à une économie circulaire – plus économe et efficiente, découplant croissance économique et consommation de ressources non renouvelables, préconisant un bouclage des flux de matières et favorisant la maintenance, la réparation, la réutilisation ou encore le recyclage – apparaît de plus en plus comme « la bonne chose à faire » auprès des institutions, entreprises et universitaires. La mise en place de pratiques d'économie circulaire paraît en effet pertinente dans la réalisation des objectifs du développement durable. Toutefois, entreprendre et mettre en œuvre des pratiques d'économie circulaire est moins aisé que la simple représentation des boucles de circularité ne le laisserait paraître. Ainsi, certains secteurs industriels ont besoin d'être activés ou accompagnés dans cette transition pour transformer pleinement leur potentiel de circularité. C'est le cas de l'industrie des véhicules lourds. Le secteur des véhicules est en effet particulièrement intéressant et challengeant dans une perspective d'économie circulaire, possédant à la fois des poches de valeurs non pleinement exploitées, et un fort potentiel d'amélioration.

Les véhicules lourds (de plus de 3,5 tonnes) ne sont soumis à aucune réglementation sur la gestion de leur fin de vie contrairement aux véhicules particuliers (directive européenne 2000/53/EC sur les véhicules hors d'usage de moins de 3,5 tonnes, incluant des taux minimums de récupération, recyclage, et valorisation matière). Les constructeurs de véhicules lourds et engins de chantier ont une faible traçabilité après-vente, et la tendance européenne à l'export des véhicules considérés en fin de vie, bien souvent via des filières illégales, vers des pays d'Europe de l'Est ou d'Afrique, qui n'ont pas les infrastructures pour valoriser et recycler au mieux leurs engins en fin de vie. Cette situation engendre des pertes économiques pour les acteurs européens, et a un impact néfaste pour l'environnement lié à l'abandon ou à la non valorisation de ces engins en fin de vie. Un des objectifs de la thèse est de fournir des clés permettant d'améliorer la gestion de fin de vie des véhicules lourds et leurs performances dans une perspective d'économie circulaire.

Dans le même temps, être capable de mesurer, améliorer et piloter la performance de circularité des produits industriels est d'importance capitale dans une période de transition vers des pratiques industrielles plus durables. Toutefois, sans définition stabilisée de l'économie circulaire, le nombre d'indicateurs de circularité, de périmètres et d'ambitions inégales, est toujours plus croissant, créant un flou autour de leurs bonnes utilisations et appropriations par les praticiens industriels. Un autre objectif de cette thèse est d'apporter une clarification sur ces indicateurs de circularité, pour faciliter leurs usages et adoptions. Bien que les indicateurs évoqués dans la thèse aient pour vocation à être employés pour tout type de secteur, l'industrie des véhicules lourds en est le cadre d'application.

La thèse s'intéresse dans une première partie à la situation des véhicules lourds au regard du prisme de l'économie circulaire. En mobilisant des investigations sur le terrain industriel et une revue de littérature étendue, les meilleures pratiques de circularité et les obstacles persistants au sein de l'industrie des véhicules légers et lourds sont comparés selon les quatre pierres angulaires de l'économie circulaire définies par la Fondation Ellen MacArthur (conception circulaire, nouveaux modèles d'affaires, logistique inversée, écosystème) et des quatre boucles principales du modèle circulaire (maintenance, réutilisation, reconditionnement, recyclage). Ces pratiques exemplaires ont été synthétisées au sein d'un guide, pour faciliter leur diffusion et appropriation par des acteurs industriels qui pourront s'en servir comme source d'inspiration ou de benchmarking dans leurs pratiques d'économie circulaire. Plus particulièrement, une étude industrielle pilote a été menée en collaboration avec un fabricant d'engin de manutention souhaitant étendre son activité de reconditionnement d'engin en fin de vie. Ce cas d'étude, à un niveau plus micro et opérationnel sur la capacité de gestion et de revalorisation des véhicules lourds, permet d'étudier sous quelles conditions la récupération et le traitement du gisement de certains véhicules lourds sur le territoire français ou européen, fait sens pour un industriel et son réseau de collaborateurs. Par le biais de deux démantèlements complets d'engin, entrecoupés d'un atelier de travail mêlant différents corps de métiers, une amélioration du processus de démantèlement est proposée et validée d'un point de vue organisationnel et technique. Une analyse économique et environnementale des opérations de démantèlement et de valorisation de l'engin lourd a également été effectuée. De plus, la thèse propose un premier outil d'aide à la décision pour aider l'industriel à valoriser au mieux son engin en fin de vie, au travers d'une modélisation multi-échelles, ancrée dans la réalité du terrain industriel, considérant (i) les caractéristiques de l'engin récupéré et de ses composants clés, (ii) les propriétés et capacités du processus de démantèlement, et (iii) l'état des filières de valorisation incluant par exemple la demande et les prix du marché. Les implications et limites liées à ce cas d'étude sont discutées en détail, dans le but d'orienter de futures recherches et/ou expérimentations cherchant à faciliter et améliorer la gestion de fin de vie des véhicules lourds.

En complément, pour parvenir à une analyse plus quantitative de la performance de circularité d'un secteur industriel, ou de certains de ces composants clés, l'utilisation d'indicateurs de circularité appropriés s'impose.

Dans une deuxième partie, après avoir mis en exergue les bénéfices offerts par l'emploi d'indicateurs, une revue systématique des jeux d'indicateurs de circularité actuels permet d'aboutir à une première taxonomie, apportant ainsi une clarification sur leurs utilisations possibles à plusieurs niveaux : micro (produits, processus de l'entreprise), méso (organisation des filières, symbioses industrielles) et macro (enjeux régionaux, nationaux et globaux). Au total, plus de 50 ensembles d'indicateurs de circularité ont été recensés, caractérisés et classifiés selon les 10 catégories de la taxonomie proposée. Un outil d'aide à la sélection du jeu d'indicateurs le plus approprié à une situation ou à un besoin industriel a été développé, interrogeant la base de données liée à cette taxonomie. Plus particulièrement, en se servant de cette classification ordonnée d'indicateurs, une focalisation est faite sur le potentiel d'indicateurs de circularisation à un niveau micro pour accompagner les industriels dans leur transition vers des pratiques plus circulaires, tout en y intégrant des aspects managériaux. Plusieurs de ces indicateurs et de leurs outils associés ont été appliqués sur un cas d'étude industriel cherchant à évaluer et améliorer la performance de circularité d'un composant clé d'un véhicule lourd, discutant ainsi des apports et limites des indicateurs existants. En s'appuyant sur les limites des indicateurs actuels pour évaluer la performance de circularité des produits industriels, un nouvel indicateur de circularité est proposé et sa construction détaillée. La première version de cet indicateur est expérimentée sur le même cas d'étude, permettant ainsi une comparaison pertinente quant à son apport pour le développement de produits plus circulaires. Le travail autour de cette typologie et expérimentation d'indicateurs de circularité ouvre également sur l'identification de chantiers prometteurs pour réaliser le mouvement vers une économie circulaire, effective, efficiente et durable. D'une part, des recommandations sont émises pour le développement d'indicateurs de circularité futurs. D'autre part, si certains indicateurs ont permis de cibler où agir sur la chaîne de valeur et quels leviers d'actions activer pour stimuler la fermeture des boucles d'économie circulaire, il conviendrait d'être en capacité d'évaluer dans quelle proportion l'activation de certains leviers contribue à une amélioration de la performance de circularité. Ainsi, en perspective, une méthodologie multi-outils (combinant analyse de flux de matière, cartographie cognitive floue, analyse structurelle, et dynamique des systèmes) est proposée pour modéliser, simuler et évaluer l'impact de différents mécanismes ou incitations pouvant contribuer à fermer la boucle de certains composants clés et matériaux stratégiques.

En termes de livrables, en plus de la production scientifique telle que plusieurs publications dans des revues à comité de lecture ou des communications lors de conférences internationales, la thèse développe, expérimente et fournit des documents et outils opérationnels destinés aux praticiens industriels. Notons (a) l'outil d'aide à la sélection d'indicateur(s) de circularité le(s) plus approprié(s) à une situation donnée, (b) le guide des meilleures pratiques de l'industrie des véhicules légers et lourds au regard de l'économie circulaire, ou encore (c) un premier outil d'aide à la décision pour orienter les opérations de démantèlement et de valorisation d'un engin lourd en fin de vie. En effet, une volonté transversale de de la thèse est d'assurer la bonne compatibilité entre les contributions académiques (états de l'art, cadres méthodologique, propositions de modèles, publications) et leurs applicabilités dans la réalité industrielle. En outre, les analyses, modèles et discussions retranscrites au sein de la thèse pourront servir à alimenter des réflexions et actions politiques et/ou industrielles, que ce soit autour de la mesure et du pilotage de l'économie circulaire au travers d'indicateurs de circularité, ou dans la mise en œuvre d'une hypothétique future réglementation concernant la fin de vie des véhicules lourds, à l'instar de la Directive Européenne 2000/53/EC qui impose des taux de réutilisation, recyclage et valorisation minimums pour les véhicules légers hors d'usage (VHU), incluant le principe de responsabilité étendue des producteurs (REP).

Abstract

Title:

Monitoring and advancing the circular economy transition – Circularity indicators and tools applied to the heavy vehicle industry

General overview:

Implementing circular economy (CE) practices is increasingly acknowledged as a convenient solution to meet the goals of sustainable development. Meanwhile, there is at present no recognized way of measuring how effectively a region or a company is in making the transition to a circular economy, nor holistic monitoring tools for supporting such a process. New methods and tools are required to support industrial practitioners in their transition towards more circular practices, as well as to monitor the effects of CE adoption. In absence of regulations addressing the end-of-life management of their fleet, the heavy vehicles industry is a particular industrial sector – of huge economic and environmental importance, but barely addressed from a research perspective – that needs to be boosted in its move to a CE. An in-depth preliminary study reveals indeed huge potential to develop CE solutions in the heavy vehicles sector. This research explores the improvement potential for closing industrial material and components loops.

On this basis, the objectives of the present PhD thesis are: to provide an integrated and comprehensive framework to measure, improve and monitor the circularity performance of complex industrial systems; to identify the best mechanisms and action levers to close the loop on heavy vehicles and associated key components - providing thus decision-making support for the end-of-life management of heavy vehicles. At the intersection of design engineering and industrial ecology, this Ph.D thesis - by articles - aims to provide new meaningful insights both for academics and industrial practitioners. In fact, for each chapter, academic publications and industrial deliverables are given, illustrating and disseminating both theoretical contributions and practical implications. Particularly, it includes: a proposed taxonomy of circularity indicators and its associated selection tool; an experimentation and critical analysis of several circularity indicators on a heavy vehicle's key component; the design of a multi-tool methodology to model, simulate and quantify the impact of potential circular strategies; an industrial pilot study on an end-of-life heavy vehicle, dealing with the techno-economic and environmental analysis of possible recovery options.

Essay 1: Towards a circular economy of heavy vehicles?

With 270 million light vehicles and 20 million heavy-duty and off-road (HDOR) vehicles in use in the European Union, the automotive and HDOR industries form two major sectors of the European economy. Each year, 12 million light vehicles plus 1 million HDOR vehicles reach the end of their lives. In a circular economy perspective, the following two questions are of growing concern: (i) to what extent is the circular economy achieved and implemented in the automotive and HDOR sectors? (ii) what industrial practices and regulations are prevalent and commendable for the circular economy? The end-of-life management of light vehicles (subject to the ELV Directive 2000/53/EC) has been widely studied in the literature, but the end-of-life stage of HDOR vehicles has long been neglected by researchers. To fill this gap, both extensive literature survey and in-depth industrial investigations are conducted. Key factors, i.e. regulations, business models and market evolution, and integration of new emerging technologies affecting the circular economy performance of the automotive and HDOR sectors are analysed. Lessons learned from best industrial practices are highlighted, and remaining challenges for a more circular economy are identified. The two industries are compared in terms of the four building blocks of the circular economy and the four possible feedback loops defined by the Ellen MacArthur Foundation. To facilitate their dissemination, the main findings are synthesized through a benchmarking template of best circular practices in the light- and heavy-duty vehicles industry.

Essay 2: Circularity indicators, enablers of a circular economy?

Worldwide, academics, industrialists and politicians all agree on the need to use circular economy-related measuring instruments to manage the CE transition at different systemic level. In this context, a wide range of circularity indicators – including metrics, indices, index and assessment framework – has been developed in recent years i.e. between 2010 and today. Yet, because there is no one single definition of the CE concept, being clear about what is measured by the growing number of C-indicators is essential to ensure their proper use. Through a systematic literature review – considering both academic and grey literature – more than 50 sets of C-indicators (developed by scholars, consulting companies and governmental agencies) have been identified and classified into

a need-based taxonomy driven by the usage of such indicators. Furthermore, an Excel-based query tool has been developed to facilitate the appropriate selection and dissemination of such circularity indicators.

Essay 3: Industrial case studies (related to essays 1 & 2), including:

- An experimentation and critical analysis of C-indicators on one key component from a heavy vehicle, and on its associated value chain at the scale of the European Union. This first case study is proposed on a catalytic converter, which contains a non-negligible amount of platinum, considered as critical raw materials by the European Commission. Importantly, through this case study, a multi-tool method – combining material flow analysis, fuzzy cognitive mapping, structural analysis, scenarios generation and system dynamics – has been designed to model, simulate and qualify the impact of potential and promising CE strategies.
- A techno-economic and environmental analysis of the recovery options – i.e. considering trade-offs between the different circular economy loops – of a used heavy vehicle and its associated components. This industrial pilot study has been conducted in collaboration with a French constructor of heavy vehicles and its international reconditioning center. Interestingly, a multi-scale model has been proposed to fit with industrial reality when selecting end-of-life pathways, considering in the same framework: (i) the condition of the used vehicle and key components, (ii) the dismantling process and capabilities, (iii) the end-of-life recovery channels and associated market. This case study also includes the design and experimentation of practical templates and dismantling calculation sheets for a sound end-of-life management of heavy vehicles.

In perspective, recommendations on future research directions and actions for a sound management of end-of-life heavy vehicles, as well as for an enhanced monitoring framework of the circular economy performance of industrial products, are discussed and justified.

Key words: Circular economy, circularity indicators, end-of-life management, heavy vehicles industry, sustainability, industrial engineering.

Graphical abstract

Towards a Circular Economy of Heavy Vehicles



Absence of EoL regulations, lack of infrastructures, illegal exports, env. burden, eco. loss, etc.

In-depth literature review and field investigations

Four feedback loops and four building blocks of the CE

Identification of best practices and key action levers to close-the-loop

Comparison with the automotive industry

Application on an industrial pilot study with Manitou Reman

Eco, env, tech, org, analysis of the reconditioning of a used machine



Assess - Circularity Indicators adapted to Designers and Industrialists

Important degree of fuzziness and limitations

Growing number of circularity indicators

Life-Cycle Impact Assessment

Need-based taxonomy of 50 sets of CI
"CI: The Advisor" Excel-based query tool

Correlation between circularity scores and sustainability scores?

Development of a Circularity Potential Indicator, including 20 attributes, based on the 4 building blocks of the CE

Application on an Industrial Case Study

System Modeling

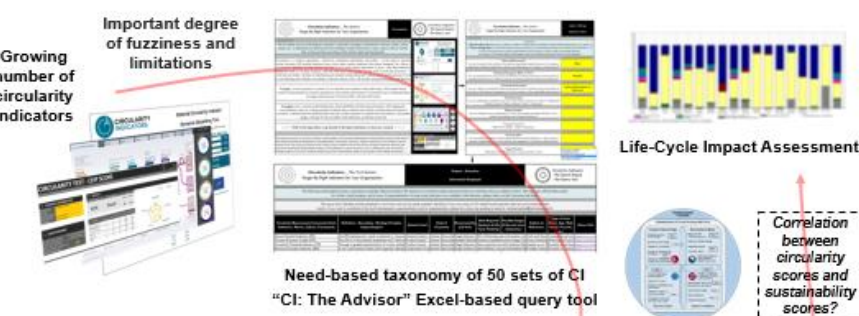

Building Block	Attributes	Score
BB01 - Circular Product <td>ATT01 - Material Selection = 2/5/5 ATT02 - Modular Product Design = 1/5/1/5 ATT03 - Design for Disassembly = 2/5/5 ATT04 - Design for Upgradability = 2/5/5 ATT05 - Design for Longevity = 2/5/5</td> <td>2.5/5</td>	ATT01 - Material Selection = 2/5/5 ATT02 - Modular Product Design = 1/5/1/5 ATT03 - Design for Disassembly = 2/5/5 ATT04 - Design for Upgradability = 2/5/5 ATT05 - Design for Longevity = 2/5/5	2.5/5
BB02 - New Business Model <td>ATT06 - Design for PSS = 0/0/5 ATT07 - Leasing or Rental Schemes = 0/0/5 ATT08 - After-sales Services = 3/3/1/5 ATT09 - Take-Back Offers = 0/0/5 ATT10 - Sharing Platform = 0/0/5</td> <td>0/5</td>	ATT06 - Design for PSS = 0/0/5 ATT07 - Leasing or Rental Schemes = 0/0/5 ATT08 - After-sales Services = 3/3/1/5 ATT09 - Take-Back Offers = 0/0/5 ATT10 - Sharing Platform = 0/0/5	0/5
BB03 - Reverse cycles <td>ATT11 - Traceability = 0/0/5 ATT12 - Take-Back Process = 1/5/0/5 ATT13 - Collection Mechanisms = 1/5/1/5 ATT14 - Treatment Facilities = 2/2/5/5 ATT15 - E-o-L Collaborations = 0/0/5</td> <td>1.5/2/2/5</td>	ATT11 - Traceability = 0/0/5 ATT12 - Take-Back Process = 1/5/0/5 ATT13 - Collection Mechanisms = 1/5/1/5 ATT14 - Treatment Facilities = 2/2/5/5 ATT15 - E-o-L Collaborations = 0/0/5	1.5/2/2/5
BB04 - System Conditions <td>ATT16 - Product Conditions = 3/3/1/5 ATT17 - Actors' Behaviours = 2/2/1/5 ATT18 - Policy Framework = 0/0/5 ATT19 - Second-Hand Market = 2/2/5 ATT20 - Financial Incentives = 0/0/5</td> <td>3.3/1/5</td>	ATT16 - Product Conditions = 3/3/1/5 ATT17 - Actors' Behaviours = 2/2/1/5 ATT18 - Policy Framework = 0/0/5 ATT19 - Second-Hand Market = 2/2/5 ATT20 - Financial Incentives = 0/0/5	3.3/1/5

Improve - How to "Close-the-Loop" on Platinum from Catalytic Converters?

Highlight of important economic and environmental value buckets for European stakeholders

2017 Joint Conference ISIE and ISSST

12th Society And Materials International Conference

Presentations at French & International Conferences

Designing a multi-tool method to model and simulate circularity performance

Material Flow Modeling

Fuzzy Cognitive Mapping

Structural Analysis-MICMAC

Morphological Analysis MORPHOL

System Dynamics Simulation

"What if?" scenarios to evaluate the environmental and economic impacts of CE related strategies

Interest and feedback from European industrialists involved in this challenge

1 kg of primary Pt = 40 tons CO₂ eq. + 200 GJ + 30 k€

Technological feasibility to recycle Pt from CC > 95 %

Secondary Pt could divide by 20 the environmental cost

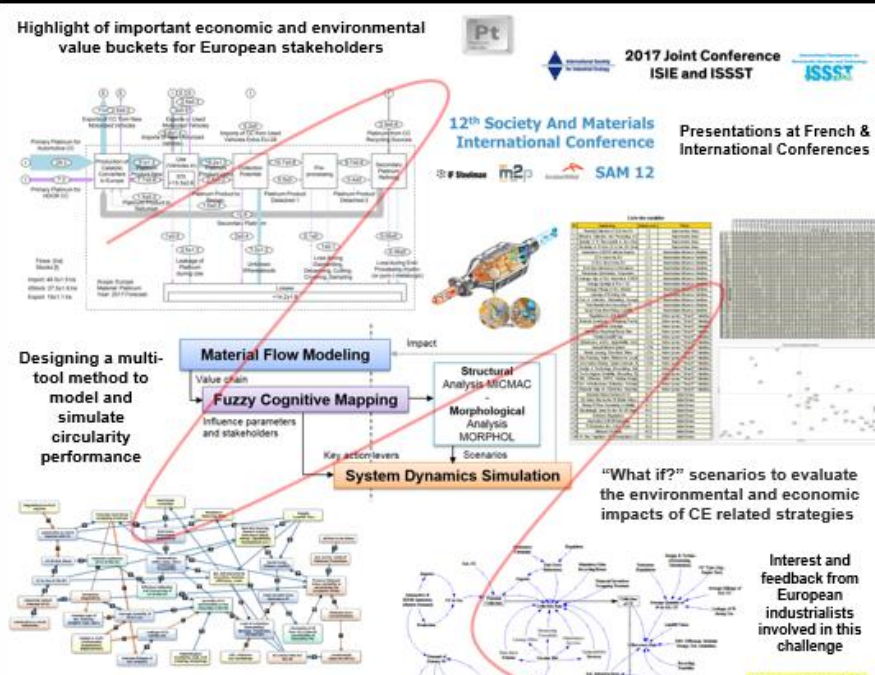

Table of Contents

ACKNOWLEDGEMENTS	V
SHORT BIOGRAPHY	VII
RESUME	IX
ABSTRACT	XII
LIST OF ACRONYMS	XVIII
LIST OF FIGURES	XIX
LIST OF TABLES	XXI
1. INTRODUCTION	1
1.1. FOREWORD	1
1.1.1. General context.....	1
1.1.2. Theoretical background.....	4
1.1.3. Illustrative examples	10
1.2. MOTIVATIONS AND CHALLENGES	13
1.2.1. Why the circular economy? Why the heavy vehicle industry?	13
1.2.2. Towards a circular heavy vehicle industry: between challenges and opportunities	14
1.2.3. A need for circularity indicators in achieving and monitoring a circular economy	15
1.3. RESEARCH QUESTION	16
1.3.1. Research gaps and objectives	16
1.3.2. Expected contributions: academic and industrial ones	17
1.4. RESEARCH APPROACH AND FOUNDATIONS	18
1.4.1. Related research fields	19
1.4.2. Proposed multi-methodological framework	19
1.5. POSITIONING OF THE THESIS	22
1.5.1. Within academic and research communities	22
1.5.2. Within governmental organizations	23
1.5.3. Within industrial and consulting companies.....	24
1.6. STRUCTURE OF THE MANUSCRIPT	25
1.6.1. Outline of the thesis	25
1.6.2. Declaration of previous publications.....	26
2. ESSAY #1 – TOWARDS A CIRCULAR ECONOMY OF HEAVY VEHICLES?	28
2.1. HEAVY VEHICLES ON THE ROAD TO THE CIRCULAR ECONOMY IN THE EU?	30
2.1.1. Introduction and background.....	30
2.1.2. Materials and methods.....	31
2.1.3. Results.....	34
2.1.4. Discussion and concluding remarks.....	45
2.2. EXTENSION OF THE GEOGRAPHICAL SCOPE TO THE U.S.	47

2.2.1.	Introduction	47
2.2.2.	Research methodology	48
2.2.3.	Heterogeneity of circular economy enablers/facilitators	48
2.2.4.	Homogeneity of remaining challenges	51
2.2.5.	Conclusion and perspectives	53
2.3.	BENCHMARKING TEMPLATE OF BEST CIRCULAR PRACTICES	54
2.3.1.	Presentation.....	54
2.3.2.	Practical benchmarking template of circular economy practices	55
2.3.3.	Examples of diffusion and communication of circular practices.....	57
2.3.4.	Examples of open access online tools	58
2.3.5.	Dissemination of the template and industrial feedbacks.....	59
2.4.	SUMMARY OF ESSAY #1 AND TRANSITION WITH ESSAYS #2 & #3	61
3.	ESSAY #2 – C-INDICATORS, ENABLERS OF A CIRCULAR ECONOMY?	62
3.1.	PROPOSED FRAMEWORK FOR THE DESIGN OF CIRCULARITY INDICATORS	64
3.1.1.	Introduction	64
3.1.2.	Literature review	64
3.1.3.	Results.....	68
3.1.4.	Discussion	71
3.1.5.	Conclusion	75
3.2.	DEVELOPMENT OF A NEW CIRCULARITY INDICATOR.....	77
3.2.1.	Introduction	77
3.2.2.	Literature background	77
3.2.3.	Results.....	80
3.2.4.	Application	83
3.2.5.	Conclusion and way forward	84
3.3.	TAXONOMY AND APPROPRIATE CHOICE OF CIRCULAR ECONOMY INDICATORS	85
3.3.1.	Introduction	85
3.3.2.	Materials and methods.....	87
3.3.3.	State of the art	89
3.3.4.	Proposed taxonomy of C-indicators and associated selection tool.....	93
3.3.5.	Discussion	98
3.3.6.	Conclusion and perspectives	101
3.4.	SUMMARY OF ESSAY #2 AND TRANSITION WITH ESSAY #3	103
4.	ESSAY #3 – INDUSTRIAL CASE STUDIES	104
4.1.	CLOSING-THE-LOOP ON A KEY COMPONENT OF THE HEAVY VEHICLE INDUSTRY	108
4.1.1.	Experimentation of circularity indicators.....	108
4.1.2.	Additional contribution from material flow analysis and C-indicators	116
4.1.3.	Multi-tool methodology to close-the-loop on industrial components	130
4.2.	CIRCULAR MANAGEMENT OF AN END-OF-LIFE HEAVY VEHICLE: AN INDUSTRIAL PILOT STUDY.....	139
4.2.1.	Contextualisation	139

4.2.2.	Complementary literature survey and field investigations	142
4.2.3.	Proposed problem-solving approach and support tools	146
4.2.4.	Results: technico-economic and organisational recommendations	148
4.2.5.	Next steps: promising future research and remaining industrial challenges	154
5.	GENERAL DISCUSSION AND CONCLUSION	156
5.1.	ACADEMIC AND INDUSTRIAL CONTRIBUTIONS	156
5.2.	EDUCATIONAL, MANAGERIAL AND POLICY IMPLICATIONS	158
5.2.1.	Supporting education in circular economy	158
5.2.2.	Managing material, economic and information flows with C-indicators	158
5.2.3.	Revitalizing the policy discussion related to the heavy vehicles end-of-life	159
5.3.	PERSPECTIVES AND FUTURE RESEARCH	161
5.3.1.	Limitations and further validation	161
5.3.2.	Directions for future research	162
5.4.	PERSONAL PUBLICATIONS	166
6.	REFERENCES.....	168
APPENDIX A – GLOSSARY OF DEFINITIONS		183
APPENDIX B – INTERVIEW GUIDES AND REPORTS.....		191
APPENDIX C – DETAILS ON THE CIRCULARITY INDICATORS REVIEWED		195
APPENDIX D – RESOURCES FOR THE WORKSHOP ON THE C-INDICATORS.....		197
APPENDIX E – TUTORIAL VIDEOS TO USE THE C-INDICATORS ADVISOR TOOL		203
APPENDIX F – UNCERTAINTY ANALYSIS OF THE LEAKAGE OF PLATINUM		205
APPENDIX G – DATA TEMPLATE TO SUPPORT THE END-OF-LIFE MANAGEMENT OF HEAVY VEHICLES....		209
APPENDIX H – EVOLUTION OF THE PH.D. THESIS ILLUSTRATED THROUGH POSTERS		212

List of Acronyms

- ACEA: European Automotive Manufacturers Association
- ADEME: French Environment & Energy Management Agency
- BB: Building blocks
- BM: Business model
- CC: Catalytic converters
- CE: Circular economy
- C-indicators: Circularity indicators
- CRM: Critical raw materials
- EASAC: European Academies Science Advisory Council
- EC: European Commission
- EEA: European Environment Agency
- ELV: End-of-life vehicles
- EMF: Ellen MacArthur Foundation
- EoL: End-of-life
- EPA: Environmental Protection Agency
- EPR: Extended Producer Responsibility
- EU: European Union
- HDOR: Heavy-duty and off-road
- HDV: Heavy-duty vehicles
- ICCT: International Council on Clean Transportation
- IDIS: International Dismantling Information System
- IE: Industrial Ecology
- IPCC: Intergovernmental Panel on Climate Change
- ISIE: International Society for Industrial Ecology
- LCA: Life cycle assessment
- LDV: Light-duty vehicles
- MFA: Material flow analysis
- NRMM: Non-road mobile machinery
- OBJ: Objective
- OECD: Organisation for Economic Co-operation and Development
- PGM: Platinum group metals
- Pt: Platinum
- Reman: Remanufacturing
- RG: Research gap
- SD: Sustainable development
- SDG: Sustainable development goals
- SDI: Sustainable development indicators
- UNEP: United Nations Environment Programme

List of Figures

Figure 1 – Earth Overshoot Days, by countries (source: Global Footprint Network, 2018)	1
Figure 2 – Current status of the control variables of the planetary boundaries (source: Steffen et al. 2015)	2
Figure 3 – Forerunner concepts and schools and thought (in bold) of the circular economy, a chronological timeline ...	5
Figure 4 – Illustrations of the circularity concept by diverse practitioners (source: Blomsma and Brennan, 2017)	7
Figure 5 – Evolution of the search interest on circular economy and industrial ecology (worldwide)	8
Figure 6 – Bibliometric analysis of the publications on circular economy and industrial ecology	9
Figure 7 – Word clouds of circular economy, industrial ecology and eco-design definitions	9
Figure 8 – The circular economy loops of the tyre industry (sources: Plan C on the left, ADEME on the right)	10
Figure 9 – Circular economy monitoring framework (source: European Commission, 2018a)	12
Figure 10 – The circular economy in France through 10 key indicators (source: Magnier, 2017)	12
Figure 11 – Example of an abandoned end-of-life heavy vehicle: economic loss and environmental burden	13
Figure 12 – Overview of the heavy vehicle industry at different systemic levels, illustrated with logos	14
Figure 13 – Multi-scale and multi-stakeholder complexity of the heavy vehicle industry all along the lifecycle	15
Figure 14 – Research gaps, associated objectives, and their positioning in the manuscript	16
Figure 15 – Schematic illustration of the multi-methodological and multi-field research approach	18
Figure 16 – Industrial engineering research process applied to the present thesis	21
Figure 17 – Positioning of the thesis in a global environment of stakeholders playing a role in the CE transition	24
Figure 18 – Graphical outline of the thesis	25
Figure 19 – Research schedule and historical timeline of the Ph.D thesis from September 2015 to August 2018	26
Figure 20 – End-of-life vehicle processing for the automotive sector (source: Toyota, 2016)	35
Figure 21 – Renault’s remanufacturing network to close the loop (source: EMF, 2013a)	40
Figure 22 – Common architecture and shared technology to facilitate spare parts reuse (source: Volvo, 2015)	41
Figure 23 – Caterpillar’s remanufacturing value chain to close the loop, excerpt from Snodgrass (2012)	42
Figure 24 – Illustrations of the three free tools experienced to measure product circularity: the CET, CEIP and MCI ..	70
Figure 25 – Proposed hierarchy of desired features to design a circularity measurement framework	73
Figure 26 – 4 building blocks of the circular economy (EMF, 2013) and associated key attributes considered	81
Figure 27 – Overview of the framework. Insights from top-down and bottom-up approaches	82
Figure 28 – Application of the framework on the case study and obtained results	83
Figure 29 – Synopsis of the sub-section 3.3 and research process in developing a taxonomy of C-indicators	86
Figure 30 – Sources of inspiration for the proposed taxonomy of C-indicators	88
Figure 31 – Bibliographical study: distributions of the C-indicators identified	89
Figure 32 – Overview of the selection tool: The C-Indicators Advisor	97
Figure 33 – Positioning and contributions of the industrial pilot study	107
Figure 34 – Snapshot of the tool: The Circularity Indicators Advisor	111
Figure 35 – Results from the experimentation of the Material Circularity Indicator (MCI)	112
Figure 36 – Results from the experimentation of the Circular Economy Indicator Prototype (CEIP)	112
Figure 37 – Results from the experimentation of the Circularity Potential Indicator (CPI)	112
Figure 38 – Are the C-indicators compliant with the circular economy paradigm?	114
Figure 39 – Reasons of the platinum supply risk for the EU (source: Alonso et al. 2012)	117

Figure 40 – MFA of platinum from catalytic converters (EU-28, 2017, with uncertainties)	123
Figure 41 – Demarcation between light (blue) and heavy vehicles (purple) platinum flows	124
Figure 42 – Framework to calculate circularity indicators based on MFA (source: Graedel et al. 2011).....	125
Figure 43 – 5 steps to design a value chain from scratch, by Farel and Yannou (2013).....	131
Figure 44 – Illustrated overview of the multi-tool methodology to close-the-loop on industrial components	132
Figure 45 – Structural analysis and design technique (SADT) diagram – Level A-0.....	135
Figure 46 – SADT diagram – Level A0 detailed with levels A1-A2-A3-A4.....	135
Figure 47 – Functional analysis system technique (FAST) diagram	136
Figure 48 – Overview of the fuzzy cognitive mapping (FCM) developed.....	136
Figure 49 – List of variables, matrix MICMAC and dependence-influence graph	137
Figure 50 – Overview of the system dynamics (SD) model	138
Figure 51 – Synoptic view of the industrial pilot study conducted with a remanufacturing center of heavy vehicles ...	139
Figure 52 – Logos of the Manitou Company and its International Remanufacturing Center	140
Figure 53 – Overview of the stepwise process of the industrial pilot study conducted with Manitou Reman	142
Figure 54 – Complementary literature review and field investigations	143
Figure 55 – Schematic view of multi-scale modeling approach.....	146
Figure 56 – Gantt chart of the dismantling process before improvement (baseline)	148
Figure 57 – Photos of the first dismantling test	149
Figure 58 – Ishikawa 6M cause-effect diagram to highlight the room for improvement in the recovery process	149
Figure 59 – Streamlined and efficient dismantling process in the automotive industry	150
Figure 60 – Gantt chart of the newly proposed and adjusted dismantling process	151
Figure 61 – Photos of the tools recommended and acquired to smooth the dismantling process	151
Figure 62 – Gantt chart of the newly validated dismantling process after a second dismantling test	152
Figure 63 – Photos of the second and sound organized dismantling operation.....	152
Figure 64 – Spreadsheet to select preferred CE loops for the recovered components of an EoL heavy vehicle.....	153
Figure 65 – Economic analysis: cost of dismantling and benefits from reuse, reman, and material recovery.....	153
Figure 66 – Illustrations of the dismantling manual under development (source: Manitou Reman).....	155
Figure 67 – Closing the gap between academia and university, to link with Figure 19 (page 26)	157
Figure 68 – Chronological evolution of the management of end-of-life vehicles (ELV) in Europe	160
Figure 69 – Draft of a roadmap for a circular economy of heavy vehicles in Europe	160
Figure 70 – Empirical list of the data that can be captured in a heavy vehicle, with associated technologies	163
Figure 71 – Heavy vehicle catalytic converter.....	198
Figure 72 – The C-indicators Advisor: video tutorials and links	204
Figure 73 – Mathematical model to estimate the leakage of platinum (software: Simulink, Matlab R2018).....	205
Figure 74 – Input distributions and sampling (Sobol method, 250 samples)	207
Figure 75 – Uncertainty propagation using Monte Carlo simulation.....	208
Figure 76 – Statistical analysis and probability values (box plot)	208
Figure 77 – End-of-life vehicle processing in the automotive industry, based on Toyota (2016) plus additional sources of information (INDRA, 2016a; Directive 2000/EC/53) and consulted experts.....	210

List of Tables

Table 1 – Most used terms in the definitions of: circular economy, industrial ecology, and eco-design	9
Table 2 – Variety of quantified CE impacts on climate change mitigation (source: Deloitte Sustainability, 2016).....	11
Table 3 – Articles included in this Ph.D. thesis by publication	27
Table 4 – Overview of the sub-section 2.1 and description of the associated article	28
Table 5 – Overview of the sub-section 2.2 and description of the associated article	29
Table 6 – Definitions and features of automotive and HDOR sectors	32
Table 7 – Description of the resources used in the multi-method research	33
Table 8 – Regulations applied to automotive and HDOR sectors and relevant to the circular economy	36
Table 9 – Best practices (BP) and challenges (C) in both sectors to close the loops	43
Table 10 – Best practices (BP) and challenges (C) in both sectors in regard to the CE building blocks	44
Table 11 – Comparison of ELV regulations (automotive sector only) between the EU and the U.S.....	49
Table 12 – End-of-life management of heavy- and light-duty vehicles in the EU and the U.S.....	52
Table 13 – Overview of the sub-section 3.1 and description of the associated article	62
Table 14 – Overview of the sub-section 3.2 and description of the associated conference paper	62
Table 15 – Overview of the sub-section 3.3 and description of the associated article	63
Table 16 – Tools description, characteristics and operating mode.	68
Table 17 – Description of the four circularity loops, according to EMF CE butterfly model (2013)	74
Table 18 – Positioning of the three tools experienced in regard to the five proposed requirements.....	75
Table 19 – Indicators, methods and tools to measure products' circularity and associated limits	78
Table 20 – Comparison of top-down and bottom-up approaches to design indicators.....	79
Table 21 – Five-stage methodology to develop indicators, adapted from Brown (2009).....	80
Table 22 – Scoring system associated to Likert scales and items developed	82
Table 23 – Criteria and research filters used to identify C-indicators	88
Table 24 – Existing reviews, experimentations and critical analyses of C-indicators.....	92
Table 25 – Categories for the proposed taxonomy of C-indicators	93
Table 26 – Categorisation of C-indicators according to the micro-, meso- and macro- levels of the CE	93
Table 27 – Repartition of C-indicators into the main categories of the proposed taxonomy.....	96
Table 28 – Use cases of C-indicators at the micro level of the CE	98
Table 29 – Framework to evaluate the utilization and utility of indicators (Park and Kremer, 2017).....	100
Table 30 – Overview of the sub-section 4.1.1 and description of the associated papers and workshops.....	105
Table 31 – Overview of the sub-section 4.1.2 and description of the associated article and presentation	105
Table 32 – Overview of the sub-section 4.1.3 and description of the associated poster presentation.....	106
Table 33 – Overview of the sub-section 4.2 and description of the associated working paper.....	107
Table 34 – Agenda of the workshop on C-indicators (conducted in 2018)	109
Table 35 – Results from the experimentation of the C-Indicators Advisor (acronyms are detailed in appendix C)	110
Table 36 – Results from the experimentation of the Circular Economy Toolkit (CET)	111
Table 37 – Data quality score and associated uncertainty values (inspired by: BIO by Deloitte, 2015).....	120
Table 38 – Value chain of the platinum from catalytic converters in the EU-28.....	121
Table 39 – Description of stocks and flows: values, data sources and uncertainties.....	122

Table 40 – Evolution and comparison of MFA related to PGM in the EU	125
Table 41 – Environmental impact comparison between primary and secondary platinum	127
Table 42 – Detail of the key steps, activities and deliverables of the industrial pilot study	142
Table 43 – Inspiration and transfer of best practices from state-of-the-art automotive dismantling process.....	150
Table 44 – Summary of the academic and industrial contributions in regard to the initial objectives.....	156
Table 45 – Future challenges for the heavy vehicle industry	157
Table 46 – Evaluation framework to assess engineering models (source: Ben Ahmed et al. 2010)	161
Table 47 – Future research directions on circularity indicators	162
Table 48 – 70 definitions related to circular economy.....	186
Table 49 – 35 definitions related to eco-design (source : European Network of Ecodesign Centres, 2014).....	189
Table 50 – 13 definitions related to industrial ecology	190
Table 51 – Summary of industrial stakeholders interviewed	192
Table 52 – Nomenclature, acronyms and sources of the 55 C-indicators reviewed in the proposed taxonomy	195
Table 53 – Factsheet template for clear documentation on C-indicators.....	196
Table 54 – Agenda of the workshop on C-indicators, including activities details, materials needed and duration	197
Table 55 – Simplified bill of materials (BoM) of the catalytic converter	198
Table 56 – Geographical scope and logistic information related to the catalytic converter value chain.....	199
Table 57 – Construction of the probability distribution for the key variable “LossPerKm”	205
Table 58 – Parameters and variables of the model, with mean values and associated uncertainties	206

1. INTRODUCTION

In the introductory chapter, the general context of this Ph.D. thesis related to the circular economy and the heavy vehicle industry, in a sustainable development perspective, is first presented in sub-section 1.1. The specific motivations and challenges of this research are then introduced in sub-section 1.2, by describing the current issues on the end-of-life management of such heavy vehicles, and highlighting the need for circularity indicators in monitoring the transition towards a more circular economy. This leads to formulate the research question, driving this three-year project, which is divided into three main objectives depicted in sub-section 1.3. The research approach used to fill both the research and industrial gaps identified and to achieve the associated objectives is described in sub-section 1.4, combining the contributions from several relevant research fields and their related scientific research methodologies. Given the vast scope of research linked to the circular economy, the boundaries and positioning of this thesis are outlined in sub-section 1.5, framing as such this project and expected contributions. Finally, the detailed structure of dissertation, including three essays and a conclusion chapter, is laid out in sub-section 1.6.

1.1. FOREWORD

1.1.1. General context

1.1.1.1. What about the sustainable development?

As I write this introduction (n.b. in summer 2018), the Earth Overshoot Day has moved from late September in 1997 to August, 1st, in 2018, the earliest date since the world first went into overshoot in the early 1970s. Earth Overshoot Day marks the date when humanity's annual demand on nature exceeds what Earth's ecosystems can regenerate in a year (Global Footprint Network, 2018). Globally, this means humanity is using natural resources 1.7 times faster than ecosystems can regenerate. This is akin to using 1.7 Earths. At a national scale, Figure 1 details the specific Overshoots Days by countries, illustrating the huge impact on the environment of western societies. On an individual level, one can calculate his own ecological footprint and have an estimate of his personal overshoot day, by using the footprint calculator developed by the Global Footprint Network (2018).

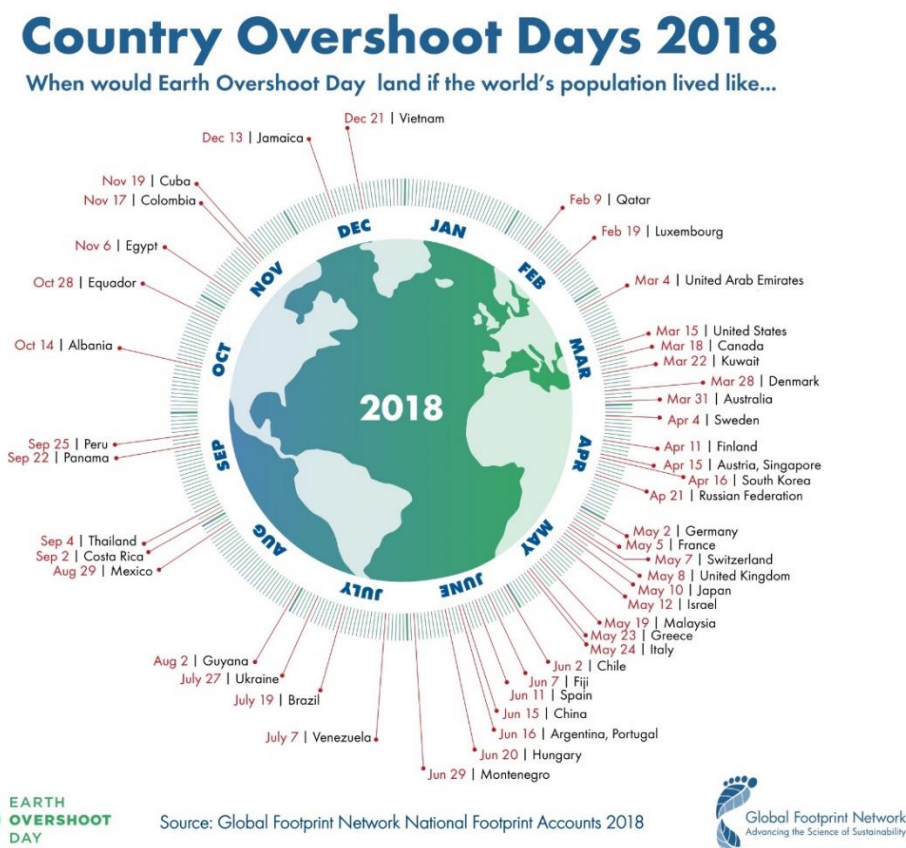

Figure 1 – Earth Overshoot Days, by countries (source: Global Footprint Network, 2018)

In addition to this mainstream reference and relative sustainability indicator, the sustainability of anthropogenic activities can be evaluated more scientifically through absolute sustainability indicators, like the ones of the planetary boundaries. Introduced in 2009, the planetary boundary concept aims to define the environmental limits within which humanity can safely operate. Steffen et al. (2015) provided an updated and extended analysis of this planetary boundary framework: of the original nine proposed boundaries, they identified three (including climate change) that might push the Earth system into a new state if crossed and that also have a pervasive influence on the other boundaries. On Figure 2, the green zone is the safe operating space, the yellow represents the zone of uncertainty (increasing risk), and the red is a high-risk zone. For example, the control variable shown for climate change is the atmospheric CO₂ concentration.

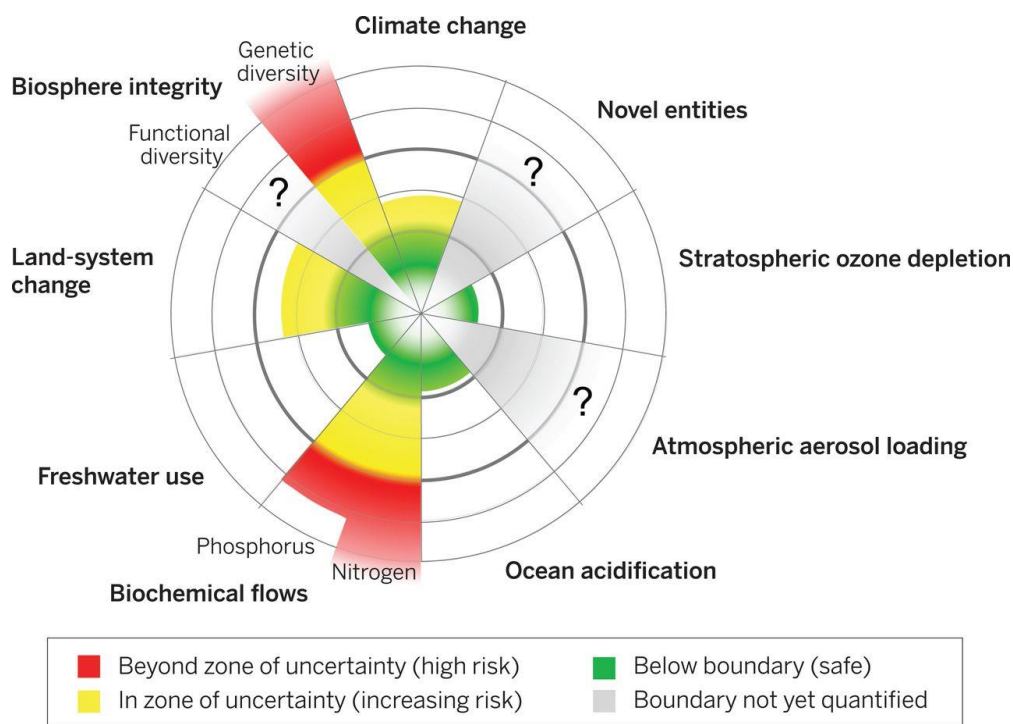

Figure 2 – Current status of the control variables of the planetary boundaries (source: Steffen et al. 2015)

Since the industrial revolution, science has evolved more and more quickly. New tools aiming at people to live better have been designed. New technologies have often revolutionized the way we live, made somehow our lives easier but ended up causing pollution and climate alteration. Most often the consequences have not been foreseen or thought over, and some new breakthroughs linked to technological progress can also come into conflict with moral or social progress (n.b. these debates are out of scope of the present thesis). More precisely, since the first industrial revolution, the use of factories and mass production has led to a depletion of certain natural resources, leaving the environment damaged.

In 1987, the Brundtland report (World Commission on Environment and Development, 1987) emphasized the global environmental emergency and promoted sustainable development. Nowadays, the world is still facing important environmental issues such as biodiversity loss or global warming and pollution. Across the globe, scientists undoubtedly are warning: environmental issues are threatening our world (Ripple et al. 2017). Population growth, urbanization, industrialization, and climate change, just to name a few, are all drivers for making a shift for global material cycle in a context of sustainable development. Despite all that, the figures show we are still not completely using our natural resources wisely and sustainably.

Against this background, the United Nations (UN) adopted several sustainable development goals (SDG) in 2015 and set specific targets for each of them to be achieved over the next 15 years. Indeed, the UN 2030 agenda for sustainable development includes 17 lofty goals for tackling the most pressing social and environmental challenges. For instance, the SDG 9 (Build resilient infrastructure, promote sustainable industrialization and foster innovation) and the SDG 12 (Ensure sustainable consumption and production patterns) are directly related to managing natural resources. Importantly, the circular economy can support the reaching of such SDG (Schroeder et al. 2018).

1.1.1.2. *What about the circular economy and the sustainable development?*

CE practices can potentially contribute to achieve a significant number of SDG targets. According to Schroeder et al. (2018), CE practices can be applied as a “toolbox” and specific implementation approaches for achieving a sizeable number of SDG targets. For example, achieving, or even striving for, the SDG 12 will require a complete overhaul of our linear, take-make-waste patterns of production and consumption in favor of a circular system - a restorative or regenerative system in which all products are designed and marketed with reuse and recycling in mind. Accordingly, to Deloitte Sustainability (2016), climate and resources are two vital assets threatened by the current economic model. On a planet with finite material resources, a circular economy is therefore a necessity to sustain and improve human life and well-being. The circular economy concept is defined more closely in the sub-sections 1.1.2 and 1.1.3, through its historical background and related concepts.

Adopting such CE principles could not only benefit Europe socially (e.g. create 100,000 new jobs within the next five years) and environmentally but could also generate a net economic benefit of €1.8 trillion by 2030 (McKinsey, 2015). Yet, while the CE paradigm seems to be a relevant mean to meet the goals of sustainable development, it remains of the utmost importance to measure and monitor the impacts of a transition towards a more circular economy (Geissdoerfer et al. 2017), especially in industrial practices, where trade-offs can occur between circularity and sustainability. Recently, academics (e.g. Linder et al. 2017), think tanks (e.g. EMF, 2015) and legislative board (EC, 2015) highlighted the need of circularity indicators to support industrial practitioners (e.g. engineers, designers, managers) and businesses in the assessment, improvement and monitoring of the circularity performance of their products, services and systems.

1.1.1.3. *What about the industry, the circular economy and the sustainable development?*

According to Murray et al. (2017), there have long been calls from industry for guidance in implementing strategies for sustainable development. Interestingly, the circular economy represents the most recent attempt to conceptualize the integration of economic activity and environmental wellbeing in a sustainable way within resource-limited societies (Murray et al. 2017). Yet, even if the adoption of circular practices can seem appealing, some industrial sectors need to be supported in their shift towards such a paradigm. This is particularly the case of the heavy vehicle industry.

Presently, the end-of-life management of heavy vehicles is still a marginal activity, not submitted to end-of-life regulation, which leads to the leakage of high added value components and precious materials, such as platinum contained in catalytic converters. Moreover, circular economy and sustainability considerations applied to the heavy vehicles sector are fresh research themes. Contrary to light vehicles - i.e. cars which are subject to an end-of-life regulation (Directive 53/2000/EC) with mandatory recycling and recovery rates - the end-of-life management of heavy vehicles is a barely addressed issue in scientific literature. Section 1.2 exposes in more detail the reasons that make the heavy-duty and off-road (HDOR) vehicle sector an interesting research topic regarding the CE.

1.1.1.4. *What about the policy, the industry, the circular economy and the sustainable development?*

Moving towards a more circular economic model is one of the objectives of the European Union at the 2020 horizon. An action plan for the circular economy has been set up by the European Commission (2015) to promote the reparability, upgradability, durability, and recyclability of products. Moreover, public policies and regulatory framework, such as the extended producer responsibility (EPR) are increasingly pushing industrial actors to implement end-of-life management strategies for the products they design, develop and manufacture to ensure proper recovery and recycling.

Indeed, western societies are getting increasingly environment-oriented and sustainable development is now part of more and more political programs. Yet, while some industrial sectors are directly concerned by end-of-life regulations and associated EPR schemes – e.g. the end-of-life vehicles (ELV under 3.5 tons) and the waste electrical and electronic equipment (WEEE) European Directives – the management of certain important waste streams is left behind. This is especially the case of the heavy vehicle industry, including heavy-duty vehicles such as trucks and non-road mobile machineries such as construction and agricultural equipments.

1.1.2. Theoretical background

Before getting into the substance of this thesis, it is worthy to define what is meant by a circular economy, as well as to depict the historical foundations and forerunner concepts associated to the circular economy. Notably, clarifications are established on the positioning between industrial ecology (IE) and circular economy (CE).

1.1.2.1. Definitions of a circular economy

Today, as there is no one clear, standardized or crystalized definition of the circular economy concept, it might result in many different meanings and interpretations. As such, an effort is made to position against these definitions and to avoid any ambiguity in each research contribution of this manuscript. Rizos et al. (2017) analyzed and compared 12 definitions related to circular economy. Prieto-Sandoval et al. (2018) and Korhonen et al. (2018) reviewed respectively 13 and 11 definitions of the CE concept extracted from top-tier international journals. Reviewing 25 definitions as well, Sacchi Homrich et al. (2018) highlight that the circular economy concept comes from different epistemological fields and there is still a lack of consensus and convergence in the literature. So far, the most complete review has been performed by Kirchherr et al. (2017), identifying and scrutinizing 114 definitions, highlighting the core principles, aims and enablers of the circular economy through this sample. An interesting finding is that 83 (73%) of these 114 definitions have been proposed between 2012 and 2017, showing how emerging and young the circular economy research field is. According to Kirchherr et al. (2017), such analyses are of the utmost importance to bring more coherence in the circular economy concept, because they argue that significantly varying circular economy definitions may eventually result in the collapse of the concept. Based on these extensive reviews, here are the latest and most comprehensive definitions of the circular economy concept proposed by scholars. For a bigger picture, a compilation of numerous circular economy definitions is available in Appendix A, and a text analysis on these definitions is performed in sub-section 1.1.2.3, comparing objectively the numerous definitions of circular economy, industrial ecology and eco-design. Fortunately, all definitions of circular economy agree that it is definitely opposed to the so-called linear model “take-make-waste”. CE is looking for a better management of resources throughout the life cycle of systems and is characterized by closed loops, promoting maintenance, sharing, leasing, reuse, remanufacturing and recycling. CE aims to retain the highest utility and value of products, materials, and resources at all times, to minimize the generation of waste.

- Prieto-Sandoval et al. (2018) advance that four main components should be included in definition of CE: (i) the recirculation of resources and energy, the minimization of resources demand, and the recovery of value from waste, (ii) a multi-level approach, (iii) its importance as a path to achieve sustainable development, and (iii) its close relationship with the way society innovates. According to the authors, these four components can help scientific community and policy makers to get a consensus in this field. Therefore, they defined circular economy as “an economic system that represents a change of paradigm in the way that human society is interrelated with nature and aims to prevent the depletion of resources, close energy and materials loops, and facilitate sustainable development through its implementation at the micro (enterprises and consumers), meso (economic agents integrated in symbiosis) and macro (city, regions and governments) levels.”
- To Geisendorf and Pietrulla (2017), in a circular economy: “the value of products and materials is maintained, waste is avoided, and resources are kept within the economy when a product has reached the end of its life. CE starts with the circular design of the main stages of a product’s life cycle. Transportation should be designed supporting circularity at all these stages, and the product has to be designed in a way to enable circularity at all stages. This micro perspective is embedded in meso and macro perspectives, which allow realizing additional circularity, possibly through synergies. The meso and macro levels thus also require a circular design and coordination.”
- Kirchherr et al. (2017) define the circular economy as “an economic system that replaces the end-of-life concept with reducing, alternatively reusing, recycling and recovering materials in production/distribution and consumption processes. It operates at the micro level (products, companies, consumers), meso level (eco-industrial parks) and macro level (city, region, nation and beyond), with the aim to accomplish sustainable development, thus simultaneously creating environmental quality, economic prosperity and social equity, to the benefit of current and future generations. It is enabled by novel business models and responsible consumers.”

Blomsma and Brennan (2017) consider the circular economy as an umbrella concept. Hirsch and Levin (1999) define an umbrella concept as: “a broad concept or idea used loosely to encompass and account for a set of diverse phenomena”. Umbrella concepts create a relation between pre-existing concepts that were previously unrelated, or not related in the manner the umbrella concept proposes, by focusing the attention on a particular shared quality or characteristic of the concepts it encompasses. As such, it seems appropriate to conceptualize the

CE as an umbrella concept. Indeed, applied to the circular economy, and the various resource strategies individually related to such paradigm, this concept offers a new framing of these strategies by drawing attention to the relationship and complementary between these strategies. Interestingly, Blomsma (2018) provides an overview of waste and resource management frameworks, developed by a variety of actors, that inspired the circular economy or that took inspiration from the latter. For instance, the following frameworks are featured as input for the Ellen MacArthur Foundation’s circular economy model (EMF, 2013): regenerative design, biomimicry, natural capitalism blue economy, cradle-to-cradle, performance economy, industrial symbiosis (in bold letters in Figure 3). In this line, Geisendorf and Pietrulla (2017) compare the characteristics of such CE related concepts, including also reverse logistics. Kovács (2017) evaluates the CE concept in contrast with other related concepts that have been used in other disciplines such as industrial ecology and supply chain management, in order to understand what is novel, and how the circular economy extends or combines previous streams of literature. Theoretical roots and concepts associated to the circular economy are illustrated in Figure 3 through a chronological timeline. Further definitions of CE related concepts are given in Appendix A.

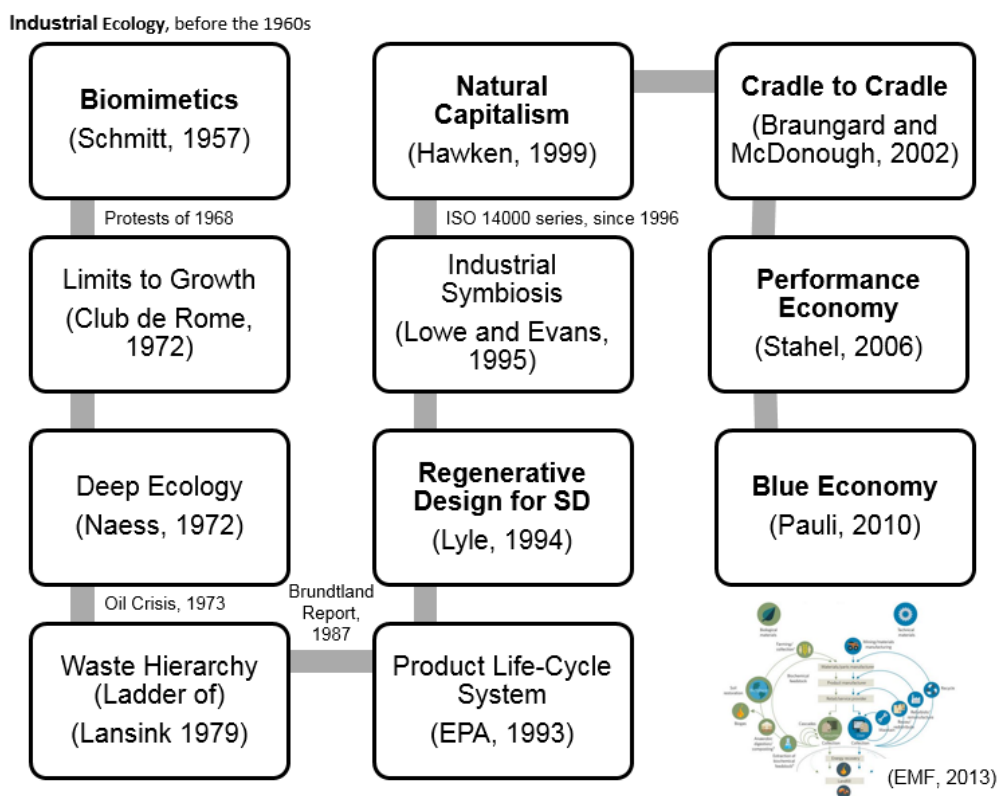

Figure 3 – Forerunner concepts and schools and thought (in bold) of the circular economy, a chronological timeline

To better understand the circular economy paradigm, its historical foundations are discussed in the following sub-section, through the lens of industrial ecology and related concepts.

1.1.2.2. From industrial ecology to circular economy, through related concepts

The research on the CE concept is still emerging (Korhonen et al. 2018) but the CE paradigm is not totally new. In accordance with (Sauvé et al. 2016), what is new is the momentum that the concept is gaining among business practitioners, policy advocates, companies and academics. We can then wonder whether the circular economy is the new industrial ecology – a kind of industrial ecology 2.0 – at the dawn of the 21st century. An analysis of the key discussions and latest debates related to the relationships between the circular economy, industrial ecology and other related concepts is proposed in this sub-section in order to position our work against these concepts.

Although ideas regarding industrial ecology exist since at least the 1940s, the official birth of the “industrial ecology” concept can be related to scientific article by Frosch and Gallopoulos (1989) that suggested the need for “an industrial ecosystem” in which “the use of energies and materials is optimized, wastes and pollution are minimized, and there is an economically viable role for every product of a manufacturing process” (ISIE, 2015). The goal is to

have industries work together in order to move from a linear to a cyclical closed loop system. A concrete demonstration of this concept started in 1972 in Denmark, in Kalundborg, and is still ongoing.

Back in the 1990s, industrial ecology was considered in the research literature as an emerging framework. Erkman (1998) viewed industrial ecology as a mean to implement sustainable considerations in an industrial society. To Røine (2000) the most important issue in industrial ecology was to unite two main interests: ecological sustainability on the macro level, and business economy profit on the micro level. This means that knowledge from different actors and disciplines are needed to implement necessary processes of change. Garner and Keoleian (1995) identified future needs for the development of industrial ecology, asking for a clearer definition of this field and its concepts, as it is the case at the moment for the circular economy. Lifset and Graedel (2002) discussed the challenges of setting out the goals and boundaries of industrial ecology as an emerging field, which especially resonates with the current state of the circular economy concept: “Set them too conservatively and the potential of the field is thwarted. Set them too expansively and the field loses its distinctive identity. Spend too much time on this task and scarce resources may be diverted from making concrete progress in the field. But in a field with a name as provocative and oxymoronic as industrial ecology, the description of the goals and definitions is crucial. No field has unanimity on goals and boundaries. A field as new and as ambitious as industrial ecology surely has a long way to go to achieve even a measure of consensus on these matters. As a new field, industrial ecology is a cluster of concepts, tools, metaphors and exemplary applications and objectives. “

On this basis, Ehrenfeld (2004) asked if industrial ecology was a new field or only a metaphor: “in the 10 years since industrial ecology first became a topic of academic interest, it has grown as a field of inquiry and has produced a community of practice in several sectors including academia, business, and government”. To him, even as the shape of industrial ecology becomes clearer, ideas like industrial ecology must become institutionalized to have much effect on the reality of everyday activities. In parallel, the circular economy paradigm has been being materialized in China, as part of the law adopted on 29 August 2008 entitled "Circular Economy Law of the People's Republic of China". The purpose of this law is to promote the CE to improve the use of resources and protect the environment and thus enable sustainable development. It defines the CE as "a generic term used to refer to all reduction, reuse and recycling activities carried out during the production, circulation and consumption process". In France, the circular economy concept was officially first mentioned during the “Grenelle de l'Environnement” and formalized in 2013 through the creation of the National Institute of Circular Economy (INEC) (Bonet et al. 2014).

Saavedra et al. (2018) analyzed the theoretical contribution of IE in the transition to CE, indicating several aspects in which IE contributes to the CE such as conceptual, technical and political aspects. Through the review of 43 publications representing the contributions of IE to the development of CE, it has been identified that the evolution of CE would not be possible without the existence of IE concepts and tools. Moreover, according to some findings in the literature, CE is sometimes considered as a broader discipline than IE because of the inclusion of economic and policy issues. Based on the co-citation network, CE based research from an IE perspective can further encourage collaboration between these two research communities. In order to achieve this systematic transition towards a CE at a macro level, the collaboration of the business community, policy makers and institutions is also fundamental.

To Prieto-Sandoval et al. (2018), industrial ecology is seen as a transitional object (notably from the 1960s to the 2000s) serving the shift from a linear to a circular economy, by moving from an explorative or “cowboy” economy to a regenerative one, through restorative and cyclical steps. Blomsma and Brennan (2017) exposed a draft of a research agenda for industrial ecology to contribute to the development of circular economy. To guide the development of the CE concept towards wide implementation and alignment with sustainable development, further integration of social theories with IE is required. This entails incorporating perspectives from other disciplines, such as law, ethics, economics, system dynamics, and sociology and organizational studies, within IE.

All in all, Blomsma and Brennan (2017) depict the stages the circular economy concept has gone through: the period from the 1960s to the 1980s is described as the preamble, the one from the 1990s to the 2010s as the excitement. According to the authors, today's period is facing the validity challenge, and forecasts three possible pathways for future work: coherence, permanent issue, construct collapse. Actually, the circular economy concept is nowadays gaining more and more traction from academic, business and industry, think tanks and consulting companies, as well as legislative and advisory boards (Blomsma and Brennan, 2017), as illustrated in Figure 4.

1.1.2.3. Circular economy, industrial ecology, and eco-design: current positioning

Circular economy and industrial ecology are currently two moving and fuzzy concepts, both subject to different interpretations. For the French Environment & Energy Management Agency (ADEME), industrial and territorial ecology (EIT) is one of the 7 pillars of the circular economy, as well as eco-design. From this standpoint, the EIT is mainly reduced to the dimension of industrial symbiosis and eco-industrial parks. For other authors, such as Erkman (1997) who prefers the term industrial ecology (without adding the notion of territory, because the industry is in essence implanted in a territory), the two concepts are relatively close. Globally, the circular economy concept seems more easily accessible and understandable to the general public (loops representation) and the industrial world (economic profit), e.g. through the actions and communications of the Ellen MacArthur Foundation, while industrial ecology represents the scientific field, e.g. through the International Society for Industrial Ecology, that can allow the deployment of such a circular economy.

Yet, the question of the relationship between the circular economy and the industrial ecology, is still stirring a vivid debate between scholars through scientific articles (Bucket, 2015; Chebbi and Figuière, 2016) or even on the web exchange platform ResearchGate where researchers try to figure out “what is the difference between circular economy and eco-industry”, just to cite one example. Also, a special issue of Yale’s Journal of Industrial Ecology “Exploring the Circular Economy” asked somehow if industrial ecology is the science of the circular economy. Even if the review of existing literature on this topic has provided some answers, as detailed in the previous sub-section, both a bibliometric analysis and text mining techniques are used hereafter to provide new and objective insights .

Bibliometric analysis belongs to the scientometry research field, which addresses the quantitative analysis of activity and scientific networks (Leydesdorff and Van den Besselaar, 1997). Regarding the text mining analysis, term frequency, as one efficient and simple text mining method (Gaikwad et al. 2014), is the technique used here to analyze and compare the definitions of circular economy, industrial ecology and eco-design. The French National Scientific Research Center (CNRS) established a practical list of resources and computer-based tools to perform such analyses.

On the one hand, Google Trends and Harzing Publish or Perish software are used to conduct the bibliometric analysis, as displayed in Figures 5 and 6. The five most important international research journals in CE and IE considered for the bibliometric analysis, regarding the number of publications with CE and/or IE as key words, are the following: Journal of Clean Production, Journal of Industrial Ecology, Resources Conservation and Recycling, MDPI Sustainability, and Waste Management. On the other hand, two free online tools are used to perform the text mining: (i) Textalyser, to sort out the most used terms in the definitions of circular economy, industrial ecology, and eco-design, as summarized in Table 1; (ii) Wordle to generate illustrative word clouds based on these definitions, as illustrated in Figure 7. The 70 definitions of circular economy, 35 definitions of eco-design, and 13 definitions of industrial ecology considered for the text mining are all listed in Appendix A.

Figure 5 shows the global public interest over time: numbers on the Y-axis represent search interest relative to the highest point on the chart for the given region (i.e. worldwide) and time (i.e. from 2004 to 2018). This chart reveals an ever growing interest in circular economy from 2012 to the present day, while industrial ecology was more popular in the 2000s. This trend has also prevailed lately in the wording used in scientific publications as illustrated in Figure 6.

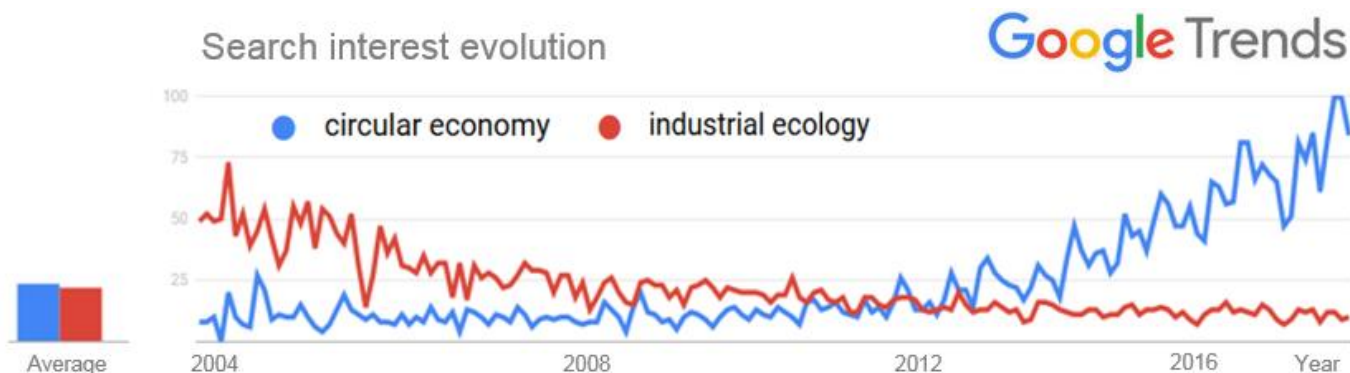

Figure 5 – Evolution of the search interest on circular economy and industrial ecology (worldwide)

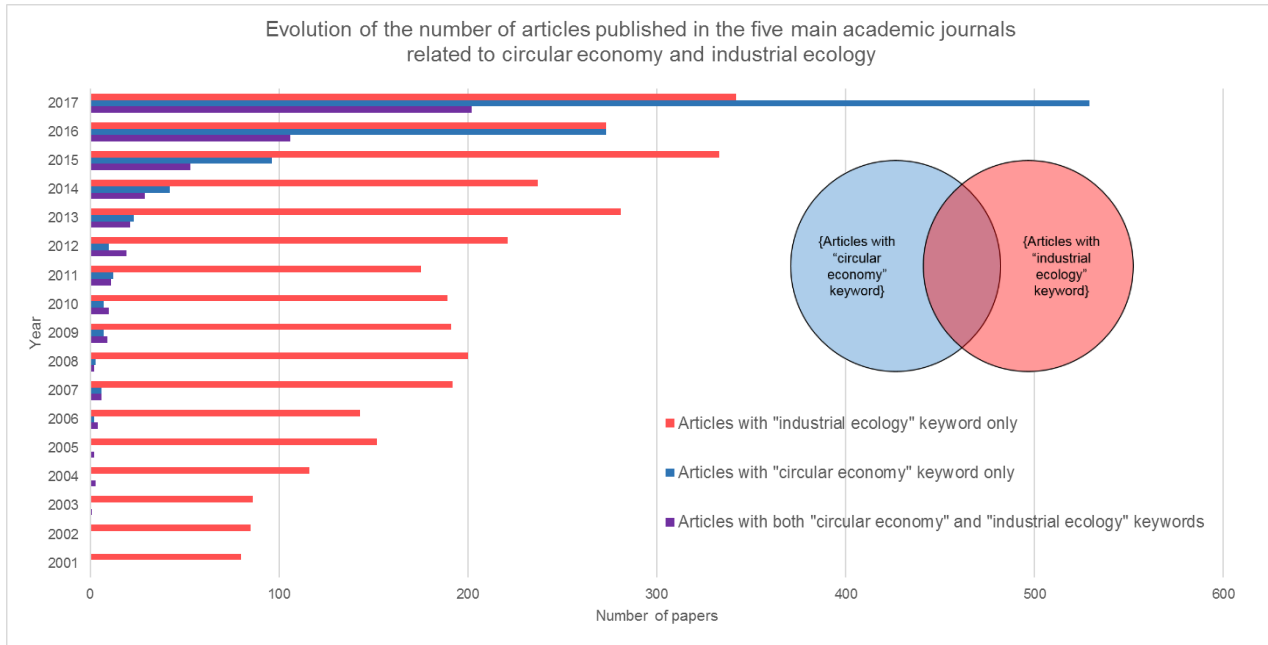

Figure 6 – Bibliometric analysis of the publications on circular economy and industrial ecology

Through the text mining analysis, even if it is difficult to draw sharp interpretation, some trends can be noticed. Regarding the similarities, both CE and IE concepts consider the industrial products and waste in their definitions. System thinking is also central in both CE and IE, because designing out wastes and closing the loop of industrial products needs a holistic understanding and support. Regarding the differences, the word “resources” is most often used in CE definitions while the word “energy” is more employed in IE definitions. Also, the notions of end-of-life strategies appear in CE definitions through the words “recycling” and “reuse” while IE definitions talk more about the production phase with the word “manufacturing”. In this line, eco-design is interesting as a micro approach aiming to design and develop environmentally sound products, which can serve both IE and CE. Eco-design principles do not deal with concrete end-of-life processes, but prepare products so that they can be maintained, reused, remanufactured, or recycled through CE loops.

Table 1 – Most used terms in the definitions of: circular economy, industrial ecology, and eco-design

Most cited words	Circular economy	Industrial ecology	Eco-design
#1	economy	ecology	design
#2	circular	industrial	environmental
#3	resources	systems	eco
#4	materials	natural	product
#5	economic	energy	life
#6	waste	material	cycle
#7	system	economic	process
#8	use	waste	impacts
#9	products	human	development
#10	value	environmental	products
#...	energy, production, development, consumption, recycling, industrial, reuse, design	products, ecosystems, manufacturing, industry, system	environment, integration, stages, reduce, account



Figure 7 – Word clouds of circular economy, industrial ecology and eco-design definitions

1.1.3. Illustrative examples

As an appetizer, after the theoretical introduction, defining and positioning the terms of this dissertation, four concrete examples of circular practices are discussed in this sub-section to highlight both the rich promises and complex challenges in achieving a circular economy. The first two examples are directly related to the heavy vehicle industry, while the two others illustrate some current issues associated to the measurement and monitoring of the circular economy performance.

1.1.3.1. Retreading of tyres: a historical contributor to the CE

Retreading is a remanufacturing process in the tyre industry that involves replacing the tread of a used tyre, mostly used for the heavy-duty and off-road vehicles, due to the high cost and consumption of such heavy tyres. Driven by the industrial dynamism that follows the post-war reconstruction in a context of scarcity of rubber, the sector is operating since the 1950s. Actually, the tyre industry has internalized many of the CE principles by acting and investing on every stage of the tyre lifecycle, from design to end-of-life, as illustrated in Figure 8 (ETRMA, 2015). On the left, the circular economy for tyres is viewed through the four feedback loops of a circular economy defined by the EMF (2013), namely, maintenance (leasing), reuse (repair and second-hand market), remanufacturing (retreading) and recycling (granulate products). On the right, the seven pillars of a circular economy defined by the ADEME are illustrated, namely eco-design (reducing the mass, and the environmental impact during design and development, using secondary materials) industrial ecology (using by-products from tyres production as alternative fuel) product-service system (selling the number of kilometers instead of the property) maintenance and second-hand market (selling second-hand tyres) reuse (repairing a punctured tyre) remanufacturing (retreading) recycling (using the end-of-life tyres as raw materials for another application like synthetic grass).

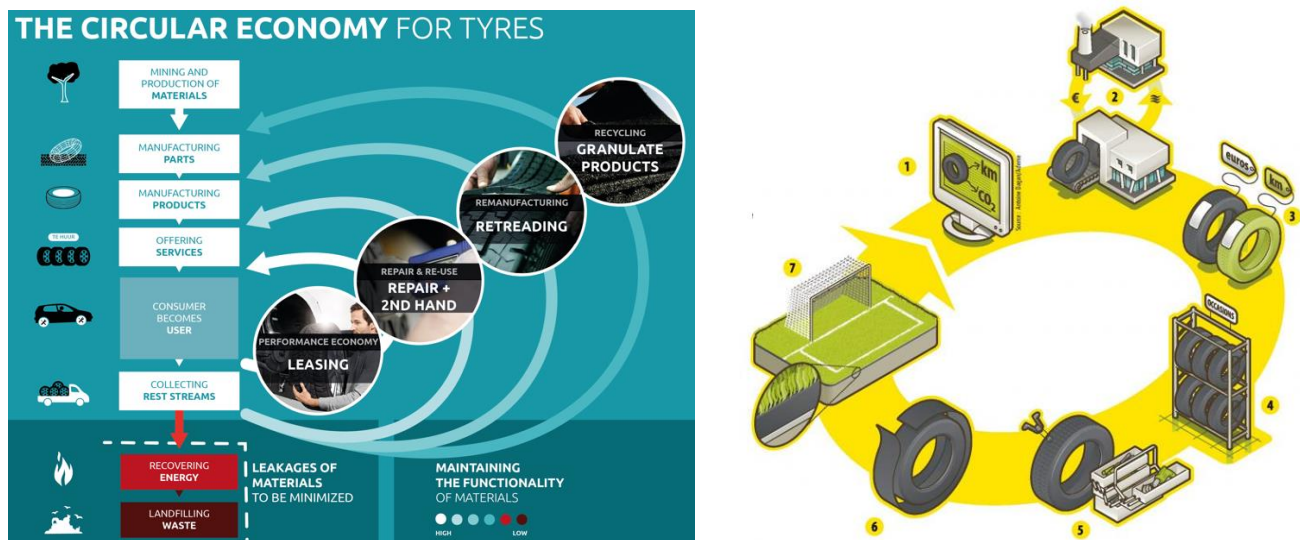

Figure 8 – The circular economy loops of the tyre industry (sources: Plan C on the left, ADEME on the right)

According to Michelin (2016) a premium tyre for a heavy vehicle with an initial lifetime of 220,000 km can be retreaded up to two times, having the same performance of a brand new one. The overall lifespan of a tyre produced in Europe is therefore 660,000 km, reducing the use of raw materials by 70%. Even if the EU tyre market is one of the most technologically advanced in the world – tyres have developed to a high-tech product, minimising rolling resistance and noise and improving driving comfort as well as safety in all weather conditions, complying with relevant EU regulations on chemicals, products and waste (ETRMA, 2015) – there is still room for improvement. In fact the Viktoria Sweden Institute (2017) is working on a project called “Integrated sensors and new recycling technology for heavy vehicle tyres”. The project aims to build knowledge about how the actors in the value chain for heavy vehicle tyres can increase resource productivity by the use of materials based on IoT (Internet of Things) technology, and serviced based value propositions. In fact, the usage and reuse of tyres could be optimized if users, fleet managers and repair shops have access to real time information of the “health” of tyres.

Although the tyre industry appears to be well-advanced in the implementation of circular practices, it is only one component of a complete heavy vehicle. Actually, the heavy vehicle industry, as a whole, is far from being totally circular. Nonetheless, the tyre example can serve as an inspiration and it is further developed in this thesis.

1.1.3.2. Caterpillar: an industrial pioneer in the CE

In 2005, at the Geneva Environment Meetings, Walter R. Stahel (2005) took the example of Caterpillar, and its emerging remanufacturing activity to illustrate the technical feasibility, economic profitability and potential sustainable benefits associated to closed-loop industrial systems: “In 1972, Caterpillar Inc. started remanufacturing diesel engines at the request of a large client. At the time, the company doubted the economic feasibility of remanufacturing and was largely unaware of its impact on the environment – but very few people knew of sustainability in 1972. The decision to start the remanufacturing of diesel engines was taken by Caterpillar in the early 1970s, in response to the request from a major new customer which selected Caterpillar as OEM-supplier of diesel engines for a new delivery van. At this time, the remanufacturing of components by OEMs was standard in the U.S. car and truck business, but not in Caterpillar's core business of heavy earthmoving equipment, where independent local remanufacturers were active. Today, Caterpillar is convinced of the economic feasibility of remanufacturing, and the additional benefits with regards to the quality image of its products. It all makes good business sense. The environmental advantages of remanufacturing - in comparison to manufacturing - are perceived but not yet measured; the even larger positive impacts of remanufacturing on sustainability are slowly emerging. Remanufacturing is still an area largely unexploited by engineering research, and offers therefore plenty of opportunities at different levels. This also means that there is plenty of room for innovation and improvement - for those who can see it and take advantage of it!”

The Caterpillar case is further analysed and developed in Section 2 of the present manuscript. Notably, as it appears to be a good and leading example for the heavy vehicle industry in its shift towards a more circular economy, the transfer of best practices from one sector to another or from one company to another is particularly discussed in Section 2.

1.1.3.3. Measuring the impact of CE practices on climate change

Deloitte Sustainability (2016) investigated to what extent the circular economy can contribute to the reduction of greenhouse gas (GHG) emissions, by reducing the amount of energy needed by industrial production processes to transform primary raw materials into usable products. The quantification of circular economy measures potential for GHG emission mitigation is challenging because of numerous approaches and estimations discussed in the literature, as detailed in Table 2. This example shows the importance of a well-defined scope (e.g. geographical, time, CE strategies considered) to communicate the results of circularity and sustainability indicators. Altogether, through recirculating materials and products, potential savings can represent a 33% reduction of the emissions related to the production of goods consumed in the EU. Knowing that keeping the global warming below 2°C would require a reduction of around 50% of total global emissions (IPCC, 2015) by 2050, the uptake of CE strategies has therefore the potential to make a substantial contribution in mitigating emissions related to the production of material goods.

Table 2 – Variety of quantified CE impacts on climate change mitigation (source: Deloitte Sustainability, 2016)

Geographical scope	CE strategies investigated	GHG emission reduction	References
World	Electric, shared and autonomous vehicles, food waste reduction, regenerative and healthy food chain, passive houses, urban planning, renewable energies	17,000 Mt CO ₂ eq. in 2030	EMF, 2015
World	Recovery and reuse, lifetime extension, sharing and service model, circular design, digital platforms	7,500 Mt CO ₂ eq. in 2030	Circle economy, 2016
Europe	Recycling	176 Mt CO ₂ eq. (policy targets) 278 Mt CO ₂ eq. (tech. potential)	BIO for European Commission, 2011
Europe	Waste directives	62 Mt CO ₂ eq. in 2030	EC, 2014
France	Packaging recycling	2.1 Mt CO ₂ eq. in 2013	Climat for Eco-Emballages, 2015

1.1.3.4. Indicators for monitoring the circular economy

According to the European Commission (2018a), in the transition to a more circular economy, monitoring the key trends and patterns is key to understand how the various elements of the circular economy are developing over time, to help identify success factors in Member States, and to assess whether sufficient action has been taken. The monitoring framework on the circular economy as set up by the European Commission (2018a) consists of 10 indicators, structured in four categories as illustrated in Figure 9: (i) production and consumption, (iii) waste management, (iv) secondary raw materials, and (iv) competitiveness and innovation. The ten indicators aim to quantify the following aspects: EU self-sufficiency for raw materials, green public procurement, waste generation; food waste; overall recycling rates; recycling rates for specific waste streams, contribution of recycled materials to raw materials demand; trade in recyclable raw materials; private investments, jobs and gross value added, patents.



Figure 9 – Circular economy monitoring framework (source: European Commission, 2018a)

The French Ministry of the Environment and Energy also defined and calculated 10 key indicators for monitoring the circular economy at a national level, i.e. for measuring the circularity of the French economy, and comparing France's position to other countries and European averages (Magnier, 2017). The 10 indicators chosen cover the seven pillars of a circular economy, defined by the ADEME: as illustrated in Figure 10, four indicators are applied to the early phases (extraction/use of resources and sustainable purchasing, eco-design, industrial and territorial ecology, and the functional economy), followed by three indicators for the second action area (responsible consumption, and extension of product lifespan), and two indicators for the end of the cycle (recycling). Finally, an indicator examining employment in the circular economy addresses the cycle as a whole. Yet, to some, this framework is quite incomplete to effectively evaluate the circular economy performance of a country. For example, according to discussions with an expert from the Pôle Ecoconception, the indicator "Ecolabels" is not a sufficient information to assess the true contribution of eco-design in a circular economy. Fortunately, other circularity indicators have been or are currently being developed. In fact, these two sets of 10 indicators are only two of the 55 sets of C-indicators reviewed, analyzed and organised through a proposed taxonomy in this dissertation, in Section 3, including notably a tool designed to select the most appropriate C-indicators for a given context.

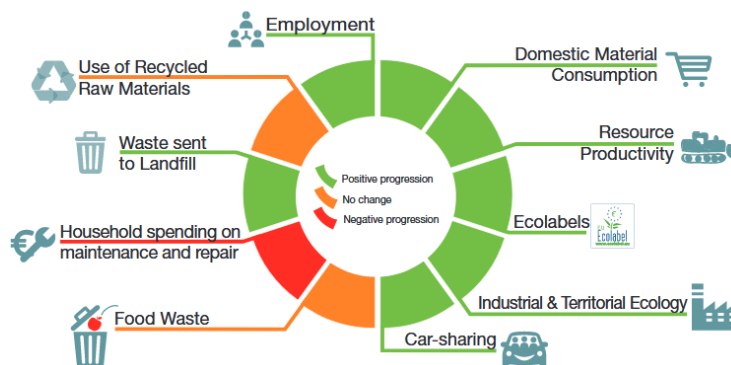

Figure 10 – The circular economy in France through 10 key indicators (source: Magnier, 2017)

1.2. MOTIVATIONS AND CHALLENGES

1.2.1. Why the circular economy? Why the heavy vehicle industry?

This sub-section motivates and defines the challenges addressed by this Ph.D. thesis and explains why it is worthwhile looking at. Why research on the circular economy implementation in industry is important? Why is this thesis particularly focused on the heavy vehicle industry? Who industrial actors and what stakes are involved in the end-of-life management of heavy-duty and off-road vehicles? Why is moving towards a more circular economy not that straightforward? How this transition can be supported and catalyzed? The research on the circular economy and the heavy vehicle industry may seem quite independent and not directly correlated at first sight. Yet, these two promising research fields appear to be complementary to each other. On one the hand, the circular economy is a complex concept and an emerging research topic. Notably, the conditions of its sustainable implementation in industrial practices remain to be discussed and established. On the other hand, the heavy vehicle sector is an interesting application framework that needs to be supported in its transition towards more circular practices. What makes the research on the circular economy within the heavy vehicle industry both relevant and complex is further developed hereafter in sub-section 1.2.2.

Circular economy aims at decoupling economic growth from resources consumption. A particular interest of the circular economy concept lies in its compatibility and consistency with sustainable development through its three associated pillars. Indeed, it aims directly not only at economic benefits (e.g. value creation and savings by reducing the purchase of primary raw materials), but also at environmental benefits (e.g. impact reduction) and indirectly at social benefits (e.g. job creation). Companies are becoming more and more aware of the risks associated with the linear economy. In fact, issues such as the scarcity of natural resources, volatility of commodity prices and environmental concerns (e.g. regulations setting recycling targets) call for a re-thinking of their consumption and production patterns. Against this background, companies are increasingly recognizing the potential of circular economy models to increase the value of their products and materials and to mitigate the risks associated with volatile materials prices and supply. While benefits and opportunities of a circular economy are appealing, challenges for industrial practitioners to shift for their businesses and products into more circular practices still exist. Particularly, the end-of-life management of the heavy vehicle industry needs to be enhanced and supported in a circular economy perspective. As an illustration, Figure 11 depicts the situation related to heavy vehicles we want to avoid both for its negative environmental impact on our planet and for the economic loss of materials, components and added value provided by the original equipment manufacturer. Meanwhile, companies, institutions and researchers agree on the need to assess circularity at several and complementary systemic levels. Circularity indicators and their assessment framework can provide companies with methods and tools for evaluating the regenerative capacity of their products, allowing them to determine how advanced they are in moving from the linear model to the circular model.



Figure 11 – Example of an abandoned end-of-life heavy vehicle: economic loss and environmental burden

1.2.2. Towards a circular heavy vehicle industry: between challenges and opportunities

With 270 million light vehicles and 20 million heavy-duty and off-road (HDOR) vehicles in use in the European Union, automotive and HDOR industries are two major sectors in the European economy. Each year, 12 million light vehicles plus 1 million HDOR vehicles are reaching their end-of-life. In terms of mass, it represents the same order of magnitude. Yet, so far no European policies deal with the end-of-life management (e.g. setting up mandatory recycling and recoverability rates like in the automotive industry under the ELV Directive 2000/53/EC), representing as such a key challenge for reaching a circular economy in this industry.

According to discussions with an expert from Cider Engineering (2016), an expertise center specialized in the treatment of end-of-life vehicles and machineries, the current end-of-life management of heavy vehicles is unsatisfactory in terms of safety, technical means, environmental impacts and economic considerations. More concretely, there is currently a poor traceability after the sale and use of heavy equipments, recycling channels are marginal while the collection, shipment and treatment of end-of-life heavy vehicles by illegal operators is a flourishing business. Based on the significant quantity of end-of-life vehicles and their remaining economic value (ADEME, 2006), there is a real end-of-life economy to create in a circular economy perspective (CETIM, 2014), by optimizing the collection, dismantling and recovery of such vehicles, and by putting back on the markets the materials, components and vehicles resulting from the circular practices and loops, namely: maintenance, reuse, remanufacturing and recycling. Nevertheless, no economic model has been validated yet by the actors in that sector (Cider Engineering, 2016). In fact, at present, this industry is facing a lack of infrastructures, methods and support to do so. When existing, dismantling process are poorly designed and are often incorrectly dimensioned.

From a research perspective, the end-of-life management of heavy vehicles is barely studied in the scientific literature. In addition, the complexity of this industrial sector, plus its considerable environmental and economic impact, makes it particularly relevant for figuring out how to implement circular practices. Interestingly, the heavy vehicle industry can be viewed as an industrial complex system (Cluzel, 2012) based on the multiplicity of stakeholders involved at different scales, as illustrated in Figure 12. Also, forecasting circular practices throughout the value chain of this sector is also facing a problem of time, considering e.g. the time gap between the design and end-of-life of heavy vehicles, as detailed in Figure 13. Ideally, in a circular economy and systemic mindset, all life cycle steps have to be considered, from the design of heavy vehicles and key components, to their end-of-life management (reuse, remanufacturing, recycling), through their selling (marketing aspects and business models) and usage (consumption, maintenance, communication, after-sales tracking), as mapped in Figure 13.

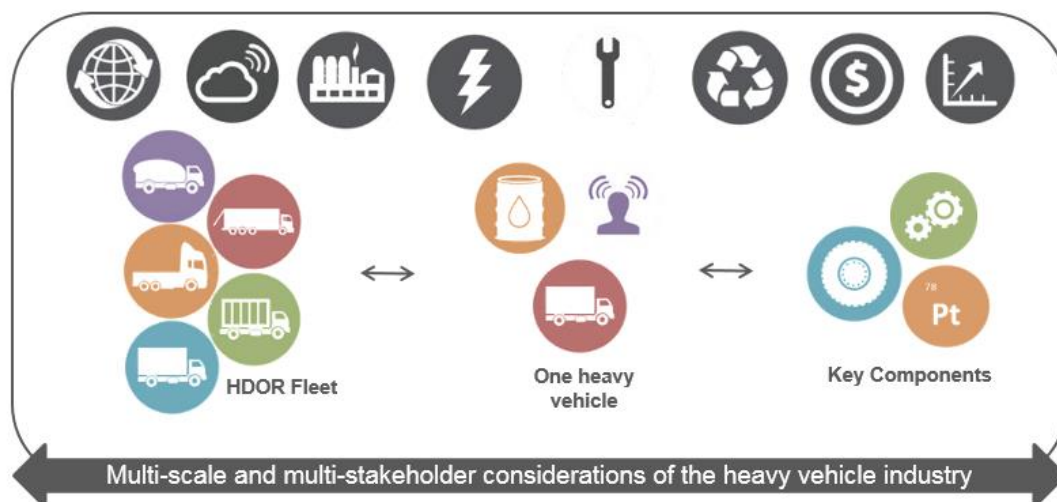

Figure 12 – Overview of the heavy vehicle industry at different systemic levels, illustrated with logos

In a nutshell, the absence of end-of-life regulation in the heavy vehicle industry makes particularly relevant and challenging to seek improvement potential, suitable circular strategies, and key actions levers to close-the-loop on heavy-duty and off-road vehicles and associated key components. Moreover, the complexity of that industrial sector makes it interesting to experiment existing circularity indicators and to design new ones with the aim to support the transition towards more circular practices.

1.2.3. A need for circularity indicators in achieving and monitoring a circular economy

The circular economy has a dynamic nature that is difficult to assess and monitor but interesting to show through indicators (Bonet et al. 2014). At the beginning of this Ph.D. thesis, there was no recognized way of measuring how effective a country or even a company is in making the transition to a circular economy, nor holistic monitoring tools for supporting such a process (EMF, 2015; EEA, 2016). Only a small number of published studies designed or discussed circular economy indicators, therefore calling for additional research (Ghisellini et al., 2015). On the micro level of circular economy implementation, this *a priori* absence of suitable circular economy indicators and associated dashboard for companies risks jeopardizing its development on the ground. Without indicators, the company cannot report on its progress and on the impact of its circular strategies, nor disseminate best practices. By measuring the efforts of promising industrial sectors in their move towards more circular practices, it would be possible to steer more effectively the transition to a true sustainable development in industry (Bonet et al. 2014). In fact, to follow and successfully achieve the shift towards a more circular economy, it becomes essential for circular economy actors (e.g. industrial practitioners such as engineers, designers, managers) to get the right and suitable indicators, methods and tools to measure and quantify this progress (Griffiths and Cayzer, 2016; Geng et al. 2013).

Yet, monitoring progress towards a circular economy is a challenging task. The transition towards a circular economy is not limited to certain materials or sectors. It is a systemic change that affects the entire economy (EC, 2018a). Furthermore, one of the critical questions in the circular economy is how we should measure its performance, since its objectives are substantially different from those in the traditional linear economy (EASAC, 2016). Eyckmans et al. (2018) highlight the complexity of determining a credible and usable indicator for the circular economy, notably because the circular economy does not possess an unambiguous definition, and current recycling indicators as metrics of circular economy activity are methodologically unsatisfactory regarding the scope of the circular economy concept. In parallel, with the intensification of scientific publications dealing with the CE over the past five years, (as illustrated in Figure 6), one additional challenge is to keep the literature review up-to-date, to be aware of the latest studies and achievements on the development of circularity indicators, so as not to become out-of-date before this dissertation gets published. Also, it is important not to forget older but relevant studies addressing the issue of closing-the-loop but maybe without mentioning the circular economy as a key word.

Last but not least, another challenge is to reduce the gap between academic research on sustainable development (including e.g. circular economy or eco-design) and industrial adoption of proposed methods and tools. Research on circular economy must be conducted in order to deliver practical and easy-to-use toolkits (Bonet et al. 2014).

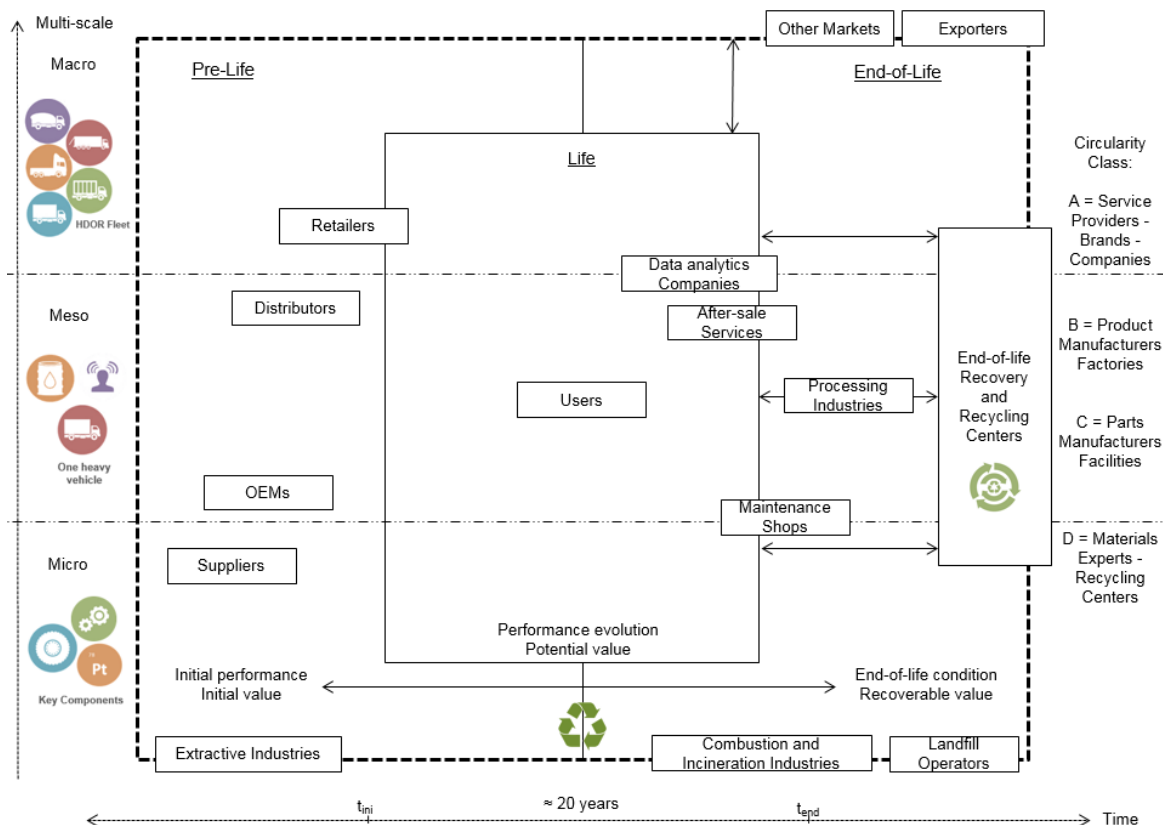

Figure 13 – Multi-scale and multi-stakeholder complexity of the heavy vehicle industry all along the lifecycle

1.3. RESEARCH QUESTION

1.3.1. Research gaps and objectives

In performing initial literature surveys and investigations on the industrial ground, several challenges related to an effective implementation of circular practices of the heavy vehicle sector have been identified both from a research perspective and from an industrial perspective. Actually, industrial needs related to the end-of-life management of heavy vehicles, as well as specific research and knowledge gaps in monitoring the circular economy at an industrial level have been discussed.

The three significant challenges this thesis aimed to address are: (i) the lack of infrastructures, studies methods, tools to support and improve the end-of-life management of heavy vehicle in a context of circular economy; (ii) the need of appropriate circularity indicators and associated assessment framework to foster and monitor the transition; and (iii) the effective integration and uptake of developed methods and tools by the industry to finally close-the-loop on heavy vehicles and key components.

Against this background, the main research question that drives the present Ph.D. thesis is the following:

How to measure, improve and monitor the circularity performance of the heavy vehicle industry?

This promising and challenging research question (RQ) is associated to three key objectives (OBJs), themselves related to the research gaps (RGs) aforementioned, and summarized in Figure 14.

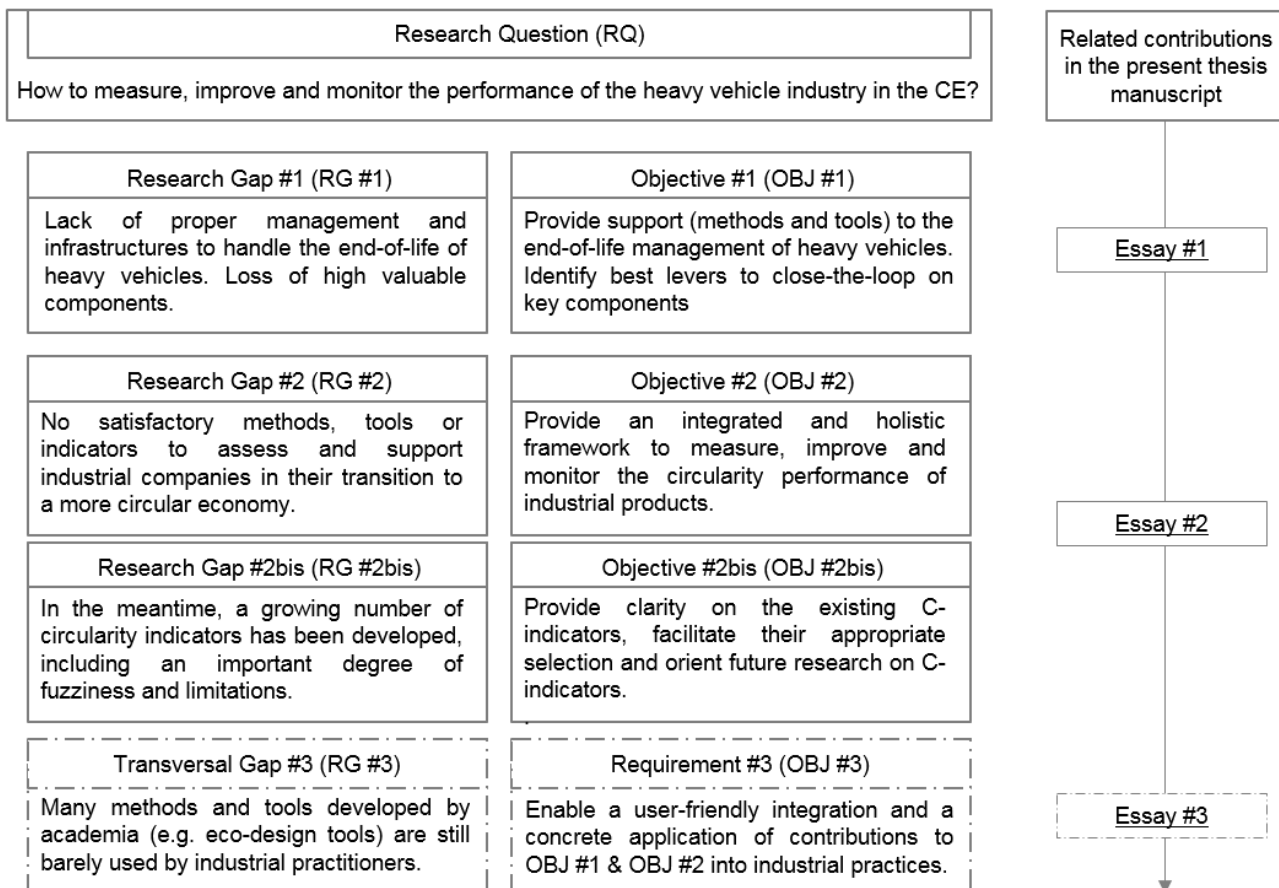

Figure 14 – Research gaps, associated objectives, and their positioning in the manuscript

Note that given the acceleration of publications on circular economy and the recent increasing development of circularity indicators by academics, consulting companies and governmental agencies, the objective #2 has been refined and enhanced (i.e. completed by an objective #2bis) to best fit with actual research and industrial needs.

1.3.2. Expected contributions: academic and industrial ones

This dissertation examines how a particular and complex industrial sector can be supported in its transition towards more circular practices, through appropriate methods, tools, and indicators. The outcomes of this Ph.D. are expected to shed some lights on a promising research theme which is the circular economy in an industrial context of sustainable development. In fact, this thesis aims to enrich the scientific literature addressing the proper design and suitable usage(s) of circularity indicators, as well as to provide practical guidelines and tools for industrial practitioners in the heavy vehicle sector in order to achieve an enhanced end-of-life management of such vehicles. As research studies related to the end-of-life management of heavy-duty and off-road vehicles are scarce, this dissertation will first eliminate a gap in the literature. Then, it is expected to provide an in-depth understanding on the purposes, benefits and use of circularity indicators, before experimenting some of them in an industrial environment.

This manuscript is therefore expected to extend the current knowledge of the circular economy (particularly on circularity indicators), applied on an industrial sector (the heavy vehicle industry) both (i) by building upon existing theories, frameworks or methods, and (ii) by presenting new empirical work and generating useful insights through concrete actions in an industrial environment. Importantly, in addition to academic papers that are certainly more technical or theoretical, this research work pays a particular attention in providing deliverables that are more understandable, usable, and applicable for industrial practitioners. Indeed, because academic works are sometimes considered “off the ground” by industry, the transposition of academic findings into practical tools, methods or guidelines for real and effective industrial use is addressed, so as to bridge the gap between academia and industry (Appleyard, 2017). This Ph.D. thesis is indeed expected to matter both in academia and industry. Actually, for an emerging scientific field such as the circular economy, it is even more essential that the results from research have to be transferred into practice, to share and promote the knowledge on best circular practices. In this way, a considerable part of this thesis is not only constructed and consolidated from industrial investigations but also confronted with on the know-how and needs of several industrialists (e.g. Liebherr, Manitou, Cider Engineering), through interactions (interviews, site visits, collaborations) with them.

For instance, in essay #1, the best circular practices inventoried through the research articles in sub-sections 2.1 and 2.2 aim to be applied on the industrial ground. As such, a practical 2-page benchmarking template of circular strategies is proposed in sub-section 2.3 to disseminate the research outcomes and to get a better feedback from the practice. Indeed, it has been shared with several industrialists from the heavy vehicle sector who provide some interesting feedback on it. In essay #2, an Excel-based tool is developed to ease the selection of suitable circularity indicators regarding e.g. the needs of an industrial practitioner. In essay #3, the findings of two industrial case studies are exposed: one case study experimenting circularity indicators on a key component from the heavy vehicle industry to assess its circularity performance and identify relevant areas of improvement; one industrial pilot study in collaboration with a remanufacturing center addressing the end-of life management of a whole heavy equipment, from the improvement of the dismantling process to the proposition a decision-making tool aiming to select the best end-of-life options (reuse, remanufacturing, recycling) for the recovered components.

To provide not only independent contributions to each research gap, but also consistent answers, or at least new insights, to the objectives, we opt for a Ph.D. thesis comprised of a set of publications. In fact, to address the aforementioned challenges and meet these anticipated contributions, the Ph.D. manuscript is divided into complementary working packages, combining each several promising methods. The sub-section 1.4 describes the research approach to fill the current gaps. Explaining in detail the research methods can also inspire current or future Ph.D. candidates in industrial and design engineering to take advantage of multi-methodology approaches (Baran 2010), because industrial engineering and design science can learn from other research disciplines, and vice versa. The sub-section 1.5 examines how this thesis relates to other work related to the circular economy at the intersection of academic research, industrial practices, and policy. Last but not least, each of the three essays seeks to provide a unique, valuable and complementary contribution to the main research question. In this light, every specific industrial and research contribution regarding the gaps identified are explicitly outlined in each of the three essays. Especially, sub-sections 2.4 and 3.4 synthesize the theoretical and empirical insights provided and the articulation between the three essays.

1.4. RESEARCH APPROACH AND FOUNDATIONS

The present Ph.D. thesis combines several methods into an original multi-methodology to go further than what each methodology individually allows. Indeed, researchers should not limit themselves to one preferred research methodology (Brewer and Hunter, 1989). This dissertation addresses the circular economy implementation within the heavy vehicle industry, mainly from industrial and design engineering perspectives, but not only. This topic is indeed interesting for industrial ecology and engineering research fields, as well as for industrial practitioners. Moreover, Murray et al. (2017) also highlight the multidisciplinary nature of the circular economy paradigm which appears in more and more research fields. Through the design of a framework to measure and improve the circularity performance of complex industrial systems, this research project aims to identify the best action levers to close-the-loop on heavy vehicles and associated key components. Research methods deployed to bridge both the research and industrial gaps identified are described in this sub-section. In particular, the relevance of using a multi-methodological approach, combining design research methods with complementary approaches coming from other research fields and disciplines, to tackle complex new research paradigms such as the circular economy (Di Lucchio, 2017; Papalambros, 2015) – requiring a systemic vision as well as lifecycle thinking – is discussed and concrete illustrations of mixed methods taken from the present Ph.D. thesis are given. Figure 15 gives a schematic representation of the research fields and methodological streams explored. Also, in order to strengthen the industrial dimension and to validate the proposed approaches, the input and feedback from industrial practitioners are actively sought all along this Ph.D. thesis.

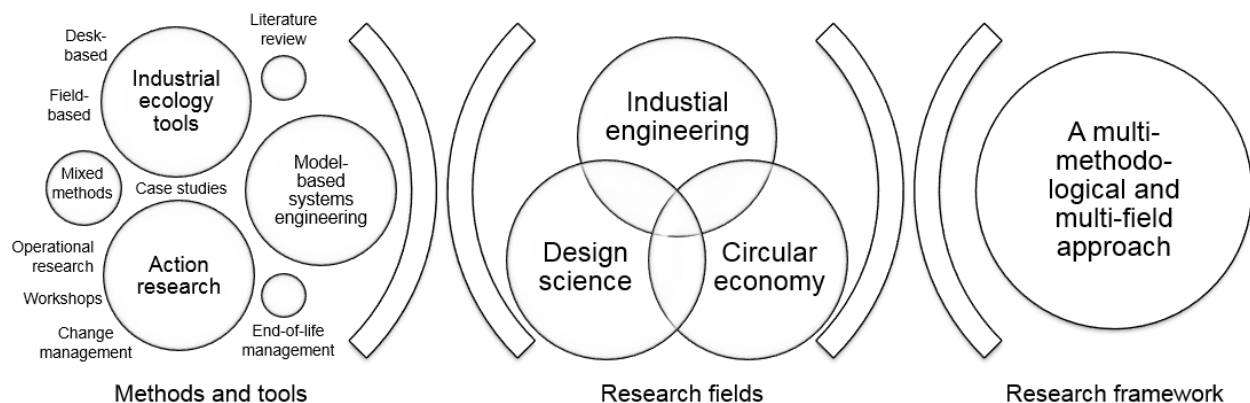

Figure 15 – Schematic illustration of the multi-methodological and multi-field research approach

Basically, the core of each essay of this dissertation is based on the following research activities: literature review, plus industrial survey, proposition or adaptation of a methodology, development of a model and/or a tool, experimentation, and interpretation. An overview of the theoretical background and definitions related to these research activities is provided hereafter.

First, literature review is a fundamental scientific activity and research method. Conducting a literature review aims to identify specific research and knowledge gaps and to discover valuable knowledge and information (Knopf, 2006). In the present thesis, the literature survey is completed by investigations on the industrial ground both to get new empirical data and to test the usability of a proposed method or tool in an industrial environment through real world case studies.

Then, a methodology is generally developed within a particular paradigm and embodies the philosophical assumptions and principles of this paradigm (Mingers and Brocklesby, 1997). A methodology is a structured set of guidelines or activities to assist people in undertaking research or intervention. A conceptual framework provides a way thinking, organizing or approaching an area. It is not as powerful as a model in terms of explaining, nor does it have to be subjected to the same rigor of conformity that a theory or model would require. A model is often developed within a framework. A model can be descriptive, explanatory or theoretical. It can be used to evaluate, simulate and generate predictions, as well as to provide insights and directions.

Finally, experimentation refers to a method that is commonly used in empirical science. As a method, scientific experiments require rigorous research, planning and implementation in order to verify and validate a hypothesis based on empirical data and observations. The scientific method involves observing a phenomenon, forming an idea about what you observed, testing your idea with an experiment to see if it is correct, recording the results of your experiment, and analyzing the results to arrive at a conclusion.

1.4.1. Related research fields

First and foremost, before going into details regarding the research fields related to the present Ph.D. thesis, I would like to share a question my supervisors and I had at the start of this research: “what are the positioning and the role of industrial and design engineering research communities in the circular economy transition?” Here is an extract of our vision, supported by relevant literature, on what we believe the industrial and design engineering community can bring in supporting the shift to a more circular economy. Because CE is absent or nascent in many industrial sectors, we argue both industrial engineering and design engineering can contribute by providing the keys, guidelines, methods and tools for industrial practitioners (e.g engineers, designers, managers) to move towards more circular practices, but also by assessing the sustainable performance of the circular economy implementation. Indeed, circular design is an emerging field that needs new frameworks and tools to help establishing innovative solutions across sectors (Earley, 2017). “Design is a purposeful activity aimed at changing existing situations into preferred ones” (Simon, 1969), thus making the transition to a CE feasible, as well as demonstrating its benefits, are critical when implementing circular design. Additionally, “the science of design is in predicting, analyzing and optimizing the trade-offs of potential futures” (Papalambros, 2015). On this basis, “design must be addressed scientifically, as important stakes are concerned. In essence, design consists of starting with issues, goals and expected performance and proposing acceptable and feasible design plans” (Yannou, in Papalambros, 2015)

Yet, research into design and the emergence of a research community in this area has been relatively new. Many authors trace the intellectual origins of design science to Herbert Simon’s study of the “Sciences of the Artificial” (Cross, 1993; Simon, 1969). Design is complex, balancing the needs of multiple stakeholders, and requiring a multitude of areas of knowledge to be exploited, as well resources spread across space and time. Design of complex systems aims at developing methods and tools supporting decision-making with regard to design of products, services, systems, processes, and organizations. Design of sustainable systems consists in modeling, measuring and optimizing the environmental and sustainable performance of complex systems in their environment. Research in design engineering produces models, methods and tools that influence industrial practices. In parallel, industrial design practices provide situations and contexts that researchers observe and analyze for better comprehension and improvement. Design research and industrial design practices are as such intertwined but the design research community has difficulty to assess its impact on industrial practices (Chakrabarti and Lindemann, 2016). Against this background, in this thesis, the researcher, as part of transformation projects in industry, acts both as an observer and actor: (i) active observations are essential to discover and analyze closely the current industrial challenges, as well as clearly explaining the motivations of the research with the aim to bring suitable contributions; (ii) proposition of actions in an industrial environment are necessary to test the validity of the developed models

Within an industrial engineering research department, where this Ph.D. thesis was carried out, the research approach usually consists of: a field diagnosis, a model-driven engineering approach (modeling, analysis, simulation, optimization), an experimentation of new methodologies (and a measure of their effectiveness), and a prediction of the benefits or precautions to be taken when deploying the methodology (Yannou and Petiot, 2011) as illustrated in Figure 16. Also, the discipline of operational research develops and uses mathematical and computational methods for decision-making, applied in our case in an industrial environment. Thus, the research philosophy to achieve the aforementioned objectives takes inspiration not only from the industrial engineering research field (Yannou and Petiot, 2011), but also from the design science (as an emerging research area and community within the design society, developing an increasing consideration on sustainable design), as well as operational research (e.g. system dynamics in system engineering or multi-criteria optimisation), and mixed methods research approaches (coming from social science research, including data collection methods, observations procedures, interviews forms). Last but not least, it is worth mentioning this thesis has benefit from a collaboration within the industrial ecology program at UC Davis (6 months there as a Fulbright visiting researcher).

1.4.2. Proposed multi-methodological framework

To tackle efficiently the three challenging research gaps of this project, the problem-solving approach is to use a multi-methodological research approach, built on several promising research fields, as illustrated in Figure 15. Actually, the Ph.D thesis is mainly built around several methodological streams: multi-methodology, design science, action research, industrial engineering and system engineering (modelling and simulation), with some interactions and overlaps between these streams. For instance, key concepts of industrial ecology include systems analysis, material and energy flows, multidisciplinary approach, analogies to natural systems, and closed-loop systems (Garner and Keoleian, 1995). Note that this choice of methods is influenced by the disciplinary roots of the Ph.D.

thesis, the expertise areas of the research department the Ph.D. candidate belongs, as well as the researcher's background, curiosity, and creativity.

Using several research methods is obviously not something new, and a Ph.D. thesis is often based on different but complementary methods. For example, here are two Ph.D. theses in industrial engineering using successfully a multi-methodology research approach:

- i. Idjis (2015) combines three systemic modeling methods: SCOS'M (Systemics for Complex Organisational Systems' Modelling), cognitive mapping, and system dynamics, to characterize the recovery network of its object of study, understand its dynamics and identify the key variables in these dynamics.
- ii. In his action-research project, Lamé (2017) assembles different methodological combinations, including interviews, observations, Soft Systems Methodology, discrete event simulation, and system dynamics, to motivate and manage a transformation project in real-time.

Using this multi-methodology mindset is particularly valuable because the circular economy requires systemic and lifecycle thinking. Therefore, we intend to challenge the assumption that the combination of a priori promising research methods could positively contribute to the circular economy. Arguments in favor of a multi-methodology have emphasized the fact that it is actually necessary to deal effectively with the full richness of the real world where problem situations are inevitably highly complex and multi-dimensional (Mingers and Brocklesby, 1997). They proposed a framework for mixing methodologies that can attend to the relative strengths of different methodologies and provide a basis for constructing multi-methodology designs. Mingers and Brocklesby (1997) have argued that multi-paradigm approaches are both desirable and feasible, although there are a number of difficulties and problems to be overcome. The essence of multi-methodology is linking together parts of methodologies, possibly from different paradigms. For example, a system dynamics model could be seen as a model of reality, or as a detailed and dynamic cognitive map. Because all methods of data collection have limitations, the use of multiple methods can neutralize or cancel out some of the disadvantages of certain methods. (Brewer and Hunter, 1989). Furthermore, the strengths of each approach can complement each other. It enables the researcher to answer confirmatory and exploratory questions at the same time (Cameron, 2009). Thus, to really understand a situation, a system and its surroundings, especially as complex as CE and the heavy vehicles industry, we argue it is preferable to explore and understand it from several perspectives and mixed standpoints. Actually, as it is further detailed and illustrated through a concrete example in sub-section 2.1.2, the use of mixed methods is a pragmatic approach to research and investigation. Diversifying the sources through data triangulation (the use of a variety of data sources) and methodological triangulation (the use of multiple methods to study a research problem) was essential here, because the main information concerning the end-of-life of heavy vehicles cannot be obtained via the scarce academic literature published on the subject. For instance, Interviews, meetings and site visits with diverse stakeholders linked to HDOR vehicles were useful not only to validate or question the information found in the literature, but also to collect new complementary information.

Thus, several research streams, coming from the aforementioned disciplines with their associated methods and tools, frame this Ph.D. thesis. For instance, it includes:

- Desk-based (extensive literature review) and field-based (ground investigations) research for in-depth investigations within the HDOR industry;
- Hybrid top-down and bottom-up approach to design an integrated and holistic circularity measurement framework;
- Cognitive mapping and system dynamics to model and assess the consequences of action levers in the circularity performance of industrial products;
- Industrial ecology tools such as material flow analysis and life cycle assessment to evaluate environmental performance of CE loops;
- Industrial case studies and workshops to test, validate or enhance the new methods and tools developed;
- Design for remanufacturing and industrial workshop to improve the dismantling of used heavy vehicles;
- Multi-criteria optimisation from operational research to consider both environmental and economic parameters when analyzing different possible end-of-life pathways of HDOR vehicles and associated key components.

Eventually, Gericke et al. (2017) draw the importance of ensuring proper validation of methods deployed in the design research area, to appreciate the scientific soundness of the outcomes obtained by the use of these methods. According to general system theory, models are the basis of problem solving and knowledge construction. Models are then the interface between a subject and a real-world system to solve problem and to construct knowledge (Ben Ahmed et al. 2010). Models are also used to analyze an existing system and therefore to understand and predict its behavior to steer it.

As such, the research must also address how to ensure the scientific validity of results through the methods deployed. This questioning makes sense because the quality of the results depends on the quality of both the data and methods used or developed (including the limits of models, assumptions, and uncertainties). For instance, successfully arguing the following question is of the utmost importance: “is my model to measure and enhance the circularity performance of industrial products a satisfactory model?”. Hence, evaluating these models is crucial to ensure the quality of the constructed knowledge (Ben Ahmed et al. 2010). The validation of research methods and processes deployed in industry is therefore of the utmost importance and is further discussed, locally in each essay, and globally in the conclusion section.

On the one hand, the feedback from academic experts - whether when submitting an article or presenting at a conference – may be a relevant gauge regarding the validity of research results. Also, interviews and case studies carried out with industrial practitioners from the heavy vehicle industry provide additional inputs to adjust the methods and tools developed. In this line, measure of success can include the adoption by industry of developed methods and tools, as well as the number of citations of published research articles, as an indicator of the relevance of the research contribution. On the other hand, Ben Ahmed et al. (2010) propose an evaluation framework to assess existing model or models under construction, including 28 criteria grouped into 4 systemic axes: ontology, functioning, evolution and teleology. Regarding the methods and models we deployed, using this framework seems promising to tackle more in-depth the issue of research reliability and validity, in order to consolidate scientifically the results.

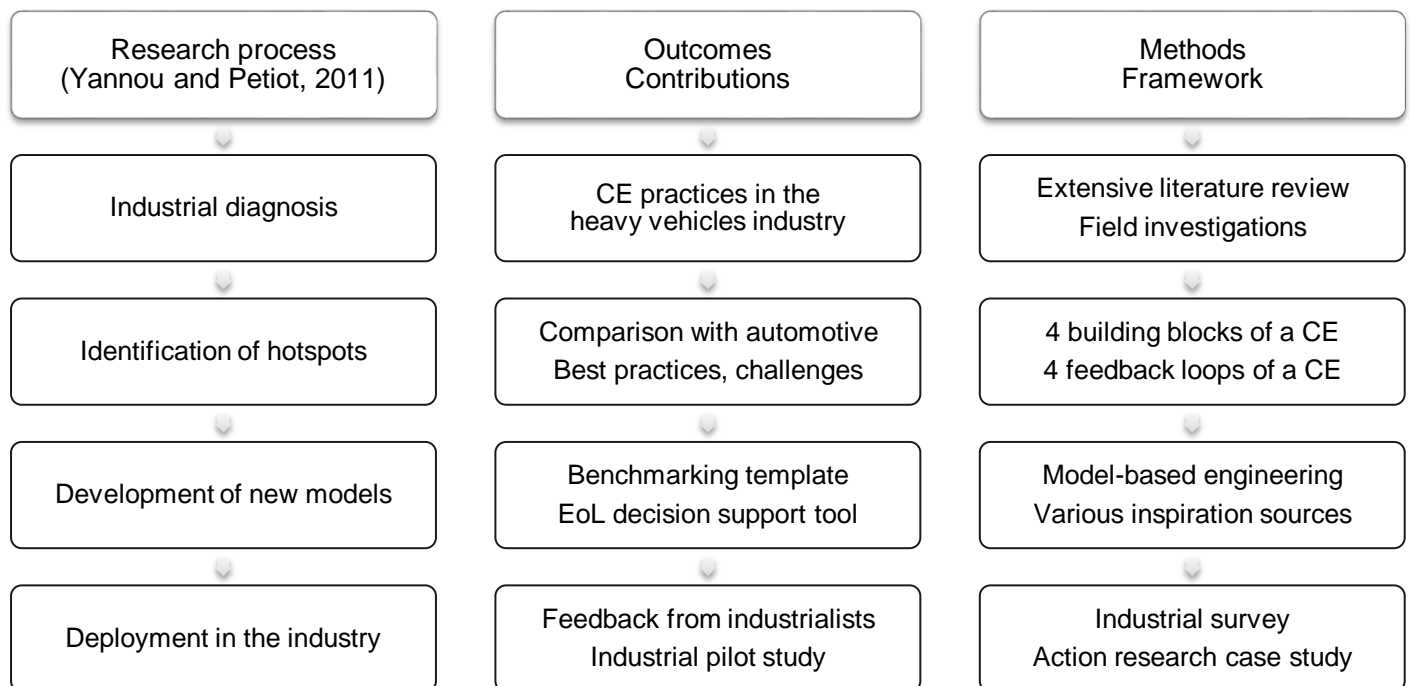

Figure 16 – Industrial engineering research process applied to the present thesis

1.5. POSITIONING OF THE THESIS

After focusing on the objectives pursued and the means deployed to achieve them, resorting to different methods from several disciplinary fields, the thesis is put into perspective in the light of the national and international research communities, governmental agencies and companies working on the circular economy – on its development, implementation and monitoring – as outlined in Figure 17. The different positioning, presented below, are useful not only to identify in what purposes the scientific and industrial, political community can be interested in this research work but also to clearly identify the original and innovative aspects of this work regarding existing approaches, i.e. to understand what relevant insights can be added to what is already know. Indeed, given the large number of studies on the circular economy done worldwide and by diverse actors (Prieto-Sandoval et al. 2018), including different approaches and multiple applications, it is important to position the contribution of this work in a global context.

1.5.1. Within academic and research communities

First, within the industrial engineering department where this thesis has been mainly conducted, two research teams are working on the design and industrial management of sustainable circular systems: the design engineering team and the sustainable economy team. Interestingly, both team are building an industrial chair called “monitoring the circular economy” in collaboration with the French National Institute of the Circular Economy (INEC) plus other industrial and economic partners. As such, the present thesis contributes directly to this project of industrial chair and is expected to be one the scientific bases through the work on circularity indicators to monitor industrial activities. It is also worth mentioning other Ph.D. theses recently or currently conducted in France, addressing the circular economy from in industrial engineering perspective. Let’s take the example of the G-SCOP laboratory at the Grenoble Institute of Technology. In his Ph.D dissertation, Dwek (2017) provided two original contributions to circular product design: a tool for the integration of material circularity in product design and a framework to characterize material cycling networks. Importantly, he proposed an indicator of circular material value that measures the potential value that the material holds for future cycles. The circular material value equation includes four design variables (design yield, functional unit, mass, and material degradation after use) and five network variables (price, market risk, material criticality, transformation process yield coefficient, and end-of-life scenario functional degradation coefficient). Under the supervision of Prof. Zwolinski, Stec is working on the development of strategies, methods and tools that can both convince decision makers of circular economy values in the design phase, and ease the implementation of circular strategies for designers (Stec and Zwolinski, 2018).

At the European level, the European Commission, under the H2020 program and through Marie Skłodowska-Curie Actions is funding several research projects, including Ph.D. theses directly related to the advancement and implementation of a circular economy. It includes promising ongoing programs such as the “Circular European Economy Innovative Training Network” (CIRC€UIT) and the “Circular Economy: Sustainability Implications and Guiding Progress” (CRESTING). For instance, the CRESTING brings 15 early stage researcher based in eight universities across six EU countries, and is divided in five work packages (WP). Interestingly, one of the work packages (WP5) aims to investigate the issue of measuring the sustainability of circular economy, by understanding the main methodological issues relating to measurement and proposing suitable indicators, methods and tools for measuring both the extent and effects of the circular economy on the sustainability, for different sectoral contexts and scales. Particularly, it mentioned the development of methods and tools to assess the circular economy performance at a company level. It also aims to translate these analyses into specific actions for managing the transformation to the CE. On the other hand, in Northern Europe the “Circular Economy Integration in the Nordic Industry” (CIRCit) is a research project, coordinated by Prof. McAloone from the Technical University of Denmark, to support the implementation of circular economy principles in industry, including an expected work package entitled “Sustainability Impact Assessment for Circular Economy” with researchers working on circularity metrics, circular product design and circular economy business models (Pieroni et al. 2018). Even if the present thesis is not part of such exciting projects, it can contribute and serve as foundational work for current and future research on circularity indicators. More globally, the Ellen MacArthur Foundation has developed an international network of universities and research departments which develop circular economy research and teaching materials. For example, the University of California-Davis and its Industrial Ecology Program, where this thesis has been conducted for six months, belongs to this network.

Within the eco-design, industrial ecology and circular economy research fields and related research communities, let’s mention: the EcoSD network (first network of eco-design researchers in France) that organized each year a thematic workshop. This year (n.b. in 2018), the main topic of this workshop is the circular economy; the International Society for Industrial Ecology (ISIE) that promotes industrial ecology as a way of finding innovative

solutions to complicated environmental problems, and facilitates communication among scientists, engineers, policymakers, managers and advocates who are interested in how environmental concerns and economic activities can be better integrated; the Design Society, in which there is a growing interest on sustainability considerations. For instance, worldwide researchers are gathered together in one of the special interest groups (SIGs) of the Design Society, namely the Sustainable Design SIG. During their last meeting at the ICED17 conference, several issues were pointed out regarding the knowledge dissemination on sustainable design, including the difficulty to bridge the gap between academics and industries. On this basis, three working groups were launched to address these issues: industrial collaboration, knowledge dissemination, and methods and tools in which I participate. As such, this thesis pays a particular attention on how research on circular economy can provide industry with hands-on support. Note that since the 1980, the series of International Conferences on Engineering Design have supported strongly the development of engineering design methodologies (Cross, 1993). More specifically, regarding the contributions of the design science in the sustainability research area, different eco-design methods and tools have been developed since the early 1990s (Pigosso et al. 2010).

1.5.2. Within governmental organizations

Despite its various socio-economic and environmental benefits, the transition towards a circular economy is requiring a policy framework supporting it (Wilts, 2017). The key challenge is to have a coordinated approach across different policy areas and governance levels. China was the first country adopting a law related to the circular economy in 2008. Since then, several regions have follow this path such as the European Union, at a continental level, or France, at a national level, and are developing programs to foster and catalyze the circular economy transition. Interestingly, at this level of circular economy implementation, circularity indicators are increasingly see as a relevant policy instruments to manage the transition and to monitor its effects.

In fact, France is more and more committed to a circular economy. The transition towards such an economic model is now recognized by the law as one of the five pillars of sustainable development (Article L110-1 of the Environment Code). Particularly, the French Secretary of State of the Minister for Ecological and Solidarity Transition considers that "the circular economy is the best example possible reconciliation between economy and ecology". In addition to the 10 key indicators to monitor the circular economy put in place by the France government, as illustrated in sub-section 1.1.3, the French Ministry of Ecological and Solidarity Transition (2018) has proposed a circular economy roadmap including quantified objectives such as: to reduce by 30% the consumption of resources by 2030, or to reduce by 50% the quantity of resources sent to landfill in 2025 compared to the 2010 baseline. Furthermore, the roadmap discussed several measures that are expected to be considered in the drafting of a new European waste directive by 2019. One of the measure is directly related to the end-of-life management of vehicles, a topic addressed in this thesis. In fact, the creation and/or extension of the extended producer responsibility (EPR) for some industrial sector is mentioned. Actually, contrary to the automotive industry (vehicles under 3.5 tons), the heavy vehicle industry is so far not considered by the EPR, and such a regulation could foster the stakeholders of this industry to work together with the aim of a better end-of-life management of their fleet (see essay #1 for more details).

At the European level, moving towards a more circular economic model is one of the pillars of the EU 2020 strategy. The European Commission (2015) has notably proposed an action plan for the circular economy by promoting the reparability, upgradability, durability, and recyclability of products, shaping the EU Commission's agenda. Particularly, the European Commission (2018b) intends to improve the knowledge base for measuring circular economy progress, as illustrated in section 1.1.3 through the European circular economy monitoring framework. Importantly, around 1 billion euros from Horizon 2020's final Work Programme (2018-2020) are invested into research, innovation and financing of projects and initiatives that will support our circular economy ambitions, including the CRESTING program aforementioned. Also, the European Circular Economy Stakeholder Platform is a newly online open space to strengthen the cooperation among circular economy actors and facilitate the sharing of expertise and relevant circular practices. For instance, it might be interesting to share the best industrial practices of the automotive and heavy vehicle industries in their transition to a more circular economy on that platform.

More specifically, critical raw materials are one of the five prioritized sectors of the EU action plan for the CE. Given the diversity of materials a heavy vehicle is made of, it is likely to contain some critical raw materials. In fact, catalytic converters from heavy vehicles contain a non-negligible amount of platinum, listed as one of the critical raw materials by the EU. Against this background, closing-the-loop on such an important material for the European economy is of the utmost importance and is further addressed in sub-section 4.1. Last but not least, the Conseil Européen de Remanufacture (CER, European Remanufacturing Council), enduring output of the European Remanufacturing Network project (ERN, 2018), has the ambition to triple the value of Europe's remanufacturing

sector to €100 billion by 2030, by making remanufacturing a normal part of a product life cycle. In the present thesis, some of the best practices and case studies reported by the ERN regarding remanufacturing activities in different industries are used to improve the dismantling and recovery operations of an emerging remanufacturing center, through an industrial pilot study detailed in sub-section 4.2.

1.5.3. Within industrial and consulting companies

Just to mention a recent and concrete example, at the end of the year 2017, the London Waste and Recycling Board was seeking a contractor to provide technical assistance in the development of circular economy metrics and indicators for London. In fact, developing a set of metrics and indicators that can demonstrate progress towards a more circular economy in London is considered as critical by the London Waste and Recycling Board to influence policy makers and attract funding. Their requirements and expected outcomes are as follows: a range of metrics/indicators at the city level, taking a deeper look at the built environment and food sectors; a short narrative description of each metric/indicator, with an information on whether the metric/indicator would work at a company level; the currently available data source from which the metric/indicator could be derived, or the data that would need to be accessed to create the metric/indicator; the calculations required to create the metric/indicator; and the replicability of the metric/indicator across cities or companies.

As a matter of fact, as key performance indicators are an indispensable managerial tool in industrial practices, companies willing to embrace the potential benefits offered by a circular economy are needing suitable circularity indicators to assess their progress from linear to circular practices, as well as the impacts of their circular strategies and projects. On this basis, the Ellen MacArthur Foundation, plus other think tanks and consulting companies have started developed circularity indicators to assess how estimate a product or company perform in the circular economy, as it is further analyzed in essay #2. For instance, the material circularity indicator developed by the EMF (2015) and intended to be used by product designers, as well as for internal reporting, procurement decisions, and the evaluation or rating of companies, is first experienced on an industrial product in sub-section 3.1. Furthermore, in the heavy vehicle industry, some companies are currently working on developing their own set of circular metrics, such as Volvo Trucks Sweden according to discussions with its environment and innovation director (see sub-section 2.3)

Although the main focus of this thesis is on the circularity of industrial products (from the heavy vehicle sector), the taxonomy of circularity indicators, detailed in sub-section 3.3, inventories and classifies indicators for all the levels of the circular economy implementation.

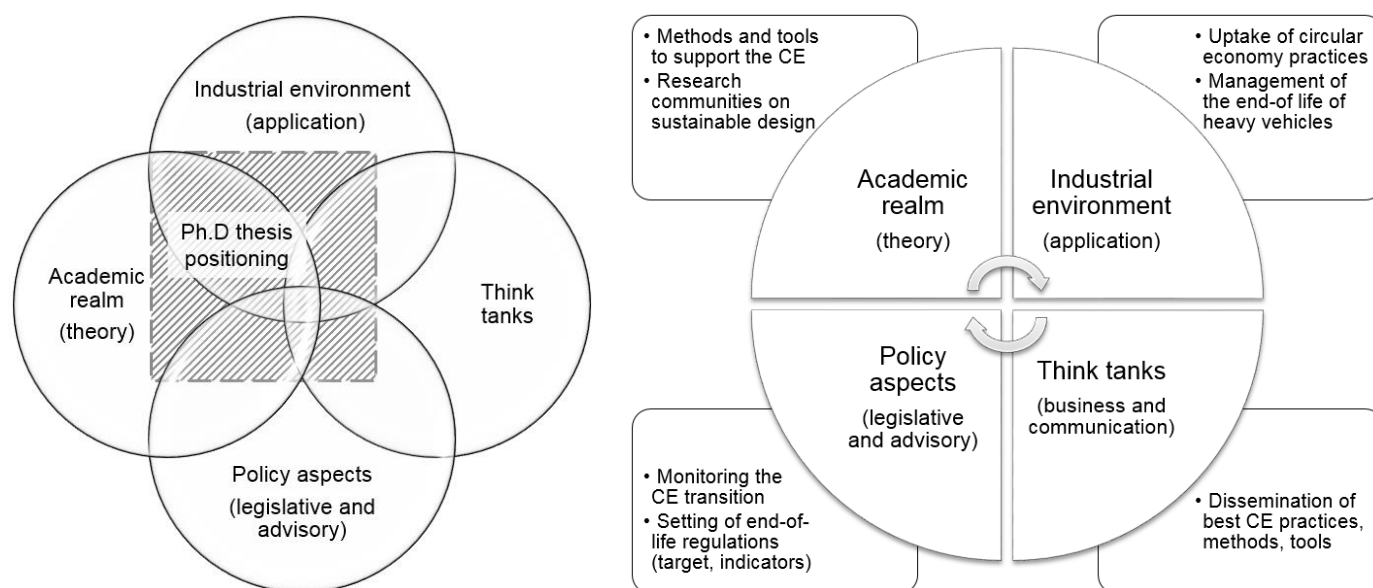

Figure 17 – Positioning of the thesis in a global environment of stakeholders playing a role in the CE transition

1.6. STRUCTURE OF THE MANUSCRIPT

At this point, the initial observations and challenges that drive the present Ph.D. thesis, as well as the precise objective of this research project have been presented. The multi-methodological research approach to address the research gaps and meet the expected contributions have then been drawn. Finally, this work has been positioned within the international research, industrial and policy contexts on the circular economy. In this sub-section, the remaining structure of the thesis is described, and illustrated through Figures 18 & 19.

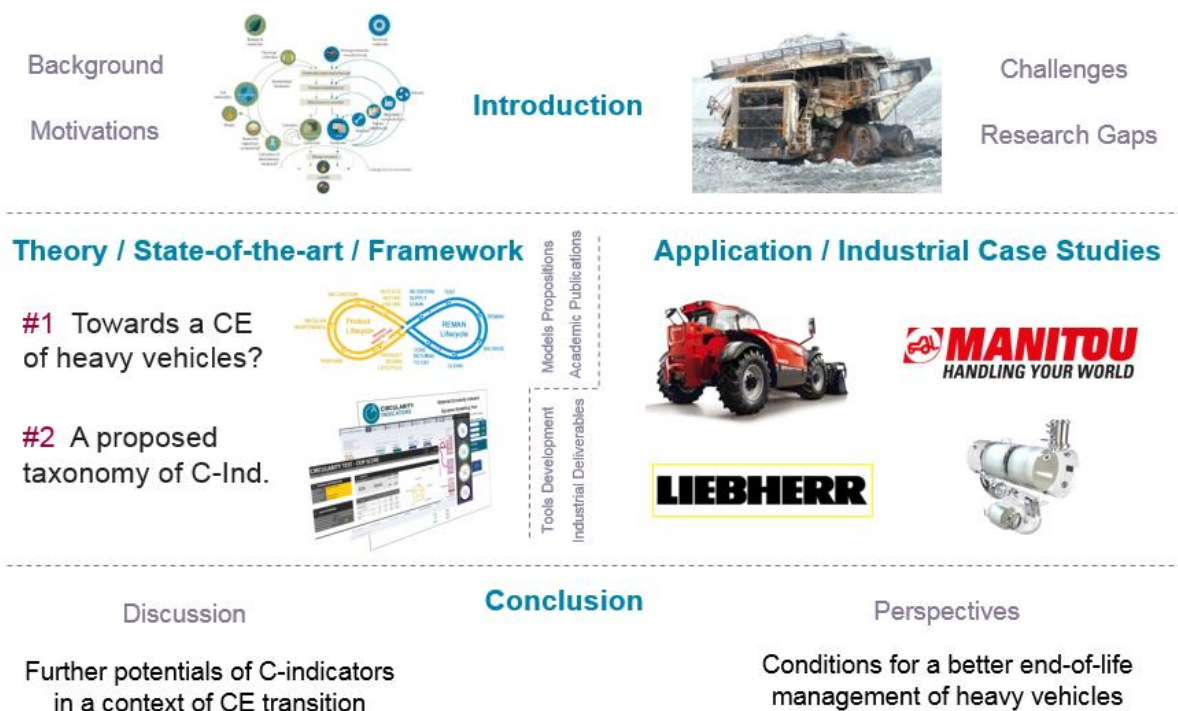

Figure 18 – Graphical outline of the thesis

1.6.1. Outline of the thesis

Paltridge (2002) described four different types of dissertation formats: (i) the traditional simple dissertation, (ii) the traditional complex, (iii) the topic-based dissertation, and (iv) the compilation of research articles. The present dissertation refers mainly to the latter, even if some similarities with the second and third formats can also be observed. This format includes several studies, each composed of its own introduction, methods, results, and conclusions, with various articles written in the format of journal articles, framed with introductory and concluding sections. Each article can be read independently, as a complete entity, and includes its own literature review. Nonetheless, in this case, the combination of several research articles has to form a coherent picture and logical whole. This Ph.D. by publication has been the preferred option here in order to divide efficiently the work into several complementary work packages, as well as to develop skills in writing articles for submission to peer reviewed journals, and thereby get constructive feedbacks from peers during the thesis period.

This thesis is comprised of an introductory section, three original essays, and a conclusion section. Under the introductory section, the background, purpose and context of the thesis are presented. It provides an extended framework for the three essays, introducing the research results as a whole, and ensuring logical links between the articles. Each essay is divided into two or three parts and is based on the work of the research articles detailed in Table 3. The core of this thesis is indeed developed as a series of scientific papers published or submitted for publication in international peer-reviewed journals or presented at international conferences. Each essay includes clarification concerning how it is interrelated to the other essays and related research papers. The conclusion section brings the general discussion on the research and industrial contributions of the thesis, as well as its limitations. It includes recommendations for promising future research on the end-of-life management of heavy vehicles in a circular economy perspective, and on circularity indicators that can be applied in other industrial sectors to manage and catalyze the transition from a linear to a more circular economy.

More precisely, in section 2 (essay #1), the situation of the heavy vehicle industry is closely examined through the lens of the circular economy paradigm. It includes two research articles, discussing the best practices and remaining challenges both in the EU and in the U.S., complemented by a more practical deliverable aiming at disseminating these best circular practices in industry. In section 3 (essay #2), the focus is made on circularity indicators, as enablers of a circular economy. It includes three research articles providing a comprehensive view of the potential contributions of such indicators in the move towards a more circular economy, as well as two tools developed to ease the appropriate use and implementation of circularity indicators at different levels. In section 4 (essay #3), two industrial case studies are reported to close-the-loop on the heavy vehicle industry and associated key components, putting into practice the findings of essays #1 and #2. Importantly, at the end of each section, the linkages and complementary between the outputs one essay to another one are discussed, contributing together in supporting the transition to a more circular economy. Also, each section begins with a detailed overview of each article that forms, in all, the three consistent essays.

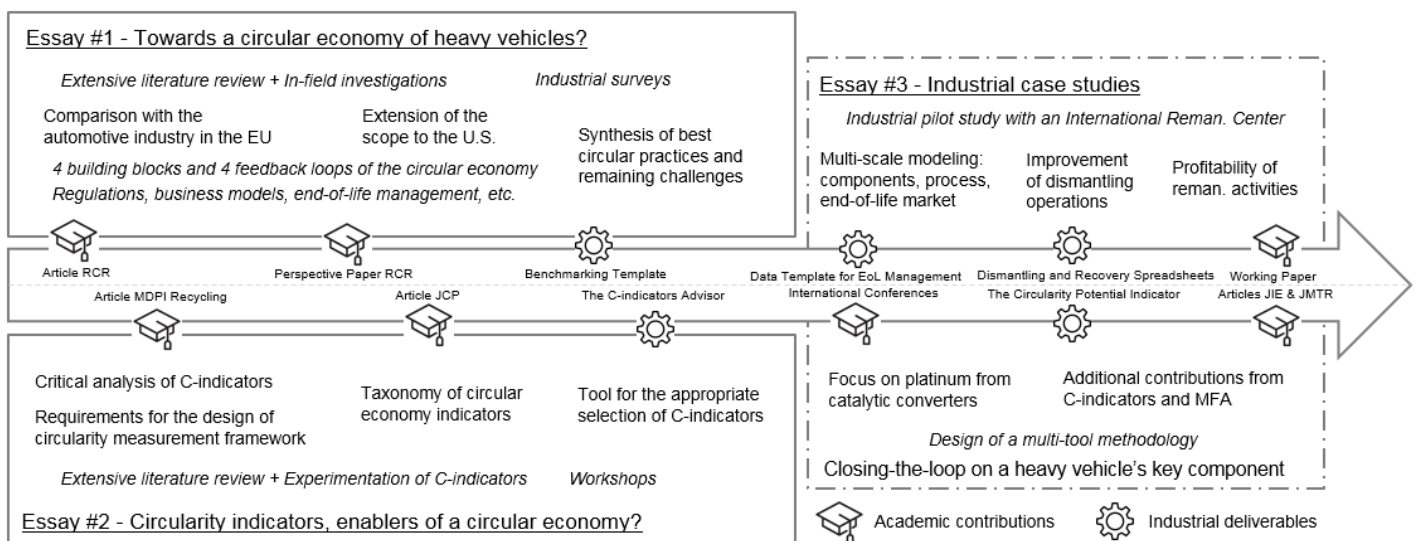

Figure 19 – Research schedule and historical timeline of the Ph.D thesis from September 2015 to August 2018

1.6.2. Declaration of previous publications

On this basis, the following parts are structured as a collection of essays, containing several research articles, all of which have been, or are about to be, submitted to peer-reviewed journals, or have been presented at acknowledged international conferences, as highlighted in Table 3. Even if I agree peer-reviewed journals articles should be – and have been – prioritized, as they are the most impacting type of publication in the academic world, I also believe that mixing the research materials and contributions (e.g. through conferences presentations, posters, videos, practical templates, tools) can significantly enhance the dissemination of the research results, and in our case their consideration and implementation by industrialists. As such, in addition to academic articles, an effort is made in each essay to deliver such additional elements. Eventually, if journals articles are readily acknowledged in the scientific community, doing a Ph.D thesis by publication has downside: a certain level of repetition is likely to appear. I ask for the reader's understanding on this point. To ease the reading, the articles have been reworked a bit to reduce abusive and avoid unnecessary repetitions, and all references have been gathered at the end of the dissertation – clustered by section, and listed in alphabetical order.

I certify that this thesis, and the research to which it refers, is the product of my own work. I also certify that the present thesis describes work completed during my registration as a Ph.D. student at CentraleSupélec, Université Paris-Saclay, within the Industrial Engineering Research Department (Laboratoire Génie Industriel), from September 2015 to August 2018. More precisely, the key ideas, primary contributions, data collections, analyses, model developments, experimentations, and interpretations, were performed by the first author of the articles summarized in Table 3. The contribution of co-authors were as follows: they helped in framing the initial ideals through discussions, provided feedback about the contents, reviewed and commented on the writing.

Table 3 – Articles included in this Ph.D. thesis by publication

Thesis section	Title of the article	Type of publication	Status
Essay #1 Sub-section 2.1	Saidani, M., Yannou, B., Leroy, Y., Cluzel, F. 2017. Heavy vehicles on the road towards the circular economy: Analysis and comparison with the automotive industry. Resources, Conservation and Recycling, 135, 108-122.	Journal article Res. Cons. Recy.	Published
Essay #1 Sub-section 2.2	Saidani, M., Kendall, A., Yannou, B., Leroy, Y., Cluzel, F. 2018. What about the circular economy of vehicles in the U.S.? An extension of the analysis done in the EU. Resources, Conservation and Recycling, 136, 287-288.	Perspective paper Res. Cons. Recy.	Published
	Saidani, M., Kendall, A., Yannou, B., Leroy, Y., Cluzel, F. 2018. Management of end-of-life vehicles in the U.S.: comparison with the EU in a circular economy perspective.	Journal article Cal. Manag. Rev.	To submit
Essay #2 Sub-section 3.1	Saidani, M., Yannou, B., Leroy, Y., Cluzel, F. 2017. How to assess product performance in the circular economy? Proposed requirements for the design of a circularity measurement framework. Recycling, 2, 6.	Journal article MDPI Recycling	Published
Essay #2 Sub-section 3.2	Saidani, M., Yannou, B., Leroy, Y., Cluzel, F. 2017. Hybrid top-down and bottom-up framework to measure products' circularity performance. International Conference on Engineering Design, Aug. 2017, Vancouver, Canada.	Conference paper ICED 17	Published <i>Presented</i>
Essay #2 Sub-section 3.3	Saidani, M., Yannou, B., Leroy, Y., Cluzel, F., Kendall, A. 2019. A taxonomy of circular economy indicators. Journal of Cleaner Production, 207, 542-559.	Journal article Jour. Clean. Prod.	Published
Essay #3 Sub-section 4.1.1	Saidani, M., Yannou, B., Leroy, Y., Cluzel, F. 2018. Monitoring the circular design of industrial products. Insights from workshops on circularity indicators.	Working paper Design Studies or ICED19	In progress
Essay #3 Sub-section 4.1.2	Saidani, M., Kendall, A., Yannou, B., Leroy, Y., Cluzel, F. 2018. Closing the loop on platinum from catalytic converters: contributions from material flow analysis and circularity indicators. 12th International Conference on Society & Materials, Session 4: Circular economy, beyond the hype, May 2018, Metz, France.	Journal article Jour. Indus. Ecol. - Augmented version of a conference abstract	Submitted - <i>Presented</i>
Essay #3 Sub-section 4.1.3	Saidani, M., Yannou, B., Leroy, Y., Cluzel, F. 2017. How to close the loop of platinum from heavy vehicles catalytic converters? Framework to evaluate the impact of several promising action levers. Joint Conference ISIE-ISSST, Jun. 2017, Chicago, United States.	Conference abstract and poster ISSST-ISIE 2017	<i>Presented</i>
Essay #3 Sub-section 4.2	Saidani, M., Ouisse, H., Yannou, B., Leroy, Y., Cluzel, F. 2018. Dismantling, remanufacturing and recovery of an end-of-life heavy vehicle: technico-economic and organisational lessons learnt from an industrial pilot study.	Working paper Res. Cons. Recy. or Int. Jour. Reman.	In progress

2. ESSAY #1 – TOWARDS A CIRCULAR ECONOMY OF HEAVY VEHICLES?

This first essay is composed of two research articles, as detailed in Tables 4 and 5, and of one benchmarking template of best circular practices intended to industrial practitioners of the heavy vehicle industry.

In sub-section 2.1, the first paper lets the reader discover the heavy vehicle industry, its mechanisms, stakeholders, and current challenges. It aims to provide a comprehensive overview of the situation and progress of the heavy vehicle industry in a context of circular economy transition in the EU, comparing to the situation of the automotive sector. Clarifying grey and underexploited areas in this sector, it discusses the missed opportunities and highlights what areas are improvable in a circular economy perspective. The following questions are indeed addressed: How far is the circular economy achieved and implemented in automotive and HDOR sectors? What industrial practices are prevalent and commendable in the light of a circular economy? Notably, the best circular practices and remaining challenges are investigated and highlighted through both the four feedback loops and the four building blocks of the CE defined by the Ellen MacArthur Foundation (2015). A complementary analysis, thanks to investigations carried out in the U.S., is made in sub-section 2.2. Using a similar framework, it compares the situation of the U.S. light and heavy vehicle industry to the European one regarding the end-of-life management of such vehicles in order to get complementary insights on best circular practices. In this line, sub-section 2.3 provides an industrial deliverable more operational than the two previous academic research articles. The benchmarking template of best circular practices, detailed in this sub-section, has been disseminated to diverse stakeholders of the heavy vehicle industry and feedbacks from several of them are discussed. Also, the transfer and application of best circular practices and know-how from one industrial sector to another or from one geographical sector to another are considered.

All in all, the research contributions from this essay can lead on to practical applications, for instance to help industrial practitioners and policy makers take up the challenges and seize opportunities to close the loops on heavy vehicles and associated components through different circular strategies. Particularly, this essay provides a sound basis for the industrial pilot study, detailed in sub-section 4.2, addressing the end-of-life management of an entire used heavy vehicle in collaboration with a remanufacturing center.

Table 4 – Overview of the sub-section 2.1 and description of the associated article

Original title	Heavy vehicles on the road towards the circular economy: Analysis and comparison with the automotive industry
Published in	<i>Resources, Conservation and Recycling, Special Issue on Circular Economy, 2017.</i>
Key words	Circular economy (CE), automotive, heavy vehicles; end-of-life management, CE strategies, CE implementation.
Highlights	<ul style="list-style-type: none"> – In-depth study reveals huge potential to develop CE solutions in the heavy vehicles sector. – Impacts of regulations, business models, and emerging technologies are analysed for CE performance. – Best industrial practices and remaining challenges are examined for a CE of light and heavy vehicles. – Streamlined, well-controlled dismantling, reuse and recycling are preferred options for the automotive industry. – Uneven but growing remanufacturing and loosely controlled exports are preferred options for the HDOR industry.
Abstract	With 270 million light vehicles and 20 million heavy-duty and off-road (HDOR) vehicles in use in the European Union, the automotive and HDOR industries form two major sectors of the European economy. Each year, 12 million light vehicles plus 1 million HDOR vehicles reach the end of their lives. In a circular economy perspective, the following two questions are of growing concern: (i) to what extent is the circular economy achieved and implemented in the automotive and HDOR sectors? (ii) what industrial practices and regulations are prevalent and commendable for the circular economy? The end-of-life management of light vehicles (subject to the ELV Directive 2000/53/EC) has been widely studied in the literature, but the end-of-life stage of HDOR vehicles has long been neglected by researchers. To fill this gap, both extensive literature survey and in-depth industrial investigations were conducted. Key factors, i.e. regulations, business models and market evolution, and integration of new emerging technologies affecting the circular economy performance of the automotive and HDOR sectors were analysed. Lessons learned from best industrial practices are highlighted, and remaining challenges for a more circular economy are identified. The two industries are compared in terms of the four buildings blocks of the circular economy and the four possible feedback loops defined by the Ellen MacArthur Foundation. This research work can lead on to practical applications, e.g. help industrial practitioners and policy makers take up the challenges and seize opportunities to close the loops for HDOR vehicles through different approaches.
Audioslides	http://audioslides.elsevier.com/ViewerLarge.aspx?source=1&doi=10.1016/j.resconrec.2017.06.017

Table 5 – Overview of the sub-section 2.2 and description of the associated article

Original title	Management of end-of-life vehicles in the U.S.: comparison with the European Union in a circular economy perspective
To submit to	<i>California Management Review, in late 2018.</i>
Note	A short and summarized version of this article has been published in <i>Resources, Conservation and Recycling, as a Perspective Paper in early 2018, entitled: What about the circular economy of vehicles in the U.S.? An extension of the analysis done in the EU by Saidani et al. (2017)</i>
Key words	Circular economy, end-of-life management, end-of-life vehicles, recycling, policy making, extended producer responsibility, American-European comparison.
Abstract	The EoL management of heavy-duty and off-road vehicles (HDOR) in the United States (U.S.), as in the European Union (EU), is a research topic barely explored in the scientific literature. This gap in research, along with lagging policies and regulations for considering light and heavy-duty vehicles end-of-life (EoL) in the U.S. has not gone unnoticed by relevant industry stakeholders. The EoL business practices and regulations imposed on these sectors in the EU are considerably different than the same sectors in the U.S., and provide an interesting comparison case for EoL management of vehicles. It is with this perspective that this research undertakes an analysis of the appropriate transfer and application of best practices, regulations and know-how from one industrial sector (e.g. the automotive sector) to another one (e.g. the HDOR sector) and from a geographic region (e.g. the EU) to another one (e.g. the U.S.) in a context of transition towards a more circular economy. To develop this juxtaposition, an updated literature review as well as industrial field investigations were done in the U.S. with the aim of providing supplementary insights to the initial questions and findings raised by Saidani et al. (2017) for the EU. While the EU appears to be a few steps ahead of policy activity regarding the management of ELVs (but only for the automotive sector), the U.S. HDOR sector presents some aspirational industrial practices, e.g. collaboration between HDOR aftermarket actors or the Caterpillar example, supporting parts remanufacturing and facilitating reuse. Finally, this study opens on remaining challenges and circular economy opportunities for both regions, as well as for emerging and newly industrialized countries whose automotive markets are growing fast.

2.1. HEAVY VEHICLES ON THE ROAD TO THE CIRCULAR ECONOMY IN THE EU?

2.1.1. Introduction and background

Climate change, global warming, and the depletion of natural resources from anthropic root causes can no longer be contested, as highlighted in numerous Intergovernmental Panel on Climate Change reports (IPCC, 2014; IPCC, 2015). Thus optimal designs, uses and management of resources and systems are more than ever essential to protect human societies and ensure biodiversity. Furthermore, as reported by the McKinsey Commodity Price Index (MGI, 2013), resource prices have increased significantly since the turn of the 21st century. The dependence of industries on raw materials, such as precious or rare metals, presents highly strategic challenges for supply management. Besides shortages of metals and their supply challenges in Europe, the rise in global demand for raw materials has created extraordinary price volatility (Hagelüken et al., 2016).

For the automotive and heavy-duty and off-road (HDOR) vehicle industries, these added costs are increasing by several million euros from one year to the next (ACEA, 2015). With 270 million light vehicles (passenger cars and light commercial vehicles) and 20 million HDOR vehicles in use in Europe (ICCT, 2016), the automotive and HDOR sectors are two industrial giants in Europe. Their ever-growing economic and environmental footprints are uncontested: the turnover generated by the automotive sector represents 6.5% of the European Union (EU) gross domestic product, and more than 12 million people are employed in the sector (ACEA, 2016). Being able to forestall shortages and secure supplies of raw materials is of the utmost importance for manufacturers (Sievers and Tercero, 2012). Equally, the geopolitical issues around raw materials and resource efficiency are being integrated at the EU level (EC, 2010; EC, 2011; EC, 2014a; EC, 2015). Some 12 million light vehicles plus 1 million heavy vehicles are taken off the roads every year in the EU, which amounts to millions of tonnes of what actually constitute valuable resources (EMF, 2013a; Weiland, 2014): automotive and HDOR manufacturers thus have a direct interest in more sustainable management of their products, components and materials in order to stay competitive in the face of price rises and volatility.

To support both economic growth and sustainable resource management, the circular economy (CE) paradigm offers rich opportunities for industrial practitioners: the promises and benefits expected from circular practices have been comprehensively discussed in the literature (EMF, 2013b; CIRAIG, 2015; MGI, 2015; Lacy, 2015; Ghisellini et al., 2016). CE is viewed as a restorative solution with the potential to eliminate waste (EC, 2016a; EEA, 2016, EEA, 2015); it can also both secure Europe's competitiveness and ensure benefits through the three pillars of sustainable development (Banaité, 2016; Sauvé et al., 2016; Geissdoerfer et al., 2017). In particular, the use of closed-loop approaches mitigates manufacturers' dependency on virgin materials, and attenuates price volatility (Kiser, 2016). Even so, some industrial fields still need help in their transition from a linear to a more circular economy: companies may lack capacity, information, indicators and targets to move toward CE solutions (EASAC, 2016). To date, much more attention has been paid to end-of-life management in the automotive sector than in the HDOR sector.

End-of-life (EoL) management and recycling issues for cars, i.e. in the automotive sector, have been extensively studied in the literature in the last two decades from different perspectives (Tukker and Cohen, 2004; Wells and Orsato, 2005; Reuter et al., 2006; Froelich et al., 2007; Chemineau, 2011; Millet et al., 2012; Farel et al., 2013; Yi and Park, 2015; El Halabi, 2015; Despeisse et al., 2015; Simic, 2015; Idjis et al., 2017). By contrast, there is a current paucity of studies on waste minimisation and EoL for HDOR vehicles, which seems principally due to the absence of EoL regulations and extended producer responsibilities. Most of the research on HDOR vehicles has focused on the design and use phase of heavy vehicles. This approach is justified, since some 80% of the total environmental impact throughout the entire life cycle of vehicles, light or heavy, is generated during the use phase (Hill et al., 2012; Manitou Group, 2016). Current US and EU improvement road maps related to HDOR vehicles barely address the EoL value chain of HDOR vehicles, and instead emphasise optimising the design and use phases (ERTRAC, 2012; USDoE, 2013; Poulikakos et al., 2013): research work focuses mainly on saving fuel during the use phase (Walnum and Simonsen, 2015), mitigating emissions (ERTRAC, 2012), and integrating lightweight materials (USDoE, 2013).

The EoL management of HDOR vehicles is nonetheless an important issue for research and industry, whose readiness to identify unexploited or wasted opportunities is a prerequisite for further progress. The preliminary field diagnosis that prompted and steered our research in the HDOR sector, in a CE perspective, identified the following two drivers:

- Tonnage of EoL HDOR vehicles is of the same order of magnitude as that of EoL ELVs in Europe. This tonnage is around 1 million tons in France (ADEME, 2006). Hence the economic, environmental and social stakes in the

HDOR industry are potentially at least as high as in the automotive industry, and so constitute a significant area for job creation and improvement, of importance to both public policy makers and industrial practitioners;

- Lack of current regulations for the EoL of HDOR vehicles comparable to the ELV Directive 2000/53/EC in force, should urge watchful industrial practitioners to plan ahead for likely future or emerging regulations.

On this basis, the HDOR sector can be meaningfully positioned in a move towards CE. This paper offers a comprehensive overview of the situation and progress of the HDOR industry in Europe in a CE perspective. It reports on existing initiatives and incentives from the HDOR industry in line with CE principles. In particular, it highlights emerging approaches, such as new integrated technologies or innovative business models in their contributions and impacts in CE. The situation and progress of the automotive industry will also be examined as a benchmark to learn from best practices. Based on both an in-depth literature review through different types of resources, e.g. academic papers, industrial, government and consulting reports, company websites, and investigations in the industrial field, key insights and answers to the following questions will be presented:

- To what degree is CE achieved and implemented in the automotive and HDOR sectors?
- What CE-compatible practices already exist for these sectors?
- How do existing policy frameworks foster the move towards CE?

In what follows, these questions are studied with reference to the four building block CE model defined by the Ellen MacArthur Foundation (EMF, 2013b).

Sub-section 2.1.2.1 defines the terms and boundaries of the study. Sub-section 2.1.2.2 describes the research methodology and investigations undertaken to obtain a comprehensive view of the automotive and HDOR sectors in a CE perspective. Sub-section 2.1.2.3 details comparison criteria to evaluate the automotive and HDOR industries with regard to CE. In sub-section 2.1.3, several key factors affecting the CE performance of both the automotive and the HDOR sectors are analysed. Relevant insights from industrial companies are also presented. In particular, the end of sub-section 2.1.3 reviews best practices and remaining challenges in these two sectors in their movement towards an efficient and effective CE. Finally, sub-section 2.1.4 points to relevant research perspectives for further work to support a shift from a linear to a more circular economy in the automotive and HDOR industries.

2.1.2. Materials and methods



2.1.2.1. Definitions, scope and boundaries of the study

2.1.2.1.1 Distinction between light (automotive sector) and heavy (HDOR sector) vehicles

The automotive sector encompasses motor road vehicles weighing less than 3.5 tons and is covered by the ELV Directive 2000/53/EC in Europe. Less simply, heavy-duty and off-road (HDOR) vehicles are composed of two categories, namely heavy-duty vehicles (HDVs), mainly trucks, and non-road mobile machinery (NRMM), mainly agricultural and construction machinery (EC and ERN, 2015). HDV classifications are typically based on the maximum loaded weight of the truck, typically using the gross vehicle weight rating (GVWR), and they vary by geographical location; for instance US and EU classifications are different. GVWR is defined as the maximum allowable total weight of a road vehicle or trailer that is loaded, including the weight of the vehicle. The UK Vehicle Type Approval Agency calls NRMM any mobile machine, or item of transportable industrial equipment not intended for carrying passengers or goods on the road, and powered by a combustion engine (DfT, 2016). In the grey literature HDVs and NRMM are usually brought together under the term HDOR, because of their similar regulations, emissions, materials, mass, and components: HDOR = HDV + NRMM.

The HDOR industry includes firms that manufacture and remanufacture components or parts of off-highway equipment generally used in the construction, farming, mining, and oil and gas drilling industries. HDOR equipment is therefore much more diverse than vehicles in the automotive sector: in contrast to light vehicles, the HDV sector covers all types of trucks weighing more than 3.5 tons, while the NRMM sector covers a very broad range of machinery, including construction machinery (e.g. excavators, compactors, loaders, forklift trucks, dumpers, bulldozers and mobile cranes), and agricultural and farming machinery (e.g. harvesters and cultivators). Common and specific features of automotive and HDOR sectors are summarised in Table 6.

Table 6 – Definitions and features of automotive and HDOR sectors

	Automotive sector	Heavy-Duty and Off-Road (HDOR) sector	
Sub-category	Light Vehicles 	Heavy-Duty Vehicles (HDVs) 	Non-Road Mobile Machinery (NRMM) 
Definition	Road vehicles weighing less than 3.5 tons (Directive 2000/53/EC).	Nominally defined as vehicles weighing more than 3.5 metric tons (UNECE, 2016).	Mobile machines not intended for carrying passengers or goods on the road, and powered by a combustion engine (DfT, 2016).
Examples	Passenger cars & commercial-light vehicles.	Trucks, buses.	Tractors, excavators, forklift trucks.
Applications, markets, usage.	Mainly private individuals for daily use. Mainly BtoC (business to consumer).	Mainly used for commercial purposes, notably for freight (ICCT, 2015). Mainly BtoB (business to business).	Agriculture, construction, mining and forestry. Mainly BtoB (business to business).
Final owners	Private individuals, garages, insurers.	Transport and freight companies.	Civil engineering, mining and rental companies.
Major constructors	Toyota, Volkswagen, Renault.	Volvo Truck, MAN, Daimler, Scania, DAF.	Caterpillar, Komatsu, Volvo CE, John Deere, Liebherr, JCB.
Main figures	270 million light vehicles in use in Europe (ICCT 2016).	7 million trucks and trailers (from 3.6 to 40 tons) in use in Europe (ICCT, 2016).	10 million agriculture tractors, 2 million off-road, construction and mining vehicles in use in Europe (Weiland, 2014).
	12 million ELV in Europe each year (EMF, 2013a)	Around 1 million EoL HDOR units in Europe each year (Weiland, 2014).	

2.1.2.1.2 Geographical scope

The geographical scope of the study is limited to the EU (28 Member States) for the following reasons: (i) automotive and HDOR markets are large in the EU, (ii) EU environmental regulations are among the most stringent in the world, offering a gold standard for other countries, which are usually moving towards what is current in the EU in terms of regulations, (iii) the authors of the present paper are located in France, and the stakeholders interviewed were mostly based in Europe. Thus the European situation could be expected to provide a sound basis for gaining an understanding of the position and issues of the automotive and HDOR sectors in a CE perspective.

2.1.2.2. Research methodology











To cover the automotive and HDOR industries broadly and conduct an extensive research study throughout the whole value chain, from a multi-actor viewpoint in a CE perspective, a multi-method research approach (Creswell, 2003) was implemented. Creswell and Plano Clark (2007) define multi-method research as combined-method study in which a researcher uses multiple methods of data collection and analysis. Mixed-method research offers several advantages: (i) triangulation, i.e. seeking convergence of findings, (ii) complementarity, i.e. overlapping different facets of an issue, and (iii) development potential, i.e. the first method is used sequentially as input to the second method (Clarke, 2005). Here, two main types of research were used: desk-based and field-based.

Our desk-based research comprised a literature review, library research, database research and online research using key words. Diversifying the sources was essential here, because the main information and data concerning the EoL of HDOR vehicles cannot be obtained via the scant academic literature published on the subject: much relevant information was thus gathered through industrial, government and consulting agency reports, and from the internet websites of HDOR actors.

Our field-based research was through direct contact with the industrial reality through a 5-month internship at a major NRMM manufacturer, surveys, face-to-face meetings, telephone interviews, and attendance at workshops and conferences related to the subject. Field-based research was essential in this study because state-of-the-art information is owned by industrial companies: meetings or teleconference interviews with diverse stakeholders linked to HDOR vehicles were useful not only to confirm, validate or challenge the information found in the literature, but also to collect new complementary information, data, and expert impressions or opinions, and find out more about existing collaborations between actors that could not have been gleaned from reports.

A detailed description of the multi-method research approach, including the variety of resources used for data collection, is given in Table 7.

Table 7 – Description of the resources used in the multi-method research

Resources used		Description, details & contributions
Desk-based research	Field-based research	
Research papers		The following databases were used, some academic some not: Science Direct, Web of Science, Scopus, Springer, Taylor & Francis, Google Scholar and Google. Keywords included combinations and variations of terms such as: vehicle, heavy-duty, off-road, end-of-life, recycling, reuse, remanufacturing, dismantling, disassembly, circular economy, circular business model, circular product design, telematics, regulation, etc. While the end-of-life management and impacts of cars have been widely investigated and reviewed by scholars, e.g. around 100 peer-reviewed journal articles on ELV recycling published between 2003 and 2013 (Simic, 2013), the end-of-life of heavy vehicles has seldom been addressed.
Reports		Grey literature, such as reports and technical watches from government and specialised agencies, private companies and consultants were also reviewed, notably to make up for the paucity of information about HDOR vehicles end-of-life and circular economy practices and implementation in the academic literature. For instance, annual reports from major HDOR equipment manufacturers (e.g. Volvo Group Sustainability Report 2015) contain much relevant information on actual progress towards the circular economy.
Regulations		European regulations concerning automotive and HDOR sectors and related, directly or indirectly, to the circular economy were reviewed. EU regulations were available at: http://eur-lex.europa.eu . Reports from the European Commission assessing the impact of certain regulations were also reviewed.
Websites		Major constructors' and manufacturers' websites were systematically reviewed for remanufacturing, telematics, sustainability and the circular economy. Online interviews with managers and videos about end-of-life processing were also analysed to capture additional information.
Databases		Information and statistics available on the Eurostat database website were scanned to obtain an overview of the numbers of HDOR vehicles in Europe, and their relative weighting compared with cars: http://ec.europa.eu/eurostat/fr/data/database .
	Internship	A research internship was carried out at one of the major industrial manufacturers of NRMM and spare parts in Europe. During the 5-month internship, managers from different departments were met to discuss the situation and action of the company on the road to the circular economy.
 	Interviews: – in person during planned meetings; – by audio.	Interviews with field experts were conducted at different stages of the study to confront desk-based research with industrial reality. The interviews were conducted through a semi-structured questionnaire. A generic questionnaire adaptable to the interviewee was designed: it is given in Appendix B, along with the list of HDOR experts encountered. Each consulted expert was systematically asked about their circular practices. These interviews thus yielded indications of enablers and barriers for improved end-of-life management and circular practices in the HDOR sector.
	Site visits	A visit to an NRMM rental company was made. The director manager was met, and gave his strategic view in a circular economy perspective. The NRMM storage warehouse was also visited.
	Thematic day: conference and workshop	Attendance at an annual academic-industrial meeting on the responsibilities of actors for end-of-life vehicles. Discussions were also extended to heavy vehicle end-of-life at a round table.

Far from being a trivial research work, the interest of this study lies in the fact it goes further than a simple collection of data but provides an intelligent capitalization and construction of knowledge for automotive and HDOR sector in the light of circular economy. Thus, one of the contribution of this article is to organise information to give relevant meaning and directions, interpretation and understanding of the issue of HDOR vehicles issues, such as their end-of-life management, in a context of circular economy. Thus, it aims at highlighting current best practices in those sectors, as well as relevant areas that need further investigations to effectively move towards a more circular economy. The outputs can be seen as a reference book of knowledge containing a cross of qualitative and quantitative information, bringing a critical perspective on the current situation in the heavy vehicle industry.

2.1.2.3. Criteria to compare automotive and HDOR sectors through the lens of the circular economy

To analyse the situation of both the automotive and the HDOR sectors in a CE perspective, two complementary approaches were used. First, as there are several ways to close the loop (cf. Lansink's waste hierarchy ladder developed in 1979) (Parto et al., 2007; Recycling, 2016), the different pathways that help close the loops are used as criteria for comparison. The four possible feedback loops in the circular economy butterfly diagram proposed by

the Ellen MacArthur Foundation (EMF, 2013b), were scrutinised, namely: (i) maintain or prolong, (ii) reuse, (iii) remanufacture or refurbish, and (iv) recycle.

Additionally, to complete this focus on EoL loops and encompass the CE paradigm more broadly, current situations and practices in the automotive and HDOR sectors were also analysed in terms of the CE building blocks defined by the EMF (2013b). The shift toward a more circular economy involves four fundamental building blocks, namely: (i) circular product design, (ii) new business models, (iii) reverse networks, and (iv) enablers and favourable system conditions. These comparison criteria were selected not only to ensure a systemic analysis of the CE concept applied to these two industrial sectors, but also because the CE model proposed by the EMF is one of the best known and most widely shared and acknowledged visions of CE among academics and industrial practitioners.

In the following section, current EoL practices (sub-section 2.1.3.1), regulations (sub-section 2.1.3.2), business model evolution (sub-section 2.1.3.3), and promises and challenges of emerging technologies (sub-section 2.1.3.4) are used as comparison factors to set in parallel the situations and progress of the automotive and HDOR sectors on the road to CE. Insights from industrial practitioners (e.g. manufacturers) are also given to illustrate business strategies contributing to CE, and practical difficulties that still have to be overcome in a CE perspective. Finally, best practices and remaining challenges from both the automotive and the HDOR industries are summarised at the end of Section 2.1.3 for the four CE feedback loops and the four CE building blocks as described above (EMF, 2013b).

2.1.3. Results

2.1.3.1. *Current end-of-life situations*

The contributions of reuse, remanufacturing, recycling and export were studied in both industries. As explained in detail below, whereas the EoL processing of the automotive sector is increasingly well-organised and fully formalised in the EU, the EoL management of HDOR vehicles is more disparate, less well-developed and poorly controlled.

2.1.3.1.1 *Preferred end-of-life options and circular practices for the automotive industry*

Social, economic, and environmental aspects in the development of an industrial ecology of the automotive sector have been widely discussed in the literature (Tukker and Cohen, 2004; Wells and Orsato, 2005). Likewise, the EoL management of the automotive sector has benefited from much academic research and industrial breakthroughs over the entire EoL value chain: collection and allocation (Chemineau, 2011; Simic, 2015), reuse, remanufacture of components, or recycling of materials (Reuter et al., 2006; Froelich et al., 2007; Millet et al. 2012; Indra, 2016), and dismantling (El Halabi et al., 2015; IDIS, 2016).

Diener and Tillman (2016) give a concise overview of current vehicle EoL management, showing that (i) component reuse (with or without remanufacturing) and materials recycling are prevalent in the automotive sector, (ii) such EoL management of vehicles leads to economic savings and environmental benefits, and (iii) integration of both new technologies, e.g. connected devices with numerous electrical components, and new materials to reduce vehicle weight are creating new challenges to EoL recycling; as a consequence, not only the integration of new technologies in recycling centres such as the Internet of Things (IoT) and connected devices (Yi and Park, 2015), but also recycling issues for new hybrid vehicles including lithium-ion batteries (Idjis et al., 2017) are now being studied.

In the case of Sweden, studied by Diener and Tillman (2016), an estimated 7% of total cars out of use are exported or left to rust; 2% of cars out of use go directly to material handling facilities, where in line with Directive 2000/53/EC they are prepared for shredding, hazardous materials removal and depollution. The remaining cars (91% of cars out of use) go to dismantlers to recover components and materials for reuse and recycling.

Overall, EoL in the automotive sector, driven by EoL vehicle (ELV) regulations, described in sub-section 2.1.3.2., is increasingly controlled, organised and streamlined. Spare parts reuse and recycling of materials are the preferred EoL options and circular practices for the automotive industry. The ELV dismantling procedure is properly established and mastered by automotive recycling centres, as shown in Figure 20. Out of the 12 million vehicles taken off the roads in Europe each year (EMF, 2013a), 7–8 million tons of EoL vehicles are properly handled in Europe at authorised treatment facilities (ATFs) (EC, 2016b). According to experts from ADEME (French

environmental agency) and INDRA (precursor and leading player in vehicle recycling in France), around 10% of vehicle mass is removed in a depollution phase (oils, fluids, chemicals, batteries, airbags), and another 10% of vehicle mass is removed on dismantling spare parts (outer and inner parts of high value or with a reuse potential, plus transmission system parts). This step is crucial, since the resale of spare parts is the main source of income for recycling companies (INDRA, 2016a). However, as automotive spare parts are less costly than HDOR ones, remanufacturing is often unprofitable and is therefore less well-developed for light vehicle components. The remaining 80% of vehicle mass is finally sent to shredder and smelting facilities to recycle materials so as to meet mandatory standards.

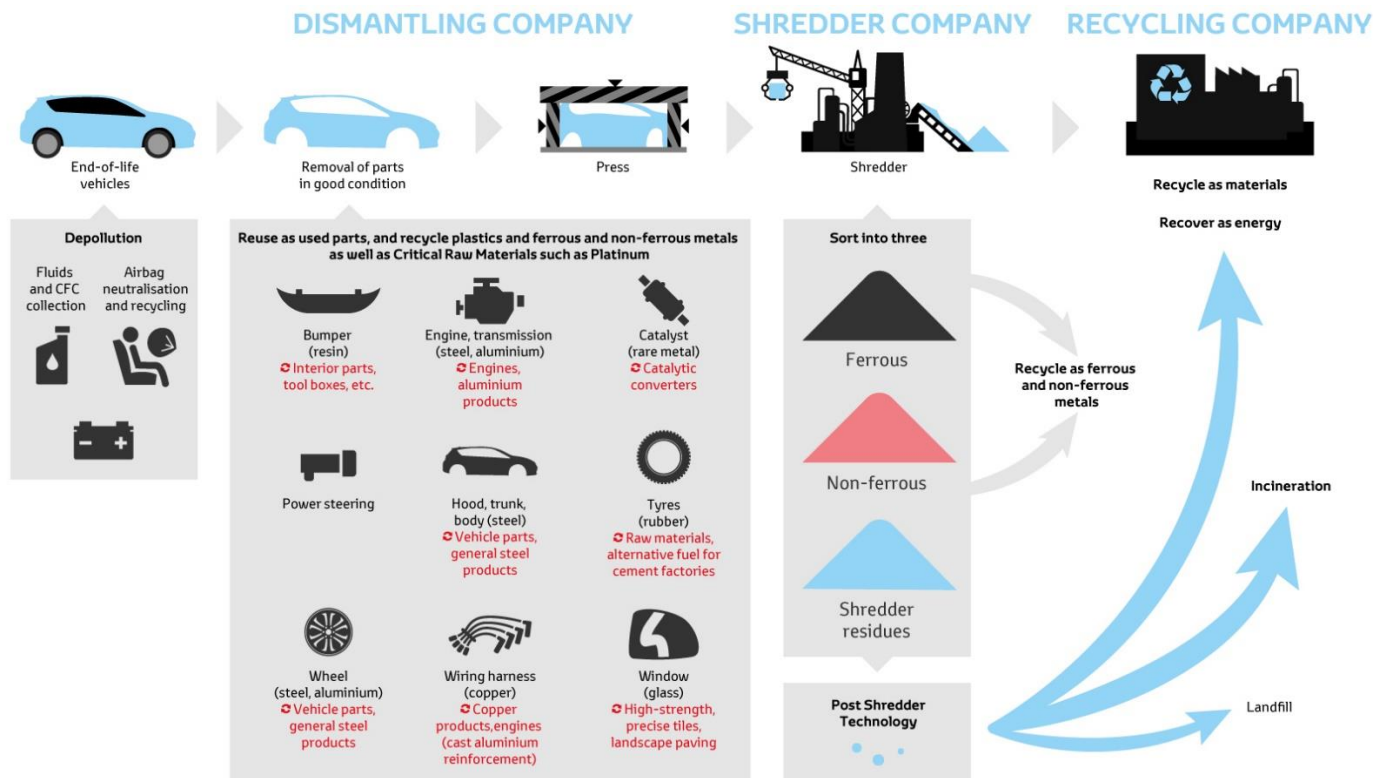

Figure 20 – End-of-life vehicle processing for the automotive sector (source: Toyota, 2016)

2.1.3.1.2 Preferred end-of-life options and circular practices for the HDOR industry

Dismantling and recycling of EoL HDOR vehicles is still a minority market outlet compared with resale and export. The export and resale of HDOR vehicles is currently commercially viable. However, this channel does not deal satisfactorily with the ultimate EoL of these heavy vehicles. According to the interviews carried out and knowledge gained in the 5-month internship, the environmental awareness of actors in this sector seems low. Furthermore, there are no specific EoL treatment facilities dedicated to heavy vehicles, unlike light vehicles (ADEME, 2006). CETIM (2014) performed a technological watch on the EoL and dismantling channels for heavy vehicles in France and in Europe (Western and Central Europe): some CE loops for HDOR vehicles, such as remanufacturing, refurbishing and reuse, are operating well, HDOR components being mainly refurbished by remanufacturing processes to give HDOR vehicles a second life. However, these overhauled HDOR vehicles are then exported to developing countries that do not have the means to dismantle and recycle heavy vehicles properly at the end of their lifespans.

The EoL management of HDOR vehicles is still a marginal and poorly structured activity in Europe. Recycling HDOR vehicles is often voluntary and not fostered by recycling targets or extended producer responsibility. To illustrate this point, according to the Center for Remanufacturing and Reuse (Walsh, 2013) in the UK, out of all heavy vehicles reaching their EoL, 50% are reused or resold in other countries after major refurbishment, 43% are remanufactured to extend their lifespan in the UK, and 7% are dismantled and recycled in the UK. In Sweden, approximately 50% of trucks were estimated to be exported after 5 years of domestic use (Diener and Tillman, 2016). Likewise, according to a director of an NRMM rental company, brand new NRMM is usually resold after five

years of use to an intermediary actor who exports it to Eastern Europe and North Africa. This is because clients prefer to rent HDOR vehicles in mint condition, and after five years in use the original manufacturer warranty has often expired.

Additionally, as reported by an expert at CIDER Engineering, the number of non-authorized infrastructures handling EoL HDOR vehicles is still too high. Moreover, even in the most developed European countries, current EoL treatment of HDOR is not satisfactory as regards safety, economic, environmental, and technical aspects. In this light, according to CIDER Engineering, true CE needs the optimisation of dismantling processes and the reintroduction on the market of not only components and spare parts, but also materials derived from a well-established recovery procedure.

To explain the marked difference observed between the two sectors, we review key factors impacting their EoL management: regulations, market and business model evolution, and new and emerging technologies.

2.1.3.2. Impacts of existing regulations

End-of-life in the automotive sector is subject to a set of regulations. By contrast, to date there are no overall EoL regulations for the HDOR industries. HDOR vehicles are presently concerned only by cross-sector regulations, such as those for EoL tyres and oil depollution. A concise overview of the regulations related, directly or indirectly, to CE and applied to the automotive and HDOR sectors is given in Table 8.

Table 8 – Regulations applied to automotive and HDOR sectors and relevant to the circular economy

Regulation type	Automotive sector	HDOR sector
End-of-life regulations (mandatory recycling and/or recovery targets)	Yes: Directive on ELV 2000/53/EC; Directive 2008/33/EC (amendment).	None
Extended Producer Responsibility	Yes, included in the ELV Directive	None for the whole HDOR vehicle
Emissions regulations	Euro 6b for light vehicles	Euro 6 for HDVs; Stage IV for NRMM.
Cross-sector regulatory frameworks for both automotive and HDOR vehicles and components	Extended Producer Responsibility (EPR) for, tyres, oils, batteries and electrical and electronic equipment (EEE); Directive 2002/96/EC WEEE (Waste Electrical & Electronic Equipment); Regulation (EC) No 1907/2006 REACH (Registration, Evaluation, Authorisation and Restriction of Chemicals); Directive 2008/35/EC RoHS (Restriction of Hazardous Substances).	
Additional, complementary or other policy frameworks linked, directly or indirectly, to the circular economy	Directive 2005/64/EC (on the type-approval of motor vehicles with regard to their reusability, recyclability and recoverability); Directive 2002/151/EC (certification of destruction for ELV handling); Directive 2003/138/EC (components and materials coding standard for vehicles); Directive 2005/293/EC (detailed rules for monitoring compliance with the ELV Directive targets).	None

In the automotive sector, European Directive 2000/53/EC aims to reduce waste from EoL vehicles. The scope of this directive is limited to passenger cars and light commercial vehicles up to nine seats and up to a total weight of 3.5 tons. The directive sets targets for reuse, recycling, and recovery. Since January 2015, these have been a minimum 85% reuse and recycling rate and a minimum 95% reuse and recovery rate for each vehicle. The directive includes Extended Producer Responsibility (EPR), which involves different actors and involves the following mechanisms:

- Free take-back of EoL vehicles (ELVs) and used tyres since January 2007;
- Producer obligation for providing not only take-back of ELVs through accessible networks of authorised treatment facilities (ATFs) and collection points, but also dismantling information for new vehicles within six months of their being placed on the market;
- Database for the automotive sector: International Dismantling Information System (IDIS);
- Public Responsibility: the registered owner of a vehicle who wants to discard it as waste is required to bring it to an ATF for appropriate treatment and recovery;
- Certificates of Destruction: since January 2007, when an EoL vehicle is deposited at an ATF, the operator of that facility shall issue a certificate of destruction to the registered owner.

Idjis et al. (2013, 2017) see this legislation as pushing for more cooperation between the actors of the automotive sector, such as original equipment manufacturers (OEMs), authorised treatment facilities, end users, and other EoL third parties. The effectiveness, relevance, strengths and weaknesses of the ELV Directive (2000/53/EC) have been discussed by the European Commission (EC, 2014b), and one conclusion drawn is that the various environmental and economic benefits of the ELV Directive outweigh the costs of its implementation: the costs of complying with the Directive are estimated by the industry to be significant, e.g. for car manufacturers to remove hazardous substances, or for recyclers to develop the technologies necessary to meet the targets, but they are outweighed by the profits gained from the sales of recycled parts. However, two major challenges remain. First, the collection and treatment of ELVs by illegal operators and the illegal shipment of ELVs are still flourishing businesses: increasing co-operation among European Union member states is therefore needed to ensure tracking and follow-up of de-registered and exported vehicles. Second, a new issue has appeared: the introduction of complex electronic systems and composite materials in modern vehicles poses significant technological challenges for maintaining the overall reuse, recycling, and recovery rates of ELVs. The ACEA (2015) likewise acknowledges that the ELV Directive has proven highly effective in reducing discard of waste from vehicles, increasing reuse, recycling and recovery, and ensuring that ELVs are treated in an environmentally sound way.

Meanwhile, in the HDOR sector, except for legal necessities such as REACH and RoHS, emissions regulations (Euro 6 in Europe for HDVs and Stage IV for NRMM) and cross-sector regulatory frameworks (EPR on tyres, oils and batteries), as detailed in Table 8, there are no regulations or directives that compel the HDOR industry to apply more sustainable management of vehicle EoL. In Europe, there are some 20 million HDOR vehicles in use that are not subject to overall EoL regulations (Weiland, 2014). According to an expert from ADEME (French environmental agency), although a possible extension of the ELV Directive (2000/53/EC) to EoL HDOR vehicles was mooted by Spanish representatives at the European Commission in Brussels in 2014, no new European legislation concerning HDOR vehicles is expected in the short term. In the absence of any regulation in the HDOR industry, the HDOR manufacturers are not asked to deal with the retired fleet. Motivation of manufacturers to participate in EoL HDOR projects, and in circular practices, has to be sought elsewhere, for example in the residual value of EoL HDOR vehicles, or in the reuse or recovery of key components and materials for second-hand products that require less primary raw materials extraction, energy, and labour.

Wilts et al. (2016) stress the importance of policy mixes, such as waste targets for resource efficiency and extended producer responsibility, in driving progress towards a more circular economy. The impact of recent CE policy initiatives in Europe, such as the “European Commission Circular Economy Package” (EC, 2015) has not yet been evaluated. Nevertheless, the policies and targets in place do not directly concern the HDOR vehicle industry. Furthermore, the question of materials ownership and responsibility in CE also remains unanswered for many industrial sectors including the HDOR sector, and is therefore a key challenge in seeking insights on “how the loop will close and by whom?” (Velis and Vrancken, 2015).

2.1.3.3. *Business model evolution: impacts of remanufacturing and PSS*

In the automotive and HDOR industries, new business models are emerging and will continue to flourish, favouring usage-based income opportunities, both for ownership and servicing of vehicles (IBM, 2009): evolution towards more circular businesses and processes could offer economic, environmental and social benefits through remanufacturing (Japke, 2009; Kwak and Kim, 2016) or product-service-system (PSS) practices (Bocken et al., 2015; Tukker, 2015). These business practices that seek to close the loops in the automotive and HDOR sectors are examined in this sub-section.

Automotive vehicles in use far outnumber HDOR vehicles, at around 270 million against 20 million in the EU (ICCT, 2016). However, HDOR vehicles use more remanufactured components, and HDOR components are 4–5 times more expensive (Weiland, 2014). For light vehicles, standard components that are remanufactured are mainly starters and alternators, fuel injection parts, electronic control modules, transmissions, engines, gearboxes and turbochargers. For HDOR vehicles, further components are remanufactured, such as hydraulic pumps and cylinders, water and oil pumps, oil coolers, air compressors and actuators, radiators, retarders and particle filters, differentials and hydraulics, and tyres. HDOR component values and dimensions are also much higher: for instance, an average car transmission weighs 40 kg, whereas an average HDOR transmission weighs 200 kg. Overall, in Europe, the HDOR remanufacturing market is performing well, with 3.5 million remanufactured spare parts sold in 2013, corresponding to 3.7 billion euros in annual sales and 279,000 tons of annual CO₂ savings. In comparison, the European automotive remanufacturing business is estimated to be worth 5.7 billion euros. As a relevant illustration, retreading HDOR tyres is one of the most successful HDOR remanufacturing practices. Unlike

car tyres, which have a low value and are not worth retreading, the value of HDOR tyres for mining or construction applications is high and so such practices are attractive. The European market for HDOR tyres is vast, with a market share of retreaded and remanufactured HDOR tyres of 3.8 million units, corresponding to 1.1 billion euros in annual sales and a source of non-negligible environmental savings (285,000 tons of annual CO₂ saved) (Weiland, 2014). The remanufacturing market for HDOR vehicles was also recently analysed by the European Commission and the European Remanufacturing Network (EC and ERN, 2015). Globally, the HDOR sector is currently worth 122 billion euros to the European economy, which includes new manufacturing and repair of HDOR equipment. More specifically, the European remanufacturing market was estimated to be worth 4.1 billion euros in 2014, consistent with the figure of 3.7 billion euros in 2013, as stated above. Germany is estimated to account for 27% of the market, France, Italy and UK representing 15%, 13% and 12% respectively. The sector is estimated to employ 20,000 people in more than 500 firms in Europe (EC and ERN, 2015).

However, some issues still have to be tackled to reach the full potential of the HDOR remanufacturing market. HDOR spare parts handling and processing are very heterogeneous. Some components are well-suited to profitable remanufacturing (e.g. tyres, alternators and starters account for 70% of the remanufactured market), but others are directly replaced by brand-new parts (e.g. catalytic converters and pneumatic brakes account for 75% of the brand-new market) (Weiland, 2014). Additionally, the requirement to keep large inventories of remanufactured components to cover all the potential parts that may need replacing is a prohibitive obstacle, and only attempted by the largest OEMs (e.g. Caterpillar and JCB). A few smaller businesses indicated that they felt they were too small to get involved in remanufacturing activities, and it would not be cost-effective for them to embark on such activities. On the other hand, the aftersales market, previously managed and handled by third-party companies and intermediaries, is now becoming a key challenge for OEMs, competing with independent firms.

Compared with the automotive sector, the remanufacturing market for HDOR stands out by some specific features: not only is it already a sizeable business area, but it can also claim a greater growth potential than any other industrial sector, according to the CRR Institute in the UK (Walsh, 2013) (Chapman et al., 2010). NRMM rental, for instance, is still a growing market that has not yet reached its full potential (CETIM, 2014). As a result of the acceleration of technological innovation and the increasing complexity of equipment, the construction sector is also characterised by a rising demand related to continuous maintenance services for equipment leased on a 24/7 basis. Teams, infrastructures and organisations capable of repairing or replacing failing equipment using remanufactured products are increasingly active (CETIM, 2014). Major manufacturer companies such as Caterpillar are well aware of the current trend in business model evolution: “before, core business was manufacturing, soon it could be remanufacturing” (Snodgrass, 2012).

In Europe, the remanufacturing market for HDOR parts is therefore large, competitive and very dynamic, with great promise of growth. Manufacturers have identified this growing market, creating special services and channels of remanufactured products for their clients. Rental companies are also increasingly entering this market, while also starting to compete with original equipment manufacturers to extend the operational lifespan of their heavy vehicles (CETIM, 2014). While remanufacturing activities are still alive throughout the EU, the increased availability of inexpensive new aftermarket parts from Asia has reportedly made it difficult for remanufacturers in Western Europe to remain competitive (USITC, 2012).

Lastly, Diener et al. (2015) set out to determine whether product-service-system (PSS) was really a relevant solution for materials efficiency in the HDOR sector. In their study, the following questions were addressed: “what would the company do differently if they were to sell truck function and retain truck function throughout the truck’s lifecycle?” and “how would changes made by the companies affect the materials use required to deliver truck function?”. To assess the potential effects and benefits of PSS on materials efficiency, three HDOR components made mainly of steel were considered (engine, gearbox, and wheel-end). Experiments on Business Model Canvas (BMC) and Material Flow Analysis (MFA) comparing current state and modified PSS-state concluded on a benefit of 23% for materials efficiency for the latter. However, while organisational capabilities (networks and resources) were considered in this study, financial aspects (cost structure and revenue streams) and possible exportations to less developed countries lie outside its scope.

2.1.3.4. *Integration of emerging and promising technologies: challenges and new opportunities*

New and emerging technologies integrated in automotive and HDOR vehicles, such as telematics, Internet of things (IoT) and connected devices, should be intelligently used as enablers. They could be deployed as a means to an end, rather than as an end in itself, for industrial operators to manage their automotive or HDOR vehicles and

components throughout their life cycles, and thereby run more competitive and greener businesses (Walker and Manson, 2014; Husnjak et al., 2015; Gnimpieba, 2015). Telematics systems are automobile systems that combine wireless communications for automatic roadside assistance and remote diagnostics. A review of available telematics systems offering an analysis of the usefulness of each telematics solution was made by the NSTSCE (2012). The contributions of telematics during the use phase, e.g. fuel savings, have been widely studied and are beyond the scope of the present paper. To give an example, a case study on real benefits of telematics has shown that telematics can be used to monitor and improve safe driving behaviour as well as monitor and improve fuel economy in trucks (USDoT, 2014). Importantly, the question of the potential contributions of new and emerging technologies as a support in the move towards CE in the automotive and HDOR industries, is becoming increasingly significant: telematics and associated connected devices could certainly facilitate and foster new and closer relationships between suppliers, service providers and users, through customised insurance, take-back offers, technical warnings, and preventive maintenance (NSTSCE, 2012). Also, thanks to the tracking and monitoring of transportation systems with the IoT, enhanced control of illegal exports will be possible. According to IBM (2009), telematics will be an indispensable part of tomorrow's heavy vehicles. Whereas today's vehicle diagnostic techniques typically require the technician to physically connect to the vehicle, the future capabilities of telematics will enable remote vehicle diagnostics.

Additionally, IoT sensors add intelligence to automotive and HDOR vehicles as hundreds of sensors fitted on vehicles such as commercial trucks generate large volumes of real-time data. The current challenge is to translate the data thus obtained into meaningful information that optimises, for instance, vehicle usage or maintenance (Intel, 2015). Some ongoing research and studies are ready to go further, capturing real-time performance, user activities and feedback from the field, not only for the purpose of real-time usage optimisation, but also to improve the future design of vehicles and machinery considering their entire life cycle (Ma et al., 2014). However, only a small proportion of automotive HDOR vehicles are currently equipped and monitored with such advanced telematics systems: a survey performed in 2014 by the Association of Equipment Manufacturers found that 62% of US construction companies had no plans to implement telematics anytime soon. Also, according to a director manager from an NRMM rental company, such technologies are not seen as really useful for small machinery users, but only for major construction sites with large fleets of heavy machinery working together. Another challenge is to link these telematics and connected devices with business models facilitating the EoL management, (prolong, maintain, reuse, remanufacture, recycle), of automotive and HDOR vehicles. Among innovative business models interlinking leasing services and connected devices, a geo-tracking online platform allowing HDOR equipment, and particularly NRMM, to be localised, that is available in a chosen area at both end of usage and EoL is increasingly used by civil engineering companies (Matexchange, 2016). As advocated by a road construction site supervisor from Colas, who has used NRMM since 1979 and has therefore noted some evolution, it would be useful to have more information about the wear and tear of components through the use of such connected devices in order to prevent component breakdown and forecast more accurate preventive maintenance, and thereby contribute to the circular economy in practice.

2.1.3.5. Industrial practices, initiatives and incentives to close the loops

To illustrate the previous sub-sections with concrete examples from the industrial field, we now make an in-depth analysis of best industrial practices in the automotive and HDOR sectors to close the loop. The practices of major NRMM constructors in progress towards CE were analysed: Liebherr (DE ownership), Caterpillar (US), John Deere (US), Volvo Construction Equipment (SE), and Manitou (FR). Likewise, remanufacturing programmes and innovative commercial offers of five main HDV constructors were analysed to gain relevant insights and identify best initiatives in a CE perspective (Volvo Truck (SE), Scania (SE), MAN (DE), DAF (NL) and Daimler Trucks North America (US)). For the automotive sector, the example of French major constructor Renault was taken to illustrate best automotive practices on the road to CE. In the NRMM sector, although Caterpillar has the most extended and developed remanufacturing program and offer, several commercial offers related to aftersales services from main NRMM constructors are also discussed. In the HDV sector, the example of Volvo Truck lends significant insights into the EoL stage and new business offers.

2.1.3.5.1 Insights from automotive operators

Renault was chosen by the Ellen MacArthur Foundation to illustrate CE in the automotive industry (EMF, 2013a). In 2012, Renault's Choisy-le-Roi plant remanufactured around 200,000 components of six types of mechanism, such as gearboxes and injectors. In this remanufacturing centre, the savings from producing a remanufactured part

compared with a new part are 80% less energy, 88% less water, and 92% less chemicals. In terms of raw materials, the Choisy-le-Roi factory does not send any waste to landfill: 43% of a carcass is re-usable (72% of the mass of a gearbox and 37% of the mass of an engine); 48% is recycled in the company’s foundries to produce new parts, and the remaining 9% is valorised in processing centres, meaning the entire recovery process is waste-free. Additionally, Renault has built a network for the efficient, profitable EoL treatment of vehicles, which includes INDRA (a pioneer in automotive recycling) and Suez Environment (a specialist in global waste management and recycling), as illustrated in Figure 21.

More specifically, the INDRA network activities help disseminate best practices among EoL treatment facilities regarding management, depollution, dismantling and recycling of ELVs (INDRA, 2016a). INDRA also “provides ELV centres with a dedicated software suite, designed to meet their every need and guarantee traceability throughout the chain, from the administrative management of vehicles to evaluating demand, dismantling, and the technical identification of reusable parts intended for resale” (INDRA, 2016b). This recent advance helps fill a gap noted by Despeisse et al. (2015), who examined the circularity of EoL vehicles in the UK and Japan. A clear lack of an information system to support the EoL management in a centralised way was observed. They report that data collected and available were still insufficient to understand and decide on the best fate of components and materials. Since this study was completed, progress has been made in these areas: the complete handling of ELVs is becoming an increasingly efficient industrialised procedure. For instance, the entire dismantling time has been optimised to 3 hours per vehicle, and state-of-the-art ELV centres can ensure the complete disassembly of 25 vehicles per day.

Overall, by prolonging and maintaining the lifespan of the vehicles by parts remanufacturing, the factory in Choisy has created a comprehensive circular model. Moreover, this activity complies closely with the principles of the three pillars of sustainability. First, socially, it involves a skilled workforce and creates jobs locally (325 employees are working on the site). To be economically viable (turnover of 100 million euros), remanufacturing has to be performed within the market region in which the vehicles are used. Though 30–50% less expensive, the remanufactured parts have the same guarantee, and are subject to the same quality control tests as new parts. Lastly, environmentally, it retains added value of components and saves energy, while reducing waste, as detailed quantitatively above.

Additionally, in the automotive sector, research projects and investigations also focus on mechanisms to improve recycling and recovery rates during early design and development phases, and thereby the circularity of vehicle components or materials. Garcia et al. (2015) propose a tool for evaluating the impact of innovation on the EoL pathway of a vehicle. The goal of this tool, called OSIRIS (Simulation Tool of the Impact on Recyclability of Innovations), developed in collaboration with the French automotive manufacturer PSA, is to help the engineers of the innovation department evaluate the impact of their innovations on a vehicle’s recoverability rates.



Figure 21 – Renault’s remanufacturing network to close the loop (source: EMF, 2013a)

2.1.3.5.2 *Insights from HDV sector practitioners*

In terms of design and during product development, the Volvo Group (2015) meets major prerequisites to fit CE principles: Volvo’s trucks are largely recyclable, almost 85% of their weight consisting of metal, mostly iron, steel and aluminium. The additional materials are mainly plastic, rubber and materials from electronic components. Today, approximately one third of a Volvo Group truck is produced from recycled materials, and 80% of the engine can be reused. The Volvo Group has developed manuals and other tools to assist disassembly workers in extracting the most from used vehicles. For instance, the dismantling manual (Volvo Truck Corporation, 2012) provides practical and illustrated recommendations about the possible handling, reuse or recycling of chemicals and fluids (oil, AdBlue, solvents, coolant, brake fluid, refrigerant, glycol, glue, washer fluid, sulphuric acid) and other components and materials (batteries, air bags, belt tensioners, oil filters, laminated glass, silencer, electrical and electronic waste, lamps and tubes, switches, gas discharge lamps, brake discs, rubber).

When a Volvo FH Globetrotter is properly dismantled, i.e. 95% of its weight (approximately 7,000 kg), the total resale of spare parts can reach 40,000 euros. According to an environmental manager at Volvo Truck Recycling, the EoL processing of a truck is much more complex, energy and labour-intensive, as well as less well developed than in the automotive sector. In a Volvo dismantling plant, EoL processing comprises cleaning and depollution (i.e. batteries and fluids removal), undressing (i.e. headlights, sheet metal bodywork, and cabin removal), dismantling (all components to access the engine) and butchering (axles, chassis, wheels). It also requires two expert garage mechanics working for three days in a workshop with specific tools.

The remanufacturing market share of Volvo is also expanding, a good indicator of the move towards CE. In 2015, the total sales of remanufactured components amounted to 0.83 billion euros, an increase of almost 20% over 2014. Remanufactured components reduce customers’ ownership and operating costs (Volvo Group, 2015). Volvo is also one of the most mature companies for telematics integration in their HDOR fleet. In 2015, approximately 470,000 Volvo Group vehicles were connected via different telematics solutions, including services such as Volvo Dynafleet, Renault OptiFleet, UD Telematics and the Volvo CE CareTrack, in a fleet of more than two million trucks.

Regarding circular product design practices, many of the Volvo Group’s products have a common architecture and shared technology (CAST) based on a modularised concept and standard interfaces. The Volvo Group’s heavy-duty and medium-duty engine platforms are at the centre of the CAST strategy, as illustrated in Figure 22. There is also a high degree of commonality in electronics and transmissions. This modular product design (MPD) approach makes remanufacturing and reuse of spare parts easier, and thereby contributes to the shift towards CE. Furthermore, according to Ma and Okudan Kremer (2014), adopting a systematic MPD strategy leads to benefits in terms of the three pillars of sustainability.



Figure 22 – Common architecture and shared technology to facilitate spare parts reuse (source: Volvo, 2015)

Another industrial example that illustrates the transition of HDVs towards CE is the DAF Company. DAF has already anticipated a possible extension of the European Directive related to ELV (2000/53/EC). More than 93% of all the materials in a standard DAF truck can now be reused. For example, the plastic parts of a DAF truck can easily be separated during dismantling. Like Volvo, DAF provides special sorting guides for each truck type. Also, DAF is proactive in the remanufacturing and reuse of components. In DAF's overhaul workshop in Eindhoven, an annual total of more than 50,000 parts are overhauled and supplied for reuse. These parts include starter motors, fuel pumps, gearboxes and even complete engines. These exchange parts are of a similar quality to new parts, and the same guarantee is provided for both.

2.1.3.5.3 Insights from NRMM sector practitioners

Caterpillar is a renowned model of an off-road equipment company embracing CE through remanufacturing; it ended runner-up among The Circularity 2016 Finalists. Caterpillar has incorporated CE principles across its value chain, including product development, supply chain, dealer network, and customer relationships. Caterpillar's remanufacturing activity began in 1973, and has since grown to encompass 17 facilities worldwide, employing over 4,100 people dedicated to remanufacturing activities in a business model with an emphasis on component recovery. In 2012 Caterpillar's remanufacturing programme took back over 2.2 million EoL units for remanufacturing, representing (i) 73,000 tons of materials, including 50,000 tons of iron; (ii) 6,000 different remanufactured products such as engines, fuel systems, and tyres. Incentives such as a deposit scheme and voluntary take-back of products ensure that large quantities of parts are returned to Caterpillar, as shown in Figure 23. Caterpillar has a global network of remanufacturing hubs in which the returned products are remediated; in Europe the following sites undertake remanufacturing activities: Chaumont in France; Bazzano, Castelvetro, Frosinone, and San Eusebio in Italy, Radom in Poland; and Shrewsbury and Skinningrove in the UK. Another success factor for Caterpillar's remanufacturing program is that the company considers the entire product life cycle during the design phase, taking into account types of materials used and ease of disassembly for repair, remanufacture, reuse or recycling. The company also implements digital technology to drive circular transformation via its remanufacturing. One example is the telematics platform "Caterpillar Product Link", which provides information about the location, utilisation and condition of any given equipment, which facilitates remanufacturing processing. Lastly, Caterpillar is also finding ways to expand its remanufacturing business model to help address growing environmental concerns, such as the electronics waste increasingly left by HDOR equipment (Snodgrass, 2012). All in all, the company's circular economy portfolio generated almost 10 billion euros in 2014, accounting for 18% of the company's total sales and revenues.

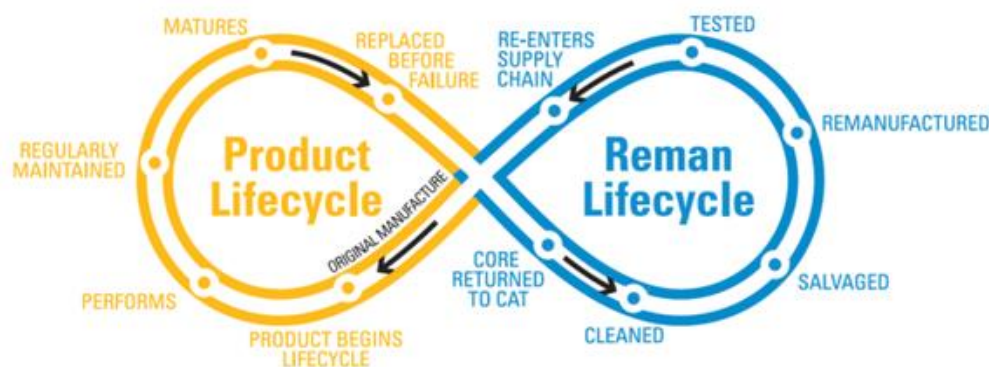

Figure 23 – Caterpillar's remanufacturing value chain to close the loop, excerpt from Snodgrass (2012)

Recently more and more other companies have been developing their remanufacturing offers in order to stay competitive. For instance, Liebherr has been extending its remanufacturing programme since 2004 at its Ettlingen site in Germany, offering three remanufacturing options for a range of components: exchange, general overhaul or repair. Concerning emerging technologies and connected devices for HDOR equipment, the telematics platform LiDAT, designed and developed by Liebherr, includes maintenance management with services such as an automatic reminder of routine maintenance (e.g. gearbox oil changes or maintenance on brakes) or date planning for acceptance procedures (e.g. expert inspections). Fostering preventive maintenance is thus one good step towards maintaining and prolonging the lifespan of NRMM, and so contributes positively to CE. Similarly, John Deere's JDLink telematic offer allows owners and fleet managers to monitor equipment remotely: the JDLink telematics system includes location tracking, remote diagnosis and repair sessions for a better traceability and usage of the machine throughout its life cycle.

Taking into account the different legislations for automotive and HDOR sectors, it is noteworthy that Renault offers an example of practices commonly applied by other car manufacturers in the EU, such as the German Volkswagen Group, whereas the approaches of Volvo, DAF and Caterpillar are not followed by their competitors in the HDOR sector. Possible transfer of best practices from light vehicles to heavy ones, and *vice versa*, are analysed in the next sub-section through the lens of the circular economy.

2.1.3.6. Best practices and remaining challenges in a CE perspective

The situation of automotive and HDOR sectors on the road towards CE are compared and summarised in Table 9 through the four generic loops of the CE model defined by the EMF (2013b), and in Table 10 in terms of the four building blocks of a CE defined as well by the EMF (2013b). Best practices (BP) and remaining challenges (C) are indicated as relevant.

Table 9 – Best practices (BP) and challenges (C) in both sectors to close the loops









Feedback loops of CE	Description (EMF, 2013b)	Automotive sector	HDOR sector
Maintain Prolong 	The goal is to keep artefacts in circulation as long as possible, with as high a value as possible. Design for service and maintenance. From (end) user to (new) user (including sometimes a third party)	BP: <ul style="list-style-type: none"> Extension of the lifetime of the vehicle economically viable thanks to the remanufacturing of spare parts: example of Renault and its remanufacturing plant. C: <ul style="list-style-type: none"> Environmental and economic trade-offs between extending the lifespan of old vehicles and introducing brand new vehicles, which pollute less. 	BP: <ul style="list-style-type: none"> Capturing real-time performance and users' activities from the industrial level to improve future design and machinery considering whole life cycle. Maintenance management with services such as automatic reminder of technical warning or preventive maintenance activities. C: <ul style="list-style-type: none"> Poor traceability aftersales from the manufacturer side to intervene properly for repairing components during the life of an HDOR vehicle.
Reuse Redistribute 	Design for reuse and optimisation of second-hand market to avoid value loss. From end-user to service providers.	BP: <ul style="list-style-type: none"> Well-established dismantling system is a viable source of second-hand parts to the automotive aftermarket. Feedback information about current stocks and market demand provided to state-of-the-art recycling centre. Computer software specialising in monitoring second-hand spare parts and their dismantling for resale. C: <ul style="list-style-type: none"> Acceptance of second-hand parts by consumers. 	BP: <ul style="list-style-type: none"> In the UK, 50% of all heavy vehicles reaching their end-of-life are reused or resold in other countries with major refurbishment; 43% are remanufactured to extend their lifespan in the UK. Redistribution of second-hand components is a profitable business: e.g. when a Volvo FH Globetrotter is dismantled properly (95% of its weight, i.e. 7,000 kg), the overall resale of spare parts can reach 40,000 euros. C: <ul style="list-style-type: none"> Numerous uncertainties about the quantity and location of end-of-life HDOR vehicles, and about the quality and conditions of used spare parts.
Remanufacture 	Returning a product to its original performance with a warranty. Process that makes extensive reuse possible. From end-user to manufacturer factories or remanufacturing centres.	BP: <ul style="list-style-type: none"> Renault's Choisy-le-Roi remanufacturing centre with its associated collaborative and reverse supply chain network. C: <ul style="list-style-type: none"> Limited number of remanufactured spare parts from light vehicles. 	BP: <ul style="list-style-type: none"> More remanufacturing spare parts than in the automotive sector. Retreading of HDOR tyres. In 2012 Caterpillar's remanufacturing programme took back over 2.2 million end-of-life units for remanufacturing, representing 73,000 tons of materials. C: <ul style="list-style-type: none"> Disassembly and remanufacturing of many newly-designed and more advanced components is not possible without damage. Some components are still systematically replaced by brand-new ones: e.g. catalytic converters or pneumatic brakes.
Recycle 	Design for materials recovery. Loss of original product's added value. From end-user to recycling centres.	BP: <ul style="list-style-type: none"> Well-organised federation of a significant part of the vehicle recycling industry through a specialised computer system. OEMs have to publish vehicle disassembly guidance according to legislation. C: <ul style="list-style-type: none"> Illegal recycling channels still exist. Recycling targets are still defined by weight. 	BP: <ul style="list-style-type: none"> Dismantling manuals are available for most of Volvo's trucks. DAF has already anticipated a possible extension of the European ELV Directive (2000/53/EC) More than 93% of all materials in a standard DAF truck can be reused. C: <ul style="list-style-type: none"> HDOR vehicles are very heterogeneous, hampering the design of generic end-of-life infrastructure to recycle efficiently. Ultimate end-of-life of HDOR vehicles in countries without proper dismantling recycling infrastructure to recover high added value components.

Table 10 – Best practices (BP) and challenges (C) in both sectors in regard to the CE building blocks

Building blocks of CE	Description (EMF, 2013b)	Automotive sector	HDOR sector
 <p>Circular Design Product</p>	Product design that facilitates the reuse, remanufacturing, recycling and recovery of components and materials.	<p>BP:</p> <ul style="list-style-type: none"> Eco-design practices, tools and environmental requirements are increasingly integrated within the design and development processes. <p>C:</p> <ul style="list-style-type: none"> Trade-off between the need to improve performance during the use phase (e.g. making vehicles lighter often requires replacing steel with lighter materials, such as aluminium, polymers, composites or carbon fibres) and design for recycling. Integration of electronic systems leads to new challenging issues for reuse in another vehicle, operator-friendly remanufacturing or recycling. 	<p>BP:</p> <ul style="list-style-type: none"> Volvo's trucks are highly recyclable: 85% of their weight consists of iron, steel and aluminium. One third of a Volvo Group's truck is produced from recycled materials. Modular product design: the high degree of commonality of Volvo Group's products facilitates the remanufacturing and reuse of spare parts. <p>C:</p> <ul style="list-style-type: none"> Complex components (multi-material plus small electrical parts) are often impossible to dismantle without damaging them and are less re-usable.
 <p>New Business Model (BM)</p>	Innovative business models (BM) that enable circular value chain, foster exchanges and products loops.	<p>BP:</p> <ul style="list-style-type: none"> Cooperation and shared information between automotive actors - from manufacturers to second-hand dealers through authorised treatment facilities - to meet the ELV Directive and make profits from the EoL management of cars. <p>C:</p> <ul style="list-style-type: none"> Used parts market in the EU is still small compared with used parts markets in Middle East, Asia and North Africa. 	<p>BP:</p> <ul style="list-style-type: none"> OEMs creating special services and remanufactured offers for their clients: continuous maintenance services for leased equipment on a 24/7 basis. Innovative BM interlinking leasing services and connected devices: a geo-tracking online platform allowing localisation of HDOR equipment. Caterpillar's take-back programme including a deposit scheme and voluntary take-back of products. <p>C:</p> <ul style="list-style-type: none"> Initial investments required to launch circular practices are non-negligible. Increased availability of less expensive aftermarket parts from Asia.
 <p>Reverse Cycles</p>	Reverse logistics recovering products back from users into the supply chain.	<p>BP:</p> <ul style="list-style-type: none"> Free take-back of end-of-life vehicles. High accessibility of collection points (at least one every 50 km in France). Renault and its collaborative network all along the end-of-life value chain. <p>C:</p> <ul style="list-style-type: none"> ELV that reached non-authorized treatment facilities. Final owners unaware of the free take-back of their end-of-life vehicles. 	<p>BP:</p> <ul style="list-style-type: none"> Emergence of telematic systems and connected devices to foster the tracking of HDOR fleet. <p>C:</p> <ul style="list-style-type: none"> Lack of transparency of the end-of-life value chain due to the significant number of subcontractors and intermediary third parties. The question of who will own, fund and be responsible for infrastructures for reverse cycles is unclear.
 <p>Enablers & Favourable System Conditions</p>	A number of system conditions that can help businesses make the transition, such as education, policies, collaborations and market mechanisms.	<p>BP:</p> <ul style="list-style-type: none"> Large numbers of HDOR units in circulation: 270 million in the EU. End-of-life vehicles Directive (2000/53/EC) with mandatory levels of reuse, recovery and recycling. Sweden, an example where 91% of cars out of use are taken to dismantlers. <p>C:</p> <ul style="list-style-type: none"> Time period between pre-life and end-of-life: 17.5 years for cars. Meanwhile, technologies and materials used evolve. Around 4 million European ELV are still handled by non-authorized or illegal treatment facilities: in France, 1.1 million ELV are properly handled by ATF out of 1.8 million ELV generated each year: loss of 700.000 ELV in illegal treatment facilities. 	<p>BP:</p> <ul style="list-style-type: none"> Large numbers of HDOR units in circulation: 20 million in the EU. High residual value of components and materials included in EoL HDOR vehicles. Enhanced fleet management location tracking, remote diagnosis and repair sessions aiming at a better traceability throughout the life cycle. 470,000 Volvo Group vehicles are connected via different telematics devices in a fleet of more than two millions trucks. <p>C:</p> <ul style="list-style-type: none"> Time period between pre-life and end-of-life: around 20 years for HDOR vehicles. Meanwhile, technologies and materials used are evolving. No end-of-life regulations for HDOR vehicles, nor extended producer responsibilities. Current mind-set of HDOR actors and users.

2.1.4. Discussion and concluding remarks

Globally, the implementation of the circular economy, which is still at an initial stage of development, has mainly focused on recycling rather than on reuse (Ghisellini et al., 2015). The HDOR industry case is an exception to this trend: remanufacturing is the preferred option for the EoL of HDOR vehicles, rather than dismantling and recycling. From a sustainability point of view, this is a commendable and praiseworthy practice in that it offers heavy vehicles a second life. However, second-hand heavy vehicles are then usually resold to emerging markets and developing countries that do not have the proper technologies to dismantle, recover or recycle heavy vehicles that have reached their ultimate EoL, which then become a severe burden for the environment, with loss of precious metals. Developing countries lack proper waste collection and treatment systems (Diaz, 2017), and have a number of problems related to waste management that still need to be resolved: lack of political will, absence of rules and regulations for solid waste management, insufficient funds, and absence of educational programmes.

On the other hand, even in more developed countries in Western Europe such as France, dismantling and recycling channels for heavy vehicles are in their early development stages, and it is still difficult to find and identify the relevant interlocutors and right actors (ADEME, 2006; CETIM, 2014). To date, materials recycling or recovery are therefore not the preferred pathways for the EoL of HDOR vehicles: at the European level, both industrial operators and policy makers are not proactive enough in the setting of standards related to the EoL management of HDOR equipment. In addition, the profitability of dismantling infrastructures for HDOR vehicles has yet to be proved. At the moment, exports of HDOR vehicles are profitable for the end-owners, but this is globally a non-sustainable solution, because the importing developing countries do not possess factories to recycle properly. Additionally, exports outside Europe lead to significant leakage of value for European manufacturers, from strategic, economic and environmental points of view. Simply stated, the EoL of HDOR vehicles is an important concrete opportunity for maintaining resources in Europe, and for securing the supply of rare and precious materials from resource scarcity and price volatility, which is not fully exploited today. Lastly, even if this issue is somewhat outside the scope of the present paper, European countries will have to assist developing countries in preserving value from EoL equipment and creating a circular economy (Diaz, 2017).

Major stakeholders of the HDOR industry, such as original equipment manufacturers or EoL expertise centres, are becoming increasingly aware of these missed opportunities. These challenges and opportunities had also been identified and confirmed by a business development manager from one of the main European construction equipment manufacturers, interviewed during our investigations. OEMs are beginning to understand that the stakes are high, and adapt their offers accordingly (e.g. Volvo and Caterpillar's business model evolution as detailed above). To go even further and fully achieve the potential and promises of CE, the HDOR vehicle sector can learn from the automotive sector in the following areas of best circular practices:

- Well-organised EoL value chain of ELV in the EU. Well-established dismantling and systematic recycling procedures in ATFs, motivated and propelled by the ELV directive and EPR.
- Involvement of research and engineering expertise centres (e.g. INDRA operating in France) within the EoL value chain to help close the loops of products and materials by providing state-of-the-art tools, methods and software platforms.
- Transparent collaboration networks between automotive manufacturers, EoL treatment facilities and intermediary third parties from the EoL value chain. For instance, collaboration between industrial manufacturers all along the value chain is one of the key elements of the framework proposed by Witjes and Lozano (2016) to move effectively towards CE through more sustainable business models.

However, the mere implementation of regulations is not sufficient to ensure a smooth evolution towards sustainable CE. The example of waste electrical and electronic equipment (WEEE) is noteworthy. WEEE, which is subject to numerous regulations in Europe (e.g. Directive 2012/19/EC) is often exported, legally or illegally, "just to end up in some of the most polluted places in the world: being reprocessed under lax or no regulations to recover value via acid leaching and burning, which results in public health disasters and extensive environmental pollution in West Africa and South-East Asia" (Velis, 2015). Industrial operators (e.g. engineers, managers, designers) must be able to rely on a state-of-the-art literature on integrating and implementing circular practices. For instance, Lieder and Rashid (2016) proposed a framework to be used as a CE implementation strategy in the context of the manufacturing industry. More broadly, Moreno et al. (2016) developed a conceptual framework for circular economy design strategies (e.g. design for resource conservation, design for slowing resource loops, or design for whole systems design). This therefore gives guidance for practitioners wishing to design for new circular business models in practice.

Future research needs to go further and make a more quantitative assessment of the remaining distance that has to be gone to reach full CE for HDOR vehicles and associated spare parts. Saidani et al. (2017) provide guidelines for the design and development of new frameworks, tools and indicators for measuring product circularity. More specifically, Di Maio et al. (2017) propose a new value-based indicator to assess the performance of actors in the supply chain in terms of resource efficiency and CE. Quantification of missed value buckets for European HDOR actors should then be an enabler for both the European Commission, in considering a new regulated framework for HDOR vehicle EoL, and European industrial practitioners to exploit these opportunities gainfully. With this purpose, CIDER Engineering, an engineering centre dedicated to dismantling, recycling and remanufacturing heavy equipment and vehicles, performed a technological watch, in France and in a few strategic European countries, to (i) evaluate the quantity and deposit of EoL and second-hand HDOR vehicles, and (ii) identify last owners and intermediary third parties in the EoL value chain. According to experts from ADEME and in agreement with experts in the HDOR industry, the access to key information, such as the exact materials composition of an EoL HDOR vehicle, the current deposit stocks or the efficiency of EoL channels handling HDOR vehicles, would help bring the EoL processing of HDOR vehicles into a greener economy. It would also be useful to have real-time forecast information about the wear and tear of HDOR components in order to prevent the failure of key components, schedule more accurate preventive maintenance, and thereby contribute to circular economy implementation in practice. Further research to evaluate the environmental impact of the possible loops for each HDOR component and material will be needed to enlarge the limited amount of literature documenting this subject to date (Niero and Olsen, 2016). Each possible HDOR EoL scenario has its own consequences on the criteria of sustainability (economic, environmental and social). Also, stakeholders have their own goals and preferences regarding these criteria. The authors stress the value of all research, both theoretical and applied, experimental projects and any other initiatives that could hasten the drafting of suitable directives for end-of life HDOR vehicles, and help develop innovative processes and new control of procedures for their EoL management.

2.2. EXTENSION OF THE GEOGRAPHICAL SCOPE TO THE U.S.

2.2.1. Introduction

2.2.1.1. Background and motivation

End-of-Life Vehicles (ELVs) are one of the most valuable sources of secondary raw materials (Roza and Terzi, 2018). As the unidirectional model of production, so called linear economy, is unsustainable, a move towards a circular economy (CE) is becoming increasingly important, and the point of interest of many scholars, industrial practitioners and policymakers (Esposito et al. 2018; Bocken et al. 2017). However, despite the potential sustainable – economic, environmental, and social – benefits that more circular practices could bring, the challenges to both businesses and policymakers are diverse (Esposito et al. 2018). To accelerate the transition to a circular economy, members-states of the European Union (EU), as well as other countries such as China (McDowall et al. 2017), are deploying a broad range of policy instruments (Slavik et al., 2018). Proper collection and policy are indeed key enablers to establish and optimize a circular supply chain (Buruza and Tomas, 2017). For instance, regulations must prohibit illegal collection channels, inappropriate disposal, and enable manufacturers in collaboration with recycling facilities to recycle both their own as well as competitors' products.

Yet, there is currently no policy framework regulating the end-of-life (EoL) management of heavy vehicles. Also, a review of the published literature shows that the EoL management of heavy-duty and off-road (HDOR) vehicles in the U.S. is, as in the European Union (EU), a research topic still barely explored in the scientific literature (Saidani et al. 2017). This gap in research, along with lagging policies and regulations for considering light and heavy-duty vehicles EoL in the U.S. has not gone unnoticed by relevant industry stakeholders. According to Wilson (2017), CEO of the U.S. Automotive Recyclers Association: "Different countries are on different parts of the path related to end-of-life management of vehicles. By looking at how other countries deal with their industry, one can choose some parts of the path that are desirable and try to avoid some of the paths that are unpleasant." It is with this perspective that this research undertakes an analysis of the appropriate transfers and applications of best practices, regulations and know-how from one industrial sector (e.g. the automotive sector) to another one (e.g. the HDOR sector) and from a geographic region (e.g. the EU) to another one (e.g. the U.S.). It examines some suitable practices (e.g. the extended producer responsibility), challenges (e.g. an underground economy), and potential solutions (e.g. data standardization for after-sales services) in a context of CE transition.

The relevance of the juxtaposition of the U.S. and the EU situations is first justified (sub-section 2.2.1.2). Then, after exposing the research methodology (sub-section 2.2.2), an overview of the main findings, which analyze similarities and differences through the lens of policymaking and business practices in the management of EoL vehicles, is presented (sub-sections 2.2.3 and 2.2.4) and summarized (tables 11 and 12). In particular, the actual regulatory framework, plus tangible and advisable industrial practices are revealed through a closer look at a comparison between the State of California in the U.S. and France in the EU. Finally, in sub-section 2.2.5, remaining challenges and CE opportunities are given for the U.S., the EU, and also for emerging countries and newly industrialized countries – e.g. BRIC countries (Brazil, Russia, India and China) – whose automotive markets are growing fast.

2.2.1.2. End-of-life vehicles in the U.S. and in the EU

The U.S. and the European automotive markets are similar in terms of number of vehicles, but those vehicles vary with respect to size and age. Automobile ownership worldwide has exceeded 1 billion since 2010. The U.S. and the EU account for 50% of this total number, each having respectively 240 million and 270 million vehicles in circulation (Sakai et al. 2014; ACEA, 2017). Also the number of annual deregistered automobiles (20 million in the U.S. and 14 million in the EU) is of the same order of magnitude (Bento et al. 2013; USDOT, 2017), as well as the number of annual end-of-life vehicles (ELVs) officially recovered (12 million in the U.S. and 8 million in the EU) according to figures found on Statista website (2017).

Regarding the end-of-life management and processing of their vehicles, as in Europe, the state-of-the-art American authorized treatment facilities (ATFs) handle properly and very efficiently the decontamination, dismantling and shredding processes, according to SCADA (2017): "Vehicle fluids and other regulated materials are extracted and properly recycled. Recovered parts are then sold to repair other cars at a savings of up to 80% over the cost of new parts. Recyclable materials are sent to a processor, and manufactured into new products." While the American and European fleets and associated recycling industries share many commonalities, the vehicles that comprise these fleets are quite different. The average ELV in France weighs 1,040 kg and is 17.5 years old, while the average ELV in California is 1,700 kg and 15.6 years old.

2.2.2. Research methodology

2.2.2.1. Research framework

In a context of transition towards a CE, this study – extending the geographical scope of the analysis done in the EU by Saidani et al. (2017) – is motivated and made possible by a research collaboration during the academic year 2017-2018 between two universities, the University of California-Davis in the U.S. and the Paris-Saclay University in France, and supported by the Franco-American Fulbright Commission. Saidani et al. (2017) discussed the best practices and remaining challenges for a circular economy (CE) of light and heavy vehicles in the European Union. Particularly, regulations and industrial practices related to light and heavy vehicles sector were examined in a CE perspective. It has been observed that the size of the European automotive plus heavy-duty and off-road (HDOR) markets, and the fact that they are subject to stringent and advanced regulations in Europe. The end-of-life business practices and regulations imposed on these sectors in the EU are considerably different than the same sectors in the U.S., and provide an interesting comparison case for the EoL management of vehicles. To develop this comparison, an updated literature review as well as industrial field investigations were done in the U.S. with the aim of providing supplementary insights to the initial questions raised by Saidani et al. (2017). These questions include: (i) to what extent is CE achieved and implemented in the automotive and HDOR sectors, (ii) what industrial practices and regulations are prevalent and supportive of CE goals, (iii) what are the key challenges both regions have to deal with for an enhanced circular economy of vehicles, and (iv) how could the U.S. could learn from best practices implemented in the EU, and vice versa?

2.2.2.2. Materials and methods

Materials and methods deployed for this study include a simplified version of the research methodology used for the analysis in the EU by Saidani et al. (2017), applying both desk-based and field-based research (see sub-section 2.1.2):

- Here the desk-based research comprises an update of the published literature, industrial reports, and current regulations in the U.S. – using combinations of following keywords in the scholar and industrial databases used by Saidani et al. (2017): {end-of-life management, heavy vehicles, heavy-duty and off-road vehicles, automotive, recycling, remanufacturing, recovery, regulations, extended producer responsibility, shredders, United States of America, USA, U.S., American, California}.
- The field-based research was through (i) discussions and interviews with non-governmental organization (e.g. the Automotive Recyclers Association, the National Stewardship Action Council, the Californian Product Stewardship Council) and industrialists (e.g. Caterpillar, Holt of California) actively involved in the automotive or HDOR industries, as well as (ii) attendance at one seminar indirectly related to the subject at the Institute of Transportation Studies within the University of California-Davis.

2.2.3. Heterogeneity of circular economy enablers/facilitators

2.2.3.1. Regulatory frameworks

While the American and European analogy in ELVs is noteworthy in terms of amount of vehicles, the primary difference between these two regions lies in their regulatory frameworks. In the EU, automobile recycling targets are established under the ELV Directive 2000/EC/53, which, since 2015, sets a minimum of 85% for reuse plus recovery and 95% for reuse plus recycle, as detailed in Table 11. European automotive manufacturers and importers are responsible for recycling costs based on the principle of Extended Producer Responsibility (EPR). The EPR, also known as product stewardship, is a regulation requiring that producers organize and pay for treatment and recycling of waste arising from their products at end of life. By providing a robust framework of requirements for collection and recycling, EPR has already moved entire industries – like the automotive sector in the EU – towards a more circular economy, as opposed to a more limited company-by-company approach (Kunz et al. 2018). As a result, the EoL processing of the automotive sector is increasingly streamlined and well-organised in the EU. Note that this European Directive concerns the automotive sector only, and thus the EoL management of HDOR vehicles is more uncertain and poorly controlled. Indeed, to date, there is no overall end-of-life regulations concerning the HDOR industry in the EU. The end-of-life management of HDOR vehicles is still a marginal and barely structured activity in Europe (Saidani et al. 2017)

In contrast, in the U.S., there are neither national regulations, such as EPR, nor quantitative recycling targets for the disposal of light- or heavy-duty vehicles. The result is inconsistent regulations states. The recycling of ELVs is

only managed under existing and cross-sector regulations on environmental protection (Konz, 2009; Sakai et al. 2014). Also, contrary to the EU, no parties are particularly specified or responsible for implementing EoL activities or providing recycling infrastructures in the U.S. Legislation is, as such, a key action lever to enter EoL vehicles into appropriate circularity loops. The European experience has demonstrated the viability and success of law-making to encourage the reuse, of automotive parts, and its associated remanufacturing and recycling markets. The latest European example in this regard can be found in France: in line with the EU action plan for the circular economy (EC, 2015), the French environmental ministry introduced legislation, which became active in 2017, mandating that automotive repair shops should offer clients, whenever possible, the choice between spare parts coming from CE loops – i.e. parts that can be reused in their existing state or after remanufacturing - and originally manufactured parts

On this basis, some organizations in the U.S. – such as the National Stewardship Action Council (NSAC) and the Automotive Recyclers Association (ARA) – are working to make progress with legislation and to change attitudes progressively towards more responsible and sustainable practices. The NSAC, founded in 2015 as an affiliate of the California Product Stewardship Council, is acting in speeding up the process of creating new laws to both support EPR and to provide a CE in the U.S. Yet, according to Heidi Sanborn, NSAC Executive Director, no new legislation related to the end-of-life management of light- or heavy-duty vehicles is under development in the U.S. or in California. In fact, the NSAC needs active industry participation and involvement – e.g. from both automotive producers and recycling facilities – before beginning or considering legislative proceedings, like working on a bill setting up an EPR for the automotive market. In addition, Wilson (2017), CEO of the ARA, confirms that the current U.S. political administration is not really pledging for new environmental regulations and automakers still fear the use of second-hand parts from CE loops will lower their economic benefits. Nevertheless, the ARA is still advocating in front of U.S. Congress members – to take the regulation process forward. Also, because proper education appears to be another key action lever to close-the-loop, the ARA University in the U.S. has developed the first eLearning Center that communicates best practices for the automotive recycling industry, including courses such as dismantler training, as well as parts grading or sales specialized training, to achieve a sound end-of-life management of salvaged vehicles.

Table 11 – Comparison of ELV regulations (automotive sector only) between the EU and the U.S.

Geographical scope	European Union (EU)	United States of America (U.S.)
Key figures	<ul style="list-style-type: none"> – EU (2010s average): Automobile ownership: 270 million; Deregistered automobiles: 14 million; Number of ELVs: 8 million. Production of 20 million of new cars in 2016. Average vehicle age in use: 11.5 years (same in the U.S.) – France (2014): Average weight of ELV: 1040 kg; Average lifespan: 17.5 years; 1684 ATFs, 61 licensed shredders; 1.1 million ELVs properly and legally recovered by ATFs (Authorized Treatment Facilities) over the 1.8 million produced and lost in illegal recycling channels. 	<ul style="list-style-type: none"> – U.S. (2010s average): Automobile ownership (2010): 240 million; Deregistered automobiles: 20 million; Number of ELVs: 12 million. Production of 12 million of new cars in 2016. In the US, from 297 licensed shredders in 2014 to 274 ones reported in 2016. – California (2010s average): Average weight of ELV = 1700 kg; Average lifetime for passenger cars: 15.6 years; 1.2 million vehicles reached the end of their useful lives in 2017. 1,100 auto dismantlers under licensed. Yet, an estimated 30% of all ELVs are being processed through unlicensed and unregulated dismantlers.
Key points of the end-of-life regulation in the automotive industry	<ul style="list-style-type: none"> – ELV Directive 2000/53/EC targets M1, i.e. 4-wheeled vehicles with seating capacity of nine or less, including passenger vehicles, and N1, i.e. freight vehicle with maximum load capacity under 3,500 kg. – Strict recycling targets are established in the EU: since 2015 a minimum of 85% for reuse plus recovery, 95% for reuse plus recycle. – In the EU, parties responsible for recycling costs include automotive manufacturers and importers (and finally users) based on the principle of EPR. 	<ul style="list-style-type: none"> – No national regulation exists for the disposal of automotive waste. Instead, individual States are free to adopt inconsistent regulations. Without regulated treatment procedures, ELV disposal facilities in many States are free to irresponsibly dispose of ELV waste that does not create potential revenue. (Konz, 2009) – No specific recycling goals nor recovery targets in the US. – Rather, in the US, no parties are particularly specified or responsible for recycling costs.

2.2.3.2. Industrial and marketing action levers

Meanwhile, when political actions are neither proactive nor supportive, closing-the-loop of the automotive industry has to be motivated by other considerations, such as economic ones. For instance, the embracement of circular practices – such as product as a service, product life extension, convenient maintenance, recovery and recycling, just to name a few – by automotive manufacturers could generate \$400-600 billion potential additional revenue for them by 2030 worldwide (Accenture, 2016), thus making the adoption of CE practices a very profitable activity in the automotive market. Even if some automakers in the U.S. are starting slowly to collaborate with recycling automotive third-parties, the ARA notices a lack of clear and committed support to parts reutilization from automotive OEMs. The two main challenges are to: (i) make U.S. automakers aware of economic opportunities offered by circular practices, and (ii) to assist them in their transition towards more circular businesses, e.g. by disseminating best industrial practices and their associated benefits. In the EU, the positive net value of the collected end-of-life vehicles is high enough to finance collection and treatment operations thanks to take-back schemes organized by a collaboration between recycling centers and producers (Delmas and Cuerel Burbano, 2011). Thus, the US automotive industry could take inspiration not only from European automotive actors but also from their U.S. heavy-duty and off-road industry, as explained hereafter.

In the absence of a regulatory framework addressing the EoL management of their fleet (DoT CA, 2017), HDOR producers, well aware of the remaining value of their used equipments, offer a growing number of remanufactured HDOR equipment along with new products as a part of their aftermarket product offerings. Indeed, many HDOR producers recognize the value of remanufacturing, and an estimated 200-300 firms remanufacture HDOR equipment in the US (USITC, 2013). For example, the largest HDOR equipment company Caterpillar is leading the way by producing both new and remanufactured HDOR equipment in the US and worldwide, through a wide network of collaborators to ensure circular supply chain including reverse logistics. As stated in Saidani et al. (2017), Caterpillar's remanufacturing programme took back annually around 2.2 million EoL units for remanufacturing, representing (i) 73,000 tons of materials, including 50,000 tons of iron; (ii) 6,000 different remanufactured products such as engines, fuel systems, and tyres. Incentives such as a deposit scheme and voluntary take-back of products ensure that large quantities of parts are returned to Caterpillar. For instance, at a regional level, the company Holt of California is the authorized distributor for Caterpillar, placing on the market remanufactured parts in cooperation with local stakeholders and customers.

In Europe, a similar story can be told but in the light-duty sector. The French automaker Renault has developed collaborations with third parties to ensure an efficient reverse supply chain supporting closed-loop reused, remanufacturing and recycling of end-of-life vehicles, both to comply with the ELV Directive 2000/EC/53 and to achieve sustainable profits. Operating a network of 350 dismantlers that have disassembled more than 110,000 vehicles in 2016, Renault is working with INDRA Engineering, a pioneer in automotive recycling and Suez Environment, a specialist in global waste management. Similarly, a joint venture named Encory has been launched in September 2016 between German automaker BMW Group and ALBA Group to enhance reverse logistics, supporting therefore the reuse and remanufacturing of used automotive parts. In the U.S., the State of California is already trying to develop and implement sound practices in terms of ELVs management. As INDRA Engineering operating in France (Saidani et al. 2017), the State of California Auto Dismantlers Association (SCADA) operates state-of-the-art and licensed recycling facilities that take responsibility for recycling and disposing of ELVs using environmentally responsible practices, as well as selling used vehicle parts (SCADA, 2017). In line with increasingly strict emissions regulations, the State of California Vehicle Retirement Program proposes a scrapping premium offer (up to \$1,500) as a catalyst for retiring old vehicles from the road to enter into proper and authorized end-of-life channels.

2.2.4. Homogeneity of remaining challenges

2.2.4.1. *An underground economy*

Nonetheless, both regions could perform better from a circular economy perspective. For instance, in France – with more than 1,650 authorized treatment facilities (ATFs) and 60 licensed shredders – 1.1 million ELVs are properly and legally recovered by ATFs over the 1.8 million produced each year and lost in illegal recycling channels. Similarly, in California – with around 1,100 auto dismantlers licensed by the California Department of Motor Vehicles – 1.2 million vehicles reach annually the end of their useful lives, among which 30% of all are being processed through unlicensed dismantlers (SCADA, 2017). Actually, despite their differing political commitment to ELVs management, the U.S. and the EU are facing similar challenges to achieve an enhanced circularity of their used or retired vehicles within closed-loop systems.

As illustrated with the numbers above, the gap between deregistered cars and ELVs entering in ATFs is not negligible. Significantly, the SCADA (2017) identifies and blames an “underground economy” of unregulated dismantlers that do not have the same environmental regulatory requirements, insurance obligations, and tax liability as required for licensed dismantlers. This unfair trading and competition leads many licensed operators out of business. For instance, in California, the number of licensed dismantlers has declined from 1236 to 1072 in five years, between 2011 and 2016. To address this issue, SCADA urges for better cooperation between key stakeholders in the automotive industry in California, including the Department of Motor Vehicles, the Board of Equalization, and the California Environmental Protection Agency. Likewise, the 1,650 ATFs distributed in the French territory do not succeed in collecting every ELV. Tons of ELVs leak from European end-of-life channels, to be exported to Eastern Europe or North Africa where infrastructure to handle, dismantle and recycle ELVs are underdeveloped.

As such, Sakai et al. (2014) suggest that “a global consensus on the rules for ELV management systems and on their operation at an international level” should be required and achieved. Similarly, focusing on e-wastes produced in Europe, Palmeira et al. (2018) showed the poor management of growing amounts of e-wastes has given rise to illegal international trading of such wastes, resulting in environmental harm, unsafe working conditions, and loss of economic opportunities for the European Union. To combat the illegal market, potential solutions are exposed concluding that the best means of combating this unfair trade is to apply an enhanced take-back system.

2.2.4.2. *Towards a standardization of parts data*

Another obstacle for a better circularity of parts and materials from ELVs is the inconsistent access to standardized, understandable and usable data for all players of this industry. Particularly, the access to the OEMs’ information on vehicle parts is essential for automotive recycling businesses to put back on the market the right parts at the right prices. The European Commission has already pinpointed this challenge, stating that “information on all parts of the vehicle shall be made available in a database easily accessible to independent operators” (Article 6 of Regulation (EU) No 566/2011). In a circular economy perspective and to reach a sustainable management of ELVs’ parts, this information is of utmost important due to the increasing complexity of vehicles, including the growing number of parts, electronic components, and composite materials.

While the HDOR actors have already realized this issue and are actually implementing measures in this regard, the ARA advocates for similar actions within the U.S. automotive sector, whether by regulations setting or by cooperation between OEMs and end-of-life third parties. Taking the lead, the Heavy Duty (HD) Distribution Association (HDDA, 2017) and HD Manufacturer Association are creating product data standards for the HDOR aftermarket, involving manufacturers, distributors, data system providers, and maintenance centers. Thus, by standardizing and streamlining aftermarket product data, the communication about product and system attributes will be improved across the HD aftermarket, resulting in getting the right part more effectively for end-customers and fostering remanufacturing and reuse of components, critical elements for advancing the shift towards a more circular economy.

Before concluding, a comparison table of best practices and main remaining challenges in the EoL management of light- and heavy-duty vehicles for both regions, is given in Table 12 as a summary of the sub-sections 2.2.3 and 2.2.4.

Table 12 – End-of-life management of heavy- and light-duty vehicles in the EU and the U.S.

Industrial sector	Heavy-duty & off-road (HDOR) vehicles		Light-duty vehicles (automotive sector)	
Geographical scope	European Union (EU)	United States of America (U.S.)	EU	U.S.
Reman. market (i.e. revenue generated by annual sales of reman. parts)	European HDOR remanufacturing market corresponds to 3.7 billion euros in annual sales in 2013.	U.S. market for remanufactured HDOR equipment: \$4.5 billion in 2009 to \$6.8 billion in 2011.	European automotive remanufacturing business is estimated to be worth 5.7 billion euros in 2013.	U.S. market for remanufacturing cars has generated a revenue of \$5.0 billion in 2017.
Regulations	No regulatory framework for the EoL management.	Same with left. Regulations regarding imports and exports.	European Directive ELV 2000/53/EC. More details in Table 11	No national regulation. More details in Table 11.
High focus on emissions regulations with increasingly strict pollution standard to meet for manufacturers and users to maintain their system up-to-date and compliant over time.				
Exports	Eastern Europe and North Africa, where there is a lack of infrastructures, knowledge and skills to handle properly the ELVs.	EPA (Environmental Protection Agency) requirements for importing and exporting vehicles and engines such as a Certificate of Conformity.	Eastern Europe and North Africa, where there is a lack of proper infrastructures, knowledge and skills to handle properly the ELVs.	Vast majority of U.S. exports of HDOR parts are to FTA (Free Trade Agreements) partners, mainly to Mexico where they are often remanufactured and shipped back to the US.
Associations (e.g. collaborations and lobbying)	Less developed than in the US. More disparate. Few experts involved such as Cider Engineering.	A lot of associations/networks involved (see below), related to trucks parts, aftermarket services.	In France: INDRA and its network of recycling facilities, connected to OEMs (e.g. Renault). In Germany: Encory.	ARA (Automotive Recyclers Association) at a national level. In California: SCADA, similar to INDRA.
Examples of best practices	Remanufacturing offers and services, with more HDOR remanufactured spare parts than in the automotive sector. Here are other examples of best circular practices: - retreading of HDOR tyres; - dismantling manual available for most of Volvo's trucks. - more than 93% of all materials in a standard DAF truck can be reused.	Remanufacturing offers and services (e.g. Caterpillar). Willing of establishing product information and data standards for the heavy-duty aftermarket supply chain, involving e.g. the HDDA (Heavy Duty Distribution Association), (HDMA) Heavy Duty Manufacturers Association, and the International Truck Parts Association in North America for both the U.S and Canada.	Transparent collaborative network. Well-established dismantling and systematic recycling procedures within the ATFs, motivated and propelled by the ELV directive and EPR. New French law active since 2017 mandating that automotive workshops should offer customers the choice between spare parts from the circular economy (i.e. used or reman parts) and newly produced parts.	Selling used vehicle parts under Standard Industrial classification. SCADA established the industry's premier certification program within the US to foster an enhanced ELVs management. 2017 California Cash for Clunkers Vehicle as a scrapping premium incentive. ARA University: premier online training resource of the professional automotive recycling industry.
Remaining challenges and areas for improvement	Implementation of regulatory framework for EoL management. Better control of exports. Enhanced collaborations between end-of-life stakeholders. Issue of monitoring the heavy equipments during their usage (for preventive maintenance and traceability).		Thriving underground economy of unlicensed and unregulated dismantlers. Unfair competition between authorized treatment facilities (ATFs) and unlicensed or illegal operators that have the same access to salvaged vehicles than ATFs who comply and have to pay extra costs.	

2.2.5. Conclusion and perspectives

To conclude, it has been found that the CE of vehicles in the EU is mainly driven and stimulated by the ELV directive 2000/EC/53 including the EPR principle, forcing industrial automakers to cooperate with end-of-life third parties to meet the mandatory recovery, reuse and recycling targets. In contrast, progress towards an augmented circularity of vehicles in the U.S. is pushed less consistently by individual actors and associations advocating for a circular economy. While the EU appears to be a few steps ahead of policy activity regarding the management of ELVs (but only for the automotive sector), the U.S. HDOR sector presents some aspirational industrial practices, e.g. collaboration between HDOR aftermarket actors or the Caterpillar example, supporting parts remanufacturing and facilitating reuse. Nevertheless, discussing the role EPR plays in the EU attempt to move towards a more circular economy, Kunz et al. (2018) found that despite positive results in EPR so far (in implementing some aspects of circular economy), a number of challenges remain and have to be addressed, including how to ensure proper enforcement of recycling standards, how to ensure incentives for improved design for recyclability, and the need for harmonized legislation and coordination between all stakeholders. As such, to move towards a truly circular eco-system of both automotive and HDOR industries, we highlight the importance not only of a proper regulatory framework (e.g. in the EU for the automotive sector) but also of a common vision and shared commitment between all industrial actors concerned in the (re)use of automotive parts and HDOR equipments.

Each region and these two industrial sectors can learn from one another by sharing their best political, industrial and business practices, and by implementing them through e.g. benchmarking, joint venture or international cooperation. Actually, connecting complementary understanding is an important milestone to unlock the great potential of an operational circular economy (Esposito et al. 2018). Furthermore, newly industrialized countries – such as China or India – where the number of vehicles reaching their end-of-life will soon outnumber the European or American figures should be a focus of research and advocacy for improving ELV management and CE. In this light, we also believe it is of utmost significance for them to anticipate and to take inspiration from the best existing practices in both the EU and the U.S. and innovate towards even more effective management. Lishan et al. (2018) address this important and yet under-explored issue by analyzing the environmental and economic performances of remanufactured operations performed on one HDOR equipment (a loading machine) in China. Specifically, this study compares the environmental and economic benefits between two remanufacturing scenarios and the business-as-usual case, with empirical data indicating significant environmental gains from remanufacturing, which may encourage greater use of this process in future. As Cossu (2018) likes to remember, a detritus (e.g. a salvaged EoL vehicle) does not represent an end but rather a step towards the future, it opens up to perspectives affording new opportunities.

2.3. BENCHMARKING TEMPLATE OF BEST CIRCULAR PRACTICES

2.3.1. Presentation

Circular economy (CE) aims to maximize the use and value of products, materials and components as long as possible. It is achieved through “circularity loops” such as components remanufacturing, reuse and recycling. Importantly, CE implementation could lead to economic and environmental benefits. Indeed, several companies have already implemented circular practices such as circular design strategies associated to circular business models. Yet, to ensure effectively this transition, many circular projects still need to be properly activated and managed. Thus, taking inspiration from implemented and working CE practices can be an appropriate endeavour.

In order to spread best circular practices faster and in an operational way for industrial players, a both synthesized and practical benchmarking template has been developed based on the findings of two academic articles published in the international journal Resources, Conservation and Recycling (Saidani et al. 2017, 2018) (sub-section 2.2 & 2.2). Indeed, at a time when industrial actors are not systematically aware, do not have the access or the time to read over academic publications, this present document is a timely initiative and complementary industrial deliverable to support the transition towards real and profitable circular businesses, by diffusing and disseminating good industrial practices in a context of CE transition.

It is intended to the players of the heavy-duty and off-road (HDOR) vehicle industry. In absence of regulation monitoring the end-of-life management of such heavy vehicles, contrary to the automotive industry subject to the ELV Directive 2000/EC/53 in the European Union, other motivations and actions levers have to be found out to close-the-loop on used heavy vehicles and associated valuable components and materials. In particular, the following datasheet is designed for environmental manager, business development manager, communication manager, strategic leader or remanufacturing centers working on CE projects and willing to implement such circular practices. In fact, it could be used as strategic roadmap towards the CE, to position relatively to competitors, to motivate and inspire further circular strategies, to define quantitative objectives of circularity, to communicate internally or externally about sustainability, to raise awareness of employees or to train workforce (e.g. engineers, designers) on CE principles.

A bundle of the best circular practices are presented through several industrial examples. They are organized according to the four building blocks of the CE defined by the Ellen MacArthur Foundation (EMF, 2013b) and in line with lifecycle thinking and systemic approach (considering most of the stakeholders of these industries, i.e. extractive industry, suppliers, designers, makers, distributors, retailers, users, after-sale services, end-of-life centers). Notably, some quantitative impacts of circular practices on the three pillars of sustainability (i.e. economic, environmental, and social) are given. Here are the sample of companies and OEMs from which best CE practices have been taken, gathering the different industries of light-duty, heavy-duty, on-road and off-road vehicles, so that the commendable circular design and business practices can be learn from one sector to one another:

- For the automotive industry (e.g. cars), examples of best circular practices are taken from French automaker Renault and its collaborative network, including INDRA Automotive Recycling.



RENAULT



- For the heavy-duty vehicle (e.g. trucks) industry: Volvo Trucks, and DAF.



VOLVO TRUCKS



- For the construction equipment, agricultural machinery and off-road vehicle (e.g. excavators or tractors) industry: Caterpillar, Liebherr, Komatsu, and John Deere.



LIEBHERR

KOMATSU



- For the handling vehicle (e.g forklift trucks) industry: Fenwick-Linde, Manitou, and Toyota Material Handling.



Circular Opportunities	Competitors	Your Company: e.g. 		
	Best Practices	Current Situation	Objectives	Action Plan Actions Levers Actors - Resources
Reverse Cycles - Recover Reman. Reuse	<ul style="list-style-type: none"> Renault's Choisy-le-Roi factory: 200,000 renovated components by year (motors, transmissions, injectors, gearboxes). Environmentally, 80% of energy, water and chemical products saved. Socially, it involves a skilled workforce and creates jobs locally (325 employees). Economically viable (turnover of 100 million euros). 	<u>Reman. parts:</u> <u>Sustainability / Circularity Indicators:</u>		
	<ul style="list-style-type: none"> In 2012 Caterpillar's remanufacturing programme took back over 2.2 million end-of-life units for remanufacturing, representing 73,000 tons of materials, and including 6,000 different remanufactured products. In DAF's overhaul workshop in Eindhoven, an annual total of more than 50,000 parts are overhauled and supplied for reuse, including starter motors, fuel pumps, and complete engines. These exchange parts are of a similar quality to new parts, and the same guarantee is provided for both. 			
	<ul style="list-style-type: none"> Dismantling manuals are available for most of Volvo's trucks. DAF provides special sorting guides for each truck type. 	<u>Dismantling guide:</u> <u>Reman. process:</u>		
	<ul style="list-style-type: none"> Fenwick-Linde has its standardized reman. process: inspection, cleaning, repairing, replacement, repainting, quality control. Liebherr offers three remanufacturing options for a range of components: exchange, general overhaul or repair, at its Ettlingen site in Germany. 			
Favourable System Conditions - Facilitate Enable Gain	<ul style="list-style-type: none"> Komatsu: incorporation of IoT (internet of thing) into some of their tractors: real-time data streams about what parts need to be replaced when and how the machines are being used. Telematics platform Caterpillar Product Link, provides information about the location, utilisation and condition of several heavy equipments. 470,000 Volvo Group vehicles are connected via different telematics devices in a fleet of more than two million trucks. 	<u>Telematics, IoT (or other technologies):</u> <u>Formation:</u>		
	<ul style="list-style-type: none"> Automotive Recyclers Association University: premier online training resource in the U.S. for the professional of the automotive recycling industry. 			
	<ul style="list-style-type: none"> 2017 California cash for clunkers vehicles (1,500\$) as a scrapping premium offer. In 2014, Caterpillar's circular economy portfolio generated almost 10 billion euros, accounting for 18% of the company's total sales and revenues. In 2015, the total sales of Volvo Truck's remanufactured components amounted to 0.83 billion euros, an increase of almost 20% over 2014. 	<u>Financial incentives:</u> <u>Communication:</u>		
	<ul style="list-style-type: none"> Communication & public recognition: See examples of Renault and Caterpillar. Open access tool: Manitou Reduce Program and Total Cost of Ownership. 			

2.3.3. Examples of diffusion and communication of circular practices

- Interactive report – Caterpillar and the circular economy: <http://reports.caterpillar.com/sr/economy.php>
- Youtube video – Renault and the circular economy: https://www.youtube.com/watch?v=WKwarK_qELk

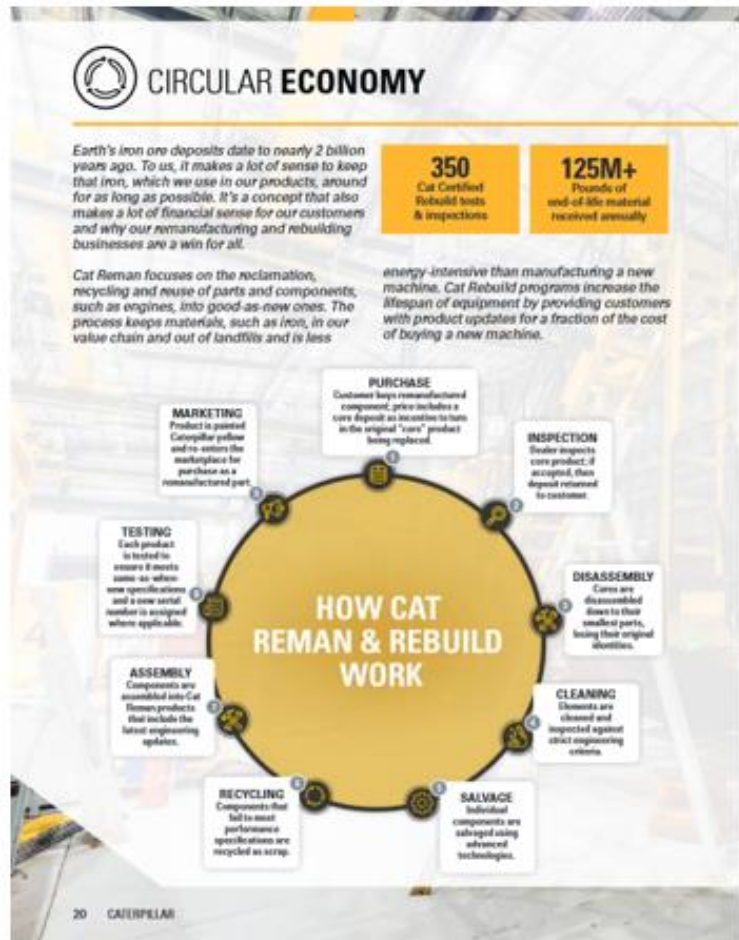
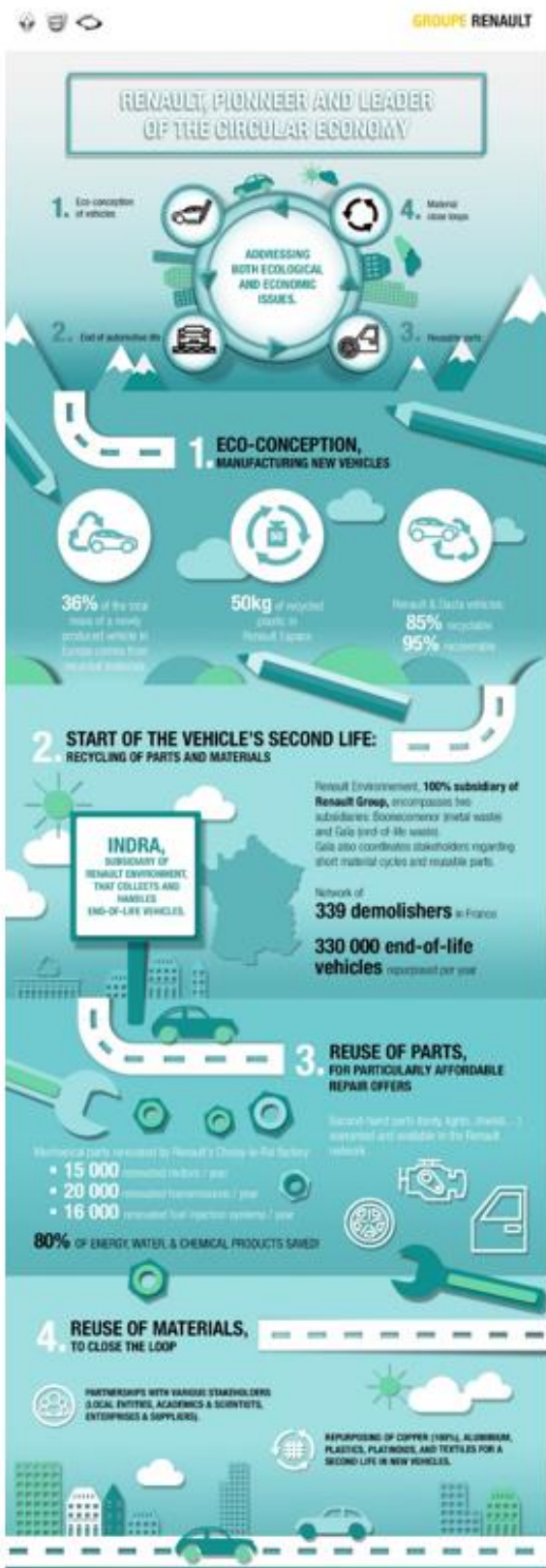

2.3.4. Examples of open access online tools

- Web links: <http://reduce.manitou.com> <http://tco.manitou.com/>

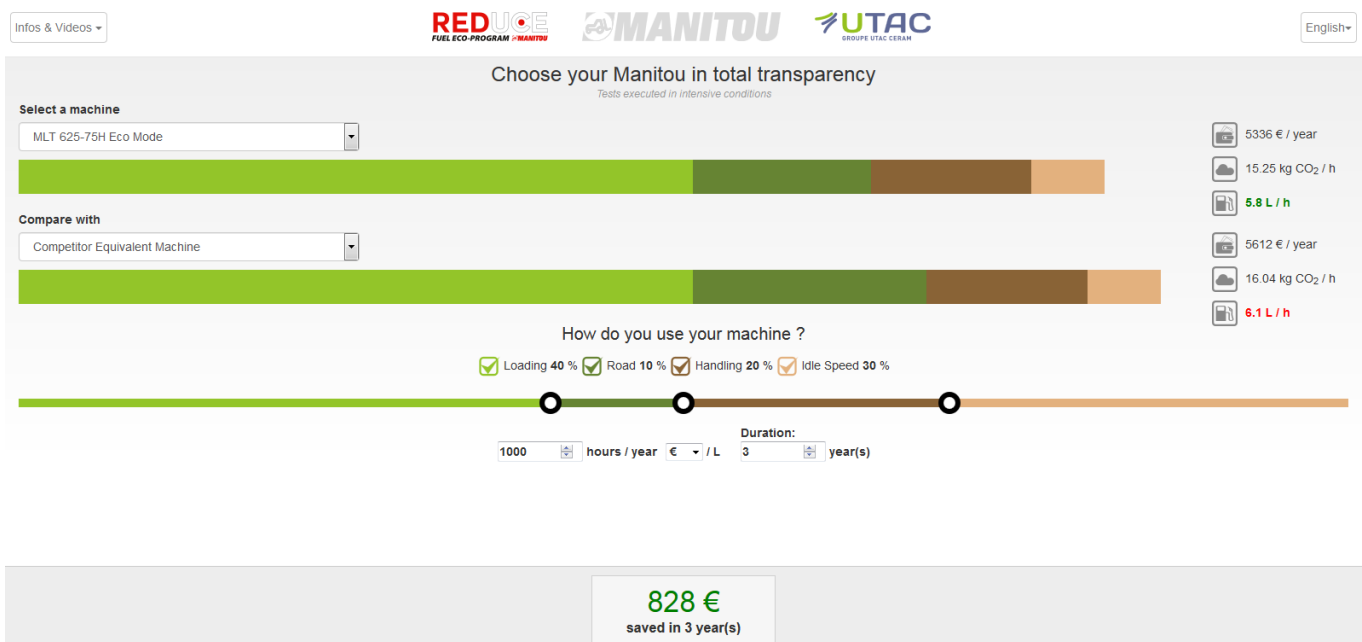

Manitou Total Cost of Ownership Calculator

The Manitou group recognizes how important it is for users of handling equipment to know their costs so they can control them. Hence, Manitou offers a TCO (Total Cost of Ownership) calculator. To calculate the TCO of your equipment, please chose your configuration (monetary currency, metric system, machine type, fuel) and adjust the values of the various parameters. The results are presented automatically as hourly costs and a pie chart that clearly shows the extent of the various parameters in the Overall TCO.

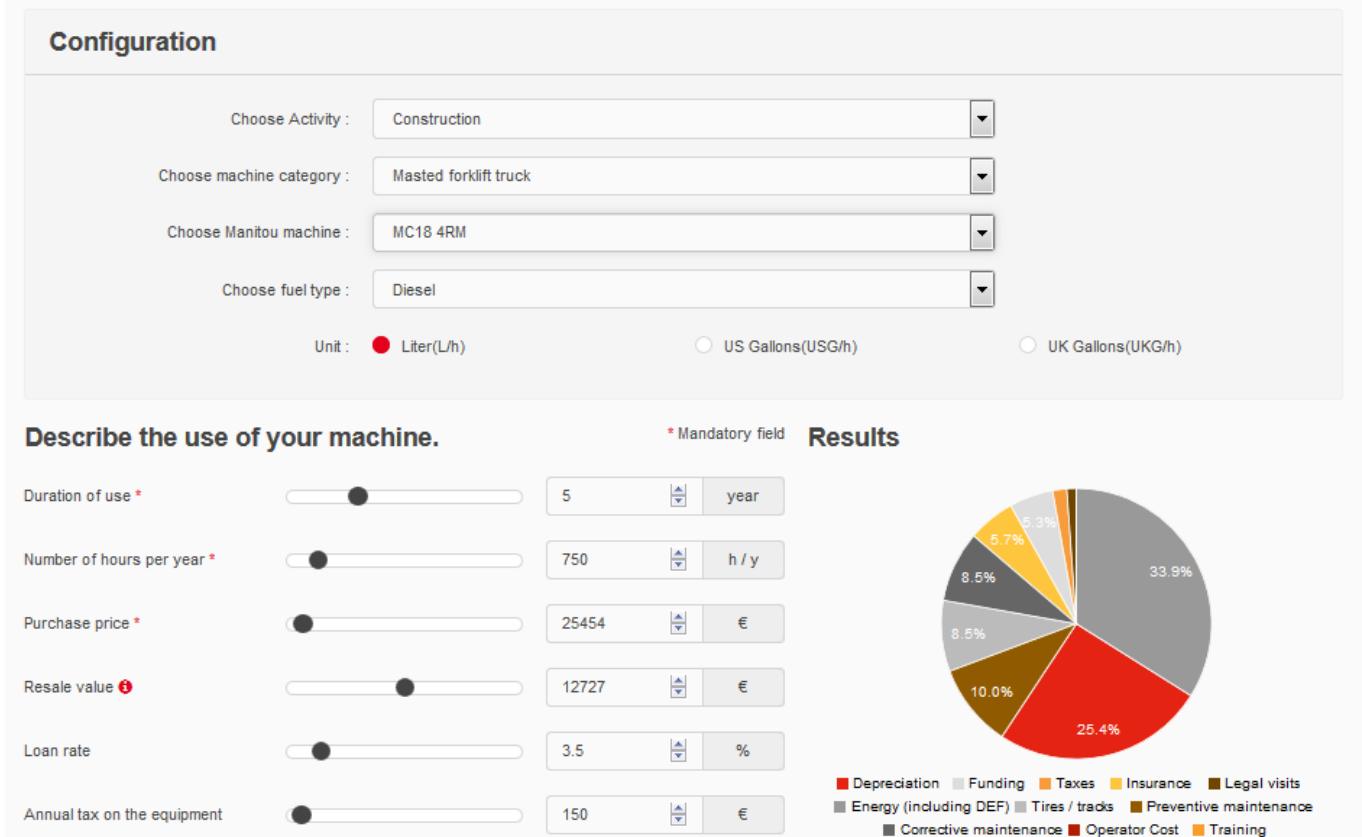

2.3.5. Dissemination of the template and industrial feedbacks

2.3.5.1. Contacted companies and industrialists

First, major companies to contact, in order to disseminate and get feedback on template of circular practices, have been identified through the following rankings:

- Top 12 world's construction equipment manufacturers, in decreasing order, based on sale volume (USUBC, 2015): Caterpillar (USA); Komatsu (Japan); Volvo Construction Equipment (Sweden); Hitachi Construction Equipment (Japan); Liebherr (Germany); Sany (China); Zoomlion (China); Terex (USA); Doosan (South Korea); John Deere (USA); XCMG (China); JCB (UK); ... Manitou (France ~25th).
- Top 7 truck manufacturers, in decreasing order, based on worldwide revenue (Statista, 2018): Daimler AG Trucks (Mercedes-Benz, Freightliner, etc.); Volvo Trucks; Paccar Trucks (Kenworth); MAN Trucks; Scania Trucks; DAF; Iveco.
- Top 10 automotive manufacturers, in decreasing order, by motor vehicle production (Wikipedia, 2018): Toyota; Volkswagen Group; Hyundai / Kia; General Motors; Ford; Nissan; Fiat Chrysler; Renault; Groupe PSA.

Then, the method used to find out relevant contact persons, and industrialists within these companies, is an Internet search on Google and LinkedIn, based on the following keywords (both in English and French): {Company Name AND Circular Economy; Company Name AND Sustainability; Company Name AND Responsabilité Sociale Entreprise (RSE); Company Name AND Corporate Social responsibility (CSR); Company Name AND Economie Circulaire; Company Name AND Responsable Environnement; Company Name AND Responsable Développement Durable; Company Name AND Sustainable Development Director}

Finally, once a relevant and potentially interested person has been identified, and information contact found, an email was sent, explaining the purpose of such a document and asking for some constructive feedback on it, as it follows:

“Subject: Sharing and Positioning Best Circular Economy Practices in Your Industry

Dear M. ..., Ms. ...,

Currently a PhD student in industrial engineering at the Paris-Saclay University (part of my research has also been conducted at the UC Davis), my work examines the material used to produce heavy duty vehicles and their fate at vehicle retirement with the aim of identifying opportunities to "close-the-loop" on vehicle materials and components.

Given your position of ... at ..., I thought you might be interested by some of the key findings.

And willing to help more concretely companies making the transition towards a more circular economy, after discussing with several industrial actors, I came up with the idea that a template summarizing the main findings and examples of relevant circular practices would be more suitable to disseminate “best practices” into companies, and to share this knowledge of good circular practices.

As such, please find attached this template of best circular practices related to your industry. In fact, this template includes industrial strategies and business examples in line with circular economy principles. By providing sound information on circular economy implementation, we believe the dissemination of good practices can create a right incentive to increase circularity. For instance this template should enable to help identify the available and effective levers of action to “close-the-loop”, as well as to support the implementation of circular economy projects at different and complementary levels.

I would be grateful if you could give me any feedback regarding the interest (or not) of such a template for your industrial practices, whether it could be used for benchmarking, communication, inspiration for future circular projects (i.e. by learning from good practices, etc.) or in case you want to share another circular practices that could be included in this template. Also, I would really appreciate to know if this template provided you with new insights or ideas to figure out “what could/should be done at your level to move to more circular practices?” and to know if you have any other KPIs (Key Performance Indicators) to measure and monitor the circularity in your company?

Sincerely, Michael”

2.3.5.2. Industrial feedbacks

In all, the template has been sent and shared to 22 industrialists (sustainable development managers, environment engineers, business development manager, corporate social responsibility manager, etc.) from the following companies (by alphabetical order): Caterpillar (x3), Daimler Trucks (x1), JCB India (x1), John Deere (x2), Komatsu (x1), Liebherr (x1), Manitou (x1), PSA (x1), Renault (x1), Renault Trucks (x1), Scania (x3), Toyota France (x1), VI Conseils (x1), Volvo CE (x1), Volvo Trucks (x3).

So far, we received a positive and constructive feedback from 5 of them, in addition to the comments of the managers from Liebherr Machines Bulle and Manitou Reman with whom two more advanced industrial case studies are conducted (see essay #3).

For instance, the head of responsible business from Scania confirmed it is a “very interesting research topic and great initiative to summarize best practice” and indicated this document will be shared internally to the appropriate persons. According to the remanufacturing manager from Manitou (translated from French), such template is very useful to push forward the sustainable development actions undertaken by the CSR department, to inspire the design and engineering department at developing more circular products, as well as to help defining realistic targets and proper action plans (including resources and budgets) to achieve these objectives.

Here is the insightful and illustrative feedback from the parts and services manager at Volvo Construction Equipment (translated from French): “Thank you for sharing your work, it is a very interesting topic, very important for the future. It is perfectly in line with the values of Volvo. The topics covered in your template are almost all covered at Volvo CE with more or less maturity. Within the parts and services department, we are currently working on a “1st life”, “2nd life”, “3rd life” and “4th life” approach considering different the entire lifetime of a machine, with associated adaptive offers for the customers. Finally, the total cost of ownership (TCO) is an aspect that we are also working on but with some difficulties because it depends on many parameters, including the type of machine and the type of application (which are much more diverse in our industry).”

Last but not least, here is the very interesting and critical feedback of the director environment and innovation from Volvo Trucks Sweden, making a smooth transition to the topic of circularity indicators addressed in the next section and following essay: “Thanks for sharing this information. It was a very good overview and shows well the different aspects and opportunities. I think the template works well as a “checklist” and inspiration. However, I missed a couple of interesting aspects such as circular metric (how to measure circularity), sensors and similar (how to better understand usage for better re-use and recycling) and content knowledge (know what materials you have in your truck/machine). We are right now involved in research projects regarding e.g. circular metric. In that project we also try to understand the sustainability aspects of circularity.”

2.4. SUMMARY OF ESSAY #1 AND TRANSITION WITH ESSAYS #2 & #3

What's inside Essay #1 in a nutshell

Highlights:

- Extensive literature survey and in-depth ground investigations to explore the heavy vehicle industry.
- Comparison between the automotive (light-duty vehicle) industry and the heavy vehicle industry.
- Comparison of the end-of-life management of used vehicles between the European Union and the U.S.
- Comparisons based on the four feedback loops and four building blocks of a circular economy.
- Analysis of the regulations, business models and new technologies on the circularity performance.
- Identification of best practices and remaining challenges in a circular economy perspective.

Academic deliverables: 1 journal article published; 1 perspective paper published.

Industrial deliverables: 1 benchmarking template of best circular practices for the heavy vehicle industry.

Contributions related to research gaps and objectives:

- ✓ Objective 1: Identification of best practices and key action levers to close-the-loop.
- ✓ Objective 2: Qualitative analysis of the circularity performance of the heavy vehicle industry.
- ✓ Objective 3: Dissemination of the main key findings and positive feedback from industrial stakeholders.

Perspectives (remaining challenges and promising future research):

- Being able to estimate the remaining distance to reach a complete circular economy.
- Moving from qualitative to more quantitative results, through the use of suitable circularity indicators.
- Transferring best practices (e.g. dismantling process) from the automotive sector to the heavy vehicle one.
- Setting up appropriate regulations framing the end-of-life of the heavy-duty and off-road vehicles.
- Providing access to real-time information about the wear and tear of key components.

Linkages with Essays #2 & #3

In essay #2, we:

- Explore the potential contributions of circularity indicators to foster, catalyze and monitor the move towards more circular practices.
- Experiment several circularity indicators on a key component from the heavy vehicle industry.

In essay #3, we:

- Report the insights provided by two industrial case studies from the heavy vehicle sector: one case study on a catalytic converter, and one industrial pilot study on an entire used heavy vehicle (an 8-ton forklift truck) in collaboration with a remanufacturing center.

3. ESSAY #2 – C-INDICATORS, ENABLERS OF A CIRCULAR ECONOMY?

This second essay is composed of three research articles, each representing one sub-section as detailed in tables 13, 14 & 15, and all related to circularity indicators, with the purpose of assessing, monitoring and catalyzing the progress towards a circular economy.

As managing the circularity performance of technical products is both a challenging task and a point of increasing importance, in sub-section 3.1, several circularity indicators and associated measurement framework are first experienced. On this basis, a critical analysis of existing indicators is made and relevant insights revealed. Particularly, guidelines to design new circularity indicators aiming at evaluating the performance of products in a circular economy are proposed and discussed. In this line, in sub-section 3.2, a new circularity indicator is developed to fill certain limits of the circularity indicators analyzed. This newly proposed indicator is designed to evaluate the potential performance of circularity of an industrial product during the phase of (re-)design and development. In the meantime, the number of circularity indicators developed by scholars, consulting companies or governmental agencies has significantly increased. As such, the sub-section 3.3 introduces a taxonomy of circularity indicators and provides a query tool to facilitate the identification and selection of the most appropriate set(s) of circularity indicator(s). Eventually, challenges for future research on circularity indicators (e.g. the uptake by industry, the issue of data access, or the robustness and complementary between indicators) are discussed.

Table 13 – Overview of the sub-section 3.1 and description of the associated article

Original title	How to assess product performance in the circular economy? Proposed requirements for the design of a circularity measurement framework
Published in	<i>MDPI Recycling, as an Original Research Article, in 2017.</i>
Key words	Circular economy, product circularity, measurement, indicators, tools, critical analysis, case study.
Abstract	Assessing product circularity performance is not straightforward. Meanwhile, it gains increasingly importance for businesses and industrial practitioners who are willing to effectively take benefits from circular economy promises. Thus, providing methods and tools to evaluate then enhance product performance—in the light of circular economy—becomes a significant but still barely addressed topic. Following a joint agreement on the need to measure product circularity performance, this paper provides an overview of mechanisms aiming to help industrial practitioners in this task. In fact, three existing approaches to measure product circularity performance have been tested on an industrial case study and criticized regarding both their applicability in industry and their accordance with circular economy principles. Although these methods and tools deliver a first and rapid trend of product circularity performance, the whole complexity of circular economy paradigm is far from being considered. In addition, operational guidance for engineers, designers or managers to improve their products in a circular economy context are missing. As a result, both recommendations for industrial practitioners and guidelines for the design and development of new frameworks, tools and indicators aiming at measuring product circularity performance are provided. This includes cornerstones, key requirements and practical implications to support enhanced circularity measurement that will be developed in further work, accordingly to circular economy paradigm and industrial reality.

Table 14 – Overview of the sub-section 3.2 and description of the associated conference paper

Original title	Hybrid top-down and bottom-up framework to measure products' circularity performance
Published in	<i>Proceedings of the International Conference of Engineering Design, in 2017 (ICED17).</i>
Key words	Circular economy, circularity indicators, sustainability, design for X, case study.
Abstract	Industrial practitioners are increasingly willing to shift their products and businesses into more circular models. Circular economy paradigm requires optimization of system rather than components. Yet, existing methods and tools, intended to designers, engineers or managers, to assess and improve products' circularity potential are both lacking of systemic vision and operational considerations. This research work contributes to fill this gap through the design of a holistic and integrated framework aiming at measuring, improving and monitoring product circularity performance. The developed framework is based on a hybrid top-down - objective-driven - and bottom-up - data-driven - approach including the four building blocks of the circular economy defined by the Ellen MacArthur Foundation. First mature steps of the proposed framework are detailed and experienced on an industrial case study. Insights for an enhanced products' circularity performance measurement and improvement framework are also discussed and lead to further promising research perspectives.

Table 15 – Overview of the sub-section 3.3 and description of the associated article

Original title	A taxonomy of circular economy indicators
Published in	<i>Journal of Cleaner Production, as a Review Article, in 2019.</i>
Key words	Circular economy, circularity indicators, taxonomy, selection tool.
Highlights	<ul style="list-style-type: none"> – There is a growing need to monitor the circular economy transition and to measure its effects. – An increasing number of CE measuring instruments have been developed by scholars and organisations. – 55 sets of circularity indicators (C-indicators) are reviewed and classified. – A need-driven taxonomy is proposed to clarify their purposes and possible usages. – An associated selection tool is provided to facilitate the identification of suitable C-indicators. – The uptake of C-indicators by the industry and other promising challenges are discussed.
Abstract	<p>Implementing circular economy (CE) principles is increasingly recommended as a convenient solution to meet the goals of sustainable development. New tools are required to support practitioners, decision-makers and policy-makers towards more circular practices, as well as to monitor the effects of CE adoption. Worldwide, academics, industrialists and politicians all agree on the need to use CE-related measuring instruments to manage this transition at different systemic levels. In this context, a wide range of circularity indicators (C-indicators) has been developed in recent years. Yet, as there is not one single definition of the CE concept, it is of the utmost importance to know what the available indicators measure in order to use them properly. Indeed, through a systematic literature review – considering both academic and grey literature – 55 sets of C-indicators, developed by scholars, consulting companies and governmental agencies, have been identified, encompassing different purposes, scopes, and potential usages. Inspired by existing taxonomies of eco-design tools and sustainability indicators, and in line with the CE characteristics, a classification of indicators aiming to assess, improve, monitor and communicate on the CE performance is proposed and discussed. In the developed taxonomy including 10 categories, C-indicators are differentiated regarding criteria such as the levels of CE implementation (e.g. micro, meso, macro), the CE loops (maintain, reuse, remanufacture, recycle), the performance (intrinsic, impacts), the perspective of circularity (actual, potential) they are taking into account, or their degree of transversality (generic, sector-specific). In addition, the database inventorying the 55 sets of C-indicators is linked to an Excel-based query tool to facilitate the selection of appropriate indicators according to the specific user’s needs and requirements. This study enriches the literature by giving a first need-driven taxonomy of C-indicators. It provides a synthesis and clarification to the emerging and must-needed research theme of C-indicators, and sheds some light on remaining key challenges like their effective uptake by industry. Eventually, limitations, improvement areas, as well as implications of the proposed taxonomy are intently addressed to guide future research on C-indicators and CE implementation.</p>

3.1. PROPOSED FRAMEWORK FOR THE DESIGN OF CIRCULARITY INDICATORS

3.1.1. Introduction

Circular economy is not fully a new concept but is rather based on a combination of fundamental and founding concepts such as, according to the Ellen MacArthur Foundation (EMF, 2017a), Industrial Ecology, Biomimetics, Natural Capitalism, Regenerative Design, Cradle to Cradle, and Blue Economy. In accordance with Sauv   et al. (2016), what is new is the momentum that this concept is gaining among business practitioners (e.g., Renault, Caterpillar, Danone, Cisco), consultancy firms (e.g., McKinsey Global Institute, Accenture Strategy), governments (e.g., China and European Union), non-governmental organizations or associations (e.g., Ellen MacArthur Foundation), and academics (e.g., teaching programs, international conferences or special issues of journals related to circular economy) (EMF, 2013; EC, 2014; EC, 2015a; Accenture Strategy, 2017; MGI, 2017; EMF, 2017b). A particular interest of the circular economy concept lies in its compatibility and consistency with sustainable development—through its three associated pillars. Indeed, it aims directly not only at economic benefits (e.g., value creation and savings by reducing the purchase of primary raw materials), but also at environmental benefits (e.g., impact reduction) and indirectly at social benefits (e.g., job creation) (Accenture Strategy, 2017; MGI, 2017). As such, companies and collectives are increasingly willing to move towards more circular and sustainable economic and business model as a way of commercial differentiation, competitive advantage and potential growth with economic spinoffs. These are the reasons why industrial actors, non-expert in circular economy, are requiring support and guidance in their shift from a linear to a more circular economy. As key performance indicators (KPI) are widely used and acknowledged in industrial practices (Parmenter, 2015), developing appropriate circularity indicators appears to be relevant in the context of circular economy transition. To date, this segment of circularity measurement is mainly handled and operated by consultancy firms, that are not strongly connected to rigorous academic and scientific research methods, relying upon their proper business and marketing expertises (e.g., the Circle Scan & Circle Assessment developed by Circle Economy cooperative (2014, 2017) or the Closed-Loop Calculator developed by Kingfisher, 2014).

While benefits and opportunities of circular economy are appealing, challenges for industrial practitioners to shift for their businesses and products into more circular practices still exist. Actually, companies, institutions and researchers agree on the need to assess circularity at several and complementary systemic levels, as it will be detailed in sub-section 3.1.2. One central question then emerges: during design or re-design phases, how to assess the circularity potential of a product, component or material, all along the lifecycle, and throughout the value chain? Producing frameworks, methods and tools to answer this issue is essential, as a first step, to then efficiently improve the circularity of goods. This paper provides an overview of current ways to measure product performance in a context of circularity. The methods used for this paper consisted of both a literature review and a case study. One of the main significant aspects of this research work lies in the experimentation and critical analysis of these different existing tools through the industrial case study. As a result, this paper delivers not only recommendations for industrial practitioners but also guidelines for the design of frameworks—including tools and indicators—aiming at an enhanced product circularity measurement. Indeed, key requirements are highlighted to support the development and/or validation of new and more advanced tools and indicators that will assess product-level circularity performance.

The rest of this paper is structured as follows. After highlighting the need for circularity indicators, circularity measurement at different implementation levels is detailed in sub-section 3.1.2. Through the case study, test and critical analysis of three existing tools are performed in sub-section 3.1.3. Based on identified limits and on insights from literature, practical implications and proposed requirements for product-level circularity measurement are discussed in sub-section 3.1.4. Finally, sub-section 3.1.5 summarizes the main findings and opens up future perspectives for both industrial practitioners and researchers on the road towards product circularity assessment, improvement and monitoring.

3.1.2. Literature review

The research methodology utilized in this paper is a literature review (Fink, 1998). This was conducted first in order to get the current knowledge and practices in terms of product circularity measurement. The research conducted was based on both academic articles and non-academic organizations contributions. As recently stated by Geissdoerfer et al. (2017): “the inclusion of non-peer-reviewed articles is appropriate since circular economy is a new area of research, and (...) has not been extensively addressed by peer reviewed articles” contrary to areas of research such as recycling or sustainability. On the one hand, the focus on peer reviewed papers ensures scientific soundness. On the other hand, research works or projects carried out, as well as methods, tools or indicators

developed by other organizations (such as the Ellen MacArthur Foundation) involved in the circular economy transition and working closely with businesses could reflect current industrial reality and needs regarding product circularity, and therefore bring additional meaningful insights.

In this light, the following data sources have been examined: Science Direct, Web of Science, SAGE, Springer, Taylor & Francis, Google Scholar, Google, Ellen MacArthur Foundation, Institut de l'Economie Circulaire (French Institute working on the circular economy), ADEME (French Environmental Agency). Keywords included: “circular economy” OR “circularity” AND “indicator” OR “measurement” OR “assessment”. The selection process was as it follows. First, based on scanning titles, abstracts and/or short contents, works—including peer reviewed academic journals, conference papers, research reports, postgraduate dissertations, books, websites and tools—which were considered as non-relevant regarding product-level circularity measurement have been discarded. Then, those which were dealing directly with or getting indirectly connections with product circularity measurement have been looked at extensively and critically.

3.1.2.1. *Positioning on the definitions of circular economy*

A good understanding of the main definitions of circular economy proposed by major organizations and academics, and positioning ongoing work in relation to these definitions, are suitable as a first step before analysing the tools, proposing and discussing requirements for not only an efficient but also an effective measurement of products' circularity in order to support progress towards a more circular economy.

To date, there is no standard definition of the circular economy concept. However, the different definitions of Economy Circular, proposed or established by major organizations and academic researchers, share much in common, tend to formalize and converge towards the same paradigm (Carencotte, 2012). The CIRAIG performed an extensive literature review and inventory of key circular economy definitions (CIRAIG, 2015). All circular economy definitions agree that circular economy is definitely opposed to the linear model “make-take-waste”. In addition, circular economy is looking for a better management of resources throughout the lifecycle of systems and it is characterized by closed loops, promoting maintenance, reuse, remanufacturing and recycling.

In this paper, as a basis for analyzing the existing tools, we will refer at the circular economy definition proposed by the Ellen MacArthur Foundation (2013), including five fundamental characteristics (design out waste, build resilience through diversity, work towards energy from renewable sources, think in systems, think in cascades) and four building blocks (circular product design, innovative business model, reverse cycles, enablers and system conditions). Particularly, to fit totally with the circular economy paradigm, system thinking is fundamental. Indeed, according to Balanay and Halog (2016), systems thinking is central in circular economy, because designing out wastes and closing the loop needs a holistic understanding and support for broad-based acceptance and success of interventions towards circularity. Moreover, the Ellen MacArthur Foundation butterfly circular economy model is one of the most acknowledged and used in businesses, as well as in academic circles (Lieder and Rashid, 2016).

3.1.2.2. *Joint agreement on the need to assess circular economy performance*

To follow and successfully achieve the transition towards a more circular economy, it is becoming essential for actors and industrial practitioners—such as engineers, designers, managers—to get suitable methods and tools, including indicators, to measure and quantify this progress (Geng et al. 2012; Griffiths and Cayzer, 2016). In fact, the interests of such indicators lie in their ability to summarize and concentrate the great complexity of our dynamic environment, in order to manage a comprehensive amount of meaningful information (Godfrey and Todd, 2001). Furthermore, indicators are a way to assess change and could therefore be used as an important tool to support the evolution from a linear economy to a more circular one (Church and Rogers, 2006). In a report about circular economy and metals recycling, conclusion is made on the necessity, due to the current lack notices in this area, to develop methods and tools that aim at assessing and monitoring overall performance of the circular economy for the environment (Carencotte et al. 2012). According to Kingfisher (2014), one system cannot get more closed loop unless knowing how closed loop it was in the first place. In fact, it should be relevant to measure circularity degree of current systems, processes and products to evaluate the remaining distance to achieve a self-sustaining economy, truly circular (Arnsperger and Bourg, 2016). On the other hand, with the current increasing attention about sustainability and sustainable development, it will not be surprising that a quantifiable sustainability rating would one day be required for all the manufactured products via some regulations (Sabaghi et al. 2016). A similar decision leading to a regulatory framework and mandatory rates will also be plausible and conceivable for the

circular economy. Indeed, several laws related to circular economy are slowly but surely beginning to emerge, namely in China, in the European Union or more recently in France (Section IV of the Act concerning the Energy Transition to Green Growth aims to promote Circular Economy). Yet, in the European Union, circular economy evaluation systems and their associated methodology are still under development (Banaité, 2016). Last but not least, in agreement with the European Academies Science Advisory Council (EASAC, 2016), one of the critical questions linked to the circular economy is how we should measure its performance. For the EASAC, indicators are essential for circular economy assessment at all levels.

3.1.2.3. *Different levels of circular economy measurement*

Circular economy models and implementations are usually performed at three systemic levels. Circular implementation at macro level fits with city, province, region, nation, meso level fits with eco-industrial parks, while micro level corresponds to single company or consumer. Balanay and Halog (2016) confirmed this classification: circular economy macro-layer referring to society, meso-layer to inter-enterprise and micro-layer to enterprise. Banaité (2016) also analysed and clustered circular economy evaluation systems into three levels: evaluation at micro level for single company or consumer, evaluation at meso level for symbiosis association, and evaluation at macro level for city, province, region or country.

Through their analyses, the EASAC (2016) found out that many available indicators may be appropriate for monitoring progress towards a circular economy. These indicators were grouped into sustainable development, environment, material flow analysis, societal behaviour, organizational behaviour and economic performance. However, product circularity performance was not directly considered in these indicators. Likewise, most circular economy indicators reviewed by Ghisellini et al. (2016) are standing at macro-level (nation level) and meso-level (inter-firm level) but barely at micro-level.

For instance, at a macro level, the Waste & Resources Action Programme (WRAP, 2017) estimated that 19% of the UK economy is circular in 2010. Based on a material flow analysis, this circular score of 19% relates to weight of domestic material input (600 million tonnes) entering the economy compared with the amount of material (115 million tonnes) recycled. On the other hand, China had released its first Circular Economy Evaluation Indicator Systems (Geng et al. 2012) that provides two separate sets of indicators: one at a micro-level for the general evaluation of the circular economy on development for both individual region and national-level analysis to provide guidance for future circular economy development planning; and one at meso-level to assess the state of circular economy development at the industrial park level.

According to Geng et al. (2012), although the application of this indicator system may bring certain benefits, problems and challenges still exist, including for example, the lack of indicators for businesses. Additionally, circular economy evaluation at micro level is actually based on cleaner production and green consumption what is not full circular economy approach. Indicators that claim to be circular economy indicators at micro level do not encompass the whole complexity of circular economy and all possible end-of-life options to close the loop. For instance, the evaluation indicator system of circular economy in iron and steel enterprises that includes 13 indicators grouped into 3 categories (resource input and consumption index, resource flow and recycling index, resource output and management index) is mainly focused on resource efficiency through recycling and therefore does not consider other end-of-life scenarios (Zhou et al. 2013). Likewise, the quantitative Evaluation of Circular Economy Based on Waste Input-Output Analysis composed of 14 indicators is mainly focused on waste production/recovery and lacks of systemic consideration (Li, 2012).

Huamao and Fengqi (2007) explored the circular economy concept from the viewpoint of the system theory. From this standpoint, an important characteristic of the circular economy is its layers. All the layers of circular economy are “interdependent, interactive and mutually restricted”. Actually, As Huamao and Fengqi pointed out: “the layers of circular economy are to influence and interact with each other, and the higher layers take the lower layers as the basis and guide the development of the latter”. Besides, according to Lieder and Rashid (2016), the circular economy level of discussion is highly granular and rarely touching operational level. Ghisellini et al. (2016) confirmed that current indicators are barely focused on the circularity at the scale of individual products. In addition, a lack of connection between the three layers of circular economy implementation is noticed.

Thus, a more specific or detailed level could be relevant to further focus on the very core and essence of circular economy, which is the circulation and recirculation of products and materials in (open or closed) loops. For instance, such focal point will be helpful for companies—manufacturers and industrials practitioners—willing to

manage and improve the circularity of products and components they design, develop, manufacture or sell. That is the reason why the authors suggest a fourth circularity level: a nano level as a more refined level focusing on the circularity of products, components and materials, included in three wider systemic levels, all along the value chain and throughout their entire lifecycle. That nano level—i.e., an operational and product-level including components and materials—could serve as a common denominator within these three levels, and could enable not only to make the links between these levels but also to have a closer look at the effective performance of circular economy implementation.

Methods, tools and indicators to assess product circularity, developed by researchers and organizations for companies, at the micro level, will be analysed in further details in the following sub-section.

3.1.2.4. Existing indicators, methods and tools to measure product circularity

According to a report from European Environmental Agency (EEA, 2016), there is at present no recognized way of measuring how effective the European Union, a country or even a company is in making the transition to a circular economy, nor are there holistic monitoring tools for supporting such a process. In the same way, only a small number of published studies design or discuss circular economy indicators, therefore calling for additional research (Ghisellini et al. 2016). Likewise, in agreement with the Ellen MacArthur Foundation, there are no official or recognized indicators, methods and tools to measure company performance in the shift from a linear economic model to a more circular one and neither tools to support and follow that transition (EMF, 2015). Indeed, circular economy indicators are at an initial stage of development (Giurco et al. 2014). Existing indicators and assessments have not the capacity to capture the entire circular economy performance of products (Franklin-Johnson, 2016). Chinese researchers also acknowledge that current indicators were not designed considering systemic aspects, closed-loops or feedback features that characterize circular economy paradigm (Geng et al. 2012).

Franklin-Johnson and her colleagues, within their work published in 2016 “Resource Duration as a managerial indicator for Circular Economy performance”, provide a novel indicator for environmental evaluation performance linked to circular economy, on the basis of which circular economy central point is value creation through materials retention in a loop of high added value (Franklin-Johnson, 2016). The longevity indicator called “Resource Duration” measures material retention based on the amount of time a resource is kept in use, regarding three following aspects: initial lifetime; durability earned through reuse or refurbishing; durability gained thanks to recycling. This non-monetary indicator is only focused on environmental efficiency of resources and could therefore be used as a local or complementary indicator, rather than a global one which could embrace the whole circular economy paradigm.

On the other hand, Amaya (2012) contributes to provide a framework for designers willing to quantify environmental benefits offered by closed-loop strategies for industrial products, considering both remanufacturing and product-service-system (PSS) solutions. The objective was to provide easy to use methods and tools for designers to allow them quantifying the environmental benefits related to the use of a closed loop strategy. Amaya’s model has been developed to assess from an environmental point of view the data of the operations and activities around products’ lifecycle with final non-classic disposal scenarios (e.g., remanufacturing as end-of-life scenario or multiple uses by service offers system as a business strategy). Nevertheless, economic dimensions are neither tested nor considered in the case studies developed. With only environmental arguments but without any cost considerations, companies are not likely to enter in a remanufacturing or PSS business model.

Starting from these observations, academic and organizations—like the European Commission or the Ellen MacArthur Foundation—are well aware of this lack of circularity indicators for products and are willing to fill these gaps by initiating projects that aim at measuring the circularity of products and the transition towards this circularity. For instance, the Ellen MacArthur Foundation decided to launch the “Circularity Indicators Project” in May 2015. According to the Ellen MacArthur Foundation (2015), the benefits of proper circularity indicators could be significant: from decision-making tool for industrial practitioners, to internal reporting, through rating or evaluation of companies. For instance, managers, designers and engineers could take into account circularity as one of the indicators for design decisions. In addition, such indicators could compare different products, or facilitate the setting of product circularity targets. However, recent models developed to achieve circularity measurement of industrial products present notable limits. Indeed, in 2015, the CIRAIG (2015) reviewed and pointed out the limitations of two frameworks aiming at measuring circularity: the Material Circularity Indicator (MCI) (EMF, 2015) and the Circle Assessment (CA) (Circle Economy, 2017). In this paper, the MCI will be analyzed, tested and critiqued. Yet the CA is out of the scope of this paper since, according to email exchange with Shyamm Ramkumar—knowledge and

innovation manager at Circle Economy to get access to the online survey—the CA is not a tool that is used for analyzing products throughout the whole value chain, but rather organizations (Circle Economy, 2014). In our study, in addition to the MCI, two other tools—that have been identified as particularly conceived for product circularity evaluation—will also be reviewed, experienced and critically examined: the Circular Economy Toolkit (CET) (Evans and Bocken, 2013) and the Circular Economy Indicator Prototype (CEIP) (Griffiths and Cayzer, 2016). A more detailed description of these three tools is elaborated in the following sub-section.

3.1.3. Results

In order to complement the findings from the literature review analysis, a case-study approach was adopted to allow a deeper insight into the desired and required features for an efficient and effective assessment of product circularity performance. Importantly, experiments and analyses performed through the case study aim at providing additional and meaningful information to: (i) guide industrial practitioners in their products circularity assessment; and (ii) establish a list of key features for the development of new frameworks—including indicators and tools—aiming at an enhanced measurement and monitoring of product circularity potential.

3.1.3.1. Tools description, characteristics, and modus operandi

Three existing tools, available online or on-demand for free, aiming at measuring product performance in a context of circular economy, have been selected through the literature review analysis. Tools description, characteristics and operating mode are synthesized in Table 16.

The Material Circularity Indicator (MCI) is describes by the Ellen MacArthur Foundation (2015) as a tool for European companies to assess their products and business models performance in a context of circular economy. This indicator is particularly intended for use in product design but could also be used in internal reporting or for procurement and investment decisions. The indicator developed is based on an Excel calculation sheet available online for free. To evaluate the circularity performance at the product level, a spreadsheet tool is also provided (as shown in Figure 24) in order to aggregate multi-materials as well as some guidance on normalizing factors for individual products' weight within a general portfolio (e.g., revenues, product mass, and raw materials costs).

The Circular Economy Toolkit (CET) is an assessment tool to identify potential improvement of products' circularity (Evans and Bocken, 2013). This tool is also freely accessible online. It consists of answering—in a trinary format (yes/partly/no or high/medium/low)—33 questions divided into 7 sub-categories, similarity to the lifecycle stages considered in an environmental qualitative assessment: 7 questions related to design, manufacture and distribute; 3 related to usage; 6 related to maintenance and repair of the product; 3 related to reuse and redistribution of the product; 10 related to refurbish and remanufacture; 2 related to product-as-a-service; 2 related to product recycling at end-of-life.

The Circular Economy Indicator Prototype (CEIP), developed by Griffiths and Cayzer (2016), available on demand, aims at evaluating product performance in the context of circular economy. The CEIP is designed on an Excel calculation sheet. The CEIP uses a points-based questionnaire. Fifteen weighted questions are divided into 5 lifecycle stages, namely: design or redesign; manufacturing; commercialisation; usage; and end-of-life. Once the questionnaire is completed, one gets an overall score of the product circularity performance plus a spider diagram showing circularity performance across different parts of the lifecycle.

Table 16 – Tools description, characteristics and operating mode.

Tools Characteristics	Circular Economy Toolkit (CET)	Material Circular Indicator (MCI)	Circular Economy Indicator Prototype (CEIP)
Description	It is an assessment tool to identify potential improvement of products' circularity.	It aims at helping companies to measure their transition towards a circular economy.	The CEIP aims at evaluating product performance in the context of circular economy.
Platform Support	Dynamic Webpage	Excel Spreadsheet	Excel Spreadsheet
Inputs	33 trinary-based questions divided into 7 sub-categories related to lifecycle stages.	Different percentages (reused, recycling) about material origin (feedstock) and destination (after use).	15 weighted questions divided into 5 lifecycle stages.
Outputs	Qualitative: Improvement potential at 3 level (high, medium, low) for every of the 7 sub-categories.	Quantitative: The MCI, single score, gives a value between 0 and 1 where higher values indicate a higher circularity.	Quantitative: The CEIP score (%) and a radar diagram showing aggregated score for each lifecycle stage.

3.1.3.2. Case study: tools experimentation based on a real industrial product

To test and compare the outputs provided by each tool, the same industrial product—and its associated dataset—is used. The industrial product used in this case study is a catalytic converter that equipped heavy off-road vehicles such as excavators or mobile cranes. The manufacturing company, one of the European leader in machinery construction equipment, seeks to improve the traceability and circularity of their products, notably their catalytic converters considered as a key component due to high value of precious metals—platinum—containing inside. This system is significant for conducting the present case study because, according to Hagelüken et al. (2016), while metallurgical recovery rates for platinum group metals from automotive catalysts may be over 95%, the effective recycling rate is currently around 60%. The catalytic converter is a mandatory equipment to fit with emissions regulations. The platinum is the core element of this system as it allows the transformation and catalysis of toxic pollutants into less or non-toxic gases. As the emissions regulations are increasingly strict, the quantity of precious metal is likely to rise. As such, the company is willing to close the loop of catalytic converters they design and develop, to maintain and recover the platinum contain in their product in order to mitigate the purchase of primary, precious and expensive raw materials, submitted to increased price volatility.

As inputs, data and information about the pre-life (e.g., bill of materials, product design features, production process, logistic aspects), and the life (e.g., lifespan, market destination, business model related to the product) of the catalytic converter were provided by manufacturer, suppliers and through market analysis. Assumptions about the end-of-life (e.g., destination after use, collection rate, treatment facilities, and recycling efficiency) of the catalytic converter were made based on worldwide and European statistic and discussion with the company. As such, inputs required by each tool were filled.

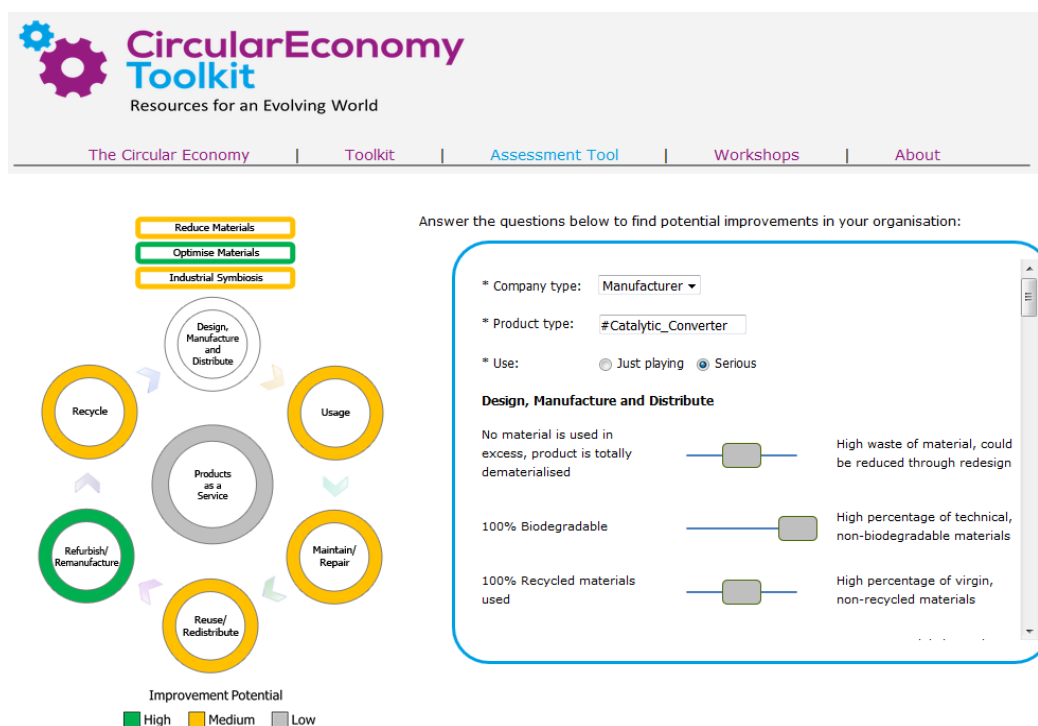

As outputs, results provided by the three tools experienced on this catalytic converter are illustrated in Figure 24. The Circular Economy Toolkit (CET) gives following recommendations to enhance catalytic converter circularity performance: high improvement potentials regarding product remanufacturing and materials optimization to enhance circularity, and medium improvement potentials related to usage, maintain, reuse and recycle phase. The Material Circularity Indicator (MCI) delivers a MCI score for each material used in the product. The three main materials of the catalytic converter were assessed: a MCI score of 0.70 for the stainless steel, 0.33 for the cordierite, and 0.46 (as shown in Figure 24) for the platinum. The aggregated MCI score for the product, based on a normalizing factor that is the material mass multiplied by the material price, is 0.48. This combined MCI score is close to the score provided by the Circular Economy Indicator Prototype (CEIP): 42% (as shown in Figure 24) which is considered as a “good” circularity performance according to the developers of the tool (Griffiths and Cayzer, 2016). Moreover, the CEIP provides a table and a radar diagram detailing the circularity performance scores for each lifecycle stage.



CIRCULARITY TEST - CEIP SCORE

Version 2.0
 Updated 06/08/2014
 Contact percyg@hotmail.com

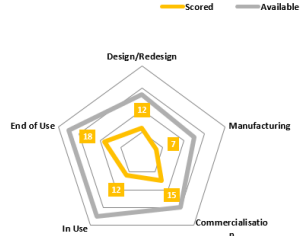
Instructions Complete the General Information section (1), then answer the questions in the Circularity Test (2) and finally, view the results (3). Answer on the yellow boxes and navigate with the yellow arrows.

1 GENERAL INFORMATION	3 RESULTS																																									
Product Name Catalytic Converter SKU Code Manufacturer Code Assessment date November 2016 Assessed by Michael Saidani	42% Good																																									
<table border="1" style="width: 100%; border-collapse: collapse;"> <thead> <tr> <th>Lifecycle</th> <th># Questions</th> <th>Scored</th> <th>Available</th> <th>Rating</th> <th>Ranking</th> </tr> </thead> <tbody> <tr><td>Design/Redesign</td><td>3</td><td>12</td><td>27</td><td>44%</td><td>Good</td></tr> <tr><td>Manufacturing</td><td>2</td><td>7</td><td>25</td><td>28%</td><td>Fair</td></tr> <tr><td>Commercialisation</td><td>3</td><td>15</td><td>30</td><td>50%</td><td>Good</td></tr> <tr><td>In Use</td><td>4</td><td>12</td><td>35</td><td>34%</td><td>Fair</td></tr> <tr><td>End of Use</td><td>3</td><td>18</td><td>35</td><td>51%</td><td>Good</td></tr> <tr><td>TOTAL</td><td>15</td><td>64</td><td>152</td><td>42%</td><td>Good</td></tr> </tbody> </table>	Lifecycle		# Questions	Scored	Available	Rating	Ranking	Design/Redesign	3	12	27	44%	Good	Manufacturing	2	7	25	28%	Fair	Commercialisation	3	15	30	50%	Good	In Use	4	12	35	34%	Fair	End of Use	3	18	35	51%	Good	TOTAL	15	64	152	42%
Lifecycle	# Questions	Scored	Available	Rating	Ranking																																					
Design/Redesign	3	12	27	44%	Good																																					
Manufacturing	2	7	25	28%	Fair																																					
Commercialisation	3	15	30	50%	Good																																					
In Use	4	12	35	34%	Fair																																					
End of Use	3	18	35	51%	Good																																					
TOTAL	15	64	152	42%	Good																																					
2 QUESTIONNAIRE																																										
The questionnaire intends to evaluate in what degree the product fosters the Circular Economy principles throughout its different lifecycle stages.	To respond the questions click the link below 																																									



CIRCULARITY INDICATORS
AN APPROACH TO MEASURING CIRCULARITY



MCI = 0,46

Material Circularity Indicator Dynamic Modelling Tool

Drag the sliders to change input values and see how the MCI changes!

Feedstock

Reused: 0%

Recycled: 33%

Recycling efficiency: 95%

Destination after use



0%

50%

95%

Lifespan

Functional units: 1,0 x industry average

Computation of the MCI:

V	0,67
W ₀	0,50
W _F	0,02
W _C	0,03
W	0,52
X	1,00
f(X)	0,90
LFI	0,60
MCI	0,46

Select normalising factor: **Material Mass x Price**

No.	Name of component range of the Catalytic Converter	Material Mass x Price of component	MCI of ref. component
1	Canning (Stainless Steel)	20	0,70
2	Substrate (Cordierite)	6	0,33
3	Coating (Platinum)	150	0,46
4			
5			
6			
7			
8			
9			
10			
11			
12			
13			
14			
15			
16			
17			
18			
19			
20			

Total Material Mass x Price: **176**
 Combined Material Circularity Indicator: **0,48**

Combined Material Circularity Indicator

MCI = 0.48

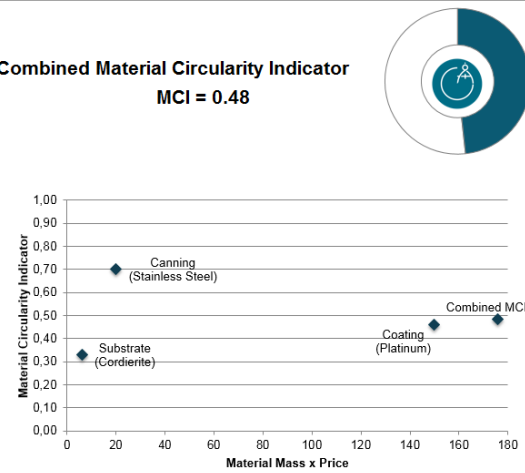

Figure 24 – Illustrations of the three free tools experienced to measure product circularity: the CET, CEIP and MCI

3.1.3.3. *Critical analysis: strengths, weaknesses and limitations of existing tools*

These three tools share the advantages of being user-friendly, even for the non-specialist of circular economy, and time-efficient providing a first overview of product circularity performance. More precisely, the CET provides a first trend of improvement opportunities. The main advantage of this tool is that it considers both business opportunity and product design in the qualitative assessment. Notably, this tool assesses business opportunities (including financial viability and market growth potential) through possible extensions—according to inputs provided—of following services: maintain/repair, reuse/redistribute, refurbish/remanufacture and products as a service, as illustrated partly in Figure 24. The CET online platform is also easy to understand even for non-expert in circular economy. On the other hand, The MCI is interesting to assess flow material potential of products circularity with relatively small amount of inputs data. Therefore, it could effectively be used by industrial practitioners to compare product circularity performance with different material combinations. Eventually, the CEIP presents the following strengths: ease of use, simplicity, speed, and the fact it could be used as an effective metaphor for the diffusion of circular economy principles in industrial practices.

However, the three tools have both weaknesses and limitations in the measurement of product performance in the light of circular economy. First, the Circular Economy Toolkit may be seen as too superficial to encompass the actual complexity of circular economy, in the way this toolkit is similar to a qualitative environmental checklist assessment with a trinary-based questionnaire. With the ternary scale, the user has the habit to put the cursor in the middle. In addition, some questions could lead to different interpretations (e.g., what is considered as many or few mechanical connections?). On the other hand, the MCI is not sufficient by itself to evaluate effective circularity of a given company and several products or components. Specifically, by standing only at the material scale contained in products or components, several essential aspects that are relevant to make progress towards a more circular model are not taken into consideration. For instance, these include modularity, upgradability, connectivity, easy disassembly or design for preventive maintenance of products that are recognized as enablers of an efficient circular economy. Interactions with other components (optimizing systems rather than components is the one of the key paradigm of circular economy) are not taken into consideration. Collaborations between stakeholders, inside the actors network, or reverse logistic, which are also crucial elements for a strong and functioning circular economy are either not explicitly considered. The scope of the MCI is narrower than what circular economy stands for, such as systems thinking. Last but not least, the MCI does not explicitly favor closed loops, that is to say, more granular levels of recovery beyond recycling and reuse, such as remanufacturing or refurbishment. It is assumed that the mass of the product does not change from manufacture to the end of use. In particular, this means that no part of the product is consumed, degraded or lost during its use. In addition, downcycling, i.e., the material quality loss in the recycling process is not taken into account. Eventually, the CEIP interpretation through a single score hides the true circular economy complexity. The binary scoring system used for some question could be quite reductive for some questions. The authors of the CEIP (Griffiths and Cayzer, 2016) acknowledge a superficial commitment with decision-makers and that the reliability of the questionnaire is based on the case study specific context: the 15 questions are mainly focused on the manufacturing and end-of-life stages of the product lifecycle, and therefore neglect certainly other circular economy crucial aspects. Indeed, several attributes suitable to move towards an efficient circular economy of products are not taken into account such as, modularity, design for disassembly, upgradability, used of new technology or connected devices: for instance, sensors to enable product traceability.

In a nutshell, even if these tools provide a first and rapid overview of product circularity performance, they do not cover all aspects of the circular economy and miss some important elements. Furthermore, they do not deliver practical or operational guidance for industrial practitioners to improve the product circularity of their products. As such, there is a lot of room for improvement regarding existing tools assessing product circularity performance. Additionally, to limitations highlighted below, authors of existing tools acknowledge the need for further investigations and developments in the area of product performance in a context of circular economy. As an example, the developers of the CEIP (Griffiths and Cayzer, 2016) foster not only to consider deeper the trade-off between simplicity and engagement with decision-making, but also to expend the design of circularity indicators to other industrial sectors.

3.1.4. **Discussion**

In this sub-section, success conditions, required and desired features for an effective measure of product circularity performance are discussed. First, key requirements are proposed for the design of frameworks—including indicators and tools—aiming at an enhanced product circularity assessment. Thereafter, practical implications and guidelines are provided as a support to the development and implementation of such frameworks. In addition,

recommendations are delivered for industrial practitioners on how to proceed in their product circularity measurement and monitoring.

3.1.4.1. *Proposed requirements for a product circularity measurement framework*

Based not only on the findings revealed through the experience of existing tools—i.e., their strengths, weaknesses and limitations regarding circular economy principles and industrial applicability—but also on acknowledged and well-funded recommendations from literature review, requirements for properly measuring product performance in the light of circular economy are highlighted. Basically, future enhanced frameworks for product circularity assessment should both share the same advantages of existing tools reviewed and fill their limitations—i.e., address and overcome the weaknesses pointed out.

The core question is indeed to define what are the ideal, desired or required features for designing a framework aiming at product circularity measurement and monitoring. One has to bear in my mind that such a framework is mainly intended to industrial practitioners that is to say mainly to engineers, designers and managers responsible in the design and development of products. Saidani et al. (2016) translate industrial practitioners' needs into eight criteria for selecting most suitable eco-design tool for improvement purposes fitting with companies' constraints and context. With a similar mindset, ideal product circularity measurement tool features are derived from complementary industrial and academic works.

First, the framework should not only be integrated and holistic (Halog and Manik, 2011) to fit with circular economy paradigm but also, adaptative, modular to be compatible or plug-in with complementary existing methods and tools in order to use the strengths of different previous works. Then, it would be better if the circularity measurement tool could work at the scale of thousands of products (Kingfisher, 2012). For the European Environmental Agency (EEA, 2016), because of the complex dynamics governing the transition, the monitoring framework needs to be flexible, allowing the adaptation of indicators and focus areas to maintain its effectiveness throughout the evolution towards more circular practices. Additionally, taking into account the entire value chain may result in the creation of a considerably greater resource efficiency potential (Bleischwitz and Wilts, 2013). Hence, it should be lifecycle thinking and system thinking (Balanay and Halog, 2016). In addition, Arnspurger and Bourg (2016) reflect on the foundations of circularity indicators for an economy authentically and genuinely circular. They conclude a circular indicator, or a set of circular indicators, should definitely be systemic by design so that to prevent any major rebound effects or negative impact transfers (e.g., circular improvements focused only on micro level would lead to deterioration to more macro or meso levels). It should therefore articulate genuinely micro, meso and macro considerations. To Huamao and Fengqi (2007), circular economy should be a mean to reach unification among economic, environmental and social benefits, and ultimately realize the objective of sustainable development.

Then, the European Academies Science Advisory Council (EASAC, 2016) recently questioned what basic criteria should be applied in selecting indicators for monitoring the progress toward circular economy. As such, some key principles to consider were highlighted, notably: links with sustainability and industry compatibility (i.e., circular economy should harness existing sustainability-related compliance data), or communication (i.e., the effectiveness with which indicators communicate with the stakeholders). Future circularity measurement and monitoring tools should be designed and developed in software accessible to most users. For instance, Microsoft Excel could be used due to its high level of diffusion and utilization across multiple business sectors. Last but not least, in accordance with business common sense and rules of thumb, it is suitable that the framework is user-friendly, time-efficient and intelligible (easy and pleasant to use, understand and communicate) for all industrial practitioners non-expert in circular economy, and provides gateway for enhancing products and components circularity by offering a comprehensive and operational view of circularity improvement opportunities.

Required, desired and ideal features are synthesis and classified within a proposed hierarchy inspired by Maslow's pyramid of needs (Maslow, 1943) and adapted here to appropriate design of tools aiming at product performance measurement in a context of circular economy, as illustrated in Figure 25. First, the two requirements positioned at the base of the pyramid—(i) "systemic by design" and (ii) "integrated and operational"—are considered as mandatory and required features, respectively (i) to ensure a holistic approach—i.e., to consider the whole complexity of circular economy paradigm during product circularity measurement—and (ii) to be fit with industrial practices during design and development phases. Then, the two following requirements—(iii) "adaptive and flexible" and (iv) "intuitive user interface"—are seen as additional and desired features, respectively (iii) to have the ability to consider different products from diverse industrial sectors, and (iv) to be effectively and efficiently used by practitioners. Finally, the requirement placed at the top of the pyramid—(v) "connection to sustainable development

pillars”—is deemed as an ultimate and ideal feature, reminding us that circular economy targets and measures should not be a goal in itself but rather a means to an end in order to achieve a more sustainable development and society (Huamao and Fengqi, 2007). Each of the five elements are elaborated in the next sub-section and practical implications are discussed to meet these requirements.

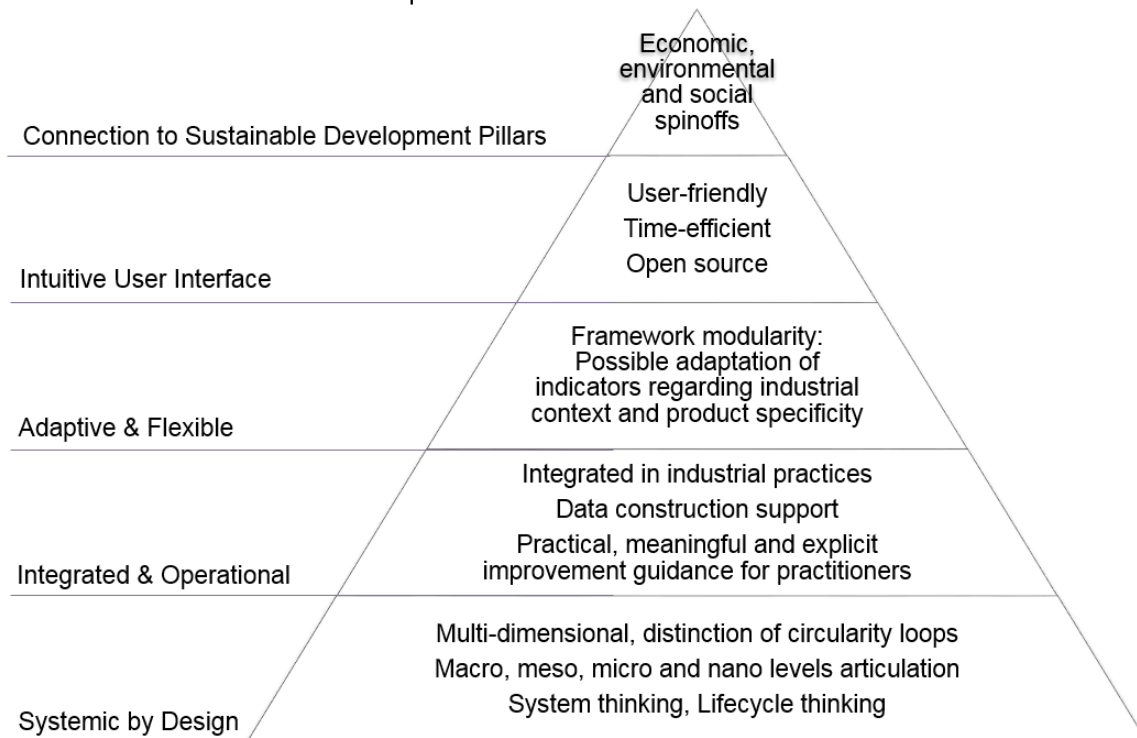





Figure 25 – Proposed hierarchy of desired features to design a circularity measurement framework

3.1.4.2. Practical implications and guidance for the design of such a framework

As aforementioned and illustrated in Figure 25, we recommend that the design and construction of an advanced framework to measure product circularity should consider mainly five cornerstones, namely: (i) systemic by design; (ii) integrated and operational; (iii) adaptive and flexible; (iv) intuitive user interface; (v) connection with sustainable development pillars. Let us have a closed look at the consideration of each requirement to develop and implement effectively such a framework.

First, the “systemic by design” cornerstone highlights that the measurement tool should encompass a wide spectrum of the circular economy paradigm — including its complexity and principles. Such as lifecycle thinking, consideration of systemic levels and interplay between implementation levels (macro, meso, micro, and nano) are essential for an effective measure of product performance in the light of circular economy. Additionally, a multi-dimensional scoring system representing different perspectives of circular economy should be preferred, and ideally, distinction between circularity loops — in direct link with Lansink’s ladder of waste hierarchy (Parto et al. 2007; Recycling, 2017) — should be established (Wilts et al. 2016). As there are different ways to close the loop, the overall circularity score should go further than a single and global score that encompasses and consider all different possible closed-loops at the same level without differentiation. Hence, we propose to rank these loops from circularity class A to D, which corresponds respectively from the most inner-loop to the most outer-loop of the Ellen MacArthur Foundation butterfly circular economy model (EMF, 2013), as illustrated in Table 17. Additionally, in Moreno et al. (2016), recommendations are made to enable designers to fully consider the holistic implications for design within a circular economy, by reviewing 30 Design for X (DfX) concepts, covering thus a range of strategies that could be adopted to design and develop more circular products. Indeed, the definition of DfX methods—that are particularly fitted to the circular economy implementation—used by Moreno et al. (2016) is the following: “a combination of eco-design strategies including Design for Environment and Design for Remanufacture, which leads to other design strategies such as Design for Upgrade, Design for Assembly, Design for Disassembly, Design for Modularity, Design for Maintainability”.

Table 17 – Description of the four circularity loops, according to EMF CE butterfly model (2013)

Circularity Loops	EMF (2013) Logo	Description and Associated DfX Tools
Circularity class A: Maintain/Prolong		The goal is to keep them in circulation as long as possible, with as high value as possible. Design for longevity, upgradeability, sharing.
Circularity class B: Reuse/Redistribute		Optimization of second-hand market to avoid loss of added value. Design for PSS (e.g., leasing, maintenance).
Circularity class C: Refurbish/Remanufacture		Returning a product to at least its original performance with a warranty. Design for reuse in manufacture.
Circularity class D: Recycle		Loss of original product's added value. Design for material recovery.

Second, the “integrated and operational” cornerstone emphasizes that the framework needs to be fit with industrial practices. According to Dufrene et al. (2013), integrated design is a practice to integrate different values (e.g., functions, aesthetics, manufacturability, assemblability, recyclability) of the product lifecycle in the early phases of the design process. As such, developed framework should be compatibility and complementarity with other tools and softwares used during product design and development phases, to help for instance decision-making. In addition, to be operational, as one of the main challenges to evaluate properly product circularity lies on the ability to gather adequate data, the framework should support data construction. In this light, a standardized input datasheet could be develop to facilitate the data collection, for instance divided in several sections such as technical data (e.g., bill of materials) and market or organizational data (e.g., supply chain, end-of-life pathways). Third, the “adaptive and flexible” cornerstone underlines that the framework should be designed with a modular and non-frozen approach in order to be continuously improved through time and feedback. Indeed, in consonance with the EASAC (2015): “a circular economy needs to be flexible enough to be able to move and adapt with the quickening pace of new developments in this arena”. Among the tools reviewed, the MCI is both general enough and extendable to be applied to numerous industrial sectors and therefore to serve as a basis for developing new and advanced product circularity measurement framework specific to particular industrial sectors. As a concrete example, with the MCI tool used as a reference, Verberne (2016) developed a more sophisticated method for measuring the circularity performance of a building and its associated parts.

Fourth, the “intuitive user interface” cornerstone highlights the importance of designing a proper graphical user interface (GUI) for non-expert in circular economy. In order to be time-efficient and user-friendly, the GUI should ease the acquisition of data, as well as enable a comfortable visualization of the results. Designers and developers could take inspirations from the three tools experienced in this paper. Indeed, the interfaces of the MCI, the CET and the CEIP are particularly clear, easy to use and to understand rapidly.

Fifth, the “connection to sustainable development pillars” cornerstone stresses that the actual impact of circularity should be analyzed against the sustainability performance of given a product entering in a circular economy loop. According to Geissdoerfer et al. (2017) the overall benefits of circularity outweigh the drawbacks regarding impacts on sustainable development pillars, but in some cases, circularity could result to negative impacts on certain aspects of sustainability. It becomes therefore relevant to check if the potential circularity of goods—including products, components and materials—will lead to effective benefits regarding sustainability, or under which conditions and trade-offs between the three pillars. In line with ScoreLCA (2015), such evaluation and consideration will enable to prioritize different types of loops in order to identify the most relevant loop for a material or product in terms of sustainability.

3.1.4.3. Positioning of the three tools in regard to the proposed requirements

The analysis of tools’ compliance with the proposed requirements is performed in Table 18 in order to identity both best practices (+) and room for improvement (–) as an inspiration for the development of advanced frameworks aiming at assessing product circularity performance. Furthermore, such an examination provides additional insights for practitioners in the selection between these tools and their use during product design and development phases.

Table 18 – Positioning of the three tools experienced in regard to the five proposed requirements

Tools Requirements	Circular Economy Toolkit (CET)	Material Circular Indicator (MCI)	Circular Economy Indicator Prototype (CEIP)
Systemic by design	<ul style="list-style-type: none"> +: Lifecycle thinking (complete i.e., pre-life, life, and end-of-life phases are covered). +: Consideration of several DfX related to circular economy. -: No distinction of circularity loops. 	<ul style="list-style-type: none"> +: Lifecycle thinking (but exclusively focused on material origin, usage intensity, recycling and reuse). -: No consideration of major DfX related to product circularity performance. -: No distinction of circularity loops. 	<ul style="list-style-type: none"> +: Lifecycle thinking (but mainly focused on manufacturing and end-of-life). +/-: Consideration of some DfX but exclusively related to manufacturing and end-of-life steps. -: No distinction of circularity loops.
Integrated and Operational	<ul style="list-style-type: none"> -: Lack of support in data construction. Do not provide concrete guidance for product circularity improvement. 	<ul style="list-style-type: none"> -: Lack of support in data construction. Do not provide practical guidance for product circularity improvement. 	<ul style="list-style-type: none"> -: Lack of support in data construction. Superficial commitment with decision-making.
Adaptive and Flexible	<ul style="list-style-type: none"> +: Applicable for a great range of products. -: Frozen version. 	<ul style="list-style-type: none"> +: Applicable for all kinds of real physical products. Excel datasheets that could be edited. 	<ul style="list-style-type: none"> +: Excel datasheets that could be edited. -: Designed particularly for the home improvement sector.
Intuitive User Interface	<ul style="list-style-type: none"> +: Free, available online, easy to use and to understand. Time-efficient i.e., once one has all the data, it takes around 15 min. 	<ul style="list-style-type: none"> +: Downloadable freely, easy to use and to understand. Very time-efficient i.e., once one has all the data, it takes less than 5 min. 	<ul style="list-style-type: none"> +: Free, available on demand, easy to use and to understand. Time-efficient i.e., once one has all the data, it takes around 15 min.
Connection to Sustainable Development Pillars	<ul style="list-style-type: none"> +: Business opportunities are covered (including financial viability and market growth potential). -: Other aspects are not directly addressed. 	<ul style="list-style-type: none"> -: The impacts of product circularity performance on the three pillars of sustainability are not explicitly addressed. 	<ul style="list-style-type: none"> -: The impacts of product circularity performance on the three pillars of sustainability are not explicitly addressed.

In a nutshell, the MCI is interesting to assess flow material potential of products circularity quickly with relatively few inputs data. Indeed, it provides a rapid overview and could be used effectively by industrial practitioners to compare products with different material combinations. The CET delivers information about product circularity improvement potential at each stage of the lifecycle, but without given further practical recommendations on how to proceed to improved it. The graphical user interface of this tool is very intuitive and user-friendly even for non-circular economy experts. However, a comprehensive knowledge of the product all along lifecycle is required to answer properly the 33 questions requested. The CEIP is intended for industrial practitioners and decision-makers who are looking for ease of use, simplicity and speed in the evaluation of their products' circularity during design and development phases. Nevertheless, the access to a lot of information is required to complete the 15 input questions.

3.1.5. Conclusion

The use cases of product circularity performance indicators could be relevant for informative, comparative, ameliorative and communicative purposes during product design and development phases. Just to mention a few examples, they could serve as a gateway to enhance the circularity of products and associated value chains thanks to the identification of hotspots and areas for improvement, as well as to define tangible circular targets for products.

The broader impact and contribution of this work rely on the potential to foster, in an organized way, the development of new product circularity measurement frameworks intended to industrial practitioners as a support to their shift towards a more circular economy of goods. As such, analyses and proposed requirements are intended not only for managers, designers or engineers who seek to assess and improve their product circularity potential but also for researchers who are eager to develop new indicators, methods and tools aiming at measuring and enhancing product circularity. The requirements we have discussed could represent a first step to novel perspectives on product circularity measurement. In addition, knowing the different features and practical usage of

each tool (e.g., insights provided, time required, level of detail, data considered in input, etc.) is crucial both to judge the operability of each tool reviewed and to recommend most appropriate and suitable tool—or combination of tools—for industrial practitioners regarding their context, needs and constraints.

Additionally, description, test and critical analysis of each tool, performed in this article, could serve as references and guidance for industrial practitioners. In fact, some indicators and tools could be better in one situation, such as comparing rapidly the impact of two different materials on circularity performance (e.g., the Material Circularity Indicator); others are more product-centric and lifecycle thinking (e.g., the Circular Economy Toolkit or the Circular Economy Performance Indicator). Furthermore, according to a given situation (e.g., target audience or beneficiaries, i.e., user of the tool, time available, desired level of detail, etc.) or a specific kind of product, one method could be more suitable than another one. For instance, the three tools reviewed are helpful when managers need to have rapid qualitative information and overview on which areas a product could be improved to be integrated into a more circular value chain.

Although they provide a first and a rapid overview of products' circularity, current tools neither consider the whole complexity of the circular economy paradigm, nor provide operational guidance for engineers, designers or managers to improve their products in a context of circular economy. Beyond product circularity performance measurement, methods and tools should be developed to provide companies suitable ways and mechanisms to monitor in advance the fate of their products, components, and materials. New developed tools should help businesses concretely in their move towards a more circular economy by orienting industrial practitioners to the best practices aiming at improving product circularity.

The research and analyses carried out in this paper present the three following limitations: (i) the inadequate coverage of the data availability issue; (ii) the non-consideration of biological cycle; and (iii) the absence of in-depth discussion regarding metrics and scoring systems. On the one hand, measuring potential product circularity potential during the design or redesign of a product assumes the access to a significant quantity and variety of both technical and market data. Our case study did not face this issue because a comprehensive life cycle inventory and a life cycle assessment of the catalytic converter had been performed prior. On the other hand, as the system used in the case study belonged exclusively to the technical cycle, the focus has been made on technical nutrients and their inherent cycles. Thus, the biological cycle — according to the left side of the circular economy butterfly diagram modelled by the Ellen MacArthur Foundation (2013) — was out of the scope of this research work. In addition, reflection on the metrics and scoring system for measuring product circularity performance was non-comprehensively addressed in this present article. Future research discussions could include more in-depth analysis of circularity scores definitions and mathematical basis. Last but not least, considering the repercussions of the potential circularity of a given product during early design phases on the economic, environmental and social spinoffs would be an existing area for future research on the development of new frameworks aiming at assessing product circularity performance.

Even if a holistic and integrated tool to measure, improve and monitor product circularity potential performance is currently under development by the present authors, we encourage further work to contribute at providing new ways and mechanisms aiming at product performance measurement and improvement in the context of circular economy. For information, the ongoing development tool, following recommendations provided in this article, is promising in the way it claims to be both holistic and integrated. Based on the four building blocks of circular economy defined by the Ellen MacArthur Foundation (2013), it will cover a wider spectrum of circular economy paradigm than the existing tools. Using a hybrid top-down (objective-driven based on circularity scores) and bottom-up (data-driven based on industrial and market fields) approach, it will ensure to be relevant and integrated to real industrial practices.

3.2. DEVELOPMENT OF A NEW CIRCULARITY INDICATOR

3.2.1. Introduction

Companies are increasingly interested in moving their products and businesses towards a more circular economy to benefit from significant economic and environmental advantages promised by the latter (EMF, 2015). Indeed, even if there is no crystalized definition of circular economy yet, this concept aims at decoupling economic growth from consumption of natural finite resources (EMF, 2013). Thus, an efficient circular economy model could both lead companies to capture additional value from their products and manufacturers to mitigate risks from materials' price volatility and short of supply. Furthermore, according to a study realized by the McKinsey Global Institute (MGI, 2015), adopting circular economy principles could not only benefit Europe environmentally and socially but also generate a net economic benefit of €1.8 trillion by 2030. However, the MGI acknowledges that the results of such numerical finding are indicative, since their models rely on multiple assumptions, and calls therefore for more research. Although the promises of a circular economy seem to be appealing, there are still a lot of challenges in its real implementation. So that the move towards a circular economy operates, companies should be supported in this transition from a linear model to a more circular one.

Meanwhile, the current lack of operational support to help industrial companies assessing, improving and monitoring the circularity of their products, components and materials is a reality (EMF, 2015). Hence, the main motivation of the present study is to contribute in the process of moving from an idealized vision of circular economy to a functional and operational one by giving the means to industrial practitioners (i.e. managers, engineers, designers) to measure, enhance and monitor the circularity of their products. In this light, two research questions have then emerged. First, how to assess the circularity potential of a product - complex or not, industrial or not - during early design and development process? Second, how to measure the circularity performance of a product in use, on the market, in order to redesign the product or to rethink and reshape associated business model? Critical analysis of existing methods and tools assessing products' circularity performance are performed and key limitations are highlighted. As a result, both scientific and industrial communities should be interested in the construction and application of a new and more comprehensive framework providing keys to measure and enhance products' circularity performance.

Contrary to existing methods and tools, the holistic and integrated developed framework - using a hybrid top-down and bottom-up approach - claims to encompass a wider spectrum of circular economy complexity, based on the four building blocks of the circular economy defined by the Ellen MacArthur Foundation (2013). A case study is proposed on a catalytic converter, which contains a non-negligible amount of platinum group metals (PGM) considering as critical raw materials by the European Commission (EC, 2010). The framework highlights promising design guidelines to protect critical resources and thus it assists companies to become more resource sensitive.

After underlining the need for circularity measurement, existing indicators, methods and tools to assess circularity of products are reviewed in sub-section 3.2.2. Insights to design and develop suitable indicators are also provided in the literature review section. The proposed framework, based on a hybrid approach that combines both top-down and bottom-up analyses to define relevant circularity indicators, is detailed in sub-section 3.2.3. Application of the framework on a real industrial complex product is performed in sub-section 3.2.4. Comparison with existing tools to validate actual contributions of the developed framework is also proposed in sub-section 3.2.4. Finally, reflections to enhance proposed framework and directions for future work are discussed in sub-section 3.2.5.

3.2.2. Literature background

The circular economy concept has been and is still widely discussed in literature. For instance, Ghisellini et al. (2015) have recently provided an extensive review of the circular economy literature of last two decades including the main circular economy features and perspectives: origins, basic principles, advantages and disadvantages, modelling and implementation of the circular economy at different systemic levels, notably at the macro level (i.e. referring to city, region or country implementation) and the meso level (i.e. referring to symbiosis association or inter-enterprise implementation). However, the area of monitoring circularity at a micro level (i.e. at the company level) and at a more micro level (i.e. at the level of products, components and materials) - called here the nano level - has been barely discussed in literature (Saidani et al. 2017a). Likewise, according to Lieder and Rashid (2016), the circular economy level of discussion is often decorrelated from product consideration and circulation, that is to say, from the core of circular economy implementation. In order to address particularly this area, corresponding to the level of design engineering, the scope of the present state-of-the-art is then narrow to products' circularity measurement and associated indicators. Meanwhile, even if focus is made on products' circularity, considering

whole product value chain (i.e. lifecycle and systemic thinking) is essential to fit with circular economy paradigm. As such, interaction - and inclusion - of nano and micro levels within wider levels of the circular economy implementation will be addressed in the proposed framework. In fact, a systemic vision of the circular economy is required to avoid negative and unintended impact transfers (Arnsperger and Bourg, 2016).

3.2.2.1. Measuring circular economy performance at product level

When companies are willing to improve the environmental performance of their products, an environmental assessment is usually performed first - e.g. a life cycle assessment (LCA). Similarly, to identify hotspots and areas of improvement in order to move towards a more circular economy, it would be helpful to assess the potential performance of products' circularity first. Product circularity performance provides additional information than a LCA by focusing on possible ways and mechanisms to close the loops. Yet, there is at present no recognized way of measuring how effective a country or a company is positioned in making the transition to a circular economy, nor holistic monitoring tools for supporting such a process (EMF, 2015). Academic researchers and organisations working on the circular economy concept and application agree on the necessity to measure progress in the transition towards circularity of products. More precisely, to follow and successfully achieve the shift from a linear economy to a circular one, it becomes essential for industrial practitioners such as engineers, designers, and managers to get the right and suitable methods and tools, including indicators, to measure and quantify this progress (Griffiths and Cayzer, 2016). Indeed, indicators are a way to assess change. Moreover, indicators have the ability to summarize the great complexity of our dynamic environment to manage a comprehensive amount of information. It should be therefore relevant to measure the circularity degree of current systems, processes and products to evaluate the remaining distance to achieve a self-sustaining economy, truly circular (Arnsperger and Bourg, 2016). Circular economy indicators are at an initial stage of development and existing ones do not have the capacity to capture the entire circular economy performance of products (Franklin-Johnson et al., 2016). Limitations of existing tools and indicators related to product circularity measurement are summarized in Table 19.

Table 19 – Indicators, methods and tools to measure products' circularity and associated limits

Sources	Indicators, Methods and Tools	Identified Limits & Gaps
(Amaya, 2012)	Assessment of the environmental benefits provided by closed-loop strategies (remanufacturing and PSS) for industrial products.	Design methods of PSS associated services (e.g. maintenance and/or remanufacturing) are not covered; Absence of cost model; Lack of transparency about the proposed method.
(Ellen MacArthur Foundation, 2015)	Material Circularity Indicator (MCI)	Materials scale only; Limited to a small spectrum of circular economy complexity (e.g. do not considered whole value chain and the focus is only on two end-of-life options: reuse and recycling).
(Evans and Bocken, 2013)	Circular Economy Toolkit (CET)	Similar to an environmental assessment checklist; Qualitative; Simple trinary choice model in the possible answers; Superficial guidance.
(Franklin-Johnson et al., 2016)	Longevity Indicator: "Resource Duration"	Complementary indicator: the focus is only on eco-effectiveness that do not cover a wide range of circular economy paradigm; Non-monetary.
(Griffiths and Cayzer, 2016)	Circular Economy Indicator Prototype (CEIP)	Single score based on 15 questions, mainly focused on the manufacturing and end-of-life phases; Economics and whole value chain are not covered.

In a nutshell, even if these methods, tools and indicators could provide a first trend of products' performance in the context of circular economy, they are neither considering the entire complexity of the circular economy (e.g. interaction between systemic levels, stakeholders' collaborations through end-of-life value chain, integration of all possible end-of-life options to close the loops, circular business models), nor operational enough for industrial practitioners to design and develop more circular products. The interest of this study lies in the development of a framework including more consistent indicators to assess circularity performance of products that are both relevant for industrial practitioners through operational implementation and in accordance with the circular economy paradigm and complexity. Before starting the construction of such a framework related to products' circularity measurement, let us have a look at methods to design indicators properly in a rigorous and scientific way.

3.2.2.2. Material and methods for designing indicators

3.2.2.2.1 Definitions and overall recommendations for designing indicators

On the one hand, according to Park and Kremer (2017), there is no widely accepted definition of what constitutes an indicator. However, this paper adopts the view of the OECD (2014) where an indicator is defined as "a quantitative or qualitative factor or variable that provides a simple and reliable means to measure achievement, to reflect changes connected to an intervention, or to help assess the performance of a development actor". Thus, indicators provide an effective tool for measuring progress and performance. On the other hand, a metric is usually considered, by convention, as a calculated or composite measure or quantitative indicator based upon two or more indicators or measures. Metrics help to put a variable in relation to one or more other dimensions. For better and easier understanding in this paper, we will be talking about indicators, even if they represent a value quantified with standardized units - i.e. a measure - or a composite, multi-dimensional structure of data - i.e. a metric. Even if indicators are widely used in both industrial companies and scientific literature, no methodical standard has been developed yet on how to design indicators. Let us have a look at few insights identified in the scientific literature that deal with the design of indicators. Particularly, Brown (2009) provides generic guidelines for the development and reporting of indicators. This methodology is structured into five stages: establishing the purpose of the indicators; designing the conceptual framework; selecting and designing the indicators; interpreting and reporting the indicators; maintaining and reviewing the indicators. In this light, Brown's methodology will be used as a basis for the developed framework, as detailed in Table 21 in sub-section 3.2.3.

3.2.2.2.2 Top-down and bottom-up approaches for designing indicators

Definitions and characteristics of both top-down and bottom-up approaches are available below in Table 20. Little et al. (2016) notice that there is little connection between the two approaches in the indicators construction, notably in the field of sustainability which is largely fragmented. Indeed, the majority of the studies use a top-down approach (Park and Kremer, 2017). However, both approaches have several times been used simultaneously to define sustainability indicators adapted to specific industrial sectors. For instance, Faucheux et al. (2003) developed sustainability indicators that were obtained through an innovative bottom-up top-down approach. They delivered proofs of the feasibility, effectiveness and legitimacy of such hybridization to the development and application of indicator systems. Additionally, this linking of bottom-up and top-down perspectives has an extremely important communication function in the context of indicator system development. Chamaret et al. (2007) have used such a hybrid approach to develop suitable (i.e. transferable, generic and scientifically valid) sustainable development indicators in extraction and mining field. As a bottom-up pattern, they used a participatory approach to both involve users and get practitioners' opinions about desired indicators. Weiland (2006) recommends, for the elaboration of sustainability indicator sets, a combination of a top-down-approach with a bottom-up-approach, and alerts about the limitations of each approach, as shown in Table 20. More recently, Park and Kremer (2017) perform an extensive literature review on previous research on categorization and selection of sustainability indicators and compare both approaches to define and select indicators, as highlighted in Table 20. They suggest the bottom-up approach can complement the prevailing ad hoc categorization of indicators from the top-down approach. Comparison of both approaches and their contributions in the construction of indicators is performed in Table 20.

Table 20 – Comparison of top-down and bottom-up approaches to design indicators

Approaches	Top-Down	Bottom-Up
Definitions & Principles	Indicator systems based on applying accepted international classifications of indicators (Faucheux et al., 2013). Criteria are pre-defined in a framework according to technical meanings and then allocated indicators in each category based on their perceived theoretical similarities (Park and Kremer, 2017). Goal-driven. Analysis. Decomposition.	Indicator proposals based on local perceptions of issues and significance. Based also on appreciation of the preoccupations expressed by stakeholders (Faucheux et al., 2013). Indicators and categories are created from available data and information (Park and Kremer, 2017). Data-driven. Synthesis. Clustering.
Advantages (+)	Generally defined by experts at high levels (Chamaret et al., 2007). Theoretically cover a comprehensive spectrum of indicators and provide well-defined indicator categories (Park and Kremer, 2017).	Implicated more stakeholders and increased stakeholders' adhesion to indicators (Chamaret et al., 2007). Indicators more useful and usable for practitioners (Park and Kremer, 2017).

<p>Drawbacks & Limits (-)</p>	<p>Lack of legitimacy in the eyes of stakeholders (Chamaret et al., 2007). Do not always respond to the specific circumstances of a sector. Lack of consideration for indicator utility in practice. Risk of considering only problems already known (Weiland, 2006). Often results in redundant and ambiguous indicators across categories (Park and Kremer, 2017).</p>	<p>Risk of not depicting all aspects of the issue comprehensively (Weiland, 2006). Difficulties to link and interpret a large amount of raw data from different stakeholders and markets. Data heterogeneity and variety. Time-consuming.</p>
-----------------------------------	--	--

To date and to the best of our knowledge, the combination of top-down and bottom-up approaches has not been used yet to define and select indicators related to the evaluation of product performance in a context of circular economy. Lieder and Rashid (2016) applied top-down and bottom-up approaches to link in the same framework the macro-level (nations) and micro-level (companies) of circular economy implementation. The top-down approach considered first national effort through society, legislation and policies, while the bottom-up approach focused more on individual company effort through manufacturing industries, competitiveness and profitability. Yet, further considerations on product circularity performance through the whole value chain were missing. On this basis, a hybrid framework is used to generate products' circularity indicators by combining the strengths of both approaches.

3.2.3. Results

3.2.3.1. Construction of the proposed framework and associated indicators

To structure the framework and associated indicators construction, the five-stage methodology proposed by Brown (2009) is used as explained in Table 21. Furthermore, as mentioned and justified above, a combination of top-down and bottom-up approaches is used to develop our indicators within a framework to assess products' circularity performance.

Table 21 – Five-stage methodology to develop indicators, adapted from Brown (2009)

Stage Number - Name	Description	Application in our case
#1 - Establishing the purpose of the indicators	Identify clearly the target audience and determine the scope of the indicator set.	To support industrial practitioners in the circularity measurement of their products, components and materials.
#2 - Designing the conceptual framework	A conceptual framework provides a formal way of thinking about a topic area. It is a valuable tool for building coherent indicators set.	Hybrid method that combines the strengths of top-down and bottom-up ways to design indicators, ensuring holistic and integrated approach.
#3 - Selecting and designing the indicators	Selection criteria should be used as a tool to evaluate the proposed indicators to ensure they are relevant and measurable.	Framework based on the four building blocks of the circular economy according to Ellen MacArthur Foundation (2013).
#4 - Interpreting and reporting the indicators	A mix of graphs and comments is generally more effective for a public audience than large amounts of texts.	An Excel spreadsheet will be first developed to facilitate dissemination and communication of indicators in an organized, understandable way.
#5 - Maintaining and reviewing the indicators	Open consultation with stakeholders, including technical and subject-matter experts, data providers, the target audience, and other interested groups.	Not mature enough and therefore left for future work: include feedback from a review process to react by making adjustments to the indicators set (empirical validation process).

As explained in Table 21, stages from 1 to 3 are applied in our case, while stages 4 and 5 are left for further work as the proposed framework is at an initial stage of development.

3.2.3.2. Insights from the top-down approach

The overall product' circularity score at the top level will be derived from sub-scores, based on the Ellen MacArthur Foundation circular economy model and its four building blocks (BB), namely: circular product design; new business model; reverse cycles; enablers and favourable system conditions. These are key building blocks needed on a systemic level to shift business in a more circular direction. In fact, the successful implementation of circular models depends on the combined leveraging of these key building blocks (EMF, 2013). The Ellen MacArthur Foundation circular economy model was chosen because it is one of the most acknowledged in the literature at the moment and it has garnered a wide adoption by both academics and industrial practitioners (EMF, 2015). Also, each building block encompasses a wide spectrum of the circular economy complexity through different systemic levels - macro, meso, micro and nano - of the circular economy implementation. Particularly, to ensure a holistic view during the framework construction, main attributes selected to characterize the building blocks were positioned in regard with the levels of circular economy implementation, as illustrated in Figure 26.

Each of the four building blocks basically contributes to close the loop of products and materials in its own way but also needs the support of three remaining building blocks. As an example, a modular product that could be easily disassemble for remanufacturing or upgradability will need an efficient collection system, infrastructures and market interest or regulatory obligations to enter in a proper and effective circular loop. Furthermore, the first building block is, for instance, essential because product design is one of the most important sectors influencing global sustainability. Decisions made during product design and development not only relate to material and manufacturing choices but have also a far-reaching effect on the product's entire life cycle. An efficient circular economy requires the consistent eco-friendly design of products that increases lifetimes, provides the same service with less material requirement, and facilitates repair and resale, product upgrades, modularity and remanufacturing, component reuse, and finally, end-of-life recycling (Hass et al., 2015). Hagelüken et al. (2016), Moreno et al. (2016), the European Commission (EC, 2015a), the Ellen MacArthur Foundation (EMF, 2015), etc. outline also many additional factors that could impact circularity of goods, showing each of the four building blocks is a cornerstone for a successful circularity of products, components and materials. Numerous works have indeed been done previously in each of these four building blocks, but often in a separate manner. In fact, main weakness of existing methods, tools, and indicators, reviewed in sub-section 3.2.2, lies in the fact they do not cover these four building blocks simultaneously. The proposed framework is a timely and convenient opportunity to use best insights and practices from literature and to combine the strengths of complementary existing works and reflections to efficiently cover all aspects, or at least a wide spectrum, of products' circularity performance.

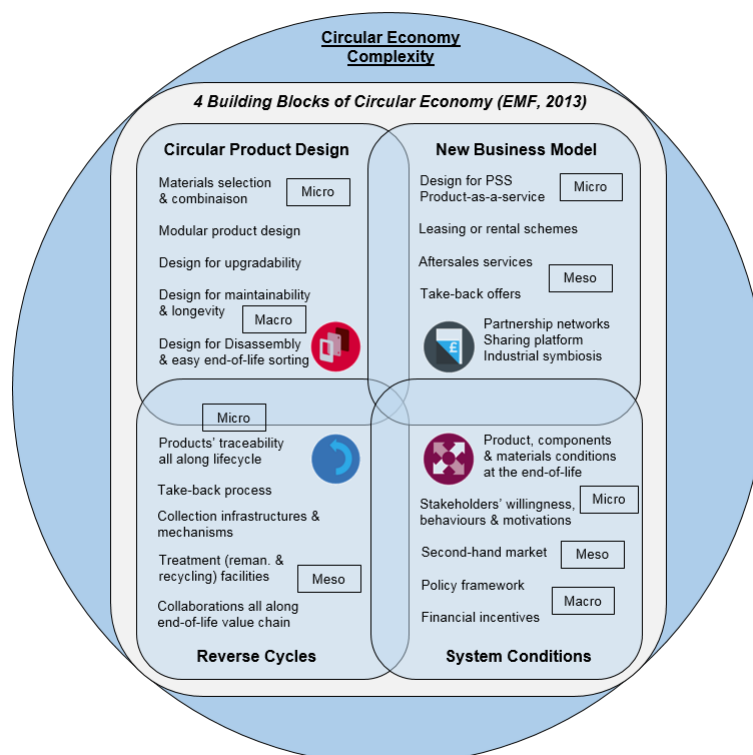

Figure 26 – 4 building blocks of the circular economy (EMF, 2013) and associated key attributes considered

3.2.3.3. Insights from the bottom-up approach

Data-driven approach consists in three main steps, as detailed in Figure 27, and starts with the identification of data providers and stakeholders in order to fit with industrial practices and to be as integrated as possible. Using a lifecycle thinking approach (i.e. pre-life, life and end-of-life stages are considered), data collection and construction are performed regarding not only product features but also markets, business models, existing collaborations, or regulations related to the product. An extract of data collection methods and collectable data types is available in Figure 27. Data collected are used to efficiently evaluate each building block through associated attributes. Consequently, the question of the transformation of qualitative information, provided by the bottom-up approach, into scores to feed the indicators, developed through the top-down approach, have to be tackled. One simple-yet-effective and intuitive solution is to create scales to translate qualitative statement into values that could be used in quantitative inputs for the indicators. Different conceptual rating scales exist such as Likert scale, Guttman scale, or Bogardus scale (Dawis, 1987). The Bogardus scale and Guttman scale are both cumulative scales, that is to say agreement with any item implies agreement with all preceding items. As such, there are therefore not suitable for our usage. Regarding our context, Likert scale seems to be an effective solution for a systematic and straightforward development of scales. Moreover, Likert scale is the most used and recognized in the design science field. In fact, a Likert item is simply a statement that the respondent is asked to evaluate by giving it a quantitative value. Here, each attribute is assessed through at least one multi-choice question. A score - from 0 to 5 - is given to each possible answer according Likert scales developed and illustrated in Table 22. When several questions are used to assess a single attribute, a non-weighted average is performed to give each attribute a score from 0 to 5. As an illustration, a practical example will be detailed in sub-section 3.2.4.

Table 22 – Scoring system associated to Likert scales and items developed

Number of possible answers	Assigned scores to the possible answers (the higher the contribution to circularity is, the higher the score is)						
	2	0			5		
3	0		2.5		5		
4	0		1.67		3.33	5	
5	0	1.25		2.5		3.75	5

3.2.3.4. Overview of the integrated and holistic framework

An overview of the developed framework - based on the hybrid top-down bottom-up approach - is shown in Figure 27, including different insights provided by the association of both approaches, and adapted to the context of products' performance measurement in the light of circular economy.

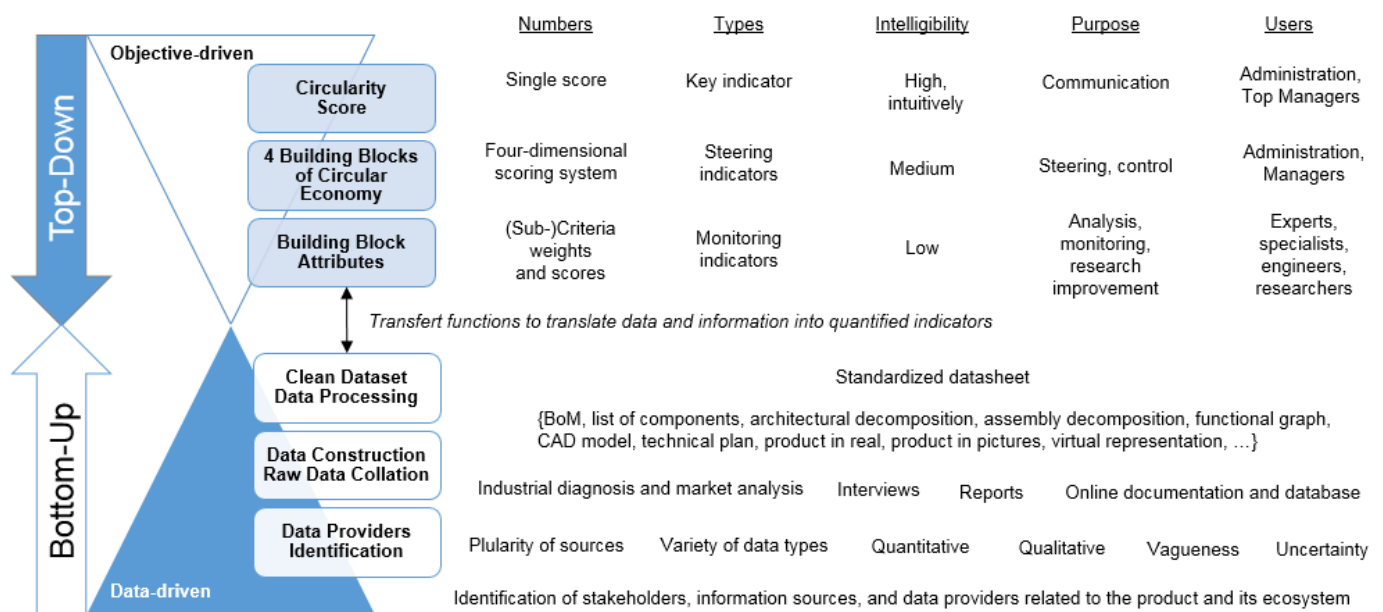

Figure 27 – Overview of the framework. Insights from top-down and bottom-up approaches.

3.2.4. Application

3.2.4.1. Case study presentation and context

The product whose circularity performance is measured through the developed framework is a catalytic converter for non-road mobile machinery. It is designed and developed by a large European construction equipments manufacturer. A catalytic converter is a key and mandatory component in motorized vehicles (e.g. cars, heavy-duty vehicles and non-road mobile machinery) which converts toxic pollutants (exhaust gases produced from motor combustion) into less or non-toxic gases. There are mainly composed by three components: the casing in stainless steel, the substrate in cordierite, and the coating containing precious metals groups such as platinum, essential element to realize the catalytic conversion and reduction. As emissions regulations are becoming increasingly strict not only in Europe and North America, but even in emerging countries, the quantity of precious metals in catalytic converters will rise to meet future standards. On this basis, a project manager, who has recently heard about the circular economy concept, wants to know how the catalytic converters they design and develop could be more circular to retain the value of precious metals in their business and thus benefit from both economic and environmental spinoffs related to platinum exploitation.

3.2.4.2. Operating principle and first practical use of the framework

The first experienced version of the framework is composed of 20 attributes (5 for each building blocks) - as shown in Figures 26 and 28 - that are acknowledged, through literature, to foster products' circularity performance. In inputs, each of the 20 attributes is assessed through one or several multi-choice questions and the rating is made according to Likert scales detailed in sub-section 3.2.3. For example, one of the questions assessing the attribute "take-back process" of the product, included in the building block "reverse cycle", is related to the organisation and maturity of the current tack-back process and proposes four possible answers, scored according to Table 22: (i) "non-existent", scored with a "0"; (ii) "marginal", scored with a "1.67"; (iii) "in development", scored with a "3.33"; (iv) "well-established", scored with a "5". For the first operational version of this framework, assumption is made that each building block and associated attributes have the same importance regarding product circularity performance. In fact, to make calculations as easy as possible, if the overall circularity indicator is scored out of 100, each building block is scored out of 25 and attributes out of 5. In outputs, the overall circularity score, representing the product performance potential in a context of circular economy, is not only available but scores for each of the four building blocks (BB#) and associated attributes (ATT#) are also provided, as shown in Figure 28.

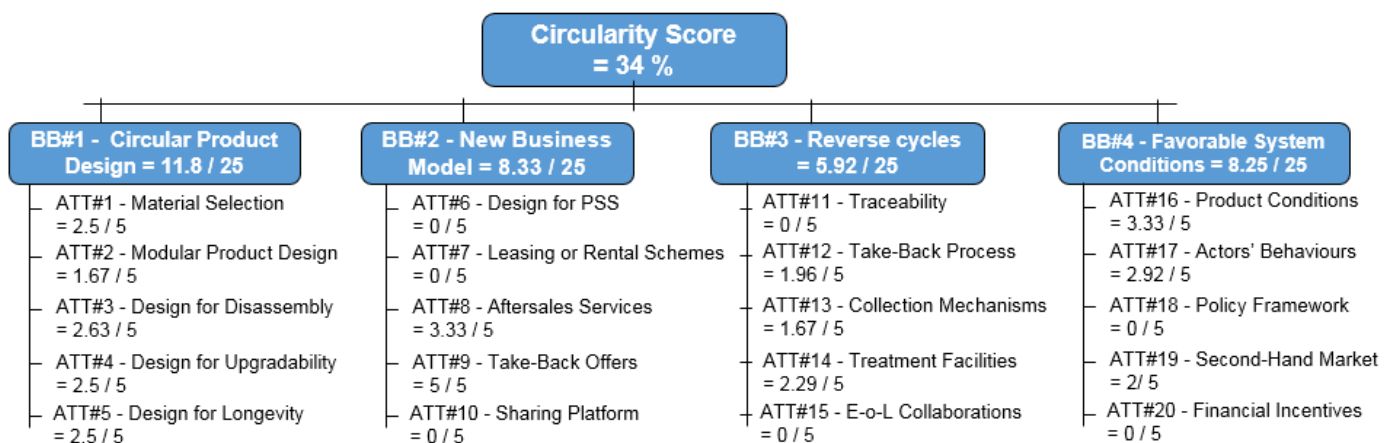

Figure 28 – Application of the framework on the case study and obtained results

3.2.4.3. Insights from the case study: findings and discussion

Contrary to existing tools reviewed in sub-section 3.3.2 and experienced in Saidani et al. (2017a), such as the MCI or the CEIP, which provide a single score, the developed framework has the advantage to deliver a multi-dimensional and transparent scoring system. Indeed, results reducing the overall product circularity performance into one single indicator should be interpreted with caution. Additionally, it could be considered as counterintuitive to use a single indicator for a concept like circularity which is clearly multi-faceted (Griffiths and Cayzer, 2016). That is the reason why we provide not only a single and overall circularity score but also complementary scores

associated to the four building blocks of the circular economy. Thus, it has the advantage to confront the user to the circular economy complexity gradually: a non-specialist in circular economy may have first a simple overview and trend of product's circularity, then one can look more precisely at the details, that is to say, at the four building blocks (BB) and their associated attributes (ATT). For instance, through this case study, some attributes that directly depend of company's and suppliers' responsibilities are rapidly identified (e.g. ATT#2 or ATT#6) as relevant actions levers for enhancing circularity performance. The results also show the importance of systemic considerations to reach a high and effective circularity. Here, even if take-back offers for catalytic converts are appealing (ATT#9 has a score of 5 out of 5) due to the high value of platinum, reverse cycles are for the moment poorly developed (BB#3 has a score of 5.92 out of 25) regarding the catalytic converters installed in non-road mobile machinery.

3.2.5. Conclusion and way forward

Measuring products and materials effective circularity could be performed by counting the proportions of products and materials that enter, or not, in a loop of the circular economy model (Graedel et al., 2011). However, at this stage - during product usage - it is often too late and difficult for designers to improve circularity, since the product is already on the market or at the end-of-life. This is the reason why it becomes helpful for industrial practitioners to have the means to estimate potential circularity performance during early phases of new or re-design product development. Even if existing tools provide a first and a rapid overview of products' circularity performance, they neither consider the whole complexity of circular economy paradigm, nor provide operational guidance for engineers, designers or managers willing to improve their products in the light of circular economy. The proposed framework experienced in this paper addresses this need by contributing to fill some of these gaps. The first version developed is promising since it has the advantages to be more holistic and more integrated. Indeed, thanks to the hybridization of a top-down - objective-driven - approach and a bottom-up - data-driven - approach, it simultaneously covers a wider spectrum of the circular economy than existing tools, and considers industrial practices and available data. Nevertheless, this research project is still at an embryonic stage and, as the framework has the convenience to be modular, flexible and therefore easily extendable, several worthwhile areas are left for future improvement:

- Refine the overall circularity score: as there are different ways to close the loop in a circular economy, the overall circularity score should go further than a single and overall score that considers all different possible closed-loops at the same level with no differentiation any;
- Improve and validate the scoring system: further investigations and tests with industrial practitioners should be performed in order to enhance scoring system, define appropriate aggregation method (e.g weighting or fuzzy logic) and therefore ensure more robustness;
- Consider uncertainties in the circularity score and assessment methodology due to the time scale issue of long life products (e.g. available technologies and actors involved might change between product development phases and actual end-of-life);
- Provide explicit design guidelines: based on building blocks and attributes scores, outputs should orientate industrial practitioners towards best available methods and tools to enhance product circularity performance, such as a state-of-the-art eco-innovation manual (O'Hare et al., 2014);
- Highlight involved stakeholders for each attribute, and beneficiaries of the product circularity, including manufacturers, politics, users, recyclers, retailers, society, environment;
- Ensure not only the completeness of indicators but also the consistency between an improvement in circularity score and benefits from sustainable development viewpoint.

3.3. TAXONOMY AND APPROPRIATE CHOICE OF CIRCULAR ECONOMY INDICATORS

3.3.1. Introduction

3.3.1.1. Context and motivations

3.3.1.1.1 A circular economy in transition, for the sake of sustainable development

In 1987, the Brundtland Commission called for the creation of new ways to assess progress toward sustainable development (SD), resulting in the emergence of a wide variety of sustainable development indicators (SDI) advanced by academics, companies, environmental agencies and governmental organizations. (Hardi and Zdan, 1997; Jesinghaus, 2014). Now, the adoption of circular economy (CE) practices appears as a timely, relevant and practical option to meet the goals of SD. In fact, Schroeder et al. (2018) showed that the implementation of CE approaches can be applied as a “toolbox” for achieving a sizeable number of SD targets. Accordingly, the CE paradigm is being extensively explored by institutions as a possible path to increase the sustainability of our economic system (Elia et al. 2017). To some, e.g. Linder et al. (2017), the ultimate goal of a CE is a SD. Sustainability can be regarded as an abstract concept for which many stakeholders find difficult to create targets for, in the way it can have diverse meanings to different stakeholders (Earley, 2017). Similarly, the analysis of 114 CE-related definitions by Kirchherr et al. (2017) provides a quantitative evidence that CE means also different things to different people. Nonetheless, both concepts need appropriate means of evaluation to forge ahead. Bocken et al. (2017) outline the importance of indicators in taking the circularity to the next level. In fact, advancing the discussion of the CE to a higher level requires to reach a shared understanding and common language (Blomsma and Brennan 2017). For instance, assessment methods such as the use of indicators can play a key role in generating a deeper understanding and integration of the CE, e.g. in helping industrial practitioners setting suitable circular targets.

3.3.1.1.2 A growing need for circularity indicators: history and current issues

The measurement of circularity is at the center of many questions recently raised by researchers, such as: how to measure the progress of the transition towards a CE? (Potting et al. 2016); how should we measure its performance since its objectives – e.g. reduce, reuse, recycle – are substantially different from those in the traditional linear economy? (EASAC, 2016); how is circularity measured in businesses and economies? (Bocken et al. 2017); how should product-level circularity be measured? (Linder et al., 2017). According to the EASAC (2015), companies may lack the information, confidence and capacity to move to CE solutions due to a lack of (i) indicators and targets, (ii) awareness on alternative circular options and economic benefits, and (iii) the existence of skills gaps in the workforce and lack of CE programmes at all levels of education (e.g. in design, engineering, business schools). In fact, information exchange is actually cited as a constraint to the success of CE practices (Winans et al. 2017). Consistently, without an evaluation framework or support from the industry, CE initiatives are not sustained. By conducting an analysis of indicators that may be appropriate for monitoring progress towards a circular economy, the EEA (2016) noticed the current knowledge base on the CE is rather fragmented. The EEA stated that more structured information is thus needed to inform decision-making and to improve circular business investment decisions. This statement concurs with Haas et al. (2015) for who it is imperative to determine the current state of circularity so that one can have a benchmark against which to track improvements.

On this basis, it is now commonly acknowledged that to promote CE, the introduction of monitoring and evaluation tools like indicators to measure and quantify this progress becomes essential (Walker et al. 2018; Acampora et al. 2017; Cayzer et al. 2017; Akerman, 2016; Di Maio and Rem, 2015; Su et al. 2013; Geng et al., 2012). The European Commission has also recognized this need for circularity indicators through its action plan for the CE (EC, 2015a) stating that “to assess progress towards a more circular economy and the effectiveness of action at EU and national level, it is important to have a set of reliable indicators”. Additionally, to Wisse (2016), it is important to measure the effectiveness of circular strategies deployed at national, regional, and local levels. As a consequence, more and more attempts at developing indicators for the CE concept are found in the literature (Akerman, 2016). Actually, numerous circularity indicators – as listed in Appendix C – have been developed in the last few years, but in an inconsistent manner regarding their scopes, purposes, and possible applications. Yet, the lack of academic and scientific knowledge on CE indicators is a barrier for further implementation (Akerman, 2016). In this line, Linder et al. (2017) underline an urgent need to carefully review the available solutions for measuring circularity, so as to find solutions to their varying weaknesses, or to identify some complementarities. As a response to this recent growing number of fuzzy and multifaceted C-indicators, a clarification on these indicators would be appreciated to facilitate therefore their dissemination and proper usages.

3.3.1.2. Objectives and definitions

3.3.1.2.1 Research gaps and contributions

Dealing with the humongous number of available SDI, Bell and Morse (2008) allege that "now we have developed so many indicators that we are having to ask ourselves, what exactly are we measuring". Without entering into a philosophical debate raised by these authors, in regard to the truth behind the indicators – "your truth is not necessarily my truth, truth is a relative term, and indicators are also relative devices" – which would be way out of the scope here, it makes sense and seems appropriate to clarify here what the existing and so called C-indicators are measuring exactly. Even though the research area on C-indicators is in expansion and is becoming increasingly discussed through the academic literature, there is still a lack of in-depth investigation on their completeness, classification, possible complementary and applicability from an industrial or political perspective. This is partly due to the magnitude of the CE paradigm. Indeed, because of the various and diverse definitions of the CE, some C-indicators are not always very explicit on what they aim to measure, or are not properly positioned e.g. regarding the different principles of the CE. As a consequence, they may be interpreted into many different ways.

The main contribution of this article is therefore to trim the fuzziness on current C-indicators and thus to clear up their utility in an organized, understandable and usable manner. To do so, a proposed taxonomy of C-indicators, adapted to users – either industrialists (e.g. engineers, designers, managers) or policy-makers – and its associated selection tool, are developed and presented in detail. This actual challenge is in agreement with Behrens et al. (2015) underlining the multitude of existing indicators can create confusion, or by Geisendorf and Pietrulla (2017) advancing the measurement of circularity is considered to play a crucial role in the transition, but there is no prevailing opinion on which operationalization to use. We do understand that finding suitable indicators can be a difficult task in the light of this important number of available C-indicators, but we argue it could be facilitated by the design of an appropriate classification scheme and associated selection tool.

The sub-section 3.3 is structured in the following way, as illustrated in Figure 29. The specific terms used all along this study are defined hereafter. Sub-section 3.3.2 exposes the research methodology to identify, analyse and characterize the C-indicators, as well as to construct this taxonomy. Relevant literature is then discussed in sub-section 3.3.3: the particular interest and applicability of indicators for an enhanced CE are developed, and prior taxonomies in sustainability and eco-design related fields are reviewed. Sub-section 3.3.4 details the proposed taxonomy and its associated selection tool. Sub-section 3.3.5 uses the classification and characterization of C-indicators to discuss and question more in-depth their potentiality in the CE transition, as well as their current limitations. Sub-section 3.3.6, hence, opens on future areas of investigation to advance further the CE implementation.

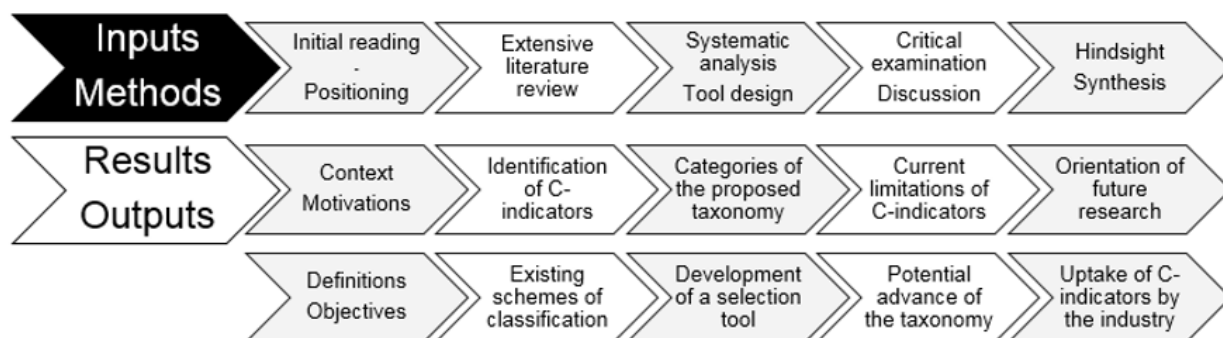

Figure 29 – Synopsis of the sub-section 3.3 and research process in developing a taxonomy of C-indicators

3.3.1.2.2 Definition of terms and positioning for this study

The measurement of the circularity performance can lead to several interpretations, as the CE is a fuzzy defined concept. Furthermore, a critical examination of the literature on the CE made by Hass et al. (2015) reveals a lack of precise definitions and criteria for assessing measures to improve the circularity of the economy. Therefore, let us first clarify the terms that are used all along this article.

3.3.1.2.2.1 Positioning on circular economy definitions

CE definitions have been comprehensively reviewed by scholars. Sacchi et al. (2018) pointed out the lack of consensus on terminologies and definitions for the CE among scholars, politicians and practitioners investigating

the trends, gaps, and convergence of the CE literature – through a sample composed of 327 academic articles. Similarly, Kirchherr et al. (2017) reviewed 114 circular economy definitions which were coded on 17 dimensions. In this article, we refer to the uniting and synthesized definition they proposed: CE is defined as “an economic system that replaces the ‘end-of-life’ concept with reducing, alternatively reusing, recycling and recovering materials in production/distribution and consumption processes. It operates at the micro level (products, companies, consumers), meso level (eco-industrial parks) and macro level (city, region, nation and beyond), with the aim to accomplish sustainable development, thus simultaneously creating environmental quality, economic prosperity and social equity, to the benefit of current and future generations”.

3.3.1.2.2.2 *Indicators and related semantic field*

A similar story can be told for defining indicators. In fact, the term “indicator” has been defined in various ways in the literature (Park and Kremer, 2017; OECD, 2014; Joung et al. 2013; Singh et al. 2012; EEA, 2003) and there is no one widely agreed upon definition for an indicator. This article adopts the global view of the OECD (2014) where an indicator is defined as “a quantitative or qualitative factor or variable that provides a simple and reliable means to measure achievement, to reflect changes connected to an intervention, or to help assess the performance of a development actor”. An indicator framework entails a collection of indicators that “conveys a broader purpose and significance to the individual indicator and provides a comprehensive picture of some entity” (Wisse, 2016). Therefore, indicators simplify information, can help to reveal complex phenomena, and provide an effective tool for measuring progress and performance. Purposes and benefits of the use of indicators are further developed in sub-section 3.3.3.1.

Also, it is important to notice that other terms are found to describe assessment tools, such as “measures”, “metrics”, “index”, or “indices”. In fact, the use of suitable synonyms during the research process (see sub-section 3.3.2.1) is fundamental to ensure a comprehensive identification of existing C-indicators. Even if slight semantic differences are noticed between those terms, most researchers use them interchangeably. As such, for the wording used all along this article, the term indicator is privileged for a better understanding but also because of its generality and common use in the literature. To deal with and manage properly a significant number of indicators, it can be useful to define a classification (i.e. a taxonomy or a typology) of indicators in order to ease their selection process (Lützkendorf and Balouktsi, 2017).

3.3.1.2.2.3 *Taxonomy and/or typology*

The same goes also for the terms “typology” and “taxonomy” that are often used interchangeably, even if subtle differences can be noticed between these two terms. Typology is the study or system of sorting a large group into smaller groups according to similar features or qualities (Davidson, 1952). Typology creates useful heuristics and provides a systematic basis for comparison. Taxonomy is related to an empirical scheme of classification, suitable for descriptive analysis (Smith, 2002). Although often associated with the biological sciences, taxonomic methods are also employed in numerous disciplines that face the need for categorization schemes. In the scientific literature related to sustainability indicators, eco-design tools or even circular economy business model, the term “taxonomy” is mainly used when it comes to the classification of such indicators, tools or business models, e.g. Rousseaux et al. (2017), Urbinati et al. (2017), Moreno et al. (2016), Bovea and Pérez-Belis (2012). As such, the term “taxonomy” has been preferred to describe the identification, characterization and classification of C-indicators in the present article.

3.3.2. **Materials and methods**

3.3.2.1. *Research methodology*

The research method employed in this article is a systematic and extended literature review. The function of a review article is to synthesize literature, to identify research gaps, to highlight emerging patterns, and to recommend new research areas. Here, for the sake of completeness in the identification and screening of C-indicators, the research process includes:

- Combinations of following terms: ‘circular economy’, ‘circularity’, ‘evaluation’, ‘assessment’ ‘measure’, ‘indicators’, ‘indices’, ‘index’, and ‘metrics’ for the database search in title, abstract and keywords fields.
- Academic and non-academic databases: the review was based on both peer-reviewed journals articles or conferences papers and on grey literature. Indeed, in addition to academic literature, complementary sources (e.g. reports, policy communications) were consulted to widely cover the existing knowledge on C-indicators.

As such, articles and C-indicators included in this study that are not necessary peer-reviewed – but will be indicated as such, for transparency, in the taxonomy.

Note that this study is limited to C-indicators and related publications in English, and the age of materials reviewed (time coverage) is from the emergence of C-indicators, i.e. 2010 to the submitted date of this research, viz. May 2018. All criteria and associated research items used for the literature review are summarized in Table 23.

Table 23 – Criteria and research filters used to identify C-indicators

Criteria		Research item and filter
Key words		{circular economy OR circularity} AND {indicators, indices, index, metrics, measure, assessment, evaluation}
Databases	Academic	Science Direct, SAGE, Springer, Taylor and Francis, Wiley, Emerald, JSTOR, and Google Scholar.
	Non-academic	Web-pages and reports from lobby organizations (e.g. the Ellen MacArthur Foundation), research organisations (e.g. the European Environmental Agency), and governmental agencies (e.g. the European Commission) through Google searches.
Language		English
Geographic scope		Worldwide
Publication years (age of material)		(2000 –) 2010 – May 2018

In addition to the systematic literature review carried out to identify the existing C-indicators, a supplementary literature survey was done in parallel – as shown in Figure 30, illustrating the steps of the research process – in order to get inspiration from studies related to the design and proposal of taxonomies previously developed, notably in the fields of sustainability and eco-design. The terms “taxonomy”, “typology” and “classification”, plus “sustainability” and “eco-design” were hence used as a way of expanding the literature search.

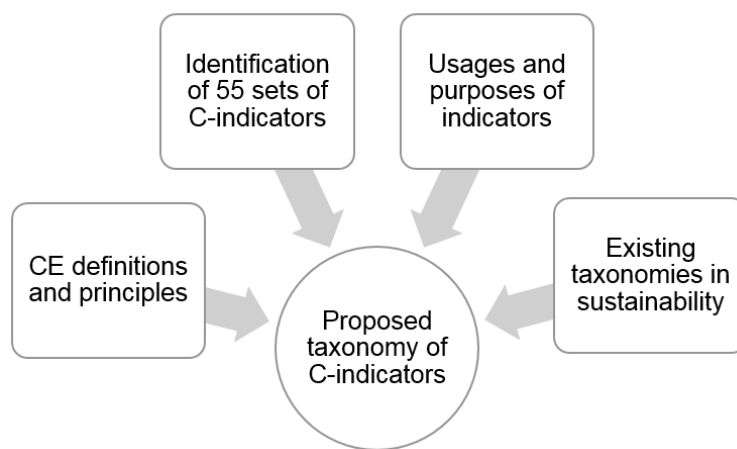

Figure 30 – Sources of inspiration for the proposed taxonomy of C-indicators

3.3.2.2. Material investigation and bibliographic analysis

The analysis found 55 sets of C-indicators, coming from 27 journal articles, 2 conference papers, 1 master thesis, 7 technical reports, and 12 websites, tools (n.b. some publications include more than one set of C-indicators). Although the research period starts in 2000, the first specific publication on C-indicators found was from 2010. Since, the increasing number of studies published reveals a clear interest on this topic. Figure 31 shows the distribution of identified sets of C-indicators by origins of development, coverage of CE levels, geographic scope (considering the affiliation of the first author) and time period, confirming the research area of C-indicators is in expansion. Note that among the 20 sets of C-indicators at the micro level of CE, 17 of them have been developed by European contributors. On the contrary, among the 19 sets of C-indicators at the macro level of CE, 9 have been developed by Chinese actors. Indeed, academic publications on the macro level of CE come mostly from China-related cases (Sacchi et al. 2017).

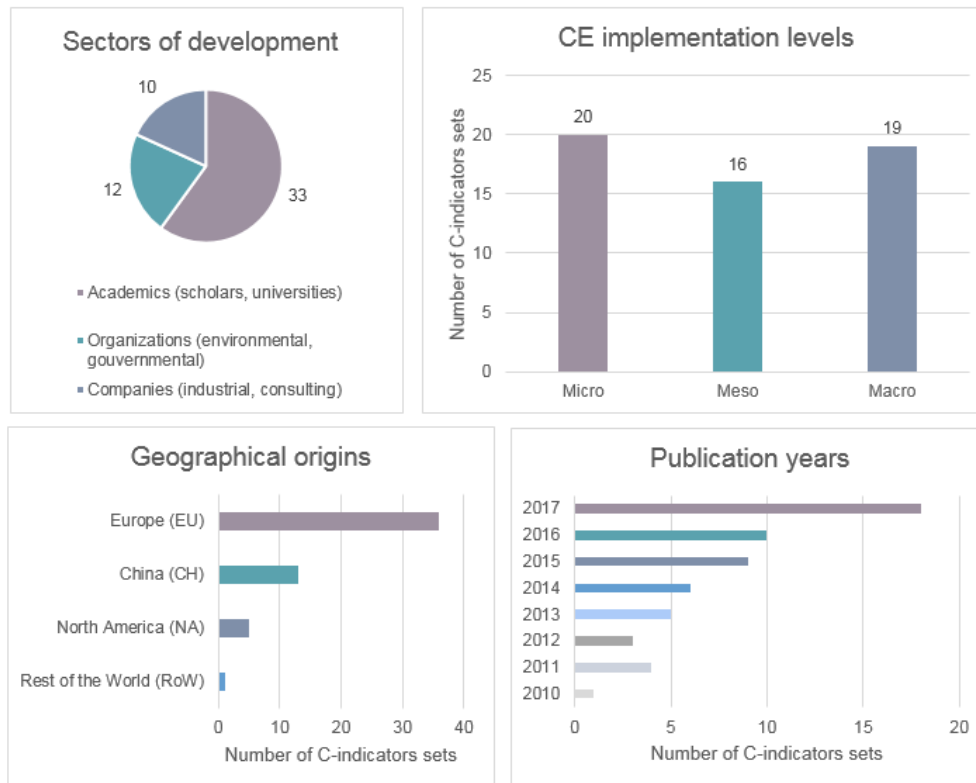

Figure 31 – Bibliographical study: distributions of the C-indicators identified

Then, the information retrieved from existing C-indicators – by collecting and analysing all references found, and carefully examining the C-indicators features, principles and possible applications – was structured to propose a classification of C-indicators to facilitate their selection, use and appropriation by industrial practitioners, decision-makers, investors and/or policy-makers interested in moving towards more circular practices.

3.3.3. State of the art

3.3.3.1. Indicators: purposes, usages, and benefits

The purposes and advantages offered by the use of indicators have been extensively discussed in the literature. Let us summarize first their principal generic features and benefits, and then especially in regard to the measurement of the CE performance. In fact, indicators have: the ability to summarize, focus and condense the complexity of the dynamic environment to a manageable amount of meaningful knowledge (Singh et al. 2012), that is to say, the potentiality of relaying complex information in a simplified and useful manner (Wisse, 2016); the capability to communicate, raise public awareness on important issues (e.g. potential environmental impacts), and to indicate whether or not targets will be met (EEA, 1999). Moreover, indicators are a powerful tool which can be used in a wide variety of ways such as in the assessment, improvement and monitoring of the sustainability (e.g. economic, environmental, and social) and circularity performance (e.g. resource use, resource loss, renewability) (Elia et al. 2017; Arnsperger and Bourg, 2016). Indicators can also be used as managerial and decision-making instruments to: report or pilot activities; define goals, quantitative targets, and track progress; arbitrate potential trade-offs and impact transfers; inform investment choices and guide policy-making; communicate externally; support education and training. Last but not least, according to Wass et al. (2014), indicators contribute to the need of short cuts and rules of thumb to support decision-making.

Specifically in regard to the CE, C-indicators can function as a springboard for a transition toward more circular practices, thanks to their different potential uses (Linder et al. 2017): as a key performance indicators (to benchmark and compare industries), as product labels (to inform consumer choices), as a basis for regulatory change. For Thomas and Birat (2013), they are essential to capture the stakes of reuse and recycling at the end-of-life of products during decision making. In response to the complexity related to the CE paradigm, considering the interrelations between different actors all along the value chain implied in the CE implementation, C-indicators can provide a standardized language to simplify information exchange, understanding, and thus ease this transition (Verberne, 2016). With such a baseline in place, businesses adopting CE principles can collaborate, advance

together, and set targets against which progress towards circularity can be measured. Walker et al. (2018) add that the aim of C-indicators is to inform life cycle design decisions without the need for a full and time-consuming life cycle analysis.

3.3.3.2. *Taxonomies in sustainability and eco-design*

Taxonomies facilitate the diffusion of organised knowledge and allow to achieve a higher maturity level on a given concept (Xavier et al. 2015). Different methodologies of classification have been proposed over the last decades, notably in response to the growing number of sustainable development indicators and eco-design tools. Therefore, before starting the review and classification of C-indicators, let us take inspiration from previous work on developed categorisation schemes of indicators and tools in the fields of sustainable development and eco-design.

3.3.3.2.1 *Classification of sustainable development indicators*

Given the number and diversity of sustainability indicators that have been developed, it was becoming more and more difficult for decision- and policy-makers to grab their meaning and relevance. Therefore, some means of structuring and analysing indicators were requested (EEA, 1999) and have emerged. Sustainability indicators often appear classified in regard to three dimensions (Ruiz-Mercado, 2012) e.g. Krajnc and Glavic (2003) who classified 89 indicators according to environmental, economic and social areas; or Sikdar (2003) who created a hierarchical indicator system of these three dimensions depending on how many aspects are measured by the indicator.

Nonetheless, other categorisation schemes have been proposed in the literature. The EEA (2003) classified sustainability-related indicators into five groups: (i) descriptive indicators (including state, pressure or impact variables, expressed in absolute scale); (ii) performance indicators (using the same variables as descriptive indicators but are connected with target values, measuring the distance between the current situation and the desired situation); (iii) efficiency indicators (providing insight into the efficiency of products and processes in terms of – economic and environmental – resources, emissions and waste per unit output); (iv) policy effectiveness indicators (related the actual change of environmental variables to policy efforts); and (v) total welfare indicators. Singh et al. (2012) gave an overview of various sustainability development indicators (SDI) and grouped them into the following categories: innovation, knowledge and technology indices; development indices; market and economy based indices; eco-system based Indices; composite sustainability performance indices for industries; product based sustainability index; sustainability indices for cities; environmental indices for policies, nations and regions; environment indices for industries; social and quality of life based indices; energy based indices; ratings. Additionally, the classification and evaluation of SDI can be done based on the following dimensions: aspects of the sustainability to be measured by indicators; techniques used for development of index like relative or absolute, quantitative or qualitative, unidimensional or multidimensional; measurement of sustainability in terms of input (i.e. means) or output (i.e. ends); clarity and simplicity in its content, purpose and method; availability of data (Singh et al. 2012).

In the meantime, new sets of sustainability indicators have been developed and this classification debate still prevails today (Park and Kremer, 2017). Indeed, despite the variety of available environmental sustainability indicators, Park and Kremer (2017) notice the absence of a commonly accepted categorization framework often creates confusion and inhibits indicator deployment in practice. As a solution, using text-mining techniques, 55 environmental sustainability indicators were extracted from extant literature and grouped into 5 relevant categories to clarify their usage and facilitate their application in companies: (i) environmental impact and chemical release; (ii) pollution from emissions and wastes; (iii) end of life management and chemicals usage related indicators; (iv) raw materials and facility management related indicators; and (v) energy and water management.

3.3.3.2.2 *Classification of eco-design methods and tools*

Following the emergence of eco-design tools that started in the 1990s, several authors have then proposed various classification systems of such tools since 2000. For example, Janin (2000) determined two main categories: environmental assessment and improvement. Hernandez-Pardo et al. (2011) proposed a use-oriented classification regarding three properties: complexity, type, and main function of the eco-design tools.

Bovea and Pérez-Belis (2012) reviewed and classified eco-design assessment tools to facilitate their integration into the product design process. With the intention of providing designers with a guide to selecting the eco-design tool that best fits a specific application, a taxonomy was made according to criteria such as: (i) the method used for

the environmental assessment; (ii) the product requirements that need to be integrated in addition to the environmental ones; (iii) whether the tool has a life cycle perspective; (iv) the qualitative and quantitative nature of the environmental evaluation; (v) the stages of the conceptual design process where the tool can be applied; and (vi) whether the tool has been applied to a case study.

According to Rousseaux et al. (2017), all these classifications are generally intended for engineers and designers to help them in their search for ecodesign solutions, but are hardly linkable to the various functions of a company. On this basis, Rousseaux et al. (2017) updated and consolidated the literature review and analysis on eco-design tools by characterizing 629 eco-design tools into a taxonomy, classifying these tools into 22 categories of ecodesign tools and 5 departments in companies. Furthermore, a web-based guide was made available freely to assist companies in finding the most suitable eco-design tools according to their needs.

3.3.3.3. Taxonomies of CE-related tools

3.3.3.3.1 Classification of CE business models and CE design strategies

To inform and help industrial practitioners (e.g. managers, engineers, designers) in selecting or defining their future circular product design and circular business models, researchers have developed taxonomies to identify what business models or design strategies are the most suitable to their needs. Lewandowski (2016) presented an extensive analysis of 20 types of circular business models, identifying and classifying the CE characteristics according to a business model structure, such as the business model canvas. More recently, Urbinati et al. (2017) proposed a taxonomy of CE business models based on the degree of adoption of circularity along two major dimensions: (i) the customer value proposition and interface; and (ii) the value network. Lüdeke-Freund et al. (2018) conducted a review and analysis of 26 existing CE business models, which resulted in a taxonomy, relying on the six main patterns identified for these circular business models: (i) repair and maintenance; (ii) reuse and redistribution; (iii) refurbishment and remanufacturing; (iv) recycling; (v) cascading and repurposing; and (vi) organic feedstock business model patterns.

In a complementary manner, Moreno et al. (2016) proposed a taxonomy of Design for X (DfX) approaches contributing to the implementation of circular design. The taxonomy is based on three DfX approaches: (a) design for resource conservation; (b) design for slowing resource loops; and (c) whole systems design. The taxonomy includes as well five circular design strategies: (i) design for circular supplies; (ii) design for resource conservation; (iii) design for long life use of products; (iv) design for multiple cycles; and (v) design for systems change. Then, a circular design tool (Moreno et al. 2017) was built to present this taxonomy in a non-scientific language with the aim to educate and inspire during the concept development phase. Hollander et al. (2017) depicted a new taxonomy of design approaches for product integrity in a CE, contributing to a deeper understanding on the role of product design in a CE. Thus, their proposed taxonomy provides a basis for comparison and communication that can help product designers make design decisions that will facilitate the transition from a linear to a more CE.

3.3.3.3.2 First inventories, reviews and critical analysis of C-indicators

Hass et al. (2015) proposed a set of key indicators to track physical resources, where the degree of circularity of the global economy is measured as the share of actually recycled materials in the total of processed materials. It has been estimated only 6% of all materials processed by the global economy are recycled and contribute to closing the loop. Most of the processed materials (66%) left the global economy as wastes and emissions and a large fraction (27%) was attributed to stocks of buildings, infrastructures, and other products with long life spans. ScoreLCA (2015) identified four stakes in the assessment of CE loops – loops evaluation, loops ranking, loops implementation, loops monitoring – each one with its own methodological stakes. The first objective is to evaluate the environmental, economic and social impacts of loops. The second one is to compare and prioritize different types of loops and to identify the most pertinent solution. The third one is to help the implementation of the selected solutions. Finally, the last objective is to evaluate the evolution of the systems and the performance of the implemented loops. Three major categories of loop assessment methodologies were identified: (i) material flow analysis; (ii) life cycle assessment; and (iii) evaluation and monitoring indicators. Similarly, Wisse (2016) identified three prominent types of frameworks for measuring the CE: (i) material flow accounts; (ii) eco-efficiency indicators; and (iii) hybrid indicators. Reviewing both sustainability and C-indicators, Akerman (2016) established differences between CE core indicators and adapted sustainability indicators. He divided these indicators into five categories: (i) resource productivity; (ii) environmental aspects; (iii) economic opportunities; (iv) social aspects; and (v) waste management. The EASAC (2016) underlined that many available indicators may be appropriate for monitoring progress towards a CE and grouped them into sustainable development, environment, material flow analysis,

societal behavior, organizational behavior and economic performance. Yet, only macro-level indicators were considered and other aspects, such as product circularity performance, were not directly considered in these indicators. Banaité and Tamošiūnienė (2016) analysed and provided insights on what should be taking into account when setting up circular economy indicators, through a C-indicators selection model, but at a macro level too.

Before proposing a new C-indicator at a micro level – the PCM (n.b. all acronyms of C-indicators are detailed in Appendix C) – Linder et al. (2017) reviewed five existing product-level C-indicators according to the following criteria, chosen for scientific robustness: construct validity, reliability, transparency, generality, and aggregation principles. Three existing C-indicators – the MCI, CET, and CEIP – to measure product circularity performance have been as well tested by Saidani et al. (2017a) on an industrial case study and then criticized regarding both their practical applicability in industry and compliance with CE principles. Walker et al. (2018) have tested and compared the results given by these three C-indicators with an LCA-based method for the assessment of material circularity. Elia et al. (2017) proposed a taxonomy of methodologies which can be used to measure the environmental effectiveness of CE strategies, based on two factors: (i) the index-based method typology - distinguishing single synthetic indicators and sets of multiple indicators usually divided into several categories; (ii) the parameters to be measured – such as material and energy flow, land use and consumption, and other life cycle based. Pauliuk (2018) proposed a dashboard of C-indicators at the organizational level, completing as such the BS 8001:2017 – standard for implementing CE in organizations – which has weak links to existing accounting and quantitative assessment frameworks, stipulating also that organizations are solely responsible for choosing appropriate CE indicators. The dashboard was set up to select core indicators for the quantitative assessment of CE strategies for organizations and product systems. For instance, for the goal “maintain financial value”, the CEI is recommended as a possible indicator, and for the goal “maintain nonfinancial value”, the MCI is indicated. Methods of calculation and references are also given in the dashboard to facilitate the use of such indicators.

In summary, a complete overview of C-indicators reviewed in the literature is available in Table 24. In total, 28 different C-indicators and associated framework have been reviewed by several authors. In this study, through an extensive literature review, 55 sets of C-indicators have been identified, resulting – to the best of our knowledge – in the most comprehensive analysis of C-indicators so far. They are all listed in Appendix C. The uncounted variety among these indicators provides a relevant basis to start their characterization and classification within an appropriate taxonomy of C-indicators.

Table 24 – Existing reviews, experimentations and critical analyses of C-indicators

References Authors and Year	Type of publication or journal's name	Type of review and analysis	Number and names of C-indicators considered (acronyms are detailed in appendix C)
CIRAIG, 2015	Environmental Report	Description	2: MCI, CA
Otero, 2015	Master's Thesis	Description and comparative analysis	4: MCI, ICT, CECAC, CA
Akerman, 2016	Master's Thesis	Description and comparative analysis	4: MCI, CA, NCEIS, IPCEIS
Wisse, 2016	Master's Thesis	Description and comparative analysis	4: FCIM, NCEIS, IPCEIS, EPICE
Banaité, 2016	Journal of security and sustainability issues	Description	5: BCI, ECEDC, ERCE, DEA, IEDCE
Cayzer et al. 2017	International Journal of Sustainable Engineering	Description and critical analysis, plus experimentation on the developed indicator	7: CEIP, CET, MCI, EVR, RDI, NCEIS, IPCEIS
Saidani et al. 2017a Saidani et al. 2017b	MDPI Recycling Int. Conference Paper	Description, experimentation and critical analysis	4: MCI, CET, CEIP, CPI
Linder et al. 2017	Journal of Industrial Ecology	Description and critical analysis, plus experimentation on the developed indicator	6: CEI, MCI, C2C, EVR, RP, PCM
Acampora et al. 2017	Int. Conference Paper	Description and relevance to a specific sector	8: CEPI, RPI, CEIP, CET, CEI, MCI, EISCE, FCIM
Elia et al. 2017	Journal of Cleaner Production	Description and classification	13: RPI, CEI, MCI, EVR, HLCAM, RP, FCIM, NCEIS, IPCEIS, ZWI, RCEDI, EPICE, EWMFA
Azevedo et al. 2017	MDPI Resources	Description and classification	13: RPI, CEI, MCI, EVR, HLCAM, RP, FCIM, NCEIS, IPCEIS, ZWI, RCEDI, EPICE, EWMFA
Pauliuk, 2018	Resources, Conservation and Recycling	Description and classification	12: CEPI, CEIP, PCM, CEI, MCI, C2C, EVR, RDI, EISCE, NCEIS, IPCEIS, ECEDC
Walker et al. 2018	MDPI Sustainability	Description, experimentation and critical analysis	6: CEIP, CET, CEI, MCI, C2C, VRE

3.3.4. Proposed taxonomy of C-indicators and associated selection tool

In complementarity with existing taxonomies of eco-design tools (e.g. Rousseaux et al. 2017; Bovea and Pérez-Belis, 2012), circular economy business models (Urbinati et al. 2017), and to supplement the first reviews of C-indicators (Pauliuk, 2018; Elia et al. 2017), a taxonomy of C-indicators is proposed and detailed hereafter. In fact, on the grounds of the increasing number of C-indicators developed recently – with different scopes, purposes and usages – the objective is to provide clarity on these indicators, so as to guide CE practitioners towards the right set of indicators, regarding their needs and requirements. As such, the review and analysis of over 50 sets of C-indicators developed and used by academics, companies, environmental organisations or even governmental agencies, have led to their classification into a need-based taxonomy driven by the usage of such indicators, including 10 categories to differentiate and specify these C-indicators, inspired by the CE principles and indicators characteristics. For practical use, a computer-based query tool has been designed to help identifying the most relevant indicators regarding the user’s needs, among the databank of 55 sets of C-indicators.

3.3.4.1. Definition of the categories for the proposed taxonomy

All the 10 categories to classify, differentiate and orient the use of proper C-indicators are summarized in Table 25. Categories from #1 to #4 are specific to the CE paradigm. Categories #5 to #6 are related to the particular usages and fields of application of these C-indicators. Categories #7 and #8 are linked to the basic features of indicators. Category #9 is dedicated to the assessment framework associated to each C-indicator, facilitating for instance its computation. Category #10 specifies the background in which each C-indicator has been developed.

Table 25 – Categories for the proposed taxonomy of C-indicators

Categories (criteria)	#1 - Levels (micro, meso, macro)	#2 - Loops (maintain, reuse/reman, recycle)	#3 - Performance (intrinsic, impacts)	#4 - Perspective (actual, potential)	#5 - Usages (e.g. improvement, benchmarking, communication)
	#6 - Transversality (generic, sector-specific)	#7 - Dimension (single, multiple)	#8 - Units (quantitative, qualitative)	#9 - Format (e.g. web-based tool, Excel, formulas)	#10 - Sources (academics, companies, agencies)

First, C-indicators can be divided into micro-level (organization, products, and consumers), meso-level (symbiosis association, industrial parks) and macro-level (city, province, region or country) indicators (Kirchherr et al. 2017). Indeed, CE models and implementations are usually performed at three systemic levels (Acampora et al. 2017; Linder et al. 2017; Ghisellini et al. 2016). As such, these different levels of implementation of CE require the development of different indicator frameworks that measure the CE performance at national, regional, and more local levels (Wisse, 2016; Su et al. 2013; Geng et al. 2012). Examples of C-indicators at these three levels are given in Table 26.

Table 26 – Categorisation of C-indicators according to the micro-, meso- and macro- levels of the CE

Levels	Applications	Example n°1	Example n°2	Example n°3
Macro	Cities, Regions, Nations	Evaluation of CE Development in Cities (ECEDC)	Regional CE Development Index (RCEDI)	National CE Indicator System (NCEIS)
Meso	Businesses, Industrial Symbiosis	Sustainable Circular Index (SCI)	Circular Economic Value (CEV)	Circle Assessment (CA)
Micro	Products, Components, Materials	Circular Economy Indicator Prototype (CEIP)	Product-Level Circularity Metric (PCM)	Material Circularity Indicator (MCI)

While the CE only means recycling from the viewpoint of certain actors, it encompasses reducing, reusing and recycling activities for others (Kirchherr et al. 2017). As such, existing C-indicators do not systematically consider all the potential CE loops. On this basis, the second category characterizes the feedback loops taken into consideration by these C-indicators, namely, maintain/prolong, reuse/remanufacturing and recycling, according to the technosphere part of the CE butterfly diagram proposed by the Ellen MacArthur Foundation (EMF, 2015).

For the third category, a differentiation is drawn on another central element: the circularity performance, considering whether an intrinsic circularity or a consequential circularity i.e. the effects resulted by such circularity. In fact, some C-indicators measure the inherent circularity (e.g. recirculation rates of resources) while others depict the consequences of CE loops (e.g. on sustainability). In line with Potting et al. (2016), monitoring progress towards a circular economy should address the transition process as well as its effects. More precisely, the EEA (2016) put the emphasis on the fact that assessing the circularity performance should consider both the progress of the process (e.g. resource efficiency, evolution of material consumption) and effects of a CE transition (e.g. evolution of energy consumption, added value of products and services, employment levels). Actually, the measurement of success of the implementation of CE loops should capture economic and environmental benefits (Geisendorf and Pietrulla, 2017). Overall, it has been assumed that benefits of CE adoption outweigh the drawbacks regarding sustainable impacts, but sometimes it could result to negative impacts (Geissdoerfer et al. 2017). As such, it is relevant to check and make sure the potential circularity of the systems will lead to effective benefits regarding sustainability, or to know under what conditions.

The fourth category adds a temporal focus on the CE measurement – retrospective or prospective – and makes a distinction between an actual and a potential circularity. According to Potting et al. (2016), it is useful to evaluate CE transitions by measuring progress before (*ex ante*), during (*ex durante*) and after (*ex post*) the transition process: “An *ex ante* evaluation is relevant to explore whether proposed CE transitions actually have potential to bring about the intended CE effects. *Ex durante* evaluation is important to monitor whether a CE transition process follows the planned route, and leads to the desired effects. *Ex post* evaluations should determine whether the effects of the CE transition process are in accordance with the set goals.” Similarly, to Kok et al. (2013), indicators can be used both in the post-process evaluation and in the pre-process design.

For the fifth category, a highlight is made on the possible uses of the available C-indicators. These indicators provide all a certain degree of information on the CE by assessing one or several criteria of the four categories aforementioned. Yet, in accordance with the literature review, there are different potential usages of a C-indicator. The influence degree of indicators is discussed by Lützkendorf and Balouktsi (2017), distinguishing action-oriented indicators that help decision-makers in formulating clear targets and strategies, from information-oriented indicators that help decision-makers in understanding the current situation. Note that the classification of C-indicators in this category is subjected to more subjectivity in the way it demands more interpretations which could vary regarding the users of the C-indicator. For instance, one may deviate some indicators from their initial purposes to better meet their needs. That is the reason why the proposed clustering of indicators in this category only informs on the *a priori* suitable usages of C-indicators, among the four following generic options: (i) information purposes, helping to understand the situation (e.g. tracking progress, benchmarking, identifying areas of improvement); (ii) decision-making purposes, helping to take action (managerial activities, strategies formulation, policy choice); (iii) communication (internally on the achievements to the stakeholders, externally to the public); and (iv) learning (education of workforce, awareness among consumers).

In the sixth category, the transversality of C-indicators among sectors, segments, or industries is indicated. By analogy with the classification of eco-design tools by Rousseaux et al. (2017), generic C-indicators are applicable to all sectors, to any type of company, regardless of its size, location, field or activity. Sector-specific ones are focused on particular sector applications and provide more operational responses. For instance, the PCM developed by Linder et al. (2017) has a high degree of generality and can be applied across different product categories, whereas the BCI developed by Verberne (2016) is designed to assess the circularity performance in the building industry.

The seventh category aims to differentiate the dimensionality of C-indicators. C-indicators of low dimensionality – i.e. that translate circularity into a single number – are useful for managerial decision making (Linder et al. 2017), whereas a high dimensionality can provide a higher degree of intelligibility more suitable for experts – e.g. designers or engineers – in the assessment of product circularity performance (Saidani et al. 2017b). Knowing the degree of intelligibility of C-indicators is important to select indicators that are specifically understandable (Lützkendorf and Balouktsi, 2017) for the intended users e.g. a manager non-expert in CE or a research specialized in the CE implementation.

The eighth category gives information of the indicators units, in order to distinguish the C-indicators in terms of their measurability, whether they use a quantitative or qualitative approach. The units used to calculate circularity are a fundamental aspect of any C-indicator (Linder et al. 2017). Units among the sets of C-indicators identified in the proposed taxonomy include different types such as: mass, time (duration in use), intensity (emission, energy, and consumption), return on investment (savings, profit), availability (resources use, recycling rates in percentage). In

fact, measuring progress of the CE transition means gathering quantitative, semi-quantitative and/or qualitative data and compiling them into indicators which provide meaningful information.

The ninth level examines the format of the assessment framework associated to the C-indicators in order to ease their calculation. It has been found that the C-indicators are linked whether to formulas to compute manually (the most common option) or to computational tool (including dynamic excel spreadsheet, web-based tool, or other softwares).

Finally, because these C-indicators have been developed by various kind of actors – (i) academia; (ii) industrial companies or consulting agencies; and (iii) governmental or environmental organizations – not having the same requirements in terms of scientific validity (e.g. peer-reviewed), the tenth category indicates the development background and origins of the C-indicators.

3.3.4.2. Statistical analysis of existing C-indicators at the micro level

The overall distribution of the 55 sets C-indicators have been first analyzed in the literature section. A more refined analysis of their repartition within the aforementioned categories is now given in Table 27. Particularly, a focus is made here on the 20 sets of C-indicators available at the micro level of the CE to examine more in-depth their distribution across the proposed categories. The view provided by the synthesis and organisation of C-indicators through the present taxonomy gives indeed some interesting trends that deserve to be emphasized, for instance to identify some lacks among this cluster of C-indicators:

- Regarding the CE loops considered by reviewed micro-level C-indicators (category #2), the majority of them (90%) encompasses recycling loops, while 65% considerer remanufacturing activities and/or reuse loops, and less than half of them – 45% – take explicitly into consideration all the main CE loops (i.e. prolong/maintain, remanufacturing/reuse, and recycle) within the same and consistent indicators set. Even if these C-indicators at the micro-level do not include all the aspects of the CE, they tend to encapsulate more than the recycling option. By comparison, macro-level C-indicators, mainly developed in China, have a stronger focus on recycling than on other CE loops.
- In connection with the circularity performance (category #3): 80% of the C-indicators at the micro level of the CE evaluate an intrinsic circularity. 40 % examine directly the impacts on sustainability aspects induced by the circularity of tangible goods. Only 20% include both – i.e. inherent and consequential circularity – simultaneously within the same C-indicators framework. Note that when considering the circularity effects on sustainable development, most of the C-indicators depict economic and environmental impacts, social consequences remaining barely addressed. This missing dimension is an issue often highlighted within SDI framework, according to Singh et al. (2012): “Only few of them have an integral approach taking into account environmental, economic and social aspects. In most cases the focus is on one of the three aspects”. As such, Geng et al. (2012) called for a more systematic evaluation system that integrates and harmonizes relationships between indicators of environmental, economic, and social development so that they could effectively supplement one another.
- In terms of the (retro- or pro-) perspective aspects of C-indicators (category #4), 8 sets of C-indicators out of 20 are dedicated to assess a potential circularity while 12 out of 20 are designed to deliver information on an effective – intrinsic or consequential – circularity. Note that one could make use of these 12 C-indicators sets to project on a hypothetical circularity levels. More interestingly, when crossing categories #3 and #4 it has been found that a very few number of micro-level C-indicators attempt to evaluate the potential impacts of CE loops on the sustainability performance i.e. by attempting to predict the economic or environmental benefits of circularity.
- Concerning the dimensionality, 60% propose a single indicator that aggregates the circularity performance at the micro scale, summarizing therefore several facets of the CE into a one-dimension information, which could be arguable (Cayzer et al. 2017). In fact, there is no existing standardized method to aggregate the performances of all the CE loops into a single indicator (Elia et al. 2017).
- Only 3 C-indicators sets among the 20 reviewed here at the micro level are designed for sector-specific purposes. Most of them – i.e. 17 out of 20 - are quite generic in the way they could be applied in a diverse range of products. Yet, these micro-level C-indicators are still in a pilot phase, and even if they can claim a certain transversality, most of them have been solely applied and tested on one specific product or industrial sector.

- Last but not least, an interesting fact is that almost half of these C-indicators – 45% – are linked to a computational tool, making their application and implementation more convenient for practitioners. By comparison, at the macro level of the CE implementation, the wide majority of C-indicators framework are still embodied in a textual format.

This systemic demarcation of C-indicators and their mapping through the developed taxonomy aims not only at highlighting current limitations but also at orienting future research to fill these gaps, as developed in sub-sections 3.3.5 and 3.3.6.

Table 27 – Repartition of C-indicators into the main categories of the proposed taxonomy (numbers in brackets indicate the number of C-indicators fitting a given criteria)

Categories	Micro (out of 20)	Meso (out of 16)	Macro (out of 19)
Loops	recycling (18) reuse/reman (13) maintenance (9) all (9)	recycling (16) reuse/reman (12) maintenance (7) all (7)	recycling (18) reuse/reman (10) maintenance (6) all (5)
Performance	intrinsic (16) impact (8) both (4)	intrinsic (9) impact (11) both (4)	intrinsic (17) impact (15) both (13)
Perspective	potential (8) effective (12)	potential (9) effective (8)	potential (2) effective (17)
Dimensionality	single (12) multiple (8)	single (5) multiple (11)	single (1) multiple (18)
Transversality	generic (17) sector-specific (3)	generic (14) sector-specific (2)	generic (18) sector-specific (1)
Format	computational tool (9) textual format (11)	computational tool (4) textual format (12)	computational tool (0) textual format (19)

3.3.4.3. Selection tool: the C-indicators advisor

In the literature related to eco-design tools, additionally to the developed taxonomies, authors have proposed diverse ways to identify the most relevant tools for a specific context, for instance, through multi-dimensional graphs (Bovea and Pérez-Belis, 2012), decision tree or associated online tool (Rousseaux et al. 2017). Here, the knowledge captured through this analysis and classification of C-indicators was synthesized in an Excel spreadsheet, used for developing a selection tool of C-indicators. The selection tool has been designed using Microsoft Excel software so that it can be disseminated and updated easily. “The C-Indicators Advisor” is indeed an Excel-based tool with macro enabled which is linked to the database of 55 sets of C-indicators classified according to the proposed taxonomy. Snapshots of this tool are given in Figure 32. The goal of this selection tool is to support the users in identifying and selecting the most appropriate circularity indicators in line with their requirements. It is mainly intended to industrial practitioners, decision-makers and policy-makers working in CE projects. But it remains accessible to everyone – novice or expert – interested in the circular economy implementation, e.g. in order to discover the possible contributions of C-indicators and how they can be used in practice.

In the input interface of the Excel file, eight questions are asked to direct the users towards the most suitable C-indicator(s) and related assessment framework, similarly to an expert system based on eight questions. Selection criteria are the following: i) level of measurement; ii) circularity perspective; iii) circularity performance; iv) circularity loop; v) dimensionality; vi) usages and purposes; vii) transversality; viii) type and format. Once the query is completed, a click on the round logo at the top of the Excel spreadsheet, as illustrated in Figure 32, will launch the search. Then, the tool directs the user automatically to the results table of recommended C-indicators. The advisor matches and selects the indicators to display according to an advanced filtering system – using Excel macros – that linked the query inputs to the organized databank of C-indicators.

In outputs, appropriate indicator(s) are identified and the following information is displayed: a) C-indicator name; b) working principle; c) details about the systemic level; d) details about the kinds of circularity; e) details about the dimensionality and unit; f) data required to compute the indicator; g) possible useful usages; h) authors and references; j) internet access link. Interestingly, a direct internet access link to each of the recommended C-indicators and their associated assessment framework (e.g. formulas to compute, web-based tool) is indicated, to get further details and, if relevant, to start experimenting and implementing such indicator(s).

Note that this selection tool of C-indicators is flexible in the way the databank is not frozen and may be easily updated. As such, it is possible to contribute in return to the tool development, enrichment, or consolidation, e.g. if researchers, industrialists or policy-makers are aware of, have tested, or are developing (new) C-indicators that are not inventoried yet in the actual databank. Indeed, a key challenge is to succeed in maintaining the databank up-to-date, regarding the increasing number of studies and articles published in relation to the CE. Last but not least, two complementary 2-minute videos have been recorded and put online to (i) explain simply how the selection tool works (here is the link of the tutorial video: <https://youtu.be/nRNbWyHRzic>) and to (ii) illustrate the use of this tool through an industrial example (here is the link of the case study showing the application of the tool for identifying appropriate C-indicators in an industrial context: <https://youtu.be/kd51SsX0Be4>).

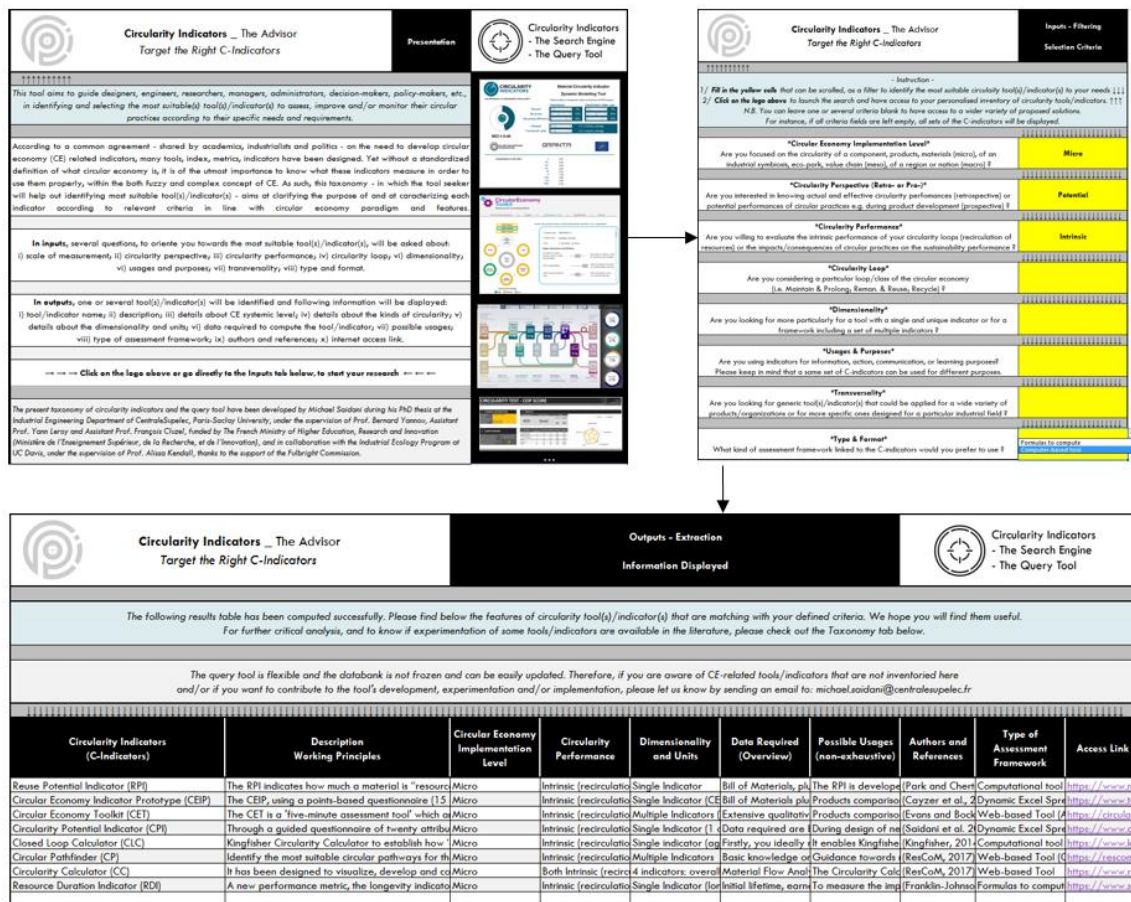

Figure 32 – Overview of the selection tool: The C-Indicators Advisor

3.3.4.4. Use cases as a first validation of the proposed taxonomy

A first practical validation of the developed taxonomy is proposed by using its selection tool. The objective here is to check its robustness and contributions on the identification of appropriate C-indicators, based on use cases focused on the micro level of the CE – with the data published in literature – exploring how C-indicators can help (re-)designing better circular and sustainable products (e.g. used starter engines, prototype tidal energy device, or catalytic converter). More precisely, as we claim a need-based taxonomy, particularly driven by industrial needs at the CE micro-level, we are wondering whether: (i) the selection tool and associated taxonomy recommend the same C-indicators that are used in published case studies; and (ii) there is any other complementary set of C-indicators that would be also appropriate regarding to the initial purpose of a given case study.

Seven published use cases of C-indicators at the micro level of the CE – in which, one or several C-indicators are tested or used – have been identified to experience the proposed taxonomy and its associated selection tool, as illustrated in Table 28. The first column indicates the industry, product or material for which the circularity is measured. The second column specifies the objectives and purposes behind the use of C-indicators for each case study. The column three outlines the C-indicators originally considered and used in the case study. After translating

the needs and requirements describing each case study into query inputs of the selection tool as indicated in the fourth column, C-indicators recommended are displayed in the fifth column.

Table 28 – Use cases of C-indicators at the micro level of the CE

Case study and references	Overview of the initial objectives, needs and/or requirements	C-indicators used in the initial study	Query entered	C-indicators found by the advisor
Wine industry Acampora et al. 2017	To measure circular practices, considering notably the recycling and reuse of secondary raw materials.	3: CEI, MCI, RPI	Micro AND Recycle AND Reuse	10: CC, CEI , CEIP, CET, CPI, IOBS, MCI , PCM, RPI , RDI
Mobile phone and precious metals Franklin-Johnson et al. 2016	To enable managers to control the three longevity drivers: product use, refurbishment, recycling. To maximize resources exploitation through all the CE loops.	1: RDI	Micro AND Potential AND All the loops	6: CC, CEIP, CET, CLC, CPI, RDI
Plastic waste treatment Huysman et al. 2017	To quantify the CE performance of different plastic waste treatment options, considering the environmental benefits.	1: CEPI	Micro AND Actual AND Impact AND Recycle	5: CEI, CEPI , CI, EVR, PCM
Used starter engines Linder et al. 2017	To measure economic value capture through remanufacturing, reuse and recycling.	1: PCM	Micro AND Actual AND Impact	7: C2C, CEI, CEPI, CI, EVR, IOBS, PCM
Widgets EMF, 2015	To compare the circularity of two products, considering products lifetime, and materials recycled or reuse.	1: MCI	Micro AND Actual AND Intrinsic AND Generic	7: C2C, CI, EOL-RRs, IOBS, MCI , RIs, RRs
Prototype tidal energy device Walker et al. 2018	To compare the effectiveness of different material efficiency strategies and the correlation between product circularity and the environmental efficiency.	3: CEIP, CET, MCI <i>in combination with LCA indicators</i>	Micro AND Potential AND Impact	1: CC
Catalytic converter Saidani et al. 2017	To evaluate circularity potential improvement during design and development process.	3: CEIP, CET, CPI	Micro AND Potential AND Generic	7: CC, CEIP, CET , CP, CPI , RDI, RPI

For the mobile phone, plastic waste treatment, used starter engines and widgets case studies, the process is the following: one new C-indicator is developed and experimented on a specific use case that particularly fits with the indicator scope and purpose. On the other hand, the wine industry and prototype tidal energy device case studies seem more relevant here in the way the authors selected several C-indicators as relevant for their specific use cases among the sets of C-indicators they have initially identified and reviewed. For instance, in the wine industry case study, three C-indicators (MCI, CEI, RPI) have been selected as suitable out of the eight identified (CEPI, RPI, CEIP, CET, CET, MCI, EISCE, FCIM); and for the prototype tidal energy device case study, three were selected (MCI, CET, CEIP) among the six identified (MCI, CET, CEIP, CEI, C2C, VRE).

In most cases (6 out of 7), the C-indicators initially used have been also advised by the selection tool and supplementary indicators have been suggested as well, which might have been insightful for these studies. On the other hand, the “prototype tidal energy device” case study (Walker et al. 2018) highlights the lack of multi-dimensional indicators considering both product circularity and sustainable performance within the same framework. Mathematically, regarding the combinatory aspects of the query tool, the approximately 300 possible pathways through criteria combination - among the 50+ sets of C-indicators inventoried - ensure a rapid convergence towards the most suitable C-indicator(s).

3.3.5. Discussion

3.3.5.1. Gaps filled and remaining limitations in the measurement of the CE

The identification and classification of available C-indicators allow to get a comprehensive and updated overview of the progress made on the circularity assessment, as well as to comment on the gaps filled in last few years (e.g. the measurement of CE at a micro level) and on the remaining challenges to orient future research (e.g. the uptake of C-indicators by industrialists, or the issue of data availability to compute the indicators). On this basis, this tool seeker can serve the proper dissemination of appropriate C-indicators to monitor and support the CE transition in

industry and policy making. Moreover, the potential complementarity or supplementarity between existing C-indicators is a point that would require further discussion and analysis. Also, the question of how indicators could complement one another has indeed still not been addressed satisfactorily.

3.3.5.1.1 *Progress at the micro-level and complementarity between C-indicators*

Our study shows that previous statements advancing that few C-indicators are situated at the micro-level of the CE are somehow no longer true. For instance, in articles published in 2017, it has been said that “a deep research on CE assessment and indicators is still lacking, in particular on the micro level” and that “few studies are focusing on how to measure effectively the circularity level of a product, a supply chain or a service” (Elia et al. 2017), or that the evaluation of product circularity performance is a barely addressed topic (Saidani et al. 2017a). Actually, in line with Walker et al. (2018) who mentioned a growing number of C-indicators at the micro level, our systematic review inventories 20 C-indicators at the micro level of the CE. Nonetheless, many of these C-indicators are under development and still in the pilot phase (Walker et al. 2018). According to Acampora et al. (2017), research about indicators for measuring the application level of CE strategies is still in its earliest phase, particularly on the micro level. This low degree of maturity (combined with a high degree of genericity) could be an explanation of their low degree of adoption in industrial practices (assumption based on the extrapolation of the scarce implementation of eco-design tools or sustainability indicators in industry, discussed in the scientific literature). Even if some progress has been and are currently done at this micro level, we believe the call made by Elia et al. (2017) “for further research about more effective CE strategies evaluation” remains relevant. More concretely, some existing and generic C-indicators at the micro level could serve as a suitable basis for the development of new ones more adapted for a specific context. For instance, Verberne (2016) developed a sector-specific indicators set for the building industry: the Building Circularity Indicators (BCI) based on modifications made on the Material Circularity Indicator (MCI) created by the Ellen MacArthur Foundation (EMF, 2015), facilitating as such its use for industrialists from the building sector, and demonstrating C-indicators can be built on one another.

Additionally, Elia et al. (2017) add no single existing indicator encompasses all the requirements of the CE paradigm. To them, “focusing on one single dimension of the CE (e.g. resource use) represents a limitation in the assessment of CE models, leaving other important factors, such as emissions and energy use”. Only few of the C-indicators attempt to provide a more holistic approach taking into account both intrinsic circularity and the effects of this circularity e.g. on the three pillars of sustainable development. On this basis, coupled approaches mixing several C-indicators appear as a solution for an augmented measurement of the circularity performance. For instance, Figge et al. (2018) proposed a two-dimensional indicator, combining a longevity indicator – capturing how long product systems retain resource materials – with a circularity one – quantifying the number of times that a resource is passing through different phases in a value chain – in order to inform better decision making in the sustainable management of resource use. Pauliuk (2018) also emphasized that physical circularity indicators (e.g. the MCI, C2C or CEIP) can be complemented by monetary ones (e.g. the PCM, CEI, or EVR). The Ellen MacArthur Foundation (EMF, 2015) completed its MCI with environmental indicators such as water and energy consumption or greenhouse gas emissions to add a sustainable component when assessing the inherent circularity of materials. The comparison of C-indicators with LCA results may indeed reveals potential trade-offs e.g. between the goals of resources circularity and reducing environmental burden (Walker et al. 2018). Geissdoerfer et al. (2017) remind that in some cases, improving the intrinsic circularity performance might result in a negative environmental impact along the life cycle. Furthermore, the best end-of-life pathway may also vary when looking at the cost or at social component. That is why Figge et al. (2018) encourage further research on the combination between circularity measures and life cycle sustainability indicators. Finally, consequential LCA – contrary to the commonly used attributional LCA - is another possible solution still barely explored to evaluate the implementation of future CE projects. According to ScoreLCA (2015), “this method is capable of taking into account market evolutions to evaluate the environmental consequences of developing a new system or making a precise decision. By studying the environmental impacts associated with the implementation of a recycling loop or with the substitution of raw materials by recycled materials, it is possible to evaluate the effect this evolution might have on the environment or the market”. Yet, the application of consequential LCA demands an important knowledge and numerous data related to the evaluated sector.

3.3.5.1.2 *Current limits and potential solutions: data issue and industrial uptake*

Wisse (2016) depicted an overview of knowledge gaps and shortcomings in the CE assessment literature, including a lack of: (i) knowledge and best practices of C-indicator frameworks; (ii) stakeholders’ engagement in the design process of indicator frameworks; and (iii) CE indicators representing holistic fields. As similar challenges are found

and have been extensively discussed in the fields of eco-design tools or sustainability indicators, CE researchers – ideally together with practitioners – should consider this existing literature in order to anticipate and overcome the identified barriers so as to facilitate the effective implementation of C-indicators in industrial practices. In fact, Rossi et al. (2016) explored the main barriers that prevent the implementation of eco-design approaches in industrial companies, and proposed possible strategies to overcome these barriers. In line with Bovea and Pérez-Belis (2012), most of the eco-design tools are not applied in a systematic way in companies due to their complexity, the time required to implement them and the lack of environmental knowledge. Park and Kremer (2017) remind that companies need to understand the relevance and potential benefits of environmental sustainability indicators to use them in the management of their operations. Yet, they state that “the lack of information with regards to the utility of indicators and the technical and theoretical orientation of indicators hamper their implementation in practice.” Park and Kremer (2017) conducted thus an industrial survey on the utilization and utility of environmental sustainability indicators. As the research on C-indicators is still in development, a similar study, e.g. by using (an adapted version of) the framework they proposed, as exposed in Table 29, may be relevant to get a higher accuracy on the degree of awareness, interest and use of current C-indicators by industrialists.

Table 29 – Framework to evaluate the utilization and utility of indicators (Park and Kremer, 2017)

Main criteria	Sub-criteria	Description	Input values
Utilization: current and future usage of an indicator	Used in practice	Current usage of an indicator	1: not used; 2: in adoption phase; 3: currently used
	Future implementation	Likelihood of implementing an indicator in the future	1: no; 2: yes
Utility: inherent value and feasibility of an indicator	Usefulness	Perceived economic and operational value of an indicator	1-5, with 5 being the most useful
	Practicality	Perceived cost and time to learn and implement an indicator	1-5, with 5 being the most practical

Another key challenge to the proper computation of C-indicators is the need for various and important quantity of data all along the value chain. Much of this information is difficult to obtain and must be provided by the actors in the product chain itself (Potting et al. 2016). The data issue is indeed a major barrier to a wider use of indicators in companies due to the time and cost needed to collect them, the lack of information exchange in businesses, as well as confidential aspects (Birat, 2012). As such, special focus should be made on the data required to feed the indicators (Lützendorf and Balouktsi, 2017). Furthermore, to Geissdoerfer et al. (2017), measurement as a means of improvement and optimization is still very much in an experimental phase, but it should increasingly be supported by the evolution of digital technologies, such as the Internet of Things. This could lead to the availability of completely new data sets, especially at the micro level of circularity, to assess the circularity performance of products, components and materials through the entire lifecycle. Currently, at the macro level, e.g. at the European level, a lot of relevant data for the circular economy are available thanks to the direct involvement of key data providers like Eurostat, the Joint Research Centre or the EEA (EC, 2015b).

3.3.5.2. Areas of improvement and flexibility of the proposed taxonomy

The ten proposed categories and their associated criteria to classify existing C-indicators do not claim to be completely exhaustive, but rather to be a practical, usable and understandable way to find out an appropriate set of C-indicator for a given context. Indeed, the proposed categories encompass the main CE features (categories #1 to #4), the possible use of C-indicators (categories #5 and #6) and the key characteristics of their associated assessment framework (categories #7 to #10), allowing therefore a clear and rapid differentiation between C-indicators. Nevertheless, one could advance other possible – complementary or supplementary – categories to sort them out:

- The EEA (2016) suggested the measure and reporting of the degree of circularity achievements should be specified throughout the life cycle of products or systems, that is to say on the following stages: design (e.g. easy of disassembly), production (evolution of the overall (primary, secondary) use of materials), consumption (lifespan, use intensity), end-of-life (volume of landfill evolution).
- Additionally, at the micro level of CE implementation, to facilitate the integration of C-indicators in the industrial design and development process, it could be interesting to inform on which steps certain C-

indicators can provide guidance and recommendations – e.g. on project scoping, concept definition, design definition, or product implementation as proposed by the ResCoM project (2017). CE-related tools and indicators available on the ResCoM platform have also an indication about their preparation, calculation and implementation time.

- ScoreLCA (2015) indicates a classification of material loops in three categories: (i) closed loops (short and mainly B2B); (ii) open loops (longer and mainly B2C); and (iii) cascade recycling like downcycling that considers the quality of recycled materials, which can therefore complete resource-oriented indicators mainly focused on the quantity of materials (Elia et al. 2017).
- In analogy to thermodynamics, it could also be relevant to indicate the extensive or intensive properties of C-indicators, notably at the meso and macro levels of CE implementation. While intensive indicators are independent of the size of the system, the value of extensive indicators depends of the system size. In order to make indicator results better comparable across countries, regions, cities or across different industrial sectors, intensive indicators are preferable (Eisfeldt, 2017) and extensive ones need to be normalized.

According to the original use of taxonomies in biology and natural sciences, Davidson (1952) reminded “the principles of taxonomy have not always been constant, they have changed as the objectives of taxonomy have altered through the years”. At first, their major objectives were to enable the identification and classification of species. Then, it was to determine the interrelationships between identified species. As such, and by analogy with this, we can argue the future steps will be to establish further links and correlations between existing C-indicators. Eventually, one has to bear in mind such characterisation of C-indicators has to be questioned and updated on a regular basis because of the complex and rapid dynamics governing the CE transition (EEA, 2016). According to the EEA (2016), a CE monitoring framework should be flexible to maintain the indicators effectiveness throughout the evolution of the transition. Indeed, any indicator set – particularly in the fields of sustainability and circularity – should be adaptive enough to reflect the varying and time-evolving stakeholders’ needs (Lützkendorf and Balouktsi, 2017). Against this background, a next update of the proposed taxonomy could be to add a compatibility matrix between the C-indicators e.g. based on their associations and/or occurrences in published use cases. Such information would enrich the taxonomy by offering an augmented orientation in the selection of an appropriate set of C-indicators.

3.3.6. Conclusion and perspectives

One of the core questions around the CE is how to measure its progress and performance at different levels, regarding how complex and fuzzy this CE concept can be. As a response to the need of monitoring the CE transition, an increasing number of attempts to develop circularity indicators have been noticed in the last few years, covering more or less the multi-facets of the CE. In this article, the taxonomically sound characterisation and classification of 55 sets of C-indicators brings some clarity on their purposes and therefore support their appropriate use and dissemination, notably thanks to a user-friendly selection tool associated to the database of these C-indicators. Through the developed taxonomy, the organised categorisation of C-indicators can assist industrial practitioners and policy-makers who need to be informed to make decisions on CE-related projects. Indeed, without C-indicators it is difficult to draw any conclusions, and having the wrong C-indicator could lead to non-appropriate conclusion. Limitations of the proposed taxonomy, as well as some improvement areas that need be investigated further have already been partly mentioned in the discussion section. Yet, further emphasis is placed here to expand and open up the discussion on three key perspective: (i) the advanced robustness of – existing and future – C-indicators; (ii) their enhanced adoption by industrialists to conduct CE strategies; and (iii) their contribution to catalyze the transition towards a more CE. As such, this article provides a baseline for new and upcoming investigations into the potential development and implementation of *ad hoc* C-indicators. The following sub-sections aim to guide more precisely future research on the measurement of the CE performance.

3.3.6.1. Further evaluation of existing C-indicators

Future work should evaluate and judge more objectively the definition, relevance and scientific sound of C-indicators, so that one can have more trust and confidence in their use. Delivering insights at the question of which criteria to use to do so is an essential first step. According to the EEA (2003), a good indicator should: communicate in a sound way a simplified reality; match the interest of the target audience; be attractive to the eye and accessible; be easy to interpret; be representative of the issue or area being considered; invite action: show developments over a relevant time interval; go with a reference value for comparing changes over time; be comparable with other indicators that describe similar areas, sectors or activities; and be scientifically well-founded.

Weiland (2006) proposed methodical requirements for sustainability indicators such as: having a clear rationale; representing an adequate image of complex system; having face validity; being specified clearly; being repeatable. To choose indicators related to resource efficiency, the European Commission (EC, 2014) used the following criteria: policy relevance; coverage of all relevant categories and resources; coherence and completeness; transparency of trade-offs and negative side effects such as burden shifting; applicability to different levels of economic activities. Other lists of criteria for selecting indicators have been put forward, notably by managers or consulting companies. For instance, the consulting agency Deloitte (BioIS, 2012) has recommended the usage of RACER criteria (relevant, acceptable, credible, easy, robust) to evaluate indicators' suitability. Other efficient mnemonics ways are usually used in companies to define and select indicators, inspired from managerial best practices such as SMART (specific, measurable, achievable, relevant, timed) or CREAM (clear, relevant, economic, adequate, monitorable). These acronyms represent commonly used criteria for performance indicators. They are widely used in the manifold sectors to provide 'rule of thumb' guidance to managers identifying most suitable indicators. Importantly, it is widely acknowledged that indicators are only relevant and useful if they fit the user's needs (Bouni, 1998). More recently, some authors provide more particular guidance and recommendations for the development of C-indicators (Iacovidou et al. 2017; Saidani et al. 2017a). Using such criteria and framework can therefore be meaningful during the definition, development and setup of future C-indicators, as well as in the validation of newly proposed C-indicator sets.

3.3.6.2. *Further uptake of C-indicators by industrial practitioners*

By shedding a light on a wide variety of existing C-indicators in an organized and understandable manner, we argue this study can contribute in their appropriate use in practice. Indeed, the proposed taxonomy can be a first step in making practitioners aware of the opportunities offered by the application of suitable C-indicators and therefore could support their effective uptake by industry. As the CE transition process consists of means (e.g. product chain partners, knowledge development), activities (e.g. knowledge exchange, experimentation of new business models) and achievements (e.g. circularity of resources, lowering environmental impact) (EEA, 2016; Potting et al. 2016), information given by C-indicators can serve as a useful binder e.g. for managers in charge of monitoring the transition towards more circular practices. Indeed, in the transition movement to the CE, indicators are needed to track progress and to provide direction on where to go next. Interestingly, the further development of sector-specific C-indicators can concretely foster their adoption, e.g. in the building sector (Núñez-Cacho et al. 2018; Verberne, 2016). In this line, to make this circular vision more straightforward and shared by decision-makers as well as industrial practitioners, efforts must be done on: the appropriate level of intelligibility of C-indicators (e.g. the indicators discretization) in accordance to their main recipients; the simple translation of the information given by a C-indicator into precise actions or practical recommendations; the correlation between circularity heuristics and more tangible impacts; the integration of C-indicators e.g. in the industrial development process to design more circular products. Also, communication on best practices or successful examples of how C-indicators have helped managerial activities to orientate actions in CE projects, as well as new experimentations of C-indicators for steering circular strategies, should be foster to lead and inspire this shift towards a more CE. Finally, as mentioned in the previous section, making C-indicators more transparent and trustworthy e.g. in anticipating the environmental or economic performance and thus enlightening decision-making (Thomas and Birat, 2013), will make them certainly more applicable in return.

3.3.6.3. *Further implementation of the CE*

To put things in perspective, one has to bear in mind C-indicators are solely one element in the overall process of the CE transition. In fact, even if this work offers a valuable framework for future research related to the measurement, improvement and monitoring of the CE performance, it is important to remind, in line with the EMF (2013), that the successful implementation of CE models relies on the synergy between key building blocks including product design, new business models, reverse logistics, enablers and systems conditions. From that standpoint, C-indicators can be considered as interesting enablers of the move to a more CE. Yet, the information provided by those C-indicators has to be translated into suitable actions for managing the CE transition. As such, other methods, tools and resources can complementary help the implementation of CE. For instance, published recently, the BS 8001:2017 is the first standard to guide organizations in implementing the principles of the CE. Globally, the implementation of CE strategies requires new organizational and business models, enhanced technologies (Hass et al. 2015), augmented know-how and shared knowledge (Park and Chertow, 2014), as well as a redefinition of industrial process and product innovations (EEA, 2016). And all these changes have to be economically, socially and environmentally sustainable to guarantee a successful implementation of the CE – effective and efficient – in the long run.

3.4. SUMMARY OF ESSAY #2 AND TRANSITION WITH ESSAY #3

What's inside Essay #2 in a nutshell

Highlights:

- Extensive literature review of circularity indicators.
- Comprehensive and organised inventory of 55 sets of C-indicators through a taxonomy.
- Development of a query tool to support the selection of appropriate circularity indicators.
- First experimentation of several C-indicators on an industrial product from the heavy vehicle sector.
- Critical analysis of C-indicators at the micro level of circular economy implementation.
- Limitations of existing indicators and associated measuring tools.
- Proposition of a framework to design new circularity indicators.
- Design of a new circularity indicator aiming at evaluating the circularity potential of industrial products.
- Discussion on the contributions of C-indicators in the shift towards more circular practices.

Academic deliverables: 2 journal articles published; 1 conference paper published.

Industrial deliverables: 2 tools developed: the Circularity Potential Indicator; the C-Indicators Advisor.

Contributions related to research gaps and objectives:

- ✓ Objective 1: Identification of areas of improvement to close-the-loop on one heavy vehicle key component.
- ✓ Objective 2: Proposition of a new circularity indicator. Clarification and classification of existing C-indicators.
- ✓ Objective 3: Application of circularity indicators on an industrial product. Development of a computer-based tool to ease the selection of appropriate circularity indicators.

Perspectives (remaining challenges and promising future research):

- Evaluate systematically if an improvement of the circularity performance leads to sustainable benefits.
- Enhance and validate the tool aiming at measuring, improving and monitoring the circularity potential.
- Provide examples on how C-indicators can contribute in designing and developing more circular products.
- Think of solutions to ease the calculation and implementation of C-indicators (e.g. data access issue).
- Keep the database of the C-Indicators Advisor tool up-to-date.
- Develop a web-based version of this Excel-based query tool.

Linkages with Essays #1 & #3

In essay #1, we have:

- Analyzed qualitatively the circularity performance of the heavy vehicle industry through the four feedback loops and the four building blocks of a circular economy.
- Outlined the need for circularity indicators in order to measure the remaining distance some industrial practices have to fulfill in their shift towards a more circular economy.
- Provided the basis for experimenting circularity indicators in a complex industrial environment.

In essay #3, we:

- Experience further C-indicators through two workshops, revealing unexpected possible contributions from the use of such indicators.
- Propose a multi-tool methodology to close-the-loop on products and present the first results applied on the catalytic converter case study.
- Study the additional inputs from material flow analysis and C-indicators to close the loop.
- Perform an industrial pilot study on two end-of-life heavy vehicles to assess the feasibility and profitability of implementing circular practices such as remanufacturing.

4. ESSAY #3 – INDUSTRIAL CASE STUDIES

In this third and last essay, two industrial case studies are conducted to apply and illustrate more concretely the research exposed on essays #1 and #2, related to the implementation of circular economy practices and the use of circularity indicators, with the heavy vehicle industry as application field. The objectives of these case studies are not only to test and validate the usefulness and operability of the best practices, methods, tools and indicators presented in this thesis but also to bring real visible contributions for the industry in its move towards more circular practices. Interestingly, as one of the case studies deals with closing-the-loop of one key industrial component, while the other one addresses the end-of-life management of an entire used heavy vehicle, these two examples are complementary representative of the industrial complexity linked to the management of flows in the heavy vehicle industry, from circular design to end-of-life treatment, through reuse, remanufacturing and recycling options.

In sub-section 4.1, as detailed in tables 30, 31 & 32, the catalytic converter example is used to further experiment and compare circularity indicators, as well as to test additional tools used to model and evaluate the contributions of promising action levers to close-the-loop on industrial components:

- In sub-section 4.1.1, the C-Indicator Advisor tool and four C-indicators at the micro level of the CE implementation are experienced by doctoral students and industrialists through two workshops. Participants are asked to provide feedback about the relevance, complexity, user-friendliness or potential usages of such circularity indicators. The values calculated for each indicators are collected as well. As they are all working on the same industrial product with the same dataset, the variability of their results and circularity scores calculated is also compared to discuss the reliability or the uncertainty given by the values of such indicators.
- In sub-section 4.1.2, to complement the evaluation of the circularity potential of an industrial product at a micro scale, the circular economy performance of its associated value chain is assessed thanks to material flow analysis (MFA). Particularly, among the 55 sets of C-indicators inventoried in the developed taxonomy, the framework proposed by Graedel et al. (2011), including several C-indicators, is used to measure the circularity performance of a metal within its related product value chain, based on a MFA model. As such, it becomes interesting to compare the circularity potential of one catalytic converter (at its pre-life, during design and development phases) with the actual circularity performance of its value chain according to recovery and recycling rates (MFA-based results). The additional contributions from MFA and C-indicators provide a quantitative and localized identification of the improvement opportunities, as well as interesting value buckets not fully exploited yet, on the platinum value chain. For instance, the growing stockpile of platinum from catalytic converter in use urges for better collection mechanisms and the leakage of platinum during the use phase (attrition of the catalytic converter) needs further attention. It also gives a solid and up-to-date baseline to track and seek progress on the circularity performance of the platinum value chain.
- In sub-section 4.1.3, to model and evaluate the impact of potential promising action levers (e.g. new regulations, design for remanufacturing, business model evolution, take-back offers, financial incentives, scrapping premium) on the circularity performance of platinum from catalytic converters in Europe, a multi-tool methodology is proposed and the first results are given. It includes the use and application of: material flow analysis and C-indicators, fuzzy-cognitive mapping, structural analysis, scenarios generation, and system dynamics.

In sub-section 4.2, as detailed in Table 33 and Figure 33, an action research approach is conducted in collaboration with a French manufacturer of heavy handling machines and its emerging remanufacturing center. This industrial pilot study considers the entire end-of-life management of a whole heavy vehicle, from the dismantling to the recovery of used parts, through remanufacturing. It illustrates as such the multiple dimensions to consider when closing-the-loop on heavy vehicles, namely: technical and organisational knowledge (e.g. infrastructures, tooling, dismantling process and remanufacturing feasibility), as well as economic and environmental considerations (e.g. solutions to optimize the value recovered according to market needs, through the identification of potential recovery channels). To do so, a multi-scale modelling is proposed, taking into account: (i) the conditions of the end-of-life heavy vehicle and of its key components, (ii) the capability of the remanufacturing center, (iii) the market demands and possible recovery channels. Moreover, to enhance their current dismantling process, best practices from the automotive sector, discussed in essay #1 are adapted, tested and validated on a dismantling operation, resulting in several improvements (in terms of organisation, time, and comfort for the operator). Also, a practical spreadsheet, to be used by the industrialist, is proposed as a decision-making support to identify and compare the possible end-of-life pathways of their recovered components in order to select the most appropriate one(s) according to the economic and environmental aspects of each circular option, among reuse, remanufacturing and recycling. Last but not least, in the conclusion section, the possible generalisation and adaptation of the insights provided by these specific case studies to other industrial products or sectors are discussed.

Table 30 – Overview of the sub-section 4.1.1 and description of the associated papers and workshops

Original title	Circularity Indicators: the Advisor
Presented at	<i>International Design Engineering Technical Conferences & Computers and Information in Engineering Conference (IDETC/CIE 2018) in August 2018, special session: design tool showcase</i>
To submit to	<i>ICED19 or Design Studies, under the title: Monitoring the circular design of industrial products. Insights from workshops on circularity indicators.</i>
Key words	Circular economy, circularity indicators, design for circularity, selection tool, workshop, doctoral school, industrial case study.
Abstract	Over 50 sets of circularity indicators – created and used by academia, consulting companies and governmental agencies worldwide – have been reviewed and classified into a need-based taxonomy driven by the usage of such indicators. A query tool associated to the proposed taxonomy databank – using MS Excel with macros – has been designed to help identifying the most relevant indicators regarding the user needs. In inputs, eight questions are asked about the: i) scale of measurement; ii) circularity perspective; iii) circularity performance; iv) circularity loop; v) dimensionality; vi) usages and purposes; vii) transversality; viii) type and format. In outputs, appropriate indicators are identified and following information is displayed: a) tool/indicator name; b) working principle; c) systemic level; d) kind of circularity; e) dimensionality and unit; f) data required to compute the indicator; g) possible usages; h) authors and references; j) internet access link. The tool is first presented through an industrial example of a company willing to measure, improve and monitor the circularity performance of a product – a catalytic converter – that the company designed and developed. Based on the company’s needs and requirements, the tool proposes several potentially useful circularity indicators and associated calculation framework at a micro level – the one of products and materials – which aim at (i) evaluating circularity potential of industrial products during design and development process, (ii) providing guidelines for circular design improvement, (iii) facilitating benchmarking with competing products. Then, participants have two possible options: (1) Participants may test and experience the selection tool on their own projects to find out which circularity indicators suit the best to their need. It is possible for them to work individually (or in small group) on their own project or case study linked to the circular economy. As such, they are proposed to experience, and feed the query tool with their requirements so as to identify indicators that might be relevant for them. Finally, as access links are provided to explore the recommended indicators given in output – including associated working principle and calculation methods – attendees are free to test such circularity indicators. (2) For participants who do not have a particular case study or sufficient data to experience the tool by their own, but who are interested in testing the query tool and recommended indicators, it is possible to operate the data from the catalytic converter example.

Table 31 – Overview of the sub-section 4.1.2 and description of the associated article and presentation

Original title	Closing the loop on platinum from catalytic converters: contributions from material flow analysis and circularity indicators
Submitted to	<i>Journal of Industrial Ecology, on August 2018 (minor revision in October 2018).</i>
Note	<i>First results have been presented at the 12th International Conference on Society & Materials (SAM12) in May 2018 (abstract and podium session).</i>
Key words	Circular economy, platinum, catalytic converter, value chain, MFA, circularity indicators.
Abstract	In this study, material flow analysis (MFA) is applied to quantify and break the obstacles for advancing a circular economy (CE) of platinum (Pt) from catalytic converters (CC) in Europe. First, the value chain and related stakeholders are mapped out in a MFA-like model to both facilitate the assessment of stocks and flows, and get a comprehensive view of potential action levers and resources to close-the-loop. Then, through the cross analysis of numerous data sources, two MFA are completed: (i) one general MFA, and (ii) one sector-specific MFA, drawing a distinction between the fate of Pt from (a) light-duty vehicles, under the ELV Directive 2000/EC/53, and (b) heavy-duty and off-road vehicles. Key findings reveal a leakage of around 15 tons of Pt outside the European market in 2017. Although approximately one quarter of the losses are due to in-use dissipation, 65 % are attributed to insufficient collections and unregulated exports. Comparing the environmental impact between primary and secondary production, it has been estimated that halving the leakages of Pt during usage and collection could prevent the energetic consumption of 1.3×10^3 TJ and the greenhouse gases emission of 2.5×10^2 kt CO ₂ eq. Through the lens of circularity indicators, activating appropriate action levers to enhance the CE performance of Pt in Europe is of the utmost importance in order to secure future productions of new generations of CC

and fuel cells. Moreover, the growing stockpile of Pt from CC in use urges for better collection mechanisms. Also, the CC attrition during use and associated Pt emissions in the environment appears as non-negligible. Based on the scarce and dated publications in this regard, we encourage further research for a sound understanding of this phenomenon that can negatively impact human health. The interpretation and implication of the MFA results is the first step of a multi-tool methodology presented at the ISIE-ISSST Joint Conference in 2017. Next steps include fuzzy cognitive mapping, structural analysis, scenarios generation and system dynamics to model and simulate the effects of key action levers on the Pt value chain – mapped through MFA – in a CE perspective. More generally, we argue that combination of MFA with complementary tools from engineering and/or social sciences could contribute in supporting industrial actors and decision makers to move towards more circular practices.

Table 32 – Overview of the sub-section 4.1.3 and description of the associated poster presentation

Original title	How to close the loop of platinum from heavy vehicles catalytic converters? Framework to evaluate the impact of promising action levers
Presented at	<i>First results have been presented at the 9th biennial conference of the International Society (ISIE) and the 25th annual conference of the International Symposium on Sustainable Systems and Technology (ISSST/ISIE 2017 (abstract and poster session).</i>
Key words	Circular economy, closing-the-loop, critical raw materials, platinum, catalytic converter, modeling and simulation, material flow analysis, fuzzy cognitive mapping, prospective scenarios.
Abstract	As detailed in the previous sub-section, the interest of recovering platinum from catalytic converter of heavy vehicles, arises for economic (high valuable component due to the non-negligible presence of platinum that costs around 30,000 €/kg), environmental (low platinum concentration in mines (below 10 g/t) required large consumption of energy to be extracted and refined), social (ore mining conditions are increasingly drastic) and geostrategic (more than 90% of platinum reserves are located in South Africa and Russia) reasons. Even if some marginal channels exist, the collection rate of platinum from catalytic converters in Europe is still low (around 50%). As heavy vehicles are not considered by any end-of-life directive contrary to the automotive sector submitted to the ELV directive EC/2000/53 in Europe, the objective of this applied research work is to evaluate the impact of other actions levers to close the loop on catalytic converters from heavy vehicles which contain larger amount of platinum than in cars. To date, a number of issues that still need to be tackling to close the loop of platinum have been outlined in literature but there is a lack of operational improvement proposal or simulation to assess “what if” scenarios, and therefore evaluate the impact of different changes. Indeed, even though research the on end-of-life management has an extensive literature, there is still lack of in-depth investigation on how to effectively improve the overall end-of-life collection, recovery and efficiency related to platinum from heavy-duty vehicles catalytic converters. Thus, new insights are needed to address and overcome the barriers, systematically analysed in previous state-of-the-art, to an effective circular economy of platinum. In this light, the main objectives of this work are twofold, (i) to construct a methodology that aims at assessing the impact of different actions levers on the road toward the circular economy, (ii) to experience the proposed approach through a significant industrial case study from a manufacturer willing to know how close the loop of their product containing precious raw materials, in order to benefit from economic and environmental spinoffs. Through MFA and SD modeling and simulations, promising actions levers (e.g. re-design to facilitate end-of-life recovery, take-back and remanufacturing offers, product-as-a-service, mandatory recycling rate) will be analyzed. Also, methods of prospective will be used to define relevant and realistic scenarios. The developed approach will assess the contribution of different actions levers in “closing-the-loop” by simultaneously considering environmental and economic parameters. In this paper, we will try to summarize the issues of platinum recovery from end-of-life heavy vehicles, to explain in detail the approach and to present first results of application. The proposed method consists in five steps. The first step is about modeling the current situation (defining scope, boundaries of the study, identifying stakeholders, representing value chain). Second step deals with the identification and selection of promising and possible action levers. Third step with scenarios elaboration. Fourth step with simulations realisation. Last step with results analysis and presentation to get feedback from actors. The broader impact of this work will be to provide significant new insights for industrial practitioners about mechanisms to maintain platinum deposit contained in catalytic converter in Europe and therefore to secure supply chain. As such, it will represent a valuable contribution to sustainability of resources for the European platinum sector in the light of the circular economy.

Table 33 – Overview of the sub-section 4.2 and description of the associated working paper

Original title	Dismantling, remanufacturing and recovery of an end-of-life heavy vehicle: techno-economic and organisational lessons learnt from an industrial pilot study.
To submit to	<i>Working paper for Resources, Conservation and Recycling, or another International Journal dealing with remanufacturing issues, in late 2018.</i>
Key words	Heavy vehicles, remanufacturing, dismantling process, end-of-life management, industrial pilot study, economic recovery, circular economy.
Abstract	To date, a limited number of in-depth case studies addressing the end-of-life management of heavy vehicles have been reported in the scientific literature. An industrial pilot study is conducted with an emerging international remanufacturing center of heavy vehicles to bring a contribution to this gap. This industrial pilot study considers the entire end-of-life management of a whole heavy vehicle, from the dismantling to the recovery of used parts, through remanufacturing. A first dismantling operation on a whole used heavy vehicle is performed and closely analyzed to identify hotspots and areas for improvement. Based on that and taking inspiration from the best practices of the automotive recycling sector, a new dismantling process is designed including improvement in terms of organisation, resources used, disassembly time, and comfort for the operator. This new process is then tested and validated through a second dismantling experimentation. In parallel, combining literature survey and ground investigations, a multi-scale model, associated to a practical spreadsheet, is proposed and applied to compare and select the most appropriate end-of-life options of recovered components, considering: (i) the condition of the used vehicle and residual values of key components, (ii) the dismantling process and capabilities, (iii) the end-of-life recovery channels and associated market.

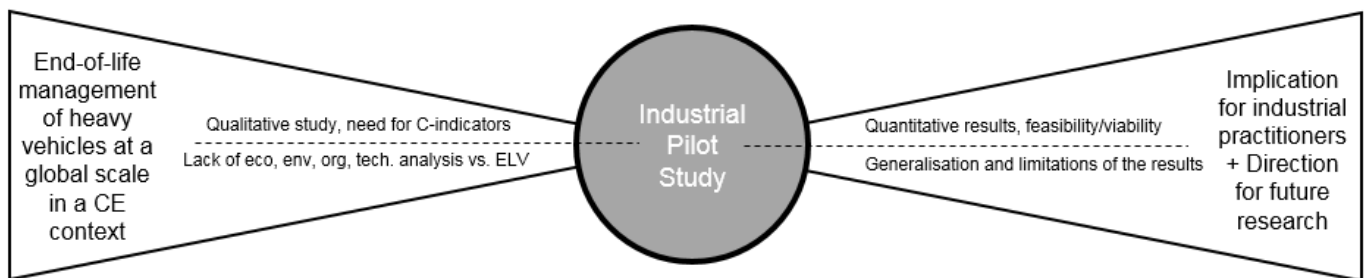

Figure 33 – Positioning and contributions of the industrial pilot study

4.1. CLOSING-THE-LOOP ON A KEY COMPONENT OF THE HEAVY VEHICLE INDUSTRY

4.1.1. Experimentation of circularity indicators

4.1.1.1. Context and objectives

Moving towards circular design, industrial and business practices is increasingly encouraged in a context of sustainable development (Geissdoerfer et al. 2017). Following a common agreement - shared by academics, industrialists and politics - on the need to provide circular economy related indicators at different systemic levels to facilitate and monitor this transition, many circularity tools, metrics, and indicators have been developed in the last few years. In fact, design for circularity is an emerging field that needs new integrated frameworks, including tools and indicators, to help establishing and monitoring innovative solutions across sectors in line with the circular economy paradigm (Earley, 2017).

Yet, without a stabilized definition of what circular economy is, it is of utmost importance to know what available circularity indicators measure in order to use them properly. As such, more than 50 sets of circularity indicators – created and used by scholars, consulting companies and governmental agencies worldwide – have been reviewed and classified into a need-based taxonomy driven by the usage of such indicators, as detailed in essay #2.

In this paper, the focus is made on the circularity performance of industrial products, i.e. at the micro scale of the circular economy implementation. The results of two workshops experimenting several C-indicators on an industrial case study are presented. Particularly, the C-Indicators Advisor tool is first used to identify the most suitable indicators according to the specificities of the case study.

The objectives of the two workshops, conducted in 2017 and 2018 during the Spring School EcoSD “Eco-design of complex system” endorsed by the Design Society, are to:

- Introduce the challenges of measuring the circularity performance of industrial products through C-indicators;
- Test the C-indicators Advisor tool and receive feedback from industrial and academic participants;
- Compare the variability in the circularity scores obtained from one group to another, and working on the same industrial product;
- Experience further C-indicators and ask participants to make a critical analysis regarding their compliance to the circular economy paradigm, their applicability in industry, their robustness, or their user-friendliness.

Additionally, through the industrial case study, participants question how C-indicators can contribute in designing and developing more circular products and systems. In other words, we discuss to what extent these C-indicators provide guidance to enhance the circularity potential of products during the (re)design and development process. Results and insights provided by the participants are reported, summarized and discussed.

The comments provided by each participant are also put into perspective with: (i) our prior critical analysis (to complement, validate or invalidate it) on C-indicators; (ii) critical reviews on some C-indicators found in the scientific literature (e.g. Linder et al. 2017). The limitations of the interpretations made from these two workshops are then discussed.

Last but not least, as the findings reveal not only some unexpected potential contributions from the use of C-indicators, but also possible unintended use of C-indicators to catalyze the shift to a more CE, we detail and provide all the elements to adapt and (re)use this workshop: whether in an industrial environment (e.g. to train industrial practitioners (designers, engineers, or managers) on how they can assess and enhance the circularity performance of their products), or for education purposes in a training sequence (e.g. to introduce the circular economy or more specifically to educate the professional of tomorrow in developing more circular products, services and systems).

4.1.1.2. Workshop design

For reasons of time constraints, regarding the planning and organisation of the Spring School EcoSD, in which the workshops have been conducted in 2017 and 2018, the entire session has to fit in half a day (i.e. in three hours). The precise timeline of each activity performed during the workshop is detailed in Table 34. After a short ice-breaking activity, the challenges of assessing the circularity performance at different systemic levels are introduced and the case study is presented. Then, based on the industrial needs specific to the case study, the participants, by groups, use the C-Indicators Advisor tool to identify suitable C-indicators, and two of these indicators are experimented by each group. Eventually, they question the strengths, complementarity and weaknesses of each approach in the light of circular economy, and in response to industrial practitioners willing to evaluate and improve the circularity performance of their products. Importantly, the workshop has been designed so that the participants have the time to fill out the responses documents completely (see Appendix D) in order to collect their feedback and constructive criticism on the C-indicators they test. All the resources and further details regarding the organisation of the proposed workshop are available in Appendix D, including: an ice-breaking activity, the datasheet related to the industrial case study, and the responses documents.

Table 34 – Agenda of the workshop on C-indicators (conducted in 2018)

Group	45 min	45 min	30 min	30 min	30 min
#1	Ice-breaking activity. Presentation.	Experimentation of the C-Indicators Advisor tool. Selection of suitable indicators.	MCI	CET	Comparison of the results and discussion.
#2			CEIP	CEPI	
#3			CPI	MCI	
#4			CET	CEIP	

As illustrated and applied in a workshop reported by Leroy et al. (2015) comparing the environmental evaluation of ideas in the early phases of the design process from several groups, the Design Research Methodology (Blessing and Chakrabarti, 2009) recommends to use one control group has a comparative baseline. Results provided by our first experimentation of these C-indicators are considered under the “control group”. Also, to compare the results and comments brought by the two workshops with our prior studies and critical analysis on C-indicators, the same catalytic converter example is used. The CET (Circular Economy Toolkit), MCI (Material Circularity Indicator), CEIP (Circular Economy Indicator Prototype), and CPI (Circularity Potential Indicator) are the four circularity indicators tested. We selected these four indicators (at the micro level of the circular economy) because they are all coming with an open access computer-based assessment tool (whether a dynamic spreadsheet or a web tool) which makes the calculation more manageable, whereas other potentially relevant indicators are not directly or freely accessible, or are only embodied in a textual format. The description of these tools are further detailed in essay #2.

In addition, Leroy et al. (2015) recommend that each group should experience two cases in order to be able to compare them. As such, each group test two different circularity indicators on the same industrial product. The specific context of this real-world industrial case study and the required data to experiment the C-indicators are recalled in a two-page datasheet, available in Appendix D. For the first session (in 2017), the 10 participants were splitted into two groups of three and two groups of two. For the second session (in 2018), the 14 participants were splitted into two groups of four and two groups of three. The group distribution is made to be equivalent (regarding the number of students and industrialists in each groups, when possible). All in all, workshops were performed for a total of 24 attendees (mainly Ph.D. students conducting their research in France, but also 2 students coming for European universities, 2 assistant professors, and 4 industrialists). During the first session, only two already knew some of the indicators and only one had experienced them before. During the second, only one already knew two of the indicators but had never experienced them.

During the two workshops, participants are surveyed about each C-indicator they experiment, using these questions:

- According to you, do the C-indicator tested encompass the whole complexity of the CE paradigm?
- What are the missing points of the C-indicator to an enhanced measurement of products' circularity?
- Is the tool relevant for industrial practitioners (designers, managers, engineers) willing to improve the circularity performance of their products during the (re-)design and development phases?
- Do you see another suitable potential use(s) of this tool? If yes, for what purposes?
- Other comments e.g. related to the format, utility, areas for improvement, etc. of the C-indicator.

Note that while the evaluation of the circularity performance (circularity score of the industrial product) was obtained per group for each C-indicator, participants' feedbacks were individual.

4.1.1.3. Results and discussion

4.1.1.3.1 Test of the C-Indicators Advisor tool

The C-Indicators Advisor tool has been developed between 2017 and 2018 (i.e. between the two workshops), so it has been experimented for the first time during the second session of this workshop in 2018. Table 35 compares how the requirements provided by the industrialist of the case study are translated in inputs of the tool to identify the *a priori* most appropriate C-indicators. Note that the query tool is designed so that when a criteria input is left blank (-), no filter is applied and it offers therefore a wider variety of C-indicators in output.

Table 35 – Results from the experimentation of the C-Indicators Advisor (acronyms are detailed in appendix C)

Input (see below)	Control	Group #1-18	Group #2-18	Group #3-18	Group #4-18
Level	Micro	Micro	Micro	Micro	Micro
Perspective	-	Potential	Actual (effective)	Potential	-
Performance	Intrinsic	Intrinsic	Intrinsic	-	-
Loop	All loops	All loops	All the loops	All the loops	All the loops
Dimensionality	-	-	-	-	-
Transversality	-	-	-	-	Generic
Usages	-	-	-	Decision-making	-
Type and format	-	-	-	-	-
Output (C-indicators advised by the tool)	9: CEIP, CET, CPI, CLC, CP, MCI, BCI, IOBS, RDI	6: CEIP, CET, CPI, CLC, CP, RDI	2: MCI, IOBS	6: CEIP, CET, CPI, CLC, CP, RDI	7: CEIP, CET, CPI, CP, MCI, IOBS, RDI

After reading the complementary information provided in output of the tool for each C-indicator advised, the participants were asked which indicator(s) they would particularly recommend to use and for which reason(s). Group #1-18 and Group #3-18 recommended the CPI for the following reasons: “it corresponds well to the need of the project manager”, “it seems complete”, “to evaluate the circularity potential of a product”, “spreadsheet already configured”. Group #2-18 and Group #4-18 advised the MCI for the following reasons: “it is adaptable to materials, products, and company”, “it is an Excel-based tool”, “to evaluate the circularity performance of materials”. Group #3-18 additionally prescribed the RDI because it is “good for decision-making”.

All participants were also asked if they had in mind other criteria that could be used to refine further the selection of C-indicators. While the current criteria was sufficient enough for Group #2-18 and Group #4-18, Group #1-18 would have appreciated an indication about the “user-friendliness” on how to calculate the indicator and the availability of an example of application. To Group #3-18, the circularity strategies proposed under the “loop” criteria are not exhaustive. Eventually, participants had the possibility to comment freely about the relevance of the C-Indicators Advisor tool (e.g. for a specific usage by industrialists or academics) and on their user experience (e.g. about the utility and usability of the tool). A participant valued it was “very interesting to reduce and select the number of indicators”. Another one, who “had no experience on C-indicators”, reported “it seems to be a useful tool to know which indicators exist and what are the differences between them” and highlighted the “clear interface” of the tool. Regarding the areas for improvement, one mentioned it misses the open access feature (stating that using an Excel spreadsheet is not really open access) and the integration of the data to other tools used during the design and development phases of an industrial product.

Circularity Indicators _ The Advisor
Target the Right C-Indicators

Presentation

↑↑↑↑↑↑↑↑

This tool aims to guide designers, engineers, researchers, managers, administrators, decision-makers, policy-makers, etc., in identifying and selecting the most suitable tool(s)/indicator(s) to assess, improve and/or monitor their circular practices according to their specific needs and requirements.

According to a common agreement - shared by academics, industrialists and politics - on the need to develop circular economy (CE) related indicators, many tools, index, metrics, indicators have been designed. Yet without a standardized definition of what circular economy is, it is of the utmost importance to know what these indicators measure in order to use them properly, within the both fuzzy and complex concept of CE. As such, this taxonomy - in which the tool seeker will help out identifying most suitable tool(s)/indicator(s) - aims at clarifying the purpose of and at characterizing each indicator according to relevant criteria in line with circular economy paradigm and features.

In inputs, several questions, to oriente you towards the most suitable tool(s)/indicator(s), will be asked about:
i) scale of measurement; ii) circularity perspective; iii) circularity performance; iv) circularity loop; vi) dimensionality; vi) usages and purposes; vii) transversality; viii) type and format.

In outputs, one or several tool(s)/indicator(s) will be identified and following information will be displayed:
i) tool/indicator name; ii) description; iii) details about CE systemic level; iv) details about the kinds of circularity; v) details about the dimensionality and units; vi) data required to compute the tool/indicator; vii) possible usages; viii) type of assessment framework; ix) authors and references; x) internet access link.

→ → → **Click on the logo above or go directly to the Inputs tab below, to start your research** ← ← ←

The present taxonomy of circularity indicators and the query tool have been developed by Michael Saidani during his PhD thesis at the Industrial Engineering Department of CentraleSupélec, Paris-Saclay University, under the supervision of Prof. Bernard Yannou, Assistant Prof. Yann Leroy and Assistant Prof. François Cluzel, funded by The French Ministry of Higher Education, Research and Innovation (Ministère de l'Enseignement Supérieur, de la Recherche, et de l'Innovation), and in collaboration with the Industrial Ecology Program at UC Davis, under the supervision of Prof. Alissa Kendall, thanks to the support of the Fulbright Commission.

Circularity Indicators
- The Search Engine
- The Query Tool

Figure 34 – Snapshot of the tool: The Circularity Indicators Advisor

4.1.1.3.2 Experimentation of C-indicators: CET, MCI, CEIP, CPI

4.1.1.3.2.1 Variability in the results

The quantitative comparison of the circularity scores obtained by the different groups shows a higher variability in the results of C-indicators assessing a circularity potential (CET, CEIP, CPI) than the MCI which evaluates an actual circularity, as illustrated in Table 36 and Figures 35, 36 & 37. Further explanations of the variability in the results, using though the same dataset, are discussed in the next sub-section. Note that although such a variability is noticed in the improvement potential assessed by the CET, and in the circularity scores of the CEIP and CPI, they highlight locally the same areas of improvement to a better circularity of the catalytic converter. The qualitative analysis of the participants’ feedbacks on their user experience illuminates interesting possible usages and areas for improvement of these C-indicators.

Table 36 – Results from the experimentation of the Circular Economy Toolkit (CET)

Circular Economy Toolkit (CET)					
Improvement Potential	Control	Group #4-17	Group #1-17	Group #4-18	Group #1-18
Reduce Material	Medium	Medium	Low	Medium	Medium
Optimise Materials	High	High	Medium	High	High
Industrial Symbiosis	Medium	Low	Medium	Medium	Low
Design	None	None	Low	None	None
Usage	Medium	Low	Medium	Medium	Low
Maintain	Medium	High	Medium	Medium	High
Reuse	Medium	Medium	Medium	Medium	Medium
Refurbish	High	High	Medium	Medium	Medium
Recycle	Medium	Medium	Medium	Medium	Medium
Product as a Service	Low	Medium	Medium	Medium	High

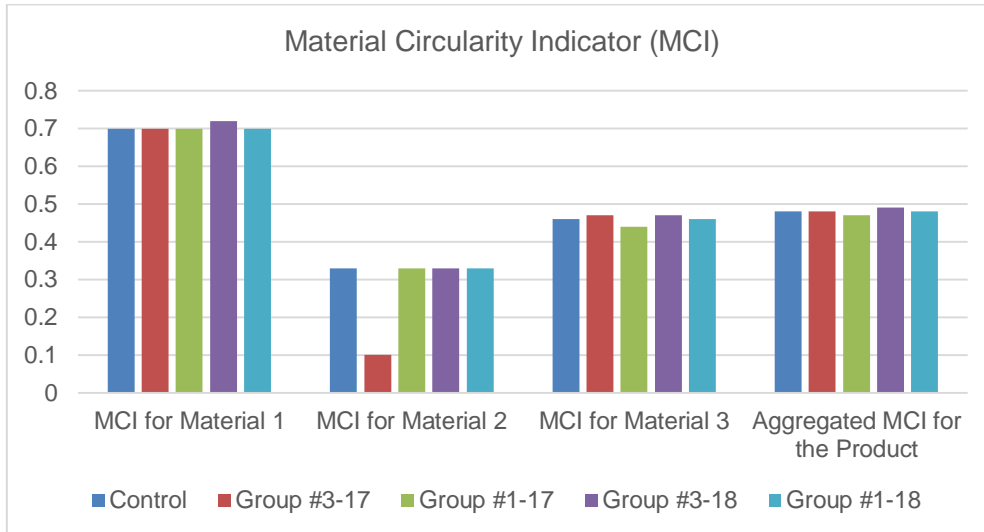

Figure 35 – Results from the experimentation of the Material Circularity Indicator (MCI)

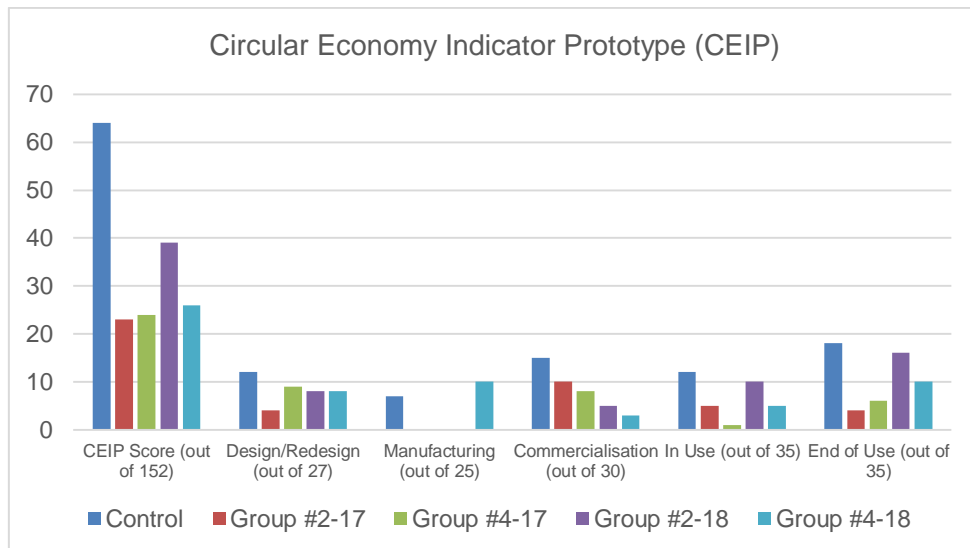

Figure 36 – Results from the experimentation of the Circular Economy Indicator Prototype (CEIP)

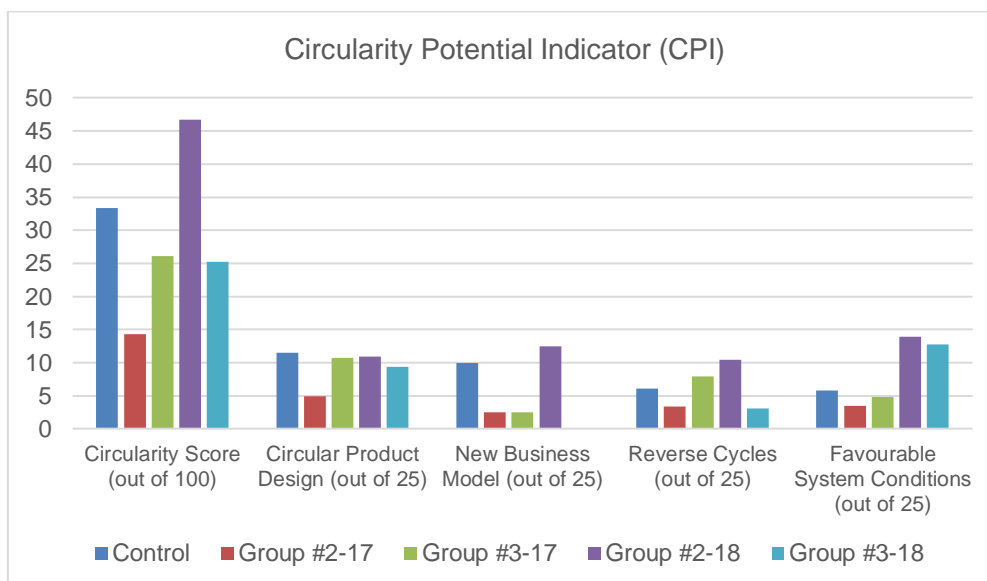

Figure 37 – Results from the experimentation of the Circularity Potential Indicator (CPI)

4.1.1.3.2.2 *Qualitative feedback and critical analysis*

Regarding a possible explanation about the variability in the circularity scores between each group working on the same case study, almost all the participants mentioned an important uncertainty when answering a question asked by the CEIP, CET or CPI. They stated the reasons of this uncertainty are based both on the lack of clarity certain questions and on their lack of knowledge on the industrial product and its associated ecosystem. In fact, some answers are subjective to the interpretation and background of the user (e.g. “easy”, “hard”, “cheap”, “expensive” in the CET or “very”, “few” in the CPI) which can explain the aforementioned variability in the results. On the other hand, most participants valued not only the user-friendliness (i.e. the tools are easy to use and it straightforward to understand how they work) but also the time-efficiency (once the data are available and properly collected) of the four tools allowing a practical computation of the circularity scores.

Regarding the missing points and elements these indicators should consider for an enhanced measurement of the product circularity performance, the following comments and suggestions were made. Several participants noticed the economic aspects (e.g. costs of logistics and end-of-life treatment compared to the inherent value of materials) are not directly taking into consideration by the C-indicators they experienced. Specifically related to the MCI, the comparison between the cost of recycling operations, plus the value of secondary materials against the cost of virgin material production, plus the value of primary materials, is reported as a missing point. One participant suggests to connect the separate spreadsheets of the MCI (i.e. one file at material level and one file at the product level) into one single tool. More generally, the location and transportation of the product, as well as the business models associated the product are also some points barely addressed by these C-indicators that should have deserved more attention according to some participants. Eventually, one participant would have appreciated to be informed about the role and responsibilities of players involved in each activity that affects the circularity performance, while another one would have valued the fact the C-indicators explicitly display the equation or mathematical calculation to get the circularity scores (e.g. the weighting factors used in the CPI).

Regarding the relevance of C-indicators and their associated measurement tools for industrial practitioners willing to improve the potential circularity performance of their products during (re-)design and development phases, participants provide comments on each C-indicator as it follows. The CET is mainly viewed as useful both for products' comparison and for quickly identifying where improvements can be made. One also mentioned that to be really relevant, the CET has to be used by experts that know the product deeply in order to answer all the questions accurately. The MCI is recognized as a practical and simple tool for a quick analysis of a product, providing an early evaluation on material circularity, as well as to be used as a first step in the circularity assessment before digging more deeply into improvement areas. The CEIP appears also relevant for a quick comparison of design strategies, checking the main aspects of circularity. Yet, for some, the level of details required in input data is rather high, while further considerations on business models and marketing aspects are missing in the list of questions asked to compute the CEIP. To most participants, the CPI seems useful as a comprehensive checklist, to improve the circularity performance of products, covering design for product circularity, looking at policy and taking into account the business models. Globally, the participants also discussed the genericity of these tools. To some, it is a true advantage that they all can be applied on a wide variety of products. To others, it is an obstacle to go further in the actual improvement of the products, by considering specific and professional knowledge related to the product and its ecosystem.

Some of these comments are in agreement and complementary with the research carried out by Griffiths and Cayzer (2016) interviewing circular economy players about the CEIP, who mentioned the tool: “is easy to follow”, could be used “as a training exercise for engineers”, “as a checklist”, “to understand the levers for working on circularization”, “is best suited for incremental changes”, could be extended to “a comparison of 2-3 product versions on one page”. The insights provided by the two workshops are also supplementary to the analyses made by Linder et al. (2017), whose paper on product circularity metrics states that one avenue for future research, related to the adoption of C-indicators in industrial practices, is to examine how collaborative research can contribute to the further development, testing, and implementation of robust and legitimate C-indicators. Linder et al. (2017) particularly discuss the construct validity, reliability, transparency, generality and aggregation principles of five circularity indicators, including the MCI (EMF, 2015). According to them, circular metrics of low dimensionality, such as the MCI, are useful for managerial decision making but their operationalization may appear to be problematic. Additionally, they found that many of the data inputs required might be uncertain or depend on several factors or assumptions, such as the destination of a product after use or the efficiency of recycling processes. They also state that a fully functioning circular economy metric should be able to examine the relationship between product circularity and other variables, such as cost savings (Linder et al. 2017).

Participants were also asked if the C-indicators they tested cover the whole complexity of the circular economy. As illustrated in Figure 38, for the four indicators there is no unambiguous consensus among the participants regarding this question. It is therefore difficult to draw meaningful conclusions regarding the compliance between what is assessed by the C-indicators and the circular economy paradigm. After discussion with some participants, one explanation of their different answers lies on the fact these concepts (complexity of the circular economy, system thinking, lifecycle thinking) are not so well-defined to them, and thereby lead to several subjective interpretations.

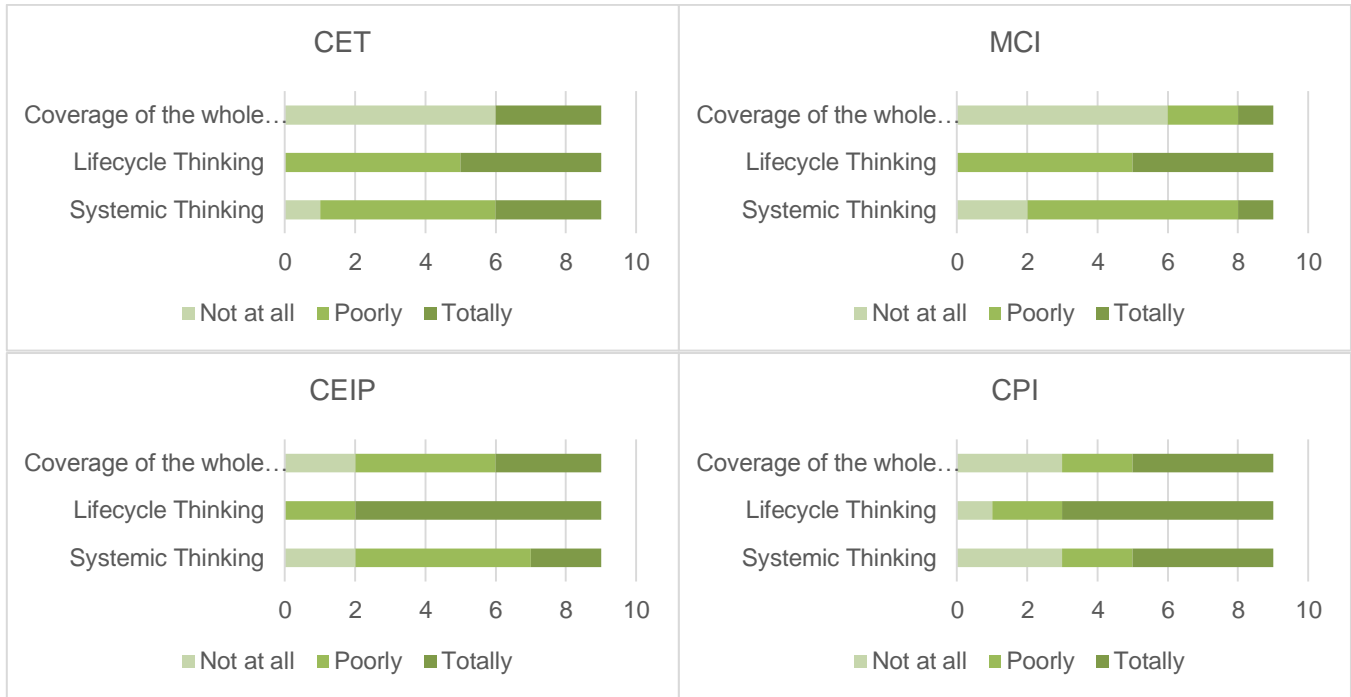

Figure 38 – Are the C-indicators compliant with the circular economy paradigm?

Regarding other potential suitable use(s) of these C-indicators and associated tools, participants saw promising applications of C-indicators in various contexts. Interestingly, many participants said such indicators could have benefits beyond the assessment of the product circularity performance, both in education and industry. For instance, for educational purposes, by being applied on a real-world case study, these C-indicators could be used to introduce in a concrete way the many different facets of the circular economy. More generally, such a hands-on workshop on C-indicators can train current industrial practitioners (e.g. designers, engineers, managers) or the professional of tomorrow to think concretely and critically on how to design and develop more circular systems, as well as to have the tools to pilot industrial and managerial activities in a circular economy perspective.

4.1.1.3.3 Limitations

So far, the workshops have been conducted two times with a total of 24 attendees, mainly from academia. As such, readers should not generalize the results because the values and criticisms made by industrial practitioners may differ. For instance, we discussed if the C-indicators and their associated measurement tools are relevant for supporting industrial practices based on the insights provided by the participants. Even if they provided constructive feedbacks based on their current projects with industry or previous industrial experiences, further experimentations of these C-indicators in an industrial environment are required to demonstrate their actual and effective relevance. Also, post-workshop interviews can be relevant to validate the findings and exchange the viewpoints of one participant to one another. Yet, combining the discussions made on essay #2 and the new insights provided by these two workshops, we argue the use of C-indicators can not only enable the integration of circular thinking into the product design and development process, but also support sustainable manufacture by assisting companies in assessing and improving the circularity of their products, services and systems. On this basis, guidelines are given in the following sub-section to conduct this kind of workshop both for (i) educational purposes (e.g. on a training sequence related to circular economy or sustainable design), and (ii) industrial applications (e.g. to train engineers on circular economy principles or on managerial aspects to evaluate and monitor their circular economy strategies).

4.1.1.4. *Replicability of the workshop in other contexts (educational and industrial)*

Motivated by the aforementioned feedback, we intend to provide a turnkey and flexible workshop. The guidelines to reproduce such a workshop are detailed below and all the resources are available in Appendix D. One can adapt this proposed organisation (e.g. number of groups, C-indicators experimented) regarding the audience (e.g. training sequence for students, continuing education for engineers) and time available to best fit his or her needs. Note that the workshop has been designed to be time-efficient, and the half-day format fits particularly with industrial constraints in time when it comes to conduct workshops on sustainable design or eco-innovation (Saidani et al. 2016).

Scope of the workshop and audience: The workshop aims to guide designers, engineers, researchers, managers, administrators, decision-makers, policy-makers, etc., in identifying and selecting the most suitable(s) tool(s)/indicator(s) to assess, improve and/or monitor their circular practices according to their specific needs and requirements. For instance, using such tools, designers would be able to integrate more easily circular thinking, as well to evaluate the potential circularity performance of their ideas. A designer is defined as any person who is primarily involved with the generation and development of ideas that leads to the development of new products or services. Moreover, it is also open to everyone (i.e. with a novice, intermediate or expert level) interested in circular design and life cycle thinking, in order to discover the possible contributions of circularity indicators and how they can be used in practice. Indeed, it is not necessary to use these tools to be an expert or have prior experience with circular economy practices or knowledge.

Synopsis of the workshop: After an ice-breaking activity (one activity is suggested in Appendix D) and an introduction on the circular economy concept, as well as on the challenges related to its implementation, the C-Indicators Advisor is first presented through an industrial example of a company willing to measure, improve and monitor the circularity performance of a product – a catalytic converter – that the company designed and developed. Based on the company's needs and requirements, results propose several potentially useful circularity indicators and associated calculation methods, frameworks, or tools at a micro level – the one of products and materials – which aim at (i) evaluating circularity potential of industrial products during design and development process, (ii) providing guidelines for circular design improvement, (iii) facilitating benchmarking with competing products. As a candidate set of circularity indicators, four C-indicators and their associated computer-based assessment tools, aiming at enhancing product circularity potential performance during design or re-design phases are ready to be used. Also, it is possible to use the C-Indicator Advisor so as to identify and experiment other C-indicators to evaluate the circularity performance of a given company, or region. For information, this C-indicator Advisor tool is flexible in the way the databank is not frozen and may be easily updated. As such, it is possible and highly appreciated for attendees to contribute in return to the tool development or consolidation, e.g. if participants are aware of – have tested, or are developing – new circular economy related tools and indicators that are not inventoried in the present databank.

Regarding the experimentation of C-indicators, participants may have two possible options: (1) Participants may test and experience the selection tool on their own projects to find out which circularity indicators suit the best to their needs. It is possible for them to work individually (or in small group) on their own project or case study linked to the circular economy. As such, they are proposed to experience, and feed the query tool with their requirements so as to identify indicators that might be relevant for them. Then, as web access links are provided to explore the recommended indicators in output – including associated working principle and calculation methods – attendees are free to test such circularity indicators. (2) For participants who do not have a particular case study or sufficient data to experience the tool by their own, but who are interested in testing the query tool and recommended indicators, it is possible to operate the data from the catalytic converter example to do so. A synthesized two-page datasheet is provided to get enough information and knowledge on the industrial environment and product to feed the tool and to experience various circularity indicators. For all, a response document template is given to participants who want to keep track of their findings or to provide feedbacks on the tool.

Eventually, here is a list of what is mainly needed to conduct such a workshop: Station with computers. Microsoft Windows and Microsoft Excel with macros are required to use and run the query tool. Datasheet and responses documents as detailed in Appendix D. There is no special need for the location, just enough room for tables, chairs, and computers, close to power outlets if possible. Ideally, an Internet access is required so that participants can experience the tool and have access to a wide variety of circularity indicators on their own computers – if not, the tool and some indicators experimented could be stored and made available in a USB key.

4.1.2. Additional contribution from material flow analysis and C-indicators

4.1.2.1. Introduction

4.1.2.1.1 Context

Critical raw materials (CRM) are one of the five priority sectors identified in the European Union (EU) action plan (EC, 2015) for a more circular economy (CE). Platinum (Pt) is one of the 27 CRM listed by the European Commission, based on its high economic importance, supply risk, import reliance, and low end-of-life recycling input rate (EC, 2017). The key objectives of the European policy (EC, 2015) on CRM are: (i) the reduction of import dependency by improving supply conditions from EU and other sources and providing resource efficiency and alternatives in supply; (ii) bringing Europe to the forefront in raw materials sectors and mitigating their negative environmental and social impacts. Actually, platinum group metals (PGM) are fundamental for emerging technologies – e.g. the platinum currently in use in catalytic converters (CC) and soon in fuel cells (Valérian, 2016; Senk et al. 2012) – and the EU is 98% reliant on platinum imports (EC, 2017). In Europe, the demand of platinum is mainly driven by their use in CC – 69% of the overall demand, estimated approximately to 70 tonnes (Deloitte Sustainability, 2017) – which are mandatory devices used to reduce tailpipe emissions from motorized vehicles.

The European Commission (2014) defines the CE as an economy “where the value of products, materials and resources is maintained in the economy for as long as possible, and the generation of waste minimised”. On this basis, securing a sustainable availability of CRM can be accomplished by improving the circularity efficiency of the entire value chain e.g. through the implementation of closed-loop approaches (Stahel, 2016). In fact, the adoption of CE strategies can be a long-term strategy to mitigate the risks of CRM supply at the European scale (Gaustad et al. 2018; UNEP, 2013) e.g. by improving recycling rates of scarce metals from end-of-life vehicles (Andersson et al. 2017) like the platinum which may be functionally recycled in its main application without facing the issue of downcycling. Furthermore, state-of-the-art refining centers can recover up to 98% of the platinum from used CC (JM, 2017). As such, platinum appears as an ideal candidate for the application of CE principles. Yet, currently the circularity performance of platinum in Europe is not optimal: the recycling rate of platinum from CC is estimated to be between 50 and 60 % (Hagelüken et al. 2016), indicating thus opportunities for improvement in a context of CE of products and materials.

Complementary to prior academic and industrial works discussing ways to close-the-loop on platinum, the main objective of this study consists of clarifying the current European value chain of platinum from CC in an operational way, that is to say, to map both qualitatively and quantitatively the distribution of flows, stocks and losses, as well as the stake-holders on this value chain, using material flow analysis (MFA). As a result, key economic, environmental and organisational value buckets are highlighted. The findings provide a relevant basis to support industrial actors, decision-makers, and policy-makers, in the orientation of their actions, in the way they will be in a better position to visualize where to act, which stakeholders are involved, and what level of improvement – e.g. environmental and economic benefits – could be expected. The main contribution of this paper is thus in accordance with Senk et al. (2012) and Andersson et al. (2017), sharing that the increase of deep knowledge on the use and end-of-life pathways of CRM in the EU will enable the European society to transfer more resources into economically efficient and technically manage-able metal reserves.

4.1.2.1.2 Understanding the supply risk for the EU

The European Commission (EC, 2017) recently highlights and reminds the economic importance of platinum and its associated supply risk for the EU, as shown in Figure 39. The following key elements, extracted from various sources and summarized hereafter, provide a better and comprehensive understanding of these concerns for the EU:

- **Concentrated production:** First, the fact that European mining projects cannot compete worldwide production makes it essential to develop better recycling processes, so as to strengthen the autonomy and competitive edge of the European industry (CGE, 2015; Alonso et al. 2012). In fact, the EU mine production makes a small contribution to the European platinum supply, with an annual production of about one tonne (EC, 2017) when the overall European annual demand is around 70 tonnes. The EU is actually dependent on imports for the majority of metals that feed technology and advanced industries, such as platinum coming mainly from South Africa and Russia, where long-term stability is not assured (CETIM, 2017). For instant, in 2012, strikes by South African miners have impacted on production and may do so in the future (Sievers and Tercero, 2012).

- **Declining ore grades:** The average PGM concentration in the mines – e.g. in South Africa – is below 10 g/t (Hagelüken, 2014). In addition, the PGM industry is progressively forced to exploit lower grades and more expensive PGM ores (Bardi and Carporali, 2014), resulting in increasingly higher cost, as well as CO₂ emissions and energy consumption for the production of primary platinum. On the opposite, catalytic converter contains some 2,000 g/t of PGM in the ceramic brick (Hagelüken, 2014) making their recovery attractive from a sustainability standpoint. In a nutshell: platinum primary mining is characterized by low grade, high volume and fixed location; platinum urban mining is characterized by high grade, millions of units and global dissemination. In this context, extracting urban mines seems therefore a suitable sustainable solution to avoid landfill of metals and overcome long-term supply disruptions.
- **Increasing demand:** It is acknowledged that the demand of PGM will increase in the years ahead (JM, 2016; EC, 2015) due to: (i) the imposition of increasingly strict emission control e.g. in the heavy-duty and off-road sector, which has been and will continue to be a source of significant platinum demand growth in response to the introduction of the Euro VI legislation for heavy-duty vehicles in 2014 and the preparation of the Stage V legislation for non-road engines becoming active in 2020; (ii) the expected increase of fuel cells in electric vehicles. Indeed, according to Johnson Matthey (2016): “In the longer term the move away from carbon-based fuels for powering road vehicles may lead to reduced demand for platinum in catalytic converters. However, if fuel cell vehicles achieve significant market penetration in the future this is very likely to lead to increased demand for platinum”.

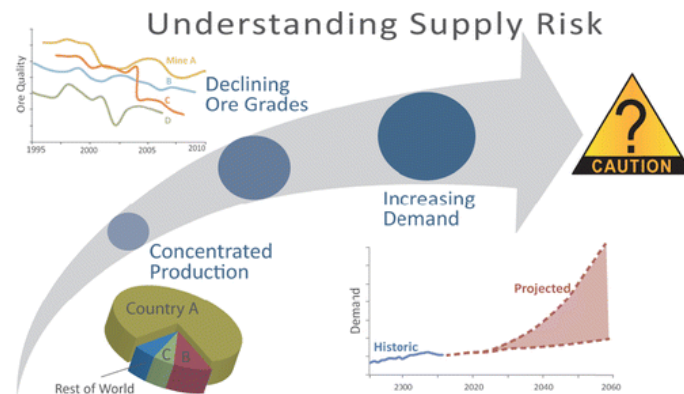

Figure 39 – Reasons of the platinum supply risk for the EU (source: Alonso et al. 2012)

4.1.2.1.3 Environmental and economic challenges

Out of 63 metals investigated and compared on a per kilogram basis, Nuss and Eckelman (2014) revealed that the platinum group metals and gold display the highest environmental burdens. The environmental impact of the primary production of platinum is actually tremendous: around 40 tons CO₂ eq. plus 200 GJ to produce 1 kilogram of platinum (see sub-section 4.1.2.4.3). Hopefully, the secondary production of PGM can significantly minimize the environmental impact – i.e. regarding emission reduction and energy savings – of the overall PGM supply, especially when state-of-the-art technologies from European refining centers are used (Van der Voet, 2018; Hagelüken et al. 2016). In fact, it has been estimated in average that the use of secondary platinum from end-of-life CC could divide by 20 the environmental cost (see sub-section 4.1.2.4.3). In addition to this environmental value bucket, the high value of PGM makes their recycling attractive (Mathieux et al. 2017): the price of 1 kilogram of platinum fluctuates indeed around 30,000 €. As a consequence, there is an important interest for European industrialists to recover the remaining material quantity of their systems, notably for European actors who need to buy platinum to manufacture catalytic converters. Moreover, the reuse of PGM metals recovered from catalytic converters does not require high costs compare to primary ore extraction (Fornalczyk and Saternus, 2013), notably at a time mining conditions are expected to become increasingly difficult due to lower ore grades. On this basis, closing-the-loop of PGM in Europe is of the utmost importance both from economic and ecological viewpoints (Fornalczyk and Saternus, 2013). Despite all that, the recycling rate of platinum from automotive catalysts is only estimated to 50-60% (Hagelüken et al. 2016; UNEP, 2013). To cite the UNEP (2013): “Taking the relative price levels of precious metals into account, it seems surprising that those metals do not have the highest end-of-life recycling rates among all metals”. This reality is even more regrettable when one knows 98% of the PGM content of spent automotive catalysts can be repeatedly recovered (JM, 2017) using state-of-the-art recycling centers. All in all, it seems not only feasible but also of great importance to enhance the circularity performance of platinum contained in catalytic converters.

4.1.2.1.4 *Research gaps and expected contributions*

This study is of course not the first to address this issue. In fact, several authors have proposed and discussed possible measures for improving the recycling rates of CRM and thus their circularity performance. For instance, Gaustad et al. (2018) examined CE strategies to mitigate critical material supply issues. Accordingly, Lapko et al. (2018) made a focus on closed-loop supply chain (CLSC) as a promising strategy for securing long-term availability of materials. Their findings underline the need for interactions between supply chain actors, a sound competitive environment for recycling processes, and investment in technologies and infrastructure development if CLSC for CRM is to be developed. More precisely, the work of Hagelüken and colleagues (2009, 2012, 2014, and 2016, just to name a few) provide the most advanced research on the issue of recovery platinum from autocatalysts both at the German and European scale, including extensive discussion on potential relevant action levers to close-the-loop. To close the recycling loop new business models will need to be introduced to provide strong incentives for returning products at their end-of-life (EoL), efficient collection being the largest challenge to Hagelüken (2014). The gap to reach an augmented recycling rate is also caused among other factors by exports of EoL vehicles to regions with insufficient recycling infrastructures, and by a long and opaque EoL value chain in Europe (Hagelüken et al. 2016).

In fact, the entire value chain of platinum in the EU is complex and difficult to quantify accurately regarding the large number of actors involved and the distribution of vehicles all across Europe, including imports and exports. Despite these difficulties, its modeling appears to be a prerequisite in the gain of deep – quantitative and localized – knowledge, with the aim to advance a CE of platinum in Europe. In previous work, Saurat and Bringezu (2008) analyze flows of three platinum group metals (platinum, palladium, rhodium) and the environmental impacts associated with their supply in Europe through MFA, in combination with a model of environmental pressures related to the production of PGM outside Europe. This study provides results for the year 2004 within the geographical scope of the EU-25, plus Norway and Switzerland, and taking into consideration the major industrial sectors of PGM use, namely the chemical, petroleum, and glass industries; jewelry, dentistry, electronic equipments; and car catalyts.

More recently, following the call for a “study on data needs for a full raw materials flow analysis” launched by the European Commission in 2012, a materials system analysis (MSA) was carried out to investigate the flows and stocks of 28 raw materials throughout their entire life cycle, including the platinum (BIO by Deloitte, 2015). MSA is similar to a MFA in the way it consists of a mapping of the flows of materials through the economy, as raw materials, components or products, in terms of entry into the economy (extraction and import), movement through the economy (production, consumption, and exports), additions to stock, and end-of-life through either disposal or recovery. This study provides results for the year 2012 within the geographical scope of the EU-28, and considering as well as the main product groups using platinum (i.e. automotive catalyts, industrial catalyts, electronic, jewellery, and biomedical applications).

A first contribution of this article is to update the previous MFA related to the platinum value chain in the EU which provide results for the year 2004 (Saurat and Bringezu, 2008) and 2012 (BIO by Deloitte, 2015). A comparison between these previous studies and the present findings – e.g. order of magnitude of the flows, environmental repercussions – is particularly discussed in sub-section 4.1.2.4.1.

Interestingly, the present study has the following distinguishing characteristics and contributions:

- Specific focus on the platinum from catalytic converters within the EU, and modeling the associated value chain system at a detailed level: this study is indeed sector- and product-specific, and complement therefore more general studies dealing with the European platinum value chain (BIO by Deloitte, 2015; Saurat and Bringezu, 2008);
- Demarcation between platinum contained in light vehicles, under the ELV Directive 2000/EC/53 and platinum contained in heavy vehicles, not subject to mandatory minimum recycling or recovery rates;
- Mapping of key actors on the value chain, i.e. of actors who can have an influence on the circularity performance of platinum in the EU;
- Evaluation of the environmental and economic repercussions due to the leakages of platinum for European stakeholders, by comparison to the potential reuse of secondary platinum;
- Application of circularity indicators on the end-of-life value chain (collection, pre-processing and end-processing) to get an augmented knowledge of improvement areas on the circularity performance, as well as to track progress and assess the impacts of potential action levers.

4.1.2.2. *Materials and methods*

4.1.2.2.1 *Research methodology*

The material flow analysis (MFA) is the main methodology used here to provide meaningful insights to the objectives aforementioned. The research process to perform proper MFA implies literature review, data collection, hypothesis and extrapolation development, crossing different data sources, and therefore uncertainty analysis for sensible information flows. The rationale having selected the MFA methodology is detailed in this section, through a synthesized literature survey. Specific data acquisition and material analysis for the present case study are developed in the following sub-section.

Material flow analysis, also known as material flow accounting, is a systematic assessment of the flows and stocks of materials within a system defined in space and time (Brunner and Rechberger, 2003). It has become one of the most acknowledged tools in the industrial ecology field to control material use and industrial processes, as well as to create loop-closing industrial practices (Takeyama et al. 2016). MFA is thus an efficient tool to map material flows and stocks across the economy (Bollinger, 2012; Mathieux and Brissaud, 2010). In fact, it allows to quantify the material efficiency and the improvement potential of the value chain associated to a product or material. As reviewed by Moriguchi and Hashimoto (2016), MFA has often been used to capture flows of valuable resources contained in end-of-life vehicles, such as aluminum, steel, copper, lead, and zinc, or even to analyze lithium-ion battery waste flows from electric vehicles in the future. On this basis, MFA can notably be useful for decisions concerning waste management, to inform both policy, research and managerial choices (Bellstedt, 2015).

Furthermore, the promising bridge and association between MFA and the CE has been mentioned by Bellstedt (2015) in the way the CE provides a sense of purpose and direction to the analysis, while in turn MFA generates transformational knowledge for a transition to a more CE. MFA is thus an appropriate basis for monitoring the physical flows during the CE implementation (Kalmykova et al. 2017). In comparison with emergy analysis and input-output analysis, the MFA method allows addressing more comprehensive and integrated representation of materials/products flow and stock externalities, in addition of being the most mature approach. Interestingly MFA models allow also the identification of actors managing the flows. For instance, Diener and Tillman (2016) used MFA to create a map of the system, to estimate the physical flows in the system, in order to finally identify opportunities for an improved end-of-life management. Yet, to Bellstedt (2015) product-specific MFAs are at present barely developed, excepted for a limited number of products covered by regulations.

In this study, the MFA methodology is applied to quantify and break the hurdles for advancing a CE of platinum contained in catalytic converters in Europe. The MFA was conducted in two phases using STAN (subSTance flow ANalysis) software (Cencic and Rechberger, 2008) with the consideration of data uncertainties. First, the value chain and related stakeholders are mapped out in a MFA-like model to both facilitate the assessment of stocks and flows, and get a comprehensive view of potential action levers and resources. Then, two MFA are completed: (i) one general MFA, and (ii) one sector-specific MFA, drawing a distinction between the fate of platinum from (a) light-duty vehicles, under the ELV Directive 2000/EC/53, and (b) heavy-duty and off-road vehicles, not subject to such a regulatory framework.

Brunner and Rechberger (2003) provide key guidelines to perform a consistent MFA, striving for transparency and manageability. In a nutshell, conducting a proper MFA consists of the following steps:

- Identifying the material(s) of interest: Platinum from catalytic converters;
- Determining the system boundaries: The spatial system boundary is the EU-28 and the system boundary in time is the year 2017;
- Identifying the activities or processes of interest: The main lifecycle stages of European value chain of platinum contained in catalytic converters (see sub-section 4.1.2.3.1. for more details);
- Calculation of the stock and flows: This step is entirely described, explained and illustrated in sub-section 4.1.2.3.2.

For better transparency regarding the present scope of analysis, it is valuable to remind that the core structure and function of the catalytic converter is composed of three main components: (i) the canning, also called the converter housing; (ii) the catalyst support, also called the substrate or ceramic brick in cordierite; and (iii) the coating, also called the catalyst washcoat. The platinum contained in the coating is the only material considered in this study. The end-of-life pathways of the steel from the canning (cut then recycled in still mill) or of the ceramic (shredded then reused in cement factory) are out of the scope of the present study.

4.1.2.2.2 *Data collection and uncertainty analysis*

To complete the expected MFA, an in-depth cross analysis of numerous data sources – i.e. technical, industrial, and market reports, European statistics, as well as academic publications and communications from environmental or governmental agencies – has been conducted. Actually, complementary publications from different fields – i.e. from industrial ecology e.g. Hagelüken et al. (2016), from industrial engineering e.g. Fornalczyk and Saturnus (2013), and from chemical science e.g. Pospiech (2012) – have been used. Some data are considered reliable as they are derived from official statistics – e.g. Eurostat (2017), JM (2017), and ICCT (2016). Yet, some assumptions and extrapolations have to be made to determine the value of certain flows for the year 2017 at the European scale. For this reason, uncertainty analysis has been considered to support the transparency and reliability of the results. Data quality assessment is indeed encouraged by the EC (2015). Indeed, sustainability problems are usually difficult to manage due to the presence of complexity along with a series of uncertainties and vagueness (Sabaghi et al. 2016). The STAN software, used to perform the MFA, allows the consideration of data uncertainties (Cencic and Rechberger, 2008) and provides a data reconciliation feature (Cencic, 2016). In the STAN methodology, it is assumed that uncertain quantities are normally distributed, given by their mean value and standard deviation.

Leroy (2009) described different methods and procedures for data quality management in life cycle inventory. The use of a pedigree matrix to evaluate the quality of a data is particularly recommended. In the pedigree matrix proposed by Weidema and Wesnaes (1996), each input parameter is evaluated from 1 (good) to 5 (bad) on five quality criteria (reliability, completeness, temporal correlation, geographical correlation, and technological correlation) arguing these criteria are independent and sufficient to characterize information. The properties of normal distributions can be as such characterized according to the quality index determined by the pedigree matrix. In fact, this semi-quantitative method translates the quality index of a given data into a quantified confidence interval for the value of this data. A more pragmatic approach was developed by BIO by Deloitte (2015) to give a quality assessment of the results of the MSA (see Table 37) in order to ensure the reliability and consistency of these results. According to the authors, this approach has the advantage: “to be very simple to implement, in order not to make more complex the development of the MSA; to allow the tracking and the transparent assessment of the robustness of the results provided for each parameter of the MSA; to highlight important missing information or results of inferior quality with the purpose to stimulate institutions and stakeholders to close the information gaps by carrying out studies or data gathering activities”.

Even the approach developed by pedigree matrix proposed by Weidema and Wesnaes (1996) is now widely used in the LCA field, it was not straightforward in the present case to determine with accuracy and consistency all the criteria pedigree matrix for all the different flows, regarding the variety of data sources. As such, the uncertainty levels of the input data are quantified using the pragmatic approach proposed by BIO by Deloitte (2015). More precisely, for each data used and/or parameter calculated for a flow of the MFA, a quality score from 1 to 4 is attributed according to the criteria presented in Table 37. Following the principle of a pedigree matrix, the data quality indicators are transformed into estimates of the uncertainty – i.e. the value of the standard deviation around the mean value – which increases according to how low the data quality is.

Table 37 – Data quality score and associated uncertainty values (inspired by: BIO by Deloitte, 2015)

Sources of data	Criteria for the quality score of the data used	Criteria for the quality score of the parameters calculated	Quality score	Uncertainty values for the MFA stocks and flows	Stocks and flows concerned (see Table 38)
Data published or given from experts	Direct use of data from a source	Using only data from sources	4	No uncertainty	I1
	Basic extrapolation of data from a source	Using at least one extrapolation of data from a source	3	Standard deviation = 10% of the mean value	F1, F2, R1, L3, L4, E1
Estimation or hypothesis	Estimation of data based on known facts	Using at least one estimation of data based on known facts	2	Standard deviation = 20% of the mean value	I2, I3, I4, R2, R3, E2, L2, F3, F4, P3
	Hypothesis	Using at least one hypothesis	1	Complete sensitivity analysis performed	L1

On this background, the MFA modeling and computation can be now properly conducted. First, a graphical model of the MFA is built (flows, processes, systems boundaries, text fields) representing the platinum value chain for catalytic converters in the EU. Then, known data (mass flows, stocks and transfer coefficients) are directly assigned in the MFA model for flows with no uncertainty on it, e.g. high quality data provided by JM (2017). For each flow estimated through combination of uncertain data, assumptions and/or extrapolations, a mean value and associated standard deviation are defined according to the data quality model proposed by BIO by Deloitte (2015). Finally, the data reconciliation functionality of STAN is applied to adjust all stock and flow values in accordance with the mass balance, and to determine the most plausible values of unknown quantities (missing flows, changes in stocks). All data sources, mean values and standard deviations calculated for each stock and flow are reported in sub-section 4.1.2.3.2.

4.1.2.3. Results

4.1.2.3.1 Visualization of the value chain

The European value chain of platinum contained in catalytic converters includes the following key processes, as illustrated in Table 38: production, use and stockpile, collection, pre-processing and refining. The dotted line marks the system boundary of the system i.e. the stocks and flows occurring in the EU-28. The graphical MFA-like model is the first stage of the MFA methodology conducted here to capture visually the missed opportunities and value buckets within the value chain. It provides indeed a good knowledge and comprehensive vision of the current value chain and mechanisms of the platinum contained in catalytic converters (potential collection, imports, exports, end-of-life process). Moreover, in Table 38, key stakeholders of this value chain are mapped out and assigned to each process. An estimate of the order of magnitude on the number of actors is also informed, as well as their geographical locations. Examples of companies playing a key role are also given. Interestingly, the top and the bottom of the catalytic converter value chain are well-defined, delimited and dominated by a few global and European players. Some of the key manufacturers and refiners operating in the European market are Johnson Matthey, BASF or Umicore. On the contrary, the use phase involves a wider variety of actors disseminated all across Europe, making the collection process difficult, not sufficiently well-established and controlled especially the for heavy-duty and off-road vehicles.

Table 38 – Value chain of the platinum from catalytic converters in the EU-28

<p>MFA model</p> <p>Acronyms of the flows: I: Input F: Flow E: Export R: Reuse L: Leakage</p>	<p>Scope: Europe Material: Platinum Year: 2017</p>					
Categories of stakeholders	Mining companies	OEMs, Suppliers	Users, After-sales services	Catalyst Collectors	Catalyst Decanners	Processing industry
Order of magnitude of # of actors	1 – 10	10 – 100	~1.000.000	100 - 1000	10 - 100	1 – 10
Geographical location	South Africa (~ 90 % of the market)	UK, Belgium, Germany, etc.	Worldwide	Shadow zone	Shadow zone	UK, Belgium, Germany, Italy
Examples	Anglo Platinum, Implats	Johnson Matthey (JM), Umicore, BASF	Wide variety of users (industry, consumer, etc.)	High and fuzzy numbers of intermediates	Multirex' Auto, IPM Recycling	JM refineries, BASF, Umicore Smelter-Refining

4.1.2.3.2 Calculation of stock and flows

The description of the MFA flows and stocks, illustrated in Table 38, is now detailed through Table 39, including: name, value, data sources and quality assessment. Note that for the data quality assessment, the approach proposed by BIO by Deloitte (2015) is applied to characterize the uncertainty values.

As input information of the MFA model, the following stocks and flows have been assigned, either directly (based on known data with no uncertainty on it: I1) or after calculation (based on extrapolation of data from a source, or estimation of data based on known facts, with associated uncertainty according to the Table 37: F1, F2, R1, L3, L4, E1, I2, I3, R2, R3, E2, L2, and P3). Importantly, for the flow I1, which has the highest uncertainty regarding the values found in different publications, an independent uncertainty analysis have been performed, resulting in a mean value of 3.5 tons with a standard deviation of 1.3 tons (normally distributed), as detailed in Appendix F. Then, for the flows F3, F4, and I4, and the accumulation in stock P3 the data reconciliation functionality of STAN, coupled with transfer coefficients for the flows F3 and F4, have been deployed to determine the most plausible values of these missing quantities. Finally, all stock and flow values and uncertainties have been adjusted in accordance with the mass balance and the nonlinear data reconciliation algorithm implemented in STAN use (Cencic, 2016).

Table 39 – Description of stocks and flows: values, data sources and uncertainties

Flow #	Flow name	Mean Value	Data sources	Data quality assessment (BIO by Deloitte, 2015)	
				Quality score of the data used (overall)	Quality score of the parameter calculated
I1	Primary platinum for Europe	Input data (given): 36.6 tons	JM, 2017	4	n/a (not applicable)
I2	Imports of new vehicles with catalytic converters (CC)	Input data (calculated): 6.8 tons	ACEA, 2017 ICCT, 2016 Saidani, 2015 Belcastro, 2012 Ravindra et al. 2004 Amatayakul and Ramnas, 2001	2	2
I3	Imports of CC from used vehicles	Input data (calculated): 0.2 tons	Eurostat, 2017 Lorz, 2017 Saidani, 2015 Belcastro, 2012 Ravindra et al. 2004 Amatayakul and Ramnas, 2001	2	2
I4	Platinum from CC recycling sources extra from EU-28	Calculated (2.9 tons) through the data reconciliation algorithm of STAN software	No data found	n/a	2
F1	Platinum used for production of new CC	Input data (calculated): 38.7 tons	ACEA, 2017 JM, 2017 ICCT, 2016 Saidani, 2015 Weiland, 2014 Belcastro, 2012 Ravindra et al. 2004 Amatayakul and Ramnas, 2001	3	3
F2	Platinum content in used CC	Calculated, based on transfer and mass balance	ACEA, 2017 Eurostat, 2017 ICCT, 2016 Saidani, 2015 Belcastro, 2012 Ravindra et al. 2004 Amatayakul and Ramnas, 2001	3	3
F3	Platinum content in recovered CC	Calculated, based on transfer coefficients and mass balance	Various (see F2, I3, R2, L2)	2	2
F4	Platinum content from CC entering the refining center	Calculated, based on transfer coefficients and mass balance	Various (see F3, L3)	2	2
R1	Secondary platinum from recycled CC	Input data (calculated) 12.6 tons	JM, 2017 Eurostat, 2017	3	3
R2	Platinum from	Input data	JM, 2017	2	2

	used CC (to reman.)	(calculated): 1.5 tons	ICARRE95		
R3	Platinum from second-hand CC	Input data (calculated): 1.5 tons	JM, 2017 ICARRE95	2	2
L1	Leakage of platinum during use	Input data (calculated): 3.5 tons See Appendix F.	Bardi and Caporali, 2014 Kalavrouziotis and Koukoulakis, 2009 Barbante et al. 2001 Artelt et al. 1999, ...	1	1
L2	Unknown whereabouts (non-controlled exports, illegal market, etc.)	Input data (calculated): 9.2 tons	Eurostat, 2017 Lorz, 2017	2	2
L3	Loss during pre-processing	Calculated, based on transfer coefficient: 10% of platinum from pre-processing	Hagelüken et al. 2016 Fornalczyk and Saturnus, 2013 Pospiech, 2012	3	3
L4	Loss during end-processing	Calculated, based on transfer coefficient: 3.5% of platinum from end-processing	Hagelüken et al. 2016 Fornalczyk and Saturnus, 2013 Pospiech, 2012	3	3
E1	Exports of CC from European market	Input data (calculated): = 13.5 tons	ACEA, 2017	3	3
E2	Exports of used vehicles with CC	Input data (calculated): 5.5 tons	Lorz, 2017 Eurostat, 2017	2	2
P3	Movements in stocks (Platinum content from CC in use in Europe)	Input data (calculated): 570 tons	ACEA, 2017 JM, 2017 ICCT, 2016; Weiland, 2014	2	2

4.1.2.3.3 New quantitative insights from MFA

The computed MFA of the platinum contained in catalytic converters in the EU-28 for the 2017 year is displayed in Figure 40, including all quantitative stocks and flows with associated uncertainties, following Sankey diagram principles for platinum mass – i.e. the thickness of the lines indicates the relative magnitude of the flows – and showing platinum losses occurring all along the value chain.

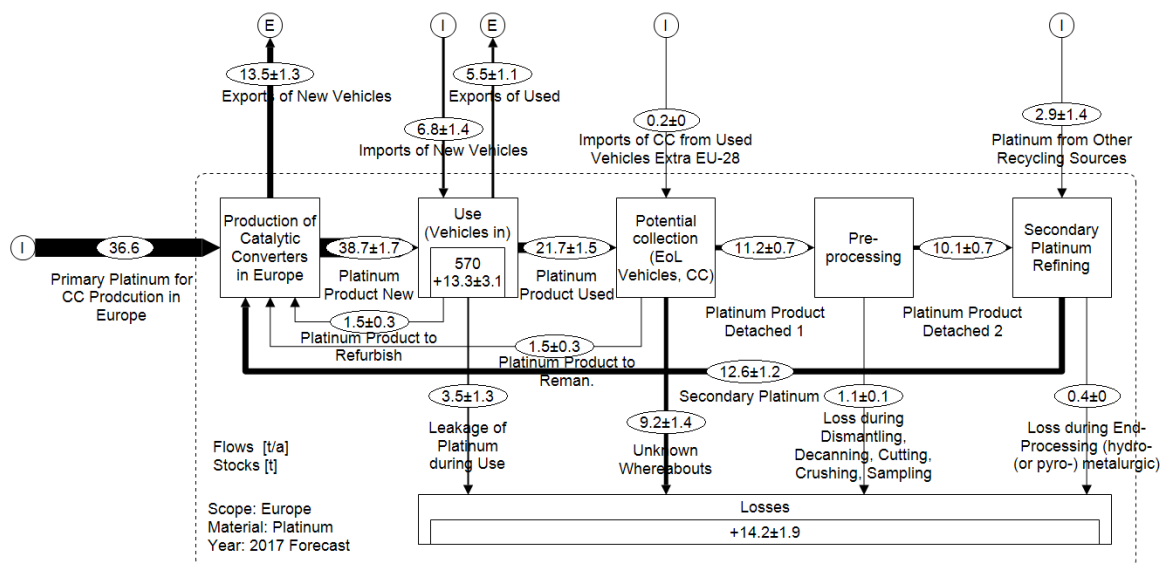

Figure 40 – MFA of platinum from catalytic converters (EU-28, 2017, with uncertainties)

A differentiation is then made between platinum flows belonging to whether light-duty vehicles (flows in blue) or heavy-duty and off-road vehicles (flows in purple), as illustrated in Figure 41. Note that no demarcation was possible to make for the three flows in grey, and for readability reasons, the uncertainties values were not displayed in the second MFA.

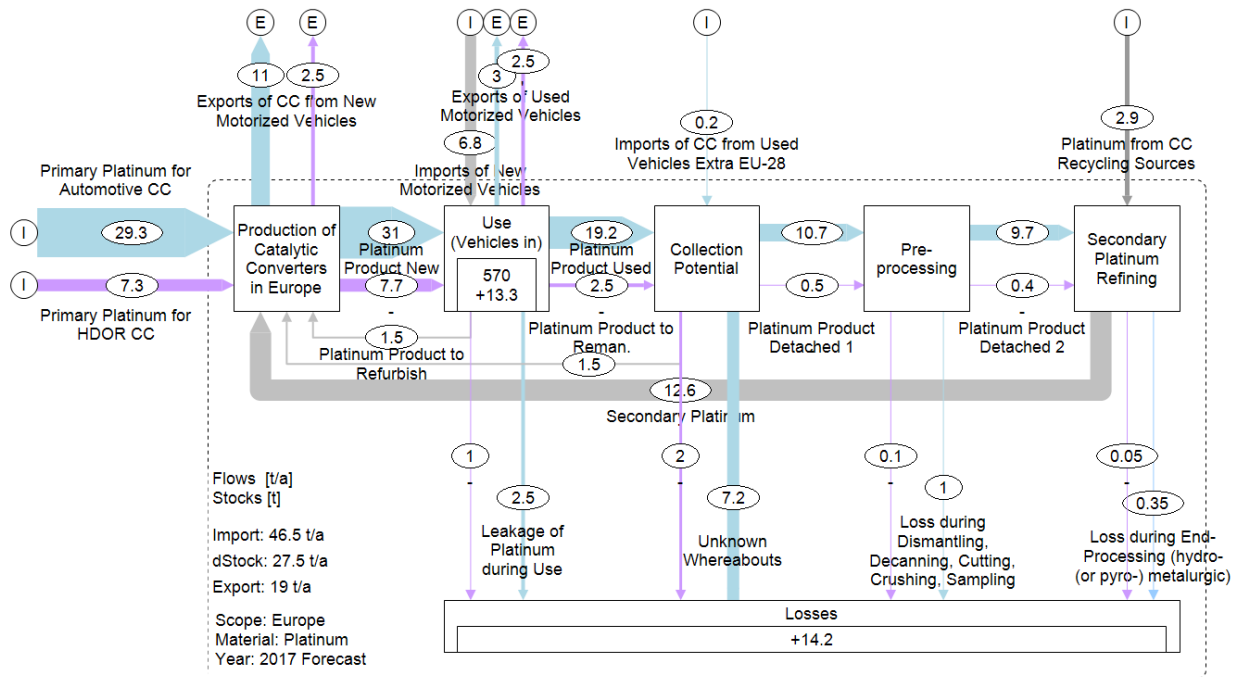

Figure 41 – Demarcation between light (blue) and heavy vehicles (purple) platinum flows

Consequences and repercussions of the losses and leakages of platinum all along the value chain are discussed in sub-section 4.1.2.4. In fact, main environmental and economic value buckets related to the potential augmented use of secondary platinum are highlighted. Interestingly, a focus is also made on the intrinsic circularity performance of this value chain through the application of circularity indicators.

4.1.2.4. Discussion

4.1.2.4.1 Comparison of the MFA results with previous studies

First, before advancing the interpretation of our findings, some validation elements of the computed MFA are discussed here to ensure an augmented transparency and trustworthiness of the discussion section.

The order of magnitude of the key and most sensitive flows of the present MFA are compared with the values of prior platinum MFA conducted in the EU, as summarized in Table 40. In fact, Saurat and Bringezu (2008) quantified the in-use stock of PGM (including platinum, palladium and rhodium) in catalytic converters to almost 500 tons for the year 2004, within the EU-25. More recently, BIO by Deloitte (2015) estimated the annual quantity of platinum added to stocks to be equivalent to 12 tons, with an in-use stock of 710 tons of platinum content all application being considered, for the year 2012 and within the EU-28. They also estimated the losses due to in-use dissipation of platinum finished-products to be equal to 10.4 tons, including in this total not only the contributions from catalytic converters, but also industrial catalysts and medical applications.

On the other hand, Saurat and Bringezu (2008) showed that the environmental impacts created by secondary production of PGM in European refining center are significantly lower than those of primary production in South Africa, regarding emissions of sulphur carbon dioxide, as well as total material requirement. Eventually, our results are somehow in line with Hagelüken's estimation, predicting in 2006 that the annual losses from the autocatalyst lifecycle could reach 10 tonnes of PGM by 2020 (Hagelüken et al. 2009).

Table 40 – Evolution and comparison of MFA related to PGM in the EU

	(Saurat and Bringezu, 2008)	(BIO by Deloitte), 2015	Present MFA
Time scope (year)	2004	2012	2017
Geographical scope	EU-25, plus Norway and Switzerland	EU-28, plus Norway and Switzerland	EU-28, plus Norway and Switzerland
Materials of interest	Platinum, palladium, rhodium	Platinum	Platinum
Applications considered	Catalytic converters	All applications being considered	Catalytic converters
In-use stock	~ 500 tons	710 tons	~ 580 tons
Annual quantity added to in-use stock	-	12 tons	13.3 tons ± 3.1 tons
In-use dissipation	-	10.4 tons	3.5 tons ± 1.3 tons
Functional recycling	12 tons	13.6 tons	15.6 tons ± 1.8 tons

4.1.2.4.2 Circular economy performance of the value chain

In addition to the MFA representation – highlighting the hotspots where platinum losses occur – the use of appropriate indicators can reveal opportunities to better the sustainable performance of industrial ecosystems by displaying trends, scales and relations of materials consumed, dissipated and discarded (Wernick and Ausubel, 1995). Actually, the examination of MFA models is particularly relevant to establish the appropriateness of indicators for guiding managerial decisions intended to perpetuate resource movement in a CE (Franklin-Johnson et al. 2016). For example, in order to detect trends and critical points in the evolution of recycling chains, Dwek and Zwolinski (2015) showed it can be particularly relevant to employ performance ratios obtained from the flows of the MFA, such as: production efficiency, accumulation ratio, utilization efficiency, or secondary supply ratio. Graedel et al. (2011) provide a framework to measure the circularity performance of a metal within its related product value chain, at several levels of a MFA model, as illustrated through Figure 42. Recycling rates (RRs) are indeed often used as measure for the degree of circularity of an economy and can be splitted into different indicators (Haupt et al. 2017).

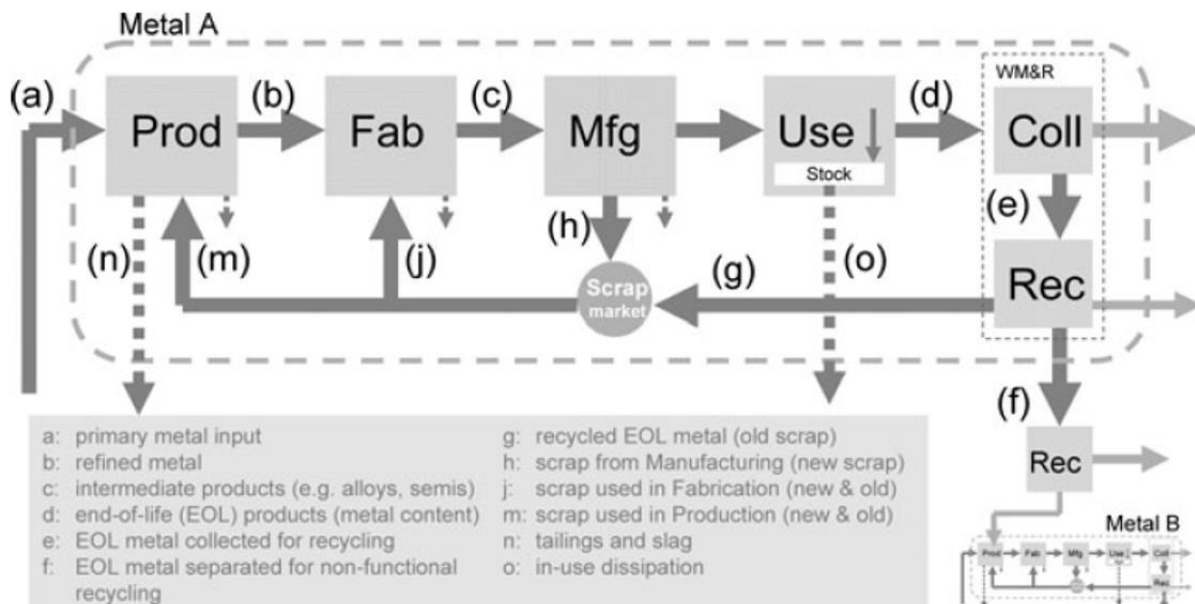

Figure 42 – Framework to calculate circularity indicators based on MFA (source: Graedel et al. 2011)

For instance, the old scrap collection rate (CR), corresponding in the present case to the ratio of used catalytic converters effectively collected and entering the recycling process, is defined and calculated through the eq. 1:

$$CR = e_1/d = 11.2 \pm 0.7 + 3.0 \pm 0.6 / 21.7 \pm 1.5 + 1.5 \pm 0.3 = 61 \% \pm 10 \quad (eq. 1)$$

The end-of-life process efficiency rate (EOL_ER), including here pre-processing and end-processing (i.e. refining), is given by the eq.2:

$$EOL_ER = \frac{g}{e_2} = \frac{12.6 \pm 0.7 - 2.9 \pm 1.4}{11.2 \pm 0.7} = 87\% \pm 2.4 \quad (eq. 2)$$

The end-of-life recycling rate (EOL_RR), referring here to functional or closed-loop recycling, and adapted according to the present MFA by considering both reuse and recycling (i.e. collection and processing yield), is given by the eq.3:

$$EOL_RR = \frac{g}{d} = \frac{12.6 \pm 0.7 - 2.9 \pm 1.4 + 3.0 \pm 0.6}{21.7 \pm 1.5 + 1.5 \pm 0.3} = 55\% \pm 16 \quad (eq. 3)$$

The recycled content (RC), also known as end-of-life recycling input rate (EOL_RIR), measuring the ratio of secondary material used in the total material required for production (ISO 14044, EU-JRC 24708), is given by the eq.4:

$$RC = \frac{j + m}{a + j + m} = \frac{12.6 \pm 1.2 + 3.0 \pm 0.6}{36.6 + 12.6 \pm 1.2 + 3.0 \pm 0.6} = 30\% \pm 4.5 \quad (eq. 4)$$

The resource leakage from the system is also a meaningful indicator, determining the resource fraction that is leaving the product system and indicating therefore to what extent the loop is closed (Sinha et al. 2014). In our case, among the 36.6 tons of primary platinum demand for one year in Europe for autocatalyst application, almost 40% of this quantity (14.2 tons) are lost this same year for the European economy (n.b. controlled imports and exports are well-balanced and thus not considered in this calculation).

These findings are well-aligned (same order of magnitude) with the value of recycling rates for PGM used in automotive catalysts (EOL_RR evaluated between 50 and 60%) discussed by different authors (e.g. Hagelüken et al. 2016). Regarding the materials processed that come from recycled sources (referring here to the RC indicator), the economy is still far away from a true circular model as stated by Haas et al. (2005). This study confirms the two central reasons and obstacles in closing material cycles pinpointed by Haas et al. (2015): low end-of-life recovery rates, and in-use stocks accumulation. More interestingly, the results illustrate and put the emphasis on important facts reveals by Haupt et al. (2017) in the management and transition towards a more circular economy through recycling rates.

Indeed, comparing different recycling rates in a CE context at different scales, Haupt et al. (2017) conclude that the currently used rates are not suitable as a performance indicator for a CE for three following key facts that are summarized and discussed hereafter:

- First, recycling and circularity rates do not share one common definition, e.g. at the European scale between member states. Because of the inconsistent definition of national recycling rates, some current rates used are not comparable. In fact, from a managerial and political standpoint, this variety of indicators can be confusing and is therefore not the most convenient way to define, communicate, and compare proper goals that every stakeholder can understand in the same way. For this reason, the CE action plan of the EC (2017a) calls for harmonized indicators in order to manage the proposed targets for the recycling and reuse of materials – e.g. within the EU Raw Materials Information System (RMIS), launched at the end of 2017, to help coordinate other EU-level data and information on raw materials (Mathieux et al. 2017). In line with Haupt et al. 2017, be clear on which rate (e.g. whether CR, EOL-RR or RC) is used, measured, and communicated is a key starting point to monitor the contribution waste management to a CE in an integrated and meaningful manner. For instance, the RC appears as a good measure of the circular use of CRM in the contribution of recycling to meet the materials demand in the EU (Deloitte Sustainability, 2017).
- Second, collection rates (CR) are often communicated, reflecting the input into the recycling system, but give neither an adequate picture of the available quantity of secondary resources produced that become effectively available (EOL_RR) nor indication about the final destination of these materials, showing the actual contribution of secondary materials to initial demand (like the RC indicator does). They fail as such to describe how much material is kept within material cycles (Haupt et al. 2017). Nevertheless, according to Linder et al. (2017), the proper combination of indicators should allow to measure circularity at complementary levels in a more nuanced manner. The use of a set of complementary indicators would indeed provide in-depth

information, e.g. at different part of the value chain to prioritize and focus actions at more applied levels, such as technical and engineering levels.

- Third, today's recycling and circularity indicators focus mainly on the closing of material cycles, with the environmental benefits and impacts often remain unaddressed or decorrelated from the analysis. The comparison of lifecycle analysis results and recycling rates may also reveal potential trade-offs between the goals of resources recovery and lowering environmental impacts (Geissdoerfer et al. 2017). To bridge this gap, environmental and economic repercussions of the current leakages of platinum are discussed in the following sub-section, as well as improvement potentials to advance the circularity performance of the platinum value chain from catalytic converters in the EU.

4.1.2.4.3 Environmental and economic implications

The MFA results reveal an overall leakage of around 15 tons of Pt outside the European market in 2017, showing that considerable amounts of platinum could be recovered. In this section, this mass flow of platinum lost is translated and interpreted in terms of economic loss and environmental burden. Then, the implementation of potential improvement solutions are discussed.

According to Cullen (2017), two key guiding questions to assess the end-of-life options for materials or products from an environmental perspective are: “how much energy is required to restore the recovered material back to the desired material or product?” and, “how does this quantity compare with obtaining the desired material or product from virgin or primary sources?”. Accordingly, Table 41 compares how much energy is required to produce one kilogram of platinum between its primary production in South African mines and its secondary production in European refining centers, crossing several relevant data sources. As noticed by Glaister and Mudd (2010), non-negligible amounts of energy can be saved when platinum is recycled from used catalytic converters compared to raw production. In addition to the energy demand, the global warming potential (GWP) is the most used category to quantify the environmental impacts of PGM production (IPA, 2016). On this basis, the comparison of environmental impacts associated with platinum primary and secondary production is made in terms of energy consumption and GWP considering greenhouse gases (GHG) emissions, as given in Table 41.

Table 41 – Environmental impact comparison between primary and secondary platinum

	1 kg of primary platinum	1kg of secondary platinum
Energy demand (GJ / kg)	200	10
GHG emissions (t CO ₂ -eq/kg)	40	2
Data sources and references	Average values based on Bossi and Gediga (2017), EASAC (2016), Montmasson-Clair (2016), Cairncross (2014), Glaister and Mudd (2010).	Average values based on JM (2017), Bossi and Gediga (2017), EASAC (2016), IPA (2016), Glaister and Mudd (2010).

As a result, comparing the environmental impact between primary and secondary production, it has been estimated that halving the leakages of platinum during the use and collection phases could prevent the energetic consumption of 1.3×10^3 TJ and the greenhouse gases emissions of 2.5×10^2 kt CO₂ eq. Yet, it must be kept in mind that such assumption would in a first time only improved the CR and EOL_RR values, and that to effectively mitigate the environmental and improve the circularity performance, the RC value as to be enhanced in the same way. This means the import of primary platinum should decrease in favour of the use of secondary refined platinum. Concretely, regarding the current annual import of platinum which is superior to 36 tons, such improvement potential would reduce the primary import by one quarter. Even if 100% of PGM from end-of-life products were to be recycled, however, the rate of secondary production input would still be limited, and primary PGM would still be needed. Primary and secondary production of PGM are indeed complementary and mutually dependent.

Additionally, knowing that the price of one kilogram of platinum fluctuates around 30 k€ (JM, 2017), these losses also result in high economic losses valuing up to hundreds of millions of euros for European stakeholders. Last but not least, the CC attrition during its usage and the associated emissions of PGM particles in the environment – detailed in Appendix F – appears as non-negligible. Based on the scarce and dated publications in this regard, we encourage further research for a sound understanding of this phenomenon that can negatively impact human health (Wang and Li, 2012). Bardi (2014) adds that, in such a case, PGM: “are potentially dangerous pollutants and have generated serious concerns regarding their effects on the environment and on human health”; and, “are dispersed in the environment at very low concentrations and are lost forever for all practical purposes”.

4.1.2.5. Conclusion

4.1.2.5.1 Opportunities for improvement

Among the estimated 15 tons of platinum lost, approximately one quarter of the leakages is due to in-use dissipation, and two thirds are attributed to insufficient collections and unregulated exports. As a consequence, activating appropriate action levers to enhance the overall collection, recovery, and input rates of secondary platinum in the value chain is of the utmost importance in order to secure future and sustainable productions of new generations of CC and fuel cells. Moreover, the growing stockpile of Pt from CC in use (estimated at over 580 tons in 2017) is an additional hindrance to closing material loops.

Therefore, in-use CC represents an important and non-fully exploited value bucket which urges for better collection mechanisms. For instance, the ICARRE95 (Innovative Car Recycling 95%) project highlights collect conditions to successfully close the loop: it includes sufficient volume collectable as well as a transparent network of end-of-life actors working together e.g. through constructors (e.g. Renault), collector (Synova recycling) authorized treatment facilities (INDRA Automobile Recycling), catalytic converter recyclers (Hensel), refining center (Johnson Matthey), to the manufacturing of a new catalytic converter. To date, there has been much focus on the recovery channel of catalytic converters from light duty vehicles compared to heavy ones, not subject to end-of-life regulation. Yet, the end-of-life market in the heavy-duty and off-road vehicles sector presents a high economic potential (Saidani et al. 2018), particularly regarding the quantity of precious metals a single catalytic converter from one heavy vehicle can contain.

Complementary ways of closing-the-loop on platinum from catalytic converters are discussed on the literature, but mostly at a qualitative and macro level, including recommendations such as “a betted enforcement of transboundary waste shipment rules to limit the export of genuine scrap cars” (Hagelüken, 2012). In accordance with Saurat and Bringezu (2008), such control could become part of an international material flow management system, through the cooperation of the automotive and recycling industries. Yet, the main challenge is still to keep track of PGM in exported vehicles (mainly to Eastern Europe and North Africa countries) and to manage the recovery of the parts after use in these regions as well.

More generally, Hagelüken (2012) depicts seven conditions for effective recycling of a product, material or metal: (1) technical recyclability of the material or metal combination; (2) accessibility of the relevant components; (3) economic viability, whether intrinsically or externally created; (4) collection mechanisms to ensure the product is available for recycling; (5) entry into the recycling chain and remaining therein up to the final step; (6) optimal technical and organisational set-up of this recycling chain; (7) sufficient capacity along the entire chain to make comprehensive recycling happen.

4.1.2.5.2 Next steps

The MFA conducted here is the first step of a multi-tool methodology presented at the ISIE-ISSST Joint Conference in 2017 (Saidani et al. 2017c) to quantify the impact of potential CE strategies and offer science-based arguments in CE decision-making. Next steps include fuzzy cognitive mapping, structural analysis, scenarios generation and system dynamics to model, simulate and evaluate the effects of key action levers on the platinum value chain (mapped out in sub-section 4.1.2.3) and its circularity performance (discussed in section 4.1.2.4):

- Fuzzy cognitive mapping, to make an inventory, map and link both influencing parameters and potential actions levers on a semi-quantitative causal graph;
- Structural analysis, to select key influence parameters and promising actions levers;
- Scenarios generation, to set up different relevant prospective scenarios;
- System dynamics, to simulate and compare the influence of selected actions levers on the CE performance, including stocks and flows, plus feedback loops.

The last step would consist on circling back to the present MFA, in order to report and compare the potential impacts on the current value chain and actors' network. As such, we are willing to demonstrate that the combination of MFA with complementary tools from engineering and social sciences could contribute in supporting industrial actors and decision makers to move towards more circular practices.

4.1.2.5.3 Further perspectives

The circularity of the CRM is essential for maintaining future and sustainable resource security in the European Union (EC, 2017). Yet reality is still far from being a perfect circular model (Haas et al. 2015). Our findings notably illustrate areas of work on the value chain of platinum contained in catalytic converter to improve its performance in a CE perspective. Securing the uncertain supply critical raw materials is crucial and requires a sound and consistently updated knowledge base (Mathieux et al. 2017).

Actually, in line with previous studies on this issue related specifically to PGM – e.g. Saurat and Bringezu (2008) providing a first overview of major platinum flows and processes in the EU, or Deloitte Sustainability (2017) providing also an important base of background information to help monitoring the circularity level of CRM in the EU – the present findings give an updated baseline to track progress on circularity performance, by providing a quantitative and localized identification of the improvement opportunities on the European platinum value chain.

Interesting value buckets of such potential recovery of precious metals from catalytic converter in Europe, which are not fully exploited yet, have been highlighted. The environment plus economic implications for the European stakeholders have been extensively discussed. On this basis, the results can also be used independently to oriente both future research and political or industrial actions.

In parallel, and more globally to put things into perspectives, Lovik et al. (2018) delivered a comprehensive overview and detailed analysis of current developments and research projects on supply security of critical and precious metals in Europe. They reviewed an extensive number of industrial activities, policies, and projects initiated in the EU to secure the future supply of CRM, distinguishing particularly, projects on primary supply, secondary supply, substitution and material efficiency, all along the lifecycle.

4.1.3. Multi-tool methodology to close-the-loop on industrial components

4.1.3.1. Context and objectives

As detailed in the previous sub-section, the interest of recovering platinum from catalytic converter of heavy vehicles, arises for economic (high valuable component due to the non-negligible presence of platinum that costs around 30,000 €/kg), environmental (low platinum concentration in mines (below 10 g/t) required large consumption of energy to be extracted and refined), social (ore mining conditions are increasingly drastic) and geostrategic (more than 90% of platinum reserves are located in South Africa and Russia) reasons.

Even if some marginal channels exist, the collection rate of platinum from catalytic converters in Europe is still low (around 50%). As heavy vehicles are not considered by any end-of-life directive contrary to the automotive sector submitted to the ELV directive EC/2000/53 in Europe, the objective of this applied research work is to evaluate the impact of other actions levers to close the loop on catalytic converters from heavy vehicles which contain larger amount of platinum than in cars.

To date, a number of issues that still need to be tackling to close the loop of platinum have been outlined in literature but there is a lack of operational improvement proposal or simulation to assess “what if” scenarios, and therefore evaluate the impact of different changes. Indeed, there is still a lack of in-depth investigations on how to effectively improve the overall end-of-life collection and recovery rates of heavy vehicles and associated key components and materials.

Thus, new insights are needed to address and overcome the barriers, analyzed in previous studies, to an effective circular economy of platinum from catalytic converters. In this light, the main objectives of this work are twofold, (i) to construct a methodology that aims at assessing the impact of different actions levers that can contribute in the move to a more circular economy, (ii) to experience the proposed approach through an industrial case study (with a construction equipment manufacturer willing to know more about the possible and relevant action levers to close the loop on the catalytic converters they develop).

The proposed approach aims to assess the contributions of different actions levers to close the loop on an industrial component. Through material flow analysis and system dynamics models, valuable actions levers (e.g. re-design to facilitate end-of-life recovery, take-back and remanufacturing offers, product-as-a-service, mandatory recycling rate) are examined. Fuzzy cognitive mapping, combined with structural analysis, are used to identify and select these most promising actions levers. Also, methods of prospective are expected to be used so as to define relevant and realistic scenarios.

In this sub-section, we explain in detail the proposed approach, the main sources of inspiration from the scientific literature, and present the first results. The broader impact of this work would be able to provide new insights for industrial practitioners about mechanisms to maintain platinum deposit contained in catalytic converter in Europe and therefore to secure future supply. As such, it can represent a valuable contribution to resource sustainability for the European platinum sector in the light of the circular economy.

4.1.3.2. Literature survey

First, a focus is made on the studies combining several methods and tools to address complex issues in the fields of sustainable design and circular economy, as sources of inspiration of the proposed multi-tool methodology. Interestingly, some approaches combine methods and tools from the same field (e.g. industrial ecology tools such as material flow analysis and life cycle analysis) while others put together tools from industrial ecology, system engineering or value analysis in a same framework to come up with new valuable insights and methodologies. Then, a short presentation, plus examples of applications, of the methods and tools identified as relevant to meet the aforementioned objectives are given.

4.1.3.2.1 Multi-tool approaches in the fields of sustainable design and circular economy

Halog and Manik (2011) developed an integrated methodological framework for modelling and eventually designing sustainable and resilient systems by capitalizing the complementary strengths of different methods, including: life cycle thinking methods such LCA, multiple criteria decision analysis (MCDA), system dynamics (SD), agent based modelling (ABM), and geographic information systems (GIS). Indeed, they advanced that “sustainable

development is a complex, multi-dimensional phenomenon, with a breadth and depth that cannot be fully covered by the current portfolio of reductionist-oriented tools” (Halog and Manik, 2011). More precisely, because the existing life cycle thinking and MCDA methods are considered as steady-state methods whereby they provide snapshots of hotspots based on historical data (i.e. they do not provide projections or trends in the future), modelling the dynamic interrelationships of the key variables over time is needed to make the results more useful for decision and policy makers. As such, system dynamics and agent based modelling tools are deployed to take into account the interconnections and thus create a dynamic computational sustainability assessment of the system investigated. Additionally, they mentioned that the use of geographic information systems can be explored to assist spatial analysis. All in all, Halog and Manik (2011) used different software packages and modelling tools to implement and experiment their proposed framework. On the other hand, Idjis (2015) combined three modeling and simulation methods: SCOS'M (Systemics for Complex Organisational Systems' Modelling), cognitive mapping, and system dynamics, to characterize the recovery network of vehicles batteries, by understanding its dynamics and identifying the key variables in these dynamics. More simply, Turner et al. (2016) combined material flow analysis and life cycle assessment as a support tool for solid waste management decision making.

4.1.3.2.2 Multi-method approach to design a sustainable recovery channel

Farel and Yannou (2013) addressed the development of a multi-actor value chain from a design point of view, considering both technical and organizational issues. They argued the value chain system could exist if: it is economically viable as a whole; it is profitable and interesting for all stakeholders; it could sustain to the external changes; it can be coordinated and managed. One of the main challenge is therefore to find ways or mechanism to make the system and its value chain sustainable. Against this background, they proposed a multi-method approach to model, analyze and evaluate a given industrial ecosystem, so as to generate future scenarios and provide evaluation criteria for decision makers. As illustrated in Figure 43, it includes the following steps: modeling material and information flow, establishing the value network, structural analysis, scenarios generation, simulation and evaluation.

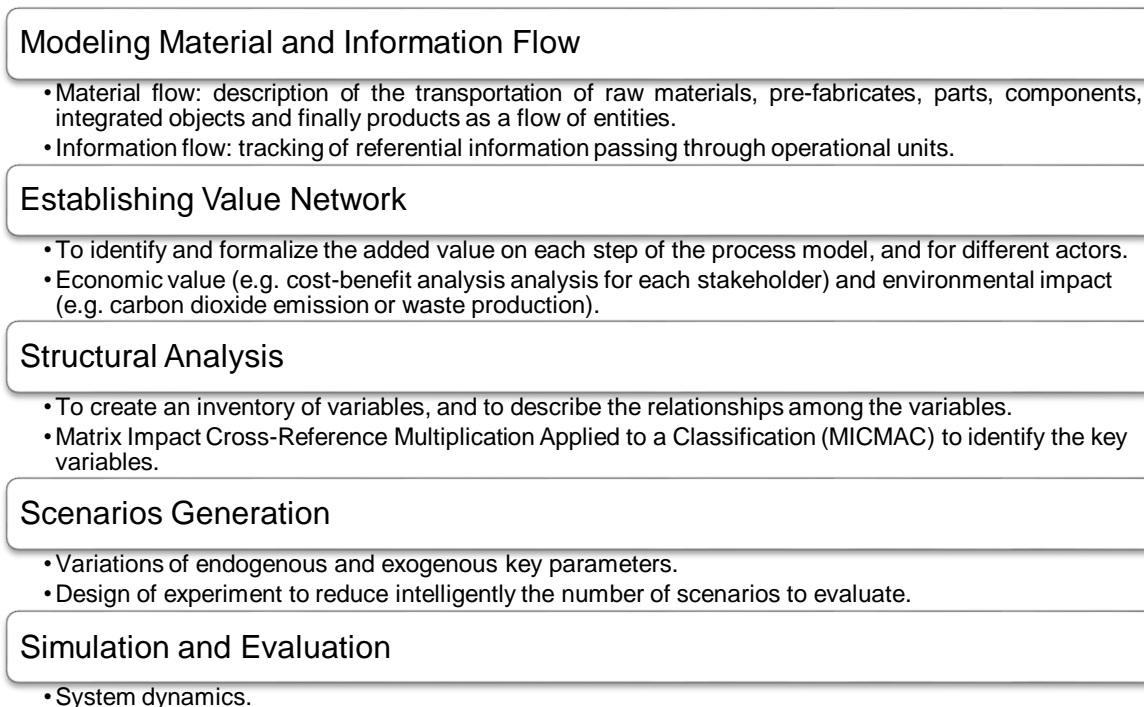

Figure 43 – 5 steps to design a value chain from scratch, by Farel and Yannou (2013)

In our present case, even if we are not starting from scratch to improve the circularity performance of the platinum value, the combination of tools aforementioned appears to be inspirational to model and assess the impact of different mechanisms or action levers in the (re)design of more sustainable or circular systems. In fact, we argue that using an appropriate combination of some of these approaches could contribute in (re-)shaping a value chain and industrial practices in a circular economy perspective, by providing industrial decision makers and policy-makers with well-founded analysis and detailed insights on the most promising ways to close-the-loop.

4.1.3.3. First results and next steps

4.1.3.3.1 Proposed multi-tool methodology

The proposed approach consists in five steps, combining the contributions of several methods and tools, as illustrated in Figure 44. The first step is about modeling the current situation (defining the scope, boundaries of the study, identifying stakeholders, and representing the value chain) through material flow analysis in order to quantitatively describe the system, its areas of improvement, as well as to identify the economic and environmental value buckets. Second step deals with the identification and selection of promising and possible action levers through fuzzy cognitive mapping and structural analysis. At the end of this stage, a presentation of the key outcomes is made to an industrial player, expert in this field, to have a first feedback and validation of the preliminary results. Third step deals with scenarios elaborations. Fourth step with simulations realisation. Last step with results analysis and dissemination of the findings.

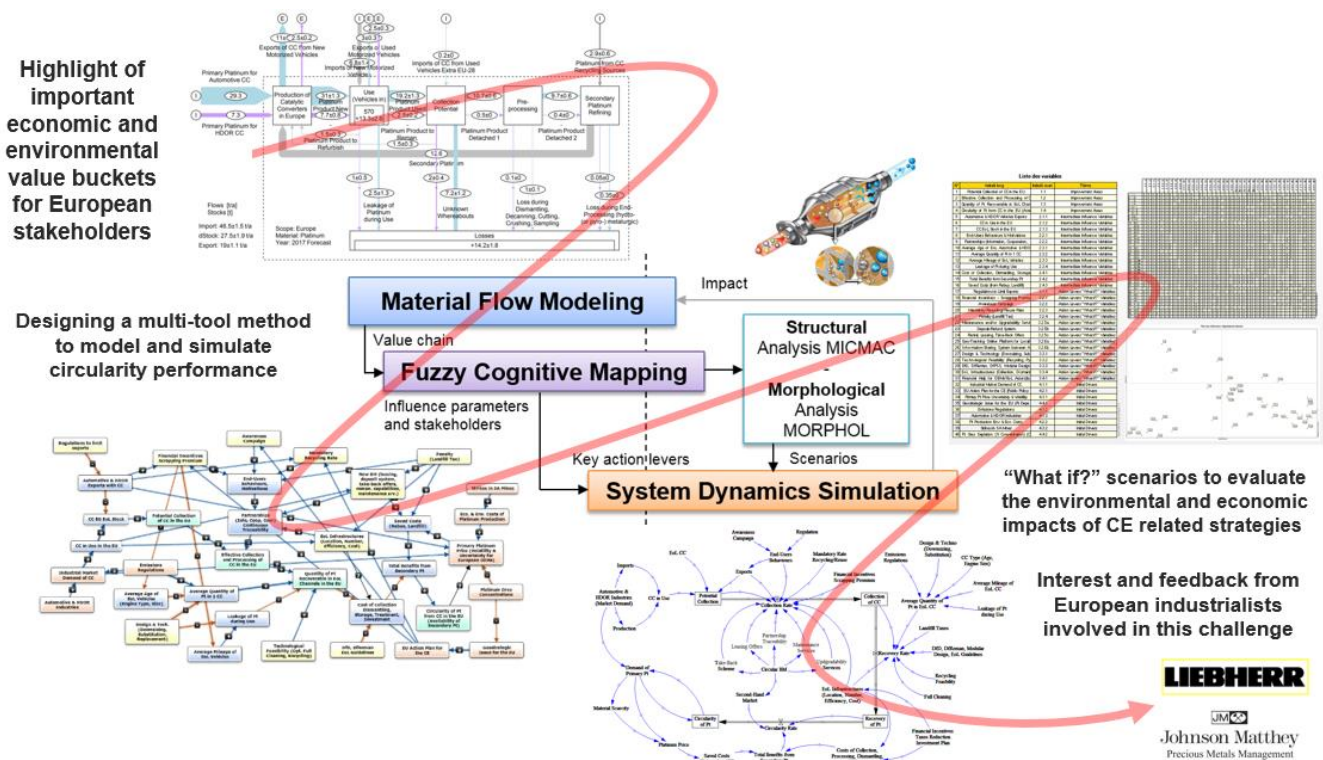

Figure 44 – Illustrated overview of the multi-tool methodology to close-the-loop on industrial components

4.1.3.3.2 Description and application of the tools

4.1.3.3.2.1 Material flow analysis (MFA) and C-indicators

The results from the MFA methodology have been presented and discussed in the sub-section 4.1.2.

4.1.3.3.2.2 Fuzzy cognitive mapping (FCM)

Fuzzy cognitive mapping (FCM) – also known as concept map, heuristic map, or causal graph – provides a nonlinear way to visually start to unfold the complexity of design problems. FCM is a practical tool to model the relations between the elements of complex systems. In a FCM, the information is indeed branched out in multiple directions providing designers and other stakeholders with a more holistic view of possible unforeseen connections. More precisely, FCM represents knowledge by defining three characteristics of a system: the components of the system; the positive or negative relationships between the components; the degree of influence that one component can have on another, defined using semi-quantitative weightings (Gray et al. 2013). FCM utilizes fuzzy logic in the

creation of a weighted and directed cognitive map. Additionally, once a FCM is developed, it can be deployed to test “what if” scenarios allowing users to evaluate several configurations of a given system (Papageorgiou and Salmeron, 2011). For instance, Gnoni et al. (2017) used a fuzzy cognitive map model to quantify the impacts on the social, economic and environmental dimensions induced by the transition from an ownership-based to a product-as-a-service based business model, considering both direct and reverse supply chain of a large appliance product.

In the present case, using the free and web-based software Mental Modeler, developed by Gray et al. (2013), FCM is deployed to develop a semi-quantitative models of the actions levers that could affect the circularity performance of the value chain of platinum for catalytic converters. In fact, it enables to list and define a first visual relationship between these variables, as illustrated in Figure 48: improvements areas are highlighted in green, action levers in yellow, influence variables in purple and drivers in red. Note this software can also be used to run “what if” scenarios so as to determine how the system might react under a range of possible changes. Each causal link is indeed assigned with a polarity, either positive (+) or negative (-) to indicate how the variables evolve. Yet, before simulating such possible variations, this inventory and analysis of action levers is enhanced by a structural analysis: using both the functional analysis system technique (FAST) to complete more rigorously the list of potential action levers, and the matrix-based multiplication applied to a classification (MICMAC) to select the key variables. Also, we found that the use of a FCM is relevant as a first approach to map and model the interactions between several variables in a visual way. Yet, it becomes less practical when the number of variables or interactions increases significantly compared to the use of a matrix such as the MICMAC, as illustrated in Figures 48 and 49. Eventually, the FCM, coupled with a structured analysis and design technique (SADT) model, will serve as creating the architecture of the system dynamics model.

4.1.3.3.2.3 *Structural analysis: FAST, SADT and MICMAC*

Structured analysis and design technique (SADT) is a systems engineering methodology for describing systems as a hierarchy of functions, as well as for more detailed structured analysis for requirements definition and structured design (Marca and McGowan, 1988). The SADT's representation, illustrated in Figures 45 and 46, going from general to more detailed levels, is the following: a main box where the name of the process or the action is specified. On the left-hand side of this box, the incoming arrows are the inputs of the action, i.e. it represents the data or consumables that are needed by the activity. On the upper part, the incoming arrows are the data necessary for the action, i.e. the conditions which influence the execution of an activity but are not consumed. On the bottom of the box, the incoming arrows are the means used to accomplish the activity. On the right-hand side of the box, the outgoing arrows are the outputs of the action, i.e. the data or products that are produced by the activity.

Functional analysis system technique (FAST) is a technique to develop a graphical representation showing the logical relationships between the functions of a project, product, process, or service, based on the questions “how” and “why” (SAVE International, 1999). The development of a FAST diagram aids in thinking about the problem objectively and in identifying the scope of the project by showing the logical relationships between functions. The FAST diagram is particularly suitable to verify if, and to illustrate how, a proposed solution achieves the needs of the project, and to identify unnecessary, duplicated or missing functions. It notably helps to: define, simplify and clarify the issue and its associated objectives, organize and understand the relationships between functions, identify the missing functions, and stimulate creativity.

In our case, we use the system engineering formalism to build a comprehensive and well-structured list of influence parameters or actions levers (considered by this formalism as functions) that can contribute to the following main objective: to achieve a circular economy of platinum contained in catalytic converters, as stated in the FAST and SADT diagrams in Figures 45 and 47. The related sub-objectives and areas of improvement are reported in a more detailed SADT diagram in Figure 46.

In all, the final list – available in Figure 48 – of potentially relevant actions levers, drivers and influence variables inventoried have resulted from: general literature review on circular economy exposed all along this dissertation, specific knowledge on the catalytic converters and its ecosystem, including the automotive and heavy vehicle industry thanks to literature survey, investigations on the industrial ground as exposed in essay #1, and the insights provided by the C-indicators applied on this system, as detailed in essay #2. Note that this list of actions levers is also closely related to the value chain and the associated stakeholders, as mapped in the MFA.

Furthermore, as recommended by Farel and Yannou (2013), it is essential from a practical point of view to identify the key variables so as to set up relevant scenarios generation and feasible simulations. The matrix impact cross-reference multiplication applied to a classification (MICMAC) is a tool that structures the pooling of ideas (Godet, 2007). This method identifies the main variables which are both influential and dependent, that is to say, those which are essential to the evolution of the system. First, a direct influence matrix is filled out as depicted in Figure 49, answering the following question for each square of the matrix: “is the variable X influence the variable Y?”, in association with the scoring system that follows: “no” = 0; “potentially” = 1; “indirectly” = 2; and “directly” = 3. Then, the indirect classification is obtained by increasing the power of the matrix. It enables one not only to confirm the importance of certain variables but also to uncover certain key variables which, because of their indirect actions, play an important role, not identifiable through direct classification. The structural analysis conducted by Farel and Yannou (2013) to design a recovery chain for the glass from end-of-life vehicles included three successive phases: creating an inventory of variables, describing the relationships among the variables, and identifying the key variables (using this MICMAC method).

Based on the computation of the MICMAC matrix, the dependence-influence chart, shown on Figure 49, enables to make a cluster of the least important variables (passive and/or inactive), and a cluster of the most important variables (active and/or critical) considered as key variables. The least important variables include: {average EoL age/mileage; design and technology (downsizing, substitution); technological feasibility (recycling, pyro- and hydro-metallurgic refining process); awareness campaign}. The most important variables include: {HDOR vehicles exports with CC; regulations to limit exports; mandatory recycling/reuse rate; end-users behaviours and motivations; CC EoL stock in the EU; average quantity of Pt in CC; primary Pt price uncertainty and volatility for OEMs; geostrategic issue for the EU (Pt dependency); Pt production env. & eco. costs}. These preliminary findings have been presented to an industrial expert from a company that designs and develops catalytic converters. According to him, the obtained classification makes sense and he did not see any other important variables that could have been missed. After having identified the key variables of the system, Godet (2001) proposes to use and connect morphological analysis with probabilistic analysis to build a prospective basis so as to identify the most plausible scenarios for decision-makers.

4.1.3.3.2.4 *Next steps: system dynamics (SD) and scenarios generation*

System dynamics (Forrester, 1961) is a computer-aided approach to policy analysis and design. It applies to dynamic problems arising in complex social, managerial, economic, or ecological systems characterized by interdependence, mutual interaction, information feedback, and circular causality behavior (Richardson, 2013). As such, it seems particularly relevant to address circular economy related problem using this system dynamic approach. For instance, based on the complexity of interactions existing within their system under consideration, Idjis et al. (2017) opted for a system dynamics approach to model and optimize a recycling network of lithium batteries in the automotive industry. Rodrigues et al. (2017) proposed a causal loop diagram based tool so that industrial decision makers can assess the potential benefits of ecodesign by testing multiple scenarios and strategies. Sinha et al. (2014) adopted a dynamic systems modeling approach to identify leverage points for closing the material flow loop and approaching a circular economy related to the mobile phone product system. After presenting a conceptual model of a mobile phone product system based on industrial symbiosis, they implemented the conceptual model in a dynamic stocks and flows model. Then, they identified potential drivers for closing the metal flow loops. Eventually, they proposed a future optimized scenario by tuning the potential drivers. Interestingly, two indicators were used to assess the circularity performance of their product system: (i) a loop leakage indicator, determining the resource fraction that is leaving the product system, and indicating as such to what extent the loop is closed; (ii) a loop efficiency indicator, determining how efficiently the resources are utilized by the system (Sinha et al. 2014). Last but not least, according to Idjis et al. (2017), it is useful for stakeholders and decision-makers to have access to simulated data, showing the situations of a system in a long term perspective, following the various possible evolution of key variables. Idjis et al. (2017) recommend also that those situations, called scenarios, should be generated intelligently from the crossing of dynamic evolution of key variables of the system.

In the present case, a SD model can be particularly compatible and complementary to our MFA model (see subsection 4.1.2) as they both describe reality by means of stocks and flows (Inghels et al. 2016). In fact, the stocks (levels) and the flows (rates) that affect the MFA are also essential components of system dynamics model. In this line, the quantitative results from the MFA model provides a relevant baseline to compare the evolution of stocks and flows through the system dynamics simulation. Figure 50 gives a first overview of the system dynamics models developed using Vensim software.

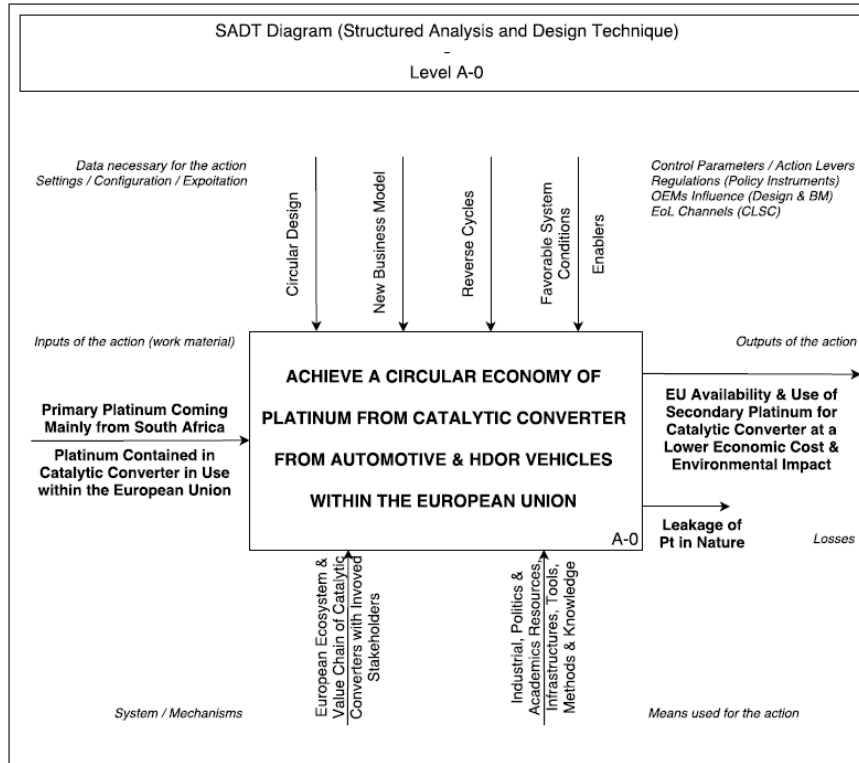

Figure 45 – Structural analysis and design technique (SADT) diagram – Level A-0

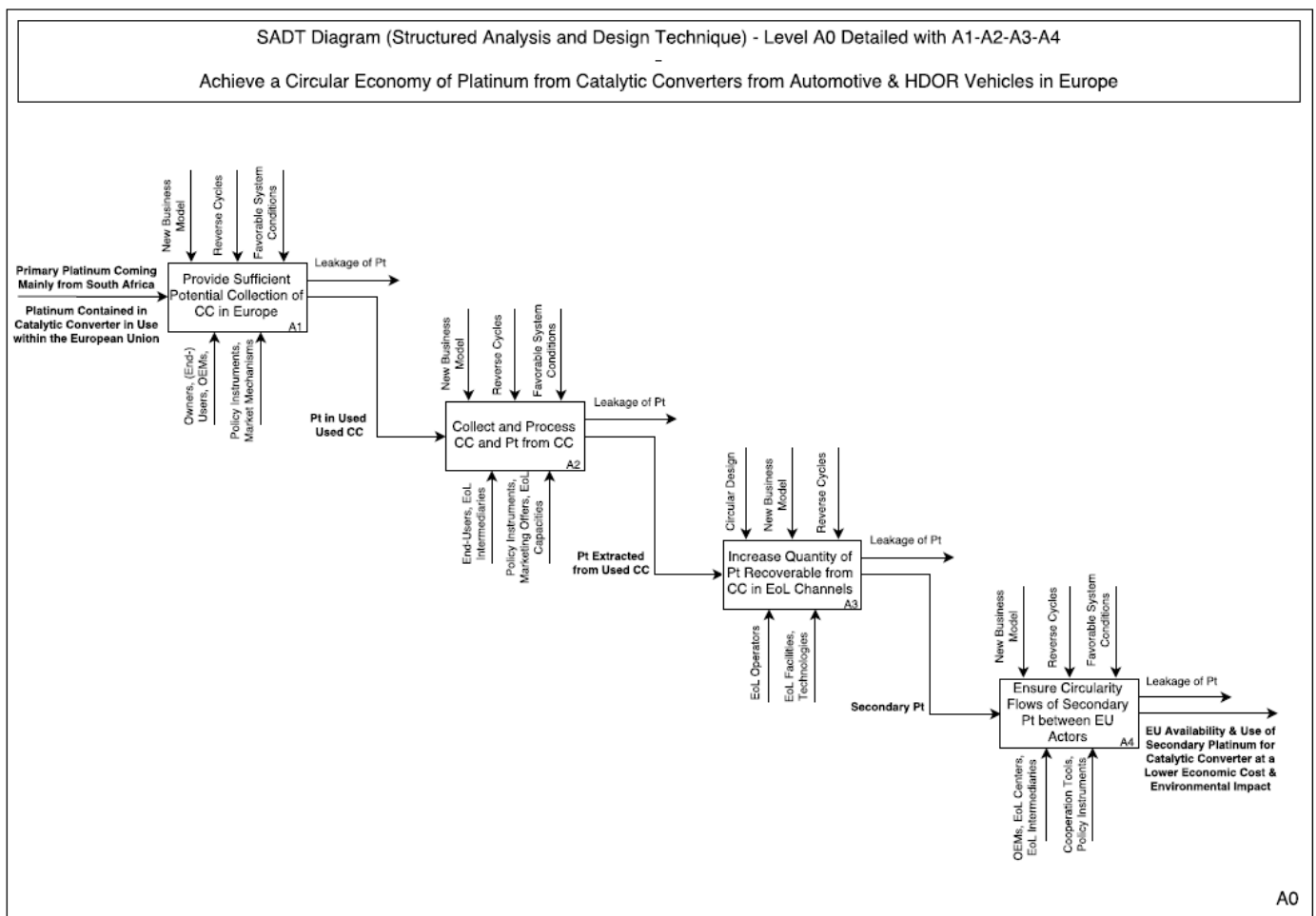

Figure 46 – SADT diagram – Level A0 detailed with levels A1-A2-A3-A4

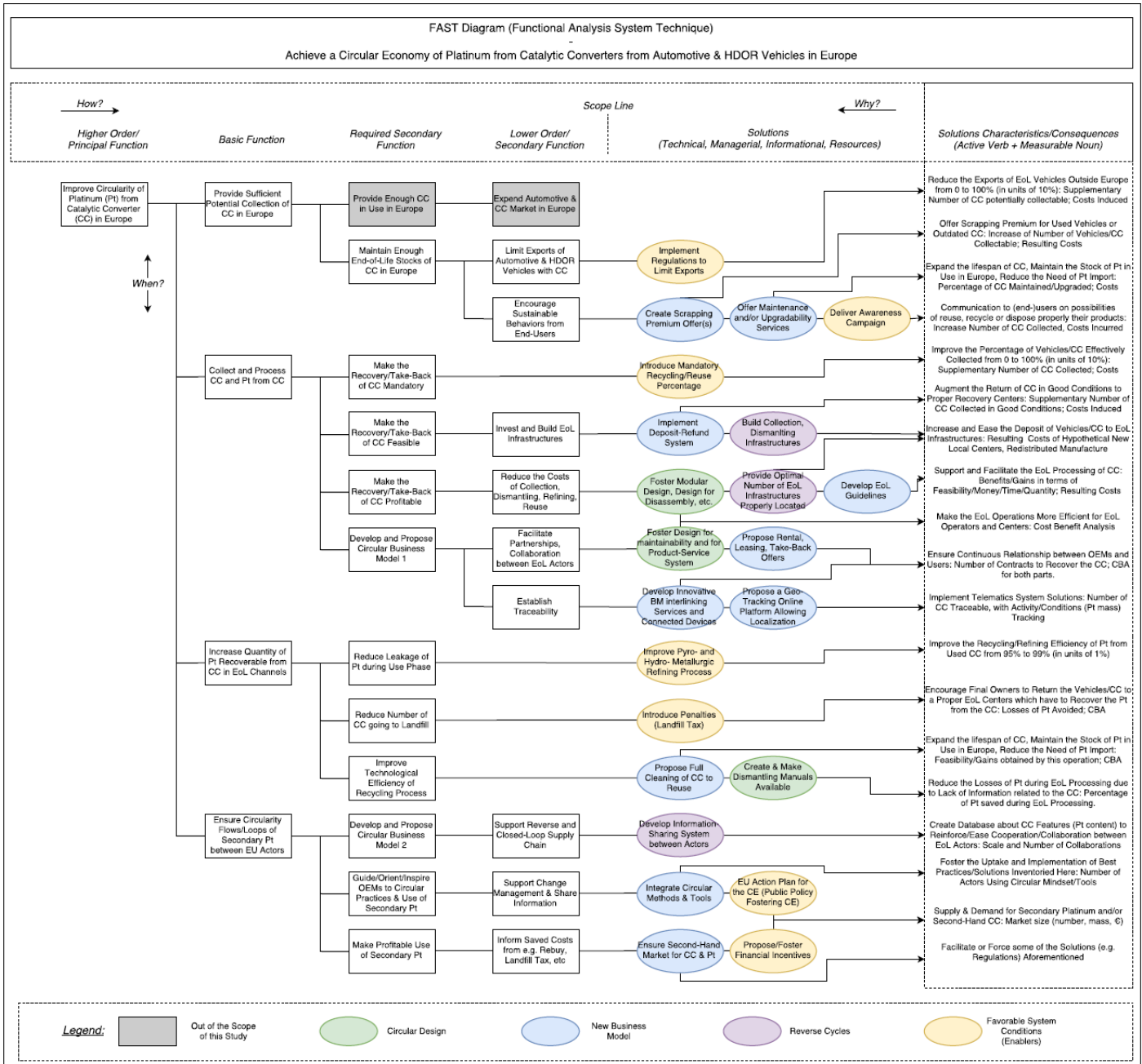

Figure 47 – Functional analysis system technique (FAST) diagram

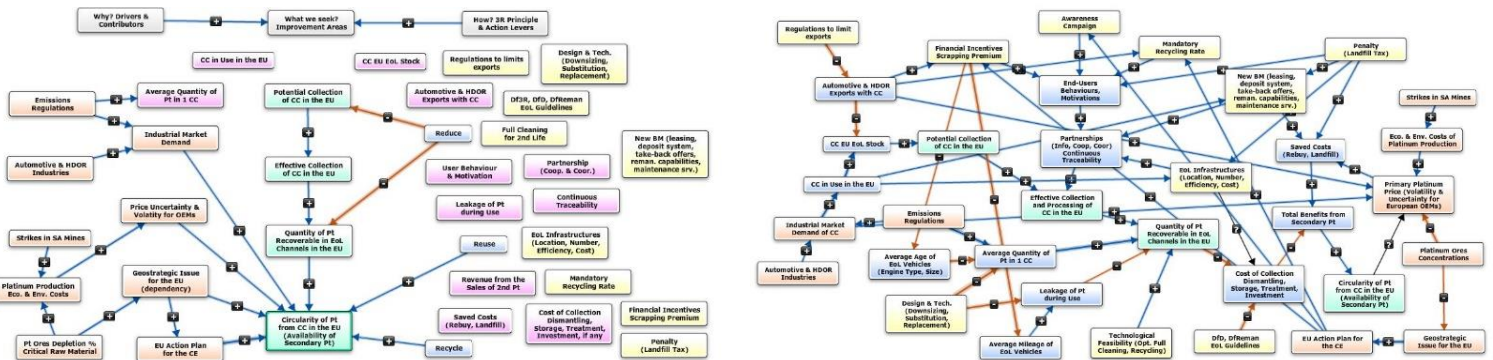

Figure 48 – Overview of the fuzzy cognitive mapping (FCM) developed

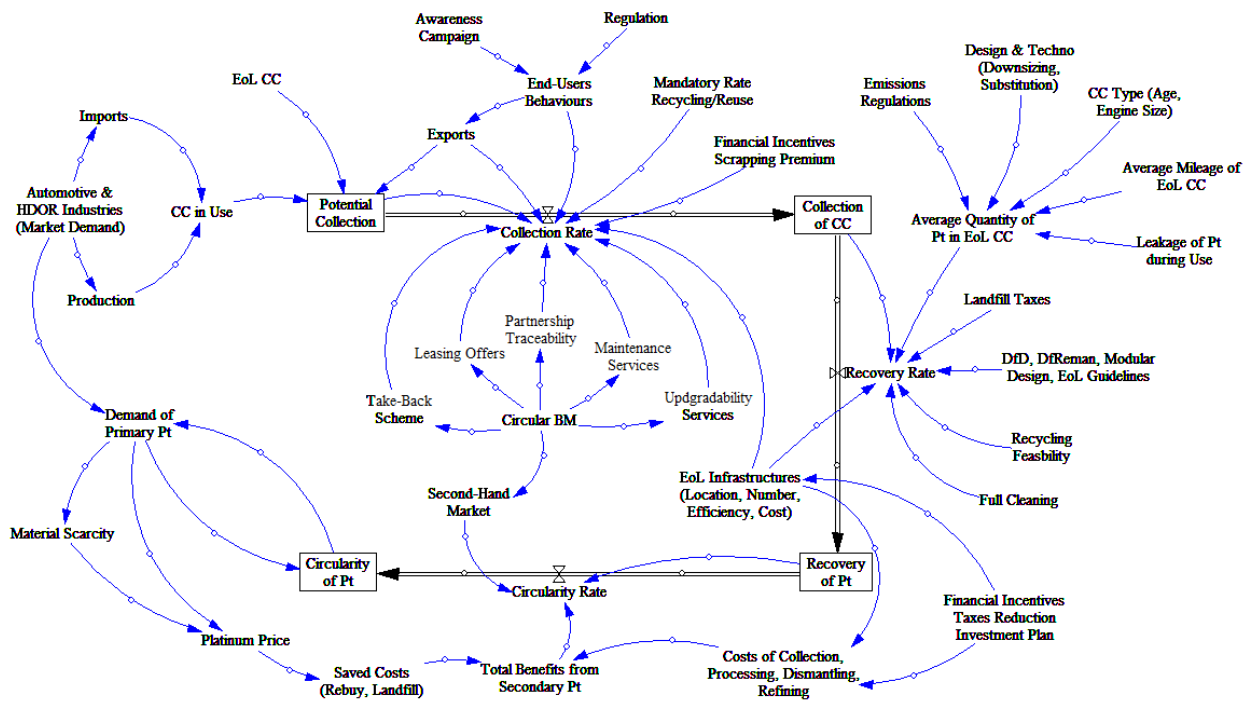
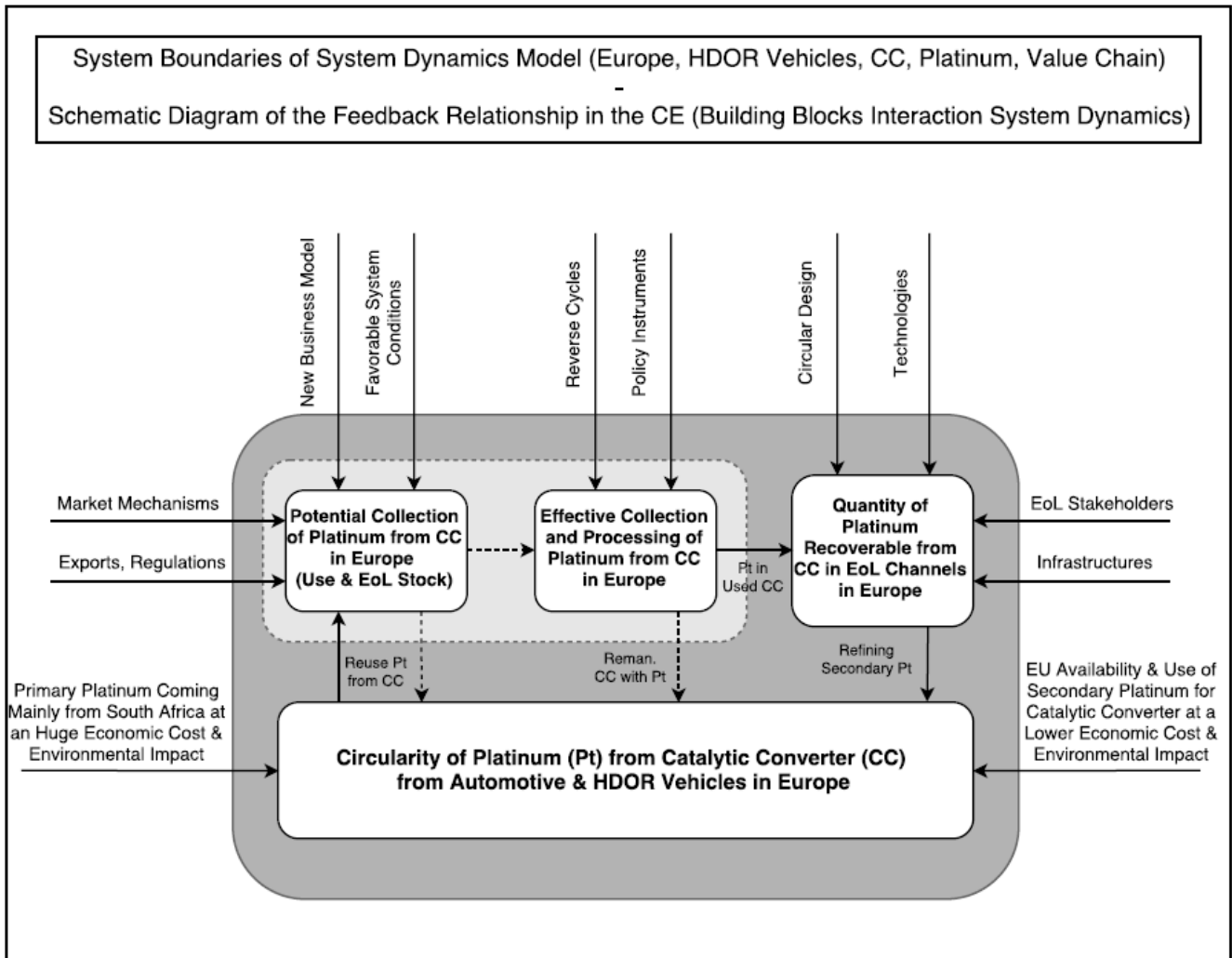

Figure 50 – Overview of the system dynamics (SD) model

4.2. CIRCULAR MANAGEMENT OF AN END-OF-LIFE HEAVY VEHICLE: AN INDUSTRIAL PILOT STUDY

After focusing on the circularity performance of a key component from the heavy vehicle industry, the challenges and opportunities related to the end-of-life management of an entire heavy vehicle – from the proposition of an improved dismantling process to the selection of best recovery options between reuse, remanufacturing and recycling – is exposed in this section through an industrial pilot study. Figure 51 gives a synthetic overview of the content of this research work conducted in collaboration with a remanufacturing center of heavy vehicles.

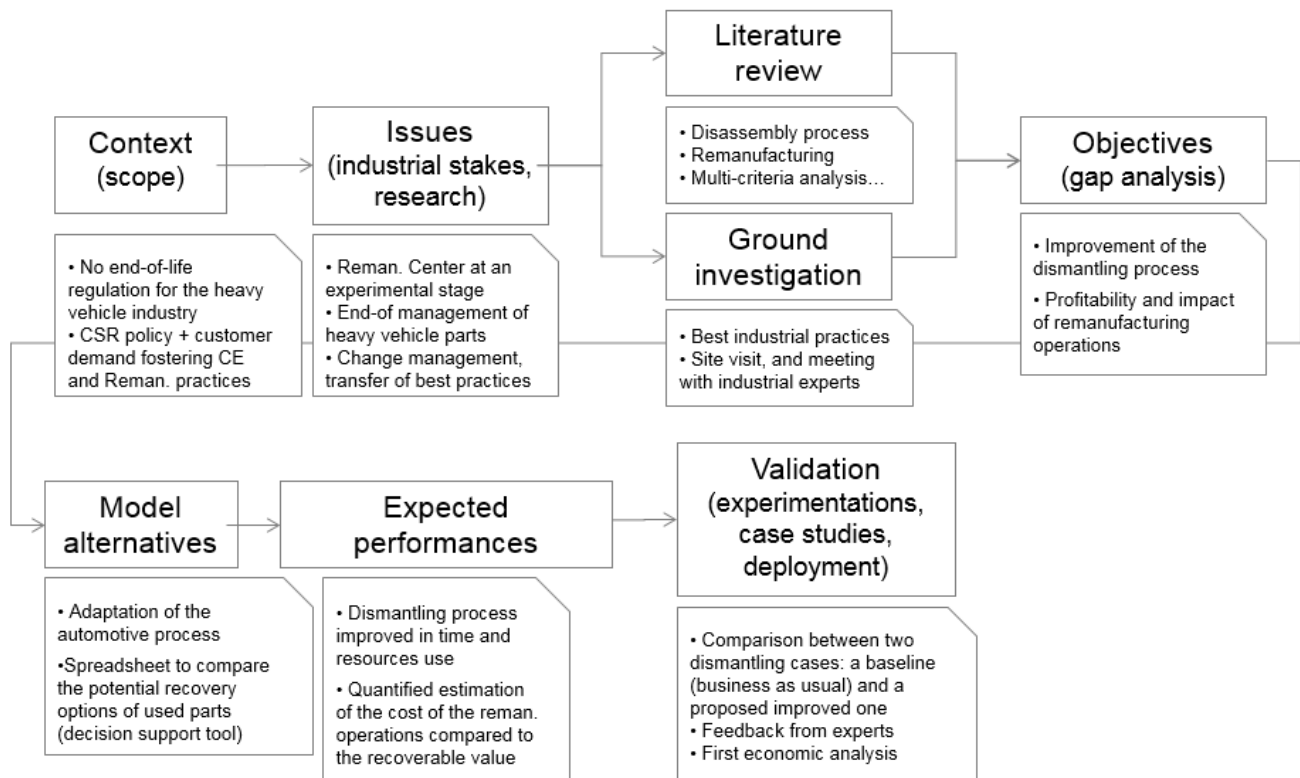

Figure 51 – Synoptic view of the industrial pilot study conducted with a remanufacturing center of heavy vehicles

4.2.1. Contextualisation

4.2.1.1. Research background and industrial context

4.2.1.1.1 End-of-life management and remanufacturing: between opportunities and challenges

Remanufacturing is the closed-loop industrial process of restoring used products to like new condition by a certain process of cleaning, disassembling, inspection and assembling. It is an efficient circular strategies to close-the-loop (Pigozzo et al. 2010) on industrial components, by extending their useful lives rather than being landfilled or recycled, and by recapturing as such their added value. Indeed, the Remanufacturing Industries Council (2018) inventoried the potential beneficial impacts of remanufacturing practices, including: cost savings for the manufacturers and lower prices for the customers, higher profit margin, better customer relationships availability with a shorter lead time, associated services (leasing, take-back, upgrading), reduced raw materials consumption, reduced energy consumption, reduction of CO₂ emissions, reduction of materials sent to landfill, local jobs, skilled jobs, new manufacturing techniques. For instance, in the heavy vehicle industry, through a case study conducted in Russia with Volvo Construction Equipment to expend and implement its remanufacturing activity, Sandvall (2006) illustrated that remanufacturing adds a competitive edge to manufacturing firms on after sales services as customers are given an overall cheaper product upgrade and wider products range at lower prices (for e.g. a remanufactured engine costs around 60-70% of an equivalent new engine). Further definitions of end-of-life related strategies, such as refurbishing, reconditioning, repairing, recycling, recovery, etc. are listed in Appendix A.

Yet, exploiting the potential profitability of a remanufacturing activity is not straightforward and depends on several factors, such as: the collection process and reverse logistic, the uncertain condition of a returned product, the additional cost and necessary resources. In fact, Casper and Sundin (2018) discussed today's challenge in the automotive remanufacturing, from the collection of used vehicles to the disassembly and recovery of keys parts. The main fields of challenges identified are: the important need for a continuing qualification of staff and engineers, an efficient core management, the consideration of pricing models and the competence to handle the growing variety and complexity of core parts in terms of quality and location. Sandvall (2006) demonstrated that once a remanufacturing activity is set up on appropriate circumstances, costs and machine downtime could decrease, and also reminded that it is not systematically the option to follow, stating that sometimes other end-of-life alternatives are better. On this basis, implementing an efficient and effective remanufacturing activity in the heavy vehicle industry needs to be supported by suitable methods, tools, and expertises. This study provides insights on how to identify and apply improvement potentials in the end-of-life management of heavy vehicles, from the dismantling to the economic recovery of such worn-out heavy vehicles, through remanufacturing operations.

4.2.1.1.2 *Manitou International Remanufacturing Center (Manitou Reman)*

The Manitou Group is a large equipment manufacturer, designing, developing and manufacturing mainly handling, lifting and earthmoving machineries, such as forklift trucks. Even if the heavy vehicle industry is presently not subject to the ELV Directive 2000/53/EC, Manitou is increasingly concerned about the end-of-life fate of its heavy machineries, based on the following reasons: growing customer demand related to the maintenance, take-back or end-of-life recovery of their equipments, potential economic benefits by exploiting this market and associated value bucket, anticipation of possible upcoming regulations on the obligation to offer second-hand parts (like in the automotive industry in the EU), business competition with independent remanufacturer, and a CSR policy more and more interested in applying circular economy principles. Against this background, Manitou has recently launched its "Reman Parts Program" to expand its products portfolio by offering the possibility to buy second-hand and remanufactured components. To further develop this offer and feed its stock of parts that are potentially recoverable, a subsidiary entity, the Manitou International Remanufacturing Center, has been created in 2013, whose the logos are depicted in Figure 52. Even if this fresh entity interacts with others departments of Manitou, such as the engineering design, or the parts and services departments, the remanufacturing center can be viewed as a SME (small and medium entreprise), composed of two technical managers, one accounting officer, one sale manager, one purchasing manager, and four technicians.

As such, this remanufacturing center is currently looking to extend its remanufacturing offer and has been interested in the findings reported in this thesis manuscript to enhance their current practices, in order to achieve a sound and profitable end-of-life management of the collected machineries. Particularly, after some preliminary discussions and a rapid industrial diagnosis, many areas of improvement have been identified, from the dismantling process to the selection of best end-of-life options for the recovered parts, through the remanufacturing of key components. In this way, we found relevant to study to what extent best practices analyzed in essay #1 could be transposed in their industrial practices. Additionally, to fully exploit this case study and provide relevant solutions that match with industrial reality, a complementary literature survey and further ground investigations have been performed, resulting in the proposition of a multi-scale model to select the most appropriate end-of-life options considering (i) the condition of the used machinery, (ii) the capabilities of the dismantling and remanufacturing activities, (iii) the recovery channels available. Last but not least, a practical datasheet and its associated spreadsheet have been designed to assist the industrialist all along the end-of-life operations. Note that during this industrial project, an intern has been hired by the remanufacturing center for six months to help collecting and formatting the data.



Figure 52 – Logos of the Manitou Company and its International Remanufacturing Center

4.2.1.2. Industrial needs, objectives and expected contributions

To date, a limited number of in-depth case studies addressing the end-of-life management of heavy vehicles have been reported in the scientific literature (Lishan et al. 2018). Through this industrial pilot study, the objectives are not only to bring a contribution to fill this gap but also to provide the original equipment (re)manufacturer with insights and practical solutions in the following areas:

- Technical and organisational: to optimize their dismantling process (in terms of resources used, tooling, working conditions, disassembly time);
- Economic: to assess, enhance and monitor the profitability of their remanufacturing activities (i.e. to know how to extract more value out of their machines and key components after use);
- Environmental: to measure the impact of their practices (to what extent the dismantling, remanufacturing, and recovery activities offer environmental benefits).

At this time, the first two points have been addressed and their outcomes are reported hereafter, through a technico-economic analysis and associated economic and organisational recommendations. The environmental analysis needs further data (that are being collected) before drawing a meaningful comparison between the impact of remanufactured parts and newly manufactured ones.

A complementary objective is to provide insights on how to implement the best practices and methodologies from an industrial sector (automotive industry) to another one (heavy vehicle industry), as well to discuss the replicability and generalisation of the proposed approach and models in other industrial environments to close-the-loop on heavy vehicles. In addition to the issues related to the characterization of the used heavy vehicle and the modeling of the dismantling process, the scientific challenges are also to develop an integrated and systemic modeling of the possible recovery channels, so as to explore and compare the end-of-life alternatives before deciding on the most appropriate one(s) from a technico-economic perspective. Last but not least, a key contribution lies in finding out a suitable way to integrate academic and conceptual circular economy framework to a more practical one for real and sustainable industrial use. Particularly, this study provides the industrialist with readable and easy-to-use versions of the models developed through (i) a template document to collect the data, and (ii) a spreadsheet, as a decision support tool to select the best end-of-life options.

4.2.1.3. Collaborative action research approach

The main research approach used in this study is an action research pilot study conducted in collaboration with an industrial actor of the end-of-life management of heavy vehicles. In an action research approach, the researcher moves from the role of neutral observer to a more active participatory role whilst retaining academic rigor (Gustavsen, 2008; McManners, 2015; Bocken et al. 2018). Interestingly, action research case studies have shown their relevance to push forward both the research and industrial practices in pressing areas such as sustainability challenges (Yin, 2013; Bocken et al. 2018). Particularly, a pilot experiment is a small scale preliminary study conducted in order to evaluate the feasibility (e.g. in terms of time, cost, resources) of an emerging activity prior to consider a full-scale implementation (Eldridge et al. 2016).

The findings presented hereafter are the result of a one-year collaborative research project part with Manitou Reman, as illustrated through the timeline of the project in Figure 53. The detail of the main steps, activities and outcomes related to this industrial pilot study are described in Table 42. Particularly, the first in-depth analysis of a dismantling operation has allowed to highlight the hotspots and areas of improvement. Feedbacks from the technician and the reman. manager, as well as from the design department, have been actively sought to perform a workshop aiming at generating improvement solutions for the dismantling operations. As a result, a proposed dismantling process has been tested and validated through a second dismantling operation. In parallel, many information have been collected following the developed data template, and a spreadsheet has been designed to organize and compile these data so as to guide the reman. manager in selecting the best end-of-life options for the recovered components.

Notably, this action research case study combines inputs from scientific literature review with best practices from field investigations (sub-section 4.2.2) to propose a multi-scale model and associated tools to manage the end-of-life activities in practice (sub-section 4.2.3), in order to achieve the aforementioned objectives, and thereby to meet the industrial needs (sub-section 4.2.4).

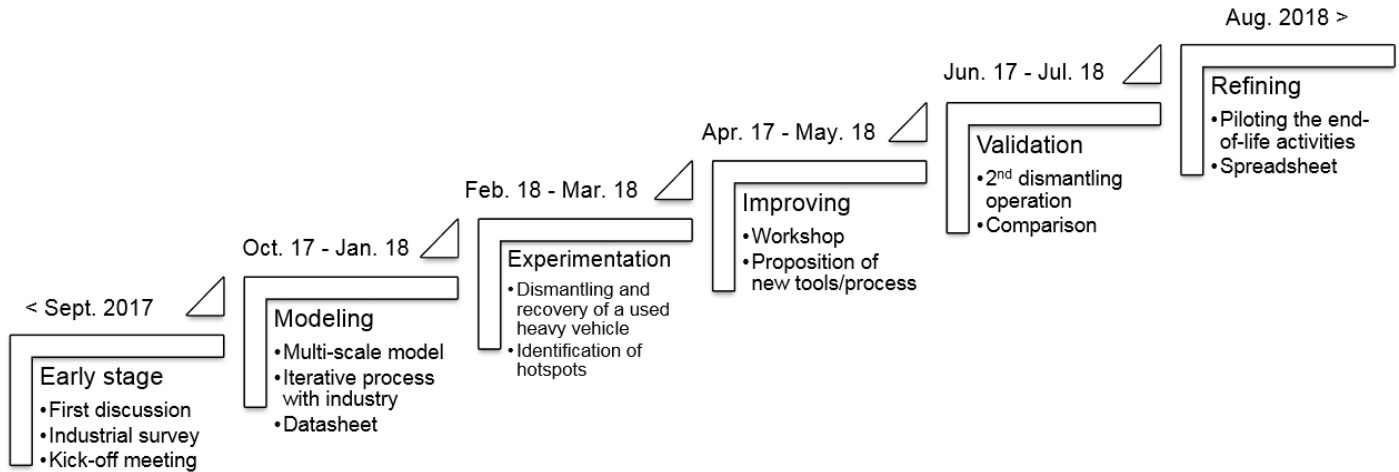

Figure 53 – Overview of the stepwise process of the industrial pilot study conducted with Manitou Reman

Table 42 – Detail of the key steps, activities and deliverables of the industrial pilot study

Steps	Inputs / Activities	Outputs / Deliverables
Early stage	Several meetings (first presentation, industrial survey, identification of shared interest, feasibility of such pilot study, project kick-off).	Definition of objectives, expected deliverables, required data and available resources (end-of-life machinery, technician, intern recruitment).
Modeling	Inspiration from literature review and best practices from the automotive industry. Data preparation and first collection (iterative process with reman. manager).	Multi-scale model with multi-dimension data. Data template.
Experimentation	Observation, photos, and videos, of the dismantling operations. Industrial visit of the remanufacturing center. Further round of data collection and analysis.	Organised timeline of the dismantling process. Identification of hotspots (problems and pains), and areas of improvement in the disassembly operations.
Improving	Post-treatment analysis of the dismantling operations. Workshop with inputs from technician, reman. manager, design department, parts and services department, and inspiration from the well-defined and streamlined dismantling process in the automotive industry.	Proposition of new tools to facilitate and accelerate several disassembly operations. Proposition of a newly time-efficient and well-organized dismantling process.
Validation	2 nd dismantling and recovery of an end-of-life heavy vehicle. Feedback from the technician and reman. manager.	Spreadsheet for the dismantling operations. First economic analysis (cost and benefits of the reman. activity).
Refining	Further organisational, technical, economic and environmental analyses.	Spreadsheet to calculate the profitability of reman. activities comparing possible end-of-life options for the recovered components. Initiation of a dismantling manual. Identification of further and promising challenges for a full-scale implementation.

4.2.2. Complementary literature survey and field investigations

This sub-section presents the specific literature and the industrial practices, as depicted in Figure 54, that have been used as inspirational sources to improve the dismantling process, or are expected to be used to further improve the developed spreadsheet, as well as to provide insights in the design of future generations of heavy vehicles (e.g. considering design for remanufacturing, for end-of-life-recovery or for circular economy approaches). Note that this sub-section is complementary to the commendable circular economy practices reported in essay #1, which also serve as relevant inputs to the models and improvement solutions proposed in this industrial pilot study.

As studies related to the end-of-life management of heavy vehicles are scarce in the scientific literature published, it is particularly relevant to question the transfer of best practices from the automotive recycling industry, as well as to further investigate on the industrial ground to look at emerging circular practices implemented in the heavy vehicle industry, and to exchange with other industrialists in this field who are interested or are starting to conduct similar industrial pilot studies. This sub-section synthesizes the literature survey and findings from the industrial ground, so as to select the approach or to propose a mix of approaches that seems relevant to fill the need of this pilot study.

Literature review State of the art



Field investigations Industrial practices



Disassembly methods and tools
 Remanufacturing process and guidelines

Model-based engineering approaches

Multi-criteria analysis
 Economic and environmental indicators

Circular business model

Cider Engineering: expertise center in the EoL management of HDOR vehicles

INDRA Automobile Recycling: adapted and advanced solutions to ELVs

Caterpillar, Volvo CE, Fenwick-Linde: examples of circular EoL practices

Manitou Reman. Center: iterative process to properly define and feed the template

Figure 54 – Complementary literature review and field investigations

4.2.2.1. Insights from industrial actors in the automotive and heavy vehicle industries

First, a focus is made on the know-how of French industrial centers having a hands-on expertise in the end-of-life management of light-duty vehicles (INDRA Re-source engineering solutions) and in the dismantling process of heavy vehicles (CIDER Engineering). Then, a recent insightful dismantling operation on two heavy military supervised by Nexter Systems is shortly mentioned (due to confidentiality reasons, not to disclose sensitive information). Finally, examples of best remanufacturing practices in the heavy-duty and off-road vehicle industry reported by the European Manufacturing Network (ERN) are analyzed.

INDRA Re-source engineering solutions has developed engineering and software solutions to ease the disassembly of end-of-life vehicles (ELV) and manage the economic recovery of second-hand parts or used materials. In fact, all of INDRA's authorised ELV centres benefit from the same software solution to support them in their work related to the end-of-life management and recovery of used vehicles, including: a computer-based tool for the administrative management of vehicles (V2), and a software (6PO) to facilitate the dismantling and to manage the stock demand, levels and sales. As such, 6PO enables the technical identification of reusable parts intended for resale. According to INDRA, operating this network enables recycling companies to benchmark and share good practice techniques, in order to meet government targets and to increase their visibility.

CIDER Engineering is an engineering and expert center dedicated to dismantle, recycle and remanufacture heavy equipments and vehicles, with the purpose of helping companies, producers and manufactures in the end-of-life management of their heavy vehicles. CIDER Engineering entails a documentation center dedicated to the reuse, recovery, recycling and dismantling process technologies. CIDER Engineering used to have a workshop equipped with industrial means to study and carry out the dismantling of any type of heavy equipment. Their industrial tools enable: to study the means, methods and processes suitable for the treatment of end-of-life vehicles; to increase reuse, recycling and recovery rates; to propose innovative and ergonomic dismantling tools; to prepare dismantling industrialization. Notably, the discussions with the manager of Cider Engineering have contributed to have a first

comprehensive and detailed view of the issues related to the end-of-life management, and then to make an inventory of all the data that must be considered in the economic analysis of end-of-life options, considering (i) the conditions of the used heavy vehicles, (ii) the dismantling process, (iii) the potential recovery channels.

Nexter Systems, a manufacturer of military heavy vehicles has recently conducted a pilot study on the dismantling of their end-of-life equipments. Through the dismantling of two military vehicles, the goals were to identify the locks and to assess the performance of the disassembly operations (costs, technical feasibility, recycling rates, etc.) in order to propose areas for improvement in design. A comparison has been made between the theoretical and effective recyclability of the military vehicles, using the ELV Directive (2000/53/EC) as a reference. All in all, the complete dismantling, including disassembly of the vehicle, disassembly of the components, sorting, storage and denaturation (specific to the military industry), requested 3 operators and lasted 440 hours. Finally, an economic analysis has been conducted comparing the costs of such operations with the potential economic recovery of the remaining parts and materials.

The European Remanufacturing Network, through its remanufacturing processes toolkit (ERN, 2016), provides state-of-the-art knowledge and experience as well as best practices of various successful remanufacturing companies. It includes notably two examples of companies that manufacture forklift trucks and have implemented successfully a remanufacturing activity. On the one hand, Fenwick-Linde has developed a collaborative network with channels of collection, sorting, revalorization. 98% of the components of their end-of-life forklift trucks could be recovered or recycled, and annually 83% of the 2,700 tons of end-of-life waste (oil, tyres, batteries, etc.) are recovered. The company has also a standardized remanufacturing process, as it follows: (i) control machine conditions; (ii) check components, and replacement if needed; (iii) repaint; and (iv) quality control. On the other hand, Toyota Material Handling Sweden indicates 90% of the used forklift comes from rental agreements that run from one month to 10 years (the rest is bought from the market), and their remanufactured forklift trucks (that are given with a warranty of 3 months or 6 months) are respectively sold at a price of 60% or 80% of newly manufactured forklift trucks (that usually come with a warranty of 12 months). The 5-step remanufacturing process implemented is the following: (i) inspection at the gate to determine the age, wornness and ability of the used forklift truck to be sold to a new customer; (ii) cleaning the forklift truck in an environmentally controlled manner; (iii) repairing parts that needs to be repaired, changing wear and tear parts; (iv) repainting to meet the new customer demands; and (v) testing the remanufactured forklift truck to ensure it meets the new customer requirements.

4.2.2.2. *Economic and environmental analysis of end-of-life strategies*

Through a case study with Volvo Construction Equipment, aiming at implementing and expanding the remanufacturing activities in Russia, Sandvall (2006) questioned “what variables are necessary to define why and how Reman can be a possible alternative to buy a new product or simply repair an existing one, and when are alternatives a better option?” For the implementation of a remanufacturing activity, this study highlighted several key variables which are: the level of regulations, range of components, mass, age of machines, usage of machines, cultural acceptance of reman, customer education of reman, costs of exporting/importing used components and reman components, costs of transportation of used components and reman components, costs of adding reman to an existing production plant, costs of setting up a production plant with reman, market potential, market stability, market strategic importance.

Moreover, an end-of-life option decision problem requires the considerations of the revenues and costs (economic and/or environmental) of each alternative available for a component. Lee et al. (2001) used an objective function to determine the optimal end-of-life options considering simultaneously the end-of-life cost and the environmental impact. To compute the end-of-life economic value of components, the following costs and potential benefits are taking into account: the reuse value, remanufacturing value, recycle value, incinerate value, landfill cost, special handling cost, collection cost and processing cost. Lee et al. (2010) developed an end-of-life decision model for determining the economic levels of remanufacturing and disassembly under environmental regulations. Lee et al. (2014) proposed a product end-of-life index that enables designers to make informed decision on design alternatives for an optimal product performance at the end-of-life stage.

Japke (2009) developed a methodology to assess the economic benefits of a remanufacturing activity, applying the following steps: mapping the process of remanufacturing; reporting the cost drivers associated with each stage of the process; computing the different types of costs that are involved in the process. The cost elements include: the transportation cost, cleaning cost, categorizing cost, disassembly cost, inspection cost, remanufacturing cost, assembly cost. The cost drivers encompass: the number of parts, the reverse logistic distance, part weight, part

size and material type. To facilitate its computation, the generic cost estimation framework has been developed in Microsoft Excel, it includes input/output sheet, cost calculation sheet, and assumption and ground rules sheet (Japke, 2009). To Kwak and Kim (2013), the profitability of remanufacturing is a function of {original product design, quality and quantity of EoL products, cost of remanufacturing operations, feasibility, technical and operational issues, market demand for remanufactured products, reuse or upgrade question}. Through a case study considering a manufacturer that produces new products and also remanufactured versions of the new products that become available at the end of their life cycle, Kwak and Kim (2015) proposed a decision-support model to maximize the total life-cycle profit. The proposed model searches for an optimal product design (design specifications and the selling price) for the new and remanufactured products. It optimizes both the initial design and design upgrades at the end-of-life stage and also provides corresponding production strategies, including production quantities and take-back rate. The model, available on a spreadsheet with the use of a solver, has been extended to a multi-objective model that maximizes both economic profit and environmental-impact saving, under the green profit zone, a pareto-like surface (Kwak and Kim, 2017).

Luglietti et al. (2014) developed a decision support tool to evaluate the environmental and economic implications of different end-of-life strategies, and applied it to an end-of-life automotive engine. In particular, three alternatives end-of-life options are compared: remanufacturing, reuse and recycling (material recovery). The results are shown in a bidimensional graph (eco-efficiency diagram) displaying the three alternatives with their economic revenue and environmental gain. The environmental impact assessment (in CO₂ eq. emissions) of the three end-of-life alternatives considers: the treatment process for each option, the recycling process for the material recovery option, the avoided manufacturing for the reuse and remanufacturing options, and the avoided raw materials extraction for each option. The revenue associated to material recovery option corresponds to the revenue from selling materials (steel, cast iron and aluminium). The revenue associated to the reuse and remanufacturing options corresponds to the selling of the second-hand or newly refurbished engine. The operation costs for all options include energy consumption and operation costs. Igarashi (2016) used a model of multi-criteria optimization for lower disassembly cost, higher recycling and CO₂ saving rates by an environmental and economic parts selection, and subsequent disassembly line balancing. The results are highlighted on a pareto-optimal frontier through a 3-dimension chart with the following axes: recycling cost, recycling rate, CO₂ saving rates. Ma and Kremer (2015) proposed a fuzzy logic-based approach to determine product component end-of-life option, considering trade-offs between the three dimensions of sustainability: the residual value for the economic pillar; the land use and eco-indicator for the environmental pillar; the human toxic potential and job creation for the social pillar.

Van Loon and Van Wassenhove (2017) developed a tool manufacturers can use to assess whether remanufacturing is economic and environmentally attractive compared to the production of new components, via the use of several variables describing the costs of acquiring used products, the remanufacturing operations and the sales activities. The decision variables are the twofold: the number of used products, and the number of reused components. The parameters considered are: the number of refurbished components, number of recycled components, number of new components, demand for remanufactured products, fraction of reusable components present in the used product, fraction of non-reusable components, purchase price of one used component, cost of acquisition, cost to disassemble one used product, cost to refurbish one component, cost to recycle one component, cost to buy one new component, cost of additional small parts per remanufactured product, cost of assembly, cost of distribution, and the environmental impact of aforementioned activities (i.e. collection, disassembly, refurbishing, assembly, transportation, recycling). Based on their analysis with a supplier in the automotive industry, Van Loon and Van Wassenhove (2017) found that used core prices and remanufacturing yield rates have a large impact while an optimised design for remanufacturing can only marginally improve the situation.

4.2.2.3. *Design for disassembly, remanufacturing and end-of-life recovery*

In addition, eco-design or circular design approaches such as design for disassembly, for remanufacturing and for end-of-life recovery can be insightful both to further study what variables are important to consider in our analysis and to be able to provide relevant feedback to the design department after the possible identification of hotspots during the disassembly of the used heavy vehicles.

Pigosso et al. (2010) presented five eco-design methods focused on the integration of end-of-life strategies, with a special attention to remanufacturing. Hatcher et al. (2011) provided as well a comprehensive review (analyzing the format, style, key purpose, design stage, advantages, disadvantages, and use in industry) of several design for remanufacturing methods and tools developed by academics, including for instance, the REPRO² tool or the RemPro matrix which are detailed below. One striking observation made by Hatcher et al. (2011) is that these tools

are barely used in industry. On this basis, Hatcher et al. (2011) made some key recommendations for future research, including: the need for greater exploration into the organisational factors affecting the integration of design for remanufacturing approaches into the design process, the need to study or test different products and case companies, and the need to investigate the value of design for remanufacturing, both from a designer perspective and a remanufacturer perspective. For instance, Ismail (2016) developed a framework to guide designers toward sustainable remanufacturing, fostering the industrial uptake of the existing academic methods and tools related to remanufacturing.

The RemPro matrix (Lindkvist and Sundin, 2016) shows the relationship between the essential product properties (ease of identification, verification, access, handling, separation, securing, alignment, stacking) and the generic remanufacturing process steps (inspection, cleaning, disassembly, storage, reprocess, reassembly, testing), indicating to the designer which product property facilitates each remanufacturing process step. The REPRO² (REmanufacturing with the aid of PROduct PROfiles tool) (Lopez, 2004) is a design tool which aims to assist designers in creating products which are easier to remanufacture. By studying the profile of 28 products already remanufactured with success, core variables which are essential for the success of remanufacturing operations have been identified, including: the ratio between the remanufactured product price and the new product price, the ratio between the buy-back cost and the new product price, the ratio between the remanufacturing cost and the new product price, the ratio between the energy required for remanufacturing and the energy for new production, the ratio between the mass of recovered components and the mass of the product.

4.2.3. Proposed problem-solving approach and support tools

4.2.3.1. Overall modeling approach

The objective is to provide the industrialist (e.g. reman. manager) with a readable methodology and practical tools to determine systematically the most appropriate end-of-life alternative(s) for the used heavy vehicles collected and recovered components after the dismantling operations, regarding the conditions of the worn-out vehicles and associated components, the market demand and the potential recovery channels.

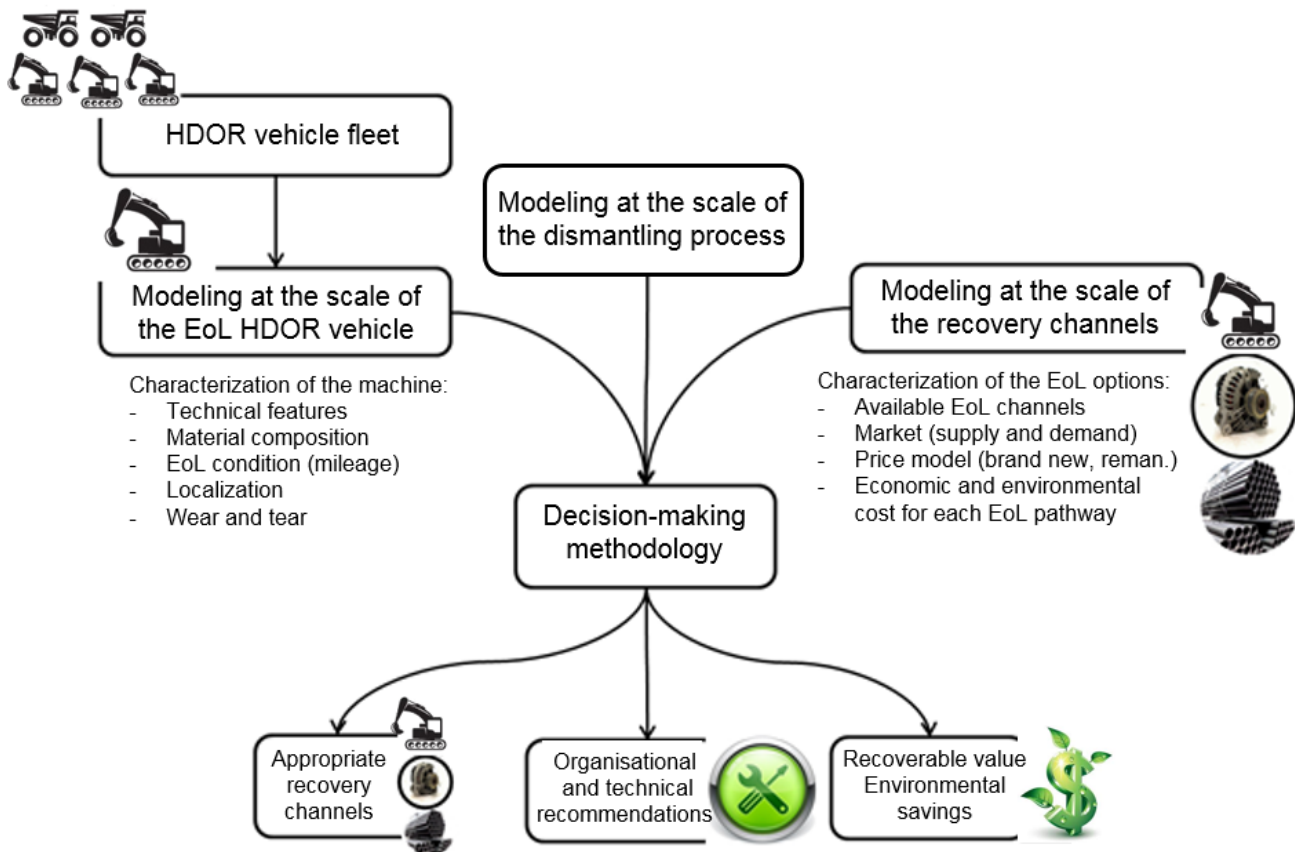

Figure 55 – Schematic view of multi-scale modeling approach

To do so, the global model must integrate different micro-models, as illustrated in Figure 55, characterizing at complementary scales: (i) the conditions of used heavy vehicles and associated components; (ii) the capabilities and performance of the dismantling process; and (iii) the possible end-of-life options according to the existing channels for materials recovery and regarding the market demand for used or remanufactured spare parts.

In this pilot study, the remanufacturing, repairing and resale of the entire heavy vehicle (i.e. the heavy vehicle as a functional whole) is not considered (according to preliminary discussions with the reman. manager, the two used heavy vehicles collected to conduct the two dismantling experimentation can only be valued through the reuse, remanufacturing of spare parts or by the recycling of materials). As such, the end-of-life options considered for each component are the following: reuse as it is to feed the production line or the heavy vehicles being repaired, sale as it is through the second-hand market; remanufacturing to feed the production line or the heavy vehicles being repaired, sale after remanufacturing as a certified remanufactured part; and material recovery (i.e. recycling).

From the collection and initial diagnosis of the used heavy vehicle, the proposed approach and multi-scale modeling – materialized by a practical data template and its associated spreadsheet detailed hereafter – must be able to: compare different end-of-life scenarios; provide the cost of dismantling and the value that can be recovered according to each possible end-of-life option; and finally, help the industrialist (here the reman. manager) to make the best decision regarding the end-of-life pathways of the recovered components and materials.

4.2.3.2. *Data template*

Based on the literature review and industrial investigations, a data template has been designed to put together all the elements of information that need to be collected in order to conduct properly both the dismantling experimentation and the technico-economic analysis. The methodology to construct the data template was the following: first, all the elements considered as relevant from the literature survey and ground investigations aforementioned were inventoried. Then, a first draft was presented to the reman. manager to check with him if there were any important missing points and to have this feedback of this first version. Although he valued the completeness of this document, he asked for a more practical version. As such, the data template has been simplified, refined and divided into three separate pages (i.e. one datasheet for each micro-model). A blank version of this data template is available in Appendix G.

More precisely, the purpose of this template is to provide the industrialist with a pre-filled document, facilitating the compilation and exploitation of the data. It includes the sets of technical and organizational parameters to be informed at different levels (end-of-life heavy vehicle and components, dismantling process, recovery channels) in order to carry out the economic and environmental analysis of the recovery of an end-of-life machine, in relation with market constraints and recovery opportunities.

4.2.3.3. *Spreadsheet*

Eventually, to deliver relevant and usable outcomes that fit with the industrial and market realities, the overall model combines complementary micro-models integrated in a single spreadsheet, which characterized quantitatively: the machine and components to be valued, the dismantling process, and finally the possible recovery options and associated value chains. The use of this spreadsheet is further detailed in the sub-section 4.2.3.3.

The pre-filled datasheets and spreadsheet have been designed as practical tools to support to the industrialist in answering the following questions: What data are needed? How to compile and use the information to make right economic (and environmental decisions) related to the end-of-life options of a used heavy vehicle and associated components? Particularly, they provide guidelines all along the end-of-management of a heavy vehicle:

- Before the dismantling activity: to be informed of the data that need to be filled in; to complete upstream information that is already known; to be prepared to extract the information during the dismantling;
- During the dismantling operations: to measure and report directly the data requested or to know exactly what to record (videos, photos, notes);
- After the dismantling activity: to fill out the missing data with complementary post-dismantling information; to add any relevant comments.

4.2.4. Results: technico-economic and organisational recommendations

4.2.4.1. Lessons learnt from the first dismantling operation

A first dismantling experience on an entire end-of-life forklift truck, as illustrated in Figure 57, has been set up and conducted with the following purposes:

- Mapping and visualization of the current dismantling process;
- Identification of hotspots (e.g. disassembly difficulties, pains for the operator during certain operations);
- Baseline for quantitative improvement of the dismantling process;
- Collection of data (to feed the datasheet/spreadsheet at the scale of the dismantling process);
- Economic analysis of the dismantling cost, compared to the remaining value of the recovered components.

In fact, according to discussions with the reman. manager, no dismantling process has been formalized in the past. The disassembly operations are only based on the expertise of the operator and his technical experience, which might be efficient at the beginning but may have room for optimization according to the reman. manager of this remanufacturing center. The idea is that this first dismantling experimentation, from which data are collected and post-treated, would help identifying the areas of improvement to come up with a more systematic dismantling process, optimized or at least enhanced in terms of time and resources used.

This first dismantling operation lasted 5 days with one full-time operator, following the procedure and time illustrated in Figure 56. During these 5 days, videos were recorded, photos were taken, and notes reported (including feedbacks from the operator in charge of the dismantling). Based on the post-analysis of all the data collected, an Ishikawa diagram has been proposed to synthesized in an organized and manageable manner all the causes that may have an effect of a poorly efficient and badly dimensioned dismantling process, as depicted in Figure 58.

Non-optimized dismantling process in time and resources (Manitou Reman, February 2018)

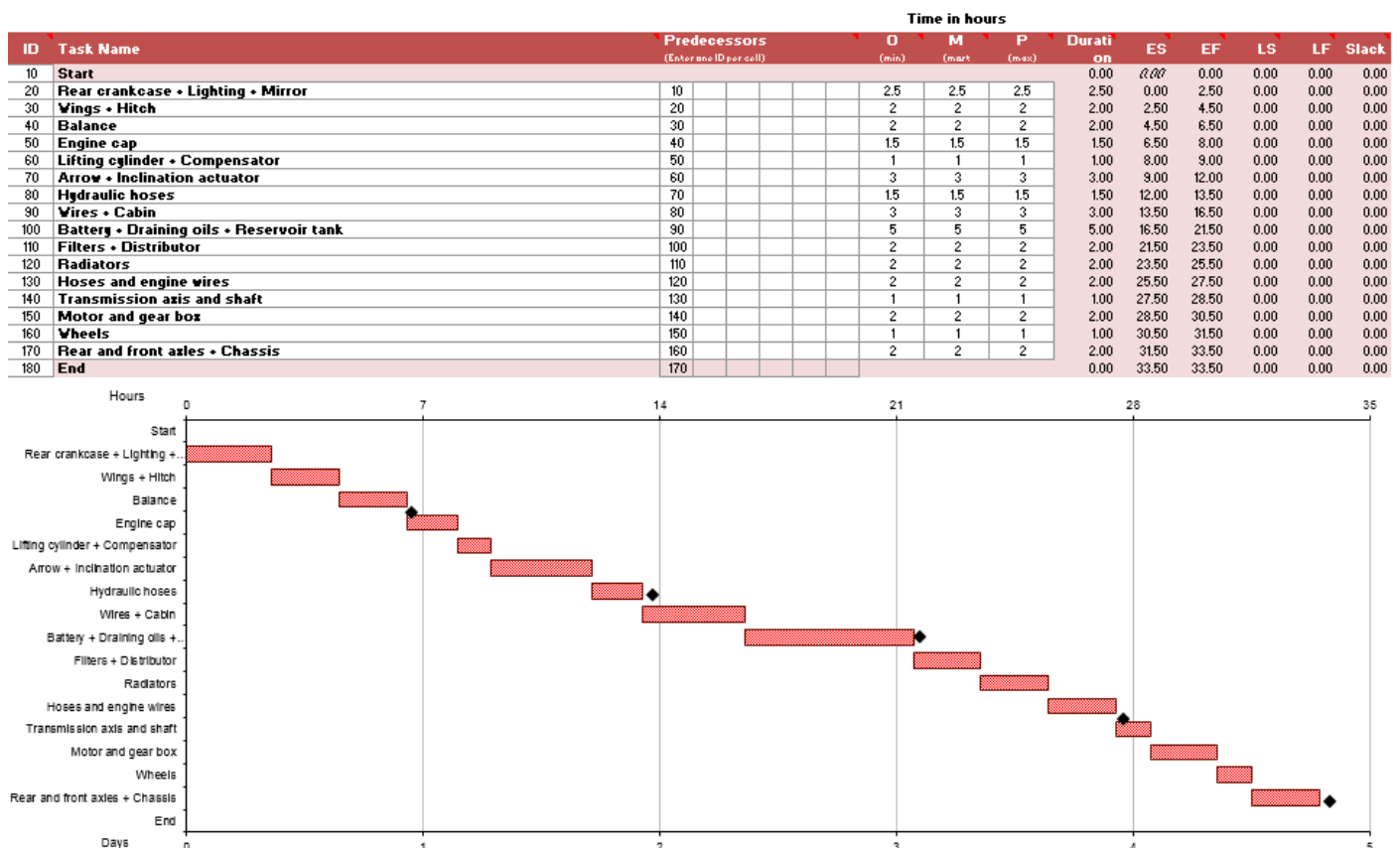

Figure 56 – Gantt chart of the dismantling process before improvement (baseline)



Figure 57 – Photos of the first dismantling test

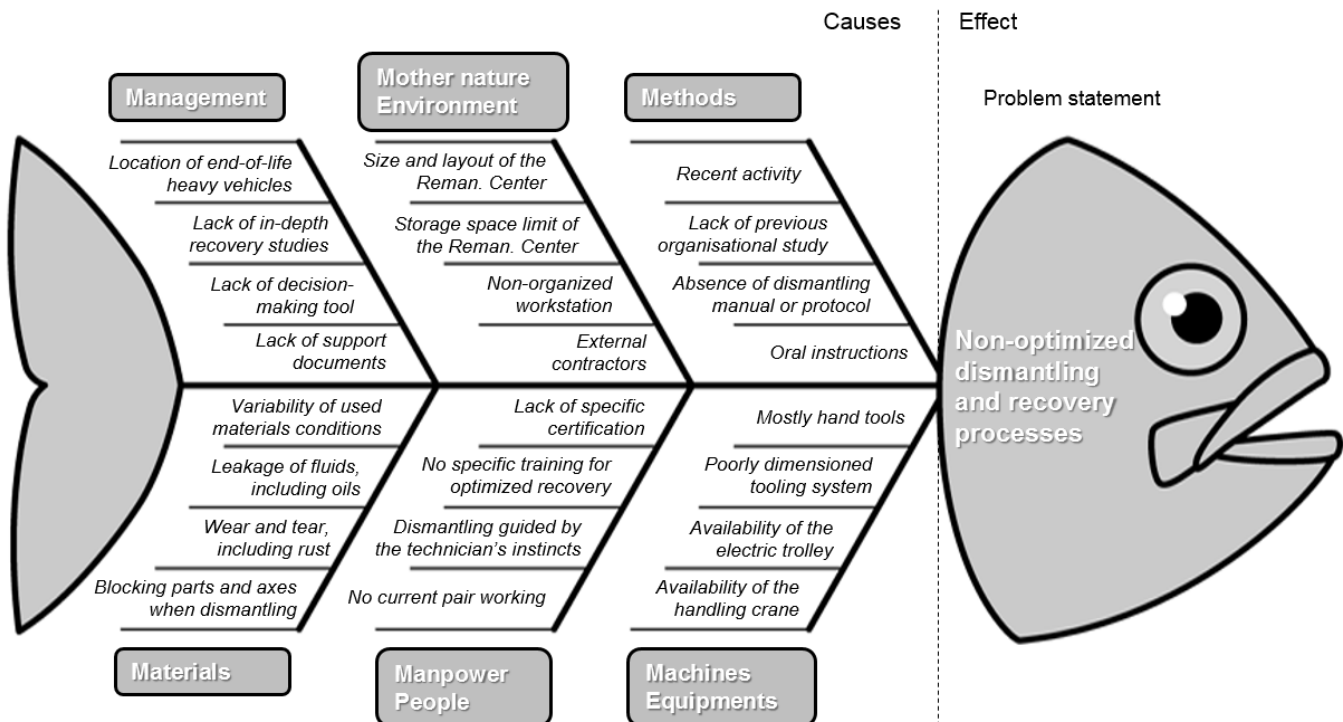

Figure 58 – Ishikawa 6M cause-effect diagram to highlight the room for improvement in the recovery process

4.2.4.2. Improvement of the dismantling process

Against this background, a two-day workshop has been realized to generate suitable proposals for improvement in the dismantling operations. The expected contribution of this workshop lied is the proposition and detailed design of an enhanced dismantling process in terms of time (to decrease the overall cost of the dismantling operations), efficiency, and comfort for the operator. In accordance with the reman. manager, the room for maneuver and possible levers of actions were: the modification of the current dismantling procedure (operations order, adjustment of lead time), and the possibility to acquire new dismantling resources (materials, tools). To come up with a new feasible dismantling process optimized in time and resources used whilst facilitating the disassembly operations for the technician, best practices from the automotive recycling industry were used as a source of inspiration, as illustrated in Figure 59, with a critical analysis of what is actually transferable to the disassembly of a specific heavy vehicle (forklift truck) as detailed in Table 43. In parallel, the insights provided by the first dismantling test and its post-treatment analysis were used, as well as technical feedbacks from the operator related to its pains during certain disassembly operations and related possible improvement solutions. Also, resources from the International Dismantling Information System (IDIS), and its section “Equipment for Treatment of ELV” were used to propose new tools that could facilitate the most sensitive or time-consuming disassembly operations. As a result, a new dismantling procedure has been designed, as displayed in Figure 60, grouping, where possible, the disassembly operations that required the same tooling, and complying with the constraints of predecessors in terms of accessibility.

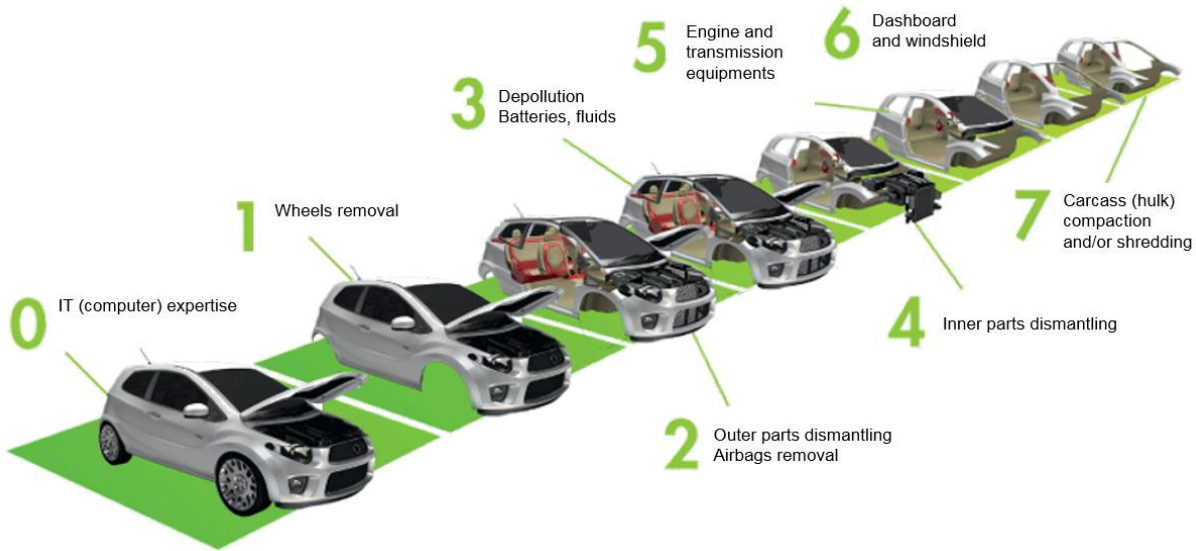

Figure 59 – Streamlined and efficient dismantling process in the automotive industry (source: Indra, 2016, translated from French)

Table 43 – Inspiration and transfer of best practices from state-of-the-art automotive dismantling process

Characteristics	INDRA automotive recycling	Manitou International Reconditioning Center	Transfer of best practices (adaptation possibilities)
Process Resources Performance	Optimized: 1h30 by end-of-life car; 6 specialized technicians at 6 specific workstations (15 min each); up to 25 cars a day.	Non-optimized: 35h by end-of life heavy machinery, 1 technician; 1-5 heavy vehicles by month.	Re-organisation in the dismantling process, resulting in time-saving.
Tools	Automatized and pivotable disassembly line, power-driven tools.	Handling crane, handling trolley, standard hand tools.	More fitted tools, better dimensioned, for time-efficiency and technician comfort/safety.
Dismantling process steps	#0 IT (computer) expertise, inspection of the vehicle, specific disassembly instructions.	Manual inspection, no computer-based expertise.	Dismantling manual being considered, to support the disassembly.
	#1 Wheels removal	Wheels are removed at the end of the dismantling process.	Wheels are kept on the heavy vehicle to ensure his stability.
	#2 Outer parts dismantling	Engine crankcase on day 1, engine cap on day 2, cabin on day 3.	To regroup these dismantling operations.
	#3 Depollution (batteries, fluids)	Done on day 3, after dismantling all the outer parts, and the arrow, but leads to leakages of fluids the first three days of operations.	Compromise to find: fluids are left to facilitate the move of the arrow, but their leakages are a time and environmental issue.
	#4 Inner parts dismantling	Mixed with the dismantling of outer parts, no systematic and repeatable procedure.	Operations that could be mutualized for time-efficiency.
	#5 Engine and transmission equipments	Done at the end, in case the heavy vehicle has to be moved.	Position in the dismantling process is correct, but the tooling could be better adapted.
	#6 Dashboard and windshield removal	Disassembly of the cabin.	Reuse of some parts if needed
	#7 Carcass (hulk) compaction and/or shredding	Remaining parts are put in temporary storage bins.	Augmented materials recovery
Valorization	Oriented and targeted disassembly, based on the cars' conditions (age, wear and tear, etc.) and the market demand, according to the real-time database of an IT software.	The procedure is not formalized, based on experience, on discussion between the remanufacturing center and other departments of the company. No IT support.	Data template and spreadsheet with the list of components, current stock pricing information, monthly sales, etc. to identify the best recovery options.

Proposition of a new dismantling process, improved in time and resources use

ID	Task Name	Predecessors (Enter one ID per cell)	Time in hours			Duration	ES	EF	LS	LF	Slack
			O (min)	M (max)	P (max)						
10	Start					0.00	0.00	0.00	0.00	0.00	0.00
20	Day 1: Outer components (using standard hand tools + electric trolley at the end of	10	7	7	7	7.00	0.00	7.00	0.00	0.00	0.00
30	Rear crankcase + Lighting + Mirror	10	2	2	2	2.00	0.00	2.00	0.00	0.00	0.00
40	Wings + Hitch	30	2	2	2	2.00	2.00	4.00	0.00	0.00	0.00
50	Motor cap	40	1.5	1.5	1.5	1.50	4.00	5.50	0.00	0.00	0.00
60	Balance	50	1.5	1.5	1.5	1.50	5.50	7.00	0.00	0.00	0.00
	Day 2: Heavy components (using handling crane + new tools for cutting the hoses)	60	7	7	7	7.00	7.00	14.00	0.00	0.00	0.00
70	Lifting cylinder + Compensator	60	1	1	1	1.00	7.00	8.00	0.00	0.00	0.00
80	Arraw + Inclination actuator	70	3	3	3	3.00	8.00	11.00	0.00	0.00	0.00
90	Hydraulic hoses	80	1.5	1.5	1.5	1.50	11.00	12.50	0.00	0.00	0.00
100	Cabin (dashboard, etc.)	90	1.5	1.5	1.5	1.50	12.50	14.00	0.00	0.00	0.00
	Day 3: Complete depollution (using new pumps and well-dimensioned containers)	100	7	7	7	7.00	14.00	21.00	0.00	0.00	0.00
110	Battery + Draining oils + Fuel tanks	100	3	3	3	3.00	14.00	17.00	0.00	0.00	0.00
120	Filters + Distributor	110	2	2	2	2.00	17.00	19.00	0.00	0.00	0.00
130	Radiator	120	2	2	2	2.00	19.00	21.00	0.00	0.00	0.00
	Jour 4 : Engine system (using adapted e.g. handle extension Allen socket)	130	6	6	6	6.00	21.00	27.00	0.00	0.00	0.00
140	Hoses + Wires	130	1	1	1	1.00	21.00	22.00	0.00	0.00	0.00
150	Engine and gear box	140	1.5	1.5	1.5	1.50	22.00	23.50	0.00	0.00	0.00
160	Transmission axis and shaft	150	0.5	0.5	0.5	0.50	23.50	24.00	0.00	0.00	0.00
170	Wheels	160	1	1	1	1.00	24.00	25.00	0.00	0.00	0.00
180	Rear and front axles + Chassis	170	2	2	2	2.00	25.00	27.00	0.00	0.00	0.00
190	End	180				0.00	27.00	27.00	0.00	0.00	0.00

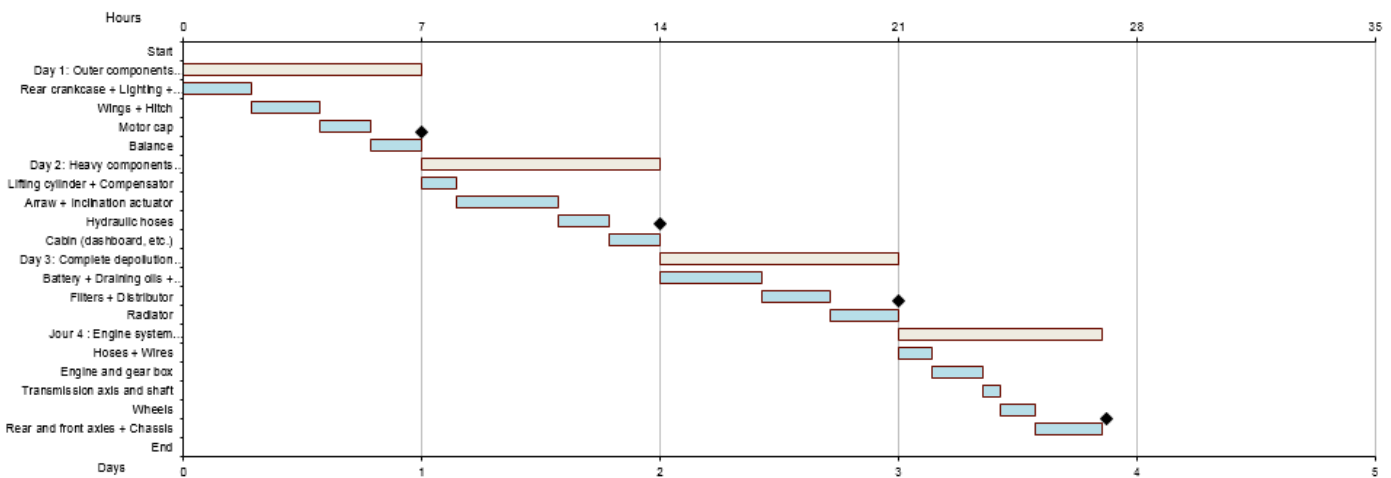

Figure 60 – Gantt chart of the newly proposed and adjusted dismantling process

The main modifications (including the order and grouping of several disassembly operations) proposed through the new dismantling process compared to the baseline are highlighted in blue in Figure 60. Notably, we make the assumption that the use of new, specific and more adapted tools could contribute in reducing the lead time of these disassembly operations. As such, the acquisition of the following tools was suggested, as illustrated in Figure 61: a fluid pump connected to a tank of great capacity to drain the fluids more efficiently (depollution operations), a wheeled bin to avoid the leakages of oils on the floor, an hydraulic shear to cut the hoses more quickly, a more handy cordless power tool with Allen sockets extension to reach difficult access components and screws. All the propositions have been validated by the reman. manager and the technician. As a result, we expect a reduction of the overall dismantling time of 22% – from 5 days (33.5 hours) to 4 days (26 hours) – for the next dismantling of a similar forklift truck.



Figure 61 – Photos of the tools recommended and acquired to smooth the dismantling process

4.2.4.3. Validation and adjustment from a second dismantling experimentation

In order to validate or adjust the proposed dismantling process, a second supervised and recorded dismantling experimentation has been conducted (see Figure 63) with the newly organisational support (timeline of the disassembly operations) and materials support aforementioned to guide and assist the operator in charge of the dismantling. As reported in Figure 62, the reduction of the lead time for several disassembly operations has been reached, resulting in a shift from 5 days to 4 days, or even less (i.e. by splitting the 21 hours of work into 3 days), to dismantle such a forklift truck. Note that while the overall organisation by day of the dismantling process has been followed, some minor changes in the order of disassembling some components have been done by the technician for practical reasons. Importantly, feedbacks from the technician confirmed both (i) the new tooling gives him for more comfort and efficiency in the most challenging tasks, and (ii) the fact that having a process to follow allows to be better organized, i.e. not to hesitate about what to do next and therefore to save time. The economic analysis associated to the dismantling operations is detailed in the next sub-section. Also, further promising research areas and industrial improvements (e.g. generalization to other heavy vehicles, design of a detailed dismantling manual) are finally discussed.

Validation and adjustment of the proposed dismantling process (Manitou Reman, June 2018)

ID	Components	Tooling	Predecessors (Enter into ID per cell)	Time in hours			Durati on	ES	EF	LS	LF	Slack
				O (min)	M (hour)	P (max)						
10	Start						0,00	0,00	0,00	0,00	0,00	0,00
20	Day 1: Outer components dismantling + Balance removal		10	2,5	2,5	2,5	2,50	0,00	2,50	0,00	0,00	0,00
30	Lighting (15 min) + Mirror and support (15 min)	Standard hand tools	10	0,5	0,5	0,5	0,50	0,00	0,50	0,00	0,00	0,00
40	Wings (15 min) + Rear crankcase (10 min)	Standard hand tools	30	0,5	0,5	0,5	0,50	0,50	1,00	0,00	0,00	0,00
50	Motor cap (30 min)	Standard hand tools	40	0,5	0,5	0,5	0,50	1,00	1,50	0,00	0,00	0,00
60	Hitch + Balance (45 min)	Handling crane	50	1	1	1	1,00	1,50	2,50	0,00	0,00	0,00
	Day 2: Arrow and actuators + Depollution (fluids)											
70	Articulation axis (30 min) + Arrow (1h)	Inertia wrench	60	6	6	6	6,00	2,50	8,50	0,00	0,00	0,00
80	Lifting cylinder (20 min) + Compensator (20 min)	Handling crane	70	1	1	1	1,00	4,00	5,00	0,00	0,00	0,00
90	Battery + Oils + Coolant liquid + Fuel (2h30)	Electric pump + Container	80	2,5	2,5	2,5	2,50	5,00	7,50	0,00	0,00	0,00
100	Dashboard (10 min) + Hoses (1h)	Standard hand tools	90	1	1	1	1,00	7,50	8,50	0,00	0,00	0,00
	Day 3: Driver cabin + Hydraulic circuit, hoses and wires											
110	Door (10 min) + Steering wheel (5 min) + Seat (5 min) + Viper blade	Standard hand tools	100	2,5	2,5	2,5	2,50	8,50	11,00	0,00	0,00	0,00
120	Fuel tank (10 min) + Oil reservoir (40 min) + Distributor (30 min)	Standard hand tools	110	1	1	1	1,00	11,00	12,00	0,00	0,00	0,00
130	Hoses (2h) + Transmission shaft (30 min)	Standard hand tools	120	2,5	2,5	2,5	2,50	12,00	14,50	0,00	0,00	0,00
	Day 4: Engine and mechanical transmission + Sorting and storage											
140	Engine (40 min) + Gear box (30 min)	Electric trolley + Handling crane	130	1	1	1	1,00	14,50	15,50	0,00	0,00	0,00
150	Wheels (1h) + Rear axle (15 min) + Front axle (15 min)	Torch + Standard hand tools	140	1,5	1,5	1,5	1,50	15,50	17,00	0,00	0,00	0,00
160	Chassis (1h)	Handling crane	150	1	1	1	1,00	17,00	18,00	0,00	0,00	0,00
170	Steel deck (30 min) + Inclination actuator (30 min)	Handling crane	160	1	1	1	1,00	18,00	19,00	0,00	0,00	0,00
180	Storing parts and cleaning workstation (2h30)	Electric trolley	170	2	2	2	2,00	19,00	21,00	0,00	0,00	0,00
190	End		180				0,00	21,00	21,00	0,00	0,00	0,00

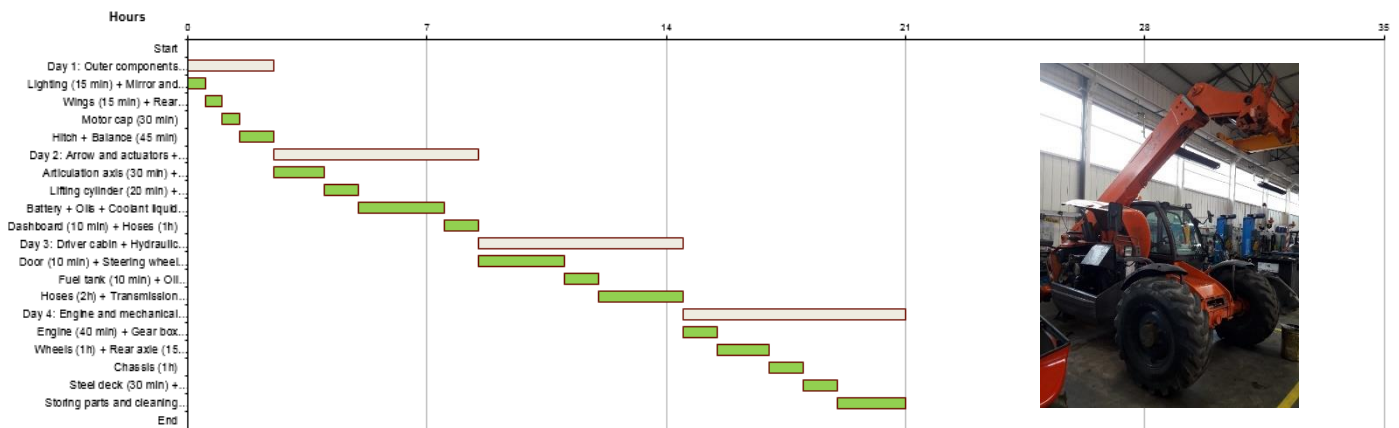

Figure 62 – Gantt chart of the newly validated dismantling process after a second dismantling test



Figure 63 – Photos of the second and sound organized dismantling operation

4.2.4.4. Preferred recovery options in a circular economy perspective

A spreadsheet has been designed to assist the industrialist (here the Reman. Center) in selecting the best end-of-life options for the components recovered after the dismantling, regarding economic (profit), environmental (impact) and marketing (stock/demand) aspects. An extract of the spreadsheet is provided in Figure 64. Note that this decision support tool is in French, but the key sections are schematically explained below in English. Also, sensitive data (e.g. mass, costs, stock, demand) of this specific industrial case study are hidden for confidentiality purposes.

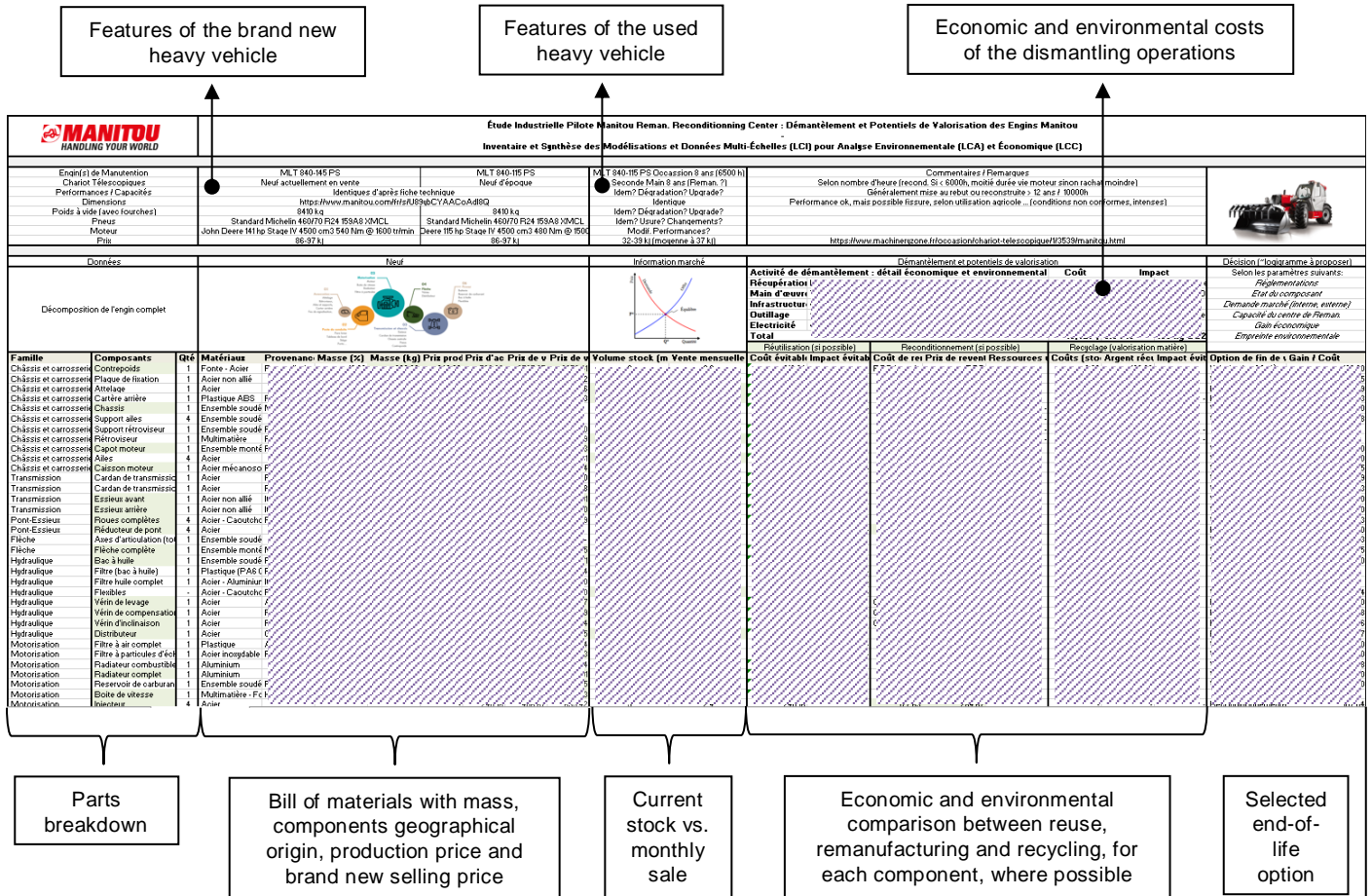

Figure 64 – Spreadsheet to select preferred CE loops for the recovered components of an EoL heavy vehicle

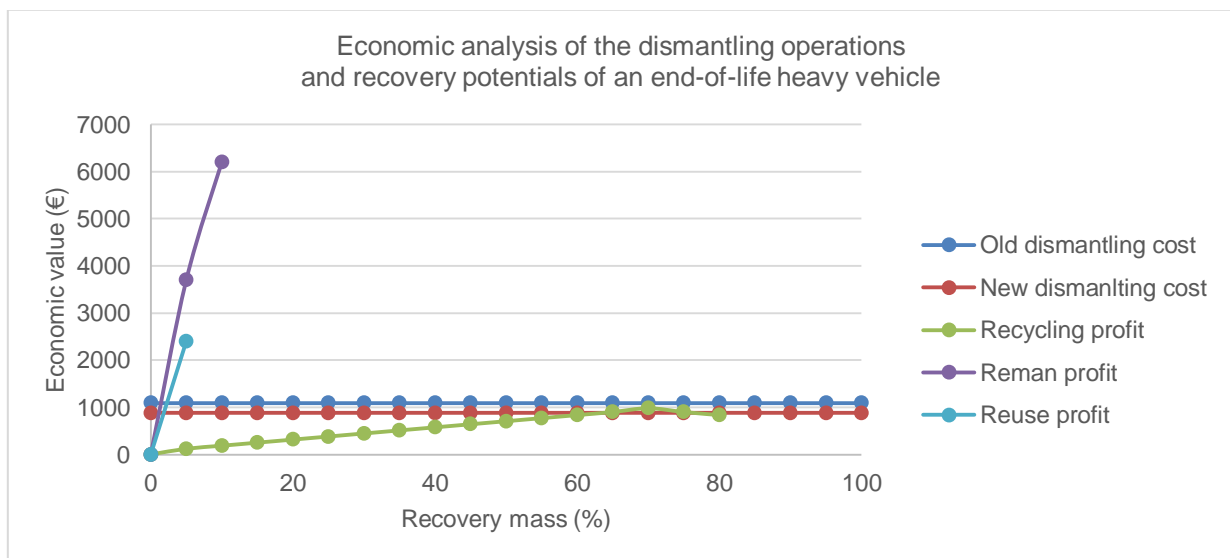

Figure 65 – Economic analysis: cost of dismantling and benefits from reuse, reman, and material recovery

This spreadsheet puts together the three micro-models detailed in sub-section 4.2.3, and following the data template, it combines data coming from complementary sources: (i) modelling of the used heavy vehicle and related components (data coming from the design department and the reman. center); (ii) modelling of the dismantling process (data coming from the experimentation within the reman. center); (iii) and modelling of the recovery channels (data coming from the reman. center, and from independent research) and the market demand (data coming from the sales department, and from the parts and services department).

Based on the data collected, it has been possible to conduct a first economic analysis, while other complementary data are needed to perform an environmental evaluation as well. For each components with a recovery potential, an economic analysis is made comparing the additional processing effort and the recoverable economic value related to the possible end-of-life options. Particularly, to evaluate the profitability of remanufacturing some key components, a comparison is also made with the costs of manufacturing new products.

All in all, to be profitable, the sum of all the economic recovery potentials have to be superior to the cost of the dismantling operation, plus the buy-back price of the end-of-life heavy vehicle. The dismantling costs include the: workforce and supervision, amortization of the building and tools, electricity and consumables. Note that the improvement of the dismantling process, in terms of time, combined with the acquisition of new tools, allow to slightly reduce the cost of one dismantling operation as illustrated in Figure 65.

Figure 65 shows that while the profit made by material recovery enables to offset the dismantling cost, the company has a strong interest in further considering the reuse and remanufacturing of parts which are the most cost-effective solutions. On this basis, the company is currently conducting some “proof of concept” studies to evaluate the technical and economic feasibility of remanufacturing other key components.

As displayed in Figure 65, the X-axis corresponds to the recovery mass, demonstrating it is possible to reach the minimum and mandatory targets of the ELV Directive 2000/53/EC, with presently a material recovery mass of 80% of the entire heavy vehicle, while components remanufacturing and reused represent respectively around 10% and 5%, for a total of almost 95%. Note also that the material recovery is profitable up to 75% of the mass of the heavy vehicle (mainly steel and aluminum) and the 5% remaining are a cost for the reman. center (sub-contractors in charge of the handling of special substances recovery).

According to discussions with the reman. manager, the spreadsheet is both comprehensive and practical for him. Moreover, even we have to bear in mind if the results from the present economic analysis may significantly vary from a used heavy vehicle to another, such results provide a strong basis to assess the conditions of an extension of their remanufacturing activities, as well as to negotiate the buy-back price of a used machinery based on its actual recovery potential.

4.2.5. Next steps: promising future research and remaining industrial challenges

In this sub-section, based on the lessons learnt from this case study, the promising future research and industrial challenges to achieve a more advance circular economy in the heavy vehicle industry are discussed.

This research was limited by one in-depth industrial pilot study case, including two dismantling experimentation, a workshop and feedbacks from industrialists. As such, further research are desirable to investigate how the proposed approach, improvement solutions, and developed support tools (data template and spreadsheet) could be adapted, generalized and/or reused to support the end-of-life management of other types of heavy vehicles.

It is hoped the insights provided both by this industrial case study and the essay #1 of this thesis manuscript can foster businesses of the heavy vehicle industry in implementing more and more circular strategies, projects and practices. We argue that industrialists (managers, designers, engineers) can use this knowledge to accelerate their transition towards a more circular economy. Concretely, based on the lessons learned, Manitou is taking its Remanufacturing Center to the next level by prototyping a first dismantling manual as illustrated in Figure 66, and by increasing the communication about their end-of-life solutions.

More generally, further research and investigations are truly encouraged to move from an industrial pilot study to a full scale industrial deployment of sound end-of-life management practices in the heavy vehicle industry, considering economic (profitability), environmental (impact savings), technical (feasibility, circular design), organisational (processes, collaborations, reverse supply chain) and political (regulations) aspects. For instance, next steps and/or further work could include:

- Environmental impact analysis of the dismantling operations and environmental impact comparison between the production of remanufactured and newly manufactured components. For example, Lishan et al. (2018) compared the environmental performance of manufactured and remanufactured loading machine in China: they used the life cycle analysis (LCA) methodology to compare the environmental impacts and cost of a manufactured loading machine (S1) with its remanufactured counterparts under two return-back scenarios: remanufacturing at the original factory (S2) and at regional dealers (S3). The results showed that climate change effects of S1, S2 and S3 were 4.4t, 1.3 t, 0.92 t CO₂-eq respectively.
- Uncertainties in the quantity and quality of returned heavy vehicles collected for remanufacturing. For example, Aydin et al. (2017) proposed a methodology to determine the optimal product returns for remanufacturing with consideration of the uncertainty in the quantity and quality of returns. The develop model studies not only the effects of new product sales and demand for remanufactured products on used product returns, but also the effects of quality of returns on the remanufacturing cost.
- Flexibility in the dismantling process: to evolve from a systematic and improved dismantling process to a smart and optimized one, according to the initial diagnosis of the recovered heavy vehicle and components, the market demand and internal capabilities; to integrate the micro-models proposed into a system engineering platform/software so as to explore systematically the configurations of the disassembly sequence, in link with the available recovery channels of heavy machinery components.
- Eco-design, modular and circular design considerations, based on the dismantling hotspots identified, for the future development of heavy vehicles in order to facilitate their disassembly, remanufacturing and end-of-life recovery. In the present case study, a feedback has been made to the design department so as to feed their current eco-design checklist.
- Investigation on the location of used and end-of-life heavy vehicles at a regional and national level: it is indeed an essential aspect to ensure the proper collection of such vehicles. Solutions include product-service systems (PSS) related business models to keep the ownership of the heavy vehicle, and/or the use of sensors and telematic systems to allow the traceability, plus preventive maintenance, of the machine during its use.
- Reflexion on the possibility to extend the ELV Directive 2000/53/EC to the heavy vehicle industry, including the implementation of an extended producer responsibility (EPR) scheme for this industrial sector. Note that this point is further developed in the conclusion and perspective section of this thesis.



Figure 66 – Illustrations of the dismantling manual under development (source: Manitou Reman)

5. GENERAL DISCUSSION AND CONCLUSION

In this conclusion section, we first review the academic and industrial contributions of this PhD thesis in regard to the initial gaps and objectives detailed in the introduction. Then, we further discuss how the new insights reported in this manuscript can have managerial and policy implications to foster the move towards a more circular economy in the heavy vehicle industry, and more generally thanks to the use of circularity indicators that can be deployed in various industrial contexts to monitor, manage and improve the circular flow of materials, products or systems. Limitations of the present findings are also analyzed, as well as their possible generalization or adaptation to other industrial sectors. Finally, promising and exciting future research to close-the-loop in a wider context are exposed.

5.1. ACADEMIC AND INDUSTRIAL CONTRIBUTIONS

The main research question that has driven this thesis was: “how to measure, improve and monitor the CE performance of the heavy vehicle industry?” The goal of the thesis was thus to develop and experiment models, methods and tools that could contribute in advancing a circular economy within the heavy vehicle industry. Table 44 synthesized the main productions of this PhD thesis, showing how they contribute both to fill the initial research and industrial gaps identified in the introduction, so as to achieve the expected objectives. As such, the outcomes of this PhD thesis hold promises as a response to the challenges of implementing circular practices in the heavy vehicle industry, as well as of monitoring and catalyzing the circular economy transition through appropriate circularity indicators. This study enriches the literature by addressing extensively two complementary fresh research themes – (i) the end-of-life management of heavy vehicles and (ii) the circularity indicators. Indeed, while (i) the end-of-life management of heavy vehicles has long been neglected from a research perspective, contrary for example to the use phase of such heavy vehicles or the end-of-life management in the automotive recycling industry, (ii) the circularity performance of technical products is a point of increasing importance. Notably, this PhD thesis provides industrialists with solutions for a better end-of-life management of their heavy vehicles in a circular economy perspective, including benchmarking template, circularity indicators, dismantling and recovery spreadsheets. The methods and tools developed have been tested in an industrial environment using real product data, and the key findings from literature survey and ground investigations have been circulated to the right industrialists.

Table 44 – Summary of the academic and industrial contributions in regard to the initial objectives

Research gaps (RGs) Objectives (OBJs)	Propositions Contributions
RG #1: Lack of proper management and infrastructures to handle the end-of-life of heavy vehicles. Loss of high valuable components. - OBJ #1: Provide support (methods and tools) to the end-of-life management of heavy vehicles. Identify best levers to close-the-loop on key components	Identification of commendable circular practices in the automotive and heavy vehicle industries, synthesized in a practical benchmarking template. Development of spreadsheets, successfully tested in an industrial environment, (i) to improve the dismantling process of an end-of-life heavy vehicle, (ii) to select the most suitable end-of-life options of recovered components. Proposition and application of a multi-tool methodology, including circularity indicators and material flow analysis to close-the-loop on a key component from the heavy vehicle industry.
RG #2: No satisfactory methods, tools or indicators to assess and support industrial companies in their transition to a more circular economy. - OBJ #2: Provide an integrated and holistic framework to measure, improve and monitor the circularity performance of industrial products.	First experimentation of circularity indicators at the micro level of the circular economy implementation on an industrial product. Comparison and critical analysis on existing circularity indicators. Proposition of a framework to design new circularity indicators. Development of a new circularity indicator and of its associated Excel-based calculation tool to assess the circularity potential of industrial products: the Circularity Potential Indicator.
RG #2bis: In the meantime, a growing number of circularity indicators has been developed, including an important degree of fuzziness and limitations. - OBJ #2bis: Provide clarity on the existing C-indicators: facilitate their appropriate selection and orient future research on C-indicators.	Comprehensive literature review of circularity indicators. Classification of 55 sets of circularity indicators into a need-driven taxonomy, including 10 categories. Development of an Excel-based query tool to facilitate the selection of most appropriate set(s) of circularity indicators for a given context: the Circularity Indicators Advisor tool. Discussion on the potential contributions and remaining challenges related to the uptake of circularity indicators as catalyst in the transition to a more circular economy.
RG #3: Many relevant methods and tools developed by academia (e.g. eco-design tools) are still barely used by industrial practitioners. - OBJ #3: Enable a user-friendly integration and a concrete application of contributions to OBJ #1 & OBJ #2 into industrial practices.	Dissemination of best circular practices and feedback from industrialists. Workshops experimenting circularity indicators. Design of practical templates and spreadsheets to assist the end-of-life management and recovery of heavy vehicles. Interactions with the industrial world: (i) case study on a catalytic converter to experiment circularity indicators; and (ii) industrial pilot study with Manitou Reman to test the multi-scale model and decision support tool developed for a sound end-of-life management.

Notably, Figure 67, which complements Figure 18 from the introduction, illustrates how the research conducted matters both from the academic and industrial realms, and also how academic and industry tenants can collaborate and contribute together in supporting the shift towards more circular and sustainable practices. Actually, in the “closed loop” circular economy research model, it is critical to continually test the real-world implementation of theoretical circular economy tools, while at the same time using findings and challenges illuminated by applications to generate new research questions (Babbitt et al. 2018). Particularly, this dissertation sheds some lights on the remaining challenges the heavy vehicle industry must address to reach an efficient, effective, and sustainable circular economy. Below, we propose to complete the areas of improvement for the heavy vehicle industry identified by the US Department of Energy (USDoE, 2013) and the European Road Transport Research Advisory Council (ERTRAC, 2012). In their improvement roadmaps for the future of heavy vehicles, as synthesized in Table 45, the main focus was made on technological improvement during the design phase, and fleet optimization during the use phase, while the end-of-life management (e.g. maintenance, collection, recovery, recycling considerations) is left behind. As such, based on our findings, further important items related to the circular economy implementation have been added to this checklist in Table 45.

Table 45 – Future challenges for the heavy vehicle industry

Improvement checklist for the heavy vehicle industry that future research should address (USDoE, 2013; ERTRAC, 2012)	Pre-Life	Life	End-of-Life
Renewable in the energy pool, electrification, hybridisation	x		
Next generation of high efficiency powertrain	x		
More aerodynamic solutions	x		
Light weighting (wheels, chassis, powertrain) based on new materials	x		
Flexibility in architecture with modules for different transport segments	x		
Breakthrough concepts (e.g. platooning, hybrid electric heavy vehicles)	x	x	
Lower noise pollution (bearings, motor, road surface, aerodynamics, air)	x	x	
Improve the fuel economy, enhance internal combustion efficiency		x	
Reduce exhaust emissions, minimise the emission of greenhouse gas		x	
Reduce the dependence on oil, use advanced fuels		x	
Efficient self-operating trucks, reducing the driver impact		x	
Remove congestion (intelligent logistic solutions, e.g. green corridor or hubs)		x	
Avoid accidents, decrease fatality and severe injuries		x	
Decrease cargo lost to theft and damage		x	x
Information about available truck based on real-time diagnosis		x	x
Truck integrated in the mobility system for new services		x	x

Further challenges for an augmented circular economy of heavy vehicles	Pre-life	Life	End-of-life
Integration of circular design in the next generations of heavy vehicles	x		x
Disassembly guides, specific training dedicated to the dismantling profession	x		x
Making new heavy vehicles from the materials and parts of used ones	x		x
Traceability after sales, preventive maintenance, collection of used heavy vehicles		x	x
Service-based business models, facilitating the tracking and collection		x	x
Integrated end-of-life management system, collaboration manufacturers/recyclers			x
New recycling technology for electronic equipments and composite materials			x
Fighting illegal exports or uncontrolled end-of-life treatment of heavy vehicles			x
Framing the end-of-life management by setting up an EPR and recovery targets			x
Appropriate infrastructures and resources to properly dismantle and recover			x

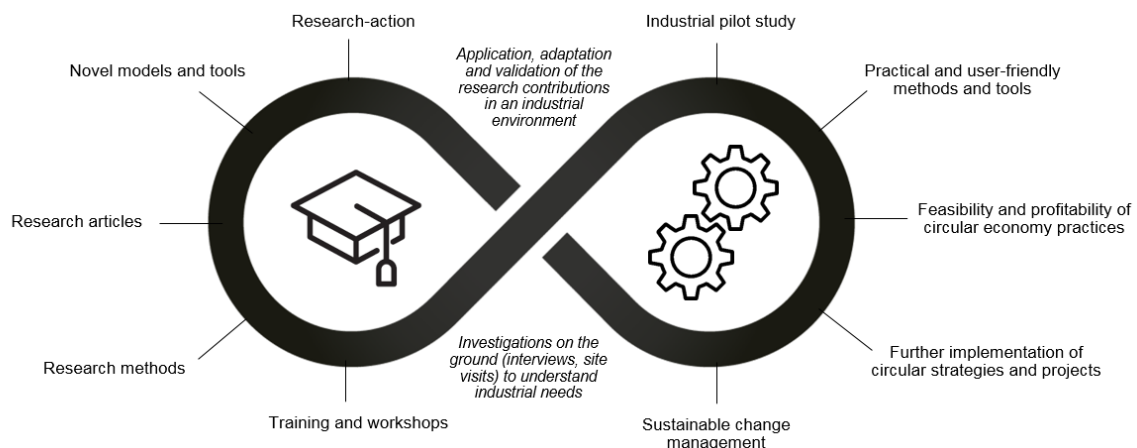

Figure 67 – Closing the gap between academia and university, to link with Figure 19 (page 26)

5.2. EDUCATIONAL, MANAGERIAL AND POLICY IMPLICATIONS

In addition to the academic outputs (e.g. publications in peer-reviewed journals) and industrial applications (e.g. improvement of dismantling operations), it is hoped the studies conducted and reported in this thesis can: (i) have a positive impact on CE education, (ii) support circular business practices, and (iii) feed policy discussion.

5.2.1. Supporting education in circular economy

In addition to their primary objectives, circularity indicators and their associated measurement framework can be used as relevant and practical educational tools, as discussed in sub-section 4.1.1. For example, the proposed workshop experimenting several circularity indicators on an industrial product can easily be reproduced – e.g. in an engineering practical class working in the design and development of a new product or system – using the data and resources support provided in Appendix D.

More generally, as Cervantes (2007) proposed a methodology for teaching industrial ecology (IE), including lectures, practical lessons and projects on real industrial ecosystems, it could be interesting to adapt or update this framework and associated resources for teaching circular economy. In line with Cervantes (2007), we argue that teaching these new topics is essential to the proper dissemination of sustainable practices in society. In fact, in the same way Industry 4.0 (digitalization, additive manufacturing, cyber-robotics) is gaining traction in engineering design education, there is no doubt that theoretical and practical knowledge on circular economy (e.g. designing circular systems, proposing and implementing innovative business models, having repair and maintenance skills) are going to be of the utmost importance.

On this basis, some academics have started developing CE-related courses. For instance, Andrews (2015) put together the circular economy and design thinking to teach designers on sustainability, stating that designers are crucial for the development of a circular economy. Note also the CE education courses proposed by the network of universities of the Ellen MacArthur Foundation (e.g. Cranfield University, TU Delft). Last but not least, some companies are also getting interested in CE training. According to the EMF, to help embedding circularity long term in the company, Renault wants to build knowledge and capabilities around the topic of short-loop recycling by sponsoring research works, developing skills in its workforce and promoting this topic in education.

Yet, analyzing the emerging studies of CE in education, Kopnina (2018) notices “a mismatch between expectations of the sponsor companies and those of students on the one hand and a mismatch between theory and practice on the other hand”. As such, developing teaching materials and tutorial classes using complex industrial products and real world data to train future engineers so that they will be operational when facing CE-related challenges seems crucial. Concretely, the two case studies addressed in the thesis could be adapted and reused as interesting industrial examples in an engineering training sequence whether related to the CE, IE or sustainability, e.g. within the newly proposed pedagogical sequence at CentraleSupélec called “Circular Economy & Industrial Systems”.

5.2.2. Managing material, economic and information flows with C-indicators

Circularity indicators can be used for a wide variety of purposes, as illustrated all along this thesis manuscript. Nevertheless, their *raison d'être* is to help monitoring the circular economy transition at different levels (e.g. at a company, value chain, or regional level) and for various players (e.g. designers, managers, policy-makers). Using the right indicator(s) is essential for these stakeholders to assess properly the circularity performance of a given product, company, or region, so as to take and adjust actions accordingly.

To support circular economy players managing their circular strategies and projects with the most appropriate indicator(s), a taxonomy of circularity indicators is proposed in this thesis, associated to a query tool: the Circularity Indicator Advisor, which includes a database of 55 sets of circularity indicators. For instance, some may look for physical circularity indicators such as the Material Circularity Indicator (EMF, 2015) while others may be interested in monetary indicators such as the Product-level Circularity Metric (Linder et al. 2017).

Last but not least, some circularity measurement frameworks can do both, such as the Circularity Calculator (ResCoM, 2017) detailed in Appendix C. It includes four performance indicators (overall product, potential value capture, recycled content, reuse index) to visualize and evaluate simultaneously the material flows and financial value of closing loops. Interestingly, even if it is aimed to be used by designers working in the fuzzy front end of product development (to compare different circular design alternatives), it summarizes the circularity information in a manageable way which can be understood easily and circulated to all the stakeholders involved.

5.2.3. Revitalizing the policy discussion related to the heavy vehicles end-of-life

To date, there is no overall end-of-life regulation concerning the heavy vehicle industry in the EU. The end-of-life management of the heavy-duty and off-road vehicles is still marginal and barely structured activity in Europe. Actually, the recycling of such heavy vehicles is often performed on a voluntary basis and is not supported by any mandatory recycling target or extended producer responsibility (EPR) scheme.

Similarly, the industrial treatment of end-of-life vehicles (ELV) was once a sector completely unregulated. However, in recent years, with the implementation of the ELV Directive 2000/53 including minimum recovery rates and an EPR scheme, the situation has changed radically: the automotive recycling industry has become more organized, streamlined, and is now well-established in Europe. Concretely, these regulations have forced the manufacturers to take into consideration the end-of-life of their vehicles, from the design to the collection, dismantling and recycling. As such, it can be legitimately argued that the implementation of an appropriate legislation could foster a sound end-of-life management of heavy-duty and off-road vehicles.

5.2.3.1. Elements for a regulated end-of-life management in the heavy vehicle industry

According to discussions with experts from the ADEME and from the manager of Cider Engineering, the idea of extending of the ELV to other vehicles has been mentioned by a Spanish representative in 2015, during a European Commission meeting at Brussels, but without giving effect. Back in 2006, the French Environment and Energy Management Agency (ADEME, 2006) has conducted a study on the end-of-life of the means of transport not covered by the ELV Directive 2000/53/EC, but without further action. Considering that the tonnage of end-of-life heavy-duty and off-road vehicles is of the same order of magnitude as that of cars in Europe – e.g. around 1 million tons in France (ADEME, 2006) – the end-of-life management of heavy vehicles constitutes a relevant line of work both for the governmental authorities and industrial actors.

The industrial pilot study, reported in this thesis and which will be pursued beyond the thesis, conducted in collaboration with a heavy vehicle manufacturer and its emerging remanufacturing center, provides first promising results regarding the feasibility, as well as the profitability – under certain conditions – of a supervised dismantling and recovery of end-of-life heavy vehicles, and therefore can foster similar practices at a wider scale. In the long run, we encourage similar industrial experimentations and believe they can be an entry point before the setting up and operational implementation of an end-of-life regulation.

In fact, by showing concrete opportunities of value creation in the end-of-life management of heavy vehicles, it is hoped that such studies can contribute in raising the interest of industrial stakeholders – including OEMs, end users, EoL facilities – in maintaining the end-of-life heavy vehicles within the EU to be properly dismantled and recovered. Nonetheless, to relocate the circularity of heavy vehicles in Europe, and thus ensure secondary parts and materials supply, the support of an end-of-life regulated framework is highly commendable, e.g. to avoid illegal exports and to ensure the supply of sufficient quantity of used vehicles in EoL centers.

Also, lessons learned from return of experiences on existing extended producer responsibility (EPR) schemes could lead other industrial sectors in the proper implementation of such principle. For example, BIO by Deloitte (2014) analyzed the performance of current EPR schemes in the EU (batteries, ELVs, oils, packaging, WEEE) to provide guidelines for the implementation of EPR in other sectors, including: share of responsibilities and dialogue between stakeholders, cost coverage and true cost principle, fair competition, transparency and surveillance, organisational aspects and share of responsibilities between actors.

5.2.3.2. Retrospective on the regulated automotive recycling industry

In hindsight, it took 13 years from the first reflections (Brown et al. 1993) on a circular end-of-life management of the car industry to the operational implementation of the ELV Directive 2000/53/EC in 2006, as illustrated in Figure 68. Note that, in the meantime, this transition has been supported by the emergence of scientific papers (Schmidt and Fleischer, 1997; Coppens, 1999; Coppens et al. 2002) and technical reports (AFNOR, 1996; Ford, 1996; Haquin, 1996) addressing the challenges related to a sound end-of-life management of such light-duty vehicles. Considering the inertia to make things move and to change “business as usual” in the industrial world, a similar story may be foreseen for the heavy vehicle industry.

Indeed, moving from disparate circular practices to a full-scale circular economy requires various changes and deliberate actions of different actors (institutions, regulations, industrial stakeholders) (Wilts, 2017). Furthermore, in analogy with the circular economy agenda for secondary production of metals in Europe (Van der Voet et al. 2018), actions must be taken soon while benefits will become apparent only at the long term. Because such transition is time-consuming and stepwise, the definition of a roadmap or research agenda can be particularly relevant.

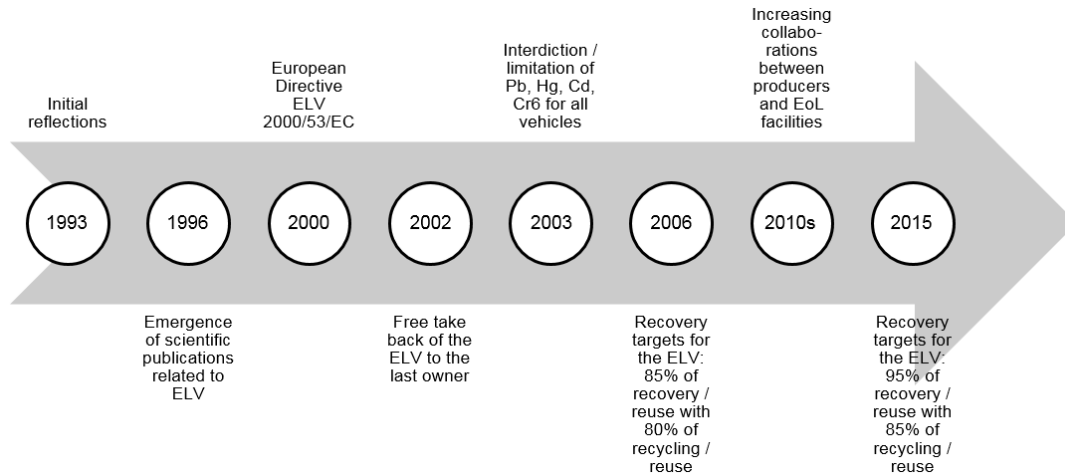

Figure 68 – Chronological evolution of the management of end-of-life vehicles (ELV) in Europe

5.2.3.3. Draft of a roadmap/research agenda for a sound and regulated end-of-life management of heavy vehicles

A research agenda is a roadmap or framework that guides inquiry (Keller-Margulis, 2014). It is usually employed to specify gaps in knowledge in a specific area and serves to orient decision-making about which projects or new research questions to pursue. For instance, Lopes de Sousa Jabbour et al. (2018) proposed a pioneering roadmap to enhance the application of CE principles in organisations by means of industry 4.0 approaches. On this basis, recommendations were given for scholars, policy makers, and managers. On the other hand, combining inputs from both academic and industry experts, Despeisse et al. (2017) proposed a research agenda to determine enablers and barriers for 3D printing to achieve a CE, examining specifically six areas: design, supply chains, information flows, entrepreneurship, business models and education.

Inspired by the recently developed CE-related research agenda in several industries, a draft of roadmap for a circular economy of heavy vehicles in Europe, which goes hand in hand with Table 45, is proposed in Figure 69. It is particularly based on the findings (best practices and remaining challenges in the automotive and heavy vehicle industries) exposed in essay #1 and on lessons learned from the industrial pilot study in essay #3 (see sub-section 4.2.5). Circularity indicators, detailed in essay #2 and further experimented in essay #3 are also a key part of the proposed roadmap to monitor the transition of the heavy vehicle industry towards more circular practices, and to evaluate as well its performance. Of course, the content of such a roadmap needs to be presented to industrialists of this field and to experts from governmental agencies such as the French Environment and Energy Management Agency (ADEME) to be further refined or approved, before being disseminated and implemented.

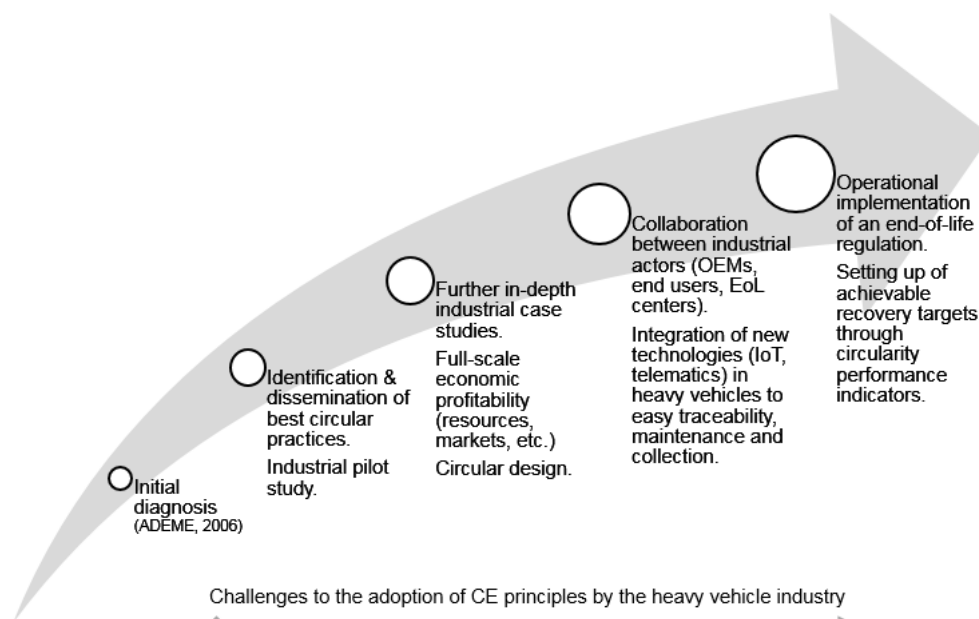

Figure 69 – Draft of a roadmap for a circular economy of heavy vehicles in Europe

5.3. PERSPECTIVES AND FUTURE RESEARCH

In addition to the potential practical implications for education, business or policy making, this work opens many lines of thought and provides a valuable basis for future research related to the circularity indicators and to the end-of-life management of heavy vehicles in a context of circular economy transition.

5.3.1. Limitations and further validation

A first validation of the findings reported in this thesis – including the proposition or adaptation of research approaches, as well as the design and application of methods and tools – has been provided both by: (i) peer reviews through the submission of research articles in specialized journals or presentation at international conferences (see sub-section 5.4); (ii) industrial feedbacks through case studies (see section 4) and dissemination of the key results (see sub-section 2.3). Also, the significant body of scientific literature (see section 6) on which this thesis is based reinforces its soundness.

To further consolidate scientifically the developed models, it may be worth in future research to use the rigorous and comprehensive framework proposed by Ben Ahmed et al. (2010), as detailed in Table 46. This evaluation framework aims to evaluate the validity and relevance of engineering models. For instance, it could be used to further develop and enhance: (i) the content of the Circularity Potential Indicator, which is based on the modelling of the circular economy through its four buildings blocks and four feedback loops (see sub-section 3.2); the multi-scale modeling to compare and select the best end-of-life options(s) for recovered heavy vehicles (see sub-section 4.2).

Eventually, the specific limitations of the research contributions of this thesis, and related areas for future research have been discussed in each of the three essays, leaving the door open for several future dissertations or research projects. Hereafter, further recommendations on future research directions and actions for a sound management of end-of-life heavy vehicles, as well as for an enhanced monitoring of the circular economy performance of industrial products, are illustrated and justified. In this line, in the next sub-section, a focus is made on promising and exciting research that I not only want to further explore, but also encourage future researchers to delve into.

Table 46 – Evaluation framework to assess engineering models (source: Ben Ahmed et al. 2010)

4 systemic axes	28 criteria	Description
Ontology	Incompleteness	The risk of missing a concept or a misspecification of one of the concepts.
	Consistency	The degree of uniformity, standardization, and freedom from contradiction among the model concepts.
	Self-descriptiveness	The ability of the model to embed enough information to explain the model objectives and properties.
	Independences	The independency of the model from the subject who has elaborated it.
Functioning	Attractiveness	How attractive the model may be to the user.
- Interaction with users	Reusability	The efficiency of a model in facilitating a selective use of its components or submodels.
	Usability	How the model allows the user to learn in order to operate, prepare the model inputs, and interpret its outputs.
	Learnability	How the model itself helps the user learn more on its application.
	Abstractness	How a model allows a user to perform only the necessary functions relevant to a particular purpose.
	Understandability	How the model permits the user to understand whether the model is suitable and how it can be used for particular tasks and conditions of use.
	Operability	How the model allows the user to operate and control it.
	Adaptability	The ease with which the model meets contradictory users' constraints and users' needs.
- Behavior under normal conditions	Controllability	How efficiently the model reacts differentially to the different actions it is submitted to.
	Repeatability	How the model generates the same results under the same functioning conditions.
	Generality	How the model performs a broad range of functions.
	Interoperability	The ability of two or more models or model components to exchange information and to use the information exchanged.
	Replaceability	How the model can be used instead of another specified model for the same purpose in the same environment.
	Usability compliance	How the model can comply with standards, conventions, style guides, or regulations relating to usability.

- Behavior under stressful conditions	Error tolerance	The ability of the model to continue an operation normally despite the presence of erroneous inputs.
	Fault tolerance	The ability of a model to continue an operation normally despite the presence of model component faults.
	Error proneness	The ability of a model to allow the user to intentionally or unintentionally introduce errors into the model or misuse the model.
Evolution	Flexibility	How easily modifications can be carried out in order to use the model in applications or environments other than those for which it has been specifically designed.
	Extendibility	How easily modifications can be performed in order to increase the model functional capacity.
	Maintainability	How easily modifications can be carried out in order to correct model faults.
	Testability	How easily modifications can be performed within the validation stage of the model.
Teleology	Accuracy/precision	How well the model provides the right or agreed results or effects with the expected degree of accuracy.
	Efficiency	How well the model provides an appropriate performance, relative to the amount of resources used (time, human resources, etc.), under stated conditions.
	Effectiveness	The ability of the model to target all aspects of the goal.

5.3.2. Directions for future research

5.3.2.1. Pushing forward the circular economy with circularity indicators

In the present thesis, an extensive review of C-indicators has been conducted, resulting in a proposed taxonomy which classifies 55 sets of C-indicators. Also, a proposed framework for the design of circularity indicators has been proposed, and a new circularity indicator developed. Eventually, several circularity indicators have been experimented on an industrial case study. Against this background, key areas of improvement for an augmented measurement and monitoring of the circular economy performance have been identified, as synthesized in Table 47, with the aim to guide the future development and implementation of *ad hoc* circularity indicators.

Table 47 – Future research directions on circularity indicators

Main topics	Details and ideas
Fine-tune the circularity scores	Evaluate the construct validity, reliability, transparency, generality and aggregation principles of circularity indicators (Linder et al. 2017). Distinction of circularity loops in the overall circularity score or through a more detailed score. Advanced and justified scoring systems, including indication on the level of uncertainty.
Uptake by industry	Provide industrialists with practical guidance, based on the circularity score(s). Indicate the actors impacted by the C-indicators and how the C-indicators are influenced by stakeholders (e.g. contributors and beneficiaries of an enhanced circularity performance). Support data construction to compute the C-indicators (e.g. through computer-based tools). Integrate C-indicators in the product and development process.
Link to sustainability aspects	Study the relationship between an improvement in a circularity score and its impacts on different sustainability indicators.

For a concrete example, specific areas of improvement related to the Circularity Potential Indicator are detailed in sub-section 3.2.5. On the other hand, regarding the Circularity Indicator Advisor tool developed in this thesis (sub-section 3.3.4), one challenge is to keep the database of circularity indicators up to date, and one way to foster its uptake by circular economy players is to develop a web-based version of the Excel-based query tool, so as to make it more accessible. Moreover, the correlation between potential circularity indicators (see sub-section 4.1.1) and effective circularity indicators (see sub-section 4.1.2) is a line of research that needs to be further investigated. Also, the variability in the circularity scores provided by different potential circularity indicators applied on the same product raises questions. As a consequence, future works should incorporate uncertainty considerations in the assessment methodology of such indicators.

Last but not least, knowing that an ISO standard, namely the “ISO14009 - Guidelines for incorporating redesign of products and components to improve material circulation”, dealing with the CE implementation at a micro level is under development and due to be completed in late 2020, we might expect to have the first standardized product circularity indicator. In fact, the purpose of this upcoming ISO standard is to “provide guidance on analyzing existing products prior to redesign, identifying measures for improvement and reflecting those measures into the redesign of the products and components with focus on material circulation”.

5.3.2.2. Taking the heavy vehicle industry to the next level in a circular economy perspective

Among the avenues of improvement for a sound management of end-of-life heavy vehicles (particularly discussed in sub-sections 2.1.4, 4.2.5, and summarized in Table 45 and in Figure 69), the possible use of emerging technologies integrated in such heavy vehicles to monitor their usage, track their performance and location, is a point that deserves closer attention. Indeed, in essay #1 (sub-section 2.1.3.4), we have shortly discussed how telematics systems, RFID technology, Internet of things and other connected devices or wireless technologies can contribute in a circular economy of heavy vehicles. Here, we remind the main points and enrich the discussion with new elements to stimulate future research in this topic.

Figure 70 gives an overview of all the data that can be captured and displayed in a heavy vehicle. Connected to an *ad hoc* IT network, and shared with involved stakeholders (manufacturers, after sales services, maintenance and repair centers, end-of-life facilities), such information could foster the implementation of circular practices in the heavy vehicle industry by:

- Monitoring and reporting in real-time on the wear and tear of key components (e.g. e-diagnosis on tyres) for preventive maintenance;
- Locating the heavy vehicles at their end of life, preventing thereby the illegal exports and/or uncontrolled treatment of second-hand heavy vehicles;
- Facilitating the dismantling and recovery, by applying adapted disassembly sequences based on the continuous diagnosis of the conditions of the heavy vehicle throughout its lifetime;
- Using the user-generated contents to design more circular and sustainable (e.g. design for low consumption/emissions, design for maintenance, design for recovery) heavy vehicles.

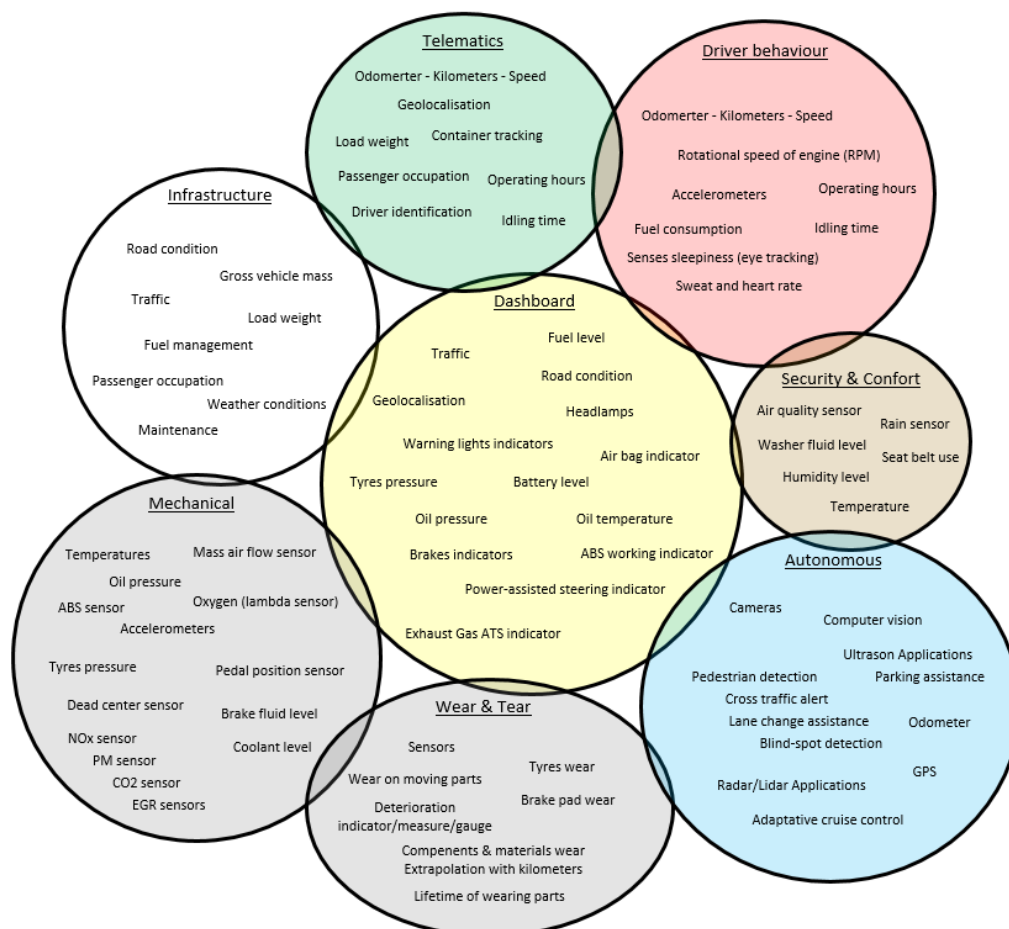

Figure 70 – Empirical list of the data that can be captured in a heavy vehicle, with associated technologies

5.3.2.3. Using multi-methodology and multi-tool approaches to come up with more insightful outcomes

The reasons for using a multi-methodology approach to achieve the objectives of this thesis have been exposed in the introduction section. Then, the three essays have illustrated how the research on circular economy and its implementation in industrial practices can be supported by a combination of methods and tools coming from e.g. design engineering, industrial ecology and operational research.

Even if the use of multiple methods seems commendable to conduct a Ph.D. thesis¹ or other research project dealing with complex and pressing subjects, some interesting questions remain to be discussed more widely so as to apply properly and in a scientifically justified manner such multi-methodologies, and thereby to come up with more insightful research products: how a method traditionally belonging to a specific disciplinary field can be used and contribute to the research in another field; how to validate the compatibility between methods from different research streams; how to justify or demonstrate a multi-methodology approach is better (i.e. brings more insightful results) than another classical or mono-method approach.

For instance, in his Ph.D. thesis conducted within a computing and information systems department, Hill (2009) adopted design science as a suitable research approach for solving a problem in information systems practice. Also, mixing methods from operational research and industrial engineering for improving healthcare management system the Ph.D. thesis of Lamé (2017) addresses this topic and provides interesting food for thought on that matter. In future, analyzing and sharing more similar examples can contribute to shed some light on these questions.

5.3.2.4. Generalizing and/or adapting the proposed models, methods and tools to other industrial contexts

Similarly to the issue of methodological compatibility and transfer between different research streams (i.e. mixing methods from diverse paradigms), the question of the replicability of an approach or a method tailored in a specific industrial sector to another sector deserves a closer look. Particularly, the potential generalization and adaptation of the approaches, models and tools proposed in this dissertation, and applied to the heavy vehicle industry, to other industries that are facing similar challenges in their transition to a more circular economy is also a line of research that can be further investigated.

In essay #1, the best circular practices and remaining challenges of the automotive and heavy vehicle industries – which share some similarities (e.g. components, materials) but have also their own specificities (e.g. regulations, marketing practices) – have been put in parallel through the four feedback loops and the four building blocks of a circular economy. Also, two geographical regions – the U.S. and the EU – have been compared in regard to their management of end-of-life vehicles. The aim was to analyze and support the possible transfer of commendable circular practices from one sector to another. In this line, a practical benchmarking template has been proposed and disseminated to key industrial players of the heavy vehicle industry. Interestingly, in essay #3, best practices from the automotive recycling industry have been used to improve the dismantling process of an end-of-life heavy vehicle in a remanufacturing center. On the other hand, in essay #2, one of the ten categories of the developed taxonomy of C-indicators is related to the transversality of indicators, i.e. making a distinction between generic and sector-specific C-indicators (see section 3.3.4 for more details).

Against this background, to extend the discussion, it can be now interesting to study how two more separate industrial sectors can learn from one another in their transition towards a circular economy. For instance, to what extent the research contributions and industrial practices that support the circular economy in the automotive and heavy vehicle sectors could be transferable or adapted to other sectors that are facing similar challenges in the management of their end-of-life fleet, such as the aircraft industry. In other words, how the aircraft industry can benefit from the approaches, methods and tools developed in the automotive or heavy vehicle industries that seem commendable in a circular economy transition, and *vice versa*.

¹ In teaching multi-methodology research courses to doctoral students, Baran (2010) demonstrated how students gain knowledge of both quantitative and qualitative paradigms and become effective in incorporating mixed methodology in their research. As a result, the majority of students that have followed this program finally opted for a mixed methodology approach in their dissertation. Interestingly, instructors in this program have made an effort to introduce students to a multi-methodological approach focusing on the appropriateness of utilizing mixed methods to answer a broad range of research questions.

In fact, while neglected for a long time, the end-of-life stage of the aircraft's life cycle has come into greater focus in recent years (Ribeiro and Gomes, 2015) as a consequence of: the increasing number of aircraft which are reaching the end of their working life; the important added value components and materials that can be recovered; the trend in the transportation sector which goes to legislation in terms of EPR scheme. Presently, similarly to the heavy vehicle industry, there is no regulation which regulates the treatment of worn-out aircrafts, and the research on end-of-life aircraft is quite new (Keivanpour et al. 2015). As such, according to Ribeiro and Gomes (2015), developing a framework for managing the end-of-life stage of aircrafts is crucial to close the loop and achieve true sustainability in the aircraft industry.

Note that among the two market leaders, Airbus and Boeing, the handling of end-of-life aircrafts is now increasingly being considered, in the prospect of facing a future legislative regulation. For instance, Airbus has started a project called "Process for Advanced Management of End-of-Life Aircraft". Moreover, flag carriers companies such as Air France and KLM have initiated programs for aircraft recovery. For example, at the Engines, Equipment and Services department of Air France Industries and KLM Engineering & Maintenance, five new possible destinations for used aircrafts are being investigated through a Reverse project: re-use, dismantling and recertification, being sold as seen, reconditioning as a non-aeronautical product, treatment as waste. Additionally, in academic research, some methods and tools are being developed to facilitate the end-of-life recovery of aircrafts such as a decision support tool for the disassembly of reusable parts on an end-of-life aircraft (Camelot et al. 2013), or a decision tool for the selection of eco-design strategy intended to aircraft manufacturers (Keivanpour et al. 2014).

5.3.2.5. *Moving from a circular economy to a thrilling, unlimited, resource free, and sustainable space economy?*

In sub-section 4.1.2, to secure a sustainable supply of critical raw materials (e.g. platinum group metals) we have highlighted the need and analyzed solutions to move from the traditional and high-environmental impact ore mining (e.g. platinum mine in South Africa) to a more sustainable urban mining (e.g. refining platinum from used catalytic converters) in a circular economy perspective. Yet, according to Van der Voet et al. (2018), even there is no doubt that the share of secondary production of metals would significantly reduce emissions and secure supply, the circular economy agenda for metals is a long-term agenda and is expected to become really effective only in the second half of the twenty-first century.

In parallel, what if we are able to move from on-earth ore mining or urban mining to asteroid mining, so as to evolve from the so-called "rare-earth metals" to "abundant space metals". Not only to dream a bit at the end of this dissertation, but also to give elements showing this is not completely a fanciful dream but an attainable prospect, let us discuss this opportunity of exploiting new resources, as well as related areas of future research for a sustainable space economy.

Actually, the concentration of platinum in some asteroids (up to 100 grams per ton) is way greater than the decreasing concentration on Earth (few grams per ton) (Sonter, 2012; Hagelüken, 2014). Moreover, recent investigations also estimated the abundance of platinum in near-Earth asteroids is almost 200 times the one on Earth (Planetary resources, 2017). Yet, while the technical feasibility (Sanchez and McInnes, 2012) and economic profitability (Andrews et al. 2015) on extracting resources from near-Earth asteroids have been investigated, the environmental sustainability of such operations remains to establish.

Some first environmental arguments for asteroid mining have been stated by MacWhorter (2015) and Hennig (2016). However, these arguments are not quantified. Hence, the question whether or not asteroid mining could have significant environmental benefits (e.g. compared to the mining and recycling of platinum on Earth) has not been answered satisfactorily (Hein, 2017). It provides thereby an exciting line of future research with several scientific and methodological challenges related to the life cycle analysis and impact assessment outer space (Hein et al. 2018): for instance, how to compare the environmental impact between terrestrial mining and in-space mining of platinum (e.g. what is the environmental impact of an asteroid mining mission, how to consider the impact of debris generation during processing on a space environment, what are the boundaries, how to define a suitable functional unit, how to select appropriate impact indicators, etc.)

Key changes. Re-thinking. New order. Think global. Feel personal. Do local. And share it. The way some science fiction does.

5.4. PERSONAL PUBLICATIONS

Here are the research contributions directly related to this manuscript and written during the Ph.D. thesis period:

Journal articles:

- Published:
 - Saidani, M., Yannou, B., Leroy, Y., Cluzel, F. 2017. How to assess product performance in the circular economy? Proposed requirements for the design of a circularity measurement framework. *Recycling*, 2, 6.
 - Saidani, M., Yannou, B., Leroy, Y., Cluzel, F. 2017. Heavy vehicles on the road towards the circular economy: Analysis and comparison with the automotive industry. *Resources, Conservation and Recycling*, 135, 108-122.
 - Saidani, M., Kendall, A., Yannou, B., Leroy, Y., Cluzel, F. 2018. What about the circular economy of vehicles in the U.S.? An extension of the analysis done in the EU by Saidani et al. (2017). *Resources, Conservation and Recycling*, 136, 287-288.
 - Saidani, M., Yannou, B., Leroy, Y., Cluzel, F., Kendall, A. 2019. A taxonomy of circular economy indicators. *Journal of Cleaner Production*, 207, 542-559.
- Submitted:
 - Saidani, M., Yannou, B., Leroy, Y., Cluzel, F. 2018. New circularity indicators, as enablers of the circular economy? « Des indicateurs catalyseurs de l'économie circulaire ? ». Submitted to *Revue Technologie et Innovation*. In Press.
 - Saidani, M., Kendall, A., Yannou, B., Leroy, Y., Cluzel, F. 2018. Closing the loop on platinum from catalytic converters: contributions from material flow analysis and circularity indicators. Submitted to *Journal of Industrial Ecology* (minor revision).

International conferences:

- Papers and podium sessions:
 - Saidani, M., Yannou, B., Leroy, Y., Cluzel, F. 2017. Hybrid top-down and bottom-up framework to measure products' circularity performance. International Conference on Engineering Design, ICED 17, Aug. 2017, Vancouver, Canada. DS 87-1, Vol 1. *Resource Sensitive Design, Design Research Applications and Case Studies*.
 - Saidani, M., Kendall, A., Yannou, B., Leroy, Y., Cluzel, F. 2018. Closing the loop on platinum from catalytic converters: contributions from material flow analysis. 12th International Conference on Society & Materials, May 2018, Metz, France. *Session 4: Circular economy, beyond the hype*.
- Posters:
 - Saidani, M., Yannou, B., Leroy, Y., Cluzel, F. 2016. Towards a Circular Economy of Heavy-Duty & Off-Road Vehicles and Associated Key Components. PhD student and industry meeting day on sustainable development, Oct. 2016, Montreuil, France.
 - Saidani, M., Yannou, B., Leroy, Y., Cluzel, F. 2017. How to close the loop of platinum from heavy vehicles catalytic converters? Framework to evaluate the impact of several promising action levers. Joint Conference ISIE-ISSST, June 2017, Chicago, United States.
 - Saidani, M., Yannou, B., Leroy, Y., Cluzel, F. 2018. Taxonomy and Choice of Appropriate Set of Circularity Indicators. ATA EcoSD 2018, Orange Gardens, Châtillon, France.
- Tool showcase:
 - Saidani, M., Yannou, B., Leroy, Y., Cluzel, F. 2018. Circularity Indicators: The Advisor. Proceedings of the ASME 2018 International Design Engineering Technical Conferences & Computers and Information in Engineering Conference, IDETC/CIE 2018, Aug. 2018, Quebec City, Quebec, Canada.

Here are the articles not directly related to the manuscript but written during the Ph.D. thesis period:

- Book chapters:
 - Saidani, M. 2017. Organiser et réussir son atelier d'éco-innovation en une demi-journée. Déployer l'innovation – Méthodes, outils, pilotage et cas d'étude, Techniques de l'Ingénieur, Les Fiches Pratiques – Génie Industriel, 978-2-85059-129-7.
 - Saidani, M. 2017. Superviser et prolonger sa démarche d'éco-innovation grâce aux Indicateurs de Performance Environnementale Clés. Déployer l'innovation – Méthodes, outils, pilotage et cas d'étude, Techniques de l'Ingénieur, Les Fiches Pratiques – Génie Industriel, 978-2-85059-129-7.
- Conference proceedings:
 - Saidani, M., Cluzel, F., Leroy, Y., Auclair, A. 2017. Time-Efficient Eco-Innovation Workshop Process in Complex System Industries. Design 2016, May 2016, Dubrovnik, Croatia. DS 84: Proceedings of the DESIGN 2016 14th International Design Conference.
 - Asadi, N., Guaragni, F., Johannknecht, F., Saidani, M., Scholle, P., et al. 2017. Success factors of an IPD based approach in a remote multidisciplinary team environment - Reflections on a case study. 21th International Conference on Engineering Design, ICED 17, Aug 2017, Vancouver, Canada. DS 87-9, Vol 9: Design Education.
 - Hein, A. M., Saidani, M., Tollu, H. 2018. Exploring Potential Environmental Benefits of Asteroid Mining. 69th International Astronautical Congress (IAC), Bremen, Germany, 1-5 October 2018.

For an up-to-date list of the author's publications, please check out:

<https://cv.archives-ouvertes.fr/michael-saidani> and / or https://www.researchgate.net/profile/Michael_Saidani

6. REFERENCES

INTRODUCTION

- ADEME-French Environment & Energy Management Agency. 2006. Etude sur la fin de vie de tous les moyens de transport en France, à l'exception des véhicules couverts par la directive Véhicules Hors d'Usage. Etude réalisée par BioIS pour l'ADEME, Novembre 2006.
- ADEME-French Environment & Energy Management Agency. 2015. Nos expertises, Économie circulaire.
- Appleyard, D. 2017. Mind the gap: A bridge between industry and academia, *Renewable Energy Focus*, 18, 36-38.
- Baran, M. 2010. Teaching multi-methodology research courses to doctoral students. *International Journal of Multiple Research Approaches*, 4 (1), 19-27.
- Ben Ahmed, W., Mekhilef, M., Yannou, B., Bigand, M. 2010. Evaluation framework for the design of an engineering model. *Artificial Intelligence for Engineering Design, Analysis and Manufacturing*, 24 (1), 107-125.
- Blomsma, F. 2018. Collective 'action recipes' in a circular economy – On waste and resource management frameworks and their role in collective change, *Journal of Cleaner Production*, 199, 969-982.
- Blomsma, F., Brennan, G. 2017. The Emergence of Circular Economy: A New Framing Around Prolonging Resource Productivity. *Journal of Industrial Ecology*, 21, 603-614.
- Bonet, D., Petit, I., Lancini, A. 2014. L'économie circulaire : quelles mesures de la performance économique, environnementale et sociale ?. *Revue française de gestion industrielle*, 33, 4.
- Brewer, J., Hunter, A. 1989. *Multimethod research: A synthesis of styles*. Thousand Oaks, CA, US: Sage Publications, Inc. 209 pp.
- Buclet, N. 2015. *Ecologie industrielle et économie circulaire: définitions et principes*. Economie circulaire et écosystèmes portuaires, Editions EMS, Management & Société, pp.27-41, 2015.
- Chakrabarti A., Lindemann U., 2016. *Impact of Design Research on Industrial Practice: Tools, Technology, and Training* Springer.
- Chemineau, L., 2011. Développement d'une méthode d'éco-conception basée sur la modélisation et l'évaluation des filières de valorisation. Application au secteur automobile. ENSAM.
- CNRS-Centre National de la Recherche Scientifique. 2018 Ressources de scientométrie. <http://www.cnrs.fr/dist/scientometrie.html>
- Cross, N. 1993. A history of design methodology. *Design Methodology and Relationships with Science*, 15-27.
- Deloitte Sustainability. 2016. Circular economy potential for climate change mitigation. Report, November 2016.
- Di Lucchio, L. 2017. Design for Next Challenges. *The Design Journal*, 20 (1), 1-8.
- Dwek, M. 2017. Integration of material circularity in product design. PhD Thesis, in *Environmental and Society*, at Université Grenoble Alpes, English.
- Earley, R. 2017. Circular Design Futures. *The Design Journal*, 20 (4), 421-434.
- EC-European Commission, 2015. Closing the loop, an EU action plan for the Circular Economy, Communication from the commission to the European parliament, the council, the European economic and social committee and the committee of the regions, Brussels, Belgium, December 2015.
- EC-European Commission. 2018a. Communication from the Commission to the European Parliament, the Council, the European Economic and Social Committee and the Committee of the Regions: A monitoring framework for the circular economy. Strasbourg, France, 16.1.2018.
- EC-European Commission. 2018b. Circular economy – Indicators. Eurostat. <http://ec.europa.eu/eurostat/web/circular-economy/indicators>
- Ehrenfeld, J. 2004. Industrial ecology: a new field or only a metaphor? *Journal of Cleaner Production*, 12, 825–831.
- EMF-Ellen MacArthur Foundation. 2013. *Towards the Circular Economy – Economic and Business Rationale for an Accelerated Transition*. Chapter 3. UK: Cowes.
- EMF-Ellen MacArthur Foundation. 2015. *Circularity Indicators – An Approach to Measure Circularity*. Methodology & Project Overview. Cowes, UK.
- ENEC-European Network of Ecodesign Centres., 2014. *Envisioning Ecodesign: Definitions, Case Studies and Best Practices*. Technical Report.
- EPA-U.S. Environmental Protection Agency. 1993. *Product Life-Cycle System*. Life Cycle Design Guidance Manual: Environmental Requirements and the Product System, Office of Research and Development, Washington, DC.
- Eriksson, K.E., Robèrt, K.H. 1991. The Natural Step, From the Big Bang to Sustainable Societies. *Reviews in Oncology*, 30 (6), 5–14.
- Erkman, S. 1997. Industrial Ecology: an historical view. *Journal of cleaner production*. 1-10.
- Erkman, S. 1998. *Vers une écologie industrielle : comment mettre en pratique le développement durable dans une société hyper industrielle*. Ed. Charles Léopold Mayer, Paris.
- ERN-European Remanufacturing Network. 2018 Case Study Tool. <https://www.remanufacturing.eu/case-study-tool.php>
- ETRMA. 2015. Position paper on circular economy bringing about a resource efficient and competitive Europe. Brussels, 29 September 2015.
- Eyckmans, J., García-Barragán, J.-F., Rousseau, S. 2018. Defining and measuring the circular economy: A mathematical approach. Project: IECOMAT (Integrated economic modeling of material flows). Pre-print. March 2018.
- Farel, R., Yannou, B., Bertoluci, G., 2013. Finding best practices for automotive glazing recycling: A network optimization model. *J. Clean. Prod.* 52, 446–461. doi:10.1016/j.jclepro.2013.02.022
- Figuière, C., Chebbi, A. 2016 *Écologie Industrielle et Économie Circulaire. Concurrentes ou complémentaires ? XXXIIèmes journées du développement ATM, Catastrophes, vulnérabilités et résiliences dans les pays en développement*, Jun. 2016, Lille, France.
- French Ministry of Ecological and Solidarity Transition. 2018. 50 measures for a 100% circular economy. *Circular Economy Roadmap*. French Report.
- Froelich, D., Haoues, N., Leroy, Y., Renard, H., 2007. Development of a new methodology to integrate ELV treatment limits into requirements for metal automotive part design. *Miner. Eng.*, 20, 891–901.
- Frosch, R.A., Gallopoulos, N.E. 1989. Strategies for Manufacturing. *Scientific American*, 261, 144-152.
- Gaikwad, S.V., Chaugule, A., Patil, P. 2014. Text mining methods and techniques. *International Journal of Computer Applications*, 85, 17.
- Garner, A., Keoleian, G.A. 1995. *Industrial Ecology: An Introduction*. Pollution Prevention and Industrial Ecology. National Pollution Prevention Center for Higher Education, University of Michigan.
- Geisendorf, S, Pietrulla, F. 2017. The circular economy and circular economic concepts—a literature analysis and redefinition. *Thunderbird International Business Review*.
- Gericke, K., C. Eckert, and M. Stacey. 2017. "What do we need to say about a design method?" In: *Proceedings of the 21st International Conference on Engineering Design (ICED17)*, Vol. 7: Design Theory and Research Methodology, Vancouver, Canada, 21.-25.08.2017.
- Global Footprint Network. 2018. Earth Overshoot Day. <https://www.overshootday.org/newsroom/press-release-english/>
- Hirsch, P. M., Levin, D. Z. 1999. Umbrella advocates versus validity police: A life-cycle model. *Organization Science*, 10 (2), 199–212.
- IPCC-Intergovernmental Panel on Climate Change. 2015. *Climate Change 2014: Mitigation of Climate Change (Vol. 3)*. Cambridge University Press.
- Idjis, H. 2015. "The recovery network of end-of-life batteries from electric vehicles: contribution to the modeling of an emerging complex organizational system." PhD Thesis. *Industrial Engineering*. Université Paris-Saclay.
- ISIE-International Society for Industrial Ecology. 2015. A Short History of Industrial Ecology. <https://is4ie.org/about/history>
- Kirchherr, J., Reike, D., Hekkert, M. 2017. Conceptualizing the circular economy: An analysis of 114 definitions, *Resources, Conservation and Recycling*, 127, 221-232.

- Knopf, J. W. 2006. Doing a literature review. *Political Science & Politics*, 39 (01), 127-132.
- Korhonen, J., Nuur, C., Feldmann, A., Birkie, S.E. 2018. Circular economy as an essentially contested concept. *Journal of Cleaner Production*, 175, 544-552.
- Kovács, G. 2017. Circular economy vs. closed loop supply chains: what is new under the sun? *Constructing A Green Circular Society*. Book. Edited by Munjur E. Mouna Jaana Sorvari Pekka Oinas. First edition. November 2017.
- Lamé, G. 2017. "Integrating hospital departments: an operations management approach for cancer care." PhD Thesis. Design Engineering and Operational Research. Université Paris-Saclay.
- Leydesdorff, L., Van den Besselaar, P. 1997. Scientometrics and communication theory: Towards theoretically informed indicators. *Scientometrics*, 38 (1), 155-174.
- Lifset, R. J., Graedel, T. E. 2002. Industrial ecology: Goals and definitions. In *Handbook of industrial ecology*, edited by R. U. Ayres and L. W. Ayers. Cheltenham, UK: Edward Elgar.
- Lowe, E.A., Evans, L.K. 1995. Industrial Symbiosis, Industrial Ecology and Industrial Ecosystems. *Journal of Cleaner Production*, 3 (1), 47–53.
- Lyle, J.T. 1994. *Regenerative Design for Sustainable Development*. New York, NY: John Wiley & Sons.
- Magnier, C. 2017. 10 Key Indicators for Monitoring the Circular Economy. 2017 Edition. Document published by: The Monitoring and Statistics Directorate (SOeS). Ministry of the environment, energy and marine affairs, in charge of international relations on climate change.
- Maudet, C., Bertoluci, G., 2007. Decision aid tool and design approach for plastic recycling chain integration in the automotive industry, in: *Proceedings of ICED 2007, the 16th International Conference on Engineering Design*. Paris, pp. 1–13
- McDonough, W., Braungart, M. 2002. *Cradle to Cradle: remaking the way we make things*. North Point Press.
- Michelin, 2016. Life Cycle Assessment of tyres – Comparison of environmental impacts of different truck tyres scenarios. Groupe Michelin, February 2016.
- Mingers, J., Brocklesby, J. 1997. Multimethodology: Towards a framework for mixing methodologies. *Omega - International Journal of Management Science*, 25 (5), 489-509.
- Murray, A., Skene, K., Haynes, K. 2017. The Circular Economy: An Interdisciplinary Exploration of the Concept and Application in a Global Context. *J Bus Ethics*, 140, 369–380.
- Paltridge, B. 2002. Thesis and dissertation writing: An examination of published advice and actual practice. *English for Specific Purposes*, 21, 125-143.
- Papalambros P.Y., 2015. Design Science: Why, What and How. *Design Science*, 1 (1).
- Pauli, G. 2010. *The Blue Economy: 10 years, 100 innovations, 100 million jobs*. Paradigm Publications.
- Pieroni, M.P., Pigosso, D.C.A., McAlloone, T.C. 2018. Sustainable Qualifying Criteria for Designing Circular Business Models. *Procedia CIRP*, 69, 799-804.
- Pigosso, D.C.A, Zanette, E.T., Filho, A.G., Ometto, A.R., Rozenfeld, H. 2010. Ecodesign methods focused on remanufacturing, *Journal of Cleaner Production*. 18 (1).
- Pôle eco-conception. 2015. Éco-conception et économie circulaire. www.eco-conception.fr/static/economie-circulaire.html
- Prieto-Sandoval, V., Jaca, C., Ormazabal, M. 2018. Towards a consensus on the circular economy, *Journal of Cleaner Production*, 179, 605-615.
- Ripple, W.J., Wolf, C., Newsome, T.M., Galetti, M., Alamgir, M., Crist, E., Mahmoud, M.I., Laurance, W.F. 15,364 scientist signatories from 184 countries. 2017. World Scientists' Warning to Humanity: A Second Notice, *BioScience*, 67 (12), 1026–1028.
- Rizos, V., Tuokko, K., Behrens, A. 2017. The Circular Economy: a review of definitions, processes and impacts. Centre for European Policy Studies, Research report, No 2017/08.
- Robert, F.A., Gallopoulos, N.E. 1989. Strategies for manufacturing. *Scientific American*, 189 (3), 152.
- Røine, K. 2000. Does industrial ecology provide any new perspectives? Reports and Communications from Norwegian University of Science and Technology, Industrial Ecology Programme, Report n° 3/2000.
- Saavedra, Y.M.B., Iritani, D.R., Pavan, A.L.R., Ometto, A.R. 2018. Theoretical contribution of industrial ecology to circular economy, *Journal of Cleaner Production*, 170, 1514-1522.
- Sacchi Homrich, A., Galvão, G., Gamboa Abadia, L., Carvalho, M.M. 2018. The circular economy umbrella: Trends and gaps on integrating pathways. *Journal of Cleaner Production*, 175, 525-543.
- Schroeder, P., Anggraeni, K., Weber, U. 2018. The Relevance of Circular Economy Practices to the Sustainable Development Goals. *Journal of Industrial Ecology*.
- Simon, H. A. 1969. *The sciences of the artificial*. Cambridge, MA.
- Stahel, W. 2006. *The Performance Economy*. 2nd ed., Palgrave MacMillan.
- Stec, T., Zwolinski, P. 2018. Using Values Management for Shifting Companies to Circular Economy. *Procedia CIRP*, 69, 805-809.
- Steffen, W., Richardson, K., Rockström, J., et al. 2015. Planetary boundaries: Guiding human development on a changing planet, *Science*, 13, 347.
- Viktoria. 2017. Circular economy in a business eco-system: Integrated sensors and new recycling technology for heavy vehicle tyres. <https://www.viktoria.se/projects/circular-economy-in-a-business-eco-system-integrated-sensors-and-new-recycling-technology>
- WCED-World Commission on Environment and Development. 1987. *Our common future—Report of the World Commission on Environment and Development (The Brundtland Report)*. Oxford, UK: Oxford University Press.
- Wilts, H. 2017. International police trends and practices toward circular economy development. *Constructing A Green Circular Society*. Book. Edited by Munjur E. Mouna Jaana Sorvari Pekka Oinas. First edition. November 2017
- Yannou, B., Petiot, J.-F. 2011. A View of Design (and JMD): The French Perspective. *Journal of Mechanical Design, American Society of Mechanical Engineers*, 133 (5), 1-2.

ESSAY #1

- Accenture. 2016. Automotive's Latest Model: Redefining Competitiveness through the Circular Economy. Report. Available online (1 April 2018): <https://www.accenture.com/us-en/insight-redefining-competitiveness-through-circular-economy>
- ACEA-European Automotive Manufacturers Association. 2015. ACEA Position Paper on Circular Economy. September 2015.
- ACEA-European Automotive Manufacturers Association. 2016. Facts about the Automobile Industry. Available online (1 November 2016): <http://www.acea.be/automobile-industry/facts-about-the-industry>
- ACEA-European Automotive Manufacturers Association. 2017. Statistics – Vehicles in use. Available online (1 April 2018): <http://www.acea.be/statistics/tag/category/vehicules-in-use>
- ADEME-French Environment & Energy Management Agency. 2006. Etude sur la fin de vie de tous les moyens de transport en France, à l'exception des véhicules couverts par la directive Véhicules Hors d'Usage. Etude réalisée par BiolS pour l'ADEME, Novembre 2006.
- Banaité, D. 2016. Towards circular economy: analysis of indicators in the context of sustainable development. *Social Transformations in Contemporary Society*, 2016 (4).
- Bento, A. M., Roth, K D., Zuo, Y. 2013. Vehicle Lifetime Trends and Scrappage Behavior in the U.S. Used Car Market. Available at SSRN: <http://dx.doi.org/10.2139/ssrn.2262593>
- Bocken, N., Bakker, C., De Pauw, I. 2015. Product design and business model strategies for a circular economy. *Sustainable Design & Manufacturing Conference*, Seville, 12-14 April 2015.
- Bocken, N.M., Olivetti, E. A., Cullen, J. M., Potting, J., Lifset, R. 2017. Taking the circularity to the next level: A special issue on the circular economy. *Journal of Industrial Ecology*, 21(3), 476–482.
- Buruzs, A., Tomas, A. 2017. A Review on the Outlook of the Circular Economy in the Automotive Industry. *International Journal of Environmental and Ecological Engineering*, 11 (6).
- CETIM, 2014. Filière de fin de vie et de déconstruction des engins lourds. Note veille, Matériels de Travaux Publics, Mines et Forage, Septembre 2014.
- Chapman, A., Bartlett, C., McGill, I., Parker, D., Walsh, B. 2010. A snapshot of the remanufacturing industry in UK in 2009. CRR, Centre for Remanufacturing and Reuse, UK, August 2010.
- Chemineau, L. 2011. Développement d'une méthode d'éco-conception basée sur la modélisation et l'évaluation des filières de valorisation : application au secteur automobile. PhD Thesis, Sciences de l'ingénieur [physics]. Ecole nationale supérieure d'arts et métiers - ENSAM, 2011. French.
- CIRAIG. 2015. Circular Economy: A Critical Literature Review of Concepts, Bibliothèque et Archives nationales du Québec (BAnQ), August 2015. ISBN 978-2-9815420-0-7.
- Clarke, R. J. 2005. Research Models and Methodologies. HDR Seminar Series, Faculty of Commerce, Spring Session 2005.
- Cossu, R. 2018. Why this journal? Why this name?. *Detritus*, Vol. 1, pp. 1-2
- Creswell, J. W. 2003. *Research design: qualitative, quantitative, and mixed methods approaches*. Thousand Oaks, CA: Sage Publications, 2nd Edition.
- Creswell, J.W., Plano Clark, V.L. 2007. *Designing and Conducting Mixed Methods Research*. Thousand Oaks, CA: Sage.
- Delmas, M. A., Cuerel Burbano, V. 2011. The Drivers of Greenwashing. *California Management Review*, Vol. 54, No. 1 (Fall 2011), pp. 64-87
- Despeisse, M., Kishita, Y., Nakano, M., Barwood, M. 2015. Towards a Circular Economy for End-of-Life Vehicles: A Comparative Study UK – Japan. *Procedia CIRP*, 29, 668-673.
- DfT-Department for Transport. 2016. Non-Road Mobile Machinery (NRMM) definition. Available online (1 November 2016): <http://www.dft.gov.uk/vca/enforcement/non-road-mobile-mach.asp>
- Di Maio, F., Rem, P.C., Baldé, K., Polder, M. 2017. Measuring resource efficiency and circular economy: A market value approach, *Resources, Conservation and Recycling*, 122, 163-171.
- Diaz, L.F., 2017. Waste management in developing countries and the circular economy. *Editorial, Waste Manag. Res.*, 35 (1), 1–2.
- Diener, D., Tillman, A.-M. 2015. Component end-of-life management: Exploring opportunities and related benefits of remanufacturing and functional recycling. *Resources, Conservation and Recycling*, 102, 80-93.
- Diener, D., Tillman, A.-M. 2016. Scrapping steel components for recycling - Isn't that good enough? Seeking improvements in automotive component end-of-life. *Resources, Conservation and Recycling*, 110, 48-60.
- Diener, D., Williander, M., Tillman, A.-M. 2015. Product-Service-Systems for Heavy-Duty Vehicles – An Accessible Solution to Material Efficiency Improvements? *Procedia CIRP*, 30, 269-274.
- Directive 2000/53/EC of the European Parliament and of the Council of 18 September 2000 on end-of life vehicles. *Official Journal of the European Communities* (21 October 2000).
- Directive 2001/116/EC of 20 December 2001 adapting to technical progress Council Directive 70/156/EEC on the approximation of the laws of the Member States relating to the type-approval of motor vehicles and their trailers.
- Directive 2002/151/EC: Commission Decision of 19 February 2002 on minimum requirements for the certificate of destruction issued in accordance with Article 5(3) of Directive 2000/53/EC of the European Parliament and of the Council on end-of-life vehicles.
- Directive 2002/24/EC of the European Parliament and of the Council of 18 March 2002 relating to the type-approval of two or three-wheel motor vehicles and repealing Council Directive 92/61/EEC.
- Directive 2002/96/EC of the European Parliament and of the Council of 27 January 2003 on waste electrical and electronic equipment (WEEE).
- Directive 2003/138/EC: Commission Decision of 27 February 2003 establishing component and material coding standards for vehicles pursuant to Directive 2000/53/EC of the European Parliament and of the Council on end-of-life vehicles.
- Directive 2005/293/EC: Commission Decision of 1 April 2005 laying down detailed rules on the monitoring of the reuse/recovery and reuse/recycling targets set out in Directive 2000/53/EC of the European Parliament and of the Council on end-of-life vehicles.
- Directive 2005/64/EC of the European Parliament and of the Council of 26 October 2005 on the type-approval of motor vehicles with regard to their reusability, recyclability and recoverability.
- Directive 2008/33/EC of the European Parliament and of the Council of 11 March 2008 amending Directive 2000/53/EC on end-of-life vehicles, as regards the implementing powers conferred on the Commission.
- Directive 2008/35/EC of the European Parliament and of the Council of 11 March 2008 amending Directive 2002/95/EC on the use of certain hazardous substances in electrical and electronic equipment (RoHS).
- DoT CA. 2017. What are the rules and regulations for truckers in California?. Available online (1 April 2018): <http://www.dot.ca.gov/hq/paffairs/faq/faq32.htm>
- EASAC-European Academies Science Advisory Council. 2016. Indicators for a circular economy. EASAC policy report 30, November 2016. ISBN: 978-3-8047-3680-1.
- EC-European Commission. 2010. Critical Raw Materials for the EU. Report of the Ad-hoc Working Group on defining critical raw materials, June 2010.
- EC-European Commission. 2011. Roadmap to a Resource Efficient Europe. Communication from the commission to the European parliament, the council, the European economic and social committee and the committee of the regions, Brussels, Belgium, September 2011. SEC (2011) 1067 final.

- EC-European Commission. 2014a. Towards a circular economy: A zero waste programme for Europe, September 2014.
- EC-European Commission. 2014b. Ex-post evaluation of certain waste stream Directive. Final Report, 18 April 2014, Bio Intelligence Service, Arcadis, Institute for European Environmental Policy.
- EC-European Commission. 2015. Closing the loop, an EU action plan for the Circular Economy, Communication from the commission to the European parliament, the council, the European economic and social committee and the committee of the regions, Brussels, Belgium, December 2015.
- EC-European Commission. 2016a. Resource Efficiency. Available online (1 November 2016): http://ec.europa.eu/environment/resource_efficiency/index_en.htm
- EC-European Commission. 2016b. End of Life Vehicles. Available online (1 November 2016): <http://ec.europa.eu/environment/waste/elv/index.htm>
- EC-European Commission, ERN-European Remanufacturing Network, 2015. Remanufacturing Market Study, for Horizon 2020. Chapter 9: Heavy-Duty and Off-Road equipment, November 2015.
- EEA-European Environment Agency. 2015. Circular economy in Europe - Developing the knowledge base. 37 pp., 21 x 29.7 cm, ISBN 978-92-9213-719-9, doi:10.2800/51444.
- EEA-European Environment Agency. 2016. More from less - Material resource efficiency in Europe. 151 pp., 21 x 29.7 cm, ISBN 978-92-9213-736-6, doi:10.2800/240736.
- El Halabi, E., Third, M., Doolan, M. 2015. Machine-based Dismantling of End of Life Vehicles: A Life Cycle Perspective. *Procedia CIRP*, 29, 651-655.
- EMF-Ellen MacArthur Foundation. 2013a. The Circular Economy Applied to the Automotive Industry. Available online (1 November 2016): <http://www.ellenmacarthurfoundation.org/circular-economy/interactive-diagram/the-circular-economy-applied-to-the-automotive-industry>
- EMF-Ellen MacArthur Foundation. 2013b. Towards the circular economy - Economic and business rationale for an accelerated transition.
- EMF-Ellen MacArthur Foundation. 2015. Circularity Indicators – An Approach to Measure Circularity. Methodology & Project Overview. Cowes, UK.
- ERTRAC-European Road Transport Research Advisory Council. 2012. European Roadmap, Heavy Duty Truck. Report, September 2012.
- Esposito, M., Terence T., Soufani K. 2018. Introducing a Circular Economy: New Thinking with New Managerial and Policy Implications. *California Management Review*, 1–15
- Eurostat. 2016. End-of-life vehicles statistics. Available online (1 November 2016): http://ec.europa.eu/eurostat/statistics-explained/index.php/End-of-life_vehicle_statistics
- Farel, R., Yannou, B., Bertolucci, G. 2013. Finding best practices for automotive glazing recycling: a network optimization model. *Journal of Cleaner Production*, 52, 446-461.
- Froelich, D., Haoues, N., Leroy, Y., Renard, H. 2007. Development of a new methodology to integrate ELV treatment limits into requirements for metal automotive part design. *Minerals Engineering*, 20, 891–901.
- Garcia, J., Millet, D., Tonnelier, P. 2015. A tool to evaluate the impacts of an innovation on a product's recyclability rate by adopting a modular approach: automotive sector application. *International Journal of Vehicle Design, Inderscience*, 1, 1-18.
- Geissdoerfer, M., Savaget, P., Bocken, N.M.P., Hultink, E.J. 2017. The Circular Economy – A new sustainability paradigm? *J. Clean. Prod.* 143, 757-768.
- Ghisellini, P., Cialani, C., Ulgiati, S. 2016. A review on circular economy: the expected transition to a balanced interplay of environmental and economic systems. *J. Clean. Prod.* 114, 11-32.
- Gnimpieba, Z., Nait-Sidi-Moh, A., Durand, D., Fortin, J. 2015. Using Internet of Things Technologies for a Collaborative Supply Chain: Application to Tracking of Pallets and Containers. *Procedia Computer Science*, 56, 550-557.
- Hagelüken, C., Lee-Shin, J., Carpentier, A., Heron, C. 2016. The EU Circular Economy and Its Relevance to Metal Recycling. *Recycling* 1 (2), 242-253.
- HDDA. 2017. Product Standards for Heavy-Duty Aftermarket in Development - August 25, 2017. Available online (1 April 2018): <http://autocare.org/Who-We-Are/Segments/HDDA/HDDA--Heavy-Duty.html>
- Hill, N., et al. 2012. EU Transport GHG: Routes to 2050 II. The role of GHG emissions from infrastructure construction, vehicle manufacturing, and ELVs in overall transport sector emissions. Available online (1 November 2016): www.eurtransportghg2050.eu
- Husnjak, S., Peraković, D., Forenbacher, I., Mumdziev, M. 2015. Telematics System in Usage Based Motor Insurance. *Procedia Engineering*, 100, 816-825.
- IBM Global Business Services Automotive. 2009. Truck 2020 transcending turbulence. Executive Report 2009, IBM Institute for Business Value.
- ICCT-International Council on Clean Transportation. 2015. Overview of the heavy-duty vehicle market and CO2 emissions in the European Union. Working Paper, December 2015.
- ICCT-International Council on Clean Transportation. 2016. European Vehicles Market Statistics. Pocketbook 2015-2016.
- IDIS-International Dismantling Information System, 2016. Available online (1 November 2016): <http://www.idis2.com/index.php?action=home&language=english>
- INDRA Automobile Recycling. 2016a. Available online (1 November 2016): http://www.indra.fr/en/recycling_engineering.html
- INDRA Automobile Recycling. 2016b. Available online (1 November 2016): <http://www.indra.fr/en/IT-solutions.html>
- Intel. 2015. Internet of Things Sensors Add Intelligence to Trucks. Available online (1 November 2016): <http://www.intel.com/content/www/us/en/internet-of-things/customer-stories/saia-trucking-adds-intelligence-with-intel.html>
- IPCC-Intergovernmental Panel on Climate Change. 2014. Climate Change 2014: Impacts, Adaptation and Vulnerability: Regional Aspects. Cambridge University Press.
- IPCC-Intergovernmental Panel on Climate Change. 2015. Climate Change 2014: Mitigation of Climate Change (Vol. 3). Cambridge University Press.
- Japke, O. 2009. Practice Guidelines, Development of a framework for assessing the economic benefits of remanufacturing. CRR, Center for Remanufacturing & Reuse, UK.
- Kiser, B. 2016. Circular economy: Getting the circulation going. *Nature*, 531, 443–446, 24 March 2016.
- Konz, R. 2009. The End-of-Life Vehicle (ELV) Directive: The Road to Responsible Disposal. *Minn. J. Int'l L.*, 18/43.
- Kunz, N., Mayers, K., Van Wassenhove, L. N. 2018. Stakeholder Views on Extended Producer Responsibility and the Circular Economy. *California Management Review*, 1–26.
- Kwak, M., Kim, H. 2016. Modeling the Time-Varying Advantages of a Remanufactured Product: Is “Reman” Better Than “Brand New”? *J. Mech. Des* 138 (5).
- Lacy, P. 2015. Growth, Innovation and Customer Value through the Circular Economy. *Accenture Strategy*, 2015.
- Lieder, M., Rashid, A. 2016. Towards circular economy implementation: A comprehensive review in context of manufacturing industry. *J. Clean. Prod.*, 115, 36–51.
- Lishan, X., Weiling, L., Qinghai, G., Lijie, G., Guoqin, Z., Xiji, C. 2018. Comparative life cycle assessment of manufactured and remanufactured loading machines in China. *Resources, Conservation and Recycling*, 131, 225-234.
- Ma, J., Kwak, M., Kim, H. M. 2014. Demand Trend Mining for Predictive Life Cycle Design, *J. Clean. Prod.*, 68, 189-199.
- Ma, J., Okudan Kremer, G. 2014. A Systematic Literature Review of Modular Product Design (MPD) from the Perspective of Sustainability, *Int J Adv Manuf Technol*, 86.
- Manitou Group. 2016. Handling your world. Annual Report 2015. May 2016.

- Matexchange. 2016. Available online: (accessed on 1 November 2016): <http://www.matexchange.fr/>
- McDowall, W., Geng, Y., Huang, B., Barteková, E., Bleischwitz, R., Türkeli, S., Doménech, T. 2017. Circular economy policies in China and Europe. *Journal of Industrial Ecology*, 21 (3), 651–661.
- MGI-McKinsey Global Institute. 2013. Resource Revolution: Tracking global commodity markets. McKinsey Sustainability & Resource Productivity Practice, September 2013.
- MGI-McKinsey Global Institute. 2015. Europe's Circular Economy Opportunity, Report, September 2015.
- Michelin. 2016. Michelin Challenge Bibendum Community, Vehicles and the Circular Economy. Available online (1 November 2016): <https://community.michelinchallengebibendum.com/docs/DOC-2364>
- Millet D., Yvars P.A., Tonnelier P. 2012. A method for identifying the worst recycling case: Application on a range of vehicles in the automotive sector. *Resources, Conservation and Recycling*, 68, 1-13.
- Moreno, M., de los Rios, C., Rowe, Z., Charnley, F. 2016. A Conceptual Framework for Circular Design. *Sustainability*, 8, 937.
- Niero, M., Olsen, S.I. 2016. Circular economy: To be or not to be in a closed product loop? A Life Cycle Assessment of aluminium cans with inclusion of alloying elements, *Resources, Conservation and Recycling*, 114, 18-31.
- NSTSC-National Surface Transportation Safety Center for Excellence. 2012. Market Guide to Fleet Telematics Services, Creating a Consumer's Guide to Currently Available Aftermarket Solutions. Tammy E. Trimble & Darrell S. Bowman, December 2012.
- Palmeira, V. N., Guarda, G. F., Kitajima, L. F. W. 2018. Illegal international trade of e-waste – Europe. *Detritus*, 1, 48-56.
- Parto, S., Loorbach, D., Lansink, A. 2017. Transitions and institutional change: the case of the Dutch waste subsystem. In: *Industrial Innovation and Environmental Regulation*.
- Poulikakos, L.D., Heutschi, K., Soltic, P. 2013. Heavy duty vehicles: Impact on the environment and the path to green operation. *Environmental Science & Policy*, 33, 154-161.
- Recycling. 2016. Available online (1 November 2016): <http://www.recycling.com/downloads/waste-hierarchy-lansinks-ladder/>
- Regulation (EC) No 1907/2006 on the Registration, Evaluation, Authorisation and Restriction of Chemicals (REACH) and setting up a European Chemicals Agency
- Reuter, M.A., van Schaik, A., Ignatenko, O., de Haan, G.J. 2006. Fundamental limits for the recycling of end-of-life vehicles. *Minerals Engineering*, 19, (5), 433–449.
- Rosa P., Terzi S. 2018. Improving end of life vehicle's management practices: An economic assessment through system dynamics. *Journal of Cleaner Production*, 184, 520-536
- Saidani, M., Yannou, B., Leroy, Y., Cluzel, F. 2017. Heavy vehicles on the road towards the circular economy: Analysis and comparison with the automotive industry. *Resources, Conservation and Recycling*, 135, 108-122.
- Saidani, M., Kendall, A., Yannou, B., Leroy, Y., Cluzel, F. 2018. What about the circular economy of vehicles in the U.S.? An extension of the analysis done in the EU by Saidani et al. (2017). *Resources, Conservation and Recycling*, 136, 287-288.
- Sakai, S., Yoshida, H., Hiratsuka, J. et al. 2014. An international comparative study of end-of-life vehicle (ELV) recycling systems. *J Mater Cycles Waste Manag*, 16 (1).
- Sauvé, S., Bernard, S., Sloan, P. 2016. Environmental sciences, sustainable development and circular economy: Alternative concepts for trans-disciplinary research. *Environmental Development*, 17, 48-56.
- SCADA-State of California Auto Dismantlers Association. 2017. The Underground Economy: Report & Recommendations. Available online (1 April 2018): <https://www.dtsc.ca.gov/GetInvolved/ReviewPanel/upload/SCADA-DTSC-IRP-Ltr-1-16-dskv1.pdf>
- Sievers, H., Tercero, L. 2012. European dependence on and concentration tendencies of the material production. *Polinares*, EU Policy on Natural Resources, March 2012.
- Simic, V. 2013. End-of-life vehicle recycling - A review of the state-of-the-art. *Tehnički vjesnik – Technical Gazette* 20. 2. 2013. p. 371-380.
- Simic, V. 2015. A two-stage interval-stochastic programming model for planning end-of-life vehicles allocation under uncertainty. *Resources, Conservation and Recycling*, 98, 19-29.
- Slavík, J., Remr, J., Vejchodská, E. 2018. Relevance of selected measures in transition to a circular economy: the case of the Czech Republic. *Detritus*, 1, 144-155.
- Snodgrass D. 2012. Sustainable development – Our focus & commitment. *Cat Reman*, Septembre 2012.
- Statista. 2017, Importing Vehicles and Engines. Available online (1 April 2018): <https://www.epa.gov/importing-vehicles-and-engines>
- Statista. 2017, Motor Vehicle Production. Available online (1 April 2018): <https://www.statista.com/topics/975/motor-vehicle-production>
- Statista. 2017, US Light Vehicle Average Curb Weight. Available online (1 April 2018): <https://www.statista.com/statistics/660493/us-light-duty-vehicle-average-curb-weight>
- Statista. 2018. Worldwide leading truck manufacturers based on production figures. Available online (1 April 2018): <https://www.statista.com/statistics/270293/worldwide-leading-truck-manufacturers-based-on-production-figures/>
- Toyota. 2016. Available online: <https://www.toyota-europe.com/world-of-toyota/feel/environment/better-earth/recycle>
- Tukker, A. 2015. Product services for a resource-efficient and circular economy – a review. *Journal of Cleaner Production*, 97, 76-91.
- Tukker, A., Cohen, M. J. 2004. Industrial Ecology and the Automotive Transport System. *Journal of Industrial Ecology*, 8, 14–18.
- UNECE-United Nations Economic Commission for Europe. 2016. Heavy-Duty Vehicles Classification in Europe. Available online (1 November 2016): <http://www.unece.org/trans/main/wp29/wp29wgs/wp29gen/wp29classification.html>
- USDoE-US Department of Energy. 2013. Energy Efficiency & Renewable Energy, Workshop Report: Trucks and Heavy-Duty Vehicles Technical Requirements and Gaps for Lightweight and Propulsion Materials. February 2013.
- USDoT-US Department of Transportation. 2014. Study of the Impact of a Telematics System on Safe and Fuel-efficient Driving in Trucks, April 2014.
- USDoT-US Department of Transportation. 2017. National Transportation Statistics. Available online (1 April 2018): https://www.rita.dot.gov/bts/sites/rita.dot.gov.bts/files/publications/national_transportation_statistics/index.html
- USITC-US International Trade Commission. 2012. Remanufactured Goods: An Overview of the U.S. and Global Industries, Markets, and Trade. Chapter 4: Heavy-Duty and Off-Road (HDOR) Equipment, Investigation No. 332-525, USITC Publication 4356, October 2012.
- USITC-US International Trade Commission. 2013. The USITC Remanufacturing Report: Key Findings, Observations, and Insights. The 2013 Remanufacturing Industry Roundtable April 11, 2013.
- USUBC. 2015. Top 50 manufacturers of construction machinery. Report. Jul. 2015. Available online (1 April 2018): http://www.usubc.org/files/Zeppelin_top_50_manufacturer_%20construction%20machinery.pdf
- Velis, C.A. 2015. Circular economy and global secondary material supply chains. *Editorial, Waste Manag. Res.*, 33 (5), 389–391.
- Velis, C.A., Vrancken, K.C. 2015. Which material ownership and responsibility in a circular economy? *Editorial, Waste Manag. Res.*, 33 (9), 773–774.
- Volvo Group. 2015. The Volvo Group Annual and Sustainability Report 2015. Report, pp. 22.
- Volvo Truck Corporation. 2012. Disassembly instructions, complete vehicle. Service Information, Volvo Truck Corporation, Göteborg, Sweden, 2012.
- Walker, G., Manson, A. 2014. Telematics, urban freight logistics and low carbon road networks. *Journal of Transport Geography*, 37, 74–81.
- Walnum, H.J., Simonsen, M. 2015. Does driving behavior matter? An analysis of fuel consumption data from heavy-duty trucks. *Transportation Research Part D: Transport and Environment*, 36, 107–120.

- Walsh, B. 2013. Remanufacturing in Europe – The business case. CRR, Centre for Remanufacturing and Reuse, UK, May 2013.
- Weiland, F.W. 2014. European remanufacturing of heavy-duty and off-road vehicle components (including tyres): a hidden giant? FWJ Consulting, May 2014.
- Wells, P., Orsato, R. J. 2005. Redesigning the Industrial Ecology of the Automobile. *Journal of Industrial Ecology*, 9, 15–30.
- Wikipedia. 2018. List of manufacturers by motor vehicle production. Available online (1 April 2018): https://en.wikipedia.org/wiki/List_of_manufacturers_by_motor_vehicle_production
- Wilson, M. 2017. Key to the concept – Automotive manufacturers must embrace parts reuse because it is key to the industry's circular economy. *Recycling Today*, August 31, 2017. Available online (1 April 2018): <http://www.recyclingtoday.com/article/automotive-parts-reuse/>
- Wilts, H., Von Gries, N., Bahn-Walkowiak, B. 2016. From Waste Management to Resource Efficiency - The Need for Policy Mixes. *Sustainability*, 8, 622.
- Witjes S., Lozano R. 2016. Towards a more Circular Economy: Proposing a framework linking sustainable public procurement and sustainable business models. *Resources, Conservation and Recycling*, 112, 37-44.
- Yi, H-C., Park, W.J. 2015. Design and Implementation of an End-of-Life Vehicle Recycling Center Based on IoT (Internet of Things) in Korea. *Procedia CIRP*, 29, 728-733.

ESSAY #2

- Acampora, A., Preziosi, M., Merli, R., Lucchetti, M.C. 2017. Environmental Management Systems in the Wine Industry: Identification of Best Practices toward a Circular Economy. 23rd International Sustainable Development Research Society Conference, June 14-16 2017, School of Management Universidad de los Andes Bogotá, Colombia.
- Accenture Strategy. 2017. Gaining an edge: Growth, innovation and customer value from the circular economy. Available online: <https://www.accenture.com/us-en/insight-circular-economy-gaining-edge> (Accessed on 1 March 2017).
- Advancing Sustainability LLP. 2013. Circular Benefits Tool. <https://www.advancingsustainability.com/wwd-sustainability#circularity> (accessed 15 May 2018).
- Akerman, E. 2016. Development of Circular Economy Core Indicators for Natural Resources - Analysis of existing sustainability indicators as a baseline for developing circular economy indicators. Master of Science Thesis, Stockholm.
- Amaya, J. 2012. Assessment of the environmental benefits provided by closed-loop strategies for industrial products. PhD Thesis, French, Grenoble University, Industrial Engineering, Design and Manufacturing.
- Arnsperger, C.; Bourg, D. 2016. Vers une économie authentiquement circulaire: Réflexions sur les fondements d'un indicateur de circularité. *Revue de l'OFCE*, 145, 1.
- Azevedo, S.G., Godina, R., Matias, J.C.O. 2017. Proposal of a Sustainable Circular Index for Manufacturing Companies. *Resources*, 6, 63.
- Balanay, R., Halog, A. 2016. Charting Policy Directions for Mining's Sustainability with Circular Economy. *Recycling*, 2, 219–231.
- Banaité, D. 2016. Towards Circular Economy: Analysis of Indicators in the Context of Sustainable Development. International Scientific Conference for Young Researchers, Social Transformations in Contemporary Society: Vilnius, Lithuania, 2–3 June 2016.
- Banaité, D., Tamošiūnienė, R. 2016. Sustainable development: the circular economy, indicators' selection model. *Journal of security and sustainability issues*, 6, 2.
- Behrens, A., Taranic, I., Rizos, V., 2015. Resource Efficiency Indicators for Policy-Making, CEPS (Centre for European Policy Studies) Working Document, n°415, November 2015.
- Bell, S., Morse, S. 2008. Sustainability Indicators: Measuring the immeasurable, 2nd Ed, Earthscan, London.
- BiolS-Bio Intelligence Service. 2012. Assessment of Resource Efficiency Indicators and Targets. Final Report Prepared for the European Commission, DG Environment. Institute for Social Ecology, and Sustainable Europe Research Institute, Paris, France, 2012.
- Birat, J.-P. 2012. Materials, beyond Life Cycle Thinking. *Rev. Metall.*, 109 (5), 273-291.
- Bleischwitz, R., Wilts, H. 2013. An international metal covenant: A step towards global sustainable resource management. In *Factor X: Re-Source—Designing the Recycling Society*; Springer: Heidelberg, Germany, 87–98.
- Blomsma, F., Brennan, G. 2017. The emergence of circular economy: a new framing around prolonging resource productivity
- Bocken, N. M., Olivetti, E. A., Cullen, J. M., Potting, J., Lifset, R. 2017. Taking the Circularity to the Next Level: A Special Issue on the Circular Economy. *Journal of Industrial Ecology*, 21, 476-482.
- Bovea, M.D., Pérez-Belis, V. 2012. A taxonomy of ecodesign tools for integrating environmental requirements into the product design process. *Journal of Cleaner Production*, 20 (1), 61-71.
- Brown, D. 2009. Good Practice Guidelines for Indicator Development and Reporting. Third World Forum on 'Statistics, Knowledge and Policy', 27-30 October 2009 Busan, Korea.
- C2C. 2014. Impact study: Technical report—Pilot study impact study of the cradle to cradle certified products program, Cradle to Cradle Products Innovation Institute, Oakland, CA. www.c2ccertified.org/impact-study (accessed 15 May 2018).
- Carencotte, F., Geldron, A., Villeneuve, J., Gaboriau, H. 2012. Economie circulaire et recyclage des métaux. *Geosciences*, 15, 64–71.
- Cayzer, S., Griffiths P., Beghetto, V. 2017. Design of indicators for measuring product performance in the circular economy, *International Journal of Sustainable Engineering*.
- Chamaret, A., O'Connor, M. 2007. Top-down/bottom-up approach for developing sustainable development indicators for mining. *International Journal of Sustainable Development*, 10 (1/2), 161-174.
- Chun-Rong, J., Jun, Z. 2011. Evaluation of Regional Circular Economy Based on Matter Element Analysis. *Procedia Environmental Sciences*, 11, 637-642.
- Church, C., Rogers, M. 2006. Designing for Results: Integrating Monitoring and Evaluation in Conflict Transformation Programs. Search for Common Ground: Washington, DC, USA, p. 228.
- CIRAIG. 2015. Circular Economy: A Critical Literature Review of Concepts; Bibliothèque et Archives Nationales du Québec (BANQ): Quebec City, QC, Canada.
- Circle Economy and PGGM. 2014. Circle Assessment <https://www.circle-economy.com/assessing-circular-trade-offs/#.Wic7PHIryM8> (accessed 15 May 2018).
- Circle Economy and PGGM. 2014. Circularity Assessment for Organizations: Draft Indicators v. 0.2. 23 pp.
- Circle Economy. 2014. Circularity Assessment for Organisations: Draft Indicators v. 0.2. Circle Economy: Amsterdam, The Netherlands, p. 23.
- Circle Economy. 2017. Circle Assessment Tool—Measuring Circularity and Identifying Opportunities to Adapt Circular Strategies. Available online: <http://www.circle-economy.com/tool/circleassessment/> (accessed on 1 February 2017).
- Cullen, J. M. 2017. Circular Economy: Theoretical Benchmark or Perpetual Motion Machine?. *Journal of Industrial Ecology*, 21, 483–486.
- Davidson, J. F. 1952. The Use of Taxonomy in Ecology. *Ecology*, 33 (2), 297-299, *Ecological Society of America*, <http://www.jstor.org/stable/1930650> (accessed 15 May 2018).
- Dawis, R. V. 1987. Scale construction. *Journal of Counseling Psychology*, 34 (4), 481.
- Di Maio, F., Rem, P.C. 2015. A robust indicator for promoting circular economy through recycling. *Journal of Environmental Protection*, 6, 1095-1104.
- Di Maio, F., Rem, P.C., Baldé, K., Polder, M. 2017. Measuring resource efficiency and circular economy: A market value approach. *Resources, Conservation and Recycling*, 122, 163–171.
- Dufrene, M., Zwolinski, P., Brissaud, D. 2013. An engineering platform to support a practical integrated eco-design methodology. *CIRP Ann. Manuf. Technol.*, 62, 131–134.
- Earley, R. 2017. Circular Design Futures. *The Design Journal*, 20 (4), 421-434.
- EASAC-European Academies Science Advisory Council. 2015. Circular Economy: A Commentary from the Perspectives of the Natural and Social Sciences. European Academies Science Advisory Council: Halle, Germany.
- EASAC-European Academies Science Advisory Council. 2016. Indicators for a Circular Economy. EASAC Policy Report 30, Halle, Germany.
- EC-European Commission. 2010. Critical Raw Materials for the EU. Report of the Ad-hoc Working Group on defining critical raw materials, June 2010.
- EC-European Commission. 2014. Communication from the Commission to the European Parliament, the Council, the European Economic and Social Committee and the Committee of the Regions: Towards a Circular Economy: A Zero Waste Programme for Europe. Brussels, Belgium.
- EC-European Commission. 2015a. Closing the loop – An EU action plan for the Circular Economy. The Circular Economy Package Proposal. Communication from the Commission to the European Parliament, the Council, the European Economic and Social Committee and the Committee of the Regions. Brussels, Belgium.

- EC-European Commission. 2015b. Resource Efficiency Scoreboard. <http://ec.europa.eu/eurostat/web/environmental-data-centre-on-natural-resources/resource-efficiency-indicators/resource-efficiency-scoreboard> (accessed 15 May 2018).
- EC-European Commission. 2016. Circular Impacts Project EU. <http://circular-impacts.eu/start> (accessed 15 May 2018).
- EC-European Commission. 2017. Eurostat: Circular Economy Overview. <http://ec.europa.eu/eurostat/web/circular-economy/overview> (accessed 15 May 2018).
- EEA-European Environment Agency. 1999. Environmental indicators typology and overview. Technical report No 25/1999.
- EEA-European Environment Agency. 2003. Environmental Indicators: Typology and Use in Reporting. Peder Gabrielsen and Peter Bosch, Internal Working Paper, August 2003.
- EEA-European Environment Agency. 2016. Circular economy in Europe - Developing the knowledge base. EEA Report No 2/2016, 37 pp.
- EEA-European Environment Agency. 2016. More from Less—Material Resource Efficiency in Europe. European Environment Agency (EEA): Copenhagen, Denmark, p.151.
- Eisfeldt, F. 2017. PSILCA – A Product Social Impact Life Cycle Assessment. Database version 2.1., Documentation Version 3, December 2017.
- Elia, V. Grazia Gnoni, M., Tornese, F. 2017. Measuring circular economy strategies through index methods: A critical analysis. *Journal of Cleaner Production*, 142 (4), 2741-2751.
- EMF-Ellen MacArthur Foundation. 2013. Towards the Circular Economy—Economic and Business Rationale for an Accelerated Transition. Ellen MacArthur Foundation: Cowes, UK, Chapter 3.
- EMF-Ellen MacArthur Foundation. 2015. Circularity Indicators—An Approach to Measure Circularity. Methodology & Project Overview. Ellen MacArthur Foundation (EMF): Cowes, UK.
- EMF-Ellen MacArthur Foundation. 2017a. Schools of Thought. Available online: <https://www.ellenmacarthurfoundation.org/circular-economy/schools-of-thought> (accessed on 1 February 2017).
- EMF-Ellen MacArthur Foundation. 2017b. Partners. Available online: <http://www.ellenmacarthurfoundation.org/about/partners> (accessed on 1 February 2017).
- Evans, J., Bocken, N. 2013. The Circular Economy Toolkit. <http://circulareconomytoolkit.org/> (accessed 15 May 2018).
- Faucheux, S., Hue, C., O'Connor, M. 2003. A bottom-up / top-down methodology for indicators of corporate social performance in the European aluminum industry. *Cahier du C3ED N° 03-01*, Janvier 2003.
- Figge, F., Thorpe, A. S., Givry, P., Canning, L., Franklin-Johnson, E. 2018. Longevity and Circularity as Indicators of Eco-Efficient Resource Use in the Circular Economy. *Ecological Economics*, 150, 297-306.
- Fink, A. 1998. *Conducting Research Literature Reviews: From Paper to the Internet*. Sage: Thousand Oaks, CA, USA.
- Fogarassy, C., Kovács, A., Horváth, B., Böröcz, M. 2017. The development of a circular evaluation (CEV) tool. *Hungarian Agricultural Engineering*, 31, 10–20.
- Franklin-Johnson, E., Figge, F., Canning, L. 2016. Resource duration as a managerial indicator for Circular Economy performance, *Journal of Cleaner Production*, 133, 589-598.
- Gan, X., Fernandez, I.C., Guo, J., Wilson, M., Zhao, Y., Zhou, B., Wu, J. 2017. When to use what: Methods for weighting and aggregating sustainability indicators. *Ecological Indicators*, 81, 491-502.
- Geisendorf, S., Pietrulla, F. 2017. The circular economy and circular economic concepts—a literature analysis and redefinition. *Thunderbird International Business Review*, 2017, 1–12.
- Geissdoerfer, M., Savaget, P., Bocken, N.M.P., Hultink, E.J. 2017. The Circular Economy—A new sustainability paradigm? *J. Clean. Prod.*, 143, 757–768.
- Geng, Y., Fu, J., Sarkis, J., Xue, B. 2012. Towards a national circular economy indicator system in China: An evaluation and critical analysis. *J. Clean. Prod.*, 23, 216–224.
- Genovese, A., Acquaye, A.A., Figueroa, A., Koh, S.C.L. 2017. Sustainable supply chain management and the transition towards a circular economy: Evidence and some applications. *Omega*, 66, 344–357.
- Ghisellini, P., Cialani, C., Ulgiati, S. 2016. A review on circular economy: The expected transition to a balanced interplay of environmental and economic systems. *J. Clean. Prod.*, 114, 11–32.
- Giurco, D., Littleboy, A., Boyle, T., Fyfe, J., White, S. 2014. Circular economy: Questions for responsible minerals, additive manufacturing and recycling of metals. *Resources*, 3, 432–453.
- Godfrey, L., Todd, C. 2001. Defining thresholds for freshwater sustainability indicators within the context of South African water resource management. In *Proceedings of the 2nd WARFAWaternet symposium*, Cape Town, South Africa, 30–31 October 2001.
- Graedel, T. E., Allwood, J., Birat, J.-P., Buchert, M., Hagelüken, C., Reck, B.K., Sibley, S.F., Sonnemann, G. 2011. What Do We Know About Metal Recycling Rates?. *Journal of Industrial Ecology*, 15 (3), 355-366.
- Griffiths, P., Cayzer, S. 2016. Design of indicators for measuring product performance in the circular economy. *International Conference on Sustainable Design and Manufacturing, SDM 2016*, 307-321.
- Guo-gang, J., Jing, C. 2011. *Research on Evaluation of Circular Economy Development*. 8th International Conference on Innovation & Management, Kitakyushu, Japan.
- Haas, W., Krausmann, F., Wiedenhofer, D., Heinz, M. 2015. How circular is the global economy?: An assessment of material flows, waste production, and recycling in the European Union and the world in 2005. *Journal of Industrial Ecology*, 19 (5), 765–777.
- Hagelüken, C., Lee-Shin, J., Carpentier, A., Heron, C. 2016. The EU Circular Economy and Its Relevance to Metal Recycling. *Recycling* 1 (2), 242-253.
- Halog, A., Manik, Y. 2011. Advancing Integrated Systems Modelling Framework for Life Cycle Sustainability Assessment. *Sustainability*, 3, 469–499.
- Hardi, P., Zdan, T. 1997. *Principles in Practice. Assessing Sustainable Development*. IISD-International Institute for Sustainable Development, Winnipeg.
- Haupt, M., Vadenbo, C., Hellweg, S. 2017. Do We Have the Right Performance Indicators for the Circular Economy?: Insight into the Swiss Waste Management System. *Journal of Industrial Ecology*, 21, 615–627.
- Hernandez-Pardo, R., Brissaud, D., Mathieux, F., Zwolinski, P. 2011. Contribution to the characterization of ecodesign projects. *Int. J. Sustain. Eng.*, 4 (4), 301-312.
- Hollander, M.C., Bakker, C.A., Hultink, E.J. 2017. Product design in a circular economy: development of a typology of key concepts and terms. *J. Ind. Ecol.* 21, 517–525.
- Huamao, X., Fengqi, W. 2007. Circular Economy Development Mode Based on System Theory. *Chin. J. Popul. Res. Environ.*, 5, 92–96.
- Huysman, S., De Schaepmeester, J., Ragaert, K., Dewulf, J., De Meester, S., 2017. Performance indicators for a circular economy: a case study on post-industrial plastic waste. *Resour. Conserv. Recycl.* 120, 46–54.
- Iacovidou, E., Velis, C.A., Purnell, P., Zwirner, O., Brown, A., Hahladakis, J., Millward-Hopkins, J., Williams, P.T. 2017. Metrics for optimising the multi-dimensional value of resources recovered from waste in a circular economy: a critical review. *J. Clean. Prod.*, 166, 910-938.
- J. Ind. Ecol.*, 21 (3), 603-614.
- Janin, M., 2000. *Démarche d'éco-conception en entreprise. Un enjeu : construire la cohérence entre outils et processus ("A framework of ecodesign in enterprise. A challenge: Construction of the coherence among tools and processes")*. PhD thesis. ENSAM, Chambéry, France (in French).

- Jesinghaus, J. 2014. *Bellagio Principles for Assessing Sustainable Development*. Encyclopedia of Quality of Life and Well-Being Research, Springer Publishers.
- Joung, C.B., Carrell, J., Sarkar, P., Feng, S.C. 2012. Categorization of indicators for sustainable manufacturing. *Ecological Indicators*, 24, 148-157.
- Kingfisher. 2014. *The Business Opportunity of Closed Loop Innovation*. Closed Loop Innovation Booklet. Kingfisher: Westminster, UK.
- Kirchherr, J., Reike, D., Hekkert, M. 2017. Conceptualizing the circular economy: An analysis of 114 definitions, *Resources, Conservation and Recycling*, 127, 221-232.
- Kok, L., Wurpel, G., Ten Wolde, A. 2013. *Unleashing the Power of the Circular Economy*. Report for Circle Economy, IMSA, Amsterdam.
- Krajnc, D., Glavic, P. 2003. Indicators of sustainable production. *Clean Technol. Environ. Policy*, 5 (3), 279–288.
- Lehmann, Z. 2013. The zero waste index: a performance measurement tool for waste management systems in a 'zero waste city'. *Journal of Cleaner Production*, 50, 123-132.
- Lewandowski, M. 2016. Designing the Business Models for Circular Economy – Towards the Conceptual Framework. *Sustainability*, 8, 43.
- Li H., Bao W., Xiu C., Zhang Y., Hongbin Xu, H. 2010. Energy conservation and circular economy in China's process industries. *Energy* 35, 4273–4281.
- Li, R.H., Su, C.H. 2012. Evaluation of the circular economy development level of Chinese chemical enterprises. *Procedia Environ. Sci.*, 13, 1595–1601.
- Li, S. 2012. Quantitative Evaluation of Circular Economy Based on Waste Input-Output Analysis. *Procedia Environ. Sci.*, 12, 65–71.
- Lieder, M., Rashid, A. 2016. Towards circular economy implementation: a comprehensive review in context of manufacturing industry. *Journal of Cleaner Production*, 115, 36-51.
- Linder, M., Sarasini, S., van Loon, P. 2017. A Metric for Quantifying Product-Level Circularity. *Journal of Industrial Ecology*, 21, 545–558.
- Little, J., Hester, E., Carey, C. 2016. Assessing and Enhancing Environmental Sustainability: A Conceptual Review. *Environmental science & technology*, 50 (13), 6830-6845.
- Lüdeke-Freund, F., Gold, S., Bocken, N. M. 2018. A Review and Typology of Circular Economy Business Model Patterns. *Journal of Industrial Ecology*. doi:10.1111/jiec.12763
- Lützkendorf, T., Balouktsi, M. 2017. Assessing a Sustainable Urban Development: Typology of Indicators and Sources of Information. *Procedia Environmental Sciences*, 38, 546-553.
- Magnier, C., 2017. 10 Key Indicators for Monitoring the Circular Economy. The Monitoring and Statistics Directorate, Paris.
- Marco Capellini, Sustainable Design & Consulting. 2015. Measure the circularity of a public lighting system. <https://www.capcon.it/en/measure-the-circularity-of-a-public-lighting-system/> (accessed 15 May 2018).
- Maslow, A. 1943. A Theory of Human Motivation. *Psychol. Rev.*, 50, 370–396.
- MGI-McKinsey Global Institute. 2015. *Europe's Circular Economy Opportunity*. Report, September 2015.
- MGI-McKinsey Global Institute. 2017. *Europe's Circular Economy Opportunity*. Available online: <http://www.mckinsey.com/business-functions/sustainability-and-resource-productivity/our-insights/europes-circular-economy-opportunity> (Accessed on 1 March 2017).
- Moreno, M., De los Rios, C., Rowe, Z., Charnley, F. 2016. A Conceptual Framework for Circular Design, *Sustainability* 8, (9), 937.
- Moreno, M.A., Ponte, O., Charnley, F. 2017. Taxonomy of design strategies for a circular design tool. PLATE conference, Product Lifetimes and the Environment, Conference Proceedings, C. Bakker and R. Mugge (Eds.), Delft University of Technology.
- Núñez-Cacho, P., Górecki, J., Molina, V., Corpas-Iglesias, F.A. 2018. New Measures of Circular Economy Thinking In Construction Companies. *Journal of EU Research in Business*, Vol. 2018.
- OECD-Organisation for Economic Co-operation and Development. 2014. *Measuring and managing results in development co-operation*. November 2014.
- O'Hare, J. A., McAloone, T. C., Pigosso, D. C. A., Howard, T. J. 2014. *Eco-Innovation Manual: Working version for Pilot Application*. United Nations Environment Programme (UNEP), September 2014, 119 p.
- Otero, J.C. 2015. *Circularity assessment for companies: elements for a general framework*. Master's Thesis in Industrial Ecology. Department of Energy and Environment. Chalmers University of Technology. Gothenburg, Sweden.
- Park J.Y., Chertow M.R. 2014. Establishing and testing the "reuse potential" indicator for managing wastes as resources. *J Environ Manage.*, 137, 45-53.
- Park, K., Kremer, G. 2017. Text mining-based categorization and user perspective analysis of environmental sustainability indicators for manufacturing and service systems. *Ecological Indicators*, 72, 803-82.
- Parmenter, D. 2015. *Key Performance Indicators: Developing, Implementing, and Using Winning KPIs*. John Wiley & Sons: Hoboken, NJ, USA, p. 448.
- Parto, S., Loorbach, D., Lansink, A. 2007. Transitions and institutional change: The case of the Dutch waste subsystem. In *Industrial Innovation and Environmental Regulation*; United Nations University Press: Tokyo, Japan.
- Pauliuk, S. 2018. Critical appraisal of the circular economy standard BS 8001:2017 and a dashboard of quantitative system indicators for its implementation in organizations. *Resources, Conservation and Recycling*, 129, 81-92.
- Pauliuk, S., Kondo, Y., Nakamura, S., Nakajima, K. 2017. Regional distribution and losses of end-of-life steel throughout multiple product life cycles – insights from the global multiregional MaTrace model. *Resour. Conserv. Recycl.*, 116, 84–93.
- PGGM, 2015. *Circularity Assessment Tool*. <https://www.circle-economy.com/actiam-launching-customer-for-circularity-assessment-tool/#.Wic4cnlryM8> (accessed 15 May 2018).
- Potting, J., Hekkert, M., Worrell, E., and Hanemaaijer, A. 2016. *Circular Economy: Measuring innovation in product chains*. PBL Netherlands Environmental Assessment Agency, The Hague.
- Qing Y., Qiongqiong G., Mingyue C. 2011. Study and Integrative Evaluation on the development of Circular Economy of Shaanxi Province. *Energy Procedia*, 5, 1568–1577.
- Recycling. 2017. Available online: <http://www.recycling.com/downloads/waste-hierarchy-lansinks-ladder/> (accessed on 1 February 2017).
- ResCoM-Resource Conservative Manufacturing Project. The ResCoM platform and tools. <http://www.rescoms.eu/platform-and-tools> (accessed 15 May 2018).
- Rossi, M., Germani, M., Zamagni, A. 2016. Review of ecodesign methods and tools. Barriers and strategies for an effective implementation in industrial companies, *Journal of Cleaner Production*, 129, 361-373.
- Rousseaux, P., Gremy-Gros, C., Bonnin, M., Henriel-Ricordel, C., Bernard, P., Flourey L., Staigre, G., Vincent, P. 2017. "Eco-tool-seeker": A new and unique business guide for choosing ecodesign tools, *Journal of Cleaner Production*, 151, 546-577.
- Ruiz-Mercado, G.J. 2012. Sustainability Indicators for Chemical Processes: I. Taxonomy. *Ind. Eng. Chem. Res.*, 51, 2309–2328.
- Sabaghi, M., Mascle, C., Baptiste, P., Rostamzadeh, R. 2016. Sustainability assessment using fuzzy-inference technique (SAFT): A methodology toward green products. *Expert Syst. Appl.* 2016, 56, 69–79.
- Sacchi Homrich, A., Galvão, G., Gamboa Abadia, L., Carvalho, M.M. 2018. The circular economy umbrella: Trends and gaps on integrating pathways. *Journal of Cleaner Production*, 175, 525-543.
- Saidani, M., Cluzel, F., Leroy, Y., Auclair, A. 2016. Time-efficient eco-innovation workshop process in complex system industries. In *Proceedings of the 14th International Design Conference*, Dubrovnik, Croatia, 16–19 May 2016.
- Saidani, M., Yannou, B., Leroy, Y., Cluzel, F. 2017a. How to Assess Product Performance in the Circular Economy? Proposed Requirements for the Design of a Circularity Measurement Framework. *Recycling*, 2, 6.

- Saidani, M., Yannou, B., Leroy, Y., Cluzel, F. 2017b. Hybrid top-down and bottom-up framework to measure products' circularity performance. Proceedings of the 21th International Conference on Engineering Design, ICED 17, Vancouver, Canada.
- Sauvé, S., Bernard, S., Sloan, P. 2016. Environmental sciences, sustainable development and circular economy: Alternative concepts for trans-disciplinary research. *Environ. Dev.*, 17, 48–56.
- Scheepens, A. E., Vogtlander, J. G., Brezet, J. C. 2016. Two life cycle assessment (LCA) based methods to analyse and design complex (regional) circular economy systems. Case: Making water tourism more sustainable. *Journal of Cleaner Production*, 114, 257–268.
- Schroeder, P., Anggraeni, K., Weber, U. 2018. The Relevance of Circular Economy Practices to the Sustainable Development Goals. *Journal of Industrial Ecology*.
- ScoreLCA. 2015. Circular Economy: Concepts and Evaluation Methods. ScoreLCA, Villeurbanne, France.
- Sikdar, S. K. 2003. Sustainable development and sustainability metrics. *AIChE J.*, 49 (8), 1928–1932.
- Singh, R.K., Murty, H.R., Gupta, S.K., Dikshit, A.K. 2012. An overview of sustainability assessment methodologies, *Ecological Indicators*, 15 (1), 281-299.
- Smith, K.B. 2002. Typologies, taxonomies, and the benefits of policy classification. *Policy Studies Journal*, Sep. 2002.
- Smol, M., Kulczycka, J., Avdiushchenko, A. 2017. Circular economy indicators in relation to eco-innovation in European regions *Clean Techn Environ Policy*, 19 (3), 669–678.
- Su, B., Heshmati, A., Geng, Y., Yu, X. 2013. A review of the circular economy in China: Moving from rhetoric to implementation. *J. Clean. Prod.*, 42, 215–227.
- Talwar, S. 2017. Circular Economy indicators for India: a scientific macro assessment of 5 circular economic measures, and their comparative performance to global industrial hubs. ISIE-ISSST 2017 Conference: Science in Support of Sustainable and Resilient Communities, Chicago, USA.
- Thomas, J.-S., Birat, J.-P. 2013. Methodologies to measure the sustainability of materials – focus on recycling aspects. *Rev. Metall.*, 110 (1), 3-16.
- Urbinati, A., Chiaroni, D., Chiesa, V. 2017. Towards a new taxonomy of circular economy business models. *Journal of Cleaner Production*, 168, 487-498.
- US Chamber Foundation. 2017. Measuring Circular Economy, Circular Economy Toolbox, USA. <https://www.uschamberfoundation.org/circular-economy-toolbox/about-circularity/measuring-circular-economy> (accessed 15 May 2018).
- Van Schaik, A., Reuter, M.A. 2016. Recycling Indices Visualizing the Performance of the Circular Economy, *World of Metallurgy*, 69, 4.
- VBDO. 2015. Circular Economy: Company Assessment Criteria. Utrecht, Netherlands.
- Verberne, J. 2016. Building Circularity Indicators—An Approach for Measuring Circularity of a Building. Master's Thesis, Eindhoven University of Technology, Eindhoven, The Netherlands.
- Viktoria Swedish ICT. 2015. Measuring business model circularity as a means to promote resource productivity. Gothenburg.
- Waas, T., Hugé, J., Block, T., Wright, T., Benitez-Capistros, F., Verbruggen, A. 2014. Sustainability assessment and indicators: Tools in a decision-making strategy for sustainable development. *Sustainability*, 6, 5512–5534.
- Walker, S., Coleman, N., Hodgson, P., Collins, N., Brimacombe, L. 2018. Evaluating the Environmental Dimension of Material Efficiency Strategies Relating to the Circular Economy. *Sustainability*, 10, 666.
- Weiland, U. 2006. Sustainability Indicators and Sustainable Development. In: Wuyi, W., Krafft, T., Kraas, F.: *Global Change, Urbanization and Health*. China Meteorological Press, Beijing, pp. 241–250.
- Wen, Z., Meng, X. 2015. Quantitative assessment of industrial symbiosis for the promotion of circular economy: A case study of the printed circuit boards industry in China's Suzhou New District. *J. Clean. Prod.*, 90, 211–219.
- Wilts, H., Von Gries, N., Bahn-Walkowiak, B. 2016. From Waste Management to Resource Efficiency—The Need for Policy Mixes. *Sustainability*, 8, 622.
- Winans, K., Kendall, A., Deng, H., 2017. The history and current applications of the circular economy concept. *Renewable and Sustainable Energy Reviews*, 68 (1), 825-833.
- Wisse, E. 2016. Assessment of indicators for Circular Economy: The case for the Metropole Region of Amsterdam, Faculty of Geosciences Theses, Utrecht University, Master Sustainable Business and Innovation.
- WRAP-Waste & Resources Action Programme. 2017. WRAP's Vision for the UK Circular Economy to 2020. Available online: <http://www.wrap.org.uk/content/wraps-vision-uk-circular-economy-2020> (accessed on 1 February 2017).
- Wu, H., Shi, Y., Xia, Q., Zhu, W. 2014. Effectiveness of the policy of circular economy in China: A DEA-based analysis for the period of 11th five-year-plan. *Resources, Conservation and Recycling*, 83, 163–175.
- Xavier, A.F., Naveiro, R.M., Aoussat, A., Reyes, T. 2017. Systematic literature review of eco-innovation models: Opportunities and recommendations for future research. *Journal of Cleaner Production*, 149, 1278-1302.
- Zhou, Z., Chen, X., Xiao, X. 2013. On Evaluation Model of Circular Economy for Iron and Steel Enterprise Based on Support Vector Machines with Heuristic Algorithm for Tuning Hyper-parameters. *Appl. Math. Inf. Sci.*, 6, 2215–2223.

ESSAY #3

- ACEA-European Automobile Manufacturers' Association. 2017. Vehicles in use, Europe 2017. ACEA Report. Accessed on April 2018: http://www.acea.be/uploads/statistic_documents/ACEA_Report_Vehicles_in_use-Europe_2017.pdf
- Alonso, E., Field, F. R., Kirchain, R. E. 2012. Platinum Availability for Future Automotive Technologies. *Environmental Science & Technology*, 46 (23), 12986-12993.
- Amatayakul, W., Ramnas O. 2001. Life cycle assessment of a catalytic converter for passenger cars. *Journal of Cleaner Production*, 9, 395–403.
- Andersson, M., Ljunggren Söderman, M., Sandén, B. A. 2017. Are scarce metals in cars functionally recycled?, *Waste Management*, 60, 407-416.
- Artelt, S., Kock, H., König, H.P., Levsen, K., Rosner, G. 1999. Engine dynamometer experiments: platinum emissions from differently aged three-way catalytic converters. *Atmos Environ*, 33, 3559-3567.
- Aydin, R., Kwong, C.K., Geda, M.W., Kremer, G.E.O. 2017. Determining the optimal quantity and quality levels of used product returns for remanufacturing under multi-period and uncertain quality of returns. *Int J Adv Manuf Technol*.
- Barbante, C., Veysseyre, A., Ferrari, C., Van de Velde, K., Morel, C., Capodaglio, G., Cescon, P., Scarponi, G., Boutron, C. 2001. Greenland snow evidence of large scale atmospheric contamination for platinum, palladium, and rhodium. *Environ Sci Technol*, 35, 835-839.
- Bardi, U., Caporali, S. 2014. Precious Metals in Automotive Technology: An Unsolvable Depletion Problem? *Minerals*, 4, 388-398.
- Belcastro, E. L. 2012. Life Cycle Analysis of a Ceramic Three-Way Catalytic Converter. Virginia Tech, Master Thesis.
- Bellstedt, C. 2015. Material Flow Analysis for a Circular Economy Development: A Material Stock Quantification Method of Urban Civil Infrastructures with a Case Study of PVC in an Amsterdam Neighbourhood, Delft University of Technology, Master Thesis. English.
- BIO by Deloitte. 2015. Study on Data for a Raw Material System Analysis: Roadmap and Test of the Fully Operational MSA for Raw Materials. Prepared for the European Commission, DG GROW.
- Björklund, A.E. 2002. Survey to improve reliability in LCA. *International Journal of LCA*, 7 (2), 64-72.
- Bocken, N.M.P., Schuit, C.S.C., Kraaijenhagen, C. 2018. Experimenting with a circular business model: Lessons from eight cases. *Environmental Innovation and Societal Transitions*. In press.
- Bollinger, L. A., Davis, C., Nikolić, I., Dijkema, G. P. 2012. Modeling metal flow systems. *Journal of Industrial Ecology*, 16 (2), 176–190.
- Bossi, T., Gediga, J. 2017. The Environmental Profile of Platinum Group Metals, *Johnson Matthey Technology Review*, 61, (2), 111–121.
- Brunner, P. H., Rechberger, H. 2003. Practical handbook of material flow analysis. CRC Press.
- Cairncross, E. 2014. Health and environmental impacts of platinum mining. Report from South Africa, on behalf of PHM March 2014.
- Casper, R., Sundin, E. 2018. Addressing Today's challenges in automotive remanufacturing. *Jnl Remanufactur*. In press.
- Cencic, O. 2016. Nonlinear data reconciliation in material flow analysis with software STAN. *Sustainable Environment Research*, 26, 291-298.
- Cencic, O., Rechberger, H. 2008. Material Flow Analysis with Software STAN. *Journal of Environmental Engineering and Management*, 18 (1), 5.
- CEPLACA. 1997. Assessment of environmental contamination risk by platinum, rhodium and palladium from automobile catalyst. Environmental and climate programme, European Union, ENV4-CT97-0518.
- CETIM. 2017. Recyclage des métaux stratégiques. Note de veille technologique du CETIM.
- CGE-Conseil général de l'économie. 2015. L'économie circulaire ou la compétition pour les ressources. La Documentation Française. French.
- Chemineau, L. 2011. Développement d'une méthode d'éco-conception basée sur la modélisation et l'évaluation des filières de valorisation : application au secteur automobile. PhD Thesis, Sciences de l'ingénieur [physics]. Ecole nationale supérieure des arts et métiers (ENSAM). French.
- Cullen, J. M. 2017. Circular Economy: Theoretical Benchmark or Perpetual Motion Machine?. *Journal of Industrial Ecology*, 21, 483-486.
- Davis W.S. 1992. Tools and Techniques for Structured Systems Analysis and Design. Addison-Wesley.
- Deloitte Sustainability, British Geological Survey, Bureau de Recherches Géologiques et Minières, Netherlands Organisation for Applied Scientific Research, 2017. Study on the review of the list of Critical Raw Materials — Criticality Assessment. Report prepared for the European Commission.
- Diener, D.L., Tillman, A.N. 2015. Component end-of-life management: Exploring opportunities and related benefits of remanufacturing and functional recycling, *Resources, Conservation and Recycling*, Volume 102, 2015, Pages 80-93.
- Diener, D., Tillman, A.-M. 2016. Scrapping steel components for recycling - Isn't that good enough? Seeking improvements in automotive component end-of-life. *Resources, Conservation and Recycling*, 110, 48-60.
- Dubiella-Jackowska, A., et al. 2008. Platinum Group Elements in the Environment: Emissions and Exposure. Chapter 3, in *Reviews of Environmental Contamination and Toxicology*, Volume 199, David M. Whitacre (eds.), Springer.
- Dwek, M., Zwolinski, P. 2015. How can we predict the evolution of recycling chains? *Matériaux & Techniques*, 103, 1.
- Earley, R. 2017. Circular Design Futures. *The Design Journal*, 20, 4, 421-434.
- EASAC-European Academies Science Advisory Council. 2016. Priorities for critical materials for a circular economy. EASAC policy report 29, November 2016.
- EC-European Commission. 2014. Communication from the Commission to the European Parliament, the Council, the European Economic and Social Committee and the Committee of the Regions: Towards a Circular Economy: A Zero Waste Programme for Europe. Brussels, Belgium.
- EC-European Commission. 2015. Closing the loop – An EU action plan for the Circular Economy. The Circular Economy Package Proposal. Communication from the Commission to the European Parliament, the Council, the European Economic and Social Committee and the Committee of the Regions. Brussels, Belgium.
- EC-European Commission. 2017. Study on the review of the list of Critical Raw Materials, Critical Raw Materials Factsheets. Luxembourg: Publications Office of the European Union, June 2017.
- Eldridge, S.M., Lancaster, G.A., Campbell, M.J., Thabane, L., Hopewell, S., et al. 2016. Defining Feasibility and Pilot Studies in Preparation for Randomised Controlled Trials: Development of a Conceptual Framework. *Plos One*, 11 (3).
- EMF-Ellen MacArthur Foundation. 2015. Circularity Indicators – An Approach to Measure Circularity. Methodology & Project Overview. Cowes, UK.
- ERN-European Remanufacturing Network. 2016. Map of Remanufacturing Processes Landscape. June 2016.
- EU-JRC 24708 EN. 2010. International reference life cycle data system (ILCD) handbook—General guide for life cycle assessment—Detailed guidance. First edit. European Commission Joint Research Center Institute for Environment and Sustainability. Luxembourg: Publications Office of the European Union.
- Eurostat. 2017. End-of-life vehicles statistics. Accessed on April 2018: http://ec.europa.eu/eurostat/statistics-explained/index.php/End-of-life_vehicle_statistics
- Farel, R., Yannou, B. 2013. A Method to Design a Value Chain from Scratch. A. Chakrabarti and R. V. Prakash (eds.), ICoRD'13, Lecture Notes in Mechanical Engineering, Springer India.
- Farel, R., Yannou, B., Bertoluci, G. 2013. Finding Best Practices for Automotive Glazing Recycling: a Network Optimization Model. *Journal of Cleaner Production*, 52, 446-461.
- Fornalczyk, A., Saternus, M. 2013. Platinum recovery from used auto catalytic converters in electrorefining process. *Metalurgija*, 52, 2, 219-222.
- Forrester, J.W. 1961. *Industrial Dynamics*. Cambridge MA: Productivity Press.
- Gaustad, G., Krystofik, M., Bustamante, M., Badami, K. 2018. Circular economy strategies for mitigating critical material supply issues. *Resources, Conservation and Recycling*, 135, 24-33.

- Geissdoerfer, M., Savaget, P., Bocken, N.M., Hultink, E.J. 2017. The Circular Economy—A new sustainability paradigm? *J. Clean. Prod.*, 143, 757–768.
- Glaister, B. J., Mudd, G. M. 2010. The environmental costs of platinum–PGM mining and sustainability: Is the glass half-full or half-empty? *Minerals Engineering*, 23 (5), 438–450.
- Gnoni, M.G., Mossa, G., Mummolo, G., Tornese, F., Verriello, R. 2017. Circular Economy strategies for electric and electronic equipment: a Fuzzy Cognitive Map. *Environmental Engineering & Management Journal*, 16, 8, 1807-1817.
- Godet, M. 2001. *Creating Futures: scenario-building as a strategic management tool*, Economica-Brookings, Paris.
- Godet, M. 2007. *Manuel de prospective stratégique*, Dunod, Paris.
- Graedel, T.E., Allwood, J.M., Birat, J.-P., Buchert, M., Hagelüken, C., Reck, B.K., Sibley, S.F., Sonnemann, G. 2011. What Do We Know About Metal Recycling Rates? *J. Ind. Ecol.* 15, 355–366.
- Gray, S., Cox, L., Henly-Shepard, S. 2013. Mental modeler: A fuzzy-logic cognitive mapping modelling tool for adaptive environmental management. *Proceedings of the 46th International Conference on Complex Systems*.
- Groen, E.A., et al. 2017. Methods for global sensitivity analysis in life cycle assessment. *Int J Life Cycle Assess.*, 22, 1125.
- Gustavsen, B. 2008. Action research, practical challenges and the formation of theory. *Action Research*, 6 (4), 421–437.
- Haas, W., Krausmann, F., Wiedenhofer, D., Heinz, M. 2015. How Circular is the Global Economy?: An Assessment of Material Flows, Waste Production, and Recycling in the European Union and the World in 2005. *J. Ind. Ecol.* 19, 765–777.
- Hagelüken, C. 2012. Recycling the Platinum Group Metals: A European Perspective. *Effective recycling systems for pgm-containing materials will ensure sustainable supply. Platinum Metals Rev.*, 56 (1).
- Hagelüken, C. 2014. Recycling of (critical) metals, in: G. Gunn (Ed.), *Critical Metals Handbook*, John Wiley & Sons, 41–69.
- Hagelüken, C., Buchert, M., Ryan, P. 2009. Materials flow of platinum group metals in Germany. *International Journal of Sustainable Manufacturing*, 1, 330–346.
- Hagelüken, C., Lee-Shin, J. U., Carpentier, A., Heron, C. 2016. The EU Circular Economy and Its Relevance to Metal Recycling. *Recycling*, 1, 242-253.
- Hatcher, G.D., Ijomah, W.L., Windmill, J.F.C. 2011. Design for remanufacture: a literature review and future research needs. *Journal of Cleaner Production*, 19, 17 (18), 2004-2014.
- Haupt, M., Vadenbo, C., Hellweg, S. 2017. Do We Have the Right Performance Indicators for the Circular Economy?: Insight into the Swiss Waste Management System. *Journal of Industrial Ecology*, 21, 615–627.
- Helmers, E. 1997. Platinum Emission Rate of Automobiles with Catalytic Converters, *Environmental Science and Pollution Research*, 4, 100.
- Hill, R.F., Mayer, W.J. 1977. Radiometric determination of platinum and palladium attrition from automotive catalysts. *IEEE Trans. Nucl. Sci.*, 24, 2549–2554
- ICCT-International Council on Clean Transportation. 2016. *European Vehicles Market Statistics. Pocketbook 2015-2016*.
- Idjis, H., Da Costa, P., Attias, D. 2017 *Is Electric Vehicles Battery Recovery a Source of Cost or Profit?, The Automobile Revolution*, Springer.
- Igarashi, K., Yamada, T., Gupta, S.M., Inoue, M., Itsubo, N. 2016. Disassembly system modeling and design with parts selection for cost, recycling and CO2 saving rates using multi criteria optimization. *Journal of Manufacturing Systems*, 38, 151-164.
- Inghels, D., Dullaert, W., Raa, B., Walther, G. 2016. Influence of composition, amount and life span of passenger cars on end-of-life vehicles waste in Belgium: A system dynamics approach. *Transportation Research Part A: Policy and Practice*, 91, 80-104.
- IPA-International Platinum Group Metals Association. 2016. *Autocatalysts and platinum group metals. PGM fact sheets*.
- IPA-International Platinum Group Metals Association. 2016. *The LCA of platinum group metals. PGM fact sheets*.
- Ishikawa, K. 1976. *Guide to Quality Control*. Asian Productivity Organization. ISBN 92-833-1036-5.
- Ismail, N.H. 2016. *2-DFR: a framework to guide designers toward sustainable remanufacturing*. PhD Thesis. Industrial Engineering. Grenoble INP.
- ISO-International Organization for Standardization. 2006. *ISO 14044. Environmental management—Life cycle assessment—Requirements and guidelines*. Geneva, Switzerland: International Organization for Standardization.
- Japke, O. 2009. *Development of a framework for assessing the economic benefits of remanufacturing*. CRR, Center for Remanufacturing & Reuse, UK.
- JM-Johnson Matthey. 2017. *PGM Market Report May 2017: Summary of Platinum Supply & Demand*. Johnson Matthey Precious Metals Management.
- Kalavrouziotis, I.K., Koukoulakis, P.H. 2009. The environmental impact of the platinum group elements (Pt, Pd, Rh) emitted by the automobile catalyst converters. *Water Air Soil Pollut*, 196, 393–402.
- Kalmykova, Y., Sadagopan, M., Rosado, L. 2018. Circular economy – From review of theories and practices to development of implementation tools. *Resources, Conservation and Recycling*, 135, 190-201.
- König, H.P., Hertel, R.F., Koch, W., Rosner, G. 1992. Determination of the platinum emissions from three-way catalyst-equipped gasoline engine. *Atmos Environ*, 992, 741-745.
- Kwak, M., Kim, H. 2013. Market Positioning of Remanufactured Products with Optimal Planning for Part Upgrades. *Journal of Mechanical Design*, 135.
- Kwak, M., Kim, H. 2015. Design for life-cycle profit with simultaneous consideration of initial manufacturing and end-of-life remanufacturing. *Engineering Optimization*, 47 (1), 18-35.
- Kwak, M., Kim, H. 2017. Green profit maximization through integrated pricing and production planning for a line of new and remanufactured products. *Journal of Cleaner Production*, 142.
- Laner, D., Rechberger, H., Astrup, T. 2014. Systematic Evaluation of Uncertainty in Material Flow Analysis. *Journal of Industrial Ecology*, 18(6), 859-870.
- Laner, D., Rechberger, H., Astrup, T. 2015. Applying Fuzzy and Probabilistic Uncertainty Concepts to the Material Flow Analysis of Palladium in Austria. *Journal of Industrial Ecology*.
- Lapko, Y., Trianni, A., Nuur, C., Masi, D. 2018. In Pursuit of Closed-Loop Supply Chains for Critical Materials: An Exploratory Study in the Green Energy Sector. *Journal of Industrial Ecology*. doi:10.1111/jiec.12741
- Lee, H.B., Cho, N.W., Hong, Y.S. 2010. A hierarchical end-of-life decision model for determining the economic levels of remanufacturing and disassembly under environmental regulations. *Journal of Cleaner Production*.
- Lee, H.M., Lu, W.F., Song, B. 2014. A framework for assessing product End-Of-Life performance: reviewing the state of the art and proposing an innovative approach using an End-of-Life Index. *Journal of Cleaner Production*.
- Lee, S.G., Lye, S.W., Khoo, M.K. 2001. A multi-objective methodology for evaluating product end-of-life options and disassembly. *Int J Adv Manuf Technol*, 18, 148–156.
- Leroy, Y. 2009. *Développement d'une méthodologie de fiabilisation des prises de décisions environnementales dans le cadre d'ACV basée sur l'analyse et la gestion des incertitudes sur les données d'inventaires*. Arts et Métiers ParisTech. PhD thesis. French.
- Leroy, Y., Tyl, B., Vallet, F., Cluzel, F. 2015. Environmental evaluation of ideas in early phases: a challenging issue for design teams. *DS 80-1 Proceedings of the 20th International Conference on Engineering Design (ICED 15), Design for Life*, 1, 117-126, Jul 2015, Milan, Italy.
- Linder, M., Sarasini, S., van Loon, P. 2017. A Metric for Quantifying Product-Level Circularity. *Journal of Industrial Ecology*, 21, 545–558.
- Limer, E. 2016. There Is Platinum in the Dirt on the Side of the Road. <https://popularmechanics.com/science/a21091/platinum-in-highway-dirt/>

- Lishan, X., Weiling, L., Qinghai, G., Lijie, G., Guoqin, Z., Xiji, C. 2018. Comparative life cycle assessment of manufactured and remanufactured loading machines in China. Resources, Conservation and Recycling. In press.
- List, J., 2016. Mining platinum from the road. Accessed on April 2018: <https://hackaday.com/2016/06/06/mining-platinum-from-the-road/>
- Lopez-Ontiveros, M. 2004. Intégration des contraintes de remanufacturabilité en conception de produits. PhD Thesis. Industrial Engineering. Grenoble INP. French.
- Lorz, B. 2017. The End-of-life vehicles (ELV) Directive and its implementation, European Commission, DG EN-VUN-ECE Conference, Geneva, 20 March 2017.
- Løvik, A. N., Hagelūken, C., Wäger, P. 2018. Improving supply security of critical metals: Current developments and research in the EU. Sustainable Materials and Technologies, 15, 9-18.
- Luglietti, R., Taisch, M., Magalini, F., Cassina J., Mascolo, J.E. 2014. Environmental and economic evaluation of end-of-life alternatives for automotive engine. International Conference on Engineering, Technology and Innovation (ICE), Bergamo.
- Ma, J., Kremer, G.E.O. 2015. A fuzzy logic-based approach to determine product component end-of-life option from the views of sustainability and designer's perception. Journal of Cleaner Production, 108, 289-300.
- Marca, D.A., McGowan, C.L. 1988. SADT: structured analysis and design technique. McGraw-Hill Book Co., Inc.: New York.
- Mathieux, F., Ardente, F., et al. 2017. Critical Raw Materials and the Circular Economy – Background report. JRC Science-for-policy report. Publications Office of the European Union, Luxembourg, 2017.
- Mathieux, F., Brissaud, D. 2010. End-of-life product-specific material flows analysis. Application to aluminum coming from end-of-life commercial vehicles in Europe. Resources, Conservation and Recycling, 55 (2), 92-105.
- Matlab R2018a. Sensitivity Analysis. Accessed on April 2018: <https://fr.mathworks.com/help/sldo/sensitivity-analysis.html>
- McManners, P. 2015. The action research case study approach: A methodology for complex challenges such as sustainability in aviation. Action Research, 1-16.
- Moldovan, M., et al. 2006. Release of Particulate and Acid Soluble Palladium from Catalytic Converters into the Environment, Chapter 2, in Palladium Emissions in the Environment Analytical Methods, Environmental Assessment and Health Effects, Editors: Zereini, Fathi, Alt, Friedrich (Eds.)
- Montmasson-Clair, G. 2016. Mining, energy and low-carbon economy in South Africa: a platinum case study. 2016 TIPS Forum, Trade & Industrial Policy Strategies, 14-15 June 2016.
- Moriguchi Y., Hashimoto, S. 2016. Material Flow Analysis and Waste Management. Taking Stock of Industrial Ecology, Chapter 12, 247-262.
- Nuss, P., Eckelman M. J. 2014. Life Cycle Assessment of Metals: A Scientific Synthesis. PLOS ONE, 9 (7).
- Palacios, M.A., Gómez, M., Moldovan, M, et al., 2000. Platinum-group elements: quantification in collected exhaust fumes and studies of catalyst surfaces. Sci Total Environ, 257, 1-15.
- Papageorgiou, E.I., Salmeron, J.L. 2011. Review of Fuzzy Cognitive Map Research during the last decade. IEEE Transactions on Fuzzy Systems, 1-14.
- Peters, G. 2007. Efficient algorithms for life cycle assessment, input-output analysis, and monte-carlo analysis. Int. J. Life Cyc Ass. 12, 373-380.
- Pospiech, B. 2012. Studies on platinum recovery from solutions after leaching of spent catalysts by solvent extraction. Physicochemical Problems of Mineral Processing, 48, 1, 239.
- Rauch, S., Hemond, H.F., Barbante, C., et al. 2005. Importance of automobile exhaust catalyst emissions for the deposition of platinum, palladium, and rhodium in the Northern Hemisphere. Environmental Science & Technology, 39, 8156-8162.
- Rauch, S., Morrison, G.M. 2008. Environmental Relevance of the Platinum Group Elements. Elements, 4, 259-263.
- Ravindra, K., Bencs, L., Van Grieken, R. 2004. Platinum group elements in the environment and their health risk". Sci Total Environ, 318, 1-43.
- Remanufacturing Industries Council. 2018. The Impacts of Remanufacturing, <http://www.remanouncil.org/>
- Richardson, G.P. 2013. System Dynamics. In: Gass S.I., Fu M.C. (eds) Encyclopedia of Operations Research and Management Science. Springer, Boston, MA.
- Rodrigues, V., Pigosso, D., McAloone, T. 2017. Building a business case for ecodesign implementation: a system dynamics approach. Proceedings of the 21st International Conference on Engineering Design (ICED17), Vol. 1: Resource-Sensitive Design, Design Research Applications and Case Studies, Vancouver, Canada.
- Rosa, P., Terzi, S. 2018. Improving end of life vehicle's management practices: An economic assessment through system dynamics, Journal of Cleaner Production, 184, 520-536.
- Rosner, G, Hertel, R.F. 1986. Health risk assessment of platinum emissions from automotive exhaust gas catalysts. Staub Reinhalt Luft, 46, 281-285 (in German).
- Saidani, M., 2015. Life Cycle Assessment (LCA) of Selective Catalytic Reduction on Filter (SCRf) from Non-Road Mobile Machinery (NRMM). Liebherr Machines Bulle, Ecole Centrale Paris, Master Thesis.
- Saidani, M., Cluzel, F., Leroy, Y., Auclair, A. 2016. Time-efficient eco-innovation workshop process in complex system industries. In Proceedings of the 14th International Design Conference, Dubrovnik, Croatia, 16–19 May 2016.
- Saidani, M., Yannou, B., Leroy, Y., Cluzel, F. 2017a. How to assess product performance in the circular economy? Proposed requirements for the design of a circularity measurement framework. Recycling, 2, 6.
- Saidani, M., Yannou, B., Leroy, Y., Cluzel, F. 2017b. Hybrid top-down and bottom-up framework to measure products' circularity performance. International Conference on Engineering Design, ICED 17, Aug 2017, Vancouver, Canada. DS 87-1, Vol 1: Resource Sensitive Design, Design Research Applications and Case Studies.
- Saidani, M., Yannou, B., Leroy, Y., Cluzel, F., 2017c. How to Close the Loop of Platinum from Heavy Vehicles Catalytic Converters? Framework to Evaluate the Impact of Several Promising Action Levers. ISIE-ISSST Joint Conference, June 2017, Chicago, United States.
- Saidani, M., Kendall, A., Yannou, B., Leroy, Y., Cluzel, F. 2018. What about the circular economy of vehicles in the U.S.? An extension of the analysis done in the EU by Saidani et al. (2017). Resources, Conservation and Recycling, 136, 287-288.
- Saltelli, A., Ratto, M., Andres, T., Campolongo, F., Cariboni, J., Gatelli, D., et al. 2008. Global Sensitivity Analysis: The Primer. Wiley.
- Sandvall, F. 2006. The Remanufacturing Offer: A Case Study of Volvo Construction Equipment, Implementing and Expanding Reman in Russia. School of Business, Stockholm University, Bachelor thesis.
- Saurat, M., Bringezu, S. 2008. Platinum Group Metal Flows of Europe, Part 1. Journal of Industrial Ecology, 12, 754–767.
- SAVE International. 1999. Function Analysis Systems Technique: The Basics. The Value Society, March 1999.
- Senk, D., Meyer, F., Pretz, T., Abrasheva, G. 2012. Strategies for fulfilment of critical raw materials demand in Eu-rope. Revue De Métallurgie, 109 (5), 333-339.
- Sievers, H., Tercero, L. 2012. European dependence on and concentration tendencies of the material production. Polinares, EU Policy on Natural Resources, March 2012.
- Sinha, R., Laurenti, R., Singh, J., Frostell, B. 2014. System dynamics approach for investigating a circular economy in the global mobile phone product system. The international conferences ICT4S – ICT for Sustainability.
- Stahel, W. R. 2016. The circular economy. Nature, 531, 435-438.
- Statista, 2017. Vehicles road traffic. Accessed on April 2018: <http://www.statista.com/markets/419/topic/487/vehicles-road-traffic>.
- Takeyama, K., Ohno, H., Matsubae, K., Nakajima, K., Kondo, Y., Nagasaka, T. 2016. Dynamic material flow analysis of nickel and chromium associated with steel materials by using MaTrace. Matériaux & Techniques, 104, 6-7, 610.

- Turner, D.A., Williams, I.D., Kemp, S. 2016. Combined material flow analysis and life cycle assessment as a support tool for solid waste management decision making *Journal of Cleaner Production*, 129, 234-248.
- UNEP. 2013. Metal Recycling-Opportunities, Limits, Infrastructure – A Report of the Working Group on the Global Metal Flows to the International Resource Panel; United Nations Environment Program: Paris, France.
- Valérian, F. 2016. Métaux rares et dépendance stratégique. *Annales des Mines - Responsabilité et environnement*, 2, 82. French.
- Van der Voet, E., Van Oers, L., Verboon, M., Kuipers, K. 2018. Environmental Implications of Future Demand Scenarios for Metals: Methodology and Application to the Case of Seven Major Metals. *Journal of Industrial Ecology*. doi:10.1111/jiec.12722
- Van Loon, P., Van Wassenhove, L.N. 2017. Assessing the economic and environmental impact of remanufacturing: a decision support tool for OEM suppliers. *International Journal of Production Research*.
- Wang, Y., Li, X. 2012. Health Risk of Platinum Group Elements from Automobile Catalysts. *Procedia Engineering*, 45, 1004-1009.
- Wei, W., Larrey-Lassalle, P., Faure, T. et al. 2015. How to conduct a proper sensitivity analysis in life cycle assessment: taking into account correlations within LCI data and interactions within the LCA calculation model. *Environ Sci Technol.*, 49 (1), 377-385.
- Weidema B., Wesnaes M. S. 1996. Data quality management for life cycle inventories – an example of using data quality indicators. *Journal of Cleaner Production*, 4, 167-174.
- Weiland, F. W. 2014. European remanufacturing of heavy-duty and off-road vehicle components (including tyres): a hidden giant? FWJ Consulting, May 2014.
- Wernick, I. K., Ausubel, J. H., 1995. National material metrics for industrial ecology. *Resources Policy*, 21 (3), 189-198.
- Yin, R.K. 2013. *Case Study Research Design and Methods*, 5th ed. SAGE Publications, Thousand Oaks, CA, USA.
- Zereini, F., Skerstupp, B., Alt, F., Helmers, E., Urban, H. 1997. Geochemical behaviour of platinum group metals (PGE) in particulate emissions by automobile exhaust catalysts: experimental results and environmental investigations. *Sci Total Environ*, 206, 137-146.
- Zio, E. 2013. *The Monte Carlo Simulation Method for System Reliability and Risk Analysis*. London: Springer (Springer Series in Reliability Engineering).

CONCLUSION AND APPENDICES

- ADEME-French Environment & Energy Management Agency. 2006. Etude sur la fin de vie de tous les moyens de transport en France, à l'exception des véhicules couverts par la directive Véhicules Hors d'Usage. Etude réalisée par BioIS pour l'ADEME, Novembre 2006.
- AFNOR-Agence Française de Normalisation. 1996. Conception des véhicules en vue de l'optimisation de leur valorisation en fin de vie, Norme AFNOR, July 1996, 27 pp.
- Allenby, B. 2006. The ontologies of industrial ecology. *Progress in Industrial Ecology*. Inderscience Enterprises Ltd. 3 (1/2): 28–40.
- Allenby, B.R., Graedel, T.E. 1995. *Industrial Ecology*. Prentice-Hall, Engelwood Cliffs, NJ.
- Andrews, D. 2015. The circular economy, design thinking and education for sustainability. *Local Economy*, Vol. 30 (3), 305-315.
- Andrews, D., Bonner, K., Butterworth, A., Calvert, H. 2015. Defining a successful commercial asteroid mining program. *Acta Astronaut.*
- Babbitt, C.W., Gaustad, G., Fisher, A., Chen, W., Liu, G. 2018. Closing the loop on circular economy research: From theory to practice and back again. *Resources, Conservation and Recycling*, 135, 1-2.
- Baran, M. 2010. Teaching multi-methodology research courses to doctoral students. *International Journal of Multiple Research Approaches*, 4 (1), 19-27.
- Ben Ahmed, W., Mekhilef, M., Yannou, B., Bigand, M. 2010. Evaluation framework for the design of an engineering model. *Artificial Intelligence for Engineering Design, Analysis and Manufacturing*, 24 (1), 107-125.
- BIO by Deloitte. 2014. Development of Guidance on Extended Producer Responsibility (EPR). Final Report for the European Commission – DG Environment.
- Blomsma, F. 2018. Collective 'action recipes' in a circular economy – On waste and resource management frameworks and their role in collective change, *Journal of Cleaner Production*, 199, 969-982.
- Brown S., Steinstra S., Ludvigsen, K. 1993. *Closing the Loop: The Car Recycling Challenge*, Euromotor Reports Limited: London.
- Camelot, A., Baptiste, P., Mascle, C. 2013. Decision support tool for the disassembly of reusable parts on an end-of-life aircraft. *Industrial Engineering and Systems Management (IESM) 2013*, Proceedings of International Conference in Rabat, IEEE, 1-8.
- Cervantes, G. 2007. A methodology for teaching industrial ecology. *International Journal of Sustainability in Higher Education*, 8 (2), 131-141.
- Coppens, C. 1999 Méthode de conception en vue d'optimiser la valorisation des Véhicules Hors d'Usage. Thèse de Doctorat de l'ENSAM, ADEME, PSA Peugeot Citroën.
- Coppens, C., Lecoq, M., Millet, D., Michaud, P. 2002. Evaluating and improving the recovery aptitude of an automobile function: the PSA approach. *Int. J. Vehicle Design*, 29 (4), 307–316.
- Despeisse, M., Baumers, M., Brown, P., et al. 2017. Unlocking value for a circular economy through 3D printing: A research agenda. *Technological Forecasting and Social Change*, 115, 75-84.
- ENEC-European Network of Ecodesign Centres., 2014. *Envisioning Ecodesign: Definitions, Case Studies and Best Practices*. Technical Report.
- ERTRAC-European Road Transport Research Advisory Council. 2012. *European Roadmap, Heavy Duty Truck*, September 2012.
- Ford. 1996. *World-wide design requirements system: complete vehicle recycling*. Environmental and Safety Engineering.
- Frosch, R.A. 1992. *Industrial Ecology: A Philosophical Introduction*. Proceedings of the National Academy of Sciences, USA 89 (February 1992): 800–803.
- Guillemin, P., Friess, P. 2009. *Internet of Things Strategic Research Roadmap*. Report. CERP-IoT. September 2009.
- Hagelüken, C. 2014. Recycling of (critical) metals, in: G. Gunn (Ed.), *Critical Metals Handbook*, John Wiley & Sons, 41–69.
- Haquin, B. 1996. Recyclage: objectif 'zéro déchet'. *R&D Renault*, 2, 16–31.
- Hawken, P. 1993. *The Ecology of Commerce*. New York: Harper Business.
- Hein, A. M., 2017. *Ressourcenabbau auf Asteroiden - Technologien, Architekturen, und Potential*. Presentation. Hochschule Aachen, FH Aachen, University of Applied Sciences, 30 November 2017.
- Hein, A. M., Saidani, M., Tollu, H. 2018. Exploring Potential Environmental Benefits of Asteroid Mining. 69th International Astronautical Congress (IAC), Bremen, Germany, 1-5 October 2018.
- Hennig, A., 2016. *Policy Recommendations for Economically and Socially Valuable Asteroid Mineral Resource Exploitation Activities*.
- Hill, G. 2009. *A Framework for Valuing the Quality of Customer Information*. PhD thesis. Computing & Information Systems Dept. University of Melbourne.
- Jelinski, L.W., Graedel, T. E., Laudise, R. A., McCall, D. W., Patel, C.K.N. 1992. *Industrial Ecology: Concepts and Approaches*. Proceedings of National Academy of Sciences, USA 89 (February 1992).
- Keivanpour, S., Kadi, D.A., Mascle, C. 2014. *Toward a Decision Tool for Eco-Design Strategy Selection of Aircraft Manufacturers Considering Stakeholders Value Network*. *SAE Int. J. Mater. Manf.*, 7 (1), 73-83.
- Keivanpour, S., Kadi, D.A., Mascle, C. 2015. End of life aircrafts recovery and green supply chain (a conceptual framework for addressing opportunities and challenges). *Management Research Review*, 38 (10), 1098-1124.
- Keller-Margulis, M.A. 2014. *Developing A Research Agenda*, University of Houston, 2014. Accessed on April 2018: <https://www.ssspresearch.org/earlycareerforum/developing-research-agenda>
- Kopnina, H. 2018. *Teaching Circular Economy: Overcoming the Challenge of Green-washing*. S. Dhiman, J. Marques (eds.), *Handbook of Engaged Sustainability*, Springer International Publishing AG 2018.
- Korse, M. 2018. *Extended waste hierarchy*. <http://blog.mauritskorse.nl/en/>
- Lopes de Sousa Jabbour, A.B., Jabbour, C.J.C., Godinho Filho, M. et al. 2018. Industry 4.0 and the circular economy: a proposed research agenda and original roadmap for sustainable operations. *Ann Oper Res*. In press.
- M. Lindahl, E. Sundin, J. Östlin and M. Björkman. 2006. Concepts and definitions for product recovery Analysis and clarification of the terminology used in academia and industry. *Springer, Innovation in Life Cycle Engineering and Sustainable Development*, 123–138.
- MacWhorter, K. 2015. *Sustainable Mining: Incentivizing Asteroid Mining in the Name of Environmentalism*. *Wm. Mary Envtl. L. Pol'y Rev.*
- Magnier, C. 2017 *10 Key Indicators for Monitoring the Circular Economy*. 2017 Edition. Document published by: The Monitoring and Statistics Directorate (SOeS). Ministry of the environment, energy and marine affairs, in charge of international relations on climate change Planetary resources. 2017. Asteroids. <http://www.planetaryresources.com/asteroids/#asteroids-intro>
- Ribeiro, J.S., Gomes, J.O. 2015. *Proposed Framework for End-of-life Aircraft Recycling*. *Procedia CIRP*, 26, 311-316.
- Rousseau, D. 2018. On the Architecture of Systemology and the Typology of Its Principles. *Systems* 2018, 6, 7.
- Sanchez, J., McInnes, C. 2012. Assessment on the feasibility of future shepherding of asteroid resources. *Acta Astronaut.*
- Schmidt, W.P., Fleischer, G. 1997. High recycling rates = high reduction of environmental burdens? In *Proceeding of R'97*, Genève.
- Sonter, M. J. 2012. *The Technical and Economic Feasibility of Mining the Near-Earth Asteroids*. Thesis, University of Wollongong.
- UNEP/SETAC, 2007. *Life Cycle Management. A Business Guide to Sustainability*. UNEP/SETAC Life Cycle Initiative, Paris, France.
- UNEP/SETAC, 2011. *Global Guidance Principles for Life Cycle Assessment Databases*, UNEP/SETAC Life Cycle Initiative, Paris, France.
- USDoe-US Department of Energy, Energy Efficiency & Renewable Energy. 2013. *Workshop Report: Trucks and Heavy-Duty Vehicles Technical Requirements and Gaps for Lightweight and Propulsion Materials*, February 2013.
- Van der Voet, E., Van Oers, L., Verboon, M., Kuipers, K. 2018. *Environmental Implications of Future Demand Scenarios for Metals: Methodology and Application to the Case of Seven Major Metals*. *Journal of Industrial Ecology*. In press.
- Worrell, E., Reuter, M. 2014. *Handbook of Recycling. State-of-the-art for practitioners, analysts, and scientists*. 1st edition. Elsevier.

APPENDIX A – GLOSSARY OF DEFINITIONS

CIRCULAR ECONOMY RELATED TERMS

Biobased economy	The biobased economy is one that is based upon biological materials that can be composted and act as feedstock for the growth of new crops. It is often seen as one side of the circular economy. (Korse, 2018)
Blue economy	The blue economy aims to better serve basic human needs, such as food security, fertile soil, clean water, medicines and jobs, whilst staying within planetary boundaries. It poses that this can be done through working with natural processes, as they have the ability to transform apparent scarcity into sufficiency and even abundance. (Blomsma, 2018)
Circular economy	<i>See on page X the 70 definitions related to circular economy.</i>
Circularity	The number of times a resource is used, remaining useful with a certain degree of utility in the value chain, through circular economy loops. (Figge et al. 2018)
Cradle-to-cradle	C2C aims to improve and preserve human and environmental health, remedying a “materials-in-the-wrong-place problem”, whilst continuing to serve current wants and needs. This is achieved through application of eco-effectiveness: managing materials either through using or mimicking the nutrient cycles in biological food webs. (Blomsma, 2018)
Decoupling	This term refers here to the breaking of a link between an environmental variable and an economic one. (Eurostat) (Magnier, 2017)
Eco-design	<i>See on page X the 35 definitions related to eco-design.</i>
Ecological economy	An ecological economy is about the balance between all ecological systems in relation to the economy. To enable the economy to extract value from the ecology, economy activity should also give space and actively support the regenerative capacity of the ecological spheres. (Korse, 2018)
Gig economy	The gig economy is also performance based, but especially on the short term. It focusses especially on temporary service contracts created by independent professionals and not so much through products. (Korse, 2018)
Green economy	The green economy is one that reduces environmental risks and use of resources thereby supporting environmental recovery and development while growth is still possible. Social equity is also important as the green economy should be inclusive. (Korse, 2018)
Industrial ecology	<i>See on page X the 13 definitions related to industrial ecology.</i>
Industrial symbiosis	A sub-field of industrial ecology (Chertow and Park, 2016), Industrial Symbiosis is not associated with a single organization or a specific person as its advocate, although the first academic article on industrial symbiosis is generally attributed to Lowe and Evans (1995). Instead, the case study of Kalundborg in Denmark fulfils the role of icon or illustrative symbol: referring to the material and energetic by-product exchanges between the industrial facilities located there. The purpose of industrial symbiosis is to create environmental and economic benefits in manner that matches industrial inputs/outputs to the carrying capacity of the Earth. This can be achieved through optimizing manufacturing systems by reintroducing relevant relationships between production facilities. (Blomsma, 2018)
Longevity	The amount of time a resource is being used (Figge et al. 2018)
Loops (material-)	Any system where one or several end-of-life flows are treated without destroying them to produce secondary raw materials and to limit the use of primary raw materials. (ScoreLCA, 2015)
Next economy	The next economy is low-carbon, innovative opportunity rich and export-oriented. New business models are required as well as smart infrastructure to enable the next economy to emerge. (Korse, 2018)
Performance economy	Performance economy is the remedy to stagnating levels of wealth and growth, excessive resource consumption, high levels of waste and rising levels of debt and unemployment through the pursuit of radical performance improvements, such as radical efficiency, utility, smart solutions, miniaturization and system solutions (Blomsma, 2018).

Regenerative design	The regenerative design aims to provide the necessities of daily life: energy, shelter, water, food and waste processing, through ecologically harmonious development that by its very nature requires no mitigation, whilst recognizing that humans are integrally part of the environment, with an emphasis on system and infrastructure design, inspired by ecosystems. (Blomsma, 2018)
Sharing economy	The sharing economy, alike the performance economy, focused on access and services instead of ownership. However, ownership is needed to be able to share. Goods and services are shared among the public through platforms. True sharing-economy services are non-profit. (Korse, 2018)
Smart economy	The smart economy is based upon technology and the use of open data to streamline economic activities and resource flows with new business models. (Korse, 2018)
Waste hierarchy	The waste hierarchy aims to create better environmental outcomes (i.e. reduced landfilling), by facilitating better decision-making. It offers guidance on the effectiveness of alternative strategies that direct resources away from landfill. Hierarchical organisation of strategies (in order of reducing importance): reduce, reuse, recover, and dispose. (Blomsma, 2018)

END-OF-LIFE STRATEGIES RELATED TERMS

Composting	The process of converting organic matter (via controlled aerobic decomposition) to create a soil additive which improves soil structure and provides nutrients for plants. This may be undertaken domestically or at a municipal site. (BS 8887-2:2009)
Dismantlability	Ability of component parts to be removed from the vehicle. (ISO 1176) (ISO 22628:2002)
Extended producer responsibility	An environmental policy approach in which a producer's responsibility for a product is extended to the post-consumer stage of a product's life cycle.
Incineration	The process of combustion of organic waste materials to generate electric power or heat. (BS 8887-2:2009)
Landfill	The process of disposing of waste by burial. (BS 8887-2:2009)
Reconditioning	It is a process of restoring the parts or components to functional state but not above original specification by resurfacing, repainting etc. (Lindahl et al. 2006)
Recovery	<ol style="list-style-type: none">1. Any operation the principal result of which is waste serving a useful purpose by replacing other materials which would otherwise have been used to fulfil a particular function (or waste being prepared to fulfil that function). (Waste Framework Directive 2008/98/EC, Article 3)2. Reprocessing in a production process of the waste materials for the original purpose or for other purposes, together with processing as a means of generating energy. (ISO 1176) (ISO 22628:2002)
Recoverability	Ability of component parts, materials or both that can be diverted from an end-of-life stream to be recovered. (ISO 1176) (ISO 22628:2002)
Recoverability rate	Percentage by mass (mass fraction in percent) of the new vehicle potentially able to be recovered, reused or both. (ISO 1176) (ISO 22628:2002)
Recycling	<ol style="list-style-type: none">1. Any recovery operation by which waste materials are reprocessed into products, materials or substances whether for the original or other purposes. It includes the reprocessing of organic material, but does not include energy recovery and the reprocessing into materials that are to be used as fuels or for backfilling operations. (Waste Framework Directive 2008/98/EC, Article 3)2. Reprocessing in a production process of the waste materials for the original purpose or for other purposes, excluding processing as a means of generating energy. (ISO 1176) (ISO 22628:2002)3. Reprocessing of recovered materials at the end of product life, returning them into the supply chain. (Handbook of Recycling, 2014, p.10)4. The processing of waste materials for their original purpose or for other purposes, excluding energy recovery. (BS 8887-2:2009)
Recyclability	Ability of component parts, materials or both that can be diverted from an end-of-life stream to be recycled. (ISO 1176) (ISO 22628:2002)
Recyclability rate	Percentage by mass (mass fraction in percent) of the new vehicle potentially able to be recycled, reused or both. (ISO 1176) (ISO 22628:2002)

Refurbishing	The process of returning a used product to a satisfactory working condition by rebuilding or repairing major components that are close to failure, even where there are no reported or apparent faults in those components. (BS 8887-2:2009)
Remanufacturing	<ol style="list-style-type: none">1. It is the process where used products are restored to like new condition by a certain process of cleaning, disassembling, inspection and assembling. Sometimes products are modernized and upgraded to new specification. (Lindahl et al. 2006)2. The process of returning a used product to at least its original performance with a warranty that is equivalent or better than that of the newly manufactured product. (BS 8887-2:2009)
Repair	The process of returning a faulty or broken product or component back to a usable state. (BS 8887-2:2009)
Repurposing	The process of utilizing a product or its components in a role that it was not originally designed to perform. (BS 8887-2:2009)
Reuse	<ol style="list-style-type: none">1. Any activity via which substances, materials or products that are not rubbish are used again for the same purpose for which they were originally designed. (French Environmental Code) (Magnier, 2017)2. Any operation by which component parts of end-of-life vehicles are used for the same purpose for which they were conceived. (ISO 1176) (ISO 22628:2002) (Waste Framework Directive 2008/98/EC, Article 3)3. The process by which a product or its components are put back into use for the same purpose at EoL. (BS 8887-2:2009)
Reusability	Ability of component parts that can be diverted from an end-of-life stream to be reused. (ISO 1176) (ISO 22628:2002)

RESEARCH APPROACH RELATED TERMS

Data quality	Characteristics of data that relate to their ability to satisfy stated requirements. (UNEP/SETAC, 2011)
Framework	A construct that defines concepts, values and practices to facilitate understanding, reporting and analysis of a given situation, theory or complex issues. (Xavier et al. 2017; Tomhave, 2005)
Heuristic	Approach based on experience, intuition, belief or convention. (Rousseau, 2018)
Mechanism	Logical assembly of components, elements, or parts, and the associated energy and information flows, that enables a machine, process, or system to achieve its intended result.
Method	<ol style="list-style-type: none">1. Specific procedure within a technique. (UNEP/SETAC, 2007)2. A method is a set of procedures to develop a process. (Xavier et al. 2017; Tomhave, 2005)
Methodology	<ol style="list-style-type: none">1. Coherent set of methods. (UNEP/SETAC, 2007)2. A methodology is a targeted construct that defines specific practices, procedures and rules for implementation or execution of a specific task or function. (Xavier et al. 2017; Tomhave, 2005)
Model	A conceptual constructs that represent processes, variables and relationships without, necessarily, providing specific guidelines or practices for implementation. (Xavier et al. 2017; Tomhave, 2005)
Qualitative indicators	Qualitative indicators are nominative: they provide information on a particular issue using words. (UNEP/SETAC, 2007)
Quantitative indicator	A quantitative indicator is a description of the issue assessed using numbers. (UNEP/SETAC, 2007)
Scientific	Approach based on scientific laws, theories or models. (Rousseau, 2018)
Tool	<ol style="list-style-type: none">1. Everything that will be used by methods in the development of a process or task. (Xavier et al. 2017; Bunney and Dale, 1997)2. Instrument used to perform a procedure. (UNEP/SETAC, 2011)
Uncertainty	Uncertainty refers to the lack of certainty, e.g. in the prediction of a certain outcome, in a measurement, or in an assessment results. It is a general term used to cover any distribution of data caused by either random variation or bias. (UNEP/SETAC, 2007)

CIRCULAR ECONOMY DEFINITIONS (70)

Table 48 – 70 definitions related to circular economy

#	Source	Definition
1	ADEME, 2014	An exchange and production based economic system that, at all stages of the product or service life cycle, aims to increase the efficiency of resource use and reduce the impact on the environment while developing the well-being of individuals.
2	Aldersgate	A circular economy is a restorative industrial economy in which materials flows are of two types: biological nutrients, designed to re-enter the biosphere safely, and technical nutrients (non-biological materials), which are designed to circulate at high quality, with their economic value preserved or enhanced.
3	Article 70 of the French law on Energy Transition for Green Growth	The transition towards a circular economy aims to move away from the linear economic model, based on a system of “take, make, dispose, by calling for a more moderate and responsible consumption of natural resources and raw materials, as well as, in order of priority, the prevention of waste production, and, in accordance with an established hierarchy of waste treatment methods, the reutilization, recycling, or, failing these, repurposing of waste materials. It also includes the promotion of industrial and territorial ecology, along with product eco-design, the use of materials issuing from natural renewable sources, sustainable public procurement, extension of product lifespans, waste prevention, the prevention, reduction and monitoring of product disposal, leakage or emission of pollutants and toxic substances, as well as waste management, the development of use value, exchange value, and information regarding the ecological, economic and social costs of contributing to this new prosperity.
4	Bastein et al. 2013	The circular economy transition “is an essential condition for a resilient industrial system that facilitates new kinds of economic activity, strengthens competitiveness and generates employment”.
5	Birat, 2015	CE is a contemporary concept that describes how materials and resources should be handled in the future.
6	Blomsma and Brennan, 2017	Circular economy is a general term covering all activities that reduce, reuse, and recycle materials in production distribution, and consumption processes.
7	Chinese CE promotion Laws	Circular economy is defined as “a generic term for the reducing, reusing and recycling activities conducted in the process of production, circulation and consumption”.
8	CIRAIG	An innovative management style that integrates social, economic and environmental dimensions in a business approach that stimulates local economic development and job creation while reducing the impact of human activity on the environment and resources through cooperation of local actors.
9	Circle Economy	The circular economy is a concept in which growth and prosperity are decoupled from natural resource consumption and ecosystem degradation. By refraining from throwing away used products, components and materials, instead re-routing them into the right value chains, we can create a society with a healthy economy, inspired on and in balance with nature.
10	Circular Academy	A circular economy is a transformative economy redefining production and consumption patterns, inspired by ecosystems principles and restorative by design, which increases resilience, eliminates waste and creates shared value through an enhanced circulation of material and immaterial flows.
11	Circular Economy in Australia, 2016	CE is an alternative model that anticipates and designs for biological and technical 'nutrients' to be continuously re-used at the same quality, dramatically reducing our dependency on sourcing new materials
12	COARA Commercial Asset Recycling, 2016	CE is driven by the desire to use the value in products we already have that might previously have been thought of as waste. But a transition from the traditional linear economy where we use raw materials to make a product, use it and then discard that product once it has ceased to function, or simply becomes outdated, requires changes in product design, the manufacturing process, supply chain, consumer perception and attitude.
13	EEA, 2014	Circular economy “refers mainly to physical and material resource aspects of the economy – it focuses on recycling, limiting and re-using the physical inputs to the economy, and using waste as a resource leading to reduced primary resource consumption”.
14	EEA, 2016	A circular economy provides opportunities to create well-being, growth and jobs, while reducing environmental pressures. The concept can, in principle, be applied to all kinds of natural resources, including biotic and abiotic materials, water and land.
15	Ellen MacArthur Foundation	To shift from a linear model of resource consumption that follows a ‘take-make-dispose’ pattern An industrial system that is restorative or regenerative by intention and design, distinguishing between technical and biological cycles. It replaces the ‘end-of-life’ concept with restoration, shifts towards the use of renewable energy, eliminates the use of toxic chemicals, which impair reuse, and aims for the elimination of waste through the superior design of materials, products, and systems and, within this, business models. A circular economy goes beyond the pursuit of waste prevention and waste reduction to inspire technological, organisational, and social innovation throughout the value chain in order to ‘design-out’ waste from the beginning, rather than relying solely on waste recycling at the end of the chain.
16	European Commission	Circular economy is defined as a transition where the value of products, materials and resources is maintained in the economy for as long as possible, and the generation of waste minimized. It is a development strategy that enables economic growth while optimising consumption of resources, deeply transforms production chains and consumption patterns, and redesigns industrial systems at the system level.
17	European Parliament Research Service	An economic model based inter alia on sharing, leasing, reuse, repair, refurbishment and recycling, in a closed loop, which aims to retain the highest utility and value of products, components and materials at all times.
18	France’s national Strategy for Ecological Transition and SD	This new model of a circular economy, with its moderate use of carbon and natural resources, can be defined as an economic system for production, exchange and consumption designed and organised so as to minimise net extraction of resources (fossil fuels, raw materials, water, land and environments) and polluting emissions, which are a source of negative effects on public health and the environment on both a local and global scale.
19	French Economic, Environmental and Social Council	The concept of circular economy is to seek the maximum reuse of by-products of each process of production or consumption in order to reintegrate them and prevent their degradation in waste, regarding them as potential resources. This concept encompasses upstream reduction of waste thanks to eco-design, the shift from product sale service offer, supports reuse and finally recycling.

20	French Environment Ministry	Economic concept that is part of the sustainable development framework and whose main objective is to produce goods and services while limiting consumption and waste of raw materials, and saving water and energy sources. It aims to deploy a new economy, no longer linear but circular, based on the principle of closing the loops of products, services, waste, materials, water and energy.
21	Geissdoerfer et al. 2017	A regenerative system in which resource input and waste, emission, and energy leakage are minimised by slowing, closing, and narrowing material and energy loops. This can be achieved through long-lasting design, maintenance, repair, reuse, remanufacturing, refurbishing, and recycling.
22	Geng, 2008	CE “means the realization of a closed loop of materials flow in the whole economic system.” (...) “implying a closed-loop of materials, energy and waste flows”
23	Geng and Doberstein, 2008	CE has the potential to overcome current environmental and resource management problems while achieving improvements in resource productivity and eco-efficiency. CE encourages the creation of a conservation oriented society, seeking to reduce both total consumption and waste production. CE is normally understood to mean the realization of a closed loop of materials flow in the economic system.
24	Ghisellini et al. 2016	The radical reshaping of all processes across the life cycle of products conducted by innovative actors has the potential to not only achieve material or energy recovery but also to improve the entire living and economic model.
25	Gregson et al. 2015	The circular economy seeks to stretch the economic life of goods and materials by retrieving them from post-production consumer phases. This approach too valorizes closing loops, but does so by imagining object ends in their design and by seeing ends as beginnings for new objects. The circular economy is a simple, but convincing, strategy, which aims at reducing both input of virgin materials and output of wastes by closing economic and ecological loops of resource flows.
26	Haas et al. 2015	CE, material flows are either made up of biological nutrients designed to re-enter the biosphere, or materials designed to circulate within the economy (reuse and recycling)”. The circular economy is a simple, but convincing, strategy, which aims at reducing both input of virgin materials and output of wastes by closing economic and ecological loops of resource flows.
27	Haupt et al. 2017	The concept of circular economy conceives of a production and consumption system with minimal losses of materials and energy through extensive reuse, recycling, and recovery.
28	Heck, 2006	The utilisation of sustainable energy is crucial in a circular economy. The transition to a circular economy would require addressing the challenge of establishing a sustainable energy supply as well as decisive action in several other areas such as agriculture, water, soil and biodiversity.
29	Hepler, 2015	A successor to the practice of old school “reduce, reuse, recycle” mantras, these examples of unconventional material repurposing help illustrate the much-hyped circular economy d a more ambitious, and more marketing-friendly, rethinking of how product materials and packaging can be cycled back into supply chains.
30	Hobson, 2016	The CE has been defined as an industrial system that is restorative or regenerative by intention and design. It replaces the end-of-life concept with restoration, shifts towards the use of renewable energy, eliminates the use of toxic chemicals, which impair reuse and return to the biosphere, and aims for the elimination of waste through the superior design of materials, products, systems and business models.
31	House of Commons, Environmental Audit Committee, 2014,	CE maximizes the sustainable use and value of resources, eliminating waste and benefiting both the economy and the environment. It offers an alternative to the predominant current approach where resources are used for one purpose and then discarded. The idea is not new, and is associated with a range of concepts such as ‘cradle to cradle’ design and ‘industrial ecology’, which draw inspiration from biological cycles and emphasize the importance of optimising the use of resources in a system over time. A circular economy includes a range of processes, or ‘cycles’, in which resources are repeatedly used and their value maintained wherever possible.
32	Hu et al. 2011	CE focuses on resource-productivity and eco-efficiency improvement in a comprehensive way, especially on the industrial structure optimization of new technology development and application, equipment renewal and management renovation. CE focuses on resource-productivity and eco-efficiency improvement in a comprehensive way, especially on the industrial structure optimization of new technology development and application, equipment renewal and management renovation.
33	Jiao and Boons, 2014	CE was defined as a holistic concept covering the activities of ‘reduce, reuse, and recycle’ in the process of production, circulation, and consumption.
34	Kirchherr et al. 2017	A circular economy describes an economic system that is based on business models which replace the ‘end-of-life’ concept with reducing, alternatively reusing, recycling and recovering materials in production/distribution and consumption processes, thus operating at the micro level (products, companies, consumers), meso level (eco-industrial parks) and macro level (city, region, nation and beyond), with the aim to accomplish sustainable development, which implies creating environmental quality, economic prosperity and social equity, to the benefit of current and future generations. It is enabled by novel business models and responsible consumers.
35	Li et al. 2010	CE aims at closed-loop material and energy systems in all sectors of industry in order to reduce the use of natural resources and the environmental impact
36	Lieder and Rashid, 2016	CE is to an increasing extent treated as a solution to series of challenges such as waste generation, resource scarcity and sustaining economic benefits
37	Linder and Williander, 2015	An economy “in which the conceptual logic for value creation is based on utilizing economic value retained in products after use”.
38	Ma et al. 2014	A circular economy is a mode of economic development that aims to protect the environment and prevent pollution, thereby facilitating sustainable economic development.
39	Ma et al. 2015	CE is specifically based on both resource efficiency and eco-efficiency, and its purpose is to acquire a set of key measures to move towards a more circular, green, and sustainable economy.
40	Mathews et al., 2011	A closed cycle of material and energy flows.
41	Mitchell, 2015	A circular economy is an alternative to a traditional linear economy (make, use, dispose) in which we keep resources in use for as long as possible, extracting the maximum value from them whilst in use, then recovering and reusing products and materials.
42	Moreau et al. 2017	A circular economy is restorative and regenerative by design, and aims to keep products, components, and materials at their highest utility and value at all times. The concept is a continuous positive development cycle

		that preserves and enhances natural capital, optimizes resource yields, and minimizes system risks by managing finite stocks and renewable flows.
43	Murray et al. 2017	An economic model wherein planning, resourcing, procurement, production and reprocessing are designed and managed, as both process and output, to maximize ecosystem functioning and human well-being.
44	Naustdalslid, 2017	The term “circular economy” as mentioned in these measures is a generic term for the reducing, reusing and recycling activities conducted in the process of production, circulation and consumption.
45	Nguyen et al. 2014	CE aims to eradicate wasted not just from manufacturing processes, as lean management aspires to do, but systematically, throughout the life cycles and uses of products and their components.
46	Niero et al. 2017	The circular economy, defined as a restorative or regenerative industrial system by intention and design.
47	OPAI & MVO Nederland	A circular economy is an industrial economy, which has resilience as intention and replaces usage by using. The circular economy is based on closing loops and (where possible, infinitely) extending cycles.
48	Park et al. 2010	The CE policy seeks to integrate economic growth with environmental sustainability, with one element relying on new practices and technological developments.
49	Peters et al. 2007	The central idea is to close material loops, reduce inputs, and reuse or recycle products and waste to achieve a higher quality of life through increased resource efficiency.
50	Preston, 2012	Circular economy is an approach that would transform the function of resources in the economy. Waste from factories would become a valuable input to another process – and products could be repaired, reused or upgraded instead of thrown away.
51	Sacchi Homrich et al. 2018	CE is a strategy that emerges to oppose the traditional open-ended system, aiming to face the challenge of resource scarcity and waste disposal in a win-win approach with economic and value perspective.
52	Sauvé et al. 2016	Circular economy refers to the “production and consumption of goods through closed loop material flows that internalize environmental externalities linked to virgin resource extraction and the generation of waste”.
53	Singh and Ordenez, 2016	CE is an economic strategy that suggests innovative ways to transform the current predominantly linear system of consumption into a circular one, while achieving economic sustainability with much needed material savings.
54	Smol et al. 2015	Transition to a more circular economy requires changes throughout value chains, from product design to new business models, from new ways of turning waste into a resource to new modes of consumer behaviour.
55	Stahel, 2016	A “circular economy” would turn goods that are at the end of their service life into resources for others, closing loops in industrial ecosystems and minimizing waste. It would change economic logic because it replaces production with sufficiency: reuse what you can, recycle what cannot be reused, repair what is broken, and remanufacture what cannot be repaired.
56	Su et al. 2013	The focus of the circular economy gradually extends beyond issues related to material management and covers other aspects, such as energy efficiency and conservation, land management, soil protection and water.
57	The Petit Larousse dictionary, 2016	An economic system founded on frugality, limited consumption, and the recycling of materials and services.
58	The Dutch House of Representatives	A circular economy is an economic system that takes the reusability of products and materials and the conservation of natural resources as starting point. It also strives for value creation for people, nature and the economy in each part of the system.
59	The Waste Resources Action Programme	A circular economy is an alternative to a traditional linear economy (make, use, dispose) in which we keep resources in use for as long as possible, extract the maximum value from them whilst in use, then recover and regenerate products and materials at the end of each service life.
60	TNO	A circular economy is an economic and industrial system based on the reuse of products and raw materials, and the restorative capacity of natural resources. It attempts to minimize value destruction in the overall system and to maximize value creation in each link in the system.
61	Tukker, 2015	CE is based on the “win-win” philosophy that a prosper economy and healthy environment can be co-existed.
62	Wei et al. 2014	CE is a model of economic development to maximize the use of resources and protect the environment. Guided by the theory of recycled economy, green supply chain management, as a new notion of management, plays a more and more important role in the development of manufacturing industry in Guangxi.
63	Wen et al. 2007	CE and eco-industry are effective ways to solve sustainable development problems on resources, environment and economy.
64	World Resource Forum	The concept “circular economy” describes an industrial economy in which material flows keep circulating at a high rate (in terms of quality, property, function, range of use) without the materials entering the biosphere, unless they are biological nutrients.
65	Wu et al. 2014	CE aims to achieve optimum production by minimizing natural resource utilization and pollution emission simultaneously, and minimum wastage by reusing the wastes from production and minimum pollution by recycling and restoring the technically useless wastes.
66	Xue et al. 2010	Circular economy is the outcome of over a decade’s efforts to practice sustainable development by the international communities, and is the detailed approach towards sustainable development.
67	Yang and Feng, 2008	Circular economy is an abbreviation of “Closed Materials Cycle Economy or Resources Circulated Economy” (...). The fundamental goal of circular economy is to avoid and reduce wastes from sources of an economic process, so reusing and recycling are based on reducing.
68	Yuan et al. 2008	CE was promoted in China as a new development strategy to alleviate the shortage of resource supply by improving the resource productivity and the eco-efficiency of production and consumption. CE is a political strategy aiming to alleviate the resource scarcity and reduce pollution, and so it is essential to find effective ways to educate or train people so that they can implement the concept into their everyday work and life.
69	Zhang et al. 2009	CE could be considered a path to sustainable development where industrial symbiosis in eco-industrial parks (EIPs) constitutes an important segment of this strategy.
70	Zhu et al. 2011	CE promotes continuous economic development without generation of significant environmental and resource challenges. It advocates that economic systems can and should operate according to the materials and energy cycling principles that sustain natural systems. CE also emphasizes the recycling of essential materials and energy as well as the capacity for one entity’s wastes to be used as a resource by another entity through self-organization capacities.

ECO-DESIGN DEFINITIONS (35)

Table 49 – 35 definitions related to eco-design (source : European Network of Ecodesign Centres, 2014)

#	Source	Definition
1	AFNOR standard NF 30-264	Refers to the systematic integration of environmental aspects from the outset of the design and development of products (goods and services, systems) with the aim of reducing the negative environmental impact throughout the life cycle while still performing to an equal or superior level.
2	Alonso, 2006	Ecodesign integrates environmental criteria in the design of products and services, so as to get the reduction of environmental impacts they produce, taking into account all stages of their life cycle.
3	Bhamra and Lofthouse 2007	Environmental considerations are considered at each stage of the design process.
4	Bhamra, 2004	Ecodesign is understood to be the systematic integration of environmental considerations into the design process across the product life cycle, from cradle to grave.
5	Borchardt et al. 2011	Ecodesign is a set of project practices oriented to the creation of eco-efficient products and processes.
6	Brezet and van Hemel, 1997	Eco-design considers environmental aspects at all stages of the product development process, striving for products which make the lowest possible environmental impact throughout the product life cycle.
7	Dewulf et al. 2013	It comprises the systematic integration of environmental aspects into product design with the aim to reduce the overall environmental impact of the product throughout its whole life cycle.
8	Dewulf, 2013	Ecodesign and Design for Environment (DfE) are terms for strategies that aim to integrate environmental considerations into product design and development.
9	Ecodesign Directive, 2005	Ecodesign is the integration of environmental aspects into product design with the aim of improving the environmental performance of the product throughout its whole life cycle.
10	Ecodesign Platform working, 1996	Ecodesign assumes that the effect a product has on the environment should be considered and reduced at all stages along the product life cycle.
11	EDC, 2006	Ecodesign is simply good design and good business practice. It's a way of thinking and doing.
12	EFA standard, 2003	Through the integration of Life Cycle Thinking and evaluation of environmental impacts new methods and tools will be needed in the product development process to develop environmentally preferable products. Ecodesign therefore will become an integrated part of the state of technology product development processes.
13	European Commission, 2012	Ecodesign implies taking into account all the environmental impacts of a product right from the earliest stage of design. In particular, this avoids uncoordinated product planning (e.g. eliminating a toxic substance should not lead to higher energy consumption, which on balance could have a negative impact on the environment).
14	Fiksel, 1996	Ecodesign is a process that develops a product that meets cost, performance, quality, as well as environmental attributes of a product by integrating environmental aspects into product design engineering process.
15	Fuad-Luke, 2002 (Ecodesign – The Sourcebook, Glossary)	A design process that considers the environmental impacts associated with a product throughout its entire life from acquisition of raw materials through production/manufacturing and use to end of life. At the same time as reducing environmental impacts ecodesign seeks to improve the aesthetic and functional aspects of the product with due consideration to social and ethical needs. Ecodesign is synonymous with the terms design for environment (DfE), often used by the engineering design profession, and lifecycle design (LCD) in North America.
16	Guelere Filho et al. 2007	Ecodesign (Europe) or Design for Environment (US) implies a new way of developing products where environmental aspects are given the same status as functionality, durability, costs, time-to-market, aesthetics, ergonomics and quality. Ecodesign aims at improving the product's environmental performance and may be seen as a way of developing products in accordance with the sustainable development concept.
17	IHOBE, 2011	Ecodesign is the integration of environmental aspects into product design and development with the aim of reducing adverse environmental impacts throughout a product's life cycle.
18	Interreg, 2005	Ecodesign (also design for the environment, life cycle design, environmentally conscious design) is the systematic methodology that incorporates environmental considerations into the design process of products.
19	ISO 14006 standard, 2011	Ecodesign is the integration of environmental aspects into product design and development with the aim of reducing adverse environmental impacts throughout a product's life cycle.
20	ISO 14062 standard, 2002	Doesn't define ecodesign but discussed integration of environmental considerations in product development.
21	Karlsson and Luttrupp, 2006	Eco-design is about design in and for sustainable development.
22	Lexique encyclopedia, 2006	Ecodesign is a method of designing products that takes into account their impact on the environment at all stages of their life cycle.
23	Lindhal and Ekermann, 2013	Eco-design is not a specific method or tool, but rather a way of better design through analyzing and synthesizing in order to reduce environmental impacts throughout the product's life cycle.
24	Manzini, 2005	The term "ecodesign" indicates a design activity aimed at connecting what is "technically possible" to what is "ecologically necessary" in order to formulate new socially and culturally acceptable proposals.
25	Ölundh, 2006	Modernizing ecodesign means taking advantage of environmental benefits and the innovation potential when developing solutions rather than using ecodesign simply to ensure that legal requirements or customer demands are met.
26	OVAM, 2003	Ecodesign assumes that the effect a product has on the environment should be considered and reduced at all stages along the product life cycle. These stages include the extraction of the raw materials, the manufacturing of the product, its marketing and distribution, the use and finally, the disposal of a product.
27	Pigosso et al. 2010	Ecodesign is a proactive approach of environmental management that aims to reduce the total environmental impact of products.
28	Platcheck, 2008	Ecodesign is a holistic view in that, starting from the moment we know the environmental problems and its causes, we begin to influence the conception, the materials selection, the production, the use, the reuse, the recycling and final disposition of industrial products.
29	Plouffe et al. 2011	Ecodesign involves simultaneously taking into account the environmental impacts associated with the selection

		of materials, the manufacturing process, the storage and transportation phase, usage, and final disposal.
30	Pole Ecoconception, 2004	Eco-design helps reduce the negative environmental impacts throughout the life cycle of the product during the design phase.
31	Sherwin and Evans, 2000	The design of a product, service or system with the aim of minimising the overall impact on the environment.
32	Sustainable minds, 2013	Ecodesign systematically incorporates environmental decisions into the design process. Three key approaches shape the framework and practice of ecodesign: life cycle thinking; decreasing environmental impact early in the design process; environment as an additional design requirement.
33	Wikipedia encyclopedia	Ecodesign is an approach to design of a product with special consideration for the environmental impacts of the product during its whole life cycle.
34	Wimmer et al. 2004	Ecodesign is how to integrate environmental considerations into product design and development.
35	Zhao et al. 2010	DFE is a practice by which environmental considerations are integrated into product and process engineering design procedures.

INDUSTRIAL ECOLOGY DEFINITIONS (13)

Table 50 – 13 definitions related to industrial ecology

#	Source	Definition
1	ADEME, 2015	Industrial and territorial ecology, also referred to as industrial symbiosis, is a form of intercompany organisation based around shared energy and material flows or aggregation of company needs.
2	Allenby and Graedel, 1993	Industrial ecology is the means by which humanity can deliberately and rationally approach and maintain a desirable carrying capacity, given continued economic, cultural, and technological evolution. The concept requires that an industrial system be viewed not in isolation from its surrounding systems, but in concert with them. It is a systems view in which one seeks to optimize the total materials cycle from virgin material, to finished material, to component, to product, to waste product, and to ultimate disposal. Factors to be optimized include resources, energy, and capital.
3	Allenby, 1992	Somewhat teleologically, industrial ecology may be defined as the means by which a state of sustainable development is approached and maintained. It consists of a systems view of human economic activity and its interrelationship with fundamental biological, chemical, and physical systems with the goal of establishing and maintaining the human species at levels that can be sustained indefinitely, given continued economic, cultural, and technological evolution.
4	Allenby, 2006	Industrial ecology takes a whole systems approach and also that it involves many disciplines – not just the technical, economic and environmental fields but also fields such as sociology and philosophy, ethical philosophy in particular. A systems-based, multidisciplinary discourse that seeks to understand emergent behaviour of complex integrated human/natural systems
5	Erkman, 1997	Industrial ecology is a study aimed at understanding the circulation of materials and energy flows; therefore, IE must first understand how the industrial ecosystem works, how it is regulated and its interactions with the biosphere in order to determine how the industrial ecosystem can be restructured to resemble how natural ecosystems function.
6	Frosch and Gallopoulos, 1989	The traditional model of industrial activity... should be transformed into a more integrated model: an industrial ecosystem. In such a system the consumption of energy and materials is optimized, waste generation is minimised, and the effluents of one process...serve as the raw material for another.
7	Frosch, 1992	The idea of an industrial ecology is based upon a straightforward analogy with natural ecological systems. In nature an ecological system operates through a web of connections in which organisms live and consume each other and each other's waste. The system has evolved so that the characteristic of communities of living organisms seems to be that nothing that contains available energy or useful material will be lost.
8	Gillaspy	Industrial ecology is the study of industrial systems aimed at identifying and implementing strategies that reduce their environmental impact. Industries, extract raw materials and natural resources from the Earth and transform them into products and services that meet the demands of the population.
9	Hawken, 1993	Industrial ecology provides for the first time a large-scale, integrated management tool that designs industrial infrastructures "as if they were a series of interlocking, artificial ecosystems interfacing with the natural global ecosystem." Industry is going beyond life-cycle analysis methodology and applying the concept of an ecosystem to the whole of an industrial operation, linking the "metabolism" of one company with that of another.
10	Jelinski et al. 1992	Industrial ecology is a new approach to the industrial design of products and processes and the implementation of sustainable manufacturing strategies. It is a concept in which an industrial system is viewed not in isolation from its surrounding systems but in concert with them. Industrial ecology seeks to optimize the total materials cycle from virgin material to finished material to component, product, waste products, and to ultimate disposal.
11	Lifset and Graedel	The very name industrial ecology conveys some of the content of the field. Industrial ecology is industrial in that it focuses on product design and manufacturing processes. It views firms as agents for environmental improvement because they possess the technological expertise that is critical to the successful execution of environmentally informed design of products and processes. Industry, as the portion of society that produces most goods and services, is a focus because it is an important but not exclusive source of environmental damage. Industrial ecology is ecological in at least two senses.
12	The Global Development Research Center	Industrial ecology conceptualizes industry as a man-made ecosystem that operates in a similar way to natural ecosystems, where the waste or by product of one process is used as an input into another process. Industrial ecology interacts with natural ecosystems and attempts to move from a linear to cyclical or closed loop system.
13	White, 1994	The study of the flows of materials and energy in industrial and consumer activities, of the effects of these flows on the environment, and of the influences of economic, political, regulatory and social factors on the flow, use and transformation of resources.

APPENDIX B – INTERVIEW GUIDES AND REPORTS

GENERIC INTERVIEW GUIDE

The semi-structured interview guide used to discuss circular economy implementation with automotive and HDOR actors, was divided into four main sections:

- i. General information about the actor and company questioned, including company name, activity, size and geographical location, background, business model(s), suppliers and clients, existing collaborations, vehicle types.
Q#0: In a word, what are the current main needs and issues you have to deal with?
- ii. Regulatory aspects, including current regulations to be complied with, and anticipation of upcoming regulations.
Q#1: What are the current regulations you have to comply with?
Q#2: What are your strategies to deal with upcoming or future regulations?
Q#3: Do you have any interest in an extension of ELV Regulations to Heavy Vehicles?
- iii. Management of life cycle, including: pre-life (design, manufacturing, logistics), life (use, maintenance, upgrading), end-of-life (reuse, recovery, remanufacturing, refurbishing, recycling, disposal), and integration of emerging technologies.
Q#4: In which steps of the life cycle of HDOR Vehicles is your company involved?
Q#5: What are the highest value components or operations, in terms of cost, environmental impact, complexity, and technology? Are your systems “eco-designed”? Easy to disassemble?
Q#6: What are the types of systems that fail most often? What are the parts that require most maintenance?
Q#7: Are your systems well designed and dimensioned for your purpose of usage? What parts have evolved a lot since you have been using HDOR vehicles? What parts need some upgrade according to your experience; what could be improved to facilitate maintenance or efficiency during usage?
Q#8: Do you get any feedback during the use phase from the customer or user, for real use or perception? If so, how? If not, do you think it could be of interest for your operations?
Q#9: What is the fate of your systems (vehicles, components, materials) at their end-of-life (EoL), when they no longer function?
Q#10: Do you propose second-hand systems (vehicles, components, materials) in your business operations? Examples?
Q#11: Do you make money from the EoL of your system? How? Who with? Do you collaborate with EoL recycling channels, operators or exporters? Examples?
Q#12: Are you aware of new technologies such as Telematics, Internet of Things, and Big Data in your industrial field? If so, are you aware of the benefits they could bring to your organisation?
Q#13: Have you already implemented such devices in your systems or practices? Do you use them? What do they bring your organisation (positive or negative)? If so, what devices, for what purposes? If not, are you planning to use them in the (near) future?
- iv. Sustainability issues and circular economy positioning, including social and economic situations, environmental concerns and circular economy transition.
Q#14: What could be improved regarding the social or economic dimensions of your companies? Do you have any KPIs (Key Performance Indicators) to measure these aspects?
Q#15: Are you currently undertaking or planning to undertake any environmental actions? Examples? Have you heard of the ISO 14001 certification?
Q#16: What is the main reason, or trigger for these actions? Environmental sensitivity, economic benefits, pressure from customers or regulations, or profitability of selling green products?
Q#17: Are you aware of the Circular Economy model, and of the opportunities and benefits it could bring you?
Q#18: What could/should be done at your level to move towards a more efficient circular model?

The above generic questionnaire served as a guide but was adapted for each interview. The following companies, agencies and persons were interviewed and contributed to the sub-section 2.1 of the essay #1 of the present Ph.D thesis: raw materials national expert from ADEME (French environmental agency), end-of-life transportation means coordinator from ADEME, project manager from INDRA (precursor and leading player in vehicle recycling in France), director manager from CIDER Engineering (private agency expert HDOR dismantling), director manager from TORA Location (NRMM rental company), road construction site supervisor from COLAS (major user of NRMM), sustainable development manager from MANITOU (handling equipment manufacturer).

SPECIFIC INTERVIEW GUIDES

Complementary to the generic interview guide, (i) a more specific interview guide has been prepared and written in French to conduct the interviews with two representative from the ADEME (French Environment & Energy Management Agency); (ii) a simplified version of the generic interview guide has been used to perform 30-minute interviews in the U.S. due to time constraints (focusing the questions on regulations, extended producer responsibility, information management system, business models and best end-of-life practices in the light of a circular economy); and finally (iii) to experiment, question and validate the interest of the proposed benchmarking template (sub-section 2.3 of essay #1) several industrial practitioners of the heavy vehicles industries have been contacted. These secondary interview guides are available on demand.

The objectives of conducting such interviews were to: get the viewpoints of keys actors involved in the eco-system of heavy vehicle industry; assess of the current situation; check industrial needs; get more information about HDOR vehicles companies' current practices, future projects, and collaborations (e.g. knowing the operating of existing end-of-life channels; deepen our knowledge of the interplay between actors; get data and/or industrial case studies to feed and test the developed models. Indeed, these interviews enabled: a better understanding of the whole eco-system of heavy vehicle industry; to define the role of main actors in the value chain; to highlight the main relations between stakeholders; to identify the available levers of action to close-the-loop; find how to implement relevant methods at different levels within this current eco-system. Moreover, it aimed at involving and sensitizing every contacted actor in the move towards circular economy, as well as it may initiate and federate stakeholders into a more circular economy through collaborations. A list of relevant and complementary industrial contacts (i.e. considering the entire value chain) has been established and appropriate contact strategy have been chosen according to the industrial contact availability and interest. The main idea was to first ask generic and common questions for each stakeholders, and then more specific ones, according to the type of actors.

LIST OF EXPERTS AND INDUSTRIAL ACTORS INTERVIEWED (BY CHRONOLOGICAL ORDER)

Table 51 – Summary of industrial stakeholders interviewed

Organisation	Position	Date, Duration, Type	Contribution in
ADEME	Raw materials national expert	Mars 2016, 1 hour, audio	Section 2.1
ADEME	End-of-life vehicle coordinator	April 2016, 1 hour, audio	Section 2.1
LIEBHERR	Business development manager	July 2016, 1 hour, webconf.	Section 2.1
CIDER Engineering	Director/manager	July 2016, 1 hour, webconf.	Section 2.1
COLAS	Road construction site supervisor	July 2016, 1 hour, face-to-face	Section 2.1
KILOUTOU (TORA Location)	Director/manager	August 2016, 1 hour, face-to-face	Section 2.1
MANITOU	Corporate responsibility manager	September 2016, 1 hour, audio	Section 2.1
INDRA Automotive Recycling	Project manager	January 2017, 1 hour, webconf.	Section 2.1
MANITOU	Corporate responsibility manager	January 2017, 1 hour, audio	Section 2.1
CIDER Engineering	Director/manager	February 2017, ½ hour, audio	Section 4.2
DGA	Eco-design expert	February 2017, 1 hour, face-to-face	Section 4.2
DGA + MANITOU + MANITOU Reman. Center	Eco-design, CSR & Reman. managers	July 2017, 2 hours, webconf.	Section 4.2
MANITOU Reman. Center	Reman. manager	September 2017, 1 hour, webconf.	Section 4.2
Auto. Recyclers Association	C.E.O.	October 2017, ½ hour, audio	Section 2.2
National Stewardship Council	Executive director	October 2017, ½ hour, audio	Section 2.2
Californian Product Stewardship Council	Executive director	November 2017, ½ hour, audio	Section 2.2
HOLT of California	Caterpillar logistic service	November 2017, ½ hour, audio	Section 2.2
LIEBHERR	Business development manager	January 2018, 1 ½ hour, webconf.	Section 2.1
MANITOU Reman. Center	Reman. manager, intern and technicians	Mars 2018, 1-day visit, face-to-face	Section 4.2
NEXTER	Eco-design expert	April 2018, ½ day visit, face-to-face	Section 2.3
VOLVO Trucks	Director environment innovation	April 2018, email	Section 2.3
SCANIA	Head of responsible business	April 2018, email	Section 2.3
VOLCO CE	Parts & services leader	April 2018, email	Section 2.3
MANITOU Reman. Center	Reman. manager, intern and technicians	On a regular (weekly or monthly) basis from Sept. 2017 to July 2018	Section 4.2

INTERVIEW REPORTS

Individual interview reports are available on demand. Note that the main elements and contributions brought by conducted interviews have been synthesized and stated all along the essay #1 of the present Ph.D thesis.

EXAMPLE OF INTERVIEW REPORT (IN FRENCH) – ADEME 2016

Dans le cadre de cette **thèse**, j'ai eu l'opportunité d'échanger avec deux membres de la **Direction Economie Circulaire et Déchets** de l'Agence de l'environnement et de la maîtrise de l'énergie (ADEME), à savoir **Alain Geldron, Expert National Matières Premières**, le 24 mars 2016 ; et **Eric Lecointre, Coordinateur Déchets des Moyens de transports hors d'usage**, le 4 avril 2016.

Ces **deux interviews**, de durée **une heure chacune**, ont suivi une **structure semi-directive** afin de cibler certains points de ma thèse tout en laissant une part de liberté intéressante aux deux experts interviewés, et ont abordé des **aspects complémentaires** selon l'expertise propre à chacun des deux experts.

Les **tenants et aboutissants** du rapport **ADEME (2006)** « Etude de la Fin de Vie des moyens de Transport en France (Hors VHU) », les **métaux précieux** contenus dans les véhicules lourds, ainsi que les **filières et réglementations de fin de vie** ont entre autres été discutés. Ci-dessous une **synthèse des éléments importants** évoqués.

Rapport (ADEME, 2006)

Pour Alain Geldron, la question initiale et donc le but de cette étude était de savoir « s'il y avait quelque chose à faire d'un point de vue réglementaire » sur la fin de vie de ces moyens de transports hors véhicules particuliers (VHU). Eric Lecointre confirme cet objectif en précisant qu'il s'agissait également d'une « mise à jour informative de l'état des lieux commencé au début des années 1990 sur la maturité des filières de traitement et les aspects réglementaire ». Malgré les principaux constats de ce rapport (le gisement des véhicules lourds en fin de vie est du même ordre de grandeur que celui des véhicules particuliers en terme de masse ; une grande part à l'export ; la présence de filières illégales), aucun projet d'évolution réglementaire sur la fin de vie de ces véhicules est prévu.

Quant à la mise à jour de ce rapport, qui date de près de 10 ans, Eric Lecointre mentionne une nouvelle étude menée par CIDER Engineering. Eric Lecointre n'a pas encore accès aux résultats (problème de données non publiques) mais m'oriente vers deux personnes au sein de CIDER, à savoir Olivier Gaudeau, Ressources Industries (membre de CIDER), et expert en gamme de démantèlement et optimisation ; ou Adrien Dainotto, directeur de CIDER. Eric Lecointre m'a fourni les coordonnées de ces deux personnes pour entrer en contact.

Métaux Précieux

Alain Geldron, Expert National Matières Premières, a longuement parlé sur les métaux précieux et terres rares contenus dans les véhicules (PGM (Platine, Rhodium, Palladium) dans les pots catalytiques d'échappement ; Terres rares (Néodyme, Praséodyme, Samarium) dans les aimants permanents des moteurs des véhicules électriques/hybrides + Lithium dans les batteries + Électronique embarquée (et IoT, objets connectés) mais soumis à la directive WEEE.) Pour lui, c'est l'ensemble de l'écosystème qu'il faut considérer et non uniquement les aspects environnementaux, en s'appuyant sur l'exemple du concret sur le lithium : son prix relativement peu élevé rend les filières de recyclage non rentables pour le moment. L'aspect temporel est également très important. Alain Geldron m'oriente vers deux sources d'information potentiellement pertinentes pour ma thèse, à savoir un nouveau contact du nom d'Alain Rolla, spécialiste terres rares et métaux rares chez Rhodia ; et le site mineralinfo.fr du ministère de l'environnement, avec des données mondiales.

Filières et Réglementations de Fin de Vie

Selon Alain Geldron, la seule filière de fin de vie officiellement existante pour la fin de vie des véhicules lourds est celle de la ferraille (l'essentiel en masse de la ferraille est réutilisé ou bien recyclé en fin de vie). A la connaissance d'Eric Lecointre, il n'y a pas d'initiative prévue du côté français pour rédiger une réglementation sur la fin de vie des véhicules lourds. Cela est pour lui lié au fait que, malgré la potentielle utilité d'une telle réglementation, le ministère de l'écologie, en troupe réduite, est aujourd'hui surbooké. Cependant, Eric Lecointre informe que ce point a été évoqué à Bruxelles, à la CE, il y a 18 mois, par des représentants espagnols pour étendre VHU aux véhicules lourds. Eric Lecointre mentionne également l'émergence d'une filière, officielle et réglementée, de fin des bateaux

de plaisance au 1^{er} janvier 2017 (N.B. update du 11 avril 2016 : « La mise en place d'une filière REP de la déconstruction des bateaux de plaisance est reportées d'un an. »). Il serait intéressant pour moi de voir l'étude préliminaire et la méthode entreprise qui mène à l'émergence, la validation d'une filière de fin de vie, ainsi que les différences et points communs que l'on peut retrouver avec les véhicules lourds.

Points ouverts

Pour finir, ci-dessous les questions intéressantes à se poser et à essayer de résoudre, selon les deux experts ADEME :

- Comment amener ces engins en fin de vie dans un réseau d'économie verte, transparente, en opposition à l'économie grise ?
- Quel est le besoin réel des entreprises de Travaux Publics (TP) ?
- Question sur la place du recyclage dans une économie qui est en croissance ? Question encore plus importante lorsque la demande est récente.
- Vérifier quels sont les matériaux et parties des véhicules lors qui sont soumis à la responsabilité étendue des producteurs (REP) ?
- Remontées d'informations sur ce que l'on ne sait pas aujourd'hui : compositions matières exactes en fin de vie ; quantifier, mesurer les stocks, gisements, états accidentés ; efficacité des circuits de recyclage ?

Echanges complémentaires, fin 2016, par email avec Eric Lecointre pour obtenir des précisions sur deux points

i) J'ai appris qu'une extension de la réglementation VHU aux véhicules lourds avait été proposé par des représentants espagnols, il y a environ 18 mois, à Bruxelles, lors d'une réunion à la Commission Européenne. Sauriez-vous me donner plus de détails (nom, appartenance à quel organisme, ...) sur ces personnes ? Je demande cela car il peut être intéressant pour moi de voir pour quelles raisons les espagnols sont sensibles à cette problématique et les démarches entreprises là-bas.

→ « Je n'ai malheureusement pas les noms et coordonnées des représentants espagnols au TAC ELV de Bruxelles. Bruno Miraval du MEEM pourrait les avoir mais cela remonte maintenant à pas mal de temps. »

ii) Suite aux différents constats du rapport ADEME (2006) (masse du gisement en fin de vie des véhicules hors VHU = masse gisement en fin de vie des VHU en France), une réglementation sur la fin de vie des véhicules lourds n'est pas encore la priorité de l'ADEME ou du ministère de l'environnement (troupes réduites et surbookées). Pouvez-vous m'informer sur les priorités actuelles (à court ou moyen terme) de l'ADEME (au sein de votre direction/service) et du ministère de l'environnement ?

→ « Je vous laisse le soin d'échanger avec Bruno Miraval sur les priorités du Ministère de l'Environnement, de l'Energie et de la Mer (MEEM) pour ce qui concerne les autres moyens de transports hors d'usage mais je crains que la forte mobilisation actuelle du MEEM sur les filières VHU, Huiles usagées, pneus et plus récemment bateaux de plaisance, ne laissent que très peu de place pour initier des réflexions sur le sujet. Pour ce qui concerne l'ADEME et bien que le temps nous soit aussi compté, nous sommes prêts à accompagner des programmes d'études/R&D touchant les autres moyens de transports que les voitures. »

APPENDIX C – DETAILS ON THE CIRCULARITY INDICATORS REVIEWED

NOMENCLATURE OF THE CIRCULARITY INDICATORS

Table 52 – Nomenclature, acronyms and sources of the 55 C-indicators reviewed in the proposed taxonomy

Acronyms	C-Indicators	Sources (authors and year)
ACT	Assessing Circular Trade-offs (ACT)	Circle Economy and PGGM, 2014
BCI	Building Circularity Indicators (BCI)	Verberne, 2016
C2C	Material Reutilization Part (C2C)	C2C, 2014
CA	Circle Assessment (CA)	Circle Economy and PGGM, 2014
CAT	Circularity Assessment Tool (CAT)	PGGM, 2015
CBT	Circular Benefits Tool (CBT)	Advancing Sustainability LLP, 2013
CC	Circularity Calculator (CC)	ResCoM, 2017
CECAC	Circular Economy Company Assessment Criteria (CECAC)	VBDO, 2015
CEI	Circular Economy Index (CEI)	Di Maio and Rem, 2015
CEII	Circular Economy Indicators for India (CEII)	Talwar, 2017
CEIP	Circular Economy Indicator Prototype (CEIP)	Cayzer et al. 2017
CEMF	Circular Economy Monitoring Framework (CEMF)	European Commission, 2017
CEPI	Circular Economy Performance Indicator (CEPI)	Huysman et al. 2017
CET	Circular Economy Toolkit (CET)	Evans and Bocken, 2013
CETUS	Circular Economy Toolbox US (CETUS)	US Chamber Foundation, 2017
CEV	Circular Economic Value (CEV)	Fogarassy et al. 2017
CI	Circularity Index (CI)	Cullen, 2017
CIPEU	Circular Impacts Project EU (CIPEU)	European Commission, 2016
CIRC	Circularity Material Cycles (CIRC)	Pauliuk et al. 2017
CLC	Closed Loop Calculator (CLC)	Kingfisher, 2014
CP	Circular Pathfinder (CP)	ResCoM, 2017
CPI	Circularity Potential Indicator (CPI)	Saidani et al. 2017
DEA	Super-efficiency Data Envelopment Analysis Model (DEA)	Wu et al. 2014
ECEDC	Evaluation of CE Development in Cities (ECEDC)	Li et al. 2010
EISCE	Evaluation Indicator System of Circular Economy (EISCE)	Zhou et al. 2013
EMCEE	Indicators for Material Input for CE in Europe (IMCEE)	EEA, 2016
EoL-RRs	End-of-Life Recycling Rates (EoL-RRs)	Graedel et al. 2011
EPICE	Environmental Protection Indicators (EPICE) in a context of CE	Su et al. 2013
ERCE	Evaluation of Regional Circular Economy (ERCE)	Chun-Rong and Jun, 2011
EVR	Eco-efficient Value Ratio (EVR)	Scheepens et al. 2016
EWMFA	Economy-Wide Material Flow Analysis (EWMFA)	Haas et al. 2015
FCIM	Five Category Index Method (FCIM)	Li and Su, 2012
HLCAM	Hybrid LCA Model (HLCAM)	Genovese et al. 2017
ICCEE	Indicators for Consumption for CE in Europe (ICCEE)	EEA, 2016
ICT	Circularity Indicator Project (ICT)	Viktoria Swedish ICT, 2015
IECEE	Indicators for Eco-design for CE in Europe (IECEE)	EEA, 2016
IECF	Indicators of Economic Circularity in France (IECF)	Magnier, 2017
IEDCE	Integrative Evaluation on the Development of CE (IEDCE)	Qing et al. 2011
IOBS	Input-Output Balance Sheet (IOBS)	Marco Capellini, 2017
IPCEE	Indicators for Production for CE in Europe (IPCEE)	EEA, 2016
IPCEIS	Industrial Park Circular Economy Indicator System (IPCEIS)	Geng et al. 2012
MCI	Material Circularity Indicator (MCI)	EMF, 2015
MRCCEI	Measuring Regional CE–Eco-Innovation (MRCEEI)	Smol et al. 2017
NCEIS	National Circular Economy Indicator System (NCEIS)	Geng et al. 2012
PCM	Product-Level Circularity Metric (PCM)	Linder et al. 2017
RCEDI	Regional Circular Economy Development Index (RCEDI)	Guo-Gand and Jing, 2011
RDI	Resource Duration Indicator (RDI)	Franklin-Johnson et al. 2016
RES	EU Resource Efficiency Scoreboard (RES)	Eurostat, 2015
RIs	Recycling Indices (RIs) for the CE	Van Schaik and Reuter, 2016
RP	Resource Productivity (RP)	Wen and Meng, 2015
RPI	Reuse Potential Indicator (RPI)	Park and Chertow, 2014
RRs	Recycling Rates (RRs)	Haupt et al. 2016
SCI	Sustainable Circular Index (SCI)	Azevedo et al. 2017
VRE	Value-based Resource Efficiency (VRE)	Di Maio et al. 2017
ZWI	Zero Waste index (ZWI)	Zaman and Lehmann, 2013

PRACTICAL DATASHEET ON C-INDICATORS PRESENTATION AND DISSEMINATION

To Lützkendorf and Balouktsi (2017), indicators need to be clearly and precisely described and documented. They add that “the development of a factsheet for each individual indicator that contains all necessary fields and presents available information in a unique template is necessary. Structuring such a factsheet serves two purposes: to optimize the information management by identifying and listing all possible data sources – and their providers – as well as to identify the acting stakeholders and their options/opportunities for action”. Accordingly, we also believe the development of such factsheet would also further ease the dissemination of C-indicators to the public, through appropriate channels of communication. Inspired by the (i) requirements and criteria proposed by Lützkendorf and Balouktsi (2017), (ii) communication provided by ResCoM on their online platform of CE tools, plus (iii) the categories of our developed taxonomy, here is a proposition of a template to describe and document C-indicators in a clear and usable manner (applied hereafter on the Circularity Calculator (ResCoM, 2017), for illustration).

Table 53 – Factsheet template for clear documentation on C-indicators

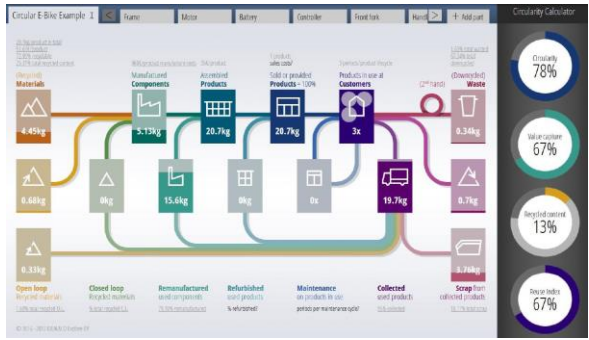
C-indicator/tool name	Circularity Calculator (CC)
Short description	Quickly compare the potential of different circular design strategies
Working principle – Assessment method	Modelisation, visualization and evaluation of material flows and the financial value of closing loops
CE level of implementation	Micro
Object of assessment	Product service system and business
C-loops considered	Remanufacturing, reuse and recycling
Where/when to apply	Project scoping, definition and product design phases
Time needed	Two to four hours, once data are available
C-perspective (pro- or retro-)	Potential
C-performance (intrinsic or consequential)	Both
Units – Measurability	Quantitative (%)
Dimensionality	4 performance indicators: overall product circularity, potential value capture, recycled content, reuse index
Data required, availability, providers	BoM, costs of materials, production and sales, potential part of reuse, remanufacturing and recycling
Possible usages	To inform strategic decisions and design requirements, before costly investments or consequential decisions have been made, to compare different circular design scenarios, used by cross-department product development teams
Influenced by stakeholders	Design and business decisions
Stakeholders impacted	Designers working in the fuzzy front end of product development (to help)
Transversality (generic, sector-specific)	Could be apply to a wide variety of products, services
Associated tool	Computerized assessment tool
Source – Reference	ResCoM project*, 2017
Access link	http://www.rescoms.eu/platform-and-tools
Illustration - Snapshot	 <p>The screenshot displays the 'Circularity Calculator' interface for a 'Circular E-Bike Example'. It features a material flow diagram with stages: Materials (4.45kg), Manufactured Components (2.13kg), Assembled Products (20.7kg), Sold to product Customers (20.7kg), and Products in use at Customers (3x). It also shows 'Open loop' (6.68kg), 'Closed loop' (6.53kg), 'Remanufactured' (15.6kg), 'Refurbished' (0kg), 'Maintenance' (0kg), and 'Collected' (19.7kg) flows. On the right, four circular gauges show: Circularity (78%), Value capture (67%), Recycled content (13%), and Reuse index (67%).</p>

*For information, the ResCoM (Resource Conservative Manufacturing) project, co-funded by the European Commission, ended in October 2017 by providing a new online platform including methodologies and tools to support manufacturers in designing products for a circular economy. This collection of online tools aims to help manufacturers adopting a systemic approach to apply circular economy principles in their product designs and thus to capture value by closing the loop. The ResCoM platform brings together software applications and descriptive (i.e. non-software) tools and methods to support decision-making and implementation of closed-loop product systems.

APPENDIX D – RESOURCES FOR THE WORKSHOP ON THE C-INDICATORS

SUGGESTED ORGANISATION OF THE WORKSHOP

The table below proposes a time-efficient distribution of the activities to conduct the workshop in half a day.

Table 54 – Agenda of the workshop on C-indicators, including activities details, materials needed and duration

	Activities	Resources	Duration
#1	Ice-breaking activity	Answer sheet (see below)	15 min
#2	Presentation (circular economy and C-ind.)	Slideshow	30 min
#3	Use of the C-indicators Advisor Selection of appropriate C-indicators	Excel-based tool with macros enabled 1-page response document (see next pages)	45 min
#4	Experimentation of 2 C-indicators Critical analysis	Excel-based and web-based tools 2-page datasheet, 2 response documents	2 x 30 min
#5	Comparison of the results and discussion	Slideshow	30 min

SYNOPSIS OF THE WORKSHOP

First, the challenges of assessing circularity performance at different systemic levels are introduced. A taxonomy of circularity indicators is then presented and its associated query tool is experienced. Through the workshop, several tools aiming at measuring the circularity of materials/products/systems are applied on a real world industrial case study. Participants particularly question the strengths, complementary and weaknesses of each approach regarding their compliance to the circular economy paradigm and industrial needs.

ICE-BREAKING ACTIVITY

At the beginning of the workshop, participants are asked to share their current knowledge related to the following question on an individual answer sheet. Such an ice-breaking activity aims to involve the participation of every attendees, making them think on these question. It also enables to provide immediate feedback, allowing them to position their current knowledge on the circular economy and circularity indicators, as answers are collected and read to every one (anonymously).

What is your definition of a circular economy?	
Can you cite one or two example(s) of circular practices:	
What should measure/consider a circularity indicator?	
Do you know some C-indicators? If so, which one(s)?	

DATASHEET FOR THE INDUSTRIAL CASE STUDY AND RESPONSE DOCUMENTS FOR THE WORKSHOP

INDUSTRIAL CONTEXT

Catalytic converters are mandatory devices to limit the pollution generated by the motorized vehicles. In return, a large amount of precious metals is needed for their production and operation. Indeed, pollution control systems installed on heavy equipment such as construction machinery contain large quantities platinum, making recycling particularly interesting. A project manager has recently heard about the circular economy concept. As such, he wants to know how the catalytic converters they design and develop could be more circular to retain the value of precious metals in their business operations. The project manager is more interested in the impacts of future designs and potential business models changes on the performance of the intrinsic circularity of his product. He is particularly looking for indicators aiming at evaluating circularity potential improvement during design and development process. He wants to consider all possible loops of the circular economy. He is open to use whether one or several indicators, with no preference at this moment regarding the indicator format or assessment methodology.



Figure 71 – Heavy vehicle catalytic converter

SIMPLIFIED VERSION OF THE CATALYTIC CONVERTER

The core structure and function of the catalytic converter is composed of three main components:

- Canning, also called converter housing;
- Catalyst support, also called substrate or ceramic brick in cordierite;
- Coating, also called catalyst washcoat.

INFORMATION RELATED TO THE PRE-LIFE OF THE PRODUCT

Table 55 – Simplified bill of materials (BoM) of the catalytic converter

Components	Materials	Mass (kg)	Price (€/kg)	Recycled feedstock	Destination after use (if collected)	Recycling efficiency
Canning (Converter Housing)	Stainless Steel	10	2	90 % (manufacturer data)	Steel mill for recycling	100 %
Substrate (Catalyst Support)	Cordierite	3	2	0 % (100% primary raw materials)	Cement factory for recycling	100 %
Coating (Catalyst Washcoat)	Platinum	0.005	30000	33 % (global average)	PGM refinery	95 %

Additional comments: In the current production process, there is no direct reused of parts/components in the feedstock inputs. In the current production process of catalytic converter, according to the 2017 Johnson Matthey Report, around two third of platinum is coming from virgin sources and around one third from recycled materials. According to original equipment manufacturer, 90% of stainless steel is coming from recycled materials while all cordierite is coming from primary raw materials.

INFORMATION RELATED TO THE LIFE OF THE PRODUCT

- The lifespan of the product is 10 years or 15000 working hours. During the use phase, assumption is made (or access to the latest customer survey shows) that current product is used as long and as intensely as an industry average product of similar type;
- We assumed, from the manufacturer perspective, that current business model of this product is based on direct sales and no traceability after sales;
- Loss of value - i.e. degradation - during lifetime: -10% of platinum concentration;
- No product lifetime extension, neither product warranty after 8000 hours of use;
- Value at the end of its mean lifespan: still high due to remaining quantity of the precious metal.

INFORMATION RELATED TO THE END-OF-LIFE OF THE PRODUCT

Based on market investigation, current collection rate of catalytic converters from non-road mobile machinery is assumed to be around 50 % due to (illegal) export and its high added value through the use of precious metal (platinum).

However, this collection is performed mainly by a third part and there is almost no recovery or take-back of the catalytic converter performed by the original equipment manufacturer.

Among the catalytic converter collected after use, there is currently no direct reuse, remanufacturing or refurbishment of the product.

Collected catalytic converter are disassembled, sent and resold at convenient recycling facilities.

Based on state-of-the-art technologies, recycling efficiency of platinum for catalytic converter is 95%, recycling efficiency of stainless steel and cordierite is 100%. The total lack of end-of-life regulation for such heavy vehicles is a real barrier to overcome.

COMPLEMENTARY INFORMATION ALL ALONG THE VALUE CHAIN

Table 56 – Geographical scope and logistic information related to the catalytic converter value chain

Components	Materials	Material Origin Source	Manufacturing Location	Final Equipment Location	Destination Markets (brand new equipment)	Secondary Destination market (EoL)	EoL treatment facilities location
Canning (Converter Housing)	Stainless Steel	Spain	UK (included components assembly stage)	{Germany (2 plants), Austria (3, plants), France (1 plant)}	{Germany, Switzerland, Austria, France, Belgium, Netherland, Italy}	{Eastern Europe, North Africa}	In every country
Substrate (Catalyst Support)	Cordierite	USA	Mexico				Almost in every country
Coating (Catalyst Washcoat)	Platinum	South Africa	UK				{UK, Belgium}

Additional information sources available include: {Internet (e.g. constructor website); your knowledge; hypothesis; support of the supervision team}

THE C-INDICATORS ADVISOR TOOL



Circularity Indicators _ The Advisor Target the Right C-Indicators

RESULTS (ONE BY GROUP) GROUP # =

INPUTS

To identify the *a priori* most appropriate C-indicators for the case study needs, please translate the requirements provided by the industrial manager into the following inputs (report your inputs below and remember you can leave some criteria/inputs blank to have access to a wider variety of C-indicators):

Level =

Perspective =

Performance =

Loop =

Dimensionality =

Transversality =

Usages and purposes =

Type and format =

OUTPUTS

Please indicate the acronyms of the C-indicators advised by the tool:

CRITICAL ANALYSIS (INDIVIDUALLY) NAME =

INTERPRETATION

After reading the complementary information provided for each C-indicator advised, which indicator(s) would you particularly recommend to use? For which reason(s)?

SELECTION CRITERIA

Do you have in mind other criteria that could be used to refine further the selection of appropriate C-indicators?

UTILITY AND USABILITY

Comment freely about the relevance of this C-Indicators Advisor (for industrialists, for academics, etc.) and on your user experience:

INDICATOR/TOOL #1 = CET



RESULTS (ONE BY GROUP) GROUP # =

Please report the results (outputs) obtained after completing the Circular Economy Toolkit - Assessment Tool:

→ Indicate the **Improvement Potential** (High – Medium – Low) for the following strategies:

Reduce Materials =

Optimise Materials =

Industrial Symbiosis =

Design =

Usage =

Maintain =

Reuse =

Refurbish =

Recycle =

Product as a Service =

CRITICAL ANALYSIS (INDIVIDUALLY) NAME =

COMPLIANCE WITH CIRCULAR ECONOMY PRINCIPLES

Is the tool system thinking: Not at all – Poorly – Totally

Is the tool lifecycle thinking: Not at all – Poorly – Totally

According to you, does the assessment tool cover the whole complexity of the circular economy?

What are the missing points?

What points are not relevant regarding the circularity performance evaluation?

Shall one absolutely increase the circularity “improvement potential” to be more sustainable?

RELEVANCE OF THE TOOL

Is the tool relevant for industrial practitioners (designers, managers, engineers) willing to improve the circularity of their products during product (re-)design and development phases? Please comment.

Do you see another suitable potential use(s) of this tool? If yes, for what purposes?

AREAS OF FEEDBACK

Did you know this tool before? Yes – No Have you ever used it? Yes – No

User friendliness (easy to use and to understand): Yes – No Intuitive user interface: Yes – No

Time-efficient (once you have the data): Yes – No

Uncertainties when you are answering a question (on average): Low – Medium – High

Other personal impression (content, format, utility, areas for improvement, etc.):

INDICATOR/TOOL #2 = MCI

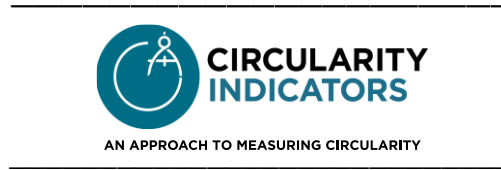

Results (One by Group) Group # =

Please report the results (outputs) obtained after completing the MCI Material-Level & Product-Level Tools:

MCI for Material 1 =

MCI for Material 2 =

MCI for Material 3 =

Aggregated MCI for the Product =

INDICATOR/TOOL #3 = CEIP

CEIP SCORE

Results (One by Group) Group # =

Please report the results (outputs) obtained after completing the Circular Economy Indicator Prototype (CEIP) Tool:

CEIP Score: / 152

Design/Redesign: / 27

Manufacturing: / 25

Commercialisation: / 30

In Use: / 35

End of Use: / 35

INDICATOR/TOOL #4 = CPI



Circularity Performance Indicator

Unlock the Circularity Potential of your Product

Results (One by Group) Group # =

Please report the results (outputs) obtained after completing the Circularity Potential Indicator (CPI) Tool:

Circularity Score (out of 100) =

Circular Product Design (out of 25) =

New Business Model (out of 25) =

Reverse Cycles (out of 25) =

Favourable System Conditions (out of 25) =

APPENDIX E – TUTORIAL VIDEOS TO USE THE C-INDICATORS ADVISOR TOOL

THE CIRCULARITY INDICATORS ADVISOR – TUTORIAL

Video link: <https://youtu.be/nRNbWyHRzic>

Foreword: Video tutorials are not only used to share knowledge but also to help users and provide more visual documentation. This tutorial is designed for industrial practitioners such as designers, engineers, managers as well as decision-makers or policy-makers who want to learn how they could use and implement appropriate circularity indicators in practice in their projects. It may also be useful for circular economy learners by providing an easy exploration of circularity indicators and associated assessment framework, in line with the circular economy paradigm, lifecycle thinking and systemic perspective.

Video tutorial script:

Introduction: “Hi and welcome to this tutorial video. I’m Michael and I’m a French PhD student at the Paris-Saclay University. This tutorial will show you how to find out the most appropriate circularity indicators according to your needs and requirements, thanks to an Excel based tool with macros.”

Outline: “The video is divided into 3 parts. First the tool will be introduced. Then, we will see how to insert the input data. Finally, after launching/running the search, we will have a look on the results and outputs provided by the tool.”

Part 1: “Because of the growing development of circularity indicators with different purposes and focuses (for example the micro, meso or macro level of circular economy) and with several potential usages (for instance, benchmarking, improvement or communication), this tool aims to support practitioners identifying and selecting the most appropriate circularity indicators regarding their needs.

It has the advantage of being very user-friendly, simple to use and needs no prerequisites, the only preparatory steps is just to make sure you macros are enabled, by simply clicking on this button when opening the Excel file (if needed, you can also check out the description section for more information).”

Part 2: “In the input interface of the Excel file you can specify the features you are looking for. In fact, you will be asked about the scale of measurement, different kinds of circularity, as well as the dimensionality, usages, transversality, and format of these indicators. If you are not sure about one criteria, you can leave it blank and you will have access to a wider variety of recommended indicators, and still be able to refine your selection afterwards. Little trick, if all criteria fields are left empty, every tool available among the inventory will be displayed.”

Part 3: “To start the search, click on the logo at the top. You will be automatically directed to the results table where recommended indicators are displayed/listed. It includes key information describing each indicators. Particularly, an internet access link is provided to get more details, to test the indicator and associated assessment framework and why not implement it in your projects.”

Conclusion: “Last but not least, the query tool is flexible in the way the databank is not frozen and can be easily updated. Therefore, if you are aware of circular economy related tools and indicators that are not inventoried here and if you want to participate in the tool's development, experimentation or implementation, feel free to contact us.”

Bonus #1: What’s behind the tool? This circularity indicators query tool uses a databank of more than 50 sets of indicators and associated to guide you towards the most appropriate indicators set in line with your needs and requirements.

Bonus #2: Another video experiencing this tool through an industrial use case is available (click on the link in the description section to check out this example)

Description: If you have issues activating your macros in Excel, please check out: <https://support.office.com/en-us/article/enable-or-disable-macros-in-office-files-12b036fd-d140-4e74-b45e-16fed1a7e5c6>

THE CIRCULARITY INDICATORS ADVISOR – APPLICATION ON AN INDUSTRIAL CASE STUDY

Video link: <https://youtu.be/kd51SsX0Be4>

Video script:

“Hi and welcome to this tutorial video. To illustrate more concretely how the tool works, let’s take the example of an industrial company.

In this scenario, the company wants to measure, improve and monitor the circularity performance of a catalytic converter they designed and developed.

More precisely, a project manager has recently heard about the circular economy concept. As such, he wants to know how the catalytic converters they design and develop could be more circular to retain the value of precious metals in their business operations.

Now, let’s see how the company needs and requirements are translated into the following inputs:

As the focus is on an industrial product and associated key components/materials, let’s select the micro level of circular economy.

The project manager is more interested in the impacts of future designs and potential business models changes on the performance of the inherent circularity of his product.

He wants to consider all possible loops of the circular economy.

He is open to use whether one or several indicators, with no preference at this moment regarding the format of indicator and associated assessment methodology.

Finally, simply click on this logo at the top to run the search.

As a result, four circularity indicators potentially useful for the company are recommended in this scenario, with details provided for each indicator.

And a direct internet access link is given to start experimenting the recommended indicators within their associated assessment framework, and if relevant, implementing them in the circular economy project and strategy of the company.”



The Circularity Indicators Advisor - Tutorial

<https://youtu.be/nRNbWyHRzic>



The Circularity Indicators Advisor - Example

<https://youtu.be/kd51SsX0Be4>

Figure 72 – The C-indicators Advisor: video tutorials and links

APPENDIX F – UNCERTAINTY ANALYSIS OF THE LEAKAGE OF PLATINUM

LEAKAGE OF PLATINUM DURING THE USE PHASE OF CATALYTIC CONVERTERS

MODEL DESIGN

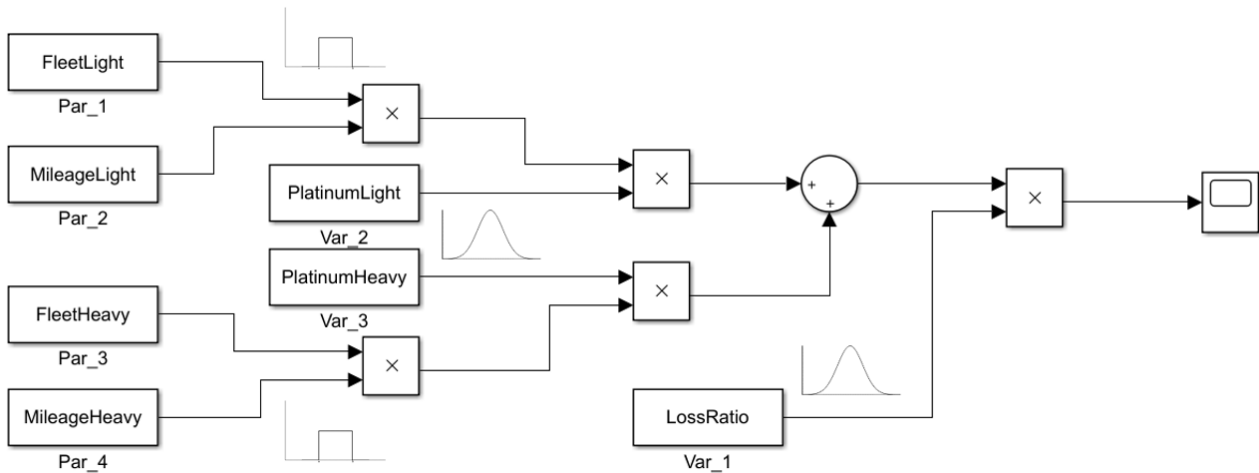

Figure 73 – Mathematical model to estimate the leakage of platinum (software: Simulink, Matlab R2018)

The construction of probability distributions to perform an uncertainty analysis using Monte Carlo simulation (Zio, 2013) is illustrated in Figure 73 and detailed in Tables 57 and 58. As illustrated in Table 57, the minimum and maximum values for the loss of platinum from catalytic converters in operation are respectively 0.1 $\mu\text{g}/\text{km}$ and 1.5 $\mu\text{g}/\text{km}$. An intermediate value of 0.8 $\mu\text{g}/\text{km}$ has been also estimated, based on real driving conditions. On this basis, we assumed 99% of the values are ranging between 0.1 and 1.5 $\mu\text{g}/\text{km}$ of platinum normally distributed around the mean value of 0.8 $\mu\text{g}/\text{km}$ of platinum. Indeed, in a normal distribution, it is assumed that 99% of the value are ranged between three standard deviation (σ) around the mean value (μ): $\mu \pm 3\sigma$.

Table 57 – Construction of the probability distribution for the key variable “LossPerKm”

Variable “LossPerKm”				
	Loss of platinum ($\mu\text{g}/\text{km}$)	0.1	0.8	1.5
Comments	Average of the minimal values range discussed in the literature.	Mean value found in the literature, based on real driving conditions.	Maximal value deduced from the literature.	
References	(CEPLACA, 1997) (Palacios et al. 2000)	(Helmerts, 1997) (Wang and Li, 2012)	(Hill and Mayer, 1977) (Bardi and Carporali, 2014)	

According to ACEA (2017), Statista (2017) and ICCT (2016): (i) the number of light-duty vehicles in use in Europe is of approximately 250 million and around 10 million of heavy-duty and off-road are equipped with a catalytic converters in Europe; (ii) the average annual mileage is estimated to be of 15,000 km for light-duty, and of 45,000 km for heavy-duty vehicles in Europe. For these four parameters, as the data are extracted from official European statistic, a relatively low and consistent uncertainty margin is attributed, as detailed in Table 58. Also, the average age of the European vehicles fleet is estimated around 11.5 years. Therefore, both new and old generation of catalytic converters are currently in use.

In regard to the average platinum mass in one light-duty vehicle: (i) Amatayakul and Ramnas (2001) accounted for 2 grams of platinum to perform a life cycle analysis (LCA) of a catalytic converter for passenger cars; (ii) Ravindra et al. (2004) specified the washcoat, carrier of the active precious metal, contains typically the total amount of 1.5-2.5 grams of platinum on its surface; and Fornalczyk (2013) confirmed platinum content in a light-duty automotive catalytic converter is still ranging between 1 and 3 grams on average. As such, a normal distribution has been defined for the mass of platinum in light-duty vehicles with the following attributes: a mean value of 2 grams and a standard deviation of 0,33, assuming therefore 99% of catalytic converters contain between 1 and 3 grams of platinum normally distributed around 2 grams.

On the other hand, the uncertainty is higher for heavy-duty equipments due to a wider range of engine power, the updates of emission regulations, and the evolution of autocatalyst technologies over time. Based on the value used in a comparative LCA of catalytic converters for heavy machineries (Saidani, 2015) and on discussion with industrialists (Saidani et al. 2018), a representative average platinum mass for a given catalytic converter for heavy-duty vehicles can be estimated around 5 grams.

All these values and their associated uncertainties are summarized in Table 58.

Table 58 – Parameters and variables of the model, with mean values and associated uncertainties

Parameters	Name	Uniform distribution (range)	Units
Par_1	FleetLight	(250 +/- 10%)	Millions of vehicles
Par_2	MileageLight	(15000 +/- 10%)	Kilometers
Par_3	FleetHeavy	(10 +/- 10%)	Millions of vehicles
Par_4	MileageHeavy	(45000 +/- 10%)	Kilometers
Variables	Name	Normal distribution (mean value; standard deviation)	Units
Var_1	LossPerKm	(0.8; 0.23)	µg of platinum, translated (homogenisation) in LossRatio per kilometer
Var_2	PlatinumLight	(2; 0.33)	g of platinum
Var_3	PlatinumHeavy	(5; 0.5)	g of platinum

MODEL SIMULATION

A global sensitivity analysis explores the simultaneous effects of input variations on the output of a mathematical model. The present analysis has been performed using the Sensitivity Analysis tool from Matlab R2018a and Simulink Design Optimization software. It follows the usual scheme and steps of conducting a sensitivity analysis, proposed by Groen et al. (2017) and Saltelli et al. (2008):

- Step 1: Define input distributions. The first step is to specify the probability distribution function and related distribution characteristics for each parameter/variable. As aforementioned, the input parameters/variables and their uncertainties are represented by probability density functions, using both the empirical and theoretical knowledge of the system to choose suitable probability distributions.
- Step 2: Propagate uncertainty according to the computation model. Second, for each parameter/variable, multiple values are generating according to the probability distributions, as illustrated in Figure 74. Regarding the number of parameters and variables, a reasonable number of samples has been fixed to 250, drawing as such a sufficiently large number of random samples for all input variables. Moreover, because random sampling can result in large gaps between some samples and close clustering of other samples, a quasi-random sampling (e.g. Sobol method giving more systematic space filling) has been preferred to avoid such gaps and clusters.

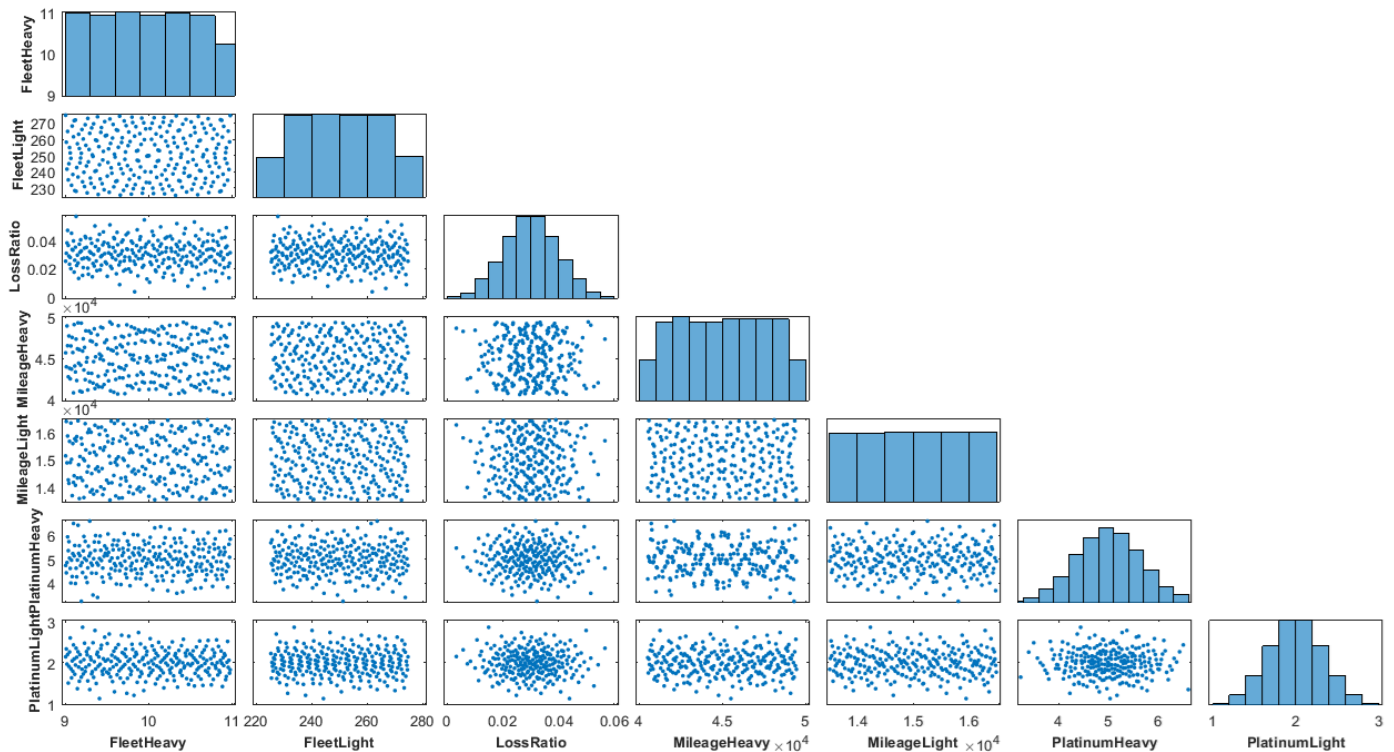

Figure 74 – Input distributions and sampling (Sobol method, 250 samples)

- Step 3: Calculate output distribution. Then, using Monte Carlo simulations, each combination of parameter/variable values are evaluated following the mathematical model given in Figure 73. The expected output of these simulations is a probability distribution estimating the losses of platinum from catalytic converters for one year at the scale of the European Union, as illustrated in Figure 75.

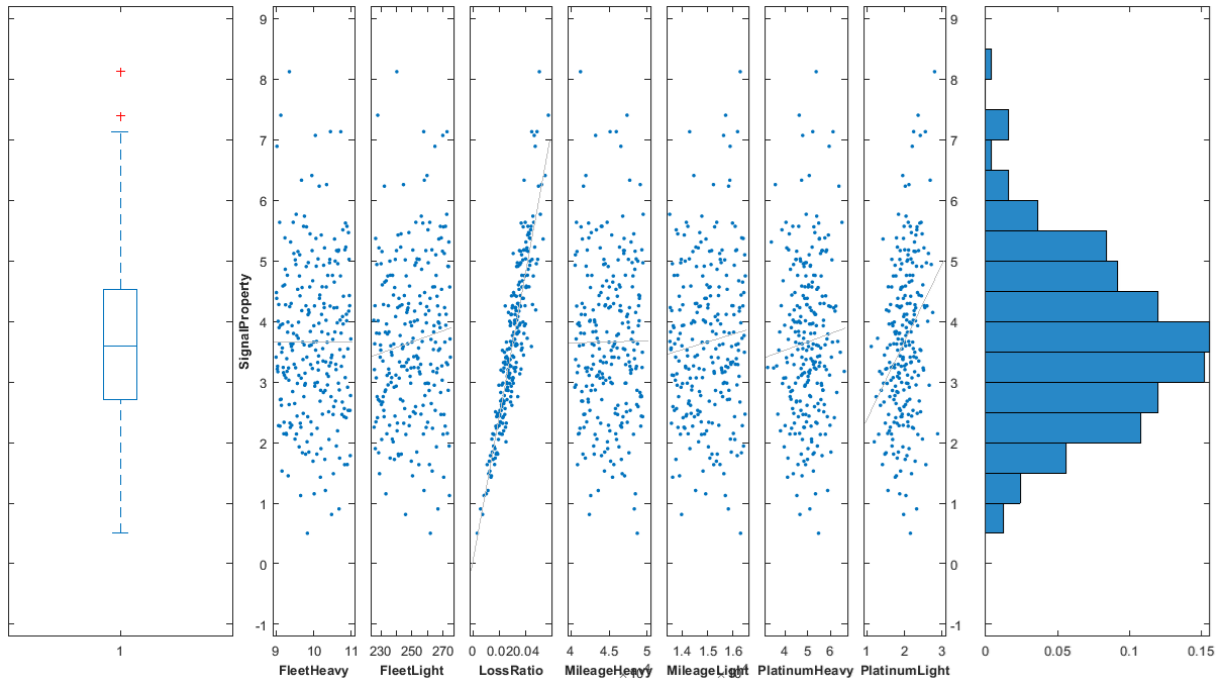

Figure 75 – Uncertainty propagation using Monte Carlo simulation

- Step 4: Statistical analysis and probability values. Eventually, after the uncertainty propagation is performed and a distribution function of the output is obtained, a statistical analysis is done, providing the following key values for the leakage of platinum from catalytic converters at the scale of the European Union for the 2017 year: a median value of 3.59 tons, a mean value of 3.47 tons, and a standard deviation of 1.35 tons, as shown in Figure 76.

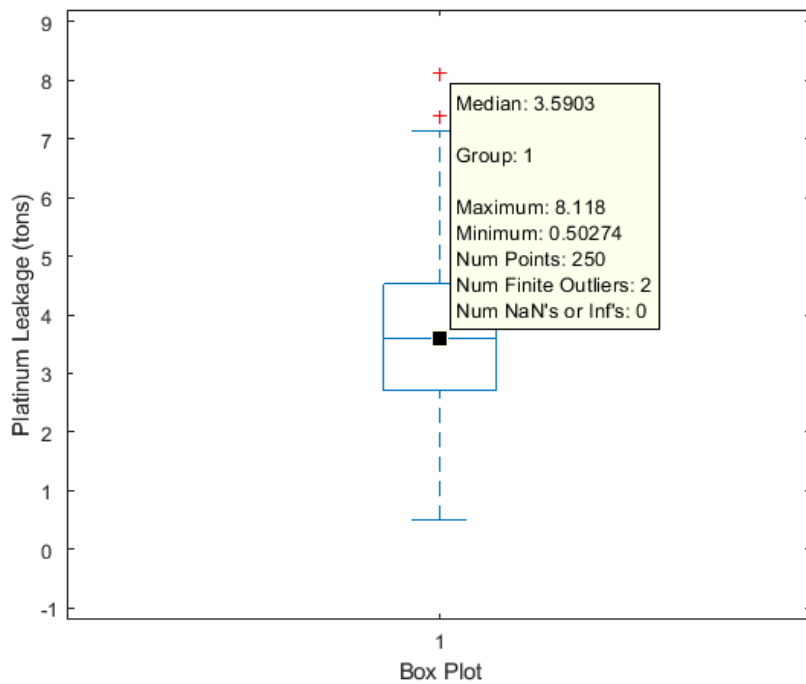

Figure 76 – Statistical analysis and probability values (box plot)

APPENDIX G – DATA TEMPLATE TO SUPPORT THE END-OF-LIFE MANAGEMENT OF HEAVY VEHICLES

DATASHEET AT THE SCALE OF THE END-OF-LIFE HEAVY VEHICLE

CHARACTERIZATION OF THE MACHINE

- ✓ Reference and type of machine:
- ✓ Nomenclature and/or technical datasheet, if available:
- ✓ Selling price of the brand new equipment vs. total cost of manufacturing
- ✓ Range price on the second-hand market
- ✓ Age and mileage of the worn-out machine:
- ✓ Condition of the recovered machine (wear and characterization): Intact – Accidented – End of life – Obsolete
- ✓ Degree of functionality: Still operational but dismantling for what reason(s) – Overall performance degradation
Important wear and tear of some components
- ✓ Traceability during use (e.g. change of parts) if any:

CHARACTERIZATION OF KEY COMPONENTS

What are the key components of the machine?

It may be a component that includes one or several of the following characteristics: {high economic value; heavy mass; greater environmental impact; core product technology; technological, manufacturing or assembly complexity that requires a strong expertise; significant manufacturing time; bottlenecks; high specificity or high transversality}.

- Outer components: bodywork, doors, windows, lenses, bumpers, lights, tyres
- Inner components: seats, control instruments, electronics, etc.
- Transmission systems: different fluids (transmission fluid, brake fluid, engine oil, petrol), batteries, engine, transmission (differential, gearboxes), chassis, catalytic converters, etc.
- Special equipment for handling operations: platforms, telehandlers / elevators, forks, etc.

Key components #	Mass / Materials Prices (brand new, buying to suppliers, selling to users)	Conditions (wear and tear, functional, etc.)	Accessibility and ease of dismantling (1 = Easy ; 4 = Difficult)	Transversality (compatibility with other machines)	Reuse or reman. opportunities?	Possible do to so at the Reman. Center?
...						

To close-the-loop effectively and efficiently, it is suitable to know what are the components and materials that have to be dealt with, in order to identify and select appropriate second-hand uses, e.g by considering the cost of different possible EoL options and to the value recoverable associated to these potential EoL pathways.

DATASHEET AT THE SCALE OF THE DISMANTLING PROCESS

PRE-DISMANTLING INFORMATION

- Reverse logistic aspects: distance, mean of transportation and cost to return the used machine to the Reman. Center:
- Current dismantling process, including steps and time: (illustrations or guidance documentation, if available)

What are the similarities and differences with the standardized, streamlined and well-established dismantling and recovery process (see figure below) of an ELV in Europe? (*regulated by the European Directive 2000/EC/53*)

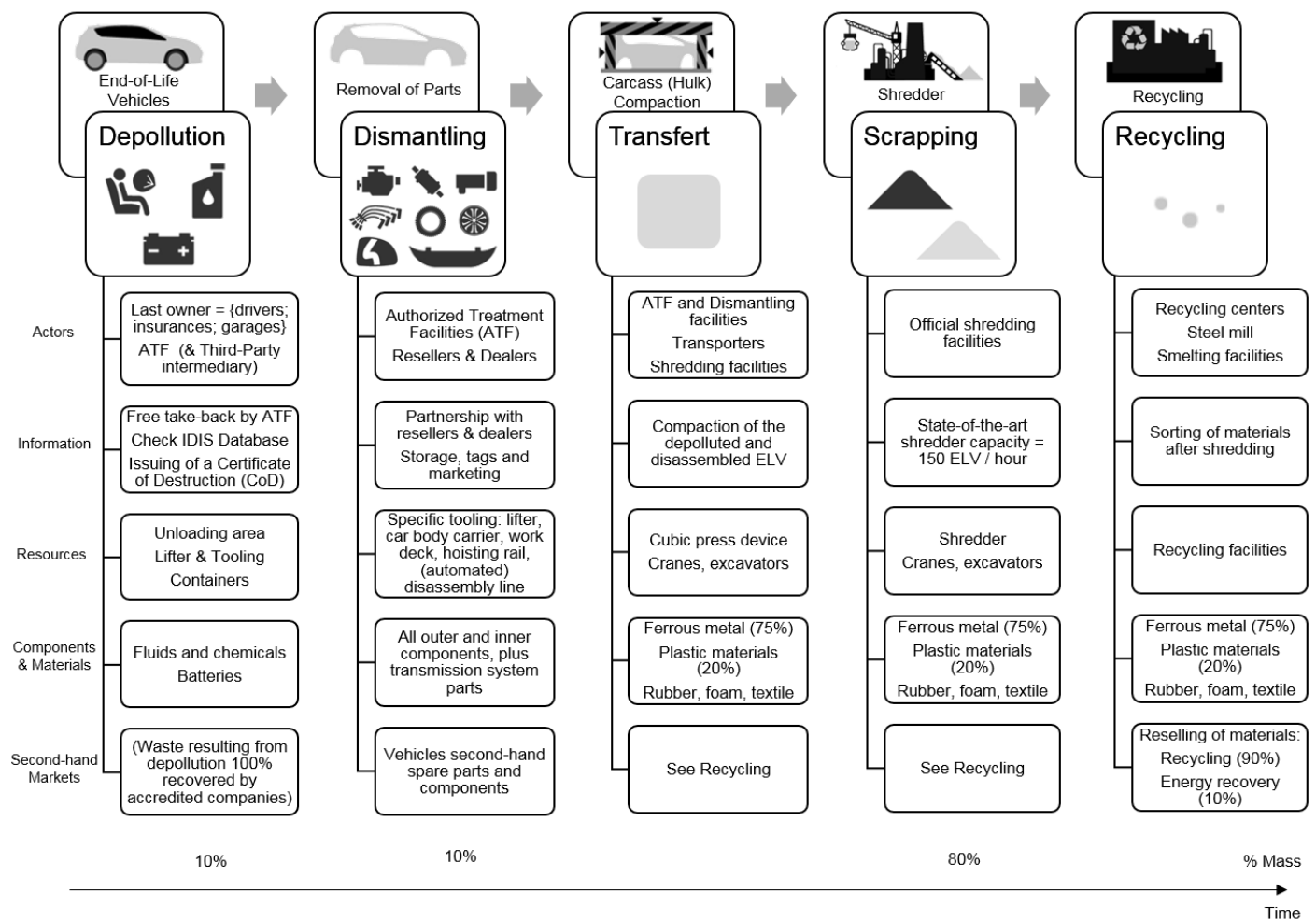

Figure 77 – End-of-life vehicle processing in the automotive industry, based on Toyota (2016) plus additional sources of information (INDRA, 2016a; Directive 2000/EC/53) and consulted experts

What resources are available and mobilized for the dismantling operations? (equipment, tools, labor and skills). If possible, indicate the associated economic (price, ...) and environmental costs (energy consumption, ...)

Do you already know the fate of some components that will be dismantled from the machine?

DISMANTLING PROCESS (EQUIPMENTS, OPERATIONS, ACTIVITIES)

Disassembly sequence: fill in the table below, if possible add photos or videos highlighting the dismantling hotspots.

Operation #	Component(s)	Time	Resources used	Energy consumption, etc.
...				

- Classification mode of the disassembly operations: partial or total; targeted/selective/flexible or systematic; destructive or non-destructive ? (number of components or parts concerned for each case)
- Total duration of disassembly operations:
- Total cost of the dismantling activity, including: workforce, supervision, electricity, tooling depreciation, infrastructures, cost of storage, other recycling cost (e.g. handling of hazardous substances)
- Total energy consumption (electricity, machine power supply, etc.):
- Difficulties encountered, including: accessibility, positioning, force required, time required, persons required:
- Access to key components facilitated by design or a dismantling guide / repair manual?
- Disassembly points easily recognizable: No – Yes but damaged by wear and tear – Yes

POST-DISMANTLING INFORMATION

After the inspection and sorting of the recovered components, the information in the table below will help defining the best end-of-life options for second-hand components and/or materials.

Recovered component #	Conditions: second-hand part price, recoverable value of materials	Reusable as it is (for which purpose?)	Further disassembly envisaged?	Possible to Remanufacture?
...				

Characterization of the rest of the machine (components remaining, ready to be refurbished?), if partial dismantling:

DATASHEET AT THE SCALE OF POSSIBLE END-OF-LIFE OPTIONS AND RECOVERY CHANNELS

Recovery options #	Components and materials concerned	In stock quantity vs. demand (current or forecast)	Costs of the operation (eco, env) Potential benefits	Subcontractor Location
Internal reuse	<i>Examples: Tyres, depending on the wear and tear</i>			
Resale as second-hand parts	Some outer components			
Remanufacturing to reach conformity then option # 1 or 2	<i>Gearbox / motor / alternator / turbo / injector / gearbox</i>			
Material recovery	<i>Steel / aluminum / copper / plastics / miscellaneous fluids (oils, liquids ...)</i>			

APPENDIX H – EVOLUTION OF THE PH.D. THESIS ILLUSTRATED THROUGH POSTERS



SAIDANI Michael, PhD Candidate
YANNOU Bernard, LEROY Yann,
CLUZEL François, Supervisors
Laboratoire Génie Industriel, CentraleSupélec
Université Paris-Saclay, France
Contact : michael.saidani@cep.fr

Eco-Design & Circular Economy of Heavy-Duty & Off-Road (HDOR) Vehicles

Contextual Framework

HDOR Features & Issues	Regulations
<ul style="list-style-type: none"> ▪ Mass of EoL HDOR = Mass of ELV in France [ADEME 08] ▪ Poor traceability after sales & Recycling channels are marginal ▪ Shipment of HDOR by illegal operators is still a flourishing business [EC & Bio by Deloitte 14] 	<ul style="list-style-type: none"> ▪ Absence of a regulatory framework for EoL & CO₂ emissions of HDOR, contrary to ELV (2000/53/EC) ▪ Extended Producer Responsibility for some spare parts ▪ Beware: Geographical disparity of EoL & Emissions Regulations ▪ REACH; WEEE; RoHS
Emerging Technologies	Industrial Needs
<ul style="list-style-type: none"> ▪ Intelligent Transportation System ▪ More & more devices connected to the OBD (On Board Diagnosis) ▪ GPS + RFID + IoT + Telematics + Big Data Analytics applied to transportation and construction industries 	<ul style="list-style-type: none"> ▪ Anticipate upcoming regulations ▪ Develop new Business Model (e.g. PSS, Telematics Offers) ▪ Eco-management in real-time (e.g. eco-drive, preventive maintenance) ▪ Reduce dependency on oils & precious raw materials ▪ Waste Management & Treatment

HDOR Vehicles & Sustainability Issues

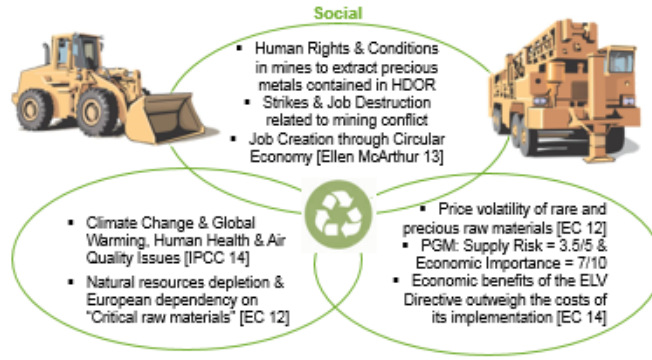

Social

- Human Rights & Conditions in mines to extract precious metals contained in HDOR
- Strikes & Job Destruction related to mining conflict
- Job Creation through Circular Economy [Ellen McArthur 13]

Environment

- Climate Change & Global Warming, Human Health & Air Quality issues [IPCC 14]
- Natural resources depletion & European dependency on "Critical raw materials" [EC 12]

Economic

- Price volatility of rare and precious raw materials [EC 12]
- PGM: Supply Risk = 3.5/5 & Economic Importance = 7/10
- Economic benefits of the ELV Directive outweigh the costs of its implementation [EC 14]

Research Question & Objectives

Research Question

- How to optimize the sustainable management of a fleet of HDOR throughout all life cycle, at different scales and for all stakeholders thanks to the help of the new and emerging technologies, IoT & Telematic Systems?

→ Significant issue divided into five linked & complementary WorkPackages (WP)



Multi-Scales & Multi-Stakeholders Approach Throughout All Life Cycle

Objectives

- For Academics = To develop relevant frameworks to handle the 3 sustainability pillars within socio-technical complex systems
- For Industrials = To foster and help companies to a sustainable management of their HDOR fleet all along the life cycle
- For Policy-Makers = To support strategic policy decisions concerning the EoL of HDOR

Problem-Solving Method

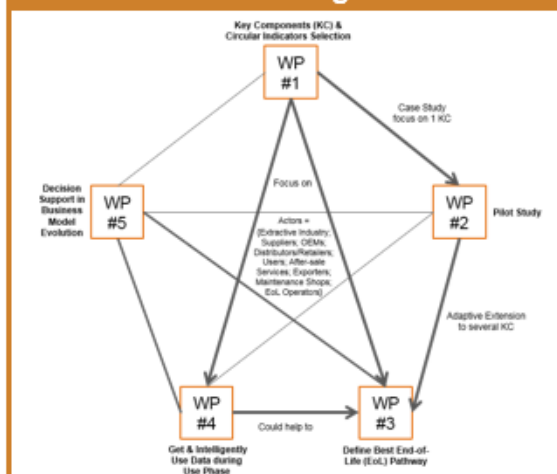

Key Components (KC) & Circular Indicators Selection

Actors = (Extractive Industry, Suppliers, OEMs, Distributors/Retailers, Users, After-sale Services, Exporters, Maintenance Shops, Col. Operators)

Progress, Perspectives & Next Steps

- ✓ Extensive Literature Review
- ✓ Key words = [Circular Economy; Design for 3R; End-of-Life Options; End-of-Life Vehicles; Modular Product Design; Sustainable Business Model; Sustainable System Design; Telematics & IoT Applications for HDOR; Upgradability; Usage Modeling in Design; Usage Predictive Model; Value Chain Design]
- ✓ Main References = [Farel & Yannou 13] [Kim et al. 16] [Ma & Kremer 15, 18]
- ✓ Gaps Identified:
 - Lack of tools to monitor overall performance of the circular economy;
 - A need to aggregate as many sustainability themes as possible into a framework, and from a dynamic point of view;
 - How to include user-generated contents, and organize consumption and maintenance feedbacks, in real-time and also during design process.
- ✓ Meetings with experts from ADEME, french environmental agency
- ✓ Establishment of a Contact List, with potential industrial companies to collaborate
- ✓ WP#1 Progress = Great range of criteria to select Key Components
- ✓ WP#3 Progress = Identification & Definition of 10 End-of-Life Options
- ✓ WP#4 Progress = Mapping of Information that could be captured in Heavy Vehicles

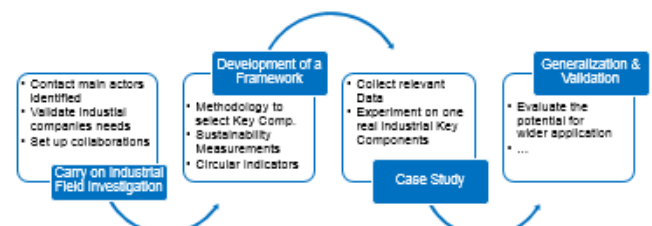

References

- [EC 12] Report on Critical Raw Materials for the EU, European Commission, 2012.
- [EC 14] Ex-post evaluation of certain waste stream Directives, European Commission, 2014.
- [Farel & Yannou 13] Farel R., Yannou B., A Method to Design a Value Chain from Scratch, ICORD' 13, Lecture Notes in Mechanical Engineering, India, 2013.
- [Ellen McArthur 13] McArthur, E., Towards the circular economy, Journal of Industrial Ecology.
- [IPCC 14] Climate Change 2014: Synthesis Report, IPCC, 2014.
- [Kim et al. 16] Kim H., et al., Research Perspectives in Sustainable Design, Design Science.
- [Ma & Kremer 15] Ma J., Kremer G., A sustainable modular product design approach with key components and uncertain EoL strategy consideration, Journal of Cleaner Production, 2015.

CRIEC 2016
14-17 June 2016, Chatenay-Malabry, France



Team Design Engineering
Laboratoire Génie Industriel



SAIDANI Michael, PhD Candidate
YANNOU Bernard, LEROY Yann,
CLUZEL François, Supervisors
Laboratoire Génie Industriel, CentraleSupélec
Université Paris-Saclay, France
Contact : michael.saidani@ecp.fr

Towards a Circular Economy of Heavy-Duty & Off-Road (HDOR) Vehicles and Associated Key Components (KC)

Contextual Framework

HDOR Features & Issues	Regulations
<ul style="list-style-type: none"> ▪ Mass of EoL HDOR = Mass of ELV in France [ADEME 06] ▪ Poor traceability after sales & Recycling channels are marginal ▪ Shipment of HDOR by illegal operators is still a flourishing business [EC & Bio by Deloitte 14] 	<ul style="list-style-type: none"> ▪ Absence of a regulatory framework for EoL & CO₂ emissions of HDOR, contrary to ELV (2000/53/EC) ▪ Extended Producer Responsibility for some spare parts ▪ Beware: Geographical disparity of EoL & Emissions Regulations ▪ REACH; WEEE; RoHS
Emerging Technologies	Industrial Needs
<ul style="list-style-type: none"> ▪ Intelligent Transportation System ▪ More & more devices connected to the OBD (On Board Diagnosis) ▪ GPS + RFID + IoT + Telematics + Big Data Analytics applied to transportation and construction industries 	<ul style="list-style-type: none"> ▪ Anticipate upcoming regulations ▪ Develop new Business Model (e.g. PSS, Telematics Offers) ▪ Eco-management in real-time (e.g. eco-drive, preventive maintenance) ▪ Reduce dependency on oils & precious raw materials ▪ Waste Management & Treatment

HDOR Vehicles & Sustainability Issues





Social

- Human Rights & Conditions in mines to extract precious metals contained in HDOR
- Strikes & Job Destruction related to mining conflict
- Job Creation through Circular Economy [Ellen McArthur 13]



Economic

- Price volatility of rare and precious raw materials such as Platinum Group Metals [EC 12]
- Economic benefits of the ELV Directive outweigh the costs of its implementation [EC 14]

Environment

- Climate Change & Global Warming, Human Health & Air Quality Issues [IPCC 14]
- Natural resources depletion & European dependency on "Critical raw materials" [EC 12]

Research Question, Multimethodology & Objectives

Research Question

- How to enhance the sustainable management of HDOR Vehicles all along their life cycle, at different scales and for all stakeholders thanks to the help of new and emerging technologies, in the context of Circular Economy?

Multimethodology

- Holistic & integrated framework that combined the strengths of complementary methods & tools



Multi-Scales & Multi-Stakeholders Approach Throughout All Life Cycle

Objectives

- For Academics = To develop relevant frameworks to handle the 3 sustainability pillars within socio-technical complex systems
- For Industrial Sector = To foster and help companies in a more sustainable management of their HDOR fleet all along life cycle
- For Policy-Makers = To support strategic policy decisions on the End-of-Life of HDOR Vehicles

Case Study on 1 KC - The Catalytic Converter



Why is it a Key Component ?

- Emission regulations are increasingly strict
- Essential control device to make the air cleaner
- Contains Precious Group Metals (e.g. Platinum)
- Tremendous cost and environmental impacts



Data Construction

- Life cycle thinking approach
- Mix of data from mining operators, equipments manufacturers, users, market trends, recycling centers, environmental agencies reports, ...

→ Consolidation of all the data in one standardized Excel data sheet

Previous Work & Current Situation

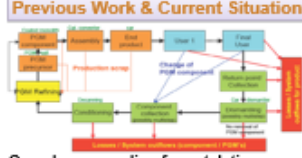

▪ Open loop recycling for catalytic converters → Overall platinum recycling rate below 50% [Hagelüken et al. 16]

Modelling Stages

1. Cognitive Mapping



- To list and link all influencing parameters
- Comprehensive overview of the system

2. Up-to-date MFA of the value chain



- Quantitative information about the existing channel, stock and losses

3. Refined Graphical Model



- System Dynamics model
- Feedback loops that fit to the circular economy paradigm

SD Simulations

Simulations & Forecasts [Farel & Yannou 13]

How to close the loop of Platinum from Catalytic Converters of HDOR Vehicles? → Prospective scenarios construction to evaluate potential environmental & economic impacts

- What will happen if a minimum mandatory recycling rate of HDOR Vehicles is implemented?
- What if collection rate is improved by 10% or if design is modified for easy disassembly? ...

Progress & Next Steps

Building Block of a Circular Economy (IPCC 14)

Product Design	New BM	Reverse Cycles	System Conditions
Material Selection Design for 3R Design for X...	Circular BM Sharing Platform PSS...	Collection, Sorting & Treatment Sys. Closed-Loop SC...	Collaboration Sharing incentives Environmental rules...



Validation

Case Study

- Process modeling and simulation steps
- Circularity score
- Recommendations to move towards a more circular economy







Generalisation

- Compare outcomes with results from existing tools
- Feedback from industrial experts and practitioners

Dissemination

- Provide a ready-to-use methodological kit to measure and improve circularity for industries
- Inform environmental agencies

Exchanges with Main Stakeholders all along Value Chain Insights from Best Industrial Practitioners









References

- [EC 12] Report on Critical Raw Materials for the EU, European Commission, 2012.
- [EC 14] Ex-post evaluation of certain waste stream Directives, European Commission, 2014.
- [EMF 15] Ellen Mc Arthur Foundation, Towards the circular economy: Business Rationale for an accelerated transition, 2015.
- [Farel & Yannou 13] Farel R., Yannou B., A Method to Design a Value Chain from Scratch, ICoRD' 13, Lecture Notes in Mechanical Engineering, India, 2013.
- [IPCC 14] Climate Change 2014: Synthesis Report, IPCC, 2014.
- [Hagelüken et al. 16] Hagelüken C., et al., The EU Circular Economy and Its Relevance to Metal Recycling, Recycling Volume 1, Issue 2, 2016.



JUIN-DD'16
18 Octobre 2016, Montreuil, France



Michaël SAIDANI

Page 213

PhD thesis



SAIDANI Michael, PhD Candidate
YANNOU Bernard, LEROY Yann,
CLUZEL François, Supervisors
Laboratoire Génie Industriel, CentraleSupélec
Université Paris-Saclay, France
Contact: michael.saidani@centralesupelec.fr

How to Close the Loop of Platinum from Heavy Vehicles Catalytic Converters? Framework to Evaluate the Impact of Several Promising Action Levers

1. Context - Key Figures

- Emission regulations are increasingly strict
- Catalytic converters (CC) are mandatory devices
- Contain a non-negligible amount of Platinum (Pt)
- European dependency on "critical raw materials" such as Pt coming mainly from South Africa [EC, 12]
- No EoL regulations for heavy vehicles in Europe
- Boom of circular economy (CE) practices to explore



Tremendous Economic Cost: 1 kg of Platinum = 30 k€

Environmental Burden (GHG Emissions + Energy):
1 kg of Primary Platinum = 40 tons CO₂ eq. + 200 GJ

Technological Feasibility to Recycle Pt from CC > 95 %

- Interest for European industrialists to recover the Pt of their systems
- Secondary Pt from EoL CC could divide by 20 the environmental cost

2. Objectives

- Make an inventory of influence parameters to close-the-loop & link the identified parameters to stakeholders' action levers
- Quantify the impact of key actions levers on the CE performance by considering both environmental & economic parameters
- Propose and test a methodology to do so on an industrial system

4. A Multi-Tool Methodology

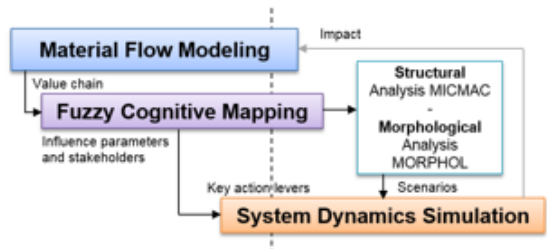

1. Material Flow Analysis (MFA) with STAN

- To have a comprehensive and quantitative view of the current value chain and its important sub-systems (collection rates, exports, EoL chain efficiency, ...)
- To capture visually the missed opportunities and value buckets
- To identify involved stakeholders on the value chain



2. Fuzzy Cognitive Mapping (FCM) with Mental Modeler

- To map and link both influencing parameters and potential actions levers of a complex system on a semi-quantitative causal graph

3. Structural Analysis with MICMAC

- To select key influence parameters and promising actions levers

4. Scenarios Generation with MORPHOL

- To set up different relevant prospective scenarios
- To evaluate the potential environmental and economic impacts

→ Looping to report the impact on the value chain and actors' network

References

- [EC, 12] Report on Critical Raw Materials for the EU, European Commission, 2012.
- [Farel et al., 13] Farel, R., Yannou, B., Bertoluci, G., Finding Best Practices for Automotive Glazing Recycling: a Network Optimization Model, Journal of Cleaner Production, 2013.
- [Hagelöken et al., 16] Hagelöken, C., et al., The EU Circular Economy and its Relevance to Metal Recycling, Recycling Volume 1, Issue 2, 2016.
- [Djds et al., 17] Djds, H., De Costa, P., Alties, D., Is Electric Vehicles Battery Recovery a Source of Cost or Profit?, The Automobile Revolution, Springer, 2017.
- [Johnson Matthey, 2017] PGM Market Report May 2017, Summary of Platinum Supply & Demand in 2016 and Forecast for 2017, JM Precious Metals Management, 2017.

3. Literature Review - Industrial Diagnosis

Current Value Chain of Platinum from Catalytic Converter

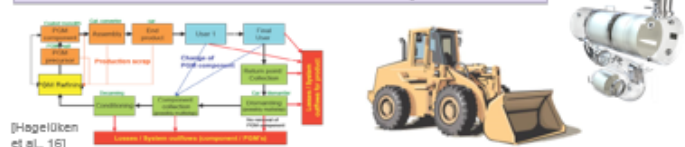

- Overall platinum recycling rate from autocatalyst = 50% (less for heavy vehicles)
→ How to improve the end-of-life recycling rate of Pt & the recovery of CC in Europe?
- Many qualitative recommendations and opportunities are discussed in the literature
- But there is a lack of quantitative studies to evaluate the impact of possible solutions

Methods & Tools to Model and Simulate CE Strategies

- Use several tools (from industrial ecology, sustainability, prospective methods, etc) and their complementary strengths to cover the whole complexity of the CE paradigm (e.g. systemic & lifecycle thinking, ...)

Features Tools	Modeling services	Simulation- based	Feedback loops	Value Network ...
MFA	X		(X)	X
System Dynamics (8D) ...		(X)	X	

- Multimethodology (mix of modeling and simulation tools) inspiration from the works of [Farel et al., 13] SD to design an end-of-life (EoL) value chain of glass from EoL cars [Djds et al., 17] Cognitive mapping & SD to design a recycling network for lithium-ion batteries

5. Application - First Results

1. Material Flow Analysis + Stakeholders Mapping + Value Buckets

- 1 MFA for the Pt value chain from CC, at the European scale, data from [JM, 17]
- 1 MFA for the Pt need, use and recovery from the point of view of an European company manufacturing and selling CC
→ Quantified information about the existing channels, with stocks and losses for the European Union and for one OEM

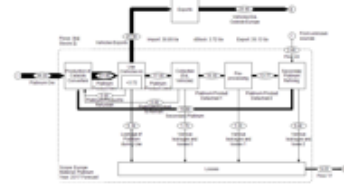

Examples of involved actors



Value Bucket: Stock of CC in use in Europe
Annual Import > 36 tons of Primary Platinum

Value Bucket: Halve the import of Primary Pt
→ Savings of: 700 k tons CO₂ eq. & 3 000 TJ

2. Fuzzy Cognitive Mapping + Clusters of Action Levers



6. Perspectives - Next Steps

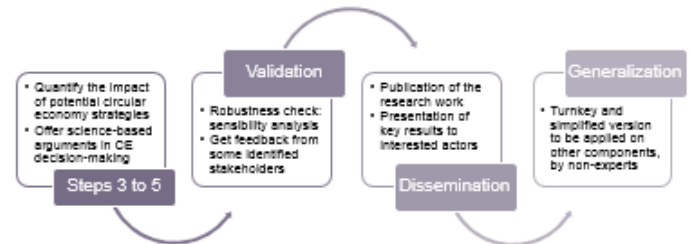

2017 Joint Conference
ISIE and ISSST



ISIE-ISSST 2017

June 25-29, 2017 | Chicago, Illinois, USA



SAIDANI Michael, YANNOU Bernard,
LEROY Yann, CLUZEL François
Laboratoire Génie Industriel, CentraleSupélec
Université Paris-Saclay, France
Contact: michael.saidani@centralesupelec.fr

Taxonomy and Choice of Appropriate Set of Circularity Indicators

The Circularity Indicators Advisor

Circularity Indicators (CI)

- The circular economy (CE) seems promising to meet the goals of sustainable development (Schroeder et al. 2010)
- Yet, two key challenges have still to be addressed:
 - How to support CE practitioners in this transition?
 - How to assess the circularity performance?
- Joint agreement on the need to measure the progress towards circularity in order to enhance and monitor the impacts, and benefits of this transition. (Geng et al. 2013) (EC, 2015) (Ceylan et al. 2017)

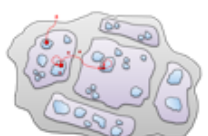

Potentially useful applications: circularity and sustainability performance assessment, improvement guidelines, decision-making, management, benchmarking, communication, etc.

- Due to an increasing number of CI with many different scopes, purposes and usages, the objective is to provide clarity on these indicators, so as to guide CE practitioners towards the right set of indicators, regarding their needs and requirements.

Level	Definition	Example
Macro	City, region, nation	19% of the UK economy is circular in 2010
Meso	Inter-entreprise	CEPs performance
Micro	Company, Products, Materials	Material Circularity Indicator

Proposed Taxonomy

- Research approach** = Extensive literature review on CE-related indicators.
- Identification, analysis and classification of over 50 sets of circularity indicators developed and used by academics, businesses, consulting companies, environmental organisations and governmental agencies.
- In line and in complementarity with existing taxonomies of eco-design tools** (Rousseaux et al. 2017) (Rovati and Pérez-Belis, 2012) and of circular economy business models (Lubinet et al. 2017)
- Clustering method:** Proposition of a need-based taxonomy, driven by the usages of such indicators.
- Combinatory aspects:** The approximately 200 possible pathways thought criteria combination - among the 50 sets of indicators inventoried - ensure a rapid convergence towards the most suitable circularity indicator(s).

Categories (criteria)	Levels (micro, meso, macro)	Loops (maintain, reuse/remain, recycle)	Perspective (actual, potential)	Performance (intrinsic, impacts)	Units (quantitative, qualitative)
	Dimension (single, multiple)	Usages (e.g. improvement, benchmarking, communication)	Sources (academics, companies, agencies)	Transversality (generic, sector-specific)	Format (e.g. web-based tool, Excel, formulas)

Selection Tool

- Presentation**
Goal: To support the users in identifying and selecting the most appropriate circularity indicators in line with their objectives.
Audience: Industrial practitioners (e.g. designers, engineers, managers) decision-makers and policy-makers working in CE projects.
Software: Microsoft Excel worksheet based tool with macro enabled.
Database: A pool of more than 50 sets of circularity indicators.
- Input Data**
In the **input interface** of the Excel file, one can specify the desired features, by answering 8 multiple-choice questions, e.g. if one is interested in measuring the inherent circularity (i.e. recirculation of resources) or the consequences (i.e. impacts) of such circularity?
- Run the Search**
Once the **query** is completed, a click on the round logo at the top starts the search.
- Outputs**
The tool directs automatically to the **results table** of recommended indicators. It includes a short description of each selected indicator, its working principle, the data required to be computed, and a summary of its potentially useful usages.
- Explore, Test, & Implement**
A direct **internet access link** to each of the recommended indicators and their assessment framework is also indicated, to get more details on the indicator, to experiment their associated assessment framework (e.g. formulas to compute, web-based tool, dynamic Excel spreadsheet, etc.) and, if relevant, to start implementing such indicator(s) in diverse circular economy project(s).



Circularity Indicators - The Advisor

Target the Right Indicators for Your Organization

Inputs - Filtering Selection Criteria

1/ Fill in the yellow cells that can be scrolled, as a filter to identify the most suitable circularity tool(s)/indicator(s) to your needs. !!!
2/ Click on the logo above to launch the search and have access to your personalised inventory of circularity tools/indicators. !!!
N.B. You can leave one or several criteria blank to have access to a wider variety of proposed solutions.
For instance, if all criteria fields are left empty, every tool available among the inventory will be displayed.

Are you focused on the circularity of products, components, materials (micro), of a company, organization, industrial ecosystem, eco-park, value chain (meso), of a region or nation (macro)?	Mixed
Are you interested in knowing actual and effective circularity performances (retrospective) or potential performances of circular practices e.g. during product development (prospective)?	Potential
Are you willing to evaluate the intrinsic performance of your circularity loops (recirculation of resources) or the impacts/consequences of circular practices on the sustainability performance?	Intrinsic (Recirculation of Resources)
Are you considering a particular loop/class of the circular economy (i.e. Class A = Maintain & Prolong, Class B = Repair & Reuse, Class C = Recycle)?	
Are you looking for more particularly for a tool with a single and unique indicator or for a framework including a set of multiple indicators?	
Usages & Purposes (Filter Not Available - Under Construction)	
Are you looking for generic tool(s)/indicator(s) that could be applied for a wide variety of products/organizations or for more specific ones designed for a particular industrial field?	
Type & Format? What kind of tool(s)/indicator(s) would you prefer to use?	Formulas to compute Computational tool Dynamic Excel spreadsheet Web-based tool Assessment framework

Use Cases - Experimentation

The following work table has been completed successfully. Please find below the features of circularity tools/indicators that are meeting your defined criteria. We hope you will find them useful!
The table of search results, and its list of recommendations of suitable tools/indicators are available in the Results, above the end of the Selection tool interface.
The queries have been made on the database of circularity tools and have been updated. Therefore, you can access 17 circularity tools/indicators that are not listed below.
The list of search results is available in the Results, above the end of the Selection tool interface.

Circularity Indicator Name/Author/Year	Definition	Proposed Working Principle	Business level	Field of Interest	Assessment/Measurement	Input Data	Output	Type of Tool (Excel, Web, etc.)	Access Link
Circularity Indicator for the Construction Industry (CI-CI) (2015)	The CI-CI is a circularity indicator for the construction industry.	CI-CI is a circularity indicator for the construction industry.	Construction	Construction	CI-CI is a circularity indicator for the construction industry.	CI-CI is a circularity indicator for the construction industry.	CI-CI is a circularity indicator for the construction industry.	CI-CI is a circularity indicator for the construction industry.	CI-CI is a circularity indicator for the construction industry.
Circularity Indicator for the Manufacturing Industry (CI-MI) (2015)	The CI-MI is a circularity indicator for the manufacturing industry.	CI-MI is a circularity indicator for the manufacturing industry.	Manufacturing	Manufacturing	CI-MI is a circularity indicator for the manufacturing industry.	CI-MI is a circularity indicator for the manufacturing industry.	CI-MI is a circularity indicator for the manufacturing industry.	CI-MI is a circularity indicator for the manufacturing industry.	CI-MI is a circularity indicator for the manufacturing industry.
Circularity Indicator for the Retail Industry (CI-RI) (2015)	The CI-RI is a circularity indicator for the retail industry.	CI-RI is a circularity indicator for the retail industry.	Retail	Retail	CI-RI is a circularity indicator for the retail industry.	CI-RI is a circularity indicator for the retail industry.	CI-RI is a circularity indicator for the retail industry.	CI-RI is a circularity indicator for the retail industry.	CI-RI is a circularity indicator for the retail industry.

- Focus on the micro level of CE (i.e. company, products, components and materials):
- To explore how appropriate CI can help (re-)designing better circular products.
- To experience the tool on CI use cases published in literature to test its robustness (e.g. on used starter engines, prototype tidal energy device, and catalytic converter).
- Perspectives: to link CI heuristics with tangible impacts; to keep the databank up-to-date.

→ Tutorial video <https://youtu.be/nRNbWYHRzic>
→ Industrial application <https://youtu.be/kd51SsX0Be4>

References

Schroeder, S.C., Glinne, R. and Miles, J.D.: 2010, 'Progress of a Sustainable Circular Index for Manufacturing Companies', *Resources*, 9, 85.

Rovati, S.G. and Pérez-Belis, V.: 2012, 'A taxonomy of knowledge tools for integrating environmental requirements into the product design process', *Journal of Cleaner Production*, Volume 30, pp. 1741-1751.

Ceylan, S., Collins, P. and Baghelis, V.: 2017, 'Design Indicators for measuring green performance in the circular economy', *International Journal of Sustainable Engineering*, Volume 11, pp. 1-12.

Blis, V. et al.: 2017, 'Measuring circular economy strategies through Index methods: A critical analysis', *Journal of Cleaner Production*, Volume 142, pp. 2741-2751.

Blon Masclafour Foundation (BMF): 2016, 'Circularity Indicators - An Agreement to Measure Circularity', *Technology & Project Operations*, Geneva, UK.

Burgener Commission (BC): 2016, 'Closing the Loop - An EU Action Plan for the Circular Economy', COM (2016) 6142, Brussels, Belgium.

Debaecker, M., Seargey, P. and Baeten, P.M.: 2017, 'The Circular Economy - A new sustainability paradigm?' *Journal of Cleaner Production*, Volume 143, pp. 797-798.

Geng, Y. et al.: 2013, 'Towards a rational circular economy indicator system in China: An evaluation and critical analysis', *Journal of Cleaner Production*, Volume 23, pp. 248-254.

Paulus, S.: 2015, 'A dashboard of quantitative system indicators for its implementation in organizations', *Resources, Conservation and Recycling*, Volume 102, pp. 31-52.

Rousseaux, P. et al.: 2017, 'Benchmarking: A new and unique business profile for sharing eco-design tools', *Journal of Cleaner Production*, Volume 151, pp. 308-317.

Saidani, M., Yannou, B., Leroy, Y. and Cluzel, F.: 2017, 'How to Assess Product Performance in the Circular Economy?' *Engineering*, 11, 1-12.

Saidani, M., Yannou, B., Leroy, Y. and Cluzel, F.: 2017, 'Hybrid heuristics and benchmarking framework to measure product's circularity performance', *ICIS 17*.

Debaecker, P., Janssens, K. and Vriens, V.: 2016, 'The Relevance of Circular Economy Practices in the Sustainable Development Goals', *Journal of Industrial Ecology*, Volume 18, pp. 427-432.

Lubinet, L. et al.: 2017, 'Towards a new taxonomy of circular economy business models', *Journal of Cleaner Production*, Volume 148, pp. 427-432.

SAIDANI Michael, PhD Candidate
YANNOU Bernard, LEROY Yann,
CLUZEL François, Supervisors
Laboratoire Génie Industriel, CentraleSupélec
Université Paris-Saclay, France
Contact: michael.saidani@centralesupelec.fr

Measuring and Monitoring Progress Towards the Circular Economy (CE)
Application to the Heavy Vehicle Industry

Towards a Circular Economy of Heavy Vehicles



Absence of EoL regulations, lack of infrastructures, illegal exports, env. burden, eco. loss, etc.

In-depth literature review and field investigations

Four feedback loops and four building blocks of the CE

Identification of best practices and key action levers to close-the-loop

Comparison with the automotive industry

Application on an industrial pilot study with Manitou Reman

Eco, env, tech, org, analysis of the reconditioning of a used machine



Assess - Circularity Indicators adapted to Designers and Industrialists

Important degree of fuzziness and limitations

Growing number of circularity indicators

Life-Cycle Impact Assessment

Need-based taxonomy of 50 sets of CI
"CI: The Advisor" Excel-based query tool

Correlation between circularity scores and sustainability scores?

Circularity Score = 34%

BBM1 - Circular Product Design = 11.8 / 15	BBM2 - New Business Model = 8.2 / 12.6	BBM3 - Reverse cycles = 1.8 / 2.6	BBM4 - System Conditions = 8.2 / 28
AT181 - Material Selection = 2.5 / 5 AT182 - Modular Product Design = 1.8 / 5 AT183 - Design for Disassembly = 2.4 / 5 AT184 - Design for Upgradability = 2.5 / 5 AT185 - Design for Longevity = 2.5 / 5	AT186 - Design for PSS = 0 / 5 AT187 - Leasing or Rental Schemes = 0 / 5 AT188 - Alternatives Services = 3.3 / 5 AT189 - Take-Back Offers = 5 / 5 AT190 - Sharing Platform = 0 / 5	AT191 - Traceability = 0 / 5 AT192 - Take-Back Process = 1.9 / 5 AT193 - Collector Mechanisms = 1.8 / 5 AT194 - Treatment Facilities = 2.2 / 5 AT195 - E-o-L Collaborators = 0 / 5	AT196 - Product Conditions = 3.2 / 5 AT197 - Actor' Behaviours = 2.8 / 5 AT198 - Policy Framework = 0 / 5 AT199 - Second-Hand Market = 2 / 5 AT200 - Financial Incentives = 0 / 5

Development of a Circularity Potential Indicator, including 20 attributes, based on the 4 building blocks of the CE

Application on an Industrial Case Study

LIEBHERR

System Modeling

Improve - How to "Close-the-Loop" on Platinum from Catalytic Converters?

Highlight of important economic and environmental value buckets for European stakeholders

2017 Joint Conference ISIE and ISSST

12th Society And Materials International Conference

Presentations at French & International Conferences

Designing a multi-tool method to model and simulate circularity performance

Material Flow Modeling

Fuzzy Cognitive Mapping

Structural Analysis MICMAC

Morphological Analysis MORPHOL

System Dynamics Simulation

"What if?" scenarios to evaluate the environmental and economic impacts of CE related strategies

Interested and feedback from European Industrialists involved in this challenge

LIEBHERR

Johnson Matthey
Precision Metals Management

1 kg of primary Pt = 40 tons CO₂ eq. + 200 GJ + 30 k€
Technological feasibility to recycle Pt from CC > 95 %
Secondary Pt could divide by 20 the environmental cost

This page intentionally left blank.

Titre : Piloter et catalyser la transition vers une économie circulaire - Outils et indicateurs appliqués à l'industrie des véhicules lourds

Mots clés : Economie circulaire, indicateurs de circularité, gestion de la fin de vie, industrie des véhicules lourds, développement durable, génie industriel.

Résumé : Cette thèse fournit des clés pour mesurer, améliorer et piloter la performance de circularité de produits industriels à différentes échelles d'implémentation de l'économie circulaire (micro, meso, macro). Plusieurs indicateurs de circularité y sont expérimentés au travers d'un cas d'étude industriel et une analyse critique de ces indicateurs est effectuée au regard, entre autres, du paradigme de l'économie circulaire, et de leur intégration dans les pratiques industrielles de (re)conception et développement de produits et services. Dans le même temps, en réponse au nombre croissant d'indicateurs de circularité développés, de périmètres et d'ambitions inégales, une taxonomie d'indicateurs de circularité est proposée dans le but de clarifier le flou actuel autour de cette nébuleuse d'indicateurs de circularité. Cette classification ordonnée d'indicateurs est accompagnée de son outil informatique d'aide à la sélection afin de faciliter leurs usages appropriés. Un nouvel indicateur de circularité est également développé et expérimenté, puis des recommandations pour le développement d'indicateurs futurs sont discutées. Bien que les indicateurs évoqués dans la thèse aient pour vocation à être utilisés pour tout type de secteur, l'industrie des véhicules lourds en est le cadre d'application. En effet, en l'absence de réglementation européenne sur la fin de vie de ces véhicules, il s'agit d'identifier, de questionner et de tester les leviers d'actions que cette industrie peut activer pour améliorer sa performance dans une perspective d'économie circulaire.

Tout d'abord, les meilleures pratiques et les défis actuels de l'industrie des véhicules légers et des véhicules lourds sont mis en exergue au regard des quatre pierres angulaires de l'économie circulaire définis par la Fondation Ellen MacArthur (conception circulaire, nouveaux modèles d'affaires, logistique inversée, écosystème) et des quatre boucles principales du modèle circulaire (maintenance, réutilisation, reconditionnement, recyclage). Ces pratiques exemplaires sont synthétisées au sein d'un guide de deux pages pour faciliter leur diffusion et adoption par les praticiens industriels désirant mettre en œuvre de tels modèles de circularité. Par la suite, une étude industrielle pilote a été menée avec un constructeur d'engins de manutention cherchant à développer son activité de reconditionnement d'engins en fin de vie. Inspiré par des investigations sur le terrain couplé à un état de l'art étendu, une modélisation multi-échelles – a) engin et composants clés, b) processus de démantèlement, c) filières de valorisation – a permis (i) de proposer et de valider une amélioration (en temps et en ressources) des opérations de démontage d'un point de vue organisationnel et technique, (ii) d'effectuer une analyse économique et environnementale des activités de démantèlement et de valorisation. Un premier outil d'aide à la décision a également été conçu pour accompagner l'industriel dans la valorisation optimale de son engin en fin de vie. Des réflexions sur la généralisation et transposition des approches développées à d'autres engins ou secteurs sont données, ainsi que des pistes de recherche prometteuses pour accomplir davantage la transition vers une économie circulaire – effective, efficiente et durable.

Title: Monitoring the circular economy with circularity indicators – Application to the heavy vehicle management and industry

Keywords: Circular economy, circularity indicators, end-of-life management, heavy vehicle industry, sustainability, industrial engineering.

Abstract: Implementing circular economy practices is increasingly acknowledged as a convenient solution to meet the goals of sustainable development. Meanwhile, there is at present no recognized way of measuring how effectively a region or a company is in making the transition to a circular economy, nor holistic monitoring tools for supporting such a process. New methods and tools are required to support industrial practitioners in their transition towards more circular practices, as well as to monitor the effects of circular economy adoption. In absence of regulations addressing the end-of-life management of their fleet, the heavy vehicles industry is both a challenging and promising industrial sector – of huge economic and environmental importance, but barely addressed from a research perspective – that needs to be boosted in its move to a more circular economy. An in-depth preliminary study reveals indeed huge potential to develop circular strategies and solutions in the heavy vehicles sector. This research explores the improvement potential for closing industrial material and components loops.

On this basis, the objectives of the present Ph.D. thesis are: to provide an integrated and comprehensive framework to measure, improve and monitor the circularity performance of complex industrial systems; to identify the best mechanisms and action levers to close the loop on heavy vehicles and associated key components - providing thus decision-making support for the end-of-life management of heavy vehicles. At the intersection of design engineering and industrial ecology, this Ph.D thesis - by articles - aims to provide new meaningful insights both for academics and industrial practitioners. In fact, for each chapter, academic publications and industrial deliverables are given, illustrating and disseminating both theoretical contributions and practical implications. For instance, it includes: a proposed taxonomy of circularity indicators and its associated selection tool; an experimentation and critical analysis of several circularity indicators on a heavy vehicle's key component; the design of a multi-tool methodology to model, simulate and quantify the impact of potential circular strategies; an industrial pilot study on an end-of-life heavy vehicle, dealing with the techno-economic and environmental analysis of possible recovery options.

