



HAL
open science

On the study of the different factors influencing the structure and the texture of semi-humid baked aerated cereal products: sensory and instrumental dimensions of texture

Coralie Blanchard

► To cite this version:

Coralie Blanchard. On the study of the different factors influencing the structure and the texture of semi-humid baked aerated cereal products: sensory and instrumental dimensions of texture. Other. Université de Bourgogne, 2014. English. NNT : 2014DIJOS001 . tel-01985715

HAL Id: tel-01985715

<https://theses.hal.science/tel-01985715v1>

Submitted on 18 Jan 2019

HAL is a multi-disciplinary open access archive for the deposit and dissemination of scientific research documents, whether they are published or not. The documents may come from teaching and research institutions in France or abroad, or from public or private research centers.

L'archive ouverte pluridisciplinaire **HAL**, est destinée au dépôt et à la diffusion de documents scientifiques de niveau recherche, publiés ou non, émanant des établissements d'enseignement et de recherche français ou étrangers, des laboratoires publics ou privés.

DOCUMENT CONFIDENTIEL

UNIVERSITE DE BOURGOGNE

Ecole Doctorale Environnement, Science et Santé
Agrosup Dijon - Faculté des sciences et techniques

THESE DE DOCTORAT
Discipline : Sciences des Aliments

CORALIE BLANCHARD

On the study of the different factors influencing the structure and the texture of semi-humid baked aerated cereal products: sensory and instrumental dimensions of texture

Etude des facteurs influençant la structure et la texture de produits céréaliers alvéolés de cuisson semi-humide : une approche instrumentale et sensorielle de caractérisation de la texture

Thèse soutenue le 16 janvier 2014, à AgroSup Dijon, Dijon

Membres du Jury

Pr. Catherine DACREMONT, Professeur à AgroSupDijon, Présidente du jury

Pr. Bernard CUQ, Professeur à SupAgro Montpellier, Rapporteur

Pr. Camille MICHON, Professeur à AgroParisTech, Massy, Rapporteur

Dr. Sylvie CHOLLET, Enseignant Chercheur à l'ISA de Lille, Examineur

Pr. Dominique CHAMPION, Professeur à AgrosupDijon, directeur de thèse

Dr. Hélène LABOURE, Maître de Conférences à AgroSupDijon, Co-directeur de thèse

Dr. Alette VEREL, Responsable R&D équipe IPR, LU France - Mondelez International,
Co-encadrante industrielle

ACKNOWLEDGMENTS

This work results from the collaboration between R&D department of LU France, part of Mondelez International, and PAPC scientific team, part of the University of Burgundy.

I'd like first to thank Jean Michel Cayot, LU France R&D director, Michel Infantes, LU France Nutrition and Ingredient Food Process (IPR) team manager during my PhD, as well as EMMA now PAPC team directors successively Philippe Cayot and Rémi Saurel for their welcoming, giving me the opportunity to work within their team with many tools and facilities to lead on this project.

I'd like especially to acknowledge the "Biological Material Rheology and Structure – RMB" Platform, ESIREM Analytical material platform, Welience Agroalimentaire, Analytical Chemistry, the CSGA sensory platform in AgroSupDijon, University of Burgundy for the access to their resources and facilities let at my disposal to run all my experiments within the various fields of investigation. Reading, Banbury and Munich Analytical Research Centers, are acknowledge for their welcoming, analytical support on Tomography and Microscopy analysis realized on cake matrices and for the scientific discussion we had, a special thank address to Carole Elleman and Paul Soper.

I'd like to thank all the members who positively answer to our query for the evaluation of my PhD:

M. Bernard Cuq, Professeur at SupAgro Montpellier

Ms. Camille Michon, Professeur at AgroParisTech, Massy

Ms. Sylvie Chollet, Research – Teacher scientist at ISA, Lille

And Ms. Catherine Dacremont, Professeur at AgroSupDijon

My acknowledgement goes directly to Dominique Champion my PhD supervisor for her welcoming, availability, help and support, at each step of this PhD, even when studies' path steep, but also for her sympathy and for sharing few moments of technical issues...

I want to say many thanks also to Hélène Labouré, tightly linked to my PhD supervision team, for her availability and her help especially within the field of sensory analysis but also for all her advices on panel management, data treatment and writing steps, while meeting into the sensory world and thinking about the softness in mouth item.some sensory thinking session's reminds.

I'd like to thank Aliette Verel, my manager at Lu France – Kraft Food, for her welcoming, help and support and for the opportunity she gave me to work on this project with the team and facilities of LU Research Center and for the work and visit done in Reading.

I'd like to thank all Dominique, Hélène and Aliette for their encouragements, advices, for their professionalism and for having shared their experiences and knowledge bringing work to success.

I'd like to address my acknowledgments as well to all the other members of my PhD committee, Marie-Christine Marcuz, Vincent Carnus, Delphine Dugard and Lélia Notardonato, for their availability, having shared their experience, for their advices, their time as often as we had a one day meeting in Palaiseau, Saclay or Dijon but also for having shared either panel or pilot plant team to run part of our investigations.

Be all my colleagues in Mondelez acknowledged

I really want to say thank you to all my pilot plant colleagues for sharing their availability, their experience and their skills... No more cake and biscuits secrets, right! Thanks also for their everyday smiles, tremendous support, endeavoring to adopt positive attitude while baking was unfortunately over at 9 a.m someday in oct2011!

...We strive and succeed! Should I write their name, they'll know what's about but all my thanks to Didier, Elise, Jean-Pierre, Marc, Michel, Nicolas, Pierre-Marie,

... Christian, Denis, Jean, Jean-Claude, Laurent, Rui, Ségolène ... Nicolas and Jean-Luc, with a special skill in egg's issue !... and particular thanks to Pascal and Luis for their assistance and sympathy.

Be all my colleagues within the Research/IPR team at the early time I was with them acknowledged for their help, mini market experience but first and foremost for their everyday sympathy and smiles: Aliette, Chantal, Claire, Fatiha, François, Hélène, Isabel, Jean-Luc, Pierre, Robin.

I won't forget Jérôme for our starchy project, Elisabeth and Helene for sharing sensory advices & experiences.

Be all my colleagues in AgroSupDijon and University of Burgundy acknowledged

Special thanks to Hélène, Monique Jouannot and Amélie Pécourt for their availability, help and professionalism while endeavouring to set up and train our panel. We strive but succeed. Be all the members of 3 panels either flash or descriptive acknowledge for their presence, kindness, regularity and work.

I'd like to say thank you to Nicolas Sok, for his everyday sympathy, kindness, just a wink to our traditional coffee break, but also for his advices and the scientific projects we shared on starch, XRD, staling and so on...

Thanks to Céline Lafarge, Bernard Colas, Marie-Laure Léonard, Thomas Karbowiak, Yann Roche, and Yoann Rousselin for their sympathy, their availability, technical support and advices.

Without missing Bernadette, who's better called Bernouche, her help, availability and early morning presence in the lab.

Many thanks to Alex for her every day smile, cheerfulness, but also for her help and for the words she always finds to make us feeling reassured and positive.

I would like to adress a special thank to all my students, from 2009 to 2012 either interns or engineer, for the work they've done, but also for their sympathy and for the pleasure I had working with them on specific scientific projects...so, thank you to Sandy, Anne Laure and Angélique; Stéphanie, Matthieu, Marie-Flora and Aymen; Charlotte, Vincent and Amélie; Nicolas; Tiara; Rose; Claire and Melanie.

I'd never want to forget all my lab friends, co-workers, sharing offices, labour, data treatment till 3 a.m, instruments issues, scientific discussions but also coffee, lunch, homemade recipes and so many enjoy full moments we had and we'll still have ... particular thanks to Emilie, Manal and Fatma also Ashish, Attaf, Dat, Koi, Leila, Lucie, Mia, Mario, Tatiana, Yecaterina...

Special shares addressed to Emilie for our carpool, common motivation to learn things and common success of the MBA-PhD cursus... We've done it!

Additional wink to Jean-Luc for having shared rich scientific experiences and articles writ'in, for all our discussions, and for his everyday company while coming back to the office... don't worry/be happy.

A special acknowledge to Simone and his family for their kindness and support without whom these few years of PhD work would probably not be the same, thanks for his affection and patience. Timon's back!

May I miss friends and colleagues! Be all of them acknowledged for their help and availability

Many thanks to all of the people I've been working with for their contribution to this PhD work success, scientifically, humanly, working environment and beneficial experiences.

I'd not have completed this work without the support of my family, my mother, my dad, who gave me the education and the opportunity to go to the University as soon as it was possible. Many thanks to my brother for his complicity, presence and for all the moment we share.

Many thanks to the insatiable dancing team in Dijon also in Avignon, and to all my friends anywhere in the world for their kindness, support that help me to make it through over time.

Guess, forgot ...

.....Melena would never be acknowledged enough for the strength she is substantially providing me every day as to be merely happy.

RESUME

La texture, manifestation sensorielle des propriétés structurales, mécaniques et de surface d'un matériau constitue un paramètre clé dans l'évaluation des produits alimentaires. Elle reflète leur qualité, leur fraîcheur et influence l'acceptabilité du produit par le consommateur déterminant l'intention de ré-achat.

Dans la littérature scientifique, la plupart des travaux portant sur la texture des produits céréaliers ont étudié des matrices alimentaires telles que le pain ou les biscuits mais plus rares sont les travaux sur les gâteaux type cake. L'objectif de ce travail est donc de caractériser le moelleux d'un produit de type cake de sa mise en place à son évolution au cours de la conservation du produit au moyen de méthodes instrumentales et sensorielles.

Dans un premier temps, nous avons étudié l'influence de la nature de la farine, du procédé de fabrication et de l'aération des produits sur caractère moelleux au travers de méthodes instrumentales et sensorielles. La caractérisation instrumentale des produits moelleux et la structure de leur mie ont été évaluées par des mesures rhéologiques (texturomètre, DMTA) et d'imagerie (XR-Tomography). La caractérisation sensorielle a été menée par l'établissement d'un profil sensoriel de la texture avec un panel entraîné évaluant l'aspect des produits et les sensations perçues au toucher et en bouche.

Dans un second temps, nous avons étudié les propriétés fonctionnelles des farines et de leurs composants en milieu modèle et complexe par différentes méthodes physico-chimiques (rhéologie des pâtes, analyse enthalpique différentielle, microscopie, diffraction RX).

Enfin, les mesures sensorielles et instrumentales ont été mises en relation via une analyse factorielle multiple dans le but de déterminer des méthodes instrumentales permettant de caractériser le caractère moelleux des produits de type cake.

Les résultats montrent que l'aération de la mie et la composition de la farine sont les facteurs clés du moelleux dans ce type de produit. L'évaluer et le sélectionner sur la base de ses caractéristiques physico-chimiques (élasticité, fermeté, aération) s'avère possible compte tenu de la stabilité de sa texture au cours du temps afin de pouvoir anticiper sur l'acceptabilité du produit par le consommateur le plus tôt possible dans son processus de développement.

MOTS CLES : MOELLEUX / CAKE /RHEOLOGIE / AERATION / ANALYSE SENSORIELLE DU PROFIL DESCRIPTIF DE TEXTURE / PROFIL FLASH / FARINE DE BLE

ABSTRACT

Since texture is the manifestation of structural, mechanical and surface properties of a material, it represents a key characteristic for food materials. It reflects food quality, freshness perception influencing consumer acceptance.

Studies encountered in the scientific literature that are devoted to cereal based foods texture are foremost based on bread also biscuits scarcely on cakes.

This study entitled 'study of the different factors influencing the structure and the texture of semi-humid baked aerated cereal products: sensory and instrumental dimensions of texture' focus on cake softness characterization, set up and evolution.

First, the investigation of the influence of soft wheat flour origin, making process and aeration properties on cake texture is proposed.

Instrumental characterization of cake texture properties was performed through high deformation using TPA and relaxation tests. Several approaches were attempted to determine cake crumb structure including rheology, microscopy; image analysis and X Ray-Tomography.

Sensory characterization of cake texture was achieved through descriptive texture profile involving establishment of our trained panel.

Second, we peer into the functional properties of wheat flour also of its gluten and starch components, physico-chemical methods among which fluid rheology, differential scanning calorimetry, optic microscopy and X-Ray powder diffraction are employed.

The results are discussed in terms of physical and chemical changes that cake dough ingredients undergo upon making process. This investigation highlights that several parameters are substantially involved in cake structure set up and final texture perception. Suitable flour choice (composition, components quality) and aeration management are critical factors for the elaboration of a product to be perceived the softest as possible. Also, regarding evolution of texture, it is possible to state on the selection of a product whether than another at early development stages allowing anticipate on consumer acceptance.

KEY WORDS: SOFTNESS / CAKE / RHEOLOGY / CRUMB AERATION / SENSORY DESCRIPTIVE TEXTURE PROFILE / FLASH PROFILE / WHEAT FLOUR

ABBREVIATIONS

AFNOR	Association Française de Normalisation (French Normalization Association)
ANOVA	Analysis Of Variance
AR	Aspect Ratio
Aw	Water Activity
AX	Arabinoxylans
B_	In mouth sensory evaluation item category
CAP	Control of Assessor Performances
Circ	Circularity
CTY	Crousty Flour (Soft wheat flour)
DIA	Digital Image Analysis
DMA	Dynamic Mechanical Analyzer
DS	Damaged Starch
DSC	Differential Scanning Calorimetry
DSP	Descriptive Sensory Profile
E'	Elastic modulus
E''	Viscous modulus
E*	Apparent Young modulus
F	Force (N)
Fmax	Maximal Force under compression (mechanical firmness, TPA)
FP	Flash Profile
GI	Gluten Index
GL	Grey level
GRU	Gruau Rouge Flour (Medium-Hard wheat flour)
HAC	Hierarchical Ascendant Classifications
IA	Image Analysis
ISO	International Standard Organization
K	Consistency index (Pa.s)
MCA	Mean Cell Area
MFA	Multifactorial Analysis
MRI	Magnetic Resonance Imaging
NIR	Near Infra-Red Spectroscopy
NMR	Nuclear Magnetic Resonance
NSP	Non Starch Polysaccharides
Pa	Pascal (N.m ⁻²)
PCA	Principal Component Analysis
RH	Relative Humidity
ROI	Region of Interest

RV coef	Relative Variation (In MFA it is the relation between data tables)
RVA	Rapid Visco Analyzer
Rx	Relaxation gradient
S	Surface
SEM	Scanning Electron Microscopy
SH	Sulfhydryl groups
SRC	Solvent Retention Capacity
STD	Standard sample
T_	In Touch sensory evaluation item category
Tan δ	Loss factor
Tg	Glass transition temperature
Theta	Bragg Angle (XRD)
TPA	Texture Profile Analysis
V_	Visual sensory evaluation item category
WAC	Water Absorption Capacity
WRC	Water Retention Capacity
XRD	X-Ray Diffraction
XRT	X-Ray Tomography
ϵ	Strain
η	Apparent viscosity
ρ	Density of the material (g/cm ³)
σ	Stress

SUMMARY

GENERAL INTRODUCTION.....	1
CHAPTER 1: SCIENTIFIC CONTEXT	4
Section I: Sensory dimension of cake texture and cake softness	6
1. Sensory science for texture evaluation.....	6
1.1 Sensory science: historical and definitions	6
1.2 Sensory science: interest on texture evaluation of foods	7
1.3 “Texture is a sensory property”	8
2. The multidimensional nature of food texture.....	11
2.1. An overview.....	11
2.2. Food appearance importance and assessment	11
2.3. In touch texture properties.....	12
2.4. In mouth texture characteristics	12
2.5. The case of cake softness: definitions and difficulties!.....	13
3. Food texture sensory evaluation: concepts and methodology considerations	15
3.1. What are the main sensory tests and methods: a classification overview.....	15
3.2. Discriminative tests	16
3.3. Descriptive tests: conventional and alternatives methods.....	16
4. Food texture properties assessment: its relation with instrumental measurements	20
4.1. Sensory – instrumental related studies	21
4.2. The case of solid foods texture	21
5. Sensory dimension of texture: a conclusion	24
Section II: From the structure to the texture of foods	26
1. Aerated cereal materials: food foams, a cellular solids concept.....	27
1.1. Solid foam concept: an introduction	27
1.2. Solid foam formation and characteristics: application to bakery products.....	28
1.3. On the characterization of cellular solids porous structure: application to bakery products.....	29
2. Structure – Texture and mechanical properties of cellular solids	32
2.1. Physical properties of food materials: a rheological approach	32
2.2. Dynamic rheology approach	36
2.3. Bakery products texture investigations.....	37
3. Influence of the porous structure of cellular solids on its mechanical behavior.....	37
3.1. From the batter to the solid food foam	37
3.2. The relative density of cellular solids.....	38
3.3. Other factors influencing cellular solids properties	39
3.4. Cellular solids characterization: an aeration and mechanical assessment.....	40
4. Conclusion: from the structure to the texture of foods.....	41

<i>Section III: Structure and composition of cake products: a physico-chemical approach</i>	43
1. Cake composition, processing and structure set up: a physico-chemical approach	43
1.1. <i>Cake composition</i>	43
1.2. <i>Cake processing</i>	43
2. Focusing on wheat flour composition and its physico-chemical properties.....	45
2.1. <i>Wheat flour origin and composition: an overview</i>	45
2.2. <i>Wheat flour minor components</i>	46
2.3. <i>Flour proteins composition and functionalities</i>	49
2.4. <i>Wheat flour starch : functionalities in hydrated systems</i>	54
3. The other cake's components: origin, functions and interactions	63
3.1. <i>Sugars</i>	63
3.2. <i>Lipids</i>	64
3.3. <i>Proteins</i>	65
3.4. <i>Water</i>	66
4. An overview of transformations undergone upon process and storage	66
5. Conclusion: Structure and composition of cake products	67
<i>SCIENTIFIC CONTEXT CONCLUSION</i>	68

CHAPTER 2: MATERIALS and METHODS.....	69
1. Cake's formulation.....	69
1.1. <i>On the cake ingredients: Table XVI.</i>	69
1.2. <i>Cake model: dough composition and applied variation</i>	71
2. Cake' processing	72
2.1. <i>Cake' models processing</i>	72
2.2. <i>Pilot plant experiments</i>	72
2.3. <i>Laboratory experiments</i>	74
2.4. <i>Storage conditions</i>	74
3. Dough and baked product control.....	76
3.1. <i>Dough and baked products water content</i>	76
3.2. <i>Dough and baked products water activity</i>	76
3.3. <i>Dough apparent viscosity and consistency coefficient</i>	76
3.4. <i>Relative dough and cake density measurements</i>	77
4. Flour properties and associated characterization methods.....	79
4.1. <i>Flour moisture content</i>	79
4.2. <i>Flour particle size</i>	79
4.3. <i>Flour composition and water absorption capacity</i>	79
4.4. <i>Thermal behavior: DSC measurements</i>	80
4.5. <i>Starch hydrothermal behavior through viscosity measurement</i>	81
4.6. <i>Starch granule swelling through particle size evolution measurement</i>	81
4.7. <i>Flour X-Ray diffraction characterization; starch crystallinity</i>	82
5. Aeration characterization.....	83
5.1. <i>Aeration characterization by cake slices scans and image analysis:</i>	83
5.2. <i>X-Ray Tomography measurements</i>	86

6.	On the rheological methods.....	88
6.1.	<i>High strain rheology measurements for cake texture analysis</i>	89
6.2.	<i>Small-strain level rheology: dynamic rheology</i>	90
7.	Statistics	92
8.	Sensory method: Flash Profiling	92
8.1.	<i>Flash profiling principle</i>	92
8.2.	<i>Flash profile set up and sequence</i>	94
9.	Conventional descriptive sensory profiling	95
9.1.	<i>Principle and objectives</i>	95
9.2.	<i>Descriptive Texture Profile: description of our sequence: Figure 57</i>	97
9.3.	<i>Data capture, treatment, panel performances: a statistical approach</i>	100
CHAPTER 3: RESULTS		101
<i>Section I: Making process parameters influence cake texture</i>		101
1.	Mixing process scale impacts cake's textural properties?	101
2.	Ingredient incorporation order and mixing process type effects on physico-chemical properties of cake' dough and baked product: a laboratory scale study	105
2.1.	<i>Impact on dough properties</i>	105
2.2.	<i>Impact on final cake product characteristics</i>	106
2.3.	<i>Dough and cake product characteristics influenced by making process</i>	107
3.	Making process impacts cake's physico-chemical and sensory properties: a Pilot (P1) scale study .	108
3.1.	<i>Impact exerted on the cake dough physico-chemical properties.</i>	109
3.2.	<i>Influence of making process on the sensory perception of cakes</i>	112
4.	Conclusion: How does making process parameters and formulation affect soft cake texture properties?	115
<i>Section II: The impact of cake aeration on its textural properties and evolution upon storage</i>		116
1.	Baking powder level influences aeration and physico-chemical properties of cake samples.....	117
1.1.	<i>Impact on crude and cooked dough physico-chemical characteristics</i>	117
1.2.	<i>Aeration level impacts visual based sensory responses</i>	119
1.3.	<i>Instrumental aeration investigations: to finer characterization scales</i>	120
1.4.	<i>Cake aeration features: instrumentally measurements are commensurate with visual perception.</i> ...	126
2.	Aeration level mechanical properties of cake product: a rheological approach.....	129
3.	Aeration level influences mechanical properties and sensory perception of cakes.....	131
3.1.	<i>Aeration impacts sensory properties of cake products</i>	131
3.2.	<i>Overall properties of cakes endowed with distinct aeration are perceived through visual, in touch and in mouth sensory assessment of texture.</i>	132
4.	Cake aeration impacts its textural properties: a conclusion	133

<i>Section III: Influence of wheat flour composition and wheat flour functionalities on dough and cake textural properties.</i>	125
1. Granulometry and composition considerations.....	128
1.1. <i>Flours particle size</i>	128
1.2. <i>Flour composition</i>	130
2. Wheat flour hydration properties	131
3. Wheat flour proteins functionalities: their influence on cake dough formation and on final product mechanical properties.	133
3.1. <i>Flour proteins level</i>	134
3.2. <i>Flour proteins nature</i>	135
3.3. <i>Flour proteins influence cake dough development</i>	136
3.4. <i>Emulsifying properties of flour proteins</i>	137
3.5. <i>Flour proteins impact cake crumb aeration and mechanical properties.</i>	137
4. Wheat flour starch: physico-chemical properties, hydro-thermal behavior and its involvement in cake making.....	140
4.1. <i>Starch level influence</i>	141
4.2. <i>Starch gelatinization extent</i>	141
4.3. <i>Starch granule composition and structural properties</i>	142
5. On the impact of wheat flour nature on cake texture properties: a thorough sensory-instrumental approach.	147
6. Hydro-thermal transformations of flour-water and cake media: influence of flour composition and quality.	150
6.1. <i>Starch swelling and water-flour media porosity</i>	151
6.2. <i>Protein influence (sterical entanglement)?</i>	152
6.3. <i>Granule crystallinity</i>	153
7. Conclusion: flour nature impacts cake softness & structure set up	153
<i>Section IV: Cake' textural properties evolution along storage: evaluation of the time impact from both a physico-chemical and a sensory point of view.</i>	155
1. Evolution of cake' physico-chemical characteristics over a short-time period	155
2. Impact of long-term storage on cake's textural properties.	157
2.1. <i>Evolution of the mechanical properties of cakes along storage</i>	157
2.2. <i>Evolution of the sensory properties of cakes along storage</i>	158
3. Impact of storage on cake texture: a multi-dimensional approach	161
4. Impact of storage on cake texture: a conclusion.....	162
GENERAL DISCUSSION	163
1. Cake texture study: questions, expectations and model establishment	163
2. The multidimensional approach of cake texture study	166
2.1. <i>Wheat starch granule swelling characterization</i>	166

2.2.	<i>Crystalline/amorphous level evaluation: flour nature and methods</i>	167
2.3.	<i>Flour proteins: evaluation and nature considerations</i>	168
2.4.	<i>Aeration instrumental evaluation</i>	168
3.	Is the aeration of a cake product key for its softness perception?.....	171
4.	Crumb bubbles properties	172
5.	Cake texture set up and evolution: its relation to softness.....	174
CONCLUSION		175
SYNTHESE EN FRANCAIS.....		177
1.	Contexte économique et objectifs de l'étude	177
2.	Contexte scientifique de l'étude.....	177
2.1.	<i>Le moelleux: une caractéristique sensorielle de texture</i>	177
2.2.	<i>Relation entre structure et texture des matériaux alimentaire</i>	178
2.3.	<i>Structure et composition des produits céréaliers alvéolés</i>	180
3.	Matériel et méthodes	181
3.1.	<i>Les matrices échantillon</i>	181
3.2.	<i>Analyses physico – chimiques</i>	182
3.3.	<i>Mesures des propriétés mécaniques des pâtes et produits finis</i>	182
3.4.	<i>Méthodes de caractérisation de l'aération de la mie</i>	185
3.5.	<i>Méthodes de caractérisation sensorielle des produits finis</i>	185
4.	Résultats et interprétations.....	187
4.1.	<i>Impact du procédé sur les caractéristiques physico chimiques et sensorielles de gâteaux moelleux:..</i> 188	
4.2.	<i>Impact de la nature de la farine et du niveau d'aération sur le moelleux : caractérisation instrumentale et sensorielle de la texture des gâteaux</i>	189
4.3.	<i>Caractéristiques physico-chimiques et fonctionnalités des farines</i>	191
5.	Discussion.....	193
6.	Conclusion.....	196
REFERENCES		198
PUBLICATION AND COMMUNICATION LIST		217
SCIENTIFIC ARTICLE		218
POSTER		219
ANNEXES.....		220

TABLES LIST

Table I : Example of several investigations led on various cereal-based products regarding their structure and texture properties.....	2
Table II : Frequency (in count) of the most associated quality terms with the freshness of breads, biscuits and cakes after their consumption by a number of 115 consumers: extracted from (Heenan et al., 2009).....	8
Table III : Classification of Textural Characteristics into mechanical (1), geometrical (2) and other (3) classes parameters including both textural and ‘popular’ terms (Szczesniak, 1963a).	9
Table IV : ‘Appearance’, ‘By touch’, ‘Mouth feel’ terms and their corresponding definition coming out from the attribute’s list proposed for the assessment of bread sensory quality in descriptive sensory analysis (Callejo, 2011).....	12
Table V : Sensory evaluation methods classification according to the type of question asked to the panel, the type of test and the level of the judges training.....	16
Table VI : Sensory evaluation: main characteristics, advantages and drawback aspects of several conventional and alternative descriptive analysis methods.....	18
Table VII : Definition of hardness, springiness, stickiness and cohesiveness parameters with respect to both its sensory and instrumental significance; adapted from (Bourne, 2002d; Meullenet, 1998; Szczesniak, 1963b, 1987).	22
Table VIII : Sensory – Instrumental assessment of various food products and correlation between tested methods.....	23
Table IX : Examples of aeration quantification methods applied to the characterization of cereal food foams porous structure: tools, advantages and drawbacks.	30
Table X : Texture measurements applied to bakery sample: testing methods, conditions and recorded parameters.	38
Table XI : Bread crumb bubbles orientation influence exerted on the product mechanical properties: adapted from (Hibberd & Parker, 1985).....	40
Table XII : Some aeration features: examples of parameters and its range of value in the case of bread crumb samples porous structure assessment.....	41
Table XIII: Main components encountered in bakery products: adapted from Kiger and Kiger, 1967.	43
Table XIV : Wheat flour composition with regards to its extraction rate.....	48
Table XV : Sizes ranges and morphology of different starches: adapted from (Atwell, 2001b, Buléon et al., 1998, Tester et al., 2004).....	54
Table XVI : Name, source and specifications of the used ingredients.....	71
Table XVII : Model cakes composition (lab scale and pilot scale production). Ingredient composition is expressed for each compound in dry matter percentage	71
Table XVIII: Pilot plant trials: product classification according to the variation factor applied to cake sample formulation and/or process conditions. Numbers signification is further depicted in the legend. Letters in italic correspond to the used sample name.	73
Table XIX : Synthesis of the different parameters measured upon cake processing on cake dough before and after baking; these values are the targeted controlled parameters for pilot and lab models.	78
Table XX : Computed crumb bubbles dimension features, units and their meaning.....	85
Table XXI : Crumb bubbles shape descriptors significance and its extreme values representation: adapted from (Impoco et al., 2006, 2007).....	85

Table XXII : Scanning acquisition and image reconstruction parameters applied to the microstructure study of cake's samples using X-Ray microtomography technology.....	87
Table XXIII : Making process parameters at three different scales in "standard conditions" for several studied samples.....	102
Table XXIV: Impact of the making process scale on the cake samples physico-chemical characteristics. Measurements were performed prior baking and after one day of storage. Main crude and baked dough controlled parameters; water activity (A_w) and water content (%H ₂ O): (a). Dough apparent viscosity is given for a shear rate of 2.5 rpm (Brookfield measurement) (b)....	102
Table XXV: Analytical values measured on cake batter prior to the baking step.....	105
Table XXVI : Products code listing and sample description.....	109
Table XXVII : Physico-chemical properties of cake batters assessed prior baking step on pilot-plant-made samples. Data are ranked on the basis of dough density values.....	110
Table XXVIII : Parameters measured (mean values \pm standard deviation) after ingredients mixing, resting and baking steps on crude dough and baked product – P2 scale; dough apparent viscosity at 25°C, 2.5 rpm (η), density (ρ), and final cake height at the centre (H). Not significantly different between samples, $A_w^{(1)}$ and water ⁽²⁾ contents are also given.....	117
Table XXIX : Aeration features issued from several cake crumb sample X-R Tomography scan. Each cake sample image has been further analyzed using imageJ software. Parameters are represented as the mean value calculated from a set of at least 10 images (\pm confidence interval).	123
Table XXX : Variables and individuals \cos^2 values given from the basis of the MFA performed on both instrumental and visually assessed aeration features.	127
Table XXXI : Correlation matrix of variables obtained after the MFA performed on data originating from both the instrumental assessment of aeration features and the sensory results based on a visual evaluation mode. These latter characterization modalities respectively represent the first and second group of data given in the table underneath.	128
Table XXXII: Relatives proportions of flour particle size distribution classes, measured by laser granulometry for three flour types (chosen within soft flours) in volume percentage: Crouty (CTY, soft), Gruau Rouge (GRU, Medium Hard) and Lu2000 (STD, intermediate).....	129
Table XXXIII : Composition of three distinct wheat' flours in damaged starch, protein (NIR analysis based data) and gluten proteins as well (Gluten index methodology based data).	130
Table XXXIV : Studied flour comparison on the basis of solvent retention capacity profile of: sucrose solution (pentosans and gliadins absorption) and lactic acid solution (glutenins absorption). It provides an estimation of the relative differences between flours components portion.	130
Table XXXV: 'water absorption capacity' values for several flour components: damaged starch, pentosans, proteins: adapted from (Hamer & Hosenev, 1998).	131
Table XXXVI : Impact of flour nature on the crude dough physico-chemical parameters values (dough density and viscosity) and on the baked product characteristics (product density and height).	133
Table XXXVII : Bubble wall thickness estimation based on the analysis of cake pieces from the bottom to the top of the sample using X-Ray Tomography scanned images	140
Table XXXVIII : Effect of wheat flour origin on temperature and associated energy of enthalpy values recorded on the gelatinization endothermic peak (DSC thermograms).....	141
Table XXXIX : Effect of wheat flour origin on pasting temperature and peak viscosity values measured using the Rapid Visco Analyzer.....	142

Table XL : Illustration of the correlation between textural instrumentally measured parameters and sensory items. R^2 correlations coefficients results from MFA performed on instrumental and sensory data sets obtained on the three studied flours after 1 month storage.....	149
Table XLI : Selected sensory attributes and instrumental parameters for the study of cake texture. The most relevant that are related to cake softness perception are written in bold.	165
Table XLII : Multidimensional characterization of cake texture: illustration of the main factors that are involved in cake texture establishment according to the studied products characteristics including: flour composition, structural properties, and their resulting sensory perception. For a thorough view on these latter, the relative level of these characteristics is associated to the results depicted all along the document and represented as (-) / (0) or (+) for low / intermediate or high levels, respectively.	170

Tableau I: Descripteurs retenus à l'issue de le mise en place du panel dédié à l'analyse du profil de texture sur produits moelleux : items de texture visuels (gauche), au toucher (centre), en bouche (droite).	187
Tableau II : Composition des farines étudiées en amidon endommagé, protéines et en qualité des protéines	192
Tableau III : Paramètres sensoriels et instrumentaux sélectionnés pour l'étude de la texture de gâteaux moelleux. Représentation des interrelations entres paramètres de même échelle de caractérisation et des plus pertinents.	194
Tableau IV: Illustration du caractère multi-dimensionnel de la texture. Résumé des principaux facteurs impliqués dans la mise en place (et l'évolution) de la texture de gâteaux moelleux vis-à-vis des différentes caractéristiques étudiées. Composition de la farine en amidon et protéines, propriétés structurales et de texture, perception sensorielle.	195

FIGURES LIST

Figure 1 : The different dimensions of sensory analysis; an assessment through the senses of sight, smell, touch and taste.....	6
Figure 2 : The involvement of the senses in the texture perception during food consumption process: adapted from (Chen, 2009, Chouvardas et al., 2008, Wilkinson et al., 2000)	11
Figure 3 : Examples of common methods used in discriminative testing	16
Figure 4 : Representation of the main steps in an expert panel set up and training.....	17
Figure 5 : Representation of the Flash Profile methodology steps.....	19
Figure 6 : From structure to food texture perception: methodologies and scientific fields apply to the texture study; adapted from (Wilkinson et al., 2000).	26
Figure 7 : Inter Relationship between Material – Structural – Mechanical Properties; Adapted from (Sozer et al., 2011).....	27
Figure 8 : Cellular solid example: digital image of polyurethane - left image - and starch foam structure – right image - (Hermann, 1990, Liu et al., 2003).	27
Figure 9 : Cellular solid porous structure example: open-cell polyurethane foam - left - and closed-cell polyethylene foam - right - (Gibson, 2005).	28
Figure 10 : Cellular solids cell representation (unit cells drawn as cubes, so that $l=h$): a statement of whether it is open (a) or closed (b). Most of them behave like open-cell foams. Adapted from (Ashby & Medalist, 1983).	28
Figure 11 : Dough bubble formation and evolution as followed during the mixing and baking process: from left to right, unbaked dough, upon baking and final baked product: adapted from (Bloksma, 1990a).....	28
Figure 12 : Structure of aerated cereal solid (bread-like sample) observed by X-Ray Tomography: (a) 3D representation of an aerated baked cereal solid (Della Valle, 2006) and (b) 2D sections of a 3D image of bread crumb (Lassoued et al., 2007).	31
Figure 13 : X-Ray tomography images representing the bubble growth undergoes by a cellular cereal product upon fermentation (from 0 to 70 minutes) : \varnothing 7mm (Babin et al., 2005).	31
Figure 14: Aerated cereal product structure model; piece of bread crumb reconstruction from its X- Ray Tomography 3D scan image : a) Sphere packing approach (Lassoued, 2005, Lassoued et al., 2007); b) matrix continuity with closed cells connections (Maire et al., 2003).....	31
Figure 15 : Ideal rheological responses representation, from the left to the right: elastic, viscous and plastic behavior.	32
Figure 16 : Elasticity (Young) modulus evolution as a function of temperature (and water content) of an amorphous polymer. Schematic representation of the case of simple macromolecule (left) and impact of molecular weight (centre); Young modulus evolution at two distinct temperatures as a function of time (right).....	33
Figure 17 : Illustration of the three mechanical behavior models: idealized undeformed cell in an open-cell foam (a), elastic foam under linear elastic bending (b); elastomeric (c) elastic-plastic (d), and brittle foam (e) under uniaxial compression (F value) using an Instron testing machine: (Gibson, 2005).	34
Figure 18 : Example of a cake crumb stress-strain curve, illustrating the response of an elastic-plastic foam-like behavior under compression test using an Instron-like machine while assessed between two parallel plates (a); typical stress-strain curve shape for a solid foam (b). Adapted from (Attenburrow et al., 1989, Corradini & Peleg, 2008, Gibson & Ashby, 1982).....	35

Figure 19: E' (black markers) and E'' (white circle and square) modulus values evolution as a function of the applied frequency. Measurement was performed at 25°C with a strain rate of $9.10^{-3}\%$ on two equivalent bread crumb samples.....	37
Figure 20: Different Factors Affecting Food Material Properties; Adapted from (Sozer et al., 2011)	42
Figure 21: Cake dough processing: main steps and their respective function.....	44
Figure 22 : The wheat kernel: structure, composition and wheat flour components (Bechtel & Pomeranz, 1980, Feillet, 2000, Khan & Shewry, 2009).	45
Figure 23 : Wheat flour proteins classification and characteristics: adapted from (Atwell, 2001c, Osborne, 1907, Shewry et al., 2009).	49
Figure 24 : Demonstration of the viscoelastic properties endowed by gluten (left), extensibility/viscosity of gliadin (center picture) and elasticity of glutenin (right).	50
Figure 25 : Schematic representation of the macro-molecular organization of glutenins, gliadins and the formation of the gluten network in dough.....	51
Figure 26 : Wheat flour dough observed with a scanning electron microscope (Hoseney & Rogers, 1990) cited in (Chiotelli & Le Meste, 2002).	51
Figure 27 : Representation of the organization and alignment of glutenins and its sub-units under shearing stress as dough kneading (Eliasson & Larsson, 1993).	52
Figure 28 : Representation of glutenins chemical structure and its disulphide bonds.....	52
Figure 29: Amylose/amylopectin relative contents of starches coming from various botanical sources and their respective granular image obtained by Scanning Electron Microscopy (SEM): adapted from (Atwell, 2001b, Buléon et al., 1998, Tester et al., 2004).	54
Figure 30 : Representation of the basic chemical structure of starch units and its α -1,4 and α -1,6 glycosidic bonds (Right). Amylose and amylopectin chains structure representation (Left).....	55
Figure 31 : Representation of the starch granule at different structure levels: adapted from (Buléon et al., 1998, Tester et al., 2004).....	56
Figure 32 : Temperature range and phenomenon taking place while starch granules are heated with an excess of water during gelatinization: from (Eliasson & Larsson, 1993).	57
Figure 33 : Starch modifications undergone upon wheat based product manufacture: adapted from (Banks & Greenwood, 1975, Blanshard & Frazier, 1986).	57
Figure 34 : Influence of hydrothermal treatment in excess of water conditions on the starch granule state and morphological evolution (Buléon et al., 1990).....	58
Figure 35 : Starch gelatinization phenomenon illustrated through the measurement of the viscosity evolution upon heating-cooling cycle of a flour-water paste using the Rapid Visco Analyzer (RVA) as a function of time and temperature.	59
Figure 36 : X-Ray diffraction patterns illustrating the progressive crystallinity loss when heated at different temperatures - right pattern side - (Ratnayake & Jackson, 2007).	60
Figure 37 : Evolution of the Water Activity (A_w , left axis) and the Elastic modulus (E' , right axis) as a function of time in the early staling phenomenon phases of a bread crumb stored at room temperature (Pavinee & Vodovotz, 2001).	60
Figure 38 : Sucrose and sodium chloride effects on wheat starch gelatinization temperatures. Represented as a function of the solute-water co-solvent molecular weight (Chiotelli et al., 2002).	61
Figure 39 : Influence of water content and storage temperature exerted on wheat starch isothermal re-crystallization as illustrated by the Lauritzen–Hoffman simulation (the dependence	

of the rate of retrogradation at a constant storage temperature on the water content was attempted using this latter theory) (Farhat et al., 2000).....	62
Figure 40 : Starch granule in the presence (left boxes) or in the absence (right boxes) of lipids. Drawn outline (top) and microscopy pictures (bottom). Optical microscopy pictures were obtained at 65°C for a 20% triolein potato starch-in-water dispersion: adapted from (Chiotelli & Le Meste, 2002, Chiotelli & Le Meste, 2003).	64
Figure 41 : Amylose helix – monoglyceride complex representation: adapted from (Atwell, 2001b, Buléon et al., 1998, Putseys et al., 2010).	65
Figure 42 : Sodium pyrophosphate and sodium carbonate basic chemical structure	69
Figure 43 : Polyglycerol Esters of Fatty Acids (PEG) = E475;.....	70
Figure 44 : Process diagram including mixing, resting, baking, and cooling down steps with the associated parameters. Sample controls positions (in green) are indicated for both the dough and the baked product.	75
Figure 45 : Illustration of a fluid viscosity. Representation of viscosity, shear rate and shear stress.....	77
Figure 46 : Particle distribution profiles obtained for three distinct wheat flours: a) Crouty, 100% Soft ; b) LU 2000, 50% Soft, 50% Medium Hard ; c) Gruau Rouge, 100% Medium hard.	79
Figure 47 : Cell scale reference (magnification level of 10 and 40) for starch granule size evaluation	81
Figure 48 : Illustration of cake slice aeration through the visualization of crumb bubbles on scan images from two distinct samples.	83
Figure 49: Illustration of the results of successive treatment undergone by a sliced cake scanned image using imageJ software: initial image (a), after contrast adjustment (b), after image transformation in a binary mode and noise reduction (c).	83
Figure 50 : Illustration of two kinds of samples: cake slices scan images before and after image analysis (imageJ software, 1.46j5 version). Regions of interest in black represent air inside bubbles zones.....	84
Figure 51 : Image analysis illustration from the initial cake slice scanned image (top) applying the macro program developed for this purpose using imageJ software. Crumb bubbles that are numbered can be described as with delimited areas (bottom)......	84
Figure 52 : Outline of x-ray a Microtomograph such as the Skyscan 1172.....	86
Figure 53 : Representation of the X-Ray Tomography measurement on cake' samples and the multiple scanned elements occurring upon testing.....	87
Figure 54 : Representation of a TPA (left) and a relaxation test (right) profile with the textural features associated to each measurement: F_{max} , Young modulus and recovery percentage.	89
Figure 55 : Schematic representation of the phase shift between the material solicitation (full line) and its response (dotted line) under a dynamic solicitation.	90
Figure 56 : Flash Profiling procedure: description of the different steps encountered in our study for the flash profiling to be performed on our 14 cake samples.....	93
Figure 57 : Descriptive sensory profile sequence representation including the different steps of recruitment, training, measurement, data treatment and performances control.	96
Figure 58 : Illustration of the sensory differences perceived between cake samples produced at P1 scale. The product map has been obtained by performing a MFA on the whole set of data involving 'visual', 'in touch' and 'in mouth' texture items following Flash Profile (10 panelists) on 3.5 months cakes. The sample codes in bold represents the 'product barycentre' position.....	104
Figure 59 : Illustration of the sensory differences perceived between cake samples produced at P2 scale. Sensory data including visual, in touch and in mouth items evaluation were analyzed	

by the way of PCA. Data set arises from the descriptive sensory profile performed with 15 trained panelists on the 5 cake samples (3 months of storage). The sample codes in bold represents the 'product barycentre' relative position.....	104
Figure 60 : Cake density (measured one day after the sample production) represented as a function of the dough consistency index values. Illustration of the influence of distinct cake dough mixing processes on the correlation between the latter parameters (LAB scale study).....	106
Figure 61 : Measured cake firmness (a) and cell wall mobility (b) as a function of the applied process. Measurements were performed on cakes after 1 day of storage.	107
Figure 62 : Representation of the baked product density as a function of cake batter density for different cake samples whose mixing process, resting conditions and composition were modified.	110
Figure 63 : Representation of the global perception (all items included in the analysis) using the hierarchical classification; the MFA has been performed on visual, in touch and in mouth sensory characteristics of 14 cake samples. Cake sample were assayed 1 month after their production. Letter H and K exactly correspond to the same sample which was presented twice to assess panel performances (repeatability). Sample codes that are circled belong to the same group and display unsubstantial differences (red point = group node).	113
Figure 64 : MFA Product map representation obtained from the assessment of the cake's sensory properties in terms of visual (top), in touch (center) and in mouth (bottom) perceived texture. Cake samples were assessed 1 month after their production. Hierarchical analysis results performed for each set of categorized items is represented: sample codes that are circled exhibit unsubstantial differences between each other and belong to the same group (Hierarchical analysis). Sample code in bold corresponds to the group identifier. These five samples are chosen and studied further along the document to precise the impact of several factors (flour nature and baking powder level).	114
Figure 65 : An illustration of the impact of baking powder level of cake aeration; pictures (transversal cut) and grey level scanned images (longitudinal cut).....	118
Figure 66 : Sensory scores obtained on visually assessed items for the distinct products as a function of baking powder levels.	119
Figure 67 : Leavening agent level effect visualization on cake slices images (a) and on bubble mean size given as the mean Feret diameter value (b) +/- confidence intervals. Distinct letters means that sample are significantly different for the considered parameter.	120
Figure 68 : Effect of the leavening agent level on cake crumb bubble size distribution within the 0 to 4.5 mm and upper bubble Feret's diameter ranges based on the flat bed scanner image acquisition and analysis (i.e., large scale characterization).	121
Figure 69 : Transversal cuts X-Ray Tomography images showing the bottom part of cake samples.....	122
Figure 70 : Effect of the leavening agent level on cake crumb bubble size distribution within the whole range of bubble sizes. Feret's diameter ranges were obtained from the combined results of flat bed scanner images and of X-Ray Tomography scanning methodology. The figure is based on a continuous bubble size ranges span. The left side of the figure illustrates the finest bubbles quantization that could have been fairly estimated in the larger scale approach. X-Ray tomography based distribution is shown instead with smaller feret's diameters intervals. The right side of the figure corresponds to the actual scanning characterization that highlights the remaining part of the distribution including large bubbles.	124
Figure 71 : Leavening agent effect on bubble shape factors: circle-like shaped level inversely represented by its 'aspect ratio, AR' (left) and the uneven surface - inversely represented by its	

'circularity' - (right) parameters +/- confidence intervals. AR and Circ shape factors values both originates from X-Ray Tomography images. Distinct letters define significantly different samples.	125
Figure 72 : MFA representation of the inter-relation between sample aeration features; comparison was made with both visually assessed items, and instrumentally determined bubble characteristics	128
Figure 73 : Textural parameters mean values obtain with a compression test using a TAXT2 instrument. Young modulus (E), and Cohesiveness were obtained from the double uniaxial compression test. Relaxation gradient (Rx) was obtained from the relaxation test (single compression, maintained strain during 60sec). Samples with different letters exhibit significantly different values for the parameter.....	129
Figure 74 : Sensory assessed parameters on cake products made with 3 distinct baking powder levels. Sensory modalities are represented by their category letter (V = Visual, T = In Touch, B = In Mouth) followed by the name of the sensory evaluated item. Assign letters NS means that the item evaluation is not significantly different between samples. Assigned numbers close to the item name means that significant differences have been recorded between samples; 2 or 3 represents the number of sample groups arising from post-hoc Newman-Keuls ANOVA test (if 3, thence, each sample differ from one another).	131
Figure 75 : Instrumental (a) and sensory (b) PCA projections.....	133
Figure 76 : Representation of the succession of events that happen upon cake making process, while focusing on the flour components functionalities and the related properties to be studied.	127
Figure 77 : Particle size distribution profiles (explained in volume) obtained for three distinct wheat flours: a) Crousty (CTY), 100% Soft ; b) Lu2000 (STD), 50% Soft, 50% Medium Hard ; c) Gruau Rouge (GRU), 100% Medium hard.	128
Figure 78 : Water absorption capacity of three wheat flours based on the measurement of water sorption retention capacity (AACC International, 2009).	132
Figure 79 : SRC water absorption capacity as a function of the flour damaged starch content (%). The linear curve represents the evaluated correlation between the mean values obtained for three different types of flour.	132
Figure 80 : Evolution of the viscosity of water-flour mix samples as a function of time and temperature. Measurements were carried out using a Rapid Visco Analyzer and performed on wheat starch powder, GRU and CTY wheat flour. RVA profile (top) and its "pasting zone" (bottom) illustrate flour proteins influence on flour viscous properties under hydro-thermal conditions.	134
Figure 81 : Effect of flour protein content and flour type on the swelling behavior observed at the initial stages of the viscosity increase.	135
Figure 82 : Illustration of the impact of the flour nature used in cake products (1 month storage) on Tan δ (left) and relaxation gradient (right) parameters. Tan Delta is considered as crumb bubble wall rigidity evaluation parameter and represents the calculated modulus ratio E''/E' (i.e. Young modulus viscous behavior component divided by Young modulus elastic behavior component). Higher is the recorded Tan δ values, lower is the sample cell wall rigidity. Relaxation gradient informs on the sample initial response when applying a compression that is further maintained. Higher Rx index explains a stronger relaxation of the sample.....	138
Figure 83 : Impact of flour nature on several cake sample textural properties (Young modulus left; cohesiveness, right). Measurements were driven using a TAXT ₂ texturometer under compression. While sample deforms (% compression distance), the response is recorded as the resulting force responses.	138

Figure 84 : Bubble diameter distribution, in frequency and spanning over a 0 - 4.5 mm.	139
Figure 85 : RVA pasting profile of several flours assessed under hydration and heating conditions (water-flour mix, %H ₂ O).....	142
Figure 86 : Observation of wheat flour starch granules of GRU and CTY wheat flours (left and right images respectively). Images were obtained using a light microscope at magnification of 10 (top) and 40 (centre and bottom). Total wheat flour was stained using % iodine solution (KI 2%, I ₂ 1g) to allow the selective observation of starch granules. Image was captured with a digital camera adapted on a light microscope.....	143
Figure 87 : Comparison of CTY and GRU wheat flour starch granules size at ambient temperature. Illustration of the distribution of starch granule sizes spanning from 0 to 25µm diameter. Profile is based on 8 light microscopy images (x40 magnification) followed by image analysis allowing the detection and calculation of iodine - stained starch granules	144
Figure 88 : Illustration of CTY and GRU flours starch swelling: evolution of wheat flour starch granule size (Mean Feret diameter) as a function of temperature. Results hereby were obtained in flour – water suspension over hydro-thermal conditions, stained with iodine solution (KI 2%, I ₂ 1g), further subjected to light microscope observation (X40) and image analysis.....	144
Figure 89 : X-Ray diffractograms spanning from a 10 to 30° Bragg angle range of wheat flour starch, CTY and GRU flours.	146
Figure 90 : Comparison of the relative crystalline area of flour samples from X-Ray diffractograms analysis. Values are given as a dry matter starch basis and compared to a 100% starch level.	146
Figure 91 : Impact of flour nature on cake texture properties: a sensory – mechanical – aeration study represented using the resulting product-variable map from the MFA performed on a full range of data obtained on cakes after 1 month of storage; V (Visual sensory measured) – T (In touch) – B (In mouth) – Ph (physico-chemical characterization) – IA and Alv (Aeration measured items) – Rh (Rheology/Mechanical parameter)	148
Figure 92 : Representation of the measured impact of flour nature on sensory also instrumental (mechanical – aeration). The MFA was performed on a full range of data obtained on cakes after 1 month of storage. Two groups of data are used: instrumental (including physico-chemical, mechanical, aeration features) and sensory (including Visual, In touch, in Mouth).....	149
Figure 93 : Illustration of the impact of gluten protein level on CTY soft wheat flour RVA profile. CTY flour was substituted at 5, 10 and 15% of vital gluten proteins.	151
Figure 94 : Comparison of starch swelling and media porosity between CTY and GRU flour at ambient temperature then upon heating. Illustration of the influence of wheat flour starch granules size and heterogeneity.....	152
Figure 95 : CTY and GRU flour at ambient temperature then upon heating: wheat flour proteins impact on starch swelling.	152
Figure 96 : Evolution of cake sample properties over a 1 to 45 days of storage. Cakes density evolution of three processed dough (left) and recovery percentage parameter evolution of STD sample (right).	156
Figure 97 : Evolution of the textural properties of a reference sample (STD) over a storage period of 3 months. Illustration of its elastic loss (left, Rx) and its firmness increase (right, Fmax)	156
Figure 98 : Evolution of mechanical parameters - percentage of recovery (a) and Tan Delta values (b.) - measured on cake's samples over time. Samples originate from P2 scale production and were studied after 1, 3 and 5 months of storage.	158
Figure 99 : Illustration of the impact of the time of storage on texture cake perception. Cluster analysis is based on center-reduced data from mean values of the sensory response for each attribute assessed on each sample after 1 month, 3 months and 5 months of storage.....	159

Figure 100 : Evolution of the levels of in touch Firmness, Elasticity two in touch texture attributes and of softness upon storage (after 1, 3 and 5 months). Results are given as a mean of a session group data involving 15 panelists and including three measurements for each sample. For these items, firmness, elasticity and softness, time effect p value is 0.0001; 0.0000; and 0.7460 respectively. Timex x product effect p value is 0.000; 0.000 and 0.037, respectively.	160
Figure 101 : Illustration of the effect of the time of storage on the sample position one from another using MFA based on the analysis of Instrumental and sensory data.....	161
Figure 102 : Illustration of the multidimensional and multidisciplinary aspect of cake softness study.	163

Figure 1 : Terminologies, disciplines (gauche) et méthodologies (droite) associées à l'étude ce la texture adapté de (Wilkinson et al., 2000).....	178
Figure 2 : Relations entre les propriétés structurales et mécaniques des matériaux alimentaires; adapté de (Sozer et al., 2011).	179
Figure 3 : Représentation des principaux facteurs et produits testés au cours de l'étude.....	182
Figure 4 : Analyse du profil de texture (TPA) : courbe obtenue par double compression (30% de déformation ; 5 secondes entre compressions) d'un échantillon de cake standard ; la consistance du produit est calculée à partir du ratio Aire1/Aire2.	184
Figure 5 : Courbe obtenue par le test de relaxation (simple compression maintenue durant 60 secondes) sur un échantillon de type standard. La pente en début de relaxation est notée 'Rx'.	184
Figure 6 : Global : Exemple de carte produit obtenue à partir de l'analyse de l'ensemble des descripteurs de texture Visuelle, au Toucher et en Bouche, pour des produits âgés de 3,5 mois. Les cercles représentent les groupes de produits au sein desquels les échantillons ne sont pas perçus significativement différents.	189
Figure 7 : Représentation du cercle de variable et de la carte produits issu de l'analyse des données instrumentales et sensorielles par AFM sur des échantillons de gâteaux moelleux âgés de 1 mois.	190

ANNEXES INDEX

Annexe 1 : Mechanical properties of food foams. Illustration of the mechanical behavior of several cell structure (a', b', c') involved in the global response of solid foams: theoretical strain-stress curves (a, b, c).	221
Annexe 2 : Instruction given to Flash Profile panelists at each session.....	222
Annexe 3 : Flash profile response sheet example	224
Annexe 4 : Descriptive Sensory Profile attributes arising from soft cake texture investigation: items list obtained after vocabulary generation and reduction, associated definitions and evaluation mode used by the panelist to perform the sensory evaluation. Attributes are distinguished between visual, in touch and in mouth evaluation process.....	225
Annexe 5 : Main assessed textural and aeration parameters which are kept for the following analysis and included into the statistical treatment.....	227
Annexe 6 : Soft cake sample process and formulation parameters applied to generated distinct aeration and classified as a function of the nature of the factor.....	228
Annexe 7 : Main assessed textural and aeration parameters which are kept for the following analysis and included into the statistical treatment.....	229
Annexe 8 :Items list, associated definitions and protocol of assessment used by the panelist to perform the sensory evaluation.....	230
Annexe 9 : Panel's performances illustrated by the results obtained with CAP method data treatment: ANOVA (judge+product+interaction) performed on each VISUAL, IN TOUCH and IN MOUTH assessed sensory attributes. The kept items, all along storage, from 1 to 5 months are bolded. Sensory assessment was performed in a descriptive profile on cake products after 1 month of storage at room temperature. Panel was composed of 15 panelists, measurements includes 3 repetitions for each assessed product, with a total of 20 evaluated items.	231
Annexe 10 : Sensory in touch and in mouth items values obtained during sensory evaluation session on cakes taking place after 1 month storage with a trained panel composed of 15 panelists. Data ranges from a 1 to 10 sensory linear scale.	234
Annexe 11 : Comparison of GRU (right images) and CTY wheat flours (left images) based on the evolution of starch granules aspect upon swelling while undergoing structural changes over hydration and heating conditions as observed using light microscopy. Wheat flour media were stained using % iodine solution (KI 2%, I ₂ 1g).....	235
Annexe 12 : Evolution of water – flour suspensions granulometry over heating from ambient temperature to 80°C: comparison of Crousty (top) and Gruau (bottom profile).....	236
Annexe 13 : Illustration of the correlation between the parameters studied on cake samples at various characterization scales.....	237
Annexe 14 : Panel performances assessment using CAP method.	238

GENERAL INTRODUCTION

.....*Toute connaissance est une réponse à une question.*

Pierre Bachelard

Texture is described as the sensory and functional manifestation of the structural, mechanical and surface properties of foods detected through sight, hearing, touch and kinesthetics senses (Szczesniak, 2002). Accordingly, texture represents an important parameter for consumer food quality and freshness perception also influencing its overall acceptance (Civille, 2011, Dobraszczyk, 2008, Heenan et al., 2009).

Food texture is directly related to the physicochemical properties of a product that are the result of intrinsic materials properties, its composition and its structure (Bourne, 2002b). Under adequate parameters, ingredients together undergo a sequence of making process operations that progressively let the structure settle up (Aguilera & Lillford, 2008). Therefore, the understanding of the relationship between the structure, the mechanical properties and the physico-chemical properties of a food material is of a fundamental interest in food materials science (Michel & Sagalowicz, 2008).

Within the field of cereal products, various studies report on these aspects. However, most of the investigations have been conducted on bread as well as on dryer cereal products such as biscuits and cookies, whether not as many on cakes: Table I.

In **bread** application, various criteria are considered to determine the specific quality of flour. They include flour strength, development time, and even protein composition parameters. They are useful to choose a flour type instead of another that suits better (Goesaert et al., 2005, Panozzo et al., 1993, Park et al., 2006, Tronsmo et al., 2003).

In dryer products such as **biscuits or cookies**, the quality of flour depends on its protein content that should whether be relatively low but also depends on its extensibility abilities (Abang Zaidel et al., 2008, Chevallier et al., 2000, Fustier et al., 2008, Maache-Rezzoug et al., 1998) as well as on its low damaged starch content (Barak et al., 2012).

The study of the intermediate products under processing is usually important to control and manage the final food characteristics because it is the result of the influence of processing on the food structure properties. For instance, bread dough displays both viscous and elastic behavior owing to the gluten protein network set up.

Several topics are proposed in these investigations that are whether related to dough or final product: Table I. To confirm the preference of flour for a wished application, numerous “flour quality tests” are used allowing flour composition

determination, hydration ability and hydro-thermal properties assessment (Macritchie, 1984, Miralbés, 2004, Posner, 2009, Preston & Williams, 2003).

The composition of food products usually need to be considered as well as individual compounds properties, their interaction and competition. The structure that is further established partly depends on ingredients interactions. The creation of structure is of a major importance in food product development and improvement (Aguilera, 2005, Burbidge, 2012, Hadiyanto et al., 2007).

Table I : Example of several investigations led on various cereal-based products regarding their structure and texture properties.

Products	Investigation topic	References / authors
Wheat, cereals	Wheat flour and cereal behavior -- bread, cake batters and biscuits process – sensory quality, freshness cereal foam aeration	(Belitz et al., 2009, Blanchard et al., 2012b, Edoura-Gaena et al., 2007, Hadiyanto et al., 2007, Heenan et al., 2009, Niranjana & Silva, 2008b)
Bread	Bread crumb set up, quality, aeration, texture - importance of gluten and starch, addition of modified starches.	(Angioloni & Collar, 2009, Cuq et al., 2003, Lagrain et al., 2012, Miyazaki et al., 2006, Rózyło & Laskowski, 2011)
Cake	Cake batter characteristics (visco-elasticity) – flour fractions and flour components (starch, soluble proteins, pentosans) – physical and sensory properties of cakes	(Chesterton et al., 2011, Donelson & Wilson, 1960, Gaines & Donelson, 1982, Holme, 1962, Kim, 1992, Kim et al., 2012, Lee et al., 2005, Wilderjans et al., 2010)
Biscuits	Flour components impact and interactions. Main biscuits ingredients influence on biscuits rheology / quality / physicochemical properties. Biscuits structure, texture, density, color, size,...	(Allais et al., 2006, Baltsavias et al., 1999, Chevallier et al., 2000, Fustier et al., 2008, 2009b, Maache-Rezzoug et al., 1998, Mamat et al., 2010, Papantoniou et al., 2004, Sudha et al., 2007)
Cookies	Flour nature and composition, cookies quality (density, dimensions, appearance), ingredient impact (gluten, sucrose, fats) on cookie texture, ...	(Barak et al., 2012, Barrera et al., 2007, Fustier et al., 2009a, Hadinezhad & Butler, 2009, Jacob & Leelavathi, 2007, Pareyt et al., 2009a, Pareyt et al., 2009b, Slade & Levine, 1994)

Both gas content and the bubble size distribution govern the properties of aerated foods in addition with the mechanical properties of foamy structures. These characteristics are most likely difficult to control in aerated foods (Labbafi et al., 2007).

Indeed, air incorporation depends both on the aeration process (beater speed or additional air incorporation) and on the physico-chemical properties of the batter - i.e.

viscosity and surface tension - (Chesterton et al., 2011, Meza et al., 2011, Sahi & Alava, 2003).

Thence, peering into their influence on the final product, their origin and the way it can be managed is of a key importance.

The understanding of the relationship between the perception of food and its structure is of increasing interest for food product manufacturers that are subjected to environment, market trends changes and innovation needs such as new ingredients, health demands, new products launches, attractive food texture creation (Hadiyanto et al., 2007). They thus expect to perform the quickest also the most accurate control of the structural-textural properties of the resulting food material (Johnson, 2003, Wilkinson et al., 2000).

Because sensory perception of texture is a complex process that, through oral processes, involves many senses, a multidisciplinary and multidimensional approach is usually required (Wilkinson et al., 2000). Hereby, the study of the relationship between physico-chemical properties, structure and texture perception of cake products is proposed with relation to softness. It combines rheology measurements, ingredients properties, as well as sensory characterization of cake's texture.

Analyses were run on several selected flours, cakes and manufacture conditions. The multidisciplinary and multidimensional dimensions of this investigation actually aim to answer to the following questions:

- How do we characterize softness?

- * How do we measure soft cakes texture from an **instrumental** point of view?
- * How do we measure **sensory** perception of softness on cake products?

- What are the main factors influencing texture set up and evolution of cake softness amongst?

- * Making process
- * Aeration level and features
- * Flour nature
- * Is there a right process – aeration – flour combination that can be suggested to generate the softest cake as possible?

- What are the main parameters related to soft cake texture and their correlation between instrumental and sensory perception evaluation.

CHAPTER 1: SCIENTIFIC CONTEXT

.....*Credo ud intelligam*

Saint Augustin

In this study we investigate the influence of flour nature, making process and aeration properties on cake texture set up and evolution. A focus was particularly made on cake softness in order to compare textural perceptions to instrumentally assessed properties.

In order to be able to understand what are the main factors involved in soft cakes texture and the way it can be measured, we first need to describe the scientific knowledge background around the different fields of interest we are working on including three main scientific domains: sensory science, material science as well as food chemistry.

Cake's texture and especially cake's softness properties investigation require a thorough characterization of the **sensory** perceptions experienced by assessors and consumers while tasting the product. Softness can be described by numerous attributes involving several sensory levels of assessment, foremost related to the in touch and in mouth feeling. Still, as a sensory characteristic, softness actually represents a **textural** item that arise from the global product structure.

Else, cake products can be considered as solid foams. They are endowed with **textural** and rheological properties which are mainly explained in the field of **material science**. The **structure** of the product can be assessed by various methods related to its physical characteristics.

A cake sample is also characterized by its **composition** and the way it is **processed**, thence leading to the final product **structure**. Various **ingredients** are usually involved in the dough making process, among which flour components and water. Owing to their specific functionalities, they give to the dough its overall properties.

With respect to its **structure**, its **composition**, the way it is made up and it behaves, soft cake product pertains to both bread and biscuit - like manufactured product. It can actually be considered as **bread** in terms of its structural, textural properties as well as its aspects because it belongs to the solid food foams category of products. Meanwhile, cake making process and formulation involve various ingredients that are mixed together. This composition makes cake products closer to **biscuits** than bread. While biscuits are flour rich and water poor, cake are made up with a larger amount of water and exert a strong effect on leavening, aeration, as well as crumb and crust structure.

This first chapter, foremost aims to provide to the reader the main scientific knowledge that are required further along the document in the different fields we are interested in detailing. The multi-scale approach which has been used to investigate cake texture in a more thorough manner is also illustrated. Later, it helps to answer to several questions with regards to the characterization of soft cake texture and the key parameters involved in its set up and evolution.

This chapter will thence be divided into three parts.

First, the texture as a sensory property will be reviewed including both sensory definitions and texture evaluation methods.

Then, the texture of a product will be related to its structural properties, and in a larger extent to its physical properties.

Finally a focus will be made on a finer scale in order to estimate what are the main ingredients influencing dough structure and cake texture, how it affects its final properties, but also what is the contribution of the main flour components.

Section I: Sensory dimension of cake texture and cake softness

1. Sensory science for texture evaluation

1.1 Sensory science: historical and definitions

The field of sensory science has been firstly reviewed in the 60's (Amerine et al., 1965) and sensory evaluation has been further defined as “a scientific method used to evoke, measure, analyze, and interpret those responses to products as perceived through the senses of sight, smell, touch, taste, and hearing” (Lawless & Heymann, 2010a, Stone & Sidel, 2004a). The French normalization committee merely defines sensory analysis as “the product properties assessment as experienced by the senses” (AFNOR, 1992).

Then, it represents the measurement of a product quality perceived by human, or even by animals characterized through various methods involving the five senses of sight, smell, taste, touch and hearing.

The increasing interest of researcher and industry for the understanding of products consumer perceptions particularly comes from the development of manufactured food including the need to create attractive products and to improve their overall acceptability over a longer storage period (Sidel & Stone, 1993).

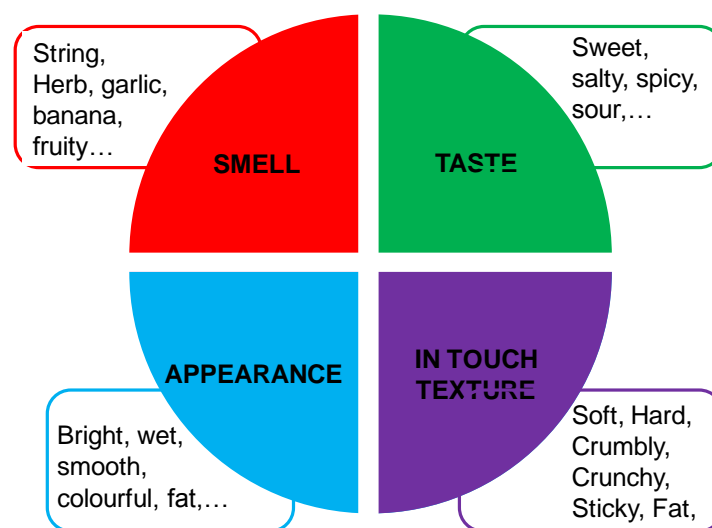

Figure 1 : The different dimensions of sensory analysis; an assessment through the senses of sight, smell, touch and taste.

Although a wide range of applications exists, sensory science further extends to oral processing and physiology (Agrawal et al., 2002, Chen, 2009), pleasure (Desmet & Schifferstein, 2008), flavor (Auvray & Spence, 2008) and chemical factors, but also texture (Nishinari, 2004) and interactions between senses which illustrates the multidisciplinary nature of sensory science (Meilgaard et al., 2007).

Many methods have been developed in order to carry out specific sensory studies. Among the diversity of products and developed methodologies, tests using sensory panels must be conducted under controlled conditions, using appropriate and accurate experimental designs, methods and statistical analyses. A sensory panel must be treated as a tool to produce reliable, consistent, and reproducible results (Shepherd et al., 1988).

Under sensory properties assessments, different characteristics are usually taken into account among which food texture is an important factor for the sensory quality evaluation of food (Bourne, 2002a): Figure 1.

1.2 Sensory science: interest on texture evaluation of foods

The study of texture is an important consideration to make in the development and the preservation of food quality. It is rather not that important in liquid beverages or thin soups but it acts in a larger extent in products in which the texture is highly pronounced such as meat, fruits, cheese, candies and the most part of cereal-based foods including extruded cereals, biscuits, bread and cakes (Bourne, 2002a).

Consumer awareness to food texture has been early discussed (Szczesniak & Kahn, 1971). In some specific cases, the texture has been demonstrated to be a sensory pleasure source and is also associated with food freshness and quality (Chen, 2009, Civille, 2011). For instance, the loss of crispness leads to the rejection of the considered product by the consumer because it means that the freshness has been lost and that the product is not eatable any more (Roudaut et al., 1998, Szczesniak & Kahn, 1971).

In cereal products including bread, biscuits and cakes, the freshness perception has been studied (Heenan et al., 2009):

Table II. The study was asking for the participants (about 100 judges) to describe the freshness of each presented product type including biscuits, breads and cakes by their own words. Word citation frequencies (if above 10 times) were then recorded for its qualitative information. Different terms were found to be associated with particular product types. It was actually demonstrated that the product quality associated to its freshness is mainly driven by its appearance and its texture; moist and soft in the case of bread and cakes, and dry and crispy in the case of biscuits.

<p>The importance of food texture has been discussed regarding the food sensory perception and its acceptance by consumers. We know need to define more precisely what do we know about texture with regards to the way it can be measured and in relation with its different dimensions.</p>

Table II : Frequency (in count) of the most associated quality terms with the freshness of breads, biscuits and cakes after their consumption by a number of 115 consumers: extracted from (Heenan et al., 2009).

TERMS	ASSESSED PRODUCT & CONSUMPTION		
	Bread	Biscuits	Cakes
Softness	72	-	66
Odour	55	33	54
Smell	24	13	19
Flavour	37	23	31
Aroma	19	-	21
Crunchy	10	66	-
Crispness	21	-	-
Appearance	18	15	28
Colour	13	-	49
Moistness	46	-	62
Yeasty	34	--	-
Taste	50	43	46

1.3 “Texture is a sensory property”

1.3.1 *Early investigations on texture and its attributes*

Studies on texture dates back already to the late 19th and early 20th centuries (Brandt et al., 1963). Szczesniak first emphasize the important contribution of texture in food product quality and define it as “the association of the whole sensory perception of food as well as its structural and mechanical food properties” (Szczesniak, 1963a).

Later, a classification of texture items was proposed, providing from the previously cited definition, a description of each category and words in the terminology (Szczesniak, 1963a). This classification includes mechanical, geometrical and other characteristics such as fat perception (Table III).

Within the same period, a standard intensity scaling was established aiming to a quantitative evaluation of food texture for the hardness, brittleness, chewiness, gumminess, viscosity, and adhesiveness attributes (Szczesniak et al., 1963). Later, (Jowitt, 1974) emphasizes the active approach of food texture compared to taste or odor perceptions: food texture includes both visual assessment and product-mouth chewing interactions.

In 1989, Drake pointed out the difficulty for food texture to be assessed all around the world by only a few attributes. A list of items taking into account the cultural differences within the field of sensory science worldwide was proposed (Drake, 1989).

A 54 English terms list defining sensory textural/rheological properties of foods was provided with their equivalent terms in 22 other languages including for example hard, stiff, springy, compressible, friable, and sticky. Based on the analysis of the whole words list, words appear to fall into 6 different properties groups which are viscous, plastic, elastic, compressible, cohesive and adhesive.

Table III : Classification of Textural Characteristics into mechanical (1), geometrical (2) and other (3) classes parameters including both textural and 'popular' terms (Szczesniak, 1963a).

MECHANICAL CHARACTERISTICS : kinesthetically measured reaction to stress			
<u>Primary parameters</u>	<u>Secondary parameters</u>	<u>Definition</u>	<u>Usual terminology</u>
Hardness		Force to attain a given deformation of the food product	Soft => Firm => Hard
Viscosity			Thin => Viscous
Elasticity			Plastic => Elastic
Adhesiveness		Force required to remove the sample from a surface (tooth, palate)	Sticky => Tacky => Gooney
Sensory Cohesiveness	Brittleness	Degree to which the sample deforms rather than rupture	Crumbly => Crunchy => Brittle
	Chewiness		Tender => Chewy => Tough
	Gumminess		Short => Pasty => Gummy

GEOMETRICAL CHARACTERISTICS : tactile perception of particles: their size, shape, orientation		
<u>Parameter name</u>	<u>Definition</u>	<u>Terminology (other examples)</u>
Smoothness	Absence of particles	Coarse
Gritty	Small and hard particles	Crystalline
Grainy	Small particles	Cellular
Powdery	Fine particles (film)	...
Fibrous	Long and stringy particles	

OTHER CHARACTERISTICS : perception of water or fat by the tactile senses			
<u>Primary parameters</u>	<u>Secondary parameters</u>	<u>Definition</u>	<u>Usual terminology</u>
Moisture content	Moistness & moisture release	Wetness level perception	Dry => Moist => Wet => Watery
Fat content	Oiliness	Fattiness, liquid fat level perception	Oily
	Greasiness	Solid fat level perception	Greasy

1.3.2 *The definition of texture*

Nowadays, thanks to the contribution of many scientists involved in this field, a more precise definition of food texture also approved by the international organization for normalization committee (ISO) has been proposed (AFNOR, 1992).

The definition states that:

“texture is the sensory and functional manifestation of the structural (geometrical), mechanical and surface properties of foods detected through the senses of vision, hearing, touch and kinesthetic”. This definition thus conveys important concepts as cited in the food texture review paper of (Szczesniak, 2002):

- “1. **Texture is a sensory property** and, thus, only a human being (or an animal in the case of animal food) can perceive and describe it. The so-called texture **testing instruments** can **detect** and **quantify** only certain physical parameters which then must be interpreted in terms of sensory perception;
2. **Texture is a multi-parameter attribute**, not just tenderness or chewiness, but a gamut of characteristics;
3. **Texture derives from the structure of the food** (molecular, microscopic or macroscopic);
4. **Texture is detected by several senses**, the most important ones being the senses of **touch** and **pressure**.”

They also add that the sense of touch is one of the main important characteristic which helps to firstly describe a product by the way of the assessment of its resistance or its fragility while taken into the fingers.

As define above ISO 11036 (AFNOR, 1994), three texture properties classes (geometrical, mechanical and surface) are able to best describe this sensory dimension: Table III.

According to the common principles of sensory evaluation it is interesting to mention at this stage what are the main methods provided by the field of sensory science. The explanation of how can be conducted a sensory study regarding the study of the texture properties of a cake product will be also interesting.

This description will allow a suitable choice for further investigations and is presented in the following section of this chapter.

2. The multidimensional nature of food texture

2.1. An overview

Texture is actually both a multi-parameter and a multi scale material property: Figure 2. As a consequence, while assessing the texture of foods, and particularly of cakes, a wide range of characteristics needs to be taken into consideration.

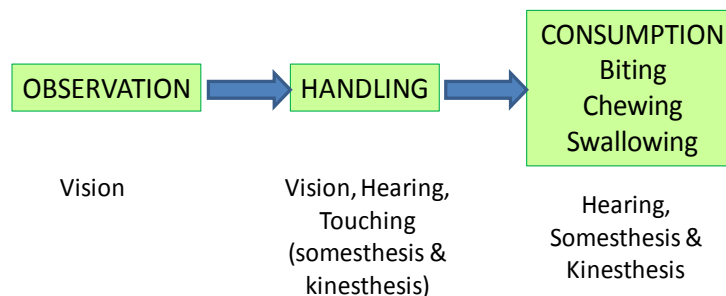

Figure 2 : The involvement of the senses in the texture perception during food consumption process: adapted from (Chen, 2009, Chouvardas et al., 2008, Wilkinson et al., 2000)

Then, a food texture terminology has even been proposed (Jowitt, 1974) highlighting these various perceptions and introducing terms related to material behavior under stress or strain (firm, elastic, sticky, crumbly), material structure (smooth, powdery, coarse, aerated) and its mouth feel characteristics (dry, creamy, oily).

Moreover, visual, odor, in touch and in mouth texture as well as flavor attributes belonging to bread sensory descriptive studies have been reviewed and a list of terms proposed in parallel with their corresponding definition for the assessment of bread sensory quality (Callejo, 2011): Table IV.

2.2. Food appearance importance and assessment

In many cases, the appearance determines whether or not to buy or to eat the food product. It is color for fruits or meats (Risvik, 1994), crumb structure for breads and cakes (Gonzales-Barron & Butler, 2008a, b), and even brightness or humidity (Laitinen et al., 1993). Bread crumb appearance panelists' perception has for instance been investigated in relation with image analysis features (Gonzales-Barron & Butler, 2008c). Visual is the sense responsible for aspect evaluation in human. Crumb's aeration characteristics such as bubble dimensions or homogeneity within the crumb as well as crumb or crust color can be taken into consideration: Table IV.

The appearance and the tactile perception of bread texture were demonstrated as an important criterion involved in consumers' acceptability. Both in touch and in mouth perceptions results from the crumb cell structure which when fine, relatively homogeneous and thin walled, is responsible for a softer and more elastic texture whilst coarser crumb led to the least. Also, as cake belongs to solid foams materials category our focus on appearance and texture is clearly justified.

Table IV : ‘Appearance’, ‘By touch’, ‘Mouth feel’ terms and their corresponding definition coming out from the attribute’s list proposed for the assessment of bread sensory quality in descriptive sensory analysis (Callejo, 2011).

ATTRIBUTES CLASS	ATTRIBUTE NAME	DEFINITION
APPEARANCE	Crust darkness	Degree of color darkness in the crust ranging from light brown to dark brown
	Crumb darkness	Degree of color darkness in the crumb ranging from white to dark brown
	Crumb Cell Number	Crumb cell number per cm ²
	Crumb Cell Homogeneity	Homogeneity of the size of the crumb cells
	Crust Thickness	Thickness of crust of side part
‘BY TOUCH’ Texture	Crumb firmness	Resistance to the crumb pressure in the finger
	Crumb Elasticity	Sample ability to return to the starting position after its compression
‘MOUTH FEEL’ Texture	Moistness bread crumb	Amount of saliva produced in the oral cavity during sample chewing
	Adhesiveness	Analysis after compression between the tongue and the palate. Degree to which the product adheres to the palate

2.3. In touch texture properties

Owing to the fact that it is the first direct interaction taking place between the food product and the human assessor, perception experienced through the touch has also been reviewed few times (Chouvardas et al., 2008, Strassburg et al., 2009).

A study involving the comparison of fifteen bread dough was performed; although the texture perception judgment was realized only on visual and in touch perceptions it led to the generation of many attributes illustrating that a very rich vocabulary and information can be obtained only through the senses of sight and touch (Lassoued et al., 2008).

2.4. In mouth texture characteristics

However, in mouth perceptions can have a critical influence on the overall texture evaluation as it would be the case when assessing products expected to be crunchy, crispy (involving additional sense of hearing) or in the opposite soft and elastic. In fact, the sensory response need to agree with the sensory representation of the given food product, further perceived as sophisticated, of quality and as a source of pleasure without creating an annoying senses to consumers (Civille, 2011, Krishna, 2011, Stone & Sidel, 2004b).

Relations between texture and mastication have been discussed in parallel with the nature and the mechanical properties of food describing expected textural properties

(Bourne, 2004). Pan breads endow chewy and deformable crumb but a very tough crust texture whereas cake has a tender, moist also displaying a slightly chewy texture.

Besides, in mouth perception gives additional information to the assessor as many food transformations take place within the mouth (Van der Bilt et al., 2006). While food breakdown occurs, particles are size reduced, dispersed into the mouth and salivation process starts (Agrawal et al., 2000, Agrawal et al., 1997). In parallel, the sample temperature, its texture, its structure evolves along mastication process until swallowing (Agrawal et al., 2002, Chen, 2009).

The swallowing process actually includes the product disintegration, its softening by saliva absorption and its 'melting' owing to the solid to liquid phase change while food is warmed up into the mouth (Bourne, 2004). Such modifications create a wide variety of sensory stimuli characterized by their nature and intensity consequently making the "in mouth" assessment of food texture relatively complex which justify the increasing interest and studies led on food oral processing. The assessment of the hardness has been investigated with regards to the bite force recorded over a wide hardness range from elastic to plastic also brittle materials.

Although the chew/swallow ratio usually increase with food hardness (Hiemae et al., 1996), the product nature exert an influence on the applied force either closely related to the product hardness - brittle and plastic foods - or to its deformation behavior if elastic (Mioche & Peyron, 1995, Mioche et al., 1993).

As it is the case in many sensory characteristics such as food flavor (Auvray & Spence, 2008), food texture properties are usually related to various perceptions in which both structural and chemical stimuli are involved (Figure 2). Creaminess (De Wijk et al., 2003) and softness illustrate the multi-parameter aspect of texture (Tunick, 2010).

2.5. The case of cake softness: definitions and difficulties!

For cakes, freshness and softness properties perception is of a main importance whereas for other cereal products such as dry biscuits or extruded foods the brittle-crisp texture is requested to prove the quality of the product (Sozer et al., 2011, Szczesniak, 2002). Among recorded texture properties and particularly in baked products such as cakes or breads, although the softness represents an important attribute it is not define exactly.

The softness attribute is widely used and found in many countries as reviewed recently (Lawless & Heymann, 2010b). It is usually not fully describe neither as the opposite of hard nor as the synonym of smooth or non cohesive. Another notion was introduced by Jowitt (1974) defining the term soft as a low resistance to deformation by applied force. Although softness definition is given

from a sensory point of view in the French Normalization Association document (AFNOR, 1992) as a low level of hardness, this texture perception for which evaluation conditions, physiological, and cultural parameters are also involved, is difficult to define (Drake, 1989, Lawless & Heymann, 2010b).

In the early 1980's, the International Organization for Standardization, (Standard 5492/3, 1979) gives the following definition to the adjective "soft": 'As a texture characteristic, describes a product which displays a slight resistance to deformation. The corresponding noun is "softness".

However, it also defines hard as the characteristic which displays a product to a substantial resistance to deformation or breaking. The corresponding noun, "*Hardness*" is the perceived force required to break the sample into several pieces during the first bite by the molars.

Whilst the difficulty to define it precisely, and differences observed according to the type of assessed product it is known that softness is related to the freshness perception of cakes and breads. It has indeed been demonstrated that softness was the most frequently use item to describe such quality (Heenan et al., 2009):

Table II. Interestingly, in this study the term softness was considered as the most important term to characterize bread and cakes freshness for 63% and 57% of the panelists, respectively.

In addition while describing a product the item "soft" always refers to a positive sensory perception of the evaluated product whatever its function (cake, bread, pillow, ...). For instance, performed on rice cakes (mochi), a study involving both sensory and instrumental methods reveal that the perceived softness was a reciprocal of the hardness with additional positive relation with smoothness (Chuang & Yeh, 2006).

In some cases, softness is not integrated within the sensory attributes list. Indeed, in a study led on the impact of Chinese cakes ingredient composition variations on its sensory perception, the sensory panel had not assigned intensity values for softness but authors mention that it correspond to the lowest hardness (Jia et al., 2008).

Several senses are involved in the foods texture perception so that visual, in touch and in mouth sensory experiences need to be taken in account for an optimal evaluation of the food texture and especially of cakes on which we are focused. Softness actually appears as a perception related to a various number of sensory characteristics which the contribution is not precisely known.

Besides, human body is the only measurement tool able to take into account, at the same time, a wide variety of characteristics perceived on one product. It is

then able to communicate on multi-dimensions information from its appearance to its taste, even to its perception while it is masticated then swallowed.

Aware of these abilities, it is however necessary to understand what are the chemical and the physical contributions exerted on the overall food texture properties.

This explains the need to develop a clearer understanding of the sensory properties endowed by a food product in relation with its instrumental characteristics.

3. Food texture sensory evaluation: concepts and methodology considerations

3.1. What are the main sensory tests and methods: a classification overview

Sensory analysis can be considered as a technique including a large amount of methods for the measurement of accurate responses in which human is considered as the assessment tool.

Under controlled conditions, the panel leader provide product to be evaluated by the assessors who form the panel. According to its own perceptions (quality, intensity and pleasure) they build a sensory response (Depledts & Société Scientifique d'Hygiène Alimentaire, 2009) aiming either to identify, to compare or to describe samples.

Depending on the objective of the study, the objective of the sensory test, the type of products, but also the nature of the wished judge training, distinct sensory methods can be applied (Lawless & Heymann, 2010a, Meilgaard et al., 2007).

Three main sensory analyses techniques can be distinguished (Table V). They are classified in the hedonic responses, the discrimination tests and the descriptive tests which are also further divided in distinct methods.

The first one is used to determine whether or not preferences do exists between samples and if the judges enjoy eating this food, but cannot thoroughly characterize a sample. The second one, commonly named difference or discriminative testing is based on the detection of the product distinctions among the samples presented to the panel.

The third one, descriptive profiling is based on the product evaluation among the other products or assessed alone. It can thus be related to a classification of product characteristics (qualitative description) or to the quantification of the intensity of a given attribute (Murray et al., 2001).

Table V : Sensory evaluation methods classification according to the type of question asked to the panel, the type of test and the level of the judges training.

Method class (test type)	Requested answer to the question?	Panelists characteristics - requested training -
Affective (Hedonic)	How well are products liked or which ones are preferred?	Merely screened products - Untrained subjects -
Discriminative (Analytical)	Are the products perceived different or equivalent in any way?	Screened for their sensory acuity, oriented to test method - not necessarily trained -
Descriptive (Analytical)	How do products differ in a given sensory characteristic (scaling or ranking)?	Screened for their sensory acuity, motivation and availability - Usually slightly to highly trained -

3.2. Discriminative tests

These kind of sensory tests merely attempt to identify a sample for its characteristics among the others assessed products if perceptible differences actually exists. Some examples are given (Figure 3) but these methodologies are not developed in details in this document.

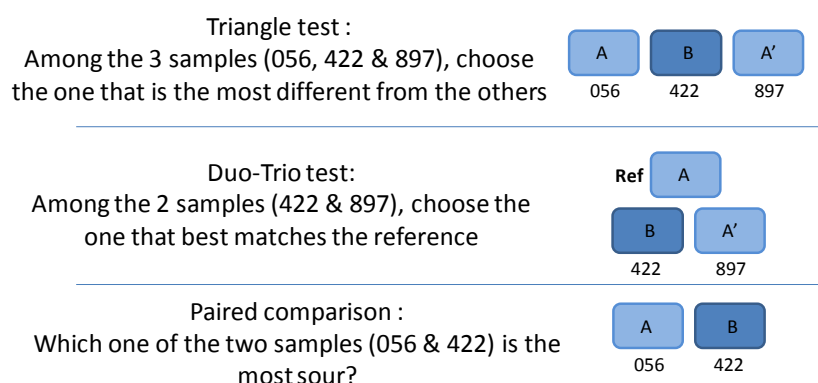

Figure 3 : Examples of common methods used in discriminative testing

3.3. Descriptive tests: conventional and alternatives methods.

Descriptive sensory analyses are considered as the most sophisticated tools among the various sensory techniques: Table VI (Hootman, 1992, Meilgaard et al., 2007). They can give access to at least a rich, at the very best a thorough sensory description of the studied product properties. Relative or absolute differences can be obtained between tested samples.

Using conventional descriptive profile, a thorough description of the product sensory properties is established (AFNOR, 2002). If necessary, only one or two sensory modalities can be assessed. Our study will for instance be focused on a descriptive texture profile, although the same principles are largely applied in other sensory domains. The conventional descriptive profile is divided into different steps, including

panel recruitment and performances assessment (8 to 15 selected panelists), items generation and definition, training and finally measurement sessions (Bourne, 2002d, Lawless & Heymann, 2010a): Figure 4.

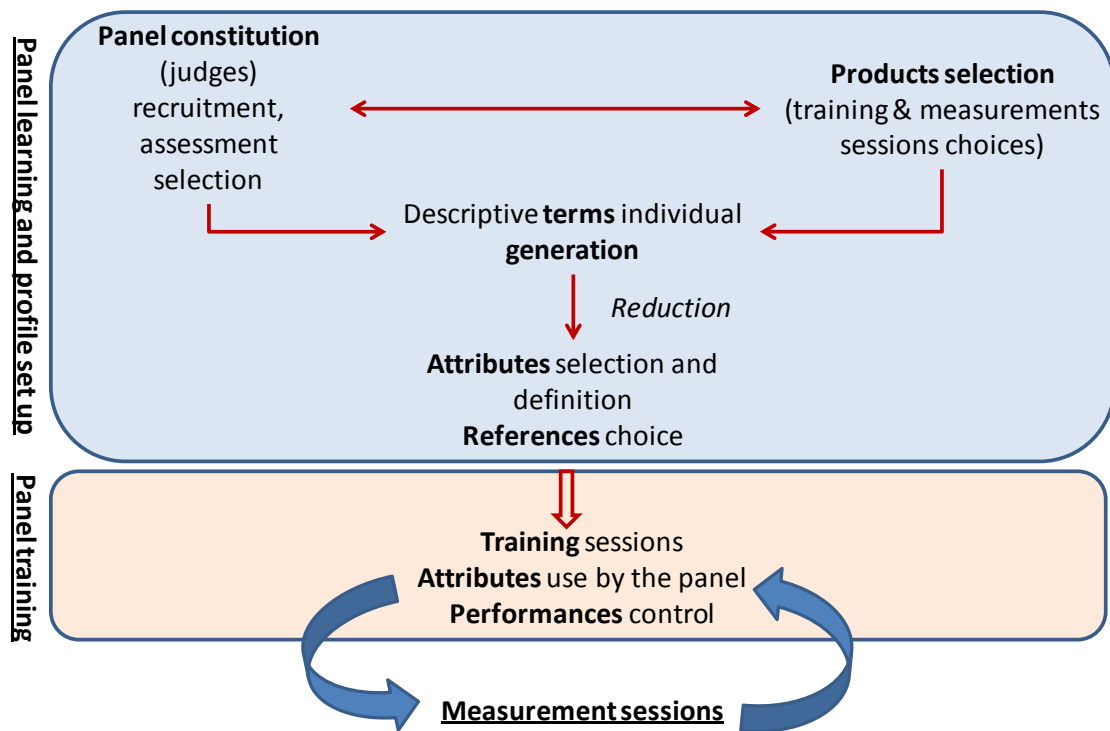

Figure 4 : Representation of the main steps in an expert panel set up and training.

Besides, although conventional descriptive profiling techniques provide accurate description of the overall product sensory properties, limitations arise from the way it is brought into play. It requires a high level of training and investment of both panel and panel leader. Panelists are thus used to evaluate samples and are especially trained to be able to measure their sensation. It provides precise information that can unless be farther from what customer might really perceive. It is also costly to set up and is a time consuming method. As a result, alternatives descriptive methods have gained popularity in the field of sensory science (De Cássia dos Santos Navarro da Silva et al., 2012, Dehlholm et al., 2012). Even though they do not provide thorough characterization, they bring faster answers, at a reduced cost and they can be closer to the perception of the product by larger customer span.

Table VI : Sensory evaluation: main characteristics, advantages and drawback aspects of several conventional and alternative descriptive analysis methods.

	Conventional Methods				Alternatives methods		
	Sensory Texture Profile	Quantitative Descriptive Analysis	Spectrum descriptive analysis	Conventional descriptive profile	Free Choice Profiling	Flash Profile	Projective Mapping
Vocabulary generation	Universal ⁽¹⁾	Panel specific	Universal ⁽¹⁾	Panel specific, collective definition	Idiosyncratic	Idiosyncratic (scarcely collective)	Idiosyncratic
Training	Yes	Yes, items set up	Yes, extensive	Yes, items set up	No	No	No
Scale & measure	Absolute 0 to 7 points scale	Absolute, but relative product judgments	Absolute, pre-learned absolute intensities 0 to 14 points scale	Absolute	Relative intensity scale	Classification, relative scale; no intensity record	Map of the product space
Intensity ref ⁽²⁾	No	No	Yes	Yes	No	No	No
Analysis	PCA (Principal Component Analysis), MFA (Multifactorial Analysis), Cluster Analysis				MFA, Procrustes analysis		
Application	Comparison of products with distinct textures	Explore small differences between, samples	Comparison of even large differences between samples	Comparison of samples on selected items	Relative intensity differences, on a large set of products	Classification of samples in classes from large product sets.	product inter-distances measurement
Advantages	High degree of precision & absolute differences provided				Cost effective : no required training and good sensibility		
	Deep investigation of the nature of product differences					Large set of products	
Inconvenient	High degree of training => Time consuming				Simple differences observations		Ample sample sets required to fully distinguish products
	Already defined vocabulary	Restricted product space, no references use	Already defined vocabulary				
References	(Brandt et al., 1963) ; (AFNOR, 1994); (Civille & Liska, 1975, Szczesniak, 1963b, 1975, 1987)	(Stone et al., 1965, Stone & Sidel, 2004c)	(Civille & Liska, 1975)	(Civille & Liska, 1975)	(Williams & Langron, 1984)	(Sieffermann, 2000) (Dairou & Sieffermann, 2002)	(Kihlberg et al., 2004)

⁽¹⁾Universal: Universal: Items list already defined in table; ⁽²⁾Intensity ref: No products references served as intensities standards.

Several techniques can be used as a variation of the common product description (Table VI). The concept of the alternatives methods is based on the fact that a sensory evaluation can be flexible, rapid, and accurate enough to provide reliable information on the relative sensory positioning of different sample within a group of products without intense training (Albert et al., 2011, Moussaoui & Varela, 2010, Veinand et al., 2011). In some cases, it is indeed not necessary to obtain a complete description of the samples but just gets an idea on what are their main sensory characteristics and their relevancy.

The Flash Profile (FP), amongst alternative methods is divided into three main steps: attributes generation, sample ranking and data analysis (Figure 5).

Compared to the conventional descriptive testing the use of Flash profiling also allow the assessment of a very large number of products at the same time. It has already been the case in the study led on 49 commercial puree (Dairou & Sieffermann, 2002) or 14 jams at once (Tarea et al., 2007). Investigations have also been carried out using Flash Profile on various other products; yoghurts or fresh cheese (Delarue & Sieffermann, 2004), chewing gums (Delarue & Loescher, 2004) as well as baked products (Lassoued et al., 2008).

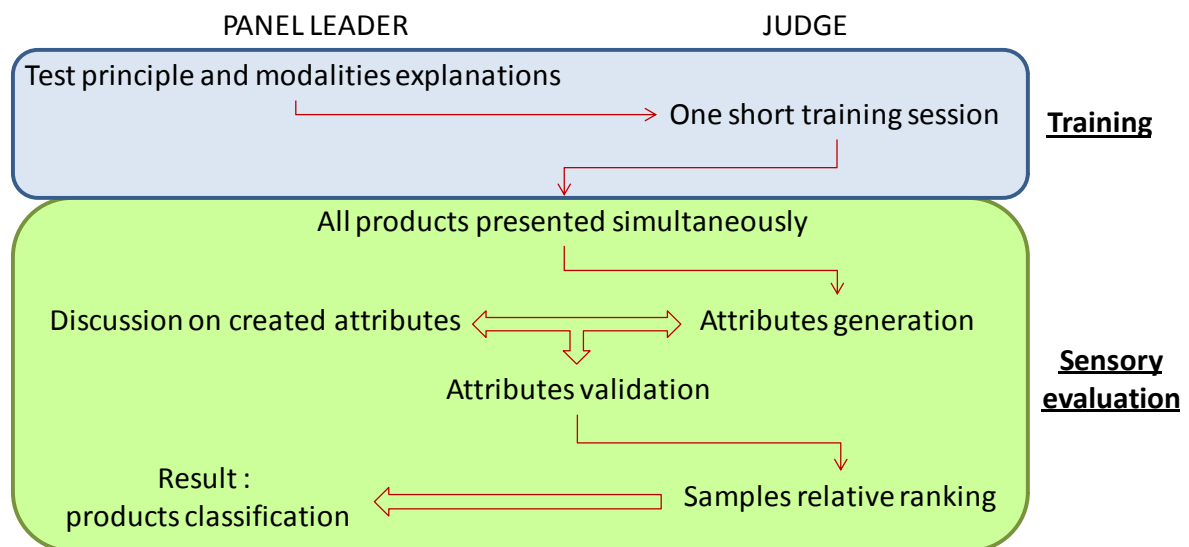

Figure 5 : Representation of the Flash Profile methodology steps.

Relations between results obtained by the way of conventional descriptive profile and Flash Profile methods were actually found, but also, though in a lesser extent, between their vocabularies (Blancher, 2007, Delarue & Sieffermann, 2004).

Also, the use of conventional profile in parallel with alternatives methods using panelists with distinct training level (Albert et al., 2011) or with consumer panels (Veinand et al., 2011) has already shown that consistent and comparable results can be obtained (Stone & Sidel, 2004c, Worch et al., 2010).

Sensory perception of texture is the results of a large number of stimuli providing information with respect to food mechanical, geometrical and surface properties. Visually, in touch or in mouth upon mastication, food texture can be assessed by the way of descriptive measurements. Although conventional profile is a reference method and is the most complete, alternative methods can also provide useful information which can be obtained faster with a non expert panel. It has especially been illustrated above in the case of Flash and Conventional Profiling comparisons (Dairou & Sieffermann, 2002, Dehlholm et al., 2012, Delarue & Sieffermann, 2004, Veinand et al., 2011). The power of a sensory response is that it can be obtained under conditions which are close to the consumer (Sauvageot, 2001). Even conducted in a controlled environment (sensory dedicated room) within specific sessions, the judge is the tool from whom the whole sensory description is given and the integration of a global response given by the panel is possible to best describe the product.

4. *Food texture properties assessment: its relation with instrumental measurements*

Since the texture property impact on food products quality perception has been emphasized in the early 1960's, many scientists gain an interest in studying food texture by the way of both sophisticated sensory methods and instrumentally developed analysis. Sensory science technique are actually also designed to meet industrial needs because instrumental measurements provide results which can be used to screen sample prior to be further characterized by sensory evaluation. It is usually less time-consuming and represents a lower cost.

It is worthy of note that in this objective much progress have been made during the last mid-century to allow scientists to be all the richer for such a complex concept. Always aiming to better understand, measure, and then control the texture, numerous methods have been tested on various applications including solid, semi-solid or liquid foods (Sidel & Stone, 1993). With respect to the diversity of tests attempted to improve and accurately characterize the texture of a food product it is hard to make up one's mind among the various methods. Therefore, why do so many methods exist to study the sensory – instrumental relation of food texture? First, numerous definitions of food texture were proposed over the years supplemented upon knowledge progress until the last texture definition (Szczeniak, 2002). Second, because a wide variety of food products exist which thus lead to different in mouth breakdown, chewing patterns and texture perception. Third, owing to the fact that one food taking apart from the others endows several texture characteristics.

4.1. Sensory – instrumental related studies

The texture is assessed in the initial (first bite), the second (masticatory) and the final (residual perception) phase (Bourne, 2002b, Szczesniak, 1963b, 1975). Reported by several scientists, development of texture nomenclature effectively relates sensory with instrumental studies including rheological measurements (Brandt et al., 1963, Szczesniak, 1963a, 1987, Szczesniak et al., 1963). Still, factors can exert an influence on attempted correlation among which similarity between the measurements conditions which should be closer as possible, the nature of the tested material (heterogeneity), and the selection of sensory scales and terms which might involve few characteristics within the same parameter.

Specific studies have been performed on various products from bread (Brady & Mayer, 1985) to fats (Marshall, 1990) attempting either to study particular texture attributes (crispness, creaminess, softness) or to characterize both the instrumental and sensory dimensions of food (possibly encountered from a liquid to a solid state). According to their multi-dimensional aspect, some attributes are dealing with the fact that they cannot be clearly defined and thus justify the need to be investigated by the way of different approaches from both instrumental and sensory measurements.

This is for instance the case of crispness, investigated in bread products (Roudaut et al., 1998, Roudaut et al., 2002) or creaminess for which soups (Daget & Joerg, 1991), creamy desserts (Daget et al., 1987, De Wijk et al., 2003, Tournier, 2006) and yoghurts (Cayot et al., 2008) were assessed.

The relationships between foods rheology and eating action including palatability, food breakdown as well as large deformation texture assessments, fracture and particle size have been discussed few years ago (Nishinari, 2004). The surface properties of foods and its particles presence upon chewing are also important factors influencing texture perception. Graininess perception was demonstrated to be dependent of particles sizes, shape and hardness. Particles are for instance not perceived until size reach 80 microns (Tyle, 1993), and even higher if particles are soft and rounded (polyethylene) or relatively hard and flat (mica). Still, if particles are hard and angular, their grittiness can be already perceived from 11 microns.

4.2. The case of solid foods texture

Texture is judged more important for solid than for liquid foods. Such findings were attributed by the fact that “the magnitude order of the change in hardness is more remarkable for solid foods than that in viscosity for liquid foods” and that human is more sensitive to changes in the hardness perception (elastic modulus) than in the viscosity of foods (Nishinari, 2004).

For instance, the Young's modulus (elastic modulus) is defined as the slope of the stress-strain curve under a small deformation range of the product, which may be related to the first sensation in mouth when a solid food is ingested and before the mastication process begins.

Moreover, depending on the food structure, a wide variety of tests types can be used such as extension, compression but also fracture tests and other parameters than those previously listed.

Table VII : Definition of hardness, springiness, stickiness and cohesiveness parameters with respect to both its sensory and instrumental significance; adapted from (Bourne, 2002d; Meullenet, 1998; Szczesniak, 1963b, 1987).

Textural parameter	Sensory definition and scale meaning	Instrumental definition - double compression test - (unit)
Hardness	Force required to entirely bite through the sample when placed between molars teeth. 1=soft sample ; 14 = hard	<i>maximum load applied to the samples during the first compression</i> <i>1st curve peak force (N)</i>
Cohesiveness	Amount of deformation undergone by a material before rupture when biting completely through the sample. 1= strong compression level before rupture 14 = easy sample rupture (small deformation enough to break apart)	<i>Energy ratio:</i> <i><math>\frac{\text{Area under the 2nd compression curve}}{\text{Area under the 1st compression curve}}</math></i>
Stickiness	Degree of sample stickiness to fingers, tongue or palate and energy required to separate teeth after chew down 1 = strong adhesion displayed by the sample 14 = No adhesion behavior	Work of adhesion , energy required to pull out the sample from the compression plunger <i>area under the negative curve</i>
Springiness (elasticity)	Degree or rate at which the sample returns to its original size/shape after partial compression between the tongue and palate. 1 = stays 'compressed' and deformed 14 = quick return to initial size and shape	<i>Recovery level after compression.</i> <i>Ratio of the duration of contact with the sample during the second compression (2nd curve width / from its rise to the highest force point)</i> <i>to that during the first compression = d_2/d_1</i>

The study of the relationship between sensory and instrumental texture profile attributes has been led for many years. In 1975, Breene wrote that the Texture Profile Analysis (TPA, see chapter 2, §1.6) via interpretation of stress-strain curves is, and will continue to be, extremely useful in evaluating the textural quality of foods, particularly when parameters can be correlated with sensory assessments" (Breene, 1975).

Using this concept, texture was particularly investigated on a wide variety of foods (Breene, 1975, Meullenet, 1998). For instance, twenty-one food samples from caramels to marshmallows including fruits and breads were tested by the TPA using an Instron universal testing machine and by sensory analysis with a trained panel. Definition of each respective parameter is also summarized in the Table VII.

Other applications are also illustrated in the Table VIII, underlying the main texture characteristics which were evaluated by the two sets of methods (instrumental and sensory) and the corresponding correlations.

A study on **bread**s, in regards with both instrumental and sensory properties has been conducted (Lassoued et al., 2008). The Flash profiling method was led in parallel with instrumental characterization including uniaxial compression and texture image analysis. Correlations were highlighted between texture, and sensory measurements. Samples which were having a higher crumb density and Young modulus exhibit also a higher sensory elasticity. Authors have shown that cells distribution parameters were also correlated between sensory and instrumental assessments. Both mechanical properties and crumb structure were relevant to best characterize the cake crumb texture. Those findings again illustrate the multi-parameters aspect of texture study and the need to take into account the appearance as an assessor (Callejo, 2011).

Table VIII : Sensory – Instrumental assessment of various food products and correlation between tested methods

Sample type	Sample size/shape	Deformation rate and test	Evaluated properties	Correlation coefficients	Reference
rye and “French” breads	2.5 cm thick and 2.5 cm in diameter	80%, 2 cycle compression	Hardness Cohesiveness Elasticity Chewiness	0.4 to 0.5	(Brady & Mayer, 1985)
Chinese cakes	2mm thick (cake surface sample)	60%, 2 cycle compression	Hardness Chewiness Stickiness	0.97 0.96 0.71	(Jia et al., 2008)
From caramel to marshmallows including fruits and breads	Not given	70%, 2 cycle compression	Hardness Cohesiveness Springiness Chewiness	0.76 0.83 Uncorrelated Uncorrelated	(Meullenet, 1998)

In a multiple physical approach, bread crumb grain characteristics were also measured among physical and mechanical tests (Angioloni & Collar, 2009). The authors found that the crumb structure was very heterogeneous (cell distribution, size). Even though the great variability was observed for both samples, either whole pan or white bread, they also observe that the shape and cell structure opening can be affected by

the composition of the bread. Still, it is always critical and important to select the test principle that best fit texture parameters and matches the food to be assessed.

The selection of sensory attributes for their characteristics and definition should be closely related to the actual chemical and rheological properties of the considered product. In many cases sensory texture attributes were studied in relation with instrumentally determined textural parameters.

The sensory evaluation of food products is based on the human senses which are able to simultaneously perceive various material properties. Moreover, texture properties such as hardness, stickiness, cohesiveness, springiness, may not be independent from each other. Even though it is difficult to find a good correlation between the oral perception of a food and its instrumental features for this reason, the texture profile analysis (TPA) has been frequently used.

5. Sensory dimension of texture: a conclusion

The definition of sensory science focusing on how to describe and study the perception of food texture has been developed in this chapter. Texture is actually a sensory property (Szczesniak, 2002). According to Bourne, it is also a food property which derives from its structure and its composition owing to food process which undergoes (Bourne, 2002b, Bourne, 2002c).

The production of attractive food product is a need for the food industry interested in creating and provide new texture and sensations to consumers (Aguilera, 2005).

The consumer can have a clearer idea of the experienced texture property (softness) which makes it easier to assess than for scientists who need to use several parameters to best approach the product sensory characteristics. Depending on the product nature, a similar measure can provide responses which are not always correlated to sensory attributes. Meanwhile, several instrumental measurements can be required to characterize one sensory item as it is usually the case for multi-dimension attributes.

Besides, various sensory methods can also be applied to characterize the overall sensory properties of a food product. Whilst conventional descriptive profiles are most frequently used, alternatives methods which have been more recently developed can be useful regarding its practical aspects and the responses quality particularly to answer to specific questions.

The understanding of the relationship between food texture perception and its texture has been reviewed. The compression test is the most used method in the study of crumb mechanical properties. It can merely attempt to assess products

elasticity or hardness or to follow the evolution of textural properties along storage such as bread staling.

Although food texture perception is primarily perceived through the tactile sense then the in mouth sensations, its appearance also contributes to the overall texture evaluation. It is the case in 'soft' cereal products such as cakes or breads in which the appearance can be important to be taken in account. It is mainly characterized by the product crust surface properties (smooth or tough, shiny or not), its volume (developed or not upon cooking) as well as its crumb porosity (bubble size, opening, homogeneity). This explains the increasing importance of a multi-disciplinary approach which requires sensory science but also food structure research area (Wilkinson et al., 2000).

In our study, cakes product are studied and can be considered as solid foams in which aeration characteristics and bubbles properties are as important as the overall rheological sample behavior (Attenburrow et al., 1989). Rheological parameters as well as food microstructure and macrostructure will be therefore reviewed in the following chapter.

Section II: From the structure to the texture of foods

As pointed out in the previous section, appearance, taste, aroma and texture are involved in consumer sensory appreciation. Therefore, the management of sensory properties of a food product is key for food industry. This study is actually neither about aroma nor taste perceptions but is mainly focused on cake appearance and textural properties which are important parameters in the overall evaluation of food perception.

According to its definition, the textural properties of foods derive from their structure which is progressively degraded upon oral processes (Wilkinson et al., 2000): Figure 6. The relationship between food structure and its texture thus needs to be well understood in the considered food domain in order to direct the formulation towards cake products in agreement with consumer expectations.

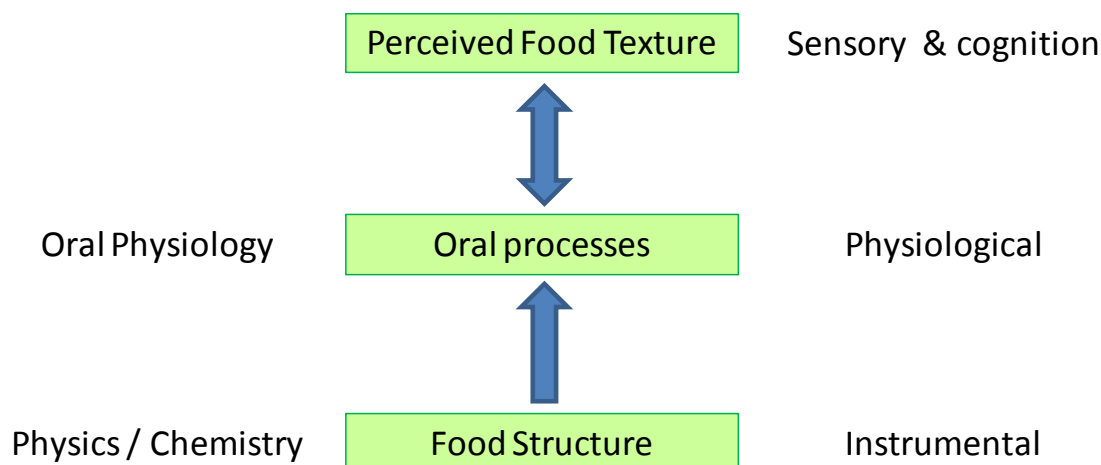

Figure 6 : From structure to food texture perception: methodologies and scientific fields apply to the texture study; adapted from (Wilkinson et al., 2000).

The multi dimensional aspect of aerated cereal based product structure has been therefore studied from both the whole product textural properties (mechanical behavior of food materials) and the porous aspect of solid foams (bubbles characteristics and their physical properties): Figure 7 (Sozer et al., 2011).

Bubble size heterogeneity and shape are also involved in the mechanical solid foam behavior, affecting cell wall resistance (Niranjan & Silva, 2008a). Consequently, its morphological and mechanical characteristics are important to control the textural properties of the food product. Such parameters can be influenced by its ingredients composition, interactions and baking conditions as pointed out in a recent review (Sozer et al., 2011). Using different characterization methods, mechanical measurements, imaging, and mathematical models the structural organization of aerated products can thus be investigated.

This section will first focus on solid foam and aeration characteristics with regards to its structural impacts and measurements methods. Then, the mechanical properties of food products especially regarding viscoelastic behavior will be described. Finally, a short review on the impact that aeration exert on mechanical properties is proposed: Figure 7.

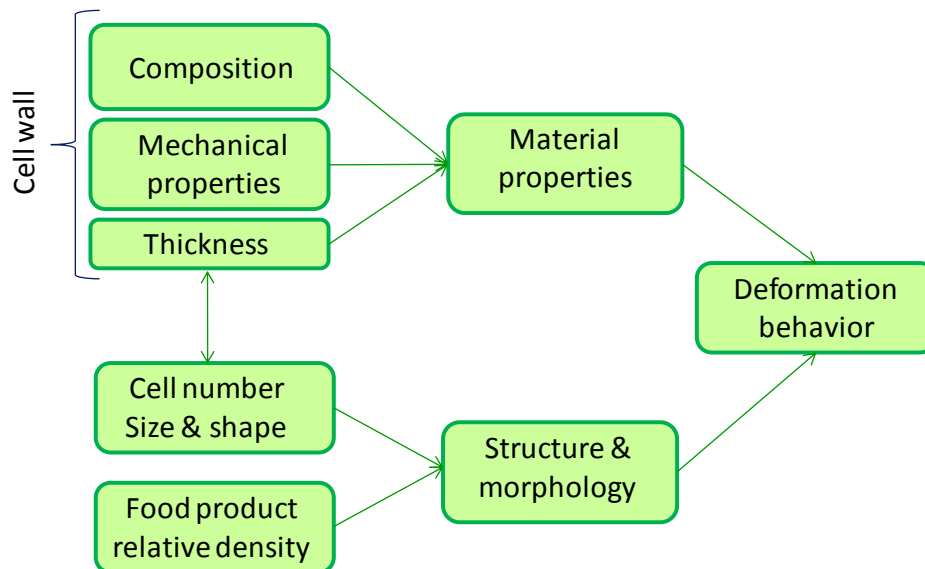

Figure 7 : Inter Relationship between Material – Structural – Mechanical Properties; Adapted from (Sozer et al., 2011).

1. *Aerated cereal materials: food foams, a cellular solids concept*

1.1. Solid foam concept: an introduction

Aerated cereal based products such as cakes or breads fall into the 'group of soft cellular solid food products'. It is for instance the case of cellular solids materials such as polyurethane foams or starch based foams (Figure 8).

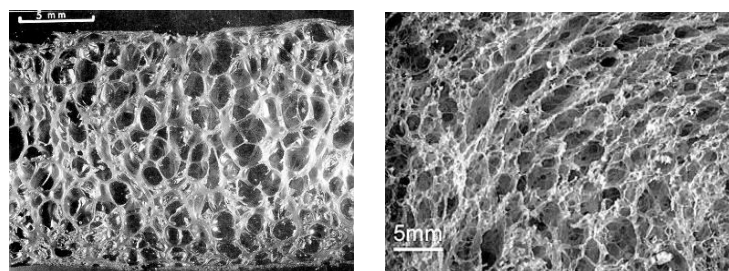

Figure 8 : Cellular solid example: digital image of polyurethane - left image - and starch foam structure – right image - (Hermann, 1990, Liu et al., 2003).

Air is a component of several food products usually present as a dispersed phase of bubbles or pores within a solid matrix (Niranjan & Silva, 2008a). Air bubbles are thus relatively abundant structural foam elements (Gibson & Ashby, 1997, Maire et al., 2003), especially in food foams, either solids such as bread, cakes, aerated chocolate bars or semi-solid foams such as whipped cream or 'mousse' (Corradini & Peleg, 2008).

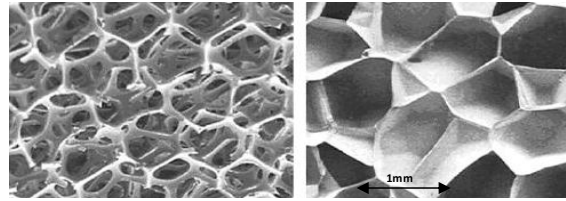

Figure 9 : Cellular solid porous structure example: open-cell polyurethane foam - left - and closed-cell polyethylene foam - right - (Gibson, 2005).

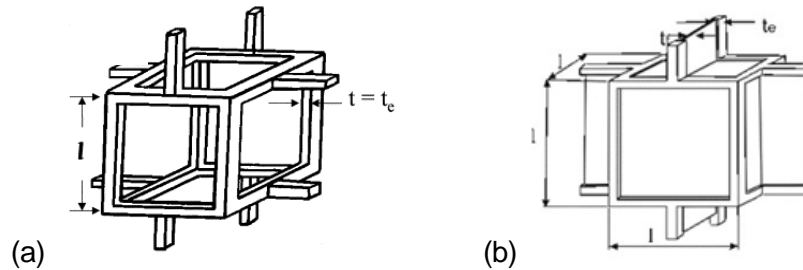

Figure 10 : Cellular solids cell representation (unit cells drawn as cubes, so that $l=h$): a statement of whether it is open (a) or closed (b). Most of them behave like open-cell foams. Adapted from (Ashby & Medalist, 1983).

Solid foam is defined as a three dimensions cellular solid, containing cells entrapped in an inter-connected network. Their typology is determined by the geometry of the solid and the gaseous phase as well as cell wall connections in between them (Scanlon & Zghal, 2001, Zghal et al., 2002): Figure 9, Figure 10.

1.2. Solid foam formation and characteristics: application to bakery products

Actually belonging to aerated cereal-based product, bread is considered as a soft solid foam (Scanlon et al., 2000). At a macroscopic level, it contains two phases which are air (fluid phase) and cell wall (solid phase). However, although apparently isolated one from another within the crumb, air containing bubbles are connected. The cake batter actually undergoes complex interactions and modifications upon mixing and baking process. The 'wet and semi-liquid state dough' is transformed in a 'dry product leading to the so called 'solid foam' Bread or cakes crumbs were described as open-cells solid foam (Figure 10a) which are obtained by the baking of closed-cells foam, i.e. the dough (Bloksma, 1990a): Figure 11.

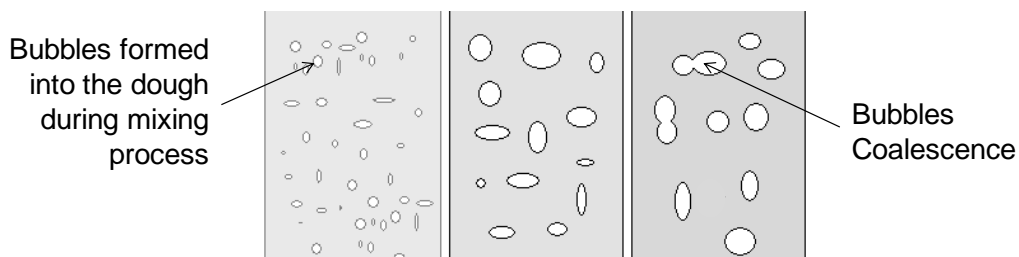

Figure 11 : Dough bubble formation and evolution as followed during the mixing and baking process: from left to right, unbaked dough, upon baking and final baked product: adapted from (Bloksma, 1990a).

1.3. On the characterization of cellular solids porous structure: application to bakery products

Both bread crumb physical and visual texture are interrelated product quality factors that should be considered as a single entity. This pointed out the need to investigate the porous structure of cellular solids using various crumb characterization methods (Scanlon & Zghal, 2001). It can be either led for a global internal product assessment or for a structure evolution measurement upon processing, various methods can be applied. Always followed by image treatment and analysis, image acquisition can either be simple to perform or require very specific tools.

1.3.3 Simple methods and Digital Image Analysis (DIA)

Meanwhile sophisticated techniques usually allow an in depth characterization of materials porous structure, many crumb features evaluation approaches using less expensive method have been published (Gonzales-Barron & Butler, 2008b, Pérez-Nieto et al., 2010, Sapirstein et al., 1994): Table IX.

Nowadays, image and video capture tools allow time-recording, high acquisition rates as well as many other facilities. For instance, image scanning resolutions and threshold techniques have been compared for their ability to quantify bread crumb aeration features further providing a wide range of parameters such as bubbles size and shape factors (Farrera-Rebollo et al., 2012). A relatively simple assessment of crumb grain characteristics can thus be performed by DIA with a good image resolution and accurate responses using 'free' or at least easily affordable method: Table IX.

1.3.4 Sophisticated techniques and models

To study the structure of solid foams, the best technologies are those that are either non- or minimally invasive, such as various scattering (light, x-ray, neutrons) and NMR techniques: Table IX. On account of the increasing interest in the creation of complex aerated food microstructure, scientists have gain concern with the development of non-invasive methods making able the visualization and the computation of the internal material porous structure. Consequently, investigations are evolving towards the establishment of refined models to be able to develop and analyze such complex food material (Lim & Barigou, 2004). Images of the architecture encountered in the case of different cellular materials (metals, polymers, concrete foams, or foods) indeed clearly show similarities (Gibson & Ashby, 1997, Maire et al., 2003).

Although it is obvious that the overall structure is involved in the global foam behavior, such evidence always needs to be related to the constitutive material, and the nature of the mechanical stress-strain response. Therefore suitable modeling approaches taking into account cellular structure have been already investigated: Figure 14, Table IX.

Table IX : Examples of aeration quantification methods applied to the characterization of cereal food foams porous structure: tools, advantages and drawbacks.

Method name	Material and study objective	Remarks	Authors	Method advantages	Method inconvenient
Digital Image Analysis (DIA) : Camera, scanner and video tools	Bread crumb assessment and DIA development	Simple camera use	(Sapirstein et al., 1994)	Working system on a personal computer	Sample images acquisition : - manual contrast set up - small bubbles hard to identify cells are truncated with 2D assessment (due to bread sectioning)
	Flour and process conditions effect on bread crumb	Sawed bread crumb slices	(Zghal et al., 2001, 2002)	Relatively simple to assess Direct bubbles quantification	
	Flour component effect on bread crumb volume and fineness	Erosion & dilatation treatment Resolution $(177)^2 \mu\text{m}^2$	(Rouillé et al., 2005b)		
	Bread crumb granulometry; Aerated cereal structure study upon fermentation and baking, coalescence and matrix extension	Flatbed scanner use (2D characterization) and image texture analysis	(Lassoued et al., 2007); Figure 12, Figure 14		
X-Ray Tomography		Spatial resolution $10\mu\text{m}$	(Della Valle, 2006); Figure 12	3D analysis, volume consideration High resolution (10 to $100\mu\text{m}$) Non invasive Density differences detection (strong contrast between void and matter) allow:	Equipment cost and availability Analysis cost and complexity Acquisition duration
	3D bread crumb morphology, porosity and void connectivity	10mm cube sample Resolution $50\text{-}60\mu\text{m}$	(Wang et al., 2011)	- Opaque and heterogeneous foam imaging - Cell connection to be visualized	
	Bread crumb bubble growth upon fermentation	Resolution $15\mu\text{m}$; 180° sample rotation	(Babin et al., 2006); Figure 13 (Babin et al., 2005)		
	3D bread crumb quantitative analysis and mechanical properties assessment	Sample height (25mm), width and thickness (12mm); Image analysis using Image J	(Falcone et al., 2005)		
Magnetic Resonance Imaging (MRI)	Bread crumb and porous structure evolution upon baking; Continuous monitoring of the entire baking process	Construction of oven compatible with the MRI system; Resolution 1mm^2	(Lucas et al., 2008) (Wagner et al., 2008)	- Non-destructive method - Well adapted to heterogeneous matrix study; - Acquisition quality - Interesting Resolution; high resolution 2D images extraction from 3D acquisition ($100\mu\text{m}$)	Instrument and measurement cost Instrument availability and complexity Water content of baked bread makes difficult to obtain clear images of grain structure (pre-soaking in organic solvent might be required)
	Flour components impact on bubble growth during fermentation		(Rouillé et al., 2005a)		
Modeling approaches	Solid foam materials		(Ashby & Medalist, 1983, Gibson, 2005, Lakes, 1989)	Simple deformation mechanism	Unit structural elements
	Bread crumb samples - Simulation of bubble growth		(Maire et al., 2003); (Lassoued et al., 2007) Figure 14	Simulation from reconstructed structures	Require modeling knowledge and facilities. Image first acquired with specific tools
	Gas diffusion modeling in bread dough		(Chiotellis & Campbell, 2003a, b)		

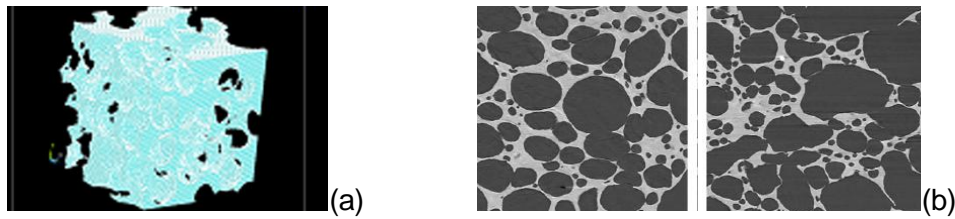

Figure 12 : Structure of aerated cereal solid (bread-like sample) observed by X-Ray Tomography: (a) 3D representation of an aerated baked cereal solid (Della Valle, 2006) and (b) 2D sections of a 3D image of bread crumb (Lassoued et al., 2007).

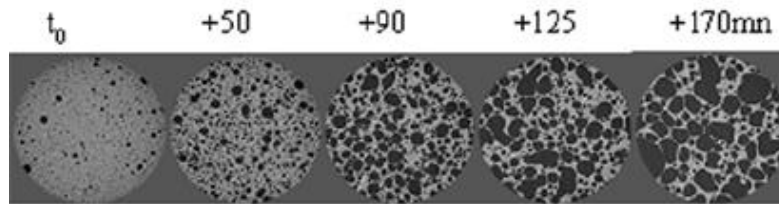

Figure 13 : X-Ray tomography images representing the bubble growth undergoes by a cellular cereal product upon fermentation (from 0 to 70 minutes) : Ø 7mm (Babin et al., 2005).

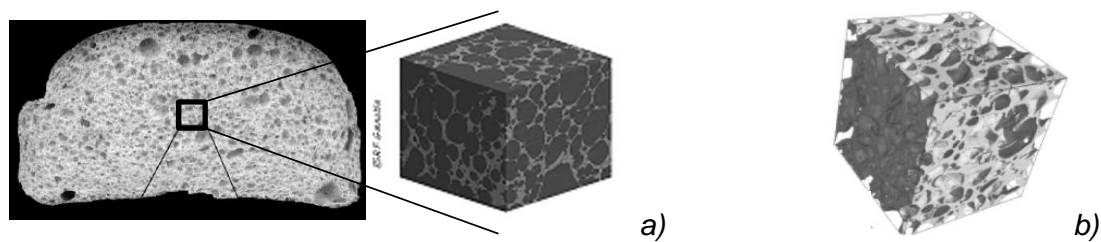

Figure 14: Aerated cereal product structure model; piece of bread crumb reconstruction from its X-Ray Tomography 3D scan image : a) Sphere packing approach (Lassoued, 2005, Lassoued et al., 2007); b) matrix continuity with closed cells connections (Maire et al., 2003).

The characterization of the aerated structure of bakery products is based on various parameters including bubble size, shape, distribution as well as cell wall thickness (Zghal et al., 2002): Figure 7.

Several approaches exist to characterize the aeration of bakery products, widely used in the case of bread to monitor bubble growth upon resting or baking step. Still, it could be usefully applied to cakes. The choice of one method rather than another is led by its availability, the required equipment and if whether or not, the relevant information can be provided with accuracy. Even, some investigations have been carried out using a wide range of methods including microscopy, scanning and porosity quantization of bread crumb (Datta et al., 2007) or merely aims to compare free or at least relatively inexpensive methods (Farrera-Rebollo et al., 2012).

Therefore, two kinds of approaches can be usefully applied for the study of the 3D structure of cellular food materials: on the one hand, a simple digital analysis making able the overall aeration structure characterization (macroscopic) and on the other hand, to go further along the characterization, the use of more sophisticated tools such as X-Ray Tomography.

Besides, crumb porous characterization has already been carried out either to relate image analysis with sensory description (Angioloni & Collar, 2009, Gonzales-Barron & Butler, 2008c) or to merely affect sample morphology with textural properties (Farrera-Rebollo et al., 2012, Gonzales-Barron & Butler, 2008b, Pérez-Nieto et al., 2010). In bakery products such as bread or cakes, textural properties are directly related to the study of the mechanical properties of solid foams as it belongs to aerated cereal based foods.

2. Structure – Texture and mechanical properties of cellular solids

The structural basis of texture includes different organization levels (Aguilera & Stanley, 1999, Aguilera et al., 2000). The molecular (molecule interactions and dynamics), the microscopic (macromolecule organization), the mesoscopic (viscoelasticity) and the macroscopic (overall texture) structural levels are indeed determinants of textural quality. In this part, we merely attempt to discuss textural properties regarding mechanical assessment of the studied food product.

2.1. Physical properties of food materials: a rheological approach

2.1.1. Rheology concepts

Food rheology focuses on the study of the deformation and flow of a food material. Rheology science field can be applied to any product and very useful as far as we can measure it (plastics, glues, paintings liquids, printing inks...).

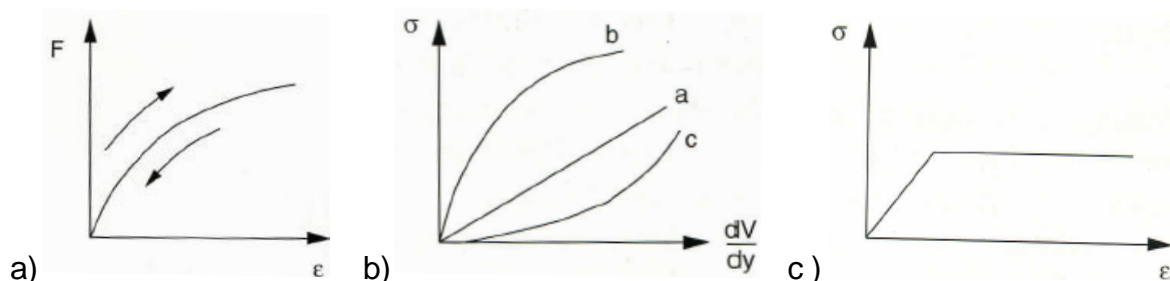

Figure 15 : Ideal rheological responses representation, from the left to the right: elastic, viscous and plastic behavior.

With $\sigma = F/S$ = stress; $\epsilon = \Delta h/h$ = strain; F = Force; S = Surface on which F is applied; h = sample initial length; Δh = sample deformation; and where $\sigma = \eta \cdot (dV/dy)$ with V = displacement speed and η = dynamic viscosity; a, b and c corresponds respectively to newtonian, pseudoplastic, and thickening fluid.

It is the study of the manner in which materials respond to applied stress or strain. Three main theoretical rheological behaviors can be encountered: elasticity, viscosity and plasticity: Figure 15.

Elasticity (Figure 15a) represents the ability of a material to recover its shape after the application of a deformation. It is the typical behavior of springs. Viscosity (Figure 15b) corresponds to fluids behavior which exhibit a displacement while submitted to a strain. It is usually well illustrated by the influence of the deformation rate on stress/strain curves. Plasticity (Figure 15c) is characterized by a plasticity threshold under which permanent deformation cannot be observed.

2.1.2. From simple to complex rheological responses

In the case of food products, complex rheological responses are usually recorded (Bhandari & Roos, 2012). More precisely when assessing the rheological properties of cellular products such as bread or cakes, a visco-elastic response is measured. This means that both rigid and viscous behaviors are involved in the overall rheological response and that they need to be taken in account when characterizing sample properties. To be kept 'soft', such a product has to display specific physical characteristics. Food materials operate mostly in the ductile or rubbery region - for instance in the case of bread or cakes - above the so-called glass transition whereas many dry cereal-based products such as biscuits or breakfast cereals are expected to have a brittle fracture behavior: Figure 16 (left).

The vitreous-rubbery transition undergone by the polymer (or the entire material) through the glass transition is characterized by its glass transition temperature (T_g). It can be induced by increasing either the temperature (Bizot et al., 1997) or the water content (Slade & Levine, 1995): Figure 16 (left).

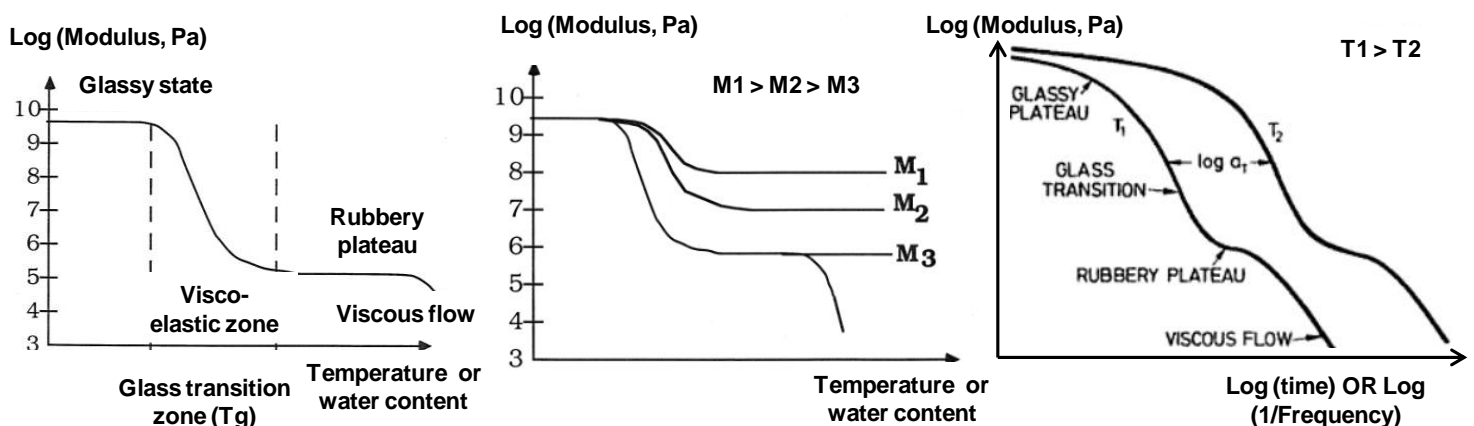

Figure 16 : Elasticity (Young) modulus evolution as a function of temperature (and water content) of an amorphous polymer. Schematic representation of the case of simple macromolecule (left) and impact of molecular weight (centre); Young modulus evolution at two distinct temperatures as a function of time (right).

Below the glass transition, polymer chains mobility is extremely low and frozen in a random conformation, characterizing the solid and glassy state. When submitted to a temperature or a water content increase, motions at the molecular level initiate which enable short molecules segments (3–20 monomers) raising up its mobility. Above its T_g , the material becomes rubber-like: Figure 16 (right)

Because water exerts a plasticizing effect on the amorphous zones, shifting its T_g to a lower value, it has the same influence in terms of physical transformation than a temperature increase. When this latter is lowered, the product displays a rigid behavior (glassy state). If temperature or water content enhancements are too high, the product reaches its liquid state thus becoming viscous: Figure 16 (center graph).

2.1.3. Stress-strain relation and bakery products mechanical behavior

Bread or cakes actually needs to display a physical behavior within the rubbery plateau. This latter is characterized by a temperature range in which the Young Modulus is kept constant. Young's modulus is determined by the initial slope of the compressive stress–strain curve and is used as a sample elasticity indicator (a deformation is elastic when is reversible and as the stress rapidly increase with strain application).

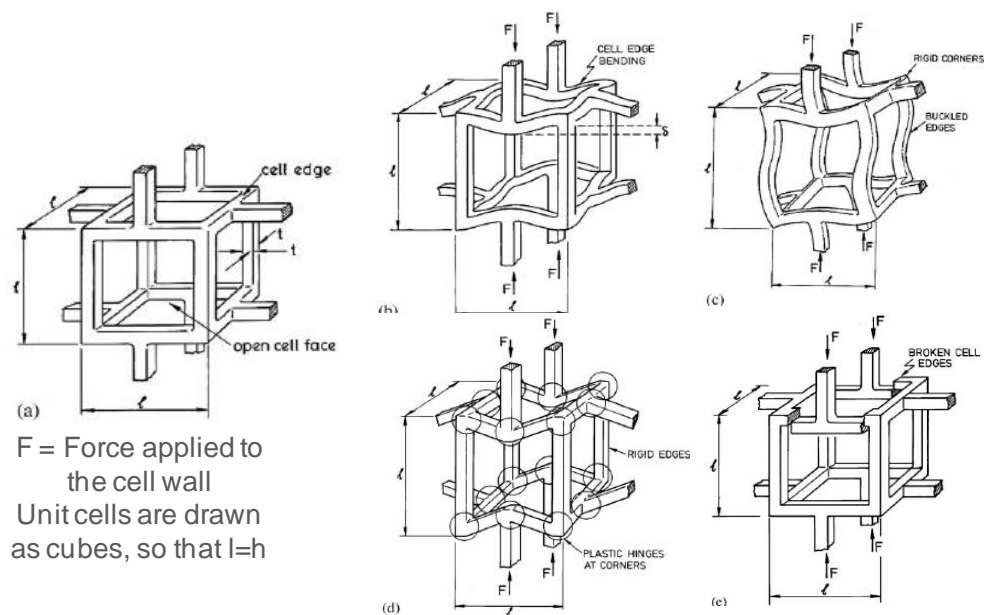

Figure 17 : Illustration of the three mechanical behavior models: idealized undeformed cell in an open-cell foam (a), elastic foam under linear elastic bending (b); elastomeric (c) elastic-plastic (d), and brittle foam (e) under uniaxial compression (F value) using an Instron testing machine: (Gibson, 2005).

Therefore, in the case of cakes, the rubbery plateau has to be as long as possible to allow the product to be able to undergo temperature changes without physical transformation leading to a degradation of its texture properties. Chain molecular weight can for instance affect this length: Figure 16. Moreover, by shifting the T_g to a lower

value, the presence of water or the addition of other plasticizer (polyols such as glycerol) to the formula can enhance textural quality conservation.

From the previously cited theory, three distinct mechanical behaviors can be distinguished by either their deformation ability or breaking resistance: elastomeric foams, plastic foams and brittle materials: Figure 17. They are characterized by a distinct force-deformation relationship while assessed by tensile or compression tests.

The typical shape of the stress-strain curve for solid foam under compression (Figure 18) is characterized by three distinct regimes illustrated by three successive regions (Gibson, 2005, Gibson & Ashby, 1982):

- In the first region (I), the stress drop rapidly and linearly with the strain. This zone corresponds to the **linear elastic regime**. The apparent Young Modulus (E^*), an important elasticity parameter is determined by this first curve zone (initial curve slope) where the deformation is mostly not reversible.
- In the Second region (II), cell wall are compressed from a 'stress threshold' value and the deformation in not reversible. This zone corresponds to the **stress plateau** during which a progressive cell collapse takes place.
- In the Third region (III), the material **densification** occurs as only few amount of air remains into the bubbles which are getting crushed while cell whole are tightly compacted. In this last zone, the stress increase much more than the strain, cell entirely collapse, cell edges and faces are loaded against one another.

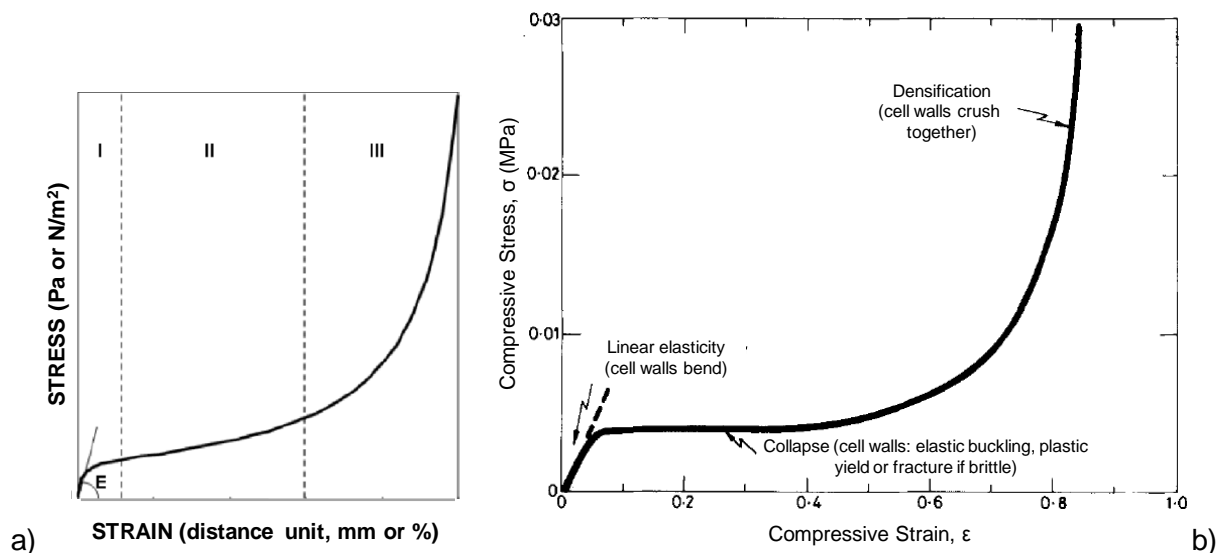

Figure 18 : Example of a cake crumb stress-strain curve, illustrating the response of an elastic-plastic foam-like behavior under compression test using an Instron-like machine while assessed between two parallel plates (a); typical stress-strain curve shape for a solid foam (b). Adapted from (Attenburrow et al., 1989, Corradini & Peleg, 2008, Gibson & Ashby, 1982).

It is worthy of note that in some extent, low relative densities (10–30%) are observed in many cellular solids (including bakery products) so that they can be deformed up to large strains (70–80%) before densification occurs.

Moreover, the length and proper characteristics of each region can vary according to the nature of the solid foam and its cells whether plastic or brittle. Although mechanical properties, cell wall surfaces as well as geometrical structure characteristic of the foam are taken into account in Gibson theory (Figure 17 & Figure 18) but is applicable only to cellular solids for which cells are uniform (size, shape and orientation).

2.2. Dynamic rheology approach

Characterization of cell wall mechanical properties has been applied to bread crumb samples (Chiotelli & Le Meste, 2002, Lassoued, 2005). Such samples usually display a highly heterogeneous crumb structure making difficult the direct application of the theory. Dynamic rheology approach has been therefore used. Non-destructive, allowing to investigate material structural properties, measurement can be performed to assess modifications undergone by samples upon temperature or humidity changes.

Viscoelastic behavior of cereal dough and baked product are nonlinear; the measured deformation (level or speed), undergone by the assessed sample is not proportional to the applied stress (Bloksma, 1990b). While assessed using a dynamic rheology approach, at very low strain (under 1%), measurement are considered to be performed within the pseudo-linear domain: viscoelastic parameters are independent from applied strain (or deformation amplitude): zone I (Figure 18).

The determination of the 'linear zone' is therefore required while assessing viscoelastic properties of materials using dynamic methods. It is worthy of note that for a visco-elastic solid material presenting a rubbery plateau, $E' > E''$ (Figure 19). In this case, E' and E'' modulus were obtained for frequencies ranging from 0.01 to 20 Hz.

As for the apparent Young modulus and at a given frequency, E' value decrease when water content rose up owing to the plasticizing effect of water. It has also been observe in the case of an increasing oil level due to fat lubricant effect. The rigidity modulus E' can thus be retained as the parameter characterizing the bubble's wall mechanical properties (Lassoued, 2005) as well as the E'/E'' ratio which is independent from the sample size, and represents the loss factor ($\tan\delta$).

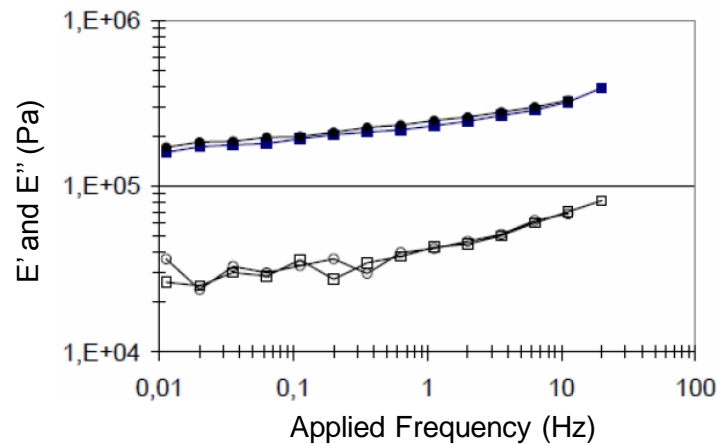

Figure 19: E' (black markers) and E'' (white circle and square) modulus values evolution as a function of the applied frequency. Measurement was performed at 25°C with a strain rate of $9.10^{-3}\%$ on two equivalent bread crumb samples.

2.3. Bakery products texture investigations

Measures such as the Texture Profile Analysis (TPA) and relaxation tests are often used to characterize the texture of soft products. This kind of measurement aims to determine textural parameters for which the relation with sensory features has been shown relevant and with a good accuracy (developed in the section 1): Table X.

3. *Influence of the porous structure of cellular solids on its mechanical behavior*

3.1. From the batter to the solid food foam

Aerated structure is also rather 'randomly' established during the making process undergoes by dough components leading to heterogeneous products. Cake batter density, usually from 0.6 to 1 g/cm³, has been demonstrated to be of a particular importance as a key factor for texture formation and final volume of the cake (Donelson & Wilson, 1960, Kim, 1992, Kim et al., 2012).

In addition, Kim (2012) pointed out the fact that this relationship does not occur systematically which may be strongly dependent of the cake batter composition. A higher batter viscosity was indeed observed in dough with increasing flour replacement by fibers (0 to 9% flour) which then might affect the gas retention ability in baked products. Moreover, even though it is not the only factor involved in the presence of air, many air cells are incorporated into the dough during mixing process, thus lowering the foam density and usually leading to a greater final baked product volume.

Table X : Texture measurements applied to bakery sample: testing methods, conditions and recorded parameters.

Test type	Sample size & probe diameter	Strain level & deformation speed	Recorded parameters examples	Authors
Uniaxial compression	40mm thick 50mm diameter	60% strain 1 mm/sec	Compression work	(Sozer et al., 2011)
Two cycle compression	25 mm thick 25 mm diameter	80% strain	Hardness Cohesiveness Elasticity	(Brady & Mayer, 1985)
	Many samples types application	70% strain	Hardness Cohesiveness	(Meullenet, 1998)
	Moon cake crust 2mm thick	60% strain	Hardness Stickiness Chewiness	(Jia et al., 2008)
Two cycle compression (Puncture test)	26 mm thick 20 mm diameter 3 mm probe diameter	20% strain 0,16 mm/sec	Hardness Cohesiveness	(Scher et al., 1997)
Relaxation test	26 mm thick 20 mm diameter 30 mm probe diameter	20% strain 16 mm/sec	Fmax F(300 secondes)	
Two cycle compression	20 mm thick 25 mm diameter 25 mm probe diameter	50% strain 0,5 mm/sec 30sec gap between compressions	Hardness Springiness Cohesiveness	(Angioloni & Collar, 2009)
Relaxation test		20% strain 0,5mm/sec 10 min kept deformation	Max Force Stress decay rate	
Dynamic strain (sinusoidal)		0,04% strain 0,1 to 10Hz compression frequencies	Stress (Pa) Firmness	
Creep recovery measurement	plate plate geometry (40mm diameter)	Time sweep 0,001 to 5% strain 1Hz	Compliance (Strain/shear stress)	(Van Bockstaele et al., 2011)

3.2. The relative density of cellular solids

As previously illustrated (Figure 10), whether the open or closed cell nature and dimensions of a solid foam are important parameters (Gibson & Ashby, 1997). Still its relative density has been defined by these authors as the main structural characteristic of the material that can affect its elastic and mechanical properties (Ashby & Medalist, 1983). The relative density corresponds to ρ^*/ρ_S ratio: ρ^* is the density of the cellular material; ρ_S is the one of the matter, forming cell walls. It can provide porosity information, and an analytical treatment for the mechanical behavior of a broad range of cellular materials.

Despite the fact that those findings have firstly been established on numerous non food materials (i.e. polymers and metals), and that they doesn't take into account any other structural parameters than the relative density (cell geometry, cell wall, edges and face conductivity,...), this approach has been successfully applied amongst a wide variety of products including aerated bakery products such as bread or starch based products (Attenburrow et al., 1989), whey protein foams (Foegeding et al., 2006) as well as fruits, ice cream and chocolate as reviewed by Aguilera (Aguilera & Stanley, 1999, Aguilera et al., 2000).

3.3. Other factors influencing cellular solids properties

In spite of its importance, the relative density is neither the only nor the main factor affecting mechanical properties of 'solid foam'.

Indeed, bread but also cakes usually exhibit an open-cell structure including numerous interconnections in-between cells which depend on the cell wall elasticity and gas retention ability (Scanlon & Zghal, 2001, Zghal et al., 2001, 2002). In the latter, with regards to the application in bakery products materials, Young's modulus was significantly correlated with bread crumb density ($R^2 = 0.78$ to 0.97) and cell number within a 1 cm^3 given volume ($R^2 = 0.56$ to 0.84) whereas a negative correlation was observed between Young's modulus and cell area ($R^2 = -0.66$ to -0.85). In addition, according to Ashby assumptions (1983), at low strains, the modulus of elasticity characterizes the 'deformability' of a sample. Defined as the slope of the stress-strain curve, it is also related to the foam density and nature as illustrated by the following equation (Ashby & Medalist, 1983, Ashby, 2006, Lakes, 1989).

$$E/E_s = k (\rho^*/\rho_s)^n$$

[E_s represents the cell wall material's modulus, ρ and ρ_s , the respective density of the entire foam and cell wall; however, constant numbers k and n depends on the foam nature (composed either of open or of closed-cell) and the cell wall thickness.]

3.3.1. *Product homogeneity.*

As previously shown (Figure 18), cellular solids can be suggested to subsequent deformations. Even though a narrow strain range (only few percent) is usually more accurate for the elastic properties measurement of cellular solids, the lack of homogeneity of bakery products crumb due to its porous structure makes the mechanical behavior more complex to study (Scanlon & Zghal, 2001). It arises from the heterogeneity of the distribution of cells within the crumb leading to differences between loaves and across bread slices. In this study, higher firmness has been for instance reported in the center than on the crumb edges.

3.3.2. Product expansion and cell orientation.

Stress-strain curve as a matter of fact depends on the compression direction with respect to the expansion into the oven as to explain bread crumb firmness variability: Table XI (Hibberd & Parker, 1985).

Table XI : Bread crumb bubbles orientation influence exerted on the product mechanical properties: adapted from (Hibberd & Parker, 1985).

Parameter	E : Young Modulus (kN/m ²)		σ_c : Critical Stress value ^(a) (N/m ²)	
	Parallel	Perpendicular	Parallel	Perpendicular
Compression orientation regarding bread crumb expansion axe				
Parameter range value	3 - 6.5	8 - 18	690 - 900	760 - 1350

^(a): The critical Stress value is the threshold stress reached on the stress-strain evolution curve upon material compression, starting from the plateau zone (Figure 18).

Authors showed that such samples were heterogeneous in terms of their global physical texture, which is easily understood by the relatively random mechanisms basis of crumb formation. And so, on the bubble orientation, giving rises to a 'well standardized method in order to assess mechanical properties of solid food foams. An additional factor to these geometrical characteristics of the cellular structure is that the mechanical properties of bread crumb will be influenced by the mechanical properties of the cell wall materials themselves (Chen et al., 1994).

3.4. Cellular solids characterization: an aeration and mechanical assessment

The cellular structure of food materials, from both macroscopic (porosity, volume, fraction, and so the relative density) and microscopic scale (cell wall thickness, cell diameter, and their distributions, interconnections between air cells), influence its mechanical behavior (Scanlon & Zghal, 2001, Zghal et al., 2002).

To include all these dimensions and the impact they exert on the mechanical properties of aerated cereal products, various parameters has to be taken in account. Amongst assessed features, bubble size, cell wall thickness and elasticity, interconnection occurrence, bubble distribution and uniformity as well as the measure of its density (Kim et al., 2012): Table XII.

Gibson and Ashby have been working on cellular solids and developed models in order to better characterize and understand the structural and mechanical properties of this material category. The mechanical properties of a material, rather also food products, derive from its structure at different scales, from macroscopic to molecular including microscopic, which, in turn, are determined by its ingredient composition and

processing conditions: Figure 20. The understanding of aerated cereal products structure especially of cakes thus requires measuring and controlling its physical characteristics.

Table XII : Some aeration features: examples of parameters and its range of value in the case of bread crumb samples porous structure assessment.

Authors and methof	Sample density (g/cm ³)	Void fraction (%)	Cell size: area (mm ²) or diameter (mm)	Cell wall thickness (mm)	Additional remarks
(Babin et al., 2005); XRT	0.18 – 0.41	0.1 – 0.7	$\Phi = 0.1 – 0.9$	0.18 – 0.3	E = 29 to 94
(Falcone et al., 2005); XRT	n.g	0.8	n.g	0.3	Highest $\rho \Leftrightarrow$ highest E
(Lassoued et al., 2007); XRT	0.2 -0.4	n.g	S= 0.84 – 1.5	0.19 – 0.25	
(Rouillé et al., 2005a); MRI	0.22 to 0.38	n.g	Φ from 0 to 5	n.g	Φ class : 50% under 1mm, 4% upper 3mm
(Zghal et al., 2002); DIA	0.20	n.g	S = 0.1 to 200	0.5 – 2.5	E = 280 to 440
(Zghal et al., 2001); DIA	n.g	0.47 – 0.49	S = 0.50 - 0.65	0.76 – 0.84	Crumb grain uniformity = Small (<4mm) / large (>4mm) cell count = 30 to 42 index value
(Angioloni & Collar, 2009);scanning and DIA	n.g	0.7 – 0.81	S = 0.34 – 0.63	n.g	Maximal stress measured under compression (20% strain) = 120 – 260 N

XRT = X-Ray Tomography; DIA = Digital Image Analysis; MRI = Magnetic resonance Imaging; ρ = Density (g/cm³); Φ = Diameter (mm); E = Measured Young modulus (KPa); N = Newton unit; S = Surface (mm²); n.g = Not given in the reference paper.

4. Conclusion: from the structure to the texture of foods

On the one hand, 2D or 3D studies can be carried out to characterize the porous structure of a solid food material, using either simple scanning methods, or microscopy, or more refined techniques such as Magnetic Resonance Imaging (MRI), or X-Ray Tomography. The association with theoretical concepts has been useful to better understand several food solid foam behavioral tendencies but is usually more complex while attempting to assess properties of anisotropic foams such as bakery products.

On the other hand, physical and especially rheological properties of solid food foam need to be investigated in relation with both its textural and mechanical behavior (elasticity, brittleness...) which can be assessed by static and dynamic rheology. In addition, mechanical properties are important for food foams which can undergo modifications while packed, transferred or stored in various conditions thus affecting their rheological properties.

In a multiple ingredient food, such properties are affected by the volume fraction as stated by cellular solid theory but also by their respective distribution and especially the nature and extent of the interactions taking place between those phases which are in

turn strongly dependent of the nature and composition of the matrix (Pareyt et al., 2009b). In the case of food products, particularly in cakes, the contribution of its various components leads to complex rheological responses. As a consequence, depending on the surrounding conditions or on its composition (temperature, water content, other ingredients) food material can move in and out of the brittle-ductile region which is unwished in semi-humid aerated cereal-based products such as in the case of the object of our investigation.

The global structure of a food product takes into account its overall properties (Bourne, 2002b). It requires rheological understanding of individual ingredients their relation to food processing, and their final perception (Fischer & Windhab, 2011) which can evolve upon storage: Figure 20.

Bringing together the information based on both structural classification and experimental characterization of several aerated food products as well as their potential impact on both food perception and intake is rather answering few questions (Campbell & Mougeot, 1999). Somehow, structural properties of foods are strongly related to their microstructure organization. It is mostly affected by the mechanism that food products can undergo while they are processed and which can be led either by ingredients nature, their interactions or their transformations for instance upon baking.

Therefore, the composition of the considered food product also need to be reviewed in regards with the respective functions of cake dough components involved in the structure set up and in its evolution along storage.

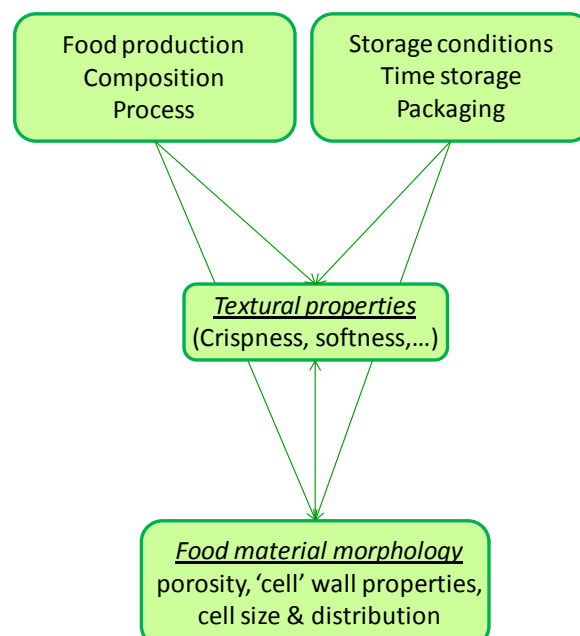

Figure 20: Different Factors Affecting Food Material Properties; Adapted from (Sozer et al., 2011)

Section III: Structure and composition of cake products: a physico-chemical approach

The structure of solid foams such as aerated cereal products can vary according to its formulation and the way it is processed; especially the bubble growth mode in bread products (Hibberd & Parker, 1985, Niranjana & Silva, 2008a) as well as the nature and variety of ingredients which thence makes it more complex to manage.

1. *Cake composition, processing and structure set up: a physico-chemical approach*

1.1. Cake composition

While bread is mainly made up with water and flour, other cereal based products such as cakes also include sugars, fats and eggs: Table XIII. Water activity depressors such as polyols (maximum 5%), are commonly added to bakery products while manufactured further allowing a longer storage period (months). Displaying a low relative density ($0.2 - 0.5 \text{ g/cm}^3$) a wide product variety is provided for consumers (Kiger & Kiger, 1967). Although the basic ingredients are encountered in many bakery products formula, the nature of ingredients and the way it is processed also differs (hydration level; mixing time, type and strength; flour origin,...) in between two products. Both cake processing and composition are described further with more details.

Table XIII: Main components encountered in bakery products: adapted from Kiger and Kiger, 1967.

<i>Basic ingredients</i>	<i>Bakery products</i>	<i>Pastry & cakes</i>
Flour	Basic ingredients +	Basic ingredients +
	Sugars (0 to 8%)	Sugars (16 to 25%)
Water	Fat (0 to 6%)	Fat (10 to 18%)
		Eggs
Salt		Emulsifiers (~1 to 2%)
Leavening agent	Yeast	Baking powder (~1%)

1.2. Cake processing

Dough making process consist in three basic steps: mixing, resting, and oven baking. They need to be fully managed and controlled regarding transformations undergone by ingredients and interactions taking place in-between them. Structural and physico-chemical modifications occurring upon process gives to the dough its specific properties also influencing final product behaviour: Figure 21.

Dough composition and mixing steps are responsible for the resulting physical properties of the dough including its viscosity and its aeration (Cauvain & Young, 2007, Cauvain et al., 2007). Apart from the obvious ingredient mixing function, the mixing step is a critical operation during which the structure of the dough is formed. It is involved in the development of the viscoelastic properties of gluten but also incorporates air that further influences dough rheological properties (Campbell, 2003, Dobraszczyk & Morgenstern, 2003).

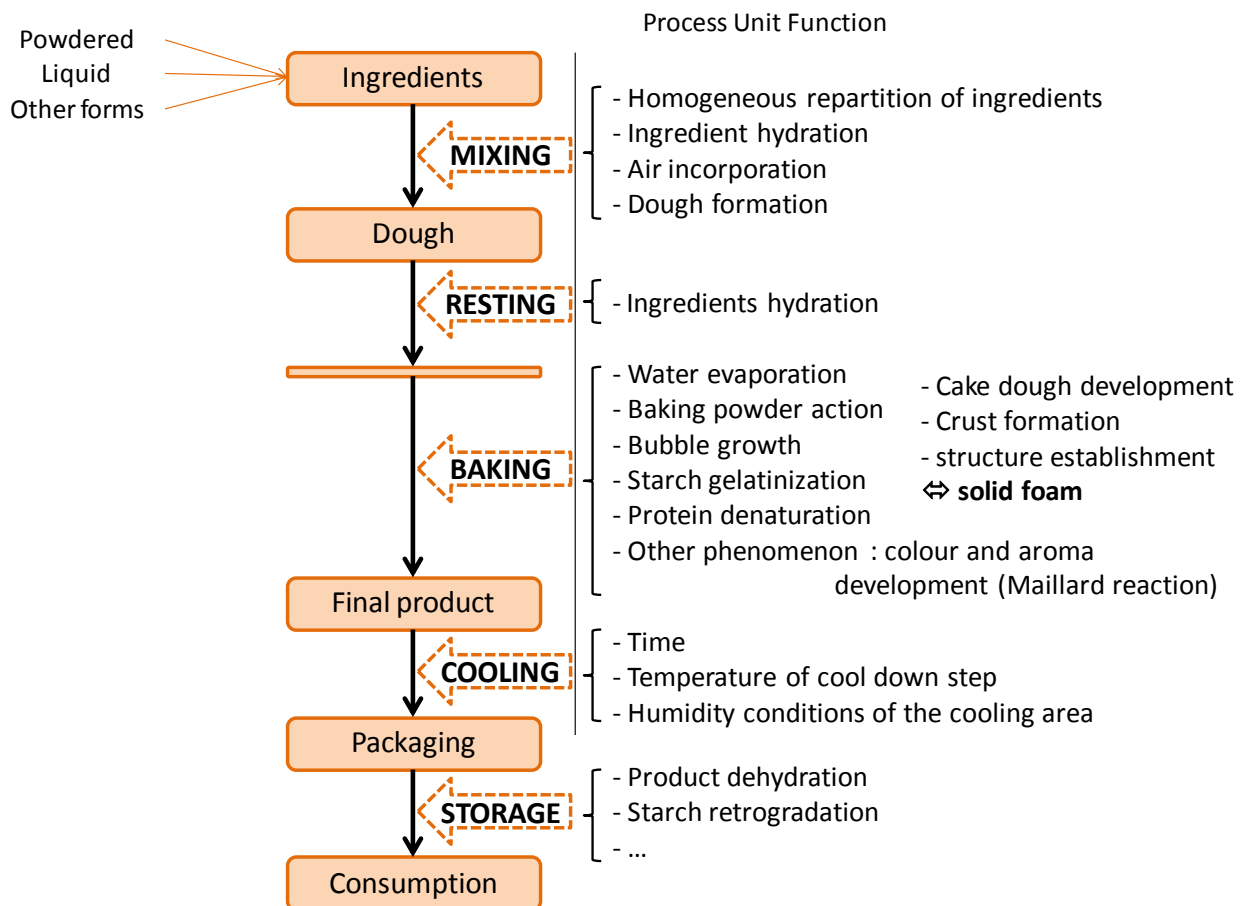

Figure 21: Cake dough processing: main steps and their respective function

Origin, structure and retention of gas bubbles in bread have been examined and discussed already in regards with the wide variety of mixers design and mixing operation encountered in the food industry (Buehler, 2006, Niranjana & Silva, 2008b). Although created and grown by leavening agent action (yeast or chemical agent), or provided by other processes such as punching or shaping, gas bubbles mainly appears to be incorporated to the dough upon mixing step. In raised bread, pre-existing bubbles apparently added at this stage act as nucleation sites and grow up thereafter but process and leavening agents do not make new ones (Buehler, 2006).

2. Focusing on wheat flour composition and its physico-chemical properties

2.1. Wheat flour origin and composition: an overview

2.1.1. *On the wheat kernel composition*

Wheat flour comes from the inside part of the wheat kernel: the endosperm. Indeed, the wheat kernel, like any seed has a complex structure and contains many individual components (Atwell, 2001a). It is divided into three main anatomical regions: Figure 22.

The germ represents about 3% of the kernel. Localized inside the seed, most of the lipids and essential nutrients are concentrated in this part.

The outer protective layer, the bran, represents about 14% (weight) of the kernel. It is rich in fibers and minerals. The aleurone is usually accounting for half of the bran (7%) and does separate the outer layers from the starchy endosperm.

The inner region, the endosperm, represents the major portion of the wheat kernel. It endows an energy storage function. Its main components, starch and proteins which are set aside for energy provide while plant grows are the primary constituents of flour (Atwell, 2001c): Figure 22.

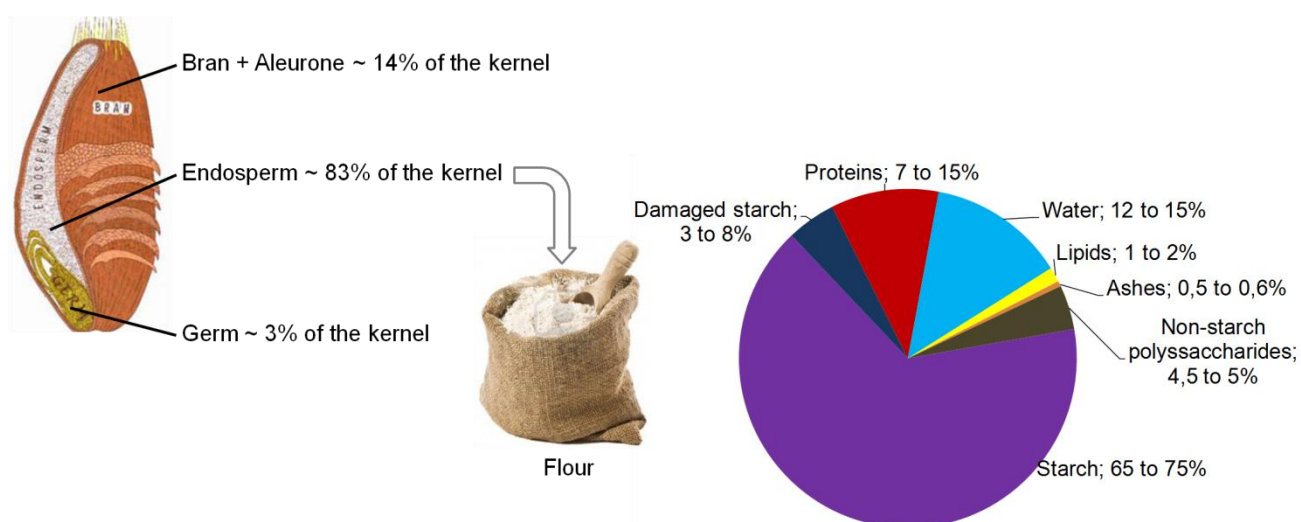

Figure 22 : The wheat kernel: structure, composition and wheat flour components (Bechtel & Pomeranz, 1980, Feillet, 2000, Khan & Shewry, 2009).

2.1.2. *Wheat flour and grain hardness*

Wheat flour is obtained by the reduction of the wheat kernel to smaller particles. Bran materials are separated from the starchy endosperm of the kernel. The latter is further reduced in finer particles by the way of different milling steps including kernel breaking, grading, milling and sieving leading to the so called flour (Posner, 2009).

However, it is worthy of note that flour type, depending on its use needs to be carefully chosen in regards with its specific qualities. The chosen flour must indeed meet the expectation of the users and achieve the performances required in terms of both manufacturing and final product characteristics.

Hence, three main kinds of flour can be distinguished based on the classification of their milling abilities which is related to the hardness of the kernel: durum, hard and soft. Hard wheat requires more energy than soft wheat because each individual kernel needs a higher force to be crushed. Also, several indicators help to decide whether or not to use the flour for bread, biscuits, soft cakes, or even pasta. The protein or damaged starch levels can be quoted as examples. Hard and soft wheat flours are therefore commonly used in most of the bakery products (including bread and cakes) as well as in biscuits manufacture whereas pasta is made up from a durum wheat basis (Pasha et al., 2010, Pomeranz et al., 1984).

Besides, within the soft wheat flour category, different levels of hardness can be encountered allowing the distinction between flour either used for cakes (softer) or for breads (harder). Due to a distinct composition, wheat flour can thus display various properties depending on the kernel hardness level from which it comes from (Pasha et al., 2009, Pasha et al., 2010).

Therefore, slight but key differences can be encountered between wheat varieties, leading to a wide range of flour compositions and responsible for its specific functionalities. This explains for instance why several flours are used for biscuit rather than for bread applications and why the opposite is leading to poor-quality products (Addo et al., 1990, Færgestad et al., 1999, Macritchie, 1984, Mikhaylenko et al., 2000, Sapirstein et al., 2007).

Both the milling and the food industry need to be aware of the composition of the flour which is employed regarding its specific uses. Milling yields, proteins nature and level, damaged starch content as well as several other categories of technological parameters, (physico-chemical, and sensory functions) are usually required to determine whether or not the flour is ready to be used for the wished application and the class it belongs to (Addo et al., 1990, Collar & Bolla Ñn, 2005, Miralbés, 2004, Tronsmo et al., 2003).

2.2. Wheat flour minor components

Flour contains a large number of chemical constituents among which starch and proteins accounts for about 70% and 12% of the overall wheat flour, respectively (Posner, 2009): Figure 22.

However, although representing a smaller proportion, wheat flour also contains minor constituents such as damaged starch, non-starch polysaccharides including pentosans or arabinoxylans as well as wheat flour lipids. They clearly contribute to flour functional properties and are key factors of wheat quality.

2.2.1. *Non Starch Polysaccharides*

Non Starch Polysaccharides (NSP) comprises carbohydrates such as cellulose and pentosans. Considered as minor constituents (Hoseney, 1994, Kulp & Ponte, 1981), these latter are composed of insoluble and soluble fractions (accounting respectively for 1.5% and 1 to 1.5%). Nevertheless, pentosans groups of molecules (i.e arabinoxylans) are involved in the overall wheat flour water absorption capacity (Douglas, 1981, Duyvejonck et al., 2011, Holme, 1962).

Owing to their water-binding capacity both insoluble (Michniewicz et al., 1990) and soluble pentosans (Shogren et al., 1988) may significantly affect the rheological properties of the resulting dough and thereby influence the quality of bread, biscuits (Fustier et al., 2008) or cakes along their process (Schiraldi et al., 1996) and their storage (Fessas & Schiraldi, 1998). It can dry out the dough, avoid a proper leavening of the product upon baking (denser and firmer products) as well as promote a quicker hardening of the food structure (undesirable evolution).

2.2.2. *Damaged Starch*

Pressure, crushing or shearing stress are commonly undergone by flour upon milling process. Damaged starch (DS) is first and foremost the result of these conditions and is related to the wheat grain hardness. Frequently encountered in larger proportion in wheat coming from 'hard' varieties, damaged starch is able to absorb water and swell at room temperature. Hence, it influences the rheological properties of wheat flour dough (Berton et al., 2002, Duyvejonck et al., 2011).

Both dough stickiness and consistency increase have been described in bread, flat breads and cookies dough foremost owing to its water absorption capacity and its higher amylase sensitivity (Barrera et al., 2007, Dodds, 1971, Ghodke et al., 2009, Kaletunc & Breslauer, 2003). An increasing dough consistency was evidenced in cookies dough for damaged starch levels ranging from 2.8 to 8.8% of the flour: the recorded consistency values although depending on the assessed conditions were at least three times higher (Gaines et al., 1988).

Regarding the effect of several flour components on water binding capacity, Duyvejonck (2011) attempted to understand whether a distinct level of individual flour constituents could be responsible for the modification of flour SRC values. Although the contribution of proteins, arabinoxylans (AX) and damaged starch (DS) to the Water Retention Capacity (WRC) has been investigated, only the DS content was positively related to WRC (Pearson coefficient of 0.84), ranging from 55 to 66 for 5.2 to 8.0% DS, respectively.

2.2.3. Ashes & fibers

The least, ash, is slightly less represented (from 0.4 to 1%). Flour are commonly classified on the basis of their ash percentage, particularly in France (legal typology defined in 1963) giving flour quality grades such as T45, T55, T80 (Table XIV) among which T55 is the most frequently used flour for bakery products.

Table XIV : Wheat flour composition with regards to its extraction rate.

Flour Type	T45	T55	T65	T80	T110	T150
Extraction rate	65 to 70%	75 to 78%	78 to 82%	82 to 85 %	85 to 90%	90 to 98%
Minerals content (ash)	< 0.5	0.50 to 0.62	0.62 to 0.75	0.75 to 0.90	1.0 to 1.2	> 1.4
Dietary fibers	4.7	5.0		5.6	6.0	
Recommended Application	Cakes, pastries, biscuits	bread, cakes, Viennese pastries, biscuits	Traditional white bread (French type)	Special breads	Wholemeal breads	Bran loaf

Chemical composition of flours strongly depends on the milling extraction rate which is lowered meanwhile starch extraction percentage decreases, and on the amount of constituents coming from the external layers of the kernel such as minerals and fibers (Belitz et al., 2009). Although flour protein, ash contents and water absorption have been shown to directly increase with the flour extraction rate (Kaletunc & Breslauer, 2003, Mao & Flores, 2001, Ramírez-Wong et al., 2007), relation between ash and DS content has never been demonstrated mostly owing to their respective origin.

2.2.4. Flour endogenous lipids

Although lipids are widely distributed in the kernel, they are considered as minors constituents in all but the germ. They rather only account for about 1 to 2% of the wheat flour (Addo & Pomeranz, 1991, Bechtel & Pomeranz, 1980, Feillet, 2000, Khan & Shewry, 2009).

Despite the fact that they are poorly represented compared to starch or proteins endogenous lipids significantly affect as well the quality of bakery products (Hoseney et al., 1970). Through the presence of both hydrophilic and hydrophobic groups, polar lipids such as endogenous lipids act as surfactants. Flour lipids can facilitate air incorporation upon mixing, stabilize gas cells, retard firming rate but also affect volume and grain of the crumb (Sroan & MacRitchie, 2009).

Although the main determinants of wheat quality are endosperm texture (grain hardness), protein content and gluten strength (Pasha et al., 2010) a negative correlation between starch surface lipids abundance and physical kernel hardness has been highlighted (Day et al., 1999, Finnie et al., 2010, Turnbull & Rahman, 2002).

2.3. Flour proteins composition and functionalities

2.3.1. *Wheat flour proteins classification*

Proteins constitute 7 to 15% of common wheat flour (Atwell, 2001c). Within the 'soft wheat flour category', the protein content of the considered flour depends on its end-use; it can vary from 7-9% in the case of cake or pastry to 12-14% for bread flours.

A classification of the different wheat proteins, based on their solubility has been devised by Osborne in the early 1900's (Osborne, 1907). Later, Shewry proposed a biological and biochemical properties based classification (Shewry et al., 1986). They are commonly divided into gluten proteins and 'non-gluten proteins' respectively accounting for 80-85% and 15-20% of the total wheat flour proteins. The latter is composed of proteins which are either soluble in water or soluble in dilute salt solutions (Belitz et al., 2009) ; amongst 'non-gluten proteins' albumins which make up about 9 to 13% and globulins accounting for about 6 to 8% of the total wheat flour proteins: Figure 23.

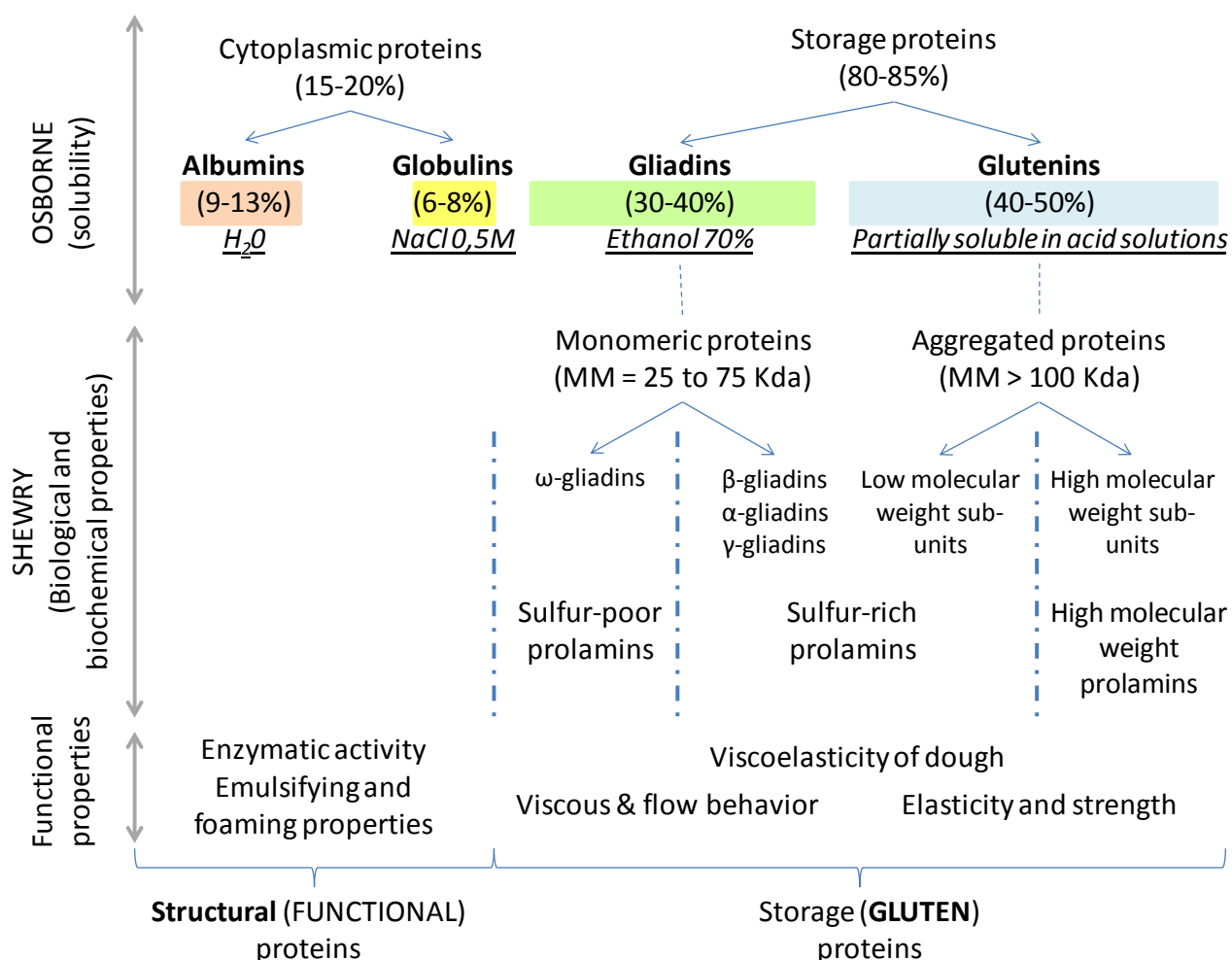

Figure 23 : Wheat flour proteins classification and characteristics: adapted from (Atwell, 2001c, Osborne, 1907, Shewry et al., 2009).

Another group of proteins has been described in wheat, triticale as well as in barley accounting for about 5 to 10% of wheat flour proteins (Darlington et al., 2000, Ramírez et al., 2003). Also known as puroindolins, they are encountered both at the surface of starch granules, strongly interacting with its components (Veraverbeke & Delcour, 2002) and in overall flour extracts (Oda & Schofield, 1997).

This protein category due to its amphiphilic nature is able to bind lipids and as a 'surface-active protein group' exhibits foaming and emulsifying abilities (Baldwin, 2001, Douliez et al., 2000). Interactions with endogenous flour lipids have been investigated in relation with their foaming properties (Dubreil et al., 1997). It has also been shown to be a key factor of grain hardness as it is foremost encountered in soft wheat (Pasha et al., 2010).

2.3.2. *Special issue on gluten proteins nature and their impact on bakery product characteristics*

Due to their foremost hydrophobic and viscoelastic properties, gluten proteins, are usually separated from the starch by the way of lixiviation process involving wheat flour washing under continuous water provide. It thus moves apart the 'starch milk' from the 'viscoelastic gluten paste'.

2.3.2.1. Gluten proteins, gliadins and glutenins

The wheat flour dough making behavior is generally ascribed to the visco-elastic properties of its gluten proteins (Veraverbeke & Delcour, 2002): gliadin, a monomeric protein and glutenin, a polymeric structured protein (Shewry et al., 1989).

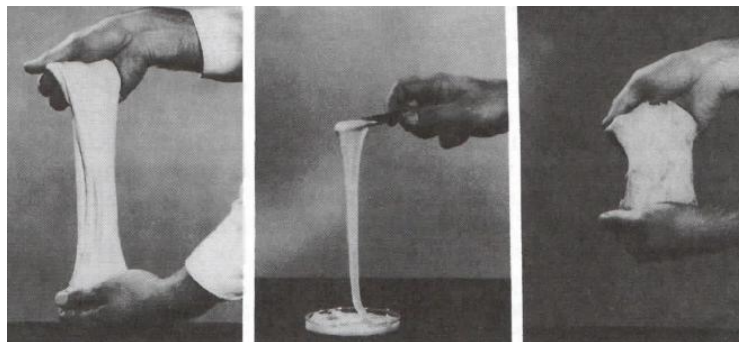

Figure 24 : Demonstration of the viscoelastic properties endowed by gluten (left), extensibility/viscosity of gliadin (center picture) and elasticity of glutenin (right).

Under hydration, gluten forms a viscoelastic network which encompass both proteins: glutenins are responsible for dough elasticity while gliadins endow it with viscous and extensible properties (Janssen et al., 1996, Uthayakumaran et al., 1999): Figure 24. They belong to the prolamin class of seed storage protein, rich in proline and glutamine but poor in lysine and arginine amino acids: Figure 23. Glutenins are particularly rich in sulfur and their polymeric structure mainly arises from inter-molecular disulphide bonds established in-between molecular units: Figure 25.

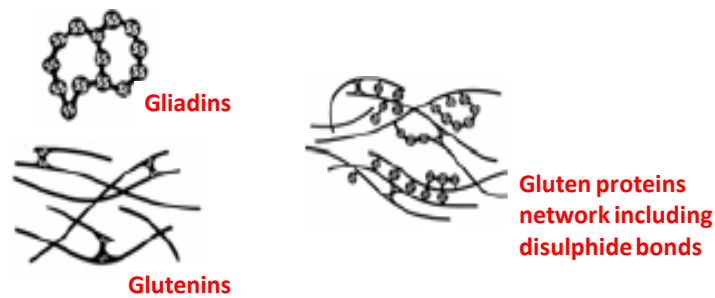

Figure 25 : Schematic representation of the macro-molecular organization of glutenins, gliadins and the formation of the gluten network in dough.

2.3.2.2. Gluten proteins and bakery products structure set up

Wheat-based food processing generally develops and sets the gluten protein network as it is the case in most of bakery products. In bread making gluten proteins contribute to dough properties, bread loaf volume, and structure (Delcour et al., 2012, Finney & Barmore, 1948): Figure 26.

Meanwhile, it has been evidenced from the observation of distinct flour performances while made up from wheat varieties displaying different protein content (Huebner et al., 1990, Huebner & Wall, 1976). It has been speculated that such modifications leading to either high or moderated dough strength can affect final crumb structure and textural attributes such as softness (Scanlon et al., 2000, Zghal et al., 2001). An improved flour strength, enhance bread crumb extensibility and resistance to gas cell coalescence, thereby showing a more uniform and a finer crumb structure which in turn arise from fewer crumb defects. A global increase of loaf volume was also evidenced. The conclusions of this study imply that events occurring in the dough persist as well and that affect the bread crumb mechanical properties (Zghal et al., 2002).

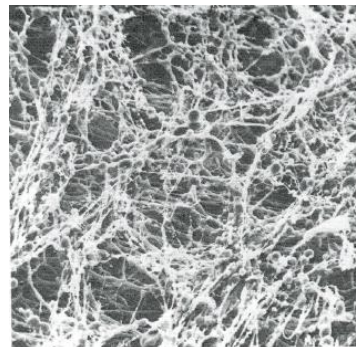

Figure 26 : Wheat flour dough observed with a scanning electron microscope (Hoseney & Rogers, 1990) cited in (Chiotelli & Le Meste, 2002).

Whilst gas-holding prominent ability is attributed to gluten (Arendt et al., 2008, Gallagher et al., 2003), soft wheat flours produces dough with inferior gas-holding properties compared to those obtained with harder wheat flour (Goesaert et al., 2005, Uthayakumaran et al., 2000). Also, gliadins have been demonstrated to exhibit foaming properties (Mita et al., 1977; Thewissen et al., 2011).

It is generally accepted that what makes wheat unique among the cereals is the viscoelasticity of the hydrated gluten proteins, which thus underpin its use for bread and bakery products manufacture (Delcour et al., 2012). In low hydrated conditions, protein-protein interactions takes place through interchain hydrogen bonding of glutamine amino-acid residues. As the hydration level increases, the system tends to gain in mobility and hydrogen bonded structures form between the chains and between water and glutamine residues (Shewry et al., 2001). The dough extension undergone upon mixing process and progressive hydration let the proteins align themselves along the shearing plane (Peighambardoust et al., 2006): Figure 27.

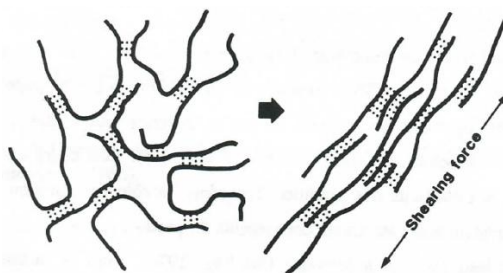

Figure 27 : Representation of the organization and alignment of glutenins and its subunits under shearing stress as dough kneading (Eliasson & Larsson, 1993).

Meanwhile, prominent reactions include sulfhydryl groups (SH) oxidation and SH-disulfide (SS) interchange creating disulphide bonds thus increasing dough strength dragging into its elastic behavior (Tatham & Shewry, 1985, Wieser, 2007): Figure 28. The glutenin proteins are particularly important in conferring high levels of elasticity to the dough (i.e. its strength) because they are strongly involve in the formation of the disulphide-bonded structures which are settled in dough (Shewry & Tatham, 1997). Water therefore exerts a key function in the establishment of such a network. If insufficient water meets the hydration needs of the entire dough ingredients, the gluten is not properly hydrated and the dough elasticity does not fully develop.

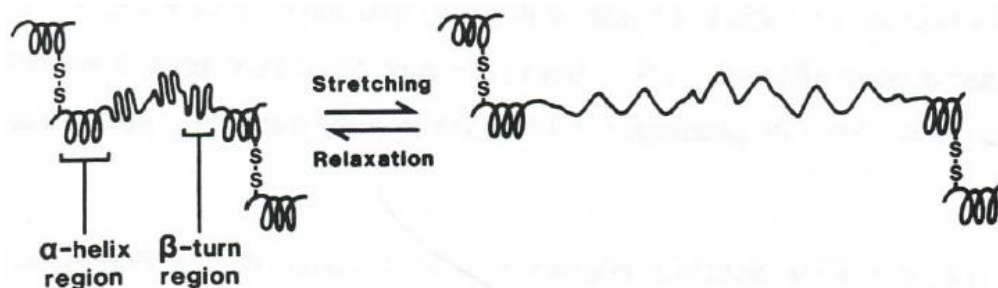

Figure 28 : Representation of glutenins chemical structure and its disulphide bonds.

Upon mixing, the dough actually passes from an unorganized system to a continuous viscoelastic, three-dimensional network of gluten within which starch and air are embedded (Attenburrow et al., 1990). This network formation can be influenced by the presence of solutes into the matrix environment. In the case of sucrose presence, a

reduction in consistency, increased stickiness, lower tenacity and improved extensibility is traditionally reported in either hydrated (Chiotelli & Le Meste, 2002, Salvador et al., 2006) or dryer systems (Pareyt et al., 2009a). Thence, addition of sucrose entails a significant modification of the rheological properties of the dough. The mechanism whereby sugars and especially sucrose limit starch gelatinization and inhibits continuous gluten network set up could be related to both water availability and enhanced water interactions with gluten and starch. Its affinity for water could be merely responsible for restricted water access (insufficient hydroxyl groups available for hydrogen bonding of water) thus lowering water absorption by gluten and starch (Oikku & Rha, 1978). The resulting dough, less consistent also requires longer development times to unfold gluten proteins and allow its protein network to properly develop (Salvador et al., 2006).

Gluten finally gives bread and bakery products elasticity, strength and gas-retaining properties. Furthermore, it is speculated that the structure and texture of soft wheat products are also, at least to some degree, shaped by the heat-induced changes in gluten proteins. As in bread, such interactions and reactions which takes place in-between ingredients provides the cohesiveness required to form a dough product and allows it to rise though keeping the leavening gas created within the batter.

Upon baking, gluten undergoes structural modifications. Protein denaturation occurs while the dough is oven-baked and is followed by proteins reticulation for temperatures above 55°C. These findings were attributed to the spatial reorganization of disulphide bonds and not to the creation of any other cross-links (Eliasson & Larsson, 1993). That way, the presence of disulphide bonds and hydrogen interactions endow gluten proteins with a higher stability under heating conditions (Cavella et al., 1990).

The unique structure of gluten imparts several physical properties which are of a major importance in wheat flour product manufacture such as cake production. Flour proteins quantity and quality needs to be considered while assessing functional properties of wheat flours regarding its end-use owing to the fact that different flours may display distinct protein patterns, composition and functionalities. Notwithstanding minor roles of different non-gluten proteins and other minor wheat flour constituents, gluten proteins are major determinant of bakery products quality (Goesaert et al., 2005, Moore & Hosney, 1986).

In crude dough and baked products, gluten proteins form a continuous matrix in which starch granules are embedded and dispersed. The development of a tridimensional network takes part to the gas-holding and bubble stabilization (Attenburrow et al., 1990, Eliasson & Larsson, 1993, Hosney, 1991, Hosney & Rogers, 1990) of the dough and so to the expansion and final texture of the product. The formation of this protein network is as it also accounts for starch involved in the crumb structure set up.

2.4. Wheat flour starch : functionalities in hydrated systems

2.4.1. Starch, an overview

Synthesize by photosynthetic reaction from solar energy, starch is the main storage carbohydrate of plants and always represents a major portion in weight of plant composition (Copeland et al., 2009): Table XV.

Table XV : Sizes ranges and morphology of different starches: adapted from (Atwell, 2001b, Buléon et al., 1998, Tester et al., 2004).

Starch from	Wheat	Maize	Waxy maize	Amylo maize	Rice	Pea	Potato	Tapioca (manioc)
Type	Cereal	Cereal	Cereal	Cereal	Cereal	Leguminous	Tuber	Tuber root
Starch content (%)	65-80	65-80	60-70	50-65	75-90	43-48	60-65	80-90
Granule diameter (µm)	2-40	5-30	5-30	5-30	1-8	5-10	15-100	1-35
Granule profile	bimodal	bimodal	Bimodal	Bimodal	monomodal	Bimodal	Skew distribution	monomodal
Granule shape	Round lenticular	polyhedral	Polygonal, round	Polygonal, round, irregular	Polyhedral Compound granule	Polyhedral kidney shaped	Ellipsoidal	Spherical/oval & truncated

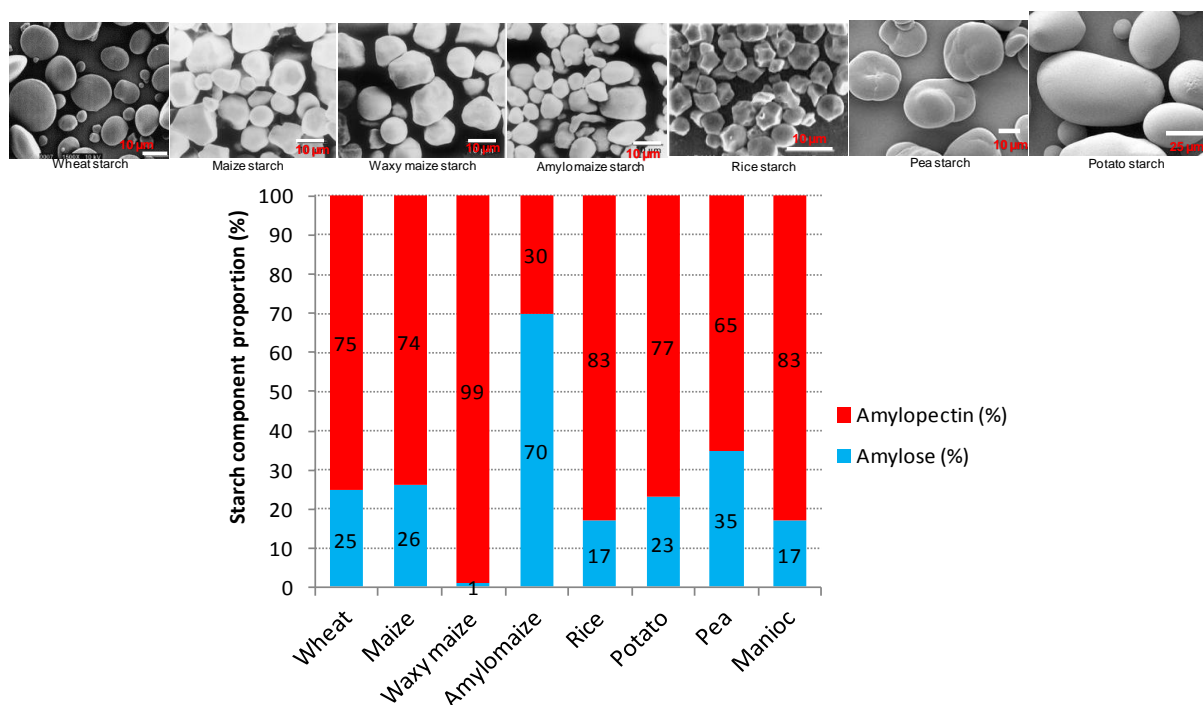

Figure 29: Amylose/amylopectin relative contents of starches coming from various botanical sources and their respective granular image obtained by Scanning Electron Microscopy (SEM): adapted from (Atwell, 2001b, Buléon et al., 1998, Tester et al., 2004).

Starch structure is somehow organized on a four length scales: molecular composition, lamellar organization, growth rings structure and the whole granule morphology, ranging from the Angström unit to the μm length units. It is essentially composed of amylose and amylopectin accounting together for 98-99% of the total material. The remaining 1-2% contains lipid - 0.5 to 1.2% - (Finnie et al., 2010), amino acids - 0.1 to 0.6% - (Baldwin, 2001) and minerals - 0.1 to 0.4% - whilst latter is negligible in the case of cereal starches (Belitz et al., 2009).

Furthermore, both the starch level and the relative amount of each one of these polysaccharides varies according the botanical source where they come from: Figure 29. Functional properties of starches coming from distinct origins are thus partly influenced by the amylose – amylopectin composition (Fredriksson et al., 1998).

2.4.2. Starch chemical structure

Regardless of its origin, starch is basically built of D-glucose, forming either a chain or a ring which is referred to as a pyranose ring. Starch consists primarily of D-glucopyranose polymers linked by α -1,4 and α -1,6 glycosidic bonds. These linkages are represented in both amylose and amylopectin polymers. Nonetheless, amylose and amylopectin differs each other from the branching level extent: Figure 30.

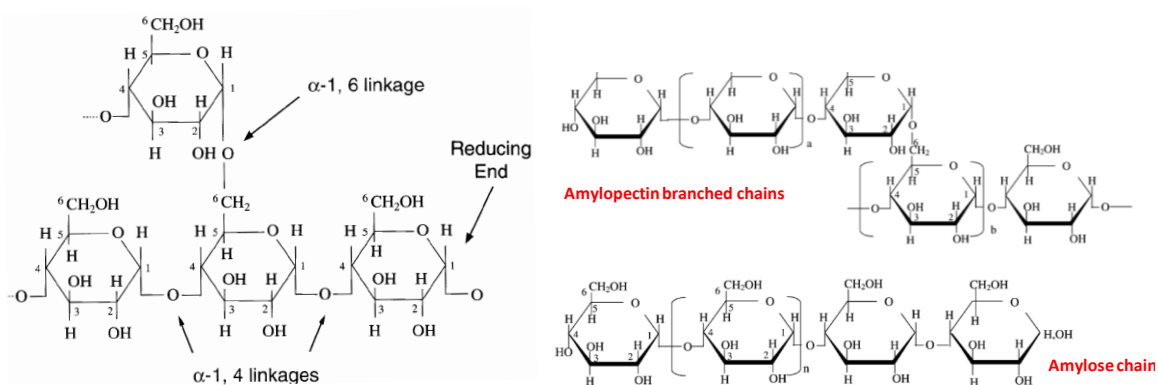

Figure 30 : Representation of the basic chemical structure of starch units and its α -1,4 and α -1,6 glycosidic bonds (Right). Amylose and amylopectin chains structure representation (Left).

Amylose is an essentially linear polymer mainly composed of α -1,4-linked D-glucopyranose molecules (10^5 to 10^6 Da). A small number of α -1,6-linked branches may be encountered. On the opposite, amylopectin is a large branched polysaccharide composed of linear chain (amylose-like structured) which are inter-linked by the way of α -1,6 linkages. The latter represents a large proportion of the overall linkages (4-6%) within an amylopectin molecule leading to a count of about 20,000 branches. Although not equal, the multiplicity of branches in such a structure is a common feature of both amylopectin and glycogen molecules. Amylopectin molecular weight is much higher than amylose one (about 10^8 Da).

2.4.3. Granular structure of starch

In its native state, starch is a granular shaped semi-crystalline structure which size (1 to 100 μm) and morphology vary according to its botanical source: Table XV (Singh et al., 2003). Native starch granule appears as alternating concentric dark and clear areas from a point called hilum. Clear areas are mainly composed of amorphous regions which foremost contain amylose whereas dark areas are semi-crystalline composed of both amorphous and crystalline lamella.

The latter mainly contains amylopectin: Figure 31. Double helical structures formed by adjacent chains of amylopectin give rise to crystalline lamellae. Branching point constitute the amorphous regions.

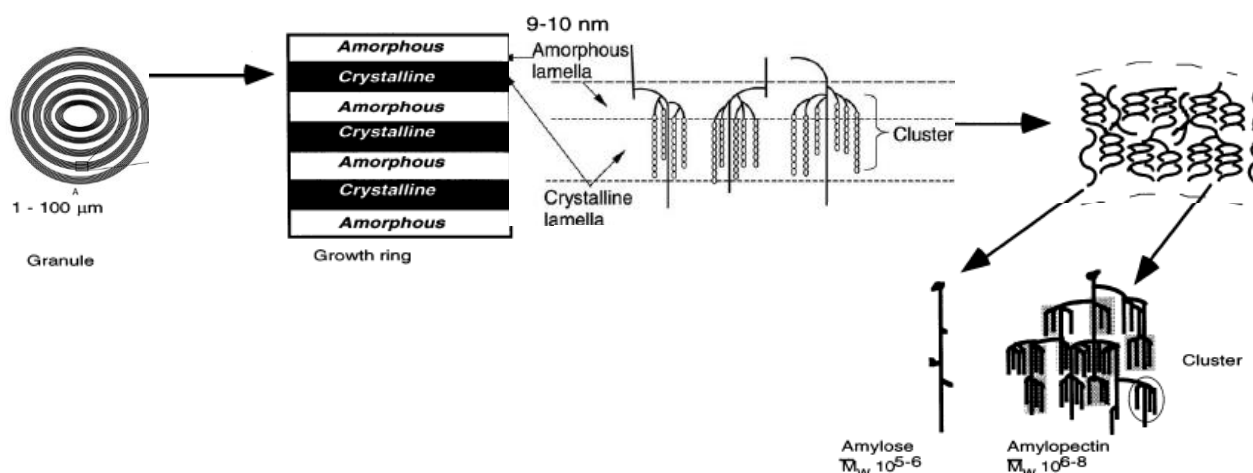

Figure 31 : Representation of the starch granule at different structure levels: adapted from (Buléon et al., 1998, Tester et al., 2004).

Relative starch crystallinity is usually difficult to measure even though studies are commonly performed using reference samples (fully amorphous or crystallized samples). The difficulty particularly arises from the natural presence of amorphous regions in native starches and complex molecular changes while gelatinized. Starch crystalline level (in native or retrograded starch forms) can for instance be investigated by the way of solid state NMR, Differential Scanning Calorimetry (DSC) or X-Ray diffraction (XRD) (Kaletunc & Breslauer, 2003, Primo-Martín et al., 2007, Zobel & Stephen, 2006). Nevertheless, the qualitative assessment of the crystal nature in native starches is more commonly realized compared to its quantitative measurement (Baks et al., 2007, Champenois, 1994).

Using XRD, crystallinity level of native wheat starch samples has been estimated from 20% (Ratnayake & Jackson, 2007) to 36% (Gidley & Bociek, 1985). The crystallinity of different starches sources has also been measured by XRD, ranging from 15% for high-amylose starch to 40% for waxy wheat starch (Zobel, 1988).

When starch granules are placed in cold water or heated under dry conditions, they keep no soluble. Conversely, starch granule structure can be damaged and disappear under specific conditions. The hydrothermal transformation that starch undergoes upon hydration and heating is called gelatinization.

2.4.4. *Hydrothermal transformation of starch*

2.4.4.1. Starch gelatinization

In most of the cereal based food products, starch is subjected to hydrothermal treatments, whilst both granular structure and semi-crystalline organization are modified (Primo-Martín et al., 2007, Svensson & Eliasson, 1995).

Starch gelatinization is thus a dynamic process undergone by wheat starch granules under heating and hydrated conditions (Figure 32) which is somehow responsible for the wide variety of food product structure and texture (Hoseney, 1994) and arising from both the process and the different ingredients used in product manufacture: Figure 33.

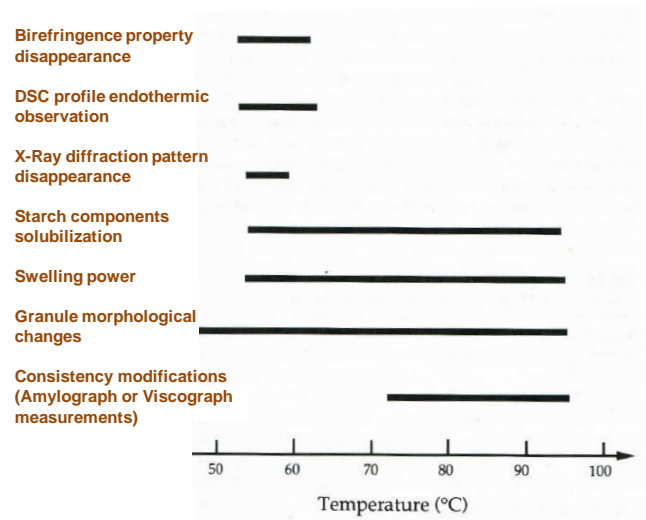

Figure 32 : Temperature range and phenomenon taking place while starch granules are heated with an excess of water during gelatinization: from (Eliasson & Larsson, 1993).

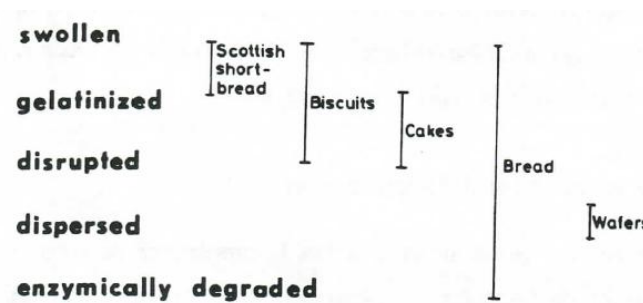

Figure 33 : Starch modifications undergone upon wheat based product manufacture: adapted from (Banks & Greenwood, 1975, Blanshard & Frazier, 1986).

2.4.4.2. Starch gelatinization phenomenon

Starch gelatinization correspond to the irreversible phenomenon of starch granule swelling followed by the dispersion and the solubilization of the compounds it contains while it is heated in excess water conditions (>60%). It is going through three main stages where it is successively swelled (sorption phase), gelatinized and solubilized (dispersed): Figure 34. All the previously described length scales (molecular to granular) are thought to contribute to the gelatinization phenomenon.

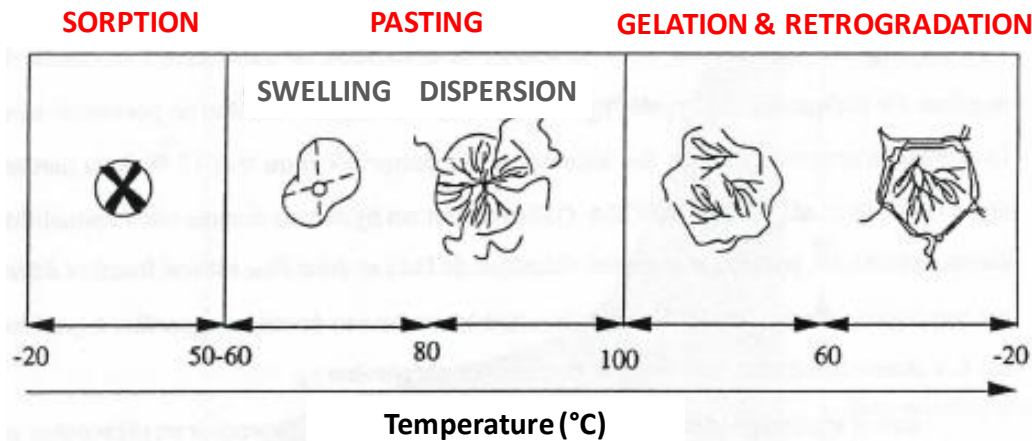

Figure 34 : Influence of hydrothermal treatment in excess of water conditions on the starch granule state and morphological evolution (Buléon et al., 1990).

Different physical transformations are taking place inside the granule while the flour-water system is heated. First, water is absorbed giving rise to a higher mobility together with the heat. This swelling is also responsible for the global viscosity increase of the water-starch heated system: Figure 35.

During gelatinization, water actually acts as a plasticizer (that is a compound or a molecule which is able to improve the flexible property of a material, thus increasing its glass transition temperature (T_g)). The raising temperature then allows the amorphous zones T_g to be reached. Water and heat energy goes through connecting molecules from amorphous zones to crystalline regions, entering tightly bound amorphous regions of double helical structures to swell amylopectin, thus causing crystalline structures to melt and break free. Starch granules progressively lose their birefringence and the 'Maltese crosses' are not anymore visible under polarized light (Primo-Martín et al., 2007). Meanwhile, starch swelling goes on until the rupture of the starch granule. This breakdown eventually happens when the swollen granule has reached its maximum 'size and deformation'. This overall disruption allows for leaching of amylose and amylopectin molecules to surrounding water with the remaining granule 'skeleton'.

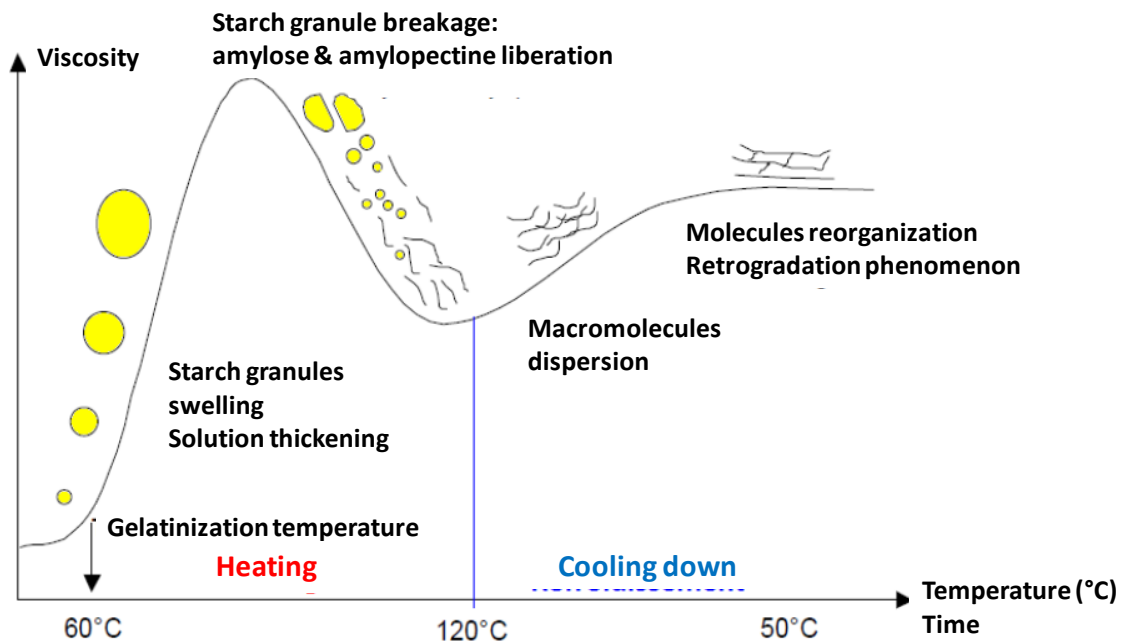

Figure 35 : Starch gelatinization phenomenon illustrated through the measurement of the viscosity evolution upon heating-cooling cycle of a flour-water paste using the Rapid Visco Analyzer (RVA) as a function of time and temperature.

Following the three main required transformations of water sorption, amorphous zones glass transition and crystalline zones melting, starch granules are then disrupted. When granules breakdown occurs, the solubilization of its components out of the granule (breakdown in viscosity level) takes place progressively thereby causing the paste viscosity to fall off: Figure 35.

As the temperature progressively decreases, for instance while product cool down occur after baking step, amylose and amylopectin components reorganize themselves, forming a gel network structure: this is the gelation phenomenon.

The overall gelatinization phenomenon can be characterized by the way of different methods including viscosity evolution of water-starches pastes (Figure 35) or calorimetric approaches (Chiotelli & Le Meste, 2002, Eliasson & Karlsson, 1983) - but also by qualitative methods such as microscopy or X-ray diffraction (Baks et al., 2007, Biliaderis et al., 1980, Ratnayake & Jackson, 2008). In the latter case, diffractograms progressively undergo pattern modifications: Figure 36.

Instead of forming a stable 'gelled' structure, starch compounds are able to crystallize. This is known as the retrogradation phenomenon, which is, upon storage of bakery products, one of the main factors responsible for their undesirable staling (drying and firming of the overall product leading to inappropriate texture).

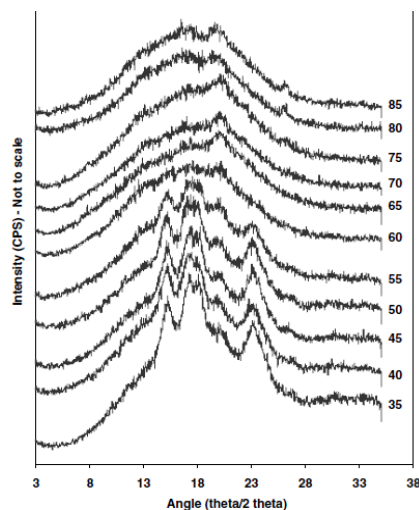

Figure 36 : X-Ray diffraction patterns illustrating the progressive crystallinity loss when heated at different temperatures - right pattern side - (Ratnayake & Jackson, 2007).

2.4.5. Retrogradation and Staling phenomenon:

Retrogradation corresponds to the recrystallization of gelatinized starch gels with time. Amylose and amylopectin are suggested to display distinct roles in the starch retrogradation phenomenon (Gudmundsson, 1994).

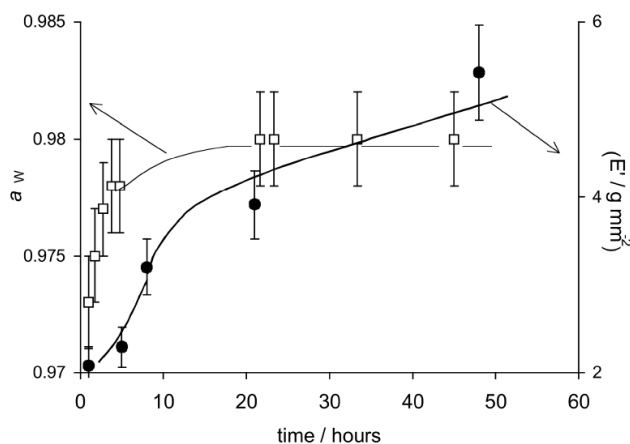

Figure 37 : Evolution of the Water Activity (a_w , left axis) and the Elastic modulus (E' , right axis) as a function of time in the early staling phenomenon phases of a bread crumb stored at room temperature (Pavinee & Vodovotz, 2001).

Due to its linear organization, amylose is able to quickly form crystals. Therefore, retrogradation is characterized by amylose crystallization within the first hours whereas amylopectin is mainly responsible for its evolution along a longer storage period (Miles et al., 1985, Ring et al., 1987). Amylose is responsible for short-term rather than long-term rheological and structural changes which are mostly attributed to amylopectin.

This unwished phenomenon is mainly observed through the bread staling. The degree of gelatinization or the retrogradation level can be assessed using different techniques, including rheological methods, crystallography, thermal analysis as well as spectroscopic measurements (Karim et al., 2000).

Moreover, it seems to be a dynamic process occurring in the early aging of the products. The evolution in terms of firmness and water activity has been investigated and modifications were attributed to retrogradation phenomenon: Figure 37. Indeed, the crystallization involved in the latter phenomenon results in both the water release from the molecules association in a crystalline form and the global decrease of the molecular motions in-between created crystals.

2.4.6. Dough ingredients influencing starch gelatinization.

Many ingredients affect in diverse ways the gelatinization properties of starch which in turn displays a determinant role in the setting of baked products crumb structure (Bean & Yamazaki, 1978b).

The first one, water, has to be provided in a sufficient level to allow starch molecules hydration, swelling and further gelatinization. The starch gelatinization delay was supposed to be partially due to water - starch interactions and to structural disorganization of starch leading to better granule structure stabilization while heated.

Ascertain by Differential Scanning Calorimetry – DSC - sugars (Ahmad & Williams, 1999b), and notably sucrose (Chiotelli et al., 2000) increase both the starch gelatinization temperature (linearly) and its enthalpy: Figure 38.

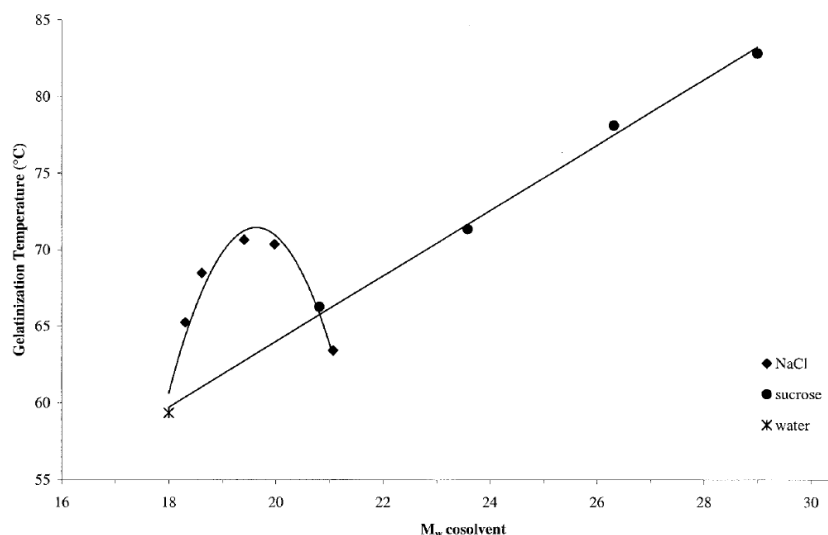

Figure 38 : Sucrose and sodium chloride effects on wheat starch gelatinization temperatures. Represented as a function of the solute-water co-solvent molecular weight (Chiotelli et al., 2002).

Carbohydrates widen and delay the gelatinization temperature range because they can interact with water to the detriment of the other constituents encountered in its environment. Meanwhile sucrose 'binds' some of the water, it lowers the water activity

and the amount of water available for starch hydration and gelatinization. In addition, they are able to stabilize the granule structure owing to starch-sucrose interactions settled on its surface. While water is known to exert a plasticizing effect (i.e, depresses glass transition temperature), sugars act as 'anti-plasticizers', thereby responsible for a global reduction in the flexibility of the amorphous regions which further may contribute to the delay of the gelatinization process (Chiotelli et al., 2000).

The impact of sodium chloride on gelatinization has also been investigated (Chiotelli et al., 2002) using DSC. It appears that the effect of salt was depending on its concentration. The highest gelatinization temperature ($\sim 70^{\circ}\text{C}$) was recorded for intermediate tested salt concentration (20%). Such findings were attributed to the effect of small solute properties in aqueous solutions and polymer-solute interactions: Figure 38. The so-called salting-in and salting-out effects, originally described for protein systems are thus involved respectively in the stabilization and destabilization of the starch structure. It thereby prevents or promotes gelatinization (Ahmad & Williams, 1999a, Chiotelli et al., 2002).

Lipids are somehow also involved in the gelatinization phenomenon. Their ability to complex with starch surface can limit granule swelling and widen the gelatinization temperature range. However, it has been ascertain that triglycerides have no impact on gelatinization temperature and energy for potato starch (Chiotelli & Le Meste, 2003).

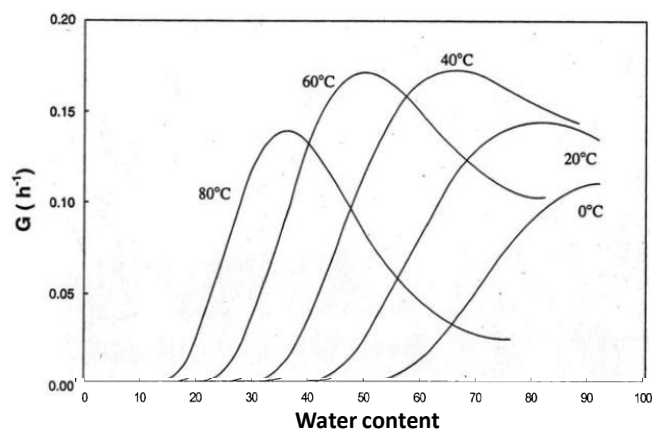

Figure 39 : Influence of water content and storage temperature exerted on wheat starch isothermal re-crystallization as illustrated by the Lauritzen–Hoffman simulation (the dependence of the rate of retrogradation at a constant storage temperature on the water content was attempted using this latter theory) (Farhat et al., 2000).

Other components used in bakery products can be responsible for gelatinization phenomenon delay or modifications such as fibers, pentosans and damaged starch, which are naturally present in flours. Their strong ability to bind water enhances the competition for water which is thus less available for starch to gelatinize.

Retrogradation phenomenon occurrence and rate can also be influenced by different factors. The water content and storage temperature greatly affect the rate and extent of retrogradation of starch gels as it is responsible for lowering the glass transition temperature and increase molecular motions: Figure 39.

Other compounds, encompassing lipids and surfactants, can retard or interfere with the retrogradation by direct interaction with starch avoiding starch molecules to naturally re-associate. Sugar and salt owing to both their water affinity in dough which is then responsible for a partial starch gelatinization and their lowering glass transition temperature effect are also known to reduce in a certain extent the retrogradation level in bakery products.

3. The other cake's components: origin, functions and interactions

3.1. Sugars

In addition to their flavoring function small carbohydrates molecules (referred as sugars) are involved in dough technological and physico-chemical properties (Bushuk, 1998). Various sugars have been investigated with regard to batter properties such as viscosity and strength of cake dough. They have been found to help to liquefy studied systems such as cake batter owing to the decrease of friction in-between molecules and to the starch swelling extent limitation (Bean & Yamazaki, 1978a, b).

Recently, dough properties were assessed as a function of sugar content in a low water and high fat and sugar level matrices (Pareyt et al., 2009b). A linear increase of the dough elasticity when sucrose levels were decreased (31.2-21.9% range) has been observed. Such findings were attributed to a more pronounced gluten development in the relatively low-sucrose recipes. Indeed, under proper hydration, as it is usually the case during bread making, gluten protein forms a viscoelastic dough. Overall ingredients addition may counteract or even prevent dough development (Pareyt et al., 2009a).

In addition, at moderate amounts, sucrose can act as a softener due to its ability to retain water thus controlling or limiting the other ingredients hydration (Bean & Yamazaki, 1978b, Maache-Rezzoug et al., 1998).

Therefore, because of their physico-chemical properties, sucrose and sugars syrups are strongly involved in the final product characteristics improvement. They can influence both sweet taste and every phenomenon occurring upon process among which gelatinization.

3.2. Lipids

In aerated cereal products, lipids are usually coming from butter, oil, eggs, and are eventually brought by milk. Each fat category (saturated, mono or poly-unsaturated) exhibits specific structure and properties which does not allow an easy use of distinct lipid sources instead.

However, in any case, lipid presence drags to the reduction of dough rigidity. Although used for their gas retention and crumb softening effects (Cauvain & Young, 2007), they act as lubricants. It was for instance illustrated in the case of triglycerides dispersing in between intra-granular space while investigating a starch granule – water and dough systems: Figure 40. Dough displayed a higher elasticity and lower rigidity as the lipid content was increased (Chiotelli & Le Meste, 2002). When fat is added in large quantities, its lubricating effect is highly pronounced; hence a very little water is needed to achieve a soft consistency of the dough.

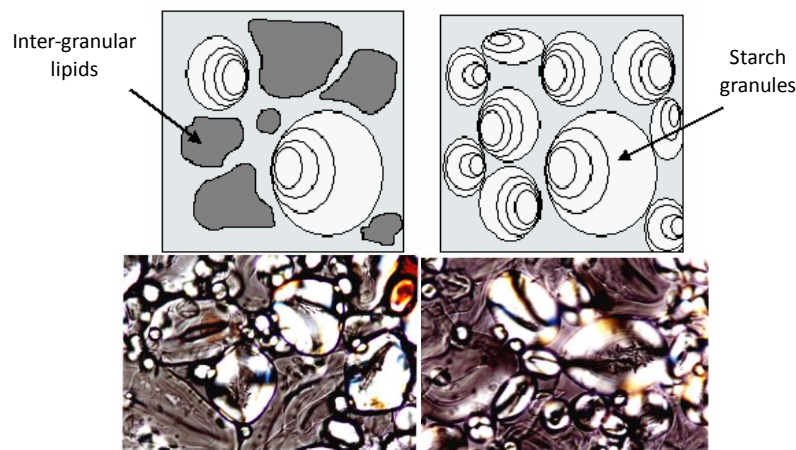

Figure 40 : Starch granule in the presence (left boxes) or in the absence (right boxes) of lipids. Drawn outline (top) and microscopy pictures (bottom). Optical microscopy pictures were obtained at 65°C for a 20% triolein potato starch-in-water dispersion: adapted from (Chiotelli & Le Meste, 2002, Chiotelli & Le Meste, 2003).

For instance, in less hydrated systems (cookies dough), when mixed with the flour before its hydration, the fat prevents the formation of a gluten network and produces a less elastic dough (Maache-Rezzoug et al., 1998). In addition, it can affect starch granules physicochemical behavior on which a thin fatty layer can settle (Chiotelli & Le Meste, 2003).

Lipids also influence texture properties of bakery products along storage as it is known to rather limit starch retrogradation phenomenon by the inclusion of fatty acid chain into the amylose helix (Gudmundsson, 1994). Such interactions help to better stabilize baked product texture and if not avoid, at least reduce its staling (Kulp & Ponte, 1981).

It is worthy of note that the use of emulsifiers also affect staling rate and level on account of their composition (mono and di-glycerides) and molecular structure (Putseys

et al., 2010). Small emulsifiers can actually enter the starch granule and complex internally with amylose: Figure 41, during the processing of starch-based systems such as bread or cake making (Krog & Jensen, 1970). The fat (and shortening) contributes to the plasticity of the dough and both act as lubricants.

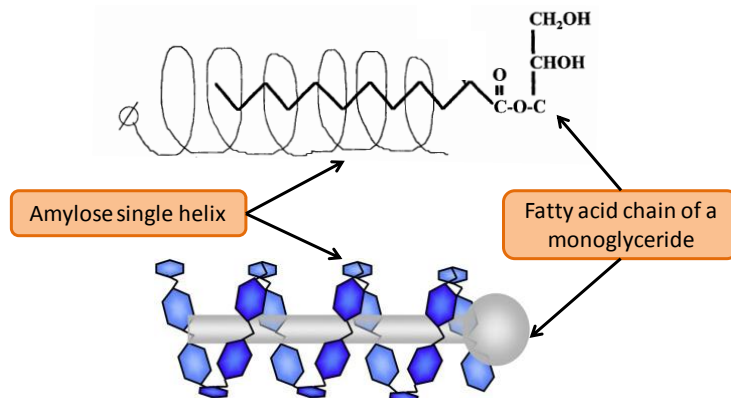

Figure 41 : Amylose helix – monoglyceride complex representation: adapted from (Atwell, 2001b, Buléon et al., 1998, Putseys et al., 2010).

3.3. Proteins

Proteins in dough are mainly brought by eggs, milk, and flour (gluten proteins). Whilst their denaturation occurs upon baking step as proteins are heat sensible molecules they are involved in both the dough rheological properties, structure forming and the final product texture (Attenburrow et al., 1990).

Added under different possible forms such as whole egg, yolk, white, fresh or liquid, egg proteins are well known for their wide range of texture and surface functional properties (Lorient & Matringe, 1993). They thus act as food ingredients and are used in baked products mainly for their foaming capacity, foaming stability (egg white proteins exhibit this ability reinforced by egg yolk) as well as their emulsifying properties through the function of egg yolks (Kralik et al., 1990), thus providing a softer and lighter texture. Eggs and egg proteins are also involved in the forming of dough owing to the fact that distinct egg levels investigated in both low and high temperature flour-based systems displayed different mechanical characteristics and evolution. Such findings were partly attributed to the rheologically assessed structure of the product in which the combination of starch gelatinization and protein gel set up is involved (Migliori et al., 2011).

As discussed above in the case of gluten proteins, a network involving disulphide bonds in between proteins such as glutenins units can be also formed (Attenburrow et al., 1990, Wieser, 2007). In addition, proteins are amphiphilic components which may be able to position at the interface between aqueous and lipid phases helping to stabilize the dough. In the case of cake batters, further leading to an aerated structure, this tensioactive property is also useful at the air interface and to provide a better repartition of the materials within the product (Örnebro et al., 2000).

3.4. Water

Water is in our case mainly provided by flour, eggs, also glucose-fructose syrups. One part of the water is also merely directly added to the mix (Atwell, 2001c). It is responsible for the ingredients hydration. It also allows starch gelatinization and gluten development giving rise to the visco-elastic network formation and the establishment of the final product structure.

Upon baking, the crust formation is the phenomenon which avoid water loss from the dough (Vanin et al., 2009). It thus keep the humidity inside and improve the final texture quality of soft products, enhancing their overall freshness perception (Heenan et al., 2009). Crust formation then does not allow the cake under baking to expand anymore and the final structure rather evolutes inside the product. Temperature raise more rapidly, starch gelatinization occurs and structure is fixed.

After baking, water which has not been 'removed' from the dough can distribute within the product owing to water activity differences between distinct crumb areas which is for instance responsible for fruit fillings migrations, crust softening or even inside firming (Fessas & Schiraldi, 1998). Other phenomenon, such as components re-hydration or starch retrogradation owing to the re-crystallization of starch components, can arise from this water repartition changes (Kulp & Ponte, 1981, Tang et al., 2008).

Although main aerated cereal products ingredients are flour, sugars, fat, eggs and leavening agent, water is an important component. It allows ingredients hydration and makes them able to interact between each other. Water also acts as a plasticizer and contributes to the dough structure set up and further, to the baked product texture as a function of their nature, proportions and interactions.

4. *An overview of transformations undergone upon process and storage*

The large number of ingredients especially in cakes and the various production methods result in a wide range of cake types. Yet, foremost composed of fat, sugar, eggs and flour, the dough is transformed upon baking into a cellular cake crumb with wished soft texture and sweet taste. Starch and proteins represent the key structure forming components of cake. Thence, knowledge of their functionality in cake making holds promise for the quality improvement of this kind of products.

Interactions which are taking place within the dough while it is processed act therefore as key factors for the final product characteristics. Bakery products making starts by adding ingredients which are mixed thereby forming dough in which air is entrapped and gluten network developed.

Upon baking, starch start to swell and the gelatinization phenomenon takes place while the dough is progressively heated. Meanwhile, proteins denaturation occurs at

temperature above 50-60°C, also creating disulphide-bonds through 'thermoreticulation' which is involved in the overall product structure set up (Cauvain & Young, 2007).

In addition, with the increase in temperature both at the surface and inside the dough, the product develops. This expansion is the consequence of the water evaporation and gas creation leading to the bubble growth. Gas cell coalescence can occur, by the cell wall breakdown then forming larger bubbles and a more open structure (Deshlahra et al., 2009). When the crust forms, water evaporation slows down and the structure is somehow 'fixed' (Vanin et al., 2009). Therefore, if the water content is unsuitably low, the dough is not able to develop leading to only partial starch gelatinization (Baks et al., 2007, Chaunier et al., 2008, Kirby et al., 2003).

The addition of fats, emulsifiers and plasticizers helps to plasticize and lubricates the batter. Thence, it improves dough development (Pareyt et al., 2011), but also favor air incorporation during mixing by enhancing gas cell interface stabilization together with endogenous flour lipids (Murray, 2007) and proteins (Primo-Martin et al., 2006).

Higher gluten proteins content globally improve gas retention into the dough. The gluten network settled upon ingredients mixing and hydration should furthermore allow the dough to be extensible enough not to cause cell wall breaking. Indeed, if cell walls exhibit unsuitable elasticity further expansion capacity can be lowered leading to a less aerated structure or enhanced bubble wall rupture (Gan et al., 1990, Primo-Martin et al., 2006).

In regards with the various data and information which can be found in the scientific literature, it appears that both gluten and starch strongly contribute to the baked product firming. First and foremost, starch undergo retrogradation phenomenon involving starch compounds which crystallize whereas gluten re-structure and strengthen possibly due to a water release and chain organization modifications (Aynie-Davidou, 1994).

5. Conclusion: Structure and composition of cake products

Controlling technology and final product is of a key importance for food industry (Abdullah, 2008b). In the baking industry, ingredients and process works together to create the desired structure and texture aiming to produce the best wished quality.

Regardless to the nature of the ingredients, the global composition of a bakery product strongly influences its final quality. It is also possible to assess their characteristics by the use of a wide range of methods providing specific responses depending on conditions to be investigated.

Further, ingredients nature and functionalities are of a main importance through the wide range of interactions taking place within the dough upon making process and inside the product while it is then stored.

SCIENTIFIC CONTEXT CONCLUSION

This section highlights the importance of a deep investigation of the structure of the product together with the influence of its ingredients composition on the perceived texture in regards with the overall product quality.

In-between the bread and biscuit fields, cake's characteristics need to be considered as an intermediate product for which the properties and the encountered behaviour belong to both scientific domains.

First, owing to its aerated structure, which mainly arises from the product making process, cakes are considered as solid food foams. In the scientific literature, various studies are focused on bread structure set up upon resting and baking whereas cake structure is scarcely described. Therefore, due to its structural organization, many concerns are focused on baked bread which is somehow considered as the closest cereal-based aerated product.

Then, bread manufacture is somehow simple in terms of formulation. Related to this statement, ingredient interactions and modifications undergone by bread components are not intended to be compared to what actually happens upon cake making process. Even though hydration levels are distinct, the more complex composition encountered in cake justify the concern on studies reported in the case of biscuit systems or cake-dough-like models.

Therefore assumptions that both bread structure and biscuit ingredient composition needs to be considered in the aim to thoroughly investigate cake softness have been taken into account.

As described in the present section, cake texture investigation involves several aspects and a multi-scale approach should be employed to be able to study product texture in relation with its structural characteristics and its ingredients in addition with the making process responsible for the final cake properties. Responses on both the sensory perception and the mechanical properties of such products are intended to be obtained which justify the multi-scale characterization approach of such a soft texture.

In this objective, the present study aims to investigate the aerated cereal product texture especially regarding its softness and its evolution upon storage, as a function of cake aeration, making process and cake formulation, thereafter focused on flour and its components.

.....Beaucoup de réflexion et non beaucoup de connaissances,
voilà à quoi il faut tendre
Démocrite , les Penseurs grecs avant Socrate

..... La recherche comporte et comportera toujours une part importante d'activité créatrice
Pierre Joliot

CHAPTER 2: MATERIALS and METHODS

Food material models: on the cake samples production, control and storage

1. Cake's formulation

1.1. On the cake ingredients: Table XVI.

1.1.1. Flours

Three distinct wheat flours were employed for cake production. A soft wheat flour (Crousty = CTY), a 100% medium hard flour (Gruau rouge = GRU) and a flour composed of a 50% soft + 50% medium hard wheat flour mix (Lu2000 = LU). This ingredient will be further described in a more thorough way and associated characterization will be depicted in part 3.

1.1.2. Plasticizer: glycerol

Glycerol belongs to polyols group of molecules with a $C_3H_8O_3$ ($M_W = 92,1$ g/mol) chemical formula. **Erreur ! Source du renvoi introuvable..** Registered as E422 in food additives classification he is commonly employed in food products mainly acting as a plasticizer and a water activity depressor to allow food products to be safely stored.

1.1.3. Leavening agents

Two different kinds of leavening agents do exists. Chemical leavening agent is employed in cake products rather than yeast in bread.

Baking powder is always used as a combination of a basic and an acid component such as sodium carbonate ($NaHCO_3 \Leftrightarrow M_W = 84$ g/mol; E500) and potassium hydrogenotartrate ($C_4O_6H_5K$) or sodium pyrophosphate ($Na_2H_2P_2O_7$): Figure 42. Sodium pyrophosphate (E450i) compound acts as a leavening agent in baking powder.

It is based for instance in the case of sodium carbonate - sodium pyrophosphate combination on the following acid-base reaction and their dissociation under heating is encountered.

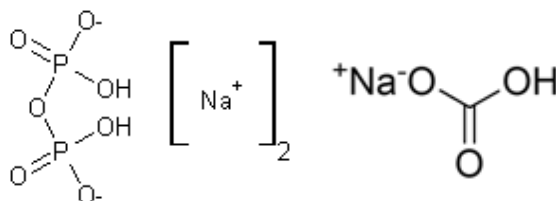
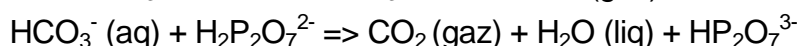
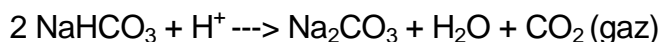
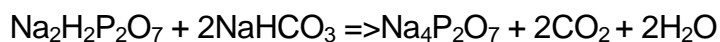

Figure 42 : Sodium pyrophosphate and sodium carbonate basic chemical structure

The neutralization value represents the amount of acid to 'neutralize' the bicarbonate (NV). It is equal to a factor of 72 in the case of sodium acid pyrophosphate.

Producing carbon dioxide such compounds allow bubble growth thus giving rise to the aerated structure of the final bakery product. The reaction may start upon dough mixing and resting but is mainly activated under humid and heating conditions.

1.1.4. Emulsifiers (shortenings)

Emulsifiers correspond to agents allowing immiscible phases to be mix together. Shortenings which are used in batter usually contain both mono- and diglycerides emulsifiers. Such components allow a better dispersion of fat and water into the dough because of their hydrophilic-hydrophobic property (called amphiphilic) and are mainly used for this function (Hasenhuettl, 2008).

Their function and efficiency is usually related to their solubility in each phase which can be evaluated by their Hydrophilic Lipophilic Balance (HLB). A value comprised in-between 1 and 20 provide a classification of the most lipophilic to the most hydrophilic compound (Griffin, 1949). Emulsifiers are rarely added into bread formulations but in most of cakes or bakery products as soon as they contain fats (Atwell, 2001c; Hasenhuettl, 2008; Kim, 1992). They then provide softer and tender products as they also display an anti-staling behavior.

The emulsifier incorporated in our cake dough is composed of both Lactic esters of mono- and diglycerides (13%; LACTEM = E472b) and of polyglycerol esters of fatty acids (22%; PEG = E475). Emulsifiers within the E472b category are widely used especially for their ability to stabilize emulsions, and to give to the product its required viscosity. They are usually included in different spreads, starch based food and in the bakery industry. Emulsifiers belonging to the E475 group are extensively used cake mixes, bakery and pastry products as it helps the wetting of a suspended powder, its dispersion and act as a thickener as well (Figure 43). Their HLB values are comprised in-between 3 to 4 and in-between 6 to 11 for LACTEM and PEG respectively.

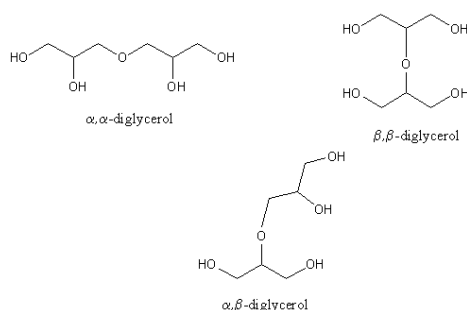

Figure 43 : Polyglycerol Esters of Fatty Acids (PEG) = E475;
chemical formula $[R-(OCH_2-CH(OR)-CH_2O)_n-R]$

Table XVI : Name, source and specifications of the used ingredients

Ingredient	Provider (France)	Ingredient specification
Crousty Flour	Evelia	100% soft wheat flour
Lu2000 Flour	UniLoire	50% soft + 50% medium hard wheat flour mix, T55
Gruau Rouge Flour	Grands Moulins de Paris	100% medium hard wheat flour
Sucrose	Tereos	300-500µm granulometry
Glucose-fructose syrup	CARGILL Benelux BV	71 Dextrose Equivalent
Rapeseed oil	Primance	Liquid form at ambient temperature (melting around -20°C)
Eggs	Ovipac, ovoteam	Whole liquid eggs, 11.6% proteins
Plasticizer	Univar	Glycerol
Emulsifier	COGNIS Illertissen	Mono and Diglycerides : E472b + polyglycerol (E475)
Sodium Pyrophosphate	Univar	Na ₄ P ₂ O ₇ ; Na ₂ H ₂ P ₂ O ₇ form
Sodium bicarbonate	Univar	NaHCO ₃
Greasing agent	Bakemark Ingredients	Oil spray

1.2. Cake model: dough composition and applied variation

Cake manufacture was performed at two production scales: laboratory and pilot. Two cake models have therefore been settled up for a larger application and for experimental facilities. Their composition was kept equal in both scales is presented in Table XVII. Elaborated with the so-called 'standard flour' Lu2000, these models are considered as the two reference samples for the study of cake texture set up, parameters and evolution along storage.

Table XVII : Model cakes composition (lab scale and pilot scale production). Ingredient composition is expressed for each compound in dry matter percentage

Ingredient name	Ingredient content (%dry matter)
Flour	26.44
Glucose-fructose syrup	12.50
Sucrose	15.10
Liquid eggs	3.96
Fat	9.73
Water	(5.50)
Glycerol	5.04
Emulsifier	1.10
Na PyroPhosphate	0.52
Na Bicarbonate	0.45

The development of a laboratory scale model allows us to study the impact of different processing parameters on dough properties, texture set up and at relatively short period of storage time, the texture evolution. The pilot scale model development allows us to work on larger sample batches under controlled conditions, closer to the industrial scale. For the needs of sensory analysis and multi-measurement kinetic study, larger production batches were thence possible.

2. *Cake' processing*

2.1. Cake' models processing

The dough was obtained by mixing ingredients (6 minutes in total) including flour, sugar, eggs, fat, water and baking powder (Table XVII) in a bowl mixer with a flat beater.

The standard making process which has been applied for reference samples is presented in Figure 44. Each dough sample was prepared using the same dry matter content in order to enable comparisons between samples. The mix was kept into the bowl for 30 min at room temperature, corresponding to the resting step prior to be oven baked. Since both developed pilot plant and lab models include mixing, resting, baking, and cooling steps, process parameters values have been adapted to produce targeted characteristics for dough and baked product: Table XIX.

Besides, modifications of several making process parameters including ingredients mixing order, resting time duration as well as resting time temperature have been applied. Specific processes have been also tested in order to modify dough and baked product characteristics, in the attempt to investigate further along the impact of making process parameters on sample expected features. Such conditions are further described.

2.2. Pilot plant experiments

In the pilot plant trials, the making process remain unchanged for samples in which only the flour source (GRU and CTY) or the leavening agent level (LVm50 and LVp50) have been modified: Table XVIII.

Specific pilot plant scale apparatus and tools were employed as referred as follows. In the pilot plant production, dough has been prepared by mixing ingredients using a Hobart kneader (HSM20 133E model, Hobart Manufacturing U.K. Braunton Rad. Barnstaple. Devon EX31 1GD. UK) prior to be oven baked using a POLIN oven (8000 TER Model, ING POLIN eC. SpA – 37135 VERONA – Italy) on 20 mould metallic plates (individual moulds dimension: 10 x 5 x 2 cm).

Variations have been applied in terms of mixing process type (RC versus STD), ingredients mixing order (SBK versus STD), resting time duration (RT_1H30 and

RT_4H00 versus STD). In some cases, a multiple variation factor has been applied with a modification of 2 or 3 factors simultaneously.

On the one hand, variations in the making process type (RC instead of STD) in addition with a higher or lower baking powder level (either -50% or +50% instead of STD level) for distinct flour based cake samples (CTY or GRU instead of STD flour) have been tested leading to various samples among which only the following cake samples conditions have been kept for further analyses: CTY_RC_LVm50; CTY_RC_LVp50; GRU_RC_LVp50. On the other hand, a modification of the resting time duration (RT = 1H30 instead of 30 minutes) in addition with the resting time temperature (40°C instead of ambient temperature, 25°C) has also been applied to the initially developed reference sample (STD) conditions.

It thereby led to various conditions and cake samples types which have been characterized in terms of both physico-chemical and sensory properties. This study will be further depicted in the second results section.

Table XVIII: Pilot plant trials: product classification according to the variation factor applied to cake sample formulation and/or process conditions. Numbers signification is further depicted in the legend. Letters in *italic* correspond to the used sample name.

Flour nature ¹	Baking powder level ²	Mixing process conditions ^{3,4}	Resting conditions ⁵	Multiple factor modifications ^{7,8}
Crousty (S) = <i>CTY</i>	50% less baking powder = <i>LVm50</i>	Sobinka ³ = <i>SBK</i>	30 minutes* at 25°C = STD	'Robot Coupe' process, Crousty flour, 50% more baking powder = <i>RC_CTY_LVp50</i>
LU 2000 (SMH)* = <i>STD</i>	0* = <i>STD</i>	Reference ^{3*} = <i>STD</i>	1H30 at 25°C = <i>RT_1H30</i>	'Robot Coupe' process, Crousty flour, 50% less baking powder = <i>RC_CTY_LVm50</i>
GruauRouge (MH) = <i>GRU</i>	50% more baking powder = <i>LVp50</i>	Robot Coupe ⁴ = <i>RC</i>	4H00 at 25°C = <i>RT_4H00</i>	'Robot Coupe' process, Gruau Rouge flour, 50% more baking powder = <i>RC_GRU_LVp50</i>
				1H30 at 40°C ⁷ = <i>RT_1H30_40°</i>

*The reference product conditions are represented in bold; only one cake sample (STD for standard) has been obtained with the standard flour nature (Lu2000), the standard baking powder level, mixing type and resting time.

1: Sample classification according to flour type: Soft (S); Medium Hard flour (MH) and a SMH flour arising from a flour mix of these latter flour types.

2: Baking powder level expressed as a variation percentage with respect to the reference sample level.

3: Variation of ingredient incorporation order upon mixing. The Sobinka dough sample (SBK) has been prepared in a Hobart kneading bowl equipped with a flat beater. Mixing process correspond to a successive addition and mixing steps of Flour+sucrose / water+glucose syrup / baking powder + emulsifier / eggs+glycerol. The final mixing step corresponds to the addition of the fat phase as the last ingredient to be incorporated to the dough.

4: Mixing type variation: 'robot coupe (RC)' corresponds to a high shearing mixing process (all ingredients mixed simultaneously in a mixer-like equipment)

5: Resting time (RT) duration variation, at room temperature

7: Compared to the reference sample, both resting time and temperature conditions were modified.

8: Combination of several dough making process parameters compared to the reference sample: process nature (RC = Robot Coupe mixing), flour origin (CTY = Crousty, GRU = Gruau Rouge) and baking powder level (LV +50 or -50% compared with standard level); Presented samples have been selected from the comparison of the whole range of products arising from the initial experimental design (2 factors, 3 levels mixing process (data not shown)).

2.3. Laboratory experiments

Trials in laboratory conditions have been realized in the attempt to investigate the impact of process scale conditions on dough and baked product characteristics. Therefore, an experimental work has been settled up. Flour, sucrose, emulsifier and baking powder are encountered as powdery components. Water, glucose-fructose syrup, liquid eggs and plasticizer are presented in a liquid form as well as the liquid fat (rapeseed oil). Only ingredients incorporation order was varied, the formula remains unchanged within studied processes and compared to pilot plant trials:

* The reference process « **STD** »: powdery ingredients are firstly added, followed by all the liquids whereas oil is incorporated as the third and last component: Figure 44.

* Process « **WATER** »: Powdery ingredients are first mixed, followed by liquid ingredients, except water. After the powder-liquid mix, water is added and dough is formed. The oil is the last incorporated ingredient.

* Process « **POWDER** »: liquid components in addition with solubilized sucrose are firstly mixed together. Oil is then added. Powdery ingredients are incorporated at final.

The three STD, WATER and POWDER processed dough are prepared at a laboratory scale mixing the ingredients within a kneading bowl from Kitchen'aid kneader (KitchenAid professional, KPM5 Model, Kitchenaid ; St Joseph, Michigan, USA), equipped with a flat beater and following the 'Lab' model parameters

* Process named « **MIX** »: all the ingredients are added together in the same mixer bowl and simultaneously mixed.

Dough sample were then oven baked (Sconvex 92 oven; Bourgeois, 74210 FAVERGES) using a metallic plate (12 individual moulds of 10 x 5 x 2 cm each).

2.4. Storage conditions

After baking and cooling down, cake samples were packed in aluminum based film (TAGHLEEF Industries, 30µm thickness x 227mm wide). They were sealed using either a production line automatic machine (General System pack, G5P45 EVO, Franco Pack, France) for Pilot plant production or the manual Multivac sealer (Type n° A 300/16, Sepp Haggmüller CmBH & Co.KG) for samples directly prepared into the lab. The packaging has been chosen to avoid contact with ambient air, to limit light penetration but also to prevent sample from water loss.

In both cases, samples were stored at ambient temperature (22-25°C), in dark space and carefully placed to prevent sample squeezing if settled too tightly.

Since no changes have been recorded on sample water content evolution as shown by previous measurements performed at different storage time, this film and its dimensions have been used for the whole lab and pilot scales production.

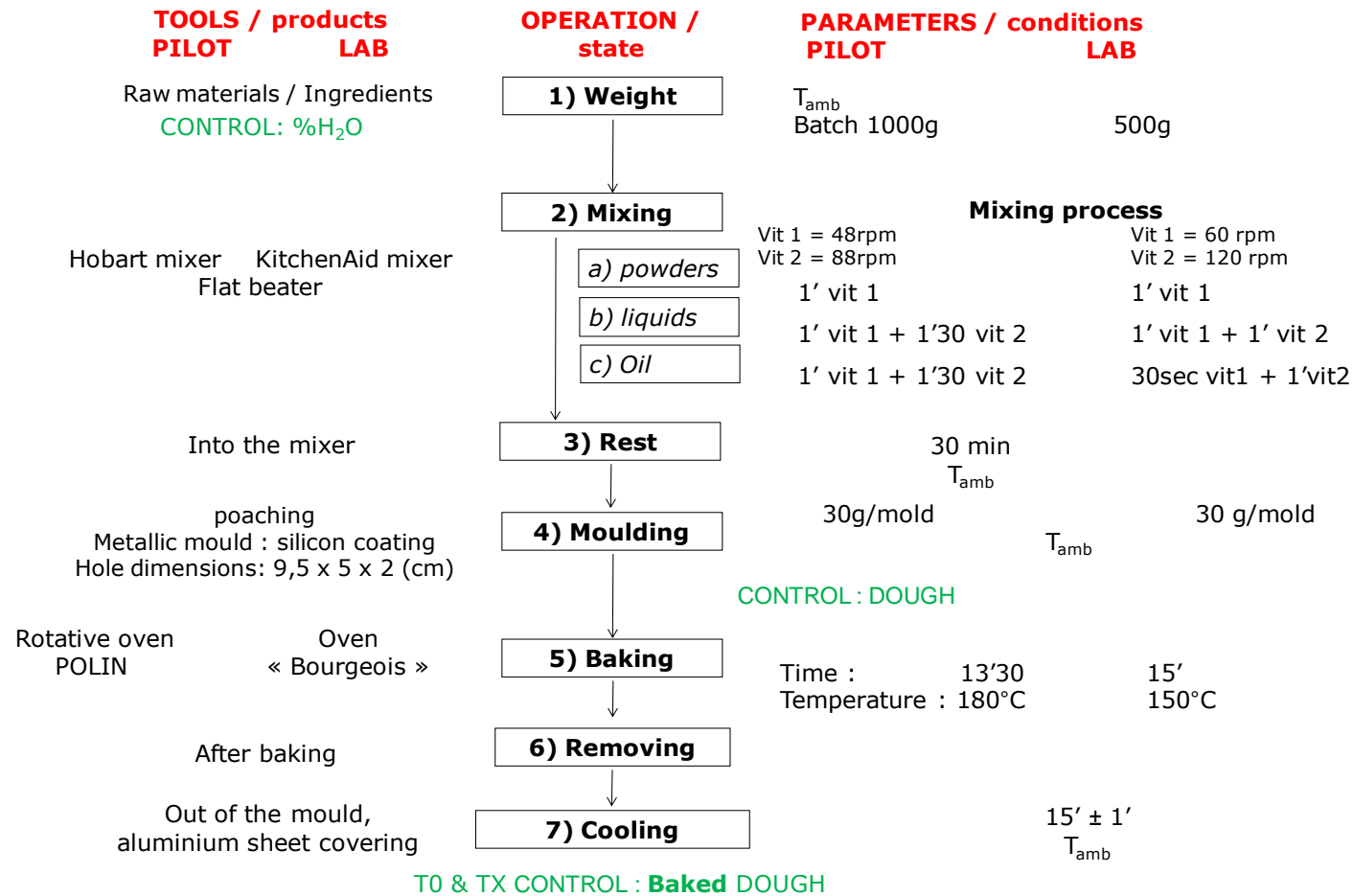

Figure 44 : Process diagram including mixing, resting, baking, and cooling down steps with the associated parameters. Sample controls positions (in green) are indicated for both the dough and the baked product.

3. Dough and baked product control

Among controlled parameters, the dough viscosity but also its water activity, water content as well as its density were measured. On the baked product, several parameters have been measured including water content, water activity, cake density as well as cake height.

3.1. Dough and baked products water content

Ingredients, dough or mashed cake samples were dried up for respectively 24 hours at 104°C or 90 minutes at 134°C allowing sample water content determination (NF ISO 712, 2010). About 1,2g ± 0,1g were weighed in aluminum pan before and after drying.

$\text{Sample dry matter (\%)} = 100 - \frac{100 \times [(\text{Sample weight before drying} - \text{Sample weight after drying})]}{(\text{Sample weight before drying})}$
--

The calculation of the water proportion is based on the recorded mass difference (International, 1995). The mass loss indicates the percentage of water removed from the sample by drying.

3.2. Dough and baked products water activity

The water activity (A_w) of a system is defined as the ratio of the water vapor pressure measured on the sample surface (P) on the pure water vapor pressure (P_0).

$$A_w = P/P_0 \text{ and } A_w * 100 = \%RH$$

The A_w determination is based on this equation and is related to the relative humidity of the sample at equilibrium (RH). RH (%) is also related to the water content of the same sample by the 'sorption isotherm' (Schmidt, 2008). A_w first and foremost traduces the availability of water for hydration of other constituents of the system, for reactions to take place or microorganism to grow up. This parameter is often used to follow the stability of a food product upon storage and its preservation abilities.

Both dough and mashed cake sample water activity were measured using the A_w meter AquaLab CX-2 instrument (Aqualab, Decagon Devices Inc., Pullman, Washington USA). The sample is placed in a plastic A_w meter cup prior to be introduced into the apparatus. This latter is calibrated with salt solutions at saturating concentration used as references (i.e.: NaBr (HR 59%) and NaCl (HR 75%)). The recorded A_w value is obtained after system equilibration and is given as A_w units' ± 0,003.

3.3. Dough apparent viscosity and consistency coefficient

When a fluid is disposed in between two parallel plates (the bottom plate is not moving) and submitted to a shear force F the fluid undergoes a displacement. The Force value divided by the liquid to plate contact area gives the shear stress (t), whereas the shear rate is expressed as $g = v/h$ (with v = velocity between the top and bottom plate,

and h the distance in-between plates). The slope of the relation between shear stress-shear rate gives the viscosity (η). If a straight line is obtained, the fluid is called Newtonian (viscosity does not depend on shear stress or shear rate). In food products the relation isn't linear as complex interactions between food constituents are involved and influence their rheological behavior (Bourne, 2002b).

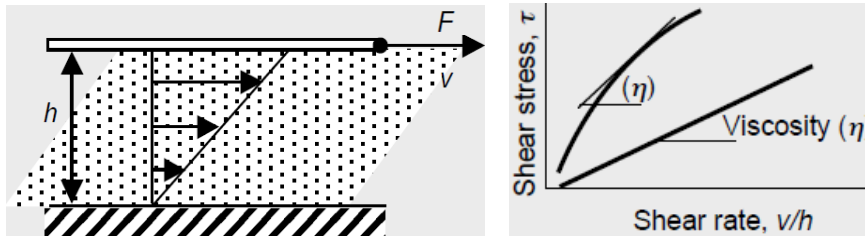

Figure 45 : Illustration of a fluid viscosity. Representation of viscosity, shear rate and shear stress.

To fit shear rate - shear stress $\dot{\gamma}$ (s^{-1}) and σ (Pa), respectively, in food rheology, several models have been developed amongst power law model.

Dough viscosity was measured prior baking with an SR5 rheometer (Rheometric Scientific Inc., USA) controlled by RSI Orchestrator software. A stress ramp (0 to 800 Pa) was applied to the dough samples at a controlled temperature ($25 \pm 0.5^\circ C$) using cone-plan geometry (angle: 0.019 rad). Dough consistency coefficient and flow index were determined for each sample using the power law model:

$\tau = K (\dot{\gamma})^n$ with τ the shear stress (in Pa), K the consistency coefficient (in Pa.s), $\dot{\gamma}$ the shear rate (s^{-1}) and n the flow index.

Apparent viscosity (η_{app}) was determined as for $\sigma = \sigma_0 + \eta_{app} \dot{\gamma}^n$

with η_{app} the apparent viscosity of the fluid at a given $\dot{\gamma}$ shear rate value (2.5 rpm in our study), σ and σ_0 the shear stress (Pa) and n the flow index.

3.4. Relative dough and cake density measurements

3.4.1. *Dough density measurement*

A recipient with a given volume is filled up with the dough sample. The ratio between this dough sample weight and the same volume of water allow determination of dough density (AACC International, 1999c).

$$\text{Dough density (g/cm}^3\text{)} = \frac{\text{Sample weight (g) in a given V volume (cm}^3\text{)}}{\text{Water weight in this volume (cm}^3\text{)}}$$

3.4.2. Cake density measurement

Relative baked product density has been measured following the rapeseed volume displacement method (AACC International, 2001).

The employed rapeseed density has first to be determined. Pour in rapeseed until the seeds fill the recipient of a known volume ($V_{\text{recipient}}$). Empty out this recipient once weighed with rapeseeds, thence giving rapeseed density value by dividing its total mass (m_{rapeseed}) by $V_{\text{recipient}}$ (g/cm^3). The entire cake sample is then weighed (m_{sample}) and introduced in the same recipient. The seeds are then allowed to settle and fill in around the cake sample and the entire rapeseed+sample is weighed again ($m_{\text{rapeseed} + \text{sample}}$) leading to the determination of the relative cake density (d_{sample}) by the following calculation:

$$d_{\text{sample}} = m_{\text{sample}} / V_{\text{sample}}$$

$$V_{\text{sample}} = (m_{\text{rapeseed}} - m_{\text{recipient}}) - [(m_{\text{rapeseed} + \text{sample}} - m_{\text{recipient}}) - m_{\text{sample}}] / d_{\text{rapeseed}}$$

$$d_{\text{rapeseed}} = (m_{\text{rapeseed}} - m_{\text{recipient}}) / V_{\text{recipient}} = (m_{\text{rapeseed}} - m_{\text{recipient}}) / m_{\text{eau}}$$

Table XIX : Synthesis of the different parameters measured upon cake processing on cake dough before and after baking; these values are the targeted controlled parameters for pilot and lab models.

Sample nature	Parameter	Unit	Value
CRUDE dough	A_w	u.a	0.84
	Water content	%H ₂ O	25.7 – 26.3
	Density	g/cm^3	0.88 – 1.00
	Consistency coefficient	cP (mPa.s)	60 – 70.10 ³
BAKED product	A_w	u.a	0.69 – 0.71
	Water content	%H ₂ O	15.5 – 16.5
	Density	g/cm^3	0.29 – 0.33
	Sample height	mm	31 – 32

4. Flour properties and associated characterization methods

4.1. Flour moisture content

The moisture content was determined in accordance with the regulatory protocol (NF ISO 712, 2010), by oven drying at 134°C for 90 minutes (Williams et al., 2008).

4.2. Flour particle size

Determinations of particle size distribution were performed using a laser granulometer instrument (Mastersizer 2000, version 5.12F, Malvern Instruments) according to the AACC method (AACC International, 1999b): Figure 46.

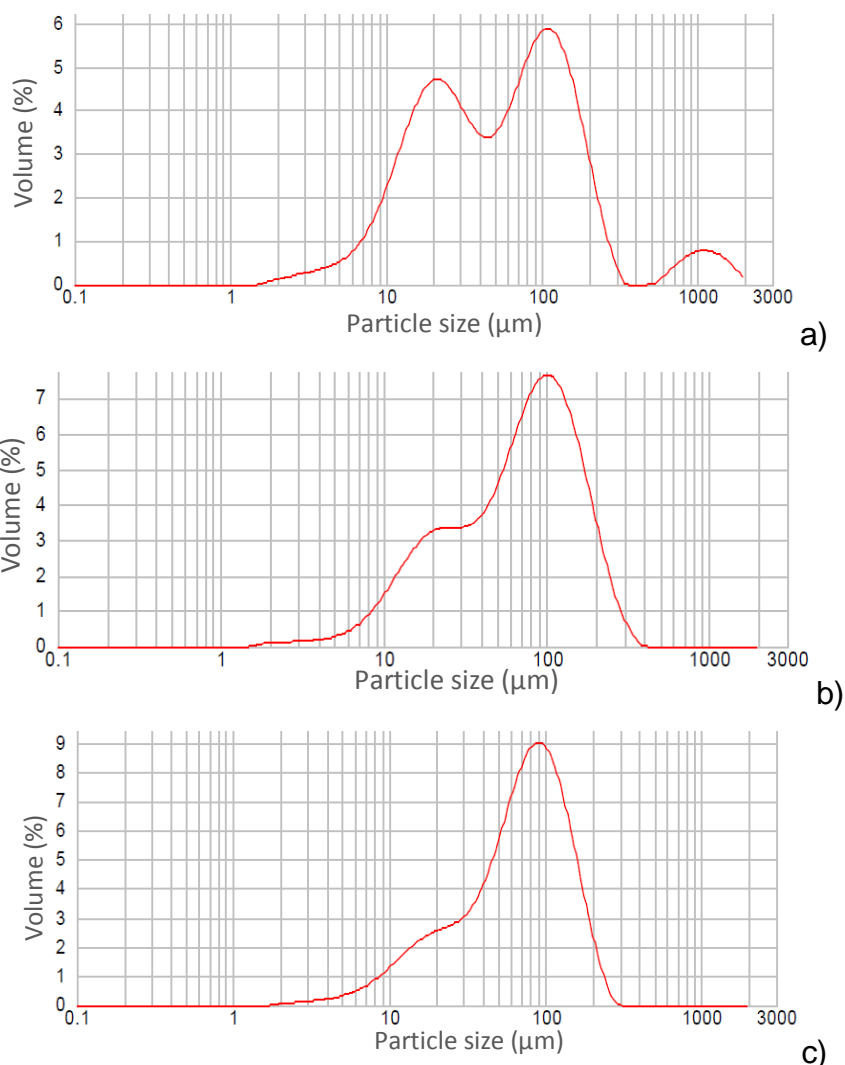

Figure 46 : Particle distribution profiles obtained for three distinct wheat flours: a) Crousty, 100% Soft ; b) LU 2000, 50% Soft, 50% Medium Hard ; c) Gruau Rouge, 100% Medium hard.

4.3. Flour composition and water absorption capacity

Flour proteins (AACC International, 1999a) and damaged starch contents were determined by Near Infrared Reflectance (NIR) according to the AACC method using a Near Infrared Analyzer (Antaris NIR Analyzer, Nicolet IS Industrial Solutions) and its

operating software (Thermo Nicolet Corp, version 1.2, Build 2008). This method was also used to determine the total water absorption of the flour (Burns & Ciurczak, 2007). Data obtained with this method have been calibrated on the basis of nitrogen quantitation using Kjeldahl assay (Osborne, 1986), and farinograph absorption value, respectively (Osborne, 2006, Osborne et al., 1982).

The Gluten content and the Gluten Index (GI) values were determined on wheat flour (AACC International, 2000). Analyses were performed using The Glutomatic 2100 system (Perten Instruments). The GI is calculated as the ratio between the weight of the fraction passing through the centrifuge sieve and the initial total gluten weight obtained after the washing step (lixiviation). Gluten index, as a gluten quality definer, is used to compare gluten network strength (Collar & Bolla Ān, 2005). A high GI value corresponds to a strong gluten network.

Water Retention Capacity analysis (WRC), based on the Solvent Retention Capacity (SRC) of American Association of Cereal Chemists (AACC) method (AACC International, 2009), was carried out on the different flours and sample fractions using water as the solvent (Gaines, 2000b). The SRC test, is commonly employed to evaluate the baking quality of wheat flour (Slade & Levine, 1994). It actually combines the analysis of the entire flour regarding its ability to retain some solvent with respect to the fractions contained into flours (Gaines, 2000a). The retention capacity is usually measured for four water-based solvents and relates flour functionality to specific flour components which thereby provide a practical flour quality profile to predict its baking performances.

Amongst the four distinct solvents which are used to perform the test, sucrose solution ($500\text{g}\cdot\text{kg}^{-1}$) is associated with pentosans and gliadins content; lactic acid solution ($50\text{g}\cdot\text{kg}^{-1}$) with glutenin fraction; sodium carbonate (Na_2CO_3 ; $50\text{g}\cdot\text{kg}^{-1}$) is associated with levels of damaged starch. The water solvent retention represents the total solvent absorption capacity (all-cited soluble components of the flour).

The SRC is the weight of solvent held by the tested flour after multiple mixing phases and centrifugation. It is expressed as a fraction of the original flour weight (14% dry matter basis). In our case, the only WRC has been assessed.

$$\text{WRC} = 100 \times [(m(\text{pellet})/m(\text{flour}))-1] \times [(100 - 14)/(\% \text{MS flour})]$$

In the equation, WRC is expressed in percentage and mass unit in grams.

4.4. Thermal behavior: DSC measurements

Differential Scanning Calorimetry (DSC) measurements were run with Q20 calorimeter (TA Instruments) driven by its operating software (TA Universal Analysis). DSC has been applied to evaluate flour thermal behavior, especially regarding its

gelatinization characteristics (temperature and energy level). Flour samples were assessed using a 10°C/min from 25°C to 120°C thermal treatment. 10mg of samples flour+water were prepared in aluminium pan (30% flour) then let 45min at ambient temperature for hydration.

4.5. Starch hydrothermal behavior through viscosity measurement

Measurements were performed using a Rapid Visco Analyzer (RVA Super 4, Newport Scientific, 2005) under Thermocline software control (TCW version 3.04, Newport Scientific). 3.5 g of flour and 25 g water were mixed in an aluminium cylindrical bowl (adjusted dry matter). Temperature variations were applied to the sample during measurements (the temperature was increased from 25°C to 95°C over 6 min, maintained constant for 3 min at 95°C and then decreased from 95°C to 25°C over 7 min). Viscosity (in cP) was then reported as a function of time and temperature. The maximum viscosity value determined during the isothermal step at 95°C was recorded to enable sample comparisons.

4.6. Starch granule swelling through particle size evolution measurement

4.6.1. *Stained starch visualization using light microscopy*

To study the flour starch swelling under hydrothermal conditions, light microscopy observations were conducted. Starch was selectively stained (iodine solution).

Each flour sample (GRU and CTY) was poured and stirred in water (3% flour) for 30 minutes at ambient temperature. Following hydration, samples was heated from 25°C to 90°C for 15 minutes under controlled heating. Several flour suspensions were regularly sampled and immediately sank into liquid nitrogen in order to stop granule swelling and avoid its size evolution. Sampling temperatures were chosen at 30 – 40 – 45 – 55 – 65 – 80°C. Measurement and sampling were duplicated.

Starch flour components were stained using iodine solution (1% iodine and 2% potassium iodide solution basis both supplied by Sigma Aldrich) allowing individual coloration of amylose and amylopectin in blue and pink, respectively. 0.06mL of each flour sample was dispersed in 0.5mL of staining solution.

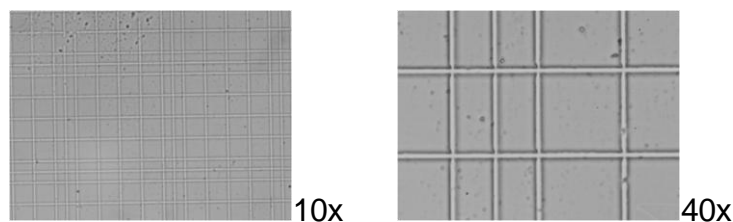

Figure 47 : Cell scale reference (magnification level of 10 and 40) for starch granule size evaluation

Stained flour sample was placed under light microscopy (Labophot-2, CAD instrumental) thence highlighting the starch granules. Pictures of 8 to 10 areas at a magnification of 40 were taken using the microscope connected camera (CCD Hitachi KP-111). A Toma cell was placed to set pictures scale on the basis of a level of magnification of 10 and 40 times: Figure 47. Pictures were recorded as a function of time and temperature and analyzed using ImageJ software to determine starch granule size (mean granule diameter) at each swelling stage.

4.6.2. *Starch granule size using laser granulometry*

Liquid laser granulometer was used to evaluate the particle size of flour suspension samples (Mastersizer Granulometer, Hydro 2000 SM Small Volume Sample Dispersion Unit Malvern Instrument). Measured particles sizes varied from 0.05 to 880 μm .

The same heating conditions as described for microscopic evaluation were used to prepare samples. Following heating and liquid nitrogen treatment, flour suspension was diluted into water (from 0.3 to 1.8 % in water according to granulometer measurement capacity and obscuration) then was poured into dedicated pumped system. Flour particle size distribution was recorded as the percentage of particles measured in each diameter range (considering spherical particles) passing through the measurement unit.

4.7. Flour X-Ray diffraction characterization; starch crystallinity

Powder X-ray crystallography has been realized on wheat flour samples. Diffraction data were collected on a Panalytical Empyrean diffractometer. The X-ray source was graphite monochromated MoKa radiation ($\lambda=0.71073$) from a sealed tube. The lattice parameters were obtained by least-squares fit to the optimised setting angles of the entire set of collected reflections. No significant temperature drift was observed during the data collections. Data were reduced by using Denzo (Otwinowski & Minor, 1997) software and the structure was solved by direct methods using the SIR97 program. Refinements were carried out by full-matrix least-squares on F2 using the SHELXL97 program on the complete set of reflections.

A-type crystal displays specific peak characteristics with Bragg angles values (2θ) of 9.9, 11.2, 15.0, 17.0, 18.1 and 23.3°. B-type characteristics 2θ are 5.6, 15.0, 17.0, 22.0 and 24.0°. The level of crystallinity in several flour samples was calculated based on diffractograms using bragg angles values characteristic of starch crystals. Determination of diffractograms peak presence and characteristics were then performed using WinPLOTR- 2006 (V0.50; jan2011) from Full Prof Suite program (V2.05; July 2011). OriginPro 8SR3 was used for peak area evaluation.

5. Aeration characterization

Aeration was characterized by the way of two distinct methods allowing the evaluation of crumb features at two different scale levels: a flat bed scanner and the X-Ray tomography technology were used in this attempt. Both methods provided images which were thereafter submitted to an image analysis (imageJ software).

5.1. Aeration characterization by cake slices scans and image analysis:

Thin cake **slices** (longitudinal axis) were prepared with a ham slicer machine. Slices thickness ($2.5 \pm 0.8\text{mm}$ depending of the sample fragility) allowed us to visualize cake bubbles by transparency: **Figure 48**. Images were obtained using a flatbed scanner (EPSON Perfection V330), at 8 bit grey scale format (800 ppp resolution). For a better contrast, a dark and plain background was used while acquiring the images.

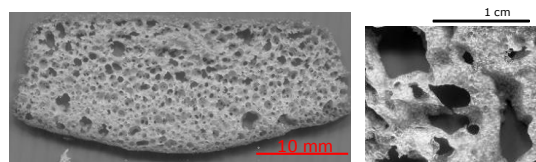

Figure 48 : Illustration of cake slice aeration through the visualization of crumb bubbles on scan images from two distinct samples.

The scanned images were first treated further analyzed using the software Image J (version 1.46j5 - <http://rsb.info.nih.gov/ij/>). Designing bars of known lengths allow pixel values to be converted into distance units. The largest possible rectangular cross-section of the images was cropped, avoiding cake surface selection on the scanned slice.

5.1.1. *On the image analysis process*

The observed contrast between pores and crumb matrix allows the determination of image feature in a binary mode. Therefore, after a threshold adjustment, the grey level images were ultimately converted into binary mode images, characterized by a pixel value of either 0 (black areas = pores) or 255 (white areas): Figure 49.

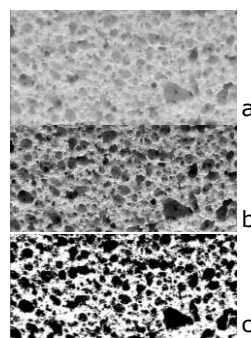

Figure 49: Illustration of the results of successive treatment undergone by a sliced cake scanned image using imageJ software: initial image (a), after contrast adjustment (b), after image transformation in a binary mode and noise reduction (c).

This sampling technique was thus suitable for the analysis of different cake types and various slices nature spanning from small to very large bubble sizes and from dense to very fragil crumb matrices: Figure 50.

A median filter with a 2 pixel radius was then applied to the cropped image limiting its noise, and broken or interconnected bubbles to be miscounted. Applying the watershed function to the image, objects of '0' pixel value were delimited, thereafter allowing bubbles to be identified. These areas, namely 'regions of interest' (ROI), correspond to the actual bubbles: Figure 51.

The established macro program is given in the next part.

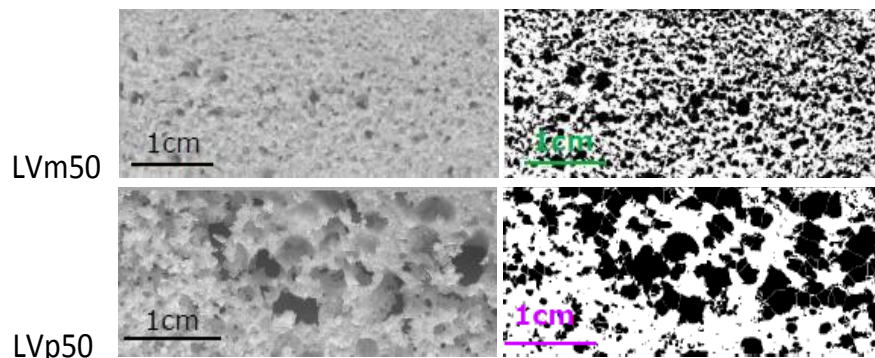

Figure 50 : Illustration of two kinds of samples: cake slices scan images before and after image analysis (imageJ software, 1.46j5 version). Regions of interest in black represent air inside bubbles zones.

Each ROI (bubble) was subjected to the quantification of its features, considering their definition and algorithms as already computed in different systems (Farrera-Rebollo et al., 2012, Igathinathane et al., 2008, Pérez-Nieto et al., 2010).

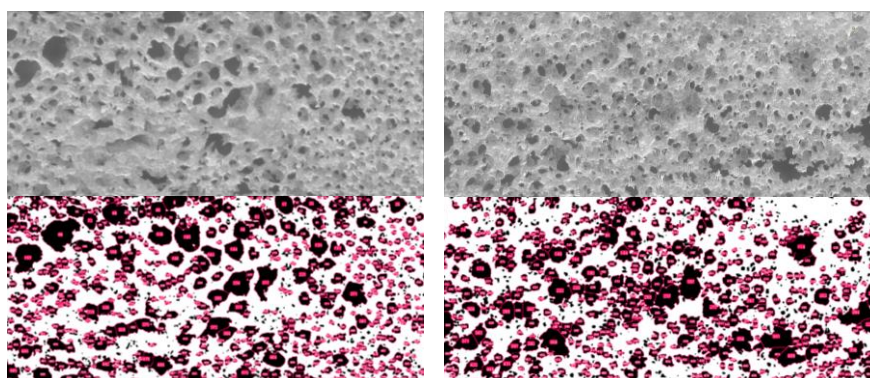

Figure 51 : Image analysis illustration from the initial cake slice scanned image (top) applying the macro program developed for this purpose using imageJ software. Crumb bubbles that are numbered can be described as with delimited areas (bottom).

5.1.2. Image features description

Several features were settled up including objects dimension characteristics (size and orientation), shape factors (circularity, roundness, area distribution) and porous structure (bubble distribution within the crumb) information as described in previous studies (Impoco et al., 2012): Table XX and Table XXI.

The bubble size distribution profile has been set up using 10 diameter ranges and quantifying the frequency of appearance of ROI diameters within this range as described within the last steps of the following macro program.

Table XX : Computed crumb bubbles dimension features, units and their meaning.

Name	Unit	Meaning
Mean area	mm ²	Bubble area
Mean intensity	0-255 u.a	Grey level mean intensity; Information about the relative portion of air within tested slices
Mean Feret diameter	mm	Evaluation of bubble diameter if considered as a circle object
Feret X*	mm	Projection of Feret's diameter on the X axis
Feret Y*	mm	Projection of Feret's diameter on the Y axis

* X and Y feret's diameter together informs on ROI orientation characteristics

Table XXI : Crumb bubbles shape descriptors significance and its extreme values representation: adapted from (Impoco et al., 2006, 2007).

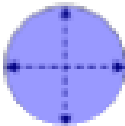
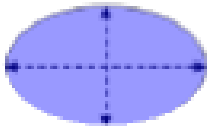
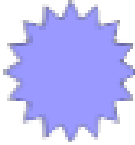
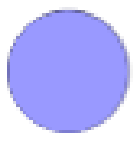
Shape descriptor	Formula	Meaning	Low value	High value
Roundness⁽¹⁾ (1 u.a max)	$\frac{4.A}{\pi D^2_{max}}$	Related to the circular - elongation shape level of ROI; A value of 1 for roundness means a perfect circle.		
Circularity⁽²⁾ (1 u.a max)	$\frac{4\pi . A}{p^2}$	Related to the ROI surface roughness (bubble wall regularity).		

⁽¹⁾Roundness is often used instead of Aspect Ratio with the opposite meaning (D_{max}/D_{min}).

⁽²⁾Circularity also know as shape factor

♦ *The cake slices image analysis macro program*

```
run("Set Scale...", "distance=4734 known=100 pixel=1 unit=mm global");
run("8-bit");
run("Brightness/Contrast...");
run("Enhance Contrast", "saturated=0.4 normalize equalize");
run("Threshold...");
setThreshold(0, 124);
run("Convert to Mask");
run("Make Binary");
```

```

run("Median...", "radius=4");
run("Watershed");
run("Set Measurements...", "area mean display redirect=None decimal=3");
run("Measure");
run("Set Measurements...", "area mean perimeter fit shape feret's display
redirect=None decimal=3");
run("Analyze Particles...", "size=0.10-Infinity circularity=0.00 -1.00
show=Nothing display summarize add");
run("Summarize");
run("Distribution...", "parameter=Area or=10 and=0-5");
run("Distribution...", "parameter=Feret or=10 and=0-5");
    
```

5.2. X-Ray Tomography measurements

5.2.1. *X-ray Tomography method principle*

X-ray Tomography technique is based on the fact that the intensity of the x-ray pattern depends on the density of the matrix the laser goes through. It allows the visualization and the evaluation of microstructural features of materials such as food foams (Salvo et al., 2003). Whence it is especially applied to the study of the porous – brittle structure of coffee bean (Frisullo et al., 2012), chocolate, as well as fruits (Barcelon et al., 1999, Léonard et al., 2008), rice (Zhu et al., 2012) and even meat (Frisullo et al., 2009) . Furthermore, it has already been applied to several investigations led on bread dough following bubble growth (Abdullah, 2008a, Babin et al., 2006), or baked bread (Falcone et al., 2005) also attempted on cake (Lin & Miller, 2000). 2D or 3D characterization can be provided.

Internal structures are reconstructed as a set of flat cross sections which are then used to analyze the two and three dimensional morphological parameters of object. The measurement is non-destructive and requires minimal sample preparation.

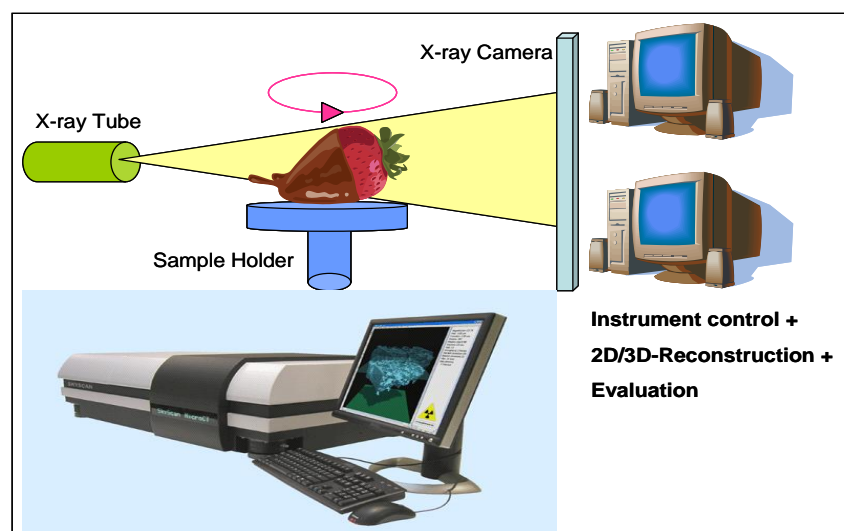

Figure 52 : Outline of x-ray a Microtomograph such as the Skyscan 1172

5.2.2. X-ray Tomography sample preparation

Cake samples were cut on the side (as show the image). Two subsamples were cut at a size of 10x10x10 mm, in order to show the top and bottom part of the cake as a continuous structure. Before X-ray scanning to be performed, the samples were stored over night in order to increase stability of the sample by hardening /drying them.

5.2.3. Image acquisition: scanning and reconstruction parameters

Images were acquired on a X-Ray tomograph Skyscan 1172 with a X-Ray beam of 50 kV and 199 μ A. Al filter was used. Scans were performed with the Skyscan control program (version 1.5.8.0, A Hamamatsu 10 Mp camera) and were reconstructed using the Skyscan recon software (version 1.5.1.1). With the X-Ray tomograph instrument, a 360° radioscopic image data of an inspection object placed on a sample table is obtained using an X-ray Image Intensifier by turning the table while irradiating the sample with X-rays. The accrual resolution is dependent on the distance between the sample holder and the x-ray camera. Detail detectability is < 2 μ m, the maximum sample diameter is 68 mm.

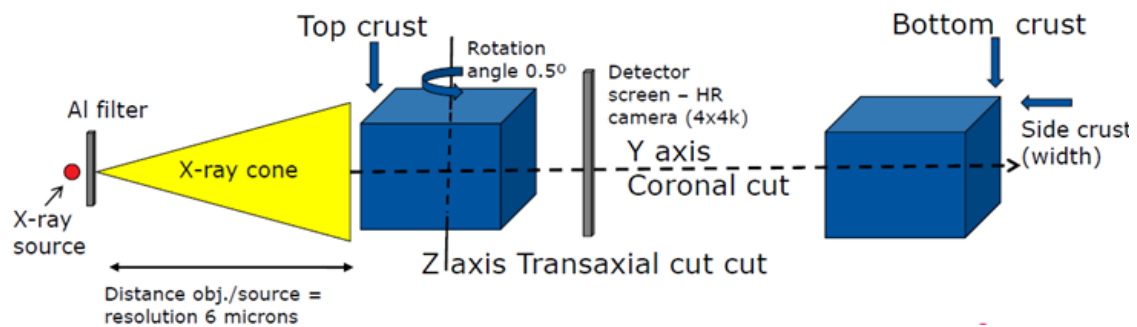

Figure 53 : Representation of the X-Ray Tomography measurement on cake' samples and the multiple scanned elements occurring upon testing.

Table XXII : Scanning acquisition and image reconstruction parameters applied to the microstructure study of cake's samples using X-Ray microtomography technology.

Parameters of scanning		Parameter of reconstruction	
Camera pixel	4000x2096	Setting contrast	0.000 –0.020
Resolution	6 μ m	Smoothing	8
Scans dimension	180°	Ring artifact reduction	20
rotation step	0.5	Beam hardening	51
frame averaging	5		
Random movements	5		
Scan duration	1h51		

◆ *Tomograph image analysis macro program*

```
run("Set Scale...", "distance=824 known=10 pixel=1 unit=mm global");
run("Make Binary");
run("Invert");
run("Median...", "radius=2");
run("Watershed");
run("Set Measurements...", "area standard perimeter fit shape feret's
integrated display redirect=None decimal=4");
run("Analyze Particles...", "size=0.01-Infinity circularity=0.00-1.00
show=Nothing display summarize");
run("Summarize");
run("Distribution...", "parameter=Area or=10 and=0-0.1");
run("Distribution...", "parameter=Feret or=10 and=0-1");
```

6. On the rheological methods

Rheology is defined as the **science of deformation** and flow of matter characterizing properties such as viscosity or elasticity. In other words, rheology is the study of stress-strain relationship and illustrates the instrumental measurement of material texture (Bourne, 2002c).

Sample can either undergo a stress, σ (Pa unit) or a strain, ϵ (% or length unit) which is always associated to its response.

* $\sigma = F/S$ force / surface on which it is applied

* $\epsilon = \Delta h/h$ absolute deformation / initial length

Two main rheological measurements can be distinguished one from another and applied to solid or semi-solid materials study; high-strain and small-strain rheology:

In the former case, texture analysis can be conducted. Relatively high strain is applied to the measured sample: higher than 5% of its total length. Such measurements either evaluate the material resistance upon a given deformation or its ability to deform while submitted to a stress.

In the latter case, small-strain rates are applied, usually under 1% of the total sample length. High strain application could indeed be responsible for a depletion of its structural properties. This approach gives additional information on the material internal structure without causing sample damage. It is also known as dynamic rheology for which a sinusoidal and time-dependent variation of the strain is applied.

6.1. High strain rheology measurements for cake texture analysis

6.1.1. *Instrument, sampling and test conditions*

Texture analysis has been investigated in a compression mode by the way of high strain rheology. In such a measurement category, the deformation undergone by the sample is relatively strong and able to affect the overall product structure. The deformation is applied as a compression of a given distance through the assessed product and applied from its surface. The **TAXT_{2,i}** Texture Analyzer (Stable Microsystems, Ltd., Godalming, Surrey, UK) was used in parallel with its operating Texture Expert Exceed software, whereby the recorded compression force is recorded as a function of strain compression percentage upon testing time.

6.1.2. *Tests and textural features*

Two kinds of tests are practically applied to the sample: Texture Profile Analysis (**TPA**) and **relaxation** tests. In both cases, tests were run using a 40 mm diameter aluminum probe, and a compression of 30% of the total sample height has been applied. Cake surfaces are first removed and a sample cylinder is cut out of the product (diameter: 25 mm and thickness: 19 ± 2mm).

TPA test has actually been developed in the aim to imitate mastication-like conditions. It consists of two successive sample compressions (30%) separated by an inter-compression period (5 seconds): Figure 54.

Textural features are recorded among which the maximal force obtained upon compression (F_{max}), the area under the curve associated to the first compression (A_1) and to the second one (A_2). Cohesiveness feature is given by the A_2/A_1 ratio. Young modulus corresponds to the curve slope while sample resistance force rises up upon compression strain. The Young modulus computation is based on the values recorded at the first stages of applied strain: initial stress-strain curve slope chosen in-between 1 and 4% strain against corresponding force values.

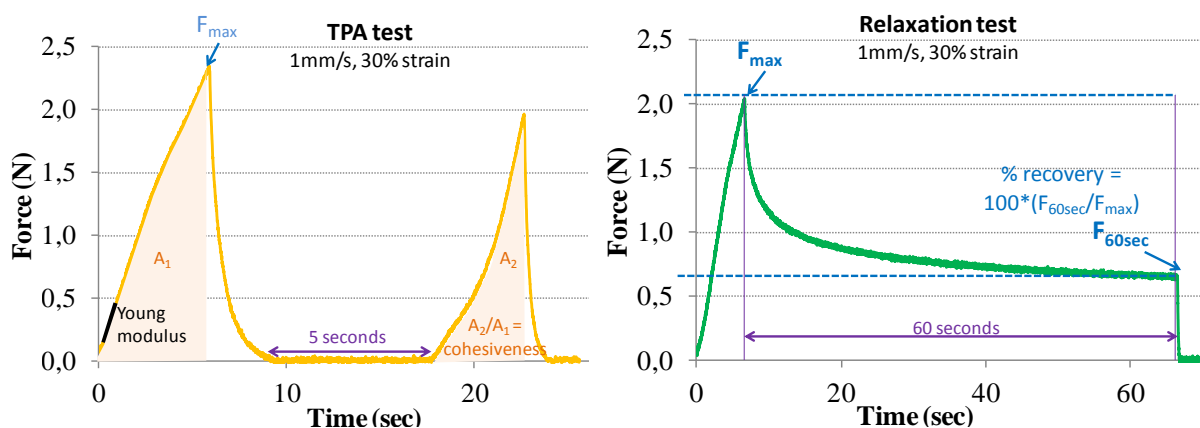

Figure 54 : Representation of a TPA (left) and a relaxation test (right) profile with the textural features associated to each measurement: F_{max} , Young modulus and recovery percentage.

Relaxation test consist in a single compression and the strain is kept for a given period of time: Figure 54. In our case the deformation was kept for 60 seconds prior test end. Several textural parameters were recorded on the relaxation test profile: Fmax and Young modulus were obtained as described in the case of the TPA test; recovery percentage determination involving both the maximal recorded force and the residual force value once the strain is removed is computed as followed.

$$\% \text{ Recovery} = 100 \times (F_{\max} - F_{60\text{seconds}}) / F_{\max}$$

It represents somehow the sample resistance level when submitted to long strain application with respect to its initial hardness (F_{\max}). The highest the recovery percentage the highest the resistance loss upon deformation is maintained.

6.2. Small-strain level rheology: dynamic rheology

Dynamic rheology allows the investigation of the viscoelastic properties which are endowed by the studied material. These latter are expressed in terms of both the storage modulus and the loss modulus which are in turn traducing the former elastic and the later viscous behavior displayed by a material, rather close to a solid-like or a liquid-like compound. The principle of the dynamic rheology method of analysis is to deform the sample without leading to its destructuration.

In the present case, it especially means that the cell wall constituting the cake crumb should not be disrupted by the applied strain and that the assessed time range allows the material to recover its initial shape.

The sinusoidal deformation applied to a given sample is characterized by a pulsation of $\omega=2\pi f$, with f the imposed measurement frequency. The sample rheological response (force F , N) to the sollicitation (deformation γ) was recorded by the way of a force sensor. Such a response can be either in phase with the deformation (ideal solid), or partially out of phase with an angle value δ (phase difference angle): Figure 55.

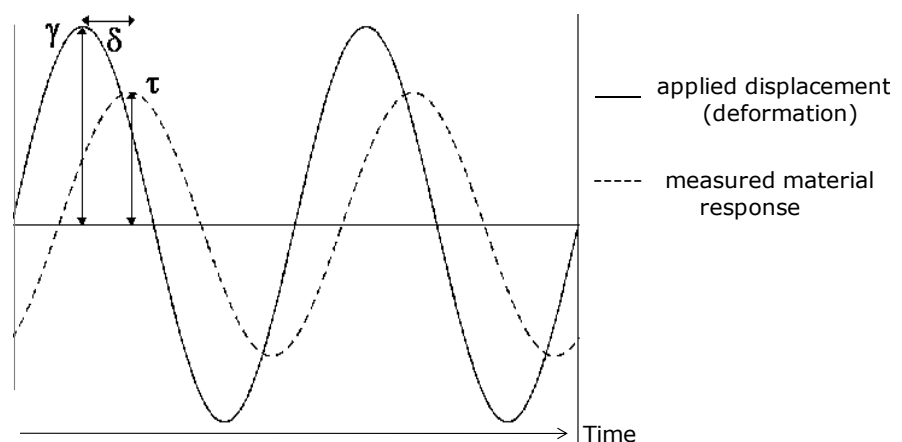

Figure 55 : Schematic representation of the phase shift between the material sollicitation (full line) and its response (dotted line) under a dynamic sollicitation.

The viscoelastic behavior of a material can be described by its complex modulus, E^* or G^* respectively in the case of uniaxial or shear deformation and explains the overall material resistance to deformation:

$$G^* = \sigma^*/\gamma^* = G' + iG'' \text{ in the case of shearing deformation}$$

$$\text{Or } E^* = \sigma^*/\epsilon^* = E' + iE'' \text{ in the case of uniaxial deformation}$$

The components of the complex young' modulus are defined by the following equations:

$$E' = \sigma_0 / \epsilon_0 \cos\delta \text{ and } E'' = \sigma_0 / \epsilon_0 \sin\delta$$

It represents the calculated modulus ratio E''/E' (i.e. Young modulus viscous behavior component divided by Young modulus elastic behavior component).

It is worthy of note that the same equations can be applied under shearing conditions to determine G' and G'' moduli, using the corresponding shear rate (γ) instead of the uniaxial strain (ϵ) into the equation.

E' (or G') as the real complex number equation represents the conservative part whereas E'' (or G'') as the imaginary component represents the dissipative part; σ^* and σ_0 the stress and its amplitude, respectively; γ^* the shear rate; ϵ^* and ϵ_0 the uniaxial strain and its amplitude respectively.

The storage modulus (E') illustrates the matter rigidity and corresponds to the stored energy of the sollicitation undergone by the material and further restituted as a reversible deformation.

The loss modulus (E'') illustrates the matter viscosity thus, its liquid-like behavior. It corresponds to the deformation energy which is dissipated as heat.

The calculated E''/E' ratio, computed for uniaxial deformations - or the G''/G' ratio in the case of shearing - is known as the loss factor or loss angle ($\text{Tan}\delta$). It actually corresponds to the lost to stored energy. $\text{Tan}\delta$, as such involving moduli ratio is a sample-dimensions-independent parameter. It will thereby be considered all along the study to compare samples each other and upon storage.

This phase difference angle, δ , reflects the structural properties of a material. Ranging from 0 to $\pi/2$ (ideal cases), several kinds of material behavior can be encountered as a function of the δ value.

- $\delta = 0$: the stress and strain are in phase and are independent from the applied sollicitation frequency: the behavior is 'elastic linear.
- $\delta = \pi/2$: the stress is in phase with the strain rate illustrating the behavior of a Newtonian viscous material.
- $0 < \delta < \pi/2$: while sample deforms, a part of the provided energy is stored and the remaining is dissipated which actually characterize the physical behavior of a visco-elastic material.

Cake' samples rheological behavior has been studied using a Dynamic Mechanical Analyzer (DMA), the Viscoanalyzer VA2000 (METRAVIB R.D.S., SMDHR01, Limonest, France) and its operating software (Dynatest & VA 2000 version VA-LSDAS-12). Driven in a traction – compression mode, the analysis consisted in the measurement of the sample response while submitted to a sinusoidal deformation, characterized by its level (constant compression distance of $2 \cdot 10^{-5}$ m; about 0.1% strain) and performed under a frequency range of 5 to 150 Hz.

Sample were prepared by cutting out a cylinder from one entire cake using a 20mm diameter punch (17.5 ± 1.5 mm height). The cylinder was free of cake surface and cake sides and arised from a cake picked up amongst the studied samples, ergo a solely one per test. Each test was run at least in triplicates.

7. Statistics

The raw data were analyzed using statistical software (Statistica Kernel 5.5., StatSoft France, 1984-2000). ANOVA tests were performed followed by a post hoc test (Newman Keuls), mean classification method). In all graphs, the mean confidence interval (at 5%) is represented. Hierarchical Ascendant Classification (HAC or Cluster analysis) was performed on 'normalized' data using Statistica. PCA was also led on mean values data sets using the same software.

Multifactorial Analysis (MFA) was performed using SPAD statistical analysis software (SPAD, Decisia,).

8. Sensory method: Flash Profiling

8.1. Flash profiling principle

Flash Profile has been proposed and its use go back in time about a decade ago (Dairou & Sieffermann, 2002, Sieffermann, 2000). It is a rapid descriptive sensory method in which each panelist has to choose and use its own words to evaluate in a comparative way a given product space. This latter is simultaneously and wholly presented to the assessors group as one product set. Untrained subjects are usually recruited. Still, they are also selected in respect to their sensory skills as they must be able to describe their sensory perception without any trouble or difficulties. According to the major perceived differences among the products within the set, the generation of list of terms that best commensurate with the product description is requested from each one of the assessor.

Then, in the following Flash Profile (FP) step, subjects are merely asked to rank the products on an ordinal scale for each attribute that they individually create: (no intensity is asked to be assigned. The session duration depends on the type and the number of samples to be evaluated and can last from 2 hours to half a day.

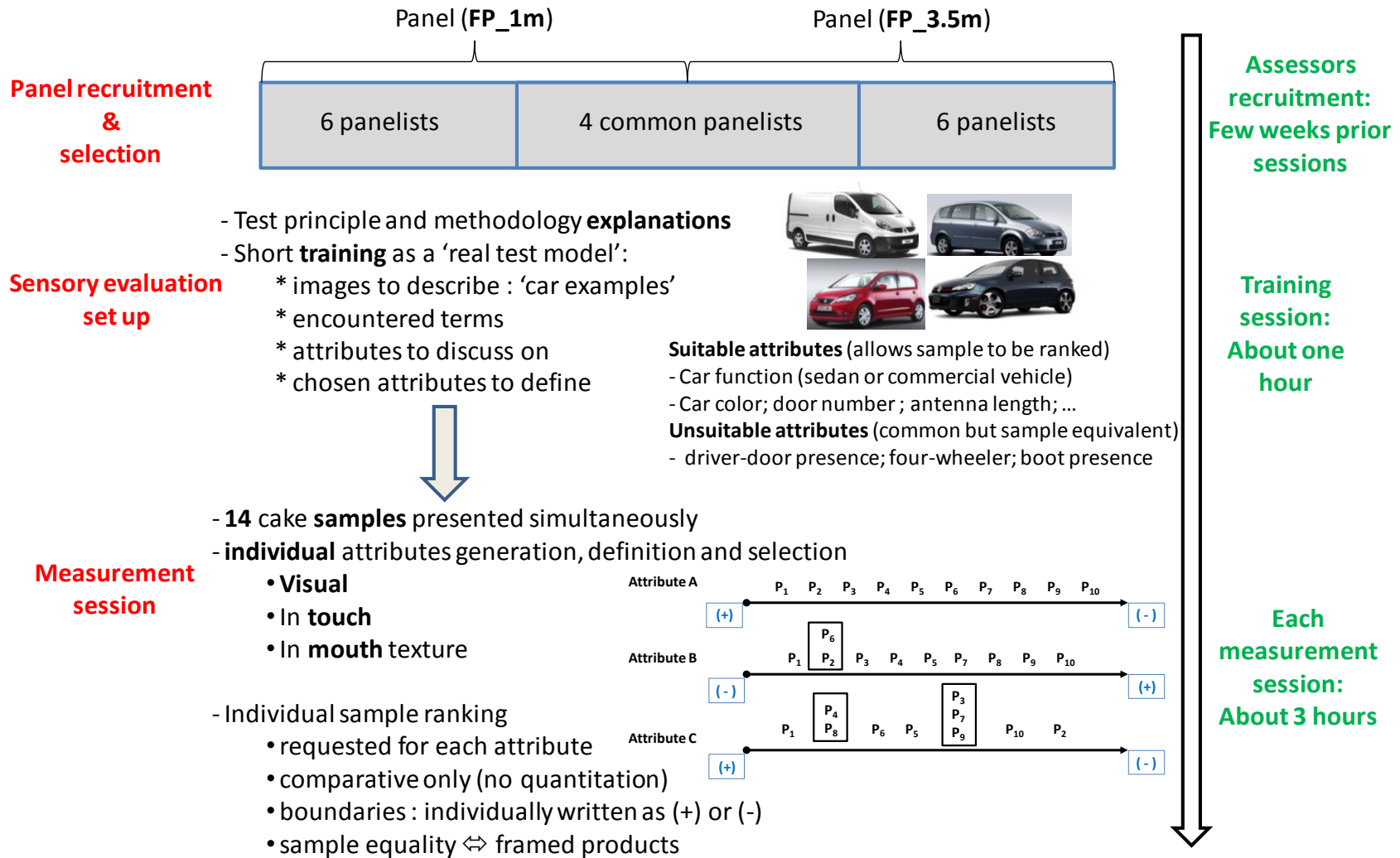

Figure 56 : Flash Profiling procedure: description of the different steps encountered in our study for the flash profiling to be performed on our 14 cake samples.

The use of a comparative method instead of a purely descriptive one display several advantages such as a better discrimination among assessed samples, a selection of terms associated to the product set thereby usually allowing a larger, more specific and relevant sensory vocabulary to be generated (Delarue & Sieffermann, 2004). In addition, a previous experience of panelists on the product space is not required for Flash Profile to be used ergo needing a shorter training and time to be performed (Dehlholm et al., 2012, Moussaoui & Varela, 2010).

FP also shows practical feasibility on the evaluation of a large food product set (Blancher, 2007, Tarea et al., 2007).

It helps as well to quickly identify the relative importance of the main sensory characteristics encountered among the studied products, and a qualitative sensory positioning of samples (Sieffermann, 2000, Sieffermann et al., 2004).

8.2. Flash profile set up and sequence

The flash profile evaluation was performed according to Flash Profile method described by Dairou and Siefferman (2002) and an additional approach, involving the kinetic aspect of cake texture was included. The same cake samples batches were evaluated in two distinct FP sessions, at two evolution stages: 1 month (annotated as FP_1m) and 3.5 months (FP_3.5m) after their production.

The different steps associated to the FP methodology followed to perform this study are presented in Figure 56.

8.2.1. Panel characteristics and session set up

The panel dedicated to the FP comprises ten assessors, untrained, males (3) and females (7) from 20 to 50 years old. They were recruited to perform the sensory evaluation of fourteen cake sample. The first 10 panelists of FP_1m as well as 6 of the 10th of FP_3.5m were chosen as 'naïve' subjects . Four judges were common to both FP_1m and FP_3.5m assessing the sample set for the first time during FP_1m and the second time for FP_3.5m. The six other assessors have evaluated the sample set for the first time in each case. Assessors received an introduction to the evaluation and a short training on car images as an example.

8.2.2. Flash profile measurement session

A flash profile evaluation has been brought into play on fourteen cake samples. Amongst sample set, one product was presented twice. It foremost serves as panelist' performances and repeatability control. Instructions were given orally also written to the assessors (Annexe 2) and response paper sheets were at their disposal (Annexe 3).

Panelists were allowed to use as much time as they needed. One full product was provided for the test, more if necessary and water at their disposal. Since cake are sensitive to dehydration, samples were distributed in their original packaging and additional plastic bag easy to be sealed back was provided. Panelists were ask to carefully replace the product once evaluated on each item.

It has been asked to the judges to look at the products, touch them and thereafter to taste them. Thence, in front of the given number of products presented simultaneously, each of the ten judges individually attempts to describe with its own words the set of products focus on the descriptive terms and avoiding hedonic terms. They further generated their own free choice vocabularies covering the sensory variations in the whole sample set as soon as they were related to the sample texture and that they belong to the following categories: product aspect, in touch texture perception, in mouth texture perception. The solely vocabulary development lasted about 30 minutes. Assessors were allowed to generate as much terms as they wanted to, as soon as the selected items were common to the whole sample group, but discriminative enough to be able to further establish a product ranking.

Then, samples were ranked attribute per attribute, on an ordinal scale anchored by each judge according to its own choice. The assessors were allowed to apply the same rank to two or more samples if no difference was perceived, thereby surrounding the actual sample equality on the response sheet. Among the fourteen presented samples one product was evaluated twice by each assessor in sensory booths.

8.2.3. On the data record and further statistical treatment

The entire profiling period, including vocabulary development, lasted about 3 hours (+/- 30'). Data were collected on a paper form, manually captured and statistically analyzed using Multivariate analysis. Multiple Factor Analysis –MFA- (Escofier and Pagès, 2008), was performed using SPAD statistic software (Winspad v5.5; 1996-2002; Decisia, Pantin, France) and considering each subject responses as one data set.

9. Conventional descriptive sensory profiling

9.1. Principle and objectives

The main objective of a descriptive sensory profile (DSP) is to accurately describe with a minimum of words as well as with a maximum of relevancy and efficiency sample to be studied in order to provide a reliable, reproducible and comprehensive product' "identity card" (AFNOR, 2002). The aim of all descriptive techniques is to generate quantitative data which describes the similarities and differences among a set of products (Lawless & Heymann, 2010a, Stone & Sidel, 2004c).

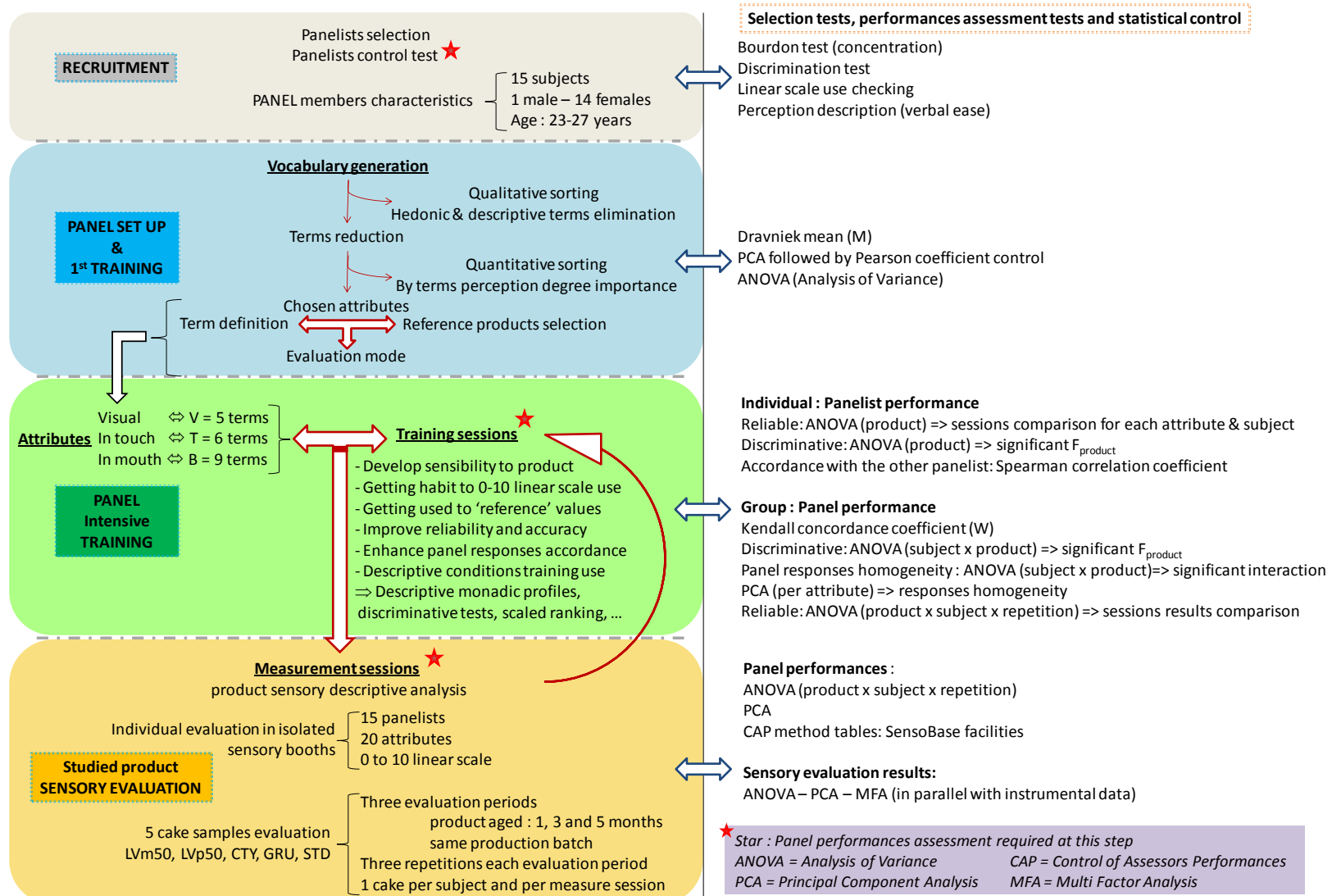

Figure 57 : Descriptive sensory profile sequence representation including the different steps of recruitment, training, measurement, data treatment and performances control.

Prior to product evaluation step, the descriptive techniques basic framework includes the recruitment of panel members, appropriate vocabulary generation and selection, panel performances control and thereafter, numerous training steps (Murray et al., 2001, Stone & Sidel, 2004a). Conversely to the FP, DSP involves a trained panel rather than untrained consumers (Meilgaard et al., 2007). Potential panel members need to be screened for their ability to discriminate between similar samples, rate products for intensity and in our case, identify texture characteristics (Lawless & Heymann, 2010b).

9.2. Descriptive Texture Profile: description of our sequence: Figure 57

9.2.1. *The panel recruitment*

Both the selection of judges and the assessment of their ability to describe their sensory experiences are included in the panel recruitment procedure. This step merely attempts to choose panel members based on their ability to easily describe their perceptions, their acuity and sensibility to the product.

Few tests have been conducted to verify these latter: amongst methodologies, memorization test, concentration assessment (Bourdon test), linear scale use, sample discrimination ability (classification test) and verbal description ease have been controlled. In the case of texture, the attributes list is usually not a source of any difficulty.

In our case, sensory measurement merely attempts to analyze samples texture perception instead of being concentrate on their taste perception abilities, odor sensitivity or color detection which require additional selection and training sessions.

Each judge is unique in terms of perception and physiological equipment as well as in his past experience on food products. Therefore, although including repetitions it is also necessary to work with a number of judges high enough to allow the optimal product characterization. The number of judges is usually comprised between 8 to 20 judges when the panel is under training but can be higher depending on the sensory profile nature (AFNOR, 2003) (NF ISO 8586-1: Guide général pour la sélection, l'entraînement et le contrôle des sujets).

The panel actually comprised 15 subjects, among which 14 females and 1 male, aged 22 to 27 years.

9.2.2. *The sensory attribute generation, selection and definition*

According to normalized methodologies, attributes generation was performed especially on texture (AFNOR, 1992, 1994). Samples were presented to the judge who individually generates a list of words corresponding to the products in terms of visual, in touch and in mouth perceived sensory characteristics.

Run over two sessions with a total of 10 cake samples either arising from our own production or commercial samples, the generation of words was asked to be individual and recorded on paper responses sheet. Then, the list was pre-reduced avoiding any hedonic term to be assigned thereby keeping the most relevant terms (AFNOR, 2003). A total of 146 terms was thus kept for the next reduction step which has been performed with another 4-products set. This latter reduction has been done using statistical tools including Dravniek mean (M), ANOVA (subject x judge) and PCA analysis combined with Pearson R^2 in order to further decrease the number of words and improve its overall relevancy and reliability.

Final attributes are thereafter determined in agreement with the whole panel by the way of a discussion on each one of the generated words to decide whether to keep it for the final list of items. The most relevant terms that are kept for further analysis are called 'sensory attributes'. Their meaning, the evaluation methodology as well as scale levels references are defined in accordance with the panel group. The intensity references are also chosen allowing the sensory evaluation to be as accurate as possible. For the considered attribute, at least two food products are determined and selected which represent the lowest and the highest level of the sensory perception. A total number of 20 items have been chosen and defined including 5 visual (aspect), 6 in touch texture and 9 in mouth description attributes: Annexe 4.

9.2.3. Training and control of our panel

Selected panelists are specially trained for the task to be done: product quantitative description. Expert panels are trained in the aim to enhance their performances and improve the global response quality (Bourne, 2002d). Reliability, accuracy and discrimination are the three main characteristics required for a panel to be conducted (Pineau, 2006, Schlich, 1996). It has been shown that consumer panel and panel experts can lead to similar results, regarding product discrimination and result reproducibility (Worch et al., 2010).

However, owing to a higher experience on the assessed products which is brought by training, expert panels provide a richer vocabulary with more specific attributes and a lower variability. In addition, it merely requires very few panelists (8-15) whereas a large number is required for consumer's tests (80) which are therefore more reliable for kinetic studies. Panel performances are assessed using statistical methods on data groups.

Panel training encompasses term generation, concept alignment and panel testing phases (AFNOR, 2003). The amount of training required is dependent upon the method used as well as the product(s) to be tested. Equally, or possibly more, important than a panelists' sensory acuity is their motivation and is important as well to the quality of the data obtained (Chambers et al., 2004).

Training sessions aim to get the judges able on many samples to well discriminate products, and to use accurately, with a high reproducibility the chosen attributes (Pineau, 2006). They consist in the evaluation of the intensity level of different products within the same category. Specific training sessions are also taking place to work on some attribute references and scaling when require. Panel performance evaluation is thus following sensory training and measurement sessions useful to give a feed-back on the global analysis quality.

Because a common agreement between panelists' responses within the group is important to attest of the data set quality, panel performances needs to be controlled. Statistical methods are used in this aim. This is performed by the way of panel data treatment including Analysis of variance (ANOVA), Spearman correlation coefficient and Kendall concordance coefficient (W) which respectively help to determine if subjects are able to discriminate products, and if whether individual responses are in accordance with the overall group evaluation or isolated.

9.2.4. Measurement sessions

Measurement sessions started once panel displayed a high repeatability, reproducibility on samples with few days in-between (ANOVA product and mean square comparison between repetitions), and was sensible enough on the product evaluation (ANOVA product-subject, PCA). During measurement sessions, samples were presented individually and evaluated for each attribute on a 10 cm linear scale (AFNOR, 2003). One cake for each panelist was distributed in its original sealed packaging, at ambient temperature. Apple slices and water were let at their disposal. No restriction on the sample quantity they should consume was given. Still, each panelist was asked to successively evaluate the visual then in touch finally in mouth items based on a monadic sequential profile, attribute per attribute.

The first sensory evaluation was performed on 1 month old products, followed by a second and a third session for which samples from the same batches were respectively tested after 3 and 5 months of storage. Each measurement was divided in 3 sessions to allow repetition to be performed. Every session, independently realized was used to individually analyze each one of the 5 studied products (GRU, CTY, LVp50, LVm50 and STD) on the 20 selected item by the 15 judges isolated in sensory booths.

In-between measurements sessions, training sessions were taking place, once a week for long lasting periods without measurements (from 1 to 2.5 months, and 3 to 4.5 months) and twice a week during the two weeks that precede measurement session (2.5 to 3 months and 4.5 to 5 months). Panel was asked for the sensory evaluation of typical products either commercial or model samples. The aim was to maintain a high level of training and regularly check panel group performances.

9.3. Data capture, treatment, panel performances: a statistical approach

Each sensory booth was equipped with a computer screen linked to Fizz sensory software (Fizz, Biosystèmes, France, 1994-2010, Version 2.46b) which thereby allows the sensory evaluation to be easily conducted and which facilitate data collection.

A 3-factor ANOVA has been realized (subject x product x repetition) on the whole items set to see whether the panel discriminate products; if F_{product} is not significant, then, panelists are not able to properly distinguish samples on this item, which thence need to be eliminated. Then, if an interaction is highlighted (product x subject), PCA need to be observe to whether determine if it arise from a real disagreement between panelists or if it merely come from a scale intensity difference in the assigned notation: Annexe 4.

Attributes for which a misunderstanding between panelists and for which no difference is recorded among studied products are therefore eliminated from the data treatment thereafter led on data set to see whether sample are distinct from each-other and on which attribute the distinction is based.

A PCA analysis led on the whole retained items is also later used to better visualize data in a multi-dimensional way and a correlation table is detailed on items correlations existing in-between samples. Hierarchical Ascendant Classifications (HAC) or 'Clustering' was also realized in the attempt to identify different groups of products. Elementary statistical analysis, ANOVA, PCA and HAC were performed using Statistica software (Version 10.0 StatSoft Inc,France).

The overall and individual panel performances were controlled using the CAP methodology - Control of Assessor Performances (Schlich, 1997). Analyses were performed on data series recorded after 1, 3 and 5 months. CAP Tables allow the visualization of panel sensory performances based on descriptive profile results while a series of products have been measured on several items. Repetitions are required to be able to apply this method on a data set. Three independent tables were thus provided for each tested storage conditions.

The product differences importance and their reliability for the whole group are measured. Also, an evaluation of the group accordance between product differences levels and the relative scale variability between panelists is covered. MultiFactorAnalysis (MFA) was led on sensory data set in correlation with instrumentally obtained results using SPAD statistic software (Winspad v5.5; 1996-2002; Decisia, Pantin, France).

.....« *La science remplace du visible compliqué par de l'invisible simple.* »

Jean Perrin

CHAPTER 3: RESULTS

Influenced by its making process and its ingredient composition, cake texture is also the result of various interactions taking place in between its components. The structure of the so-called solid foam evolves all along processing and storage also affected by its temperature, moisture and other conditions modifying its textural properties....

Section I: Making process parameters influence cake texture

Cake sample manufacture merely consists of an ingredient mixing followed by baking steps which is further expected to give rise to a wished product. In addition, all along the making process, many parameters can be modified, affecting in some extent the properties of the created product. The potential influence exerted on its sensory perception has also to be taken in account, whence the present section. This first part aims to illustrate and explain in what an extent the process making might impact cake dough and baked product characteristics. Both making process scale and the type of mixing will be investigated using physico-chemical and sensory approaches.

This section will thus be divided in three main parts;

First, the impact of the production scale will be investigated and illustrated for a few samples, with regards to both crude and baked dough characteristics.

Second, the influence of different mixing processes on the physico-chemical properties of cake batter and on the resulting baked product will then be described.

Third, a more thorough approach on the study of the impact of making process (together with its formulation) on physico-chemical and sensory properties of cakes will finally be depicted.

1. Mixing process scale impacts cake's textural properties?

The influence of sample production batches has been controlled at each step of the sample making process including crude dough characteristics, baked product physico-chemical and sensory properties. With regards to the recorded data, it does not exert any influence, making us able to compare samples created under the same formulation and making process conditions whenever they were produced.

Data coming from distinct batches were thus combined and expressed as the mean value (\pm confidence interval). Three different scales were investigated: **Table XXIII**. Indeed, cake sample production for analysis has been performed in laboratory conditions (Lab) and in a pilot plant using either relatively small batch equipment - P1 -

(25 cakes each, static oven) or larger manufacturing equipment - P2 - (400 cakes, continuous oven production). Both dough and cake physico-chemical characteristics were thence taken into account to let the comparison to be performed. In this purpose, at least three distinct samples are presented for each scale in Table XXIV.

Table XXIII : Making process parameters at three different scales in “standard conditions” for several studied samples.

Making Process Scale	Mixing kneader volume/dough kg	Oven type	Number of samples produced per batch
LAB	500g	Static oven baking	16
P1	3kg	Static oven baking	25
P2	6kg (2 batches)	Continuous baking	400

Regardless the differences between studied samples within one scale type, it appears that applying the Lab, P1 or P2 making process particularly affects the cake characteristics while unbaked (dough apparent viscosity and relative density), but also influences the level of development of the cake upon baking as well as its final density: Table XXIV (b).

Table XXIV: Impact of the making process scale on the cake samples physico-chemical characteristics. Measurements were performed prior baking and after one day of storage. Main crude and baked dough controlled parameters; water activity (A_w) and water content (% H_2O): (a).

Dough apparent viscosity is given for a shear rate of 2.5 rpm (Brookfield measurement) (b).

All data represents mean value \pm confidence interval of the considered parameter.

	Parameter	LAB	P1 & P2
DOUGH	A_w	0.84 ± 0.01	0.82 ± 0.01
	H_2O (%)	28.6 ± 0.1	26.4 ± 0.4
BAKED PRODUCT	A_w	0.70 ± 0.00	0.70 ± 0.02
	H_2O (%)	16.9 ± 0.2	17.7 ± 0.60

(a)

SCALE LEVEL	Sample	DOUGH		BAKED PRODUCT	
		Density (g/cm^3)	Apparent viscosity (mPa.s)	Height (mm)	Density (g/cm^3)
LAB - Laboratory SCALE	STD	0.845	68900	30.0	0.296
	CTY	0.889	61950	27.5	0.319
	GRU	0.814	79230	30.8	0.272
P1 - Pilot Plant SCALE	STD	0.822	85600	31.8	0.387
	CTY	0.843	66500	29.9	0.404
	GRU	0.801	105000	32.8	0.367
	LVm50	1.045	72800	31.5	0.443
	LVp50	0.749	80000	26.0	0.379
P2 - Pilot Plant SCALE	STD	0.869	88400	29.0	0.393
	CTY	0.975	56000	27.0	0.432
	GRU	0.869	109500	30.5	0.362
	LVm50	0.967	73400	25.0	0.466
	LVp50	0.769	93200	26.0	0.377

(b)

It is worthy of note that P1 and P2 products appears more similar each other than 'Lab' scale samples. It merely originates from the common Pilot plant mixing process operated for P1 and P2 (equal kneading and batch quantity). Such a mixing process foremost exerts an influence on the cake dough consistency index which is in turn a parameter that illustrates the mixing efficiency. It is observed to be higher in P1 and P2 than at lab scale. Meanwhile, scale impact is also observed on baked products for which a slightly higher difference is recorded between P1 and P2. Baking step actually increases differences on cake product height and density parameters as the oven and baking cycles were adapted from P1 to P2 either involving a static or a continuous oven use. Although differences are detected between Lab, P1 and P2 scales considering one sample, results also suggest that, regardless the scale levels that is brought into play, the effect of several studied factors is equivalent while solely considering the samples characteristics within one scale: Table XXIII, Table XXIV.

Therefore, while considering samples based on a quantitative characterization, it appears important to compare samples belonging to one scale only. These findings also confirm that a comparison between samples based on their relative differences can be realized from one scale to another.

The sensory perception of cakes arising from the two process scales was studied. Due to the nature of expected answers and to the quantity of product that was possible to produce at each scale, sensory analysis was run involving either a genuinely untrained (P1 samples, Flash Profile (FP)) or a well-trained panel (P2 samples, Descriptive Sensory Profile (DSP)). Texture attributes that were evaluated were at least very close or equivalent in terms of both item name and meaning in P1 and P2 sensory profiles results. The comparison of both scales is represented on MFA (Figure 58) and PCA (Figure 59) product map. Unless process was different, the same sample position is observed. It should be undertaken that, from a sensory point of view, the vicinity of sensory responses is encountered on sensory product maps and can solely be based on the relative sample position.

The physico-chemical characteristics (of either crude or baked samples), but also the sensory perceived differences between three distinct making process scales - Lab, P1 and P2 - were ascribed to the sample nature, modifying its relative properties within each studied scale. **The impact of several factors** including making process type, ingredient incorporation, flour nature and baking powder level **has been shown to be exerted on samples whatever the making process scale is, showing equivalent relative variations within one scale.** This allows the study of each scale individually but brings forth to the possible validation from scale to scale and one another.

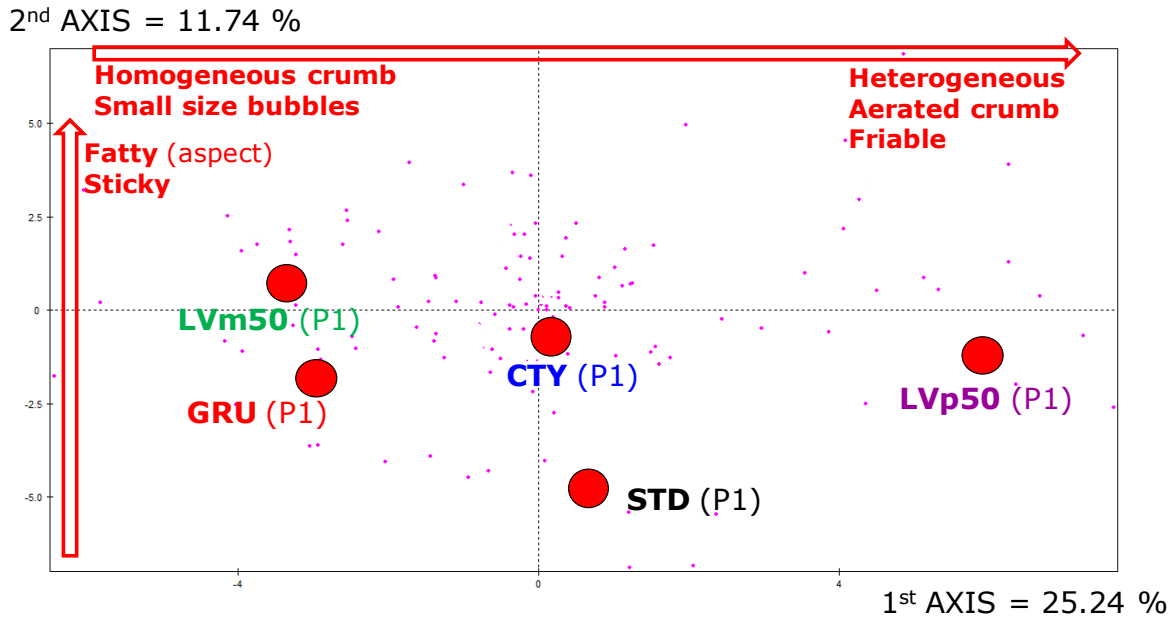

Figure 58 : Illustration of the sensory differences perceived between cake samples produced at P1 scale. The product map has been obtained by performing a MFA on the whole set of data involving 'visual', 'in touch' and 'in mouth' texture items following Flash Profile (10 panelists) on 3.5 months cakes. The sample codes in bold represents the 'product barycentre' position.

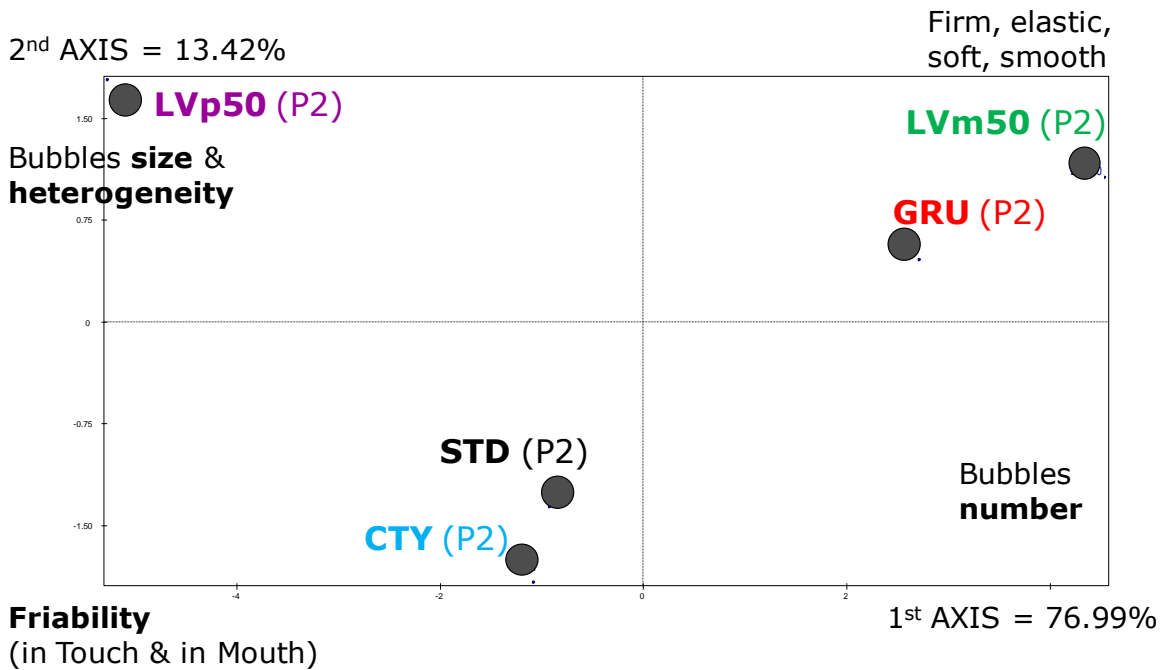

Figure 59 : Illustration of the sensory differences perceived between cake samples produced at P2 scale. Sensory data including visual, in touch and in mouth items evaluation were analyzed by the way of PCA. Data set arises from the descriptive sensory profile performed with 15 trained panelists on the 5 cake samples (3 months of storage). The sample codes in bold represents the 'product barycentre' relative position

2. *Ingredient incorporation order and mixing process type effects on physico-chemical properties of cake' dough and baked product: a laboratory scale study*

The impact of the ingredient incorporation order upon mixing and the mixing type was investigated on the cake dough and the baked product, and illustrated on physico-chemical parameters at a LAB scale.

Three samples were compared, the reference process sample (STD); a modified mixing order sample (WATER) and another sample obtained from a high shearing mixing process (MIX) that actually consists in using a mixer machine instead of a kneader. All the powdery, then liquids ingredients were mixed prior the addition of fat (liquid form) in the case of STD sample. In WATER sample, the same order than STD was applied but the water was added separately prior fats, still after the other liquid ingredients (eggs, glucose syrup, ...). For the MIX sample, all the ingredients, whatever the liquid or powdery state were incorporated at the same time and mixed together using a mixer-like kneader.

2.1. Impact on dough properties

The impact of the nature of the process has been measured on cake batter: Table XXV. Water content was kept constant (27.25 ± 0.53). It appears that dough made up with distinct mixing process can be distinguished from their density. Indeed 'Mix' process tends to globally increase the density of the cake batter compared to the 'Std' and 'Water' samples. On the one hand, this is mainly related to the fact that a regular mixing process in which ingredients are progressively incorporated is apply for 'Std' and 'Water' samples. On the other hand, the 'Mix' process does neither allow the protein network to develop (high shearing stress) nor a proper integration of air into the dough. Dough density and consistency index parameters were in line with these remarks while considering 'Water', 'Std' and 'Mix' processes (LAB scale): Table XXV.

Table XXV: Analytical values measured on cake batter prior to the baking step.

	STD	WATER	MIX
A_w	0.833 ± 0.003 ^(a)	0.843 ± 0.003 ^(b)	0.835 ± 0.003 ^(a)
Dough density (g/cm³)	0.845 ± 0.021 ^(a)	0.825 ± 0.007 ^(a)	0.980 ± 0.001 ^(b)
K (mPa.s)*	55 400 (n=0.68) ± 196 ^(b)	57 300 (n=0.68) ± 336 ^(c)	41 300 (n=0.73) ± 122 ^(a)

*K = consistency index in mPa.s.

It could be hypothesized that in addition with the high shearing nature of the mix process which already makes arduous to embody air, the lower mixing time does not give time enough to let ingredients being in contact with water molecules. Ergo, it does not allow a proper ingredient hydration. These findings suggest that a lower hydration that in turns, lead to a lower network development give rise to the resulting dough

consistency index which is observed in the case of MIX making process to be very low (Table XXV).

Besides, it appears that higher is the dough density, lower is the dough consistency index and that it is somehow evolving in a linear way. The correlation between dough parameters, recorded at a Lab scale has not been shown because solely based on three points (three mixing processes, LAB scale study).

2.2. Impact on final cake product characteristics

After baking, product exhibit a distinct development but neither the cake weight, owing to a different water loss during baking nor its water content were affected by the modification of the mixing process.

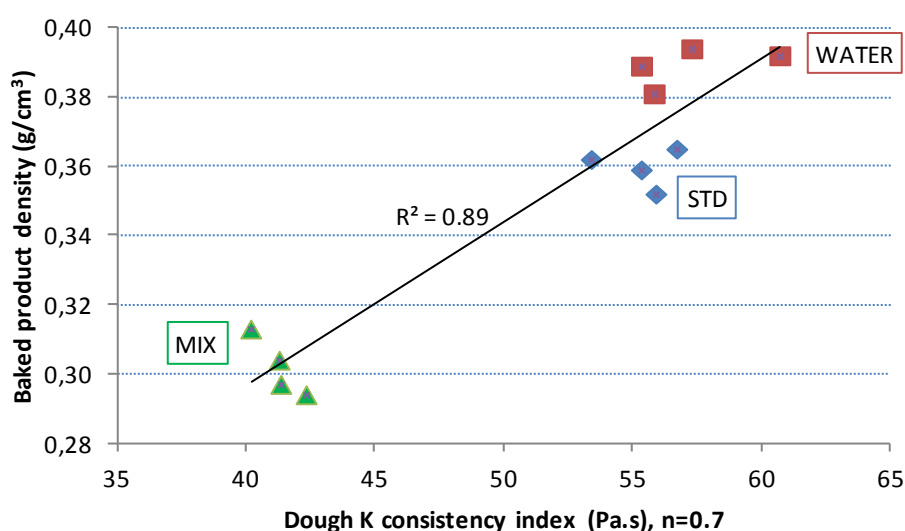

Figure 60 : Cake density (measured one day after the sample production) represented as a function of the dough consistency index values. Illustration of the influence of distinct cake dough mixing processes on the correlation between the latter parameters (LAB scale study).

The water activity instead was equivalent in samples 'Std', 'Water' and 'Mix' (0.665 ± 0.005). Nonetheless, product development was clearly modified by either the mixing type or the ingredient incorporation order. Compared to the reference 'Std' sample, cake prepared with 'Water' process displayed a lower height whereas 'Mix' shows the highest final cake height. Distinct baked product densities were also recorded for the different studied processes. Still, baked product density was observed to be in line with the measured dough viscosity. According to these results, sample with lower viscosity dough evidenced a higher development thence a lower final density: Figure 60.

In terms of textural and mechanical properties, 'Water' sample clearly show dissimilarities amongst the other samples: Figure 61. Indeed, this latter display the highest firmness but also the lowest $\text{Tan}\delta$ value (i.e. the lowest cell wall relaxation (i.e.

related to its mobility)) meanwhile the samples 'Std' and 'Mix' are not significantly different for these parameters.

Interestingly, the 'Mix' sample, showing strong differences while unbaked exhibit properties which are commensurate with the 'Std' sample (firmness and $\text{Tan } \delta$). It is also worthy of note that 'Std', 'Water' as well as 'Mix' samples exhibit the same ability to respond to a long strain application (no significant differences on %recovery parameter, data not shown). This could possibly be explained by the influence and compensative effect of both the lower density of the 'Mix' sample and the higher level of crumb bubbles cell walls relaxation whereas the opposite is observed in the case of the 'Water' sample.

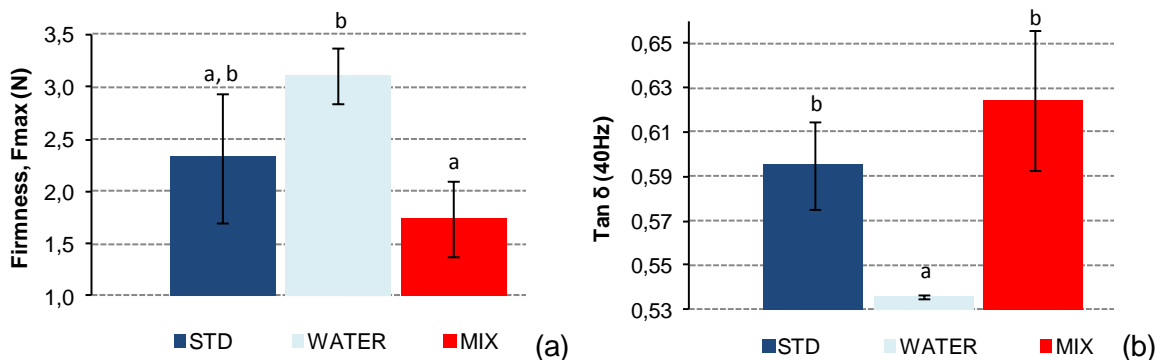

Figure 61 : Measured cake firmness (a) and cell wall mobility (b) as a function of the applied process. Measurements were performed on cakes after 1 day of storage.

The ingredient hydration may be facilitated in the 'Water' sample implying a stronger network set up. It initially display a higher consistency index, does not develop properly, leading to a dense structure with rigid cell walls which in turn help the structure to resist to a long deformation application. Conversely, in 'Mix' sample, instead of an appropriate hydration, an inordinate mixing is probably responsible for the low viscosity of the dough, its high density (rending harder air incorporation) but also its properties under and after baking (strong development, low final density and firmness product): Figure 61.

2.3. Dough and cake product characteristics influenced by making process

The 'Water' sample shows a low development, a higher density and a firmer texture as well as a lower elasticity (low $\text{Tan } \delta$) than the others samples. It is the only baked product to be discarded from the other studied samples on the basis of its characteristics. It can be supposed first that the water coming from the other ingredients whether lead to an over mixing of the dough instead of allowing its proper hydration and impairing at the same time dough components expected interactions, especially between proteins. Conversely, the late addition of the remaining water may then be

partly responsible for a partial ingredient hydration. It illustrates both its higher consistency index and its lower density. Still, as the last water incorporation and mixing is relatively short and occurs late, the sample cannot develop properly upon baking (weak cell walls) and high consistency.

It has been ascertain that the 'Mix' process that involves high shearing and short contact time generates dough with a low consistency index. These findings underpin the insufficient hydration of the dough. In the reverse order, the higher hydration level of 'Std' consequently increase the dough consistency index as well as its elasticity (protein interactions involvement). Air bubbles that are progressively embedded into the matrix can be thence more efficiently retained over baking step.

Based on these results, it could be anticipated that ingredient mixing in addition with its proper hydration gives rise to protein interactions consequently increasing dough consistency index also affecting its density and that implies modifications on both dough and cake properties. Notwithstanding differences applied to the mixing process, and according to the measured properties, it appears that the impact is first and last exerted on dough though having a fair effect on final cake product mechanical characteristics.

The understanding of making process parameters effects on cake batter and baked product is important to be concerned whence being able to better predict the influence of process modifications often brought into play for industrial needs. In this study, carried on at a laboratory scale, the studied processes (i.e., incorporation order as well as the mixing type) were chosen to mimic various industrial processes. The next part depict results obtained while studying the impact of different making process technologies on physico-chemical and sensory properties of cakes at a pilot scale P1.

3. Making process impacts cake's physico-chemical and sensory properties: a Pilot (P1) scale study

This study has been performed at one scale (P1), and several parameters were varied: Table XXVI. Different kinds of mixing processes were applied, involving either a mixer or a kneader. In this latter case, ingredients were mixed in a kneader bowl using a flat beater though the applied ingredient incorporation order was modified. It has been shown that the making process impacts batter density, viscosity but also leads to slight modifications of the cake height and density. Yet, sensory properties of cakes might also be affected involving visual, in touch and in mouth characteristics. It could as well be traduced by the mechanical properties measured on final cake, affecting its overall texture and more precisely its crumb bubble wall properties in addition with its aeration.

In this part, a sensory-scale approach is proposed for which a Flash Profile

sensory test has been performed. The use of this specific method is justified by the high number of making process parameters and formulation modification also including a combination of these factors which in turn yield a high number of samples to be assessed.

Mixing process foremost exerts an influence on dough sample properties while the impact on cake properties was not genuinely significant. Nevertheless, the impact of the different studied factors will be expressed firstly paying regards to the impact exerted on the physico-chemical properties of the cake batter. Then, the impact exerted on the baked product will be described and analyzed in terms of sensory perception.

Table XXVI : Products code listing and sample description

Sample code	Sample name	Sample description
A	RT_4H	Resting time 4 hours
B	STD	Reference sample
C	CTY	Crousty flour based sample
E	RT_1H30_Ta	Resting time 1h30, room T°
F	RC	'Robot coupe' mixing process: high shearing mix
G	GRU	Gruau Rouge flour based sample
H	SBK	Sobinka mixing order: Flour+sugar/water+glucose syrup/baking powder + emulsifier/eggs/oil
J	LVp50	50% more baking powder compared to the reference sample level
L	LVm50	50% less baking powder compared to the reference sample level
O	CTY_RCm50	Crousty flour, 'Robot coupe' mixing process, 50% less baking powder level
P	GRU_RCp50	Gruau rouge flour, 'Robot coupe' mixing process, 50% more baking powder level
S	CTY_RCp50	Crousty flour, 'Robot coupe' mixing process, 50% more baking powder level
X	RT_1H30_T40	Resting time 1h30, 40°C

3.1. Impact exerted on the cake dough physico-chemical properties.

Samples were controlled before baking for their water content, water activity and the subsequent parameters were also measured: dough density and viscosity: Table XXVII. Even though different viscosity levels were recorded for cake batter's samples, no correlation was highlighted between dough viscosity and cake density ($R^2 = 0.52$). It has rather been observed that dough and final cake density were somehow correlated for few samples as far as the flour is kept between compared samples: Figure 62.

However, no correlation is observed between batter and final products densities while modifying resting time (RT), mixing incorporation order (RC or SBK) or flour nature (CTY, GRU and STD): Figure 62. Such findings could be ascribed by several factors that obviously directly belong to the cake structure set up taking place along making process as well as the physico-chemical also mechanical properties of the dough. The impact of dough ingredients hydration should also be considered in a slighter extent.

Prominent interactions occurring upon mixing foremost give to the dough its elasticity and a certain ability to retain gas into the dough. While baking step dry out the dough by

water evaporation from the dough, it also allows cake development to occur driven by gas formation and crumb bubble growth.

Table XXVII : Physico-chemical properties of cake batters assessed prior baking step on pilot-plant-made samples. Data are ranked on the basis of dough density values.

Sample	CRUDE DOUGH		BAKED PRODUCT	
	dough density (g/cm ³)	App viscosity (mPa.s)*	product height	product density (g/cm ³)
RT 4H	0,744 ^(a)	90800 ^(d)	32,7 ^(b)	0,411 ^(c,d)
RT 1H30 40°C	0,747 ^(a)	72400 ^(b)	32,5 ^(b)	0,376 ^(b)
LVp50	0,749 ^(a)	72200 ^(b)	25,5 ^(a)	0,379 ^(b)
RT 1H30	0,767 ^(a)	90600 ^(d)	33,9 ^(c)	0,379 ^(b)
<i>GRU</i>	<i>0,801^(b)</i>	<i>105000^(e)</i>	<i>31,3^(b)</i>	<i>0,367^(a)</i>
STD	0,812^(b)	89200^(d)	31,9^(b)	0,392^(c)
<i>CTY_RCp50</i>	<i>0,837^(c)</i>	<i>40000^(a)</i>	<i>29,6^(a,b)</i>	<i>0,395^(c)</i>
<i>GRU_RCp50</i>	<i>0,840^(c)</i>	<i>66800^(b)</i>	<i>32,5^(b)</i>	<i>0,358^(a)</i>
<i>CTY</i>	<i>0,843^(c)</i>	<i>77200^(c)</i>	<i>31,4^(b)</i>	<i>0,381^(b,c)</i>
SBK	0,853 ^(c)	78000 ^(c)	33,6 ^(c)	0,365 ^(a)
RC	0,973 ^(d)	52000 ^(a)	35,3 ^(c)	0,394 ^(c)
<i>CTY_R Cm50</i>	<i>1,018^(d)</i>	<i>42800^(a)</i>	<i>35,3^(c)</i>	<i>0,430^(d)</i>
LVm50	1,045 ^(d)	76400 ^(c)	35,5 ^(c)	0,444 ^(d)

* = Apparent Viscosity measured using a Brookfield instrument at 2.5 rpm.

STD sample is represented in bold. Samples made with a distinct flour basis than the reference one are written italic.

Water content measured in dough samples = 26.19 ± 0.40; and in cake samples = 17.16 ± 0.55.

Values followed by the same letters in a column are not significantly different.

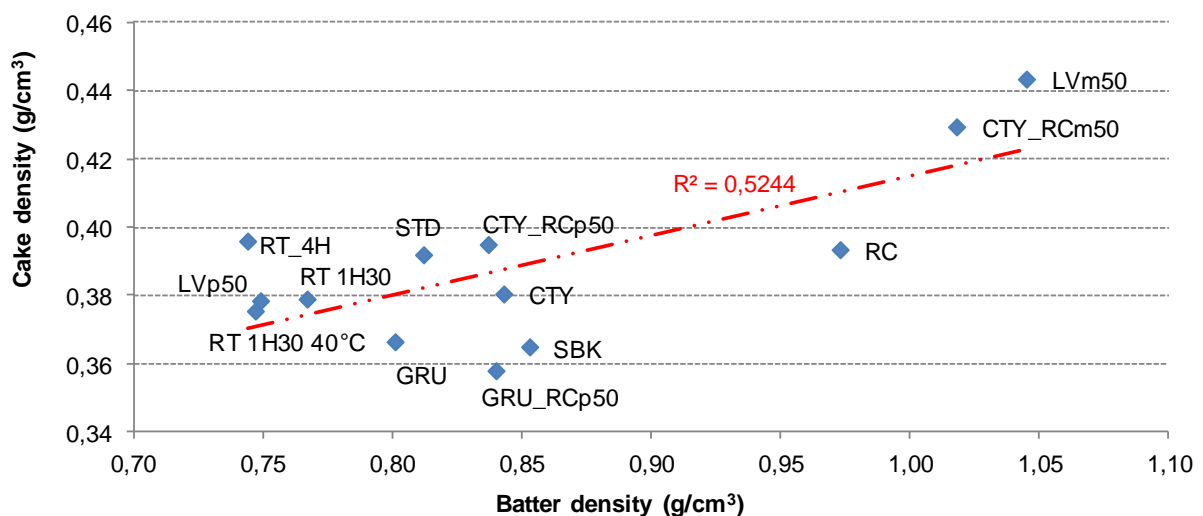

Figure 62 : Representation of the baked product density as a function of cake batter density for different cake samples whose mixing process, resting conditions and composition were modified.

Both phenomena lead to the overall expansion of the product structure from semi-liquid foam, the dough, to solid foam, the cake. Once raised up, the baked cake can still evolve. Indeed, three cases can be quoted as examples, illustrated by samples which were actually investigated.

First, an exacerbated development can originate from highly aerated dough initially: it can either be due to an extended resting time (RT samples) or a higher baking powder level (samples “*p50”). Besides, this can also occur if a strong bubble growth happens upon baking (facilitated gas bubble formation also bubble enlargement) and if the dough mechanical properties are already too weak; soft flour and impaired hydration (CTY samples). In such a case, the inordinate expansion is responsible for mechanical properties depletion of the final structure which further collapse (weak cell walls).

Second, a stronger network set up should be able to retain more gas and to maintain the developed structure even if raised up in a relatively large extent; the use of relatively strong flour. Then, in such a case, a relatively high dough density can give rise to a highly aerated cake i.e., lower final product density. Hence, the hypothesis based on the assumption that a low dough density is supposed to give low cake density can be discarded owing to the fact that, too scarce, it is solely visualized if the cake flour remains the same within the investigated sample range.

Third, the equilibrium between crumb bubble formation and growth with the mechanical ability of the material to retain gas and keep the structure once baking step has occurred (STD, GRU, also *m50 samples): Figure 62.

Such discrepancies yield the absence of correlation between dough and baked products relative densities. Several phenomena actually even up while cake undergoes modifications of its overall structure upon baking, which in turn also impact its mechanical properties.

As explain in the first section, baking powder level exerts alone a strong impact on dough and foremost cake densities. When a novel process is applied in addition with baking powder level modification, the influence on density also turns out important.

The cake batter characteristics as previously depicted can bear distinct properties to the final product while it is baked; cake dough initial aeration, crumb bubble growth and gas retention ability as well as cake mechanical properties can be quoted as the main involved factors.

The description and explanation of these differences between studied samples will be the purpose of the next part foremost encompassing various process and formulation factors to peer on the main cake products sensory characteristics.

3.2. Influence of making process on the sensory perception of cakes.

In regards with the influence exerted on both cake aeration and physical properties, a sensory flash profile has been carried out in order to wholly compare the studied cake samples between them and even so identify their differences. The aim was first and foremost to determine whether a given process, specific flour or a combination of these latter could modify the global texture perception of cake samples.

Since result comes as 2D product map MFA for each sensory dimension of the texture, samples were codified using distinct letters (Table XXVI).

Figure 64 show the overall perception and the visual, in touch, in mouth texture items evaluation of the fourteen studied samples. Sample positions were assigned using the 'barycentre' position of each sample. Amongst products, H and K correspond to the same sample (SBK) presented twice to assess panel performances. Hence, they were systematically classified in the same group, thus disclosing equivalent characteristics according to panelist' evaluation. This information is necessary to be able to exploit Flash Profiling data as it means that panelist genuinely answer with proper accuracy.

According to the hierarchical classification involving the overall sensory evaluation, four classes of products can be distinguished: Figure 63.

Process conditions including resting time duration or temperature, mixing incorporation order and mixing type are further perceived equivalent to the reference sample 'STD'. Still, changes are observed whilst process conditions combine flour nature or leavening agent level modification as well. It is for instance the case of 'O' and 'S' samples, respectively containing -50% and +50% baking powder. Although they are both made of Crouty flour, and involve RC process, the baking powder amount actually orientates the sample differentiation. Therefore, standard sample (STD), extreme leavening agent levels (LVm50, LVp50) and sample with distinct flour nature (CTY, GRU) are brought out on the product map using colored circles.

In the light of the product map which has been built with the whole Flash Profiling range of items, products are first and foremost clearly separated on the basis of their aeration (Figure 63). Strongest differences are indeed observed in terms of bubble size and crumb aeration homogeneity, mainly owing to the leavening agent level as LVm50 and LVp50 are extreme samples on the first axis. Also, distinctions on the basis of the sample firmness and denseness perception add another dimension to the sample discrimination.

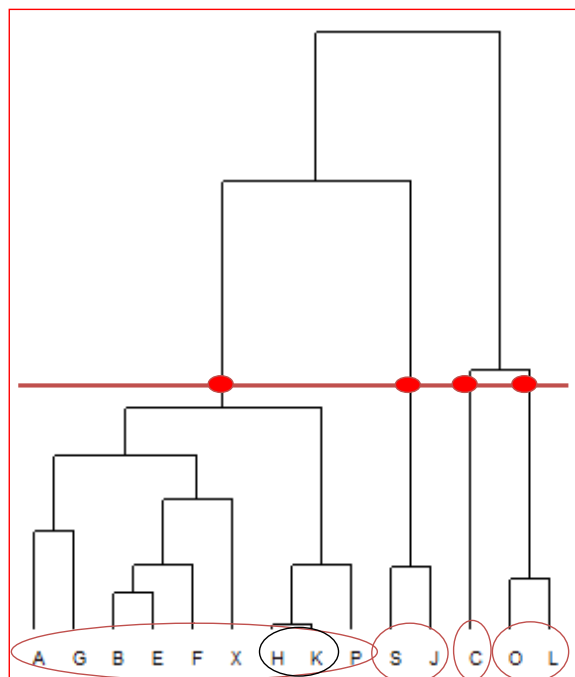

Figure 63 : Representation of the global perception (all items included in the analysis) using the hierarchical classification; the MFA has been performed on visual, in touch and in mouth sensory characteristics of 14 cake samples. Cake sample were assayed 1 month after their production.

Letter H and K exactly correspond to the same sample which was presented twice to assess panel performances (repeatability). Sample codes that are circled belong to the same group and display unsubstantial differences (red point = group node).

The visual, in touch and in mouth dimensions of the sensory evaluation were first thoroughly taken into account (Figure 63).

It clearly appears that whatever the making process nature which was undertaken, samples were globally equivalent to standard sample (group containing the 'B' code, i.e. STD). The other samples were involving either a modification of flour nature (C and G) or a baking powder level (L, O, J and P).

In the attempt to go further in classifying the products for their perceived textural properties, individual data treatments were carried out involving the visual, the in touch and the in mouth evaluation of cake' texture items separately: Figure 64. Interestingly, additional information is exposed as slightly distinct product classifications were obtained regarding the generated items types (visual, in touch, in mouth). HAC analysis evidence four to five sample classes visualized in the product map by the large surrounded areas,. It is worthy of note that representative samples of each class are common while assessing visual, in touch and in mouth items dimensions.

Thence, STD, GRU, CTY, LVm50 and LVp50 are depicted in each MFA product map (Figure 64) as previously illustrated for the overall sensory properties assessment (Figure 63).

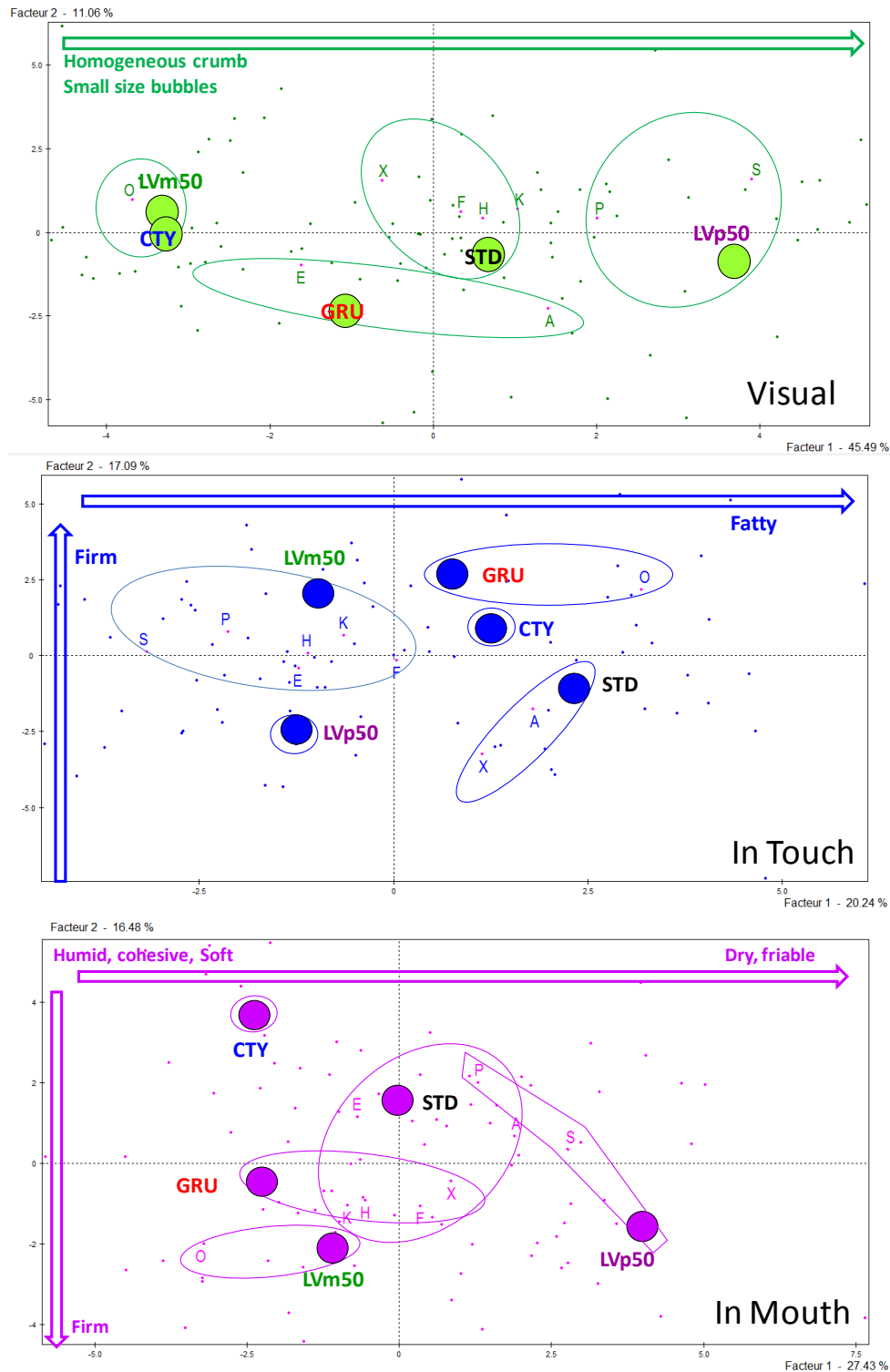

Figure 64 : MFA Product map representation obtained from the assessment of the cake's sensory properties in terms of visual (top), in touch (center) and in mouth (bottom) perceived texture. Cake samples were assessed 1 month after their production. Hierarchical analysis results performed for each set of categorized items is represented: sample codes that are circled exhibit unsubstantial differences between each other and belong to the same group (Hierarchical analysis). Sample code in bold corresponds to the group identifier. These five samples are chosen and studied further along the document to precise the impact of several factors (flour nature and baking powder level).

The assessment of the mechanical properties of the studied samples has been performed in parallel with the sensory evaluation (data not shown). Results given by these approaches were in line with what it could be expected from the sensory evaluation.

Besides, the studied process variations disclose a limited impact, only modifying batter characteristics whereas the effect exerted on cakes appears to be mainly driven by other factors than the making process.

4. Conclusion: How does making process parameters and formulation affect soft cake texture properties?

The study of the impact of more than one factor involving either composition and process conditions or a combination of these latter was performed using a multi-scale and multi-measurement approach.

The scale level is important to consider when quantitatively characterizing the impact of several factors. As illustrated at two scales especially using sensory characterization, the relative differences between samples are equivalently observed within one scale and one another. Given that it has been highlighted on several factors, it somehow allows extrapolating from one scale to another.

According to the results depicted in this 'process' section, it appears that making process exerts an influence on cake dough but that differences are even up after cake baking step. This study was as well carried out on a wide range of products created by the way of the use of various parameters including mixing process, resting time conditions and flour composition.

It is worthy of note that the latter can affect texture properties more than expected. Ergo, this parameter should be investigated. Whence, the concern with the impact of the nature of the flour to be used in the production of soft cakes products.

.....« *Nous parvenons quelquefois, en poursuivant nos recherches,
à trouver la vérité là où nous nous y attendions le moins.*»
Quintilien

Section II: The impact of cake aeration on its textural properties and evolution upon storage

In this section, the study of the baking powder factor on aeration characteristics and its influence on soft cake texture will be discussed.

We indeed suppose that bubble characteristics and its repartition within the crumb can affect both the cake mechanical properties and the perception. In the attempt to thoroughly investigate cake aeration properties, an instrumental-sensory approach has been led again in this chapter.

The baking powder level has been modified and the influence exerted on samples was studied to see whether a distinct aeration can affect the overall cake properties. Cake's aeration features characterizing the cake material porous structure will be first presented in parallel with its visual assessment mainly focused on the macroscopic scale evaluation. Then, rheological measurements will be presented also regarding in touch and in mouth perception. Finally, a thorough approach, including the whole range of assessed sensory properties and instrumental measurements will allow us to deeper study the correlations between the results at different scale and to know whether or not we can predict its texture only from its aeration.

It is worthy of note that a 50 percent variation of leavening powder level has been chosen. Unsubstantial effect of lower levels (30% variations and under) was measured in another study (data not shown). Meanwhile 30 to 50 percent baking powder based content variation appears as a prominent modification. Briefly, a variation of 30 percent of baking powder level was judged insufficient to generate enough differences between samples STD, LVp and LVm by the Kraft Food expert panel (data not shown).

Therefore, a higher value has been further apply, whence the chosen 50 percent variation. In order to create distinct aeration levels we choose to use three distinct baking powder contents: LVm50, STD and LVp50 cake contain baking powder levels of 0.5, 1, and 1.5%, respectively (0,6-0,8 and 1,2 g/gram dough respectively). Whilst the leavening powder ratio remains unchanged (within the P1 scale samples, and keep equal within the P2 scale), if any, subsequent baking powder level modifications were compensated by flour. From a formulation point of view, regarding LV level and batch sizes, 50% represents a genuinely insignificant variation (unchanged dry matter and proportions).

1. *Baking powder level influences aeration and physico-chemical properties of cake samples*

1.1. Impact on crude and cooked dough physico-chemical characteristics

The density of a sample illustrates its aeration level, i.e., the actual air proportion encountered inside the material (Campbell, 2003). STD product densities (both crude and baked dough) are in line with what it is usually measured on cake batter and baked cake - about 0.8 and 0.3 g/cm³, respectively - (Campbell & Mougeot, 1999).

It could be anticipated that a positive variation of the baking powder level incorporated into the dough formula would generate a larger gas amount. It is then responsible for the decreasing dough but also baked product density while air portion evolves upon resting and baking steps. A higher cake final height mostly due to a tremendous leavening agent action is thus expected. The actual measured parameters are given in Table XXVIII.

Table XXVIII : Parameters measured (mean values \pm standard deviation) after ingredients mixing, resting and baking steps on crude dough and baked product – P2 scale; dough apparent viscosity at 25°C, 2.5 rpm (η), density (ρ), and final cake height at the centre (H). Not significantly different between samples, Aw⁽¹⁾ and water⁽²⁾ contents are also given.

Parameter	η (mPa.s); shear rate 24 rad.s ⁻¹ .	ρ (g/cm ³)		H (mm)
		Dough (before baking)	Cake (stored 1 day)	Cake (stored 1 day)
LVm50	73 400 \pm 11 597 ^(a)	0.97 \pm 0.04 ^(c)	0.47 \pm 0.02 ^(b)	25.0 \pm 0.6 ^(a)
STD	88 400 \pm 4 950 ^(b)	0.87 \pm 0.02 ^(b)	0.39 \pm 0.01 ^(a)	29.0 \pm 0.5 ^(b)
LVp50	93 200 \pm 2 263 ^(c)	0.77 \pm 0.01 ^(a)	0.38 \pm 0.01 ^(a)	26.0 \pm 0.3 ^(a)

Samples with the same letter are not significantly different.

(1) Aw: 0.82 \pm 0.01 and 0.72 \pm 0.01 for the dough and the cake, respectively

(2) Water content (%): 26.4 \pm 0.8 and 19.1 \pm 0.3 for the dough and the cake, respectively

Product aeration is enhanced as the baking powder increase. The overall product density is consequently decreased though Aw and water content parameters are not disturbed and kept constant regardless the sample nature. Prior baking, LVp50 sample might already contain a higher air fraction compared to STD or LVm50, owing to the action of a larger baking powder amount that already generates gas during resting step.

Besides, dough apparent viscosity rose up when a higher level of leavening agent is incorporated to the cake formula. This parameter, measured on dough upon resting time is probably affected by the slight but not insubstantial action of baking powder. We indeed suppose that the higher recorded cake batter viscosity is related to an enhanced ingredient hydration that further forms the dough. It might be induced by the indirect

action of pH modification while adding baking powder in a larger extent (pH 6.7 and 7.1 for LVm50 and LVp50, respectively). Modifying its solubility, it might then be able to promote protein hydration and protein network development whence illustrated by the raised dough viscosity. Endowed with relatively high apparent viscosity compared to the other samples, LVp50 might also enhance air bubbles retention, once embedded into the dough that further undergoes volume growth over baking.

These quoted facts bring higher dough resistance to shearing, thus recorded as a higher viscosity. A linear effect is observed between leavening agent level and the measured dough viscosity ($y = 19800x + 65200$, $R^2 = 0.92$).

However, neither the cake height nor its density is proportional to the baking powder level. Compared to the 'STD' sample, the baked product volume was decreased by both the lowest and the highest leavening agent amount: Table XXVIII.

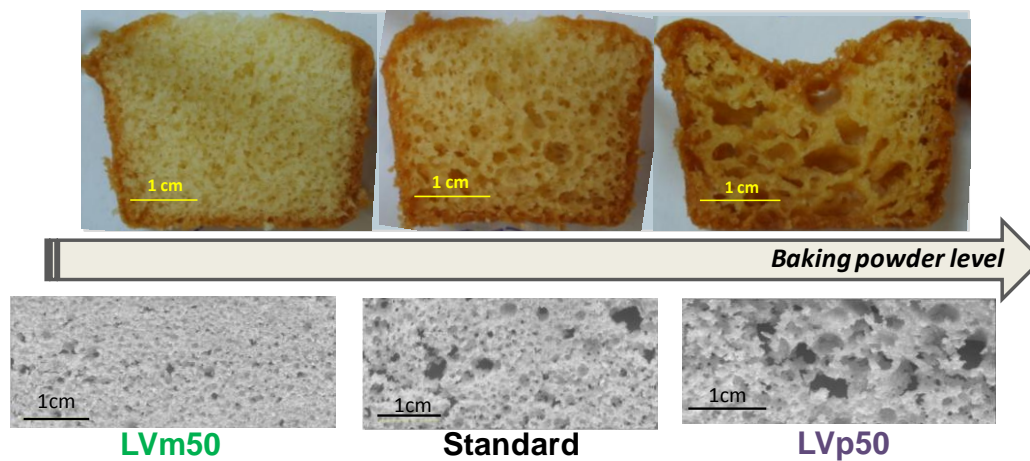

Figure 65 : An illustration of the impact of baking powder level of cake aeration; pictures (transversal cut) and grey level scanned images (longitudinal cut).

Whilst originating from slightly tougher and more aerated dough, LVp50 sample, after baking display a low height. Such discrepancies discard the hypothesis from which highly aerated dough automatically lead to highly aerated cake. It foremost argues that the final sample volume can be impaired while it is processed. Such effects can be assigned to a smaller raising agent level than required in the case of 'LVm50' which is consequently not sufficient to allow the product to develop properly also leading to a denser product. Conversely, 'LVp50' rises out of all proportion owing to an intensified baking powder action. The structural fragility brought by this exacerbated development, thence depleting cell wall resistance conduct the 'LVp50' cake sample to fall down in his centre: Figure 65. It explains both why LVp50 cake sample disclose a smaller height than expected and why its density is equivalent to STD: Table XXVIII.

These findings confirm that the LVp50 dough, endowed with a relatively high initial aeration and reinforced by its relatively high apparent viscosity, is able to strongly develop upon baking (Pérez-Nieto et al., 2010). However, its highly aerated structure is further disrupted while removing from the oven and let for cooling down. Incommensurate with its aeration level and its height, its crumb cell wall resistance remains too weak to allow the structure to be maintained, whence the low final product height: Figure 65.

The solely observation of cake samples betray tremendous differences between products in terms of visible aeration. To ensure the quantization of the cake aeration visual perception a sensory analysis has been brought into play firstly considering visually assessed items.

1.2. Aeration level impacts visual based sensory responses

Cake and crumb aspect, as well as several bubbles characteristics were enumerated and quantitatively evaluated using conventional descriptive profile. Amongst visual sensory items, products height, crumb bubble size and its heterogeneity were kept for further analysis to be conducted: Annexe 7, Annexe 8. Inversely, the bubble number evaluation item was discarded; actually forming two distinct group of values, as illustrated by the product*panelists PCA, panelist responses were thus highly dispersed and responsible for the significant product*subject interaction. The actual panel performances including the ability to discriminate products, the measurements repeatability and results homogeneity within the group are reported in the Annexe 9.

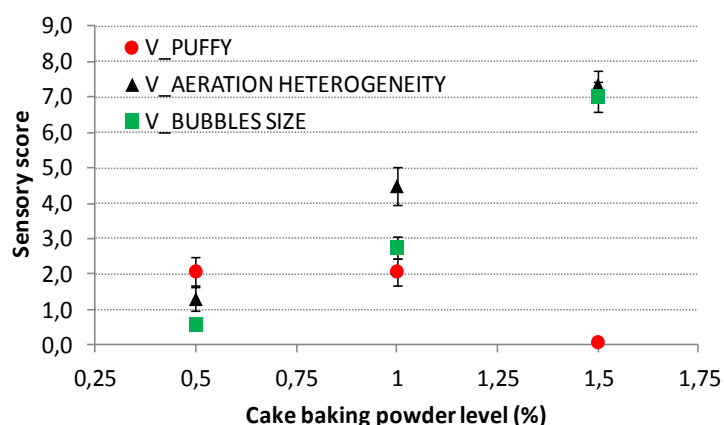

Figure 66 : Sensory scores obtained on visually assessed items for the distinct products as a function of baking powder levels.

On a 0 to 10 linear scale, visually assessed parameters show that higher is the baking powder content, higher is the perceived bubble size and crumb bubble heterogeneity. 'STD' shows values ranging in-between the LVm50 and LVp50

samples which confirms its relative intermediate perceived aeration position: Figure 66. As previously measured also discussed, the sample central height is still smaller in 'LVp50' instead of being enhanced. However, because the item V_Puffy does not strictly corresponds to the height of the product but whether it has developed in its centre, equivalent results were given for both STD and LVm50 samples whereas LVp50, in the light of the Figure 65, show a hollow in its centre.

Therefore, the 'LVp50' sample undoubtedly presents a heterogeneous distribution of the bubbles within its crumb. It also appears to exhibit large and cracked cells rather than clearly define and circle-shaped bubbles: Figure 65, Figure 66. Unless sought, such differences between studied cake samples need to be understood and depicted with more details ergo involving a deeper study of their porous structure.

1.3. Instrumental aeration investigations: to finer characterization scales

Crumb bubbles structure characterization has been undertaken using flat bed scanner and X-Ray tomography scanning methodologies. Bubble features determination provided by scan image treatment allows the distinction between the three samples crumb. Several aeration features were actually exploited among which bubble dimensions, shape and distribution within the cake crumb (Igathinathane et al., 2008, Impoco et al., 2012).

As expected, it has been ascertain that LVm50 cake displays significantly smaller bubbles than the two other samples STD and LVp50: Figure 67, a. Mean bubble Feret's diameter significantly rose up while adding a larger baking powder amount: Figure 67, b.

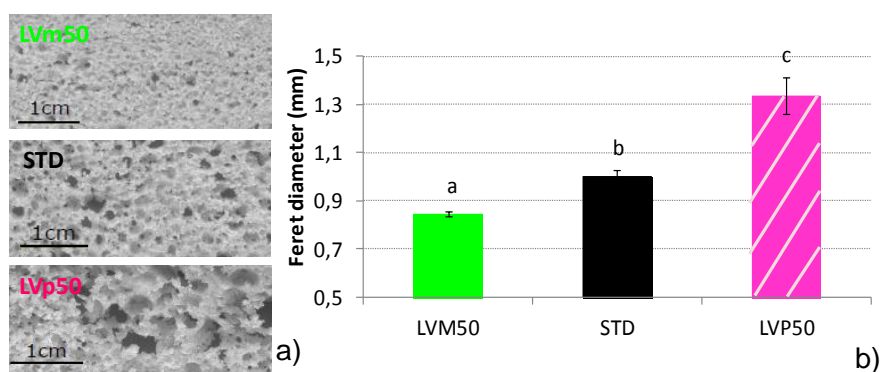

Figure 67 : Leavening agent level effect visualization on cake slices images (a) and on bubble mean size given as the mean Feret diameter value (b) +/- confidence intervals. Distinct letters means that sample are significantly different for the considered parameter.

The global crumb bubble size distribution, on a relatively global - close to visual, i.e. scanner method – dimension span is presented Figure 68, a. For clarity, data were grouped in ten categories based on the mean Feret's diameter value of detected objects and ranging from 'under 0.5mm' to 'upper 4.5 mm'. The object detection frequency is

represented for each diameter range in percentage. While looking to the bubble size distribution, it appears that major differences are visualized within the range of small bubbles (0.5 to 1 mm Feret’s diameter) and larger bubble size classes (more than 3 mm diameter). ‘LVm50’ contains many small size bubbles (diameter from 0.1 to 3 mm) whereas ‘LVp50’ exhibit a more open structure with higher bubble diameter and wider bubble size distribution: Figure 68.

Bubbles which display a diameter under 0.5 mm are more difficult to attribute and to be distinguished within the solid phase according to the scan images. Also, as a results of a better segmentation of small objects (i.e. bubbles), it has been shown on sweet bread crumb images that the detection of these latter is enhanced while scan image resolution increase (Farrera-Rebollo et al., 2012). Though the detection of a number of objects displaying larger areas are almost not influenced by the image resolution, the proportion of smallest particles (0.1 mm² area) increase with the chosen scanner resolution so that the number of detected objects gets higher while improving the image dpi value. This noteworthy proportion of smallest detected bubbles area could somehow betray another repartition of small objects.

Besides, the minimum distance between objects to be distinguished by human sight is about 0.2 mm. Thence, particles with smaller diameters, might not be considered as crumb cells by consumer or professional assessors, when evaluating crumb structure (Farrera-Rebollo et al., 2012) whereas with areas larger than 4 mm can be considered as bread crumb defects (Sapirstein et al., 1994). Notwithstanding, an additional approach has been employed whereby the characterization at a finer scale allows to precise what could eventually be comprised within the ‘small object span’.

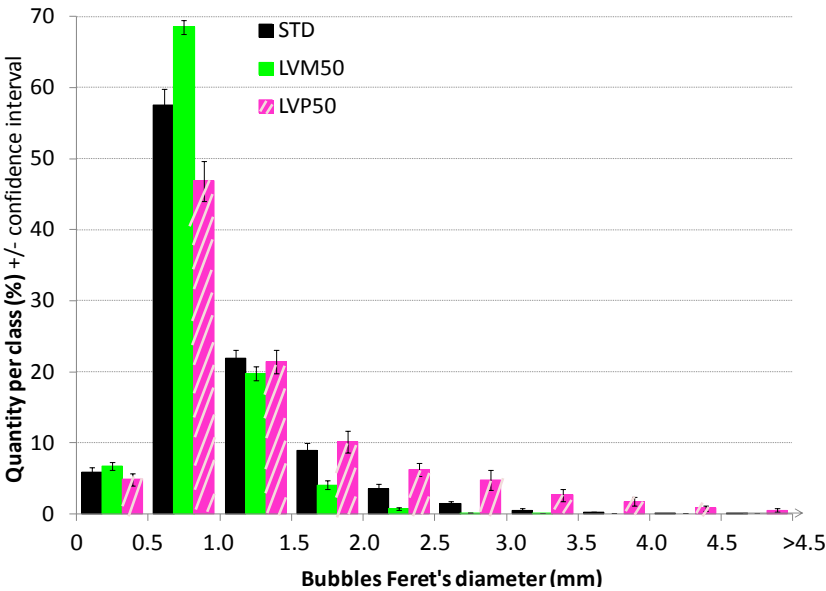

Figure 68 : Effect of the leavening agent level on cake crumb bubble size distribution within the 0 to 4.5 mm and upper bubble Feret’s diameter ranges based on the flat bed scanner image acquisition and analysis (i.e., large scale characterization).

Using an X-ray Tomography approach to better clarify the impact of leavening agents on bubble and its wall characteristics, we were able to visualize the inner crumb porous structure, including much smaller pores than those that can be seen at a larger scale: Figure 69. Air fraction is represented in black whereas the solid phase is shown in grey. Through the scan images obtained by X-RT, finer pores can deservedly be highlighted. Ranging from 10 to 100 μ m these pores are clearly detected as embedded within the solid phase (cake crumb bubble walls).

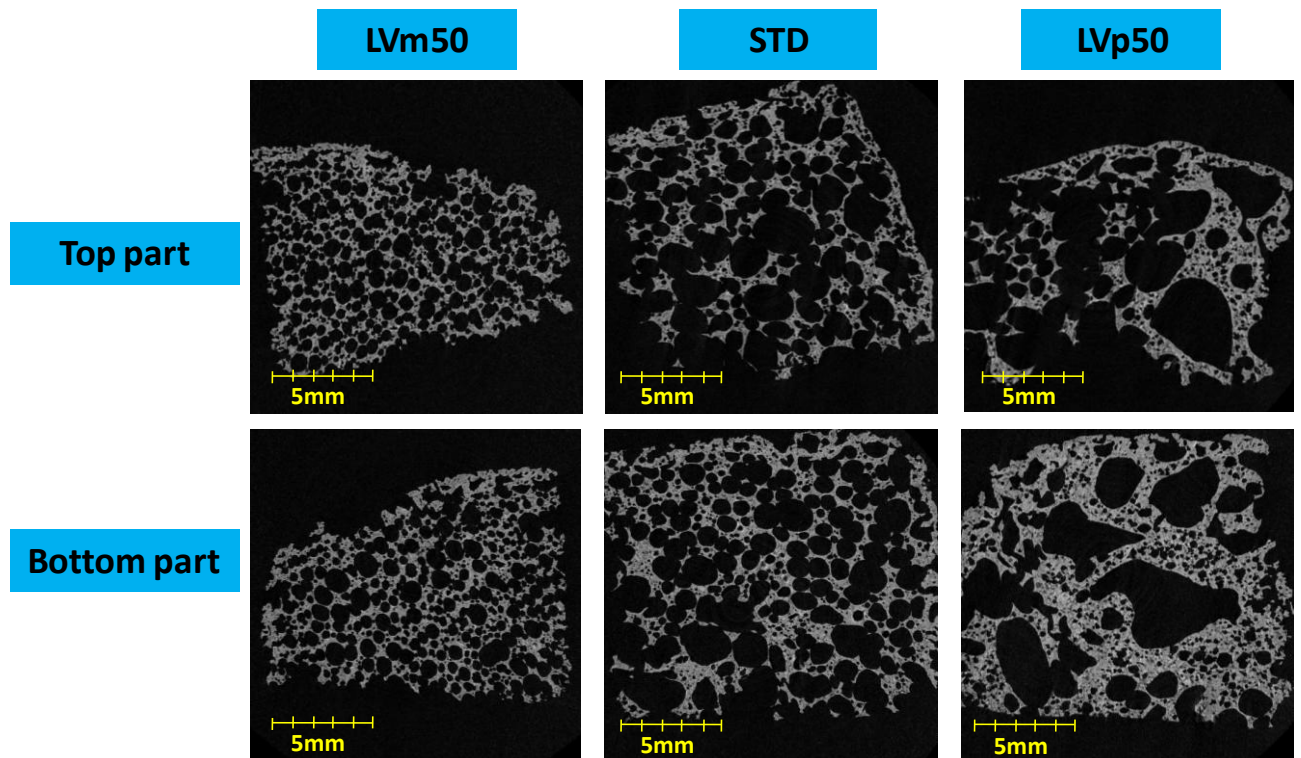

Figure 69 : Transversal cuts X-Ray Tomography images showing the bottom part of cake samples.

LVm50 sample exhibit a homogeneous bubble size distribution with relatively small size bubbles whereas LVp50 sample display a much coarser crumb structure. While measuring LVp50 sample aeration features a substantial difference is observed between what could actually be anticipated and what has actually been sought out. A wide range of big bubble was expected instead of a tremendous number of small size bubbles that constitutes the major portion of LVp50 detected ROI (Regions Of Interest, i.e., air bubbles). Several prominent variations originating from baking powder level modifications in cakes are illustrated among which size, shape, distribution parameters and cell wall dimensions: Table XXIX.

Such findings inquire into the actual reason of these aeration features values. As long as the sample X-R scan image is reconstituted from the recorded raw data, it encompasses the overall cake material structure. Image analysis allows bubbles to be individualized and further counted. To peer further along the case of LVp50 cake

sample, its crumb undoubtedly reveals high bubble wall porosity: Figure 69. Embedded within the solid matrix, these empty volumes, i.e., air are even smaller than what it has been analyzed in the case of STD and LVm50.

Studied samples set forth thicker cell wall as the baking powder level increase: Table XXIX. LVm50 display smaller bubbles as well as thinner cell walls compared to the reference baking powder level illustrated by STD sample.

Table XXIX : Aeration features issued from several cake crumb sample X-R Tomography scan. Each cake sample image has been further analyzed using imageJ software. Parameters are represented as the mean value calculated from a set of at least 10 images (\pm confidence interval).

Aeration feature	Mean diameter - Feret (mm) ³		ROI perimeter- Perim (mm) ⁴		Cell wall thickness (mm)	
	Scan ¹	XRT ²	Scan ¹	XRT ²	Bottom	Top
LVm50	0.84 \pm 0.01 ^(a)	0.84 \pm 0.01 ^(a)	2.45 \pm 0.03 ^(a)	1.35 \pm 0.02 ^(b)	0.22 \pm 0.02 ^(a)	0.21 \pm 0.02 ^(a)
STD	1.00 \pm 0.03 ^(b)	1.00 \pm 0.03 ^(b)	2.91 \pm 0.09 ^(b)	1.69 \pm 0.03 ^(c)	0.31 \pm 0.02 ^(b)	0.36 \pm 0.03 ^(b)
LVp50	1.34 \pm 0.08 ^(c)	1.34 \pm 0.08 ^(c)	3.96 \pm 0.24 ^(c)	1.19 \pm 0.03 ^(a)	1.00 \pm 0.10 ^(c)	0.69 \pm 0.05 ^(c)

Aeration feature	Aspect Ratio - AR - (u.a.) ⁵		Shape factor – Circ (u.a.) ⁵	
	Scan ¹	XRT ²	Scan ¹	XRT ²
LVm50	1.55 \pm 0.02 ^(a)	1.36 \pm 0.02 ^(a)	0.65 \pm 0.00 ^(b)	0.79 \pm 0.00 ^(b)
STD	1.57 \pm 0.01 ^(a)	1.38 \pm 0.02 ^(a)	0.66 \pm 0.01 ^(b)	0.79 \pm 0.01 ^(b)
LVp50	1.63 \pm 0.02 ^(b)	1.52 \pm 0.02 ^(b)	0.63 \pm 0.01 ^(a)	0.73 \pm 0.01 ^(a)

Samples with the same letter are not significantly different.

¹ = Parameter values obtained using Flat Bed Scanner images of cake crumb slices.

² = Parameters values obtained using the X-Ray Tomography images of cake' pieces (2D image acquisition)

³ = Feret's diameter corresponds to the longest distance between any two points along the considered ROI (Region of Interest) boundary. For circle-shaped objects, it approaches the actual area diameter.

⁴ = Perimeter of the detected ROI represents the length of its outside boundary.

⁵ = Aspect Ratio = 1/Roundness; The aspect ratio of the particle's fitted ellipse. AR traduces the ROI elongation level.

⁶ = Shape Factor, also known as 'circularity' or 'form factor'; 0 = uneven edges; 1 = perfect circle-shape.

According to the zone where it has been cut whether the bottom or the top part of the cake, while peering into the resulting images, different porous structures are visualized: Figure 69. Top-bottom heterogeneity also differs depending on the sample taken into account. Also, the main differences illustrated by those images mostly refer to the bubble dimension and shapes (Figure 71, Table XXIX), as well as to bubble size distribution.

LVm50 demonstrates a very homogeneous structure throughout the sample, with a much finer size distribution compared to the two other samples while images are observed. In addition, whichever the zone, porous structure appears homogeneous

although mean cell diameter is slightly lower within the bottom than the top part (54 μ m and 77 μ m mean diameter, respectively).

STD presents a heterogeneous structure as air size distribution seems to differ from the surface to the inner part of the cake as well as between the top and the bottom of the sample. The bottom part of STD cake is less heterogeneous in comparison with the corresponding top images of the cake which also shows larger and deformed bubbles. Scarcely aerated lumps are also observed. Size pore varies between 0.5 to 8 mm. The air structure exhibit a large amount of air coalescence, showing a fairly unstable air interface. Still, its bubbles appear regularly distributed over a wide range of bubble sizes: Figure 70.

Sample 'LVp50' demonstrates a more exacerbated structure containing very large pores, and very small embedded within the cell wall. The highly inter-connected air gas foremost illustrated by the uneven edges importance (Figure 71) influences the cake integrity (semi collapsed structure).

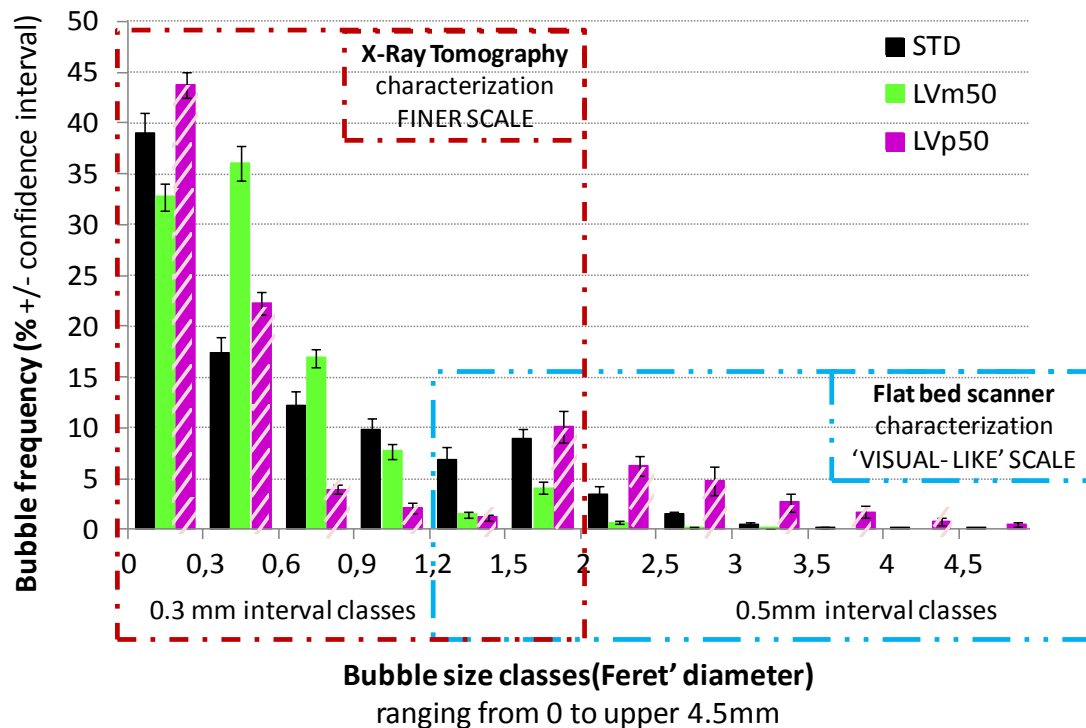

Figure 70 : Effect of the leavening agent level on cake crumb bubble size distribution within the whole range of bubble sizes. Feret's diameter ranges were obtained from the combined results of flat bed scanner images and of X-Ray Tomography scanning methodology. The figure is based on a continuous bubble size ranges span. The left side of the figure illustrates the finest bubbles quantization that could have been fairly estimated in the larger scale approach. X-Ray tomography based distribution is shown instead with smaller feret's diameters intervals. The right side of the figure corresponds to the actual scanning characterization that highlights the remaining part of the distribution including large bubbles.

Both bottom and top images show a coarse and heterogeneous crumb structure. Analyzed with optimized parameters ((Salman, 2006)), the mean bubble size varies in a larger extent within the bottom part, also including thicker cell wall: Table XXIX. In parallel, according to the measurement of the cakes aeration by scanned image analysis, baking powder level also affects other dimensions of bubbles characteristics such as bubble circularity (commensurate with the regularity of the pore border, and inversely related to the encountered uneven edges level), and roundness: Figure 71.

Moreover, the assigned values of aspect ratio (inversely the roundness) were lower for LVm50 and STD than for LVp50 as the leavening agent level increases (aspect ratio of 1.55; 1.57 and 1.63). LVp50 bubbles thus exhibit elongations toward a more elliptical shape (Impoco et al., 2007).

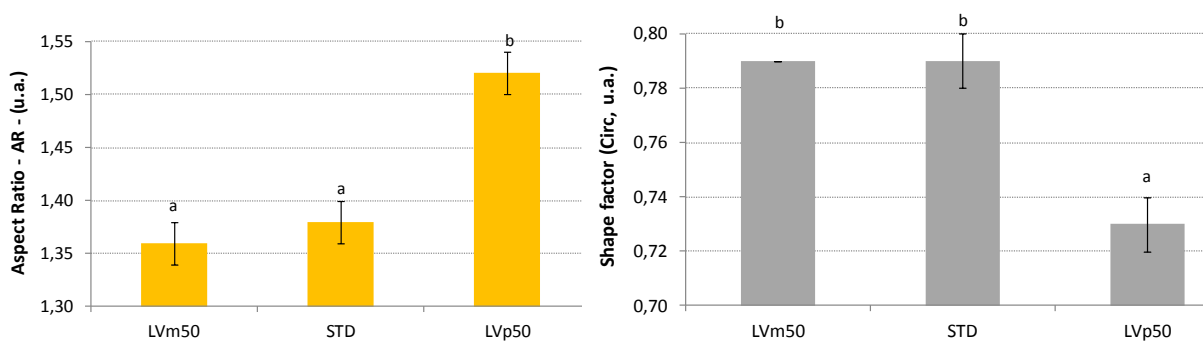

Figure 71 : Leavening agent effect on bubble shape factors: circle-like shaped level inversely represented by its 'aspect ratio, AR' (left) and the uneven surface - inversely represented by its 'circularity' - (right) parameters +/- confidence intervals. AR and Circ shape factors values both originates from X-Ray Tomography images. Distinct letters define significantly different samples.

This finding again illustrates that both the aeration level and the shape of the bubble was modified by the baking powder addition. Thence, LVm50 and STD, regardless the bubble size and distribution show relatively regularly shaped bubbles whereas LVp50 is somehow displaying an exaggerated aeration. Besides, differences highlighted between STD and LVm50 samples were mainly based on their actual bubble size and their heterogeneity. With very small bubbles representing the major portion of its volume (Figure 70), LVm50 exhibits a homogeneous and dense crumb. Conversely, the reference sample STD exhibit strong bubble dimensions and distribution variations are even visualized inside the crumb while considering the same slice.

Bubble size distribution previously illustrated using the scanning methodology (Figure 68) genuinely corresponds to a 'large scale characterization. Indeed, it is fairly related to what has been calculated using a finer scale analysis, i.e. X-Ray tomography methodology (Figure 70). The main reasons of the observed discrepancies between the results obtain from either scanning or X-Ray instruments originated from the fact that this latter provide higher resolution images with a higher accuracy and sensitivity that allow visualizing the inner porous structure of cake material.

A modification of the baking powder level incorporated into the dough can strongly influence crude then baked cake dough properties. Prominent effects were observed and quantified. In the case of LVp50, the higher aeration and apparent viscosity of its dough were assigned to both the direct baking powder action and its indirect pH increase. Leading to a better hydration of ingredients, the expected tougher cake sample is undone by an exacerbated aeration of the final product within which crumb bubbles walls remain too weak to support the overall material structure whence its hollowly centre. The utmost tested level sample, i.e. LVp50 reveals a highly aerated structure containing both large bubbles and very small bubbles that are genuinely embedded within the solid cell wall matrix.

It thus justifies our investigation carried out by the way of both sensory assessment and instrumentally measured aeration features.

1.4. Cake aeration features: instrumentally measurements are commensurate with visual perception.

Both sensory and bubble characterization approaches were used to seek out the features which best characterize cake aeration. The latter, carried out either by a simple scanning method or an X-Ray tomography measurement led to the conclusion that a higher leavening agent quantity enhance heterogeneity and rupture of gas cells, whilst are bigger in LVp50 samples (Figure 67, Figure 68). The crumb grain appears fine to coarse with increasing baking powder level. These assumptions were confirmed by cake visual assessment in which bubble size and number were considered in parallel with its distribution (bubble heterogeneity): Figure 72.

Visual sensory perception is strongly related to instrumental characterization of aeration. Indeed while considering ‘scanning based methodology results’ in comparison with visual based attributes, variables appears highly correlated and a high RV coefficient value between the sensory and the instrumental groups of data is obtained: Figure 72, Table **XXXI**.

More precisely, sensory evaluation of bubble dimension (V_Bubble size) was in line with instrumentally measured bubble diameter, expressed as ‘Feret’. Denser samples, contains a larger amount of finer bubbles, homogeneously distributed in size, and were also puffier: Figure 65, Figure 68. Conversely, LVp50 sample for which a lower density was recorded appears to contain less but large bubbles, with uneven edges. Represented by a more exacerbated aeration the sample is also perceived as the most heterogeneous.

According to the depicted results, instrumental measurements appear more discriminant than sensory characterization. As illustrated by MFA, sensory results are represented on a single axe whereas instrumental characterization can be described on both axe 1 and

2: Table XXX, Figure 72. Then, additional information is given by instrumental parameters that are well represented on axe 2. Sensory responses do not provide these latter. Instrumental characteristics enable us to differentiate STD from the other sample on the basis of mean grey level; STD display lower grey level mean intensity, then higher spaces forming bubbles.

Table XXX : Variables and individuals \cos^2 values given from the basis of the MFA performed on both instrumental and visually assessed aeration features.

	COS ² values	
	1 st axis	2 nd axis
Ph_Density	0.64	0.36
Alv_Mean Int	0.01	0.99
Alv_Bubble Number	0.96	0.04
Alv_Circularity (regular edges)	0.51	0.49
Alv_Feret	1.00	0.00
Alv_Roundness	0.98	0.02
V_PUFFY	0.89	0.11
V_BUBBLE SIZE	1.00	0.00
V_AERATION HETEROGENEITY	0.95	0.05
LVm50	0.84	0.16
STD	0.97	0.03
LVp50	0.12	0.88

We have been investigating aeration level and properties from both a sensory and instrumental point of view, using, in this latter either a 'large, close to human sight, or a much finer scale of characterization. Pointed out that the actual bubble size is fairly related to the baking powder level, we discard the hypothesis based on the fact that a higher baking powder level automatically increases the bubble size and crumb heterogeneity. It mainly depends on the way each volume (both air and solid phases) is distributed within the crumb that leads to the overall cake structure.

Uneven edges of LVp50 in addition with both very large and very small bubbles leads to a tremendously aerated material that strongly influence its mechanical and sensory properties. These findings could turn out important in the light of the mechanical also sensory based properties of such a product because the solely aeration level (visible crumb size and homogeneity) clearly appears insufficient to thoroughly characterized the sample aeration. The next part will thence describe and know whether or not a distinct aeration only resulting from three leavening agent concentrations could be responsible for mechanical and textural properties modifications.

RESULTS : 2nd section – CRUMB AERATION

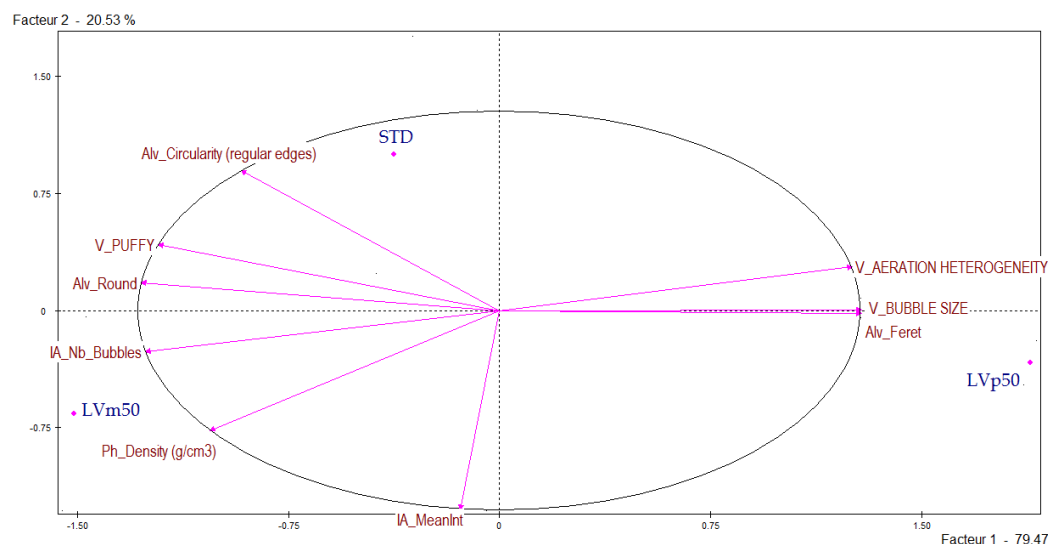

Figure 72 : MFA representation of the inter-relation between sample aeration features; comparison was made with both visually assessed items, and instrumentally determined bubble characteristics

Table XXXI : Correlation matrix of variables obtained after the MFA performed on data originating from both the instrumental assessment of aeration features and the sensory results based on a visual evaluation mode. These latter characterization modalities respectively represent the first and second group of data given in the table underneath.

	First data group : INSTRUMENTAL-BASED AERATION FEATURES						Second data group: VISUAL (SENSORY)-BASED DATA		
	Ph_Density	Alv_Mean Intensity	Alv_Bubble Number	Alv_Circ*	Alv_Feret	Alv_Round	V_PUFFY	V_BUBBLE SIZE	V_AERATION HETEROGENEITY
Ph_Density	1.00								
Alv_Mean Intensity	0.68	1.00							
Alv_Bubble Number	0.91	0.31	1.00						
Alv_Circ*	0.15	-0.62	0.56	1.00					
Alv_Feret	-0.79	-0.09	-0.98	-0.73	1.00				
Alv_Round	0.71	-0.03	0.94	0.81	-0.99	1.00			
V_PUFFY	0.56	-0.22	0.86	0.90	-0.95	0.98	1.00		
V_BUBBLE SIZE	-0.80	-0.11	-0.98	-0.71	1.00	-0.99	-0.94	1.00	
V_AERATION HETEROGENEITY	-0.90	-0.32	-1.00	-0.55	0.97	-0.94	-0.85	0.98	1.00

RV coefficients for these two groups were respectively 0.983 and 0.979 with the MFA axes, and the RV coefficient between the groups is given as 0.925. Numbers in bold represents the positive (in green) and negative (red) significant correlations between variables ($p < 5\%$).

2. Aeration level mechanical properties of cake product: a rheological approach

Applied baking powder levels modifications have been shown to strongly influence of soft cake products aeration. Although involved in the product aspect, aeration can also influence the foam structure and its overall mechanical properties, whence the need to inquire into these resulting effects. This second part thus aims to study the impact of baking powder level on baked products mechanical characteristics and to investigate the effect of such modifications on its sensory properties for which in touch and in mouth perceptions are discussed.

Within the crumb, a distinct bubble size, bubble distribution and the way it has grown up into the crumb upon baking are supposed to exert an impact on individual cell wall rigidity and to affect the mechanical behavior of the entire product.

While submitted to a strain either applied by a compression test, or by the consumer (using both its fingers and its teeth), the product response can thereby be highlighted. Amongst approaches, the high strain rheology is particularly developed, providing information on the overall cake texture and its crumb cell wall rigidity: Figure 73.

Although slight differences are recorded between $\text{Tan}\delta$ values (data not shown) LVM50 display the lowest mobility, thereby illustrating the highest cell wall rigidity. LVM50 is also able to quickly and strongly respond to an applied strain as illustrated by its relatively high Young Modulus.

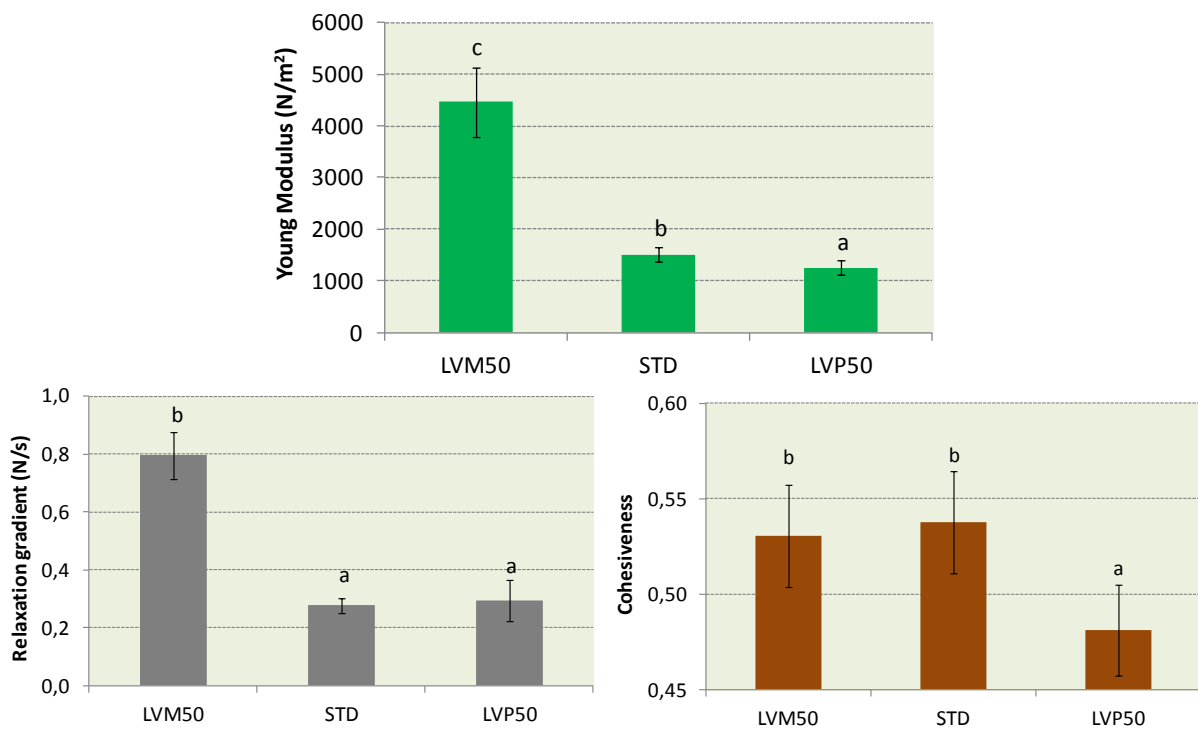

Figure 73 : Textural parameters mean values obtain with a compression test using a TAXT2 instrument.

Young modulus (E), and Cohesiveness were obtained from the double uniaxial compression test. Relaxation gradient (Rx) was obtained from the relaxation test (single compression, maintained strain during 60sec). Samples with different letters exhibit significantly different values for the parameter.

Smaller bubbles and stronger cell walls were measured which might be responsible for such textural features observations. As a results, the LVm50 sample deforms slowly under compression compared to the other samples, keeping its initial shape until strain reach a level too high for the porous structure to be maintained also commensurate with its dense structure.

Conversely, the other samples LVp50 and STD approximately display the same mechanical behavior. Equivalent rigidity (Tan delta values, Young modulus) and elasticity (Rx) have been recorded. Not able to properly respond to the applied strain they also display a low firmness (data not shown), the lowest Young modulus as well as the lowest Rx index: Figure 73.

It mainly owes to the fact that LVm50 has been shown to exhibit a high density due to the fine bubbles it is made with resulting in a highly cohesive and tough structure. In the opposite, and illustrated by the lowest recorded cohesiveness value LVp50 is endowed with weaker mechanical properties. Its apparently very thick cell wall, containing a large amount of pores instead of solid phase is foremost responsible for such an effect, impairing the ability of the cell wall to properly respond to a mechanical solicitation

As stated by its aeration features, and by the ‘medium baking powder level’ which has been applied, STD sample is expected to show a mechanical behavior in-between the two extreme LVm50 and LVp50 samples. Interestingly, with regards to measured parameters, STD product does not show a proper intermediate behavior. Although its cell wall rigidity is equivalent to both LVm50 and LVp50, it rather behaves like LVp50 for short time responses (Fmax, Young, Rx) whereas longer deformation responses are observed to be closer to LVm50 (cohesiveness, recovery percentage): Figure 73. It might commensurate with a fragile not the least resistant but relatively elastic structure owing to its cell wall mobility and overall aeration characteristics.

As evidenced by its mechanically based features, LVp50 sample, is neither able to resist to the applied strain nor to successive compressions. The depleted elastic properties, in addition with the low rigidity endowed by this latter and the least cohesive behavior, confirm that the deformations undergone by this sample rather corresponds to a global fragility of the product within which exacerbated bubble dimensions and uneven cell wall edges could genuinely be responsible for the whole cake structure weakening.

It is thereby obvious that the bubble dimensions and distribution are important to be taken in account while considering a sample such as cake products because aeration influences its mechanical properties. Still, it needs to be described using a sensory characterization dimension to see whether a distinct aeration impacts the overall or specific sensory perceptions.

3. Aeration level influences mechanical properties and sensory perception of cakes

3.1. Aeration impacts sensory properties of cake products

Sensory evaluated items differ between studied products mainly in terms of aeration including the bubble size, and its heterogeneity, as well as on the firmness and softness: Figure 74. Aeration items differentiate extreme samples LVm50 and LVp50 from STD. This latter, with an intermediated aeration is perceived less fatty and slightly more elastic in touch.

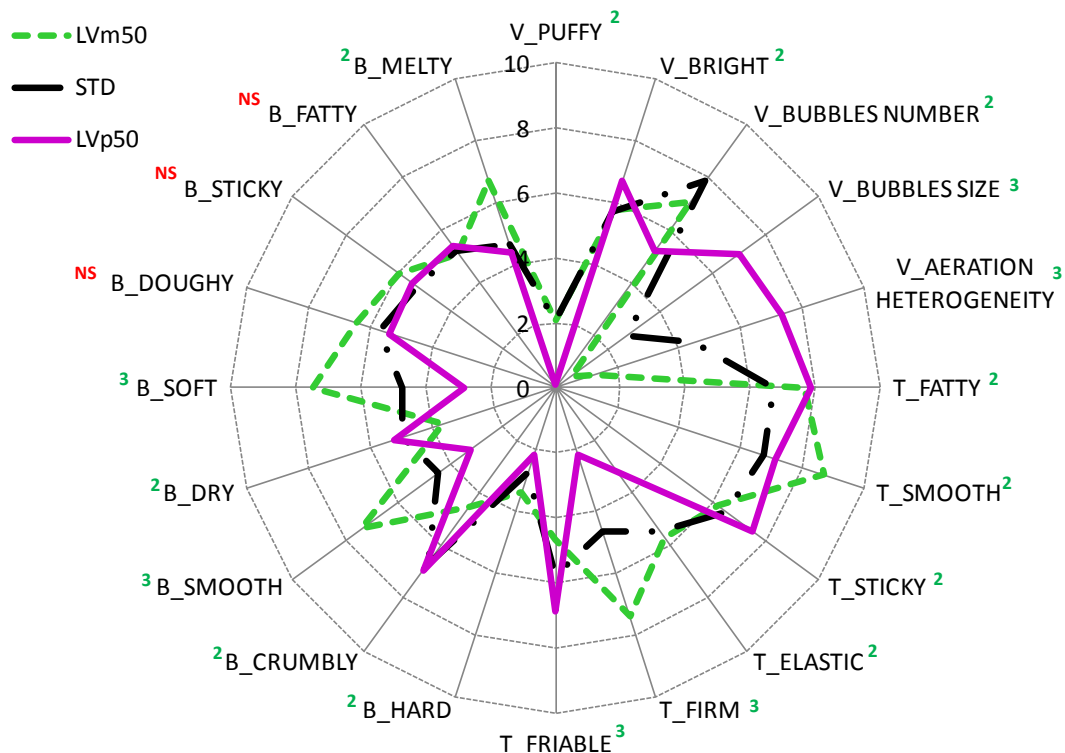

Figure 74 : Sensory assessed parameters on cake products made with 3 distinct baking powder levels. Sensory modalities are represented by their category letter (V = Visual, T = In Touch, B = In Mouth) followed by the name of the sensory evaluated item. Assign letters NS means that the item evaluation is not significantly different between samples. Assigned numbers close to the item name means that significant differences have been recorded between samples; 2 or 3 represents the number of sample groups arising from post-hoc Newman-Keuls ANOVA test (if 3, thence, each sample differ from one another).

According to these results, samples LVp50 and STD are mainly perceived friable in touch and globally weak compared to LVm50 sample. They are indeed neither perceived firm nor elastic especially for LVp50 sample. However, in the reverse order, LVm50 is the only product to be sensory evaluated as soft, melty, elastic instead of being classified with the standard product for which the aeration was closer. Sample which are perceived friable in touch are further perceived crumbly in mouth.

Among describe items, B-soft, B-smooth, T-Firm, V-Aeration heterogeneity, V-bubble size significantly discriminated the 3 products and a relatively linear relation is observed between the baking powder level and the sensory response. Higher is leavening agent level, lower is the firmness in touch, the softness, the smoothness in mouth and higher is the dryness.

Therefore, on the basis of such evidences, solely considering the impact of aeration level (baking powder action), a soft product should not be friable (upper than 5 on the 0-10 used scale). It should whether be firm, elastic, smooth in mouth, melty but also display a relatively low level of aeration with fine bubbles homogeneously distributed. LVm50 cake sample represents such a product in this section. As a result, the three dimensions of the sensory study needs to be considered because sensory perception takes into account a wide range of product characteristics to develop the global sensory response.

Hence, visual, in touch and in mouth texture evaluation have been compared. Correlation has been attempted with instrumentally measured parameters in order to understand which ones of the measured features can disclose the best correlation with product properties.

3.2. Overall properties of cakes endowed with distinct aeration are perceived through visual, in touch and in mouth sensory assessment of texture.

This last part merely attempts to compare the different results recorded by the way of several characterization levels. We first and foremost tackle the correlation between instrumental and sensory aeration features with physical parameters and the overall range of sensory product perception (Annexe 7).

The influence of baking powder level, strictly modifying aeration exerted on the overall textural characteristics of the studied samples will thus be analyzed in a more thorough way. It then endeavors to identify the most relevant parameters to describe aerated products texture and to select physical parameters that best fit discriminative sensory items.

Comparing products in terms of either instrumentally measured characteristics (Figure 75a) or sensory perception (Figure 75b), PCA projections of variables and studied samples appear commensurate with each other. These observations are then reinforced while peering into the MFA results (MFA not shown). High correlation coefficients have actually been obtained between sensory and instrumental assessment of sample aeration and mechanical properties (RV coefficient for instrumental – sensory MFA groups is: 0.919).

Visually assessed items are directly related to bubble measured parameters: bubble number, size and heterogeneity: Figure 75. Then, on a strictly mechanical point

of view, in touch perception also needs to be considered in relation with textural parameters. For instance, perceived as the firmest product, LVm50 also exhibits the highest maximal force value under compression.

Sensory firmness is mainly related to the overall product density (correlation coefficient = 0.91) and to the instrumental assessment of product firmness (0.93) but also indicates in relation with the recorded Young Modulus (1.00) how much is the sample able to resist to the compression undergone while it is submitted to mastication. It is also useful to measure how far the material structure can be maintained over a longer strain, providing elasticity behavior and rigidity information.

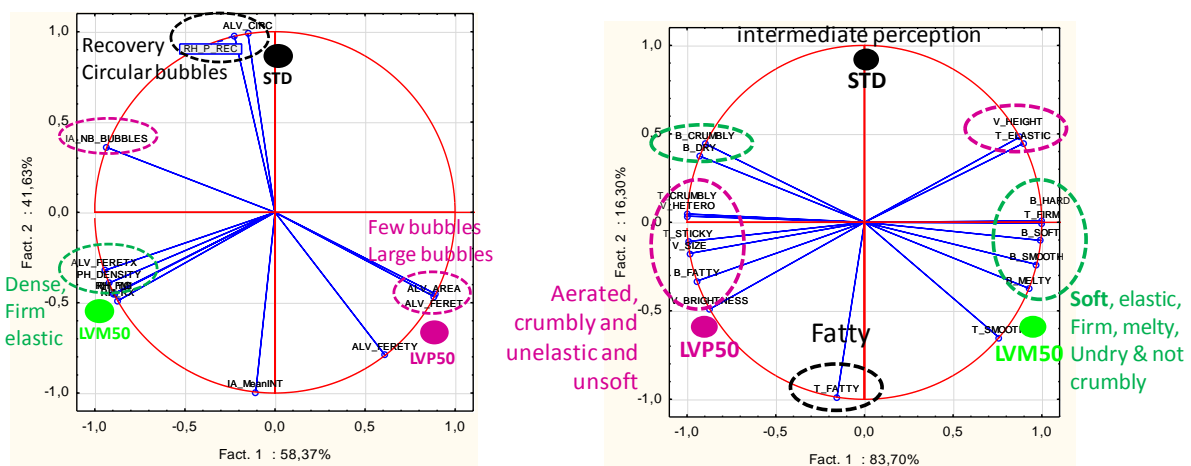

Figure 75 : Instrumental (a) and sensory (b) PCA projections.

4. Cake aeration impacts its textural properties: a conclusion

In this section, the impact of baking powder on soft cake aeration and textural features has been presented. Strong differences were observed in terms of aeration characteristics between the studied products. Aeration features, including both bubble dimension and distribution parameters were measured using both simple scanning and X-Ray Tomography methods. Results were in line with visually assessed items.

When the comparison is made between the products from their mechanical properties, slightly less distinct behaviour were identified that even up samples such as LVp50 and STD. Nevertheless, it finally appears that LVm50, which is denser and puffy, is characterized by positively perceived items such as smooth, melty or soft. Aeration features also exert an influence on the overall product properties because the cake keeps its firmness and elasticity upon storage owing to its overall porous structure. It exposes the finest bubbles with a homogeneous repartition of their size and well-shaped bubbles. Such regularity might also be responsible for the denser structure, elasticity and a lower breakage in mouth, making it smoother instead of crumbly.

In the opposite, the highest baking powder level lead to products disclosing large bubbles, heterogeneously distributed within the crumb which in addition, is composed of

uneven cell wall edges. Therefore, the sensory perception of LVp50 is mostly directed by its exacerbated aeration and is mainly characterized by its ugly aspect, friability, as well as low firmness and elasticity.

Besides, even though STD sample is closer to LVm50 in terms of aeration, it appears to be globally positioned as LVp50 (Figure 72). Sensory perceived properties and mechanically assessed parameters can be responsible for such vicinity. It might be explained by the fact that irregular bubble distribution is also observed within the crumb in addition with a lower ability to resist to compression strain which in turn can be responsible for its lack of elasticity. Thence, taking into account the overall sensory dimensions, it seems that the textural properties of cakes are more important than bubble actual size if the product displays a relatively low aeration level. When the bubble size and heterogeneity is exacerbated, the main characteristics of the cake arise from this too aerated structure thereby leading to a weakened foam. Above a bubble size threshold in-between the STD and LVp50, the particular shape or orientation could thus not be as important as the actual bubble size range (Blanchard et al., 2012a).

With such investigations, it appears that a given aeration can exert a strong influence on soft cake products as it was illustrated by the extreme created aeration (LVp50 and LVm50). Also, depending on the aeration level, textural characteristics may be revealed as more important features as it was the case between LVm50 and STD.

The textural properties of relatively low aerated cake products clearly appear to mainly depend on the mechanical characteristics of its structure. For instance LVm50 sample is firm, elastic and cohesive thus bringing a relatively low friability perception. It is also endowed with a very homogeneous bubble size distribution whilst are fine bubbles with more rigid cell walls that foremost relates to the dense structure of this sample. In this case, the aeration is an important not a limiting effect on the overall sample perception.

Conversely, highly aerated products exhibit higher friability, and lower softness for which low firmness and elasticity values were measured. For instance, LVp50 exposes a fragile overall structure mainly driven by the behavior of its cell walls that in turn can easily be broken. These latter, large and strong are weakened by the presence of a large amount of fine pores that brings forth to a lack of resistance under strain, elasticity and leading to the friable, not smooth neither soft nor elastic perception of the cake.

Owing to the fact that a proper aeration should not be too exacerbated, but that an 'optimum' range of bubble size has been highlighted (under 2 mm) it would be an element of importance to investigate the way aeration can be modified in a slightly less extent by the way of other factors on which it can be taken action such as making process parameters or other ingredients. Hence, the following section will focus on the impact the use of distinct flours to highlight eventual textural properties modification.

Section III: Influence of wheat flour composition and wheat flour functionalities on dough and cake textural properties.

Known to strongly influence final product properties, the choice of a suitable flour is usually made as a function of the wished application (Hoseney & Rogers, 1990, Kaletunc & Breslauer, 2003, Khatkar, 2002). For instance, particularly soft wheat flours will whether be brought into play in biscuits instead of bread (Pomeranz, 1968).

To confirm the preference of flour for a wished application, numerous “flour quality tests” are used allowing flour composition determination, hydration ability and hydro-thermal properties assessment (Macritchie, 1984, Miralbés, 2004, Posner, 2009, Preston & Williams, 2003).

In **bread** application, various criteria including flour strength, development time, and even protein composition parameters that are considered to determine the specific quality of flour are employed to effectively leave apart a flour type instead of another that suits better (Goesaert et al., 2005, Panozzo et al., 1993, Park et al., 2006, Tronsmo et al., 2003).

In dryer products such as **biscuits or cookies**, the quality of flour depends on its protein content that should whether be relatively low but also depends on its extensibility (Abang Zaidel et al., 2008, Chevallier et al., 2000, Fustier et al., 2008, Maache-Rezzoug et al., 1998) as well as on its low damaged starch content (Barak et al., 2012).

In cake products, hydration level, processing conditions but also ingredients complexity are whether close to bread and biscuits making conditions, respectively (Donelson & Wilson, 1960, Færgestad et al., 2000). Flour is the main cake’s formula ingredient. It naturally contains various components among which starch and gluten proteins, its main constituents. Upon cake making process, while mixed with other ingredients it let interactions occurring within the mix progressively leading to the formation of a dough further oven baked.

These phenomena directly depend on the flour composition, its functional properties and the nature of the other ingredients that can enhance or impart the proper development of the dough (Collar & Bolla Ñn, 2005). Solely considering the flour nature, the actual level of modifications displayed from the flour – ingredients mix to the final dough is foremost related to the succession of events occurring while it is processed:

- the hydration properties of the considered flour components exerting an influence on the dough formation and all along the making process.
- its composition in proteins, that influence the gluten network establishment, dough and cake structure formation.

- its composition in starch that substantially determines the hydro-thermal properties of flour and the final structure of the cake.

Whence the interest to peer into the functional properties of several types of flours with regards to their respective impact on dough then cake's characteristics. The selection of soft flours with distinct levels of hardness was attempted to study the influence of flour composition variations (components quantity and quality) on its functional properties in various conditions: water-flour mix and cake-like dough.

The purpose of this chapter is to investigate the main flour characteristics that may influence cake structure set up and evolution upon storage: wheat flour hydration abilities, protein and starch components.

First depicting the studied wheat flour, the focus will further be made to tackle on flour functionalities according to both their hydration properties and their composition. A particular investigation led on wheat flour proteins then on flour starch will be undertaken: Figure 76. Finally, the flour type will be investigated with regards to its impact on soft cakes texture; both instrumentally and sensory assessed parameters will be endeavored to explain the variations measured between samples and see whether it is commensurate with the studied flour components functional properties.

The final aim is to understand in what way flour can be responsible for cake texture set up and properties and if a specific flour should be preferentially advised for soft cakes.

.....« La science consiste à passer d'un étonnement à un autre. »

Aristote

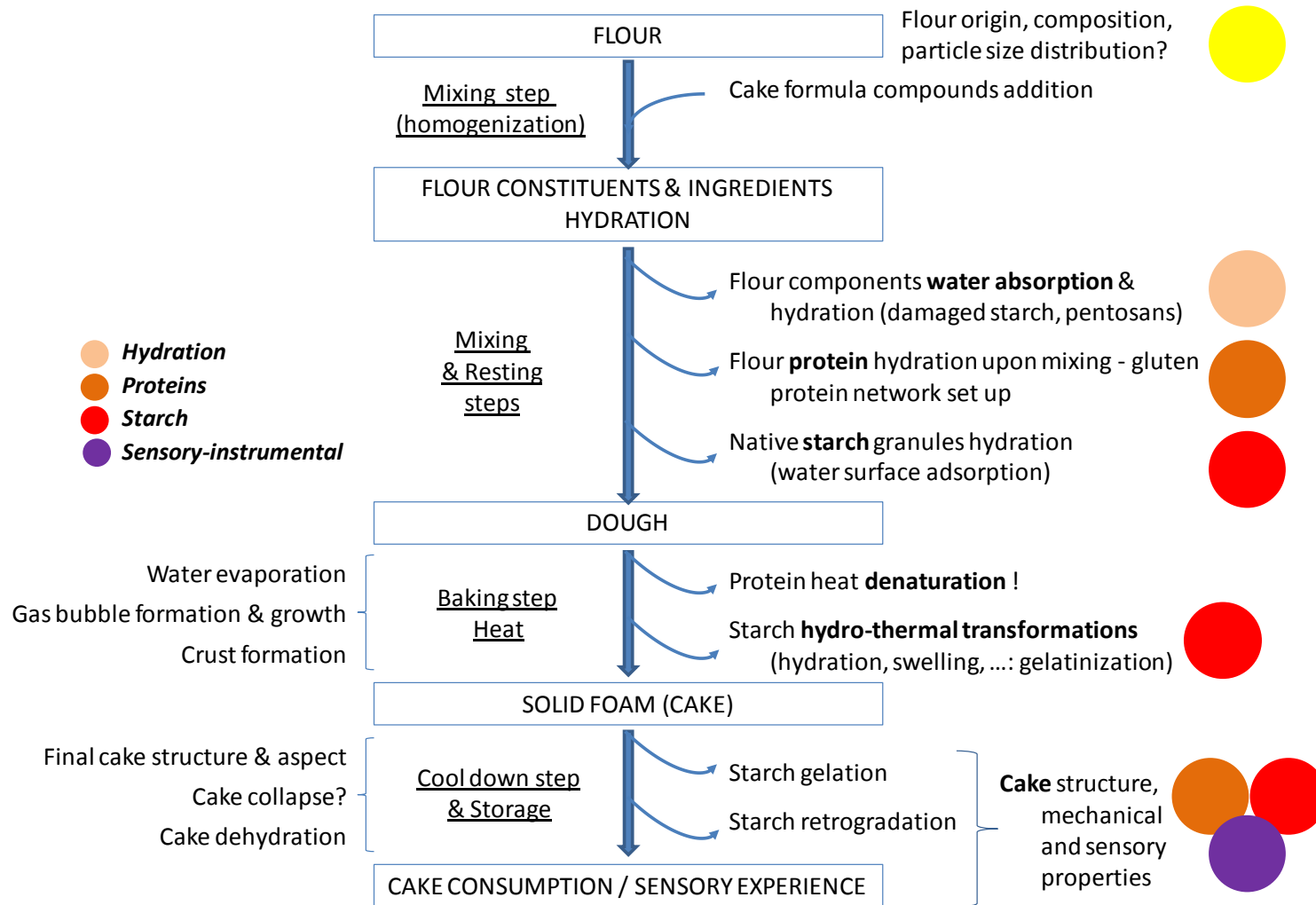

Figure 76 : Representation of the succession of events that happen upon cake making process, while focusing on the flour components functionalities and the related properties to be studied.

1. Granulometry and composition considerations

Three wheat flours have been chosen to conduct the study: Crousty (CTY), Gruau rouge (GRU), LU 2000 (STD). The soft wheat flour, CTY is mainly employed for biscuits manufacture. Conversely, the medium hard wheat flour, GRU, is foremost used for bread and bakery products (also yeast leavened dough). The flour chosen as the reference one, STD is composed of a mix of both a soft and a medium hard flour. This latter wheat flour is used for a wider range of applications mainly including cake' products and serve as the reference flour for the present study. Studied flour particle size distribution and overall composition are described thereafter.

1.1. Flours particle size

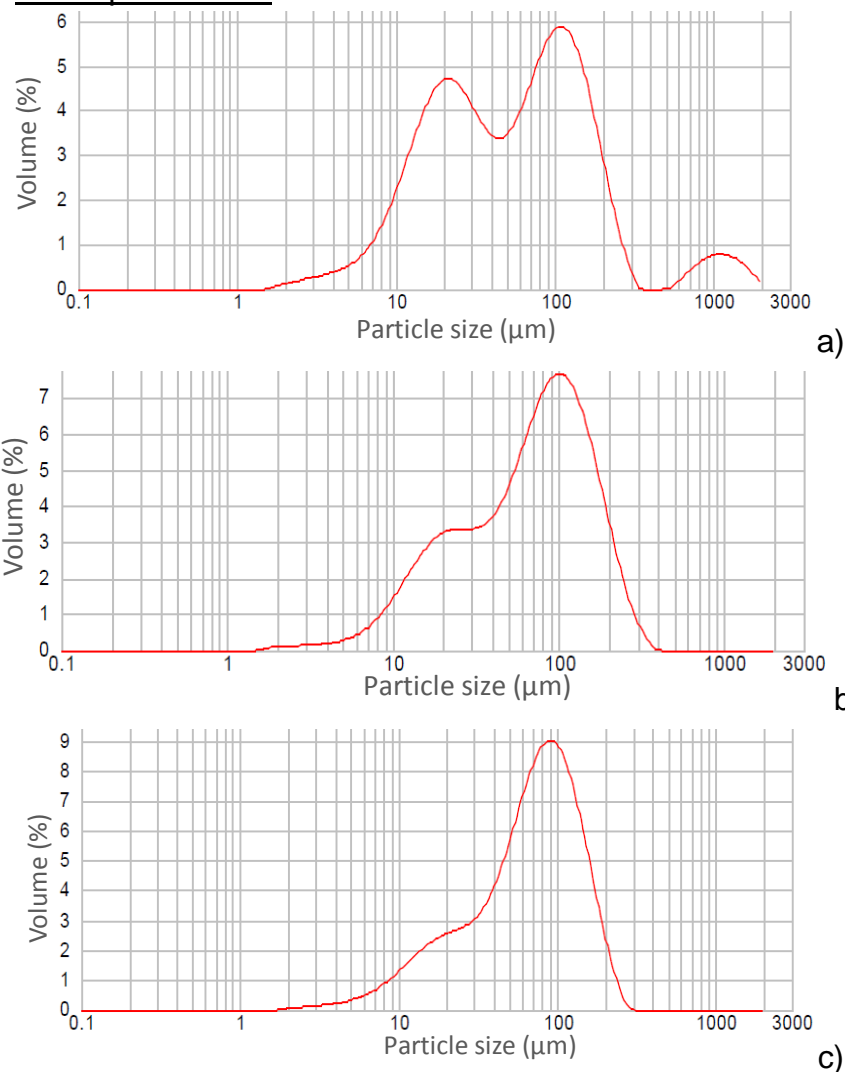

Figure 77 : Particle size distribution profiles (explained in volume) obtained for three distinct wheat flours: a) Crousty (CTY), 100% Soft ; b) Lu2000 (STD), 50% Soft, 50% Medium Hard ; c) Gruau Rouge (GRU), 100% Medium hard.

Figure 77 shows a bimodal distribution with specific particle size levels within each 'class'. Median particle size was 52 μm (± 1.7) and 71 μm (± 1.5) for CTY and GRU, respectively. CTY flour small and large particles median size are 22.5 μm and 112.5 μm , respectively (Figure 1). Softer is the flour wider is its particle size distribution and heterogeneously spread out. In softest flour, small particles are encountered in a large extent at the expense of coarse fractions: Table XXXII.

Table XXXII: Relatives proportions of flour particle size distribution classes, measured by laser granulometry for three flour types (chosen within soft flours) in volume percentage: Crousty (CTY, soft), Gruau Rouge (GRU, Medium Hard) and Lu2000 (STD, intermediate).

Flour name	Particles size distribution classes (% in volume)			
	< 40 μm	40 – 60 μm	60 – 120 μm	120 – 600 μm
Crousty (CTY)	47.68	9.76	23.21	19.35
LU 2000 (STD)	28.94	11.56	32.86	26.64
Gruau Rouge (GRU)	29.54	14.93	37.08	18.45

Finer and coarser flour sample fractions belong to distinct particle size classes depending on the flour nature and can display distinct composition profile and properties (Kuakpetoon et al.). These authors highlight that regardless the flour hardness level, the smaller fractions contains less proteins but higher damage starch content compared to the coarser fractions. Although native starch granules are known to be comprised in-between 5 to 35 μm diameter (A and B starch granules), the starch included in the finer fractions is foremost spherical and regularly shaped whereas biggest fractions contains other flour compounds and starch embedded into the protein matrix, showing irregular shape and rough surface.

Led on 5 flour fractions with flour particle diameter spanning from 0 to 35 μm , an early study demonstrates that protein content and nature varied within this range according to the considered fraction (Jones et al., 1959). Free wedge proteins are mainly represented in the finest fraction from 0 to 17 μm and about the third of the protein amount is included within 13 to 28 μm fractions range. Considering the whole flour fractions, it has also been highlighted that the overall protein content even up between the finest (less than 35 μm) and the coarser flour particle size ranges (upper 35 μm). In this latter, flour components interacts each other forming bigger structural units explaining the actual coarse fraction composition. Also, the smallest particle size fraction (under 30 μm) displayed the lowest ash and protein contents (Mao & Flores, 2001).

Thence, peering into the overall particle size distribution it could be anticipated that the relative composition of the studied flours differs from one to another and that influences its functionalities, which is the purpose of the next part.

1.2. Flour composition

As already depicted (see 1st section), wheat flour originates from the kernel milling and is composed of a wide range of components among which starch and proteins together representing the major wheat flour portion, but also compounds that are considered as “minors constituents” (small proportion in flour). Flour macro-molecular composition effectively varies according to the studied wheat flour type: Table XXXIII. Amongst investigated flours, differences are foremost encountered between the softest (CTY) and the hardest (GRU) flour. Softer the wheat flour, lower the protein content, the damaged starch content and lower the flour’ water absorption: Table XXXIV.

Studying the flour nature impact on cake dough, it appears that STD always exhibit intermediate values. For instance, on the basis of baked product height and density, differences are observed neither between STD and CTY nor between STD and GRU. Still, GRU set apart from CTY on several points. These findings justify the preferred comparison of GRU and CTY, discarding, in some cases, STD in the next few parts.

Table XXXIII : Composition of three distinct wheat’ flours in damaged starch, protein (NIR analysis based data) and gluten proteins as well (Gluten index methodology based data).

Flour nature (name)	Damaged starch (%)	Protein (%)	Dry Gluten (% flour basis)	Gluten Index (GI) %MS based
CTY_Flour	3.45 ± 0.06 ^(a)	9.74 ± 0.03 ^(a)	7.40 ± 0.11 ^(b)	48.76 ± 2.81 ^(a)
STD_Flour	6.01 ± 0.11 ^(b)	9.85 ± 0.03 ^(b)	6.99 ± 0.15 ^(a)	84.46 ± 2.04 ^(c)
GRU_Flour	7.20 ± 0.07 ^(c)	13.82 ± 0.03 ^(c)	10.99 ± 0.10 ^(c)	76.62 ± 4.47 ^(b)

Table XXXIV : Studied flour comparison on the basis of solvent retention capacity profile of: sucrose solution (pentosans and gliadins absorption) and lactic acid solution (glutenins absorption). It provides an estimation of the relative differences between flours components portion.

Flour nature	SRC Sodium Carbonate % (damaged starch)	SRC Lactic Acid % (glutenins)	SRC Sucrose % (pentosans & gliadins)
CTY_Flour	70.6 ± 3.5 ^(a)	89.7 ± 1.2 ^(a)	85.2 ± 1.9 ^(a)
STD_Flour	80.5 ± 2.7 ^(b)	107.3 ± 1.4 ^(b)	94.5 ± 2.1 ^(b)
GRU_Flour	87.7 ± 2.3 ^(c)	138.4 ± 1.5 ^(c)	103.3 ± 2.3 ^(c)

Studying the composition characteristics of the selected flours is of a strong interest in order to better explain their behavior in either a simple (flour-water) or a multiple ingredients system (i.e. dough).

A flour- water then cake dough-like system investigation is proposed to inquire into the effect of flour type in the case of relatively complex matrix conditions, under hydration, based on the events that successively happen over cake making process, from the

actual ingredient mix to the final cake product: Figure 76. In addition with their particle size distribution, specific flour functionalities are also largely driven by their composition.

2. *Wheat flour hydration properties*

Flour particles are highly hygroscopic and are able to quickly absorb cold water then swell under hydration. Wheat flour hydration properties are of a critical importance as soon as it partly controls flour storage ability, but that also influence its behavior while it is processed to make cereal food products. A series of events occur when flour particles come into contact with water molecule or watery ingredients.

During milling a significant fraction of the starch granules is mechanically damaged, affecting their physico-chemical properties (Hoseney, 1994). Damaged starch with its tremendous ability to bind water can be quoted as one of the main components responsible for the water absorption property and contributes to absorb about his weight in water. Pentosans also imparts for its important water absorption ability: Table XXXV.

Table XXXV: ‘water absorption capacity’ values for several flour components: damaged starch, pentosans, proteins: adapted from (Hamer & Hoseney, 1998).

Flour constituent	Water Absorption Capacity (g/g compound)
Starch (undamaged)	0.4
Damaged Starch	1.0 to 4.0
Proteins	2.0
Pentosans	10.0

Investigations of the hydration properties of both soft and hard wheat flours also of several flour components have been carried out few years ago under vapor condensation conditions (Roman-Gutierrez et al., 2002). Regardless the sample type, changes at the wheat flour particles surface were pointed out. Micrographs were slightly out of focus traducing an apparent ability to swell under hydration.

In flours samples, as described by the authors, the visualized effect of hydration may primarily concern pentosans and starch particles (also damaged starch) instead of gluten matrix within which these are embedded and that effectively exhibit low surface wettability and adsorption capacity (Roman-Gutierrez et al., 2003).

Hereby, three wheat flour samples have been assessed for their hydration capacity, using both Near Infra Red Spectroscopy- NIR - (data not shown) and Water Retention Capacity: Figure 78. The harder is the flour, the higher is its water absorption. GRU flour water absorption is 25% higher than CTY flour (Figure 78, Table XXXV). Notwithstanding the correlation attempted on water retention in cold water and damaged starch content is based on the results obtained for three flours: Figure 79.

Distinct wheat flours were compared while incorporated into a cake formula. The resulting dough samples display different levels of consistency index. In addition with the water absorption capacity property it is most probably related to the flour damaged starch and not starchy polysaccharides (such as pentosans) content of the flours.

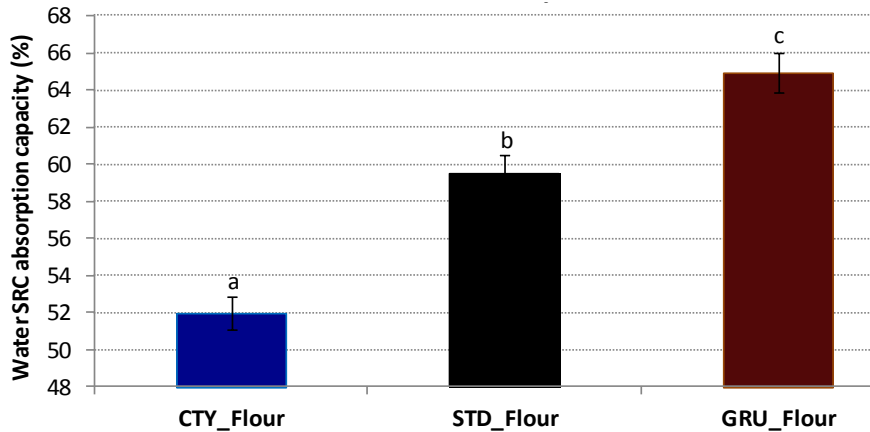

Figure 78 : Water absorption capacity of three wheat flours based on the measurement of water sorption retention capacity (AACC International, 2009).

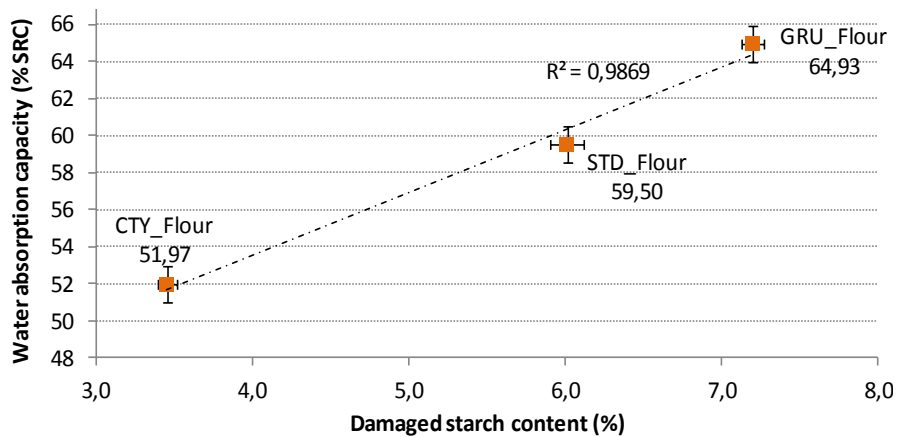

Figure 79 : SRC water absorption capacity as a function of the flour damaged starch content (%). The linear curve represents the evaluated correlation between the mean values obtained for three different types of flour.

Already demonstrated in bread and cookies, the high hydration capacity of damaged starch leads to the increase of the dough consistency and stiffness (Barak et al., 2012, Barrera et al., 2013, Mao & Flores, 2001). The higher damaged starch and pentosans levels negatively impact dough thickening and extensibility (Jovanovich et al., 2003). The resulting dough consistency increase helps to improve gas retention and dough development upon baking. GRU actually appears to have grown significantly better than CTY flour based sample (30 and 27 mm height, respectively).

The assumption that a distinct hydration capacity observed between wheat flour samples is not only driven by damaged starch and pentosans can be suggested, involving other wheat flour constituents. Damaged starch increases initial water absorption and prevents optimum gluten formation during mixing (Barrera et al., 2007).

Table XXXVI : Impact of flour nature on the crude dough physico-chemical parameters values (dough density and viscosity) and on the baked product characteristics (product density and height).

Dough parameter	Flour	CTY_Flour	STD_Flour	GRU_Flour
Dough density (g/cm ³)		0.98 ^(b) ± 0.01	0.87 ^(a) ± 0.02	0.87 ^(a) ± 0.03
Dough apparent viscosity (2.5 rpm, cP)		56 000 ^(a) ± 2828	88 400 ^(b) ± 4950	109 500 ^(c) ± 6364
Cake height (mm)		27.0 ^(a) ± 0.5	29.0 ^(a,b) ± 0.6	30.5 ^(b) ± 0.4
Cake density (g/cm ³)		0.43 ^(b) ± 0.04	0.39 ^(a,b) ± 0.03	0.36 ^(a) ± 0.02

Softest the wheat, lowest the damaged starch proportion produced during the milling process. Therefore, it could partly explain the relatively low dough consistency measured in CTY compared to GRU: Table XXXVI.

A substantial influence of flour proteins and starch can be exerted on flour functionalities while it is processed to make dough. Involved in the overall development ability of the dough, flour proteins can actually contribute to the gas retention of the dough and bubble growth to properly happen. Meanwhile, the dough strength and the level of gluten network formation are important in baking process quality (Pomeranz, 1968). An extensive gluten network is suitable for bread making whereas weaker dough suits better for cookies and cakes manufacture (Gaines, 1990).

3. Wheat flour proteins functionalities: their influence on cake dough formation and on final product mechanical properties.

GRU is richer in total and gluten proteins than CTY. These latter accounts for 80% and 76% of flour proteins content, respectively: Table XXXIII. As an estimation of the gliadins/glutenins ratio (Barak et al., 2013, Curic et al., 2001), the gluten index indicates that CTY flour sample display the lowest GI. A higher gliadin' relative content is thus encountered into CTY flour sample compared to the GRU flour (AACC International, 2000, Ram et al., 2005). SRC based data indicates differences in the 'SRC sucrose/SRC Lactic Acid' ratio, considered to approximate "gliadins/glutenin" ratio. Gluten index (GI) calculation flesh out SRC data based: Table XXXIV.

Hence, it could be anticipated that flour samples such as GRU displaying a relatively high amount of proteins, also a high GI and which are brought into play for cake production will set forth more consistent cake dough than with CTY.

Higher dough apparent viscosity has indeed been measured in the case of GRU compared to the STD and CTY flour based cake dough: Table XXXVI. The concern of both wheat flour protein quantity and quality marked out the first hypothesis that could

partly explain these findings: Table XXXIII. Flour-water mix viscosity is known to be positively related and mainly driven by its gluten proteins content while maintained at ambient temperature whereas further sample viscosity evolution owes to starch upon gelatinization (Chiotelli & Le Meste, 2002).

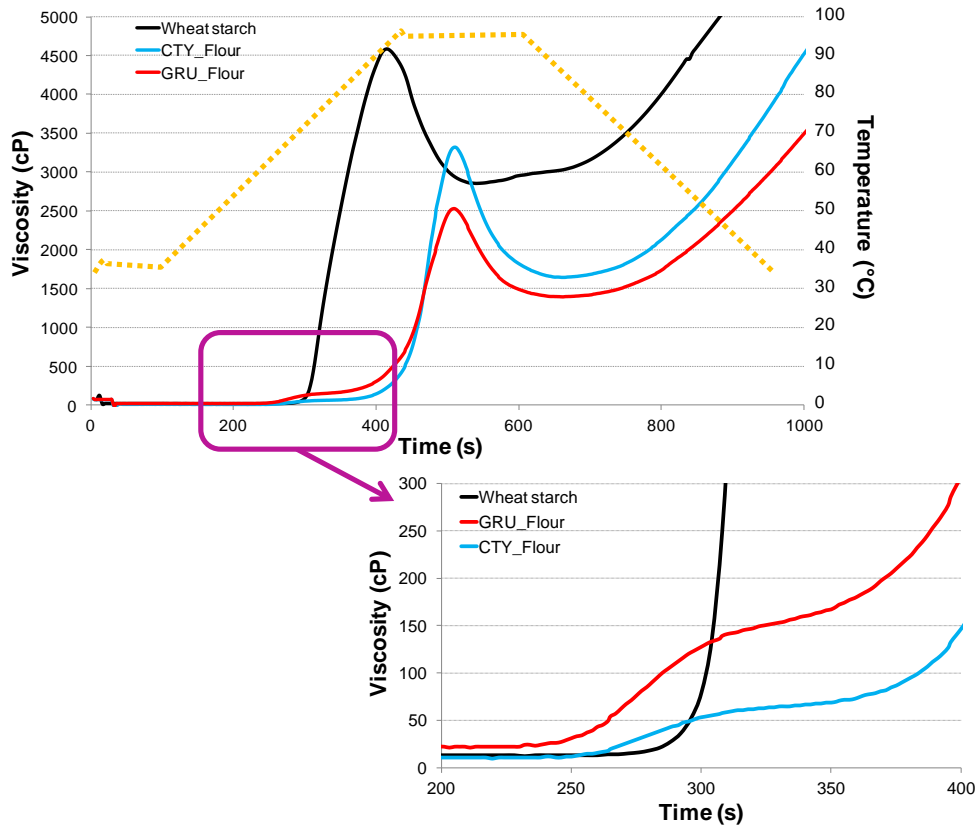

Figure 80 : Evolution of the viscosity of water-flour mix samples as a function of time and temperature. Measurements were carried out using a Rapid Visco Analyzer and performed on wheat starch powder, GRU and CTY wheat flour. RVA profile (top) and its “pasting zone” (bottom) illustrate flour proteins influence on flour viscous properties under hydro-thermal conditions.

3.1. Flour proteins level

Consistent with the distinct level of flour proteins that were studied, it also confirms the flour-water system behavior while carrying out viscous properties analysis; RVA profile illustrates the main differences between two flour samples and a starch sample, thereafter focusing on the curve zone where viscosity increase starts: Figure 80. Starch - water sample viscosity strongly rise up upon heating. A tremendous slope change (90° angle) can effectively be visualized on the Time = f(Viscosity) curve: Figure 80 top. In flour - water system, it merely highlights that as the temperature progressively increases a slight sample thickening occurs showing a ‘shouldered’ RVA profile: Figure 80 bottom. Under hydration and heating conditions, this latter could merely be due to the presence of proteins in wheat flour.

To state if whether it is strictly related to the level of protein in flour samples, a part of the flour incorporated into the assay has been substituted by vital gluten powder. GRU flour exhibit marked viscosity evolution differences in addition with a more pronounced “shouldering” effect than CTY): Figure 81. An enhanced “shoulder” can be noticed on the CTY sample when gluten is added to the flour-water system that confirms the relative swelling hindrance.

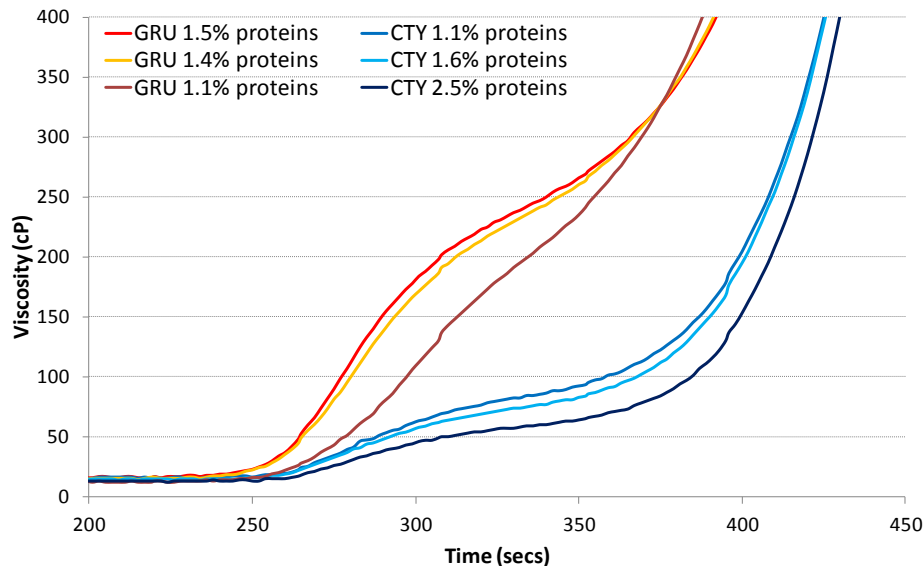

Figure 81 : Effect of flour protein content and flour type on the swelling behavior observed at the initial stages of the viscosity increase.

It appears that protein modulate wheat flour particles swelling. It impairs the attempted viscosity increase observed in the assessed sample (GRU sample partly substituted with starch). Conversely, it also highlights that in the case of equivalent protein content CTY never even up the GRU profile so that additional should be considered in addition with the overall flour protein level. The distinct Gliadin/Glutenin ratio can merely be responsible for this undoubtedly different dough behavior and a modification is recorded on its apparent viscosity.

3.2. Flour proteins nature

Gluten proteins tend to increase the consistency of a dough over kneading or mixing process (Dexter et al., 1994). Accordingly, upon mixing, gluten proteins progressively hydrate and gluten network set up (Shewry et al., 2001, Shewry & Tatham, 1997). While more gliadins lead to weaker dough, i.e. endowed with a lower strength and mixing tolerance (Khatkar et al., 2013), glutenins, are mainly responsible for the elastic property of gluten whence particularly interesting in bread manufacture. It has been recently shown that, as the gliadin' proportion increase among gluten proteins, the compactness of the gluten structure reduced considerably. It leads to the formation of a more open and weak gluten network (Khatkar et al., 2013). A positive linear correlation

($r^2 = 0.860$) has been observed between flour GI values and extensographic quality - maximum dough resistance to extension - (Curic et al., 2001).

Ergo, since water-flour systems at relatively low temperature illustrates the dough consistency, the depicted differences between sample behavior result from a specific flour absorption capacity, protein content as well as protein nature profile.

In our case, while brought into play to make cakes, incorporated as a dough ingredient, CTY flour, which exhibit a low protein content, high gliadins/glutenin ratio, and a low GI, genuinely leads to a more extensible, and less resistant dough (Curic et al., 2001): Table XXXVI. Gluten proteins provide gas-retaining properties allowing gluten network to properly set up instead of a too extensible dough for which both gas retention and dough leavening are not avoided at least impaired (Hoseney, 1991).

3.3. Flour proteins influence cake dough development

The presence of a distinct level of proteins amongst studied flours give rise to another hypothesis based on cake development ability upon oven baking and its final height. Whilst a higher proportion of air is initially present within the dough it is still entrapped at least even up once the product has leaven upon baking. Actually, the same sample classification regarding dough density ranges prior and after baking are indeed obtained: Table XXXVI. CTY flour based samples are always denser than GRU ones.

Thence, we can merely make the assumption that air bubbles which has been formed during the mixing step remains embedded within the matrix, grew up, and that already formed air bubbles are not lost after baking (Deshlahra et al., 2009), so that the relative proportion differences should be kept between samples.

GRU might have the ability to better entrap air then forming bubble embedded into the dough matrix whence the higher apparent viscosity and low dough density of the dough.

Conversely, it appears that the differences measured between CTY and GRU flour based samples drop when dough undergo baking transformations. While about 10% variations are measured for dough density (GRU and CTY dough density of 0.98 and 0.87 g/cm³, respectively), a 16% variation is recorded after baking (GRU and CTY baked product density of 0.43 and 0.36 g/cm³, respectively): Table XXXVI.

Such discrepancies actually states on the ability of the CTY flour based samples to develop upon baking. It has indeed been demonstrated on pan breads that an increasing level of total gliadins and (not only its individual sub-fractions, i.e. α -, β -, γ - and ω -gliadins), substantially improve loaf volumes (Khatkar et al., 2002). In addition, relatively low total proteins amounts (8-9%) are known to confer better extensibility and spreadability of the dough which is usually considered desirable for the texture and the overall quality of soft wheat products. It is therefore consistent with the common use of

soft flours into soft wheat products such as cakes and biscuits (Dobraszczyk & David, 2001, Khatkar, 2002).

3.4. Emulsifying properties of flour proteins

Flour proteins can bring its higher elasticity to the dough (Figure 82) but can also exert an influence on its emulsifying ability. Wheat proteins have actually been demonstrated in a few papers and further reviewed to be endowed with interfacial properties, contributing to their foaming and stabilizing impact (Örnebro et al., 2000).

These authors especially investigated gluten' proteins for their foaming properties, although wheat flour proteins have been classified in the past according to their solubility and physico-chemical properties into soluble (amongst, hydrophilic and amphiphilic) and insoluble (gluten) constituents (Osborne, 1907, Shewry et al., 2009, Shewry et al., 1986). Gluten proteins actually involve both hydrogen bonds and hydrophobic interactions which can be either strengthen or reduced by the way of redox molecules actions (Lagrain et al., 2012, Mejri et al., 2005).

According to several authors, gliadins (belonging to the gluten proteins) could particularly be endowed with emulsifying properties in addition with hydrophobic-hydrophilic properties (Li et al., 2004, Thewissen et al., 2011).

Owing to such interfacial properties, they could thence be able to enhance foaming and promote the stabilization of wheat flour based products such as bread (Örnebro et al., 2000). Besides, it is also possible to increase gluten proteins emulsifying and foaming ability by the way of their hydrolysis: (Drago & González, 2000).

3.5. Flour proteins impact cake crumb aeration and mechanical properties.

With respect to GRU, the crude CTY dough display a relatively high density but already contain gas encompass into cells forming the dough matrix: Table XXXVI. With an equivalent composition and the same process apply to both samples, the CTY dough is thence able to develop upon baking step. Notwithstanding bubble growth and gas formation upon leavening agent reactions, CTY product display a higher density and a lower final height compared to GRU based sample. It can be hypothesized that because cell walls are too weak, the cake structure, produced during baking step cannot be maintained as high as it initially develops. These findings could most probably originate from the collapse phenomenon undergone by the CTY cake sample while removed from the oven which might thus be responsible for both its final density increase and a low final cake height

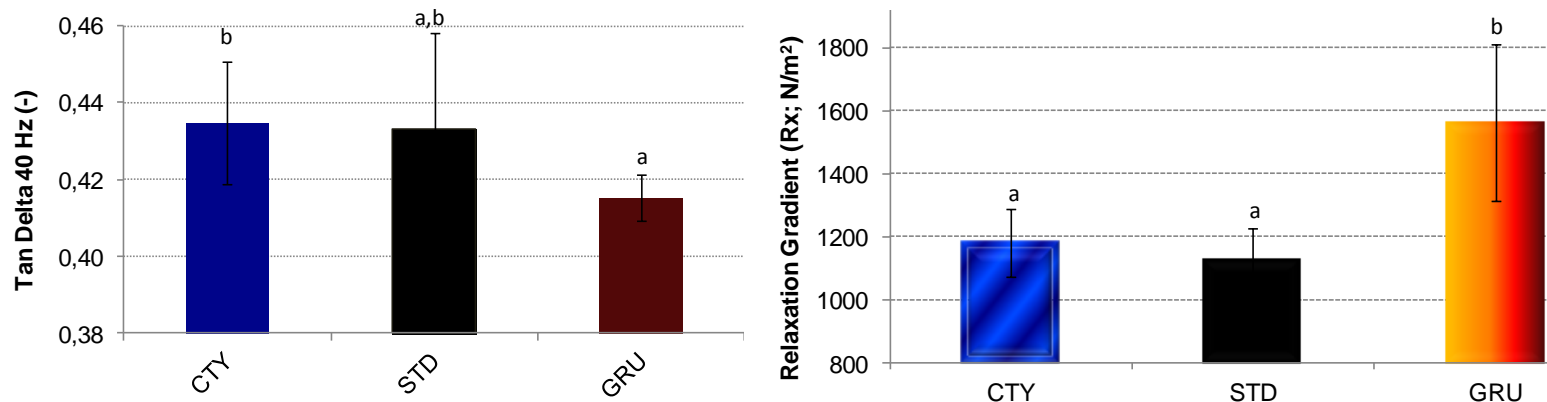

Figure 82 : Illustration of the impact of the flour nature used in cake products (1 month storage) on $\tan\delta$ (left) and relaxation gradient (right) parameters. $\tan\delta$ is considered as crumb bubble wall rigidity evaluation parameter and represents the calculated modulus ratio E''/E' (i.e. Young modulus viscous behavior component divided by Young modulus elastic behavior component). Higher is the recorded $\tan\delta$ values, lower is the sample cell wall rigidity. Relaxation gradient informs on the sample initial response when applying a compression that is further maintained. Higher Rx index explains a stronger relaxation of the sample.

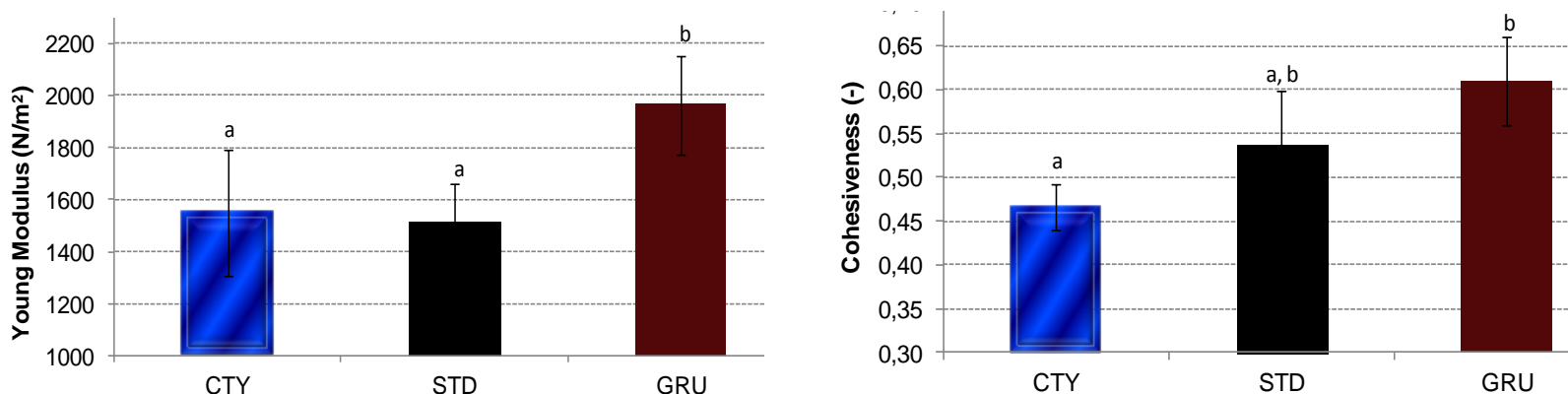

Figure 83 : Impact of flour nature on several cake sample textural properties (Young modulus left; cohesiveness, right). Measurements were driven using a TAXT₂ texturometer under compression. While sample deforms (% compression distance), the response is recorded as the resulting force responses.

Bubble wall acts as a hindrance for air that is entrapped into cells. If the cell wall resistance is high enough to support gas pressure, then bubble is formed and grew up. In the case of CTY, we could suppose that a lower resistance and a higher extensibility of the dough do not hamper bubble growth enough. Given that this latter step should not hinder bubble formation, then, several hypothesis can be quoted that might interfere over making process and explain the behavior of the different flours individually incorporated into the cake dough.

Cake collapse can be also be related either to an exacerbated development obviously too important to let the baked product to be structured, or in another extent to the cell wall composition and sample resistance properties. After baking, the cell wall resistance has indeed been recorded on cakes (Figure 82).

GRU based flour cake products display higher Tan Delta also higher relaxation gradient (i.e., cell wall strength evaluation) values than the other samples CTY and STD. It exhibit higher cell wall elasticity whence greater overall resistance under compressive force (see Young modulus values) and its ability to quickly respond to successive deformations (cohesiveness): Figure 83.

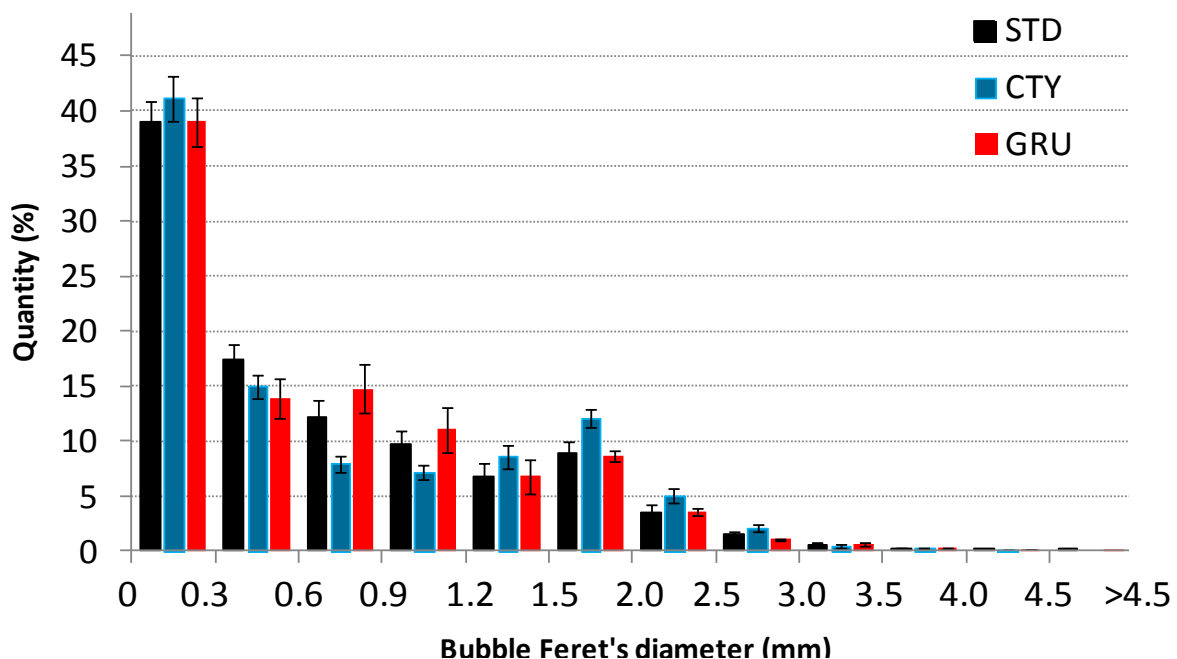

Figure 84 : Bubble diameter distribution, in frequency and spanning over a 0 - 4.5 mm.

Cake's hardness is not influenced by the flour nature (F_{max} , data not shown). While sample deforms under compressive strain, STD, CTY and GRU display an equivalent maximal force ' F_{max} ' value. A compensative effect of the product density and its mechanical properties can thus be supposed in the case of F_{max} . Merely, the lower resistance of CTY based cakes explains the equivalent F_{max} results that GRU and CTY flour based samples.

Such assumptions may also originate from the fact that different aeration profile and a distinct bubble wall thickness are observed between CTY and GRU flour based cake samples: Figure 84, Table XXXVII. These facts deservedly reinforce the hypothesis based on cake mechanical properties ergo the need to be concerned about the impact of protein nature on the dough and cake properties.

Table XXXVII : Bubble wall thickness estimation based on the analysis of cake pieces from the bottom to the top of the sample using X-Ray Tomography scanned images

Sample name	Bottom cake pieces	Top cake pieces
CTY	0.38 ± 0.04	0.35 ± 0.02
STD	0.31 ± 0.02	0.36 ± 0.03
GRU	0.27 ± 0.10	0.22 ± 0.02

The higher protein content in addition with its gluten proteins composition substantially improves GRU dough physico-chemical properties. Yet, at the initial stages of making process, i.e. dough mixing, GRU flour could also exhibit an enhanced foaming effect compared to CTY flour. For instance, the use of GRU flour in dough appears to improve its ability to entrap air, its apparent viscosity but also helps the cake structure to be maintained once it is baked, as it provides stronger cell wall properties.

Exerting a strong influence on the mechanical properties of the cake dough, such compounds might also be responsible for the physico-chemical characteristics of the baked product, whence an impact on crumb cell wall mechanical properties.

Meanwhile, the differences observed in terms of bubble growth and cake structure set up might be owed to the flour protein composition and functionalities but might also involve starch transformations including its gelatinization.

4. *Wheat flour starch: physico-chemical properties, hydro-thermal behavior and its involvement in cake making.*

In the previous parts, the purpose was whether to seek on the impact of flour hydration capacity then of flour proteins on dough and cake physico-chemical properties. Since starch represents the major wheat flour component, it exerts a strong influence on flour functionality. Undergoing hydrothermal transformations, it can be deservedly anticipated that starch is able to substantially influence dough also cake properties as studied in flour-water and in dough-like systems. Specific starch properties investigation first and last requires the analysis of flour sample under hydration and heat.

The starch gelatinization has been driven using Differential Scanning Calorimetry (DSC). Gelatinization temperature and enthalpy have been quantified. They respectively illustrate the gelatinization phenomenon occurrence and extent: Table XXXVIII.

Table XXXVIII : Effect of wheat flour origin on temperature and associated energy of enthalpy values recorded on the gelatinization endothermic peak (DSC thermograms).

Parameters	Onset temperature T_0 (°C)	Peak temperature G (°C)	Energy ΔH_G (J/g MS flour => J/g MS starch)
CTY_Flour	57.22 ± 0.38	63.14 ± 0.56	7.43 ± 0.52 => 8.56 ± 0.85
STD_Flour	56.01 ± 0.24	62.51 ± 0.22	7.40 ± 0.69 => 8.79 ± 1.18
GRU_Flour	54.74 ± 0.70	61.30 ± 0.88	7.30 ± 0.10 => 9.24 ± 0.19

T_0 , G and ΔH_G respectively corresponds to the gelatinization onset temperature, peak temperature and energy required for wheat starch gelatinization to occur (starch crystalline area melting and vitreous transition of amorphous zones).

ΔH_G (J/g dry matter starch) represents the enthalpy for one starch equivalent weight unit.

GRU flour gelatinization occurs significantly earlier compared to STD and CTY. The same ranges of energy were expected to be obtained for the studied flour samples as wheat starch gelatinization enthalpy has been demonstrated to span from 6 to 11 J/g MS starch for a water-starch mix hydration level of 1:1 and 20:1, respectively (Tester & Morrison, 1990a). If extrapolated to our study, the calculated enthalpy approaches 9 J/g starch, which is consistent with what has been measured.

Several hypotheses can be suggested regarding each flour sample behavior related to its starch granule composition, structure, interactions and physico-chemical properties.

4.1. Starch level influence

Wheat flour gelatinization temperature differences between CTY and GRU could be partly explained by their starch level (Table XXXVIII). Also, while flour is mixed with water, a competition for the available water obviously takes place between flour constituents (damaged starch and proteins Table XXXIII). These elements might explain the delayed gelatinization. CTY effectively exhibit the highest gelatinization temperature but contains the least protein and damaged starch content compared to GRU flour. With its higher starch content CTY is expected to display a larger but slower swelling until the close packing phenomenon happen. However, no significant energy differences were detected between samples, discarding the involvement of wheat flour starch content alone.

4.2. Starch gelatinization extent

Driven using a Rapid Visco-Analyzer (RVA), several flour-water suspension viscosity evolution were recorded over constant shearing and heating conditions. The resulting profiles provide information on the gelatinization phenomenon occurrence: Figure 85. Yet, RVA pasting temperature determinations were consistent with DSC results that genuinely differentiate the CTY and GRU flours: Table XXXVIII,

Table XXXIX.

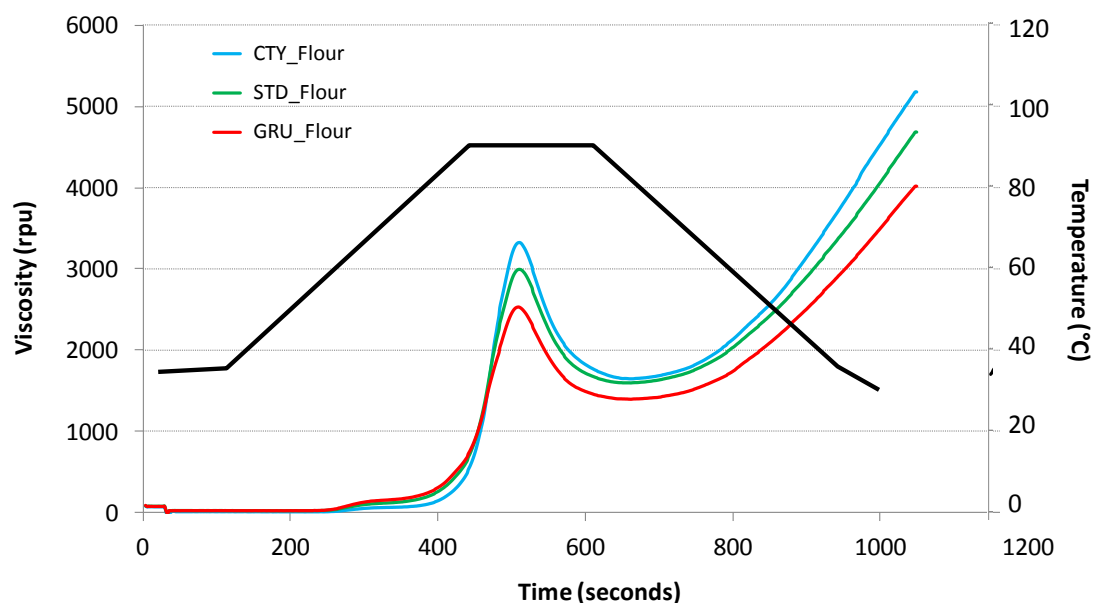

Figure 85 : RVA pasting profile of several flours assessed under hydration and heating conditions (water-flour mix, %H₂O).

Table XXXIX : Effect of wheat flour origin on pasting temperature and peak viscosity values measured using the Rapid Visco Analyzer.

RVA Parameters	Peak viscosity (cP)	Pasting temperature (°C)
CTY_Flour	3304 ^(c) ± 86.9	62.10 ^(c) ± 0.05
STD_Flour	2986 ^(b) ± 60.6	61.00 ^(a) ± 0.03
GRU_Flour	2536 ^(a) ± 8.3	60.20 ^(b) ± 0.04

It argue that swelling which set in during initial baking step increase considerably the system viscosity up to a maximum which has been found to differ between flour samples while assessing the viscous properties of flour-water systems under hydro-thermal conditions: Figure 85,

Table XXXIX.

Such discrepancies let infer the involvement of other factors directly related to starch granule composition and physico-chemical properties.

4.3. Starch granule composition and structural properties

4.3.1. *Swelling properties*

Studied flours can differ on the basis of their ability to quickly absorb water and the swelling level of their starch granule thence delaying or enhancing the gelatinization phenomenon. Earlier, flour particles surface properties (wettability and water drop surface adsorption) were investigated (Roman-Gutierrez et al., 2003). However, no significant differences were evidenced between hard and soft wheat flours that could have explained a distinct behavior against water.

Ergo, an enhanced viscosity in addition with a lower porosity of the medium while brought into play with water could be anticipated for CTY flour. It is thence supposed that a wider distribution improve the ability of swelled starch particles for a better space occupancy in a given volume of flour-water mix, enhancing sample viscosity in a higher extent than that observed in the case of GRU: Figure 85.

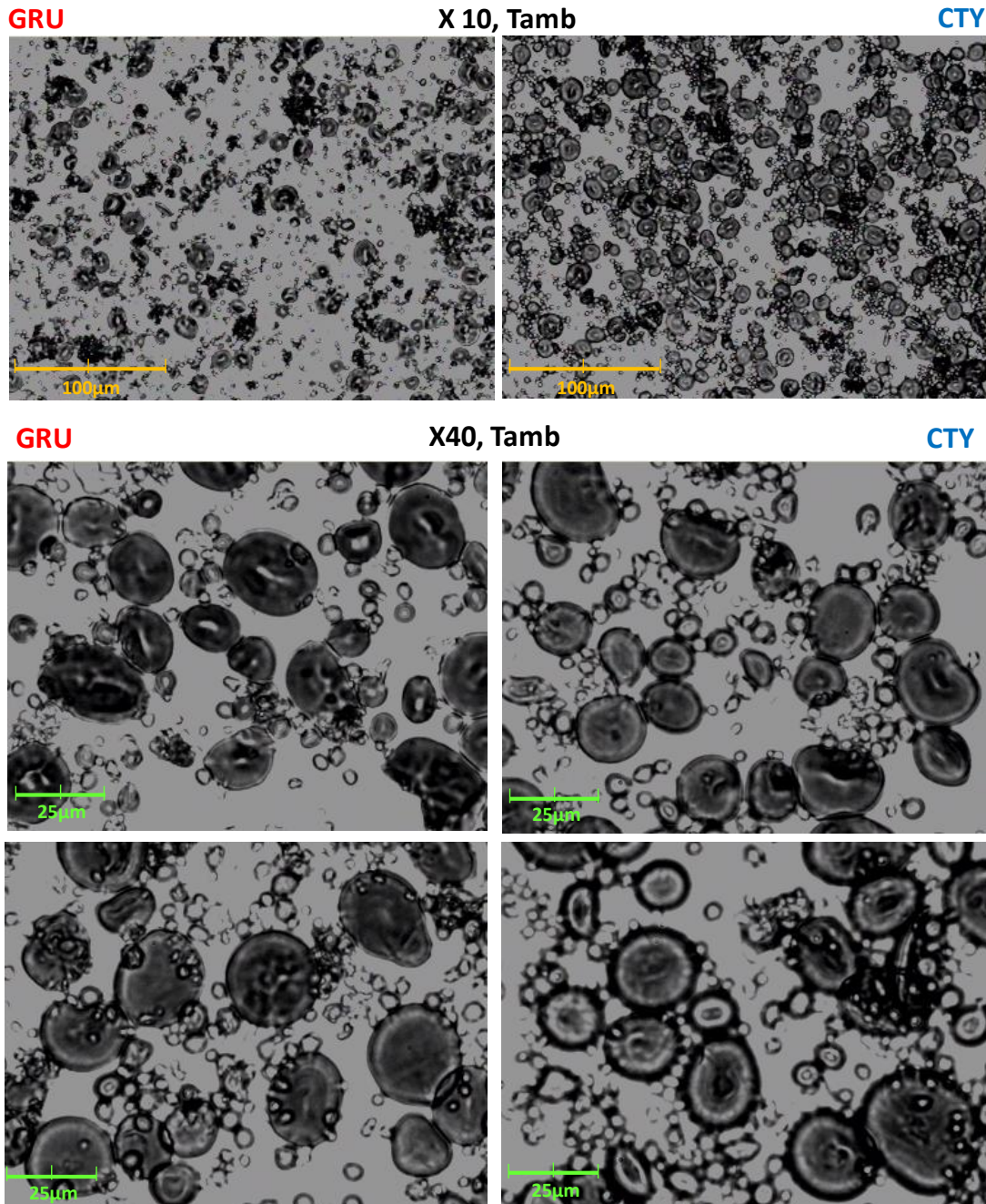

Figure 86 : Observation of wheat flour starch granules of GRU and CTY wheat flours (left and right images respectively). Images were obtained using a light microscope at magnification of 10 (top) and 40 (centre and bottom). Total wheat flour was stained using % iodine solution (KI 2%, I₂ 1g) to allow the selective observation of starch granules. Image was captured with a digital camera adapted on a light microscope.

4.3.2. Granule size distribution and evolution over hydrothermal treatment

CTY and GRU flours initially show a slightly different starch granule size distribution while considering flour suspensions micrographs in which for instance CTY appears to span over a wider range of starch granules sizes: Figure 86.

Accordingly, CTY has a larger proportion of very small starch granules than GRU flour: Figure 88. In addition, the largest detected starch granules (diameter above 10µm) represent 30% of GRU starch granules whereas it accounts for 20% of CTY granules. These variations represent few differences in proportion but induce a larger difference in terms of volume and space occupancy.

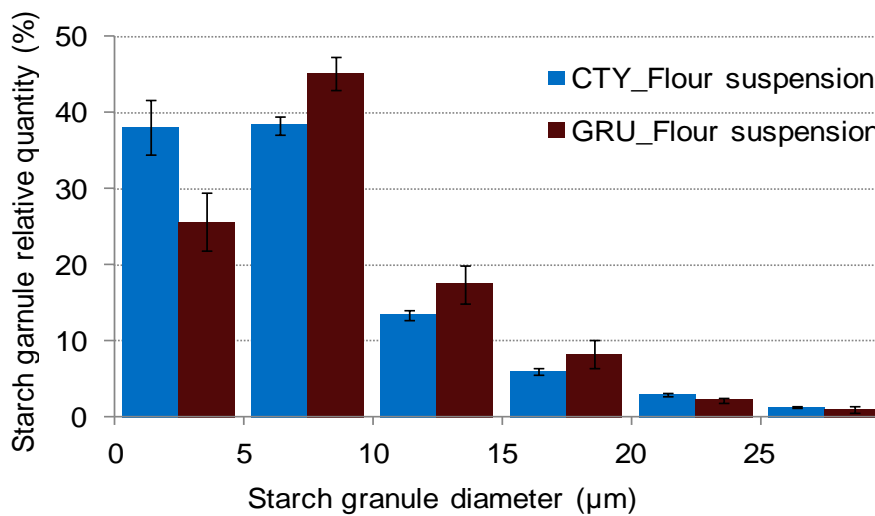

Figure 87 : Comparison of CTY and GRU wheat flour starch granules size at ambient temperature. Illustration of the distribution of starch granule sizes spanning from 0 to 25µm diameter. Profile is based on 8 light microscopy images (x40 magnification) followed by image analysis allowing the detection and calculation of iodine - stained starch granules

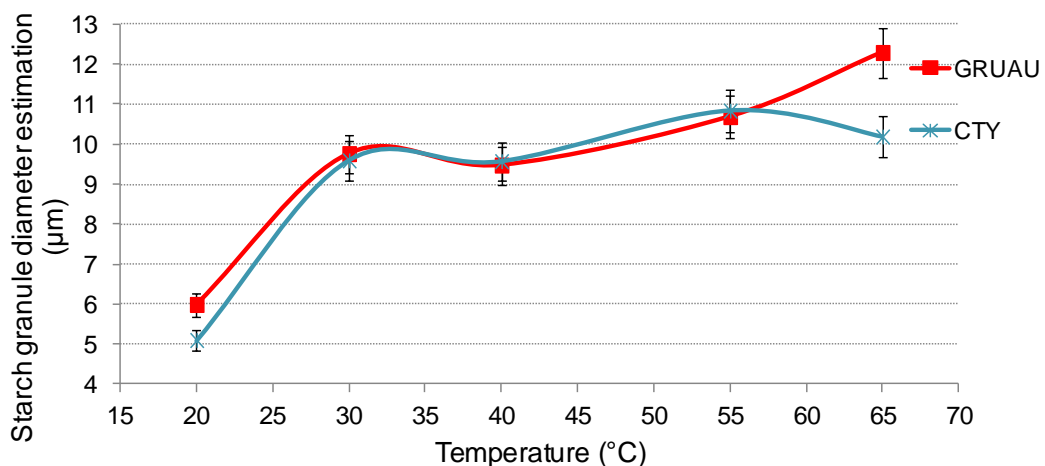

Figure 88 : Illustration of CTY and GRU flours starch swelling: evolution of wheat flour starch granule size (Mean Feret diameter) as a function of temperature. Results hereby were obtained in flour – water suspension over hydro-thermal conditions, stained with iodine solution (KI 2%, I2 1g), further subjected to light microscope observation (X40) and image analysis.

The evolution of starch granule dimensions in water – flour suspensions was evaluated under hydration and heating. In such conditions, progressive swelling occurs. Although it appears slightly quicker in the early heating steps (20 to 30°C) for CTY than for GRU flour, no differences are evidenced for additional temperature increases up to 55°C: Figure 88. Mean starch granule size keep growing for GRU while it remains almost stable for CTY in-between the last assessed temperatures (55-65°C).

Such measurements were primarily visualized on micrographs while analyzed at different temperatures: Annexe 11. This behavior has also been approached using laser granulometry over heating of water-flour suspension: Annexe 12.

Further heated, starch granules disruption should obviously occur.

Commensurate with wheat starch granules swelling evolution, viscosity evolution witness to the higher hydration and swelling ability of CTY starch compared to GRU: Figure 85 to Figure 88. Wheat flour starch amylose-amylopectin ratio can influence the temperature, the duration and the required energy for gelatinization to happen – section I - (Fredriksson et al., 1998). Whence, inherent in the actual starch granule ability to hydrate, starch granule size distribution and its inner organization (granule crystallinity level) might directly impart or improve wheat flour behavior.

4.3.3. Granular structure and composition of starch considerations

Since the gelatinization phenomenon encompasses both the amorphous areas (i.e. amylose) vitreous transition and the crystalline areas (i.e. amylopectine) melting, the enthalpy of gelatinization ΔH_G contributes to the evaluation of the phenomenon extent (Chen et al., 2011, Tester et al., 2004). Although considering CTY, GRU and STD gelatinization properties, a tendency based on the studied flours can be assumed: harder is the flour, lower is the gelatinization temperature and higher appears the level of energy required for gelatinization to occur: Table XXXVIII.

ΔH_G is considered as to the evaluation of the relative flour starch crystallinity, ergo the quality and crystal proportion within starch granules (Tester & Morrison, 1990b).

A slight rising tendency as the flour hardness increase is observed on CTY and GRU ΔH_G levels (8.56 and 9.24 J/g starch (dry matter basis), respectively). It could whether be anticipated that flour nature had little if any effect on the starch gelatinization extent and on the relative amount of amylopectin that melt upon hydro-thermal treatment. It might conversely point out a distinct starch granule organization. A tendency to require lower energy for granule melting in CTY than in the others could be related to a higher level of amorphous regions and/or a better water sorption ability.

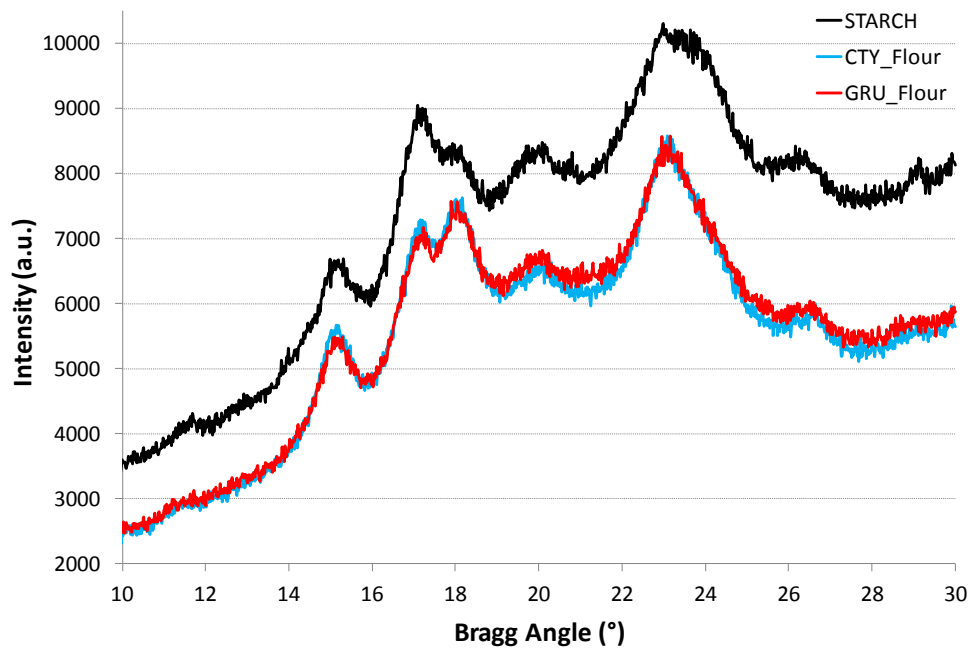

Figure 89 : X-Ray diffractograms spanning from a 10 to 30° Bragg angle range of wheat flour starch, CTY and GRU flours.

To go further along the understanding of the origin of the distinct flour functionalities we inquire into the evaluation of the crystalline/amorphous areas proportion within starch granules to seek out the potential differences existing between GRU and CTY flour. X-Ray Diffraction measurements have been undertaken (Blazek & Gilbert, 2011). Commensurate with previous studies performed on starch, not flour samples, a powder XRD instrument was used (Baks et al., 2007, Cheetham & Tao, 1998). The level of crystallinity in studied flour samples was calculated based on diffractograms using bragg angles values characteristic of starch crystals: Figure 89. CTY and GRU show a slightly distinct crystalline-amorphous area ratio. Crystalline part accounts for 3.62% less in CTY than in GRU: Figure 90.

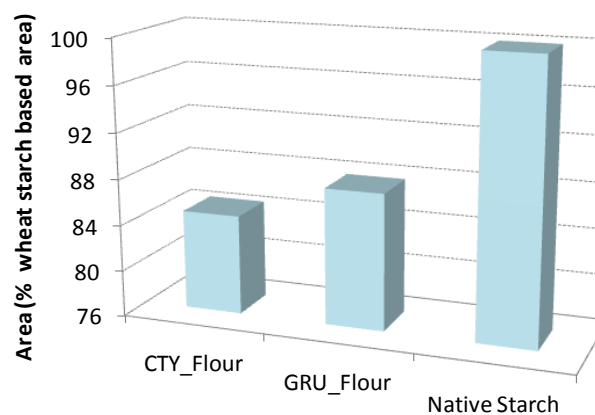

Figure 90 : Comparison of the relative crystalline area of flour samples from X-Ray diffractograms analysis. Values are given as a dry matter starch basis and compared to a 100% starch level.

The contribution of several characterization methods reinforces the hypothesis that CTY probably display less crystalline wheat starch granules than GRU. Ergo, it could partly explain why, in comparison with GRU, the CTY flour has a lower starch gelatinization enthalpy in addition with a delayed gelatinization phenomenon occurrence as illustrated by both DSC and RVA results: Table XXXVIII,

Table XXXIX.

Protein involvement could be inferred regarding its relative impact on granule swelling, close packing occurrence and viscosity flour media evolution upon heating. A steric entanglement explanation could be given to illustrate the actual behavior of flour within which proteins account for a larger proportion. It could partly underpin the fact that for an early gelatinization, the dough structure develops upon baking in a slightly lower extent, until that proteins denaturation and starch gelatinization occur.

Once the cake dough has undergone various and prominent modifications, it can be considered that, its overall structure is settled down (further even up by the cooling down stage and impaired upon storage). Conversely, when gelatinization set in later, not inordinate, at least higher product development is expected prior the cake dough evolution slows down.

As explained in the depicted in the previous parts, depending on starch gelatinization level, protein content and composition, the cake structure is whether expected to collapse or to maintain its shape. Although brought into play using the same manufacture conditions, distinct flours were incorporated to obtain different final cake products. Yet, the composition of the product might exert a substantial influence on its mechanical, above all sensory properties whence the need to investigate the critical sensory aspect in addition with its instrumentally measured features.

5. *On the impact of wheat flour nature on cake texture properties: a thorough sensory-instrumental approach.*

While studying the impact of flour nature in cake textural properties, a mechanical also sensory evaluation approach has been driven. The comparison made on the basis of the cake crumb aeration features has also been attempted.

The why and therefore was first to better understand the link between instrumental and sensory properties on samples that were initially expected to exhibit quite close characteristics; second, with the most thorough approach as possible, to identify the main cake texture modification that can solely comes from the 'flour parameter variation'. Although involving a distinct composition, thence obvious modifications in terms of flour components level also functionalities, the extent of the variation remain unknown. It justifies the need to investigate aeration features in addition with textural parameters: Figure 91.

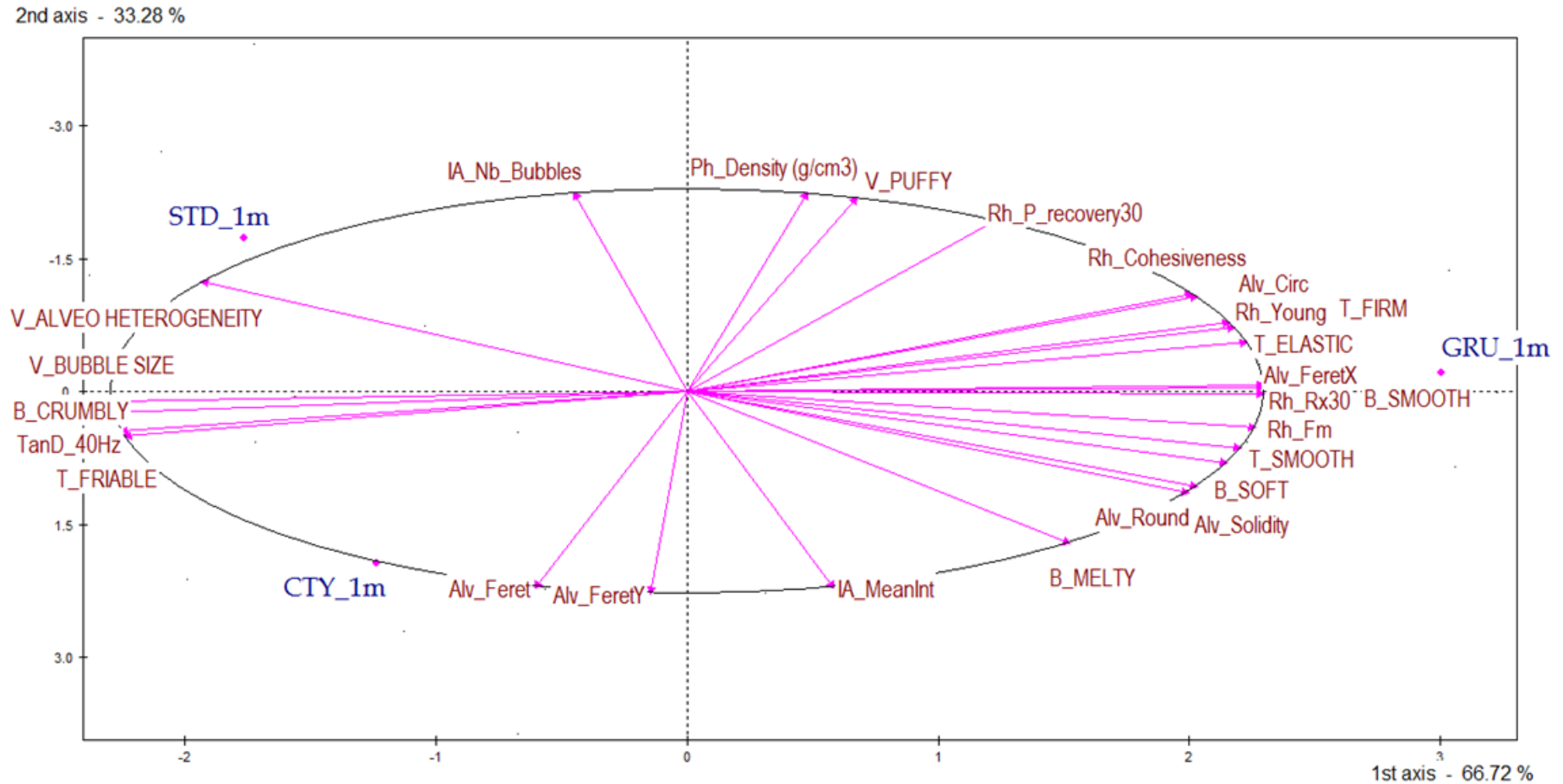

Figure 91 : Impact of flour nature on cake texture properties: a sensory – mechanical – aeration study represented using the resulting product-variable map from the MFA performed on a full range of data obtained on cakes after 1 month of storage; V (Visual sensory measured) – T (In touch) – B (In mouth) – Ph (physico-chemical characterization) – IA and Alv (Aeration measured items) – Rh (Rheology/Mechanical parameter)

Sensory-instrumental data were consistent each other on the basis of flour nature study: Figure 92. CTY but also STD flour based cakes exhibit a close sensory profile: they are not different on the first axis basis accounting for 66%. Cakes that are produced using soft flours are more heterogeneously aerated obviously considered as more friable and sensitive to breakdown (TanDelta – T_Friable and B_Crumbly parameters). These flours, differentiated on the basis of instrumental parameters illustrates that such features are probably too far from sensory sensibility and that they cannot be perceived.

Table XL : Illustration of the correlation between textural instrumentally measured parameters and sensory items. R^2 correlations coefficients results from MFA performed on instrumental and sensory data sets obtained on the three studied flours after 1 month storage.

Instrumental\Sensory	T_Firm	T_Elastic	B_Soft	T_Friable	B_Crumbly
Fmax	+ 0.88	+ 0.91	+ 0.98	- 0.92	- 0.96
Young	+ 1.00	+ 0.99	+ 0.76	- 0.99	- 0.97
Rx	+ 0.94	+ 0.97	+ 0.94	- 0.97	- 0.99
TanDelta	- 1.00	- 0.99	- 0.85	+ 1.00	+ 1.00

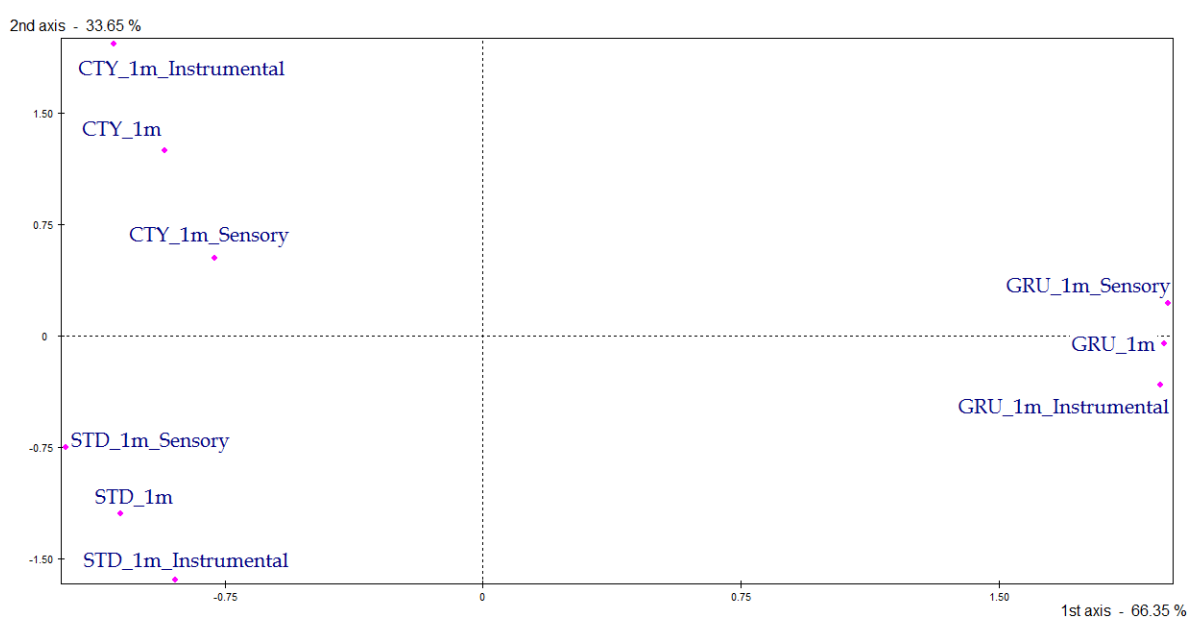

Figure 92 : Representation of the measured impact of flour nature on sensory also instrumental (mechanical – aeration). The MFA was performed on a full range of data obtained on cakes after 1 month of storage. Two groups of data are used: instrumental (including physico-chemical, mechanical, aeration features) and sensory (including Visual, In touch, in Mouth).

Conversely, GRU based cakes are perceived less aerated, exhibiting better bubbles homogeneity. Bubble roundness and circularity probably contributes to this homogeneous aeration perception in addition with the higher elasticity of bubble wall (TanDelta). GRU based cakes are also perceived as firmest (T_Firm), more elastic

(T_Elastic) and softest (B_Soft). This is shown to be related to parameters such as firmness (Fmax), Young modulus (Young) and relaxation gradient (Rx): Table XL.

The comparison of instrumental data and sensory perception measurement of texture show that sensory results are less discriminative and less sensitive than analytical data on several aspects: Figure 92. Indeed, instrumental characterization provides parameters that might not be perceptible such as bubble shape regularity. Also, CTY and STD samples display a close sensory perception with regards to their in touch also in mouth perception (33.65% contribution). The difference mainly appear on the slightly less 'puffy' aspect of CTY compared to STD cakes. Accordingly, the density of CTY cake was found to be higher than STD.

Generally speaking, the perception of GRU flour based cakes are from a sensory point of view perceived using positive items (soft, firm, elastic, smooth, melty) whereas CTY and STD flour based cake samples are describe using different items negatively associated to texture (friable and crumbly, heterogeneous, dry).

These different levels of perceptions are directly related to the nature of the flour incorporated into the formula. Whilst flour type is varied, no modifications are applied within the other cake ingredients. It thus highlight that the flour alone, owing to its composition and its functional properties can significantly influence cake structure set up and perception of the final product according to its aspect, in touch properties and in mouth sensations.

The measurement of several parameters using instrumental characterization can provide suitable and accurate information on the cake perception that would be obtained setting up a panel. Conversely, the sensory characterization of cake sample eventually provide consumer-like response and helps in evaluating items that are difficult to approach in any other system.

6. *Hydro-thermal transformations of flour-water and cake media: influence of flour composition and quality.*

Even with an equivalent mixing process, the use of CTY flour to make cake dough acts in the reverse order leading to low viscosity sample that impair air entrapment. Since protein can hamper swelling for steric reasons, the influence exerted on starch swelling ability impacts flour viscous properties.

CTY flour was assessed with RVA for its viscous properties under hydration and temperature. With increasing levels of gluten, CTY flour displays decreasing peak viscosity values. Following starch granule disruption, breakdown was also lower and a longer 'plateau' prior further starch gelation was observed: Figure 93. It may be caused

by lower water availability for starch to properly gelatinize and a higher starch entanglement within protein network that avoid viscosity to fall down drastically.

Conversely, GRU flour assessed with increasing levels of wheat starch displays sharper and higher peak viscosity, final viscosity and stronger decrease after granule disruption. It merely illustrates the starch contribution to viscosity evolution upon its hydro-thermal transformation. These results also highlight that not any equivalent behavior is observed whether with equalize starch or gluten proteins in CTY and GRU flours respectively.

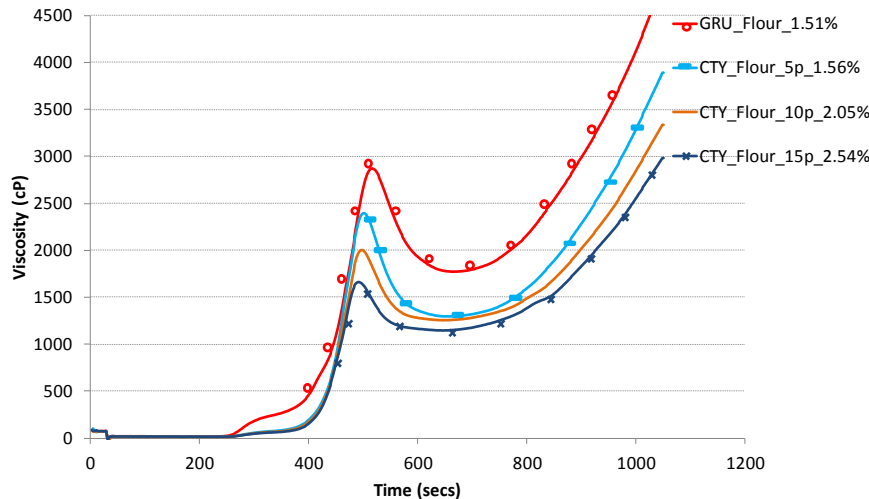

Figure 93 : Illustration of the impact of gluten protein level on CTY soft wheat flour RVA profile. CTY flour was substituted at 5, 10 and 15% of vital gluten proteins.

Several hypotheses regarding starch gelatinization phenomenon were proposed. They are based on starch granule swelling abilities, crystallinity and on the influence of protein on starch hydration, swelling properties swelling and viscosity.

6.1. Starch swelling and water-flour media porosity

We supposed that the starch granule distribution, its width and heterogeneity could impact flour-water systems viscosity by the way of distinct space occupancy: Figure 94. In a simple water-flour system, the softest flour always gives the higher viscosity values as recorded with RVA. CTY indeed displays a higher viscosity than GRU flour-water systems.

The heterogeneous starch granule distribution of CTY flour at room temperature combined to a relatively high small granule proportions contributes to lower the space available in-between swell starch granules while temperature is rising up. It consequently increases the viscosity of the water-flour medium. Although influenced by available water and space, starch granule swelling under hydration and temperature can also be impacted by the presence of other compounds. Whether incorporated ingredients or flour components such as flour protein might also be directly involved in starch behavior under hydrothermal conditions.

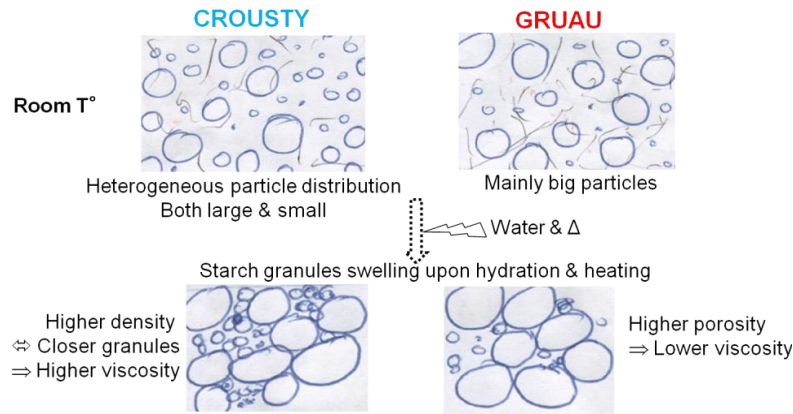

Figure 94 : Comparison of starch swelling and media porosity between CTY and GRU flour at ambient temperature then upon heating. Illustration of the influence of wheat flour starch granules size and heterogeneity.

6.2. Protein influence (sterical entanglement)?

We hypothesized that flour protein hamper starch swelling due to sterical entanglement: Figure 95. in addition with lower water availability for starch in the presence of proteins is thus supposed to be responsible for different phenomena. Since proteins lower contact in-between starch granules, starch swelling is limited, viscosity of the flour-water system is reduced, and starch gelatinization occurrence can be imparted.

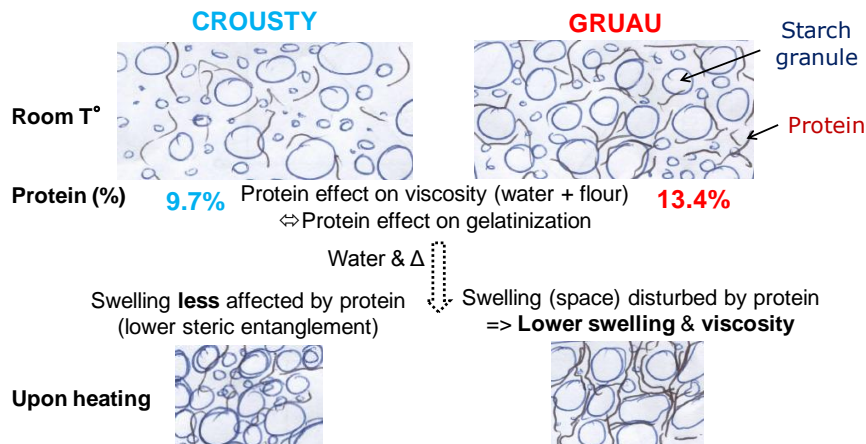

Figure 95 : CTY and GRU flour at ambient temperature then upon heating: wheat flour proteins impact on starch swelling.

In CTY flour, with relatively lower protein content than in GRU, starch swelling is thus less affected by the presence of proteins and gelatinization take place in a higher extent. In the case of GRU, close packing is probably not reached although granules deform and disrupt quickly compared to CTY.

According to the relative composition of studied flours, we supposed that the presence of a larger proportion of proteins in GRU is one additional factor responsible for the lower starch gelatinization level, the higher viscosity of dough at room temperature and conversely, the higher viscosity increase of CTY based flour systems.

Still, the lower protein content and smaller starch granules in CTY soft wheat flour compared to GRU cannot thoroughly explain the gelatinization phenomenon differences between these flours. Starch granule structure and crystallinity have been taken into account as an additional factor that might bring more elements.

6.3. Granule crystallinity

Since amorphous regions have been demonstrated to indirectly control onset gelatinization temperature in waxy starches (Shi & Seib, 1992). Using X-ray in combination with DSC and birefringence, peering into starch gelatinization transitions, Liu team highlight that significant endothermic transitions are closely related to an evolution in crystallinity (Liu et al., 1991). Higher proportion of amorphous zones within the granule could impart granule hydration effectiveness and deformation consecutively delay gelatinization occurrence.

Large granules have shown higher total crystallinity than small granules (Vermeulen et al., 2005). CTY has smaller starch granules amongst overall particle size measurement. GRU flour, containing larger granules could present a higher crystallinity.

Slight differences have been measured on the basis of CTY and GRU flour respective diffractograms in comparison with native starch sample. CTY starch appears less crystalline than GRU starch. The higher amorphous proportion in CTY thus contributes to delay starch gelatinization phenomenon.

All these elements indicate that a slight not substantial difference may exist in the crystalline/amorphous region of studied flours. It could partly be responsible of CTY and GRU flour behavior in water and within cake dough.

7. Conclusion: flour nature impacts cake softness & structure set up

The impact of the flour type has been pointed out on dough then cake properties. In this aim, various parameters were assessed on dough and on final cake product. They were depicted in this section including product physico-chemical characteristics (consistency, dough and cake density, cake height), mechanical properties, several aeration features as well as numerous sensory textural attributes evaluation.

Flour functionalities depend on the quantity and the quality of its components, amongst, starch and proteins. While assessing the wheat flour granulometry, it is for instance obvious that it is directly related to the overall flour composition originating from the flour type that has been selected to be studied.

Then, the composition of flour influences its hydration properties that are mainly driven by the nature of its constituents, especially the absorption ability of highly hygroscopic compounds such as damaged starch and pentosans. Also, flour proteins hydration occurring upon mixing progressively helps the visco-elastic network to be settled up due

to interaction that are taking place in-between protein units. While gluten network establishes, dough viscosity increases, forming a visco-elastic dough that is purposed to be further baked.

Upon baking, as the temperature of the dough is rising up, starch undergoes hydro-thermal transformations: a series of modifications including starch gelatinization that influences the final product structure happen. Possibly related to starch granule structure and crystallinity, the speed also the level of starch gelatinization can be impacted.

Once baked as the cake progressively cool down, changes can also occur that are mostly driven by the pressure resistance ability of the sample. *If crumb cell walls are too weak, the structure collapses modifying the final baked product height and density instead of keeping its oven-baking shape.* Starch component, somehow undergoing various transformations over the cake making process also impart the overall sample evolution after baking and upon storage that is related to the starch retrogradation.

According to the depicted effects of wheat flour nature on these various parameters, possible explanations obviously appear to have a combined influence on cake properties. Leavened baked foods such as bread (yeast leavened dough) and cake (chemical leavening agent) owe their “quality” also to their aerated structure (Deshlahra et al., 2009).

The actual aeration of the product is mainly achieved through establishment and growth of bubbles in the dough during mixing and baking and their subsequent transformation into interconnected gas cells forming the crumb bubbles.

Indeed, if a right combination of starch, proteins content, and components hydration is provided, the structure should set up and maintain once baking step has occur. Flour composition and its compounds functionalities tremendously impact the dough physico-chemical behavior and the nature of the interaction that are taking place upon mixing and baking. Therefore, the attempt of the study specifically performed on flour was to assess its functionalities foremost regarding starch and proteins to evaluate whether it had little if any effect on both the dough and the final baked product.

These flour characteristics, regarding its hydration properties, its protein profile as well as its starch functionalities thence influence the overall cake properties measured either mechanically or based on aeration features in addition with the characterization of its sensory perception. A good balance of composition and hydration is attempted in flours to be used for soft cake applications.

Section IV: Cake' textural properties evolution along storage: evaluation of the time impact from both a physico-chemical and a sensory point of view.

The impact of storage period length has been investigated from 1 day to 6 months. For each studied samples, mechanical also physico-chemical measurements have been performed at each stage to control its properties. Sensory analyses have been included thus providing a more thorough characterization. The sensory approach deals with the product perception quantization in regards with the studied attributes.

1. Evolution of cake' physico-chemical characteristics over a short-time period

The characteristics of the samples made up in lab conditions, i.e. STD cake and the two process modifications described earlier in this document (MIX and WATER) will be depicted in this first section with regards to the time influence exerted on its physico-chemical properties. It will be illustrated over a relatively short period of storage (from 0 to 45 days).

Following the cake' samples density evolution, a slight density increase is observed at the initial stage of storage. From 14 days, it remains significantly stable for the whole sample set. Considering the mechanical properties of these samples, the same evolutions levels are also observed between STD, MIX and WATER. The increasing value of the percentage of recovery is represented as an example for STD cake' sample: Figure 96.

The strongest evolution is actually recorded during the first week of storage. Thereafter, this increase progressively slows down to reach a plateau (from about 1 month). Indeed, no significant parameters values differences are observed between 30 to 45 days that can be considered as a point from which mechanical properties start to stabilize.

This evolution is also visualized on the relaxation gradient (Rx) for which a progressive increase has been recorded in the same conditions. It is encountered on samples made up at a larger production scale and studied longer (over 3 months) as well: Figure 97. Regarding the evolution of Rx but also Young modulus (data not shown) that follows the same curve, the increasing firmness could thus be the result of both the recorded increasing density and the rigidity of cake samples: Figure 97. Denser and more resistant to a global compression cakes also appear to progressively lose their elasticity.

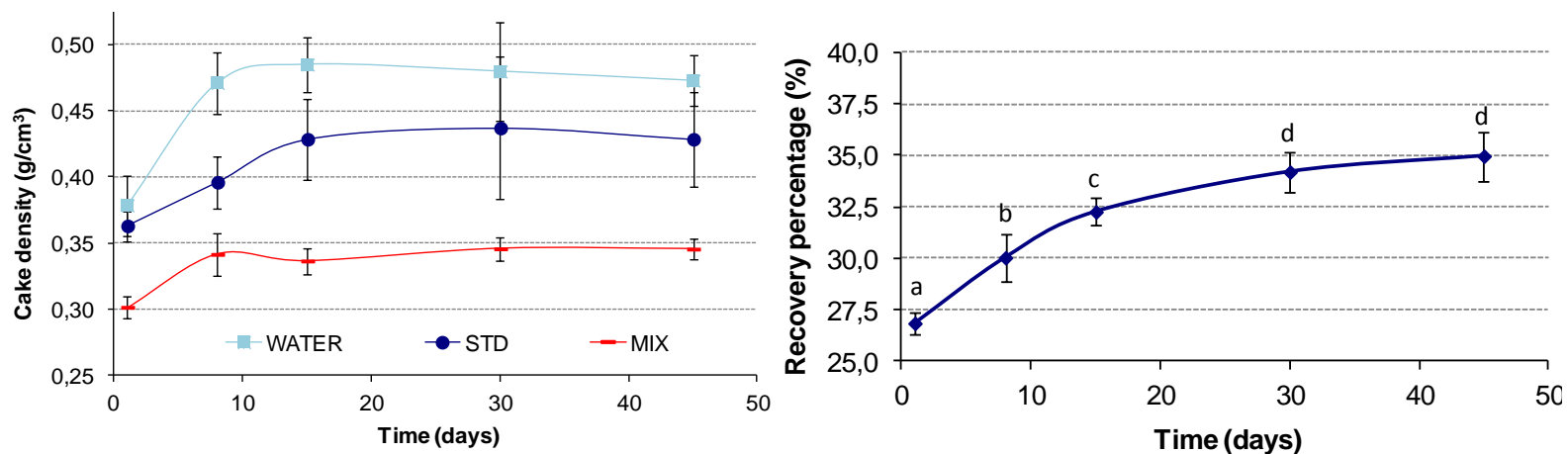

Figure 96 : Evolution of cake sample properties over a 1 to 45 days of storage. Cakes density evolution of three processed dough (left) and recovery percentage parameter evolution of STD sample (right).

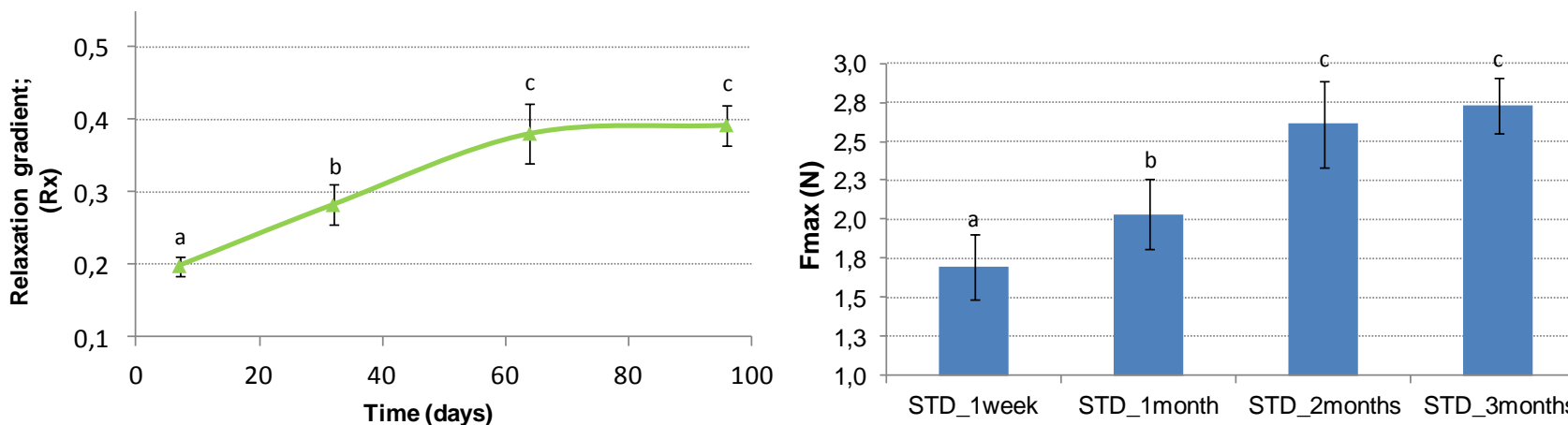

Figure 97 : Evolution of the textural properties of a reference sample (STD) over a storage period of 3 months. Illustration of its elastic loss (left, Rx) and its firmness increase (right, Fmax)

2. Impact of long-term storage on cake's textural properties.

As ascertain in the previous chapters and shown on our samples, cake texture was affected by both the flour nature basis used while it is process, its crumb aeration levels and the making process scale. Under storage, because of its composition and the physical state of its components, cake products are supposed to evolve. The short-term storage investigation indicates that the studied parameters are mainly modified during the first weeks of storage, so that the cake properties evolution occurs quickly after being produced. The starch retrogradation phenomenon, taking place over this period of storage could be at the origin of such evolution on cake samples.

Nevertheless, this study merely ascertains the influence of time on cake mechanical characteristics. A sensory analysis was necessary to be performed in order to be able to evaluate the perceived evolution level. Then the relative vicinity of the experienced sensory perception with regards to the measured sample properties along storage would be obtained. Meanwhile, cake products are usually manufactured and stored until at least one month prior to be sold. Thence, it was important to verify whether the observed stabilization from about 30 days of storage was maintained over time or merely corresponds to a 'stage' prior a new evolution step. A longer storage could be responsible for late sample modifications.

Mechanical properties as well as sensory perception were therefore controlled over a 5 months period. It consisted in the assessment of five cake samples at 1 month, then 3 and 5 months after its manufacture.

2.1. Evolution of the mechanical properties of cakes along storage

The evolution of texture features along storage is represented for several parameters: Figure 98. Then, time exerts a common impact on the recovery percentage which significantly increases within the first three months of storage, illustrating the progressive loss of the ability to respond to a long strain application: Figure 98. In addition, the evolution slows down after 3 months of storage as it is not observed to be linear on the whole studied period. Interestingly, it is also the case for the other recorded mechanical parameters (data not shown) denoting that the major evolution period is quite 'short' and that it mainly occurs in the initial phase.

The significant decrease recorded while measuring the loss factor ($\tan\delta$) indicates a rigidity increase of crumb bubbles cell walls upon storage (lower relaxation abilities).

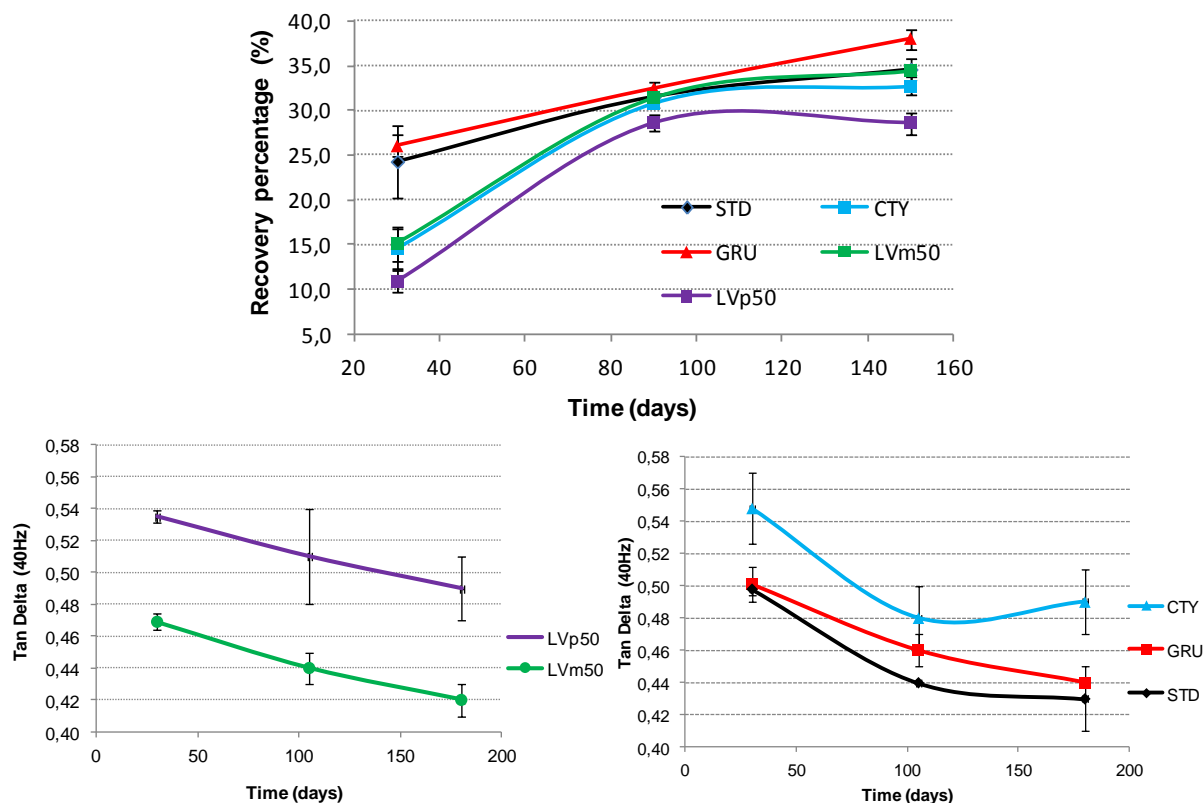

Figure 98 : Evolution of mechanical parameters - percentage of recovery (a) and Tan Delta values (b.) - measured on cake's samples over time. Samples originate from P2 scale production and were studied after 1, 3 and 5 months of storage.

Although these findings confirm the previous observations conducted on a shorter time of storage additional information is necessary in order to determine whether the consumer is able to significantly perceive an evolution of the sensory textural properties experienced while cake sample is stored.

2.2. Evolution of the sensory properties of cakes along storage

First, a P1 production scale study has been led involving a large of samples using a Flash Profiling sensory approach. Measurements were performed after 1 and 3,5 months of storage on 14 studied cake samples. Realized independently and involving 10 judges in each session, equivalent attributes were generated by the panelists themselves. According to the results obtained for these two separated sensory analyses, and notwithstanding the quantitative evolution that could have been measured along this period, we do observe that sensory relative differences between samples are kept along storage (data not shown). These findings illustrates both that the relative differences

between studied samples (equivalent sample positions on resulting MFA maps) and the cake characteristics (attributes equivalency) are maintained along storage.

Second, a P2 scale investigation has been led and is thereafter depicted based on a descriptive sensory profile characterization of cakes and over a 1 to 5 months period.

Among the evaluated attributes span, only discriminative items for which the panel was accurate and repeatable were kept for any further data analysis. To state, data recorded after each session were analyzed for the product and time effects. Besides, an additional data treatment was performed using the CAP method in order to control individual and overall panelist's performances. CAP table, Flash table and individual agreement with the panel are thus presented for each sensory session: Annexe 14.

Taken individually, and considering the evaluated attributes in addition with their respective level each judge was either in agreement or in slight agreement with the panel group (Nalpha values higher than 1.5). Moreover, while considering discriminative attributes (high Fprod value, see CAP Table) separately, panelists appears in agreement with the overall panel response (small Finter value, see CAP Table).

Notwithstanding the actual period while session was taking place, the items 'doughy', 'dry', 'hard', 'sticky as well as 'fatty' in touch and in mouth were not able to significantly differentiate cake' samples and were then removed prior additional data treatment.

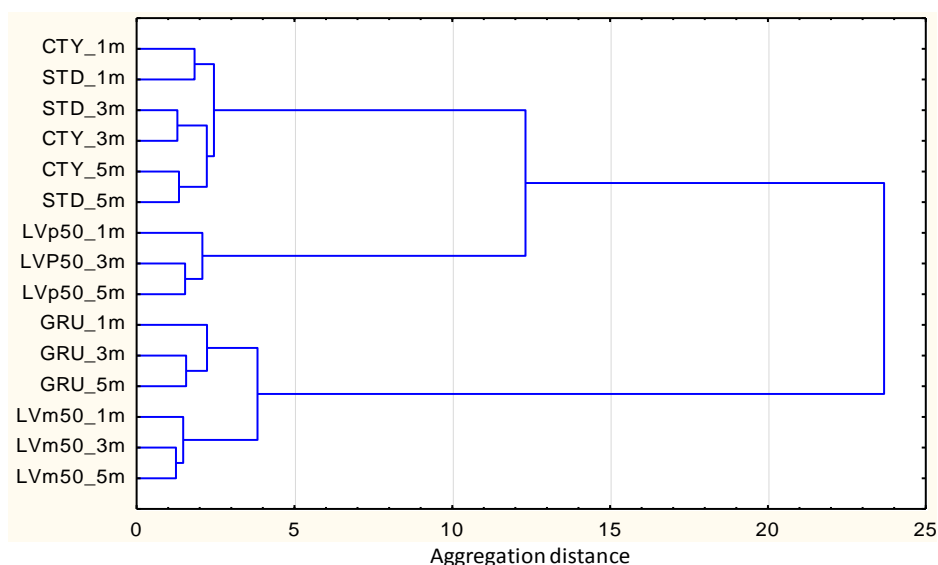

Figure 99 : Illustration of the impact of the time of storage on texture cake perception. Cluster analysis is based on center-reduced data from mean values of the sensory response for each attribute assessed on each sample after 1 month, 3 months and 5 months of storage.

Quantitative information was obtained on the impact of the time of storage on sensory perception of cakes. As illustrated on the cluster analysis, the results show that, from a strictly sensory point of view, time does not affect the relative characteristics of one product compared to another: Figure 99. Therefore, considering the overall range of

characteristics they appear to be at 5 months as different as they were after one month storage.

Over the 1 to 5 month period, considering the whole set of data, time effect was significant. Still, time effect for each product analyzed individually was not significant. It means that several products are more sensitive to storage also that items level can differently evolve within product set. LVm50 does not show evolution over storage.

Among significantly discriminative attributes, visually assessed items kept constant along storage. It is also the case of softness in mouth constant all over the studied period: Figure 100. However, the overall sensory properties evolution tendency is mainly attributed to the slight increase of in touch firmness, loss of elasticity and in mouth cake crumbliness measured after 5 months of storage. Interestingly, firmness increase and elasticity decrease occur within the 1 to 3 months storage period.

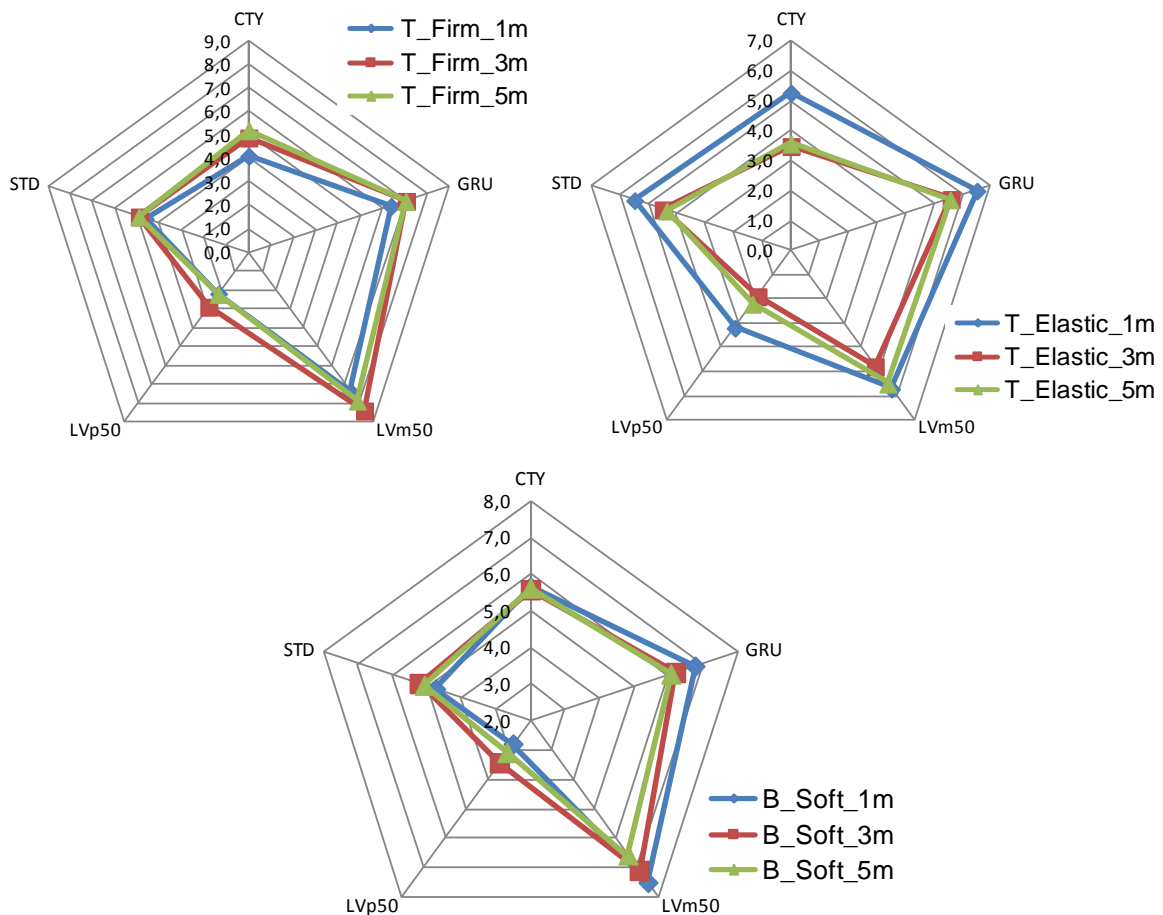

Figure 100 : Evolution of the levels of in touch Firmness, Elasticity two in touch texture attributes and of softness upon storage (after 1, 3 and 5 months). Results are given as a mean of a session group data involving 15 panelists and including three measurements for each sample. For these items, firmness, elasticity and softness, time effect p value is 0.0001; 0.0000; and 0.7460 respectively. Timex x product effect p value is 0.000; 0.000 and 0.037, respectively.

3. Impact of storage on cake texture: a multi-dimensional approach

The influence of the time of storage has been investigated on cake samples sensory perception in parallel with its physico-chemical properties, mechanical behavior and aeration features. Results obtained with instrumental measurements were consistent with what have been quantified by sensory evaluation (data not shown).

The results given for the five studied products - STD, CTY, GRU, LVm50 and LVp50 are based on the thorough analysis of both instrumental and sensory data (Figure 101). Each point corresponds to the 'barycentre' of the product. Its relative position is given for every time of storage that has been measured. Three points are represented for each product onto the products map: i.e. for one month then three and five month's evaluation.

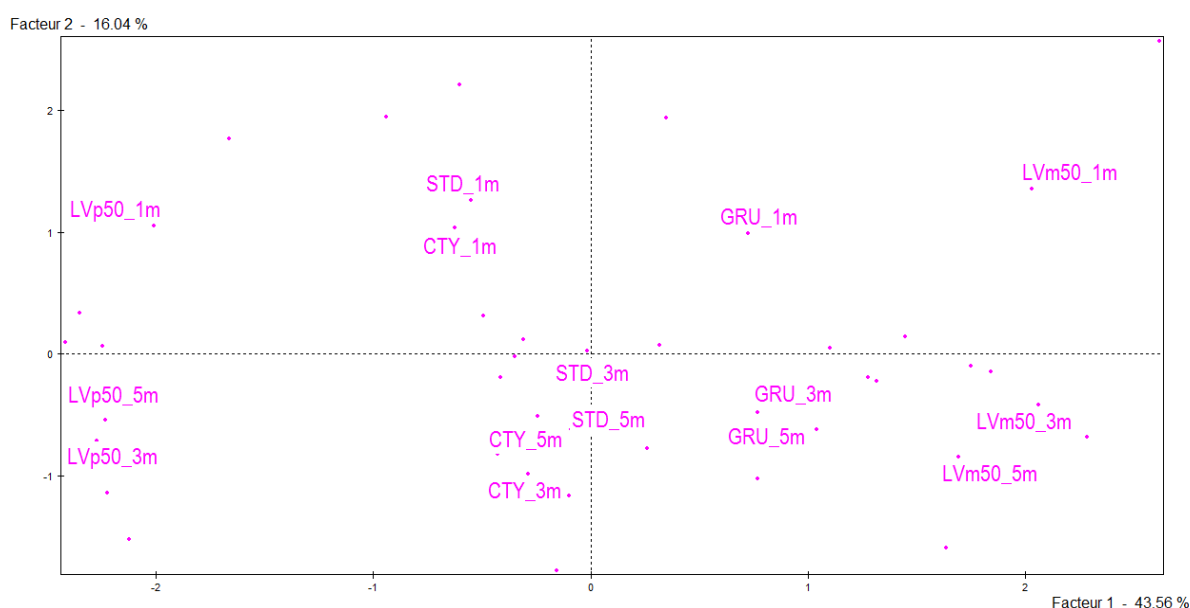

Figure 101 : Illustration of the effect of the time of storage on the sample position one from another using MFA based on the analysis of Instrumental and sensory data.

It appears that modifications solely occur at the early stages of storage. The evolution rate is indeed important from one day to one month further until three months. No more evolution is observed after 3 months: a plateau is reached. Neither physico-chemical, mechanical parameters nor sensory properties are affected over a longer period of storage. It has been illustrated whatever the sample nature and production scale.

Although less sensitive in terms of time influence, sensory evaluation study confirms the results obtained from instrumental measurements and helps to identify the main attributes concerns by the time influence. Evolution tendencies were actually highlighted on in touch and in mouth textural attributes such as firmness, elasticity, also friability, and crumbliness denoting that structural even physico-chemical modifications occurs upon storage.

4. Impact of storage on cake texture: a conclusion

The impact of the time of storage exerted on cake samples made up using different making process, at various aeration levels, also based on several wheat flour' type was investigated.

The study merely demonstrates that the cake' textural characteristics mainly evolve during the initial stages of storage and that this evolution foremost concerns the cake's mechanical properties. Unless it shows slight differences along storage, cake's sensory perception are not genuinely modified while it undergoes modifications over time. In addition,

Though, after 1 month of storage, evolution rate slows down and a plateau is visualized from a 3 months period. Nonetheless, time mainly affect product during the first stages of storage and the perceived texture evolution mainly evidence a slight firmness increase, and a decrease of the overall sample elasticity. These results have been obtained from a mechanical also sensory approach. It ergo reinforce the conclusion that the main variations appears early in the storage process and that it mainly concern the physical properties thence textural cake properties. Aeration features are indeed not affected by the time factor and cake visual perception neither.

The differences encountered between samples at short term storage are kept further. In some cases, samples even up for the considered characteristic such as the recovery percentage upon the studied period. Besides, an evolution of the sensory perception of softness has not been highlighted, illustrating that this characteristics remain constant upon storage, even over a 5 month time period.

.....L'important n'est pas de convaincre,mais de donner à réfléchir
Bernard Werber

GENERAL DISCUSSION

1. *Cake texture study: questions, expectations and model establishment*

The influence of several factors including making process, aeration characteristics and flour nature on cake texture set up and evolution has been investigated. The study was particularly focused on cake softness.

First, the investigation aims to understand what are the main factors involved in cake' softness and how do these factors influence cake texture set up and evolution over time.

Second, the characterization of cake softness has been undertaken using multidisciplinary also multidimensional approach to be able to identify the key attributes of sensory and instrumental measurement of soft cake texture. Third, especially peering into the study of cake softness, several instrumental parameters which can be considered as the most representative regarding softness texture perception have been proposed.

Cake products can be considered as solid foams like breads but with the complexity of a biscuit formula. A relatively low level of information can be found in the available scientific literature while peering into cake products properties. The lack concerns especially structure and texture inter-relation, suitable measurement tools determination as well as sensory perception of cakes attributed to textural characteristic. Covering the fields of solid foams physical properties, ingredients and especially flour functionalities as well as sensory characteristics of food products texture, this study intends to thoroughly approach softness investigation: Figure 102.

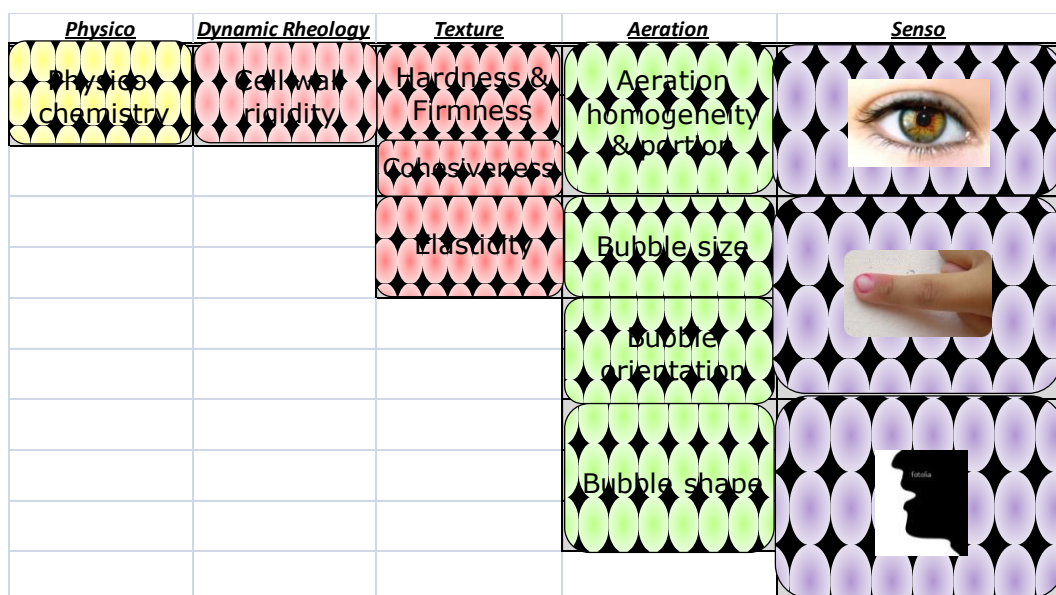

Figure 102 : Illustration of the multidimensional and multidisciplinary aspect of cake softness study.

Various measurements of crumb texture can be performed on both the dough and the baked product such as dough viscosity, density and crumb firmness and porosity (Zhou et al., 2011). Working on the impact of different shortening types on cake texture a combination of instrumental and sensory dimensions was used, and shows that a soft cake (sensory) is a cake high cake (large volume), firm with a lower density.

Uniaxial compression testing has been used providing valuable information related to the mechanical characteristics of food. Among textural parameters, hardness shows a good correlation with instrumental data as expressed in early studies on texture properties of food (Szczeniak, 1963b, 1987, 2002). Hardness (force required to compress the sample between molars), vs mechanical properties such as cohesiveness (amount of deformation prior rupture of the sample) and the degree of recovery after initial and partial compression (elasticity) were the most relevant parameters to characterize mechanical differences in-between studied products.

In mouth perception is not always related to mechanical behavior and rheology parameters. In mouth perception is indeed usually more complex than a solely physical process. While mechanical perception of textural properties are important within the mastication process, salivation and in mouth sensations are additional key factors.

Table XLI illustrates the main parameters that should be kept as the most relevant to describe cake softness. While density and cake height vary according to flour nature, water activity and content were kept as constant. Relative density does not constitute a relevant parameter to explain cake softness. However, softness is positively related to elasticity and firmness that are described by Young and F_{max} values, respectively. It is also closely related to crumb bubble cell wall rigidity and to crumb aeration. This latter should, in soft cake, be homogeneous with fine bubbles and a matrix porosity showing thick enough bubble wall.

Cake softness is negatively related to properties such as friability, crumbliness also dryness. Cake sample fragility has been highlighted with dynamic rheology also perceived by our panelists but remains difficult to quantify.

The comparison between several products shouldn't be solely based on the textural characteristics. The most relevant example actually concerns dryness and meltiness in mouth as it is not closely related to any physical property and cannot be determined whether using rheology or any physical method.

Table XLI : Selected sensory attributes and instrumental parameters for the study of cake texture. The most relevant that are related to cake softness perception are written in bold.

Physico-chemistry	Mechanical	Aeration / crumb bubbles	Sensorial
Density (0) No correlation with Softness	Firmness = Fmax* - uniaxial compression - Same evolution as Young (+)	Bubble size Fine bubbles (+)	<u>Softness</u>
Water activity Constant, regardless sample	Cell wall rigidity = TanDelta** - DMTA - Same as relaxation index (+)	Bubble heterogeneity Homogeneous bubble distribution (+)	Elasticity (+)
Water content Constant, regardless sample		Bubble number Related to bubble size / heterogeneity	Friability (-)
Cake height (0) No direct correlation with Softness (collapse phenomenon)		Crumb matrix porosity (XR tomography) Not cost effective	Meltness (+) dryness (-)

(0) Indicate that there is no relation with cake softness

(+) Indicate that the parameter is positively related to softness

(-) Indicate that softness is whether negatively affected by the parameter

* Fmax values evolve as young modulus and is chosen as the most suitable parameter for hardness/firmness characterization.

** TanDelta measured with dynamic rheology method give valuable results. Since it describes crumb elasticity / cell wall rigidity more precisely than relaxation index it can be considered as the most suitable for mesoscopic evaluation scale

2. *The multidimensional approach of cake texture study*

First requirement was to work on a basic formula and a definite process. Then, peering into the study of the effect of several making processes and dough composition parameters, distinct products were produced.

Therefore, the long lasting first step has been dedicated to the selection of the most relevant products to be further deeply studied according to the measurement of their level of differences.

It includes process and formula set up and an associated instrumental control. Further characterizations were conducted over storage. It involved instrumental also sensory facilities and require dealing with human resources for specific skills such as pilot plant, food physics, chemistry and sensory fields experts.

For those reasons but also because products were studied over time, each characterization step was subjected to different sources of variations. Pilot plant also characterization and measurement control tools were obviously planned for their availability, loading time and duration and for the kinetic part of cake analysis.

Cake product matrix and ingredients nature in addition with the various fields of investigations justify the levels of characterization that have been taken into account all along this study. Several scales and analyses categories were indeed required to lead on the study from the early beginning to the characterization of the main cake properties: Table XLII.

Measurements were both dedicated to cake study and settled up to be used for any other variation applied to this product category.

2.1. Wheat starch granule swelling characterization

Quantitative also qualitative approaches were used in order to evaluate the extent and speed of starch granules swelling.

Methods using microscope observation were associated to the evaluation of wheat flour-water suspension particle size. Results show that starch swelling was related to a relative decrease of overall particle size whereas images illustrate progressive granule size growth. Such discrepancies might be explained by different phenomena. The circular shape of the granule disrupts over swelling and could possibly lead to under-estimation of particle size. Swelling is also linked to starch granule surface modifications. Lipids also proteins that contribute to starch granule volume are thus leaving from its surface, creating individual particles also decreasing relative granular size.

Therefore, deep in the way starch swelling could be more precisely quantified is of a strong interest. Real-time granule size evaluation over hydro-thermal transformation

could have been done with laser granulometry instrument. With a time-to-time measurement, the different steps of starch granule swelling could be followed in details.

Also peering into dynamic method of granule size evaluation, the determination of its shape lost over hydro-thermal transformation and kinetically followed would be of a strong interest in order to differentiate flours as a function of their starch granules water absorption ability and structure evolution.

RVA method involving viscosity evolution measurements over hydro-thermal conditions gives valuable elements to differentiate flours on the basis of both extent and speed of swelling. It also highlights the substantial effect of gluten protein on overall starch swelling, and gelatinization extent. CTY and GRU flour starch granules evolve in a distinct way mainly because of the protein content, starch granule size and internal structure.

2.2. Crystalline/amorphous level evaluation: flour nature and methods

Instrumental evaluation of CTY and GRU wheat flour crystallinity has been realized using powder XRD.

The evaluation of starch also flour crystallinity using this method has been used several times attempting to either compare quantification methods (Gidley & Bociek, 1985, Morrison et al., 1994) or to follow crystallinity evolution over time (Primo-Martín et al., 2007). The main limit of the method is directly related to the highly amorphous nature of flour. It substantially influences the estimated value of crystalline/amorphous ratio. Still, this ratio can be used as a qualitative evaluation index to compare crystallinity between starch and flours (García et al., 2009, Zeng et al., 2011).

According to the relative measurement of GRU and CTY crystallinity, the softest flour, CTY with more starch also smaller granules tends to be less crystalline than GRU. To confirm such hypothesis it could have been interesting to use another method and to verify the differences within the result obtained either with X-Ray diffraction or hydrolysis methods (Biliaderis et al., 1980).

With these different elements, we could expect an answer on starch gelatinization speed, extent and starch granule nature influence measurement on these parameters. The establishment of a suitable method to compare flour on the basis of the nature and composition of their starch would be the final inquiries.

Still, the presence of protein has been shown to be able to hamper starch swelling thus disturbing its individual functional properties. While assessed in a flour-water system or in cake dough, starch – protein interactions or competition have to be taken into account.

2.3. Flour proteins: evaluation and nature considerations

As explained in the previous chapters, distinct behavior were observed and measured while studying several flours. Their respective protein composition was particularly considered. In order to understand the impact of their relative differences on measured behavior and suitability for cake manufacture and storage, we first focus on gluten proteins. The determination of flour protein composition in CTY and GRU flours has been attempted. According to their chemical properties especially related to their affinity to several solvents, soluble proteins, amphiphilic but also gliadins and glutenins can be isolated (Khan & Shewry, 2009, Osborne, 1907). In this objective a sequential extraction of flour proteins according to their specific solvent affinity was undertaken. The extraction steps were realized prior further quantification of protein content using Kjeldhal method.

However, it was difficult to obtain purified enough extracts and to get reliable estimation of its protein content. The method did not provide relevant results. Peer into the characterization of the protein composition in studied flour would be of a strong interest. It could be useful to validate whether a protein profile is suitable for cake production instead of another. The correction of slight differences that can be encountered every year while new wheat crop is provided could also be helpful.

Flour protein sequential extraction, quantification and a resulting composition of flour that would best suit for cake production would have been important information.

2.4. Aeration instrumental evaluation

Imaging techniques have in common three steps. It includes image capture, object detection and measurements of structure and morphology of the sample. Image acquisition remains the determinant step that influences the followings and the final results. While the limitations of bubble morphology measurements have been widely discussed in the literature, sample preparation also image acquisition are key for aeration characterization (Labbafi et al., 2007, Wang et al., 2011).

In our study, aeration investigation has been conducted using two methods.

Using flat-bed scanner followed by image analysis can be considered as the initial characterization step while bubble dimensions are unknown and need to be determined. Though it gives relevant results and precise enough, this method can be subjected to difficulties when the samples are fragile and crumbly such as LVp50 for which more products were needed for sampling.

It is a time consuming approach and has thus been carefully settled up. First sampling steps, including slicing, image capture set up but also image analysis require have been

settled up to be applied to any studied product. An automatic method would be the next step with slices scan and associated result distribution to the assessor.

X-Ray tomography was first expected to give both 2D and 3D aeration estimation. The study revealed that it was not possible to quantitatively evaluate neither qualitatively compare sample on the basis of their volume. The highly interconnected bubble network was the main reason of such difficulties.

Still, X-Ray tomography illustrates the cell wall breakage and the open cell nature of cake crumb. In addition with these observations, the 2D images revealed a distinct level of porosity inside the crumb matrix that was not visible through flat-bed scanning method. Crumb internal porosity thence contributes to explain the high level of friability and crumbliness of some of the studied samples such as LVp50.

LVm50 and LVp50 were especially considered for their tremendous aeration differences. It span from fine bubbles in a dense structure to wide bubbles built in a fragil product. Since selected products were made up with distinct aeration and coming from different flour sources, we face large level of variations that generate difficulties to be equivalently assessed. It requires standardized analysis establishment in order to keep the same way of assessment and not to vary measurement parameters amongst studied samples.

Even though aeration level and bubble size distribution constitutes key parameters that govern the properties of the foam, they are somehow difficult to control. Also, a lack of reproducibility is often observed in the manufacturing of aerated food foams (Labbafi et al., 2007).

The use of two complementary approaches suits for the most complete characterization of our products and their differences at a large also finer scale. While compared to sensory perceived aeration, only the size and heterogeneity of bubbles were observed to differ between products. Orientation, shape factors and crumb bubble regularity were not directly related to sensory variations.

Unless the evaluation of aeration using instrumental methods shows limitations including bubble size threshold, porosity, shape and not sensory related characteristics, it provides several elements that justify the level of differences and behavior studied sample: Table XLII.

GENERAL DISCUSSION

Table XLII : Multidimensional characterization of cake texture: illustration of the main factors that are involved in cake texture establishment according to the studied products characteristics including: flour composition, structural properties, and their resulting sensory perception. For a thorough view on these latter, the relative level of these characteristics is associated to the results depicted all along the document and represented as (-) / (0) or (+) for low / intermediate or high levels, respectively.

Studied product	Molecular	Mesoscopic/ Mechanical	Macroscopic/Aeration	Sensory perception In touch/in mouth
LVm50	Protein quantity (0) No protein dilution	Density 'ρ' (+) Firmness 'Fmax' (++) Structure maintained after baking	Bubble homogeneity (+) Fine bubbles size (+) < 0.85mm	Soft Elastic Smooth Melty
GRU	Protein quantity (+) Protein quality (+) Foaming abilities (+)	Density 'ρ' (0) Firmness 'Fmax' (++)	Bubble homogeneity (+) Fine bubbles size (+) < 0.85mm	
STD	Protein quantity (0) Foaming ability (-)	Cell wall rigidity 'Tanδ' (-) Density 'ρ' (0)	Bubble homogeneity (-)	Friable Crumbly Doughy
CTY	Protein quantity (-) Starch quantity (+)	Cell wall rigidity 'Tanδ' (-) Swelling (++) Structure lost after baking	Bubble homogeneity (0) Fine bubble (0)	
LVp50	Protein quantity (0) Protein dilution => lack of structure Lipid dilution within cell wall, wide distribution (dryness)	Cell wall rigidity 'Tanδ' (--) => Fragility Firmness 'Fmax' (-) Elasticity 'app Young modulus' (-)	Heterogeneous bubble distribution Exacerbated bubble size > 2mm	Dry Friable

3. *Is the aeration of a cake product key for its softness perception?*

Emphasized or depleted by a merely slight modification of baking powders levels, cake aeration level was varied. Soft cake samples displaying extremely distinct structures, either dense or undoubtedly exacerbated aeration were thus created.

First, aeration influenced the viscous behavior of cake batter. LVp50 and GRU flour, with a lower density exhibit higher apparent viscosity than CTY, LVm50 even STD samples. The continuous phase consistency (i.e. the batter), is related to the overall viscous behavior of cake batters while the bubble phase consistently contributes to the dough elasticity (Chesterton et al., 2011). It then influences dough rheology while it is studied under shearing. Authors conclude that such parameters are likely to be most appropriate probe of microstructure in cake batters and that flour nature has a particular influence (Meza et al., 2011).

As described in particular studies for other matrices (Edoura-Gaena et al., 2007), we highlight that aeration impacts considerably the mechanical also sensory properties of cake product. In our study, consequences on cake product texture were mainly related to bubble size heterogeneity within the crumb. While the most aerated exhibits tremendous bubble growth, porous matrix lead to a weak structure (not firm but friable and crumbly), responsible for the lack of rigidity and elasticity of bubble wall.

When taken individually, products made up with the lowest or the highest baking powder level merely 'display percentage of recovery' differences upon storage. The most aerated product evinces a fragile structure for which a slight modification is traduced by a large difference, compensated by the easily structure breakage. Aeration level does not affect the overall evolution of samples upon storage.

Final product perception as described by the panel could then be influenced by bubble features and distribution. In another study, several attributes were encountered to be closely related to cake/biscuits batter characteristics such as its degree of aeration also number of bubbles (Edoura-Gaena et al., 2007). No clear relationship was found between crumb density and batter density. In our case, no relation has been highlighted between sensory perception of cake product and cake batter characteristics but between final cake aeration features and measured aeration parameters: Table XLII.

In addition, the presence of very large bubbles is not expected by customers in cake products. A size threshold has to be reached for bubble to be detected by human sight (Gonzales-Barron & Butler, 2008a, c). According to the studied cakes, this bubble mean diameter acceptance threshold seems to be comprised in between 0.8 and 1.5 mm. Therefore, the instrumental characterization of aeration provides additional

information compared to what a sensory profile can reach. Helpful to understand and explain several in touch and in mouth items, few aeration features are not directly related to aeration perception (i.e. shape and small size bubbles values).

However, the in mouth sensation demonstrated that products displaying high aeration (density lower than 0.4 g/cm^3) in addition with an obvious lack of elasticity and rigidity, were also perceived as dry, friable and crumbly: Table XLII.

4. Crumb bubbles properties

Cake elasticity and resistance to breakdown are mainly driven by gluten proteins (Veraverbeke & Delcour, 2002). They closely depend on the cell wall properties (Delcour et al., 2012). Exerting a positive influence on the final volume, thus its relative density, the protein quantity, its nature and the interactions taking place in-between cake components should let the structure resistant enough to keep its shape after baking step while sample are expected to cool down. GRU flour is richer in proteins especially in gluten. Hence, it is expected to generate dough endowed with a higher strength that provides gas holding properties upon baking. It also allows baked product structure to be maintained after baking step while it is removed from the oven, during cool down and then over storage.

Higher relative glutenin content also improve the ability of dough to entrap air and to keep it over resting then baking step, once embedded into its matrix. This ability of the overall structure to facilitate gas retention point out the consequences on the air proportion encountered in the studied samples, to see whether the flour nature can significantly affect this parameter.

The in mouth perception of dryness and crumbliness in products that were more aerated (LVp50) could be due to an important lipid droplets dispersion within matrix that in turn can't provide enough lubrication effect (Pareyt et al., 2011, Sarkar & Singh, 2012). Indeed, in addition with its tremendous aeration, LVp50 revealed with XR tomography small bubble inclusions within bubble walls. Still, a relatively high level of crumbliness was recorded for CTY flour cakes as well, with a lower aeration.

It can be affected by a high level of crumb porosity but it is also mainly related to gas cell stabilization capacity of the matrix (Sroan et al., 2009, Sroan & MacRitchie, 2009).

Flour proteins can bring its higher elasticity to the dough but can also exert an influence on its emulsifying ability. Wheat proteins have actually been demonstrated in a few papers and further reviewed to be endowed with interfacial properties, contributing

to their foaming and stabilizing impact (Örnebro et al., 2000). These authors especially investigated gluten' proteins for their foaming properties, although wheat flour proteins have been classified in the past according to their solubility and physico-chemical properties into soluble (amongst, hydrophilic and amphiphilic) and insoluble (gluten) constituents (Osborne, 1907, Shewry et al., 2009, Shewry et al., 1986).

Gluten proteins actually involve both hydrogen bonds and hydrophobic interactions which can be either strengthen or reduced by the way of redox molecules actions (Lagrain et al., 2012, Mejri et al., 2005). According to several authors, gliadins could particularly be endowed with emulsifying properties according to their hydrophobic-hydrophilic properties (Li et al., 2004, Thewissen et al., 2011).

Gluten network establishment, its structure as well as protein interfacial properties have been suggested to play an important function in the formation and stabilization of crumb bubbles (Brooker, 1996, Pareyt et al., 2011). Polar lipids have been shown at the surface of gas cell (Finnie et al., 2010). They contribute to the stabilization of crumb bubbles forming though a liquid lamellae, hydrophobic, endowed with interfacial properties (Chung, 1986, Sroan & MacRitchie, 2009). Owing to such interfacial properties, they could thence be able to enhance foaming and promote the stabilization of wheat flour based products such as bread (Örnebro et al., 2000). Besides, it is also possible to increase gluten proteins emulsifying and foaming ability by the way of their hydrolysis: (Drago & González, 2000).

As measured with Solvent Retention Capacity and Gluten Index methods, GRU would contain a higher glutenin proportion than gliadins compared to what has been recorded for CTY flour, hence enhancing the strengthening effect on cake dough (Barak et al., 2013).

If the overall sample resistance is too weak, then a collapse can happen. GRU protein profile appears to suit better and avoid the collapse phenomenon that follows baking step and that is also taking part of final cake aspect and quality.

The protein composition differences encountered between CTY and GRU flour are partly responsible for the distinct behavior observed while incorporated into a cake dough matrix. Hydration capacity and interactions of the different components within the dough are the main additional factors to be involved.

5. Cake texture set up and evolution: its relation to softness

During the first three weeks of storage, cake evolution foremost concern textural parameters. Retrogradation of flours obviously takes place at this stage. While cake firmness increases, crumb bubble wall mobility reduces. This evolution has been observed in a higher extent for STD product and CTY soft wheat flour than for the other formulations. It could be explained by a whether higher gelatinization level in these flours than in GRU for the reasons depicted above.

A tendency of LVp50 to evolve in the opposite way highlights its overall fragility. A slight reduction of crumb bubble walls mobility (TanDelta) was observed over time from 1 to 5 months. Increase of TanDelta is related to the fragility of the product for which even though small deformation were applied, the cell wall breaking occurs.

Therefore, tremendous aeration leads to structural fragility whereas a dense product allows stabilizing the rigidity and firmness evolution. In case of extreme porosity, these properties are not closely impacted by the nature of the flour but to a whether unsuitable crumb porosity. Flour can't thoroughly correct cake properties while its structure is already too far from target. With the highest porosity, the product can't be brought to softness.

LVm50 and GRU products were considered as the softest products as measured mover the investigation period. It means that both the structure of the product, i.e., relatively dense solid foam, and the nature of the flour that compose the cake are important to consider.

Although cake ingredients hydration appears as an important parameter, even with making process variations, flour can be considered as the main factor that influences structural and textural properties of the final product. Wheat flour composition and properties are thus largely driven by the balance between proteins and starch granules quantity also quality. These compounds and their respective functionalities impart starch gelatinization extent and speed but also cake structure set up which is key for final cake properties to engender the softest cake as possible.

.....« *Le paradoxe de la science est qu'il n'y a qu'une réponse à ses méfaits et à ses périls*

..... encore plus de science. »

Romain Gary

CONCLUSION

This manuscript entitled 'study of the different factors influencing the structure and the texture of semi-humid baked aerated cereal products: sensory and instrumental dimensions of texture' tackle on the understanding of cake softness key characteristics, set up and evolution.

The influence of several parameters on the texture of wheat flour based cakes has been depicted and analyzed. Making process, cake crumb aeration also flour nature factors were varied. Peering into ingredients ratio, nature and processing conditions impact on their structural also textural and sensory characteristics, this investigation was however dedicated to cake products properties.

Cake softness texture is characterized by product firmness and elasticity illustrated both by instrumental and sensory analysis. Sensory measurements related to softness also highlight that aeration play an important role. The high level of aeration (measured and perceived) as well as bubble rigidity were related to cake crumbliness. This latter is inversely correlated to cake softness.

Following sensory perception study also texture and structure evaluation, physico-chemical properties of flour and its compounds were described.

In order to better understand the behavior of different flour nature while implemented into cake dough, water-flour systems physico-chemical properties have been studied.

Cake structure set up first implies suitable dough hydration and structuration. It is mainly influenced by flour composition (especially flour gluten proteins) whether than making process with which no impact on cake characteristics was significantly highlighted. Since the dough is oven-baked, the changes that occur over heating are foremost dependent on flour composition (especially on its starch properties).

Therefore, the main factor involved in texture set up and evolution of cake softness is the flour quality. The aeration level, also strongly affecting cake structure and softness perception can be managed in food industry by gas addition, leavening agent dosage but is substantially affected by flour quality. Cake product either displaying over-aerated or dense structure was considered as 'extreme' sample whether not perceived as 'soft'.

The influence of both the flour protein content and nature could basically impact the crude dough aeration and the gluten network set up as far as GRU and CTY flours contain an undoubtedly significant distinct protein profile.

Consequently, a medium-hard flour such as GRU in the present study is the most suitable for cake manufacture to engender the softest texture.

First, high deformation rheology method in addition with macroscopic aeration features determination is the first approach that would help in the selection of suitable products for further characterization.

Then, methods that would be measuring the resistance of crumb cell wall (dynamic rheology) in addition with porosity characterization (XR tomography) would be of a substantial interest to go deeper in the choice of the softest.

Finally, once selected, the sensory characterization would provide final indicators on customer acceptance regarding the chosen product and his experienced pleasure.

Several topics would be interesting to peer into. Considering that the flour is the main factor influencing cake texture properties even with making process variations the study of the wheat flour components is key.

Sensory attributes such as aerated, crumbly and friable were related to a negative qualification of the product overwhelming its potential softness perception. The macromolecular composition of the continuous phase of the dough includes starch, proteins but also lipids. The repartition of such compounds within continuous phase would be visible at a microscopic scale. It could provide important elements on cake structure set up also evolution over cooling and storage.

Since starch is the main flour component, investigation on granule swelling, gelatinization extent and its speed would provide a deeper understanding of the dough development phenomenon over baking but also add elements to understand the relative evolution over storage.

In addition, since wheat flour protein have a substantial influence on bubble formation and evolution also maintaining the overall cake structure, a more thorough characterization of wheat flour protein quality would help in the choice of a flour whether than another.

Flour nature and characteristics that should be chosen or manage regarding protein/starch balance are of a key interest.

.....« *Quand on met la main à la pâte, il en reste toujours quelque chose aux doigts.* »

Proverbe français

SYNTHESE EN FRANCAIS

Etude des facteurs influençant la structure et la texture de produits céréaliers alvéolés de cuisson semi-humide : une approche instrumentale et sensorielle de caractérisation de la texture

1. Contexte économique et objectifs de l'étude

L'industrie des biscuits et gâteaux représente un secteur important du marché alimentaire et celui des gâteaux moelleux en constitue une part non négligeable chez LU France. La croissance enregistrée sur cette catégorie nous pousse à vouloir développer de nouveaux outils et à accroître nos connaissances dans le domaine pour atteindre un niveau de compréhension des phénomènes mis en jeu lors de la mise en œuvre et au cours de la conservation de tels produits.

Les objectifs sont donc d'être capables d'innover et de créer de nouvelles références dans la catégorie « moelleux ». Pour ce faire, il est indispensable d'accroître la maîtrise de la qualité des produits et de la contrôler au cours du temps.

La texture d'un matériau se définit comme la manifestation sensorielle et fonctionnelle de la structure, de ses propriétés mécaniques et de surface. Elle est perceptible par les sens du toucher, de l'ouïe et de la vue (Szczeniak, 2002).

La texture d'un produit alimentaire représente un paramètre clé dans la perception par le consommateur de son niveau de qualité et de fraîcheur. Elle l'acceptabilité du produit et peut déclencher l'acte d'achat (Civille, 2011, Dobraszczyk, 2008, Heenan et al., 2009).

L'étude du caractère moelleux de produits céréaliers alvéolés d'un point de vue physico-chimique a pour principaux objectifs de :

Comprendre les phénomènes qui interviennent dans la formation et la conservation du moelleux ; focus sur l'impact de la composition de la farine.

Savoir décrire le caractère moelleux par des paramètres instrumentaux, des paramètres sensoriels.

Approfondir les relations entre le moelleux perçu sensoriellement et sa caractérisation physico-chimique.

2. Contexte scientifique de l'étude

2.1. Le moelleux: une caractéristique sensorielle de texture

Le moelleux est une caractéristique texturale dont il n'existe pas de définition précise du fait de son caractère multi-composant. D'un point de vue strictement sensoriel, le recueil de la norme AFNOR ayant trait à l'analyse sensorielle (AFNOR,

1992) le définit comme étant un faible niveau dureté. Cependant il s'agit d'une perception de texture influencée par les conditions de dégustation, les paramètres physiologiques mais aussi par le pays d'origine et la culture du consommateur (Drake, 1989, Lawless & Heymann, 2010).

La compréhension de la dynamique et de la structuration des produits moelleux d'un point de vue macroscopique et moléculaire ainsi que l'impact des ingrédients sur la mise en place et la conservation de la texture est en ce sens d'un intérêt particulier (Michel & Sagalowicz, 2008). L'étude de la texture d'un produit implique la caractérisation de sa perception sensorielle par les consommateurs (Borwankar, 1992, Szczesniak, 2002).

La confrontation des propriétés physico-chimiques mesurées instrumentalement aux caractéristiques sensorielles évaluées est nécessaire afin d'en comprendre les relations.

2.2. Relation entre structure et texture des matériaux alimentaire

La texture d'un aliment est étroitement liée à ses propriétés physico-chimiques, conséquences de sa composition et de sa structure (Bourne, 2002a): Figure 103. Cette dernière est mise en place au cours d'une succession d'opérations unitaires dont la première étape correspond au mélange des ingrédients (Aguilera & Lillford, 2008).

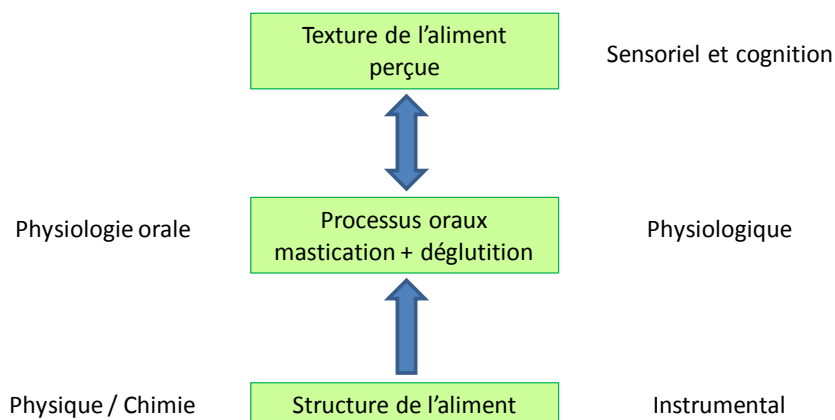

Figure 103 : Terminologies, disciplines (gauche) et méthodologies (droite) associées à l'étude de la texture adapté de (Wilkinson et al., 2000).

Les gâteaux moelleux, produits céréaliers alvéolés peuvent être considérés comme des mousses solides. En termes de caractéristiques structurales et de composition, sont comparables à des matrices alimentaires de type pain et biscuits, respectivement. En effet, un rapprochement de la structure des produits mis en œuvre dans ce projet peut être fait avec la structure alvéolaire des produits de panification comme le pain pour lequel un grand nombre d'études sont identifiables et accessible dans la littérature scientifique. Par ailleurs, la proximité des gâteaux moelleux avec les biscuits est imputable à la complexité en termes de composition et de mélange initial des ingrédients (mais dans un système environ deux fois moins hydraté).

Néanmoins, le pain comme les biscuits présentent des caractéristiques propres et le milieu, bien que complexe ne reflète pas exactement les conditions dans lesquelles évoluent nos produits moelleux au cours de leur fabrication et de leur stockage.

Afin de satisfaire à l'étude de certaines propriétés il est possible de travailler sur des outils dont l'intérêt est commun à ces types de matrices alimentaires.

Une caractérisation de la structure alvéolaire d'une pâte à pain a déjà été menée en faisant appel à la technique de tomographie par rayons-X permettant de mesurer l'évolution de la taille des bulles au cours de la levée de la pâte ou de la cuisson (Babin et al., 2006).

La comparaison de l'évaluation de l'aération de produits céréaliers alvéolés a déjà été menée dans le but comparer les résultats d'analyse d'image de mies à des mesures sensorielles de l'aération (Angioloni & Collar, 2009, Gonzales-Barron & Butler, 2008). Les résultats montraient une corrélation entre les niveaux d'aération (taille relative et nombre de bulles) mesurés instrumentalement et sensoriellement. Egalement, la morphologie et la structure des produits a été comparée à leurs propriétés texturales (Farrera-Rebollo et al., 2012, Pérez-Nieto et al., 2010).

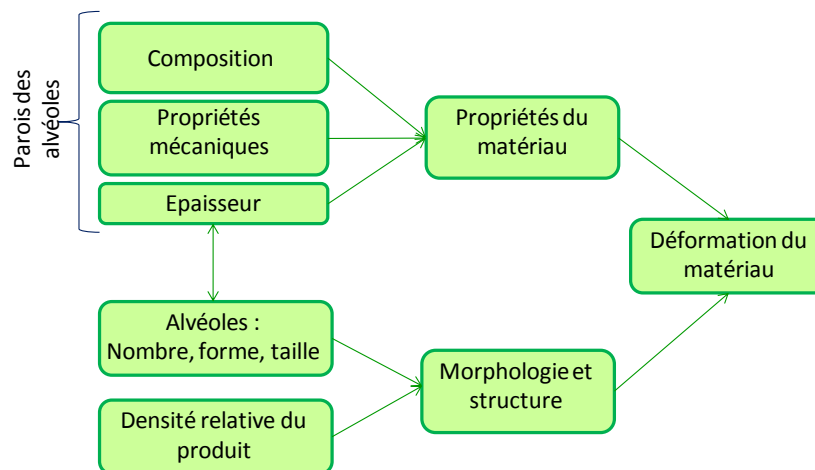

Figure 104 : Relations entre les propriétés structurales et mécaniques des matériaux alimentaires; adapté de (Sozer et al., 2011).

Dans cet objectif de caractérisation de la texture, certains chercheurs se sont d'ores et déjà penchés sur des paramètres rhéologiques permettant une bonne corrélation avec des paramètres mesurés sensoriellement (Szczeniak, 1963a, Szczeniak, 1963b). Il a ainsi pu être montré que la fermeté au des produits alimentaires était corrélée à la force maximale mesurée dans un test de compression simple (pour des déformations au moins égales à 10% de la hauteur de l'échantillon analysé). De la même façon, le rapport des aires des pics enregistrés consécutivement à une double de compression (force en fonction de la déformation appliquée en distance) traduit la cohésion d'un matériau alimentaire alors que le collant est mesuré par l'aire du pic pour des forces négatives.

Dans les matrices de types biscuits, les propriétés des pâtes et les interactions entre composants de la formule sont des paramètres clés qui influencent les premières

étapes de mises en œuvre des ingrédients et conditionnent les caractéristiques des produits finis (Edoura-Gaena et al., 2007, Fustier et al., 2009).

L'étude de la texture d'un produit alimentaire requiert à la fois la caractérisation de sa structure, et la compréhension des propriétés physico-chimiques des ingrédients pris individuellement ainsi que de leurs interactions au cours du procédé de fabrication.

La perception finale du produit en dépend (Bourne, 2002b, Fischer & Windhab, 2011). La structure des mousses solides est dépendante de la composition et des conditions de mise en œuvre des ingrédients influençant particulièrement le niveau d'aération des produits de panification (Hibberd & Parker, 1985, Niranjana & Silva, 2008): Figure 104. Ainsi, la formulation du produit étudié est importante à considérer de part l'impact des fonctionnalités des composants de la formule sur la mise en place de sa structure, de sa texture et de son évolution au cours du temps (Goesaert et al., 2005, Rosell, 2011).

2.3. Structure et composition des produits céréaliers alvéolés.

Alors que le pain se compose d'eau, de farine, de levure et de sel, d'autres produits céréaliers alvéolés comme les gâteaux sont en plus de la farine (30%) également constitués d'œufs, de sucres (16-25%), de matières grasses (10 – 18%) et d'émulsifiants (1-2%) et de poudres levantes (1%) (Kiger & Kiger, 1967).

Ces derniers incluent souvent des dépresseurs d'activité de l'eau tels que des polyols dotant les produits d'une capacité de conservation plus élevée (plusieurs semaines à plusieurs mois).

La fabrication des produits moelleux consiste ensuite en trois principales étapes : le mélange des ingrédients, le repos puis la cuisson de la pâte. Après cuisson, le produit fini (densité relative de 0.2 à 0.5 g/cm³) est refroidi puis conditionné. Bien que les ingrédients de base soient communs, leur proportions relatives et la façon de les mettre en œuvre permet l'obtention d'une large gamme de produits aux consommateurs.

Peu de données explicitant l'impact des ingrédients sur la texture des produits tels que nous souhaitons les étudier sont disponibles dans la littérature scientifique.

Une grande quantité d'informations dans la bibliographie explicitant le rôle des ingrédients dans des milieux modèles (1, 2 voire 3 composants en mélange) peut être trouvée (Chiotelli & Le Meste, 2003, Chiotelli et al., 2002, Wilderjans et al., 2008). Cependant, beaucoup d'interrogations restent sans réponses quant au comportement de ces mêmes composés en milieu complexe (constituants de nature, propriété différentes et sujets à des transformations liés au procédé et aux autres composants du système).

Les propriétés résultant des interactions de nature variable entre les constituants de tels systèmes s'ajoutent en effet à la complexité de l'étude et accroissent les difficultés d'extrapolation de ce qui a déjà été réalisé sur des systèmes simplifiés.

Néanmoins, quelques équipes de recherches, dont l'équipe de Pareyt (Pareyt et al., 2009, Sudha et al., 2007) travaillent sur l'impact de composés tels que les sucres sur la texture de biscuits dans le cadre de formule relativement complexe. Cependant, nos produits se trouvent dans des conditions d'hydratation plus élevées que celles des biscuits rendant difficile voire parfois fausse une superposition des comportements observés dans des produits fortement hydratés comme les gâteaux moelleux.

La farine, un des ingrédients majoritaires des produits céréaliers alvéolés tels que les gâteaux moelleux (30%) présente par ailleurs une composition complexe et variant en fonction de la variété de blé considérée ou encore de ses conditions de cultures (Goesaert et al., 2005, Mikhaylenko et al., 2000). En effet, la présence de plusieurs catégories de protéines, de polysaccharides tels que l'amidon, de lipides et d'autres composés minoritaires est susceptible d'influencer la texture des produits finis (Pomeranz, 1988). Le comportement à la fois des pâtes en mélange, au cours de la cuisson ou bien des produits finis au cours du stockage peut être affecté par ces variations de composition entraînant une modification de la structure et donc de la texture de telles matrices alimentaires.

La capacité de certaines farines à générer sous des conditions données un type de structure au sein d'un milieu tel que les pâtes jaunes pourrait être justifiée par la variation des fonctionnalités des protéines et de l'amidon.

Amidon et protéines de blé sont les deux principaux composants de la farine. Ils à la pâte ses propriétés de viscosité et de fluidité en milieu hydratés et au cours de la cuisson, avec respectivement un phénomène d'hydratation des protéines, et de gélatinisation de l'amidon (Chiotelli et al., 2002).

L'amidon de blé, composant majoritaire de la farine de blé, est lui-même responsable des propriétés hydro-thermiques de l'amidon. Il est fortement impliqué dans le gonflement de la pâte en cours de cuisson et dans le phénomène de rassissement des produits finis au cours de la conservation.

Les protéines de la farine de blé et en particulier des protéines de gluten, de nature hydrophobe représentent de 75 à 95% des protéines (8-14% de la farine). Elles sont responsables des propriétés de visco-élasticité des pâtes et de la capacité de résistance des parois cellulaires à la pression exercée par le gaz des alvéoles.

3. Matériel et méthodes

Afin de caractériser les différents niveaux de structure des produits considérés (de l'échelle macroscopique à moléculaire) il est indispensable d'en identifier les outils et les méthodes d'étude pertinents, adaptés et suffisamment performants.

3.1. Les matrices échantillon

Une maquette de gâteau moelleux est fabriquée à base de farine de blé, de sucre, d'œuf et d'huile. On distingue les ingrédients introduits sous forme de poudre

(farine, saccharose, émulsifiant et poudres levantes), des ingrédients liquides (eau, sirop de glucose-fructose, œuf, plastifiant) et de l'huile de colza.

Les principaux types d'échantillons générés sont présentés dans la figure ci-après. Dans le procédé de référence, les poudres sont ajoutées en premier et mélangées puis les liquides en second et pour finir, l'huile.

Ce procédé a été utilisé pour tous les produits sélectionnés suivants : Standard (STD), Gruau Rouge (GRU), Crousty (CTY) LVm50 et LVp50 (moins 50% et plus 50% de poudres levantes par rapport à la référence, respectivement).

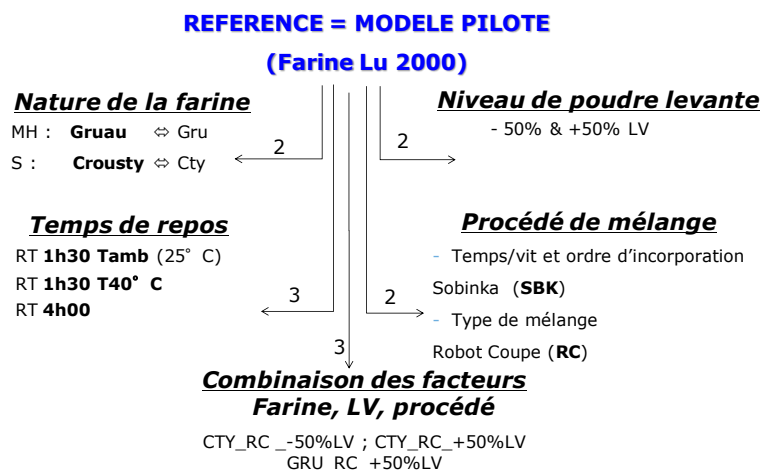

Figure 105 : Représentation des principaux facteurs et produits testés au cours de l'étude.

STD = Echantillon standard dit 'référence' en termes de process, nature de farine (Soft/Medium-Hard) et niveau de poudre levantes standard

LVm50, LVp50 = Echantillon de gâteau avec un niveau de poudre levante réduit et augmenté de 50% par rapport au standard, respectivement

GRU et CYY = Echantillons fabriqués sur une base de farine 'Gruau Rouge' (farine medium hard, profil de farine pour produits de panification) et 'Crousty' (Farine de blé tendre Soft, profil de farine à biscuit), respectivement.

3.2. Analyses physico – chimiques

La caractérisation et le contrôle des matières premières ainsi que des produits au cours de leur fabrication (pâtes à gâteaux) et des produits finis pendant leur stockage, ont été réalisés. Plusieurs paramètres ont ainsi été contrôlés de façon régulière pour s'assurer de la répétabilité des mesures, de l'homogénéité des produits et pour en quantifier les évolutions dans les mêmes conditions.

Les mesures de **teneur eau**, d'**activité de l'eau** et de **densités** ont été effectuées sur les pâtes crues et cuites et la mesure de la hauteur sur les produits finis. Les produits cuits ont fait l'objet d'un suivi au cours du temps au cours duquel chacun des paramètres a été mesuré (de 1 jour à 6 mois à raison de une fois par semaine le premier mois et une fois par mois au-delà).

3.3. Mesures des propriétés mécaniques des pâtes et produits finis

Les propriétés de texture des aliments tels que le gâteau moelleux et de sa pâte ont été étudiées par des méthodes rhéologiques.

La rhéologie correspond à l'étude des déformations ou des écoulements de la matière (Bourne, 2002c). C'est donc une mesure instrumentale de la texture.

On distingue deux types de mesures en rhéologie des solides :

- des mesures en rhéologie à grande déformation qui permettent l'analyse de la texture (en régime transitoire). Ces mesures indiquent la résistance du matériau à supporter une grande déformation (supérieure à 5%) ou sa capacité à se déformer sous l'action d'une contrainte.
- Des mesures en rhéologie à faible déformation – généralement en régime transitoire - qui donne des informations sur la structure du matériau. Il s'agit en effet de ne pas déstructurer le matériau, et donc de le solliciter sans l'abîmer. Les déformations appliquées sont inférieures à 1% : il s'agit de la rhéologie dynamique pour laquelle on introduit une variation sinusoïdale temporelle de la contrainte.

3.3.1. Rhéologie à grande déformation (analyse de texture).

Dans le cas des gâteaux moelleux, de tels outils doivent être utilisés en vue de comprendre quelle pourrait être la réaction du produit étudié à la contrainte appliquée dans la bouche d'un consommateur. Ce type de mesure nous permet en effet de mimer les conditions de mise en bouche (et de mastication) (Szczesniak, 1963b, Szczesniak, 1987). L'échantillon est découpé à l'emporte-pièce (diamètre de 25 mm et épaisseur de 13 ± 2 mm). Le texturomètre *TA.XT2.i* (Stable Microsystems, Ltd., Godalming, Surrey, GB) fait subir une déformation au produit et enregistre la contrainte qui en résulte. Deux types de sollicitation.

- **TPA (Texture Profile Analysis) ou analyse du profil de texture** (Figure 106)

L'appareil applique 2 compressions successives de 30% de déformation avec un intervalle de 5s entre les deux. En sont déduits les modules de Young (calculé sur la base de la pente entre 1 et 4% de déformation), les forces maximales, et le rapport des deux aires correspondant à la réponse aux deux compressions successives (consistance A_1/A_2).

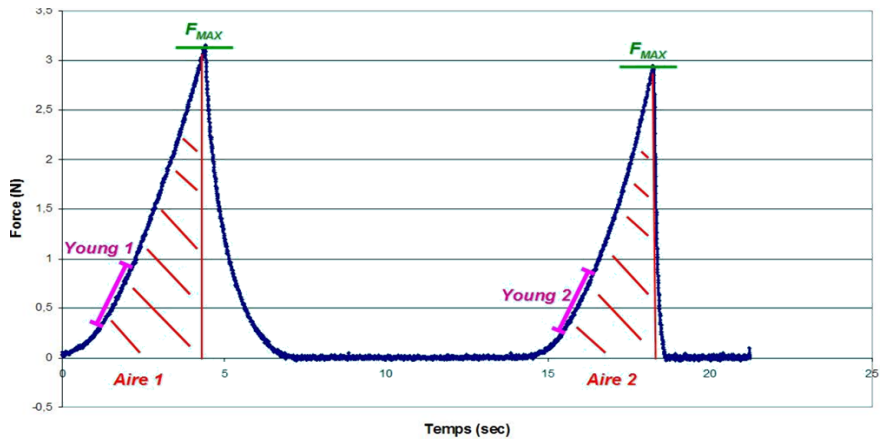

Figure 106 : Analyse du profil de texture (TPA) : courbe obtenue par double compression (30% de déformation ; 5 secondes entre compressions) d'un échantillon de cake standard ; la consistance du produit est calculée à partir du ratio Aire1/Aire2.

- Test de relaxation (Figure 107)

L'appareil applique une seule compression de 30% et la maintient pendant 60s. En sont déduits le module de Young, la pente en début de relaxation (Rx, calculé sur les trois premières secondes de relaxation) ainsi que le pourcentage de recouvrance ($100 \cdot (F_{END}/F_{MAX})$).

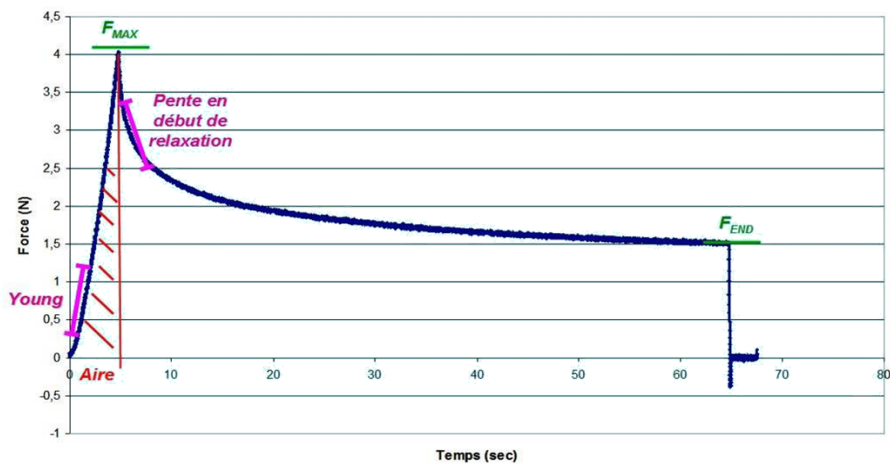

Figure 107 : Courbe obtenue par le test de relaxation (simple compression maintenue durant 60 secondes) sur un échantillon de type standard. La pente en début de relaxation est notée 'Rx'.

3.3.2. Rhéologie à faible déformation (rhéologie dynamique).

La **rhéologie dynamique** permet de caractériser les propriétés viscoélastiques d'un produit intermédiaire entre un solide et un liquide, qui s'expriment en termes de module de conservation et de module de perte :

Le module de conservation (E') rend compte de la rigidité de la matrice. Il correspond au stockage de l'énergie de la sollicitation restituée en une déformation réversible.

Le module de perte (E'') rend compte de la viscosité. Il correspond à la dissipation de l'énergie de la déformation en chaleur. Le facteur de perte ($\tan\delta = E''/E'$) est le rapport de l'énergie dissipée sur l'énergie conservée. $\tan\delta$ est indépendant de la forme de l'échantillon. C'est pourquoi, il est souvent employé dans les études comparatives. $\tan\delta$ sera la valeur utilisée pour les produits étudiés au cours de ce projet. Ce paramètre est un indicateur de la mobilité moléculaire du système ce qui nous permettra dans le cadre de notre problématique de pouvoir mesurer la rigidité de la paroi des alvéoles de la mie du gâteau. Une détermination préalable des conditions de test et un protocole d'étude adapté à la catégorie de produits étudiés ont ainsi été nécessaires.

L'échantillon est découpé à l'emporte-pièce (diamètre de 20 mm et épaisseur de 13 ± 2 mm). Un test de balayage sur une plage de fréquence allant de 5 à 150 Hz est utilisé à une déformation constante de $2 \cdot 10^{-5}$ m (0,1%). L'appareil utilisé est le viscoanalyseur à déformation imposée (*MetraVib R.D.S, Limonest, France*).

3.4. Méthodes de caractérisation de l'aération de la mie

Le niveau de résistance des parois des produits finis mais aussi des parois des alvéoles est évalué par des méthodes de caractérisation de ses propriétés mécaniques. L'étude des propriétés d'aération de tels produits, dits mousses solides est en ce sens d'un intérêt particulier pour pouvoir les comparer et les relier. Elle est basée sur l'évaluation des paramètres suivants : dimensions des alvéoles, forme, distribution au sein de la mie et épaisseur des parois des alvéoles (Zghal et al., 2002).

Deux types d'approches ont été mises en œuvre dans le but de mesurer le niveau d'aération de la mie des produits finis. D'une part, l'emploi d'une méthode de caractérisation à l'échelle macroscopique, correspondant à une échelle de l'ordre de 0.1mm à quelques mm. Elle a été menée par analyse d'image sur une photo de l'échantillon. D'autre part, l'utilisation d'un tomographe rayon X afin de pouvoir caractériser à une échelle plus fine la structure alvéolaire des matrices (échelle de l'ordre de $1\mu\text{m}$ à 1 mm).

Cependant, la seule utilisation de paramètres rhéologiques et la caractérisation du niveau d'aération et de porosité ne peut pas suffire à l'étude approfondie de la texture de matériaux alimentaires tels que les gâteaux moelleux pour lesquels la notion d'aspect, de sensation au toucher et de mise en bouche sont étroitement liées à l'appréciation globale du caractère moelleux en bouche.

3.5. Méthodes de caractérisation sensorielle des produits finis

L'approche sensorielle implique la génération d'un vocabulaire spécifique et consensuel dans un espace produit bien défini. Chaque description s'accompagne

d'une définition précise, d'un mode d'évaluation établi, ainsi que de produits dits 'référence' qui définissent l'espace produit.

Ceci implique donc souvent la mise en place et l'entraînement spécifique d'un panel sur une période longue comme c'est le cas des **profils sensoriels descriptifs** où une échelle de valeur permet d'atteindre la quantification du paramètre sensoriel évalué.

Le **profil flash** se présente souvent comme une alternative au profil descriptif. Il permet cependant de ne mesurer des différences entre des produits de façon qualitative (classement). Il reste néanmoins une méthode performante et permet une évaluation relativement rapide de l'espace produit considéré.

Les deux types de méthodes sensorielles ont été utilisés. Le profil flash a été déployé sur un nombre important de produits dans le but de qualifier les échantillons les uns par rapport aux autres. Une sélection des échantillons d'intérêt a ainsi été possible sur la base des différences relatives entre groupes de produits. La caractérisation des produits retenus a ainsi été menée de façon plus approfondie par l'intermédiaire du profil descriptif de texture.

3.5.1. Le profil Flash

Il s'agit de présenter simultanément l'ensemble de l'espace produit à évaluer. Chaque panéliste identifie ensuite avec son propre vocabulaire un certain nombre de caractéristiques sensorielles communes à chacun des produits mais leur permettant de les différencier et donc de les classer. Cette description est libre et individuelle. Dans la dernière étape du profil, les échantillons sont évalués de façon comparative ; pour chaque terme généré, le panéliste procède à un classement des produits les uns par rapport aux autres (les égalités entre échantillons étant tout à fait possibles) en fonction du niveau (intensité) du descripteur perçu.

2 évaluations ont été menées sur les mêmes produits à 2 mois d'intervalle pour tester l'effet temps avec des juges communs (1 mois et 3,5 mois de stockage). La séance, unique et individuelle a duré de 2 à 4h en fonction des panélistes. 14 produits ont été évalués (dont un produit présenté en double). 10 juges dits 'naïfs' sur ces produits ont été recrutés sur la base de leur 'non participation à une étude sensorielle sur les produits moelleux ou de panification en tant que panel expert' et 'sur leur capacité à exprimer leur perceptions sensorielles.'

Il a été demandé aux 10 panélistes d'évaluer les caractéristiques sensorielles de texture visuelle, au toucher et en bouche des 14 produits.

Les résultats du classement de chacun des produits sur chacun des descripteurs est ensuite analysé statistiquement par Analyse Factorielle Multiple (AFM) en considérant un juge = un tableau de donnée. Le facteur produit et le facteur temps ont été étudiés.

3.5.2. Le profil de texture, analyse descriptive

Constitué de 15 personnes, après une séance de génération de termes sensoriels correspondant à la gamme de produit étudiée (i.e. gâteaux moelleux), nous avons

L'analyse individuellement de l'impact du procédé de fabrication, du niveau d'aération, de la nature de la farine puis de façon générale de l'évolution des propriétés sensorielles et physico-chimiques des produits au cours du temps ont été réalisées à partir de plusieurs matrices sélectionnées au cours de l'étude.

4.1. Impact du procédé sur les caractéristiques physico chimiques et sensorielles de gâteaux moelleux:

L'influence de la nature du mélange et de l'échelle de fabrication (labo/pilote) sur la pâte crue et le produit fini ont été évalués. La compréhension des effets du procédé de fabrication sur la texture d'une pâte à gâteau et du produit cuit est importante afin de prédire l'influence d'un changement de formulation.

Les paramètres pris en compte dans cette étude sont l'ordre d'incorporation des ingrédients lors de la fabrication de la pâte ainsi que le mode de mélange de ces ingrédients. La texture finale du produit a été étudiée par l'intermédiaire de différentes méthodes mettant en parallèle plusieurs outils de rhéologie, et de caractérisation sensorielle. Cependant, aucune différence n'a été démontrée entre les différents types de mélange. L'influence de l'échelle (labo à pilote) qui a été étudiée en parallèle a montré que les mêmes formulations fabriquées selon le même procédé de fabrication à une échelle différente présentaient des propriétés distinctes en termes de caractéristiques des pâtes. Cependant, la comparaison des produits au sein d'une même échelle aboutis aux mêmes différences relatives entre produits.

Cette partie de l'étude permet d'un point de vue industriel d'orienter les choix technologiques et de justifier de l'intérêt dans le cas des produits étudiés de pouvoir sélectionner des échantillons de nature différente sur la base de la comparaison avec d'autres références produits.

Le premier contrôle effectué sur les données concerne la position des deux échantillons correspondant au produit répété qui dans l'absolu doivent être évalués de façon identique. L'analyse était en effet pertinente et répétable pour les profils à 1 mois comme à 3,5 mois (échantillons évalués très proches voire strictement identiques)

Les principales conclusions de cette évaluation sensorielle ont été les suivantes :

- * De grandes différences observées en termes de taille et d'homogénéité de l'aération.
- * Ces distinctions très importantes ont été orientées par un niveau d'alvéolation extrême du fait des variations de niveaux de poudres levantes -50 et +50% (Figure 108).

Le facteur 'poudre levante' guide la classification des produits où une combinaison de facteur avait été appliquée, annulant de fait l'éventuel impact procédé + farine qui lui est rattachée.

- * **Le procédé de mélange n'influence pas de façon significative la texture des produits** au sein de l'espace produit défini. La nature des farines utilisées et les

niveau de poudres levante appliqués conditionnent les variations entre les échantillons étudiés.

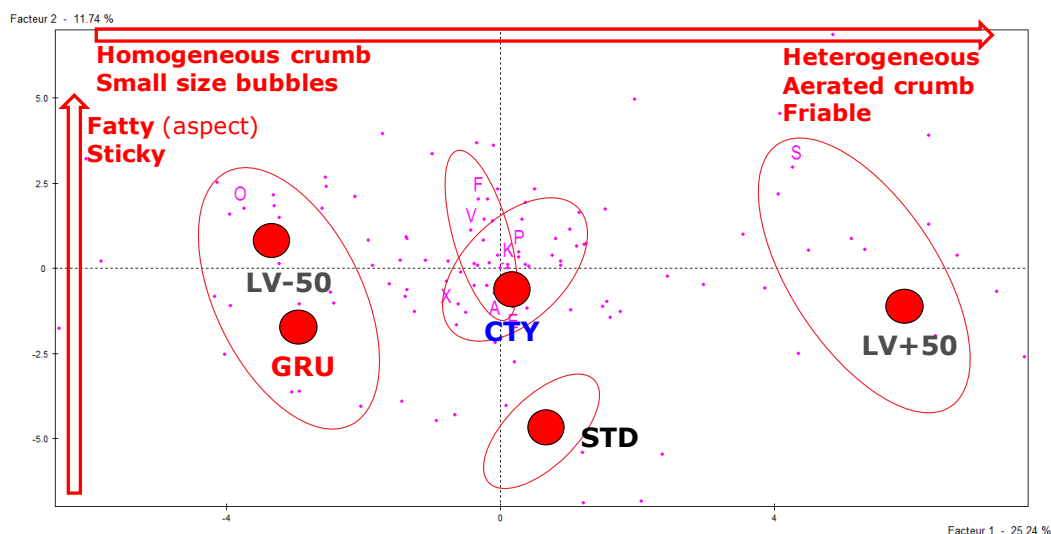

Figure 108 : Global : Exemple de carte produit obtenue à partir de l'analyse de l'ensemble des descripteurs de texture Visuelle, au Toucher et en Bouche, pour des produits âgés de 3,5 mois. Les cercles représentent les groupes de produits au sein desquels les échantillons ne sont pas perçus significativement différents.

4.2. Impact de la nature de la farine et du niveau d'aération sur le moelleux : caractérisation instrumentale et sensorielle de la texture des gâteaux

Un profil descriptif de texture a été mis en place pour cette partie sensorielle de l'étude. La caractérisation de la structure et des propriétés physicochimiques des mêmes produits a été réalisée. Il s'agit de mener une étude cinétique des paramètres de texture par une double approche intégrant des mesures à différentes échelles instrumentales et à l'échelle sensorielle.

Les résultats obtenus à l'échelle sensorielle indiquent que les produits sont classés en différentes catégories. Ils sont au premier abord discriminés par leur niveau d'aération (positions extrêmes sur la carte). Certains produits à alvéolation plus proche et relativement intermédiaires se distinguent ensuite par leurs caractéristiques en bouche (positions centrales sur la carte).

A partir de ces résultats et des mesures menées en parallèle avec des méthodes instrumentales de quantification de l'aération et des propriétés mécaniques des échantillons, une analyse de corrélation a été réalisée. La méthode statistique d'Analyse Factorielle Multiple (AFM) a été employée pour mener cette comparaison et les résultats qui en sont issus sont présentés en Figure 109.

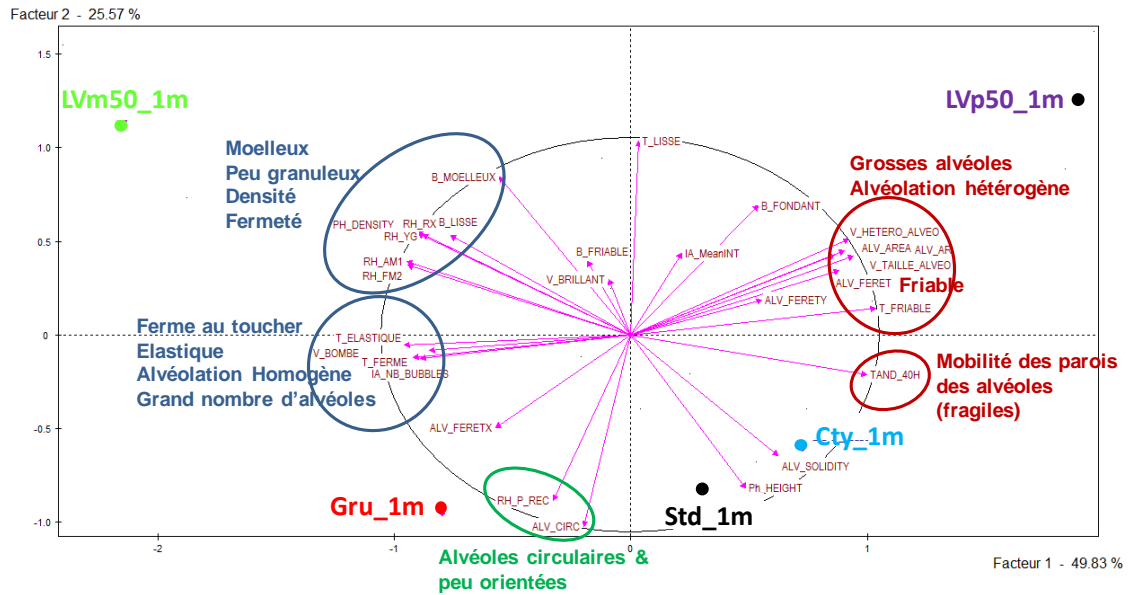

Figure 109 : Représentation du cercle de variable et de la carte produits issu de l'analyse des données instrumentales et sensorielles par AFM sur des échantillons de gâteaux moelleux âgés de 1 mois.

A l'issue de cette analyse l'impact de différents facteurs de variations (nature de la farine et proportion de poudre levante) sur les caractéristiques des échantillons étudiés a pu être mis en évidence. En effet, ceci implique non seulement une variation du niveau d'aération, de ses caractéristiques mais également des propriétés mécaniques ainsi que de la perception sensorielle des produits finis.

La **quantité ajoutée de poudre levante affecte la taille et la distribution des alvéoles de la mie** des gâteaux moelleux menant dans les cas extrêmes (LVp50) à un produit au développement exacerbé, trop fragile et s'affaissant très rapidement entraînant notamment des valeurs élevées de notes attribuées pour des descripteurs à connotation négative : LVp50 est perçu très friable, sec mais ni moelleux, ni ferme. Il présente de grosses alvéoles mais n'est pas dense. Il n'est pas élastique mais présente des parois fragiles et est peu développé.

Le 'gradient' d'aération ne semble cependant pas être uniquement lié au niveau de poudre levante ajouté puisqu'à quantité constante en poudre levante, une simple variation de la nature de la farine conduit à des produits présentant une alvéolation légèrement différente dans chacun des cas. Gru, Std et Cty possèdent des alvéoles de taille intermédiaire par rapport à celles mesurées pour LVm50 et LVp50 mais leur orientation (mesures instrumentales) et leur distribution au sein de la mie apparaît distincte (mesures instrumentales et sensorielles).

Le **descripteur moelleux** apparaît dans les échantillons que l'on caractérisera comme étant, **ferme et fondant, voire élastique, mais non friable non sec présentant une aération fine et homogène**. Confirmé à la fois par les mesures

instrumentales et sensorielles, les produits LVm50 et Gru sont plutôt denses, fermes, élastiques, avec une mie relativement fine et homogène et sont perçus moelleux.

La nature de la farine ajoute ici une dimension supplémentaire à la problématique puisque permettant d'agir sur l'aspect des produits (bombé et aération) sur la perception au toucher de leur fermeté et élasticité (confirmé par les mesures en rhéologie grande déformation), ainsi que sur la perception du moelleux, du sec et du friable en bouche. L'utilisation d'une farine plutôt qu'une autre mène en effet à des produits de consistance et perception différentes, Les produits fabriqués avec la farine GRU sont élastiques, fermes et moelleux. Ceux fabriqués avec CTY sont friables, relativement secs et non moelleux, tout comme dans le cas de Std.

Certaines caractéristiques d'aération ne sont pas perceptibles sensoriellement et ne semblent être mesurées que de façon instrumentale (orientation des bulles, circularité). C'est également le cas pour les caractéristiques sensorielles telles que le fondant ou le gras en bouche, difficile à approcher instrumentalement puisqu'elles font appel à un ensemble de stimuli en bouche au cours de la mastication.

Après 1 mois de stockage (Figure 109) mais aussi après 3 et 6 mois (non illustré), il apparaît donc que les caractéristiques d'aération des échantillons (taille, forme, orientation, distribution) sont principalement liées au niveau de poudre levante mais pas uniquement puisque la nature de la farine impacte de façon non négligeable certains paramètres, notamment en termes d'homogénéité de la mie. Par ailleurs, les propriétés mécaniques et sensorielles permettent de distinguer les produits de façon plus précise dans le cas où leur niveau d'aération est proche.

La prise en compte du facteur temps a permis de noter que les principales évolutions ont lieu lors du premier mois de conservation. Celles-ci ont principalement été montrées en termes de caractéristiques rhéologiques (accroissement de la fermeté et de la résistance des parois des alvéoles). Au-delà, aucune modification sensible n'a été remarquée et la mesure des perceptions sensorielles n'a pas mis en évidence de modification entre 1 et 5 mois. **Le moelleux, notamment reste strictement identique au cours du temps et les différences entre produits restent constantes sur cette période de l'étude.**

4.3. Caractéristiques physico-chimiques et fonctionnalités des farines

L'impact de la nature de la farine constitue l'un des facteurs influençant les propriétés rhéologiques des pâtes crues, et impactant de façon non négligeable les caractéristiques physico-chimiques et sensorielles des produits finis.

Les fonctionnalités des farines sont étroitement liées à leur composition. Qualité et quantité, en particulier de l'amidon et des protéines de blé mais aussi de l'amidon endommagé. La répartition granulométrique de la farine ainsi que les proportions relatives de ces composants ont été évalués : Tableau II.

Tableau II : Composition des farines étudiées en amidon endommagé, protéines et en qualité des protéines

Nature de la farine	Amidon endommagé (%)	Protéines (%)	Gluten sec (% base farine)	Gluten Index (GI) %matière sèche
CTY_Farine	3.45 ± 0.06 ^(a)	9.74 ± 0.03 ^(a)	7.40 ± 0.11 ^(b)	48.76 ± 2.81 ^(a)
STD_Farine	6.01 ± 0.11 ^(b)	9.85 ± 0.03 ^(b)	6.99 ± 0.15 ^(a)	84.46 ± 2.04 ^(c)
GRU_Farine	7.20 ± 0.07 ^(c)	13.82 ± 0.03 ^(c)	10.99 ± 0.10 ^(c)	76.62 ± 4.47 ^(b)

La composition des farines influence directement ses propriétés d'hydratation. Ces dernières sont principalement reliées aux propriétés hygroscopiques de certains de ses composants comme les pentosanes ou encore l'amidon endommagé. Cependant, les protéines ont la capacité de s'hydrater au cours du procédé de mélange lors de la fabrication de la pâte permettant la mise en place progressive d'un réseau protéique visco-élastique. Ce réseau de protéines de gluten s'établissant au cours du mélange, un accroissement de la viscosité est enregistré alors que la pâte est encore à température ambiante. Au cours de la cuisson, la température s'élève et la viscosité continue à augmenter. Il s'agit alors de l'impact des transformations hydrothermiques de l'amidon, impliquant le gonflement des granules d'amidon et l'ensemble du phénomène de gélatinisation. La structure des granules d'amidon, leur niveau de cristallinité mais également les interactions et compétitions avec les autres composants de la farine constituent des hypothèses soulevées pour expliquer les variations enregistrées entre les produits fabriqués avec des farines de nature différentes.

Le niveau et la vitesse de gélatinisation pouvant être influencés par de tels facteurs, la mise en place de la structure pourra en être d'autant impactée. En effet, une fois cuit, les gâteaux moelleux sont refroidis. Une simple réduction de la pression des échantillons combinés à un développement trop élevé peut conduire à l'affaissement de leur structure. C'est le cas des échantillons fait à partir de la farine CTY (farine dite 'Soft', relativement pauvre en protéines (<10%)). Ces produits sont en effet soupçonnés se développer de façon trop importante par rapport à la capacité de résistance des parois des alvéoles des produits. Les raisons principales sont liées à la composition respective en protéines de gluten, trop faible et à la qualité de l'amidon qui aurait un gonflement rapide et important.

A l'inverse le produit fait à base de farine GRU (farine dite 'Medium Hard', relativement riche en protéines (13%)). GRU, présente une structure relativement rigide et qui se maintient même en sortie de four et au cours de la conservation.

Dans le pain comme dans les gâteaux, la texture aérée est directement reliée à la perception des produits visuellement et conditionne ainsi leur qualité (Deshlahra et al., 2009). L'aération des produits est conditionnée par la mise en place et la croissance des bulles d'air initiées au cours du procédé de mélange des ingrédients puis de la cuisson de la pâte. Des fusions de bulles d'air au sein de la mie peuvent alors avoir

lieu au cours de cette étape. Un bon équilibre de composition entre amidon, protéines et hydratation des composants de la farine est indispensable pour que la structure de la mousse solide se mette en place et soit maintenue après l'étape de cuisson.

Ainsi, la composition des farines et les fonctionnalités de ses composants impactent fortement les propriétés physico-chimiques des pâtes et des produits finis ainsi que la structure liée aux interactions entre composants qui s'établissent au cours de la cuisson.

5. Discussion

La compréhension de la texture et les aspects clés affectant son acceptabilité sont essentiels pour le développement de produits à texture souhaitée ou pour l'amélioration de produits existants afin de garantir la satisfaction des consommateurs (Heenan et al., 2009, Strassburg et al., 2009). Ceci s'ajoute à l'importance de la perception de la texture dans l'évaluation d'un produit alimentaire (Strassburg et al., 2009, Wilkinson et al., 2000).

Le conditionnement des produits a été choisi pour limiter les pertes en eau liées à des transferts au travers du film d'emballage. Nous avons sélectionné un emballage ayant des propriétés barrières à l'eau et l'air importantes afin d'éviter toute conclusion liée à une évolution de l'humidité au sein du sachet. Ces produits sont relativement fragiles et nécessitent un stockage dans le temps pour les besoins du caractère cinétique de l'étude de l'évolution de la texture d'un point de vue à la fois physico-chimique et sensorielle. Les conditions de fabrications d'un tel produit doivent donc être maîtrisées pour supporter des temps de stockage long (6 mois minimum) sans devenir sensible microbiologiquement. Il a ainsi été établi en début de projet une formule et un procédé simplifié qui soient également adaptés à cette contrainte de conservation.

Au travers des paramètres étudiés, les différents facteurs impliqués dans la description sensorielle et physicochimique du moelleux ont pu être mis en parallèle : Tableau III.

Les caractéristiques à l'échelle moléculaire reposent essentiellement sur la composition des farines. Celle-ci impacte la perception sensorielle du produit fini de part la structure qu'elle confère au matériau lors du procédé de fabrication: Tableau IV.

Tableau III : Paramètres sensoriels et instrumentaux sélectionnés pour l'étude de la texture de gâteaux moelleux. Représentation des interrelations entre paramètres de même échelle de caractérisation et des plus pertinents.

Critères physico-chimiques	Caractéristiques mécanique	Aération / Bulles de la mie	Sensoriel
Densité (0) Aucune corrélation avec le moelleux	Dureté = Fmax * - compression uniaxiale – Evolution semblable au module d'Young (+)	Taille des bulles Fines (+)	<u>Moelleux en bouche</u>
Activité de l'eau Paramètre constant entre produits et au cours du temps	Rigidité des parois des alvéoles = TanDelta** - DMTA (dynamique) - Similaire au coefficient de relaxation Rx (+)	Hétérogénéité de l'alvéolation Distribution homogène des bulles (+)	Elasticité au toucher (+)
Teneur en eau des produits finis = constante (produit, temps)		Nombre de bulles Relation avec la taille des bulles / l'hétérogénéité de l'alvéolation	Fragilité/Friabilité au toucher et en bouche (-)
Hauteur des cakes –centre (0) Pas de corrélation avec le moelleux (affaissement de structure)		Porosité de la matrice (tomographie RX) Caractérisation complexe et coûteuse	Fondant (+) Sec (-) En bouche

(1) Indique qu'aucune relation n'a été montrée avec la perception du moelleux

(+) Indique que le paramètre est positivement relié au moelleux sensoriel

(-) Indique que le moelleux sensoriel est plutôt négativement affecté par le paramètre considéré.

* La dureté mesurée évolue de la même façon que le module d'Young et est donc choisi comme de le paramètre permettant de caractériser la fermeté des produits et leur dureté.

** TanDelta, facteur de perte est mesuré par une méthode de rhéologie dynamique permettant de quantifier la mobilité des parois des alvéoles et donc d'approcher l'élasticité de la mie / la rigidité des parois. Cette évaluation est plus précise que la mesure du coefficient de relaxation Rx menée par rhéologie grande déformation. Tan Delta est ainsi considéré comme le plus pertinent pour la caractérisation structurale des produits (échelle mésoscopique).

Tableau IV: Illustration du caractère multi-dimensionnel de la texture. Résumé des principaux facteurs impliqués dans la mise en place (et l'évolution) de la texture de gâteaux moelleux vis-à-vis des différentes caractéristiques étudiées. Composition de la farine en amidon et protéines, propriétés structurales et de texture, perception sensorielle.

Produit \ Echelle	Moléculaire	Mésoscopique/ Mécanique	Macroscopique/Aération	Perception sensorielle Toucher / en bouche
LVm50	Teneur en protéines (0) <i>Pas de dilution de la qté de protéines</i>	Densité (+) Dureté / Fermeté (++) Rigidité de la paroi des alvéoles (++) <i>Maintien de la structure après cuisson</i>	Alvéolation homogène (+) Fines bulles – taille (+) < 0.85mm	MOELLEUX (B) ELASTIQUE (T) LISSE (T&B) FONDANT (B)
GRU	Teneur en protéines (+) Qualité des protéines (+) Propriétés foisonnantes ! (+)	Densité (0) Dureté / Fermeté (++) Rigidité de la paroi des alvéoles (+) <i>Maintien de la structure après cuisson</i>	Alvéolation homogène (+) Fines bulles – taille (+) < 0.85mm	
STD	Teneur en protéines (0) Propriétés foisonnantes (-)	Rigidité de la paroi des alvéoles (-) Densité (0)	Alvéolation homogène (-)	FRAGILE (T) FRIABLE (B) PATEUX (B)
CTY	Teneur en protéines (-) Quantité relative d'amidon (+)	Rigidité de la paroi des alvéoles (-) Gonflement des granules d'amidon (++) <i>Perte de structure/affaissement après cuisson</i>	Alvéolation homogène (0) Fines bulles – taille (0)	
LVp50	Teneur en protéines (0) Dilution des protéines => manqué/perte de structure Dilution des matières grasses dans les parois des bulles, large distribution (perception de sec)	Rigidité de la paroi des alvéoles (--) => Fragilité du produit Dureté / Fermeté (-) Elasticité (-)	Distribution hétérogène de l'alvéolation Taille de bulles exacerbée > 2mm	SEC (B) FRIABLE (T&B)

(0,-,+); Pour une vue plus macro de ces facteurs, leur niveau sur chaque produit et leur impact relatif sur les propriétés sensorielles les caractérisant (colonne de droite) est associé aux signes (-) / (0) ou (+) pour faible : moyen à hauts niveaux, respectivement.

(B,T) = item de texture mesuré par une évaluation au Toucher (T) et/ou en Bouche (B)

STD = Echantillon standard dit 'référence' en termes de process, nature de farine (Soft/Medium-Hard) et niveau de poudre levantes standard

LVm50, LVp50 = Echantillon de gâteau avec un niveau de poudre levante réduit et augmenté de 50% par rapport au standard, respectivement

GRU = Echantillon fabriqué sur une base de farine 'Gruau Rouge' (farine medium hard, profil de farine pour produits de panification)

CTY = Echantillon fabriqué sur base de farine 'Crusty' (Farine de blé tendre Soft, profil de farine à biscuit).

6. Conclusion

Cette étude intitulée “Etude des facteurs influençant la structure et la texture de produits céréaliers alvéolés de cuisson semi-humide : une approche instrumentale et sensorielle de caractérisation de la texture” s’attache à la compréhension de la mise en place de la texture de gâteaux moelleux fabriqués à base de farine de blé et de son évolution au cours du temps.

L’influence de plusieurs paramètres sur leur texture a été décrite et analysé. Le **procédé de fabrication**, l’**aération de la mie** et la **nature de la farine** ont été soumis à variations afin d’en mesurer l’impact sur les propriétés des produits à différentes échelles de caractérisation.

Le principal facteur influençant l’évaluation des produits était le **niveau d’aération de la mie**. Une bonne corrélation a été mise en exergue entre aération mesurée et aspect visuel perçu. Certains paramètres sont apparus sensiblement différents à l’échelle instrumentale alors qu’ils n’étaient pas détectés sensoriellement (orientation des bulles).

L’aération joue un rôle non négligeable affectant à la fois la structure de la mousse solide mais également la perception de son moelleux. Ce paramètre d’aération peut dans certains cas **être maîtrisé**, sinon contrôlé par injection de gaz, ajout de poudres levantes mais aussi par la **qualité de la farine**, (nature de ses protéines et propriétés foisonnantes). Les produits étudiés présentant une **aération exacerbée** et aux structures les moins denses **n’étaient pas perçus comme moelleux** mais plutôt comme des produits extrêmes et atypiques. Certains descripteurs de perception de la texture tels que le fondant et le sec restent néanmoins difficilement mesurables à l’échelle instrumentale.

La texture des gâteaux moelleux a ainsi été caractérisée instrumentalement par leur fermeté et leur élasticité, illustré à la fois par des mesures instrumentales et sensorielles.

La densité des produits finis n’a pas été reliée à des caractéristiques de texture car impliquant d’autres phénomènes dépendant de la nature et de la composition structurale des gâteaux étudiés. Forte aération et faible rigidité des parois des alvéoles étaient reliées à la friabilité des produits au toucher et en bouche.

Après une caractérisation approfondie de la texture et de la structure alvéolaire des produits, les propriétés physico-chimiques des farines et de leurs constituants ont été étudiées. La caractérisation du comportement des farines dans des systèmes simples (farine sous hydratation) à multi-composants (pâte à gâteau) a été menée.

La mise en place de la structure des produits de type cake implique en premier lieu une hydratation des ingrédients de la formule puis une structuration des ingrédients dans la pâte. Ceci est principalement influencé par la composition des farines et en particulier par les protéines de gluten. Ensuite, les changements qui interviennent au cours de la phase de cuisson au four sont ainsi majoritairement

dépendants de la nature de la farine et en particulier de l'amidon de blé. L'étude de l'impact du procédé de fabrication et notamment de la nature du mélange et de l'ordre d'incorporation des ingrédients n'a pas révélé de modification sur les produits finis.

La **variabilité à la fois de la quantité et de la qualité des protéines de gluten** dans les farines étudiées impacte l'aération de la pâte fabriquée et la formation de son réseau de gluten. Les farines CTY et GRU mises en œuvre se distinguent en effet par leur profil protéique. La farine GRU, medium-hard apparaît à l'issue de cette étude comme la plus adaptée à la fabrication de gâteaux pour l'obtention des caractéristiques texturales du moelleux.

La **rhéologie haute déformation** combinée à une mesure de l'alvéolation constituent les premières approches permettant de rapidement caractériser l'aération et de procéder à une première sélection des produits considérés. L'évaluation de la résistance des parois des alvéoles de la mie (par **rhéologie dynamique**) en parallèle à la caractérisation de sa porosité (**Tomographie RX**) sont d'un intérêt certain pour aller plus loin dans l'analyse et le choix des produits au caractère moelleux marqué.

Enfin, à l'issue de la mise en œuvre de ces différentes étapes de contrôle des produits, la caractérisation de leur texture d'un point de vue sensoriel permet d'apporter des informations complémentaires non négligeables sur le ressenti global du produit par le consommateur et sur son acceptabilité.

Plusieurs progrès et thématiques d'étude peuvent être suggérés vis-à-vis. La prise en considération de la qualité des farines mises en œuvre dans les gâteaux fait en effet partie des points clés influençant la texture des produits de façon même plus remarquable que la modification du procédé de fabrication.

Les items sensoriels tels que '**aéré et friable**' **qualifiaient négativement la perception de la texture** des échantillons dans **l'espace produit considéré**. Les aspects fondants pâteux semblent vraiment important pour les produits. La composition macro-moléculaire de la pâte inclus l'amidon, des protéines et des lipides. La mesure de la répartition de ces composants dans la phase continue, i.e., la mie, à l'échelle microscopique permettrait d'apporter des éléments complémentaires quant à la structuration, la mise en place et l'évolution de la texture au cours du temps

L'amidon étant le principal composant de la farine, une étude de la capacité de gonflement des granules et du niveau de gélatinisation a été envisagée.

Les protéines de la farine ayant un rôle particulier dans la mise en place et le maintien des alvéoles et de la structure finale des produits, l'initiation de la formation des bulles de gaz doit être suivie. Ainsi, la nature et les caractéristiques des composants de la farine et de la farine de blé en général doivent être choisies et maîtrisées vis-à-vis de l'équilibre amidon/protéines des farines.

REFERENCES

.....« Entendre ou lire sans réfléchir est une occupation vaine ;
.....réfléchir sans livre ni maître est dangereux. »
Confucius

- AACC International.** 1999a. 39-10.01 - Near-Infrared Reflectance Method for Protein Determination in Small Grains.
- AACC International.** 1999b. 55-40.01 - Particle Size of Wheat Flour by Laser Instrument.
- AACC International.** 1999c. 55-50.01 - Specific Volume Measurement.
- AACC International.** 2000. 38-12.02 - Wet Gluten, Dry Gluten, Water-Binding Capacity, and Gluten Index.
- AACC International.** 2001. 10-05.01 - Guidelines for Measurement of Volume by Rapeseed Displacement.
- AACC International.** 2009. 56-11.02 - Solvent Retention Capacity Profile.
- Abang Zaidel, D. N., Chin, N. L., Abdul Rahman, R., and Karim, R.** 2008. Rheological characterisation of gluten from extensibility measurement. *Journal of Food Engineering*, 86 (4): 549-556.
- Abdullah, M. Z.** 2008a. Image Acquisition Systems. In: D. W. Sun (Ed.), *Computer Vision Technology for Food Quality Evaluation*. Academic Press, Elsevier, Amsterdam. (3-35).
- Abdullah, M. Z.** 2008b. Quality Evaluation of Bakery Products. In: D. W. Sun (Ed.), *Computer Vision Technology for Food Quality Evaluation*. Academic Press, Elsevier, Amsterdam. (481-522).
- Addo, K., Coahran, D. R., and Pomeranz, Y.** 1990. A New Parameter Related to Loaf Volume Based on the First Derivative of the Alveograph Curve. *Cereal Chemistry*, 67 (1): 64-69.
- Addo, K., and Pomeranz, Y.** 1991. Lipid Binding and Fatty Acid Distribution in Flour, Dough, and Baked and Steamed Bread. *Cereal Chemistry*, 68: 570-572.
- AFNOR.** 1992. ISO 5492. ICS number: 67.240. Analyse Sensorielle - Vocabulaire / Sensory Analysis - Vocabulary. p107.
- AFNOR.** 1994. ISO 11036. ICS number: 67.240. Analyse Sensorielle - Méthodologie - Profil de la texture / Sensory Analysis - Methodology - Texture Profile. p16.
- AFNOR.** 2002. Analyse Sensorielle, (6th ed.). AFNOR. (pp. 636).
- AFNOR.** 2003. ISO 13299. ICS number: 67.240. Analyse Sensorielle - Méthodologie - Directives générales pour l'établissement d'un profil sensoriel / Sensory Analysis - Methodology - General guidance for establishing a sensory profile. p24.
- Agrawal, K. R., Lucas, P. W., and Bruce, I. C.** 2000. The Effects of Food Fragmentation Index on Mandibular Closing Angle in Human Mastication. *Archives of Oral Biology*, 45 (7): 577-584.
- Agrawal, K. R., Lucas, P. W., Prinz, J. F., and Bruce, I. C.** 1997. Mechanical Properties of Foods Responsible for Resisting Food Breakdown in the Human Mouth. *Archives of Oral Biology*, 42 (1): 1-9.
- Agrawal, K. R., Lucas, P. W., Prinz, J. F., and Bruce, I. C.** 2002. Food Physics and Oral Physiology. *Food Quality and Preference*, 13 (4): 203-213.
- Aguilera, J. M.** 2005. Why Food Microstructure? *Journal of Food Engineering*, 67 (1-2): 3-11.
- Aguilera, J. M., and Lillford, P. J.** 2008. Structure–Property Relationships in Foods. In: J. M. Aguilera and P. J. Lillford (Eds.), *Food Materials Science*. Springer, New York. (229-253).
- Aguilera, J. M., and Stanley, D. W.** 1999. Microstructural Principles of Food Processing and Engineering, (2nd ed.). Springer, Verlag. (pp. 450).
- Aguilera, J. M., Stanley, D. W., and Baker, K. W.** 2000. New Dimensions in Microstructure of Food Products. *Trends in Food Science & Technology*, 11 (1): 3-9.

- Ahmad, F. B., and Williams, P. A.** 1999a. Effect of Salts on the Gelatinization and Rheological Properties of Sago Starch. *Journal of Agricultural and Food Chemistry*, 47 (8): 3359-3366.
- Ahmad, F. B., and Williams, P. A.** 1999b. Effect of Sugars on the Thermal and Rheological Properties of Sago Starch. *Biopolymers*, 50 (4): 401-412.
- Albert, A., Varela, P., Salvador, A., Hough, G., and Fiszman, S.** 2011. Overcoming the Issues in the Sensory Description of Hot Served Food with a Complex Texture: Application of QDA, Flash Profiling and Projective Mapping using Panels with Different Degrees of Training. *Food Quality and Preference*, 22: 463-473.
- Allais, I., Edoura-Gaena, R.-B., and Dufour, E.** 2006. Characterisation of lady finger batters and biscuits by fluorescence spectroscopy. Its relation with density, color and texture. *Journal of Food Engineering*, 77 (4): 896-909.
- Amerine, M. A., Pangborn, R. M., and Roessler, E. B.** 1965. Principles of Sensory Evaluation of Food. Academic Press, New York. (pp. 602).
- Angioloni, A., and Collar, C.** 2009. Bread Crumb Quality Assessment: a Plural Physical Approach. *European Food Research and Technology*, 229 (1): 21-30.
- Arendt, E. K., Morrissey, A., Moore, M. M., and Dal Bello, F.** 2008. Gluten-free Breads. In: E. K. Arendt and F. Dal Bello (Eds.), *Gluten-Free Cereal Products and Beverages*. Academic Press, San Diego. (289-VII).
- Ashby, M., and Medalist, R.** 1983. The Mechanical Properties of Cellular Solids. *Metallurgical and Materials Transactions*, 14 (9): 1755-1769.
- Ashby, M. F.** 2006. The Properties of Foams and Lattices. *Philosophical Transactions of the Royal Society A: Mathematical, Physical and Engineering Sciences*, 364 (1838): 15-30.
- Attenburrow, G., Barnes, D. J., Davies, A. P., and Ingman, S. J.** 1990. Rheological Properties of Wheat Gluten. *Journal of Cereal Science*, 12 (1): 1-14.
- Attenburrow, G. E., Goodband, R. M., Taylor, L. J., and Lillford, P. J.** 1989. Structure, Mechanics and Texture of a Food Sponge. *Journal of Cereal Science*, 9 (1): 61-70.
- Atwell, W. A.** 2001a. An Overview of Wheat Development, Cultivation, and Production. *Cereal Foods World*, 46 (2): 59-62.
- Atwell, W. A.** 2001b. Starches. American Association of Cereal Chemists, St Paul, Minnesota, USA. (pp. 122).
- Atwell, W. A.** 2001c. Wheat Flour. American Association of Cereal Chemists, St Paul, Minnesota, USA. (pp. 134).
- Auvray, M., and Spence, C.** 2008. The Multisensory Perception of Flavor. *Consciousness and Cognition*, 17 (3): 1016-1031.
- Aynie-Davidou, S.** 1994. Thesis: *Contribution à l'étude des facteurs physico-chimiques qui contrôlent la texture des produits céréaliers de cuisson*. Université de Bourgogne (University of Burgundy), Dijon, France. pp. 190.
- Babin, P., Della Valle, G., Chiron, H., Cloetens, P., Hoszowska, J., Pernot, P., Réguerre, A. L., Salvo, L., and Dendievel, R.** 2006. Fast X-ray Tomography Analysis of Bubble Growth and Foam Setting During Breadmaking. *Journal of Cereal Science*, 43 (3): 393-397.
- Babin, P., Della Valle, G., Dendievel, R., Lassoued, N., and Salvo, L.** 2005. Mechanical Properties of Bread Crumbs from Tomography Based Finite Element Simulations. *Journal of Materials Science*, 40 (22): 5867-5873.
- Baks, T., Ngene Ikenna, S., Van Soest, J. J. G., Janssen, A. E. M., and Boom, R. M.** 2007. Comparison of Methods to Determine the Degree of Gelatinisation for Both High and Low Starch Concentrations. *Carbohydrate Polymers*, 67 (4): 481-490.
- Baldwin, P. M.** 2001. Starch Granule-Associated Proteins and Polypeptides: A Review. *Starch - Stärke*, 53: 475-503.
- Baltsavias, A., Jurgens, A., and Van Vliet, T.** 1999. Properties of Short-Dough Biscuits in Relation to Structure. *Journal of Cereal Science*, 29 (3): 245-255.

- Banks, W., and Greenwood, C. T.** 1975. Starch and its Components, (Vol. 27.). Wiley-VCH Verlag GmbH, Edinburgh. (pp. 342).
- Barak, S., Mudgil, D., and Khatkar, B. S.** 2012. Effect of flour particle size and damaged starch on the quality of cookies. *Journal of Food Science and Technology*. 1-7.
- Barak, S., Mudgil, D., and Khatkar, B. S.** 2013. Relationship of gliadin and glutenin proteins with dough rheology, flour pasting and bread making performance of wheat varieties. *LWT - Food Science and Technology*, 51 (1): 211-217.
- Barcelon, E. G., Tojo, S., and Watanabe, K.** 1999. X-ray Computed Tomography for Internal Quality Evaluation of Peaches. *Journal of Agricultural Engineering Research*, 73 (4): 323-330.
- Barrera, G., Pérez, G., Ribotta, P., and León, A.** 2007. Influence of Damaged Starch on Cookie and Bread-making Quality. *European Food Research and Technology*, 225 (1): 1-7.
- Barrera, G. N., Bustos, M. C., Iturriaga, L., Flores, S. K., León, A. E., and Ribotta, P. D.** 2013. Effect of damaged starch on the rheological properties of wheat starch suspensions. *Journal of Food Engineering*, 116 (1): 233-239.
- Bean, M. M., and Yamazaki, W. T.** 1978a. Wheat Starch Gelatinization in Sugar Solutions I: Sucrose, Microscopy and Viscosity effects. *Cereal Chemistry*, 55 (6): 936-944.
- Bean, M. M., and Yamazaki, W. T.** 1978b. Wheat Starch Gelatinization in Sugar Solutions II: Fructose, Glucose and Sucrose: Cake performance. *Cereal Chemistry*, 55 (6): 945-952.
- Bechtel, D. B., and Pomeranz, Y.** 1980. *Advances in Cereal Science and Technology*, (Vol. 3.). American Association of Cereal Chemists, St Paul, MN, USA).
- Belitz, H.-D., Grosch, W., and Schieberle, P.** 2009. Cereals and Cereal Products Food Chemistry. In: H.-D. Belitz, W. Grosch and P. Schieberle (Eds.), *Food Chemistry*. (4th ed. Chemistry and Materials Science). Springer, Berlin Heidelberg. (670-745).
- Berton, B., Scher, J., Villieras, F., and Hardy, J.** 2002. Measurement of Hydration Capacity of Wheat Flour: Influence of Composition and Physical Characteristics. *Powder Technology*, 128 (2-3): 326-331.
- Bhandari, B. B., and Roos, Y.-H.** 2012. *Food Materials Science and Engineering*, (1st ed.). Blackwell, Oxford, UK. (pp. 417).
- Biliaderis, C. G., Maurice, T. J., and Vose, J. R.** 1980. Starch Gelatinization studied by Differential Scanning Calorimetry. *Journal of Food Science*, 45 (6): 1669-1674.
- Bizot, H., Le Bail, P., Leroux, B., Davy, J., Roger, P., and Buléon, A.** 1997. Calorimetric Evaluation of the Glass Transition in Hydrated, Linear and Branched Polyanhydroglucose Compounds. *Carbohydrate Polymers*, 32: 33-50.
- Blanchard, C., Champion, D., Verel, A., and Labouré, H.** 2012a. Aeration of Hydrated Cereal Based Products : Impact on Rheological and Sensory Properties. In: INRA (Ed.) *Food Oral Processing - FOP*. Wiley-Blackwell, Beaune, FRANCE, 2012 , july 3-5th.
- Blanchard, C., Labouré, H., Verel, A., and Champion, D.** 2012b. Study of the impact of wheat flour type, flour particle size and protein content in a cake-like dough: proton mobility and rheological properties assessment. *Journal of Cereal Science*, 56 (3): 691-698.
- Blancher, G.** 2007. Thesis: *Perception sensorielle de la texture de gels en France et au Vietnam et prédiction des profils sensoriels par des mesures instrumentales.*, Ecole Nationale des Industries Agricoles et Alimentaires, Paris. pp. 230.
- Blanshard, J. M. V., and Frazier, P. J.** 1986. *Chemistry and Physics of Baking Materials, Processes, and Products*, (Special Publication ed.). Royal Society of Chemistry, London, UK. (pp. 284).
- Blazek, J., and Gilbert, E. P.** 2011. Application of small-angle X-ray and neutron scattering techniques to the characterisation of starch structure: a review. *Carbohydrate Polymers*, 85 (2): 281-293.
- Bloksma, A. H.** 1990a. Dough Structure, Dough Rheology, and Baking Quality. *Cereal Foods World*, 35 (2): 237-244.
- Bloksma, A. H.** 1990b. Rheology of the Breadmaking Process. *Cereal Foods World*, 35: 228-236.

- Bourne, M. C.** 2002a. Chapter 1 - Texture, Viscosity and Food. *Food Texture and Viscosity*. (2nd ed.). Academic Press, London. (1-32).
- Bourne, M. C.** 2002b. Food Texture and Viscosity: Concept and Measurements, (2nd ed.). Academic Press, New York. (pp. 427).
- Bourne, M. C.** 2002c. Relationship Between Rheology and Food Texture *Engineering and Food for the 21st Century*. (Food Preservation Technology). CRC Press).
- Bourne, M. C.** 2002d. Sensory Methods of Texture and Viscosity Measurement *Food Texture and Viscosity*. (2nd ed.). Academic Press, London. (257-291).
- Bourne, M. C.** 2004. Relation between Texture and Mastication. *Journal of Texture Studies*, 35: 125-143.
- Brady, P. L., and Mayer, S. M.** 1985. Correlations of Sensory and Instrumental Measures of Bread Texture. *Cereal Chemistry*, 62 (1): 70-72.
- Brandt, M. A., Skinner, E. Z., and Coleman, J. A.** 1963. Texture Profile Method. *Journal of Food Science*, 28 (4): 404-409.
- Breene, W. M.** 1975. Application of Texture Profile Analysis to Instrumental Food Texture Evaluation. *Journal of Texture Studies*, 6 (1): 53-82.
- Brooker, B. E.** 1996. The Role of Fat in the Stabilisation of Gas Cells in Bread Dough. *Journal of Cereal Science*, 24 (3): 187-198.
- Buehler, E. J.** 2006. Bread Science: The Chemistry and Craft of Making Bread, Carrboro, North Carolina. (pp. 254).
- Buléon, A., Colonna, P., and Leloup, V.** 1990. Les amidons et leurs dérivés dans les industries des céréales. *Industries Alimentaires et Agricoles (IAA)*, 6: 515-532.
- Buléon, A., Colonna, P., Planchot, V., and Ball, S.** 1998. Starch Granules: Structure and Biosynthesis. *International Journal of Biological Macromolecules*, 23 (2): 85-112.
- Burbidge, A.** 2012. Design of Food Structure for Enhanced Oral Experience. In: INRA (Ed.) *Food Oral Processing - FOP*. Wiley-Blackwell, Beaune, FRANCE, 2012, July 3-5th, pp. 357-379.
- Burns, D. A., and Ciurczak, E. W.** 2007. Handbook of Near-Infrared Analysis (Third edition ed.). CRC Press, pp. 826.
- Bushuk, W.** 1998. Interactions in Wheat Doughs. In: R. J. Hamer and R. C. Hosney (Eds.), *Interactions: The Keys to Cereal Quality*. American Association of Cereal Chemists, St. Paul, Minnesota. (1-16).
- Callejo, M. J.** 2011. Present Situation on the Descriptive Sensory Analysis of Bread. *Journal of Sensory Studies*, 26: 255-268.
- Campbell, G. M.** 2003. Aerated Foods. In: B. Caballero (Ed.), *Encyclopedia of Food Sciences and Nutrition*. Academic Press, Oxford. (55-61).
- Campbell, G. M., and Mougeot, E.** 1999. Creation and Characterisation of Aerated Food Products. *Trends in Food Science & Technology*, 10 (9): 283-296.
- Cauvain, S. P., and Young, L. S.** 2007. Breadmaking Processes *Technology of Breadmaking*. (2nd Edition ed.). Springer US, New York. (21-49).
- Cauvain, S. P., Young, L. S., and Stauffer, C. E.** 2007. Principles of Dough Formation. In: Springer (Ed.), *Technology of Breadmaking*. Springer US. (299-332).
- Cavella, S., Piazza, L., and Masi, P.** 1990. Thermomechanical Analysis of Gluten - Starch - Water Mixtures. Influence of Testing Conditions and Composition. *Italian Journal of Food Science*, 2 (4): 235-248.
- Cayot, P., Schenker, F., Houzé, G., Sulmont-Rossé, C., and Colas, B.** 2008. Creaminess in Relation to Consistency and Particle Size in Stirred Fat-free Yogurt. *International Dairy Journal*, 18 (3): 303-311.
- Chambers, D. H., Allison, A.-M. A., and Chambers, E.** 2004. Training Effects on Performance of Descriptive Panelists. *Journal of Sensory Studies*, 19 (6): 486-499.
- Champenois, Y.** 1994. Thesis: *Compréhension de la gélification et de la gélification de l'amidon dans les produits céréaliers de cuisson humide*. University of Nantes, Nantes, France. pp. 177.

- Chaurier, L., Chrusciel, L., Delisée, C., Della Valle, G., and Malvestio, J.** 2008. Permeability and Expanded Structure of Baked Products Crumbs. *Food Biophysics*, 3 (4): 344-351.
- Cheetham, N. W. H., and Tao, L.** 1998. Variation in crystalline type with amylose content in maize starch granules: an X-ray powder diffraction study. *Carbohydrate Polymers*, 36 (4): 277-284.
- Chen, J.** 2009. Food Oral Processing - A Review. *Food Hydrocolloids*, 23 (1): 1-25.
- Chen, P., Whitney, L. F., and Peleg, M.** 1994. Some Tensile Characteristics of Bread Crumb. *Journal of Texture Studies*, 25 (3): 299-310.
- Chen, P., Yu, L., Simon, G. P., Liu, X., Dean, K., and Chen, L.** 2011. Internal structures and phase-transitions of starch granules during gelatinization. *Carbohydrate Polymers*, 83 (4): 1975-1983.
- Chesterton, A. K. S., Meza, B. E., Moggridge, G. D., Sadd, P. A., and Wilson, D. I.** 2011. Rheological characterisation of cake batters generated by planetary mixing: Elastic versus viscous effects. *Journal of Food Engineering*, 105 (2): 332-342.
- Chevallier, S., Colonna, P., Della Valle, G., and Lourdin, D.** 2000. Contribution of Major Ingredients during Baking of Biscuit Dough Systems. *Journal of Cereal Science*, 31 (3): 241-252.
- Chiotelli, E., and Le Meste, M.** 2002. Thesis: *Influence de la formulation sur le comportement thermomécanique de l'amidon*. University of Burgundy, Dijon, France. pp. 299.
- Chiotelli, E., and Le Meste, M.** 2003. Effect of Triglycerides on Gelatinisation and Rheological Properties of Concentrated Potato Starch Preparations. *Food Hydrocolloids*, 17 (5): 629-639.
- Chiotelli, E., Pulosio, G., and Le Meste, M.** 2002. Effect of Sodium Chloride on the Gelatinization of Starch: A Multimeasurement Study. *Biopolymers*, 63 (1): 41-58.
- Chiotelli, E., Rolée, A., and Le Meste, M.** 2000. Effect of Sucrose on the Thermomechanical Behavior of Concentrated Wheat and Waxy Corn Starch-Water Preparations. *Journal of Agricultural and Food Chemistry*, 48 (4): 1327-1339.
- Chiotellis, E., and Campbell, G. M.** 2003a. Proving of Bread Dough I: Modelling the Evolution of the Bubble Size Distribution. *Food and Bioproducts Processing*, 81 (3): 194-206.
- Chiotellis, E., and Campbell, G. M.** 2003b. Proving of Bread Dough II: Measurement of Gas Production and Retention. *Food and Bioproducts Processing*, 81 (3): 207-216.
- Chouvardas, V. G., Miliou, A. N., and Hatalis, M. K.** 2008. Tactile Displays: Overview and Recent Advances. *Displays*, 29 (3): 185-194.
- Chuang, G. C.-C., and Yeh, A.-I.** 2006. Rheological Characteristics and Texture Attributes of Glutinous Rice Cakes (mochi). *Journal of Food Engineering*, 74 (314-323): 314.
- Chung, O. K.** 1986. Lipid-protein interactions in wheat flour, dough, gluten, and protein fractions. *Cereal Foods World*, 31 (3): 242-256.
- Civille, G. V.** 2011. Food Texture: Pleasure and Pain. *Journal of Agricultural and Food Chemistry*, 59 (5): 1487-1490.
- Civille, G. V., and Liska, I. H.** 1975. Modifications and Applications to Foods of the General Foods Sensory Texture Profile Technique. *Journal of Texture Studies*, 6 (1): 19-31.
- Collar, C., and Bolla Ñn, C.** 2005. Relationships between Dough Functional Indicators during Breadmaking Steps in Formulated Samples. *European Food Research and Technology*, 220 (3): 372-379.
- Copeland, L., Blazek, J., Salman, H., and Tang, M. C.** 2009. Form and Functionality of Starch. *Food Hydrocolloids*, 23 (6): 1527-1534.
- Corradini, M. G., and Peleg, M.** 2008. Solid Food Foams. In: J. M. Aguilera and P. J. Lillford (Eds.), *Food Materials Science: Principles and Practice*. (Food Engineering Series). Springer, New York. (169-202).
- Cuq, B., Abecassis, J., and Guilbert, S.** 2003. State diagrams to help describe wheat bread processing. *International Journal of Food Science & Technology*, 38 (7): 759-766.
- Curic, D., Karlovic, D., Tusak, D., Petrovic, B., and Dugum, J.** 2001. Gluten as a Standard of Wheat Flour Quality. *food technology and biotechnology*, 39 (4): 353-361.

- Daget, N., and Joerg, M.** 1991. Creamy Perception II: In Model Soups. *Journal of Texture Studies*, 22 (2): 169-189.
- Daget, N., Joerg, M., and Bourne, M.** 1987. Creamy Perception I: In Model Dessert Creams. *Journal of Texture Studies*, 18 (4): 367-388.
- Dairou, V., and Sieffermann, J. M.** 2002. A Comparison of 14 Jams Characterized by Conventional Profile and a Quick Original Method, the Flash Profile. *Journal of Food Science*, 67 (2): 826-834.
- Darlington, H. F., Tecsi, L., Harris, N., Griggs, D. L., Cantrell, I. C., and Shewry, P. R.** 2000. Starch Granule Associated Proteins in Barley and Wheat. *Journal of Cereal Science*, 32 (1): 21-29.
- Datta, A. K., Sahin, S., Sumnu, G., and Ozge Keskin, S.** 2007. Porous Media Characterization of Breads Baked Using Novel Heating Modes. *Journal of Food Engineering*, 79 (1): 106-116.
- Day, L., Greenwell, P., Lock, S., and Brown, H.** 1999. Analysis of Wheat Flour Proteins Related to Grain Hardness Using Capillary Electrophoresis. *Journal of Chromatography A*, 836 (1): 147-152.
- De Cássia dos Santos Navarro da Silva, R., Minim, V. P. R., Simiqueli, A. A., Da Silva Moraes, L. E., Gomide, A. I., and Minim, L. A.** 2012. Optimized Descriptive Profile: A Rapid Methodology for Sensory Description. *Food Quality and Preference*, 24 (1): 190-200.
- De Wijk, R. A., Van Gemert, L. J., Terpstra, M. E. J., and Wilkinson, C. L.** 2003. Texture of Semi-solids: Sensory and Instrumental Measurements on Vanilla Custard Desserts. *Food Quality and Preference*, 14 (4): 305-317.
- Dehlholm, C., Brockhoff, P. B., Meinert, L., Aaslyng, M. D., and Bredie, W. L. P.** 2012. Rapid Descriptive Sensory Methods – Comparison of Free Multiple Sorting, Partial Napping, Napping, Flash Profiling and Conventional Profiling. *Food Quality and Preference*, 26 (2): 267-277.
- Delarue, J., and Loescher, E.** 2004. Dynamics of Food Preferences: A Case Study with Chewing Gums. *Food Quality and Preference*, 15 (7–8): 771-779.
- Delarue, J., and Sieffermann, J.-M.** 2004. Sensory Mapping using Flash Profile. Comparison with a Conventional Descriptive Method for the Evaluation of the Flavour of Fruit Dairy Products. *Food Quality and Preference*, 15 (4): 383-392.
- Delcour, J. A., Joye, I. J., Pareyt, B., Wilderjans, E., Brijs, K., and Lagrain, B.** 2012. Wheat Gluten Functionality as a Quality Determinant in Cereal-Based Food Products. *Annual Review of Food Science and Technology*, 3 (1): 469-492.
- Della Valle, G.** 2006. Détermination de la structure cellulaire et des mécanismes d'alvéolation in situ de produits céréaliers par tomographie RX. In: INRA (Ed.) *Colloque Ponan des "bons" aliments; Biopolymères, Interaction et assemblages*. Nantes.
- Depled, F., and Société Scientifique d'Hygiène Alimentaire.** 2009. Évaluation Sensorielle: Manuel Méthodologique, (3ème ed.). Lavoisier, Paris.
- Deshlahra, P., Mehra, A., and Ghosal, D.** 2009. Evolution of Bubble Size Distribution in Baked Foods. *Journal of Food Engineering*, 93 (2): 192-199.
- Desmet, P. M. A., and Schifferstein, H. N. J.** 2008. Sources of Positive and Negative Emotions in Food Experience. *Appetite*, 50 (2–3): 290-301.
- Dexter, J. E., Preston, K. R., Martin, D. G., and Gander, E. J.** 1994. The Effects of Protein Content and Starch Damage on the Physical Dough Properties and Bread-making Quality of Canadian Durum Wheat. *Journal of Cereal Science*, 20 (2): 139-151.
- Dobraszczyk, B. J.** 2008. Structured Cereal Products. In: J. M. Aguilera and P. J. Lillford (Eds.), *Food Materials Science*. Springer New York. (475-500).
- Dobraszczyk, B. J., and David, A. V.** 2001. Cereals and Cereal Products: Technology and Chemistry (1 ed. Vol. 1.). Aspen Publishers, Aithersburg, Md. pp. 370.
- Dobraszczyk, B. J., and Morgenstern, M. P.** 2003. Rheology and the Breadmaking Process. *Journal of Cereal Science*, 38 (3): 229-245.
- Dodds, N. J. H.** 1971. Damaged Starch Determination in Wheat Flours in Relation to Dough Water Absorption. *Starch - Stärke*, 23 (1): 23-27.

- Donelson, D. H., and Wilson, J. T.** 1960. Effect of the Relative Quantity of Flour Fractions on Cake Quality. *Cereal Chemistry*, 37: 241-262.
- Douglas, S. G.** 1981. A Rapid Method for the Determination of Pentosans in Wheat Flour. *Food Chemistry*, 7 (2): 139-145.
- Douliez, J.-P., Michon, T., Elmorjani, K., and Marion, D.** 2000. Mini Review: Structure, Biological and Technological Functions of Lipid Transfer Proteins and Indolines, the Major Lipid Binding Proteins from Cereal Kernels. *Journal of Cereal Science*, 32 (1): 1-20.
- Drago, S. R., and González, R. J.** 2000. Foaming properties of enzymatically hydrolysed wheat gluten. *Innovative Food Science & Emerging Technologies*, 1 (4): 269-273.
- Drake, B.** 1989. Sensory Textural/Rheological Properties - A Polyglot List. *Journal of Texture Studies*, 20 (1): 1-27.
- Dubreil, L., Compoin, J.-P., and Marion, D.** 1997. Interaction of Puroindolines with Wheat Flour Polar Lipids Determines their Foaming Properties. *Journal of Agricultural and Food Chemistry*, 45 (1): 108-116.
- Duyvejonck, A. E., Lagrain, B., Pareyt, B., Courtin, C. M., and Delcour, J. A.** 2011. Relative Contribution of Wheat Flour Constituents to Solvent Retention Capacity Profiles of European Wheats. *Journal of Cereal Science*, 53 (3): 312-318.
- Edoura-Gaena, R.-B., Allais, I., Trystram, G., and Gros, J.-B.** 2007. Influence of aeration conditions on physical and sensory properties of aerated cake batter and biscuits. *Journal of Food Engineering*, 79 (3): 1020-1032.
- Eliasson, A.-C., and Larsson, K.** 1993. Cereals in Breadmaking: A Molecular Colloidal Approach. CRC Press, New York. (pp. 376).
- Eliasson, A. C., and Karlsson, R.** 1983. Gelatinization Properties of Different Size Classes of Wheat Starch Granules Measured with Differential Scanning Calorimetry. *Starch - Stärke*, 35 (4): 130-133.
- Færgestad, E. M., Magnus, E. M., Sahlström, S., and Næs, T.** 1999. Influence of Flour Quality and Baking Process on Hearth Bread Characteristics Made Using Gentle Mixing. *Journal of Cereal Science*, 30 (1): 61-70.
- Færgestad, E. M., Molteberg, E. L., and Magnus, E. M.** 2000. Interrelationships of Protein Composition, Protein Level, Baking Process and the Characteristics of Hearth Bread and Pan Bread. *Journal of Cereal Science*, 31 (3): 309-320.
- Falcone, P. M., Baiano, A., Zanini, F., Mancini, L., Tromba, G., Dreossi, D., Montanari, F., Scuur, N., and Del Nobile, M. A.** 2005. Three-dimensional Quantitative Analysis of Bread Crumb by X-ray Microtomography. *Journal of Food Science. E: Food Engineering and Physical Properties*, 70 (3): E265-E272.
- Farhat, I. A., Blanshard, J. M. V., and Mitchell, J. R.** 2000. The Retrogradation of Waxy Maize Starch Extrudates: Effects of Storage Temperature and Water Content. *Biopolymers*, 53 (5): 411-422.
- Farrera-Rebollo, R. R., Salgado-Cruz, M. P., Chanona-Pérez, J., Gutiérrez-López, G. F., Alamilla-Beltrán, L., and Calderón-Domínguez, G.** 2012. Evaluation of Image Analysis Tools for Characterization of Sweet Bread Crumb Structure. *Food and Bioprocess Technology*, 5 (2): 474-484.
- Feillet, P.** 2000. Le grain de blé: Composition et Utilisations. INRA, Paris. (pp. 308).
- Fessas, D., and Schiraldi, A.** 1998. Texture and Staling of Wheat Bread Crumb: Effects of Water Extractable Proteins and 'Pentosans'. *Thermochimica Acta*, 323 (1-2): 17-26.
- Finney, K. F., and Barmore, M. A.** 1948. Loaf Volume and Protein Content of Hard Winter and Spring Wheats. *Cereal Chemistry*, 25: 291-312.
- Finnie, S. M., Jeannotte, R., Morris, C. F., Giroux, M. J., and Faubion, J. M.** 2010. Variation in Polar Lipids Located on the Surface of Wheat starch. *Journal of Cereal Science*, 51 (1): 73-80.
- Fischer, P., and Windhab, E. J.** 2011. Rheology of Food Materials. *Current Opinion in Colloid & Interface Science*, 16 (1): 36-40.

- Foegeding, E. A., Luck, P. J., and Davis, J. P.** 2006. Factors Determining the Physical Properties of Protein Foams. *Food Hydrocolloids*, 20 (2-3): 284-292.
- Fredriksson, H., Silverio, J., Andersson, R., Eliasson, A. C., and Åman, P.** 1998. The Influence of Amylose and Amylopectin Characteristics on Gelatinization and Retrogradation Properties of Different Starches. *Carbohydrate Polymers*, 35 (3-4): 119-134.
- Frisullo, P., Barnabà, M., Navarini, L., and Del Nobile, M. A.** 2012. Coffea arabica beans microstructural changes induced by roasting: An X-ray microtomographic investigation. *Journal of Food Engineering*, 108 (1): 232-237.
- Frisullo, P., Laverse, J., Marino, R., and Del Nobile, M. A.** 2009. X-ray computed tomography to study processed meat microstructure. *Journal of Food Engineering*, 94 (3-4): 283-289.
- Fustier, P., Castaigne, F., Turgeon, S. L., and Biliaderis, C. G.** 2008. Flour Constituent Interactions and their Influence on Dough Rheology and Quality of Semi-sweet Biscuits: A Mixture Design Approach with Reconstituted Blends of Gluten, Water-solubles and Starch Fractions. *Journal of Cereal Science*, 48 (1): 144-158.
- Fustier, P., Castaigne, F., Turgeon, S. L., and Biliaderis, C. G.** 2009a. Impact of commercial soft wheat flour streams on dough rheology and quality attributes of cookies. *Journal of Food Engineering*, 90 (2): 228-237.
- Fustier, P., Castaigne, F., Turgeon, S. L., and Biliaderis, C. G.** 2009b. Impact of endogenous constituents from different flour milling streams on dough rheology and semi-sweet biscuit making potential by partial substitution of a commercial soft wheat flour. *LWT - Food Science and Technology*, 42 (1): 363-371.
- Gaines, C. S.** 1990. Influence of chemical and physical modification of soft wheat protein on sugar-snap cookie dough consistency, cookie size, and hardness. *Cereal Chemistry*, 67 (1): 73-77.
- Gaines, C. S.** 2000a. Collaborative study of methods for solvent retention capacity profiles (AACC method 56-11). *Cereal Foods World*, 45 (7): 303-306.
- Gaines, C. S.** 2000b. Collaborative study of methods for solvent retention capacity profiles. Report of the AACC committee on soft wheat flour (AACC method 56-11). *Cereal Foods World*, 45: 303-306.
- Gaines, C. S., and Donelson, D. H.** 1982. Cake Batter Viscosity and Expansion upon Heating. *Cereal Chemistry*, 59 (4): 237-240.
- Gaines, C. S., Donelson, D. H., and Finney, P. L.** 1988. Effects of Damaged Starch, Chlorine Gas, Flour Particle Size, and Dough Holding Time and Temperature on Cookie Dough Handling Properties and Cookie Size. *Cereal Chemistry*, 65 (5): 384-389.
- Gallagher, E., Gormley, T. R., and Arendt, E. K.** 2003. Crust and Crumb Characteristics of Gluten Free Breads. *Journal of Food Engineering*, 56 (2-3): 153-161.
- Gan, Z., Angold, R. E., Williams, M. R., Ellis, P. R., Vaughan, J. G., and Galliard, T.** 1990. The Microstructure and Gas Retention of Bread Dough. *Journal of Cereal Science*, 12 (1): 15-24.
- García, N. L., Famá, L., Dufresne, A., Aranguren, M., and Goyanes, S.** 2009. A comparison between the physico-chemical properties of tuber and cereal starches. *Food Research International*, 42 (8): 976-982.
- Ghodke, S. K., Ananthanarayan, L., and Rodrigues, L.** 2009. Use of Response Surface Methodology to Investigate the Effects of Milling Conditions on Damaged Starch, Dough Stickiness and Chapatti Quality. *Food Chemistry*, 112 (4): 1010-1015.
- Gibson, L. J.** 2005. Biomechanics of Cellular Solids. *Journal of Biomechanics*, 38 (3): 377-399.
- Gibson, L. J., and Ashby, F.** 1997. Cellular solids: Structure & Properties, (2nd ed.). Cambridge University Press, Cambridge, UK. (pp. 510).
- Gibson, L. J., and Ashby, M. F.** 1982. The Mechanics of Three-Dimensional Cellular Materials. *Proceedings of the Royal Society of London. Series A, Mathematical and Physical Sciences*, 382 (1782): 43-59.
- Gidley, M. J., and Bociek, S. M.** 1985. Molecular Organization in Starches: A Carbon 13 CP/MAS NMR Study. *Journal of the American Chemical Society*, 107 (24): 7040-7044.

- Goesaert, H., Brijs, K., Veraverbeke, W. S., Courtin, C. M., Gebruers, K., and Delcour, J. A.** 2005. Wheat Flour Constituents: How they Impact Bread Quality, and How to Impact their Functionality. *Trends in Food Science & Technology*, 16 (1-3): 12-30.
- Gonzales-Barron, U., and Butler, F.** 2008a. Discrimination of Crumb Grain Visual Appearance of Organic and Non-organic Bread Loaves by Image Texture Analysis. *Journal of Food Engineering*, 84 (3): 480-488.
- Gonzales-Barron, U., and Butler, F.** 2008b. Fractal Texture Analysis of Bread Crumb Digital Images. *European Food Research and Technology*, 226 (4): 721-729.
- Gonzales-Barron, U., and Butler, F.** 2008c. Prediction of Panellists' Perception of Bread Crumb Appearance using Fractal and Visual Textural Features. *European Food Research and Technology*, 226 (4): 779-785.
- Griffin, W. C.** 1949. Classification of Surface-Active Agents by HLB. *Journal of the Society of Cosmetic Chemists*, 1 (5): 311-326.
- Gudmundsson, M.** 1994. Retrogradation of Starch and the Role of its Components. *Thermochimica Acta*, 246 (2): 329-341.
- Hadinezhad, M., and Butler, F.** 2009. Effect of flour type and dough rheological properties on cookie spread measured dynamically during baking. *Journal of Cereal Science*, 49 (2): 178-183.
- Hadiyanto, H., Asselman, A., Van Straten, G., Boom, R. M., Esveld, D. C., and Van Boxtel, A. J. B.** 2007. Quality prediction of bakery products in the initial phase of process design. *Innovative Food Science & Emerging Technologies*, 8 (2): 285-298.
- Hamer, R. J., and Hosney, R. C.** 1998. Interactions: the Key to Cereal Quality. American Association of Cereal Chemists, St. Paul, Minnesota, U.S.).
- Heenan, S. P., Hamid, N., Dufour, J.-P., Harvey, W., and Delahunty, C. M.** 2009. Consumer Freshness Perceptions of Breads, Biscuits and Cakes. *Food Quality and Preference*, 20 (5): 380-390.
- Hermann.** 1990. Thermodynamique des Etats de la Matière, (1ère ed.). (pp. 566).
- Hibberd, G. E., and Parker, N. S.** 1985. Measurement of the Compression Properties of Bread Crumb. *Journal of Texture Studies*, 16 (1): 97-110.
- Hiiemae, K., Heath, M. R., Heath, G., Kazazoglu, E., Murray, J., Sapper, D., and Hamblett, K.** 1996. Natural Bites, Food Consistency and Feeding Behaviour in Man. *Archives of Oral Biology*, 41 (2): 175-189.
- Holme, J.** 1962. Characterization Studies on the Soluble Proteins and Pentosans of Cake Flour. *Cereal Chemistry*, 39: 132-144.
- Hootman, R. C.** 1992. Manual on Descriptive Analysis Testing for Sensory Evaluation. ASTM International., Philadelphia, USA. (pp. 57).
- Hosney, R. C.** 1991. Wheat Gluten : Rheological and Gas Retaining Properties. *Advances in experimental medicine and biology*, 302: 657-666.
- Hosney, R. C.** 1994. Principles of Cereal Science and Technology, (2nd ed.), St Paul, MN).
- Hosney, R. C., Pomeranz, Y., and Finney, K. F.** 1970. Functional (breadmaking) and Biochemical Properties of Wheat Flour Components VI: Gliadin, Lipid, Glutenin Interactions in Wheat Gluten. *Cereal Chemistry*, 47: 135-140.
- Hosney, R. C., and Rogers, D. E.** 1990. The Formation and Properties of Wheat Flour Doughs. *Critical Reviews in Food Science and Nutrition*, 29 (2): 73-93.
- Huebner, F. R., Kaczkowski, J., and Bietz, J. A.** 1990. Quantitative Variation of Wheat Proteins from Grain at Different Stages of Maturity and from Different Spike Locations. *Cereal Chemistry*, 67 (5): 464-470.
- Huebner, F. R., and Wall, J. S.** 1976. Fractionation and Quantitative Differences of Glutenin from Wheat Varieties Varying in Baking Quality. *Cereal Chemistry*, 53 (2): 258-269.
- Igathinathane, C., Pordesimo, L. O., Columbus, E. P., Batchelor, W. D., and Methuku, S. R.** 2008. Shape identification and particles size distribution from basic shape parameters using ImageJ. *Computers and Electronics in Agriculture*, 63 (2): 168-182.

- Impoco, G., Carrato, S., Caccamo, M., Tuminello, L., and Licitra, G.** 2006. Image analysis methods for industrial application: quantitative analysis of cheese microstructure using SEM imagery. *ASAS Joint Annual Meeting*. Minneapolis, USA.
- Impoco, G., Carrato, S., Caccamo, M., Tuminello, L., and Licitra, G.** 2007. Quantitative analysis of cheese microstructure using SEM imagery. In: S. Congress (Ed.) *Communications to SIMAI Congress*. vol. 2, pp. 1-10.
- Impoco, G., Fuc, N., Pasta, C., Caccamo, M., and Licitra, G.** 2012. Quantitative analysis of nanostructures' shape and distribution in micrographs using image analysis. *Computers and Electronics in Agriculture*, 84 (2012): 26-35.
- International, A.** 1995. Official Methods of Analysis. *Moisture determination gravimetry method (vacuum oven) - n° 925.09*. AOAC International.
- Jacob, J., and Leelavathi, K.** 2007. Effect of fat-type on cookie dough and cookie quality. *Journal of Food Engineering*, 79 (1): 299-305.
- Janssen, A. M., Van Vliet, T., and Vereijken, J. M.** 1996. Rheological Behaviour of Wheat Glutens at Small and Large Deformations : Effect of Gluten Composition. *Journal of Cereal Science*, 23 (1): 33-42.
- Jia, C., Kim, Y. S., Huang, W., and Huang, G.** 2008. Sensory and Instrumental Assessment of Chinese Moon Cake: Influences of Almond Flour, Maltitol Syrup, Fat, and Gums. *Food Research International*, 41 (9): 930-936.
- Johnson, M.** 2003. Importance of Texture Measurement *Food Product Design*.
- Jones, C. R., Halton, P., and Stevens, D. J.** 1959. The Separation of Flour into Fractions of Different Protein Contents by Means of Air Classification. *Journal of Biochemical and Microbiological Technology and Engineering*, 1 (1): 77-98.
- Jovanovich, G., Campaña, L., Cardos, M., and Lupano, C. E.** 2003. Correlation Between Starch Damage, Alveograph Parameters, Water Absorption and Gelatinization Enthalpy in Flours obtained by Industrial Milling of Argentinian Wheats. *Journal of Food Technology*, 1 (4): 168-172.
- Jowitt, R.** 1974. The Terminology of Food Texture. *Journal of Texture Studies*, 5 (3): 351-358.
- Kaletunc, G., and Breslauer, K. J.** 2003. Characterization of Cereals and Flours: Properties, Analysis and Applications. Marcel Dekker, Inc., New York, US. (pp. 496).
- Karim, A. A., Norziah, M. H., and Seow, C. C.** 2000. Methods for the Study of Starch Retrogradation. *Food Chemistry*, 71 (1): 9-36.
- Khan, K., and Shewry, P. R.** 2009. Wheat Chemistry and Technology, (4th ed.). AACC International, Inc., St Paul, USA. (pp. 467).
- Khatkar, B. S.** 2002. Functionality of Wheat Flour Components and Bakery Ingredients. Guru Jambheshwar University, p. 79.
- Khatkar, B. S., Barak, S., and Mudgil, D.** 2013. Effects of gliadin addition on the rheological, microscopic and thermal characteristics of wheat gluten. *International Journal of Biological Macromolecules*, 53 (0): 38-41.
- Khatkar, B. S., Fido, R. J., Tatham, A. S., and Schofield, J. D.** 2002. Functional Properties of Wheat Gliadins. I. Effects on Mixing Characteristics and Bread Making Quality. *Journal of Cereal Science*, 35 (3): 299-306.
- Kiger, J. L., and Kiger, J. G.** 1967. Techniques modernes de la biscuiterie, pâtisserie-boulangerie industrielles et artisanales et des produits de régime, (Vol. 1.). Dunod. (pp. 595).
- Kihlberg, I., Johansson, L., Kohler, A., and Risvik, E.** 2004. Sensory Qualities of Whole Wheat Pan Bread - Influence of Farming System, Milling and Baking Technique. *Journal of Cereal Science*, 39 (1): 67-84.
- Kim, C. S.** 1992. Interactions Between Starches, Sugars, and Emulsifiers in High-ratio Cake Model Systems. *Cereal Chemistry*, 69 (2): 206-212.
- Kim, J. H., Lee, H. J., Lee, H.-S., Lim, E.-J., Imm, J.-Y., and Suh, H. J.** 2012. Physical and Sensory Characteristics of Fibre-enriched Sponge Cakes made with *Opuntia Humifusa*. *LWT - Food Science and Technology*, 47 (2): 478-484.

- Kirby, R. M., Bartram, J., and Carr, R.** 2003. Water in Food Production and Processing: Quantity and Quality Concerns. *Food Control*, 14 (5): 283-299.
- Kralik, G., Komendonovic, V., and Petricevic, A.** 1990. Physico-chemical Properties of Eggs, (Vol. 13.), Montpellier, France. (pp. 245-248).
- Krishna, A.** 2011. An integrative review of sensory marketing: Engaging the senses to affect perception, judgment and behavior. *Journal of Consumer Psychology*, XXXXXXX (XXXXXX): 20.
- Krog, N., and Jensen, B. N.** 1970. Interaction of Monoglycerides in Different Physical States with Amylose and their Anti-firming Effects in Bread. *International Journal of Food Science & Technology*, 5 (1): 77-87.
- Kuakpetoon, D., Flores, R. A., and Milliken, G. A.** 2001. Dry Mixing of Wheat Flours: Effect of Particle Properties and Blending Ratio. *LWT - Food Science and Technology*, 34 (3): 183-193.
- Kulp, K., and Ponte, J. G. J.** 1981. Staling White Pan Bread: Fundamental Causes. *Critical Reviews in Food Science and Nutrition*, 15 (1): 1-48.
- Labbafi, M., Thakur, R. K., Vial, C., and Djelveh, G.** 2007. Development of an on-line optical method for assessment of the bubble size and morphology in aerated food products. *Food Chemistry*, 102 (2): 454-465.
- Lagrain, B., Wilderjans, E., Glorieux, C., and Delcour, J. A.** 2012. Importance of Gluten and Starch for Structural and Textural Properties of Crumb from Fresh and Stored Bread. *Food Biophysics*, 7 (2): 173-181.
- Laitinen, J., Hyvönen, T., and Maliranta, H.** 1993. Sensory Evaluation of Sweet Rolls, Ginger Cookies and Cakes made with Butter, Oil or Margarine. *Food Quality and Preference*, 4 (1-2): 94.
- Lakes, R. S.** 1989. Cellular Solids, (Vol. 22.). Pergamon Press. (pp. 397).
- Lassoued, N.** 2005. Thesis: *Structure alvéolaire des produits céréaliers de cuisson en lien avec les propriétés rhéologiques et thermiques de la pâte : Effet de la composition*. Unpublished Sciences alimentaires, Paristech, ENSIA PARIS. pp. 339.
- Lassoued, N., Babin, P., Della Valle, G., Devaux, M.-F., and Réguerre, A.-L.** 2007. Granulometry of Bread Crumb Grain: Contributions of 2D and 3D Image Analysis at Different Scale. *Food Research International*, 40 (8): 1087-1097.
- Lassoued, N., Delarue, J., Launay, B., and Michon, C.** 2008. Baked Product Texture: Correlations between Instrumental and Sensory Characterization using Flash Profile. *Journal of Cereal Science*, 48 (1): 133-143.
- Lawless, H. T., and Heymann, H.** 2010a. Sensory Evaluation of Food: Principles and Practices, (second edition ed.). Springer, New York, NY).
- Lawless, H. T., and Heymann, H.** 2010b. Texture evaluation. In: D. R. Heldman (Ed.), *Sensory Evaluation of Food: Principles and Practices*. (2nd ed. Food Science Text Series). Springer, New York. (587).
- Lee, S., Kim, S., and Inglett, G. E.** 2005. Effect of Shortening Replacement with Oatrim on the Physical and Rheological Properties of Cakes. *Cereal Chemistry*, 82 (2): 120-124.
- Léonard, A., Blacher, S., Nimmol, C., and Devahastin, S.** 2008. Effect of far-infrared radiation assisted drying on microstructure of banana slices: An illustrative use of X-ray microtomography in microstructural evaluation of a food product. *Journal of Food Engineering*, 85 (1): 154-162.
- Li, W., Dobraszczyk, B. J., and Wilde, P. J.** 2004. Surface properties and locations of gluten proteins and lipids revealed using confocal scanning laser microscopy in bread dough. *Journal of Cereal Science*, 39 (3): 403-411.
- Lim, K. S., and Barigou, M.** 2004. X-ray Micro-computed Tomography of Cellular Food Products. *Food Research International*, 37 (10): 1001-1012.
- Lin, C. L., and Miller, J. D.** 2000. Pore structure and network analysis of filter cake. *Chemical Engineering Journal*, 80 (1-3): 221-231.
- Liu, H., Lelievre, J., and Ayoung-Chee, W.** 1991. A study of starch gelatinization using differential scanning calorimetry, X-ray, and birefringence measurements. *Carbohydrate Research*, 210 (0): 79-87.

- Liu, Z., Chuah, C. S. L., and Scanlon, M. G.** 2003. Compressive Elastic Modulus and its Relationship to the Structure of a Hydrated Starch Foam. *Acta Materialia*, 51 (2): 365-371.
- Lorient, D., and Matringe, E.** 1993. Propriétés fonctionnelles des protéines de l'oeuf et des ovoproduits. In: Y. Nys (Ed.) *Qualité des produits avicoles. II, Qualité de l'oeuf et des ovoproduits: comptes rendus du 5ème Symposium européen sur la qualité de l'oeuf et des ovoproduits - Quality of poultry products. II, Quality of eggs and egg products : proceedings of the 5th European symposium on the quality of eggs and egg products.* vol. 1. Branche française de la W.P.S.A, Tours, pp. 285-290.
- Lucas, T., Wagner, M., Quellec, S., and Davenel, A.** 2008. NMR Imaging of Bread and Biscuit In: G. A. Webb (Ed.), *Modern Magnetic Resonance.* Springer Netherlands. (1795-1799).
- Maache-Rezzoug, Z., Bouvier, J.-M., Allaf, K., and Patras, C.** 1998. Effect of Principal Ingredients on Rheological Behaviour of Biscuit Dough and on Quality of Biscuits. *Journal of Food Engineering*, 35 (1): 23-42.
- Macritchie, F.** 1984. Baking Quality of Wheat Flours. In: C. O. Chichester, E. M. Mrak and B. S. Schweigert (Eds.), *Advances in Food Research.* (Vol. 29.). Academic Press. (201-277).
- Maire, E., Fazekas, A., Salvo, L., Dendievel, R., Youssef, S., Cloetens, P., and Letang, J. M.** 2003. X-ray tomography applied to the Characterization of Cellular Materials. Related finite Element Modeling Problems. *Composites Science and Technology*, 63 (16): 2431-2443.
- Mamat, H., Abu Hardan, M. O., and Hill, S. E.** 2010. Physicochemical properties of commercial semi-sweet biscuit. *Food Chemistry*, 121 (4): 1029-1038.
- Mao, Y., and Flores, R. A.** 2001. Mechanical Starch Damage Effects on Wheat Flour Tortilla Texture. *Cereal Chemistry*, 78 (3): 286-293.
- Marshall, R. J.** 1990. Combined Instrumental and Sensory Measurement of the Role of Fat in Food Texture. *Food Quality and Preference*, 2 (2): 117-124.
- Meilgaard, M., Civille, G. V., and Carr, B. T.** 2007. *Sensory Evaluation Techniques*, (4th ed.). CRC Press, New York. (pp. 464).
- Mejri, M., Rogé, B., BenSouissi, A., Michels, F., and Mathlouthi, M.** 2005. Effects of some additives on wheat gluten solubility: A structural approach. *Food Chemistry*, 92 (1): 7-15.
- Meullenet, J. F.** 1998. Relationship Between Sensory and Instrumental Texture Profile Attributes. *Journal of Sensory Studies*, 13 (77-93): 77.
- Meza, B. E., Chesterton, A. K. S., Verdini, R. A., Rubiolo, A. C., Sadd, P. A., Moggridge, G. D., and Wilson, D. I.** 2011. Rheological characterisation of cake batters generated by planetary mixing: Comparison between untreated and heat-treated wheat flours. *Journal of Food Engineering*, 104 (4): 592-602.
- Michel, M., and Sagalowicz, L.** 2008. Probing Food Structure. In: J. M. Aguilera and P. J. Lillford (Eds.), *Food Materials Science.* Springer New York. (203-226).
- Michniewicz, J., Biliaderis, C. G., and Bushuk, W.** 1990. Water-insoluble Pentosans of Wheat: Composition and some Physical Properties. *Cereal Chemistry*, 67 (5): 434-439.
- Migliori, M., Gabriele, D., Baldino, N., Lupi, F. R., and De Cindio, B.** 2011. Rheological Properties of Batter Dough: Effect of Egg Level. *Journal of Food Process Engineering*, 34 (4): 1266-1281.
- Mikhaylenko, G. G., Czuchajowska, Z., Baik, B. K., and Kidwell, K. K.** 2000. Environmental Influences on Flour Composition, Dough Rheology, and Baking Quality of Spring Wheat. *Cereal Chemistry*, 77 (4): 507-511.
- Miles, M. J., Morris, V. J., Orford, P. D., and Ring, S. G., .** 1985. The Roles of Amylose and Amylopectin in the Gelation and Retrogradation of Starch. *Carbohydrate Research*, 135 (2): 271-281.
- Mioche, L., and Peyron, M. A.** 1995. Bite Force Displayed during Assessment of Hardness in Various Texture Contexts. *Archives of Oral Biology*, 40 (5): 415-423.
- Mioche, L., Peyron, M. A., and Culioli, J.** 1993. The Role of the Bite Force in Hardness Perception. *Food Quality and Preference*, 4 (1-2): 95.

- Miralbés, C.** 2004. Quality Control in the Milling Industry using Near Infrared Transmittance Spectroscopy. *Food Chemistry*, 88 (4): 621-628.
- Miyazaki, M., Van Hung, P., Maeda, T., and Morita, N.** 2006. Recent advances in application of modified starches for breadmaking. *Trends in Food Science & Technology*, 17 (11): 591-599.
- Moore, W. R., and Hosney, R. C.** 1986. The Effects of Flour Lipids on the Expansion Rate and Volume of Bread Baked in a Resistance Oven. *Cereal Chemistry*, 63 (2): 172-174.
- Morrison, W. R., Tester, R. F., and Gidley, M. J.** 1994. Properties of Damaged Starch Granules. II. Crystallinity, Molecular Order and Gelatinisation of Ball-milled Starches. *Journal of Cereal Science*, 19 (3): 209-217.
- Moussaoui, K. A., and Varela, P.** 2010. Exploring Consumer Product Profiling Techniques and their Linkage to a Quantitative Descriptive Analysis. *Food Quality and Preference*, 21: 1088-1099.
- Murray, B. S.** 2007. Stabilization of Bubbles and Foams. *Current Opinion in Colloid & Interface Science*, 12 (4-5): 232-241.
- Murray, J. M., Delahunty, C. M., and Baxter, I. A.** 2001. Descriptive Sensory Analysis: Past, Present and Future. *Food Research International*, 34 (6): 461-471.
- NF ISO 712.** 2010. Méthodes de référence. Céréales et produits céréaliers - Détermination de la teneur en eau.
- Niranjan, K., and Silva, S. F. J.** 2008a. Bubble-Containing Foods. In: J. M. Aguilera and P. J. Lillford (Eds.), *Food Materials Science: Principles and Practices*. Springer New York, New York. (281-303).
- Niranjan, K., and Silva, S. F. J.** 2008b. Bubbles in Foods: Creating Structure out of Thin Air! In: G. F. Gutiérrez-López, G. V. Barbosa-Cánovas, J. Welti-Chanes and E. Parada-Arias (Eds.), *Food Engineering: Integrated Approaches*. (Food Engineering Series). Springer, New York. (183-192).
- Nishinari, K.** 2004. Rheology, Food Texture and Mastication. *Journal of Texture Studies*, 35 (2): 113-124.
- Oda, S., and Schofield, J. D.** 1997. Characterisation of Friabilin Polypeptides. *Journal of Cereal Science*, 26 (1): 29-36.
- Olku, J., and Rha, C.** 1978. Gelatinisation of Starch and Wheat Flour Starch—A Review. *Food Chemistry*, 3 (4): 293-317.
- Örnebro, J., Nylander, T., and Eliasson, A.-C.** 2000. Critical Review - Interfacial Behaviour of Wheat Proteins. *Journal of Cereal Science*, 31 (2): 195-221.
- Osborne, B. G.** 1986. The use of near infrared reflectance spectroscopy in the control of flour protein content. *Journal of Chemical Technology & Biotechnology*, 36 (8): 364-366.
- Osborne, B. G.** 2006. Near-Infrared Spectroscopy in Food Analysis *Encyclopedia of Analytical Chemistry*. John Wiley & Sons, Ltd).
- Osborne, B. G., Douglas, S., and Fearn, T.** 1982. The application of near infrared reflectance analysis to rapid flour testing. *Journal of Food Technology*, 17: 355-363.
- Osborne, T. B.** 1907. Proteins of the Wheat Kernel. *Carnegie Institution of Washington*, 84: 1-119.
- Otwinowski, Z., and Minor, W.** 1997. Processing of X-ray diffraction data collected in oscillation mode. In: C. W. Carter, Sweet Jr. & R. M. and A. Press (Eds.), *Methods in Enzymology*. (Vol. 276.). Elsevier. (307-326).
- Panozzo, J. F., Hannah, M. C., O'Brien, L., and Bekes, F.** 1993. The Relationship of Free Lipids and Flour Protein to Breadmaking Quality. *Journal of Cereal Science*, 17 (1): 47-62.
- Papantoniou, E., Hammond, E. W., Scriven, F., Gordon, M. H., and Schofield, D. J.** 2004. Effects of endogenous flour lipids on the quality of short-dough biscuits. *Journal of the Science of Food and Agriculture*, 84 (11): 1371-1380.
- Pareyt, B., Brijs, K., and Delcour, J. A.** 2009a. Sugar-Snap Cookie Dough Setting: The Impact of Sucrose on Gluten Functionality. *Journal of Agricultural and Food Chemistry*, 57 (17): 7814-7818.
- Pareyt, B., Finnie, S. M., Putseys, J. A., and Delcour, J. A.** 2011. Lipids in Bread Making: Sources, Interactions, and Impact on Bread Quality. *Journal of Cereal Science*, 54 (3): 266-279.

- Pareyt, B., Talhaoui, F., Kerckhofs, G., Brijs, K., Goesaert, H., Wevers, M., and Delcour, J. A.** 2009b. The Role of Sugar and Fat in Sugar-snap Cookies: Structural and Textural Properties. *Journal of Food Engineering*, 90 (3): 400-408.
- Park, S. H., Bean, S. R., Chung, O. K., and Seib, P. A.** 2006. Levels of Protein and Protein Composition in Hard Winter Wheat Flours and the Relationship to Breadmaking. *Cereal Chemistry*, 83 (4): 418-423.
- Pasha, I., Anjum, F. M., and Butt, M. S.** 2009. Genotypic Variation of Spring Wheats for Solvent Retention Capacities in Relation to End-use Quality. *LWT - Food Science and Technology*, 42 (1): 418-423.
- Pasha, I., Anjum, F. M., and Morris, C. F.** 2010. Grain Hardness : A Major Determinant of Wheat Quality. *Food Science and Technology International*, 16 (6): 511-522.
- Pavinee, C., and Vodovotz, Y.** 2001. Bread Staling. Clydesdale, F. M. (eds), CRC Press, Florida, U.S.A. (pp. 172).
- Peighambardoust, S. H., Van der Goot, A. J., Van Vliet, T., Hamer, R. J., and Boom, R. M.** 2006. Microstructure Formation and Rheological Behaviour of Dough under Simple Shear Flow. *Journal of Cereal Science*, 43 (2): 183-197.
- Pérez-Nieto, A., Chanona-Pérez, J. J., Farrera-Rebollo, R. R., Gutiérrez-López, G. F., Alamilla-Beltrán, L., and Calderón-Domínguez, G.** 2010. Image Analysis of Structural Changes in Dough During Baking. *LWT - Food Science and Technology*, 43 (3): 535-543.
- Pineau, N.** 2006. Thesis: *La performance en analyse sensorielle, une approche base de données*. University of Burgundy, Dijon, France. pp. 244.
- Pomeranz, Y.** 1968. Relation Between Chemical Composition and Bread-Making Potentialities of Wheat Flour. In: C. O. Chichester, E. M. Mrak and G. F. Stewart (Eds.), *Advances in Food Research*. (Vol. 16.). Academic Press. (335-455).
- Pomeranz, Y., Bolling, H., and Zwingelberg, H.** 1984. Wheat Hardness and Baking Properties of Wheat Flours. *Journal of Cereal Science*, 2 (3): 137-143.
- Posner, E. S.** 2009. Wheat Flour Milling, (4th ed.). AACCI International, Inc., St Paul, MN, USA. (pp. 468).
- Preston, K. R., and Williams, P. C.** 2003. Flour: Analysis of Wheat Flours. In: B. Caballero (Ed.), *Encyclopedia of Food Sciences and Nutrition*. (2nd ed.). Academic Press, Oxford. (2543-2550).
- Primo-Martin, C., Hamer, R. J., and De Jongh, H. H. J.** 2006. Surface Layer Properties of Dough Liquor Components: Are they Key Parameters in Gas Retention in Bread Dough? *Food Biophysics*, 1 (2): 83-93.
- Primo-Martín, C., Van Nieuwenhuijzen, N. H., Hamer, R. J., and Van Vliet, T.** 2007. Crystallinity Changes in Wheat Starch during the Bread-making Process: Starch Crystallinity in the Bread Crust. *Journal of Cereal Science*, 45 (2): 219-226.
- Putseys, J. A., Lamberts, L., and Delcour, J. A.** 2010. Amylose-inclusion Complexes: Formation, Identity and Physico-chemical Properties. *Journal of Cereal Science*, 51 (3): 238-247.
- Ram, S., Dawar, V., Singh, R. P., and Shoran, J.** 2005. Application of solvent retention capacity tests for the prediction of mixing properties of wheat flour. *Journal of Cereal Science*, 42 (2): 261-266.
- Ramírez-Wong, B., Walker, C. E., Ledesma-Osuna, A. I., Torres, P. I., Medina-Rodríguez, C. L., López-Ahumada, G. A., Salazar-García, M. G., Ortega-Ramírez, R., Johnson, A. M., and Flores, R. A.** 2007. Effect of Flour Extraction Rate on White and Red Winter Wheat Flour Compositions and Tortilla Texture. *Cereal Chemistry*, 84 (3): 207-213.
- Ramírez, A., Pérez, G. T., Ribotta, P. D., and León, A. E.** 2003. The Occurrence of Friabilins in Triticale and Their Relationship with Grain Hardness and Baking Quality. *Journal of Agricultural and Food Chemistry*, 51 (24): 7176-7181.
- Ratnayake, W. S., and Jackson, D. S.** 2007. A New Insight into the Gelatinization Process of Native Starches. *Carbohydrate Polymers*, 67 (4): 511-529.

- Ratnayake, W. S., and Jackson, D. S.** 2008. Starch Gelatinization. *Advances in Food and Nutrition Research*, 55: 221-268.
- Ring, S. G., Colonna, P., L'Anson, K. J., Kalichevsky, M. T., Miles, M. J., Morris, V. J., and Orford, P. D.** 1987. The Gelation and Crystallisation of Amylopectin. *Carbohydrate Research*, 162 (2): 277-293.
- Risvik, E.** 1994. Sensory Properties and Preferences. *Meat Science*, 36 (1–2): 67-77.
- Roman-Gutierrez, A., Sabathier, J., Guilbert, S., Galet, L., and Cuq, B.** 2003. Characterization of the surface hydration properties of wheat flours and flour components by the measurement of contact angle. *Powder Technology*, 129 (1–3): 37-45.
- Roman-Gutierrez, A. D., Guilbert, S., and Cuq, B.** 2002. Description of Microstructural Changes in Wheat Flour and Flour Components during Hydration by using Environmental Scanning Electron Microscopy. *LWT - Food Science and Technology*, 35 (8): 730-740.
- Roudaut, G., Dacremont, C., and Le Meste, M.** 1998. Influence of Water on the Crispness of Cereal-Based Foods: Acoustic, Mechanical, and Sensory Studies. *Journal of Texture Studies*, 29 (2): 199-213.
- Roudaut, G., Dacremont, C., Vallès Pàmies, B., Colas, B., and Le Meste, M.** 2002. Crispness: a Critical Review on Sensory and Material Science Approaches. *Trends in Food Science & Technology*, 13 (6–7): 217-227.
- Rouillé, J., Bonny, J. M., Della Valle, G., Devaux, M. F., and Renou, J. P.** 2005a. Effect of Flour Minor Components on Bubble Growth in Bread Dough during Proofing Assessed by Magnetic Resonance Imaging. *Journal of Agricultural and Food Chemistry*, 53 (10): 3986-3994.
- Rouillé, J., Della Valle, G., Devaux, M. F., Marion, D., and Dubreil, L.** 2005b. French Bread Loaf Volume Variations and Digital Image Analysis of Crumb Grain Changes Induced by the Minor Components of Wheat Flour. *Cereal Chemistry*, 82 (1): 20-27.
- Różyło, R., and Laskowski, J.** 2011. Breads: Physical Properties. In: J. Gliński, J. Horabik and J. Lipiec (Eds.), *Encyclopedia of Agrophysics*. (Encyclopedia of Earth Sciences Series). Springer Netherlands. (91-93).
- Sahi, S. S., and Alava, J. M.** 2003. Functionality of emulsifiers in sponge cake production. *Journal of the Science of Food and Agriculture*, 83 (14): 1419 - 1429.
- Salman, N.** 2006. Image Segmentation Based on Watershed and Edge Detection Techniques. *The International Arab Journal of Information Technology*, 3 (2): 104-110.
- Salvador, A., Sanz, T., and Fiszman, S. M.** 2006. Dynamic Rheological Characteristics of Wheat Flour–water Doughs. Effect of Adding NaCl, Sucrose and Yeast. *Food Hydrocolloids*, 20 (6): 780-786.
- Salvo, L., Cloetens, P., Maire, E., Zabler, S., Blandin, J. J., Buffière, J. Y., Ludwig, W., Boller, E., Bellet, D., and Josserond, C.** 2003. X-ray micro-tomography an attractive characterisation technique in materials science. *Nuclear Instruments and Methods in Physics Research Section B: Beam Interactions with Materials and Atoms*, 200: 273-286.
- Sapirstein, H. D., David, P., Preston, K. R., and Dexter, J. E.** 2007. Durum Wheat Breadmaking Quality: Effects of Gluten strength, Protein Composition, Semolina Particle Size and Fermentation Time. *Journal of Cereal Science*, 45 (2): 150-161.
- Sapirstein, H. D., Roller, R., and Bushuk, W.** 1994. Instrumental Measurement of Bread Crumb Grain by Digital Image Analysis. *Cereal Chemistry*, 71 (4): 383-391.
- Sarkar, A., and Singh, H.** 2012. Oral Behaviour of Food Emulsions *Food Oral Processing - FOP*. Wiley-Blackwell. (111-137).
- Sauvageot, F.** 2001. Les Caractéristiques d'une Réponse Sensorielle - Characteristics of Sensory Responses. *Biotechnologie, Agronomie, Société et Environnement - Biotechnology, Agronomy, Society and Environment*, 5 (3): 171-179.
- Scanlon, M. G., Sapirstein, H. D., and Fahloul, D.** 2000. Mechanical Properties of Bread Crumb Prepared from Flours of Different Dough Strength. *Journal of Cereal Science*, 32 (3): 235-243.

- Scanlon, M. G., and Zghal, M. C.** 2001. Bread Properties and Crumb Structure. *Food Research International*, 34 (10): 841-864.
- Scher, J., Linder, M., and Hardy, J.** 1997. Etude des relations entre propriétés mécaniques et caractère moelleux de pâtisseries industrielles de type madeleine = Study of the relations between mechanical properties and soft character of industrial pastry of type «madeleine». *Les cahiers de Rhéologie*, 15 (4): 529-538.
- Schiraldi, A., Piazza, L., Brenna, O., and Vittadini, E.** 1996. Structure and Properties of Bread Dough and Crumb. *Journal of Thermal Analysis and Calorimetry*, 47 (5): 1339-1360.
- Schlich, P.** 1996. Multivariate analysis of a sensory database to learn about panel performances. *2nd European User Meeting on Multivariate Data Analysis*. Como, Italy.
- Schlich, P.** 1997. CAP: une méthode et un outil de contrôle rapide et synthétique des performances des sujets en évaluation sensorielle descriptive A. G. *Agro-Industrie*. Versailles, pp. 8.1-8.10.
- Schmidt, S. J.** 2008. Water Mobility in Foods. In: G. V. Barbosa-Cánovas, A. J. Fontana, S. J. Schmidt and T. P. Labuza (Eds.), *Water Activity in Foods: Fundamentals and Applications*. Blackwell Publishing Ltd, Oxford, UK. (47-108).
- Shepherd, R., Griffiths, N. M., and Smith, K.** 1988. The Relationship Between Consumer Preference and Trained Panel Responses. *Journal of Sensory Studies*, 3 (1): 19-35.
- Shewry, P. R., D'Ovidio, R., Jenkins, J. A., and Békés, F.** 2009. Wheat Grain Proteins. In: K. Khan and P. R. Shewry (Eds.), *Wheat Chemistry and Technology*. (4th ed. Grain Science References). AACC International, Inc. (223-298).
- Shewry, P. R., Halford, N. G., Field, J. M., and Tatham, A. S.** 1989. The Structure and Functionality of Wheat Gluten Proteins. In: L. Murray (Ed.) *Australian Cereal Chemistry Conference*. Royal Australian Chemical Institute. Cereal Chemistry Division, Melbourne.
- Shewry, P. R., Popineau, Y., Lafandra, D., and Belton, P.** 2001. Wheat Glutenin Subunits and Dough Elasticity: Findings of the EUROWHEAT Project. *Trends in Food Science & Technology*, 11 (12): 433-441.
- Shewry, P. R., and Tatham, A. S.** 1997. Disulphide Bonds in Wheat Gluten Proteins. *Journal of Cereal Science*, 25 (3): 207-227.
- Shewry, P. R., Tatham, A. S., Forde, J., Kreis, M., and Mifflin, B. J.** 1986. The Classification and Nomenclature of Wheat Gluten Proteins: a Reassessment. *Journal of Cereal Science*, 4 (2): 97-106.
- Shi, Y.-C., and Seib, P. A.** 1992. The structure of four waxy starches related to gelatinization and retrogradation. *Carbohydrate Research*, 227 (0): 131-145.
- Shogren, M. D., Hashimoto, S., and Pomeranz, Y.** 1988. Cereal Pentosans: their Estimation and Significance. IV. Pentosans in Wheat Flour Varieties and Fractions. *Cereal Chemistry*, 65 (3): 182-185.
- Sidel, J. L., and Stone, H.** 1993. The Role of Sensory Evaluation in the Food Industry. *Food Quality and Preference*, 4 (1-2): 65-73.
- Sieffermann, J.-M.** 2000. Le profil flash - un outil rapide et innovant d'évaluation sensorielle descriptive. In: AGORAL (Ed.) *XIIIèmes rencontres "L'innovation: de l'idée au succès"* Montpellier, France., pp. 335-340.
- Sieffermann, J. M., Delarue, J., Tarea, S., and Danzart, M.** 2004. Proposition pour une Sélection Simple des Principaux Facteurs Physiques Expérimentaux lors d'une Démarche de Formulation Sensorielle. In: C2S (Ed.) *11ème journées de formulation*. Paris.
- Singh, N., Singh, J., Kaur, L., Singh Sodhi, N., and Singh Gill, B.** 2003. Morphological, Thermal and Rheological Properties of Starches from Different Botanical Sources. *Food Chemistry*, 81 (2): 219-231.
- Slade, L., and Levine, H.** 1994. Structure-function relationships of cookie and cracker ingredients. In: H. Farid (Ed.), *The science of cookie and crackers production*. Chapman & Hall/AVI, New York).

- Slade, L., and Levine, H.** 1995. Glass Transitions and Water-Food Structure Interactions. In: J. E. Kinsella and S. L. Taylor (Eds.), *Advances in Food and Nutrition Research*. (Vol. 38.). Academic Press. (103-269).
- Sozer, N., Dogan, H., and Kokini, J. L.** 2011. Textural Properties and Their Correlation to Cell Structure in Porous Food Materials. *Journal of Agricultural and Food Chemistry*, 59 (5): 1498-1507.
- Sroan, B. S., Bean, S. R., and MacRitchie, F.** 2009. Mechanism of gas cell stabilization in bread making. I. The primary gluten–starch matrix. *Journal of Cereal Science*, 49 (1): 32-40.
- Sroan, B. S., and MacRitchie, F.** 2009. Mechanism of Gas Cell Stabilization in Breadmaking. II. The secondary Liquid Lamellae. *Journal of Cereal Science*, 49 (1): 41-46.
- Stone, H., Pangborn, R. M., and Ough, C. S.** 1965. Techniques for Sensory Evaluation of Food Odors. In: C. O. Chichester and E. M. Mrak (Eds.), *Advances in Food Research*. (Vol. 14.). Academic Press. (1-32).
- Stone, H., and Sidel, J. L.** 2004a. Descriptive Analysis. *Sensory Evaluation Practices*. (3rd ed.). Academic Press, San Diego. (201-245).
- Stone, H., and Sidel, J. L.** 2004b. Introduction to Sensory Evaluation *Sensory Evaluation Practices*. (3rd ed.). Academic Press, San Diego. (1-19).
- Stone, H., and Sidel, J. L.** 2004c. *Sensory Evaluation Practices*, (3rd ed.). Academic Press, San Diego, CA).
- Strassburg, J., Burbidge, A., and Hartmann, C.** 2009. Identification of Tactile Mechanisms for the Evaluation of Object Sizes during Texture Perception. *Food Quality and Preference*, 20 (4): 329-334.
- Sudha, M. L., Srivastava, A. K., Vetrmani, R., and Leelavathi, K.** 2007. Fat replacement in soft dough biscuits: Its implications on dough rheology and biscuit quality. *Journal of Food Engineering*, 80 (3): 922-930.
- Svensson, E., and Eliasson, A.-C.** 1995. Crystalline Changes in Native Wheat and Potato Starches at Intermediate Water Levels during Gelatinization. *Carbohydrate Polymers*, 26 (3): 171-176.
- Szczesniak, A. S.** 1963a. Classification of Textural Characteristics. *Journal Food Science*, 28 (4): 385-389.
- Szczesniak, A. S.** 1963b. Objective Measurements of Food Texture. *Journal of Food Science*, 28 (4): 410-420.
- Szczesniak, A. S.** 1975. General Foods Texture Profile Revisited-Ten years Perspective. *Journal of Texture Studies*, 6 (1): 5-17.
- Szczesniak, A. S.** 1987. Correlating Sensory with Instrumental Texture Measurements - An Overview of Recent Developments. *Journal of Texture Studies*, 18 (1): 1-15.
- Szczesniak, A. S.** 2002. Texture is a Sensory Property. *Food Quality and Preference*, 13 (4): 215-225.
- Szczesniak, A. S., Brandt, M. A., and Friedman, H. H.** 1963. Development of Standard Rating Scales for Mechanical Parameters of Texture and Correlation Between the Objective and the Sensory Methods of Texture Evaluation. *Journal of Food Science*, 28 (4): 397-403.
- Szczesniak, A. S., and Kahn, E. L.** 1971. Consumer Awareness of and Attitudes to Food texture. *Journal of Texture Studies*, 2 (3): 280-295.
- Tang, J., Liu, J., and Zhang, P.** 2008. Effects of Gluten Protein Fractions on Dough Property and Products Quality in Common Wheat. *Scientia Agricultura Sinica*, 41 (9): 2937-2946.
- Tarea, S., Cuvelier, G., and Sieffermann, J. M.** 2007. Sensory Evaluation of the Texture of 49 Commercial Apple and Pear Purees. *Journal of Food Quality*, 30 (6): 1121-1131.
- Tatham, A. S., and Shewry, P. R.** 1985. The Conformation of Wheat Gluten Proteins. The Secondary Structures and Thermal Stabilities of α -, β -, γ - and ω -Gliadins. *Journal of Cereal Science*, 3 (2): 103-113.
- Tester, R. F., Karkalas, J., and Qi, X.** 2004. Starch: Composition, Fine Structure and Architecture. *Journal of Cereal Science*, 39 (2): 151-165.

- Tester, R. F., and Morrison, W. R.** 1990a. Swelling and Gelatinization of Cereal Starches I. effects of amylopectin, amylose & lipids. *Cereal Chemistry*, 67 (6): 551-557.
- Tester, R. F., and Morrison, W. R.** 1990b. Swelling and Gelatinization of Cereal Starches II. Waxy Rice Starches. *Cereal Chemistry*, 67 (6): 558-563.
- Thewissen, B. G., Celus, I., Brijs, K., and Delcour, J. A.** 2011. Foaming properties of wheat gliadin. *Journal of Agricultural and Food Chemistry*, 59 (4): 1370-1375.
- Tournier, C.** 2006. Thesis: *Interaction Texture - Flaveur : Mécanismes physico-chimiques ou mécanismes congénitifs? Application à un gel laitier onctueux.- Texture - flavour cross-modal interactions in dairy desserts: physico-chemical or cognitive mechanisms? Application to a creamy dairy dessert.* University of Burgundy, Dijon. pp. 212.
- Tronsmo, K. M., Færgestad, E. M., Schofield, J. D., and Magnus, E. M.** 2003. Wheat Protein Quality in Relation to Baking Performance Evaluated by the Chorleywood Bread Process and a Hearth Bread Baking Test. *Journal of Cereal Science*, 38 (2): 205-215.
- Tunick, M. H.** 2010. Food Texture Analysis in the 21st Century. *Journal of Agricultural and Food Chemistry*, 59 (5): 1477-1480.
- Turnbull, K.-M., and Rahman, S.** 2002. Endosperm Texture in Wheat. *Journal of Cereal Science*, 36 (3): 327-337.
- Tyle, P.** 1993. Effect of Size, Shape and Hardness of Particles in Suspension on Oral Texture and Palatability. *Acta Psychologica*, 84 (1): 111-118.
- Uthayakumaran, S., Gras, P. W., Stoddard, F. L., and Bekes, F.** 1999. Effect of Varying Protein Content and Glutenin-to-Gliadin Ratio on the Functional Properties of Wheat Dough. *Cereal Chemistry*, 76 (3): 389-394.
- Uthayakumaran, S., Newberry, M., Keentok, M., Stoddard, F. L., and Bekes, F.** 2000. Basic Rheology of Bread Dough with Modified Protein Content and Glutenin-to-gliadin Ratios. *Cereal Chemistry*, 77 (6): 744-749.
- Van Bockstaele, F., De Leyn, I., Eeckhout, M., and Dewettinck, K.** 2011. Non-linear Creep-recovery Measurements as a Tool for Evaluating the Viscoelastic Properties of Wheat Flour Dough. *Journal of Food Engineering*, 107 (1): 50-59.
- Van der Bilt, A., Engelen, L., Pereira, L. J., Van der Glas, H. W., and Abbink, J. H.** 2006. Oral Physiology and Mastication. *Physiology & Behavior*, 89 (1): 22-27.
- Vanin, F. M., Lucas, T., and Trystram, G.** 2009. Crust Formation and its Role during Bread Baking. *Trends in Food Science & Technology*, 20 (8): 333-343.
- Veinand, B., Godefroy, C., Adam, C., and Delarue, J.** 2011. Highlight of Important Product Characteristics for Consumers: Comparison of Three Sensory Descriptive Methods Performed by Consumers. *Food Quality and Preference*, 22 (5): 474-485.
- Veraverbeke, W. S., and Delcour, J. A.** 2002. Wheat Protein Composition and Properties of Wheat Glutenin in Relation to Breadmaking Functionality. *Critical Reviews in Food Science and Nutrition*, 42 (3): 179-208.
- Vermeulen, R., Goderis, B., Reynaers, H., and Delcour, J. A.** 2005. Gelatinisation related structural aspects of small and large wheat starch granules. *Carbohydrate Polymers*, 62 (2): 170-181.
- Wagner, M. J., Loubat, M., Sommier, A., Le Ray, D., Collewet, G., Broyart, B., Quintard, H., Davenel, A., Trystram, G., and Lucas, T.** 2008. MRI Study of Bread Baking: Experimental Device and MRI Signal Analysis. *International Journal of Food Science & Technology*, 43 (6): 1129-1139.
- Wang, S., Austin, P., and Bell, S.** 2011. It's a Maze: The Pore Structure of Bread Crumbs. *Journal of Cereal Science*, 54 (2): 203-210.
- Wieser, H.** 2007. Chemistry of Gluten Proteins. *Food Microbiology*, 24 (2): 115-119.
- Wilderjans, E., Luyts, A., Goesaert, H., Brijs, K., and Delcour, J. A.** 2010. A model approach to starch and protein functionality in a pound cake system. *Food Chemistry*, 120 (1): 44-51.
- Wilkinson, C., Dijksterhuis, G. B., and Minekus, M.** 2000. From Food Structure to Texture. *Trends in Food Science & Technology*, 11 (12): 442-450.

- Williams, A. A., and Langron, S. P.** 1984. The use of Free-choice Profiling for the Evaluation of Commercial Ports. *Journal of the Science of Food and Agriculture*, 35 (5): 558-568.
- Worch, T., Lê, S., and Punter, P.** 2010. How Reliable are the Consumers? Comparison of Sensory Profiles from Consumers and Experts. *Food Quality and Preference*, 21 (3): 309-318.
- Zeng, J., Li, F., Gao, H., and Ru, Z.** 2011. Comparison of A and B starch granules from three wheat varieties. *Molecules*, 16 (12): 10570-10591.
- Zghal, M. C., Scanlon, M. G., and Sapirstein, H. D.** 2001. Effects of Flour Strength, Baking Absorption, and Processing Conditions on the Structure and Mechanical Properties of Bread Crumb. *Cereal Chemistry*, 78 (1): 1-7.
- Zghal, M. C., Scanlon, M. G., and Sapirstein, H. D.** 2002. Cellular Structure of Bread Crumb and its Influence on Mechanical Properties. *Journal of Cereal Science*, 36 (2): 167-176.
- Zhou, J., Faubion, J. M., and Walker, C. E.** 2011. Evaluation of different types of fats for use in high-ratio layer cakes. *LWT - Food Science and Technology*, 44 (8): 1802-1808.
- Zhu, L.-J., Dogan, H., Gajula, H., Gu, M.-H., Liu, Q.-Q., and Shi, Y.-C.** 2012. Study of kernel structure of high-amylose and wild-type rice by X-ray microtomography and SEM. *Journal of Cereal Science*, 55 (1): 1-5.
- Zobel, H. F.** 1988. Molecules to Granules: A Comprehensive Starch Review. *Starch - Stärke*, 40 (2): 44-50.
- Zobel, H. F., and Stephen, A. M.** 2006. *Starch Food Polysaccharides and Their Applications*. CRC Press. (25-85).

PUBLICATION AND COMMUNICATION LIST

SCIENTIFIC ARTICLE

Blanchard C., Labouré H., Verel A., Champion D. 2012. Study of the impact of wheat flour type, flour particle size and protein content on proton mobility in a cake-like dough using proton low field Nuclear Magnetic Resonance. *Journal of Cereal Science*, 56: 691-698.

POSTER :

Blanchard C., Champion D., Verel A., Labouré H. FOOD ORAL PROCESSING, FOP Congress- 2012, july 3-5th, Beaune, France. Aeration of Hydrated Cereal Based Products : Impact on Rheological and Sensory Properties

SCIENTIFIC ARTICLE

C. Blanchard, H. Labouré, A. Verel, D. Champion. 2012. Blanchard C. et al. 2012. Study of the impact of wheat flour type, flour particle size and protein content on proton mobility in a cake-like dough using proton low field Nuclear Magnetic Resonance. *Journal of Cereal Science*, 56: 691-698.



Study of the impact of wheat flour type, flour particle size and protein content in a cake-like dough: Proton mobility and rheological properties assessment

C. Blanchard^{a,b,*}, H. Labouré^{c,d,e}, A. Verel^b, D. Champion^d

^aUMR 1166 Equipe PMCP, AgropolisDijon, L. enjolivand France, F-21000 Dijon, France
^bUMR 1044, Institut National de la Recherche Agronomique, F-33610 Saint-Jean-Pied-de-Port, France
^cUMR 1082 Centre de Sciences de l'Alimentaire et de l'Homme, F-20000 Ajaccio, France
^dINRA, UMRI 124 Centre de Sciences du Goût et de l'Alimentation, F-21000 Dijon, France
^eUMR 1044 Centre de Sciences de l'Alimentaire et de l'Homme, F-20000 Ajaccio, France

ARTICLE INFO

Article history:
 Received 23 April 2012
 Received in revised form 2 August 2012
 Accepted 4 August 2012

Keywords:
 Soft wheat flour
 Flour particle size
 Gluten proteins
 Low field NMR

ABSTRACT

The study of food products is always a challenge due to the number of components involved and the interactions that may occur between them. Water is a particular ingredient which interacts with all hydrophilic components, although affinities may differ for limiting water amount. During this study, results obtained using ¹H NMR on cake dough were compared in terms of the effects of flour type (soft or medium hard), the addition of gluten (35–20%) and the use of soft flour fractions (flour particle fractions smaller or larger than 50 µm). T₂ values and the signal intensities of different proton populations were studied as a function of the wheat protein contents of dough samples. Physicochemical characterization methods were used to better understand how the origin and particle size of flour might impact the hydration properties and mobility of a model system. Increasing the protein content in dough samples was related to an increase of the mobility of fat protons and of the least mobile proton population (relaxation times ranging from 175 to 180 ms and from 5 to 7 ms, respectively).

© 2012 Elsevier Ltd. All rights reserved.

1. Introduction

Cake dough is basically made up of proteins, lipids, carbohydrates, water and air, which may interact to confer different macro-structural properties on the baked product. Wheat flour can be considered as the main ingredient as it usually accounts for about 30% in standard recipes. The relative contents of flour components may vary as a function of factors such as wheat variety, environment, and the flour extraction process (Gossart et al., 2005; Mikheyenko et al., 2006). They are for instance responsible for water absorption, dough strength and viscoelasticity, as well as the final structure of products. We focused this study on soft wheat flour. Its functionalities are well adapted to bakery products, so it is used by most cake and bread making factories (Hoseney and Rogers, 1996).

The principal component, starch, accounts for about 70–80% of the total flour, whereas lipids (1.1–2.5% (MacRitchie, 1981)),

pentosans (1.5–3%) and damaged starch (3–8%) are little represented (Pomeroy, 1988). Soft wheat flour also contains 85–12% proteins, with gluten proteins accounting for about 80–85% (Hoseney, 1994). Gluten is composed of both gliadins and glutenins and plays an important role in cake-making as it is responsible for dough structure (Gossart et al., 2005). It has been shown that under hydration, gliadins form a viscoelastic structure, glutenins are responsible for dough elasticity while gliadins endow it with viscous properties (Janssen et al., 1996; Uthajakumaran et al., 2000). In the case of bread, flour composition can significantly alter final product quality (Pasha et al., 2010).

Magnus and collaborators studied wheat flour composition variability in correlation with dough physical properties and bread loaves (Magnus et al., 2000). Using partial least squares regression analysis, they showed that among flour chemical constituents, proteins exerted a strong impact on dough extensibility and bread loaf volume.

The effects of relative quantities of flour components, including

POSTER

Blanchard C., Champion D., Verel A., Labouré H. FOOD ORAL PROCESSING, FOP Congress- 2012, July 3-5th, Beaune, France. Aeration of Hydrated Cereal Based Products : Impact on Rheological and Sensory Properties



ANNEXES

Annexe 1 : Mechanical properties of food foams. Illustration of the mechanical behavior of several cell structure (a', b', c') involved in the global response of solid foams: theoretical strain-stress curves (a, b, c).

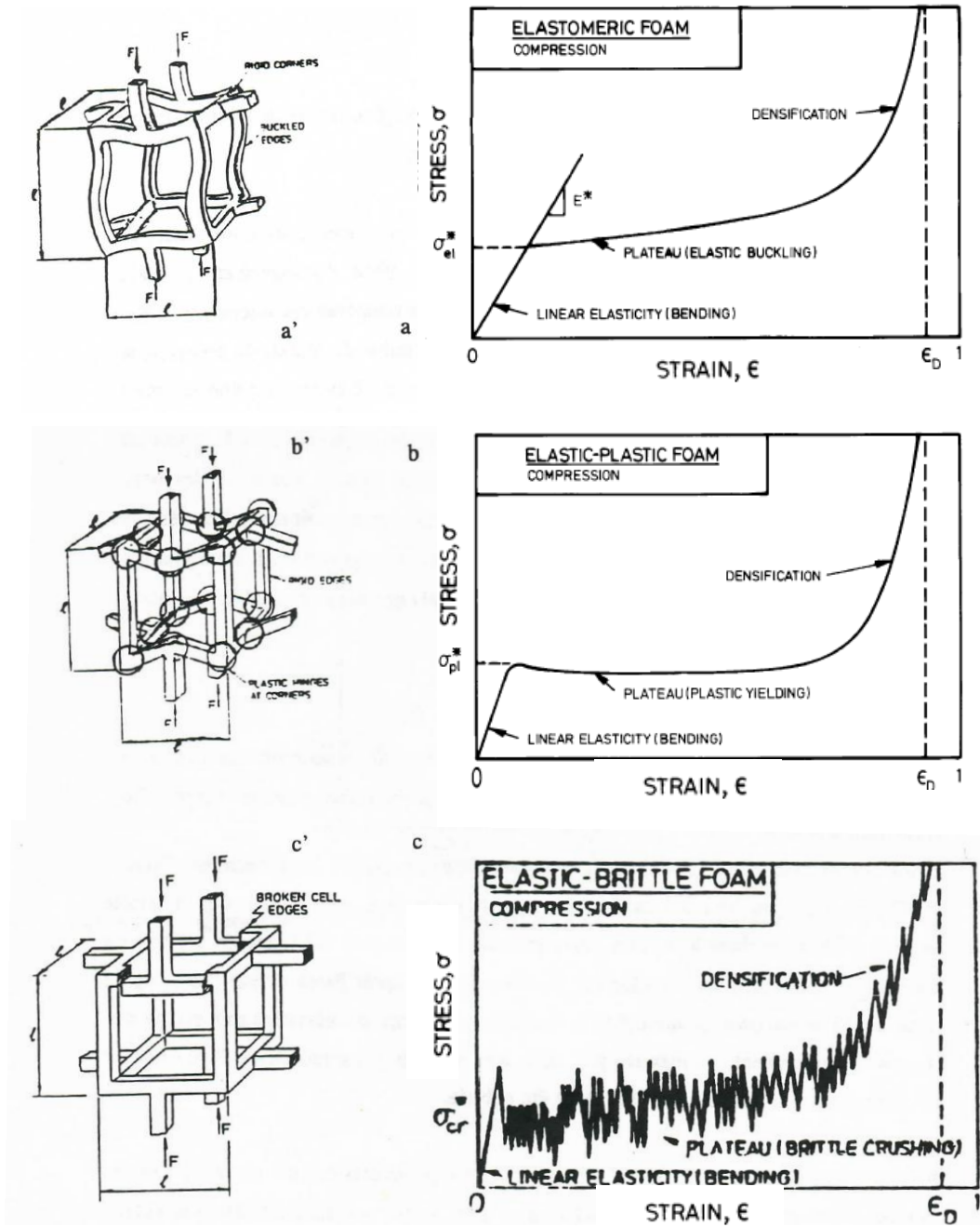

Annexe 2 : Instruction given to Flash Profile panelists at each session

Consignes pour le test : évaluation sensorielle sur des cakes sucrés

Ce test est prévu pour une durée de 3 heures. Il se peut que vous ayez besoin de plus ou moins de temps.

14 échantillons vont vous être présentés simultanément codés par des lettres (qui ne se suivent pas forcément).

Vérifiez d'abord que vous avez bien les produits suivants :

A	B	C	E	F	G	H
J	K	L	O	P	S	X

Chaque échantillon est présenté dans son emballage et disposé dans un sachet plastique et refermable. Ce type de produit étant sensible au dessèchement, il est important de remettre le « gâteau » dans le sachet lorsque l'on ne l'évalue pas.

Vous avez à disposition de l'eau pour vous rincer la bouche, des assiettes en plastique et des serviettes en papier, un couteau, un stylo, des « Fiches descripteurs », les consignes du test.

Si vous avez besoin de quoi que ce soit durant la séance, n'hésitez pas à nous demander, de l'eau, du matériel, un échantillon supplémentaire, etc....

1) Dans un premier temps

Il s'agit à partir de l'ensemble des produits, de générer des **termes** qui décrivent selon vous les caractéristiques sensorielles traduisant **les principales différences effectivement** constatées entre les produits que vous aurez à votre disposition. Vous vous focaliserez **sur les différences de textures** entre les produits que ce soit au moyen **de la vue, au toucher (doigt)** et lors de la mise en **bouche**.

Pour chaque terme, vous aurez à votre disposition une fiche dite « FICHE DESCRIPTEUR »

Vous y indiquerez le nom du terme et ce que représente pour vous ce « terme »

- sa définition selon vos propres termes (explication, synonymes, antonymes, etc...)
- et la façon dont vous l'évaluez sur le produit :

Notez par exemple s'il s'agit d'un critère basé sur **l'aspect du produit** comment vous l'évaluer, s'il s'agit d'un terme représentant vos sensations de **texture au toucher** par simple contact, ou en appuyant dessus, ou etc...même chose s'il s'agit des critères d'évaluation pour la **texture perçue en bouche**, au moment de la mise en bouche, au cours de la mastication ou à la déglutition du produit, etc,...

N'utiliser pas de terme quantitatif (intense, fort.....) ou de terme hédonique (je n'aime pas, j'adore, je préfère....)

2) Dans un deuxième temps,

pour **chacun** des termes générés, vous **classerez** les produits sur une échelle sans oublier de noter vos bornes sur cette échelle (à votre guise, et ce qui sera pour vous le plus naturel et facile pour vous repérer).

Exemples :

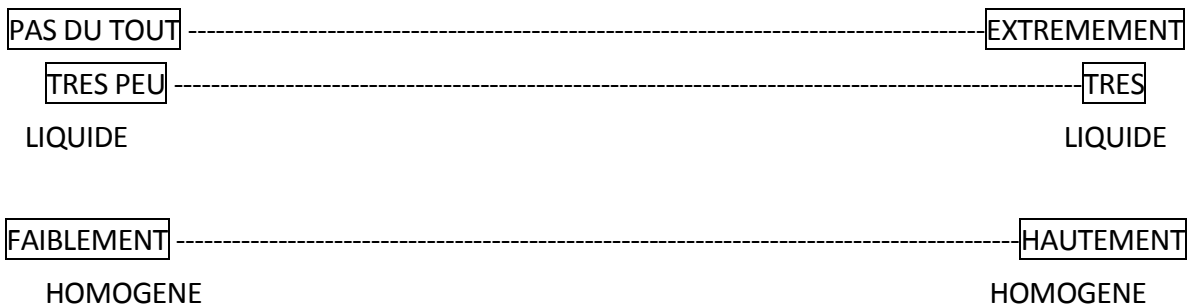

Lors du classement, les ex-aequo sont autorisés. Dans le cas où vous classez les produits au même rang sur l'échelle entourez-les : car certains produits pourraient vous sembler très proches ou totalement identiques pour le descripteur évalué.

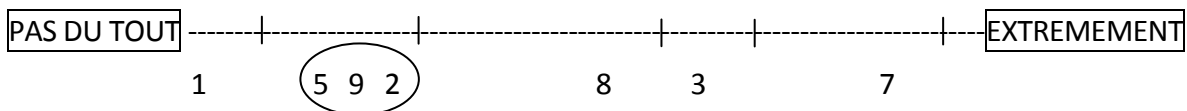

Merci d'avance

N'hésitez pas en cas de besoin, nous restons à votre disposition

Bon test

Annexe 3 : Flash profile response sheet example

FICHE DESCRIPTEUR

DESCRIPTEUR :

DEFINITION DU DESCRIPTEUR

MODE D’EVALUATION DU DESCRIPTEUR :

CLASSIFICATION DES PRODUITS SUR UNE ECHELLE

N.B. : Pensez bien à indiquer les bornes de l'échelle.

Nom

Prénom

Annexe 4 : Descriptive Sensory Profile attributes arising from soft cake texture investigation: items list obtained after vocabulary generation and reduction, associated definitions and evaluation mode used by the panelist to perform the sensory evaluation. Attributes are distinguished between visual, in touch and in mouth evaluation process.

Item	Definition	Assessment protocol
VISUAL		
Puffy	Overall puffiness of cake sample upper surface	Take the cake in the hand in between the fingers, place the cakes at the same height than the eyes, side part, and evaluate the puffiness of the sample
Brightness	Light reflection level on cake sample surface	Take the cake in the hand in between the fingers, turn under the light and evaluate the light reflect intensity at the surface of the sample
Bubble Number	Air bubble quantity visible inside the cake crumb	Take each side of the cake in-between the fingers, break the cake in two parts from the middle and quantify the number of bubble visualized within the broken side of the crumb.
Bubble Size	Crumb bubble diameter evaluation	Take each side of the cake in-between the fingers, break the cake in two parts from the middle and evaluate the size of the observed crumb bubbles
Bubble Heterogeneity	Bubble size variability into the cake crumb	Take each side of the cake in-between the fingers, break the cake in two parts from the middle and evaluate the crumb bubble size heterogeneity (level of differences)
IN TOUCH		
Fatty	Leaving a fatty and slippery feeling on the fingers after touching the upper cake surface	Let fingers touching the upper surface of the cake and evaluate the bright aspect of the sample left on the fingers (fatty deposit)
Smooth	Absence of relief on the upper cake surface	Let fingers touching the upper surface of the cake and evaluate the level of presence of particules on this surface
Sticky	Ability of the product to adhere to the fingers	Put one finger on the middle of the upper surface of the product and quantify the force necessary to unstick the finger from the cake
Elastic	Ability of the cake to recover its initial shape after a deformation applied with one finger	Put the cake on the table, upper surface on the top side, press the cake center with the finger (entering into the cake). Then, evaluate the rapidity level of the product to recover its initial shape
Firm	Resistance of the product while a pression is applied on its surface (product firmness)	Press the cake with the forefinger and evaluate the level of hardness exhibited to resist to the applied finger pressure.
Friable	Ability of the cake to be parsed in small particules (crumb fragments)	Take each side of the cake in-between the fingers, break the cake in two parts from the middle. Slightly rub the inner crumb visible surface. Evaluate the overall ability of the cake crumb to break apart into small particules.

ANNEXES

Item	Definition	Assessment protocol
IN MOUTH		
Sticky	Product adhesion to the palate and the tongue	Introduce the cake into the mouth, masticate and feel the degree of stickiness it display into the mouth, on the teeth and on the palate
Crumbly	Product ability to breakdown and parse in crumb fragments into the mouth	Introduce the cake into the mouth. At the beginning of the mastication process, after 1 to 2 mastication cycles, quantify the amount of particles breaking apart into the mouth
Hard	Resistance force while introducing the cake into the mouth	While introducing the cake into the mouth, evaluate the hardness to introduce the teeth into the cake (requested force)
Smooth	Ability of the cake not to form any particle while mastication takes place	Introduce the cake into the mouth, masticate and evaluate the presence of particles by touching the palate with the tongue
Melty	Product ability to quickly liquefy into the mouth and to get slippery into the mouth	Introduce the cake into the mouth, masticate and allow salivation process going on. Then, evaluate the ability of the product to be slippery and to melt into the mouth
Doughy	Ability of the product to form a dough-like paste after the mastication	Introduce the cake into the mouth, and evaluate, upon mastication, the ability of the sample
Dry	Product ability to dry the mouth and lead to a high level of salivation	Introduce the cake into the mouth, masticate and evaluate the amount of saliva necessary to masticate and swallow it
Fatty	Ability to form a thin fat layer into the mouth, on the palate and on the teeth (fatty fim feeling)	Introduce the cake into the mouth, masticate and evaluate at the end of the mastication the presence of a fatty layer into the mouth
Soft	Product softness (suppleness) measurement while product is masticated : product should be both lighty and elastic, neither hard, nor compact but flabby neither	Upon mastication, while the cake is into the mouth, evaluate the flexibility and suppleness level of the sample

Annexe 5 : Main assessed textural and aeration parameters which are kept for the following analysis and included into the statistical treatment

Instrumentally measured (aeration)	Instrumentally measured (mechanical)	Visual perception	In touch perception	In mouth perception
Bubble diameter (Ferret)	Cake density	Product puffiness	Smooth	Hard
Bubble area fraction (%)	Maximal compression force	Cake surface Brightness	Fatty	Smooth
Mean Grey Level Intensity	Young Modulus	Bubbles size	Sticky	Soft
Feret X	Relaxation gradient	Bubble heterogeneity	Firm	Crumbly
Feret Y	Recovery percentage		Elastic	Dry
Circularity	TanDelta (40Hz)		Crumbly	Fatty
Roundness				Melty

Annexe 6 : Soft cake sample process and formulation parameters applied to generated distinct aeration and classified as a function of the nature of the factor.

Flour nature ¹	Baking powder level ²	Mixing process nature ^{3,4}	Dough resting conditions ⁵	Combined Factors ^{7,8}
Crousty (S)	- 50%	Plonsk ³	30 minutes*	1H30, 40°C ⁷
LU 2000 (SMH)*	- 30%	Sobinka ³	45 minutes	RC_CTY_LV+50
GruauRouge (MH)	0*	STD ^{3*}	1H30	RC_CTY_LV-50
	+ 30%	Robot Coupe (RC) ⁴	2H15	RC_GRU_LV+50
	+ 50%		4H00	

*The reference product is indicated in bold and the addition of the chosen parameters made up 'standard sample'.

1: Classification as a function of product variety and flour type : either Soft (S) or Medium Hard (MH) even a flour mix coming from both of these latter (SMH)

2: Level expression in % with respect to standard product leavening agent level.

3: Ingredient incorporation order variation, mixing in a kneading-like machine (Hobart)

Sobinka and Plonsk processes was consisting in adding alternatively powder and liquid ingredients

Sobinka mixing order: successive addition and mixing step of Flour+sucrose / water+glucose syrup / baking powder + emulsifier / eggs+glycerol / oil

Plonsk mixing order: successive addition and mixing step of all powdery ingredients (flour+sucrose+baking powder+emulsifier) / eggs+glycerol / water+glucose syrup / oil

4: Mixing type variation: 'robot coupe' corresponds to a high shearing mixing process (all ingredients mixed simultaneously in a mixer-like machine)

5: Resting time duration variation, at room temperature

7: Resting time duration and temperature conditions higher than the reference sample.

8: Combination of several parametes : process nature (RC = Robot Coupe mixing), flour origin (CTY = Crousty, GRU = Gruau Rouge) and baking powder level (LV +50 or-50% compared with standard level);

Indicated products have been selected from the comparison of the whole range of products which were firstly created for the first experimental design (2 factors, 3 levels for each mixing process).

Annexe 7: Main assessed textural and aeration parameters which are kept for the following analysis and included into the statistical treatment

Instrumentally measured (aeration)	Instrumentally measured (mechanical)	Visual perception	In touch perception	In mouth perception
Bubble diameter (Ferret)	Cake density	Product puffiness	Smooth	Hard
Bubble area fraction (%)	Maximal compression force	Cake surface Brightness	Fatty	Smooth
Mean Grey Level Intensity	Young Modulus	Bubbles size	Sticky	Soft
Feret	Relaxation gradient	Bubble heterogeneity	Firm	Crumbly
Circularity	Recovery percentage		Elastic	Dry
Roundness	TanDelta (40Hz)		Crumbly	Fatty
				Melty

Annexe 8: Items list, associated definitions and protocol of assessment used by the panelist to perform the sensory evaluation

Item	Definition	Assessment protocol
VISUAL		
Puffy	Overall puffiness of cake sample upper surface	Take the cake in the hand in between the fingers, place the cakes at the same height than the eyes, side part, and evaluate the puffiness of the sample
Brightness	Light reflection level on cake sample surface	Take the cake in the hand in between the fingers, turn under the light and evaluate the light reflect intensity at the surface of the sample
Bubble Number	Air bubble quantity visible inside the cake crumb	Take each side of the cake in-between the fingers, break the cake in two parts from the middle and quantify the number of bubble visualized within the broken side of the crumb.
Bubble Size	Crumb bubble diameter evaluation	Take each side of the cake in-between the fingers, break the cake in two parts from the middle and evaluate the size of the observed crumb bubbles
Bubble Heterogeneity	Bubble size variability into the cake crumb	Take each side of the cake in-between the fingers, break the cake in two parts from the middle and evaluate the crumb bubble size heterogeneity (level of differences)
IN TOUCH		
Fatty	Leaving a fatty and slippery feeling on the fingers after touching the upper cake surface	Let fingers touching the upper surface of the cake and evaluate the bright aspect of the sample left on the fingers (fatty deposit)
Smooth	Absence of relief on the upper cake surface	Let fingers touching the upper surface of the cake and evaluate the level of presence of particules on this surface
Sticky	Ability of the product to adhere to the fingers	Put one finger on the middle of the upper surface of the product and quantify the force necessary to unstick the finger from the cake
Elastic	Ability of the cake to recover its initial shape after a deformation applied with one finger	Put the cake on the table, upper surface on the top side, press the cake center with the finger (entering into the cake). Then, evaluate the rapidity level of the product to recover its initial shape
Firm	Resistance of the product while a pression is applied on its surface (product firmness)	Press the cake with the forefinger and evaluate the level of hardness exhibited to resist to the applied finger pressure.
Friable	Ability of the cake to be parsed in small particules (crumb fragments)	Take each side of the cake in-between the fingers, break the cake in two parts from the middle. Slightly rub the inner crumb visible surface. Evaluate the overall ability of the cake crumb to break apart into small particules.
IN MOUTH		
Sticky	Product adhesion to the palate and the tongue	Introduce the cake into the mouth, masticate and feel the degree of stickiness it display into the mouth, on the teeth and on the palate
Crumbly	Product ability to breakdown and parse in crumb fragments into the mouth	Introduce the cake into the mouth. At the beginning of the mastication process, after 1 to 2 mastication cycles, quantify the amount of particles breaking apart into the mouth
Hard	Resistance force while introducing the cake into the mouth	While introducing the cake into the mouth, evaluate the hardness to introduce the teeth into the cake (requested force)
Smooth	Ability of the cake not to form any particle while mastication takes place	Introduce the cake into the mouth, masticate and evaluate the presence of particles by touching the palate with the tongue
Melty	Product ability to quickly liquefy into the mouth and to get slippery into the mouth	Introduce the cake into the mouth, masticate and allow salivation process going on. Then, evaluate the ability of the product to be slippery and to melt into the mouth
Doughy	Ability of the product to form a dough-like paste after the mastication	Introduce the cake into the mouth, and evaluate, upon mastication, the ability of the sample
Dry	Product ability to dry the mouth and lead to a high level of salivation	Introduce the cake into the mouth, masticate and evaluate the amount of saliva necessary to masticate and swallow it
Fatty	Ability to form a thin fat layer into the mouth, on the palate and on the teeth (fatty film feeling)	Introduce the cake into the mouth, masticate and evaluate at the end of the mastication the presence of a fatty layer into the mouth
Soft	Product softness (suppleness) measurement while product is masticated : product should be both lighty and elastic, neither hard, nor compact but flabby neither	Upon mastication, while the cake is into the mouth, evaluate the flexibility and suppleness level of the sample

Annexe 9 : Panel's performances illustrated by the results obtained with CAP method data treatment: ANOVA (judge+product+interaction) performed on each VISUAL, IN TOUCH and IN MOUTH assessed sensory attributes. The kept items, all along storage, from 1 to 5 months are bolded. Sensory assessment was performed in a descriptive profile on cake products after 1 month of storage at room temperature. Panel was composed of 15 panelists, measurements includes 3 repetitions for each assessed product, with a total of 20 evaluated items.

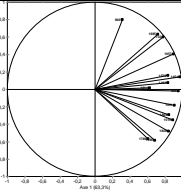
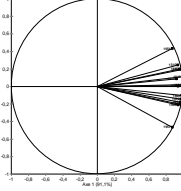
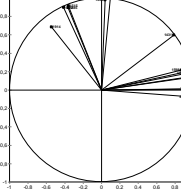
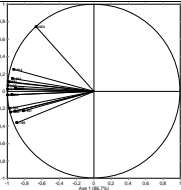
ITEM (Visual)	Fprod value (pprod)	Finter value (pinter)	ACP	Kept item
V_Puffy	14.69 (<.0001)	3.12 (<.0001)		YES
V_Brightness	12.02 (<.0001)	2.23 (<.0001)		YES
V_BB size	86.39 (<.0001)	4.42 (<.0001)		YES
V_BB number	8.09 (<.0001)	8.61 (<.0001)		NO
V_Aeration Heterogeneity	66.79 (<.0001)	1.78 (.0009)		YES

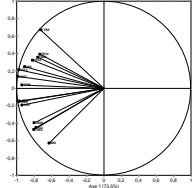
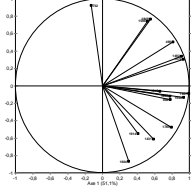
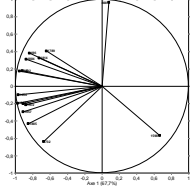
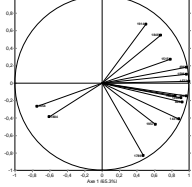
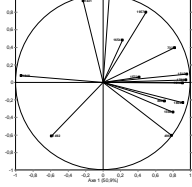
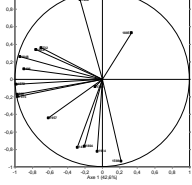
ITEM (In touch)	Fprod value (pprod)	Finter value (pinter)	ACP	Kept item
T_Firm	30,8 (<.0001)	4,29 (<.0001)		YES
T_Smooth	9,9 (<.0001)	2,52 (<.0001)		YES
T_Elastic	9,82 (<.0001)	4,52 (<.0001)		YES
T_Friable	11,79 (<.0001)	4,21 (<.0001)		YES
T_Sticky	2,92 (.0290)	2,83 (<.0001)		NO
T_Fatty	3,42 (.0142)	4,02 (<.0001)		NO

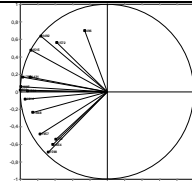
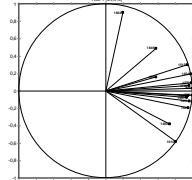
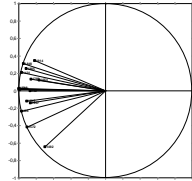
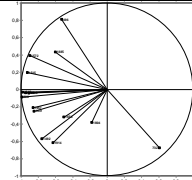
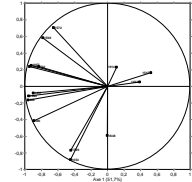
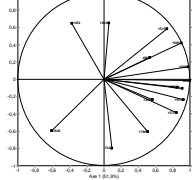
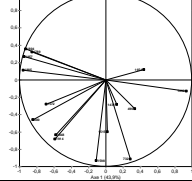
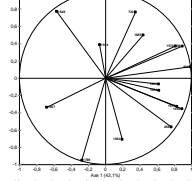
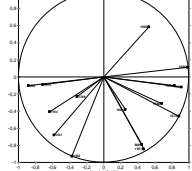
ITEM (In mouth)	Fprod value	Finter value	ACP	Kept item
B_Crumbly	11.54 (<.0001)	3.1 (<.0001)		YES
B_Smooth	24.99 (<.0001)	2.53 (<.0001)		YES
B_Soft	35.98 (<.0001)	2.52 (<.0001)		YES
B_Melty	7.84 (<.0001)	2.82 (<.0001)		YES
B_Hard	6.73 (.0007)	2.43 (<.0001)		(YES)
B_Dry	5.62 (.0002)	3.33 (<.0001)		(YES)
B_Fatty	1.97 (.1101)	3.24 (<.0001)		(YES)
B_Doughy	1.76 (.1482)	3.23 (<.0001)		NO
B_Sticky	1.37 (.2533)	2.04 (<.0001)		NO

Annexe 10 : Sensory in touch and in mouth items values obtained during sensory evaluation session on cakes taking place after 1 month storage with a trained panel composed of 15 panelists. Data ranges from a 1 to 10 sensory linear scale.

Parameter	LVm50	STD	LVp50
T_Smooth	8.67 ^(b)	6.75 ^(a)	7.12 ^(a)
T_Fatty	7.69 ^(b)	6.72 ^(a)	7.87 ^(b)
T_Sticky	6.16 ^(a)	6.54 ^(a,b)	7.48 ^(b)
T_Firm	7.37 ^(c)	4.63 ^(b)	2.19 ^(a)
T_Elastic	5.69 ^(b)	5.48 ^(b)	3.18 ^(a)
T_Friable	4.65 ^(a)	5.76 ^(b)	6.86 ^(b)
B_Hard	3.39 ^(a)	2.76 ^(a,b)	2.16 ^(a)
B_Smooth	7.36 ^(c)	4.47 ^(b)	3.25 ^(a)
B_Soft	7.50 ^(c)	4.74 ^(b)	2.81 ^(a)
B_Crumbly	4.54 ^(a)	6.71 ^(b)	6.95 ^(b)
B_Dry	3.66 ^(a)	4.96 ^(b)	5.23 ^(b)
B_Fatty	5.09 ^(a)	5.22 ^(a)	5.37 ^(a)
B_Melty	6.69 ^(b)	4.62 ^(a)	4.35 ^(a)

Annexe 11 : Comparison of GRU (right images) and CTY wheat flours (left images) based on the evolution of starch granules aspect upon swelling while undergoing structural changes over hydration and heating conditions as observed using light microscopy. Wheat flour media were stained using % iodine solution (KI 2%, I₂ 1g).

25 - 30°C

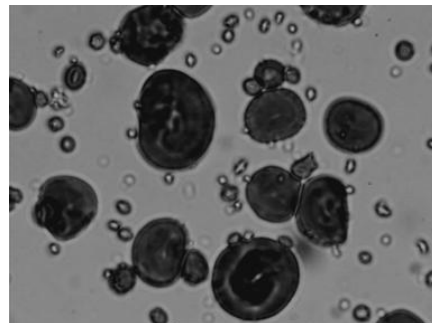
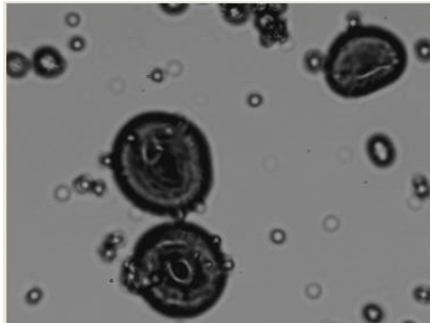

38 - 40°C

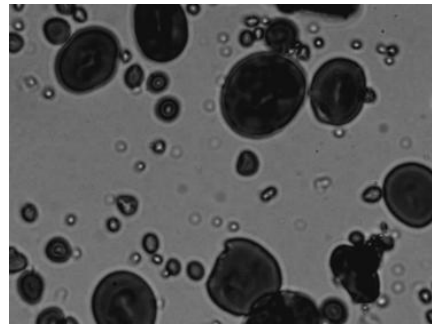
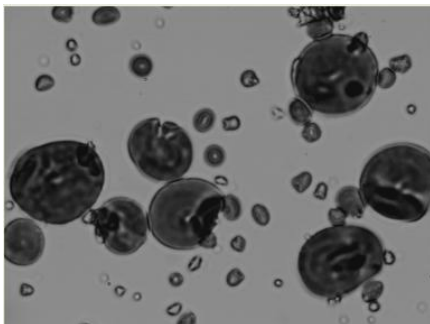

55 - 60°C

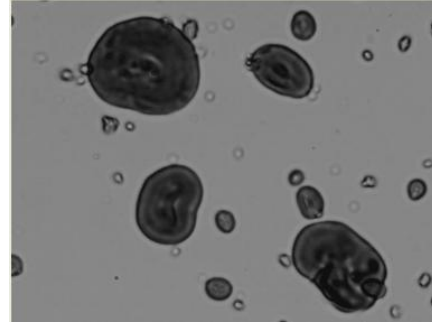
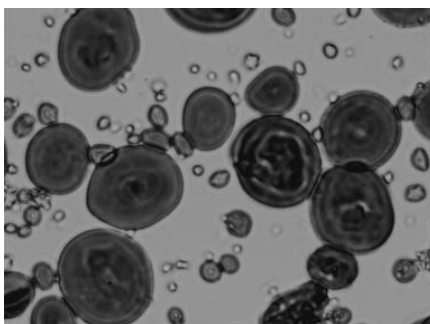

60 - 64°C

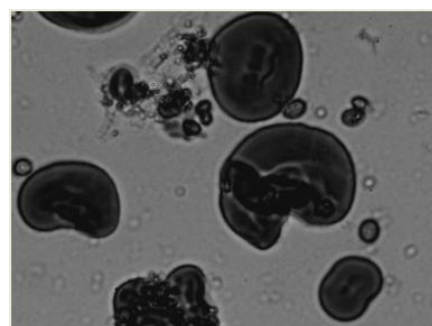
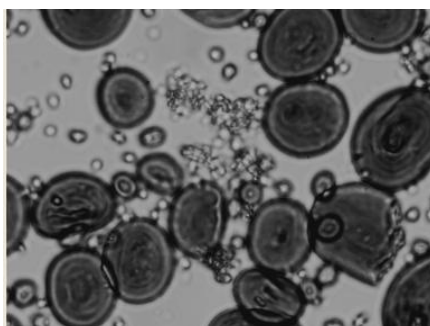

CTY

GRU

Annexe 12 : Evolution of water – flour suspensions granulometry over heating from ambient temperature to 80°C: comparison of Crousty (top) and Gruau (bottom profile).

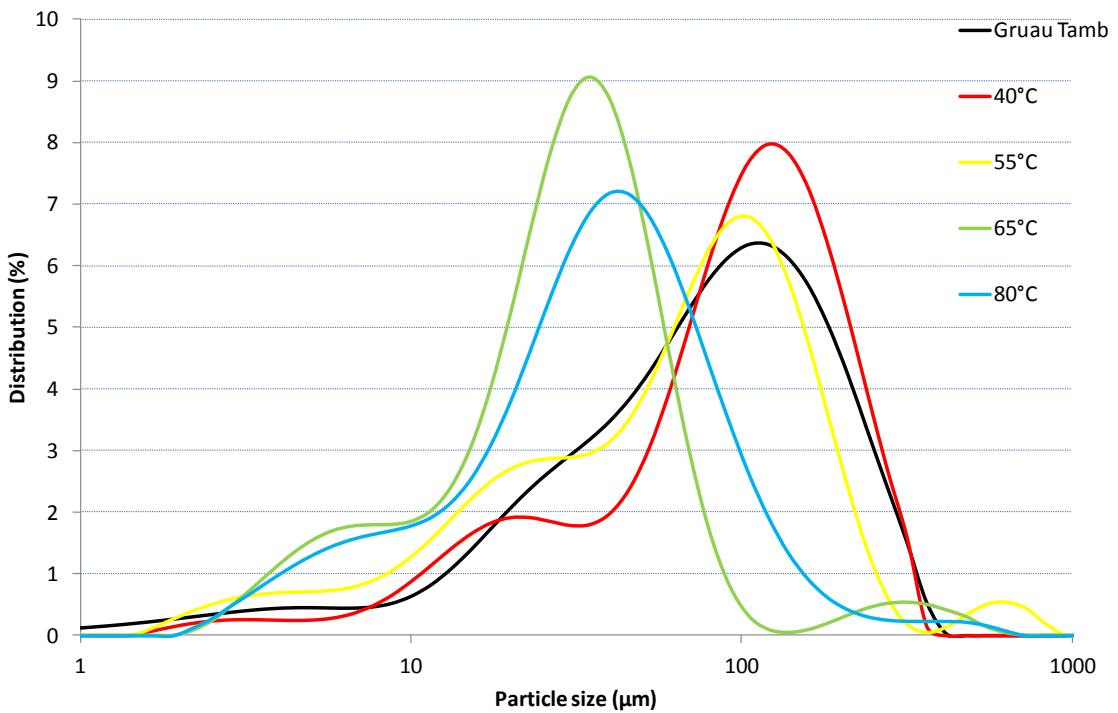
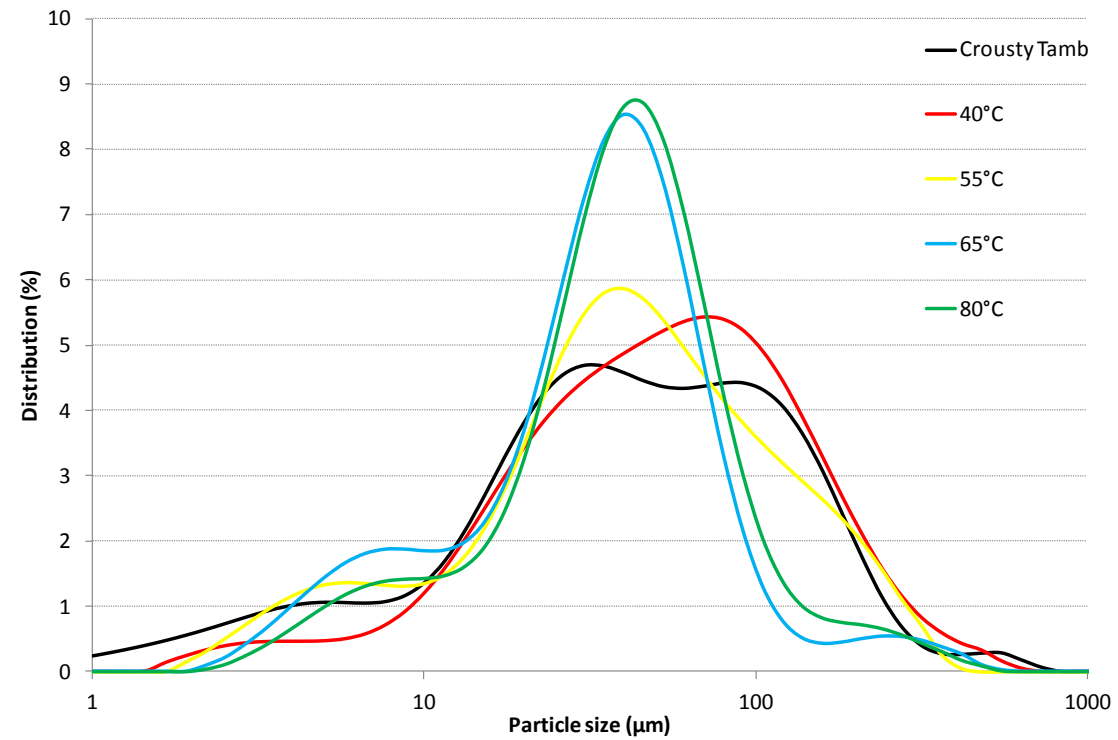

Annexe 13 : Illustration of the correlation between the parameters studied on cake samples at various characterization scales.

MFA correlation coefficient table (right under) are given for physico-chemical parameters, aeration features as well as sensory attributes as a result of the MFA performed on two distinct groups of data (i.e., instrumental and sensory). The corresponding variables codes are given in the second table thereafter.

	C10 C9	C13 C23	C14 C24	C15 C26	C16 C27	C17	C18	C19	C20	C21	C22	C2	C3	C4	C5	C7
C10	1.00															
C13	-0.94	1.00														
C14	-0.85	0.98	1.00													
C15	0.85	-0.98	-1.00	1.00												
C16	0.34	-0.63	-0.78	0.78	1.00											
C17	1.00	-0.97	-0.89	0.89	0.41	1.00										
C18	-0.86	0.98	1.00	-1.00	-0.77	-0.90	1.00									
C19	-0.58	0.82	0.92	-0.92	-0.96	-0.64	0.91	1.00								
C20	0.59	-0.82	-0.93	0.93	0.96	0.65	-0.92	-1.00	1.00							
C21	0.73	-0.92	-0.98	0.98	0.89	0.78	-0.97	-0.98	0.98	1.00						
C22	0.81	-0.96	-1.00	1.00	0.82	0.85	-1.00	-0.95	0.95	0.99	1.00					
C2	0.56	-0.80	-0.91	0.91	0.97	0.62	-0.90	-1.00	1.00	0.98	0.94	1.00				
C3	-0.31	0.61	0.77	-0.77	-1.00	-0.38	0.75	0.96	-0.95	-0.88	-0.81	-0.96	1.00			
C4	0.59	-0.83	-0.93	0.93	0.96	0.65	-0.92	-1.00	1.00	0.98	0.95	1.00	-0.95	1.00		
C5	0.55	-0.80	-0.91	0.91	0.97	0.61	-0.90	-1.00	1.00	0.97	0.94	1.00	-0.97	1.00	1.00	
C7	0.94	-0.77	-0.61	0.61	-0.01	0.91	-0.64	-0.26	0.27	0.45	0.56	0.24	0.04	0.28	0.23	1.00
C8	0.48	-0.74	-0.87	0.87	0.99	0.54	-0.85	-0.99	0.99	0.95	0.90	1.00	-0.98	0.99	1.00	0.14
C9	0.74	-0.48	-0.28	0.28	-0.38	0.69	-0.30	0.12	-0.10	0.08	0.21	-0.14	0.40	-0.10	-0.15	0.93
C23	-0.22	-0.11	-0.32	0.32	0.84	-0.15	-0.30	-0.67	0.66	0.50	0.39	0.68	-0.86	0.65	0.69	-0.55
C24	0.86	-0.98	-1.00	1.00	0.78	0.89	-1.00	-0.92	0.92	0.98	1.00	0.91	-0.76	0.92	0.90	0.62
C26	0.90	-0.71	-0.55	0.54	-0.09	0.87	-0.57	-0.18	0.19	0.37	0.49	0.15	0.12	0.19	0.14	1.00
C27	-0.95	1.00	0.97	-0.97	-0.62	-0.97	0.98	0.80	-0.81	-0.91	-0.95	-0.79	0.60	-0.82	-0.78	-0.78
C30	0.98	-0.99	-0.94	0.94	0.51	0.99	-0.95	-0.73	0.74	0.85	0.91	0.71	-0.49	0.74	0.70	0.85
C8	0.64	0.60	-0.03	0.94	0.81	-0.99										

Physico-chemical parameters	SENSORY items	Aeration features
	Visual (V), In touch (T) and in mouth (B)	
C2 - Ph_Density (g/cm3)	C10 - V_PUFFY	C23 - IA_MeanInt
	C13 - V_BUBBLE SIZE	
	C14 - V_AERATION HETEROGENEITY	
C3 - TanD_40Hz		C24 - IA_Nb_Bubbles
C4 - Rh_Fm	C15 - T_FIRMN	C26 - Alv_Circ
	C16 - T_SMOOTH	
	C17 - T_ELASTIC	
	C18 - T_FRIABLE	
C5 - Rh_Young		C27 - Alv_Feret
C7 - Rh_Cohesiveness	C19 - B_CRUMBLY	C30 - Alv_Round
	C20 - B_MELTY	
	C21 - B_SMOOTH	
	C22 - B_SOFT	
C8 - Rh_Rx		

Annexe 14 : Panel performances assessment using CAP method.

1/ Individual panelist' performances using the Nalpha* indice which measure the level of agreement between a panelist and all the other members of the considered panel.

Results are given for each panelist (code), for the one month, 3 and 5 months sessions series.

Panelist	Nalpha (1m)	Nalpha (3m)	Nalpha (5m)
1431	2.17	1.87	1.86
1492	1.98	2.03	1.86
1515	2.27	2.91	2.01
1527	2.23	1.92	1.76
1598	2.10	1.80	1.80
1654	2.29	2.12	2.04
1789	2.00	1.84	1.99
1804	2.27	1.94	1.84
1848	2.10	1.90	1.88
1885	2.20	2.08	1.85
1914	2.15	2.03	1.80
1957	2.18	1.87	1.92
496	2.19	2.01	1.97
732	2.06	1.83	1.97
800	2.26	0.00	0.00
Mean	2.16	1.81	1.77

*the Nalpha indice value should at least be in the range of 1.5 to 2.5 (panelist in agreement $N\alpha > 2$, or in slight agreement with the panel $1.5 < N\alpha < 2$).

2/ FLASH TABLE

This table allows highly correlated attributes to be represented within the same variable group. Mean values which are far away from the global mean value (gmean) are then either highlighted in yellow or in green to illustrate whether the actual attribute mean value is under or higher gmean, respectively Results are given separately for the one month (a.), 3 months (b.) and the five months (c.) sessions series (i.e. 3 measurements sessions each). Attributes are then classified and individually considered. Each Flash Table shows the panel ability (F value) to discriminate products on each attribute (and its significance 'PROB', the F box should be colored in green).

Flash Table								
<i>15 panelists - 5 products - 20 attributes</i>								
ATTRIBUTE	F	PROB	gmean	LVm50	GRU	CTY	STD	LVp50
V_HETERALV	66.69	.000	3.75	-1.3	-2.45	-3.2	+4.45	+7.34
V_TAILALV	87.01	.000	2.87	-0.58	-1.35	2.65	2.75	+7.01
B_FRIABLE	12.02	.000	5.86	-4.53	-4.43	+6.72	+6.69	+6.95
T_FRIABLE	11.73	.000	5.41	-4.62	-3.69	+6.06	5.78	+6.88
B_SEC	7.11	.000	4.3	-3.65	3.97	-3.71	+4.94	+5.23
	-	-	-					
B_GRAS	2.06	.099	5.47	5.08	5.54	+6.18	5.21	5.35
B_COLLANT	1.45	.228	5.56	5.99	5.85	5.17	5.31	5.49
B_PATEUX	1.87	.129	5.91	6.44	6.45	5.57	5.68	5.42
	-	-	-					
B_MOELL	37.75	.000	5.51	+7.52	+6.77	5.67	-4.78	-2.83
B_LISSE	26.56	.000	5.24	+7.38	+6.44	-4.66	-4.48	-3.26
B_FOND	8.23	.000	5.35	+6.69	5.6	5.51	-4.63	-4.33
T_LISSE	9.96	.000	7.61	+8.68	+8.2	7.3	-6.75	-7.13
T_ELAST	9.88	.000	5.23	5.69	+6.53	5.28	5.48	-3.18
	-	-	-					
T_FERME	30.69	.000	4.94	+7.39	+6.39	-4.08	4.64	-2.18
V_BOMBE	14.78	.000	1.43	+2.07	+1.93	-1	+2.07	-0.08
B_DUR	5.95	.000	2.83	+3.36	+3.75	-2.19	2.71	-2.13
	-	-	-					
V_NBALV	7.92	.000	7.18	7.04	+8.06	7.67	+7.87	-5.26
	-	-	-					
T_GRAS	3.45	.014	7.67	7.71	7.8	+8.23	-6.72	7.88
V_BRILL	12.01	.000	6.76	-5.76	+7.58	+8.07	-5.69	6.7
T_COLLANT	2.95	.028	6.98	-6.19	7.18	7.48	6.56	+7.5

(a.)

<p style="text-align: center;">Flash Table 15 panelists - 5 products - 20 attributes</p>								
ATTRIBUTE	F	PROB	gmean	LVp50_3m	STD_3m	CTY_3m	GRU_3m	LVm50_3m
B_MOELL	17.67	.000	5.51	-3.45	5.22	5.56	+6.2	+7.1
B_LISSE	29.15	.000	5.87	-3.22	-5.25	5.61	+7.08	+8.21
B_FOND	9.81	.000	5.86	-4.65	-5.33	5.93	6.22	+7.19
V_NBALV	15.35	.000	7.41	-4.94	7.68	7.8	+8.2	+8.45
T_LISSE	14.49	.000	7.04	-6.24	6.8	-5.97	+7.49	+8.7
T_FERME	51.72	.000	5.63	-2.9	-4.9	-4.89	+7.06	+8.38
B_PATEUX	7.22	.000	6.41	-5.69	-5.99	6.07	+7.03	+7.27
B_COLLANT	4.44	.004	6.15	-5.5	6.22	6.2	-5.56	+7.27
T_ELAST	16.79	.000	4.04	-1.87	4.48	-3.5	+5.6	+4.77
B_DUR	3.15	.022	2.83	2.37	2.86	-2.22	+3.59	3.09
V_BOMBE	26.38	.000	1.76	-0.31	1.53	1.46	+3.38	+2.14
V_HETERALV	92.65	.000	3.61	+7.92	3.51	3.21	-2.45	-0.94
V_TAILALV	68.63	.000	2.61	+6.32	2.27	2.34	-1.61	-0.48
B_FRIABLE	20.81	.000	5.74	+7.55	+6.85	+6.8	-4.01	-3.46
B_SEC	4.26	.005	4.68	+5.61	5.05	4.8	4.31	-3.62
B_GRAS	1.53	.207	6.71	6.74	7.02	6.97	-6.27	6.57
T_GRAS	1.73	.157	7.91	-7.54	8.01	8.11	7.97	7.94
V_BRILL	4.55	.003	7.19	-6.76	+7.65	+7.76	7.09	-6.69
T_COLLANT	1.96	.113	7.3	7.24	+7.95	7.39	7.03	6.87
T_FRIABLE	10.49	.000	5.6	+6.45	+6.21	+6.95	-4.06	-4.31

(b.)

<p style="text-align: center;">Flash Table 15 panelists - 5 products - 20 attributes</p>								
ATTRIBUTE	F	PROB	gmean	Lvm50_5m	GRU_5m	CTY_5m	STD_5m	LVp50_5m
V_TAILALV	66.82	.000	2.32	-0.4	-1.21	2.06	2.06	+5.84
V_HETERALV	57.09	.000	3.34	-0.67	-2.27	-2.29	+3.93	+7.54
B_FRIABLE	11.06	.000	4.89	-3.31	-2.9	+6.15	+6.01	+6.05
T_FRIABLE	13.42	.000	4.47	-3.56	-2.92	+5.09	4.95	+5.83

T_GRAS	0.30	.879	7.84	7.68	7.94	7.98	7.87	7.75
B_GRAS	3.83	.008	6.58	-5.82	6.39	+7.39	6.24	7.06
T_COLLANT	3.50	.013	7.12	-6.35	7.44	7.29	+8.06	-6.45
V_BRILL	3.80	.008	7.07	6.93	7.57	+7.78	7.1	-5.97

T_LISSE	16.68	.000	6.85	+8.73	+7.55	-6.3	6.43	-5.26
B_LISSE	26.49	.000	6	+8.41	+7.22	-5.22	-5.31	-3.84
B_PATEUX	2.80	.035	6.52	+7.42	6.57	6.54	6.24	-5.81

B_MOELL	15.97	.000	5.37	+6.71	+6.38	5.56	4.89	-3.3
B_FOND	7.53	.000	5.56	+6.72	+6.17	5.33	5.16	-4.4
V_NBALV	12.41	.000	7.47	+8.1	+8.38	7.87	7.85	-5.14

T_FERME	44.15	.000	5.45	+7.86	+7.03	5.21	-4.92	-2.22
V_BOMBE	11.37	.000	1.77	+2.28	+2.35	1.55	+2.29	-0.4
T_ELAST	17.64	.000	4.23	+5.48	+5.57	-3.58	4.35	-2.19

B_DUR	5.94	.001	2.73	+3.49	+3.38	-2.3	2.34	-2.13
B_SEC	1.75	.153	4.89	5.38	4.79	-4.01	4.97	5.28
B_COLLANT	1.04	.397	5.84	6.25	5.95	6.1	5.37	5.55

(c.)

.....« *L'écurie use plus le cheval que la course* »

Proverbe français